

# PHILIPS

**hue** personal  
wireless  
lighting

wall switch module



User manual  
Benutzerhandbuch  
Notice d'emploi  
Manual de usuario  
Manual do usuário  
Manuale d'uso

## Table of content

• <b>Important purchase and installation tips</b>	3
• <b>General safety instructions</b>	4
• <b>Installation instructions Europe</b>	5
• What's in the box	7
• Rocker switch – 1 way	8
• Rocker switch variants	10
• Rocker switch – 2 gang	11
• Rocker switch – 2 way	14
• Rocker switch – 3 way	15
• Push-in wire connector usage	16
• Push buttons	17
• <b>Installation instructions United States and Canada</b>	18
• What's in the box	20
• Single pole switch	21
• Switch variants	23
• 3-way switch	25
• Wire-nut usage	27
• <b>Technical data</b>	28
• <b>App features and reset instructions</b>	29
• <b>Battery replacement</b>	30

# Important purchase and installation tips

## Before purchase

- Examine how your light switch is installed to determine if the Hue wall switch module will work and function properly with the type of your light switch.

 Attention! Always make sure your circuit breaker is off before removing the light switch plate.

- Determine if there is enough room in your electrical box to install the Hue wall switch module. The Hue wall switch module measures 4.3 cm x 1 cm x 3.7 cm (width x depth x height)
- Watch tutorial videos and/or read documentation of the light switch from the manufacturer to determine if your light switch is suitable.

 \* Requires Hue bridge and only compatible with Hue light sources  
\* The product is battery powered and does not need a neutral wire to be available

## Before installation

Attention! Electrical devices may only be installed and connected by electrically skilled persons.

- For safe installation, commissioning and operation, read the installation and legal guide before use.
- Always switch off the circuit breaker before any assembly, maintenance or replacement of the battery.
- Ensure no one switches on the circuit breaker during assembly, disassembly, or replacement of the battery.
- Cover up any live wires.

## During installation

- Take a photo of the original light switch's wiring before removing them. The provided wires with the Hue wall switch module will generally be inserted into the same places, while the original wires from your home's electricity will be terminated with a wire connector (Europe) or wire nut (United States and Canada)
- Don't connect your original (live) wires to the wall switch module. The module is battery powered. Only the provided wiring should be used.
- Complete the installation before pushing the button on the Hue wall switch module or adding it in the Hue app.

 The Hue wall switch module may start blinking if accidental contact is made (e.g., if the two included wires touch or if you press the light switch once connected), If this happens, it's safe to continue with the physical installation. After finishing the installation, set up the Hue wall switch module in the Hue app.

## After installation

- Even a lamp that is switched off is permanently supplied with mains voltage. When replacing a light source, turn off the circuit breaker.
- Before any maintenance on your light switch, for example changing the battery of the module, make sure to turn off the circuit breaker.

 Attention! Consult an electrician for support when in doubt.

# General safety instructions

## For your safety



### DANGER HAZARD OF ELECTRIC SHOCK

Safe electrical installation must be carried with proven knowledge in the following areas:

- Connecting installation networks
- Connecting electrical devices
- Handling electric cables
- Safety standards, local wiring rules and regulations



**DANGER!** Electrical shocks when live parts are touched can be fatal.

- Prepare well, take your time and avoid distraction
- Use the right equipment to do the installation
- Keep children on a safe distance from any installation and maintenance work

Note: when one of the above points are not met, don't proceed and consult an electrician or local authority for guidance.



On our support page application notes for installers, how-to-video and FAQ's can be found.

## General safety instructions Europe



- EN** Work on Electrical installations is in some countries only allowed by a qualified electrician. For support contact a local electrician or authority.
- DE** Die Arbeit an Elektroinstallationen ist in einigen Ländern nur qualifizierten Elektrikern gestattet. Wenden Sie sich zur Unterstützung an einen Elektriker oder eine Behörde vor Ort.
- FR** Dans certains pays, les travaux sur les installations électriques ne peuvent être effectués que par des électriciens qualifiés. Pour toute demande d'assistance, veuillez contacter un électricien ou votre autorité locale.
- ES** En algunos países, únicamente los electricistas cualificados pueden trabajar en instalaciones eléctricas. Si necesitas asistencia, ponte en contacto con la autoridad o con un electricista local.
- IT** In alcuni paesi, solo gli elettricisti qualificati possono svolgere lavori relativi alle installazioni elettriche. Per informazioni, contatta il tuo elettricista di fiducia oppure l'autorità preposta.
- PT** Em alguns países, apenas os eletricitas qualificados podem realizar trabalho em instalações elétricas. Para obter assistência, contacte um eletricitista ou uma autoridade local.



- EN** The electrical circuit and attached light source will always be powered after installation, turn off the circuit when replacing a light fixture / battery.
- DE** Der Stromkreis und die angeschlossene Lichtquelle werden nach der Installation immer mit Strom versorgt. Schalten Sie daher den Stromkreis aus, wenn Sie eine Leuchte / Batterie austauschen.
- FR** Le circuit électrique et la source lumineuse raccordée seront toujours alimentés après l'installation. Par conséquent, mettez le circuit hors tension lors du remplacement d'un luminaire / pile.
- ES** Tras la instalación, el circuito eléctrico y la fuente de luz conectada siempre tendrán alimentación eléctrica. Apaga el circuito cuando cambies una luminaria / batería.
- IT** Dopo l'installazione, il circuito elettrico e la sorgente luminosa collegata rimangono sempre alimentati. Spegni il circuito per sostituire l'apparecchio per illuminazione / batteria.
- PT** O circuito elétrico e a fonte de luz associada estarão sempre ligados à alimentação após a instalação. Quando substituir um equipamento de luz / pilha, desligue o circuito.

## Installation instructions Europe

- ⓘ • Attention! Electrical devices may only be mounted and connected by electrically skilled persons.
- For safe installation, commissioning and operation, the instruction and legal manual with the product must be read.
- Before any assembly or disassembly or replacement of the battery always switch off the circuit breaker.

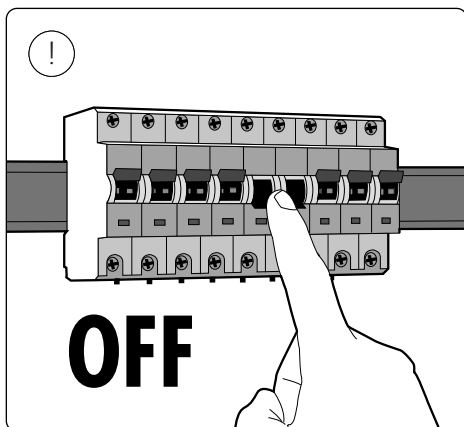

- Make always sure nobody can switch on the circuit breaker while working
- It's advised to check if there is no voltage, ground and shortcut on any parts
- Cover up live wires
- Test if the power is off before proceeding

Only proceed when above is checked.

- ⓘ Advice: print this manual, striketrough above points to ensure a safe working situation

## What's in the box\*

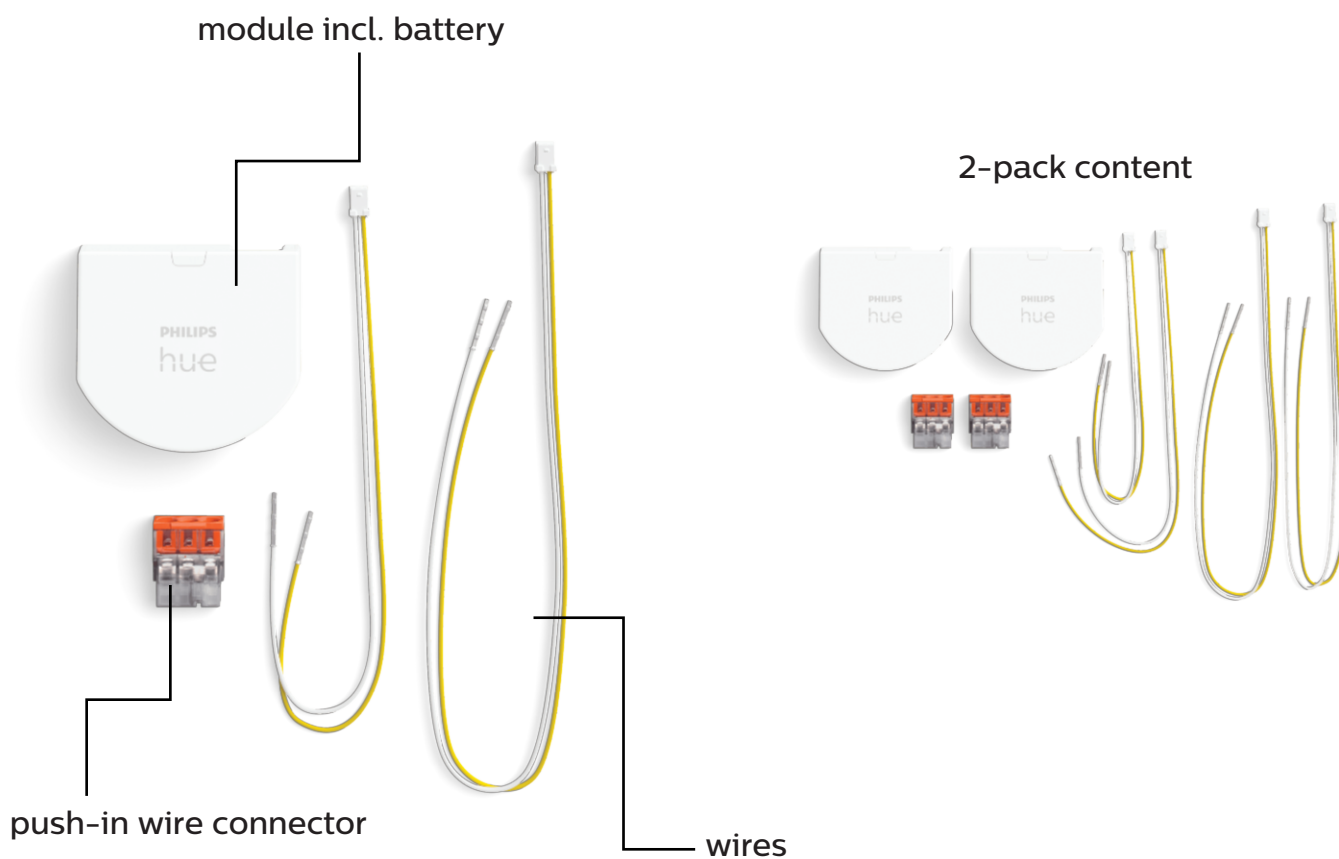

### Needed tools, not included

Excl.

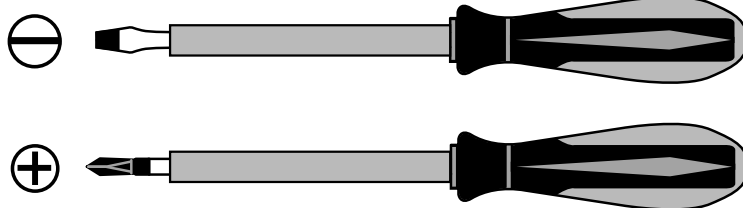

\* Requires Hue bridge and only compatible with Hue light sources

# Rocker switch 1-way

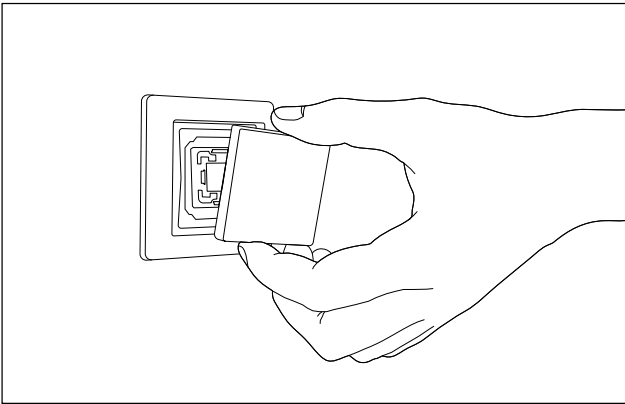

1. Turn-off circuit breaker
2. Dismount light switch

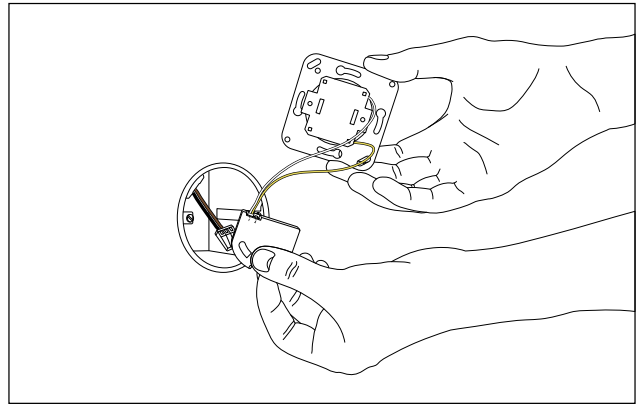

6. Connect the provided yellow and white wire to the light switch and module. Don't extend the provided wires. Use the positions where you removed the original (live) wires.

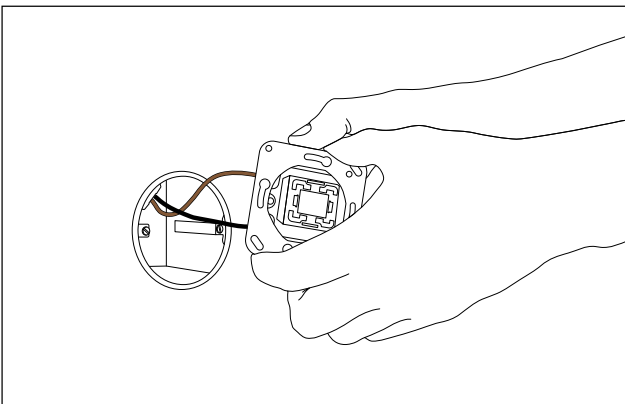

3. Remove original (live) wires  
Tip! Take a photo of the position of the wiring

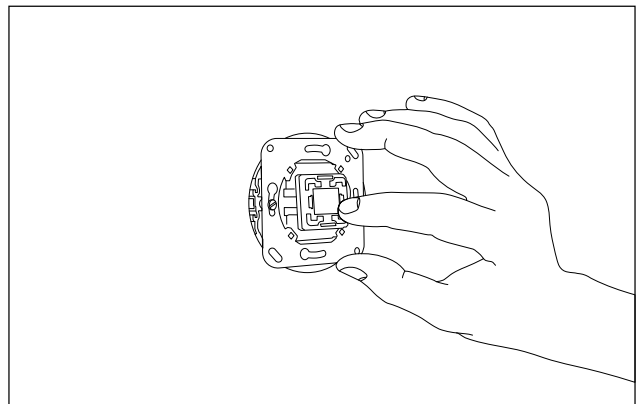

7. Place the module into the installation box

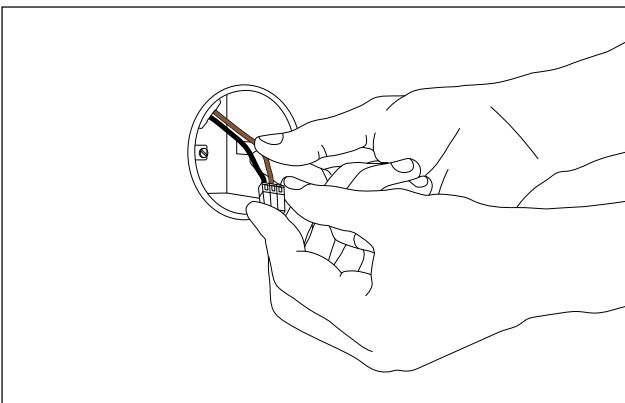

4. Place original (live) wires to the push-in wire connector
5. Push the connector in the installation box

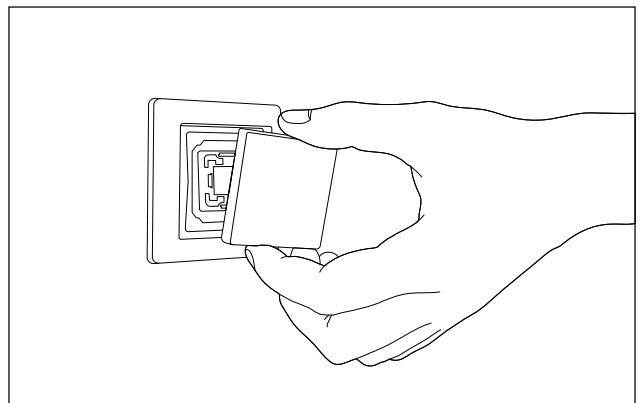

8. Put back the light switch
9. Turn on the circuit breaker
10. Open the Hue app and select settings -> accessory configuration to add the module.



## Rocker switch 1-way

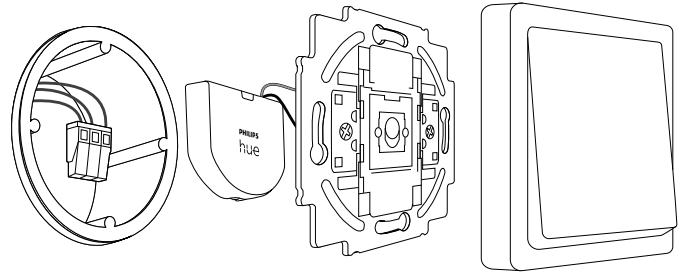

- 1-way switching using a rocker type switch is the default for the Hue wall switch module in the Hue app.
- This installation is for connecting a single switch controlling 1 light point or circuit.
- For circuit diagrams please review the application notes on our FAQ page.

1. In most cases only the 2 disconnected (live) wires must be placed in the provided push-in wire connector.

Never add a neutral and/or ground wire to the provided push-in wire connector.

**Tip! Make a picture before removing the wires to remember the location.**

2. Place 1 set of the provided yellow and white wires in position in the module (see image 1).

3. Place the end of the wires in the same position where you removed the original (live) wires from the light switch. In below example white will go on the top of your switch and yellow on the bottom.

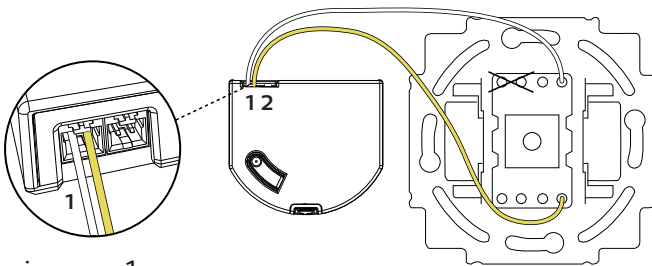

image 1

- When adding the module to your accessories in the Hue app, follow the instructions and select single rocker for this installation (see image 2).

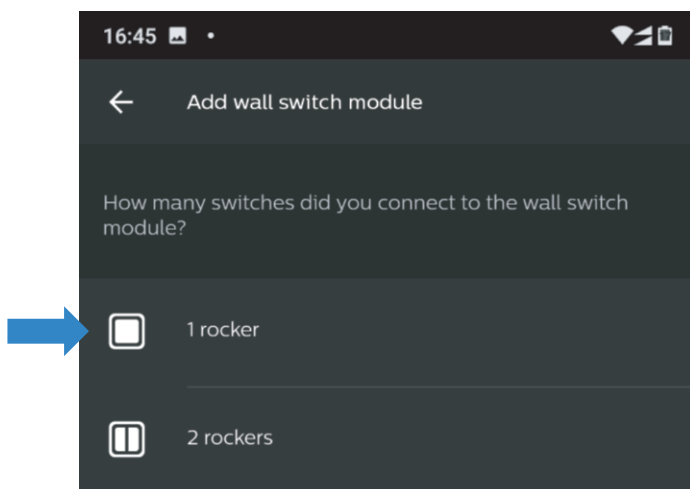
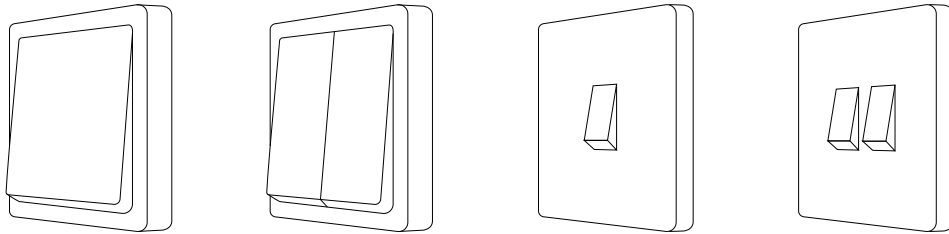

image 2

## Rocker switch variants

- A rocker light switch typically has two positions, On and Off and works like a seesaw.
- We support 1 gang and 2 gang rocker switches per wall switch module.



- There are many of variances of light switches and the module works with most common switch types with the following exceptions:
  - We don't recommend to use the module with switches that combine power outlets and light switches.
  - The module doesn't work in combination with dimmers and dimming modules.
- Find below commonly found switches and where to connect the provided yellow and white cables.

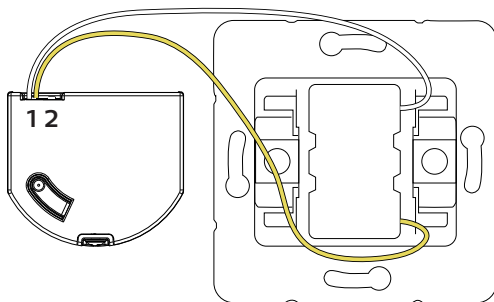

Standard switch with side mounting

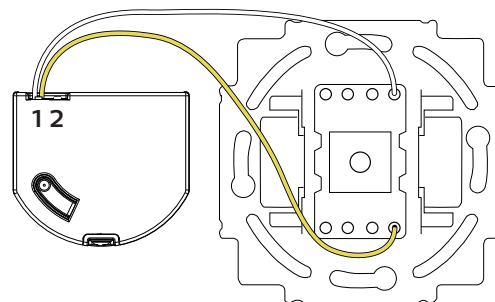

Standard switch with backside mounting

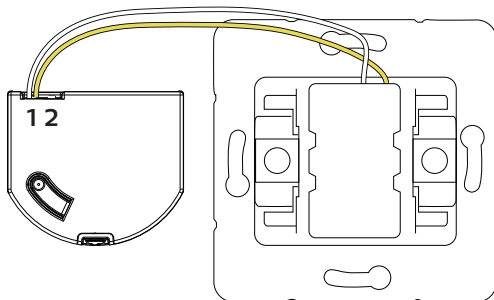

Standard switch with top mounted wires

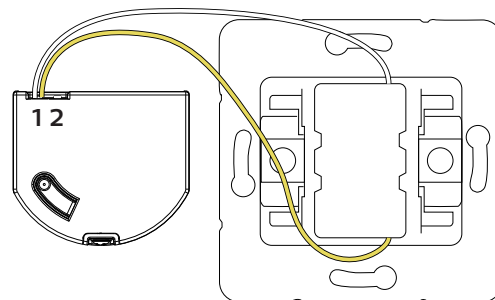

Standard switch with top and bottom mounted wires

- When in doubt if your switch is suitable for installation, contact an electrician for support.

## Rocker switch 2-gang

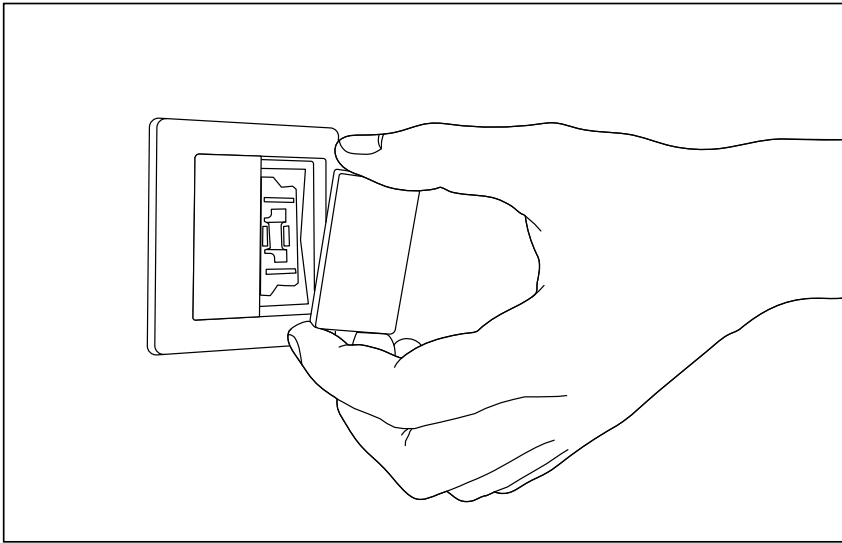

1. Turn-off circuit breaker
2. Dismount light switch

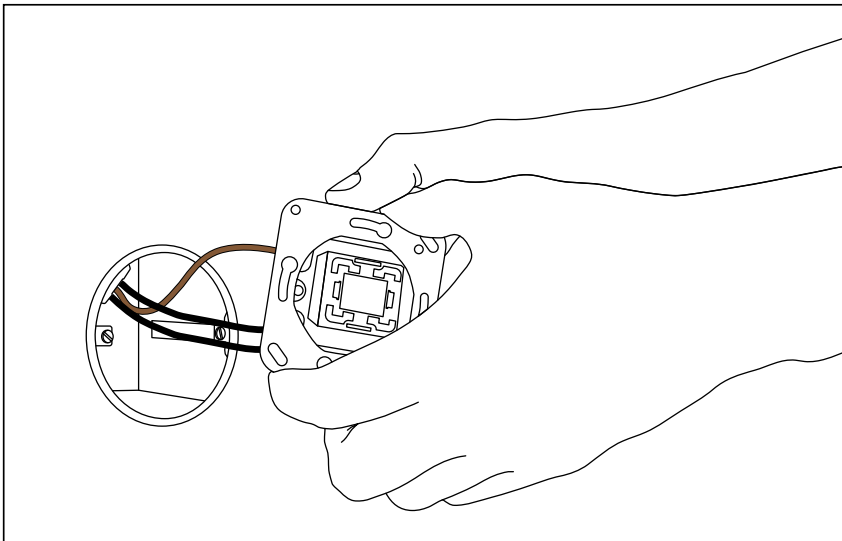

3. Remove original (live) wires  
Tip! Take a photo of the position of the wiring

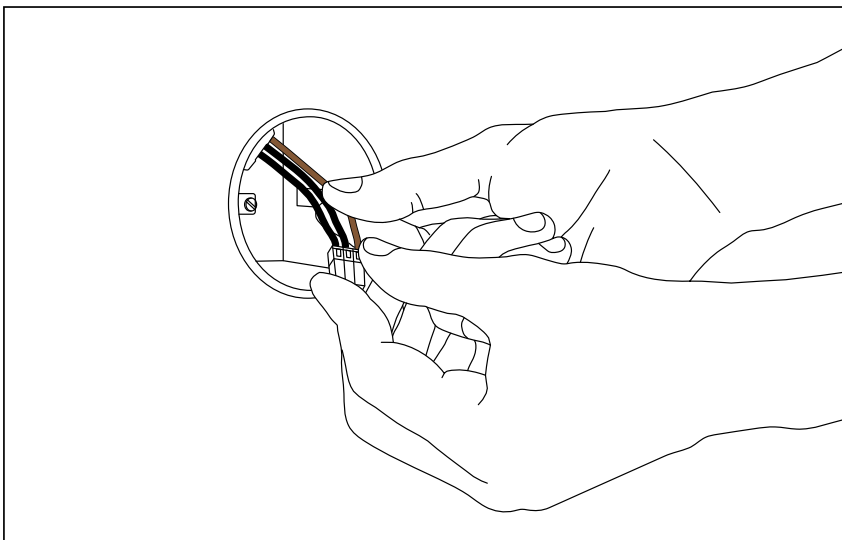

4. Place original (live) wires to the push-in wire connector
5. Push the connector in the installation box

## Rocker switch 2-gang

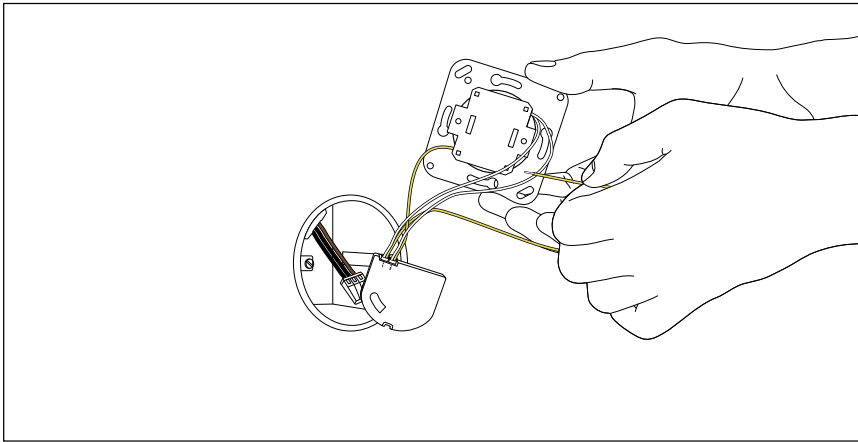

6. Connect one yellow and the white wires to the light switch and module.

Don't extend the provided wires

Use the positions where you removed the original (live) wire

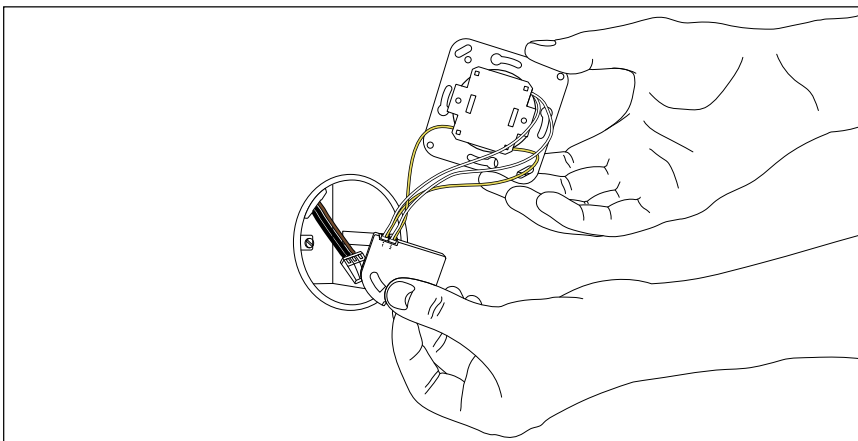

7. Place the additional yellow wire into one of the available positions.

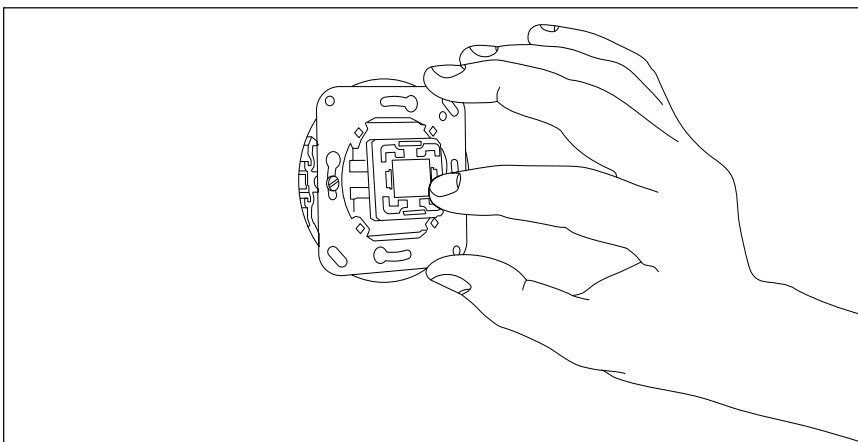

8. Place the module into the installation box

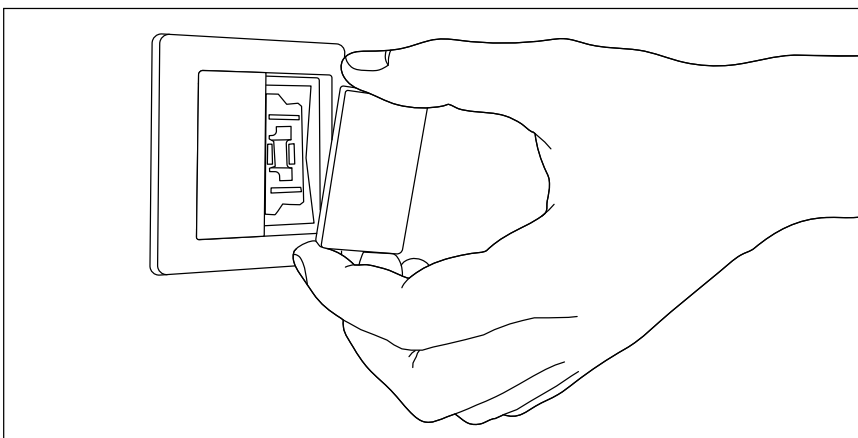

9. Install the light switch
10. Turn on the circuit breaker
11. Open the Hue app and select settings -> accessory configuration to add the module

## Rocker switch 2-gang

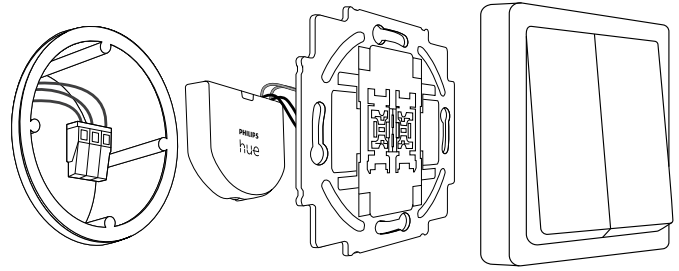

- 2-gang switching is the second default for the Hue wall switch module in the Hue app.
  - This installation is for two switches, in one frame, controlling two light points or circuits.
  - For circuit diagrams please review the application notes on our FAQ page.
1. In most cases only the 3 disconnected (live) wires have to be added to the provided push-in wire connector. Never add neutral and or ground to the push-in wire connector.  
**Tip! Make a picture before removing the wires to remember the location.**
  2. You need to use two sets of wiring, one in position 1 and one in position 2 (see image 1) in the module.
  3. Place the provided white wires in the same position where you removed your original (live) wires from the light switch, in below example on the top of the switch and one yellow on the bottom.
  4. The additional yellow wire must be added to an additional empty position on your switch. Many manufactures indicate the additional position using a visual indicators such as an arrow (see image 2)

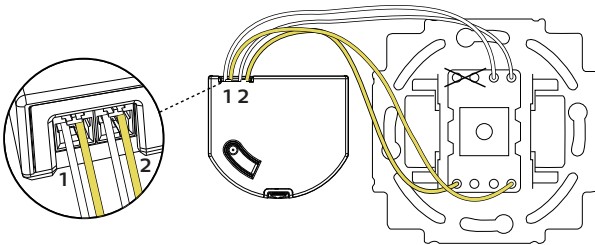

image 1

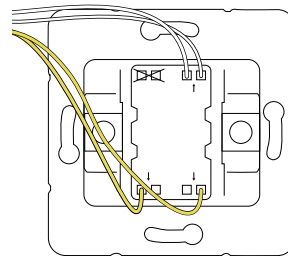

image 2

- When adding the module to your accessories in the Hue app, select double rocker for this installation (see image 3)

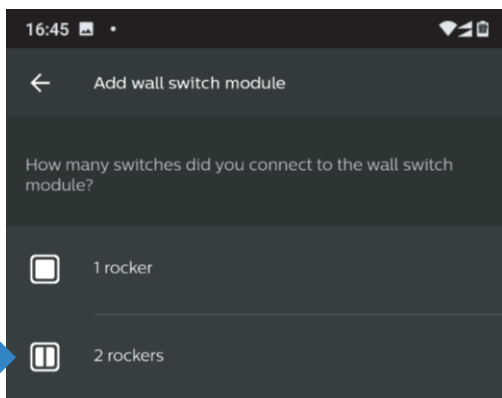
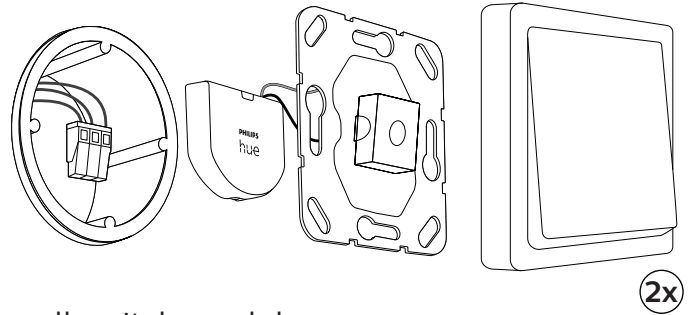

image 3

- ⓘ Keep the app open until the product is fully installed and you are guided to the next screen

## Rocker switch 2-way



- For 2-way switching you will need 2 Hue wall switch modules.
1. Follow the same installation instructions as connecting a 1-way switch with the following exception:  
In most cases only the 3 disconnected (live) wires will have to be added to the provided push-in wire connectors in each of the installation boxes. Never add neutral and/or ground to the push-in wire connector.
- ⓘ Attention! Always make sure for **all** switches there is no voltage, and corresponding circuit breaker(s) are turned off.
2. One removed original (live) wire will not be replaced with the provided wires with the Hue wall switch module, install the provided wires according to the 1-way switch guidance.

You will find 2-way switches typically in hallways and stairways or bigger rooms that gives control over a light point from two positions (see image 1).

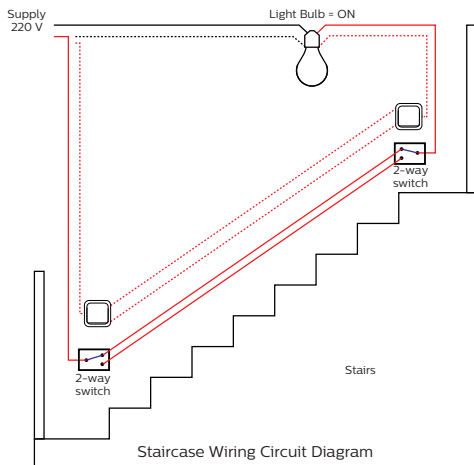

image 1

- Follow in the app the same installation steps for the wall module as regular 1-way switching and select single rocker (see image 2) for both modules.

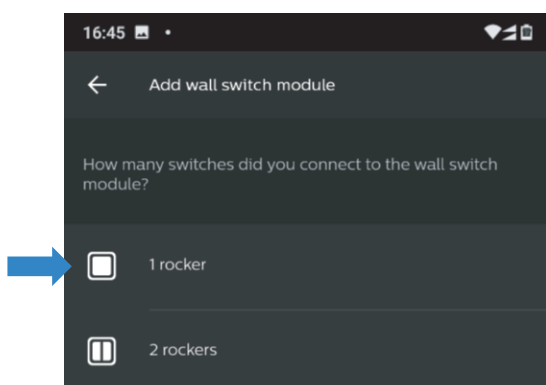
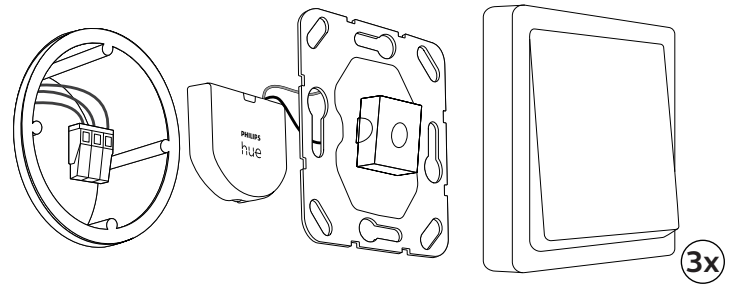

image 2

- ⓘ Keep the app open until the product is fully installed and you are guided to the next screen

## Rocker switch 3-way



- For 3-way switching (intermediate switching) you will need 3 Hue wall switch modules.
1. Follow the same installation instructions as connecting a 1-way switch with the following exception:  
In most cases in two installation boxes the 3 disconnected (live) wires will have to be added to the provided push-in wire connector. An additional 4-wire push-in wire connector is needed (not provided) for the intermediate switch in one of the three installation boxes.
- ⚠ Attention! Always make sure for **all** switches there is no voltage, and corresponding circuit breaker(s) are turned off.
2. Some removed original (live) wires will not be replaced with the provided wires with the Hue wall switch module, install the provided wires according to the 1-way switch guidance.

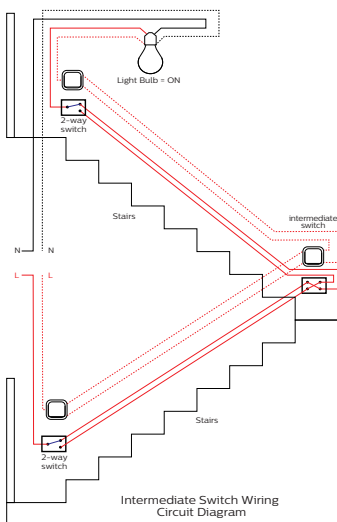

You will find 3-way switches typically in hallways and stairways or bigger rooms that gives control over a light point from 3 positions (see image 1).

image 1

- Follow in the app the same installation steps for the wall module as regular 1-way switching and select single rocker (see image 2) for both modules.

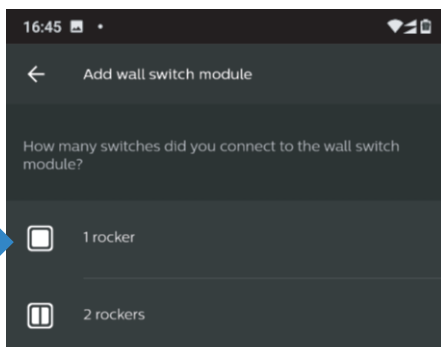

image 2

- ⚠ Keep the app open until the product is fully installed and you are guided to the next screen

## Push-in wire connector instructions

1. Select the right (live) wires

ⓘ Attention! Don't add neutral or ground wires to the push-in wire connector

2. Straighten the wires (cut when necessary to straighten the wires)

3. Make sure the copper part can be fully put inside the connector

4. Push the wires into the connector until their locked securely in place

ⓘ Attention!

- No copper should be outside the connector.
- Stranded wires should not be used with the provided connector. (see image 1)
- Choose an appropriate connector for stranded wires (not provided).

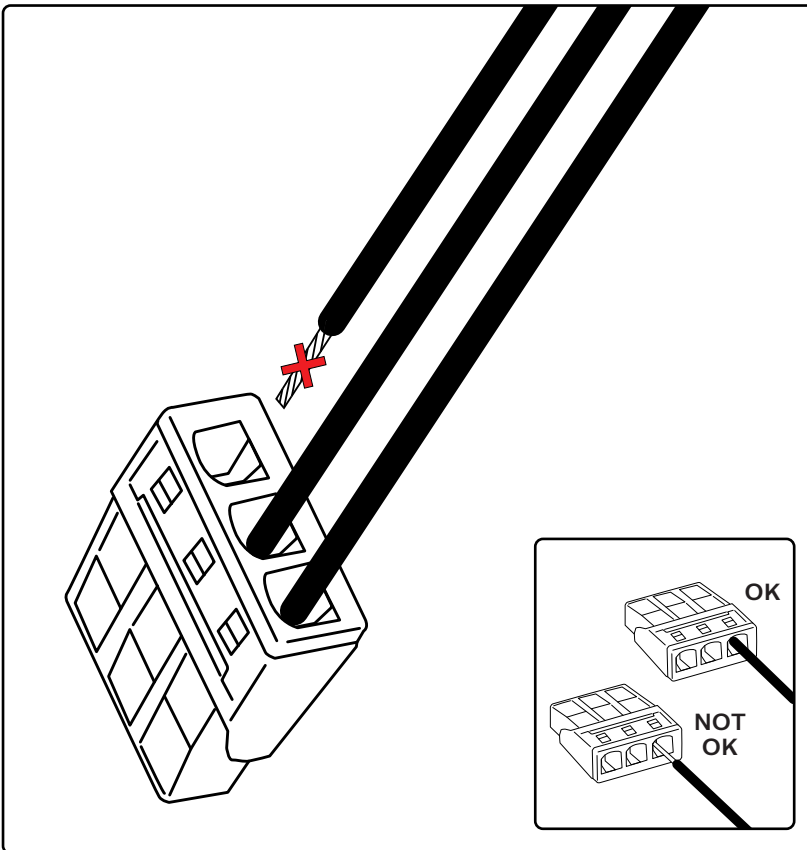

image 1



## Push buttons

- A push button switch returns to a neutral position directly after being pushed, using often a spring inside the switch, which is not the case for rockers switches that work like a seesaw.
- From appearance these could sometimes look very similar to rockers switches or dimmers.
- A push button can't be turned to dim but could sometimes look very similar to a dimmer because of it's round shape.

ⓘ When it's determined a push button is used please select during the configuration in the app single or double push button (see image 1).

The push button configuration can be found following the bottom button on the initial “add wall switch module” screen. (see image 2)

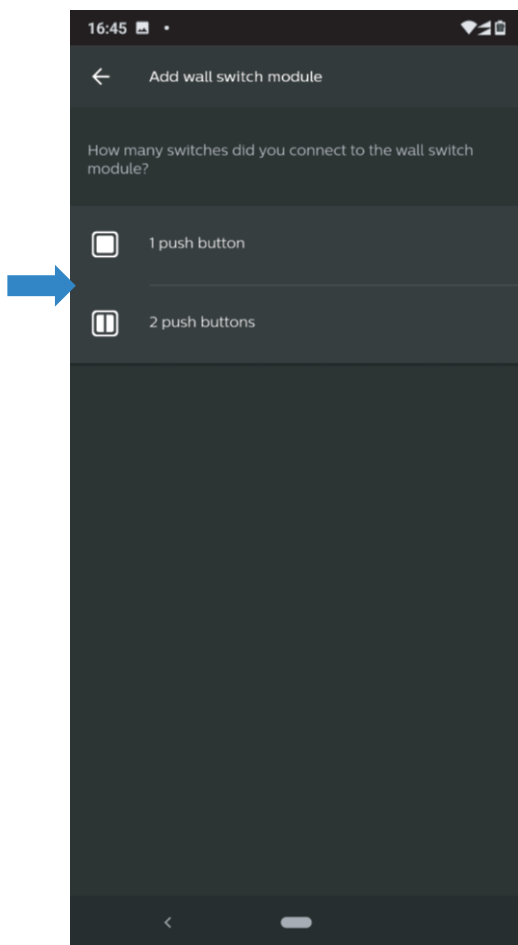

image 1

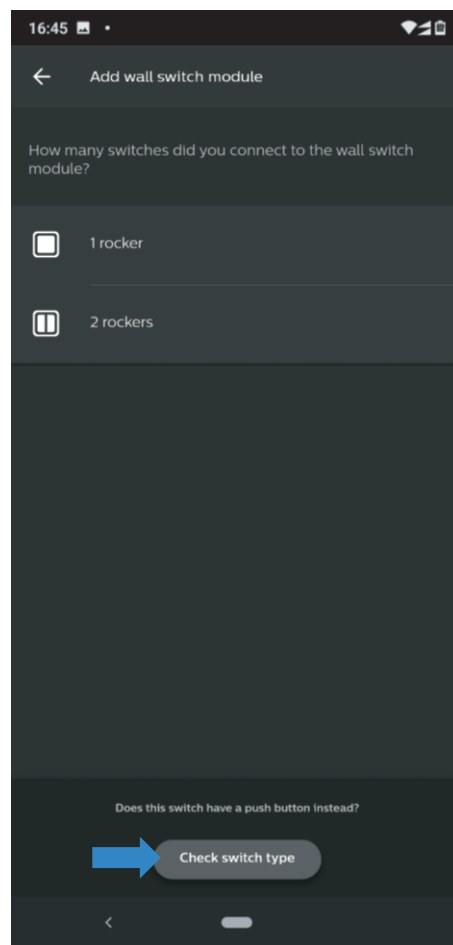

image 2

ⓘ Keep the app open until the product is fully installed and you are guided to the next screen

## General safety instructions United States and Canada



- EN** Work on Electrical installations is in some countries only allowed by a qualified electrician. For support contact a local electrician or authority to install the product in accordance with national and electrical codes.
- FR** Dans certains pays, les travaux sur les installations électriques ne peuvent être effectués que par des électriciens qualifiés. Pour toute demande d'assistance, veuillez contacter un électricien ou votre autorité locale afin d'installer le produit conformément aux codes nationaux et de l'électricité.
- ES** En algunos países, únicamente los electricistas cualificados pueden trabajar en instalaciones eléctricas. Si necesitas asistencia, ponte en contacto con la autoridad o con un electricista local para instalar el producto de acuerdo a las legislaciones nacionales.



- EN** The electrical circuit and attached light source will always be powered after installation, turn off the circuit breaker when replacing a light fixture / battery.
- FR** Le circuit électrique et la source lumineuse raccordée seront toujours alimentés après l'installation. Par conséquent, mettez le circuit hors tension lors du remplacement d'un luminaire / pile.
- ES** Tras la instalación, el circuito eléctrico y la fuente de luz conectada siempre tendrán alimentación eléctrica. Apaga el circuito cuando cambies una luminaria / batería.

# Installation instructions United States and Canada

- ⓘ • Attention! Electrical devices may only be mounted and connected by electrically skilled persons.
- For safe installation, commissioning and operation, the instruction and legal manual with the product must be read. Ensure always install the product according to the local electrical code.
- Before any assembly or disassembly or replacement of the battery always switch off the circuit breaker.

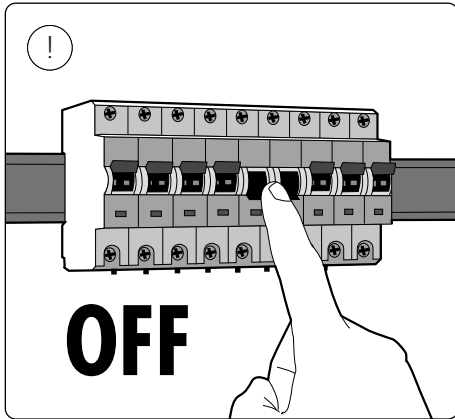

- Make always sure nobody can switch on the circuit breaker while working
- It's advised to check if there is no voltage, ground and shortcut on any parts
- Cover up live wires
- Test if the power is off before proceeding

- ⓘ Only proceed when above is checked.  
Advice: Print the manual and strikethrough above points to ensure a safe working situation

After installation:

- Always make sure your room after installation has at least one light switch left that can cut the power physically

- ⓘ **NOTE:** If the wiring in the wall box does not resemble any of these configurations, consult an electrician.

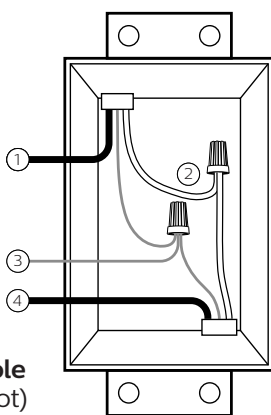

**Single Pole**  
1. Line (Hot)  
2. Neutral  
3. Ground  
4. Load

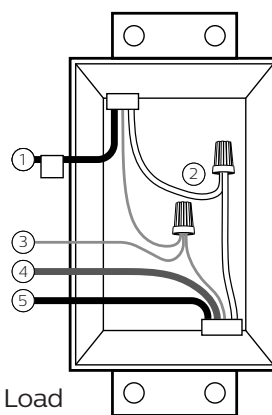

**3-Way**  
1. Line or Load  
2. Neutral  
3. Ground  
4. First Traveler - note colour  
5. Second Traveler - note colour

# What's in the box\*

## Single pack

## Double pack

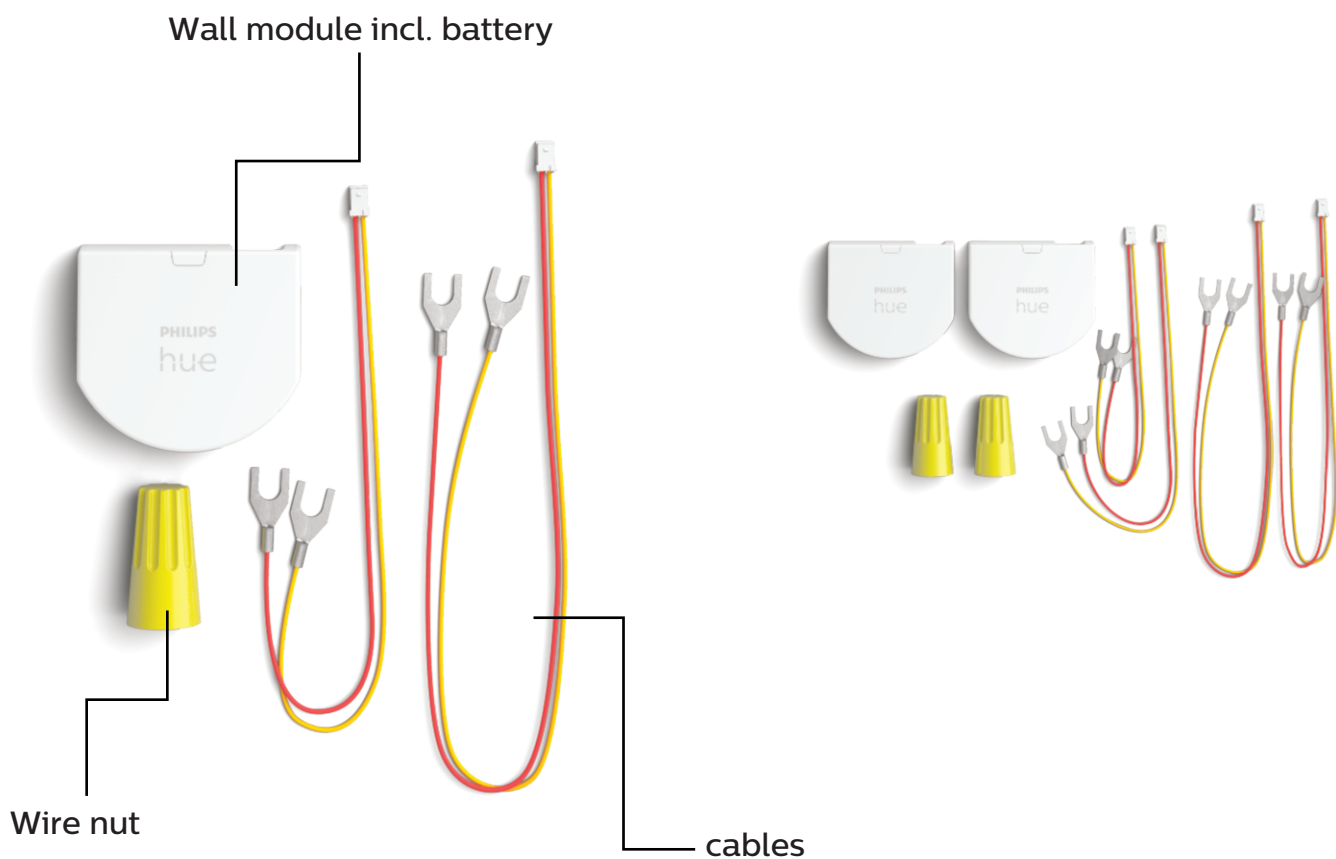

## Needed tools, not included

Excl.

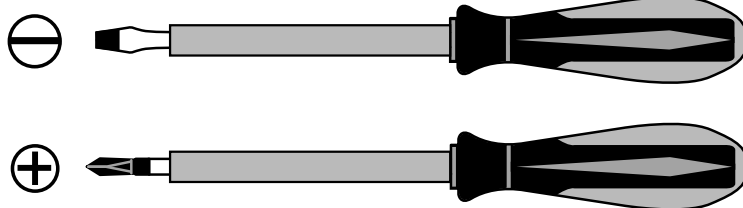

\* Requires Hue bridge and only compatible with Hue light sources

## Toggle/paddle switch Single pole

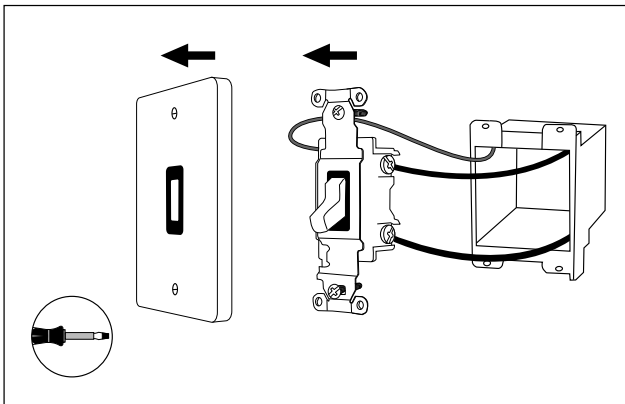

1. Turn-off circuit breaker
2. Dismount light switch

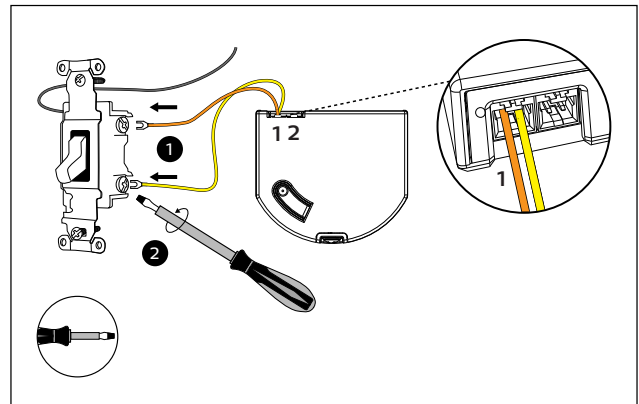

6. Connect the provided orange and yellow wire to the module and light switch using the screw terminals for the fork connectors  
Don't extend the provided wires

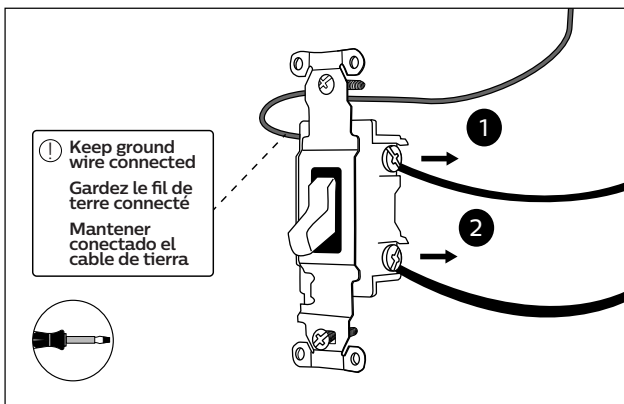

3. Remove original (HOT) wires but keep ground connected  
Tip! Take a photo of the position of the wiring

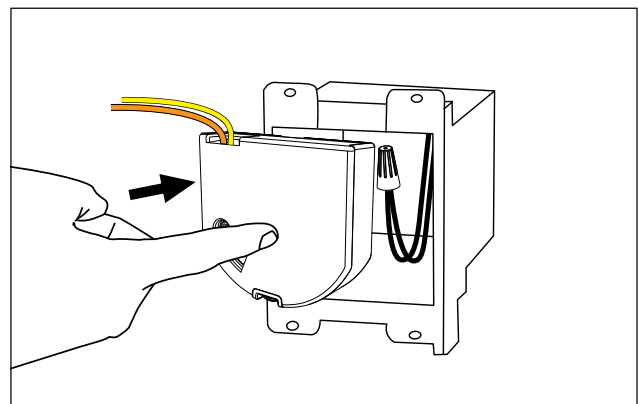

7. Place the module into the installation box

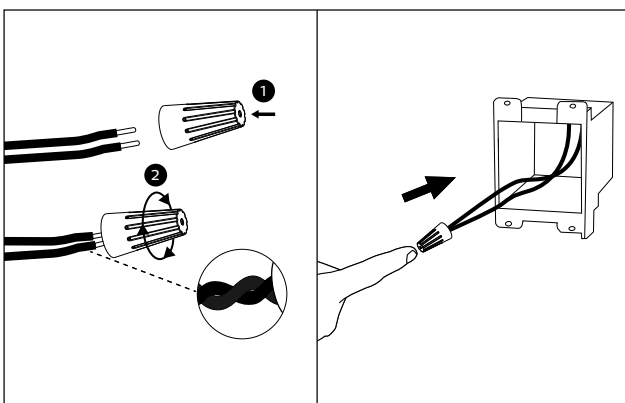

4. Place original (HOT) wires into the wire nut. Never add a neutral (white wire) to the wire nut.
5. Push the wire nut and cables in the installation box

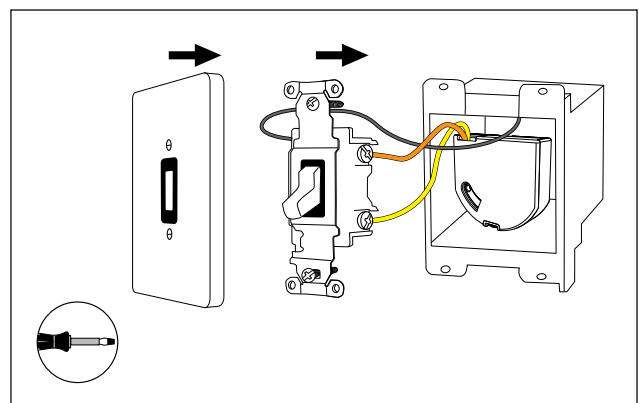

8. Put back the light switch
9. Turn on the circuit breaker
10. Open the Hue app and select settings -> accessory configuration to add the module

## Toggle/paddle switch

### Single pole

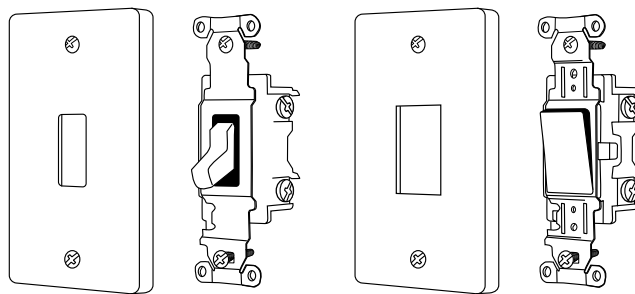

- Single pole switching using a toggle or paddle switch is the default for the Hue wall switch module in the Hue app.
  - This installation is for connecting a single switch controlling 1 light point or circuit.
  - For circuit diagrams please review the application notes on our FAQ page.
1. In most cases only the 2 disconnected HOT wires must be placed in the provided wire nut.  
Never add a neutral and/or ground wire to the wire nut.  
Tip! Make a picture before removing the wires to remember the location.
  2. Place 1 set of the provided orange and yellow wires in position 1 in the module (see image 1) .
  3. Place the provided fork connectors in the same position where you removed the original wires from the light switch. Orange will go on the top of your switch and yellow on the bottom (When push-in wires are used instead of screw terminals, disassemble these HOT wires from the switch and use screw terminals for the provided wires with fork connectors.)

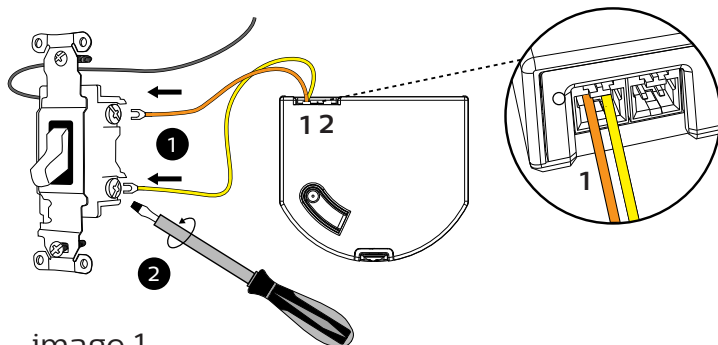

image 1

- When adding the product to your accessories in the Hue app, follow the instructions and select single rocker for this installation (see image 2).

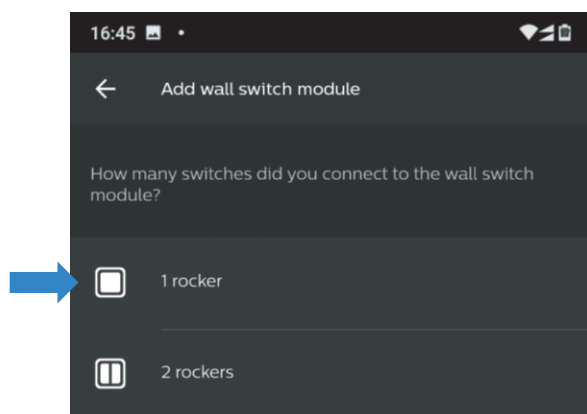
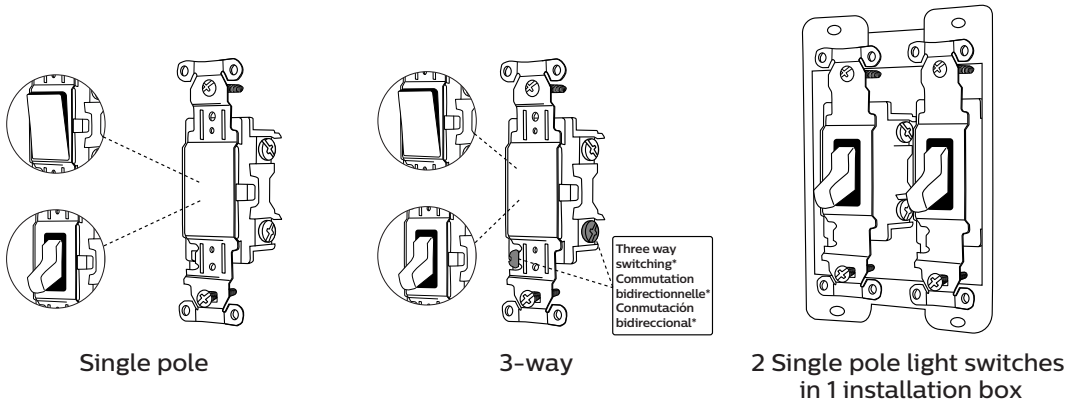

image 2

# Toggle and paddle switch variants

- A toggle or paddle light switch typically has two positions, On and Off.
- We support 2 switches per wall switch module.



- There are many of variances of light switches.
- We don't recommend to use the module with switches that combine power outlets and light switches.
- The module doesn't work in combination with dimmers and dimming modules or backstab light switches without terminal screws.



- Attention! Please note that by using the wall switch module any on/off markings on the light switch might not longer follow the state of the lights.
- Find below commonly found switches and where to connect the provided orange and yellow cables.
- When in doubt if your switch is suitable for installation, contact an electrician for support.
- Dismount the existing original wires and replace with provided wires when screw terminals are used. (When push-in wires are used, disassemble these wires and use screw terminals for the provided wires)

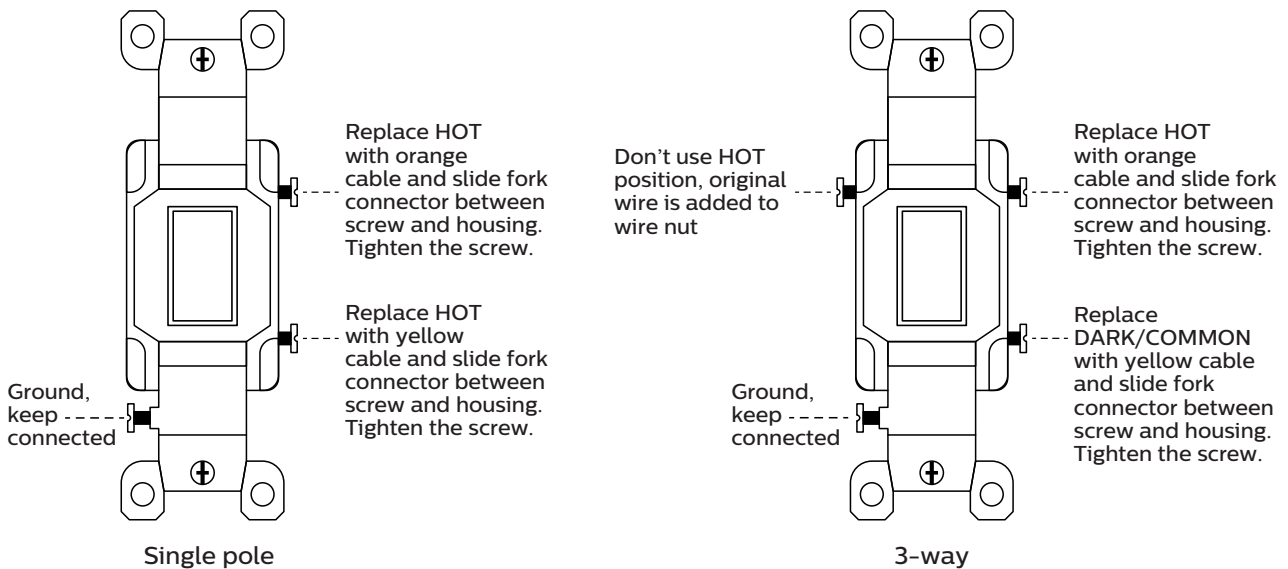

## Toggle and paddle switch 2 single pole inputs

- Switching 2 single pole inputs is the second default for the Hue wall switch module in the Hue app.
  - This installation is for a two switch, in one installation box, controlling two light points or circuits.
  - For circuit diagrams please review the application notes on our FAQ page.
1. In this situation the 4 hot wires need to be placed into a wire nut(s). The supplied wire nut can contain 3 wires max. Never add neutral and or ground to wire-nut
  2. You need to use two sets of the provided wiring, one in position 1 and one in position 2 in the module. (see image 1)
  3. Place the provided fork connectors in the same position where you removed the original HOT wires from the light switch. Orange will go on the top of your switch and yellow on the bottom (When push-in wires are used instead of screw terminals, disassemble these HOT wires from the switch and use screw terminals for the provided wires)

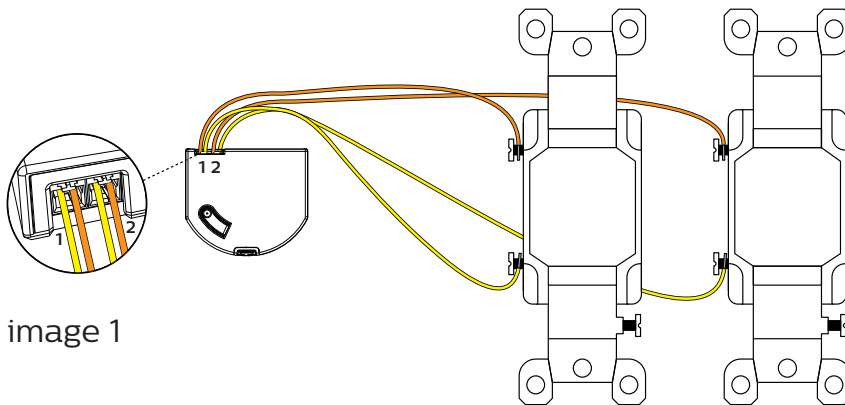

image 1

- When adding the product to your accessories in the Hue app, select double rocker for this installation (see image 2)

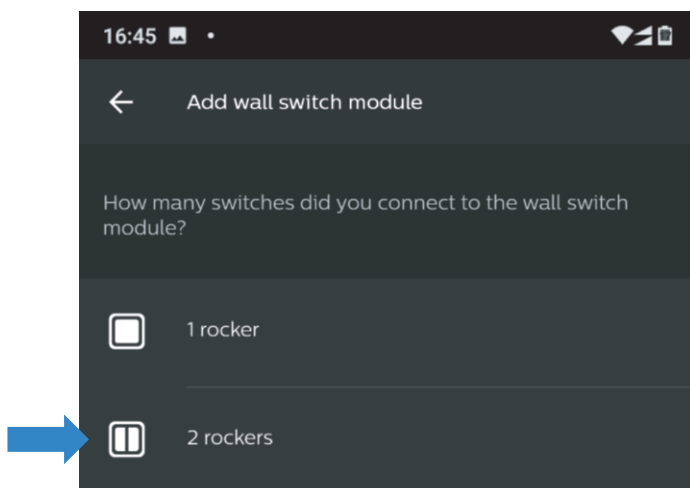
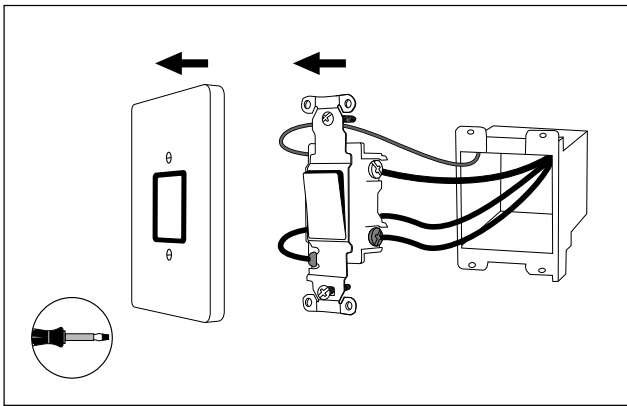

image 2



# Toggle/paddle switch 3-way



1. Turn-off circuit breaker
2. Dismount light switch

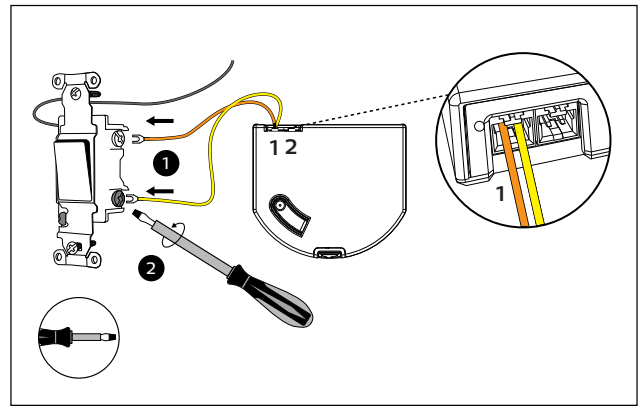

6. Connect the provided orange and yellow wire to the module and light switch using the screw terminals for the fork connectors  
Don't extend the provided wires

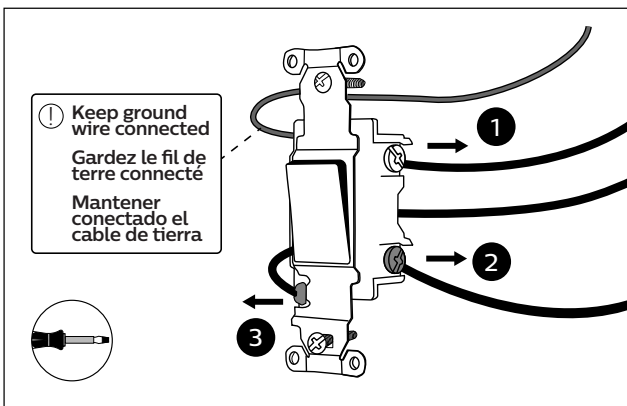

3. Remove original (HOT) wires but keep ground connected  
Tip! Take a photo of the position of the wiring

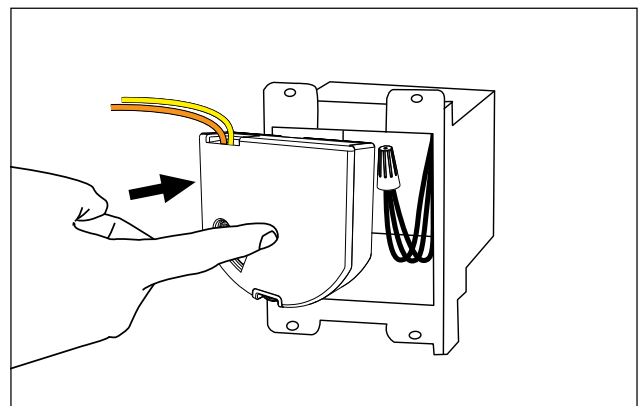

7. Place the module into the installation box

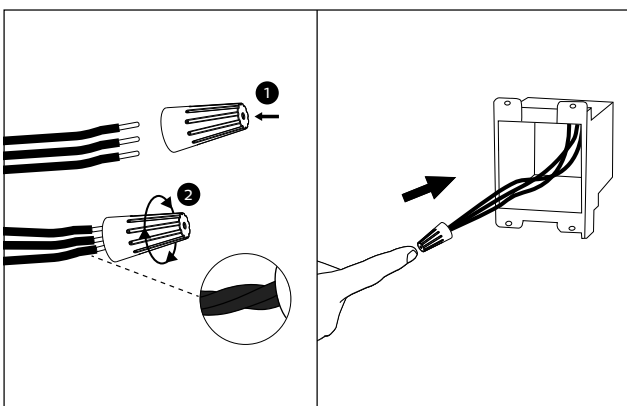

4. Place original (HOT) wires into the wire nut. Never add a neutral (white wire) to the wire nut.
5. Push the wire nut and cables in the installation box

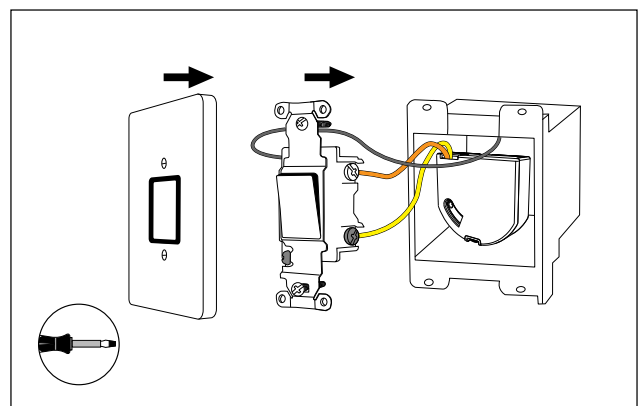

8. Put back the light switch
9. Turn on the circuit breaker
10. Open the Hue app and select settings -> accessory configuration to add the module

## Toggle/paddle switch 3-way

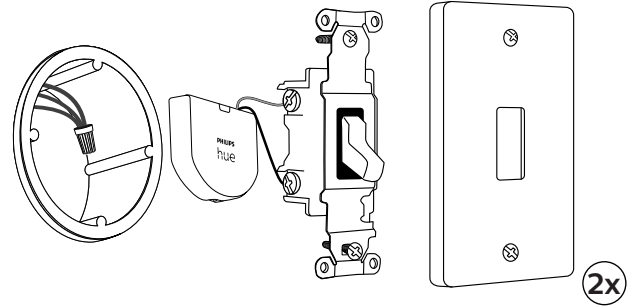

- For 3-way switching you will need 2 Hue wall switch modules.

1. Follow the same installation instructions as connecting as a single pole switch with the following exception:

In most cases only the 3 disconnected wires will have to be added to the provided wire nut. each of the installation boxes. Never add neutral and/or ground to the wire nut.

- ⚠ Attention! Always make sure for **all** switches there is no voltage, and the corresponding circuit breaker(s) are turned off.

2. One removed original HOT wire will not be replaced with the provided wires with the Hue wall switch module, install the provided wires according to the 3-way switch guidance.

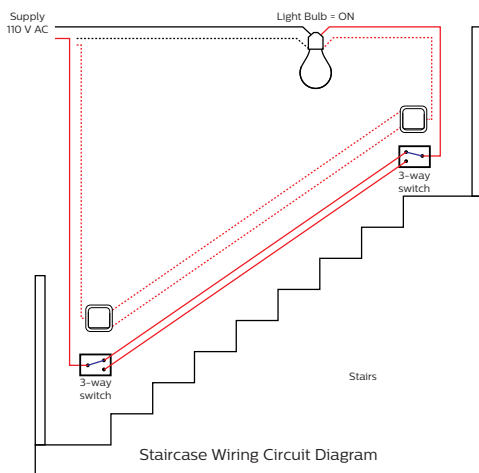

You will find 3-way switches typically in hallways and stairways or bigger rooms that gives control over a light point from two positions (see image 1).

image 1

- Follow in the app the same installation steps for the wall module as a regular single pole switch and select single rocker (see image 2) for both modules.

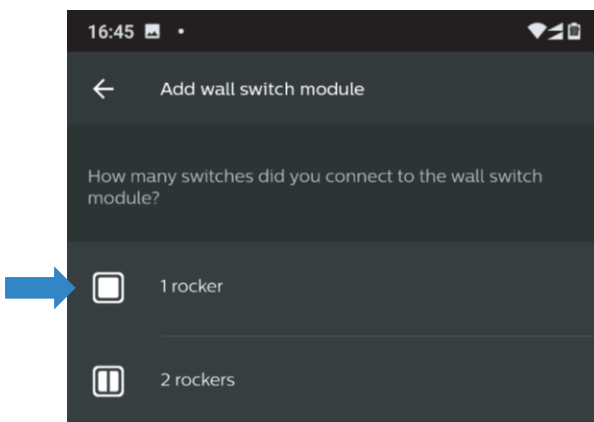

image 2

## Wire nut instructions

1. Select the right wires (line (hot) and load (hot))
2. Create straight wires (cut when necessary to straighten the wires)

ⓘ • Attention! Don't add neutral (white wire) or ground wires (green/copper) to the push-in wire connector

3. Create strip gage (exposed copper) of 3/8" (9.5mm) by removing insulation or cutting back copper to length.
4. Insert wires straight into the wire nut

ⓘ • Attention! Make sure the full copper part is inside the connector

5. Rotate clockwise until two twist are visible (see image 1)

• Usage of installation tape is advised (not provided)

ⓘ Attention!  
No copper should be outside the connector.  
Stranded wires should not be used with the provided connector  
Choose an appropriate connector for stranded wires (not provided).

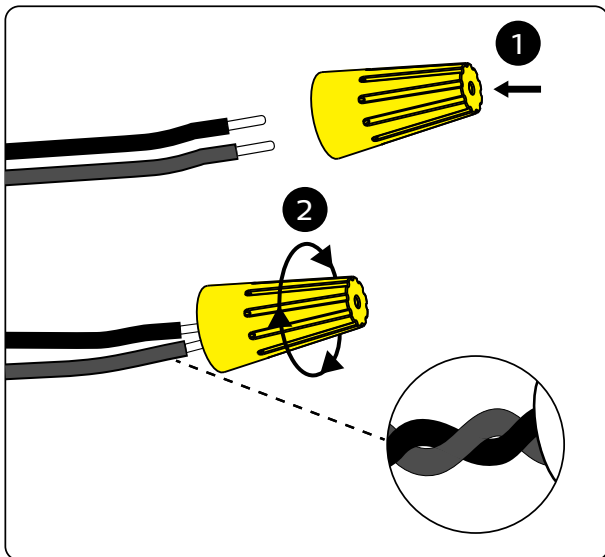
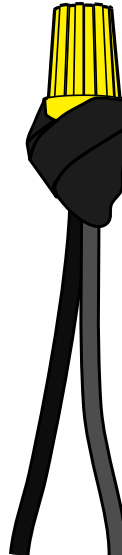

image 1



## Technical data

Technical data	
Rated voltage	DC 3 V
Battery type	CR2450
Ambient temperature	+5 ... +35 C
Storage temperature	-25 ... + 70 C
Protection class	III
Communication protocol	ZigBee 3.0
Radio frequency	2.400 ... 2.483 GHz
Transmission capacity	1 mW
Battery life	> 5 years
Dimensions	43.3 x 37.7 x 10.2 mm

## App features and reset instructions

Feature	Usage
Basic on/off	Traditional light switching
Scene toggle on rocker switch types	Switch gently lights from Off to On position within 3 seconds for next scene. Scenes are available in a loop 1-2-3-1..
Scene toggle on push button switch types	Repeatedly press within 3 seconds for next scene Scenes are available in a loop 1-2-3-1..
Dimming (only for push button switch types)	Hold to dim down, release and hold for opposite direction

### Reset instructions

In the unlikely event the Switch is not functioning properly or becomes unresponsive perform the following actions:

1. Remove the wall switch module from your accessory configuration in the Hue app from the configuration screen
2. Turn off the circuit breaker
3. Get access to the wall switch module by dismounting the light switch
4. Press and hold the reset button > 10 seconds until the red light blinks (image 1)
- 4a. Replace the battery if the red light doesn't blink (see next page)
5. Make sure push-in wire connector (EU) and wire nut (US and CAN) are still secure in place showing no copper part outside it
6. Put back the wall switch module and light switch
7. Turn on the circuit breaker
8. Re-install the Hue wall switch module in the app

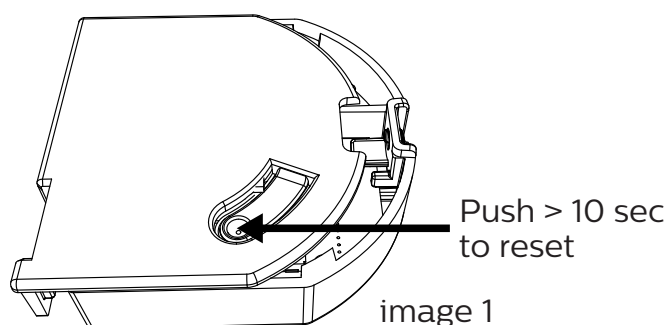

# Battery replacement

## Replacement instructions

ⓘ Attention! Consult your B-manual for important safety information on coin cell batteries use and disposal

1. Turn off circuit breaker
2. Dismount light switch to get access to the module
3. Remove the cables from the module
4. Open the module following below instructions
5. Exchange battery
6. Close the module following below instructions
7. Make sure push-in wire connector (EU) and wire nut (US and CAN) or still secure in place show no copper part outside it
8. Put back the module and assemble the light switch
9. Turn on the circuit breaker

