



Operation manual Gallery Plus

Version 6.0

N12274 Revision A • October 2016

Copyright © 2016 Thermo Fisher Scientific Inc. and its subsidiaries. All rights reserved.

Thermo Fisher Scientific Inc. provides this document to its customers with an analyzer purchase to use in the analyzer operation. This document is copyright protected and any reproduction of the whole or any part of this document is strictly prohibited, except with the written authorization of Thermo Fisher Scientific.

The contents of this document are subject to change without notice. No representations are made that this document is complete, accurate or errorfree. All technical information in this document is for reference purposes only. System configurations and specifications in this document supersede all previous information received by the purchaser.

Use of this analyzer in a manner not specified by the manufacturer could impair any protection provided by the analyzer. No responsibility and no liability is assumed for any errors, omissions, damage or loss that might arise out of the use or inability to use this analyzer.

This document is not part of any sales contract. This document shall in no way govern or modify any Terms and Conditions of Sale, which Terms and Conditions of Sale shall govern all conflicting information between the two documents.

Manufactured by
Thermo Fisher Scientific Oy
Ratastie 2, P.O.Box 100
FI-01621 Vantaa
Finland
Tel: +358 10 329 200
E-mail: system.support.fi@thermofisher.com

Safety information

Physical handling of this analyzer requires a team effort. The analyzer is too heavy and bulky for one person alone to handle safely.

Figure 1. Safety labeling outside analyzer

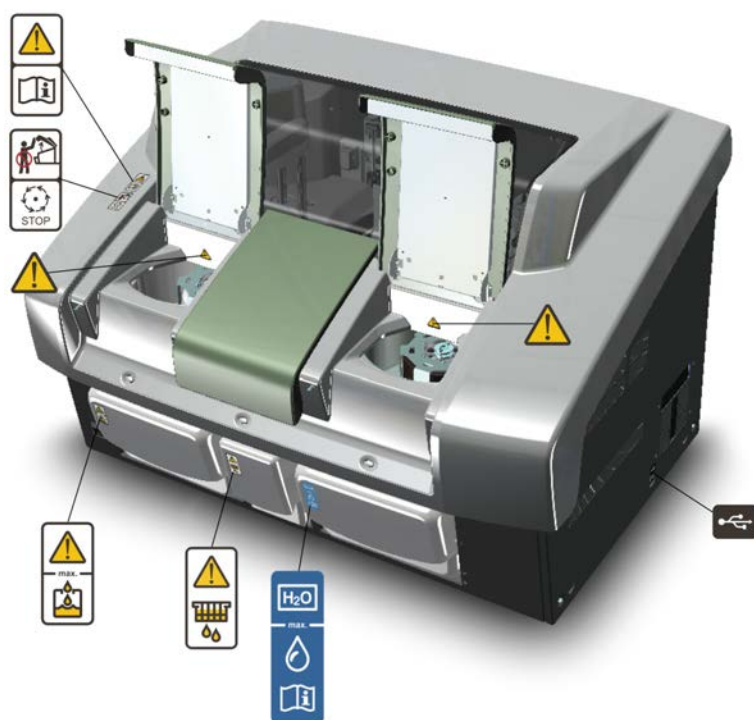

Safe operation



Warning

Follow the instructions to ensure the correct and safe operation.

All surfaces under the main cover are potential sources of toxicants and irritating biological agents. Use protective gloves, spectacles and clothes.

Main cover



Warning

Do not open the cover, if the analyzer is in the **Running** or **Analyzing** state.

If the cover is opened when analysis is going on, tests under processing are lost. Mechanical parts may move a few seconds after opening the main cover. Refer to Operation Manual on how to stop analyzer safely.

Cuvette waste bin



Warning

The cuvette waste bin and cuvettes are a potential source of toxicants and irritating biological agents.

Treat the cuvette waste bin and used cuvettes as other dangerous material in laboratory. Use protective gloves, spectacles and clothes when working with the waste water container. The operator must be cautious when working with the cuvette waste bin.

Waste water container



Warning

The waste water container is a potential source of toxicants and irritating biological agents.

Treat the waste water container as other dangerous material in laboratory. Use protective gloves, spectacles and clothes when working with the waste water container. The operator must be cautious when working with the waste water container.

Deionized water container



Information

Keep the deionized water container away from a potential source of toxicants and irritating biological agents.

Use only as a deionized water container and clean as instructed. Do not overfill the container, see the maximum water limit.

Racks



Caution

Racks are potential sources of toxicants and irritating biological agents.

USB cable



Information

Use only for connection between the analyzer and workstation. The maximum length of the USB cable is 2 meters.

Figure 2. Safety labeling inside analyzer

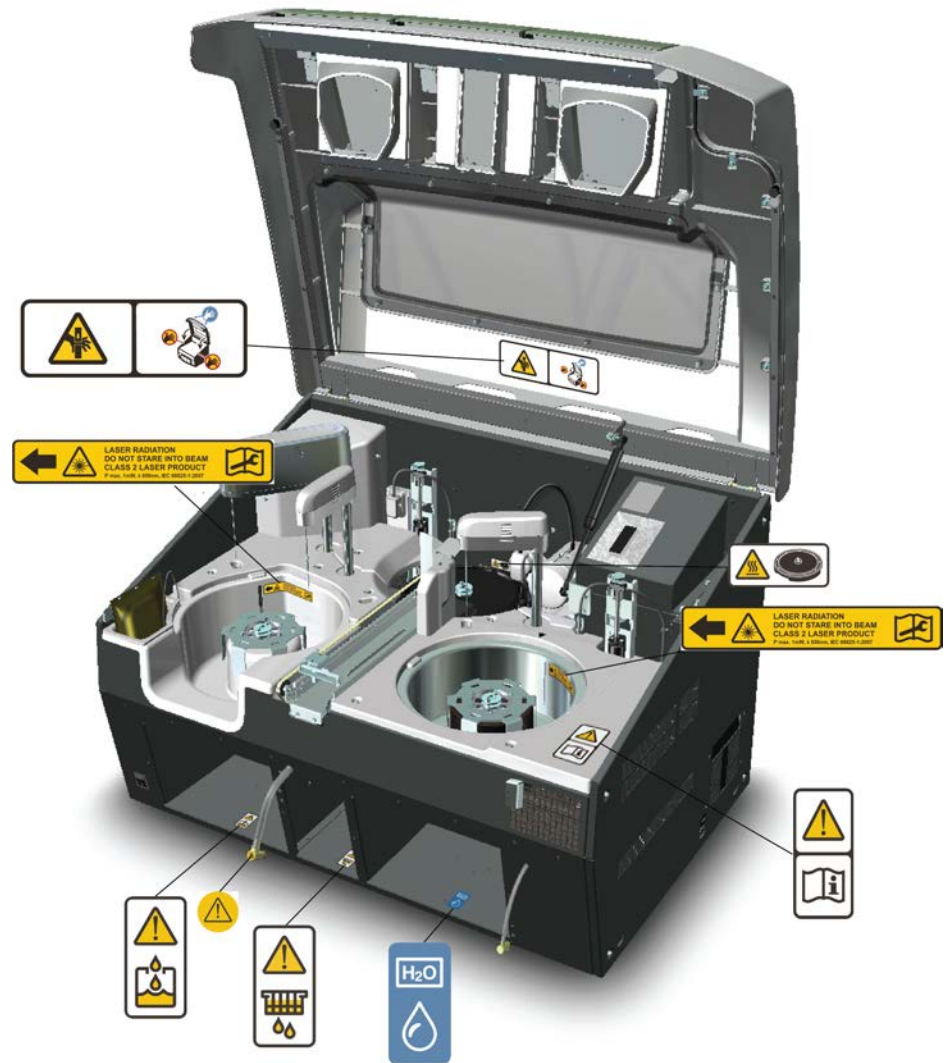

Safe operation



Warning

Follow the instructions to ensure the correct and safe operation.

All surfaces under the main cover are potential sources of toxicants and irritating biological agents. Use protective gloves, spectacles and clothes.

Figure 3. Tubing connector



Tubing connector



Warning

The tubing connector of the waste water container is a potential source of toxicants and irritating biological agents.

Main cover



Caution

When closing the cover, put your hands to the left and right side on its outer front surface (see the blue areas in the sign) and press the cover downwards until you hear a "click" sound.

Incubator



Caution

The surface of the incubator might be hot. Always keep the insulating cover in its place.

Barcode reader



Caution

Laser detects the barcodes. Keep the covers closed during analysis.

Laser radiation. Do not stare into beam. Class 2 laser product.

- The laser follows the IEC 60825-1:2007 standard.
 - The maximum output of laser radiation is 1 mW.
 - The emitted wavelength is 650 nm.
-

Notices

When the system is delivered to you, it meets the pertinent electromagnetic compatibility (EMC) and safety standards as described below.

Standards

Table 1. Conformity with the following international standards and regulations

Standard	Title
<ul style="list-style-type: none"> EN ISO 12100 	Safety of machinery – General principles for design – Risk assessment and risk reduction.
<ul style="list-style-type: none"> EN 61010-1 IEC 61010-1 UL 61010-1 CAN/CSA-C22.2 No. 61010-1 	Safety requirements for electrical equipment for measurement, control, and laboratory use - Part 1: General requirements.
<ul style="list-style-type: none"> EN 61010-2-010 IEC 61010-2-010 CAN/CSA-C22.2 No. 61010-2-010 	Safety requirements for electrical equipment for measurement, control, and laboratory use - Part 2-010: Particular requirements for laboratory equipment for the heating of material.
<ul style="list-style-type: none"> EN 61010-2-081+A1 IEC 61010-2-081+A1 CAN/CSA-C22.2 No. 61010.2.081 	Safety requirements for electrical equipment for measurement, control, and laboratory use - Part 2-081: Particular requirements for automatic and semi-automatic laboratory equipment for analysis and other purposes.
<ul style="list-style-type: none"> EN 61326-1 	Electrical equipment for measurement, control and laboratory use – EMC requirements – Part 1: General requirements.
<ul style="list-style-type: none"> EN 61000-6-2 	Electromagnetic compatibility (EMC) – Part 6-2: Generic standards – Immunity for industrial environments.
<ul style="list-style-type: none"> EN 61000-6-3 	Electromagnetic compatibility (EMC) – Part 6-3: Generic standards – Emission standard for residential, commercial and light-industrial environments.
<ul style="list-style-type: none"> FCC CFR 47 Part 15 	Subpart B, Class B. EMC Requirements for US.

Standard	Title
<ul style="list-style-type: none"> EN 50581 	Technical documentation for the assessment of electrical and electronic products with respect to the restriction of hazardous substances.

CE



The CE mark attached on Gallery Plus (chemistry analyzer, type 862) indicates the conformity with the EMC (electromagnetic compatibility) directive 2004/108/EC and Machinery Directive 2006/42/EC and RoHS directive (Restriction of the use of certain hazardous substances in electrical and electronic equipment) 2011/65/EU.

EC Declaration of Conformity found as an appendix.

Changes that you make to your system may void compliance with one or more of these EMC and safety standards. Changes to your system include replacing a part or adding components, options, or peripherals not specifically authorized and qualified by Thermo Fisher Scientific. To ensure continued compliance with EMC and safety standards, replacement parts and additional components, options, and peripherals must be ordered from Thermo Fisher Scientific or one of its authorized representatives.

FCC Notice

This equipment has been tested and found to comply with the limits for a Class B digital device, pursuant to part 15 of the FCC Rules. These limits are designed to provide reasonable protection against harmful interference in a residential installation. This equipment generates, uses and can radiate radio frequency energy and, if not installed and used in accordance with the instructions, may cause harmful interference to radio communications. However, there is no guarantee that interference will not occur in a particular installation. If this equipment does cause harmful interference to radio or television reception, which can be determined by turning the equipment off and on, the user is encouraged to try to correct the interference by one or more of the following measures:

- Reorient or relocate the receiving antenna.
- Increase the separation between the equipment and receiver.
- Connect the equipment into an outlet on a circuit different from that to which the receiver is connected.
- Consult the dealer or an experienced radio/TV technician for help.

WEEE Compliance

This product is required to comply with the European Union's Waste Electrical & Electronic Equipment (WEEE) Directive 2012/19/EU. It is marked with the following symbol:



Thermo Fisher Scientific has contracted with one or more recycling/disposal companies in each EU Member State, and these companies should dispose of or recycle this product. For further information on Thermo Fisher Scientific's compliance with these directives, the recyclers in your country, and information on Thermo Fisher Scientific products which may assist the detection of substances subject to the RoHS Directive contact us by e-mail: weee.recycle@thermofisher.com.

(this page was intentionally left blank)

Contents

Preface	Preface.....xvii
	Intended use..... xvii
	Intended audience.....xvii
	Product documentation..... xvii
	Document revision history..... xviii
	Document symbols and conventions..... xix
	Symbols in manual..... xix
	Document conventions.....xix
Chapter 1	Operating environment.....1
Chapter 2	Instructions when using corrosive reagents.....3
Chapter 3	Routine operation.....5
Chapter 4	Using analyzer..... 13
	Using analyzer locally..... 13
	Covers..... 14
	Operation buttons..... 14
	Status lights..... 15
	Cuvettes.....15
	Sample rack types.....16
	Placing rack labels..... 19
	Main analyzer parts.....21
	Switching analyzer on..... 21
	Switching analyzer off..... 22
	Emergency stop.....22
	Using user interface.....22
	Logging on to program.....22
	Logging off program.....22
	Closing user interface.....23
	Command buttons.....23
	Status indications.....24
	Navigating menu.....24
	Main view (F1).....25
	Sample view (F2).....27
	Test and reagent view (F3).....27
	Calibration and quality control view (F4).....28
	System view (F5).....28
Chapter 5	Actions before starting up..... 29
	Checking ECM rinse liquid bag.....29

	Filling deionized water container.....	30
	Emptying waste water container.....	32
	Emptying cuvette waste bin.....	34
	Filling cuvette loader.....	34
Chapter 6	Starting up.....	37
Chapter 7	Reagents.....	39
	Reagent indication information.....	40
	Inserting system reagents.....	41
	Inserting user-defined reagents.....	42
	Checking reagent barcodes.....	44
	Blocking reagent vial.....	44
	Unblocking reagent vial.....	44
	Removing reagent vial.....	44
Chapter 8	Performing calibrations and quality controls.....	45
	Calibrations.....	45
	Calibrating.....	45
	Displaying calibrators and controls.....	46
	Inserting calibrators.....	46
	Reviewing calibration results.....	47
	Comparing calibrations.....	49
	Accepting calibration.....	49
	Rerunning calibration.....	50
	Rerunning a single calibration point.....	50
	Rejecting calibration.....	50
	Rejecting measurement.....	50
	Canceling rejections.....	51
	Quality controls.....	51
	Performing quality control.....	52
	Displaying quality controls.....	52
	Inserting quality controls.....	52
	Reviewing quality control results.....	53
	Reviewing cumulative data.....	55
	Viewing quality control parameters.....	55
	Accepting quality control results.....	56
	Rejecting quality control results.....	56
Chapter 9	Samples.....	57
	Detecting interferences of samples.....	58
	Inserting barcoded samples.....	58
	Defining non-barcoded samples.....	61
	Defining non-barcoded samples as batch.....	62
	Defining requests to sample.....	63
	Test scheduling principles.....	64
	Defining calculated test request to sample.....	64
	Defining external test request to sample.....	65
	Defining requests to rack.....	65
	Inserting non-barcoded samples to rack.....	65

	Inserting sample racks into analyzer.....	67
	Checking sample barcodes.....	68
	Blocking sample.....	68
	Removing sample rack.....	68
	Clearing rack information.....	68
	Clearing rack position information.....	69
	Removing sample details.....	69
	Removing request.....	69
	Defining urgent tests.....	70
	Accepting errors.....	70
	Handling rack with barcode error.....	71
	Handling invalid rack data.....	71
Chapter 10	Starting analysis.....	73
Chapter 11	Viewing requests.....	75
Chapter 12	Viewing test statuses.....	77
Chapter 13	Managing results.....	79
	Accepting results.....	80
	Rerunning tests.....	80
	Rerunning test with dilution.....	81
	Rejecting results.....	81
	Reducing variation in test results.....	81
Chapter 14	Reporting results.....	83
	Generating report based on tests.....	84
	Generating report based on samples.....	84
	Reporting daily results.....	84
	Reporting all results.....	84
	Canceling printing.....	85
	Excel report.....	85
	Sending results to LIS.....	86
Chapter 15	Clearing daily files.....	87
Chapter 16	Standby.....	89
Chapter 17	Archive.....	91
	Searching archived results.....	91
	Saving archived results.....	92
Chapter 18	Request counter.....	93
Chapter 19	Checking messages.....	95
	Accepting messages.....	95
	Error messages.....	96
	Measurement errors.....	96
	Messages from workstation.....	101
	Messages to and from analyzer (0 - TRAREC).....	101
	Timetable (1 - Timet).....	101
	Response handler (2 - RH).....	104

Contents

	User interface (3 - UI).....	109
	Laboratory information management system (4 - LIMS).....	111
	Master (5 - MASTER).....	113
	Messages from analyzer's nodes.....	121
	Boot (6 - BOOT).....	121
	Motor (7 - MOTOR).....	122
	Photometer (8 - PHOTO).....	124
	Electrode (9 - ELECTRODE).....	126
	Control (10 - CONTROL).....	128
	Report (13 - REPORT).....	130
Chapter 20	Using remote connection.....	133
	Joining support session.....	133
	Leaving support session.....	135
Chapter 21	Saving debug files.....	137
Chapter 22	System actions.....	139
	Showing software version.....	139
	Requesting water blank.....	139
	Fetching ECM prime.....	139
	Adding ECM rinse liquid.....	139
	Requesting extra wash.....	139
	Removing cuvettes from incubator.....	139
	Checking temperatures.....	140
	Checking pressure sensor.....	140
	Cleaning probes manually.....	140
	Performing monthly maintenance wash.....	140
Chapter 23	Maintenance.....	141
	Daily maintenance.....	141
	Weekly maintenance.....	141
	Monthly maintenance.....	142
	Occasional maintenance.....	144
	Electrode maintenance.....	144
	Periodical maintenance.....	146
	Managing maintenance tasks.....	146
	Acknowledging maintenance task.....	147
	Viewing maintenance history.....	147
Appendix 1	Checklist.....	149
Appendix 2	Consumables and accessories.....	151
Appendix 3	Barcode specification.....	155
Appendix 4	EC declaration of conformity.....	157
	Glossary.....	159

Preface

Operation Manual contains instructions on how to operate the analyzer during normal operation. This manual explains how to perform basic operations, calibrations, troubleshoot and maintenance requisites.

Intended use

Thermo Scientific Gallery Plus is a discrete, automated chemistry analyzer. In addition to photometric measurement, the analyzer supports electrochemical measurement (ECM) technique.

Gallery Plus is specifically designed e.g. for food, beverages, water, environmental and different bioprocess applications. Thermo Scientific Gallery Plus is offered with various system applications. Furthermore, the analyzer supports user definable application setup.

Gallery Plus *Beermaster* model is dedicated for beer and wort quality control and analysis.

Intended audience

This manual is addressed to the operator, the person who operates the analyzer on a daily basis. The operator must be trained in and should have a basic knowledge of how to operate the analyzer.

Note It is recommended to follow good laboratory practices (GLP).

Product documentation

The product documentation consists of the following manuals:

- Operation Manual contains instructions on how to operate the analyzer during normal operation once it has been installed. The manual can be used to find out what needs to be done before running analyses and how to run analyses. The manual also contains daily maintenance task descriptions and a troubleshooting guide.
- Reference Manual contains operational and analysis principle descriptions and lists test parameters per test.
- Installation Manual contains instructions on how to install the analyzer. The manual describes procedures for mechanical and electrical installation. The chapters are organized in the chronological order in which the analyzer should be installed.

- Service Manual contains instructions on how to service and maintain the analyzer. The manual also describes procedures for adjusting the analyzer and information about the analyzer parts. The manual also lists spare parts and accessories. Service Manual is provided only to the trained service engineers.
- The LIS Interface manual contains instructions on how to integrate the analyzer into the Laboratory Information System (LIS). The manual describes the communication between the analyzer and the host, using the RS-232 or TCP/IP interface.

Document revision history

Document version and date	Document code	Software version	History
A/July 2011	N12274	3.0	Document created.
B/August 2011	N12274	3.0	Ordering code for touchscreen revised.
A/February 2012	N12274	4.0	UPS recommendations added and the Consumables and accessories list updated.
A/July 2012	N12274	4.1	Instructions for saving archived test results and maintenance of new reference electrode added.
B/October 2012	N12274	4.1	PC configuration and instructions for clearing daily files updated.
A/June 2013	N12274	5.0	Updated sample and maintenance tasks information.
A/October 2013	N12274	5.1	Checked the content against 5.1 software. Updated barcode sticker instructions.
B/December 2013	N12274	5.1	Added a disclaimer note in Managing test results section. Instructions for calculated tests updated.
A/July 2014	N12274	5.2	Added EC declaration as an appendix. Checked the content against 5.2 software.
A/June 2015	N12274	5.3	Added Test scheduling principles and instructions to unblock vial. Added new parameter to include/exclude rejected QC results to the Cumulative data graph. Updated contact information.
A/October 2016	N12274	6.0	Added information about new sample rack types and tube support plate. Added information about request counter, clot detection, new system actions and how to save debug files. Updated Results and Archive sections because of new filtering criteria. Replaced a main cover gas spring with a new one in analyzer pictures. Added information about new error reporting tool.

The original language of these instructions is English.

Document symbols and conventions

Symbols in manual

This manual uses notes that point out important information related to the correct and safe operation of the analyzer. Therefore, comply fully with all notices.

Note The note icon informs the operator of relevant facts and conditions.

CAUTION The caution icon indicates important information or warnings related to the concept discussed in the text. It might indicate the presence of a hazard which could result in the corruption of software or damage to equipment or property.

Document conventions

- Important abbreviations and terms in this manual are spelled out in Glossary.
- The last command of the user interface menu path is presented in bold, for example: Select F2 > Samples > **New**.
- Menu names in the user interface are shown in bold, for example: Select the correct test from the **Test name** drop-down menu in the Results view.
- Parameter names are shown in italics, for example: The test can be taken into or out of use with the *In use* parameter.
- Parameter values are indicated with quotation marks, for example: The values of the *In use* parameter are “Yes” and “No”.
- The statuses and messages are shown in Courier font, for example `NO valid calibration`.

(this page was intentionally left blank)

Operating environment

Note The electromagnetic environment should be evaluated prior to operation of the analyzer. Do not use this analyzer in close proximity to sources of strong electromagnetic radiation, for example, unshielded intentional RF-sources. They may interfere with the proper operation.

Note Installing any 3rd party software to the workstation PC is not supported by Thermo Fisher Scientific. The 3rd party software (e.g. antivirus software) can interfere with the analyzer performance and, for instance, generate error messages like “internal timing error” or “master used too much time”. Thermo Fisher Scientific is not responsible for possible errors due to 3rd party software installed by customer.

Note It is not recommended to connect the workstation to the Internet due to the risk of viruses, unless specifically requested by Thermo Fisher Scientific in order to join a remote support session. To use remote connection, refer to the instructions in [Using remote connection](#) on page 133.

❖ Dimensions

Table 2. Dimensions and weight of the analyzer

Description	cm / kg	in / lb
Width	94 cm	37.0 in
Height	62 cm / 130 cm	24.4 in / 51.2 in
Depth	70 cm	27.6 in
Weight	110 kg	242.5 lb

Note Dimensions are given without workstation and display.

❖ Power supply

Table 3. Power supply to the analyzer

Description	Value
Voltage	100 - 240 VAC ± 10%
Frequency	50 - 60 Hz ± 5%

1 Operating environment

Operating environment

Description	Value
Power consumption	300 W

Note It is recommended to have UPS for power loss protection in analyzer and workstation. Connect UPS only to the workstation, monitor and analyzer. Do not connect UPS to the printer.

Table 4. Minimum recommendation for UPS

Description	Value
UPS minimum recommendation, VA	1500

❖ Analyzer's decibel level (dB)

Average noise level at 1 meter <60 dB(A).

❖ Environmental conditions

- Ambient temperature: 18...30 °C
- Relative humidity: 40 - 80%, non-condensing
- Altitude: < 2000 m from the sea level
- Heat output: 680 (without ECM) / 750 (with ECM) BTU/h
- Electromagnetic environment:
 - basic electromagnetic environment (residential, office, laboratory, light industry)
 - industrial electromagnetic environment

❖ Water requirements

Follow the local water regulations set for the laboratory. The following specification is a minimum requirement for water. Requirements for Clinical Laboratory Reagent Water (CLRW) developed by Clinical and Laboratory Standards Institute (CLSI).

Table 5. Clinical laboratory reagent water requirements

Description	Value
Resistivity	$\geq 10 \text{ M}\Omega \cdot \text{cm}$ referenced to 25 °C
TOC	< 500 ppb
Micro-organisms	< 10 CFU/ml
Particle-free	$\geq 0.22 \mu\text{m}$

Instructions when using corrosive reagents

Use of reagents containing highly volatile solvents and strong acids may increase a risk of corrosion. To reduce the risk of corrosion, special attention should be paid for the daily maintenance of the analyzer.

Instructions for daily maintenance

- Empty the cuvette waste bin of used cuvettes preferably after each test run or at least at the end of the day while the analyzer is still on.
- Flush the cuvette waste bin with water to remove the reagent residues.
- Put the cuvette waste bin back to the analyzer and switch the analyzer off.
- By the end of the day, take the reagents away from the analyzer.
- Open the analyzer's main cover to ventilate the analyzer and leave the cover open for at least 30 minutes.
- Wipe all visible reagent spills with a cloth moistened with a mild detergent.
- Empty the waste water container and clean with tap water.

Recommendation:

When corrosive reagents are used with the Gallery family analyzer it is recommended to ensure that the laboratory is properly and adequately ventilated. Optionally, the analyzer can be placed under a fume hood.

(this page was intentionally left blank)

Routine operation

❖ Preparing analyzer and workstation

1. Switch on the analyzer from the main switch.



2. Switch on the workstation.
3. Log on to the computer and the program.
4. Place onboard deionized water container that has been degassed overnight.



5. Ensure waste container is empty.

3 Routine operation

Routine operation



6. Ensure cuvette waste bin is empty.



7. Fill the cuvette loader.



8. Check the ECM rinse liquid bag, if applicable.

Note

When the ECM rinse liquid is finishing and the message is shown in the Consumables field, check the latest test results as a precaution and replace the sample with a new one.

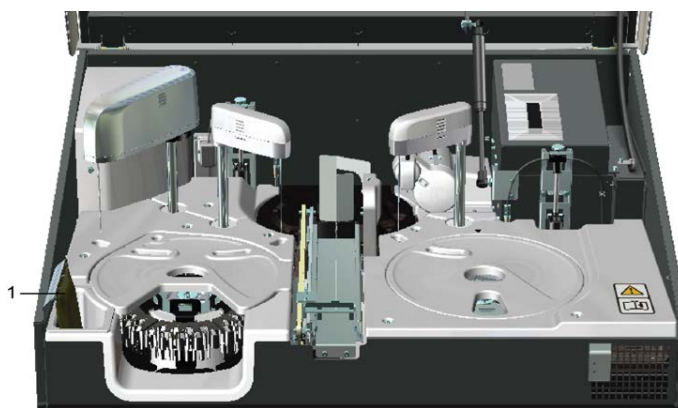

1 - ECM rinse liquid bag

❖ Starting up

1. Perform the start-up procedure by clicking **Start-up** in the main view.

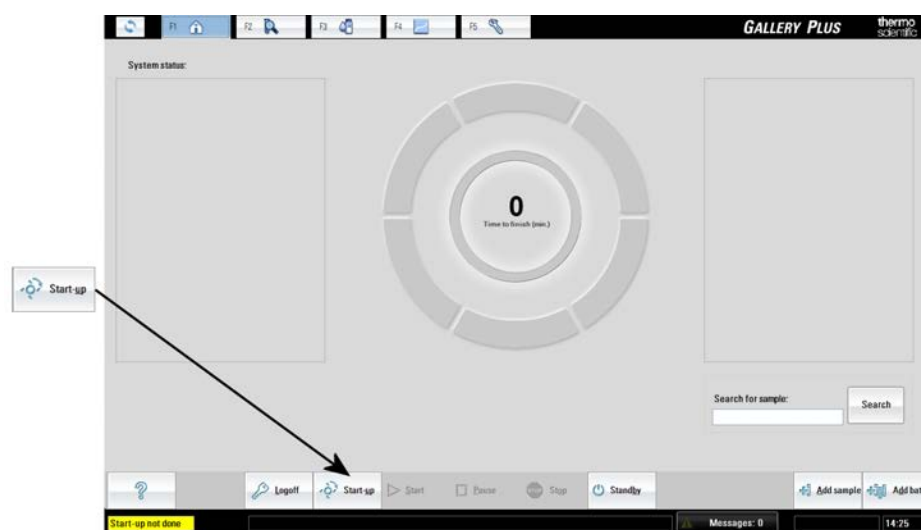
**❖ Inserting system reagents**

1. Remove the cap from the vial and make sure that there are no air bubbles.
2. Open the reagent cover and insert the system reagent into the disk. Make sure that the barcodes on the vials are facing you.

3 Routine operation

Routine operation



Note If user-defined reagents are used, refer to the chapter describing reagents.

❖ **Calibrating/performing quality controls**

1. Select F4 > **Cal/QC selection**.
 - a. Click the **Calibration** tab and select a test to check which calibrators are needed.
 - b. Click the **QC** tab, select a QC profile and a test to check which controls are needed.
2. Needed calibrators/controls are shown on the right.
3. Select F2 > **Racks** to add calibrators/controls into the rack.
4. Insert calibrators/controls in sample cups into the rack.
5. Insert the rack into the analyzer.
6. Select F4 > Cal/QC selection > **Calibration** or **QC**, select a test and click **Calibrate** or **Perform QC**.
7. Select F1 > **Start** to perform the requested calibrations/controls.



❖ **Inserting samples**

1. Insert the sample tubes or the cups into the rack. Make sure that the barcodes on the vials are readable from the opening of the rack position.

Note If non-barcoded samples are used, refer to the chapter describing samples.

2. Insert the rack into the analyzer.



❖ **Analyzing**

1. Start the analysis by clicking **Start** in the main view.

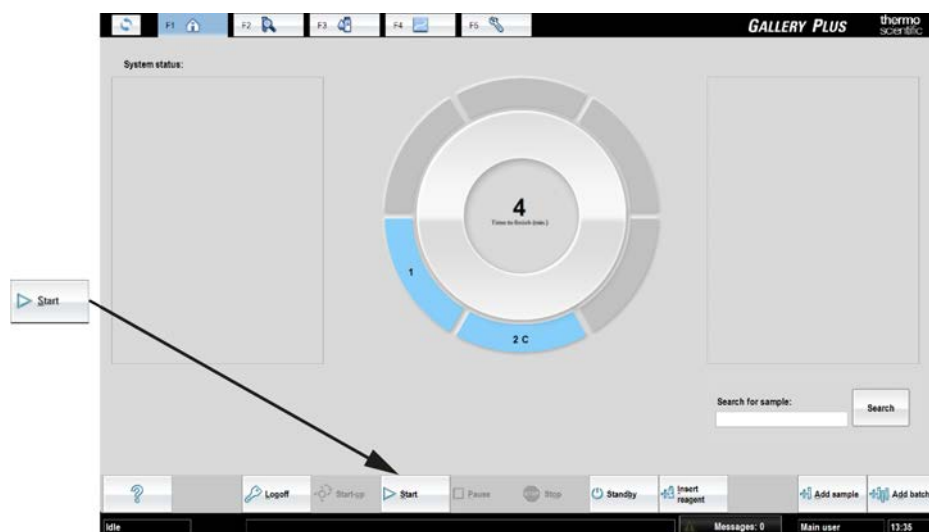

❖ **Reporting results**

1. Select F2 > **Reports**.
2. Select Samples or Tests from **Select items to report** drop-down menu.
3. Select which results are reported.
4. Print results or create excel report.

❖ **Removing reagents**

1. Select F3 > **Reagents**.
2. Select the vial to be removed.
3. Click **Remove vial**.
4. Remove the vial.

3 Routine operation

Routine operation

❖ Removing samples, calibrators and controls

1. Select F2 > **Rack disk**.
2. Select the rack to be removed.
3. Click **Remove rack**.
4. Remove the rack.

❖ Clearing daily files

1. Select F5 > Actions > **Clear daily files**.

Note Performing **Clear daily files** operation deletes all test results (except control results) if **Sample results archived** parameter in the page F5 > Configuration > **Laboratory** is set **No**.

Note **Clear daily files** operation cannot be performed if there are results waiting for acceptance.

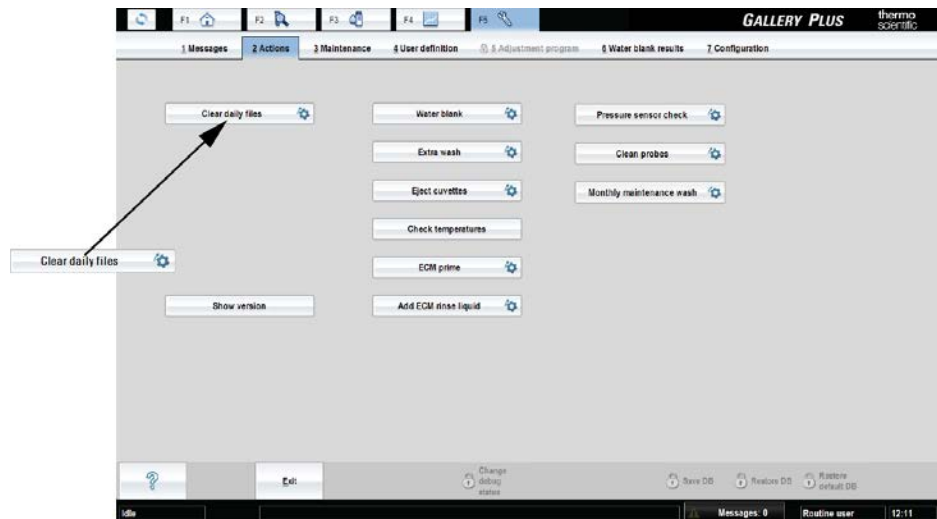

❖ Performing standby procedure

1. Insert a cup with 2 ml washing solution to the selected sample rack position.
2. If the analyzer has an ECM unit, insert a cup with 2 ml cleansing solution to the selected sample rack position.
3. Insert the rack into the analyzer.
4. Click **Standby** in the main view.

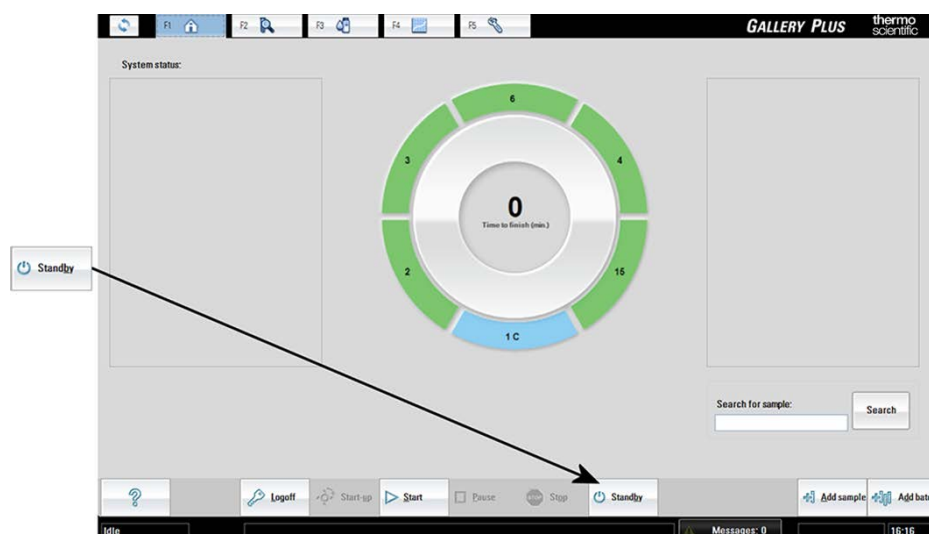

❖ Switching off analyzer and workstation

Note Switch off the analyzer and workstation only if no reagents are onboard.

1. Select F5 > Actions > **Exit**.
2. Switch off the workstation.
3. Switch off the analyzer.

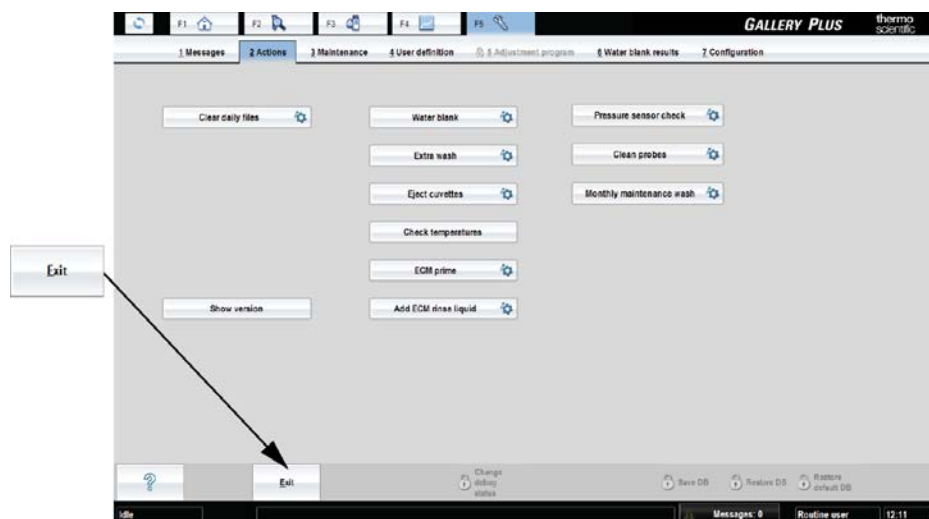

❖ Emptying waste container and bin

1. Empty waste water container.
2. Empty cuvette waste bin.

(this page was intentionally left blank)

Using analyzer

The analyzer utilizes a discrete cell technology which enables the simultaneous analysis of several different parameters from the same sample. In parallel of photometric tests, the electrochemical (ECM) tests can be run. The ECM unit uses ion-selective electrodes for pH measurement. Also conductivity can be measured over a broad range. The analyzer's throughput is up to 350 tests per hour when using one-reagent methods.

- Using analyzer locally
- Using user interface

Using analyzer locally

Figure 4. Analyzer parts

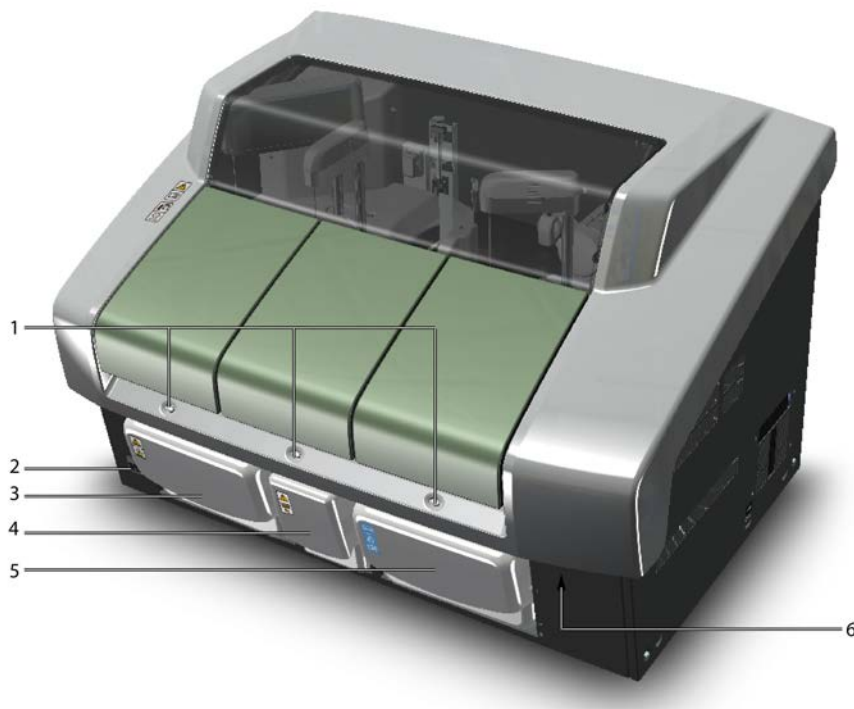

4 Using analyzer

Covers

- 1 - Operation buttons
- 2 - Main switch
- 3 - Waste container
- 4 - Cuvette waste bin
- 5 - Water container
- 6 - Lock handle under the main cover

Covers

The analyzer has covers for loading the samples, cuvettes and reagents.

Figure 5. Covers



- 1 - Main cover
- 2 - Sample cover
- 3 - Cuvette cover
- 4 - Reagent cover
- 5 - Lock handle under the main cover

Open the main cover by pressing the handle under the main cover and lift the cover up. The handle is located close to the analyzer's front-right corner.

Operation buttons

The analyzer has buttons which are used to open the covers in the analyzer. After the covers are open, the operator can feed in cuvettes, sample racks or reagents. The buttons also indicate the status of the analyzer. The main switch is located on the front panel.

Figure 6. Operation buttons



- 1 - Main switch
- 2 - Button for sample racks
- 3 - Button for cuvette loader
- 4 - Button for reagents

Status lights

The lights on the front panel indicate the status of the analyzer:

- If the light is blinking, the wheel is turning inside the analyzer and the cover is locked.
- If the light is on, the cover is unlocked and the operator is allowed to open it.

Cuvettes

A single cuvette package contains 18 cuvettes and each cuvette has 10 cells. Each cell can hold 300 μ l of the sample. The analyzer dispenses samples and reagents into the cells of a cuvette. The cuvettes are disposable.

A maximum of two cuvette packages can be fed into the analyzer at the same time.

Note Cuvettes are for single-use only.

4 Using analyzer

Sample rack types

Note The quality of results is guaranteed only with the Thermo Scientific cuvettes.

Figure 7. Cuvettes



Sample rack types

The analyzer supports three different sample rack types. The racks are color-coded and each rack type has specified rack ID numbering. Standard analyzer package includes six pieces of sample rack 9 - standards. All other sample racks must be ordered separately.

Sample rack 9 - standard

Positions: 9

Rack ID: 1-79

Color: Black



Supported cups

Volume	Diameter x height	Note
0.5 ml cup	13 x 25 mm	Recommended cup height
2 ml cup	13 x 25 mm	Recommended cup height
4 ml cup	17 x 38 mm	

Supported tubes

Volume	Diameter x height	Note
5 ml tube	13 x 75 mm	
7 ml tube	13 x 100 mm	
10 ml tube	16 x 100 mm	Positions 5-9 only

Sample rack 9 - blue **Positions: 9** **Rack ID: 80-99** **Color: Blue**



Supported cups

Volume	Diameter x height	Note
0.5 ml cup	13 x 25 mm	Recommended cup height
2 ml cup	13 x 25 mm	Recommended cup height
4 ml cup	17 x 38 mm	

Supported tubes

Volume	Diameter x height	Note
5 ml tube	13 x 75 mm	
7 ml tube	13 x 100 mm	
10 ml tube	16 x 100 mm	Positions 5-9 only

Note The rack IDs 80-99 are supplied with the blue color rack. The service engineer must adjust the different aspiration height.

Sample rack 18 - non-barcoded **Positions: 18** **Rack ID for cups: 401-449** **Color: Black**
Rack ID for tubes: 451-499



Supported cups

Volume	Diameter x height	Note
0.5 ml cup	13 x 25 mm	
2 ml cup	13 x 25 mm	

Supported tubes

Volume	Diameter x height	Note
7 ml tube	13 x 100 mm	Only non-barcoded tubes

Note The service engineer must do the rack adjustment before this rack can be used.

In the **Sample rack 9 - standard** and **Sample rack 9 - blue**, sample tubes can be secured in place by using a tube support plate. The tube support plate can be ordered separately.

4 Using analyzer

Using analyzer

Figure 8. Tube support plate installed in the **Sample rack 9 - standard**



Figure 9. Inserting cups



Note When inserting the cup, make sure the cup shoulder stays above the top edge of the rack.

Figure 10. Inserting sample tubes



Note The test tubes must be non-transparent in color. If transparent tubes are used, a sticker is needed on the side.

Placing rack labels

Make sure that all the racks have barcode labels. In case of a missing barcode label, for example, when extra racks have been ordered, stick a barcode label on the rack:

1. Make sure that the rack ID label and barcode label you are about to use have the same ID number.
2. Stick the rack ID label on the rack as shown in the following figures.
3. Stick the barcode label as shown in the following figures. Make sure that the barcode is not aligned on the tube position's lip and there is no gap between the lip and the barcode.

Figure 11. Aligning a barcode on the rack



- 1 - Lip of the tube position
- 2 - Barcode

Note Make sure you place the correct rack labels on the racks.

The rack IDs are divided as follows:

4 Using analyzer

Using analyzer

- Sample rack 9 - standard for cups and tubes: 1 - 79
- Sample rack 9 - blue for cups and tubes: 80-99
- Sample rack 18 - non-barcoded for cups: 401-449
- Sample rack 18 - non-barcoded for tubes: 451-499

Figure 12. Barcode label and rack ID label on 9-position sample racks (Rack IDs 1-79 and 80-99)



Figure 13. Barcode label, rack ID label and infolabel on 18-position sample rack for tubes (ID numbers 451 - 499)

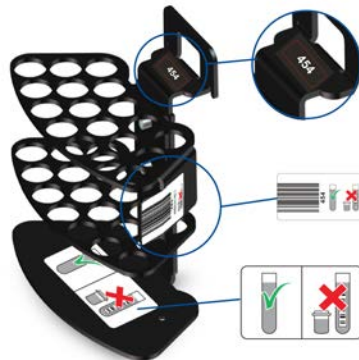
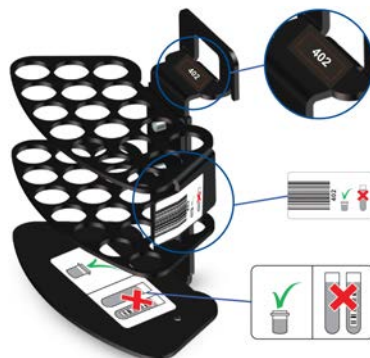
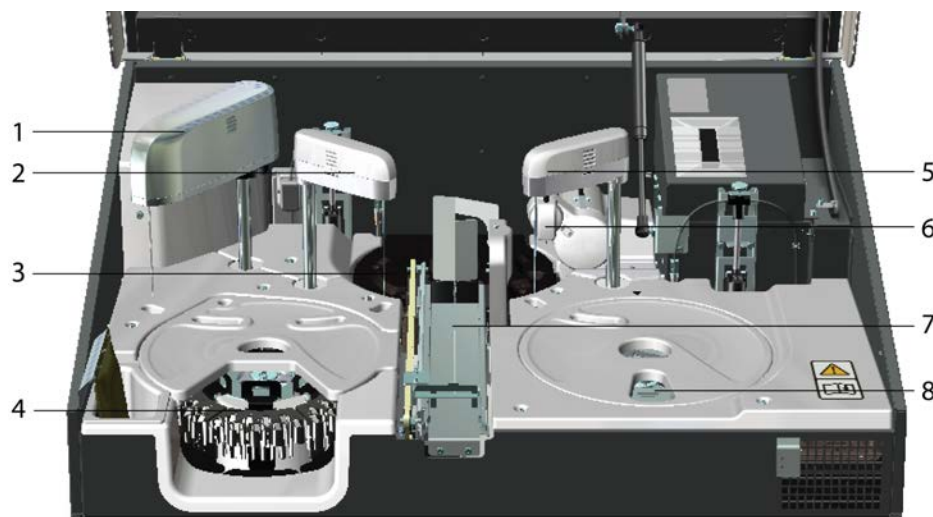

Figure 14. Barcode label, rack ID label and infolabel on 18-position sample rack for cups (ID numbers 401 - 449)



Main analyzer parts

Figure 15. Main analyzer parts



- 1 - ECM unit, if applicable.
- 2 - Sample dispenser
- 3 - Incubator
- 4 - Sample racks
- 5 - Reagent dispenser
- 6 - Mixer
- 7 - Cuvette loader
- 8 - Reagent disk

Note Do not store items inside the analyzer.

Switching analyzer on

To switch on the analyzer:

1. Switch on the analyzer from the main switch.
2. Start the computer.
3. Switch on the monitor.
4. Log on to the computer.
5. Log on to the program.

Note Opening the main cover is prohibited before the user interface is in the state of **start up not done**. If you open the cover during initialization, the analyzer continues initializing, and some parts inside the analyzer are moving.

When the analyzer is switched on, the software checks the content of the racks and reagent disk, and updates the user interface according to it.

The analyzer is designed to be grounded through the power cable. Connect the analyzer to a power supply with an effective ground connection.

4 Using analyzer

Switching analyzer off

After switching on the analyzer, allow 15 minutes for temperature stabilization.

Note Restart the computer at least once a week to ensure reliable performance of the system.

Switching analyzer off

Note Run the standby procedure before switching off the analyzer.

To switch off the analyzer:

1. Select F5 > Actions > **Exit**.
2. Shut down the computer.
3. Switch off the monitor.
4. Switch off the analyzer from the main switch.

Note Switching off the analyser will turn off reagent cooling.

Note Restart the computer at least once a week to ensure reliable performance of the system.

Note Switching off either the analyzer or the workstation resets the cuvette calculator. Empty the cuvette waste bin before starting the analyzer or the workstation.

Emergency stop

Click **STOP** in the main view to stop the analyzer immediately.

Opening the main cover will also stop all the actions of the analyzer.

Using user interface

Logging on to program

To log on:

1. Type the username.
2. Type the password.
3. Click **OK**.

Logging off program

To log off, click **Logoff** in the main view (F1).

Closing user interface









To close the user interface, select F5 > Actions > **Exit**.

Command buttons

- To access different views, click a tab or press the corresponding key on the keyboard. For example, press F2 to access the sample view.
- To access the lower level tabs, click the tab or press Alt and the corresponding menu number. For example, press Alt + 4 to view the sample results.
- To sort lists, click a column heading.
- The most common command buttons are listed below. Other buttons are explained when the related view is introduced.





Note If the touchscreen is in use, clicking a button means touching the button on the screen. For example, click **Print** indicates that the operator touches the **Print** button.

Table 6. Command buttons

Command button		Description
New		Adding a new sample, for example.
Cancel		Restoring the previous settings.
Save		Saving the changes.
Print		Printing out the list shown in the view.
Refresh		Refreshing the view.
Delete		Deleting a selected item.
Navigating		Navigating between the current and previous view.
Add		Adding a new value in the list.
Edit		Editing existing values in the list.

4 Using analyzer

Status indications

Command button		Description
Remove		Removing existing value from the list.
Search		Searching a test from the list, for example. Click the search button and type the keyword to the field.
Browse		Scrolling the list up and down.
Help		Showing more information about the current view.
View more/less		Showing or hiding the details in the list.

Status indications

The following indications in the main view show the status of the racks.

Table 7. Indications

Indicator	Indication	Example
Red	Alarm	Barcode error
Light blue	Not started	Rack has been loaded
Blue*	Analyzing	Analysis on-going
Green	Ready	All requests accepted

* The rack which contains at least one calibrator or control will stay dark blue even when not analysing.

Navigating menu

The menu structure has five main tabs.

- The main view (F1) shows
 - the system status.
 - the status of supplies, samples and results.
 - the calibrations, quality controls and tests to be accepted.
 - the latest message

- The sample view (F2) shows detailed information about samples, racks, requests and results. In this view, the operator can also generate reports and browse the archive.
- The test and reagent view (F3) shows the statuses of the tests and reagents. It is also possible for Main user to define the settings for tests, washes, reagents and profiles in this view.
- The calibration and quality control view (F4) shows the calibrations and quality controls (QC) and their results. It is also possible to define the settings for calibrators and quality controls in this view.
- The system view (F5) shows the possible error messages, system actions, maintenance tasks and the water blank results. This view also contains the user accounts and the configuration and adjustment settings.

The user categories have been predefined, each with different rights and default passwords. The user rights define which views the operator can access.

Main view (F1)

Press **F1** to access the main view. The main view summarizes the tasks, for example, load a new cuvette package.

Figure 16. Main view

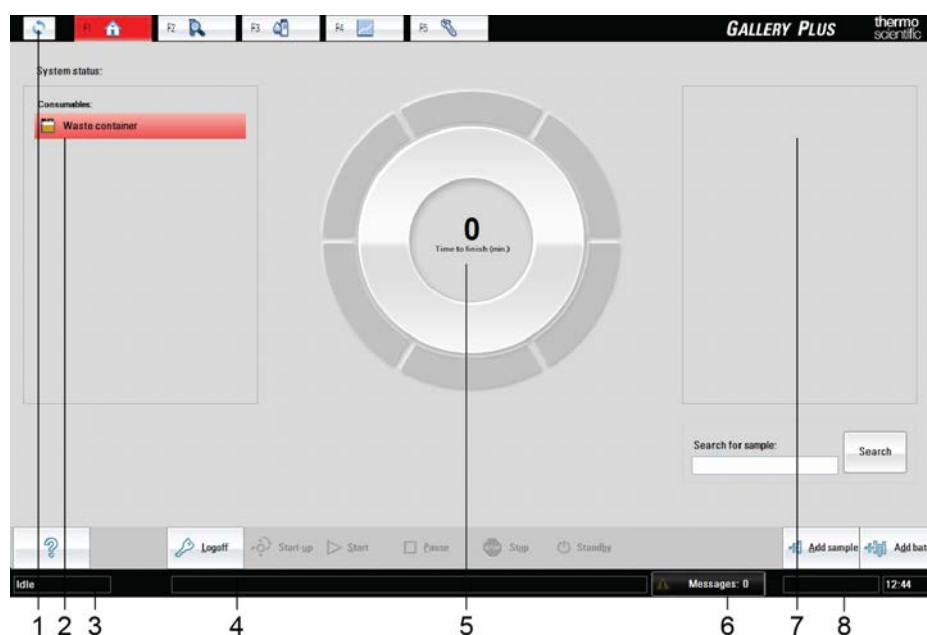

- 1 - Navigate between current and previous view
- 2 - Status of the samples and the supplies
- 3 - Status of the analyzer
- 4 - The latest message
- 5 - Remaining time
- 6 - Total number of unaccepted messages
- 7 - Calibrations and tests/samples/groups to be accepted
- 8 - User name

Status of the samples and supplies are shown on the left. If the samples, reagents, controls and calibrators are expiring or short, a message shows the ID of the specific item. If the analyzer has detected a clot in the sample, control or calibrator, it is shown here. The ID of an invalid test is

4 Using analyzer

Using analyzer

also shown in the list. For example, if more cuvettes are needed, the text **Cuvettes** is shown in the *Consumables* field. Click the indicator for more information about the message.









The wheel shows the status of the racks and the remaining time to finish the analysis.

Measured results to be accepted are shown on the right. The displayed results are grouped by tests, samples or groups depending on the **Result acceptance mode** setting in the **Configuration** window.

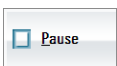
For example, when the sample mode is selected, you can accept sample test results by clicking the sample ID in the **Samples to accept** field. The results are ready for acceptance after all requests for the sample are measured. You can also accept results directly in the F2 > **Results** tab.

The status of the analyzer is shown in the lower left corner of the status bar.

Table 8. Main view buttons

Command button		Description
Logoff		Logging off.
Start-up		Performing the start-up procedure.
Start		Starting the analysis.
Pause		Pausing the analysis.
Stop		Stopping the analysis.
Standby		Setting analyzer to standby.
Add sample		Adding a sample.
Add batch		Adding samples as a batch.
Messages		Showing all existing messages. The latest message is shown on the status bar.

Command button	Description
Search 	Typing the sample ID to the Search field to search the sample status.

Table 9. Analyzer statuses

Status	Description
Not in use	The analyzer is not in use or an error has occurred which needs to be corrected.
Connecting	The program is connecting to the analyzer.
Start-up not done	The start-up procedure is needed.
Running	The analyzer is performing tasks other than running analyses. For example, the analyzer is moving the cuvettes.
Analysing	The analyzer is running analyses.
Closing	The analyzer is stopping its tasks.
Idle	The analyzer is not performing any tasks.

Sample view (F2)

Press **F2** to access the sample view.

1. The **Samples** tab shows information about samples. The operator can also add or delete sample details.
2. The **Rack disk** tab shows the content and status of the sample racks in the analyzer.
3. The **Racks** tab shows detailed information about the selected sample rack. You can define the content of the rack in this view.
4. The **Results** tab shows information about results. The operator can also accept, rerun, rerun with dilution or reject the results.
5. The **Reports** tab generates and prints reports.
6. The **Requests** tab shows the information about sample requests.
7. The **Archive** tab shows the archived sample information.
8. The **Request counter** tab shows the number of performed requests and used cuvettes.

Test and reagent view (F3)

Press **F3** to access in the test and reagent view.

1. The **Test status** tab shows the status information about tests.
2. The **Reagents** tab shows the content of the reagent disk in the analyzer and information about the selected reagent vials. You can block, insert and remove vials in this view.
3. The **Test definition** tab contains the settings for the tests.

4 Using analyzer

Using analyzer

4. The **Reagent definition** tab contains the settings for the reagents.
5. The **Wash definition** tab contains the settings for washes.
6. In the **Profile definition** tab, Main user can add tests to a profile. When the profile is activated, the analyzer runs tests included in the profile. If the test is in the state "Not in use", the analyzer does not run the test even if it is included in the selected profile.

Calibration and quality control view (F4)

Press **F4** to access the calibration and quality control view.

1. The **Cal/QC selection** tab shows the information about the quality controls (QC) and calibrations. You can also define a **QC profile** in this view.
2. The **QC results** tab shows the results of the quality controls.
3. The **Calibration results** tab shows the results of the calibrations.
4. The **Cal/Ctrl definition** tab contains the settings for the controls and calibrators.

System view (F5)

Press **F5** to access the system view.

1. The **Messages** tab shows the error messages.
2. The **Actions** tab gives access to the maintenance tasks that can be performed.
3. The **Maintenance** tab shows the maintenance tasks.
4. The **User definition** tab allows the operator to define the access rights for each user.
5. The **Adjustment program** tab is for service engineers, to adjust the analyzer.
6. The **Water blank results** tab shows the water blank results.
7. The **Configuration** tab contains the user-specific configuration settings.

Actions before starting up

To ensure a flexible and reliable operation of the analyzer, perform the following actions before starting the daily routines:

- Check the ECM rinse liquid, if applicable
- Fill the deionized water container
- Make sure that the waste water container is empty
- Make sure that the cuvette waste bin is empty
- Fill the cuvette loader

Note The sample and reagent disks are checked when the main cover is closed.

- Checking ECM rinse liquid bag
- Filling deionized water container
- Emptying waste water container
- Emptying cuvette waste bin
- Filling cuvette loader

Checking ECM rinse liquid bag

If **ECM rinse liquid** is shown in the Consumables field, change the ECM rinse liquid bag.

To change the bag:

1. Open the main cover.
2. Detach the old ECM rinse liquid bag.
3. Connect the tube of the new ECM rinse liquid bag to the tube of the ECM dispensing pump.
4. Hang the bag back in its place.
5. Close the main cover.
6. Select F5 > Actions > **Add ECM rinse liquid** to fill the tube with liquid.

5 Actions before starting up

Filling deionized water container

Figure 17. Checking ECM rinse liquid bag

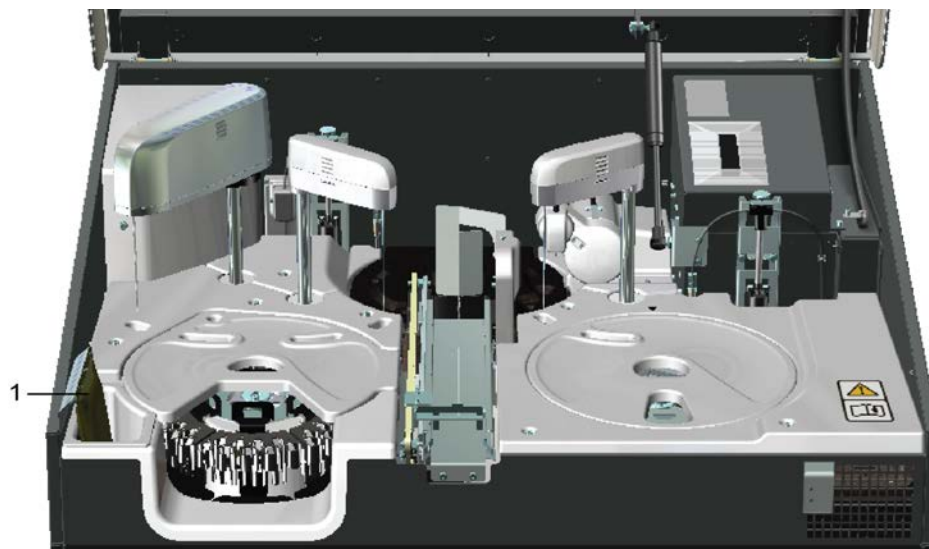

1 - ECM rinse liquid bag

Note

When the ECM rinse liquid is finishing and the message is shown in the Consumables field, check the latest test results as a precaution and replace the sample with a new one.

Filling deionized water container

The deionized water container is located on the right, under the reagent cover. It is recommended to fill the water container the previous day to degas the water. Furthermore, replace the container with fresh water at least twice a week. The 8-liter container covers approximately 4 hours' operation time. Fill the water container when the **water** message is shown in the main view. The analyzer shifts to a **Closing** state when the container runs out of water. After filling the water container, press **Start** to continue.

Note Clean the deionized water container before using the analyzer for the first time. For instructions, see [Cleaning water containers and tubing](#) on page 143.

Figure 18. Critical water level

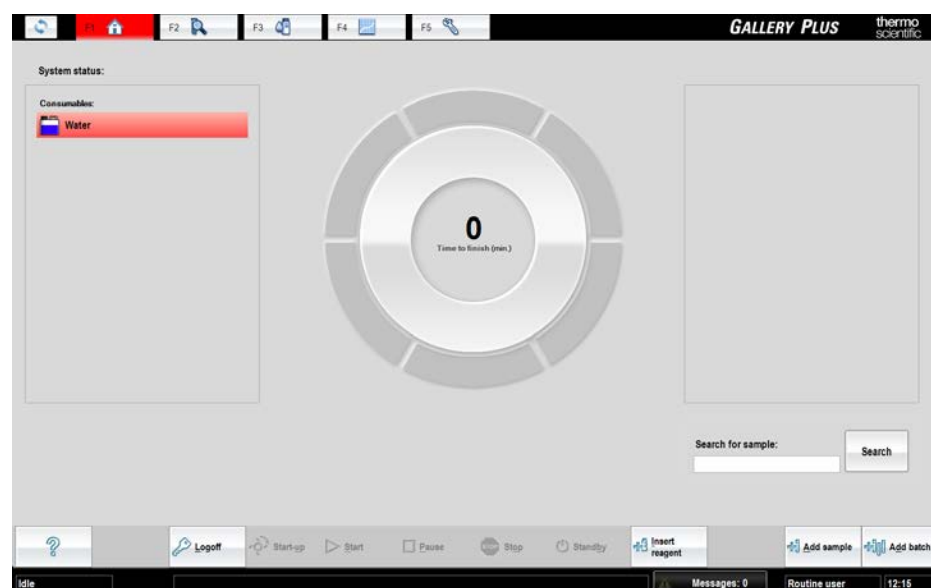

To fill the water container:

1. Pull out the container partially.
2. Press down the clip on the connector.
3. Detach the connector.

Note It is important to disconnect the connector and tubing before pulling out the container. Do not pull the tubing.

4. Pull out the container.



5. Wipe the connector with a lint-free cloth.
6. Open the cap.
7. Fill the water container with deionized water, up to the maximum level indicated.

5 Actions before starting up

Emptying waste water container



8. Close the cap.
9. Place the container partially back in its place.
10. Attach the connector.
11. Place the container back in its place.

Emptying waste water container

The waste water container is located on the left under the sample rack cover. It is recommended to empty the waste water container after running the daily operations. Furthermore, check the container before daily routines. The 8-liter container covers approximately 4 hours' operation time. Empty the waste water container when the **Waste** message is shown in the main view.

Figure 19. Waste water container is full

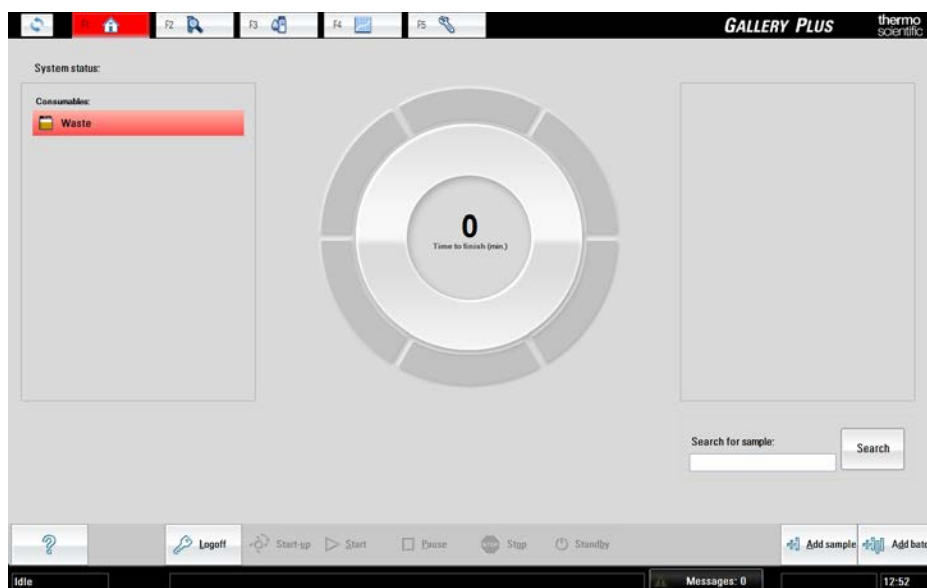

To empty the waste water container:

1. Pull out the container partially.

The maximum water level on the container is indicated with the following sign.

Figure 20. Maximum water level



2. Press down the clip on the connector.
3. Detach the connector.

The connector is equipped with a drop stopper.

4. Pull out the container.



5. Wipe the connector with a lint-free cloth.
6. Open the cap.
7. Empty the waste water container.
8. Rinse the container with tap water.
9. Add commercially available disinfectant into the empty waste water container to prevent bacterial growth.
10. Close the cap.
11. Place the container partially back in its place.
12. Attach the connector.
13. Place the container back in its place.

5 Actions before starting up

Emptying cuvette waste bin

Emptying cuvette waste bin

The cuvette waste bin is located in the middle, under the cuvette loader. The cuvette waste bin has space for 100 cuvettes and the program keeps a track of the used cuvettes. Empty the cuvette waste bin at the latest when the **Cuvette waste** message is shown in the main view.

To empty the cuvette waste bin:

1. Pull out the cuvette waste bin.



2. Empty the cuvette waste bin.
3. Rinse the cuvette waste bin with tap water.
4. Place the cuvette waste bin back in its place.

Note It is recommended to empty the cuvette waste bin after running the daily operations. Furthermore, check the cuvette waste bin before daily routines.

Note Switching off either the analyzer or the workstation resets the cuvette calculator. Empty the cuvette waste bin before starting the analyzer or the workstation.

Filling cuvette loader

Load a new cuvette package when the **Cuvettes** message is shown in the main view. The analyzer has one or less cuvette packages left when the text is displayed on the yellow background. If the background is red, the cuvettes are finished and the analyzing comes to a stop.

To load new cuvette packages:

1. Press the cuvette loader button.
2. When the light is on, open the cover.
3. Load the cuvette package.

Note Feed maximum 2 cuvette packages at the same time to avoid jamming the cuvette loader.

4. Remove the tape from the package.

5 Actions before starting up

Actions before starting up



5. Close the cover.

Note Do not touch the optical surface of the cuvette. The measurement signal goes through the long side of the cuvette.

Note Run QCs daily to ensure the correct operation of the analyzer.

(this page was intentionally left blank)

Starting up

The start-up procedure must be performed before starting the analysis.

The start-up procedure performs the following actions:

- performs necessary initialization procedures
- rinses and washes the probes and tubing
- measures water blank
- checks the operational condition of the pressure sensor

Either insert new vials and request new calibrations or accept the existing ones before continuing. The analyzer cannot be used for other purposes during the start-up procedure.

The **Startup not done** message is shown in the main view if the procedure is not performed.

If the pressure sensor check fails in the start-up, the analyzer goes into **Startup not done** state.

To perform the start-up for an analyzer without the ECM unit:

1. Click **Start-up** in the main view.
2. Click **Yes** to confirm performing the start-up.
3. If you want to print a list of old reagents and calibrations, click Print. To close the list, click **OK**.
4. If there are maintenance tasks to be done, these are shown in a list. To close the list, click **OK**.

To perform the start-up for an analyzer with the ECM unit:

1. Select F2 > Racks > **Fill rack**.
2. Select the rack from the **Racks** field.
3. Select a rack position.
4. Click **Controls**.
5. Select *ECM prime* from the list.
6. Insert ECM prime at the selected sample rack position.
7. Insert the rack into the analyzer.
8. Click **Start-up** in the main view.
9. Click **Yes** to confirm performing the start-up.
10. If you want to print a list of old reagents and calibrations, click Print. To close the list, click **OK**.
11. If there are maintenance tasks to be done, these are shown in a list. To close the list, click **OK**.

(this page was intentionally left blank)

Reagents

To check the status of reagents, select F3 > **Reagents**. The reagent positions are shown in the view. Select specific reagent to view its details on the right. For example, this view can be used to check when a specific reagent expires.

Note Do not refill the reagent vials.

Figure 21. Reagents view

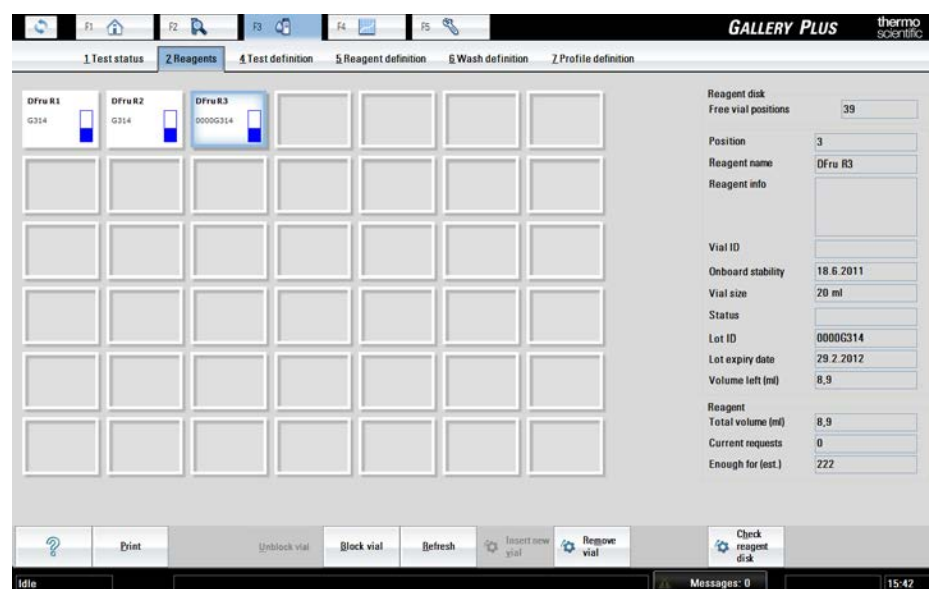







- Reagent indication information
- Inserting system reagents
- Inserting user-defined reagents
- Checking reagent barcodes
- Blocking reagent vial
- Unblocking reagent vial
- Removing reagent vial

Reagent indication information

To check the statuses of reagents, select F3 > **Reagents**.

The following indications show the status of the reagent.

Table 10. Reagent statuses

Indicator	Indication	Description
Blue		OK The reagent is used normally.
Yellow		Alarm limit The reagent is below alarm limit.
Red		Short The reagent is short and it cannot be used for the tests.
Brown		Expired The reagent is expired or its stability in the analyzer has expired.
Violet		Discarded The reagent vial cannot be identified.
Gray		Blocked The reagent is not in use.

To view the reagent details, click the specific reagent and the details are shown on the right.

Table 11. Detailed reagent information

Field	Description
Free vial positions	Shows how many positions are free.
Position	Shows the position for the reagent.
Reagent name	Shows the reagent's name.
Reagent info	Shows additional reagent information.

Field	Description
Vial ID	Shows the vial's identification.
Onboard stability	Shows the reagent's stability on board in days.
Vial size	Shows the size of the reagent vial.
Status	Shows the reagent's status. The status information is not shown if the status is OK.
Lot ID	Shows the manufacturing identification of the reagent.
Lot expiry date	Shows the expiring date of the reagent's lot.
Volume left (ml)	Shows the remaining reagent volume in the vial. The volume is shown after the first dispensing.
Total volume (ml)	Shows the total reagent volume in the disk. The volume is shown after the first dispensing. If the reagent disk contains, for example, two vials of the same reagent that have both been dispensed from, the combined volume is shown.
Current requests	Shows the unanalyzed requests that are using the selected reagent.
Enough for (estimation)	Shows the estimation how many requests can be run with the remaining reagent. The estimation is shown after the first dispensing.

Inserting system reagents

Note Run QC when a new vial is loaded.

To insert reagents:

1. Remove the vial's cap before inserting a reagent into the analyzer and check that there are no air bubbles inside the vial.



7 Reagents

Inserting user-defined reagents

2. Press the reagent cover button to open the cover.
3. When the light is on, open the cover.
4. Insert the vial in the centermost vial position.
Ensure that the vial is deep enough in the disk.

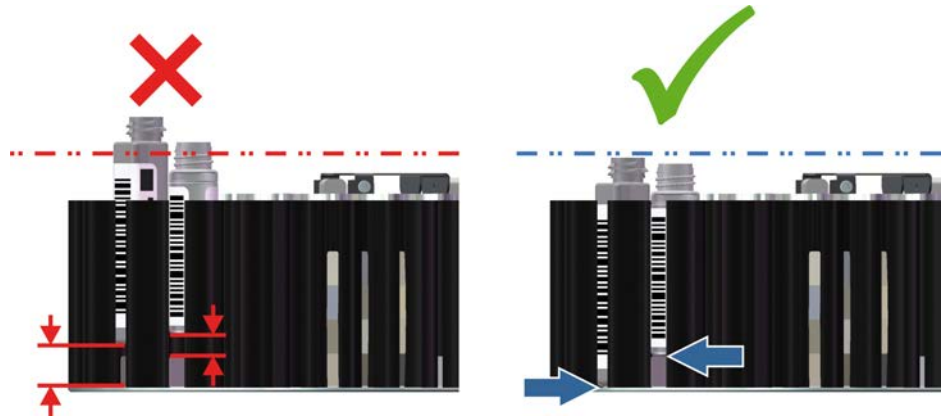

5. Ensure that the vial's barcode is facing you.



6. Close the cover.

Inserting user-defined reagents

You can insert a new reagent vial into a free vial position or replace an empty vial with a new one.

Note Run QC when a new vial is loaded.

To insert a reagent:

1. Remove the vial's cap before inserting a reagent into the analyzer and check that there are no air bubbles inside the vial.



2. Select F3 > **Reagents**.
3. Select a free position from the view.
You can also replace a short reagent by selecting the short reagent's position.
4. Click **Insert new vial**.
5. Select the correct reagent and vial size from the list. The list shows the reagents that are needed for the requested tests.

Figure 22. Selecting reagent

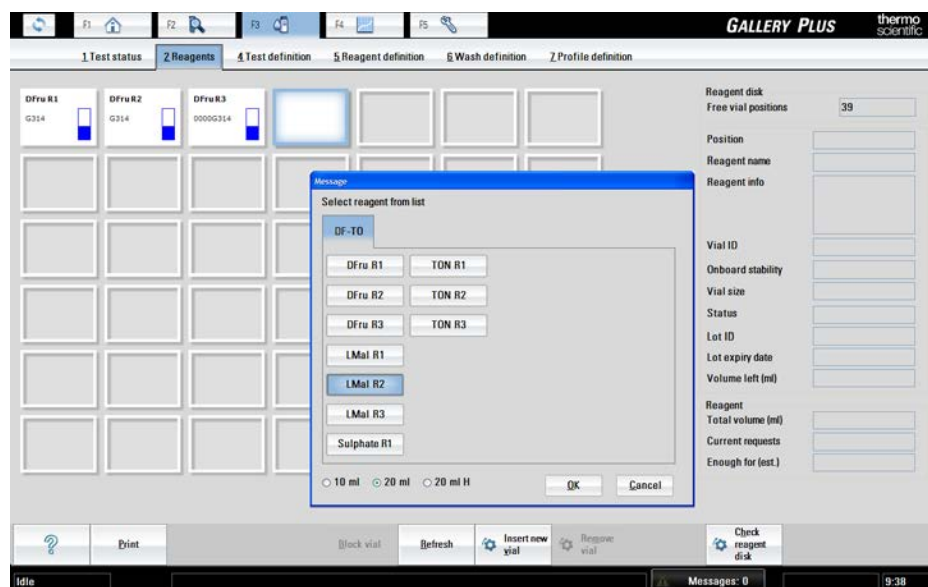

6. Click **OK**.
7. When the light is on, open the cover.
8. Insert the reagent vial in the centermost position.
9. Close the cover.

7 Reagents

Checking reagent barcodes

Checking reagent barcodes

To check the content of the reagent disk, select F3 > Reagents > **Check reagent disk**. The reagents' barcodes are read and the view is updated.

Blocking reagent vial

If the reagent is blocked, the analyzer is no longer using the reagent for the analyses. The function is useful, for example, after all the requests have been performed.

To block a reagent vial:

1. Select F3 > **Reagents**.
2. Select a reagent.
3. Click **Block vial**.

Unblocking reagent vial

To unblock a reagent vial:

1. Select F3 > **Reagents**.
2. Select a reagent.
3. Click **Unblock vial**.

Removing reagent vial

To remove a reagent vial:

1. Select F3 > **Reagents**.
2. Select a reagent.
3. Click **Remove vial**.
4. When the light is on, open the reagent cover.
5. Remove the reagent.
6. Close the cover.

Performing calibrations and quality controls

- Calibrations
- Quality controls

Calibrations

To calibrate, select F4 > Cal/QC selection > **Calibration**. The tests are shown on the list. The details show the date of the previous calibration and the date when the test should be calibrated next time. Also, the status of calibration is shown on the list.

Note Load calibrators/controls in sample cups into the sample racks.

Figure 23. Calibration view

The screenshot displays the 'GALLERY PLUS' software interface. At the top, there is a menu bar with function keys F1 through F5. Below the menu bar, there are four tabs: '1 Cal/QC selection', '2 QC results', '3 Calibration results', and '4 Cal/Ctrl definition'. The '3 Calibration results' tab is active, and within it, the 'Calibration' sub-tab is selected. The main area contains two tables. The left table lists various tests and their calibration status, with 'D-Fructose' highlighted. The right table shows details for 'Water' and 'Sugar std', both with a status of 'Missing'. At the bottom of the interface, there are buttons for 'Print' and 'Calibrate', and a status bar showing 'Messages: 0', 'Routine user', and '15:32'.

Test	Previous	Next	Cal. status
AceticAcid			No calibration
Ammonia			No calibration
Calcium			No calibration
CitricAcid			No calibration
D-Fructose			No calibration
D-Glucose			No calibration
D-Lac acid			No calibration
Ethanol			No calibration
Glu+Fu			No calibration
GluFuSucr			No calibration
Glycerol			No calibration
Iron			No calibration
L-Lac acid			No calibration
L-Mal acid			No calibration
Magnesium			No calibration

Cal/Ctrl	Rack pos.	Lot	Status
Water			Missing
Sugar std			Missing

Calibrating

8 Performing calibrations and quality controls

Displaying calibrators and controls

To calibrate:

1. Select F4 > Cal/QC selection > **Calibration**.
2. Select the correct test from the list on the left. To select multiple tests, press CTRL and select the tests or drag with a mouse. Needed calibrators and controls are shown on the right.
3. Insert the calibrators into the analyzer. See [Inserting calibrators](#) on page 46.
4. Click **Calibrate**.
5. Return to main view and click **Start** to perform requested calibrations.

Note Furthermore, run QCs when calibrating.

Note Calibrate the analyzer, if the quality control results are not within defined limits.

Note Run QCs daily to ensure the correct operation of the analyzer.

Displaying calibrators and controls

To check which calibrators and controls are needed:

1. Select F4 > Cal/QC selection > **Calibration**.
2. Select test(s) from the list on the left or click **Cals/Ctrls needed**.
If you select test(s), their calibrators and controls are shown on the right. If you click **Cals/Ctrls needed**, the calibrators and controls needed in the pending calibration are shown on the right.

Inserting calibrators

Check that the lot number in the calibrator vial and the concentrations in the value sheet match the user-interface information. A new calibrator cannot be inserted into the analyzer when the older, expired one is still in the analyzer. Remove the expired calibrator, before inserting new calibrator.

To insert a calibrator:

1. Select F2 > Racks > **Fill rack**.
2. Select a sample rack from the **Racks** field.

Note Do not select the rack that is inside the analyzer.

3. Select the rack position.
4. Click **Calibrators**.
5. Select the calibrator from the list on the right.
6. Insert the calibrator in sample cup into the rack.



7. Press the sample cover button to open the cover.
8. When the light is on, open the cover.
9. Insert the rack.



10. Close the cover.

Reviewing calibration results

To view calibrations results for a certain test:

1. Select F4 > **Calibration results**. By default, the tests with unaccepted calibrations are shown. If you want to see all the tests click **All**.
2. Select the test from the **Test** drop-down menu.
 - Dates for the accepted calibrations are shown on the **Date** drop-down menu. The latest calibration is shown by default. Select a certain date to view an older calibration.
 - To show the results as numeric values with maximum precision, click **Scientific view**. By default, the scientific view is not in use.

8 Performing calibrations and quality controls

Performing calibrations and quality controls

- The **Status** field shows the status of the calibration. The possible statuses are shown in the following table.

Table 12. Calibration statuses

Status	Description
Accepted	Calibration is accepted.
No calibration	Test has no calibrations.
Expired	A new calibration is required.
Pending	Calibration is requested.
To be accepted	Calibration needs to be accepted.

- The **Accepted** field shows the date and time when the calibration was accepted.
- The **Checked** field shows the date and time when the accepted calibration was checked. When the expired calibration is checked, its status remains as **Expired** but it can be temporarily used in analysis.
- The **Errors** field shows the possible errors that occur during the calibration.
- For the nonlinear and ECM test, the coefficient of determination is shown, as well as Δ response.
- The test type specific information is shown in the view.
- The calibration curve is shown on the right.
- To view the detailed information about one measurement point, click the View more button and select one row from the table.
- The table below contains detailed information about the curve:
 - calibrator name
 - response value
 - calculated concentration
 - the concentration defined in the calibration parameters
 - lot number
 - possible errors during the calibration

Figure 24. Calibration results view

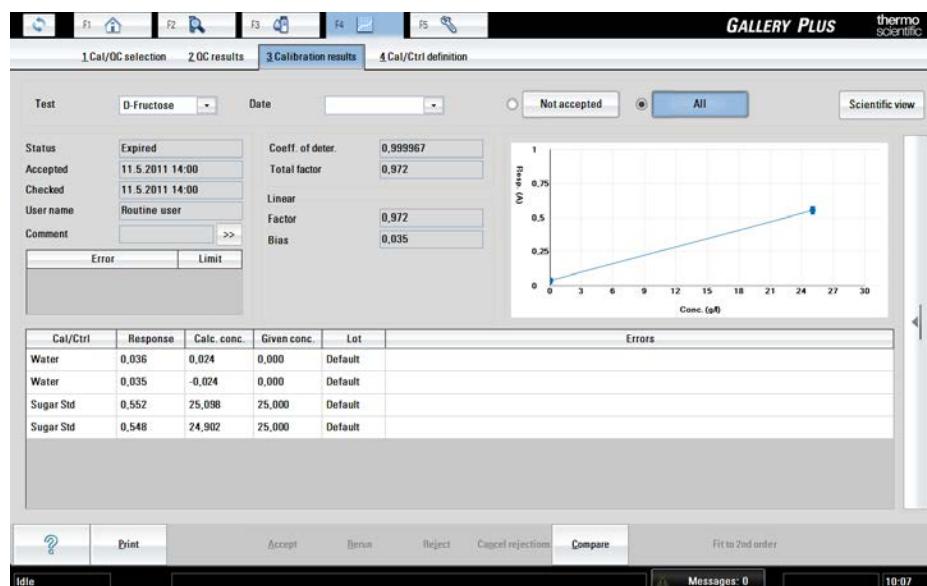

Comparing calibrations

To compare the results of a new calibration to a previous calibration:

1. Select F4 > **Calibration results**.
2. Click **All**.
3. Select the test from the **Test** drop-down menu.
4. Select one calibration time from the **Date** drop-down menu.
5. To compare two calibrations, click **Compare**.
6. Select an calibration that needs to be compared to the current calibration.
7. Click **OK**.

Accepting calibration

To accept a calibration:

1. Select F4 > **Calibration results**.
2. Select the test from the **Test** drop-down menu.
3. If needed, add a comment in the **Comment** field:
 - a) Click **Edit**.
 - b) Type a comment in the **Comment** window.
 - c) Click **OK**.
4. Click **Accept**.

Note It is not possible to reject accepted results.

8 Performing calibrations and quality controls

Rerunning calibration

Rerunning calibration

To rerun a calibration:

1. Select F4 > **Calibration results**.
2. Select the test from the **Test** drop-down menu.
3. Click **Rerun**.
4. Click **Start**.

Note It is not possible to rerun accepted results.

Rerunning a single calibration point

To rerun a measurement:

1. Select F4 > **Calibration results**.
2. Select the test from the **Test** drop-down menu.
3. Select the result to be rerun from the table.
4. Click **Rerun** to rerun the selected calibrators/controls.
5. Click **Start**.

Note It is not possible to rerun accepted results.

Rejecting calibration

If a calibration is rejected, the current calibration is replaced with previous accepted calibration. When the previous accepted calibration is taken into use, the checking date for the calibration is updated. The expiry date of the calibration is calculated from the date when the calibration is checked last time.

To reject a calibration:

1. Select F4 > **Calibration results**.
2. Select the test from the **Test** drop-down menu.
3. Click **Reject** to reject the selected calibration.

Note The calibration curve is recalculated based on the previous accepted calibration.

Rejecting measurement

If the measurement is rejected, the measurement point is removed from the calibration curve.

To reject a measurement:

1. Select F4 > **Calibration results**.
2. Select the test from the **Test** drop-down menu.

3. Select the results to be rejected.
4. Click **Reject**.

Note The calibration curve is recalculated.

Canceling rejections

To take the rejected calibration measurements back into use, click **Cancel rejections**. The rejected requests of the calibration are recalculated and redisplayed in the view. This is possible only if the calibration has not been accepted.

Quality controls

To perform the manual quality control (QC), select F4 > Cal/QC selection > **QC** and select **QC profile**. The tests are shown in a list. The details show the date when the previous QC was performed for the test and the status of QC. The existing QC profiles are listed on the QC profile menu above the list.

Select a test from the list on the left to show the controls that are included in the test. The control details are shown on the list on the right. Name, rack position, lot ID and status of control are listed.

Note Load controls in sample cups into the sample racks.

Figure 25. Quality control view

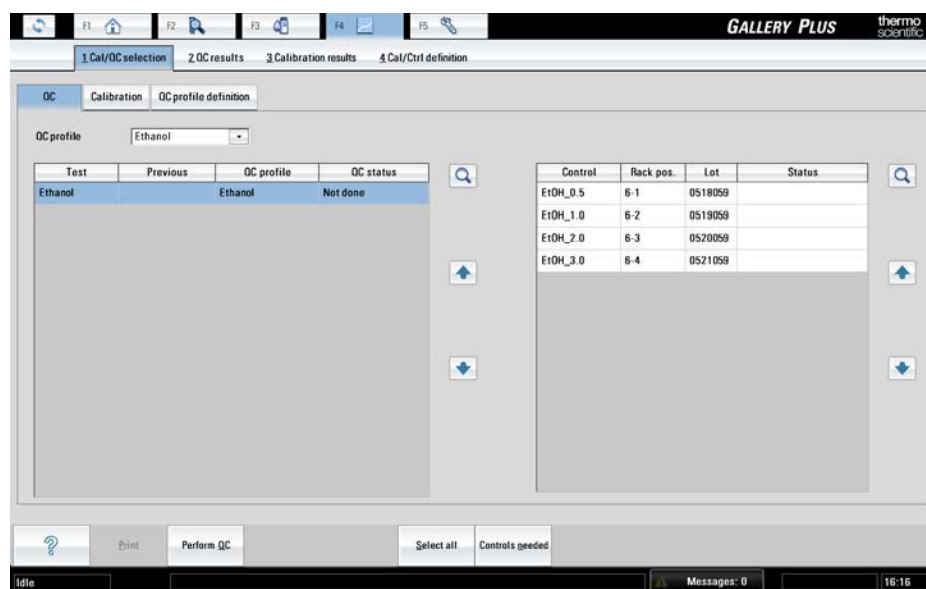

Performing quality control

Note A test must be calibrated before you can run a quality control.

To perform quality control (QC):

1. Select F4 > Cal/QC selection > **QC**.
2. Select **QC profile**.
3. Select a test. To select multiple tests, press CTRL and select the tests or drag with a mouse. To perform all QCs in the **QC profile**, click **Select all**. Needed controls are shown on the right.
4. Insert the controls into the rack. See [Inserting quality controls](#) on page 52.
5. Insert the rack into the analyzer.
6. Click **Perform QC**.
7. Return to the main view and click **Start** to perform the requested QCs.

Note Calibrate the analyzer, if the quality control results are not within defined limits.

Note Run QCs daily to ensure the correct operation of the analyzer.

Note Run QC when a new vial is loaded.

Displaying quality controls

To check which controls are needed:

1. Select F4 > Cal/QC selection > **QC**.
2. Select a profile from the **QC profile** drop-down menu or tests from the list on the left.
3. Click **Controls needed** to show the controls on the right.

Missing controls are also shown in the main view.

Inserting quality controls

Note It is recommended to insert all the immediately needed controls into the rack for easy daily operations. However, analysis should only be performed with controls that have been freshly inserted in the analyzer.

Check that the lot number in the control vial and the concentrations in the value sheet match the user-interface information. A new control sample cannot be inserted into the analyzer when the older, expired one is still in the analyzer. Remove the expired control sample before inserting new control sample.

To insert a control sample:

1. Select F2 > Racks > **Fill rack**.
2. Select the sample rack from the **Racks** field.

Note Do not select the rack that is inside the analyzer.

3. Select the rack position.
4. Click **Controls**.
5. Select the control from the list on the right.
6. Insert a control sample cup into the rack.



7. Press the sample cover button to open the cover.
8. When the light is on, open the cover.
9. Insert the rack.



10. Close the cover.

Reviewing quality control results

To view quality control (QC) results, select F4 > QC results > **QC results**. By default, the unaccepted results are shown.

8 Performing calibrations and quality controls

Performing calibrations and quality controls

Figure 26. QC results view

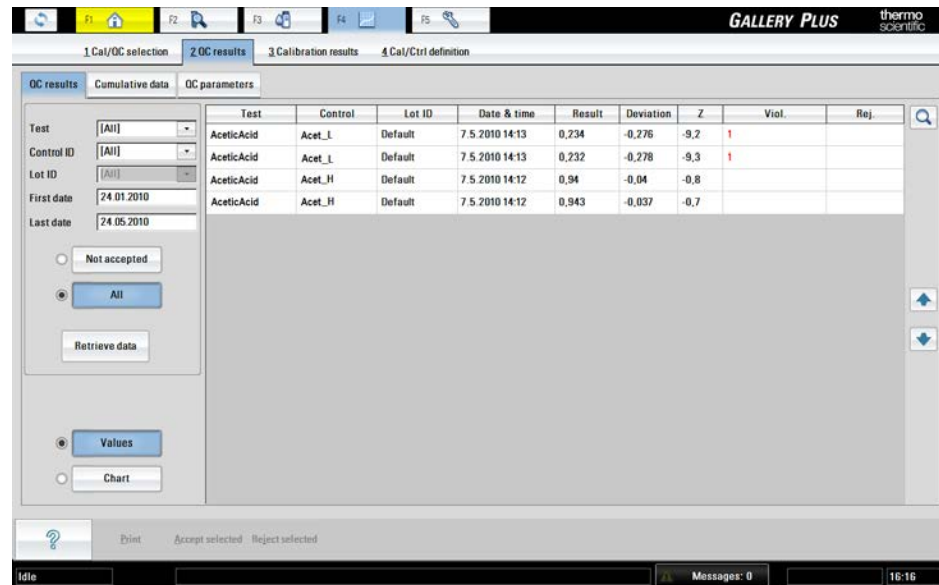

To view the QC results, define all or one of the following options:

- the test from the **Test** drop-down menu
- the control from the **Control ID** drop-down menu
- the start date in the **First date** field
- the end date in the **Last date** field

Click **Retrieve data** to view the results.

If the **Not accepted** option is selected, only the results which are not accepted are shown. If the **All** option is selected, all results are shown.

If the **Values** button is selected, the results are shown in a numeric format. If the **Chart** button is selected, the results are shown both in the numeric and graphical format. By default, the results are shown in a numeric format.

If the QC result has QC rule violation, the result is displayed in red color.

Table 13. QC results

Column	Description
Test	Showing the name of the test
Control	Showing the name of the control
Lot ID	Showing the lot ID of the control
Date and time	Showing the timestamp when the control has been calculated
Result	Showing the result of a measurement
Deviation	Showing the result's deviation from the control value defined in the parameters.

Column	Description
Z	Showing the reference value for the deviation defining how the result's deviation and control's stable standard deviation are related. The reference value is calculated as follows: $Z = ([QC \text{ result}] - [\text{Control value defined in parameters}]) / [\text{standard deviation}]$
Viol.	Showing the violated rule. The list of x from the rule $x:y*SD$.
Rej.	Showing whether the result has been rejected or not.

Reviewing cumulative data

The operator can review the QC results as cumulative data. To view the cumulative data, select F4 > QC results > **Cumulative data**.

If a control lot has changed during the reporting period, the change is displayed with a vertical line in the graph. The values of each lot are displayed in separate rows.

All the accepted QC results are included in the cumulative data after the daily files have been cleared. Rejected QC results can also be included in the graph by defining it with parameter in Configuration > **Laboratory** tab.

The daily cumulative data show the QC results measured on a certain day.

Viewing quality control parameters

To view the quality control (QC) parameters, select F4 > QC results > **QC parameters**. The view shows the procedure details for a test selected in the **QC results** or **Cumulative data** view. The **QC parameters** view lists the procedure, controls and rules used in analysis.

Figure 27. QC parameters view

Accepting quality control results

To accept the quality control results:

1. Select F4 > QC results > **QC results**.
2. Select all or one of the following options:
 - the test from the **Test** drop-down menu
 - the control from the **Control ID** drop-down menu
3. Type the start date in the **First date** field for the search.
4. Type the end date in the **Last date** field for the search.
5. Click **Retrieve data** to show the results.
6. Select the results to be accepted.
7. Click **Accept selected** to accept the results.

Note Results can be accepted only if errors have not occurred.

Rejecting quality control results

Accepted results can be rejected as long as the daily log has not been cleared. To reject the quality control results:

1. Select F4 > QC results > **QC results**.
2. Select all or one of the following options:
 - the test from the **Test** drop-down menu
 - the control from the **Control ID** drop-down menu
3. Type the start date in the **First date** field for the search.
4. Type the end date in the **Last date** field for the search.
5. Click **Not accepted** or **All**, depending on whether QC has been accepted or not.
6. Click **Retrieve data** to show the results.
7. Select the results to be rejected.
8. Click **Reject selected** to reject the results.

Samples

To define a new sample or edit sample data, select F2 > **Samples**. Furthermore, if samples do not have barcodes, define the sample details in the **Samples** view.

The list shows identifications for both the sample and group. Also, the sample's position in a rack is shown on the Position field. The rack's number is shown first and then the sample's position in rack. For example, position 1-2 indicates that the sample is located in a rack number 1 and its position is 2 in the rack.

Figure 28. Samples view

The screenshot shows the 'Samples' view in the GALLERY PLUS software. The main window is divided into several sections:

- Table:** A table with columns 'Sample ID', 'Group ID', and 'Position'. It lists three samples: Sample 1, Sample 2, and Sample 3, all with their respective Group IDs and empty Position fields.
- Form:** A form for editing sample details. Fields include:
 - Sample ID: Sample 1
 - Sample type: Sample type 1
 - Man. dil. 1+: 0,0
 - Group ID: Sample 1
 - Group name: (empty)
 - Sender: (empty)
 - Rack: (empty)
 - Position: (empty)
 - Ref. ranges: (empty)
 - Status: Pending
- Test Selection Grid:** A grid with columns 'A-NO' and 'OX-Z'. It contains various test names such as Acetalde, D-Glucose, Iron, AceticAcid, D-Lac acid, Isoc acid, Ammonia, Ethanol, Lact(Gluc), Calcium, Glu+Fru, Lactose, Chol Food, GluFruSucr, L-Lac acid, CitricAcid, Glycerol, L-Mal acid, D-Fructose, HB acid, and NOPA.
- Bottom Bar:** Includes a 'STAT' button, a 'Dilution 1+' field set to 0, and a 'Print' button.

Note It is recommended to use the barcoded samples to ensure the correct analysis of the samples.

- Detecting interferences of samples
- Inserting barcoded samples
- Defining non-barcoded samples
- Defining non-barcoded samples as batch
- Defining requests to sample
- Test scheduling principles
- Defining calculated test request to sample
- Defining external test request to sample

9 Samples

Detecting interferences of samples

- Defining requests to rack
- Inserting non-barcoded samples to rack
- Inserting sample racks into analyzer
- Checking sample barcodes
- Blocking sample
- Removing sample rack
- Clearing rack information
- Clearing rack position information
- Removing sample details
- Removing request
- Defining urgent tests
- Accepting errors
- Handling rack with barcode error
- Handling invalid rack data

Detecting interferences of samples

- Inspect samples visually.
- Ensure that samples do not contain clots.
- Bubbles in sample cups affect erroneous results, because surface detector in the sample probe cannot find liquid properly. For example, pipette bubbles away carefully.
- Mix thawed samples thoroughly before use.
- Ensure that there is enough sample for requested tests.
- When centrifuging and handling samples, follow the instructions of tube manufacturers.
- In the case of samples with complex or unknown matrices, you can use the method of standard addition. For more information, refer to the Reference Manual.

Inserting barcoded samples

Note Sample cannot be inserted directly into the analyzer. Insert the sample first into the rack and feed the rack into the analyzer.

Note Check that the sample material is homogeneous and representative.

Note If the analyzer contains the ECM unit, one sample rack position is always reserved for ECM prime.

To insert the samples:

1. Remove the sample's cap before inserting the sample into the analyzer.

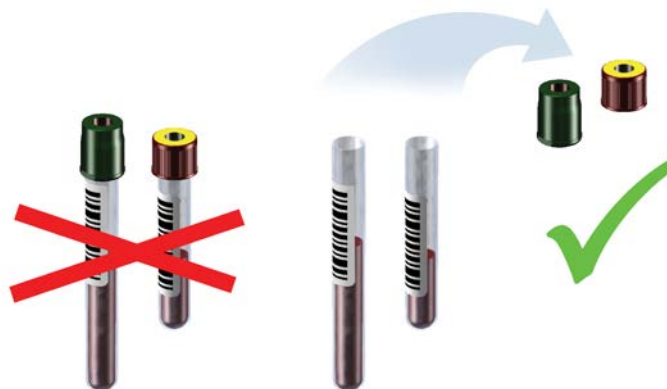

2. Insert the sample tubes or the cups into the rack.
Ensure that the sample tubes are deep enough in the rack.

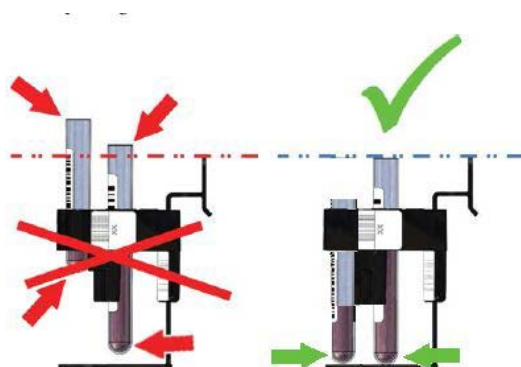

3. Make sure that the barcodes on the vials are readable from the opening of the rack position.

9 Samples

Samples



4. Press the sample cover button to open the cover.
5. When the light is on, open the cover.
6. Insert the rack.



7. Close the cover.

Defining non-barcoded samples

Figure 29. Defining sample and test name details

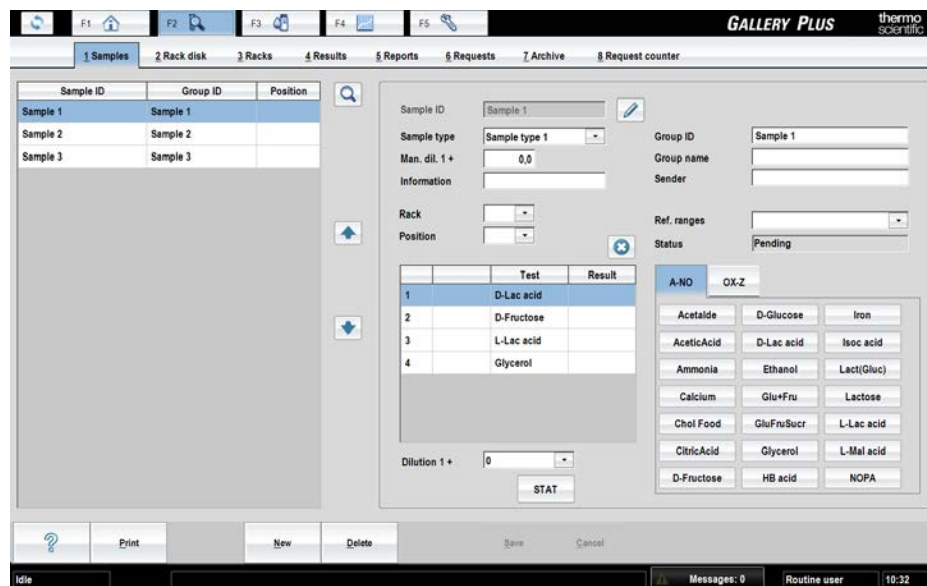

Note To save the information while defining the details, click **Save**.

To define the details for non-barcoded samples:

1. Select F2 > **Samples**.

Note You can also click **Add sample** in the main view.

2. Click **New**.
3. Type the identification to the **Sample ID** box.
4. Click **Confirm** to check that the given ID is unique.
5. Select a correct sample type from the **Sample type** menu.
6. Define the manual dilution in **Man. dil. 1+** if the sample has been diluted beforehand. This information is used when calculating the sample results. Define one part of sample and X parts of diluent. For example, 1+4 and 1:5 have the same dilution. The maximum manual dilution is 1+999, that is 1:1000.
7. Type the additional sample information to the **Information** box.
8. Select the rack from the **Rack** drop-down menu.
9. The free rack position is shown on the **Position** menu. To change the position, select a new position from the menu.
10. Type sample's identification to the **Group ID** box.
11. Type sample's name to the **Group name** box.
12. Type sender to the **Sender** box.
13. Select reference range for the sample from the **Ref. ranges** drop-down menu if needed.
14. Tests and profiles are shown in alphabetical order on the right.

9 Samples

Defining non-barcoded samples as batch

- a) You can select separate tests and test profiles. The selected tests are listed on the left.
 - b) If needed, type a different dilution to the **Dilution 1+** box. If the dilution has been changed, "D" is shown next to the test name.
15. Click **Save**.
 16. Insert a sample tube or a cup at the correct position to the rack. Ensure that the sample tubes are deep enough in the rack.

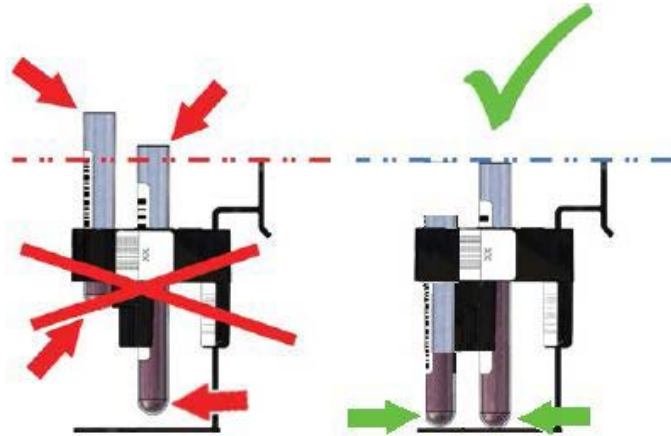

17. Insert the rack.

Defining non-barcoded samples as batch

Batch entry is convenient when several samples without barcodes need to be tested. However, batch entry is only possible when all the samples have the same requests.

To define sample details as a batch:

1. Select F2 > Racks > **Batch Entry**.
2. Define a common prefix for all samples to the **Samples prefix** box.
3. Define the first sequence number of the batch to the **ID Start** box.
4. Define the last sequence number of the batch to the **ID End** box.
5. Define the manual dilution in **Man. dil. 1+** if the samples have been diluted beforehand. This information is used when calculating the sample results. Define one part of sample and X parts of diluent. For example, 1+4 and 1:5 have the same dilution. The maximum manual dilution is 1+999, that is 1:1000.
6. Select a correct sample type from the **Sample type** menu.
7. Tests and profiles are shown in alphabetical order on the right. The operator can select separate tests and test profiles. The selected tests are listed on the left.
8. Click **Save**.

To define more sample details, select F2 > **Samples**.

Note The sample is assigned an identification automatically as Sample prefix + sequence number.

Figure 30. Batch entry view

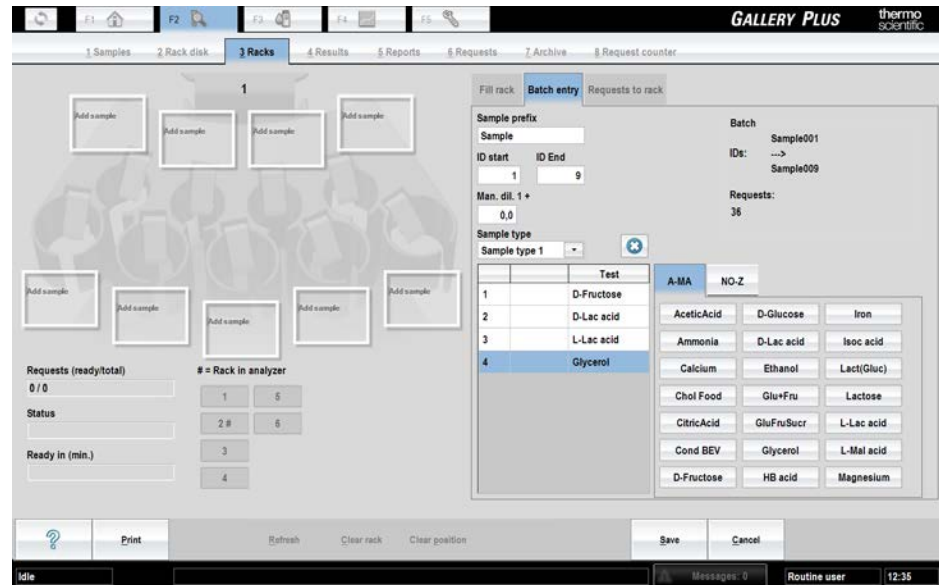

Defining requests to sample

To define requests to an individual sample:

1. Select F2 > **Samples**.
2. Select the sample from the list.
3. Select the test or profile from the list on the right.

The selected tests and profiles are shown in the list on the left.

Figure 31. Defining requests to sample

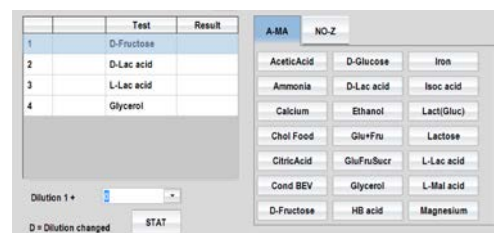

4. If needed, type a different dilution to the **Dilution 1+** box. If the dilution has been changed, "D" is shown next to the test name.
5. Click **Save**.

The test scheduling is based on wash definitions and stat flag. See further information in [Test scheduling principles](#) on page 64.

Test scheduling principles

The analyzer performs several analyses simultaneously. Test requests prioritizing principles are as follows:

1. Calibrations of the STAT requests
2. STAT requests
3. Calibration requests
4. QC requests
5. Up to the first 300 requests starting from the first position of a rack. The prioritizing for a sample's request is as follows:
 - a. Requests containing contaminative reagents, which have been defined as a following reagent in a large wash.
 - b. Requests containing contaminative reagents, which have been defined as a following reagent in other than a large wash.
 - c. All other requests based on the duration of the test, the longest first.
6. The sequence is repeated starting from the step 5 for all racks in inserting order as long as higher priority requests (steps 1-4) are not made.

Defining calculated test request to sample

Define a calculated test request to an individual sample as a normal test request. If a test consists of several subtests, test requests are created automatically.

To define calculated test requests to an individual sample:

1. Select F2 > **Samples**.
2. Select the sample from the list.
3. Select the calculated test from the list on the right.

The selected test and possible subtests are shown in the list on the left.

4. Click **Save**.

Note If the calculated test consists of subtests, which are using different sample types, you need to first define subtests' requests to each sample type and after that define a calculated test request to one sample used in these subtests.

Note In case you have requested more than once the calculated test, the photometric test will be analyzed only once.

Defining external test request to sample

To define external test requests to an individual sample:

1. Select F2 > **Samples**.
2. Select the sample from the list.
3. Select the external test from the list on the right.

The selected test is shown in the list on the left.

The program opens the **Result** dialog.

4. Type the result and click **Save**.

Note The results of external tests are printed to the reports (F2 > **Reports**) but they are not displayed in the F2 > **Results** view.

Defining requests to rack

Same requests can be defined for all the samples in the same rack at the same time.

To define requests to rack:

1. Select F2 > Racks > **Requests to rack**.
2. Select the rack from the **Racks** field.
3. Tests and profiles are shown in alphabetical order on the right. The operator can select separate tests and test profiles. The selected tests are listed on the left.
4. Click **Save**.

Inserting non-barcoded samples to rack

To add samples to racks, select F2 > Racks > **Fill rack**. The ID of the selected rack is shown at the top of the view. The rack details are shown below the rack positions. Details show both the ready requests and the total amount of the requests. Also, the status and the estimated finishing time of the rack is shown. The sample rack can hold samples, controls or calibrators.

Figure 32. Racks view

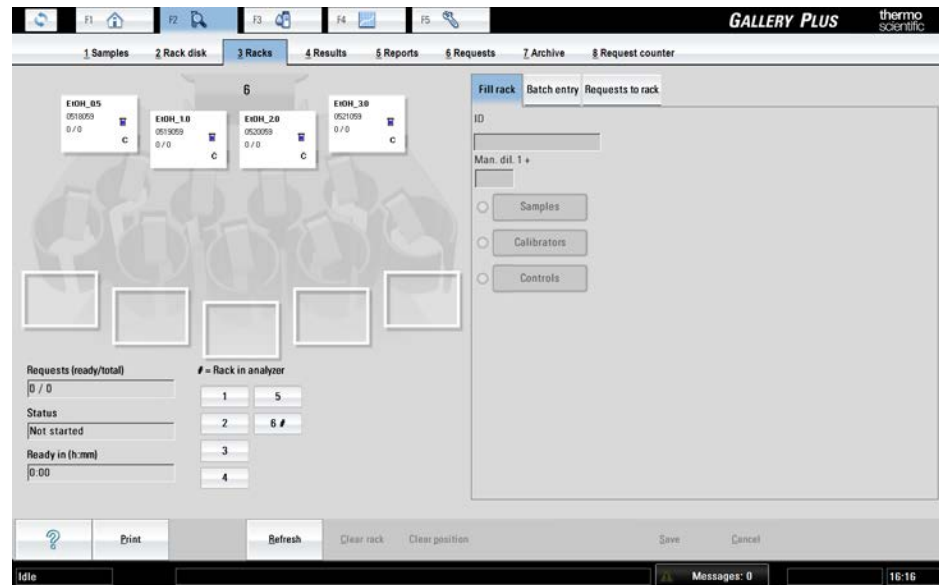

The analyzer automatically recognizes the standard sample racks, which have the rack ID between 1-6. All the other sample racks must be introduced to the analyzer.

To introduce a rack to the analyzer:

1. Open the sample cover.
2. Insert an empty sample rack into the analyzer.
3. Close the cover. The analyzer recognizes the rack type and the rack comes visible on the F2 > **racks** tab.
4. Open the cover and remove the rack.

To add sample, control or calibrator to a rack:

1. Select F2 > Racks > **Fill rack**.
2. Select the rack from the **Racks** field.
The selected rack must not be inside the analyzer.
3. Select the rack position.
4. Select the corresponding item.
 - a) Samples
 - b) Calibrators
 - c) Controls
5. Select the sample, calibrator or control from the list that will appear on the right. The selected item will be shown on the selected position.
6. If needed, select the sample from the rack and define the manual dilution in the **Man. dil. 1+** field and press Enter.
7. Insert sample to the rack.

Note Check that the sample material is homogeneous and representative.

Note It is also possible to create new sample IDs by typing a new ID to the **ID** field.

Inserting sample racks into analyzer

After the sample details have been defined:

1. Remove the sample's cap before inserting the sample into the analyzer.



2. Press the sample cover button to open the cover.
3. When the light is on, open the cover.
4. Insert the rack.



5. Close the cover.

Note Sample cannot be inserted directly into the analyzer. Insert the sample first into the rack and feed the rack into the analyzer.

Checking sample barcodes

To check the content of the sample disk:

1. Remove the rack from the analyzer.
2. Ensure that the barcodes are properly aligned.
3. Place the rack back in the analyzer.

The samples' barcodes are read and the view is updated.

Blocking sample

If the sample is blocked, the analyzer no longer uses it for the analyses. The sample can be removed when convenient, which can be, for example, after all the requests have been performed.

To block a sample:

1. Select F2 > **Rack disk**.
2. Select the sample to be blocked.
3. Click **Block sample**.

Removing sample rack

To remove a rack:

1. Select F2 > **Rack disk**.
2. Select the rack to be removed.
3. Click **Remove rack**.
4. When the light is on, open the cover.
5. Remove the rack.
6. Close the cover.

Clearing rack information

To clear the information on all positions from a rack:

1. Select F2 > Racks > **Fill rack**.
2. Select the rack from the **Racks** field.
3. Click **Clear rack** to remove the sample information from the rack.

Note The rack must be taken away from the analyzer before this action.

Clearing rack position information

To clear the information on a rack position:

1. Select F2 > Racks > **Fill rack**.
2. Select the rack from the **Racks** field.
3. Select the rack position.
4. Click **Clear position** to remove the sample information.

Note The rack must be taken away from the analyzer before this action.

Removing sample details

To remove sample details:

1. Select F2 > **Samples**.
2. Select the correct sample from the list.
3. Click **Delete**.

Note Sample details cannot be removed from a sample that is inside the analyzer, or during the analysis.

Removing request

To remove a request:

1. Select F2 > **Samples**.
2. Select the correct sample from the list.
3. Select the correct request from the list on the right.
4. Click the remove button  above the list.
5. Click **Save** to confirm the removal.

Note To restore the previous requests, click **Cancel** before clicking **Save**.

9 Samples

Defining urgent tests

Figure 33. Removing request

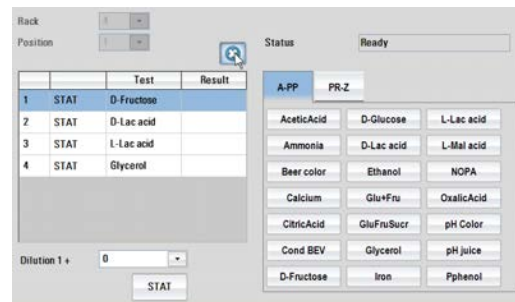

Note You can remove the request if the test has not been started yet but during the analysis requests cannot be removed.

Defining urgent tests

To insert an urgent test:

1. Select F2 > **Samples**.
2. Define sample details.
3. Click **STAT**.
4. Select tests.
5. Selected tests are shown on the list on the left and the text "STAT" is shown next to the test name.
6. Click **Save**.
7. Insert the urgent sample to the analyzer as a normal sample.

Figure 34. Defining urgent test

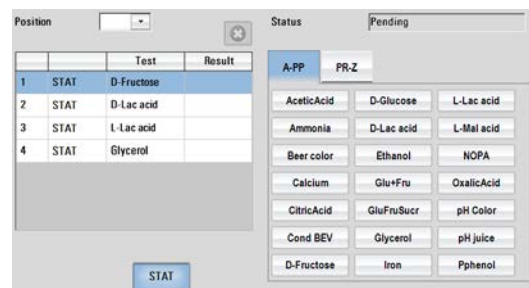

The urgent tests are marked with an exclamation point (!) in the test result view.

Accepting errors

It is necessary to accept sample rack errors in order for the system to accept valid sample for analysis.

The possible statuses:

- **Unknown ID**
 - Replace the barcodes, if the barcode of a sample is not recognized in the rack. For example, the barcodes cannot be read. Run the analysis.
 - Accept errors, if the unknown sample does not have any requests.

To accept the errors:

1. Select F2 > **Rack disk**.
2. Select a rack.
3. Click **Accept errors**.

- **Discarded**
 - The errors of the sample with **Unknown ID** have been accepted.
- **Duplicate ID**
 - The given ID exists twice in the system. For example, the barcode exists twice.
 - Remove the rack, define a new ID for the sample and run the analysis.
- **Barcode error**
 - Barcode of the rack is not recognized.
 - Remove the rack from the analyzer and check the barcode.
 - Replace the invalid barcode or rack.
 - Same rack ID exists already in the system and the analyzer gives **Duplicate rack ID** ([%]) error message.
 - Remove the duplicate rack from the analyzer.

Handling rack with barcode error

If the status **Barcode error** is shown in the **Racks** view (F2 > **Rack disk**), the barcode of the rack is not recognized, or the same rack ID exists already in the system.

Remove the rack and check the barcode. Replace the invalid barcode or rack.

Handling invalid rack data

If the status **Unknown sample** is shown in the **Racks** view (F2 > **Rack disk**), reading of the sample position has failed. The unrecognized samples are not analyzed. Continue by clicking **Accept errors**.

If the status **Duplicate ID** is shown in the **Racks** view (F2 > **Rack disk**), the given ID exists twice in the system. Remove the rack, define new ID for the sample and run the analyses.

(this page was intentionally left blank)

Starting analysis

Start the analysis by clicking **Start** in the main view.

Note It is not allowed to use the ECM unit without its cover.

Figure 35. Starting analysis

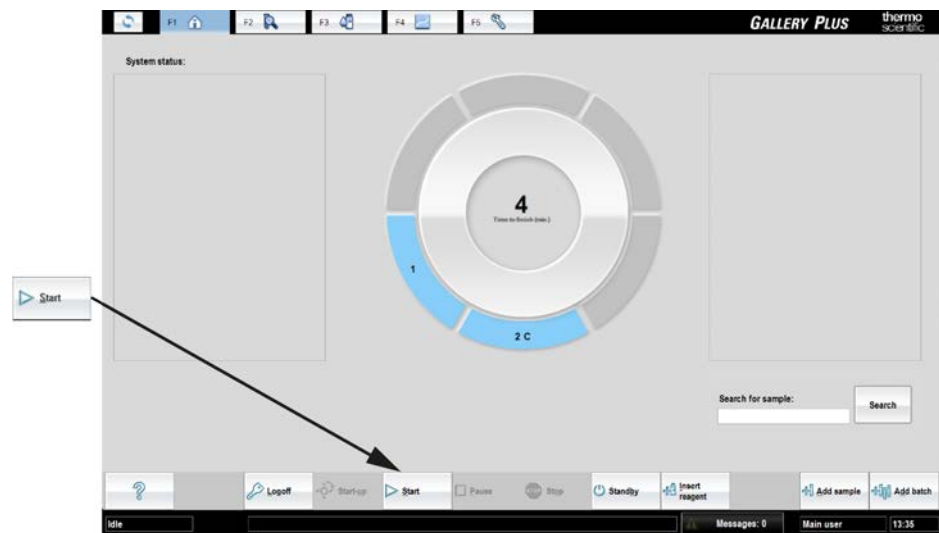

(this page was intentionally left blank)

Viewing requests

To view requests:

1. Select F2 > **Requests**.
2. Click **In analyzer** to view the requests under processing.
 - To view all requests, click **All**.
3. Select the request type from the **Request type** drop-down menu. The possible request types:
 - All
 - Sample
 - Control
 - Calibrator
 - External
 - Calculated
4. Select **In analyzer** to show only the samples currently onboard the analyzer, or **All** to show all requests.

The **Requests** view displays details like request type, ID, test name, status and special comments, if any. STAT requests are indicated with a red "STAT" text.

Figure 36. Requests view

Nbr	Req. type	ID	Test name	Status	Special note	Rack pos.	#
1	Sample	Wine1	L-Lac acid	requested			
2	Sample	Wine1	Glycerol	requested			
3	Sample	Wine1	D-Fructose	requested			
4	Sample	Wine1	D-Lac acid	requested			

(this page was intentionally left blank)

Viewing test statuses

To view a summary of the tests, select F3 > **Test status**. The status of reagents, quality controls (QC) and calibrations related to a certain test are shown. In the QC column is shown status of the latest requested routine or manual QC. Notes are also shown in the list. Select a test to show the missing reagents, controls and calibrators which are shown under the **Details** field.

Figure 37. Test status view

Test	Reagents	Calibr.	QC	Other
AceticAcid	Not inserted	No calibration		
Ammonia	Not inserted	No calibration		
Calcium	Not inserted	No calibration		
Chol Food	Not inserted	No calibration		
CitricAcid	Not inserted	No calibration		
Cond BEV		No calibration		
D-Fructose	Not inserted	No calibration		
D-Glucose	Not inserted	No calibration		
D-Lac acid	Not inserted	No calibration		
Ethanol	Not inserted	No calibration		
Glu+Fru	Not inserted	No calibration		
GluFruSucr	Not inserted	No calibration		
Glycerol	Not inserted	No calibration		
HB acid	Not inserted	No calibration		
Iron	Not inserted	No calibration		
Isoc acid	Not inserted	No calibration		
Lact(Gluc)	Not inserted	No calibration		
L-Lac acid	Not inserted	No calibration		

Reagents		In analyzer
Acet R1		
Acet R2		

Controls		In analyzer

Calibrators		In analyzer
Water		
Acet 0.25		
Acet 0.5		
Acet 0.75		
Acet 1.0		

(this page was intentionally left blank)

Managing results

Note Each laboratory is responsible to validate the user-defined applications to prove the performance of the test.

To manage results, select F2 > **Results**. Result details are listed in the view. The list shows the results and identifications for samples and controls. Also the units, statuses, dilutions and possible errors are shown. You can filter the list by the test name, sample ID, group ID and group name. In the **Request type** field, you can select whether to view only sample or control results.

Quality controls measured during the calibration are shown in the **Calibration results** view (F4 > **Calibration results**).

Figure 38. Results view

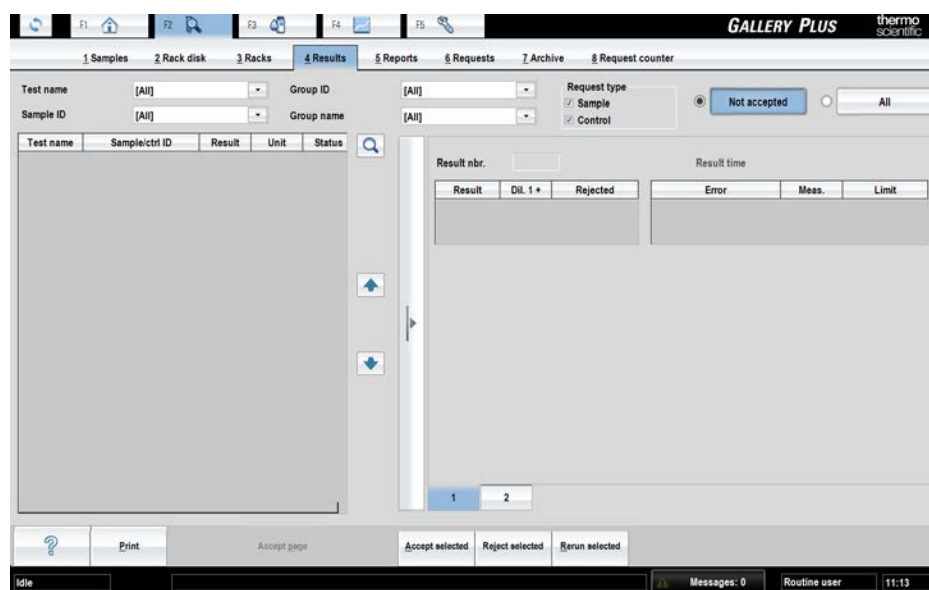

The possible statuses:

- Measured
- Calculated (calc.)
- Automatically accepted (aut.acc.)
- Manually accepted (man.acc.)
- Automatically rejected (aut.rej.)
- Manually rejected (man.rej.)

Several samples can be selected simultaneously by pressing CTRL and clicking the results. To cancel the selection, click the result again.

13 Managing results

Accepting results

- Accepting results
- Rerunning tests
- Rerunning test with dilution
- Rejecting results
- Reducing variation in test results

Accepting results

To accept results:

1. Select F2 > **Results**.
The results to be accepted are also shown in the main view.
2. Select the test, sample ID, group ID or group name from the corresponding drop-down menu.
3. Select the results to be accepted.
4. If needed, add a comment:
 - a) Open tab **2** of the details page on the right.
 - b) Type a comment in the **Comment** field.If multiple results are selected, the comment is saved for the result shown in the details page.
5. Click **Accept selected** to accept the selected results.

Note To accept the whole view, click **Accept page**.

Rerunning tests

To rerun tests:

1. Select F2 > **Results**.
2. Select the test, sample ID, group ID or group name from the corresponding drop-down menu.
3. Select the result to be rerun.
4. Click **Rerun selected** to rerun the selected tests.
If multiple tests have been selected, the program asks "Results will be rerun with original dilution. Rerun results?" Click **Yes**.
5. Click **OK**.

Rerunning test with dilution

To rerun tests:

1. Select F2 > **Results**.
2. Select the test, sample ID, group ID or group name from the corresponding drop-down menu.
3. Select the result to be rerun.
4. Click **Rerun selected** to rerun the selected test.
5. Type the dilution into the **Enter dilution (1 +)** field or select a dilution from the list.
6. Click **OK**.

Rejecting results

To reject results:

1. Select F2 > **Results**.
2. Select the test, sample ID, group ID or group name from the corresponding drop-down menu.
3. Select the results to be rejected.
4. If needed, add a comment:
 - a) Open tab **2** of the details page on the right.
 - b) Type a comment in the **Comment** field.If multiple results are selected, the comment is saved for the result shown in the details page.
5. Click **Reject selected** to reject the selected result.

Reducing variation in test results

If there is variation in the tests results, there may be air bubbles in the syringe. Use Tubing maintenance solution (981712) to remove the air bubbles. For instructions, see [Cleaning water containers and tubing](#) on page 143.

(this page was intentionally left blank)

Reporting results

To generate a report, select F2 > **Reports**. The report can be printed out according to the samples or tests. The operator can also select which results are reported. The results which meet the defined criteria are shown on the **Report** field on the left.

The reporting formats:

- Paper
- Excel (.csv format)

Figure 39. Reports view

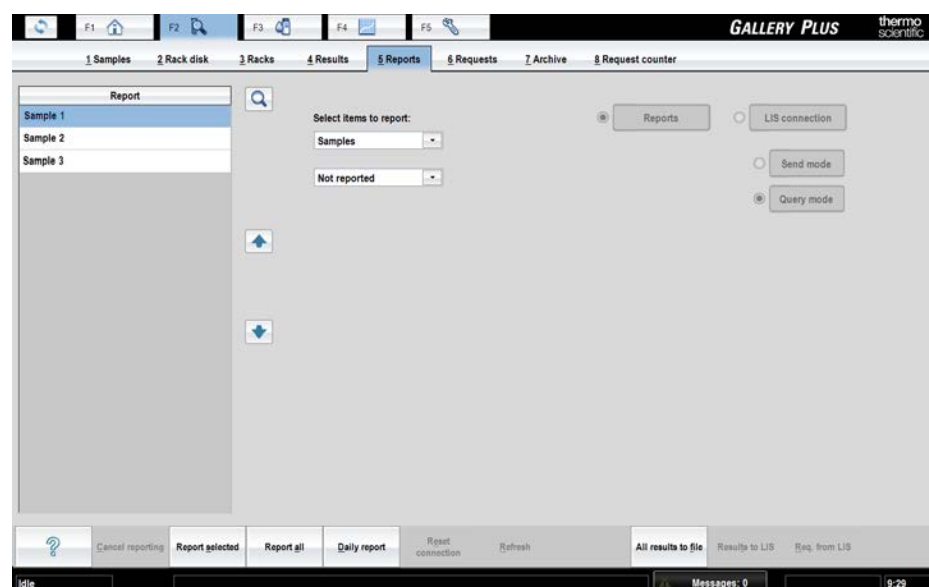

- Generating report based on tests
- Generating report based on samples
- Reporting daily results
- Reporting all results
- Canceling printing
- Excel report
- Sending results to LIS

14 Reporting results

Generating report based on tests

Generating report based on tests

To generate a report:

1. Select F2 > **Reports**.
2. Under **Select items to report**, select **Tests**.
3. Under **Select items to report**, select all results to be reported.
4. Under **Select items to report**, select whether the rejected results are included in the report or not.
5. Select the test to be reported.
6. Click **Report selected**.

To report all tests, click **Report all**.

Generating report based on samples

To generate a report:

1. Select F2 > **Reports**.
2. Under **Select items to report**, select **Samples**.
3. Under **Select items to report**, select which results are reported:
 - Not reported
 - All
4. Select the samples to be reported.
5. Click **Report selected**.

To report all samples, click **Report all**.

Reporting daily results

To report a summary of the daily results:

1. Select F2 > **Reports**.
2. Click **Daily report**.

Reporting all results

To report all results:

1. Select F2 > **Reports**.
2. Under **Select items to report**, select **Samples** or **Tests**.
3. Click **Report all** or **All results to file**.

Canceling printing

If **Report all** has been clicked, it is possible to cancel the print jobs which have not been sent to the printer by clicking **Cancel reporting**.

Excel report

To generate an Excel report:

1. Select F2 > **Reports**.
2. Click **All results to file**.
3. Select the correct folder.
4. Add the file name.
5. Click **Save**.

Note Save the file in .csv format.

Excel may be used to review the data, however saving the file in Excel may change the data format.

Table 14. Excel report description

Excel column	Description
A	Sample ID, Control ID
B	Sample (P), Control (C), Calibrator (A)
C	Test name
D	Test type: Photometric (P), ECM (I), External (E), Calculated (C)
E	Result
F	Unit of the reported result
G	Result time showing date and time
H	Urgent sample (STAT) is indicated with exclamation point ("!")
I	Status: Automatically accepted (AA), Manually accepted (MA), Automatically rejected (AR), Manually rejected (MR)
J	Error numbers are listed. For more information about the error numbering, refer to the LIS Interface manual.
K	Notes: Rerun (R)
L	Dilution 1+

14 Reporting results

Sending results to LIS

Excel column	Description
M	Manual dilution (not available for control or calibrator samples)
N	Response
O	Photometric: Blank response
P	Side absorbance (Absorbance unit)
Q	Number of points used
R-AC	Main absorbances 1-12 (Absorbance unit),
AD	Blank side absorbance (Absorbance unit)
AE-AP	Blank absorbances 1-12 (Absorbance unit)
AQ	Rate (A/min)
AR	Calibrator conc.

Sending results to LIS

It is possible to send results manually to LIS.

To send results to LIS:

1. Select F2 > **Reports**.
2. Select **LIS connection**.
3. Select **Send mode**.
4. Under **Samples**, select which results are reported:
 - Not sent
 - Sent
5. Select the samples to be reported.
6. Click **Results to LIS**.

Note Use **Refresh** button to update the sample list.

Clearing daily files

Clear daily files every day after the daily routines. The procedure can be performed when analysis or reporting are not running.

Clearing daily files includes:

- Clearing sample information from the racks. The calibration and control information is not cleared from the racks.
- Archiving the calibrator and quality control (QC) results
- Archiving sample and result information
- Deleting test, sample, request, result and QC batches

To clear the daily files:

1. Select F5 > **Actions**.
2. Click **Clear daily files**.

Note **Clear daily files** operation cannot be performed if there are results waiting for acceptance.

Note Performing **Clear daily files** operation deletes all test results (except control results) if **Sample results archived** parameter in the page F5 > Configuration > **Laboratory** is set **No**.

(this page was intentionally left blank)

Standby

Run the standby procedure once a day after the daily routines.

Running the standby procedure performs the following actions:

- washes the electrodes, probes and the mixer paddles.
- moves used cuvettes to the cuvette waste bin.
- switches off the stepping motors.

To perform the standby procedure:

1. Select F2 > Racks > **Fill rack**.
2. Select the rack from the **Racks** field.
3. Select a rack position.
4. Click **Controls**.
5. Select *WashSol* from the list.
6. Insert a cup with 2 ml Washing Solution at the selected rack position.
7. For an analyzer with ECM unit:
 - a) Select another rack position.
 - b) Click **Controls**.
 - c) Select *Cleansol* from the list.
 - d) Insert a 2 ml cup of cleansing solution to the selected rack position.
8. Insert the rack into the analyzer.
9. Select F1 > **Standby**.

(this page was intentionally left blank)

Archive

Test results and control results are stored in the archive.

Note Performing **Clear daily files** operation deletes all test results (except control results) if **Sample results archived** parameter in the page F5 > Configuration > **Laboratory** is set **No**.

Note All calibration results can viewed in F2 > **Calibration**.

Figure 40. Archive view

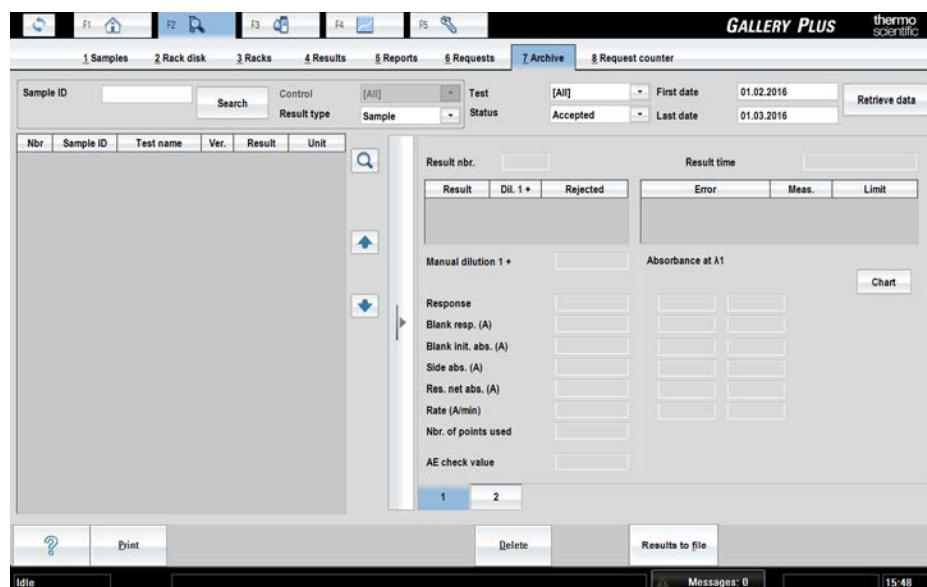

- Searching archived results
- Saving archived results

Searching archived results

You can search the archive for the result of a specific sample or for results matching defined criteria.

To search the results of a specific sample using sample ID:

1. Click F2 > **Archive**.

17 Archive

Saving archived results

2. Define the time period the results are searched for to the fields **First date** and **Last date**. You can also use the **Test** and **Status** fields as a filtering criteria.
3. Select **Sample** from the **Result type** list.
4. Type the sample ID in the **Sample ID** field.
You can also search by typing only the first few characters of the ID.
5. Click **Search**. The software opens the **Search results** window.
6. Select the wanted Sample ID from the list and press OK. The results are displayed on the list.

To search the results of a specific control using control ID:

1. Click F2 > **Archive**.
2. Define the time period the results are searched for to the fields **First date** and **Last date**. You can also use the **Test** and **Status** fields as a filtering criteria.
3. Select **Control** from the **Result type** list.
4. Select the control ID in the **Control** list.
5. Click **Retrieve data**. The results are displayed on the list.

To search all type of results:

1. Click F2 > **Archive**.
2. Select **All** from **Result type** list.
3. Define the time period the results are searched for to the fields **First date** and **Last date**. You can also use the **Test** and **Status** fields as a filtering criteria.
4. Click **Retrieve data**. The results are displayed on the list.

Saving archived results

You can save searched results to the file in Excel-format.

To save selected results to the file:

1. Click F2 > **Archive**.
2. Search results using **Search** or **Retrieve data** buttons.
3. Click **Results to file**.

The program opens **Enter file name** dialog.

4. Enter file name and select the correct folder.
5. Click **Save**.

Note Save the file in .csv format.

Excel may be used to review the data, however saving the file in Excel may change the data format.

Request counter

Note This window is visible only when activated in the F5 > Configuration > **Laboratory** window. Request counter is intended to be used only in special purposes and specified user rights are needed to set it on.

In the request counter window, you can view and print the numbers of performed requests and used cuvettes. The request counter shows the number of accepted, rejected and rerun requests for samples, calibrators and controls. The number of diluted sample requests is also included in calculation. Calculated and external tests are not included in the calculation.

Note If the Request counter is set on, the archiving is also automatically set on and it is not possible to change this setting. Deleting results from the archive is prevented as well.

To view and print performed requests:

1. Select from the *Test* list whether you like to view requests for all tests or one specific test.
2. Select whether you like to view request numbers performed in the current day or in a specific time period.
3. Click **Retrieve data**.
4. Click **Print**.

If you want to print report to csv file, click **Results to file**.

(this page was intentionally left blank)

Checking messages

To show messages, click **Messages** in the status bar or select F5 > **Messages**. By default, unaccepted messages are shown. Click **All** to show all messages. The latest message is shown in a status bar. The list shows the timestamp, explanation and ID of the messages. Click the message row to view the message details on the right.

Figure 41. Messages view

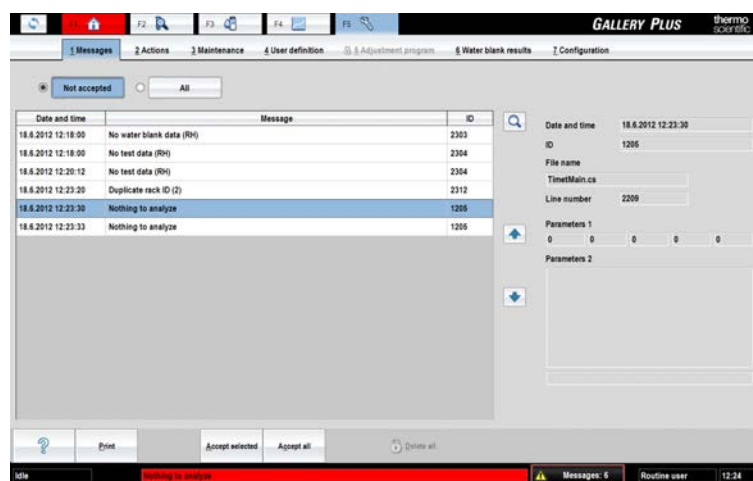

Note When contacting Service, provide the message details.

- [Accepting messages](#)
- [Error messages](#)

Accepting messages

To accept messages:

1. Select F5 > **Messages**.
2. Select the messages to be accepted.
3. Click **Accept selected**.

Note To accept all unaccepted messages, click **Accept all**.

Error messages

Measurement errors

Table 15. Measurement errors

Error flag	Definition	Result acceptance
Abs. high	Measured absorbance is above the parameter <i>Max allowable absorbance (A)</i> given in the Configuration > Analyzer tab.	The automatic acceptance is changed to manual acceptance.
Batch incomplete	Some quality control measurements are missing. Requests of the routine and action based QC batches will not be reanalyzed. If for example sample or reagent is running short, the request is discarded and status is reported as "Batch incomplete".	The automatic acceptance is changed to manual acceptance.
Bias limit max	Bias of standard addition curve is above the parameter <i>Bias limit max</i> given in the Test definition > Flow tab.	The automatic acceptance is changed to manual acceptance.
Bias limit min	Bias of standard addition curve is below the parameter <i>Bias limit min</i> given in the Test definition > Flow tab.	The automatic acceptance is changed to manual acceptance.
Bichr. net abs.	The measured difference between the main and the side wavelengths is below the parameter <i>Residual net abs.</i> given in the Test definition > Flow tab for the kinetic measurement. Rerun is done automatically with dilution if the dilution limit is exceeded at the same time.	The automatic acceptance is changed to manual acceptance.
Blank init abs. high	The result of kinetic blank measurement is above the parameter <i>Blank Init. abs. max</i> given to the kinetic blank measurement in the Test definition > Flow tab.	The automatic acceptance is changed to manual acceptance.
Blank init abs. low	The result of kinetic blank measurement is below the parameter <i>Blank Init. abs. min</i> given to the kinetic blank measurement in the Test definition > Flow tab.	The automatic acceptance is changed to manual acceptance.
Blank resp. high	The response of blank measurement is above the parameter <i>Blank Resp. max</i> given to the blank measurement in the Test definition > Flow tab.	The automatic acceptance is changed to manual acceptance.

Error flag	Definition	Result acceptance
Blank resp. low	The response of blank measurement is below the parameter <i>Blank Resp. min</i> given to the blank measurement in the Test definition > Flow tab.	The automatic acceptance is changed to manual acceptance.
Calculation error	A calculation error has occurred. The reasons for the error are shown in the Messages window.	The automatic acceptance is changed to manual acceptance.
Coeff. of det. limit	Coefficient of determination is calculated for standard addition curve. If the value is below the limit, an error message is shown.	The automatic acceptance is changed to manual acceptance.
Crit. limit high	The result is above the parameter <i>Critical limit max</i> given in the Test definition > Limits tab.	The automatic acceptance is changed to manual acceptance.
Crit. limit low	The result is below the parameter <i>Critical limit min</i> given in the Test definition > Limits tab.	The automatic acceptance is changed to manual acceptance.
Dil. limit high	The measurement has been carried out and the result is above the parameter <i>Measuring range max</i> of a certain dilution step given in the Test definition > Limits tab. Case 2: The measurement has been carried out and the <i>Check rate max</i> is above the parameter <i>Max rate (A/min)</i> given in the Test definition > Flow tab (Absolute value). The first result could be near to zero.	Rerun is done automatically with higher dilution. If Dil. limit high error flag is given to the final result the automatic acceptance is changed to manual acceptance.
Dil. limit low	The measurement has been carried out and the result is below the parameter <i>Measuring range min</i> of a certain dilution step given in the Test definition > Limits tab.	Next dilution step is performed. If Dil. limit low error flag is given to the final result the automatic acceptance is changed to manual acceptance.
Init abs. high	The absorbance measurement result is above the parameter <i>Initial absorbance max</i> given in the Test definition > Limits tab. Applicable for photometric tests only.	The automatic acceptance is changed to manual acceptance.
Init abs. low	The absorbance measurement result is below the parameter <i>Initial absorbance min</i> given in the Test definition > Limits tab. Applicable for photometric tests only.	The automatic acceptance is changed to manual acceptance.

19 Checking messages

Checking messages

Error flag	Definition	Result acceptance
Linearity	With the linear cut curve type, the linear part of the curve is so short that only the first or the second point is included. The reaction ends too early during the measurement time. The calculation of the response always requires at least three points. This error flag is also set if the nonlinearity limit (mA/min) has been exceeded and the absolute value of the reaction rate in the beginning of the measurement is lower than in the end. All measured points are used for the calculations. With the linear curve type, the parameters <i>Nonlinearity conc.</i> and <i>Nonlinearity %</i> have been achieved. Parameters are given in the Test definition > Flow tab for the kinetic measurement.	The automatic acceptance is changed to manual acceptance.
Liquid movement	An error with liquid movement in the ECM block has occurred.	The automatic acceptance is changed to manual acceptance.
Outside calibration	Results calculated with calibration type Logit-log 4, Logit-log 5, 2nd order and spline: Measurement is out of the calibration range.	If the result is outside calibration and dilution is in use, outside calibration flag is not given and the rerun is done automatically with dilution. If the outside calibration flag is given to the final result, the automatic acceptance is changed to manual acceptance.
Point(s) out of curve	One or more measured absorbance points fall out of the curve calculated according to linear regression.	The automatic acceptance is changed to manual acceptance.
Reaction direction	The reaction direction is different from the test parameters.	The automatic acceptance is changed to manual acceptance.
Reference range high	The result is above the parameter <i>Maximum value</i> given in the Test definition > Limits tab.	The automatic acceptance is changed to manual acceptance.
Reference range low	The result is below the parameter <i>Minimum value</i> given in the Test definition > Limits tab.	The automatic acceptance is changed to manual acceptance.

Error flag	Definition	Result acceptance
Rule {0} violated	The result of quality control sample is not within acceptable limits given in the Test definition > Flow tab.	Batch not connected to calibration: <ul style="list-style-type: none"> The automatic acceptance is changed to manual acceptance. Sample requests are not accepted automatically if any QC request has the rule violation and user has not accepted all QC requests. Batch connected to calibration: <ul style="list-style-type: none"> The automatic acceptance is changed to manual acceptance.
Slope limit max	Slope of standard addition curve is above the parameter <i>Slope limit max</i> given in the Test definition > Flow tab.	The automatic acceptance is changed to manual acceptance.
Slope limit min	Slope of standard addition curve is below the parameter <i>Slope limit min</i> given in the Test definition > Flow tab.	The automatic acceptance is changed to manual acceptance.
Test limit high	The result is above the parameter <i>Test limit max</i> given in the Test definition > Limits tab.	The automatic acceptance is changed to manual acceptance.
Test limit low	The result is below the parameter <i>Test limit min</i> given in the Test definition > Limits tab.	The automatic acceptance is changed to manual acceptance.
Unstable	An ECM measurement is unstable.	The automatic acceptance is changed to manual acceptance.
Unstable (CAL1)	An ECM rinse liquid measurement is unstable.	The automatic acceptance is changed to manual acceptance.

Table 16. Calibration errors

Error flag	Definition	Calibration acceptance
Bias limit max	Bias is above the parameter <i>Bias limit max</i> in the Test definition > Calibration tab.	The automatic acceptance is changed to manual acceptance.

19 Checking messages

Checking messages

Error flag	Definition	Calibration acceptance
Bias limit min	Bias is below the parameter than <i>Bias limit min</i> in the Test definition > Calibration tab.	The automatic acceptance is changed to manual acceptance.
Calculation	Calculation error has occurred during the calibration calculation. The reasons for the error are shown in the Messages window.	The calibration cannot be accepted.
Calculation error	A calculation error has occurred during the calibration calculation. The reasons for the error are shown in the Messages window.	The automatic acceptance is changed to manual acceptance.
Coeff. of det. limit	Coefficient of determination is calculated for calibration. If the value is lower than the limit, an error message is shown.	The automatic acceptance is changed to manual acceptance.
E.e. out of limit	At least one of the calibration points is out of error limits.	The automatic acceptance is changed to manual acceptance.
Extreme found	The calibration curve/equation has an extreme inside the calibration area.	The calibration cannot be accepted.
Factor limit max	Factor is above the parameter <i>Factor limit max</i> given in the Test definition > Calibration tab. Applicable for photometric tests only.	The automatic acceptance is changed to manual acceptance.
Factor limit min	Factor is below the parameter <i>Factor limit min</i> given in the Test definition > Calibration tab. Applicable for photometric tests only.	The automatic acceptance is changed to manual acceptance.
Point error	Calibration point is out of error limit(s).	The automatic acceptance is changed to manual acceptance.
Slope limit max	Slope is higher than <i>Slope limit max</i> given in the Test definition > Calibration tab. Applicable for ECM-tests only.	The automatic acceptance is changed to manual acceptance.
Slope limit min	Slope is lower than <i>Slope limit min</i> given in the Test definition > Calibration tab. Applicable for ECM-tests only.	The automatic acceptance is changed to manual acceptance.
Unstable	An ECM measurement is unstable.	The automatic acceptance is changed to manual acceptance.

Error flag	Definition	Calibration acceptance
Unstable (CAL1)	An ECM rinse liquid measurement is unstable.	The automatic acceptance is changed to manual acceptance.

Messages from workstation

Messages to and from analyzer (0 - TRAREC)

Message ID	Message
1	Process is going down (TRAREC)
102	Message queue error (TRAREC)
103	Message queue error (TRAREC)
104	Message queue error (TRAREC)
105	Message queue error (TRAREC)
106	Message queue error (TRAREC)

An internal communication error. Perform the start-up procedure to continue the analysis. If the problem persists, contact Service.

Message ID	Message
999	TRAREC error message [%]

A percent sign [%] indicates an error message number. A software problem. Restart the workstation.

If the problem persists, contact Service.

Timetable (1 - Timet)

Message ID	Message
1001	Process is going down (Timet)
1002	Serious software error (Timet)
1003	Message queue error (Timet)

An internal communication error. Perform the start-up procedure to continue the analysis. If the problem persists, restart the workstation.

19 Checking messages

Checking messages

If the problem persists after restart, contact Service.

Message ID	Message
1021	Database lock error (Timet)
1022	Error when doing database operation (Timet)
1031	Wrong data from database (Timet)
1032	Wrong data from an other process (Timet)
1033	Internal data error (Timet)

An internal communication error. Perform the start-up procedure to continue the analysis. If the problem persists, remove racks and clear daily files.

If the problem persists after removing racks and clearing daily files, contact Service.

Message ID	Message
1201	Analyzing not allowed (check water, cuvettes, containers and covers)

Check

- The deionized water container is full and in its place.
- The waste water container is empty and in its place.
- The cuvette waste bin is empty and in its place.
- The cuvettes are loaded.
- The covers are closed.
- The analyzer is not in the running mode.

To start the analysis, press **Start**.

Message ID	Message
1202	Analyzing not allowed (start-up not done)

Perform the start-up procedure to start the analysis.

Message ID	Message
1203	Impossible dilution ratio 1 + [%] in test [1], sample [2]

A percent sign [%] indicates the dilution ratio. [1] indicates the test name and [2] sample name. Check the test and sample data.

Message ID	Message
1204	Electrode direct setting / request dilution ratio mismatch in test [%], sample [1]

A percent sign [%] indicates the test name and [1] indicates the sample name. Check the sample data.

Message ID	Message
1205	Nothing to analyze

Check that sample racks are OK. For example, check that the barcode reader is able to read the barcodes and the racks are in the analyzer. Insert samples into the racks, feed racks into the analyzer and check that the samples have requests defined.

Message ID	Message
1206	Analyzing stopped (check messages)

Perform remedy procedures and continue analysis.

If the problem persists, contact Service.

Message ID	Message
1207	Analyzing stopped (PAUSE has been pressed)

To continue the analysis, press **Start**.

Message ID	Message
1208	Test [%] requires incubation before action [1] (reagent [2] wash)

A percent sign [%] indicates test name, [1] indicates the ordinal number of an action in the defined test flow, and [2] the reagent ID. Check the test flow definition.

Message ID	Message
1209	Lot concentration is missing (control [%], test [1])

A percent sign [%] indicates the control ID and [1] test name. Define the concentration for the current lot. To continue the analysis, press **Start**.

19 Checking messages

Checking messages

Message ID	Message
1210	Filter is missing (test [%], wavelength [1])

A percent sign [%] indicates the test ID and [1] the wavelength of the missing filter. If the filter is missing from filter wheel, contact Service.

Message ID	Message
1218	Internal timing error

Analyzer's tick length does not match with the original tick. Analysis continues.

Message ID	Message
1219	Control [%1] is missing for [%2].

The first percent sign [%1] indicates the control name and the second [%2] test name. The message appears when the control required by the routine QC is short, expired or missing from the analyzer. Insert the control in the analyzer. You can continue analysis without missing control but you must accept results manually.

Message ID	Message
1999	Timet error message [%]

A percent sign [%] indicates an error message number. A software problem. Analysis continues. If the problem persists, contact Service.

Response handler (2 - RH)

Message ID	Message
2001	Process is going down (RH)

An internal communication error. Restart the software.
If the problem persists, contact Service.

Message ID	Message
2002	Serious software error (RH)
2003	Message queue error (RH)

An internal communication error. Analyzer goes to **Start-up not done** state. Perform the start-up procedure to continue the analysis.

If the problem persists, contact Service.

Message ID	Message
2011	Calculation error: zero divider (RH)
2012	Calculation error: log from negative (RH)
2013	Calculation error: too high exponent (RH)

An internal calculation error. For example, calibration is not successful.

Message ID	Message
2021	Database lock error (RH)

An internal software problem handling the database. The analysis stops immediately. Press **Start** to continue the analysis. If the problem persists, restart the workstation.

If the problem persists after restart, contact Service.

Message ID	Message
2022	Error when doing database operation (RH)
2031	Wrong data from database (RH)
2032	Wrong data from an other process (RH)
2033	Internal data error (RH)

An internal software error. Perform the start-up procedure to continue the analysis. If the problem persists, remove racks and clear daily files.

If the problem persists after removing racks and clearing daily files, contact Service.

Message ID	Message
2301	Reagent disk is full of vials

To add a new reagent, remove an existing reagent from the analyzer when analysis is not in progress.

Message ID	Message
2302	Rack disk full of racks

Remove an existing rack from the analyzer before adding a new rack.

19 Checking messages

Checking messages

Message ID	Message
------------	---------

2303	No water blank data (RH)
------	--------------------------

Perform the start-up procedure.

Message ID	Message
------------	---------

2304	No test data (RH)
------	-------------------

A notification message. Message does not require action from the operator.

Message ID	Message
------------	---------

2305	Duplicate unique reagent vial
------	-------------------------------

The operator has inserted the same reagent vial twice into the analyzer. Remove another reagent vial.

Message ID	Message
------------	---------

2306	Poor water blank measurement ([%], SD)
------	--

For example, a poor water blank measurement 340 nm SD=2.1 mA. A percent sign [%] indicates the measured wavelength and SD=mA indicates the measured standard deviation.

First, perform the start-up procedure. If the problem persists, try the following:

- Wash the deionized water container as instructed in the maintenance instructions.
- Empty the cuvette loader and reload it. Perform water blank in the **Actions** view.

If the problem persists, contact Service.

Message ID	Message
------------	---------

2307	Reagent vial had an unknown barcode ([%])
------	---

A percent sign [%] indicates the unknown barcode number. The analyzer did not recognize the barcode.

Check that the correct barcode is readable through the opening of the vial position. If the vials have two barcodes, insert the vial so that the longer barcode is readable through the opening of the vial position.

The barcode ID for the reagent is defined in the **Reagent definition** view. Remove reagent from the analyzer. Define the barcode ID in the **Reagent definition** view when analysis is not in progress. Insert reagent back into the analyzer.

Message ID	Message
------------	---------

2308	Wrong rack type, ID [%]
------	-------------------------

A percent sign [%] indicates the rack number. Check the rack type, because sample and reagent racks differ from each other. Sample rack has 9 positions and reagent rack 6 positions.

Message ID	Message
------------	---------

2309	Rack without barcode
------	----------------------

Remove the rack from the analyzer and check the quality of the barcode label. Change the barcode label, if necessary.

Message ID	Message
------------	---------

2310	No valid calibration
------	----------------------

Request calibration in the **Calibrations** view. After calibration has been accepted, requests can be analyzed.

Message ID	Message
------------	---------

2311	Filter is missing (test [%], wavelength [1])
------	--

A percent sign [%] indicates the test ID and [1] the wavelength of the missing filter. Contact Service.

Message ID	Message
------------	---------

2312	Duplicate rack ID ([%])
------	-------------------------

A percent sign [%] indicates the rack ID number. Check that the different racks do not have the same IDs. Analyzer ignores the last inserted rack. Insert samples into a new rack.

Message ID	Message
------------	---------

2313	A new rack detected by analyzer ([%])
------	---------------------------------------

An information message. A percent sign [%] indicates the rack ID number. Analyzer informs the operator about a new rack and the analysis continues.

Message ID	Message
------------	---------

2314	Unknown reagent vial found in position [%]
------	--

A percent sign [%] indicates the reagent position. The analyzer does not recognize the vial.

19 Checking messages

Checking messages

Message ID	Message
2315	Unknown reagent barcode ID ([%])

A percent sign [%] indicates the barcode number. The analyzer does not recognize the barcode.

Remove vial from the analyzer and inspect the barcode. Check the reagents' data in the **Reagent definition** view and insert vial back into the analyzer.

Message ID	Message
2317	Too low signal from lamp, filter [%]

A percent sign [%] indicates the filter number. Perform the start-up procedure to continue the analysis.

If the problem persists, contact Service.

Message ID	Message
2322	Reflex test missing

An information message. Take the reflex test into use in the **Test definition** view. Set value "Yes" to *In use* parameter. Analysis continues.

Message ID	Message
2327	Temperature out of range ([%])

A percent sign [%] indicates where the fault took place. Temperature is below its target value. Analysis stops after the analyzer has completed the on-going requests. Restart the analyzer and check the laboratory temperature.

If the problem persists, contact Service.

Message ID	Message
2328	Temperature out of range ([%])

A percent sign [%] indicates where the fault took place and sends out a warning message that the disk is too warm. Restart the analyzer and check the laboratory temperature. If the reagent disk is too warm, change reagents and run manual quality controls.

If the problem persists, contact Service.

Message ID	Message
2329	Too low reference from lamp, filter [%]

A percent sign [%] indicates the filter number. Perform the start-up procedure to continue the analysis.

If the problem persists, contact Service.

Message ID	Message
2999	Response handler error message [%]

A percent sign [%] indicates an error message number. A software problem. Analysis continues.

User interface (3 - UI)

Message ID	Message
3001	Process is going down (UI)
3002	Serious software error (UI)
3003	Message queue error (UI)

An internal communication error. Perform the start-up procedure to continue the analysis.

If the problem persists, contact Service.

Message ID	Message
3011	Calculation error: zero divider (UI)
3012	Calculation error: log from negative (UI)
3013	Calculation error: too high exponent (UI)

An internal calculation error. For example, calibration is not successful.

Message ID	Message
3021	Database lock error (UI)

An internal software problem handling the database. The analysis stops immediately. Press **Start** to continue the analysis. If the problem persists, restart the workstation.

If the problem persists after restart, contact Service.

19 Checking messages

Checking messages

Message ID	Message
3022	Error when doing database operation (UI)

An internal software problem handling the database. Analysis continues. If the problem persists, restart the workstation.

If the problem persists after restart, contact Service.

Message ID	Message
3031	Wrong data from database (UI)
3032	Wrong data from an other process (UI)

An internal communication error. Perform the start-up procedure to continue the analysis. If the problem persists, remove racks and clear daily files.

If the problem persists after removing racks and clearing daily files, contact Service.

Message ID	Message
3033	Internal data error (UI)
3034	Wrong data from an other window (UI)

An internal communication error. Analysis continues. If the problem persists, remove racks and clear daily files.

If the problem persists after removing racks and clearing daily files, contact Service.

Message ID	Message
3041	Cannot open or read [%] (UI)

A percent sign [%] indicates a file name. Selected file is not readable. Contact Service.

Message ID	Message
3042	Corrupted [%] (UI)

A percent sign [%] indicates a file name. Selected file is corrupted. Contact Service.

Message ID	Message
3508	[%] file create failed

A percent sign [%] indicates a file name.

A software problem in the configuration data. Restart the workstation.

If the problem persists after restart, contact Service.

Message ID	Message
3511	Not enough free space on hard disk

Delete unnecessary files from workstation.

Message ID	Message
3513	DB request count is approaching [%]. Use clear daily files.

A percent sign [%] indicates the maximum number of the files.

Select F5 > Actions > **Clear daily files** to clear daily files.

Message ID	Message
3999	UI error message [%]

A percent sign [%] indicates an error message number. A software problem. Analysis continues.

Laboratory information management system (4 - LIMS)

Message ID	Message
4001	Process is going down (LIS)
4002	Serious software error (LIS)
4003	Message queue error (LIS)

A software problem. Restart the workstation. Perform the start-up procedure to continue the analysis.

If the problem persists, contact Service.

Message ID	Message
4022	Error when doing database operation (LIMS)

An internal software problem related to the database. Analysis continues. If the problem persists, restart the workstation.

If the problem persists after restart, contact Service.

Message ID	Message
4032	Wrong data from an other process (LIMS)

An internal software problem. Restart the workstation.

19 Checking messages

Checking messages

If the problem persists after restart, contact Service.

Message ID	Message
4401	Serial line parameter error (LIMS)
4402	Wrong serial port (LIMS)

Check the serial interface parameters in the **Configuration** view.

Message ID	Message
4403	Write error (LIMS)
4404	Read error (LIMS)

Connection error. Contact Service.

Message ID	Message
4406	Communication time-out (LIMS)

Connection error. Contact Service.

Message ID	Message
4407	Transmission error (LIMS)
4409	Message buffer error (LIMS)
4414	M record transmission failed

Connection error. Contact Service.

Message ID	Message
4415	TCP/IP client cannot connect to server (LIMS)

Connection error. Contact Service.

Message ID	Message
4416	Invalid test online name [%] (LIMS)

A percent sign [%] indicates the test online name.

If the problem persists, contact Service.

Message ID	Message
4417	Test [%] not in use (LIMS)

A percent sign [%] indicates the test name.

If the problem persists, contact Service.

Message ID	Message
4999	LIMS error message [%]

A percent sign [%] indicates an error message number. A software problem. Analysis continues.

Master (5 - MASTER)

Message ID	Message
5001	Internal data error (Master)

A software problem. Analysis stops immediately. Another message specifies the problem, for example, probe error.

If the problem persists, contact Service.

Message ID	Message
5002	Master error: used too much time

The analyzer is behind the schedule. Analyzer recovers automatically.

Message ID	Message
5003	Master error: cannot send CAN-message

Workstation cannot send a message to the board. Analysis stops. Restart the analyzer to check if the software causes the problem.

If the problem persists, contact Service.

Message ID	Message
5004	Master error: unexpected node [%] boot

A percent sign [%] indicates an error message number. Restart the analyzer to check if the software causes the problem.

If the problem persists, contact Service.

19 Checking messages

Checking messages

Message ID	Message
5007	[%] initialization failed

A percent sign [%] indicates an analyzer part.

- Rack disk
 - If a mechanical obstacle is detected, open the cover and remove the obstacle, for example, incorrectly placed reagent vial. Run water wash before continuing.
 - Sample racks are inserted incorrectly. Check the racks and run water wash before continuing.
 - If the problem persists, contact Service.
- Incubator
 - If a mechanical obstacle is detected, remove the obstacle. Run water wash before continuing.
 - Restart the analyzer.
 - If the problem persists, contact Service.

Message ID	Message
5010	CAN initialization failure

A software problem. Restart the workstation.

If the problem persists, contact Service.

Message ID	Message
5011	Analyzer turned off

An information message. Analyzer has been switched off. Switch on the analyzer from the main switch.

Message ID	Message
5012	Photometer delay should be adjusted ([%])

A software problem. Restart the workstation.

If the problem persists, contact Service.

Message ID	Message
5014	[%]: liquid level detection error

Liquid detected falsely above the surface. Analysis stops. Restart the workstation.

If the problem persists, contact Service.

Message ID	Message
5015	Cuvette unit initialization failed ([%])

If an obstacle is detected, remove it. Run water wash before continuing. Press **Start** to continue the analysis. Restart the workstation.

If the problem persists, contact Service.

Message ID	Message
5016	Cuvette funnel sensor error

A mechanical problem. Contact Service.

Message ID	Message
5017	[%] hit an obstacle

A percent sign [%] indicates analyzer part. The message is also given after message 5028 when the analyzer is initializing.

- Check the straightness of the probe or mixer.
- Remove an obstacle and perform water wash before continuing.

If the problem persists, contact Service.

Message ID	Message
5020	Cuvette check found a dirty cuvette

Empty the cuvette loader and reload it. Perform water blank in the **Actions** view.

Message ID	Message
5021	Cuvette jammed when inserting cuvette to incubator

Cuvettes are not properly placed in the cuvette loader. Empty the cuvette loader manually and reload it. If a damaged cuvette is in the cuvette loader or in the incubator, remove the cuvette. Restart the workstation and analyzer.

If the problem persists, contact Service.

19 Checking messages

Checking messages

Message ID	Message
------------	---------

5022	Analyzer adjustment file error
------	--------------------------------

An adjustment file has corrupted and the connection to the analyzer has not been established. Restart the analyzer and workstation.

If the problem persists, contact Service.

Message ID	Message
------------	---------

5023	Node [%] sent wrong data
------	--------------------------

A percent sign [%] indicates a board number. A software problem. Press **Start** to continue the analysis. If the problem persists, restart the analyzer.

If the problem persists after restart, contact Service.

Message ID	Message
------------	---------

5024	Internal data error (Master)
------	------------------------------

A software problem. Analysis stops immediately. Another message may specify the problem, for example, probe error.

If the problem persists, contact Service.

Message ID	Message
------------	---------

5026	Node [%] sent a wrong message
------	-------------------------------

A percent sign [%] indicates a board number. A software problem. Press **Start** to continue the analysis. If the problem persists, restart the analyzer.

If the problem persists after restart, contact Service.

Message ID	Message
------------	---------

5027	Node [%] did not boot
------	-----------------------

A percent sign [%] indicates a board number. Closes connection to the analyzer. Restart the workstation.

If the problem persists, contact Service.

Message ID	Message
5028	[%] hit an obstacle, corrected automatically

A percent sign [%] indicates analyzer part.

An information message. The message is given before the message 5017 when the analyzer is initializing.

Message ID	Message
5029	Node [%] did not respond

A percent sign [%] indicates a board number. Closes connection to the analyzer. Restart the workstation.

If the problem persists, contact Service.

Message ID	Message
5032	Pressure sensor check failed

The operational check for the pressure sensor failed in the start-up or when performed manually. Check diluent water and repeat Pressure sensor check operation.

If the problem persists, contact Service.

Message ID	Message
5033	Pressure sensor malfunction

The pressure sensor malfunction occurred in the start-up or when performed Pressure sensor check. Check diluent water and repeat Pressure sensor check operation.

If the problem persists, contact Service.

Message ID	Message
5034	Pressure sensor: tubing blocked

The pressure sensor has detected overpressure and tubing is probably blocked. Analyzer goes into Start up not done state. Run start up. If problem persists, run monthly maintenance wash and pressure sensor check.

If the problem persists, contact Service.

19 Checking messages

Checking messages

Message ID	Message
------------	---------

5035	[%] initialization failed
------	---------------------------

A percent sign [%] indicates analyzer part. If an obstacle is detected, remove it. Run water wash before continuing. Press **Start** to continue the analysis. Restart the workstation.

If the problem persists, contact Service.

Message ID	Message
------------	---------

5036	Pressure sensor: no water
------	---------------------------

The pressure sensor has detected lack of diluent water. Add diluent water and repeat Pressure sensor check operation.

If the problem persists, contact service.

Message ID	Message
------------	---------

5038	[%] initialization failed
------	---------------------------

A percent sign [%] indicates analyzer part. Check that dispenser can move vertically. If an obstacle is detected, remove it. Run water wash before continuing. Press **Start** to continue the analysis. Restart the workstation.

If the problem persists, contact Service.

Message ID	Message
------------	---------

5039	[%] opened unexpectedly
------	-------------------------

A percent sign [%] indicates the opened cover. Close the cover and press **Start** to continue the analysis.

Message ID	Message
------------	---------

5040	Main cover opened
------	-------------------

An information message. The main cover is opened and actions are stopped immediately. Moving parts are moved to their resting positions.

Message ID	Message
------------	---------

5041	Main cover closed
------	-------------------

An information message. The main cover closed.

Message ID	Message
------------	---------

5044	[%] initialization failed
------	---------------------------

A percent sign [%] indicates analyzer part. Restart the workstation. Run water wash before continuing. Press **Start** to continue the analysis.

If the problem persists, restart the workstation.

Message ID	Message
------------	---------

5048	[%] position corrected automatically
------	--------------------------------------

A percent sign [%] indicates analyzer part. Correction procedure is performed automatically.

Message ID	Message
------------	---------

5049	[%] feedback error
------	--------------------

A percent sign [%] indicates analyzer part. Perform the start-up procedure to continue the analysis. If an obstacle is detected, check that the rack disk or incubator can move. Run water wash before continuing. Restart the workstation.

If the problem persists, contact Service.

Message ID	Message
------------	---------

5058	[%] position corrected automatically
------	--------------------------------------

A percent sign [%] indicates analyzer part. Correction procedure is performed automatically.

Message ID	Message
------------	---------

5059	[%] feedback error
------	--------------------

A percent sign [%] indicates analyzer part.

If the problem persists, contact Service.

Message ID	Message
------------	---------

5062	Liquid transfer problem (Electrode)
------	-------------------------------------

The liquid detector in the ECM block is not able to find the liquid-air boundary.

- Check if the ECM drift control is short and change the bag.
- Ensure that the contact between end slices and liquid detection wires are tight enough.

19 Checking messages

Checking messages

If the problem persists, contact Service.

Note If the combination of the error messages 5062 and 5067 is observed, contact Service.

Message ID	Message
5065	Syringes should be adjusted (adjustment program)

Perform the start-up procedure to continue the analysis.

If the problem persists, contact Service.

Message ID	Message
5066	Workstation sent wrong data.

A software problem. Press **Start** to continue the analysis.

If the problem persists, contact Service.

Message ID	Message
5067	[%] init failed

A percent sign [%] indicates analyzer part. If an obstacle is detected, remove it. Restart the analyzer. Run water wash before continuing. Press **Start** to continue the analysis.

If the problem persists, restart the analyzer.

Note If the combination of the error messages 5062 and 5067 is observed, contact Service.

Message ID	Message
5999	Master error message [%]

A percent sign [%] indicates an error message number. A software problem. Analysis continues.

Messages from analyzer's nodes

Boot (6 - B00T)

Message ID	Message
6001	Boot [%]: unexpected start of application

A percent sign [%] indicates a board number. Closes connection to the analyzer due to the broken board. Restart the analyzer.

If the problem persists, contact Service.

Message ID	Message
6002	Boot [%]: checksum error

A percent sign [%] indicates a board number. Closes connection to the analyzer. Restart the analyzer.

If the problem persists, contact Service.

Message ID	Message
6241	Boot [%]: unknown command [1]
6242	Boot [%]: unknown parameter(s), command [1]
6243	Boot [%]: wrong node type [1]
6244	Boot [%]: configuration error
6245	Boot [%]: decode error, command [1]
6246	Boot [%]: supply voltage error
6247	Boot [%]: supply voltage error
6248	Boot [%]: internal error [1]
6249	Boot [%]: CAN-message overflow
6250	Boot [%]: internal warning [1]

A percent sign [%] indicates a board number. Analysis continues.

If the problem persists, contact Service.

19 Checking messages

Checking messages

Message ID	Message
6999	Boot [%]: error message [1]

A percent sign [%] indicates a board number and [1] the message code. A software problem. Analysis continues.

Motor (7 - MOTOR)

Message ID	Message
7051	Motor [%]: wrong action

A percent sign [%] indicates a board number. Closes connection to the analyzer. Restart the analyzer.

If the problem persists, contact Service.

Message ID	Message
7052	Motor [%]: feedback error, wrong position
7053	Motor [%]: feedback error, device has been moved

A percent sign [%] indicates a board number. Analysis continues.

If an obstacle is detected, remove it before continuing. Run water wash before continuing. Restart the workstation.

Message ID	Message
7054	Motor [%]: over-current error

A percent sign [%] indicates a board number. Restart the analyzer.

If the problem persists, contact Service.

Message ID	Message
7055	Motor [%]: production test error [1]

A percent sign [%] indicates a board number and [1] an error code. Closes connection to the analyzer due to the broken board. Restart the analyzer.

If the problem persists, contact Service.

Message ID	Message
7241	Motor [%]: unknown command [1]

Message ID	Message
7242	Motor [%]: unknown parameter(s), command [1]

A percent sign [%] indicates a board number and [1] a command number. Closes connection to the analyzer. Restart the analyzer.

If the problem persists, contact Service.

Message ID	Message
7243	Motor [%]: wrong node type [1]
7244	Motor [%]: configuration error

A percent sign [%] indicates a board number and [1] a board type. Restart the analyzer.

If the problem persists, contact Service.

Message ID	Message
7245	Motor [%]: decode error, command [1]

A percent sign [%] indicates a board number and [1] a command number. A software problem. Press **Start** to continue the analysis. If the problem persists, restart the analyzer.

If the problem persists after restart, contact Service.

Message ID	Message
7246	Motor [%]: supply voltage error
7247	Motor [%]: supply voltage error

A percent sign [%] indicates a board number. Restart the analyzer.

If the problem persists, contact Service.

Message ID	Message
7248	Motor [%]: internal error [1]

A percent sign [%] indicates a board number and [1] an error code. Restart the workstation and analyzer.

If the problem persists, contact Service.

Message ID	Message
7249	Motor [%]: CAN-message overflow

A percent sign [%] indicates a board number. Restart the analyzer and workstation.

19 Checking messages

Checking messages

If the problem persists, contact Service.

Message ID	Message
7250	Motor [%]: internal warning [1]

A percent sign [%] indicates a board number and [1] an error code. An information message. Analysis continues.

If the problem persists, contact Service.

Message ID	Message
7999	Motor [%]: error message [1]

A percent sign [%] indicates a board number and [1] an error message code. A software problem. Analysis continues.

Photometer (8 - PHOTO)

Message ID	Message
8011	Photometer: filter disk speed high
8012	Photometer: filter disk speed low
8014	Photometer: reference level high
8015	Photometer: reference level low
8016	Photometer: signal level high
8018	Photometer: filter wheel synchronization error

Perform the start-up procedure to continue the analysis.

If the problem persists, contact Service.

Message ID	Message
8241	Photometer: unknown command [%]
8242	Photometer: unknown parameter(s), command [%]

A percent sign [%] indicates a command number. Closes connection to the analyzer. Restart the analyzer.

If the problem persists, contact Service.

Message ID	Message
8243	Photometer: wrong node type [%]
8244	Photometer: configuration error

A percent sign [%] indicates a board type number. Closes connection to the analyzer. Restart the analyzer.

If the problem persists, contact Service.

Message ID	Message
8245	Photometer: decode error, command [%]

A percent sign [%] indicates a command number. A software problem. Press **Start** to continue the analysis. If the problem persists, restart the analyzer.

Message ID	Message
8246	Photometer: supply voltage error
8247	Photometer: supply voltage error

Incorrect supply voltage detected in the board. Restart the analyzer.

If the problem persists, contact Service.

Message ID	Message
8248	Photometer: internal error [%]

A percent sign [%] indicates an error number. Internal error in the photometer. Check that the incubator cover is unbroken and in place. Press **Start** to continue the analysis.

If the problem persists, contact Service.

Message ID	Message
8249	Photometer: CAN message overflow

A software problem. Restart the analyzer.

If the problem persists, contact Service.

Message ID	Message
8250	Photometer: internal warning [%]

A percent sign [%] indicates an error code. An information message. Analysis continues.

19 Checking messages

Checking messages

If the problem persists, contact Service.

Message ID	Message
8999	Photometer error: message [%]

A percent sign [%] indicates an error message number. A software problem. Analysis continues.

Electrode (9 - ELECTRODE)

Message ID	Message
9031	Electrode: unstable measurement ([%])

A percent sign [%] indicates the electrode's name (color). Repeat analysis of the request. If the error is continuously repeated for the same electrode, the electrode requires maintenance or needs to be changed. See [Electrode maintenance](#) on page 144.

Message ID	Message
9032	Electrode: DVM level low ([%])
9033	Electrode: DVM level high ([%])

A percent sign [%] indicates an electrode's name (color).

- If there is a loose contact between the electrode pin and electrode cap, press sides of the signal wire's cap gently with pliers.
- If an electrode is dirty, wash the electrode with washing solution.
- If an electrode is expired, change the electrode.
- If all electrodes give too low or too high DVM, the filling solution may be missing from the reference electrode or it may be damaged. Check the reference electrode and fill the inner chamber with fresh filling solution as necessary. Check the electrode pin and change if needed. See [Electrode maintenance](#) on page 144.

Restart the analyzer.

If the problem persists, contact Service.

Message ID	Message
9034	Electrode: impedance level high ([%])
9035	Electrode: impedance level low ([%])

A percent sign [%] indicates an electrode's name. Impedance level is too high or too low. Restart the analyzer.

If the problem persists, contact Service.

Message ID	Message
9241	Electrode: unknown command ([%])
9242	Electrode: unknown parameter(s), command ([%])

A percent sign [%] indicates a command number. A software problem. Restart the analyzer.
If the problem persists, contact Service.

Message ID	Message
9243	Electrode: wrong node type [%]

A percent sign [%] indicates a board type. Closes connection to the analyzer. Restart the analyzer.
If the problem persists, contact Service.

Message ID	Message
9244	Electrode: configuration error

A software problem. Restart the analyzer.
If the problem persists, contact Service.

Message ID	Message
9245	Electrode: decode error, command [%]

A percent sign [%] indicates a command number. A software problem. Press **Start** to continue the analysis. If the problem persists, restart the analyzer.
If the problem persists after restart, contact Service.

Message ID	Message
9246	Electrode: supply voltage error
9247	Electrode: supply voltage error

Incorrect power supply detected in the board. Restart the analyzer.
If the problem persists, contact Service.

Message ID	Message
9248	Electrode: internal error [%]

A percent sign [%] indicates an error number. A software problem. Restart the analyzer.
If the problem persists, contact Service.

19 Checking messages

Checking messages

Message ID	Message
9249	Electrode: CAN message overflow

Restart the analyzer and workstation.
If the problem persists, contact Service.

Message ID	Message
9250	Electrode: internal warning [%]

A percent sign [%] indicates a warning number. Analysis continues.
If the problem persists, contact Service.

Message ID	Message
9999	Electrode error: message [%]

A percent sign [%] indicates an error message number. A software problem. Analysis continues.
If the problem persists, contact Service.

Control (10 - CONTROL)

Message ID	Message
10071	Control: fuse broken

The board's fuse is broken. Contact Service.

Message ID	Message
10072	Control: shortcircuit, channel [%]
10073	Control: wire broken, channel [%]

A percent sign [%] indicates where the fault took place. Restart the analyzer.
If the problem persists, contact Service.

Message ID	Message
10074	Control: BCR error, channel [%]

A percent sign [%] indicates the barcode reader in which the fault took place. A notification message. A problem with barcode reader has occurred. Message does not require action from the operator.

If the problem persists, contact Service.

Message ID	Message
10075	Control: production test error [%]

A percent sign [%] indicates an error code. Restart the analyzer.

If the problem persists, contact Service.

Message ID	Message
10241	Control: unknown command [%]
10242	Control: unknown parameter(s), command [%]

A percent sign [%] indicates a command number. Closes connection to the analyzer. Restart the analyzer.

If the problem persists, contact Service.

Message ID	Message
10243	Control: wrong node type [%]

A percent sign [%] indicates a board type. Restart the analyzer.

If the problem persists, contact Service.

Message ID	Message
10244	Control: configuration error

A configuration error. Restart the analyzer.

If the problem persists, contact Service.

Message ID	Message
10245	Control: decode error, command [%]

A percent sign [%] indicates a command number. A software problem. Press **Start** to continue the analysis. If the problem persists, restart the analyzer.

If the problem persists after restart, contact Service.

Message ID	Message
10246	Control: supply voltage error

19 Checking messages

Checking messages

Message ID	Message
------------	---------

10247	Control: supply voltage error
-------	-------------------------------

Incorrect power supply detected in the board. Restart the analyzer.

If the problem persists, contact Service.

Message ID	Message
------------	---------

10248	Control: internal error [%]
-------	-----------------------------

A percent sign [%] indicates an error number. Internal software error in the board. Restart the analyzer.

If the problem persists, contact Service.

Message ID	Message
------------	---------

10249	Control: CAN-message overflow
-------	-------------------------------

Restart the analyzer and workstation.

If the problem persists, contact Service.

Message ID	Message
------------	---------

10250	Control: internal warning [%]
-------	-------------------------------

A percent sign [%] indicates a warning number. An information message. Analysis continues.

If the problem persists, contact Service.

Message ID	Message
------------	---------

10999	Control error: message [%]
-------	----------------------------

A percent sign [%] indicates an error message number. A software problem. Analysis continues.

If the problem persists, contact Service.

Report (13 - REPORT)

Message ID	Message
------------	---------

13606	No printer installed
-------	----------------------

The printer drivers are missing. Install the printer when analysis it not going on. Check that connecton to printer is OK and the printer is on. Try printing again. If the problem persists, restart the analyzer.

If the problem persists after restart, contact Service.

Message ID	Message
13999	Report error: message [%]

A percent sign [%] indicates an error message number. A software problem. Analysis continues.

If the problem persists, contact Service.

(this page was intentionally left blank)

Using remote connection

Remote connection to the workstation is possible using Cisco WebEx, a web-based meeting and remote access software. It is included in the workstation Windows image.

Note An Internet connection is required for using the WebEx software. It is recommended to disconnect Internet connection immediately after the support session as instructed in [Leaving support session](#) on page 135.

Note It is not allowed to change the workstation's information security settings.

- [Joining support session](#)
- [Leaving support session](#)

Joining support session

To join a support session:

1. Connect the network cable to the workstation.



1 - Ethernet port for network connection

2. Open Internet Explorer.
3. Type CDDFINLAND.WEBEX.COM in the address field and press Enter.
4. If asked whether you want to set your web page preferences for this site, click **Yes**.
5. Click **Join** to enter the support session.

20 Using remote connection

Using remote connection

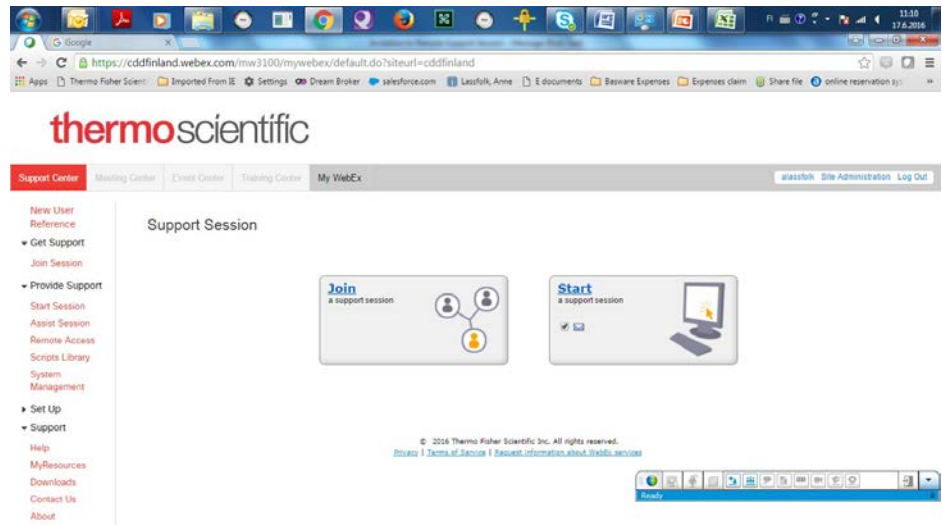

6. Fill in the required information, type verification characters to the text box below the verification picture and click **Sign Up Now**.

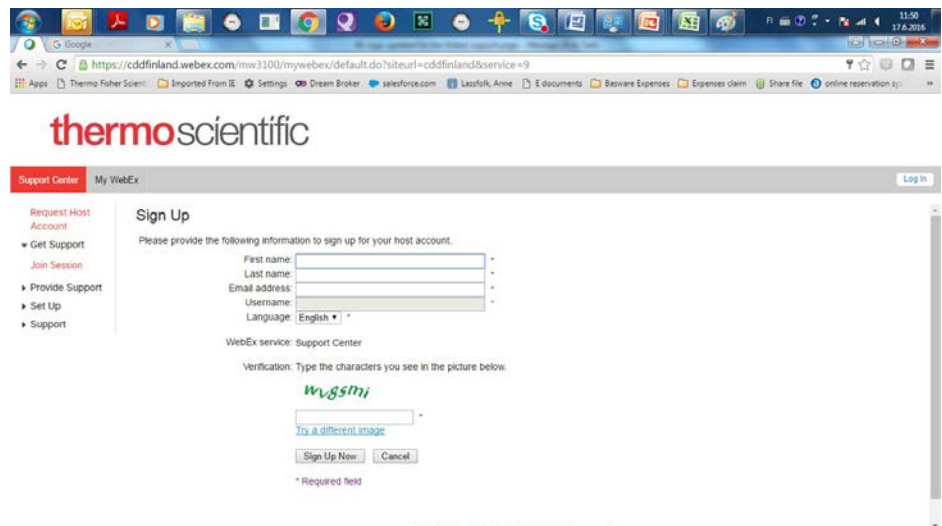

7. Join the session by following the instructions.
 - a) If you are joining the session for the first time, install the ActiveX Control, OR
 - b) Click **Click here**.

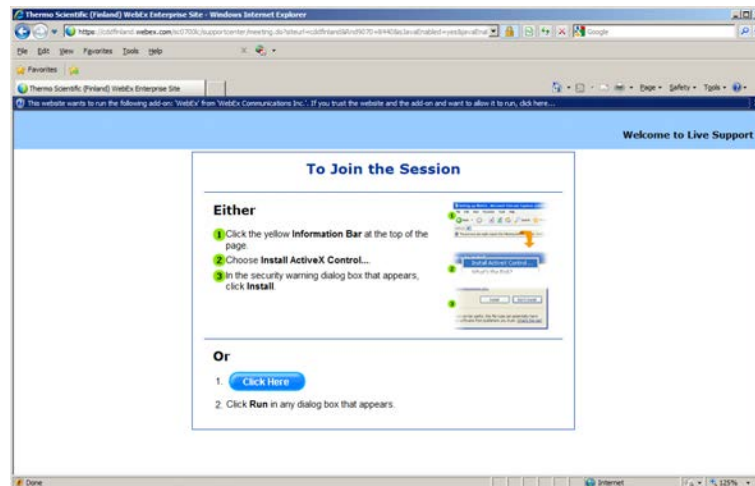

Leaving support session

To leave a support session:

1. Click the **Leave Session** button.

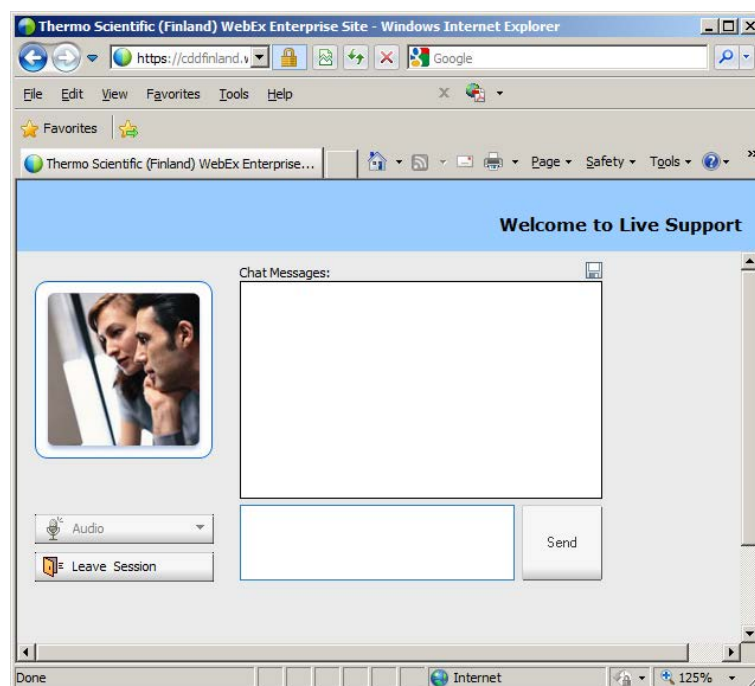

2. Click Yes in the **Leave session** dialog.
3. Disconnect the cable from the workstation.
4. Restart the workstation.

(this page was intentionally left blank)

Saving debug files

Analyzer records events from different internal sources and stores this information to various debug files. These debug files are useful for troubleshooting. You can easily save these files into a zip file using **Error Reporter Tool** which is located on the desktop.

The analyzer stores debug files up to 90 days.

Figure 42. Error reporter tool

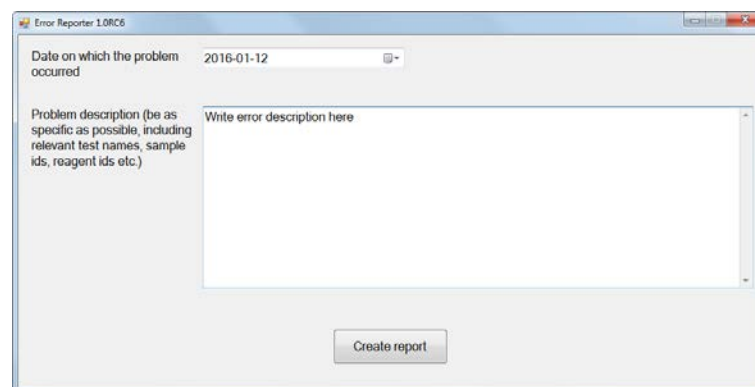

To save debug files into a zip file:

1. Open the **Error Reporter** tool by double-clicking the shortcut on the desktop.
2. Enter the date on which the problem occurred in the **Date on which the problem occurred** field.
3. Enter a description of the problem in the **Problem description** field. The description should be as detailed as possible.
4. Click the **Create report** button.
5. Select a location and type a name for the error report in the **Save file** dialog.
6. Click **Save**.

(this page was intentionally left blank)

System actions

Showing software version

To show the software version, select F5 > Actions > **Show version**.

Requesting water blank

To request a water blank, select F5 > Actions > **Water blank**.

This action is not possible when analyzer is in the **Start-up not done** state.

Fetching ECM prime

To fetch the ECM prime, insert a cup with 2 ml ECM prime into the sample rack and select F5 > Actions > **ECM Prime**.

This action is not possible when analyzer is in the **Analyzing** state.

Adding ECM rinse liquid

To change or add the ECM rinse liquid, select F5 > Actions > **Add ECM rinse liquid**.

This action is not possible when analyzer is in the **Analyzing** state.

Requesting extra wash

To wash tubes, pumps, syringe and probes with deionized water, select F5 > Actions > **Extra wash**.

This action is not possible when analyzer is in the **Analyzing** state.

Removing cuvettes from incubator

To remove the cuvettes from the incubator, select F5 > Actions > **Eject cuvettes**.

This action is not possible when analyzer is in the **Analyzing** state.

22 System actions

Checking temperatures

Checking temperatures

To check the temperatures of the incubator, analyzer and the reagent disk, select F5 > Actions > **Check temperature**.

The default temperature for incubator is set to 37 °C. If the temperature is out of range, an error message is shown but the analysis continues.

By default, the higher temperature alarm limit for the reagent disk is set to 20 °C. If the reagent disk is too warm, run a manual quality control (QC) and change the reagents.

Checking pressure sensor

To check the operational condition of the pressure sensor, select F5 > Actions > **Pressure sensor check**.

This action is possible when analyzer is in the **Start-up not done** or **Idle** state.

Cleaning probes manually

To lift dispensers up for manual cleaning, select F5 > Actions > **Clean probes**. Obey the instructions in the user interface.

This action is possible when analyzer is in the **Start-up not done** or **Idle** state.

Performing monthly maintenance wash

To perform monthly maintenance wash action, select F5 > Actions > **Monthly maintenance wash**.

This action is possible when analyzer is in the **Start-up not done** or **Idle** state.

Maintenance

Daily maintenance

Note Before maintaining the analyzer, perform the standby procedure. For instructions, see [Standby](#) on page 89.

- Clear daily files.
 - For instructions, see [Clearing daily files](#) on page 87.
- Waste water container
 - Empty and clean with tap water.
 - Add commercially available disinfectant into the empty waste water container to prevent bacterial growth.
- Empty the cuvette bin.
 - For instructions, see [Emptying cuvette waste bin](#) on page 34.
- Reagent storage
 - Wipe up condensed water from storage, if necessary. Depending on the humidity in the laboratory, it might be necessary to perform the task only weekly.

Weekly maintenance

Note Before maintaining the analyzer, perform the standby procedure. For instructions, see [Standby](#) on page 89.

- Analyzer surfaces
 - Wipe the analyzer surfaces with a cloth moistened with mild detergent.
- Cuvette waste bin
 - Wash the cuvette waste bin in a dish washer (60°C) or with 70% ethanol.

23 Maintenance

Monthly maintenance

- Probes and mixer paddle
 - Clean with a tissue moistened at first with deionized water then with 50 - 60% ethanol and finally with deionized water again.

Note If you are measuring ethanol or similar tests, clean the probes and mixer paddle only with deionized water. Cleaning with alcohol-based solution may interfere with the test results.

- Check that the probes are straight.

Note Check the probes and mixer paddle also after a mechanical failure.

- Wash wells
 - Move the probes and mixer to the upper position.
 - Clean wash wells with cotton buds.
- To keep the sample disk and reagent disk dry, wipe off the moisture that can be condensed onto or under the wheel.
 - Depending on the humidity in the laboratory, it might be necessary to perform the task daily.
- Database

CAUTION The database is designed to be analyzer specific due to traceability reasons.

- Backup the database on a USB flash drive. For instructions, refer to the Reference Manual.

Note Regularly scan the USB flash drive with an anti-virus software to protect the workstation against viruses.

- Computer
 - Restart the computer to ensure the reliable performance of the analyzer.

Monthly maintenance

Note Before maintaining the analyzer, perform the standby procedure. For instructions, see [Standby](#) on page 89.

Turn off the analyzer and workstation.

- Incubator
 - Clean the incubator's cuvette positions with a lint-free cloth moistened with mild detergent.

Turn on the analyzer and workstation.

- Cleaning water containers and tubing

Note Washing procedure must be done once in a month and can be performed also if air bubbles are recognized in the syringe.

Note Liquid can spill during shaking. Therefore, use protective eyewear, gloves and clothing.

Note It is recommended to use two deionized water containers: one for washing solution and another for deionized water used for rinsing the tubing.

Note If the maintenance procedure is performed in the morning, fill the water container in the previous day to degas the water and prevent the air bubbles in the tubing.

1. Empty both waste and water container.
 2. Rinse the waste water container twice with 0.5 liter of tap water.
 3. Add 800 ml of deionized water, 200 ml Washing Solution 4,5% (980929, 984030) and 40 ml Tubing maintenance solution (981712) to the deionized water container.
 4. Mix carefully to prevent foaming.
 - Use a paper towel on top of the cap to prevent the liquid from spilling.
 5. Place both containers into the analyzer and attach the connectors.
 6. Select F5 > Actions > **Extra wash**.
 7. Wait until the analyzer is in the **Start up not done** or **Idle** state.
 8. Remove both containers from the analyzer.
 9. Empty the washing solution from the deionized water container into the waste water container.
 10. Shake the waste water container with the cap closed.
 - Use a paper towel on top of the cap to prevent the liquid from spilling.
 11. Place the waste water container back to its place and attach the connectors.
 12. Fill the water container with deionized water.
 13. Place the water container back to its place and attach the connector.
 14. Click F5 > Actions > **Monthly maintenance wash**.
 15. Empty the waste water container.
 16. Rinse the waste water container three times with 0.5 liter of tap water.
 17. Place the waste water container back to its place and attach the connectors.
 18. Rinse the deionized water container used in the cleaning procedure at least six times with 0.5 liter of deionized water and shake well with the cap closed.
 - Use a paper towel on top of the cap to prevent the liquid from spilling.
 19. Fill the deionized water container with deionized water to degas water before taking it into use.
 - The maximum water level on the container is indicated with the water level sign.
- To avoid damage, do not autoclave the containers.
 - Do not wash the deionized water container in a dish washer.

Occasional maintenance

Before maintaining the analyzer, run the standby procedure.

- Sample racks and reagent disk
 - Wash the racks and reagent disk to remove splashes.
- In case of a mechanical failure, visually check for the straightness of probes.
- Touchscreen
 - Clean with a soft cloth and a standard glass cleaner, but avoid products containing ammonia.
 - Always spray the glass cleaner on the cloth and then clean the touchscreen. Glass cleaner sprayed directly on to the monitor can cause damage.

Note For more detailed information, refer to the manufacturer's instructions.

- Air ventilation
 - Rinse the analyzer's inlet filters with tap water and allow to dry before returning.

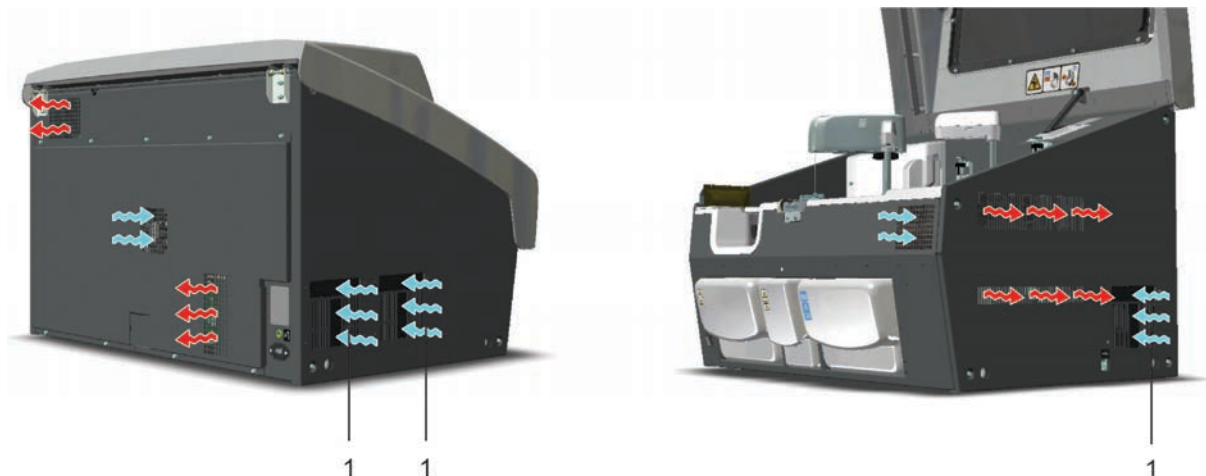

1 - Inlet filter

Electrode maintenance

Note This section applies only to analyzers equipped with the ECM unit.

Proper electrode maintenance ensures:

- Faster response
- Longer lifetime
- More reliable measurements

Use washing and cleansing solution regularly to keep pH electrodes and the reference electrode in good condition.

For the pH electrode, no other maintenance is required.

The lifetime of the reference electrode depends on maintenance and especially on the liquid junction zone not becoming blocked. The electrode must never dry out and should therefore always be filled with the proper salt-bridge solution. If the below recommendations are followed, a proper calibration should be able to be performed easily. If this is not the case, the electrode should be changed or examined more closely.

❖ **Refresh the reference electrode filling solution**

The direction of flow in the reference electrode should always be from the inner reference chamber out into the measuring solution. As this one-way flow cannot be unilaterally achieved, the reference electrode filling solution should be refreshed regularly, for example once a month.

Check also that the reference filling solution is at optimal level:



1 - Optimal filling solution level

❖ **Remove blockage from liquid junctions**

Liquid junctions can occasionally become blocked due to crystallization. To remove the crystals, try the following:

- Flick the crystals out:
 1. Remove the electrode Ag/AgCl pin.
 2. Rinse the Ag/AgCl pin with deionized water.
 3. Detach the filling solution bag.
 4. Flick the electrode upside down to remove any loose crystals.
 5. If crystals are still present:
 - a. Rinse the Ag/AgCl pin with 3 M KCl.
 - b. Flick the electrode upside down to remove any loose crystals.
 6. Reassemble and refill the electrode.

Other types of blockage can also occur, for example, in the form of a precipitate (black) of silver chloride. In case the silver chloride coating has been removed from the inner pin (inner electrode), change the inner pin or the whole reference electrode.

A malfunction can also be caused by trapped air bubbles. These bubbles can be removed by gently tapping the electrode or, if tapping is ineffective, by flinging it in your hand in a rapid, downward motion. Ensure also that there are no air bubbles in the filling tube.

23 Maintenance

Periodical maintenance

❖ Ensure sufficient humidity

If the reference electrode is in regular use, the humid atmosphere within the block is enough and no extra storage steps need be taken. However, if the analyzer is out of use for an extended period of time (>1 week), store the reference electrode:

1. Remove the reference electrode from the ECM block.
2. If the original cap of the reference filling solution bag is available, disconnect the bag from the electrode and close the cap.
3. If the cap is not available, leave the bag attached to the electrode.
4. Soak a lint- and contaminant-free paper in 3 M KCl, and wrap it gently around the electrode.
5. Place the whole assembly in a sealed zipper storage bag.
6. Store the assembly in a refrigerator (+2 ... +8 °C).

Periodical maintenance

It is recommended to perform periodical maintenance at least once a year. This recommendation is based on the load of the analyzer. The local distributor can allow exceptions from the recommendations based on the local conditions. Exceptions made must not deteriorate the reliability of the analyzer or accuracy of the test results.

Only trained service engineers are allowed to perform the periodical maintenance tasks. To get periodical maintenance, contact the local supplier.

Managing maintenance tasks

To check the statuses of the maintenance tasks, select F5 > **Maintenance**.

Figure 43. Maintenance view

Nbr	Operation	Previous	Next	!
1	Start analyzer software	18.06.2012	25.06.2012	
2	Login	18.06.2012	19.06.2012	
3	Check the water container			!
4	Check the waste water container			!
5	Empty the cuvette waste bin			!
6	Add cuvettes			!
7	Check the ECM rinse liquid			!
8	Start-up	18.06.2012	19.06.2012	
9	Remove racks			!
10	Clear daily files	28.05.2012	29.05.2012	!
11	Standby	30.04.2012	01.05.2012	!
12	Logout	18.06.2012	19.06.2012	
13	Clean the surface with wet tissue			!
14	Empty the waste containers			!

Acknowledging maintenance task

To acknowledge a maintenance task:

1. Click F5 > Maintenance > **Operations** tab.
2. Select the maintenance task to be acknowledged from the list.
You can select and acknowledge multiple maintenance tasks by holding down CTRL or SHIFT key while selecting the tasks.
3. Click **Mark performed**.
4. Enter comment and/or data in the fields on the right, if needed. If you have selected multiple maintenance tasks, the typed text in the comment and/or data fields is saved only for the item you selected last.
5. Click **Save**.

Viewing maintenance history

To view the maintenance history:

1. Click F5 > Maintenance > **Operations** tab.
2. Click **History**.
3. Narrow the search by defining a date in the **First date** and/or **Last date** fields.
4. Click **Retrieve data**.

(this page was intentionally left blank)

Month/Year _____

Serial # _____

For procedure descriptions, please refer to the latest revision of the Gallery/Gallery Plus Operation Manual - Maintenance or Online Help

DAILY (approx 5 mins)	1	2	3	4	5	6	7	8	9	10	11	12	13	14	15	16	17	18	19	20	21	22	23	24	25	26	27	28	29	30	31
Beginning of Day																															
Wipe up condensed water from reagent storage (if necessary)																															
Check and/or fill DI water container																															
EMC unit - Check/change ECM Rinsing solution bag (if applicable)																															
Load Decacell cuvettes (if necessary)																															
Perform start up (check water blank if necessary)																															
Check reagent volumes																															
End of Day																															
Report all results																															
Run Stand-by procedure																															
Remove samples																															
Clear daily files																															
Wipe up condensed water from reagent storage (if necessary). Depending on the humidity in the laboratory, it might be necessary to perform the task only weekly.																															
Clean reagent/sample racks (if necessary)																															
Empty and rinse solid waste & waste water containers <i>Operator's Initials</i>																															

WEEKLY (Approx 20 mins)	1	2	3	4	5
Backup database on USB flash drive/hard drive					
Exit software					
Power down workstation and instrument					
Wash liquid and solid waste containers thoroughly					
Clean the probes and the mixer. Check that the probes are straight.					
Clean the wash wells					
ECM unit - Check/refill the ECM Reference electrode (if applicable)					
Wipe the analyzer surfaces with a cloth moistened with mild detergent					
Power up the instrument and workstation <i>Operator's Initials</i>					

MONTHLY (Approx 60 mins)	
Clean water containers and tubing (follow instructions from the manual)	
Exit software and power down workstation and instrument	
Clean incubator cuvette positions	
Power up the instrument and workstation <i>Operator's Initials</i>	
Occasional Maintenance	
Clean the monitor screen	
Rinse the analyzer inlet filters (if necessary)	
 <i>Operator's Initials</i>	

Annual Preventive Maintenance

Date: _____ FSE: _____

Consumables and accessories

Table 17. Consumables for Gallery

Ordering code	Item	
986540	DECACELL cuvettes	5400 tests
989220	0,5 ml sample cups	1000 pcs
989221	2 ml sample cups	1000 pcs
984618	4 ml sample cups	1000 pcs
984619	7 ml tubes	1000 pcs
984050	10 ml reagent bottles	5 pcs
981456	20 ml reagent bottles	16 pcs
984030	Washing solution 4.5%	4 x 20 ml
980929	Washing solution 4.5%	6 x 100 ml
980659	Cleansing solution	100 ml
981712	Tubing maintenance solution	6 x 20 ml
984330	ECM pH 2 standard	2 x 60 ml
984331	ECM pH 4 standard	2 x 60 ml
984332	ECM pH 7 standard	2 x 60 ml
984333	ECM pH 10 standard	2 x 60 ml
984334	ECM pH 12 standard	2 x 60 ml
984335	ECM conductivity 0.1 standard	1 pc
984336	ECM conductivity 1.4 standard	2 x 60 ml
984337	ECM conductivity 13 standard	2 x 60 ml
984338	ECM conductivity 112 standard	1 pc

Ordering code	Item	
984340	ECM prime	4 x 20 ml
984998	ECM rinse liquid	4 x 400 ml
984717	Bag for ECM Reference	5 x 2 ml
984996	Reference electrode	1 pc
984997	pH electrode	1 pc
SP06666	Sample rack 9 - standard	6 pcs
SP06699	Sample rack 9 - blue	3 pcs
SP06618	Sample rack 18 - non-barcoded	3 pcs
SP15010	Tube Support Plate	6 pcs

Table 18. Start-up kit (986100)

Ordering code	Item	
986100	Start-up kit	1 pc
Consists of:		
981712	Tubing maintenance solution	6 x 20 ml
986540	DECACELL cuvettes	5400 tests
989221	2 ml sample cups	1000 pcs
981456	20 ml reagent bottles	16 pcs

Table 19. Complete start-up kit (986101)

Ordering code	Item	
986101	Complete start-up kit	1 pc
Consists of:		
981712	Tubing maintenance solution	6 x 20 ml
986540	DECACELL cuvettes	5400 tests
989221	2 ml sample cups	1000 pcs
984618	4 ml sample cups	1000 pcs
984619	7 ml tubes	1000 pcs

Ordering code	Item	
981456	20 ml reagent bottles	16 pcs
984050	10 ml reagent bottles	5 pcs

Table 20. ECM start-up kit (986200)

Ordering code	Item	
986200	ECM start-up kit	1 pc
Consists of:		
984996	Reference electrode	1 pc
984997	pH electrode	1 pc
984399	EC Assembly	1 pc
SP09701	Spacer slice 9 mm	1 pc
980659	Cleansing solution	100 ml
984340	ECM prime	4 x 20 ml
984998	ECM rinse liquid	4 x 400 ml

Table 21. Upgrade kits

Ordering code	Item	
SP10973	Touchscreen	1 pc
SP10992	2D scanner	1 pc
SP06730	ECM upgrade kit	1 pc
	Electrodes and standard solutions must be ordered separately.	

Note Upgrade kits include all required parts.

(this page was intentionally left blank)

Barcode specification

Note It is strongly recommended that the laboratory employs check digits (CLSI AUTO2-A2) for ensuring the integrity of the sample identification process.

The analyzer supports the following barcodes:

- Code 128
- Code 39
- Codabar
- Interleaved 2 of 5

Code 128 is recommended; all other barcode types should be replaced with Code 128 according to CLSI AUTO2-A2.

❖ Barcode placement

The center of the label should be placed at the center of the placement zone. The label should be applied below the top 14 mm of the tube and above the bottom 20 mm of the tube according to CLSI AUTO2-A2. The label width must be 5 mm less than the circumference of the tube according to NCCLS AUTO02-A2.

The label skew shall be less than $\pm 5^\circ$ according to NCCLS LIS7-A and less than $\pm 7\%$ according to CLSI AUTO2-A2 with respect to the axis of the sample container.

Figure 44. Correct placement of barcode according to CLSI AUTO2-A2

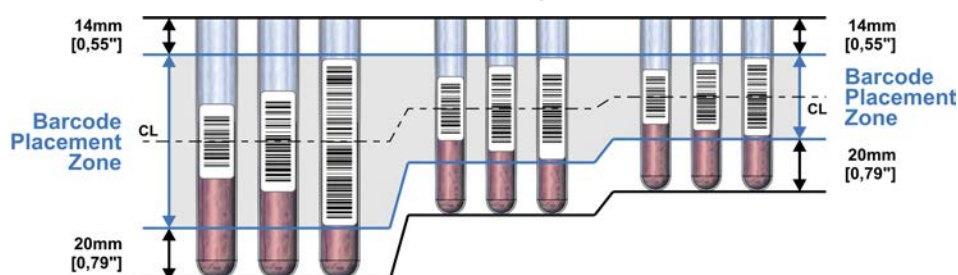
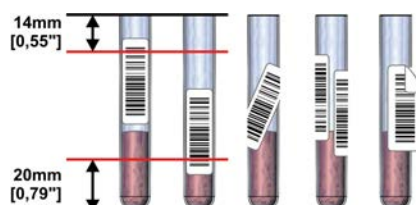

Figure 45. Wrong placement of barcode



❖ Reading zone

The minimum length of the barcode is 10 mm and minimum width is 5 mm less than the circumference of the tube according to NCCLS LIS7-A. The minimum number of characters is

3. The quiet zone must be at least ten times the minimum width of the narrow bar (10 x 0.127 mm or greater) according to CLSI AUTO2-A2. According to the manufacturer of the barcode reader, the recommended quiet zone with the barcodes is 3.5 mm (0.14 inch) in the barcode label on both sides of the barcode.

Figure 46. Reading zone

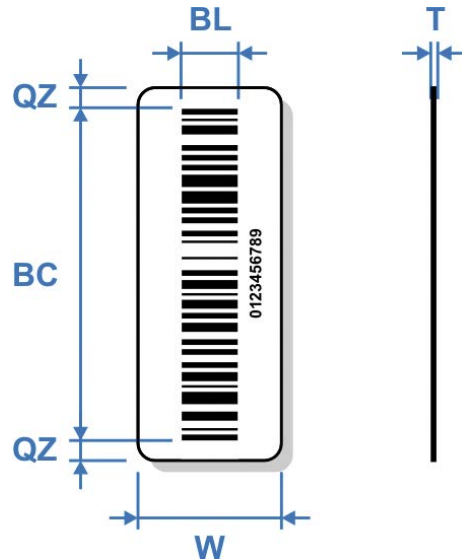

BC - Barcode

- min. line thickness: 0.127 mm (5.9 mil)

- min. number of characters: 3

BL - Barcode length: min. 10 mm (0.4 in.)

QZ - Quiet zone: recommended 3.5 mm (0.14 in.)

T - Label thickness (including adhesive): max. 0.090 mm (3.6 mil)

W - Label width: 5 mm (0.2 in.) less than the circumference of the tube

❖ **Other Requirements**

- The minimum width of a narrow bar is 0.127 mm (CLSI AUTO2-A2).
- The thickness of the label and its associated adhesive shall be less than 0.090 mm (CLSI AUTO2-A2).
- No more than four labels, including the manufacturers label, should be affixed to a tube. The maximum thickness of all labels is 0.36 mm (14.2 mil). (CLSI AUTO2-A2)
- The barcode print quality shall be at least of quality C according to ANSI X3.182-1990.
- Label opacity must be sufficient to prevent the reading of any barcode printed on an underlying label. The recommended label opacity is 90% or greater. (CLSI AUTO2-A2).

❖ **References**

- CLSI AUTO2-A2: Laboratory Automation: Bar Codes for Specimen Container Identification; Approved Standard – Second Edition CLSI 2006.
- NCCLS LIS7-A – Standard Specification for Use of Bar Codes on Specimen Tubes in the Clinical Laboratory, American Society for Testing and Materials 2003.
- ANSI Standard X3.182-1990 – Bar Code Print Quality Guideline, American National Standards Institute 1990.
- Scanteam 3600 Technical Manual, Welch Allyn, Rev. C, p.3-7.

EC DECLARATION OF CONFORMITY

Manufacturer's Name: Thermo Fisher Scientific Oy

Manufacturer's Address: Ratastie 2
FI-01620 Vantaa
FINLAND

declares that

Product **Chemistry Analyzer**
Product name **Gallery Plus**

Type **862**

Product Codes: **98620001**
98621001

are in conformity with the relevant provisions of the following EC directives, including the latest amendments, and with national legislation implementing these directives:

2006/42/EC	Machinery Directive
2004/108/EC	EMC Directive (Electromagnetic compatibility)
2011/65/EU	RoHS Directive (Restriction of the use of certain hazardous substances in electrical and electronic equipment)

and that the following harmonized standards have been applied:

EN ISO 12100:2010
EN 61010-1:2001
EN 61010-2-010:2003
EN 61010-2-081:2002 + A1:2003
EN 61326-1:2006
EN 61000-6-2:2005
EN 61000-6-3:2007
EN 50581:2012

This Declaration is valid for all instruments which are placed on the market by ourselves on or after July 5th, 2016 and which bear the CE marking.

Responsibility on the technical file:

Name: Sirpa Riistama-Laari, Senior R&D Manager
Address: Ratastie 2, FI-01620 Vantaa, Finland

Vantaa, July 5th, 2016

Thermo Fisher Scientific Oy

Heli Ketonen
Quality Engineer
Quality Assurance and Regulatory Affairs
Analyzers & Automation
Clinical Diagnostics

Glossary

C

CLRW Clinical Laboratory Reagent Water

CLSI Clinical and Laboratory Standards Institute

D

DB Database

DVM Digital Voltage Measurement

E

ECM Electrochemical Measurement

G

GLP Good Laboratory Practices

I

ID Identification

L

LIS Laboratory Information System

Q

QC Quality Control

S

SD Standard Deviation

STAT Statim; immediately

U

UPS Uninterruptable Power Supply