

# THE ELECTRONIC ENGINEER

a CHILTON publication/FEBRUARY 1972

---

Technology or profits—Part 2  
These growth markets spell \$ for EEs

---

Introducing a new course:  
Packaging

---

The automotive electronics story:  
A \$5 billion a year market by 1980, if . . .



GM's Trevor Jones:

**24 x 5M ≠ 5M x 24**

The new math—Detroit style

PLUS  
**DATA**  
COMMUNICATIONS

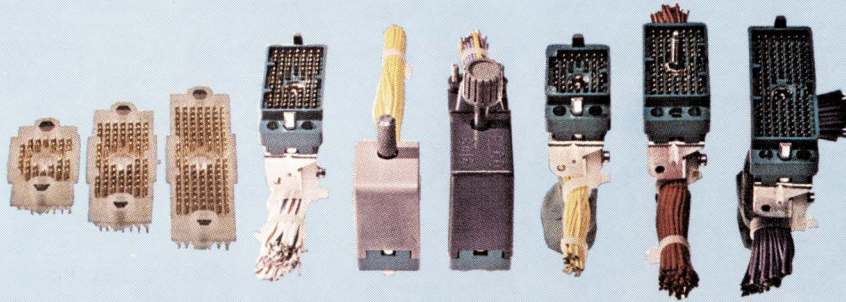

A line-up of input-output rack and panel and cable-to-cable connectors with contact spacing on .100" centers. Elco's solution to the burgeoning packaging squeeze in electronic circuitry.

Let's take muster. First, the Series 8026 R/P and cable-to-cable connector that's equipped with the Elco high-reliability crimp-and-insert mini Varilok™ contact. Team a Series 8026 117-contact plug with its corresponding receptacle, and you have a 117-contact connector that's in the same envelope as a 56-contact connector on .150" spacing. But packing more than twice the contacts in the same space.

Then, by the numbers. The 75-contact 8026 connector will fit in the same space as a 38-contact connector on .150" spacing. And the 8026 33-contact connector is one of the smallest 33-contact R/P

connectors you've ever seen. And for back-up, we offer Series 8026 connector with 55 and 79 contacts on .125" square grid.

For your I/O back-panel applications, Elco Series 5540 connectors are available in the same sizes as the 8026, but use the field-proven Varicon™ contact with .025" square wire wrappable posts. They incorporate—as do the 8026's—a new female turnable jackscrew that eliminates any possibility of damage to plate contacts in difficult or blind mating situations. Both series use standardized polarizing and keying hardware to prevent unmatched plugs and receptacles from being mated.

And by no small coincidence, hardware standardization lets you minimize your in-house and field

stocking requirements, and allows you to use the same manufacturing set-up to assemble all sizes.

Besides helping you cope with your close-order circuits, this roster of connectors will help you effect other cost economies. Like using your existing 8016 panel punches. Reducing inventory because they can do duty in R/P and cable-to-cable applications as well as be used as an I/O. On a performance/price basis, these high density connectors are your best buy because quality is equal to or better than, and published prices are much less than those of their pin-and-socket counterparts.

There's one more bonus. Immediate availability. Both Series. All sizes. Another service in keeping with CONNECTRONICS, Elco's Total Connector Capability.

# 100-MIL CLOSE-ORDER DRILL

For full details on these new connectors from Elco, contact:

Elco, Willow Grove Division,  
Willow Grove, Pa. 19090  
(215) 659-7000

Elco, Pacific Division,  
2200 Park Place,  
El Segundo, Calif. 90245  
(213) 675-3311



Operations in USA, Australia, Belgium, Canada, Denmark, England, France, Germany, Israel and Japan. Sales offices throughout the world. In Europe, Elco Belge, 77 Blancefloerlaan, Antwerp, Belgium, Tel. 03-190064. In the Far East, Elco International, TBR Building, 2-10-2 Nagata-cho, Chiyoda-ku, Tokyo 100, Japan, Tel. 580-2711/5.

Copyright © 1971 Elco Corp. All rights reserved.

Circle Reader Service #1

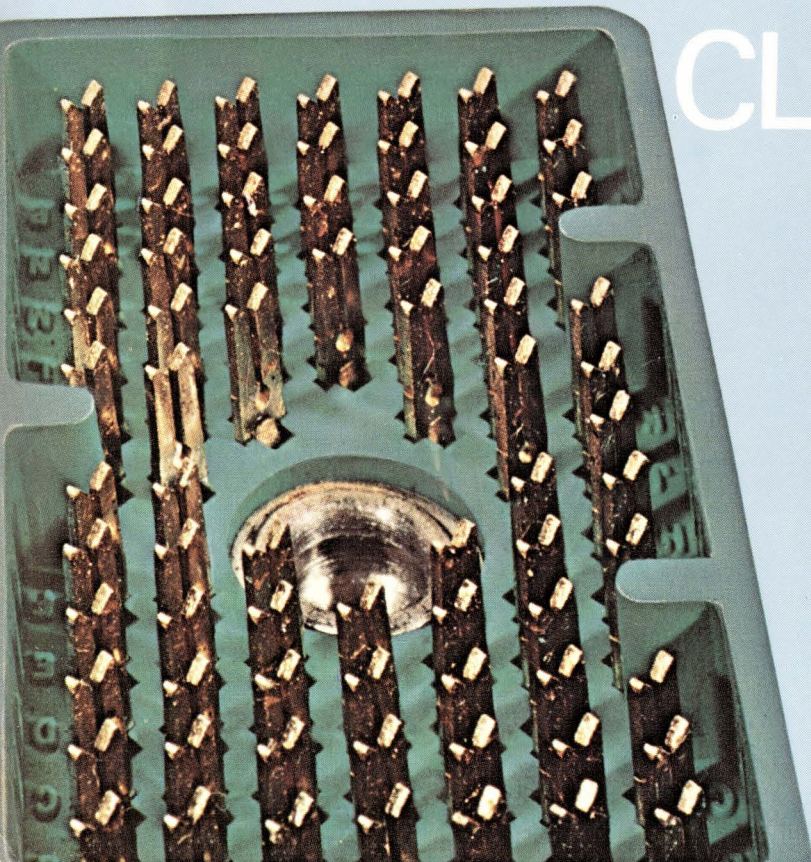

# DIP

## DUAL-INLINE-PACKAGED REED RELAYS

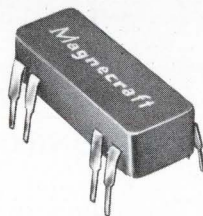

Magnecraft is proud to announce its new DIP (dual-inline-package) line of 8-pin reed relays. These new relays are designed not only to be compatible with the standard packaging developed for integrated circuits, but to offer Magnecraft quality at a low cost. This unique design gives further savings by offering the user the optimum in automated insertion and other economical installation techniques associated with printed circuit applications.

These fantastic new epoxy molded reed relays are ideal for use in circuits where high density packaging is essential. The 5VDC IC compatible versions of these relays will operate directly from TTL or DTL circuits.

Other standard coil voltages are available from stock in 6, 12, and 24VDC as well as contact configurations in 1 form A, 2 form A, 1 form B, and 1 form C. Most versions are also offered with a choice of an internal clamping diode.

**Magnecraft**® **ELECTRIC COMPANY**

5575 NORTH LYNCH AVENUE • CHICAGO, ILLINOIS 60630 • 312 • 282-5500 • TWX 910-221-5221

THE ELECTRONIC ENGINEER • Feb. 1972

# FREE!

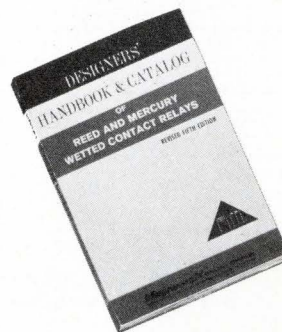

## REED RELAY HANDBOOK

The purpose of this 120-page handbook is to assist the design engineer in specifying the proper reed relay for a given application. The book contains a glossary of terms, principles of operation, applications and design requirements as well as specifying and testing data. New products include the complete line of DIP Reed Relays.

Circle Reader Service #2

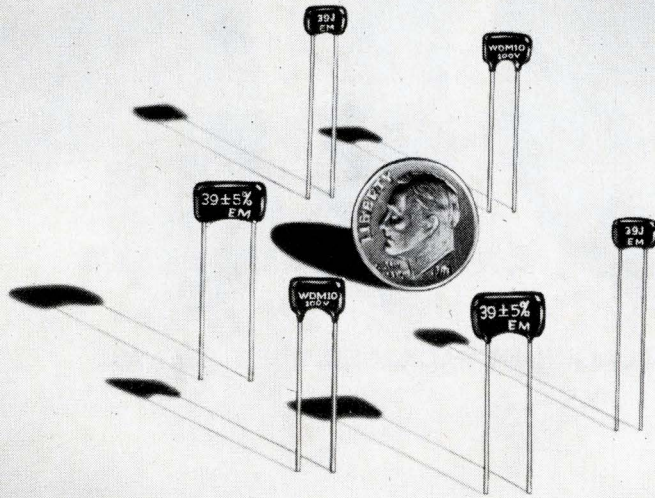

## They're Small and Reliable\*

### EL-MENCO DM5 — DM10 — DM15 — ONE COAT DIPPED MICA CAPACITORS

STYLE	WORKING VOLTAGE	CHARACTERISTIC	CAPACITANCE RANGE
DM5	50VDC	C	1pF thru 400pF
		D, E	27pF thru 400pF
		F	85pF thru 400pF
DM5	100VDC	C	1pF thru 200pF
		D, E	27pF thru 200pF
		F	85pF thru 200pF
DM10	100VDC	C	1pF thru 400pF
		D, E	27pF thru 400pF
		F	85pF thru 400pF
DM15	100VDC	C	1pF thru 1500pF
		D, E	27pF thru 1500pF
		F	85pF thru 1500pF
DM5	300VDC	C	1pF thru 120pF
		D, E	27pF thru 120pF
		F	85pF thru 120pF
DM10	300VDC	C	1pF thru 300pF
		D, E	27pF thru 300pF
		F	85pF thru 300pF
DM15	300VDC	C	1pF thru 1200pF
		D, E	27pF thru 1200pF
		F	85pF thru 1200pF
DM10	500VDC	C	1pF thru 250pF
		D, E	27pF thru 250pF
		F	85pF thru 250pF
DM15	500VDC	C	1pF thru 750pF
		D, E	27pF thru 750pF
		F	85pF thru 750pF

Where space and performance are critical, more and more manufacturers are finding that El-Menco miniaturized dipped mica capacitors are the reliable solution. The single coat is available in three sizes: 1-CRH, 1-CRT and 1-CE.

The 1-CRH DM "space savers" easily meet all the requirements of MIL and EIA specifications, including moisture resistance. The 1-CE and 1-CRT units also meet the requirements of MIL and EIA specifications, except that they have less moisture protection because of their thinner coating; these capacitors, therefore, are ideally suited where potting will be used. Note: DM10 and DM15 units are still available in the standard 4-CR size.

**Specify "El-Menco" and be sure . . .** the capacitors with proven reliability. Send for complete data and information.

\*Normally, El-Menco 39 pF capacitors will yield a failure rate of less than 0.001% per thousand hours at a 90% confidence level when operated with rated voltage and at a temperature of 85°C. Rating for specific applications depends on style, capacitance value, and operating conditions.

## THE ELECTRO MOTIVE MFG. CO., INC.

WILLIMANTIC, CONNECTICUT 06226

Dipped Mica • Molded Mica • Silvered Mica Films • Mica Trimmers & Padders  
Mylar-Paper Dipped • Paper Dipped • Mylar Dipped • Tubular Paper

West Coast Manufacturers contact: COLLINS & HYDE CO., 900 N. San Antonio Rd., Los Altos, California 94022  
5380 Whittier Blvd., Los Angeles, California 90022

ALSO SOLD NATIONALLY THROUGH ELECTRONIC PARTS DISTRIBUTORS

# THE ELECTRONIC ENGINEER

February 1972 Vol. 31 No. 2

**Cover:** It's not that the auto makers took a different kind of algebra in school, it's just that capturing the automotive electronics business requires a different perspective, according to Trevor O. Jones. Jones, Director of General Motor's Electronic Control Systems group and a former aerospace engineer, contends that "24 Apollo spacecrafts times 5M parts is different than 5M vehicles times 24 parts." See p. 56 for what Detroit wants from electronic engineers and their companies which hope for a piece of that \$5 billion market by the end of this decade.

- 8 Editorial
- 12 Up to Date
- 27 Microworld
- DC-1 Data Communications
- DC-2 Data Communications Editorial
- DC-5 Data Communications Feature
- DC-8 Data Communications News
- DC-9 Data Communications Applications
- DC-10 Computer Systems Design Conference Preview
- DC-11 Data Communications Products
- 51 Packaging Course
- 56 Challenge
- 65 New Product Feature
- 66 Microworld New Products
- 70 Lab New Products
- 74 Literature
- 79 Advertising Index

---

## 16 TECHNOLOGY OR PROFITS?—PART 2 By Alberto Socolovsky

Are we weathering the economic storms that have buffeted the electronics industry? It'll make no difference if there is no real growth throughout the rest of the '70s. For the markets that offer the greatest sources of profit through technology and how you can win them, read this.

---

## 27 SILICON ON SAPPHIRE: a technology comes of age

By D. J. Dumin and E. C. Ross

If you've been looking for the high speed of bipolar with the low manufacturing cost of MOS, silicon on sapphire, a new technology, may be your answer. With no possibility of leakage between devices and a low drain-to-substrate capacitance, this could be a real winner.

---

## DC-1 DATA COMMUNICATIONS following page 32

In this monthly section, we bring you the latest in data systems, products, news, and trends.

---

## DC-2 INTERCONNECTION—AN FCC OVERVIEW By Bernard Strassburg

Where does the interconnection squabble stand? Let the FCC's Common Carrier Chief tell you.

---

## DC-5 ASYNCHRONOUS TRANSMISSION By Steve Stuart and Ralph Ungermann

Synchronous or asynchronous? When transmitting long distance digital data which way should you go? For some requirements, asynchronous looks very attractive because of the greater simplicity of equipment needed. Here's a basic look at the pros and cons to help make your decision.

---

## DC-10 COMPUTER DESIGNERS GET A TWO-COAST SHOW

Whether you're in Anaheim, Calif., on Feb. 22-24 or Boston, Mass., on April 18-20, if you're interested in computer technology, you're in the right place. The Computer Systems Design Conference has a 200-booth exhibit, and technical programs with some of EE's top editors.

---

## 51 THE LITTLE BUGS THAT TAMED THE BIG PACKAGES

By A. Socolovsky and S. Ruth

Why a course on packaging? Not too long ago that would have been a valid question, but not today. The speed and complexity of circuits have now made it an integral part of the design function. In coming months, we'll explore IC packages, circuit boards & cables, back panels, etc.

---

## 56 AUTOMOTIVE ELECTRONICS IS NO LEMON By John McNichol

For the past decade, the reality of putting the electronic engineer's expertise into the massive car design market has hovered over the horizon. However, the Director of GM's Electronic Control Systems group tells why Detroit now needs EEs for what could be a \$5 billion market.

---

**NOW:  
THE OP AMP  
YOU CAN  
PROGRAM**



**Our new  $\mu$ A776: Closest thing to a universal op amp yet devised.**

We call the  $\mu$ A776 our "do-everything" op amp. It probably is the next industry standard: one high quality device that, with the addition of a simple external resistor, can be tailored for optimum performance over an enormous span of applications. From the world's linear leader.

**$\mu$ A776 Typical Performance**

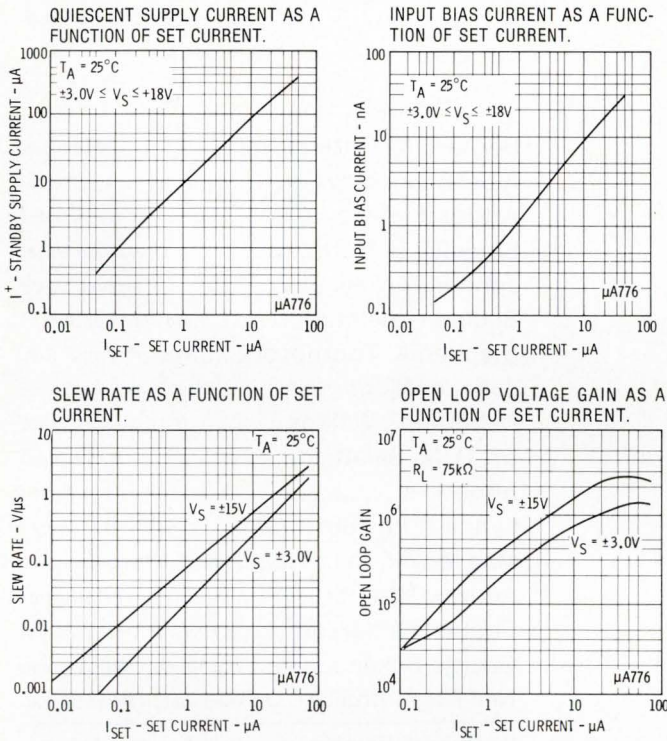

The wide range of available characteristics makes it extremely versatile. And useful. It is adjustable for either standard or micropower application. It can be biased to have any of a number of fixed characteristics; or biased so that the characteristics of the amplifier can be

varied in response to an input signal. And it can be turned on or off externally.

The  $\mu$ A776 offers superior operation at levels similar to standard general purpose op amps. In fact, when biased with a  $15\mu\text{A}$  set current, it has approximately the same gain, slew rate and bandwidth as a  $\mu$ A741. But with an *order of magnitude improvement* in input bias current, input offset current, noise current and power dissipation.

Or you can operate it from a supply voltage of only  $\pm 1.2\text{V}$ . This means the device can be run off of two battery cells and with the proper set resistor the total power drain of the op amp will be lower than the battery leakage.

The broad versatility of the  $\mu$ A776 means it is ideal for micropower applications, battery powered systems, medical electronics, long-time integrators, high-accuracy sample and hold, frequency processors and active filters. For many uses, it becomes the only op amp you need specify on your standard parts list.

Available with complete data package, from your friendly Fairchild distributor.

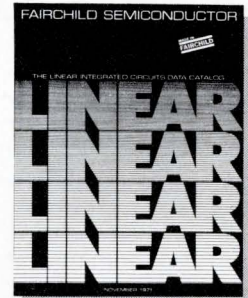

**New LIC Data Book**

The  $\mu$ A776 is the newest of 17 general and specific purpose op amps. All fully described in our new LIC Data Book: 320 pages covering 84 quality LIC devices.

Available now by writing to the address below.

**MADE IN FAIRCHILD**



# KEPCO TALKS POWER SUPPLY TECHNOLOGY:

## A new tool for system designers...

Almost all of today's programmable d-c power supplies are controlled with respect to their *positive* output terminal. That means that when you seek to program such power supplies with a voltage signal, or the output of a DAC, the power supply's *plus* terminal is common to your signal source. When silicon NPN power transistors are used in a *series* regulator; that's the way the polarities work out.

Kepeco's new interface devices, the NTC, employ a *shunt* regulator configuration to reverse the normal control polarities. Each NTC is a complete power supply, capable of what we term "operational programming," which means that its output can be determined on the basis of input and feedback parameters with its *NEGATIVE* terminal common. Other power supplies couple to it in a non-inverting, unity-gain fashion to function as repeaters or voltage followers.

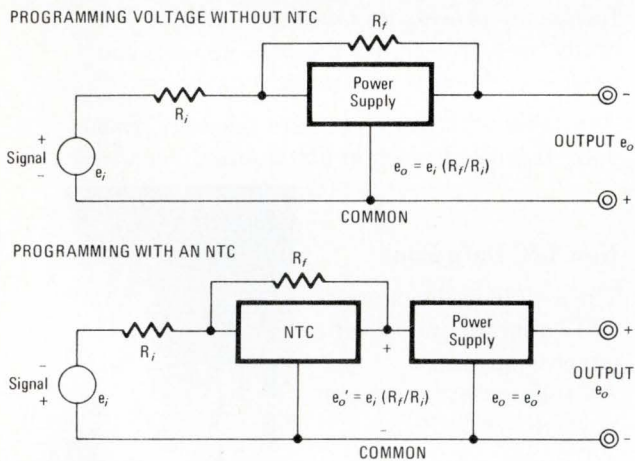

There are two NTC models:

NTC 200	0-200V at 0-10 mA	\$190.00
NTC 2000	0-2000V at 0-1 mA	\$325.00

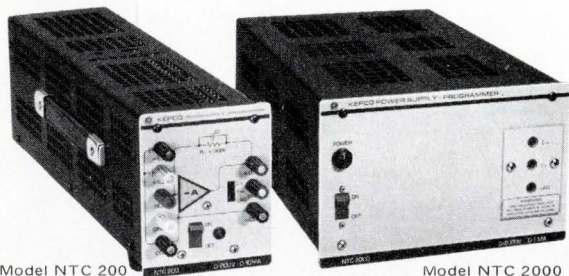

When not functioning as the inverting amplifier for a power supply-booster, the NTC can serve in its own right as a low-powered (2 watt) d-c source with fast-slewing capability: 3V/ $\mu$ sec. for the NTC 2000, 1V/ $\mu$ sec. for the NTC 200; and low ripple: less than 0.01% or 5 mV, whichever is greater. Their high gain:  $>0.5 \times 10^6$  volts per volt, suits NTC for a variety of complementary OP-Amp roles.

For full information on NTC, request Bulletin 146-1267.

# KEPCO®

Write Department DU-19

KEPCO, INC. • 131-38 SANFORD AVENUE • FLUSHING, N.Y. 11352  
(212) 461-7000 • TWX # 710-582-2631

Circle Reader Service #5

# THE ELECTRONIC ENGINEER

February 1972  
Vol. 31 No. 2

Bernard M. Gittelman.....Publisher  
Alberto Socolovsky.....Editor  
Arthur J. Boyle.....Managing Editor  
Smedley B. Ruth.....Associate Editor  
John E. Hickey, Jr.....Features Editor  
Sheldon Edelman.....Western Editor S. F.  
Stephen A. Thompson.....Western Editor L. A.  
John McNichol.....New Directions Editor  
Deborah P. Wilkins.....Assistant Editor  
Dr. O. M. Salati.....Consultant  
Anne Axe.....Editorial Assistant  
Lynda Rothstein.....Editorial Assistant  
Mae Moyer.....Editorial Reader Service  
Andrew Mittelbrunn.....Chilton Art Director  
Phaue Featherson.....Artist  
George Baker.....Washington News Bureau  
Neil Regeimbal.....Washington News Bureau  
K. Robert Brink.....Publishing Vice President

#### Executive and Editorial Offices:

One Decker Square, Bala-Cynwyd, Pa. 19004  
Tel: (215) SH 8-2000

#### Address Mail to:

56th & Chestnut Sts., Philadelphia, Pa. 19139

#### Western Offices:

Stephen A. Thompson  
3727 W. 6th St., #202, Los Angeles, Calif. 90005  
Tel: (213) DU 7-1271

#### Sheldon Z. Edelman

199 First St., Rm. 335, Los Altos, Calif. 94022  
Tel: (415) 941-6655

**Chilton Officers & Directors:** Robert E. McKenna, President; John H. Kofron, Charles W. Hevner, William A. Barbour, Sr. Vice Presidents; Richard H. Groves, K. Robert Brink, Publishing Vice Presidents; James Miades, Vice President, Finance; James A. Naughton, Vice President, Creative Services; Christian H. Miller, Secretary; Thomas J. Casper, Spencer H. Collmann, John P. Kushnerick, Raymond O. Nelson, Eugene C. Beaudet, William A. Phair, David Acton, Donald P. Jones, Richard C. Sorlien.

Monthly publication of Chilton Company, Chestnut & 56th Sts., Phila., Pa. 19139. (Area Code 215) SHerwood 8-2000. Controlled circulation postage paid at Philadelphia, Pa. \$1 a copy. Subscription rates U. S. and U. S. Possessions: 1 yr. \$12.00; 2 yrs. \$20.00. Canada 1 year \$14.00; 2 yrs. \$25.00. All other countries 1 yr. \$20.00; 2 yrs. \$35.00. © Chilton Company 1972. Title Reg. U.S. Patent Office. Reproduction or reprinting prohibited except by written authorization. Microfilm reproductions of **The Electronic Engineer** and its predecessors, **Electronic Industries** and **Tele-Tech**, may be obtained from University Microfilms, 313 N. First St., Ann Arbor, Mich.

#### The Chilton Electronics and Instrumentation Group

The Electronic Engineer  
Instruments and Control Systems  
Instrument & Apparatus News  
Medical Electronics News  
Electronic Component News

Chilton



# LSI Transmitter And Receiver Create Dual-Mode Flexibility In Data Terminal Designs

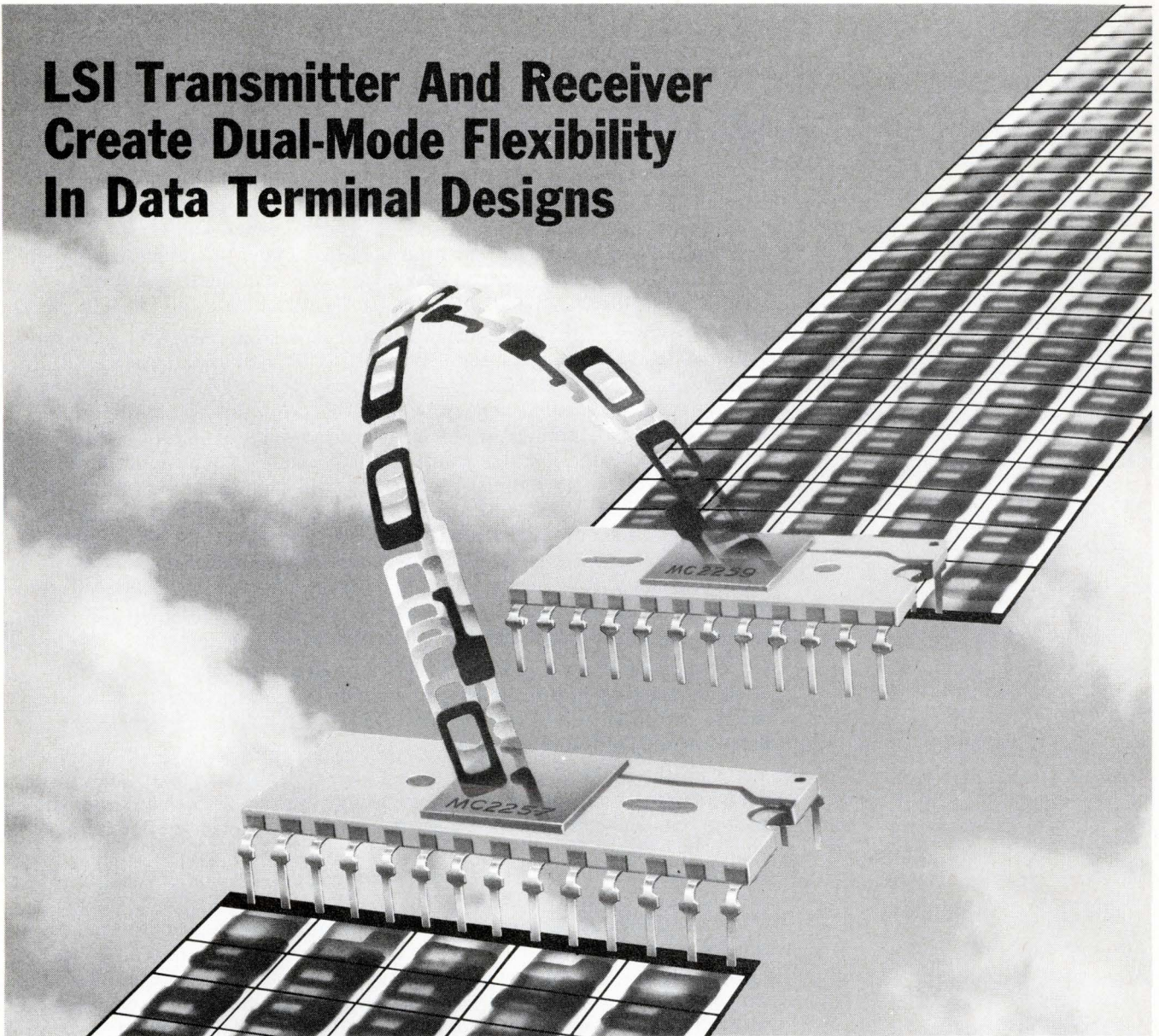

A different, and improved, approach to the terminal transmitter and receiver functions in data communications systems is available now in Motorola's new MOS LSI MC2257 and MC2259. They operate in both asynchronous and synchronous modes to provide a new dimension of flexibility. Compared to present bipolar designs they make big reductions in package count and space requirements. When the receive-only function is required there is no need to buy and waste half the unit. And both parts are compatible with TTL circuitry.

These exciting innovations are designed to serve the requirements of the ubiquitous communications input-output section of data communications systems. Use them in alphanumeric CRTs, serial printers, teletypes, various types of remote terminals, factory data collection terminals, concentrators and multiplexers, and mini-computers.

MC2257, the transmitter, takes parallel binary data in the form of characters and transmits them serially. Internally generated parity (odd or even), when applicable, and control bits (a start bit and one or two stop

bits) for the asynchronous mode are transmitted with the characters. It displaces up to 30 bipolar packages.

The receiver, MC2259, accepts serial data, organizes the bits into fixed word lengths corresponding to characters and transfers them to a buffer register where the characters are accessed in a parallel format. Provision of a wired-OR configuration on all outputs is a feature it shares with the MC2257. On-chip synchronization of the clock to data is provided for both synchronous and asynchronous operation. An over-run signal is generated to denote a lost character, and an error is indicated when received parity differs from the externally selectable parity. This part eliminates some 41 bipolar units.

Both packages are dual in-line ceramic, 24 pin for the MC2257 and 28 pin for the MC2259. The low pricing is remarkable at \$13.60 for the MC2257 and \$18.60 for the MC2259. Learn more about this unique pair of data communications adapters by writing to Motorola Semiconductor Products Inc., P. O. Box 20912, Phoenix, AZ 85036. Or just go right out and buy a get acquainted quantity from your Motorola distributor now.



**MOTOROLA MOS**  
—the broad line is our specialty!

## What's wrong under the hood?

The sheer size of the automotive industry has for the past 10 years both attracted and baffled manufacturers of electronic components. If we don't count earlier applications such as door switches and harness connectors, the first company to hit paydirt was Motorola when, under the daring inspiration of Les Hogan and John Welty, it developed silicon rectifier diodes for the alternators of 1960 Chryslers.

Since then, the dreams of semiconductor men have been filled with visions of gluing all kinds of electronic components on to millions of automobiles. But so far, while most semiconductor manufacturers have made noises that they are interested in, or made contacts with, or sold a few prototypes—or even some production quantities—to the automobile Establishment, only three or four companies have scored any measure of success under the hood. Motorola claims seniority, TRW familiarity, Texas Instruments the most sophisticated application (anti-skid control), and RCA most of the sales—perhaps half of \$20 million. In addition, Solitron is aggressively pursuing the “automotive aftermarket,” at parts and speed shops—another \$10 million market. Not much of a claim for a market touted to be in the billions by 1980. Why? Trevor Jones, GM's top electronics man, put it very simply: “a 30¢ power semiconductor can't compete with a lower-priced switch.”

Of course it can't, not yet. But, as Jones himself points out in p. 56 of this issue, thanks to the forthcoming legislation on automobile pollution and safety, the dollars will be not in replacing switches, but in implementing detection and control functions too complex for switches.

Yet while the *business* opportunities that the new legislation and systems will open are important, shouldn't the *employment* opportunities they will create both in semiconductor plants and at automotive companies be even more important? They are, but don't expect them to heal the gaping wounds the 1970 recession left in the ranks of aerospace engineers. George Mueller, president of Systems Development Corp., estimates that it takes \$50k/year worth of sales by an aerospace company to employ one engineer or scientist, while the corresponding figure for the automotive industry is \$10 million. Our figures, which we compiled during last year's campaign on opportunities for our reader\*, are a little less pessimistic: each cut of \$10 million in aerospace cost the jobs of 60-65 engineers, while only 10-15 of them could find employment with each \$10 million of new electronic systems in automobiles. In other words, we estimate that, if automotive electronics is a \$5 billion industry by 1980, it will have created about 5000 to 7500 jobs for engineers.

We cannot afford to lose these jobs, or those dollars. The electronic revolution in the automobile is not taking place just in the U.S., as the Bosch injection system in Volkswagens and the work of Dr. G. Villa at Fiat prove. Jones, himself an EE who worked in aerospace, has a few nudges for semiconductor manufacturers, and words of wisdom for EEs on how to succeed under the hood. His nudges must be acknowledged, and his advice heeded, or else by 1980 we'll be wondering how come the cars and the electronic systems are coming from abroad, and where did the jobs and the dollars go.



'We can put all this into a chip this small . . .'

Alberto Socolovsky  
Editor

\*See "Appointment in Washington," *The Electronic Engineer*, May 1971, p. 28.

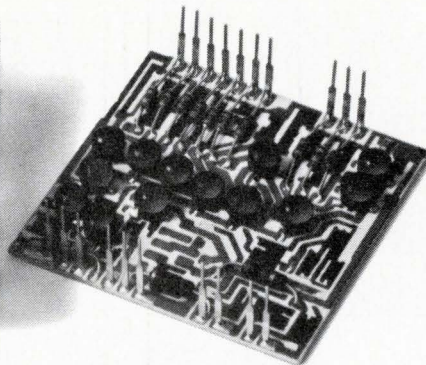
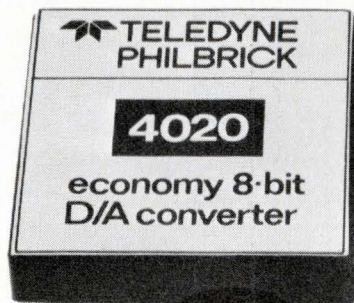

# Ours. A bit ahead of theirs.

Another \$19 DAC? But, don't put us down until you've tried it.

Competition gives you exactly what you pay for... a \$19 circuit... no more, no less. Ours is based on Philbrick's famous 4006/4007 digital to analog converters selling originally for \$70 to \$75.

Combined thick-film and re-flow techniques have endowed our 4020/4021 8-bit model with higher performance than you'll get from any competitive unit. Things like — linearity of  $\pm 1/2$  LSB with a settling time of  $25 \mu\text{sec}$  and temperature coefficient of  $40 \text{ ppm}/^\circ\text{C}$ .

Match this with any other \$19 DAC and you'll know why we say it's a bit ahead of theirs.

Looking for a 10-bit model?

Then compare our 4022/4023 \$29 version with anybody's. We welcome the comparison. Evaluation samples are yours for the asking. While you're asking, request our new 1972 Product Guide.

Ask your local Philbrick representative or write, Teledyne Philbrick, Allied Drive at Route 128, Dedham, Massachusetts 02026. For toll-free ready data dial (800) 225-7883. In Mass., (617) 329-1600.

## Philbrick Data Converters. The good ones.

# The NAKED MINI™

## \$1450

### The bare maximum.

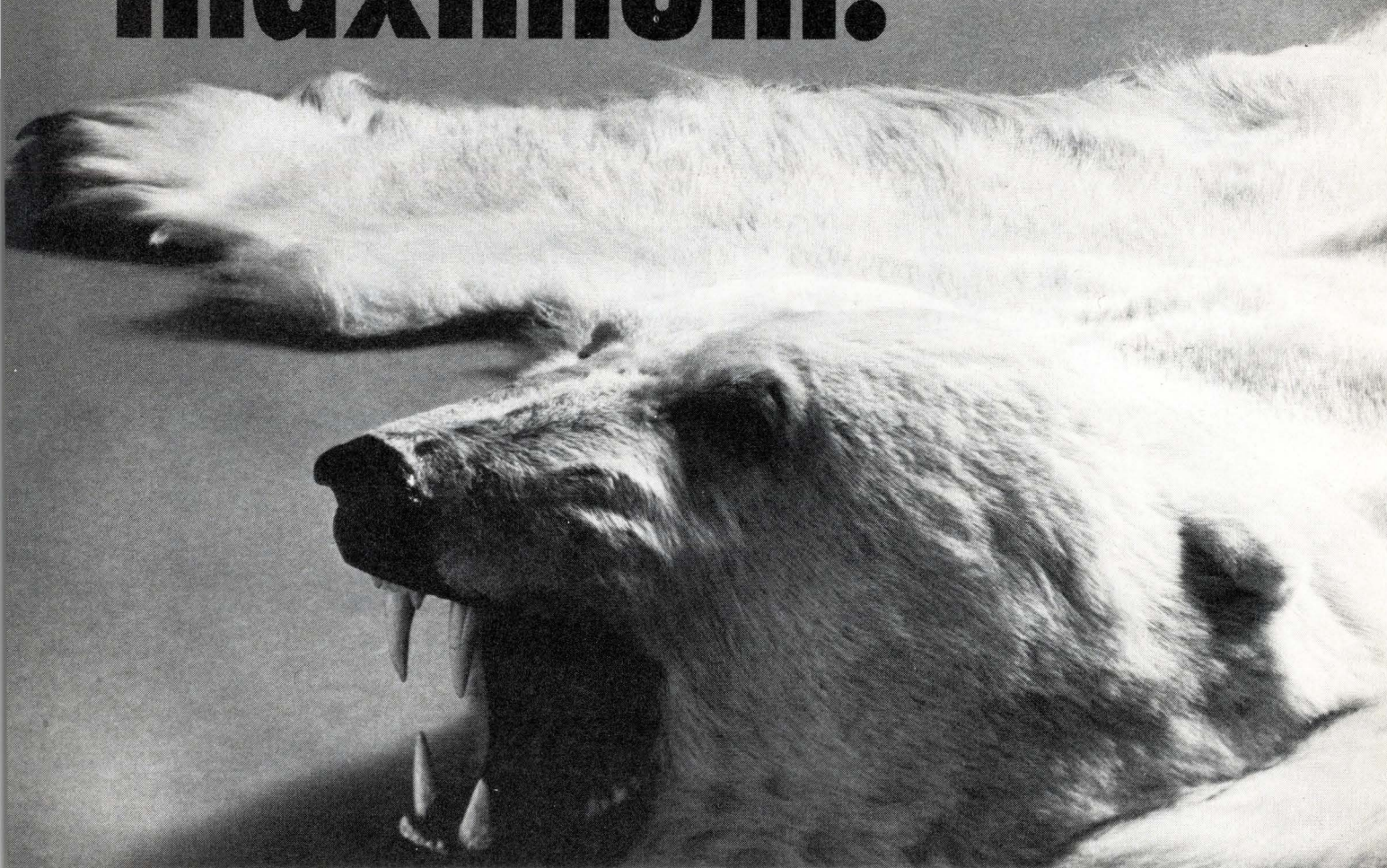

The Computer Automation NAKED MINI™ is naked. But it's not stripped. And that's an important difference.

To us, if a minicomputer is stripped, it's not even a computer. It's only a limited controller. Loose cards and components without even a memory. Sort of a do-it-yourself kit. That's not what you get from us.

The NAKED MINI is a fully-operational, general purpose computer with 4K of expandable memory.

With our NAKED MINI 8-bit and 16-bit computers, the only things missing are the power supply, console, and chassis. That's all.

No, the NAKED MINI is not a stripped computer. Far from it. It has the complete power of a stand-alone system. It's an integral unit, designed for maximum useability and interface-

ability. It's fully tested and warranted. And it comes with a complete line of standard software.

In fact, you get a lot of features that costlier stand-alone computers don't even have. Standard items like our 145 basic instructions (76 with the 8-bit), the most powerful instruction sets on the market. Three direct memory channels. Vectored priority interrupts. Hardware arithmetic features. And 32K of core. Plus hardware multiply/divide and full byte operations on our 16-bit machines.

Even though our NAKED MINI's have all this horsepower and flexibility, think of them as a component. A component ready to be thoroughly buried inside your OEM product.

Because of its low price tag, the NAKED MINI makes it economically feasible to design your product with a mini-

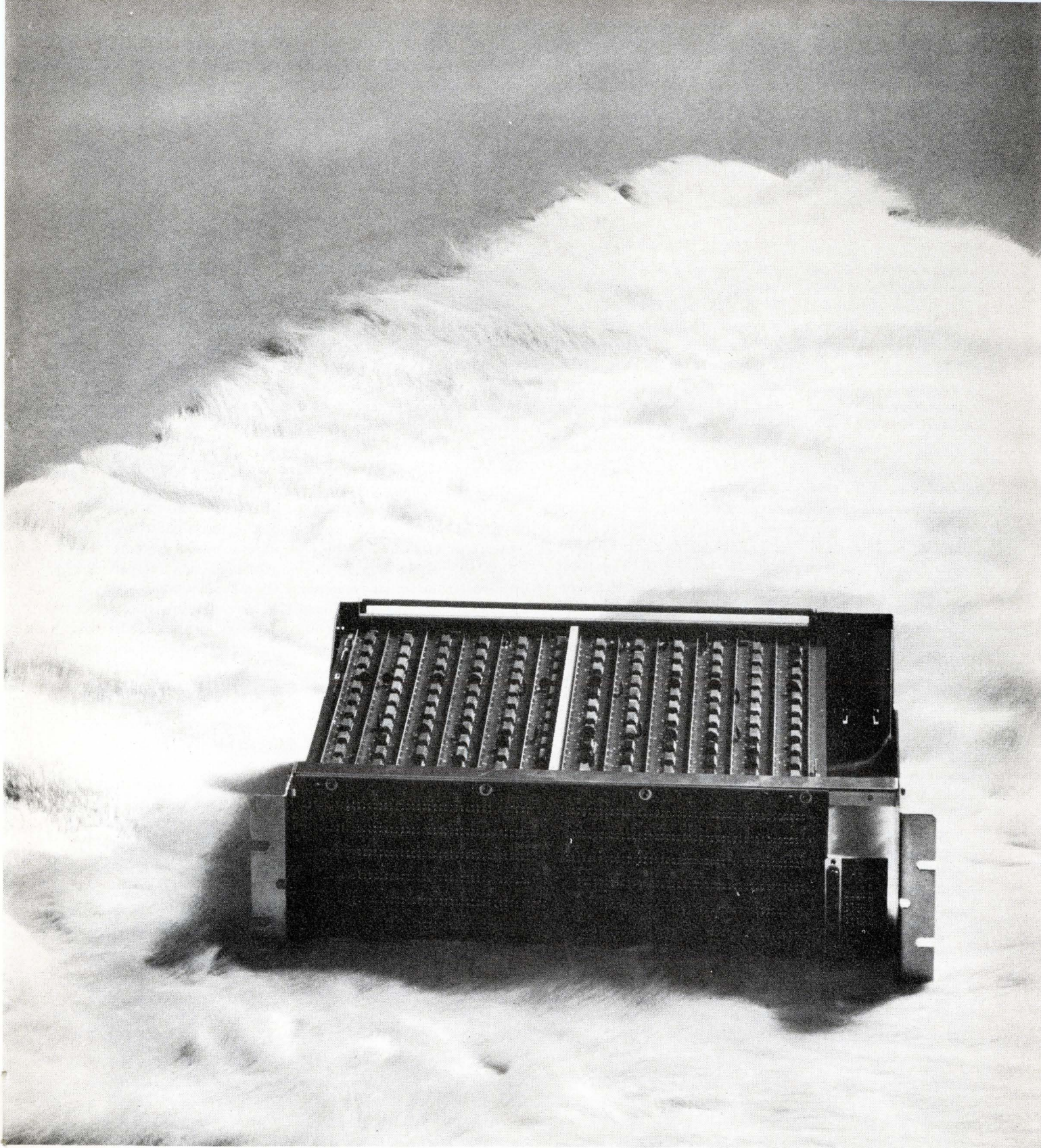

computer, rather than hardwired circuitry. This enhances your system performance, while reducing system costs considerably.

For the systems designer, the NAKED MINI concept means an opportunity to get the full computer power of our packaged machines. But at the price of a component. Take a look at our quantity pricing list. We think you'll agree.

We'll be glad to send you full specification details, including a complete listing of the standard instruction set and software. Just write or call us.

The NAKED MINI has nothing to hide.

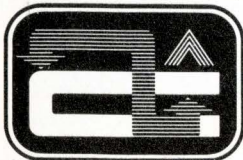

#### Naked Mini Quantity Pricing

	10-19	20-49	50-99	100-199	200 plus
NAKED MINI-16					
4K	\$2500.	\$2400.	\$2300.	\$2200.	\$1995.
2K	2200.	2100.	2000.	1900.	1725.
NAKED MINI-8					
8K	\$2275.	\$2125.	\$2000.	\$1925.	\$1730.
4K	1975.	1825.	1700.	1600.	1450.

(NAKED MINI's are sold on firm purchase orders in minimum quantities of 10 units.)

#### COMPUTER AUTOMATION, INC.

895 West 16th Street • Newport Beach, California  
92660 • Phone (714) 642-9630 • TWX 910-596-1377

**FCC accepts transmitter** . . . The FCC recently granted type acceptance to Laser Link Corp.'s five-channel microwave transmitter. Designed for use in long haul and local distribution service for cable TV and wideband data transmission applications, initial use will be in the CATV field. Here the transmitter, as part of a series of relays, will let cable systems import up to five TV channels from as far away as 250 miles. Unlike conventional microwave systems, relay points need just one microwave carrier instead of five, and the system requires no video demodulation/remodulation at the relays or terminals.

**Cashing in on the chips** . . . If you're an electronic manufacturer or a semiconductor supplier that needs custom monolithic chips, here's a unique offer you're sure to be interested in. Integrated Circuit Engineering Corp. (ICE) is offering you a free bipolar wafer processed from your mask set. The offer is based on ICE acceptance of a commercial grade mask set; is limited to one wafer per U.S. continental company; and expires March 1. For full details on this unusual offer contact Gary M. Orman, Vice President, ICE Corp., 4900 E. Indian School Rd., Phoenix, Ariz. or call him at (602) 959-4760.

**All is not lost in space** . . . With the approaching end of the Apollo moon missions came President Nixon's decision to go ahead with the proposed \$5.5 billion space shuttle. NASA estimates that each shuttle flight would cost less than \$10 million, since the space shuttle would remain in orbit and could be used many times. The system is expected to be ready for operation by 1980. With as many as 50,000 new jobs expected to be created, it's good news for engineers. Although it can't replace the 200,000 jobs lost with the phasing out of the Apollo and other space programs, many of the new jobs are likely to be in Southern California, one of the areas hardest hit by military and space cutbacks.

**Will land mobile kill that busy signal?** . . . The FCC now faces AT&T's controversial proposal for a high-capacity mobile communications system that purports to relieve the limitations of assigned frequencies and the overload of existing telephone services. The new system would operate in the 806-881 MHz band recently allocated by the FCC for mobile communications service. AT&T is prepared to go all out for their system provided, among other things, a full 75 MHz be allocated to wireline common carriers exclusively. Motorola denounces the 75-MHz allocation as extravagant and unnecessary, and claims that "18 MHz is an ample allocation for the initiation of a comprehensive cell system." And Glenn R. Petersen of GE's Mobile Radio Dept. states that the FCC's allocated frequencies will not "provide a permanent solution to channel availability for mobile radio users." He suggests, instead, "space-division" multiplexing to meet the unexpected spectrum crunch.

**Packard's packing up to go** . . . When Deputy Defense Secretary David Packard recently resigned from his prestigious, though pressing position, he left with a spiel of typical "Packardisms" concerning the politics involved in defense decisions. Packard always spoke his mind, which is why he was able to defeat political pressures when it came to initiating a new weapons procurement policy and reorganizing the Pentagon. No wonder nearly all industry leaders regard Packard as a legend, regret his resignation, and realize he left behind a tough spot to fill.

**Moving towards MOV** . . . General Electric is on the move with a new family of semiconductor devices, called GE-MOV<sup>TM</sup> (metal-oxide varistors), designed to protect all types of electronic equipment—home entertainment, automotive systems, complex communications systems, etc.—against high voltage surges. Although Japanese patents cover the varistor material, GE produces it under a licensing agreement with Matsushita. Eyeing many potential applications in the automotive industry for the new device, GE predicts the total market will grow to \$20-30 million in five years.

**Circle Reader Service #220**

**Ions for sale: approximately 10<sup>-11</sup>¢ apiece** . . . Requests have been so numerous that Accelerators Inc. is setting up an implantation service. Standard implants are boron, phosphorous, arsenic, or antimony ions in wafers that are heated or at room temperature. Energies run between 30 and 300 kV, while doses go as high as 10<sup>15</sup> ions/cm<sup>2</sup>. Although the setup charge per species is \$150, implantation price depends on dose and lot size. One to ten wafers doped to 10<sup>13</sup> ions/cm<sup>2</sup>, for example, cost \$25/wafer; 10<sup>15</sup> ions/cm<sup>2</sup> cost \$125/wafer. Other ions, energies, and doses are negotiable. Accelerators Inc., 212 Industrial Blvd., Austin, Tex. 78704.

**Circle Reader Service #221**

**Would you go to a conference** . . . if you were told that at least half of the papers were on subjects that are here to stay? And that you could hear and speak to the men who are not only at the forefront of technology, but who have the authority to tell you what's ahead? In the field of semiconductors that conference is the International Solid State Circuits Conference to be held in Philadelphia, Feb. 16-18.

Among the subjects that are here to stay and that you'll hear about are memories, automotive and consumer electronics, readouts and displays, charge-transfer devices, linear ICs, and microwave semiconductors. And among the people you'll talk to about what's ahead are Dr. Robert Noyce of Intel, Steve Levy of Motorola, and Fred Bucy of TI. There'll also be leaders of these growing markets from overseas.

Registration: IEEE members, \$25 before Feb. 11, \$30 after. Nonmembers, \$30 and \$35. If you can't attend, order the Digest of Technical Papers for \$10 before Feb. 11, \$15 after. Nonmembers, \$15 and \$20.

# C-LINE MICROWAVE PIN DIODES

Choose the best  
and still pay less for your  
microwave switching needs

## C-LINE MICROWAVE PIN DIODES — SPECIFICATIONS

Type	Maximum Total Capacitance (0V, 1GHz) $C_T$ pF	Maximum Series Resistance (100mA, 1GHz) $R_s$ $\Omega$	Minimum Carrier Lifetime ( $I_r = 10mA$ ) $\tau$ us
UM4001B	3.0	0.5	5.0
UM7001B	0.9	1.0	2.5
UM7101B	1.2	0.6	2.0
UM7201B	2.2	0.2	1.5
UM6001B	0.5	1.7	1.0
UM6101B	0.7	1.0	1.0
UM6201B	1.1	0.4	1.0
UM6601B	0.4	2.5	1.0

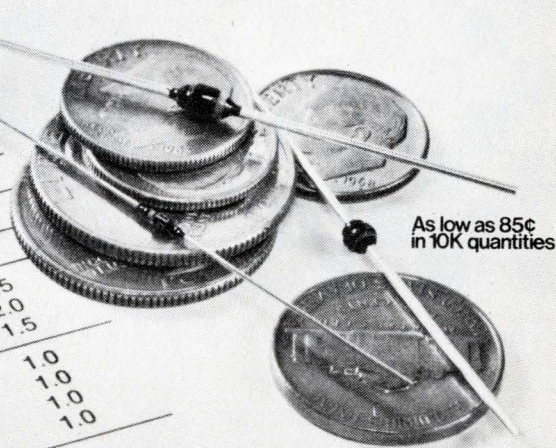

As low as 85¢  
in 10K quantities

You can now select capacitance, resistance and carrier lifetime and get circuit optimization at the industry's lowest prices. These new 100V PIN diodes from Unitrode all feature low distortion and low insertion loss for microwave applications such as TR switches, antenna selectors, receiver channel selectors, switching matrices and attenuators in AGC circuits. They're available off the shelf at your local Unitrode distributor. Samples on request.

For fast action, call Sales Engineering collect at (617) 926-0404, Unitrode Corporation, Dept. 2 W, 580 Pleasant Street, Watertown, Mass. 02172

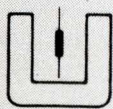

**UNITRODE** quality takes the worry out of paying less.

# POWERTEC WINS POWER RACE

**With Record Low Prices For New,  
High Performance OEM Series**

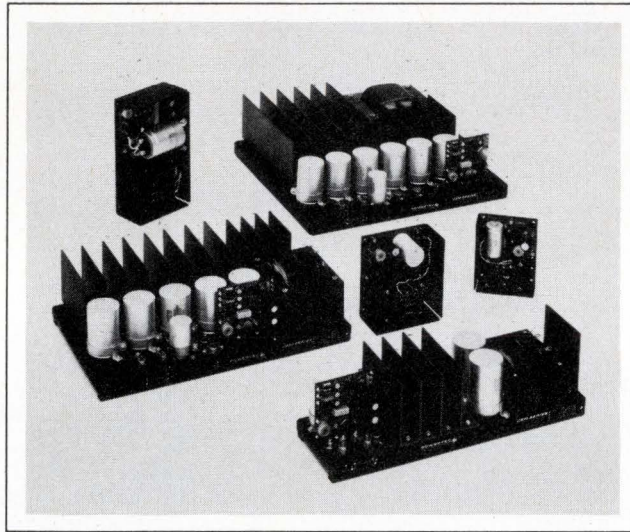

## ALL MODELS DELIVERABLE FROM STOCK IN 24 HOURS

Leading the power supply industry with new low prices, top performance and reliability, Powertec's new OEM Series offers 7 popular voltages, in six basic sizes, with 42 power output combinations and is main frame, peripheral and instrument rated.

Available from stock, the OEM Series is a "no frills" fundamental new design — not a price cut, loss leader! Don't take a chance on an also-ran! Get a winner from THE power people at THE power house — Powertec. Request free application data and catalog.

Model Number	*(5)		*(15)		*(24)			Unit Price
	5V	6V	12V	15V	18V	20V	24V	
2B(*)	3A	2.5A	1.5A	1.3A	1.0A	1.0A	1.0A	\$24.95
2C(*)	6A	5A	3.0A	2.8A	2.0A	2.3A	2.3A	\$44.00
2D(*)	12A	10A	6.5A	6.0A	4.5A	5.0A	5.0A	\$75.00
2E(*)	25A	23A	15A	14A	10A	12A	11A	\$129.00
2F(*)	50A	46A	30A	28A	20A	24A	22A	\$219.00
2G(*)	75A	68A	45A	42A	30A	36A	33A	\$299.00

- REGULATION: Line  $\pm .05\%$ , Load  $\pm .05\%$
- INPUT: 115 VAC  $\pm 10V$  47-63Hz
- RIPPLE: 1mv RMS (5 & 15V), 3mv RMS (24V)

- O.L. PROTECTION: Current limit/foldback
- RESPONSE: 50 $\mu$ sec typical
- TEMPERATURE: 0°C to 40°C derated to 71°C

**POWERTEC INC.** an Airtronics subsidiary  
9168 De Soto Ave., Chatsworth, California 91311 (213) 882-0004 TWX 910-494-2092



Hewlett-Packard's new \$395 calculator . . . performs like a scientific calculator even though it's priced like an arithmetic one. You'll be receiving details on the new machine if you're on HP's mailing list, so watch your mail. Better yet, watch for a full description of the calculator in our next month's issue, or

**Circle Reader Service #222**

3 1/2 digits in hand . . . is what you'll hold with Keithley's new \$325 DVM. At the end of the probe, which is no larger than a fat souvenir ball-point pen, is an autoranging read-out display that exhibits solid-state digits and the scale (ac, dc, kΩ, and MΩ). A 3-ft curly cord attached to the probe plugs into a logic-and-power supply box. Warm-up time is 2 s. There'll be more details about this new system in our next issue. In the meantime,

**Circle Reader Service #223**

**Bounding into the billions** . . . According to Frost & Sullivan Inc., a well known technological research organization, the test and measurement instrument market will reach \$2.44 billion by 1980. This means an average yearly increase of 7.5% which Frost & Sullivan attributes to the growing use of automatic test systems and computers in the semiconductor and IC fields, the increased use of modular instruments for specific functions, and the growing number of portable instruments.

**Minicomputers under \$3000** . . . It's a competitive world for the minis. The General Automation 12/10, introduced at \$2850 for single units, is an 8-bit, 4k byte machine. Among eight other models also introduced is a 16-bit computer for \$3950. For a 4k memory, this price is lower than for other similar new machines, such as Data General's Nova 1210 (\$4350 each) and Digital Equipment Corp's PDP-11/03 (\$4670).

But for OEM customers, GA's real improvement is not so much in price and options as in sales terms. An OEM can now *rent* a computer for 30 days, a service he can't get from any other vendor. And on a quantity order, GA will *allow up to one year*, without penalty, from the date of delivery of the first unit until the quantity contract begins. In effect, this adds up to a full year to a delivery contract, which usually runs for another year. Hewlett-Packard can spread delivery over 18 months from the order. DEC, DG, and most other vendors allow one year for delivery contracts, without grace periods. GA has also instituted a *90-day warranty*, which the OEM may split between his plant and his customer's location over a six-month period. DG provides 30+30 days over a period of about three months, while DEC warrants for only 30 days after acceptance. But the best warranty policy in the market seems to be HP's, which replaces parts free for 15 months. For more information about

General Automation

Data General

Digital Equipment Corp.

Hewlett-Packard

**Circle Reader Service #224**

**Circle Reader Service #225**

**Circle Reader Service #226**

**Circle Reader Service #227**

**25,000 chips per hour... mean**

**LARGEST INVENTORY  
FASTEST DELIVERY  
LOWEST COST  
FINEST QUALITY**

**...from USCC/Centralab**

Yes, it's true! Because demand for ceramic chip capacitors in hybrid microelectronics will more than double within the next two years, USCC's production capability on popular sizes will increase to 25,000 per hour by mid-1972. That's over 50 million annually, with a demonstrated failure rate level of only .001%/1000 hours.

New automation techniques and materials cost reduction mean to you as a customer: fastest delivery and lowest prices on the finest quality ceramic chip capacitor on the market.

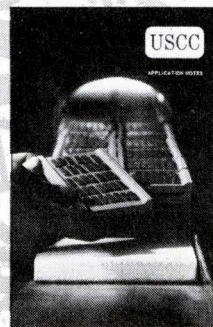

For your free copy of our Ceramic Capacitor Catalog and Applications Manual on how to use chip capacitors more advantageously, write: USCC/Centralab, 2151 N. Lincoln Street, Burbank, California 91504 or circle the information retrieval number below.

**USCC**

U. S. CAPACITOR  
CORPORATION



**CENTRALAB**  
Electronics Division • GLOBE-UNION INC.

**Circle Reader Service #11**

# The Challenge of This Decade: Technology or Profit?

The breakthrough will come when engineers and government team up with industry and marry technological innovation to marketing know-how. The time is now.

by Alberto Socolovsky, Editor

In our last issue we singled out the main reason for the slump in electronics sales during 1970: It was because the military market, while still the main user of electronics, no longer subsidizes the *growth* of the industry as it did during the decade of the '60s. From now on growth must come from varied and intense sales development in other markets. These markets will eventually become the major source of more jobs for our engineer readers and extra sales for the manufacturers of components, instruments and subsystems. These are the new markets we will discuss in this installment. Developing them is a challenge, with hazards as well as opportunities, but a challenge that must be met.

## PART II

Matrix-1970

Copyright 1971 The Electronic Engineer Magazine

USERS	MFR'S	Passive Comp's.	Semiconds. (Discrete)	ICs	Hybrid Circuits	Linear Modules	Microwave Comp's.	Materials	Connectors	Relays	Panel Meters	Read-Outs	Power Supplies	Lab Instr's.	Commun. Prod's.	Minicomp. & Peripherals	Distributors
COMPUTERS & PERIPHERALS	20-35	15	20-50	10-30	2	3	10-30	30-40	5-10	2	10-20	20-50	5	5	5-20	15	
INSTRUMENTATION	5-10	10	5	5	10-20		5	8-10	2	10-30	10-20	20-60	5	3	5-20	3	
COMMUNICATIONS SYSTEMS	10-20	10	5-10	5	2	15	5	10-20	50	5-10	10-20	5-10	5-10	10	5-20	5	
CONSUMER ELECTRONICS	10-25	20	5-10	10-20	2	1	5	10-15	1	10	5-10	2	4	2	1-2	5	
INDUSTRIAL CONTROL SYSTEMS	5-15	15	10-20	10-20	5-10	5	5	5	5	10-15	5-10	10	3	5-10	5-15	1-5	
COMPONENTS & SUBASSEMBLIES		5	2	1-5		2	5	1		5	2	5-10	10	5	2-20	1-5	
GOVERNMENT (MILITARY & AEROSPACE)	30-50	20-40	15-30	20	35-50	50-95	5-10	35-50	15-35	40-80	5-20	20-70	40-70	20-40	20-45	50-70	
GOVERNMENT (CIVILIAN)	2-3	5-10	2	1								1	1	10-25	6-10	2	
MEDICAL ELECTRONICS			3	1-5	5-15	5	2	2	2-5	5-10	5	5-10	3		5-10	2	
BUSINESS MACHINES	5-15	5	5-10	5-10		3	5-10	3	10-20		5	2-5	2	20-25	2	8	
RESEARCH LABORATORIES	5	2		1	10	5		2	1	1	2	2	10		10-30	1	
AUTOMOTIVE							15-25		8	2-5			1				
NON-OEM USERS									6					10	10-40		
AIRLINES					5						2-10	2	10	5	10	10	

Figure 8

## The Picture for 1970

**Figure 8**, bottom of facing page, is a matrix which shows how the electronics companies of our readers bought electronics components, instruments and subsystems from electronic manufacturers in 1970.

The markets these manufacturers concentrated on in 1970 are represented by the cells of the matrix. The numerals within these cells indicate the dollars spent by users, expressed as a percentage (or a range of most common percentages) of the total dollar volume *sold* by the manufacturers.

For example, the matrix shows that the relays *bought* by MANUFACTURERS OF COMMUNICATIONS SYSTEMS amounted to 50% of the total sales made by *relay manufacturers*. Since the relay market in the U. S. in 1970 was about \$270 million, then \$135 million worth of *relays* were used in COMMUNICATIONS SYSTEMS AND EQUIPMENT.

Those cells within the matrix which represent markets of *major* importance are outlined with *heavy ruled lines*. They clearly show, for instance, that *military and aerospace* accounted for a large part of the sales for just about every type of manufacture during 1970. It is equally apparent that the *computers and peripherals* market was second in importance. This matrix shows a cross section of sales within the industry for 1970. As such, it is two-dimensional and portrays manufacturers sales by *applications*.

Yet there is another dimension—exports—which became very important in 1970 when the U. S. market was depressed. Here are the export percentages for the first three types of manufacturers which appear in the matrix.

Manufacturers	Total Sales (millions of \$)	% Exports
Passive components	1,111	8.4
Discrete semiconductors	769	17.2
Integrated circuits	524	19.1

You will notice that among components manufacturers, the IC companies have done the best job of marketing their products abroad.

That's tremendously significant because exports will be a strong source of industry growth in the near future.

## What's Ahead?

So much for 1970. Now, before we attempt to build a similar matrix for the next few years, let's examine some of the growth markets that head the rows of the matrix. It is important to study them for two reasons: first, because they represent the kinds of equipment and systems which our electronic engineer readers now build. Second, because if these markets, say, double by 1975, and the use of a certain kind of component in them remains constant, *then the market for that component will double, too*.

For example, Charles Phipps of Texas Instruments estimates the semiconductor content of U. S.-made electronic equipment at 4.7% in 1969. That means a \$100 piece of equipment contained \$4.7 worth of semiconductors (both discrete and ICS). Phipps hopes that by 1980 such content will increase to 7%. This means that a doubling of a user market will triple the sales of semiconductors.

On the other hand, the use of some components will undoubtedly decrease. Even in a growing market their sales may increase at a slower rate or not at all.

Let's start, then, with the first row.

## Computers and Peripherals

Computers and peripherals comprised the second most important market during 1970. According to the EIA, hardware sales by American manufacturers of computers and peripherals amounted to \$5.16 billion in 1970. See **Figure 9**, next page. When we evaluate in terms of hardware, the Department of Commerce forecast for this industry, we anticipate a tremendous growth of about 80% in five years to an impressive \$8.8 billion in 1975! This forecast may seem staggering after the withdrawal of RCA from the computer field. But RCA's failure was related to its own overall marketing strategy, not by the future potential of this market.

## Computers & Peripherals (U. S. Production)

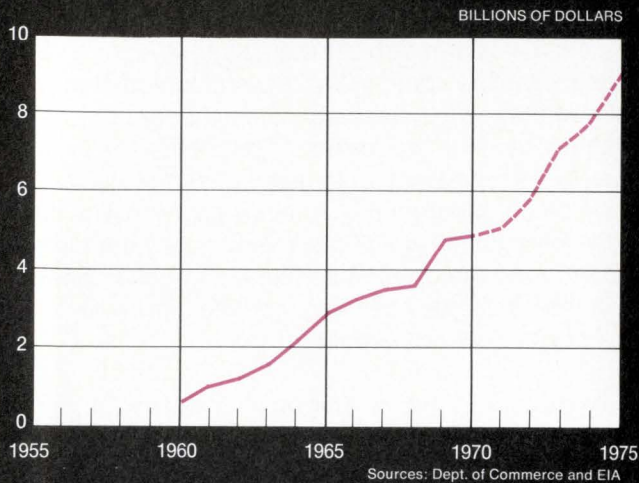

Figure 9

Where will these billions of dollars come from? There was hardly any growth at all in this market in 1971—the industry barely held its own. An increase is projected for 1972 as shown in **Figure 9**, top left. This will result largely from an increase in sales in the U.S., thanks to the tax investment credit which is now in effect. However, there will be little growth from imports in 1972 because Japan and Western Europe are now on the brink of a recession which is expected to last through the year. Consequently, their purchases of American equipment, priced in more competitive dollars, will not bring more business to American companies before 1973.

The growth for computers and peripherals may slow down in 1974 when the market may be affected by a ripple of the 1970 recession in the U. S. **Figure 9** indicates full growth, both domestic and from exports, for 1975.

All this paints a most optimistic picture, but we are certain that American manufacturers of computers and peripherals have what it takes to capitalize on these opportunities.

That's the U. S. picture. Now, let's analyze this market further by looking at the third dimension of our matrix. What about *exports*? We get the answer when we examine the production of computers and peripherals by manufacturers in the foreign countries that buy components, instruments and subsystems from the U. S.

## Computers & Peripherals (International Production)

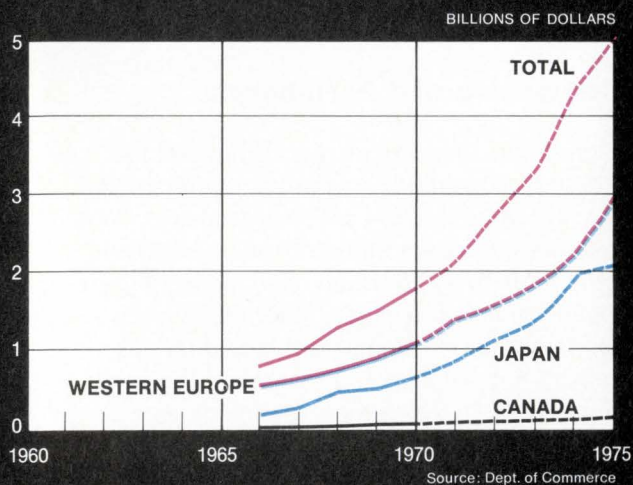

Figure 10

**Figure 10**, bottom left, reveals that the production of computers and peripherals in the remainder of the free world amounted to \$1.8 billion in 1970. It is expected to more than double to \$5.1 billion by 1975. Production by countries beyond the iron curtain is not included in these estimates because only now is our own government making a realistic appraisal of the kinds of components and equipment we can export to them.

Adding together the dollars shown in **Figures 9 and 10**, we estimate that the market in the free world will more than double from just under \$7 billion in 1970, to about \$14 billion in 1975.

We will skip instrumentation because this market is presently depressed as a result of

cutbacks by its prime customer, the military. It will take some time to find new dollars for instrumentation in non-military applications. That is, with the exception of the automotive and pollution markets which will be discussed later.

## **Communications Systems**

There are two growth segments to the communications systems market: data terminals and data communications equipment. In 1970 the market for data terminals amounted to \$510 million. It is expected to surge to \$1.3 billion by 1975 and to \$3 billion by 1980. For this growth to take place the manufacturers of data terminals will have to make a sustained effort to penetrate such markets as retailing. However, it must be kept in mind that retailers will buy such equipment *only* if it will help them cut costs, increase efficiency or make more money. Obviously, the engineer who best understands the problems of retail merchandising will be able to help his company develop marketable products.

Once these terminals are installed they will generate data, and the data will have to be transmitted. Thanks to a resolution by the Federal Communications Commission last year, allowing new data communications carriers to compete with the Bell System and Western Union, there will be an increased demand for carrier and transmission equipment.

There will also be an additional need for new types of digital equipment to interface computers, peripherals and terminals to the new data communications networks, much like the way modems now interface them with the telephone network. An early example of such units is the synchronous "digital data set" which Datran has designed for its proposed network, and Paradyne's new high speed modem for batch terminals. The volume of data both the carriers and the interface equipment will handle is expected to increase nine fold in this decade.

It is important for engineers as well as management to stay abreast of developments in this field, because not only technical but also legal factors such as communication

tariffs will influence the development of data communications equipment. As a matter of fact controversy is now raging at the FCC, between Bell and the independent manufacturers of modems to determine who is responsible for the performance of a data link.

Now we should examine this field from the point of view of exports, as we did above for computers and peripherals. Unfortunately, exports of data communications equipment have been hampered because of non-tariff restrictions in both Western Europe and Japan. For example, in selling to the government-owned communications utilities of Western Europe, U. S. companies must compete with well-established companies such as Plessey and Standard-Elektrik Lorenz. While these companies have the overt support of their local governments, our companies either get no help from our government or are even hindered by antitrust regulations.

In Japan, Nippon Telephone and Telegraph, the local utility, specifies that *only* Japanese equipment—even software—may be used for its new billion dollar Public Data Communications Project.

The only influence that can help U. S. manufacturers compete against these restrictions is that of our own government, which only recently became sensitive to the unfairness of these restrictive practices.

## **Consumer Products**

The manufacturers of consumer electronics products in the U.S. were the first to feel the impact of both the recession and the rise in imports. See **Figure 11**, next page. The 1970 recession also delayed the development of the next important consumer market—video recording—which now will not take place before the end of 1973. As a matter of fact, both CBS and Sony, the two companies which seem to have the edge in this market, will concentrate their sales efforts in 1972-73 on institutions such as universities and in industrial training programs. From these sales they will develop a base that will permit them to move into the consumer market.

## Consumer Products

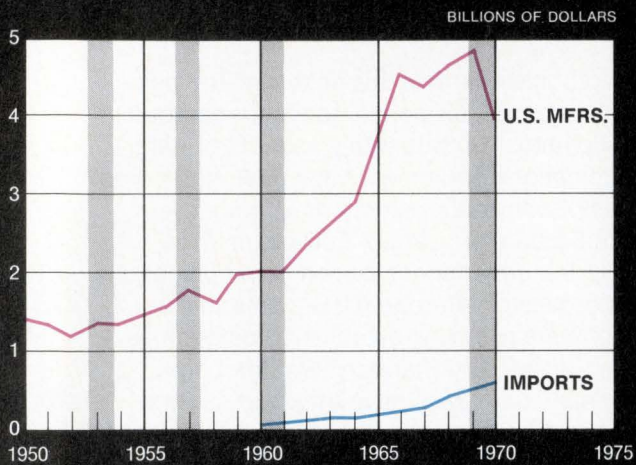

Figure 11

As of now it appears that foreign manufacturers will control the bulk of this market. The only thing that can alter this situation is for U. S. manufacturers to make a determined effort to develop low-cost equipment, such as RCA is doing with its laser-based SelectaVision system.

### Government – Military and Aerospace

We said earlier that the military and aerospace market will decline in importance, even though it is still the single most important customer for electronic components, equipment and systems. It will remain that way in 1972. Yet there are discrete segments of the military market for which there is an immediate sales potential. Such is the case with electronic counter-measures (ECM), now in demand because they are tied in to strategic programs (Safeguard, Minuteman III, nuclear submarines and F-14 aircraft) which will continue to be funded.

### Government – Civilian

The applications for the civilian branch of the government will be under the control of such agencies as DOT (for urban and high-speed interurban transportation); HEW (for medical electronic equipment); HUD (for low-cost, modular housing) and, most important today, by the Environmental Protection Agency.

The astute engineer will become as familiar with the policies, programs, directives and contractual requirements of these agencies as he is with the best of his present customers. And well he may for, in 1975, one or more of these agencies *should* be among his best customers.

To learn more about the opportunities developing at the Environmental Protection Agency, the editors of *The Electronic Engineer* recently interviewed Dr. Stanley Greenfield who is head of EPA's Research and Monitoring. His department has a budget of \$160 million to be spent in 1972. His department also influences the spending of another sum almost as large but which will be allocated to states and local governments. During 1972 some of this money will be spent in evaluating the kinds of instrumentation systems and monitoring transducers needed to measure and control the four forms of pollution: water, air, noise and solid wastes.

Even though the procurement cycle may take three or four years before the EPA or the state and local governments issue any contracts, *now* is the time for electronics companies to establish a rapport with Dr. Greenfield's department. *Now* is the time to get in on the ground floor at the design state. For instance, dissolved oxygen is today the most common measurement for water pollution and the EPA is interested in low-cost, perhaps digital, transducers to monitor it.

### Business Machines

The business machine market first presented opportunities to the manufacturers of components when Xerox originally introduced its office copiers. Today, low-cost calculators seem to offer similar promise.

As a matter of fact, this field is now moving swiftly. As recently as 1970, it appeared that U. S. manufacturers were locked out of the market for low-cost calculators. The market seemed to be firmly in the control of the Japanese. To be sure, Japanese manufacturers will still make almost all calculators sold in 1972 in the U. S. for less than \$750. However, the incipient Japanese recession has prompted the Japanese to halve their prices. At the same time, calculator components like readouts, keyboards and MOS integrated circuits have progressed so much that today it is feasible to mass-manufacture a calculator with less than one hour's worth of labor in this country. As the incidence of labor shrinks, so does the price advantage of the Far Eastern manufacturers.

However, it would make little marketing sense for electronic companies to make and sell low-cost calculators by themselves. Department stores such as Montgomery Ward and Alexander's of New York think they can sell them in quantity for just under a retail price of \$100. While these stores have the organization to sell and

service calculators, they would need at least a mark-up of 50% to do it.

### Automotive

Traditionally, the vehicle segment of the automotive market has been a source of frustration for electronics manufacturers. For example, Detroit has been known to dictate the price at which it would become interested in using a particular component. If car manufacturers can buy miniature incandescent signal lamps for a few pennies each, they won't pay much more for light-emitting diodes.

On the other hand car manufacturers are today under pressure from the government to come up with solutions to the automobile pollution and safety problems by 1975. Among all the modules the integrated circuits manufacturers hope to sell to Detroit, the car makers are interested in and already working on voltage regulators, ignition and braking systems and multiplexing of sensors. See **Figure 12**, below.

### ICs in Automobiles

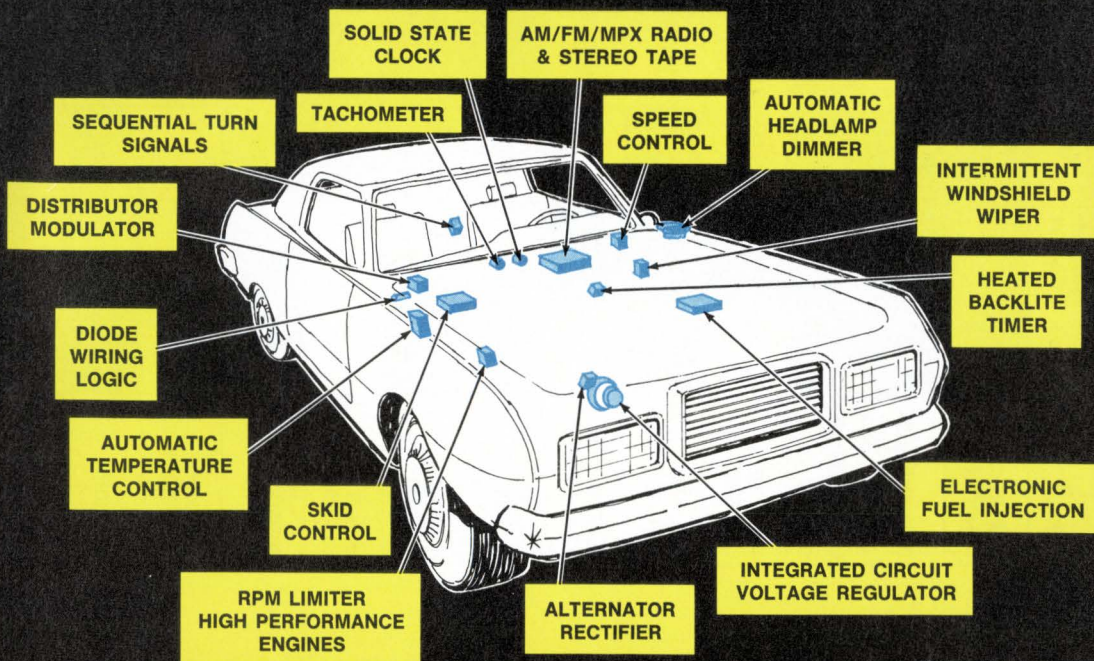

Source: Texas Instruments

Figure 12.

# Matrix

Copyright 1971 The Electronic Engineer Magazine

USERS \ MFR'S.	Passive Comp's.	Semiconds. (Discrete)	ICs	Hybrid Circuits	Linear Modules	Microwave Comp's.	Materials	Connectors	Relays	Panel Meters	Read-Outs	Power Supplies	Lab Instr's.	Commun. Prod's.	Minicomp. & Peripherals	Distributors
COMPUTERS & PERIPHERALS	20-35	15	20-50	10-30	2	3	10-30	30-40	5-10	2	10-20	20-50	5	5	5-20	15
INSTRUMENTATION	5-10	10	5	5	10-20		5	8-10	2	10-30	10-20	20-60	5	3	5-20	3
COMMUNICATIONS SYSTEMS	10-20	10	5-10	5	2	15	5	10-20	50	5-10	10-20	5-10	5-10	10	5-20	5
CONSUMER ELECTRONICS	10-25	20	5-10	10-20	2	1	5	10-15	1	10	5-10	2	4	2	1-2	5
INDUSTRIAL CONTROL SYSTEMS	5-15	15	10-20	10-20	5-10	5	5	5	5	10-15	5-10	10	3	5-10	5-15	1-5
COMPONENTS & SUBASSEMBLIES		5	2	1-5		2	5	1		5	2	5-10	10	5	2-20	1-5
GOVERNMENT (MILITARY & AEROSPACE)	30-50	20-40	15-30	20	35-50	50-95	5-10	35-50	15-35	40-80	5-20	20-70	40-70	20-40	20-45	50-70
GOVERNMENT (CIVILIAN)	2-3	5-10	2	1								1	1	10-25	6-10	2
MEDICAL ELECTRONICS			3	1-5	5-15	5	2	2	2-5	5-10	5	5-10	3		5-10	2
BUSINESS MACHINES	5-15	5	5-10	5-10		3	5-10	3	10-20		5	2-5	2	20-25	2	8
RESEARCH LABORATORIES	5	2		1	10	5		2	1	1	2	2	10		10-30	1
AUTOMOTIVE							15-25		8	2-5			1			
NON-OEM USERS									6					10	10-40	
AIRLINES					5					2-10	2	10	5	10	10	

Figure 13



With the introduction of more electronics systems in automobiles and the enforcement of pollution controls, the car makers have also become interested in test equipment. Ford is spending \$8 million for computer-controlled gas analyzers for use in its assembly plants in California, and has issued contracts for such systems to Honeywell and bought equipment for them from Beckman, Digital Equipment Corp., General Automation and Hewlett-Packard.

### Plans for the '70s

All of the foregoing provide ample evidence that there are many growth opportunities for electronic manufacturers in the next few years. And remember, we have touched on only a few of the most promising areas. There are many, many more. Our purpose is to demonstrate simply that such opportunities do exist.

Even more important is the fact that new markets are the *only* source of growth for the industry. It is important that they be recognized as such not only by all companies who want to grow but also by all engineers who want to be important contributors to that growth.

This was the main reason why we commissioned the nationwide study of the electronics market which we mentioned earlier. You will remember that we asked the executives of major electronics companies 2 basic questions. We provided their answers to the first question "What are the principal markets you are selling in 1970?" in the matrix which appeared in **Figure 8**.

The second question concerned the future, from 1972 on. To find out which markets electronics companies planned to develop in the next five to ten years, we asked this question: "How do you expect your sales to change in the next few years in relation to your sales in 1970?"

Their answers are qualitative, not quantitative and they appear in the same matrix. See **Figure 13**, at left.

### Colors tell the future

The *numerals* within the cells of this matrix are the same as in the original matrix, that

is they are sales percentages for 1970.

The *colors* now tell us whether the manufacturers believe those 1970 percentages will remain the same, go down, or increase.

— RED cells mean *decline*.

— YELLOW cells indicate percentages that will remain more or less *the same*.

— BLUE cells mean *increase*.

Notice how the *red* (indicating a *decrease* in percentage) affects sales to the military market. Also observe that the color *blue* (indicating an *increase*) predominates in most of the markets we have discussed in the previous pages of this report, as they were singled out for growth by the manufacturers who were questioned.

We encourage you to study the color relationships in the fields in which you and your company are interested. If your technical and marketing strategies do not now call for special efforts against the *blue* markets, something is wrong and an immediate reassessment of goals by your company's management is imperative.

### Percentages are not enough

Even a glance at the matrix shows that the color blue appears far more often than the red or yellow. That's why the matrix presents an optimistic picture. Blue represents growth and has been recognized as such by the companies that participated in our research. But, these figures represent *percentages*, not dollars. The dollars will come and the jobs will grow only when a determined, aggressive and competitive industry no longer waits for the mailman to bring another RFQ from the Department of Defense; and only if the industry innovates and develops new applications *now* to be marketed profitably in the *new* markets of the '70s.

Technology or profit? We can have *both*. It's up to an enlightened company management.

*And for the first time in the history of the industry, it is also up to the engineer. You.*

**P&B solid state  
hybrid relays work  
up to 100 times longer  
than conventional relays.  
More than  $10^7$  operations.**

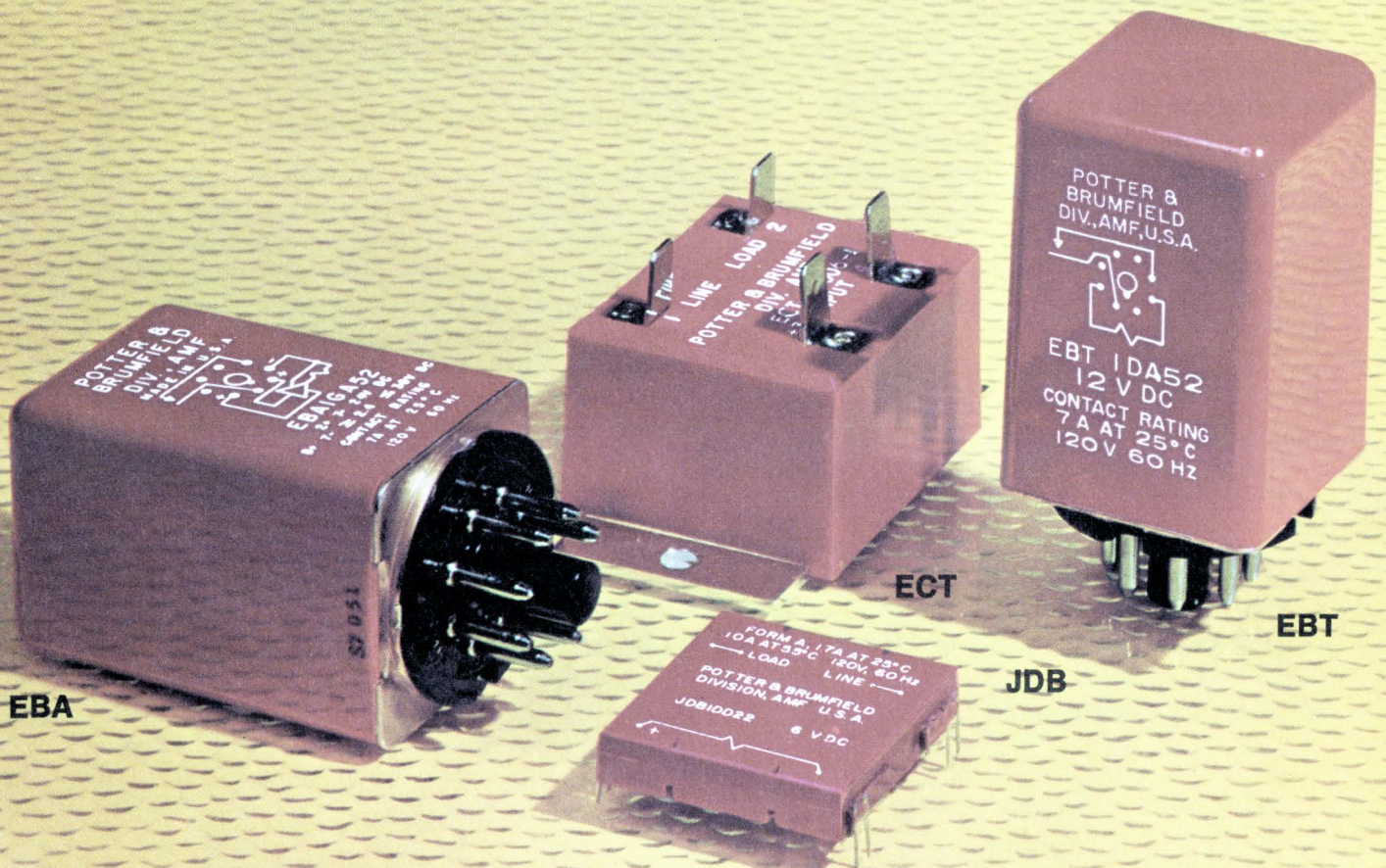

The expected minimum life of P&B Solid State Hybrid Relays is in excess of 10 million operations for standard load current and ambient temperature combinations.

This uncommon longevity, plus exceptional reliability and a wide range of switching options, offers solutions to many critical switching problems. For example, you can interface semiconductor logic circuits with inductive loads like motors, solenoids and contactors.

P&B Solid State Hybrids will switch up to 7 ampere loads with input control signals as low as 60 microwatts. And they come in a variety of package sizes and terminal styles.

#### Special triac, special reed

P&B Hybrids owe much of their reliability and outstanding performance to the combining of a reed relay and triac, each having characteristics specially selected to complement the other. This careful mating of semiconductor and relay greatly enhances the reliability of each and, in combination, produces a switching function of consistently superior performance.

#### Special snubber network

The internal RC network across the "contact" is tailored to the

triac specifications and "contact" load ratings to limit sporadic, transient-induced conduction, to provide reliable turn-off of inductive loads, yet to minimize the off-state 60 Hz leakage current.

**EBT Series** switches 7 amps, 60 Hz @ 25° C ambient with normal load voltage of 120 V. Rated 5 amps. rms 60 Hz @ 55° C ambient. Operate time, 2 msec. Release time, 10 msec. Coil voltages from 6 to 48 VDC at nominal power of 290 mW. Has conventional octal-type plug-in terminals for mounting convenience. Fits P&B KR Series 8-pin sockets for conversion to screw terminals.



**EBA Series** has the same switching characteristics, package and mounting of EBT, but with control signal amplifier. Standard sensitivity is 60 microwatts. Requires 12, 18, or 24 VDC supply.



**ECT Series** has similar specifications as EBT but with a special

package designed for direct to chassis mounting. Widely used in business machines and appliances. The ECT has quick-connect terminals. Screw-terminal adapters available.

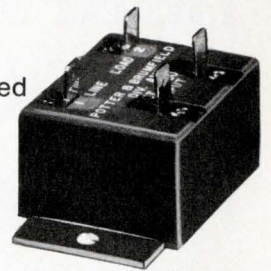

**JDB Series** is a Dual Thin-Line reed-triggered triac for use on printed circuit boards. Designed for interfacing solid state circuits to 120 V 60 Hz loads such as contactors, fractional HP motors and solenoids. Form A contacts will switch 1.7 amps. at 25° C ambient or 1.0 A rms 60 Hz at 55° C ambient.

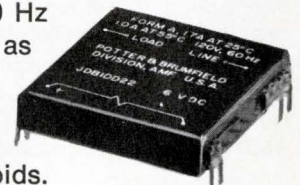

Potter & Brumfield Solid State Hybrid relays are available from leading electronic parts distributors. For complete information call or write your nearest P&B representative or Potter & Brumfield Division of AMF Incorporated, Princeton, Indiana 47670. Telephone 812 385-5251. In Europe, AMF International Limited, Oxford, Oxon, England and AMF Elettrica, S.p.A., Milan, Italy.



**P&B makes more of more kinds of relays than anybody in the business.**

**Anybody.**

# Here's enough to put you onto flat flexible cable.

Now you can have all the benefits of flat cable—weight, density and flexibility—to use it, everywhere. Our full line of connectors, specifically designed to take advantage of what flat flexible cable offers, will take you wherever you want to go—cable-to-cable, cable-to-wire, cable-to-post and cable-to-printed-circuit board. Now with the addition of our newest one-piece connector, we can also offer cable-to-printed-circuit board with a card-edge connector.

Once you decide on how to go, AMPECONOMATION, our unique automated termination technique, makes getting there fast, reliable and easy. No need to prepare the cable. Just cut to length and the machine terminates up to 3400 connections per hour . . . automatically. Four areas of contact, made with our exclusive insulation displacement crimp technique, assures the utmost in reliability.

We can supply connectors and application machine for flat cable assembly production in your plant, or provide finished assemblies to your specifications, ready for your equipment. For complete information write:

**AMP Incorporated, Industrial Division, Harrisburg, Pa. 17105.**

**AMP**  
 INCORPORATED

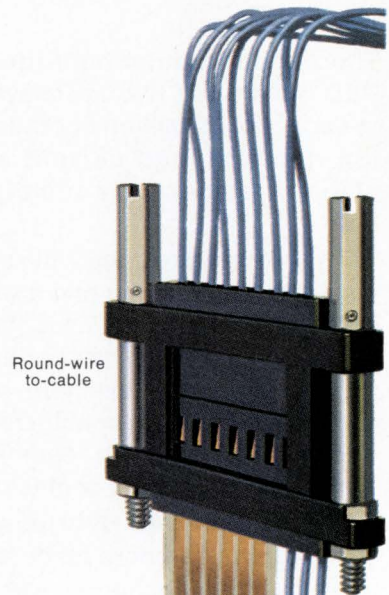

Round-wire  
to-cable

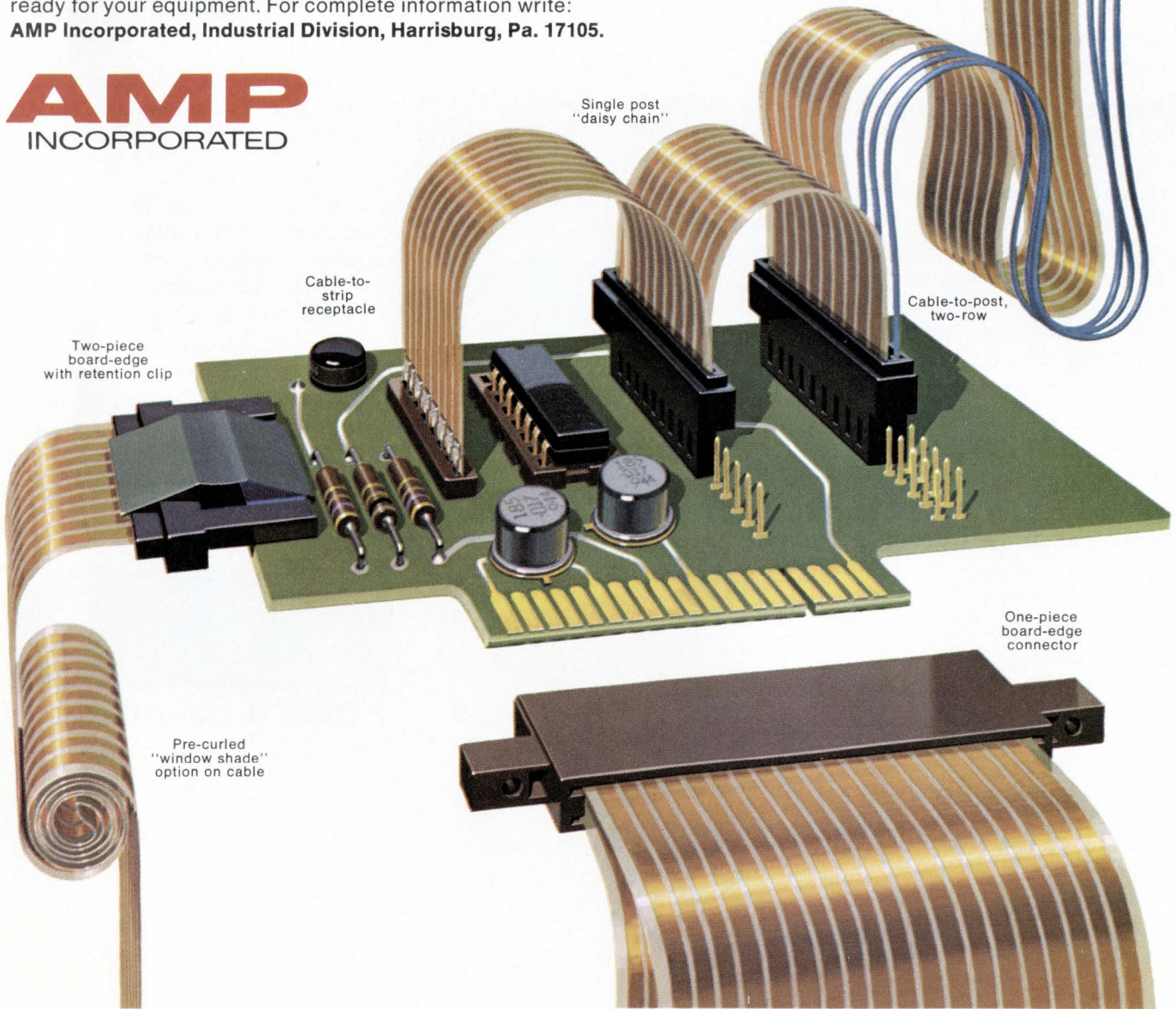

Two-piece  
board-edge  
with retention clip

Cable-to-  
strip  
receptacle

Single post  
"daisy chain"

Cable-to-post,  
two-row

One-piece  
board-edge  
connector

Pre-curved  
"window shade"  
option on cable

# Silicon-on-sapphire;

## a technology comes of age

David J. Dumin and Edward C. Ross, Inselek Co., Princeton, N.J.

The semiconductor market has divided along fairly distinct lines into separate application areas for bipolar and MOS technologies. Where speed is the primary consideration, bipolar circuits are used; where cost is the overriding concern, MOS is usually the choice.

Although not generally realized, it is a theoretical fact that the gain-bandwidth products of MOS and bipolar transistors are comparable. But since the output impedance of an MOS transistor is about two orders of magnitude larger than that of a bipolar transistor of similar area, the parasitic capacitances you find in monolithic silicon circuits severely limit the performance of the MOS transistor. The result is that monolithic MOS is slower than bipolar, mostly

because of the output loading effect of the large parasitic capacitances between the device terminals and the common substrate. On the other hand, bipolar technology is more expensive because of the additional processing steps required, and the larger area required per function. A better IC technology would be one which combines the high speed of bipolar with the low manufacturing cost of MOS. The silicon-on-sapphire technology (SOS) does just that.

### Material requirements

The starting material for SOS ICs is a thin layer (nominally  $1 \mu$ ) of silicon grown on an insulating sapphire substrate. The sapphire is single crystal and is cut so that the silicon layer grown on its surface is single crystal  $\langle 100 \rangle$  oriented. You can choose another orientation of the sap-

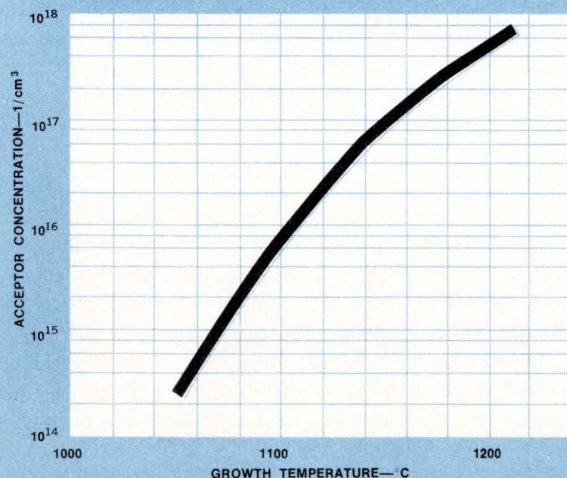

FIG. 1—ACCEPTOR CONCENTRATION VS. GROWTH TEMPERATURE FOR (100) SOS

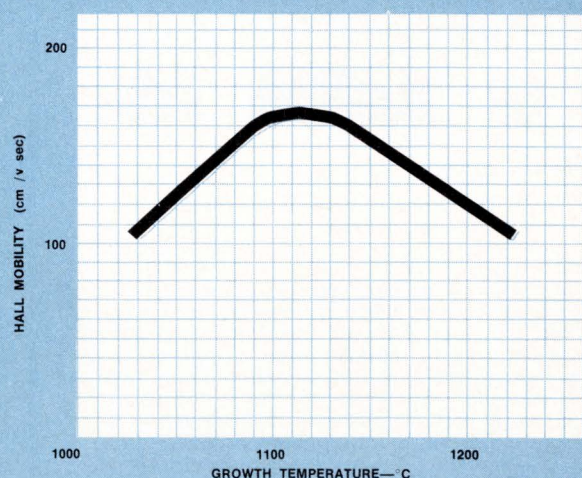

FIG. 2—HALL MOBILITY VS. GROWTH TEMPERATURE FOR (100) SOS

phire to produce either  $\langle 110 \rangle$  or  $\langle 111 \rangle$  silicon. But most applications today use the  $\langle 100 \rangle$  orientation because it provides the lower threshold voltage necessary for TTL compatibility.

The epitaxial growth of silicon on the sapphire is similar in many ways to the standard growth of silicon on bulk silicon. While both  $\text{SiCl}_4$  and  $\text{SiH}_4$  have been used to grow the silicon, just about all of the sos produced today

is grown by the thermal decomposition of  $\text{SiH}_4$ . Silane ( $\text{SiH}_4$ ) can be produced commercially in pure form and by the addition of small quantities of arsine ( $\text{AsH}_3$ ) or phosphine ( $\text{PH}_3$ ) to the gas stream during growth, will give you n-type films of controlled resistivity from 0.001 ohm-cm to 20 ohm-cm. By adding  $\text{B}_2\text{H}_6$  to the gas stream during growth, you'll come up with p-type films in the same resistivity range. Most mos applications use films with 1-10 ohm-cm resistivity, and these are quite easy to grow with good control of the resistivity.

Autodoping of the thin silicon films takes place during growth on both bulk silicon and sapphire. In the case of sos, small quantities of aluminum can leave the sapphire substrate and dope the film p-type. This aluminum autodoping mechanism has been studied extensively and the fact is that growth at temperatures below 1050°C produces negligible amounts of aluminum in the film. High quality films, as indicated by high values of Hall mobility and low aluminum autodoping, will grow in the 100-1050°C range. In figs. 1 and 2, you'll find plots of typical carrier concentration and Hall mobility vs growth temperature.

Since sos films are very thin, it is possible to change the film properties during the high temperature steps inherent in mos processing. Heating the films in hydrogen at high temperature results in more aluminum being released into the films. Heating them in oxidizing ambients tends to leach out p-type impurities and push out n-type impurities. (This is a process well known in bulk silicon.) Heating the films in inert atmospheres usually has relatively little effect on film properties. The sos films are mechanically stronger than the bulk silicon wafers and do not break as easily when subjected to bulk silicon processing temperatures. An indication of the high degree of crystallinity you can get with sos/mos technology is the fact that the effective field-effect mobility for holes in p-channel devices is typically  $225 \text{ cm}^2/\text{v-s}$ .

### Processing

The first step in processing sos/mos is to selectively remove the silicon film by standard photolithic techniques. This silicon etch will give you islands of single crystal silicon separated by insulating sapphire. Devices formed in these islands are dielectrically isolated from one another.

The immediately apparent advantage of mos fabricated with sos is that there is no possibility of leakage between devices caused by field inversion since there is no silicon between them. Similarly, there is no stray capacitance introduced by metallization lines running among the devices. The metal now lies directly on the insulating sapphire which is exposed around the silicon regions.

(Continued on p. 30)

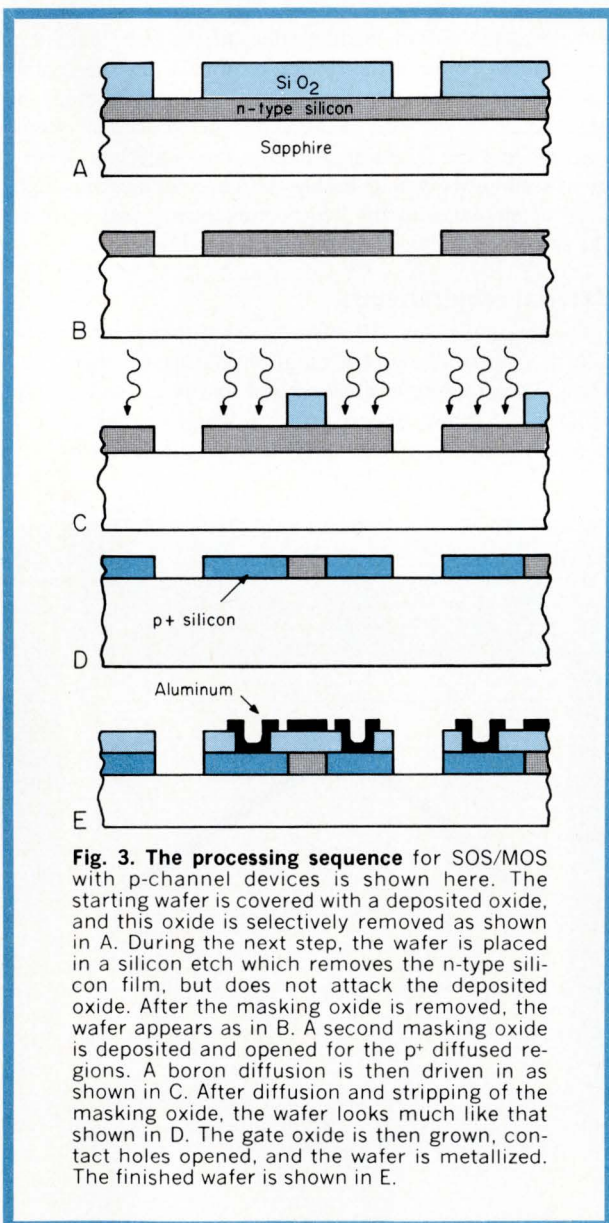

**Fig. 3. The processing sequence** for SOS/MOS with p-channel devices is shown here. The starting wafer is covered with a deposited oxide, and this oxide is selectively removed as shown in A. During the next step, the wafer is placed in a silicon etch which removes the n-type silicon film, but does not attack the deposited oxide. After the masking oxide is removed, the wafer appears as in B. A second masking oxide is deposited and opened for the p<sup>+</sup> diffused regions. A boron diffusion is then driven in as shown in C. After diffusion and stripping of the masking oxide, the wafer looks much like that shown in D. The gate oxide is then grown, contact holes opened, and the wafer is metallized. The finished wafer is shown in E.



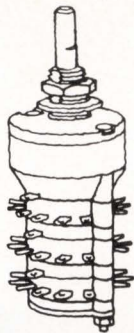

## Enclosed switch quality at open wafer prices

Here is the newest addition to the Grayhill top quality line of enclosed rotary switches with up to 12 decks, 6 poles per deck, 12 positions per pole.

Competitively priced with open wafer switches... designed especially to be produced in volume without sacrificing traditional Grayhill quality.

Available with 30° or 36° angles of throw... positive "stall-free" detent... only 3/4" diameter behind panel. Series 71 Rotary Switches add up to the excellence you expect from Grayhill at an unexpectedly low price.

For our latest Engineering Catalog write or phone:  
Grayhill, Inc., 543 Hillgrove Ave.,  
La Grange, Illinois 60525.  
(312) 354-1040.



Circle Reader Service #16

**BUSSCO GETS IT ALL TOGETHER...**

For less. Circuit board busses replace multi layer boards. Clip-on buss eliminates soldering and wrapping. Noisy, bulky wire harnesses are replaced by laminated buss bars. Call Bussco today.

**BUSSCO ENGINEERING INC.**  
122 Penn St. • El Segundo, CA. • (213) 322-6580 • TWX 910-348-6295

Circle Reader Service #17

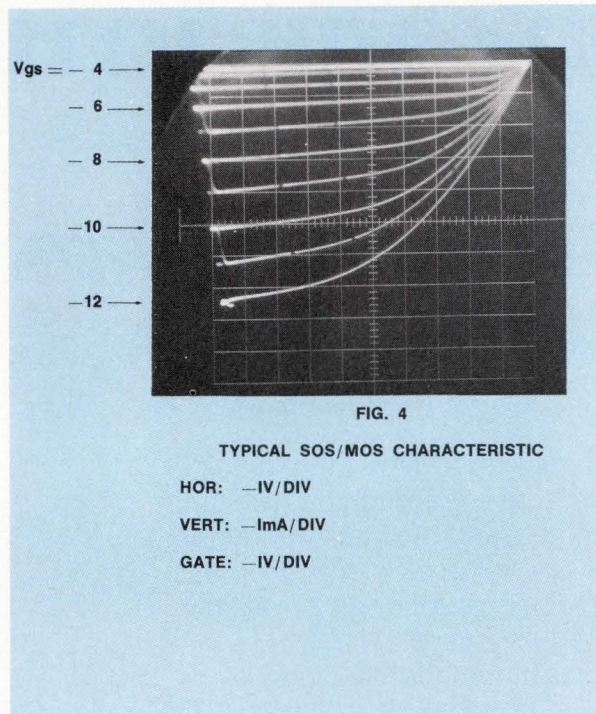

Another important advantage, but not so readily apparent, is that the drain-to-substrate capacitance can be drastically reduced by diffusing the contact regions completely through the silicon film to the sapphire substrate. Now, no depletion region can form on the bottom of the contact region and the capacitance is reduced by a factor of 50 or more. This reduction of capacitance is particularly attractive for linear applications, since the non-linear drain-to-substrate capacitance of monolithic circuits always limits device performance.

### The results

Indicative of the results you get with SOS/MOS technology is the three-terminal device characteristic shown in fig. 4. This is representative of the individual devices used in Inselek's LO1, a quad arrangement for linear applications. The device shown has an on resistance of 500Ω and a gain-bandwidth product of 400 MHz. If your main concern is with switching applications you'll want to note that the use of an isolated device substrate eliminates the usual problem of source-to-body effect.

INFORMATION RETRIEVAL

Integrated circuits





## Some think their working day is a real challenge. Some don't.

If you sat for eight hours sticking tiny little components into even tinier little holes, you might not be too excited about your job either.

But, even if people don't like the work, there are machines that do, the Dyna/Pert electronic component inserting machines from USM.

Dyna/Pert offers an entire line of component inserting equipment from small bench models, to semi-automatic units, to totally automated conveyor systems. Many of them can be either NC or computer controlled. Dyna/Pert also has automatic sequencing systems and DIP inserters.

What's more, Dyna/Pert machines don't take coffee breaks, call in sick or look for new jobs. They just keep on producing at up-time rates in excess of 90%.

A Dyna/Pert machine will even pay for itself after a short period of time, and then start paying you. So don't you think it's time you woke up to Dyna/Pert?

For further information contact your local USM office, or write USM Corporation, Dyna/Pert Dept., Machinery Division, 181 Elliott St., Beverly, Mass. 01915.

Visit the USM display at Booth 720 during Nep/Con West.



**USM Corporation**  
**Machinery Division**

The Productivity People

Circle Reader Service #18

The people at  
**Ecole**  
**Polytechnique**  
 liked the  
 new IEC  
 "Generateurs  
 de Fonctions  
 Modele F31"  
 so well they  
 bought ten  
 of them

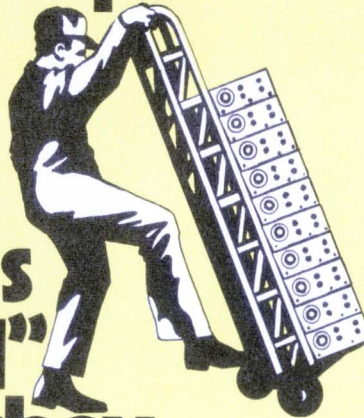

IF YOU'D LIKE TO FIND OUT WHY,  
 CALL JOHN NORBURG AT 714-772-2811 COLLECT

Merci, Montreal's Ecole Polytechnique. And our thanks for similar volume orders for other IEC Series 30 models from Middlesex College, the Universities of Alberta and Wyoming, Algonquin College, and other farflung educational institutions. Everywhere, decision-makers are getting the most for their money with the IEC Function Generator that exactly suits their needs. At just \$295, the F31 does what an oscillator can do, and then some! Like square waves, triangles and voltage offset. Plus better sine wave purity than comparably-priced oscillators. Meanwhile, at \$495, the F34 (illustrated) includes sweep, trigger, gate and pulse. In fact, each of the four Series 30 models has a host

of special features. And each embodies such inherent quality that we boast one of the lowest "returned for repair" rates in the industry. Ecole Polytechnique bought its IEC Function Generators after careful evaluation alongside competitive instruments. And got the most for the money. How come? Contact our John Norburg for answers and complete technical information by same-day mail.



IEC F34 Function Generator

**SERIES 30 HIGHLIGHTS** F34: (\$495) —  
*Frequency Range:* 0.03 Hz to 3 MHz.  
*Waveforms:* Sine, square, triangle, dc, pulse.  
*Output Amplitude:* 10 mv pp to 10 v pp into 50Ω.  
*Sine Distortion:* <0.3% up to 30 kHz, <0.5% to 300 kHz, <2% to 3 MHz. *Rise/Fall Times:* <60 ns. *Offset:* ±5 v into 50Ω. *VCG Range:* >1000:1. *Operating Modes:* Continuous, Triggered, Gated, Tone Burst, Continuous Sweep, Triggered Sweep. *Sweep Width:* up to 1000:1. Set width directly on tuning dial. *Sweep Time:* 10μsec to 100 sec. *Other Features:* Voltage Analog of Frequency, Sync Input, Output Limit Indicator, plug-in IC's. F33: (\$395) — Same as F34, but without Sweep, Tone Burst and Voltage Analog of Frequency. F32: (\$345) — Same as F33, but without Pulse, Trigger and Gate Modes and Sync Input. F31: (\$295) — Same as F32, but without VCG and Output Limit Indicator. Output Amplitude is 100 mv pp to 10 v pp into 50Ω.

**IEC** GIVES YOU THE MOST FOR YOUR MONEY

**INTERSTATE ELECTRONICS CORPORATION** A Subsidiary of A-T-O Inc. Dept. 7000, Box 3117, Anaheim, Cal. 92803  
 (714) 772-2811 TWX 714-776-0280 TELEX 655443 & 655419

FEBRUARY 1972

# DATA COMMUNICATIONS



Common Carrier Chief  
Bernard Strassburg:  
The FCC & interconnection

Basic bits of data on  
asynchronous transmission

Data communications  
news and products

## Interconnection—an FCC overview

Interconnection has become a household word as well as a reality in this nation's communications environment. It is now about three years since the FCC established the principle that the public's use of the switched telephone network could not be restricted except as necessary to prevent harm to the network. By the landmark *Carterfone* decision the Commission struck down those restrictions in the tariffs of the telephone companies which rested on the presumption that any equipment that was not furnished, installed and maintained, or specifically authorized by the telephone company was *per se* harmful to the network.

The results of this action by the FCC are evidenced by the tremendous increase in the variety of terminal and peripheral communications gear that has become available since the *Carterfone* decision. This, in turn, has expanded the utility and value of the telephone system. At the same time, the new policy has brought into existence an increasing number of companies, outside of the common carrier community, who are now engaged in the development, manufacture, installation, sale and maintenance of communications equipment and systems. And—not surprisingly—the spur of competition generated by this policy has galvanized many telephone companies into new sales and marketing activities.

Notwithstanding the substantial progress that has been made in the interconnection field, there are still some basic issues to be resolved. The Tariff, as revised since *Carterfone*, requires that hard-wire or direct connections of customer equipment to the network must meet certain conditions. Thus, the equipment must be connected by a "connecting arrangement" provided only by the telephone company and where the equipment has a network signalling (pulse or dial) capability, a separate network signalling unit must be obtained from the telephone company. These requirements are designed to protect the network from harmful voltages, line imbalance and the input of improper signals into the switching mechanism of the network.

Independent manufacturers and others, understandably, question these interface requirements as unnecessary and burdensome. They urge that their products can be depended upon to perform correctly and to prevent any real harm to the network. The FCC has nevertheless felt justified in following a cautious policy by liberalizing interconnection practices only where there is reasonable certainty that perform-

---

### Introducing Bernard Strassburg

The Common Carrier Chief of the Federal Communications Commission is no stranger to these pages (Aug. 1971, p. DC-3) or to the problem of interconnection. In his function at the FCC, he must deal with the everyday complaints of the two antagonists in this vital issue—AT&T and the independent data modem manufacturers—as well as any user problems. To bring together all interested parties, their complaints and recommendations, a general public inquiry will be announced this month. Looking over the recent history of interconnection, Strassburg notes with approval that "it has accelerated the growth of communications, as even the common carriers would be the first to admit. What we at the Common Carrier Bureau want is the most efficient use of the communications plant."

---

ance of the network will not be jeopardized. Obviously, ill-considered interconnection practices might well result in adverse consequences which could be irreversible.

Consistent with this policy the FCC requested the National Academy of Sciences to study the technical aspects of the interconnection problem. It reported back in June 1970 that unrestricted hard-wire interconnection could cause serious harm to the network. It concluded that such harm could be prevented by the existing protective provisions of the tariffs, as well as the alternative program, under which customer equipment would be certified as meeting prescribed standards. In addition, it advocated an extensive system of enforcement to ensure compliance.

The NAS report also recommended that as a pilot-type effort, the Commission explore a certification program for PBX systems. In line with this recommendation, the Commission in March 1971 formed a PBX Advisory Committee to develop and recommend technical standards and procedures. The Committee is dealing with complex problems which previously have not been addressed by any group in a regulatory and technical environment as diverse as the United States communications system. The Committee's studies have been progressing with commendable vigor and encouraging dispatch—and with valuable input by carriers, manufacturers and users, as well as representatives of the several state regulatory agencies through the National Association of Regulatory Utility Commissioners (NARUC). The standards and procedures recommended by the PBX Advisory Committee will, of course, be relevant to the consideration of all other types of interconnection.

Federal initiative in the interconnection area is essential to obtain the required level of standardization and uniformity in interconnection policies and practices. However, the FCC actions will inevitably affect intrastate services subject to the jurisdiction of the several states. It is for this reason that the FCC has sought the active participation of the NARUC in the work of the Advisory Committee.

It is anticipated that in the near future the FCC will begin a public proceeding within which to evaluate the studies and recommendations of the Advisory Committee and alternative recommendations of others as they apply to PBX interconnection. The proceeding may also address the broader unresolved issues dealing with the interconnection of other kinds of customer-owned equipment and systems. In recognition of the intrastate interests, the Commission plans to establish a Joint Board of Federal and State Commissioners to preside over the proceedings. Hopefully, this joint effort will promote uniformity among Federal and State authorities in their treatment of the difficult interconnection issues that still remain to be resolved. Anything less than uniformity will diminish the effectiveness of the switched telephone network and its value as a national communications resource.

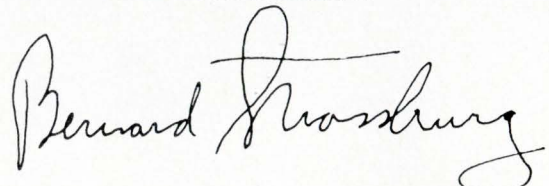

# PTM. First in the series of new modulars from Sorensen



Our new PTM modular line is tailored to be more than just another black box. For one thing, it's blue. For another, it has state-of-the-art power density. Built-in overvoltage protection on every model.

Adjustable automatic current limiting. Regulation of 0.05% + 5mV. Ripple and noise of 1 mV RMS, 5mV pk-pk. Operating temperature range from 0 to 71°C. □ PTM. The first part of our new modular line. There's a lot more coming. For more data, write Sorensen Power Supplies, Raytheon Company, 676 Island Pond Road, Manchester, N.H. 03103. Telephone (603) 668-1600. Or TWX 710-220-1339.

Package size II: 3½ x 5½ x 6½							
Model	Adjust. Range (VDC)		Current Rating (A)				Price*
	Min.	Max.	40°C	50°C	60°C	71°C	
PTM3-7	2.8	3.5	7.0	6.3	4.9	2.8	\$119
PTM5-7	4.8	5.5	7.0	6.3	4.9	2.8	\$119
PTM12-4.4	11.4	12.6	4.4	4.0	3.1	1.8	\$119
PTM15-3.5	14.25	15.75	3.5	3.1	2.5	1.6	\$119
PTM24-2.3	23	25	2.3	2.1	1.7	1.1	\$119
PTM28-2	27	29	2.0	1.8	1.5	1.0	\$119
Package size III: 3½ x 5½ x 9½							
PTM3-11	2.8	3.5	11.0	9.6	7.8	4.4	\$139
PTM5-11	4.8	5.5	11.0	9.6	7.8	4.4	\$139
PTM12-6.5	11.4	12.6	6.5	5.7	4.6	2.7	\$139
PTM15-5.5	14.25	15.75	5.5	4.9	3.9	2.5	\$139
PTM24-4	23	25	4.0	3.6	2.9	1.9	\$139
PTM28-3.5	27	29	3.5	3.1	2.6	1.8	\$139

\*USA List

**Sorensen**  
POWER SUPPLIES

Need a remedy for data  
communication headaches?



## Try our permanent cure.

If keeping your data communication system on line is becoming a headache, don't live with it. ICC can cure it. Permanently.

The ICC cure starts with tested, field-proven modems that operate reliably where ordinary data sets have problems. Then we offer professional installation, training of your personnel, prompt field service, and continuing support to keep your system operating.

With ICC, you won't just lose a headache. You'll gain new confidence in your data communication.

Send for a copy of our product catalog.



**International Communications Corporation**

7620 N.W. 36th Avenue, Miami, Florida 33147

Telephone 305 + 691-1220

*In Europe: RACAL-MILGO LIMITED Reading, Berks, England*

*Circle Reader Service #21*

a milgo company

©1971

# ASYNCHRONOUS TRANSMISSION:

some basic bits of data

**Steve Stuart and Ralph Ungermann,**

Western Digital, Newport Beach, Calif.

Long distance transmission of digital data generally requires sending the data in serial form through a single communications channel. In such a system data may be transmitted synchronously or asynchronously.

Synchronous data transmission requires that:

- a clock signal be transmitted with the data to mark the location of the data bits for the receiver;
- synchronization patterns be added to the start of the transmission so that the receiver can locate the first bit of the message;
- each data bit follow contiguously after the sync word, since one data-bit is assumed for every clock period.

Asynchronous data transmission requires neither a transmitted clock signal nor contiguous data bits. Instead, this form of transmission requires:

- a clock source at both the transmitter and the receiver;
- grouping of the bits into data characters, usually between five and eight bits in length;
- synchronizing START and STOP elements added to each data character.

## Advantages/disadvantages

Consideration of the main features of asynchronous and synchronous data transmission reveals several advantages of asynchronous vis-a-vis synchronous techniques. Perhaps the major advantage of asynchronous transmission is the greater simplicity of the transmission equipment require-

ments. For example, a clock signal needn't be transmitted with the data. And further, characters are transmitted as they become available. This is a valuable feature when you transmit data from manual-entry equipment such as keyboards.

On the other hand, asynchronous transmission does need synchronizing START/STOP elements. And these elements do use a large portion of the channel bandwidth. So here is where synchronous transmission has an advantage: its sync words use a much smaller portion of the channel than do the START/STOP elements of asynchronous transmission.

## Transmission speed

We define a baud as the reciprocal of the shortest signal element, which is usually one data-bit interval. For synchronous transmission, each signal element is one data-bit long, so the baud rate equals the bit rate. This is true for asynchronous transmission only if the STOP element is always one bit long; this is called *isochronous* transmission. But the variable STOP length often used in asynchronous transmission—as when the STOP code is longer than one bit—makes the baud rate differ from the bit rate.

You can transmit data asynchronously at fairly high baud rates: 10 kilobaud or higher over a simple twisted-pair, depending on the length of the run, type of line drivers, and so forth. Such transmission is generally limited to about two kilobaud over the telephone network, and you need modems to change the data pulses into tones suitable for that network.

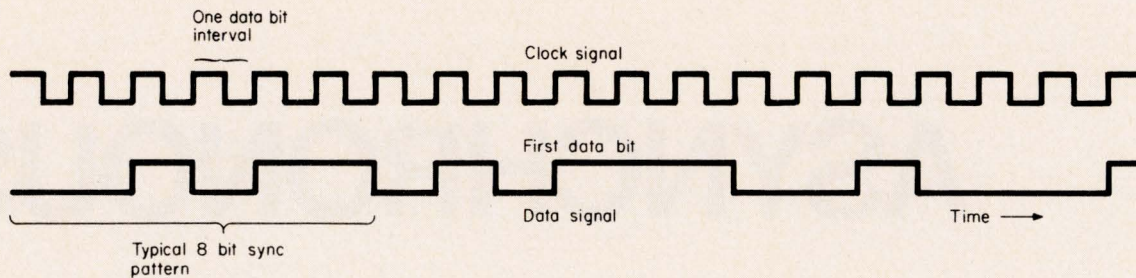

**Synchronous data transmission** requires not only a clock signal to be transmitted with the data, but also the addition of synchronization patterns. Further, each data bit follows

contiguously after the sync word, and one data-bit is assumed for every clock period. A specified clock transition (rising or falling) marks the start of each data-bit interval.

### Distortion in asynchronous transmission

A major limitation of the speed of asynchronous data transmission is distortion of the signal elements. We define such *data-bit distortion* as the ratio of the difference between the actual signal-transition and its theoretical transition to the ideal data-bit interval.

The causes of the distortion are frequency jitter and frequency offset in the clock that generates the actual waveform, channel bandwidth, noise, and so forth. In other words, the amount of distortion that you can expect on any asynchronous signal depends on the equipment used to generate the signal, and the characteristics of the communications channel.

For example, electronic signal generators are generally held to less than 1% distortion. But electromechanical sources (such as teletypes) typically generate up to 20% distortion. And the transmission channel may add yet another 5-15% distortion.

The distortion discussed so far refers only to a single character, since these measurements are referenced to the START-element transition of that character. But there also may be distortion between characters when operating at the channel's maximum possible baud rate (STOP elements of minimum length).

We generally specify this *minimum-character-interval distortion* by stating the percentage of an ideal data-bit interval that any character interval may be shortened from its ideal length.

Minimum-character-interval distortion and data-bit distortion are often equal, because the parameters that cause the one also cause the other. However, many systems may show character-interval distortions of up to 50% of a data-bit interval. This parameter is important when your system

runs at the maximum baud rate, because the receiver must be prepared to detect the next START-bit transition after the minimum character interval.

### Asynchronous receivers

Because a clock signal is not transmitted with asynchronous data, the receiver tries to locate the theoretical center of the data bits. The set value of the data bit is equal to the receiver input at this theoretical center. However, receiver inaccuracies may preclude location of the exact bit center.

For example, teletypes and other electromechanical gear may have inaccuracies due to mechanical tolerances, variations in the power-line frequency, and so forth. Electronic receivers may suffer from clock frequency offset, jitter, and resolution.

Even if the receiver clock had no offset or jitter, and ran at 16 times the baud rate, such a receiver still could locate the bit center only within 6.25%. But if you properly phase the sample clock, you can adjust this tolerance so that the sample will always be within  $\pm 3.125\%$  of the bit center. This lets you receive signals with up to 46.87% distortion.

This number—the allowable receiver input-distortion—is called the receiver *distortion margin*. Electromechanical receivers have distortion margins of 25-30%. Further, the receiver must also be prepared to accept a new character after the minimum character-interval. And finally, most receivers are specified to operate with a character-interval distortion of 50%.

Editor's note: Western Digital has available an application note discussing data transmission in general, and the company's TR1402A asynchronous receiver/transmitter in particular. (See *The Electronic Engineer*, pp. DC-18-19, Dec. 1971.) If you'd like a copy of this application note, **Circle Reader Service #201**.

The company has also announced a price reduction on the 1402A. The new price is \$22.50 ea., in 100 quantities. A 40-kbaud version, the TR1402A-03, sells for \$27.00 ea. in 100's.



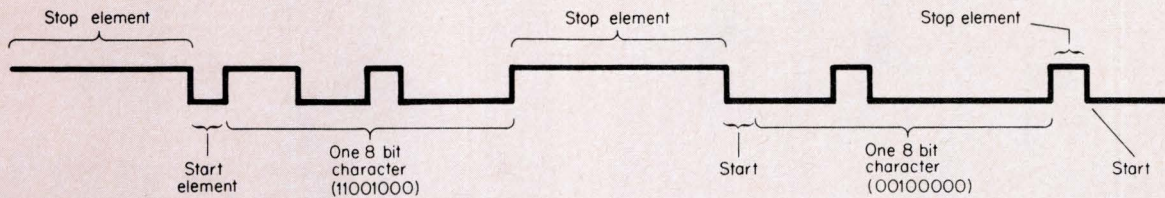

**Asynchronous data transmission** does not require a clock to be transmitted with the data; the data bits needn't be contiguous; and the bits are grouped into data characters with synchronizing START/STOP elements added. The START element is a single logic-zero (space) data-bit added to the front of each character; the STOP element is a logic-one (mark) added to the end of each character. The STOP element is held until the next data character is ready for transmission. (Asynchronous transmission is thus often called

start-stop transmission.) There is no upper limit to the length of the STOP element, but there is a lower limit that depends on the system's characteristics. Typical lower limits are 1.0, 1.42, or 2.0 data-bit intervals, although most modern systems use either 1.0 or 2.0 data-bit intervals. The negative-going transition of the START element defines the location of the data bits in one character. This transition sets the receiver's clock source, which is used to locate the center of each data bit.

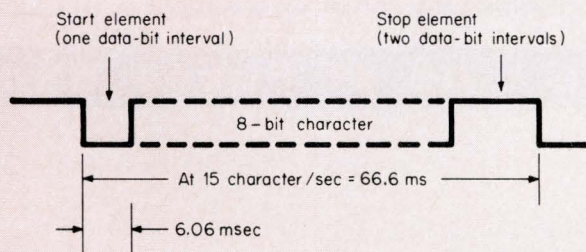

**The baud rate differs from the bit rate** when the STOP code is longer than one bit. Here, for example, each character is 11 data-bit intervals long. If 15 characters are transmitted each second, then the shortest signal element (one data-bit interval) is  $66.6 \text{ ms}/11 = 6.06 \text{ ms}$ . This gives a rate of  $1/6.06 \text{ ms} = 165 \text{ baud}$ . But since only ten bits of information (eight data bits, one START element, and one STOP element) are transmitted every 66.6 ms, the bit rate is 150 bits/s. Note that this bit and baud rate apply only if data characters are sent at the rate of 15 characters per second. The data-bit intervals are fixed by a clock source at the transmitter.

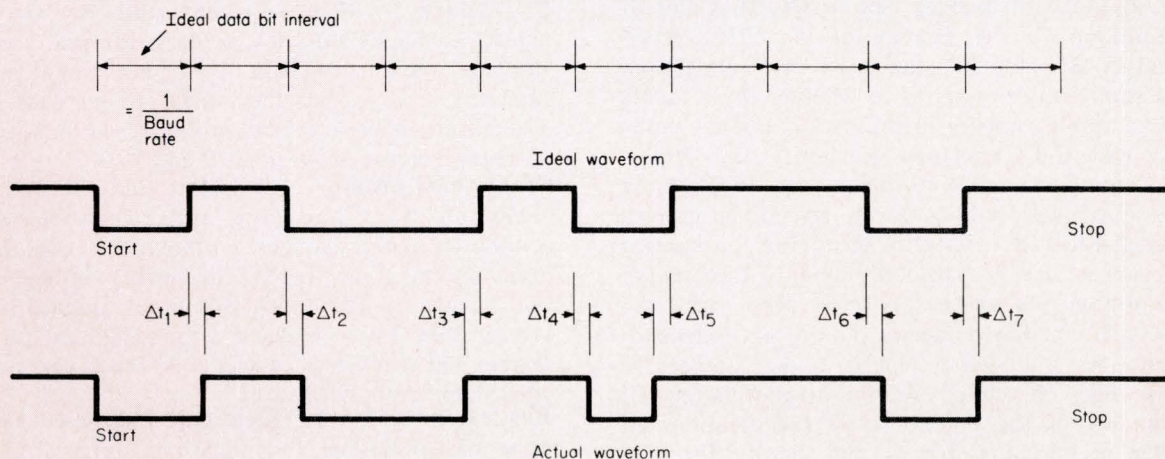

$$\text{Distortion} = \Delta t / [\text{ideal data bit interval}] = \Delta t [\text{ideal baud rate}]$$

**Distortion is the ratio** of the difference between the actual signal-transition and its theoretical transition to the ideal data-bit interval. The ideal unit-interval is equal to the reciprocal of the nominal transmission baud-rate. All data transi-

tions should ideally occur at an integer number of intervals from the START-bit negative-going transition. Actual data transitions may not occur at these ideal theoretical instants.

# FUSES

for protection of Electronic Devices

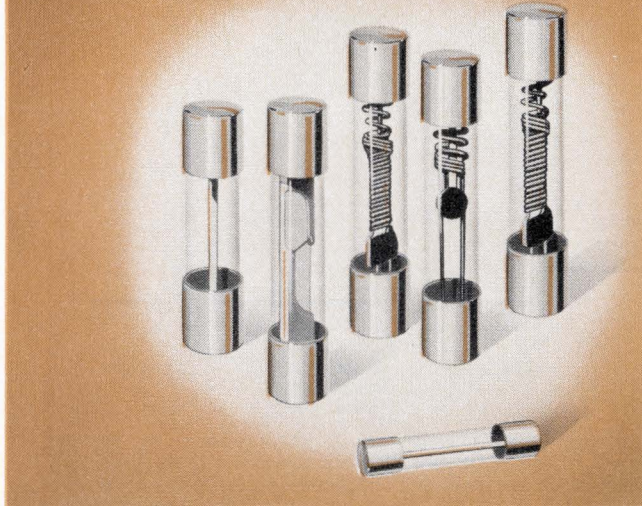

There is a complete line of BUSS Quality fuses in  $\frac{1}{4}$  x 1 inch,  $\frac{1}{4}$  x  $1\frac{1}{4}$  inch, and miniature sizes, with standard and pigtail types available in quick-acting or dual-element slow blowing varieties.

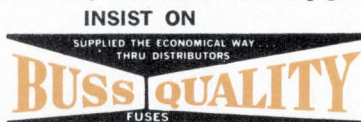

Write for BUSS Form SFB

Bussmann Mfg. Division, McGraw-Edison Co., St. Louis, Mo. 63107

# Tron Rectifier Fuses

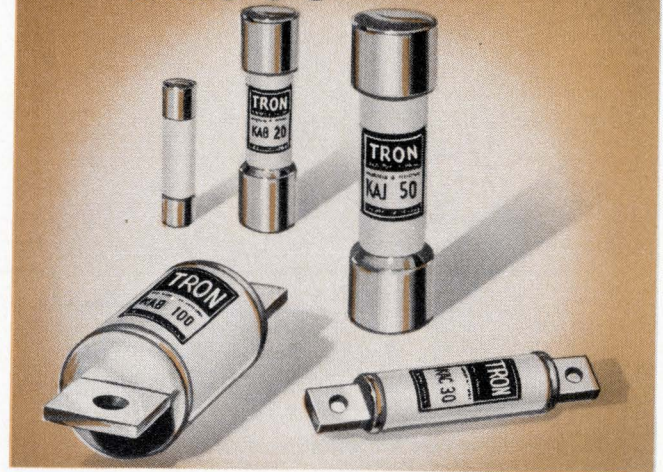

Available in sizes from  $\frac{1}{2}$  to 1000 amps for voltages up to 1500, TRON Rectifier Fuses are ideal for protecting variable speed drives, inverters, battery chargers, plating power supplies, power controls, and any other application where fast opening and great current limitation are required.

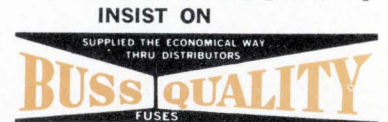

Write for BUSS Form TRFS

Bussmann Mfg. Division, McGraw-Edison Co., St. Louis, Mo. 63107

## BUSS: The Complete Line of Fuses and . . . .

### DATA COMMUNICATIONS NEWS

**More interconnection . . .** In a clear-cut statement of policy, Bernard Strassburg (see p. DC-2), Chief of the Common Carrier Bureau of the FCC, reprimanded AT&T for its stance on interconnection. "Substantial doubt exists as to whether these tariffs are reasonable, non-discriminatory and in compliance with the Carterfone decision," said Strassburg. Zeroing in on the problems that ICC's Sang Whang cited in December (see p. DC-3), Strassburg ordered AT&T to "promptly terminate its practice of refusing service or of discontinuing, or threatening to discontinue the services of customers," who use non-AT&T sanctioned devices. To prevent independent suppliers from being placed at a "competitive disadvantage," he called for non-discriminatory direct connection, the availability of specifications on so-called brand-name devices, and, finally, the continuous monitoring by the telephone company of all installation for any harm, with monthly reports being made to the Commission.

**CPI Microwave, Inc.** recently filed with the FCC for an 11-station microwave system for data communications and network video transmission.

**CATV study . . .** With total revenues expected to be \$2.2 billion by 1976, a recent study by Creative Strategies Inc., Palo Alto, projects the real crest of the CATV wave in 1977-78. As for equipment manufacturers, CSI expects the market to increase from \$72 million in 1971 to \$340 million in 1976, with the sharpest increase between 1972 and 1974.

**Employment update . . .** A recent study shows data communications hardware and telephone interconnection as the strongest employment areas in the telecommunications field. The survey of the past year, made by Personnel Resources International, Inc. of New York, shows a strong demand for designers and marketers of modems, multiplexers and other data comm hardware.

**Bits and bytes . . .** The **Electronic Industries Association** has published "Application Notes for EIA Standard RS-232C." Industrial Electronics Bulletin No. 9 reviews methods of interface between data terminals and data communications equipment employing serial binary data interchange. Available for \$2.60, you can order it from EIA, 2001 Eye St., N.W., Wash., D.C. 20006.

## A simple digital tape head driver

Robert S. Olla, National Semiconductor, Santa Clara, Calif.

Here's a simple driving circuit for a digital tape recorder head that uses just one IC and a single power source. The circuit incorporates a line driver to perform the actual driving function and to provide inhibit logic. Transistors  $Q_1$  and  $Q_2$  are switches, with one on and the other off. The switch that is on determines the direction of magnetization of the tape head.

Resistors  $R_1$  and  $R_2$  determine the current flow in the circuit and are purposely matched so that current in either direction is equal. Because the line driver can accommodate a wide variety of resistors, it, in turn, can provide a broad range of currents. The values in the diagram, for example, will give you about 20 mA.

The capacitor across the tape head removes the nanosecond switching pulses that occur when the circuit goes into the write inhibit mode. When an "O" is put on the write inhibit line, both  $Q_1$  and  $Q_2$  are gated on and current is prevented from flowing through the recording head. Because it insures against accidental erasure it is, of course, a desirable feature.

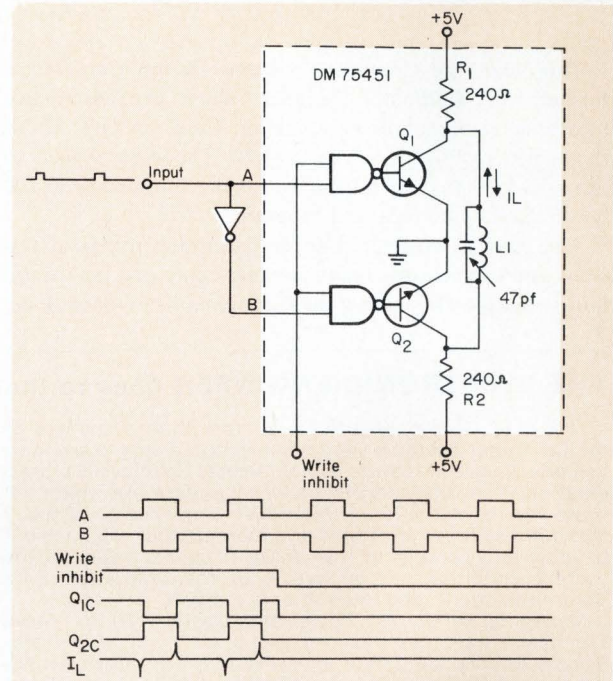

## .. Fuseholders of Unquestioned High Quality

### FUSEBLOCKS

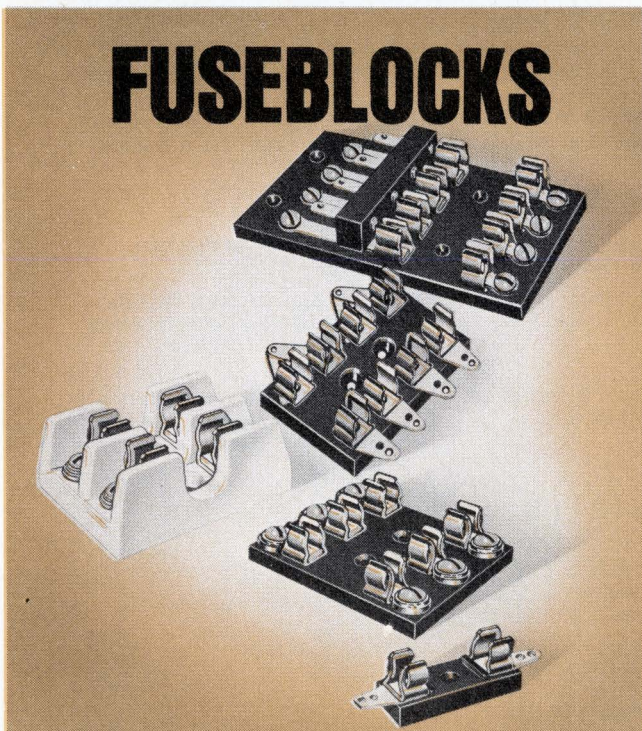

There is a full line of BUSS Quality fuseblocks in bakelite, phenolic, and porcelain, with solder, screw-type, or quick-connect terminals.

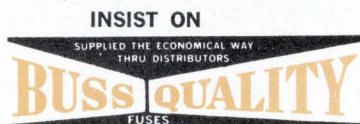

Write for BUSS Form SFB

Bussmann Mfg. Division, McGraw-Edison Co., St. Louis, Mo. 63107

### FUSEHOLDERS

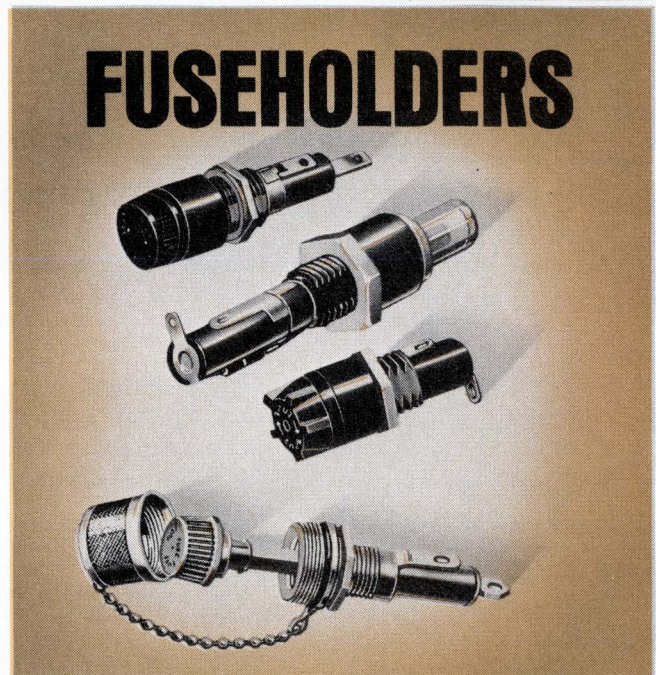

BUSS has a complete line of fuseholders to cover every application. It includes lamp indicating and alarm activating types, space-saving panel mounted types, in-line holders, RFI-shielded types, and a full line of military types. Most are available with quick-connect terminals.

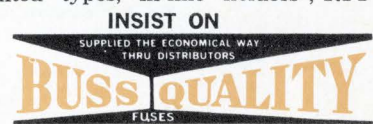

Write for BUSS Form SFB

Bussmann Mfg. Division, McGraw-Edison Co., St. Louis, Mo. 63107

# Computer designers get 2-coast show

This year, the Computer Systems Design Conference, formerly the Computer Designer's show, expands to two locations. It premieres in Anaheim, Calif. on Feb. 22-24, then shifts to Boston on April 18-20. The show expects to draw 12-15,000 at each location for the combined 150-200 booth exhibit and technical program.

The show is structured so that morning technical sessions and evening discussion seminars only overlap exhibit hours slightly, eliminating the traditional listen-or-look de-

cision. A new feature is the Professional Advancement Course, which provides an opportunity for the attendee to upgrade his skills in the expanding areas of computer system design. This year, two such courses are offered. They meet for about 2½ hours each of the three afternoons. Cost is \$35 for pre-registration, or \$40 at the conference.

For more information, contact Industrial & Scientific Conference Management, Inc., 222 West Adams St., Chicago, Illinois 60606, phone (312) 263-4866.

## THE ELECTRONIC ENGINEER goes to the show

THE ELECTRONIC ENGINEER is more than a sponsor of the Computer Systems Design show, it is a very active participant. A special feature will be Alberto Socolovsky's presentation, "The Decade of Challenge" where our editor reviews the paths that lead the industry to where it is today and outlines those strategies and markets that will enable it to grow and prosper in the 1970s. It concentrates on the current condition and prospects of the Computer, Data Communications, and International markets.

Managing Editor, Art Boyle, and Western Editor, Steve Thompson have assembled a group of top-flight industry leaders to contribute their expertise to the Professional Advancement Course, "The Use of MOS as it Applies to Computer System Design." It is aimed at computer and computer systems designers who want to know more about what MOS can do for them, and what it cannot. The course is outlined below:

### Session #1 TUESDAY

"Types of MOS and what they do for the user," B. D. "Bud" Broeker, Motorola Semiconductor

"MOS Shift registers," Dale A. Mrazek, National Semiconductor

### Session #2 WEDNESDAY

"MOS memories: the component level," Armas C. "Mike" Markkula, Intel

"MOS memories: the system level," Ron Livingston, Advanced Memory Systems

### Session #3 THURSDAY

"The role of computer-aided design in MOS ICs," Ralph Grabowski, Applicon

"Testing MOS: a user speaks," Peng K. Lim and Don G. Tipon, NCR

"Testing MOS: the equipment," Bill Mandl, Macrodata ("hands on" demonstration)

## THE CONFERENCE AT A GLANCE

TIME	TUESDAY (Feb. 22 in Anaheim) (Apr. 18 in Boston)	WEDNESDAY (Feb. 23 in Anaheim) (Apr. 19 in Boston)	THURSDAY (Feb. 24 in Anaheim) (Apr. 20 in Boston)
9:30 AM to 12:30 PM	<b>TECHNICAL SESSIONS</b>		
	<ol style="list-style-type: none"> <li>1. New Approaches to Computer Organization/Architecture</li> <li>2. Modems and Multiplexers—Design and Interface</li> <li>3. Computer Aided Design—What's Worthwhile?</li> </ol>	<ol style="list-style-type: none"> <li>4. Computer Controlled Communication Networks</li> <li>5. Interface and Design of Displays and Graphics</li> <li>6. Power and Signal Distribution for High Speed Circuits</li> </ol>	<ol style="list-style-type: none"> <li>7. Configuration of Fail Soft Systems</li> <li>8. The Economics and Technical Impact of New Developments in Peripherals on Mini-computers</li> <li>9. Programmable Controllers—What are They; How are They Used; What Next?</li> </ol>
11:30 AM to 6:00 PM	<b>EXHIBITS</b>		
1:30 PM to 4:00 PM	<b>PROFESSIONAL ADVANCEMENT COURSES :</b>		
	<ol style="list-style-type: none"> <li>#1. How to Establish the Requirements for Computer Based Systems</li> <li>#2. The Use of MOS as it Applies to Computer System Design</li> </ol>		
5:00 PM to 7:00 PM	<b>DISCUSSION SEMINARS</b>		
	<ol style="list-style-type: none"> <li>A. Mini-Computers in a Multi-processing Environment</li> <li>B. Choosing the Right Memory for a Mini-computer</li> </ol>	<ol style="list-style-type: none"> <li>C. Hardware/Software Design Tradeoffs for Computer Systems</li> <li>D. Data Terminals—Their Design, Application, and Selection</li> </ol>	
2:00 PM	<b>SPECIAL PRESENTATION :</b>		
	The Decade of Challenge		

## Micro-modular computer

The System User Engineered (SUE) minicomputer is a bus-oriented, do-it-yourself computer. All components are sub-divided into plug-in modules that can be combined into many configurations without wiring changes. The user specifies and plugs together the micro-modules he needs on a function-by-function basis.

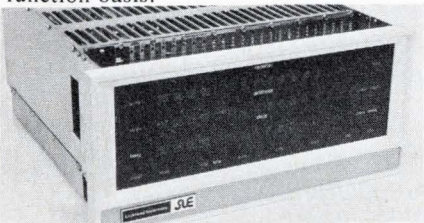

The four-layer Infibus with up to 24, 110-pin circuit card connectors, provides the common interface for data transfer between system modules. It accepts 24, 6 1/4" x 13 1/2" cards with an external power supply, or a power supply module and 16 cards. Power supply connections are at one end of the bus.

The Infibus controller card asynchronously controls direct memory transfers between system modules at rates up to five mega-words/s, resolves device request priority, and grants access to the bus. Only one is required, even if the bus is extended.

The processor is a two-card, 16-bit parallel, arithmetic-logic unit that processes two register operands in 130 ns for logic and 160 ns for arithmetic operations. It contains eight addressable general purpose registers, seven registers for accumulators and indexing, and one used as a program counter. The machine includes 108 instructions in four groups: general register, branch, shift, and control. There are 16 addressing modes and direct addressability to 32K. One bus accepts four processors, providing multiprocessor configurations. Processor precedence is determined by card placement.

Core and semiconductor memory can be intermixed. Core memory is expandable in 4K x 16 or 8K x 16, 8-bit byte-oriented blocks. Speeds are 900 ns full cycle; 300 ns write; and 500 ns read. Core can be operated interlocked, overlapped, or interleaved. Cores come in

three-card units; one contains the storage and two contain the decoding, driving, and sensing. Bipolar semiconductor RAMs or ROMs are available with 200 ns read and 250 ns write times. They expand in 1K/card increments. New technologies can be incorporated into SUE on a function-by-function basis without affecting the system.

While all components are priced separately a typical example is a 4K core mini which can be assembled for \$3,425, or for \$2,055 in 100 quantity. A 16K machine is \$9,295, or \$5,877 in 100 quantity.

Lockheed Electronics Co., 6201 E. Randolph St., Los Angeles, Calif. 90022.

**Circle Reader Service #250**

### LOGIC PANELS

These panels have provisions for mounting decoupling capacitors in plated through holes. Connections are to Vcc and ground, eliminating attachment to terminal mounting posts. Universal boards accept 14 ceramic, 4 Ta, and 1 electrolytic capacitor. Standard boards (14 or 16 pin DIP pattern) take one less ceramic. Scanbe Mfg. Corp., 3445 Fletcher Ave., El Monte, Calif.

**Circle Reader Service #251**

Magnetically plated disc with hard Ni alloy underplating. Chemplate Corp.,

**Circle Reader Service #252**

Plug Compatible MOS expansion memory for PDP-8. Signal Galaxies, Inc.,

**Circle Reader Service #253**

**This IC would be alive today if you had used CEA shielded power supplies or isolators.**

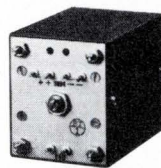
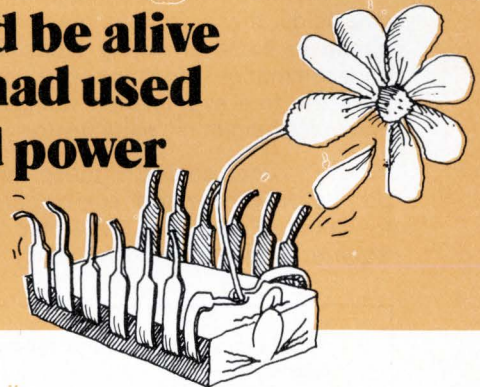

#### Glitchless Supplies

Every DC modular power supply we make has a shielded transformer. Complete isolation to 100 db. Regulation line plus load to  $\pm 0.0005\%$ . Dual supplies also available.



#### Isolationist

A small portable unit that will give you high common mode rejection, stop high frequency line transients, put an end to 60 cycle leakage current and break AC ground loops.

Write for our catalog.



**CEA**, a division of Berkleonics, Inc.

1221 S. SHAMROCK AVENUE, MONROVIA, CALIFORNIA 91016 TELEPHONE: (213) 359-9261

**Circle Reader Service #22**

# Master the NEW TECHNOLOGIES with EE's Practical Courses

Compiled by the editors of The Electronic Engineer, these courses present completely authoritative and up-to-date guidance in using every aspect of the new technologies they cover:

**Data Terminals**—Basics of data transmission • Keyboards • Line Drivers and Receivers • Modems • Multiplexers • Minicomputers as Front Ends • Teletype-writers • Facsimile equipment • Data Adapters

**Memories**—Memory types • Magnetic mainframes • Non-magnetic mainframes • Bulk storage • Systems applications • Future memories

**Optoelectronics**—Physics of light • Materials for sources and detectors • Amplifiers • Practical applications (light choppers, modulators, card and paper-tape readers, counters.)

**MOS Integrated Circuits**—Processing and applications of MOS circuits • Complimentary MOS • MOS memories (random access, read only, associative memories and cost) • Testing of complex MOS circuits

Authored by recognized experts in their respective fields, these courses are the one sure way to keep ahead in these changing times. Each course includes an examination for those who wish to qualify. All who pass the free examination will receive a formal Certificate of Completion suitable for framing.

To order copies of these courses, return the coupon below with your check or company purchase order to: **Course Editor, The Electronic Engineer, One Decker Square, Bala-Cynwyd, PA 19004, E-2.**

Please send me the following courses:	
Quantity	Cost
_____ <b>Data Terminals @ \$5.00 each</b>	_____
_____ <b>Memories @ \$5.00 each</b>	_____
_____ <b>MOS Integrated Circuits @ \$5.00</b>	_____
_____ <b>Optoelectronics @ \$4.00 each</b>	_____
Total _____	
<input type="checkbox"/> Check enclosed	<input type="checkbox"/> P.O. # _____ enclosed
Name _____	
Company _____	
Address _____	
City _____	State _____ Zip _____
E-2	

New products at the  
Computer Systems Design Conference

## EXPANDABLE RAM

The bipolar RAM MCI 3333 system expands in 1K word increments from 1K—4K, and in 9 bit increments from 9—54 bits. Primary application in microprogramming control stores requiring read/write capability, such as IBM's 3330 disc drive controller. Memory Technology Inc., 83 Boston Post Rd., Sudbury, Mass. 01776.

**Circle Reader Service #254**

## A/D CONVERTERS

The 5800 series is a self-contained, multiplexing, A/D and D/A system. Basic package can have 8 input channels, expandable to 64 single-ended, or 32 differential channels. Basic 8 channel unit is about \$1,200. Analogic Corp., Audubon Rd., Wakefield, Mass.

**Circle Reader Service #255**

## DELAY LINE PACKAGES

Tapped delay line DIPs on 0.2" centers reduce board space by 1/3 in critical applications. Others on 0.6" centers increase taps per package by factor of four. Rhombus Industries, 24284 Crenshaw Blvd., Torrance, Calif.

**Circle Reader Service #256**

## SIGNAL MEASUREMENTS

The Model 2152 measures single event analog or high rep-rate signal voltages to the nearest mV at a 1 MHz rate, with an accuracy of 1%. It determines occurrence of a known voltage to the nearest 1 ns. Technitrol, Inc., 1952 E. Allegheny Ave., Philadelphia, PA

**Circle Reader Service #257**

*Model 7700 Interactive Display Terminal* upgraded from 1,000 character display to 2,000 character display, and new accessories. Lear Siegler/Electronic Instruments.

**Circle Reader Service #258**

# An Honorable Solution to your Data Acquisition Problem

From VIDAR:

- You can derive maximum data and accuracy with relatively minimal cost.
- You can get a data acquisition system with inherent longevity.
- You can be secure with a data acquisition system designed by user-oriented engineers to facilitate your job.

Because:

VIDAR means innovation, creativity and reliability, and is a leader in the data acquisition and instrumentation industry.

VIDAR means quality assurance, and security. VIDAR creates systems capable of gathering millivolt-range signals in high common-mode noise environments, with high resolution-per-dollar accuracy, continuously, without appreciable drift or breakdown.

VIDAR has experienced installation of data acquisition systems that have provided dependable service in a broad spectrum of applications including pollution monitoring, plant process and control, structural testing, engine testing, pot line monitor and control, and battery testing.

VIDAR will provide you with a solution to your data acquisition needs. Describe your requirements on letter-head and mail to: Dick Kennedy, Product Manager.

Circle 15 on Reader Service Card

## VIDAR®

77 Ortega Avenue, Mountain View, California 94040 (415) 961-1000  
 Atlanta (404) 458-0993 • Boston (617) 922-7192  
 Chicago (312) 539-4838 • Cleveland (216) 267-0445  
 Houston (713) 864-6128 • New York (201) 647-5888  
 San Francisco (415) 327-9270 • Washington, D.C. (703) 534-6241

VIDAR DATA ACQUISITION SOLUTION •  
 DATA ACQUISITION SOLUTION • VIDAR  
 SOLUTION • VIDAR DATA ACQUISITION  
 VIDAR DATA ACQUISITION SOLUTION •  
 DATA ACQUISITION SOLUTION • VIDAR  
**POT LINE  
 MONITORING  
 AND CONTROL**

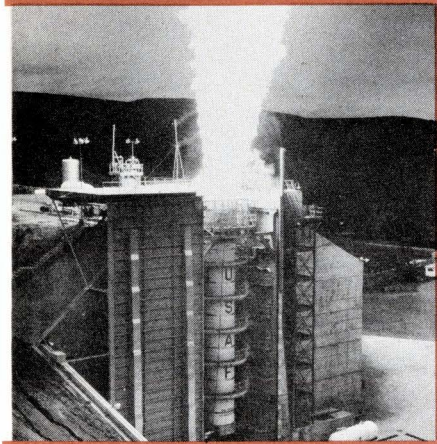
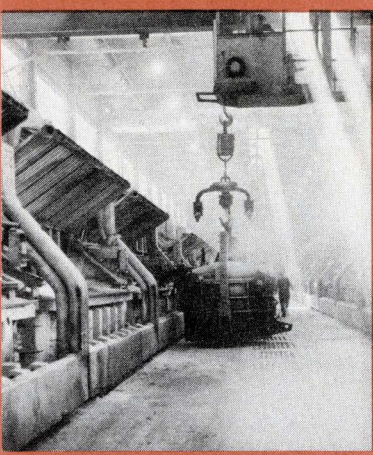

VIDAR DATA ACQUISITION SOLU  
 DATA ACQUISITION SOLUTION •  
 SOLUTION • VIDAR DATA ACQUI  
 VIDAR DATA ACQUISITION SOLU  
 DATA ACQUISITION SOLUTION •  
**ENGINE  
 TESTING**

VIDAR DATA ACQUISITION SOLUTION •  
 DATA ACQUISITION SOLUTION • VIDAR  
 SOLUTION • VIDAR DATA ACQUISITION  
 VIDAR DATA ACQUISITION SOLUTION •  
 DATA ACQUISITION SOLUTION • VIDAR  
**BATTERY  
 TESTING**

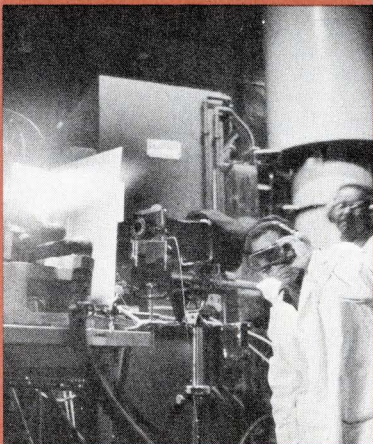

VIDAR DATA ACQUISITION SOLU  
 DATA ACQUISITION SOLUTION •  
 SOLUTION • VIDAR DATA ACQUI  
 VIDAR DATA ACQUISITION SOLU  
 DATA ACQUISITION SOLUTION •  
**PLANT  
 PROCESS  
 CONTROL**

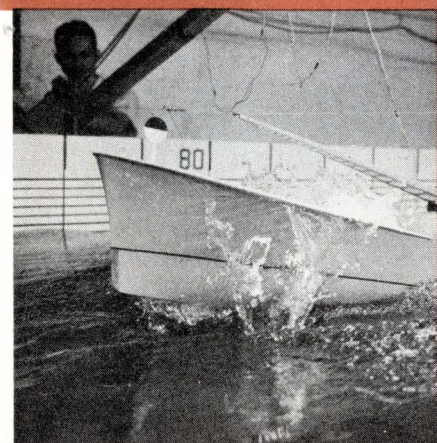
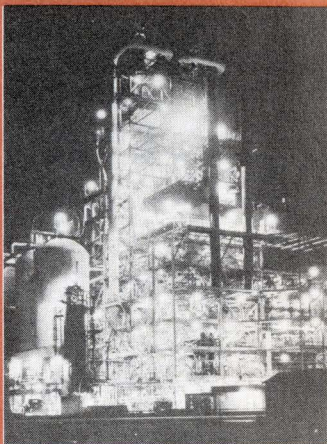

VIDAR DATA ACQUISITION SOLU  
 DATA ACQUISITION SOLUTION •  
 SOLUTION • VIDAR DATA ACQUI  
 VIDAR DATA ACQUISITION SOLU  
 DATA ACQUISITION SOLUTION •  
**STRUCTURAL  
 TESTING**

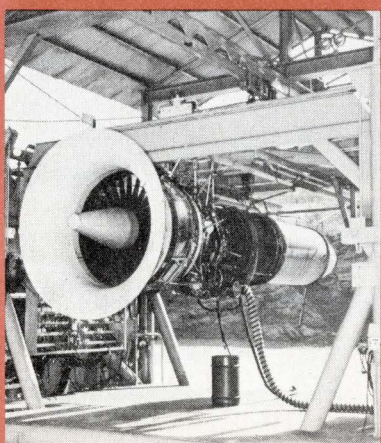

VIDAR DATA ACQUISITION S  
 DATA ACQUISITION Solutio  
 SOLUTION • VIDAR DATA A  
 VIDAR DATA ACQUISITION S  
 DATA ACQUISITION Solutio  
 SOLUTION • VIDAR DATA A  
**POLLUTION  
 CONTROL**

# Now we offer you the world's first true nonpolar wet tantalum capacitor.

We call it the ANP. And it means protection. Full protection from voltage-reversal failures. And from circuit-damaging transients.

Realizing that not every circuit needs full protection, we also came up with the AHS. Type AHS tantalum capacitors are polarized units for operation with a DC bias, including the application of a reverse voltage not exceeding 3 volts.

The new capacitors come in 32 values and 9 case sizes. Stud or PC mounting. Within specified limits, they meet requirements of MIL-C-3965.

So, if you're looking for *true* nonpolarity—or precisely limited polarity—stop looking. We've got both. And bulletin 4-608 explains the details.

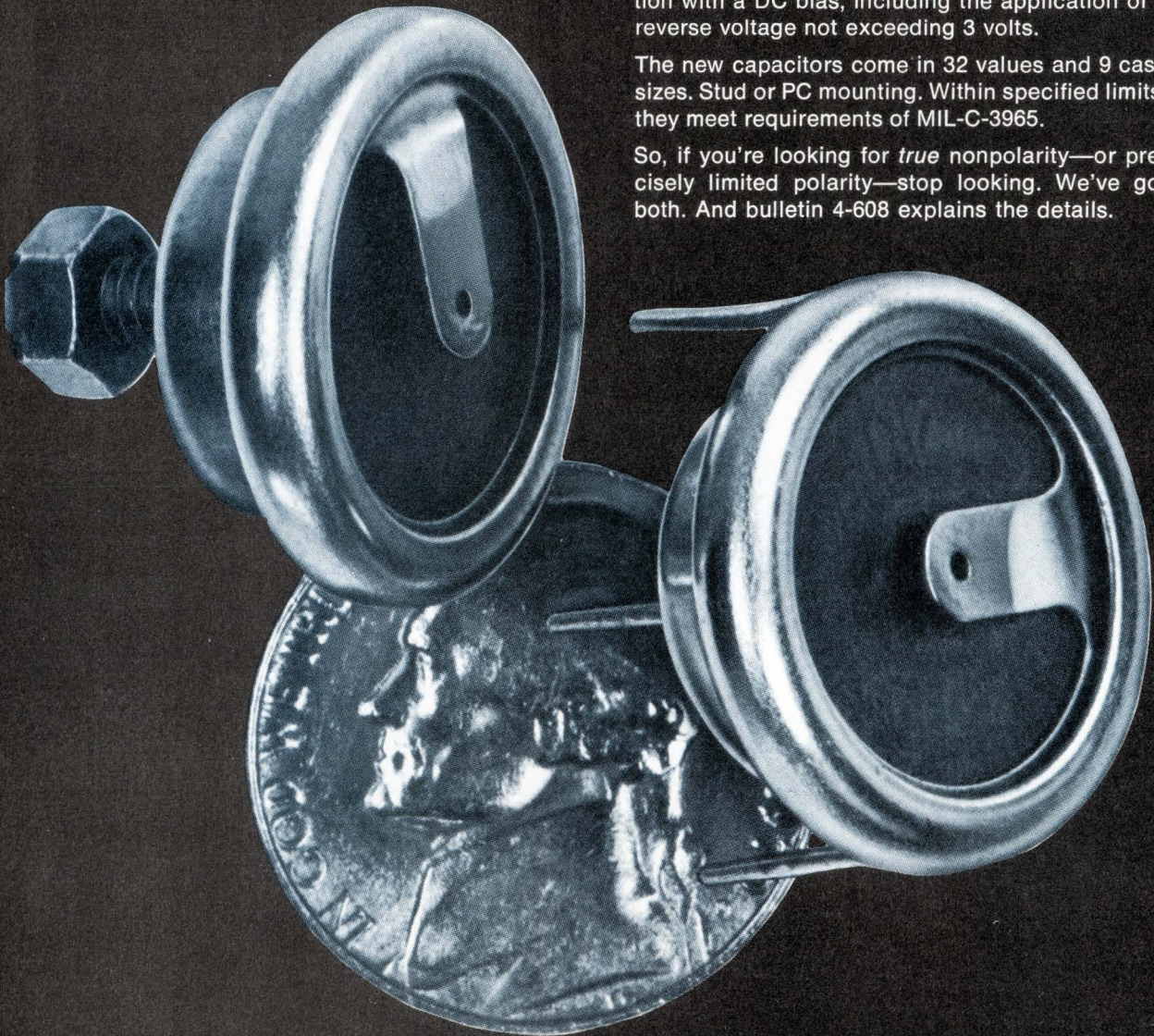

**MALLORY**

**MALLORY CAPACITOR COMPANY**

a division of P. R. MALLORY & CO. INC.  
Indianapolis, Indiana 46206

Electrical and Electronic Components • Sequence Timers • Metallurgical Products • Batteries



# Microwave Solid State SIGNAL SOURCES



## FEATURING . . .

- Portability
- Programmability
- Accuracy
- High Linearity
- Reliability

Watkins-Johnson announces the new WJ-1165 series of compact, lightweight signal sources covering the 0.5 to 18 GHz frequency range in six bands. Designed for applications where size and weight are primary considerations, these rugged and reliable micro-sources feature solid state construction for trouble-free performance.

They may be manually operated or programmed in 1 MHz increments to any discrete frequency in an octave band. A standard external sweep mode is available to accommodate sawtooth and triangular waveforms. Options include remote BCD control for discrete frequency selection, internal sweep over the entire frequency band, and error voltage input for phase locking.

### KEY SPECIFICATIONS

Frequency Range . . . . .	0.5 to 18 GHz (6 octave bands)
Power Output . . . . .	5 to 50 mW
Frequency Accuracy . . . . .	± 0.3%
Frequency Steps . . . . .	1 MHz increments
Size . . . . .	10.2 x 27.3 x 30.5 cm
Weight . . . . .	5.9 kg

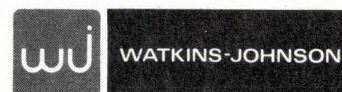

3333 HILLVIEW AVE., STANFORD INDUSTRIAL PARK, PALO ALTO, CALIF. 94304 • (415) 326-8830

# Scanbe takes the gamble out of the card game.

Our card files provide a sure thing for mounting your P.C. cards. The well known secret to Scanbe's system is the nylon guides with integral mounting feet to insure precise card/connector alignment. The guides are fixed on extruded aluminum bars between end plates or drawer frames. The extruded aluminum mounting bars offer exceptional rigidity, yet the files are rugged and lightweight.

Configurations are virtually unlimited . . . files, kits, drawers, both vertical and horizontal, and fully wired systems.

Also, this truly universal system offers any card/connector combination, any card spacing with single and multi row designs.

Let our application engineers give you a winning hand for all your packaging needs.

For the solution to your packaging problems, contact "The Packaging People" at Scanbe.



**SCANBE MANUFACTURING CORP.**

*"The Packaging People"*

3445 Fletcher Avenue  
El Monte, California 91731  
Telephone (213) 579-2300

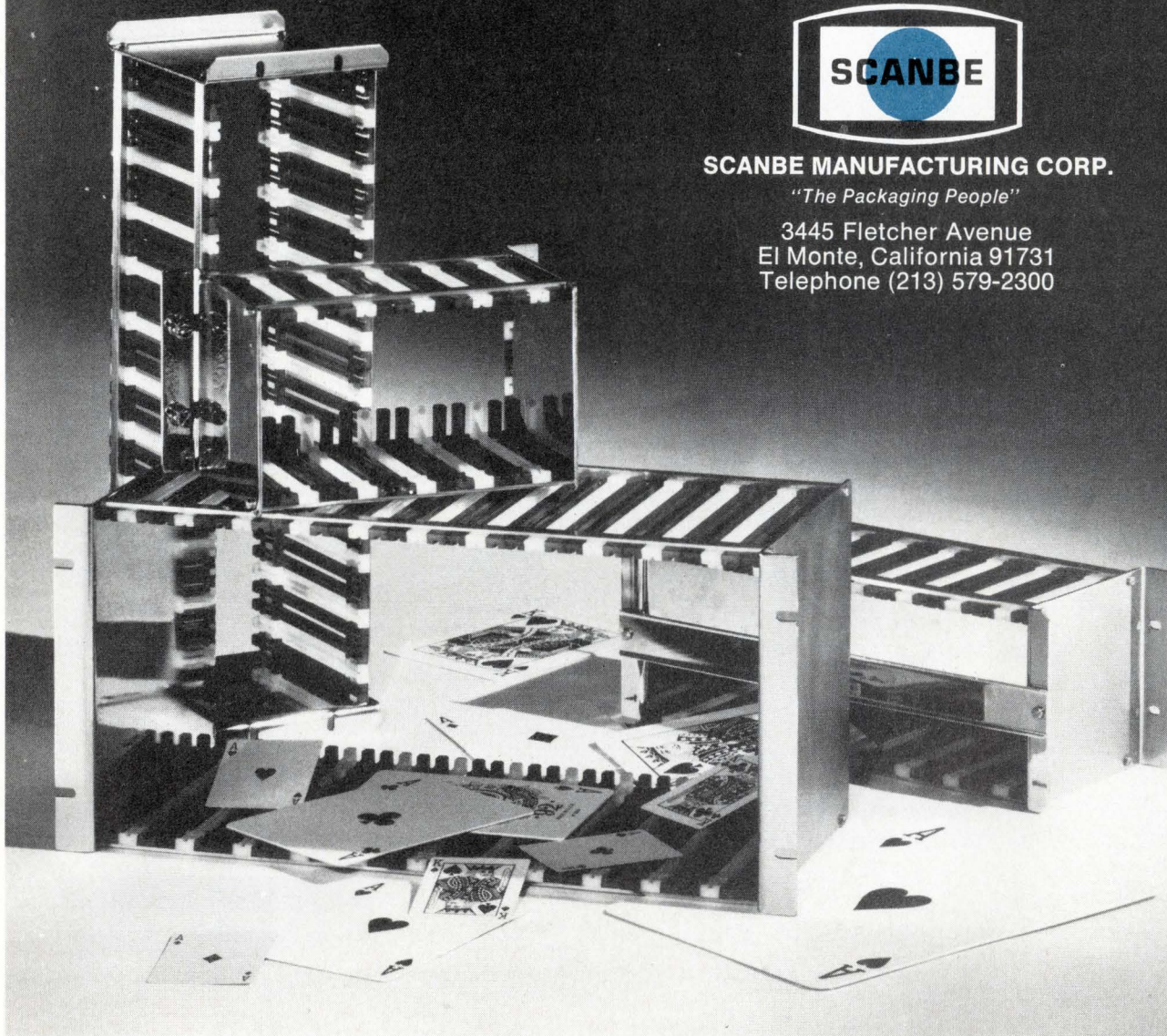

Here is your  
copy of a brand new  
reference chart  
sponsored by

**COMMUNICATIONS  
TRANSISTOR CORP.**



**RF POWER  
TRANSISTOR  
CHART**

◀ Tear it out,

**NOW**

... and  
mount it on  
your wall

If the chart is missing,  
Circle Number 41  
on the Inquiry Card  
for a copy.

## **Fault Isolation: We've just made it economically practical for commercial/industrial equipment.**

Our new Fault Indicators take the high cost out of monitoring circuit performance. With them you can isolate faulty operation, cut troubleshooting time, eliminate costly check-out equipment and procedures, reduce downtime. All at a fraction of what fault indicators have previously cost.

These BITE (Built-In-Test-Equipment) Indicators use an electrically actuated mechanical display that latches into position magnetically. When a circuit malfunction occurs—transient or continuous—the display transfers color and

latches magnetically until reset. This latch memory assures positive isolation/indication regardless of the nature of the fault.

Because of their miniature size (.320" dia.), these indicators can be mounted directly on PC boards or grouped as a system on a remote fault isolation panel. Our application engineers will be glad to assist you in the use of individual units or in the designing of a complete system to your specific requirements.

Write for details. Today.

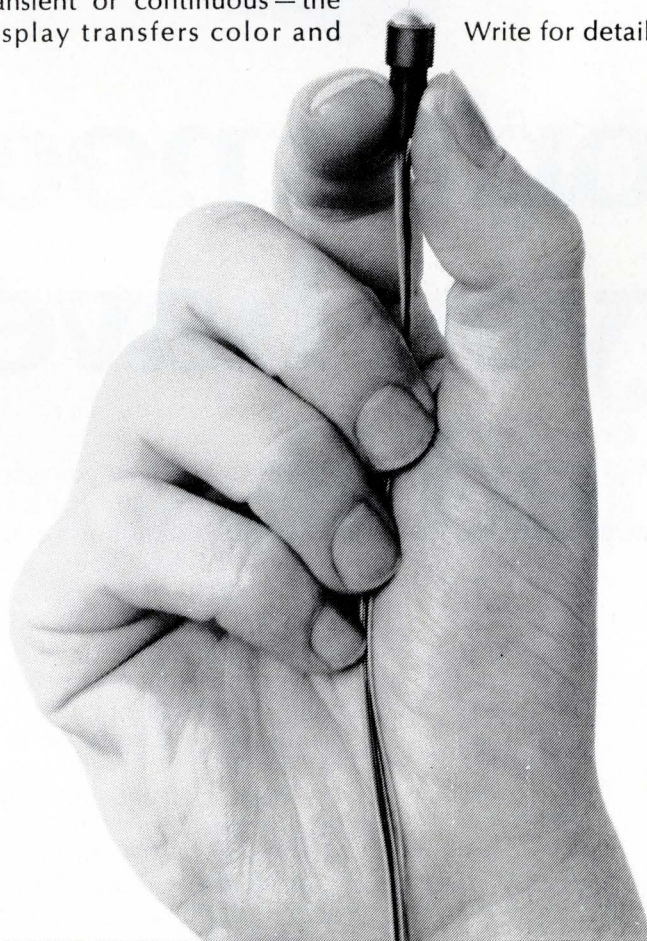

**THE A. W. HAYDON COMPANY**



232 North Elm Street, Waterbury, Conn. 06720 Tel. (203) 756-4481 TWX: 710-477-3141  
In Europe: Polymotor International · Brussels 1, Belgium

**Circle Reader Service #27**

# THE TEAC R-70.

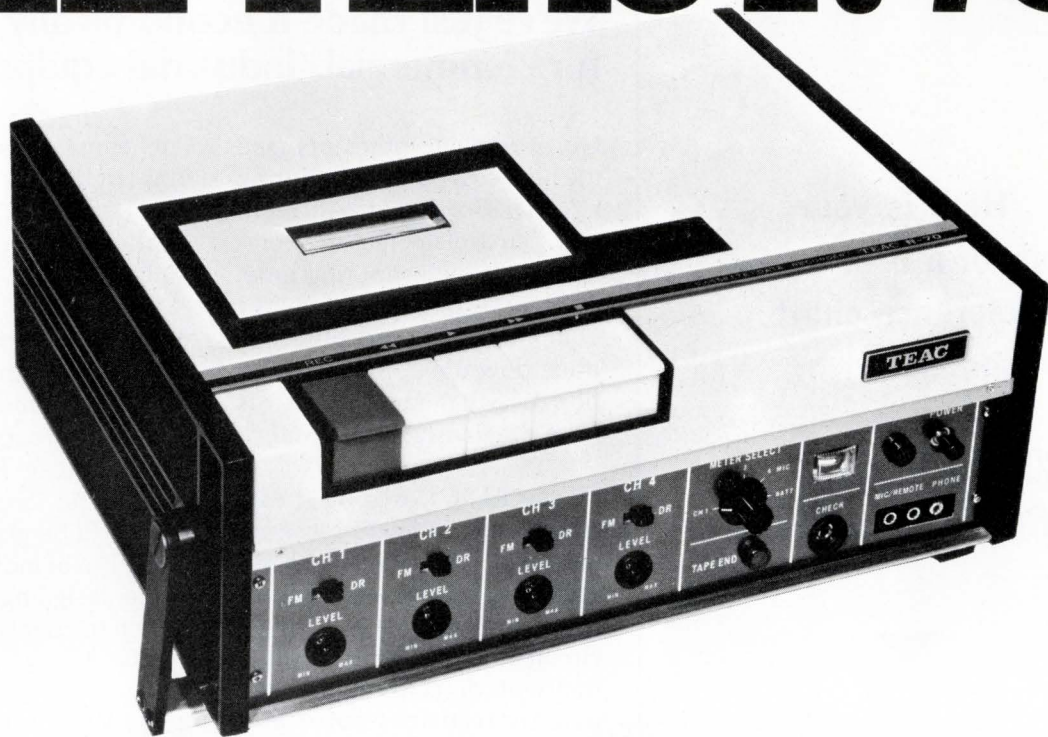

## Don't knock it if you haven't tried it.

And now you can try it. For 10 days. Free. That's how confident we, of TEAC, are about our rugged little R-70 cassette data recorder holding up its end of our reputation.

Try it. See how it performs in your operation on its own self-contained batteries, or external AC or DC.

Check its frequency response: FM mode is now DC to 800Hz; direct from 100Hz to 8kHz.

And use it either FM or DR with a flip of a switch on any of its four channels.

Locate your voiced comments or other data quickly with its built-in tape counter.

Monitor the channels individually via the built-in meter and/or by output to your scope.

Watch the warning light wink on as you reach the end of your tape in the Philips-type cassette.

Then wonder at how we packed all of these features (and more) into this 5"x14"x10" totally self-contained 14-pound data recorder.

All for the price of \$1995, including eleven accessories!

If you'd like to try out our R-70 on a current problem or project, we're game.

Just write or call Ken Williamson, Director of Marketing, Technical Products, TEAC Corporation of America, 7733 Telegraph Rd., Montebello, CA 90640. Telephone (213) 726-0303.

He'll tell you how you can

**take a  
TEAC** and try it.

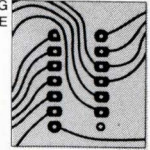

# PACKAGING with integrated circuits

The little bugs that tamed the big packages

By Alberto Socolovsky and Smedley B. Ruth,

Editorial Staff, The Electronic Engineer

There was a time when life was simple and trains ran on schedule, when an electronic circuit could be designed and prototyped without regard for how it would be finally packaged. Not so today, when the speed and sophisticated design of electronic circuits make the selection of a package a complex problem which must be solved and, most importantly, solved early.

What do we mean by a package? Where does it begin? Where does it end? What's a package to the semiconductor manufacturer, is it an integral part of a component to the semiconductor user? And does this user's packaging problem become a materials technology problem when making printed-circuits, or a problem of automation when wiring a back panel, or both?

There's hardly a piece of electronic equipment designed today without integrated circuits, lots of them. More importantly most of them come packaged in the imperfect, yet already classic, dual-in-line package. And this little bug-like package, more than any other factor, has effected a major revolution in the design of today's electronic hardware. Used not only for ICs, DIPs find their way into passive components and even relays and switches. Their regular size and lead-spacing are reflected in the myriads of plated-through holes in printed circuit boards. Their numbers have been responsible for the multiplicity of pins and wires in back panels, the numbers of contacts in connectors, and the many conductors in cable harnesses and flat cables.

It is to this revolution that this course is dedicated. It starts, just as your job does, with the selection of the proper package for your components. It then follows with the designer in considering how it will be mounted on the PC board, the type of PC board to be used, how the connection will be made to the board, and how that board fits into the overall picture. Should you use flat flexible cable? Will there be a noise or crosstalk problems and if so, what should you do to avoid it?

The course will then move to the back side of the board or panel. Several methods are available, but are you familiar with their advantages and limitations? And, how about the back panel itself? They're all covered in the following chapter of the course.

Have you considered enclosures? There are many card cages and card guides on the market today and most of them look great. But will they meet your needs? Are they

human engineered? Are they functional? Choosing an enclosure isn't simple, and the last chapters of the course will help with information about enclosures and applications.

These and many more pertinent questions will be answered in this course on "Packaging with ICs." Presented in monthly installments, it will include articles by top people in the industry, knowledgeable engineers on both sides of the fence—both manufacturers and users, and comments by your editors. Watch next month for the first installment, "The IC packages."

## OUTLINE OF THE COURSE

### Part I . . . The IC packages

Dual-in-line, flat packs and TO-packages.  
Passive components in IC-compatible packages.  
Special (edge connected diaphragm, and hybrid packages).  
Automatic and semiautomatic insertion of these components.

### Part II . . . Circuit boards and cables

PC boards—single sided, double sided, and multilayer boards.  
Flat-flexible cables and flexible circuits.  
Ground planes, coaxial lines and strip lines.  
Computer-aided design of PC boards, crosstalk and circuit substrates (ceramic).

### Part III . . . Back panel wiring

Connecting the ICs directly, and into sockets.  
back panels—metallic and insulating.  
Wiring methods—wire wrap®, Termini-point®, and Multiwire®.  
Production methods—automatic soldering and welding.  
Care of high-speed circuits—low noise and crosstalk.

### Part IV . . . Enclosures

Card cages, card guides and drawers.  
Applicable Mil-Specs.  
SHP-Standard Hardware Program (Navy).

### Part V . . . Applications

Packaging for space applications.  
Packaging for consumer applications.  
Packaging for computer and communications applications.  
Packaging for automotive applications.

The above will be published from March to July 1972. After the last chapter we will publish a final examination.

**The Electronic Engineer** confers a certificate to those readers who pass the exam.

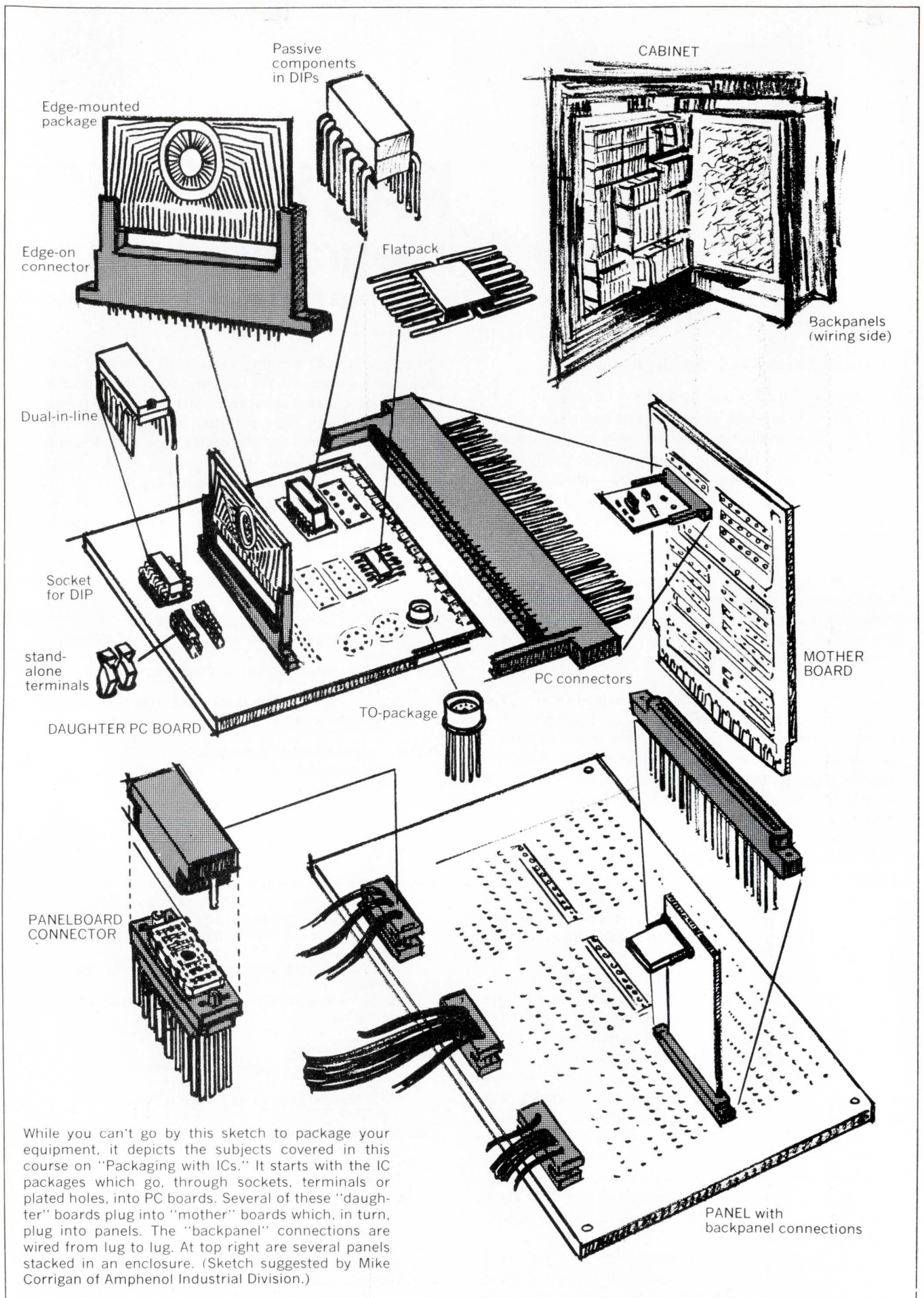

While you can't go by this sketch to package your equipment, it depicts the subjects covered in this course on "Packaging with ICs." It starts with the IC packages which go, through sockets, terminals or plated holes, into PC boards. Several of these "daughter" boards plug into "mother" boards which, in turn, plug into panels. The "backpanel" connections are wired from lug to lug. At top right are several panels stacked in an enclosure. (Sketch suggested by Mike Corrigan of Amphenol Industrial Division.)



# It's as popular as a PDP-8.

Back when PDP-8 first came out, we knew it was going to be well-received.

And that's just what happened. Over 15,000 PDP-8's have been installed already.

In fact, more PDP-8's are coming off our production line every month than all the other minis put together.

Of course it takes more than big production lines to make a runaway best seller. PDP-8 does have a lot going for it.

Like the exclusive OMNIBUS™ construction that makes interfacing a snap.

And all those PDP-8 peripherals. Over 60 standards. Plus specials.

And nobody ignores PDP-8's

library of programs. It's the biggest collection of minicomputer software in the world.

But when you get right down to it, all we did was take a great idea and bottle it.

Digital Equipment Corporation, Maynard, Mass. 01754. (617) 897-5111.

**digital**

Circle Reader Service #29

**“WHY PAY  
FOR MORE  
CONNECTOR  
PERFORMANCE  
THAN YOU  
REALLY NEED?”**

**An open letter to industry  
on our **¢**entsible connectors.**



# ITT Cannon presents a series of connectors that give you the performance you need at a price you can afford.

The day of performance for performance sake, regardless of cost, is over. And the old habit of demanding specials instead of reaching for standards is now a luxury few can afford.

That's the thinking behind our  $\text{¢}$ entsible connectors: simple, reliable, excellent performing connectors with broad applications and low cost. Take a look at our ADAPTA-CON pin and socket interconnections for P.C. and backplane applications. Or consider our rectangular, Zero Force DL INSTAMATE, a thermoplastic high density cord-to-panel or Input / Output connector. The DL's circular companion is the CL... all the same features plus breech lock coupling. Then there's the BURGUN-D, in five shell sizes, intermateable and intermountable with all D Subminiature series. Applications for these  $\text{¢}$ entsible

connectors are just about everywhere — computers, peripherals, business machines, and you name it — anywhere you want performance at low cost.

In a sense, these simple standards evolved from our many years of developing exotic specials. This same technology and design experience gave us the know-how to create and produce these  $\text{¢}$ entsible connectors.

Return to the basics with us. Find out just how well our  $\text{¢}$ entsible connectors can do the job in so many applications where connector cost was, until now, a limiting factor. You'll see how much sense it makes for you.

Tell us about your connector requirements... why not send us your application? ITT Cannon Electric, International Telephone & Telegraph Corporation, 666 E. Dyer Road, Santa Ana, California 92702. (714) 557-4700.



**CANNON ITT**

# Automotive electronics



**In the second decade of electronics in the auto, Detroit will be looking more and more to electronic engineers and their firms for help in solving its systems problems. But the big payoff in 1980 will only come to those EE's and companies who understand the implications of this Detroit-style formula:  
"24 Apollos x 5M parts  $\neq$  5M cars x 24 parts."**

Trevor O. Jones

Director of General Motors'  
Electronic Control Systems

# is no lemon

**John McNichol**, New Directions Editor

**Social news from Detroit.** *The long-rumored, much heralded engagement of the electronic industry and the automobile industry has just been announced. According to interested onlookers, the bride-to-be's new stepfather, who is with the Federal Government in Washington, was seen carrying a shotgun and a copy of emission-control and safety regulations. Well-wishers suggested that the bride's problem-solving ability and the groom's great wealth made this a perfect match. Although the happy couple predicted a long engagement, they talked of many bouncing off-spring after their marriage at the end of the decade.*

Rain pelted the windshield as the sleek white sedan entered the long oval test track. The car, resembling a Pontiac Grand Prix except for the energy-absorbing bumpers and the electronic dashboard, leapt forward as the driver floored the accelerator. A small foreign car was passed as if standing still. The speedometer readout flipped out numbers until at 80 miles per hour, the horn blared out continuously and the lights flashed intermittently. Slowing the car to cancel the alarm, the driver turned in his seat to answer our question.

"1979," was the retort.

The car: Alpha 1—General Motors' first prototype elec-

tronic car. The man: British-born Trevor Jones, Director of General Motors' Electronic Control Systems group. And the question: "When can John Q. Public drive the Alpha?"

The incident on GM's test track at Warren, Mich., is indicative of the present state of automotive electronics. Never before have prospects looked so bright for electronic engineers and their companies, but the payoff won't come until the end of this decade and it will demand an extremely cost-conscious approach.

This approach was summed by Fairchild's president Dr. Les Hogan, at a panel discussion he moderated last December at the IEEE Vehicular Electronics Conference in Detroit. Before introducing a panel of the top electronics men in Detroit, including Jones, Ford's Chuck Simmons, and Chrysler's Earl Meyers, Hogan joked, "First, I've got some good news, and then I've got some bad news. . . ."

## The good news

It relates to dollars and to employment opportunities. First, there are the numbers, the sheer volume of the market and the billions it will mean for electronic, especially semiconductor, companies. Second, there is the changing nature of the automobile, prodded by new federal regu-

---

## GM's TREVOR JONES: PUTTING ELECTRONICS ON WHEELS

When Gordon Hoffman of Mostek called Trevor Jones at his home recently, another member of Jones' family answered the phone. As the person answering the phone has the same whimsical sense of British humor as Jones, Hoffman was told, "I'm sorry, he's been dead for two years."

Persisting in kind, Hoffman questioned, "Where did he work?"

To which the reply came, "The Packard Motor Car Company."

Well, like Mark Twain who said, "that the recent reports of my demise are greatly exaggerated," the reports of Trevor Jones' state of health and recent employment are greatly exaggerated. And it may be because of putting men of his calibre in positions like director of Electronic Control Systems that General Motors has remained the giant it is, while Packard is only a name in a game of trivia.

Quick-witted, facile, and a dedicated professional EE, Jones represents a new blend of auto man. Capable of functioning as an interface between the old line 'automobile-automobile' engineer and electronic engineers, he may be responsible for introducing a new phase of electronics into the automobile.

Born in Maidstone, England, Jones joined AC Electronics in 1959. As a senior project engineer he worked on high precision miniature gyroscopes and accelerometers. Between 1960 and 1962 he was active on the B-52 bombing navigational system, and then the analysis of system requirements for advanced weapon and space systems.

This, in turn, led to his appointment in 1965 as the man responsible for the entire Apollo guidance computer program for the lunar and command modules. In 1966, he became engineering director for Military Avionics Systems.

Having become technical director for Advanced Systems Engineering in 1968, he moved over to the auto area in 1969 as director, Automotive Safety Products. In 1970, he attained his present position as director of the newly organized Electronic Control Systems group, with corporate responsibility for the integration of electronic devices in GM vehicles. This position includes the responsibility for advanced safety and emission-control systems.

In June, 1971, John Volpe, Secretary of Transportation, appointed him to the National Motor Vehicle Safety Advisory Council. He is a recipient of the British Institute of Electrical Engineers' Hooper Memorial Prize.

On the wall of Jones' fairly Spartan office is a symbol of the problems he faces and that electronic engineers must solve. It pictures a car, a 20-ft. tree, and sign standard (minus the sign), plus tracings of the radar's reaction to the obstacles. The tracings sound the death knell for radar as an integral part of the air bag system. Unfortunately, the radar identifies the sign standard as dangerous, while it does not present a true picture of the menace the tree may be in an accident. This fact ruled out using radar to trigger an air bag in early systems. As Jones says, "Let's face it, it's a physical law."

# CHALLENGE



Indicative of the increased electronics activity in Detroit is this screen room of GM's Engineering Staff. The installation can accommodate at their Technical Center one full size se-

lations and technological innovations. Jones, himself a former aerospace engineer who is systems-engineering the car, is looking to electronics engineers for devices and circuits to fill his system blocks.

□ **Size of market**—Although all three panelists point with some scorn to stories in the press that the electronic millenium has come (Jones: "I've got a briefcase full of such stories."), even the most cynical admits that by the end of this decade, Detroit will be buying between \$1-5 billion of products from electronic companies.

Defining the market, Jones quotes Dr. G. Villa, who holds a similar position with Fiat. Villa spoke recently at an Electronics Industry Conference in Turin, Italy, of 10% by 1980 to a maximum of 12% by 1985 of the cost of each car for electronics. Pretty heady figures when you realize domestic car producers just had their first 10-million car year, with 15-million cars a year projected for 1980.

□ **The systems approach**—The signs of good news are evidenced more at General Motors than at Ford or Chrysler. Ford has been designing individual electronic subsystems, adding on 10 of them in the past 10 years. Chrysler, which was the first to put Motorola's silicon diodes in its alternator back in 1960 and solid-state ignition this year (on all models), has been hampered by a lack of funds.

This leaves General Motors, which has stolen the march with the formation in 1970 of Jones' group to explore the systems approach. A fact quietly acknowledged by some insiders at Ford: "GM has really gone into electronics in a big way; frankly, they're ahead of everybody."

The charter that Jones hopes will keep them in first place is "to optimize the integration of electronic functions for cost, commonality, reliability, and maintainability; and to continuously review the state of the art of electronics relative to driver and automotive functions."

dan or two economy size models. General Motors uses it for general EMI testing and also in pattern and sensitivity tests on possible anti-collision radars.

In other words, Jones, who speaks proudly of his past association with the Apollo project, has corporate responsibility for the integration of all electronic devices, including safety and emission-control systems, into all General Motors vehicles. As he says, "This is the first serious consideration, aside from entertainment, that we've given to electronics."

Under this charter, Jones' 100-man staff has prepared Alpha 1, a prototype that consists of a Pontiac Grand Prix loaded with electronic subsystems such as anti-skid, the physiological tester, an electronic dashboard, and much more. (General Motors is also working with Delta 1, an environmental car, and Sigma 1, a safety model.) But men like Dr. Hogan have their own ideas about putting that much electronics into a car. Looking at the breadboarding for the central and satellite computers that fill much of the trunk of the Alpha, he whipped out a tape and measured the processor, insisting, "We can reduce all this to a few cubic inches."

But before electronic engineers can put Hogan's "delightful ICs," as Jones says with a touch of British whimsy, close to the engine block, they'll need environmental specs for the automobile. Trevor Jones' group is preparing a large specification to be released within the next few months, which will define all the environments of an auto and the test procedures to which electronics will be exposed. For the first time, engineers will know what they're up against when they design for what Jones refers to "as harsh an environment as any for the military, compounded by the large number of vehicles."

One of the advantages of such a group, Jones says, is that "We're able to build a lot of our own electronics, so we understand the cost. For instance, when we look at a transistor we know what it takes to buy the silicon, process

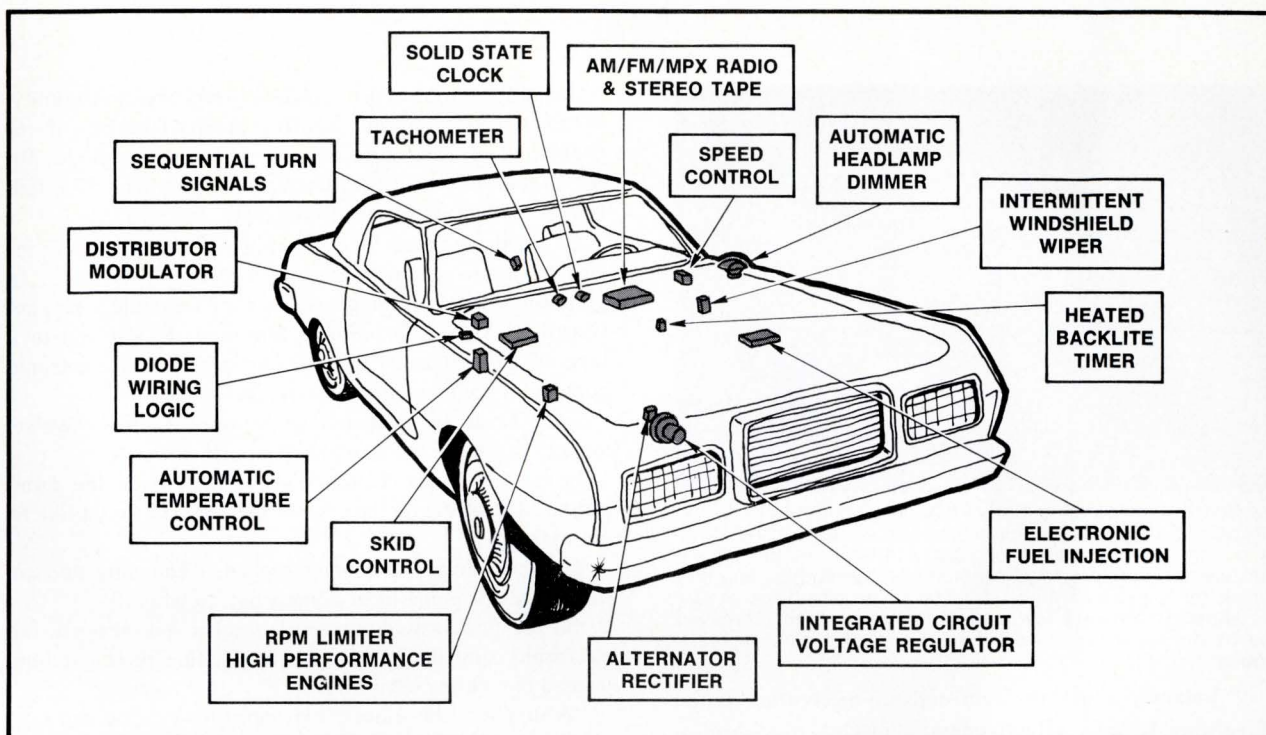

Some of the subsystems being seriously looked at in Detroit are shown here. The experimental Alpha 1 includes most of the equipment shown. In addition, Alpha 1 has extensive

it, make the package, and test it. Many times the cost boils down to the simple economics of the volume of the silicon."

□ **Legislation**—Jones, like all auto makers, admits that Washington has made the electronic industry more attractive than ever. "The pressures of technology and safety and emission-control legislation require us to take a very hard look at what electronics can do on the automobile. It will come in this decade," he notes, "but it won't come tomorrow."

Besides emission-control regulations, Washington's interest is spelled out in publication DOT/HS 820 163, "Program Plan for Motor Vehicle Safety Standards, Oct. 1971." This 108-page document, published by the National Highway Traffic Safety Administration of the Department of Transportation, includes some 14 systems and devices, with dates, which may demand an electronic solution. They range from High Speed Warning and Control in 1974 to Controls and Displays Requirements in 1977.

Other legislation pending is Michigan's own Senator Hart's bill, S967. This bill, which has passed the Senate, calls for an initial grant of \$50 million. One vital clause calls for a diagnostic exam of all new or used cars at the time of sale.

□ **History**—Concluding the good news is Jones' own view of history. He points to the inevitability of automotive electronics. An amateur historian, he plots speed as a function of time for computers from the abacus to Babbage's machine in 1833 to the present day, and the speed of transportation from the prehistoric canoe to the Apollo spacecraft. Essentially identical, the slopes of these curves represent the thrust of 20th century technology. A similar plot of automotive electronics also tends to follow the same curve. All three, he notes, have bent the knee and

control and monitoring capabilities by virtue of the central processor and several satellite processors which it carries in the trunk. (Courtesy of Texas Instruments Incorporated)

may be going into avalanche.

### The bad news

Although bad news has the reputation for travelling fast, Jones is afraid that perhaps the electronic industry hasn't gotten the message. The message for electronic engineers who want a slice of Detroit's pie is to design cost-effective devices that will suit the particular needs of the auto industry for high volume, reliable systems.

□ **Cost effectiveness**—GM's Jones points to an important function in his organization—Costs and Technology Analysis. This shop evaluates whether new electronics on a vehicle are worth the cost.

The cost can be staggering. For instance, it takes \$10,000 just to insert a new part number into the system. In addition, there must be new tooling, new servicing instructions, and a new inventory. Some industry experts estimate that a device should be 30% cheaper to make it look attractive to Detroit. There are, however, exceptions, such as items with a potent enough sales appeal that the customer may be willing to pay more.

Chrysler's Earl Meyers makes a convincing argument for how cost effective electronics can be in his analysis of the newly introduced transistorized ignition. His argument: "Electronic ignition will pay for itself within two years, and that is conservative. This solves the big problem of people not doing maintenance and results in customer satisfaction."

At GM, Jones believes that the solution to the cost of electronics, in addition to low-cost components, lies in timesharing. For instance, the electronics of the physiological tester, which tells when a driver is not fit to drive, can be shared for an anti-theft lock, a diagnostic interrogation display, a clock, a time base for a flasher, etc.

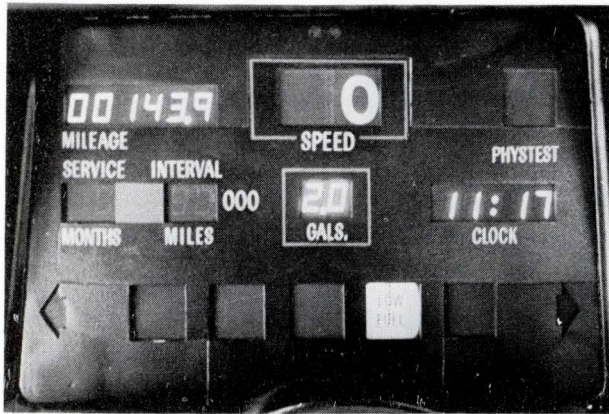

The instrument panel in GM's Alpha 1. Although strictly experimental, the Alpha 1 has helped GM get out of the starting blocks ahead of the other auto companies in solving the auto/electronics interface problems. Interestingly enough, during the period of Alpha 1 testing, the emphasis at GM has shifted from very low cost on/off sensors to increased use of digital information processing and display techniques.

□ **Volume**—Jones' theorem sums up nicely the relation of volume to cost effectiveness: "Twenty-four Apollo spacecrafts times 5 million parts is different than 5 million cars times 24 parts."

That's a vital difference, and a challenge to the semiconductor industry: "We find it very difficult, if not impossible to obtain written quotations from semiconductor houses," complains Jones. One reason is the sheer size of the market. "I recently asked a supplier of light-emitting diodes for a quote on 20 million (four per car) LEDs a year. He got out his book and pencil in great shock and said, '\$5.00.' Surprised, I asked if that was for all four diodes and he replied, 'Well, my book only goes to 100,000.' To this date, we still haven't got a quote."\*

What Jones didn't say is how much GM is willing to pay for LEDs. According to one supplier, it isn't much more than the 3 or 4 cents it pays now for miniature incandescent lamps. While Jones acknowledges that the digital electronic clock and the solid-state flasher are close to realization, he insists the price must be right. "If there's a dollar difference on a product, that's a \$5 million additional cost a year."

□ **Time**—A two-edged sword for Jones and all auto makers, they need time to systems-engineer the automobile. Having done that, they must work within the confines of the two, three or four years' leadtime. For example, some items on your 1979 Alpha could be frozen by 1976.

□ **Reliability**—A Motorola engineer has described the auto environment as "tougher than many of the toughest military environments, with unpredictably poor operating conditions, unpredictably bad maintenance (if any), and unbelievably poor mechanics."

For that reason, Jones stresses the importance of reliability. "For example," he notes, "while we're intrigued with liquid crystal for displays because of its simplicity, the highest MTBF we've seen is 1000 hours. A car may run over 300 hours a year for 10 years."

\*Editor's note: as of our publication date, Jones had finally received the quote.

Actually, auto men are justifiably leery about reliability. When Chrysler made the first across-the-board introduction of electronics in 1960—Motorola's diodes for the alternator—it suffered from an astronomical 17% failure rate in that first year of warranty.

□ **Attitude**—That Jones is aware of the electronic industry's desire to do business with Detroit is obvious. In preparing for the evening session with Fairchild's Hogan, Chrysler's Meyers and Ford's Simmons, he listened to a tape of a previous IEEE meeting which had electronic companies spelling out their message.

From Texas Instruments, he heard this plea, "We've come to the dance but don't have a partner."

In earlier tones, Fairchild's question made the same point, "Am sitting on the edge of the bed and would like to get married."

To which Jones laughingly replied, "The only unclear thing is who is going to be doing what, to whom!"

But the quick-witted Jones reserves his special barbs for electronic companies "who are just selling their catalogs instead of tackling our problems."

"A supplier," he states, "may open his catalog and say, 'There it is, 2N351, pnp. That will be \$1.70 in quantities of 10 and \$1.15 per hundred.'"

"Then we may say that it won't quite hack it and ask for a change. And it has been our experience that where a product doesn't fit, and a slight mod won't work, the industry doesn't seem to come back with a solution. What we want is a solution to the device problem in support of our solution to the systems problem. We don't want to restructure our systems problem."

Yet most semiconductor manufacturers insist Detroit should optimize their systems around their existing low-cost components. Jones doesn't think so because it usually "results in complicating the system design with higher costs."

"What I would suggest is to look at and understand the complex piece of machinery the automobile is, understand the systems we're considering, and study the Department of Transportation's Motor Vehicle Safety Standards that will require electronics. Besides, I think the electronic companies have been baffled. They don't know how to do business with us. Chrysler, Ford, and General Motors all do business in a different way."

## Needed—devices and prices

In addition to inexpensive displays, Jones is particularly interested in low-priced actuators, power semiconductors, and transducers. Looking back over the past decade on how much of a foothold electronics has taken, Jones can only point to the alternator and voltage regulator used in all models. However, these three components, he feels, will help to change the whole picture.

He refers to the problem of obtaining inexpensive actuators as "a very critical one." Transistors that can switch the 40-A solenoid in a door lock or window are expensive. Also, low-cost power actuators could make real inroads for hydraulic modulators, such as that used in anti-skid systems.

#### **BILL S976: FOR THE AUTO ELECTRONICS AFTERMARKET**

If Michigan's Sen. Hart has his way, car buyers and makers of electronic diagnostic equipment will be walking around with big smiles. Directed at saving the estimated \$30-40 billion a year spent for unnecessary car repairs, S976, which has successfully gone through the Senate, is up for House action early this year. It's directed at the \$40 billion (one-third of all repairs) wasted because of poor diagnosis, deliberate fraud, or incompetence.

Born in Sen. Hart's Anti-Trust Subcommittee in early 1968, this bill has attracted more mail than any legislation in memory, according to a member of the Subcommittee staff. All new or used cars would be subjected to a diagnostic exam at the time of sale, and when a car's safety equipment is damaged in an accident. Another important provision would allow a car owner to get a second diagnosis (for a nominal fee of \$1 or so) after a repair job to check if the mechanic did his job. Incidentally, used car buyers will be delighted to hear that a minor clause of the bill makes it illegal to turn back the odometer.

The initial grant of \$50 million, to be pumped through the Department of Transportation for 10 pilot projects, will be allocated for electronic equipment and staffing. Since a pilot project may involve an entire state or a city the size of New York, it should spell jobs for engineers and business for electronic companies.

Explaining why solid-state flashers haven't been used on all models, Jones pins the blame on power semiconductors. "A 30¢ power semiconductor," he insists, "can't compete with a lower priced switch or solenoid."

To take advantage of the convenience and economics of a digital system, GM wants, again at low cost, digital transducers. Since virtually all transducers today are analog, they're looking for either a low-cost converter or a new approach.

#### **Getting in the driver's seat**

Admittedly, dealing with the automotive Big 3 can be a frustrating business. The very environment of the automobile makes it so. The long leadtimes required for changes can't be discounted. The differing approaches of General Motors, Ford, and Chrysler for implementation of electronics add to the complexity.

However, in this second decade of auto electronics the winds of change have come to Detroit. Pushed by government regulations and advancing technology, the auto manufacturers are taking a new, more thorough look at what electronics can do. Trevor Jones and his Electronic Control Systems group are representative of this new breed. What he and his peers at Ford and Chrysler will want in the years approaching the '80s from electronic engineers are innovative designs, with the accent on low cost and high reliability, to solve their problems.

**INFORMATION RETRIEVAL**

**Careers**

**Solitron — pacesetter in automotive electronics!**

## **Monolithic & thick film hybrid circuits**

*Incorporating rugged Solitron silicon power transistors and power rectifiers, for greater reliability and economy!*

Solitron manufactures General Motors and Chrysler replacement-type voltage regulators.



The SOLI-TRON solid state ignition system.

*Solitron automotive electronic products include:*

**Custom Monolithic and Thick Film Hybrid IC's**

*Voltage Regulators*

*Windshield Wiper Controls*

*Anti-skid Devices*

**Solitron devices, Inc.**

256 Oak Tree Road  
Tappan, N. Y. 10983 (914) 359-5050

# The gate is great.

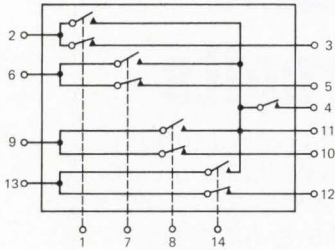

Intersil 5009/5010 4-channel analog gate. Compensating FET (pin 4) is closely matched to switching FETs. Connecting compensating FET in feedback loop of "virtual ground" inverting amplifier gives  $R_{ON(MATCH)}$  (Effective Switch-On Resistance) as low as 5 ohms.

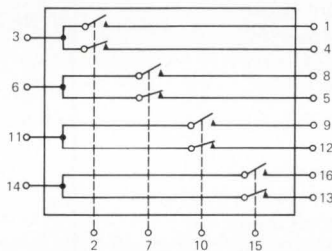

Intersil 5011/5012 4-channel analog gate.

# And a dollar a channel swings it.



## That's right. One dollar a channel.

New low prices on Intersil's 5009 Series Analog Gates bring costs down to a dollar a channel. And Intersil fabrication technology provides Effective Switch-On Resistances from 50 to 5 ohms.

Typical  $I_{D(OFF)}$  is 100pA (@ $V_{DS}=1V$ ). Gates available with from 1 to 4 channels per package, suitable for SPST, SPDT, DPST or DPDT use. They are packaged in silicone DIPs (standard) or in ceramic DIPs, and are usable with logic inputs of +5 or +15 volts with no need for an external driver.

## And the price is right.

Check these prices, at 100-piece quantities, for standard (50 ohms) and lower values of  $R_{ON(MATCH)}$ .

	Number of channels			
	4	3	2	1
50 ohms	\$ 4.00	3.30	2.40	1.30
25 ohms	6.00	4.95	3.60	1.95
10 ohms	9.00	7.40	5.40	2.90
5 ohms	13.50	11.10	8.10	4.35

## A \$9 multiplexed sample & hold.

Practical applications fall wherever you may need multiplexing, range-switching or sample & hold circuitry.

As an example, for the price of a \$4.00 Intersil 5009 and a \$5.00 Intersil 8007 FET-input op amp, you can build this complete multiplexer with sample-and-hold, providing an output decay rate of 4mV/sec. and gain error of 0.5% max. Like more examples? Ask for our comprehensive application notes. From

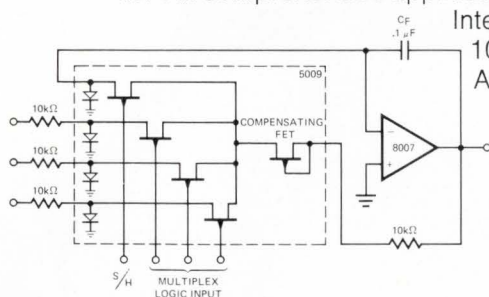

Intersil, of course.  
10900 N. Tantau  
Ave., Cupertino,  
CA 95014.

## Get 'em here.

**Intersil stocking distributors.** Schweber Electronics; Century Electronics; Semiconductor Specialists; R. V. Weatherford Co.

**Intersil area sales offices.** Los Angeles (213) 370-5766; Metropolitan New York (201) 567-5585; Minneapolis (612) 925-1844; San Francisco Bay Area (408) 257-5450.

**Overseas representatives.** Copenhagen: E. V. Johanssen A/S. Helsinki: Digelius Electronics Finland OY. Paris: Tranchant Electronique. Milan: Auriema Italia SRL. Tokyo: Internix. Madrid: Hispano Electronic S.A. Stockholm: ST-Komponent AB. Zurich: Laser & Electronic Equipt. London: Tranchant Electronics. Munich: Spezial Electronic.



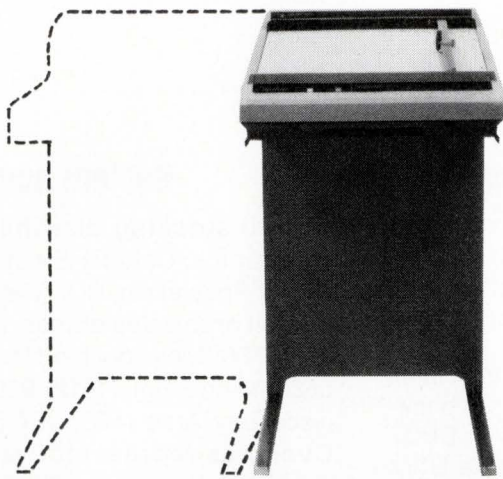

# Picture your terminal (even if it's IBM) with our \$3,300 graphic plotter.

Circle Reader Service #33

At last, everybody can see their time-share data plotted in smooth, clear graphs. Hewlett-Packard's Model 7200 Graphic Plotter will add a new visual dimension to any terminal in the business. Now, even if you're partial to IBM's 2741, you can have instant graphic solutions to every type of engineering or mathematical problem.

There's no special operation or programming knowledge needed. You control the program. Plot numerical data in points, lines, curves, circles, ellipses, bar graphs or pie charts. Or, manipulate and expand computer data

and plot in finished graphic form. You get smooth lines—not the staircase drawn by the incremental recorder.

Use the HP 7200 simultaneously with your time-share terminal or silence the terminal and use the plotter alone. Because it goes to work when the data comes in, there's no time lag.

Simple manual controls allow you to set the graph limits to fit any pre-printed grid. HP's Autogrip electrostatic holddown firmly grips any graph paper up to 11x17 inches.

You can arrange to add a graphic plotter to your existing time-share

terminal by contacting Hewlett-Packard. Buy it at \$3,300. Rent it. Lease it. Or lease to buy.

We can match a 7200 with any EIA ASCII terminal in the business . . . or even IBM's 2741. So now, everybody can be the arty type. For details, contact Hewlett-Packard, Palo Alto, California 94304; Europe: 1217 Meyrin-Geneva, Switzerland.

**HEWLETT**  **PACKARD**

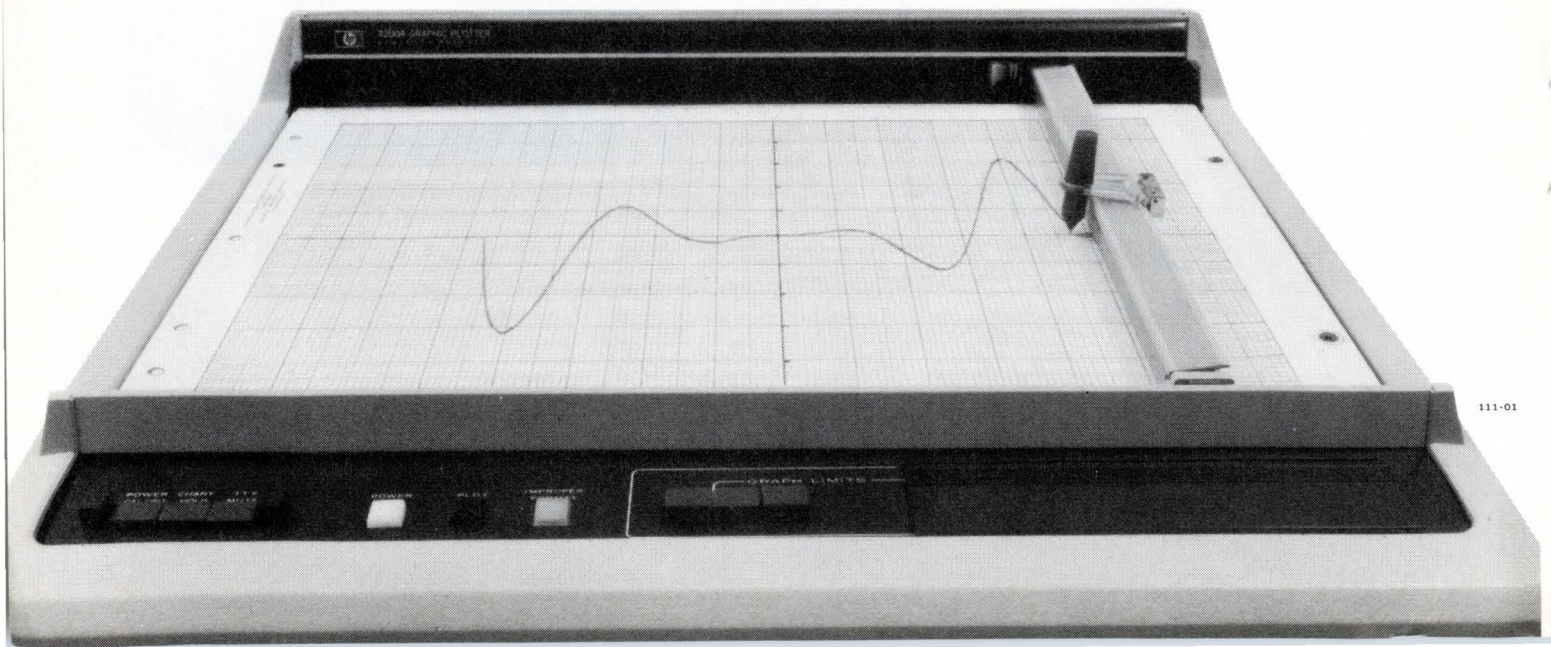

# NEW PRODUCTS

## If red displays stop you, go with green

The first, totally solid-state light-emitting products in colors other than red are now available. Monsanto's Electronic Special Products group in Cupertino, Calif. has announced green and yellow LEDs and seven-segment readouts.

The new readouts are mechanically similar to Monsanto's red MAN1 product, with 0.27-in. character heights. The green readout—called MAN5—uses GaP, and emits radiation at 5650 Å close to the maximum sensitivity region of the human eye. The yellow MAN8 uses GaAsP, and emits at 5890 Å.

Standard red-light displays (such as those made not only by Monsanto, but also Fairchild, Litronix, Motorola, TI, and others) use epitaxial GaAsP on a GaAs substrate. Yellow and green products, on the other hand, use GaP substrates. Green products have a GaP epitaxial layer, while yellow products have a nitrogen-doped, GaAsP epi layer. The band gap and the dopants determine the radiation wavelength.

The construction of the new displays is different than that of the red products. A MAN1, for example, has seven chips, each about 0.02 x 0.12 in. (0.5 x 3 mm). The MAN5 and MAN8 also use seven chips, but each chip is only about

0.5 mm square. The segments are formed with an internal, bar-shaped reflector which spreads the light so that each segment looks like a normal MAN1 segment.

The reflector is needed because, unlike GaAsP which emits along a junction, the GaP crystal is transparent. Light exits then in all directions, so it is necessary to collect it for use. Opcoa, which last year introduced a red (not green) 7-segment readout made with GaP, uses the same principle (*The Electronic Engineer*, Mar. 1971, p. 30.)

The new, discrete LEDs are mechanically identical to Monsanto's MV5020 series. The green MV5222 and yellow MV5322 each have a typical brightness characteristic of 300-ft-L at 50 mA. The only practical way to make green-emitting displays is with gallium-phosphide (GaP), and Monsanto is the first company to offer them commercially. Western Electric, General Electric's Miniature Lamp Department, and Opcoa have been making GaP products in production for about a year, but in red, not green. Opcoa makes 7-segment readout and diodes, GE makes diodes (or, as GE calls them, solid state lamps) and Western Electric makes diodes and seg-

mented displays for the Bell System. While all optoelectronic manufacturers recognize the importance of green displays, only Western Electric has been able to make them in limited production. Now, according to Clarence R. Bruce of Monsanto, his company can deliver them at the rate of 1000 a month.

Prices of the green and yellow products are high right now, but are expected to drop close to those of the red line in 12-18 months. The predominant expense is in the GaP substrate, which costs about an order of magnitude more than a GaAs substrate.

The prices stack up this way (as a reference, remember that the red MAN1 costs \$7.75 ea. in 1000-pc. lots, and the red diodes about \$0.71 ea.): in 1000-pc. lots, the green MAN5 costs \$10 ea.; yellow MAN8, \$18.75; green MV5222, \$1.95; and yellow MV5322, \$3.95. Monsanto Electronic Special Products, 10131 Bubb Rd., Cupertino, Calif. 95014. (408) 257-2140.

For Monsanto

**Circle Reader Service #269**

For General Electric

**Circle Reader Service #270**

For Opcoa

**Circle Reader Service #271**

### DIGITAL CLOCK

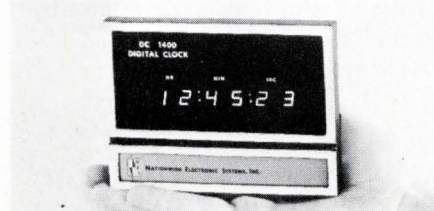

Model DC1400 is a surface mounted clock only 1/2 in. thick. It can be used in any data acquisition system, event recording, automatic controller or any other elapsed time/real time application. Completely self-contained and ready for use. Nationwide Electronic Systems, Inc., 7N662 Rte 53, Itasca, Ill. 60143.

**Circle Reader Service #272**

### CERMET POTENTIOMETER

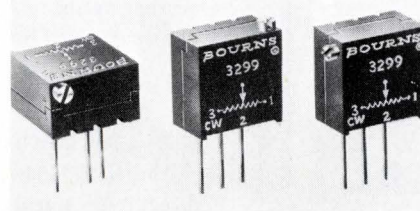

Model 3299 Trimpot® potentiometer features 25-turn, precision setability in the popular 3/8 in.<sup>2</sup> package. This 1/2 W unit has molded-in terminals. A choice of three popular pin styles gives you flexibility in circuit packaging design. \$1.20 ea. (500-999 quan.). Trimpot Products Div., Bourns, Inc., 1200 Columbia Ave., Riverside, Calif. 92507.

**Circle Reader Service #273**

### 48 POSITION READOUT

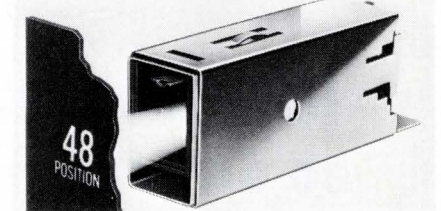

Here's a rear projection readout unit (Series 1002) that can flash 48 discrete messages on a screen and yet needs only about as much panel space as a postage stamp. It is < 3 in. long, about 1 1/3 x 3/4 in. in section, and weighs just over 3 oz. Industrial Electronic Engineers, Inc., 7720-40 Lemona Ave., Van Nuys, Calif. 91405.

**Circle Reader Service #274**

• INFINITE-LIFE LED LIGHT SOURCES • SELF CLEANING READ HEADS • STEPPING MOTORS • PHOTOTRANSISTOR LIGHT SENSORS • READ ALL TAPES WITHOUT ADJUSTMENT •

**MOST ADVANCED  
FAMILY OF PUNCHED TAPE  
READERS AVAILABLE . . . .**

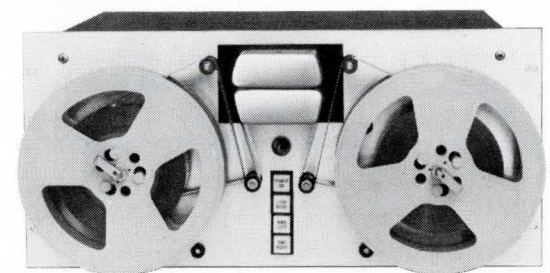
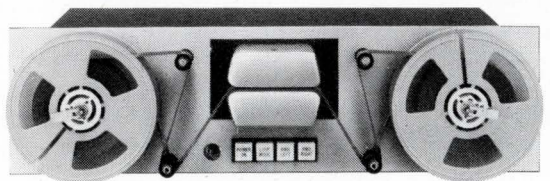
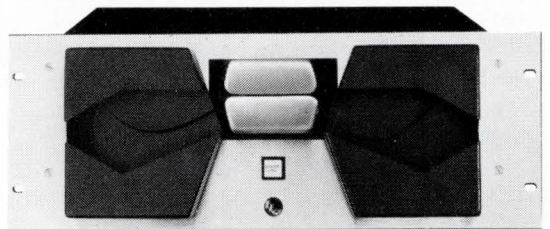
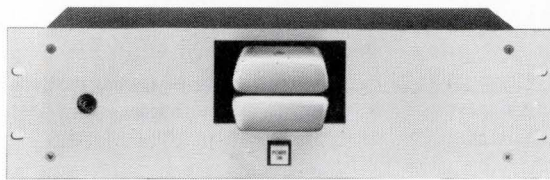
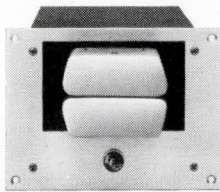

• FULLY PROPORTIONAL SERVOS • COMPATIBILITY WITH DTL, RTL AND TTL LOGIC • HIGH SPEED REWIND AND SEARCH • STOP-ON-CHARACTER ACCURACY AT 300 CHAR/SEC •

**NEW 9000 SERIES  
30 DAY FREE TRIAL  
NEW CATALOG**

ELECTRONIC ENGINEERING  
COMPANY OF CALIFORNIA

1441 East Chestnut Avenue,  
Santa Ana, California 92701  
Phone 714-547-5651



Circle Reader Service #34

1,024-BIT ROM

The 93406 is a TTL ROM with 50 ns max. access time. It is fully decoded on chip and is organized as a 256-bit by 4-word memory. The memory has open collector outputs that can be OR-tied with additional ROMs to easily expand word size. Fairchild Semiconductor.

Circle Reader Service #275

SUPER-BETA OP AMPS

The SN52108A/SN72308A, and the SN52108/SN72308, are directly interchangeable with the LM108A/LM308A and the LM108/LM308, respectively. Slew rate is 0.25 V/μs at unity gain. Texas Instruments.

Circle Reader Service #276

DUAL 100 BIT DYNAMIC SR

The "2517" uses two clock phases and operates at a relatively high frequency; typical clock rate is 4 MHz. It's for use in low cost sequential access memories and low cost buffer memories. Signetics.

Circle Reader Service #277

LOW PRICED 6-BIT D/A

The MC1406 sells for \$3.95 in hundred-up quantities. The monolithic unit uses the R-2R resistor ladder network approach. In order to use diffused resistors rather than the NiCr resistors used in most hybrids, a number of unique design philosophies have been adopted. Motorola Semiconductor.

Circle Reader Service #278

MEMORY SENSE AMP

The CA3541D, consists of two differential input amplifiers, a common second-stage amplifier, a dc restorer circuit, and an output logic gate. It converts low-level core-memory 1 pulses to saturated logic-level output pulses. Either of the input amplifiers may be gated ON with a saturated logic signal so that an incoming 1 pulse of positive or negative polarity can be detected from either of two sense lines. RCA.

Circle Reader Service #279

DUAL N-CHANNEL FET

The SMF3954, SMF3955, SMF3956, and SMF3958 are direct replacements for the 2N3954 and the 2N5452 series but offer better operating currents and temperatures. Solitron Devices.

Circle Reader Service #280

8-BIT MULTIPLIER

H1002MC is a full-wafer bipolar circuit for high-speed signal processing and digital filtering applications. It will operate at a rate of 8 million multiplications of two 8-bit words plus sign/per second. Hughes Microelectronics.

Circle Reader Service #281



**A full-function digital multimeter + A lab-quality digital AC voltmeter**  
**...both for \$595**

HP's new 3469A gives you a general-purpose digital multimeter *plus* a lab-quality digital AC voltmeter—for the price of the AC voltmeter alone. Now, you don't have to buy two (or more) instruments to get the capabilities you need—or compromise on quality to stay within your budget.

As a general-purpose multimeter, the 3469A gives you exceptional capabilities. Its 1Ω range lets you measure low-resistance components and even contact resistances of a few milliohms, with an accuracy of ±0.25% reading ±0.5% range. To make the low range easily useable, a unique offset adjustment lets you compensate for lead resistance. In

the higher ranges (100Ω to 10 MΩ), accuracy is ±0.3% reading ±0.2% range. The 3469A also gives you five DC voltage ranges (100 mV to 1000 V) and six DC ampere ranges (1 μA to 100 mA), with accuracy of ±0.2% reading ±0.2% range or better, depending on range.

As an AC voltmeter, the 3469A is unmatched at any price. You get seven voltage scales, ranging from 1000 V full-scale down to 1 mV full-scale—100 times the sensitivity of other digital meters. You also get a 10 MHz bandwidth capability—100 times greater than other digital multimeters—with a basic accuracy of ±0.3% reading ±0.3% range. And

you get a bright, ultra-reliable, shaped-character GaAsP display, that's easier to read than tubes or bar-segment numerals.

Compare the 3469A's specs with any other meter's — and you'll agree that there's no better value, at any price. For further information on the 3469A, contact your local HP field engineer, or write Hewlett-Packard, Palo Alto, California 94304. In Europe: 1217 Meyrin-Geneva, Switzerland.

091/16

HEWLETT  PACKARD

DIGITAL VOLTMETERS

**NOW AVAILABLE... A TRIMMER THAT OUTPERFORMS ALL OTHERS... AND AT LESS COST** (In small OEM quantities!)  
**COMPARE THESE TEST RESULTS OF OUR MODEL 1203:**

VISHAY TRIMMERS HAVE BETTER TEMPCO  
**20** ppm/°C

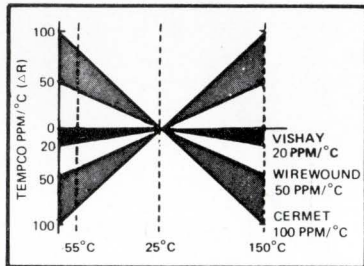

VISHAY TRIMMERS HAVE THE LOWEST NOISE  
**20 $\Omega$**  ENR

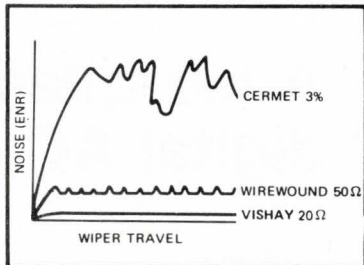

VISHAY TRIMMERS HAVE THE BEST RESOLUTION  
**.05%** SETABILITY

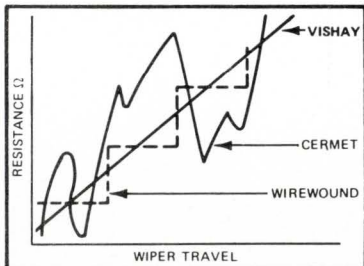

VISHAY TRIMMERS HAVE THE BEST LOAD LIFE  
**1%**

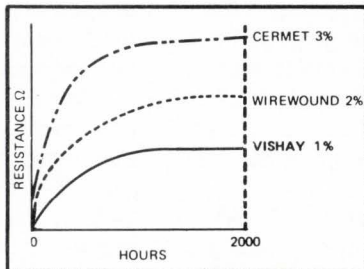

Additional Information: Request Bulletin TR103



**VISHAY RESISTOR PRODUCTS**

A DIVISION OF VISHAY INTERTECHNOLOGY, INC.  
 63 LINCOLN HIGHWAY ■ MALVERN, PENNA. 19355  
 TELEPHONE: (215) 644-1300 ■ TWX: 510-668-8944

PRECISION RESISTORS • NETWORKS • DECADE BOXES • TRIMMERS  
 Circle Reader Service #36

**MICROWORLD**

**SOS TRANSISTOR**

The L01 is a quad transistor array designed for voltage matching and switching characteristics with applications in linear rf amplifiers, tetrodes and mixers. Inselek.

Circle Reader Service #282

**VOLTAGE REGULATORS**

The 7800 series provides seven regulated voltages: 5, 6, 8, 12, 15, 18 and 24 V. Output voltage tolerance is  $\pm 5\%$ , and the units provide 0.01%/V line regulation and 30 m $\Omega$  output impedance for load regulation. Fairchild Semiconductor.

Circle Reader Service #283

**40-300 MHz AMPLIFIER**

CA601 has -66 dB intermodulation distortion, a typical gain of 30 dB and  $\pm 0.5$  dB response flatness over the operating range. TRW Semiconductor.

Circle Reader Service #284

**MODULAR MOS MEMORY SYSTEM**

Designed for main memories and bulk storage, the in-10 system has a max. cycle time of 450 ns and a max. access of 325 ns. Intel.

Circle Reader Service #285

**ELEVEN BIT D/A**

Model 848 is a complete binary converter, featuring a 4.0 V/ $\mu$ s min. slew rate. Helipot Div. of Beckman.

Circle Reader Service #286

**A CAMBION® Double "QQ" Product Line**

When your design calls for handles, standoffs, solder terminals, spacers, insulated terminals, battery holders, and basic hardware, it's nice to know there's a source that believes in quality - CAMBION. And it's also nice to know that you can get CAMBION quality in quantity. That's the CAMBION Double "Q" approach.

CAMBION puts the extra finish on handles, precise plating on significant surfaces of terminals, and long-life in plugs and jacks for almost infinite cycling. The quality stands up as the quantity goes on. All CAMBION hardware items are available "off-the-shelf."

Try the CAMBION Double "Q" approach. Tell us of your needs and we'll supply a jumbo catalog, No. 747, full of answers. Cambridge Thermionic Corporation, 445 Concord Avenue, Cambridge, Mass. 02138. In Los Angeles, 8703 La Tijera Blvd.

**There's plenty more where these come from.**



Circle Reader Service #60



## RT-01. The data entry terminal you didn't think there was the remotest chance you could afford.

An RT-01 with a 16-character keyboard, numeric Nixie\* read-out, four status indicators to display non-numeric information from your computer, Teletype and EIA serial line compatibility will only run you from \$600 to \$1000.

Or as little as \$500 without the Nixie display. Chickenfeed.

So now, if you're a big opera-

tion, you can have an RT-01 here, an RT-01 there, an RT-01 everywhere you've ever wanted one.

If you're little, you can have one at last.

We've got a booklet that'll tell you all about it that you can write for.

Or, if you're in as big a hurry as we hope you are, we've got a

**Circle Reader Service #37**

good egg who'll be happy to run right over and explain it to you.

We're the Logic Products Group, Digital Equipment Corporation, Maynard, Massachusetts 01754. (617) 897-5111.

**digital**

\*Registered trademark of Burroughs Corporation

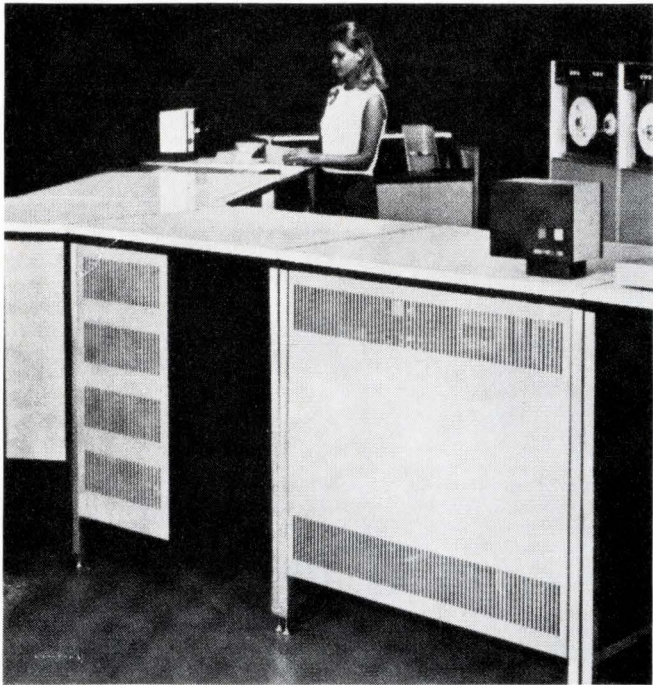

# NOW

put backbone  
in your housings  
and sell  
in your machines

First impressions often influence *final* decisions and acceptance. Even sophisticated machinery cries out for housing design that says... beauty purpose... versatility. And nothing says it better than unique Met-L-Wood® panels. They have the solid feel and characteristics of steel plate without the weight, and the beautiful, durable surface to help the machine sell itself.

Met-L-Wood panels are fast and easy to assemble... almost impossible to damage... add more sales appeal than any other material you can use. Get complete information. Send for Bulletin 661 today: MET-L-WOOD CORPORATION, 6755 West 65th Street, Chicago, Ill. 60638

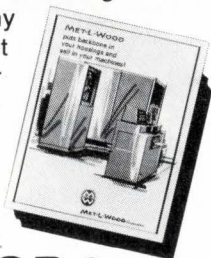

**MET-L-WOOD Corporation**  
STRUCTURAL LAMINATES SINCE 1925

Circle Reader Service #38

## LAB INSTRUMENTS

### MOS/LSI TEST SYSTEM

The S-3160 performs parametric, functional and dynamic tests on all types of MOS and bipolar shift registers, RAMs, ROMs, and complex logic arrays. Devices with up to 64 pins may be tested with input-output facilities at each pin. Devices with up to 128 pins may be tested by splitting the input-output connections. The system is controlled by a DEC PDP-11 and memory includes an 8-k core and a 65-k disc. Standard peripherals are a Tektronix Graphic Computer Terminal and a Remex high-speed paper tape reader/punch. Tektronix, Inc., Box 500, Beaverton, Ore. 97005.

Circle Reader Service #290

### PORTABLE DIGITAL MULTIMETER

Model 4440 digital multimeter features 17 ranges at 3½-digit resolution and weighs less than 2½ lbs. Designed specifically for field use, it can operate continuously for 8 to 12 hrs on four rechargeable C cells. Special features include LED readouts designed specifically for the unit, a dual slope high impedance bipolar A/D converter, a single MOS LSI plug-in chip for all of the logic circuitry, autopolarity, automatic blanking of unused digits and complete overload protection with spare fuses. Weston Instruments Div., 614 Frelinghuysen Ave., Newark, N.J. 97114.

Circle Reader Service #291

### 250-MHz PULSE GENERATOR

Model 122A has a pulse repetition frequency from 3 kHz to 250 MHz, pulse amplitudes from ±250 mV to 5 V into 50 Ω, transition times of <1 ns and an unattenuated baseline offset of 0 to ±2.5 V unaffected by attenuator or amplitude controls. It is applicable to testing fast IC logic, for computer design and production testing, for development and production testing of fast transistors and diodes, and for nuclear instrument testing and maintenance. E-H Research Laboratories, Inc., Box 1289, Oakland, Calif. 94604.

Circle Reader Service #292

### MULTICHANNEL THERMAL RECORDER

This multichannel thermal writing recorder uses Z-fold recording paper instead of rolled chart paper. The Model 7414A is a 4-channel oscillographic recorder using a hot-tip stylus. The thermal writing tip has a long life and writing is rectilinear. A closed-loop, pen position feedback system results in 99.5% trace linearity. Inquiries Manager, Hewlett-Packard Co., 1601 California Ave., Palo Alto, Calif. 94304.

Circle Reader Service #293

### CIRCUIT BOARD TEST SYSTEM

The L100 series of test systems provide functional and parametric test capabilities and an alphanumeric display that presents test results in plain English for convenient troubleshooting. It can be used to test a wide range of cards, modules, and other assemblies containing ECL, TTL, DTL, RTL, MOS and discrete logic, as well as circuits containing combinations of these types. Teradyne, Inc., 183 Essex St., Boston, Mass.

Circle Reader Service #294



# ANOTHER MYTH DESTROYED.

**Myth:** National doesn't make FET op amps. And, even if they did, they probably wouldn't be as good as bipolar devices. And, besides, everybody knows that FET op amps have lousy offset voltage and drift specs. And, FET op amps are too expensive. And, anyway, why not just go to a module house in the first place...

**Fact:** National does make FET op amps. A "family" of five devices, to be exact. Including the super precise new LH0052 (with an offset voltage of 0.1mV, an offset voltage drift of just  $5\mu\text{V}/^\circ\text{C}$ , and bias current of less than 1pA); the LH0022 (high performance good general purpose FET op amp); the LH0042 (lowest cost FET op amp on the market with even better performance than cheap module designs); the LH0033 (at  $1500\text{V}/\mu\text{S}$ , the fastest voltage follower available anywhere); the LH0032 (a  $500\text{V}/\mu\text{S}$  device); and coming soon: The precise-and-speedy new LH0062 (slew rate,  $80\text{V}/\mu\text{S}$ ; bandwidth, 15MHz; settling rate, 800nS). Significantly, each of the above was designed and manufactured completely in-house using a special chip construction technique combining the best of J-FET and bipolar technologies. All of which goes to show that FET op amps are, indeed, alive and well at National Semiconductor Corporation, 2900 Semiconductor Drive, Santa Clara, California 95051. Phone (408) 732-5000. TWX: (910) 339-9240. Cable: NATSEMICON.

**NATIONAL.**

NO SOCKETS • NO SOLDERING



**MAGNETIC RELAY**  
with  
**Custom Features**

- Low Thermal EMF
- 45-60db Isolation
- Low Contact Bounce
- Encapsulated Coil
- Bifurcated Contacts

**At No Extra Cost!**

**Printact®**

**Plugs into your PC board... mates with plated conductors**

The unique design concept of the Printact magnetic latching and non-latching relays provides <math>5.0\mu\text{v}</math> thermal EMF, 45-65 db cross talk isolation, <math>0.5\text{ms}</math> contact bounce and other custom features as standard at no extra cost. The single moving part is the pivoting armature with series break contacts held by a permanent magnet eliminating return springs, mechanical linkage and pigtail connections thus assuring reliable performance for many millions of cycles.

Available with 6, 12 or 24 VDC coils (0.5 watt G series, 1.0 watt LD series) in 2, 3 and 4 pole configuration. Series break swingers permit each pair of fixed contacts to be etched with common (Form C) or isolated (Form A plus Form B) switching between make and break circuits.

Send for catalog, 2X and 4X artwork stick-on contact patterns and Technical Notes PR262-D, which assist in simplifying PC board artwork, fabrication and procurement.

For a sample and/or data, write or call 212-EX 2-4800

Printact Relay Division, Executone, Inc., Box 1430EE Long Island City, N.Y. 11101

Circle Reader Service #40

**think woven**

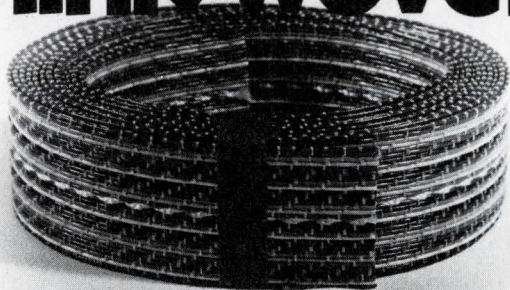

TODAY'S SPECIAL

**for economy**

Save when you buy it. Save when you use it. Today's best flat cable value brings neatness and accuracy to every application. Fast, easy handling cuts your production costs, increases system quality.

**WOVEN ELECTRONICS**

A DIVISION OF SOUTHERN WEAVING COMPANY

P.O. Box 189, Mauldin, S.C. 29662, (803) 288-4411

Circle Reader Service #42

NEW PRODUCTS

SOLID-STATE LAMP

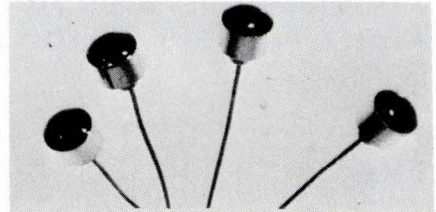

Type OSL-4 Solid-Lite® red light-emitting semiconductor lamp uses efficient electroluminescence from gallium phosphide diodes and a reflector technique for high forward brightness. It produces 2.7 mcd at only 15 mA drive current. Opcoa, Inc., 330 Talmadge Rd., Edison, N.J. 08817.

Circle Reader Service #295

POWER TRANSISTOR

The RCA-2N5919A is a 16-W 400-MHz transistor for micro-stripline and lumped-constant circuits. It is unilaterally interchangeable with the 2N5919; both are epitaxial Si npn planar devices with overlay emitter-electrode construction. However, the 2N5919A uses integral emitter ballasting to provide stabilization. RCA Solid State Div., Box 3200, Somerville, N.J. 08876.

Circle Reader Service #296

HEXIDECIMAL DISPLAY

MAN1002 is a hexadecimal LED array capable of displaying the numbers 0 through 9 as well as 14 distinct letters. Its unambiguous display and its compatibility with standard digital IC's suit it for use as a readout in computer peripheral equipment, as a cockpit display in aircraft and as a standard digital readout. Monsanto Commercial Products Co., 10131 Bubb Rd., Cupertino, Calif. 95014.

Circle Reader Service #297

DELAY LINES

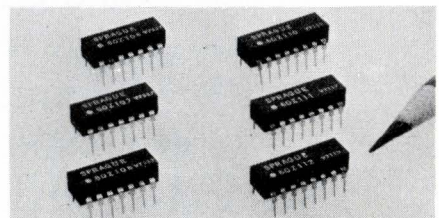

Miniature tapped lumped constant delay lines, Type 60Z, have a characteristic impedance of 100  $\Omega$  and are available as std. parts with 50, 100 or 150 ns total delay. Sprague Electric Co., 615 Marshall St., No. Adams, Mass. 01247.

Circle Reader Service #298

### EMI/RFI FILTERS

The 8000 series line of filters are specifically designed for data processing units and systems. They have insertion loss ratings of 20, 40 or 60 dB at 150 kHz. USCC/Centralab, 2151 N. Lincoln St., Burbank, Calif. 91505.

**Circle Reader Service #299**

### RESISTANCE BRIDGE

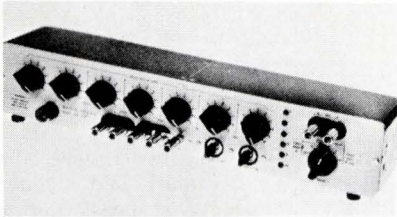

You can use the Model 1104 resistance bridge for accurately measuring ohmic value of resistors. Utilizing a basic 4-terminal Kelvin bridge and powered by an internal mercury cell, the 16 1/2 x 3 1/4 x 4 1/4 in. module is self-contained and fully portable. Vishay Inter-technology, Inc., 63 Lincoln Hwy, Malvern, Pa. 19355.

**Circle Reader Service #300**

### R&P CONNECTORS

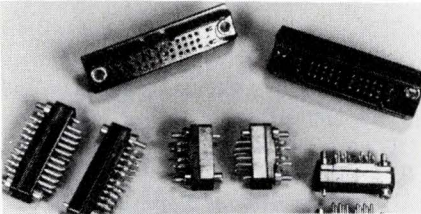

These rectangular rack-and-panel connectors have circular spring-type socket contacts for high contact pressure, low contact resistance and firm wiping action. Series 126 connectors provide 10, 16, 28 or 34 contact positions. Amphenol Industrial Div., 1830 S. 54th Ave., Chicago, Ill. 60650.

**Circle Reader Service #301**

### SILICON DIODE

At a forward current of 1 mA, the junction voltage of this new Schottky diode (Type 5082-2835) is only 340 mV. This compares with 700 mV for normal silicon pn junction diodes and 410 mV for earlier H-P Schottky-barrier diodes, and is comparable to germanium diodes. However, it has much better temp. characteristics (operating range: -55° to +125°C) than germanium diodes. Hewlett-Packard Co., 1601 California Ave., Palo Alto, Calif. 94304.

**Circle Reader Service #302**

### SOLID-STATE RELAYS

These relays provide constant operation within their rated parameters when used with all types of loads. Resistive, inductive, motor and lamp type loads demanding from 1/4 to 6 A, 120 Vac, can be switched with control voltages as low as 4.5 Vdc. Grayhill, Inc., 535 Hillgrove Ave., La Grange, Ill. 60525.

**Circle Reader Service #303**

### FET AMPLIFIERS

Two new FET-input amplifiers, Models ZA903M2 (\$45.00) and ZA903MI (\$35.00) offer low drift of 1  $\mu$ V/°C and 3  $\mu$ V/°C over 0° to 60°C operating temp. range. Also a new circuit design prevents changes in TC when making offset adjustments. Delivery from stock. Zeltex, Inc., 1000 Chalomar Rd., Concord, Calif. 94520.

**Circle Reader Service #304**

# Got Reject-itis from your tying operation?

Are you suffering through an extra amount of rejects? Things popping loose—work losing its shape after it comes off the board—vibration and heat causing havoc—systems and tools that tear up hands and tempers—that add too much weight and cost to the finished product? Tapes and ties that can't handle fungus or chemicals and refuse to hold a knot . . . ? ? ?

## Want a better system?



## TALK TO GUDEBROD!

Write to this address Now for prompt return of our Product Data Catalog

*Electronics Division*

Dept. 522

Gudebrod Bros. Silk Co., Inc. 12 South 12th Street, Philadelphia, Pa. 19107

**Circle Reader Service #43**

# Five reasons for buying the newest digital multimeter/counter

1. Our exclusive "Syncrocount"\* technique. It's why we can provide frequency as well as AC volts, DC volts and resistance measurements in a single multipurpose instrument.
2. LED READOUT offers viewing from any angle, high brightness and unlimited life.
3. 100% OVERRANGE on all scales provides 5 digit resolution from a 4 digit instrument.
4. AUTOMATIC RANGING on all functions permits use in systems or as a lab instrument.
5. AND THE PRICE TAG which needs no further amplification.

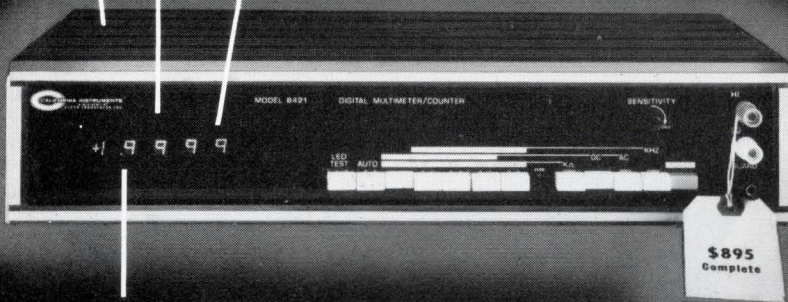

Call or write today for specifications or demonstration. Then you'll quickly discover why we say . . .

More instrument for your money from



A Division of Aiken Industries, Inc.

5150 Convoy Street • San Diego, California 92111 • (714) 279-8620

\*Patent Pending

Circle Reader Service #44

## GaAsLite products

Hot off the press is Monsanto's 1972 directory of GaAsLite products which describes their complete line of optoelectronic devices. With the aid of the directory you should be able to meet any requirement you have for visible and in-

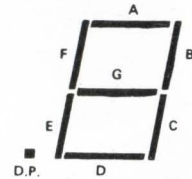

frared light-emitting diodes, LED panel indicators, display units, and modules, opto-isolators, and detectors. This one is a must and it's available from Monsanto Co., 10131 Bubb Rd., Cupertino, Calif. 95014.

Circle Reader Service #400

## Delay line catalog

In addition to the specs and product descriptions given for a complete line of electromagnetic delay lines in this 20-page catalog, you'll get a variety of extra source material. This includes standard definitions and measurements to applicable specifying data, and applications in data processing, sonar (ASW), traffic control systems, aerospace and missile industries, and more. ESC Electronics, 534 Bergen Blvd., Palisades Park, N.J. 07650.

Circle Reader Service #401

## Linear ICs

TI's complete line of linear ICs is described here—video amps, op amps, communications circuits, voltage comparators, line drivers and receivers, peripheral drivers, sense amplifiers, and memory drivers. Plus you'll find such

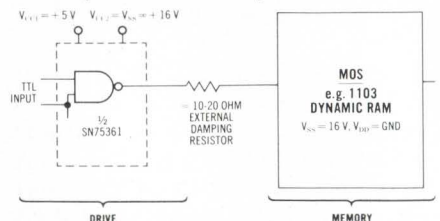

## MOS memory driver for the 1103 MOS RAM

parameters as input offset voltage, input offset current, input bias current, and slew rate for op amps, and schematics and key parameters for all other linear circuits. Texas Instruments Inc., Box 5012, MS/308, Dallas, Tex. 75222.

Circle Reader Service #402

# LITERATURE

## Solderless terminal catalog

Thorough data on pre-insulated terminals and splices is given to you in this 28-page catalog. You'll find details on the mated tool/terminal concept, their PIDG terminal, crimping, the selection of proper tooling, performance characteristics, Teflon insulation, and specs for a variety of wire ranges. AMP Inc., Harrisburg, Pa. 17105.

**Circle Reader Service #403**

## Display/memory units

Inherent memory, selective write or erase, design adaptability, rear projection, and hard copy potential are several of the features discussed in this brochure on Digivue® display/memory units. Applications in systems for providing direct readouts from digital computers and other keyboard operated equipment are covered, and there's a good discussion of operating principles. Owens-Illinois Inc., Box 1035, Toledo, Ohio 43651.

**Circle Reader Service #404**

## Computers and peripherals

Here's a 26-page booklet that introduces you to the Modcomp family—general purpose 16-bit computers supported by six language processors and four operating systems along with a variety of measurement, control, and communications subsystems. It gives you

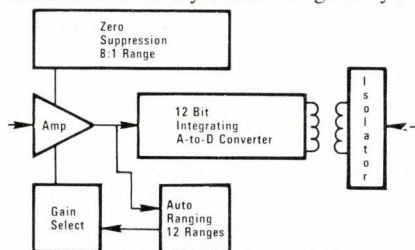

**Relay analog input subsystem**

block diagrams for each of the computers, data processing peripherals, analog input subsystems, input/output interface subsystem, and communications multiplexers. Modular Computer Systems, 2709 N. Dixie Hwy., Fort Lauderdale, Fla. 33308.

**Circle Reader Service #405**

## Pure binary switch

Data on this pure binary thumbwheel switch explains how the switch automatically converts any decimal input from 0 to 99,999 to its binary equivalent. You also receive details on function, applications, features, complete specs, detail drawings, photos, model descriptions, and installation data. The Digitran Co., 855 S. Arroyo Pkwy., Pasadena, Calif.

**Circle Reader Service #406**

## EE's 1971 editorial index

Here's an index to all of the material published in our magazine for the year 1971. You'll find it includes both a monthly and a subject index, and lists feature articles, staff reports, charts, major product features, and IC ideas. It's great for locating material for your own articles and technical reports. For your copy, send \$1 to The Electronic Engineer, 1971 Editorial Index, One Decker Sq., Bala-Cynwyd, Pa. 19004.

# send for this varflo sleeving sample and treat it rough

vinyl-coated fiberglass sleeving for Class 130,  
Type B, Category b applications

Here's what laboratory tests performed on 3 representative sizes have shown about varflo vinyl-coated fiberglass sleeving

Properties	Performance Measurements	Test Results	Test Results	Test Results	Test Results	Test Results	Test Results
Dielectric Strength	1000V	1000V	1000V	1000V	1000V	1000V	1000V
Flexibility	1000V	1000V	1000V	1000V	1000V	1000V	1000V
Heat-Resistance	1000V	1000V	1000V	1000V	1000V	1000V	1000V
Flame-Resistance	1000V	1000V	1000V	1000V	1000V	1000V	1000V
Impact Resistance	1000V	1000V	1000V	1000V	1000V	1000V	1000V
Chemical Resistance	1000V	1000V	1000V	1000V	1000V	1000V	1000V
UV Resistance	1000V	1000V	1000V	1000V	1000V	1000V	1000V

**Now test varflo yourself\***

Put this sample through your own tests for dielectric strength, flexibility, heat- and flame-resistance. Varflo will meet the most exacting specifications, including MIL-I-21557 and MIL-I-3190/2.

Meet both Class A and Class B needs at the one low price! And save double because Varflo has long shelf life, with no deterioration.

**Varflex**  
Varflex Corporation  
W. Court Street  
Rome, New York 13440  
\*additional samples on request.

WRITE TO:

**VARFLEX CORPORATION**

506 W. Court Street Rome, New York 13440

**Circle Reader Service #45**

THE ELECTRONIC ENGINEER • Feb. 1972

# FREE

## '72 HEATHKIT CATALOG

- Now with more than 350 kits to save you money
- See the new Heathkit 3½ digit multimeter for just 229.95\*

A kit form multimeter that meets lab specs for about half the cost of comparable wired units... has 3½ digits for 100 uV resolution on 200 mV range, 1V on 1000V... can be calibrated to 0.2% accuracy VDC with calibrator provided, or lab calibrated to 0.1%. There's also a new 5" triggered sweep scope at a price you can't afford to pass up... DC-10 MHz response, 50 ns sweep rate with magnification, AC-DC coupling, 50 mV sensitivity, all for only 229.95\*. Not to mention over 350 other fun-to-build, money saving kits for every hobby and professional interest... from test instruments, marine and ham radio gear, to stereo-hi-fi and color TV. The Heathkit catalog is bigger & better than ever this year. Order yours now.



HEATHKIT  
Schlumberger

HEATH COMPANY, Dept. 62-2  
Benton Harbor, Michigan 49022

Please send FREE Heathkit Catalog.

Name \_\_\_\_\_

Address \_\_\_\_\_

City \_\_\_\_\_ State \_\_\_\_\_ Zip \_\_\_\_\_

Prices & specifications subject to change without notice.  
\*Mail order prices; F.O.B. factory.

**Circle Reader Service #46**

# FREE SAMPLES

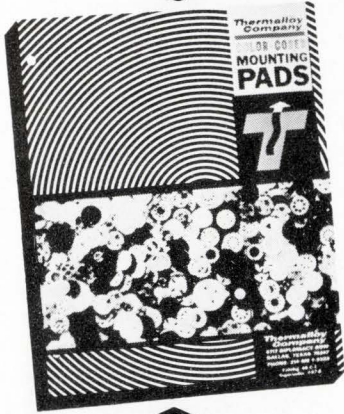

WITH  
**NEW**  
MOUNTING PAD  
CATALOG

## MOUNTING PADS

for TO-18, TO-5, duals, integrated circuits, lead converters, lead spreaders . . . all are contained in Thermalloy's new catalog. Complete mechanical drawings, materials and specifications included.



Write today  
for free  
samples and  
catalog

**Thermalloy  
Company**

8717 DIPLOMACY ROW  
DALLAS, TEXAS 75247  
PHONE: 214/637-3333  
TWX: 910/861-4410

Circle Reader Service #47

## LITERATURE

### Peripherals and interfacing handbook

Computer users will want to send for DEC's new handbook on peripherals and interfacing. The 294-page guide covers the entire PDP-11 family system, describing standard PDP-11 peripherals and operations and providing details on interfacing to the PDP-11 Unibus. Digital Equipment Corp., Maynard, Mass.

Circle Reader Service #407

### Minicomputers

Some of the features discussed in this 6-page data note include processor power, memory power, I/O power, system software, minicontrollers, and data processing peripherals. There's application information and general descriptions and photos for each member of the SPC-12 processor family. General Automation Inc., 1055 S. East St., Anaheim, Calif. 92805.

Circle Reader Service #408

### Mercury-wetted contact relays

Here's the latest information on Clare's recently introduced HCG high-speed, mercury-wetted relay. It's 20 pages of technical data that comes complete with photos, charts, design infor-

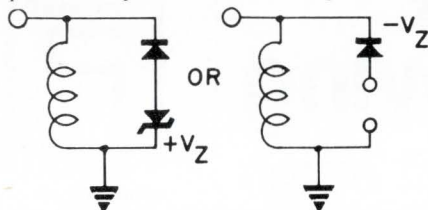

By clamping reverse coil voltage, relays will operate to 250 Hz.

mation for pin spacing, external dimensions, schematics, and available contact forms. And you're given application information as well. C. P. Clare & Co., 3101 Pratt Ave., Chicago, Ill. 60645.

Circle Reader Service #409

### The PRAM™ is

. . . an op amp that lets you digitally program one of the four input stages connected in parallel to a common output stage. This 18-page application booklet shows you how to use the PRAM circuit in 14 different applications. And for those of you who like a challenge now and then, the booklet gives you a few hints on adapting the PRAM to a number of other circuits. For your copy, write on company letterhead to Harris Semiconductor, Box 883, Melbourne, Fla. 32901. Attn: John Corser.

WITH OUR CATALOG  
YOU MAY NOT NEED  
A CUSTOM

# CAPACITOR

AND THE CATALOG  
IS YOURS  
FOR THE ASKING

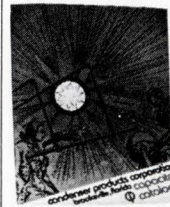

Picture a complete concise composite catalog of over 800 off-the-shelf capacitors, over 1200 variations including some weird and unusual units.

If what you need isn't there, then drop us a line, or give us a call, we'll custom design a capacitor for your circuit, and in most cases there is no charge for customizing. But check the catalog first, what you need may be there and ready for immediate shipment.

TO GET YOUR CATALOG,  
JUST DROP US A LINE.

**condenser  
products  
corporation**

Box 997, Brooksville, Florida 33512  
Phone (904) 796-3562

Circle Reader Service #48

# Circuit Savers



**DC  
CROWBARS**

Here's positive burnout protection for your ICs, transistors, power supplies and PC cards. LVC-1 DC Overvoltage Crowbar mounts in your equipment like any mini component, switches to short circuit when voltage on supply bus exceeds specified level, resets automatically when power source is removed. Trip levels 2.5 to 600V, current to 235A, reaction time less than 3 usec, MIL temperature range. For specs, application data, prices, request Bulletin 10A.

Full line of protection modules for every hi-lo voltage/current requirement. Write or call for data.

279 Skidmore Rd., Deer Park, N.Y. 11729  
Telephone: 516-586-5125

# MCG Electronics

Circle Reader Service #49

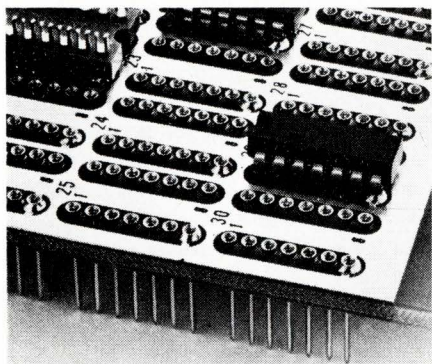

## All plug-in panels are not the same.

It's one thing to want plug-in flexibility in your circuit. It's another to get flexibility plus all the other things you'd like in a dependable point-to-point system.

Like easier IC insertion. Precision-machined contacts. Tighter contact retention. Greater reliability (we'll prove it). Unique tapered entry sockets (patent pending). Lower profile. Plus the versatility to accept 14, 16, 18, 24, 28, 36 or 40 pin IC's in a choice of panel sizes.

And we offer virtually any panel you'll need, in any number of patterns, plane-mounted or edge-connected, off the shelf or custom.

We'll also give you single-source supply for sockets, enclosures and accessories—even automatic wire wrapping whenever you need it.

The Augat way? It's a better way. Call us at (617) 222-2202. Or write for our catalog. Augat Inc., 30 Perry Ave., Attleboro, Mass. 02703. Our representation and distribution is nationwide and international.

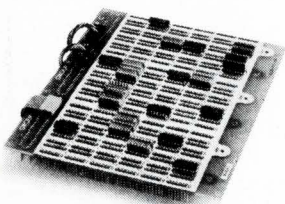

## Plug into Augat\* instead.

Circle Reader Service #50

# LITERATURE

## Core memory products

Described in this short form catalog are complete lines of cores, stacks, and systems. The cores and stacks come in a wide range of sizes, while memory systems range in size from minicomputers to large core stores. Ask for the catalog for more details from Data Products Corp., 6219 De Soto Ave., Woodland Hills, Calif. 91364.

Circle Reader Service #410

## Mainframe core memory

You can replace your present IBM System/360 mainframe memory with this one from Ampex, keep your throughput levels, and save. This brochure will show you how. Operation data and specs are included. Ampex Corp., 401 Broadway, Redwood City, Calif. 94063.

Circle Reader Service #411

## Time delay relays handbook

You'll find this 92-page handbook most helpful for specifying a time delay for a specific application. It contains a glossary of terms, principles of operation, lots of application information,

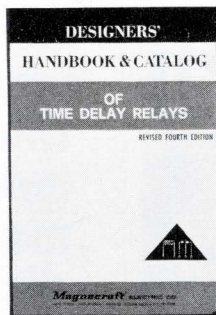

and specifying and testing data. And many new products have been added to the revised edition of this popular handbook. Magnecraft Electric Co., 5575 N. Lynch Ave., Chicago, Ill. 60630.

Circle Reader Service #412

## This is the time

... for all engineers who use good instruments to make sure they get the 1972 Hewlett-Packard Catalog. It's 416 pages of data on more than 800 instruments, systems, and accessories. If you got a copy last year, be sure to fill in the reservation certificate HP sent you. If you didn't get that certificate, you can get your copy by writing on company letterhead to Robert L. Boniface, V-P Marketing, Hewlett-Packard Co., 1601 California Ave., Palo Alto, Calif. 94304.

AMPERITE

*Top Quality*  
STILL AT  
**LOW PRICE**

**Thermostatic DELAY RELAYS**

Offer true hermetic sealing...  
Assure maximum stability and life.

**Delays: 2 to 180 seconds\***

Actuated by a heater, they operate on A.C., D.C., or Pulsating Current... Being hermetically sealed, they are not affected by altitude, moisture, or climate changes... **SPST only** — normally open or normally closed... Compensated for ambient temperature changes from -55° to +80°C... Heaters consume approximately 2 W. and may be operated continuously. The units are rugged, explosion-proof, long-lived, and inexpensive!

**TYPES:** Standard Radio Octal and 9-Pin Miniature.  
List Price, \$4.00

\*Miniatures Delays: 2 to 120 seconds.  
All Ampelite Delay Relays are recognized under component program of Underwriters' Laboratories, Inc. for all voltages up to and including 115V.

**PROBLEM? Send for Bulletin No. TR-81.**

**AMPERITE BALLAST REGULATORS**

Hermetically sealed, they are not affected by changes in altitude, ambient temperature (-50° to +70°C.), or humidity... Rugged, light, compact, most inexpensive.

List Price, \$3.00

Write for 4-p. Bulletin No. AB-51.

**AMPERITE**

600 PALISADE AVE., UNION CITY, N.J. 07087

Telephone: 201 UNION 4-9503

In Canada: Atlas Radio Corp., Ltd.,  
50 Wingold Ave., Toronto 10

Circle Reader Service #51

# PULSE GENERATOR

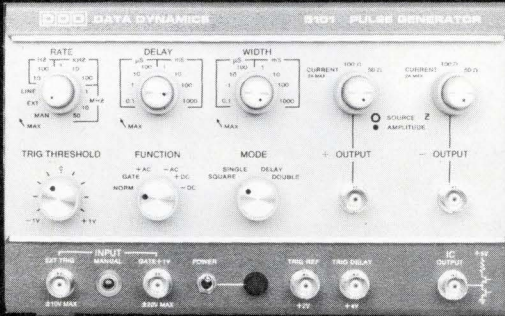

**1 Hz to 50 MHz - \$525.**

One pulse generator, the new DDD Model 5101, produces pulse rates from 1 Hz to 50 MHz and includes features only found in much more expensive equipment. For example: Single or double pulse output, special integrated circuit output, 10 ns to 1 second pulse width, 10 ns to 1 second pulse delay with short circuit proof, current output having 3ns rise (and fall) time.

Send for complete specifications, or call us collect and ask for an in-plant demonstration.

**DDD DATA DYNAMICS DIVISION**  
 240 HUMPHREY STREET, ENGLEWOOD, N. J. 07631 • (201) 567-5300  
 Circle Reader Service #52

## Antenna selection guide

Sponsored by Watkins-Johnson, this antenna selection guide will be a useful (and colorful) addition to your office. It provides technical details as well as illustrations for nearly a dozen pattern types (omnidirectional, isotropic, bi-directional, uni-directional, etc.). Also, there's a spectrum of antenna frequency ranges and a good discussion of the characteristics and matching of antennas. You probably saw this colorful wall chart in the September issue of *The Electronic Engineer*, but if you'd like another copy just

Circle Reader Service #413

## Flexible circuitry wall chart

A handy guide to flexible circuits is the wall chart that appeared in the October issue of *The Electronic Engineer*. You'll find brief reviews of design and layout factors (such as current or voltage drop, capacitance, bends and folds, terminal baring, and terminal construction) and the properties of conductor metals. Plus there's a conductor nomograph and graphs that illustrate current and temperature, impedance and capacity. The chart is sponsored by Sanders Assoc. For your free copy

Circle Reader Service #414

## Guide to microwave semiconductor power generators

This Varian-sponsored wall chart made its debut in the November issues of *The Electronic Engineer* and *Electronic Component News*. A large graph illustrates power output (W), output level (+dBm), and efficiency at various frequencies. There's a discussion of the devices and how they operate and graphs illustrating the representative characteristics of commercially available diodes and packaged oscillators. And there's a small chart on old and new band limits. Ask for your free copy.

Circle Reader Service #415

# Convert to C·A·S·H

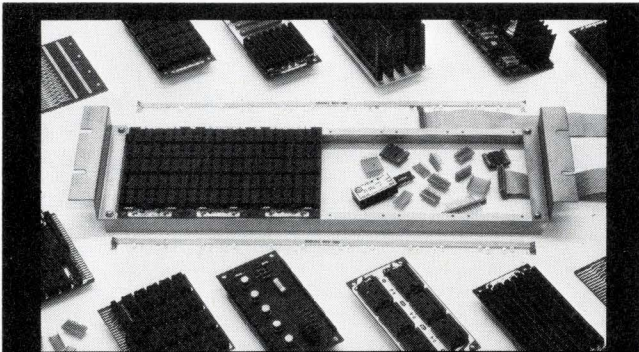

Get more for your packaging dollar. Get C·A·S·H. You're working too hard and spending too much, if you're not using C·A·S·H, the most complete DIP Packaging System available.

- **DIP/SOCKET PANELS**  
Mix and match the exact number of DIP Sockets (14, 16, 24, 36-Pin, etc.) your system requires. Panel prices start at less than \$1 per socket.
- **MOUNTING CHASSIS**  
Choose from a full selection of vertical files and horizontal drawers.
- **PLUS...** discrete-component assemblies, laminated bus bars, I/O connectors, noise filtering, power supplies, design aids, machine wiring service, and CAD documentation.

**SL** STANDARD LOGIC INC. PHONE: (714) 835-5466  
 1630 South Lyon Street • Santa Ana, California 92705 • TWX (910) 595-1707

Circle Reader Service #53

## New low-cost thumbwheel switch kit... mounts directly to your PC board!

EECO's 8000-series rotary switches let you incorporate the stator (switching pattern) as part of your board circuitry. You save on assembly time, save on interconnect wiring, save on switch mounting hardware. And you save on part cost: price of each kit is around \$2.00, in production quantities. Options include six colors, extra-wide and thin widths, lighted face, and single or double mounting. Paliney brushes provide a service life of over 1,000,000 detent operations.

## Free Kit

If you use PC boards and rotary switches — or plan to — you need our Series-8000. Just circle reader number. We'll rush you specifications and a sample switch kit.

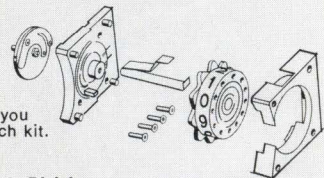

Electronic Products Division  
 Electronic Engineering Company of California  
 1441 East Chestnut Avenue, Santa Ana, California 92701  
 Telephone: (714) 547-5651

Circle Reader Service #54



# THE ELECTRONIC ENGINEER

## DISTRICT SALES MANAGERS

**EDWARD G. SHAUD**  
BALA-CYNWYD, (Pa.) 19004  
One Decker Square  
(Area Code 215) SHERWOOD 8-2000

**JOSEPH DRUCKER**  
NEW YORK 10016-600 Third Ave.  
(Area Code 212) OXFORD 7-3400

**JOHN W. BERNHARDT**  
CHICAGO 60606-120 S. Riverside  
Plaza  
(Area Code 312) 782-1400

**G. T. ALFANO**  
NEEDHAM HEIGHTS, MASS. 02194-  
570 Hillside Ave.  
(Area Code 617) 444-0010

**TERRENCE D. BUCKLEY**  
**THOMAS R. BORIS**  
LOS ANGELES 90020-3727 W.  
Sixth St. # 202  
(Area Code 213) DUNKIRK 7-1271

**RALPH PETERSEN**  
LOS ALTOS (San Francisco) 94022  
199 First St., Room 335  
(Area Code 415) 941-6655

**RICHARD DUTE**  
CLEVELAND 44114-601 Rockwell Ave.  
(Area Code 216) SUPERIOR 1-2860

**NEWTON B. COLLINSON**  
ATLANTA 30309-1776 Peachtree St.  
N.W.  
(Area Code 404) 872-4723

**MILES G. THORNTON, JR.**  
DALLAS 75206-Meadows Bldg.  
Expressway at Milton  
(Area Code 214) EMERSON 3-6426

**HAROLD E. MOTT**  
**R. DENT SHILLINGLAW**  
Houston 77027  
4151 Southwest Freeway  
Suite 735  
(Area Code 713) 621-7550

## INTERNATIONAL BUSINESS OFFICES

London, SW1Y 6PB ..... Max F. Holsinger  
67-68 Jermyn St., St. James's ..... Dir. European Sales  
01-839 6318-9 ..... K. J. Hendry, S. K. Elliott  
Cables ..... WHIP, LONDON S. W. 1

Manchester M22 5RQ ..... D. I. Goulden  
Haletop, Wythenshawe Civic Centre ..... 061-437 3293

4 Dusseldorf-Nord ..... E. Hillerbrand  
Eitelstrasse 32 ..... R. Schomburg, H. Halbit  
Dusseldorf 652031-2  
Cables ..... WHIP, DUSSELDORF

75 Paris 8e ..... S. Brown-Joussard  
70 rue de Ponthieu ..... J.-C. Lamoine  
Paris 359 65-77  
Cables ..... UIIP, PARIS 8E

Tokyo ..... C. T. Sakaguchi  
Room 814, Togin Bldg., Marunouchi  
CPO Box No. 1572 ..... Tel. 211-3506-3509  
Cables ..... CLARENESAKA TOKYO

## BUSINESS STAFF

**BERNARD M. GITTELMAN**  
*Publisher*

**DENNIS J. PERKINS**  
*Promotion Manager*

**LOUIS L. MARINES**  
*Marketing Services Manager*

**K. A. MARTINI**  
**B. A. TATUM**  
*Advertising Production*

**WILLIAM HOWAT**  
*Circulation Director*

**DAVID G. ELY**  
*Circulation Manager*

**JOSEPH P. BABCOCK**  
*Reader Service Manager*

**JOHN H. KOFRON**  
*Chilton Research Services*

**C. R. WILHIDE**  
*Washington Vice-President*

# Advertisers—February 1972

No liability is assumed for errors or omissions.  
This index is published for a convenience.

**AMF, INC., POTTER & BRUMFIELD** ..... 24, 25  
Fuller & Smith & Ross, Inc.  
**AMP, INC.** ..... 26  
Aitkin-Kynett Co., Inc.  
**AMPERITE CO.** ..... 77  
H. J. Gold Co.  
**AUGAT** ..... 77  
Creamer, Trowbridge, Case & Basford, Inc.  
**AUTOTRON, INC.** ..... 80  
Allbright Assoc.

**BUSSCO ENGINEERING, INC.** ..... 30  
T. F. Murray & Assoc., Inc.  
**BUSSMANN MFG. DIV.**  
**McGraw-Edison Co.** ..... DC-8, DC-9  
Henderson Adv. Co.

**CEA, a Div. of Berkleonics, Inc.** ..... DC-11  
Jansson Adv., Inc.  
**CALIFORNIA INSTRUMENTS CO.** ..... 74  
Robert A. Beaudette  
**COMMUNICATIONS TRANSISTOR**  
**CORP.** ..... DC-16A-DC-16H  
Hall Butler Blytheville, Inc.  
**COMPUTER AUTOMATION, INC.** ..... 10, 11  
Cochrane Chase & Co., Inc.  
**CONDENSER PRODUCTS CORP.** ..... 76  
MacMahon Sandhaus & Spear, Inc.

**DATA DYNAMICS DIV.** ..... 78  
Tek-Mark, Inc.  
**DIGITAL EQUIPMENT CORP.** ..... 53  
Creamer, Trowbridge, Case & Basford, Inc.  
**DIGITAL EQUIPMENT CORP.** ..... 69  
Kalb & Schneider, Inc.

**EEO (Electronic Engineering Co. of Calif.)** ..... 66  
Marketing Communications Assoc.  
**EEO (Electronic Engineering Co. of Calif.)** ..... 78  
The Robertson Co.  
**EDMUND SCIENTIFIC CO.** ..... 80  
Walter S. Chittick Co., Inc.  
**ELCO CORP.** ..... IFC  
Mort Barish Assoc., Inc.  
**ELECTRO MOTIVE** ..... 2  
Culver Adv., Inc.  
**EXECUTONE, INC., Printact Relay Div.** ..... 72  
J. A. Richards

**FAIRCHILD SEMICONDUCTOR** ..... 4, 5  
Carson/Roberts/Inc.

**GRAYHILL, INC.** ..... 30  
Carr Liggett Adv., Inc.  
**GUDEBROD BROS. SILK CO.** ..... 73  
Coastline Adv.

**A. W. HAYDON CO.** ..... 49  
J. B. Rundle Adv.  
**HEATH COMPANY** ..... 75  
Advance Adv. Service  
**HEWLETT-PACKARD, LOVELAND** ..... 67  
Tallant/Yates Adv., Inc.  
**HEWLETT-PACKARD, San Diego** ..... 64  
Phillips Ramsey Adv.

**ITT CANNON** ..... 54, 55  
D'Arcy-Macmanus-Intermarco, Inc.  
**INDUSTRIE BITOSSI s.a.s.** ..... 80  
**INTERNATIONAL COMMUNICATIONS CORP.** ..... DC-4  
Industrial Adv. Services, Inc.  
**INTERSIL** ..... 62, 63  
Jack Herrick Adv., Inc.  
**INTERSTATE ELECTRONICS CORP.** ..... 32  
Leland Oliver Co., Inc.

**KEPCO, INC.** ..... 6  
Weiss Adv.

**MCG ELECTRONICS** ..... 76  
Dunwoodie Adv.  
**MAGNECRAFT ELECTRIC CO.** ..... 1  
Marketronics, Inc.  
**MALLORY CAPACITOR CO.** ..... DC-14  
Aitkin-Kynett Co., Inc.  
**MET-L-WOOD CORP.** ..... 70  
Drew & Carr, Inc.  
**MICRO SWITCH** ..... 29  
N. W. Ayer & Son, Inc.  
**MOTOROLA SEMICONDUCTOR PRDTS., INC.** ..... 7  
E. B. Lane & Assoc., Inc.

**NATIONAL SEMICONDUCTOR** ..... 71  
Chiat/Day, Inc.

**POTTER & BRUMFIELD, AMF, INC.** ..... 24, 25  
Fuller & Smith & Ross, Inc.  
**POWERTEC, INC.** ..... 14  
Warren C. Wilson & Assoc.

**RCA, Solid State Division** ..... BC  
Al Paul Lefton Co., Inc.  
**RAYTHEON CO.** ..... DC-3  
Provandie Eastwood & Lombardi, Inc.

**SCANBE** ..... DC-16  
Warren C. Wilson & Assoc.  
**SPERRY Info. Displays Div.** ..... IBC  
N. A. Winter Adv.  
**STANDARD LOGIC, INC.** ..... 78  
B- Advertising  
**SOLITRON DEVICES, INC.** ..... 61  
Tobias Assoc., Inc.

**TEAC** ..... 50  
Buxton Adv.  
**TELEDYNE PHILBRICK** ..... 9  
Ingalls Assoc., Inc.  
**THERMALLOY CO.** ..... 76  
Phillips, Inc.

**USCC/CENTRALAB** ..... 15  
Brown Clark Elkus & Moses, Inc.  
**USM DYNAPERT DEPT.** ..... 31  
Klein, Kurlan, Barr & Ross  
**UNITRODE CORP.** ..... 13  
Impact Adv. Inc.

**VARFLEX CORP.** ..... 75  
Barlow/Johnson, Inc.  
**VIDAR CORP.** ..... DC-13  
Lincoln Assoc.  
**VISHAY RESISTOR PRDTS.** ..... 68  
The Larwin Agency

**WATKINS-JOHNSON CO.** ..... DC-15  
William C. Estler  
**WOVEN ELECTRONICS** ..... 72  
Prentiss Court

# LITERATURE

**THE ELECTRONIC-COMPONENTS DIVISION OF INDUSTRIE BITOSSI S.A.S., A SUBSIDIARY OF THE BITOSSI GROUP (ITALY), SEEKS SELLING OR DISTRIBUTING AGENT IN CONNECTION WITH HIGH-STABILITY METAL-FILM RESISTORS OF ITS PRODUCTION FOR THE AMERICAN MARKET. INTERESTED PERSONS SHOULD WRITE TO:**

**INDUSTRIE BITOSSI s.a.s.  
Divisione Componenti Elettronici  
50053 SOVIGLIANA VINCI (FIRENZE)  
— ITALY —**

**BANKING REFERENCES: BANCA NAZIONALE DEL LAVORO, Roma (Italy)**

**Circle Reader Service #55**

## DC power supplies

Included in this comprehensive catalog is a broad range of dc power supplies rated from milliamps to over 30 A.



Standard features are provided for each series, as are specs, schematics, options, and operating characteristics. Acopian Corp., Easton, Pa. 18042.

**Circle Reader Service #416**

## Designing services

This 16-page booklet will describe a company for you that designs proprietary "state-of-the-art-competitive" products. They concentrate on instrumentation, communications, control, computation, and data acquisition and processing. This booklet will give you details and examples of their capabilities and experience in each of these fields. Gordon Engineering Co., Audubon Rd., Wakefield, Mass. 01880.

**Circle Reader Service #417**

## Card edge connectors

A silver anniversary revised edition of a card edge connector guide includes four new series of connectors. Described are two new types of discrete connectors for wire wrapping applications and two new types which are the result of a press-fit technology eliminating soldering and reducing the cost of back panels. A three-page index is provided in the 31-pager for quick connector identification. Elco Corp., Willow Grove, Pa.

**Circle Reader Service #418**

## Data conversion system

Here are 10 pages of information on a completely integrated computer compatible data conversion system. You'll find a carefully outlined description of the AN5800 series, and details on capabilities, operation, design features, system specs, and motherboard construction. And all this is supplemented by photos, schematics, and block diagrams. Analogic Corp., Audubon Rd., Wakefield, Mass. 01880.

**Circle Reader Service #419**

**CHOOSE FROM OVER 4,000 UNUSUAL BARGAINS!**

**OPTICS • SCIENCE  
ELECTRONICS**

**FREE CATALOG!**

**1,000's OF HARD-TO-FIND  
BUYS FOR INDUSTRY**

Brand new 148-page easy-to-read edition packed with new products, charts, diagrams, illustrations. On-the-job helps; quality control aids, unique, exclusive items to speed your work, improve quality, cut development and production costs! Loaded with optical, scientific and electronic equipment available from stock for industry, research labs, design engineers, experimenters, hobbyists.

**ONE SOURCE FOR ALL YOUR NEEDS**

Tremendous variety. Terrific savings. Countless hard-to-get surplus bargains. Many "one-of-a-kinds" nowhere else. Ingenious scientific tools. Thousands of components: lenses, prisms, wedges, mirrors, mounts, all types of accessories. Hundreds of instruments: pollution testing equipment, lasers, comparators, magnifiers, microscopes, projectors, telescopes, binoculars, photo attachments, ecological items, black light equipment and America's largest collection of unique lighting products.

**BUY DIRECT WITH MONEY-BACK GUARANTEE**

Edmund ships over 5,000 orders monthly to America's largest industrials — every item guaranteed! You must be satisfied, or return your purchase in 30 days for your money back. Shop the catalog of America's largest Science-Optics-Electronics Mart with confidence! Get your FREE copy without obligation. No salesman will call. Write now for free catalog "EE."

**EDMUND SCIENTIFIC CO.  
300 EDSCORP BUILDING  
BARRINGTON, NEW JERSEY 08007**

**Circle Reader Service #56**

**photo  
controls  
for  
every  
need**



**51 sketches showing  
photo controls for**

- conveyors
- automation
- inspection
- positioning
- packaging
- smoke detection
- tension control
- weighing
- many, many others.
- cut-off
- counting
- jam-up
- limit
- orientation
- processing
- registration
- sorting
- traffic control
- winding

## NEW Catalog 71

297 pre-engineered photo controls including retro-reflective, specular reflective, fiber optic and solid state; ON/OFF and Timing Controls; tremendous selection of photo sensors and light sources. Proximity Controls. Counting Eyes. Bin level, smoke, current surge and impact controls. All illustrated, described and priced.

**See the AUTOTRON MAN in your  
area or send for Catalog 71 NOW**

**AUTOTRON, INC.**

3627 N. Vermilion, Danville, Ill. 61832  
Ph 217-446-0650 TWX 910-244-1455

**Circle Reader Service #57**

THE ELECTRONIC ENGINEER • Feb. 1972



Sperry displays are available in 3 digit, 2 digit, and 1½ (7 segment character and a 1 with + and -) digit models in both ½" and ¼" sizes.

## Compare panel meter displays

If you think that Nixie\* tubes or LED displays are the only one's you can logically use in your panel meters, you had better take a close comparison look at Sperry. The facts speak for themselves.

**COMPARE READABILITY . . .** a must requirement. Sperry displays† can be read in direct sunlight with no loss of legibility. And, continuous, "no-gap" Sperry characters make your panel meters a lot more attractive to your customers. Try the others.



**COMPARE POWER . . .** a very important factor. Under DC operation, LED's require over 500 mW — Nixie\* tubes require over 400 mW as compared to Sperry ½" with 200 mW and ¼" with 370 mW. Sperry can go down even further — to 85 mW under pulsed operation using a Sperry decoder/driver, without affecting readability. What about voltage? A simple, inexpensive DC/DC converter takes the battery voltage up to the 170 volts required to operate Nixie displays.

**COMPARE RELIABILITY . . .** simplicity is the key. Sperry displays have no wirebonds. They are so ruggedly built and reliable that they are used aboard the Boeing 747. Need we say more.



**COMPARE SIZE . . .** it's the housing to character size ratio that counts. Which display do you want in your equipment?



Sperry ½"



Sperry ¼"



LED ¼"



Nixie\* ½"

Add these Sperry advantages to greater clarity and brightness, wider viewing angle and a low cost of \$2.30\*\* per digit for either the ½" and ¼" device and you can end the comparison and specify Sperry — the right displays for your panel meters. Get the whole story on Sperry displays by requesting complete technical information using this publication's reader service card or phone or write: Sperry Information Displays Division, Post Office 3579, Scottsdale, Arizona 85257, Telephone (602) 947-8371

**SPERRY**  
INFORMATION DISPLAYS

# It's a whole new ball game in display devices!

 **SPERRY RAND**

† Patent Pending.  
\* NIXIE is the registered trade mark of the Burroughs Corporation.  
\*\* Based on 5,000 digit quantity.

Circle Reader Service #58

# Use RCA Power Hybrids— the 'building block' way to put muscle in your operational amplifiers.

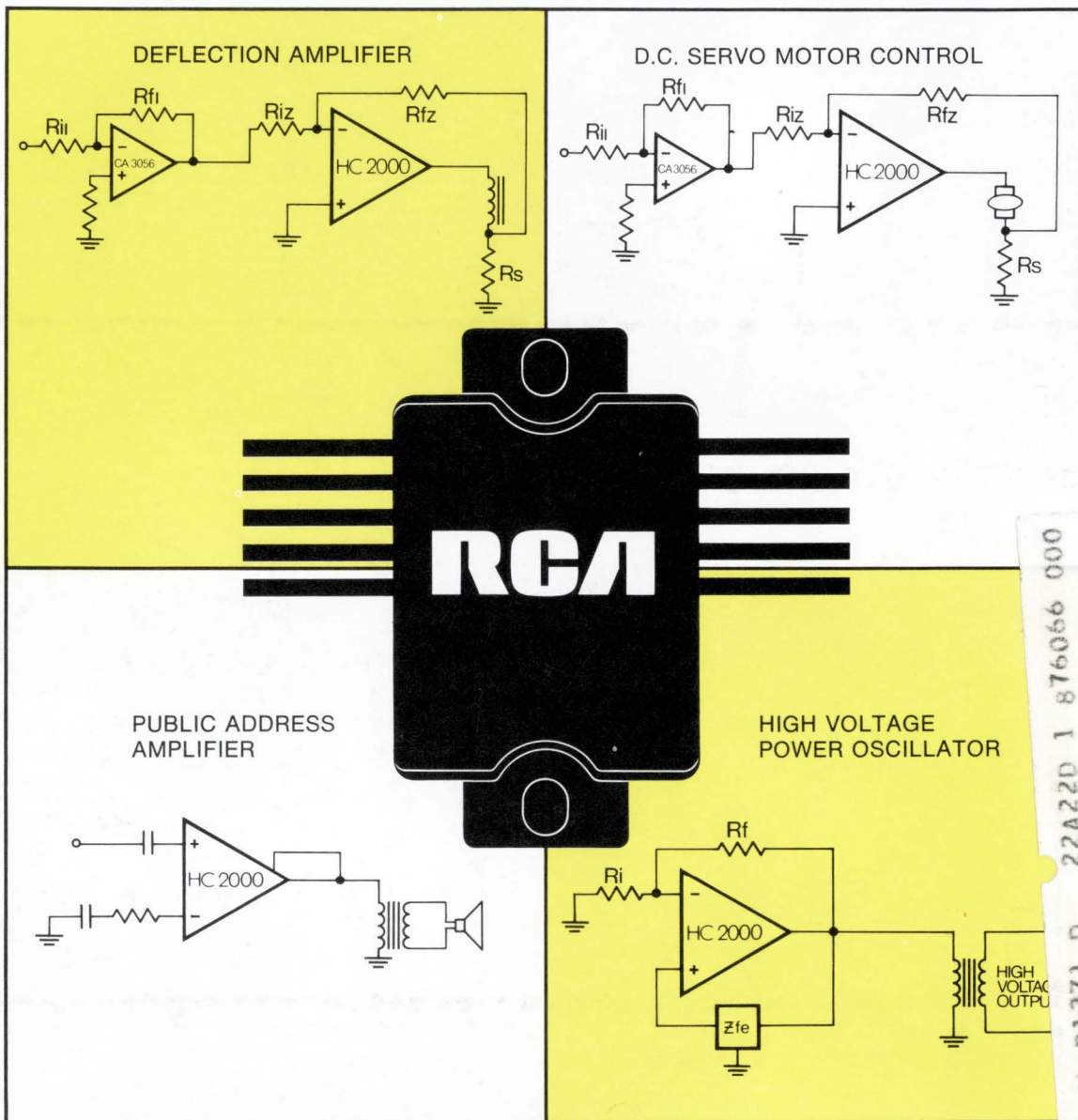

HC-2000 — \$20.00 EACH IN QUANTITIES OF 1000 OR MORE.

Are you designing to save space, weight, parts, and cost? At the same time, do you want to get the current and voltage levels that do a power job in your Op Amp and Linear circuit designs? If so, you should be looking at RCA power hybrid circuits.

In particular, check out the HC-2000. It's got real muscle. In fact, it is the premier example of the power line—offering 7 A peak cur-

rent capability in a compact plastic package. With its output capability of 100 W (rms), HC-2000 is an ideal unit for operational and linear amplifier designs in industrial and commercial equipment.

The RCA HC-2000 represents a basic amplifier providing maximum flexibility in use for a broad range of applications as typified by the schematics shown above.

For more information on HC-2000

and other RCA power hybrid circuits, see your local RCA Representative or your RCA Distributor. For technical data including an application note, write: RCA, Solid State Division, Section 59B/UC5, Box 3200, Somerville, N.J. 08876. International: RCA, Sunbury-on-Thames, U.K., or P.O. Box 112, Hong Kong. In Canada: RCA Limited, Ste. Anne de Bellevue, 810 Quebec.

00501 84 B1271 D 22A22D 1 876066 000  
 CALMA, CO  
 DONALD O. STANLEY RES ENGR 0000000  
 707 KIFER RD 94086  
 SUNNYVALE CALIF

**RCA** Solid State  
 products that make products pay off

Circle Reader Service #59