

MODEL: E88

BUILT-IN ELECTRIC OVENS

Installation and operating instructions

Dear Customer,

Thank you for selecting one of our products. We are certain it will respond fully to your needs and expectations, giving perfect results every time.

Please read this manual carefully. The instructions it contains will enable you to use the appliance correctly and to best advantage.

The manufacturer accepts no liability for damage to persons or property caused by incorrect and unsuitable installation.

The manufacturer reserves the right to apply such modifications to the appliance as are deemed appropriate, without any obligation to notify customers in advance.

SAFETY PRECAUTIONS

- To avoid any possible hazard, the appliance may be installed by qualified personnel only.
- Any repairs by unqualified persons may result in electric shock or short circuit. In order to avoid possible injuries to your body or to the appliance, do not attempt any repairs by unqualified service personnel.
- Hot fat is highly inflammable, so pay extra attention when preparing food with greas or oil.
- **Warning!** Never let children in the proximity of the oven; they are not yet aware of danger of burns. Older children may use the appliance only under your surveillance.
- The inside of the oven, also places of potential danger for children.
- **Danger of burns!** Oven and cooking accessories may become very hot during operation. To avoid burns use kitchen clothes and gloves when handling hot parts or utensils.
- Mains leak of adjacent appliances may be damaged by hotplates or if stuck between the oven doors, and produce short circuit, therefore keep them at safe distance from the appliance.

- **Take extra precautions when grilling. Intensive heat from infrared heater makes the oven and the accessories extremely hot. Use protective gloves and barbecue accessories!**
- **Perforated roast may produce spurting of hot grease (sausages). Use long grill tongs to prevent skin burns and protect your eyes.**
- **Supervise the grill at all times. Excessive heat may quickly burn your roast and provoke fire!**
- **Do not let the children in the vicinity of the grill.**

- **THIS APPLIANCE IS CONCEIVED FOR DOMESTIC USE ONLY. THE MANUFACTURER SHALL NOT IN ANY WAY BE HELD RESPONSIBLE FOR WHATEVER INJURIES OR DAMAGES ARE CAUSED BY INCORRECT INSTALLATION OR BY UNSUITABLE, WRONG OR ABSURD USE.**
- **THIS APPLIANCE IS NOT INTENDED FOR USE BY PERSONS (INCLUDING CHILDREN) WITH REDUCED PHYSICAL, SENSORY OR MENTAL CAPABILITIES, OR LACK OF EXPERIENCE AND KNOWLEDGE, UNLESS THEY HAVE BEEN GIVEN SUPERVISION OR INSTRUCTION CONCERNING USE OF THE APPLIANCE BY A PERSON RESPONSIBLE FOR THEIR SAFETY. CHILDREN SHOULD BE SUPERVISED TO ENSURE THAT THEY DO NOT PLAY WITH THE APPLIANCE.**

GENERAL INFORMATION

The oven data plate remains accessible following installation, and is exposed to view simply by opening the door.

It shows all details needed to identify the appliance, and these must be indicated when ordering replacement parts.

MADE IN EUROPE		NUM.	
TYPE:			
MOD.:		V	kW
CE		M	

Given the type and height of this built-in oven, it can be installed only in a full-height kitchen unit. Particular care must be given to the instructions on installing the oven in the unit, especially the indications regarding the size and position of the ventilation opening, which is essential for proper cooling of the enclosure and of the oven itself.

To guarantee the safety of the user, the unit housing the oven must be manufactured from materials able to withstand temperatures up to 90 °C. This includes core materials, laminates, facings and adhesives.

DEMO MODE

This is the name given to the method adopted by the oven every time the power supply fails and consequently also when switching it on for the very first time:

The aim is to display all the possible functions with a recorded sequence of commands.



In this mode the oven is NEVER really activated, as the heating elements are not switched on!!

The control panel is NOT ACTIVE so the oven does not respond to commands!



5 sec.!!

To disable the demo mode, touch the light symbol for five seconds: the oven will enter into standard operational mode and the oven is ready to be switched on.

CONTROL PANEL

View of front console

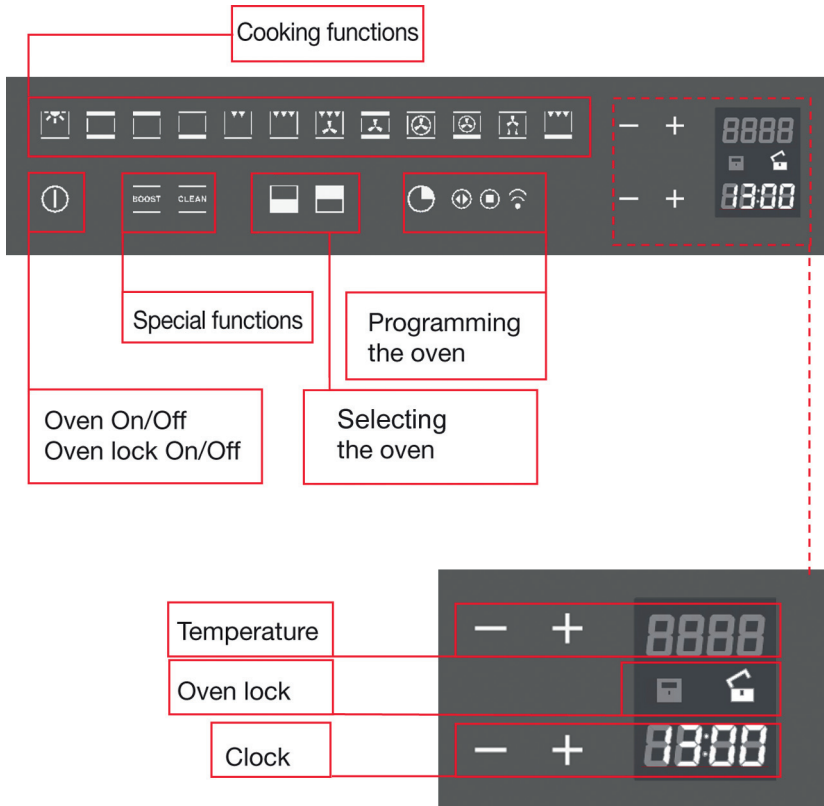

Cooking functions

The control makes a total of fourteen specific cooking functions available!

Every function has a preset temperature.

The user can change the temperature according to his personal preference.

POSSIBLE ACTIONS WITH THE OVEN SWITCHED OFF

The actions possible when the oven is switched off are:

- Switching on the oven light

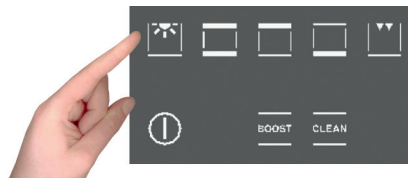

The oven light is activated/deactivated by pressing .

While the light is on, if the oven will be switched on, the oven light will switch off.

If the user does not switch it off, it is automatically deactivated after 30 minutes TO SAVE ENERGY.

- Adjusting the time

To adjust the time, keep the “TIMER FUNCTIONS” button  active for at least 3 seconds.



Adjusting the timer using the + and – keys: the separator dots flash at regular intervals (0.5 seconds) during the setting.

The time is acquired when the dots become stable.

- “Minute counter” timer function setting

Press the clock symbol  and fix the countdown with the + and - buttons



HOW TO SWITCH ON THE OVEN



The oven is switched on using the ON/OFF symbol ① shown in the figure. The control activates all the symbols, illuminating the background.

NOTE: remember that the oven can only be switched on if the key function is deactivated.



The control will wait eight seconds after the switch-on of a cooking function. Otherwise it will understand the switch-on as accidental event and automatically it will switch off the oven for safety reasons.

- Lock/Unlock the KEY function



3 Sec.!!



The key function is activated or deactivated by pressing the key ① for at least 3 seconds. It can be activated and deactivated at any time.



The OPEN padlock symbol means that the key function is not active.



The CLOSED padlock symbol means that the key function is active.

After switching on the oven, select the TOP OVEN using the key , and MAIN OVEN using the key: .

When 2 ovens are working simultaneously, the key will flash to show which oven has been selected.

A complete description of all functions is listed below.

TOP OVEN



The oven offers these following cooking functions:



ON/OFF



Oven interior light



Conventional cooking

Set the required cooking temperature between 50 and 250 °C. The red light will go out as soon as the selected temperature has been reached. The oven should be pre-heated before the food is put into cook.



Lower heating element

Set the required temperature between 50 and 250 °C. This setting is used typically for food to be reheated or warmed.



Middle Grill

Infrared grill: equipped with an energy regulator. The heat intensity of the grill can be set from 1 to 11 using the keys of temperature (+/-). This cooking mode is ideal for small amounts of food. Keep the door closed.



Grill

Infrared grill: equipped with an energy regulator. The heat intensity of the grill can be set from 1 to 11 using the keys of temperature (+/-). The oven should be heated for a few minutes before food is put under the grill.

MAIN OVEN



The oven offers these following cooking: functions:



ON/OFF



Oven interior light



Top heating element. Thermostat setting from 50°C to 200°C.



Lower heating element

Set the required temperature between 50 and 250 °C. This setting is used typically for food to be reheated or warmed.



Conventional cooking

Set the required cooking temperature between 50 and 250 °C. The red light will go out as soon as the selected temperature has been reached. The oven should be pre-heated before any food is put in to cook.



Middle Grill

Infrared grill: equipped with an energy regulator. The heat intensity of the grill can be set from 1 to 11 using the keys of temperature (+/-). This cooking mode is ideal for small amounts of food. Keep the door closed.



Grill

Infrared grill: equipped with an energy regulator. The heat intensity of the grill can be set from 1 to 11 using the keys of temperature (+/-). The oven should be heated for a few minutes before food is put under the grill.



Fan + Double Grill

Set the thermostat to the desired temperature between 50 and 250 °C. Fan operation combined with the grill lets you cook particular foods quickly and deeply. We suggest you to pre-heat the oven for a few minutes before inserting food. Keep the door closed.



Traditional cooking + Fan assisted

Set the thermostat between 50 and 250°C.

This cooking mode integrates natural convection and fan. Cooking mode is suited to bake bread, pizzas and lasagne.

Fan-forced cooking



The fan and the relative heating element come into operation, and the heat will be distributed uniformly around the entire chamber at the temperature selected with the thermostat, between 50 and 250 °C. The oven should be pre-heated before any food is put in to cook. Different types of food can be cooked simultaneously.



Bottom heating element + Circular heating element with fan. Thermostat setting from 50°C to MAX.



Defrosting

Fan for defrosting. Thermostat setting at 0°C.



Double top heating element (large area grill): thermostat setting from 50°C to 200°C. Bottom heating element: thermostat setting from 50°C to MAX.

SPECIAL FUNCTIONS

Boost (quick preheat)

This special function can be activated after a cooking function has been selected and it is used to reduce the time required to reach the set cooking temperature.

This period of time is known as preheating, and is required in practically all recipes.

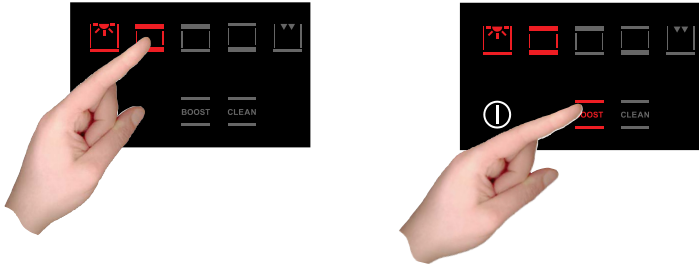

It is possible to disconnect the boost heat function or change cooking function at any time.

Clean (quick cleaning)

A correct operation is combined with the use of the lateral panels and catalytic fan cover: the oven is treated with special enamel with a micro-porous structure, which breaks down the fat projected thanks to a catalytic oxidation process which transforms residues into gaseous products.

The turbo clean function is only activated when no cooking function has been selected, so: switch on the oven and touch the symbol as shown in the figure for five seconds.

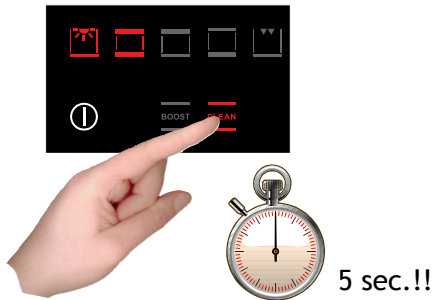



The cleaning process takes place at a temperature of 250°C and lasts one hour. Do not use it to cook the food!!

All the self-cleaning panels will perform effectively for thirty cleaning processes, after this limit the panels must be replaced.

The panels should be cleaned exclusively with tap water. Replacement parts can be ordered to your specialised dealer.



ELECTRONIC PROGRAMMER

Warning: both the ovens can be programmed in the cooking times after selecting them by switching on the TOP  and MAIN  symbols. The cooking time sequences are independent.

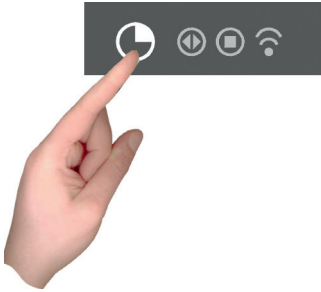
The programming of the oven offers three modes to controlling the cooking time. They are available with the standard cooking functions.



Programming the timer: cooking time

Touch the timer symbol  once. The relative symbol  lights up. The clock display will replace the indication of the current time:



The dividing dots flash to indicate that it is possible to programme the cooking time

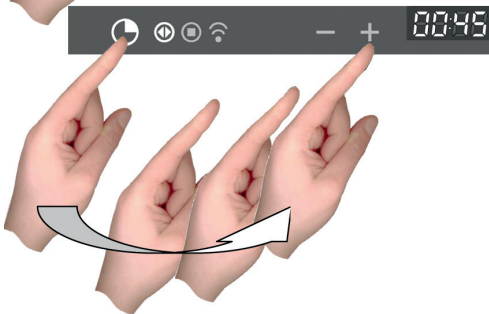

Once the cooking time has been set, the display will show the current time again and the cooking time symbol will remain switched on.

The count begins now and the symbol will flash. When the time is over, the oven will make a beeping sound, the heating elements will be switched off and cooking will stop. Press any button to stop the beeping sound.

After eight seconds, the oven switches off automatically unless other cooking functions are programmed.

Programming the timer: cooking end time

Touch the timer symbol twice. The symbol  lights up.

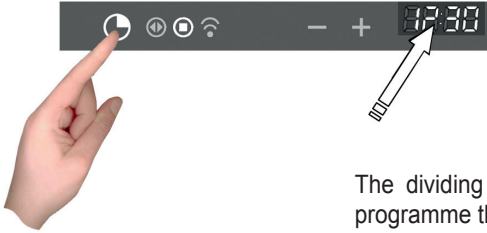

The dividing dots flash to indicate that it is possible to programme the cooking end time.

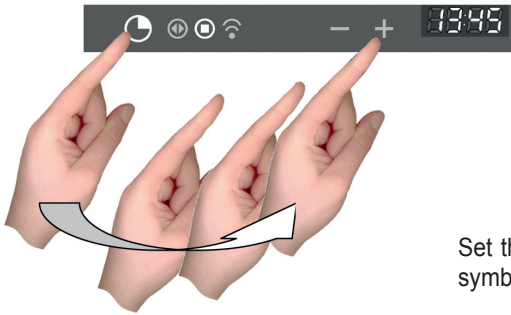

Set the cooking end time by touching the + and – symbols.



Once the cooking end time has been set, the display will show the current time again and the cooking end symbol will remain switched on.

The count begins and the symbol will flash. When the set time is reached, the oven will give off a beep, the heating elements will be switched off and cooking will stop. Press any button to stop the beeping sound.

After eight seconds, the oven switches off automatically unless other cooking functions are programmed.

Programming the timer: delayed cooking

Using the combination of the two cooking time and cooking end time modes, it is possible to programme the oven to start cooking at a later time than the current time.

For example, it is 8.30 a.m. and you're about to leave home, but you would like a roast to be ready for 1.00 p.m.. Here's what to do:



Prepare the roast for cooking and place it in the oven.

Switch on the oven, select the cooking function and set the temperature.

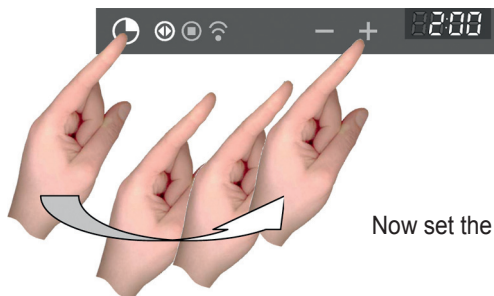

Now set the cooking time, let's say two hours.

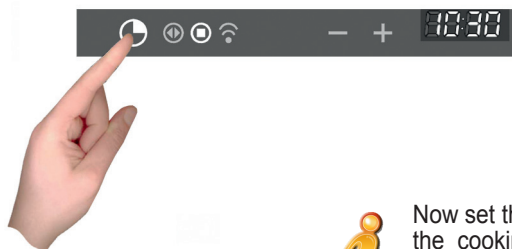

Now set the cooking end time: the control usually adds the cooking time to the current time and proposes the result as the cooking end time. In our case it will propose 10:30 (8:30+2 hours).



Change the cooking end time to make it coincide with the time you require. In our example this is 1.00 p.m.

The oven now enters into stand-by mode and the oven light switches off. When it is time to start cooking, the light will not be automatically switched on (it is logical to assume that the delayed start coincides with your absence, so it is pointless to leave the light on for no reason).



The control will automatically activate the oven at 11:00 (1:00 p.m. -2 hours) and will switch it off at 1.00 p.m.

Programming the timer: minute counter

The minute counter is a function of the timer which is independent of the operation of the oven, meaning that it does not block the cooking and does not switch off the oven, but acts as a beeper. You can set it at any time, as a reminder to check cooking on the hob, as well as the oven, or for other cooking activities.

This can also be used with the oven switched off. In this case all you have to do is touch the timer function symbol.

If the oven is switched on, you must touch the time function symbol three times until the symbol will light up.

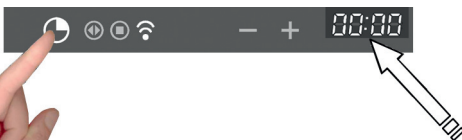

The dividing dots flash to indicate that it is possible to set the value.



COOKING TABLE FOR TOP OVEN - CONVENTIONAL COOKING

It is recommended to preheat the oven 10 min.

DISHES	LEVEL	TEMPERATURE	COOKING TIME
Yorkshire Puddin	1	200°C	30 - 40 min
Fatless Sponge Cake	1	180°C	25 - 30 min
Small Cakes	2	190°C	15 - 20 min
Fruit Plate Tart	1	200°C	40 - 45 min
Scones	2	220°C	10 - 15 min
Rich Fruit Cake	1	140°C	2 - 3 hours



COOKING TABLE FOR THE TOP OVEN WITH INFRARED HEATER OPERATING

To grill keep the door closed. 5 minutes oven preheating is recommended. Setting possibility from 50 - max (250)°C. Food is placed on the backing pan grid.

DISHES	LEVEL	TEMPERATURE	COOKING TIME	
			Side 1	Side 2
Pork steaks, Chops (4 pcs)	3	225°C	12 min	10 min
Grilled Sausages (6 pcs)	3	225°C	6 min	5 min
Toast (6 pcs)	3	225°C	1 min/25 sec.	1 min/10 sec.



COOKING TABLE FOR THE MAIN OVEN WITH INFRARED HEATER OPERATING

To grill keep the door closed. 5 minutes oven preheating is recommended. Setting possibility from 50 - max (250)°C. Food is placed on the backing pan grid.

DISHES	LEVEL	TEMPERATURE	COOKING TIME	
			Side 1	Side 2
Pork steaks, Chops (4 pcs)	Topmost 5	250°C	15 min	12 min
Roast beef (4pcs)	Topmost 5	250°C	10 min	8 min
Grilled Sausages (6 pcs)	Topmost 5	250°C	9 min	6 min
Toast (6 pcs)	Topmost 5	250°C	1 min/50 sec.	1 min/30 sec.

COOKING SELECTIONS

Select the desired cooking function.



Preheat the oven, setting the thermostat to the required temperature. Once the oven has been heated to the selected temperature, the symbol °C will stop flashing and the electronic module will perform 2 beep sounds.

Remove the drip tray when using the oven for conventional baking, roasting etc.

The tray should be left in place only when using the grill, as its purpose is to catch falling droplets of fat. Food should be placed in oven dishes with raised edges and positioned centrally under the grill. If fan-forced operation is selected, foods of different types can be cooked simultaneously (e.g. meat and fish), but in this case the respective cooking time must be observed.

If the symbol  function is selected, temperatures must be set 10 to 20°C lower than indicated in the table.

Cooking temperatures and times

Dish	Temperature in degrees centigrade	Approximate cooking time in minutes
	 	
Sweets		
Short pastry flan base	175 160	55-65
Fruit pie/tart	200 190	8-10
White leavened bread per 1 kg flour	200 190	25-35
Shortcake biscuits	200 190	30-50
Savoury biscuits	200 190	10-15
Lasagne	200 190	15-20
Meat (cooking time based on thickness)	225 210	40-50
Slow roast	175 170	12-15
Quick roast	200 190	12-15
Meat loaf	200 190	30-40
Poultry		
Duck 1.5 -2 kg	200 170	120-180
Goose 3 kg	200 180	150-210
Roast chicken	200 190	60-90
Turkey 5 kg	175 150	240 ca.
Game		
Hare	200 180	60-90
Leg of roebuck	200 180	90-150
Haunch of venison	175 175	90-180
Vegetable		
Vegetable soufflé	200 180	40-45
Fish	180 170	40-45
Pizza	210 200	20-25
Grills		
Pork chop		8-12
Sausage		10-12
Grilled chicken		25-35

ROASTING GUIDE

- Frozen meat should be thoroughly thawed before cooking. For large sizes it is advisable to thaw overnight.
- Frozen poultry should be thoroughly thawed before cooking, the time required depends on the size of the poultry e.g. a large turkey may take up to 48 hours to thaw.
- Adjust the shelf position so the meat or poultry will be in the centre of the oven.

The TIMES given in the ROASTING GUIDE are approximate.

Cook in oven 180°C (Fan oven) 200°C (Conventional oven)		Approximate cooking time
BEEF	Rare Medium Well Done	20 minutes per 450g. (1lb) plus 20 minutes 25 minutes per 450 g (1 lb) plus 20 minutes 30 minutes per 450 g (1 lb) plus 30 minutes
LAMB	Medium Well Done	25 minutes per 450 g (1 lb) plus 25 minutes 30 minutes per 450 g (1 lb) plus 30 minutes
PORK		35 minutes per 450 g (1 lb) plus 35 minutes
FOWL		20 minutes per 450 g (1 lb) plus 20 minutes

Notes:

If you are cooking a very large turkey e.g. over 141lb., we recommend that it is turned around halfway through cooking, so that both legs will be cooked evenly.

Remove any excess fat from the tin before turning, to prevent any fat splashing.

Stuffed meat or poultry should required an extra cooking time

Joints cooked in foil or covered roasters, and for lidded casseroles: add 5 minutes per 450g. (1lb) to the calculated cooking time.

Smaller joints weighting less than 1.25 k.g. (2 lb.) may require 5 minutes per 450g. (1lb) extra cooking time.

DEFROSTING AND COOLING



To defrost frozen foods, select the defrost key, place the food in the centre of the oven and close the door.

Be safe

- X DO NOT** defrost stuffed poultry using this method.
- X DO NOT** defrost larger joints of meat and poultry over 2kg.(4lb) using this method.
- X NEVER** place uncooked food for defrosting next to cooked food which is to be cooled, as this can lead to cross contamination.

Defrosting meat, poultry, and fish can be accelerated using this method but make sur they are completely thawed before cooking. Place meat and poultry on a trivet or in a vessel.

Defrosting times

- 🔥 Small or thin pieces of frozen fish or meat e.g. fish fillets, prawns, and mince will take approximately 1-2 hours. Placing the food in a single layer will reduce the thawing time.
- 🔥 A medium sized casserole will take approximately 3-4 hours.
- 🔥 A 1 1/2 kg (3lb) chicken will take approximately 5 hours.

INSTRUCTIONS FOR USE

General instructions

CAUTION: the oven door becomes hot during use. Be sure to keep children away!

Do not use the oven as a room heater.

Always be very careful when connecting other electrical appliances to the power supply if these are situated near the oven: the power cables must not come into contact with hot parts of the oven.

To ensure the oven will always be safe, any servicing — especially of electrical parts — should be entrusted exclusively by a skilled personnel.

Clean the oven every time after use: this will make it easier to remove dirt and grease and ensure that deposits do not build up.

Use earthenware oven dishes, enamelled steel or pyrex - type glass for roasting and baking, selecting a suitable size for the bulk and quantity of the food being cooked. Stainless steel ovenware is not recommended, as the metal reflects heat.

If the interior light should fail, disconnect the oven from the electrical power before removing and replacing the lamp.

Using first time

Before using the oven for the first time, clean the interior thoroughly with liquid detergent and lukewarm water. Wipe off, then heat the oven to maximum temperature and leave it switched on for 20 minutes. This will ensure that residual oil and grease used in the manufacturing process do not give off unpleasant smells when food is cooked in the oven. Once this has been done, the oven is ready for use.

CAUTION: make certain the oven is disconnected from the electrical power supply before carrying out any cleaning operation on the oven.

Final checks

Having installed the oven in its enclosure, and before switching on, be certain to check that there are no live parts accessible, and that all the packing has been removed. At this point the oven can be switched on as described in the instructions.

INSTALLATION



CAUTION:
THIS APPLIANCE MUST BE INSTALLED BY A PROFESSIONAL ELECTRICIAN, AND IN ACCORDANCE WITH THE MANUFACTURER'S INSTRUCTIONS
BEFORE CARRYING OUT ANY ADJUSTMENT OR REPAIR ON THE APPLIANCE, MAKE CERTAIN IT IS DISCONNECTED FROM THE ELECTRICAL POWER SUPPLY

Statutory regulations, technical standards, directives

The appliance must be installed in conformity with current statutory regulations and in accordance with applicable safety standards.

Installing the oven

The unit in which the oven is installed must be manufactured to a modular dimension of 600mm. Openings at least 50 mm deep must be cut both in the bottom and in the top of the unit to ensure adequate ventilation (see figure1 for essential dimensions).

During assembly, particular care must be taken not to pick up the oven by the door.

As a general rule, the oven door should never be forced or subjected to undue stresses.

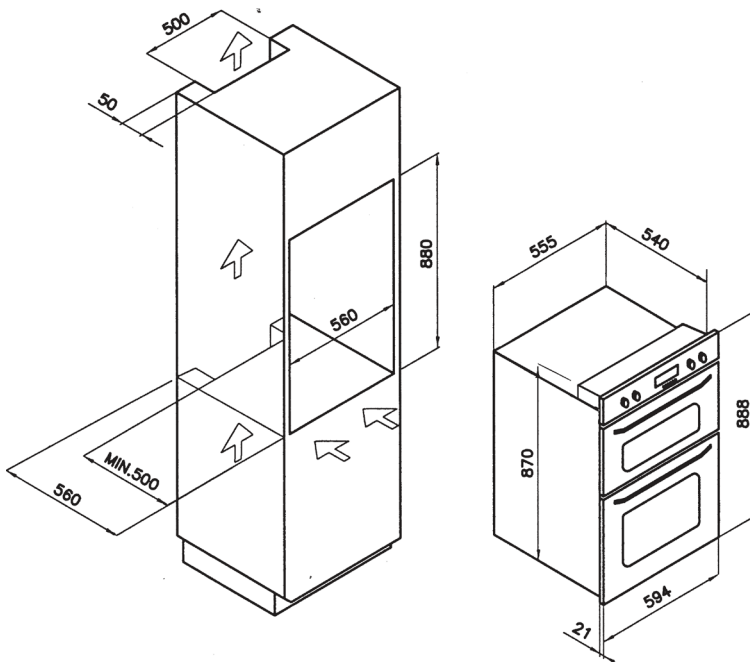

Electrical connection

Make certain the nominal a.c. power supply voltage corresponds to that indicated on the identification data plate. The appliance must be connected to the supply by way of an isolating switch with minimum contact separation of 3 mm. Suitable isolating components include automatic breakers, fuses and relays.

The oven must be connected to an efficient earth system, as prescribed by national and/or local statutory regulations.

The cable must be connected as prescribed by statutory regulations and respond to the specifications indicated on the Technical Data page.

The terminal box is located at the rear of the appliance. If a new cable is fitted, route it through the clamp and make the connections as shown in the diagram. The earth wire must be cut longer than the other wires so that it will be the last to break off in the event of the cable being tugged. Having made the connection, tighten the cable clamp and close the cover of the box.

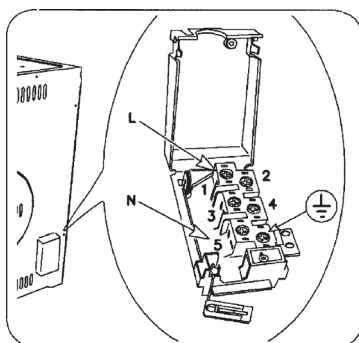

CONNECTION DIAGRAM

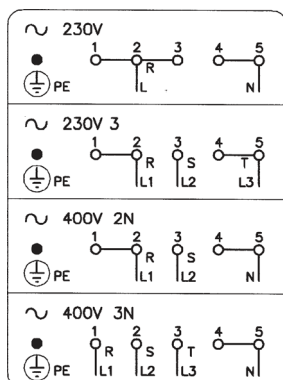

CABLE TYPES AND SECTIONS

	H05RR-F
230V~	3 x 2,5 mm ²
230V 3	4 x 1,5 mm ²
400V 2N~	4 x 1,5 mm ²
400V 3N~	5 x 1,5 mm ²

CLEANING AND MAINTENANCE

Never clean the oven with the high- pressure steam cleaning device, as it may provoke short circuit.

Before cleaning switch the cooker off and let it cool down completely.

Front side of the casing

To clean the frontal part of the cooker use conventional cleaning agents and follow the manufacturer's instructions.

Never use any aggressive cleaning agents or dish cleaning accessories which might cause scratches. For the front door glass use soft cloth and liquid cleaners for cleaning glass surfaces.

Stainless steel front:

Clean the surface with mild detergent (soap) and soft sponge which does not scratch.

Never use aggressive cleaners or solvents, otherwise you may damage the surface.

Enamel coated and plastic surfaces

Clean knobs, handles and enamelled surfaces with soft cloth and liquid cleaners, intended for use of smooth ename surfaces.

Oven

The oven may be cleaned in a traditional mode (using oven cleaners and sprays).

Otherwise respect the following cleaning tips: - Cool the oven completely before cleaning.

- The oven and the accessories must be cleaned after each use, otherwise stains might get burned in.

- Oven walls, sprayed with oil from roasting, is better clean with warm water and detergent when the oven is still tepid.

- Hard and heavily stained oven should be cleaned with special oven cleaning agents. Rinse the cleaner thoroughly and remove any detergent remaining before the next use.

- Never use aggressive cleaners, like polishing agents, dish cleaning accessories, corrosion inhibitors, or any other devices that might cause scratches.

- Coated, stainless steel or zinc-coated surfaces or aluminum parts must not come into contact with oven sprays, since they might cause damage or discoloration. The same goes for thermostat probe (if the cooker is equipped with it) and exposed heaters on the ove ceiling.

- When purchasing cleaning agents remember the environment, and strictly follow the manufacturer's instructions.

CLEANING AND MAINTENANCE

IMPORTANT: before carrying out any maintenance operations on the oven, disconnect the appliances from the main power.

The oven's side runners can be easily removed by disconnecting them from the peg in the bottom. To put them back in place, reverse this procedure.

Clean the side grids only with conventional detergents.

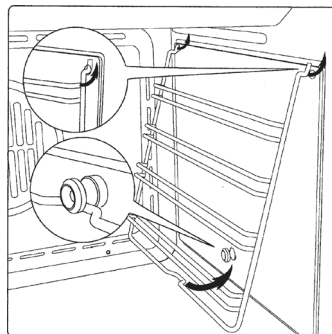

TECHNICAL DATA

Dimensions	
- height	mm 888
- width	mm 594
- depth	mm 550
- usable volume	58 + 32 liters

This appliance is manufactured in compliance with RF suppression standards.

- MODEL	Multifunction oven
- RATED VOLTAGE	230/240 - 400/415 V 3N
TOP oven	
	Nominal electrical input in W (tol. +5 /-10%)
- interior light	25 W
- tangential fan unit	20 W
- upper heating element	750 W
- grill element	1750 W
- lower heating element	850 W
- maximum electrical input	1795 W

MAIN oven (4F)	
	Nominal electrical input in W (tol. +5 /-10%)
- interior light	25 W
- radial fan unit	30 W
- tangential fan unit, large oven	10 W
- circular heating element	2300 W
- grill element	2000 W
- Maximum electrical input	2365 W
- Maximum overall electrical input	4250 W 230-240V / 3700 W 220V
- Power cable	HO5 RN- F 3 x 2,5 mm ² section
MAIN oven (7F)	
	Nominal electrical input in W (tol. +5 /-10%)
- interior light	25 W
- radial fan unit	30 W
- tangential fan unit, large oven	10 W
- circular heating element	2300 W
- middle grill	1200 W
- double grill	2200 W
- upper heating element	1000 W
- lower heating element	1100 W
- Maximum electrical input	2365 W
- Maximum overall electrical input	4250 W 230-240V / 3700 W 220V
- Power cable	HO5 RN- F 3 x 2,5 mm ² section
MAIN oven	
	Nominal electrical input in W (tol. +5 /-10%)
- interior light	25 W
- radial fan unit	30 W
- tangential fan unit, large oven	10 W
- circular heating element	2300 W
- middle grill	1200 W
- double grill	2200 W
- upper heating element	1000 W
- lower heating element	1100 W
- Maximum electrical input	3465 W
- Maximum overall electrical input	5350 W 230-240V / 4700 W 220V
- Power cable	HO5 RN- F 3 x 2,5 mm ² section

INTERIOR LIGHT: REPLACING THE LAMP

CAUTION: Disconnect the appliance from the power supply.

To replace the lamp of the oven interior light, first unscrew and remove the protective cover A.

Renew the lamp, and refit the cover A.

Max power 25 W.

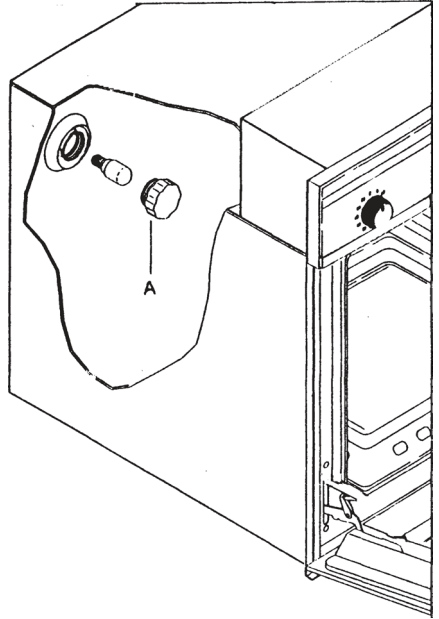

REMOVING THE OVEN DOOR

The door is easily removed, as follows:

- open the door completely;
- raise the two hinge levers as indicated in the drawing;
- close the door again until a click is produced by the levers raised previously;
- lift the door upward and away from the front of the oven to free it from the sockets;

To refit the door, locate the hinges in the sockets and return the two levers to the locking position.

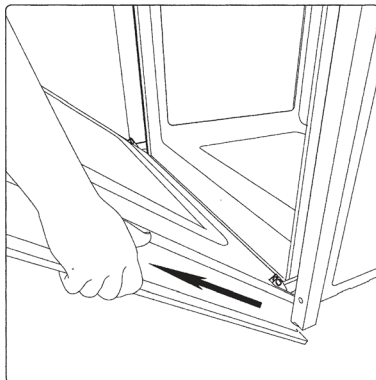
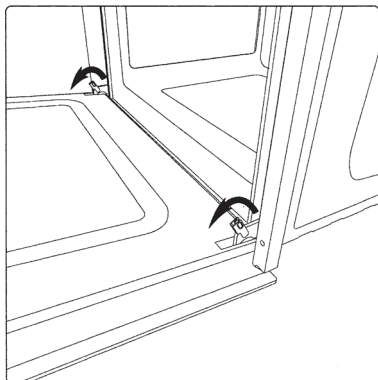

COD. 2.002.52.0