

# LiNX® Control System

REM400, Supplement to power wheelchair user manual

en **Remote  
User Manual**

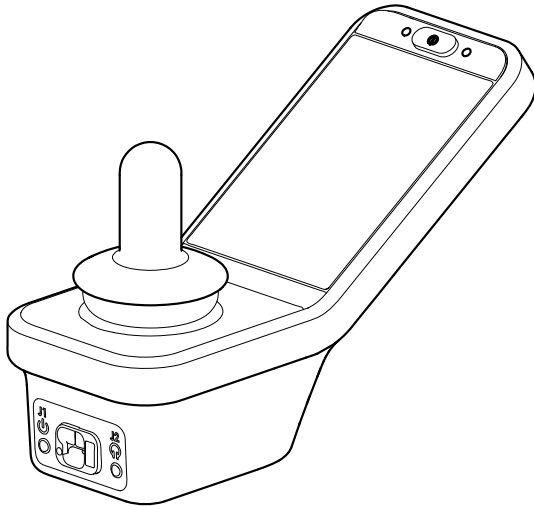

This manual **MUST** be given to the user of the product.  
**BEFORE** using this product, read this manual and save for future reference.



***Yes, you can.®***

© 2018 Invacare Corporation

All rights reserved. Republication, duplication or modification in whole or in part is prohibited without prior written permission from Invacare. Trademarks are identified by ™ and ®. All trademarks are owned by or licensed to Invacare Corporation or its subsidiaries unless otherwise noted.

Invacare reserves the right to alter product specifications without further notice.

Making Life's Experiences Possible is a registered trademark in the U.S.A.

LiNX is a registered trademark of Dynamic Controls.

Bluetooth is a registered trademark of Bluetooth SIG, Inc.

IOS is a trademark or registered trademark of Cisco in the U.S. and other countries and is used under license to Apple, Inc.

Android is a trademark of Google, LLC.

# Contents

<b>1 General</b>	<b>5</b>		
1.1 About This Manual	5		
1.2 Symbols	5		
1.3 Prescription Statement	5		
1.4 Intended Use	5		
1.4.1 Intended Use — REM400	6		
1.5 Indication for Use	6		
1.6 Service Life	6		
<b>2 Safety</b>	<b>7</b>		
2.1 General Guidelines	7		
2.1.1 Live Edit Guidelines	10		
2.1.2 Usage Guidelines	11		
2.1.3 Setup and Service Guidelines	12		
<b>3 Electromagnetic Compatibility (EMC) Information.</b>	<b>14</b>		
3.1 Electromagnetic Compatibility	14		
3.1.1 Minimizing Emissions	14		
<b>4 Components.</b>	<b>15</b>		
4.1 User interface REM400	15		
4.2 Screen composition overview	15		
4.2.1 Battery bar	16		
4.2.2 Status bar	16		
4.2.3 User function screen overview	17		
4.3 Navigation button	21		
4.4 Labels on the Product	22		
<b>5 Setup.</b>	<b>25</b>		
5.1 Connecting the remote	25		
<b>6 Usage</b>	<b>26</b>		
6.1 Operating the remote	26		
6.1.1 Controls on Menu Screen	27		
6.1.2 Settings on Menu Screen	27		
6.1.3 Configuring Menu Screen	30		
6.1.4 Locking Screen to Avoid Unintentional Response	31		
6.2 Navigating through user function screens	32		
6.2.1 Function Change Inhibits	32		
6.2.2 Using direct navigation	33		
6.2.3 Using indirect navigation	35		
6.2.4 Menu select	36		
6.2.5 Overview scan select	39		
6.2.6 Scan select	39		
6.3 Using the multipurpose buttons	42		
6.4 Using the Toggle Switches (Optional)	42		
6.5 Proportional driving mode	43		
6.5.1 Using the joystick	43		
6.5.2 Controlling the maximum speed	44		
6.6 Latched driving mode	45		
6.6.1 External stop switch	46		
6.6.2 1 Step Up	47		
6.6.3 3 Step Up	48		
6.6.4 5 Step Up	48		
6.6.5 3 Step Up/Down	49		
6.6.6 5 Step Up/Down	50		
6.6.7 Cruise Control	51		
6.7 Emergency stop	51		
6.8 Operating the position lights	52		
6.9 Operating the hazard lights	53		
6.10 Operating the turn signals	55		
6.11 Operating the horn	56		
6.12 Operating Lighting Functions and Horn via Utility Function Card	56		
6.13 Locking/unlocking the remote	57		
6.14 The sleep mode	58		
6.15 Operating powered seating functions	58		
6.15.1 Through seating screens	58		
6.15.2 Through external switches	61		
6.15.3 Speed reduction and seating function inhibits	66		
6.16 Connectivity screens	67		
6.16.1 Configuring Connectivity Card	67		

6.16.2	Mouse Mover	75	8.1.1	Fault codes and diagnosis codes	113
6.17	Switch Control	80	8.2	OON (“Out Of Neutral”)	114
6.17.1		80	8.3	Drive inhibit indication	115
6.17.2	Setting up switch control	81	<b>9</b>	<b>Technical Data</b>	<b>116</b>
6.17.3	Operating Switch Control	85	9.1	Technical specifications	116
6.18	Using secondary inputs	86	<b>10</b>	<b>Wireless Technology</b>	<b>117</b>
6.18.1	Using the Extremity Control Joystick (Chin control)	87	10.1	Wireless Technology Overview	117
6.18.2	Using the Extremity Control Joystick (Chin Control)	88	10.2	Intended Wireless (Electromagnetic) Environment	117
6.18.3	Using the Compact Single Switch Joystick	89	10.3	LiNX Wireless Functions	118
6.18.4	Using the Micro Extremity Control joystick	90	10.3.1	Mouse Mover	118
6.18.5	Using the Pediatric Compact Joystick	91	10.3.2	Remote Diagnostics	118
6.18.6	Using the Sip and Puff	93	10.3.3	Configuration	118
6.18.7	Using the Sip and Puff Head Array	95	10.4	Quality of Service	119
6.18.8	Using the Head Array	98	10.4.1	Data Integrity	119
6.18.9	Using the Four Switch Proximity Array	101	10.4.2	Safeguards and Redundancy	119
6.18.10	Using the Wireless Mouse Emulator	102	10.5	Wireless Coexistence	120
6.19	Disabling Bluetooth	105	10.6	Cybersecurity	120
6.20	Charging the batteries	105	10.6.1	Cybersecurity Controls	120
6.20.1	Battery alarms	106	10.6.2	User Actions	121
6.21	Using the USB charger	107	<b>11</b>	<b>Warranty</b>	<b>122</b>
<b>7</b>	<b>Maintenance</b>	<b>109</b>	11.1	Limited Warranty—US	122
7.1	Maintenance Information	109	11.2	Limited Warranty—Canada	122
7.2	Setup/Delivery Inspection	109	11.3	Repair or Replacement	122
7.3	Wear and Tear Information	109	11.4	Limitations and Exclusions	123
7.4	User/Attendant Inspection Checklists	110	11.5	Disclaimers	123
7.4.1	Inspect/Adjust Weekly	110			
7.4.2	Inspect/Adjust Monthly	110			
7.4.3	Inspect/Adjust Periodically	110			
7.5	Service Inspection	110			
7.5.1	Six Month Inspection	111			
7.6	Cleaning	111			
<b>8</b>	<b>Troubleshooting</b>	<b>113</b>			
8.1	Fault diagnosis	113			

# 1 General

## 1.1 About This Manual

This document is a supplement to the mobility device's documentation.

For more information about the product, for example product safety notices and product recalls, contact your local Invacare representative. Before reading this manual, make sure you have the latest version. You will find the latest version on the Invacare website. For the address and website see the back page of this manual.

## 1.2 Symbols

Signal symbols and/or words are used in this manual and apply to hazards or unsafe practices which could result in personal injury or property damage. See the information below for definitions of the signal words.



### **DANGER!**

– Danger indicates a imminently hazardous situation which, if not avoided, will result in death or serious injury.



### **WARNING!**

– Warning indicates a potentially hazardous situation which, if not avoided, could result in death or serious injury.



### **CAUTION!**

– Caution indicates a potentially hazardous situation which, if not avoided, may result in property damage or minor injury or both.



### **IMPORTANT**

– Indicates a hazardous situation that could result in damage to property if it is not avoided.



Gives useful tips, recommendations and information for efficient, trouble-free use.



This symbol identifies a list of various tools, components and items which you will need in order to carry out certain work.

## 1.3 Prescription Statement

Per 21 CFR 801.109(b)(1) the device is labeled for prescription use only.



### **CAUTION!**

Federal Law (USA) restricts this device to sale by or on the order of a licensed physician.

## 1.4 Intended Use



Refer to the user manual for the power wheelchair base and for the seating system for the intended use of the mobility device.

### **1.4.1 Intended Use — REM400**

The LiNX REM400 is a Remote of the LiNX family, intended to allow powered wheelchair users to interact with the LiNX System.

The REM400 Remote allows control of drive, actuator, lighting and connectivity functions. It provides an input for battery charging and contains a Bluetooth interface for connectivity functions only (HID and diagnostics). It is not possible to control the wheelchair via Bluetooth. The REM400 Remote allows the use of alternative drive input controls, such as head controls, and is capable of providing information about the active user input.

### **1.5 Indication for Use**

Refer to the user manual for the base and for the seat for the indication for use for the mobility device.

### **1.6 Service Life**

The expected service life is five years, presuming that the product is used daily and in accordance with safety instructions, maintenance instructions and intended use, stated in this manual.

## 2 Safety

### 2.1 General Guidelines



The safety section contains important information for the safe operation and use of this product.

Refer to the wheelchair base and seating system user manuals for additional safety and operation information.



#### **WARNING!**

##### **Risk of Death, Injury or Damage**

Improper use of this product may cause injury or damage

- If you are unable to understand the warnings, cautions or instructions, contact a health care professional or provider before attempting to use this equipment.
- DO NOT use this product or any available optional equipment without first completely reading and understanding these instructions and any additional instructional material such as user manual, service manuals or instruction sheets supplied with this product or optional equipment.



#### **WARNING!**

##### **Risk of Death, Injury or Damage**

Continued use of the product with damaged parts could lead to the product malfunctioning, causing injury to the user and/or caregiver.

- Check all product components and carton for damage and test components before use. In case of damage or if the product is not working properly, stop using the product and contact a qualified technician or Invacare for repair.



#### **WARNING!**

##### **Risk of Injury, Damage or Death**

Improper setup, service, adjustment or programming may cause injury, damage or death.

- Qualified technician MUST setup, service and program the wheelchair.
- DO NOT allow non-qualified individuals to perform any work or adjustments on the wheelchair.
- DO NOT setup or service the wheelchair while occupied except for programming or unless otherwise noted.
- Turn off power BEFORE adjusting or servicing the wheelchair. Note that some safety features will be disabled.
- Ensure all hardware is securely tightened after setup, service or adjustments.
- Warranty is void if non-qualified individuals perform any work on this product.



**DANGER!**

**Risk of Death, Serious Injury, or Damage**

Continued use of the wheelchair that is not set to the correct specifications may cause erratic behavior of the wheelchair resulting in death, serious injury, or damage.

- Performance adjustments should only be made by professionals of the healthcare field or persons fully conversant with this process and the driver's capabilities.
- After the wheelchair has been set up/adjusted, check to make sure that the wheelchair performs to the specifications entered during the set up procedure. If the wheelchair does not perform to specifications, turn the wheelchair Off immediately and reenter set up specifications. Contact Invacare, if wheelchair still does not perform to correct specifications.



**WARNING!**

**Risk of Injury or Damage**

Failure to remove the LiNX Access Key (LAK) from the wheelchair after programming is complete may lead to unauthorized access to the wheelchair settings.

- Always remove the LAK from the wheelchair when programming is complete.



**WARNING!**

**Risk of Serious Injury or Damage**

Use of unapproved accessories may result in serious injury or damage.

- Invacare products are specifically designed and manufactured for use in conjunction with approved Invacare accessories. Unapproved accessories have not been tested by Invacare and are not recommended for use with Invacare products.
- DO NOT use unapproved accessories.
- To obtain approved Invacare accessories, contact Invacare by phone or at [www.invacare.com](http://www.invacare.com).



**WARNING!**

**Risk of Serious Injury or Damage**

Loss of power due to loose electrical connections could cause the wheelchair to suddenly stop resulting in serious injury or damage.

- ALWAYS ensure that all electrical connections are tightly connected so they don't vibrate loose.



**WARNING!****Risk of Injury or Damage**

Connector pins on cables connected to the power module can still be live even when the system is off. Human contact or other materials may cause an electrical short. To prevent injury or damage due to electrical shorts:

- Cables with live pins should be connected, restrained or covered (with non-conductive materials) so they are not exposed to human contact or materials that could cause electrical shorts.
- When cables with live pins have to be disconnected, (for example, when removing the bus cable from the remote for safety reasons) make sure to restrain or cover the pins (with non-conductive materials).

**DANGER!****Risk of Death, Serious Injury, or Damage**

Corroded electrical components due to water, liquid exposure, or incontinent users can result in death, serious injury, or damage.

- Minimize exposure of electrical components to water and/or liquids. Electrical components damaged by corrosion **MUST** be replaced immediately.
- Wheelchairs that are used by incontinent users and/or are frequently exposed to water/liquids may require replacement of electrical components more frequently.

**DANGER!****Risk of Death, Serious Injury, or Damage**

Lighted cigarettes dropped onto an upholstered seating system can cause a fire resulting in death, serious injury, or damage.

Wheelchair occupants are at particular risk of death or serious injury from these fires and resulting fumes because they may not have the ability to move away from the wheelchair.

- **DO NOT** smoke while using this wheelchair.

**WARNING!****Risk of Injury, Damage or Death**

Improper routing of cable(s) may cause a tripping, entanglement or strangulation hazard that may result in injury, damage or death.

- Ensure all cable(s) are routed and secured properly.
- Ensure there are no loops of excess cable extending away from the chair.
- Close supervision and attention is needed when operating the wheelchair near children, pets or people with physical/mental disabilities.



**WARNING!**

**Risk of Injury, Damage or Death**

Pinched or severed cable(s) may be a shock or fire hazard and may cause injury, damage or death.

- Ensure all cable(s) are routed and secured properly.
- Inspect cable(s) periodically for proper routing, pinching, chafing or other similar wear.
- Replace any damaged cables immediately.



**Risk of damage to the mobility device**

There are no user-serviceable parts inside any case.

- Do not open or disassemble any case.



As a manufacturer of wheelchairs, Invacare endeavors to supply a wide variety of wheelchairs to meet many needs of the end user. However, final selection of the type of wheelchair to be used by an individual rests solely with the user and his/her healthcare professional capable of making such a selection. Invacare recommends working with a qualified rehab technology provider, such as an ATP, (Assistive Technology Professional).

The information contained in this document is subject to change without notice.

### 2.1.1 Live Edit Guidelines



**WARNING!**

**Risk of Injury or Damage**

Rapid and unfamiliar parameter changes may lead to injury or damage.

- Qualified technicians should make the user aware that in live edit mode, the performance of the wheelchair will be changed instantly.
- After programming in live edit mode, the wheelchair performance should be checked for driving safety. Ensure the wheelchair performance is appropriate to the capabilities and needs of the user.
- Users should use caution when driving the wheelchair while operating in Live Edit mode.
- Users should use care to stay in the programming range.
- Always perform live edit changes in a safe environment.



Live edit adjustments are best done in an unrestricted but safe area. The presence of an attendant is recommended.

The Bluetooth® range of the programmer is 33 ft (10 m). If the wheelchair drives out of range of the Bluetooth programmer, the programmer must reconnect before the parameters can be changed.

## 2.1.2 Usage Guidelines



### **DANGER!**

#### **Risk of Death, Serious Injury, or Damage**

Misuse of the wheelchair may cause component failure and/or the wheelchair to start smoking, sparking, or burning. Death, serious injury, or damage may occur due to fire.

- DO NOT use the wheelchair other than its intended purpose. If the wheelchair starts smoking, sparking, or burning, discontinue using the wheelchair and seek service IMMEDIATELY.



### **WARNING!**

#### **Risk of Injury, Damage or Death**

Misuse of wheelchair may result in injury, damage or death.

- Use care when operating the wheelchair on roads, streets or other roadways.
- Use care when operating the wheelchair when vision is impaired by poor lighting such as unlit rooms, during the night or similar situations.
- ALWAYS be aware of motor vehicles and your surroundings.



### **WARNING!**

#### **Risk of Injury, Damage or Death**

Use of the wheelchair while judgement or ability is impaired may result in injury, damage or death.

- DO NOT operate the wheelchair under the influence of alcohol, medications or other substances that impair judgement or function.
- Changing medications may affect your ability to operate the wheelchair. Discuss the impact on your ability to operate the wheelchair with a health care professional when changing medications.
- DO NOT operate the wheelchair under conditions where judgement or function may be impaired. This may include but is not limited to lack of sleep or poor sight.
- Always be aware of your surroundings.



### **WARNING!**

#### **Risk of Injury, Damage or Death**

Loss of traction or stability on rough or unstable terrain may cause injury, damage or death.

- Use care when operating the wheelchair on rough or unstable terrain. This would include but is not limited to areas of rock, mulch, mud, uneven pavement, roots and similar conditions.
- Be aware of your surroundings and conditions that might affect the ability to operate the wheelchair.



**WARNING!**

**Risk of Serious Injury**

Impacting objects in the surrounding environment can cause serious injury.

- When maneuvering the wheelchair around, ALWAYS have assured cleared distance with all objects in environment.



**CAUTION!**

**Risk of Injury**

Remote module can get hot when exposed to strong sunlight for long periods.

- Do not leave mobility device in direct sunlight for long periods.



**DANGER!**

**Risk of Death, Serious Injury, or Damage**

Malfunctioning joystick could cause unintended/erratic movement resulting in death, serious injury, or damage.

- If unintended/erratic movement occurs, stop using the wheelchair immediately and contact a qualified technician.

### 2.1.3 Setup and Service Guidelines



**DANGER!**

**Risk of Death, Serious Injury, or Damage**

Use of incorrect or improper replacement (service) parts may cause death, serious injury, or damage.

- Replacement parts MUST match original Invacare parts.
- ALWAYS provide the wheelchair serial number to assist in ordering the correct replacement parts.



**WARNING!**

**Risk of Serious Injury**

Sharp edges can cause serious injury.

- Be mindful that some parts may have sharp edges. Use caution when encountering these sharp edges.



**WARNING!**

**Risk of Serious Injury**

Hot surfaces can cause severe burns.

- Be mindful of potential hot surfaces and avoid touching.

**WARNING!****Risk of Death, Serious Injury, or Damage**

Improperly connected joystick could cause loss of power resulting in death, serious injury, or damage.

- Ensure the joystick is securely connected to controller.

**CAUTION!****Risk of Damage**

Operating the wheelchair in rain or dampness may cause the wheelchair to malfunction electrically and mechanically; may cause the wheelchair to prematurely rust or may damage the upholstery.

- DO NOT leave the wheelchair in a rain storm of any kind.
- DO NOT use the wheelchair in a shower.
- DO NOT leave the wheelchair in a damp area for any length of time.
- Check to ensure that the battery covers are secured in place, joystick boot is NOT torn or cracked where water can enter and that all electrical connections are secure at all times. DO NOT use if the joystick boot is torn or cracked. If the joystick boot becomes torn or cracked, replace IMMEDIATELY.

---

## 3 Electromagnetic Compatibility (EMC) Information

---

### 3.1 Electromagnetic Compatibility



Refer to the power wheelchair base and seating system user manuals for more electromagnetic compatibility information for your mobility device.

Dynamic Controls Electronic Controllers have been tested on typical, representative vehicles to confirm compliance with the following appropriate EMC standards:

- USA: ANSI/RESNA WC-2:2009 Sec 21
- Europe: EN12184:2014, ISO7176 - 21:2009

National and international directives require confirmation of compliance on particular vehicles. Since EMC is dependent on a particular installation, each variation must be tested. The guidelines in this section are written to assist with meeting EMC requirements in general.

#### 3.1.1 Minimizing Emissions

To minimise emissions and to maximise the immunity to radiated fields and ESD, follow the wiring recommendations in the LiNX System Service Manual.

## 4 Components

### 4.1 User interface REM400

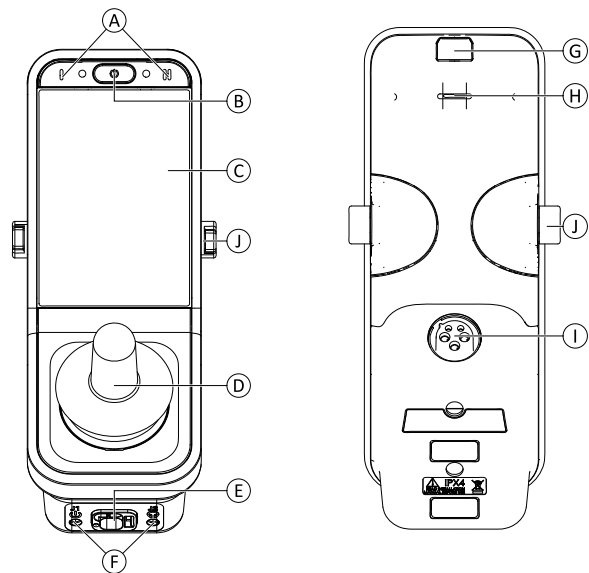

- Ⓐ Multipurpose buttons
- Ⓑ ON/OFF button/Status LED
- Ⓒ Touch display
- Ⓓ Joystick

- Ⓔ Bus socket
- Ⓕ Stereo jack sockets
- Ⓖ Infrared transmitter
- Ⓗ Speaker
- Ⓘ Charger socket
- ⓵ Toggle switches



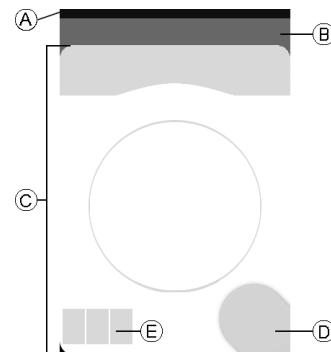

### 4.2 Screen composition overview



- Ⓐ Battery bar
- Ⓑ Status bar
- Ⓒ User function screen
- Ⓓ Navigation button

### 4.2.1 Battery bar

The battery bar provides a graphical display of the battery's current state of charge and, when a battery charger is connected, the charging status.

	Battery bar displays green when state of charge is between 60 and 100%.
	Battery bar displays orange when state of charge is between 20 and 59%.
	Battery bar displays red when state of charge is less than 20%.
	Charging.

### 4.2.2 Status bar

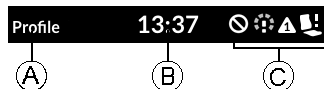

- Ⓐ Profile name
- Ⓑ Time
- Ⓒ Status information

#### Profile name



The profile name can only be set by the provider.

### Time



The time is displayed as a 12- or 24-hour clock. It is set using the coordinated universal time (UTC) and an offset based on the location (country) of the user. The UTC is automatically acquired when a system is connected to a programming and diagnostic tool. The country-based offset is set through the remote module's status screen, for more information refer to *6.1.3 Configuring Menu Screen, page 30*.

### Status information

The status information displays the current state of the LiNX system with status icons.

	This notifies you that a drive lock-out is active. A drive lock-out is a state that prevents the wheelchair being driven. Refer to <i>6.15.3 Speed reduction and seating function inhibits, page 66</i> , for more information about lock-outs and slow-downs.
	This notifies you that a drive slow-down is active. A drive slow-down is a state that prevents the wheelchair being driven at the standard speed for safety reasons. Instead, the wheelchair is allowed to drive at a reduced speed for the duration of the active drive slow-down. Refer to <i>6.15.3 Speed reduction and seating function inhibits, page 66</i> , for more information about lock-outs and slow-downs.



	<p>This notifies you that a fault occurred. The number indicates the type of fault. Refer to <i>8.1.1 Fault codes and diagnosis codes, page 113</i> for more information about fault codes.</p>
	<p>This notifies you that a seating lock-out is active. A seating lock-out is a state that prevents the wheelchair's seating being operated. Refer to <i>6.15.3 Speed reduction and seating function inhibits, page 66</i>, for more information about lock-outs and slow-downs.</p>
	<p>This notifies you that Bluetooth connectivity is disabled. Refer to <i>6.19 Disabling Bluetooth, page 105</i> for more information about disabling Bluetooth.</p>

Three battery alarms are shown on the right-hand side of the status bar, for more information refer to *6.20.1 Battery alarms, page 106*

### 4.2.3 User function screen overview

#### Left- or right-handed

With the LiNX system, it is possible, to adjust the function screens for left-handed or right-handed users.

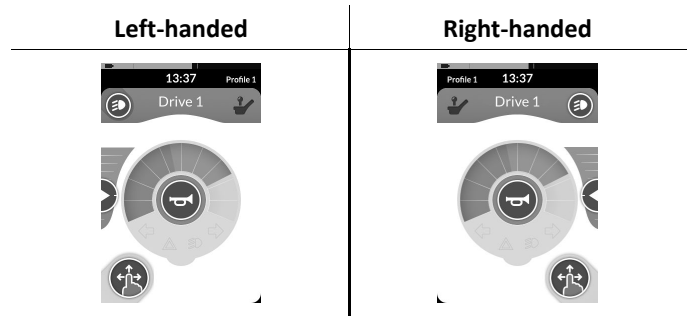

 Be aware, that in the following manual right-handed function screens are displayed only. All buttons have the same functions for right- and left-handed, so the descriptions can be used for left-handed users, too.

#### Function screen header

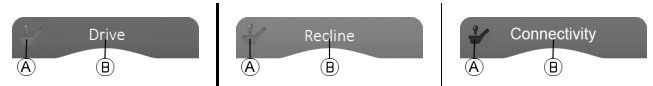







The function screen type is identified by the color of the function screen's header:

- green indicates a drive screen,
- orange indicates a seating screen and
- blue indicates a connectivity screen.
- purple indicates a utility screen.

The icon  indicates the type of primary input.

The text  is programmable by your provider and can be used to name the function.

Indicator	Meaning
	REM400 REM500
	REM2xx
	ACU
	CREM CREM-LF
	Head Array
	Sip and Puff
	User switch



## Drive screen



Drive screens can be pre-set with different maximum speeds to fit your needs and your environment. For example a drive screen with pre-set lower maximum speed can be used for indoors and a drive screen with pre-set total maximum speed for outdoors. In addition to that you can also control the pre-set maximum speed, refer to *6.5.2 Controlling the maximum speed, page 44*.

With a drive screen you are also able to sound the horn and to operate the lighting functions. Refer to *6.11 Operating the horn, page 56* and to *6.8 Operating the position lights, page 52*.

The function information displays either the latched driving mode, refer to *6.6 Latched driving mode, page 45* or the Gyro indication, see table below.

no symbol	No Gyro is connected to the system or enabled for drive function.
	Gyro disabled.
	Gyro enabled.

**Seating screen**



Seating screens are for operating the seating functions, refer to chapter 6.15.1 *Through seating screens*, page 58.

**Connectivity screen**



Connectivity screens allow you to communicate with external devices. The connectivity function included on your remote is a mouse mover. The mouse mover allows you to control the cursor on a PC or laptop's screen with a user input on the wheelchair, such as the joystick on the remote module or buttons connected via control inputs. For more information about Connectivity screens and how to use them, refer to chapter 6.16 *Connectivity screens*, page 67.

## Utility Screen



Fig. 4-1 Example of a three-quadrant (3Q) navigation utility screen



Fig. 4-2 Example of a four-quadrant (4Q) navigation utility screen

Utility screen allows you to operate system controls (such as lighting functions and horn) as well as control outputs with external inputs. The utility screen function is suitable for both three-quadrant (3Q) and four-quadrant (4Q) inputs.

Utility screen allows you to operate two controls / outputs per quadrant, according to the duration that the user input is activated:

- Ⓐ Short press / Momentary press, and
- Ⓑ Long press.

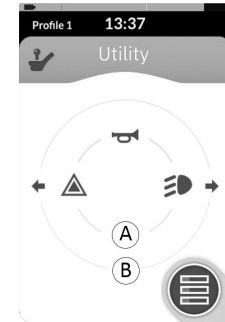

Fig. 4-3

By default, this function is only enabled for chair configurations with an external control input that will not allow the control of horn or lights. Contact your provider to change the configuration and to set up your desired operations.

For an example how to use an utility screen in daily use, see 6.12 *Operating Lighting Functions and Horn via Utility Function Card*, page 56.

## Arrangement

		Function screens					
		F1	F2	F3	F4	F5	F6
Pro- files	P1						
	P2						
	P3						
	P4						

User function screens are arranged in rows of profiles. Each profile can hold user function screens, which can be of the same type, for example all drive screens, or can be a mixture of drive, seating and connectivity screens.

The maximum number of function screens across all profiles is 40. In a configuration with five profiles, for example, each profile can hold up to eight function screens.

### 4.3 Navigation button

Depending on the configuration of the remote module and the user's needs, the navigation button is displayed bottom-left or bottom-right on the screen.

When activated, the navigation button changes its color from grey to blue.

The navigation button has two important functions:

1. A visual indication of the configured interaction mode.



Configured for swipe-and-tap actions

This means, that swiping and tapping the screen activates different functions.



Configured for tap actions

This means, that only tapping the screen activates different functions. Swipe inputs are ignored.



For more information about changing the interaction mode, refer to [6.1.3 Configuring Menu Screen, page 30](#).

2. A navigation function depending on context and activation duration. For example, a short press on the navigation button, while viewing an active user function screen, opens the screen preview display, refer to [6.2 Navigating through user function screens, page 32](#). A long press opens the status screen, refer to [6.1.3 Configuring Menu Screen, page 30](#).

Additional to the touch display, external inputs can be used to interact with the system, refer to [6.18 Using secondary inputs, page 86](#).

## 4.4 Labels on the Product

### Labels on Dynamic Controls' Parts

Labels of Dynamic Controls' parts are located on rear side of the part. Depending on the part not all labels are available.

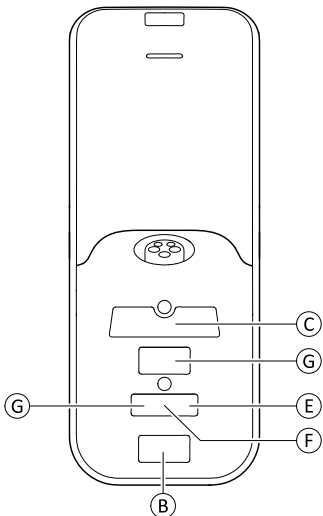

Fig. 4-4 Rear side of DLX-REM400

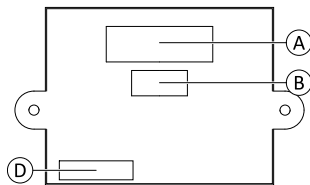



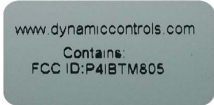

Fig. 4-5 Rear side of DLX-IN500 input module

<p>(A)</p>	<p>A photograph of a product label for DLX-REM400. The label contains a barcode, the text 'Read Installation Manual Before Use', 'DLX-REM400-A', 'LiNX® DLX-REM400', 'dynamic', 'www.dynamiccontrols.com', 'IPX4', and 'S/N: 1115119'. Eight callouts (1-8) point to specific features: 1 points to the part number, 2 to the logo, 3 to the part description, 4 to the website address, 5 to the serial number, 6 to the warning, 7 to the IPX4 rating, and 8 to the WEEE symbol.</p>	<p>Product label containing:</p> <ol style="list-style-type: none"> <li>1. Part number</li> <li>2. Dynamic Controls logo</li> <li>3. Dynamic Controls' part description</li> <li>4. Dynamic Controls' website address</li> <li>5. Serial number</li> <li>6. Warning to read manual before use</li> <li>7. Ingress protection rating</li> <li>8. WEEE symbol</li> </ol>
<p>(B)</p>	<p>A photograph of a hardware and application firmware version label. It contains the text 'H02.009' and 'S00.003'. Six callouts (1-6) point to specific parts: 1 points to the hardware version, 2 to the hardware major version, 3 to the hardware minor version, 4 to the application version, 5 to the application major version, and 6 to the application minor version.</p>	<p>Hardware and application firmware version label:</p> <ol style="list-style-type: none"> <li>1. Hardware version</li> <li>2. Hardware major version</li> <li>3. Hardware minor version</li> <li>4. Application version</li> <li>5. Application major version</li> <li>6. Application minor version</li> </ol>
<p>(C)</p>	<p>A photograph of a product label for DLX-REM050-A. It contains a barcode, the text 'S/N: A1417743', and 'DLX-REM050-A'. Four callouts (1-4) point to specific features: 1 to the logo, 2 to the barcode, 3 to the serial number, and 4 to the part number.</p>	<p>Product label containing:</p> <ul style="list-style-type: none"> <li>• Dynamic Controls' logo</li> <li>• The product's bar code</li> <li>• The product's serial number</li> <li>• The product's part number</li> </ul>

D		Tamper evident seal.
E		<p>This is the WEEE symbol (Waste Electrical and Electronic Equipment Directive).</p> <p>This product has been supplied from an environmentally aware manufacturer. This product may contain substances that could be harmful to the environment if disposed of in places (landfills) that are not appropriate according to legislation.</p> <ul style="list-style-type: none"> <li>• The ‘crossed out wheeie bin’ symbol is placed on this product to encourage you to recycle wherever possible.</li> <li>• Please be environmentally responsible and recycle this product through your recycling facility at its end of life.</li> </ul>
F	IPX4	This is the enclosure's ingress protection rating.

G	 <p>READ INSTALLATION MANUAL BEFORE USE</p>	Recommendation to read the instruction manual before using the module.
H		<p>Product label containing:</p> <ul style="list-style-type: none"> <li>• Dynamic Controls' website address</li> <li>• Dynamic Controls' Bluetooth registration</li> </ul>

**Serial number and date of manufacture**

The serial number on a Dynamic Controls product provides both the date of manufacture as well as a unique serial number for the particular module.

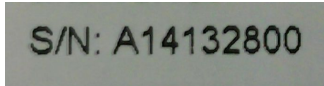

The format, as shown above, is **MYynn timer**, where:

- **M** is for the month of manufacture, using the letters A to L (A = Jan, B = Feb, C = Mar, etc.),
- **YY** is the year of manufacture,
- **nnnnnn** is a unique six digit sequential number.

For example, the remote's serial number, as shown above, begins with A14 indicating that it was manufactured in January 2014, and its unique, sequential value is 132800.

### Labels on Toggle Switches

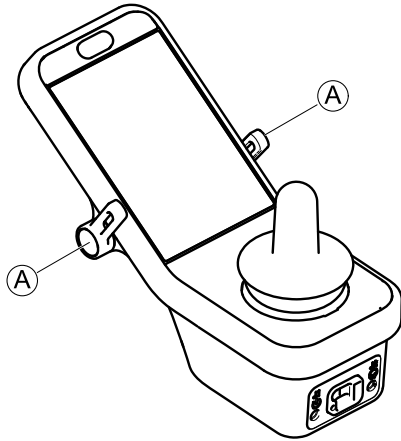

Fig. 4-6

(A)		Power
		Speed pot left
		Speed pot right
		Function and profile
		Seating

### Labels on Adaptive Switch Labs' Parts

Labels of Adaptive Switch Labs' parts are located on either on left rear side of the part (head arrays) or the interface box. Depending on the used part not all labels are available.

	<p>Product label (head array) containing:</p> <ul style="list-style-type: none"> <li>• (A): Adaptive Switch Labs' logo</li> <li>• (B): Serial number</li> </ul>
	<p>Product label (interface boxes) containing:</p> <ul style="list-style-type: none"> <li>• (A): Model number</li> <li>• (B): Serial number</li> <li>• (C): Adaptive Switch Labs' logo</li> <li>• (D): Adaptive Switch Labs' contact information</li> </ul>
<div style="border: 1px solid black; padding: 5px; width: fit-content; margin: auto;"> <p>Contains FCC ID: A8TBM71S2                      This device complies with Part 15 of the FCC Rules.                      Operation is subject to the following 2 conditions:                      (1) this device must accept any interference received.                      (2) this device must accept any interferences that may cause undesired operation.</p> </div>	<p>Product label containing:</p> <ul style="list-style-type: none"> <li>• Adaptive Switch Labs' Bluetooth registration</li> <li>• Information about conditions</li> </ul>



---

## 5 Setup

---

### 5.1 Connecting the remote

**CAUTION!****Risk of unintended stops**

If the plug of the remote cable is broken, the remote cable may come loose while driving. The remote could suddenly switch off when losing power. This results in an unintended stop.

- Always check the plug of the remote for damage. Contact your provider immediately in case of a damaged plug.

**Risk of damage to the remote**

The remote plug and connector socket fit together in one way only.

- Do not force them together.

1. Lightly push to connect the plug of the remote cable and the connector socket. The plug must lock in place with an audible click.

## 6 Usage

### 6.1 Operating the remote

#### Powering up the remote

1.

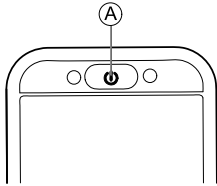

Press ON/OFF key (A).



Start screen lights up.

The status LED inside the ON/OFF button lights up green, if no fault is present at power up. After a few seconds display is ready to use.

If there is a fault with the system when powering up, the status LED indicates the fault with a series of red flashes, also a fault icon is displayed in the status bar. For more information about fault indication, refer to *8.1.1 Fault codes and diagnosis codes, page 113*

#### Powering down the remote

1. Press ON/OFF key (A).



Shut down screen is displayed.

After a few seconds the remote is powered down.

#### Attendant in charge

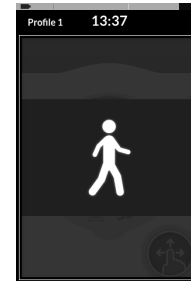

If your wheelchair is fitted with an attendant control (ACU) and the attendant control is in charge, an attendant-in-charge-overlay is displayed.

Also the status LED inside the ON/OFF button of the primary remote is turned off.

1. Press ON/OFF button of primary remote to take over control.

Attendant control powers down automatically.





 For more information about using the attendant control, refer to the manual of the attendant control.

### 6.1.1 Controls on Menu Screen

#### Buttons

Buttons are used to perform an action, such as  to close the screen.

Currently we use the following buttons on our remotes:

Symbol	Action
	Close screen
	Go back to previous screen
	Open next screen/level. It appears only if a menu entry permit further settings.
	Increase or decrease the value of hour or minute on clock

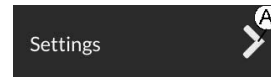



Fig. 6-1 Example of a button

1. Tap on button  to perform the action.

#### Switches

Switches are used to change between two different states, such as **ON** and **OFF**. The current state is visible on screen.



Fig. 6-2 Example of a switch

1. Tap on switch  to change the state.

#### Sliders

Sliders are used to change value of a setting continuously.

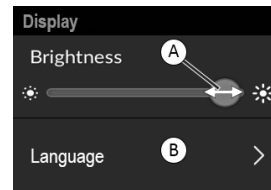



Fig. 6-3 Example of a slider

1. Tap and hold circle  within the slider.
2. Swipe circle to the right to increase the value. Swipe circle to the left to decrease the value.

### 6.1.2 Settings on Menu Screen

The remote can be configured from Menu screen. Menu screen offers different settings.

## Menu Screen

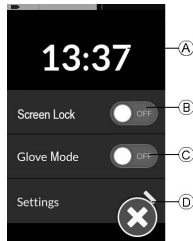

Fig. 6-4

	Entry	Function
Ⓐ	Clock	View and edit time.
Ⓑ	Screen Lock	Activate screen lock.
Ⓒ	Glove Mode	Activate Glove Mode. Touch screen becomes more sensitive, allowing to interact with screen while wearing gloves.
Ⓓ	Settings	Open settings menu

## Settings Menu

Settings menu allows you to change settings in three different categories:

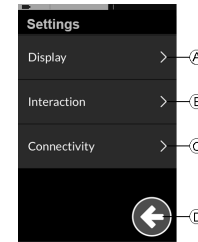

Fig. 6-5

	Entry	Function
Ⓐ	Display	Open display settings
Ⓑ	Interaction	Open interaction settings
Ⓒ	Connectivity	Open connectivity settings
Ⓓ	Back	Go back to the previous level

## Display

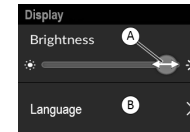

Fig. 6-6

	Entry	Function
Ⓐ	Brightness	Decrease or increase screen brightness
Ⓑ	Language	Change user interface of Menu screen to selected language

## Interaction

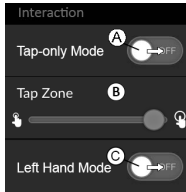



Fig. 6-7

	Entry	Function
Ⓐ	Tap-Only Mode	Toggle between tap mode and swipe-and-tap mode
Ⓑ	Tap Zone	<p>Defines the area used for detecting a tap action on touch screen. It sets the area around the point of initial contact, within a tap is recognized. Outside this area, further, continuous contact will be considered as a drag/swipe.</p> <p>Recommendation:</p> <ul style="list-style-type: none"> <li>• Good dexterity → Low value (small tap zone)</li> <li>• Poor dexterity → High value (large tap zone)</li> </ul> <p> This parameter does not change the area around fixed inputs (buttons, links, etc.). It is solely for the area around the first point of contact when tapping or swiping.</p>

	Entry	Function
Ⓒ	Left Hand Mode	<p>Toggle between right-hand and left-hand usage of remote.</p> <p>When the switch is set to ON, all user controls (navigation button, speed slider, lighting controls etc) are displayed and operable from the left-hand side of the screen.</p>

## Connectivity

For more information about connectivity settings, see 6.16.1 *Configuring Connectivity Card, page 67.*

### 6.1.3 Configuring Menu Screen

#### Opening Menu Screen

1.

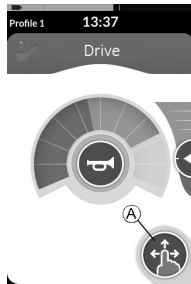

Fig. 6-8

Tap and hold navigation button **A** until Menu screen appears.

#### Closing Menu Screen

1.

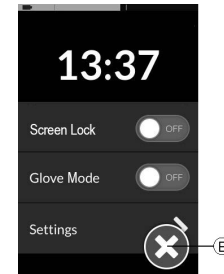

Fig. 6-9

Tap on button **E** to close Menu screen.

#### Changing Time

1. Tap on clock to edit time.

In Time Edit mode, clock displays time picker where hour and minute values can be changed independently.

2.

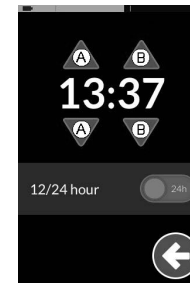

Fig. 6-10

Tap on arrows **A** to adjust hour value or **B** to adjust minute value.

3.

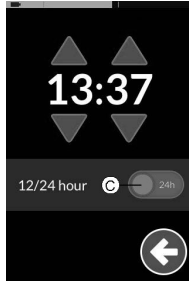

Fig. 6-11

If necessary, tap switch © to toggle between 12- and 24-hour clock.

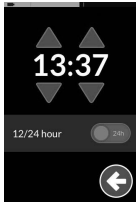

Fig. 6-12 24-hour clock

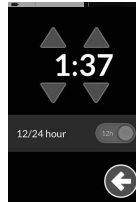

Fig. 6-13 12-hour clock

4.

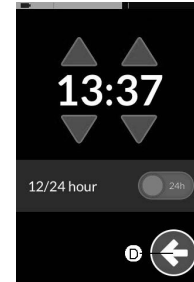

Fig. 6-14

Tap on button © to return to Menu screen.

#### 6.1.4 Locking Screen to Avoid Unintentional Response

The screen lock is a security feature that the user can activate to prevent other people accidentally or intentionally interfering with the touch screen. It also prevents any unintentional response caused by rain or other liquids that may land on the touch screen.

When the screen lock is activated, the screen continues to display normally but it does not respond to any swipe or tap action.

1.

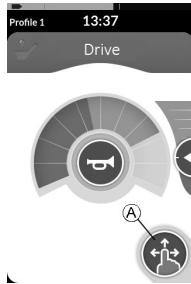

Fig. 6-15

Tap and hold navigation button (A) to open Menu screen.

2.



Fig. 6-16

Tap on Screen Lock switch (A) to lock screen.

3.

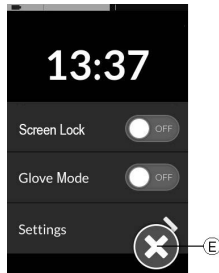

Fig. 6-17

Tap on button (E) to close Menu screen.

Screen lock is activated.



Turn remote off and on (power-cycle) to deactivate screen lock.



Keep the touch screen dry to ensure proper response during use.

## 6.2 Navigating through user function screens

How to navigate through user function screens depends on how the navigation button is configured. Refer to 4.3 *Navigation button*, page 21, for more information about the possible configurations.

You can locate and select a function screen by navigating through the programmed profiles and functions. There are a number of navigation methods that can be used, depending on your needs and abilities. These methods fall into two groups:

- direct navigation and
- indirect navigation.

### 6.2.1 Function Change Inhibits

Function change blocked is a safety feature that prevents accidental driving or seating movements, when:

- a function change should be carried out during the user performs an action on the active function.





Fig. 6-18

The user must finish his current action to change the function. Otherwise a function change blocked overlay is displayed.

### 6.2.2 Using direct navigation

You navigate profiles and functions by moving from an active function screen to an adjacent function screen. The function screen becomes active immediately.



Direct navigation is not performed with an active user input (e.g. remote), since the active user input is used to operate the active function screen only (e.g. moving the remote to drive). Instead, the user navigates through the profiles and functions using the touch screen or other control inputs.

#### Using swipe-and-tap mode

#### Changing function screens

- Swipe over screen or tap navigation button to open screen preview display.
- Swipe left or right to change function screens.
- Tap on selected function screen, tap navigation button or wait for a few seconds to activate selected function screen.

#### Changing profiles

- Profile 1

Profile 2

Profile 3



Swipe up or down to activate another profile.  
The screen view focuses on the first function screen or the last-used function screen in the profile, depending on how the programming is set up.

2. Swipe left or right to change function screens.
3. Tap on selected function screen, tap navigation button or wait for a few seconds to activate selected function screen.

### Using tap mode

#### Changing function screens



1. Tap on navigation button (short press) to open screen preview display.



2. Tap to left or right of screen that is in the middle of display to change function screens.

3. Tap on selected function screen, tap navigation button or wait for a few seconds to activate selected function screen.

### Changing profiles

- 1.



Tap above or below function screen that is in the middle of display to activate another profile.

The screen view focuses on the first function screen or the last-used function screen in the profile depending on how the programming is set up.

2. Tap on navigation button or wait for a few seconds to activate selected function screen.

1. Short press to change function screen.
2. Long press to change profile.

No screen preview is displayed. The function screens change and become active immediately.

### Using control input (CI)

A control input can be any external switch, for example, an egg switch or a lip switch at a Sip and Puff Array.

#### 6.2.3 Using indirect navigation

Indirect navigation is the ability to navigate through different profiles and function screens, independently from the touch display, with the help of the active user input (for example, a head array).

By default, the indirect navigation is disabled. Contact your provider, if indirect navigation should be enabled.

Similar to the drive function, there is a difference between a three-quadrant (3Q) and a four-quadrant (4Q) operation.

User input type	Mapping for menu select	Mapping for scan select
4Q: <ul style="list-style-type: none"> <li>• Joystick</li> <li>• Sip and Puff</li> <li>• Sip and Puff Head Array</li> </ul>	Left input: previous menu Right input: select Reverse input: next item in menu Forward input: previous item in menu	Left input: select Right input: select Reverse input: select Forward input: select
3Q: <ul style="list-style-type: none"> <li>• Head Array</li> <li>• Four Switch Proximity Array</li> </ul>	Left input: select Right input: next item in menu Reverse input: disabled Forward input (Four Switch Proximity Array only): disabled	Left input: select Right input: select Reverse input: disabled Forward input (Four Switch Proximity Array only): disabled

## 6.2.4 Menu select

With menu select, you perform both, the navigation and the function screen selection.

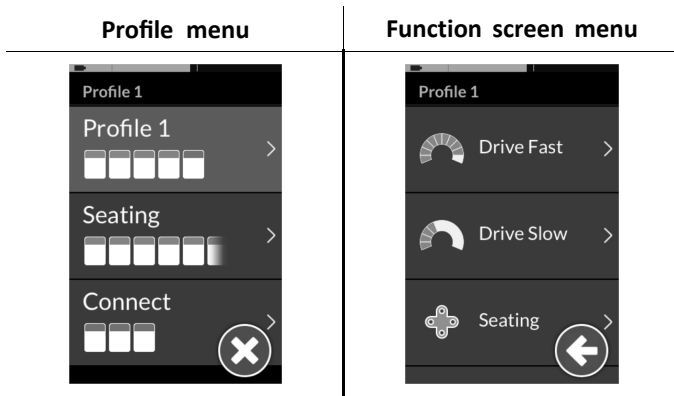

To navigate the menus with menu select, you select a profile from the profile menu and then select a function screen from the function screen menu. Before making a selection, you are free to move within the menus and free to move between the menus (profile to function screen and vice versa) as necessary.

### Navigation entry

By default the indirect navigation is started via an external switch, for example, an egg switch.

The indirect navigation can be started without an external switch, via **Stand by select**, which must be enabled by your provider. This means that the indirect navigation starts

automatically after a period of time without user activity. This period can be set by your provider.

There are two different ways, the indirect navigation is entered:

- If the Navigation entry is set to **First Profile**, the menu selection starts at the first profile in the profile menu. You select a profile, before moving into the selected profile's function screen menu. You can then either select a function screen from the function screen menu or return to the profile menu to select a different profile.
- If Navigation entry is set to **Active User Function**, the menu selection starts at the currently selected function screen in the function screen menu. From here you can choose to navigate the function screen menu, select a function screen or move up into the profile menu and select a different profile.

## Menu select with 4Q operation

1. Press external switch.  
Profile menu opens.
- 2.

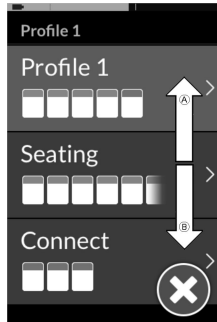

Give forward input **A** or reverse input **B** to switch between profiles.

3.

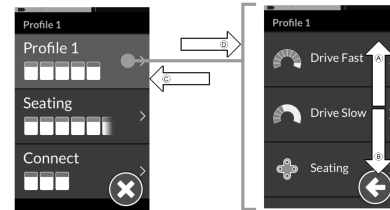

Give right input **D** to select profile.

Function screen menu opens.

Give forward input **A** or reverse input **B** to switch between function screens.

Give left input **C** to switch back to previous menu.

4.

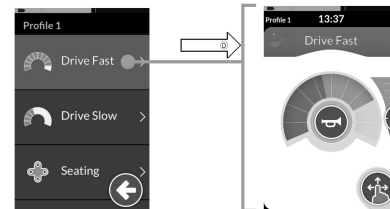

Give right input **D** to select function screen.

## Menu select with 3Q operation

1. Press external switch.  
Next function screen is displayed.
2. Press external switch again to switch through all function screens in the profile.  
As soon as all function screens are switched through, profile menu opens.

3.

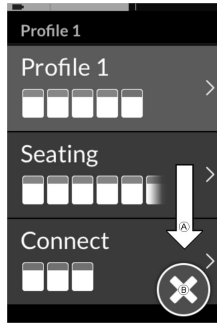

Give right input Ⓐ to change profile.

4. To close profile menu, give right input until Close button Ⓑ is selected.

Give left input to close profile menu.

5.

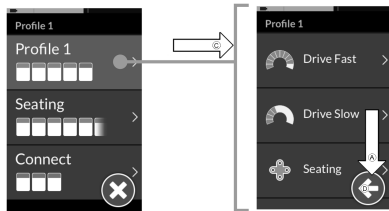

Give left input Ⓒ to select profile.

Give right input Ⓐ to change function screen.

6. To go back to profile menu, give right input until Back button Ⓓ is selected.

Give left input to go back to profile menu.

7.

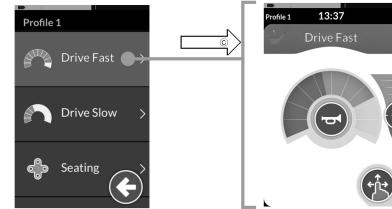

Give left input Ⓒ to select function screen.

## 6.2.5 Overview scan select

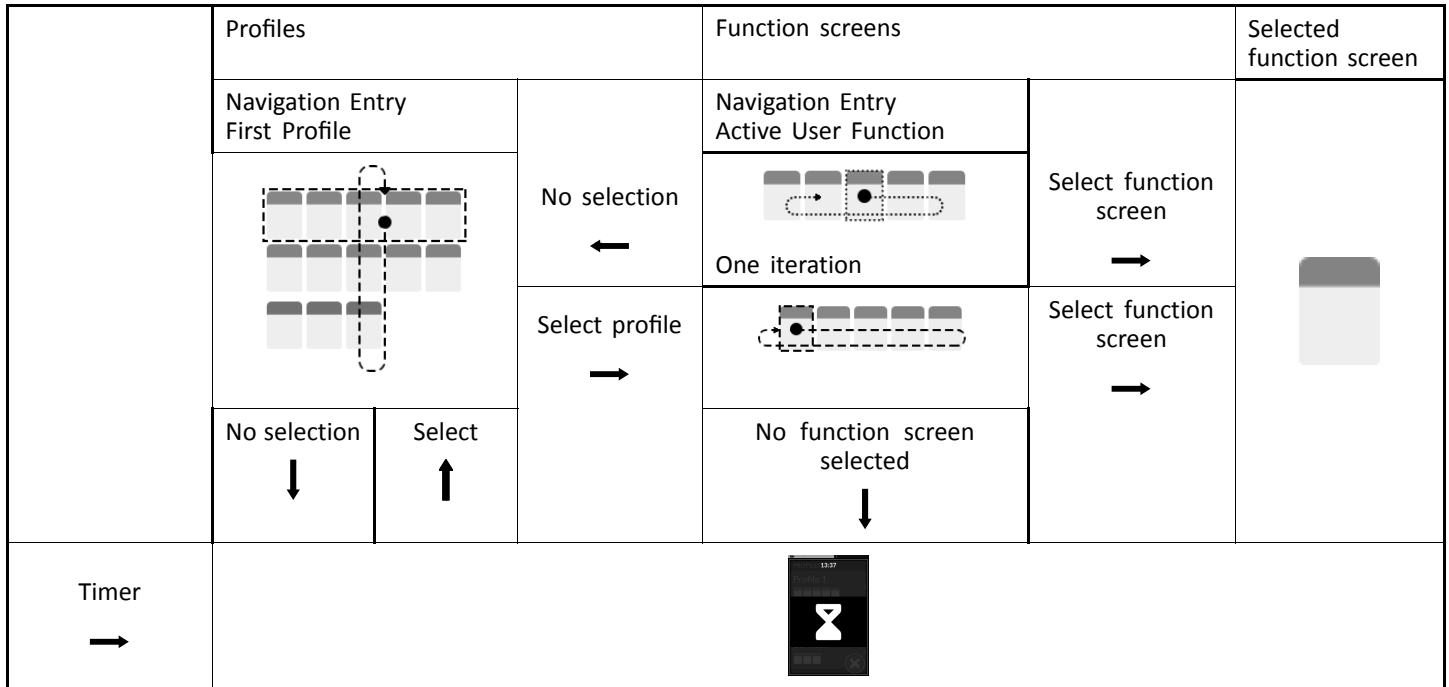

## 6.2.6 Scan select

With scan select, the system performs the navigation and you select the function screen. Scan select provides you with a semi-automated process for navigating through the profiles and function screen menus by displaying you one menu item (or navigation control) at a time.

For each menu item displayed, you can choose to select it

or ignore it. If ignored, the next menu item is displayed on the touch screen after a small period of time. The period is set by the provider.

## Function screen menu

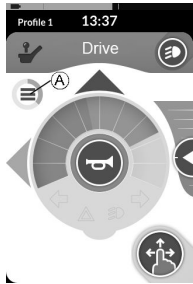

The period of time before the next item is displayed, is shown by an indicator ring (A) or an indicator bar (B).

## Profile menu

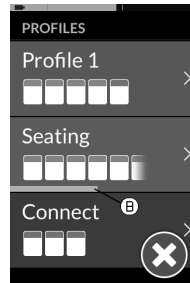

you must provide a select command. The profile menu is always entered when exiting the idle state.

### Navigation entry

By default the indirect navigation is started via an external switch, for example, an egg switch.

If **Stand by select** is enabled by your provider, the indirect navigation starts automatically after a period of time without user activity. This period can be set by your provider.

There are two different ways, the indirect navigation is entered, refer to *6.2.5 Overview scan select, page 39* for a detailed graphic:

- If Navigation entry is set to **First Profile**, the first item in the profile menu is displayed on the touch screen. If this item is not selected, the system iterates through the profile menu until a profile is selected or until the number of iterations is reached, at which point the menu displays the idle state. If a profile is selected before the system goes into the idle state, the system displays the first item in the function screen menu. If this item is not selected, the system iterates through the function screen menu until a function screen is selected or until the number of iterations is reached, at which point the menu displays the idle state.

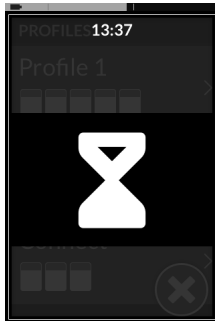

Each menu is iterated a set number of times. This number is set by your provider. If no selection is made when the set number of iterations is reached, the system enters an idle state, displayed by the overlay above.

The system can enter the idle state from either the profile menu or the function screen menu. To exit the idle state,



- If Navigation entry is set to **Active User Function**, the currently selected function screen item is displayed on the touch screen. If this function screen is not selected, the system iterates once through the remaining function screen items in the profile, wrapping around from the last menu item to the first, if necessary. During this single iteration, a function screen must be selected, otherwise the menu reverts to the profile menu. If the system reverts to the profile menu, the first item in the profile menu is displayed on the touch screen. If this item is not selected, the system iterates through the profile menu until a profile is selected or until the number of iterations is reached, at which point the menu displays the idle state. If a profile is selected before the system goes into idle state, the system displays the first item in the function screen menu. If this item is not selected, the system iterates through the function screen menu until a function is selected or until the number of iterations is reached, at which point the menu displays the idle state.

### Scan select with 4Q or 3Q operation

User input type	Mapping for scan select
4Q: <ul style="list-style-type: none"> <li>Joystick</li> <li>Sip and Puff</li> <li>Sip and Puff Head Array</li> </ul>	Left input: select Right input: select Reverse input: select Forward input: select
3Q: <ul style="list-style-type: none"> <li>Head Array</li> <li>Four Switch Proximity Array</li> </ul>	Left input: select Right input: select Reverse input: disabled Forward input (Four Switch Proximity Array only): disabled

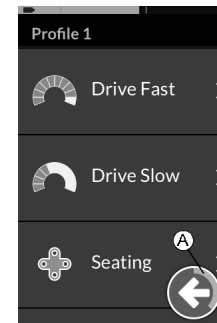

Like in menu select, it is possible, to go back from function screen menu to profile menu or close the profile menu. The control navigation items are displayed in the scanning

process. The duration of time before the next item is displayed, is shown by an indicator ring.

1. Give select input, if control navigation item Ⓐ is displayed.

### 6.3 Using the multipurpose buttons

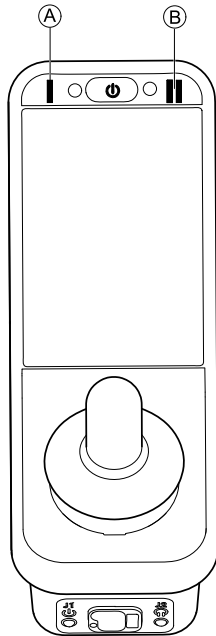

By default, you can change profiles and function screens with the multipurpose buttons.

1. Press left button Ⓐ to switch to next profile.
2. Press right button Ⓑ to switch to next function screen.

### 6.4 Using the Toggle Switches (Optional)

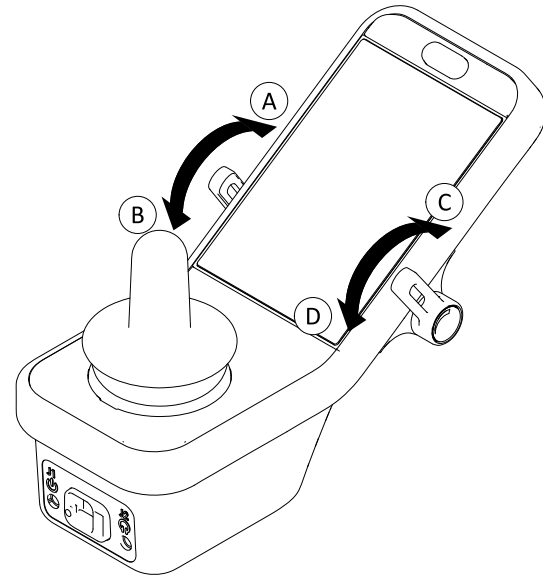

Fig. 6-19

The toggle switches are an alternative means to switch commonly-used controls and can be an option for users who, for example have difficulties to reach the ON/OFF key, multipurpose buttons or struggle to operate certain areas of the touch screen of the remote.

When the switches are deflected forwards or backwards from the neutral position, the programmed action is performed. If the switches are released, the switches return to the neutral position.

By default, the following actions are performed:

A	Left toggle switch	Forward command	Power button (On / Off)
B		Backwards command (short press)	switch to next function card
		Backwards command (long press)	Switch to next profile
C	Right toggle switch	Forward command	Increase speed by 10 %
D		Backwards command	Decrease speed by 10 %

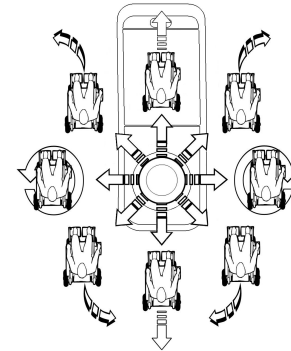

The speed of the wheelchair is proportional to the joystick deflections, so that the further the joystick is moved from the neutral position, the faster the wheelchair travels.

## 6.5 Proportional driving mode

### 6.5.1 Using the joystick

The joystick controls the direction and speed of the wheelchair.

When the joystick is deflected from the center (neutral) position, the wheelchair moves in the direction of the joystick movement.

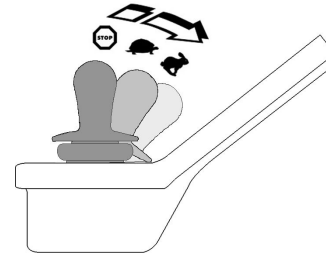

If the joystick is moved back to the neutral position, the wheelchair slows down and stops.

If the joystick is released from any position other than the neutral position, the joystick returns to the neutral position and the wheelchair slows down and stops.

The joystick can also be used to wake up the system when in sleep mode, if this parameter has been enabled by the provider. Refer to 6.14 *The sleep mode*, page 58.

### 6.5.2 Controlling the maximum speed

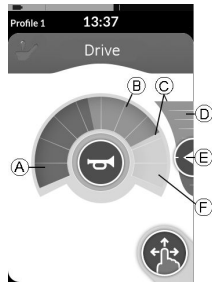

The speedometer is divided into ten segments, representing the speed range of the wheelchair. Each segment can be displayed in one of three colors.

- The green section ① displays the speed range, determined by the set point ⑤ on the speed slider ④.
- The yellow section ② displays the pre-set maximum speed range ③, depending on the programming of the drive screen.
- The grey section ⑥ displays that the total maximum speed range of the wheelchair is not reached in the depending drive function.

In each drive screen you are able to control the pre-set maximum speed depending on your needs.

1.

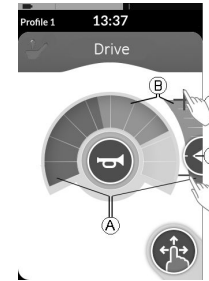

Swipe-and-tap mode	Tap mode
Slide set point ⑤ up or down, when in Swipe-and-tap mode.	Tap at top or at button of speed slider ④, when in Tap mode. Plus and minus symbols indicate where to tap.

The proportion of the green sections ① and yellow sections ② on the speedometer and the speed slider correspond to the position of the set point ⑤.

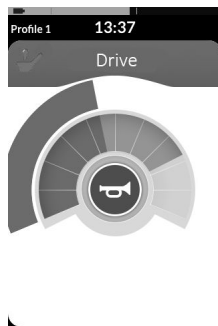

As soon as you start driving, speed slider and navigation button disappear from the display. The current speed is displayed by a green ring around the speedometer.

## 6.6 Latched driving mode

Latched driving modes allow you to latch (or maintain) a forward or reverse speed so that you can drive without continuously providing a drive command.



### Risk of unintended movement

When you send a forward or reverse command, the wheelchair drives forward or reverse at a constant speed and will continue driving at that constant speed until one of the following occurs:

- the external stop switch is pressed (refer to *6.15.2 Through external switches, page 61*),
- the emergency stop is performed (refer to *6.7 Emergency stop, page 51*),
- an opposite command is received (a reverse command when driving forward or a forward command when driving reverse) or
- the Latch Drive Timeout has expired.



To avoid potentially dangerous situations Invacare recommends to make yourself familiar with the latched driving mode, especially with the commands to stop the wheelchair.







The term command, mentioned in this manual, means the input depending on the type of control, e.g. joystick movements or sip and puff commands. Refer to *6.18.7 Using the Sip and Puff Head Array, page 95* for more information about the Sip and Puff Head Array.



By default, latched driving mode is pre-set in combination with a Sip and Puff only and with a Sip and Puff Head Array. For all other types of control, latched driving mode is not a default set-up but can be enabled by your provider.





Each drive function can be assigned with a latched driving mode by your provider. There are six latched driving modes, which are indicated on the lower left of the drive screen with the symbols displayed in the table below.

-  1 Step Up
-  3 Step Up
-  5 Step Up
-  3 Step Up/Down

 5 Step Up/Down

 Cruise Control

 The Latch Drive Timeout period is restarted whenever a subsequent drive command is given.

 The Latch Drive Timeout is set by the provider. To change the parameter, contact your provider.

### Turn commands

The wheelchair can be steered while in latched driving mode. If a turn command is given, the wheelchair remains in latched driving mode and also responds to the turn command for the duration that the turn command is given. The Latch Drive Timeout period is restarted whenever a turn command is given. When the Latch Drive Timeout expires, the wheelchairs stops.

#### 6.6.1 External stop switch

To set up a wheelchair for latched driving, an external stop switch must be fitted to the wheelchair. Ideally, the external stop switch should be highly visible and easily accessible to provide an extra level of safety and security for the user.

## External stop switch test

The external stop switch test checks that the external stop switch is functioning correctly. The test is conducted once per power cycle when:

- the wheelchair is powered up in a latched drive mode function or
- a latched drive mode function is selected following a non-latched drive mode function.



The external stop switch test is indicated by a screen overlay.

1. Press external stop switch to complete test.



The wheelchair does not drive until the external stop switch test is completed successfully.

## 6.6.2 1 Step Up



In this mode, a single drive command (forward or reverse) causes the wheelchair to accelerate to the maximum drive speed **A** of the selected drive screen and then to remain at that speed for the programmed Latch Drive Timeout period as long as no further command is given.

### Driving

1. Give drive command in desired direction (forward or reverse).
2. Release drive command.  
Wheelchair speed accelerates to maximum drive speed of the selected drive screen.

### Stopping

Use one of the following methods to stop:

- Give drive command in opposite direction (a reverse command when driving forward or a forward command when driving in reverse)
- Press external stop switch

- Perform emergency stop  
Let Latch Drive Timeout expire.

### 6.6.3 3 Step Up

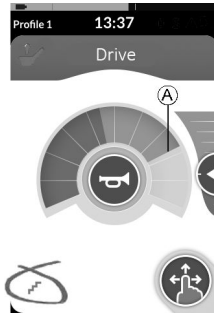

In this mode, you can step through one of three fixed speeds. The speeds available are 33%, 67% and 100% of the maximum pre-set reverse or forward speed <sup>A</sup> of the selected drive screen and then remain at that speed for the programmed Latch Drive Timeout period as long as no further command is given.

#### Driving

1. Give drive command in desired direction (forward or reverse).
2. Release drive command.  
Wheelchair speed accelerates to 33% of the maximum drive speed.
3. Give forward command when driving forward or reverse command when driving in reverse to accelerate to next fixed speed.
4. Release drive command.  
New speed is held constantly.

### Stopping

Use one of the following methods to stop:

- Give drive command in opposite direction (a reverse command when driving forward or a forward command when driving in reverse).
- Press external stop switch.
- Perform an emergency stop.
- Let Latch Drive Timeout expire.

### 6.6.4 5 Step Up

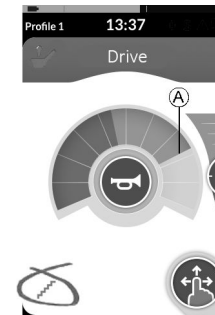

In this mode, you can step through one of five fixed speeds. The speeds available are 20%, 40%, 60%, 80% and 100% of the maximum pre-set reverse or forward speed <sup>A</sup> of the selected drive screen and then remain at that speed for the programmed Latch Drive Timeout period as long as no further command is given.



## Driving

1. Give drive command in desired direction (forward or reverse).
2. Release drive command.  
Wheelchair speed accelerates to 20% of the maximum drive speed.
3. Give forward command when driving forward or reverse command when driving in reverse to accelerate to next fixed speed.
4. Release drive command.  
New speed is held constantly.

## Stopping

Use one of the following methods to stop:

- Give drive command in opposite direction (a reverse command when driving forward or a forward command when driving in reverse)
- Press external stop switch
- Perform emergency stop
- Let Latch Drive Timeout expire

## 6.6.5 3 Step Up/Down

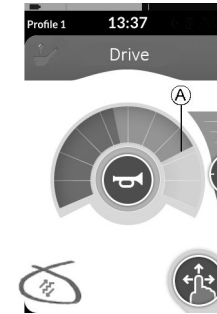

In this mode, you can step up or down through one of three fixed speeds. The speeds available are 33%, 67% and 100% of the maximum pre-set reverse or forward speed <sup>A</sup> of the selected drive screen and then remain at that speed for the programmed Latch Drive Timeout period as long as no further command is given.

## Driving

1. Give drive command in desired direction (forward or reverse).
2. Release drive command.  
Wheelchair speed accelerates to 33% of the maximum drive speed.

3. Give forward command when driving forward or reverse command when driving in reverse to accelerate to next fixed higher speed.

Give reverse command when driving forward or forward command when driving in reverse to decelerate to next fixed lower speed.

 Drive command in opposite direction must be quick, less than one second, otherwise wheelchair stops.

4. Release drive command.  
New speed is held constantly.

### Stopping

- Give drive command longer than one second in opposite direction (a reverse command when driving forward or a forward command when driving in reverse),
- Press external stop switch,
- Perform emergency stop or
- Let Latch Drive Timeout expire.

#### 6.6.6 5 Step Up/Down



In this mode, you can step up or down through one of five fixed speeds. The speeds available are 20%, 40%, 60%, 80% and 100% of the maximum pre-set reverse or forward speed  of the selected drive screen and then remain at that speed for the programmed Latch Drive Timeout period as long as no further command is given.

### Driving

1. Give drive command in desired direction (forward or reverse).
2. Release drive command.  
Wheelchair speed accelerates to 20% of the maximum drive speed.
3. Give forward command when driving forward or reverse command when driving in reverse to accelerate to next fixed higher speed.  
Give reverse command when driving forward or forward command when driving in reverse to decelerate to next fixed lower speed.

 Drive command in opposite direction must be quick, less than one second, otherwise wheelchair stops.

4. Release drive command.  
New speed is held constantly.

### Stopping

Use one of the following methods to stop:

- Give drive command longer than one second in opposite direction (a reverse command when driving forward or a forward command when driving in reverse)
- Press external stop switch

- Perform emergency stop
- Let Latch Drive Timeout expire

### 6.6.7 Cruise Control

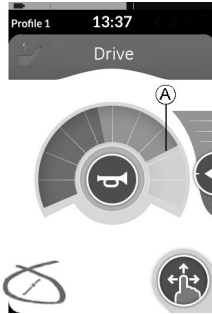

In this mode, you do not have fixed steps and can choose the latched speed by yourself and then remain at that speed for the programmed Latch Drive Timeout period as long as no further command is given.

#### Driving

1. Give and hold drive command in direction (forward or reverse) until wheelchair accelerates to desired speed.
2. Release drive command.  
Wheelchair speed is held constantly.
3. If maximum drive speed Ⓐ is not reached, give and hold drive command again in same direction.
4. Release drive command.  
New speed is held constantly.

5. Give drive command in opposite direction (reverse when driving forward or forward when driving in reverse) to decelerate speed.
6. Release drive command.  
New speed is held constantly.

#### Stopping



Use one of the following methods to stop:

- Give drive command two times in same direction quickly (less than one second)
- Press external stop switch
- Perform emergency stop
- Let Latch Drive Timeout expire

### 6.7 Emergency stop

If you press the ON/OFF button while driving, an emergency stop is carried out. The remote powers down after this.

## 6.8 Operating the position lights

-  If you drive outside, turn on the position lights under bad visibility conditions or darkness.
-  To operate the position lights, you need to stop the mobility device.

### Turn on position lights

1.



Fig. 6-20

Tap Lighting control button (A).

2.

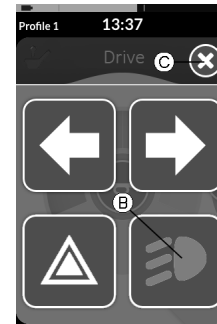

Fig. 6-21

Lighting button panel overlays screen. Tap Position lights symbol (B).



Fig. 6-22

Position lights turn on. Position lights icon becomes illuminated in the lighting dashboard.

3. Tap button (C) to close Lighting button panel.



If you start driving, the Lighting button panel overlay disappears automatically and the position lights remain turned on.

## Turn off position lights

1.



Fig. 6-23

Tap Lighting control button (A).

2.

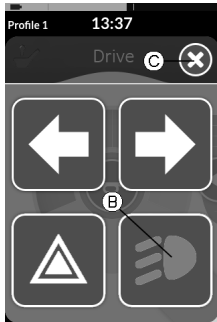

Fig. 6-24 Lighting button panel overlays screen.

Tap Light symbol (B) to turn the position lights off.

3. Tap button (C) to close Lighting button panel.



If you start driving, the Lighting button panel overlay disappears automatically.

## 6.9 Operating the hazard lights



To operate the hazard lights, you need to stop the mobility device.

### Turn on hazard lights

1.



Fig. 6-25

Tap Lighting control button (A).

2.

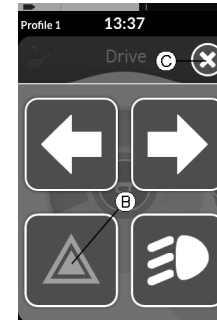

Fig. 6-26 Lighting button panel overlays screen.

Tap Hazard lights symbol **B** to turn the hazard lights on.



Fig. 6-27

Hazard lights icon becomes illuminated in the lighting dashboard.

3. Tap button **C** to close Lighting button panel.



If you start driving, the Lighting button panel overlay disappears automatically and the hazard lights remain turned on.

## Turn off hazard lights

1.



Fig. 6-28

Tap Lighting control button **A**.

2.



Fig. 6-29 Lighting button panel overlays screen.

Tap Hazard lights symbol **B** to turn the hazard lights off.



If you start driving, the Lighting button panel overlay disappears automatically.

## 6.10 Operating the turn signals



To operate the turn signals, you need to stop the mobility device.

### Turn on turn signals

1.



Fig. 6-30

Tap Lighting control button (A).

2.



Fig. 6-31 Lighting button panel overlays screen.

Tap left turn signal symbol (B) or right turn signal symbol (C) to turn the turn signal on.



Fig. 6-32

Left or right indicator icon becomes illuminated in the lighting dashboard.

3. Tap button (D) to close Lighting button panel.



If you start driving, the Lighting button panel overlay disappears automatically.



After more than ten seconds, the turn signal turn off automatically.

## Turn off turn signals

1.



Fig. 6-33

Tap Lighting control button (A).

2.

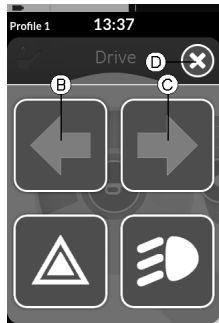

Fig. 6-34 Lighting button panel overlays screen.

Tap left turn signal symbol (B) or right turn signal symbol (C) to turn the turn signal off.



If you start driving, the Lighting button panel overlay disappears automatically.

## 6.11 Operating the horn



1. Tap horn button (A) to sound horn.  
Horn sounds as long as button is tapped.

## 6.12 Operating Lighting Functions and Horn via Utility Function Card

Via a utility function card you are able to operate the lighting functions and horn with an external input. The utility function card is part of one or more profiles and can be activated like a drive or seating function card.

1. Activate utility function card.
2. Give demand according following list.



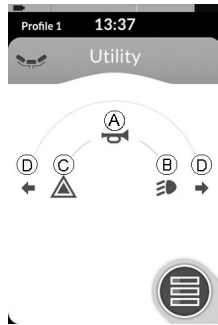





Fig. 6-35

- Give forward demand **A** to sound horn.
- Give short demand to right **B** to turn on/off position lights.
- Give short demand to left **C** to turn on/off hazard lights.
- Give long demand to left or right **D** to turn on left or right direction indicator. A short demand can be used to turn them off.

 Direction indicators turn off automatically after ten seconds.

 Activate a drive function card to drive normally, while position lights and hazard lights remain turned on.

### 6.13 Locking/unlocking the remote

 The lock feature is not set to ON at the factory, but can be enabled by your provider. If this parameter is set to ON, you can lock/unlock the system as described.

#### Locking the remote

1.

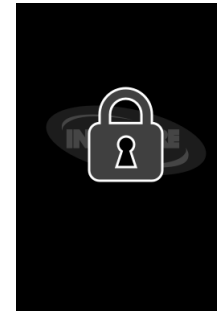

Press ON/OFF button for more than three seconds, until a locking overlay is displayed.

2. Remote powers down.

When powering up remote, locking overlay is displayed.

#### Unlocking the remote

1. Press ON/OFF button.

2.

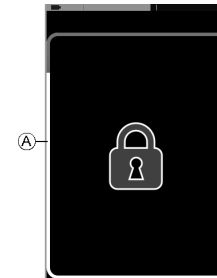

Tap on locked display until white frame around locking screen **A** is filled.

3. Touch display is unlocked and can be used again.



If you do not apply the unlock sequence or the ON/OFF button is pressed again before the unlock sequence is complete, the system returns to the locked state and powers down.

## 6.14 The sleep mode

The sleep mode is not set at the factory, but can be enabled by your provider. If this parameter is set ON, the system goes into sleep mode after a period of time without user activity. This period can be set by the provider.

Before a system goes into sleep mode, the system enters a transition period. During the transition period, the touch display and all indicators slowly dim until they are switched off.

During this transition period sleep mode can be interrupted by performing any input by moving the joystick, pressing the ON/OFF button or tapping on the touch display.

To wake the system from sleep mode, move the joystick or either press the ON/OFF button, if this parameter has been enabled by your provider.

## 6.15 Operating powered seating functions

Powered seating functions, such as powered elevating legrests or powered recline, are carried out as described below.

### 6.15.1 Through seating screens



By default, every seating screen displays a single powered seating function. Different configurations are listed below. Contact your provider to change the configuration.

Choose the seating screen with the seating function you want to operate, refer to chapter 6.2 *Navigating through user function screens, page 32.*

1.



Give forward or reverse command to operate seating function.

When a motion becomes active, navigation button disappears (A), the active direction of the motion (B) is displayed, the other becomes inactive (C) and drive lockout icon (D) is displayed in the status bar.

Motion is deactivated as soon as command is released or when motion reaches its end-of-travel.

## Displayed symbols and their meanings



Powered seat tilt



Powered recline



Seat lifter



Left or center-mount powered elevating legrest



Right powered elevating legrest



Both powered elevating legrests



Powered recline and powered elevating legrests

## Other configurations



The displayed function screens are configuration examples only.

- **Four quadrant configuration**

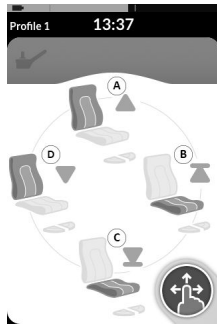

- Ⓐ Seat lifter up
- Ⓑ Powered recline up
- Ⓒ Seat lifter down
- Ⓓ Powered recline down

All four quadrants are used for operating powered seating functions.

1. Give and hold forward Ⓐ, reverse Ⓒ, left Ⓓ or right command Ⓑ to operate seating function. Motion is deactivated as soon as command is released or when motion reaches its end-of-travel.

- **Latched configuration**

A latched configuration allows you to operate a motion without continuously providing a command. A latched configuration can be a single powered seating function or a four quadrant configuration.



1. Give command to front or rear to operate seating function.
2. Release command. Motion is deactivated as soon as joystick is deflected again or when motion reaches its end-of-travel.

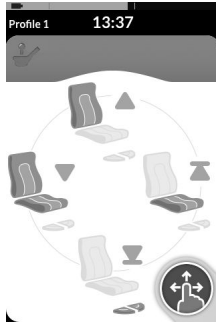

In a four quadrant configuration it is possible to mix the motion operations, like displayed in the example.

### 6.15.2 Through external switches



Not all configurations and combinations of powered seating functions through external switches are available on all products.

With an external switch, seating functions can be controlled while driving and without using seating screens.

When the seating function is activated without a seating screen, a small overlay is displayed on the touch display, to inform the user, that the seating is being controlled externally. The overlay remains on the touch display for the duration of the seating operation.



Powered recline



Elevating seat



Left or center-mount powered elevating legrest



Right powered elevating legrest



Both powered elevating legrests



Powered seat tilt



Powered recline and powered elevating legrests

### Egg switch

The egg switch alternates powered seating functions of the following single power configurations:

- Powered recline only

- Powered seat tilt only
- Center-mount elevating legrest (LNX) only

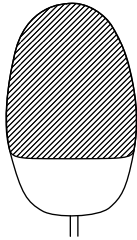

1. Make sure mobility device is on level surface and turned on.
2. Press and hold tagged area of egg switch to run powered seating function.
3. Release egg switch if desired seating position is reached. If egg switch is pressed again within three seconds, powered seating function moves into same direction.
4. To alternate direction, press egg switch after it has been released for more than three seconds.

### Stereo toggle switch

The stereo toggle switch alternates powered seating functions of the following single power configurations:

- Powered recline only
- Powered seat tilt only
- Center-mount elevating legrest (LNX) only

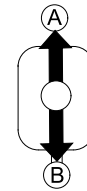

1. Make sure mobility device is on level surface and turned on.
2. Deflect and hold toggle switch up **A** or down **B** to move particular seating function. Seating function moves as long as toggle switch is deflected.

### Stereo button switch

The stereo button switch alternates powered seating functions of the following single power configurations:

- Powered recline only
- Powered seat tilt only
- Center-mount elevating legrest (LNX) only

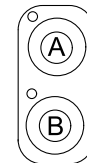

1. Make sure mobility device is on level surface and turned on.
2. Press and hold stereo buttons **A** or **B** to move particular seating function. Seating function moves as long as button is pressed.

## 4-way toggle switch

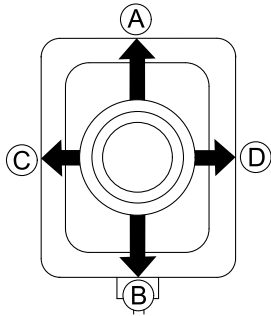

1. Make sure mobility device is on level surface and turned on.
2. Deflect and hold toggle switch to direction, that moves particular seating function.  
Seating function moves as long as toggle switch is deflected.

See the following tables for combinations of directions and powered seating functions.

 The tables show the factory settings. For reprogramming, contact your provider.

### Powered seat tilt and Powered recline

Ⓐ (Forward)	Powered seat tilt up
Ⓑ (Reverse)	Powered seat tilt down
Ⓒ (Left)	Powered recline up
Ⓓ (Right)	Powered recline down

### Powered seat tilt and LNX legrest

Ⓐ (Forward)	Powered seat tilt up
Ⓑ (Reverse)	Powered seat tilt down
Ⓒ (Left)	LNX up
Ⓓ (Right)	LNX down

### Powered recline and LNX legrest

Ⓐ (Forward)	Powered recline and LNX up
Ⓑ (Reverse)	Powered recline and LNX down
Ⓒ (Left)	LNX up
Ⓓ (Right)	LNX down

### Powered seat tilt and elevating seat

Ⓐ (Forward)	Powered seat tilt up
Ⓑ (Reverse)	Powered seat tilt down
Ⓒ (Left)	Elevating seat up
Ⓓ (Right)	Elevating seat down

### Dual powered elevating legrests

Ⓐ (Forward)	Left powered elevating legrest up
Ⓑ (Reverse)	Left powered elevating legrest down
Ⓒ (Left)	Right powered elevating legrest up
Ⓓ (Right)	Right powered elevating legrest down

## 4-way button switch

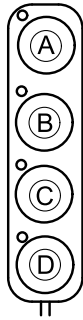

1. Make sure mobility device is on level surface and turned on.
2. Press and hold button to move particular seating function.

Seating function moves as long as button is pressed.  
See tables below for combination of buttons and powered seating functions.

 The tables show the factory settings. For reprogramming, contact your provider.

### Powered seat tilt and Powered recline

- Ⓐ Powered seat tilt up
- Ⓑ Powered seat tilt down
- Ⓒ Powered recline up
- Ⓓ Powered recline down

### Powered seat tilt and LNX legrest

- Ⓐ Powered seat tilt up
- Ⓑ Powered seat tilt down
- Ⓒ LNX up
- Ⓓ LNX down

### Powered recline and LNX legrest

- Ⓐ Powered recline and LNX up
- Ⓑ Powered recline and LNX down
- Ⓒ LNX up
- Ⓓ LNX down

### Powered seat tilt and elevating seat

- Ⓐ Powered seat tilt up
- Ⓑ Powered seat tilt down
- Ⓒ Elevating seat up
- Ⓓ Elevating seat down

### Dual powered elevating legrests

- Ⓐ Left powered elevating legrest up
- Ⓑ Left powered elevating legrest down
- Ⓒ Right powered elevating legrest up
- Ⓓ Right powered elevating legrest down



## 10-way switch

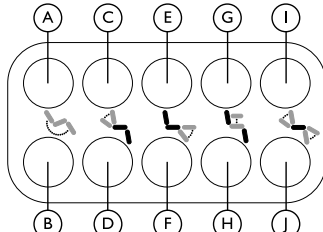

Fig. 6-36 Button Layout 1

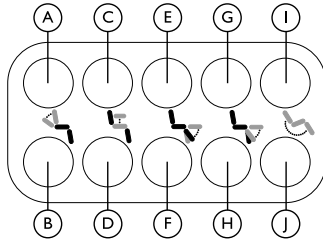

Fig. 6-37 Button Layout 2



Button layouts shown in this manual represent the factory settings. The 10-Way Switch can be customized to operate other functions than those that are shown. Contact an Invacare provider to customize the 10-Way Switch.

1. Make sure mobility device is on level surface and turned on.
2. Press and hold button to move particular seating function. Seating function moves as long as button is pressed.



The tables describe the factory settings. For reprogramming, contact your provider.

The lower row of buttons move the seating function to its home position, see table below for details.

	Button Layout 1	Button Layout 2
Ⓐ	Powered seat tilt up	Powered recline down
Ⓑ	Powered seat tilt down	Powered recline up
Ⓒ	Powered recline down	Elevating seat up
Ⓓ	Powered recline up	Elevating seat down
Ⓔ	Powered legs up	Left or center-mount powered elevating legrest up
Ⓕ	Powered legs down	Left or center-mount powered elevating legrest down
Ⓖ	Elevating seat up	Right powered elevating legrest up
Ⓗ	Elevating seat down	Right powered elevating legrest down
Ⓘ	Powered recline down + Powered legs up	Powered seat tilt up
Ⓙ	Powered recline up + Powered legs down	Powered seat tilt down

### 6.15.3 Speed reduction and seating function inhibits



The mentioned speed reduction and seating function limits do not apply to all Invacare wheelchair models.

#### Speed reduction

If the elevating seat has been adjusted above a certain point, the drive electronics considerably reduces the speed of the wheelchair. If speed reduction has been activated, drive mode can only be used to carry out movements in reduced speed and not for regular driving. To drive normally, adjust the elevating seat until the speed reduction is deactivated again.



Speed reduction is shown in the display. If the elevating seat is raised above a certain point, an icon with an exclamation point is displayed in the status bar. This indicator remains active until speed reduction is deactivated again by lowering the elevating seat.

#### Seating function inhibits

- Tilt limit



The maximum tilt limit switch is a function to prevent the seat tilt or recline from extending beyond a maximum pre-set angle, when the elevating seat is raised above a certain point. The seating electronics stops automatically, a grey exclamation point is displayed on the seating screen and tilting or reclining backwards is inhibited (A).



According to that, an icon with a seat and an exclamation point is displayed in the status bar. This indicator remains active until the tilt limit is deactivated by lowering the elevating seat.

- **Elevating seat lockout**



The seating electronics is equipped with a elevating seat lockout switch to prevent the elevating seat from rising up above a certain point when the seat tilt or recline is adjusted above a certain point. The seating electronics stops automatically, a grey exclamation point is displayed on the seating screen and extend is inhibited (A).



According to that, an icon with a seat and an exclamation point is displayed in the status bar. This indicator remains active until the elevating seat lockout is deactivated by moving seat tilt or recline up.

## 6.16 Connectivity screens

Connectivity screens allow you to communicate with external devices. Connectivity functions supported by your remote are a mouse mover and a switch control. By default, these

functions are disabled. Contact your provider to activate Connectivity Screens.

The mouse mover function allows you to control the cursor on a PC or laptop's screen with a user input on the wheelchair, such as the joystick on the remote module or external joysticks. At the moment a four-quadrant operation is needed to use the mouse mover.

The switch control function is an accessibility feature that allows you to navigate and select items on your mobile device (Android and iOS) using the remote's joystick or touch screen.

### 6.16.1 Configuring Connectivity Card

#### Pairing the LiNX system with a user's device

To pair the LiNX system with a user's device (PC, laptop or mobile device), open the connectivity settings menu.

1.

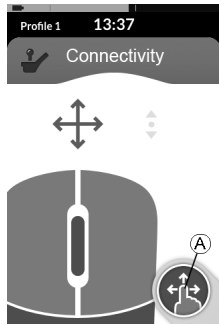

Fig. 6-38

Long press navigation button (A).

2.

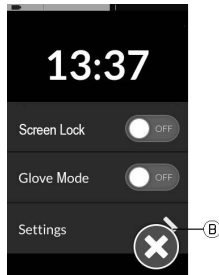

Fig. 6-39

Status display opens. Open Settings menu (B).

3.

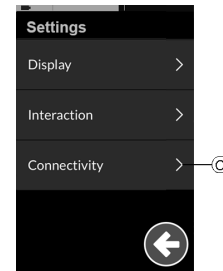

Fig. 6-40

Settings menu opens. Open Connectivity settings (C).

4.

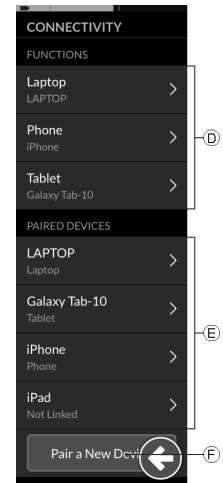

Fig. 6-41

Connectivity settings menu opens. This menu is split into two sections:

- Ⓓ Functions
- Ⓔ Paired devices

5. Tap on **Pair New Device** button Ⓕ at bottom of menu.

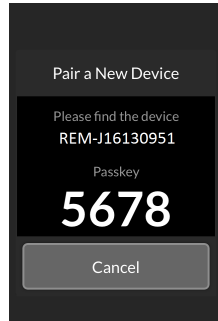

Fig. 6-42

Pairing passkey is displayed on touch screen with the name of LiNX device to pair with, in this example REM-J16130951.

### Pairing mobile device with LiNX system

- Ⓕ Perform this operation promptly to the Pairing process on your remote (see *Pairing the LiNX system with a user's device*, page 67). Otherwise, a timeout will occur.

See your mobile device's user manual for information about how to establish a Bluetooth connection with your remote.

### Pairing PC or Laptop with LiNX system

- Ⓕ Perform this operation promptly to the Pairing process on your remote (see *Pairing the LiNX system with a user's device*, page 67). Otherwise, a timeout will occur.

1. Open **Devices and Printers** dialog box on your Windows PC or laptop.

There are a number of ways to do this:

- Start → Devices and Printers,
- Start → Control Panel → Devices and Printers,
- Icon tray → click on Bluetooth Device icon

2.



Fig. 6-43

From **Devices and Printers** dialog box, click on **Add a device** button.

3.



Fig. 6-44

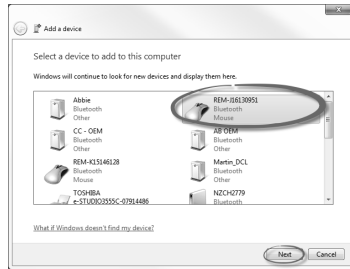

Fig. 6-45

All available devices are displayed. Locate LiNX device name that as displayed on the touch screen (REM-J16130951) and select it. Click on **Next** button.

4.



Fig. 6-46

Wait for device to connect. Click on **Next** as soon as device is connected.

5.

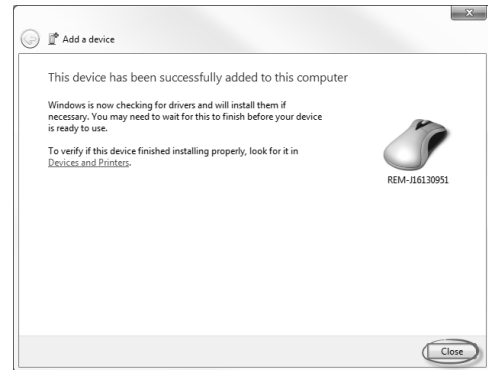

Fig. 6-47

Click on **Close** button to complete **Add a device** action.

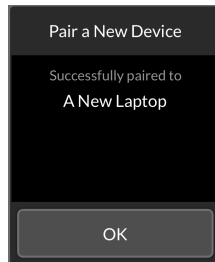

Fig. 6-48

If the device paired successfully, a confirmation screen is displayed on the remote module. Tap on the **OK** button to proceed.

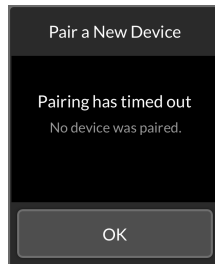

Fig. 6-49

If no device is paired within the set timeout period, a message is displayed “No device was paired”. Tap on **OK** button to proceed.



LiNX system permits up to ten devices to be paired at any time. If you have reached this limit and you need to add more devices, consider forgetting devices, that have already been paired, see *Operating the Mouse Mover*, page 79.

## Linking connectivity card with user's device

Connectivity cards must be linked to a paired device. To link a connectivity card to a device, open the connectivity settings menu.

1.

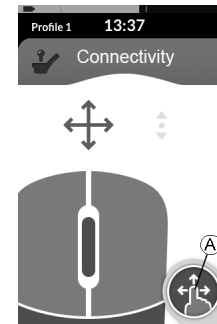

Fig. 6-50

Long press navigation button (A).

2.

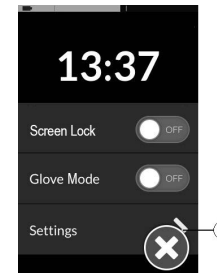

Fig. 6-51

Status display opens. Open Settings menu (B).

3.

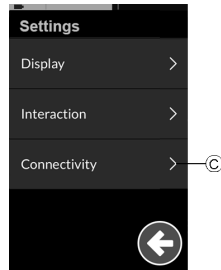

Fig. 6-52

Settings menu opens. Open Connectivity settings **C**.

4.

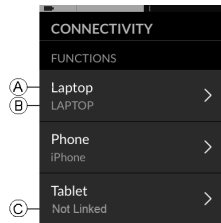

Fig. 6-53

The names of the connectivity cards are displayed in section **Functions**.

- A** Function name
- B** Linked device
- C** No linked device

5. Tap on appropriate menu item to link connectivity card with a paired device.

6. If you uses Mouse mover function card, cursor speed settings are displayed on top. Scroll down to section **Function Uses Device**.

7.

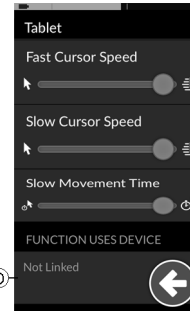
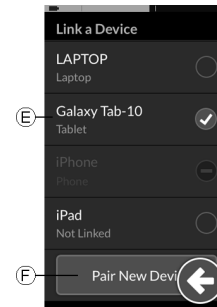

Fig. 6-54

Tap on **Not Linked** button **D**.

1.





Select one of paired devices in list **E**, or tap on **Pair New Device** button **F** to pair with new device. Currently active device is identified by a green hook behind the device name.



## Connecting devices with LiNX system

To connect to a device, select the appropriate connectivity card from a profile. If the connectivity function has been paired to a device and the device has been linked to the function, then it attempts to connect to the device via Bluetooth.

The Bluetooth status indicator shows when the Bluetooth connection between the LiNX system and the user's device is:

-  disconnected,
-  connecting or
-  connected.

If the Bluetooth fails to connect, the status reverts to disconnected.

## Removing paired devices

1.



Fig. 6-55

Long press navigation button (A).

2.

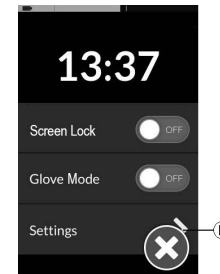

Fig. 6-56

Status display opens. Open Settings menu (B).

3.

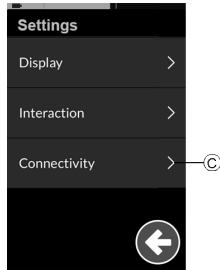

Fig. 6-57

Settings menu opens. Open Connectivity settings C.

4.

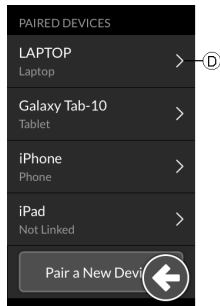

Fig. 6-58

Select paired device in section **Paired Devices**, e. g. Laptop D.

5.



Fig. 6-59

Check details on following screen and tap **Forget this Device** button.

6.

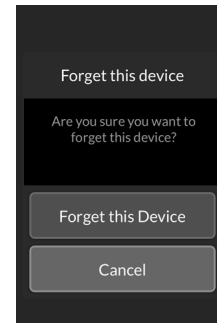

Fig. 6-60

Tap on **Forget this Device** button again or **Cancel** button, to cancel removing.

## Selecting a connectivity card

For more information about selecting user function cards, see 6.2.2 *Using direct navigation, page 33* or 6.2.3 *Using indirect navigation, page 35*.

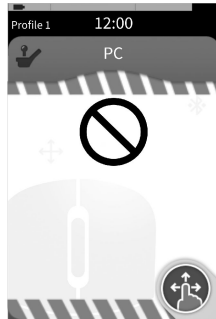

Fig. 6-61

If a connectivity card in the profile has not been configured fully or is subject to an error, it will be classed as inoperable, see image above.

There is a number of reasons why a connectivity card is inoperable. These are:

- the function's primary input is missing,
- there are hardware errors from the Bluetooth module,
- there is no device linked or
- Bluetooth has not been enabled.

For the latter two reasons, the card can be selected as these are rectified later.

## 6.16.2 Mouse Mover

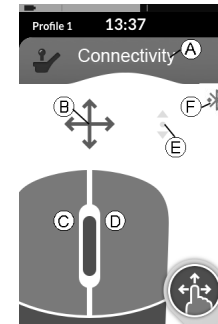







Fig. 6-62

- (A) Connectivity screen name
- (B) Mouse move indicator
- (C) Left mouse button
- (D) Right mouse button
- (E) Scroll indicator
- (F) Bluetooth connection status

Connectivity screen name		The name can be used to uniquely identify this screen's purpose.
Mouse move indicator		The mouse move indicator changes from grey to blue when active. That is, when the user input is controlling the connected device's cursor.
Left and right mouse buttons		Tap on the touch screen's left and right mouse buttons to perform left and right mouse clicks.

Scroll indicator		The scroll indicator changes from grey to blue when active. That is, when the user input is controlling the connected device's scrolling.
Bluetooth status		The Bluetooth status indicator shows the status of the Bluetooth connection between the LiNX system and your device: <ul style="list-style-type: none"> <li>• disconnected</li> <li>• connecting</li> <li>• connected</li> </ul>

### Setting up a Mouse Mover

The following set-up procedure assumes that connectivity screens are available and selectable in one or more profiles and that the connectivity screens provide mouse mover functions. It also assumes that the PC or laptop, to which the LiNX system will connect, has an active Bluetooth connection.

To use a mouse mover function:

1. the LiNX system needs to be paired (via Bluetooth) with a user's device, and
2. the connectivity screen needs to be linked to the paired device.

The set-up procedure can be performed in any order, but involves the following:

- Selecting a connectivity screen,
- pairing the LiNX system with a user's device
- linking the connectivity screen with the user's device and
- configuring the mouse mover function (cursor speed).

### Configuring the mouse mover function (cursor speed)

The cursor speed settings can be found in the connectivity function's menu.

1.

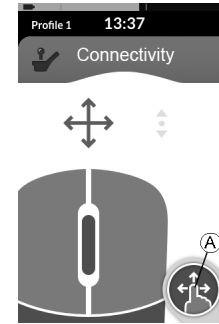

Fig. 6-63

Long press navigation button (A).

2.

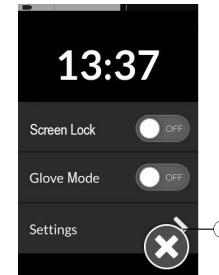

Fig. 6-64

Status display opens. Open Settings menu (B).

3.

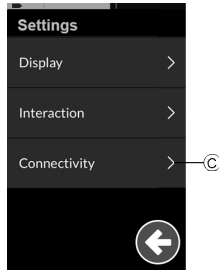

Fig. 6-65

Settings menu opens. Open Connectivity settings C.

4.

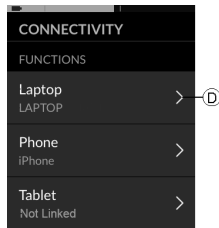

Fig. 6-66

Open connectivity function, e.g. D, to configure cursor settings.

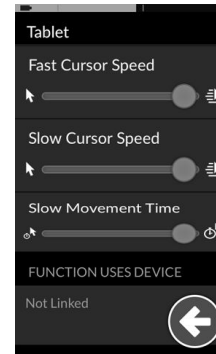

Fig. 6-67 Mouser mover — Cursor settings

For each mouse mover function the following cursor settings can be set:

- Fast Cursor Speed
- Slow Cursor Speed
- Slow Movement Time

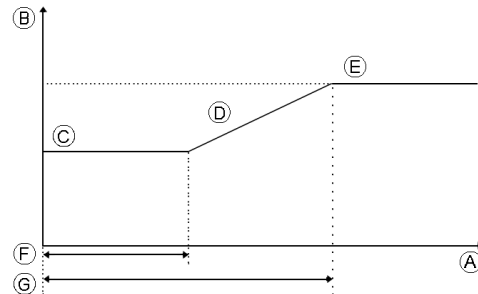

Fig. 6-68

- Ⓐ X-axis: time
- Ⓑ Y-axis: speed
- Ⓒ Slow Cursor Speed
- Ⓓ Ramp
- Ⓔ Fast Cursor Speed
- Ⓕ Slow Movement Time
- Ⓖ 2x Slow Movement Time

Slow Cursor Speed Ⓒ: Sets the speed at which the mouse cursor moves when initially deflected. It remains at this speed for the duration set by the Slow Movement Time Ⓕ. The Slow Cursor Speed is set so that you can move the mouse cursor slowly over small distances, which is useful for small adjustments, especially when moving between screen icons that are close together. Slow Cursor Speed should be set equal to or less than Fast Cursor Speed Ⓔ.

Fast Cursor Speed Ⓔ: Sets the speed at which the mouse cursor ramps Ⓓ up to after the Slow Movement Time Ⓕ has expired. During the Slow Movement Time however, the mouse cursor speed moves at the speed set by Slow Cursor Speed Ⓒ. The Fast Cursor Speed is set so that you can move the cursor quickly over large distances. Fast Cursor Speed should be set equal to or greater than Slow Cursor Speed.

Slow Movement Time Ⓕ: Sets the length of time for which the mouse moves at the Slow Cursor Speed Ⓒ before increasing to the Fast Cursor Speed Ⓔ. The ramp time, between end of Slow Cursor Speed and start of Fast Cursor Speed, is equal to the time set by this setting Ⓖ.

## Operating the Mouse Mover

The following operation description assumes that a connectivity screen with a mouse mover function has been set up as described in *Setting up a Mouse Mover*, page 76.

### Moving the cursor

The cursor moves on the user's device in the direction that is mapped to the input. The speed of the cursor is slow initially, which is ideal for close or fine movements and then speeds up after a short period (defined by Slow Movement Time) to allow the cursor to move a greater distance in a shorter time frame. For more information about cursor settings, see *Setting up a Mouse Mover*, page 76.

### Right or left click

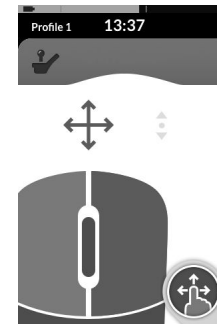

Fig. 6-69

To perform a right or left click, tap on the corresponding buttons on the touch screen. When a button is tapped, it changes color from grey to blue.

## Scrolling

The scroll mode button is an external button, such as an egg switch or buddy button.

1. Press and hold scroll mode button.
2. Use assigned user input or programmed control inputs to perform up and down scroll actions.
3. To stop scrolling, release scroll mode button.

## Disconnecting

To stop using the mouse mover function, select a different function screen from a profile. When the connectivity screen has been deselected, the Bluetooth connection disconnects.

## 6.17 Switch Control

### 6.17.1

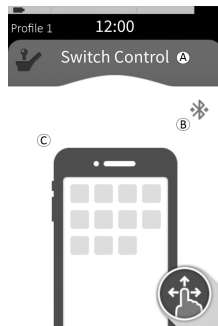





Fig. 6-70

- Ⓐ Connectivity screen name
- Ⓑ Bluetooth connection status
- Ⓒ Switch control indication

Connectivity screen name		The name can be used to uniquely identify this screen's purpose.
Bluetooth status		<p>The Bluetooth status indicator shows the status of the Bluetooth connection between the LiNX system and your device:</p> <ul style="list-style-type: none"> <li>• disconnected</li> <li>• connecting</li> <li>• connected</li> </ul>
Switch control indication		<p>The switch control indication varies depending on if your device is connected via Bluetooth and whether or not a switch control input is active:</p> <ul style="list-style-type: none"> <li>• disconnected</li> <li>• connected</li> <li>• active</li> </ul>



## 6.17.2 Setting up switch control

The following set up procedure assumes that a switch control connectivity screen is available and selectable in one or more profiles. It also assumes that the user's device (iOS or Android) to which the LiNX system connects to, has an active Bluetooth connection.

To use a switch control function:

1. the LiNX system needs to be paired (via Bluetooth) with a user's device, and
2. the switch control connectivity screen needs to be linked to the paired device.

The set up process is performed in any order, but will involve the following:

- Selecting a switch control connectivity screen,
- pairing the LiNX system with a user's device,
- linking the switch control connectivity screen with the user's device, and
- configuring switch control.

### Configuring switch control

Before you can use switch control, you need to identify the switches you will be using and assign an action to each switch. For example, if you want your mobile phone to return to Home screen when you tap on the remote's touch screen, you will need to identify the touch screen as a switch input, and then assign that switch's action to Home button.

### Configuring Switch Control (Android)

Based on different Android version in the market, the description on your mobile device can differ. For more

60101834-C

information look into your user manual or at **Android Accessibility Help** pages.

1.

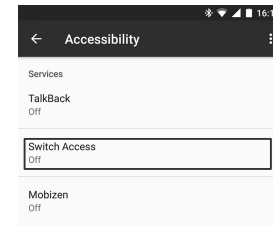

Fig. 6-71

### Settings > Accessibility > Switch Access

Open the switch control menu on your mobile device.

2.

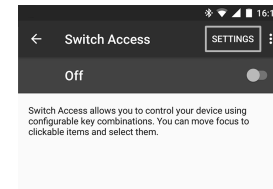

Fig. 6-72

Open **Settings** (Settings) menu.

3.

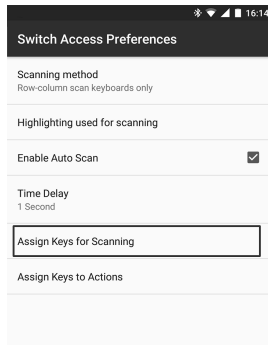

Fig. 6-73

Open **Assign Keys for Scanning** (Assign Keys for Scanning) menu or **Assign Keys to Actions** (Assign Keys to Actions) menu. Android placed functions in two different menus.

4.

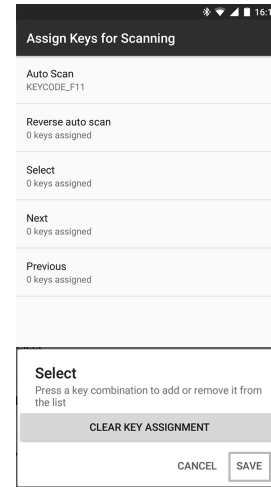

Fig. 6-74

Select the function you like to control from the list, such as **Select** (Select). You are prompted to activate your external switch.

5.

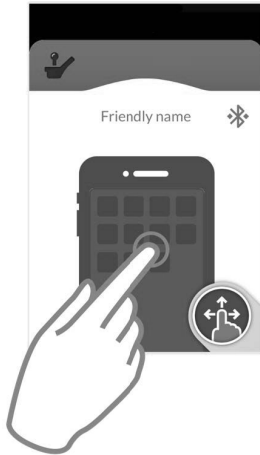

Fig. 6-75

Activate the external switch, for example tap on Touch screen or deflect joystick to the left.

6. Click on button **Save** (Save).
7. If required, repeat the steps to add more switches.

8.

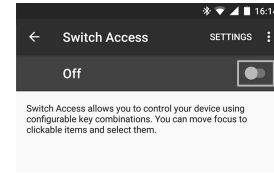

Fig. 6-76

Activate Switch Control.

9.

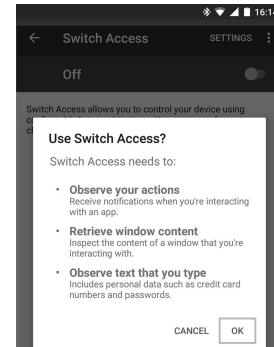

Fig. 6-77

Click button **OK** to activate Switch Control.

## Configuring Switch Control (iOS)

1.

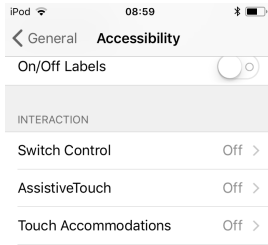

Fig. 6-78

### Settings > General > Accessibility

Open the switch control menu on your mobile device.

2.



Fig. 6-79

Open **Switches** (Switches) menu.

3.

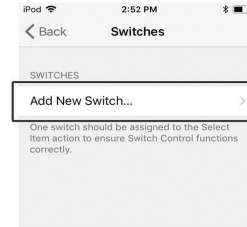

Fig. 6-80

Tap on menu entry **Add new Switch** (Add New Switch).

4.

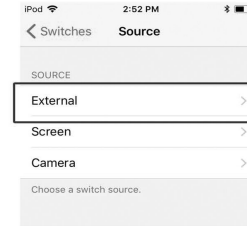

Fig. 6-81

Tap on button **External** (External). You are prompted to activate the external switch.

5.

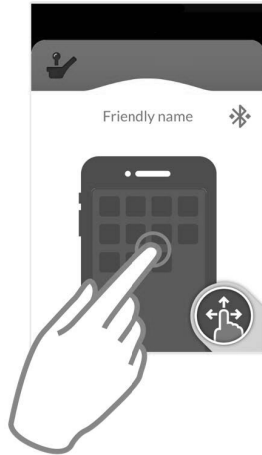

Fig. 6-82

Activate external switch, for example tap on Touch screen or deflect joystick to the left.

6.

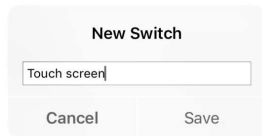

Fig. 6-83

Name external input with an unique name of your input, such as **Touch screen** or **Right**. After that, click on button **Save** (Save).

7.

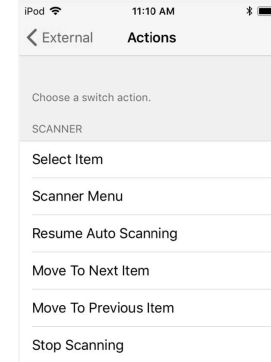

Fig. 6-84

Assign an action to switch. From the **Actions** (Actions) menu choose a switch action, such as **Select Item**.

8. If required, repeat the steps to add more switches.
- 9.

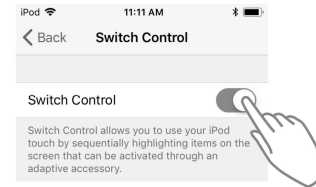

Fig. 6-85

Activate Switch Control.

### 6.17.3 Operating Switch Control

The following operation description assumes that a connectivity screen with a switch control function has been

set up as described in *6.17.2 Setting up switch control, page 81*.

### Controlling Mobile Device

1. Press the preassigned switch on your remote. Your mobile device executes the deposited action.

### Disconnecting

To stop using switch control function, select a different function screen from a profile. When the switch control connectivity screen has been deselected, the Bluetooth connection disconnects.

## 6.18 Using secondary inputs



### CAUTION!

#### Risk of injury

If an external input is used, unrequested functions or speed settings can lead to unexpected operations.

- To avoid unexpected operations, check which function is operated and what the function's speed is set to.

If you are unable to use a standard joystick, you can control the system via an external input. All following inputs are able to control the driving function. With some of the following inputs you are also able to switch the function screens to control seating or light functions, if available.

In case of a proportional joystick or the Sip and Puff Head Array, the wheelchair can be driven forward, reverse, right or left by a four-quadrant (4Q) operation without additional switches. This is different to an operation based on three

quadrants (3Q), such as a Head Array or a Four Switch Proximity Array. There you have the possibility to move forward, right or left with the aid of proximity sensors. In order to allow the wheelchair to be driven in reverse or changing function screens, an additional switch or sensor is required.

The Head Array and the Four Switch Proximity Array are provided with a Proton Box, so your provider can fit the arrays to your individual needs by using the dip switches.

Default dip switch setup:

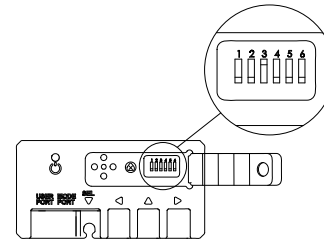

- 1 Reset/Reverse switch turned off.
- 2 Not used at the moment.
- 3 Turned on, to power up with wheelchair.
- 4 Not used at the moment.
- 5 Not used at the moment.
- 6 Audible input indicator turned off.

 All components mentioned below describe the usage of the default set-up. For individual set-up, contact your provider.

### 6.18.1 Using the Extremity Control Joystick (Chin control)

Powered adjustable

This proportional joystick needs less force to be deflected than a standard joystick.

#### Driving

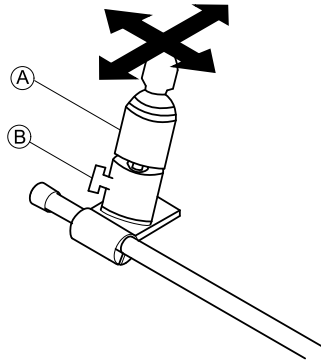

1. Deflect drive joystick **A** from neutral position to drive in desired direction.

For more information about driving, refer to *6.5 Proportional driving mode, page 43*.

 You can use wing bolt **B** to adjust the joystick to your needs.

### Changing function screens

By default an egg switch, used for function or profile changes, is mounted to the headrest.

 For difference between function screen and profile, refer to chapter *4.2.3 User function screen overview, page 17*.

1. Short press egg switch to change function screen.
2. Long press egg switch to change profile.

For operating the powered seating functions, refer to *6.15.1 Through seating screens, page 58*.

### Operating the lighting functions and horn

Via a utility function screen you are able to operate the lighting functions with an external input. The utility function screen is part of one or more profiles and can be activated like a drive or seating function screen.

- 1.

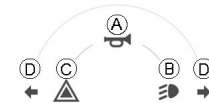
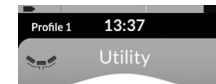

Activate utility function screen.

2. Give input to front **A** to turn on horn.
3. Give short input to right **B** to turn on/off position lights.

4. Give short input to left © to turn on/off hazard lights.
5. Give long input to left © or right © to turn on/off left or right turn signal.

 Activate a drive function screen to drive normally, while position lights and hazard lights remain turned on.

 After more than ten seconds, the turn signals turn off automatically.

### 6.18.2 Using the Extremity Control Joystick (Chin Control)

Manually adjustable

This proportional joystick needs less force to be deflected than a standard joystick.

#### Driving

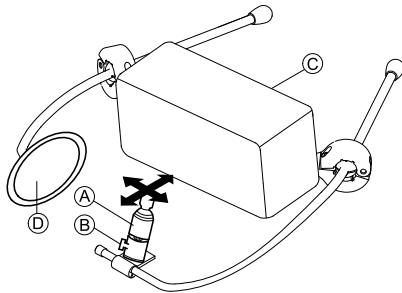

1. Deflect drive joystick **A** from neutral position to drive in desired direction.

For more information about driving, refer to *6.1 Operating the remote*, page 26.

### Moving Chin Control

1. Loosen wing bolt **B** to adjust joystick.
- 2.

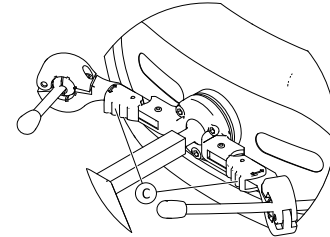

Press locking device **C** (behind headrest) and swivel joystick or egg switch inwards or outwards until it clicks in place.

### Changing function screens

 For difference between function screen and profile, refer to chapter 4.2.3 *User function screen overview*, page 17.

1. Short press egg switch **D** to change function screen.
2. Long press egg switch **D** to change profile.

For operating the powered seating functions, refer to *6.15.1 Through seating screens*, page 58.

### Operating the lighting functions and horn

Via a utility function screen you are able to operate the lighting functions with an external input. The utility function screen is part of one or more profiles and can be activated like a drive or seating function screen.



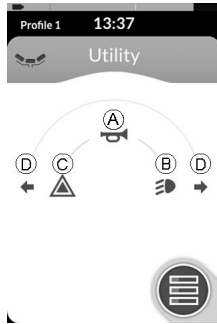

1.



Activate utility function screen.

2. Give input to front **A** to turn on horn.
3. Give short input to right **B** to turn on/off position lights.
4. Give short input to left **C** to turn on/off hazard lights.
5. Give long input to left or right **D** to turn on/off left or right turn signal.

 Activate a drive function screen to drive normally, while position lights and hazard lights remain turned on.

 After more than ten seconds, the turn signals turn off automatically.

### 6.18.3 Using the Compact Single Switch Joystick Driving

1.



Deflect joystick from neutral position to drive in desired direction.

For more information about driving, refer to *6.5 Proportional driving mode, page 43*.

#### Changing function screens

 For difference between function screen and profile, refer to chapter *4.2.3 User function screen overview, page 17*.



1. Short press joystick button (A) to change function screen.
2. Long press joystick button (A) to change profile.

For operating the powered seating functions, refer to *6.15.1 Through seating screens, page 58*.

### Operating the lighting functions and horn

Via a utility function screen you are able to operate the lighting functions with an external input. The utility function screen is part of one or more profiles and can be activated like a drive or seating function screen.

1.

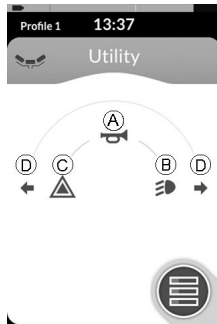

Activate utility function screen.

2. Give input to front (A) to turn on horn.
3. Give short input to right (B) to turn on/off position lights.
4. Give short input to left (C) to turn on/off hazard lights.
5. Give long input to left or right (D) to turn on/off left or right turn signal.

 Activate a drive function screen to drive normally, while position lights and hazard lights remain turned on.

 After more than ten seconds, the turn signals turn off automatically.

### 6.18.4 Using the Micro Extremity Control joystick

This proportional joystick needs only little force to be deflected.

#### Driving

1.



Deflect joystick from neutral position to drive in desired direction.

For more information about driving, refer to *6.5 Proportional driving mode, page 43*.

#### Changing function screens

 For difference between function screen and profile, refer to chapter *4.2.3 User function screen overview, page 17*.

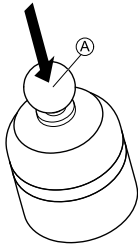

1. Short press joystick **A** to change function screen.
2. Long press joystick **A** to change profile.

For operating the powered seating functions, refer to *6.15.1 Through seating screens, page 58*.

### Operating the lighting functions and horn

Via a utility function screen you are able to operate the lighting functions with an external input. The utility function screen is part of one or more profiles and can be activated like a drive or seating function screen.

1.





Activate lighting function screen.

2. Give input to front **A** to turn on horn.

60101834-C

3. Give short input to right **B** to turn on/off position lights.
4. Give short input to left **C** to turn on/off hazard lights.
5. Give long input to left or right **D** to turn on/off left or right turn signal.

 Activate a drive function screen to drive normally, while position lights and hazard lights remain turned on.

 After more than ten seconds, the turn signals turn off automatically.

### 6.18.5 Using the Pediatric Compact Joystick

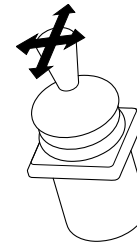

1. Deflect joystick from neutral position to drive in desired direction.

For more information about driving, refer to *6.5 Proportional driving mode, page 43*.

### Changing function screens

Refer to *6.2 Navigating through user function screens, page 32* for more information about changing the function screens.



For difference between function screen and profile, refer to chapter 4.2.3 *User function screen overview*, page 17.

For operating the powered seating functions, refer to 6.15.1 *Through seating screens*, page 58.

### Operating the lighting functions and horn

Via a utility function screen you are able to operate the lighting functions with an external input. The utility function screen is part of one or more profiles and can be activated like a drive or seating function screen.

1.



Activate utility function screen.

2. Give input to front **A** to turn on horn.
3. Give short input to right **B** to turn on/off position lights.
4. Give short input to left **C** to turn on/off hazard lights.
5. Give long input to left or right **D** to turn on/off left or right turn signal.



Activate a drive function screen to drive normally, while position lights and hazard lights remain turned on.



After more than ten seconds, the turn signals turn off automatically.

## 6.18.6 Using the Sip and Puff



### WARNING!

#### Risk of Injury or Damage

Improper mounting or maintenance of the Sip and Puff control including the mouthpiece and breath tube may cause injury or damage.

Water inside the Sip and Puff interface module may cause damage to the unit.

Excessive saliva residue in the mouthpiece/straw can reduce performance.

Blockages, a clogged saliva trap or air leaks in the system may cause Sip and Puff not to function properly.

- Ensure moving parts of the wheelchair, including the operation of powered seating, DO NOT pinch or damage the Sip and Puff tubing.
- Saliva trap MUST be installed to reduce risk of water or saliva entering the Sip and Puff interface module.
- Occasionally flush the mouthpiece to remove saliva residue.
- The mouthpiece/straw MUST be completely dry before installation.
- If Sip and Puff does not function properly, inspect system for blockages, clogged saliva trap or air leaks. As necessary, replace mouthpiece, breath tube and saliva trap.



Contact your Invacare provider for more information about maintaining and troubleshooting the Sip and Puff system.

For further maintenance and cleaning instructions, see *7 Maintenance, page 109*



Sip and Puff is not the most maneuverable or intuitive control method and therefore requires a considerable amount of training. In the early tuning stages, this is best done outdoors in an unrestricted but safe area. Also the presence of an attendant is recommended.

### Driving

The drive function screens for the Sip and Puff are pre-set in latched driving mode. For more information, refer to *6.6 Latched driving mode, page 45*.

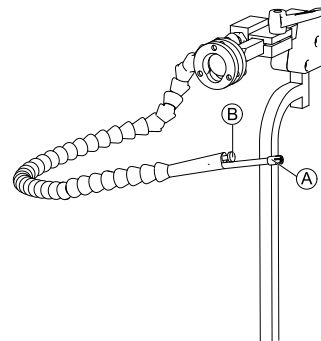

1. Puff hard into mouthpiece **A** to drive forward.
2. Sip hard at mouthpiece to drive in reverse.

3. When in latched driving mode, puff soft into mouthpiece to veer to the right.
4. When in latched driving mode, sip soft at mouthpiece to veer to the left.

 For more information about the calibration of hard and soft inputs, refer to the service manual of the LiNX system.

## Stopping

A lipswitch **B** is mounted to the mouthpiece. This switch can be used as an external stop switch, when in latched driving mode. While you are in latched driving, you do not need to give a drive input all the time, but the mouthpiece must stay inside your mouth. As soon as the lipswitch is pressed while driving, the wheelchair stops.

## Changing function screens

The lipswitch can also be used as a mode function switch.

 For difference between function screen and profile, refer to *4.2.3 User function screen overview, page 17*.

1. Stop wheelchair.
2. Short press lipswitch to change function screen.
3. Long press lipswitch to change profile.

## Operating the lighting functions and horn

Via a utility function screen you are able to operate the lighting functions with an external input. The utility function screen is part of one or more profiles and can be activated like a drive or seating function screen.

1.



Activate utility function screen.

2. Give input to front **A** to turn on horn.
3. Give short input to right **B** to turn on/off position lights.
4. Give short input to left **C** to turn on/off hazard lights.
5. Give long input to left or right **D** to turn on/off left or right turn signal.

 Activate a drive function screen to drive normally, while position lights and hazard lights remain turned on.

 After more than ten seconds, the turn signals turn off automatically.

### 6.18.7 Using the Sip and Puff Head Array



#### **WARNING!**

##### **Risk of serious injury**

Proximity sensors are sensitive to water. If enough water is present close to sensors, they may be activated and mobility device may start moving unintentionally.

- Do not operate Head Array with wet hair.
- Do not operate Head Array in wet weather.
- Do not operate Head Array in any circumstances where water may come close to sensors.



#### **WARNING!**

##### **Risk of serious injury**

Sensor pads are made of water resistant vinyl to get water quickly run off the pads before activating sensors.

If sensor pads are damaged, water may get in and mobility device may start driving unintentionally.

If sensor pads are covered by water absorbing material, mobility device may start driving unintentionally.

- Do not operate Head Array if sensor pads are damaged. Change sensor pads immediately.
- Do not cover sensor pads with any material.



#### **WARNING!**

##### **Risk of Injury or Damage**

Improper mounting or maintenance of the Sip and Puff control including the mouthpiece and breath tube may cause injury or damage.

Water inside the Sip and Puff interface module may cause damage to the unit.

Excessive saliva residue in the mouthpiece/straw can reduce performance.

Blockages, a clogged saliva trap or air leaks in the system may cause Sip and Puff not to function properly.

- Ensure moving parts of the wheelchair, including the operation of powered seating, DO NOT pinch or damage the Sip and Puff tubing.
- Saliva trap **MUST** be installed to reduce risk of water or saliva entering the Sip and Puff interface module.
- Occasionally flush the mouthpiece to remove saliva residue.
- The mouthpiece/straw **MUST** be completely dry before installation.
- If Sip and Puff does not function properly, inspect system for blockages, clogged saliva trap or air leaks. As necessary, replace mouthpiece, breath tube and saliva trap.

 Contact your Invacare provider for more information about maintaining and troubleshooting the Sip and Puff system.

For further maintenance and cleaning instructions, see *7 Maintenance, page 109*

 Sip and Puff is not the most manoeuvrable or intuitive control method and therefore requires a considerable amount of training. In the early tuning stages, this is best done outdoors in an unrestricted but safe area. Also the presence of an attendant is recommended.

Inside the Head Array pads, there are proximity sensors, that allow you to steer the wheelchair in the desired direction with the movement of your head. This means that the head does not need to touch the pads or press a switch to activate driving. If the head comes within 6 mm of a sensor, the sensor is activated and the wheelchair starts driving.

By default, the Head Array powers up as soon as the wheelchair is powered up and powers down as soon as the wheelchair is powered down.

 Be aware, that when powering up automatically with the wheelchair, your head has to be more than 6 mm away from the proximity sensors, otherwise a drive OON warning is displayed and prevents the wheelchair from driving. For more information about OON, refer to *8.2 OON ("Out Of Neutral")*, page 114

## Driving

This component combines simple sip and puff controls with head movements. Right and left turns are controlled by sensors located in the pads of the Head Array.

The drive function screens for the Sip and Puff Head Array are pre-set in latched driving mode. For more information, refer to *6.6 Latched driving mode, page 45*.

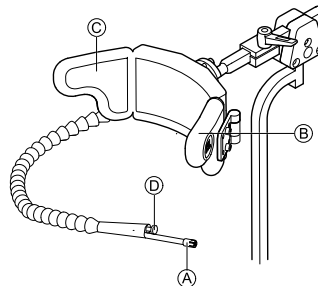

1. Puff into mouthpiece **A** to drive forward.
2. Sip at mouthpiece **A** to drive in reverse.
3. When in latched driving mode, activate left pad **B** to veer to the left.
4. When in latched driving mode, activate right pad **C** to veer to the right.

 To revolve, you only need to activate left or right pad.

## Stopping

A lipswitch **D** is mounted to the mouthpiece. This switch can be used as an external stop switch, when in latched driving mode. While you are in latched driving, you do not need to give a drive input all the time, but the mouthpiece



must stay inside your mouth. As soon as the lipswitch is pressed while driving, the wheelchair stops.

### Changing function screens

The lipswitch can also be used as a mode function switch.

 For difference between function screen and profile, refer to chapter 4.2.3 *User function screen overview*, page 17.

1. Stop wheelchair.
2. Short press lipswitch to change function screen.
3. Long press lipswitch to change profile.



Seating functions can only be operated with the right or left pad of the head array.

### Operating the lighting functions and horn

Via a utility function screen you are able to operate the lighting functions with an external input. The utility function screen is part of one or more profiles and can be activated like a drive or seating function screen.

60101834-C

1.



Activate utility function screen.

2. Give input to front **A** to turn on horn.
3. Give short input to right **B** to turn on/off position lights.
4. Give short input to left **C** to turn on/off hazard lights.
5. Give long input to left or right **D** to turn on/off left or right turn signal.

 Activate a drive function screen to drive normally, while position lights and hazard lights remain turned on.

 After more than ten seconds, the turn signals turn off automatically.

### 6.18.8 Using the Head Array



#### WARNING!

##### Risk of serious injury

Proximity sensors are sensitive to water. If enough water is present close to sensors, they may be activated and mobility device may start moving unintentionally.

- Do not operate Head Array with wet hair.
- Do not operate Head Array in wet weather.
- Do not operate Head Array in any circumstances where water may come close to sensors.



#### WARNING!

##### Risk of serious injury

Sensor pads are made of water resistant vinyl to get water quickly run off the pads before activating sensors.

If sensor pads are damaged, water may get in and mobility device may start driving unintentionally. If sensor pads are covered by water absorbing material, mobility device may start driving unintentionally.

- Do not operate Head Array if sensor pads are damaged. Change sensor pads immediately.
- Do not cover sensor pads with any material.

The Head Array is a three-quadrant operation. Inside the Head Array pads, there are proximity sensors, that allow you to steer the wheelchair in the desired direction with the movement of your head. This means that the head does not need to touch the pads or press a switch to activate driving.

If the head comes within 6 mm of a sensor, the sensor is activated and the wheelchair starts driving.

By default, the Head Array powers up as soon as the wheelchair is powered up and powers down as soon as the wheelchair is powered down.



Be aware, that when powering up automatically with the wheelchair, your head has to be more than 6 mm away from the proximity sensors, otherwise a drive OON warning is displayed and prevents the wheelchair from driving. For more information about OON, refer to *8.2 OON (“Out Of Neutral”)*, page 114

### Driving

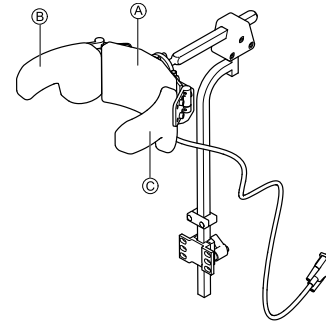

1. Activate forward drive function screen. Activate center pad **A** to drive forward.
2. Change to reverse drive function screen. Activate center pad **A** to drive in reverse.

3. Change back to forward drive function screen.  
Activate center pad **A** and right pad **B** at the same time to veer to the right.
4. Activate center pad **A** and left pad **C** at the same time to veer to the left.

Indicators for forward and reverse are shown in the display.

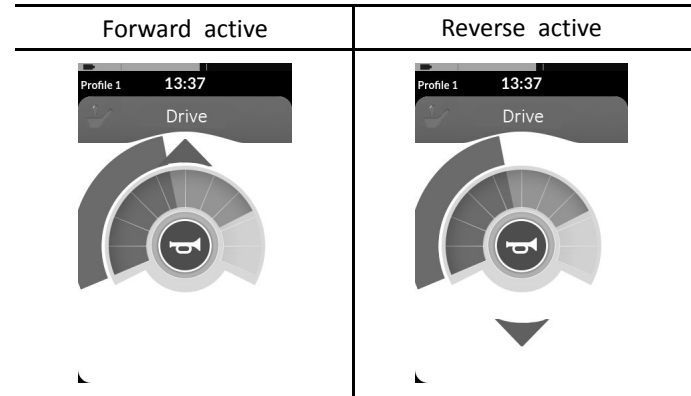
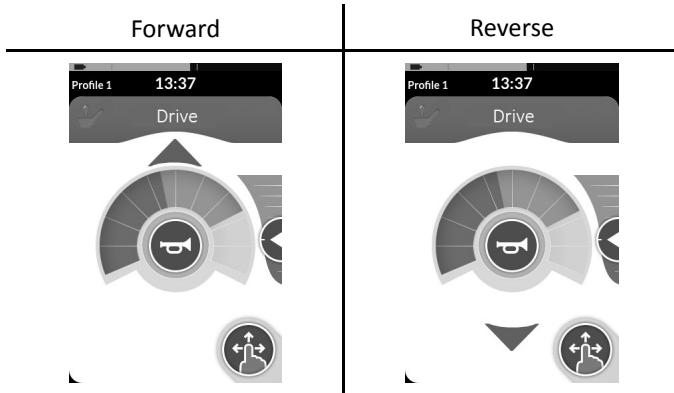

**i** To revolve, you only need to activate left or right pad.

### Changing function screens

**i** For difference between function screen and profile, refer to chapter 4.2.3 *User function screen overview*, page 17.

1. Short press mode switch to change function screen.
2. Long press mode switch to change profile.



Seating functions can only be operated with the right or left pad of the head array.

### Operating the lighting functions and horn

Via a utility function screen you are able to operate the lighting functions with an external input. The utility function screen is part of one or more profiles and can be activated like a drive or seating function screen.

1.



Activate utility function screen.

2. Give input to front **A** to turn on horn.
3. Give short input to right **B** to turn on/off position lights.
4. Give short input to left **C** to turn on/off hazard lights.
5. Give long input to left or right **D** to turn on/off left or right turn signal.



Activate a drive function screen to drive normally, while position lights and hazard lights remain turned on.



After more than ten seconds, the turn signals turn off automatically.

### 6.18.9 Using the Four Switch Proximity Array



#### WARNING!

#### Risk of serious injury

Proximity sensors are sensitive to water. If enough water is present close to sensors, they may be activated and mobility device may start moving unintentionally.

- Do not operate Four Switch Proximity Array in wet weather.
- Do not operate Four Switch Proximity Array in any circumstances where water may come close to sensors.

The Four Switch Proximity Array is a three-quadrant operation. The Four Switch Proximity Array offers four proximity sensors that allow to operate a mobility device or change the function screens. The sensors are activated, as soon as an input comes within 6 mm of the sensors.

By default, the sensors power up as soon as the wheelchair is powered up and power down as soon as the wheelchair is powered down.



Be aware, that when powering up automatically with the wheelchair, you must not cover the proximity sensors, otherwise a drive OON warning is displayed and prevents the wheelchair from driving. For more information about OON, refer to *8.2 OON ("Out Of Neutral")*, page 114



The picture below shows a configuration example in combination with an Eclipse Tray. For individual adjustment, contact your provider.

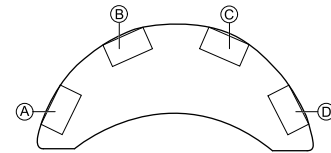

1. Cover sensor **B** to drive forward.
2. To drive in reverse, cover sensor **D** to change direction. Cover sensor **B** to drive in reverse.
3. Cover sensors **A** and **B** to veer to the left.
4. Cover sensors **C** and **B** to veer to the right.
5. Cover sensor **D** to change function screen.

Indicators for forward and reverse are shown in the display.

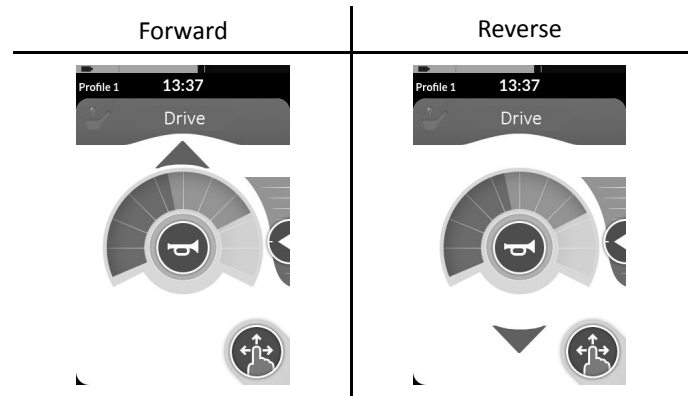

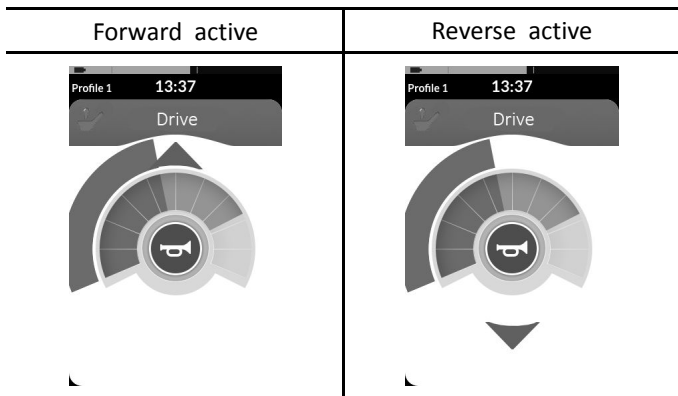

 To revolve, you only need to cover sensors **A** or **C**.

### Operating the lighting functions and horn

Via a utility function screen you are able to operate the lighting functions with an external input. The utility function screen is part of one or more profiles and can be activated like a drive or seating function screen.

1.

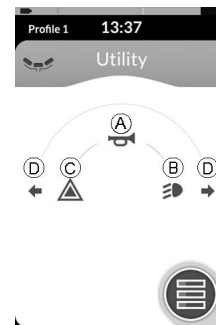

Activate utility function screen.

2. Give input to front **A** to turn on horn.
3. Give short input to right **B** to turn on/off position lights.
4. Give short input to left **C** to turn on/off hazard lights.
5. Give long input to left or right **D** to turn on/off left or right turn signal.

 Activate a drive function screen to drive normally, while position lights and hazard lights remain turned on.

 After more than ten seconds, the turn signals turn off automatically.

### 6.18.10 Using the Wireless Mouse Emulator





1. Turn on the Bluetooth on your proton box by pressing an external switch until you hear a long beep.
2. Connect the Wireless Mouse Emulator via the USB port with your computer.



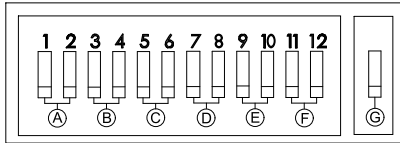

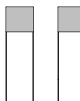
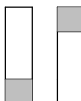
3. Mouse emulator and Head Array connect automatically.
4. Default set up is:

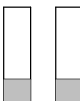
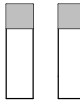
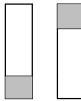

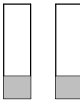
- Back pad: Mouse moves up and down
- Right pad: Mouse moves left and right
- Left pad: select

Mouse movement and behaviour can be changed via the switches at the back of the Wireless Mouse Emulator.

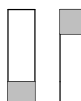
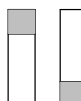
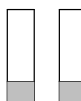
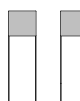
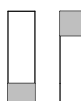
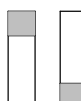
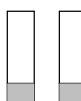

<b>(A)</b>	<b>Dip switch 1 &amp; 2: Initial mouse movement</b>			
	 slow	 medium slow	 medium fast	 fast
<b>(B)</b>	<b>Dip switch 3 &amp; 4: Maximum cursor or mouse speed</b>			
	 disabled	 2x base	 4x base	 8x base

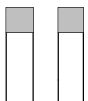
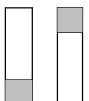
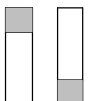
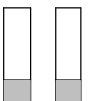
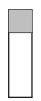
<b>(C)</b>	<b>Dip switch 5 &amp; 6: Cursor delay</b>			
	 disabled	 1.0 sec	 2.0 sec	 4.0 sec
<b>(D)</b>	<b>Dip switch 7 &amp; 8: Switch delay</b>			
	 disabled	 0.5 sec	 1.0 sec	 2.0 sec
<b>(E)</b>	<b>Dip switch 9 &amp; 10: Latch delay</b>			
	 disabled	 1.0 sec	 2.0 sec	 4.0 sec

F	Dip switch 11 & 12: Cursor movement options			
				
	3 switch	4 switch	4 switch	5 switch
G				
	OFF	ON		

A	This is a slower speed initially for precise targeting. It is set and used in conjunction with Cursor Delay to give the user the ability to move the mouse slowly at first and then speed up after a set amount of time to move across the screen efficiently.
B	This setting controls the maximum speed of the cursor and is the speed that the mouse will obtain after the initial speed. Note: The base speed is set in the control panel of the computer's mouse settings.
C	This is the initial amount of time the switch must be pressed and held before the mouse speeds up. This setting is used in conjunction with Initial Mouse Movement and Maximum Cursor settings.
D	This setting controls the amount of time the directional switches must be activated before the cursor will move. This is to allow for inadvertent switch closures. Note: This applies to directional switches only.

E	This setting controls the amount of time the Left and Right Click switch must be held before it will latch. Once the latch is no longer required, press the Right Click or Left Click switch for the same length of time to deactivate the latch.
F	Switch 11 and 12 should be in the DOWN position when using with the Head Array for 3 switch mouse emulation.
G	OFF: Original mouse speed, better for PC. ON: Increases mouse speed by 1/3, better for MAC.

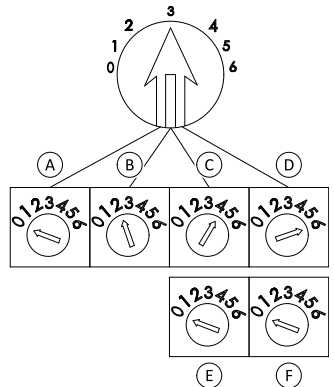

Fig. 6-86

Numbers 0 to 6 describe the action the mouse should perform. Letters A to F describe the direction of the input, which leads to the mouse action.



Number	Mouse action
0	No change
1	Down
2	Left
3	Right
4	Up
5	Right click
6	Left click

The following adjustments are examples only and can be adjusted to your needs by your provider.

	Input direction	Mouse action
Ⓐ	Reverse	No change
Ⓑ	Left	Left and right mouse direction
Ⓒ	Right	Up and down mouse direction
Ⓓ	Forward	Left click
Ⓔ	Left click	No change
Ⓕ	Right click	No change

 Input direction/Mouse action (0–6) cannot be duplicated in any two switches, except for zero.

## 6.19 Disabling Bluetooth

The embedded Bluetooth functionality can be disabled when powering up the system.

1. Press and hold the ON/OFF button for more than three seconds.



The disabled Bluetooth functionality is indicated by an icon in the status bar and the status LED inside the ON/OFF button pulsing for a duration of six seconds.

Bluetooth functionality resumes the next time the system is powered up again.

## 6.20 Charging the batteries



### WARNING!

#### Risk of Injury, Damage or Death

Improper routing of charger cord(s) may cause tripping, entanglement or strangulation hazard that may result in injury, damage or death.

- Ensure all charger cord(s) are routed and secured properly.
- Close supervision and attention is needed when charging the wheelchair near children, pets or people with physical/mental disabilities.



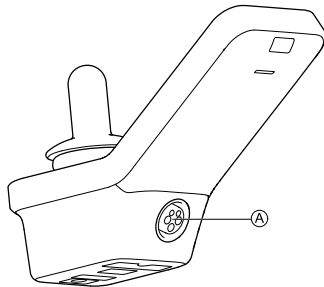

Refer to the charger user manual, the power wheelchair base user manual and instructions supplied with the batteries for more information concerning charging the batteries.



1. Plug battery charger into remote's charger socket (A).

If the remote is powered up, the battery gauge indicates the system is connected to the charger by displaying a charge sequence and then displaying the approximate battery charge state at the end of the charge sequence.

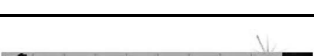
	Battery bar displays red when charge is <20%
	Battery bar displays orange when charge is between 20 and 60%
	Battery bar displays green when charge is between 60 and 100%

The LiNX system does not have to be powered up when charging the batteries, however, if it is not powered up, the battery gauge does not indicate the charging state. For more information about the charging state, refer to the user manual of your charger or the power wheelchair base user manual.

While charging, the wheelchair is in drive inhibit mode. For more information about the drive inhibit mode, refer to 8.3 *Drive inhibit indication*, page 115



**NEW Batteries Only**—The wheelchair power must be on during charging to ensure that accurate battery charge levels display on the remote. New batteries must be charged fully. The Battery synchronization Procedure **MUST** be performed within 24 hours of powering on the wheelchair. The Battery Synchronization Procedure can be found in the LiNX service manual and must be performed by a provider or qualified technician.

### 6.20.1 Battery alarms

Three battery alarms are shown on the right-hand side of the status bar:

Profile 12:00  Over voltage

This is displayed if the batteries are overcharged. Disconnect the battery charger immediately.

Profile 12:00  Low voltage

This is displayed if the batteries are empty. Power down the wheelchair and charge the batteries immediately.

Profile 12:00  Deep discharge

This is displayed if the battery voltage falls below the voltage set by Cut Off Voltage. This indicates that the battery is empty and battery damage occurs if the battery is discharged any further. The horn also sounds once every ten seconds for the duration of active deep discharge status. Power down the wheelchair and charge the batteries immediately.

## 6.21 Using the USB charger



### **WARNING!** **Risk of injury**

If you use mobile phone while operating mobility device, accidents could lead to injury or property damage.

- Only use mobile phone in conjunction with hands-free equipment to operate mobility device while driving.



### **Risk of property damage**

Handle USB charger with care, otherwise damage could occur.

- Always keep the USB charger dry. If USB charger gets wet, let USB charger dry before use.
- Do not use or store USB charger in dusty or dirty areas.
- Do not insert sharp objects into the USB ports.



### **WARNING!**

#### **Risk of Injury or Damage**

Erratic or unintended movement of the wheelchair may occur if wireless transmitters are connected to the wheelchair. To avoid injury or damage:

- DO NOT use the USB charger connector as a wireless transmitter.
- Only use the USB charger for the purposes described in this manual.

With the USB charger you can charge the battery of your mobile phone or a compatible device when you do not have access to a regular power source. Both USB ports can be used at the same time and each USB port has a charging current up to 1 A.

1.

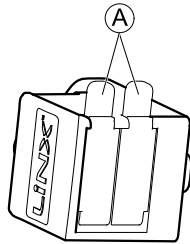

Open bung **A**.

2. Connect device with USB port.

**i** Replace bung when USB ports are not in use.

**i** The usage of the USB charger influences the drive range of the mobility device. For more information about the drive range, refer to chapter Technical Data in the user manual of your mobility device.

## 7 Maintenance

### 7.1 Maintenance Information



#### Risk of damage to the remote

There are no user-serviceable parts in any electronic component.

– Do not attempt to open any case or undertake any repairs, else warranty will be voided and the safety of the system may be compromised.



If any component is damaged in any way, or if internal damage may have occurred (for example by being dropped), have it checked by qualified personnel before operating.

Where any doubt exists, consult your nearest Invacare provider.

### 7.2 Setup/Delivery Inspection



Setup/delivery inspection should be performed by provider at time of delivery/set up.

Initial adjustments should be made to suit your personal body structure needs and preference. Thereafter weekly, monthly and periodic inspections should be performed by user/attendant between the six month service inspections.

Every six months, and as necessary, take your wheelchair to a qualified technician for a thorough inspection and servicing.

- Check all parts for shipping damage. In case of damage, DO NOT use.
- Check that cables are routed and secured properly to ensure that cables do NOT become entangled and damaged during normal operation of seating system.
- Ensure proper operation of powered functions (Example: drive, seating and legrests).

### 7.3 Wear and Tear Information

#### General Information

Normal wear and tear items and components include but are not limited to: all upholstery items including seat and back upholstery, arm and calf pads, cushions, wheels, tires and casters, all types of batteries, joystick overlays and inductive rubberized protective boots.

Invacare reserves the right to ask for any item back that has an alleged defect in workmanship. Refer to the Warranty section in this manual for specific warranty information.

Refer to the Inspection Checklists for proper preventative maintenance schedule.

This is just a general guideline and does not include items damaged due to abuse and misuse.

Product Type	Product Wear and Tear
Wheelchairs	Wheels, Brake Assembly, Hand Grips

<b>Mobility Hardware and Electronics</b>	Rubber Urethane Tires and Casters, Handgrips, Joystick Inductive Tops, Joystick Overlays, Motors and Gearboxes (if exposed to prolonged moisture, urine, etc.), Stability Lock
<b>Upholstery and Seating</b>	Arm pads, Seat Cushion Foam, Seat Cushion Covers, Back Cushion Foam, Back Cushion Covers, Headrest Foam, Headrest Covers, Footplate Covers, Calf Pad (if applicable) Foam and Cover
<b>Batteries</b>	Lead acid/Lithium, Coin cell (watch type), Gel (6 months)

## 7.4 User/Attendant Inspection Checklists



Every six months, and as necessary, take your wheelchair to a qualified technician for a thorough inspection and servicing.

Weekly, monthly, and periodic inspections should be performed by user/attendant between the six month service inspections.

Regular cleaning will reveal loose or worn parts and enhance the smooth operation of your wheelchair. To operate properly and safely, your wheelchair **MUST** be cared for just like any other vehicle. Routine maintenance will extend the life and efficiency of your wheelchair.

### 7.4.1 Inspect/Adjust Weekly

- Ensure proper operation of powered functions (Example: drive, seating and legrests).

### 7.4.2 Inspect/Adjust Monthly

- Check all components for loose, damaged or corroded components, such as connectors, terminals or cables. Contact your Invacare provider to replace damaged components.
- Ensure that all connectors are fully mated.
- Cables shall be inspected periodically to ensure that they are routed and secured properly. Periodic inspection is recommended as it may reveal loose and/or damaged cables. Contact your Invacare provider to re-secure or replace cables.
- Check for and remove any foreign objects or material.

### 7.4.3 Inspect/Adjust Periodically

- Check the joystick boot for damage. Contact your Invacare provider for replacement if damaged.
- Check that all labels are present and legible. Replace if necessary.

## 7.5 Service Inspection



Every six months take your wheelchair to a qualified technician for a thorough inspection and servicing.

Service inspections **MUST** be performed by a qualified technician.

The following are recommended items to inspect during regular service inspections performed by a qualified

technician. Actual items to be inspected during the service inspection may vary according to the specific wheelchair:

### 7.5.1 Six Month Inspection

- ❑ Cables shall be inspected periodically to ensure that they are routed and secured properly. Periodic inspection is recommended as it may reveal loose and/or damaged cables. Re-secure all loose cables and replace by following the recommendations outlined in the LiNX service manual.
- ❑ Ensure proper operation of powered functions (drive, seating, legrests, etc.).
- ❑ Inspect electrical components for signs of corrosion. Replace if corroded or damaged.
- ❑ Check that all labels are present and legible. Replace if necessary.

## 7.6 Cleaning



### **WARNING!**

#### **Risk of Injury, Damage or Death**

Electrical shock may cause injury, damage or death.

- Always unplug the product from the electrical outlet before cleaning.
- Always unplug accessories from the electrical outlet before cleaning.



### **CAUTION!**

#### **Risk of Damage**

Cleaning or maintenance may cause damage to carpeting or flooring.

- Place the wheelchair in a well ventilated area where cleaning or maintenance can be performed without risk of damage to carpeting or flooring.



### **CAUTION!**

#### **Risk of Damage**

Exposure to liquids may damage components or accessories of wheelchair and electronics.

- DO NOT spray with any type of water or liquid.
- Electrical components damaged by corrosion MUST be replaced immediately.



### **CAUTION!**

#### **Risk of Damage**

Improper cleaning may cause damage to the product.

- DO NOT use chemicals, solvents or abrasive cleaners.



Regular cleaning will reveal loose or worn parts and enhance the smooth operation of your wheelchair. To operate properly and safely, your wheelchair must be cared for just like any other vehicle.

Keep all electronic components free of dust, dirt and liquids.

**LiNX® Control System**

1. Use a cloth dampened with warm water and mild non-abrasive soap to clean this product.
2. Dry the surface with dry cloth.
3. DO NOT use solvents or kitchen cleaners.



## 8 Troubleshooting

### 8.1 Fault diagnosis

If the electronic system shows a fault, use the following fault-finding guide to locate the fault.

-  Ensure that the drive electronics system is powered up before starting any diagnosis.

**If the status display is OFF:**

- Check whether the drive electronics system is powered up.
- Check whether all cables are correctly connected.
- Ensure that the batteries are not discharged.

**If a fault number is displayed in the status display:**

- Proceed to the next section.

#### 8.1.1 Fault codes and diagnosis codes









If there is a fault with the system when it is powered up, a fault icon  is displayed in the status bar. The number inside the triangle indicates the type of fault.



Corresponding to that, the status LED inside the ON/OFF button flashes red. The number of flashes is identical to the one in the status bar.

The table below describes the fault indication and a few possible actions that can be taken to rectify the problem. The actions listed are not in any particular order and are suggestions only. The intention is that one of the suggestions may help you clear the problem. If in doubt, contact your provider.

Fault icon	Fault description	Possible action
	Remote fault	<ul style="list-style-type: none"> <li>• Check cables and connectors.</li> <li>• Contact your provider.</li> </ul>
	Network or configuration fault	<ul style="list-style-type: none"> <li>• Check cables and connectors.</li> <li>• Recharge the batteries.</li> <li>• Check charger.</li> <li>• Contact your provider.</li> </ul>
	Motor 1 <sup>1</sup> fault	<ul style="list-style-type: none"> <li>• Check cables and connectors.</li> <li>• Contact your provider.</li> </ul>
	Motor 2 <sup>1</sup> fault	<ul style="list-style-type: none"> <li>• Check cables and connectors.</li> <li>• Contact your provider.</li> </ul>
	Left magnetic brake fault	<ul style="list-style-type: none"> <li>• Check cables and connectors.</li> <li>• Check left motor (or motor lock lever) is engaged.</li> <li>• Refer to the chapter “Pushing the mobility device in freewheel mode” in the user manual of your wheelchair.</li> <li>• Contact your provider.</li> </ul>

Fault icon	Fault description	Possible action
	Right magnetic brake fault	<ul style="list-style-type: none"> <li>• Check cables and connectors.</li> <li>• Check right motor (or motor lock lever) is engaged.</li> <li>• Refer to the chapter “Pushing the mobility device in freewheel mode” in the user manual of your wheelchair.</li> <li>• Contact your provider.</li> </ul>
	Module fault (other than remote module)	<ul style="list-style-type: none"> <li>• Check cables and connectors.</li> <li>• Check modules.</li> <li>• Recharge batteries.</li> <li>• If the chair was stalled, reverse away or remove obstacle.</li> <li>• Contact your provider.</li> </ul>

- 1 Configuration of the motors depending on the wheelchair model

## 8.2 OON (“Out Of Neutral”)

OON (“Out Of Neutral”) is a safety feature that prevents accidental driving or seating movements, when:

- The system is powering up
- After a function change
- When the system comes out of an inhibit or drive lock-out

### Drive OON warning

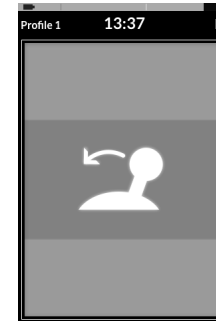

The joystick must be in the center position:

- When a system is powering up
- On a function change
- When transitioning from a drive lock-out or inhibit state

Otherwise a drive OON warning is displayed by an overlay. During a drive OON warning, the OON overlay is displayed and the wheelchair does not drive. If the joystick is returned to the center position, the warning clears and the wheelchair drives normally.

## Seating OON warning



When a system is powering up or after a function change, no direct access switches can be active, otherwise a seating OON warning is displayed.

During a seating OON warning, the OON overlay is displayed and the seating motions do not operate. If the switches are deactivated, the warning clears and the seating motions operate normally.

### 8.3 Drive inhibit indication

The drive inhibit mode ensures that the wheelchair does not drive when connected to the charger.

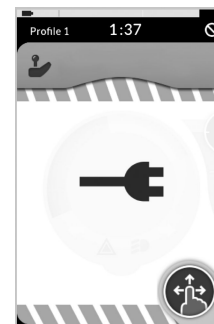

Drive inhibit mode is indicated by the screen shown.

## 9 Technical Data

### 9.1 Technical specifications

#### Mechanical specifications

Permissible operating, storage and humidity conditions	
Temperature range for operation according to ISO 7176-9:	<ul style="list-style-type: none"> <li>-13 °F (-25 °C)–122 °F (+50 °C)</li> </ul>
Recommended storage temperature:	<ul style="list-style-type: none"> <li>59 °F (15 °C)</li> </ul>
Temperature range for storage according to ISO 7176-9:	<ul style="list-style-type: none"> <li>-40 °F (-40°)–149 °F (+65 °C)</li> </ul>
Operation humidity range according to ISO 7176-9:	<ul style="list-style-type: none"> <li>0–90% RH</li> </ul>
Degree of protection:	IPX4 <sup>1</sup>

1 IPX4 classification means that the electrical system is protected against spray water.

Operating forces	
Joystick	<ul style="list-style-type: none"> <li>1.9 N</li> </ul>
Power button	<ul style="list-style-type: none"> <li>2.5 N</li> </ul>

#### Electrical specifications

Parameter	Min.	Nominal	Max.	Units
Operating voltage (V <sub>batt</sub> )	<ul style="list-style-type: none"> <li>17</li> </ul>	<ul style="list-style-type: none"> <li>24</li> </ul>	<ul style="list-style-type: none"> <li>34</li> </ul>	<ul style="list-style-type: none"> <li>V</li> </ul>
Idle current	-	<ul style="list-style-type: none"> <li>70</li> </ul>	-	<ul style="list-style-type: none"> <li>mA at 24V</li> </ul>
Quiescent current (power off)	-	-	<ul style="list-style-type: none"> <li>0.23</li> </ul>	<ul style="list-style-type: none"> <li>mA at 24V</li> </ul>

## 10 Wireless Technology

### 10.1 Wireless Technology Overview

The LiNX control system makes use of Bluetooth wireless technology. Bluetooth is a wireless communications system that is designed to operate in short-range wireless personal area networks (WPAN).

LiNX supports both the Smart (low energy) and Classic Bluetooth protocols. These operate in the spectrum range 2.400 GHz to 2.4835 GHz industrial, scientific and medical (ISM) band. Bluetooth Classic uses 79 x 1MHz channels and Bluetooth Smart uses 40 x 2MHz channels. Within a channel, data is transmitted using Gaussian frequency shift modulation. The bit rate is 1Mbit/s, and the maximum transmit power is 5mW. Both Bluetooth protocols use frequency hopping to counteract narrowband interference problems.

#### Bluetooth Technology Specifications

Technical Specification	Classic Bluetooth	Smart (low energy) Bluetooth
Class	Class 2	
Distance/Range (theoretical max.)	10m (33ft)	
Over the Air Data Rate	1–3 Mbit/s	1 Mbit/s
Application Throughput	0.7–2.1 Mbit/s	0.27 Mbit/s

Technical Specification	Classic Bluetooth	Smart (low energy) Bluetooth
Security	56/128-bit and application layer user defined	128-bit AES with Counter Mode CBCMAC and application layer user defined
Robustness	Adaptive fast frequency hopping, FEC, fast ACK	Adaptive frequency hopping, Lazy Acknowledgement, 24-bit CRC, 32-bit Message Integrity Check
Latency (from a non-connected state)	Typically 100 ms	6 ms
Network Topology	Scatternet	
Power Consumption	5 mW	
Service Discovery	Yes	
Profile Concept	Yes	

### 10.2 Intended Wireless (Electromagnetic) Environment

The intended environments for the LiNX wheelchair are defined as the users home, assisted living facilities, nursing

homes, vocational settings and health care facilities. Across these environments, there are numerous different items of both medical and non-medical equipment that also operate wirelessly.

## 10.3 LiNX Wireless Functions

The LiNX control system functions that use Bluetooth include:

- **Mouse mover**—controls the mouse cursor on a PC, laptop or other portable device.
- **Remote diagnostics**—provides status information of the powered wheelchair (battery status, fault conditions etc.).
- **Configuration**—by a trained provider, dealer, therapist or clinician using the programming and diagnostic tools, configures the LiNX control system.

### 10.3.1 Mouse Mover

The system is able to operate as a standard wireless PC mouse where the joystick or other user input can be used to move the cursor on the screen on a PC, laptop or other similar device. Buttons within the system can also be used to emulate a “left click” and “right click”.



When in Mouse Mover mode, the wheelchair is stationary and unable to drive.

### 10.3.2 Remote Diagnostics

The system transmits wheelchair-specific diagnostic information to an Apple iOS device. This information helps with the technical support of the wheelchair.

The information provides the status of the wheelchair electronics, including:

- The state of charge of the battery,
- Active and historical fault data,
- Wheelchair driving time, and
- Information about the modules attached to the wheelchair (e.g. module serial numbers).

The information updates once every 12 hours (when connected), or whenever requested by an application on the iOS device. Note that the wheelchair may be in motion at the time of transmission.

### 10.3.3 Configuration

The LiNX Programming and Diagnostic (P&D) tools use Bluetooth to communicate with the LiNX control system via the LiNX Access Key (LAK). The LAK is a standalone device that plugs into a remote module. A system cannot be configured without using the LAK and only manufacturers, trained providers, dealers, therapists or clinicians have access to the LAK. This means that end users, their friends, relatives or caregivers cannot change the configuration.

There are two levels of access:

- Manufacturer (or OEM) and
- Distributor (provider/clinician).

The levels of access permit the following:

- **LAK Manufacturer Level**  
With this level, the manufacturer sets the system's default parameters to suit a particular wheelchair.
- **LAK Distributor Level**  
With this level, a subset of the system's parameters is configured by trained providers, dealers, clinicians or therapists. Critical parameters are limited within a predetermined range as set by the manufacturer.

Whilst the wheelchair may be in motion when the system is being configured, instructions for safe use, training and built-in safety mechanisms minimize the potential for non-life threatening injuries resulting from inappropriate configuration of the wheelchair. The likelihood of the aforementioned hazardous situation occurring is remote. A human intermediary, knowledgeable in the control system and specific user needs, can intervene to prevent harm to the wheelchair user during wheelchair set-up.

The P&D tools do not allow direct control of the LiNX wheelchair. Complete control of the wheelchair remains with the end-user at all times. Should a user determine during the customization process that the wheelchair set-up is inappropriate in providing full control in everyday usage, they may return the joystick to the neutral position and the wheelchair will come to a complete and safe stop in a controlled manner.

Similarly, the user, provider, therapist or clinician, may at any time turn-off the control system using the power button/s within the system (for example, on the primary remote module or the attendant control unit). Such action will also bring the wheelchair to a complete and safe stop in a controlled manner.

## 10.4 Quality of Service

As per the risk assessment, none of these items can cause or contribute to a safety hazard should the data link be compromised. Data latency and/or the probability of loss of service creates an inconvenience only and does not inhibit the user's therapy or treatment.

### 10.4.1 Data Integrity

Errors in the integrity of the data transmitted are a nuisance and will not cause a safety related issue. Data is not used for clinical purposes.

Loss of, or incorrect data transmitted in Mouse Mover mode could result in loss of, or incorrect movement of the user's PC cursor. Similar conditions exist with normal off-the-shelf USB or wireless PC mice when their batteries are low.

Loss of diagnostic data transmitted could result in a gap in historical information presented to a service technician. Errors in the wheelchair-specific diagnostic information could result in short term erroneous information being presented to a technician. Both conditions may result in wheelchair troubleshooting taking longer than initially estimated.

Loss of configuration data transmitted in programming and diagnostic mode would result in no effect. The existing wheelchair configuration would be maintained. Errors in the configuration data transmitted would be rejected by built-in safety mechanisms and/or detected during the subsequent evaluation of the configuration updates through the prescribed user testing.



The programming and diagnostic tools serve no specific medical purpose and do not control the wheelchair's operation. Complete control of the wheelchair's actions remain with the user at all times.

### 10.4.2 Safeguards and Redundancy

Safeguards will include warnings in the user manuals around minimum separation distances, the ability to turn off the

Bluetooth connections, inherent encryption of the Bluetooth protocols, and direct indication to a user when a connection is made.

Due to the nature of the functions using the wireless technology, there is no requirement for redundancy.

Security risks are addressed by compliance to recognized standard AAMI-TIR57:2016 - Principles for medical device security - Risk management (FDA recognition No: 13-83) and the NIST Framework as appropriate.

The built-in safety features, such as and without limitation, necessity for the LiNX Access Key to be physically present when configuring the device, the use of standard Bluetooth security protocols, single connection at any point in time, limited range, limited exposure time and the visual indication of an established connection, minimize the threats and vulnerabilities from malicious attack.

## 10.5 Wireless Coexistence

Wireless coexistence testing has been conducted in line with ANSI C63.27 using the radiated anechoic chamber (RAC) test method.

The LiNX Access Key has been tested per ISO 7176-21:2009 Clause 5.2.3 at 20 v/m field strength. During testing the LiNX Access Key disconnected from its paired device when subjected to a frequency of 2.44 GHz. The function of the wheelchair was not impacted by the disruption of the LiNX Access Key wireless communication. If the LiNX Access Key becomes disconnected from its paired device during use, remove the wheelchair from the RF field and wirelessly reconnect the device.

## 10.6 Cybersecurity

The LiNX product range has been designed with cybersecurity in mind to assure device functionality and safety. The cybersecurity measures taken address:

- The embedded software,
- The programming and diagnostic tools' software, and
- Bluetooth wireless technology.

### 10.6.1 Cybersecurity Controls

A number of controls are in place to assure that the LiNX system software maintains its integrity from the point of origin to the point at which a system leaves the control of the manufacturer, and during product use.

These are summarized below:

- Devices leaving the point of origin are equipped with a tamper evident seal, which allows for the detection that a product's case has been opened and thus potentially compromised. The Factory Test Interface is not accessible without opening the case of any given module.
- Once the system leaves the point of origin, it can only have its software upgraded using the Programming and Diagnostic tools by a healthcare professional or a service technician with a LiNX Access Key (LAK) connected to the charging port. Access controls and licensing is provided through the physical LAK.
- Programming can only occur using either the P&D tools or via Single Wire Communication interface, both through the charging port. The embedded system ensures safe envelopes for programmed parameters.



- The system will only run valid software. Cyclic Redundancy Checks (CRC) are conducted on the software before it is executed.
- LiNX products use Class 2 Bluetooth wireless technology. This technology has built-in safety features that can maximize the product's integrity. These features include:
  - operating range to 10 m (33 ft);
  - the use of standard Bluetooth security protocols;
  - single connection at any point in time;
  - limited exposure time, and
  - visual indication when in a connectivity function.

### **10.6.2 User Actions**

Users are not required to take any specific actions in order to assure cybersecurity of the LiNX system. However, should the user be concerned about the Bluetooth connection for any reason, the user can switch off the Bluetooth functionality by powering down the system. The user also has the option to power up the system with the Bluetooth functionality disabled, if they so desire.

---

## 11 Warranty

---

### 11.1 Limited Warranty—US

Except as otherwise set forth below, Invacare warrants that the following components of the mobility device (“product”) will be free from defects in materials and workmanship for a period of one (1) year from the date Invacare ships the product to the original purchaser or provider: base frame, electronics and electrical components (excluding batteries), motors, powered seating actuators, gearboxes, bearings and bushings, seat frame, fixed seat post, upholstered materials, padded materials, casters, tires, and tubes (excluding normal wear and tear). Invacare warrants all product batteries will be free from defects in materials and workmanship for a period of six (6) months from the date Invacare ships the product to the original purchaser or provider. The warranties described above are referred to as the “Warranty”. A copy of the original product invoice is required for coverage under the Warranty.

### 11.2 Limited Warranty—Canada

Except as otherwise set forth below, Invacare warrants the base frame of the mobility device (“product”) will be free from defects in materials and workmanship for a period of five (5) years from the date Invacare ships the product to the original purchaser or provider. Invacare warrants that the seat frame and fixed seat post will be free from defects in materials and workmanship for a period of three (3) years from the date Invacare ships the product to the original purchaser or provider. Invacare warrants that the following components of the product will be free from defects in materials and workmanship for a period of two

(2) years from the date Invacare ships the product to the original purchaser or provider: electronics and electrical components (excluding batteries), motors, powered seating actuators, gearboxes. Invacare warrants that the following components of the product will be free from defects in materials and workmanship for a period of one (1) year from the date Invacare ships the product to the original purchaser or provider: bearings and bushings, upholstered materials (excluding normal wear and tear), padded materials (excluding normal wear and tear), brake pads (excluding normal wear and tear), casters (excluding normal wear and tear), tires and tubes (excluding normal wear and tear). Invacare warrants all product batteries will be free from defects in materials and workmanship for a period of six (6) months from the date Invacare ships the product to the original purchaser or provider. The warranties described above are referred to as the “Warranty”. A copy of the original product invoice is required for coverage under the Warranty.

### 11.3 Repair or Replacement

Invacare's sole obligation and the original purchaser's exclusive remedy under the Warranty is limited to Invacare's repair and/or replacement, at Invacare's option, of defective components and batteries covered by the Warranty. Such repair or replacement does not include any labor or shipping charges incurred by Invacare in the replacement and/or repair of any such component or battery. For Warranty service, please contact the provider from whom you purchased your product. In the event you do not receive satisfactory Warranty service, please write directly to Invacare at the address on the bottom of the back cover. Provide provider's name address, date of purchase, indicate

nature of the defect and, if the product is serialized, indicate the serial number. Do not return products to Invacare without Invacare's prior written authorization.

### **11.4 Limitations and Exclusions**

The Warranty is extended only to the original purchaser who purchases the product new and unused from Invacare or a provider. The Warranty is not extended to any other person or entity and is not transferable or assignable to any subsequent purchaser or owner. Coverage under the Warranty will end upon any such subsequent sale or other transfer of title to any other person.

The Warranty does not apply to serial numbered products if the serial number has been removed or defaced, products subject to neglect, abuse, accident, improper operation, maintenance or storage, commercial or fleet use, products modified without Invacare's express written authorization (including, but not limited to, modification through the use of unauthorized parts or attachments), products damaged by reason of repairs made to any component without Invacare's express written authorization, or to a product damaged by circumstances beyond Invacare's control, and such evaluation will be solely determined by Invacare.

The Warranty does not apply to problems arising from normal wear and tear or failure to adhere to the product instructions. A change in operating noise, particularly relative to motors and gearboxes does not constitute a failure or defect and will not be repaired or replaced as all products are expected to exhibit changes in operating noise due to aging.

### **11.5 Disclaimers**

The Warranty may not be modified or waived in any manner whatsoever without Invacare's express written authorization.

THE WARRANTY IS EXCLUSIVE AND IN LIEU OF ANY OTHER WARRANTIES, WHETHER EXPRESS OR IMPLIED, STATUTORY OR OTHERWISE, INCLUDING WITHOUT LIMITATION, THE IMPLIED WARRANTIES OF MERCHANTABILITY AND FITNESS FOR A PARTICULAR PURPOSE.

EXCEPT AND TO THE EXTENT AS MAY BE PROHIBITED BY STATE OR PROVINCIAL LAW, IN NO EVENT SHALL INVACARE BE LIABLE FOR ANY DIRECT, INDIRECT, SPECIAL, INCIDENTAL OR CONSEQUENTIAL DAMAGES RESULTING FROM OR ARISING OUT OF OR RELATED TO A DEFECT IN ANY PRODUCT, OR INVACARE'S PERFORMANCE OR FAILURE TO PERFORM ANY OF ITS OBLIGATIONS UNDER THIS WARRANTY, WHETHER OR NOT INVACARE HAS BEEN ADVISED, KNEW OR SHOULD HAVE KNOWN OF THE POSSIBILITY OF SUCH DAMAGES, INCLUDING, BUT NOT LIMITED TO, LOST PROFITS.

## Invacare Corporation

### Canada

570 Matheson Blvd E Unit 8  
Mississauga Ontario, L4Z 4G4  
Canada  
Tel: 800-668-5324  
[www.invacare.ca](http://www.invacare.ca)

### USA

One Invacare Way  
Elyria, Ohio USA  
44035  
Tel: 440-329-6000  
Tel: 800-333-6900  
[www.invacare.com](http://www.invacare.com)



60101834-C 2018-09-21



### New Zealand

Invacare New Zealand Ltd  
4 Westfield Place, Mt Wellington 1060  
New Zealand  
Tel: 0800 468 222  
[www.invacare.co.nz](http://www.invacare.co.nz)

### Australia

Invacare Australia PTY. Ltd.  
1 Lenton Place, North Rocks NSW 2151  
Australia  
Tel: 1800 460 460  
[www.invacare.com.au](http://www.invacare.com.au)



### Manufacturer

Dynamic Controls  
17 Print Place  
P.O. Box 1866  
Christchurch 8140  
New Zealand  
[www.dynamiccontrols.com/en/](http://www.dynamiccontrols.com/en/)



**Yes, you can.<sup>®</sup>**

**Making Life's Experiences Possible<sup>®</sup>**