

SECTION **SEC**

SECURITY CONTROL SYSTEM

A
B
C
D
E
F
G
H
I
J
L
M
N
O
P

CONTENTS

<p style="text-align: center;">COUPE</p> <p>BASIC INSPECTION 8</p> <p>DIAGNOSIS AND REPAIR WORKFLOW 8 Work Flow8</p> <p>INSPECTION AND ADJUSTMENT11</p> <p>ECM RE-COMMUNICATING FUNCTION 11 ECM RE-COMMUNICATING FUNCTION : De- scription 11 ECM RE-COMMUNICATING FUNCTION : Spe- cial Repair Requirement 11</p> <p>FUNCTION DIAGNOSIS12</p> <p>INTELLIGENT KEY SYSTEM/ENGINE</p> <p>START FUNCTION12 System Diagram 12 System Description 12 Component Parts Location 16 Component Description 17</p> <p>NVIS (NISSAN VEHICLE IMMOBILIZER SYS- TEM-NATS)18 System Diagram 18 System Description 18 Component Parts Location 20 Component Description 21</p> <p>VEHICLE SECURITY SYSTEM22 System Diagram22 System Description22 Component Parts Location24 Component Description24</p> <p>DIAGNOSIS SYSTEM (BCM)26</p> <p>COMMON ITEM26 COMMON ITEM : Diagnosis Description26 COMMON ITEM : CONSULT-III Function26</p>	<p>INTELLIGENT KEY26 INTELLIGENT KEY : CONSULT-III Function (BCM - INTELLIGENT KEY)27</p> <p>THEFT ALM30 THEFT ALM : CONSULT-III Function (BCM - THEFT)30</p> <p>IMMU31 IMMU : CONSULT-III Function (BCM - IMMU)31</p> <p>COMPONENT DIAGNOSIS32</p> <p>U1000 CAN COMM CIRCUIT32 Description32 DTC Logic32 Diagnosis Procedure32</p> <p>U1010 CONTROL UNIT (CAN)33 DTC Logic33 Diagnosis Procedure33</p> <p>B2190, P1610 NATS ANTENNA AMP34 Description34 DTC Logic34 Diagnosis Procedure34</p> <p>B2191, P1615 DIFFERENCE OF KEY38 Description38 DTC Logic38 Diagnosis Procedure38</p> <p>B2192, P1611 ID DISCORD, IMMU-ECM39 Description39 DTC Logic39 Diagnosis Procedure39</p> <p>B2193, P1612 CHAIN OF ECM-IMMU40 Description40 DTC Logic40 Diagnosis Procedure40</p> <p>B2013 ID DISCORD, IMMU-STRG41</p>
--	---

SEC

Description	41	B2607 STEERING LOCK RELAY	69
DTC Logic	41	Description	69
Diagnosis Procedure	41	DTC Logic	69
B2014 CHAIN OF STRG-IMMU	42	Diagnosis Procedure	69
Description	42	B2608 STARTER RELAY	71
DTC Logic	42	Description	71
Diagnosis Procedure	42	DTC Logic	71
B2555 STOP LAMP	46	Diagnosis Procedure	71
Description	46	B2609 STEERING STATUS	73
DTC Logic	46	Description	73
Diagnosis Procedure	46	DTC Logic	73
Component Inspection	48	Diagnosis Procedure	73
B2556 PUSH-BUTTON IGNITION SWITCH	49	B260B STEERING LOCK UNIT	78
Description	49	Description	78
DTC Logic	49	DTC Logic	78
Diagnosis Procedure	49	Diagnosis Procedure	78
Component Inspection	50	B260C STEERING LOCK UNIT	79
B2557 VEHICLE SPEED	51	Description	79
Description	51	DTC Logic	79
DTC Logic	51	Diagnosis Procedure	79
Diagnosis Procedure	51	B260D STEERING LOCK UNIT	80
B2560 STARTER CONTROL RELAY	52	Description	80
Description	52	DTC Logic	80
DTC Logic	52	Diagnosis Procedure	80
Diagnosis Procedure	52	B260F ENGINE STATUS	81
B2601 SHIFT POSITION	53	Description	81
Description	53	DTC Logic	81
DTC Logic	53	Diagnosis Procedure	81
Diagnosis Procedure	53	B26E1 NO RECEPTION OF ENGINE STA-	
Component Inspection	55	TUS SIGNAL	82
B2602 SHIFT POSITION	57	Description	82
Description	57	DTC Logic	82
DTC Logic	57	Diagnosis Procedure	82
Diagnosis Procedure	57	B2612 STEERING STATUS	83
B2603 SHIFT POSITION STATUS	60	Description	83
Description	60	DTC Logic	83
DTC Logic	60	Diagnosis Procedure	83
Diagnosis Procedure	60	B2617 STARTER RELAY CIRCUIT	88
B2604 PNP SWITCH	64	Description	88
Description	64	DTC Logic	88
DTC Logic	64	Diagnosis Procedure	88
Diagnosis Procedure	64	B2619 BCM	90
B2605 PNP SWITCH	66	Description	90
Description	66	DTC Logic	90
DTC Logic	66	Diagnosis Procedure	90
Diagnosis Procedure	66	B261A PUSH-BUTTON IGNITION SWITCH	91
B2606 STEERING LOCK RELAY	68	Description	91
Description	68	DTC Logic	91
DTC Logic	68	Diagnosis Procedure	91
Diagnosis Procedure	68	B261E VEHICLE TYPE	94

Description	94	KEY SLOT	122	A
DTC Logic	94	Diagnosis Procedure	122	
Diagnosis Procedure	94	KEY SLOT ILLUMINATION	123	B
B2108 STEERING LOCK RELAY	95	Description	123	
Description	95	Component Function Check	123	
DTC Logic	95	Diagnosis Procedure	123	
Diagnosis Procedure	95	KEY CYLINDER SWITCH	126	C
B2109 STEERING LOCK RELAY	96	Description	126	
Description	96	Component Function Check	126	
DTC Logic	96	Diagnosis Procedure (With LH and RH Anti-Pinch)	..126	D
Diagnosis Procedure	96	Diagnosis Procedure (With LH Anti-Pinch Only) ..	128	
B210A STEERING LOCK CONDITION SWITCH	97	Component Inspection	129	E
Description	97	HORN	131	F
DTC Logic	97	Description	131	
Diagnosis Procedure	97	Component Function Check	131	
B210B STARTER CONTROL RELAY	102	Diagnosis Procedure	131	
Description	102	HEADLAMP	133	G
DTC Logic	102	Description	133	
Diagnosis Procedure	102	Component Function Check	133	
B210C STARTER CONTROL RELAY	103	Diagnosis Procedure	133	H
Description	103	WARNING LAMP	134	I
DTC Logic	103	Description	134	
Diagnosis Procedure	103	Component Function Check	134	
B210D STARTER RELAY	104	Diagnosis Procedure	134	
Description	104	VEHICLE SECURITY INDICATOR	135	J
DTC Logic	104	Description	135	
Diagnosis Procedure	104	Component Function Check	135	
B210E STARTER RELAY	106	Diagnosis Procedure	135	
Description	106	ECU DIAGNOSIS	136	SEC
DTC Logic	106	BCM (BODY CONTROL MODULE)	136	L
Diagnosis Procedure	106	Reference Value	136	
B210F PNP/CLUTCH INTERLOCK SWITCH ..	109	Terminal Layout	136	
Description	109	Physical Values	136	
DTC Logic	109	Wiring Diagram - INTELLIGENT KEY SYSTEM/ ENGINE START FUNCTION -	137	M
Diagnosis Procedure	109	Wiring Diagram - VEHICLE SECURITY SYSTEM	
Component Inspection	114	-	150	
B2110 PNP/CLUTCH INTERLOCK SWITCH ..	115	Wiring Diagram - NVIS -	160	N
Description	115	Fail Safe	169	
DTC Logic	115	DTC Inspection Priority Chart	171	
Diagnosis Procedure	115	DTC Index	173	O
Component Inspection	120	IPDM E/R (INTELLIGENT POWER DISTRI- BUTION MODULE ENGINE ROOM)	175	P
POWER SUPPLY AND GROUND CIRCUIT ...	121	Reference Value	175	
BCM	121	SYMPTOM DIAGNOSIS	176	
BCM : Diagnosis Procedure	121	INTELLIGENT KEY SYSTEM/ENGINE START FUNCTION SYMPTOMS	176	
IPDM E/R (INTELLIGENT POWER DISTRI- BUTION MODULE ENGINE ROOM)	121	Symptom Table	176	
IPDM E/R (INTELLIGENT POWER DISTRI- BUTION MODULE ENGINE ROOM) : Diagnosis Pro- cedure	121			

VEHICLE SECURITY SYSTEM SYMPTOMS .	177	INTELLIGENT KEY	201
Symptom Table	177	INTELLIGENT KEY : CONSULT-III Function (BCM - INTELLIGENT KEY)	202
NISSAN VEHICLE IMMOBILIZER SYSTEM- NATS SYMPTOMS	178	THEFT ALM	205
Symptom Table	178	THEFT ALM : CONSULT-III Function (BCM - THEFT)	205
ON-VEHICLE MAINTENANCE	179	IMMU	206
PRE-INSPECTION FOR DIAGNOSTIC	179	IMMU : CONSULT-III Function (BCM - IMMU) ...	206
Basic Inspection	179	COMPONENT DIAGNOSIS	207
Vehicle Security Operation Check	179	U1000 CAN COMM CIRCUIT	207
ON-VEHICLE REPAIR	181	Description	207
KEY SLOT	181	DTC Logic	207
Removal and Installation	181	Diagnosis Procedure	207
PUSH BUTTON IGNITION SWITCH	182	U1010 CONTROL UNIT (CAN)	208
Removal and Installation	182	DTC Logic	208
SEDAN		Diagnosis Procedure	208
BASIC INSPECTION	183	B2013 ID DISCORD, IMMU-STRG	209
DIAGNOSIS AND REPAIR WORKFLOW	183	Description	209
Work Flow	183	DTC Logic	209
INSPECTION AND ADJUSTMENT	186	Diagnosis Procedure	209
ECM RE-COMMUNICATING FUNCTION	186	B2014 CHAIN OF STRG-IMMU	210
ECM RE-COMMUNICATING FUNCTION : De- scription	186	Description	210
ECM RE-COMMUNICATING FUNCTION : Spe- cial Repair Requirement	186	DTC Logic	210
FUNCTION DIAGNOSIS	187	Diagnosis Procedure	210
INTELLIGENT KEY SYSTEM/ENGINE START FUNCTION	187	B2190, P1610 NATS ANTENNA AMP	214
System Diagram	187	Description	214
System Description	187	DTC Logic	214
Component Parts Location	191	Diagnosis Procedure	214
Component Description	192	B2191, P1615 DIFFERENCE OF KEY	218
NVIS (NISSAN VEHICLE IMMOBILIZER SYS- TEM-NATS)	193	Description	218
System Diagram	193	DTC Logic	218
System Description	193	Diagnosis Procedure	218
Component Parts Location	195	B2192, P1611 ID DISCORD, IMMU-ECM	219
Component Description	196	Description	219
VEHICLE SECURITY SYSTEM	197	DTC Logic	219
System Diagram	197	Diagnosis Procedure	219
System Description	197	B2193, P1612 CHAIN OF ECM-IMMU	220
Component Parts Location	199	Description	220
Component Description	200	DTC Logic	220
DIAGNOSIS SYSTEM (BCM)	201	Diagnosis Procedure	220
COMMON ITEM	201	B2555 STOP LAMP	221
COMMON ITEM : Diagnosis Description	201	Description	221
COMMON ITEM : CONSULT-III Function	201	DTC Logic	221
		Diagnosis Procedure	221
		Component Inspection	223
		B2556 PUSH-BUTTON IGNITION SWITCH ...	224
		Description	224
		DTC Logic	224
		Diagnosis Procedure	224

Component Inspection	225	B260C STEERING LOCK UNIT	254
B2557 VEHICLE SPEED	226	Description	254
Description	226	DTC Logic	254
DTC Logic	226	Diagnosis Procedure	254
Diagnosis Procedure	226	B260D STEERING LOCK UNIT	255
B2560 STARTER CONTROL RELAY	227	Description	255
Description	227	DTC Logic	255
DTC Logic	227	Diagnosis Procedure	255
Diagnosis Procedure	227	B260F ENGINE STATUS	256
B2601 SHIFT POSITION	228	Description	256
Description	228	DTC Logic	256
DTC Logic	228	Diagnosis Procedure	256
Diagnosis Procedure	228	B26E1 NO RECEPTION OF ENGINE STA-	E
Component Inspection	230	TUS SIGNAL	257
B2602 SHIFT POSITION	232	Description	257
Description	232	DTC Logic	257
DTC Logic	232	Diagnosis Procedure	257
Diagnosis Procedure	232	B2612 STEERING STATUS	258
B2603 SHIFT POSITION STATUS	235	Description	258
Description	235	DTC Logic	258
DTC Logic	235	Diagnosis Procedure	258
Diagnosis Procedure	235	B2617 STARTER RELAY CIRCUIT	263
B2604 PNP SWITCH	239	Description	263
Description	239	DTC Logic	263
DTC Logic	239	Diagnosis Procedure	263
Diagnosis Procedure	239	B2619 BCM	265
B2605 PNP SWITCH	241	Description	265
Description	241	DTC Logic	265
DTC Logic	241	Diagnosis Procedure	265
Diagnosis Procedure	241	B261A PUSH-BUTTON IGNITION SWITCH ..	266
B2606 STEERING LOCK RELAY	243	Description	266
Description	243	DTC Logic	266
DTC Logic	243	Diagnosis Procedure	266
Diagnosis Procedure	243	B261E VEHICLE TYPE	269
B2607 STEERING LOCK RELAY	244	Description	269
Description	244	DTC Logic	269
DTC Logic	244	Diagnosis Procedure	269
Diagnosis Procedure	244	B2108 STEERING LOCK RELAY	270
B2608 STARTER RELAY	246	Description	270
Description	246	DTC Logic	270
DTC Logic	246	Diagnosis Procedure	270
Diagnosis Procedure	246	B2109 STEERING LOCK RELAY	271
B2609 STEERING STATUS	248	Description	271
Description	248	DTC Logic	271
DTC Logic	248	Diagnosis Procedure	271
Diagnosis Procedure	248	B210A STEERING LOCK CONDITION	
B260B STEERING LOCK UNIT	253	SWITCH	272
Description	253	Description	272
DTC Logic	253	DTC Logic	272
Diagnosis Procedure	253	Diagnosis Procedure	272

A
B
C
D
E
F
G
H
I
J
L
M
N
O
P

SEC

B210B STARTER CONTROL RELAY	277	Component Function Check	306
Description	277	Diagnosis Procedure	306
DTC Logic	277		
Diagnosis Procedure	277		
B210C STARTER CONTROL RELAY	278	HEADLAMP	308
Description	278	Description	308
DTC Logic	278	Component Function Check	308
Diagnosis Procedure	278	Diagnosis Procedure	308
B210D STARTER RELAY	279	WARNING LAMP	309
Description	279	Description	309
DTC Logic	279	Component Function Check	309
Diagnosis Procedure	279	Diagnosis Procedure	309
B210E STARTER RELAY	281	VEHICLE SECURITY INDICATOR	310
Description	281	Description	310
DTC Logic	281	Component Function Check	310
Diagnosis Procedure	281	Diagnosis Procedure	310
B210F PNP/CLUTCH INTERLOCK SWITCH .	284	ECU DIAGNOSIS	311
Description	284	BCM (BODY CONTROL MODULE)	311
DTC Logic	284	Reference Value	311
Diagnosis Procedure	284	Terminal Layout	311
Component Inspection	289	Physical Values	311
		Wiring Diagram - INTELLIGENT KEY SYSTEM/ ENGINE START FUNCTION -	312
B2110 PNP/CLUTCH INTERLOCK SWITCH .	290	Wiring Diagram - VEHICLE SECURITY SYSTEM -	326
Description	290	Wiring Diagram - NVIS -	336
DTC Logic	290	Fail Safe	345
Diagnosis Procedure	290	DTC Inspection Priority Chart	347
Component Inspection	295	DTC Index	349
POWER SUPPLY AND GROUND CIRCUIT ..	296	IPDM E/R (INTELLIGENT POWER DISTRI- BUTION MODULE ENGINE ROOM)	351
BCM	296	Reference Value	351
BCM : Diagnosis Procedure	296	Fail Safe	351
IPDM E/R (INTELLIGENT POWER DISTRI- BUTION MODULE ENGINE ROOM)	296	DTC Index	351
IPDM E/R (INTELLIGENT POWER DISTRI- BUTION MODULE ENGINE ROOM) : Diagnosis Pro- cedure	296	SYMPTOM DIAGNOSIS	352
KEY SLOT	297	INTELLIGENT KEY SYSTEM/ENGINE START FUNCTION SYMPTOMS	352
Diagnosis Procedure	297	Symptom Table	352
KEY SLOT ILLUMINATION	298	VEHICLE SECURITY SYSTEM SYMPTOMS ..	353
Description	298	Symptom Table	353
Component Function Check	298	NISSAN VEHICLE IMMOBILIZER SYSTEM- NATS SYMPTOMS	354
Diagnosis Procedure	298	Symptom Table	354
KEY CYLINDER SWITCH	301	ON-VEHICLE MAINTENANCE	355
Description	301	PRE-INSPECTION FOR DIAGNOSTIC	355
Component Function Check	301	Basic Inspection	355
Diagnosis Procedure (With LH and RH Anti-Pinch)	301	Vehicle Security Operation Check	355
Diagnosis Procedure (With LH Anti-Pinch Only) ..	303	ON-VEHICLE REPAIR	357
Component Inspection	304	KEY SLOT	357
Special Repair Requirement	305	Removal and Installation	357
HORN	306		
Description	306		

A
B
C
D
E
F
G
H
I
J
SEC
L
M
N
O
P

DIAGNOSIS AND REPAIR WORKFLOW

< BASIC INSPECTION >

[COUPE]

BASIC INSPECTION

DIAGNOSIS AND REPAIR WORKFLOW

Work Flow

INFOID:000000001344445

OVERALL SEQUENCE

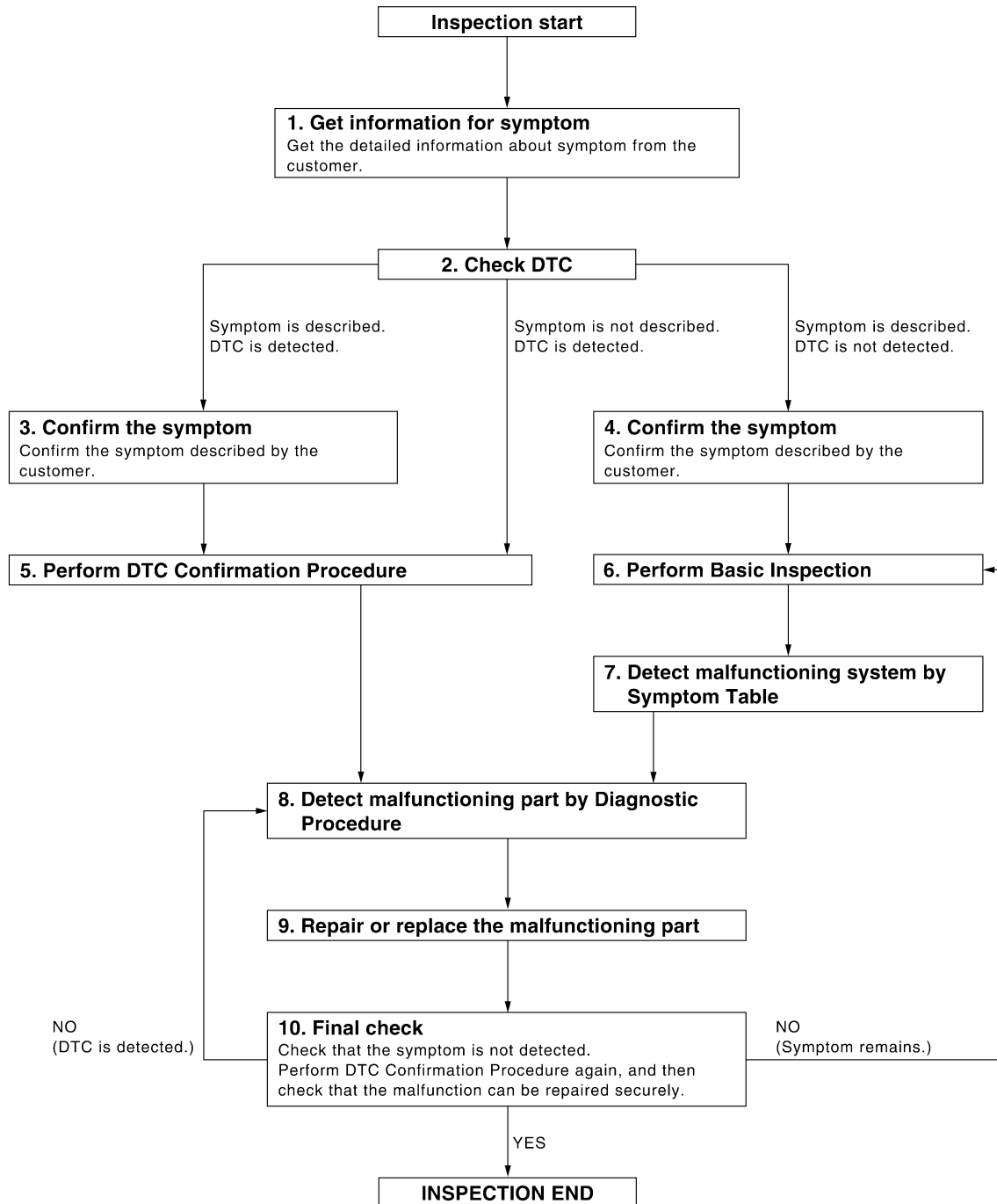

DETAILED FLOW

ALKIA0246GB

DIAGNOSIS AND REPAIR WORKFLOW

< BASIC INSPECTION >

[COUPE]

1.GET INFORMATION FOR SYMPTOM

Get the detailed information from the customer about the symptom (the condition and the environment when the incident/malfunction occurred).

>> GO TO 2.

2.CHECK DTC WITH BCM AND IPDM E/R

1. Check "Self Diagnostic Result" with CONSULT-III.
2. Perform the following procedure if DTC is displayed.
 - Record DTC and freeze frame data (Print them out with CONSULT-III.)
 - Erase DTC.
 - Study the relationship between the cause detected by DTC and the symptom described by the customer.
3. Check related service bulletins for information.

Is any symptom described and any DTC detected?

- Symptom is described, DTC is displayed>>GO TO 3.
- Symptom is described, DTC is not displayed>>GO TO 4.
- Symptom is not described, DTC is displayed>>GO TO 5.

3.CONFIRM THE SYMPTOM

Confirm the symptom described by the customer.
Connect CONSULT-III to the vehicle in "Data Monitor" mode and check real time diagnosis results.
Verify relation ship between the symptom and the condition when the symptom is detected.

>> GO TO 5.

4.CONFIRM THE SYMPTOM

Confirm the symptom described by the customer.
Connect CONSULT-III to the vehicle in "Data Monitor" mode and check real time diagnosis results.
Verify relation ship between the symptom and the condition when the symptom is detected.

>> GO TO 6.

5.PERFORM DTC CONFIRMATION PROCEDURE

Perform DTC Confirmation Procedure for the displayed DTC, and then check that DTC is detected again.
At this time, always keep CONSULT-III connected to the vehicle, and check diagnostic results in real time.
If two or more DTCs are detected, refer to [SEC-171, "DTC Inspection Priority Chart"](#) and determine trouble diagnosis order.

NOTE:

- Freeze frame data is useful if the DTC is not detected.
- Perform Component Function Check if DTC Confirmation Procedure is not included in Service Manual. This simplified check procedure is an effective alternative though DTC cannot be detected during this check.
If the result of Component Function Check is NG, it is the same as the detection of DTC by DTC Confirmation Procedure.

Is DTC detected?

- Yes >> GO TO 8.
- No >> Refer to [GI-42, "Intermittent Incident"](#).

6.PERFORM BASIC INSPECTION

Perform [SEC-179, "Basic Inspection"](#).

Inspection End>>GO TO 7.

7.DETECT MALFUNCTIONING SYSTEM BY SYMPTOM TABLE

Detect malfunctioning system according to following symptom tables based on the confirmed symptom in step 4, and determine the trouble diagnosis order based on possible causes and symptoms.

- Intelligent Key system/engine start function: [SEC-176, "Symptom Table"](#).
- Vehicle security system: [SEC-177, "Symptom Table"](#).

A
B
C
D
E
F
G
H
I
J
L
M
N
O
P

SEC

DIAGNOSIS AND REPAIR WORKFLOW

[COUPE]

< BASIC INSPECTION >

- Nissan vehicle immobilizer system-NATS: [SEC-178. "Symptom Table"](#).

>> GO TO 8.

8. DETECT MALFUNCTIONING PART BY DIAGNOSTIC PROCEDURE

Inspect according to Diagnostic Procedure of the system.

NOTE:

The Diagnostic Procedure described based on open circuit inspection. A short circuit inspection is also required for the circuit check in the Diagnostic Procedure.

Is malfunctioning part detected?

Yes >> GO TO 9.

No >> Check voltage of related BCM terminals using CONSULT-III.

9. REPAIR OR REPLACE THE MALFUNCTIONING PART

1. Repair or replace the malfunctioning part.
2. Reconnect parts or connectors disconnected during Diagnostic Procedure again after repair or replacement.
3. Check DTC. If DTC is displayed, erase it.

>> GO TO 10.

10. FINAL CHECK

When DTC was detected in step 2, perform DTC Confirmation Procedure or Component Function Check again, and then check that the malfunction have been fully repaired.

When symptom was described from the customer, refer to confirmed symptom in step 3 or 4, and check that the symptom is not detected.

Is the inspection result normal?

NO (DTC is detected)>>GO TO 8.

NO (Symptom remains)>>GO TO 6.

YES >> **INSPECTION END**

< BASIC INSPECTION >

INSPECTION AND ADJUSTMENT ECM RE-COMMUNICATING FUNCTION

ECM RE-COMMUNICATING FUNCTION : Description

INFOID:000000001344446

Performing following procedure can automatically perform re-communication of ECM and BCM, but only when the ECM has been replaced with a new one (*1).

*1: New one means an ECM which has never been energized on-board.

(In this step, initialization procedure by CONSULT-III is not necessary)

NOTE:

- When registering new Key IDs or replacing the ECM that is not brand new, refer to CONSULT-III Operation Manual NATS-IVIS/NVIS.
- If multiple keys are attached to the key holder, separate them before work.
- Distinguish keys with unregistered key ID from those with registered ID.

ECM RE-COMMUNICATING FUNCTION : Special Repair Requirement

INFOID:000000001344447

1. PERFORM ECM RE-COMMUNICATING FUNCTION

1. Install ECM.
2. Insert the registered Intelligent Key (*2), turn ignition switch to "ON".
*2: To perform this step, use the key that has been used before performing ECM replacement.
3. Maintain ignition switch in "ON" position for at least 5 seconds.
4. Turn ignition switch to "OFF".
5. Start engine.

Can engine be started?

YES >> Procedure is completed.

NO >> Initialize control unit. Refer to CONSULT-III Operation Manual NATS-IVIS/NVIS.

A
B
C
D
E
F
G
H
I
J
L
M
N
O
P

SEC

FUNCTION DIAGNOSIS

INTELLIGENT KEY SYSTEM/ENGINE START FUNCTION

System Diagram

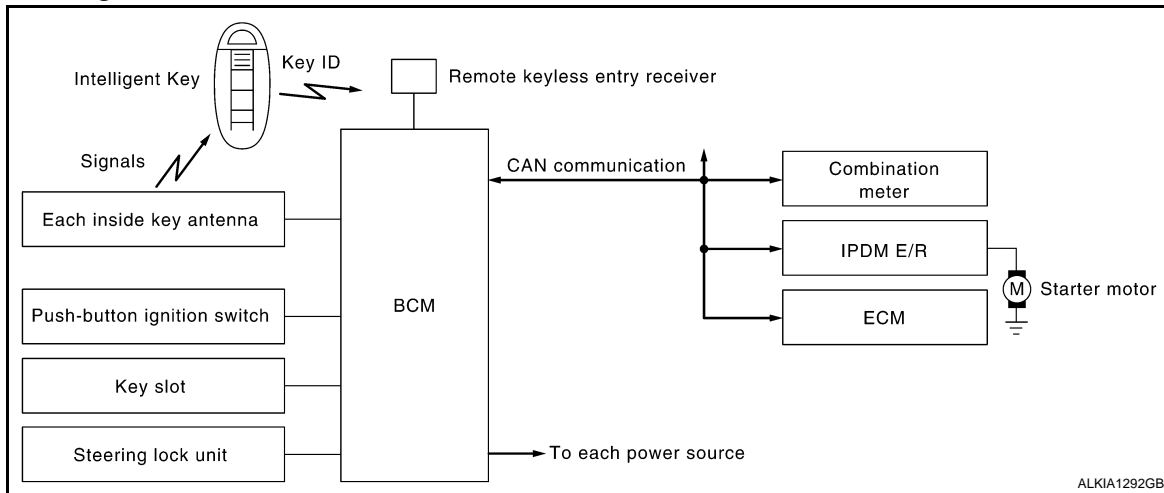

System Description

INFOID:000000001344449

INPUT/OUTPUT SIGNAL CHART

Switch	Input signal to BCM	BCM function	Actuator
Push-button ignition switch	Push switch	Engine start function	<ul style="list-style-type: none"> Steering lock relay Steering lock unit Starter relay (IPDM E/R) Starter control relay (IPDM E/R) Starter motor KEY warning lamp
CVT device (CVT models)	P range		
PNP switch (CVT models)	N, P range		
Clutch interlock switch (M/T models)	Clutch ON/OFF		
Stop lamp switch	Brake ON/OFF		
Each inside key antenna	Request signal		
Remote keyless entry receiver	Key ID		
Each door switch	Door open/close		
ECM	Engine status signal		

SYSTEM DESCRIPTION

• The engine start function of Intelligent Key system is a system that makes it possible to start and stop the engine without removing the key. It verifies the electronic ID using two-way communications when pressing the push-button ignition switch while carrying the Intelligent Key, which operates based on the results of electronic ID verification for Intelligent Key using two-way communications between the Intelligent Key and the vehicle.

NOTE:

The driver should carry the Intelligent Key at all times.

- Intelligent Key has 2 IDs [for Intelligent Key and for NVIS (NATS)]. It can perform the door lock/unlock operation and the push-button ignition switch operation when the registered Intelligent Key is carried.
- When the Intelligent Key battery is discharged, it can be used as emergency back-up by inserting the Intelligent Key to the key slot. At that time, perform the NVIS (NATS) ID verification. If it is used when the Intelligent Key is carried, perform the Intelligent Key ID verification.
- If the ID is successfully verified, and when push-button ignition switch is pressed, steering lock will be released and initiating the engine will be possible.
- If the door lock/unlock operation is performed when the Intelligent Key battery is discharged, all doors lock/unlock can be performed by operating the driver door key cylinder using the mechanical key set in the Intelligent Key.

INTELLIGENT KEY SYSTEM/ENGINE START FUNCTION

[COUPE]

< FUNCTION DIAGNOSIS >

- Intelligent Key can be registered up to 4 keys (Including the standard Intelligent Key) on request from the owner.

NOTE:

- Refer to [DLK-19, "INTELLIGENT KEY : System Description"](#) for any functions other than engine start function of Intelligent Key system.

PRECAUTIONS FOR INTELLIGENT KEY SYSTEM

- In the Intelligent Key system of model L32, the transponder [the chip for NVIS (NATS) ID verification] is integrated into the Intelligent Key. (For the conventional models, it is integrated into the mechanical key.) Therefore, the mechanical key cannot perform the ID verification, and thus it cannot start the engine. Instead, the NVIS (NATS) ID verification can be performed by inserting the Intelligent Key into the key slot, and then it can start the engine.**

OPERATION WHEN INTELLIGENT KEY IS CARRIED

- When the push-button ignition switch is pressed and brake pedal is depressed, the BCM signals the inside key antenna and transmits the request signal to the Intelligent Key.
- The Intelligent Key receives the request signal and transmits the Intelligent Key ID signal to the BCM via the remote keyless entry receiver.
- The BCM receives the Intelligent Key ID signal and verifies it with the registered ID.
- BCM transmits the steering lock unlock signal to steering lock unit and IPDM E/R if the verification results are OK.
- IPDM E/R turns the steering lock relay ON and supplies power to the steering lock unit.
- Release of the steering lock.
- BCM transmits the power supply stop signal to IPDM E/R when it confirms that the steering lock is in the unlock condition.
- IPDM E/R turns the steering lock relay OFF and stops power supply to the steering lock unit.
- BCM turns ACC relay ON and transmits the ignition power supply ON signal to IPDM E/R.
- IPDM E/R turns the ignition relay ON and starts the ignition power supply.
- BCM confirms that the shift position is P or N (CVT models).
- BCM transmits the starter request signal via CAN communication to IPDM E/R and turns the starter relay in IPDM E/R ON if BCM judges that the engine start condition is satisfied.
- IPDM E/R turns the starter control relay ON when receiving the starter request signal.
- Battery power is supplied through the starter relay and the starter control relay to operate the starter motor and to start the cranking.

CAUTION:

If a malfunction is detected in the Intelligent Key system, the "KEY" warning lamp in the combination meter illuminates. At that time, the engine cannot be started.

- When BCM received feedback signal from ECM acknowledging the engine has been initiated, the BCM transmits a stop signal to IPDM E/R and stops the cranking by turning OFF the starter motor relay. (If the engine initiating has failed, the cranking will stop automatically within 5 seconds.)

CAUTION:

When the Intelligent Key is carried outside of the vehicle (inside key antenna detection area) with the power supply in ACC or ON position, even if the engine start condition* is satisfied, the engine cannot be started.

*: For the engine start condition, refer to "PUSH-BUTTON IGNITION SWITCH OPERATION PROCEDURE".

OPERATION RANGE

Engine can be started when Intelligent Key is inside the vehicle. However, sometimes engine might not start when Intelligent Key is on instrument panel or in glove box.

OPERATION WHEN KEY SLOT IS USED

When the Intelligent Key battery is discharged, it performs the NVIS (NATS) ID verification between the integrated transponder and BCM by inserting the Intelligent Key into the key slot, and then the engine can be started.

For details relating to starting the engine using key slot, refer to [SEC-18, "System Description"](#).

BATTERY SAVER SYSTEM

When all the following conditions are met for 60 minutes, the battery saver system will cut off the power supply to prevent battery discharge.

INTELLIGENT KEY SYSTEM/ENGINE START FUNCTION

[COUPE]

< FUNCTION DIAGNOSIS >

- The ignition switch is in the ACC position
- All doors are closed
- CVT selector lever is in the P position
- No Intelligent Key failures (Intelligent Key warning indicator is not ON)

Reset Condition of Battery Saver System

CVT models

In order to prevent the battery from discharging, the battery saver system will cut off the power supply when all doors are closed, the selector lever is on P position and the ignition switch is left on ACC position for 1 hour. If any of the following conditions are met the battery saver system is released and the steering will change automatically to lock position from OFF position.

- Opening any door
- Operating with request switch on door lock
- Operating with Intelligent Key on door lock

Press push-button ignition switch and ignition switch will change to ACC position from OFF position.

M/T models

If any of the conditions above is met the battery saver system is released but the steering will not lock. In this case, the steering operation OFF to LOCK is prohibited.

STEERING LOCK OPERATION

Steering is locked by steering lock unit when ignition switch is in the OFF position, CVT selector lever is in the P position and any of the following conditions are met.

- Opening door
- Closing door
- Door is locked with request switch
- Door is locked with Intelligent Key

PUSH-BUTTON IGNITION SWITCH OPERATION PROCEDURE

The power supply position changing operation can be performed with the following operations.

NOTE:

- When an Intelligent Key is within the detection area of inside key antenna or when it is inserted to the key slot, it is equivalent to the operations below.
- When starting the engine, the BCM monitors under the engine start conditions,
 - Brake pedal operating condition (CVT models)
 - CVT selector lever position (CVT models)
 - Clutch pedal operating condition (M/T models)
 - Vehicle speed
 - Steering lock condition
 - Engine status
- Unless each start condition is fulfilled, the engine will not respond regardless of how many times the engine switch is pressed. At that time, illumination repeats the position in the order of LOCK→ACC→ON→OFF.

Power supply position	Engine start/stop condition		Push-button ignition switch operation frequency
	Brake pedal (CVT) /clutch pedal (M/T)	CVT selector lever position	
LOCK → ACC	Not depressed	Any position	1
LOCK → ACC → ON	Not depressed	Any position	2
LOCK → ACC → ON → OFF	Not depressed	Any position	3
LOCK → START ACC → START ON → START (Engine start)	Depressed	P or N position (*1)	1 [If the switch is pressed once, the engine starts from any power supply position (LOCK, ACC, and ON)]
Engine is running → OFF (Engine stop)	—	Any position Vehicle speed < 4 km/h (2 MPH)	1

INTELLIGENT KEY SYSTEM/ENGINE START FUNCTION

< FUNCTION DIAGNOSIS >

[COUPE]

Power supply position	Engine start/stop condition		Push-button ignition switch operation frequency
	Brake pedal (CVT) /clutch pedal (M/T)	CVT selector lever position	
Engine is running → ACC (Engine stop)	—	Any position other than P (*2)	1
Engine stall return operation while driving	—	P position	1

*1: When the CVT selector lever position is N position, the engine start condition is different according to the vehicle speed.

- At vehicle speed of 4 km/h (2 MPH) or less, the engine can start only when the brake pedal is depressed.
- At vehicle speed of 4 km/h (2 MPH) or more, the engine can start even if the brake pedal is not depressed. (It is the same as “Engine stall return operation while driving”.)

*2: When the CVT selector lever position is in any position other than P position and when the vehicle speed is 5 km/h (3 MPH) or more, the engine stop condition is different.

- Press and hold the push-button ignition switch for 2 seconds or more. (When the push-button ignition switch is pressed for too short a time, the operation may be invalid, so properly press and hold to prevent an incorrect operation.)
- Press the push-button ignition switch 3 times or more within 1.5 seconds. (Emergency stop operation)

A
B
C
D
E
F
G
H
I
J
L
M
N
O
P

SEC

INTELLIGENT KEY SYSTEM/ENGINE START FUNCTION

< FUNCTION DIAGNOSIS >

[COUPE]

Component Parts Location

INFOID:000000001344450

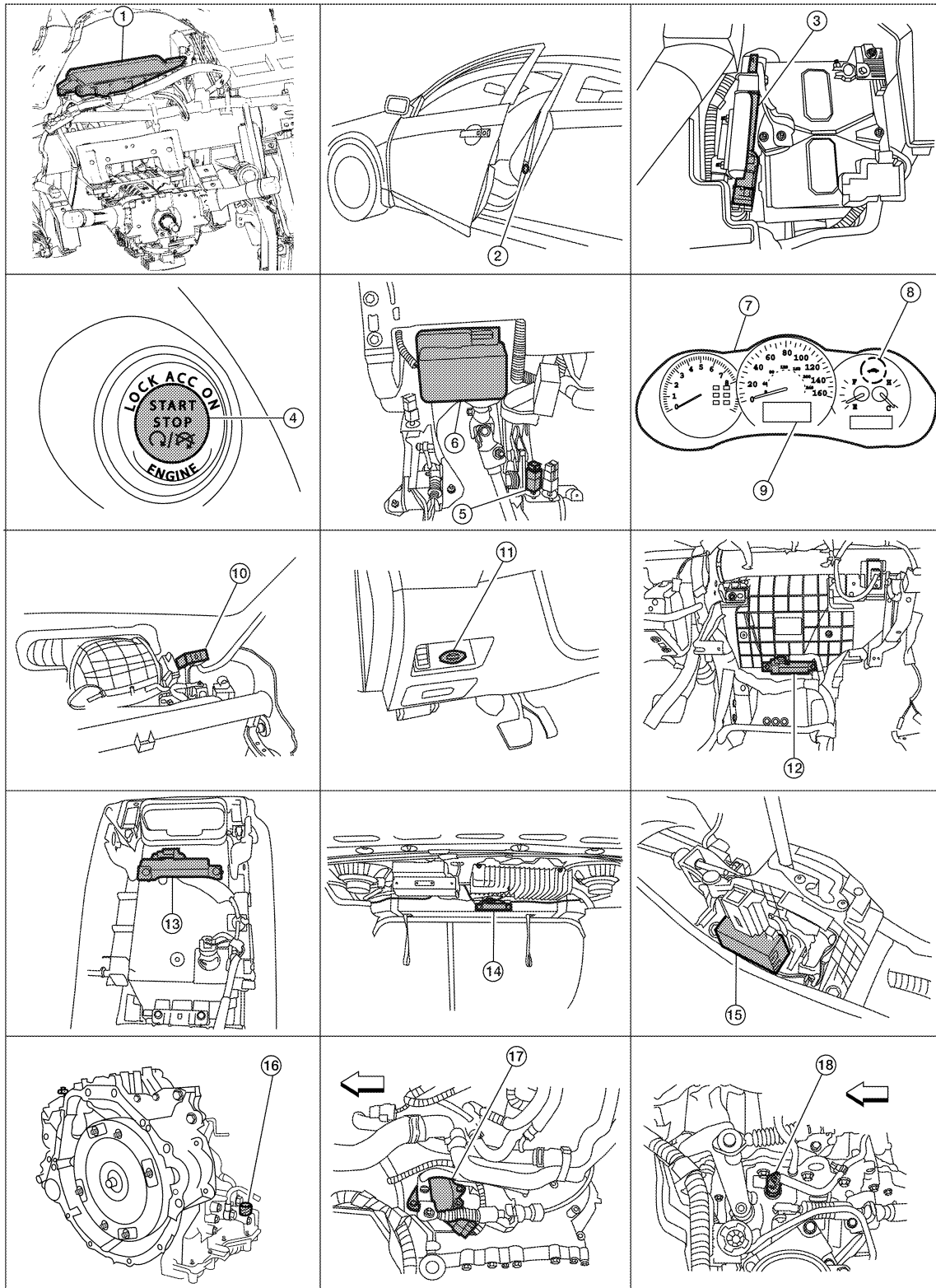

ALKIA1299ZZ

INTELLIGENT KEY SYSTEM/ENGINE START FUNCTION

< FUNCTION DIAGNOSIS >

[COUPE]

- | | | | |
|--|--|--|---|
| 1. Body control module M16, M17, M18, M19, M21
(view with instrument panel removed) | 2. Door switch LH B8
RH B108 | 3. ECM E10 | A |
| 4. Push button ignition switch M38 | 5. Stop lamp switch E38
(view with lower driver instrument panel removed) | 6. Electronic steering column lock M32
(steering column) | B |
| 7. Combination meter M24 | 8. Security indicator lamp | 9. Information display | C |
| 10. Remote keyless entry receiver M27
(view with instrument panel removed) | 11. Key slot M40 | 12. Instrument panel antenna M49
(view with instrument panel removed) | D |
| 13. Front console antenna M203
(bottom view of console) | 14. Rear parcel shelf antenna B29 | 15. CVT device (detent switch) M23
(with CVT) | E |
| 16. Park neutral position switch connector (TCM connector) F16
(with CVT/VQ) | 17. Park neutral position switch F25
(with CVT/QR) | 18. Park neutral position switch F32
(with M/T) | F |

Component Description

INFOID:000000001344451

Component	Reference
BCM	SEC-90
Steering lock unit	SEC-78
Push-button ignition switch	SEC-91
Door switch	DLK-54
CVT device (detention switch)	SEC-53
Inside key antenna	DLK-44
Remote keyless entry receiver	DLK-109
Stop lamp switch	SEC-46
Park/neutral position switch	SEC-64
Clutch switch	SEC-109
Steering lock relay	SEC-68
Starter relay	SEC-71
Starter control relay	SEC-52
Security indicator	SEC-135
Key warning lamp	SEC-134

SEC

NVIS (NISSAN VEHICLE IMMOBILIZER SYSTEM-NATS)

< FUNCTION DIAGNOSIS >

[COUPE]

NVIS (NISSAN VEHICLE IMMOBILIZER SYSTEM-NATS)

System Diagram

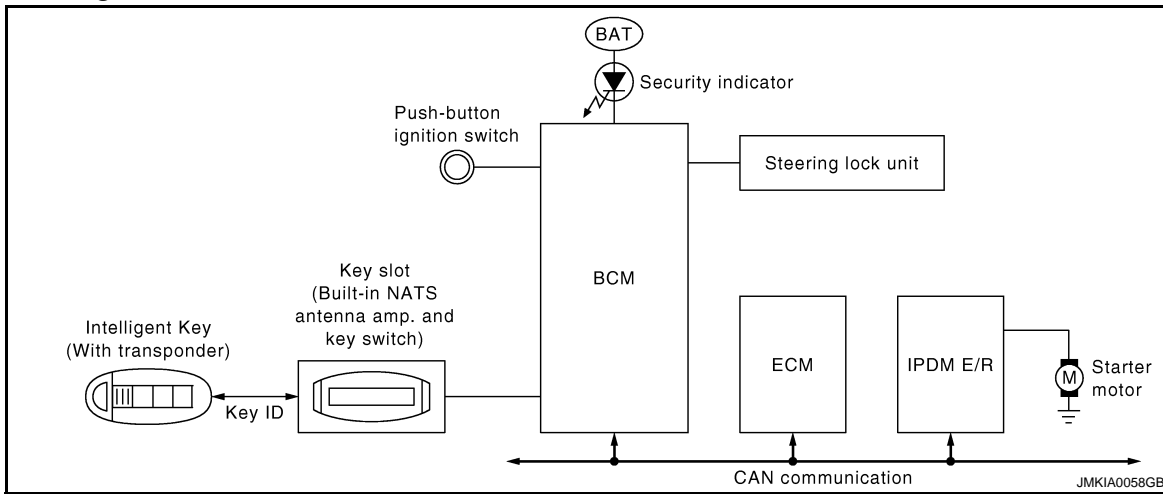

System Description

INFOID:000000001344453

INPUT/OUTPUT SIGNAL CHART

Switch	Input signal to BCM	BCM function	Actuator
Push-button ignition switch	Push switch	NVIS (NATS)	<ul style="list-style-type: none"> Steering lock relay Steering lock unit Starter relay (IPDM E/R) Starter control relay (IPDM E/R) Starter motor KEY warning lamp Security indicator lamp
CVT device (CVT models)	P range		
PNP switch (CVT models)	N, P range		
Clutch interlock switch (M/T models)	Clutch ON/OFF		
Stop lamp switch	Brake ON/OFF		
Key slot	Key ID		
Each door switch	Door open/close		
ECM	Engine status signal		

SYSTEM DESCRIPTION

- The NVIS (NATS) is an anti-theft system by registering an Intelligent Key ID in to the vehicle and prevents the engine being started by an unregistered Intelligent Key. It has a higher protection against auto thefts that duplicate mechanical key.
- It performs the ID verification when starting the engine in the same way as the Intelligent Key system. But, it performs the NVIS (NATS) ID verification when inserting the Intelligent Key and performs the Intelligent Key ID verification when carrying the Intelligent Key.
- The Intelligent Key system of L32 is not the same as the conventional models. The mechanical key integrated in the Intelligent Key cannot start the engine. When the Intelligent Key battery is discharged, the NVIS (NATS) ID verification memorized to the transponder integrated with Intelligent Key is performed by inserting the Intelligent Key into the key slot. If the verification results are OK, the engine start operation can be performed by the push-button ignition switch operation.
- Locate the security indicator and apply the anti-theft system equipment sticker, forewarn that the NVIS (NATS) is onboard with the model.
- The security indicator always blinks when the Intelligent Key is removed from the key slot and when the power supply position is in LOCK position.
- Intelligent Key can be registered up to 4 keys (Including the standard ignition key) on request from the owner.
- The specified registration is required when replacing ECM, BCM or Intelligent Key. The registrations procedure for NVIS (NATS) and registration procedure for Intelligent Key when installing the BCM, refer to CONSULT-III Operation Manual.

NVIS (NISSAN VEHICLE IMMOBILIZER SYSTEM-NATS)

[COUPE]

< FUNCTION DIAGNOSIS >

- Possible symptom of NVIS (NATS) malfunction is “Engine cannot start”. In L32, the engine can be started with the Intelligent Key system and NVIS (NATS). Identify the possible causes according to “Work Flow”, Refer to [SEC-8. "Work Flow"](#). A
- If ECM other than Genuine NISSAN is installed, the engine cannot be started. For ECM replacement procedure, refer to [SEC-11. "ECM RE-COMMUNICATING FUNCTION : Special Repair Requirement"](#). B

PRECAUTIONS FOR KEY REGISTRATION

- The key registration is a procedure that erases the current NVIS (NATS) ID once, and then re-registers a new ID operation. Therefore the registered Intelligent Key is necessary for this procedure. Before starting the registration operation collect all registered Intelligent Keys from the customer C
- When registering the Intelligent Key, performs only one procedure to register simultaneously both ID (NVIS “NATS” ID registration and Intelligent Key ID registration). D
The NVIS (NATS) ID registration is the procedure that registers the ID stored into the transponder (integrated in intelligent key) to BCM.
The Intelligent key ID registration is the procedure that registers the ID to BCM.
- When performing the Intelligent Key system registration only, the engine cannot be started by inserting the key into the key slot. When performing the NVIS (NATS) registration only, the engine cannot be started by the operation when carrying the key. The registrations of both systems should be performed. E

SECURITY INDICATOR

- Warns that the vehicle is equipped with NVIS (NATS). F
- The security indicator always blinks when the Intelligent Key is removed from the key slot and when the ignition switch is in LOCK position. G

NOTE:

Because security indicator is highly efficient, the battery is barely affected. H

I
J
K
L
M
N
O
P

SEC

NVIS (NISSAN VEHICLE IMMOBILIZER SYSTEM-NATS)

< FUNCTION DIAGNOSIS >

[COUPE]

Component Parts Location

INFOID:000000001344454

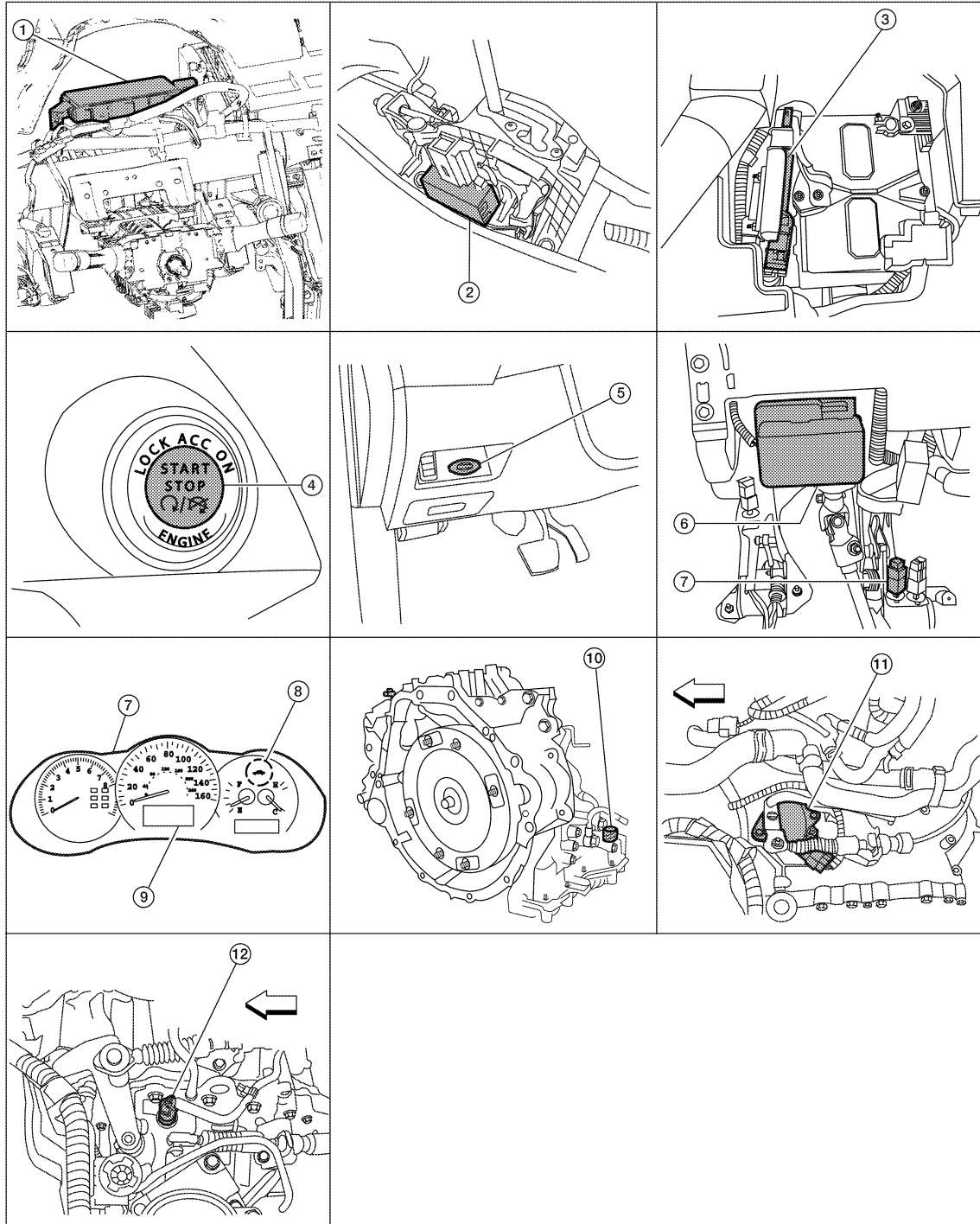

ALKIA1300ZZ

- | | | |
|--|---|---|
| 1. Body control module M16, M17, M18, M19, M21
(view with instrument panel removed) | 2. CVT device (detent switch) M23
(with CVT) | 3. ECM E10 |
| 4. Push button ignition switch M38 | 5. Key slot M40 | 6. Electronic steering column lock M32
(steering column) |
| 7. Stop lamp switch E38
(view with lower LH instrument panel removed) | 8. Security indicator lamp | 9. Information display |
| 10. Park neutral position switch connector (TCM
connector) F16
(with CVT/VQ) | 11. Park neutral position switch F25
(with CVT/QR) | 12. Park neutral position switch F32
(with M/T) |

NVIS (NISSAN VEHICLE IMMOBILIZER SYSTEM-NATS)

< FUNCTION DIAGNOSIS >

[COUPE]

Component Description

INFOID:000000001344455

Component	Reference
BCM	SEC-90
Steering lock unit	SEC-78
Push-button ignition switch	SEC-91
Door switch	DLK-54
CVT device (detention switch)	SEC-53
Inside key antenna	DLK-44
Remote keyless entry receiver	DLK-109
Stop lamp switch	SEC-46
Park/neutral position switch	SEC-64
Clutch switch	SEC-109
Steering lock relay	SEC-68
Starter relay	SEC-71
Starter control relay	SEC-52
Security indicator	SEC-135
Key warning lamp	SEC-134

A
B
C
D
E
F
G
H
I
J
L
M
N
O
P

SEC

VEHICLE SECURITY SYSTEM

< FUNCTION DIAGNOSIS >

[COUPE]

VEHICLE SECURITY SYSTEM

System Diagram

INFOID:000000001344456

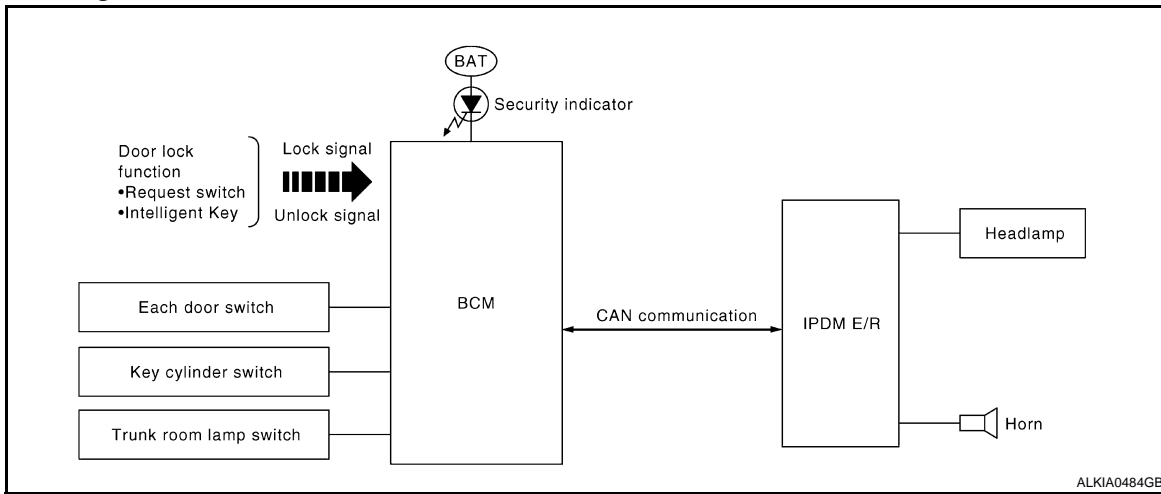

ALKIA0484GB

System Description

INFOID:000000001344457

INPUT/OUTPUT SIGNAL CHART

Switch	Input signal to BCM	BCM system	Actuator
All door switch	Open or close	Vehicle security system	<ul style="list-style-type: none"> IPDM E/R Head lamp Horn Security indicator lamp
Trunk room lamp switch			
Door key cylinder switch	Lock or unlock		
Door lock and unlock switch			
Door request switch			
Intelligent Key	Lock or unlock		
	Panic alarm		

OPERATION FLOW

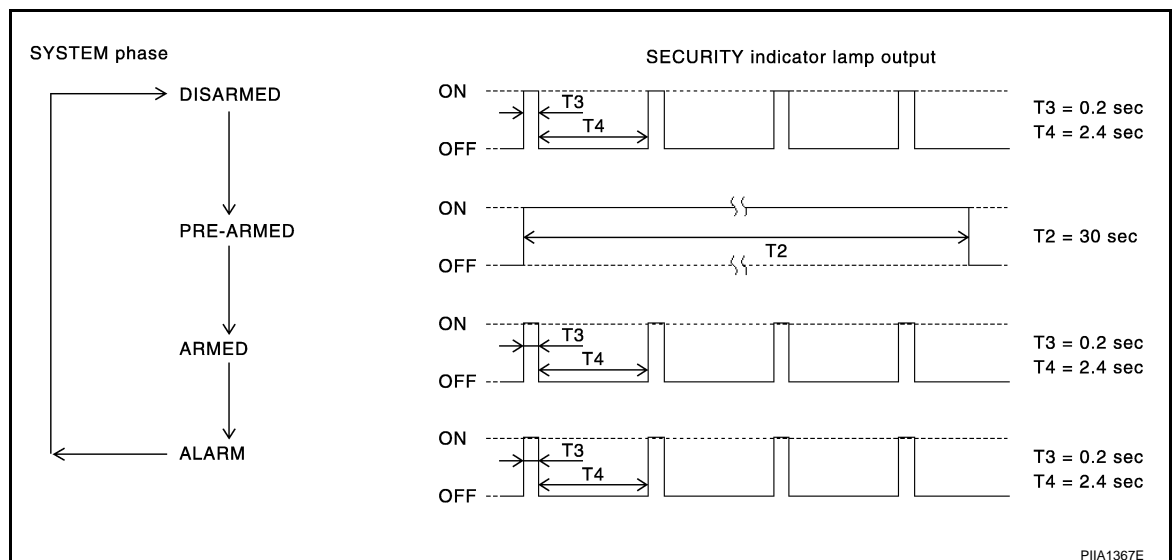

PIA1367E

SETTING THE VEHICLE SECURITY SYSTEM

Initial Condition

- Ignition switch is in OFF position.

Disarmed Phase

VEHICLE SECURITY SYSTEM

[COUPE]

< FUNCTION DIAGNOSIS >

- When doors or trunk is open, the vehicle security system is set in the disarmed phase on the assumption that the owner is inside or near the vehicle. A
- When the vehicle security system is in the disarmed phase, the security indicator lamp blinks every 2.4 seconds. B

Pre-armed Phase and Armed Phase

When the following operation 1 or 2 is performed, the vehicle security system turns into the “pre-armed” phase. (The security indicator lamp illuminates.)

1. BCM receives LOCK signal from front door key cylinder switch or Intelligent Key, after trunk and all doors are closed. C
2. Trunk and all doors are closed after front doors are locked by key or door lock and unlock switch. The security indicator lamp illuminates for 30 seconds. Then, the system automatically shifts into the “armed” phase. D

CANCELING THE SET VEHICLE SECURITY SYSTEM

When one of the following operations is performed, the armed phase is canceled. E

1. Unlock the doors with the key or Intelligent Key.
2. Turn ignition switch “ON” or “ACC” position. F

CANCELING THE ALARM OPERATION OF THE VEHICLE SECURITY SYSTEM

When unlocking the door with the key or Intelligent Key the alarm operation is canceled. G

ACTIVATING THE ALARM OPERATION OF THE VEHICLE SECURITY SYSTEM

Check that the system is in the armed phase. (The security indicator lamp blinks every 2.4 seconds.)

When the following operation 1 or 2 is performed, the system sounds the horns and flashes the headlamps for about 50 seconds. H

1. Trunk or any door is opened during armed phase.
2. Disconnecting and connecting the battery connector before canceling armed phase. I

PANIC ALARM OPERATION

Intelligent Key system will not operate horn and headlamps if the ignition switch is in the ACC or ON position. When the Intelligent Key system is triggered, ground is supplied intermittently to both headlamp relay and horn relay. J

When headlamp relay and horn relay are energized, then power is supplied to headlamps (LH and RH) and horns (HIGH and LOW).

The headlamp flashes and the horn sounds intermittently.

The alarm automatically turns off after 50 seconds or when BCM receives any signal from Intelligent Key. SEC

A
B
C
D
E
F
G
H
I
J
L
M
N
O
P

VEHICLE SECURITY SYSTEM

< FUNCTION DIAGNOSIS >

[COUPE]

Component Parts Location

INFOID:000000001344458

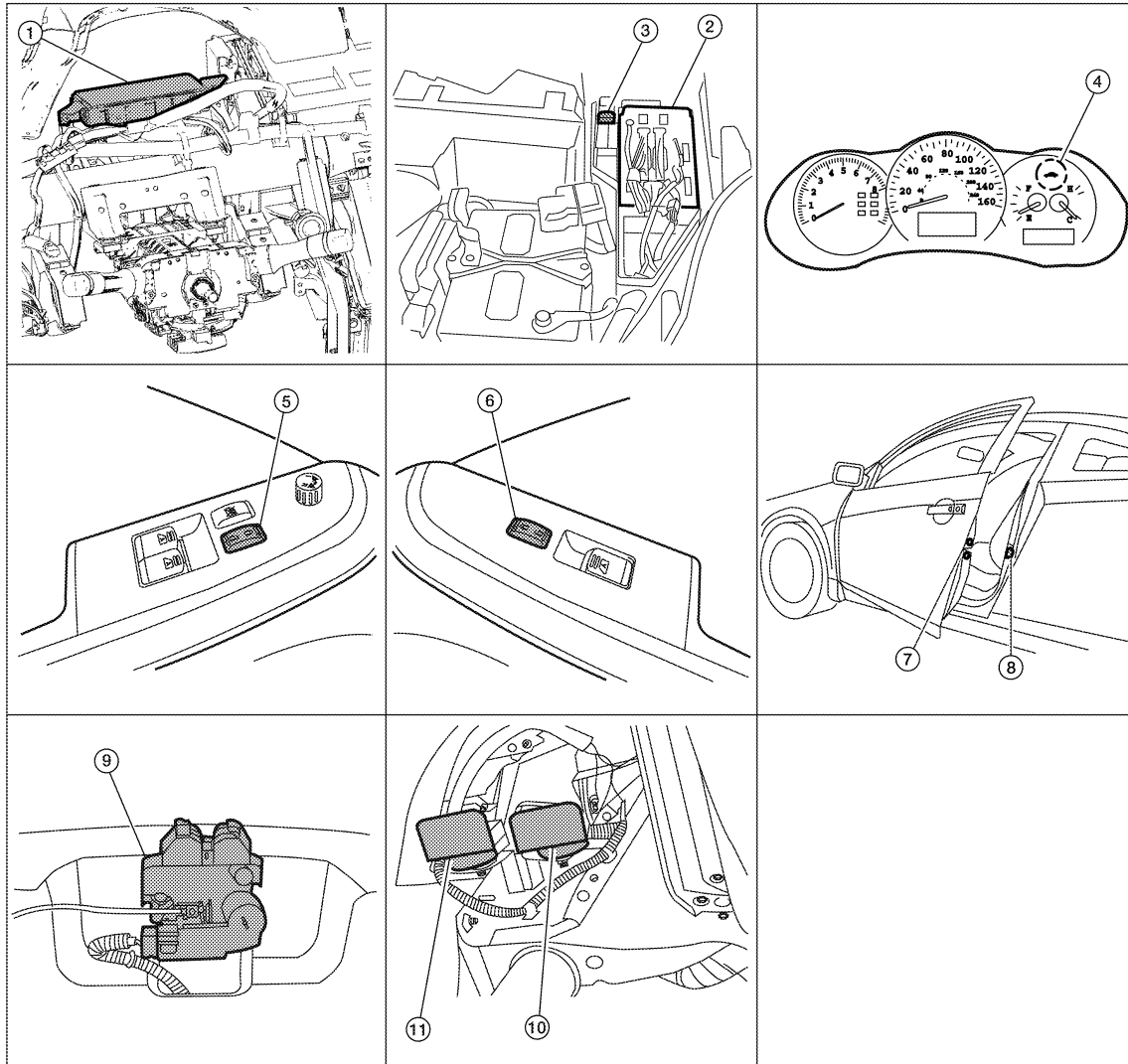

ALKIA1293ZZ

- | | | |
|--|---|---|
| 1. Body control module M16, M17, M18, M19, M21
(view with instrument panel removed) | 2. IPDM E/R E17, E18 | 3. Horn relay H-1 |
| 4. Security indicator lamp (part of combination meter) M24 | 5. Main power window and door lock/unlock switch D7, D8 | 6. Power window and door lock/unlock switch RH D105 |
| 7. Door lock assembly LH (key cylinder switch) D10 | 8. Door switch LH B8 RH B108 | 9. Trunk lamp switch and trunk release solenoid T4 |
| 10. Horn (high) E216
(view with front fender protector LH removed) | 11. Horn (low) E215 | |

Component Description

INFOID:000000001344459

Component	Reference
BCM	SEC-22
Horn relay	SEC-131
Security indicator	SEC-135
Door switch	DLK-54
Door lock actuator	DLK-96
Trunk lid lock assembly	DLK-99

VEHICLE SECURITY SYSTEM

< FUNCTION DIAGNOSIS >

[COUPE]

Component	Reference
Door key cylinder switch	DLK-70
Door lock and unlock switch	DLK-57

A

B

C

D

E

F

G

H

I

J

SEC

L

M

N

O

P

DIAGNOSIS SYSTEM (BCM)

< FUNCTION DIAGNOSIS >

[COUPE]

DIAGNOSIS SYSTEM (BCM)

COMMON ITEM

COMMON ITEM : Diagnosis Description

INFOID:000000001344460

BCM CONSULT-III FUNCTION

CONSULT-III performs the following functions via CAN communication with BCM.

Diagnosis mode	Function Description
WORK SUPPORT	Changes the setting for each system function.
SELF-DIAG RESULTS	Displays the diagnosis results judged by BCM.
CAN DIAG SUPPORT MNTR	Monitors the reception status of CAN communication viewed from BCM.
DATA MONITOR	The BCM input/output signals are displayed.
ACTIVE TEST	The signals used to activate each device are forcibly supplied from BCM.
ECU IDENTIFICATION	The BCM part number is displayed.
CONFIGURATION	This function is not used even though it is displayed.

SYSTEM APPLICATION

BCM can perform the following functions for each system.

NOTE:

It can perform the diagnosis modes except the following for all sub system selection items.

System	Sub system selection item	Diagnosis mode		
		WORK SUPPORT	DATA MONITOR	ACTIVE TEST
Door lock	DOOR LOCK	×	×	×
Rear window defogger	REAR DEFOGGER		×	×
Warning chime	BUZZER		×	×
Interior room lamp timer	INT LAMP	×	×	×
Exterior lamp	EXTERNAL LAMP	×	×	×
Wiper and washer	WIPER	×	×	×
Turn signal and hazard warning lamps	FLASHER	×	×	×
Air conditioner	AIR CONDITONER		×	
Intelligent Key system	INTELLIGENT KEY	×	×	×
Combination switch	COMB SW		×	
BCM	BCM	×		
Immobilizer	IMMU		×	×
Interior room lamp battery saver	BATTERY SAVER	×	×	×
Trunk open	TRUNK		×	
Vehicle security system	THEFT ALM	×	×	×
RAP system	RETAINED PWR		×	
Signal buffer system	SIGNAL BUFFER		×	×
TPMS	AIR PRESSURE MONITOR	×	×	

COMMON ITEM : CONSULT-III Function

INFOID:000000001344461

ECU IDENTIFICATION

Displays the BCM part No.

SELF-DIAG RESULT

Refer to [BCS-85, "DTC Index"](#).

INTELLIGENT KEY

DIAGNOSIS SYSTEM (BCM)

< FUNCTION DIAGNOSIS >

[COUPE]

INTELLIGENT KEY : CONSULT-III Function (BCM - INTELLIGENT KEY)

INFOID:000000001344462

BCM CONSULT-III FUNCTION

CONSULT-III performs the following functions via CAN communication with BCM.

Diagnosis mode	Function Description
WORK SUPPORT	Changes the setting for each system function.
SELF-DIAG RESULTS	Displays the diagnosis results judged by BCM.
DATA MONITOR	The BCM input/output signals are displayed.
ACTIVE TEST	The signals used to activate each device are forcibly supplied from BCM.

WORK SUPPORT

Monitor item	Description
REMO CONT ID CONFIR	It can be checked whether Intelligent Key ID code is registered or not in this mode.
LOCK/UNLOCK BY I-KEY	Door lock/unlock function by door request switch (driver side, passenger side and trunk) mode can be changed to operate (ON) or not operate (OFF) in this mode.
ENGINE START BY I-KEY	Engine start function mode can be changed to operate (ON) or not operate (OFF) with this mode.
TRUNK/GLASS HATCH OPEN	Buzzer reminder function mode by trunk opener request switch can be changed to operate (ON) or not operate (OFF) with this mode.
PANIC ALARM SET	Panic alarm button pressing time on Intelligent Key remote control button can be selected from the following with this mode. <ul style="list-style-type: none"> • 0.5 sec. • 1.5 sec. • OFF: Non-operation
PW DOWN SET	Unlock button pressing time on Intelligent Key button can be selected from the following with this mode. <ul style="list-style-type: none"> • 3 sec. • 5 sec. • OFF: Non-operation
TRUNK OPEN DELAY	Trunk button pressing time on Intelligent Key button can be selected from the following with this mode. <ul style="list-style-type: none"> • 0.5 sec. • 1.5 sec. • OFF: Non-operation
LO- BATT OF KEY FOB WARN	Intelligent Key low battery warning mode can be changed to operate (ON) or not operate (OFF) with this mode.
ANTI KEY LOCK IN FUNCTI	Key reminder function mode can be changed to operate (ON) or not operate (OFF) with this mode.
HORN WITH KEYLESS LOCK	Horn reminder function mode by Intelligent Key button can be changed to operate (ON) or not operate (OFF) with this mode.
HAZARD ANSWER BACK	Hazard reminder function mode can be selected from the following with this mode. <ul style="list-style-type: none"> • LOCK ONLY: Door lock operation only • UNLOCK ONLY: Door unlock operation only • LOCK AND UNLOCK: Lock/unlock operation • OFF: Non operation
ANS BACK I-KEY LOCK	Buzzer reminder function (lock operation) mode by door request switch (driver side and passenger side) can be selected from the following with this mode. <ul style="list-style-type: none"> • HORN CHIRP: Sound horn • BUZZER: Sound Intelligent Key warning buzzer • OFF: Non-operation
ANS BACK I-KEY UNLOCK	Buzzer reminder function (unlock operation) mode by door request switch can be changed to operate (ON) or not operate (OFF) with this mode.

A
B
C
D
E
F
G
H
I
J
L
M
N
O
P

SEC

DIAGNOSIS SYSTEM (BCM)

[COUPE]

< FUNCTION DIAGNOSIS >

Monitor item	Description
SHORT CRANKING OUTPUT	Starter motor can operate during the times below. <ul style="list-style-type: none"> • 70 msec • 100 msec • 200 msec
INSIDE ANT DIAGNOSIS	This function allows inside key antenna self-diagnosis.

SELF-DIAG RESULT

Refer to [BCS-85. "DTC Index"](#).

DATA MONITOR

Monitor Item	Condition
REQ SW-DR	Indicates [ON/OFF] condition of door request switch (driver side).
REQ SW-AS	Indicates [ON/OFF] condition of door request switch (passenger side).
REQ SW-BD/TR	Indicates [ON/OFF] condition of trunk opener request switch.
PUSH SW	Indicates [ON/OFF] condition of push-button ignition switch.
CLUCH SW	Indicates [ON/OFF] condition of clutch switch.
BRAKE SW 1	Indicates [ON/OFF] condition of brake switch.
DETE/CANCL SW	Indicates [ON/OFF] condition of P position.
SFT PN/N SW	Indicates [ON/OFF] condition of P or N position.
S/L -LOCK	Indicates [ON/OFF] condition of steering lock (LOCK).
S/L -UNLOCK	Indicates [ON/OFF] condition of steering lock (UNLOCK).
S/L RELAY-F/B	Indicates [ON/OFF] condition of ignition switch.
UNLK SEN-DR	Indicates [ON/OFF] condition of driver door UNLOCK status.
PUSH SW -IPDM	Indicates [ON/OFF] condition of push-button ignition switch.
IGN RLY1 F/B	Indicates [ON/OFF] condition of ignition relay 1.
DETE SW -IPDM	Indicates [ON/OFF] condition of P position.
SFT PN -IPDM	Indicates [ON/OFF] condition of P or N position.
SFT P -MET	Indicates [ON/OFF] condition of P position.
SFT N -MET	Indicates [ON/OFF] condition of N position.
ENGINE STATE	Indicates [STOP/START/CRANK/RUN] condition of engine states.
S/L LOCK-IPDM	Indicates [ON/OFF] condition of steering lock (LOCK).
S/L UNLOCK-IPDM	Indicates [ON/OFF] condition of steering lock (UNLOCK).
S/L RELAY-REQ	Indicates [ON/OFF] condition of steering lock relay.
VEH SPEED 1	Display the vehicle speed signal received from combination meter by numerical value [Km/h].
VEH SPEED 2	Display the vehicle speed signal received from ABS or VDC or CVT by numerical value [Km/h].
DOOR STAT-DR	Indicates [LOCK/READY/UNLK] condition of driver side door status.
DOOR STAT-AS	Indicates [LOCK/READY/UNLK] condition of passenger side door status.
KEY SW -SLOT	Indicates [ON/OFF] condition of key slot.
RKE OPE COUN1	When remote keyless entry receiver receives the signal transmitted while operating on Intelligent Key, the numerical value start changing.
RKE OPE COUN2	NOTE: This item is displayed, but cannot be monitored.
TRNK/HAT MNTR	Indicates [ON/OFF] condition of trunk lid.
RKE-LOCK	Indicates [ON/OFF] condition of LOCK signal from Intelligent Key.
RKE-UNLOCK	Indicates [ON/OFF] condition of UNLOCK signal from Intelligent Key.
RKE-TR/BD	Indicates [ON/OFF] condition of TRUNK OPEN signal from Intelligent Key.
RKE-PANIC	Indicates [ON/OFF] condition of PANIC button of Intelligent Key.

DIAGNOSIS SYSTEM (BCM)

< FUNCTION DIAGNOSIS >

[COUPE]

Monitor Item	Condition
RKE-P/W OPEN	Indicates [ON/OFF] condition of P/W DOWN signal from Intelligent Key.
RKE-MODE CHG	Indicates [ON/OFF] condition of MODE CHANGE signal from Intelligent Key.

ACTIVE TEST

Test item	Description
BATTERY SAVER	This test is able to check interior room lamp operation. The interior room lamp will be activated after "ON" on CONSULT-III screen is touched.
PW REMOTO DOWN SET	This test is able to check power window down operation. The power window down will be activated after "ON" on CONSULT-III screen is touched.
OUTSIDE BUZZER	This test is able to check Intelligent Key warning buzzer operation. Intelligent Key warning buzzer sounds when "ON" on CONSULT-III screen is touched.
INSIDE BUZZER	This test is able to check warning chime in combination meter operation. <ul style="list-style-type: none"> • Take away warning chime sounds when "TAKE OUT" on CONSULT-III screen is touched. • Key warning chime sounds when "KEY WARN" on CONSULT-III screen is touched. • P position warning chime sounds when "P RNG WARN" on CONSULT-III screen is touched. • ACC warning chime sounds when "ACC WARN" on CONSULT-III screen is touched.
INDICATOR	This test is able to check warning lamp operation. <ul style="list-style-type: none"> • "KEY" Warning lamp illuminates when "KEY IND ON" on CONSULT-III screen is touched. • "KEY" Warning lamp flashes when "KEY IND FSH" on CONSULT-III screen is touched.
INT LAMP	This test is able to check interior room lamp operation. The interior room lamp will be activated after "ON" on CONSULT-III screen is touched.
LCD	This test is able to check meter display information <ul style="list-style-type: none"> • Engine start information displays when "BRAKE/P" on CONSULT-III screen is touched. • Engine start information displays when "BRAKE/P/ON" on CONSULT-III screen is touched. • Key ID warning displays when "KEY ID NG" on CONSULT-III screen is touched. • Steering lock information displays when "STLCK RELES" on CONSULT-III screen is touched. • P position warning displays when "P RNG IND" on CONSULT-III screen is touched. • Intelligent Key insert information displays when "INSERT KEY" on CONSULT-III screen is touched. • Intelligent Key low battery warning displays when "KEY BAT LOW" on CONSULT-III screen is touched. • Take away through window warning displays when "TK AWAY WDW" on CONSULT-III screen is touched. • Take away warning display when "TAKE AWAY" on CONSULT-III screen is touched. • OFF position warning display when "IGN OFF WARN" on CONSULT-III screen is touched.
TRUNK/GLASS HATCH	This test is able to check trunk lid opener actuator open operation. This actuator opens when "ON" on CONSULT-III screen is touched.
FLASHER	This test is able to check security hazard lamp operation. The hazard lamps will be activated after "ON" on CONSULT-III screen is touched.
HORN	This test is able to check horn operation. The horn will be activated after "ON" on CONSULT-III screen is touched.
IGN CONT2	This test is able to check security hazard lamp operation. The hazard lamps will be activated after "ON" on CONSULT-III screen is touched.
P RANGE	This test is able to check A/T device power supply A/T device power is supplied when "ON" on CONSULT-III screen is touched.
ENGINE SW ILLUMI	This test is able to check push-ignition switch illumination operation. Push-ignition switch illumination illuminates when "ON" on CONSULT-III screen is touched.
LOCK INDCATOR	This test is able to check LOCK indicator in push-ignition switch operation. LOCK indicator in push-ignition switch illuminates when "ON" on CONSULT-III screen is touched.
ACC INDCATOR	This test is able to check ACC indicator in push-ignition switch operation. LOCK indicator in push-ignition switch illuminates when "ON" on CONSULT-III screen is touched.
IGNITION ON IND	This test is able to check INGITION ON indicator in push-ignition switch operation. LOCK indicator in push-ignition switch illuminates when "ON" on CONSULT-III screen is touched.
KEY SLOT ILLUMI	This test is able to check key slot illumination operation. Key slot illumination flash when "ON" on CONSULT-III screen is touched.

A

B

C

D

E

F

G

H

I

J

SEC

L

M

N

O

P

DIAGNOSIS SYSTEM (BCM)

< FUNCTION DIAGNOSIS >

[COUPE]

THEFT ALM

THEFT ALM : CONSULT-III Function (BCM - THEFT)

INFOID:000000001344463

APPLICATION ITEM

CONSULT-III performs the following functions via CAN communication with BCM.

Diagnosis mode	Function Description
WORK SUPPORT	Changes the setting for each system function.
DATA MONITOR	The BCM input/output signals are displayed.
ACTIVE TEST	The signals used to activate each device are forcibly supplied from BCM.

DATA MONITOR

Monitored Item	Description
REQ SW-DR	Indicates [ON/OFF] condition of door request switch (driver side).
REQ SW-AS	Indicates [ON/OFF] condition of door request switch (passenger side).
REQ SW-BD/TR	Indicates [ON/OFF] condition of trunk opener request switch.
PUSH SW	Indicates [ON/OFF] condition of push-button ignition switch
UNLK SEN-DR	Indicates [ON/OFF] condition of driver door UNLOCK status.
KEY SW -SLOT	Indicates [ON/OFF] condition of key slot.
DOOR SW-DR	Indicates [ON/OFF] condition of door switch LH.
DOOR SW-AS	Indicates [ON/OFF] condition of door switch RH.
DOOR SW-BK	This is displayed even when it is not equipped.
CDL LOCK SW	Indicates [ON/OFF] condition of lock signal from door lock/unlock switch LH and RH.
CDL UNLOCK SW	Indicates [ON/OFF] condition of unlock signal from door lock/unlock switch LH and RH.
KEY CYL LK-SW	Indicates [ON/OFF] condition of lock signal from door key cylinder switch.
KEY CYL UN-SW	Indicates [ON/OFF] condition of unlock signal from door key cylinder switch.
KEY CYL SW-TR	This is displayed even when it is not equipped.
TR/BD OPEN SW	Indicates [ON/OFF] condition of trunk lid opener switch.
TRNK/HAT MNTR	Indicates [ON/OFF] condition of trunk room lamp switch.
RKE-LOCK	Indicates [ON/OFF] condition of LOCK signal from Intelligent Key.
RKE-UNLOCK	Indicates [ON/OFF] condition of UNLOCK signal from Intelligent Key.
RKE-TR/BD	Indicates [ON/OFF] condition of TRUNK OPEN signal from Intelligent Key.

WORK SUPPORT

Test Item	Description
SECURITY ALARM SET	This mode is able to confirm and change security alarm ON-OFF setting.
THEFT ALM TRG	The switch which triggered vehicle security alarm is recorded. This mode is able to confirm and erase the record of vehicle security alarm. The trigger data can be erased by touching "CLEAR" on CONSULT-III screen.

ACTIVE TEST

Test Item	Description
THEFT IND	This test is able to check security indicator lamp operation. The lamp will be turned on when "ON" on CONSULT-III screen is touched.
VEHICLE SECURITY HORN	This test is able to check vehicle security horn operation. The horns will be activated for 0.5 seconds after "ON" on CONSULT-III screen is touched.

DIAGNOSIS SYSTEM (BCM)

< FUNCTION DIAGNOSIS >

[COUPE]

Test Item	Description
HEADLAMP(HI)	This test is able to check vehicle security lamp operation. The headlamps will be activated for 0.5 seconds after "ON" on CONSULT-III screen is touched.
FLASHER	This test is able to check vehicle security hazard lamp operation. The hazard lamps will be activated after "ON" on CONSULT-III screen is touched.

IMMU

IMMU : CONSULT-III Function (BCM - IMMU)

INFOID:000000001344464

APPLICATION ITEM

CONSULT-III performs the following functions via CAN communication with BCM.

Diagnosis mode	Function Description
DATA MONITOR	The BCM input/output signals are displayed.
ACTIVE TEST	The signals used to activate each device are forcibly supplied from BCM.

DATA MONITOR

Monitor item	Content
CONFIRM ID ALL	Indicates [YET] at all time. Switch to [DONE] when a registered Intelligent Key is inserted into the key slot.
CONFIRM ID4	
CONFIRM ID3	
CONFIRM ID2	
CONFIRM ID1	
TP 4	Indicates the number of ID which has been registered.
TP 3	
TP 2	
TP 1	
PUSH SW	Indicates [ON/OFF] condition of push-button ignition switch.
KEY SW -SLOT	Indicates [ON/OFF] condition of key slot.

ACTIVE TEST

Test item	Description
THEFT IND	This test is able to check security indicator lamp operation. The lamp will be turned on when "ON" on CONSULT-III screen touched.

U1000 CAN COMM CIRCUIT

< COMPONENT DIAGNOSIS >

[COUPE]

COMPONENT DIAGNOSIS

U1000 CAN COMM CIRCUIT

Description

INFOID:000000001344465

Refer to [LAN-7, "System Description"](#).

DTC Logic

INFOID:000000001344466

DTC DETECTION LOGIC

CONSULT-III display description	DTC Detection Condition	Possible cause
CAN COMM CIRCUIT [U1000]	When BCM cannot communicate CAN communication signal continuously for 2 seconds or more	In CAN communication system, any item (or items) of the following listed below is malfunctioning. <ul style="list-style-type: none">• Transmission• Receiving (ECM)• Receiving (VDC/TCS/ABS)• Receiving (METER/M&A)• Receiving (TCM)• Receiving (MULTI AV)• Receiving (IPDM E/R)

Diagnosis Procedure

INFOID:000000001344467

1. PERFORM SELF DIAGNOSTIC

1. Turn ignition switch ON and wait for 2 second or more.
2. Check "Self Diagnostic Result".

Is "CAN COMM CIRCUIT" displayed?

- YES >> Refer to [LAN-8, "CAN Communication Control Circuit"](#).
NO >> Refer to [GI-42, "Intermittent Incident"](#).

U1010 CONTROL UNIT (CAN)

< COMPONENT DIAGNOSIS >

[COUPE]

U1010 CONTROL UNIT (CAN)

DTC Logic

INFOID:000000001344468

DTC DETECTION LOGIC

CONSULT-III display description	DTC Detection Condition	Possible cause
CAN COMM CIRCUIT [U1010]	BCM detected internal CAN communication circuit malfunction.	BCM

Diagnosis Procedure

INFOID:000000001344469

1. REPLACE BCM

When DTC U1010 is detected, replace BCM.

>> Replace BCM. Refer to [BCS-88, "Removal and Installation"](#).

A
B
C
D
E
F
G
H
I
J
L
M
N
O
P

SEC

B2190, P1610 NATS ANTENNA AMP

< COMPONENT DIAGNOSIS >

[COUPE]

B2190, P1610 NATS ANTENNA AMP

Description

INFOID:000000001344470

Performs ID verification through BCM and Intelligent Key when push-button ignition switch is pressed. Prohibits the release of steering lock or start of engine when an unregistered ID of Intelligent Key is used.

DTC Logic

INFOID:000000001344471

DTC DETECTION LOGIC

DTC No.	Trouble diagnosis name	DTC detecting condition	Possible cause
B2190	NATS ANTENNA AMP	Inactive communication between key slot and BCM.	<ul style="list-style-type: none">• Harness or connectors (The key slot circuit is open or shorted)• Key slot• BCM
P1610			

DTC CONFIRMATION PROCEDURE

1. PERFORM DTC CONFIRMATION PROCEDURE

1. Insert Intelligent Key into the key slot.
2. Check "Self diagnostic result" with CONSULT-III.

Is DTC detected?

- YES >> Go to [SEC-34, "Diagnosis Procedure"](#).
NO >> GO TO 2.

2. PERFORM DTC CONFIRMATION PROCEDURE

1. Press the push-button ignition switch.
2. Check "Self diagnostic result" with CONSULT-III.

Is DTC detected?

- YES >> Go to [SEC-34, "Diagnosis Procedure"](#).
NO >> INSPECTION END.

Diagnosis Procedure

INFOID:000000001836911

1. INSPECTION START

Check the case in which DTC is detected.

- Case1: It is detected when Intelligent Key is inserted into key slot.
- Case2: It is detected after Intelligent Key is inserted into key slot and push-button ignition switch is pressed.

In which case is DTC detected?

- Case1. >> GO TO 2.
Case2. >> GO TO 4.

2. CHECK KEY SLOT INPUT SIGNAL

1. Turn ignition switch OFF.
2. Disconnect key slot harness connector.
3. Check voltage between key slot harness connector and ground.

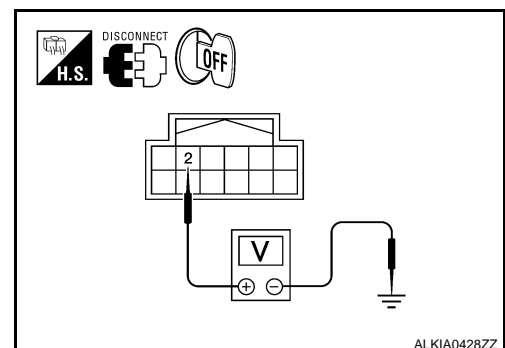

ALKIA0428ZZ

B2190, P1610 NATS ANTENNA AMP

< COMPONENT DIAGNOSIS >

[COUPE]

Key slot		Ground	Voltage [V] (approx.)
Connector	Terminal		
M40	2	Ground	Battery voltage

Is the inspection result normal?

YES >> Replace key slot.

NO >> GO TO 3.

3. CHECK KEY SLOT CIRCUIT

1. Disconnect BCM harness connector.
2. Check continuity between key slot harness connector M40 (A) terminal 2 and BCM harness connector M19 (B) terminal 68.

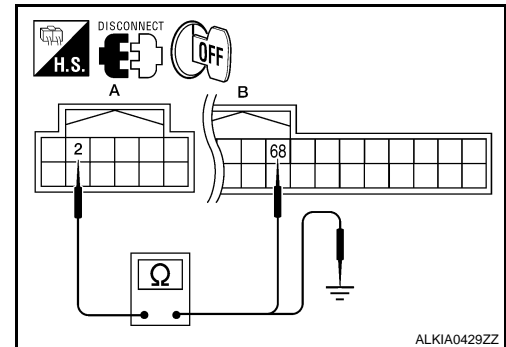

Key slot		BCM		Continuity
Connector	Terminal	Connector	Terminal	
A: M40	2	B: M19	68	Yes

3. Check continuity between key slot harness connector M40 (A) terminal 2 and ground.

Key slot		Ground	Continuity
Connector	Terminal		
A: M40	2	Ground	No

Is the inspection result normal?

YES >> GO TO 8.

NO >> Repair harness or connector.

4. CHECK PUSH-IGNITION SWITCH OPERATION

Press push-button ignition switch and check if it turns ON.

Does ignition switch turn to ON?

YES >> GO TO 5.

NO >> GO TO 7.

5. CHECK KEY SLOT COMMUNICATION SIGNAL

1. Turn ignition switch OFF.
2. Disconnect key slot harness connector.
3. Check voltage between key slot harness connector and ground.

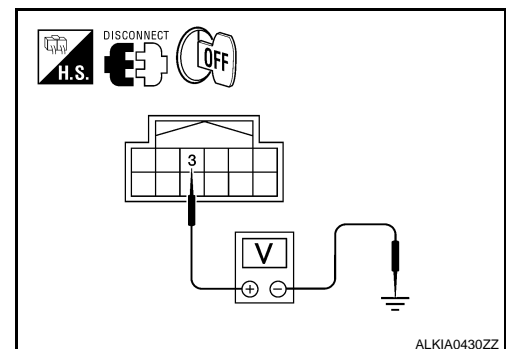

B2190, P1610 NATS ANTENNA AMP

< COMPONENT DIAGNOSIS >

[COUPE]

Key slot		Ground	Continuity
Connector	Terminal		
M40	3	Ground	Yes

Is the inspection result normal?

YES >> Replace key slot.

NO >> GO TO 6.

6. CHECK KEY SLOT COMMUNICATION SIGNAL CIRCUIT

1. Disconnect BCM harness connector.
2. Check continuity between key slot harness connector M40 (A) terminal 3 and BCM harness connector M19 (B) terminal 69.

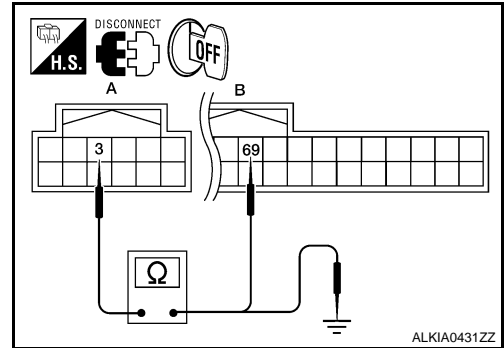

Key slot		BCM		Continuity
Connector	Terminal	Connector	Terminal	
A: M40	3	B: M19	69	Yes

3. Check continuity between key slot harness connector M40 (A) terminal 3 and ground.

Key slot		Ground	Continuity
Connector	Terminal		
A: M40	3	Ground	No

Is the inspection result normal?

YES >> GO TO 8.

NO >> Repair harness or connector.

7. CHECK KEY SLOT GROUND CIRCUIT

1. Turn ignition switch OFF.
2. Disconnect key slot harness connector.
3. Check continuity between key slot harness connector and ground.

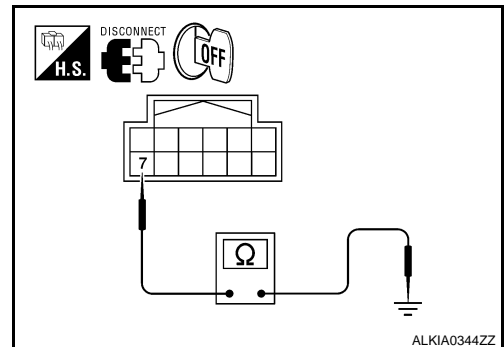

Key slot		Ground	Continuity
Connector	Terminal		
M40	7	Ground	Yes

B2190, P1610 NATS ANTENNA AMP

[COUPE]

< COMPONENT DIAGNOSIS >

Is the inspection result normal?

YES >> GO TO 8.

NO >> Repair harness or connector.

8.CHECK INTERMITTENT INCIDENT

Refer to [GI-42. "Intermittent Incident"](#).

>> INSPECTION END.

A

B

C

D

E

F

G

H

I

J

SEC

L

M

N

O

P

B2191, P1615 DIFFERENCE OF KEY

< COMPONENT DIAGNOSIS >

[COUPE]

B2191, P1615 DIFFERENCE OF KEY

Description

INFOID:000000001344473

Performs ID verification through BCM and Intelligent Key when push-button ignition switch is pressed. Prohibits the release of steering lock or start of engine when an unregistered ID of Intelligent Key is used.

DTC Logic

INFOID:000000001344474

DTC DETECTION LOGIC

DTC No.	Trouble diagnosis name	DTC detecting condition	Possible cause
B2191 P1615	DIFFERENCE OF KEY	The ID verification results between BCM and Intelligent Key are NG. The registration is necessary.	<ul style="list-style-type: none">Intelligent Key

DTC CONFIRMATION PROCEDURE

1. PERFORM DTC CONFIRMATION PROCEDURE

1. Press the push-button ignition switch
2. Check "Self diagnostic result" with CONSULT-III.

Is DTC detected?

- YES >> Go to [SEC-38. "Diagnosis Procedure"](#).
NO >> INSPECTION END.

Diagnosis Procedure

INFOID:000000001344475

1. PERFORM INITIALIZATION

Perform initialization with CONSULT-III. Re-register all Intelligent Keys. For initialization and registration of Intelligent Key. Refer to "CONSULT-III Operation Manual.

Can the system be initialized and can the engine be started with re-registered Intelligent Key?

- YES >> Intelligent Key was unregistered.
NO >> BCM is malfunctioning.
 - Replace BCM
 - Perform initialization again

B2192, P1611 ID DISCORD, IMMU-ECM

Description

INFOID:000000001344476

BCM performs the ID verification with ECM that allows the engine to start. Start the engine if the ID is OK. ECM prevents the engine from starting if the ID is not registered. BCM starts the communication with ECM if ignition switch is turned ON.

DTC Logic

INFOID:000000001344477

DTC DETECTION LOGIC

NOTE:

- If DTC B2192 is displayed with DTC U1000, first perform the trouble diagnosis for DTC U1000. Refer to [SEC-32, "DTC Logic"](#).
- If DTC B2192 is displayed with DTC U1010, first perform the trouble diagnosis for DTC U1010. Refer to [SEC-33, "DTC Logic"](#).

DTC No.	Trouble diagnosis name	DTC detecting condition	Possible cause
B2192	ID DISCORD, IMMU-ECM	The ID verification results between BCM and ECM are NG. The registration is necessary.	<ul style="list-style-type: none"> • BCM • ECM
P1611			

DTC CONFIRMATION PROCEDURE

1. PERFORM DTC CONFIRMATION PROCEDURE

1. Turn ignition switch ON under the following conditions.
 - A/T selector lever is in the P or N position
 - Do not depress the brake pedal
2. Check "Self diagnostic result" with CONSULT-III.

Is DTC detected?

- YES >> Go to [SEC-39, "Diagnosis Procedure"](#).
 NO >> INSPECTION END.

Diagnosis Procedure

INFOID:000000001344478

1. PERFORM INITIALIZATION

Perform initialization with CONSULT-III. Re-register all Intelligent Keys. For initialization and registration of Intelligent Key. Refer to "CONSULT-III Operation Manual".

Can the system be initialized and can the engine be started with re-registered Intelligent Key?

- YES >> ID was unregistered.
 NO >> BCM is malfunctioning.
 - Replace BCM
 - Perform initialization again
 - Replace ECM



B2193, P1612 CHAIN OF ECM-IMMU**Description**

INFOID:000000001344479

BCM performs the ID verification with ECM that allows the engine to start. Start the engine if the ID is OK. ECM prevents the engine from starting if the ID is not registered. BCM starts the communication with ECM if ignition switch is turned ON.

DTC Logic

INFOID:000000001344480

DTC DETECTION LOGIC**NOTE:**

- If DTC B2193 is displayed with DTC U1000, first perform the trouble diagnosis for DTC U1000. Refer to [SEC-32, "DTC Logic"](#).
- If DTC B2193 is displayed with DTC U1010, first perform the trouble diagnosis for DTC U1010. Refer to [SEC-33, "DTC Logic"](#).

DTC No.	Trouble diagnosis name	DTC detecting condition	Possible cause
B2193	CHAIN OF ECM-IMMU	Inactive communication between ECM and BCM	<ul style="list-style-type: none"> • Harness or connectors (The CAN communication line is open or shorted) • BCM • ECM
P1612			

DTC CONFIRMATION PROCEDURE**1. PERFORM DTC CONFIRMATION PROCEDURE**

1. Turn ignition switch ON under the following conditions.
 - CVT selector lever is in the P or N position.
 - Do not depress brake pedal.
2. Check "Self diagnostic result" with CONSULT-III.

Is DTC detected?

- YES >> Go to [SEC-40, "Diagnosis Procedure"](#).
 NO >> INSPECTION END.

Diagnosis Procedure

INFOID:000000001344481

1. REPLACE BCM

1. Replace BCM.
2. Perform initialization with CONSULT-III.
For initialization, refer to "CONSULT-III Operation Manual".

Does the engine start?

- YES >> BCM is malfunctioning.
 - Replace BCM.
 - Perform initialization again.
- NO >> ECM is malfunctioning.
 - Replace ECM.
 - Perform ECM re-communicating function.

B2013 ID DISCORD, IMMU-STRG

< COMPONENT DIAGNOSIS >

[COUPE]

B2013 ID DISCORD, IMMU-STRG

Description

INFOID:000000001344482

BCM performs the ID verification with the steering lock unit and releases the steering lock if both BCM and steering lock unit ID are same. BCM starts the communication with the steering lock unit when Intelligent Key is carried into the passenger compartment and the push-button ignition switch is pressed.

DTC Logic

INFOID:000000001344483

DTC DETECTION LOGIC

DTC No.	Trouble diagnosis name	DTC detecting condition	Possible cause
B2013	ID DISCORD, IMMU-STRG	The ID verification results between BCM and steering control unit are NG. The registration is necessary.	<ul style="list-style-type: none">Steering wheel lock unit

DTC CONFIRMATION PROCEDURE

1. PERFORM DTC CONFIRMATION PROCEDURE

1. Lock steering.
2. Press the push-button ignition switch
3. Check "Self diagnostic result" with CONSULT-III.

Is DTC detected?

- YES >> Go to [SEC-41, "Diagnosis Procedure"](#).
NO >> INSPECTION END.

Diagnosis Procedure

INFOID:000000001344484

1. PERFORM INITIALIZATION

Perform initialization with CONSULT-III. Re-register all Intelligent Keys.
For initialization and registration of Intelligent Key. Refer to "CONSULT-III Operation Manual".

Can the system be initialized and can steering lock be released with re-registered Intelligent Key?

- YES >> Steering lock unit was unregistered.
NO >> Replace steering wheel lock unit.

SEC

B2014 CHAIN OF STRG-IMMU

< COMPONENT DIAGNOSIS >

[COUPE]

B2014 CHAIN OF STRG-IMMU

Description

INFOID:000000001344485

BCM performs the ID verification with the steering lock unit to release the steering. BCM starts the communication with the steering lock unit when Intelligent Key is carried into the passenger compartment and the push-button ignition switch is pressed.

DTC Logic

INFOID:000000001344486

DTC DETECTION LOGIC

DTC No.	Trouble diagnosis name	DTC detecting condition	Possible cause
B2014	CHAIN OF STRG-IMMU	Inactive communication between steering control unit and BCM	<ul style="list-style-type: none"> • Harness or connectors (steering lock unit circuit is open or shorted) • Steering lock unit • BCM

DTC CONFIRMATION PROCEDURE

1.PERFORM DTC CONFIRMATION PROCEDURE

1. Lock steering.
2. Press the push-button ignition switch.
3. Check "Self diagnostic result" with CONSULT-III.

Is DTC detected?

- YES >> Go to [SEC-42. "Diagnosis Procedure"](#).
 NO >> INSPECTION END.

Diagnosis Procedure

INFOID:000000001836912

1.CHECK STEERING LOCK UNIT POWER SUPPLY

1. Turn ignition switch OFF.
2. Disconnect steering lock unit harness connector.
3. Check voltage between steering lock unit harness connector and ground while turning ignition switch from OFF to ACC.

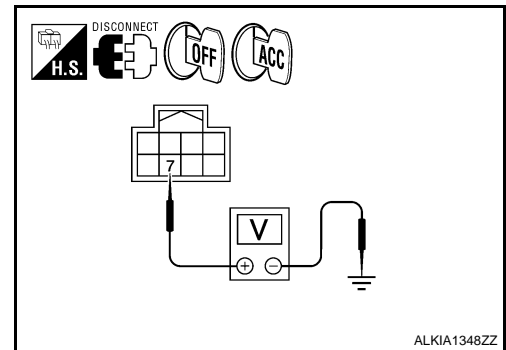

Steering lock unit		Ground	Ignition switch position	Voltage [V]
Connector	Terminal			
M32	7	Ground	OFF → ACC	Battery voltage
			OFF or ON	0

Is the inspection normal?

- YES >> GO TO 3.
 NO >> GO TO 2.

2.CHECK STEERING LOCK UNIT POWER SUPPLY CIRCUIT

1. Turn ignition switch OFF.

B2014 CHAIN OF STRG-IMMU

[COUPE]

< COMPONENT DIAGNOSIS >

2. Disconnect BCM harness connector.
3. Check continuity between steering lock unit harness connector M32 (A) terminal 7 and BCM harness connector M19 (B) terminal 94.

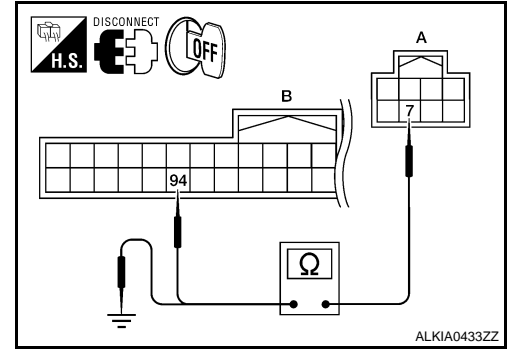

Steering lock unit		BCM		Continuity
Connector	Terminal	connector	Terminal	
A: M32	7	B: M19	94	Yes

4. Check continuity between steering lock unit harness connector M32 (A) terminal 7 and ground.

Steering lock unit		Ground	Continuity
Connector	Terminal		
A: M32	7	Ground	No

Is the inspection normal?

YES >> GO TO 6.

NO >> Repair harness or connector.

3. CHECK STEERING LOCK UNIT GROUND CIRCUIT

1. Turn ignition switch OFF.
2. Check continuity between steering lock unit and ground.

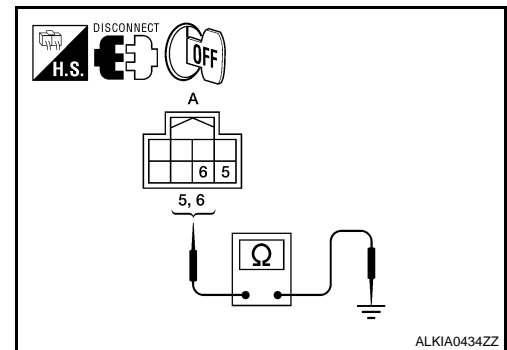

Steering lock unit		Ground	Continuity
Connector	Terminal		
M32	5	Ground	Yes
	6		

Is the inspection normal?

YES >> GO TO 4.

NO >> Repair harness or connector.

4. CHECK STEERING LOCK UNIT COMMUNICATION SIGNAL

1. Connect steering lock unit harness connector.

B2014 CHAIN OF STRG-IMMU

[COUPE]

< COMPONENT DIAGNOSIS >

- Using an oscilloscope, read voltage signal between steering lock unit harness connector and ground.

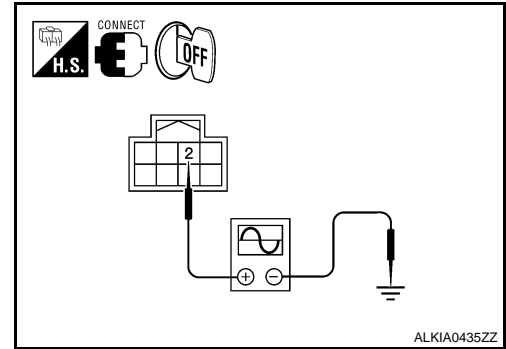

Steering lock unit		Ground	Steering lock unit condition	Value
Connector	Terminal			
M32	2	Ground	Lock	Battery voltage
			Lock or unlock	<p style="text-align: right; font-size: small;">JMKIA0066GB</p>
			For 15 seconds after unlock	Battery voltage
			15 seconds or later after unlock.	0 V

- Steering is locked** : Opening the door when ignition switch is ON to OFF.
Steering is unlocked : Ignition switch is OFF to ACC.

Is the inspection normal?

- YES >> Replace steering lock unit.
 NO >> GO TO 5.

5. CHECK STEERING LOCK UNIT COMMUNICATION CIRCUIT

- Turn ignition switch OFF.
- Disconnect BCM harness connector.
- Check continuity between BCM harness connector M19 (A) terminal 99 and steering lock unit harness connector M32 (B) terminal 2.

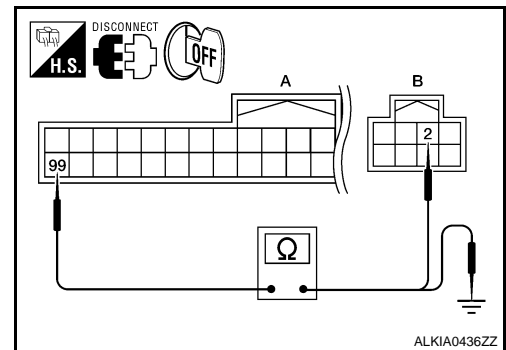

BCM		Steering lock unit		Continuity
Connector	Terminal	connector	Terminal	
A: M19	99	B: M32	2	Yes

- Check continuity between BCM harness connector M19 (A) terminal 99 and ground.

B2014 CHAIN OF STRG-IMMU

< COMPONENT DIAGNOSIS >

[COUPE]

BCM		Ground	Continuity
Connector	Terminal		
A: M19	99	Ground	No

Is the inspection normal?

YES >> GO TO 6.

NO >> Repair harness or connector.

6.CHECK INTERMITTENT INCIDENT

Refer to [GI-42. "Intermittent Incident"](#).

>> INSPECTION END.

A
B
C
D
E
F
G
H
I
J
L
M
N
O
P

SEC

B2555 STOP LAMP

< COMPONENT DIAGNOSIS >

[COUPE]

B2555 STOP LAMP

Description

INFOID:000000001344488

BCM detects the stop lamp status and confirms the stop lamp switch ON/OFF status. BCM confirms the engine start condition according to the stop lamp switch ON/OFF status.

DTC Logic

INFOID:000000001344489

DTC DETECTION LOGIC

DTC No.	Trouble diagnosis name	DTC detecting condition	Possible cause
B2555	STOP LAMP	BCM makes a comparison between the upper voltage and lower voltage of stop lamp switch. It judges from their values to detect the malfunctioning circuit.	<ul style="list-style-type: none">• Harness or connectors (stop lamp switch circuit is open or shorted)• Stop lamp switch• Fuse

DTC CONFIRMATION PROCEDURE

1. PERFORM DTC CONFIRMATION PROCEDURE

1. Depress the brake pedal and wait for at least 1 second.
2. Check "Self diagnostic result" with CONSULT-III.

Is DTC detected?

- YES >> Go to [SEC-46, "Diagnosis Procedure"](#).
NO >> INSPECTION END.

Diagnosis Procedure

INFOID:000000001836913

1. CHECK STOP LAMP SWITCH INPUT SIGNAL

1. Turn ignition switch OFF.
2. Disconnect BCM harness connector.
3. Check voltage between BCM harness connector and ground.

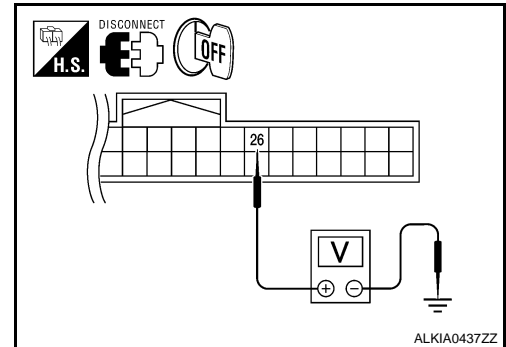

BCM		Ground	Stop lamp switch position	Voltage [V]
Connector	Terminal			
M18	26	Ground	Depressed	Battery voltage
			Released	0

Is the inspection normal?

- YES >> Stop lamp switch is OK.
NO >> GO TO 2.

2. CHECK STOP LAMP SWITCH POWER SUPPLY CIRCUIT

1. Disconnect stop lamp switch harness connector.

B2555 STOP LAMP

[COUPE]

< COMPONENT DIAGNOSIS >

- Check voltage between stop lamp harness connector and ground.

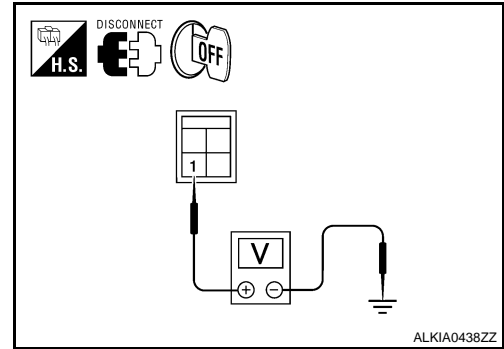

Stop lamp switch		Ground	Voltage [V]
Connector	Terminal		
E38	1	Ground	Battery voltage

Is the inspection result normal?

YES >> GO TO 3.

NO >> Check harness for open or short between stop lamp switch and fuse.

3.CHECK STOP LAMP SWITCH CIRCUIT

- Check continuity between stop lamp switch harness connector E38 (A) terminal 2 and BCM harness connector M18 (B) terminal 26.

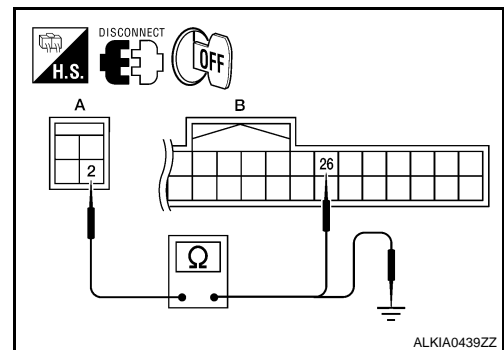

Stop lamp switch		BCM		Continuity
Connector	Terminal	Connector	Terminal	
A: E38	2	B: M18	26	Yes

- Check continuity between stop lamp switch harness connector E38 (A) terminal 2 and ground.

Stop lamp switch		Ground	Continuity
Connector	Terminal		
A: E38	2	Ground	No

Is the inspection result normal?

YES >> GO TO 4.

NO >> Repair harness or connector.

4.CHECK STOP LAMP SWITCH

Refer to [SEC-48, "Component Inspection"](#).

Is the inspection result normal?

YES >> GO TO 5.

NO >> Replace stop lamp switch.

5.CHECK INTERMITTENT INCIDENT

Refer to [GI-42, "Intermittent Incident"](#).

A
B
C
D
E
F
G
H
I
J
L
M
N
O
P

SEC

B2555 STOP LAMP

[COUPE]

< COMPONENT DIAGNOSIS >

>> INSPECTION END.

Component Inspection

INFOID:000000001836914

1. CHECK STOP LAMP SWITCH

1. Turn ignition switch OFF.
2. Disconnect stop lamp switch harness connector.
3. Check continuity between stop lamp switch terminals under the following conditions.

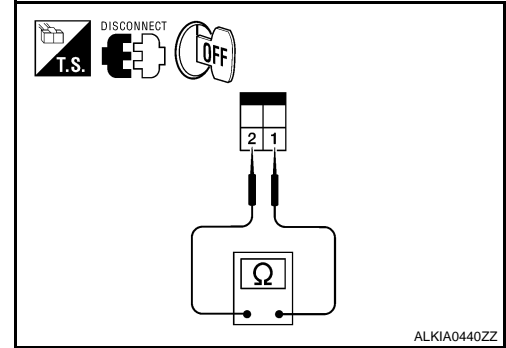

Stop lamp switch		Condition	Continuity	
Terminal				
1	2	Brake pedal	Not depressed	No
			Depressed	Yes

Is the inspection result normal?

YES >> INSPECTION END.

NO >> Replace stop lamp switch.

B2556 PUSH-BUTTON IGNITION SWITCH

< COMPONENT DIAGNOSIS >

[COUPE]

B2556 PUSH-BUTTON IGNITION SWITCH

Description

INFOID:000000001344492

The switch that changes the power supply position. BCM maintains the power supply position status. BCM changes the power supply position with the operation of the push-button ignition switch.

DTC Logic

INFOID:000000001344493

DTC DETECTION LOGIC

DTC No.	Trouble diagnosis name	DTC detecting condition	Possible cause
B2556	PUSH-BUTTON IGNITION SWITCH	BCM detects the push-button ignition switch stuck to ON for 100 seconds or more	<ul style="list-style-type: none"> • Harness or connectors (Push-button ignition switch circuit is shorted.) • Push-button ignition switch

DTC CONFIRMATION PROCEDURE

1. PERFORM DTC CONFIRMATION PROCEDURE

1. Start the engine and wait for at least 100 seconds.
2. Check "Self diagnostic result" with CONSULT-III.

Is DTC detected?

- YES >> Go to [SEC-49, "Diagnosis Procedure"](#).
 NO >> INSPECTION END.

Diagnosis Procedure

INFOID:000000001836915

1. CHECK PUSH-BUTTON IGNITION SWITCH INPUT SIGNAL

1. Turn ignition switch OFF.
2. Disconnect push-button ignition switch harness connector.
3. Check voltage between push-button ignition switch harness connector and ground.

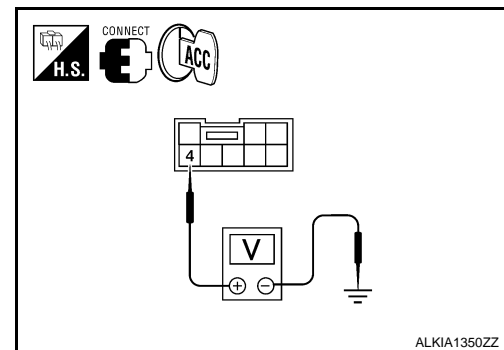

Push-button ignition switch		Ground	Voltage [V]
Connector	Terminal		
M38	4	Ground	Battery voltage

Is the inspection normal?

- YES >> GO TO 2.
 NO >> GO TO 4.

2. CHECK PUSH-BUTTON IGNITION SWITCH

Refer to [SEC-50, "Component Inspection"](#).

Is the inspection normal?

- YES >> GO TO 3.
 NO >> Replace push-button ignition switch. Refer to [SEC-182, "Removal and Installation"](#).

B2556 PUSH-BUTTON IGNITION SWITCH

[COUPE]

< COMPONENT DIAGNOSIS >

3.CHECK INTERMITTENT INCIDENT

Refer to [GI-42. "Intermittent Incident"](#).

>> INSPECTION END.

4.CHECK PUSH-BUTTON IGNITION SWITCH CIRCUIT FOR SHORT

1. Disconnect BCM harness connector and IPDM E/R harness connector.
2. Check continuity between push-button ignition switch harness connector and ground.

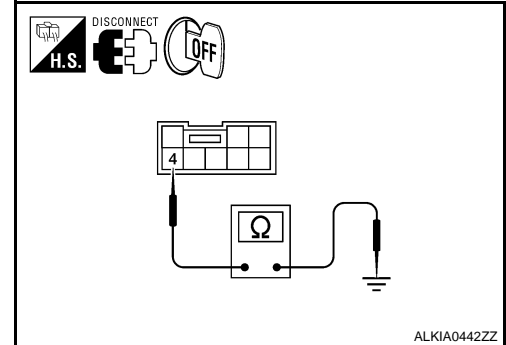

Push-button ignition switch		Ground	Continuity
Connector	Terminal		
M38	4	Ground	No

Is the inspection normal?

YES >> Replace BCM. Refer to [BCS-88. "Removal and Installation"](#).

NO >> Repair harness or connector.

Component Inspection

INFOID:000000001836916

1.CHECK PUSH-BUTTON IGNITION SWITCH

1. Turn ignition switch OFF.
2. Disconnect push-button ignition switch harness connector.
3. Check continuity between push-button ignition switch terminals under the following conditions.

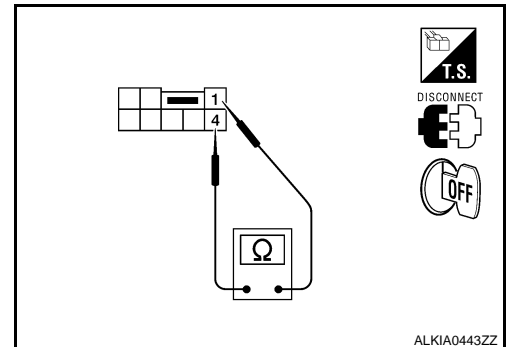

Push-button ignition switch		Condition	Continuity
Terminal			
1	4	Pressed	Yes
		Not pressed	No

Is the inspection result normal?

YES >> INSPECTION END.

NO >> Replace push-button ignition switch. Refer to [SEC-182. "Removal and Installation"](#).

B2557 VEHICLE SPEED

< COMPONENT DIAGNOSIS >

[COUPE]

B2557 VEHICLE SPEED

Description

INFOID:000000001344496

BCM receives the 2 vehicle speed signals via CAN communication. 1 signal is transmitted by the “unified meter” Another signal is transmitted by “ABS actuator and electric unit (control unit)”. BCM compares both signals to detect the vehicle speed.

DTC Logic

INFOID:000000001344497

DTC DETECTION LOGIC

NOTE:

- If DTC B2557 is displayed with DTC U1000, first perform the trouble diagnosis for DTC U1000. Refer to [SEC-32, "DTC Logic"](#).
- If DTC B2557 is displayed with DTC U1010, first perform the trouble diagnosis for DTC U1010. Refer to [SEC-33, "DTC Logic"](#).

DTC	Self-diagnosis name	DTC detecting condition	Possible causes
B2557	VEHICLE SPEED	BCM detects the following difference between the vehicle speed from “unified meter” and the one from “ABS actuator and electric unit” for 10 seconds continuously <ul style="list-style-type: none"> • One is 10km/h or more and the other is 4km/h or less. 	<ul style="list-style-type: none"> • Wheel sensor • Unified meter • ABS actuator and electric unit (control unit)

DTC CONFIRMATION PROCEDURE

1.PERFORM DTC CONFIRMATION PROCEDURE

1. Drive the vehicle at the vehicle speed of 10 km/h or more and wait for at least 10 seconds.
2. Check “Self diagnostic result” with CONSULT-III.

Is DTC detected?

- YES >> Go to [SEC-51, "Diagnosis Procedure"](#).
 NO >> INSPECTION END.

Diagnosis Procedure

INFOID:000000001344498

1.CHECK DTC WITH “ABS ACTUATOR AND ELECTRIC UNIT (CONTROL UNIT)”

Check “Self diagnostic result” with CONSULT-III. Refer to [BRC-51, "DTC No. Index"](#) (ABS), [BRC-120, "DTC No. Index"](#) (TCS/ABS) or [BRC-222, "DTC No. Index"](#) (VDS/TCS/ABS).

Is the inspection result normal?

- YES >> GO TO 2.
 NO >> Repair or replace.

2.CHECK UNIFIED METER.

Check unified meter. Refer to [MWI-4, "Work Flow"](#).

>> INSPECTION END.

A
B
C
D
E
F
G
H
I
J
L
M
N
O
P

SEC

B2560 STARTER CONTROL RELAY

< COMPONENT DIAGNOSIS >

[COUPE]

B2560 STARTER CONTROL RELAY

Description

INFOID:000000001344499

Starter control relay, integrated in IPDM E/R, permits the starter relay operation when in N or P position and the steering is locked or unlocked. It is installed in parallel with the starter relay.

DTC Logic

INFOID:000000001344500

DTC DETECTION LOGIC

NOTE:

- If DTC B2560 is displayed with DTC U1000, first perform the trouble diagnosis for DTC U1000. Refer to [SEC-32, "DTC Logic"](#).
- If DTC B2560 is displayed with DTC U1010, first perform the trouble diagnosis for DTC U1010. Refer to [SEC-33, "DTC Logic"](#).

DTC	Self-diagnosis name	DTC detecting condition	Possible causes
B2560	STARTER CONTROL RELAY	BCM detects a mismatch between the OFF request of starter control relay to IPDM E/R and the feedback. (The feedback is ON instead of OFF.)	• IPDM E/R

DTC CONFIRMATION PROCEDURE

1. PERFORM DTC CONFIRMATION PROCEDURE

1. Turn ignition switch ON under the following conditions and wait for at least 2 seconds.
 - A/T selector lever is in the P position
 - Depress the brake pedal
2. Check "Self diagnostic result" with CONSULT-III.

Is DTC detected?

- YES >> Go to [SEC-52, "Diagnosis Procedure"](#).
NO >> INSPECTION END.

Diagnosis Procedure

INFOID:000000001344501

1. CHECK DTC WITH IPDM E/R

Check "Self diagnostic result" with CONSULT-III. Refer to [PCS-41, "DTC Index"](#).

Is the inspection result normal?

- YES >> GO TO 2.
NO >> Repair or replace.

2. CHECK INTERMITTENT INCIDENT

Refer to [GI-42, "Intermittent Incident"](#).

>> INSPECTION END.

B2601 SHIFT POSITION

< COMPONENT DIAGNOSIS >

[COUPE]

B2601 SHIFT POSITION

Description

INFOID:000000001344502

BCM confirms the shift position with the following 2 signals.

- CVT selector lever
- P position signal from IPDM E/R (CAN)

DTC Logic

INFOID:000000001344503

DTC DETECTION LOGIC

NOTE:

- If DTC B2601 is displayed with DTC U1000, first perform the trouble diagnosis for DTC U1000. Refer to [SEC-32, "DTC Logic"](#).
- If DTC B2601 is displayed with DTC U1010, first perform the trouble diagnosis for DTC U1010. Refer to [SEC-33, "DTC Logic"](#).
- If DTC B2601 is displayed with DTC B2605, first perform the trouble diagnosis for DTC B2605. Refer to [SEC-66, "DTC Logic"](#).

DTC No.	Trouble diagnosis name	DTC detecting condition	Possible cause
B2601	SHIFT POSITION	BCM detects when a difference between the shift P input signal and the shift position signal received from IPDM E/R via CAN communication continues for 2 seconds or more	<ul style="list-style-type: none"> • Harness or connectors (CVT device circuit is open or shorted.) • CVT device (detention switch)

DTC CONFIRMATION PROCEDURE

1. PERFORM DTC CONFIRMATION PROCEDURE

1. Turn ignition switch ON under the following conditions, and wait for at least 2 seconds.
 - CVT selector lever is in the P position.
 - Do not depress the brake pedal.
2. Check "Self diagnostic result" with CONSULT-III.
3. Turn ignition switch ON under the following conditions, and wait for at least 2 seconds.
 - CVT selector lever is in other than P position.
 - Do not depress the brake pedal.
4. Check "Self diagnostic result" with CONSULT-III.

Is DTC detected?

- YES >> Go to [SEC-53, "Diagnosis Procedure"](#).
- NO >> INSPECTION END.

Diagnosis Procedure

INFOID:000000001836920

1. CHECK CVT DEVICE POWER SUPPLY

1. Turn ignition switch to ACC.
2. Disconnect CVT device (detention switch) harness connector.
3. Check voltage between CVT device (detention switch) harness connector and ground.

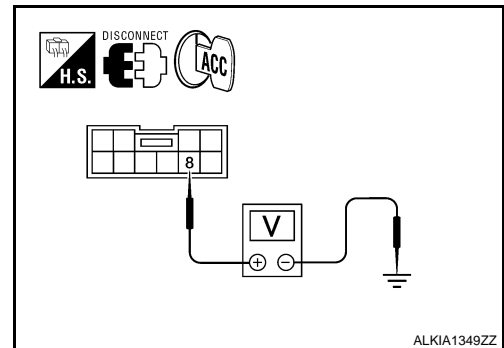

B2601 SHIFT POSITION

[COUPE]

< COMPONENT DIAGNOSIS >

CVT device (detention switch)		Ground	Voltage [V]
Connector	Terminal		
M23	8	Ground	Battery voltage

Is the inspection result normal?

YES >> GO TO 3.

NO >> GO TO 2.

2. CHECK CVT DEVICE POWER SUPPLY CIRCUIT

1. Disconnect BCM harness connector.
2. Check continuity between BCM harness connector M19 (A) terminal 84 and CVT device (detention switch) harness connector M23 (B) terminal 8.

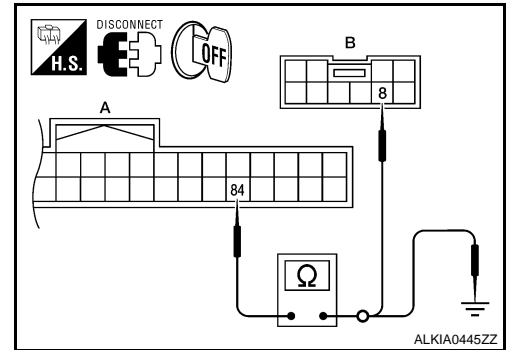

BCM		CVT device (detention switch)		Continuity
Connector	Terminal	Connector	Terminal	
A: M19	84	B: M23	8	Yes

3. Check continuity between BCM harness connector M19 (A) terminal 84 and ground.

BCM		Ground	Continuity
Connector	Terminal		
A: M19	84	Ground	No

Is the inspection result normal?

YES >> Replace BCM.

NO >> Repair harness or connector.

3. CHECK CVT DEVICE CIRCUIT (BCM)

1. Disconnect BCM harness connector and IPDM E/R harness connector.
2. Check continuity between BCM harness connector M19 (A) terminal 87 and CVT device (detention switch) harness connector M23 (B) terminal 9.

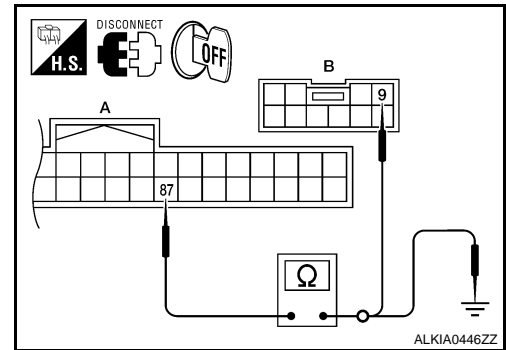

BCM		CVT device (detention switch)		Continuity
Connector	Terminal	Connector	Terminal	
A: M19	87	B: M23	9	Yes

3. Check continuity between BCM harness connector M19 (A) terminal 87 and ground.

B2601 SHIFT POSITION

[COUPE]

< COMPONENT DIAGNOSIS >

BCM		Ground	Continuity
Connector	Terminal		
A: M19	87	Ground	No

Is the inspection result normal?

YES >> GO TO 4.

NO >> Repair harness or connector.

4.CHECK CVT DEVICE CIRCUIT (IPDM E/R)

1. Disconnect BCM harness connector.
2. Check continuity between CVT device (detention switch) harness connector M23 (A) terminal 9 and IPDM E/R harness connector E17 (B) terminal 43.

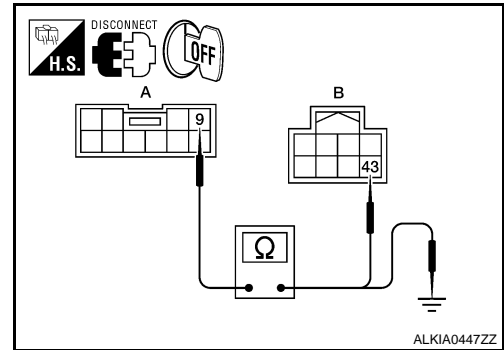

CVT device (detention switch)		IPDM E/R		Continuity
Connector	Terminal	Connector	Terminal	
A: M23	9	B: E17	43	Yes

3. Check continuity between CVT device (detention switch) harness connector M23 (A) terminal 9 and ground.

CVT device (detention switch)		Ground	Continuity
Connector	Terminal		
A: M23	9	Ground	No

Is the inspection result normal?

YES >> GO TO 5.

NO >> Repair harness or connector.

5.CHECK CVT DEVICE

Refer to [SEC-55. "Component Inspection"](#).

Is the inspection result normal?

YES >> GO TO 6.

NO >> Replace CVT device. Refer to [TM-250. "Removal and Installation"](#) (RE0F09B), or [TM-426. "Removal and Installation"](#) (RE0F10A).

6.CHECK INTERMITTENT INCIDENT

Refer to [GI-42. "Intermittent Incident"](#).

>> INSPECTION END.

Component Inspection

INFOID:000000001836921

1.CHECK ECVT DEVICE (DETENTION SWITCH)

1. Turn ignition switch OFF.
2. Disconnect CVT device (detention switch) harness connector.

B2601 SHIFT POSITION

[COUPE]

< COMPONENT DIAGNOSIS >

3. Check continuity between CVT device (detention switch) terminals as follows.

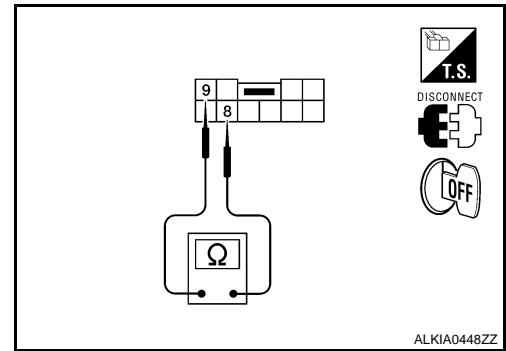

CVT device (detention switch)		Condition	Continuity	
Terminal				
8	9	CVT selector lever	P position	No
			Other than above	Yes

Is the inspection result normal?

YES >> INSPECTION END

NO >> Replace CVT device. Refer to [TM-250, "Removal and Installation"](#) (RE0F09B), or [TM-426, "Removal and Installation"](#) (RE0F10A).

B2602 SHIFT POSITION

< COMPONENT DIAGNOSIS >

[COUPE]

B2602 SHIFT POSITION

Description

INFOID:000000001344506

BCM confirms the shift position with the following 2 signals.

- CVT selector lever
- Speed signal from meter

DTC Logic

INFOID:000000001344507

DTC DETECTION LOGIC

NOTE:

- If DTC B2602 is displayed with DTC U1000, first perform the trouble diagnosis for DTC U1000. Refer to [SEC-32, "DTC Logic"](#).
- If DTC B2602 is displayed with DTC U1010, first perform the trouble diagnosis for DTC U1010. Refer to [SEC-33, "DTC Logic"](#).

DTC No.	Trouble diagnosis name	DTC detecting condition	Possible cause
B2602	SHIFT POSITION	BCM detects the following status for 10 seconds. <ul style="list-style-type: none">• Shift position is in P position• Vehicle speed is 4km/h (2 MPH) or more• Ignition switch is in the ON position	<ul style="list-style-type: none">• Harness or connectors (CVT drive circuit is open or shorted)• CVT device (detention switch)• Combination meter

DTC CONFIRMATION PROCEDURE

1. PERFORM DTC CONFIRMATION PROCEDURE

1. Start the engine under the following conditions and wait for at least 10 seconds.
 - CVT selector lever is in the P or N position
 - Depress the brake pedal.
2. Drive the vehicle for at least 10 seconds at a speed greater than 4 km/h (2 MPH).
3. Check "Self diagnostic result" with CONSULT-III.

Is DTC detected?

- YES >> Go to [SEC-57, "Diagnosis Procedure"](#).
NO >> INSPECTION END.

Diagnosis Procedure

INFOID:000000001836922

1. CHECK DTC WITH "COMBINATION METER"

Check "Self diagnostic result" with CONSULT-III. Refer to [MWI-92, "DTC Index"](#).

Is the inspection result normal?

- YES >> GO TO 2.
NO >> Repair or replace.

2. CHECK CVT DEVICE POWER SUPPLY

1. Turn ignition switch to ACC.
2. Disconnect CVT device (detention switch) harness connector.
3. Check voltage between CVT device (detention switch) harness connector and ground.

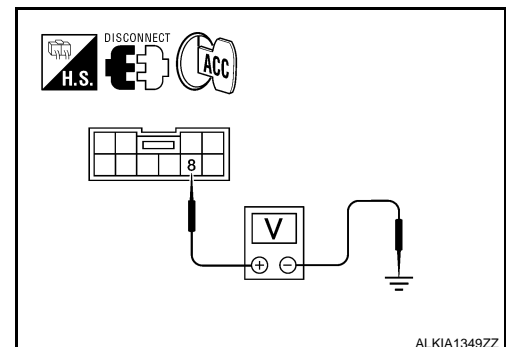

B2602 SHIFT POSITION

[COUPE]

< COMPONENT DIAGNOSIS >

CVT device (detention switch)		Ground	Voltage [V]
Connector	Terminal		
M23	8	Ground	Battery voltage

Is the inspection result normal?

YES >> GO TO 4.

NO >> GO TO 3.

3. CHECK CVT DEVICE POWER SUPPLY CIRCUIT

1. Disconnect BCM harness connector.
2. Check continuity between BCM harness connector M19 (A) terminal 84 and CVT device (detention switch) harness connector M23 (B) terminal 8.

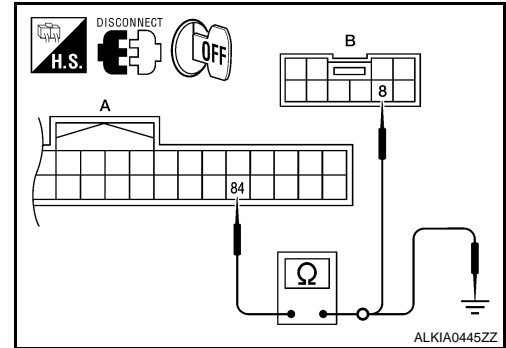

BCM		CVT device (detention switch)		Continuity
Connector	Terminal	Connector	Terminal	
A: M19	84	B: M23	8	Yes

3. Check continuity between BCM harness connector M19 (A) terminal 84 and ground.

BCM		Ground	Continuity
Connector	Terminal		
A: M19	84	Ground	No

Is the inspection result normal?

YES >> Replace BCM.

NO >> Repair harness or connector.

4. CHECK CVT DEVICE CIRCUIT

1. Disconnect BCM harness connector.
2. Check continuity between CVT device (detention switch) harness connector and BCM harness connector.

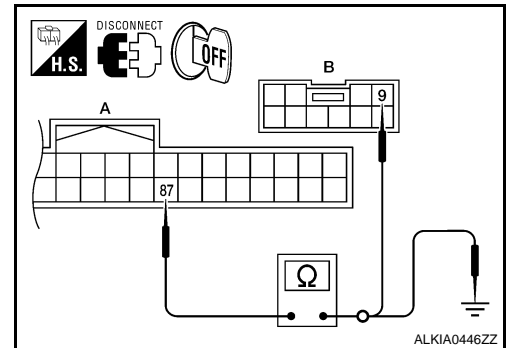

BCM		CVT device (detention switch)		Continuity
Connector	Terminal	Connector	Terminal	
A: M19	87	B: M23	9	Yes

3. Check continuity between CVT device (detention switch) harness connector and ground.

B2602 SHIFT POSITION

[COUPE]

< COMPONENT DIAGNOSIS >

BCM		Ground	Continuity
Connector	Terminal		
A: M19	87	Ground	No

Is the inspection result normal?

YES >> GO TO 5.

NO >> Repair harness or connector.

5.CHECK CVT DEVICE

Refer to [SEC-55. "Component Inspection"](#).

Is the inspection result normal?

YES >> GO TO 6.

NO >> Replace CVT device. Refer to [TM-250. "Removal and Installation"](#) (RE0F09B), or [TM-426. "Removal and Installation"](#) (RE0F10A).

6.CHECK INTERMITTENT INCIDENT

Refer to [GI-42. "Intermittent Incident"](#).

>> INSPECTION END.

A
B
C
D
E
F
G
H
I
J
L
M
N
O
P

SEC

B2603 SHIFT POSITION STATUS

< COMPONENT DIAGNOSIS >

[COUPE]

B2603 SHIFT POSITION STATUS

Description

INFOID:000000001344509

BCM confirms the shift position with the following 2 signals.

- CVT selector lever
- P/N position switch

DTC Logic

INFOID:000000001344510

DTC DETECTION LOGIC

NOTE:

- If DTC B2603 is displayed with DTC U1000, first perform the trouble diagnosis for DTC U1000. Refer to [SEC-32, "DTC Logic"](#).
- If DTC B2603 is displayed with DTC U1010, first perform the trouble diagnosis for DTC U1010. Refer to [SEC-33, "DTC Logic"](#).

DTC	Self-diagnosis name	DTC detecting condition	Possible causes
B2603	SHIFT POSITION STATUS	BCM detects the followings status for 500 ms or more when shift is in P position and, ignition switch is in ON position. <ul style="list-style-type: none">• Park/neutral position (PNP) switch: approx. 0V• CVT device (detention switch): approx 0V	<ul style="list-style-type: none">• Harness or connector (CVT device circuit is open or shorted.)• Harness or connectors [Park/neutral position (PNP) switch circuit is open or shorted.]• CVT device (detention switch)• Park/neutral position (PNP) switch

DTC CONFIRMATION PROCEDURE

1. PERFORM DTC CONFIRMATION PROCEDURE

1. Start the engine under the following conditions and wait for at least 1 second.
 - CVT selector lever is in the P position.
 - Do not depress the brake pedal.
2. Shift to N and wait for at least 1 second.
3. Shift to any gear other than P or N and wait for at least 1 second.
4. Check "Self diagnostic result" with CONSULT-III.

Is DTC detected?

- YES >> Go to [SEC-60, "Diagnosis Procedure"](#).
NO >> INSPECTION END.

Diagnosis Procedure

INFOID:000000001836923

1. CHECK DTC WITH IPDM E/R

Check "Self diagnostic result" with CONSULT-III. Refer to [PCS-41, "DTC Index"](#).

Is the inspection result normal?

- YES >> GO TO 2.
NO >> Repair or replace malfunctioning parts.

2. CHECK PNP SWITCH CIRCUIT

1. Turn ignition switch OFF.
2. Disconnect TCM harness connector and BCM harness connector.

B2603 SHIFT POSITION STATUS

[COUPE]

< COMPONENT DIAGNOSIS >

- Check continuity between TCM harness connector F16 (A) terminal 20 and BCM harness connector M18 (B) terminal 48.

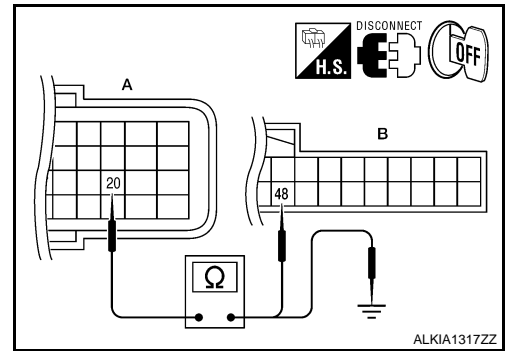

TCM		BCM		Continuity
Connector	Terminal	Connector	Terminal	
A: F16	20	B: M18	48	Yes

- Check continuity between TCM harness connector F16 (A) terminal 20 and ground.

TCM		Ground	Continuity
Connector	Terminal		
A: F16	20	Ground	No

Is the inspection result normal?

YES >> GO TO 3.

NO >> Repair harness or connector.

3. CHECK CVT DEVICE POWER SUPPLY

- Turn ignition switch OFF.
- Disconnect CVT device (detention switch) harness connector.
- Check voltage between CVT device (detention switch) harness connector and ground.

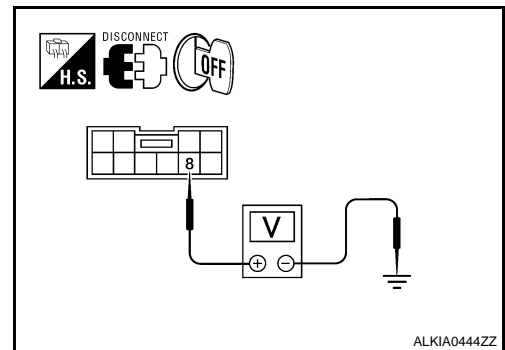

CVT device (detention switch)		Ground	Voltage [V]
Connector	Terminal		
M23	8	Ground	Battery voltage

Is the inspection result normal?

YES >> GO TO 5.

NO >> GO TO 4.

4. CHECK CVT DEVICE POWER SUPPLY CIRCUIT

- Disconnect BCM harness connector.

B2603 SHIFT POSITION STATUS

[COUPE]

< COMPONENT DIAGNOSIS >

- Check continuity between BCM harness connector M19 (A) terminal 84 and CVT device (detention switch) harness connector M23 (B) terminal 8.

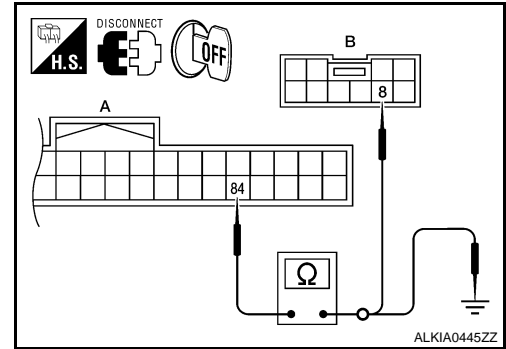

BCM		CVT device (detention switch)		Continuity
Connector	Terminal	Connector	Terminal	
A: M19	84	B: M23	8	Yes

- Check continuity between BCM harness connector M19 (A) terminal 84 and ground.

BCM		Ground	Continuity
Connector	Terminal		
A: M19	84	Ground	No

Is the inspection result normal?

YES >> Replace BCM. Refer to [BCS-88, "Removal and Installation"](#).

NO >> Repair harness or connector.

5.CHECK CVT DEVICE CIRCUIT

- Disconnect BCM harness connector.
- Check continuity between BCM harness connector M19 (A) terminal 87 and CVT device (detention switch) harness connector M23 (B) terminal 9.

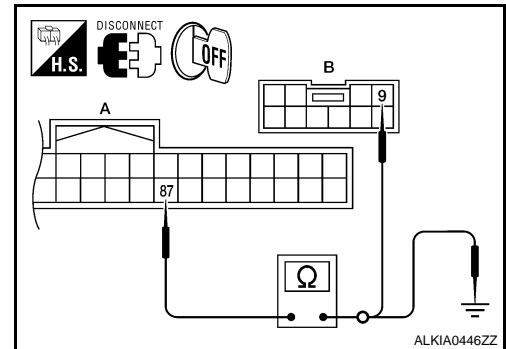

BCM		CVT device (detention switch)		Continuity
Connector	Terminal	Connector	Terminal	
A: M19	87	B: M23	9	Yes

- Check continuity between BCM harness connector M19 (A) terminal 87 and ground.

BCM		Ground	Continuity
Connector	Terminal		
A: M19	87	Ground	No

Is the inspection result normal?

YES >> GO TO 6.

NO >> Repair harness or connector.

6.CHECK CVT DEVICE

B2603 SHIFT POSITION STATUS

[COUPE]

< COMPONENT DIAGNOSIS >

Refer to [SEC-55. "Component Inspection"](#).

Is the inspection result normal?

YES >> GO TO 7.

NO >> Replace CVT device. Refer to [TM-250. "Removal and Installation"](#) (RE0F09B), or [TM-426. "Removal and Installation"](#) (RE0F10A).

7. CHECK INTERMITTENT INCIDENT

Refer to [GI-42. "Intermittent Incident"](#).

>> INSPECTION END.

A
B
C
D
E
F
G
H
I
J
L
M
N
O
P

SEC

B2604 PNP SWITCH

Description

INFOID:000000001344512

BCM confirms the shift position with the following 4 signals.

- CVT selector lever
- P/N position switch
- P position signal from IPDM E/R (CAN)
- P position signal from TCM (CAN)

DTC Logic

INFOID:000000001344513

DTC DETECTION LOGIC

NOTE:

- If DTC B2604 is displayed with DTC U1000, first perform the trouble diagnosis for DTC U1000. Refer to [SEC-32, "DTC Logic"](#).
- If DTC B2604 is displayed with DTC U1010, first perform the trouble diagnosis for DTC U1010. Refer to [SEC-33, "DTC Logic"](#).

DTC No.	Trouble diagnosis name	DTC detecting condition	Possible cause
B2604	PNP SWITCH	BCM detects the following status for 500 ms or more when the ignition switch is in the ON position. <ul style="list-style-type: none"> • P/N switch indicates vehicle is in P or N shift position. Signal from TCM indicates vehicle is in forward or reverse gear. • P/N switch indicates vehicle is in forward or reverse gear. Signal from TCM indicates vehicle is in P or N. 	<ul style="list-style-type: none"> • Harness or connectors [The park/neutral position (PNP) switch circuit is open or shorted.] • Park/ neutral position (PNP) switch • TCM

DTC CONFIRMATION PROCEDURE

1. PERFORM DTC CONFIRMATION PROCEDURE

1. Start the engine under the following conditions and wait for at least 1 seconds.
 - CVT selector lever is in the P position
 - Do not depress the brake pedal
2. Use CVT selector lever to select each gear one at a time. Wait at each gear for at least 1 second.
3. Check "Self diagnostic result" with CONSULT-III.

Is DTC detected?

- YES >> Go to [SEC-64, "Diagnosis Procedure"](#).
 NO >> INSPECTION END.

Diagnosis Procedure

INFOID:000000001344514

1. CHECK DTC WITH TCM

Check "Self diagnostic result" with CONSULT-III. Refer to [TM-216, "DTC Index"](#) (RE0F09B) or [TM-394, "DTC Index"](#) (RE0F10A).

Is the inspection result normal?

- YES >> GO TO 2.
 NO >> Repair or replace.

2. CHECK PNP SWITCH CIRCUIT

1. Turn ignition switch OFF.
2. Disconnect TCM harness connector and BCM harness connector.

B2604 PNP SWITCH

[COUPE]

< COMPONENT DIAGNOSIS >

3. Check continuity between TCM harness connector and BCM harness connector.

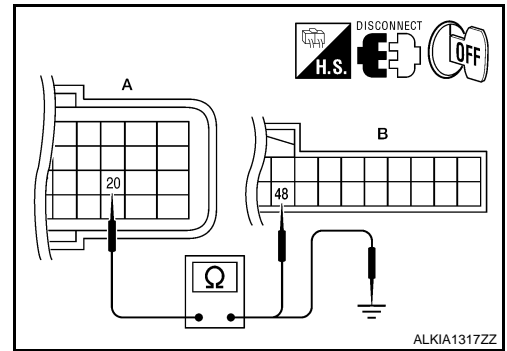

TCM		BCM		Continuity
Connector	Terminal	Connector	Terminal	
A: F16	20	B: M18	48	Yes

4. Check continuity between TCM harness connector and ground.

TCM		Ground	Continuity
Connector	Terminal		
A: F16	20	Ground	No

Is the inspection result normal?

YES >> GO TO 3.

NO >> Repair harness or connector.

3.CHECK INTERMITTENT INCIDENT

Refer to [GI-42. "Intermittent Incident"](#).

>> INSPECTION END.

A
B
C
D
E
F
G
H
I
J
L
M
N
O
P

SEC

B2605 PNP SWITCH

Description

INFOID:000000001344515

BCM confirms the shift position with the following 4 signals.

- AT selector lever
- P/N position switch
- P position signal from IPDM E/R (CAN)
- P position signal from TCM (CAN)

DTC Logic

INFOID:000000001344516

DTC DETECTION LOGIC

NOTE:

- If DTC B2605 is displayed with DTC U1000, first perform the trouble diagnosis for DTC U1000. Refer to [SEC-32. "DTC Logic"](#).
- If DTC B2605 is displayed with DTC U1010, first perform the trouble diagnosis for DTC U1010. Refer to [SEC-33. "DTC Logic"](#).

DTC No.	Trouble diagnosis name	DTC detecting condition	Possible cause
B2605	PNP SWITCH	BCM detects the following status for 500 ms or more when the ignition switch is in ON position <ul style="list-style-type: none"> • N position input signal exists. Shift position signal from IPDM E/R does not exist. • N position input signal does not exist. Shift position signal from IPDM E/R exists. 	<ul style="list-style-type: none"> • Harness or connectors [The park/neutral position (PNP) switch circuit is open or shorted.] • Park/neutral position (PNP) switch • IPDM E/R

DTC CONFIRMATION PROCEDURE

1. PERFORM DTC CONFIRMATION PROCEDURE

1. Turn ignition switch ON under the following conditions and wait for at least 1 seconds.
 - CVT selector lever is in the P or N position
 - Do not depress the brake pedal.
2. Check "Self diagnostic result" with CONSULT-III.

Is DTC detected?

- YES >> Go to [SEC-66. "Diagnosis Procedure"](#).
 NO >> INSPECTION END.

Diagnosis Procedure

INFOID:000000001344517

1. CHECK DTC WITH IPDM E/R

Check "Self diagnostic result" with CONSULT-III. Refer to [PCS-41. "DTC Index"](#).

Is the inspection result normal?

- YES >> GO TO 2.
 NO >> Repair or replace.

2. CHECK PNP SWITCH CIRCUIT

1. Turn ignition switch OFF.
2. Disconnect TCM harness connector and BCM harness connector.

B2605 PNP SWITCH

[COUPE]

< COMPONENT DIAGNOSIS >

3. Check continuity between TCM connector and BCM harness connector.

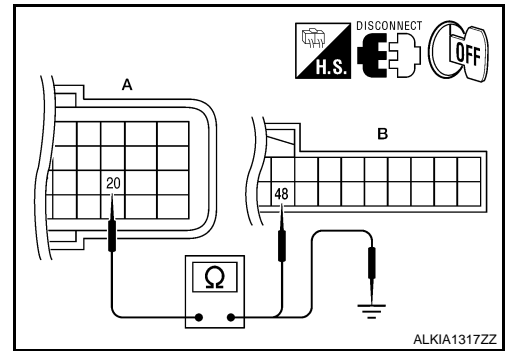

TCM		BCM		Continuity
Connector	Terminal	Connector	Terminal	
A: F16	20	B: M18	48	Yes

4. Check continuity between TCM harness connector and ground.

TCM		Ground	Continuity
Connector	Terminal		
A: F16	20	Ground	No

Is the inspection result normal?

YES >> GO TO 3.

NO >> Repair harness or connector.

3.CHECK INTERMITTENT INCIDENT

Refer to [GI-42. "Intermittent Incident"](#).

>> INSPECTION END.

A
B
C
D
E
F
G
H
I
J
L
M
N
O
P

SEC

B2606 STEERING LOCK RELAY

< COMPONENT DIAGNOSIS >

[COUPE]

B2606 STEERING LOCK RELAY

Description

INFOID:000000001344518

The steering lock relay ON signal is transmitted to IPDM E/R by BCM via CAN communication. IPDM E/R turns the steering lock relay ON and transmits the release of the steering to BCM.

DTC Logic

INFOID:000000001344519

DTC DETECTION LOGIC

NOTE:

- If DTC B2606 is displayed with DTC U1000, first perform the trouble diagnosis for DTC U1000. Refer to [SEC-32, "DTC Logic"](#).
- If DTC B2606 is displayed with DTC U1010, first perform the trouble diagnosis for DTC U1010. Refer to [SEC-33, "DTC Logic"](#).

DTC No.	Trouble diagnosis name	DTC detecting condition	Possible cause
B2606	STEERING LOCK RELAY	BCM detects that there is a mismatch between the following statuses. <ul style="list-style-type: none">• Steering lock unit ON signal transmitted by IPDM E/R• The steering lock unit status feedback	<ul style="list-style-type: none">• Steering lock relay (in IPDM E/R)

DTC CONFIRMATION PROCEDURE

1. PERFORM DTC CONFIRMATION PROCEDURE

1. Press the push-button ignition switch under the following conditions.
 - CVT selector lever is in the P or N position.
 - Do not depress the brake pedal.
2. Steering is locked.
3. Check "Self diagnostic result" with CONSULT-III.

Is DTC detected?

- YES >> Go to [SEC-68, "Diagnosis Procedure"](#).
NO >> INSPECTION END.

Diagnosis Procedure

INFOID:000000001344520

1. CHECK DTC WITH IPDM E/R

Check "Self diagnostic result" with CONSULT-III. Refer to [PCS-41, "DTC Index"](#).

Is the inspection result normal?

- YES >> GO TO 2.
NO >> Repair or replace.

2. INTERMITTENT INCIDENT

Refer to [GI-42, "Intermittent Incident"](#).

>> INSPECTION END.

B2607 STEERING LOCK RELAY

[COUPE]

< COMPONENT DIAGNOSIS >

B2607 STEERING LOCK RELAY

Description

INFOID:000000001344521

BCM requests to IPDM E/R to supply power to steering lock unit. IPDM E/R sends status of steering lock unit back to BCM.

DTC Logic

INFOID:000000001344522

DTC DETECTION LOGIC

NOTE:

- If DTC B2607 is displayed with DTC U1000, first perform the trouble diagnosis for DTC U1000. Refer to [SEC-32, "DTC Logic"](#).
- If DTC B2607 is displayed with DTC U1010, first perform the trouble diagnosis for DTC U1010. Refer to [SEC-33, "DTC Logic"](#).

DTC No.	Trouble diagnosis name	DTC detecting condition	Possible cause
B2607	STEERING LOCK RELAY	BCM detects that there is a difference between the following statuses. <ul style="list-style-type: none">• BCM request for steering lock unit power supply (ON/OFF)• IPDM E/R status of steering lock unit power supply (ON/OFF)	<ul style="list-style-type: none">• Harness or connectors (steering lock unit power supply circuit is open or shorted)• Steering lock relay (in IPDM E/R)

DTC CONFIRMATION PROCEDURE

1. PERFORM DTC CONFIRMATION PROCEDURE

1. Press the push-button ignition switch under the following conditions.
 - A/T selector lever is in the P position
 - Do not depress brake pedal
2. Steering lock is locked.
3. Check "Self diagnostic result" with CONSULT-III.

Is DTC detected?

- YES >> Go to [SEC-69, "Diagnosis Procedure"](#).
NO >> INSPECTION END.

Diagnosis Procedure

INFOID:000000001836977

1. CHECK DTC WITH IPDM E/R

Check "Self diagnostic result" with CONSULT-III. Refer to [PCS-41, "DTC Index"](#).

Is the inspection result normal?

- YES >> GO TO 2.
NO >> Repair or replace malfunctioning parts.

2. CHECK STEERING LOCK UNIT POWER SUPPLY CIRCUIT

1. Turn ignition switch OFF.
2. Disconnect steering lock unit harness connector.
3. Check voltage between steering lock unit and ground under the following conditions.

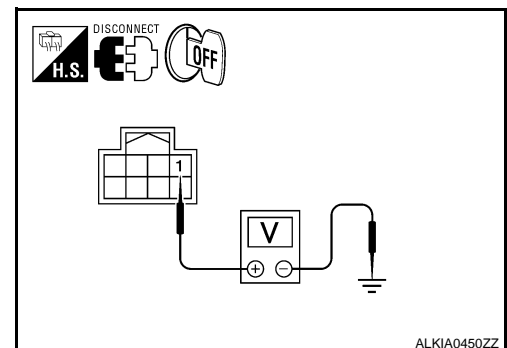

A
B
C
D
E
F
G
H
I
J
L
M
N
O
P

SEC

B2607 STEERING LOCK RELAY

< COMPONENT DIAGNOSIS >

[COUPE]

Steering lock unit		Ground	Condition	Voltage (V)
Connector	Terminal			
M32	1	Ground	Press push-button ignition switch when steering lock is in lock condition.	Battery voltage

Is the inspection result normal?

- YES >> GO TO 4.
- NO >> GO TO 3.

3. CHECK STEERING LOCK UNIT POWER SUPPLY CIRCUIT

1. Turn ignition switch OFF.
2. Disconnect IPDM E/R harness connector.
3. Check continuity between steering lock unit and IPDM E/R harness connector.

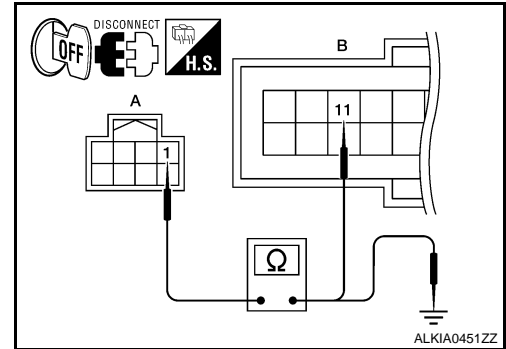

Steering lock unit		IPDM E/R		Continuity
Connector	Terminal	Connector	Terminal	
A: M32	1	B: E18	11	Yes

4. Check continuity between steering lock unit and ground.

Steering lock unit		Ground	Continuity
Connector	Terminal		
A: M32	1	Ground	No

Is the inspection result normal?

- YES >> Replace IPDM E/R. Refer to [PCS-43. "Removal and Installation"](#).
- NO >> Repair harness or connector.

4. CHECK INTERMITTENT INCIDENT

Refer to [GI-42. "Intermittent Incident"](#).

>> INSPECTION END.

B2608 STARTER RELAY

< COMPONENT DIAGNOSIS >

[COUPE]

B2608 STARTER RELAY

Description

INFOID:000000001344524

Located in IPDM E/R, it runs the starter motor. The starter relay is turned ON by the BCM when the ignition switch is in START position. IPDM E/R transmits the starter relay ON signal to BCM via CAN communication.

DTC Logic

INFOID:000000001344525

DTC DETECTION LOGIC

NOTE:

- If DTC B2608 is displayed with DTC U1000, first perform the trouble diagnosis for DTC U1000. Refer to [SEC-32. "DTC Logic"](#).
- If DTC B2608 is displayed with DTC U1010, first perform the trouble diagnosis for DTC U1010. Refer to [SEC-33. "DTC Logic"](#).

DTC No.	Trouble diagnosis name	DTC detecting condition	Possible cause
B2608	STARTER RELAY	BCM receives starter relay ON signal (CAN) from IPDM E/R even if BCM turns the starter relay OFF	<ul style="list-style-type: none"> • Harness or connectors (starter relay circuit is open or shorted.) • IPDM E/R

DTC CONFIRMATION PROCEDURE

1.PERFORM DTC CONFIRMATION PROCEDURE

1. Press the push-button ignition switch under the following conditions.
 - CVT selector lever is in the P or N position.
 - Depress the brake pedal.
2. Check "Self diagnostic result" with CONSULT-III.

Is DTC detected?

- YES >> Go to [SEC-71. "Diagnosis Procedure"](#).
 NO >> INSPECTION END.

Diagnosis Procedure

INFOID:000000001344526

1.CHECK STARTER RELAY

1. Turn ignition switch ON.
2. Check voltage between BCM harness connector and ground under the following condition.

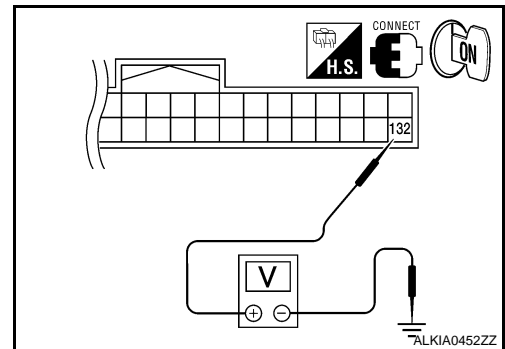

BCM		Ground	Condition	Voltage (V)	
Connector	Terminal				
M21	132	Ground	CVT selector lever	N or P position	Battery voltage
				Other than above	0
			Clutch pedal	Not depressed	0
				Depressed	Battery voltage

A
B
C
D
E
F
G
H
I
J
L
M
N
O
P

SEC

B2608 STARTER RELAY

[COUPE]

< COMPONENT DIAGNOSIS >

Is the measurement value within the specification?

YES >> GO TO 3.

NO >> GO TO 2.

2.CHECK STARTER RELAY CIRCUIT

1. Turn ignition switch OFF.
2. Disconnect BCM harness connector M21 and IPDM E/R harness connector E17.
3. Check continuity between IPDM E/R harness connector and BCM harness connector.

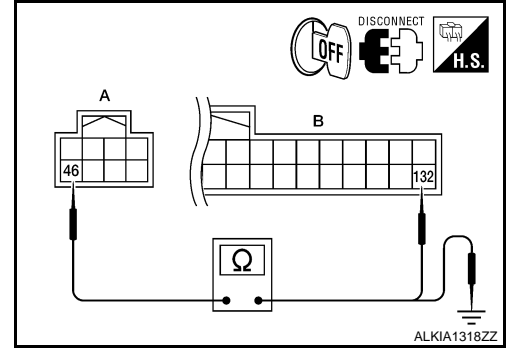

IPDM E/R		BCM		Continuity
Connector	Terminal	Connector	Terminal	
A: E17	46	B: M21	132	Yes

4. Check continuity between IPDM E/R harness connector and ground.

IPDM E/R		Ground	Continuity
Connector	Terminal		
A: E17	46	Ground	No

Is the inspection result normal?

YES >> Replace IPDM E/R. Refer to [PCS-43. "Removal and Installation"](#).

NO >> Repair harness or connector.

3.CHECK INTERMITTENT INCIDENT

Refer to [GI-42. "Intermittent Incident"](#).

>> INSPECTION END.

B2609 STEERING STATUS

< COMPONENT DIAGNOSIS >

[COUPE]

B2609 STEERING STATUS

Description

INFOID:000000001344527

There are 2 switches in the steering lock unit (steering lock/unlock switch 1 and 2). BCM compares those two switches conditions to judge the present steering status.

DTC Logic

INFOID:000000001344528

DTC DETECTION LOGIC

NOTE:

- If DTC B2609 is displayed with DTC U1000, first perform the trouble diagnosis for DTC U1000. Refer to [SEC-32, "DTC Logic"](#).
- If DTC B2609 is displayed with DTC U1010, first perform the trouble diagnosis for DTC U1010. Refer to [SEC-33, "DTC Logic"](#).

DTC No.	Trouble diagnosis name	DTC detecting condition	Possible cause
B2609	STEERING STATUS	BCM detects the malfunction of steering lock unit switches for 1 second.	<ul style="list-style-type: none">• Harness or connectors [steering lock unit circuit (BCM side) is open or shorted]• Harness or connectors [steering lock unit circuit (IPDM E/R side) is open or shorted.]• Steering lock unit• IPDM E/R

DTC CONFIRMATION PROCEDURE

1. PERFORM DTC CONFIRMATION PROCEDURE 1

1. Press the push-button ignition switch under the following conditions and wait for at least 1 second.
 - CVT selector lever is in the P position.
 - Do not depress brake pedal
 - Steering is locked
2. Check "Self diagnostic result" with CONSULT-III.

Is DTC detected?

- YES >> Go to [SEC-73, "Diagnosis Procedure"](#).
NO >> GO TO 2.

2. PERFORM DTC CONFIRMATION PROCEDURE 2

1. Turn ignition switch ON.
2. Turn ignition switch OFF.
3. Press door switch.
4. Check "Self diagnostic result" with CONSULT-III.

Is DTC detected?

- YES >> Go to [SEC-73, "Diagnosis Procedure"](#).
NO >> INSPECTION END.

Diagnosis Procedure

INFOID:000000001836925

1. INSPECTION START

Check the case in which DTC is detected.

- Case1: It is detected after ignition switch is changed from ON to OFF and door switch is pressed
- Case2: It is detected after ignition switch is changed from ON to OFF

In which case is DTC detected?

- Case1 >> GO TO 2.
Case2 >> GO TO 7.

2. CHECK BCM OUTPUT SIGNAL

A
B
C
D
E
F
G
H
I
J
L
M
N
O
P

SEC

B2609 STEERING STATUS

[COUPE]

< COMPONENT DIAGNOSIS >

1. Turn ignition switch OFF.
2. Disconnect steering lock unit harness connector and IPDM E/R harness connector.
3. Check voltage between steering lock unit harness connector and ground.

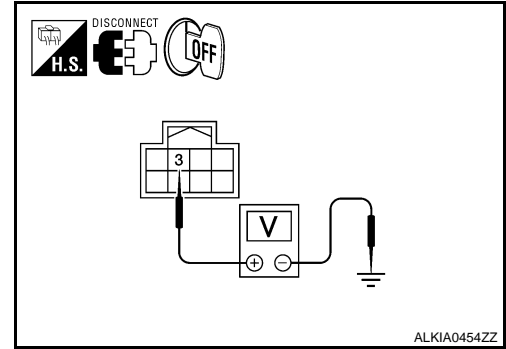

Steering lock unit		Ground	Voltage [V]
Connector	Terminal		
M32	3	Ground	Battery voltage

Is the inspection result normal?

- YES >> GO TO 4.
 NO >> GO TO 3.

3. CHECK STEERING LOCK UNIT CIRCUIT-I

1. Disconnect BCM harness connector.
2. Check continuity between BCM harness connector M19 (A) terminal 85 and steering lock unit harness connector M32 (B) terminal 3.

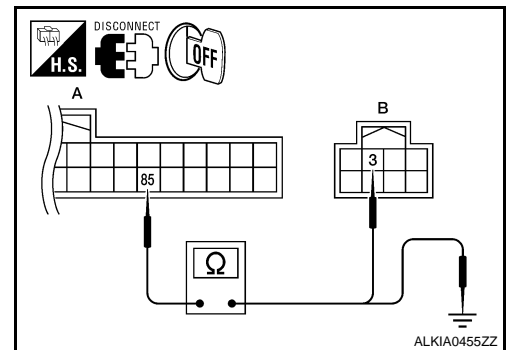

BCM		Steering lock unit		Continuity
Connector	Terminal	Connector	Terminal	
A: M19	85	B: M32	3	Yes

3. Check continuity between BCM harness connector M19 (A) terminal 85 and ground.

BCM		Ground	Continuity
Connector	Terminal		
A: M19	85	Ground	No

Is the inspection result normal?

- YES >> GO TO 6.
 NO >> Repair harness or connector.

4. CHECK IPDM E/R OUTPUT SIGNAL

1. Connect IPDM E/R harness connector.
2. Disconnect BCM harness connector.

B2609 STEERING STATUS

[COUPE]

< COMPONENT DIAGNOSIS >

3. Check voltage between steering lock unit harness connector and ground.

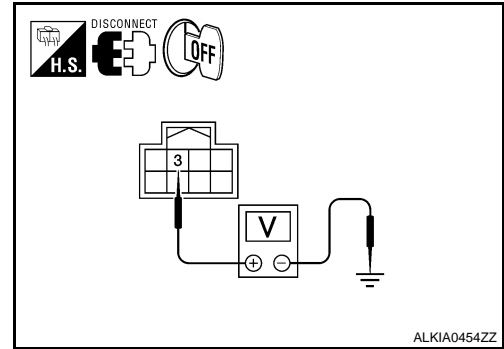

Steering lock unit		Ground	Voltage [V]
Connector	Terminal		
M32	3	Ground	Battery voltage

Is the inspection result normal?

- YES >> Replace steering lock unit.
 NO >> GO TO 5.

5.CHECK STEERING LOCK UNIT CIRCUIT-II

1. Check continuity between steering lock unit harness connector M32 (A) terminal 3 and IPDM E/R harness connector E18 (B) terminal 32.

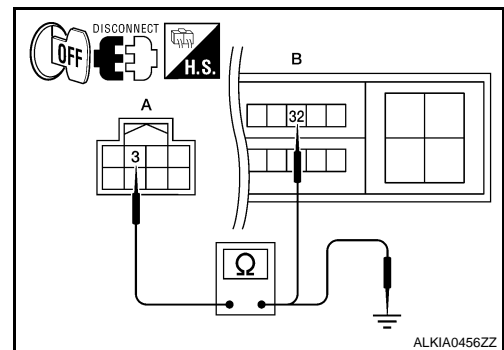

Steering lock unit		IPDM E/R		Continuity
Connector	Terminal	Connector	Terminal	
A: M32	3	B: E18	32	Yes

2. Check continuity between steering lock unit harness connector M32 (A) terminal 3 and ground.

Steering lock unit		Ground	Continuity
Connector	Terminal		
A: M32	3	Ground	No

Is the inspection result normal?

- YES >> GO TO 6.
 NO >> Repair harness or connector.

6.CHECK INTERMITTENT INCIDENT

Refer to [GI-42, "Intermittent Incident"](#).

>> INSPECTION END

7.CHECK BCM OUTPUT SIGNAL

1. Turn ignition switch OFF.
2. Disconnect steering lock unit harness connector and IPDM E/R harness connector E5.

A
B
C
D
E
F
G
H
I
J
L
M
N
O
P

SEC

B2609 STEERING STATUS

[COUPE]

< COMPONENT DIAGNOSIS >

3. Check voltage between steering lock unit harness connector and ground.

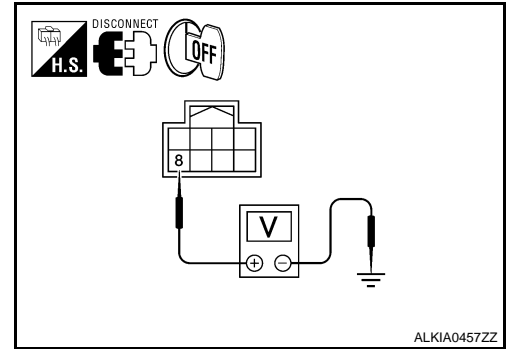

Steering lock unit		Ground	Voltage [V]
Connector	Terminal		
M32	8	Ground	Battery voltage

Is the inspection result normal?

YES >> GO TO 9.

NO >> GO TO 8.

8. CHECK STEERING LOCK UNIT CIRCUIT-I

1. Disconnect BCM harness connector M19.
2. Check continuity between BCM harness connector M19 (A) terminal 86 and steering lock unit harness connector M32 (B) terminal 8.

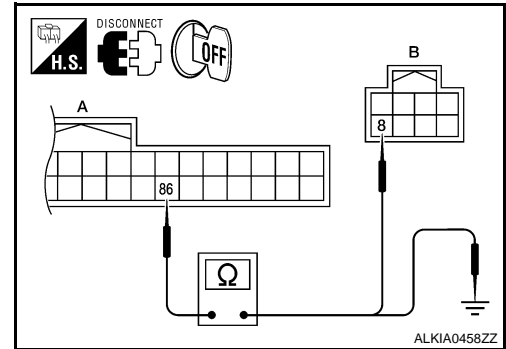

BCM		Steering lock unit		Continuity
Connector	Terminal	Connector	Terminal	
A: M19	86	B: M32	8	Yes

3. Check continuity between BCM harness connector M19 (A) terminal 86 and ground.

BCM		Ground	Continuity
Connector	Terminal		
A: M19	86	Ground	No

Is the inspection result normal?

YES >> GO TO 11.

NO >> Repair harness or connector.

9. CHECK IPDM E/R OUTPUT SIGNAL

1. Connect IPDM E/R harness connector.
2. Disconnect BCM harness connector M19.

B2609 STEERING STATUS

[COUPE]

< COMPONENT DIAGNOSIS >

- Check voltage between steering lock unit harness connector and ground.

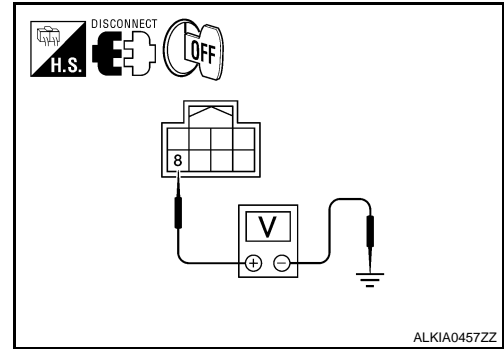

Steering lock unit		Ground	Voltage [V]
Connector	Terminal		
M32	8	Ground	Battery voltage

Is the inspection result normal?

- YES >> Replace steering lock unit.
 NO >> GO TO 10.

10.CHECK STEERING LOCK UNIT CIRCUIT-II

- Check continuity between steering lock unit harness connector M32 (A) terminal 8 and IPDM E/R harness connector E18 (B) terminal 33.

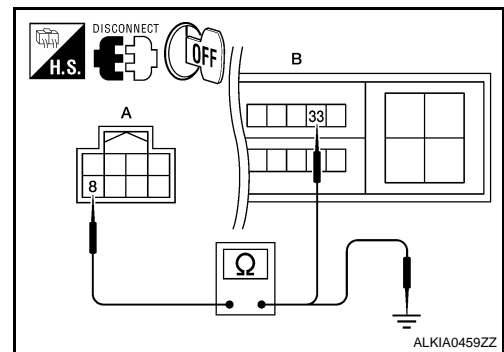

Steering lock unit		IPDM E/R		Continuity
Connector	Terminal	Connector	Terminal	
A: M32	8	B: E18	33	Yes

- Check continuity between steering lock unit harness connector and ground.

Steering lock unit		Ground	Continuity
Connector	Terminal		
A: M32	8	Ground	No

Is the inspection result normal?

- YES >> GO TO 11.
 NO >> Repair harness or connector.

11.CHECK INTERMITTENT INCIDENT

Refer to [GI-42, "Intermittent Incident"](#).

>> INSPECTION END

A
B
C
D
E
F
G
H
I
J
L
M
N
O
P

SEC

B260B STEERING LOCK UNIT

< COMPONENT DIAGNOSIS >

[COUPE]

B260B STEERING LOCK UNIT

Description

INFOID:000000001344530

The steering lock unit performs the check by itself according to the steering status.

DTC Logic

INFOID:000000001344531

DTC DETECTION LOGIC

DTC No.	Trouble diagnosis name	DTC detecting condition	Possible cause
B260B	STEERING LOCK UNIT	BCM detects malfunctioning of steering lock unit before steering unlocking.	<ul style="list-style-type: none">Steering lock unit

DTC CONFIRMATION PROCEDURE

1.PERFORM DTC CONFIRMATION PROCEDURE

1. Press the push-button ignition switch, when steering is locked.
2. Check "Self diagnostic result" with CONSULT-III.

Is DTC detected?

- YES >> Go to [SEC-78. "Diagnosis Procedure"](#).
NO >> INSPECTION END.

Diagnosis Procedure

INFOID:000000001344532

1.INSPECTION START

1. Turn ignition switch ON.
2. Check "Self diagnostic result" with CONSULT-III.
3. Touch "ERASE".
4. **Perform DTC Confirmation Procedure.**
See [SEC-78. "DTC Logic"](#).

Is the DTC B260B displayed again?

- YES >> Replace steering lock unit.
NO >> INSPECTION END.

B260C STEERING LOCK UNIT

< COMPONENT DIAGNOSIS >

[COUPE]

B260C STEERING LOCK UNIT

Description

INFOID:000000001344533

The steering lock unit performs the check by itself according to the steering status.

DTC Logic

INFOID:000000001344534

DTC DETECTION LOGIC

DTC No.	Trouble diagnosis name	DTC detecting condition	Possible cause
B260C	STEERING LOCK UNIT	BCM detects malfunctioning of steering lock unit before steering locking.	<ul style="list-style-type: none">Steering lock unit

DTC CONFIRMATION PROCEDURE

1. PERFORM DTC CONFIRMATION PROCEDURE

1. Turn ignition switch ON.
2. Turn ignition switch OFF.
3. Press door switch.
4. Check "Self diagnostic result" with CONSULT-III.

Is DTC detected?

- YES >> Go to [SEC-79. "Diagnosis Procedure"](#).
NO >> INSPECTION END.

Diagnosis Procedure

INFOID:000000001344535

1. INSPECTION START

1. Turn ignition switch ON.
2. Check "Self diagnostic result" with CONSULT-III.
3. Touch "ERASE".
4. **Perform DTC Confirmation Procedure.**
See [SEC-79. "DTC Logic"](#).

Is the DTC B260C displayed again?

- YES >> Replace steering lock unit.
NO >> INSPECTION END.

A
B
C
D
E
F
G
H
I
J
L
M
N
O
P

SEC

B260D STEERING LOCK UNIT

< COMPONENT DIAGNOSIS >

[COUPE]

B260D STEERING LOCK UNIT

Description

INFOID:000000001344536

The steering lock unit performs the check by itself according to the steering lock status (before lock, after lock and unlock).

DTC Logic

INFOID:000000001344537

DTC DETECTION LOGIC

DTC No.	Trouble diagnosis name	DTC detecting condition	Possible cause
B260D	STEERING LOCK UNIT	BCM detects malfunctioning of steering lock unit after steering locking.	<ul style="list-style-type: none">Steering lock unit

DTC CONFIRMATION PROCEDURE

1. PERFORM DTC CONFIRMATION PROCEDURE

1. Turn ignition switch ON.
2. Turn ignition switch OFF.
3. Press door switch.
4. Check "Self diagnostic result" with CONSULT-III.

Is DTC detected?

- YES >> Go to [SEC-80, "Diagnosis Procedure"](#).
NO >> INSPECTION END.

Diagnosis Procedure

INFOID:000000001344538

1. INSPECTION START

1. Turn ignition switch ON.
2. Check "Self diagnostic result" with CONSULT-III.
3. Touch "ERASE".
4. **Perform DTC Confirmation Procedure.**
See [SEC-80, "DTC Logic"](#).

Is the DTC B260D displayed again?

- YES >> Replace steering lock unit.
NO >> INSPECTION END.

B260F ENGINE STATUS

< COMPONENT DIAGNOSIS >

[COUPE]

B260F ENGINE STATUS

Description

INFOID:000000001344539

BCM receives the engine status signal from ECM via CAN communication.

DTC Logic

INFOID:000000001344540

DTC DETECTION LOGIC

NOTE:

- If DTC B260F is displayed with DTC U1000, first perform the trouble diagnosis for DTC U1000. Refer to [SEC-32, "DTC Logic"](#).
- If DTC B260F is displayed with DTC U1010, first perform the trouble diagnosis for DTC U1010. Refer to [SEC-33, "DTC Logic"](#).

DTC No.	Trouble diagnosis name	DTC detecting condition	Possible cause
B260F	INTERRUPTION OF ENGINE STATUS SIGNAL	BCM is not yet received the engine status signal from ECM when ignition switch is in ON position	• ECM

DTC CONFIRMATION PROCEDURE

1. PERFORM DTC CONFIRMATION PROCEDURE

1. Turn ignition switch ON under the following conditions.
 - CVT selector lever is in the P position.
 - Do not depress the brake pedal.
2. Check "Self diagnostic result" with CONSULT-III.

Is DTC detected?

- YES >> Go to [SEC-81, "Diagnosis Procedure"](#).
NO >> INSPECTION END.

Diagnosis Procedure

INFOID:000000001344541

1. INSPECTION START

1. Turn ignition switch ON.
2. Check "Self diagnostic result" with CONSULT-III.
3. Touch "ERASE".
4. **Perform DTC Confirmation Procedure.**
See [SEC-81, "DTC Logic"](#).

Is the DTC B260F displayed again?

- YES >> GO TO 2.
NO >> INSPECTION END.

2. REPLACE ECM

1. Replace ECM.
2. Go to [EC-1016, "BASIC INSPECTION : Special Repair Requirement"](#) (VQ35DE), [EC-24, "BASIC INSPECTION : Special Repair Requirement"](#) (QR25DE FOR CALIFORNIA) or [EC-543, "BASIC INSPECTION : Special Repair Requirement"](#) (QR25DE EXCEPT FOR CALIFORNIA).

>> INSPECTION END.

B26E1 NO RECEPTION OF ENGINE STATUS SIGNAL

< COMPONENT DIAGNOSIS >

[COUPE]

B26E1 NO RECEPTION OF ENGINE STATUS SIGNAL

Description

INFOID:000000001344542

BCM receives the engine status signal from ECM via CAN communication.

DTC Logic

INFOID:000000001344543

DTC DETECTION LOGIC

NOTE:

- If DTC B26E1 is displayed with DTC U1000, first perform the trouble diagnosis for DTC U1000. Refer to [SEC-32, "DTC Logic"](#).
- If DTC B26E1 is displayed with DTC U1010, first perform the trouble diagnosis for DTC U1010. Refer to [SEC-33, "DTC Logic"](#).

DTC No.	Trouble diagnosis name	DTC detecting condition	Possible cause
B260F	NO RECEPTION OF ENGINE STATUS SIGNAL	BCM does not receive the engine status signal from ECM when ignition switch is in the ON position	• ECM

DTC CONFIRMATION PROCEDURE

1. PERFORM DTC CONFIRMATION PROCEDURE

1. Turn ignition switch ON under the following conditions.
 - CVT selector lever is in the P or N position.
 - Do not depress the brake pedal.
2. Check "Self diagnostic result" with CONSULT-III.

Is DTC detected?

- YES >> Go to [SEC-82, "Diagnosis Procedure"](#).
NO >> INSPECTION END.

Diagnosis Procedure

INFOID:000000001344544

1. INSPECTION START

1. Turn ignition switch ON.
2. Check "Self diagnostic result" with CONSULT-III.
3. Touch "ERASE".
4. **Perform DTC Confirmation Procedure.**
See [SEC-82, "DTC Logic"](#).

Is the DTC B26E1 displayed again?

- YES >> GO TO 2.
NO >> INSPECTION END.

2. REPLACE ECM

1. Replace ECM.
2. Go to [EC-1016, "BASIC INSPECTION : Special Repair Requirement"](#) (VQ35DE), [EC-24, "BASIC INSPECTION : Special Repair Requirement"](#) (QR25DE FOR CALIFORNIA), or [EC-543, "BASIC INSPECTION : Special Repair Requirement"](#) (QR25DE EXCEPT FOR CALIFORNIA).

>> INSPECTION END.

B2612 STEERING STATUS

< COMPONENT DIAGNOSIS >

[COUPE]

B2612 STEERING STATUS

Description

INFOID:000000001344545

There are 2 switches in the steering unit. IPDM E/R compares those 2 switches conditions to judge the present steering status and transmit the result to BCM via CAN communication.

DTC Logic

INFOID:000000001344546

DTC DETECTION LOGIC

NOTE:

- If DTC B2612 is displayed with DTC U1000, first perform the trouble diagnosis for DTC U1000. Refer to [SEC-32, "DTC Logic"](#).
- If DTC B2612 is displayed with DTC U1010, first perform the trouble diagnosis for DTC U1010. Refer to [SEC-33, "DTC Logic"](#).

DTC	Self-diagnosis name	DTC detecting condition	Possible causes
B2612	STEERING STATUS	BCM detects the mismatch between the following status for 1 second <ul style="list-style-type: none">• Steering lock or unlock• Feedback of steering lock status from IPDM E/R (CAN)	<ul style="list-style-type: none">• Harness or connectors [steering lock unit circuit (BCM side) is open or shorted]• Harness or connectors [steering lock unit circuit (IPDM E/R side) is open or shorted.]• Steering lock unit• IPDM E/R

DTC CONFIRMATION PROCEDURE

1. PERFORM DTC CONFIRMATION PROCEDURE 1

1. Press the push-button ignition switch under the following conditions and wait for at least 1 second.
 - CVT selector lever is in the P or N position.
 - Do not depress brake pedal.
 - Steering is locked.
2. Check "Self diagnostic result" with CONSULT-III.

Is DTC detected?

- YES >> Go to [SEC-83, "Diagnosis Procedure"](#).
NO >> GO TO 2.

2. PERFORM DTC CONFIRMATION PROCEDURE 2

1. Turn ignition switch ON.
2. Turn ignition switch OFF.
3. Press door switch.
4. Check "Self diagnostic result" with CONSULT-III.

Is DTC detected?

- YES >> Go to [SEC-83, "Diagnosis Procedure"](#).
NO >> INSPECTION END.

Diagnosis Procedure

INFOID:000000001836926

1. INSPECTION START

Check the case in which DTC is detected.

- Case1: It is detected after ignition switch is changed from ON to OFF and door switch is pressed.
- Case2: It is detected after ignition switch is changed from ON to OFF

In which case is DTC detected?

- Case1 >> GO TO 2.
Case2 >> GO TO 7.

2. CHECK BCM OUTPUT SIGNAL

B2612 STEERING STATUS

[COUPE]

< COMPONENT DIAGNOSIS >

1. Turn ignition switch OFF.
2. Disconnect steering lock unit harness connector and IPDM E/R harness connector.
3. Check voltage between steering lock unit harness connector and ground.

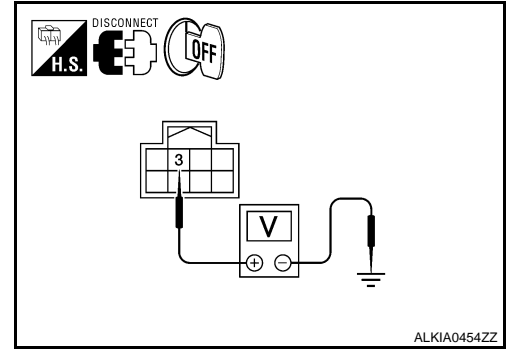

Steering lock unit		Ground	Voltage [V]
Connector	Terminal		
M32	3	Ground	Battery voltage

Is the inspection result normal?

- YES >> GO TO 4.
 NO >> GO TO 3.

3. CHECK STEERING LOCK UNIT CIRCUIT-I

1. Disconnect BCM harness connector.
2. Check continuity between BCM harness connector M19 (A) terminal 85 and steering lock unit harness connector M32 (B) terminal 3.

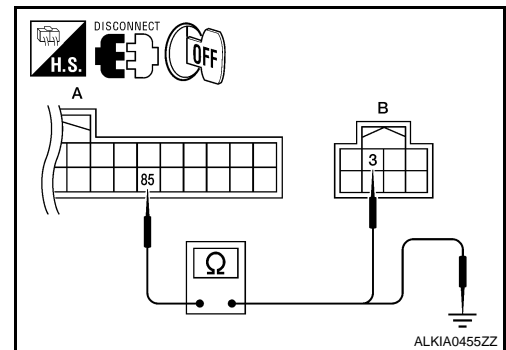

BCM		Steering lock unit		Continuity
Connector	Terminal	Connector	Terminal	
A: M19	85	B: M32	3	Yes

3. Check continuity between BCM harness connector M19 (A) terminal 85 and ground.

BCM		Ground	Continuity
Connector	Terminal		
A: M19	85	Ground	No

Is the inspection result normal?

- YES >> GO TO 6.
 NO >> Repair harness or connector.

4. CHECK IPDM E/R OUTPUT SIGNAL

1. Connect IPDM E/R harness connector.
2. Disconnect BCM harness connector.

B2612 STEERING STATUS

[COUPE]

< COMPONENT DIAGNOSIS >

3. Check voltage between steering lock unit harness connector and ground.

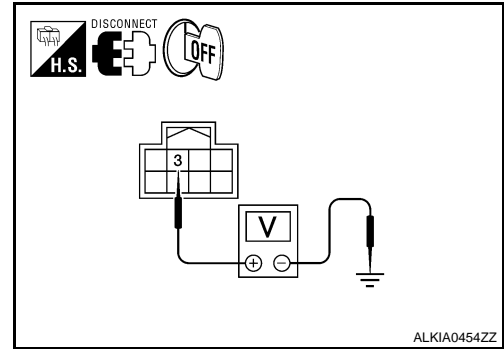

Steering lock unit		Ground	Voltage [V]
Connector	Terminal		
M32	3	Ground	Battery voltage

Is the inspection result normal?

- YES >> Replace steering lock unit.
 NO >> GO TO 5.

5.CHECK STEERING LOCK UNIT CIRCUIT-II

1. Check continuity between steering lock unit harness connector M32 (A) terminal 3 and IPDM E/R harness connector E18 (B) terminal 32.

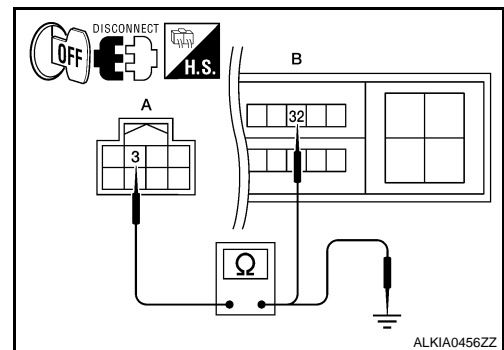

Steering lock unit		IPDM E/R		Continuity
Connector	Terminal	Connector	Terminal	
A: M32	3	B: E18	32	Yes

2. Check continuity between steering lock unit harness connector M32 (A) terminal 3 and ground.

Steering lock unit		Ground	Continuity
Connector	Terminal		
A: M32	3	Ground	No

Is the inspection result normal?

- YES >> GO TO 6.
 NO >> Repair harness or connector.

6.CHECK INTERMITTENT INCIDENT

Refer to [GI-42, "Intermittent Incident"](#).

>> INSPECTION END.

7.CHECK BCM OUTPUT SIGNAL

1. Turn ignition switch OFF.
2. Disconnect steering lock unit harness connector and IPDM E/R harness connector.

A
B
C
D
E
F
G
H
I
J
L
M
N
O
P

SEC

B2612 STEERING STATUS

[COUPE]

< COMPONENT DIAGNOSIS >

3. Check voltage between steering lock unit harness connector and ground.

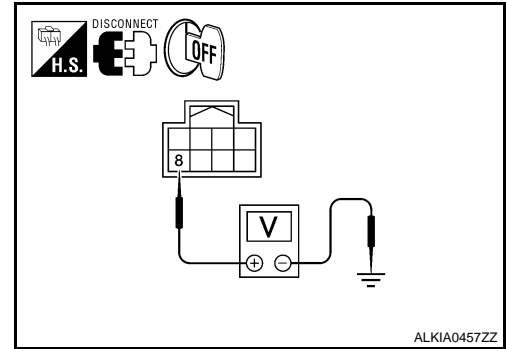

Steering lock unit		Ground	Voltage [V]
Connector	Terminal		
M32	8	Ground	Battery voltage

Is the inspection result normal?

YES >> GO TO 9.

NO >> GO TO 8.

8. CHECK STEERING LOCK UNIT CIRCUIT-I

1. Disconnect BCM harness connector.
2. Check continuity between BCM harness connector M19 (A) terminal 86 and steering lock unit harness connector M32 (B) terminal 8.

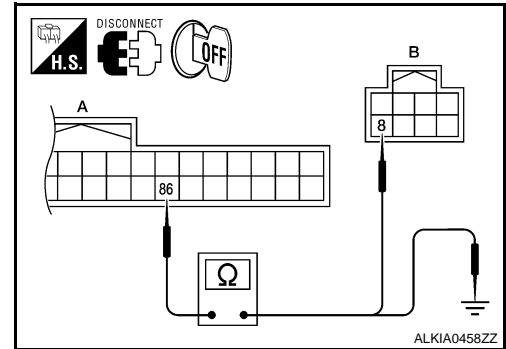

BCM		Steering lock unit		Continuity
Connector	Terminal	Connector	Terminal	
A: M19	86	B: M32	8	Yes

3. Check continuity between BCM harness connector M19 (A) terminal 86 and ground.

BCM		Ground	Continuity
Connector	Terminal		
A: M19	86	Ground	No

Is the inspection result normal?

YES >> GO TO 11.

NO >> Repair harness or connector.

9. CHECK IPDM E/R OUTPUT SIGNAL

1. Connect IPDM E/R harness connector.
2. Disconnect BCM harness connector.

B2612 STEERING STATUS

[COUPE]

< COMPONENT DIAGNOSIS >

3. Check voltage between steering lock unit harness connector and ground.

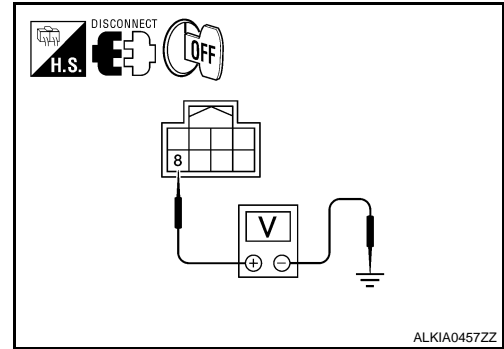

Steering lock unit		Ground	Voltage [V]
Connector	Terminal		
M32	8	Ground	Battery voltage

Is the inspection result normal?

- YES >> Replace steering lock unit.
 NO >> GO TO 10.

10.CHECK STEERING LOCK UNIT CIRCUIT-II

1. Check continuity between steering lock unit harness connector M32 (A) terminal 8 and IPDM E/R harness connector E18 (B) terminal 33.

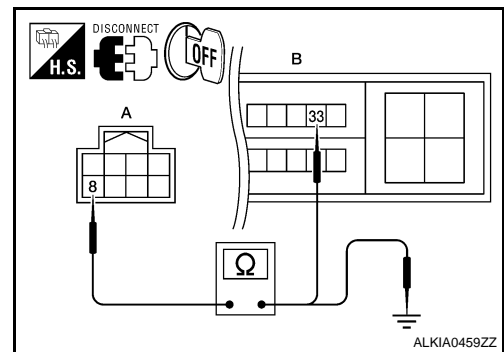

Steering lock unit		IPDM E/R		Continuity
Connector	Terminal	Connector	Terminal	
A: M32	8	B: E18	33	Yes

2. Check continuity between steering lock unit harness connector and ground.

Steering lock unit		Ground	Continuity
Connector	Terminal		
A: M32	8	Ground	No

Is the inspection result normal?

- YES >> GO TO 11.
 NO >> Repair harness or connector.

11.CHECK INTERMITTENT INCIDENT

Refer to [GI-42, "Intermittent Incident"](#).

>> INSPECTION END.

A
B
C
D
E
F
G
H
I
J
L
M
N
O
P

SEC

B2617 STARTER RELAY CIRCUIT

< COMPONENT DIAGNOSIS >

[COUPE]

B2617 STARTER RELAY CIRCUIT

Description

INFOID:000000001344548

Located in IPDM E/R, it runs the starter motor. The starter relay is turned ON by the BCM when the ignition switch is in START position. IPDM E/R transmits the starter relay ON signal to BCM via CAN communication.

DTC Logic

INFOID:000000001344549

DTC DETECTION LOGIC

NOTE:

- If DTC B2617 is displayed with DTC U1000, first perform the trouble diagnosis for DTC U1000. Refer to [SEC-32, "DTC Logic"](#).
- If DTC B2617 is displayed with DTC U1010, first perform the trouble diagnosis for DTC U1010. Refer to [SEC-33, "DTC Logic"](#).
- If DTC B2617 is displayed with DTC B2611, first perform the trouble diagnosis for DTC B2611. Refer to [PCS-59, "DTC Logic"](#).
- If DTC B2617 is displayed with DTC B210E, first perform the trouble diagnosis for DTC B210E. Refer to [SEC-88, "DTC Logic"](#).

DTC No.	Trouble diagnosis name	DTC detecting condition	Possible cause
B2617	STARTER RELAY CIRCUIT	<ul style="list-style-type: none">• An immediate operation of starter relay is requested by BCM, but there is no response for more than 1 second• BCM is not commanding starter relay activation, but BCM detects starter relay output is active	<ul style="list-style-type: none">• Harness or connectors (Starter relay circuit is open or shorted.)• IPDM E/R

DTC CONFIRMATION PROCEDURE

1. PERFORM DTC CONFIRMATION PROCEDURE

1. Turn ignition switch ON under the following conditions and wait for at least 1 second.
 - CVT selector lever is in the P position.
 - Do not depress the brake pedal.
2. Check "Self diagnostic result" with CONSULT-III.

Is DTC detected?

- YES >> Go to [SEC-88, "Diagnosis Procedure"](#).
NO >> INSPECTION END

Diagnosis Procedure

INFOID:000000001344550

1. CHECK STARTER RELAY

1. Turn ignition switch ON.
2. Check voltage between BCM harness connector and ground under the following condition.

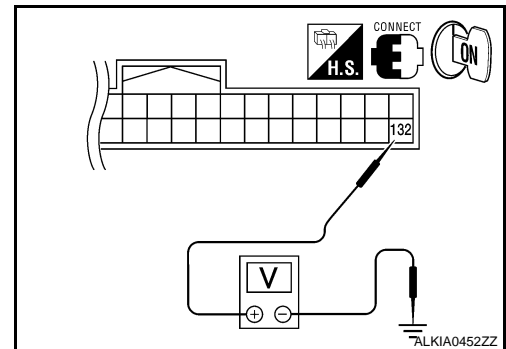

B2617 STARTER RELAY CIRCUIT

< COMPONENT DIAGNOSIS >

[COUPE]

BCM		Ground	Transmission type	Condition	Voltage (V)
Connector	Terminal				
M21	132	Ground	CVT: Select lever in Park	Ignition switch cranking or request to start	Battery voltage
				Other than above	0
			M/T: Clutch pedal depressed	Ignition switch cranking or request to start	Battery voltage
				Other than above	0

Is the measurement value within the specification.

YES >> GO TO 3.

NO >> GO TO 2.

2. CHECK STARTER RELAY CIRCUIT

- Turn ignition switch OFF.
- Disconnect BCM harness connector and IPDM E/R harness connector.
- Check continuity between IPDM E/R harness connector and BCM harness connector.

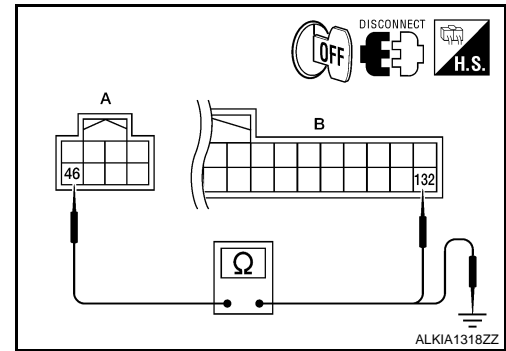

IPDM E/R		BCM		Continuity
Connector	Terminal	Connector	Terminal	
A: E17	46	B: M21	132	Yes

- Check continuity between IPDM E/R harness connector and ground.

IPDM E/R		Ground	Continuity
Connector	Terminal		
A: E17	46	Ground	No

Is the inspection result normal?

YES >> Replace BCM. Refer to [BCS-88, "Removal and Installation"](#).

NO >> Repair harness or connector.

3. CHECK INTERMITTENT INCIDENT

Refer to [GI-42, "Intermittent Incident"](#).

>> INSPECTION END.

B2619 BCM**Description**

INFOID:000000001344551

BCM requests IPDM E/R to supply power to steering lock unit. After receiving the power, the steering lock unit transmits an ON signal to BCM.

DTC Logic

INFOID:000000001344552

DTC DETECTION LOGIC

DTC No.	Trouble diagnosis name	DTC detecting condition	Possible cause
B2619	BCM	BCM detects a mismatch between the power supplied to the steering lock unit and the feedback for one second or more.	<ul style="list-style-type: none"> • BCM

DTC CONFIRMATION PROCEDURE**1. PERFORM DTC CONFIRMATION PROCEDURE**

1. Press the push-button ignition switch under the following conditions and wait for at least 1 second.
 - CVT selector lever is in the P position
 - Do not depress brake pedal
2. Check "Self diagnostic result" with CONSULT-III.

Is DTC detected?

- YES >> Go to [SEC-90, "Diagnosis Procedure"](#).
 NO >> INSPECTION END.

Diagnosis Procedure

INFOID:000000001344553

1. INSPECTION START

1. Turn ignition switch ON.
2. Check "Self diagnostic result" with CONSULT-III.
3. Touch "ERASE".
4. **Perform DTC Confirmation Procedure.**
See [SEC-90, "DTC Logic"](#).

Is the DTC B2619 displayed again?

- YES >> Replace BCM. Refer to [BCS-88, "Removal and Installation"](#).
 NO >> INSPECTION END

B261A PUSH-BUTTON IGNITION SWITCH

< COMPONENT DIAGNOSIS >

[COUPE]

B261A PUSH-BUTTON IGNITION SWITCH

Description

INFOID:000000001344554

IPDM E/R transmits the push-button ignition switch status via CAN communication to BCM. BCM receives push-button ignition switch status by hardwire input. BCM compares the 2 signals for mismatch.

DTC Logic

INFOID:000000001344555

DTC DETECTION LOGIC

NOTE:

- If DTC B261A is displayed with DTC U1000, first perform the trouble diagnosis for DTC U1000. Refer to [SEC-32, "DTC Logic"](#).
- If DTC B261A is displayed with DTC U1010, first perform the trouble diagnosis for DTC U1010. Refer to [SEC-33, "DTC Logic"](#).

DTC No.	Trouble diagnosis name	DTC detecting condition	Possible cause
B261A	PUSH-BUTTON IGNITION SWITCH	BCM detects the mismatch between the following for 1 second or more <ul style="list-style-type: none"> • Push-button ignition switch status • Push-button ignition switch status from IPDM E/R (CAN) 	<ul style="list-style-type: none"> • Harness or connectors (Push-button ignition switch circuit is open or shorted) • Between BCM and push-button ignition switch • Between IPDM E/R and push-button ignition switch

DTC CONFIRMATION PROCEDURE

1. PERFORM DTC CONFIRMATION PROCEDURE

1. Press the push-button ignition switch under the following conditions and wait for at least 1 second.
 - CVT selector lever is in the P position
 - Do not depress brake pedal.
2. Check "Self diagnostic result" with CONSULT-III.

Is DTC detected?

- YES >> Go to [SEC-91, "Diagnosis Procedure"](#).
 NO >> INSPECTION END

Diagnosis Procedure

INFOID:000000001836927

1. CHECK PUSH-BUTTON IGNITION SWITCH OUTPUT SIGNAL 1

1. Turn ignition switch OFF.
2. Disconnect push-button ignition switch harness connector and IPDM E/R harness connector.
3. Check voltage between push-button ignition switch harness connector and ground.

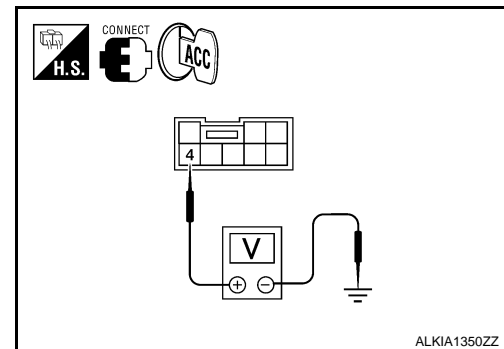

Push-button ignition switch		Ground	Voltage (V)
Connector	Terminal		
M38	4	Ground	Battery voltage

B261A PUSH-BUTTON IGNITION SWITCH

[COUPE]

< COMPONENT DIAGNOSIS >

Is the inspection result normal?

- YES >> GO TO 4.
- NO >> GO TO 2.

2. CHECK PUSH-BUTTON IGNITION SWITCH CIRCUIT

1. Disconnect BCM harness connector.
2. Check continuity between push-button ignition switch harness connector M38 (A) terminal 4 and BCM harness connector M19 (B) terminal 77.

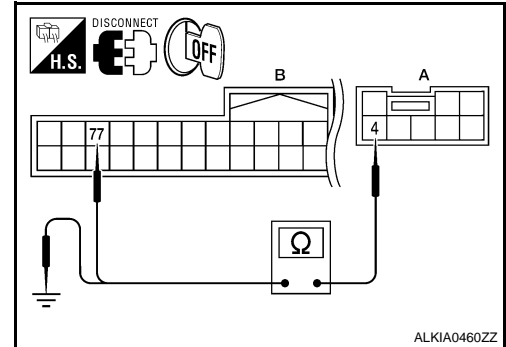

Push-button ignition switch		BCM		Continuity
Connector	Terminal	Connector	Terminal	
A: M38	4	B: M19	77	Yes

3. Check continuity between push-button ignition switch harness connector M38 (A) terminal 4 and ground.

Push-button ignition switch		Ground	Continuity
Connector	Terminal		
A: M38	4	Ground	No

Is the inspection result normal?

- YES >> GO TO 6.
- NO >> Repair harness or connector.

3. CHECK PUSH-BUTTON IGNITION SWITCH

1. Disconnect IPDM E/R harness connector.
2. Check continuity between push-button ignition switch harness connector M38 (A) terminal 4 and IPDM E/R harness connector E18 (B) terminal 28.

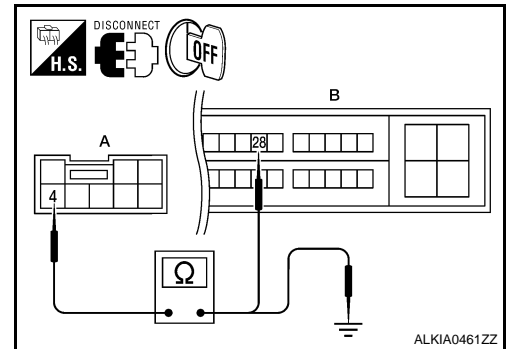

Push-button ignition switch		IPDM E/R		Continuity
Connector	Terminal	Connector	Terminal	
A: M38	4	B: E18	28	Yes

3. Check continuity between push-button ignition switch harness connector and ground.

Push-button ignition switch		Ground	Continuity
Connector	Terminal		
A: M38	4	Ground	No

B261A PUSH-BUTTON IGNITION SWITCH

[COUPE]

< COMPONENT DIAGNOSIS >

Is the inspection result normal?

YES >> GO TO 4.

NO >> Repair harness or connector.

4.CHECK INTERMITTENT INCIDENT

Refer to [GI-42. "Intermittent Incident"](#).

>> INSPECTION END

A

B

C

D

E

F

G

H

I

J

SEC

L

M

N

O

P

B261E VEHICLE TYPE

[COUPE]

< COMPONENT DIAGNOSIS >

B261E VEHICLE TYPE

Description

INFOID:000000001344557

There are two types of vehicle.

- HEV
- Conventional

DTC Logic

INFOID:000000001344558

DTC DETECTION LOGIC

NOTE:

- If DTC B261E is displayed with DTC U1000, first perform the trouble diagnosis for DTC U1000. Refer to [SEC-32, "DTC Logic"](#).
- If DTC B261E is displayed with DTC U1010, first perform the trouble diagnosis for DTC U1010. Refer to [SEC-33, "DTC Logic"](#).

DTC No.	Trouble diagnosis name	DTC detecting condition	Possible cause
B261E	VEHICLE TYPE	Difference of BCM configuration	• BCM

DTC CONFIRMATION PROCEDURE

1. PERFORM DTC CONFIRMATION PROCEDURE

1. Turn ignition switch ON.
2. Check "Self diagnostic result" with CONSULT-III.

Is DTC detected?

- YES >> Go to [SEC-94, "Diagnosis Procedure"](#).
NO >> INSPECTION END

Diagnosis Procedure

INFOID:000000001344559

1. INSPECTION START

1. Turn ignition switch ON.
2. Check "Self diagnostic result" with CONSULT-III.
3. Touch "ERASE".
4. **Perform DTC Confirmation Procedure.**
See [SEC-94, "DTC Logic"](#).

Is the 1st trip DTC B261E displayed again?

- YES >> Perform BCM configuration. Refer to CONSULT-III Operation Manual.
NO >> INSPECTION END

B2108 STEERING LOCK RELAY

< COMPONENT DIAGNOSIS >

[COUPE]

B2108 STEERING LOCK RELAY

Description

INFOID:000000001344560

The steering lock relay ON signal is transmitted to IPDM E/R by BCM via CAN communication. IPDM E/R turns the steering lock relay ON and transmits the release of the steering to BCM.

DTC Logic

INFOID:000000001344561

DTC DETECTION LOGIC

NOTE:

- If DTC B2108 is displayed with DTC U1000, first perform the trouble diagnosis for DTC U1000. Refer to [SEC-32, "DTC Logic"](#).
- If DTC B2108 is displayed with DTC U1010, first perform the trouble diagnosis for DTC U1010. Refer to [SEC-33, "DTC Logic"](#).

DTC No.	Trouble diagnosis name	DTC detecting condition	Possible cause
B2108	STRG LCK RELAY ON	IPDM E/R detects that the relay is stuck at ON position for about 1 second even if the IPDM E/R receives steering lock relay ON/OFF signal from BCM.	<ul style="list-style-type: none">• IPDM E/R

DTC CONFIRMATION PROCEDURE

1.PERFORM DTC CONFIRMATION PROCEDURE

1. Press the push-button ignition switch under the following conditions and wait for at least 1 second.
 - CVT selector lever is in the P position
 - Do not depress the brake pedal.
2. Check "Self diagnostic result" with CONSULT-III.

Is DTC detected?

- YES >> Go to [SEC-95, "Diagnosis Procedure"](#).
NO >> INSPECTION END

Diagnosis Procedure

INFOID:000000001344562

1.CHECK FUSE

1. Turn ignition switch OFF.
2. Check 10A fuse (No. 40, located in IPDM E/R).

Is the inspection normal?

- YES >> Replace IPDM E/R. Refer to [PCS-43, "Removal and Installation"](#).
NO >> Check the following.
 - Harness for open or short between IPDM E/R and battery
 - Fuse

A
B
C
D
E
F
G
H
I
J
L
M
N
O
P

SEC

B2109 STEERING LOCK RELAY

< COMPONENT DIAGNOSIS >

[COUPE]

B2109 STEERING LOCK RELAY

Description

INFOID:000000001344563

The steering lock relay ON signal is transmitted to IPDM E/R by BCM via CAN communication. IPDM E/R turns the steering lock relay ON and transmits the release of the steering to BCM.

DTC Logic

INFOID:000000001344564

DTC DETECTION LOGIC

NOTE:

- If DTC B2109 is displayed with DTC U1000, first perform the trouble diagnosis for DTC U1000. Refer to [SEC-32, "DTC Logic"](#).
- If DTC B2109 is displayed with DTC U1010, first perform the trouble diagnosis for DTC U1010. Refer to [SEC-33, "DTC Logic"](#).

DTC No.	Trouble diagnosis name	DTC detecting condition	Possible cause
B2109	STRG LCK RELAY OFF	IPDM E/R detects that the relay is stuck at OFF position for about 1 second even if the IPDM E/R receives steering lock relay ON/OFF signal from BCM.	<ul style="list-style-type: none">• Harness or connector (power supply circuit)• IPDM E/R• Battery

DTC CONFIRMATION PROCEDURE

1.PERFORM DTC CONFIRMATION PROCEDURE

1. Press the push-button ignition switch under the following conditions and wait for at least 1 second.
 - CVT selector lever is in the P or N position
 - Do not depress the brake pedal
2. Check "Self diagnostic result" with CONSULT-III.

Is DTC detected?

- YES >> Go to [SEC-96, "Diagnosis Procedure"](#).
NO >> INSPECTION END

Diagnosis Procedure

INFOID:000000001836928

1.CHECK POWER SUPPLY CIRCUIT

Check IPDM E/R power supply circuit. Refer to [PCS-19, "Diagnosis Procedure"](#).

Is the inspection normal?

- YES >> GO TO 2.
NO >> Repair the malfunctioning parts

2.CHECK FUSE

1. Turn ignition switch OFF.
2. Check 10A fuse (No. 40, located in IPDM E/R).

Is the inspection normal?

- YES >> Replace IPDM E/R. Refer to [PCS-43, "Removal and Installation"](#).
NO >> Check the following.
 - Harness for open or short between IPDM E/R and battery
 - Fuse

B210A STEERING LOCK CONDITION SWITCH

< COMPONENT DIAGNOSIS >

[COUPE]

B210A STEERING LOCK CONDITION SWITCH

Description

INFOID:000000001344566

There are 2 switches in the steering unit. IPDM E/R compares those 2 switches conditions to judge the present steering status and transmit the result to BCM via CAN communication.

DTC Logic

INFOID:000000001344567

DTC DETECTION LOGIC

NOTE:

- If DTC B210A is displayed with DTC U1000, first perform the trouble diagnosis for DTC U1000. Refer to [SEC-32, "DTC Logic"](#).
- If DTC B210A is displayed with DTC U1010, first perform the trouble diagnosis for DTC U1010. Refer to [SEC-33, "DTC Logic"](#).

DTC No.	Trouble diagnosis name	DTC detecting condition	Possible cause
B210A	STRG LCK STATE SW	BCM detects the mismatch between the following for 1 second <ul style="list-style-type: none">• Steering lock or unlock• Feedback of steering lock status from IPDM E/R (CAN)	<ul style="list-style-type: none">• Harness or connectors [steering lock unit circuit (BCM side) is open or shorted]• Harness or connectors [steering lock unit circuit (IPDM E/R side) is open or shorted.]• Steering lock unit• IPDM E/R

DTC CONFIRMATION PROCEDURE

1. PERFORM DTC CONFIRMATION PROCEDURE

1. Press the push-button ignition switch under the following conditions and wait for at least 1 second.
 - CVT selector lever is in the P or N position
 - Do not depress the brake pedal
2. Check "Self diagnostic result" with CONSULT-III.

Is DTC detected?

- YES >> Go to [SEC-97, "Diagnosis Procedure"](#).
NO >> INSPECTION END

Diagnosis Procedure

INFOID:000000001836929

1. INSPECTION START

Check the case in which DTC is detected.

- Case1: It is detected after ignition switch is changed from ON to OFF and door switch is pressed
- Case2: It is detected after ignition switch is changed from ON to OFF

In which case is DTC detected?

- Case1 >> GO TO 2.
Case2 >> GO TO 7.

2. CHECK BCM OUTPUT SIGNAL

1. Turn ignition switch OFF.
2. Disconnect steering lock unit harness connector and IPDM E/R harness connector.

A
B
C
D
E
F
G
H
I
J
L
M
N
O
P

SEC

B210A STEERING LOCK CONDITION SWITCH

[COUPE]

< COMPONENT DIAGNOSIS >

3. Check voltage between steering lock unit harness connector and ground.

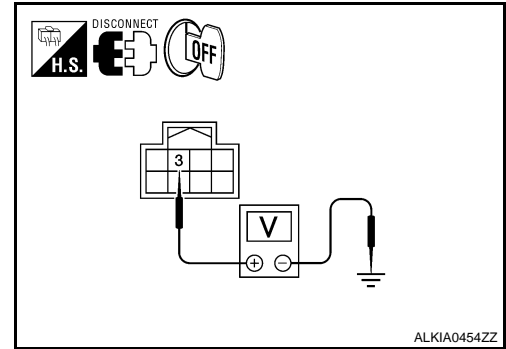

Steering lock unit		Ground	Voltage [V]
Connector	Terminal		
M32	3	Ground	Battery voltage

Is the inspection result normal?

YES >> GO TO 4.

NO >> GO TO 3.

3. CHECK STEERING LOCK UNIT CIRCUIT-I

1. Disconnect BCM harness connector.
2. Check continuity between BCM harness connector M19 (A) terminal 85 and steering lock unit harness connector M32 (B) terminal 3.

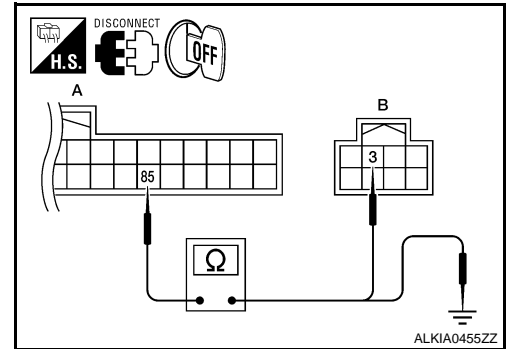

BCM		Steering lock unit		Continuity
Connector	Terminal	Connector	Terminal	
A: M19	85	B: M32	3	Yes

3. Check continuity between BCM harness connector M19 (A) terminal 85 and ground.

BCM		Ground	Continuity
Connector	Terminal		
A: M19	85	Ground	No

Is the inspection result normal?

YES >> GO TO 6.

NO >> Repair harness or connector.

4. CHECK IPDM E/R OUTPUT SIGNAL

1. Connect IPDM E/R harness connector.
2. Disconnect BCM harness connector.

B210A STEERING LOCK CONDITION SWITCH

[COUPE]

< COMPONENT DIAGNOSIS >

3. Check voltage between steering lock unit harness connector and ground.

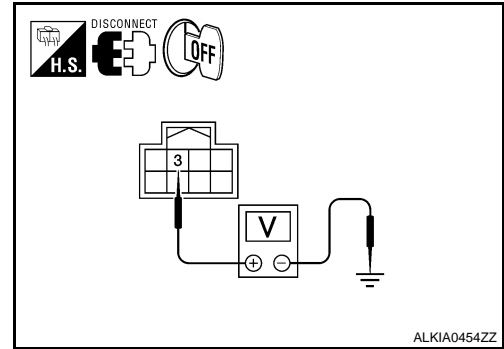

Steering lock unit		Ground	Voltage [V]
Connector	Terminal		
M32	3	Ground	Battery voltage

Is the inspection result normal?

- YES >> Replace steering lock unit.
 NO >> GO TO 5.

5.CHECK STEERING LOCK UNIT CIRCUIT-II

1. Check continuity between steering lock unit harness connector M32 (A) terminal 3 and IPDM E/R harness connector E18 (B) terminal 32.

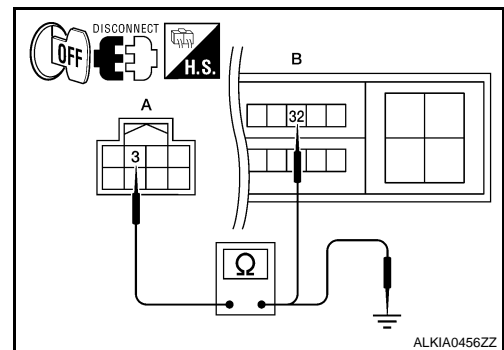

Steering lock unit		IPDM E/R		Continuity
Connector	Terminal	Connector	Terminal	
A: M32	3	B: E18	32	Yes

2. Check continuity between steering lock unit harness connector M32 (A) terminal 3 and ground.

Steering lock unit		Ground	Continuity
Connector	Terminal		
A: M32	3	Ground	No

Is the inspection result normal?

- YES >> GO TO 6.
 NO >> Repair harness or connector.

6.CHECK INTERMITTENT INCIDENT

Refer to [GI-42, "Intermittent Incident"](#).

>> INSPECTION END

7.CHECK BCM OUTPUT SIGNAL

1. Turn ignition switch OFF.
2. Disconnect steering lock unit harness connector and IPDM E/R harness connector E5.

A
B
C
D
E
F
G
H
I
J
L
M
N
O
P

SEC

B210A STEERING LOCK CONDITION SWITCH

[COUPE]

< COMPONENT DIAGNOSIS >

3. Check voltage between steering lock unit harness connector and ground.

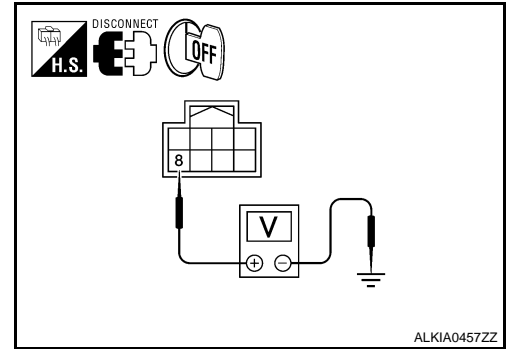

Steering lock unit		Ground	Voltage [V]
Connector	Terminal		
M32	8	Ground	Battery voltage

Is the inspection result normal?

YES >> GO TO 9.

NO >> GO TO 8.

8. CHECK STEERING LOCK UNIT CIRCUIT-I

1. Disconnect BCM harness connector M122.
2. Check continuity between BCM harness connector M19 (A) terminal 86 and steering lock unit harness connector M32 (B) terminal 8.

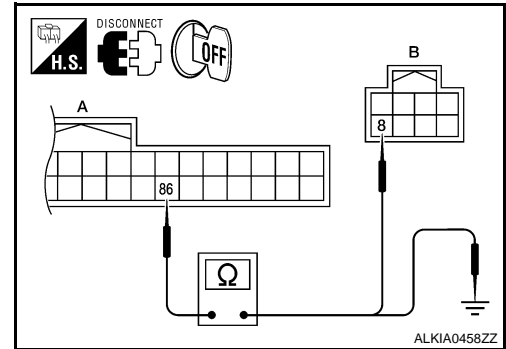

BCM		Steering lock unit		Continuity
Connector	Terminal	Connector	Terminal	
A: M19	86	B: M32	8	Yes

3. Check continuity between BCM harness connector M19 (A) terminal 86 and ground.

BCM		Ground	Continuity
Connector	Terminal		
A: M19	86	Ground	No

Is the inspection result normal?

YES >> GO TO 11.

NO >> Repair harness or connector.

9. CHECK IPDM E/R OUTPUT SIGNAL

1. Connect IPDM E/R harness connector.
2. Disconnect BCM harness connector.

B210A STEERING LOCK CONDITION SWITCH

[COUPE]

< COMPONENT DIAGNOSIS >

3. Check voltage between steering lock unit harness connector and ground.

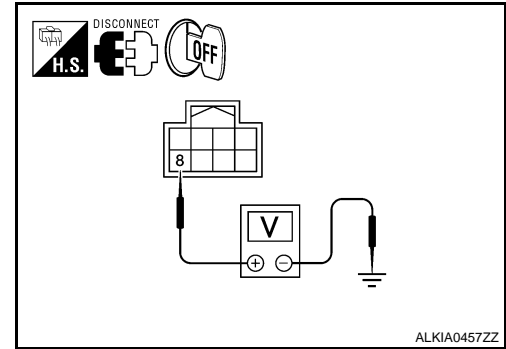

Steering lock unit		Ground	Voltage [V]
Connector	Terminal		
M32	8	Ground	Battery voltage

Is the inspection result normal?

- YES >> Replace steering lock unit.
 NO >> GO TO 10.

10.CHECK STEERING LOCK UNIT CIRCUIT-II

1. Check continuity between steering lock unit harness connector M32 (A) terminal 8 and IPDM E/R harness connector E18 (B) terminal 33.

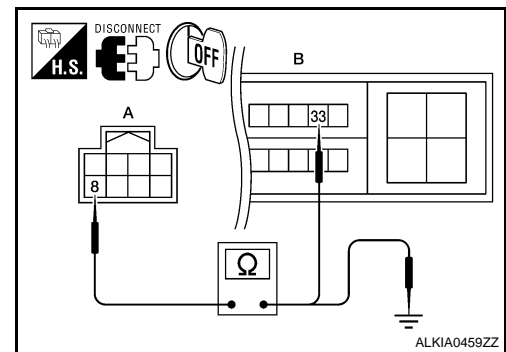

Steering lock unit		IPDM E/R		Continuity
Connector	Terminal	Connector	Terminal	
A: M32	8	B: E18	33	Yes

2. Check continuity between steering lock unit harness connector and ground.

Steering lock unit		Ground	Continuity
Connector	Terminal		
A: M32	8	Ground	No

Is the inspection result normal?

- YES >> GO TO 11.
 NO >> Repair harness or connector.

11.CHECK INTERMITTENT INCIDENT

Refer to [GI-42, "Intermittent Incident"](#).

>> INSPECTION END

A
B
C
D
E
F
G
H
I
J
L
M
N
O
P

SEC

B210B STARTER CONTROL RELAY

< COMPONENT DIAGNOSIS >

[COUPE]

B210B STARTER CONTROL RELAY

Description

INFOID:000000001344569

Starter control relay, integrated in IPDM E/R, permits the starter relay operation when in N or P position and the steering is locked or unlocked. It is installed in parallel with the starter relay.

DTC Logic

INFOID:000000001344570

DTC DETECTION LOGIC

NOTE:

- If DTC B210B is displayed with DTC U1000, first perform the trouble diagnosis for DTC U1000. Refer to [SEC-32, "DTC Logic"](#).
- If DTC B210B is displayed with DTC U1010, first perform the trouble diagnosis for DTC U1010. Refer to [SEC-33, "DTC Logic"](#).

DTC No.	Trouble diagnosis name	DTC detecting condition	Possible cause
B210B	START CONT RLY ON	IPDM E/R detects that the relay is stuck at ON position even if the followings condition are met for about 1 second. <ul style="list-style-type: none">• Starter control relay ON/OFF signal from BCM• Clutch interlock or shift park neutral position (PNP) switch input signal	<ul style="list-style-type: none">• IPDM E/R

DTC CONFIRMATION PROCEDURE

1. PERFORM DTC CONFIRMATION PROCEDURE

1. Turn the power supply position to start under the following conditions and wait for at least 1 second.
 - CVT selector lever is in the P or N position.
 - Depress the brake pedal
2. Check "Self diagnostic result" with CONSULT-III.

Is DTC detected?

- YES >> Go to [SEC-102, "Diagnosis Procedure"](#).
NO >> INSPECTION END

Diagnosis Procedure

INFOID:000000001344571

1. INSPECTION START

1. Turn ignition switch ON.
2. Check "Self diagnostic result" with CONSULT-III.
3. Touch "ERASE".
4. **Perform DTC Confirmation Procedure.**
See [PCS-41, "DTC Index"](#).

Is the DTC B210B displayed again?

- YES >> Replace IPDM E/R. Refer [PCS-43, "Removal and Installation"](#).
NO >> INSPECTION END

B210C STARTER CONTROL RELAY

< COMPONENT DIAGNOSIS >

[COUPE]

B210C STARTER CONTROL RELAY

Description

INFOID:000000001344572

Starter control relay, integrated in IPDM E/R, permits the starter relay operation when in N or P position and the steering is locked or unlocked. It is installed in parallel with the starter relay.

DTC Logic

INFOID:000000001344573

DTC DETECTION LOGIC

NOTE:

- If DTC B210C is displayed with DTC U1000, first perform the trouble diagnosis for DTC U1000. Refer to [SEC-32, "DTC Logic"](#).
- If DTC B210C is displayed with DTC U1010, first perform the trouble diagnosis for DTC U1010. Refer to [SEC-33, "DTC Logic"](#).

DTC No.	Trouble diagnosis name	DTC detecting condition	Possible cause
B210C	START CONT RLY OFF	IPDM E/R detects that the relay is stuck at ON position even if the followings condition are met for about 1 second. <ul style="list-style-type: none">• Starter control relay ON/OFF signal from BCM• Clutch interlock or shift park neutral position (PNP) switch input signal	<ul style="list-style-type: none">• IPDM E/R

DTC CONFIRMATION PROCEDURE

1. PERFORM DTC CONFIRMATION PROCEDURE

1. Turn the power supply position to start under the following conditions and wait for at least 1 second.
 - CVT selector lever is in the P or N position.
 - Depress the brake pedal
2. Check "Self diagnostic result" with CONSULT-III.

Is DTC detected?

- YES >> Go to [SEC-103, "Diagnosis Procedure"](#).
NO >> INSPECTION END

Diagnosis Procedure

INFOID:000000001344574

1. INSPECTION START

1. Turn ignition switch ON.
2. Check "Self diagnostic result" with CONSULT-III.
3. Touch "ERASE".
4. **Perform DTC Confirmation Procedure.**
See [PCS-41, "DTC Index"](#).

Is the DTC B210C displayed again?

- YES >> Replace IPDM E/R. Refer to [PCS-43, "Removal and Installation"](#).
NO >> INSPECTION END

B210D STARTER RELAY

< COMPONENT DIAGNOSIS >

[COUPE]

B210D STARTER RELAY

Description

INFOID:000000001344575

Located in IPDM E/R, it runs the starter motor. The starter relay is turned ON by the BCM when the ignition switch is in START position. IPDM E/R transmits the starter relay ON signal to BCM via CAN communication.

DTC Logic

INFOID:000000001344576

DTC DETECTION LOGIC

NOTE:

- If DTC B210D is displayed with DTC U1000, first perform the trouble diagnosis for DTC U1000. Refer to [SEC-32, "DTC Logic"](#).
- If DTC B210D is displayed with DTC U1010, first perform the trouble diagnosis for DTC U1010. Refer to [SEC-33, "DTC Logic"](#).
- If DTC B210D is displayed with DTC B2617, first perform the trouble diagnosis for DTC B2617. Refer to [SEC-88, "DTC Logic"](#).

DTC No.	Trouble diagnosis name	DTC detecting condition	Possible cause
B210D	STARTER RELAY ON	IPDM E/R detects that the relay is stuck at ON position even if the followings condition are met for about 1 second. <ul style="list-style-type: none">• Starter control relay ON/OFF signal from BCM• Clutch interlock or shift park neutral position (PNP) switch input	<ul style="list-style-type: none">• IPDM E/R

DTC CONFIRMATION PROCEDURE

1. PERFORM DTC CONFIRMATION PROCEDURE

1. Ignition switch ON under the following conditions and wait for at least 1 second.
 - A/T selector lever is P or N position
 - Do not depress the brake pedal
2. Check "Self diagnostic result" with CONSULT-III.

Is DTC detected?

- YES >> Go to [SEC-104, "Diagnosis Procedure"](#).
NO >> INSPECTION END.

Diagnosis Procedure

INFOID:000000001344577

1. CHECK STARTER RELAY POWER SUPPLY CIRCUIT

1. Turn ignition switch OFF.
2. Disconnect IPDM E/R harness connector.
3. Check voltage between IPDM E/R harness connector and ground.

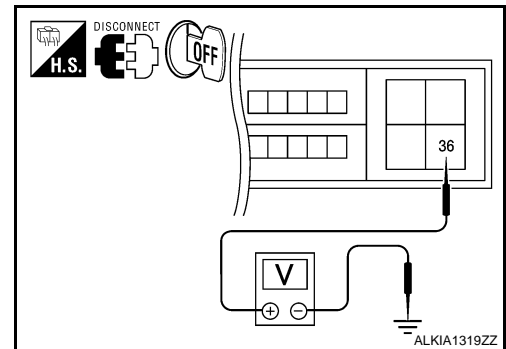

B210D STARTER RELAY

< COMPONENT DIAGNOSIS >

[COUPE]

IPDM E/R		Ground	Voltage (V)
Connector	Terminal		
E18	36	Ground	Battery voltage

Is the inspection result normal?

- YES >> Replace IPDM E/R. Refer to [PCS-43, "Removal and Installation"](#).
- NO >> Check harness for open or short between IPDM E/R and battery.

A
B
C
D
E
F
G
H
I
J
L
M
N
O
P

SEC

B210E STARTER RELAY

< COMPONENT DIAGNOSIS >

[COUPE]

B210E STARTER RELAY

Description

INFOID:000000001344578

Located in IPDM E/R, it runs the starter motor. The starter relay is turned ON by the BCM when the ignition switch is in START position. IPDM E/R transmits the starter relay ON signal to BCM via CAN communication.

DTC Logic

INFOID:000000001344579

DTC DETECTION LOGIC

NOTE:

- If DTC B210E is displayed with DTC U1000, first perform the trouble diagnosis for DTC U1000. Refer to [SEC-32, "DTC Logic"](#).
- If DTC B210E is displayed with DTC U1010, first perform the trouble diagnosis for DTC U1010. Refer to [SEC-33, "DTC Logic"](#).

DTC No.	Trouble diagnosis name	DTC detecting condition	Possible cause
B210E	STARTER RELAY OFF	IPDM E/R detects that the relay is stuck at ON position even if the followings condition are met for about 1 second. <ul style="list-style-type: none">• Starter control relay ON/OFF signal from BCM• Clutch interlock or shift park neutral position (PNP) switch input	<ul style="list-style-type: none">• IPDM E/R

DTC CONFIRMATION PROCEDURE

1.PERFORM DTC CONFIRMATION PROCEDURE

1. Turn ignition switch ON under the following conditions and wait for at least 1 second.
 - A/T selector lever is in the P or N position
 - Do not depress the brake pedal
2. Check "Self diagnostic result" with CONSULT-III.

Is DTC detected?

- YES >> Go to [SEC-106, "Diagnosis Procedure"](#).
NO >> INSPECTION END.

Diagnosis Procedure

INFOID:000000001344580

1.INSPECTION START

Check which type of transmission the vehicle is equipped with.

Which type of transmission

- CVT >> GO TO 2.
M/T >> GO TO 3.

2.CHECK STARTER RELAY OUTPUT SIGNAL/CVT MODELS

1. Turn ignition switch OFF.
2. Disconnect BCM harness connector.
3. Check voltage between BCM harness connector and ground.

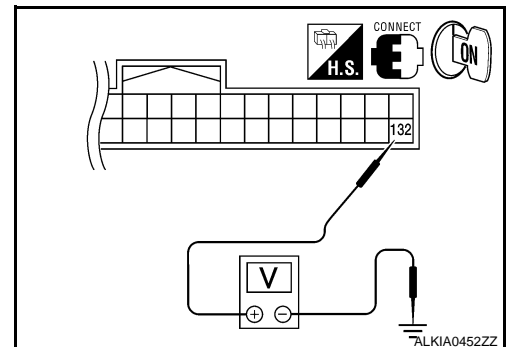

B210E STARTER RELAY

< COMPONENT DIAGNOSIS >

[COUPE]

BCM connector		Ground	Condition			Voltage (V)
Connector	Terminal		Ignition switch	Brake pedal	CVT selector lever	
M21	132	Ground	ON	Depressed	P or N	Battery voltage
					Other than above	0

Is the inspection result normal?

- YES >> GO TO 5.
- NO >> GO TO 4.

3. CHECK STARTER RELAY OUTPUT SIGNAL / M/T MODELS

1. Turn ignition switch OFF.
2. Disconnect BCM harness connector.
3. Check voltage between BCM harness connector and ground.

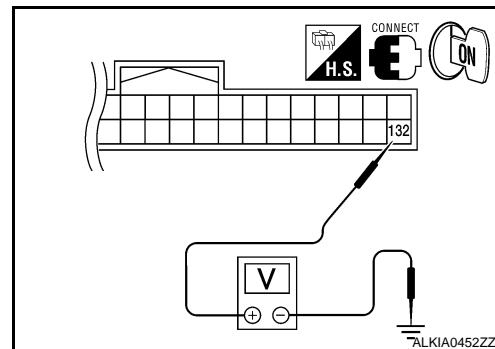

BCM connector		Ground	Condition		Voltage (V)
Connector	Terminal		Ignition switch	Clutch pedal	
M21	132	Ground	OFF	Not depressed	0
				Depressed	Battery voltage

Is the inspection result normal?

- YES >> GO TO 5.
- NO >> GO TO 4.

4. CHECK STARTER RELAY OUTPUT SIGNAL CIRCUIT

1. Disconnect IPDM E/R harness connector.
2. Check continuity between IPDM E/R harness connector and BCM harness connector.

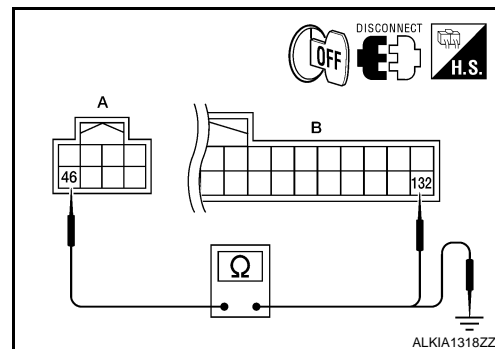

IPDM E/R		BCM		Continuity
Connector	Terminal	Connector	Terminal	
A: E17	46	B: M21	132	Yes

3. Check continuity between BCM harness connector and ground.

B210E STARTER RELAY

[COUPE]

< COMPONENT DIAGNOSIS >

IPDM E/R		Ground	Continuity
Connector	Terminal		
A: E17	46	Ground	No

Is the inspection result normal?

YES >> Replace IPDM E/R. Refer to [PCS-43, "Removal and Installation"](#).

NO >> Repair harness connector.

5. CHECK STARTER RELAY POWER SUPPLY CIRCUIT

1. Turn ignition switch OFF.
2. Disconnect IPDM E/R harness connector.
3. Check voltage between IPDM E/R harness connector and ground.

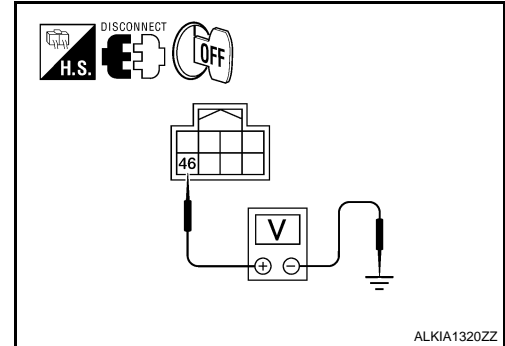

IPDM E/R		Ground	Voltage (V)
Connector	Terminal		
E17	46	Ground	Battery voltage

Is the inspection result normal?

YES >> Replace IPDM E/R. Refer to [PCS-43, "Removal and Installation"](#).

NO >> Check harness for open or short between IPDM E/R and battery.

B210F PNP/CLUTCH INTERLOCK SWITCH

< COMPONENT DIAGNOSIS >

[COUPE]

B210F PNP/CLUTCH INTERLOCK SWITCH

Description

INFOID:000000001344581

IPDM E/R confirms the shift position with the following signals.

- Park/neutral position (PNP) switch (A/T models)
- Clutch interlock switch (M/T models)
- Shift position signal from BCM (CAN)

DTC Logic

INFOID:000000001344582

DTC DETECTION LOGIC

NOTE:

- If DTC B210F is displayed with DTC U1000, first perform the trouble diagnosis for DTC U1000. Refer to [SEC-32, "DTC Logic"](#)
- If DTC B210F is displayed with DTC U1010, first perform the trouble diagnosis for DTC U1010. Refer to [SEC-32, "DTC Logic"](#).

DTC No.	Trouble diagnosis name	DTC detecting condition	Possible cause
B210F	INTER LOCK/PNP SW ON	IPDM E/R detects a mismatch between the signals below for 1 second or more. <ul style="list-style-type: none">• Clutch interlock input signal (M/T models)• Shift PNP switch input signal (A/T models)• Shift position signal from BCM (CAN)	<ul style="list-style-type: none">• Harness or connectors [Park/neutral position (PNP) switch circuit is open or shorted (A/T models)] or (Clutch interlock switch circuit is open or shorted.)• Clutch interlock switch (M/T models)• Park/neutral position (PNP) switch (A/T models)

DTC CONFIRMATION PROCEDURE

1. PERFORM DTC CONFIRMATION PROCEDURE

1. Turn ignition switch ON under the following conditions and wait for at least 1 second.
 - A/T selector lever is in the P or N position
 - Do not depress the brake pedal
2. Check "Self diagnostic result" with CONSULT-III.

Is DTC detected?

- YES >> Go to [SEC-109, "Diagnosis Procedure"](#).
NO >> INSPECTION END

Diagnosis Procedure

INFOID:000000001344583

1. INSPECTION START

Check which type of transmission the vehicle is equipped with.

Which type of transmission

- CVT >> GO TO 2.
M/T >> GO TO 5.

2. CHECK DTC WITH BCM

Refer to [BCS-85, "DTC Index"](#).

Is the inspection result normal?

- YES >> GO TO 3.
NO >> Repair or replace malfunctioning parts.

3. CHECK PNP SWITCH INPUT SIGNAL

1. Turn ignition switch OFF.
2. Disconnect IPDM E/R harness connector.
3. Turn ignition switch ON.

B210F PNP/CLUTCH INTERLOCK SWITCH

[COUPE]

< COMPONENT DIAGNOSIS >

4. Check voltage between IPDM E/R harness connector and ground under following condition.

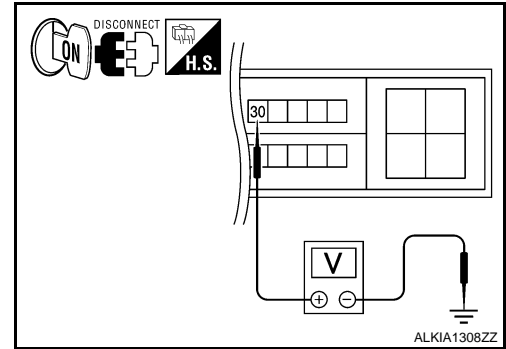

IPDM E/R		Ground	Condition	Voltage (V)
Connector	Terminal			
E18	30	Ground	P or N	0
			Other than above	Battery voltage

Is the inspection result normal?

- YES >> Replace IPDM E/R. Refer to [PCS-43. "Removal and Installation"](#).
 NO >> GO TO 4 (VQ35DE).
 NO >> GO TO 10 (QR25DE).

4.CHECK PNP SWITCH CIRCUIT

1. Turn ignition switch OFF.
2. Disconnect TCM harness connector.
3. Check continuity between IPDM E/R harness connector and TCM harness connector.

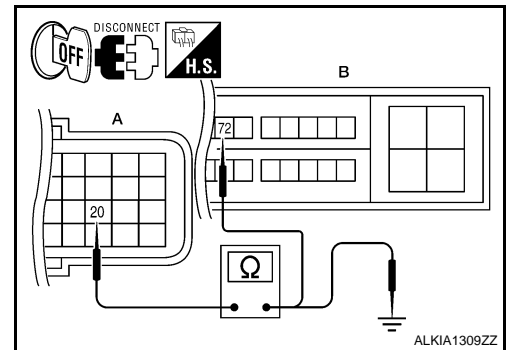

TCM		IPDM E/R		Continuity
Connector	Terminal	Connector	Terminal	
A: F16	20	B: E18	72	Yes

4. Check continuity between TCM harness connector and ground.

TCM		Ground	Continuity
Connector	Terminal		
A: F16	20	Ground	No

Is the inspection result normal?

- YES >> GO TO 8.
 NO >> Repair harness or connector.

5.CHECK CLUTCH INTERLOCK SWITCH INPUT SIGNAL (BCM)

1. Turn ignition switch OFF.
2. Disconnect BCM harness connector.

B210F PNP/CLUTCH INTERLOCK SWITCH

[COUPE]

< COMPONENT DIAGNOSIS >

3. Check voltage between BCM harness connector and ground.

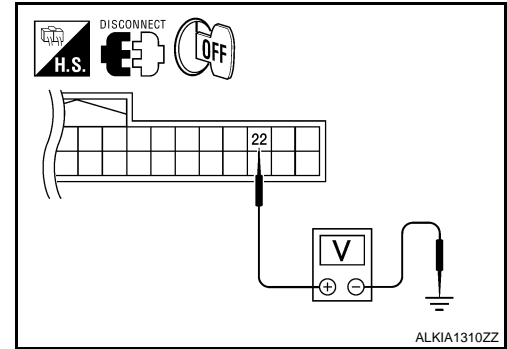

BCM		Ground	Condition	Voltage (V)	
Connector	Terminal				
M18	22	Ground	Clutch pedal	Not depressed	0
			Depressed	Battery voltage	

Is the inspection result normal?

- YES >> GO TO 6.
- NO >> GO TO 11.

6. CHECK CLUTCH INTERLOCK SWITCH INPUT SIGNAL

1. Turn ignition switch OFF.
2. Disconnect IPDM E/R harness connector.
3. Turn ignition switch ON.
4. Check voltage between IPDM E/R harness connector and ground.

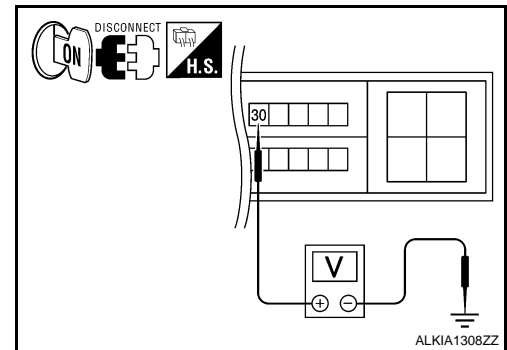

IPDM E/R		Ground	Condition	Voltage (V)	
Connector	Terminal				
E18	30	Ground	Clutch pedal	Not depressed	0
			Depressed	Battery voltage	

Is the inspection result normal?

- YES >> Replace the IPDM E/R. Refer to [PCS-43. "Removal and Installation"](#).
- NO >> GO TO 7.

7. CHECK CLUTCH INTERLOCK SWITCH POWER SUPPLY

1. Disconnect clutch interlock switch harness connector.

B210F PNP/CLUTCH INTERLOCK SWITCH

[COUPE]

< COMPONENT DIAGNOSIS >

- Check voltage between clutch interlock switch harness connector and ground.

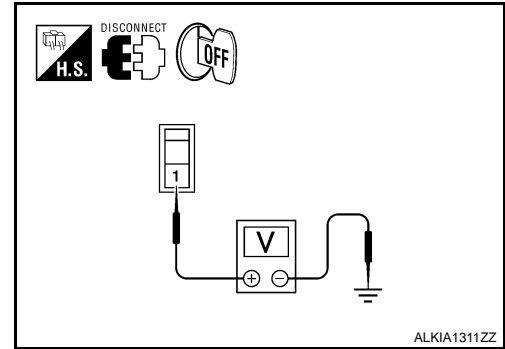

Clutch interlock switch		Ground	Voltage (V)
Connector	Terminal		
E36	1	Ground	Battery voltage

Is the inspection result normal?

YES >> GO TO 8.

NO >> Check harness for open or short between clutch interlock switch and fuse.

8.CHECK CLUTCH INTERLOCK SWITCH CIRCUIT

- Check continuity between IPDM E/R harness connector and clutch interlock switch harness connector.

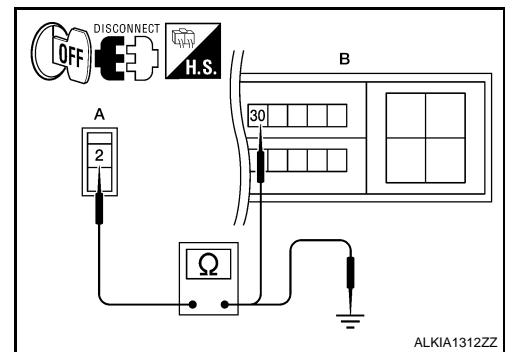

Clutch interlock switch		IPDM E/R		Continuity
Connector	Terminal	Connector	Terminal	
A: E36	2	B: E18	30	Yes

- Check continuity between clutch interlock switch harness connector and ground.

Clutch interlock switch		Ground	Continuity
Connector	Terminal		
A: E36	2	Ground	No

Is the inspection result normal?

YES >> GO TO 9.

NO >> Repair harness or connector.

9.CHECK CLUTCH INTERLOCK SWITCH

Refer to [SEC-114, "Component Inspection"](#).

Is the inspection result normal?

YES >> Replace the IPDM E/R. Refer to [PCS-43, "Removal and Installation"](#).

NO >> Replace clutch interlock switch.

10.CHECK PNP SWITCH CIRCUIT FOR CONTINUITY

- Turn ignition switch OFF.

B210F PNP/CLUTCH INTERLOCK SWITCH

[COUPE]

< COMPONENT DIAGNOSIS >

- Check continuity between IPDM E/R harness connector terminals 72 and 74.

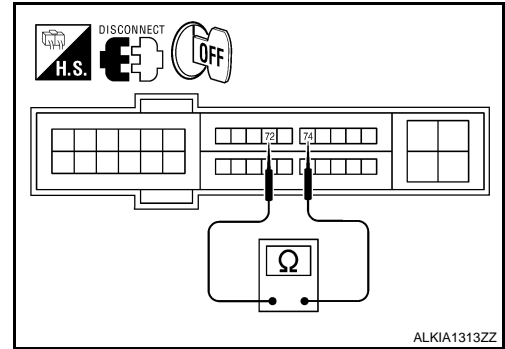

A
B
C
D
E
F
G
H
I
J
L
M
N
O
P

IPDM E/R		Condition	Continuity
Connector	Terminals		
F10	72, 74	PNP switch position	Yes
		Other	No

Is the inspection result normal?

- YES >> GO TO 11.
NO >> GO TO 12.

11.CHECK PNP SWITCH CIRCUIT FOR SHORT

Check continuity between IPDM E/R harness connector terminals 72, 74 and ground.

IPDM E/R		Ground	Continuity
Connector	Terminal		
F10	72	Ground	No
	74		

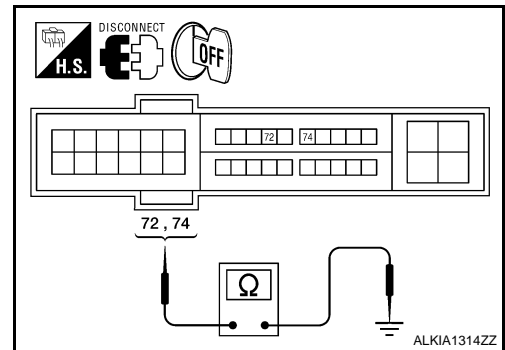

Is the inspection result normal?

- YES >> Replace the IPDM E/R. Refer to [PCS-43, "Removal and Installation"](#).
NO >> Repair or replace harness.

12.CHECK PNP SWITCH INPUT SIGNAL CIRCUIT

- Disconnect PNP switch harness connector.
- Check continuity between PNP switch and IPDM E/R harness connectors.

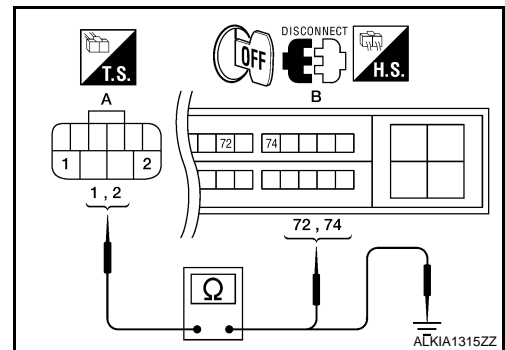

Park/neutral position switch		IPDM E/R		Continuity
Connector	Terminal	Connector	Terminal	
A: F25	1	B: F10	74	Yes
	2		72	

- Check continuity between PNP switch harness connector and ground.

SEC

B210F PNP/CLUTCH INTERLOCK SWITCH

< COMPONENT DIAGNOSIS >

[COUPE]

Park/neutral position switch		Ground	Continuity
Connector	Terminal		
A: F25	1	Ground	No
	2		

Is the inspection result normal?

YES >> Replace PNP switch.

NO >> Repair harness or connector.

13.CHECK INTERMITTENT INCIDENT

Refer to [GI-42. "Intermittent Incident"](#).

>> INSPECTION END

Component Inspection

INFOID:000000001344584

1.CHECK CLUTCH INTERLOCK SWITCH

1. Turn ignition switch OFF.
2. Disconnect clutch interlock switch harness connector.
3. Check continuity between clutch interlock switch under the following conditions.

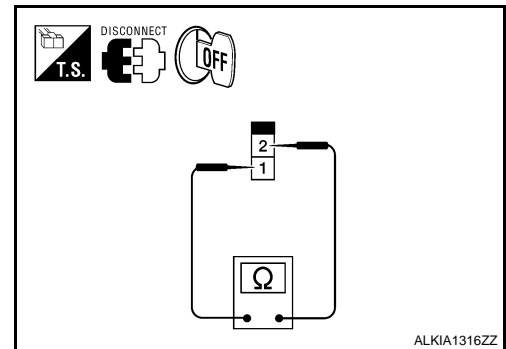

Clutch interlock switch		Condition	Continuity
Terminal			
1	2	Clutch pedal Not depressed	No
		Clutch pedal Depressed	Yes

Is the inspection result normal?

YES >> INSPECTION END

NO >> Replace clutch interlock switch.

B2110 PNP/CLUTCH INTERLOCK SWITCH

< COMPONENT DIAGNOSIS >

[COUPE]

B2110 PNP/CLUTCH INTERLOCK SWITCH

Description

INFOID:000000001344585

IPDM E/R confirms the shift position with the following signals.

- Park/neutral position (PNP) switch (A/T models)
- Clutch inter lock switch (M/T models)
- Shift position signal from BCM (CAN)

DTC Logic

INFOID:000000001344586

DTC DETECTION LOGIC

NOTE:

- If DTC B2110 is displayed with DTC U1000, first perform the trouble diagnosis for DTC U1000. Refer to [SEC-32, "DTC Logic"](#).
- If DTC B2110 is displayed with DTC U1010, first perform the trouble diagnosis for DTC U1010. Refer to [SEC-33, "DTC Logic"](#).

DTC No.	Trouble diagnosis name	DTC detecting condition	Possible cause
B2110	INTER LOCK/PNP SW	IPDM E/R detects mismatch between the signals below for 1 second or more. <ul style="list-style-type: none">• Clutch interlock input signal (M/T models)• Shift NP switch input signal (A/T models)	<ul style="list-style-type: none">• Harness or connectors [Park/neutral position (PNP) switch circuit is open or shorted (A/T models)] or (Clutch interlock switch circuit is open or shorted.)• Clutch inter lock switch (MT models)• Park/neutral position (PNP) switch (AT models)

DTC CONFIRMATION PROCEDURE

1. PERFORM DTC CONFIRMATION PROCEDURE

1. Turn the ignition switch ON under the following conditions and wait for at least 1 second.
 - A/T selector lever is in the P or N position
 - Do not depress the brake pedal
2. Check "Self diagnostic result" with CONSULT-III.

Is DTC detected?

- YES >> Go to [SEC-115, "Diagnosis Procedure"](#).
NO >> INSPECTION END

Diagnosis Procedure

INFOID:000000001836930

1. INSPECTION START

Check which type of transmission the vehicle is equipped with.

Which type of transmission

- CVT >> GO TO 2.
M/T >> GO TO 5.

2. CHECK DTC WITH BCM

Refer to [BCS-85, "DTC Index"](#).

Is the inspection result normal?

- YES >> GO TO 3.
NO >> Repair or replace malfunctioning parts.

3. CHECK PNP SWITCH INPUT SIGNAL

1. Turn ignition switch OFF.
2. Disconnect IPDM E/R harness connector.
3. Turn ignition switch ON.

B2110 PNP/CLUTCH INTERLOCK SWITCH

[COUPE]

< COMPONENT DIAGNOSIS >

- Check voltage between IPDM E/R harness connector and ground under following condition.

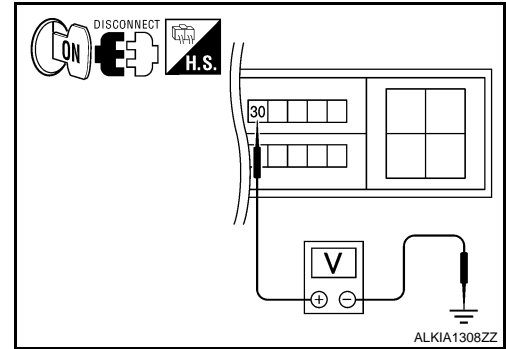

IPDM E/R		Ground	Condition	Voltage (V)
Connector	Terminal			
E18	30	Ground	P or N	0
			Other than above	Battery voltage

Is the inspection result normal?

- YES >> Replace IPDM E/R. Refer to [PCS-43. "Removal and Installation"](#).
 NO >> GO TO 4 (VQ35DE).
 NO >> GO TO 10 (QR25DE).

4. CHECK PNP SWITCH CIRCUIT

- Turn ignition switch OFF.
- Disconnect TCM harness connector.
- Check continuity between IPDM E/R harness connector and TCM harness connector.

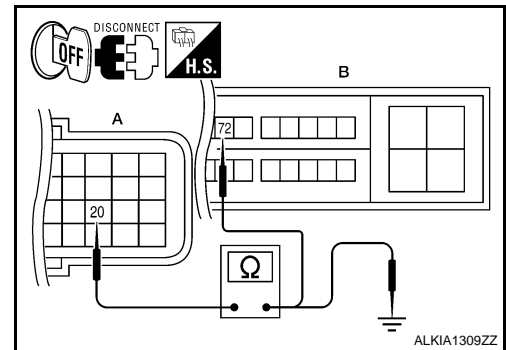

TCM		IPDM E/R		Continuity
Connector	Terminal	Connector	Terminal	
A: F16	20	B: E18	72	Yes

- Check continuity between TCM harness connector and ground.

TCM		Ground	Continuity
Connector	Terminal		
A: F16	20	Ground	No

Is the inspection result normal?

- YES >> GO TO 8.
 NO >> Repair harness or connector.

5. CHECK CLUTCH INTERLOCK SWITCH INPUT SIGNAL (BCM)

- Turn ignition switch OFF.
- Disconnect BCM harness connector.

B2110 PNP/CLUTCH INTERLOCK SWITCH

[COUPE]

< COMPONENT DIAGNOSIS >

3. Check voltage between BCM harness connector and ground.

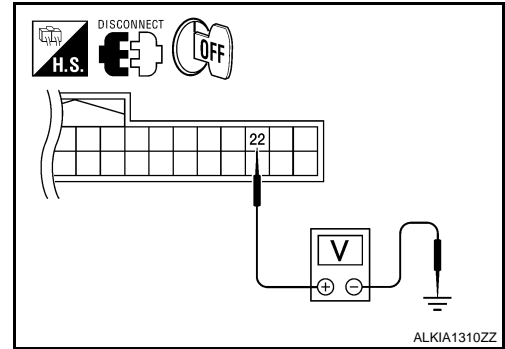

BCM		Ground	Condition	Voltage (V)
Connector	Terminal			
M18	22	Ground	Clutch pedal Not depressed	0
			Clutch pedal Depressed	Battery voltage

Is the inspection result normal?

- YES >> GO TO 6.
- NO >> GO TO 11.

6. CHECK CLUTCH INTERLOCK SWITCH INPUT SIGNAL

1. Turn ignition switch OFF.
2. Disconnect IPDM E/R harness connector.
3. Turn ignition switch ON.
4. Check voltage between IPDM E/R harness connector and ground.

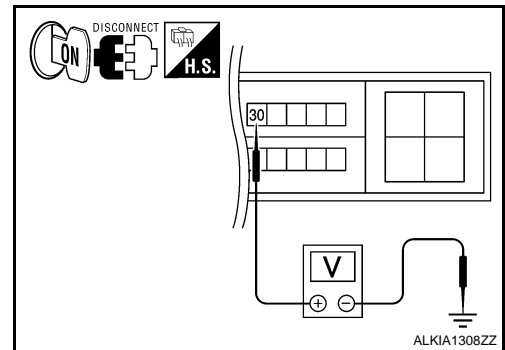

IPDM E/R		Ground	Condition	Voltage (V)
Connector	Terminal			
E18	30	Ground	Clutch pedal Not depressed	0
			Clutch pedal Depressed	Battery voltage

Is the inspection result normal?

- YES >> Replace the IPDM E/R. Refer to [PCS-43. "Removal and Installation"](#).
- NO >> GO TO 7.

7. CHECK CLUTCH INTERLOCK SWITCH POWER SUPPLY

1. Disconnect clutch interlock switch harness connector.

B2110 PNP/CLUTCH INTERLOCK SWITCH

[COUPE]

< COMPONENT DIAGNOSIS >

- Check voltage between clutch interlock switch harness connector and ground.

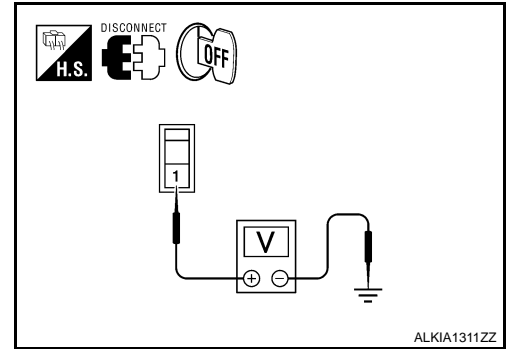

Clutch interlock switch		Ground	Voltage (V)
Connector	Terminal		
E36	1	Ground	Battery voltage

Is the inspection result normal?

YES >> GO TO 8.

NO >> Check harness for open or short between clutch interlock switch and fuse.

8. CHECK CLUTCH INTERLOCK SWITCH CIRCUIT

- Check continuity between IPDM E/R harness connector and clutch interlock switch harness connector.

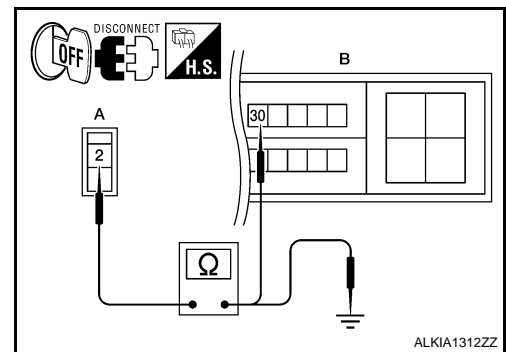

Clutch interlock switch		IPDM E/R		Continuity
Connector	Terminal	Connector	Terminal	
A: E36	2	B: E18	30	Yes

- Check continuity between clutch interlock switch harness connector and ground.

Clutch interlock switch		Ground	Continuity
Connector	Terminal		
A: E36	2	Ground	No

Is the inspection result normal?

YES >> GO TO 9.

NO >> Repair harness or connector.

9. CHECK CLUTCH INTERLOCK SWITCH

Refer to [SEC-120, "Component Inspection"](#).

Is the inspection result normal?

YES >> Replace the IPDM E/R. Refer to [PCS-43, "Removal and Installation"](#).

NO >> Replace clutch interlock switch.

10. CHECK PNP SWITCH CIRCUIT FOR CONTINUITY

- Turn ignition switch OFF.

B2110 PNP/CLUTCH INTERLOCK SWITCH

[COUPE]

< COMPONENT DIAGNOSIS >

- Check continuity between IPDM E/R harness connector terminals 72 and 74.

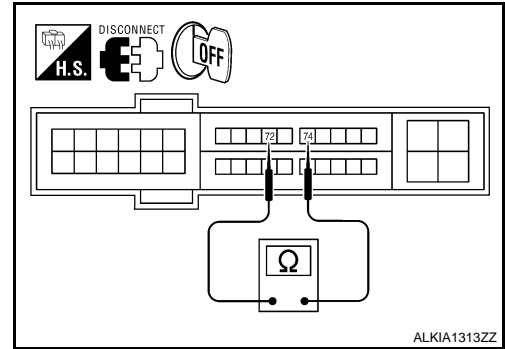

A
B
C
D
E
F
G
H
I
J
L
M
N
O
P

IPDM E/R		Condition	Continuity
Connector	Terminals		
F10	72, 74	PNP switch position	Yes
		Other	No

Is the inspection result normal?

- YES >> GO TO 11.
NO >> GO TO 12.

11.CHECK PNP SWITCH CIRCUIT FOR SHORT

Check continuity between IPDM E/R harness connector terminals 72, 74 and ground.

IPDM E/R		Ground	Continuity
Connector	Terminal		
F10	72	Ground	No
	74		

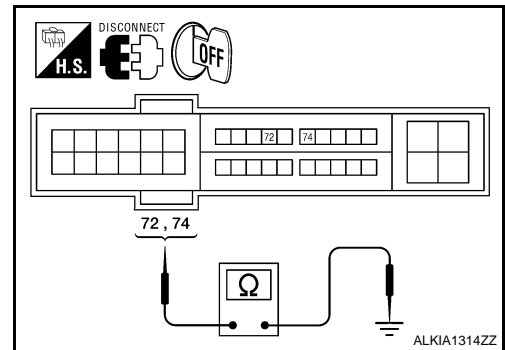

Is the inspection result normal?

- YES >> Replace the IPDM E/R. Refer to [PCS-43, "Removal and Installation"](#).
NO >> Repair or replace harness.

12.CHECK PNP SWITCH INPUT SIGNAL CIRCUIT

- Disconnect PNP switch harness connector.
- Check continuity between PNP switch and IPDM E/R harness connectors.

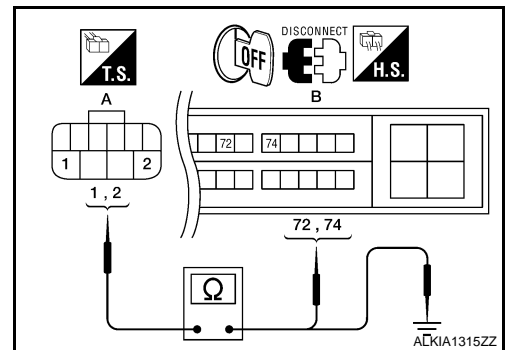

Park/neutral position switch		IPDM E/R		Continuity
Connector	Terminal	Connector	Terminal	
A: F25	1	B: F10	74	Yes
	2		72	

- Check continuity between PNP switch harness connector and ground.

SEC

B2110 PNP/CLUTCH INTERLOCK SWITCH

< COMPONENT DIAGNOSIS >

[COUPE]

Park/neutral position switch		Ground	Continuity
Connector	Terminal		
A: F25	1	Ground	No
	2		

Is the inspection result normal?

YES >> Replace PNP switch.

NO >> Repair harness or connector.

13.CHECK INTERMITTENT INCIDENT

Refer to [GI-42. "Intermittent Incident"](#).

>> INSPECTION END

Component Inspection

INFOID:000000001836931

1.CHECK CLUTCH INTERLOCK SWITCH

1. Turn ignition switch OFF.
2. Disconnect clutch interlock switch harness connector.
3. Check continuity between clutch interlock switch under the following conditions.

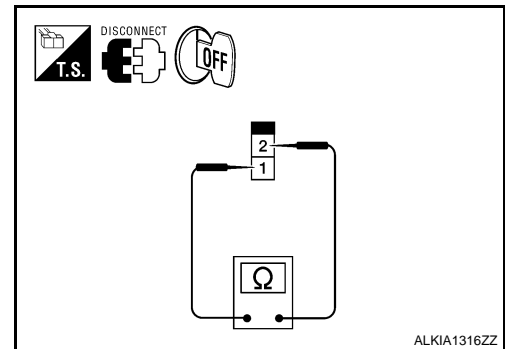

Clutch interlock switch		Condition	Continuity
Terminal			
1	2	Clutch pedal Not depressed	No
		Clutch pedal Depressed	Yes

Is the inspection result normal?

YES >> INSPECTION END

NO >> Replace clutch interlock switch.

POWER SUPPLY AND GROUND CIRCUIT

< COMPONENT DIAGNOSIS >

[COUPE]

POWER SUPPLY AND GROUND CIRCUIT

BCM

BCM : Diagnosis Procedure

INFOID:000000001344589

Refer to [BCS-36, "Diagnosis Procedure"](#).

IPDM E/R (INTELLIGENT POWER DISTRIBUTION MODULE ENGINE ROOM)

IPDM E/R (INTELLIGENT POWER DISTRIBUTION MODULE ENGINE ROOM) : Diagnosis Procedure

INFOID:000000001344591

Refer to [PCS-19, "Diagnosis Procedure"](#).

A

B

C

D

E

F

G

H

I

J

SEC

L

M

N

O

P

KEY SLOT

Diagnosis Procedure

INFOID:000000001836932

1. CHECK KEY SLOT POWER SUPPLY CIRCUIT

1. Turn ignition switch OFF.
2. Disconnect key slot connector.
3. Check voltage between slot connector and ground.

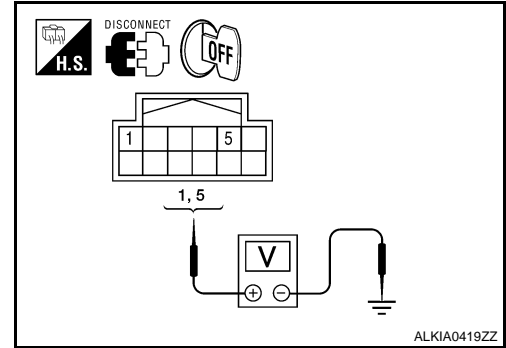

Key slot		Ground	Voltage (V) (Approx.)
Connector	Terminal		
M40	1	Ground	Battery voltage
	5		

Is the inspection result normal?

- YES >> GO TO 2.
 NO >> Repair or replace key slot power supply circuit.

2. CHECK KEY SLOT GROUND CIRCUIT

Check continuity between key slot connector and ground.

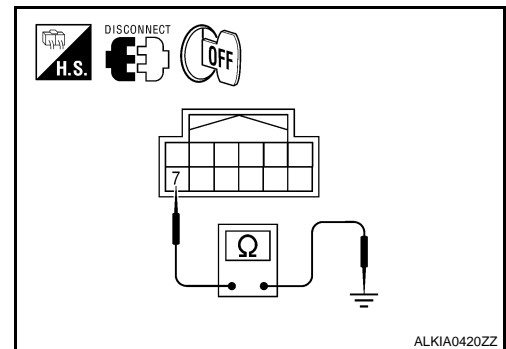

Key slot		Ground	Continuity
Connector	Terminal		
M40	7	Ground	Yes

Is the inspection result normal?

- YES >> GO TO 3.
 NO >> Repair or replace key slot ground circuit.

3. CHECK INTERMITTENT INCIDENT

Refer to [GI-42. "Intermittent Incident"](#).

>> INSPECTION END

KEY SLOT ILLUMINATION

< COMPONENT DIAGNOSIS >

[COUPE]

KEY SLOT ILLUMINATION

Description

INFOID:000000001344593

Blinks when Intelligent Key insertion is required.

Component Function Check

INFOID:000000001344594

1.CHECK FUNCTION

With CONSULT-III

Check key slot illumination ("KEY SLOT ILLUMI") Active Test mode.

Is the inspection result normal?

YES >> Key slot function is OK.

NO >> Refer to [SEC-123. "Diagnosis Procedure"](#).

Diagnosis Procedure

INFOID:000000001836933

1.CHECK KEY SLOT ILLUMINATION OUTPUT SIGNAL

Check voltage between key slot connector and ground.

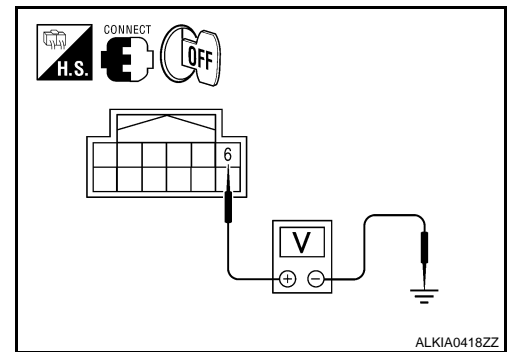

Terminals		(-)	Condition	Key slot illumination	Voltage (V) (Approx.)
(+) Key slot connector					
Terminal					
M40	6	Ground	Intelligent Key inserted	OFF	Battery voltage
			Intelligent Key removed	ON	0

Is the inspection result normal?

YES >> GO TO 6.

NO >> GO TO 2.

2.CHECK KEY SLOT POWER SUPPLY CIRCUIT

1. Turn ignition switch OFF.
2. Disconnect key slot connector.
3. Check voltage between slot connector and ground.

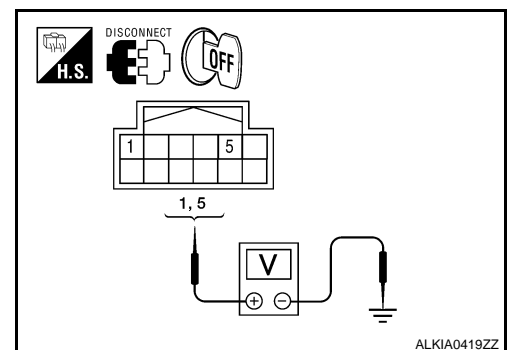

KEY SLOT ILLUMINATION

< COMPONENT DIAGNOSIS >

[COUPE]

Terminals		Voltage (V) (Approx.)
(+)	(-)	
Key slot connector	Terminal	
M40	1	Ground
	5	
		Battery voltage

Is the inspection result normal?

YES >> GO TO 3.

NO >> Repair or replace key slot power supply circuit.

3. CHECK KEY SLOT GROUND CIRCUIT

Check continuity between key slot connector and ground.

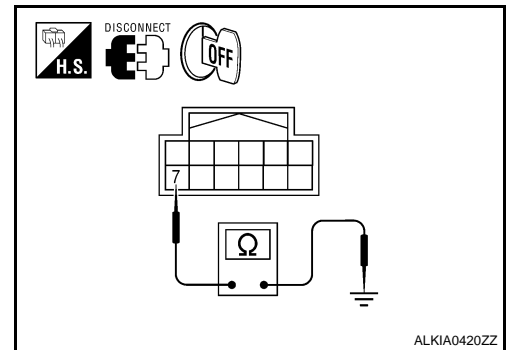

Key slot connector	Terminal	Ground	Continuity
M40	7		

Is the inspection result normal?

YES >> GO TO 4.

NO >> Repair or replace key slot ground circuit.

4. CHECK KEY SLOT CIRCUIT

1. Turn ignition switch OFF.
2. Disconnect BCM and key slot connector.
3. Check continuity between BCM connector and key slot connector.

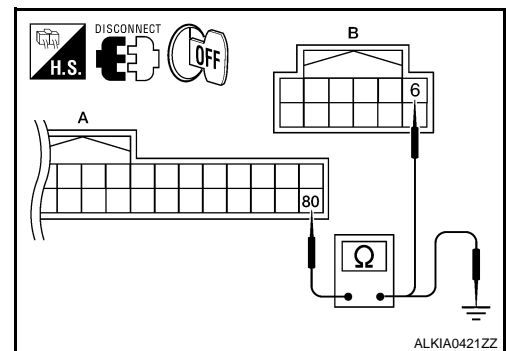

BCM connector	Terminal	Key slot connector	Terminal	Continuity
A: M19	80	B: M40	6	Yes

4. Check continuity between BCM connector and ground.

BCM connector	Terminal	Ground	Continuity
A: M19	80		

Is the inspection result normal?

KEY SLOT ILLUMINATION

[COUPE]

< COMPONENT DIAGNOSIS >

- YES >> GO TO 5.
- NO >> Repair or replace harness between BCM and key slot.

5.CHECK KEY SLOT

Refer to [DLK-73. "Component Inspection"](#).

Is the inspection result normal?

- YES >> GO TO 6.
- NO >> Replace key slot. Refer to [SEC-181. "Removal and Installation"](#).

6.CHECK INTERMITTENT INCIDENT

Refer to [GI-42. "Intermittent Incident"](#).

>> INSPECTION END.

A
B
C
D
E
F
G
H
I
J
L
M
N
O
P

SEC

KEY CYLINDER SWITCH

< COMPONENT DIAGNOSIS >

[COUPE]

KEY CYLINDER SWITCH

Description

INFOID:000000001836934

For vehicles equipped with LH and RH anti-pinch system, the main power window and door lock/unlock switch detects condition of the door key cylinder switch and transmits to BCM as the LOCK or UNLOCK signal.

For vehicles equipped with LH anti-pinch system only, the door lock assembly LH (key cylinder switch) transmits the LOCK or UNLOCK signal directly to the BCM.

Component Function Check

INFOID:000000001836935

1. CHECK DOOR KEY CYLINDER SWITCH INPUT SIGNAL

Check KEY CYL UN-SW, KEY CYL UN-SW in "DATA MONITOR" mode for "POWER DOOR LOCK SYSTEM" with CONSULT-III. Refer to [DLK-36. "DOOR LOCK : CONSULT-III Function \(BCM - DOOR LOCK\)"](#).

Monitor item	Condition
KEY CYL LK-SW	Lock : ON
	Neutral / Unlock : OFF
KEY CYL UN-SW	Unlock : ON
	Neutral / Lock : OFF

Is the inspection result normal?

YES >> Key cylinder switch is OK.

NO >> With LH and RH anti-pinch, refer to [SEC-126. "Diagnosis Procedure \(With LH and RH Anti-Pinch\)"](#).

NO >> With LH anti-pinch only, refer to [SEC-128. "Diagnosis Procedure \(With LH Anti-Pinch Only\)"](#).

Diagnosis Procedure (With LH and RH Anti-Pinch)

INFOID:000000001836936

1. CHECK DOOR KEY CYLINDER SWITCH INPUT SIGNAL

1. Turn ignition switch ON.
2. Check voltage between main power window and door lock/unlock switch connector and ground.

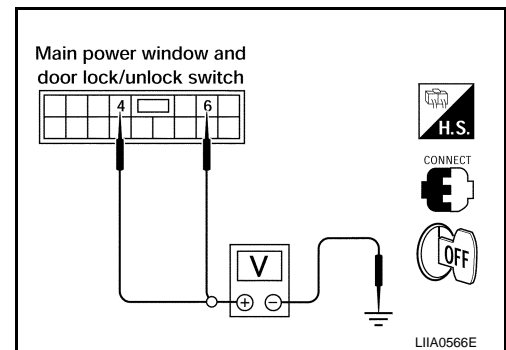

Terminals		Key position	Voltage (V) (Approx.)
(+)	(-)		
Main power window and door lock/unlock switch connector	Terminal		
D7	4	Lock	0
		Neutral / Unlock	Battery voltage
	6	Unlock	0
		Neutral / Lock	Battery voltage

KEY CYLINDER SWITCH

[COUPE]

< COMPONENT DIAGNOSIS >

Is the inspection result normal?

YES >> Replace main power window and door lock/unlock switch. Refer to [PWC-175. "Removal and Installation"](#). After that, Refer to [PWC-120. "POWER WINDOW MAIN SWITCH : Special Repair Requirement"](#).

NO >> GO TO 2

2.CHECK DOOR KEY CYLINDER SIGNAL CIRCUIT

1. Turn ignition switch OFF.
2. Disconnect main power window and door lock/unlock switch connector and door lock assembly LH (key cylinder switch) connector.
3. Check continuity between main power window and door lock/unlock switch connector and door lock assembly LH (key cylinder switch) connector.

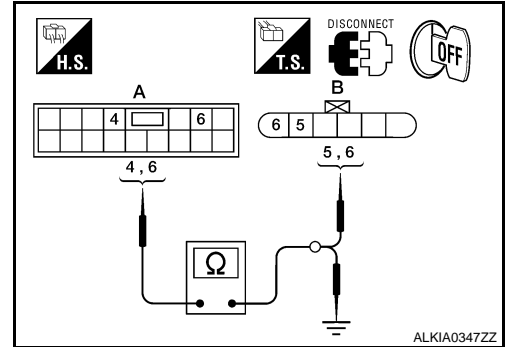

Main power window and door lock/unlock switch connector	Terminal	Door lock assembly LH (key cylinder switch) connector	Terminal	Continuity
A: D7	4	B: D10	6	Yes
	6		5	

4. Check continuity between main power window and door lock/unlock switch connector and ground.

Power window main switch connector	Terminal	Ground	Continuity
A: D7	4	Ground	No
	6		

Is the inspection result normal?

YES >> GO TO 3

NO >> Repair or replace harness.

3.CHECK DOOR KEY CYLINDER SWITCH GROUND CIRCUIT

Check continuity between door lock assembly LH connector and ground.

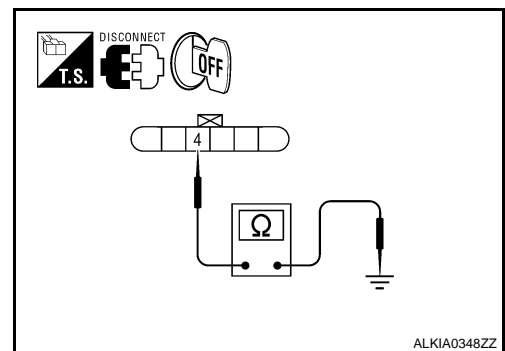

Door lock assembly LH connector	Terminal	Ground	Continuity
D10	4	Ground	Yes

Is the inspection result normal?

YES >> GO TO 4

NO >> Repair or replace harness.

KEY CYLINDER SWITCH

< COMPONENT DIAGNOSIS >

[COUPE]

4. CHECK DOOR KEY CYLINDER SWITCH

Check door key cylinder switch.

Refer to [SEC-129, "Component Inspection"](#).

Is the inspection result normal?

YES >> Check intermittent incident. Refer to [GI-42, "Intermittent Incident"](#).

NO >> Replace door lock assembly LH (key cylinder switch). Refer to [DLK-198, "FRONT DOOR LOCK : Removal and Installation"](#). After that, Refer to [DLK-11, "ADDITIONAL SERVICE WHEN REPLACING CONTROL UNIT : Special Repair Requirement"](#).

Diagnosis Procedure (With LH Anti-Pinch Only)

INFOID:000000001836937

1. CHECK DOOR KEY CYLINDER SWITCH INPUT SIGNAL

1. Turn ignition switch ON.
2. Check voltage between BCM connector and ground.

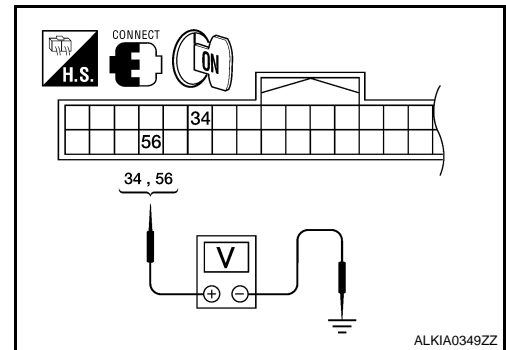

Terminals		Key position	Voltage (V) (Approx.)
(+)	(-)		
BCM connector	Terminal		
M18	56	Lock	0
		Neutral / Unlock	Battery voltage
	34	Unlock	0
		Neutral / Lock	Battery voltage

Is the inspection result normal?

YES >> Replace main power window and door lock/unlock switch. Refer to [PWC-51, "Removal and Installation"](#). After that, Refer to [PWC-19, "POWER WINDOW MAIN SWITCH : Special Repair Requirement"](#).

NO >> GO TO 2

2. CHECK DOOR KEY CYLINDER SWITCH GROUND CIRCUIT

1. Turn ignition switch OFF.
2. Disconnect door lock assembly LH (key cylinder switch) connector.
3. Check continuity between door lock assembly LH (key cylinder switch) connector and ground.

Door lock assembly LH connector	Terminal	Ground	Continuity
D10	4		Yes

Is the inspection result normal?

YES >> GO TO 3

NO >> Repair or replace harness.

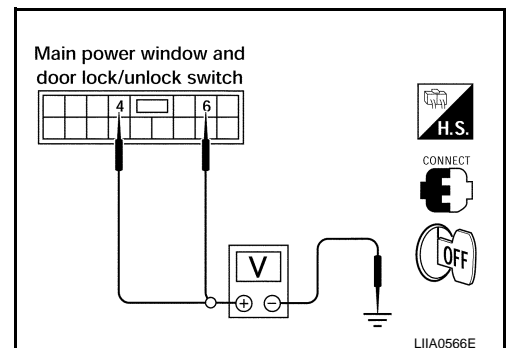

3. CHECK DOOR KEY CYLINDER SIGNAL CIRCUIT

KEY CYLINDER SWITCH

[COUPE]

< COMPONENT DIAGNOSIS >

1. Disconnect BCM connector M18.
2. Check continuity between door lock assembly LH (key cylinder switch) connector D(10) terminals 5, 6 and BCM connector M18 (B) terminals 34, 56.

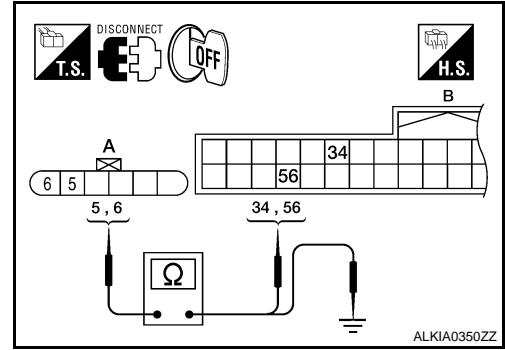

Door lock assembly LH connector	Terminal	BCM connector	Terminal	Continuity
A: D10	5	B: M18	34	Yes
	6		56	

3. Check continuity between door lock assembly LH (key cylinder switch) connector D10 (A) terminals 5, 6 and ground.

Door lock assembly LH connector	Terminal	Ground	Continuity
A: D10	5	Ground	No
	6		

Is the inspection result normal?

- YES >> GO TO 4
 NO >> Repair or replace harness.

4.CHECK DOOR KEY CYLINDER SWITCH

Check door key cylinder switch.

Refer to [SEC-129, "Component Inspection"](#).

Is the inspection result normal?

- YES >> Check intermittent incident. Refer to [GI-42, "Intermittent Incident"](#).
 NO >> Replace door lock assembly LH (key cylinder switch). Refer to [DLK-198, "FRONT DOOR LOCK: Removal and Installation"](#). After that, Refer to [PWC-137, "Special Repair Requirement"](#).

Component Inspection

INFOID:000000001836938

COMPONENT INSPECTION

1.CHECK DOOR KEY CYLINDER SWITCH

Check door lock assembly LH (key cylinder switch).

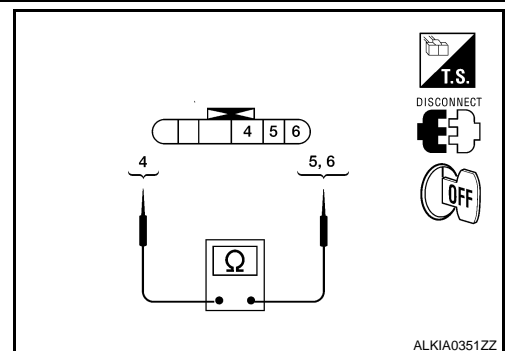

KEY CYLINDER SWITCH

< COMPONENT DIAGNOSIS >

[COUPE]

Terminal		Key position	Continuity
Door lock assembly LH (key cylinder switch)			
5	4	Unlock	Yes
		Neutral / Lock	No
6		Lock	Yes
		Neutral / Unlock	No

Is the inspection result normal?

YES >> Key cylinder switch is OK.

NO >> Replace door lock assembly LH (key cylinder switch). Refer to [DLK-198, "FRONT DOOR LOCK : Removal and Installation"](#). After that, refer to [DLK-11, "ADDITIONAL SERVICE WHEN REPLACING CONTROL UNIT : Special Repair Requirement"](#).

HORN

[COUPE]

< COMPONENT DIAGNOSIS >

HORN

Description

INFOID:000000001836940

Horn (high/low) is located inside of front bumper and operates when theft warning system is in alarm phase.

Component Function Check

INFOID:000000001836941

1.CHECK FUNCTION

1. Select HORN in "ACTIVE TEST" mode with CONSULT-III.
2. Check the horn (high/low) operation.

Test item		Description	
HORN	ON	Horn relay	ON (for 20 ms)

Is the operation normal?

- YES >> INSPECTION END.
 NO >> Refer to [SEC-131, "Diagnosis Procedure"](#).

Diagnosis Procedure

INFOID:000000001836942

1.CHECK HORN FUNCTION

Check horn function with horn switch

Do the horns sound?

- YES >> GO TO 2.
 NO >> Refer to [HRN-3, "Wiring Diagram - Coupe"](#).

2.CHECK HORN RELAY POWER SUPPLY

1. Turn ignition switch ON.
2. Perform "ACTIVE TEST" ("HORN") with CONSULT-III.
3. Using an analog voltmeter or an oscilloscope, check voltage between IPDM E/R connector E17 terminal 44 and ground.

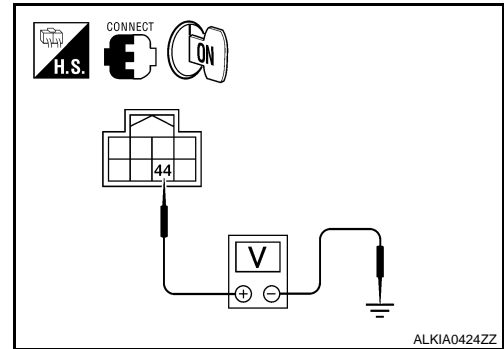

ALKIA0424ZZ

IPDM E/R		Ground	Test item	Voltage (V) (Approx.)
Connector	Terminal			
E17	44	Ground	HORN	Battery voltage → 0 → Battery voltage
			Other than above	Battery voltage

Is the inspection result normal?

- YES >> GO TO 4.
 NO >> GO TO 3.

3.CHECK HORN RELAY CIRCUIT

1. Turn ignition switch OFF.
2. Disconnect IPDM E/R and horn relay connector.

HORN

[COUPE]

< COMPONENT DIAGNOSIS >

3. Check continuity between IPDM E/R harness connector and horn relay harness connector.

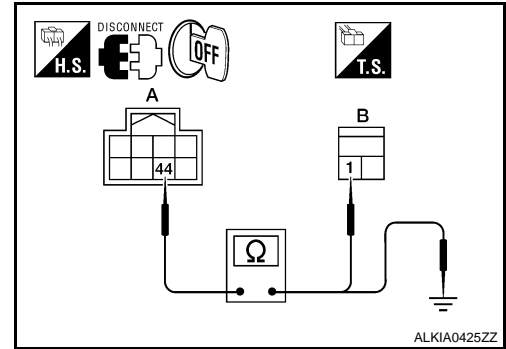

IPDM E/R		Horn relay		Continuity
Connector	Terminal	Connector	Terminal	
A: E17	44	B: H-1	1	Yes

4. Check continuity between IPDM E/R harness connector and ground.

IPDM E/R		Ground	Continuity
Connector	Terminal		
A: E17	44	Ground	No

Is the inspection result normal?

- YES >> GO TO 4.
- NO >> Repair or replace harness.

4. CHECK INTERMITTENT INCIDENT

Refer to [GI-42. "Intermittent Incident"](#).

Is the inspection result normal?

- YES >> Replace IPDM E/R. Refer to [PCS-43. "Removal and Installation"](#).
- NO >> Repair or replace the malfunctioning part.

HEADLAMP

[COUPE]

< COMPONENT DIAGNOSIS >

HEADLAMP

Description

INFOID:000000001344603

Headlamp lighting when theft warning system is alarm phase.

Component Function Check

INFOID:000000001344604

1.CHECK HEADLAMP OPERATION

Check if headlamp operate by lighting switch.

Does headlamp come on when turning switch "ON"?

YES >> Headlamp circuit is OK.

NO >> Check headlamp system. Refer to [SEC-133, "Diagnosis Procedure"](#).

Diagnosis Procedure

INFOID:000000001344605

1.CHECK HEADLAMP OPERATION

Refer to [EXL-36, "Diagnosis Procedure"](#).

Is the inspection result normal?

YES >> GO TO 2.

NO >> Repair or replace.

2.CHECK INTER MITTENT INCIDENT

Refer to [GI-42, "Intermittent Incident"](#).

Is the inspection result normal?

>> INSPECTION END.

A
B
C
D
E
F
G
H
I
J
L
M
N
O
P

SEC

WARNING LAMP

< COMPONENT DIAGNOSIS >

[COUPE]

WARNING LAMP

Description

INFOID:000000001344606

- Warning lamp is built in combination meter.
- Intelligent Key system malfunction is reported to the driver by the warning lamp illumination.

Component Function Check

INFOID:000000001344607

1.CHECK FUNCTION

1. Perform "INDICATOR" in the "Active Test" mode with CONSULT-III.
2. Check warning lamp operation.

Test item		Description	
INDICATOR	ON	Warning lamp	ON
	OFF		OFF

Is the inspection result normal?

- YES >> INSPECTION END.
NO >> Go to [SEC-134. "Diagnosis Procedure"](#).

Diagnosis Procedure

INFOID:000000001344608

1.CHECK "COMBINATION METER."

Check combination meter function. Refer to [MWI-4. "Work Flow"](#).

Is the inspection result is normal?

- YES >> GO TO 2.
NO >> Repair or replace the malfunctioning parts.

2.CHECK INTERMITTENT INCIDENT

Refer to [GI-42. "Intermittent Incident"](#).

>> INSPECTION END.

VEHICLE SECURITY INDICATOR

< COMPONENT DIAGNOSIS >

[COUPE]

VEHICLE SECURITY INDICATOR

Description

INFOID:000000001344609

- Vehicle security indicator is built in combination meter.
- NVIS (Infinity Vehicle Immobilizer System-NATS) and vehicle security system conditions are indicated by blink or illumination of vehicle security indicator.

Component Function Check

INFOID:000000001344610

1.CHECK FUNCTION

1. Perform "THEFT IND" in the "ACTIVE TEST" mode with CONSULT-III.
2. Check vehicle security indicator operation.

Test item		Description	
THEFT IND	ON	Vehicle security indicator	ON
	OFF		OFF

Is the inspection result normal?

- YES >> INSPECTION END.
NO >> Go to [SEC-135, "Diagnosis Procedure"](#).

Diagnosis Procedure

INFOID:000000001344611

1.CHECK COMBINATION METER

Check combination meter. Refer to [MWI-4, "Work Flow"](#).

Is the inspection result is normal?

- YES >> GO TO 2.
NO >> Repair or replace the malfunctioning parts.

2.CHECK INTERMITTENT INCIDENT

Refer to [GI-42, "Intermittent Incident"](#).

>> INSPECTION END.

SEC

< ECU DIAGNOSIS >

ECU DIAGNOSIS

BCM (BODY CONTROL MODULE)

Reference Value

INFOID:000000001344612

VALUES ON THE DIAGNOSIS TOOL

Refer to [BCS-41, "Reference Value"](#).

Terminal Layout

INFOID:000000001344613

Refer to [BCS-45, "Terminal Layout"](#).

Physical Values

INFOID:000000001344614

Refer to [BCS-45, "Physical Values"](#).

BCM (BODY CONTROL MODULE)

< ECU DIAGNOSIS >

[COUPE]

Wiring Diagram - INTELLIGENT KEY SYSTEM/ENGINE START FUNCTION -

INFOID:000000001344615

INTELLIGENT KEY SYSTEM/ENGINE START FUNCTION

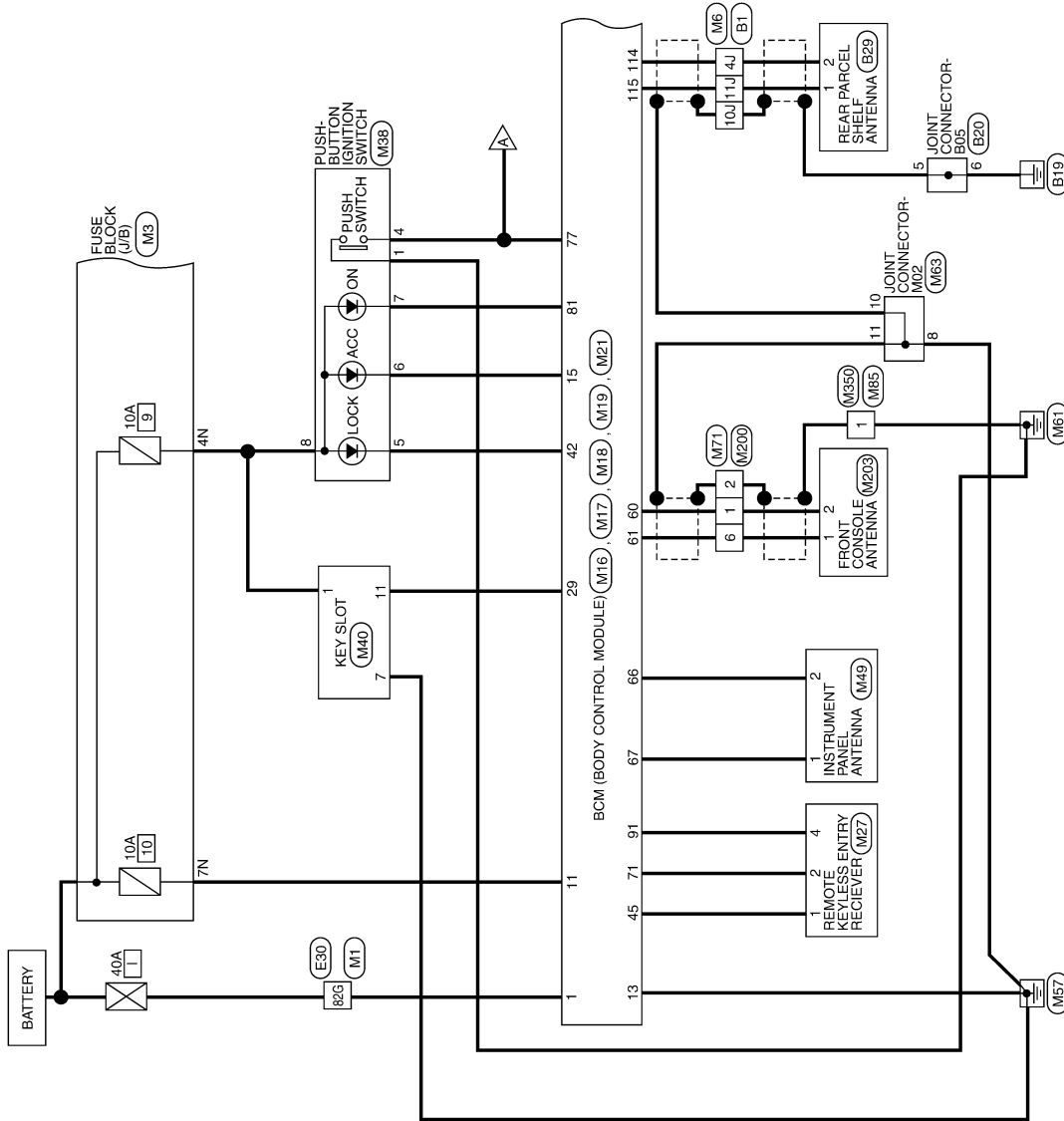

AWKWA0026GI

A
B
C
D
E
F
G
H
I
J
L
M
N
O
P

SEC

BCM (BODY CONTROL MODULE)

< ECU DIAGNOSIS >

[COUPE]

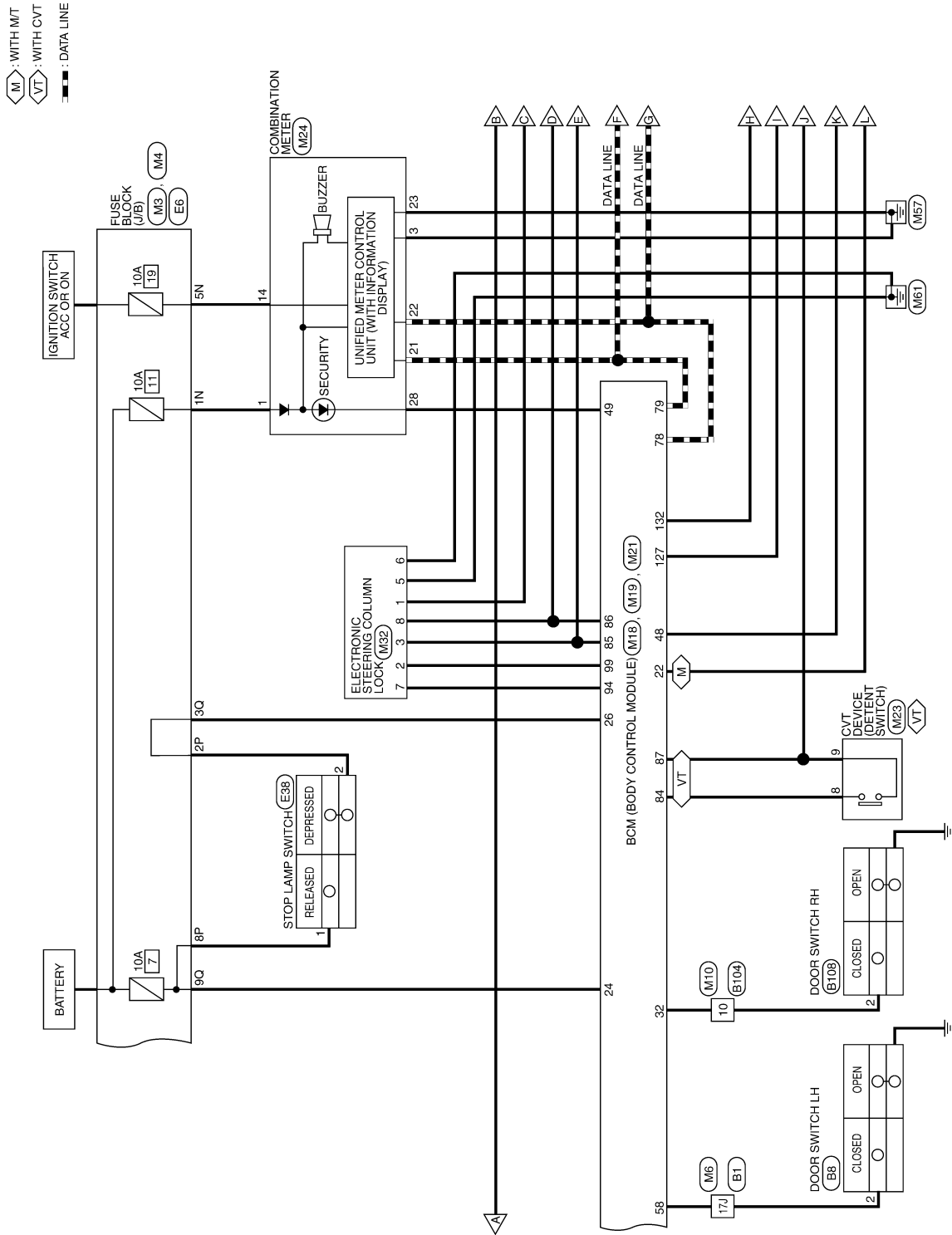

AWKWA0027GI

BCM (BODY CONTROL MODULE)

< ECU DIAGNOSIS >

[COUPE]

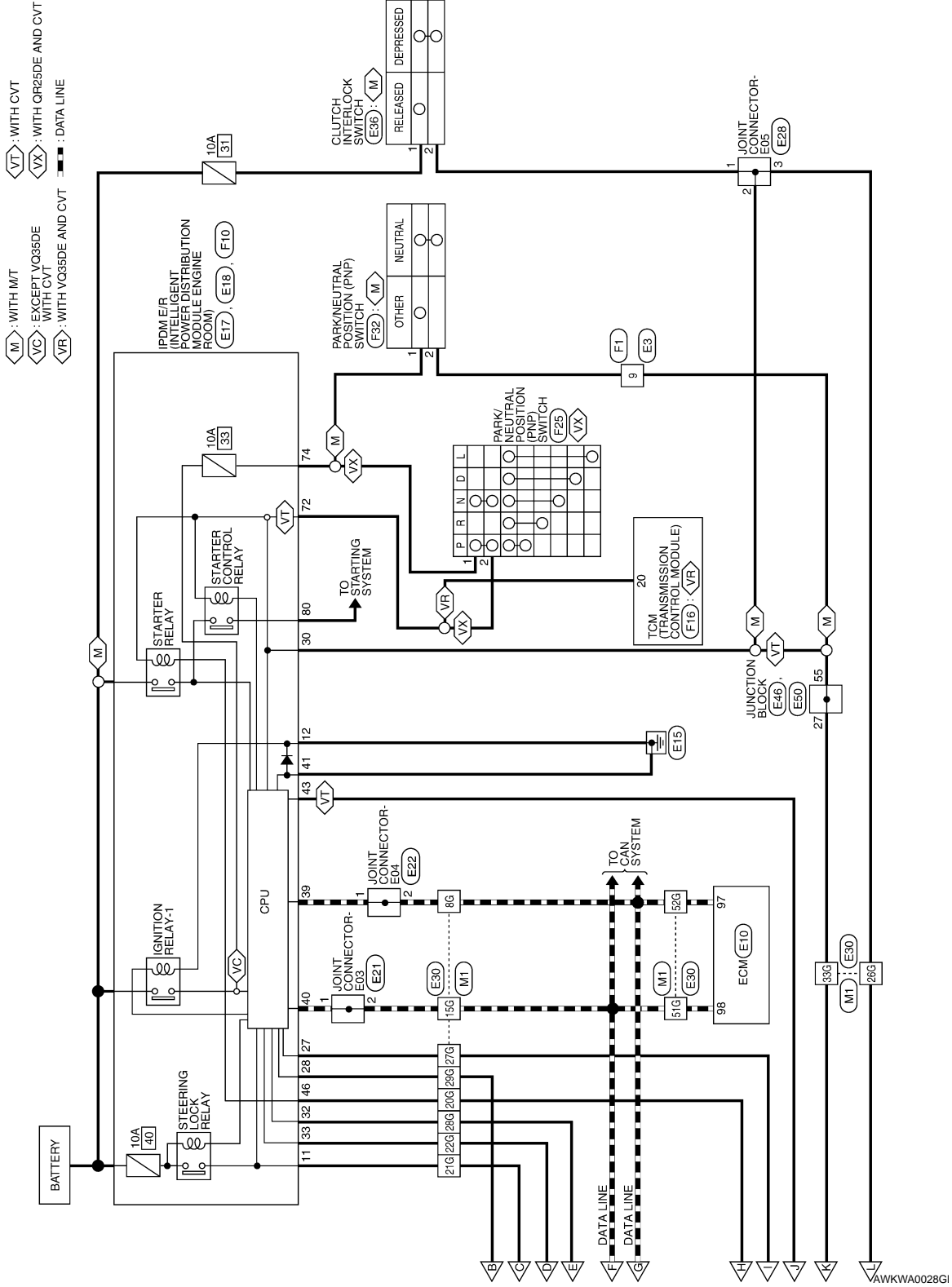

A
B
C
D
E
F
G
H
I
J
K
L
M
N
O
P

SEC

INTELLIGENT KEY SYSTEM/ENGINE START FUNCTION CONNECTORS

Connector No.	M1
Connector Name	WIRE TO WIRE
Connector Color	WHITE

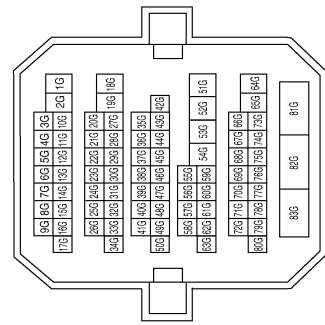

Terminal No.	Color of Wire	Signal Name
8G	P	-
15G	L	-
20G	R	-
21G	P/L	-
22G	G/R	-
26G	R/Y	-
27G	BR/W	-
28G	L/O	-
29G	BR	-
33G	R/G	-
51G	L	-
52G	P	-
82G	W/B	-

Connector No.	M3
Connector Name	FUSE BLOCK (J/B)
Connector Color	WHITE

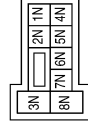

Terminal No.	Color of Wire	Signal Name
1N	W/L	-
4N	G/Y	-
5N	V/Y	-
7N	Y/R	-

Connector No.	M4
Connector Name	FUSE BLOCK (J/B)
Connector Color	WHITE

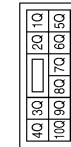

Terminal No.	Color of Wire	Signal Name
3Q	O/L	-
9Q	R/W	-

Connector No.	M6
Connector Name	WIRE TO WIRE
Connector Color	WHITE

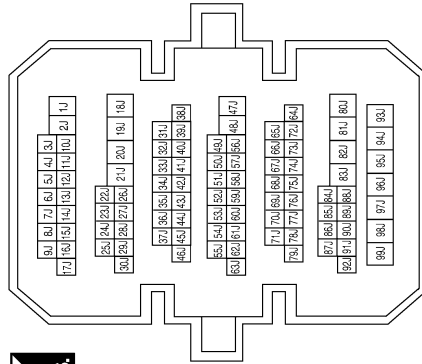

Terminal No.	Color of Wire	Signal Name
4J	B	-
10J	SHIELD	-
11J	W	-
17J	SB	-

BCM (BODY CONTROL MODULE)

< ECU DIAGNOSIS >

[COUPE]

Connector No.	M17
Connector Name	BCM (BODY CONTROL MODULE)
Connector Color	WHITE

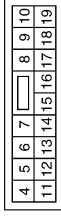

Terminal No.	Color of Wire	Signal Name
11	Y/R	BAT_BCM_FUSE
13	B	GND1
15	Y/L	ACC_LED

Connector No.	M16
Connector Name	BCM (BODY CONTROL MODULE)
Connector Color	BLACK



Terminal No.	Color of Wire	Signal Name
1	W/B	BAT_POWER_F/L

Connector No.	M10
Connector Name	WIRE TO WIRE
Connector Color	BROWN

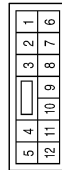

Terminal No.	Color of Wire	Signal Name
10	R/B	-

Terminal No.	Color of Wire	Signal Name
22	R/Y	CLUTCH_SW
24	R/W	STOP_LAMP_LOW_SW
26	O/L	STOP_LAMP_HIGH_SW
29	Y	FOB_IN_SW
32	R/B	AS_DOOR_SW
42	R	S/L_LOCK_LED
45	P	GND_RF2_A/L
48	R/G	SHIFT_N/P
49	L/O	IMMO_LED
58	SB	DR_DOOR_SW

Connector No.	M18
Connector Name	BCM (BODY CONTROL MODULE)
Connector Color	GREEN

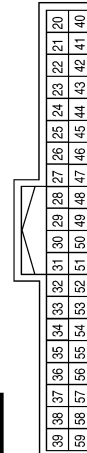

AWKIA0153GB

A
B
C
D
E
F
G
H
I
J
L
M
N
O
P

SEC

BCM (BODY CONTROL MODULE)

< ECU DIAGNOSIS >

[COUPE]

Connector No.	M19
Connector Name	BCM (BODY CONTROL MODULE)
Connector Color	BLACK



79	78	77	76	75	74	73	72	71	70	69	68	67	66	65	64	63	62	61	60
----	----	----	----	----	----	----	----	----	----	----	----	----	----	----	----	----	----	----	----

Terminal No.	Color of Wire	Signal Name
60	B/R	ROOM_ANT_2_B
61	W/R	ROOM_ANT_2_A
66	R	ROOM_ANT_1_B
67	G	ROOM_ANT_1_A



1	3	7	9		
2	4	5	6	8	10

Terminal No.	Color of Wire	Signal Name
8	Y/R	DETENT_KEY_SW
9	G/B	DETENT_KEY_SW

Terminal No.	Color of Wire	Signal Name
71	L/O	RF1_TUNER_SIGNAL
77	BR	ENG_START_SW
78	P	CAN-L
79	L	CAN-H
81	LG	IGN_ON_LED
84	Y/R	AT_DEVICE_OUT
85	L/O	S/L_CONDITION_1
86	G/R	S/L_CONDITION_2
87	G/B	SHIFT_P
91	L/R	RF1_POWER_SUPPLY
94	G/Y	S/L_POWER_SUPPLY_12V
99	L/Y	S/L_K-LINE

Connector No.	M21
Connector Name	BCM (BODY CONTROL MODULE)
Connector Color	GRAY



131	130	128	126	125	124	123	122	121	120	119	118	117	116	115	114	113	112		
151	150	149	148	147	146	145	144	143	142	141	140	139	138	137	136	135	134	133	132

Terminal No.	Color of Wire	Signal Name
114	B	TRUNK_ANT_1_B
115	W	TRUNK_ANT_1_A
127	BR/W	IGN_USM_CONT1
132	R	ST_CONT_USM

Connector No.	M24
Connector Name	COMBINATION METER
Connector Color	WHITE



1	2	3	4	5	6	7	8	9	10	11	12	13	14	15	16	17	18	19	20
21	22	23	24	25	26	27	28	29	30	31	32	33	34	35	36	37	38	39	40

Terminal No.	Color of Wire	Signal Name
1	W/L	BAT
3	B	GND
14	V/Y	ACC
21	L	CAN-H
22	P	CAN-L
23	B	GND
28	L/O	SECURITY

AWKIA0154GB

BCM (BODY CONTROL MODULE)

< ECU DIAGNOSIS >

[COUPE]

Connector No.	M27
Connector Name	REMOTE KEYLESS ENTRY RECIEVER
Connector Color	BLACK

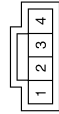

Terminal No.	Color of Wire	Signal Name
1	P	GND
2	L/O	SIGNAL
4	L/R	12V

Connector No.	M32
Connector Name	ELECTRONIC STEERING COLUMN LOCK
Connector Color	WHITE

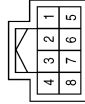

Terminal No.	Color of Wire	Signal Name
1	P/L	S/L_12V_MECHANICAL (V1)
2	L/Y	S/L_COM
3	L/O	S/L_CONDITION_1
5	B	GND
6	B	GND
7	G/Y	S/L_12V_CPU (V2)
8	G/R	S/L_CONDITION_2

Connector No.	M38
Connector Name	PUSH-BUTTON IGNITION SWITCH
Connector Color	BROWN

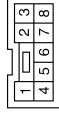

Terminal No.	Color of Wire	Signal Name
1	B	GND
4	BR	START_SW
5	R	LOCK
6	Y/L	ACC
7	LG	ON
8	G/Y	B+

Connector No.	M40
Connector Name	KEY SLOT
Connector Color	WHITE

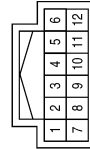

Terminal No.	Color of Wire	Signal Name
1	G/Y	B+
7	B	GND
11	Y	CARD_SW_1

Connector No.	M49
Connector Name	INSTRUMENT PANEL ANTENNA
Connector Color	GRAY



Terminal No.	Color of Wire	Signal Name
1	G	ANT+
2	R	ANT-

Connector No.	M63
Connector Name	JOINT CONNECTOR-M02
Connector Color	BLUE

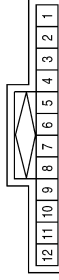

Terminal No.	Color of Wire	Signal Name
8	B	-
10	GR	-
11	GR	-

ALKIA0137GB

A
B
C
D
E
F
G
H
I
J
K
L
M
N
O
P

SEC

BCM (BODY CONTROL MODULE)

< ECU DIAGNOSIS >

[COUPE]

Connector No.	M200
Connector Name	WIRE TO WIRE
Connector Color	WHITE

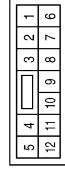

Terminal No.	Color of Wire	Signal Name
1	B/R	-
2	SHIELD	-
6	W/R	-

Connector No.	M85
Connector Name	WIRE TO WIRE
Connector Color	WHITE



Terminal No.	Color of Wire	Signal Name
1	B	-

Connector No.	M71
Connector Name	WIRE TO WIRE
Connector Color	WHITE

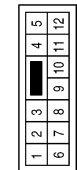

Terminal No.	Color of Wire	Signal Name
1	B/R	-
2	SHIELD	-
6	W/R	-

Connector No.	E3
Connector Name	WIRE TO WIRE
Connector Color	WHITE

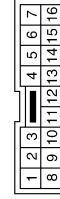

Terminal No.	Color of Wire	Signal Name
9	R/B	-

Connector No.	M350
Connector Name	WIRE TO WIRE
Connector Color	WHITE



Terminal No.	Color of Wire	Signal Name
1	B	-

Connector No.	M203
Connector Name	FRONT CONSOLE ANTENNA
Connector Color	GRAY



Terminal No.	Color of Wire	Signal Name
1	W/R	ANT+
2	B/R	ANT-

ALKIA0138GB

BCM (BODY CONTROL MODULE)

< ECU DIAGNOSIS >

[COUPE]

Connector No.	E6
Connector Name	FUSE BLOCK (J/B)
Connector Color	WHITE



Terminal No.	Color of Wire	Signal Name
2P	R/G	-
8P	Y/R	-

Connector No.	E10
Connector Name	ECM
Connector Color	BLACK

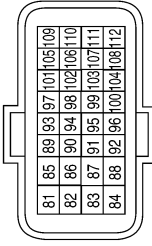

Terminal No.	Color of Wire	Signal Name
97	P	CAN-L
98	L	CAN-H

Connector No.	E17
Connector Name	IPDM E/R (INTELLIGENT POWER DISTRIBUTION MODULE ENGINE ROOM)
Connector Color	WHITE

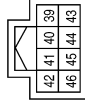

Terminal No.	Color of Wire	Signal Name
39	P	CAN-L
40	L	CAN-H
41	B	S-GND
43	G/B	DETENT_SW
46	R	START_CONT

Connector No.	E18
Connector Name	IPDM E/R (INTELLIGENT POWER DISTRIBUTION MODULE ENGINE ROOM)
Connector Color	WHITE

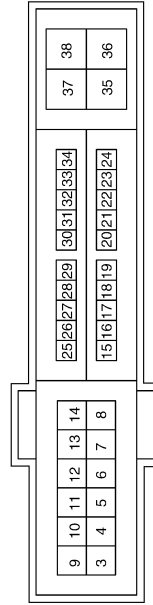

Terminal No.	Color of Wire	Signal Name
11	P/L	ESCL
12	B	P_GND
27	BR/W	IGN_SIGNAL
28	BR	PUSH_START_SW
30	R/B	CLUTCH_I/L_SW
32	L/O	SL_CONDITION_1
33	G/R	SL_CONDITION_2

Connector No.	E21
Connector Name	JOINT CONNECTOR-E03
Connector Color	WHITE



Terminal No.	Color of Wire	Signal Name
1	L	-
2	L	-

ALKIA0139GB

A
B
C
D
E
F
G
H
I
J
L
M
N
O
P

SEC

BCM (BODY CONTROL MODULE)

< ECU DIAGNOSIS >

[COUPE]

Connector No.	E22
Connector Name	JOINT CONNECTOR-E04
Connector Color	WHITE



Terminal No.	Color of Wire	Signal Name
1	P	-
2	P	-

Connector No.	E28
Connector Name	JOINT CONNECTOR-E05
Connector Color	WHITE



Terminal No.	Color of Wire	Signal Name
1	R/B	-
2	R/B	-
3	R/B	-

Connector No.	E30
Connector Name	WIRE TO WIRE
Connector Color	WHITE

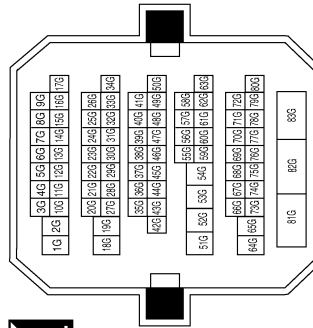

Terminal No.	Color of Wire	Signal Name
8G	P	-
15G	L	-
20G	R	-
21G	P/L	-
22G	G/R	-
26G	R/B	-
27G	BR/W	-
28G	L/O	-
29G	BR	-
33G	R/G	-
51G	L	-
52G	P	-
82G	W/B	-

Connector No.	E36
Connector Name	CLUTCH INTERLOCK SWITCH
Connector Color	BROWN



Terminal No.	Color of Wire	Signal Name
1	GW	-
2	R/B	-

BCM (BODY CONTROL MODULE)

< ECU DIAGNOSIS >

[COUPE]

Connector No.	E46
Connector Name	JUNCTION BLOCK
Connector Color	WHITE

31	30	29	28	27	26	25		
40	39	38	37	36	35	34	33	32



Terminal No.	Color of Wire	Signal Name
27	R/G	-

Connector No.	E38 (WITH M/T)
Connector Name	STOP LAMP SWITCH
Connector Color	BLACK

2	1
---	---



Terminal No.	Color of Wire	Signal Name
1	Y/R	B+
2	R/G	HIGH_SW

Connector No.	E38 (WITH CVT)
Connector Name	STOP LAMP SWITCH
Connector Color	WHITE

3	4	1	2
---	---	---	---



Terminal No.	Color of Wire	Signal Name
1	Y/R	B+
2	R/G	HIGH_SW

Connector No.	F10
Connector Name	IPDM E/R (INTELLIGENT POWER DISTRIBUTION MODULE ENGINE ROOM)
Connector Color	WHITE



53	54	55	56	57	58	69	70	71	72	73	74	75	76	77	78
47	48	49	50	51	52	59	60	61	62	63	64	65	66	67	68
						81	82	79	80						

Connector No.	F1
Connector Name	WIRE TO WIRE
Connector Color	WHITE

7	6	5	4	3	2	1		
16	15	14	13	12	11	10	9	8



Terminal No.	Color of Wire	Signal Name
72	R/B	NPSW
74	Y	START_IG_EGI
80	B/W	STARTER_MOTOR

Connector No.	E50
Connector Name	JUNCTION BLOCK
Connector Color	WHITE

56	55
----	----



Terminal No.	Color of Wire	Signal Name
55	R/B	-

ALKIA0154GB

A
B
C
D
E
F
G
H
I
J
L
M
N
O
P

SEC

BCM (BODY CONTROL MODULE)

< ECU DIAGNOSIS >

[COUPE]

Connector No.	F16
Connector Name	TCM (TRANSMISSION CONTROL MODULE)
Connector Color	BLACK

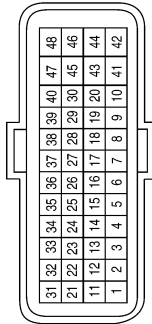

Terminal No.	Color of Wire	Signal Name
20	R/B	ST_RLY

Connector No.	F25
Connector Name	PARK/NEUTRAL POSITION (PNP) SWITCH
Connector Color	BLACK

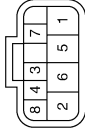

Terminal No.	Color of Wire	Signal Name
1	Y	IGN_P_N
2	R/B	P_N_OUTPUT

Connector No.	F32
Connector Name	PARK/NEUTRAL POSITION (PNP) SWITCH
Connector Color	BLACK



Terminal No.	Color of Wire	Signal Name
1	Y	-
2	R/B	-

Connector No.	B1
Connector Name	WIRE TO WIRE
Connector Color	WHITE

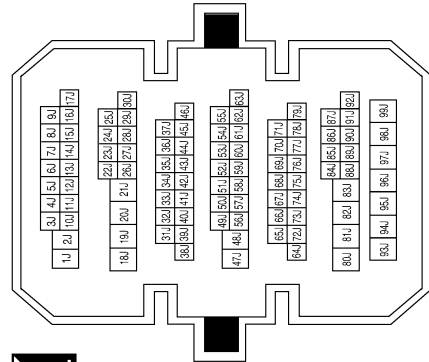

Terminal No.	Color of Wire	Signal Name
4J	B	-
10J	SHIELD	-
11J	W	-
17J	SB	-

Connector No.	B8
Connector Name	DOOR SWITCH LH
Connector Color	WHITE

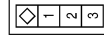

Terminal No.	Color of Wire	Signal Name
2	SB	DOOR SW (DR)

AWKIA0156GB

BCM (BODY CONTROL MODULE)

< ECU DIAGNOSIS >

[COUPE]

Connector No.	B104
Connector Name	WIRE TO WIRE
Connector Color	BROWN

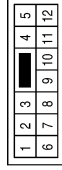

Terminal No.	Color of Wire	Signal Name
10	R/B	-

Connector No.	B29
Connector Name	REAR PARCEL SHELF ANTENNA
Connector Color	GRAY



Terminal No.	Color of Wire	Signal Name
1	W	ANT+
2	B	ANT-

Connector No.	B20
Connector Name	JOINT CONNECTOR-B05
Connector Color	GRAY

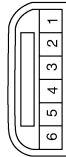

Terminal No.	Color of Wire	Signal Name
5	GR	-
6	B	-

Connector No.	B108
Connector Name	DOOR SWITCH RH
Connector Color	WHITE

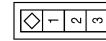

Terminal No.	Color of Wire	Signal Name
2	R/B	DOOR SW (AS)

A
B
C
D
E
F
G
H
I
J
L
M
N
O
P

SEC

AWKIA0157GB

BCM (BODY CONTROL MODULE)

< ECU DIAGNOSIS >

[COUPE]

Wiring Diagram - VEHICLE SECURITY SYSTEM -

INFOID:000000001344616

VEHICLE SECURITY SYSTEM

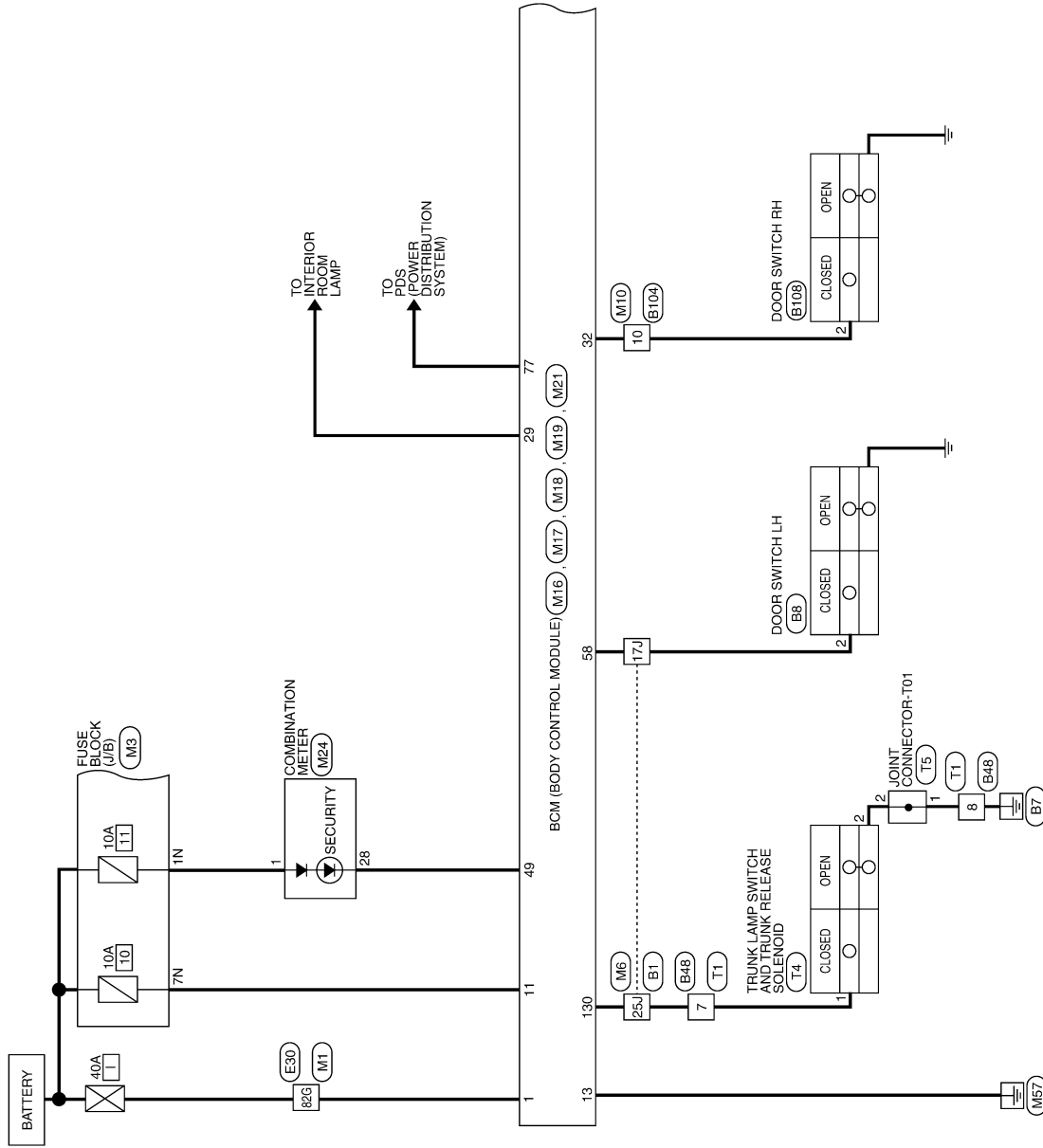

AWKWA0029GI

BCM (BODY CONTROL MODULE)

< ECU DIAGNOSIS >

[COUPE]

- : WITH LEFT POWER WINDOW ANTI-PINCH SYSTEM
- : WITH LEFT AND RIGHT POWER WINDOW ANTI-PINCH SYSTEM
- : DATA LINE

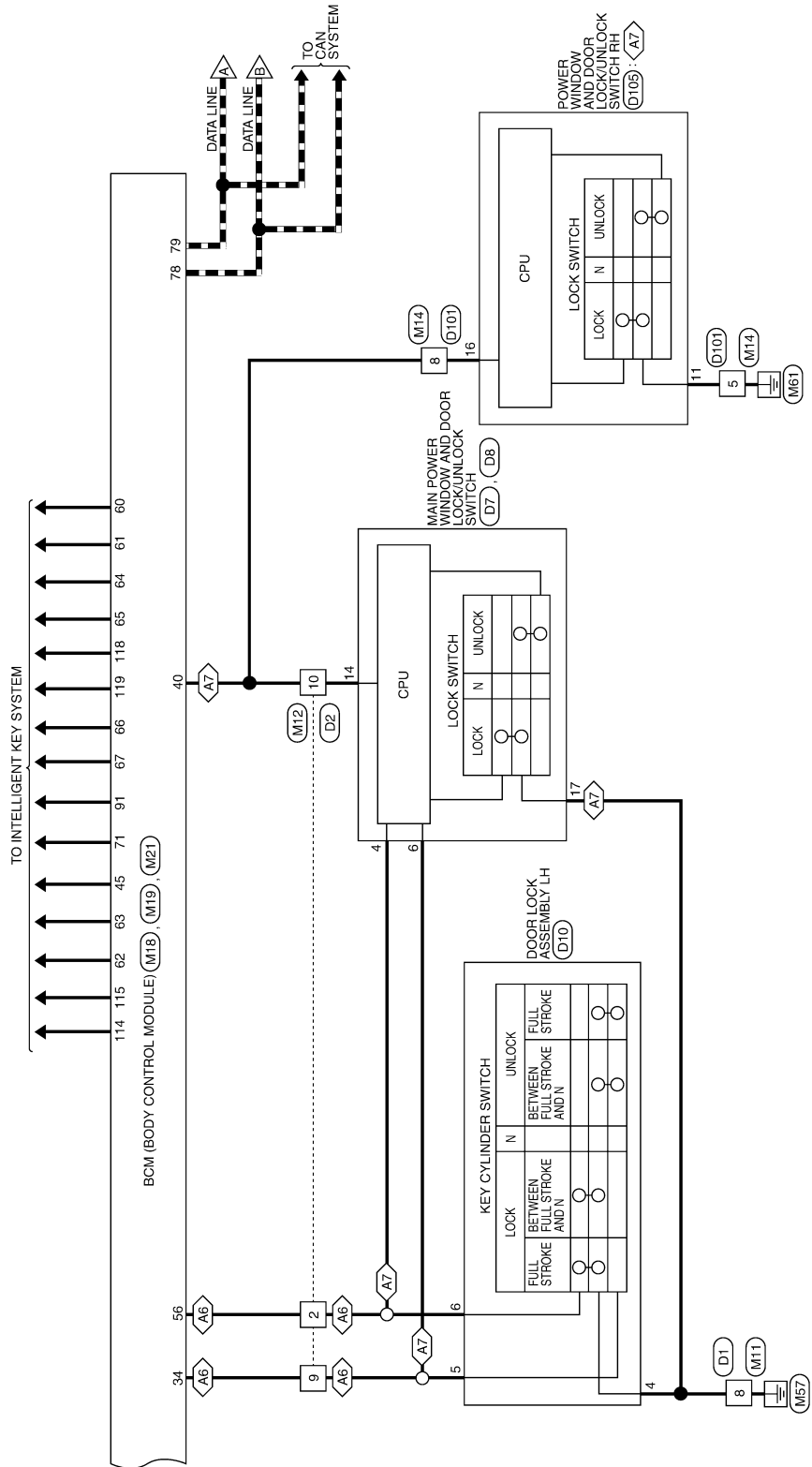

A
B
C
D
E
F
G
H
I
J
K
L
M
N
O
P

SEC

BCM (BODY CONTROL MODULE)

< ECU DIAGNOSIS >

[COUPE]

■ ■ ■ : DATA LINE

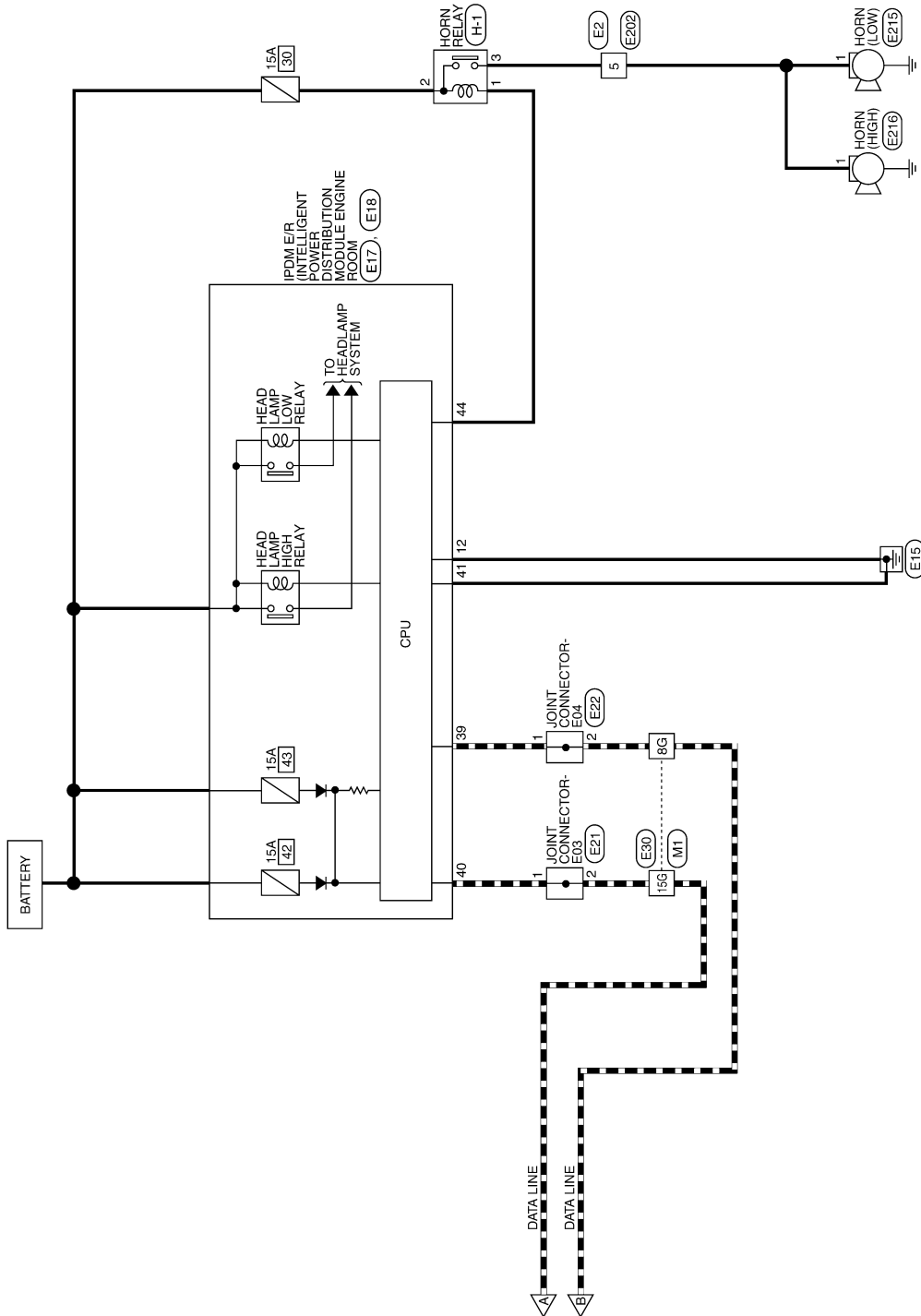

ALKWA0008GE

VEHICLE SECURITY SYSTEM CONNECTORS

Connector No.	M1
Connector Name	WIRE TO WIRE
Connector Color	WHITE

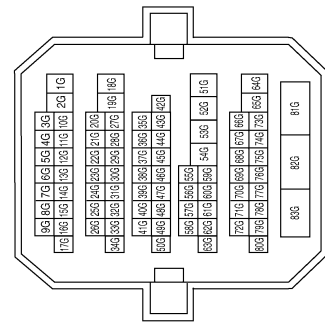

Terminal No.	Color of Wire	Signal Name
8G	P	-
15G	L	-
82G	W/B	-

Connector No.	M3
Connector Name	FUSE BLOCK (J/B)
Connector Color	WHITE

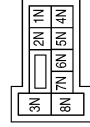

Terminal No.	Color of Wire	Signal Name
1N	W/L	-
7N	Y/R	-

Connector No.	M6
Connector Name	WIRE TO WIRE
Connector Color	WHITE

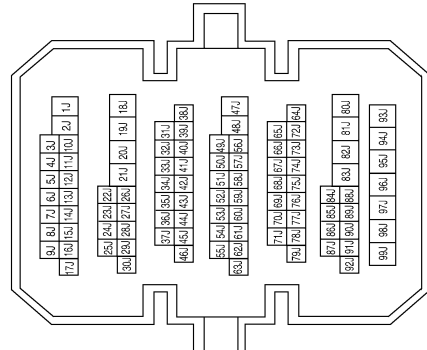

Terminal No.	Color of Wire	Signal Name
17J	SB	-
25J	Y/G	-

Connector No.	M10
Connector Name	WIRE TO WIRE
Connector Color	BROWN



Terminal No.	Color of Wire	Signal Name
10	R/B	-

AWKIA0158GB

BCM (BODY CONTROL MODULE)

< ECU DIAGNOSIS >

[COUPE]

Connector No.	M14
Connector Name	WIRE TO WIRE
Connector Color	WHITE

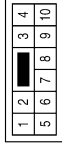

Terminal No.	Color of Wire	Signal Name
5	B	-
8	Y/G	-

Connector No.	M12
Connector Name	WIRE TO WIRE
Connector Color	WHITE



Terminal No.	Color of Wire	Signal Name
2	L/B	-
9	L/R	-
10	Y/G	-

Connector No.	M11
Connector Name	WIRE TO WIRE
Connector Color	WHITE

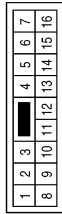

Terminal No.	Color of Wire	Signal Name
8	B	-

Connector No.	M18
Connector Name	BCM (BODY CONTROL MODULE)
Connector Color	GREEN

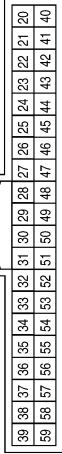

Terminal No.	Color of Wire	Signal Name
29	Y	FOB_IN_SW_1
32	R/B	AS_DOOR_SW
34	L/R	DOOR_KEY/C_UNLOCK_SW
36	GR	CENTRAL_LOCK_SW
39	GR/R	CENTRAL_UNLOCK_SW
40	Y/G	PW_K-LINE
45	P	GND_RF2_A/L
49	L/O	IMMO_LED
56	L/B	DOOR_KEY/C_LOCK_SW
58	SB	DR_DOOR_SW

Connector No.	M17
Connector Name	BCM (BODY CONTROL MODULE)
Connector Color	WHITE



Terminal No.	Color of Wire	Signal Name
11	Y/R	BAT_BCM_FUSE
13	B	GND1

Connector No.	M16
Connector Name	BCM (BODY CONTROL MODULE)
Connector Color	BLACK



Terminal No.	Color of Wire	Signal Name
1	W/B	BAT_POWER_F/L

AWKIA0159GB

BCM (BODY CONTROL MODULE)

< ECU DIAGNOSIS >

[COUPE]

Connector No.	M24
Connector Name	COMBINATION METER
Connector Color	WHITE



1	2	3	4	5	6	7	8	9	10	11	12	13	14	15	16	17	18	19	20
21	22	23	24	25	26	27	28	29	30	31	32	33	34	35	36	37	38	39	40

Terminal No.	Color of Wire	Signal Name
1	W/L	BAT
28	L/O	SECURITY

Connector No.	M21
Connector Name	BCM (BODY CONTROL MODULE)
Connector Color	GRAY



131	130	129	128	127	126	125	124	123	122	121	120	119	118	117	116	115	114	113	112
151	150	149	148	147	146	145	144	143	142	141	140	139	138	137	136	135	134	133	132

Terminal No.	Color of Wire	Signal Name
114	B	TRUNK_ANT_1_B
115	W	TRUNK_ANT_1_A
118	L/O	BACK_DOOR_ANT_B
119	BR/W	BACK_DOOR_ANT_A
130	Y/G	TRUNK_SW

Connector No.	M19
Connector Name	BCM (BODY CONTROL MODULE)
Connector Color	BLACK



79	78	77	76	75	74	73	72	71	70	69	68	67	66	65	64	63	62	61	60
99	98	97	96	95	94	93	92	91	90	89	88	87	86	85	84	83	82	81	80

Terminal No.	Color of Wire	Signal Name
60	B/R	ROOM_ANT_2_B
61	W/R	ROOM_ANT_2_A
62	B/Y	AS_DOOR_ANT_B
63	LG	AS_DOOR_ANT_A
64	V	DR_DOOR_ANT_B
65	P	DR_DOOR_ANT_A
66	R	ROOM_ANT_1_B
67	G	ROOM_ANT_1_A
71	L/O	RF1_TUNER_SIGNAL
78	P	CAN-L
79	L	CAN-H
91	L/R	RF1_POWER_SUPPLY

Terminal No.	Color of Wire	Signal Name
39	P	CAN-L
40	L	CAN-H
41	B	S-GND
44	G/W	HORN_RLY

Connector No.	E17
Connector Name	IPDM E/R (INTELLIGENT POWER DISTRIBUTION MODULE ENGINE ROOM)
Connector Color	WHITE



42	41	40	39
46	45	44	43

Connector No.	E2
Connector Name	WIRE TO WIRE
Connector Color	WHITE



1	2	3		
4	5	6	7	8

Terminal No.	Color of Wire	Signal Name
5	G	-

AWKIA0160GB

A B C D E F G H I J L M N O P

SEC

BCM (BODY CONTROL MODULE)

< ECU DIAGNOSIS >

[COUPE]

Connector No.	E18
Connector Name	IPDM E/R (INTELLIGENT POWER DISTRIBUTION MODULE ENGINE ROOM)
Connector Color	WHITE

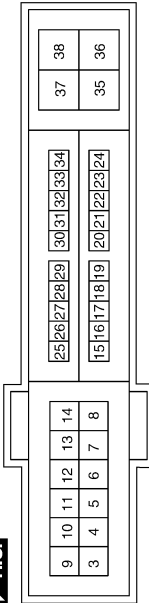

Terminal No.	Color of Wire	Signal Name
12	B	P-GND

Connector No.	E21
Connector Name	JOINT CONNECTOR-E03
Connector Color	WHITE



Terminal No.	Color of Wire	Signal Name
1	L	-
2	L	-

Connector No.	E22
Connector Name	JOINT CONNECTOR-E04
Connector Color	WHITE



Terminal No.	Color of Wire	Signal Name
1	P	-
2	P	-

Connector No.	E30
Connector Name	WIRE TO WIRE
Connector Color	WHITE

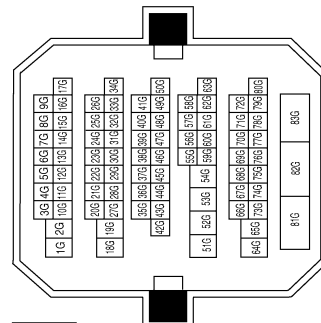

Terminal No.	Color of Wire	Signal Name
8G	P	-
15G	L	-
82G	W/B	-

Connector No.	E202
Connector Name	WIRE TO WIRE
Connector Color	WHITE



Terminal No.	Color of Wire	Signal Name
5	G	-

AWKIA0161GB

BCM (BODY CONTROL MODULE)

< ECU DIAGNOSIS >

[COUPE]

Connector No.	B1
Connector Name	WIRE TO WIRE
Connector Color	WHITE

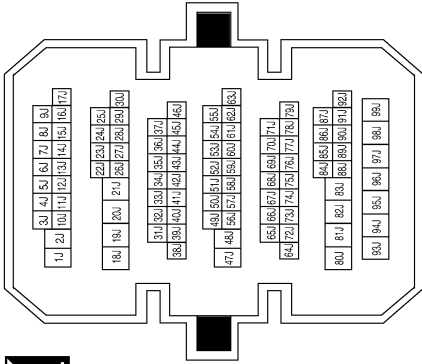

Terminal No.	Color of Wire	Signal Name
17J	SB	-
22J	R/B	-
25J	Y/G	-

Connector No.	E216
Connector Name	HORN
Connector Color	BLACK



Terminal No.	Color of Wire	Signal Name
1	G	-

Connector No.	E215
Connector Name	HORN
Connector Color	BLACK



Terminal No.	Color of Wire	Signal Name
1	G	-

Connector No.	B104
Connector Name	WIRE TO WIRE
Connector Color	BROWN

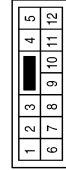

Terminal No.	Color of Wire	Signal Name
10	R/B	-

Connector No.	B48
Connector Name	WIRE TO WIRE
Connector Color	WHITE

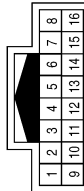

Terminal No.	Color of Wire	Signal Name
7	Y/G	-
8	B	-

Connector No.	B8
Connector Name	DOOR SWITCH LH
Connector Color	WHITE

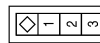

Terminal No.	Color of Wire	Signal Name
2	SB	DOOR SW (DF)

AWKIA0162GB

A
B
C
D
E
F
G
H
I
J
L
M
N
O
P

SEC

BCM (BODY CONTROL MODULE)

< ECU DIAGNOSIS >

[COUPE]

Connector No.	T4
Connector Name	TRUNK LAMP SWITCH AND TRUNK RELEASE SOLENOID
Connector Color	WHITE



Terminal No.	Color of Wire	Signal Name
1	Y/G	TRUNK_REQUEST_SW
2	B	GND

Connector No.	T1
Connector Name	WIRE TO WIRE
Connector Color	WHITE

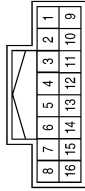

Terminal No.	Color of Wire	Signal Name
7	Y/G	-
8	B	-

Connector No.	B108
Connector Name	DOOR SWITCH RH
Connector Color	WHITE

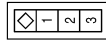

Terminal No.	Color of Wire	Signal Name
2	R/B	DOOR SW (AS)

Connector No.	D7
Connector Name	MAIN POWER WINDOW AND LOCK/UNLOCK SWITCH
Connector Color	WHITE

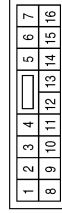

Terminal No.	Color of Wire	Signal Name
4	L/B	LOCK
6	L/R	UNLOCK
14	Y/G	COM

Connector No.	D2
Connector Name	WIRE TO WIRE
Connector Color	WHITE

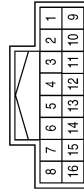

Terminal No.	Color of Wire	Signal Name
2	L/B	-
9	L/R	-
10	Y/G	-

Connector No.	T5
Connector Name	JOINT CONNECTOR-T01
Connector Color	WHITE



Terminal No.	Color of Wire	Signal Name
1	B	-
2	B	-

AWKIA0163GB

BCM (BODY CONTROL MODULE)

< ECU DIAGNOSIS >

[COUPE]

Connector No.	D101
Connector Name	WIRE TO WIRE
Connector Color	WHITE

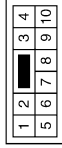

Terminal No.	Color of Wire	Signal Name
5	B	-
8	Y/G	-

Connector No.	D10
Connector Name	DOOR LOCK ASSEMBLY LH
Connector Color	GRAY

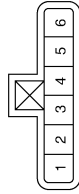

Terminal No.	Color of Wire	Signal Name
4	B	GND
5	L/R	DOOR KEY/C-UNLOCK_SW
6	L/B	DOOR KEY/C-LOCK_SW

Connector No.	D8
Connector Name	MAIN POWER WINDOW AND LOCK/UNLOCK SWITCH
Connector Color	WHITE

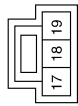

Terminal No.	Color of Wire	Signal Name
17	B	GND
18	GR	LOCK

Connector No.	D105
Connector Name	POWER WINDOW AND DOOR LOCK/UNLOCK SWITCH RH (WITH LEFT AND RIGHT WINDOW ANTI-PINCH SYSTEM)
Connector Color	WHITE



Terminal No.	Color of Wire	Signal Name
11	B	GND
16	Y/G	COM

AWKIA0164GB

A
B
C
D
E
F
G
H
I
J
K
L
M
N
O
P

SEC

BCM (BODY CONTROL MODULE)

< ECU DIAGNOSIS >

[COUPE]

Wiring Diagram - NVIS -

INFOID:000000001344617

NVIS

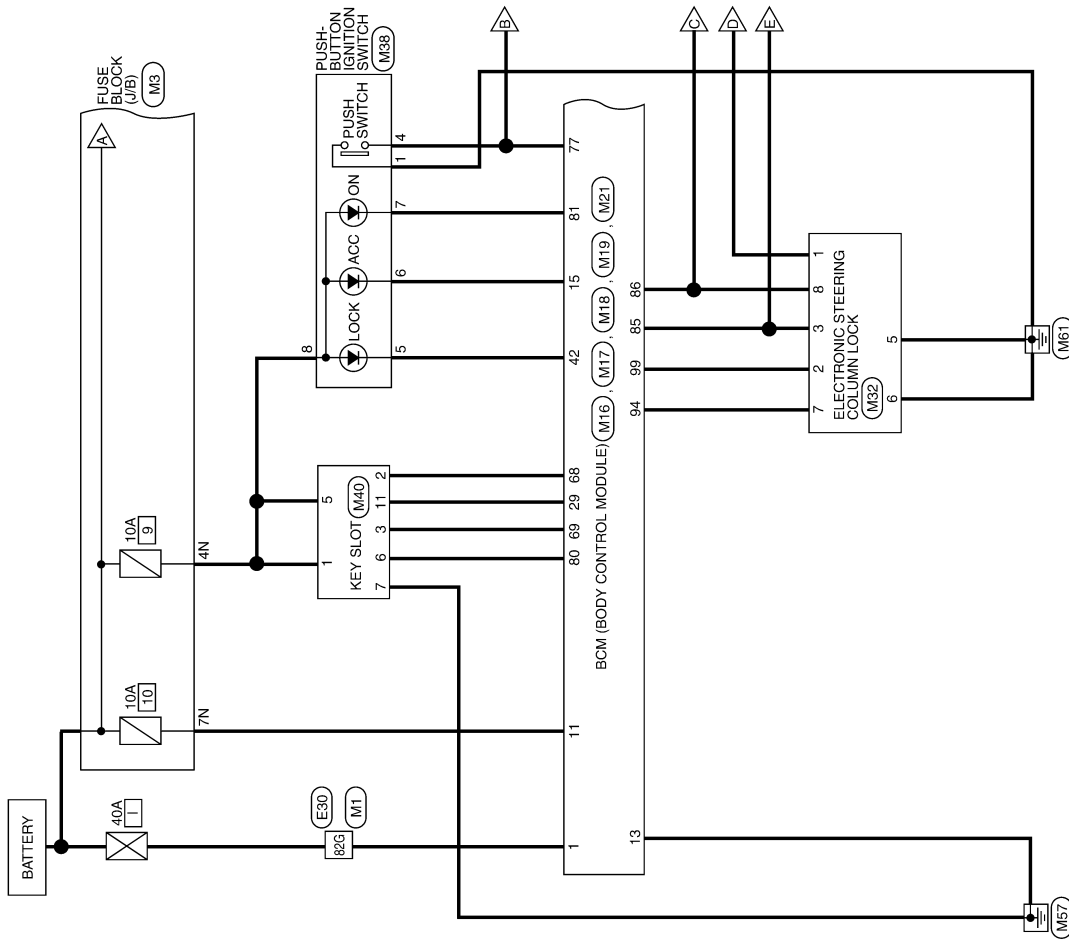

AWKWA0031GI

BCM (BODY CONTROL MODULE)

< ECU DIAGNOSIS >

[COUPE]

M : WITH M/T
VT : WITH CVT
 : DATA LINE

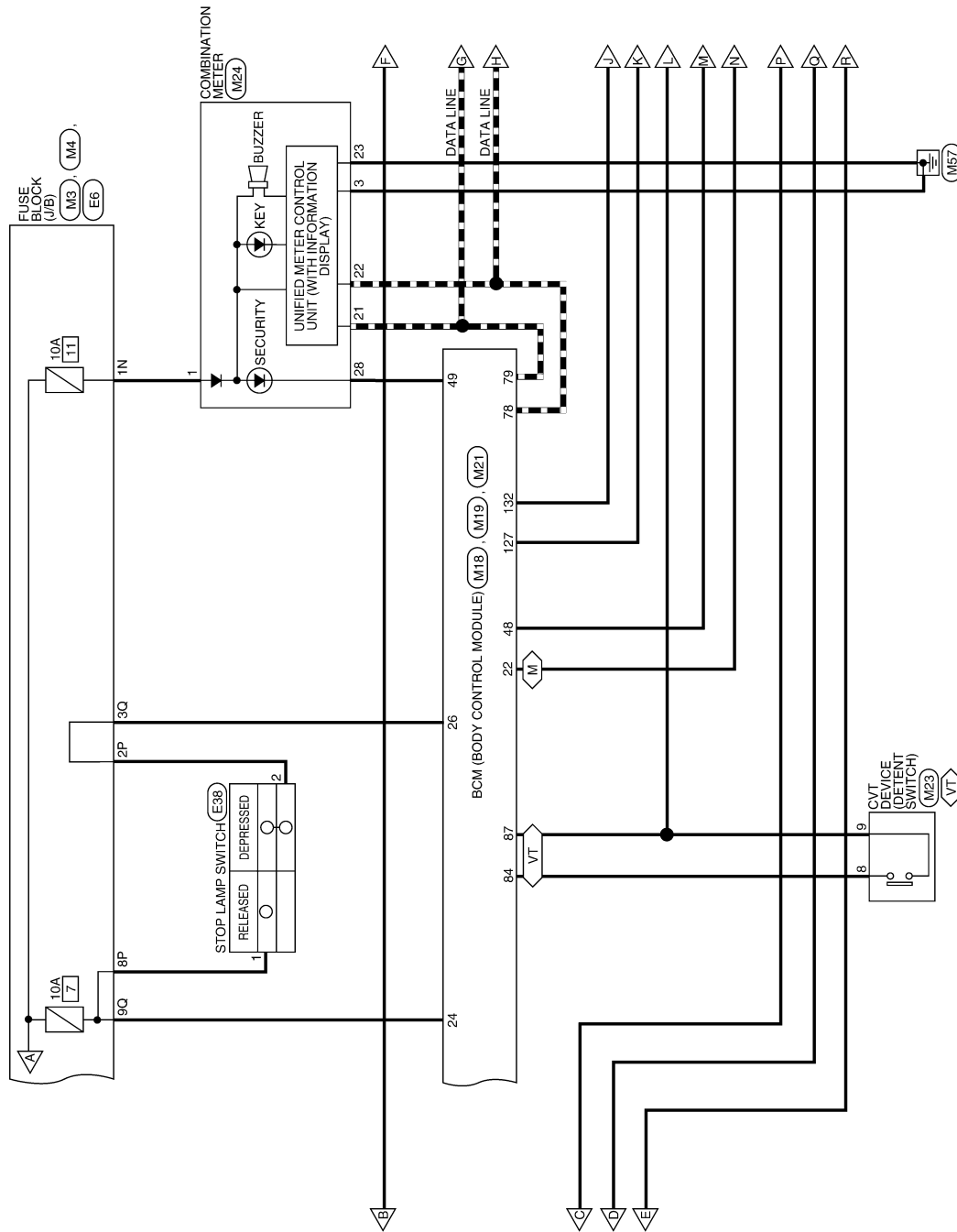

AWKWA0032GI

A
B
C
D
E
F
G
H
I
J
K
L
M
N
O
P

SEC

BCM (BODY CONTROL MODULE)

< ECU DIAGNOSIS >

[COUPE]

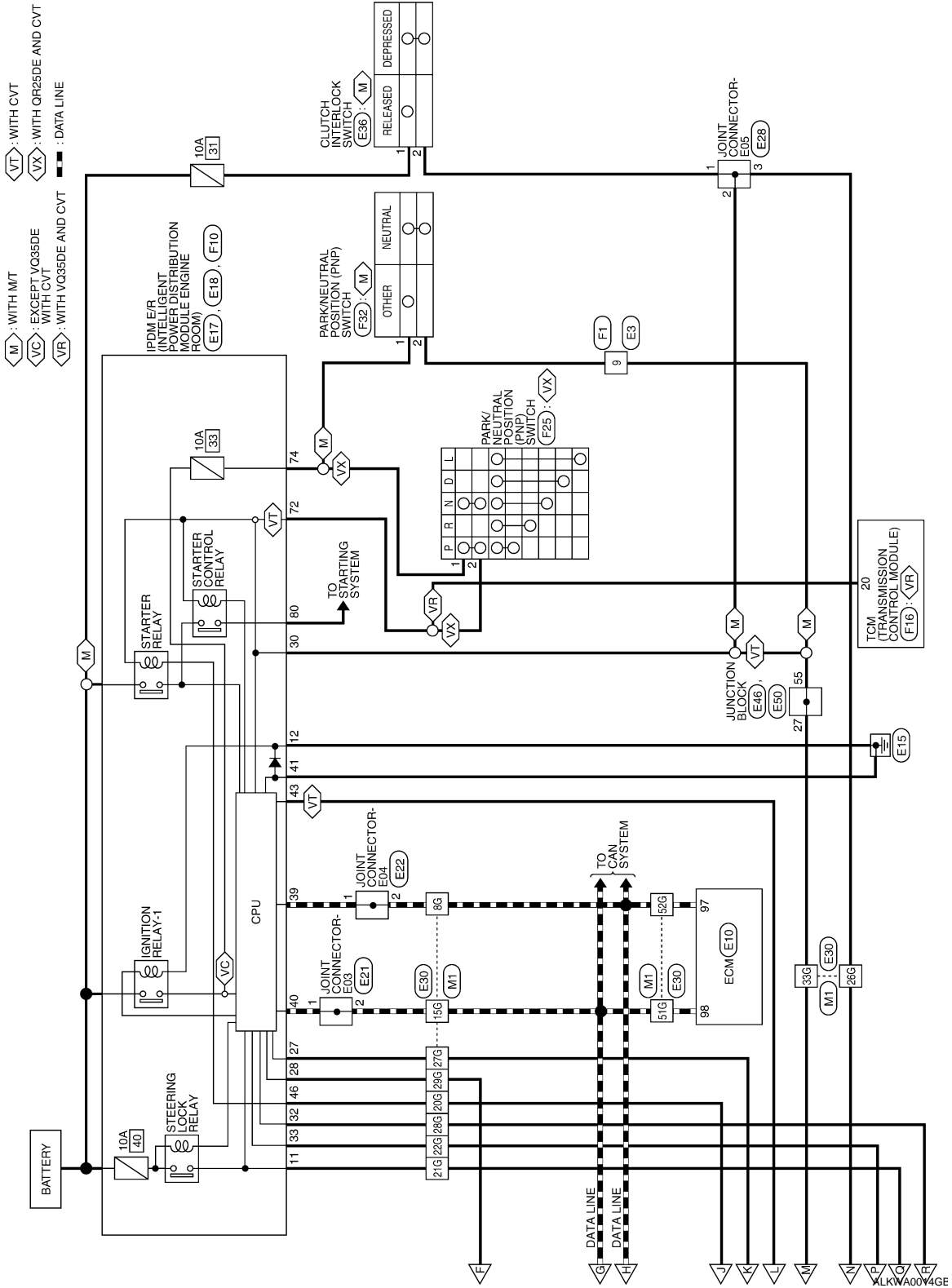

NVIS CONNECTORS

Connector No.	M1
Connector Name	WIRE TO WIRE
Connector Color	WHITE

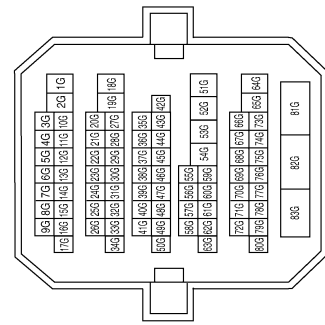

Terminal No.	Color of Wire	Signal Name
8G	P	-
15G	L	-
20G	R	-
21G	P/L	-
22G	G/R	-
26G	R/Y	-
27G	BR/W	-
28G	L/O	-
29G	BR	-
33G	R/G	-
51G	L	-
52G	P	-
82G	W/B	-

Connector No.	M3
Connector Name	FUSE BLOCK (J/B)
Connector Color	WHITE

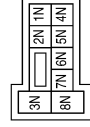

Terminal No.	Color of Wire	Signal Name
1N	W/L	-
4N	G/Y	-
7N	Y/R	-

Connector No.	M4
Connector Name	FUSE BLOCK (J/B)
Connector Color	WHITE

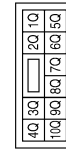

Terminal No.	Color of Wire	Signal Name
3Q	O/L	-
9Q	R/W	-

Connector No.	M16
Connector Name	BCM (BODY CONTROL MODULE)
Connector Color	BLACK



Terminal No.	Color of Wire	Signal Name
1	W/B	BAT_POWER_F/L

Connector No.	M17
Connector Name	BCM (BODY CONTROL MODULE)
Connector Color	WHITE

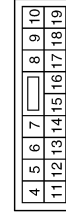

Terminal No.	Color of Wire	Signal Name
11	Y/R	BAT_BCM_FUSE
13	B	GND1
15	Y/L	ACC_LED

A
B
C
D
E
F
G
H
I
J
K
L
M
N
O
P

SEC

BCM (BODY CONTROL MODULE)

< ECU DIAGNOSIS >

[COUPE]

Terminal No.	Color of Wire	Signal Name
77	BR	ENG_START_SW
78	P	CAN-L
79	L	CAN-H
80	R/L	FOB SLOT ILLUMINATION
81	LG	IGN_ON_LED
84	Y/R	AT_DEVICE_OUT
85	L/O	S/L_CONDITION_1
86	G/R	S/L_CONDITION_2
87	G/B	SHIFT_P
94	G/Y	S/L_POWER_SUPPLY_12V
99	L/Y	S/L_K-LINE

Connector No.	M19
Connector Name	BCM (BODY CONTROL MODULE)
Connector Color	BLACK



79	78	77	76	75	74	73	72	71	70	69	68	67	66	65	64	63	62	61	60
59	58	57	56	55	54	53	52	51	50	49	48	47	46	45	44	43	42	41	40

Terminal No.	Color of Wire	Signal Name
68	G/O	FOB_READER_CLOCK
69	O	FOB_READER_DATA

Connector No.	M18
Connector Name	BCM (BODY CONTROL MODULE)
Connector Color	GREEN



39	38	37	36	35	34	33	32	31	30	29	28	27	26	25	24	23	22	21	20
59	58	57	56	55	54	53	52	51	50	49	48	47	46	45	44	43	42	41	40

Terminal No.	Color of Wire	Signal Name
22	R/Y	CLUTCH_SW
24	R/W	STOP_LAMP_LOW_SW
26	O/L	STOP_LAMP_HIGH_SW
29	Y	FOB_IN_SW_1
42	R	S/L_LOCK_LED
48	R/G	SHIFT_N/P
49	L/O	IMMO_LED

Connector No.	M23
Connector Name	CVT DEVICE
Connector Color	WHITE



1	3	7	9		
2	4	5	6	8	10

Connector No.	M21
Connector Name	BCM (BODY CONTROL MODULE)
Connector Color	GRAY



131	130	129	128	127	126	125	124	123	122	121	120	119	118	117	116	115	114	113	112
151	150	149	148	147	146	145	144	143	142	141	140	139	138	137	136	135	134	133	132

Terminal No.	Color of Wire	Signal Name
8	Y/R	DETENT_KEY_SW
9	G/B	DETENT_KEY_SW

Terminal No.	Color of Wire	Signal Name
127	BR/W	IGN_USM_CONTT1
132	R	ST_CONT_USM

AWKIA0165GB

BCM (BODY CONTROL MODULE)

< ECU DIAGNOSIS >

[COUPE]

Connector No.	M32
Connector Name	ELECTRONIC STEERING COLUMN LOCK
Connector Color	WHITE

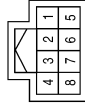

Terminal No.	Color of Wire	Signal Name
1	P/L	S/L_12V_MECHANICAL
2	L/Y	S/L_COM
3	L/O	S/L_CONDITION_1
5	B	GND
6	B	GND
7	G/Y	S/L_12V_CPU (V2)
8	G/R	S/L_CONDITION_2

Terminal No.	Color of Wire	Signal Name
1	W/L	BAT
3	B	GND
14	V/Y	ACC
21	L	CAN-H
22	P	CAN-L
23	B	GND
28	L/O	SECURITY

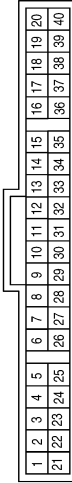

Connector No.	M24
Connector Name	COMBINATION METER
Connector Color	WHITE



Connector No.	E3
Connector Name	WIRE TO WIRE
Connector Color	WHITE



Terminal No.	Color of Wire	Signal Name
9	R/B	-

Connector No.	M40
Connector Name	KEY SLOT
Connector Color	WHITE

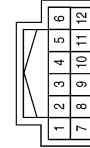

Terminal No.	Color of Wire	Signal Name
1	G/Y	B+
2	G/O	CLOCK
3	O	DATA
5	G/Y	LIGHT_BAT+
6	R/L	LIGHT_A
7	B	GND
11	Y	CARD_SW_1

Connector No.	M38
Connector Name	PUSH-BUTTON IGNITION SWITCH
Connector Color	BROWN



Terminal No.	Color of Wire	Signal Name
1	B	GND
4	BR	START_SW
5	R	LOCK
6	Y/L	ACC
7	LG	ON
8	G/Y	B+

ALKIA0143GB

A
B
C
D
E
F
G
H
I
J
K
L
M
N
O
P

SEC

BCM (BODY CONTROL MODULE)

< ECU DIAGNOSIS >

[COUPE]

Connector No.	E6
Connector Name	FUSE BLOCK (J/B)
Connector Color	WHITE



Terminal No.	Color of Wire	Signal Name
2P	R/G	-
8P	Y/R	-

Connector No.	E10
Connector Name	ECM
Connector Color	BLACK

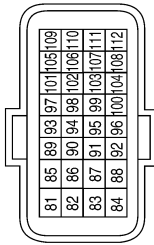

Terminal No.	Color of Wire	Signal Name
97	P	CAN-L
98	L	CAN-H

Connector No.	E17
Connector Name	IPDM E/R (INTELLIGENT POWER DISTRIBUTION MODULE ENGINE ROOM)
Connector Color	WHITE



Terminal No.	Color of Wire	Signal Name
39	P	CAN-L
40	L	CAN-H
41	B	S-GND
43	G/B	DETENT_SW
46	R	START_CONT

Connector No.	E18
Connector Name	IPDM E/R (INTELLIGENT POWER DISTRIBUTION MODULE ENGINE ROOM)
Connector Color	WHITE

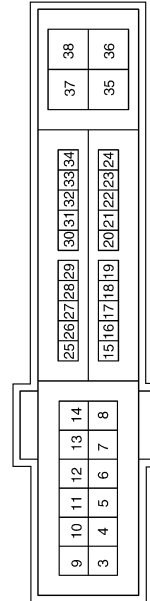

Terminal No.	Color of Wire	Signal Name
11	P/L	ESCL
12	B	P_GND
27	BR/W	IGN_SIGNAL
28	BR	PUSH_START_SW
30	R/B	CLUTCH_I/L_SW
32	L/O	SL_CONDITION_1
33	G/R	SL_CONDITION_2

Connector No.	E21
Connector Name	JOINT CONNECTOR-E03
Connector Color	WHITE



Terminal No.	Color of Wire	Signal Name
1	L	-
2	L	-

ALKIA0144GB

BCM (BODY CONTROL MODULE)

< ECU DIAGNOSIS >

[COUPE]

Connector No.	E28
Connector Name	JOINT CONNECTOR-E05
Connector Color	WHITE



Terminal No.	Color of Wire	Signal Name
1	R/B	-
2	R/B	-
3	R/Y	-

Connector No.	E22
Connector Name	JOINT CONNECTOR-E04
Connector Color	WHITE

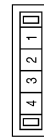

Terminal No.	Color of Wire	Signal Name
1	P	-
2	P	-

Connector No.	E36
Connector Name	CLUTCH INTERLOCK SWITCH
Connector Color	BROWN



Terminal No.	Color of Wire	Signal Name
1	G/W	-
2	R/B	-

Terminal No.	Color of Wire	Signal Name
8G	P	-
15G	L	-
20G	R	-
21G	P/L	-
22G	G/R	-
26G	R/B	-
27G	BR/W	-
28G	L/O	-
29G	BR	-
33G	R/G	-
51G	L	-
52G	P	-
82G	W/B	-

Connector No.	E30
Connector Name	WIRE TO WIRE
Connector Color	WHITE

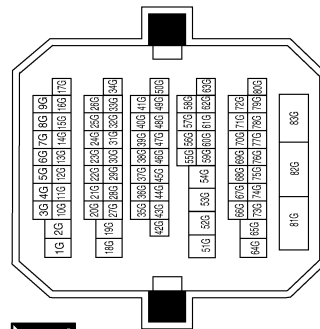

AWKIA0166GB

A
B
C
D
E
F
G
H
I
J
K
L
M
N
O
P

SEC

BCM (BODY CONTROL MODULE)

< ECU DIAGNOSIS >

[COUPE]

Connector No.	E46
Connector Name	JUNCTION BLOCK
Connector Color	WHITE



Terminal No.	Color of Wire	Signal Name
27	R/G	-

Connector No.	E38 (WITH M/T)
Connector Name	STOP LAMP SWITCH
Connector Color	BLACK



Terminal No.	Color of Wire	Signal Name
1	Y/R	B+
2	R/G	HIGH_SW

Connector No.	E38 (WITH CVT)
Connector Name	STOP LAMP SWITCH
Connector Color	WHITE



Terminal No.	Color of Wire	Signal Name
1	Y/R	B+
2	R/G	HIGH_SW

Connector No.	F10
Connector Name	IPDM E/R (INTELLIGENT POWER DISTRIBUTION MODULE ENGINE ROOM)
Connector Color	WHITE

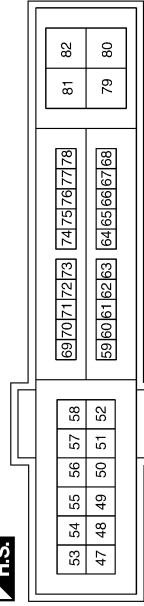

Terminal No.	Color of Wire	Signal Name
72	R/B	NPSW
74	Y	START_IG-EGI
80	B/W	STARTER_MOTOR

Connector No.	F1
Connector Name	WIRE TO WIRE
Connector Color	WHITE

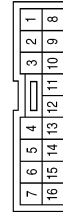

Terminal No.	Color of Wire	Signal Name
9	R/B	-

Connector No.	E50
Connector Name	JUNCTION BLOCK
Connector Color	WHITE



Terminal No.	Color of Wire	Signal Name
55	R/B	-

ALKIA0152GB

BCM (BODY CONTROL MODULE)

< ECU DIAGNOSIS >

[COUPE]

A
B
C
D
E
F
G
H
I
J
L
M
N
O
P

Connector No.	F32
Connector Name	PARK/NEUTRAL POSITION (PNP) SWITCH
Connector Color	BLACK



Terminal No.	Color of Wire	Signal Name
1	Y	-
2	R/B	-

Connector No.	F25
Connector Name	PARK/NEUTRAL POSITION (PNP) SWITCH
Connector Color	BLACK

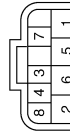

Terminal No.	Color of Wire	Signal Name
1	Y	NPSW
2	R/B	START_IG_EGI

Connector No.	F16
Connector Name	TCM (TRANSMISSION CONTROL MODULE)
Connector Color	BLACK

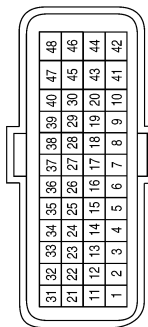

Terminal No.	Color of Wire	Signal Name
20	R/B	ST_RLY

SEC

Fail Safe

ALKIA0153GB

INFOID:000000001344618

Display contents of CONSULT	Fail-safe	Cancellation
B2013: ID DISCORD BCM-S/L	Inhibit engine cranking	Erase DTC
B2014: CHAIN OF S/L-BCM	Inhibit engine cranking	Erase DTC
B2190: NATS ANTenna AMP	Inhibit engine cranking	Erase DTC

BCM (BODY CONTROL MODULE)

< ECU DIAGNOSIS >

[COUPE]

Display contents of CONSULT	Fail-safe	Cancellation
B2191: DIFFERENCE OF KEY	Inhibit engine cranking	Erase DTC
B2192: ID DISCORD BCM-ECM	Inhibit engine cranking	Erase DTC
B2193: CHAIN OF BCM-ECM	Inhibit engine cranking	Erase DTC
B2195: ANTI-SCANNING	Inhibit engine cranking	Erase DTC
B2197: BCM-ENG-ST ID NG	Inhibit engine cranking	Erase DTC
B2557: VEHICLE SPEED	Inhibit electronic steering column lock	When normal vehicle speed signals have been received from ABS actuator and electric unit (control unit) for 500 ms
B2560: STARTER CONT RELAY	Inhibit engine cranking	500 ms after the following CAN signal communication status has become consistent <ul style="list-style-type: none"> • Starter control relay signal • Starter relay status signal
B2562: LO VOLTAGE	<ul style="list-style-type: none"> • Inhibit engine cranking • Inhibit electronic steering column lock 	100 ms after the power supply voltage increases to more than 8.8 V
B2563: HI VOLTAGE	<ul style="list-style-type: none"> • Inhibit engine cranking • Inhibit electronic steering column lock 	500 ms after the power supply voltage decreases to less than 18 V
B2601: SHIFT POSITION	Inhibit electronic steering column lock	500 ms after the following signal reception status becomes consistent <ul style="list-style-type: none"> • Selector lever P position switch signal • P range signal (CAN)
B2602: SHIFT POSITION	Inhibit electronic steering column lock	5 seconds after the following BCM recognition conditions are fulfilled <ul style="list-style-type: none"> • Ignition switch is in the ON position • Selector lever P position switch signal: Except P position (battery voltage) • Vehicle speed: 4 /h or more
B2603: SHIFT POSI STATUS	Inhibit electronic steering column lock	500 ms after the following BCM recognition conditions are fulfilled <ul style="list-style-type: none"> • Ignition switch is in the ON position • Selector lever P position switch signal: Except P position (battery voltage) • Selector lever P/N position signal: Except P and N positions (0 V)
B2604: PNP SW	Inhibit electronic steering column lock	500 ms after any of the following BCM recognition conditions is fulfilled <ul style="list-style-type: none"> • Status 1 <ul style="list-style-type: none"> - Ignition switch is in the ON position - Selector lever P/N position signal: P and N position (battery voltage) - P range signal or N range signal (CAN): ON • Status 2 <ul style="list-style-type: none"> - Ignition switch is in the ON position - Selector lever P/N position signal: Except P and N positions (0 V) - P range signal and N range signal (CAN): OFF
B2605: PNP SW	Inhibit electronic steering column lock	500 ms after any of the following BCM recognition conditions is fulfilled <ul style="list-style-type: none"> • Ignition switch is in the ON position <ul style="list-style-type: none"> - Power position: IGN - Selector lever P/N position signal: Except P and N positions (0 V) - Interlock/PNP switch signal (CAN): OFF • Status 2 <ul style="list-style-type: none"> - Ignition switch is in the ON position - Selector lever P/N position signal: P or N position (battery voltage) - PNP switch signal (CAN): ON
B2606: S/L RELAY	Inhibit engine cranking	500 ms after the following CAN signal communication status has become consistent <ul style="list-style-type: none"> • Electronic steering column lock relay signal (Request signal) • Electronic steering column lock relay signal (Condition signal)

BCM (BODY CONTROL MODULE)

< ECU DIAGNOSIS >

[COUPE]

Display contents of CONSULT	Fail-safe	Cancellation
B2607: S/L RELAY	Inhibit engine cranking	500 ms after the following CAN signal communication status has become consistent <ul style="list-style-type: none"> Electronic steering column lock relay signal (Request signal) Electronic steering column lock relay signal (Condition signal)
B2608: STARTER RELAY	Inhibit engine cranking	500 ms after the following signal communication status becomes consistent <ul style="list-style-type: none"> Starter motor relay control signal Starter relay status signal (CAN)
B2609: S/L STATUS	<ul style="list-style-type: none"> Inhibit engine cranking Inhibit electronic steering column lock 	When the following electronic steering column lock conditions agree <ul style="list-style-type: none"> BCM electronic steering column lock control status Electronic steering column lock condition No. 1 signal status Electronic steering column lock condition No. 2 signal status
B260A: IGNITION RELAY	Inhibit engine cranking	500 ms after the following conditions are fulfilled <ul style="list-style-type: none"> IGN relay (IPDM E/R) control signal: OFF (Battery voltage) Ignition ON signal (CAN to IPDM E/R): OFF (Request signal) Ignition ON signal (CAN from IPDM E/R): OFF (Condition signal)
B260F: ENG STATE SIG LOST	Maintains the power supply position attained at the time of DTC detection	When any of the following conditions is fulfilled <ul style="list-style-type: none"> Power position changes to ACC Receives engine status signal (CAN)
B2612: S/L STATUS	<ul style="list-style-type: none"> Inhibit engine cranking Inhibit electronic steering column lock 	When any of the following conditions is fulfilled <ul style="list-style-type: none"> Electronic steering column lock unit status signal (CAN) is received normally The BCM electronic steering column lock control status matches the electronic steering column lock status recognized by the electronic steering column lock unit status signal (CAN from IPDM E/R)
B2617: STARTER RELAY CIRC	Inhibit engine cranking	1 second after the starter motor relay control inside BCM becomes normal
B2618: BCM	Inhibit engine cranking	1 second after the ignition relay (IPDM E/R) control inside BCM becomes normal
B2619: BCM	Inhibit engine cranking	1 second after the electronic steering column lock unit power supply output control inside BCM becomes normal
B261E: VEHICLE TYPE	Inhibit engine cranking	BCM initialization
B26E1: ENG STATE NO RECIV	Inhibit engine cranking	When any of the following conditions is fulfilled <ul style="list-style-type: none"> Power position changes to ACC Receives engine status signal (CAN)

DTC Inspection Priority Chart

INFOID:000000001344619

If some DTCs are displayed at the same time, perform inspections one by one based on the following priority chart.

Priority	DTC
1	<ul style="list-style-type: none"> B2562: LOW VOLTAGE B2563: HI VOLTAGE B261E: VEHICLE TYPE
2	<ul style="list-style-type: none"> U1000: CAN COMM CIRCUIT U1010: CONTROL UNIT (CAN)
3	<ul style="list-style-type: none"> B2190: NATS ANTENA AMP B2191: DIFFERENCE OF KEY B2192: ID DISCORD BCM-ECM B2193: CHAIN OF BCM-ECM

BCM (BODY CONTROL MODULE)

[COUPE]

< ECU DIAGNOSIS >

Priority	DTC
4	<ul style="list-style-type: none"> • B2013: ID DISCORD BCM-S/L • B2014: CHAIN OF S/L-BCM • B2553: IGNITION RELAY • B2555: STOP LAMP • B2556: PUSH-BTN IGN SW • B2557: VEHICLE SPEED • B2560: STARTER CONT RELAY • B2601: SHIFT POSITION • B2602: SHIFT POSITION • B2603: SHIFT POSI STATUS • B2604: PNP SW • B2605: PNP SW • B2606: S/L RELAY • B2607: S/L RELAY • B2608: STARTER RELAY • B2609: S/L STATUS • B260A: IGNITION RELAY • B260B: STEERING LOCK UNIT • B260C: STEERING LOCK UNIT • B260D: STEERING LOCK UNIT • B260F: ENG STATE SIG LOST • B2611: ACC RELAY • B2612: S/L STATUS • B2614: ACC RELAY CIRC • B2615: BLOWER RELAY CIRC • B2616: IGN RELAY CIRC • B2617: STARTER RELAY CIRC • B2618: BCM • B2619: BCM • B261A: PUSH-BTN IGN SW • B26E1: ENG STATE NO RECIV • C1729: VHCL SPEED SIG ERR • U0415: VEHICLE SPEED SIG
5	<ul style="list-style-type: none"> • C1704: LOW PRESSURE FL • C1705: LOW PRESSURE FR • C1706: LOW PRESSURE RR • C1707: LOW PRESSURE RL • C1708: [NO DATA] FL • C1709: [NO DATA] FR • C1710: [NO DATA] RR • C1711: [NO DATA] RL • C1712: [CHECKSUM ERR] FL • C1713: [CHECKSUM ERR] FR • C1714: [CHECKSUM ERR] RR • C1715: [CHECKSUM ERR] RL • C1716: [PRESSDATA ERR] FL • C1717: [PRESSDATA ERR] FR • C1718: [PRESSDATA ERR] RR • C1719: [PRESSDATA ERR] RL • C1720: [CODE ERR] FL • C1721: [CODE ERR] FR • C1722: [CODE ERR] RR • C1723: [CODE ERR] RL • C1724: [BATT VOLT LOW] FL • C1725: [BATT VOLT LOW] FR • C1726: [BATT VOLT LOW] RR • C1727: [BATT VOLT LOW] RL • C1734: CONTROL UNIT
6	<ul style="list-style-type: none"> • B2621: INSIDE ANTENNA • B2622: INSIDE ANTENNA • B2623: INSIDE ANTENNA

BCM (BODY CONTROL MODULE)

< ECU DIAGNOSIS >

[COUPE]

DTC Index

INFOID:000000001344620

NOTE:

- Details of time display
- CRNT: Displays when there is a malfunction now or after returning to the normal condition until turning ignition switch OFF → ON again.
- 1 - 39: Displayed if any previous malfunction is present when current condition is normal. It increases like 1 → 2 → 3...38 → 39 after returning to the normal condition whenever ignition switch OFF → ON. The counter remains at 39 even if the number of cycles exceeds it. It is counted from 1 again when turning ignition switch OFF → ON after returning to the normal condition if the malfunction is detected again.

CONSULT display	Fail-safe	Intelligent Key warning lamp ON	Tire pressure monitor warning lamp ON	Reference page
No DTC is detected. further testing may be required.	—	—	—	—
U1000: CAN COMM CIRCUIT	—	—	—	PCS-54
U1010: CONTROL UNIT (CAN)	—	—	—	PCS-55
U0415: VEHICLE SPEED SIG	—	—	—	BCS-33
B2013: ID DISCORD BCM-S/L	×	—	—	SEC-41
B2014: CHAIN OF S/L-BCM	×	—	—	SEC-42
B2190: NATS ANTENA AMP	×	—	—	SEC-34
B2191: DIFFERENCE OF KEY	×	—	—	SEC-38
B2192: ID DISCORD BCM-ECM	×	—	—	SEC-39
B2193: CHAIN OF BCM-ECM	×	—	—	SEC-40
B2553: IGNITION RELAY	—	—	—	PCS-56
B2555: STOP LAMP	—	—	—	SEC-46
B2556: PUSH-BTN IGN SW	—	×	—	SEC-49
B2557: VEHICLE SPEED	×	×	—	SEC-51
B2560: STARTER CONT RELAY	×	×	—	SEC-52
B2562: LOW VOLTAGE	—	—	—	BCS-34
B2563: HI VOLTAGE	×	×	—	BCS-35
B2601: SHIFT POSITION	×	×	—	SEC-53
B2602: SHIFT POSITION	×	×	—	SEC-57
B2603: SHIFT POSI STATUS	×	×	—	SEC-60
B2604: PNP SW	×	×	—	SEC-64
B2605: PNP SW	×	×	—	SEC-66
B2606: S/L RELAY	×	×	—	SEC-68
B2607: S/L RELAY	×	×	—	SEC-69
B2608: STARTER RELAY	×	×	—	SEC-71
B2609: S/L STATUS	×	×	—	SEC-73
B260A: IGNITION RELAY	×	×	—	PCS-58
B260B: STEERING LOCK UNIT	—	×	—	SEC-78
B260C: STEERING LOCK UNIT	—	×	—	SEC-79
B260D: STEERING LOCK UNIT	—	×	—	SEC-80
B260F: ENG STATE SIG LOST	×	×	—	SEC-81
B2611: ACC RELAY	—	—	—	PCS-59
B2612: S/L STATUS	×	×	—	SEC-83

A
B
C
D
E
F
G
H
I
J
L
M
N
O
P

SEC

BCM (BODY CONTROL MODULE)

< ECU DIAGNOSIS >

[COUPE]

CONSULT display	Fail-safe	Intelligent Key warning lamp ON	Tire pressure monitor warning lamp ON	Reference page
B2614: ACC RELAY CIRC	—	×	—	PCS-61
B2615: BLOWER RELAY CIRC	—	×	—	PCS-64
B2616: IGN RELAY CIRC	—	×	—	PCS-67
B2617: STARTER RELAY CIRC	×	×	—	SEC-88
B2618: BCM	×	×	—	PCS-70
B2619: BCM	×	×	—	SEC-90
B261A: PUSH-BTN IGN SW	—	×	—	SEC-91
B261E: VEHICLE TYPE	×	× (Turn ON for 15 seconds)	—	SEC-94
B2621: INSIDE ANTENNA	—	—	—	DLK-44
B2622: INSIDE ANTENNA	—	—	—	DLK-47
B2623: INSIDE ANTENNA	—	—	—	DLK-50
B26E1: ENG STATE NO RES	×	×	—	SEC-82
C1704: LOW PRESSURE FL	—	—	×	WT-23
C1705: LOW PRESSURE FR	—	—	×	WT-23
C1706: LOW PRESSURE RR	—	—	×	WT-23
C1707: LOW PRESSURE RL	—	—	×	WT-23
C1708: [NO DATA] FL	—	—	×	WT-13
C1709: [NO DATA] FR	—	—	×	WT-13
C1710: [NO DATA] RR	—	—	×	WT-13
C1711: [NO DATA] RL	—	—	×	WT-13
C1712: [CHECKSUM ERR] FL	—	—	×	WT-14
C1713: [CHECKSUM ERR] FR	—	—	×	WT-14
C1714: [CHECKSUM ERR] RR	—	—	×	WT-14
C1715: [CHECKSUM ERR] RL	—	—	×	WT-14
C1716: [PRESSDATA ERR] FL	—	—	×	WT-15
C1717: [PRESSDATA ERR] FR	—	—	×	WT-15
C1718: [PRESSDATA ERR] RR	—	—	×	WT-15
C1719: [PRESSDATA ERR] RL	—	—	×	WT-15
C1720: [CODE ERR] FL	—	—	×	WT-14
C1721: [CODE ERR] FR	—	—	×	WT-14
C1722: [CODE ERR] RR	—	—	×	WT-14
C1723: [CODE ERR] RL	—	—	×	WT-14
C1724: [BATT VOLT LOW] FL	—	—	×	WT-14
C1725: [BATT VOLT LOW] FR	—	—	×	WT-14
C1726: [BATT VOLT LOW] RR	—	—	×	WT-14
C1727: [BATT VOLT LOW] RL	—	—	×	WT-14
C1729: VHCL SPEED SIG ERR	—	—	×	WT-16

IPDM E/R (INTELLIGENT POWER DISTRIBUTION MODULE ENGINE ROOM)

< ECU DIAGNOSIS >

[COUPE]

IPDM E/R (INTELLIGENT POWER DISTRIBUTION MODULE ENGINE ROOM)

Reference Value

INFOID:000000001344621

VALUES ON THE DIAGNOSIS TOOL

Refer to [PCS-20. "Reference Value"](#).

TERMINAL LAYOUT

Refer to [PCS-20. "Reference Value"](#).

PHYSICAL VALUES

Refer to [PCS-20. "Reference Value"](#).

FAIL SAFE

Refer to [PCS-39. "Fail Safe"](#).

DTC INDEX

Refer to [PCS-41. "DTC Index"](#).

A
B
C
D
E
F
G
H
I
J
L
M
N
O
P

SEC

SYMPTOM DIAGNOSIS

INTELLIGENT KEY SYSTEM/ENGINE START FUNCTION SYMPTOMS

Symptom Table

INFOID:000000001344627

Engine can not be started with all Intelligent Keys.

CAUTION:

- Follow Trouble Diagnosis Flowchart referring to “[SEC-8. "Work Flow"](#)”. Determine malfunctioning condition before performing this diagnosis.
- Check that vehicle is under the condition shown in “Conditions of vehicle” before starting diagnosis.
- Check systems shown in the “Diagnosis/service procedure” column in this order.

CONDITIONS OF VEHICLE (OPERATING CONDITIONS)

- Engine start function is ON when setting on CONSULT-III.
- Use Intelligent Key with registered Intelligent Key ID.
- One or more of Intelligent Keys with registered Intelligent Key ID is in the passenger compartment.

Diagnosis/service procedure		Reference page
1. Check power supply and ground circuit	BCM	SEC-121
	IPDM E/R	SEC-121
2. Check push button ignition switch		PCS-75
3. Check Intermittent Incident		GI-42

VEHICLE SECURITY SYSTEM SYMPTOMS

< SYMPTOM DIAGNOSIS >

[COUPE]

VEHICLE SECURITY SYSTEM SYMPTOMS

Symptom Table

INFOID:000000001344628

Procedure		Diagnostic procedure	Refer to page
Symptom			
1	Vehicle security system cannot be set by	Door switch	Check door switch DLK-54
		Trunk	Check trunk room lamp switch DLK-84
		Door outside key	Check key cylinder switch SEC-126 , or SEC-128
		Intelligent Key	Check Intelligent Key. DLK-113
		—	Check Intermittent Incident GI-42
	Security indicator does not turn ON.	Check vehicle security indicator SEC-135	
		Check Intermittent Incident GI-42	
2	* Vehicle security system does not sound alarm when	Any door is opened.	Check door switch DLK-54
			Check Intermittent Incident GI-42
3	Vehicle security alarm does not activate.	Horn alarm	Check horn SEC-131
			Check Intermittent Incident GI-42
		Head lamp alarm	Check head lamp alarm SEC-133
			Check Intermittent Incident GI-42
4	Vehicle security system cannot be canceled by	Door outside key	Check key cylinder switch SEC-126 , or SEC-128
			Check Intermittent Incident GI-42
		Intelligent Key	Check Intelligent Key DLK-113
			Check Intermittent Incident GI-42

*: Check the system is in the armed phase.

A
B
C
D
E
F
G
H
I
J
L
M
N
O
P

SEC

NISSAN VEHICLE IMMOBILIZER SYSTEM-NATS SYMPTOMS

< SYMPTOM DIAGNOSIS >

[COUPE]

NISSAN VEHICLE IMMOBILIZER SYSTEM-NATS SYMPTOMS

Symptom Table

INFOID:000000001344629

Security indicator does not turn ON or flash.

CAUTION:

- Follow Trouble Diagnosis Flowchart referring to "[SEC-8, "Work Flow"](#)". Determine malfunctioning condition before performing this diagnosis.
- Check that vehicle is under the condition shown in "Conditions of vehicle" before starting diagnosis.
- Check systems shown in the "Action" column in this order.

CONDITIONS OF VEHICLE (OPERATING CONDITIONS)

- Intelligent Key is not inserted into key slot.
- Engine switch is not depressed.

Action	Reference page
1. Check vehicle security indicator	SEC-135
2. Check Intermittent Incident	GI-42

ON-VEHICLE MAINTENANCE

PRE-INSPECTION FOR DIAGNOSTIC

Basic Inspection

INFOID:000000001344630

The engine start function, door lock function, power distribution system and NATS-IVIS/NMS in the Intelligent Key system are closely related to each other regarding control. Narrow down the functional area in question by performing basic inspection to identify which function is malfunctioning. The vehicle security function can operate only when the door lock and power distribution system are operating normally. Therefore, it is easy to identify any factor unique to the vehicle security system by performing the vehicle security operation check after basic inspection.

1. CHECK DOOR LOCK OPERATION

1. Check the door lock for normal operation with the Intelligent Key controller and door request switch. Successful door lock operation with the Intelligent Key and request SW indicates that the remote keyless entry receiver is functioning normally. Identify the malfunctioning point by referring to the DLK section if the door cannot be unlocked.

Can the door be locked with the Intelligent Key and door request switch?

- YES >> GO TO 2.
 NO >> Refer to [DLK-163, "Symptom Table"](#).

2. CHECK ENGINE STARTING

1. Checks that the engine starts when operating the Intelligent Key inserted into the key slot.

Does the engine start?

- YES >> GO TO 3.
 NO >> Refer to [SEC-176, "Symptom Table"](#).

3. CHECK STEERING LOCKING

1. Does the steering lock when operating door switch after switching the power supply from ON position (or ACC position) to LOCK position?
 If door switch is malfunctioning, BCM cannot lock the steering. If BCM does not detect DTC, steering lock unit is normal.

Does steering lock?

- YES >> GO TO 4.
 NO >> Refer to [DLK-54, "Component Function Check"](#).

4. CHECK POWER SUPPLY INDICATOR SWITCHING

1. Press push-button ignition switch and position indicator will switch from LOCK, ACC to ON gradually when steering is locked. Checks that the position indicator is illuminated at different positions of the circuit.

Is each position indicator illuminating?

- YES >> GO TO 5.
 NO >> Refer to [PCS-75, "Component Function Check"](#).

5. CHECK VEHICLE SECURITY SYSTEM

1. Check the vehicle security system for normal operation.
 The vehicle security function can operate only when the door lock and power distribution functions are operating normally.
 Therefore, it is easy to identify any factor unique to the vehicle security by performing the vehicle security operation check after this basic inspection.

>> Go to [SEC-179, "Vehicle Security Operation Check"](#).

Vehicle Security Operation Check

INFOID:000000001344631

1. INSPECTION START

Turn ignition switch "OFF" and pull out Intelligent Key from key slot.

NOTE:

PRE-INSPECTION FOR DIAGNOSTIC

[COUPE]

< ON-VEHICLE MAINTENANCE >

Before starting operation check, open front windows.

>> GO TO 2.

2. CHECK SECURITY INDICATOR LAMP

1. Lock doors using Intelligent Key or mechanical key.
2. Check that security indicator lamp illuminates for 30 seconds.

Security indicator lamp should illuminate.

OK >> GO TO 3.

NG >> Perform diagnosis and repair. Refer to [SEC-135, "Component Function Check"](#).

3. CHECK ALARM FUNCTION

1. After 30 seconds, security indicator lamp will start to blink.
2. Open any door or hood before unlocking with Intelligent Key or mechanical key, or open trunk lid without Intelligent Key or mechanical key.

Do alarm function properly.

OK >> GO TO 4.

NG >> Check the following.

- The vehicle security system does not phase in alarm mode. Refer to [SEC-177, "Symptom Table"](#).
- Alarm (horn, headlamp and hazard lamp) do not operate. Refer to [SEC-177, "Symptom Table"](#).

4. CHECK ALARM CANCEL OPERATION

Unlock any door or open trunk lid using Intelligent Key or mechanical key.

Alarm (horn, headlamp and hazard lamp) should stop.

OK >> INSPECTION END.

NG >> Check door lock function. Refer to [DLK-19, "INTELLIGENT KEY : System Description"](#).

ON-VEHICLE REPAIR

KEY SLOT

Removal and Installation

INFOID:000000001344632

REMOVAL

1. Remove the instrument lower panel LH. Refer to [IP-11. "Removal and Installation"](#).
2. Disconnect key slot connector.
3. Remove the key slot screw (A), and then remove key slot (1) from instrument lower panel LH (2).

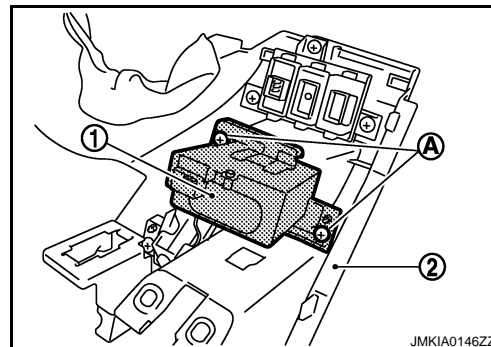

INSTALLATION

Install in the reverse order of removal.

A
B
C
D
E
F
G
H
I
J
L
M
N
O
P

SEC

PUSH BUTTON IGNITION SWITCH

< ON-VEHICLE REPAIR >

[COUPE]

PUSH BUTTON IGNITION SWITCH

Removal and Installation

INFOID:000000001344633

REMOVAL

1. Remove the cluster lid A assembly. Refer to [IP-11, "Removal and Installation"](#).
2. Remove the push-button ignition switch (1) from cluster lid A assembly, and then remove pawl (A). Press push-button ignition switch (1) back to disengage from cluster lid A assembly.

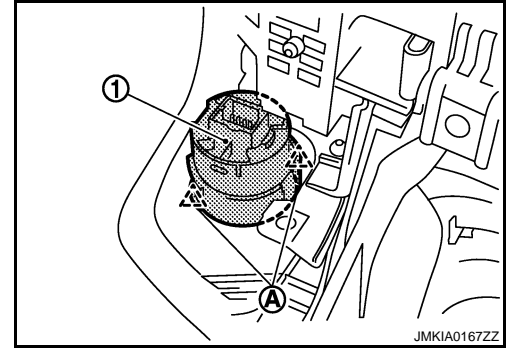

INSTALLATION

Install in the reverse order of removal.

DIAGNOSIS AND REPAIR WORKFLOW

< BASIC INSPECTION >

[SEDAN]

BASIC INSPECTION

DIAGNOSIS AND REPAIR WORKFLOW

Work Flow

INFOID:000000003185359

OVERALL SEQUENCE

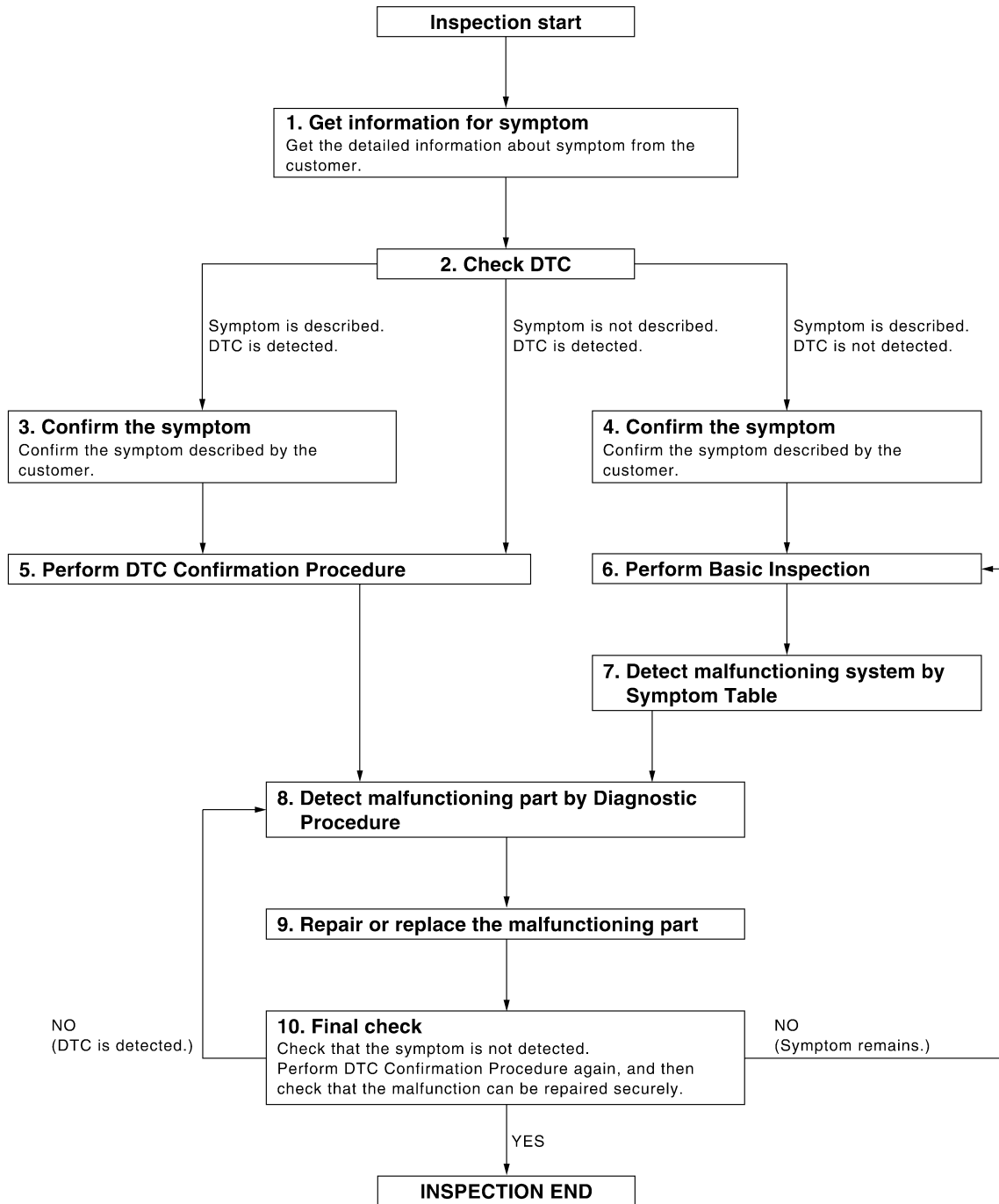

A
B
C
D
E
F
G
H
I
J
L
M
N
O
P

SEC

DETAILED FLOW

ALKIA0246GB

DIAGNOSIS AND REPAIR WORKFLOW

[SEDAN]

< BASIC INSPECTION >

1.GET INFORMATION FOR SYMPTOM

Get the detailed information from the customer about the symptom (the condition and the environment when the incident/malfunction occurred).

>> GO TO 2.

2.CHECK DTC WITH BCM AND IPDM E/R

1. Check "Self Diagnostic Result" with CONSULT-III.
2. Perform the following procedure if DTC is displayed.
 - Record DTC and freeze frame data (Print them out with CONSULT-III.)
 - Erase DTC.
 - Study the relationship between the cause detected by DTC and the symptom described by the customer.
3. Check related service bulletins for information.

Is any symptom described and any DTC detected?

Symptom is described, DTC is displayed>>GO TO 3.

Symptom is described, DTC is not displayed>>GO TO 4.

Symptom is not described, DTC is displayed>>GO TO 5.

3.CONFIRM THE SYMPTOM

Confirm the symptom described by the customer.

Connect CONSULT-III to the vehicle in "Data Monitor" mode and check real time diagnosis results.

Verify relation ship between the symptom and the condition when the symptom is detected.

>> GO TO 5.

4.CONFIRM THE SYMPTOM

Confirm the symptom described by the customer.

Connect CONSULT-III to the vehicle in "Data Monitor " mode and check real time diagnosis results.

Verify relation ship between the symptom and the condition when the symptom is detected.

>> GO TO 6.

5.PERFORM DTC CONFIRMATION PROCEDURE

Perform DTC Confirmation Procedure for the displayed DTC, and then check that DTC is detected again.

At this time, always keep CONSULT-III connected to the vehicle, and check diagnostic results in real time.

If two or more DTCs are detected, refer to [SEC-347. "DTC Inspection Priority Chart"](#) and determine trouble diagnosis order.

NOTE:

- Freeze frame data is useful if the DTC is not detected.
- Perform Component Function Check if DTC Confirmation Procedure is not included in Service Manual. This simplified check procedure is an effective alternative though DTC cannot be detected during this check. If the result of Component Function Check is NG, it is the same as the detection of DTC by DTC Confirmation Procedure.

Is DTC detected?

Yes >> GO TO 8.

No >> Refer to [GI-42. "Intermittent Incident"](#).

6.PERFORM BASIC INSPECTION

Perform [SEC-355. "Basic Inspection"](#).

Inspection End>>GO TO 7.

7.DETECT MALFUNCTIONING SYSTEM BY SYMPTOM TABLE

Detect malfunctioning system according to following symptom tables based on the confirmed symptom in step 4, and determine the trouble diagnosis order based on possible causes and symptoms.

- Intelligent Key system/engine start function: [SEC-352. "Symptom Table"](#).
- Vehicle security system: [SEC-353. "Symptom Table"](#).

DIAGNOSIS AND REPAIR WORKFLOW

[SEDAN]

< BASIC INSPECTION >

- Nissan vehicle immobilizer system-NATS: [SEC-354. "Symptom Table"](#).

>> GO TO 8.

8. DETECT MALFUNCTIONING PART BY DIAGNOSTIC PROCEDURE

Inspect according to Diagnostic Procedure of the system.

NOTE:

The Diagnostic Procedure described based on open circuit inspection. A short circuit inspection is also required for the circuit check in the Diagnostic Procedure.

Is malfunctioning part detected?

Yes >> GO TO 9.

No >> Check voltage of related BCM terminals using CONSULT-III.

9. REPAIR OR REPLACE THE MALFUNCTIONING PART

1. Repair or replace the malfunctioning part.
2. Reconnect parts or connectors disconnected during Diagnostic Procedure again after repair or replacement.
3. Check DTC. If DTC is displayed, erase it.

>> GO TO 10.

10. FINAL CHECK

When DTC was detected in step 2, perform DTC Confirmation Procedure or Component Function Check again, and then check that the malfunction have been fully repaired.

When symptom was described from the customer, refer to confirmed symptom in step 3 or 4, and check that the symptom is not detected.

Is the inspection result normal?

NO (DTC is detected)>>GO TO 8.

NO (Symptom remains)>>GO TO 6.

YES >> **INSPECTION END**

A
B
C
D
E
F
G
H
I
J
L
M
N
O
P

SEC

< BASIC INSPECTION >

INSPECTION AND ADJUSTMENT

ECM RE-COMMUNICATING FUNCTION

ECM RE-COMMUNICATING FUNCTION : Description

INFOID:000000003185360

Performing following procedure can automatically perform re-communication of ECM and BCM, but only when the ECM has been replaced with a new one (*1).

*1: New one means an ECM which has never been energized on-board.

(In this step, initialization procedure by CONSULT-III is not necessary)

NOTE:

- When registering new Key IDs or replacing the ECM that is not brand new, refer to CONSULT-III Operation Manual.
- If multiple keys are attached to the key holder, separate them before work.
- Distinguish keys with unregistered key ID from those with registered ID.

ECM RE-COMMUNICATING FUNCTION : Special Repair Requirement

INFOID:000000003185361

1. PERFORM ECM RE-COMMUNICATING FUNCTION

1. Install ECM.
2. Insert the registered Intelligent Key (*2), turn ignition switch to "ON".
*2: To perform this step, use the key that has been used before performing ECM replacement.
3. Maintain ignition switch in "ON" position for at least 5 seconds.
4. Turn ignition switch to "OFF".
5. Start engine.

Can engine be started?

YES >> Procedure is completed.

NO >> Initialize control unit. Refer to CONSULT-III Operation Manual NATS-IVIS/NVIS.

FUNCTION DIAGNOSIS

INTELLIGENT KEY SYSTEM/ENGINE START FUNCTION

System Diagram

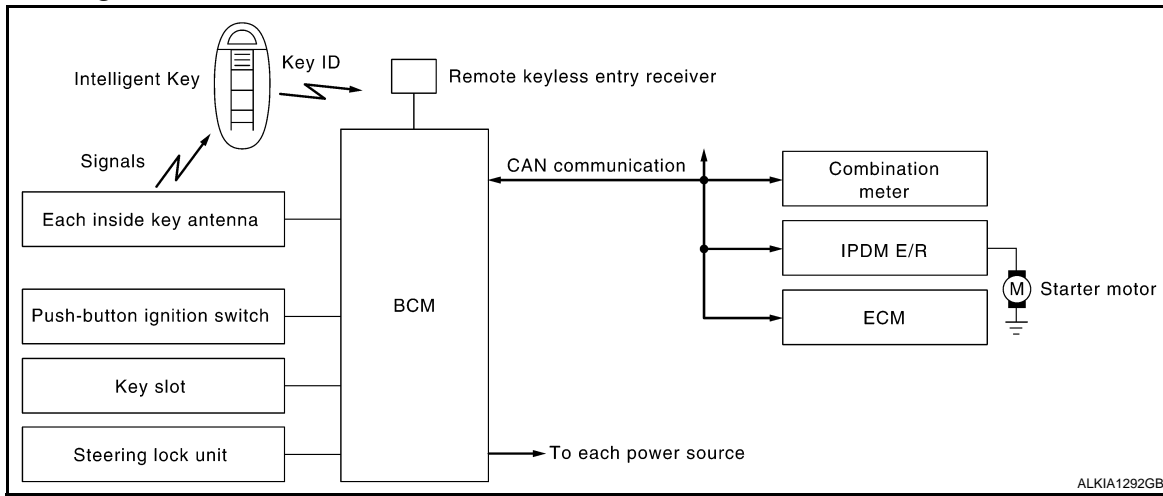

System Description

INFOID:000000003185363

INPUT/OUTPUT SIGNAL CHART

Switch	Input signal to BCM	BCM function	Actuator
Push-button ignition switch	Push switch	Engine start function	<ul style="list-style-type: none"> Steering lock relay Steering lock unit Starter relay (IPDM E/R) Starter control relay (IPDM E/R) Starter motor KEY warning lamp
CVT device (CVT models)	P range		
PNP switch (CVT models)	N, P range		
Clutch interlock switch (M/T models)	Clutch ON/OFF		
Stop lamp switch	Brake ON/OFF		
Each inside key antenna	Request signal		
Remote keyless entry receiver	Key ID		
Each door switch	Door open/close		
ECM	Engine status signal		

SYSTEM DESCRIPTION

- The engine start function of Intelligent Key system is a system that makes it possible to start and stop the engine without removing the key. It verifies the electronic ID using two-way communications when pressing the push-button ignition switch while carrying the Intelligent Key, which operates based on the results of electronic ID verification for Intelligent Key using two-way communications between the Intelligent Key and the vehicle.

NOTE:

- The driver should carry the Intelligent Key at all times.
- Intelligent Key has 2 IDs [for Intelligent Key and for NVIS (NATS)]. It can perform the door lock/unlock operation and the push-button ignition switch operation when the registered Intelligent Key is carried.
- When the Intelligent Key battery is discharged, it can be used as emergency back-up by inserting the Intelligent Key to the key slot. At that time, perform the NVIS (NATS) ID verification. If it is used when the Intelligent Key is carried, perform the Intelligent Key ID verification.
- If the ID is successfully verified, and when push-button ignition switch is pressed, steering lock will be released and initiating the engine will be possible.
- If the door lock/unlock operation is performed when the Intelligent Key battery is discharged, all doors lock/unlock can be performed by operating the driver door key cylinder using the mechanical key set in the Intelligent Key.

A
B
C
D
E
F
G
H
I
J
K
L
M
N
O
P

SEC

INTELLIGENT KEY SYSTEM/ENGINE START FUNCTION

[SEDAN]

< FUNCTION DIAGNOSIS >

- Intelligent Key can be registered up to 4 keys (Including the standard Intelligent Key) on request from the owner.

NOTE:

- Refer to [DLK-217, "INTELLIGENT KEY : System Description"](#) for any functions other than engine start function of Intelligent Key system.

PRECAUTIONS FOR INTELLIGENT KEY SYSTEM

- In the Intelligent Key system of model L32, the transponder [the chip for NVIS (NATS) ID verification] is integrated into the Intelligent Key. (For the conventional models, it is integrated into the mechanical key.) Therefore, the mechanical key cannot perform the ID verification, and thus it cannot start the engine. Instead, the NVIS (NATS) ID verification can be performed by inserting the Intelligent Key into the key slot, and then it can start the engine.

OPERATION WHEN INTELLIGENT KEY IS CARRIED

1. When the push-button ignition switch is pressed and brake pedal is depressed, the BCM signals the inside key antenna and transmits the request signal to the Intelligent Key.
2. The Intelligent Key sends the request signal and transmits the Intelligent Key ID signal to the BCM via the remote keyless entry receiver.
3. The BCM receives the Intelligent Key ID signal and verifies it with the registered ID.
4. BCM transmits the steering lock unlock signal to steering lock unit and IPDM E/R if the verification results are OK.
5. IPDM E/R turns the steering lock relay ON and supplies power to the steering lock unit.
6. Release of the steering lock.
7. BCM transmits the power supply stop signal to IPDM E/R when it confirms that the steering lock is in the unlock condition.
8. IPDM E/R turns the steering lock relay OFF and stops power supply to the steering lock unit.
9. BCM turns ACC relay ON and transmits the ignition power supply ON signal to IPDM E/R.
10. IPDM E/R turns the ignition relay ON and starts the ignition power supply.
11. BCM confirms that the shift position is P or N (CVT models).
12. BCM transmits the starter request signal via CAN communication to IPDM E/R and turns the starter relay in IPDM E/R ON if BCM judges that the engine start condition is satisfied.
13. IPDM E/R turns the starter control relay ON when receiving the starter request signal.
14. Battery power is supplied through the starter relay and the starter control relay to operate the starter motor and to start the cranking.

CAUTION:

If a malfunction is detected in the Intelligent Key system, the "KEY" warning lamp in the combination meter illuminates. At that time, the engine cannot be started.

15. When BCM received feedback signal from ECM acknowledging the engine has been initiated, the BCM transmits a stop signal to IPDM E/R and stops the cranking by turning OFF the starter motor relay. (If the engine initiating has failed, the cranking will stop automatically within 5 seconds.)

CAUTION:

When the Intelligent Key is carried outside of the vehicle (inside key antenna detection area) with the power supply in ACC or ON position, even if the engine start condition* is satisfied, the engine cannot be started.

*: For the engine start condition, refer to "PUSH-BUTTON IGNITION SWITCH OPERATION PROCEDURE".

OPERATION RANGE

Engine can be started when Intelligent Key is inside the vehicle. However, sometimes engine might not start when Intelligent Key is on instrument panel or in glove box.

OPERATION WHEN KEY SLOT IS USED

When the Intelligent Key battery is discharged, it performs the NVIS (NATS) ID verification between the integrated transponder and BCM by inserting the Intelligent Key into the key slot, and then the engine can be started.

For details relating to starting the engine using key slot, refer to [SEC-187, "System Description"](#).

BATTERY SAVER SYSTEM

When all the following conditions are met for 60 minutes, the battery saver system will cut off the power supply to prevent battery discharge.

INTELLIGENT KEY SYSTEM/ENGINE START FUNCTION

[SEDAN]

< FUNCTION DIAGNOSIS >

- The ignition switch is in the ACC position
- All doors are closed
- CVT selector lever is in the P position
- No Intelligent Key failures (Intelligent Key warning indicator is not ON)

Reset Condition of Battery Saver System

CVT models

In order to prevent the battery from discharging, the battery saver system will cut off the power supply when all doors are closed, the selector lever is on P position and the ignition switch is left on ACC position for 1 hour. If any of the following conditions are met the battery saver system is released and the steering will change automatically to lock position from OFF position.

- Opening any door
- Operating with request switch on door lock
- Operating with Intelligent Key on door lock

Press push-button ignition switch and ignition switch will change to ACC position from OFF position.

M/T models

If any of the conditions above is met the battery saver system is released but the steering will not lock. In this case, the steering operation OFF to LOCK is prohibited.

STEERING LOCK OPERATION

Steering is locked by steering lock unit when ignition switch is in the OFF position, CVT selector lever is in the P position and any of the following conditions are met.

- Opening door
- Closing door
- Door is locked with request switch
- Door is locked with Intelligent Key

PUSH-BUTTON IGNITION SWITCH OPERATION PROCEDURE

The power supply position changing operation can be performed with the following operations.

NOTE:

- When an Intelligent Key is within the detection area of inside key antenna or when it is inserted to the key slot, it is equivalent to the operations below.
- When starting the engine, the BCM monitors under the engine start conditions,
 - Brake pedal operating condition (CVT models)
 - CVT selector lever position (CVT models)
 - Clutch pedal operating condition (M/T models)
 - Vehicle speed
 - Steering lock condition
 - Engine status
- Unless each start condition is fulfilled, the engine will not respond regardless of how many times the engine switch is pressed. At that time, illumination repeats the position in the order of LOCK→ACC→ON→OFF.

Power supply position	Engine start/stop condition		Push-button ignition switch operation frequency
	Brake pedal (CVT) /clutch pedal (M/T)	CVT selector lever position	
LOCK → ACC	Not depressed	Any position	1
LOCK → ACC → ON	Not depressed	Any position	2
LOCK → ACC → ON → OFF	Not depressed	Any position	3
LOCK → START ACC → START ON → START (Engine start)	Depressed	P or N position (*1)	1 [If the switch is pressed once, the engine starts from any power supply position (LOCK, ACC, and ON)]
Engine is running → OFF (Engine stop)	—	Any position Vehicle speed < 4 km/h (2 MPH)	1

INTELLIGENT KEY SYSTEM/ENGINE START FUNCTION

< FUNCTION DIAGNOSIS >

[SEDAN]

Power supply position	Engine start/stop condition		Push-button ignition switch operation frequency
	Brake pedal (CVT) /clutch pedal (M/T)	CVT selector lever position	
Engine is running → ACC (Engine stop)	—	Any position other than P (*2)	1
Engine stall return operation while driving	—	P position	1

*1: When the CVT selector lever position is N position, the engine start condition is different according to the vehicle speed.

- At vehicle speed of 4 km/h (2 MPH) or less, the engine can start only when the brake pedal is depressed.
- At vehicle speed of 4 km/h (2 MPH) or more, the engine can start even if the brake pedal is not depressed. (It is the same as “Engine stall return operation while driving”.)

*2: When the CVT selector lever position is in any position other than P position and when the vehicle speed is 5 km/h (3 MPH) or more, the engine stop condition is different.

- Press and hold the push-button ignition switch for 2 seconds or more. (When the push-button ignition switch is pressed for too short a time, the operation may be invalid, so properly press and hold to prevent an incorrect operation.)
- Press the push-button ignition switch 3 times or more within 1.5 seconds. (Emergency stop operation)

INTELLIGENT KEY SYSTEM/ENGINE START FUNCTION

< FUNCTION DIAGNOSIS >

[SEDAN]

Component Parts Location

INFOID:000000003185364

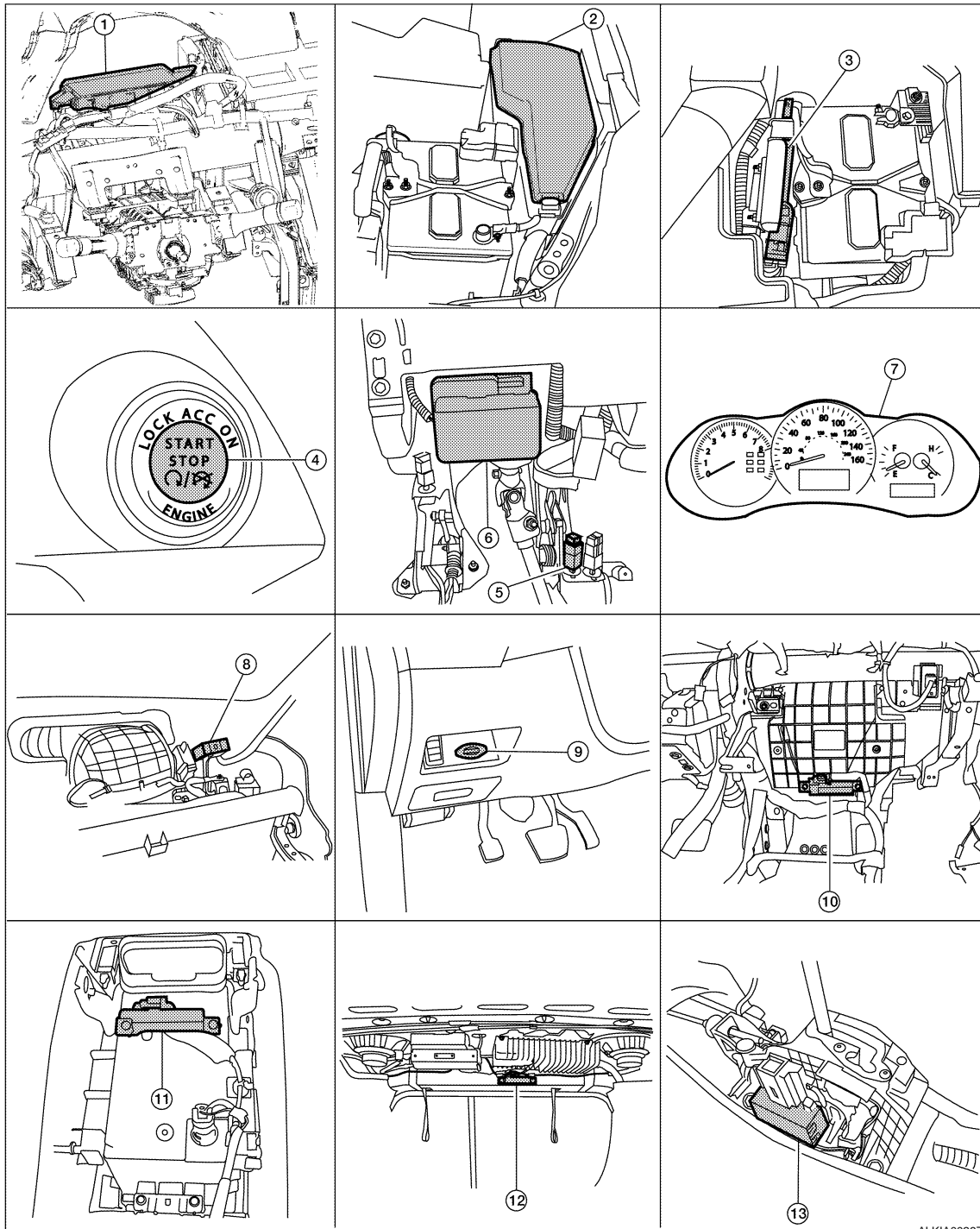

- | | | |
|---|---|---|
| 1. Body control module (view with instrument panel removed) | 2. IPDM E/R | 3. ECM |
| 4. Push button ignition switch | 5. Stop lamp switch (view with lower driver instrument panel removed) | 6. Steering lock unit (steering column) |
| 7. Combination meter | 8. Remote keyless entry receiver (view with instrument panel removed) | 9. Key slot |
| 10. Instrument panel antenna (view with instrument panel removed) | 11. Front console antenna (bottom view of console) | 12. Rear parcel shelf antenna |
| 13. Detente switch (CVT device) | | |

A
B
C
D
E
F
G
H
I
J
K
L
M
N
O
P

SEC

ALKIA0026ZZ

INTELLIGENT KEY SYSTEM/ENGINE START FUNCTION

< FUNCTION DIAGNOSIS >

[SEDAN]

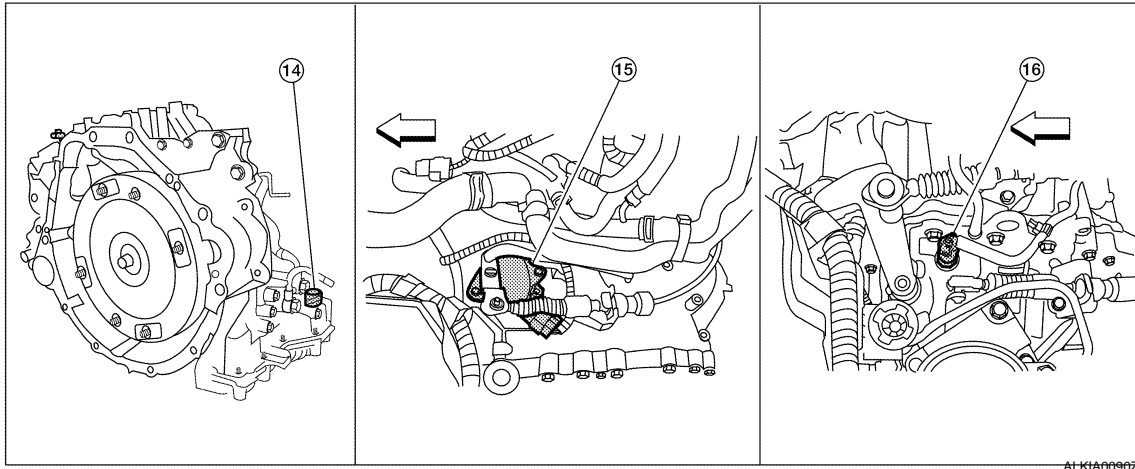

ALKIA0090ZZ

14. Park neutral position switch connector (switch inside trans) (CVT/VQ)

15. Park neutral position switch (CVT/QR)

16. Park neutral position switch (M/T)

Component Description

INFOID:000000003185365

Component	Reference
BCM	SEC-265
Steering lock unit	SEC-253
Push-button ignition switch	SEC-224
Door switch	DLK-252
CVT device (detention switch)	SEC-228
Inside key antenna	DLK-242
Remote keyless entry receiver	DLK-311
Stop lamp switch	SEC-221
Park/neutral position switch	SEC-239
Clutch switch	SEC-284
Steering lock relay	SEC-271
Starter relay	SEC-279
Starter control relay	SEC-277
Security indicator	SEC-310
Key warning lamp	SEC-309

NVIS (NISSAN VEHICLE IMMOBILIZER SYSTEM-NATS)

< FUNCTION DIAGNOSIS >

[SEDAN]

NVIS (NISSAN VEHICLE IMMOBILIZER SYSTEM-NATS)

System Diagram

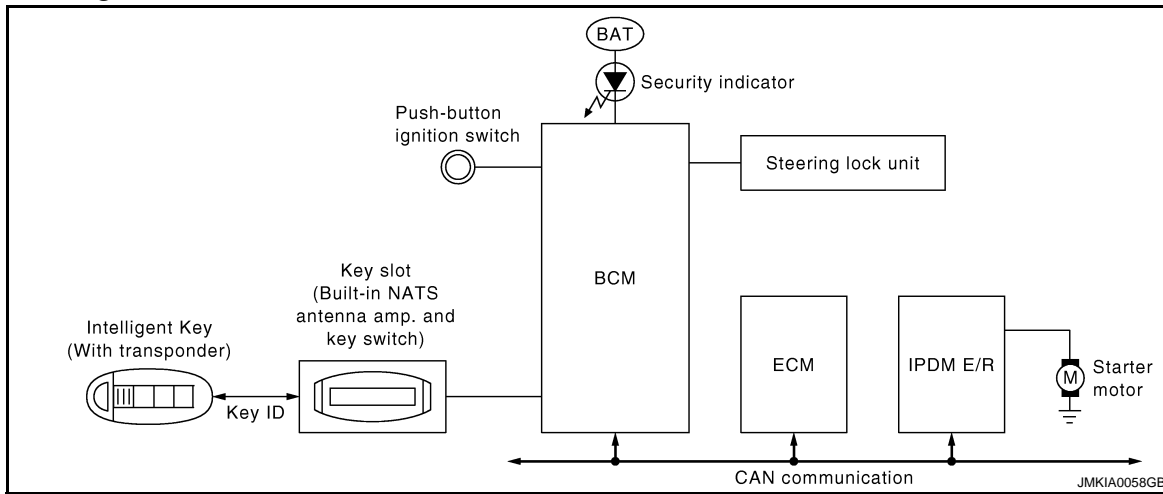

INFOID:000000003185366

System Description

INFOID:000000003185367

INPUT/OUTPUT SIGNAL CHART

Switch	Input signal to BCM	BCM function	Actuator
Push-button ignition switch	Push switch	NVIS (NATS)	<ul style="list-style-type: none"> Steering lock relay Steering lock unit Starter relay (IPDM E/R) Starter control relay (IPDM E/R) Starter motor KEY warning lamp Security indicator lamp
CVT device (CVT models)	P range		
PNP switch (CVT models)	N, P range		
Clutch interlock switch (M/T models)	Clutch ON/OFF		
Stop lamp switch	Brake ON/OFF		
Key slot	Key ID		
Each door switch	Door open/close		
ECM	Engine status signal		

SYSTEM DESCRIPTION

- The NVIS (NATS) is an anti-theft system by registering an Intelligent Key ID in to the vehicle and prevents the engine being started by an unregistered Intelligent Key. It has a higher protection against auto thefts that duplicate mechanical key.
- It performs the ID verification when starting the engine in the same way as the Intelligent Key system. But, it performs the NVIS (NATS) ID verification when inserting the Intelligent Key and performs the Intelligent Key ID verification when carrying the Intelligent Key.
- The Intelligent Key system of L32 is not the same as the conventional models. The mechanical key integrated in the Intelligent Key cannot start the engine. When the Intelligent Key battery is discharged, the NVIS (NATS) ID verification memorized to the transponder integrated with Intelligent Key is performed by inserting the Intelligent Key into the key slot. If the verification results are OK, the engine start operation can be performed by the push-button ignition switch operation.
- Locate the security indicator and apply the anti-theft system equipment sticker, forewarn that the NVIS (NATS) is onboard with the model.
- The security indicator always blinks when the Intelligent Key is removed from the key slot and when the power supply position is in LOCK position.
- Intelligent Key can be registered up to 4 keys (Including the standard ignition key) on request from the owner.
- The specified registration is required when replacing ECM, BCM or Intelligent Key. The registrations procedure for NVIS (NATS) and registration procedure for Intelligent Key when installing the BCM, refer to CONSULT-III Operation Manual NATS-IVIS/NVIS.

NVIS (NISSAN VEHICLE IMMOBILIZER SYSTEM-NATS)

[SEDAN]

< FUNCTION DIAGNOSIS >

- Possible symptom of NVIS (NATS) malfunction is "Engine cannot start". In L32, the engine can be started with the Intelligent Key system and NVIS (NATS). Identify the possible causes according to "Work Flow", Refer to [SEC-183. "Work Flow"](#).
- If ECM other than Genuine NISSAN is installed, the engine cannot be started. For ECM replacement procedure, refer to [SEC-186. "ECM RE-COMMUNICATING FUNCTION : Special Repair Requirement"](#).

PRECAUTIONS FOR KEY REGISTRATION

- The key registration is a procedure that erases the current NVIS (NATS) ID once, and then re-registers a new ID operation. Therefore the registered Intelligent Key is necessary for this procedure. Before starting the registration operation collect all registered Intelligent Keys from the customer
- When registering the Intelligent Key, performs only one procedure to register simultaneously both ID (NVIS "NATS" ID registration and Intelligent Key ID registration).
The NVIS (NATS) ID registration is the procedure that registers the ID stored into the transponder (integrated in intelligent key) to BCM.
The Intelligent key ID registration is the procedure that registers the ID to BCM.
- When performing the Intelligent Key system registration only, the engine cannot be started by inserting the key into the key slot. When performing the NVIS (NATS) registration only, the engine cannot be started by the operation when carrying the key. The registrations of both systems should be performed.

SECURITY INDICATOR

- Warns that the vehicle is equipped with NVIS (NATS).
- The security indicator always blinks when the Intelligent Key is removed from the key slot and when the ignition switch is in LOCK position.

NOTE:

Because security indicator is highly efficient, the battery is barely affected.

NVIS (NISSAN VEHICLE IMMOBILIZER SYSTEM-NATS)

< FUNCTION DIAGNOSIS >

[SEDAN]

Component Parts Location

INFOID:000000003185368

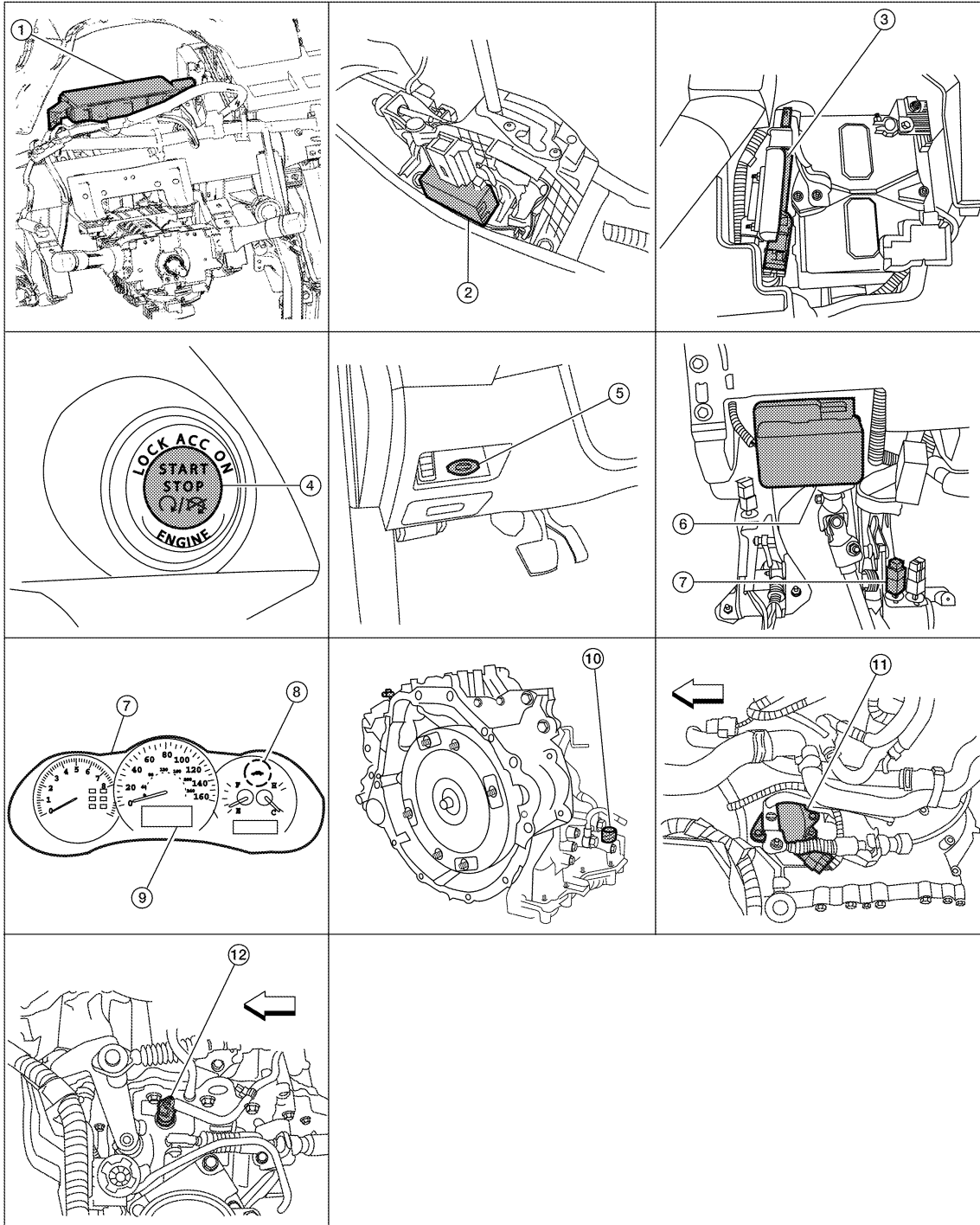

- | | | |
|--|---|---|
| 1. Body control module M16, M17, M18, M19, M21
(view with instrument panel removed) | 2. CVT device (detent switch) M23
(with CVT) | 3. ECM E10 |
| 4. Push button ignition switch M38 | 5. Key slot M40 | 6. Electronic steering column lock M32
(steering column) |
| 7. Stop lamp switch E38
(view with lower LH instrument panel removed) | 8. Security indicator lamp | 9. Information display |
| 10. Park neutral position switch connector (TCM
connector) F16
(with CVT/VQ) | 11. Park neutral position switch F25
(with CVT/QR) | 12. Park neutral position switch F32
(with M/T) |

ALKIA1300ZZ

A
B
C
D
E
F
G
H
I
J
K
L
M
N
O
P

SEC

NVIS (NISSAN VEHICLE IMMOBILIZER SYSTEM-NATS)

< FUNCTION DIAGNOSIS >

[SEDAN]

Component Description

INFOID:000000003185369

Component	Reference
BCM	SEC-265
Steering lock unit	SEC-253
Push-button ignition switch	SEC-266
Door switch	DLK-252
CVT device (detention switch)	SEC-228
Inside key antenna	DLK-242
Remote keyless entry receiver	DLK-311
Stop lamp switch	SEC-221
Park/neutral position switch	SEC-239
Clutch switch	SEC-284
Steering lock relay	SEC-270
Starter relay	SEC-246
Starter control relay	SEC-227
Security indicator	SEC-310
Key warning lamp	SEC-309

VEHICLE SECURITY SYSTEM

[SEDAN]

< FUNCTION DIAGNOSIS >

VEHICLE SECURITY SYSTEM

System Diagram

INFOID:000000003185370

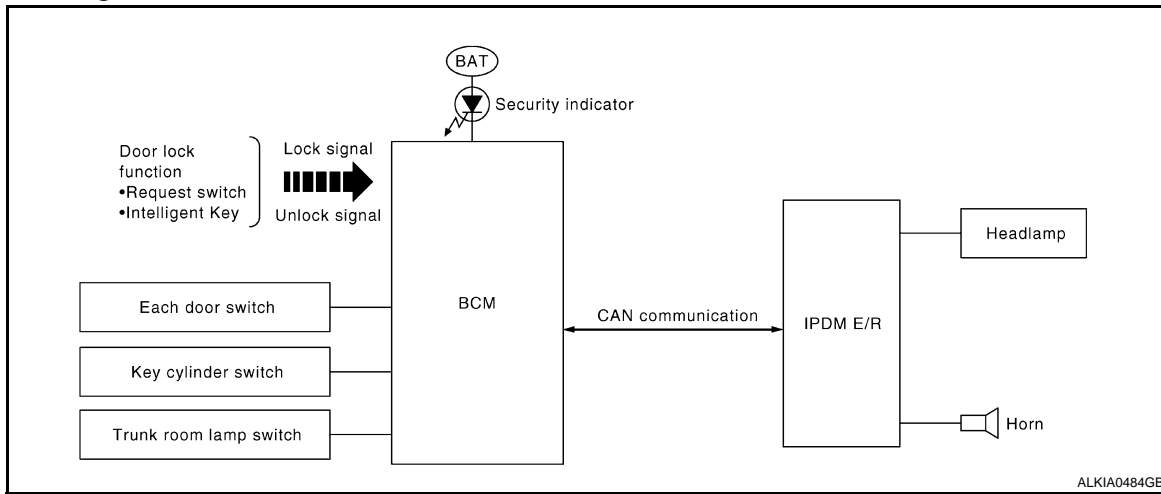

System Description

INFOID:000000003185371

INPUT/OUTPUT SIGNAL CHART

Switch	Input signal to BCM	BCM system	Actuator
All door switch	Open or close	Vehicle security system	<ul style="list-style-type: none"> IPDM E/R Head lamp Horn Security indicator lamp
Trunk room lamp switch			
Door key cylinder switch			
Door lock and unlock switch	Lock or unlock		
Door request switch			
Intelligent Key	Lock or unlock		
	Panic alarm		

OPERATION FLOW

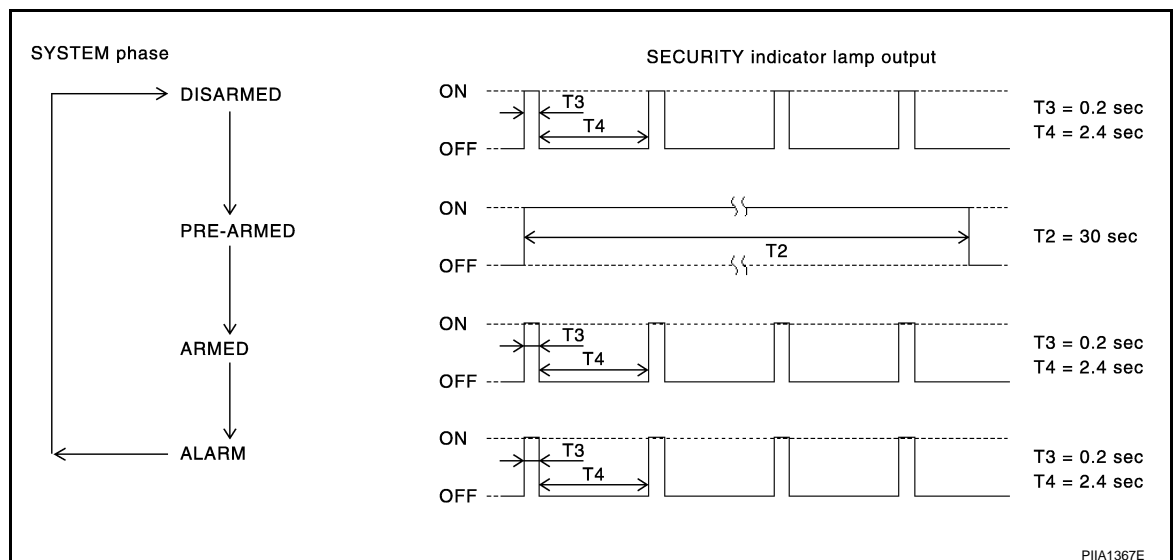

SETTING THE VEHICLE SECURITY SYSTEM

Initial Condition

- Ignition switch is in OFF position.

Disarmed Phase

VEHICLE SECURITY SYSTEM

[SEDAN]

< FUNCTION DIAGNOSIS >

- When doors or trunk is open, the vehicle security system is set in the disarmed phase on the assumption that the owner is inside or near the vehicle.
- When the vehicle security system is in the disarmed phase, the security indicator lamp blinks every 2.4 seconds.

Pre-armed Phase and Armed Phase

When the following operation 1 or 2 is performed, the vehicle security system turns into the “pre-armed” phase. (The security indicator lamp illuminates.)

1. BCM receives LOCK signal from front door key cylinder switch or Intelligent Key, after trunk and all doors are closed.
2. Trunk and all doors are closed after front doors are locked by key or door lock and unlock switch. The security indicator lamp illuminates for 30 seconds. Then, the system automatically shifts into the “armed” phase.

CANCELING THE SET VEHICLE SECURITY SYSTEM

When one of the following operations is performed, the armed phase is canceled.

1. Unlock the doors with the key or Intelligent Key.
2. Turn ignition switch “ON” or “ACC” position.

CANCELING THE ALARM OPERATION OF THE VEHICLE SECURITY SYSTEM

When unlocking the door with the key or Intelligent Key the alarm operation is canceled.

ACTIVATING THE ALARM OPERATION OF THE VEHICLE SECURITY SYSTEM

Check that the system is in the armed phase. (The security indicator lamp blinks every 2.4 seconds.)

When the following operation 1 or 2 is performed, the system sounds the horns and flashes the headlamps for about 50 seconds.

1. Hood, trunk or any door is opened during armed phase.
2. Disconnecting and connecting the battery connector before canceling armed phase.

PANIC ALARM OPERATION

Intelligent Key system will not operate horn and headlamps if the ignition switch is in the ACC or ON position. When the Intelligent Key system is triggered, ground is supplied intermittently to both headlamp relay and horn relay.

When headlamp relay and horn relay are energized, then power is supplied to headlamps (LH and RH) and horns (HIGH and LOW).

The headlamp flashes and the horn sounds intermittently.

The alarm automatically turns off after 50 seconds or when BCM receives any signal from Intelligent Key.

VEHICLE SECURITY SYSTEM

< FUNCTION DIAGNOSIS >

[SEDAN]

Component Parts Location

INFOID:000000003185372

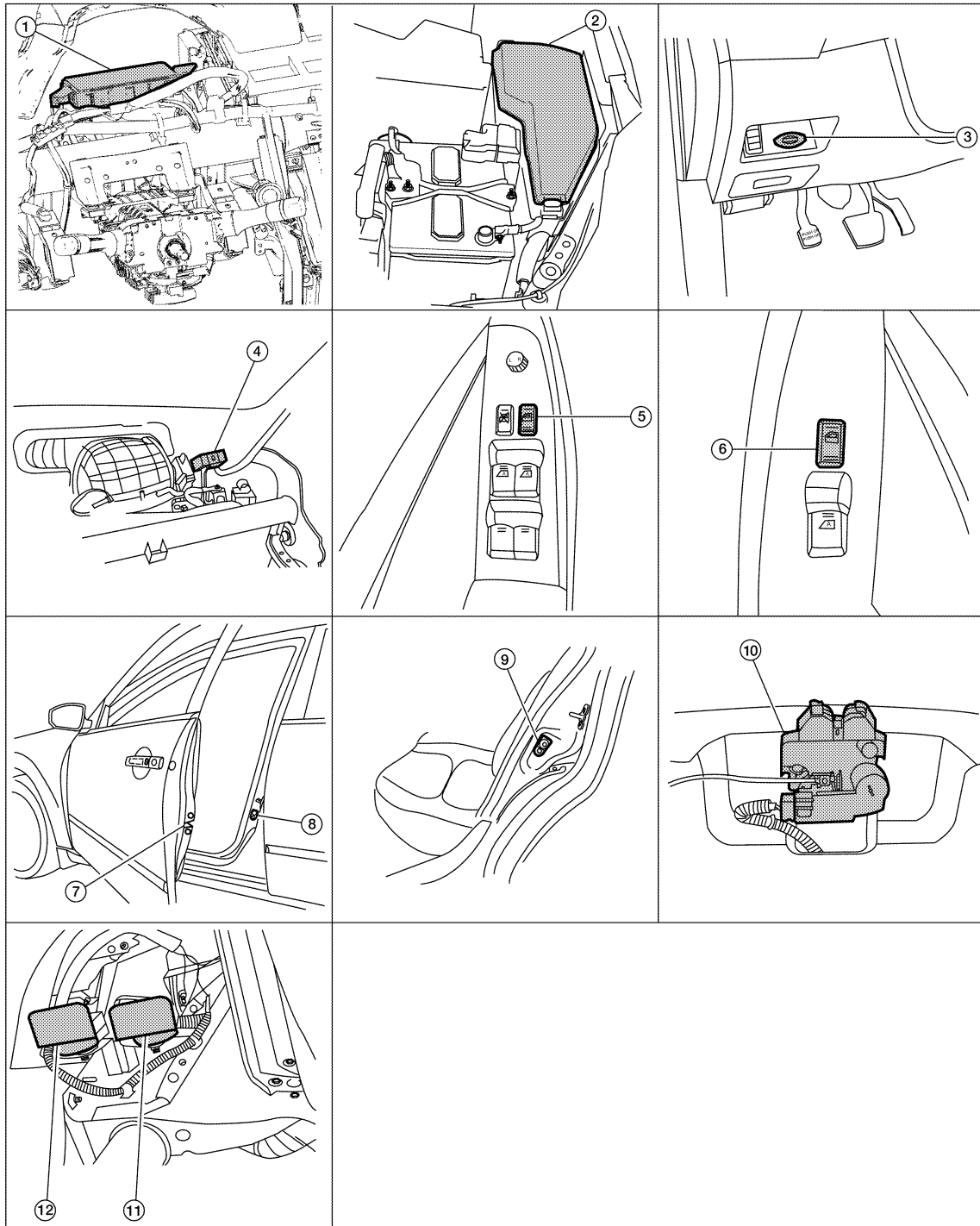

- | | | |
|---|---|---------------------------------|
| 1. Body control module (view with instrument panel removed) | 2. IPDM E/R | 3. Key slot |
| 4. Remote keyless entry receiver (view with instrument panel removed) | 5. Main power window switch | 6. Front power window switch RH |
| 7. Front door lock assembly LH (key cylinder switch) | 8. Front door switch LH | 9. Rear door switch LH |
| 10. Trunk lid lock assembly | 11. Horn (high) (view with front fender protector LH removed) | 12. Horn (low) |

ALKIA0025ZZ

A
B
C
D
E
F
G
H
I
J
L
M
N
O
P

SEC

VEHICLE SECURITY SYSTEM

< FUNCTION DIAGNOSIS >

[SEDAN]

Component Description

INFOID:000000003185373

Component	Reference
BCM	SEC-197
Horn relay	SEC-306
Security indicator	SEC-310
Door switch	DLK-252
Door lock actuator	DLK-295
Trunk lid lock assembly	DLK-301
Door key cylinder switch	DLK-269
Door lock and unlock switch	DLK-256

DIAGNOSIS SYSTEM (BCM)

[SEDAN]

< FUNCTION DIAGNOSIS >

DIAGNOSIS SYSTEM (BCM)

COMMON ITEM

COMMON ITEM : Diagnosis Description

INFOID:000000003185374

BCM CONSULT-III FUNCTION

CONSULT-III performs the following functions via CAN communication with BCM.

Diagnosis mode	Function Description
WORK SUPPORT	Changes the setting for each system function.
SELF-DIAG RESULTS	Displays the diagnosis results judged by BCM.
CAN DIAG SUPPORT MNTR	Monitors the reception status of CAN communication viewed from BCM.
DATA MONITOR	The BCM input/output signals are displayed.
ACTIVE TEST	The signals used to activate each device are forcibly supplied from BCM.
ECU IDENTIFICATION	The BCM part number is displayed.
CONFIGURATION	This function is not used even though it is displayed.

SYSTEM APPLICATION

BCM can perform the following functions for each system.

NOTE:

It can perform the diagnosis modes except the following for all sub system selection items.

System	Sub system selection item	Diagnosis mode		
		WORK SUPPORT	DATA MONITOR	ACTIVE TEST
Door lock	DOOR LOCK	×	×	×
Rear window defogger	REAR DEFOGGER		×	×
Warning chime	BUZZER		×	×
Interior room lamp timer	INT LAMP	×	×	×
Exterior lamp	HEAD LAMP	×	×	×
Wiper and washer	WIPER	×	×	×
Turn signal and hazard warning lamps	FLASHER	×	×	×
Air conditioner	AIR CONDITONER		×	
Intelligent Key system	INTELLIGENT KEY	×	×	×
Combination switch	COMB SW		×	
BCM	BCM	×		
Immobilizer	IMMU		×	×
Interior room lamp battery saver	BATTERY SAVER	×	×	×
Trunk open	TRUNK		×	
Vehicle security system	THEFT ALM	×	×	×
RAP system	RETAINED PWR		×	
Signal buffer system	SIGNAL BUFFER		×	×
TPMS	AIR PRESSURE MONITOR	×	×	×

COMMON ITEM : CONSULT-III Function

INFOID:000000003185375

ECU IDENTIFICATION

Displays the BCM part No.

SELF-DIAG RESULT

Refer to [SEC-349, "DTC Index"](#).

INTELLIGENT KEY

DIAGNOSIS SYSTEM (BCM)

< FUNCTION DIAGNOSIS >

[SEDAN]

INTELLIGENT KEY : CONSULT-III Function (BCM - INTELLIGENT KEY)

INFOID:000000003185376

BCM CONSULT-III FUNCTION

CONSULT-III performs the following functions via CAN communication with BCM.

Diagnosis mode	Function Description
WORK SUPPORT	Changes the setting for each system function.
SELF-DIAG RESULTS	Displays the diagnosis results judged by BCM.
DATA MONITOR	The BCM input/output signals are displayed.
ACTIVE TEST	The signals used to activate each device are forcibly supplied from BCM.

WORK SUPPORT

Monitor item	Description
REMO CONT ID CONFIR	It can be checked whether Intelligent Key ID code is registered or not in this mode.
LOCK/UNLOCK BY I-KEY	Door lock/unlock function by door request switch (driver side, passenger side and trunk) mode can be changed to operate (ON) or not operate (OFF) in this mode.
ENGINE START BY I-KEY	Engine start function mode can be changed to operate (ON) or not operate (OFF) with this mode.
TRUNK/GLASS HATCH OPEN	Buzzer reminder function mode by trunk opener request switch can be changed to operate (ON) or not operate (OFF) with this mode.
PANIC ALARM SET	Panic alarm button pressing time on Intelligent Key remote control button can be selected from the following with this mode. <ul style="list-style-type: none"> • 0.5 sec. • 1.5 sec. • OFF: Non-operation
PW DOWN SET	Unlock button pressing time on Intelligent Key button can be selected from the following with this mode. <ul style="list-style-type: none"> • 3 sec. • 5 sec. • OFF: Non-operation
TRUNK OPEN DELAY	Trunk button pressing time on Intelligent Key button can be selected from the following with this mode. <ul style="list-style-type: none"> • 0.5 sec. • 1.5 sec. • OFF: Non-operation
LO- BATT OF KEY FOB WARN	Intelligent Key low battery warning mode can be changed to operate (ON) or not operate (OFF) with this mode.
ANTI KEY LOCK IN FUNCTI	Key reminder function mode can be changed to operate (ON) or not operate (OFF) with this mode.
HORN WITH KEYLESS LOCK	Horn reminder function mode by Intelligent Key button can be changed to operate (ON) or not operate (OFF) with this mode.
HAZARD ANSWER BACK	Hazard reminder function mode can be selected from the following with this mode. <ul style="list-style-type: none"> • LOCK ONLY: Door lock operation only • UNLOCK ONLY: Door unlock operation only • LOCK AND UNLOCK: Lock/unlock operation • OFF: Non operation
ANS BACK I-KEY LOCK	Buzzer reminder function (lock operation) mode by door request switch (driver side and passenger side) can be selected from the following with this mode. <ul style="list-style-type: none"> • HORN CHIRP: Sound horn • BUZZER: Sound Intelligent Key warning buzzer • OFF: Non-operation
ANS BACK I-KEY UNLOCK	Buzzer reminder function (unlock operation) mode by door request switch can be changed to operate (ON) or not operate (OFF) with this mode.

DIAGNOSIS SYSTEM (BCM)

< FUNCTION DIAGNOSIS >

[SEDAN]

Monitor item	Description
SHORT CRANKING OUTPUT	Starter motor can operate during the times below. <ul style="list-style-type: none"> • 70 msec • 100 msec • 200 msec
INSIDE ANT DIAGNOSIS	This function allows inside key antenna self-diagnosis.

SELF-DIAG RESULT

Refer to [SEC-349, "DTC Index"](#).

DATA MONITOR

Monitor Item	Condition
REQ SW-DR	Indicates [ON/OFF] condition of door request switch (driver side).
REQ SW-AS	Indicates [ON/OFF] condition of door request switch (passenger side).
REQ SW-BD/TR	Indicates [ON/OFF] condition of trunk opener request switch.
PUSH SW	Indicates [ON/OFF] condition of push-button ignition switch.
CLUCH SW	Indicates [ON/OFF] condition of clutch switch.
BRAKE SW 1	Indicates [ON/OFF] condition of brake switch.
DETE/CANCL SW	Indicates [ON/OFF] condition of P position.
SFT PN/N SW	Indicates [ON/OFF] condition of P or N position.
S/L -LOCK	Indicates [ON/OFF] condition of steering lock (LOCK).
S/L -UNLOCK	Indicates [ON/OFF] condition of steering lock (UNLOCK).
S/L RELAY-F/B	Indicates [ON/OFF] condition of ignition switch.
UNLK SEN-DR	Indicates [ON/OFF] condition of driver door UNLOCK status.
PUSH SW -IPDM	Indicates [ON/OFF] condition of push-button ignition switch.
IGN RLY1 F/B	Indicates [ON/OFF] condition of ignition relay 1.
DETE SW -IPDM	Indicates [ON/OFF] condition of P position.
SFT PN -IPDM	Indicates [ON/OFF] condition of P or N position.
SFT P -MET	Indicates [ON/OFF] condition of P position.
SFT N -MET	Indicates [ON/OFF] condition of N position.
ENGINE STATE	Indicates [STOP/START/CRANK/RUN] condition of engine states.
S/L LOCK-IPDM	Indicates [ON/OFF] condition of steering lock (LOCK).
S/L UNLOCK-IPDM	Indicates [ON/OFF] condition of steering lock (UNLOCK).
S/L RELAY-REQ	Indicates [ON/OFF] condition of steering lock relay.
VEH SPEED 1	Display the vehicle speed signal received from combination meter by numerical value [Km/h].
VEH SPEED 2	Display the vehicle speed signal received from ABS or VDC or CVT by numerical value [Km/h].
DOOR STAT-DR	Indicates [LOCK/READY/UNLK] condition of driver side door status.
DOOR STAT-AS	Indicates [LOCK/READY/UNLK] condition of passenger side door status.
KEY SW -SLOT	Indicates [ON/OFF] condition of key slot.
RKE OPE COUN1	When remote keyless entry receiver receives the signal transmitted while operating on Intelligent Key, the numerical value start changing.
RKE OPE COUN2	NOTE: This item is displayed, but cannot be monitored.
TRNK/HAT MNTR	Indicates [ON/OFF] condition of trunk lid.
RKE-LOCK	Indicates [ON/OFF] condition of LOCK signal from Intelligent Key.
RKE-UNLOCK	Indicates [ON/OFF] condition of UNLOCK signal from Intelligent Key.
RKE-TR/BD	Indicates [ON/OFF] condition of TRUNK OPEN signal from Intelligent Key.
RKE-PANIC	Indicates [ON/OFF] condition of PANIC button of Intelligent Key.

DIAGNOSIS SYSTEM (BCM)

< FUNCTION DIAGNOSIS >

[SEDAN]

Monitor Item	Condition
RKE-P/W OPEN	Indicates [ON/OFF] condition of P/W DOWN signal from Intelligent Key.
RKE-MODE CHG	Indicates [ON/OFF] condition of MODE CHANGE signal from Intelligent Key.

ACTIVE TEST

Test item	Description
BATTERY SAVER	This test is able to check interior room lamp operation. The interior room lamp will be activated after "ON" on CONSULT-III screen is touched.
PW REMOTO DOWN SET	This test is able to check power window down operation. The power window down will be activated after "ON" on CONSULT-III screen is touched.
OUTSIDE BUZZER	This test is able to check Intelligent Key warning buzzer operation. Intelligent Key warning buzzer sounds when "ON" on CONSULT-III screen is touched.
INSIDE BUZZER	This test is able to check warning chime in combination meter operation. <ul style="list-style-type: none"> • Take away warning chime sounds when "TAKE OUT" on CONSULT-III screen is touched. • Key warning chime sounds when "KEY WARN" on CONSULT-III screen is touched. • P position warning chime sounds when "P RNG WARN" on CONSULT-III screen is touched. • ACC warning chime sounds when "ACC WARN" on CONSULT-III screen is touched.
INDICATOR	This test is able to check warning lamp operation. <ul style="list-style-type: none"> • "KEY" Warning lamp illuminates when "KEY IND ON" on CONSULT-III screen is touched. • "KEY" Warning lamp flashes when "KEY IND FSH" on CONSULT-III screen is touched.
INT LAMP	This test is able to check interior room lamp operation. The interior room lamp will be activated after "ON" on CONSULT-III screen is touched.
LCD	This test is able to check meter display information <ul style="list-style-type: none"> • Engine start information displays when "BRAKE/P" on CONSULT-III screen is touched. • Engine start information displays when "BRAKE/P/ON" on CONSULT-III screen is touched. • Key ID warning displays when "KEY ID NG" on CONSULT-III screen is touched. • Steering lock information displays when "STLCK RELES" on CONSULT-III screen is touched. • P position warning displays when "P RNG IND" on CONSULT-III screen is touched. • Intelligent Key insert information displays when "INSERT KEY" on CONSULT-III screen is touched. • Intelligent Key low battery warning displays when "KEY BAT LOW" on CONSULT-III screen is touched. • Take away through window warning displays when "TK AWAY WDW" on CONSULT-III screen is touched. • Take away warning display when "TAKE AWAY" on CONSULT-III screen is touched. • OFF position warning display when "IGN OFF WARN" on CONSULT-III screen is touched.
TRUNK/GLASS HATCH	This test is able to check trunk lid opener actuator open operation. This actuator opens when "ON" on CONSULT-III screen is touched.
FLASHER	This test is able to check security hazard lamp operation. The hazard lamps will be activated after "ON" on CONSULT-III screen is touched.
HORN	This test is able to check horn operation. The horn will be activated after "ON" on CONSULT-III screen is touched.
IGN CONT2	This test is able to check security hazard lamp operation. The hazard lamps will be activated after "ON" on CONSULT-III screen is touched.
P RANGE	This test is able to check A/T device power supply A/T device power is supplied when "ON" on CONSULT-III screen is touched.
ENGINE SW ILLUMI	This test is able to check push-ignition switch illumination operation. Push-ignition switch illumination illuminates when "ON" on CONSULT-III screen is touched.
LOCK INDCATOR	This test is able to check LOCK indicator in push-ignition switch operation. LOCK indicator in push-ignition switch illuminates when "ON" on CONSULT-III screen is touched.
ACC INDCATOR	This test is able to check ACC indicator in push-ignition switch operation. LOCK indicator in push-ignition switch illuminates when "ON" on CONSULT-III screen is touched.
IGNITION ON IND	This test is able to check INGITION ON indicator in push-ignition switch operation. LOCK indicator in push-ignition switch illuminates when "ON" on CONSULT-III screen is touched.
KEY SLOT ILLUMI	This test is able to check key slot illumination operation. Key slot illumination flash when "ON" on CONSULT-III screen is touched.

DIAGNOSIS SYSTEM (BCM)

< FUNCTION DIAGNOSIS >

[SEDAN]

THEFT ALM

THEFT ALM : CONSULT-III Function (BCM - THEFT)

INFOID:000000003185377

APPLICATION ITEM

CONSULT-III performs the following functions via CAN communication with BCM.

Diagnosis mode	Function Description
WORK SUPPORT	Changes the setting for each system function.
DATA MONITOR	The BCM input/output signals are displayed.
ACTIVE TEST	The signals used to activate each device are forcibly supplied from BCM.

DATA MONITOR

Monitored Item	Description
REQ SW-DR	Indicates [ON/OFF] condition of door request switch (driver side).
REQ SW-AS	Indicates [ON/OFF] condition of door request switch (passenger side).
REQ SW-BD/TR	Indicates [ON/OFF] condition of trunk opener request switch.
PUSH SW	Indicates [ON/OFF] condition of push-button ignition switch
UNLK SEN-DR	Indicates [ON/OFF] condition of driver door UNLOCK status.
KEY SW -SLOT	Indicates [ON/OFF] condition of key slot.
DOOR SW-DR	Indicates [ON/OFF] condition of front door switch LH.
DOOR SW-AS	Indicates [ON/OFF] condition of front door switch RH.
DOOR SW-RR	Indicates [ON/OFF] condition of rear door switch RH.
DOOR SW-RL	Indicates [ON/OFF] condition of rear door switch LH.
DOOR SW-BK	This is displayed even when it is not equipped.
CDL LOCK SW	Indicates [ON/OFF] condition of lock signal from door lock/unlock switch LH and RH.
CDL UNLOCK SW	Indicates [ON/OFF] condition of unlock signal from door lock/unlock switch LH and RH.
KEY CYL LK-SW	Indicates [ON/OFF] condition of lock signal from front door key cylinder switch.
KEY CYL UN-SW	Indicates [ON/OFF] condition of unlock signal from front door key cylinder switch.
KEY CYL SW-TR	This is displayed even when it is not equipped.
TR/BD OPEN SW	Indicates [ON/OFF] condition of trunk lid opener switch.
TRNK/HAT MNTR	Indicates [ON/OFF] condition of trunk room lamp switch.
RKE-LOCK	Indicates [ON/OFF] condition of LOCK signal from Intelligent Key.
RKE-UNLOCK	Indicates [ON/OFF] condition of UNLOCK signal from Intelligent Key.
RKE-TR/BD	Indicates [ON/OFF] condition of TRUNK OPEN signal from Intelligent Key.

WORK SUPPORT

Test Item	Description
SECURITY ALARM SET	This mode is able to confirm and change security alarm ON-OFF setting.
THEFT ALM TRG	The switch which triggered vehicle security alarm is recorded. This mode is able to confirm and erase the record of vehicle security alarm. The trigger data can be erased by touching "CLEAR" on CONSULT-III screen.

ACTIVE TEST

DIAGNOSIS SYSTEM (BCM)

< FUNCTION DIAGNOSIS >

[SEDAN]

Test Item	Description
THEFT IND	This test is able to check security indicator lamp operation. The lamp will be turned on when "ON" on CONSULT-III screen is touched.
VEHICLE SECURITY HORN	This test is able to check vehicle security horn operation. The horns will be activated for 0.5 seconds after "ON" on CONSULT-III screen is touched.
HEADLAMP(HI)	This test is able to check vehicle security lamp operation. The headlamps will be activated for 0.5 seconds after "ON" on CONSULT-III screen is touched.
FLASHER	This test is able to check vehicle security hazard lamp operation. The hazard lamps will be activated after "ON" on CONSULT-III screen is touched.

IMMU

IMMU : CONSULT-III Function (BCM - IMMU)

INFOID:000000003185378

APPLICATION ITEM

CONSULT-III performs the following functions via CAN communication with BCM.

Diagnosis mode	Function Description
DATA MONITOR	The BCM input/output signals are displayed.
ACTIVE TEST	The signals used to activate each device are forcibly supplied from BCM.

DATA MONITOR

Monitor item	Content
CONFIRM ID ALL	Indicates [YET] at all time. Switch to [DONE] when a registered Intelligent Key is inserted into the key slot.
CONFIRM ID4	
CONFIRM ID3	
CONFIRM ID2	
CONFIRM ID1	
TP 4	Indicates the number of ID which has been registered.
TP 3	
TP 2	
TP 1	
PUSH SW	Indicates [ON/OFF] condition of push-button ignition switch.
KEY SW -SLOT	Indicates [ON/OFF] condition of key slot.

ACTIVE TEST

Test item	Description
THEFT IND	This test is able to check security indicator lamp operation. The lamp will be turned on when "ON" on CONSULT-III screen touched.

U1000 CAN COMM CIRCUIT

< COMPONENT DIAGNOSIS >

[SEDAN]

COMPONENT DIAGNOSIS

U1000 CAN COMM CIRCUIT

Description

INFOID:000000003185379

Refer to [LAN-7, "System Description"](#).

DTC Logic

INFOID:000000003185380

DTC DETECTION LOGIC

CONSULT-III display description	DTC Detection Condition	Possible cause
CAN COMM CIRCUIT [U1000]	When BCM cannot communicate CAN communication signal continuously for 2 seconds or more	In CAN communication system, any item (or items) of the following listed below is malfunctioning. <ul style="list-style-type: none">• Transmission• Receiving (ECM)• Receiving (VDC/TCS/ABS)• Receiving (METER/M&A)• Receiving (TCM)• Receiving (MULTI AV)• Receiving (IPDM E/R)

Diagnosis Procedure

INFOID:000000003185381

1. PERFORM SELF DIAGNOSTIC

1. Turn ignition switch ON and wait for 2 second or more.
2. Check "Self Diagnostic Result".

Is "CAN COMM CIRCUIT" displayed?

- YES >> Refer to [LAN-8, "CAN Communication Control Circuit"](#).
NO >> Refer to [GI-42, "Intermittent Incident"](#).

A
B
C
D
E
F
G
H
I
J
L
M
N
O
P

SEC

U1010 CONTROL UNIT (CAN)

< COMPONENT DIAGNOSIS >

[SEDAN]

U1010 CONTROL UNIT (CAN)

DTC Logic

INFOID:000000003185382

DTC DETECTION LOGIC

CONSULT-III display description	DTC Detection Condition	Possible cause
CAN COMM CIRCUIT [U1010]	BCM detected internal CAN communication circuit malfunction.	BCM

Diagnosis Procedure

INFOID:000000003185383

1. REPLACE BCM

When DTC U1010 is detected, replace BCM.

>> Replace BCM. Refer to [BCS-88, "Removal and Installation"](#).

B2013 ID DISCORD, IMMU-STRG

Description

INFOID:000000003185384

BCM performs the ID verification with the steering lock unit and releases the steering lock if both BCM and steering lock unit ID are same. BCM starts the communication with the steering lock unit when Intelligent Key is carried into the passenger compartment and the push-button ignition switch is pressed.

DTC Logic

INFOID:000000003185385

DTC DETECTION LOGIC

DTC No.	Trouble diagnosis name	DTC detecting condition	Possible cause
B2013	ID DISCORD, IMMU-STRG	The ID verification results between BCM and steering control unit are NG. The registration is necessary.	<ul style="list-style-type: none"> Steering wheel lock unit

DTC CONFIRMATION PROCEDURE

1. PERFORM DTC CONFIRMATION PROCEDURE

1. Lock steering.
2. Press the push-button ignition switch
3. Check "Self diagnostic result" with CONSULT-III.

Is DTC detected?

- YES >> Go to [SEC-209. "Diagnosis Procedure"](#).
 NO >> INSPECTION END.

Diagnosis Procedure

INFOID:000000003185386

1. PERFORM INITIALIZATION

Perform initialization with CONSULT-III. Re-register all Intelligent Keys. For initialization and registration of Intelligent Key. Refer to "CONSULT-III Operation Manual".

Can the system be initialized and can steering lock be released with re-registered Intelligent Key?

- YES >> Steering lock unit was unregistered.
 NO >> Replace steering wheel lock unit.



B2014 CHAIN OF STRG-IMMU

Description

INFOID:000000003185387

BCM performs the ID verification with the steering lock unit to release the steering. BCM starts the communication with the steering lock unit when Intelligent Key is carried into the passenger compartment and the push-button ignition switch is pressed.

DTC Logic

INFOID:000000003185388

DTC DETECTION LOGIC

DTC No.	Trouble diagnosis name	DTC detecting condition	Possible cause
B2014	CHAIN OF STRG-IMMU	Inactive communication between steering control unit and BCM	<ul style="list-style-type: none"> • Harness or connectors (steering lock unit circuit is open or shorted) • Steering lock unit • BCM

DTC CONFIRMATION PROCEDURE

1. PERFORM DTC CONFIRMATION PROCEDURE

1. Lock steering.
2. Press the push-button ignition switch.
3. Check "Self diagnostic result" with CONSULT-III.

Is DTC detected?

- YES >> Go to [SEC-210. "Diagnosis Procedure"](#).
 NO >> INSPECTION END.

Diagnosis Procedure

INFOID:000000003185389

1. CHECK STEERING LOCK UNIT POWER SUPPLY

1. Turn ignition switch OFF.
2. Disconnect steering lock unit harness connector.
3. Check voltage between steering lock unit harness connector and ground while turning ignition switch from OFF to ACC.

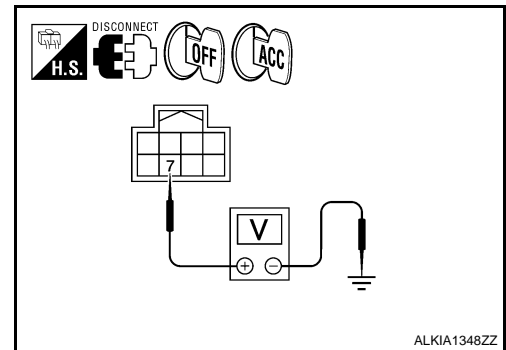

Steering lock unit		Ground	Ignition switch position	Voltage [V]
Connector	Terminal			
M32	7	Ground	OFF → ACC	Battery voltage
			OFF or ON	0

Is the inspection normal?

- YES >> GO TO 3.
 NO >> GO TO 2.

2. CHECK STEERING LOCK UNIT POWER SUPPLY CIRCUIT

1. Turn ignition switch OFF.

B2014 CHAIN OF STRG-IMMU

[SEDAN]

< COMPONENT DIAGNOSIS >

2. Disconnect BCM harness connector.
3. Check continuity between steering lock unit harness connector M32 (A) terminal 7 and BCM harness connector M19 (B) terminal 94.

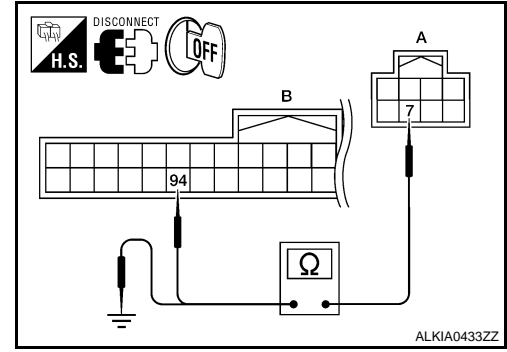

Steering lock unit		BCM		Continuity
Connector	Terminal	connector	Terminal	
A: M32	7	B: M19	94	Yes

4. Check continuity between steering lock unit harness connector M32 (A) terminal 7 and ground.

Steering lock unit		Ground	Continuity
Connector	Terminal		
A: M32	7	Ground	No

Is the inspection normal?

YES >> GO TO 6.

NO >> Repair harness or connector.

3. CHECK STEERING LOCK UNIT GROUND CIRCUIT

1. Turn ignition switch OFF.
2. Check continuity between steering lock unit and ground.

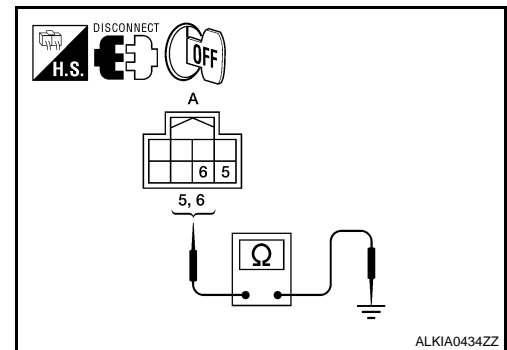

Steering lock unit		Ground	Continuity
Connector	Terminal		
M32	5	Ground	Yes
	6		

Is the inspection normal?

YES >> GO TO 4.

NO >> Repair harness or connector.

4. CHECK STEERING LOCK UNIT COMMUNICATION SIGNAL

1. Connect steering lock unit harness connector.

B2014 CHAIN OF STRG-IMMU

[SEDAN]

< COMPONENT DIAGNOSIS >

- Using an oscilloscope, read voltage signal between steering lock unit harness connector and ground.

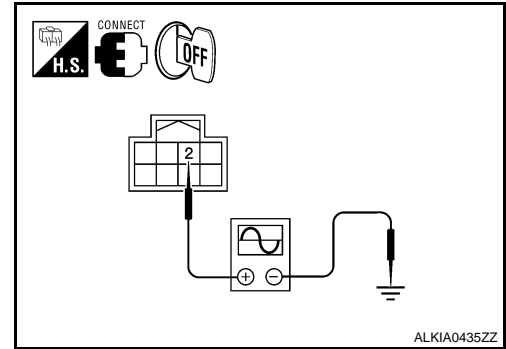

Steering lock unit		Ground	Steering lock unit condition	Value
Connector	Terminal			
M32	2	Ground	Lock	Battery voltage
			Lock or unlock	<p>JMKIA0066GB</p>
			For 15 seconds after unlock	Battery voltage
			15 seconds or later after unlock.	0 V

Steering is locked : Opening the door when ignition switch is ON to OFF.

Steering is unlocked : Ignition switch is OFF to ACC.

Is the inspection normal?

YES >> Replace steering lock unit.

NO >> GO TO 5.

5. CHECK STEERING LOCK UNIT COMMUNICATION CIRCUIT

- Turn ignition switch OFF.
- Disconnect BCM harness connector.
- Check continuity between BCM harness connector M19 (A) terminal 99 and steering lock unit harness connector M32 (B) terminal 2.

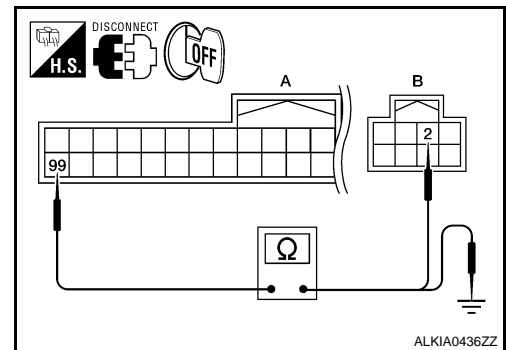

BCM		Steering lock unit		Continuity
Connector	Terminal	connector	Terminal	
A: M19	99	B: M32	2	Yes

- Check continuity between BCM harness connector M19 (A) terminal 99 and ground.

B2014 CHAIN OF STRG-IMMU

< COMPONENT DIAGNOSIS >

[SEDAN]

BCM		Ground	Continuity
Connector	Terminal		
A: M19	99	Ground	No

Is the inspection normal?

YES >> GO TO 6.

NO >> Repair harness or connector.

6.CHECK INTERMITTENT INCIDENT

Refer to [GI-42. "Intermittent Incident"](#).

>> INSPECTION END.

A
B
C
D
E
F
G
H
I
J
L
M
N
O
P

SEC

B2190, P1610 NATS ANTENNA AMP

< COMPONENT DIAGNOSIS >

[SEDAN]

B2190, P1610 NATS ANTENNA AMP

Description

INFOID:000000003185390

Performs ID verification through BCM and Intelligent Key when push-button ignition switch is pressed. Prohibits the release of steering lock or start of engine when an unregistered ID of Intelligent Key is used.

DTC Logic

INFOID:000000003185391

DTC DETECTION LOGIC

DTC No.	Trouble diagnosis name	DTC detecting condition	Possible cause
B2190	NATS ANTENNA AMP	Inactive communication between key slot and BCM.	<ul style="list-style-type: none">• Harness or connectors (The key slot circuit is open or shorted)• Key slot• BCM
P1610			

DTC CONFIRMATION PROCEDURE

1. PERFORM DTC CONFIRMATION PROCEDURE

1. Insert Intelligent Key into the key slot.
2. Check "Self diagnostic result" with CONSULT-III.

Is DTC detected?

- YES >> Go to [SEC-214, "Diagnosis Procedure"](#).
NO >> GO TO 2.

2. PERFORM DTC CONFIRMATION PROCEDURE

1. Press the push-button ignition switch.
2. Check "Self diagnostic result" with CONSULT-III.

Is DTC detected?

- YES >> Go to [SEC-214, "Diagnosis Procedure"](#).
NO >> INSPECTION END.

Diagnosis Procedure

INFOID:000000003185392

1. INSPECTION START

Check the case in which DTC is detected.

- Case1: It is detected when Intelligent Key is inserted into key slot.
- Case2: It is detected after Intelligent Key is inserted into key slot and push-button ignition switch is pressed.

In which case is DTC detected?

- Case1. >> GO TO 2.
Case2. >> GO TO 4.

2. CHECK KEY SLOT INPUT SIGNAL

1. Turn ignition switch OFF.
2. Disconnect key slot harness connector.
3. Check voltage between key slot harness connector and ground.

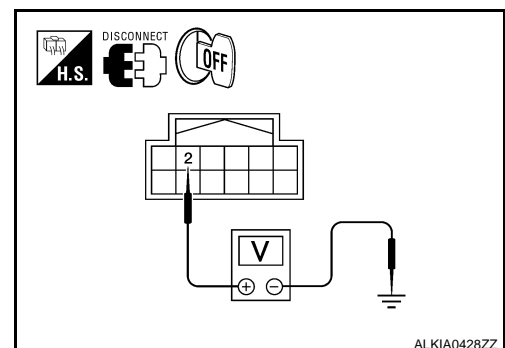

ALKIA0428ZZ

B2190, P1610 NATS ANTENNA AMP

< COMPONENT DIAGNOSIS >

[SEDAN]

Key slot		Ground	Voltage [V] (approx.)
Connector	Terminal		
M40	2	Ground	Battery voltage

Is the inspection result normal?

YES >> Replace key slot.

NO >> GO TO 3.

3. CHECK KEY SLOT CIRCUIT

1. Disconnect BCM harness connector.
2. Check continuity between key slot harness connector M40 (A) terminal 2 and BCM harness connector M19 (B) terminal 68.

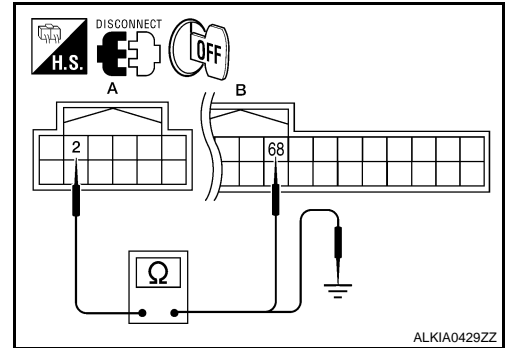

Key slot		BCM		Continuity
Connector	Terminal	Connector	Terminal	
A: M40	2	B: M19	68	Yes

3. Check continuity between key slot harness connector M40 (A) terminal 2 and ground.

Key slot		Ground	Continuity
Connector	Terminal		
A: M40	2	Ground	No

Is the inspection result normal?

YES >> GO TO 8.

NO >> Repair harness or connector.

4. CHECK PUSH-IGNITION SWITCH OPERATION

Press push-button ignition switch and check if it turns ON.

Does ignition switch turn to ON?

YES >> GO TO 5.

NO >> GO TO 7.

5. CHECK KEY SLOT COMMUNICATION SIGNAL

1. Turn ignition switch OFF.
2. Disconnect key slot harness connector.
3. Check voltage between key slot harness connector and ground.

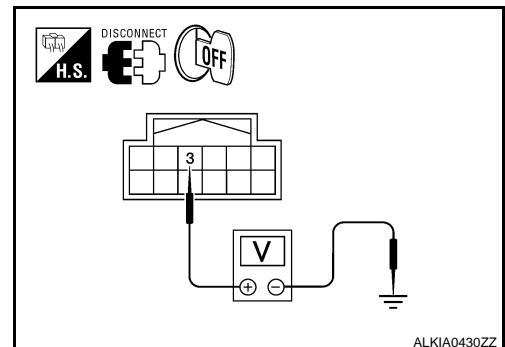

B2190, P1610 NATS ANTENNA AMP

< COMPONENT DIAGNOSIS >

[SEDAN]

Key slot		Ground	Continuity
Connector	Terminal		
M40	3	Ground	Yes

Is the inspection result normal?

YES >> Replace key slot.

NO >> GO TO 6.

6. CHECK KEY SLOT COMMUNICATION SIGNAL CIRCUIT

1. Disconnect BCM harness connector.
2. Check continuity between key slot harness connector M40 (A) terminal 3 and BCM harness connector M19 (B) terminal 69.

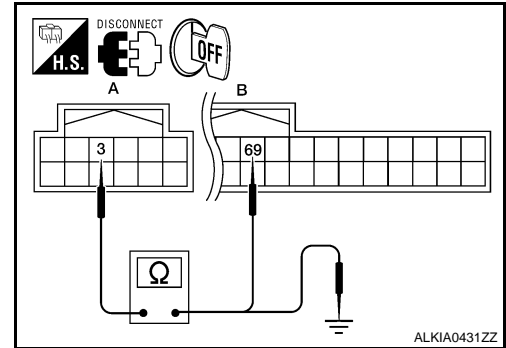

Key slot		BCM		Continuity
Connector	Terminal	Connector	Terminal	
A: M40	3	B: M19	69	Yes

3. Check continuity between key slot harness connector M40 (A) terminal 3 and ground.

Key slot		Ground	Continuity
Connector	Terminal		
A: M40	3	Ground	No

Is the inspection result normal?

YES >> GO TO 8.

NO >> Repair harness or connector.

7. CHECK KEY SLOT GROUND CIRCUIT

1. Turn ignition switch OFF.
2. Disconnect key slot harness connector.
3. Check continuity between key slot harness connector and ground.

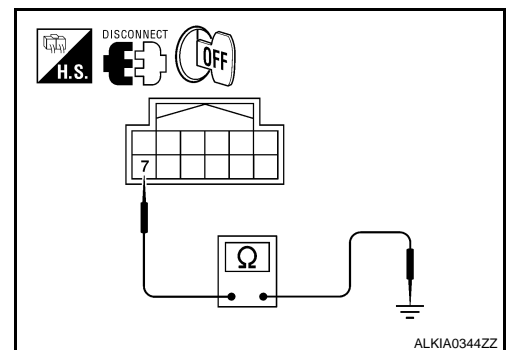

Key slot		Ground	Continuity
Connector	Terminal		
M40	7	Ground	Yes

B2190, P1610 NATS ANTENNA AMP

[SEDAN]

< COMPONENT DIAGNOSIS >

Is the inspection result normal?

YES >> GO TO 8.

NO >> Repair harness or connector.

8.CHECK INTERMITTENT INCIDENT

Refer to [GI-42. "Intermittent Incident"](#).

>> INSPECTION END.

A

B

C

D

E

F

G

H

I

J

SEC

L

M

N

O

P

B2191, P1615 DIFFERENCE OF KEY

< COMPONENT DIAGNOSIS >

[SEDAN]

B2191, P1615 DIFFERENCE OF KEY

Description

INFOID:000000003185393

Performs ID verification through BCM and Intelligent Key when push-button ignition switch is pressed. Prohibits the release of steering lock or start of engine when an unregistered ID of Intelligent Key is used.

DTC Logic

INFOID:000000003185394

DTC DETECTION LOGIC

DTC No.	Trouble diagnosis name	DTC detecting condition	Possible cause
B2191 P1615	DIFFERENCE OF KEY	The ID verification results between BCM and Intelligent Key are NG. The registration is necessary.	<ul style="list-style-type: none">Intelligent Key

DTC CONFIRMATION PROCEDURE

1. PERFORM DTC CONFIRMATION PROCEDURE

1. Press the push-button ignition switch
2. Check "Self diagnostic result" with CONSULT-III.

Is DTC detected?

- YES >> Go to [SEC-218. "Diagnosis Procedure"](#).
NO >> INSPECTION END.

Diagnosis Procedure

INFOID:000000003185395

1. PERFORM INITIALIZATION

Perform initialization with CONSULT-III. Re-register all Intelligent Keys. For initialization and registration of Intelligent Key. Refer to "CONSULT-III Operation Manual.

Can the system be initialized and can the engine be started with re-registered Intelligent Key?

- YES >> Intelligent Key was unregistered.
NO >> BCM is malfunctioning.
 - Replace BCM
 - Perform initialization again

B2192, P1611 ID DISCORD, IMMU-ECM

[SEDAN]

< COMPONENT DIAGNOSIS >

B2192, P1611 ID DISCORD, IMMU-ECM

Description

INFOID:000000003185396

BCM performs the ID verification with ECM that allows the engine to start. Start the engine if the ID is OK. ECM prevents the engine from starting if the ID is not registered. BCM starts the communication with ECM if ignition switch is turned ON.

DTC Logic

INFOID:000000003185397

DTC DETECTION LOGIC

NOTE:

- If DTC B2192 is displayed with DTC U1000, first perform the trouble diagnosis for DTC U1000. Refer to [SEC-207, "DTC Logic"](#).
- If DTC B2192 is displayed with DTC U1010, first perform the trouble diagnosis for DTC U1010. Refer to [SEC-208, "DTC Logic"](#).

DTC No.	Trouble diagnosis name	DTC detecting condition	Possible cause
B2192	ID DISCORD, IMMU-ECM	The ID verification results between BCM and ECM are NG. The registration is necessary.	<ul style="list-style-type: none">• BCM• ECM
P1611			

DTC CONFIRMATION PROCEDURE

1. PERFORM DTC CONFIRMATION PROCEDURE

1. Turn ignition switch ON under the following conditions.
 - A/T selector lever is in the P or N position
 - Do not depress the brake pedal
2. Check "Self diagnostic result" with CONSULT-III.

Is DTC detected?

- YES >> Go to [SEC-219, "Diagnosis Procedure"](#).
NO >> INSPECTION END.

Diagnosis Procedure

INFOID:000000003185398

1. PERFORM INITIALIZATION

Perform initialization with CONSULT-III. Re-register all Intelligent Keys. For initialization and registration of Intelligent Key. Refer to "CONSULT-III Operation Manual".

Can the system be initialized and can the engine be started with re-registered Intelligent Key?

- YES >> ID was unregistered.
NO >> BCM is malfunctioning.
 - Replace BCM
 - Perform initialization again
 - Replace ECM

A
B
C
D
E
F
G
H
I
J
L
M
N
O
P

SEC

B2193, P1612 CHAIN OF ECM-IMMU**Description**

INFOID:000000003185399

BCM performs the ID verification with ECM that allows the engine to start. Start the engine if the ID is OK. ECM prevents the engine from starting if the ID is not registered. BCM starts the communication with ECM if ignition switch is turned ON.

DTC Logic

INFOID:000000003185400

DTC DETECTION LOGIC**NOTE:**

- If DTC B2193 is displayed with DTC U1000, first perform the trouble diagnosis for DTC U1000. Refer to [SEC-207, "DTC Logic"](#).
- If DTC B2193 is displayed with DTC U1010, first perform the trouble diagnosis for DTC U1010. Refer to [SEC-208, "DTC Logic"](#).

DTC No.	Trouble diagnosis name	DTC detecting condition	Possible cause
B2193	CHAIN OF ECM-IMMU	Inactive communication between ECM and BCM	<ul style="list-style-type: none"> • Harness or connectors (The CAN communication line is open or shorted) • BCM • ECM
P1612			

DTC CONFIRMATION PROCEDURE**1. PERFORM DTC CONFIRMATION PROCEDURE**

1. Turn ignition switch ON under the following conditions.
 - CVT selector lever is in the P or N position.
 - Do not depress brake pedal.
2. Check "Self diagnostic result" with CONSULT-III.

Is DTC detected?

- YES >> Go to [SEC-220, "Diagnosis Procedure"](#).
 NO >> INSPECTION END.

Diagnosis Procedure

INFOID:000000003185401

1. REPLACE BCM

1. Replace BCM.
2. Perform initialization with CONSULT-III.
For initialization, refer to "CONSULT-III Operation Manual".

Does the engine start?

- YES >> BCM is malfunctioning.
 - Replace BCM.
 - Perform initialization again.
- NO >> ECM is malfunctioning.
 - Replace ECM.
 - Perform ECM re-communicating function.

B2555 STOP LAMP

< COMPONENT DIAGNOSIS >

[SEDAN]

B2555 STOP LAMP

Description

INFOID:000000003185402

BCM detects the stop lamp status and confirms the stop lamp switch ON/OFF status. BCM confirms the engine start condition according to the stop lamp switch ON/OFF status.

DTC Logic

INFOID:000000003185403

DTC DETECTION LOGIC

DTC No.	Trouble diagnosis name	DTC detecting condition	Possible cause
B2555	STOP LAMP	BCM makes a comparison between the upper voltage and lower voltage of stop lamp switch. It judges from their values to detect the malfunctioning circuit.	<ul style="list-style-type: none"> Harness or connectors (stop lamp switch circuit is open or shorted) Stop lamp switch Fuse

DTC CONFIRMATION PROCEDURE

1. PERFORM DTC CONFIRMATION PROCEDURE

- Depress the brake pedal and wait for at least 1 second.
- Check "Self diagnostic result" with CONSULT-III.

Is DTC detected?

- YES >> Go to [SEC-221, "Diagnosis Procedure"](#).
 NO >> INSPECTION END.

Diagnosis Procedure

INFOID:000000003185404

1. CHECK STOP LAMP SWITCH INPUT SIGNAL

- Turn ignition switch OFF.
- Disconnect BCM harness connector.
- Check voltage between BCM harness connector and ground.

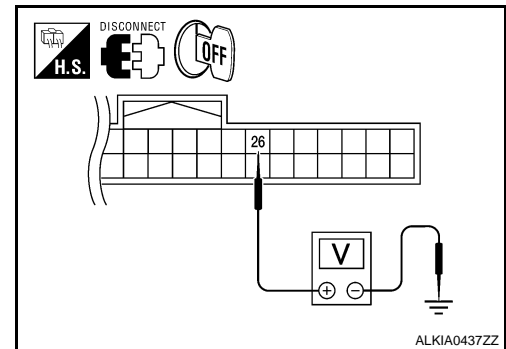

BCM		Ground	Stop lamp switch position	Voltage [V]
Connector	Terminal			
M18	26	Ground	Depressed	Battery voltage
			Released	0

Is the inspection normal?

- YES >> Stop lamp switch is OK.
 NO >> GO TO 2.

2. CHECK STOP LAMP SWITCH POWER SUPPLY CIRCUIT

- Disconnect stop lamp switch harness connector.

B2555 STOP LAMP

[SEDAN]

< COMPONENT DIAGNOSIS >

2. Check voltage between stop lamp harness connector and ground.

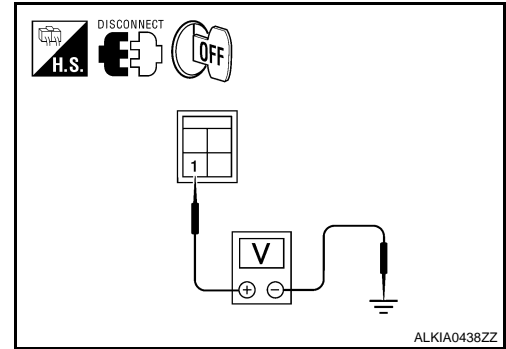

Stop lamp switch		Ground	Voltage [V]
Connector	Terminal		
E38	1	Ground	Battery voltage

Is the inspection result normal?

YES >> GO TO 3.

NO >> Check harness for open or short between stop lamp switch and fuse.

3.CHECK STOP LAMP SWITCH CIRCUIT

1. Check continuity between stop lamp switch harness connector E38 (A) terminal 2 and BCM harness connector M18 (B) terminal 26.

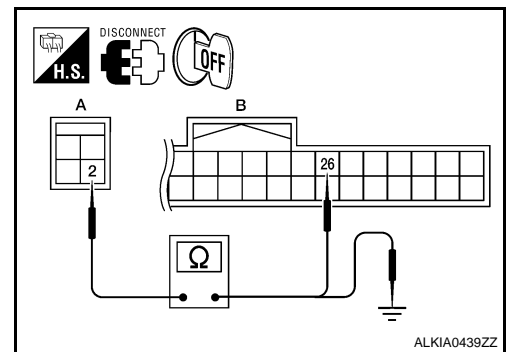

Stop lamp switch		BCM		Continuity
Connector	Terminal	Connector	Terminal	
A: E38	2	B: M18	26	Yes

2. Check continuity between stop lamp switch harness connector E38 (A) terminal 2 and ground.

Stop lamp switch		Ground	Continuity
Connector	Terminal		
A: E38	2	Ground	No

Is the inspection result normal?

YES >> GO TO 4.

NO >> Repair harness or connector.

4.CHECK STOP LAMP SWITCH

Refer to [SEC-223, "Component Inspection"](#).

Is the inspection result normal?

YES >> GO TO 5.

NO >> Replace stop lamp switch.

5.CHECK INTERMITTENT INCIDENT

Refer to [GI-42, "Intermittent Incident"](#).

B2555 STOP LAMP

[SEDAN]

< COMPONENT DIAGNOSIS >

>> INSPECTION END.

Component Inspection

INFOID:000000003185405

1. CHECK STOP LAMP SWITCH

1. Turn ignition switch OFF.
2. Disconnect stop lamp switch harness connector.
3. Check continuity between stop lamp switch terminals under the following conditions.

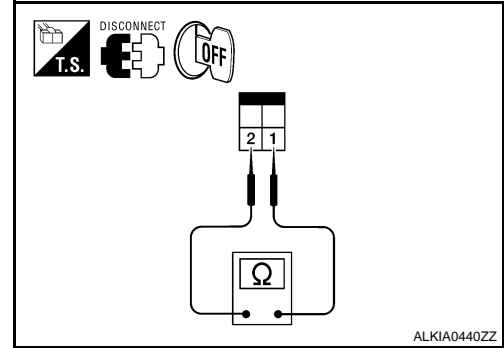

Stop lamp switch		Condition	Continuity
Terminal			
1	2	Brake pedal Not depressed	No
		Brake pedal Depressed	Yes

Is the inspection result normal?

YES >> INSPECTION END.

NO >> Replace stop lamp switch.

A
B
C
D
E
F
G
H
I
J
L
M
N
O
P

SEC

B2556 PUSH-BUTTON IGNITION SWITCH

< COMPONENT DIAGNOSIS >

[SEDAN]

B2556 PUSH-BUTTON IGNITION SWITCH

Description

INFOID:000000003185406

The switch that changes the power supply position. BCM maintains the power supply position status. BCM changes the power supply position with the operation of the push-button ignition switch.

DTC Logic

INFOID:000000003185407

DTC DETECTION LOGIC

DTC No.	Trouble diagnosis name	DTC detecting condition	Possible cause
B2556	PUSH-BUTTON IGNITION SWITCH	BCM detects the push-button ignition switch stuck to ON for 100 seconds or more	<ul style="list-style-type: none">• Harness or connectors (Push-button ignition switch circuit is shorted.)• Push-button ignition switch

DTC CONFIRMATION PROCEDURE

1. PERFORM DTC CONFIRMATION PROCEDURE

1. Start the engine and wait for at least 100 seconds.
2. Check "Self diagnostic result" with CONSULT-III.

Is DTC detected?

- YES >> Go to [SEC-224, "Diagnosis Procedure"](#).
NO >> INSPECTION END.

Diagnosis Procedure

INFOID:000000003185408

1. CHECK PUSH-BUTTON IGNITION SWITCH INPUT SIGNAL

1. Turn ignition switch OFF.
2. Disconnect push-button ignition switch harness connector.
3. Check voltage between push-button ignition switch harness connector and ground.

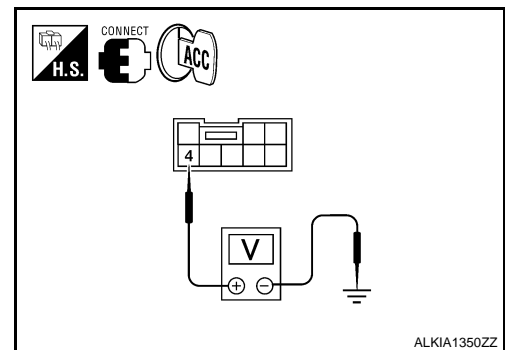

Push-button ignition switch		Ground	Voltage [V]
Connector	Terminal		
M38	4	Ground	Battery voltage

Is the inspection normal?

- YES >> GO TO 2.
NO >> GO TO 4.

2. CHECK PUSH-BUTTON IGNITION SWITCH

Refer to [SEC-225, "Component Inspection"](#).

Is the inspection normal?

- YES >> GO TO 3.
NO >> Replace push-button ignition switch. Refer to [SEC-358, "Removal and Installation"](#).

B2556 PUSH-BUTTON IGNITION SWITCH

[SEDAN]

< COMPONENT DIAGNOSIS >

3. CHECK INTERMITTENT INCIDENT

Refer to [GI-42. "Intermittent Incident"](#).

>> INSPECTION END.

4. CHECK PUSH-BUTTON IGNITION SWITCH CIRCUIT FOR SHORT

1. Disconnect BCM harness connector and IPDM E/R harness connector.
2. Check continuity between push-button ignition switch harness connector and ground.

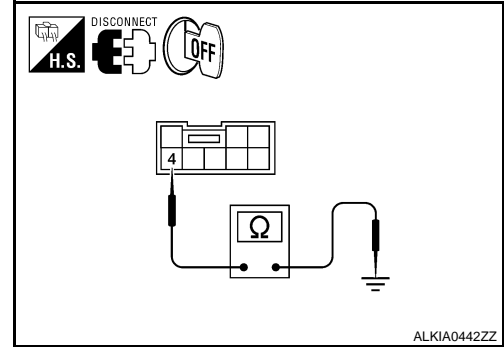

Push-button ignition switch		Ground	Continuity
Connector	Terminal		
M38	4	Ground	No

Is the inspection normal?

YES >> Replace BCM. Refer to [BCS-88. "Removal and Installation"](#).

NO >> Repair harness or connector.

Component Inspection

INFOID:000000003185409

1. CHECK PUSH-BUTTON IGNITION SWITCH

1. Turn ignition switch OFF.
2. Disconnect push-button ignition switch harness connector.
3. Check continuity between push-button ignition switch terminals under the following conditions.

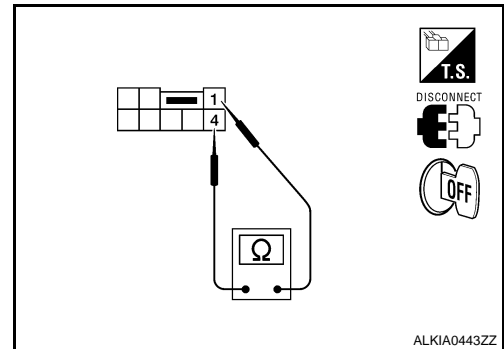

Push-button ignition switch		Condition	Continuity
Terminal			
1	4	Pressed	Yes
		Not pressed	No

Is the inspection result normal?

YES >> INSPECTION END.

NO >> Replace push-button ignition switch. Refer to [SEC-358. "Removal and Installation"](#).

B2557 VEHICLE SPEED

< COMPONENT DIAGNOSIS >

[SEDAN]

B2557 VEHICLE SPEED

Description

INFOID:000000003185410

BCM receives the 2 vehicle speed signals via CAN communication. 1 signal is transmitted by the “unified meter” Another signal is transmitted by “ABS actuator and electric unit (control unit)”. BCM compares both signals to detect the vehicle speed.

DTC Logic

INFOID:000000003185411

DTC DETECTION LOGIC

NOTE:

- If DTC B2557 is displayed with DTC U1000, first perform the trouble diagnosis for DTC U1000. Refer to [SEC-207, "DTC Logic"](#).
- If DTC B2557 is displayed with DTC U1010, first perform the trouble diagnosis for DTC U1010. Refer to [SEC-208, "DTC Logic"](#).

DTC	Self-diagnosis name	DTC detecting condition	Possible causes
B2557	VEHICLE SPEED	BCM detects the following difference between the vehicle speed from “unified meter” and the one from “ABS actuator and electric unit” for 10 seconds continuously <ul style="list-style-type: none">• One is 10km/h or more and the other is 4km/h or less.	<ul style="list-style-type: none">• Wheel sensor• Unified meter• ABS actuator and electric unit (control unit)

DTC CONFIRMATION PROCEDURE

1.PERFORM DTC CONFIRMATION PROCEDURE

1. Drive the vehicle at the vehicle speed of 10 km/h or more and wait for at least 10 seconds.
2. Check “Self diagnostic result” with CONSULT-III.

Is DTC detected?

- YES >> Go to [SEC-226, "Diagnosis Procedure"](#).
NO >> INSPECTION END.

Diagnosis Procedure

INFOID:000000003185412

1.CHECK DTC WITH “ABS ACTUATOR AND ELECTRIC UNIT (CONTROL UNIT)”

Check “Self diagnostic result” with CONSULT-III. Refer to [BRC-51, "DTC No. Index"](#) (ABS), [BRC-120, "DTC No. Index"](#) (TCS/ABS) or [BRC-222, "DTC No. Index"](#) (VDS/TCS/ABS).

Is the inspection result normal?

- YES >> GO TO 2.
NO >> Repair or replace.

2.CHECK UNIFIED METER.

Check unified meter. Refer to [MWI-4, "Work Flow"](#).

>> INSPECTION END.

B2560 STARTER CONTROL RELAY

< COMPONENT DIAGNOSIS >

[SEDAN]

B2560 STARTER CONTROL RELAY

Description

INFOID:000000003185413

Starter control relay, integrated in IPDM E/R, permits the starter relay operation when in N or P position and the steering is locked or unlocked. It is installed in parallel with the starter relay.

DTC Logic

INFOID:000000003185414

DTC DETECTION LOGIC

NOTE:

- If DTC B2560 is displayed with DTC U1000, first perform the trouble diagnosis for DTC U1000. Refer to [SEC-207, "DTC Logic"](#).
- If DTC B2560 is displayed with DTC U1010, first perform the trouble diagnosis for DTC U1010. Refer to [SEC-208, "DTC Logic"](#).

DTC	Self-diagnosis name	DTC detecting condition	Possible causes
B2560	STARTER CONTROL RELAY	BCM detects a mismatch between the OFF request of starter control relay to IPDM E/R and the feedback. (The feedback is ON instead of OFF.)	• IPDM E/R

DTC CONFIRMATION PROCEDURE

1. PERFORM DTC CONFIRMATION PROCEDURE

1. Turn ignition switch ON under the following conditions and wait for at least 2 seconds.
 - A/T selector lever is in the P position
 - Depress the brake pedal
2. Check "Self diagnostic result" with CONSULT-III.

Is DTC detected?

- YES >> Go to [SEC-227, "Diagnosis Procedure"](#).
NO >> INSPECTION END.

Diagnosis Procedure

INFOID:000000003185415

1. CHECK DTC WITH IPDM E/R

Check "Self diagnostic result" with CONSULT-III. Refer to [PCS-41, "DTC Index"](#).

Is the inspection result normal?

- YES >> GO TO 2.
NO >> Repair or replace.

2. CHECK INTERMITTENT INCIDENT

Refer to [GI-42, "Intermittent Incident"](#).

>> INSPECTION END.

A
B
C
D
E
F
G
H
I
J
L
M
N
O
P

SEC

B2601 SHIFT POSITION

[SEDAN]

< COMPONENT DIAGNOSIS >

B2601 SHIFT POSITION

Description

INFOID:000000003185416

BCM confirms the shift position with the following 2 signals.

- CVT selector lever
- P position signal from IPDM E/R (CAN)

DTC Logic

INFOID:000000003185417

DTC DETECTION LOGIC

NOTE:

- If DTC B2601 is displayed with DTC U1000, first perform the trouble diagnosis for DTC U1000. Refer to [SEC-207, "DTC Logic"](#).
- If DTC B2601 is displayed with DTC U1010, first perform the trouble diagnosis for DTC U1010. Refer to [SEC-208, "DTC Logic"](#).
- If DTC B2601 is displayed with DTC B2605, first perform the trouble diagnosis for DTC B2605. Refer to [SEC-241, "DTC Logic"](#).

DTC No.	Trouble diagnosis name	DTC detecting condition	Possible cause
B2601	SHIFT POSITION	BCM detects when a difference between the shift P input signal and the shift position signal received from IPDM E/R via CAN communication continues for 2 seconds or more	<ul style="list-style-type: none">• Harness or connectors (CVT device circuit is open or shorted.)• CVT device (detention switch)

DTC CONFIRMATION PROCEDURE

1. PERFORM DTC CONFIRMATION PROCEDURE

1. Turn ignition switch ON under the following conditions, and wait for at least 2 seconds.
 - CVT selector lever is in the P position.
 - Do not depress the brake pedal.
2. Check "Self diagnostic result" with CONSULT-III.
3. Turn ignition switch ON under the following conditions, and wait for at least 2 seconds.
 - CVT selector lever is in other than P position.
 - Do not depress the brake pedal.
4. Check "Self diagnostic result" with CONSULT-III.

Is DTC detected?

- YES >> Go to [SEC-228, "Diagnosis Procedure"](#).
NO >> INSPECTION END.

Diagnosis Procedure

INFOID:000000003185418

1. CHECK CVT DEVICE POWER SUPPLY

1. Turn ignition switch to ACC.
2. Disconnect CVT device (detention switch) harness connector.
3. Check voltage between CVT device (detention switch) harness connector and ground.

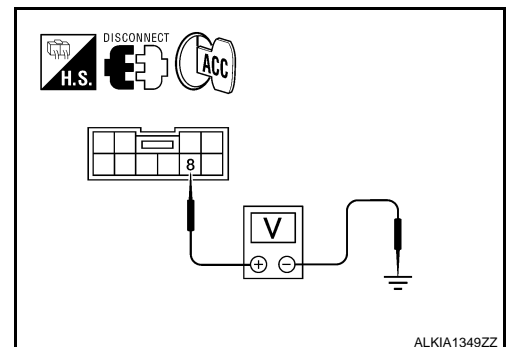

B2601 SHIFT POSITION

[SEDAN]

< COMPONENT DIAGNOSIS >

CVT device (detention switch)		Ground	Voltage [V]
Connector	Terminal		
M23	8	Ground	Battery voltage

Is the inspection result normal?

YES >> GO TO 3.

NO >> GO TO 2.

2. CHECK CVT DEVICE POWER SUPPLY CIRCUIT

1. Disconnect BCM harness connector.
2. Check continuity between BCM harness connector M19 (A) terminal 84 and CVT device (detention switch) harness connector M23 (B) terminal 8.

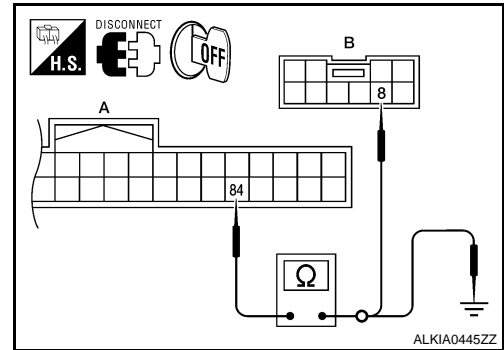

BCM		CVT device (detention switch)		Continuity
Connector	Terminal	Connector	Terminal	
A: M19	84	B: M23	8	Yes

3. Check continuity between BCM harness connector M19 (A) terminal 84 and ground.

BCM		Ground	Continuity
Connector	Terminal		
A: M19	84	Ground	No

Is the inspection result normal?

YES >> Replace BCM.

NO >> Repair harness or connector.

3. CHECK CVT DEVICE CIRCUIT (BCM)

1. Disconnect BCM harness connector and IPDM E/R harness connector.
2. Check continuity between BCM harness connector M19 (A) terminal 87 and CVT device (detention switch) harness connector M23 (B) terminal 9.

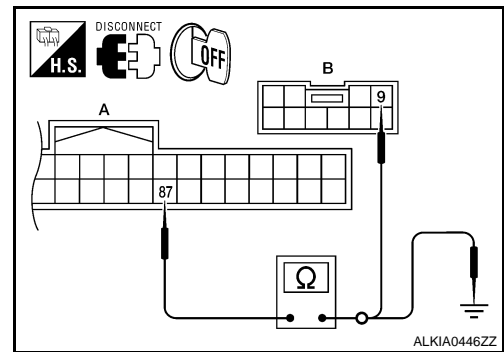

BCM		CVT device (detention switch)		Continuity
Connector	Terminal	Connector	Terminal	
A: M19	87	B: M23	9	Yes

3. Check continuity between BCM harness connector M19 (A) terminal 87 and ground.

B2601 SHIFT POSITION

[SEDAN]

< COMPONENT DIAGNOSIS >

BCM		Ground	Continuity
Connector	Terminal		
A: M19	87	Ground	No

Is the inspection result normal?

YES >> GO TO 4.

NO >> Repair harness or connector.

4. CHECK CVT DEVICE CIRCUIT (IPDM E/R)

1. Disconnect BCM harness connector.
2. Check continuity between CVT device (detention switch) harness connector M23 (A) terminal 9 and IPDM E/R harness connector E17 (B) terminal 43.

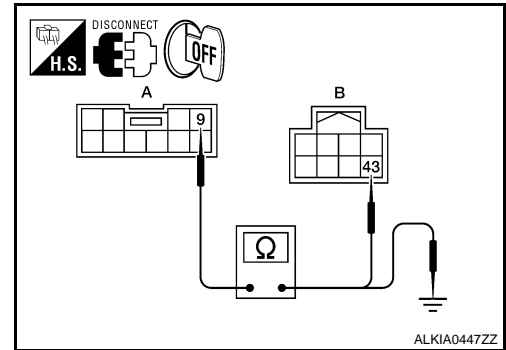

CVT device (detention switch)		IPDM E/R		Continuity
Connector	Terminal	Connector	Terminal	
A: M23	9	B: E17	43	Yes

3. Check continuity between CVT device (detention switch) harness connector M23 (A) terminal 9 and ground.

CVT device (detention switch)		Ground	Continuity
Connector	Terminal		
A: M23	9	Ground	No

Is the inspection result normal?

YES >> GO TO 5.

NO >> Repair harness or connector.

5. CHECK CVT DEVICE

Refer to [SEC-230, "Component Inspection"](#).

Is the inspection result normal?

YES >> GO TO 6.

NO >> Replace CVT device. Refer to [TM-250, "Removal and Installation"](#) (RE0F09B), or [TM-426, "Removal and Installation"](#) (RE0F10A).

6. CHECK INTERMITTENT INCIDENT

Refer to [GI-42, "Intermittent Incident"](#).

>> INSPECTION END.

Component Inspection

INFOID:000000003185419

1. CHECK ECVT DEVICE (DETENTION SWITCH)

1. Turn ignition switch OFF.
2. Disconnect CVT device (detention switch) harness connector.

B2601 SHIFT POSITION

[SEDAN]

< COMPONENT DIAGNOSIS >

3. Check continuity between CVT device (detention switch) terminals as follows.

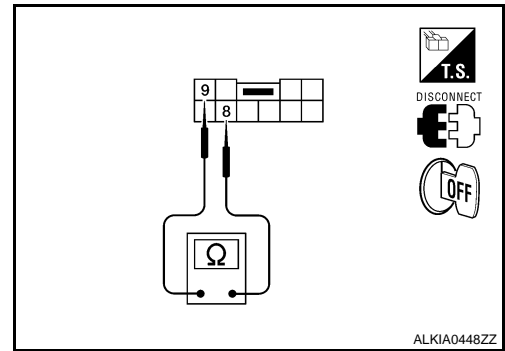

CVT device (detention switch)		Condition	Continuity	
Terminal				
8	9	CVT selector lever	P position	No
			Other than above	Yes

Is the inspection result normal?

YES >> INSPECTION END

NO >> Replace CVT device. Refer to [TM-250, "Removal and Installation"](#) (RE0F09B), or [TM-426, "Removal and Installation"](#) (RE0F10A).

A
B
C
D
E
F
G
H
I
J
L
M
N
O
P

SEC

B2602 SHIFT POSITION

[SEDAN]

< COMPONENT DIAGNOSIS >

B2602 SHIFT POSITION

Description

INFOID:000000003185420

BCM confirms the shift position with the following 2 signals.

- CVT selector lever
- Speed signal from meter

DTC Logic

INFOID:000000003185421

DTC DETECTION LOGIC

NOTE:

- If DTC B2602 is displayed with DTC U1000, first perform the trouble diagnosis for DTC U1000. Refer to [SEC-207, "DTC Logic"](#).
- If DTC B2602 is displayed with DTC U1010, first perform the trouble diagnosis for DTC U1010. Refer to [SEC-208, "DTC Logic"](#).

DTC No.	Trouble diagnosis name	DTC detecting condition	Possible cause
B2602	SHIFT POSITION	BCM detects the following status for 10 seconds. <ul style="list-style-type: none">• Shift position is in P position• Vehicle speed is 4km/h (2 MPH) or more• Ignition switch is in the ON position	<ul style="list-style-type: none">• Harness or connectors (CVT drive circuit is open or shorted)• CVT device (detention switch)• Combination meter

DTC CONFIRMATION PROCEDURE

1. PERFORM DTC CONFIRMATION PROCEDURE

1. Start the engine under the following conditions and wait for at least 10 seconds.
 - CVT selector lever is in the P or N position
 - Depress the brake pedal.
2. Drive the vehicle for at least 10 seconds at a speed greater than 4 km/h (2 MPH).
3. Check "Self diagnostic result" with CONSULT-III.

Is DTC detected?

- YES >> Go to [SEC-232, "Diagnosis Procedure"](#).
NO >> INSPECTION END.

Diagnosis Procedure

INFOID:000000003185422

1. CHECK DTC WITH "COMBINATION METER"

Check "Self diagnostic result" with CONSULT-III. Refer to [MWI-92, "DTC Index"](#).

Is the inspection result normal?

- YES >> GO TO 2.
NO >> Repair or replace.

2. CHECK CVT DEVICE POWER SUPPLY

1. Turn ignition switch to ACC.
2. Disconnect CVT device (detention switch) harness connector.
3. Check voltage between CVT device (detention switch) harness connector and ground.

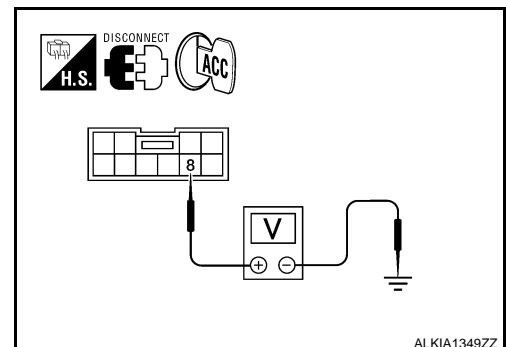

B2602 SHIFT POSITION

[SEDAN]

< COMPONENT DIAGNOSIS >

CVT device (detention switch)		Ground	Voltage [V]
Connector	Terminal		
M23	8	Ground	Battery voltage

Is the inspection result normal?

YES >> GO TO 4.

NO >> GO TO 3.

3. CHECK CVT DEVICE POWER SUPPLY CIRCUIT

1. Disconnect BCM harness connector.
2. Check continuity between BCM harness connector M19 (A) terminal 84 and CVT device (detention switch) harness connector M23 (B) terminal 8.

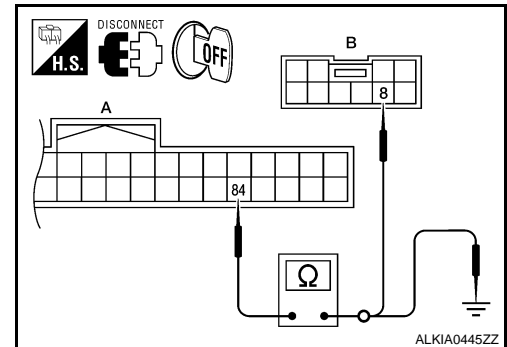

BCM		CVT device (detention switch)		Continuity
Connector	Terminal	Connector	Terminal	
A: M19	84	B: M23	8	Yes

3. Check continuity between BCM harness connector M19 (A) terminal 84 and ground.

BCM		Ground	Continuity
Connector	Terminal		
A: M19	84	Ground	No

Is the inspection result normal?

YES >> Replace BCM.

NO >> Repair harness or connector.

4. CHECK CVT DEVICE CIRCUIT

1. Disconnect BCM harness connector.
2. Check continuity between CVT device (detention switch) harness connector and BCM harness connector.

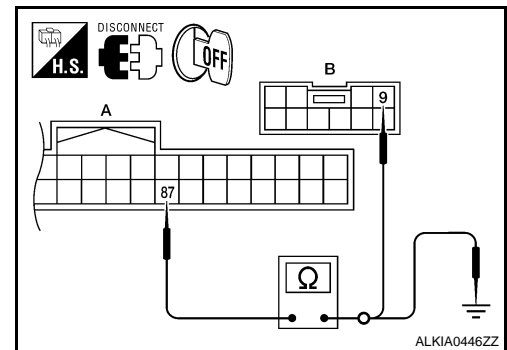

BCM		CVT device (detention switch)		Continuity
Connector	Terminal	Connector	Terminal	
A: M19	87	B: M23	9	Yes

3. Check continuity between CVT device (detention switch) harness connector and ground.

B2602 SHIFT POSITION

< COMPONENT DIAGNOSIS >

[SEDAN]

BCM		Ground	Continuity
Connector	Terminal		
A: M19	87	Ground	No

Is the inspection result normal?

YES >> GO TO 5.

NO >> Repair harness or connector.

5.CHECK CVT DEVICE

Refer to [SEC-230. "Component Inspection"](#).

Is the inspection result normal?

YES >> GO TO 6.

NO >> Replace CVT device. Refer to [TM-250. "Removal and Installation"](#) (RE0F09B), or [TM-426. "Removal and Installation"](#) (RE0F10A).

6.CHECK INTERMITTENT INCIDENT

Refer to [GI-42. "Intermittent Incident"](#).

>> INSPECTION END.

B2603 SHIFT POSITION STATUS

[SEDAN]

< COMPONENT DIAGNOSIS >

B2603 SHIFT POSITION STATUS

Description

INFOID:000000003185423

BCM confirms the shift position with the following 2 signals.

- CVT selector lever
- P/N position switch

DTC Logic

INFOID:000000003185424

DTC DETECTION LOGIC

NOTE:

- If DTC B2603 is displayed with DTC U1000, first perform the trouble diagnosis for DTC U1000. Refer to [SEC-207, "DTC Logic"](#).
- If DTC B2603 is displayed with DTC U1010, first perform the trouble diagnosis for DTC U1010. Refer to [SEC-208, "DTC Logic"](#).

DTC	Self-diagnosis name	DTC detecting condition	Possible causes
B2603	SHIFT POSITION STATUS	BCM detects the followings status for 500 ms or more when shift is in P position and, ignition switch is in ON position. <ul style="list-style-type: none">• Park/neutral position (PNP) switch: approx. 0V• CVT device (detention switch): approx 0V	<ul style="list-style-type: none">• Harness or connector (CVT device circuit is open or shorted.)• Harness or connectors [Park/neutral position (PNP) switch circuit is open or shorted.]• CVT device (detention switch)• Park/neutral position (PNP) switch

DTC CONFIRMATION PROCEDURE

1. PERFORM DTC CONFIRMATION PROCEDURE

1. Start the engine under the following conditions and wait for at least 1 second.
 - CVT selector lever is in the P position.
 - Do not depress the brake pedal.
2. Shift to N and wait for at least 1 second.
3. Shift to any gear other than P or N and wait for at least 1 second.
4. Check "Self diagnostic result" with CONSULT-III.

Is DTC detected?

- YES >> Go to [SEC-235, "Diagnosis Procedure"](#).
NO >> INSPECTION END.

Diagnosis Procedure

INFOID:000000003185425

1. CHECK DTC WITH IPDM E/R

Check "Self diagnostic result" with CONSULT-III. Refer to [PCS-41, "DTC Index"](#).

Is the inspection result normal?

- YES >> GO TO 2.
NO >> Repair or replace malfunctioning parts.

2. CHECK PNP SWITCH CIRCUIT

1. Turn ignition switch OFF.
2. Disconnect TCM harness connector and BCM harness connector.

B2603 SHIFT POSITION STATUS

[SEDAN]

< COMPONENT DIAGNOSIS >

3. Check continuity between TCM harness connector F16 (A) terminal 20 and BCM harness connector M18 (B) terminal 48.

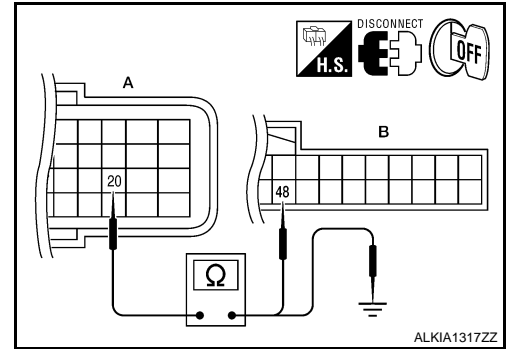

TCM		BCM		Continuity
Connector	Terminal	Connector	Terminal	
A: F16	20	B: M18	48	Yes

4. Check continuity between TCM harness connector F16 (A) terminal 20 and ground.

TCM		Ground	Continuity
Connector	Terminal		
A: F16	20	Ground	No

Is the inspection result normal?

YES >> GO TO 3.

NO >> Repair harness or connector.

3. CHECK CVT DEVICE POWER SUPPLY

1. Turn ignition switch OFF.
2. Disconnect CVT device (detention switch) harness connector.
3. Check voltage between CVT device (detention switch) harness connector and ground.

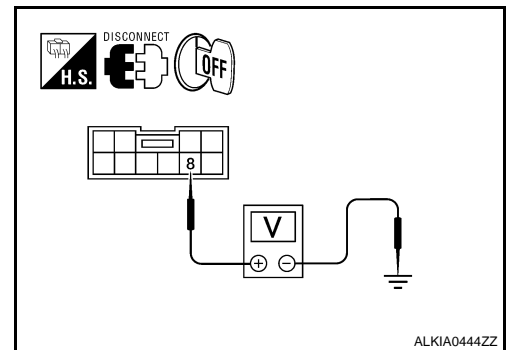

CVT device (detention switch)		Ground	Voltage [V]
Connector	Terminal		
M23	8	Ground	Battery voltage

Is the inspection result normal?

YES >> GO TO 5.

NO >> GO TO 4.

4. CHECK CVT DEVICE POWER SUPPLY CIRCUIT

1. Disconnect BCM harness connector.

B2603 SHIFT POSITION STATUS

[SEDAN]

< COMPONENT DIAGNOSIS >

- Check continuity between BCM harness connector M19 (A) terminal 84 and CVT device (detention switch) harness connector M23 (B) terminal 8.

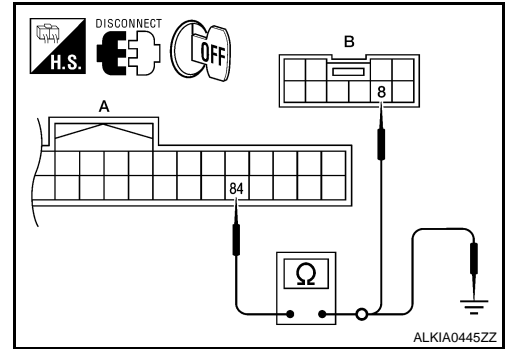

BCM		CVT device (detention switch)		Continuity
Connector	Terminal	Connector	Terminal	
A: M19	84	B: M23	8	Yes

- Check continuity between BCM harness connector M19 (A) terminal 84 and ground.

BCM		Ground	Continuity
Connector	Terminal		
A: M19	84	Ground	No

Is the inspection result normal?

YES >> Replace BCM. Refer to [BCS-88, "Removal and Installation"](#).

NO >> Repair harness or connector.

5.CHECK CVT DEVICE CIRCUIT

- Disconnect BCM harness connector.
- Check continuity between BCM harness connector M19 (A) terminal 87 and CVT device (detention switch) harness connector M23 (B) terminal 9.

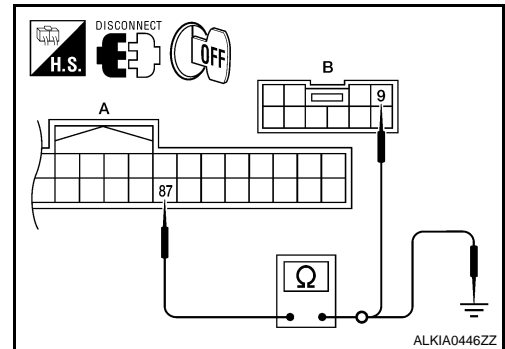

BCM		CVT device (detention switch)		Continuity
Connector	Terminal	Connector	Terminal	
A: M19	87	B: M23	9	Yes

- Check continuity between BCM harness connector M19 (A) terminal 87 and ground.

BCM		Ground	Continuity
Connector	Terminal		
A: M19	87	Ground	No

Is the inspection result normal?

YES >> GO TO 6.

NO >> Repair harness or connector.

6.CHECK CVT DEVICE

B2603 SHIFT POSITION STATUS

[SEDAN]

< COMPONENT DIAGNOSIS >

Refer to [SEC-230. "Component Inspection"](#).

Is the inspection result normal?

YES >> GO TO 7.

NO >> Replace CVT device. Refer to [TM-250. "Removal and Installation"](#) (RE0F09B), or [TM-426. "Removal and Installation"](#) (RE0F10A).

7.CHECK INTERMITTENT INCIDENT

Refer to [GI-42. "Intermittent Incident"](#).

>> INSPECTION END.

B2604 PNP SWITCH

Description

INFOID:000000003185426

BCM confirms the shift position with the following 4 signals.

- CVT selector lever
- P/N position switch
- P position signal from IPDM E/R (CAN)
- P position signal from TCM (CAN)

DTC Logic

INFOID:000000003185427

DTC DETECTION LOGIC

NOTE:

- If DTC B2604 is displayed with DTC U1000, first perform the trouble diagnosis for DTC U1000. Refer to [SEC-207, "DTC Logic"](#).
- If DTC B2604 is displayed with DTC U1010, first perform the trouble diagnosis for DTC U1010. Refer to [SEC-208, "DTC Logic"](#).

DTC No.	Trouble diagnosis name	DTC detecting condition	Possible cause
B2604	PNP SWITCH	BCM detects the following status for 500 ms or more when the ignition switch is in the ON position. <ul style="list-style-type: none"> • P/N switch indicates vehicle is in P or N shift position. Signal from TCM indicates vehicle is in forward or reverse gear. • P/N switch indicates vehicle is in forward or reverse gear. Signal from TCM indicates vehicle is in P or N. 	<ul style="list-style-type: none"> • Harness or connectors [The park/neutral position (PNP) switch circuit is open or shorted.] • Park/ neutral position (PNP) switch • TCM

DTC CONFIRMATION PROCEDURE

1. PERFORM DTC CONFIRMATION PROCEDURE

1. Start the engine under the following conditions and wait for at least 1 seconds.
 - CVT selector lever is in the P position
 - Do not depress the brake pedal
2. Use CVT selector lever to select each gear one at a time. Wait at each gear for at least 1 second.
3. Check "Self diagnostic result" with CONSULT-III.

Is DTC detected?

- YES >> Go to [SEC-239, "Diagnosis Procedure"](#).
 NO >> INSPECTION END.

Diagnosis Procedure

INFOID:000000003185428

1. CHECK DTC WITH TCM

Check "Self diagnostic result" with CONSULT-III. Refer to [TM-216, "DTC Index"](#) (RE0F09B) or [TM-394, "DTC Index"](#) (RE0F10A).

Is the inspection result normal?

- YES >> GO TO 2.
 NO >> Repair or replace.

2. CHECK PNP SWITCH CIRCUIT

1. Turn ignition switch OFF.
2. Disconnect TCM harness connector and BCM harness connector.

B2604 PNP SWITCH

[SEDAN]

< COMPONENT DIAGNOSIS >

3. Check continuity between TCM harness connector and BCM harness connector.

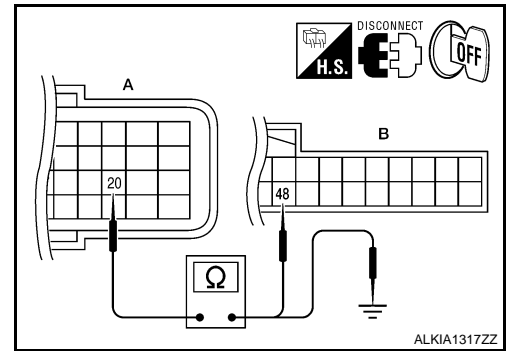

TCM		BCM		Continuity
Connector	Terminal	Connector	Terminal	
A: F16	20	B: M18	48	Yes

4. Check continuity between TCM harness connector and ground.

TCM		Ground	Continuity
Connector	Terminal		
A: F16	20	Ground	No

Is the inspection result normal?

YES >> GO TO 3.

NO >> Repair harness or connector.

3. CHECK INTERMITTENT INCIDENT

Refer to [GI-42. "Intermittent Incident"](#).

>> INSPECTION END.

B2605 PNP SWITCH

Description

INFOID:000000003185429

BCM confirms the shift position with the following 4 signals.

- AT selector lever
- P/N position switch
- P position signal from IPDM E/R (CAN)
- P position signal from TCM (CAN)

DTC Logic

INFOID:000000003185430

DTC DETECTION LOGIC

NOTE:

- If DTC B2605 is displayed with DTC U1000, first perform the trouble diagnosis for DTC U1000. Refer to [SEC-207. "DTC Logic"](#).
- If DTC B2605 is displayed with DTC U1010, first perform the trouble diagnosis for DTC U1010. Refer to [SEC-208. "DTC Logic"](#).

DTC No.	Trouble diagnosis name	DTC detecting condition	Possible cause
B2605	PNP SWITCH	BCM detects the following status for 500 ms or more when the ignition switch is in ON position <ul style="list-style-type: none"> • N position input signal exists. Shift position signal from IPDM E/R does not exist. • N position input signal does not exist. Shift position signal from IPDM E/R exists. 	<ul style="list-style-type: none"> • Harness or connectors [The park/neutral position (PNP) switch circuit is open or shorted.] • Park/neutral position (PNP) switch • IPDM E/R

DTC CONFIRMATION PROCEDURE

1. PERFORM DTC CONFIRMATION PROCEDURE

1. Turn ignition switch ON under the following conditions and wait for at least 1 seconds.
 - CVT selector lever is in the P or N position
 - Do not depress the brake pedal.
2. Check "Self diagnostic result" with CONSULT-III.

Is DTC detected?

- YES >> Go to [SEC-241. "Diagnosis Procedure"](#).
 NO >> INSPECTION END.

Diagnosis Procedure

INFOID:000000003185431

1. CHECK DTC WITH IPDM E/R

Check "Self diagnostic result" with CONSULT-III. Refer to [PCS-41. "DTC Index"](#).

Is the inspection result normal?

- YES >> GO TO 2.
 NO >> Repair or replace.

2. CHECK PNP SWITCH CIRCUIT

1. Turn ignition switch OFF.
2. Disconnect TCM harness connector and BCM harness connector.

B2605 PNP SWITCH

[SEDAN]

< COMPONENT DIAGNOSIS >

3. Check continuity between TCM connector and BCM harness connector.

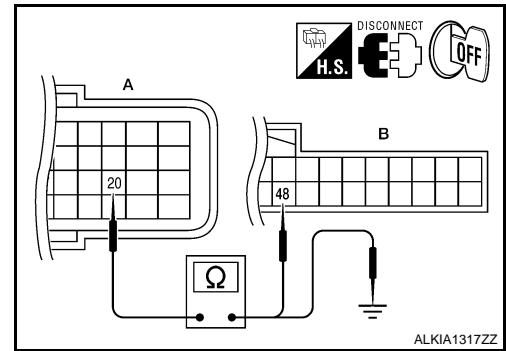

TCM		BCM		Continuity
Connector	Terminal	Connector	Terminal	
A: F16	20	B: M18	48	Yes

4. Check continuity between TCM harness connector and ground.

TCM		Ground	Continuity
Connector	Terminal		
A: F16	20	Ground	No

Is the inspection result normal?

YES >> GO TO 3.

NO >> Repair harness or connector.

3.CHECK INTERMITTENT INCIDENT

Refer to [GI-42. "Intermittent Incident"](#).

>> INSPECTION END.

B2606 STEERING LOCK RELAY

[SEDAN]

< COMPONENT DIAGNOSIS >

B2606 STEERING LOCK RELAY

Description

INFOID:000000003185432

The steering lock relay ON signal is transmitted to IPDM E/R by BCM via CAN communication. IPDM E/R turns the steering lock relay ON and transmits the release of the steering to BCM.

DTC Logic

INFOID:000000003185433

DTC DETECTION LOGIC

NOTE:

- If DTC B2606 is displayed with DTC U1000, first perform the trouble diagnosis for DTC U1000. Refer to [SEC-207, "DTC Logic"](#).
- If DTC B2606 is displayed with DTC U1010, first perform the trouble diagnosis for DTC U1010. Refer to [SEC-208, "DTC Logic"](#).

DTC No.	Trouble diagnosis name	DTC detecting condition	Possible cause
B2606	STEERING LOCK RELAY	BCM detects that there is a mismatch between the following statuses. <ul style="list-style-type: none">• Steering lock unit ON signal transmitted by IPDM E/R• The steering lock unit status feedback	<ul style="list-style-type: none">• Steering lock relay (in IPDM E/R)

DTC CONFIRMATION PROCEDURE

1. PERFORM DTC CONFIRMATION PROCEDURE

1. Press the push-button ignition switch under the following conditions.
 - CVT selector lever is in the P or N position.
 - Do not depress the brake pedal.
2. Steering is locked.
3. Check "Self diagnostic result" with CONSULT-III.

Is DTC detected?

- YES >> Go to [SEC-243, "Diagnosis Procedure"](#).
NO >> INSPECTION END.

Diagnosis Procedure

INFOID:000000003185434

1. CHECK DTC WITH IPDM E/R

Check "Self diagnostic result" with CONSULT-III. Refer to [PCS-41, "DTC Index"](#).

Is the inspection result normal?

- YES >> GO TO 2.
NO >> Repair or replace.

2. INTERMITTENT INCIDENT

Refer to [GI-42, "Intermittent Incident"](#).

>> INSPECTION END.

A
B
C
D
E
F
G
H
I
J
L
M
N
O
P

SEC

B2607 STEERING LOCK RELAY

< COMPONENT DIAGNOSIS >

[SEDAN]

B2607 STEERING LOCK RELAY

Description

INFOID:000000003185435

BCM requests to IPDM E/R to supply power to steering lock unit. IPDM E/R sends status of steering lock unit back to BCM.

DTC Logic

INFOID:000000003185436

DTC DETECTION LOGIC

NOTE:

- If DTC B2607 is displayed with DTC U1000, first perform the trouble diagnosis for DTC U1000. Refer to [SEC-207, "DTC Logic"](#).
- If DTC B2607 is displayed with DTC U1010, first perform the trouble diagnosis for DTC U1010. Refer to [SEC-208, "DTC Logic"](#).

DTC No.	Trouble diagnosis name	DTC detecting condition	Possible cause
B2607	STEERING LOCK RELAY	BCM detects that there is a difference between the following statuses. <ul style="list-style-type: none">• BCM request for steering lock unit power supply (ON/OFF)• IPDM E/R status of steering lock unit power supply (ON/OFF)	<ul style="list-style-type: none">• Harness or connectors (steering lock unit power supply circuit is open or shorted)• Steering lock relay (in IPDM E/R)

DTC CONFIRMATION PROCEDURE

1. PERFORM DTC CONFIRMATION PROCEDURE

1. Press the push-button ignition switch under the following conditions.
 - A/T selector lever is in the P position
 - Do not depress brake pedal
2. Steering lock is locked.
3. Check "Self diagnostic result" with CONSULT-III.

Is DTC detected?

YES >> Go to [SEC-244, "Diagnosis Procedure"](#).

NO >> INSPECTION END.

Diagnosis Procedure

INFOID:000000003185437

1. CHECK DTC WITH IPDM E/R

Check "Self diagnostic result" with CONSULT-III. Refer to [PCS-41, "DTC Index"](#).

Is the inspection result normal?

YES >> GO TO 2.

NO >> Repair or replace malfunctioning parts.

2. CHECK STEERING LOCK UNIT POWER SUPPLY CIRCUIT

1. Turn ignition switch OFF.
2. Disconnect steering lock unit harness connector.
3. Check voltage between steering lock unit and ground under the following conditions.

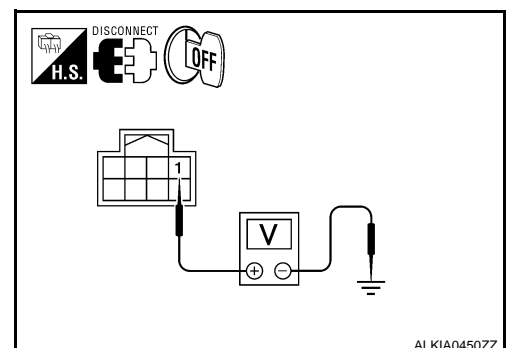

B2607 STEERING LOCK RELAY

[SEDAN]

< COMPONENT DIAGNOSIS >

Steering lock unit		Ground	Condition	Voltage (V)
Connector	Terminal			
M32	1	Ground	Press push-button ignition switch when steering lock is in lock condition.	Battery voltage

Is the inspection result normal?

- YES >> GO TO 4.
 NO >> GO TO 3.

3. CHECK STEERING LOCK UNIT POWER SUPPLY CIRCUIT

- Turn ignition switch OFF.
- Disconnect IPDM E/R harness connector.
- Check continuity between steering lock unit and IPDM E/R harness connector.

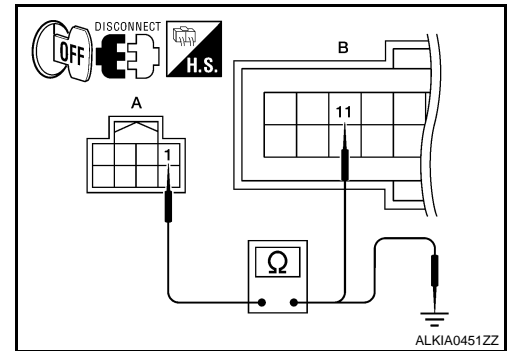

Steering lock unit		IPDM E/R		Continuity
Connector	Terminal	Connector	Terminal	
A: M32	1	B: E18	11	Yes

- Check continuity between steering lock unit and ground.

Steering lock unit		Ground	Continuity
Connector	Terminal		
A: M32	1	Ground	No

Is the inspection result normal?

- YES >> Replace IPDM E/R. Refer to [PCS-43. "Removal and Installation"](#).
 NO >> Repair harness or connector.

4. CHECK INTERMITTENT INCIDENT

Refer to [GI-42. "Intermittent Incident"](#).

>> INSPECTION END.

A
B
C
D
E
F
G
H
I
J
L
M
N
O
P

SEC

B2608 STARTER RELAY

[SEDAN]

< COMPONENT DIAGNOSIS >

B2608 STARTER RELAY

Description

INFOID:000000003185438

Located in IPDM E/R, it runs the starter motor. The starter relay is turned ON by the BCM when the ignition switch is in START position. IPDM E/R transmits the starter relay ON signal to BCM via CAN communication.

DTC Logic

INFOID:000000003185439

DTC DETECTION LOGIC

NOTE:

- If DTC B2608 is displayed with DTC U1000, first perform the trouble diagnosis for DTC U1000. Refer to [SEC-207, "DTC Logic"](#).
- If DTC B2608 is displayed with DTC U1010, first perform the trouble diagnosis for DTC U1010. Refer to [SEC-208, "DTC Logic"](#).

DTC No.	Trouble diagnosis name	DTC detecting condition	Possible cause
B2608	STARTER RELAY	BCM receives starter relay ON signal (CAN) from IPDM E/R even if BCM turns the starter relay OFF	<ul style="list-style-type: none"> • Harness or connectors (starter relay circuit is open or shorted.) • IPDM E/R

DTC CONFIRMATION PROCEDURE

1.PERFORM DTC CONFIRMATION PROCEDURE

1. Press the push-button ignition switch under the following conditions.
 - CVT selector lever is in the P or N position.
 - Depress the brake pedal.
2. Check "Self diagnostic result" with CONSULT-III.

Is DTC detected?

- YES >> Go to [SEC-246, "Diagnosis Procedure"](#).
 NO >> INSPECTION END.

Diagnosis Procedure

INFOID:000000003185440

1.CHECK STARTER RELAY

1. Turn ignition switch ON.
2. Check voltage between BCM harness connector and ground under the following condition.

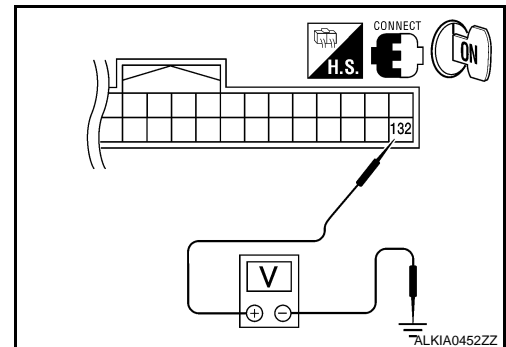

BCM		Ground	Condition		Voltage (V)
Connector	Terminal				
M21	132	Ground	CVT selector lever	N or P position	Battery voltage
				Other than above	0
			Clutch pedal	Not depressed	0
				Depressed	Battery voltage

B2608 STARTER RELAY

[SEDAN]

< COMPONENT DIAGNOSIS >

Is the measurement value within the specification?

- YES >> GO TO 3.
- NO >> GO TO 2.

2.CHECK STARTER RELAY CIRCUIT

1. Turn ignition switch OFF.
2. Disconnect BCM harness connector M21 and IPDM E/R harness connector E17.
3. Check continuity between IPDM E/R harness connector and BCM harness connector.

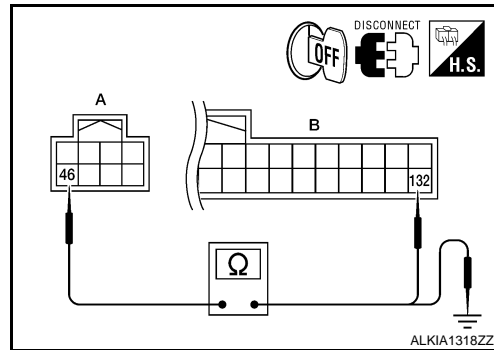

IPDM E/R		BCM		Continuity
Connector	Terminal	Connector	Terminal	
A: E17	46	B: M21	132	Yes

4. Check continuity between IPDM E/R harness connector and ground.

IPDM E/R		Ground	Continuity
Connector	Terminal		
A: E17	46	Ground	No

Is the inspection result normal?

- YES >> Replace IPDM E/R. Refer to [PCS-43. "Removal and Installation"](#).
- NO >> Repair harness or connector.

3.CHECK INTERMITTENT INCIDENT

Refer to [GI-42. "Intermittent Incident"](#).

>> INSPECTION END.

A
B
C
D
E
F
G
H
I
J
L
M
N
O
P

SEC

B2609 STEERING STATUS

< COMPONENT DIAGNOSIS >

[SEDAN]

B2609 STEERING STATUS

Description

INFOID:000000003185441

There are 2 switches in the steering lock unit (steering lock/unlock switch 1 and 2). BCM compares those two switches conditions to judge the present steering status.

DTC Logic

INFOID:000000003185442

DTC DETECTION LOGIC

NOTE:

- If DTC B2609 is displayed with DTC U1000, first perform the trouble diagnosis for DTC U1000. Refer to [SEC-207, "DTC Logic"](#).
- If DTC B2609 is displayed with DTC U1010, first perform the trouble diagnosis for DTC U1010. Refer to [SEC-208, "DTC Logic"](#).

DTC No.	Trouble diagnosis name	DTC detecting condition	Possible cause
B2609	STEERING STATUS	BCM detects the malfunction of steering lock unit switches for 1 second.	<ul style="list-style-type: none">• Harness or connectors [steering lock unit circuit (BCM side) is open or shorted]• Harness or connectors [steering lock unit circuit (IPDM E/R side) is open or shorted.]• Steering lock unit• IPDM E/R

DTC CONFIRMATION PROCEDURE

1. PERFORM DTC CONFIRMATION PROCEDURE 1

1. Press the push-button ignition switch under the following conditions and wait for at least 1 second.
 - CVT selector lever is in the P position.
 - Do not depress brake pedal
 - Steering is locked
2. Check "Self diagnostic result" with CONSULT-III.

Is DTC detected?

- YES >> Go to [SEC-248, "Diagnosis Procedure"](#).
NO >> GO TO 2.

2. PERFORM DTC CONFIRMATION PROCEDURE 2

1. Turn ignition switch ON.
2. Turn ignition switch OFF.
3. Press door switch.
4. Check "Self diagnostic result" with CONSULT-III.

Is DTC detected?

- YES >> Go to [SEC-248, "Diagnosis Procedure"](#).
NO >> INSPECTION END.

Diagnosis Procedure

INFOID:000000003185443

1. INSPECTION START

Check the case in which DTC is detected.

- Case1: It is detected after ignition switch is changed from ON to OFF and door switch is pressed
- Case2: It is detected after ignition switch is changed from ON to OFF

In which case is DTC detected?

- Case1 >> GO TO 2.
Case2 >> GO TO 7.

2. CHECK BCM OUTPUT SIGNAL

B2609 STEERING STATUS

[SEDAN]

< COMPONENT DIAGNOSIS >

1. Turn ignition switch OFF.
2. Disconnect steering lock unit harness connector and IPDM E/R harness connector.
3. Check voltage between steering lock unit harness connector and ground.

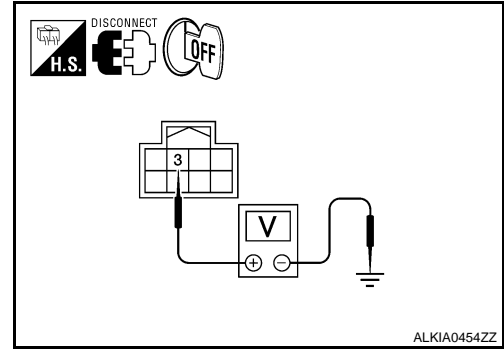

Steering lock unit		Ground	Voltage [V]
Connector	Terminal		
M32	3	Ground	Battery voltage

Is the inspection result normal?

- YES >> GO TO 4.
 NO >> GO TO 3.

3. CHECK STEERING LOCK UNIT CIRCUIT-I

1. Disconnect BCM harness connector.
2. Check continuity between BCM harness connector M19 (A) terminal 85 and steering lock unit harness connector M32 (B) terminal 3.

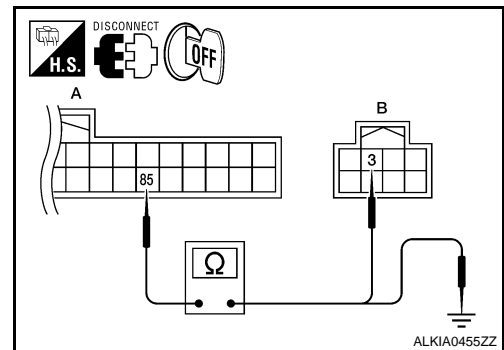

BCM		Steering lock unit		Continuity
Connector	Terminal	Connector	Terminal	
A: M19	85	B: M32	3	Yes

3. Check continuity between BCM harness connector M19 (A) terminal 85 and ground.

BCM		Ground	Continuity
Connector	Terminal		
A: M19	85	Ground	No

Is the inspection result normal?

- YES >> GO TO 6.
 NO >> Repair harness or connector.

4. CHECK IPDM E/R OUTPUT SIGNAL

1. Connect IPDM E/R harness connector.
2. Disconnect BCM harness connector.

B2609 STEERING STATUS

[SEDAN]

< COMPONENT DIAGNOSIS >

3. Check voltage between steering lock unit harness connector and ground.

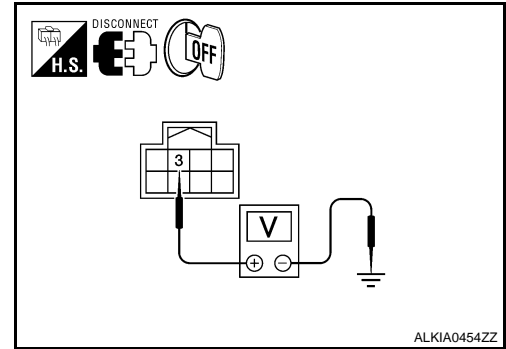

Steering lock unit		Ground	Voltage [V]
Connector	Terminal		
M32	3	Ground	Battery voltage

Is the inspection result normal?

- YES >> Replace steering lock unit.
 NO >> GO TO 5.

5.CHECK STEERING LOCK UNIT CIRCUIT-II

1. Check continuity between steering lock unit harness connector M32 (A) terminal 3 and IPDM E/R harness connector E18 (B) terminal 32.

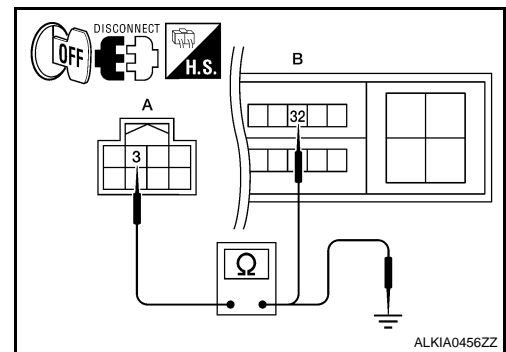

Steering lock unit		IPDM E/R		Continuity
Connector	Terminal	Connector	Terminal	
A: M32	3	B: E18	32	Yes

2. Check continuity between steering lock unit harness connector M32 (A) terminal 3 and ground.

Steering lock unit		Ground	Continuity
Connector	Terminal		
A: M32	3	Ground	No

Is the inspection result normal?

- YES >> GO TO 6.
 NO >> Repair harness or connector.

6.CHECK INTERMITTENT INCIDENT

Refer to [GI-42, "Intermittent Incident"](#).

>> INSPECTION END

7.CHECK BCM OUTPUT SIGNAL

1. Turn ignition switch OFF.
2. Disconnect steering lock unit harness connector and IPDM E/R harness connector E5.

B2609 STEERING STATUS

[SEDAN]

< COMPONENT DIAGNOSIS >

3. Check voltage between steering lock unit harness connector and ground.

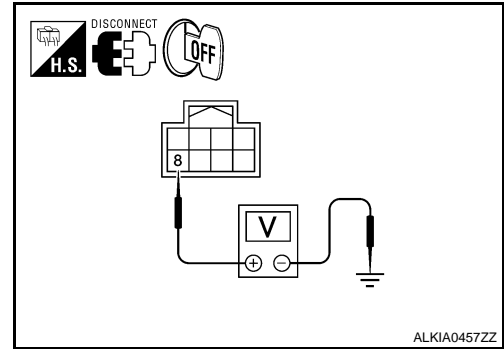

Steering lock unit		Ground	Voltage [V]
Connector	Terminal		
M32	8	Ground	Battery voltage

Is the inspection result normal?

- YES >> GO TO 9.
NO >> GO TO 8.

8.CHECK STEERING LOCK UNIT CIRCUIT-I

1. Disconnect BCM harness connector M19.
2. Check continuity between BCM harness connector M19 (A) terminal 86 and steering lock unit harness connector M32 (B) terminal 8.

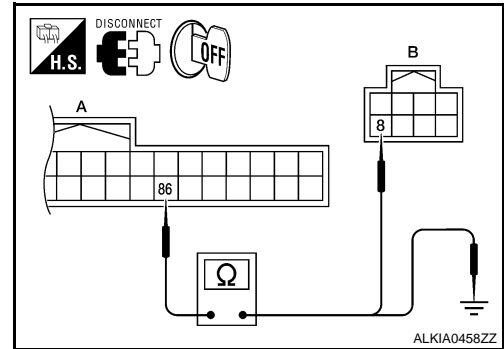

BCM		Steering lock unit		Continuity
Connector	Terminal	Connector	Terminal	
A: M19	86	B: M32	8	Yes

3. Check continuity between BCM harness connector M19 (A) terminal 86 and ground.

BCM		Ground	Continuity
Connector	Terminal		
A: M19	86	Ground	No

Is the inspection result normal?

- YES >> GO TO 11.
NO >> Repair harness or connector.

9.CHECK IPDM E/R OUTPUT SIGNAL

1. Connect IPDM E/R harness connector.
2. Disconnect BCM harness connector M19.

B2609 STEERING STATUS

[SEDAN]

< COMPONENT DIAGNOSIS >

3. Check voltage between steering lock unit harness connector and ground.

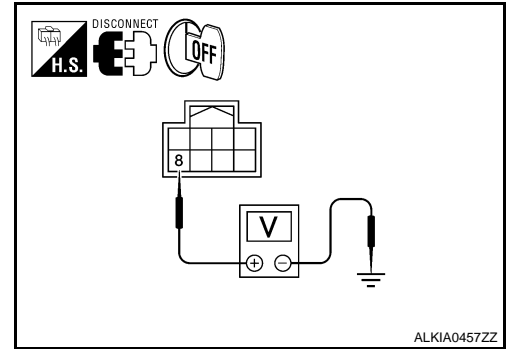

Steering lock unit		Ground	Voltage [V]
Connector	Terminal		
M32	8	Ground	Battery voltage

Is the inspection result normal?

- YES >> Replace steering lock unit.
 NO >> GO TO 10.

10. CHECK STEERING LOCK UNIT CIRCUIT-II

1. Check continuity between steering lock unit harness connector M32 (A) terminal 8 and IPDM E/R harness connector E18 (B) terminal 33.

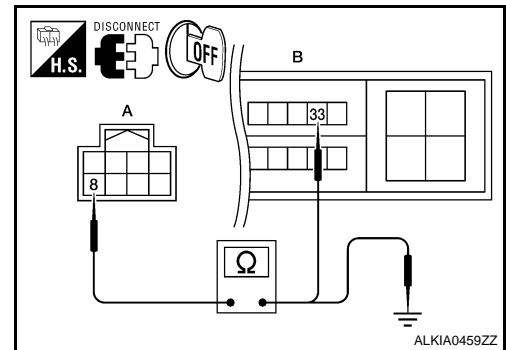

Steering lock unit		IPDM E/R		Continuity
Connector	Terminal	Connector	Terminal	
A: M32	8	B: E18	33	Yes

2. Check continuity between steering lock unit harness connector and ground.

Steering lock unit		Ground	Continuity
Connector	Terminal		
A: M32	8	Ground	No

Is the inspection result normal?

- YES >> GO TO 11.
 NO >> Repair harness or connector.

11. CHECK INTERMITTENT INCIDENT

Refer to [GI-42, "Intermittent Incident"](#).

>> INSPECTION END

B260B STEERING LOCK UNIT

[SEDAN]

< COMPONENT DIAGNOSIS >

B260B STEERING LOCK UNIT

Description

INFOID:000000003185444

The steering lock unit performs the check by itself according to the steering status.

DTC Logic

INFOID:000000003185445

DTC DETECTION LOGIC

DTC No.	Trouble diagnosis name	DTC detecting condition	Possible cause
B260B	STEERING LOCK UNIT	BCM detects malfunctioning of steering lock unit before steering unlocking.	<ul style="list-style-type: none">Steering lock unit

DTC CONFIRMATION PROCEDURE

1.PERFORM DTC CONFIRMATION PROCEDURE

1. Press the push-button ignition switch, when steering is locked.
2. Check "Self diagnostic result" with CONSULT-III.

Is DTC detected?

- YES >> Go to [SEC-253, "Diagnosis Procedure"](#).
NO >> INSPECTION END.

Diagnosis Procedure

INFOID:000000003185446

1.INSPECTION START

1. Turn ignition switch ON.
2. Check "Self diagnostic result" with CONSULT-III.
3. Touch "ERASE".
4. **Perform DTC Confirmation Procedure.**
See [SEC-253, "DTC Logic"](#).

Is the DTC B260B displayed again?

- YES >> Replace steering lock unit.
NO >> INSPECTION END.

A
B
C
D
E
F
G
H
I
J
L
M
N
O
P

SEC

B260C STEERING LOCK UNIT

[SEDAN]

< COMPONENT DIAGNOSIS >

B260C STEERING LOCK UNIT

Description

INFOID:000000003185447

The steering lock unit performs the check by itself according to the steering status.

DTC Logic

INFOID:000000003185448

DTC DETECTION LOGIC

DTC No.	Trouble diagnosis name	DTC detecting condition	Possible cause
B260C	STEERING LOCK UNIT	BCM detects malfunctioning of steering lock unit before steering locking.	<ul style="list-style-type: none">Steering lock unit

DTC CONFIRMATION PROCEDURE

1. PERFORM DTC CONFIRMATION PROCEDURE

1. Turn ignition switch ON.
2. Turn ignition switch OFF.
3. Press door switch.
4. Check "Self diagnostic result" with CONSULT-III.

Is DTC detected?

- YES >> Go to [SEC-254, "Diagnosis Procedure"](#).
NO >> INSPECTION END.

Diagnosis Procedure

INFOID:000000003185449

1. INSPECTION START

1. Turn ignition switch ON.
2. Check "Self diagnostic result" with CONSULT-III.
3. Touch "ERASE".
4. **Perform DTC Confirmation Procedure.**
See [SEC-254, "DTC Logic"](#).

Is the DTC B260C displayed again?

- YES >> Replace steering lock unit.
NO >> INSPECTION END.

B260D STEERING LOCK UNIT

[SEDAN]

< COMPONENT DIAGNOSIS >

B260D STEERING LOCK UNIT

Description

INFOID:000000003185450

The steering lock unit performs the check by itself according to the steering lock status (before lock, after lock and unlock).

DTC Logic

INFOID:000000003185451

DTC DETECTION LOGIC

DTC No.	Trouble diagnosis name	DTC detecting condition	Possible cause
B260D	STEERING LOCK UNIT	BCM detects malfunctioning of steering lock unit after steering locking.	• Steering lock unit

DTC CONFIRMATION PROCEDURE

1. PERFORM DTC CONFIRMATION PROCEDURE

1. Turn ignition switch ON.
2. Turn ignition switch OFF.
3. Press door switch.
4. Check "Self diagnostic result" with CONSULT-III.

Is DTC detected?

- YES >> Go to [SEC-255, "Diagnosis Procedure"](#).
NO >> INSPECTION END.

Diagnosis Procedure

INFOID:000000003185452

1. INSPECTION START

1. Turn ignition switch ON.
2. Check "Self diagnostic result" with CONSULT-III.
3. Touch "ERASE".
4. **Perform DTC Confirmation Procedure.**
See [SEC-255, "DTC Logic"](#).

Is the DTC B260D displayed again?

- YES >> Replace steering lock unit.
NO >> INSPECTION END.

A
B
C
D
E
F
G
H
I
J
L
M
N
O
P

SEC

B260F ENGINE STATUS

[SEDAN]

< COMPONENT DIAGNOSIS >

B260F ENGINE STATUS

Description

INFOID:000000003185453

BCM receives the engine status signal from ECM via CAN communication.

DTC Logic

INFOID:000000003185454

DTC DETECTION LOGIC

NOTE:

- If DTC B260F is displayed with DTC U1000, first perform the trouble diagnosis for DTC U1000. Refer to [SEC-207, "DTC Logic"](#).
- If DTC B260F is displayed with DTC U1010, first perform the trouble diagnosis for DTC U1010. Refer to [SEC-208, "DTC Logic"](#).

DTC No.	Trouble diagnosis name	DTC detecting condition	Possible cause
B260F	INTERRUPTION OF ENGINE STATUS SIGNAL	BCM is not yet received the engine status signal from ECM when ignition switch is in ON position	• ECM

DTC CONFIRMATION PROCEDURE

1. PERFORM DTC CONFIRMATION PROCEDURE

1. Turn ignition switch ON under the following conditions.
 - CVT selector lever is in the P position.
 - Do not depress the brake pedal.
2. Check "Self diagnostic result" with CONSULT-III.

Is DTC detected?

- YES >> Go to [SEC-256, "Diagnosis Procedure"](#).
NO >> INSPECTION END.

Diagnosis Procedure

INFOID:000000003185455

1. INSPECTION START

1. Turn ignition switch ON.
2. Check "Self diagnostic result" with CONSULT-III.
3. Touch "ERASE".
4. **Perform DTC Confirmation Procedure.**
See [SEC-256, "DTC Logic"](#).

Is the DTC B260F displayed again?

- YES >> GO TO 2.
NO >> INSPECTION END.

2. REPLACE ECM

1. Replace ECM.
2. Go to [EC-1016, "BASIC INSPECTION : Special Repair Requirement"](#) (VQ35DE), [EC-24, "BASIC INSPECTION : Special Repair Requirement"](#) (QR25DE).

>> INSPECTION END.

B26E1 NO RECEPTION OF ENGINE STATUS SIGNAL

< COMPONENT DIAGNOSIS >

[SEDAN]

B26E1 NO RECEPTION OF ENGINE STATUS SIGNAL

Description

INFOID:000000003185456

BCM receives the engine status signal from ECM via CAN communication.

DTC Logic

INFOID:000000003185457

DTC DETECTION LOGIC

NOTE:

- If DTC B26E1 is displayed with DTC U1000, first perform the trouble diagnosis for DTC U1000. Refer to [SEC-207, "DTC Logic"](#).
- If DTC B26E1 is displayed with DTC U1010, first perform the trouble diagnosis for DTC U1010. Refer to [SEC-208, "DTC Logic"](#).

DTC No.	Trouble diagnosis name	DTC detecting condition	Possible cause
B260F	NO RECEPTION OF ENGINE STATUS SIGNAL	BCM does not receive the engine status signal from ECM when ignition switch is in the ON position	• ECM

DTC CONFIRMATION PROCEDURE

1. PERFORM DTC CONFIRMATION PROCEDURE

1. Turn ignition switch ON under the following conditions.
 - CVT selector lever is in the P or N position.
 - Do not depress the brake pedal.
2. Check "Self diagnostic result" with CONSULT-III.

Is DTC detected?

- YES >> Go to [SEC-257, "Diagnosis Procedure"](#).
NO >> INSPECTION END.

Diagnosis Procedure

INFOID:000000003185458

1. INSPECTION START

1. Turn ignition switch ON.
2. Check "Self diagnostic result" with CONSULT-III.
3. Touch "ERASE".
4. **Perform DTC Confirmation Procedure.**
See [SEC-257, "DTC Logic"](#).

Is the DTC B26E1 displayed again?

- YES >> GO TO 2.
NO >> INSPECTION END.

2. REPLACE ECM

1. Replace ECM.
2. Go to [EC-1016, "BASIC INSPECTION : Special Repair Requirement"](#) (VQ35DE), [EC-24, "BASIC INSPECTION : Special Repair Requirement"](#) (QR25DE).

>> INSPECTION END.

B2612 STEERING STATUS

< COMPONENT DIAGNOSIS >

[SEDAN]

B2612 STEERING STATUS

Description

INFOID:000000003185459

There are 2 switches in the steering unit. IPDM E/R compares those 2 switches conditions to judge the present steering status and transmit the result to BCM via CAN communication.

DTC Logic

INFOID:000000003185460

DTC DETECTION LOGIC

NOTE:

- If DTC B2612 is displayed with DTC U1000, first perform the trouble diagnosis for DTC U1000. Refer to [SEC-207, "DTC Logic"](#).
- If DTC B2612 is displayed with DTC U1010, first perform the trouble diagnosis for DTC U1010. Refer to [SEC-208, "DTC Logic"](#).

DTC	Self-diagnosis name	DTC detecting condition	Possible causes
B2612	STEERING STATUS	BCM detects the mismatch between the following status for 1 second <ul style="list-style-type: none">• Steering lock or unlock• Feedback of steering lock status from IPDM E/R (CAN)	<ul style="list-style-type: none">• Harness or connectors [steering lock unit circuit (BCM side) is open or shorted]• Harness or connectors [steering lock unit circuit (IPDM E/R side) is open or shorted.]• Steering lock unit• IPDM E/R

DTC CONFIRMATION PROCEDURE

1. PERFORM DTC CONFIRMATION PROCEDURE 1

1. Press the push-button ignition switch under the following conditions and wait for at least 1 second.
 - CVT selector lever is in the P or N position.
 - Do not depress brake pedal.
 - Steering is locked.
2. Check "Self diagnostic result" with CONSULT-III.

Is DTC detected?

- YES >> Go to [SEC-258, "Diagnosis Procedure"](#).
NO >> GO TO 2.

2. PERFORM DTC CONFIRMATION PROCEDURE 2

1. Turn ignition switch ON.
2. Turn ignition switch OFF.
3. Press door switch.
4. Check "Self diagnostic result" with CONSULT-III.

Is DTC detected?

- YES >> Go to [SEC-258, "Diagnosis Procedure"](#).
NO >> INSPECTION END.

Diagnosis Procedure

INFOID:000000003185461

1. INSPECTION START

Check the case in which DTC is detected.

- Case1: It is detected after ignition switch is changed from ON to OFF and door switch is pressed.
- Case2: It is detected after ignition switch is changed from ON to OFF

In which case is DTC detected?

- Case1 >> GO TO 2.
Case2 >> GO TO 7.

2. CHECK BCM OUTPUT SIGNAL

B2612 STEERING STATUS

[SEDAN]

< COMPONENT DIAGNOSIS >

1. Turn ignition switch OFF.
2. Disconnect steering lock unit harness connector and IPDM E/R harness connector.
3. Check voltage between steering lock unit harness connector and ground.

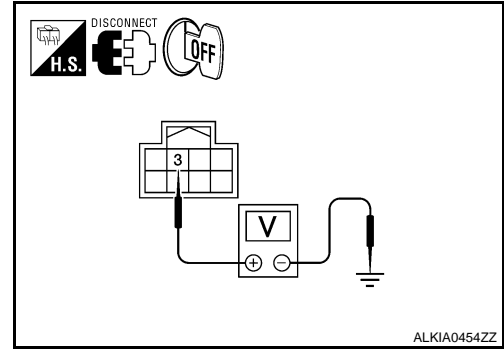

Steering lock unit		Ground	Voltage [V]
Connector	Terminal		
M32	3	Ground	Battery voltage

Is the inspection result normal?

- YES >> GO TO 4.
 NO >> GO TO 3.

3. CHECK STEERING LOCK UNIT CIRCUIT-I

1. Disconnect BCM harness connector.
2. Check continuity between BCM harness connector M19 (A) terminal 85 and steering lock unit harness connector M32 (B) terminal 3.

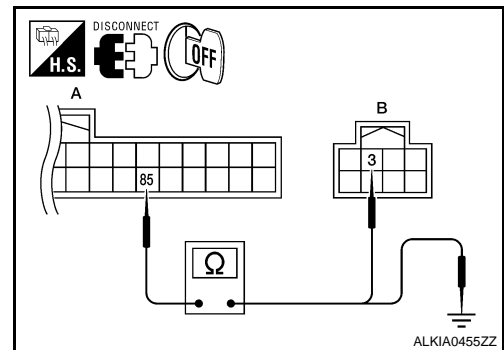

BCM		Steering lock unit		Continuity
Connector	Terminal	Connector	Terminal	
A: M19	85	B: M32	3	Yes

3. Check continuity between BCM harness connector M19 (A) terminal 85 and ground.

BCM		Ground	Continuity
Connector	Terminal		
A: M19	85	Ground	No

Is the inspection result normal?

- YES >> GO TO 6.
 NO >> Repair harness or connector.

4. CHECK IPDM E/R OUTPUT SIGNAL

1. Connect IPDM E/R harness connector.
2. Disconnect BCM harness connector.

B2612 STEERING STATUS

[SEDAN]

< COMPONENT DIAGNOSIS >

- Check voltage between steering lock unit harness connector and ground.

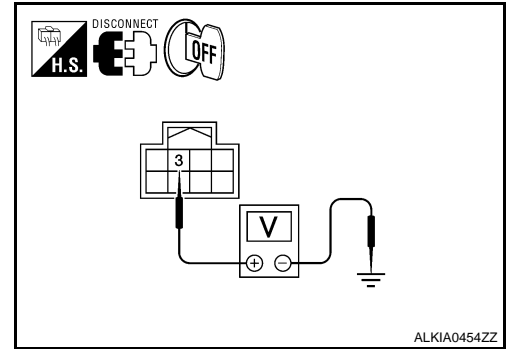

Steering lock unit		Ground	Voltage [V]
Connector	Terminal		
M32	3	Ground	Battery voltage

Is the inspection result normal?

- YES >> Replace steering lock unit.
 NO >> GO TO 5.

5.CHECK STEERING LOCK UNIT CIRCUIT-II

- Check continuity between steering lock unit harness connector M32 (A) terminal 3 and IPDM E/R harness connector E18 (B) terminal 32.

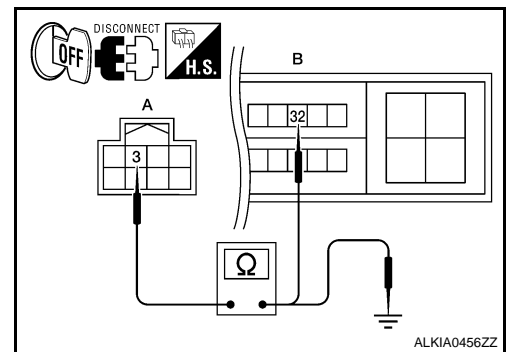

Steering lock unit		IPDM E/R		Continuity
Connector	Terminal	Connector	Terminal	
A: M32	3	B: E18	32	Yes

- Check continuity between steering lock unit harness connector M32 (A) terminal 3 and ground.

Steering lock unit		Ground	Continuity
Connector	Terminal		
A: M32	3	Ground	No

Is the inspection result normal?

- YES >> GO TO 6.
 NO >> Repair harness or connector.

6.CHECK INTERMITTENT INCIDENT

Refer to [GI-42, "Intermittent Incident"](#).

>> INSPECTION END.

7.CHECK BCM OUTPUT SIGNAL

- Turn ignition switch OFF.
- Disconnect steering lock unit harness connector and IPDM E/R harness connector.

B2612 STEERING STATUS

[SEDAN]

< COMPONENT DIAGNOSIS >

3. Check voltage between steering lock unit harness connector and ground.

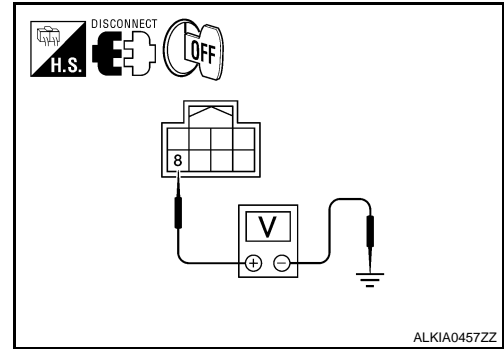

Steering lock unit		Ground	Voltage [V]
Connector	Terminal		
M32	8	Ground	Battery voltage

Is the inspection result normal?

- YES >> GO TO 9.
NO >> GO TO 8.

8. CHECK STEERING LOCK UNIT CIRCUIT-I

1. Disconnect BCM harness connector.
2. Check continuity between BCM harness connector M19 (A) terminal 86 and steering lock unit harness connector M32 (B) terminal 8.

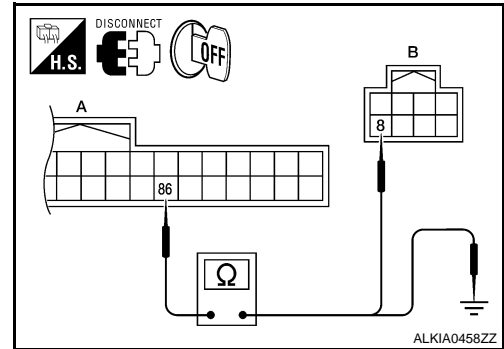

BCM		Steering lock unit		Continuity
Connector	Terminal	Connector	Terminal	
A: M19	86	B: M32	8	Yes

3. Check continuity between BCM harness connector M19 (A) terminal 86 and ground.

BCM		Ground	Continuity
Connector	Terminal		
A: M19	86	Ground	No

Is the inspection result normal?

- YES >> GO TO 11.
NO >> Repair harness or connector.

9. CHECK IPDM E/R OUTPUT SIGNAL

1. Connect IPDM E/R harness connector.
2. Disconnect BCM harness connector.

A
B
C
D
E
F
G
H
I
J
L
M
N
O
P

SEC

B2612 STEERING STATUS

[SEDAN]

< COMPONENT DIAGNOSIS >

3. Check voltage between steering lock unit harness connector and ground.

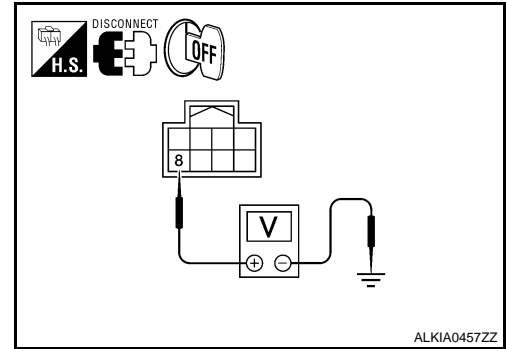

Steering lock unit		Ground	Voltage [V]
Connector	Terminal		
M32	8	Ground	Battery voltage

Is the inspection result normal?

- YES >> Replace steering lock unit.
 NO >> GO TO 10.

10.CHECK STEERING LOCK UNIT CIRCUIT-II

1. Check continuity between steering lock unit harness connector M32 (A) terminal 8 and IPDM E/R harness connector E18 (B) terminal 33.

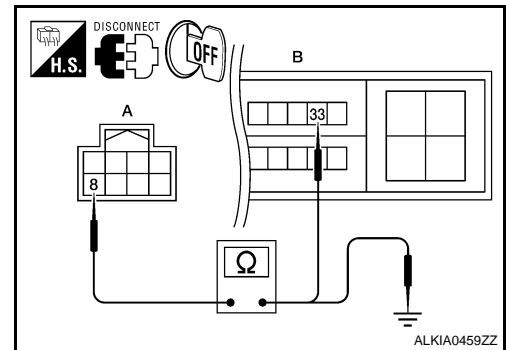

Steering lock unit		IPDM E/R		Continuity
Connector	Terminal	Connector	Terminal	
A: M32	8	B: E18	33	Yes

2. Check continuity between steering lock unit harness connector and ground.

Steering lock unit		Ground	Continuity
Connector	Terminal		
A: M32	8	Ground	No

Is the inspection result normal?

- YES >> GO TO 11.
 NO >> Repair harness or connector.

11.CHECK INTERMITTENT INCIDENT

Refer to [GI-42, "Intermittent Incident"](#).

>> INSPECTION END.

B2617 STARTER RELAY CIRCUIT

< COMPONENT DIAGNOSIS >

[SEDAN]

B2617 STARTER RELAY CIRCUIT

Description

INFOID:000000003185462

Located in IPDM E/R, it runs the starter motor. The starter relay is turned ON by the BCM when the ignition switch is in START position. IPDM E/R transmits the starter relay ON signal to BCM via CAN communication.

DTC Logic

INFOID:000000003185463

DTC DETECTION LOGIC

NOTE:

- If DTC B2617 is displayed with DTC U1000, first perform the trouble diagnosis for DTC U1000. Refer to [SEC-207, "DTC Logic"](#).
- If DTC B2617 is displayed with DTC U1010, first perform the trouble diagnosis for DTC U1010. Refer to [SEC-208, "DTC Logic"](#).
- If DTC B2617 is displayed with DTC B2611, first perform the trouble diagnosis for DTC B2611. Refer to [PCS-59, "DTC Logic"](#).
- If DTC B2617 is displayed with DTC B210E, first perform the trouble diagnosis for DTC B210E. Refer to [SEC-263, "DTC Logic"](#).

DTC No.	Trouble diagnosis name	DTC detecting condition	Possible cause
B2617	STARTER RELAY CIRCUIT	<ul style="list-style-type: none">• An immediate operation of starter relay is requested by BCM, but there is no response for more than 1 second• BCM is not commanding starter relay activation, but BCM detects starter relay output is active	<ul style="list-style-type: none">• Harness or connectors (Starter relay circuit is open or shorted.)• IPDM E/R

DTC CONFIRMATION PROCEDURE

1. PERFORM DTC CONFIRMATION PROCEDURE

1. Turn ignition switch ON under the following conditions and wait for at least 1 second.
 - CVT selector lever is in the P position.
 - Do not depress the brake pedal.
2. Check "Self diagnostic result" with CONSULT-III.

Is DTC detected?

- YES >> Go to [SEC-263, "Diagnosis Procedure"](#).
NO >> INSPECTION END

Diagnosis Procedure

INFOID:000000003185464

1. CHECK STARTER RELAY

1. Turn ignition switch ON.
2. Check voltage between BCM harness connector and ground under the following condition.

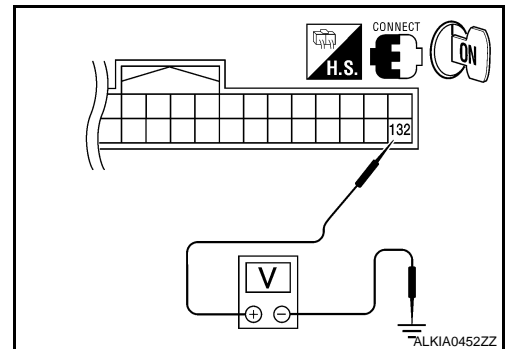

B2617 STARTER RELAY CIRCUIT

< COMPONENT DIAGNOSIS >

[SEDAN]

BCM		Ground	Transmission type	Condition	Voltage (V)
Connector	Terminal				
M21	132	Ground	CVT: Select lever in Park	Ignition switch cranking or request to start	Battery voltage
				Other than above	0
			M/T: Clutch pedal depressed	Ignition switch cranking or request to start	Battery voltage
				Other than above	0

Is the measurement value within the specification.

- YES >> GO TO 3.
- NO >> GO TO 2.

2. CHECK STARTER RELAY CIRCUIT

1. Turn ignition switch OFF.
2. Disconnect BCM harness connector and IPDM E/R harness connector.
3. Check continuity between IPDM E/R harness connector and BCM harness connector.

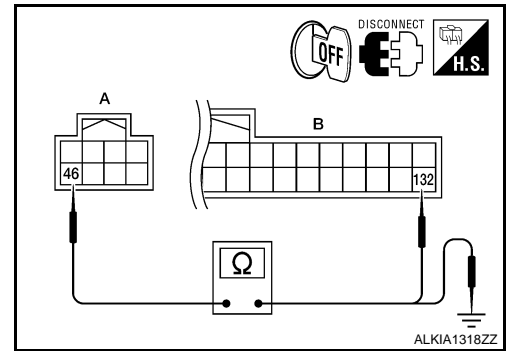

IPDM E/R		BCM		Continuity
Connector	Terminal	Connector	Terminal	
A: E17	46	B: M21	132	Yes

4. Check continuity between IPDM E/R harness connector and ground.

IPDM E/R		Ground	Continuity
Connector	Terminal		
A: E17	46	Ground	No

Is the inspection result normal?

- YES >> Replace BCM. Refer to [BCS-88. "Removal and Installation"](#).
- NO >> Repair harness or connector.

3. CHECK INTERMITTENT INCIDENT

Refer to [GI-42. "Intermittent Incident"](#).

>> INSPECTION END.

B2619 BCM

Description

INFOID:000000003185465

BCM requests IPDM E/R to supply power to steering lock unit. After receiving the power, the steering lock unit transmits an ON signal to BCM.

DTC Logic

INFOID:000000003185466

DTC DETECTION LOGIC

DTC No.	Trouble diagnosis name	DTC detecting condition	Possible cause
B2619	BCM	BCM detects a mismatch between the power supplied to the steering lock unit and the feedback for one second or more.	<ul style="list-style-type: none"> • BCM

DTC CONFIRMATION PROCEDURE

1. PERFORM DTC CONFIRMATION PROCEDURE

1. Press the push-button ignition switch under the following conditions and wait for at least 1 second.
 - CVT selector lever is in the P position
 - Do not depress brake pedal
2. Check "Self diagnostic result" with CONSULT-III.

Is DTC detected?

- YES >> Go to [SEC-265, "Diagnosis Procedure"](#).
- NO >> INSPECTION END.

Diagnosis Procedure

INFOID:000000003185467

1. INSPECTION START

1. Turn ignition switch ON.
2. Check "Self diagnostic result" with CONSULT-III.
3. Touch "ERASE".
4. **Perform DTC Confirmation Procedure.**
See [SEC-265, "DTC Logic"](#).

Is the DTC B2619 displayed again?

- YES >> Replace BCM. Refer to [BCS-88, "Removal and Installation"](#).
- NO >> INSPECTION END

A
B
C
D
E
F
G
H
I
J
L
M
N
O
P

SEC

B261A PUSH-BUTTON IGNITION SWITCH

< COMPONENT DIAGNOSIS >

[SEDAN]

B261A PUSH-BUTTON IGNITION SWITCH

Description

INFOID:000000003185468

IPDM E/R transmits the push-button ignition switch status via CAN communication to BCM. BCM receives push-button ignition switch status by hardwire input. BCM compares the 2 signals for mismatch.

DTC Logic

INFOID:000000003185469

DTC DETECTION LOGIC

NOTE:

- If DTC B261A is displayed with DTC U1000, first perform the trouble diagnosis for DTC U1000. Refer to [SEC-207, "DTC Logic"](#).
- If DTC B261A is displayed with DTC U1010, first perform the trouble diagnosis for DTC U1010. Refer to [SEC-208, "DTC Logic"](#).

DTC No.	Trouble diagnosis name	DTC detecting condition	Possible cause
B261A	PUSH-BUTTON IGNITION SWITCH	BCM detects the mismatch between the following for 1 second or more <ul style="list-style-type: none"> • Push-button ignition switch status • Push-button ignition switch status from IPDM E/R (CAN) 	<ul style="list-style-type: none"> • Harness or connectors (Push-button ignition switch circuit is open or shorted) • Between BCM and push-button ignition switch • Between IPDM E/R and push-button ignition switch

DTC CONFIRMATION PROCEDURE

1. PERFORM DTC CONFIRMATION PROCEDURE

1. Press the push-button ignition switch under the following conditions and wait for at least 1 second.
 - CVT selector lever is in the P position
 - Do not depress brake pedal.
2. Check "Self diagnostic result" with CONSULT-III.

Is DTC detected?

- YES >> Go to [SEC-266, "Diagnosis Procedure"](#).
 NO >> INSPECTION END

Diagnosis Procedure

INFOID:000000003185470

1. CHECK PUSH-BUTTON IGNITION SWITCH OUTPUT SIGNAL 1

1. Turn ignition switch OFF.
2. Disconnect push-button ignition switch harness connector and IPDM E/R harness connector.
3. Check voltage between push-button ignition switch harness connector and ground.

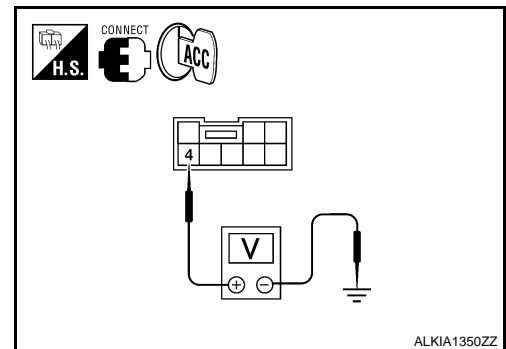

Push-button ignition switch		Ground	Voltage (V)
Connector	Terminal		
M38	4	Ground	Battery voltage

B261A PUSH-BUTTON IGNITION SWITCH

[SEDAN]

< COMPONENT DIAGNOSIS >

Is the inspection result normal?

- YES >> GO TO 4.
- NO >> GO TO 2.

2. CHECK PUSH-BUTTON IGNITION SWITCH CIRCUIT

1. Disconnect BCM harness connector.
2. Check continuity between push-button ignition switch harness connector M38 (A) terminal 4 and BCM harness connector M19 (B) terminal 77.

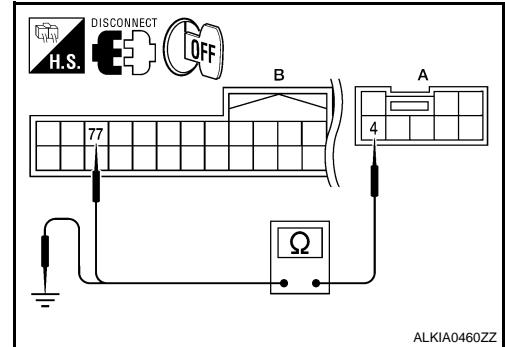

Push-button ignition switch		BCM		Continuity
Connector	Terminal	Connector	Terminal	
A: M38	4	B: M19	77	Yes

3. Check continuity between push-button ignition switch harness connector M38 (A) terminal 4 and ground.

Push-button ignition switch		Ground	Continuity
Connector	Terminal		
A: M38	4	Ground	No

Is the inspection result normal?

- YES >> GO TO 6.
- NO >> Repair harness or connector.

3. CHECK PUSH-BUTTON IGNITION SWITCH

1. Disconnect IPDM E/R harness connector.
2. Check continuity between push-button ignition switch harness connector M38 (A) terminal 4 and IPDM E/R harness connector E18 (B) terminal 28.

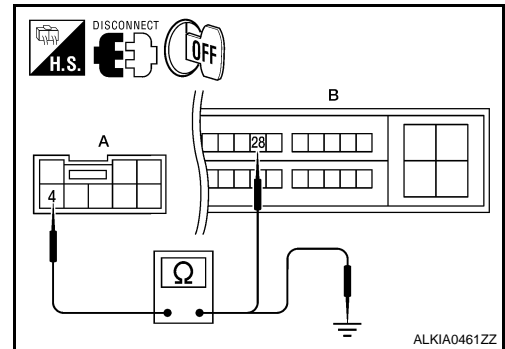

Push-button ignition switch		IPDM E/R		Continuity
Connector	Terminal	Connector	Terminal	
A: M38	4	B: E18	28	Yes

3. Check continuity between push-button ignition switch harness connector and ground.

Push-button ignition switch		Ground	Continuity
Connector	Terminal		
A: M38	4	Ground	No

A
B
C
D
E
F
G
H
I
J
L
M
N
O
P

SEC

B261A PUSH-BUTTON IGNITION SWITCH

[SEDAN]

< COMPONENT DIAGNOSIS >

Is the inspection result normal?

YES >> GO TO 4.

NO >> Repair harness or connector.

4.CHECK INTERMITTENT INCIDENT

Refer to [GI-42, "Intermittent Incident"](#).

>> INSPECTION END

B261E VEHICLE TYPE

[SEDAN]

< COMPONENT DIAGNOSIS >

B261E VEHICLE TYPE

Description

INFOID:000000003185471

There are two types of vehicle.

- HEV
- Conventional

DTC Logic

INFOID:000000003185472

DTC DETECTION LOGIC

NOTE:

- If DTC B261E is displayed with DTC U1000, first perform the trouble diagnosis for DTC U1000. Refer to [SEC-207, "DTC Logic"](#).
- If DTC B261E is displayed with DTC U1010, first perform the trouble diagnosis for DTC U1010. Refer to [SEC-208, "DTC Logic"](#).

DTC No.	Trouble diagnosis name	DTC detecting condition	Possible cause
B261E	VEHICLE TYPE	Difference of BCM configuration	• BCM

DTC CONFIRMATION PROCEDURE

1. PERFORM DTC CONFIRMATION PROCEDURE

1. Turn ignition switch ON.
2. Check "Self diagnostic result" with CONSULT-III.

Is DTC detected?

- YES >> Go to [SEC-269, "Diagnosis Procedure"](#).
NO >> INSPECTION END

Diagnosis Procedure

INFOID:000000003185473

1. INSPECTION START

1. Turn ignition switch ON.
2. Check "Self diagnostic result" with CONSULT-III.
3. Touch "ERASE".
4. **Perform DTC Confirmation Procedure.**
See [SEC-269, "DTC Logic"](#).

Is the 1st trip DTC B261E displayed again?

- YES >> Perform BCM configuration. Refer to CONSULT-III Operation Manual.
NO >> INSPECTION END

A
B
C
D
E
F
G
H
I
J
L
M
N
O
P

SEC

B2108 STEERING LOCK RELAY

< COMPONENT DIAGNOSIS >

[SEDAN]

B2108 STEERING LOCK RELAY

Description

INFOID:000000003185474

The steering lock relay ON signal is transmitted to IPDM E/R by BCM via CAN communication. IPDM E/R turns the steering lock relay ON and transmits the release of the steering to BCM.

DTC Logic

INFOID:000000003185475

DTC DETECTION LOGIC

NOTE:

- If DTC B2108 is displayed with DTC U1000, first perform the trouble diagnosis for DTC U1000. Refer to [SEC-207, "DTC Logic"](#).
- If DTC B2108 is displayed with DTC U1010, first perform the trouble diagnosis for DTC U1010. Refer to [SEC-208, "DTC Logic"](#).

DTC No.	Trouble diagnosis name	DTC detecting condition	Possible cause
B2108	STRG LCK RELAY ON	IPDM E/R detects that the relay is stuck at ON position for about 1 second even if the IPDM E/R receives steering lock relay ON/OFF signal from BCM.	<ul style="list-style-type: none">• IPDM E/R

DTC CONFIRMATION PROCEDURE

1. PERFORM DTC CONFIRMATION PROCEDURE

1. Press the push-button ignition switch under the following conditions and wait for at least 1 second.
 - CVT selector lever is in the P position
 - Do not depress the brake pedal.
2. Check "Self diagnostic result" with CONSULT-III.

Is DTC detected?

- YES >> Go to [SEC-270, "Diagnosis Procedure"](#).
NO >> INSPECTION END

Diagnosis Procedure

INFOID:000000003185476

1. CHECK FUSE

1. Turn ignition switch OFF.
2. Check 10A fuse (No. 40, located in IPDM E/R).

Is the inspection normal?

- YES >> Replace IPDM E/R. Refer to [PCS-43, "Removal and Installation"](#).
NO >> Check the following.
 - Harness for open or short between IPDM E/R and battery
 - Fuse

B2109 STEERING LOCK RELAY

< COMPONENT DIAGNOSIS >

[SEDAN]

B2109 STEERING LOCK RELAY

Description

INFOID:000000003185477

The steering lock relay ON signal is transmitted to IPDM E/R by BCM via CAN communication. IPDM E/R turns the steering lock relay ON and transmits the release of the steering to BCM.

DTC Logic

INFOID:000000003185478

DTC DETECTION LOGIC

NOTE:

- If DTC B2109 is displayed with DTC U1000, first perform the trouble diagnosis for DTC U1000. Refer to [SEC-207, "DTC Logic"](#).
- If DTC B2109 is displayed with DTC U1010, first perform the trouble diagnosis for DTC U1010. Refer to [SEC-208, "DTC Logic"](#).

DTC No.	Trouble diagnosis name	DTC detecting condition	Possible cause
B2109	STRG LCK RELAY OFF	IPDM E/R detects that the relay is stuck at OFF position for about 1 second even if the IPDM E/R receives steering lock relay ON/OFF signal from BCM.	<ul style="list-style-type: none">• Harness or connector (power supply circuit)• IPDM E/R• Battery

DTC CONFIRMATION PROCEDURE

1.PERFORM DTC CONFIRMATION PROCEDURE

1. Press the push-button ignition switch under the following conditions and wait for at least 1 second.
 - CVT selector lever is in the P or N position
 - Do not depress the brake pedal
2. Check "Self diagnostic result" with CONSULT-III.

Is DTC detected?

- YES >> Go to [SEC-271, "Diagnosis Procedure"](#).
NO >> INSPECTION END

Diagnosis Procedure

INFOID:000000003185479

1.CHECK POWER SUPPLY CIRCUIT

Check IPDM E/R power supply circuit. Refer to [PCS-19, "Diagnosis Procedure"](#).

Is the inspection normal?

- YES >> GO TO 2.
NO >> Repair the malfunctioning parts

2.CHECK FUSE

1. Turn ignition switch OFF.
2. Check 10A fuse (No. 40, located in IPDM E/R).

Is the inspection normal?

- YES >> Replace IPDM E/R. Refer to [PCS-43, "Removal and Installation"](#).
NO >> Check the following.
 - Harness for open or short between IPDM E/R and battery
 - Fuse

B210A STEERING LOCK CONDITION SWITCH

< COMPONENT DIAGNOSIS >

[SEDAN]

B210A STEERING LOCK CONDITION SWITCH

Description

INFOID:000000003185480

There are 2 switches in the steering unit. IPDM E/R compares those 2 switches conditions to judge the present steering status and transmit the result to BCM via CAN communication.

DTC Logic

INFOID:000000003185481

DTC DETECTION LOGIC

NOTE:

- If DTC B210A is displayed with DTC U1000, first perform the trouble diagnosis for DTC U1000. Refer to [SEC-207, "DTC Logic"](#).
- If DTC B210A is displayed with DTC U1010, first perform the trouble diagnosis for DTC U1010. Refer to [SEC-208, "DTC Logic"](#).

DTC No.	Trouble diagnosis name	DTC detecting condition	Possible cause
B210A	STRG LCK STATE SW	BCM detects the mismatch between the following for 1 second <ul style="list-style-type: none">• Steering lock or unlock• Feedback of steering lock status from IPDM E/R (CAN)	<ul style="list-style-type: none">• Harness or connectors [steering lock unit circuit (BCM side) is open or shorted]• Harness or connectors [steering lock unit circuit (IPDM E/R side) is open or shorted.]• Steering lock unit• IPDM E/R

DTC CONFIRMATION PROCEDURE

1. PERFORM DTC CONFIRMATION PROCEDURE

1. Press the push-button ignition switch under the following conditions and wait for at least 1 second.
 - CVT selector lever is in the P or N position
 - Do not depress the brake pedal
2. Check "Self diagnostic result" with CONSULT-III.

Is DTC detected?

- YES >> Go to [SEC-272, "Diagnosis Procedure"](#).
NO >> INSPECTION END

Diagnosis Procedure

INFOID:000000003185482

1. INSPECTION START

Check the case in which DTC is detected.

- Case1: It is detected after ignition switch is changed from ON to OFF and door switch is pressed
- Case2: It is detected after ignition switch is changed from ON to OFF

In which case is DTC detected?

- Case1 >> GO TO 2.
Case2 >> GO TO 7.

2. CHECK BCM OUTPUT SIGNAL

1. Turn ignition switch OFF.
2. Disconnect steering lock unit harness connector and IPDM E/R harness connector.

B210A STEERING LOCK CONDITION SWITCH

[SEDAN]

< COMPONENT DIAGNOSIS >

3. Check voltage between steering lock unit harness connector and ground.

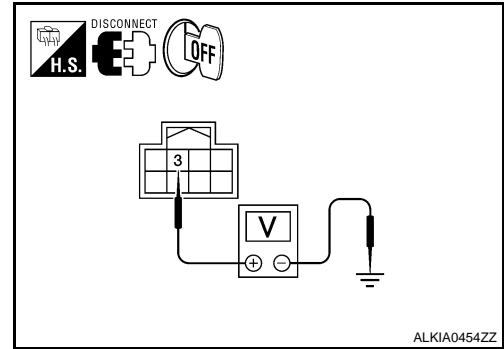

Steering lock unit		Ground	Voltage [V]
Connector	Terminal		
M32	3	Ground	Battery voltage

Is the inspection result normal?

- YES >> GO TO 4.
 NO >> GO TO 3.

3.CHECK STEERING LOCK UNIT CIRCUIT-I

1. Disconnect BCM harness connector.
2. Check continuity between BCM harness connector M19 (A) terminal 85 and steering lock unit harness connector M32 (B) terminal 3.

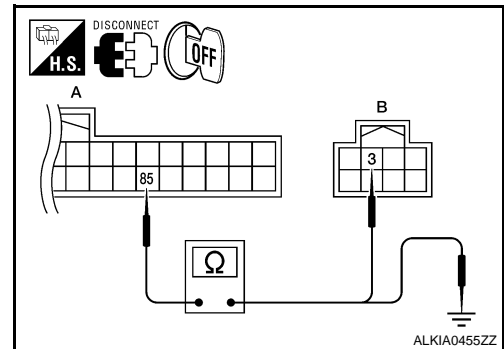

BCM		Steering lock unit		Continuity
Connector	Terminal	Connector	Terminal	
A: M19	85	B: M32	3	Yes

3. Check continuity between BCM harness connector M19 (A) terminal 85 and ground.

BCM		Ground	Continuity
Connector	Terminal		
A: M19	85	Ground	No

Is the inspection result normal?

- YES >> GO TO 6.
 NO >> Repair harness or connector.

4.CHECK IPDM E/R OUTPUT SIGNAL

1. Connect IPDM E/R harness connector.
2. Disconnect BCM harness connector.

A
B
C
D
E
F
G
H
I
J
L
M
N
O
P

SEC

B210A STEERING LOCK CONDITION SWITCH

[SEDAN]

< COMPONENT DIAGNOSIS >

3. Check voltage between steering lock unit harness connector and ground.

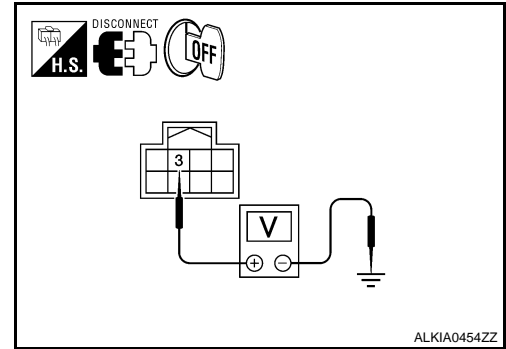

Steering lock unit		Ground	Voltage [V]
Connector	Terminal		
M32	3	Ground	Battery voltage

Is the inspection result normal?

- YES >> Replace steering lock unit.
 NO >> GO TO 5.

5.CHECK STEERING LOCK UNIT CIRCUIT-II

1. Check continuity between steering lock unit harness connector M32 (A) terminal 3 and IPDM E/R harness connector E18 (B) terminal 32.

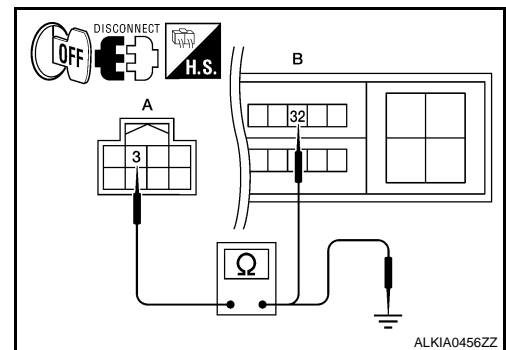

Steering lock unit		IPDM E/R		Continuity
Connector	Terminal	Connector	Terminal	
A: M32	3	B: E18	32	Yes

2. Check continuity between steering lock unit harness connector M32 (A) terminal 3 and ground.

Steering lock unit		Ground	Continuity
Connector	Terminal		
A: M32	3	Ground	No

Is the inspection result normal?

- YES >> GO TO 6.
 NO >> Repair harness or connector.

6.CHECK INTERMITTENT INCIDENT

Refer to [GI-42, "Intermittent Incident"](#).

>> INSPECTION END

7.CHECK BCM OUTPUT SIGNAL

1. Turn ignition switch OFF.
2. Disconnect steering lock unit harness connector and IPDM E/R harness connector E5.

B210A STEERING LOCK CONDITION SWITCH

[SEDAN]

< COMPONENT DIAGNOSIS >

3. Check voltage between steering lock unit harness connector and ground.

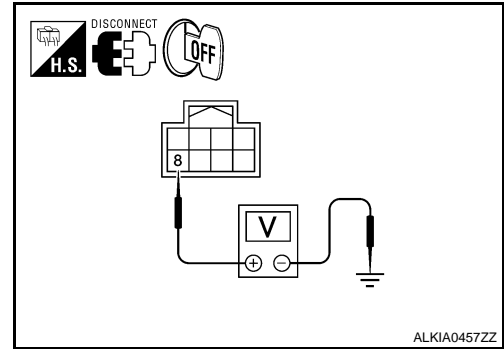

Steering lock unit		Ground	Voltage [V]
Connector	Terminal		
M32	8	Ground	Battery voltage

Is the inspection result normal?

- YES >> GO TO 9.
NO >> GO TO 8.

8. CHECK STEERING LOCK UNIT CIRCUIT-I

1. Disconnect BCM harness connector M122.
2. Check continuity between BCM harness connector M19 (A) terminal 86 and steering lock unit harness connector M32 (B) terminal 8.

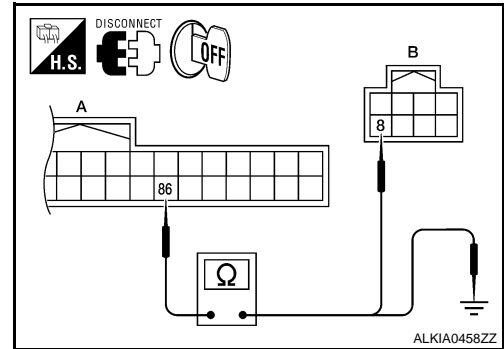

BCM		Steering lock unit		Continuity
Connector	Terminal	Connector	Terminal	
A: M19	86	B: M32	8	Yes

3. Check continuity between BCM harness connector M19 (A) terminal 86 and ground.

BCM		Ground	Continuity
Connector	Terminal		
A: M19	86	Ground	No

Is the inspection result normal?

- YES >> GO TO 11.
NO >> Repair harness or connector.

9. CHECK IPDM E/R OUTPUT SIGNAL

1. Connect IPDM E/R harness connector.
2. Disconnect BCM harness connector.

A
B
C
D
E
F
G
H
I
J
L
M
N
O
P

SEC

B210A STEERING LOCK CONDITION SWITCH

[SEDAN]

< COMPONENT DIAGNOSIS >

3. Check voltage between steering lock unit harness connector and ground.

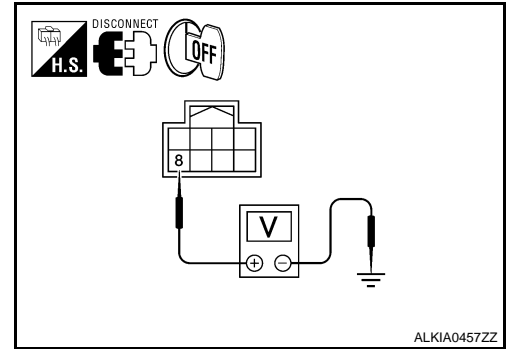

Steering lock unit		Ground	Voltage [V]
Connector	Terminal		
M32	8	Ground	Battery voltage

Is the inspection result normal?

- YES >> Replace steering lock unit.
 NO >> GO TO 10.

10.CHECK STEERING LOCK UNIT CIRCUIT-II

1. Check continuity between steering lock unit harness connector M32 (A) terminal 8 and IPDM E/R harness connector E18 (B) terminal 33.

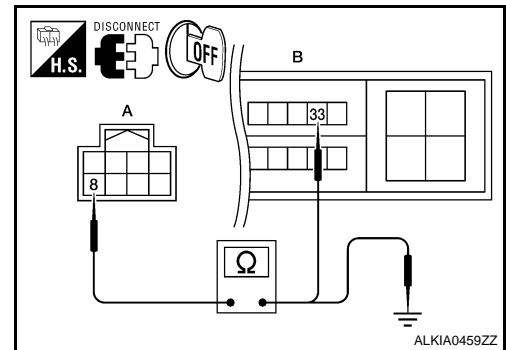

Steering lock unit		IPDM E/R		Continuity
Connector	Terminal	Connector	Terminal	
A: M32	8	B: E18	33	Yes

2. Check continuity between steering lock unit harness connector and ground.

Steering lock unit		Ground	Continuity
Connector	Terminal		
A: M32	8	Ground	No

Is the inspection result normal?

- YES >> GO TO 11.
 NO >> Repair harness or connector.

11.CHECK INTERMITTENT INCIDENT

Refer to [GI-42, "Intermittent Incident"](#).

>> INSPECTION END

B210B STARTER CONTROL RELAY

[SEDAN]

< COMPONENT DIAGNOSIS >

B210B STARTER CONTROL RELAY

Description

INFOID:000000003185483

Starter control relay, integrated in IPDM E/R, permits the starter relay operation when in N or P position and the steering is locked or unlocked. It is installed in parallel with the starter relay.

DTC Logic

INFOID:000000003185484

DTC DETECTION LOGIC

NOTE:

- If DTC B210B is displayed with DTC U1000, first perform the trouble diagnosis for DTC U1000. Refer to [SEC-207, "DTC Logic"](#).
- If DTC B210B is displayed with DTC U1010, first perform the trouble diagnosis for DTC U1010. Refer to [SEC-208, "DTC Logic"](#).

DTC No.	Trouble diagnosis name	DTC detecting condition	Possible cause
B210B	START CONT RLY ON	IPDM E/R detects that the relay is stuck at ON position even if the followings condition are met for about 1 second. <ul style="list-style-type: none">• Starter control relay ON/OFF signal from BCM• Clutch interlock or shift park neutral position (PNP) switch input signal	<ul style="list-style-type: none">• IPDM E/R

DTC CONFIRMATION PROCEDURE

1. PERFORM DTC CONFIRMATION PROCEDURE

1. Turn the power supply position to start under the following conditions and wait for at least 1 second.
 - CVT selector lever is in the P or N position.
 - Depress the brake pedal
2. Check "Self diagnostic result" with CONSULT-III.

Is DTC detected?

- YES >> Go to [SEC-277, "Diagnosis Procedure"](#).
NO >> INSPECTION END

Diagnosis Procedure

INFOID:000000003185485

1. INSPECTION START

1. Turn ignition switch ON.
2. Check "Self diagnostic result" with CONSULT-III.
3. Touch "ERASE".
4. **Perform DTC Confirmation Procedure.**
See [PCS-41, "DTC Index"](#).

Is the DTC B210B displayed again?

- YES >> Replace IPDM E/R. Refer [PCS-43, "Removal and Installation"](#).
NO >> INSPECTION END

B210C STARTER CONTROL RELAY

[SEDAN]

< COMPONENT DIAGNOSIS >

B210C STARTER CONTROL RELAY

Description

INFOID:000000003185486

Starter control relay, integrated in IPDM E/R, permits the starter relay operation when in N or P position and the steering is locked or unlocked. It is installed in parallel with the starter relay.

DTC Logic

INFOID:000000003185487

DTC DETECTION LOGIC

NOTE:

- If DTC B210C is displayed with DTC U1000, first perform the trouble diagnosis for DTC U1000. Refer to [SEC-207, "DTC Logic"](#).
- If DTC B210C is displayed with DTC U1010, first perform the trouble diagnosis for DTC U1010. Refer to [SEC-208, "DTC Logic"](#).

DTC No.	Trouble diagnosis name	DTC detecting condition	Possible cause
B210C	START CONT RLY OFF	IPDM E/R detects that the relay is stuck at ON position even if the followings condition are met for about 1 second. <ul style="list-style-type: none">• Starter control relay ON/OFF signal from BCM• Clutch interlock or shift park neutral position (PNP) switch input signal	<ul style="list-style-type: none">• IPDM E/R

DTC CONFIRMATION PROCEDURE

1. PERFORM DTC CONFIRMATION PROCEDURE

1. Turn the power supply position to start under the following conditions and wait for at least 1 second.
 - CVT selector lever is in the P or N position.
 - Depress the brake pedal
2. Check "Self diagnostic result" with CONSULT-III.

Is DTC detected?

- YES >> Go to [SEC-278, "Diagnosis Procedure"](#).
NO >> INSPECTION END

Diagnosis Procedure

INFOID:000000003185488

1. INSPECTION START

1. Turn ignition switch ON.
2. Check "Self diagnostic result" with CONSULT-III.
3. Touch "ERASE".
4. **Perform DTC Confirmation Procedure.**
See [PCS-41, "DTC Index"](#).

Is the DTC B210C displayed again?

- YES >> Replace IPDM E/R. Refer to [PCS-43, "Removal and Installation"](#).
NO >> INSPECTION END

B210D STARTER RELAY

< COMPONENT DIAGNOSIS >

[SEDAN]

B210D STARTER RELAY

Description

INFOID:000000003185489

Located in IPDM E/R, it runs the starter motor. The starter relay is turned ON by the BCM when the ignition switch is in START position. IPDM E/R transmits the starter relay ON signal to BCM via CAN communication.

DTC Logic

INFOID:000000003185490

DTC DETECTION LOGIC

NOTE:

- If DTC B210D is displayed with DTC U1000, first perform the trouble diagnosis for DTC U1000. Refer to [SEC-207, "DTC Logic"](#).
- If DTC B210D is displayed with DTC U1010, first perform the trouble diagnosis for DTC U1010. Refer to [SEC-208, "DTC Logic"](#).
- If DTC B210D is displayed with DTC B2617, first perform the trouble diagnosis for DTC B2617. Refer to [SEC-263, "DTC Logic"](#).

DTC No.	Trouble diagnosis name	DTC detecting condition	Possible cause
B210D	STARTER RELAY ON	IPDM E/R detects that the relay is stuck at ON position even if the followings condition are met for about 1 second. <ul style="list-style-type: none">• Starter control relay ON/OFF signal from BCM• Clutch interlock or shift park neutral position (PNP) switch input	<ul style="list-style-type: none">• IPDM E/R

DTC CONFIRMATION PROCEDURE

1. PERFORM DTC CONFIRMATION PROCEDURE

1. Ignition switch ON under the following conditions and wait for at least 1 second.
 - A/T selector lever is P or N position
 - Do not depress the brake pedal
2. Check "Self diagnostic result" with CONSULT-III.

Is DTC detected?

- YES >> Go to [SEC-279, "Diagnosis Procedure"](#).
NO >> INSPECTION END.

Diagnosis Procedure

INFOID:000000003185491

1. CHECK STARTER RELAY POWER SUPPLY CIRCUIT

1. Turn ignition switch OFF.
2. Disconnect IPDM E/R harness connector.
3. Check voltage between IPDM E/R harness connector and ground.

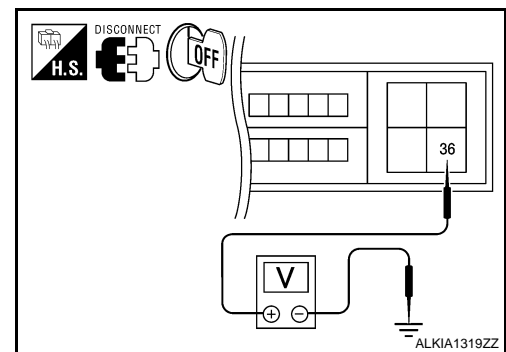

B210D STARTER RELAY

< COMPONENT DIAGNOSIS >

[SEDAN]

IPDM E/R		Ground	Voltage (V)
Connector	Terminal		
E18	36	Ground	Battery voltage

Is the inspection result normal?

- YES >> Replace IPDM E/R. Refer to [PCS-43, "Removal and Installation"](#).
- NO >> Check harness for open or short between IPDM E/R and battery.

B210E STARTER RELAY

< COMPONENT DIAGNOSIS >

[SEDAN]

B210E STARTER RELAY

Description

INFOID:000000003185492

Located in IPDM E/R, it runs the starter motor. The starter relay is turned ON by the BCM when the ignition switch is in START position. IPDM E/R transmits the starter relay ON signal to BCM via CAN communication.

DTC Logic

INFOID:000000003185493

DTC DETECTION LOGIC

NOTE:

- If DTC B210E is displayed with DTC U1000, first perform the trouble diagnosis for DTC U1000. Refer to [SEC-207. "DTC Logic"](#).
- If DTC B210E is displayed with DTC U1010, first perform the trouble diagnosis for DTC U1010. Refer to [SEC-208. "DTC Logic"](#).

DTC No.	Trouble diagnosis name	DTC detecting condition	Possible cause
B210E	STARTER RELAY OFF	IPDM E/R detects that the relay is stuck at ON position even if the followings condition are met for about 1 second. <ul style="list-style-type: none">• Starter control relay ON/OFF signal from BCM• Clutch interlock or shift park neutral position (PNP) switch input	<ul style="list-style-type: none">• IPDM E/R

DTC CONFIRMATION PROCEDURE

1. PERFORM DTC CONFIRMATION PROCEDURE

1. Turn ignition switch ON under the following conditions and wait for at least 1 second.
 - A/T selector lever is in the P or N position
 - Do not depress the brake pedal
2. Check "Self diagnostic result" with CONSULT-III.

Is DTC detected?

- YES >> Go to [SEC-281. "Diagnosis Procedure"](#).
NO >> INSPECTION END.

Diagnosis Procedure

INFOID:000000003185494

1. INSPECTION START

Check which type of transmission the vehicle is equipped with.

Which type of transmission

- CVT >> GO TO 2.
M/T >> GO TO 3.

2. CHECK STARTER RELAY OUTPUT SIGNAL/CVT MODELS

1. Turn ignition switch OFF.
2. Disconnect BCM harness connector.
3. Check voltage between BCM harness connector and ground.

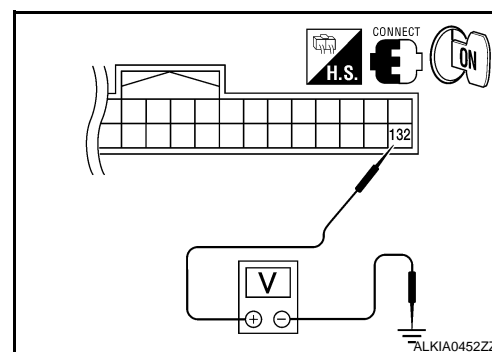

B210E STARTER RELAY

< COMPONENT DIAGNOSIS >

[SEDAN]

BCM connector		Ground	Condition			Voltage (V)
Connector	Terminal		Ignition switch	Brake pedal	CVT selector lever	
M21	132	Ground	ON	Depressed	P or N	Battery voltage
					Other than above	0

Is the inspection result normal?

- YES >> GO TO 5.
- NO >> GO TO 4.

3. CHECK STARTER RELAY OUTPUT SIGNAL / M/T MODELS

1. Turn ignition switch OFF.
2. Disconnect BCM harness connector.
3. Check voltage between BCM harness connector and ground.

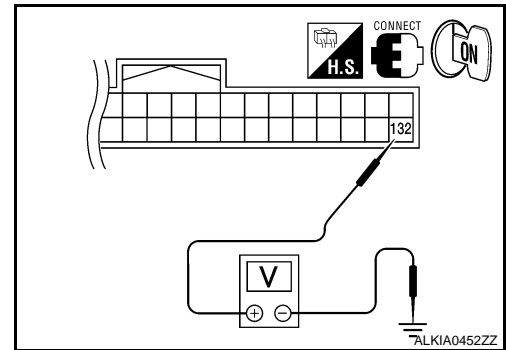

BCM connector		Ground	Condition		Voltage (V)
Connector	Terminal		Ignition switch	Clutch pedal	
M21	132	Ground	OFF	Not depressed	0
				Depressed	Battery voltage

Is the inspection result normal?

- YES >> GO TO 5.
- NO >> GO TO 4.

4. CHECK STARTER RELAY OUTPUT SIGNAL CIRCUIT

1. Disconnect IPDM E/R harness connector.
2. Check continuity between IPDM E/R harness connector and BCM harness connector.

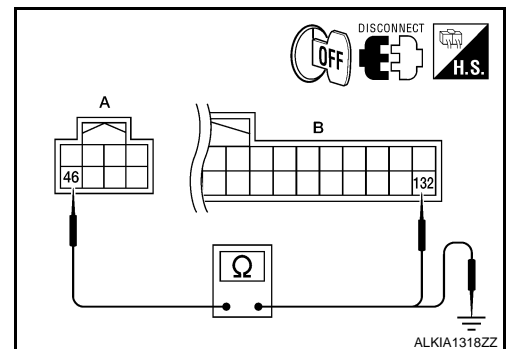

IPDM E/R		BCM		Continuity
Connector	Terminal	Connector	Terminal	
A: E17	46	B: M21	132	Yes

3. Check continuity between BCM harness connector and ground.

B210E STARTER RELAY

[SEDAN]

< COMPONENT DIAGNOSIS >

IPDM E/R		Ground	Continuity
Connector	Terminal		
A: E17	46	Ground	No

Is the inspection result normal?

YES >> Replace IPDM E/R. Refer to [PCS-43, "Removal and Installation"](#).

NO >> Repair harness connector.

5. CHECK STARTER RELAY POWER SUPPLY CIRCUIT

1. Turn ignition switch OFF.
2. Disconnect IPDM E/R harness connector.
3. Check voltage between IPDM E/R harness connector and ground.

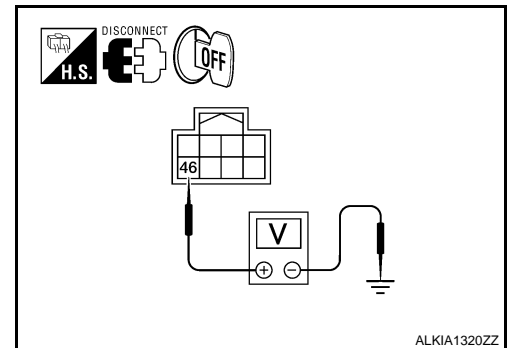

IPDM E/R		Ground	Voltage (V)
Connector	Terminal		
E17	46	Ground	Battery voltage

Is the inspection result normal?

YES >> Replace IPDM E/R. Refer to [PCS-43, "Removal and Installation"](#).

NO >> Check harness for open or short between IPDM E/R and battery.

A
B
C
D
E
F
G
H
I
J
L
M
N
O
P

SEC

B210F PNP/CLUTCH INTERLOCK SWITCH

< COMPONENT DIAGNOSIS >

[SEDAN]

B210F PNP/CLUTCH INTERLOCK SWITCH

Description

INFOID:000000003185495

IPDM E/R confirms the shift position with the following signals.

- Park/neutral position (PNP) switch (A/T models)
- Clutch interlock switch (M/T models)
- Shift position signal from BCM (CAN)

DTC Logic

INFOID:000000003185496

DTC DETECTION LOGIC

NOTE:

- If DTC B210F is displayed with DTC U1000, first perform the trouble diagnosis for DTC U1000. Refer to [SEC-207, "DTC Logic"](#)
- If DTC B210F is displayed with DTC U1010, first perform the trouble diagnosis for DTC U1010. Refer to [SEC-207, "DTC Logic"](#).

DTC No.	Trouble diagnosis name	DTC detecting condition	Possible cause
B210F	INTER LOCK/PNP SW ON	IPDM E/R detects a mismatch between the signals below for 1 second or more. <ul style="list-style-type: none">• Clutch interlock input signal (M/T models)• Shift PNP switch input signal (A/T models)• Shift position signal from BCM (CAN)	<ul style="list-style-type: none">• Harness or connectors [Park/neutral position (PNP) switch circuit is open or shorted (A/T models)] or (Clutch interlock switch circuit is open or shorted.)• Clutch interlock switch (M/T models)• Park/neutral position (PNP) switch (A/T models)

DTC CONFIRMATION PROCEDURE

1. PERFORM DTC CONFIRMATION PROCEDURE

1. Turn ignition switch ON under the following conditions and wait for at least 1 second.
 - A/T selector lever is in the P or N position
 - Do not depress the brake pedal
2. Check "Self diagnostic result" with CONSULT-III.

Is DTC detected?

- YES >> Go to [SEC-284, "Diagnosis Procedure"](#).
NO >> INSPECTION END

Diagnosis Procedure

INFOID:000000003185497

1. INSPECTION START

Check which type of transmission the vehicle is equipped with.

Which type of transmission

- CVT >> GO TO 2.
M/T >> GO TO 5.

2. CHECK DTC WITH BCM

Refer to [BCS-85, "DTC Index"](#).

Is the inspection result normal?

- YES >> GO TO 3.
NO >> Repair or replace malfunctioning parts.

3. CHECK PNP SWITCH INPUT SIGNAL

1. Turn ignition switch OFF.
2. Disconnect IPDM E/R harness connector.
3. Turn ignition switch ON.

B210F PNP/CLUTCH INTERLOCK SWITCH

[SEDAN]

< COMPONENT DIAGNOSIS >

- Check voltage between IPDM E/R harness connector and ground under following condition.

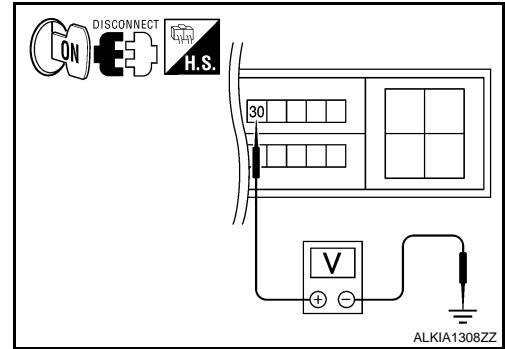

IPDM E/R		Ground	Condition	Voltage (V)
Connector	Terminal			
E18	30	Ground	P or N	0
			Other than above	Battery voltage

Is the inspection result normal?

- YES >> Replace IPDM E/R. Refer to [PCS-43. "Removal and Installation"](#).
- NO >> GO TO 4 (VQ35DE).
- NO >> GO TO 10 (QR25DE).

4.CHECK PNP SWITCH CIRCUIT

- Turn ignition switch OFF.
- Disconnect TCM harness connector.
- Check continuity between IPDM E/R harness connector and TCM harness connector.

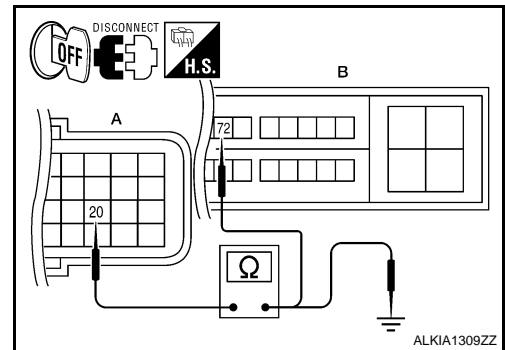

TCM		IPDM E/R		Continuity
Connector	Terminal	Connector	Terminal	
A: F16	20	B: E18	72	Yes

- Check continuity between TCM harness connector and ground.

TCM		Ground	Continuity
Connector	Terminal		
A: F16	20	Ground	No

Is the inspection result normal?

- YES >> GO TO 8.
- NO >> Repair harness or connector.

5.CHECK CLUTCH INTERLOCK SWITCH INPUT SIGNAL (BCM)

- Turn ignition switch OFF.
- Disconnect BCM harness connector.

B210F PNP/CLUTCH INTERLOCK SWITCH

[SEDAN]

< COMPONENT DIAGNOSIS >

3. Check voltage between BCM harness connector and ground.

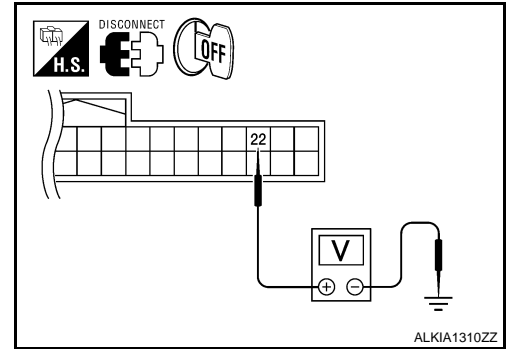

BCM		Ground	Condition	Voltage (V)
Connector	Terminal			
M18	22	Ground	Clutch pedal Not depressed	0
			Clutch pedal Depressed	Battery voltage

Is the inspection result normal?

YES >> GO TO 6.

NO >> GO TO 11.

6. CHECK CLUTCH INTERLOCK SWITCH INPUT SIGNAL

1. Turn ignition switch OFF.
2. Disconnect IPDM E/R harness connector.
3. Turn ignition switch ON.
4. Check voltage between IPDM E/R harness connector and ground.

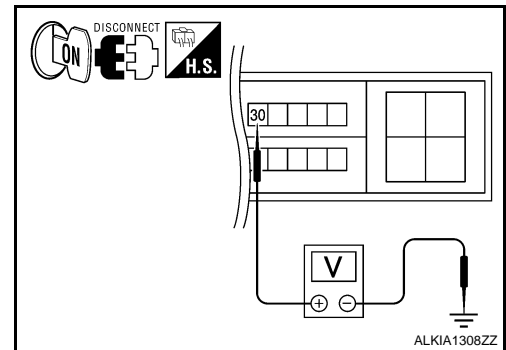

IPDM E/R		Ground	Condition	Voltage (V)
Connector	Terminal			
E18	30	Ground	Clutch pedal Not depressed	0
			Clutch pedal Depressed	Battery voltage

Is the inspection result normal?

YES >> Replace the IPDM E/R. Refer to [PCS-43. "Removal and Installation"](#).

NO >> GO TO 7.

7. CHECK CLUTCH INTERLOCK SWITCH POWER SUPPLY

1. Disconnect clutch interlock switch harness connector.

B210F PNP/CLUTCH INTERLOCK SWITCH

[SEDAN]

< COMPONENT DIAGNOSIS >

- Check voltage between clutch interlock switch harness connector and ground.

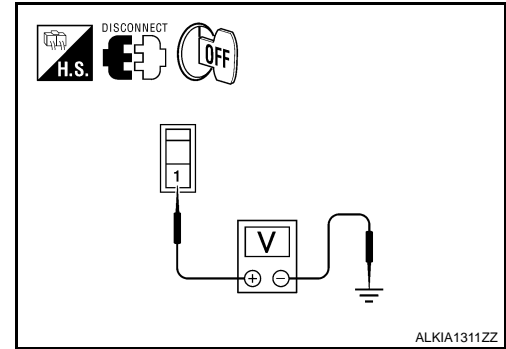

Clutch interlock switch		Ground	Voltage (V)
Connector	Terminal		
E36	1	Ground	Battery voltage

Is the inspection result normal?

YES >> GO TO 8.

NO >> Check harness for open or short between clutch interlock switch and fuse.

8.CHECK CLUTCH INTERLOCK SWITCH CIRCUIT

- Check continuity between IPDM E/R harness connector and clutch interlock switch harness connector.

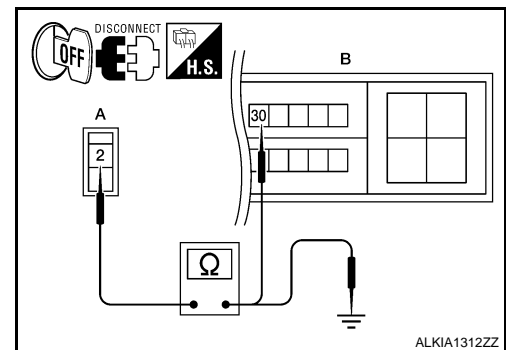

Clutch interlock switch		IPDM E/R		Continuity
Connector	Terminal	Connector	Terminal	
A: E36	2	B: E18	30	Yes

- Check continuity between clutch interlock switch harness connector and ground.

Clutch interlock switch		Ground	Continuity
Connector	Terminal		
A: E36	2	Ground	No

Is the inspection result normal?

YES >> GO TO 9.

NO >> Repair harness or connector.

9.CHECK CLUTCH INTERLOCK SWITCH

Refer to [SEC-289, "Component Inspection"](#).

Is the inspection result normal?

YES >> Replace the IPDM E/R. Refer to [PCS-43, "Removal and Installation"](#).

NO >> Replace clutch interlock switch.

10.CHECK PNP SWITCH CIRCUIT FOR CONTINUITY

- Turn ignition switch OFF.

A
B
C
D
E
F
G
H
I
J
L
M
N
O
P

SEC

B210F PNP/CLUTCH INTERLOCK SWITCH

[SEDAN]

< COMPONENT DIAGNOSIS >

- Check continuity between IPDM E/R harness connector terminals 72 and 74.

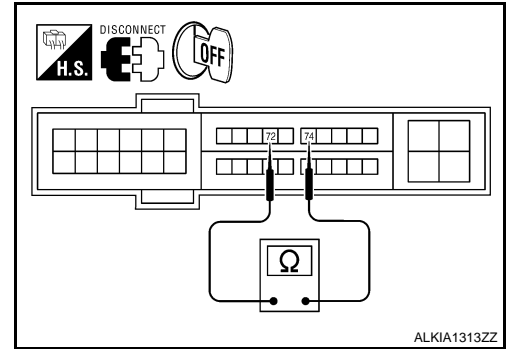

IPDM E/R			Condition	Continuity
Connector	Terminals			
F10	72	74	P or N	Yes
			Other	No

Is the inspection result normal?

YES >> GO TO 11.

NO >> GO TO 12.

11. CHECK PNP SWITCH CIRCUIT FOR SHORT

- Check continuity between IPDM E/R harness connector terminals 72, 74 and ground.

IPDM E/R		Ground	Continuity
Connector	Terminal		
F10	72	Ground	No
	74		

Is the inspection result normal?

YES >> Replace the IPDM E/R. Refer to [PCS-43, "Removal and Installation"](#).

NO >> Repair or replace harness.

12. CHECK PNP SWITCH INPUT SIGNAL CIRCUIT

- Disconnect PNP switch harness connector.
- Check continuity between PNP switch and IPDM E/R harness connectors.

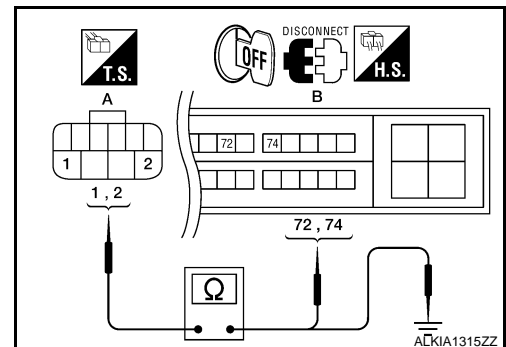

Park/neutral position switch		IPDM E/R		Continuity
Connector	Terminal	Connector	Terminal	
A: F25	1	B: F10	74	Yes
	2		72	

- Check continuity between PNP switch harness connector and ground.

B210F PNP/CLUTCH INTERLOCK SWITCH

[SEDAN]

< COMPONENT DIAGNOSIS >

Park/neutral position switch		Ground	Continuity
Connector	Terminal		
A: F25	1	Ground	No
	2		

Is the inspection result normal?

YES >> Replace PNP switch.

NO >> Repair harness or connector.

13.CHECK INTERMITTENT INCIDENT

Refer to [GI-42. "Intermittent Incident"](#).

>> INSPECTION END

Component Inspection

INFOID:000000003185498

1.CHECK CLUTCH INTERLOCK SWITCH

1. Turn ignition switch OFF.
2. Disconnect clutch interlock switch harness connector.
3. Check continuity between clutch interlock switch under the following conditions.

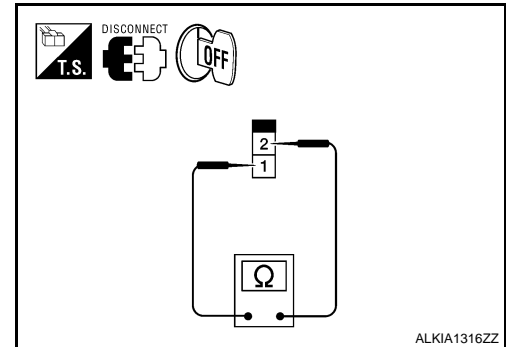

Clutch interlock switch		Condition	Continuity	
Terminal				
1	2	Clutch pedal	Not depressed	No
			Depressed	Yes

Is the inspection result normal?

YES >> INSPECTION END

NO >> Replace clutch interlock switch.

SEC

B2110 PNP/CLUTCH INTERLOCK SWITCH

< COMPONENT DIAGNOSIS >

[SEDAN]

B2110 PNP/CLUTCH INTERLOCK SWITCH

Description

INFOID:000000003185499

IPDM E/R confirms the shift position with the following signals.

- Park/neutral position (PNP) switch (A/T models)
- Clutch inter lock switch (M/T models)
- Shift position signal from BCM (CAN)

DTC Logic

INFOID:000000003185500

DTC DETECTION LOGIC

NOTE:

- If DTC B2110 is displayed with DTC U1000, first perform the trouble diagnosis for DTC U1000. Refer to [SEC-207, "DTC Logic"](#).
- If DTC B2110 is displayed with DTC U1010, first perform the trouble diagnosis for DTC U1010. Refer to [SEC-208, "DTC Logic"](#).

DTC No.	Trouble diagnosis name	DTC detecting condition	Possible cause
B2110	INTER LOCK/PNP SW	IPDM E/R detects mismatch between the signals below for 1 second or more. <ul style="list-style-type: none">• Clutch interlock input signal (M/T models)• Shift NP switch input signal (A/T models)	<ul style="list-style-type: none">• Harness or connectors [Park/neutral position (PNP) switch circuit is open or shorted (A/T models)] or (Clutch interlock switch circuit is open or shorted.)• Clutch inter lock switch (MT models)• Park/neutral position (PNP) switch (AT models)

DTC CONFIRMATION PROCEDURE

1. PERFORM DTC CONFIRMATION PROCEDURE

1. Turn the ignition switch ON under the following conditions and wait for at least 1 second.
 - A/T selector lever is in the P or N position
 - Do not depress the brake pedal
2. Check "Self diagnostic result" with CONSULT-III.

Is DTC detected?

- YES >> Go to [SEC-290, "Diagnosis Procedure"](#).
NO >> INSPECTION END

Diagnosis Procedure

INFOID:000000003185501

1. INSPECTION START

Check which type of transmission the vehicle is equipped with.

Which type of transmission

- CVT >> GO TO 2.
M/T >> GO TO 5.

2. CHECK DTC WITH BCM

Refer to [BCS-85, "DTC Index"](#).

Is the inspection result normal?

- YES >> GO TO 3.
NO >> Repair or replace malfunctioning parts.

3. CHECK PNP SWITCH INPUT SIGNAL

1. Turn ignition switch OFF.
2. Disconnect IPDM E/R harness connector.
3. Turn ignition switch ON.

B2110 PNP/CLUTCH INTERLOCK SWITCH

[SEDAN]

< COMPONENT DIAGNOSIS >

- Check voltage between IPDM E/R harness connector and ground under following condition.

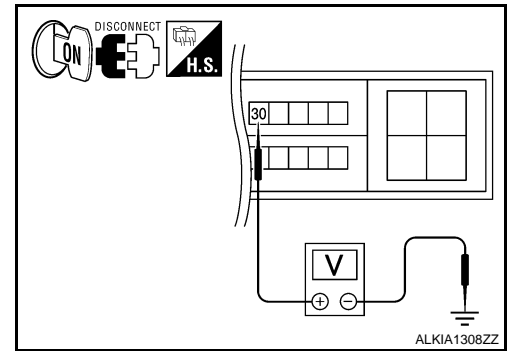

IPDM E/R		Ground	Condition	Voltage (V)
Connector	Terminal			
E18	30	Ground	P or N	0
			Other than above	Battery voltage

Is the inspection result normal?

- YES >> Replace IPDM E/R. Refer to [PCS-43. "Removal and Installation"](#).
- NO >> GO TO 4 (VQ35DE).
- NO >> GO TO 10 (QR25DE).

4.CHECK PNP SWITCH CIRCUIT

- Turn ignition switch OFF.
- Disconnect TCM harness connector.
- Check continuity between IPDM E/R harness connector and TCM harness connector.

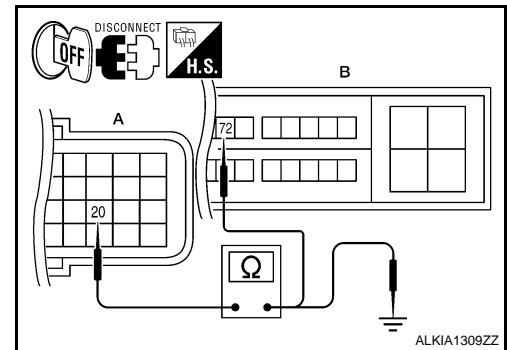

TCM		IPDM E/R		Continuity
Connector	Terminal	Connector	Terminal	
A: F16	20	B: E18	72	Yes

- Check continuity between TCM harness connector and ground.

TCM		Ground	Continuity
Connector	Terminal		
A: F16	20	Ground	No

Is the inspection result normal?

- YES >> GO TO 8.
- NO >> Repair harness or connector.

5.CHECK CLUTCH INTERLOCK SWITCH INPUT SIGNAL (BCM)

- Turn ignition switch OFF.
- Disconnect BCM harness connector.

B2110 PNP/CLUTCH INTERLOCK SWITCH

[SEDAN]

< COMPONENT DIAGNOSIS >

3. Check voltage between BCM harness connector and ground.

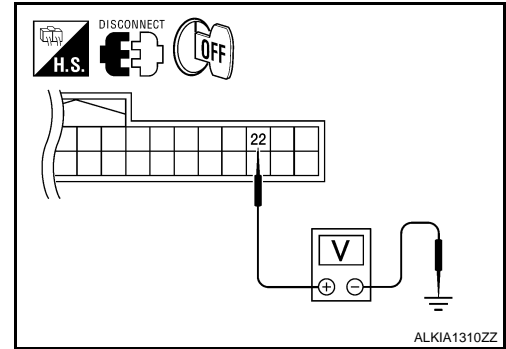

BCM		Ground	Condition	Voltage (V)
Connector	Terminal			
M18	22	Ground	Clutch pedal Not depressed	0
			Clutch pedal Depressed	Battery voltage

Is the inspection result normal?

- YES >> GO TO 6.
NO >> GO TO 11.

6. CHECK CLUTCH INTERLOCK SWITCH INPUT SIGNAL

1. Turn ignition switch OFF.
2. Disconnect IPDM E/R harness connector.
3. Turn ignition switch ON.
4. Check voltage between IPDM E/R harness connector and ground.

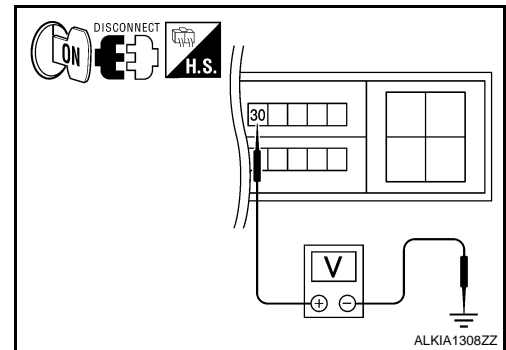

IPDM E/R		Ground	Condition	Voltage (V)
Connector	Terminal			
E18	30	Ground	Clutch pedal Not depressed	0
			Clutch pedal Depressed	Battery voltage

Is the inspection result normal?

- YES >> Replace the IPDM E/R. Refer to [PCS-43. "Removal and Installation"](#).
NO >> GO TO 7.

7. CHECK CLUTCH INTERLOCK SWITCH POWER SUPPLY

1. Disconnect clutch interlock switch harness connector.

B2110 PNP/CLUTCH INTERLOCK SWITCH

[SEDAN]

< COMPONENT DIAGNOSIS >

- Check voltage between clutch interlock switch harness connector and ground.

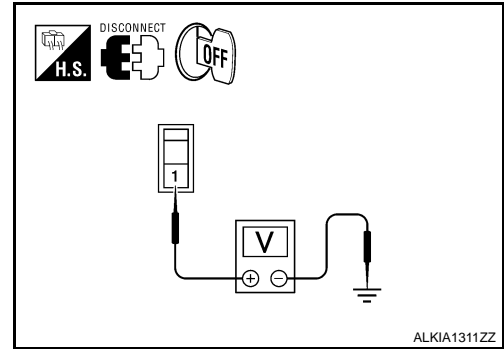

Clutch interlock switch		Ground	Voltage (V)
Connector	Terminal		
E36	1	Ground	Battery voltage

Is the inspection result normal?

YES >> GO TO 8.

NO >> Check harness for open or short between clutch interlock switch and fuse.

8.CHECK CLUTCH INTERLOCK SWITCH CIRCUIT

- Check continuity between IPDM E/R harness connector and clutch interlock switch harness connector.

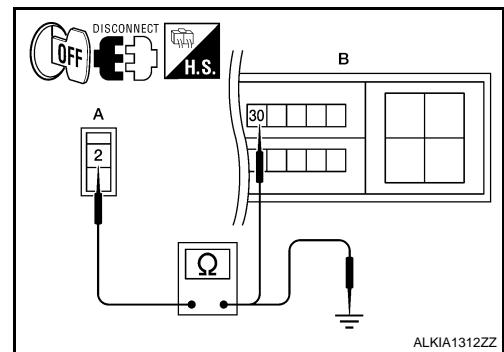

Clutch interlock switch		IPDM E/R		Continuity
Connector	Terminal	Connector	Terminal	
A: E36	2	B: E18	30	Yes

- Check continuity between clutch interlock switch harness connector and ground.

Clutch interlock switch		Ground	Continuity
Connector	Terminal		
A: E36	2	Ground	No

Is the inspection result normal?

YES >> GO TO 9.

NO >> Repair harness or connector.

9.CHECK CLUTCH INTERLOCK SWITCH

Refer to [SEC-295. "Component Inspection"](#).

Is the inspection result normal?

YES >> Replace the IPDM E/R. Refer to [PCS-43. "Removal and Installation"](#).

NO >> Replace clutch interlock switch.

10.CHECK PNP SWITCH CIRCUIT FOR CONTINUITY

- Turn ignition switch OFF.

A
B
C
D
E
F
G
H
I
J
L
M
N
O
P

SEC

B2110 PNP/CLUTCH INTERLOCK SWITCH

[SEDAN]

< COMPONENT DIAGNOSIS >

- Check continuity between IPDM E/R harness connector terminals 72 and 74.

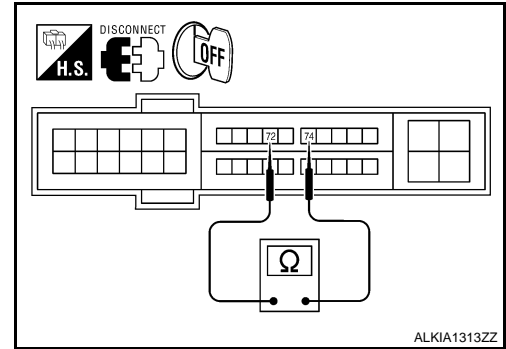

IPDM E/R			Condition	Continuity
Connector	Terminals			
F10	72	74	P or N	Yes
			Other	No

Is the inspection result normal?

YES >> GO TO 11.

NO >> GO TO 12.

11. CHECK PNP SWITCH CIRCUIT FOR SHORT

- Check continuity between IPDM E/R harness connector terminals 72, 74 and ground.

IPDM E/R		Ground	Continuity
Connector	Terminal		
F10	72	Ground	No
	74		

Is the inspection result normal?

YES >> Replace the IPDM E/R. Refer to [PCS-43, "Removal and Installation"](#).

NO >> Repair or replace harness.

12. CHECK PNP SWITCH INPUT SIGNAL CIRCUIT

- Disconnect PNP switch harness connector.
- Check continuity between PNP switch and IPDM E/R harness connectors.

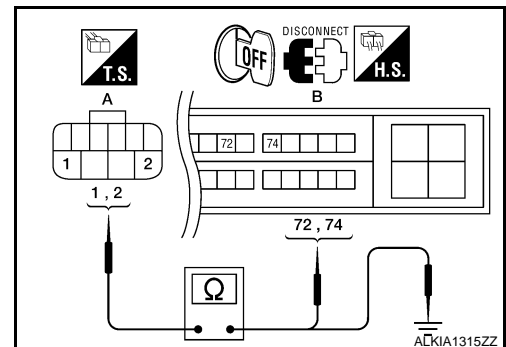

Park/neutral position switch		IPDM E/R		Continuity
Connector	Terminal	Connector	Terminal	
A: F25	1	B: F10	74	Yes
	2		72	

- Check continuity between PNP switch harness connector and ground.

B2110 PNP/CLUTCH INTERLOCK SWITCH

[SEDAN]

< COMPONENT DIAGNOSIS >

Park/neutral position switch		Ground	Continuity
Connector	Terminal		
A: F25	1	Ground	No
	2		

Is the inspection result normal?

YES >> Replace PNP switch.

NO >> Repair harness or connector.

13.CHECK INTERMITTENT INCIDENT

Refer to [GI-42. "Intermittent Incident"](#).

>> INSPECTION END

Component Inspection

INFOID:000000003185502

1.CHECK CLUTCH INTERLOCK SWITCH

1. Turn ignition switch OFF.
2. Disconnect clutch interlock switch harness connector.
3. Check continuity between clutch interlock switch under the following conditions.

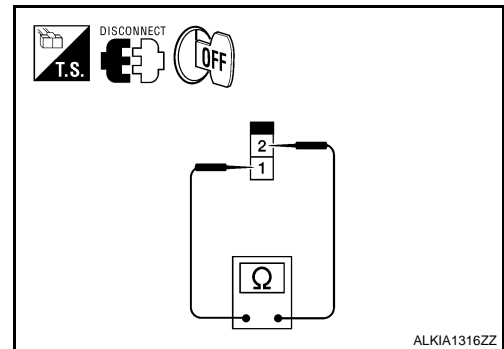

Clutch interlock switch		Condition	Continuity
Terminal			
1	2	Clutch pedal Not depressed	No
		Clutch pedal Depressed	Yes

Is the inspection result normal?

YES >> INSPECTION END

NO >> Replace clutch interlock switch.

SEC

POWER SUPPLY AND GROUND CIRCUIT

< COMPONENT DIAGNOSIS >

[SEDAN]

POWER SUPPLY AND GROUND CIRCUIT

BCM

BCM : Diagnosis Procedure

INFOID:000000003185503

Refer to [BCS-36, "Diagnosis Procedure"](#).

IPDM E/R (INTELLIGENT POWER DISTRIBUTION MODULE ENGINE ROOM)

IPDM E/R (INTELLIGENT POWER DISTRIBUTION MODULE ENGINE ROOM) : Diagnosis Procedure

INFOID:000000003185504

Refer to [PCS-19, "Diagnosis Procedure"](#).

KEY SLOT

< COMPONENT DIAGNOSIS >

[SEDAN]

KEY SLOT

Diagnosis Procedure

INFOID:000000003185505

1. CHECK KEY SLOT POWER SUPPLY CIRCUIT

1. Turn ignition switch OFF.
2. Disconnect key slot connector.
3. Check voltage between slot connector and ground.

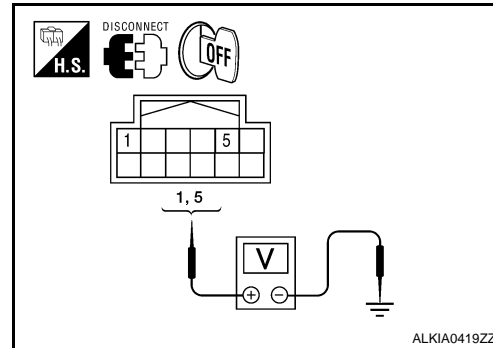

Key slot		Ground	Voltage (V) (Approx.)
Connector	Terminal		
M40	1	Ground	Battery voltage
	5		

Is the inspection result normal?

YES >> GO TO 2.

NO >> Repair or replace key slot power supply circuit.

2. CHECK KEY SLOT GROUND CIRCUIT

Check continuity between key slot connector and ground.

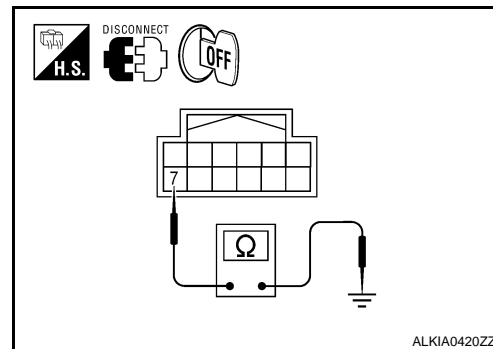

Key slot		Ground	Continuity
Connector	Terminal		
M40	7	Ground	Yes

Is the inspection result normal?

YES >> GO TO 3.

NO >> Repair or replace key slot ground circuit.

3. CHECK INTERMITTENT INCIDENT

Refer to [GI-42. "Intermittent Incident"](#).

>> INSPECTION END

A
B
C
D
E
F
G
H
I
J
L
M
N
O
P

SEC

KEY SLOT ILLUMINATION

[SEDAN]

< COMPONENT DIAGNOSIS >

KEY SLOT ILLUMINATION

Description

INFOID:000000003185506

Blinks when Intelligent Key insertion is required.

Component Function Check

INFOID:000000003185507

1.CHECK FUNCTION

With CONSULT-III

Check key slot illumination ("KEY SLOT ILLUMI") Active Test mode.

Is the inspection result normal?

YES >> Key slot function is OK.

NO >> Refer to [SEC-298. "Diagnosis Procedure"](#).

Diagnosis Procedure

INFOID:000000003185508

1.CHECK KEY SLOT ILLUMINATION OUTPUT SIGNAL

Check voltage between key slot connector and ground.

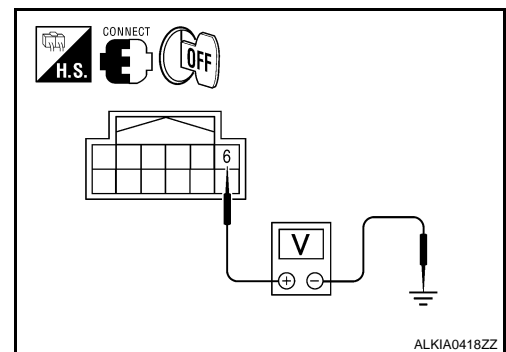

Terminals		Condition	Key slot illumination	Voltage (V) (Approx.)
(+)	(-)			
Key slot connector	Terminal			
M40	6	Intelligent Key inserted	OFF	Battery voltage
		Intelligent Key removed	ON	0

Is the inspection result normal?

YES >> GO TO 6.

NO >> GO TO 2.

2.CHECK KEY SLOT POWER SUPPLY CIRCUIT

1. Turn ignition switch OFF.
2. Disconnect key slot connector.
3. Check voltage between slot connector and ground.

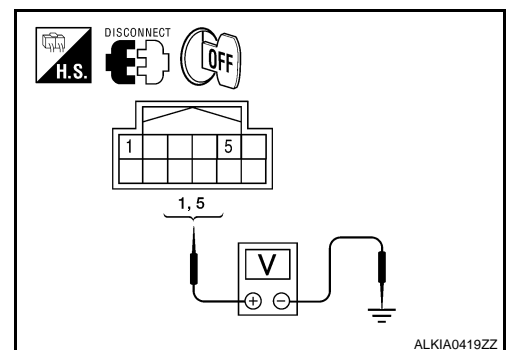

KEY SLOT ILLUMINATION

< COMPONENT DIAGNOSIS >

[SEDAN]

Terminals		Voltage (V) (Approx.)
(+)	(-)	
Key slot connector	Terminal	
M40	1	Ground
	5	
		Battery voltage

Is the inspection result normal?

YES >> GO TO 3.

NO >> Repair or replace key slot power supply circuit.

3. CHECK KEY SLOT GROUND CIRCUIT

Check continuity between key slot connector and ground.

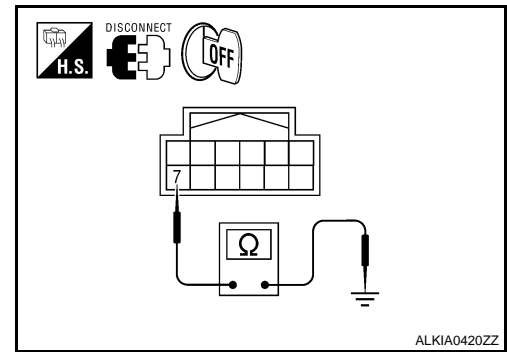

Key slot connector	Terminal	Ground	Continuity
M40	7		

Is the inspection result normal?

YES >> GO TO 4.

NO >> Repair or replace key slot ground circuit.

4. CHECK KEY SLOT CIRCUIT

- Turn ignition switch OFF.
- Disconnect BCM and key slot connector.
- Check continuity between BCM connector and key slot connector.

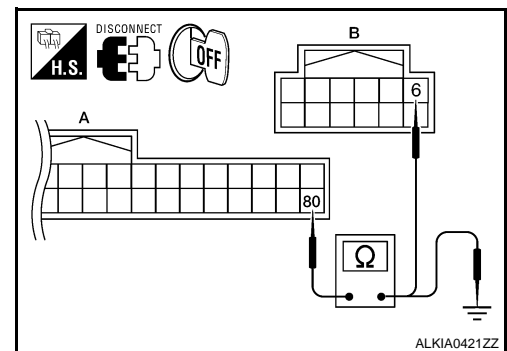

BCM connector	Terminal	Key slot connector	Terminal	Continuity
A: M19	80	B: M40	6	Yes

4. Check continuity between BCM connector and ground.

BCM connector	Terminal	Ground	Continuity
A: M19	80		

Is the inspection result normal?

A
B
C
D
E
F
G
H
I
J
L
M
N
O
P

SEC

KEY SLOT ILLUMINATION

[SEDAN]

< COMPONENT DIAGNOSIS >

YES >> GO TO 5.

NO >> Repair or replace harness between BCM and key slot.

5.CHECK KEY SLOT

Refer to [SEC-298. "Description"](#).

Is the inspection result normal?

YES >> GO TO 6.

NO >> Replace key slot. Refer to [SEC-357. "Removal and Installation"](#).

6.CHECK INTERMITTENT INCIDENT

Refer to [GI-42. "Intermittent Incident"](#).

>> INSPECTION END.

KEY CYLINDER SWITCH

< COMPONENT DIAGNOSIS >

[SEDAN]

KEY CYLINDER SWITCH

Description

INFOID:000000003185509

For vehicles equipped with LH and RH anti-pinch system, the main power window and door lock/unlock switch detects condition of the door key cylinder switch and transmits to BCM as the LOCK or UNLOCK signal.

For vehicles equipped with LH anti-pinch system only, the front door lock assembly LH (key cylinder switch) transmits the LOCK or UNLOCK signal directly to the BCM.

Component Function Check

INFOID:000000003185510

1. CHECK DOOR KEY CYLINDER SWITCH INPUT SIGNAL

Check KEY CYL UN-SW, KEY CYL UN-SW in "DATA MONITOR" mode for "POWER DOOR LOCK SYSTEM" with CONSULT-III. Refer to [DLK-206. "Work Flow"](#).

Monitor item	Condition
KEY CYL LK-SW	Lock : ON
	Neutral / Unlock : OFF
KEY CYL UN-SW	Unlock : ON
	Neutral / Lock : OFF

Is the inspection result normal?

YES >> Key cylinder switch is OK.

NO >> With LH and RH anti-pinch, refer to [DLK-269. "Diagnosis Procedure \(With LH and RH Anti-Pinch\)"](#).

NO >> With LH anti-pinch only, refer to [DLK-271. "Diagnosis Procedure \(With LH Anti-Pinch Only\)"](#).

Diagnosis Procedure (With LH and RH Anti-Pinch)

INFOID:000000003185511

1. CHECK DOOR KEY CYLINDER SWITCH INPUT SIGNAL

- Turn ignition switch ON.
- Check voltage between main power window and door lock/unlock switch connector and ground.

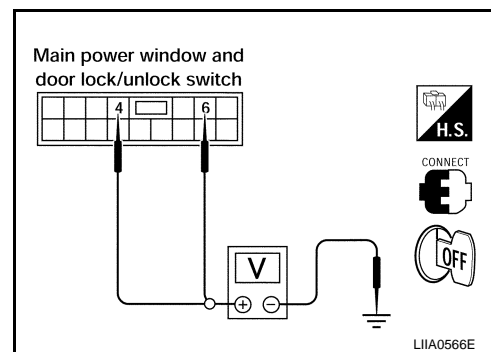

Terminals		Key position	Voltage (V) (Approx.)
(+)	(-)		
Main power window and door lock/unlock switch connector	Terminal		
D7	4	Lock	0
		Neutral / Unlock	5
	6	Unlock	0
		Neutral / Lock	5

KEY CYLINDER SWITCH

[SEDAN]

< COMPONENT DIAGNOSIS >

Is the inspection result normal?

YES >> Replace main power window and door lock/unlock switch. Refer to [PWC-255, "Removal and Installation"](#). After that, Refer to [PWC-179, "ADDITIONAL SERVICE WHEN REPLACING CONTROL UNIT : Special Repair Requirement"](#).

NO >> GO TO 2

2. CHECK DOOR KEY CYLINDER SIGNAL CIRCUIT

1. Turn ignition switch OFF.
2. Disconnect main power window and door lock/unlock switch connector and front door lock assembly LH (key cylinder switch) connector.
3. Check continuity between main power window and door lock/unlock switch connector and front door lock assembly LH (key cylinder switch) connector.

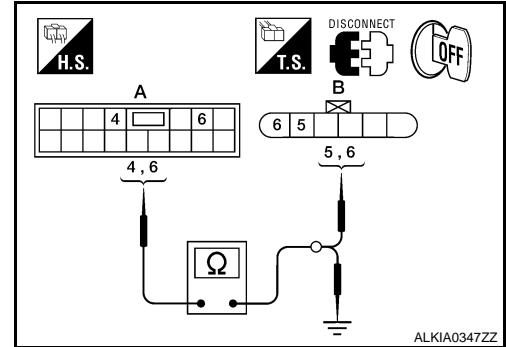

Main power window and door lock/unlock switch connector	Terminal	Front door lock assembly LH (key cylinder switch) connector	Terminal	Continuity
A: D7	4	B: D10	6	Yes
	6		5	

4. Check continuity between main power window and door lock/unlock switch connector and ground.

Power window main switch connector	Terminal	Ground	Continuity
A: D7	4	Ground	No
	6		

Is the inspection result normal?

YES >> GO TO 3

NO >> Repair or replace harness.

3. CHECK DOOR KEY CYLINDER SWITCH GROUND CIRCUIT

Check continuity between front door lock assembly LH connector and ground.

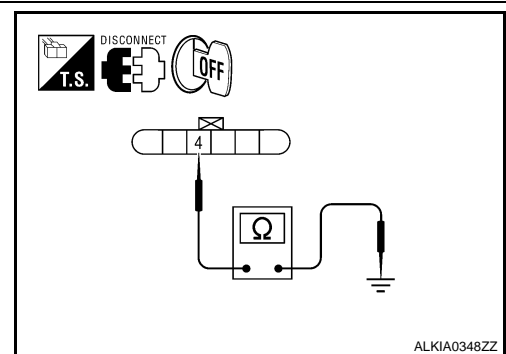

Front door lock assembly LH connector	Terminal	Ground	Continuity
D10	4	Ground	Yes

Is the inspection result normal?

YES >> GO TO 4

NO >> Repair or replace harness.

KEY CYLINDER SWITCH

[SEDAN]

< COMPONENT DIAGNOSIS >

4. CHECK DOOR KEY CYLINDER SWITCH

Check door key cylinder switch.

Refer to [SEC-304, "Component Inspection"](#).

Is the inspection result normal?

YES >> Check intermittent incident. Refer to [GI-42, "Intermittent Incident"](#).

NO >> Replace front door lock assembly LH (key cylinder switch). Refer to [DLK-403, "FRONT DOOR LOCK : Removal and Installation"](#). After that, Refer to [DLK-209, "ADDITIONAL SERVICE WHEN REPLACING CONTROL UNIT : Special Repair Requirement"](#).

Diagnosis Procedure (With LH Anti-Pinch Only)

INFOID:000000003185512

1. CHECK DOOR KEY CYLINDER SWITCH INPUT SIGNAL

1. Turn ignition switch ON.
2. Check voltage between BCM connector and ground.

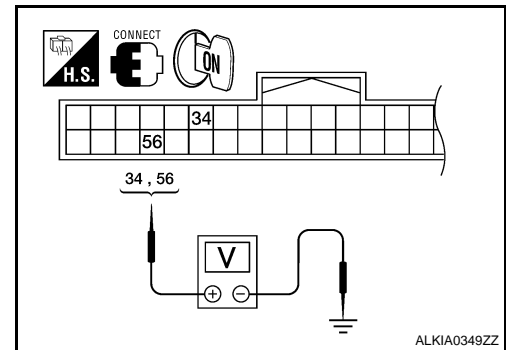

Terminals		Key position	Voltage (V) (Approx.)
(+)	(-)		
BCM connector	Terminal		
M18	56	Lock	0
		Neutral / Unlock	5
	34	Unlock	0
		Neutral / Lock	5

Is the inspection result normal?

YES >> Replace main power window and door lock/unlock switch. Refer to [PWC-255, "Removal and Installation"](#). After that, Refer to [PWC-179, "ADDITIONAL SERVICE WHEN REPLACING CONTROL UNIT : Special Repair Requirement"](#).

NO >> GO TO 2

2. CHECK DOOR KEY CYLINDER SWITCH GROUND CIRCUIT

1. Turn ignition switch OFF.
2. Disconnect front door lock assembly LH (key cylinder switch) connector.
3. Check continuity between front door lock assembly LH (key cylinder switch) connector and ground.

Front door lock assembly LH connector	Terminal	Ground	Continuity
D10	4		Yes

Is the inspection result normal?

YES >> GO TO 3

NO >> Repair or replace harness.

3. CHECK DOOR KEY CYLINDER SIGNAL CIRCUIT

1. Disconnect BCM connector M18.

A
B
C
D
E
F
G
H
I
J
L
M
N
O
P

SEC

KEY CYLINDER SWITCH

[SEDAN]

< COMPONENT DIAGNOSIS >

- Check continuity between front door lock assembly LH (key cylinder switch) connector and BCM connector M18.

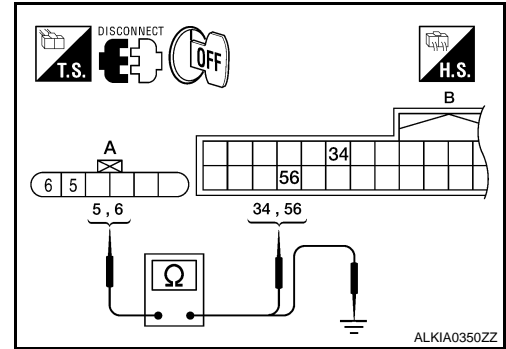

Front door lock assembly LH connector	Terminal	BCM connector	Terminal	Continuity
A: D10	5	B: M18	34	Yes
	6		56	

- Check continuity between front door lock assembly LH (key cylinder switch) connector and ground.

Front door lock assembly LH connector	Terminal	Ground	Continuity
A: D10	5	Ground	No
	6		

Is the inspection result normal?

- YES >> GO TO 4
- NO >> Repair or replace harness.

4.CHECK DOOR KEY CYLINDER SWITCH

Check door key cylinder switch.

Refer to [SEC-304, "Component Inspection"](#).

Is the inspection result normal?

- YES >> Check intermittent incident. Refer to [GI-42, "Intermittent Incident"](#).
- NO >> Replace front door lock assembly LH (key cylinder switch). Refer to [DLK-403, "FRONT DOOR LOCK : Removal and Installation"](#). After that, Refer to [DLK-209, "ADDITIONAL SERVICE WHEN REPLACING CONTROL UNIT : Special Repair Requirement"](#).

Component Inspection

INFOID:000000003185513

COMPONENT INSPECTION

1.CHECK DOOR KEY CYLINDER SWITCH

Check front door lock assembly LH (key cylinder switch).

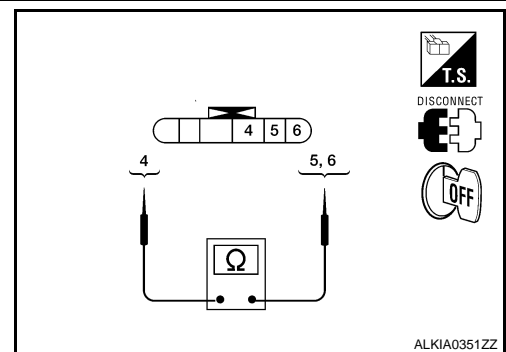

KEY CYLINDER SWITCH

< COMPONENT DIAGNOSIS >

[SEDAN]

Terminal		Key position	Continuity
Front door lock assembly LH (key cylinder switch) connector			
5	4	Unlock	Yes
		Neutral / Lock	No
6		Lock	Yes
		Neutral / Unlock	No

Is the inspection result normal?

YES >> Key cylinder switch is OK.

NO >> Replace front door lock assembly LH (key cylinder switch). Refer to [DLK-403, "FRONT DOOR LOCK : Removal and Installation"](#). After that, refer to [SEC-305, "Special Repair Requirement"](#).

Special Repair Requirement

INFOID:000000003185514

1. PERFORM INITIALIZATION PROCEDURE

Perform initialization procedure.

Refer to [DLK-209, "ADDITIONAL SERVICE WHEN REPLACING CONTROL UNIT : Special Repair Requirement"](#).

Is the inspection result normal?

YES >> Inspection end.

NO >> Check intermittent incident. Refer to [GI-42, "Intermittent Incident"](#).

SEC

HORN

[SEDAN]

< COMPONENT DIAGNOSIS >

HORN

Description

INFOID:000000003185516

Horn (high/low) is located inside of front bumper and operates when theft warning system is in alarm phase.

Component Function Check

INFOID:000000003185517

1.CHECK FUNCTION

1. Select HORN in "ACTIVE TEST" mode with CONSULT-III.
2. Check the horn (high/low) operation.

Test item		Description	
HORN	ON	Horn relay	ON (for 20 ms)

Is the operation normal?

- YES >> INSPECTION END.
NO >> Refer to [SEC-306. "Diagnosis Procedure"](#).

Diagnosis Procedure

INFOID:000000003185517

1.CHECK HORN FUNCTION

Check horn function with horn switch

Do the horns sound?

- YES >> GO TO 2.
NO >> Refer to [HRN-7. "Wiring Diagram - Sedan"](#).

2.CHECK HORN RELAY POWER SUPPLY

1. Turn ignition switch ON.
2. Perform "ACTIVE TEST" ("HORN") with CONSULT-III.
3. Using an analog voltmeter or an oscilloscope, check voltage between IPDM E/R connector E17 terminal 44 and ground.

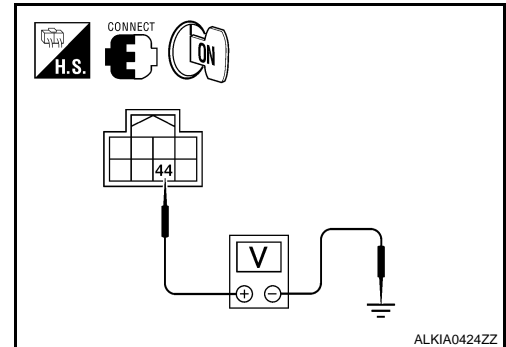

IPDM E/R		Ground	Test item	Voltage (V) (Approx.)
Connector	Terminal			
E17	44	Ground	HORN	Battery voltage → 0 → Battery voltage
			Other than above	Battery voltage

Is the inspection result normal?

- YES >> GO TO 4.
NO >> GO TO 3.

3.CHECK HORN RELAY CIRCUIT

1. Turn ignition switch OFF.
2. Disconnect IPDM E/R and horn relay connector.

HORN

[SEDAN]

< COMPONENT DIAGNOSIS >

3. Check continuity between IPDM E/R harness connector and horn relay harness connector.

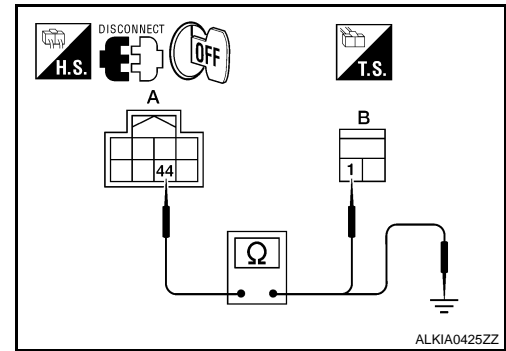

IPDM E/R		Horn relay		Continuity
Connector	Terminal	Connector	Terminal	
A: E17	44	B: H-1	1	Yes

4. Check continuity between IPDM E/R harness connector and ground.

IPDM E/R		Ground	Continuity
Connector	Terminal		
A: E17	44	Ground	No

Is the inspection result normal?

YES >> GO TO 4.

NO >> Repair or replace harness.

4.CHECK INTERMITTENT INCIDENT

Refer to [GI-42. "Intermittent Incident"](#).

Is the inspection result normal?

YES >> Replace IPDM E/R. Refer to [PCS-43. "Removal and Installation"](#).

NO >> Repair or replace the malfunctioning part.

A
B
C
D
E
F
G
H
I
J
L
M
N
O
P

SEC

HEADLAMP

Description

INFOID:000000003185518

Headlamp lighting when theft warning system is alarm phase.

Component Function Check

INFOID:000000003185519

1.CHECK HEADLAMP OPERATION

Check if headlamp operate by lighting switch.

Does headlamp come on when turning switch "ON"?

YES >> Headlamp circuit is OK.

NO >> Check headlamp system. Refer to [SEC-308, "Diagnosis Procedure"](#).

Diagnosis Procedure

INFOID:000000003185520

1.CHECK HEADLAMP OPERATION

Refer to [EXL-4, "Work Flow"](#).

Is the inspection result normal?

YES >> GO TO 2.

NO >> Repair or replace.

2.CHECK INTER MITTENT INCIDENT

Refer to [GI-42, "Intermittent Incident"](#).

Is the inspection result normal?

>> INSPECTION END.

WARNING LAMP

[SEDAN]

< COMPONENT DIAGNOSIS >

WARNING LAMP

Description

INFOID:000000003185521

- Warning lamp is built in combination meter.
- Intelligent Key system malfunction is reported to the driver by the warning lamp illumination.

Component Function Check

INFOID:000000003185522

1.CHECK FUNCTION

1. Perform "INDICATOR" in the "Active Test" mode with CONSULT-III.
2. Check warning lamp operation.

Test item		Description	
INDICATOR	ON	Warning lamp	ON
	OFF		OFF

Is the inspection result normal?

- YES >> INSPECTION END.
NO >> Go to [SEC-309, "Diagnosis Procedure"](#).

Diagnosis Procedure

INFOID:000000003185523

1.CHECK "COMBINATION METER."

Check combination meter function. Refer to [MWI-4, "Work Flow"](#).

Is the inspection result is normal?

- YES >> GO TO 2.
NO >> Repair or replace the malfunctioning parts.

2.CHECK INTERMITTENT INCIDENT

Refer to [GI-42, "Intermittent Incident"](#).

>> INSPECTION END.

A
B
C
D
E
F
G
H
I
J
L
M
N
O
P

SEC

VEHICLE SECURITY INDICATOR

< COMPONENT DIAGNOSIS >

[SEDAN]

VEHICLE SECURITY INDICATOR

Description

INFOID:000000003185524

- Vehicle security indicator is built in combination meter.
- NVIS (Infinity Vehicle Immobilizer System-NATS) and vehicle security system conditions are indicated by blink or illumination of vehicle security indicator.

Component Function Check

INFOID:000000003185525

1.CHECK FUNCTION

1. Perform "THEFT IND" in the "ACTIVE TEST" mode with CONSULT-III.
2. Check vehicle security indicator operation.

Test item		Description	
THEFT IND	ON	Vehicle security indicator	ON
	OFF		OFF

Is the inspection result normal?

YES >> INSPECTION END.

NO >> Go to [SEC-310, "Diagnosis Procedure"](#).

Diagnosis Procedure

INFOID:000000003185526

1.CHECK COMBINATION METER

Check combination meter. Refer to [MWI-4, "Work Flow"](#).

Is the inspection result is normal?

YES >> GO TO 2.

NO >> Repair or replace the malfunctioning parts.

2.CHECK INTERMITTENT INCIDENT

Refer to [GI-42, "Intermittent Incident"](#).

>> INSPECTION END.

< ECU DIAGNOSIS >

ECU DIAGNOSIS

BCM (BODY CONTROL MODULE)

Reference Value

INFOID:000000003185527

Refer to [BCS-41, "Reference Value"](#).

Terminal Layout

INFOID:000000003185528

Refer to [BCS-45, "Terminal Layout"](#).

Physical Values

INFOID:000000003185529

Refer to [BCS-45, "Physical Values"](#).

A

B

C

D

E

F

G

H

I

J

SEC

L

M

N

O

P

BCM (BODY CONTROL MODULE)

< ECU DIAGNOSIS >

[SEDAN]

Wiring Diagram - INTELLIGENT KEY SYSTEM/ENGINE START FUNCTION -

INFOID:000000003185530

INTELLIGENT KEY SYSTEM/ENGINE START FUNCTION

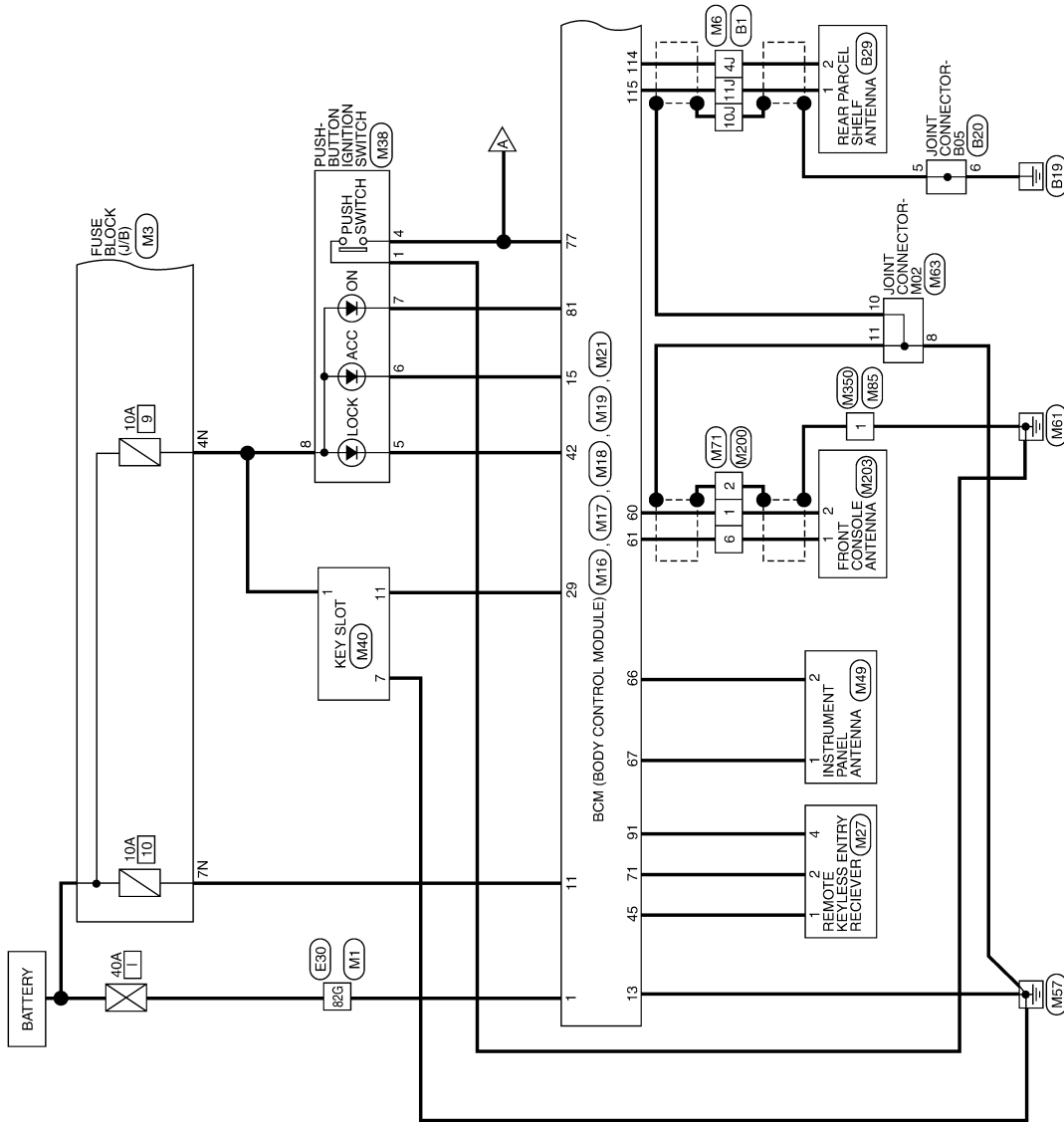

AWKWA0170GI

BCM (BODY CONTROL MODULE)

< ECU DIAGNOSIS >

[SEDAN]

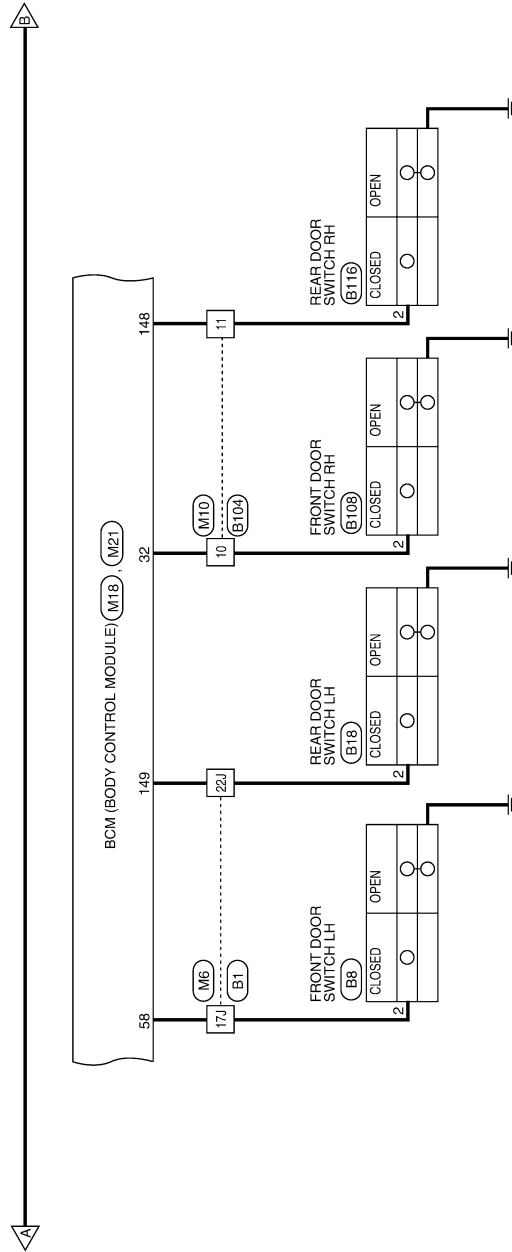

A
B
C
D
E
F
G
H
I
J
K
L
M
N
O
P

SEC

ALKWA0029GE

BCM (BODY CONTROL MODULE)

< ECU DIAGNOSIS >

[SEDAN]

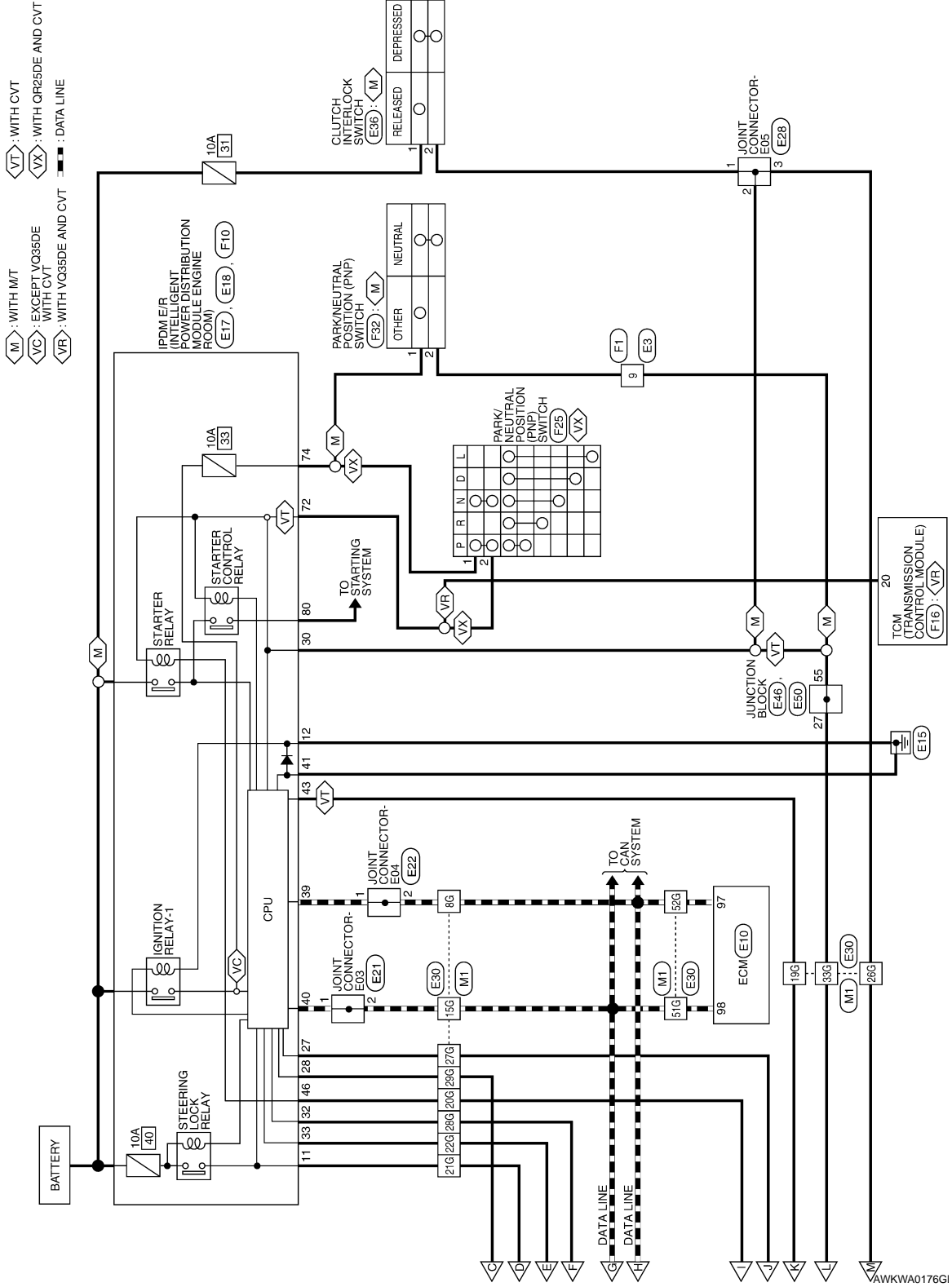

SEC

INTELLIGENT KEY SYSTEM/ENGINE START FUNCTION CONNECTORS

Connector No.	M1
Connector Name	WIRE TO WIRE
Connector Color	WHITE

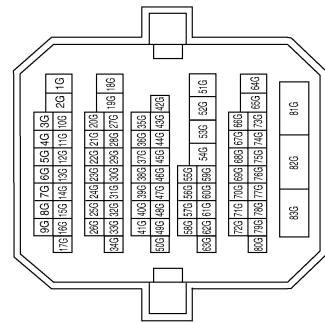

Terminal No.	Color of Wire	Signal Name
8G	P	-
15G	L	-
19G	G/B	-
20G	R	-
21G	P/L	-
22G	G/R	-
26G	R/Y	-
27G	BR/W	-
28G	L/O	-
29G	BR	-
33G	R/G	-
51G	L	-
52G	P	-
82G	W/B	-

Connector No.	M3
Connector Name	FUSE BLOCK (J/B)
Connector Color	WHITE

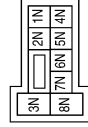

Terminal No.	Color of Wire	Signal Name
1N	W/L	-
4N	G/Y	-
5N	V/Y	-
7N	Y/R	-

Connector No.	M4
Connector Name	FUSE BLOCK (J/B)
Connector Color	WHITE

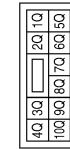

Terminal No.	Color of Wire	Signal Name
3Q	O/L	-
9Q	R/W	-

Connector No.	M6
Connector Name	WIRE TO WIRE
Connector Color	WHITE

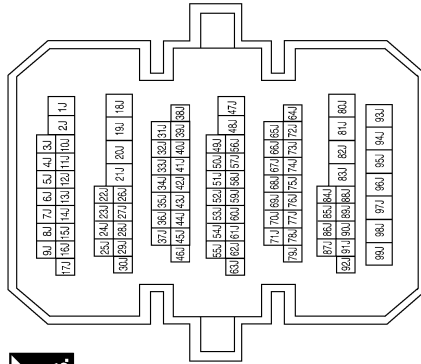

Terminal No.	Color of Wire	Signal Name
4J	B	-
10J	SHIELD	-
11J	W	-
17J	SB	-
22J	R/B	-

BCM (BODY CONTROL MODULE)

< ECU DIAGNOSIS >

[SEDAN]

Connector No.	M18
Connector Name	BCM (BODY CONTROL MODULE)
Connector Color	GREEN

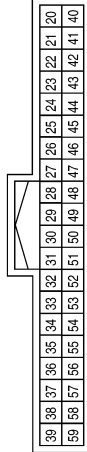

Terminal No.	Color of Wire	Signal Name
22	R/Y	CLUTCH_SW
24	R/W	STOP_LAMP_LOW_SW
26	O/L	STOP_LAMP_HIGH_SW
29	Y	FOB_IN_SW
32	R/B	AS_DOOR_SW
42	R	S/L_LOCK_LED
45	P	GND_RF2_A/L
48	R/G	SHIFT_N/P
49	L/O	IMMO_LED
58	SB	DR_DOOR_SW

Connector No.	M17
Connector Name	BCM (BODY CONTROL MODULE)
Connector Color	WHITE

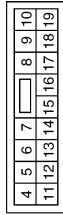

Terminal No.	Color of Wire	Signal Name
11	Y/R	BAT_BCM_FUSE
13	B	GND1
15	Y/L	ACC_LED

Connector No.	M16
Connector Name	BCM (BODY CONTROL MODULE)
Connector Color	BLACK



Terminal No.	Color of Wire	Signal Name
1	W/B	BAT_POWER_F/L

A
B
C
D
E
F
G
H
I
J
L
M
N
O
P

SEC

ALKIA0135GB

BCM (BODY CONTROL MODULE)

< ECU DIAGNOSIS >

[SEDAN]

Connector No.	M19
Connector Name	BCM (BODY CONTROL MODULE)
Connector Color	BLACK



79	78	77	76	75	74	73	72	71	70	69	68	67	66	65	64	63	62	61	60
----	----	----	----	----	----	----	----	----	----	----	----	----	----	----	----	----	----	----	----

Terminal No.	Color of Wire	Signal Name
60	B/R	ROOM_ANT_2_B
61	W/R	ROOM_ANT_2_A
66	R	ROOM_ANT_1_B
67	G	ROOM_ANT_1_A



1	3	7	9		
2	4	5	6	8	10

Terminal No.	Color of Wire	Signal Name
8	Y/R	DETENT_KEY_SW
9	G/B	DETENT_KEY_SW

Terminal No.	Color of Wire	Signal Name
71	L/O	RF1_TUNER_SIGNAL
77	BR	ENG_START_SW
78	P	CAN-L
79	L	CAN-H
81	LG	IGN_ON_LED
84	Y/R	AT_DEVICE_OUT
85	L/O	S/L_CONDITION_1
86	G/R	S/L_CONDITION_2
87	G/B	SHIFT_P
91	L/R	RF1_POWER_SUPPLY
94	G/Y	S/L_POWER_SUPPLY_12V
99	L/Y	S/L_K-LINE

Connector No.	M21
Connector Name	BCM (BODY CONTROL MODULE)
Connector Color	GRAY



131	130	129	128	127	126	125	124	123	122	121	120	119	118	117	116	115	114	113	112
151	150	149	148	147	146	145	144	143	142	141	140	139	138	137	136	135	134	133	132

Terminal No.	Color of Wire	Signal Name
114	B	TRUNK_ANT_1_B
115	W	TRUNK_ANT_1_A
127	BR/W	IGN_USM_CONT1
132	R	ST_CONT_USM
148	R/W	RR_DOOR_SW
149	R/B	RL_DOOR_SW

Connector No.	M24
Connector Name	COMBINATION METER
Connector Color	WHITE



1	2	3	4	5	6	7	8	9	10	11	12	13	14	15	16	17	18	19	20
21	22	23	24	25	26	27	28	29	30	31	32	33	34	35	36	37	38	39	40

Connector No.	M23
Connector Name	CVT DEVICE
Connector Color	WHITE



Terminal No.	Color of Wire	Signal Name
8	Y/R	DETENT_KEY_SW
9	G/B	DETENT_KEY_SW

Terminal No.	Color of Wire	Signal Name
1	W/L	BAT
3	B	GND
4	B	GND
14	V/Y	ACC
21	L	CAN-H
22	P	CAN-L
23	B	GND
28	L/O	SECURITY

BCM (BODY CONTROL MODULE)

< ECU DIAGNOSIS >

[SEDAN]

Connector No.	M27
Connector Name	REMOTE KEYLESS ENTRY RECIEVER
Connector Color	BLACK

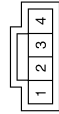

Terminal No.	Color of Wire	Signal Name
1	P	GND
2	L/O	SIGNAL
4	L/R	12V

Connector No.	M32
Connector Name	ELECTRONIC STEERING COLUMN LOCK
Connector Color	WHITE

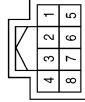

Terminal No.	Color of Wire	Signal Name
1	P/L	S/L_12V_MECHANICAL (V1)
2	L/Y	S/L_COM
3	L/O	S/L_CONDITION_1
5	B	GND
6	B	GND
7	G/Y	S/L_12V_CPU (V2)
8	G/R	S/L_CONDITION_2

Connector No.	M38
Connector Name	PUSH-BUTTON IGNITION SWITCH
Connector Color	BROWN

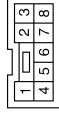

Terminal No.	Color of Wire	Signal Name
1	B	GND
4	BR	START_SW
5	R	LOCK
6	Y/L	ACC
7	LG	ON
8	G/Y	B+

Connector No.	M40
Connector Name	KEY SLOT
Connector Color	WHITE

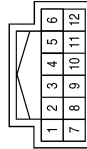

Terminal No.	Color of Wire	Signal Name
1	G/Y	B+
7	B	GND
11	Y	CARD_SW_1

Connector No.	M49
Connector Name	INSTRUMENT PANEL ANTENNA
Connector Color	GRAY



Terminal No.	Color of Wire	Signal Name
1	G	ANT+
2	R	ANT-

Connector No.	M63
Connector Name	JOINT CONNECTOR-M02
Connector Color	BLUE

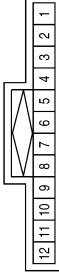

Terminal No.	Color of Wire	Signal Name
8	B	-
10	GR	-
11	GR	-

ALKIA0137GB

A
B
C
D
E
F
G
H
I
J
K
L
M
N
O
P

SEC

BCM (BODY CONTROL MODULE)

< ECU DIAGNOSIS >

[SEDAN]

Connector No.	M200
Connector Name	WIRE TO WIRE
Connector Color	WHITE

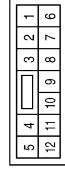

Terminal No.	Color of Wire	Signal Name
1	B/R	-
2	SHIELD	-
6	W/R	-

Connector No.	M85
Connector Name	WIRE TO WIRE
Connector Color	WHITE



Terminal No.	Color of Wire	Signal Name
1	B	-

Connector No.	M71
Connector Name	WIRE TO WIRE
Connector Color	WHITE

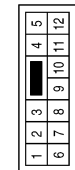

Terminal No.	Color of Wire	Signal Name
1	B/R	-
2	SHIELD	-
6	W/R	-

Connector No.	E3
Connector Name	WIRE TO WIRE
Connector Color	WHITE

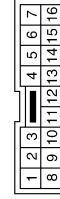

Terminal No.	Color of Wire	Signal Name
9	R/B	-

Connector No.	M350
Connector Name	WIRE TO WIRE
Connector Color	WHITE



Terminal No.	Color of Wire	Signal Name
1	B	-

Connector No.	M203
Connector Name	FRONT CONSOLE ANTENNA
Connector Color	GRAY

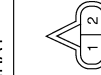

Terminal No.	Color of Wire	Signal Name
1	W/R	ANT+
2	B/R	ANT-

ALKIA0138GB

BCM (BODY CONTROL MODULE)

< ECU DIAGNOSIS >

[SEDAN]

Connector No.	E6
Connector Name	FUSE BLOCK (J/B)
Connector Color	WHITE



Terminal No.	Color of Wire	Signal Name
2P	R/G	-
8P	Y/R	-

Connector No.	E10
Connector Name	ECM
Connector Color	BLACK

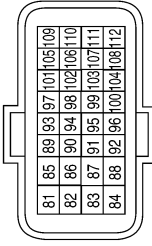

Terminal No.	Color of Wire	Signal Name
97	P	CAN-L
98	L	CAN-H

Connector No.	E17
Connector Name	IPDM E/R (INTELLIGENT POWER DISTRIBUTION MODULE ENGINE ROOM)
Connector Color	WHITE

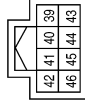

Terminal No.	Color of Wire	Signal Name
39	P	CAN-L
40	L	CAN-H
41	B	S-GND
43	G/B	DETENT_SW
46	R	START_CONT

Connector No.	E18
Connector Name	IPDM E/R (INTELLIGENT POWER DISTRIBUTION MODULE ENGINE ROOM)
Connector Color	WHITE

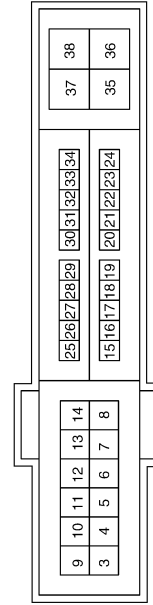

Terminal No.	Color of Wire	Signal Name
11	P/L	ESCL
12	B	P_GND
27	BR/W	IGN_SIGNAL
28	BR	PUSH_START_SW
30	R/B	CLUTCH_I/L_SW
32	L/O	SL_CONDITION_1
33	G/R	SL_CONDITION_2

Connector No.	E21
Connector Name	JOINT CONNECTOR-E03
Connector Color	WHITE

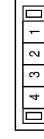

Terminal No.	Color of Wire	Signal Name
1	L	-
2	L	-

ALKIA0139GB

A
B
C
D
E
F
G
H
I
J
L
M
N
O
P

SEC

BCM (BODY CONTROL MODULE)

< ECU DIAGNOSIS >

[SEDAN]

Connector No.	E22
Connector Name	JOINT CONNECTOR-E04
Connector Color	WHITE



Terminal No.	Color of Wire	Signal Name
1	P	-
2	P	-

Connector No.	E28
Connector Name	JOINT CONNECTOR-E05
Connector Color	WHITE



Terminal No.	Color of Wire	Signal Name
1	R/B	-
2	R/B	-
3	R/B	-

Connector No.	E30
Connector Name	WIRE TO WIRE
Connector Color	WHITE

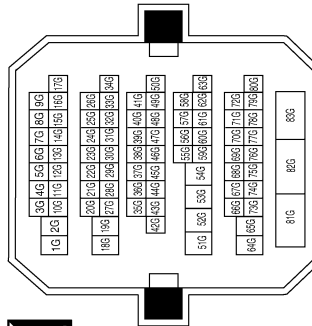

Terminal No.	Color of Wire	Signal Name
8G	P	-
15G	L	-
19G	G/B	-
20G	R	-
21G	P/L	-
22G	G/R	(WITH M/T)
22G	W	(WITH CVT)
26G	R/B	-
27G	BR/W	-
28G	L/O	(WITH M/T)
28G	LG	(WITH CVT)
29G	BR	-
33G	R/G	-
51G	L	-
52G	P	-
82G	W/B	-

Connector No.	E36
Connector Name	CLUTCH INTERLOCK SWITCH
Connector Color	BROWN



Terminal No.	Color of Wire	Signal Name
1	G/W	-
2	R/B	-

AWKIA0408GB

BCM (BODY CONTROL MODULE)

< ECU DIAGNOSIS >

[SEDAN]

Connector No.	E46
Connector Name	JUNCTION BLOCK
Connector Color	WHITE

31	30	29	28	27	26	25		
40	39	38	37	36	35	34	33	32



Terminal No.	Color of Wire	Signal Name
27	R/G	-

Connector No.	E38 (WITH M/T)
Connector Name	STOP LAMP SWITCH
Connector Color	BLACK

2	1
---	---



Terminal No.	Color of Wire	Signal Name
1	Y/R	B+
2	R/G	HIGH_SW

Connector No.	E38 (WITH CVT)
Connector Name	STOP LAMP SWITCH
Connector Color	WHITE

3	4	1	2
---	---	---	---



Terminal No.	Color of Wire	Signal Name
1	Y/R	B+
2	R/G	HIGH_SW

Connector No.	F10
Connector Name	IPDM E/R (INTELLIGENT POWER DISTRIBUTION MODULE ENGINE ROOM)
Connector Color	WHITE



53	54	55	56	57	58	69	70	71	72	73	74	75	76	77	78
47	48	49	50	51	52	59	60	61	62	63	64	65	66	67	68
						81	82								80

Connector No.	F1
Connector Name	WIRE TO WIRE
Connector Color	WHITE

7	6	5	4	3	2	1		
16	15	14	13	12	11	10	9	8



Terminal No.	Color of Wire	Signal Name
72	R/B	NPSW
74	Y	START_IG_EGI
80	B/W	STARTER_MOTOR

Connector No.	E50
Connector Name	JUNCTION BLOCK
Connector Color	WHITE

56	55
----	----



Terminal No.	Color of Wire	Signal Name
55	R/B	-

ALKIA0154GB

A
B
C
D
E
F
G
H
I
J
K
L
M
N
O
P

SEC

BCM (BODY CONTROL MODULE)

< ECU DIAGNOSIS >

[SEDAN]

Connector No.	F16
Connector Name	TCM (TRANSMISSION CONTROL MODULE)
Connector Color	BLACK

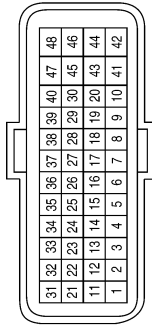

Terminal No.	Color of Wire	Signal Name
20	R/B	ST_RLY

Connector No.	F25
Connector Name	PARK/NEUTRAL POSITION (PNP) SWITCH
Connector Color	BLACK

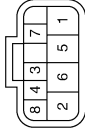

Terminal No.	Color of Wire	Signal Name
1	Y	IGN_P_N
2	R/B	P_N_OUTPUT

Connector No.	F32
Connector Name	PARK/NEUTRAL POSITION (PNP) SWITCH
Connector Color	BLACK



Terminal No.	Color of Wire	Signal Name
1	Y	-
2	R/B	-

Connector No.	B1
Connector Name	WIRE TO WIRE
Connector Color	WHITE

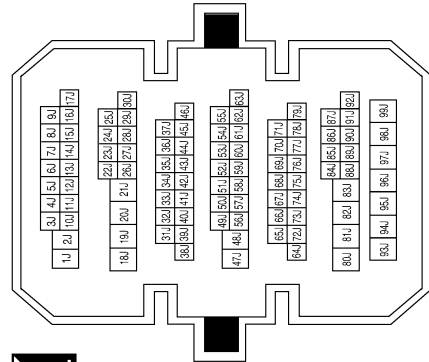

Terminal No.	Color of Wire	Signal Name
4J	B	-
10J	SHIELD	-
11J	W	-
17J	SB	-
22J	R/B	-

Connector No.	B8
Connector Name	FRONT DOOR SWITCH LH
Connector Color	WHITE

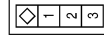

Terminal No.	Color of Wire	Signal Name
2	SB	DOOR SW (DR)

ALKIA0155GB

BCM (BODY CONTROL MODULE)

< ECU DIAGNOSIS >

[SEDAN]

Connector No.	B29
Connector Name	REAR PARCEL SHELF ANTENNA
Connector Color	GRAY



Terminal No.	Color of Wire	Signal Name
1	W	ANT+
2	B	ANT-

Connector No.	B20
Connector Name	JOINT CONNECTOR-B05
Connector Color	GRAY

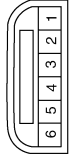

Terminal No.	Color of Wire	Signal Name
5	GR	-
6	B	-

Connector No.	B18
Connector Name	FRONT DOOR SWITCH LH
Connector Color	WHITE

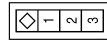

Terminal No.	Color of Wire	Signal Name
2	R/B	DOOR SW (RL)

Connector No.	B116
Connector Name	FRONT DOOR SWITCH RH
Connector Color	WHITE

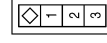

Terminal No.	Color of Wire	Signal Name
2	R/W	DOOR SW (RR)

Connector No.	B108
Connector Name	FRONT DOOR SWITCH RH
Connector Color	WHITE

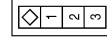

Terminal No.	Color of Wire	Signal Name
2	R/B	DOOR SW (AS)

Connector No.	B104
Connector Name	WIRE TO WIRE
Connector Color	BROWN

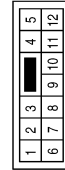

Terminal No.	Color of Wire	Signal Name
10	R/B	-
11	R/W	-

AWKIA0409GB

A
B
C
D
E
F
G
H
I
J
L
M
N
O
P

SEC

BCM (BODY CONTROL MODULE)

[SEDAN]

< ECU DIAGNOSIS >

Wiring Diagram - VEHICLE SECURITY SYSTEM -

INFOID:000000003185531

VEHICLE SECURITY SYSTEM

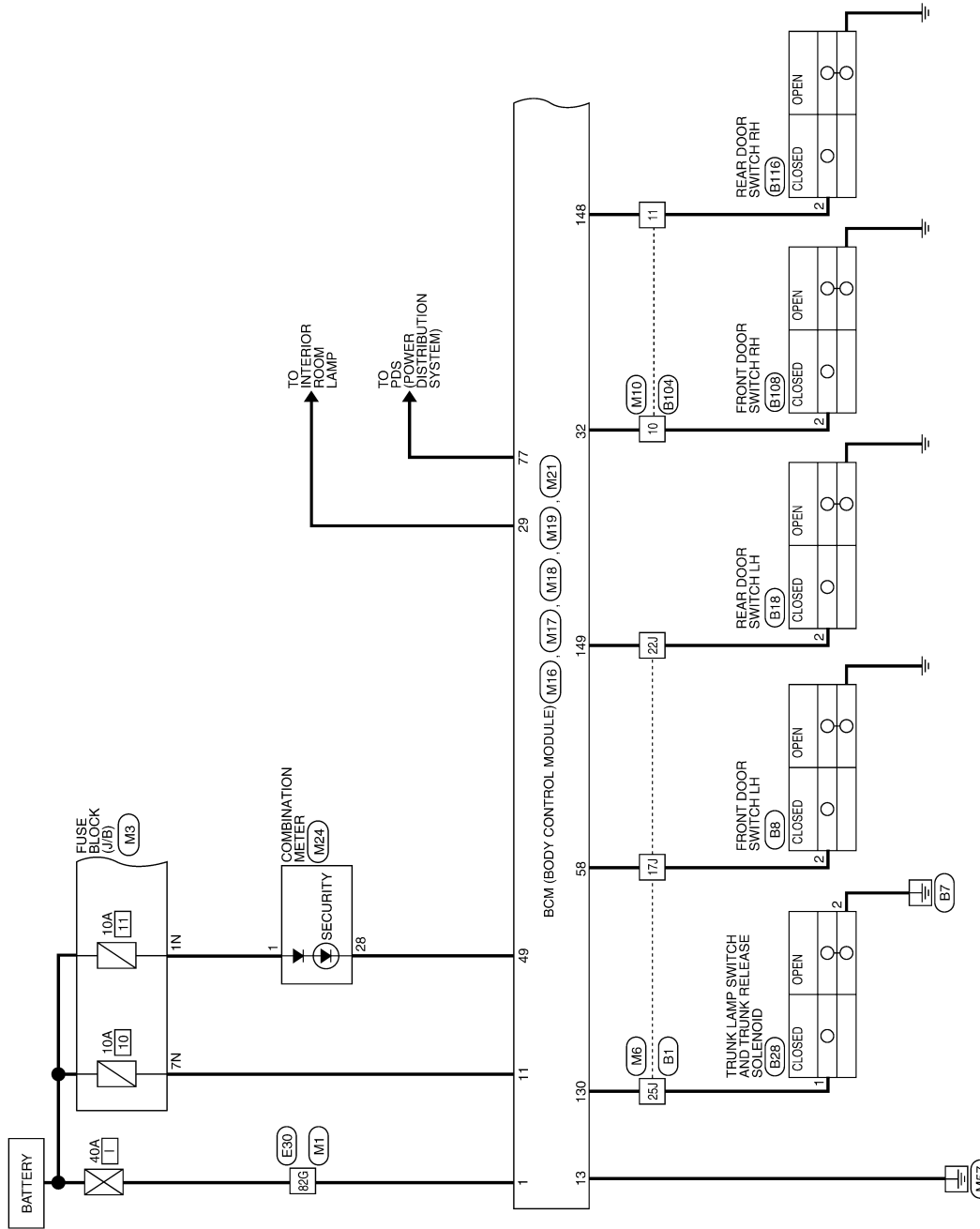

AWKWA0172GI

BCM (BODY CONTROL MODULE)

< ECU DIAGNOSIS >

[SEDAN]

- : WITH LEFT FRONT ONLY POWER WINDOW ANTI-PINCH SYSTEM
- : WITH LEFT AND RIGHT FRONT POWER WINDOW ANTI-PINCH SYSTEM
- : DATA LINE

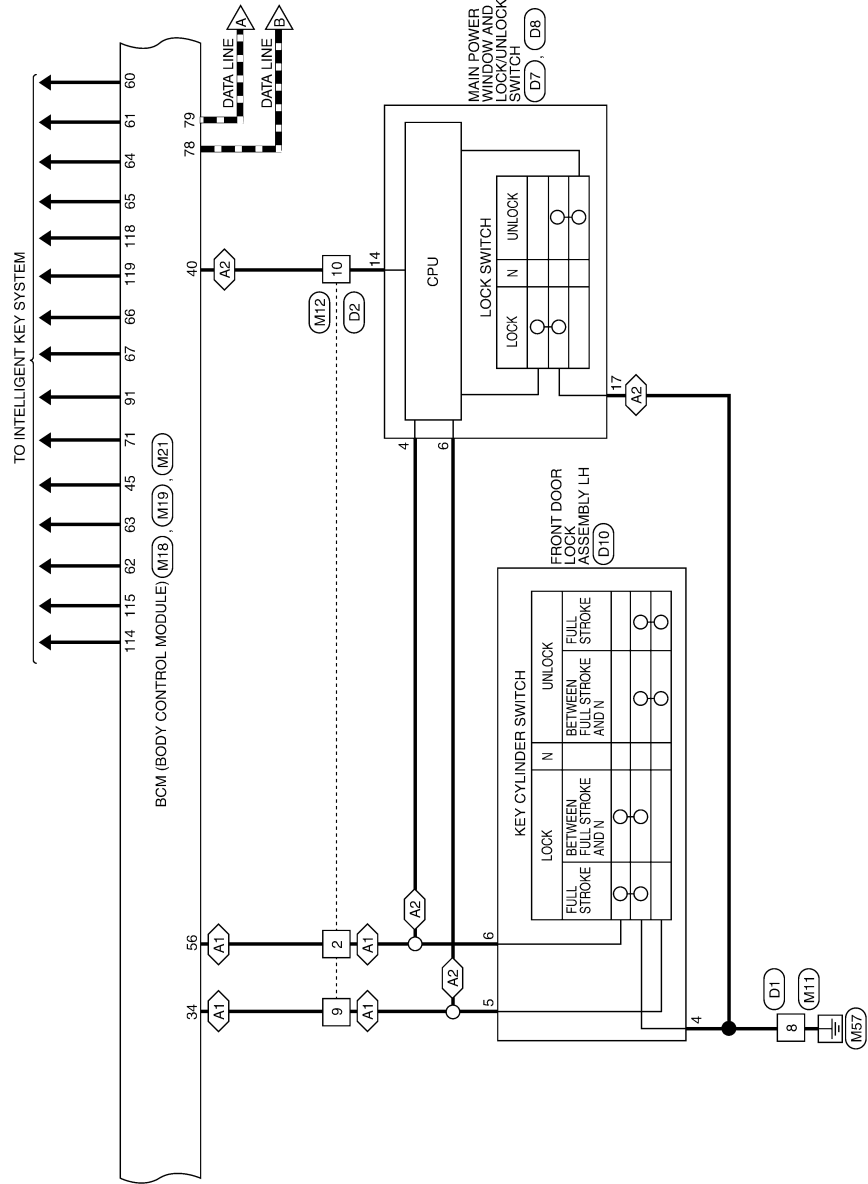

ALKWA0006GE

A
B
C
D
E
F
G
H
I
J
K
L
M
N
O
P

SEC

BCM (BODY CONTROL MODULE)

< ECU DIAGNOSIS >

[SEDAN]

■ ■ ■ : DATA LINE

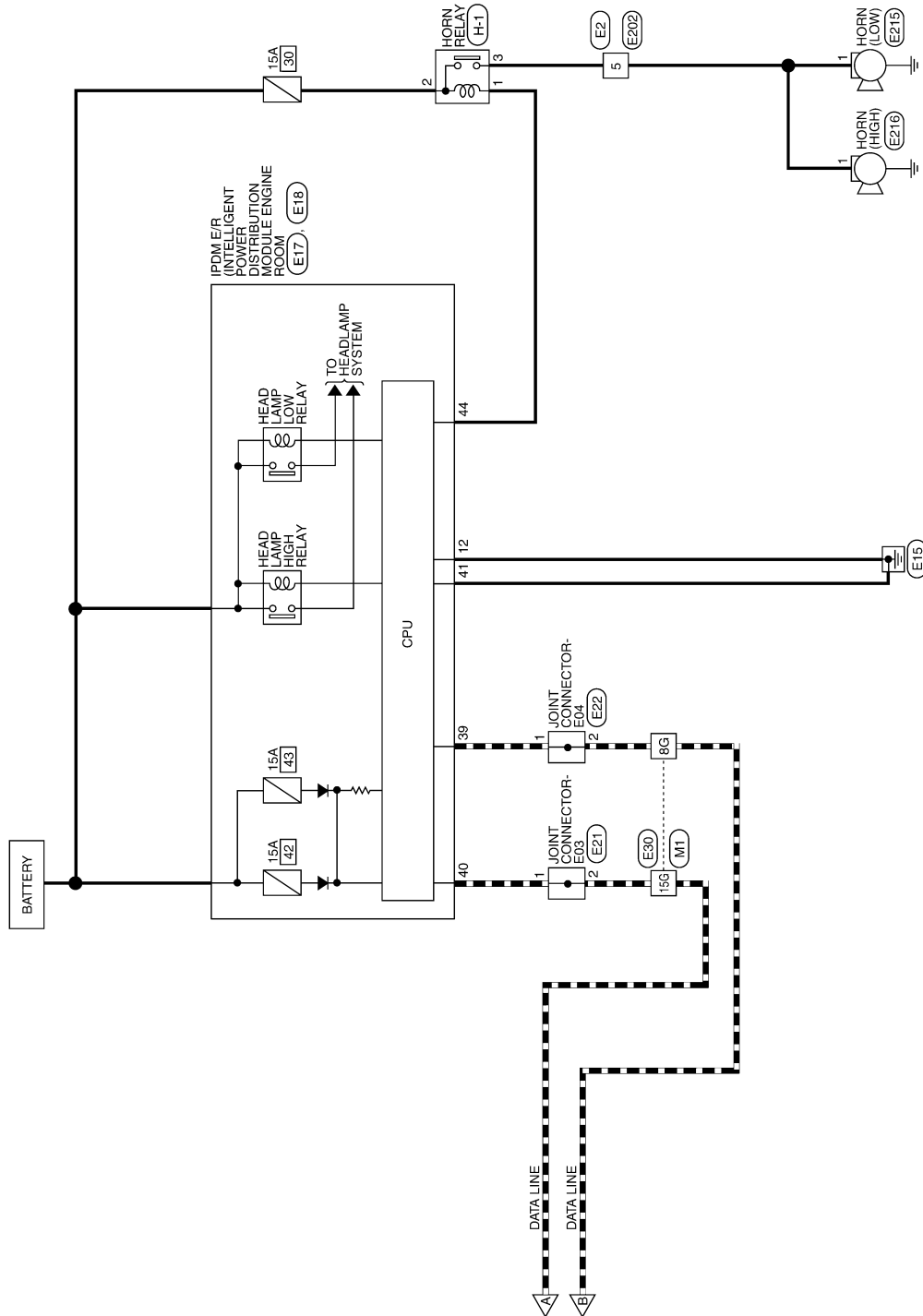

AWKWA0173GI

VEHICLE SECURITY SYSTEM CONNECTORS

Connector No.	M1
Connector Name	WIRE TO WIRE
Connector Color	WHITE

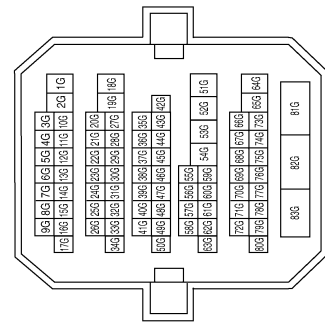

Terminal No.	Color of Wire	Signal Name
8G	P	-
15G	L	-
82G	W/B	-

Connector No.	M3
Connector Name	FUSE BLOCK (J/B)
Connector Color	WHITE

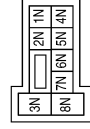

Terminal No.	Color of Wire	Signal Name
1N	W/L	-
7N	Y/R	-

Connector No.	M6
Connector Name	WIRE TO WIRE
Connector Color	WHITE

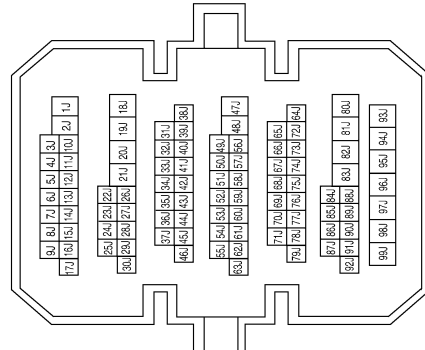

Terminal No.	Color of Wire	Signal Name
17J	SB	-
22J	R/B	-
25J	Y/G	-

Connector No.	M10
Connector Name	WIRE TO WIRE
Connector Color	BROWN



Terminal No.	Color of Wire	Signal Name
10	R/B	-
11	R/W	-

ALKIA0125GB

BCM (BODY CONTROL MODULE)

< ECU DIAGNOSIS >

[SEDAN]

Connector No.	M11
Connector Name	WIRE TO WIRE
Connector Color	WHITE

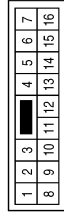

Terminal No.	8	Color of Wire	B	Signal Name	-
--------------	---	---------------	---	-------------	---

Connector No.	M12
Connector Name	WIRE TO WIRE
Connector Color	WHITE

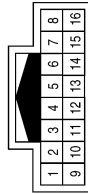

Terminal No.	2	Color of Wire	L/B	Signal Name	-
9	L/R	-	-		
10	Y/G	-	-		

Connector No.	M16
Connector Name	BCM (BODY CONTROL MODULE)
Connector Color	BLACK



Terminal No.	1	Color of Wire	W/B	Signal Name	BAT_POWER_FL
--------------	---	---------------	-----	-------------	--------------

Connector No.	M17
Connector Name	BCM (BODY CONTROL MODULE)
Connector Color	WHITE



Terminal No.	11	Color of Wire	Y/R	Signal Name	BAT_BCM_FUSE
13	B	GND1			

Connector No.	M18
Connector Name	BCM (BODY CONTROL MODULE)
Connector Color	GREEN

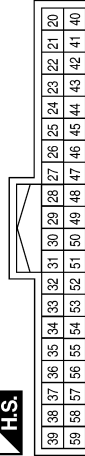

Terminal No.	29	Color of Wire	Y	Signal Name	FOB_IN_SW_1
32	R/B	AS_DOOR_SW			
34	L/R	DOOR_KEY/C_UNLOCK_SW			
36	GR	CENTRAL_LOCK_SW			
39	GR/R	CENTRAL_UNLOCK_SW			
40	Y/G	PW_K-LINE			
45	P	GND_RF2_AVL			
49	L/O	IMMO_LED			
56	L/B	DOOR_KEY/C_LOCK_SW			
58	SB	DR_DOOR_SW			

AWKIA0410GB

BCM (BODY CONTROL MODULE)

< ECU DIAGNOSIS >

[SEDAN]

Connector No.	M19
Connector Name	BCM (BODY CONTROL MODULE)
Connector Color	BLACK



79	78	77	76	75	74	73	72	71	70	69	68	67	66	65	64	63	62	61	60
99	98	97	96	95	94	93	92	91	90	89	88	87	86	85	84	83	82	81	80

Terminal No.	Color of Wire	Signal Name
60	B/R	ROOM_ANT_2_B
61	W/R	ROOM_ANT_2_A
62	B/Y	AS_DOOR_ANT_B
63	LG	AS_DOOR_ANT_A
64	V	DR_DOOR_ANT_B
65	P	DR_DOOR_ANT_A
66	R	ROOM_ANT_1_B
67	G	ROOM_ANT_1_A
71	L/O	RF1_TUNER_SIGNAL
77	BR	ENG_START_SW
78	P	CAN-L
79	L	CAN-H
91	L/R	RF1_POWER_SUPPLY

Connector No.	M21
Connector Name	BCM (BODY CONTROL MODULE)
Connector Color	GRAY



131	130	129	128	127	126	125	124	123	122	121	120	119	118	117	116	115	114	113	112
151	150	149	148	147	146	145	144	143	142	141	140	139	138	137	136	135	134	133	132

Terminal No.	Color of Wire	Signal Name
114	B	TRUNK_ANT_1_B
115	W	TRUNK_ANT_1_A
118	L/O	BACK_DOOR_ANT_B
119	BRW	BACK_DOOR_ANT_A
130	Y/G	TRUNK_SW
148	R/W	RR_DOOR_SW
149	R/B	RL_DOOR_SW

Connector No.	M24
Connector Name	COMBINATION METER
Connector Color	WHITE



1	2	3	4	5	6	7	8	9	10	11	12	13	14	15	16	17	18	19	20
21	22	23	24	25	26	27	28	29	30	31	32	33	34	35	36	37	38	39	40

Terminal No.	Color of Wire	Signal Name
1	W/L	BAT
28	L/O	SECURITY

Connector No.	E2
Connector Name	WIRE TO WIRE
Connector Color	WHITE



1	2	3		
4	5	6	7	8

Terminal No.	Color of Wire	Signal Name
5	G	-

Connector No.	E17
Connector Name	IPDM E/R (INTELLIGENT POWER DISTRIBUTION MODULE ENGINE ROOM)
Connector Color	WHITE



42	41	40	39
46	45	44	43

Terminal No.	Color of Wire	Signal Name
39	P	CAN-L
40	L	CAN-H
41	B	S-GND
44	G/W	HORN_RLY

AWKIA0411GB

A
B
C
D
E
F
G
H
I
J
K
L
M
N
O
P

SEC

BCM (BODY CONTROL MODULE)

< ECU DIAGNOSIS >

[SEDAN]

Connector No.	E18
Connector Name	IPDM E/R (INTELLIGENT POWER DISTRIBUTION MODULE ENGINE ROOM)
Connector Color	WHITE

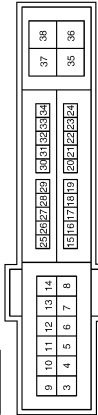

Terminal No.	Color of Wire	Signal Name
12	B	P-GND

Connector No.	E21
Connector Name	JOINT CONNECTOR-E03
Connector Color	WHITE



Terminal No.	Color of Wire	Signal Name
1	L	-
2	L	-

Connector No.	E22
Connector Name	JOINT CONNECTOR-E04
Connector Color	WHITE



Terminal No.	Color of Wire	Signal Name
1	P	-
2	P	-

Connector No.	E30
Connector Name	WIRE TO WIRE
Connector Color	WHITE

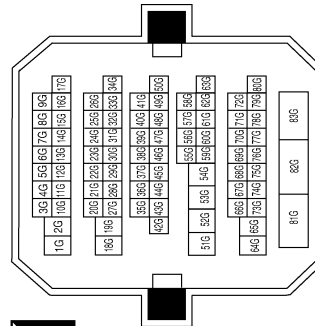

Terminal No.	Color of Wire	Signal Name
8G	P	-
15G	L	-
82G	W/B	-

Connector No.	E202
Connector Name	WIRE TO WIRE
Connector Color	WHITE

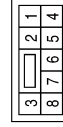

Terminal No.	Color of Wire	Signal Name
5	G	-

AWKIA0412GB

BCM (BODY CONTROL MODULE)

< ECU DIAGNOSIS >

[SEDAN]

Connector No.	E215
Connector Name	HORN
Connector Color	BLACK



Terminal No.	1	Color of Wire	G	Signal Name	-
--------------	---	---------------	---	-------------	---

Connector No.	E216
Connector Name	HORN
Connector Color	BLACK



Terminal No.	1	Color of Wire	G	Signal Name	-
--------------	---	---------------	---	-------------	---

Connector No.	B1
Connector Name	WIRE TO WIRE
Connector Color	WHITE

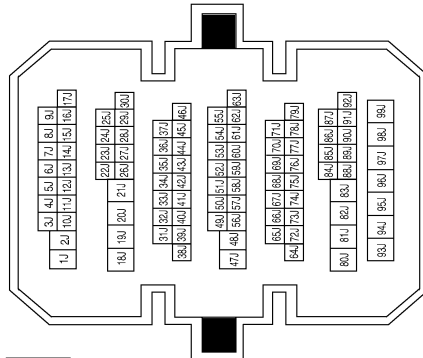

Terminal No.	17J	Color of Wire	SB	Signal Name	-
	22J		R/B		-
	25J		Y/G		-

Connector No.	B8
Connector Name	FRONT DOOR SWITCH LH
Connector Color	WHITE

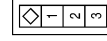

Terminal No.	2	Color of Wire	SB	Signal Name	DOOR SW (DR)
--------------	---	---------------	----	-------------	--------------

AWKIA0413GB

A
B
C
D
E
F
G
H
I
J
L
M
N
O
P

SEC

BCM (BODY CONTROL MODULE)

< ECU DIAGNOSIS >

[SEDAN]

Connector No.	B104
Connector Name	WIRE TO WIRE
Connector Color	BROWN



1	2	3	4	5
6	7	8	9	10
11	12			

Terminal No.	Color of Wire	Signal Name
10	R/B	-
11	R/W	-

Connector No.	B28
Connector Name	TRUNK LAMP SWITCH AND TRUNK RELEASE SOLENOID
Connector Color	WHITE



2	1
4	3

Terminal No.	Color of Wire	Signal Name
1	Y/G	TRUNK_REQUEST_SW
2	B	GND

Connector No.	B18
Connector Name	FRONT DOOR SWITCH LH
Connector Color	WHITE



1	2	3
---	---	---

Terminal No.	Color of Wire	Signal Name
2	R/B	DOOR SW (RL)

Connector No.	D1
Connector Name	WIRE TO WIRE
Connector Color	WHITE



7	6	5	4	3	2	1
16	15	14	13	12	11	10
9	8					

Connector No.	B116
Connector Name	FRONT DOOR SWITCH RH
Connector Color	WHITE



1	2	3
---	---	---

Terminal No.	Color of Wire	Signal Name
2	R/W	DOOR SW (RR)

Connector No.	B108
Connector Name	FRONT DOOR SWITCH RH
Connector Color	WHITE



1	2	3
---	---	---

Terminal No.	Color of Wire	Signal Name
2	R/B	DOOR SW (AS)

AWKIA0414GB

BCM (BODY CONTROL MODULE)

< ECU DIAGNOSIS >

[SEDAN]

Connector No.	D8
Connector Name	MAIN POWER WINDOW AND LOCK/UNLOCK SWITCH
Connector Color	WHITE



Terminal No.	Color of Wire	Signal Name
17	B	GND

Connector No.	D7
Connector Name	MAIN POWER WINDOW AND LOCK/UNLOCK SWITCH
Connector Color	WHITE

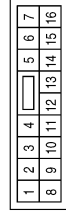

Terminal No.	Color of Wire	Signal Name
4	L/B	LOCK
6	L/R	UNLOCK
14	Y/G	COM

Connector No.	D2
Connector Name	WIRE TO WIRE
Connector Color	WHITE

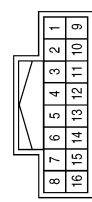

Terminal No.	Color of Wire	Signal Name
2	L/B	-
9	L/R	-
10	Y/G	-

Connector No.	D10
Connector Name	FRONT DOOR LOCK ASSEMBLY LH
Connector Color	GRAY

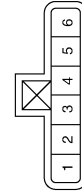

Terminal No.	Color of Wire	Signal Name
4	B	GND
5	L/R	DOOR_KEY/C_UNLOCK_SW
6	L/B	DOOR_KEY/D/C_LOCK_SW

AWKIA0415GB

A
B
C
D
E
F
G
H
I
J
K
L
M
N
O
P

SEC

BCM (BODY CONTROL MODULE)

< ECU DIAGNOSIS >

[SEDAN]

Wiring Diagram - NVIS -

INFOID:000000003185532

NVIS

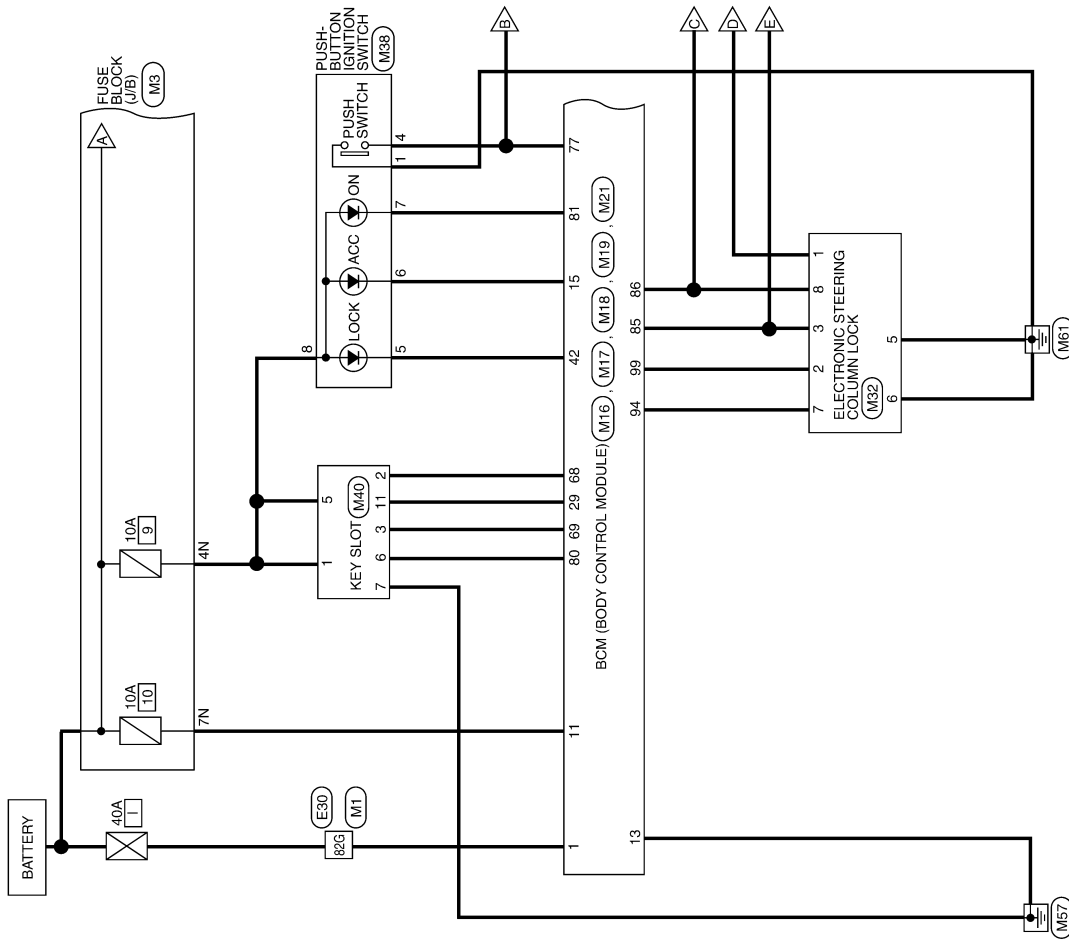

AWKWA0174GI

BCM (BODY CONTROL MODULE)

< ECU DIAGNOSIS >

[SEDAN]

M : WITH M/T
VT : WITH CVT
 : DATA LINE

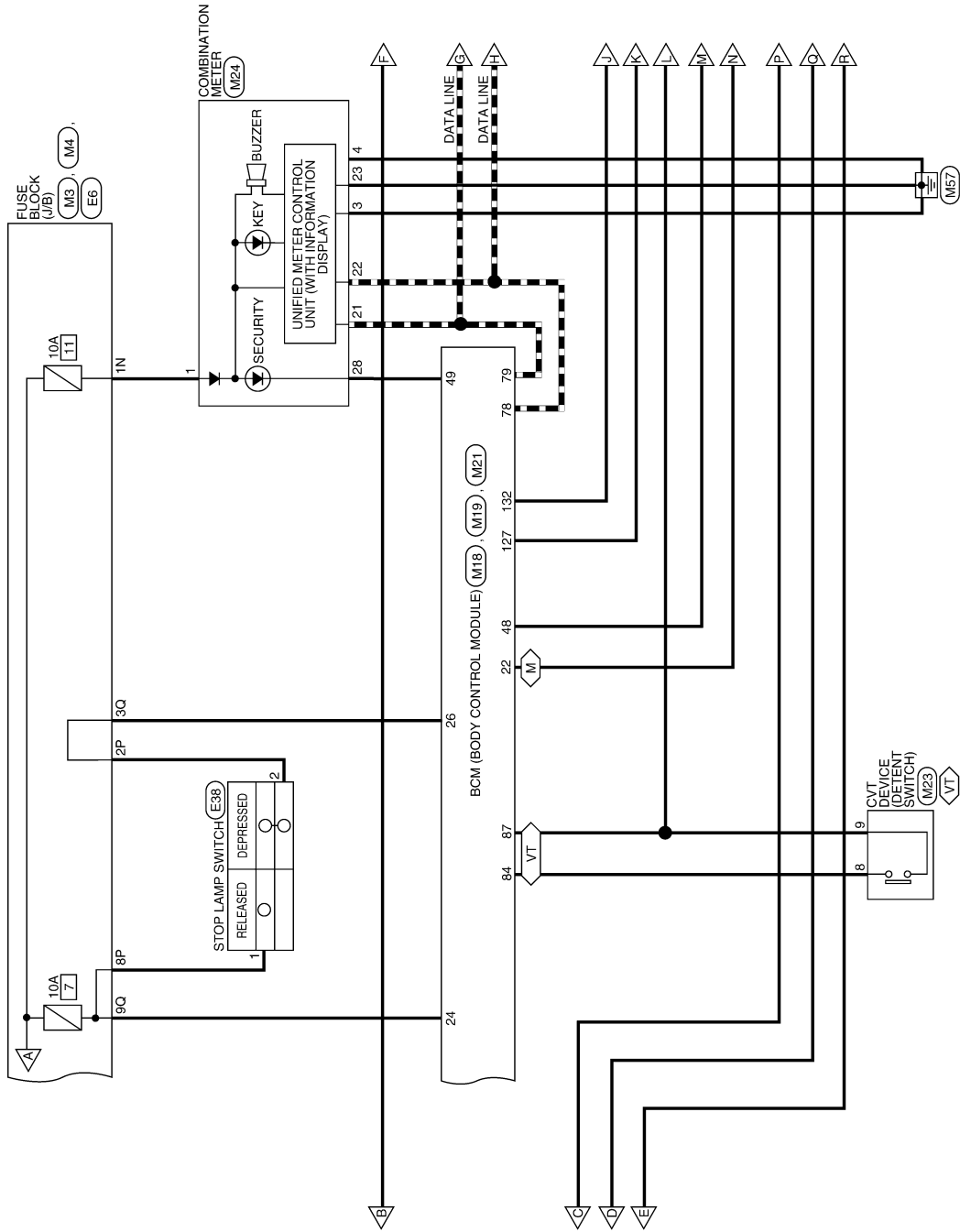

AWKWA0175GI

A
B
C
D
E
F
G
H
I
J
K
L
M
N
O
P

SEC

BCM (BODY CONTROL MODULE)

< ECU DIAGNOSIS >

[SEDAN]

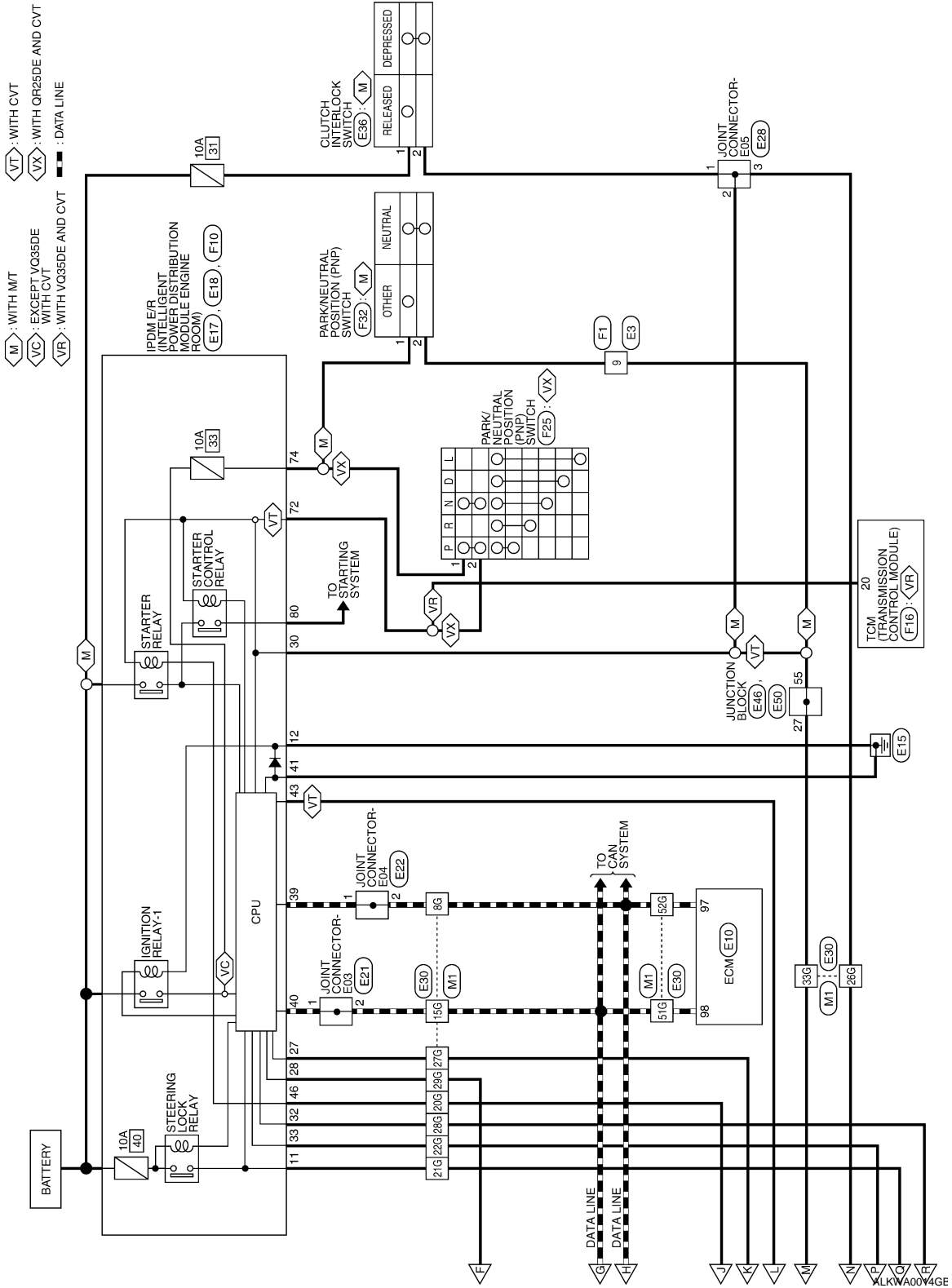

BCM (BODY CONTROL MODULE)

< ECU DIAGNOSIS >

[SEDAN]

Terminal No.	Color of Wire	Signal Name
77	BR	ENG_START_SW
78	P	CAN-L
79	L	CAN-H
80	R/L	FOB SLOT ILLUMINATION
81	LG	IGN_ON_LED
84	Y/R	AT_DEVICE_OUT
85	L/O	S/L_CONDITION_1
86	G/R	S/L_CONDITION_2
87	G/B	SHIFT_P
94	G/Y	S/L_POWER_SUPPLY_12V
99	L/Y	S/L_K-LINE

Connector No.	M19
Connector Name	BCM (BODY CONTROL MODULE)
Connector Color	BLACK

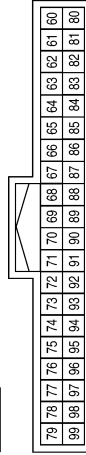

Terminal No.	Color of Wire	Signal Name
68	G/O	FOB_READER_CLOCK
69	O	FOB_READER_DATA

Connector No.	M18
Connector Name	BCM (BODY CONTROL MODULE)
Connector Color	GREEN

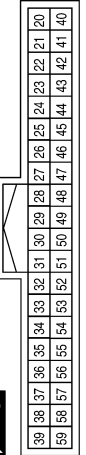

Terminal No.	Color of Wire	Signal Name
22	R/Y	CLUTCH_SW
24	R/W	STOP_LAMP_LOW_SW
26	O/L	STOP_LAMP_HIGH_SW
29	Y	FOB_IN_SW_1
42	R	S/L_LOCK_LED
48	R/G	SHIFT_N/P
49	L/O	IMMO_LED

Connector No.	M21
Connector Name	BCM (BODY CONTROL MODULE)
Connector Color	GRAY

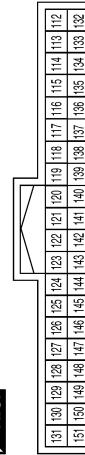

Terminal No.	Color of Wire	Signal Name
127	BR/W	IGN_USM_CONTT1
132	R	ST_CONT_USM

Connector No.	M23
Connector Name	CVT DEVICE
Connector Color	WHITE



Terminal No.	Color of Wire	Signal Name
8	Y/R	DETENT_KEY_SW
9	G/B	DETENT_KEY_SW

AWKIA0421GB

BCM (BODY CONTROL MODULE)

< ECU DIAGNOSIS >

[SEDAN]

Connector No.	M32
Connector Name	ELECTRONIC STEERING COLUMN LOCK
Connector Color	WHITE

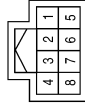

Terminal No.	Color of Wire	Signal Name
1	P/L	S/L_12V_MECHANICAL
2	L/Y	S/L_COM
3	L/O	S/L_CONDITION_1
5	B	GND
6	B	GND
7	G/Y	S/L_12V_CPU (V2)
8	G/R	S/L_CONDITION_2

Terminal No.	Color of Wire	Signal Name
1	W/L	BAT
3	B	GND
4	B	GND
14	V/Y	ACC
21	L	CAN-H
22	P	CAN-L
23	B	GND
28	L/O	SECURITY

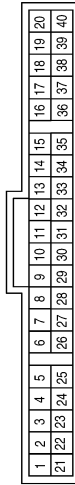

Connector No.	M24
Connector Name	COMBINATION METER
Connector Color	WHITE

Connector No.	E3
Connector Name	WIRE TO WIRE
Connector Color	WHITE



Terminal No.	Color of Wire	Signal Name
9	R/B	-

Connector No.	M40
Connector Name	KEY SLOT
Connector Color	WHITE

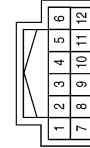

Terminal No.	Color of Wire	Signal Name
1	G/Y	B+
2	G/O	CLOCK
3	O	DATA
5	G/Y	LIGHT_BAT+
6	R/L	LIGHT_A
7	B	GND
11	Y	CARD_SW_1

Connector No.	M38
Connector Name	PUSH-BUTTON IGNITION SWITCH
Connector Color	BROWN



Terminal No.	Color of Wire	Signal Name
1	B	GND
4	BR	START_SW
5	R	LOCK
6	Y/L	ACC
7	LG	ON
8	G/Y	B+

AWKIA0416GB

A
B
C
D
E
F
G
H
I
J
K
L
M
N
O
P

SEC

BCM (BODY CONTROL MODULE)

< ECU DIAGNOSIS >

[SEDAN]

Connector No.	E6
Connector Name	FUSE BLOCK (J/B)
Connector Color	WHITE



Terminal No.	Color of Wire	Signal Name
2P	R/G	-
8P	Y/R	-

Connector No.	E10
Connector Name	ECM
Connector Color	BLACK

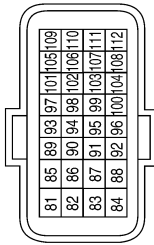

Terminal No.	Color of Wire	Signal Name
97	P	CAN-L
98	L	CAN-H

Connector No.	E17
Connector Name	IPDM E/R (INTELLIGENT POWER DISTRIBUTION MODULE ENGINE ROOM)
Connector Color	WHITE



Terminal No.	Color of Wire	Signal Name
39	P	CAN-L
40	L	CAN-H
41	B	S-GND
43	G/B	DETENT_SW
46	R	START_CONT

Connector No.	E18
Connector Name	IPDM E/R (INTELLIGENT POWER DISTRIBUTION MODULE ENGINE ROOM)
Connector Color	WHITE

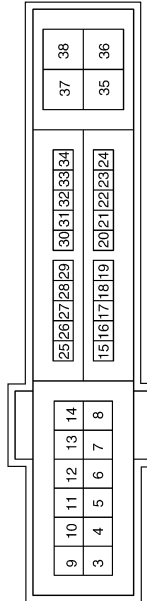

Terminal No.	Color of Wire	Signal Name
11	P/L	ESCL
12	B	P_GND
27	BR/W	IGN_SIGNAL
28	BR	PUSH_START_SW
30	R/B	CLUTCH_I/L_SW
32	L/O	SL_CONDITION_1
33	G/R	SL_CONDITION_2

Connector No.	E21
Connector Name	JOINT CONNECTOR-E03
Connector Color	WHITE



Terminal No.	Color of Wire	Signal Name
1	L	-
2	L	-

ALKIA0144GB

BCM (BODY CONTROL MODULE)

< ECU DIAGNOSIS >

[SEDAN]

Connector No.	E28
Connector Name	JOINT CONNECTOR-E05
Connector Color	BLACK



Terminal No.	Color of Wire	Signal Name
1	R/B	-
2	R/B	-
3	R/B	-

Connector No.	E22
Connector Name	JOINT CONNECTOR-E04
Connector Color	WHITE

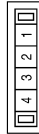

Terminal No.	Color of Wire	Signal Name
1	P	-
2	P	-

Terminal No.	Color of Wire	Signal Name
8G	P	-
15G	L	-
20G	R	-
21G	P/L	-
22G	G/R	-
26G	R/B	-
27G	BR/W	-
28G	L/O	-
29G	BR	-
33G	R/G	-
51G	L	-
52G	P	-
82G	W/B	-

Connector No.	E30
Connector Name	WIRE TO WIRE (WITH M/T)
Connector Color	WHITE

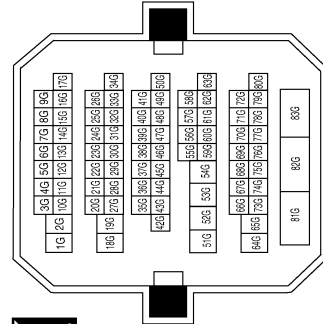

AWKIA0417GB

A
B
C
D
E
F
G
H
I
J
K
L
M
N
O
P

SEC

BCM (BODY CONTROL MODULE)

< ECU DIAGNOSIS >

[SEDAN]

Connector No.	E30
Connector Name	WIRE TO WIRE (WITH A/T)
Connector Color	WHITE

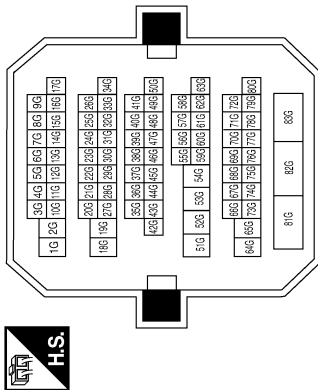

Terminal No.	Color of Wire	Signal Name
8G	P	-
15G	L	-
20G	R	-
21G	P/L	-
22G	W	-
26G	R/B	-
27G	BR/W	-
28G	LG	-
29G	BR	-
33G	R/G	-
51G	L	-
52G	P	-
82G	W/B	-

Connector No.	E36
Connector Name	CLUTCH INTERLOCK SWITCH
Connector Color	BROWN



Terminal No.	Color of Wire	Signal Name
1	G/W	-
2	R/B	-

Connector No.	E38 (WITH CVT)
Connector Name	STOP LAMP SWITCH
Connector Color	WHITE



Terminal No.	Color of Wire	Signal Name
1	Y/R	B+
2	R/G	HIGH_SW

Connector No.	E38 (WITH M/T)
Connector Name	STOP LAMP SWITCH
Connector Color	BLACK



Terminal No.	Color of Wire	Signal Name
1	Y/R	B+
2	R/G	HIGH_SW

Connector No.	E46
Connector Name	JUNCTION BLOCK
Connector Color	WHITE

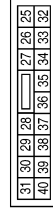

Terminal No.	Color of Wire	Signal Name
27	R/G	-

BCM (BODY CONTROL MODULE)

< ECU DIAGNOSIS >

[SEDAN]

Connector No.	F10
Connector Name	IPDM E/R (INTELLIGENT POWER DISTRIBUTION MODULE ENGINE ROOM)
Connector Color	WHITE

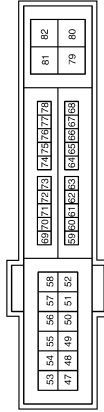

Terminal No.	Color of Wire	Signal Name
72	R/B	NPSW
74	Y	START_IG-EGI
80	B/W	STARTER_MOTOR

Connector No.	F1
Connector Name	WIRE TO WIRE
Connector Color	WHITE

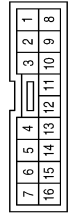

Terminal No.	Color of Wire	Signal Name
9	R/B	-

Connector No.	E50
Connector Name	JUNCTION BLOCK
Connector Color	WHITE



Terminal No.	Color of Wire	Signal Name
55	R/B	-

Connector No.	F32
Connector Name	PARK/NEUTRAL POSITION (PNP) SWITCH
Connector Color	BLACK



Terminal No.	Color of Wire	Signal Name
1	Y	-
2	R/B	-

Connector No.	F25
Connector Name	PARK/NEUTRAL POSITION (PNP) SWITCH
Connector Color	BLACK

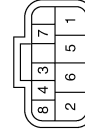

Terminal No.	Color of Wire	Signal Name
1	Y	NPSW
2	R/B	START_IG-EGI

Connector No.	F16
Connector Name	TCM (TRANSMISSION CONTROL MODULE)
Connector Color	BLACK

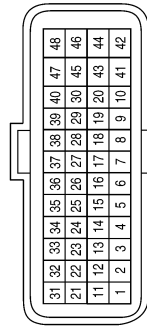

Terminal No.	Color of Wire	Signal Name
20	R/B	ST_RLY

Fail Safe

AWKIA0420GB

INFOID:000000003185533

Display contents of CONSULT	Fail-safe	Cancellation
B2013: ID DISCORD BCM-S/L	Inhibit engine cranking	Erase DTC
B2014: CHAIN OF S/L-BCM	Inhibit engine cranking	Erase DTC
B2190: NATS ANTenna AMP	Inhibit engine cranking	Erase DTC

A
B
C
D
E
F
G
H
I
J
K
L
M
N
O
P

SEC

BCM (BODY CONTROL MODULE)

< ECU DIAGNOSIS >

[SEDAN]

Display contents of CONSULT	Fail-safe	Cancellation
B2191: DIFFERENCE OF KEY	Inhibit engine cranking	Erase DTC
B2192: ID DISCORD BCM-ECM	Inhibit engine cranking	Erase DTC
B2193: CHAIN OF BCM-ECM	Inhibit engine cranking	Erase DTC
B2195: ANTI-SCANNING	Inhibit engine cranking	Erase DTC
B2197: BCM-ENG-ST ID NG	Inhibit engine cranking	Erase DTC
B2557: VEHICLE SPEED	Inhibit electronic steering column lock	When normal vehicle speed signals have been received from ABS actuator and electric unit (control unit) for 500 ms
B2560: STARTER CONT RELAY	Inhibit engine cranking	500 ms after the following CAN signal communication status has become consistent <ul style="list-style-type: none"> • Starter control relay signal • Starter relay status signal
B2562: LO VOLTAGE	<ul style="list-style-type: none"> • Inhibit engine cranking • Inhibit electronic steering column lock 	100 ms after the power supply voltage increases to more than 8.8 V
B2563: HI VOLTAGE	<ul style="list-style-type: none"> • Inhibit engine cranking • Inhibit electronic steering column lock 	500 ms after the power supply voltage decreases to less than 18 V
B2601: SHIFT POSITION	Inhibit electronic steering column lock	500 ms after the following signal reception status becomes consistent <ul style="list-style-type: none"> • Selector lever P position switch signal • P range signal (CAN)
B2602: SHIFT POSITION	Inhibit electronic steering column lock	5 seconds after the following BCM recognition conditions are fulfilled <ul style="list-style-type: none"> • Ignition switch is in the ON position • Selector lever P position switch signal: Except P position (battery voltage) • Vehicle speed: 4 /h or more
B2603: SHIFT POSI STATUS	Inhibit electronic steering column lock	500 ms after the following BCM recognition conditions are fulfilled <ul style="list-style-type: none"> • Ignition switch is in the ON position • Selector lever P position switch signal: Except P position (battery voltage) • Selector lever P/N position signal: Except P and N positions (0 V)
B2604: PNP SW	Inhibit electronic steering column lock	500 ms after any of the following BCM recognition conditions is fulfilled <ul style="list-style-type: none"> • Status 1 <ul style="list-style-type: none"> - Ignition switch is in the ON position - Selector lever P/N position signal: P and N position (battery voltage) - P range signal or N range signal (CAN): ON • Status 2 <ul style="list-style-type: none"> - Ignition switch is in the ON position - Selector lever P/N position signal: Except P and N positions (0 V) - P range signal and N range signal (CAN): OFF
B2605: PNP SW	Inhibit electronic steering column lock	500 ms after any of the following BCM recognition conditions is fulfilled <ul style="list-style-type: none"> • Ignition switch is in the ON position <ul style="list-style-type: none"> - Power position: IGN - Selector lever P/N position signal: Except P and N positions (0 V) - Interlock/PNP switch signal (CAN): OFF • Status 2 <ul style="list-style-type: none"> - Ignition switch is in the ON position - Selector lever P/N position signal: P or N position (battery voltage) - PNP switch signal (CAN): ON
B2606: S/L RELAY	Inhibit engine cranking	500 ms after the following CAN signal communication status has become consistent <ul style="list-style-type: none"> • Electronic steering column lock relay signal (Request signal) • Electronic steering column lock relay signal (Condition signal)

BCM (BODY CONTROL MODULE)

< ECU DIAGNOSIS >

[SEDAN]

Display contents of CONSULT	Fail-safe	Cancellation
B2607: S/L RELAY	Inhibit engine cranking	500 ms after the following CAN signal communication status has become consistent <ul style="list-style-type: none"> Electronic steering column lock relay signal (Request signal) Electronic steering column lock relay signal (Condition signal)
B2608: STARTER RELAY	Inhibit engine cranking	500 ms after the following signal communication status becomes consistent <ul style="list-style-type: none"> Starter motor relay control signal Starter relay status signal (CAN)
B2609: S/L STATUS	<ul style="list-style-type: none"> Inhibit engine cranking Inhibit electronic steering column lock 	When the following electronic steering column lock conditions agree <ul style="list-style-type: none"> BCM electronic steering column lock control status Electronic steering column lock condition No. 1 signal status Electronic steering column lock condition No. 2 signal status
B260A: IGNITION RELAY	Inhibit engine cranking	500 ms after the following conditions are fulfilled <ul style="list-style-type: none"> IGN relay (IPDM E/R) control signal: OFF (Battery voltage) Ignition ON signal (CAN to IPDM E/R): OFF (Request signal) Ignition ON signal (CAN from IPDM E/R): OFF (Condition signal)
B260F: ENG STATE SIG LOST	Maintains the power supply position attained at the time of DTC detection	When any of the following conditions is fulfilled <ul style="list-style-type: none"> Power position changes to ACC Receives engine status signal (CAN)
B2612: S/L STATUS	<ul style="list-style-type: none"> Inhibit engine cranking Inhibit electronic steering column lock 	When any of the following conditions is fulfilled <ul style="list-style-type: none"> Electronic steering column lock unit status signal (CAN) is received normally The BCM electronic steering column lock control status matches the electronic steering column lock status recognized by the electronic steering column lock unit status signal (CAN from IPDM E/R)
B2617: STARTER RELAY CIRC	Inhibit engine cranking	1 second after the starter motor relay control inside BCM becomes normal
B2618: BCM	Inhibit engine cranking	1 second after the ignition relay (IPDM E/R) control inside BCM becomes normal
B2619: BCM	Inhibit engine cranking	1 second after the electronic steering column lock unit power supply output control inside BCM becomes normal
B261E: VEHICLE TYPE	Inhibit engine cranking	BCM initialization
B26E1: ENG STATE NO RECIV	Inhibit engine cranking	When any of the following conditions is fulfilled <ul style="list-style-type: none"> Power position changes to ACC Receives engine status signal (CAN)

DTC Inspection Priority Chart

INFOID:000000003185534

If some DTCs are displayed at the same time, perform inspections one by one based on the following priority chart.

Priority	DTC
1	<ul style="list-style-type: none"> B2562: LOW VOLTAGE B2563: HI VOLTAGE B261E: VEHICLE TYPE
2	<ul style="list-style-type: none"> U1000: CAN COMM CIRCUIT U1010: CONTROL UNIT (CAN)
3	<ul style="list-style-type: none"> B2190: NATS ANTENA AMP B2191: DIFFERENCE OF KEY B2192: ID DISCORD BCM-ECM B2193: CHAIN OF BCM-ECM

BCM (BODY CONTROL MODULE)

< ECU DIAGNOSIS >

[SEDAN]

Priority	DTC
4	<ul style="list-style-type: none"> • B2013: ID DISCORD BCM-S/L • B2014: CHAIN OF S/L-BCM • B2553: IGNITION RELAY • B2555: STOP LAMP • B2556: PUSH-BTN IGN SW • B2557: VEHICLE SPEED • B2560: STARTER CONT RELAY • B2601: SHIFT POSITION • B2602: SHIFT POSITION • B2603: SHIFT POSI STATUS • B2604: PNP SW • B2605: PNP SW • B2606: S/L RELAY • B2607: S/L RELAY • B2608: STARTER RELAY • B2609: S/L STATUS • B260A: IGNITION RELAY • B260B: STEERING LOCK UNIT • B260C: STEERING LOCK UNIT • B260D: STEERING LOCK UNIT • B260F: ENG STATE SIG LOST • B2611: ACC RELAY • B2612: S/L STATUS • B2614: ACC RELAY CIRC • B2615: BLOWER RELAY CIRC • B2616: IGN RELAY CIRC • B2617: STARTER RELAY CIRC • B2618: BCM • B2619: BCM • B261A: PUSH-BTN IGN SW • B26E1: ENG STATE NO RECIV • C1729: VHCL SPEED SIG ERR • U0415: VEHICLE SPEED SIG
5	<ul style="list-style-type: none"> • C1704: LOW PRESSURE FL • C1705: LOW PRESSURE FR • C1706: LOW PRESSURE RR • C1707: LOW PRESSURE RL • C1708: [NO DATA] FL • C1709: [NO DATA] FR • C1710: [NO DATA] RR • C1711: [NO DATA] RL • C1712: [CHECKSUM ERR] FL • C1713: [CHECKSUM ERR] FR • C1714: [CHECKSUM ERR] RR • C1715: [CHECKSUM ERR] RL • C1716: [PRESSDATA ERR] FL • C1717: [PRESSDATA ERR] FR • C1718: [PRESSDATA ERR] RR • C1719: [PRESSDATA ERR] RL • C1720: [CODE ERR] FL • C1721: [CODE ERR] FR • C1722: [CODE ERR] RR • C1723: [CODE ERR] RL • C1724: [BATT VOLT LOW] FL • C1725: [BATT VOLT LOW] FR • C1726: [BATT VOLT LOW] RR • C1727: [BATT VOLT LOW] RL • C1734: CONTROL UNIT
6	<ul style="list-style-type: none"> • B2621: INSIDE ANTENNA • B2622: INSIDE ANTENNA • B2623: INSIDE ANTENNA

BCM (BODY CONTROL MODULE)

< ECU DIAGNOSIS >

[SEDAN]

DTC Index

INFOID:000000003185535

NOTE:

- Details of time display
- CRNT: Displays when there is a malfunction now or after returning to the normal condition until turning ignition switch OFF → ON again.
- 1 - 39: Displayed if any previous malfunction is present when current condition is normal. It increases like 1 → 2 → 3...38 → 39 after returning to the normal condition whenever ignition switch OFF → ON. The counter remains at 39 even if the number of cycles exceeds it. It is counted from 1 again when turning ignition switch OFF → ON after returning to the normal condition if the malfunction is detected again.

CONSULT display	Fail-safe	Intelligent Key warning lamp ON	Tire pressure monitor warning lamp ON	Reference page
No DTC is detected. further testing may be required.	—	—	—	—
U1000: CAN COMM CIRCUIT	—	—	—	SEC-207
U1010: CONTROL UNIT (CAN)	—	—	—	SEC-208
U0415: VEHICLE SPEED SIG	—	—	—	BCS-33
B2013: ID DISCORD BCM-S/L	×	—	—	SEC-209
B2014: CHAIN OF S/L-BCM	×	—	—	SEC-210
B2190: NATS ANTENA AMP	×	—	—	SEC-214
B2191: DIFFERENCE OF KEY	×	—	—	SEC-218
B2192: ID DISCORD BCM-ECM	×	—	—	SEC-219
B2193: CHAIN OF BCM-ECM	×	—	—	SEC-220
B2553: IGNITION RELAY	—	—	—	PCS-56
B2555: STOP LAMP	—	—	—	SEC-221
B2556: PUSH-BTN IGN SW	—	×	—	SEC-224
B2557: VEHICLE SPEED	×	×	—	SEC-226
B2560: STARTER CONT RELAY	×	×	—	SEC-227
B2562: LOW VOLTAGE	—	—	—	BCS-34
B2563: HI VOLTAGE	×	×	—	BCS-35
B2601: SHIFT POSITION	×	×	—	SEC-228
B2602: SHIFT POSITION	×	×	—	SEC-232
B2603: SHIFT POSI STATUS	×	×	—	SEC-235
B2604: PNP SW	×	×	—	SEC-239
B2605: PNP SW	×	×	—	SEC-241
B2606: S/L RELAY	×	×	—	SEC-243
B2607: S/L RELAY	×	×	—	SEC-244
B2608: STARTER RELAY	×	×	—	SEC-246
B2609: S/L STATUS	×	×	—	SEC-248
B260A: IGNITION RELAY	×	×	—	PCS-58
B260B: STEERING LOCK UNIT	—	×	—	SEC-253
B260C: STEERING LOCK UNIT	—	×	—	SEC-254
B260D: STEERING LOCK UNIT	—	×	—	SEC-255
B260F: ENG STATE SIG LOST	×	×	—	SEC-256
B2611: ACC RELAY	—	—	—	PCS-59
B2612: S/L STATUS	×	×	—	SEC-258

BCM (BODY CONTROL MODULE)

< ECU DIAGNOSIS >

[SEDAN]

CONSULT display	Fail-safe	Intelligent Key warning lamp ON	Tire pressure monitor warning lamp ON	Reference page
B2614: ACC RELAY CIRC	—	×	—	PCS-61
B2615: BLOWER RELAY CIRC	—	×	—	PCS-64
B2616: IGN RELAY CIRC	—	×	—	PCS-67
B2617: STARTER RELAY CIRC	×	×	—	SEC-263
B2618: BCM	×	×	—	PCS-70
B2619: BCM	×	×	—	SEC-265
B261A: PUSH-BTN IGN SW	—	×	—	SEC-266
B261E: VEHICLE TYPE	×	× (Turn ON for 15 seconds)	—	SEC-269
B2621: INSIDE ANTENNA	—	—	—	DLK-242
B2622: INSIDE ANTENNA	—	—	—	DLK-245
B2623: INSIDE ANTENNA	—	—	—	DLK-248
B26E1: ENG STATE NO RES	×	×	—	SEC-257
C1704: LOW PRESSURE FL	—	—	×	WT-8
C1705: LOW PRESSURE FR	—	—	×	WT-8
C1706: LOW PRESSURE RR	—	—	×	WT-8
C1707: LOW PRESSURE RL	—	—	×	WT-8
C1708: [NO DATA] FL	—	—	×	WT-13
C1709: [NO DATA] FR	—	—	×	WT-13
C1710: [NO DATA] RR	—	—	×	WT-13
C1711: [NO DATA] RL	—	—	×	WT-13
C1712: [CHECKSUM ERR] FL	—	—	×	WT-14
C1713: [CHECKSUM ERR] FR	—	—	×	WT-14
C1714: [CHECKSUM ERR] RR	—	—	×	WT-14
C1715: [CHECKSUM ERR] RL	—	—	×	WT-14
C1716: [PRESSDATA ERR] FL	—	—	×	WT-15
C1717: [PRESSDATA ERR] FR	—	—	×	WT-15
C1718: [PRESSDATA ERR] RR	—	—	×	WT-15
C1719: [PRESSDATA ERR] RL	—	—	×	WT-15
C1720: [CODE ERR] FL	—	—	×	WT-14
C1721: [CODE ERR] FR	—	—	×	WT-14
C1722: [CODE ERR] RR	—	—	×	WT-14
C1723: [CODE ERR] RL	—	—	×	WT-14
C1724: [BATT VOLT LOW] FL	—	—	×	WT-14
C1725: [BATT VOLT LOW] FR	—	—	×	WT-14
C1726: [BATT VOLT LOW] RR	—	—	×	WT-14
C1727: [BATT VOLT LOW] RL	—	—	×	WT-14
C1729: VHCL SPEED SIG ERR	—	—	×	WT-16

IPDM E/R (INTELLIGENT POWER DISTRIBUTION MODULE ENGINE ROOM)

< ECU DIAGNOSIS >

[SEDAN]

IPDM E/R (INTELLIGENT POWER DISTRIBUTION MODULE ENGINE ROOM)

Reference Value

INFOID:000000003185536

Refer to [PCS-79, "Reference Value"](#).

TERMINAL LAYOUT

Refer to [PCS-79, "Reference Value"](#).

PHYSICAL VALUES

Refer to [PCS-79, "Reference Value"](#).

Fail Safe

INFOID:000000003185537

Refer to [PCS-91, "Fail Safe"](#).

DTC Index

INFOID:000000003185538

Refer to [PCS-91, "DTC Index"](#).

A
B
C
D
E
F
G
H
I
J
L
M
N
O
P

SEC

INTELLIGENT KEY SYSTEM/ENGINE START FUNCTION SYMPTOMS

< SYMPTOM DIAGNOSIS >

[SEDAN]

SYMPTOM DIAGNOSIS

INTELLIGENT KEY SYSTEM/ENGINE START FUNCTION SYMPTOMS

Symptom Table

INFOID:000000003185539

Engine can not be started with all Intelligent Keys.

CAUTION:

- Follow Trouble Diagnosis Flowchart referring to “[SEC-183, "Work Flow"](#)”. Determine malfunctioning condition before performing this diagnosis.
- Check that vehicle is under the condition shown in “Conditions of vehicle” before starting diagnosis.
- Check systems shown in the “Diagnosis/service procedure” column in this order.

CONDITIONS OF VEHICLE (OPERATING CONDITIONS)

- Engine start function is ON when setting on CONSULT-III.
- Use Intelligent Key with registered Intelligent Key ID.
- One or more of Intelligent Keys with registered Intelligent Key ID is in the passenger compartment.

Diagnosis/service procedure		Reference page
1. Check power supply and ground circuit	BCM	BCS-36
	IPDM E/R	PCS-19
2. Check push button ignition switch		SEC-266
3. Check Intermittent Incident		GI-42

VEHICLE SECURITY SYSTEM SYMPTOMS

< SYMPTOM DIAGNOSIS >

[SEDAN]

VEHICLE SECURITY SYSTEM SYMPTOMS

Symptom Table

INFOID:000000003185540

Procedure		Diagnostic procedure	Refer to page
Symptom			
1	Vehicle security system cannot be set by	Door switch	Check door switch DLK-252
		Trunk	Check trunk room lamp switch DLK-283
		Door outside key	Check key cylinder switch DLK-269
		Intelligent Key	Check Intelligent Key. DLK-315
	—	Check Intermittent Incident GI-42	
Security indicator does not turn ON.		Check vehicle security indicator SEC-310	
		Check Intermittent Incident GI-42	
2	* Vehicle security system does not sound alarm when	Any door is opened.	Check door switch DLK-252
			Check Intermittent Incident GI-42
3	Vehicle security alarm does not activate.	Horn alarm	Check horn DLK-320
			Check Intermittent Incident GI-42
	Head lamp alarm	Check head lamp alarm SEC-308	
		Check Intermittent Incident GI-42	
4	Vehicle security system cannot be canceled by	Door outside key	Check key cylinder switch SEC-301
			Check Intermittent Incident GI-42
	Intelligent Key	Check Intelligent Key DLK-315	
		Check Intermittent Incident GI-42	

*: Check the system is in the armed phase.

A
B
C
D
E
F
G
H
I
J
L
M
N
O
P

SEC

NISSAN VEHICLE IMMOBILIZER SYSTEM-NATS SYMPTOMS

< SYMPTOM DIAGNOSIS >

[SEDAN]

NISSAN VEHICLE IMMOBILIZER SYSTEM-NATS SYMPTOMS

Symptom Table

INFOID:000000003185541

Security indicator does not turn ON or flash.

CAUTION:

- Follow Trouble Diagnosis Flowchart referring to “[SEC-183, "Work Flow"](#)”. Determine malfunctioning condition before performing this diagnosis.
- Check that vehicle is under the condition shown in “Conditions of vehicle” before starting diagnosis.
- Check systems shown in the “Action” column in this order.

CONDITIONS OF VEHICLE (OPERATING CONDITIONS)

- Intelligent Key is not inserted into key slot.
- Engine switch is not depressed.

Action	Reference page
1. Check vehicle security indicator	SEC-310
2. Check Intermittent Incident	GI-42

ON-VEHICLE MAINTENANCE

PRE-INSPECTION FOR DIAGNOSTIC

Basic Inspection

INFOID:000000003185542

The engine start function, door lock function, power distribution system and NATS-IVIS/NMS in the Intelligent Key system are closely related to each other regarding control. Narrow down the functional area in question by performing basic inspection to identify which function is malfunctioning. The vehicle security function can operate only when the door lock and power distribution system are operating normally. Therefore, it is easy to identify any factor unique to the vehicle security system by performing the vehicle security operation check after basic inspection.

1. CHECK DOOR LOCK OPERATION

1. Check the door lock for normal operation with the Intelligent Key controller and door request switch. Successful door lock operation with the Intelligent Key and request SW indicates that the remote keyless entry receiver is functioning normally. Identify the malfunctioning point by referring to the DLK section if the door cannot be unlocked.

Can the door be locked with the Intelligent Key and door request switch?

YES >> GO TO 2.

NO >> Refer to [DLK-368, "INTELLIGENT KEY : Symptom Table"](#).

2. CHECK ENGINE STARTING

1. Checks that the engine starts when operating the Intelligent Key inserted into the key slot.

Does the engine start?

YES >> GO TO 3.

NO >> Refer to [SEC-352, "Symptom Table"](#).

3. CHECK STEERING LOCKING

1. Does the steering lock when operating door switch after switching the power supply from ON position (or ACC position) to LOCK position?
If door switch is malfunctioning, BCM cannot lock the steering. If BCM does not detect DTC, steering lock unit is normal.

Does steering lock?

YES >> GO TO 4.

NO >> Refer to [DLK-252, "Component Function Check"](#).

4. CHECK POWER SUPPLY INDICATOR SWITCHING

1. Press push-button ignition switch and position indicator will switch from LOCK, ACC to ON gradually when steering is locked. Checks that the position indicator is illuminated at different positions of the circuit.

Is each position indicator illuminating?

YES >> GO TO 5.

NO >> Refer to [SEC-266, "Description"](#).

5. CHECK VEHICLE SECURITY SYSTEM

1. Check the vehicle security system for normal operation.
The vehicle security function can operate only when the door lock and power distribution functions are operating normally. Therefore, it is easy to identify any factor unique to the vehicle security by performing the vehicle security operation check after this basic inspection.

>> Go to [SEC-355, "Vehicle Security Operation Check"](#).

Vehicle Security Operation Check

INFOID:000000003185543

1. INSPECTION START

Turn ignition switch "OFF" and pull out Intelligent Key from key slot.

NOTE:

PRE-INSPECTION FOR DIAGNOSTIC

[SEDAN]

< ON-VEHICLE MAINTENANCE >

Before starting operation check, open front windows.

>> GO TO 2.

2. CHECK SECURITY INDICATOR LAMP

1. Lock doors using Intelligent Key or mechanical key.
2. Check that security indicator lamp illuminates for 30 seconds.

Security indicator lamp should illuminate.

OK >> GO TO 3.

NG >> Perform diagnosis and repair. Refer to [SEC-310, "Component Function Check"](#).

3. CHECK ALARM FUNCTION

1. After 30 seconds, security indicator lamp will start to blink.
2. Open any door or hood before unlocking with Intelligent Key or mechanical key, or open trunk lid without Intelligent Key or mechanical key.

Do alarm function properly.

OK >> GO TO 4.

NG >> Check the following.

- The vehicle security system does not phase in alarm mode. Refer to [SEC-353, "Symptom Table"](#).
- Alarm (horn, headlamp and hazard lamp) do not operate. Refer to [SEC-353, "Symptom Table"](#).

4. CHECK ALARM CANCEL OPERATION

Unlock any door or open trunk lid using Intelligent Key or mechanical key.

Alarm (horn, headlamp and hazard lamp) should stop.

OK >> INSPECTION END.

NG >> Check door lock function. Refer to [DLK-217, "INTELLIGENT KEY : System Description"](#).

ON-VEHICLE REPAIR

KEY SLOT

Removal and Installation

INFOID:000000003179588

REMOVAL

1. Remove the instrument lower panel LH. Refer to [IP-11. "Removal and Installation"](#).
2. Disconnect key slot connector.
3. Remove the key slot screw (A), and then remove key slot (1) from instrument lower panel LH (2).

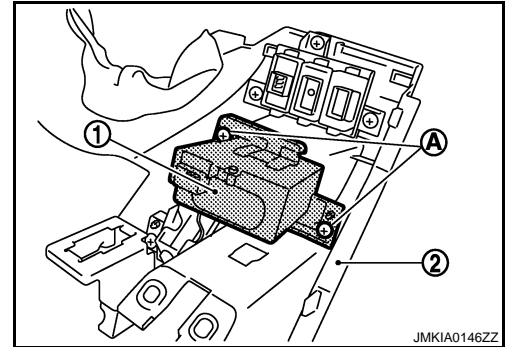

INSTALLATION

Install in the reverse order of removal.

A
B
C
D
E
F
G
H
I
J
L
M
N
O
P

SEC

PUSH BUTTON IGNITION SWITCH

< ON-VEHICLE REPAIR >

[SEDAN]

PUSH BUTTON IGNITION SWITCH

Removal and Installation

INFOID:000000003179589

REMOVAL

1. Remove the cluster lid A assembly. Refer to [IP-11, "Removal and Installation"](#).
2. Remove the push-button ignition switch (1) from cluster lid A assembly, and then remove pawl (A). Press push-button ignition switch (1) back to disengage from cluster lid A assembly.

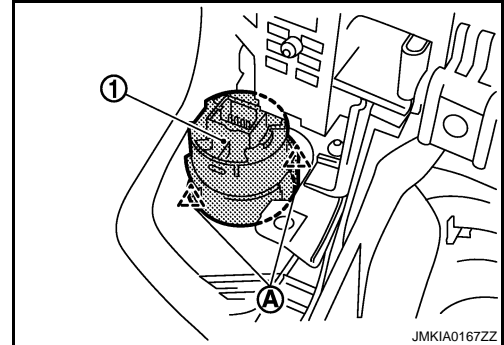

INSTALLATION

Install in the reverse order of removal.