

Mitel MiVoice 6930 IP Phone

58015128 REV03

RELEASE 1.2 USER GUIDE FOR MIVOICE BUSINESS

NOTICE

The information contained in this document is believed to be accurate in all respects but is not warranted by Mitel Networks™ Corporation (MITEL®). The information is subject to change without notice and should not be construed in any way as a commitment by Mitel or any of its affiliates or subsidiaries. Mitel and its affiliates and subsidiaries assume no responsibility for any errors or omissions in this document. Revisions of this document or new editions of it may be issued to incorporate such changes.

No part of this document can be reproduced or transmitted in any form or by any means - electronic or mechanical - for any purpose without written permission from Mitel Networks Corporation.

Trademarks

The trademarks, service marks, logos and graphics (collectively “Trademarks”) appearing on Mitel's Internet sites or in its publications are registered and unregistered trademarks of Mitel Networks Corporation (MNC) or its subsidiaries (collectively “Mitel”) or others. Use of the Trademarks is prohibited without the express consent from Mitel. Please contact our legal department at legal@mitel.com for additional information. For a list of the worldwide Mitel Networks Corporation registered trademarks, please refer to the website: <http://www.mitel.com/trademarks>.

Mitel's Power Over Ethernet (PoE) Powered Device (PD) products are covered by one or more of the U.S. patents (and any foreign patent counterparts thereto) identified at Mitel's website: www.mitel.com/patents.

For more information on the PD patents that are licensed, please refer www.cmspatents.com.

Mitel MiVoice 6930 IP Phone User Guide

58015128 - June 2017

®,™ Trademark of Mitel Networks Corporation
© Copyright 2017, Mitel Networks Corporation
All rights reserved

Software License Agreement

Mitel, hereinafter known as “Seller”, grants to Customer a personal, worldwide, non-transferable, non-sublicenseable and non-exclusive, restricted use license to use Software in object form solely with the Equipment for which the Software was intended. This Product may integrate programs, licensed to Mitel by third party Suppliers, for distribution under the terms of this agreement. These programs are confidential and proprietary, and are protected as such by copyright law as unpublished works and by international treaties to the fullest extent under the applicable law of the jurisdiction of the Customer. In addition, these confidential and proprietary programs are works conforming to the requirements of Section 401 of title 17 of the United States Code. Customer shall not disclose to any third party such confidential and proprietary programs and information and shall not export licensed Software to any country except in accordance with United States Export laws and restrictions.

Customer agrees to not reverse engineer, decompile, disassemble or display Software furnished in object code form. Customer shall not modify, copy, reproduce, distribute, transcribe, translate or reduce to electronic medium or machine readable form or language, derive source code without the express written consent of the Seller and its Suppliers, or disseminate or otherwise disclose the Software to third parties. All Software furnished hereunder (whether or not part of firmware), including all copies thereof, are and shall remain the property of Seller and its Suppliers and are subject to the terms and conditions of this agreement. All rights reserved.

Customer's use of this software shall be deemed to reflect Customer's agreement to abide by the terms and conditions contained herein. Removal or modification of trademarks, copyright notices, logos, etc., or the use of Software on any Equipment other than that for which it is intended, or any other material breach of this Agreement, shall automatically terminate this license. If this Agreement is terminated for breach, Customer shall immediately discontinue use and destroy or return to Seller all licensed software and other confidential or proprietary information of Seller. In no event shall Seller or its suppliers or licensors be liable for any damages whatsoever (including without limitation, damages for loss of business profits, business interruption, loss of business information, other pecuniary loss, or consequential damages) arising out of the use of or inability to use the software, even if Seller has been advised of the possibility of such damages.

- Software License Agreement 1
- Welcome 6
 - About this guide 6
 - Supporting documentation 6
 - Phone features 7
 - Installation and setup 7
 - Tips for your comfort and safety 7
 - Don't cradle the handset 7
 - Protect your hearing 7
 - Adjust the viewing angle 7
- Phone keys 8
 - Key panel 8
 - Key description 9
 - Dialpad keys 10
- Getting started 12
 - UI overview 12
 - Home screen 12
 - Call screen 15
 - UI navigation 16
- Customizing your phone 17
 - Using the Settings menu 18
- Status 18
- Language 20
- Call Forward 22
- Bluetooth 25
 - Enabling Bluetooth functionality 26
 - Pairing a Bluetooth device 26
 - Forgetting a Bluetooth device 28
 - Disconnecting a connected Bluetooth device 30
 - Renaming a paired Bluetooth device 31
 - Connecting to a different or disconnected Bluetooth device 32
- Audio 34
 - Ring Tones 34
 - Audio Path 34
 - Headset 36
- Display 37
- Config Teleworker 38
- Diagnostics 38

Audio Diagnostics	39
Ping	40
TCP DUMP	41
DHCP Trace	42
Restart	44
Configuring and using programmable keys	45
Speed Call	46
Other Features	46
Phone Lock	46
Call Forward Always	48
Do Not Disturb	50
Mobile Line	51
Account codes	52
Float Keys	54
Making calls	56
Dialing a number	56
Initiating a callback	56
Redialing a number	57
Receiving calls	58
Answering an incoming call	58
Manually forwarding an incoming call	58
Handling calls	60
Placing a call on hold	60
Muting the microphone	60
Transferring a call	61
Creating a multi-party conference call	62
Ending a conference and transferring remaining parties	63
Ending calls	63
Managing calls	64
Contacts	64
General functions	64
Personal folder features	68
Corporate and Mobile folder features	73
Call History	77
Deleting entries from the Call History application	78
Copying entries to the Personal folder in the Contacts application	81
Missed calls indicator	82

Voicemail	83
Visual voicemail	84
.....	84
Enabling voicemail application	84
Logging into your voicemail	85
Logging out of your voicemail	86
Playing a voicemail	86
Dialing a voicemail	87
Deleting a voicemail	88
Saving a voicemail	89
Sending voicemail to a number	89
Adding voicemail number to Contacts	90
MobileLink	92
Pairing a mobile phone using Bluetooth	93
Syncing mobile contacts	93
Syncing mobile call history	94
Viewing mobile call history	95
Viewing mobile missed calls	95
Viewing details of a mobile call history or missed call entry	96
Updating mobile call history and missed calls	97
Dialing a mobile phone call history entry	97
Adding an entry to Contacts	98
Deleting mobile call history and missed calls	99
Answering an incoming mobile call using your Mitel MiVoice 6930 IP phone	100
Moving audio from an active mobile call between your mobile phone and Mitel MiVoice 6930 IP phone	
101	
Additional features	102
Accessory support	107
Mitel M695 Programmable Key Module (PKM)	107
Mitel Wireless LAN Adapter	108
Mitel Integrated DECT Headset	109
Features	109
Using the headset	110
Charging the headset	110
Upgrading the headset	110
Checking the battery level and firmware version of the Integrated DECT Headset	111
LED status	112
Replacing the Integrated DECT Headset	112
Mitel S720 Bluetooth Speakerphone	112
Hardware features	114

Mitel Cordless Bluetooth Handset	115
Hardware features	116
LED indicator	117
Alerting tones	118
Powering on/off the Bluetooth cordless handset	118
Analog, DHSG/EHS, and USB headsets	118
Limited warranty	120
Exclusions	120
Warranty repair services	120
After warranty service	120

Welcome

The Mitel MiVoice 6930 IP phone is a premium feature-rich phone with a large color display that delivers graphically rich applications. The Mitel MiVoice 6930 IP phone provides 12 programmable self-labeling keys allowing up to 72 functions and five intuitive state sensitive softkeys.

This applications phone features superior sound quality with wideband audio, an enhanced speakerphone that utilizes advanced audio processing to achieve richer and clearer handsfree conversations, and native analog, DHSG/EHS, USB, and Bluetooth headset functionality.

The Mitel MiVoice 6930 IP phone supports MobileLink, a feature that provides seamless mobile integration using Bluetooth wireless technology. MobileLink highlights include the ability to:

- Answer a mobile phone call using your Mitel MiVoice 6930 IP phone.
- Effortlessly move mobile call audio between the Mitel MiVoice 6930 IP phone and your mobile phone.
- Sync your mobile phone's contact list with your Mitel MiVoice 6930 IP phone.

Accommodating today's high speed networks through dual Gigabit Ethernet ports, the Mitel MiVoice 6930 IP phone also offers plenty of support for Mitel and third-party peripherals and has an environmentally efficient PoE class 3 rating. The Mitel MiVoice 6930 IP phone is one of the most advanced desktop IP phones available on the market today and is ideal for any enterprise executive or manager, Teleworker, and Contact Center employee.

The 6930 IP phone is compatible with the MiVoice Business phone system.

About this guide

This guide explains how to use the basic features of your new Mitel MiVoice 6930 IP phone. Not all features listed are available by default. Your System Administrator has the ability to customize many features on this phone. Contact your System Administrator to find out which features and services are available to you on your phone system.

Supporting documentation

To access phone and system-specific documentation:

1. Log in to [Mitel Connect](#).
2. In the left-hand menu, click **Mitel OnLine**.
3. Click **Product Documentation** under the **Support** section.
4. Select **PDF Guides and Online Help** under the **End User Documents** drop-down menu.
5. In the left-hand menu, navigate to **Telephones**.

Phone features

Feature highlights include:

- 4.3" WQVGA (480x272) color TFT LCD display with brightness controls
- Built-in-two-port, 10/100/1000 Gigabit Ethernet switch
- Embedded Bluetooth 4.0
- USB 2.0 port (500mA maximum)
- Wideband handset
- Enhanced wideband, full-duplex speakerphone for handsfree calls
- Extensive support for peripherals and modules: Mitel S720 Bluetooth Speakerphone, Mitel Cordless Bluetooth Handset, Mitel Integrated DECT, Bluetooth, USB, DHS/G/EHS, and wired analog headsets, M695 Color Programmable Key Module (PKM), and Mitel Wireless LAN Adapter
- AC power adapter (sold separately)
- 12 programmable, multi-function, self-labeling keys allowing up to 72 functions and five intuitive state sensitive softkeys
- MobileLink support - seamless mobile integration using Bluetooth wireless technology

Installation and setup

Please refer to the *Mitel MiVoice 6930 IP Phone Installation Guide* included with your phone for basic installation and physical setup information.

Tips for your comfort and safety

Don't cradle the handset

Prolonged use of the handset can lead to neck, shoulder, or back discomfort, especially if you cradle the handset between your ear and shoulder. If you use your phone a lot, you may find it more comfortable to use a headset. See "[Accessory support](#)" on [page 107](#) for more information on headsets.

Protect your hearing

Your Mitel MiVoice 6930 IP phone has a control for adjusting the volume of the handset, headset, and speakerphone. Because continuous exposure to loud sounds can contribute to hearing loss, keep the volume at a moderate level.

Adjust the viewing angle

The stand for your Mitel MiVoice 6930 IP phone supports two viewing angles (30° and 60°). Adjust the stand to suit your viewing preference. For instructions on how to adjust the stand, see the *Mitel MiVoice 6930 IP Phone Installation Guide*.

Phone keys

Key panel



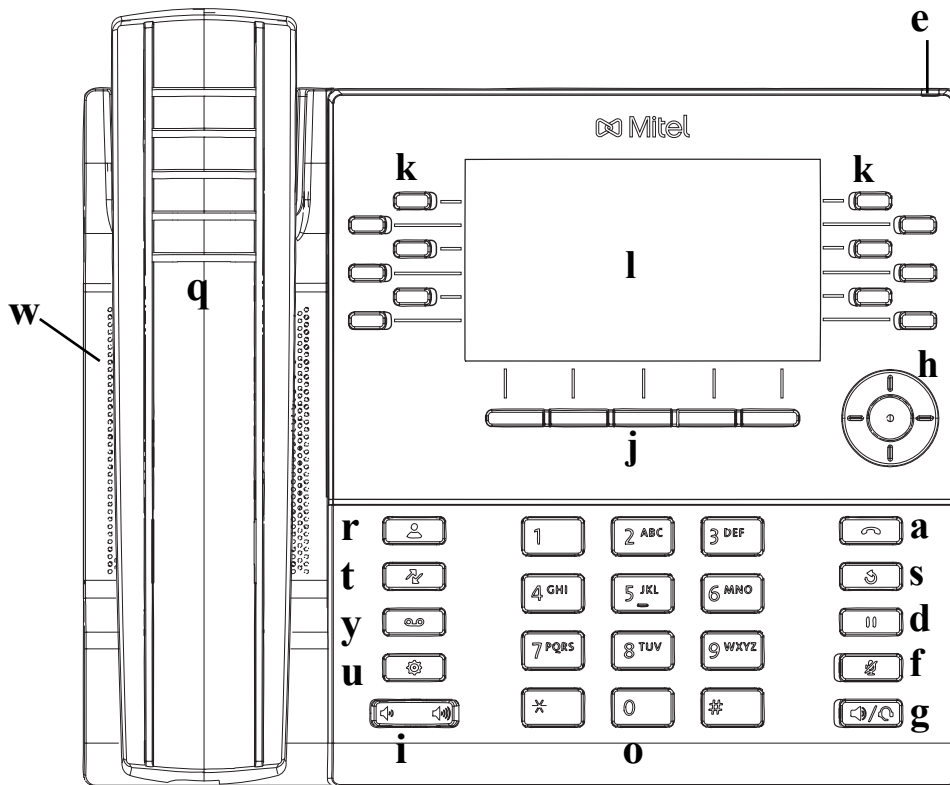









The following sections describe the various Mitel MiVoice 6930 IP phone key functions and how they can help you make and manage your calls and caller information.

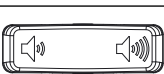

a	Goodbye Key	l	LCD Screen
d	Hold Key	o	Dialpad
e	Message Waiting Indicator (MWI)	q	Handset
f	Mute Key	r	Contacts Key
g	Speaker/Headset Key	s	Redial Key
h	Navigation Keys/Select Button	t	Call History Key
i	Volume Control	u	Settings Key
j	State-Sensitive Softkeys	w	Speaker
k	Programmable Keys	y	Voicemail Key

Key description

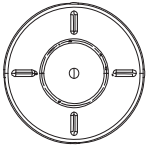
The following table describes the keys on the Mitel MiVoice 6930 IP phone:

Key	Description
	Contacts key - Displays a list of your contacts. For more information, see “ Contacts ” on page 64 .
	Call History key - Displays a list of your missed, outgoing, and answered calls. For more information, see “ Call History ” on page 77 .
	Voicemail key - Provides access to your voicemail service (if configured). For more information, see “ Voicemail ” on page 83 .
	Settings key - Provides services and settings that allow you to customize your phone. For more information, see “ Customizing your phone ” on page 17 .
	Volume controls - Adjusts the volume for the ringer, handset, headset, and speakerphone. Press the volume control keys while the phone is ringing to adjust the ringer volume. Pressing these keys during an active call adjusts the volume of the audio device being used (handset, headset, or speaker).
	Goodbye key - Ends an active call. The Goodbye key also exits an open list (such as Call History) and menus (such as the Settings menu) without saving changes.
	Redial key - Displays a list of your previously dialed calls. Pressing the Redial key twice redials the last dialed number displayed on the Home screen. For more information, see “ Redialing a number ” on page 57 .
	Hold key - Places an active call on hold. To retrieve a held call, press the applicable Line key. For more information, see “ Placing a call on hold ” on page 60 .
	Mute key - Mutes the microphone so that your caller cannot hear you (the LED beside the key turns on when the microphone is on mute). For more information, see “ Muting the microphone ” on page 60 .
	Speaker/Headset key - Transfers the active call to the speaker or headset, allowing handsfree use of the phone. For more information, see “ Audio Path ” on page 34 .
	Navigation keys and select button - Multi-directional navigation keys that allow you to navigate through the phone’s User Interface (UI). Pressing the center Select button sets options as well as performs actions such as dialing out from the Contacts or Call History . On the Home screen, the left and right navigation keys can be used to access the additional pages of programmable softkeys. For more information, see “ UI navigation ” on page 16 .
	State-sensitive softkeys - Five state-sensitive softkeys that allow you to perform different functions during specific states (i.e. when the phone is an idle, connected, incoming, outgoing, or busy state).

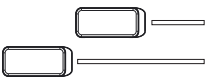
Key	Description
	<p>Programmable keys - 12 programmable, multi-function self-labeling keys that allow you to use up to 72 specific functions.</p> <p>For more information see “Configuring and using programmable keys” on page 45.</p>

Dialpad keys

The Mitel MiVoice 6930 IP phone has a dialpad with digits from 0 through 9, a * key, and a # key. Keys 2 through 9 contain the letters of the alphabet. These dialpad keys can be used to dial a phone number to make a call (see “[Making calls](#)” on [page 56](#)) and to press keys requested by an Interactive Voice Response (IVR) system. The basic inputs for the Mitel MiVoice 6930 IP phone dialpad includes the following:

Dialpad Key	Description
0	Dials 0
1	Dials 1
2 ABC	Dials 2 When entering text, this key enters A with one press, B with two presses, and C with three presses.
3 DEF	Dials 3 When entering text, this key enters D with one press, E with two presses, and F with three presses.
4 GHI	Dials 4 When entering text, this key enters G with one press, H with two presses, and I with three presses.
5 JKL	Dials 5 When entering text, this key enters J with one press, K with two presses, and L with three presses.
6 MNO	Dials 6 When entering text, this key enters M with one press, N with two presses, and O with three presses.
7 PQRS	Dials 7 When entering text, this key enters P with one press, Q with two presses, R with three presses, and S with four presses.
8 TUV	Dials 8 When entering text, this key enters T with one press, U with two presses, and V with three presses.
9 WXYZ	Dials 9 When entering text, this key enters W with one press, X with two presses, Y with three presses, and Z with four presses.

The * is called the star key. The # is called the pound key, number sign, or hash key, depending on one's nationality or personal preference. These can be used for special functions such as accessing advanced services. The star key and pound key functions are dependent on your call server's feature availability. Contact your System Administrator for more information about available functions using these keys.

When entering characters in the various **Settings** menus or in different applications (for example, when adding a contact to your **Contacts** application), advanced characters can be entered using the dialpad keys.

The following tables identifies the characters that you can use and the order in which they are accessible.

Key	Uppercase Characters	Lowercase Characters
0	0 +	0 +
1	1 . : ; = _ , - ' & () \$!	1 . : ; = _ , - ' & () \$!
2	A B C 2	a b c 2
3	D E F 3	d e f 3
4	G H I 4	g h i 4
5	J K L 5	j k l 5
6	M N O 6	m n o 6
7	P Q R S 7	p q r s 7
8	T U V 8	t u v 8
9	W X Y Z 9	w x y z 9
*	* <SPACE>	* <SPACE>
#	# / \ @	# / \ @

Getting started

The Mitel MiVoice 6930 IP phone must be set up and be configured by the System Administrator prior to its first use.

UI overview

Home screen

When the phone has successfully booted up and connected to the network, the phone displays the **Home** screen. The **Home** screen shows the date and time along with your number and last dialed number. It is the default screen displayed when the phone is in an idle state.

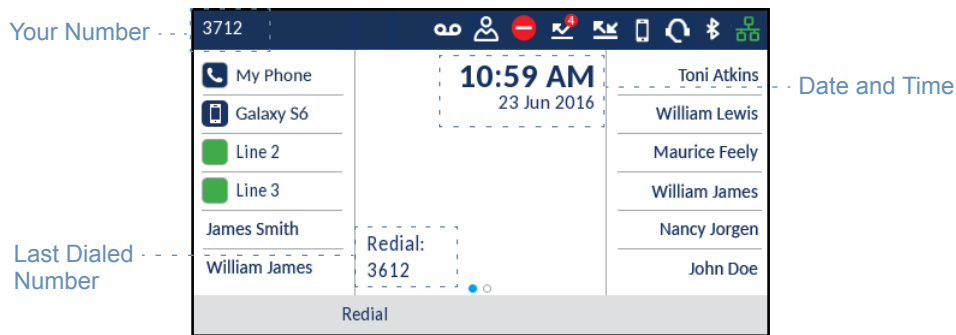

Note: Your System Administrator should have configured your number and any other administrative features required. If your number does not display on the screen, contact your System Administrator.

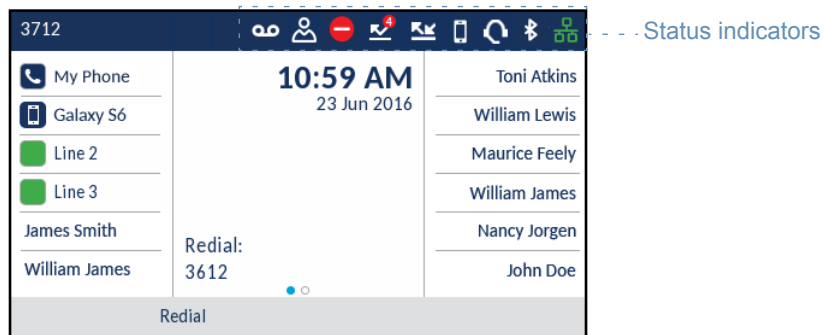

Phone and network status indicators

There are icons that display on the phone to indicate the status of the phone and network. These icons display on the upper right corner of the **Home** screen.



The following table identifies and describes the phone and network status indicators on the **Home** screen.

Icon	Description
	Network Connected - The Network Connected icon displays on the Home screen when the phone is connected to the MiVoice Business call server.

Icon	Description
	Attempting Network Connection - The Attempting Network Connection icon displays on the Home screen when the phone is attempting to connect to the MiVoice Business call server.
	Network Disconnected - The Network Disconnected icon displays on the Home screen when the phone loses connection to the MiVoice Business call server. If this icon is displayed and you are using an AC adapter for power, check that the Ethernet cable is tightly connected to the phone and to the network device port. The phone should automatically detect when it is reconnected and attempt to connect to the network. If this does not resolve the issue, check with your System or Network Administrator for assistance.
	Bluetooth Enabled - The Bluetooth Enabled icon displays on the Home screen when Bluetooth functionality has been turned on. For more information on Bluetooth functionality, see “Bluetooth” on page 25 .
	Headset Connected - The Headset Connected icon displays on the Home screen when a headset (Integrated DECT Headset, Bluetooth, USB, DHSG/EHS, or analog wired) connection has been detected. For more information on headset functionality, see “Bluetooth” on page 25 and “Mitel Integrated DECT Headset” on page 109 .
	Mobile Phone Connected - The Mobile Phone Connected icon displays on the Home screen when a mobile phone connection has been detected. For more information on headset functionality, see “Bluetooth” on page 25 .
	Speakerphone Connected - The Speakerphone Connected icon displays on the on the Home screen when a speakerphone connection has been detected. For more information on headset functionality, see “Bluetooth” on page 25 .
	Call Forward Always - The Call Forward Always icon displays on the Home screen when the Call Forward feature is enabled using the "Always" condition (as opposed to the "Busy" and "No Answer" conditions). For more information on the Call Forward feature, see “Call Forward” on page 22 .
	Missed Calls - The Missed Calls icon displays on the Home screen only when incoming calls have not been received. The number in the red badge indicates how many calls were missed. To access a list of your missed calls, press the  (Call History) key. For more information on missed calls, see “Missed calls indicator” on page 82 .
	Do Not Disturb - The Do Not Disturb (DND) icon displays on the Home screen when the DND feature is enabled. When DND is enabled, callers calling into the phone may hear a DND signal and a "Do Not Disturb" message is displayed on their phones, depending on the setting in the System Administrator Tool. For more information on the DND feature, see “Do Not Disturb” on page 50 .
	Hotdesk User - The Hotdesk User icon displays on the Home screen when you log in using your hotdesk account.
	Voicemail - The Voicemail icon displays on the Home screen only if you have new messages waiting. To access your voicemail messages, press the  (Voicemail) key. For more information on voicemail functionality, see “Voicemail” on page 83 .

Programmable keys, state-sensitive softkeys, and line keys

12 programmable keys (including the **Prime Line** key) and five state-sensitive softkeys are always displayed on the **Home** screen. The programmable keys allow you to configure up to 72 different features (such as speed calls, phone lock, DND, and so on).

Note: If enabled by your System Administrator, certain features can be programmed on the programmable keys by pressing and holding the respective programmable key. Others can only be programmed by your System Administrator through the MiVoice Business call server. See “[Configuring and using programmable keys](#)” on [page 45](#) for information on how to program the programmable keys using the phone. Contact your System Administrator for details on what features are available to be programmed through the MiVoice Business call server.

The state-sensitive softkeys change depending on the state of the phone and are used to perform different functions when the phone is in an idle, connected, outgoing, or busy state.

The **Prime Line** key is a visual indication of the status of your prime line. When your phone is in an idle state, your  (**Prime Line**) icon is solid blue. Your System Administrator may also have configured additional line appearances on your phone. Line appearance keys are solid green when your phone is in an idle state.

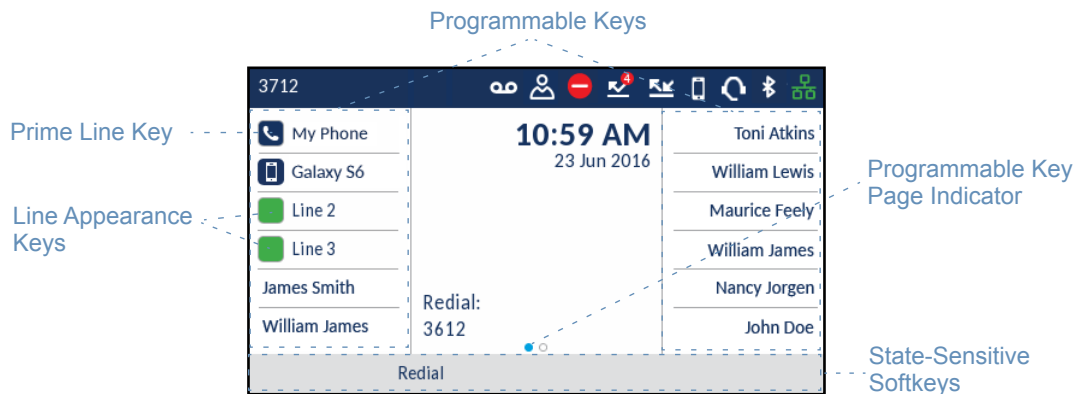



If you have 12 or more programmable keys configured, programmable page indicators are displayed above the softkeys. These dots indicate the number of programmable key pages and its relative position. Press the left and right navigation keys to switch the programmable key pages.

Call screen

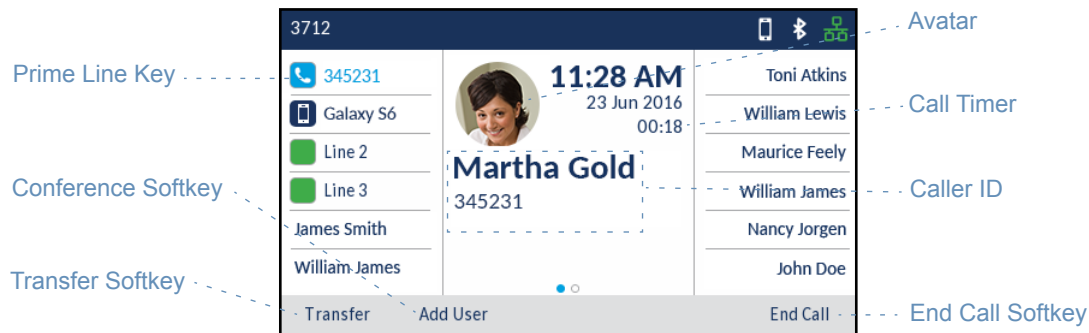

During an incoming or outgoing call and when on an active call, all the essential information regarding the call is displayed on screen, including the caller's avatar, name, number, and call duration timer. The context-sensitive softkeys also change allowing you access to more call handling features (such as **Transfer** and **Add User** during an active call).



Additionally, if the call is on the **Prime Line** key, the **Prime Line** key changes to reflect the status of the line as per the following table.

Icon	Description
	(Blinking) Indicates the prime line is ringing due to an incoming call.
	Indicates the prime line is busy.
	(Blinking) Indicates the call on the prime line is on hold.

If the call is on a different line, the applicable line appearance key change to reflect the status of the line as per the following table.

Icon	Description
	(Blinking) Indicates the applicable line is ringing due to an incoming call.
	Indicates the applicable line is busy.
	(Blinking) Indicates the call on the applicable line is on hold.

UI navigation



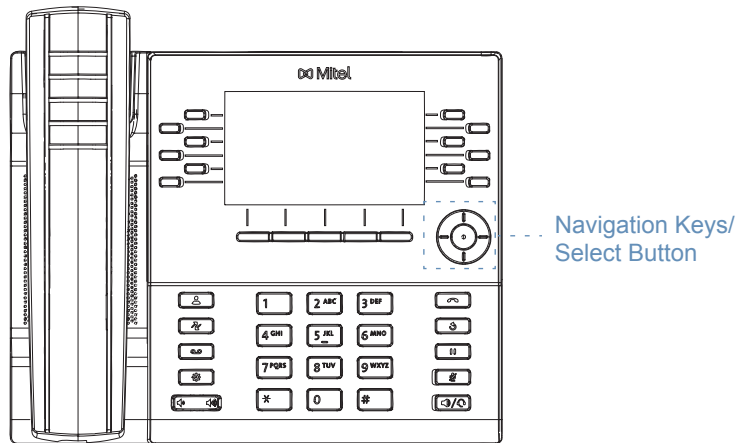













UI navigation is performed using the navigation keys located to the right of the softkeys.



There are four directional keys (up, down, left, and right) on the navigation cluster that can be used to navigate through the various applications and settings menus. The center key acts as a **Select** button that is used to set options and perform actions such as dialing out from the **Contacts** or **Call History** applications.

Customizing your phone

You can customize your phone and view your phone status by pressing the  (**Settings**) key, opening the **Settings** menu. This menu provides a single location to access all your phone settings. The following phone settings can be configured through the **Settings** menu:

Icon	Option
	Status
	Language
	Voicemail
	Call Forward
	Config Teleworker
	Diagnostics
	• Audio Diagnostics
	• Ping
	• TCP DUMP
	• DHCP Trace
	Bluetooth
	Audio
	• Ring Tones
	• Audio Path
	Display
	Restart

Notes:

1. The **Advanced** options are Administrator-level functions only, and are not accessible by the user. These options should only be set up and changed by your System Administrator.
2. The **Log Issue** softkey is used to generate a log file that can help Administrators debug issues. You should only press this softkey when requested by your System Administrator.

Using the Settings menu

1. Press the  (**Settings**) key on the phone to enter the **Settings** menu.

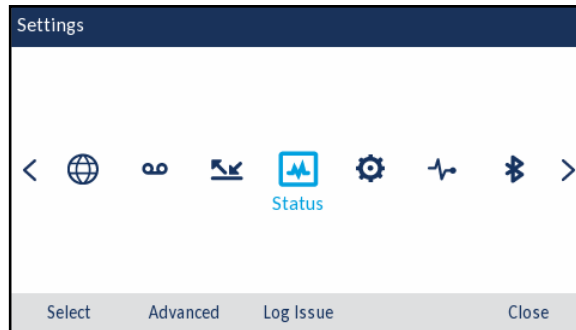

2. Use the left and right navigation keys to highlight an option and the up and down navigation keys to scroll through the sub options.
3. Press the **Select** button or **Select** softkey to select an option.
4. Use the navigation keys, dialpad keys, and softkeys that display for each setting to make any applicable changes.
5. Press the **Save** softkey to save your changes.
6. Press the  (**Goodbye**) key or the **Close** softkey at any time to exit without saving changes.

Note: For more information about **Advanced** options, contact your System Administrator.

Status

The **Status** settings in the **Settings** menu allows you to view your phone's:

- **Network General Info:**
General information regarding your phone's network settings such as IP address, subnet mask, gateway, MAC address, call server IP addresses, TFTP server IP address and port, IPA IP address, and DNS values.
- **Network Persistent Data:**
The IP addresses for call servers 1 to 4.
- **Network DHCP Info:**
Information regarding your phone's Dynamic Host Configuration Protocol (DHCP) status and T1/T2 renewal times.
- **Network Status QoS:**
Information regarding Quality of Service (QoS) features such as Virtual LAN (VLAN), Layer 2 Priority (L2P), and Differentiated Services Code Point (DSCP).
- **Port Info:**
Speed and duplex values for both the LAN and PC ports.
- **Phone Info:**
General phone-related information such as model number, hardware and call server revisions, main firmware version, and boot version.

Note: Press the **Copyright** softkey to view copyright information.

To view the **Status** menu:

1. Press the  (**Settings**) key on the phone to enter the **Settings** menu.
2. Press the **Select** button or **Select** softkey to enter the **Status** menu.
3. Use the up and down navigation keys to scroll the through the following status items:

- Network General Info

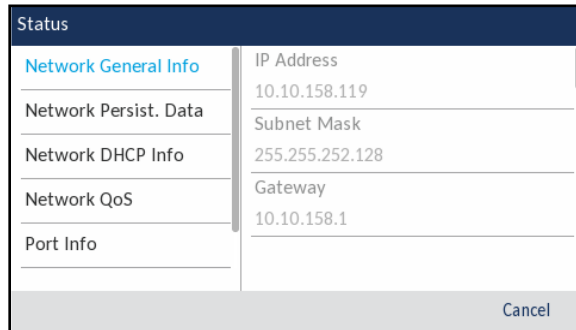

- Network Persistent Data

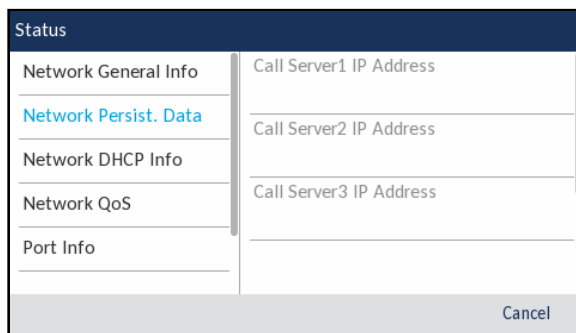

- Network DHCP Info

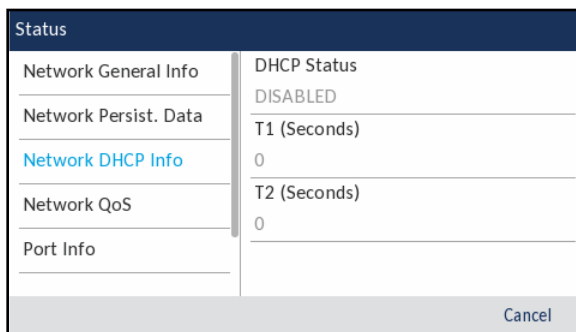

- Network Static QoS

Status	
Network General Info	VLAN Id
Network Persist. Data	-1 ()
Network DHCP Info	L2P Default
Network QoS	6
Port Info	L2P Voice
	6

Cancel

- Port Info

Status	
Network General Info	LAN Port Speed
Network Persist. Data	100M
Network DHCP Info	LAN Port Duplex
Network QoS	Full_Duplex
Port Info	PC Port Speed
	No Link

Cancel

- Phone Info

Status	
Network Persist. Data	Model
Network DHCP Info	MINET_6930
Network QoS	Hardware Rev.
Port Info	000
Phone Info	Call Server Rev.
	14.0.1.22

Copyright Cancel

4. To view more information on the selected status item, press the right navigation key and press the down navigation key to scroll through the information.

Language

The Mitel MiVoice 6930 IP phone supports the following languages:

- English
- French
- German
- Spanish
- Spanish (Latin America)

- Portuguese
- Portuguese (Brazil)
- Dutch
- Italian
- Romanian
- Russian
- Swedish
- Polish

When you set the language on the phone, all on-screen text (in idle/call screens, setting menus, and applications) displays in the selected language.

Notes:

1. All languages may not be available for selection as availability is dependent on the language files provided by the MiVoice Business call server. Contact your System Administrator for details on what languages are available in your specific environment.
2. Unofficially supported languages may be available for selection on your phone depending on the language files available on the MiVoice Business call server. If available, these languages can be used by selecting Local 1 or Local 2 in the **Language** menu.

To specify the language in which on screen text displays:

1. Press the  (**Settings**) key on the phone to enter the **Settings** menu.
2. Navigate to the **Language** setting and press the **Select** button or **Select** softkey.

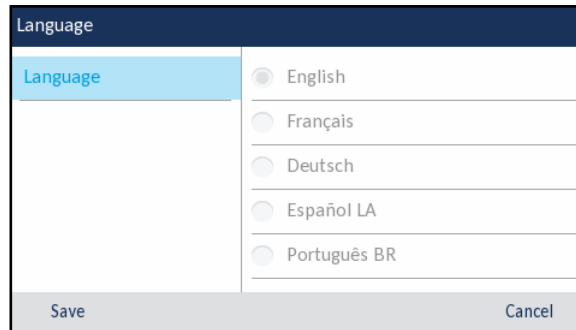

3. Press the right navigation key to move to the language selection column.
4. Use the up and down navigation keys to choose the applicable screen language.
5. Press the **Save** softkey to save your changes.

Call Forward

Call Forward on the Mitel MiVoice 6930 IP phone allows incoming calls to be forwarded to another destination. You can enable your calls to be forwarded:

- When your phone is busy (individual settings for internal and external incoming calls).
- When you're not answering the phone (individual settings for internal and incoming calls).
- All the time.

You can enable different call forward modes independently. For example, you can set different phone numbers for Always, Busy Internal, Busy External, No Answer Internal, and No Answer External, and then turn them on/off individually.

Notes:

1. A **Call Forward Always** programmable key can be created that allows you quickly enable Always mode without having to enter the **Call Forward** settings menu. For more information on the **Call Forward Always** programmable key, see [“Call Forward Always” on page 48](#).
2. If voicemail is enabled, call forwarding numbers may already be defined by your System Administrator.

To configure call forward settings:

1. Press the  (**Settings**) key on the phone to enter the **Settings** menu.
2. Navigate to the **Call Forward** setting and press the **Select** button or **Select** softkey.

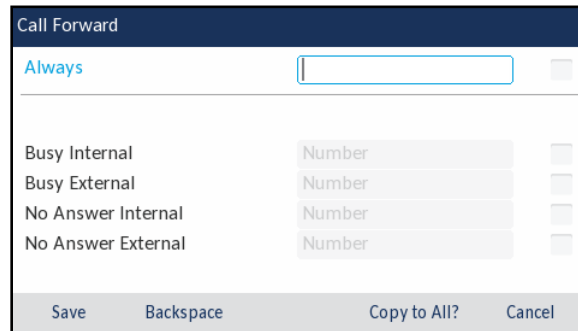

3. Enter forwarding numbers using the dialpad keys for any of the following states:
 - **Always:**
Immediately forwards all incoming calls to the specified number.
 - **Busy Internal:**
Immediately forwards internal phone calls if your line is busy.
 - **Busy External:**
Immediately forwards external phone calls if your line is busy.
 - **No Answer Internal:**
Forwards internal phone calls after several rings if you don't answer.
 - **No Answer External:**
Forwards external phone calls after several rings if you don't answer.

Notes:

1. Pressing the down navigation key moves the selection to the next input field. Pressing the right navigation key moves the selection to the corresponding checkbox.
2. Press the **Backspace** softkey to delete the last digit entered.
3. Pressing the **Copy to All?** softkey copies the call forward number of the call forward mode in focus to every call forward mode. For example, if the cursor is on the **Busy Internal** field and the field has a phone number entered, pressing the **Copy to All?** softkey assigns the same phone number to all the other modes as well.
4. Using the up and down navigation keys, move to the checkbox beside the respective call forward mode you want to enable and press the **Select** button to turn on the call forward mode.
5. Repeat steps 3 and 4 for all call forward modes you want to enable.

6. Press the **Save** softkey to save your changes.

Notes:

1. When **Call Forward Always** is enabled, it takes precedence over all other types of call forwarding.
2. If **Call Forward Always** is enabled, then the **Call Forward Always** icon is displayed on the Screen Saver.
3. If both **Call Forward Always** and **DND** are enabled, then the **DND** icon is displayed on the Screen Saver.



Call Forward Always Icon

Bluetooth

The Mitel MiVoice 6930 IP phone supports MobileLink, a feature that provides seamless mobile integration using Bluetooth wireless technology.

Note: For more information on how to use the MobileLink features, see [“MobileLink” on page 92](#).

The phone also supports the use of Bluetooth devices such as, the Mitel Cordless Bluetooth Handset, the Mitel S720 Bluetooth Speakerphone, or a Bluetooth headset as an alternate audio device. Using the **Bluetooth** settings menu, you can enable and disable Bluetooth functionality on your phone as required. You can also pair, connect, and unpair a Bluetooth device as applicable.

Notes:

1. The specific operation of third-party Bluetooth devices can vary somewhat by manufacturer and model. Ensure your Bluetooth device has been upgraded to its latest firmware revision. Refer to the documentation accompanying the Bluetooth device for details on operation, alerting tones, LEDs, and charging. Note that all Bluetooth devices will drop any call in progress if the maximum range is exceeded.
2. Attempting to pair and connect using your Bluetooth device's respective menus may cause connectivity issues. Follow the procedures listed in the sections below to ensure the connectivity of your Bluetooth device.
3. Only one Bluetooth device of each profile (i.e. handset, headset, speakerphone, and mobile phone) can be connected at one time. Connecting to a new device of the same profile will automatically result in the disconnection of the previous device of the same profile. If there is no connection to any device (within the same profile) the phone will actively look for the most recently connected device and will attempt to automatically reconnect. Manually disconnecting the device using the device's native UI will not prevent an automatic reconnection. You must either disconnect using the **Bluetooth** menu on the Mitel MiVoice 6930 IP phone, "forget" the device, or the device must be out of range to circumvent the auto reconnect process.
4. When using a multi-point Bluetooth headset with your Mitel MiVoice 6930 IP phone, do not pair your multi-point Bluetooth headset to multiple devices (For example, to your Mitel MiVoice 6930 IP phone and your mobile phone) as audio and connectivity issues may occur.
5. Some Bluetooth headsets have a proximity sensor feature that automatically changes the audio path depending on whether the headset is put on or taken off. It is strongly recommended to disable this feature when using the respective headset with the Mitel MiVoice 6930 IP phone as it may cause audio issues. Refer to the documentation accompanying the Bluetooth device for information on how to disable this feature.
6. Bluetooth headset connected to the Mitel MiVoice 6930 IP phone are limited in functionality to answering, ending, and muting calls. Additional headset features (such as rejecting calls) are not supported and will cause unexpected behavior (e.g. invoking the reject call function will answer instead of reject).

Enabling Bluetooth functionality

To enable Bluetooth functionality:

1. Press the  (**Settings**) key on the phone to enter the **Settings** menu.
2. Navigate to the **Bluetooth** setting and press the **Select** button or **Select** softkey.

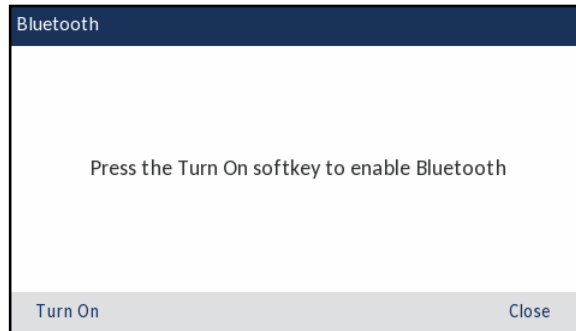

3. Press the **Turn On** softkey to enable Bluetooth functionality.

When Bluetooth functionality is enabled, a Bluetooth enabled icon  appears in the status bar on the **Home** screen.

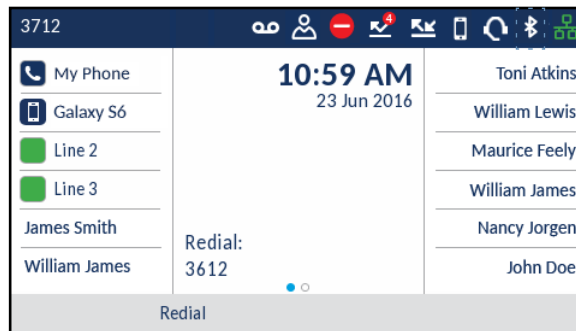

Pairing a Bluetooth device

To pair a Bluetooth device:

1. Press the  (**Settings**) key on the phone to enter the **Settings** menu.
2. Navigate to the **Bluetooth** setting and press the **Select** button or **Select** softkey.
3. Ensure Bluetooth functionality is enabled. If it is not enabled, press the **Turn On** softkey to enable Bluetooth functionality

- If required, press the down navigation key to view the list of **Available Devices**.

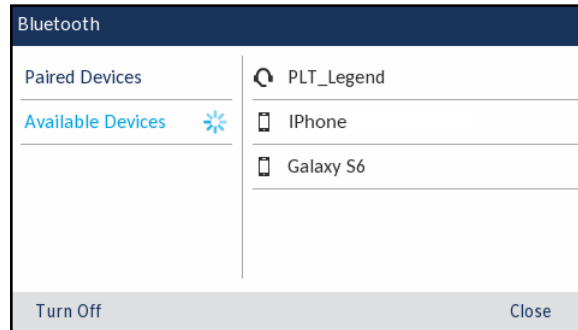

Notes:

- The Mitel MiVoice 6930 IP phone scans for supported Bluetooth devices when viewing the list of available devices. Refer to the respective Bluetooth device documentation for discovery and pairing procedures that must be performed on your Bluetooth device.
- When attempting to pair the Mitel Cordless Bluetooth Handset with the Mitel MiVoice 6930 IP phone, the device name will appear in the available devices list as "Cordless Handset" followed by the last six digits of the handset's MAC address. For more information on the Mitel Cordless Bluetooth Handset, see ["Mitel Cordless Bluetooth Handset"](#) on page 115.
- When attempting to pair the Mitel S720 Bluetooth Speakerphone with the Mitel MiVoice 6930 IP phone, the device name will appear in the available devices list as "S720 Bluetooth Speakerphone". For more information on the Mitel S720 Bluetooth Speakerphone, see ["Mitel S720 Bluetooth Speakerphone"](#) on page 112.

- Press the right navigation key to move to the Bluetooth device selection column.
- Using the up and down navigation keys, highlight the Bluetooth device you want to pair and press the **Pair** softkey.

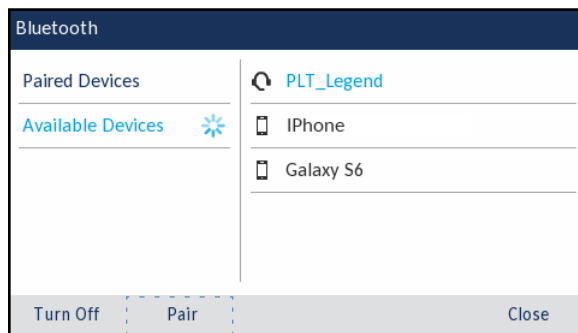

Note: For mobile phones and some other Bluetooth devices, a Bluetooth pairing request displays on both the Mitel MiVoice 6930 IP Phone and the respective mobile phone or Bluetooth device. Ensure the pairing code matches on both devices and press **Yes** on the Mitel MiVoice 6930 IP Phone and acknowledge the pairing request on your mobile phone or Bluetooth device.

7. The phone attempts to pair the Bluetooth device and if successful, automatically attempts to connect to the Bluetooth device.

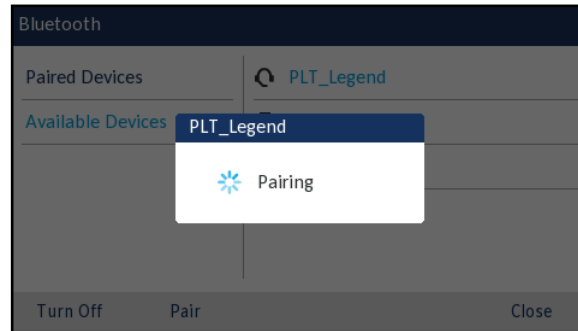

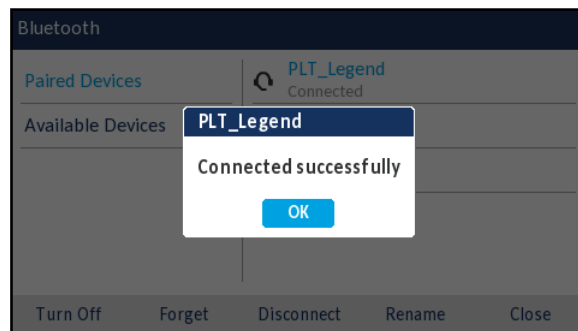

Notes:

1. If pairing or connecting fails, a failed error message displays on screen. Press **Retry** to attempt to pair or connect again, or **Cancel** to cancel the attempt.
2. If pairing and connecting a mobile phone, depending on the connection state of the mobile phone, you may need to retry multiple times before the mobile phone pairs and connects successfully. Additionally, your Mitel MiVoice 6930 IP Phone must be connected to the MiVoice Business phone system to pair and connect your mobile phone.



8. Press **OK** to acknowledge the successful connection.
The MWI indicator flashes blue when successfully connected. The connected Bluetooth device is added to the list of **Paired Devices** and is ready to use.

When a Bluetooth headset is successfully connected, a Bluetooth headset connected icon  appears in the status bar on the **Home** screen. When a mobile phone is successfully connected, a Mobile connected icon  appears in the status bar on the **Home** screen. When the Mitel S720 Bluetooth Speakerphone is successfully connected, a speakerphone connected icon  appears in the status bar on the **Home** screen.

Forgetting a Bluetooth device

To forget a Bluetooth device:

1. Press the  (**Settings**) key on the phone to enter the **Settings** menu.
2. Navigate to the **Bluetooth** setting and press the **Select** button or **Select** softkey.

3. Ensure Bluetooth functionality is enabled. If it is not enabled, press the **Turn On** softkey to enable Bluetooth functionality

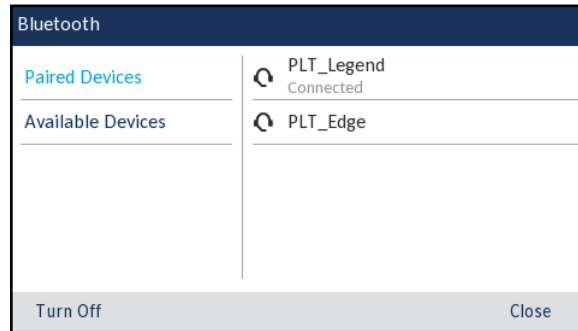

4. Press the right navigation key to move to the paired Bluetooth device selection column.
5. Using the up and down navigation keys, highlight the Bluetooth device you want to forget and press the **Forget** softkey.

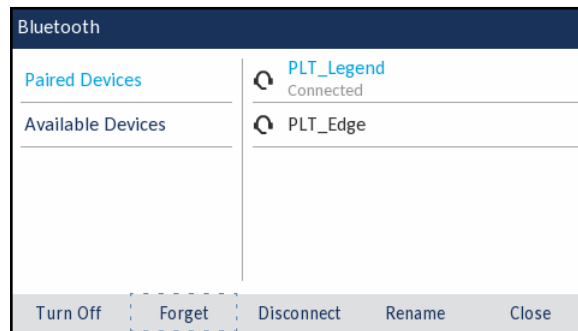

A confirmation message displays on screen.

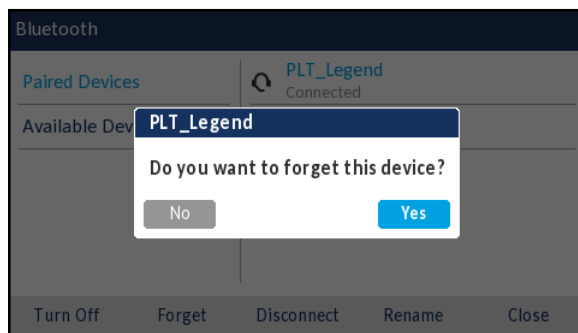

6. Press **Yes** to forget the Bluetooth device.
The Bluetooth device is removed from the list of **Paired Devices**.

Disconnecting a connected Bluetooth device

To disconnect a connected Bluetooth device:

1. Press the  (**Settings**) key on the phone to enter the **Settings** menu.
2. Navigate to the **Bluetooth** setting and press the **Select** button or **Select** softkey.
3. Ensure Bluetooth functionality is enabled. If it is not enabled, press the **Turn On** softkey to enable Bluetooth functionality

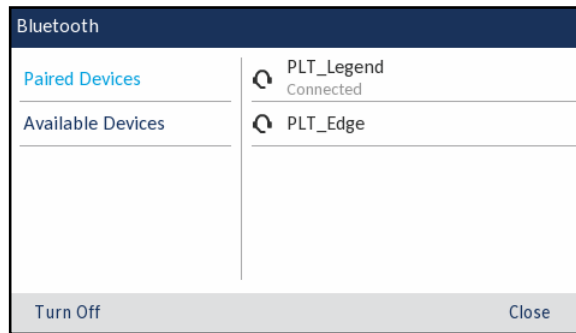

4. Press the right navigation key to move to the paired Bluetooth device selection column.
5. Using the up and down navigation keys, highlight the connected Bluetooth device you want to disconnect to and press the **Disconnect** softkey.

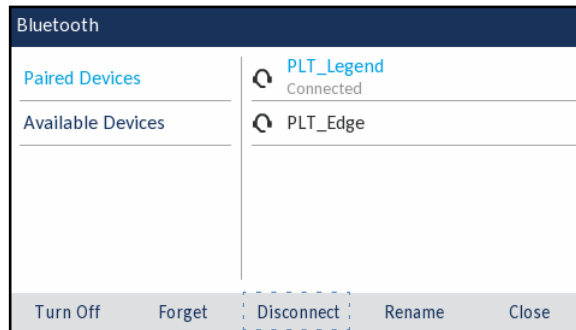

A confirmation message displays on screen.

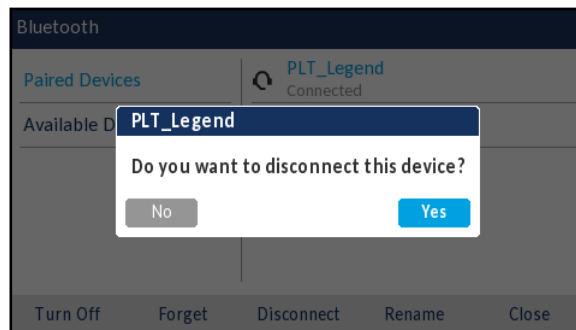

6. Press **Yes** to disconnect the Bluetooth device.
The Bluetooth device is disconnected.
7. Press the **OK** button to acknowledge the successful disconnection.

Renaming a paired Bluetooth device

To rename a paired Bluetooth device:

1. Press the  (**Settings**) key on the phone to enter the **Settings** menu.
2. Navigate to the **Bluetooth** setting and press the **Select** button or **Select** softkey.
3. Ensure Bluetooth functionality is enabled. If it is not enabled, press the **Turn On** softkey to enable Bluetooth functionality

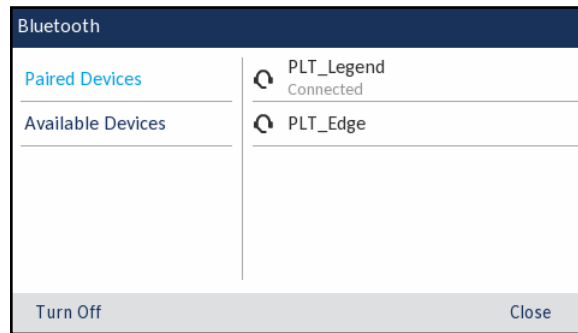

4. Press the right navigation key to move to the paired Bluetooth device selection column.
5. Using the up and down navigation keys, highlight the applicable Bluetooth device you want to rename to and press the **Rename** softkey.

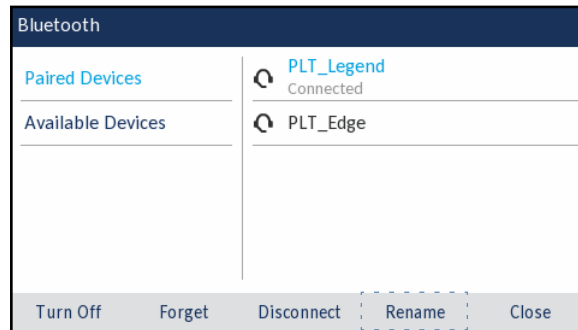

A pop up dialog appears allowing you edit the name of the Bluetooth device.

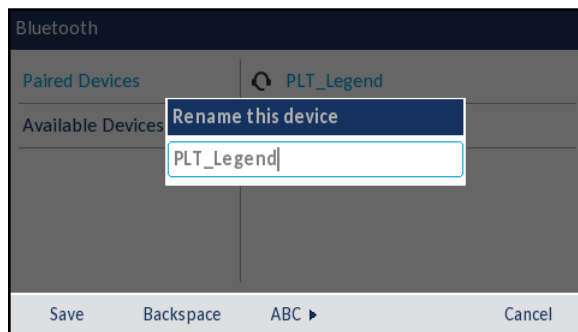

6. Edit the name of the device using the dialpad keys and press the **Save** softkey to save your changes.

Connecting to a different or disconnected Bluetooth device

To connect to a different or disconnected Bluetooth device:

1. Press the  (**Settings**) key on the phone to enter the **Settings** menu.
2. Navigate to the **Bluetooth** setting and press the **Select** button or **Select** softkey.
3. Ensure Bluetooth functionality is enabled. If it is not enabled, press the **Turn On** softkey to enable Bluetooth functionality

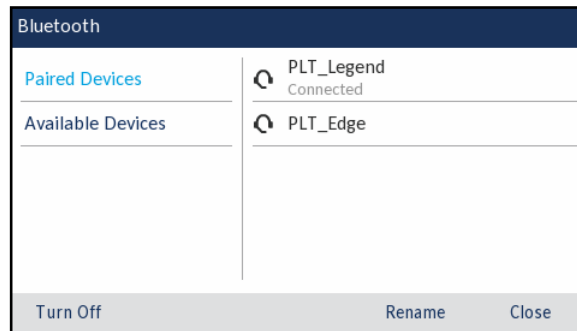

4. Press the right navigation key to move to the paired Bluetooth device selection column.

- Using the up and down navigation keys, highlight the applicable Bluetooth device you want to connect to and press the **Connect** softkey.

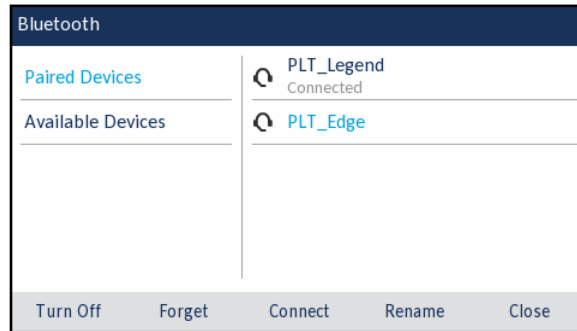

The phone attempts to connect to the device.

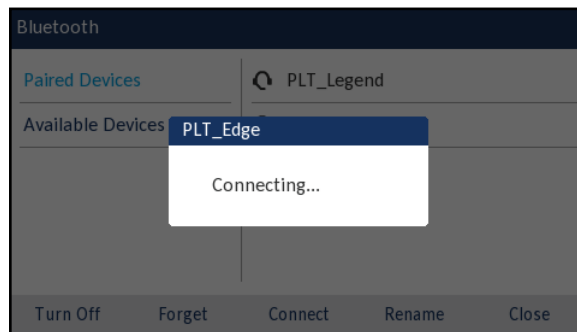

Notes:

- If connecting fails, an error message displays on screen. Press **Retry** to attempt to connect again, or **Cancel** to cancel the attempt.
- If connecting a mobile phone, depending on the connection state of the mobile phone, you may need to retry multiple times before the mobile phone connects successfully. Additionally, your Mitel MiVoice 6930 must be connected to the MiVoice Business phone system to connect your mobile phone.

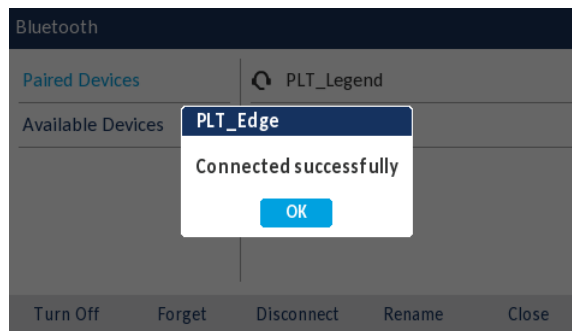

- Press the **OK** button to acknowledge the successful connection. The MWI indicator flashes blue when successfully connected. The connected Bluetooth device is ready to use.

Audio

The **Audio** setting on the Mitel MiVoice 6930 IP phone allows you to personalize ring tones, select the initial audio path used when pressing the  (**Speaker/Headset**) key, and enable or disable DHSG headset mode.

Ring Tones

There are a total of 20 (10 modern and 10 classic) distinct ring tones available for selection on the Mitel MiVoice 6930 IP phone. Two different ring tones can be configured for incoming calls from internal numbers and external numbers.

To configure ringtones for internal and external calls:

1. Press the  (**Settings**) key on the phone to enter the **Settings** menu.
2. Navigate to the **Audio > Ring Tones** setting and press the **Select** button or **Select** softkey.

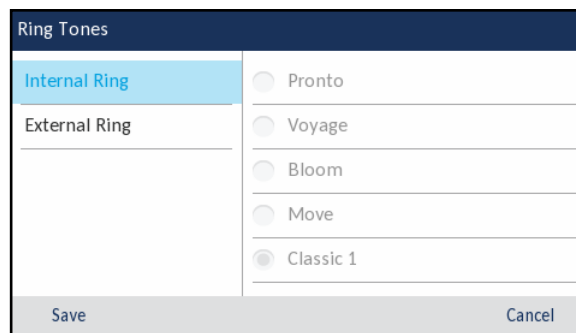





3. With the **Internal Ring** setting highlighted press the right navigation key to move to **Internal Ring** selection column.
4. Use the up and down navigation keys to scroll through the list and choose the applicable ring tone.
5. Press the left navigation key and then the down navigation key to highlight the **External Ring** setting.
6. With the **External Ring** setting highlighted press the right navigation key to move to **External Ring** selection column.
7. Use the up and down navigation keys to scroll through the list and choose the applicable ring tone.
8. Press the **Save** softkey to save your changes.

Audio Path

The Mitel MiVoice 6930 IP phone allows you go "handsfree" when handling incoming and outgoing calls by supporting the use of a headset (Integrated DECT Headset, Bluetooth, USB, analog wired, or DHSG/EHS wireless) or through speakerphone mode. The **Audio Path** setting allows you to

choose the initial audio path used when pressing the  (**Speaker/Headset**) key. There are two audio path options that you can select:

Audio path	Description
Speaker	The default setting. When using the handset, pressing the  (Speaker/Headset) key on the phone switches to the speakerphone. Pressing the  (Speaker/Headset) key again switches to the headset (if connected). When using the speakerphone or headset, lift the handset to switch to the handset.
Headset	When using the handset, pressing the  (Speaker/Headset) key on the phone switches to the headset. Pressing the  (Speaker/Headset) key again switches to the speakerphone. When using the headset or speakerphone, lift the handset to switch to the handset.

To configure the audio path:

1. Press the  (**Settings**) key to enter the **Settings** menu.
2. Navigate to the **Audio > Audio Path** setting and press the **Select** button or **Select** softkey.

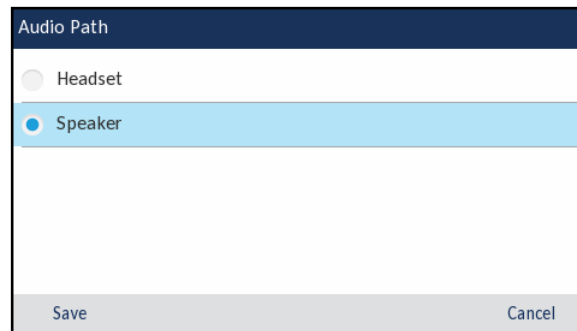

3. Use the up and down navigation keys to select the applicable audio path (**Speaker** or **Headset**).
 - Note:** If you select the **Headset** option, ensure that only one headset is connected to the phone.
4. Press the **Save** softkey to save your changes.

Headset

The **Headset** setting allows you to enable DHSG mode when a DHSG/EHS headset is connected to the phone.

To enable/disable DHSG headset mode:

1. Press the  (**Settings**) key to enter the **Settings** menu.
2. Navigate to the **Audio > Headset** setting and press the **Select** button or **Select** softkey.

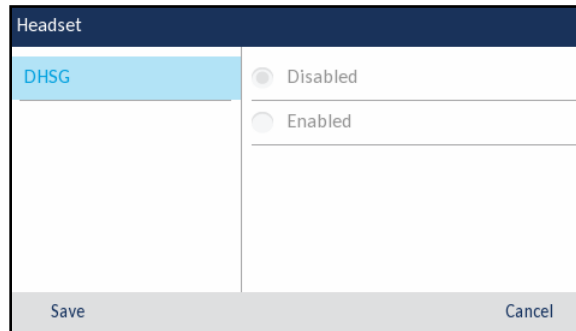

3. Press the right navigation key to move to enable/disable selection column.
4. Use the up and down navigation keys to choose the applicable setting.
5. Press the **Save** softkey to save your changes.

Display

The **Display** setting allows you to set the following on your phone:

- **Brightness Settings:**
The **Brightness Level** setting on the Mitel MiVoice 6930 IP phone allows you to set the amount of light that illuminates the LCD display.
- **Screen Saver Settings:**
The **Screen Saver Timer** setting allows you to configure the amount of time (from 1 to 90 minutes) the phone must be idle before the screen saver starts. When the specified amount of time expires, a screen saver displaying the date and time and the number of missed calls (if applicable) is displayed on screen.

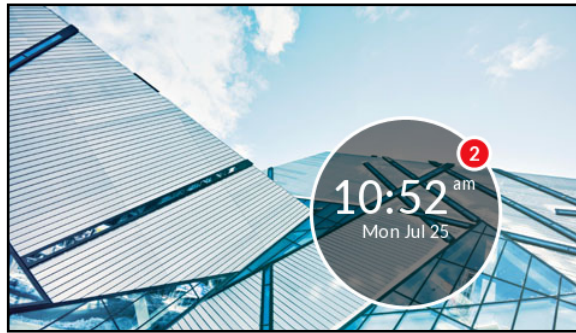

The **Dimmer Level** setting defines how brightly you want the screen to be illuminated when the screen saver is displayed.

Note: Availability of the above display settings is dependent on how your account is configured on the MiVoice Business call server.

To configure the display settings:

1. Press the  (**Settings**) key on the phone to enter the **Settings** menu.
2. Navigate to the **Display** setting and press the **Select** button or **Select** softkey.

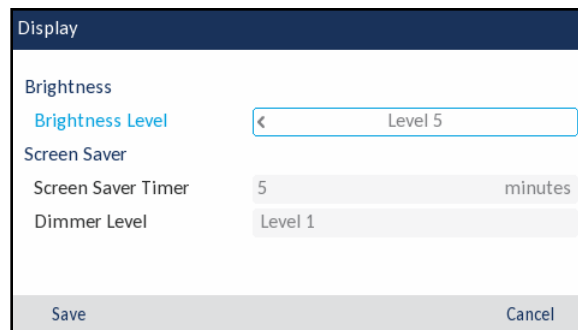

3. Use the left and right navigation keys to increase or decrease the intensity of brightness on the LCD (valid values are from Levels 1 (darkest) to 5 (brightest)).
4. Press the down navigation key to highlight **Screen Saver Timer**.
5. Enter a value, in minutes, using the dialpad keys. You can set the timer from 1 to 90 minutes. The default is 5 minutes.

6. Press the down navigation key to highlight **Dimmer Level**.
7. Use the left and right navigation keys to increase or decrease the intensity of brightness on the LCD when the screen saver is displayed (valid values are from Levels 0 (LCD off) to 5 (brightest)).
8. Press the **Save** softkey to save your changes.

Config Teleworker

The Mitel MiVoice 6930 IP phone can be configured to work in teleworker mode, which allows remote workers access to the same rich communications capabilities as in-office workers when using the IP phones.

The **Config Teleworker** menu allows you to enter the IP address of the server providing the teleworker configuration details.

To enter the IP address of the teleworker configuration server on the Mitel MiVoice 6930 IP phone:

1. Press the  (**Settings**) key on the phone to enter the **Settings** menu.
2. Navigate to **Config Teleworker** using the navigation keys and press the **Select** softkey.

Mitel MiVoice 6930 Config Teleworker

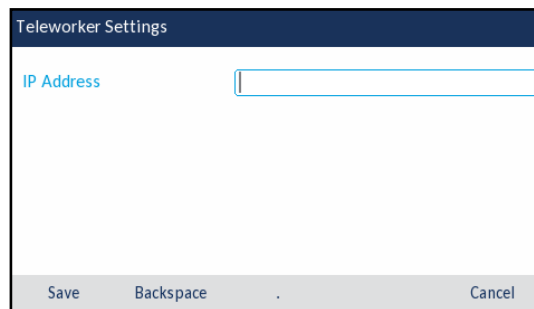

3. Enter the IP address of the server providing the teleworker configuration details in the **IP Address** field using the dialpad keys.

Note: The **Backspace** softkey can be used to delete the last digit/character entered and the dot (".") softkey can be used to enter a dot where applicable.

4. Press the **Save** softkey to save your changes.

Diagnostics

The **Diagnostics** menu allows you to perform the following diagnostic routines:

- Audio Diagnostics
- Ping
- TCP DUMP
- DHCP Trace

Audio Diagnostics

The **Audio Diagnostics** sub-menu allows you to collect up to 5 minutes of audio log files that can help to debug audio issues on the Mitel MiVoice 6930 IP phone.

To capture audio diagnostic logs on the Mitel MiVoice 6930 IP phone:

1. Press the  (**Settings**) key on the phone to enter the **Settings** menu.
2. Press the **Advanced** softkey.
3. Navigate to **Diagnostics > Audio Diagnostics** using the navigation keys and press the **Select** softkey.

Mitel MiVoice 6930 Audio Diagnostics

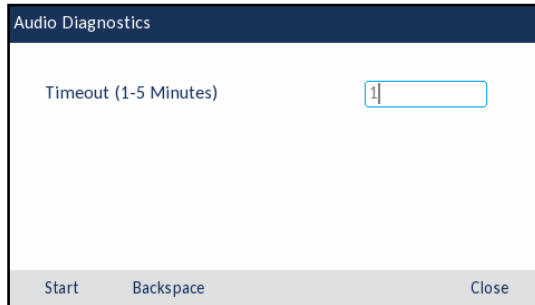

4. In the **Timeout** input field, enter the amount of time (in minutes from 1 to 5) you would like to run the audio diagnostic tool for using the dialpad keys.
The IP phone displays "Capturing..." and when the timeout elapses, "Collecting Logs..." is displayed. When all the logs have been collected, a "Complete..." message is displayed.

Note: Press the **Stop** softkey at any time to stop capturing the audio diagnostic logs.

To save the audio diagnostic logs to your PC using the Mitel Web UI:

1. Open your web browser and enter the phone's IP address or host name into the address bar.
2. Enter your username and password and click **OK/Login**.
The status window displays for the IP phone you are accessing.

Note: The default username is "root" and the default password is "73738".

3. Click on **Diagnostics**.

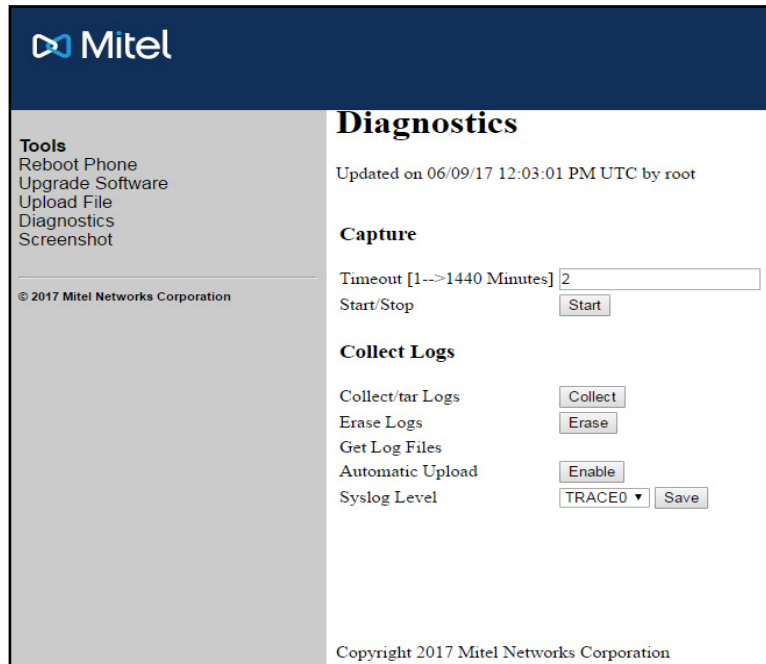

4. Click on the **Download Audio Log Files** link beside **Get Log Files**.
5. Save the file to the desired location on your computer.

Note: For more information on Mitel Web UI features, see the *Mitel MiVoice 6900 Series IP Phones Administrator Guide*.

Ping

The **Ping** sub-menu allows you to ping a host name or IP address directly from the Mitel MiVoice 6930 IP phone. This tool can be used to verify whether or not network connections between the Mitel MiVoice 6930IP phone and other network endpoints are intact.

To use the ping tool on the Mitel MiVoice 6930 IP phone:

1. Press the  (**Settings**) key on the phone to enter the **Settings** menu.
2. Press the **Advanced** softkey.
3. Input the Administrator password using the dialpad keys (default is 73738) and press the **Enter** softkey.

4. Navigate to **Diagnostics > Ping** using the navigation keys and press the **Select** softkey.

Mitel MiVoice 6930 Ping

5. In the input field, enter the host name or IP address of the network endpoint you want to ping using the dialpad keys.

Note: The **Backspace** softkey can be used to delete the last digit/character entered, the dot (".") softkey can be used to enter a dot where applicable, and the abc/123 softkey can be used to switch the dialpad keys from alphabetic to numeric.

6. Press the **Ping** softkey to begin.
The IP phone displays the number of packets sent, the number of packets received, and the Round-Trip Time (RTT) min/avg/max in milliseconds.

TCP DUMP

The **TCP DUMP** sub-menu allows you to capture TCP network packets for up to 1440 minutes (24 hours) that can in turn be used to help debug and troubleshoot various issues.

To capture TCP network packets on the Mitel MiVoice 6930 IP phone:

1. Press the  (**Settings**) key on the phone to enter the **Settings** menu.
2. Press the **Advanced** softkey.
3. Input the Administrator password using the dialpad keys (default is 73738) and press the **Enter** softkey.
4. Navigate to **Diagnostics > TCP DUMP** using the navigation keys and press the **Select** softkey.

Mitel MiVoice 6930 TCP DUMP

5. In the **Timeout** input field, enter the amount of time (in minutes from 1 to 1440) you would like to capture TCP network packet data using the dialpad keys.
The IP phone displays "Capturing..." and when the timeout elapses, "Complete..." is displayed.

Note: Press the **Stop** softkey at any time to stop capturing the TCP DUMP logs.

To save the TCP network packet logs to your PC using the Mitel Web UI:

1. Open your web browser and enter the phone's IP address or host name into the address bar.
2. Enter your username and password and click **OK/Login**.
The status window displays for the IP phone you are accessing.

Note: The default username is "root" and the default password is "73738".

3. Click on **Diagnostics**.

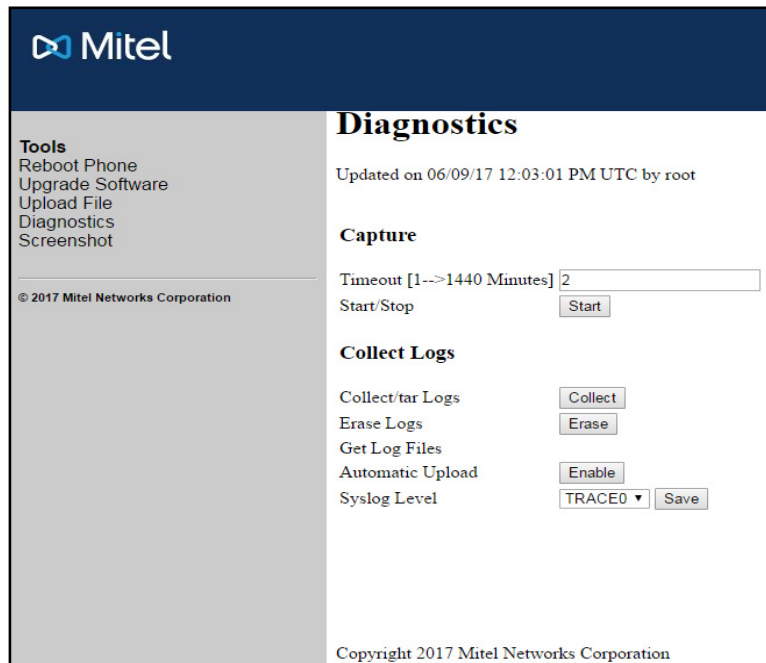

4. Click on the **Download Log Files** link beside **Get Log Files**.

5. Save the file to the desired location on your computer.

Note: For more information on Mitel Web UI features, see the *Mitel MiVoice 6900 Series IP Phones Administrator Guide*.

DHCP Trace

The **DHCP Trace** sub-menu allows you to perform a DHCP trace request. You can then review the parameters that the DHCP trace returns. After you have reviewed the trace information, the DHCP Lease is released.

To perform a DHCP trace on the on the Mitel MiVoice 6930 IP phone:

1. Press the  (**Settings**) key on the phone to enter the **Settings** menu.

2. Press the **Advanced** softkey.
3. Input the Administrator password using the dialpad keys (default is 73738) and press the **Enter** softkey.
4. Navigate to **Diagnostics > DHCP Trace** using the navigation keys and press the **Select** softkey.

Mitel MiVoice 6930 DHCP Trace

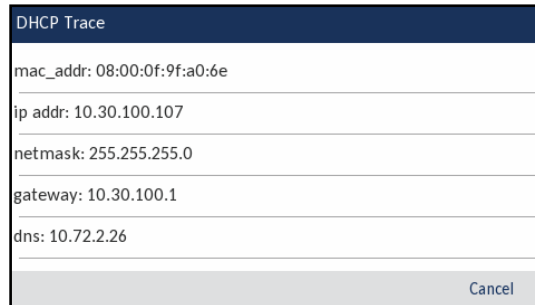

The following parameters and associated values are displayed:

- **mac_addr:**
The MAC address of the IP phone.
- **ip addr:**
The IP address of the IP phone.
- **netmask:**
The IP address range local to the IP phone.
- **gateway:**
The IP address of the network's gateway or default router IP address.
- **dns:**
The IP address of the primary DNS server.
- **icp:**
The IP address of the MiVB call server.
- **tftp:**
The IP address of the TFTP server.
- **http:**
The IP address of the HTTP server.
- **ipa:**
The IP address of the IPA server.
- **VLAN:**
The VLAN id of the IP phone.
- **I2p:**
L2P priorities for default, voice, signaling, and other.
- **dscp:**
DSCP values for default, voice, signaling, and other.

Restart

The **Restart** setting allows you to restart your phone. You may need to restart your phone if you have been asked to do so by your System Administrator should you experience any unexpected behavior.

To restart your phone:

1. Press the  (**Settings**) key on the phone to enter the **Settings** menu.
2. Navigate to the **Restart** option and press the **Select** button or **Select** softkey.

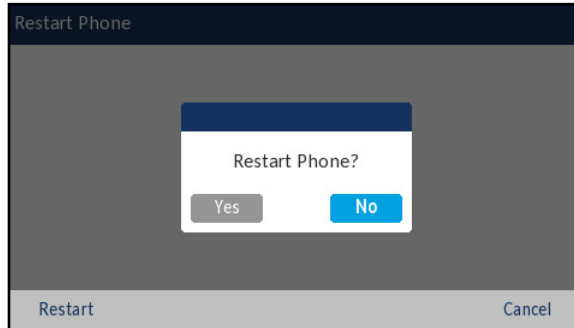

3. When the prompt, **Restart Phone?** appears, navigate to the **Yes** button and press the **Select** button or press the **Restart** softkey.

If you do not wish to restart your phone, press **No** or the **Cancel** softkey.

Note: Your phone will be temporarily out of service during the restart process.

Configuring and using programmable keys

Your Mitel MiVoice 6930 IP phone has 12 programmable, multi-function, self-labeling keys allowing you to program and use up to 72 functions.

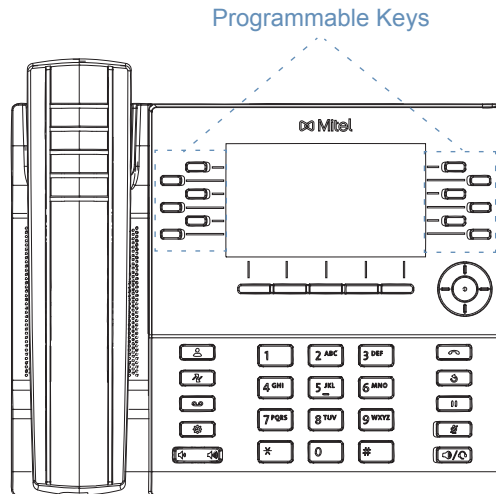

Notes:

1. If Mitel M695 Programmable Key Modules (PKMs) are attached to the phone, you can configure up to an additional 28 keys on each PKM.
2. The Mitel MiVoice 6930 IP phone allows up to three PKMs on each phone. For more information about PKMs, see [“Mitel M695 Programmable Key Module \(PKM\)”](#) on page 107.

If enabled by your System Administrator, you can program or edit the following functions on the programmable keys by pressing and holding the respective programmable key for the configured duration:

- Speed Call
- Phone Lock
- Call Forward Always
- Mobile Line
- Account Code Non Verified
- Account Code Verified

Note: Programming keys using the press-and-hold method is dependent on your Class of Service settings defined for your account on the MiVoice Business call server.

Speed Call

The **Speed Call** key allows you to dial a specified number with one key press. **Speed Call** keys can be useful as they can be programmed to dial external numbers, dial directly to another person's extension or quickly access features that use feature access codes. You can also transfer calls to or create conference calls using your **Speed Call** keys in place of dialing out manually.

To program or edit a **Speed Call** key:

1. Press and hold the applicable programmable key for the configured duration.

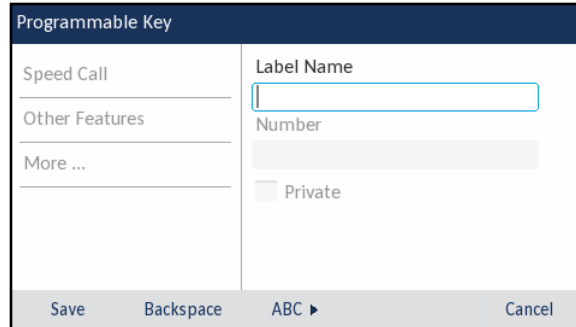

2. In the **Label Name** field, enter a label to apply to the key.

Note: If necessary, use the **ABC** softkey to specify uppercase letters or lowercase letters when entering the label and use the **Backspace** softkey to delete the last character/digit entered. To add a space, press the * (star) key twice.

3. Press the down navigation key to move to the **Number** field and enter the number using the dialpad keys.
4. (Optional) Press the down navigation key to move to the **Private** checkbox and press the **Select** button to make the key a **Private Speed Call** key. When a **Private Speed Call** key is pressed, the call is considered private and caller ID information is not displayed in the phone's call history.
5. Press the **Save** softkey to save the information to the key you selected.

To make a speed call, press the key that you have programmed with **Speed Call** functionality.

Other Features

Phone Lock

By programming a **Phone Lock** key you can lock your phone to prevent the phone from being used or configured. **Phone Lock** prevents access to all the features on the phone, with the following exceptions:

- Unlocking the set via a user PIN.
- Hot Desk Login and Logout support.
- Emergency Call Notification support.

Phone Lock has no effect on incoming calls but restricts outgoing calls, with the following exceptions:

- Calls to emergency trunk routes.
- Local operators.

All hard keys on the device are disabled except for the dialpad and volume keys. All programmable keys and softkeys are disabled except for the **Phone Lock**, **Hot Desk**, and Emergency Notification feature access keys.

To program a **Phone Lock** key:

1. Press and hold the applicable programmable key for the configured duration.
2. Press the left navigation key to move to the feature category column.
3. Press the down navigation key to highlight **Other Features**.
4. Press the right navigation key to move to the **Other Features** selection column.

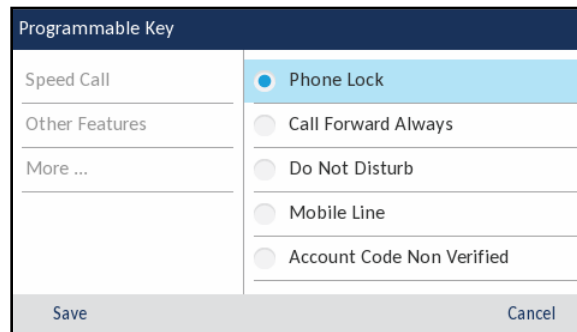

5. With **Phone Lock** highlighted, press the **Save** softkey.

To lock the phone:

1. Press the **Phone Lock** key.
A "Locked" prompt appears on screen and the **Phone Lock** key turns light blue indicating the phone is locked.

To unlock the phone:

1. Press the **Phone Lock** key again.
2. At the "Enter PIN:" prompt, enter your pin number and press the **Enter** softkey.

Call Forward Always

Programming a **Call Forward Always** key allows you to quickly enable and disable call forwarding for all calls on your phone even if you have other call forward modes enabled through your **Call Forward** settings menu.

For example, you can enable settings to forward calls to your voicemail when your phone is busy or unanswered. Then, when you leave your desk, you can quickly enable **Call Forward Always** to forward calls to another phone, such as your home phone or cell. After you return to your desk and disable **Call Forwarding Always**, the defaults for busy or unanswered conditions remain active.

To program a **Call Forward Always** key:

1. Press and hold the applicable programmable key for the configured duration.
2. Press the left navigation key to move to the feature category column.
3. Press the down navigation key to highlight **Other Features**.
4. Press the right navigation key to move to the **Other Features** selection column.
5. Navigate to **Call Forward Always** using the down navigation key.

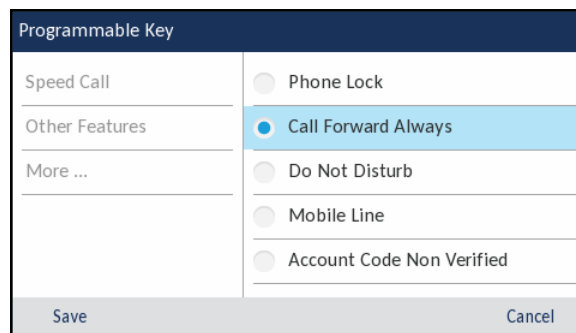

6. With **Call Forward Always** highlighted, press the **Save** softkey.

To enable **Call Forward Always**:

1. Press the key that you have programmed with **Call Forward Always** functionality. When Call Forward Always is enabled, a  (**Call Forward Always**) icon is displayed in the status bar.
2. If a number is already programmed, press **Activate** to enable forwarding to the current number or

If a number has not been programmed, enter a new destination number and then press the **Activate** softkey.

Notes:

1. When **Call Forward Always** is enabled, it takes precedence over all other types of call forwarding.
2. If **Call Forward Always** is enabled, then the **Call Forward Always** icon is displayed on the Screen Saver.
3. If both **Call Forward Always** and **DND** are enabled, then the **DND** icon is displayed on the Screen Saver.



Call Forward Always Icon

To disable **Call Forward Always**:

1. Press the key that you have programmed with **Call Forward Always** functionality.
When Call Forward Always is disabled, a  (**Call Forward Always**) icon is removed from the status bar.
2. Press the **Deactivate** softkey.

Note: When **Call Forward Always** is disabled, the default call forwarding settings are active.

Do Not Disturb

When you program and enable a **Do Not Disturb** key, callers may get a busy tone and an on-screen text message indicating that you do not wish to be disturbed, depending on the setting in the System Administrator Tool.

To program a **Do Not Disturb** key:

1. Press and hold the applicable programmable key for the configured duration.
2. Press the left navigation key to move to the feature category column.
3. Press the down navigation key to highlight **Other Features**.
4. Press the right navigation key to move to the **Other Features** selection column.
5. Navigate to **Do Not Disturb** using the down navigation key.

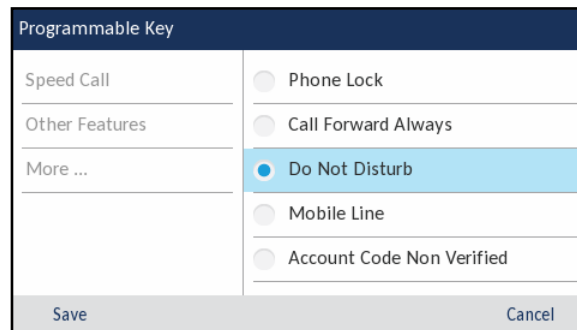

6. With **Do Not Disturb** highlighted, press the **Save** softkey.

To enable **Do Not Disturb**:

1. Press the key that you have programmed with **Do Not Disturb** functionality. When DND is enabled, a  (DND) icon is displayed in the status bar and the **Do Not Disturb** key turns red.

Note: The **DND** icon is displayed on the Screen Saver.



To disable **Do Not Disturb**:

1. Press the key that you have programmed with **Do Not Disturb** functionality. When DND is disabled, the  (DND) icon is removed from the status bar and the **Do Not Disturb** key returns to its normal color.

Mobile Line

The Mitel MiVoice 6930 IP Phone supports **Mobile Line**, a feature that provides seamless mobile integration using Bluetooth wireless technology. This feature allows you to:

- Sync your mobile phone's contact list and call history with your Mitel MiVoice 6930 IP phone.
- Answer a mobile phone call using your Mitel MiVoice 6930 IP phone.
- Move mobile call audio between the Mitel MiVoice 6930 IP phone and your mobile phone.





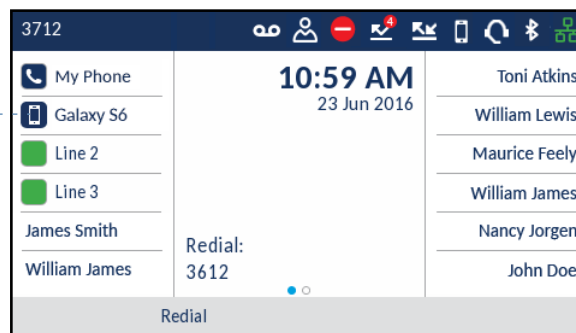

You can enable **Mobile Line** key by one of the following ways:

- Programming a **Mobile Line** key for your phone by your System Administrator. Contact your System Administrator for details on how to enable MobileLink functionality on your phone.
- Pressing and holding a programmable key.

Mobile Line Key



The **Mobile Line** key icon changes to reflect the status of the line as per the following table.

Icon	Description
	Indicates the mobile line is connected with a mobile phone and is idle.
	(Blinking) Indicates the mobile line is ringing due to an incoming call on your mobile phone.
	Indicates the mobile line is busy.
	(Blinking) Indicates an ongoing call with active audio on the mobile phone.
	(Blinking) Indicates the call on the mobile line is on hold.
	Indicates the mobile phone is not connected.

To program a **Mobile Line** key:

Note: You can program only one **Mobile Line** key.

1. Press and hold the applicable programmable key for the configured duration.
2. Press the left navigation key to move to the feature category column.
3. Press the down navigation key to highlight **Other Features**.
4. Press the right navigation key to move to the **Other Features** selection column.
5. Navigate to **Mobile Line** using the down navigation key.

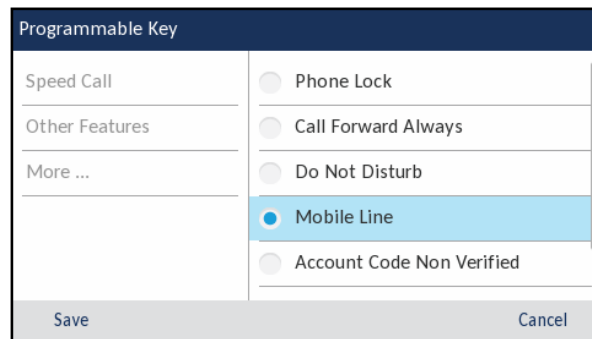

6. With **Mobile Line** highlighted, press the **Save** softkey.

For more information on how to use the **Mobile Line** key, see “[MobileLink](#)” on [page 92](#).

Account codes

Accounts codes are an effective way of grouping calls together for accounting, auditing, and reporting purposes. When you tag a call with an account code, the code is picked up in the records generated by your call server. This allows System Administrators the ability to quickly identify groups of calls, which can then be used by different departments for organizational and reporting purposes.

The following are the two types of account codes that you can add to a call:

- **Account Code Non Verified:**
A non-verified account code is one that has not been pre-programmed on your call server. Non-verified account codes can be used to group a set of calls that has not yet been verified and pre-programmed on your call server.
- **Account Code Verified:**
A verified account code is one that has been pre-programmed on your call server by a System Administrator.

Account Code Non Verified

To program an **Account Code Non Verified** key:

1. Press and hold the applicable programmable key for the configured duration.
2. Press the left navigation key to move to the feature category column.
3. Press the down navigation key to highlight **Other Features**.
4. Press the right navigation key to move to the **Other Features** selection column.
5. Navigate to **Account Code Non Verified** using the down navigation key.

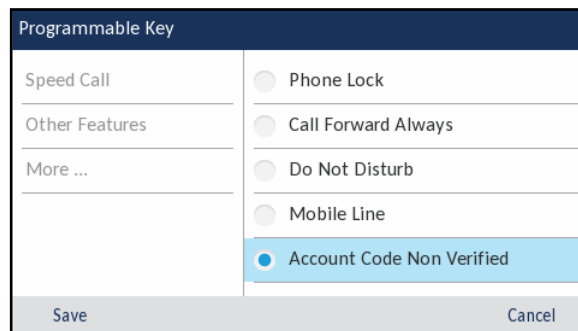

6. With **Account Code Non Verified** highlighted, press the **Save** softkey.

To assign a non-verified account code before a call:

1. Press the key that you have programmed with **Account Code Non Verified** functionality.
2. Enter the digits (up to 12) for the account code using the dialpad keys.
3. Press the # (hash) key.
4. Enter the number you wish to call.

To assign a non-verified account code during a call:

1. While on an active call, press the key that you have programmed with **Account Code Non Verified** functionality.
2. Enter the digits (up to 12) for the account code using the dialpad keys.
3. Press the # (hash) key.

Account Code Verified

To program an **Account Code Verified** key:

1. Press and hold the applicable programmable key for the configured duration.
2. Press the left navigation key to move to the feature category column.
3. Press the down navigation key to highlight **Other Features**.
4. Press the right navigation key to move to the **Other Features** selection column.
5. Navigate to **Account Code Verified** using the down navigation key.

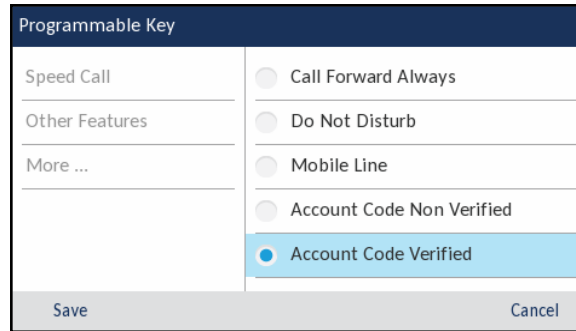

6. With **Account Code Verified** highlighted, press the **Save** softkey.

To assign a verified account code before a call:

1. Press the key that you have programmed with **Account Code Verified** functionality.
2. Enter the digits (up to 12) for the account code using the dialpad keys.
3. Press the # (hash) key.
4. Enter the number you wish to call.

To assign a verified account code during a call:

1. While on an active call, press the key that you have programmed with **Account Code Verified** functionality.
2. Enter the digits (up to 12) for the account code using the dialpad keys.
3. Press the # (hash) key.

Float Keys

The Mitel MiVoice Business 6930 IP Phone offers 12 programmable, multi-function, self-labeling keys allowing up to 72 functions and five intuitive state sensitive softkeys. You can program six of these keys as float keys. Float keys are typically used to display unanswered ringing lines on

designated keys where the ringing lines would otherwise be hidden on one of the phone's application pages. The location of the Float keys is shown in the following figure:

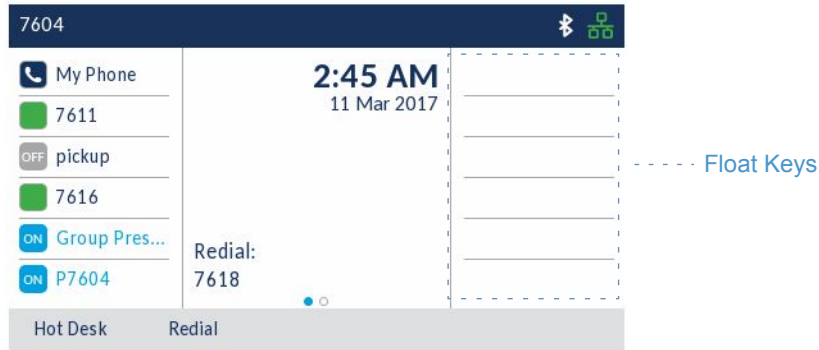

Up to six concurrent incoming calls with associated labels can appear on the Float keys. Float keys can also be used to support ringing line queues – due to the number of ringing lines at any one time, you are able to view the queue of unanswered “floated” lines, and answer them as quickly as possible.

Only the following line types are supported for float keys on the 6930 IP Phone:

- Single Line
- Key System
- Multicall

Contact your System Administrator to program Float Keys on your 6930 IP Phone.

Using Float Keys

You can set up more than six lines to float. As lines ring, they get placed into a queue which will display the first six in the float key area. If there are more than six lines configured to float, as Float Key positions are freed up, the next lines in the queue get displayed. Press the Float key of the ringing line to answer a call.

Contact your System Administrator to program Float Keys on your 6930 IP Phone.

Making calls

This section describes ways to make calls on your Mitel MiVoice 6930 IP phone, using your handset, speakerphone or headset.

Dialing a number

First, take the phone off-hook by:

- Lifting the handset for handset operation, or
- Pressing the  (**Speaker/Headset**) key or applicable **Line** key for speaker or headset operation. Your phone must be configured to use the Speaker audio path for speaker operation or Headset audio path for headset operation.

At the dial tone, enter the number you wish to call. When your party picks up, a timer appears on your display that records the length of your call.

Alternatively, you can enter the number you wish to call without taking the phone off-hook. This method of dialing will use the speakerphone or headset audio path depending on the audio path setting you selected in the **Settings > Audio > Audio Path** menu. For more information, see the section “[Audio Path](#)” on [page 34](#).

Note: When dialing, press the **Backspace** softkey to delete the last digit entered. To cancel the dialing process, press the **End Call** softkey or the  (**Goodbye**) key.

If the dialed number matches with a contact stored in the **Personal**, **Mobile** or **Corporate** folder in the **Contacts** application, then the contact name is displayed. The contact name look up is in the following order:

1. Personal Contacts, where respective Personal Contacts name is displayed.
2. Mobile Contacts, where respective Mobile Contacts name is displayed.
3. MiVoice Business System Contacts, where if the MiVoice Business System is configured with MiNET Phone Object Message Name, then the respective MiVoice Business System name is displayed.
4. Corporate Contacts, where respective Corporate Contacts name is displayed.

If there is no match, then the name returned by the MiVoice Business system is displayed.

If you are unable to make calls within certain area codes, check with your System Administrator for any toll restrictions placed on your extension that may restrict your access to long distance area codes or dialing prefixes.

Initiating a callback

The callback feature allows you to be notified when a busy phone becomes free or when a phone has been used after a no-answer condition was encountered.

To request a callback when the call you initiated is busy or has not answered:

1. Press the **Call Me Back** softkey.
2. Hang up.

When the party is available, your phone starts ringing, and the display shows the callback ringing indicator.

To answer a callback when you see the callback ringing indicator:

1. Lift the handset, or press the  (**Speaker/Headset**) key or applicable **Line** key, or Float Key (see [page 54](#)).

Redialing a number

You can redial the most recently dialed number that is displayed on the **Home** screen by pressing the **Redial** hard key twice or by pressing the **Redial** softkey.

Pressing the **Redial** hard key once accesses the **Outgoing** calls list in the **Call History** application. For more information on the **Call History** application, see [“Call History” on page 77](#).

Receiving calls

When a call is ringing at your extension, the callers name, number, and avatar (if applicable) display on the **Call** screen. Additionally, the applicable **Line** key icon flashes indicating the incoming call.

If the incoming number matches with a contact stored in the **Personal**, **Mobile** or **Corporate** folder in the **Contacts** application, then the contact name is displayed. The contact name look up is in the following order:

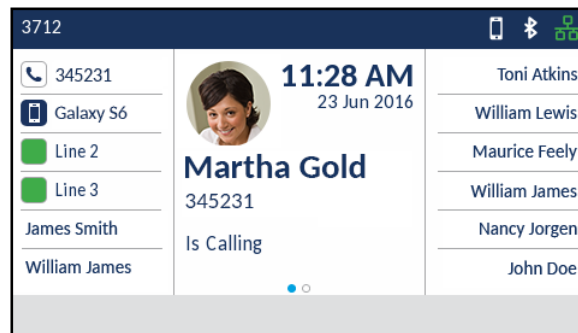

1. Personal Contacts, where respective Personal Contacts name is displayed.
2. Mobile Contacts, where respective Mobile Contacts name is displayed.
3. MiVoice Business System Contacts, where if the MiVoice Business System is configured with MiNET Phone Object Message Name, then the respective MiVoice Business System name is displayed.
4. Corporate Contacts, where respective Corporate Contacts name is displayed.

If there is no match, then the name returned by the MiVoice Business system is displayed.



Answering an incoming call

To answer an incoming call:

- Lift the handset for handset operation.
- For speakerphone operation, press the  (**Speaker/Headset**) key, or the applicable **Line** softkey, or Float Key (see [page 54](#)). Your phone must be configured to use the Speaker audio path.
- For headset operation, press the  (**Speaker/Headset**) key or the answer button on your headset (if available). Your phone must be configured to use the Headset audio path.

Note: The audio path setting you selected in the **Settings > Audio > Audio Path** menu determines if the call goes to the speakerphone or headset. For more information, see the section [“Audio Path”](#) on [page 34](#).

Manually forwarding an incoming call

If call forwarding numbers have been defined for the **Always** or **No Answer** states, press the **Forward Call** softkey to manually forward an incoming call to the defined number. A common way

of using this feature is to configure call forwarding to forward calls to your voicemail service. You can then manually decide whether to answer an incoming call or send the call to voicemail.

Notes:

1. The number defined for the **Always** state has precedence over the numbers defined for the **No Answer** states.
2. For more information on how to configure the **Call Forward** feature, see the section “[Call Forward](#)” on [page 22](#).

Handling calls

When you are connected to a call, you can use hard keys on the phone perform various action such as placing a call on hold or muting the microphone. Softkeys can also be used to perform actions such as transferring calls or creating multi-party conference calls.

Placing a call on hold

You can place an active call on hold by pressing the  (**Hold**) key.

To place a call on hold (while on an active call):

1. Press the  (**Hold**) key.

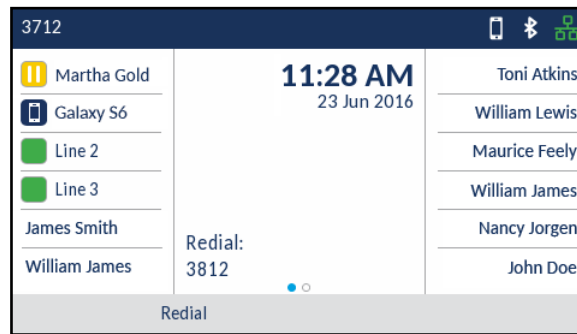

Your applicable **Line** key flashes the  (**Hold**) icon indicating the call is on hold. To let your caller know that they are on hold, music plays softly (if this has been set up on your call server).





Note: After a prolonged period of time on hold, the held call may automatically switch to an incoming call to remind you that the call was on hold.

2. To retrieve a call on hold, press the applicable **Line** key or Float Key (see [page 54](#)).

Muting the microphone

You can use the  (**Mute**) key to mute the microphone on the handset, headset, or speakerphone. When you use the  (**Mute**) key on your phone, you cannot be heard on an active call or on a conference.

To indicate a muted microphone, the LED beside the  (**Mute**) key turns on. To switch mute on or off, press the  (**Mute**) key.

Note: If you place a muted call on hold, the phone automatically takes the call off mute when you reconnect to the call.

Transferring a call

There are two types of call transfers that can be performed on the Mitel MiVoice 6930 IP phone:

- **Unattended Transfer:**
An unattended transfer is when you transfer a call directly to another extension without consulting with the person receiving the call. To do this, complete the transfer immediately after you have entered the number. The call goes directly to the extension or outside line to which you transferred.
- **Attended transfer:**
You also have the option to consult with the person to which you are transferring the call, before you complete the transfer. To do this, remain on the line until the receiving party answers the call. After consulting with the receiving party, you can either complete the transfer or cancel the transfer to go back to the original call.

To transfer a call:

1. Ensure you are on active call with the party you wish to transfer.

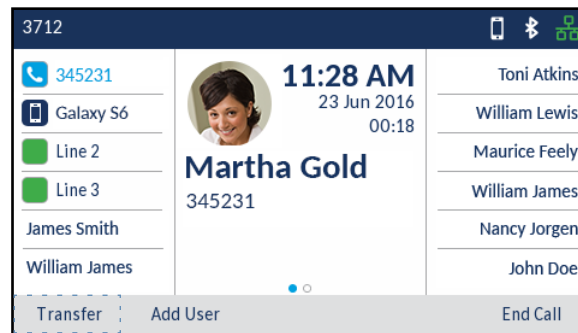

2. Press the **Transfer** softkey.
The active call is placed on hold.

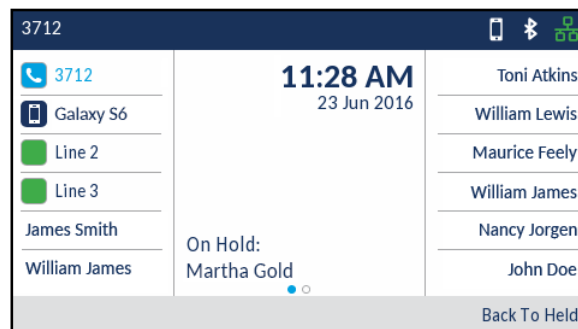

3. Enter the transfer recipient's number.

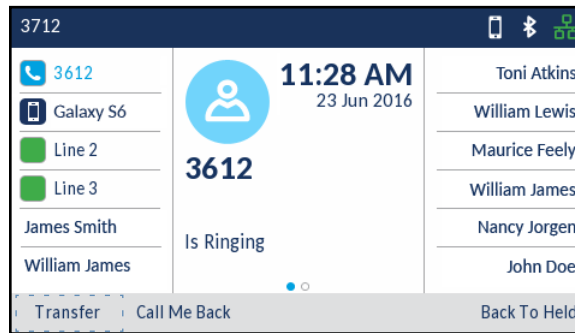

4. Press the **Transfer** softkey or hang up the handset to complete an unattended call transfer or
 Wait for an answer, consult, and then press the **Transfer** softkey or hang up the handset to complete an attended transfer.

Creating a multi-party conference call

The Mitel MiVoice 6930 IP phone supports multiples parties in a conference call.

To create a multi-party conference call:

1. Ensure you are on active call with one of the parties with whom you wish to create a conference.

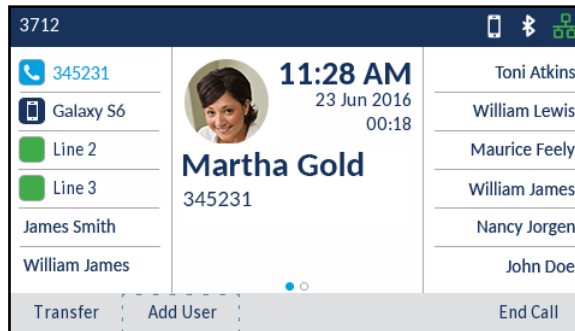

2. Press the **Add User** softkey.
 The active call is placed on hold.

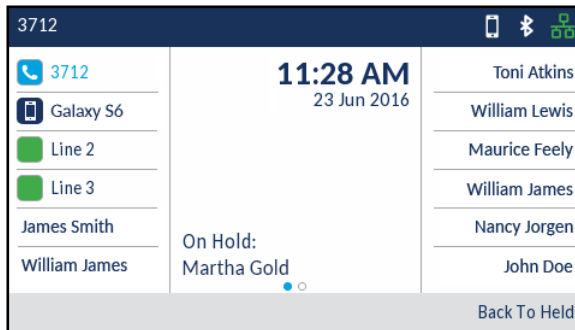

3. Enter the conference target's number.

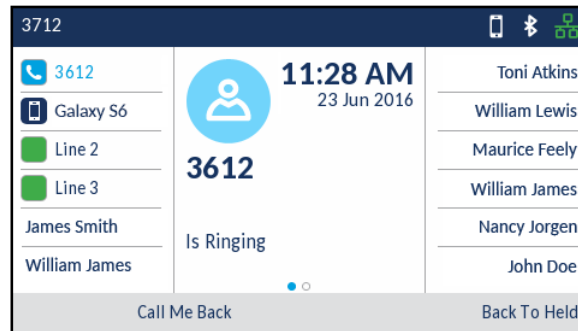

4. Wait for an answer, consult, and then press the **Join Calls** softkey to create the three-way conference call.

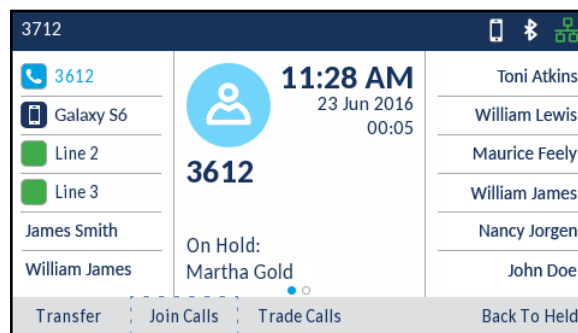

Notes:

1. Pressing the **Trade Calls** softkey swaps the active call with the other party currently on hold.
2. Pressing the **Split** softkey splits the conference call by placing all callers on hold except for the initial caller.

5. Repeat steps 2 to 4 to add additional parties to the conference.

Note: If you want to create a conference call with two parties you are already in calls with (on different line appearances), press the **Add Held** softkey and press the applicable **Line** key with the held call.

Ending a conference and transferring remaining parties

The Mitel MiVoice 6930 IP phone allows a host to easily leave a conference call without disrupting the connection of the other remaining parties.

If you are the host of a conference call and want to leave the conference, press the **Leave Call** softkey on the phone. Your phone leaves the conference call but the remaining parties are still connected together.

Ending calls

To end a call, you first need to connect or reconnect to the call if not already connected (e.g. if your caller is on hold). With the call connected, place the handset on its cradle, press the **End Call** softkey, or press the  (**Goodbye**) key.

Managing calls

The Mitel MiVoice 6930 IP phone has several features that make it easier to manage calls. Three of the main call management features include the **Contacts** application, the **Call History** application, and **Voicemail**.

Contacts

The **Contacts** application is your personal phone book and directory, conveniently stored within your phone. The Mitel MiVoice 6930 IP phone supports a localized **Personal** contact folder as well as enhanced functionality allowing for interoperability with LDAP (**Corporate**) directories. The phone also supports MobileLink synchronization with mobile phone contact lists using Bluetooth capabilities.

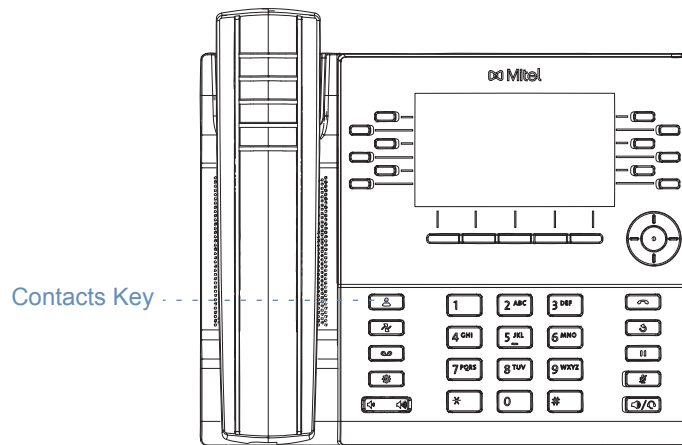

Notes:

1. Access to Corporate directories must be set up by your System Administrator.
2. For more information on syncing mobile contacts and MobileLink functionality, see “[Syncing mobile contacts](#)” on page 93.

General functions

Accessing and navigating the Contacts application

To access and navigate the Contacts application:

1. Press the  (**Contacts**) key.

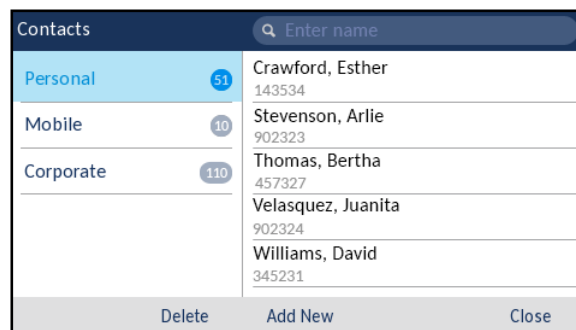

2. You can view the list of contacts on the right for each respective contact folder by pressing the up and down navigation keys.

Note: If any of the folders are empty, a "Directory empty" message displays on screen.

3. Press the right navigation key to move to the contact selection column. From this column, you can use the up and down navigation keys to scroll through the list of contacts.

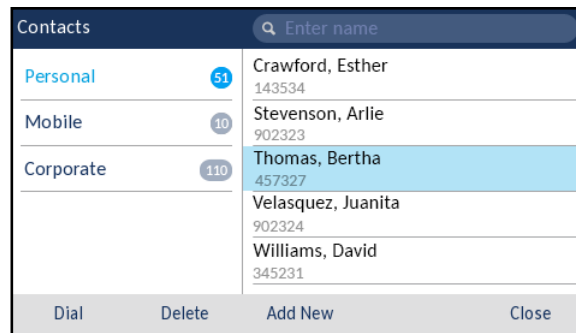

4. From the contact selection column, press the right navigation key to display the contact card for the selected contact.

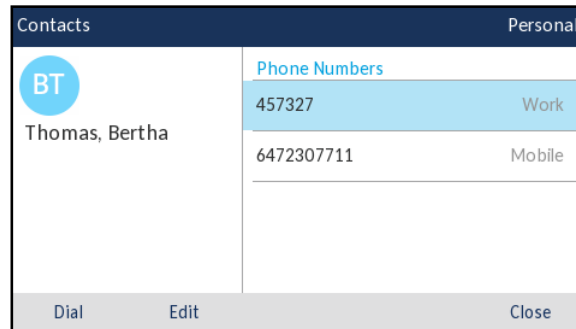

5. Press the up and down navigation keys to scroll through the list of numbers.
6. Press the  (Goodbye) key, or **Close** softkey to exit.

Performing a search

Search functionality is applied to your **Personal** and **Mobile** contact folders and your **Corporate** contact folder if your corporate directory is configured to be cached.

Note: If you do not see a number indicating the amount of contacts beside your **Corporate** folder, your corporate directory is configured to be non-cached. See “[Performing a search on a non-cached Corporate contact folder](#)” on [page 73](#) if your phone is configured to use a non-cached corporate directory.

Pressing on any dialpad key initiates the search. After entering the first few letters of the contact’s first name or last name and initiating the search, you can then quickly select a contact and perform the applicable action. Use the following procedure on the phone’s UI to perform a search.

To perform a search:

1. Press the  (**Contacts**) key.

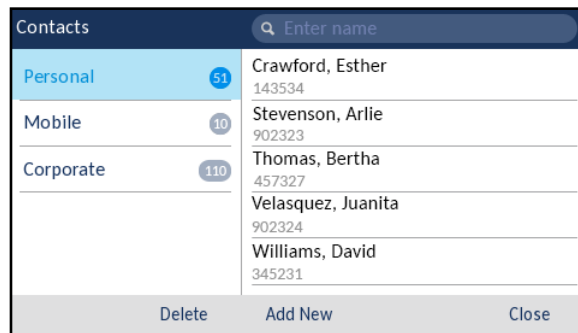

2. Using the dialpad keys enter in the first letters of the contact’s name and (if required) press the **Search** softkey.

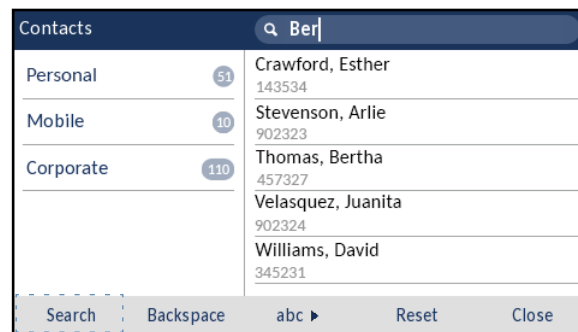

Note: Press the **Reset** softkey at any time clear the search field.

- When matches are found, navigate to the contact entry and perform your desired action.

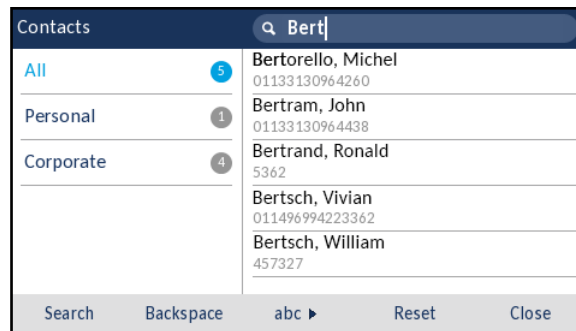



Dialing from the Contacts application

Dialing can be performed by manually navigating to the contact, selecting a phone number (if the contact has more than one) and then by picking up the handset, or by pressing the **Dial** softkey, **Select** button or  (**Speaker/Headset**) key.

To dial a contact's phone number.

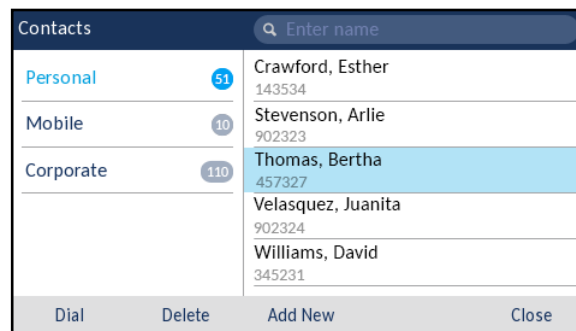
- Press the  (**Contacts**) key.
- (Optional) Using the dialpad keys input the first letters of the contact's name to initialize the search function.
- Use the navigation keys to highlight the contact you want to call.



- (Optional) If the contact has multiple phone numbers defined, press the right navigation key to navigate to the contact card and use the up and down navigation keys to select the phone number you wish to call.
- Press the **Dial** softkey, **Select** button or  (**Speaker/Headset**) key for speaker or headset operation
or
Pickup the handset for handset operation.

Personal folder features

The **Personal** folder contains the contacts (up to 50) that have been created or copied directly to the phone using the phone UI.

From the **Personal** folder you can search for a personal contact, place a call to the selected personal contact, add new personal contacts, delete all personal contacts, delete individual personal contacts, or edit existing personal contacts. You can also view contact details (e.g. avatar, name, and numbers) by navigating to the contact card.

Adding a new contact to your Personal folder

To add a new contact to your **Personal** folder:

1. Press the  (**Contacts**) key.
2. Press the **Add New** softkey.

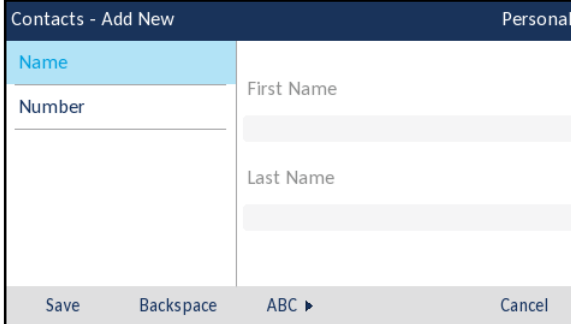

Contacts - Add New		Personal
Name	First Name	
Number	Last Name	
Save Backspace ABC ► Cancel		

3. Press the right navigation key to move to the **First Name** input field and enter the first name of the personal contact using the dialpad keys.

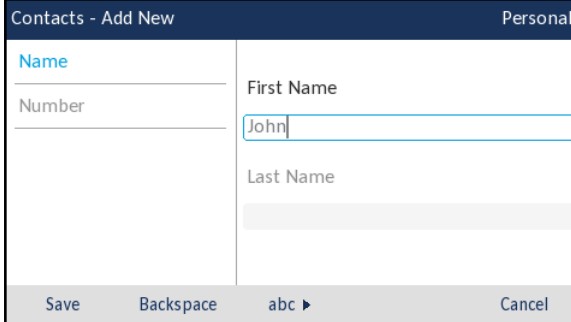

Contacts - Add New		Personal
Name	First Name John	
Number	Last Name	
Save Backspace abc ► Cancel		

4. (Optional) Press the down navigation key to move the **Last Name** input field and enter the last name of the personal contact using the dialpad keys.
5. Press the left navigation key to return to the **Name** and **Number** category column.

- Press the down navigation key to select the **Number** category.

The screenshot shows the 'Contacts - Add New' form with the 'Personal' category selected. The 'Number' category is highlighted in blue. The form has three input fields: 'Name', 'Work', and 'Mobile'. The 'Work' field is currently selected. At the bottom, there are three buttons: 'Save', 'Backspace', and 'Cancel'.

- With **Number** highlighted, press the right navigation key to move to the number type tab.

The screenshot shows the 'Contacts - Add New' form with the 'Number' category highlighted. The 'Work' number type is selected in a dropdown menu. The 'Work' field is now active. At the bottom, there are two buttons: 'Save' and 'Cancel'.

- Use the left and right navigation keys to switch the type of number to either Work, Home, or Mobile.

The screenshot shows the 'Contacts - Add New' form with the 'Number' category highlighted. The 'Home' number type is selected in a dropdown menu. The 'Home' field is now active. At the bottom, there are two buttons: 'Save' and 'Cancel'.

- Press the down navigation key to move to the number input field and enter the number of the personal contact using the dialpad keys.

The screenshot shows the 'Contacts - Add New' form with the 'Number' category highlighted. The 'Home' number type is selected. The number '5556200' is entered in the 'Home' input field. At the bottom, there are three buttons: 'Save', 'Backspace', and 'Cancel'.

10. (Optional) Press the down navigation key to move to the second number type tab field and repeat steps 8 and 9 to enter a secondary number.
11. Press the **Save** softkey to save the contact to your **Personal** folder.

Editing an existing contact in your Personal folder

To edit an existing contact in your **Personal** folder:

1. Press the  (**Contacts**) key.
2. (Optional) Using the dialpad keys input the first letters of the contact's name to initialize the search function.
3. Use the navigation keys to highlight the contact you want to edit.

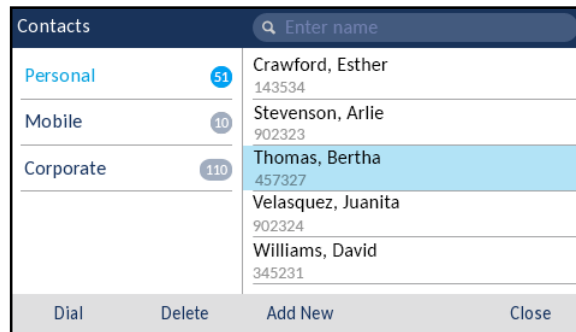

4. Press the right navigation key to view the contact card for the selected contact and press the **Edit** softkey.

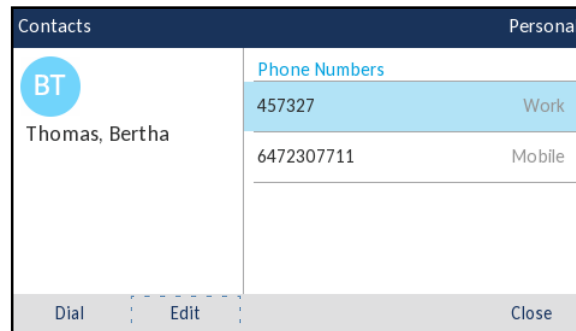

5. Use the navigation keys to navigate through the various tabs and fields and edit any information using the dialpad keys.
6. Press the **Save** softkey to save your changes.

Deleting all contacts from the Personal folder

1. Press the  (**Contacts**) key.
2. Press the **Delete** softkey.

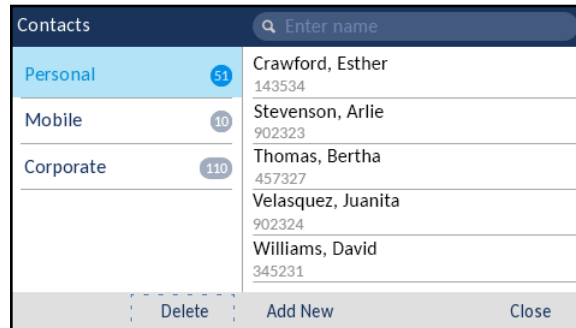

A delete all confirmation message appears on screen.

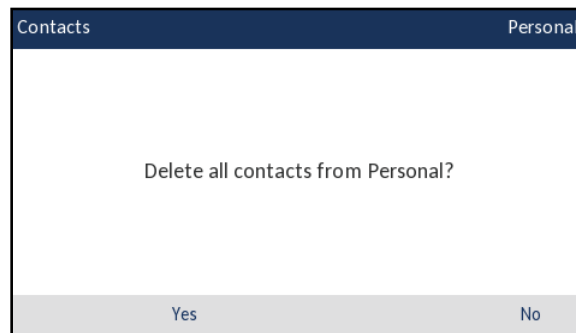

3. Press the **Yes** softkey to delete all contacts from your **Personal** folder.

Note: Press the **No** softkey to cancel the delete process.

Deleting a contact from the Personal folder

To delete contacts from your **Personal** folder:

1. Press the  (**Contacts**) key.
2. (Optional) If you want to delete an individual entry, using the dialpad keys input the first letters of the contact's name to initialize the search function.

3. Highlight the applicable contact and press the **Delete** softkey.

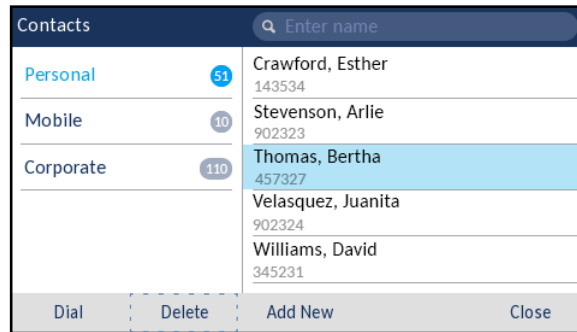

A delete confirmation message appears on screen.

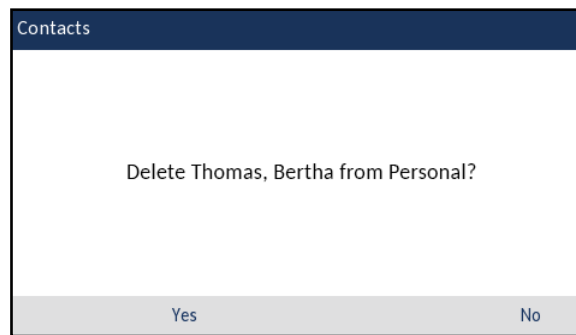

4. Press the **Yes** softkey to delete the selected contact from your **Personal** folder.

Note: Press the **No** softkey to cancel the delete process.

Corporate and Mobile folder features

The **Corporate** folder contains the contacts that are available through your corporate LDAP directory. The **Mobile** folder contains your mobile phone contacts (if synchronized).

Notes:

1. Access to corporate directories must be set up by your System Administrator.
2. Updates made to your corporate directory are reflected on your phone only at the re-synchronization time configured on the MiVoice Business phone system.
3. For more information on syncing mobile contacts and MobileLink functionality, see “[Syncing mobile contacts](#)” on page 93.

There are two types of corporate directories that can be configured:

1. **Cached:**

Contacts are cached on the phone and are viewable as a list in the **Corporate** contact folder upon entering the Contacts application. You can scroll up and down to view your list of corporate contacts. Performing a basic search applies to both the **Personal** and **Corporate** contacts folders.

2. **Non-cached:**

Contacts are not cached on the phone and therefore contacts are not available until you perform a lookup in the **Corporate** contact folder. Used for corporate directories with a large amount of contacts as caching a large amount of contacts could, at times, overload the IP phone.

You can perform all the same functions as the **Personal** folder from the **Corporate** and **Mobile** folders except for adding, deleting, and editing entries. In addition to being able to search for a corporate or mobile contact, place a call to the selected corporate or mobile contact, and view corporate or mobile contact’s contact card, you can copy the corporate or mobile contact to your **Personal** folder.

If a call is placed from the **Corporate** folder matches with a contact stored in the **Personal** or **Mobile** folder in the **Contacts** application, then the contact name is displayed. The contact name look up is in the following order:

1. Personal Contacts, where respective Personal Contacts name is displayed.
2. Mobile Contacts, where respective Mobile Contacts name is displayed.
3. MiVoice Business System Contacts, where if the MiVoice Business System is configured with MiNET Phone Object Message Name, then the respective MiVoice Business System name is displayed.

If there is no match, then the number returned by the MiVoice Business system is displayed.

Note: See “[Performing a search](#)” on page 66 for details on how to perform a search on your cached **Corporate** contact folder as well as your **Mobile** contact folder.

Performing a search on a non-cached Corporate contact folder

To perform a search on a non-cached **Corporate** contact folder:

1. Press the  (**Contacts**) key.

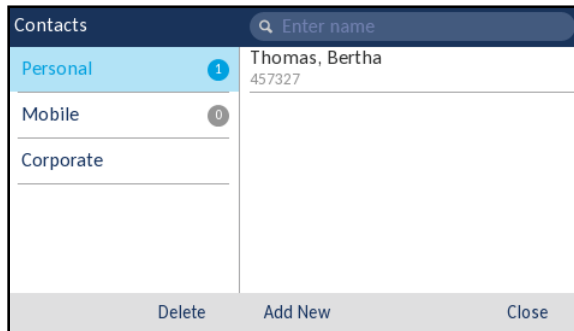

2. Using the down navigation key select the **Corporate** folder.

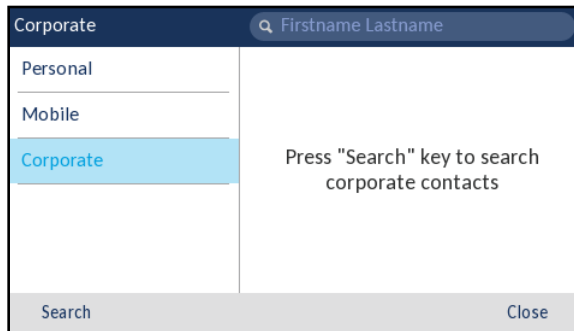

3. Press the **Search** softkey to enter the search bar.
4. Using the dialpad keys enter in the first letters of the contact's last name and press the **Search** softkey.



Note: For non-cached corporate directories, searches are based on the last name of the contact.

5. If matches are found, navigate to the contact entry and perform your desired action.

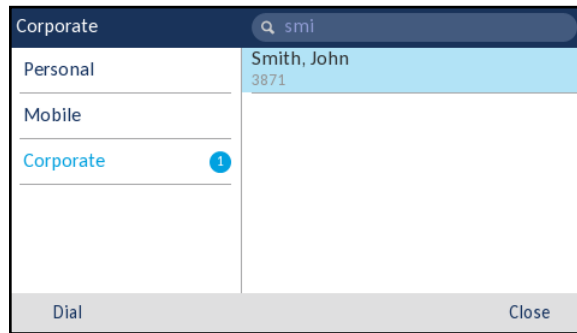

Copying a Corporate or Mobile contact to the Personal folder

To copy a contact in your **Corporate** or **Mobile** folder to your **Personal** folder:

1. Press the  (**Contacts**) key.
2. If applicable, for non-cached corporate directories, perform a search as detailed in “[Performing a search on a non-cached Corporate contact folder](#)” on page 73
or
(Optional) For cached corporate directories, using the dialpad keys input the first letters of the contact’s name to initialize the search function.
3. Use the navigation keys to highlight the corporate or mobile contact you want to copy to your **Personal** folder.

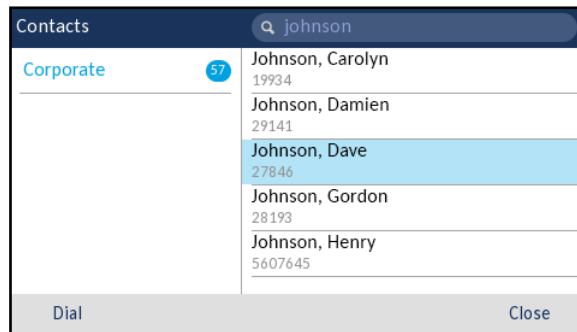

4. Press the right navigation key to view the corporate or mobile contact’s contact card.

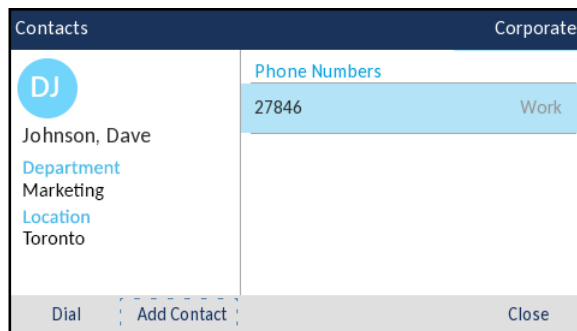

5. Press the **Add Contact** softkey.
A copy confirmation message is displayed.

Call History

The **Call History** application is a stored log of all your calls. You can view details of all your outgoing and received calls as well as any calls that were unanswered or missed. Your telephone logs the type of call, information regarding the remote party (name, number, and avatar), and the time of the call.

You can view and delete entries in the **Call History** as well as copy selected entries to the your **Personal** folder in the **Contacts** application. You can also dial an entry directly from the **Call History** application.

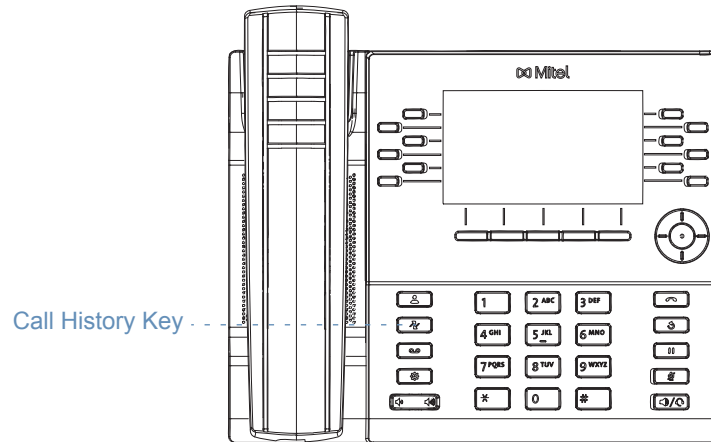

Note: For more information on syncing mobile call history and MobileLink functionality, see “Syncing mobile call history” on page 94.

The following table identifies and describes the various icons displayed in the **Call History** application:

Icon	Description
	Indicates an incoming call that was not answered (missed).
	Indicates an outgoing call (outgoing)
	Indicates an incoming call that was answered (received).

To access and use the **Call History** application:

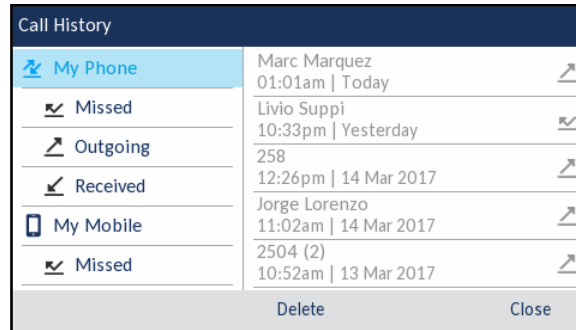

1. Press the  (**Call History**) key.



2. You can view the list of call entries on the right for each respective type of call by pressing the up and down navigation keys.
3. Press the right navigation key to move to the call entry column. From this column, you can use the up and down navigation keys to scroll through the call entries.
4. From the call entry column, press the right navigation key to display the individual call details for the selected call.



Note: The call details screen contains the date and time of the call, and the caller ID details.

5. Press the **Dial** softkey, **Select** button or  (**Speaker/Headset**) key for speaker or headset operation
or
Pickup the handset for handset operation.
6. Press the  (**Goodbye**) key, or **Close** softkey to exit.

Deleting entries from the Call History application

You can delete all entries in the **Call History** application regardless of call type, all entries within a call type folder, or individual entries.

To delete all entries from the **Call History** application:

1. Press the  (**Call History**) key.

- Use the navigation keys to highlight the **My Phone** call type folder.



- Press the **Delete** softkey.
A delete all confirmation message appears on screen.

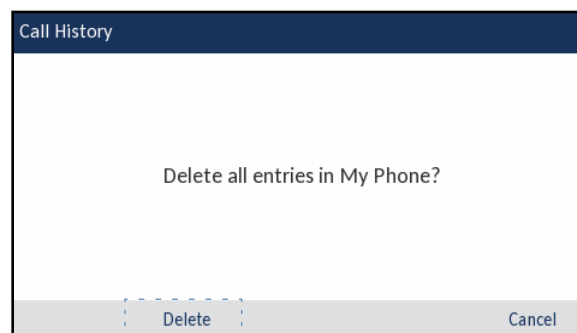

- Press the **Delete** softkey again to delete all entries in the **Call History** application.

Note: Press the **Cancel** softkey to cancel the delete process.

To delete all entries from a call type folder:

- Press the  (**Call History**) key.
- Use the navigation keys to highlight the applicable call type folder.

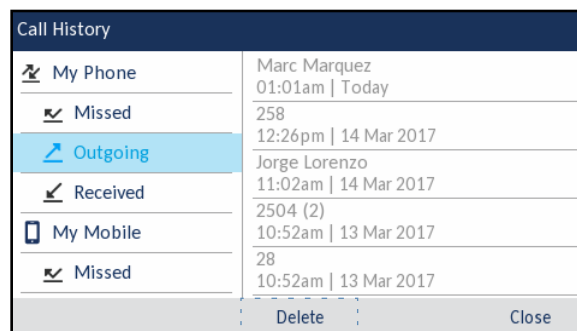

3. Press the **Delete** softkey.
A delete all confirmation message appears on screen.

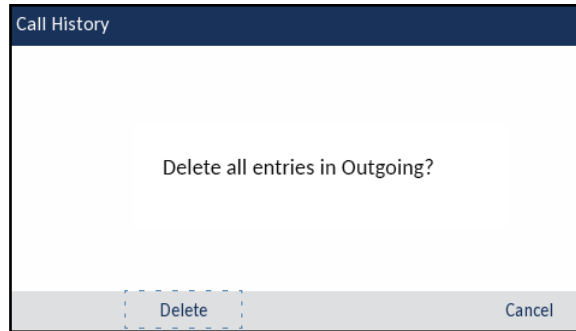

4. Press the **Delete** softkey again to delete all entries in the selected call type folder.

Note: Press the **Cancel** softkey to cancel the delete process.

To delete individual entries from a call type folder:

1. Press the  (**Call History**) key.
2. Use the navigation keys to highlight the applicable call type folder.
3. Press the right navigation key to move to the call entry column.
4. Use up and down navigation keys to highlight the individual call entry.



5. Press the **Delete** softkey.
A delete confirmation message appears on screen.

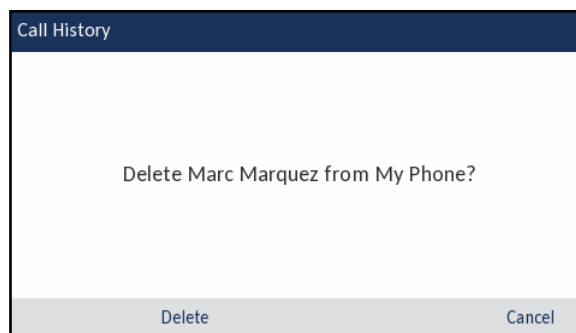

6. Press the **Delete** softkey again to delete the individual call entry.

Note: Press the **Cancel** softkey to cancel the delete process.

Copying entries to the Personal folder in the Contacts application

To copy a Call History entry to the **Personal** folder in the **Contacts** application:

1. Press the  (**Call History**) key.
2. Use the navigation keys to highlight the applicable call type folder.
3. Press the right navigation key to move to the call entry column.
4. Use the navigation keys to highlight the call entry you want to copy to your **Personal** folder in your **Contacts** application.



5. Press the **Add Contact** softkey.
A copy confirmation message is displayed.

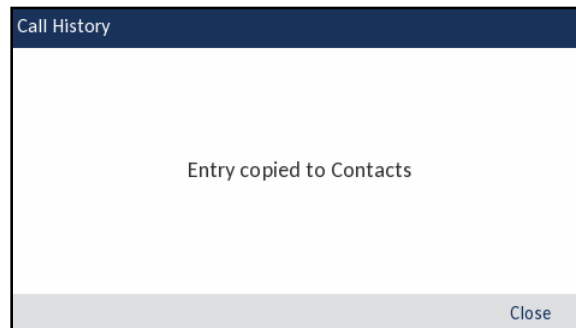

Missed calls indicator

The Mitel MiVoice 6930 IP phone has a missed calls icon located on the status bar that indicates the number of calls that went unanswered.

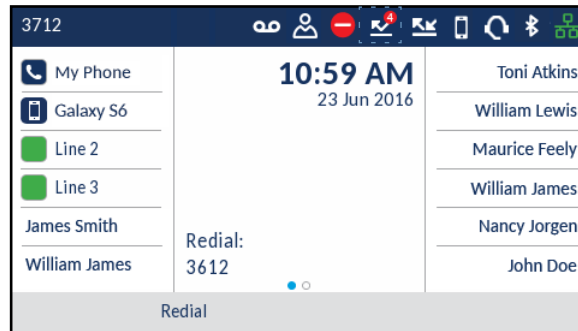



As the number of unanswered calls increment, the information associated with the calls are stored in the **Call History** application under the **Missed** call folder. When the user accesses the **Missed** call folder, the missed call indicator on the **Home** screen is removed.

Note: Missed calls are also indicated on the screensaver.

To view missed call details in Call History application:

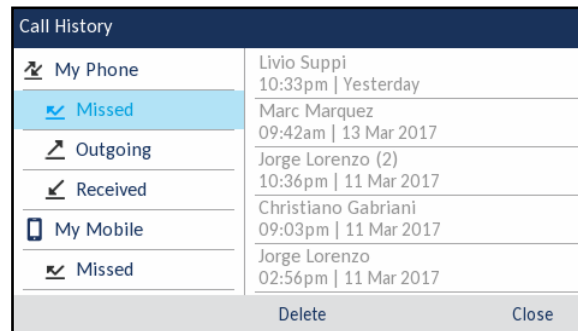
1. Press the  (**Call History**) key.
2. Use the navigation keys to highlight the **Missed** call type folder.



3. Press the right navigation key to move to the call entry column.
4. Use up and down navigation keys to highlight the individual call entry.
5. Press the right navigation key to see more detailed information about the call entry.
6. Press the  (**Goodbye**) key, or **Close** softkey to exit.
The missed calls indicator on the **Home** screen is cleared upon exit.

Voicemail

Note: Voicemail functionality must be configured by your System Administrator.

When voicemail functionality is enabled, the MWI LED on the Mitel MiVoice 6930 flashes red and the  (**Voicemail**) icon displays on the status bar indicating that voicemail messages are available. You can access your voicemail service by pressing the **Voicemail** key.

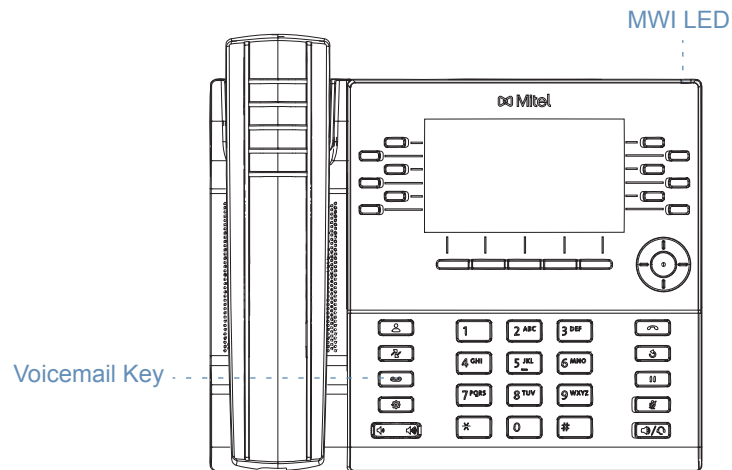

To access your voicemail:

1. Press the  (**Voicemail**) key.

Notes:

1. If the handset is offhook or if the phone is in speakerphone or headset mode, pressing the  (**Voicemail**) key will call your message center directly.
 2. The call to your message center is placed regardless of whether or not a message is pending.
2. ((Optional) If your phone is idle, press the **More** softkey to view the date and time of the last voicemail message received.

Note: Pressing the **Erase** key clears the current message indicators on the phone (i.e. MWI LED and last voicemail message received history). It does not delete the messages contained in your voicemail account.

3. If your phone is on idle, press the **Call** softkey.
4. When you are connected to your message center, follow the audio prompts to perform any applicable actions.

Note: For more detailed information on voicemail features and functionality, see the *Mitel MiVoice Business Voice Mail User Guide*.

Visual voicemail

Note: Visual voicemail functionality must be configured by your System Administrator.

Visual voicemail allows you to visually interact with your voicemail. Visual voicemail displays an accurate count of your voicemail messages on the status bar and the screen saver. The count on the screen saver is a total of missed calls and voicemail messages.

Notes:

1. If you have subscribed to Embedded Voicemail (EMEM), missed voicemail count is displayed only if the EMEM and the 6900 Series IP Phones are programmed on the same MiVoice Business System.
2. If you have subscribed to NuPoint voicemail, the message count is not supported.

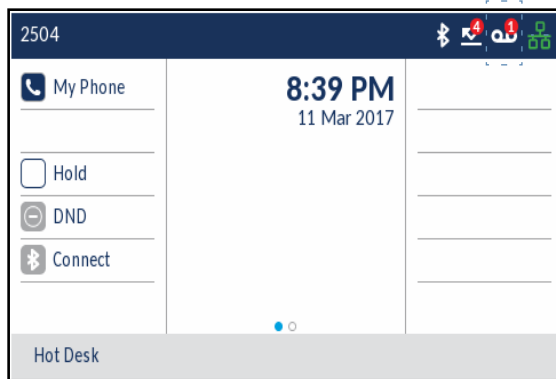

Voicemail count on status bar

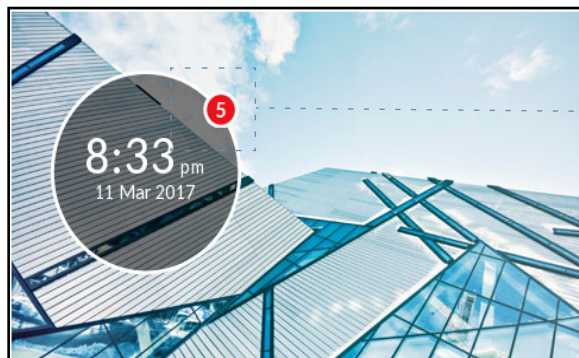

Voicemail and missed calls count on screen saver

Visual voicemail by default, selects **New** and displays new voicemail messages in Bold font. Urgent voicemail messages are indicated by a Red exclamation point.

Enabling voicemail application

To enable voicemail application:

1. Press the  (**Settings**) key on the phone to enter the **Settings** menu.

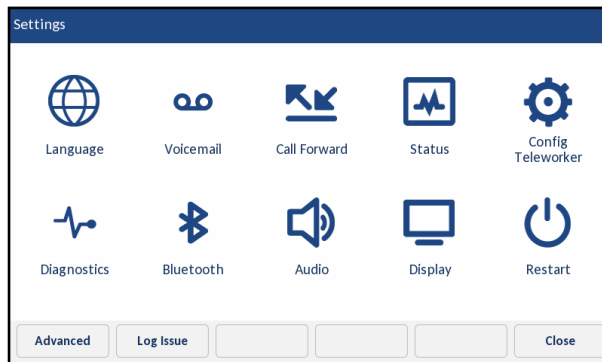

2. Navigate to **Voicemail** using the left navigation key and then press the **Select** softkey.

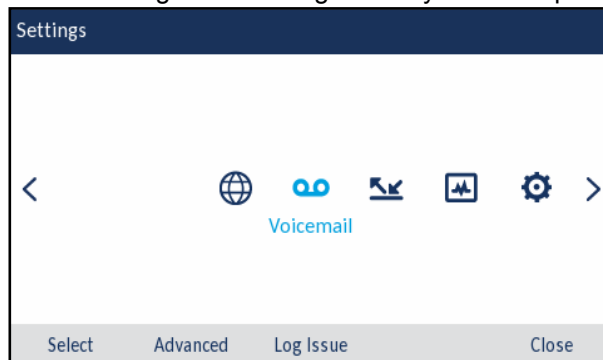

3. Press the **Select** button to select the **key opens Voicemail App** checkbox.

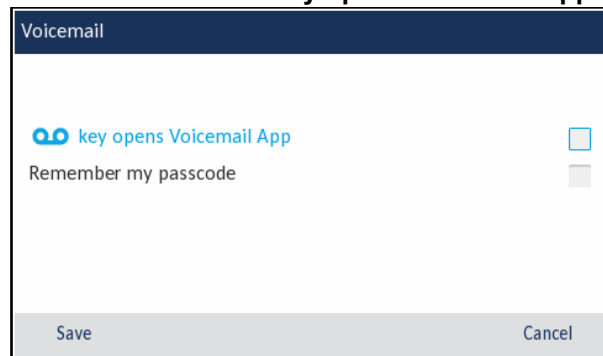

4. Press the **Save** softkey.

Note: For security reasons, the password can be enabled only from the user login screen.

Logging into your voicemail

To log into your voicemail:

1. Press the  (**Voicemail**) key.

2. In the **Passcode** field, enter the passcode.

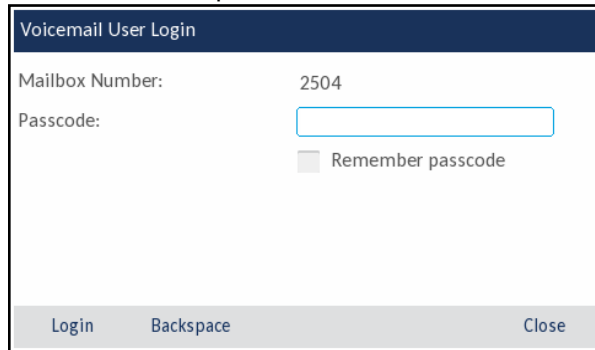

3. (Optional) Press the down navigation key and press the **Select** button to select the **Remember passcode** checkbox.

Note: If **Remember passcode** checkbox is selected, the phone stores your passcode and launches your voicemail without having to enter your passcode each time you log into your voicemail.

4. Press the **Login** softkey to log into your voicemail.

Logging out of your voicemail

To log out of your voicemail:

1. Press the **Logout** softkey.

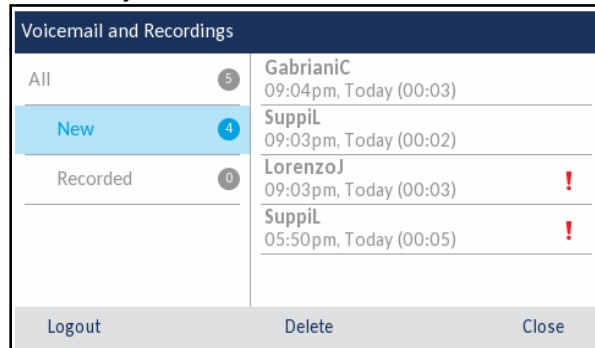

Note: After five minutes of inactivity, you are automatically logged out of your mailbox and the **Voicemail** application closes. When you close the **Voicemail** application, you are not automatically logged out of your mailbox.

Playing a voicemail

To play a voicemail:

1. Log into your voicemail.
2. Use the up and down navigation keys to choose one of the following:
 - **All** - Displays all voicemail messages.
 - **New** - Displays new voicemail messages.

- **Recorded** - Displays recorded voicemail messages.

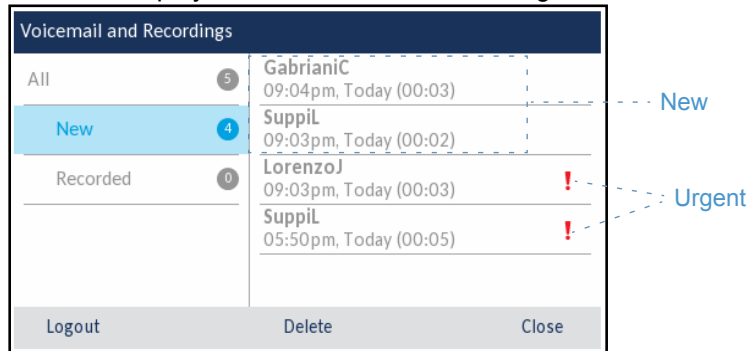

3. Press the right navigation key and then use the up and down navigations keys to choose the voicemail message you want to play.

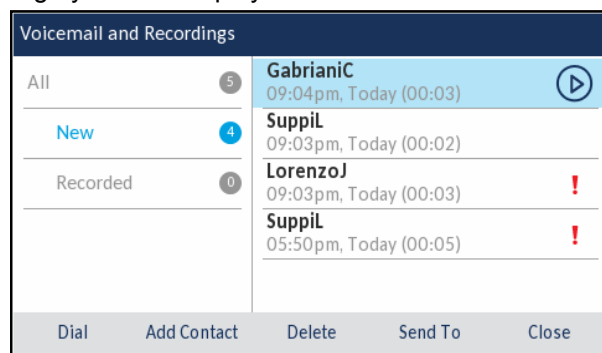

4. Press the **Select** button to play the voicemail.

Notes:

- If your voicemail system is on EMEM, then use **Replay**, **Backward**, **Forward**, and **Cancel** softkeys to control the audio of the voicemail.
- If your voicemail system is on NuPoint Unified Messaging, then pressing the **Select** button will pause or stop the voicemail audio. Use the **Cancel** softkey to cancel the operation.

Dialing a voicemail

To dial a voicemail:

1. Log into your voicemail.
2. Use the up and down navigation keys to choose one of the following:
 - **All** - Displays all voicemail messages.
 - **New** - Displays new voicemail messages.

- **Recorded** - Displays recorded voicemail messages.

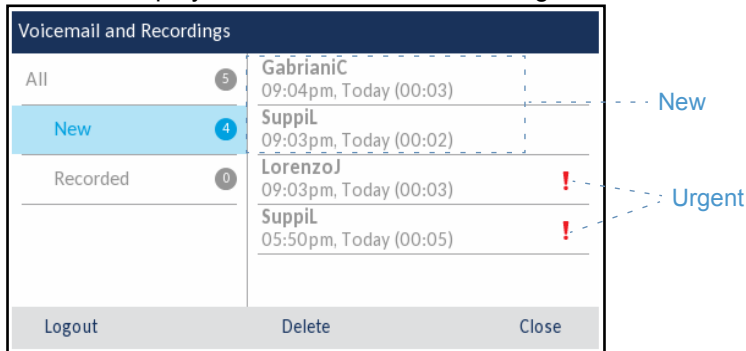

3. Press the right navigation key and then use the up and down navigations keys to choose the voicemail message you want to dial.

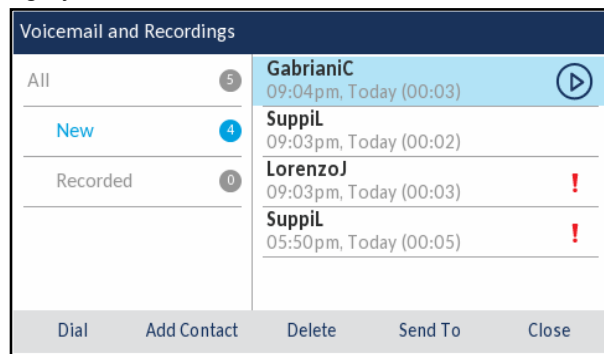

4. Press the **Dial** softkey to dial the number.

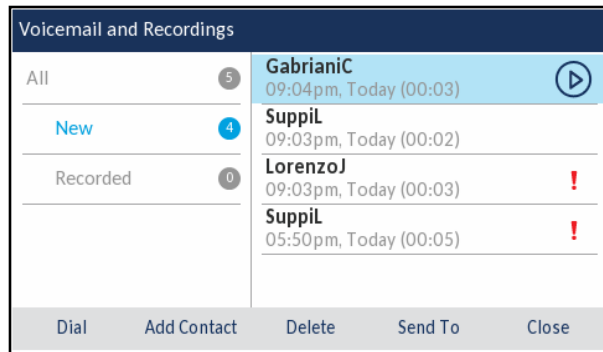

Deleting a voicemail

To delete a voicemail:

1. Log into your voicemail.
2. Use the up and down navigation keys to choose one of the following:
 - **All** - Displays all voicemail messages.
 - **New** - Displays new voicemail messages.

- **Recorded** - Displays recorded voicemail messages.

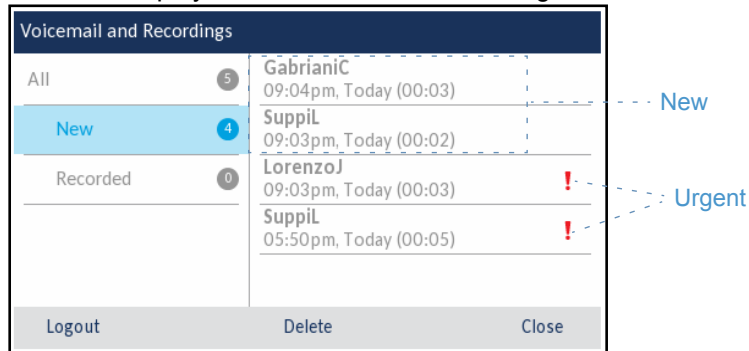

3. Press the right navigation key and then use the up and down navigations keys to choose the voicemail message you want to delete.

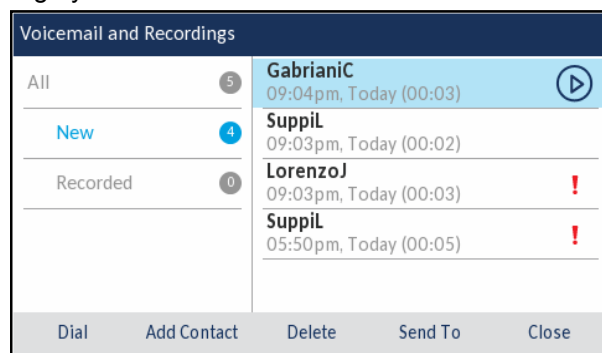

4. Press the **Delete** softkey.
A delete confirmation message appears on screen.
5. Press the **Delete** softkey to delete the voicemail.

Saving a voicemail

Visual voicemail automatically saves played voicemail messages in the **All** folder.

Sending voicemail to a number

To send a voicemail to a number:

1. Log into your voicemail.
2. Use the up and down navigation keys to choose one of the following:
 - **All** - Displays all voicemail messages.
 - **New** - Displays new voicemail messages.

- **Recorded** - Displays recorded voicemail messages.

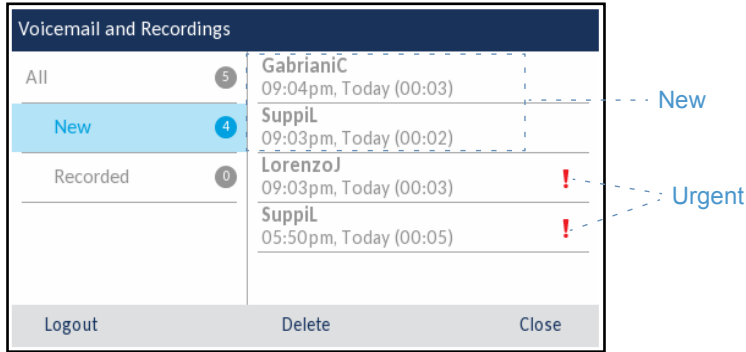

3. Press the right navigation key and then use the up and down navigations keys to choose the voicemail message you want to send to a number.

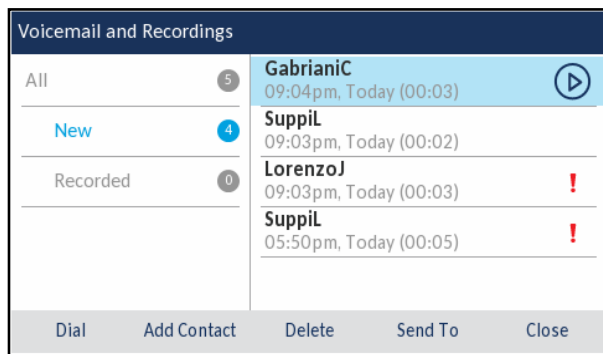

4. Press the **Send To** softkey.
5. In the **Number** field, enter the number.

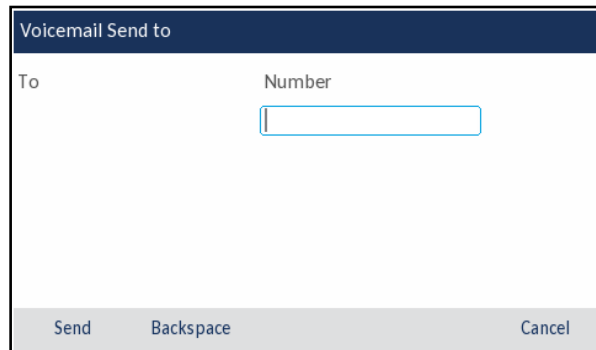

6. Press the **Send** softkey to send the voicemail to the number.

Adding voicemail number to Contacts

To add a voicemail number to the **Contacts** application:

1. Log into your voicemail.
2. Use the up and down navigation keys to choose one of the following:
 - **All** - Displays all voicemail messages.
 - **New** - Displays new voicemail messages.

- **Recorded** - Displays recorded voicemail messages.

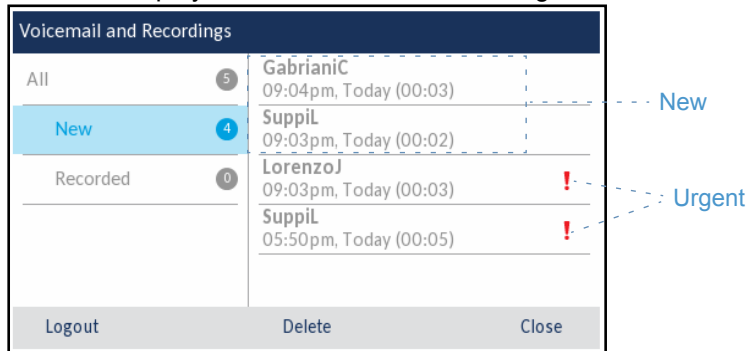

3. Press the right navigation key and then use the up and down navigations keys to choose the voicemail number you want to add to the **Contacts** application.

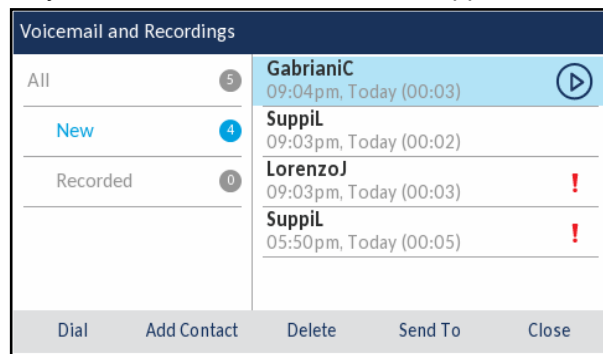

4. Press the **Add Contact** softkey.
A add confirmation message appears on screen and the voicemail number is added to the **Contacts** application.

MobileLink

The Mitel MiVoice 6930 IP Phone supports MobileLink, a feature that provides seamless mobile integration using Bluetooth wireless technology. MobileLink highlights include the ability to:

- Sync your mobile phone’s contact list and call history with your Mitel MiVoice 6930 IP phone.
- Answer a mobile phone call using your Mitel MiVoice 6930 IP phone.
- Move mobile call audio between the Mitel MiVoice 6930 IP phone and your mobile phone.

Note: The MobileLink feature is supported only on iOS and Android mobile phones.

You can enable MobileLink features by one of the following ways:

- Programming a Mobile Line key for your phone by your System Administrator. Contact your System Administrator for details on how to enable MobileLink functionality on your phone.
- Pressing and holding a programmable key. For more information, see “[Mobile Line](#)” on page 51.

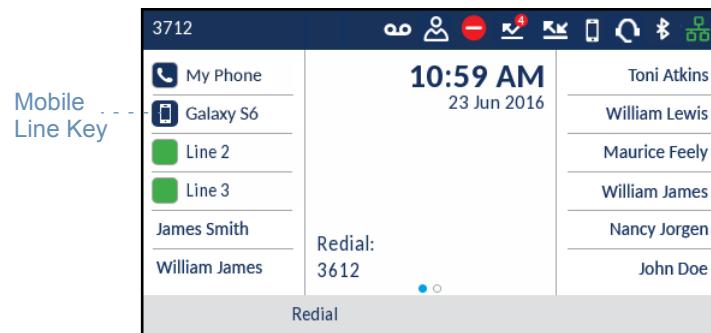

The **Mobile Line** key icon changes to reflect the status of the line as per the following table.

Icon	Description
	Indicates the mobile line is connected with a mobile phone and is idle.
	(Blinking) Indicates the mobile line is ringing due to an incoming call on your mobile phone.
	Indicates the mobile line is busy.
	(Blinking) Indicates an ongoing call with active audio on the mobile phone.
	(Blinking) Indicates the call on the mobile line is on hold.
	Indicates the mobile phone is not connected.

Note: Additional Bluetooth devices connected to your mobile phone (e.g. smartwatches, headsets, etc...) may impede or alter the behavior of the MobileLink feature. It is recommended to disconnect any additional Bluetooth devices from your mobile phone when using the MobileLink feature on your Mitel MiVoice 6930 IP Phone.

Pairing a mobile phone using Bluetooth

For instructions on how to pair your mobile phone with your Mitel MiVoice 6930 IP phone, see “[Pairing a Bluetooth device](#)” on page 26.

Syncing mobile contacts

When pairing and connecting a mobile phone for the first time, the Mitel MiVoice 6930 IP phone automatically attempts to sync your mobile contacts to the **Contacts** application.

Note: Your initial mobile contact list will remain in the **Contacts** application even if you connect to a secondary mobile phone. To update your mobile contacts so that they are aligned with the secondary mobile phone, you must manually synchronize your mobile contacts.

To manually synchronize or update your mobile contacts:

1. Ensure that you have paired your mobile phone with your 6930 IP phone. See “[Pairing a Bluetooth device](#)” on page 26.
2. Press the  (**Contacts**) key.

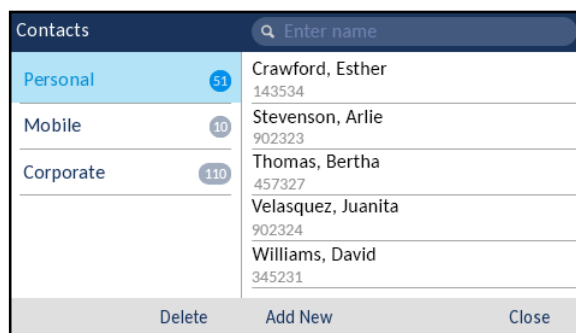

3. Navigate to the **Mobile** contacts folder.

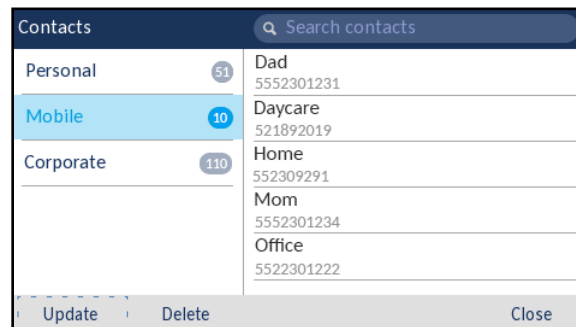

4. Press the **Update** softkey.
The Mitel MiVoice 6930 IP phone attempts to re-synchronize and update your mobile contacts.

Notes:

1. You may need to acknowledge the request on your mobile phone.
2. If the update fails, a failed to retrieve contacts message displays on screen. Press **Retry** to attempt to update again, or **Cancel** to cancel the attempt.
3. Some mobile phones will only sync contacts stored on the phone's flash memory. Contacts stored on the phone's SIM card may not sync with the Mitel MiVoice 6930 IP phone.
4. Mobile contacts are cleared from the **Contacts** application when the phone's firmware has been upgraded. If your mobile device is configured to allow for automatic re-synchronization, the Mitel MiVoice 6930 IP phone will synchronize the contacts again the next time your mobile device connects to your IP phone. If your mobile device is not configure for automatic re-synchronization, you must manually synchronize your mobile contacts.
5. For more information on the **Contacts** application, see "**Contacts**" on page 64.

Syncing mobile call history

When pairing and connecting a mobile phone for the first time, the Mitel MiVoice 6930 IP phone automatically attempts to sync your mobile call history to the **Call History** application. The **My Mobile** folder displays your mobile phone call history (missed, outgoing, and received calls) with icons. The **Missed** folder displays only your mobile phone missed calls without icons. Up to 1000 call history entries are displayed in the **My Mobile** folder, in the order latest to oldest.

The call history details displayed are name (if available), number (if available), time, and date. The call duration details are not displayed.

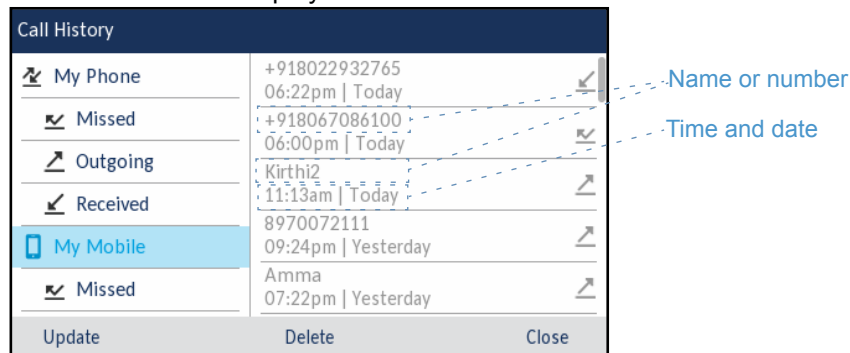

Automatic update of your mobile phone call history is not supported. For example, if a user receives a call on the mobile phone, the call record is not automatically updated in the **Call History** application. The call record is updated the next time when the mobile phone connects to the 6930 IP phone or by a manual update.

Notes:

1. You may need to acknowledge the request for Contact sharing on your mobile phone.
2. If the update fails, a failed to retrieve contacts message displays on screen. Tap **Retry** to attempt to update again, or **Cancel** to cancel the attempt.
3. Picture avatar is not supported for mobile phone call history.
4. If you pair a second mobile phone with your 6930 IP phone, the 6930 IP phone automatically syncs the mobile call history of the second mobile phone to the **Call History** application. To re-sync the mobile call history of your first (or an already paired) mobile phone to the **Call History** application, connect the mobile phone to your 6930 IP phone.
5. The **Call History** application displays the mobile phone call history even when the paired mobile phone is not connected to your 6930 IP phone.
6. The mobile phone call history is lost when the mobile phone is unpaired or your 6930 IP phone resets.
7. Mobile phone call history is supported for Hot Desk users. When a Hot Desk user logs in, the mobile phone call history of the Hot Desk user's paired mobile phone is displayed. When the Hot Desk user logs out, the mobile phone call history of mobile phone paired with the registered extension is displayed.

Viewing mobile call history

To view your mobile phone call history:

1. Ensure that you have paired your mobile phone with your 6930 IP phone. See [“Pairing a Bluetooth device”](#) on page 26.
2. Press the  (**Call History**) key.
3. Navigate to the **My Mobile** folder.
Your mobile phone call history is displayed on the screen.



Viewing mobile missed calls

To view your mobile phone missed calls:

1. Ensure that you have paired your mobile phone with your 6930 IP phone. See [“Pairing a Bluetooth device”](#) on page 26.
2. Press the  (**Call History**) key.

3. Navigate to the **Missed** folder.
Your mobile phone missed calls is displayed on the screen.

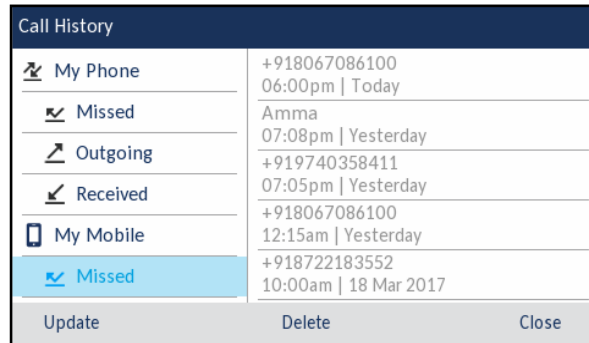

Viewing details of a mobile call history or missed call entry

To view details of a mobile call history or missed call entry:

1. Navigate to My Mobile or Missed folder. See “[Viewing mobile call history](#)” on page 95 or “[Viewing mobile missed calls](#)” on page 95.
2. Press the right navigation key to move to the call history or missed calls selection column.

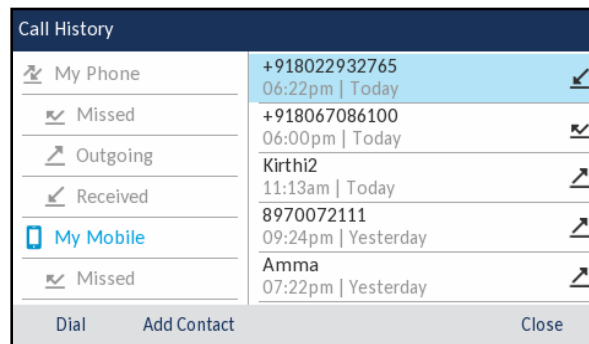

3. Use the up and down navigation keys to select the call history or missed call entry for which you want to view the details.
4. Press the right navigation key.
The details of the mobile call history or missed call entry is displayed on screen.

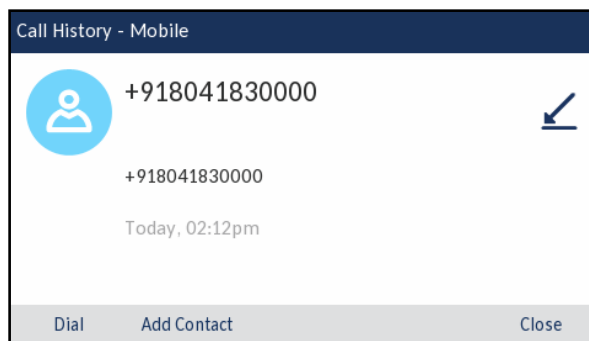













Notes:

1. Press the **Dial** softkey to dial the number associated with the entry.
2. Press the **Add Contact** softkey to add the entry to the **Contacts** application.

Updating mobile call history and missed calls

To manually update your mobile call history and missed calls:











1. Ensure that you have paired your mobile phone with your 6930 IP phone. See [“Pairing a Bluetooth device”](#) on page 26.
2. Press the  (**Call History**) key.
3. Navigate to the **My Mobile** or **Missed** folder, and then press the **Update** softkey. Your mobile call history and missed calls are updated on your 6930 IP phone.

Call History		
 My Phone	+918022932765 06:22pm Today	
 Missed	+918067086100 06:00pm Today	
 Outgoing	Kirthi2 11:13am Today	
 Received	8970072111 09:24pm Yesterday	
 My Mobile	Amma 07:22pm Yesterday	
 Missed		
Update	Delete	Close

Dialing a mobile phone call history entry

To dial a mobile phone call history or missed call entry:

1. Ensure that you have paired your mobile phone with your 6930 IP phone. See [“Pairing a Bluetooth device”](#) on page 26.
2. Press the  (**Call History**) key.
3. Navigate to the **My Mobile** or **Missed** folder.

Call History		
 My Phone	+918022932765 06:22pm Today	
 Missed	+918067086100 06:00pm Today	
 Outgoing	Kirthi2 11:13am Today	
 Received	8970072111 09:24pm Yesterday	
 My Mobile	Amma 07:22pm Yesterday	
 Missed		
Update	Delete	Close

4. Press the right navigation key to move to the call history or missed calls selection column.

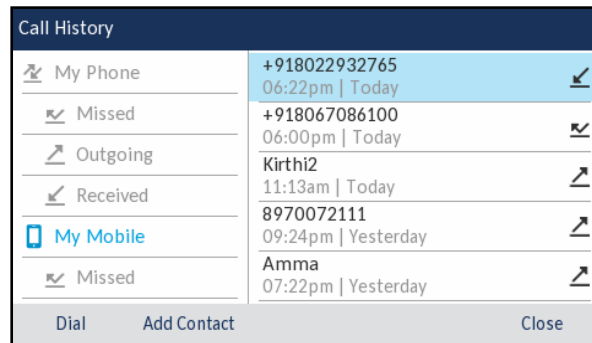

5. Use the up and down navigation keys to select the call history or missed call entry you want to dial.
6. Press the **Dial** softkey to dial the number associated with the entry.

Adding an entry to Contacts

To add a mobile phone call history or missed call entry to the **Contacts** application:

1. Ensure that you have paired your mobile phone with your 6930 IP phone. See “Pairing a Bluetooth device” on page 26.
2. Press the  (**Call History**) key.
3. Navigate to the **My Mobile** or **Missed** folder.

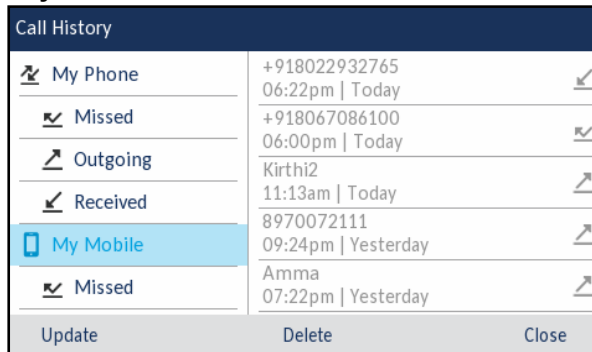

4. Press the right navigation key to move to the call history or missed calls selection column.

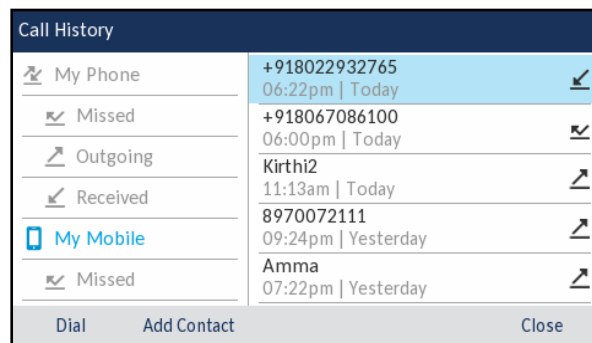

5. Use the up and down navigation keys to select the call history or missed call entry you want to add to the **Contacts** application.

6. Press the **Add Contact** softkey to add the entry to the **Contacts** application.

Deleting mobile call history and missed calls

To delete mobile phone call history and missed calls:

CAUTION: Deleting a specific call history or missed call entry is not supported. Pressing the **Delete** softkey deletes all the entries (mobile phone call history and missed calls) in the **My Mobile** folder.

1. Ensure that you have paired your mobile phone with your 6930 IP phone. See “[Pairing a Bluetooth device](#)” on [page 26](#).
2. Press the  (**Call History**) key.
3. Navigate to the **My Mobile** or **Missed** folder, and then press the **Delete** softkey.

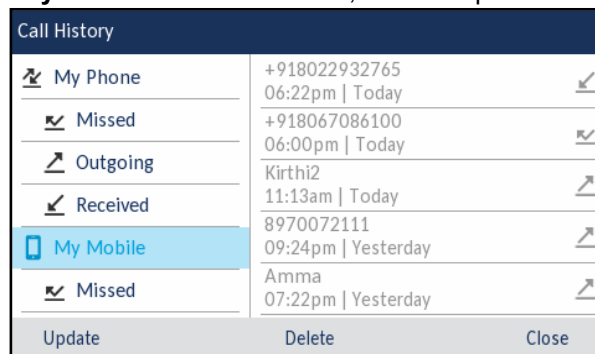

A delete all confirmation message appears on screen.

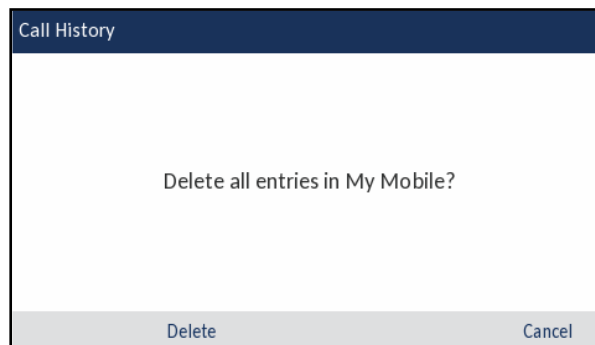

4. Press the **Delete** softkey to delete all entries in the **My Mobile** folder.

Answering an incoming mobile call using your Mitel MiVoice 6930 IP phone

When your mobile phone is paired and connected to your Mitel MiVoice 6930 IP phone, incoming calls on your mobile phone will be indicated on your Mitel MiVoice 6930 IP phone as well.

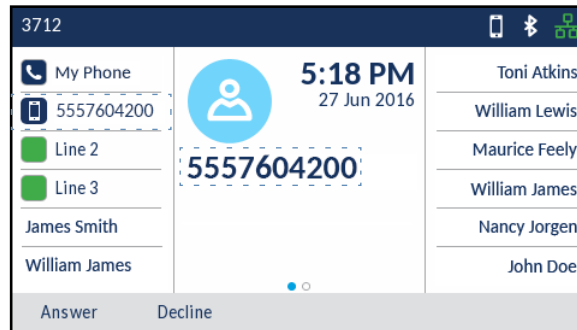

To answer the incoming mobile call using your Mitel MiVoice 6930 IP phone, lift the handset for handset operation or press the  (**Speaker/Headset**) key, blinking  **Mobile Line** key, or **Answer** softkey for handsfree operation.

Note: Press the **Decline** key to reject the incoming mobile phone call.

Moving audio from an active mobile call between your mobile phone and Mitel MiVoice 6930 IP phone

Switching mobile phone audio from your Mitel MiVoice 6930 IP phone to your mobile phone and back again is performed by a one-key-press method.

Press the **Push call** softkey to push the mobile call audio from your Mitel MiVoice 6930 IP Phone to your mobile phone.

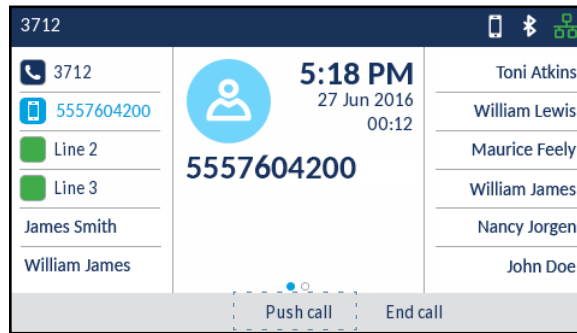

Press the  **Mobile Line** key to pull the mobile call audio from your mobile phone to the Mitel MiVoice 6930 IP Phone.

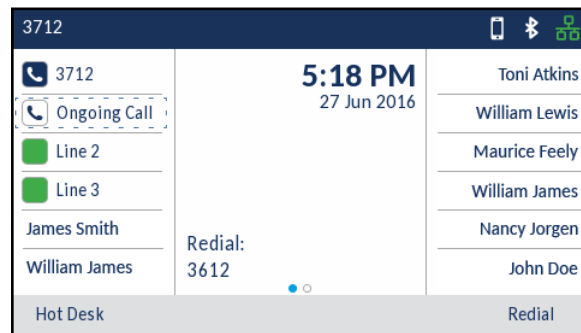

























Additional features













The following features are available using feature keys only if your System Administrator has defined a programmable key or softkey with the respective functionality on your phone.















When configured on a programmable key, icons are displayed beside the label indicating type of functionality. When a generic ON/OFF icon or a custom ON/OFF icon (such as those displayed for DND, Make Busy, Phone Lock, Call Fwd Always, Night Service, and Record a Call) is displayed, the key acts as a toggle to enable and disable the respective feature. If no icon is displayed beside the key's label, the feature either requires user input or is used to convey information.





For detailed information on how to use any of the following features, please contact your System Administrator.

Feature	Description	Icons	Type
Account Code NonVerified	Non-verified Account Codes let you enter codes on the SMDR record for billing and/or call management.		Non-Toggle
Account Code Verified	Verified Account Codes let you access features that are not normally available at a station. You enter Verified Account Codes before making a call to change the COS and COR at any station. When you hang up, the station returns to normal.		Non-Toggle
ACD	Automatic Call Distribution (ACD) functionality allows call centers to process incoming calls based on a number of customizable parameters.		Non-Toggle
Auto Answer	Auto-Answer lets you automatically answer calls that ring your Prime line.		Toggle ON/OFF
Call Fwd Always	Call Fwd Always is used to redirect all incoming calls to an alternate number.		Toggle ON/OFF
Call Fwd Busy	Call Fwd Busy is used to redirect both incoming internal and external calls to an alternate number when your phone is busy.		Toggle ON/OFF
Call Fwd Busy External	Call Fwd Busy External is used to redirect incoming external calls to an alternate number when your phone is busy.		Toggle ON/OFF
Call Fwd Busy Internal	Call Fwd Busy Internal is used to redirect incoming internal calls to an alternate number when your phone is busy.		Toggle ON/OFF
Call Fwd No Ans. External	Call Fwd No Ans. External is used to redirect incoming external calls to an alternate number when you do not answer.		Toggle ON/OFF

Feature	Description	Icons	Type
Call Fwd No Ans. Internal	Call Fwd No Ans. Internal is used to redirect incoming internal calls to an alternate number when you do not answer.	 	Toggle ON/OFF
Call Fwd No Answer	Call Fwd No Answer is used to redirect both incoming internal and external calls to an alternate number when you do not answer.	 	Toggle ON/OFF
Call Park and Call Park - Retrieve	Call Park allows you to place a call in a special hold state. You, or someone else, can then retrieve the call from another extension in the system by pressing the Call Park - Retrieve key.	 	Toggle ON/OFF
Call Pickup	Call Pickup lets you answer a call that is ringing at another station, including an attendant console.	 	Toggle ON/OFF
CDE Speedcall	This feature allows you to speed dial telephone numbers that the administrator has programmed into the system.		Non-Toggle
Direct Page	Direct Page allows you to page another telephone over its built-in speaker, even if the telephone is in use.	 	Toggle ON/OFF
Do Not Disturb	Do Not Disturb (DND) stops internal calls from ringing on your phone and returns busy tone to the caller. DND does not stop external calls from ringing nor does it affect your ability to make calls.	 	Toggle ON/OFF
DSS/Busy Lamp	You can use the Busy Lamp Field feature to monitor the status of single-line sets, single-member lines, key system lines, multicall Broadcast Groups, and Hot Desk users.	Line States	Non-Toggle
Emergency Call	The Emergency Call Notification key allows you receive emergency call notifications. Pressing the key allows you to view the caller's directory number, special instructions that are programmed for the DN in the Comments field of the CESID Assignment form, and the date and time of the call.	 	Toggle ON/OFF
Float Keys	Float keys are typically used to display unanswered ringing lines on designated keys where the ringing lines would otherwise be hidden on one of the phone's application pages.	Line States	Non-Toggle

Feature	Description	Icons	Type
Group Listen	With Group Listen, you can carry on a conversation using the handset or headset while allowing others nearby to listen to the person at the far end over the handsfree speaker.	 	Toggle ON/OFF
Group Park	Group Park allows you to place a call in a special hold state. You, or someone else, can then retrieve the call from another extension in the system. Group Park uses a single feature key to both park and retrieve calls. Any telephone programmed with the same Group Park key can retrieve the call.	 	Toggle ON/OFF
Group Presence	Group Presence allows members of call groups (Hunt, ACD, Ring, Personal Ring, and Multi-device User) to make themselves absent or present in a group. Only members who are present in a group are offered calls to that group.	 	Toggle ON/OFF
Handoff	The Handoff feature for Personal Ring Groups (PRGs) allows calls to be "Pushed" or "Pulled" between group member devices. A Push passes the call to the group, where it can be answered by any other present group device. A Pull takes an in-progress call away from another member.	 	Toggle ON/OFF
Key System	Key System Groups let multiple telephones share the same extension number. Incoming calls ring all of the idle stations, and the stations stop ringing when one member answers the call. Only one member of a Key System Group can use the line at one time.	Line States	Non-Toggle
Make Busy	The Make Busy feature ensures an ACD extension does not receive ACD calls when the agent is unavailable. The ACD extension remains in the Make Busy state until an agent deactivates it.	 	Toggle ON/OFF
Meet Me Answer	Meet-Me Answer lets you respond to a Group Page that you missed, even if you do not know the identity or location of the person that paged you.		Non-Toggle
Message Waiting Indication	Keys can be programmed as message waiting indicators which are associated with the mailboxes of other stations. The indicator flashes when a message is waiting in the associated mailbox. This allows you to look at the phone and recognize which mailboxes have messages.	 	Toggle ON/OFF

Feature	Description	Icons	Type
Multicall	Multicall Groups let multiple telephones share the same extension number. Incoming calls ring all of the idle stations, and the stations stop ringing when one member answers the call. A Multicall group allows more than one group member to use the line at the same time.	Line States	Non-Toggle
Night Answer	Night Answer lets you send your calls to another location when the system is in Night Service.	 	Toggle ON/OFF
Night Service Indication	Night Service switches the system from day service to night service and vice versa. When the system is placed into night service (usually at the end of the workday) incoming external calls ring at an extension(s) selected by the Administrator.	 	Toggle ON/OFF
Paging	Paging lets you connect to loudspeaker or paging equipment to make an announcement. You can access individual paging zones or all paging zones simultaneously. A one-way connection is established for "All Zones" paging. A two-way connection is established for "Individual Zones" loudspeaker page.	 	Toggle ON/OFF
Personal Presence	Personal Presence lets you choose which of your personal answer points you want to receive your calls at.	 	Toggle ON/OFF
Phone Lock	The Phone Lock feature locks a set, preventing access to the majority of features, with the following exceptions: unlocking the set via a user PIN, Hot Desk Login and Logout support, and Emergency Call Notification support. Phone Lock has no effect on incoming calls but restricts outgoing calls, with the following exceptions: calls to emergency trunk routes and local operators.	 	Toggle ON/OFF
Privacy Release	Privacy Release allows members of a Key System Group to disable automatic call privacy protection to allow another member of the group to join the call. When a new member enters the call the original members receive a conference tone and the privacy feature is restored.	 	Toggle ON/OFF
Record a Call	Record-a-Call (RAC) allows extension users to record a two-party call when one party is connected to a trunk. The recorded conversation is stored in the users' voice mail mailbox.	  	Toggle ON/OFF (and Pause)

Feature	Description	Icons	Type
Secretarial	A DSS key provisioned with the "secretarial" option allows you to perform a transfer to the associated device or directory number.	Line States	Non-Toggle
Single Line	The Single Line feature is used to set the prime line as a single line, whereby it is dedicated to one phone only.	Line States	Non-Toggle
Specific Group Alert	A Specific Group Alert key normally appears only on an ACD supervisor's telephone. Each Specific Group Alert key allows the supervisor to obtain queue status information for a specific agent skill group. A supervisor's telephone may have several Specific Group Alert keys.		Non-Toggle
Superkey	Superkey programming allows for easy access to telephone system features and feature-set customization.		Non-Toggle
Tag Call	Tag Call allows phone users to signal that they are the victim of a malicious call. This Malicious Call Indication is logged as an SMDR record.		Non-Toggle
User Speedcall	User Speedcall keys allow you to store external numbers under feature keys for faster dialing. You can press a Speed Call Key to dial a phone number or, during a call, to outpulse DTMF tones.		Non-Toggle
User Speedcall - Private	A private User Speedcall is a User Speedcall that is considered private, whereby Caller ID information is not displayed in the phone's call history.		Non-Toggle

Accessory support

Mitel M695 Programmable Key Module (PKM)

Up to three Mitel M695 PKMs can be attached to the right of the Mitel MiVoice 6930 IP phone providing you with 84 additional programmable keys (28 keys per PKM).

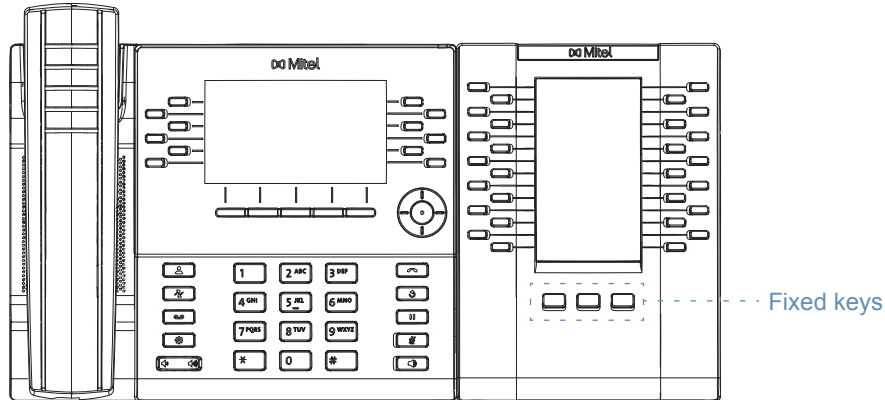

The Mitel M695 PKM features a 4.3" 480x272 pixel color backlit LCD display that provides a unified graphical user experience with the Mitel MiVoice 6930 IP phone.

The Mitel M695 PKM supports the same programmable key functions as the Mitel MiVoice 6930 IP phone. The programmable keys can only be programmed by your System Administrator.

Notes:

1. The fixed keys on the Mitel M695 PKM are not supported on the Mitel MiVoice Business System.
2. Use a IEEE 802.3at compliant PoE L2 Switch, IEEE 802.2at Inline Power Injector, or an AC to DC Adapter to power the Mitel MiVoice 6930 IP phone.
3. For information how to install your Mitel M695 PKM, see the *Mitel M695 PKM Installation Guide*.

Mitel Wireless LAN Adapter

The Mitel Wireless LAN Adapter is a wireless bridge that can add wireless connectivity functionality to your Mitel MiVoice 6930 IP phone. It allows your Ethernet-enabled phone to join a secure, high-speed network. It is software transparent meaning no changes to drivers, management tools, or applications are needed.

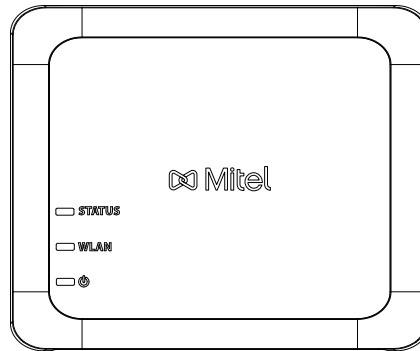

Feature highlights include:

- **Easily add robust, secure wireless capabilities to Ethernet devices:**
The Mitel Wireless LAN Adapter is a high-performance wireless network adapter which enables any Ethernet device to become an 802.11a/b/g/n dual band wireless network device, giving you freedom to place it anywhere in your facility.
- **Dual band IEEE 802.11a/b/g/n support:**
The Mitel Wireless LAN Adapter is designed to communicate in the 2.4 GHz and 5 GHz bands. Radio interference in the commonly used 2.4 GHz band can be avoided by utilizing 5 GHz.
- **Gigabit Ethernet support:**
The wired LAN port supports 10/100/1000BASE-T (auto-recognition).
- **Simple to setup and use:**
The Mitel Wireless LAN Adapter is easy to set up using the enclosed network setup cable. No special drivers or software are required.
- **Enterprise security:**
The Mitel Wireless LAN Adapter supports the following security functions:
 - WEP (64 Bit/128 Bit)
 - WPA-PSK (TKIP/AES)
 - WPA2-PSK (AES)
 - IEEE 802.1X EAP-PEAP, EAP-TLS, EAP-TTLS, EAP-FAST, EAP-LEAP

Note: For information how to install and set up your Mitel Wireless LAN Adapter, see the *Mitel Wireless LAN Adapter Setup Guide*

Mitel Integrated DECT Headset

The Mitel Integrated DECT Headset is a professional wireless headset designed for maximum performance.

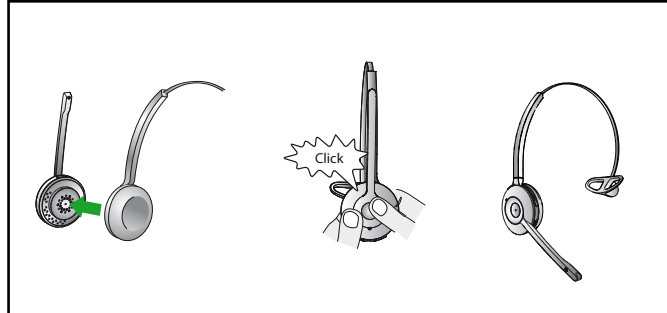

The Mitel Integrated DECT Headset is compatible with Mitel MiVoice 6930 phone. The Mitel Integrated DECT Headset is also compatible with the Mitel M695 Programmable Key Module, supporting up to three modules connected to your 6930 IP phone.

Notes:

1. Before connecting the Mitel Integrated Headset to Mitel MiVoice 6930 IP phone, ensure to disconnect (unpair) other headsets.
2. Use a IEEE 802.3at compliant PoE L2 Switch, IEEE 802.2at Inline Power Injector, or an AC to DC Adapter to power the Mitel MiVoice 6930 IP phone when connecting the Mitel Integrated DECT Headset to a Mitel M695 Programmable Key Module.

Features

- Wideband audio for exceptional sound quality.
- Volume and mute controls.
- Intuitive headset multi-function button for easy call handling.
- LED and audio indicators.
- Advanced hearing protection.
- Noise-canceling microphone.
- Up to 8 hours battery life.
- Headset recharge docking cradle.
- Visual and audio call status indicators.
- Battery indicator.

Using the headset

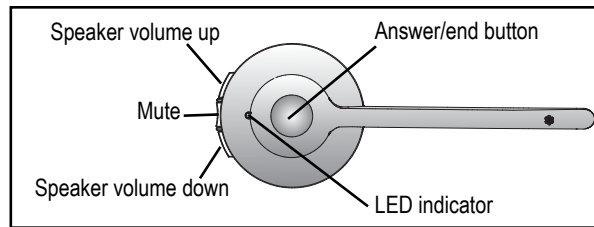

Charging the headset

To charge the headset, dock the headset in the base. When docked correctly the headset battery will begin charging.

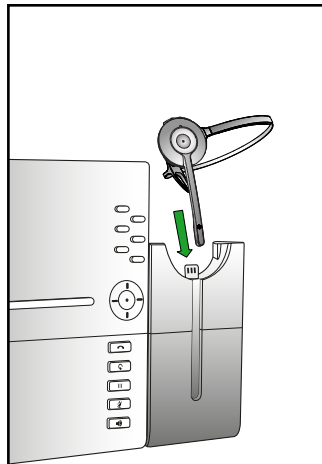

When fully charged, the headset offers up to 8 hours of talk time.

Upgrading the headset

To upgrade the headset firmware, dock the headset in the base and reboot the Mitel MiVoice 6930 IP phone.

Note: For the headset firmware upgrade, the battery level of the Integrated DECT Headset must be at 20% at least

Checking the battery level and firmware version of the Integrated DECT Headset



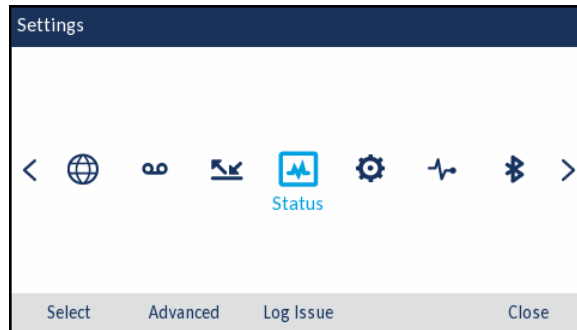



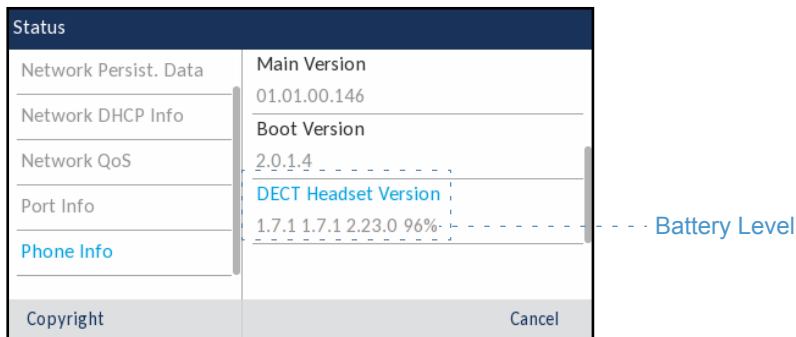

1. Press the  (**Settings**) key on the phone to enter the **Settings** menu.



2. Use the left and right navigation keys to highlight the **Status** icon.
3. Press the **Select** button or **Select** softkey.
4. Press the down navigation key to navigate to Phone Info status category.
5. Press the right navigation key.
6. Press the down navigation key to navigate to **DECT Headset Version**.



LED status

LED INDICATOR	DESCRIPTION
	Battery charging (Green - slow flash)
	Full battery (Green)
	Medium battery (Yellow)
	Low battery (Red)
	Very low battery (Red - flashing)
	Unknown battery status (White)
	Microphone muted
	Active audio between headset and base
	Searching for headset (flashing)

Note: For how to install the Mitel DECT Headset to your 6930 IP phone or the Mitel M695 Programmable Key Module, see the *Mitel Integrated DECT Headset Installation Guide*.

Replacing the Integrated DECT Headset

If the Integrated DECT Headset is malfunctioning, or if you have paired a wrong Integrated DECT Headset with the base, you must replace or repair the Integrated DECT Headset.

To replace or repair the Integrated DECT Headset:

1. Remove the headset from the base.
2. Turn off the headset by pressing the **Answer/end** button for 10 seconds until the LED indicator stops flashing.

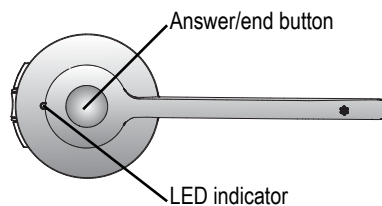

3. Dock the new headset in the base. The new headset is paired with the base after 1 minute.

Mitel S720 Bluetooth Speakerphone

The Mitel MiVoice 6930 IP phone provides support for the optional Mitel S720 Bluetooth Speakerphone. Once paired with the Mitel MiVoice 6930 IP phone, you can receive calls on the Mitel S720 Bluetooth Speakerphone. The Mitel S720 Bluetooth Speakerphone can be placed (on its base or upright using a table stand) on your work desk or in a small-to-medium conference room.

Feature highlights include:

- HD voice audio
- Omni directional microphone
- Functionally integrated with desk phone - volume / mute sync, pulling call to / from conference phone
- Connect two speakerphones wirelessly to extend speakerphone range and for stereo music playback
- Play smartphone audio from mobile with auto pause when incoming call to desk phone
- Intuitive connectivity through Bluetooth®
- Portable design, protective travel pouch, and battery powered with USB charging (15 hours of talk time)
- Flexible and scalable for office side tables and small meeting rooms

Hardware features

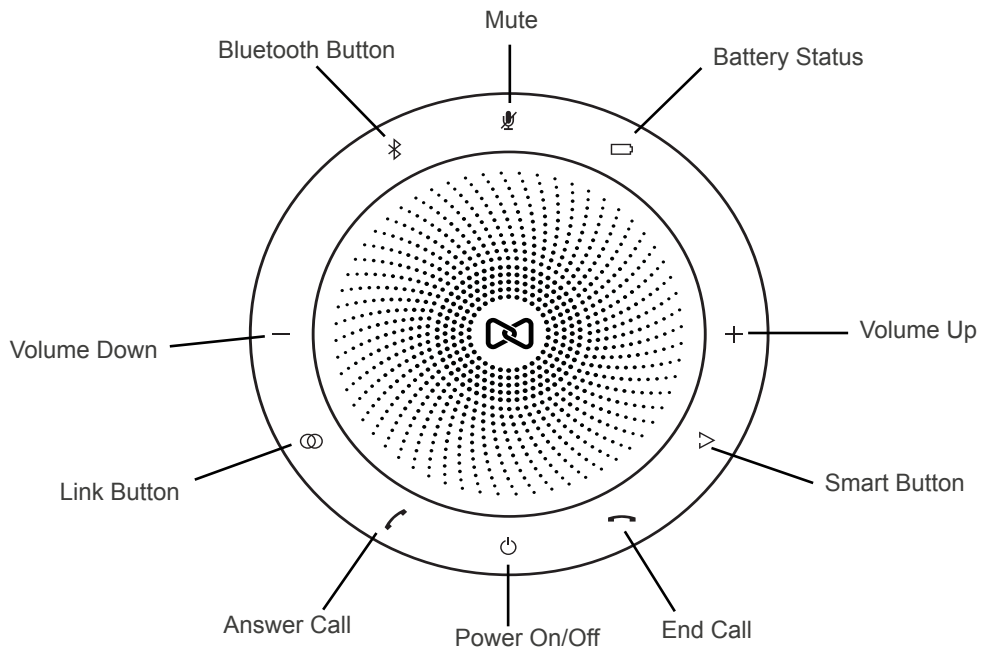



Icon	Button	Description
	Power On/Off	Turns on or off.
	Answer Call	Answers a call.
	End Call	Ends or rejects a call. Hold (8 seconds) to turn on or off voice guidance.
	Volume Up and Volume Down	Increases or decreases the volume.
	Mute	Mutes the microphone.
	Battery Status	Shows the battery status.
	Bluetooth	Connects to a Bluetooth device.
	Link	Links two speakerphones.

Icon	Button	Description
	Smart	Turns on or off the voice assistant application on your smartphone.

Notes:

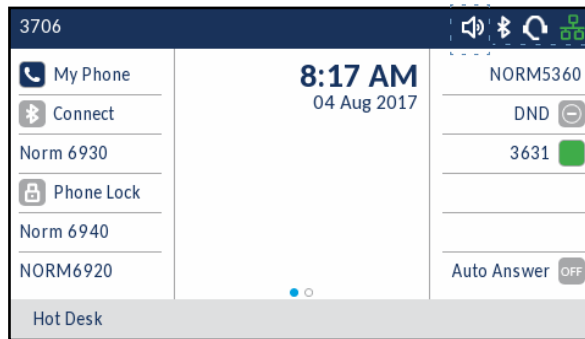
1. To pair the Mitel S720 Bluetooth Speakerphone with the Mitel MiVoice 6930 IP phone, power on the speakerphone and follow the procedures detailed in “Pairing a Bluetooth device” on page 26. The device name will appear in the available devices list as "S720 Bluetooth Speakerphone". When the speakerphone is successfully connected, a speakerphone connected icon  is displayed in the status bar on the **Home** screen.



2. If you have paired and connected your smartphone to your Mitel MiVoice 6930 IP phone, your smartphone will temporarily disconnect from the IP phone while you have a call active on the Mitel S720 Bluetooth Speakerphone. The IP phone will automatically reconnect your smartphone once the call has been terminated.
3. The  (**Speaker/Headset**) key LED on the IP phone will remain unlit when the call audio is presented on the speakerphone.
4. For information how to set up your Mitel S720 Bluetooth Speakerphone, see the *Mitel S720 Bluetooth Speakerphone Quick Start Guide*.

Mitel Cordless Bluetooth Handset

The Mitel S720 Bluetooth Speakerphone is supported with the Mitel MiVoice 6930 IP phone that allows you to instantly transform any room into a conference room. You can easily connect and enjoy the crystal clear HD audio, while maximizing productivity during conference calls through this premium portable and easy-to-use Bluetooth speakerphone.

Feature highlights include:

- Hookswitch (Initiate call/end call) key
- Volume control keys
- Mute key
- Built-in handset ringer
- LED indicators to indicate both connectivity and charging status
- At least six hours talk time

- Over 40 hours standby time
- Handset battery recharge time of three hours or less
- Operating range of up to 30 feet (10 meters) from the IP phone
- Wideband audio capable

Notes:

1. To pair the handset with the Mitel MiVoice 6930 IP phone, power on the handset and follow the procedures detailed in [“Pairing a Bluetooth device”](#) on [page 26](#). The device name will appear in the available devices list as "Cordless Handset" followed by the last six digits of the handset's MAC address.
2. For information how to set up your Bluetooth handset, see the *Mitel Cordless Bluetooth Handset Installation Guide*.

Hardware features

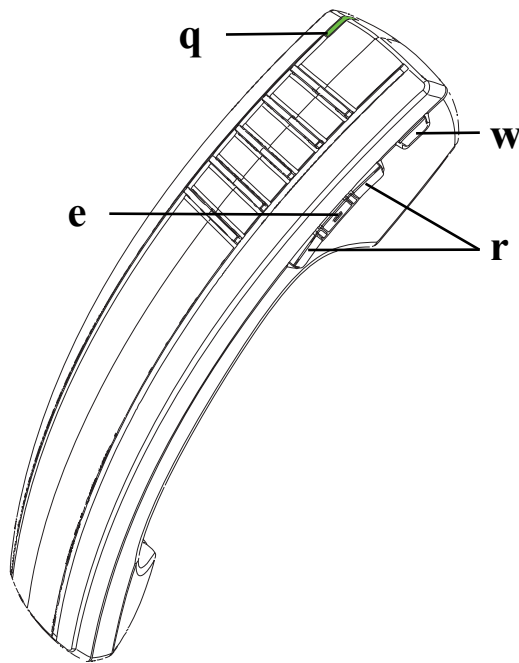

Number	Feature	Description
q	LED	Blue - Indicates the status of the handset. Green - Indicates the status of the handset battery. For more information, see “LED indicator” on page 117 .

Number	Feature	Description
w	Hookswitch key	Lifting the handset from the cradle activates the handset. If the handset is already out of the cradle, pressing the Hookswitch key is equivalent to taking the handset off hook. Pressing the key again is equivalent to placing the handset on hook. Pressing the Hookswitch key while on a speakerphone call moves the call to the cordless handset.
e	Mute key	Mutes the handset microphone so that your caller cannot hear you. For more information, see “Muting the microphone” on page 60.
r	Volume controls	Adjusts the volume for the handset. Press the key above the Mute key to increase the volume and press the key below the mute key to decrease the volume.

LED indicator

The cordless Bluetooth handset has two LEDs:

- Blue – indicates the operational status of the handset.
- Green – indicates the status of the electrical charge of the battery.

LED color, states, and indicator descriptions are as follows:

LED Color	LED State	Indicates
Blue (Handset Not in Cradle)	Blinking	Handset is not connected and is in pairing mode.
	Winking	Handset is connected but not in use.
	Fading	Handset is connected and in use.
Green (Handset in Cradle)	Solid	Battery is fully charged.
	Winking	Battery is charging. Note: It is normal for the handset LED to cycle between winking and solid as battery charge is maintained.
	Off	When handset is cradled and the LED does not flash or illuminate, this indicates an absence of battery power. During the first 30 – 60 minutes that the light is off, the battery may be trickle charging. If that is the case, the LED will resume normal behavior within that 60 minute period. If the LED remains off for more than 60 minutes, then either the battery is no longer chargeable or there is a problem in the charging circuit.

Notes:

1. Blinking denotes the LED is alternating very quickly between on and off.
2. Winking denotes the LED is alternating between being on for a short period of time and then off for a longer period of time.
3. Fading denotes the LED is alternating between fading in and out.

Alerting tones

The handset provides the following alerting tones:

Event	Tone
Power OFF	Four tones successively decreasing in pitch.
Mute key on handset ON	Two low pitched tones

Powering on/off the Bluetooth cordless handset

To power on the Bluetooth cordless handset place the handset on the IP phone's cradle.

To power off the Bluetooth cordless handset, press the **Hookswitch** key for approximately six seconds until the LED indicator turns blue and then turns completely off.

Analog, DHSG/EHS, and USB headsets

The Mitel MiVoice 6930 IP phone accepts analog and DHSG/EHS headsets through the modular RJ22/RJ45 port on the back of the phone or USB headsets through the USB port.

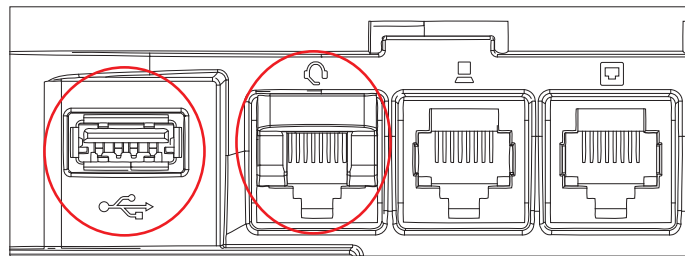

Contact your telephone equipment retailer or distributor to purchase a compatible headset.

Notes:

1. The RJ22/R45 headset port is for headset use only. Plugging any other devices into this port may cause damage to the phone and will void your warranty.
2. Customers should read and observe all safety recommendations contained in headset operating guides when using any headset.
3. Contact your System Administrator for questions regarding supported headsets or refer to the *MiVoice Business Release 8.0 Release Notes*.
4. Headsets connected to the Mitel MiVoice 6930 IP phone are limited in functionality to answering, ending, and muting calls. Additional headset features (such as rejecting calls) are not supported and will cause unexpected behavior (e.g. invoking the reject call function will answer instead of reject).
5. If both an analog (non-DHSG) headset and a USB headset are connected to the phone, the USB headset will take precedence over the analog headset (i.e. the USB headset will be functional while the analog headset will not be functional).
6. If both a DHSG headset and a USB headset are connected to the phone and DHSG is enabled, the DHSG headset will take precedence over the USB headset.
7. A connected Bluetooth headset will take precedence over all other connected headsets.

To make and receive calls using a headset:

1. Ensure that you have selected the Headset audio path (see “[Audio Path](#)” on [page 34](#)).
2. Turn the phone over and, depending on the type of headset, locate the headset jack marked f or the USB port.
 - a. If you have a USB headset, insert the headset’s USB plug into the USB port.
 - b. If you have a headset with an RJ9/RJ22 4-pin connector, insert the headset cord into the jack until it clicks into place.
 - c. If you have a DHSG/EHS headset with an RJ45 6-pin or 8-pin connector, remove the plastic headset jack adapter and then insert the cord into the jack until it clicks into place.

Note: See the *Mitel MiVoice 6930 IP Phone Installation Guide* for more information.

Limited warranty

Mitel warrants this product against defects and malfunctions in accordance with Mitel's authorized, written functional specification relating to such products during a one (1) year period from the date of original purchase ("Warranty Period"). If there is a defect or malfunction, Mitel shall, at its option, and as the exclusive remedy, either repair or replace the product at no charge, if returned within the Warranty Period. If replacement parts are used in making repairs, these parts may be refurbished, or may contain refurbished materials. If it is necessary to replace the product, it may be replaced with a refurbished product of the same design and color. If it should become necessary to repair or replace a defective or malfunctioning product under this warranty, the provisions of this warranty shall apply to the repaired or replaced product until the expiration of ninety (90) days from the date of pick up, or the date of shipment to you, of the repaired or replacement product, or until the end of the original Warranty Period, whichever is later. Proof of the original purchase date is to be provided with all products returned for warranty repairs.

Exclusions

Mitel does not warrant its products to be compatible with the equipment of any particular telephone company. This warranty does not extend to damage to products resulting from improper installation or operation, alteration, accident, neglect, abuse, misuse, fire or natural causes such as storms or floods, after the product is in your possession. Mitel will not accept liability for any damages and/or long distance charges, which result from unauthorized and/or unlawful use.

Mitel shall not be liable for any incidental or consequential damages, including, but not limited to, loss, damage or expense directly or indirectly arising from the customer's use of or inability to use this product, either separately or in combination with other equipment. This paragraph, however, shall not apply to consequential damages for injury to the person in the case of products used or bought for use primarily for personal, family or household purposes.

This warranty sets forth the entire liability and obligations of Mitel with respect to breach of warranty, and the warranties set forth or limited herein are the sole warranties and are in lieu of all other warranties, expressed or implied, including warranties or fitness for particular purpose and merchantability.

Warranty repair services

Should the product fail during the Warranty Period;

- **In North America**, please call 1-800-574-1611 for further information.
- **Outside North America**, contact your sales representative for return instructions.

You will be responsible for shipping charges, if any. When you return this product for warranty service, you must present proof of purchase.

After warranty service

Mitel offers ongoing repair and support for this product. This service provides repair or replacement of your Mitel product, at Mitel's option, for a fixed charge. You are responsible for all shipping charges. For further information and shipping instructions:

- **In North America**, contact our service information number: 1-800-574-1611.
- **Outside North America**, contact your sales representative.

Note: Repairs to this product may be made only by the manufacturer and its authorized agents, or by others who are legally authorized. This restriction applies during and after the Warranty Period. Unauthorized repair will void the warranty.

