

INSTALLATION GUIDE

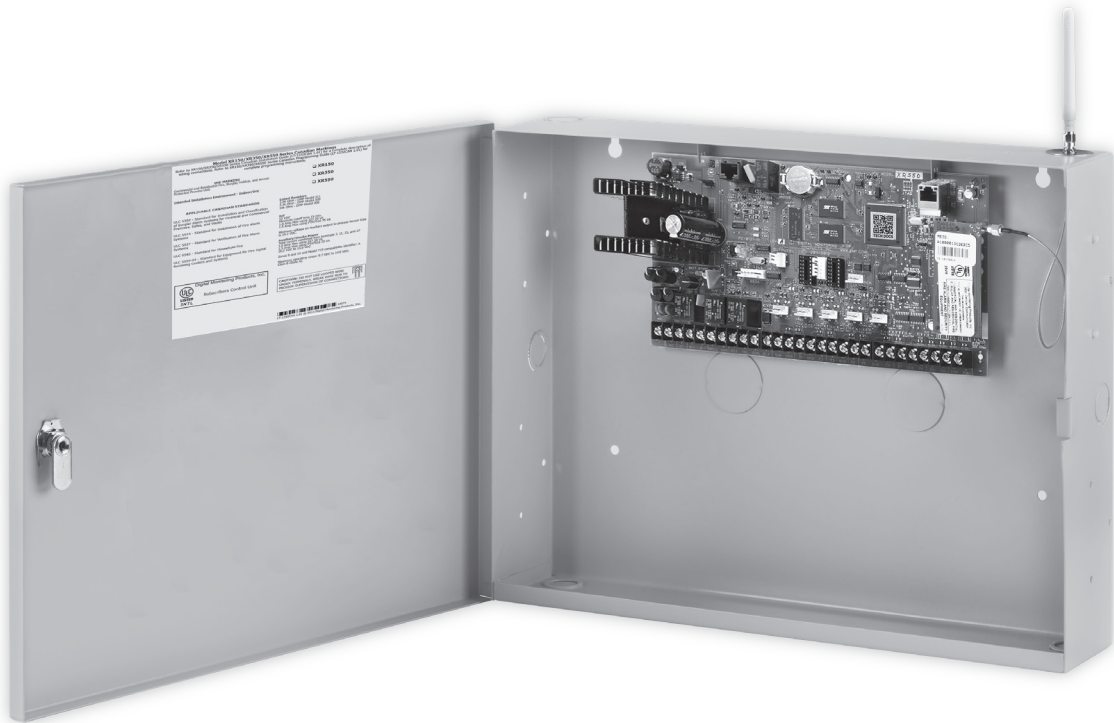

XRI 50/XR550 CANADIAN SERIES CONTROL PANEL

MODEL XR150CAN/XR550CAN Series CANADIAN INSTALLATION GUIDE

INDUSTRY CANADA NOTICE

This Class A digital apparatus complies with Canadian ICES-003.

© 2021 Digital Monitoring Products, Inc.

Information furnished by DMP is believed to be accurate and reliable.
This information is subject to change without notice.

Product Specifications

1.1	Power Supply	1
1.2	Communication	1
1.3	Panel Zones	1
1.4	Keypad Bus.....	1
1.5	LX-Bus™	1
1.6	Outputs	1
1.7	Enclosure Specifications	2

Panel Features

2.1	Description.....	2
2.2	Zone Expansion	2
2.3	Output Expansion	2
2.4	Central Station Communication.....	2
2.5	Encrypted Communications (XR550 with Encryption only).....	3
2.7	Compliance Instructions	3

System Components

3.1	Wiring Diagram	4
3.2	Lightning Protection.....	4
3.3	Accessory Devices	5
3.3	Accessory Devices (continued).....	6

Installation

4.1	Mounting the Enclosure.....	7
4.2	Mounting Keypads and Zone Expansion Modules.....	8
4.3	Connecting LX-Bus and Keypad Bus Devices	9
4.4	Wireless Keypad Association	9

Primary Power Supply

5.1	AC Terminals 1 and 2.....	9
5.2	Transformer Types	9
5.3	J12 3-Pin Header for Transformer Types	9

Secondary Power Supply

6.1	Battery Terminals 3 and 4	10
6.2	Earth Ground (GND)	10
6.3	Battery Only Restart	10
6.4	Battery Replacement Period.....	10
6.5	Discharge/Recharge.....	10
6.6	Battery Supervision.....	10
6.7	Battery Cutoff.....	10
6.8	XR150/XR550 Series Canadian Power Requirements.....	11
6.9	Standby Battery Selection	13

Bell Output

7.1	Terminals 5 and 6.....	14
-----	------------------------	----

Keypad Bus

8.1	Description.....	14
8.2	Terminal 7 - RED	14
8.3	Terminal 8 - YELLOW	14
8.4	Terminal 9 - GREEN	14
8.5	Terminal 10 - BLACK	14
8.6	J8 Programming Connection	14
8.7	Keypad Bus LEDs.....	14
8.8	OVC LED(s).....	14

TABLE OF CONTENTS

Smoke and Glassbreak Detector Output

9.1	Terminals 11 and 12	15
9.2	Current Rating.....	15

Protection Zones

10.1	Terminals 13–24.....	15
10.2	Dual EOL	15
10.3	Zone Response Time.....	15
10.4	Keypad Arming Zone.....	15

Powered Zones for 2-Wire Smoke Detectors

11.1	Terminals 25–26 and 27–28	16
------	---------------------------------	----

Dry Contact Relay Outputs

12.1	Description.....	16
12.2	Contact Rating	16
12.3	Model 431 Output Harness Wiring.....	16

Annunciator Outputs

13.1	Description.....	17
13.2	Model 300 Harness Wiring.....	17
13.3	Model 860 Relay Module	17

Wireless Bus Expansion

14.1	Description.....	17
14.2	Wireless Bus LEDs	17

LX-Bus Expansion

15.1	LX-Bus Headers	17
15.2	LX-Bus LEDs.....	17
15.3	OVC LEDs	18
16.1	Description.....	18
16.2	Ethernet LEDs	18
16.3	Network Transient Suppression	18

J3 Telephone RJ Connector

17.1	Description.....	18
17.2	J10 893A or 277 Trouble Sounder Connector	18
17.3	Notification	18
17.4	Phone Line Monitor.....	18

Reset and Tamper Headers

18.1	J16 Reset Header	19
18.2	J4 Tamper Header	19

Cellular Modules

19.1	J24 Header	19
19.2	Module Installation	19
19.3	Connecting the Antenna.....	19
20.1	LX-Bus™ Module Connection	20
20.2	Model 860 Relay Module Connection	21
20.3	Dual Zone Protection	21

Certifications

Product Specifications

1.1 Power Supply

Transformer Input:	Model 327-CAN, plug-in – Primary input: 120 Vac, 60 Hz, Secondary output: 16.5 Vac 50 VA Model FTA7516 ATC Frost from Standex Electronics – Primary input: 120 Vac, 60 Hz, Secondary output: 16 Vac 75 VA
Standby Battery:	12 VDC, 1.0 Amps Max. charging current Models 365, 366, 368, or 369 Replace every 3 to 5 years
Auxiliary:	12 VDC output at 1.0 Amp Max using Model 327CAN
Bell Output:	12 VDC at 1.0 Amp Max using Model 327CAN
Auxiliary:	12 VDC output at 1.5 Amp Max using Model FTA7516
Bell Output:	12 VDC at 1.5 Amp Max using Model FTA7516

All circuits are inherent Power Limited except the red battery wire and AC terminal.

1.2 Communication

- Built-in network communication to DMP Model SCS-1R or SCS-VR Receivers
- Built-in 128-bit or 256-bit encrypted communication to DMP Model SCS-1R or SCS-VR Receivers (XR550E only)
- Built-in Contact ID communication to DMP Model SCS-1R Receivers
- Optional 893A Dual Phone Line Module with phone line supervision
- Can operate as a local panel

Note: 256-bit encrypted messages to SCS-1R receiver only communicate when using SCS-104 Receiver Line Cards with Version 102 or higher software.

1.3 Panel Zones

Eight 1k Ohm EOL burglary zones (zones 1 to 8)

Two 3.3k Ohm EOL powered zone with reset (zones 9 and 10)

1.4 Keypad Bus

You can connect up to a total of 16 of the following supervised keypads and expansion modules to the keypad bus:

- Alphanumeric keypads
- Single-zone detectors
- Access control modules
- Wireless Keypads (maximum of 7)
- Four- and/or single-zone expansion modules

1.5 LX-Bus™

You can connect the following devices to the LX-Bus™ connections provided on the panel. See Accessory Devices section 3.3.

- Four, eight, sixteen- and/or single-zone expansion modules
- Single-zone detectors
- Relay output expansion modules
- Graphic annunciator modules

1.6 Outputs

The XR150/XR550 Series provides two Single Pole, Double Throw (SPDT) relay outputs which require the installation of two Model 305 relays, each rated 1 Amp at 30 VDC resistive (power limited sources only). A Model 431 Output Harness is required to use these outputs.

The panels also provide four open collector outputs rated for 50mA each. The open collector outputs provide ground connection for a positive voltage source. A Model 300 Output Harness is required to use these outputs.

INTRODUCTION

1.7 Enclosure Specifications

The panels are shipped in an enclosure with a transformer, End-of-Line resistors, battery leads, user's guide, and programming sheets.

Enclosure Model	Size	Color(s)	Construction (Cold Rolled Steel)
350	17.5"W x 13.5"H x 3.5"D	Gray (G) or Red (R)	18-Gauge
350A	17.5"W x 13.5"H x 3.75"D	Gray (G)	18-Gauge with 16-Gauge door
341	13.22"W x 7.0"H x 3.5"D	Gray (G)	20-Gauge
349	12.5"W x 11.5"H x 3.5"D	Gray (G)	20-Gauge
352X	14.5"W x 32.0"H x 4.0"D	Gray (G)	16-Gauge

Panel Features

2.1 Description

The DMP XR150/XR550 Series Canadian panel is a versatile 12VDC, combined access control, burglary, and fire communicator panel with battery backup. The panels provide eight on-board burglary zones and two on-board 12VDC Class B powered zones. The powered zones have a reset capability to provide for 2-wire smoke detectors, relays, or other latching devices. You can use up to sixteen supervised 32-character LCD keypads; network communications and expansion interface cards; zone and output expansion modules; and initiating and indicating circuit modules. You can also connect auxiliary devices to the panel's output relays to expand the basic system control capability. Combined current requirements of additional modules may require an auxiliary power supply. Refer to the XR150/XR550 Series Power Requirements section in this guide when calculating power requirements. The XR150/XR550 Series can communicate to DMP SCS-1R Receivers using digital dialer, cellular, network, or Contact ID communication.

2.2 Zone Expansion

Each panel provides multiple options for zone expansion.

- 10 on-board zones
- Up to 64 programmable keypad zones
- Up to 500 LX-Bus zones

Using DMP LCD keypad remote zone capability and zone expansion modules, additional zones are available on each panel:

- XR550 provides up to 574 additional zones
- XR150 provides up to 142 additional zones

The panel keypad data bus supports up to 16 supervised device addresses with each address supporting up to four programmable expansion zones (64 total).

Using the on board LX-Bus™ (LX500-LX900) connections, and any combination of single, four, eight, or sixteen-zone expansion modules and single-zone LX-Bus™ detectors, additional zones are available on each panel:

- XR550 provides up to 500 additional zones (LX500-LX900)
- XR150 provides up to 100 additional zones (LX500)

Note: Do not use shielded or twisted pair wiring for LX-Bus or Keypad Bus circuits.

2.3 Output Expansion

In addition to the two SPDT relays and four programmable open collector outputs on the XR150/XR550 Series, you can also connect up to 25 programmable Model 716 Output Expansion Modules to each LX-Bus. These modules can provide an additional 500, 300, or 100 programmable SPDT relays.

The panels provide Output Schedules for programming the 716 to perform a variety of annunciation and control functions. Also assign the 716 outputs to any panel Output Options such as Fire Alarm, Communication Fail, or Phone Trouble Outputs. Refer to the 716 Installation Guide (LT-0183).

The LX-Bus™ also supports the Model 717 Graphic Annunciator Module. Each 717 module supplies 20 switched ground outputs that follow the state of their assigned zones.

Note: The 717 supports the first eight Keypad Bus addresses. To follow Keypad Bus addresses nine through 16, install multiple 716 modules. Refer to the 717 Installation Guide (LT-0235) and 716 Installation Guide (LT-0183).

2.4 Central Station Communication

You can program the panel for reporting to DMP SCS-1R Receivers using digital dialer, cellular, network, or Contact ID communication. You can program the panel for reporting to DMP SCS-VR Virtual Receivers using cellular or network communication. The panel connects at the premises to a standard RJ31X or RJ38X telephone jack. Use the DMP 893A Dual Phone Line Module when connecting the XR150/XR550 Series panel to two separate phone lines.

2.5 Encrypted Communications (XR550 with Encryption only)

An XR550 panel with encryption communicates using 128-bit or 256-bit AES encryption. If you currently have an XR550 panel installed, you may contact DMP Customer Service with the panel serial number. The serial number(s) should be sent in writing via e-mail or fax. A separate feature key is sent for each panel to activate encrypted communications using the Feature Upgrade process. Encrypted communication cannot be enabled on a standard XR550 panel. For more information on the Feature Upgrade process see the XR150/XR550 Series Canadian Programming Guide (LT-1232CAN).

Note: 256-bit encrypted messages to SCS-1R receiver only communicate when using SCS-104 Receiver Line Cards with Version 102 or higher software.

2.6 Caution Notes

Throughout this guide you will see caution notes containing information you need to know when installing the panel. These cautions are indicated with a yield sign. Whenever you see a caution note, make sure you completely read and understand its information. Failing to follow the caution note can cause damage to the equipment or improper operation of one or more components in the system. See the example shown below.



Always ground the panel before applying power to any devices: The panel must be properly grounded before connecting any devices or applying power to the panel. Proper grounding protects against Electrostatic Discharge (ESD) that can damage system components.

2.7 Compliance Instructions

For applications that must conform to a local authorities installation standard or a National Recognized Testing Laboratory certificated system, please see the Compliance Listing Guide (LT-1330) for instructions.

System Components

3.1 Wiring Diagram

The XR550 Series diagram below shows some of the accessory modules you can connect for use in various applications. A brief description of each module follows in section 3.3.

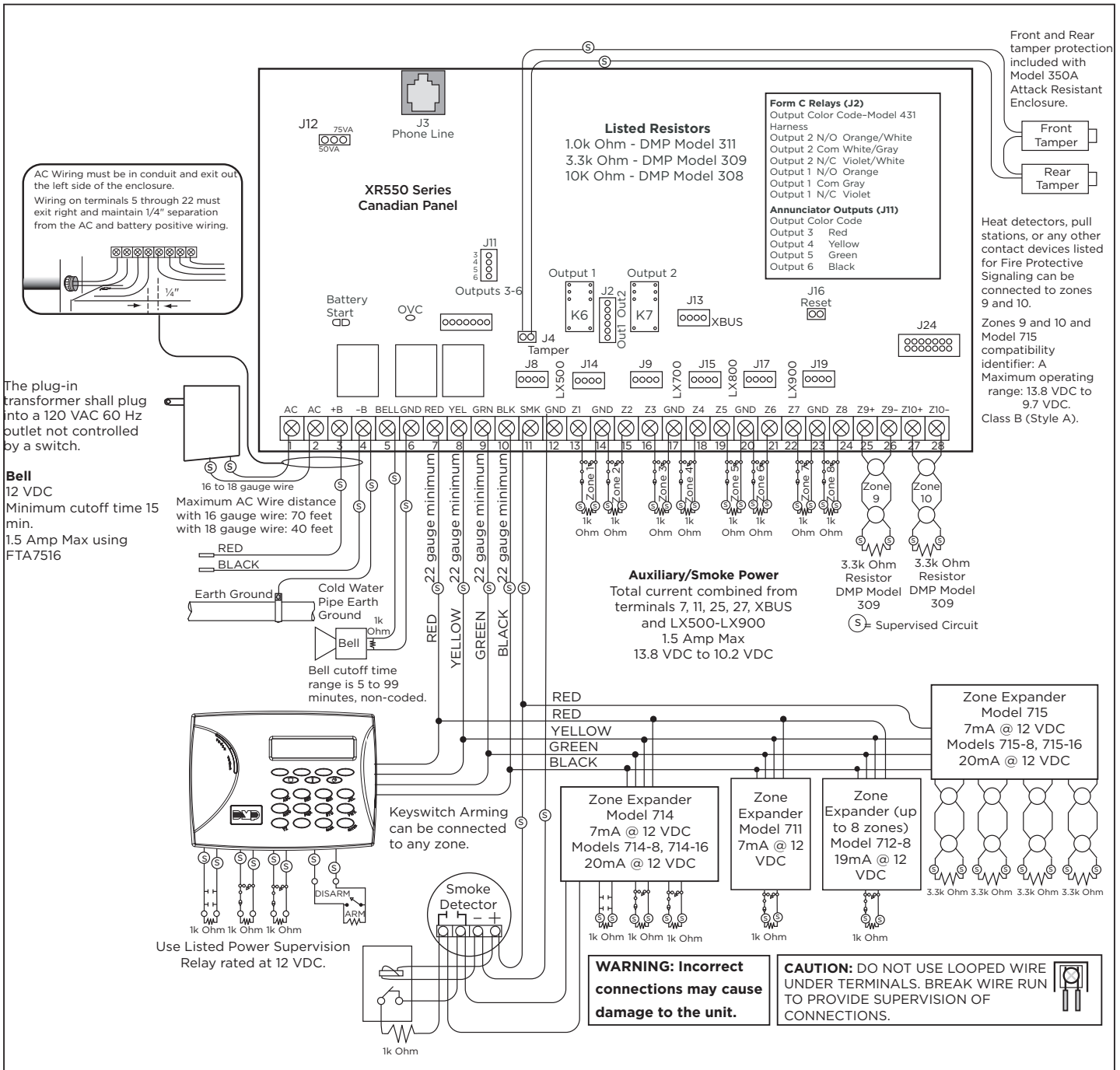

Figure 1: XR550 Canadian Wiring Diagram

3.2 Lightning Protection

Metal Oxide Varistors and Transient Voltage Suppressors help protect against voltage surges on XR150/XR550 Series input and output circuits. Additional surge protection is available by installing the DMP 370, 370RJ Lightning Suppressors or Model 270 Network Transient Suppression Module.

3.3 Accessory Devices

Cellular Communicators	
263LTE-A Cellular Communicator	Allows you to connect the XR150/XR550 Series to to the AT&T LTE network.
Accessory Modules	
270 Network Transient Suppression Module	Provides transient surge protection for the J1 Ethernet Connector.
277CAN Trouble Sounder	Provides local sounder for monitoring of panel operations and loss of Keypad Bus.
370/370RJ Lightning Suppressor	Provides protection against voltage surges on panel input and output circuits
893A Dual Phone Line Module	Allows you to supervise two standard phone lines connected to an XR150/XR550 Series panel. The 893A module monitors the main and backup phone lines for a sustained voltage drop and alerts users when the phone line is bad.
Expansion Modules	
710 Bus Splitter/Repeater	Allows you to increase keypad or LX-Bus™ wiring distance to 2500 feet.
711 Zone Expansion Module	Increases available reporting zones. Provides one Type A Class B zone.
711S Zone Expansion Module	Provides one Class B zone for connecting burglary devices.
712-8 Zone Expander	Provides Class B zones for connecting burglary devices.
714, 714-8, 714-16 Zone Expanders	Provides Class B zones for connecting burglary and non-powered fire devices.
714N-POE Network Zone Expander	Allows you to add four zones to the XR150/XR550 Series panels using IP network capability.
715, 715-8, 715-16 Zone Expanders	Provides 12VDC Class B powered zones for connecting smoke detectors, glassbreak detectors, and other 2- or 4-wire devices.
716 Output Expander	Provides four Form C relays (SPDT) and four switched grounds (open collector) for use in a variety of remote annunciation and control applications for use on the LX-Bus only.
717 Graphic Annunciator Module	Provides 20 zone following annunciator outputs (open collector) for use in a variety of remote annunciation and control applications for use on the LX-Bus only.
734, 734N, 734N-POE Wiegand Interface Modules	Provides system codeless entry, and arming and disarming using access control readers.
DMP Two-Way Wireless Devices	
1100X Series/1100XH Series Wireless Receiver	Supports up to 500 devices in residential or commercial wireless operation.
1100R Repeater	Provides additional range for wireless devices.
1100T Wireless Translator	Allows non-DMP wireless devices to integrate with DMP XR150CAN/XR550CAN Series panels.
1101 Series Universal Transmitter	Provides both internal and external contacts that may be used at the same time to yield two individual reporting zones from one wireless transmitter.
1102 Universal Transmitter	Provides an external contact.
1103 Series Universal Transmitter	Provides both internal and external contacts that may be used at the same time to yield two individual reporting zones from one wireless transmitter. Requires EOL resistor for external contact. Provides Disarm/Disable functionality.
1106 Series Universal Transmitter	Provides both internal and external contacts that may be used at the same time to yield two individual reporting zones from one wireless transmitter.
1107 Micro Window Transmitter	Provides a wireless window transmitter.
1108 Doorbell Module	Monitors doorbell presses.
1114 Four-Zone Expander	Provides four wireless zones.
1116 Relay Output	Provides one Form C relay.
1117 LED Annunciator	Provides a visual system status indicator.
1118 Remote Indicator Light	Provides a visual indication of a Panic situation.
1119 Door Sounder	Provides a battery powered sounder.
1126R Motion Detector	Ceiling mount motion detector with panel programmable sensitivity and Disarm/Disable functionality.
1127C/1127W PIR Motion Detector	Wall mount motion detector with panel programmable sensitivity and Disarm/Disable functionality.
1131 Recessed Contact	Provides a recessed contact option for door or window applications.
1135 Wireless Siren	Provides a wireless siren.
1136 Remote Sounder	Multi-function sounder that plugs directly into a standard 110VAC wall outlet.
1139 Bill Trap	Provides a silent alarm option for retail and banking cash drawers.

INTRODUCTION

1141 Wall Button	One button wall mounted wireless transmitter.
------------------	---

3.3 Accessory Devices (continued)

DMP Two-Way Wireless Devices (continued)	
1142BC Two-button Hold-up Belt Clip Transmitter	Provides two-button hold-up operation with a belt clip.
1142 Two-button Hold-up Transmitter	Provides permanently mounted under-the-counter two-button hold-up operation.
1144 Series Wireless Key Fobs	Key Fob transmitters designed to clip onto a key ring or lanyard.
1154 Wireless Four-Zone Input Module	Converts up to four existing normally closed, hardwired zones into wireless zones.
1158 Wireless 8-Zone Input Module	Allows installers to convert up to 8 existing hardwired zones into wireless zones.
1164 Wireless Synchronized Smoke Detector	Commercial or residential, battery powered, wireless, low profile, photoelectric smoke detector, with synchronizing sounder.
1166 Wireless Smoke Ring	Installs on any traditional AC-powered, three wire, interconnected smoke alarm system.
1183-135F Heat Detector	Fixed temperature heat detector.
1183-135R Heat Detector	Fixed temperature and rate-of-rise heat detector.
1184 Carbon Monoxide Detector	Carbon Monoxide Detector.
Interface Modules	
736P Radionics™ Popit Interface	Allows a Radionics™ POPIT System to interface with DMP XR150/XR550 Series panels while maintaining Radionics™ wiring.
738A Ademco Interface	Allows Ademco™ 5881 wireless receivers to interface with DMP XR150/XR550 Series panels.
738I ITI Interface Module	Allows ITI™ SuperBus™ 2000 Series wireless receivers to interface with DMP XR150/XR550 Series panels.
738Zplus Z-Wave Interface Module	Provides connection for Z-Wave modules.
Indicating and Initiating Devices	
860 Relay Output Module	Provides one relay and three relay sockets for expansion of up to four relays.
865 Supervised Style W or X Notification Circuit Module	Provides supervised alarm current when using the XR150/XR550 Series panel bell output and up to 5 Amps at 12 or 24VDC when using a listed auxiliary power supply. The 865 can supervise 2-wire or 4-wire style circuits for opens and shorts with individual LED annunciation.
866 Style W Notification Circuit Module	Provides supervised alarm current using the XR150/XR550 Series panel bell output and up to 5 Amps at 12 or 24VDC when using a listed auxiliary power supply. The 866 can supervise 2-wire Style W circuits for opens and shorts.
867 Style W LX-Bus Notification Circuit Module	Provides supervised alarm current using the XR150/XR550 Series panel bell output and up to 5 Amps at 12 or 24VDC when using a listed auxiliary power supply. The 867 connects to the XR150/XR550 Series panel LX-Bus™ and provides one 2-wire Style W notification circuit for open and short conditions. Individual Bell Relay addresses Bell Ring styles.
869 Dual Class A Style D Initiating Module	Provides two Class A, Style D, 4-wire initiating zones for connecting waterflow switches and other non-powered fire and burglary devices.
Keypads	
LCD keypads	Allows you to control the panel from various remote locations. Connect up to sixteen supervised Model 630F Remote Fire Command Center, 7060, 7063, 7070, 7073, 7160, 7163, 7170, 7173 Thinline™ keypads, 7060A, 7063A, 7070A, 7073A Aqualite™ keypads, and 7872 and 7873 Graphic Touchscreen keypads to the keypad bus using terminals 7, 8, 9, and 10.
9000 Series Wireless Keypads	Allows you to control the panel from various remote locations. Connect up to seven 9060/9063 Wireless Keypads.
9800 Series Wireless Graphic Touchscreen keypads	Allows you to control the panel from various remote locations. Connect up to seven 9862 Wireless Keypads.
Addressable Smoke Detectors	
2W-BLX, 2WT-BLX	Single-zone, addressable conventional smoke, smoke/heat detectors that connect to the LX-Bus. Includes drift compensation.

Installation

4.1 Mounting the Enclosure

The metal enclosure for the XR150/XR550 Series must be mounted in a secure, dry place to protect the panel from damage due to tampering or the elements. It is not necessary to remove the XR150/XR550 Series PCB when installing the enclosure. Figure 2 shows the mounting hole locations for the Model 350/350A Enclosures. Figure 3 shows the Model 341 Enclosure. Figure 4 shows the Model 352X panel cabinet and 352S shelf cabinet for multiple batteries.

The 350A Attack Resistant enclosure is factory shipped with one knockout on the top left of the enclosure. As needed, additional knockouts or antenna exits may be added at the time of installation. See Figure 2 for the positions on the enclosure that can be added. Each additional knockout must be filled with conduit.

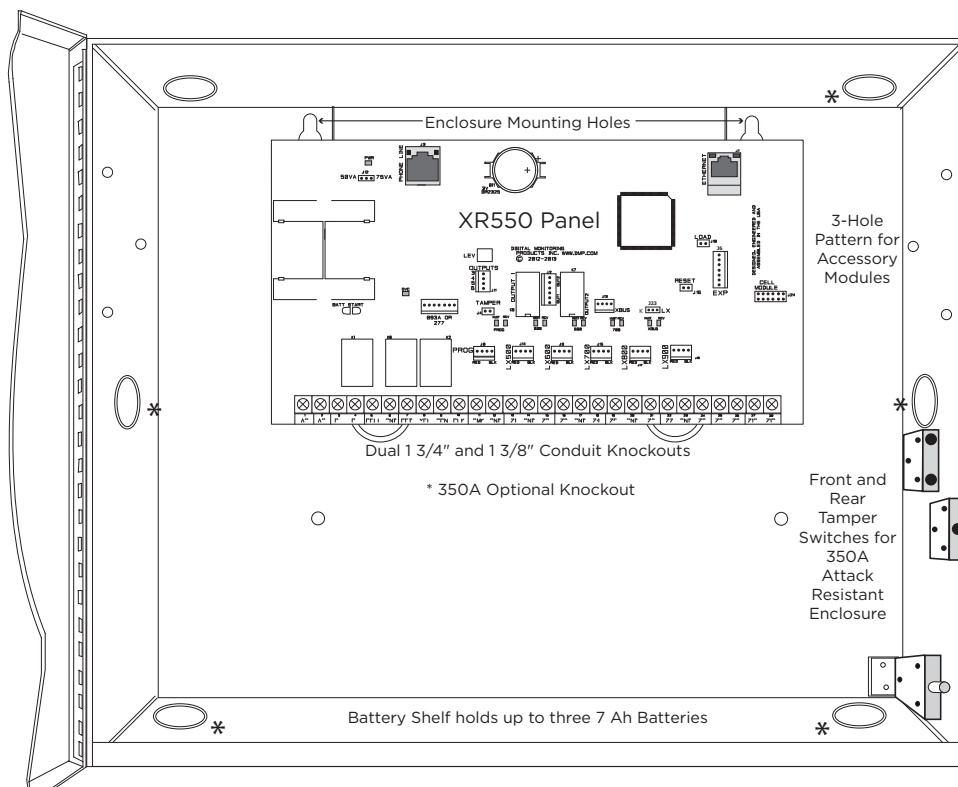

Figure 2: XR550 Series in Model 350 or 350A Enclosure

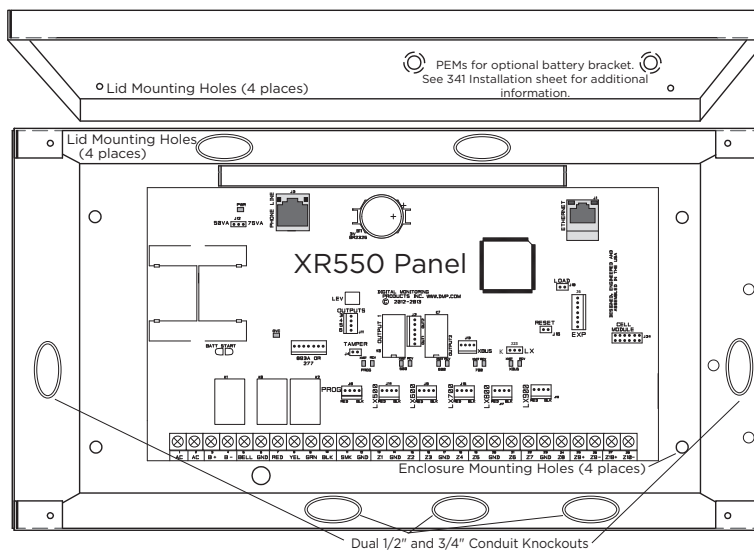

Figure 3: XR550 Series in Model 341 Enclosure

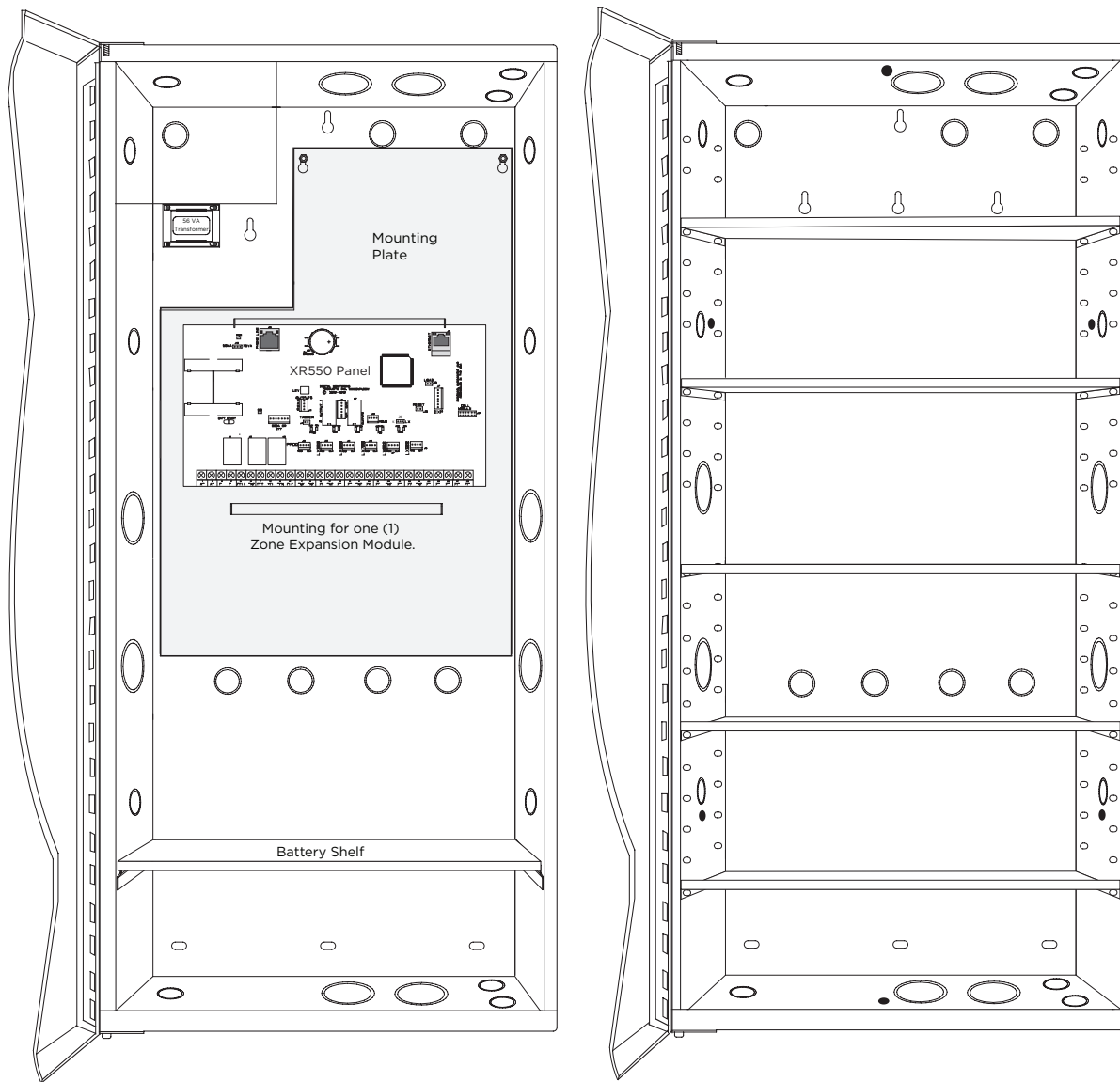

Figure 4: XR550 Series in Model 352X Enclosure and Separate 352S Enclosure with Shelves

4.2 Mounting Keypads and Zone Expansion Modules

DMP LCD keypads have removable covers that allow you to easily mount the keypad to a wall or other flat surface using the screw holes on each corner of the base. Before mounting the base, connect the keypad wire harness leads to the keypad cable from the panel and to any device wiring run to that location. Then attach the harness to the pin connector on the PC board, mount the base, and install the keypad cover making sure all of the keys extend through their respective holes.

For mounting keypads on solid walls, or for applications where conduit is required, use the Model 695 1-1/2" deep or the Model 696 1/2" deep backboxes.

The DMP 711, 712-8, 714, 715, 716, and 717 modules are each contained in molded plastic housings with removable covers. The base provides you with mounting holes for installing the unit to a wall, switch plate, or other surface.

4.3 Connecting LX-Bus and Keypad Bus Devices

Connections for LX-Bus and Keypads are provided through the J8 (PROG), J14 (LX500), J9 (LX600), J15 (LX700), J17 (LX800), J19 (LX900), and J13 (XBUS) 4-pin headers. Several factors determine the DMP LX-Bus™ and keypad bus performance characteristics: the wire length and gauge used, the number of devices connected, and the voltage at each device. When planning an LX-Bus™ and keypad bus installation, keep in mind the following information:

- DMP recommends using 18 or 22-gauge **unshielded** wire for all keypad and LX-Bus circuits. Do not use twisted pair or shielded wire for LX-Bus and keypad bus data circuits.
- On keypad bus circuits, to maintain auxiliary power integrity when using 22-gauge wire do not exceed 500 feet. When using 18-gauge wire do not exceed 1,000 feet. To increase the wire length or to add devices, install an additional power supply that is listed for Fire Protective Signaling, power limited, and regulated (12VDC nominal) with battery backup.

Note: Each panel allows a specific number of supervised keypads. Add additional keypads in the unsupervised mode. Refer to the Keypad Bus section for the specific number of supervised keypads allowed.

- Maximum distance for any one bus circuit (length of wire) is 2,500 feet regardless of the wire gauge. This distance can be in the form of one long wire run or multiple branches with all wiring totaling no more than 2,500 feet. As wire distance from the panel increases, DC voltage on the wire decreases. Maximum number of LX-Bus devices on the first 2,500 foot circuit is 40 devices.
- Maximum voltage drop between the panel (or auxiliary power supply) and any device is 2VDC. If the voltage at any device is less than the required level, add an auxiliary power supply at the end of the circuit. When voltage is too low, the devices cannot operate properly.

For additional information refer to the LX-Bus/Keypad Bus Wiring Application Note (LT-2031).

4.4 Wireless Keypad Association

Enable Wireless Keypad Association operation on both the keypad and panel:

1. Access the Installer Options Menu (3577 (INST)).
2. Select RF Survey). The keypad logo LEDs turn on red until association is successful.

Enable Wireless keypad Association operation in the XR150/XR550 panel:

Reset panel 3 times within 12 seconds. Allow the keypad bus Transmit/Receive LEDs to turn back on between each reset. For 60 seconds the panel listens for wireless keypads that are in the Installer Options Menu (3577 CMD) and have not been programmed, or associated into another panel. Those keypads are assigned to the first open device position automatically based upon the order in which they are detected. The keypad logo turns Green to indicate it has been associated with the panel.

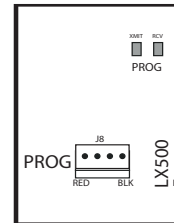

Figure 5: Keypad Bus LEDs

Primary Power Supply

5.1 AC Terminals 1 and 2

Connect the transformer wires to terminals 1 and 2 on the panel. Use no more than 70 ft. of 16 gauge or 40 ft. of 18 gauge wire between the transformer and the XR150/XR550 Series.



Always ground the panel before applying power to any devices: The XR150/XR550 Series must be properly grounded before connecting any devices or applying power to the panel. Proper grounding protects against Electrostatic Discharge (ESD) that can damage system components. See the Earth ground section.

5.2 Transformer Types

Use Model 327CAN (16.5 Vac 50 VA) plug-in or Model FTA7516 from ATC Frost.



The transformer must be connected to an unswitched 120 Vac 60 Hz electrical outlet with at least .87A of available current. **Never share the transformer output with any other equipment.**

5.3 J12 3-Pin Header for Transformer Types

Place the jumper on the left two pins for a Maximum 2 Amp (Bell+Aux+Smoke+XBUS+LX500-LX900) when using the Model 327CAN plug-in transformer (default).

Use an ATC Frost FTA7516 transformer and place the jumper on the right two pins for a Maximum, 3 Amps (Bell+Aux+Smoke+XBUS+LX500-LX900).

Secondary Power Supply

6.1 Battery Terminals 3 and 4

Connect the black battery lead to the negative battery terminal. The negative terminal connects to the enclosure ground internally through the XR150/XR550 Series circuit board. Connect the red battery lead to the battery positive terminal. Observe polarity when connecting the battery.

You can add a second battery in parallel using the DMP Model 318 Dual Battery Harness. DMP requires each battery be separated by a PTC in the battery harness wiring to protect each battery from a reversal or short within the circuit. See Figure 6.



Use sealed lead-acid batteries only: Use the Model 365 (12VDC 9 Ah), Model 366 (12VDC 18 Ah), Model 368 (12VDC 5.0 Ah), or Model 369 (12VDC 7 Ah) sealed lead-acid rechargeable battery. Batteries supplied by DMP have been tested to ensure proper charging with DMP products.

GEL CELL BATTERIES CANNOT BE USED WITH THE XR150/XR550 SERIES PANEL.

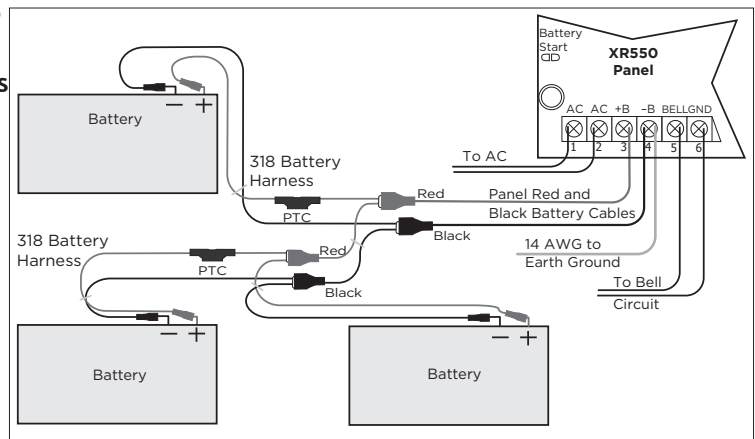

Figure 6: Wiring Multiple Batteries

6.2 Earth Ground (GND)

To provide proper transient suppression, XR150/XR550 Series panel terminal 4 must be connected to earth ground using 14 gauge or larger wire. DMP recommends connecting to a cold water pipe, ground rod, or building ground only. Do not connect to an electrical ground or conduit, sprinkler or gas pipes, or to a telephone company ground.

6.3 Battery Only Restart

When powering up the XR150/XR550 Series panel without AC power, briefly short across the battery start pads to pull in the battery cutoff relay. The leads need a momentary short only. Once the relay has pulled in, the battery voltage holds it in that condition. If the XR150/XR550 Series panel is powered up with an AC transformer, the battery cutoff relay is pulled in automatically. For more information refer to Figure 1.

6.4 Battery Replacement Period

DMP recommends replacing the battery every 3 to 5 years under normal use.

6.5 Discharge/Recharge

The XR150/XR550 Series battery charging circuit float charges at 13.8VDC at a maximum current of 1.0 Amps. Listed below are the various battery voltage level conditions:

Battery Trouble:	Below	11.9VDC
Battery Cutoff:	Below	10.2VDC
Battery Restored:	Above	12.6VDC

6.6 Battery Supervision

The XR150/XR550 Series tests the battery when AC power is present. The test is done every three minutes and lasts for five seconds. During the test, the panel places a load on the battery; if the battery voltage falls below 11.9VDC a low battery is detected. If AC power is not present, a low battery is detected any time the battery voltage falls below 11.9VDC.

If a low battery is detected with AC power present, the test repeats every two minutes until the battery charges above 12.6VDC indicating the battery has restored voltage. If a weak battery is replaced with a fully charged battery, the restored battery will not be detected until the next two minute test is completed.

6.7 Battery Cutoff

The panel disconnects the battery any time the battery voltage drops below 10.2VDC. This prevents battery deep discharge damage.

6.8 XR150/XR550 Series Canadian Power Requirements

During AC power failure, the XR150/XR550 Series panel and all connected auxiliary devices draw their power from the battery. All devices must be taken into consideration when calculating the battery standby capacity. The following table lists the XR150/XR550 Series panel power requirements. You must add the additional current draw of keypads, zone expansion modules, smoke detector output, and any other auxiliary devices used in the system for the total current required. The total is then multiplied by the number of standby hours required to calculate the total ampere-hours required.

Standby Battery Power Calculations	Standby Current	Alarm Current
XR150/XR550 Series Control Panel	Qty <u> 1 </u> x 174mA <u> 174 </u> mA	Qty <u> 1 </u> x 217mA <u> 217 </u> mA
Relay Outputs 1-2 (ON)	Qty <u> </u> x 30mA <u> </u>	Qty <u> </u> x 30mA <u> </u>
Switch Grounds 3-6 (ON)	Qty <u> </u> x 5mA <u> </u>	Qty <u> </u> x 5mA <u> </u>
Active Zones 1-8	Qty <u> </u> x 1.6mA <u> </u>	Qty <u> </u> x 2mA* <u> </u>
Active Zones 9-10	Qty <u> </u> x 4mA <u> </u>	Qty <u> </u> x 30mA <u> </u>
2-Wire Smoke Detectors	Qty <u> </u> x 0.1mA <u> </u>	Qty <u> </u> x 0.1mA <u> </u>
Panel Bell Output		1500mA <u> </u> mA
893A Dual Phone Line Module	Qty <u> </u> x 12mA <u> </u>	Qty <u> </u> x 50mA <u> </u>
263LTE-A Cellular Communicator	Qty <u> </u> x 20mA <u> </u>	Qty <u> </u> x 20mA <u> </u>
277CAN Trouble Sounder Module	Qty <u> </u> x 5mA <u> </u>	Qty <u> </u> x 5mA <u> </u>
1100X Series Wireless Receiver	Qty <u> </u> x 25mA <u> </u>	Qty <u> </u> x 35mA <u> </u>
1100XH Series Wireless High Power Receiver	Qty <u> </u> x 75mA <u> </u>	Qty <u> </u> x 102mA <u> </u>
860 Relay Output Module (one relay active)	Qty <u> </u> x 34mA <u> </u>	Qty <u> </u> x 34mA <u> </u>
All four relays active	138mA <u> </u>	138mA <u> </u>
865 Style Y or Z Notification Module	Qty <u> </u> x 26mA <u> </u>	Qty <u> </u> x 85mA <u> </u>
866 Style W Notification Module	Qty <u> </u> x 45mA <u> </u>	Qty <u> </u> x 76mA <u> </u>
867 LX-Bus Style W Notification Module	Qty <u> </u> x 30mA <u> </u>	Qty <u> </u> x 86mA <u> </u>
869 Dual Style D Initiating Module	Qty <u> </u> x 25mA <u> </u>	Qty <u> </u> x 75mA <u> </u>
7060/7160 Thinline/7060A Aqualite Keypad	Qty <u> </u> x 72mA <u> </u>	Qty <u> </u> x 87mA <u> </u>
7063/7163 Thinline/7063A Aqualite Keypad	Qty <u> </u> x 85mA <u> </u>	Qty <u> </u> x 100mA <u> </u>
7070/7170 Thinline/7070A Aqualite Keypad	Qty <u> </u> x 72mA <u> </u>	Qty <u> </u> x 87mA <u> </u>
Active Zones (EOL Installed)	1.6mA <u> </u>	Qty <u> </u> x 2mA* <u> </u>
7073/7173 Thinline/7073A Aqualite Keypad	Qty <u> </u> x 85mA <u> </u>	Qty <u> </u> x 100mA <u> </u>
Active Zones (EOL Installed)	1.6mA <u> </u>	Qty <u> </u> x 2mA* <u> </u>
7872 Graphic Touchscreen Keypad	Qty <u> </u> x 145mA <u> </u>	Qty <u> </u> x 215mA <u> </u>
Active Zones (EOL Installed)	1.6mA <u> </u>	Qty <u> </u> x 2mA* <u> </u>
7873 Graphic Touchscreen Keypad	Qty <u> </u> x 143mA <u> </u>	Qty <u> </u> x 243mA <u> </u>
Active Zones (EOL Installed)	1.6mA <u> </u>	Qty <u> </u> x 2mA* <u> </u>
734 Wiegand Interface Module	Qty <u> </u> x 40mA <u> </u>	Qty <u> </u> x 60mA <u> </u>
Active Zones (EOL Installed)	Qty <u> </u> x 1.6mA <u> </u>	Qty <u> </u> x 2mA* <u> </u>
Annunciator (ON)		Qty <u> </u> x 20mA <u> </u>
Copy Sub-Totals to next page	Sub-Total Standby <u> </u> mA	Sub-Total Alarm <u> </u> mA

*Based on 10% of active zones in alarm.

INSTALLATION

Standby Battery Power Calculations	Standby Current	Alarm Current
736P POPIT Interface Module Radionics Popex, POPITs, OctoPOPITs	Qty _____ x 25mA _____ Qty _____ x _____mA _____	Qty _____ x 25mA _____ Qty _____ x _____mA _____
738A Ademco Wireless Interface Module	Qty _____ x 75mA _____	Qty _____ x 75mA _____
738Zplus Z-Wave Interface Module	Qty _____ x 40mA _____	Qty _____ x 40mA _____
710 Bus Splitter/Repeater Module	Qty _____ x 32mA _____	Qty _____ x 32mA _____
711 Zone Expansion Module Active Zone (EOL Installed)	Qty _____ x 11mA _____ Qty _____ x 1.6mA _____	Qty _____ x 4.7mA _____ Qty _____ x 2mA* _____
711S Zone Expansion Module Active Zone	Qty _____ x 4.2mA _____	Qty _____ x 11mA _____
714 Zone Expansion Module Active Zones (EOL Installed)	Qty _____ x 7mA _____ Qty _____ x 1.6mA _____	Qty _____ x 7mA _____ Qty _____ x 2mA* _____
712-8 Zone Expansion Module Active Zones (EOL Installed)	Qty _____ x 17mA _____ Qty _____ x 1.6mA _____	Qty _____ x 17mA _____ Qty _____ x 2mA* _____
714-8, 714-16 Zone Expansion Module Active Zones (EOL Installed)	Qty _____ x 20mA _____ Qty _____ x 1.6mA _____	Qty _____ x 20mA _____ Qty _____ x 2mA* _____
715 Zone Expansion Module Active Zones (EOL Installed) 2-Wire Smokes	Qty _____ x 7mA _____ Qty _____ x 4mA _____ Qty _____ x .1mA _____	Qty _____ x 7mA _____ Qty _____ x 30mA* _____ Qty _____ x .1mA _____
715-8, 715-16 Zone Expansion Modules Active Zones (EOL Installed) 2-Wire Smokes	Qty _____ x 20mA _____ Qty _____ x 4mA _____ Qty _____ x .1mA _____	Qty _____ x 20mA _____ Qty _____ x 30mA* _____ Qty _____ x .1mA _____
716 Output Expansion Module Active Form C Relays	Qty _____ x 13mA _____	Qty _____ x 13mA _____ Qty _____ x 12mA _____
717 Graphic Annunciator Module Annunciator Outputs	Qty _____ x 10mA _____	Qty _____ x 10mA _____ Qty _____ x 1mA _____
2W-BLX, 2WT-BLX Smoke Detectors	Qty _____ x 15mA _____	Qty _____ x 35mA* _____
572 Indicator LED	Qty _____ x 20mA _____	Qty _____ x 20mA _____
Aux. Powered Devices on Terminals 7 and 11 Other than Keypads and LX-Bus Modules	_____mA	_____mA
This page only	Sub-Total Standby _____mA	Sub-Total Alarm _____mA
Sub-Totals from previous page	Sub-Total Standby _____mA	Sub-Total Alarm _____mA
*Based on 10% of active zones in alarm	Total Standby _____mA	Total Alarm _____mA
<p>Total Standby _____mA x number of Standby Hours needed _____ = _____mA-hours</p> <p>Total Alarm _____mA + _____mA-hours</p> <p>Total _____mA-hours</p> <p>X .001</p> <p>= _____Amp-hrs Required</p>		

Refer to section 6.9 for standby battery selection.

6.9 Standby Battery Selection

To choose the type and number of batteries needed for 24, 60, or 72 hours of standby power based on the Amp Hours Required calculation from section 6.8 XR150/XR550 Series Power Requirements, perform the following:

1. Select the desired standby hours required from the table below: 24, 60, or 72 hours.
2. Select the desired battery size: Model 368 (12VDC 5.0 Ah), Model 369 (12VDC 7 Ah), Model 365 (12VDC 9 Ah), Model 366 (12VDC 18 Ah).
3. Select a Max. Ah Available number that is just greater than the number calculated in Amp Hours Required.
4. Install the number of batteries shown in the corresponding No. of Batteries required column.

Example: If the Amp Hours Required calculation equals 22 Ah for 24 hours of standby time and 4.5 Ah batteries are desired, install six (6) Model 368 (12VDC, 5.0 Ah) batteries.

Note: You can use either a Model 327CAN Plug-in 50 VA or ATC Frost FTA7516 75VA Transformer with any of the Number of Batteries choices listed below.

24 hours of standby power

5.0 Ah Batteries		7 Ah Batteries		7.7 Ah Batteries		9 Ah Batteries		18 Ah Batteries	
Max. Ah Available	No. of Batteries	Max. Ah Available	No. of Batteries	Max. Ah Available	No. of Batteries	Max. Ah Available	No. of Batteries	Max. Ah Available	No. of Batteries
8	2	6	1	6	1	8	1	16	1
12	3	12	2	13	2	16	2	32	2
16	4	18	3	20	3	24	3	48	3
20	5	24	4	27	4	32	4		
24	6	31	5	34	5	40	5		
28	7	37	6	41	6				
32	8	43	7						
36	9								
40	10								

Note: 48 hours is the typical battery recharge time for any of the Number of Batteries shown in this section.

60 hours of standby power

7 Ah Batteries		7.7 Ah Batteries		9 Ah Batteries		18 Ah Batteries	
Max. Ah Available	No. of Batteries	Max. Ah Available	No. of Batteries	Max. Ah Available	No. of Batteries	Max. Ah Available	No. of Batteries
13	2	14	2	17	2	17	1
20	3	22	3	26	3	34	2
27	4	29	4	34	4	52	3
33	5	37	5	43	5	69	4
40	6	44	6	52	6		
47	7	52	7	61	7		
54	8	59	8	69	8		
60	9	67	9				
67	10						

Note: 48 hours is the typical battery recharge time for any of the Number of Batteries shown in this section.

72 hours of standby power

9 Ah Batteries		18 Ah Batteries	
Max. Ah Available	No. of Batteries	Max. Ah Available	No. of Batteries
16	2	16	1
25	3	33	2
33	4	50	3
42	5	67	4
50	6		
59	7		
67	8		

Note: 72 hours is the typical battery recharge time required for any of the Number of Batteries shown in this section.

Note: If the Amp Hours Required calculation is greater than any Max. Ah Available number shown on a table, then add power supply(s) to power some system devices allowing the Amp Hours Required calculation to be reduced. See the 710 Bus Splitter/Repeater Installation Guide (LT-0310).

Bell Output

7.1 Terminals 5 and 6

Terminal 5 supplies positive 12VDC to power alarm bells or horns. This output can be steady, pulsed, or temporal depending upon the Bell Action specified in Bell Options. Terminal 6 is the ground reference for the bell circuit. This supervised output detects 1k Ohms or less as normal. The indicating appliance can supply this resistance. If using a horn or siren, a 1k Ohm 1/2 W EOL resistor (provided) should be added across the bell circuit to provide supervision. See the Notification Appliance section for a list of approved notification appliances and the Wiring Diagrams for connections.

Keypad Bus

8.1 Description

XR150/XR550 Series panel terminals 7, 8, 9, and 10 are for the keypad bus. You can connect up to sixteen supervised keypads and multiple unsupervised keypads to the XR150/XR550 Series. In addition to DMP LCD keypads, you can also connect any combination of zone expansion modules to the data bus up to 16 devices.

Note: Do not use shielded wire for LX-Bus/Keypad Bus circuits.

8.2 Terminal 7 - RED

This terminal supplies positive 12VDC Regulated to power DMP LCD keypads and zone expansion modules. Terminal 7 also supplies power for any auxiliary device. The ground reference for terminal 7 is terminal 10.

The output current is shared with the smoke power output on terminal 11 and Zones 9 and 10. Current draw for all connected devices must not exceed the panel maximum current rating. See Power Supply in the Compliance section for maximum current in a fire listed application.

8.3 Terminal 8 - YELLOW

Terminal 8 receives data from keypads and zone expansion modules. It cannot be used for any other purpose.

8.4 Terminal 9 - GREEN

Terminal 9 transmits data to keypads and zone expansion modules. It cannot be used for any other purpose.

8.5 Terminal 10 - BLACK

Terminal 10 is the ground reference for DMP LCD keypads, zone expansion modules, and all auxiliary devices being powered by terminal 7.

8.6 J8 Programming Connection

A 4-pin header (J8) is provided to connect a keypad when using a DMP Model 330 Programming Cable. This provides a quick and easy connection for panel programming.

You may also use the Programming Header to connect Keypad Bus devices. This is an alternative to connecting keypad bus devices to terminals 7, 8, 9, and 10.

8.7 Keypad Bus LEDs

The two LEDs, located above the J8 PROG connector, indicate data transmission and receipt. The left LED flashes green to indicate the panel is transmitting keypad bus data. The right LED flashes yellow to indicate the panel is receiving keypad bus data. See Figure 5.

8.8 OVC LED(s)

The Overcurrent LED (OVC) lights red when the devices connected to the Keypad Bus and LX-Bus(es) draw more current than the panel is rated for. The LED(s) turn a steady red when lit. When the OVC LED(s) light red, the appropriate LX-Bus(es) and Keypad bus are shut down.

- The OVC LED located to the left of the 893A connector indicates overcurrent for the Keypad Bus (Terminals 7-10 and PROG header), XBUS, and LX500-LX700.
- The OVC LED to the right of the J24 Cell Module connector indicates overcurrent for LX800-LX900.

Smoke and Glassbreak Detector Output

9.1 Terminals 11 and 12

Terminal 11 supplies positive 12VDC Regulated to power 4-wire smoke detectors and other powered devices. This output can be turned off by the user for 5 seconds using the Sensor Reset User Menu option to allow latched devices to reset. Terminal 12 is the ground reference for terminal 11.

9.2 Current Rating

The Output current from terminal 11 is shared with terminals 7, 25, 27, and LX500-LX900.

Caution: The total current draw of all devices powered from the panel must be included with terminal 11 calculations and must not exceed the maximum output rating.

Protection Zones

10.1 Terminals 13–24

Zones 1 to 8 (terminals 13 to 24) on the XR150/XR550 Series panels are all grounded burglary zones. For programming purposes, the zone numbers are 1 through 8. Listed below are terminal 13 to 24 connection functions.

Terminal	Function	Terminal	Function
13	Zone 1 voltage sensing	19	Zone 5 voltage sensing
14	Ground for Zones 1 and 2	20	Ground for Zones 5 and 6
15	Zone 2 voltage sensing	21	Zone 6 voltage sensing
16	Zone 3 voltage sensing	22	Zone 7 voltage sensing
17	Ground for Zones 3 and 4	23	Ground for Zones 7 and 8
18	Zone 4 voltage sensing	24	Zone 8 voltage sensing

The voltage sensing terminal measures the voltage across a 1k Ohm End-of-Line resistor to ground. Use DMP Model 311 1k Ohm resistors. Dry contact sensing devices can be used in series (normally-closed) or in parallel (normally-open) with any of the burglary protection zones.

Each protection zone detects three conditions: Open, Normal, and Short. Listed below are voltage and resistance parameters for each condition:

Condition	Resistance on zone	Voltage on positive terminal
Open	over 1300 Ohms	over 2.0VDC
Normal	600 to 1300 Ohms	1.2 to 2.0VDC
Short	under 600 Ohms	under 1.2VDC

10.2 Dual EOL

The XR150/XR550 Series Canadian panels support the use of dual 1K EOL resistors on panel Zones 1-8. Two EOL resistors are used so a wire trouble can be indicated during the disarm period.

When dual end-of-line operation is chosen in panel programming, normal zone processing occurs with the following exception: When processing an open zone and a trouble or alarm message is NOT programmed to be sent for the open state, the panel checks to see if the wire is cut. If the wire is cut, the panel automatically sends an alarm if armed or trouble is disarmed.

ZONE STATUS

	Zone Wires Open	Zone Wires Short	Contact Normal	Contact Open
Disarmed	Trouble	Trouble	Normal	Normal
Armed	Alarm	Alarm	Normal	Alarm

10.3 Zone Response Time

A condition must be present on a zone for 500 milliseconds before it is detected by the XR150/XR550 Series panel. Ensure detection devices used on the protection zones are rated for use with this delay. Zones 1-10 can also be programmed for a fast response delay of 160 milliseconds.

10.4 Keyswitch Arming Zone

A keyswitch on an Arming type zone allows selected areas to arm and disarm without having to enter a user code.

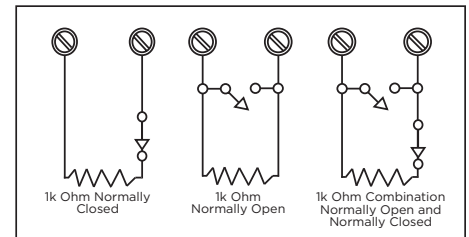

Figure 7: Protection Zone Wiring

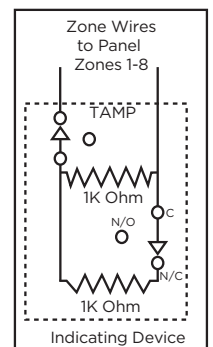

Figure 8: Dual EOL

Powered Zones for 2-Wire Smoke Detectors

11.1 Terminals 25–26 and 27–28

Panel terminals 25 through 28 provide two resettable Class B, Style A, 2-wire powered zones. For programming purposes the zone numbers are 9 and 10.

Note: The maximum wire length for either zone 9 or zone 10 is 3000 feet using 18 AWG or 1000 feet using 22 AWG. The maximum voltage is 13.8VDC and the maximum normal standby current is 1.25mA DC. The maximum line impedance is 100 Ohms. The maximum short circuit current is 56mA. Do not mix detectors from different manufacturers on the same zone.



Caution: Performing a Sensor Reset momentarily drops power to the devices on Zones 9 and 10. The panel views these zones (9 and 10) as “Open” while the power is absent.

Note: Refer to the Compliance Listing Guide (LT-1330)for list of compatible DMP 2-wire smoke detectors.

Dry Contact Relay Outputs

12.1 Description

The XR150/XR550 Series panel provides two programmable auxiliary SPDT relays when equipped with two DMP Model 305 relays in sockets K6 (Output 1) and K7 (Output 2) and a Model 431 Output Harness on the J2 6-pin Header. Each relay provides one SPDT set of contacts that can be operated by any of the functions listed below:

- | | |
|---|-------------------|
| 1) Activation by zone condition: Steady, Pulsing, Momentary, and Follow | |
| 2) Activation by 24-hour 7-day schedule: One on and one off time a day for each relay | |
| 3) Manual activation from the DMP LCD keypad menu | |
| 4) Communication failure | 12) Ready |
| 5) Armed area annunciation | 13) Armed |
| 6) Fire Alarm, Fire Trouble or Supervisory | 14) Disarmed |
| 7) Ambush Alarm | 15) Burglary |
| 8) Exit and Entry timers | 16) Phone Trouble |
| 9) System Ready | 17) Device Fail |
| 10) Late to Close | 18) Sensor Reset |
| 11) Panic Alarm | 19) Closing Wait |

Refer to the XR150/XR550 Canadian Series Programming Guide (LT-1232CAN) for specific information.

12.2 Contact Rating

The Model 305 relay contacts are rated for 1 Amp at 30VDC (allows .35 power factor). You can connect auxiliary power to the Relay Output 1 common terminal by installing the gray harness wire to terminal 7. Current draw for all connected devices must not exceed the panel maximum current rating.

12.3 Model 431 Output Harness Wiring

The relay contacts are accessible by installing the DMP 431 Output Harness on the 6-pin header labeled J2. Output 2 uses the top three prongs, and Output 1 uses the bottom three prongs. The wire harness and contact locations are shown below:

Contact	Color
Output 1 normally closed	Violet
Output 1 common	Gray
Output 1 normally open	Orange
Output 2 normally closed	Violet with white stripe
Output 2 common	White with gray stripe
Output 2 normally open	Orange with white stripe

The relay contacts must be connected to devices located within the same room as the XR150/XR550 Series panel.

Annunciator Outputs

13.1 Description

The four programmable annunciator outputs can be programmed to indicate the activity of the panel zones or conditions occurring on the system. Annunciator **outputs do not provide a voltage but instead switch-to-ground** a voltage from another source. The outputs can respond to any of the conditions listed in the Description section for Dry Contact Relays. Maximum voltage is 30VDC at 50mA.

13.2 Model 300 Harness Wiring

Access the open collector outputs by installing DMP 300 Harness on the 4-pin header labeled J11. The output locations are shown below. For listed applications, devices connected to the outputs must be located within the same room as the panel.

Output	Color	Wire	Output	Color	Wire
3	Red	1	5	Green	3
4	Yellow	2	6	Black	4

13.3 Model 860 Relay Module

Connect a Model 860 Relay Module to the J11 header on the XR150/XR550 Series panel to provide relays for outputs 3-6.

Use these relays for electrical isolation between the alarm panel and other systems or for switching voltage to control various functions. Power is supplied to the relay coils from a single wire connected to the panel auxiliary power terminal 7. The module includes one relay and provides three additional sockets for expansion of up to four relays. Mount the 860 inside the panel enclosure using the 3-hole pattern and plastic standoffs. Refer to the 860 Module Install Sheet (LT-0484) as needed.

Relay Contact Rating: 1 Amp at 30VDC (allows .35 power factor)

Wireless Bus Expansion

14.1 Description

The J13 Wireless Bus (XBUS) header provides connection for the 1100X Series or 1100XH Series Wireless Receiver. The XBUS provides up to 500 wireless zones numbered 500-999. Refer to the 1100X Series Wireless Receiver Install Guide (LT-1822) or the 1100XH Series Wireless Receiver Install Guide (LT-1823) for complete information.

- XR550 provides up to 500 zones
- XR150 provides up to 100 zones

14.2 Wireless Bus LEDs

The two LEDs, located above the XBus header, indicate data transmission and receipt. The left LED flashes green to indicate the panel is transmitting data. The right LED flashes yellow to indicate the panel is receiving data.

LX-Bus Expansion

15.1 LX-Bus Headers

There are five LX-Bus headers near the bottom of the XR150/XR550 panels:

- LX500 (J14), provides zones 500-599 (all panels).
- LX600 (J9), provides zones 600-699 (XR550 only).
- LX700 (J15), provides zones 700-799 (XR550 only).
- LX800 (J17), provides zones 800-899 (XR550 only).
- LX900 (J19), provides zones 900-999 (XR550 only).

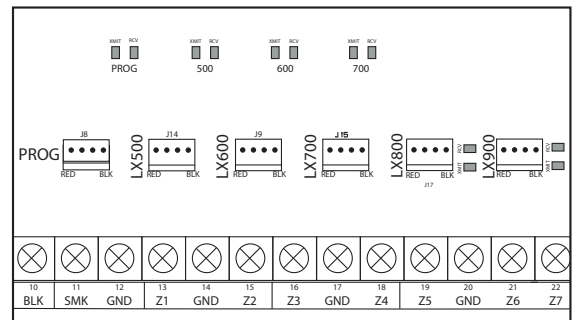

Figure 9: LX-Bus Headers and LEDs

15.2 LX-Bus LEDs

The two LEDs, located above each LX-Bus header, indicate data transmission and receipt. The left LED flashes green to indicate the panel is transmitting LX-Bus data. The right LED flashes yellow to indicate the panel is receiving LX-Bus data.

INSTALLATION

15.3 OVC LEDs

The Overcurrent LED (OVC) lights Red when the devices connected to the Keypad Bus and LX-Bus(es) draw more current than the panel is rated for. The LED(s) turn a steady Red when lit. When the OVC LED(s) light red, the appropriate LX-Bus(es) and Keypad bus are shut down.

- The OVC LED located to the left of the 893A connector indicates overcurrent for the Keypad Bus (Terminals 7-10 and PROG header), XBUS, and LX500-LX700.
- The OVC LED to the right of the J24 Cell Module connector indicates overcurrent for LX800-LX900.

J1 Ethernet Connector (Panels with Network/Encryption only)

16.1 Description

The Ethernet Connector is available on the XR150/XR550 with network or encryption to connect directly to an Ethernet network using a standard patch cable. The Ethernet Connector supports 100MB/s full duplex operation and the maximum impedance is 100 Ohms.

16.2 Ethernet LEDs

The two LEDs, located on the top edge of the J1 Ethernet Connector, indicate network connection. The right, Link LED lights up green to indicate a valid receive connection from the host network. The yellow LED lights when connected to a 100Mb network and is off when connected to a 10Mb network.

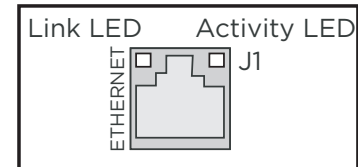

Figure 10: J1 Ethernet and LEDs

16.3 Network Transient Suppression

The Model 270 Network Transient Suppression Module to provide transient surge protection for the J1 Ethernet Connector. Refer to the Model 270 Installation Sheet (LT-1316) for complete information.

J3 Telephone RJ Connector

17.1 Description

Connect the panel to the public telephone network by installing a DMP 356 RJ Cable between the panel J3 connector and the RJ31X or RJ38X phone block. The maximum impedance is 100 Ohms. **CAUTION** - To reduce the risk of fire, use only No. 26 AWG or larger telecommunication line cord, such as DMP Model 356 Series Phone Cords.

17.2 J10 893A or 277 Trouble Sounder Connector

Connect an 893A Dual Phone Line Module or Model 277CAN Trouble Sounder to J10 on the XR150/XR550 Series. Refer to the 893A Installation Sheet (LT-0135) or 277CAN Installation Sheet (LT-1304CAN) for complete information.

17.3 Notification

The user must not repair registered terminal equipment. In case of trouble, immediately unplug the device from the telephone jack. The factory warranty provides for repairs. Registered terminal equipment may not be used on party lines or in connection with coin telephones. Notify the telephone company with the following information:

- The particular line(s) where the service is connected
- This Class A digital apparatus complies with Canadian ICES-003.
- The ringer equivalence number (REN) of 0.0
- The device make, model, and serial number

17.4 Phone Line Monitor

The XR150/XR550 Series panel has a built-in telephone monitor that monitors the phone line voltage to verify the connection to the central office. Figure 11 and the table below identify the phone block pin layout, wire numbers, and colors.

Wire Number	Wire Color
1	Gray
2	Orange
3	Black
4	Red
5	Green
6	Yellow
7	Blue
8	Brown

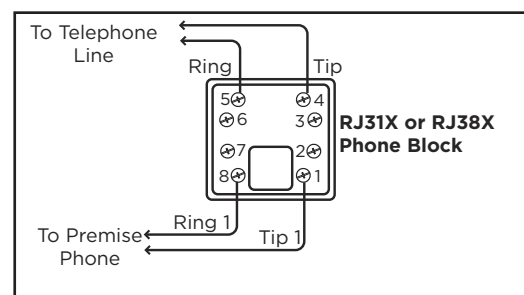

Figure 11: Phone Jack Wiring

The wires on the RJ31 that feed pins 4 and 5 should be the ONLY wires on the D-marc. All other house phone wiring should be tied to pins 1 and 8 coming back from the RJ31.

Dial tone must come into RJ31X on pins 4 and 5 and go back to house phones from pins 1 and 8. Follow these steps to determine if panel is seizing the line:

1. Unplug phone cord from RJ31X
2. Place butt-set on pins 4 and 5
3. Listen for dial tone. With dial tone present, lift either wire from pins 1 or 8
4. Listen for dial tone again. If the dial tone is present, RJ31X wiring is correct. If no dial tone is present, the RJ31X wiring is backwards. Rewire so dial tone is coming IN on 4 and 5.

If you still have trouble with the phone line, you may need to replace the RJ cord. If the dial tone is still not present, swap out the RJ31X phone block.

Reset and Tamper Headers

18.1 J16 Reset Header

The reset header is located just above the terminal strip on the right side of the circuit board and is used to reset the XR150/XR550 Series microprocessor. To reset the panel when first installing the system, install the reset jumper before applying power to the panel. After connecting the AC and battery, remove the reset jumper.

To reset the panel while the system is operational, for example, prior to reprogramming, install the reset jumper without powering down the system. Remove the reset jumper after one or two seconds.

After resetting the panel, begin programming within 30 minutes. If you wait longer than 30 minutes, you must reset the panel again.

18.2 J4 Tamper Header

The TAMPER header is for use with the optional DMP 306 Tamper Harness. The harness connects to one or more tamper switches mounted inside the panel enclosure to supervise against unauthorized enclosure opening or removal. Refer to the wiring diagram on the enclosure door for correct tamper switch wiring.

How the Tamper Works

If the enclosure is opened or removed while one or more of the system areas are armed, a panel tamper alarm is indicated. If all areas are disarmed, a panel tamper trouble is indicated.

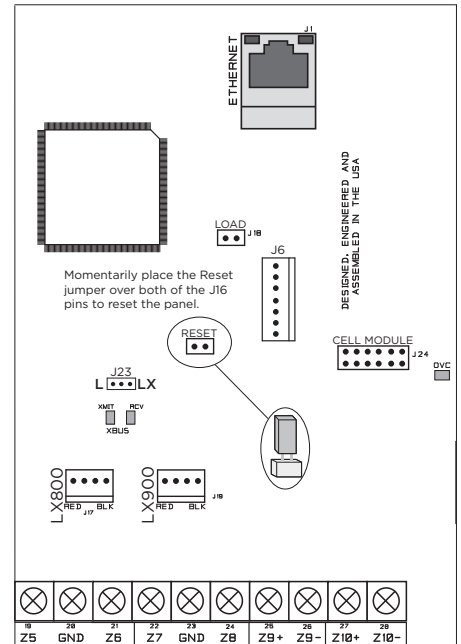

Figure 12: XR550 Series Canadian Panel Showing the Reset Jumper

Cellular Modules

19.1 J24 Header

The J24 header is located to the right of the J7 Expansion Module on the right side of the circuit board and is used to connect the DMP Model 263LTE-A Cellular Communicator. This provides a fully supervised alarm communication path for the XR150/XR550 Canadian panel. Refer to the 263LTE Series (LT-1592) Installation Sheet for complete information.

19.2 Module Installation

1. Insert the PCB standoff end with flanges into the standoff hole in the panel PCB.
 2. Align the PCB standoff with the standoff hole in the module PCB.
 3. Press the module PCB card 12 pin connector onto the Cell Module (J24) connector on the panel while applying even pressure to both sides of the board to fully seat the module. See Figure 13.
- Note:** If needed, the PCB can be removed from the enclosure to allow placement of the cell module.

19.3 Connecting the Antenna

1. Attach a 381 cable to the SMA connector on the cell module.
2. Position one of the supplied washers onto the other end of the 381 SMA connector and push the threaded end through an enclosure knockout.
3. Position the second washer onto the threaded end extending through the knockout and secure the nut.
4. Attach the included 383 Antenna to the SMA connector. See Figure 13. **Note:** As an alternative, an antenna coax can be connected directly to the cell module SMA connector when the coax enters the enclosure via conduit.

20.2 Model 860 Relay Module Connection

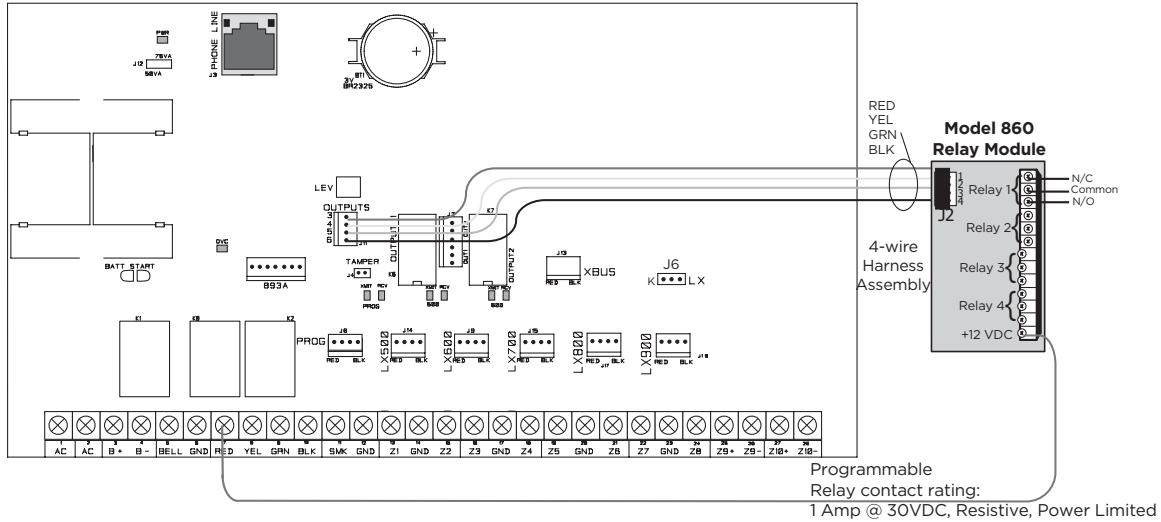

20.3 Dual Zone Protection

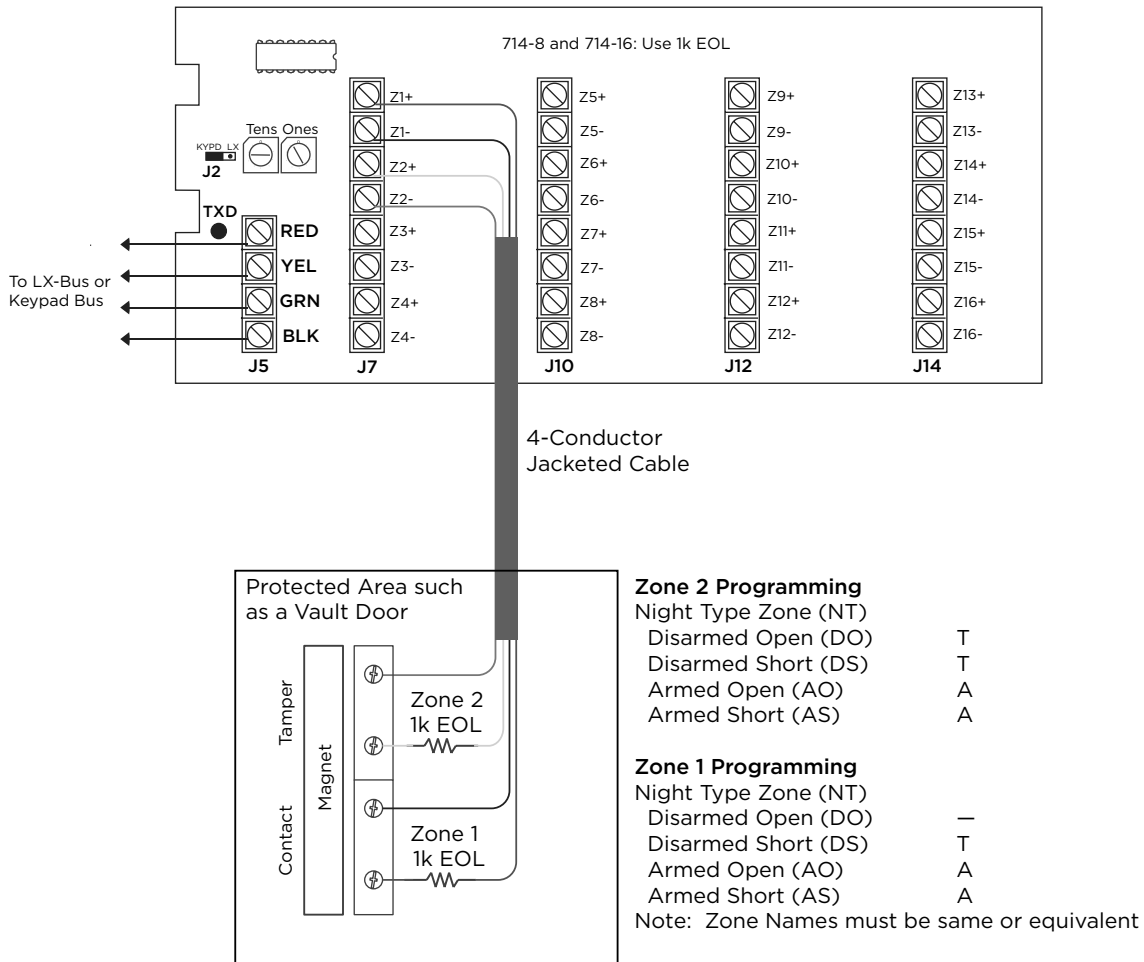

Certifications

SIA

Meets ANSI/SIA CP-01-2010 False Alarm Reduction. This Class A digital apparatus complies with Canadian ICES-003

Underwriters Laboratory of Canada (ULC) Listed

ULC S545 Household Fire

ULC C1023 Household Burglar

ULC/ORD-C1076 Proprietary Burglar

ULC S304 Central Station Burglar

ULC S559 Fire Signal Receiving Centres and Systems



800-641-4282

www.dmp.com

Designed, Engineered and
Assembled in the USA

INTRUSION • FIRE • ACCESS • NETWORKS

2500 North Partnership Boulevard

Springfield, Missouri 65803-8877