

# TRITON-D10™

## User Manual



# Contents



<b>Safety Information</b> .....	<b>v</b>
<b>Customer Support / Links</b> .....	<b>vii</b>
<b>Section 1: Introduction / General Information</b> .....	<b>1</b>
About This Manual .....	1
Serial Number / Software Version .....	1
Specifications .....	1
Powering On/Off .....	2
Emergency Shutdown .....	2
Features and Buttons .....	3
Home Screen and Title Bar .....	4
Quick-Access Menu .....	5
Printing Reports, Screenshots and Data .....	5
Scrolling (Navigation) .....	5
Icon Reference Table .....	6
Battery Pack .....	8
Safety .....	8
Removal / Installation .....	8
Charging .....	9
Ordering a Replacement .....	10
Disposal (North America) .....	10
Care and Cleaning .....	10
Accessories .....	10
Diagnostic Quick Tips - Video Series .....	11
Training Videos (Online) .....	12
<b>Section 2: Companion Applications</b> .....	<b>13</b>
Snap-on Cloud .....	13
Authorization Codes .....	14
ShopStream Connect™ (Connecting to your PC) .....	14
SureTrack® (On PC) .....	16
<b>Section 3: Data Cable / Connections</b> .....	<b>17</b>
About Ethernet Equipped Vehicles and Data Cables .....	17
Data Cable Connection (OBD-II/EOBD Vehicles) .....	17

Data Cable Connection (OBD-I Vehicles) .....	19
Optional OBD-I Data Cables and Adapters .....	20
<b>Section 4: Scanner</b> .....	<b>21</b>
Quick Links .....	21
General Information .....	21
Scanner Control Icons .....	21
Secured Vehicle Gateway™ .....	22
Quick-Access Menu .....	22
Vehicle Voltage Readout .....	22
Basic Operations .....	23
Scanner Overview .....	23
Vehicle Identification .....	23
System and Test Selection .....	25
Working with Trouble Codes .....	26
Code Scan .....	26
Codes Menu .....	26
Display Codes .....	26
Freeze Frame/Failure Records .....	27
Clear Codes .....	27
Service Resets and Relearns .....	28
Working with Data (PIDs) .....	29
Data Menu .....	29
Custom Data Lists .....	29
PID (Alarm) Indicator .....	30
Data Views (List / Graph) .....	31
Locking PIDs (to always display at top) .....	31
About the Data Buffer .....	32
About Cursors .....	33
Pausing and Reviewing Active Data .....	33
Saving Data Files .....	34
Viewing Data Files .....	35
Using Zoom .....	36
Using Triggers .....	36
Functional Tests .....	39



Troubleshooter.....	40
<b>Section 5: Vehicle Code Scan .....</b>	<b>41</b>
Using Code Scan.....	42
Total Number of Systems (modules) Analyzed .....	43
List of All the Systems Analyzed with DTCs Totals.....	43
Global OBDII DTCs .....	44
Readiness Monitor Test Status .....	44
Vehicle System Report .....	45
Printing the Vehicle System Report.....	45
<b>Section 6: Fast-Track® Intelligent Diagnostics .....</b>	<b>46</b>
Demonstration .....	46
Accessing Fast-Track® Intelligent Diagnostics.....	47
Main Menu .....	47
Wi-Fi Status Indicator .....	48
Code Results Dropdown Menu.....	48
Top Repairs Graph .....	48
Technical Bulletins (OEM Information) .....	49
Smart Data.....	50
About Smart Data PIDs .....	51
Functional Tests and Reset Procedures .....	52
Real Fixes.....	52
Troubleshooter.....	53
<b>Section 7: Quick Lookups.....</b>	<b>54</b>
Oil Specs and Resets .....	54
Operation.....	55
Fluid Capacity.....	55
Functional Reset .....	56
Reset Procedure .....	56
Tire and Wheel Service.....	57
Operation.....	58
<b>Section 8: Guided Component Tests .....</b>	<b>61</b>
Training and Classes .....	61
Power User Tests.....	62
Features and Benefits .....	62
How To.....	63
Screen Layout and Icons .....	64

Screen Layout.....	64
Guided Component Tests Control Icons .....	65
Operation.....	65
Component Information.....	66
Tests .....	67
Saving and Reviewing Data Files .....	69
<b>Section 9: Scope Multimeter .....</b>	<b>70</b>
Safety Information .....	70
Measurement Out of Range Indicator .....	70
Overview.....	71
Digital Multimeter (DMM) .....	71
Graphing Multimeter (GMM) .....	72
Lab Scope.....	73
Tests and Capabilities (Quick Reference).....	74
Test Leads and Accessories .....	75
Channel 1 Lead.....	75
Channel 2 Lead.....	75
Alligator Clips and Probes.....	76
Secondary Ignition Coil Adapter Lead and Clip-on Adapter (optional).....	76
Low Amp Current Probe (optional).....	76
Temperature Probe Adapter (optional) .....	76
Pressure Transducers and Adapters (optional) .....	77
Waveform Demonstration Tools (optional).....	77
General Information.....	78
Scope Multimeter Screen Layout and Features.....	78
Operation and Controls .....	80
Test Lead / Probe Connection .....	80
Test Lead / Probe Calibration .....	80
Control Panel and Settings .....	81
Secondary Ignition Testing.....	93
Optional Settings .....	94
Grid (on/off).....	94
Trace Divisions.....	95
Display Settings .....	96
Capturing Data .....	97
About the Data Buffer .....	97
Capturing Data (Capture Mode).....	98
Pausing Data .....	99
Reviewing Data and Using Zoom (Review Mode) .....	99



Saving Data Files.....	102
Saving Screens.....	103
General Reference .....	103
Basic Setup Tips (unknown signal type) .....	103
Using Known Good Waveforms .....	104
Troubleshooting Signals .....	106
Units of Measurement / Conversions .....	107
Glossary of Common Terms .....	109
<b>Section 10: Training and Support .....</b>	<b>111</b>
Training and Support .....	111
Setting up your Wi-Fi connection .....	111
Setting up the Snap-on Cloud .....	112
Sharing a pre and post scan report (Code Scan Report).....	112
Upgrading your device (Software Upgrades) .....	112
<b>Section 11: OBD-II/EODB .....</b>	<b>113</b>
OBD Direct.....	113
Start Communication.....	113
Connector Information.....	117
Manual Protocol Selection.....	117
OBD Training Mode .....	118
OBD-II Health Check .....	118
Global OBD-II Code Check .....	118
Global OBD-II Clear Codes .....	118
Readiness Monitors.....	119
MIL Status .....	119
<b>Section 12: Previous Vehicles and Data.....</b>	<b>120</b>
Vehicle History .....	120
Saved Data .....	121
Viewing /Printing Saved Codes and Code Scan Results .....	121
Delete Saved Data.....	121
<b>Section 13: Tools .....</b>	<b>122</b>
Tools Main Menu .....	122
Connect-to-PC (File Transfer).....	123
Get Connected.....	123
Configure Shortcut Key.....	123
System Information.....	123
Software Updates .....	123

Settings.....	124
System Settings (Display, Date & Time).....	124
Configure Scanner .....	125
Configure Scope / Meter .....	126
Configure Wi-Fi .....	126
Configure Units .....	126
<b>Section 14: Wi-Fi Connection / Troubleshooting .....</b>	<b>127</b>
Checking if Wi-Fi is On and Connected.....	127
Turning Wi-Fi On and Connecting to a Network.....	127
Add Network Advanced (Connecting to a hidden network).....	128
Wi-Fi Testing .....	129
Wi-Fi Troubleshooting and Status Messages.....	129
<b>Legal Information .....</b>	<b>132</b>



# Safety Information

## READ ALL INSTRUCTIONS

For your own safety, the safety of others, and to prevent damage to the product and vehicles upon which it is used, it is important that all instructions and safety messages in this manual and the accompanying *Important Safety Instructions* manual be read and understood by all persons operating, or coming into contact with the product, before operating. We suggest you store a copy of each manual near the product in sight of the operator.

For your safety, read all instructions. Use your diagnostic tools only as described in the tool user's manual. Use only manufacturer recommended parts and accessories with your diagnostic tools.

This product is intended for use by properly trained and skilled professional automotive technicians. The safety messages presented throughout this manual and the accompanying *Important Safety Instructions* manual are reminders to the operator to exercise extreme care when using this product.

There are many variations in procedures, techniques, tools, and parts for servicing vehicles, as well as in the skill of the individual doing the work. Because of the vast number of test applications and variations in the products that can be tested with this instrument, we cannot possibly anticipate or provide advice or safety messages to cover every situation. It is the responsibility of the automotive technician to be knowledgeable of the system being tested. It is essential to use proper service methods and test procedures. It is important to perform tests in an appropriate and acceptable manner that does not endanger your safety, the safety of others in the work area, the equipment being used, or the vehicle being tested.

It is assumed that the operator has a thorough understanding of vehicle systems before using this product. Understanding of these system principles and operating theories is necessary for competent, safe and accurate use of this instrument.

Before using the equipment, always refer to and follow the safety messages and applicable test procedures provided by the manufacturer of the vehicle or equipment being tested. Use the product only as described in its user manual. Use only manufacturer recommended parts and accessories with your product.

Read, understand and follow all safety messages and instructions in this manual, the accompanying *Important Safety Instructions* manual, and on the test equipment.

Environmental Conditions:

- This product is intended for indoor use only
- This product is rated for Pollution Degree 2 (normal conditions)

## Safety Signal Words

All safety messages contain a safety signal word that indicates the level of the hazard. An icon, when present, gives a graphical description of the hazard. Safety Signal words are:



Indicates an imminently hazardous situation which, if not avoided, will result in death or serious injury to the operator or to bystanders.



Indicates a potentially hazardous situation which, if not avoided, could result in death or serious injury to the operator or to bystanders.



Indicates a potentially hazardous situation which, if not avoided, may result in moderate or minor injury to the operator or to bystanders.



## Safety Message Conventions

Safety messages are provided to help prevent personal injury and equipment damage. Safety messages communicate the hazard, hazard avoidance and possible consequences using three different type styles:

- Normal type states the hazard.
- **Bold** type states how to avoid the hazard.
- *Italic type states the possible consequences of not avoiding the hazard.*

An icon, when present, gives a graphical description of the potential hazard.

## Safety Message Example



Risk of electric shock.

- **Prior to recycling the battery pack, protect exposed terminals with heavy insulating tape to prevent shorting.**
- **Disconnect all test leads and turn diagnostic tools off before removing the battery pack.**
- **Do not attempt to disassemble the battery or remove any component projecting from or protecting the battery terminals.**
- **Do not expose the diagnostic tool or battery pack to rain, snow, or wet conditions.**
- **Do not short circuit the battery terminals.**

*Electric shock can cause injury.*

## Important Safety Instructions

For a complete list of safety messages, refer to the accompanying *Important Safety Instructions manual*.

**SAVE THESE INSTRUCTIONS**



# Customer Support / Links

North  
America

## Website

[diagnostics.snapon.com](http://diagnostics.snapon.com)

## User Manuals / Instructions

[snapon.com/diagnostics/us/UserManuals](http://snapon.com/diagnostics/us/UserManuals)

## Phone

1-800-424-7226

## E-Mail

[diagnostics\\_support@snapon.com](mailto:diagnostics_support@snapon.com)

## Online Contact Form

[snapon.com/diagnostics/us/Contact](http://snapon.com/diagnostics/us/Contact)

## Warranty Registration

United States

[registration.snapon.com/products/us](http://registration.snapon.com/products/us)

Canada

[registration.snapon.com/products/ca](http://registration.snapon.com/products/ca)

## ShopStream Connect™

[snapon.com/diagnostics/us/SSC](http://snapon.com/diagnostics/us/SSC)

## Snap-on® Cloud

[altusdrive.com](http://altusdrive.com)

## SureTrack® Community

Use [ShopKeyPro.com](http://ShopKeyPro.com), or [ProDemand.com](http://ProDemand.com)

SureTrack Login Info: [mitchell1.com/micro/stc/](http://mitchell1.com/micro/stc/)

## Secure Vehicle Gateway™

[www.snapon.com/gateway](http://www.snapon.com/gateway)

## Training Solutions® Videos

[snapon.com/diagnostics/US/CC](http://snapon.com/diagnostics/US/CC)

YouTube®

## ShopKey® Pro

[ShopKeyPro.com](http://ShopKeyPro.com)

## ProDemand®

[ProDemand.com](http://ProDemand.com)



## Quick Links

- [Specifications](#) page 1
- [Powering On/Off](#) page 2
- [Features and Buttons](#) page 3
- [Home Screen and Title Bar](#) page 4
- [Quick-Access Menu](#) page 5
- [Battery Pack](#) page 8
- [Care and Cleaning](#) page 10
- [Training Videos \(Online\)](#) page 12
- [Diagnostic Quick Tips - Video Series](#) page 11
- [Accessories](#) page 10

## 1.1 About This Manual

The information within this manual may be applicable to multiple markets. Not all the information included may be applicable to your diagnostic tool, device or product.

All content within this manual was based on the latest information available at the time of publishing and **applicable to diagnostic software version 21.2**. Some content within this manual may not be applicable to other diagnostic software versions.

The illustrations/pictures in this document are intended as reference only and may not depict actual screen results, information, functions or standard equipment.

All information, specifications and illustrations in this document are subject to change without notice.

The content in this manual is periodically revised to ensure the latest information is included. Download the latest version of this manual and other related technical documentation from the product website (see [Customer Support / Links](#) on page vii).

## 1.2 Serial Number / Software Version

The diagnostic tool serial number and software version can be viewed from:  
**Home: Tools > System Information** (see [System Information](#) on page 123).

The diagnostic tool serial number is also located on the back of the diagnostic tool housing.

## 1.3 Specifications

Item	Description / Specification
Touch Screen	Capacitive Touch Panel
Display	10.1 inch diagonal, TFT Color LCD
	1024 x 600 resolution WSVGA
Battery	7.2 VDC 2200 mAh (16 Wh)
	Rechargeable lithium-ion battery pack
	Approximately 2.5hr @ 50% brightness run time
	Approximately 5 hour charge time
Power Supply	Supply Rating; 15VDC, 2A
DC Operating Voltage	10 to 30VDC
Width	12.8 in. (326 mm)
Height	7.0 in. (179 mm)
Depth	1.57 in. (40 mm)
Weight (including battery):	3.1 lb (1.4 kg)
Operating Temperature Range (ambient)	At 0 to 90% relative humidity (non-condensing) 32 to 113°F (0 to 45°C)
Storage Temperature (ambient)	At 0 to 70% relative humidity (non-condensing) -4 to 140°F (-20 to 60°C)
Operating Altitude	Maximum 2000 m
Environmental Conditions	This product is intended for indoor use only
	This product is rated for Pollution Degree 2 (normal conditions)





## 1.4 Powering On/Off

Press and release the **Power** button to turn on the tool.

Power may be supplied by any one of the following:

- Charged internal battery pack
- Live AC power supply (charging internal battery)
- The vehicle data link connector (DLC) (diagnostic tool data cable connected)

The tool will automatically turn on when:

- a live AC power supply is connected to the tool
- the Data Cable is connected to a vehicle data link connector

To turn off the tool, exit all functions and communication with the vehicle, then press and release the **Power** button. Follow the screen prompts to turn the tool off.

### **i** NOTE

*An optional power cable is required when testing non-OBD-II/EOBD or models that do not supply power on the DLC.*

### **IMPORTANT**

*Never connect the AC power supply adapter, or optional power cable to the diagnostic tool when communicating with a vehicle.*

### **IMPORTANT**

*All vehicle communication must be stopped **BEFORE** turning off the diagnostic tool. Never disconnect the Data Cable when the diagnostic tool is communicating with the vehicle.*

## 1.5 Emergency Shutdown

To force an emergency shutdown, press and hold the **Power** button for five seconds until the tool turns off.

Emergency shutdown should only be used if the diagnostic tool does not respond to navigation or control buttons or exhibits erratic operation.

### **IMPORTANT**

*On some vehicles, performing an emergency shutdown while communicating with the vehicle, may result in damage.*

## 1.6 Features and Buttons

### NOTE

Touch screen controls are used for most operations, however the control buttons may also be used to navigate and select functions.





Item	Description	
1	Power Supply Jack	
2	Battery Status Indicator LED	
3	Scope Meter Jacks	
4	Mini USB Jack	
5	Micro secure digital (uSD) Card - contains operating system programming. <b>IMPORTANT</b> The uSD card must be installed for operation. Do not remove the uSD card while the diagnostic tool is powered on.	
6	Data Cable Connector	
7	No / Cancel Button	
	Yes / Accept Button	
	Directional Control Buttons <i>Tip</i> - These buttons can be used for general navigation, however are especially useful in certain situations where more control is needed, compared to using the touch screen.	
	S (Shortcut) Button See <a href="#">Configure Shortcut Key</a> on page 123	
	Power (On/Off) Button	
8	Fold-out Stand	
9	Battery Pack Access	



Figure 1-1



# 1.7 Home Screen and Title Bar

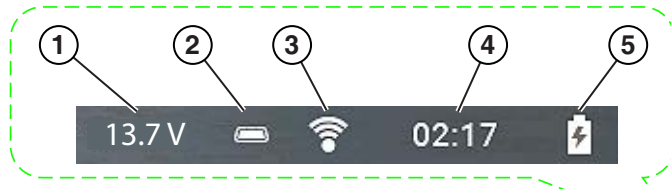

### Common Title Bar Indicators

- 1— Vehicle data link connector voltage
- 2— Active vehicle communication status
- 3— Wi-Fi connection status
- 4— Time of day
- 5— Battery charge level and power connection status

Figure 1-2

### Home Screen Icons (Links)

Scanner	
OBD-II/EOBD	
Guided Component Tests	
Scope Multimeter	
Quick Lookups	
Previous Vehicles and Data	
Training and Support	
Tools	

## 1.8 Quick-Access Menu

Use the Quick-Access Menu as a shortcut to “jump” between functions, or to **Exit** the active vehicle. This menu is available within most functions (after identifying a vehicle), and is application sensitive, being that it provides only applicable links based on your location in the software.

The menu title displays the active vehicle identification information including the VIN.



Selecting the **Home** icon opens the **Quick-Access Menu**, depending on your location in the software.

Examples:

- Scanner to OBD-II/EOBD - to check monitor status or freeze frame data etc
- Scanner to Previous Vehicles and Data - to view a code scan report, screen shot, or captured PID data
- OBD-II/EOBD to Scanner - to check enhanced codes and access Fast-Track<sup>®</sup> Intelligent Diagnostics
- Scanner to Exit Vehicle - to quickly Exit vehicle communication
- Scanner to Tools - to change display settings, turn Wi-Fi on, configure the Shortcut button or connect to a PC

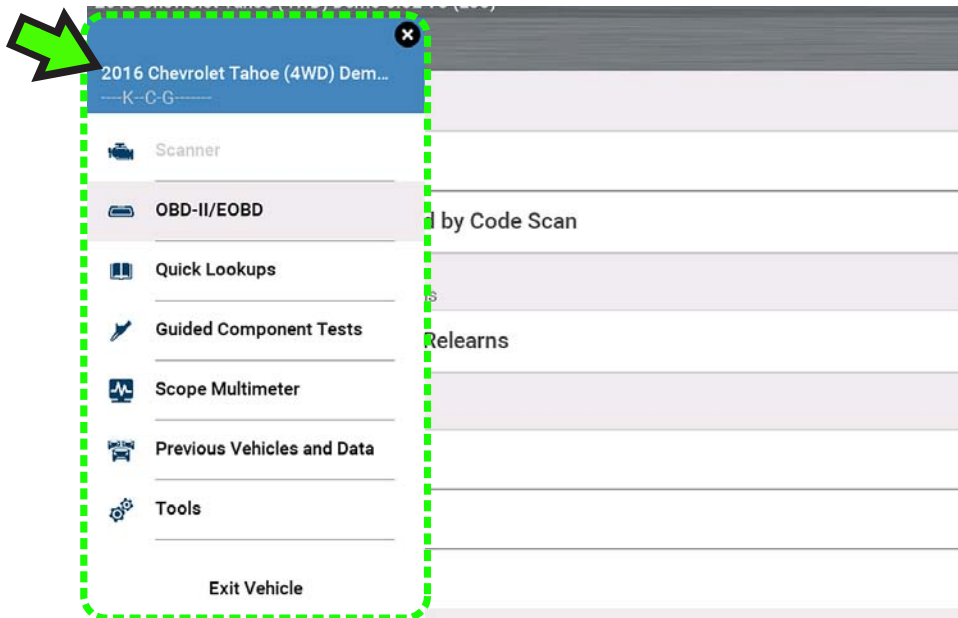

Figure 1-3

## 1.9 Printing Reports, Screenshots and Data

Use the Snap-on Cloud and ShopStream Connect to print reports, screenshots and data from the diagnostic tool. See [Snap-on Cloud](#) on page 13 and [ShopStream Connect™ \(Connecting to your PC\)](#) on page 14.

## 1.10 Scrolling (Navigation)

Onscreen scrolling controls are displayed (when applicable) to move screens up/down to view additional content. Scroll control icons display on the right-side of the screen, and may vary in appearance as shown in [Figure 1-4](#).

Multiple operation methods are:

- Touch the up/down arrow icons
- Swipe the screen up/down using your finger
- Use the up/down directional control buttons

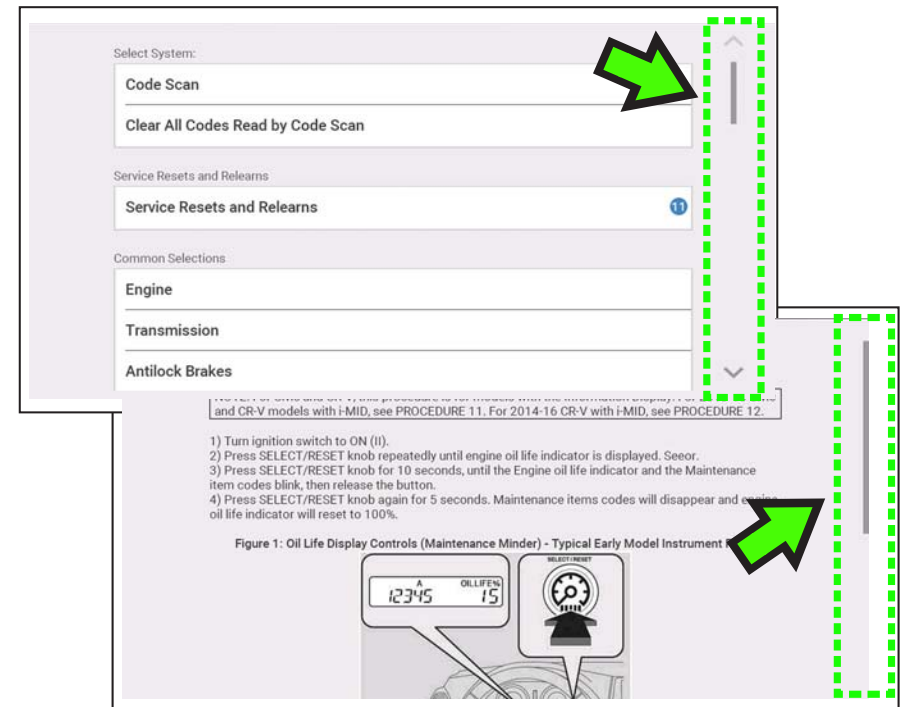

Figure 1-4

















## 1.11 Icon Reference Table









The following table includes only common icons, not all icons are shown. Some common icon controls are dependent on the applicable function and will exhibit different options based on the active function.

Scanner (Common)			
	<b>Home</b> - Return to Home screen, or open Quick-Access menu		<b>Accept</b> - Accepts the highlighted selection
	<b>Next / Forward</b>		<b>Back / Last</b>
	<b>Save</b> - Saves the active information to memory.		<b>Automatic ID</b> - Automatically completes the identification process, once connected and make/year are entered.
	<b>Single Selection (List)</b> - Select / Deselect single item from list		<b>Multi-Selection (List)</b> - Select / Deselect all items in a list
	<b>Menu View</b> - Toggle between categorized / non-categorized list view		<b>Freeze Frame</b> - Display Freeze Frame data
	<b>Pause</b> - Pauses active data collection.		<b>Start (Capture)</b> - Resumes active data collection.
	<b>Clear</b> - Erases all the PID data in the buffer and restarts data collection.		<b>Custom Data List</b> - Allows you to choose which PIDs display.
	<b>Trigger</b> - Allows you to set, arm, and clear PID triggers		<b>Change View</b> - Toggle data display between list or graph.

	<b>Zoom</b> - Incrementally increases and decreases the scale of the data displayed.		<b>Lock</b> - Locks PIDs to the top of the list.
	<b>Step Forward</b> - Allows forward movement in singular steps. (Note: To quickly step forward during Scanner data review, press and hold)		<b>Step Back</b> - Allows backward movement in singular steps. (Note: To quickly step backward during Scanner data review, press and hold)
	<b>Skip Forward</b> - Allows forward movement in multiple steps.		<b>Skip Back</b> - Allows backward movement in multiple steps.
	<b>Help</b> - Opens the Getting Started with Fast-Track® Intelligent Diagnostics slideshow.		<b>Diagnose</b> - Opens <a href="#">Fast-Track® Intelligent Diagnostics</a> for the selected code.
	<b>PID Alarm</b> - Display visual indicators for two state PIDs		<b>Sort</b> - Toggles the alpha order of a list.
	<b>Data List Selector</b> - Choose data list during functional test		<b>Tools</b> - Change units of measure
Code Scan			
	<b>Refresh</b> - Restarts the code scan		<b>System</b> - Opens the main menu of the system selected
Oil Specs & Resets			
	<b>Fluid Capacity</b> - Displays OEM engine oil specifications and capacity information.		<b>Reset Procedure</b> - Displays OEM manual service indicator reset information.
	<b>Functional Reset</b> - Opens the Scanner service reset menu.	-	-



Tire and Wheel Service			
	Displays TPMS indicator reset instructions, to perform a manual reset of the TPMS indicator.		Opens the TPMS test related Scanner menu. Options may include, view and clear codes, display data, and access functional tests using the diagnostic tool.
	Displays TPMS service information.		Displays OEM tire and wheel specifications.
Scope / Multimeter / Guided Component Tests			
	<b>Pause</b> - Pauses the data buffer		<b>Step Back</b> - moves to the previous point in the data. To quickly step backward, select this icon then press and hold the Y/✓ button.
	<b>Start (Capture)</b> - Resumes active data collection.		<b>Back 1 Frame</b> - allows backward movement by one frame. To quickly skip backward, select this icon then press and hold the Y/✓ button.
	<b>Zoom</b> - Increases and decreases screen magnification. The zoom function is only available during data review (scope paused).		<b>Expand / Collapse</b> - Toggles display of the control panel (Trace Detail).
	<b>Cursors</b> - Toggles cursors on/off.		<b>Save</b> - Saves the data stored in buffer memory to a file.
	<b>Step Forward</b> - moves to the next point in the data. To quickly step forward, select this icon then press and hold the Y/✓ button.		<b>Tools</b> - Open the Tools menu, providing options for scope and meter settings.

	<b>Forward 1 Frame</b> - allows forward movement by one frame. To quickly skip forward, select this icon (yellow frame appears around icon) then press and hold the Y/✓ button	-	-
Wi-Fi Icons			
	Indicates Wi-Fi is ON and Connected		Indicates Wi-Fi is ON, Low Signal
	Wi-Fi On - Not Connected.		Opens Wi-Fi Test screen
Previous Vehicles and Data Icons			
	<b>Delete</b> - Deletes selected item (menu dependent)		<b>Search</b> - Lists associated vehicle attachments
	<b>Activate Vehicle</b> - Starts the vehicle identification process, of the selected vehicle		

## 1.12 Battery Pack

### 1.12.1 Safety

Follow all safety guidelines when handling the battery pack.



**WARNING**

#### Risk of electric shock.

- Prior to recycling the battery pack, protect exposed terminals with heavy insulating tape to prevent shorting.
- Disconnect all test leads and turn diagnostic tools off before removing the battery pack.
- Do not attempt to disassemble the battery or remove any component projecting from or protecting the battery terminals.
- Do not expose the diagnostic tool or battery pack to rain, snow, or wet conditions.
- Do not short circuit the battery terminals.

*Electric shock can cause injury.*



**WARNING**

#### Risk of explosion.

- The Lithium battery is factory replaceable only, incorrect replacement or tampering with the battery pack may cause an explosion.

*Explosion can cause death or serious injury.*

### IMPORTANT

***The battery pack contains no user serviceable components. Tampering with the battery pack terminals or housing will void the product warranty.***

Keep the following in mind when using and handling the battery pack:

- Do not short circuit battery pack terminals.
- Do not immerse the diagnostic tool or battery pack in water, or allow water to enter the diagnostic tool or battery pack.
- Do not crush, disassemble, or tamper with the battery pack.
- Do not heat the battery pack to over 100°C (212°F), or dispose of it in a fire.
- Do not expose the battery pack to excessive physical shock or vibration.

- Keep the battery pack out of reach of children.
- Do not use a battery pack that appears to have suffered abuse or damage.
- Charge the battery pack in the appropriate charger only.
- Do not use a battery charger that has been modified or damaged.
- Use the battery pack for the specified product only.
- Store the battery pack in a cool, dry, well ventilated area.

### NOTE

*The battery pack should be used within a short period of time (about 30 days) after charging to prevent loss of capacity due to self-discharging.*

If long-term storage of the battery pack is necessary, it should be stored in a cool, dry, well ventilated place with a 30 to 75 percent state of charge to prevent loss of characteristics.

To prolong the life of your battery, turn off the diagnostic tool when not in use. The diagnostic tool has a built in charger that recharges the battery on demand whenever it is connected to a power source.

### 1.12.2 Removal / Installation

#### IMPORTANT

***Only use the manufacturer recommended original equipment replacement battery pack.***



#### REMOVAL (Figure 1-5)

1. Loosen the battery cover screw on the back-side of the diagnostic tool.
2. Pull up and out on the lower edge of the battery cover to release it.
3. Remove the battery pack in the same manner as the battery cover, pulling the bottom edge up and tilting out.

## ▶ INSTALLATION (Figure 1-5)

1. Position the battery pack as shown below with the arrows facing up.
2. Tilt the top of the battery in to align the tabs, then down to install into place.
3. Install the battery pack cover, in the opposite manner as removal, aligning the tabs and tilting down and in, into place.
4. Tighten the battery cover screw. **Do not overtighten the screw!**

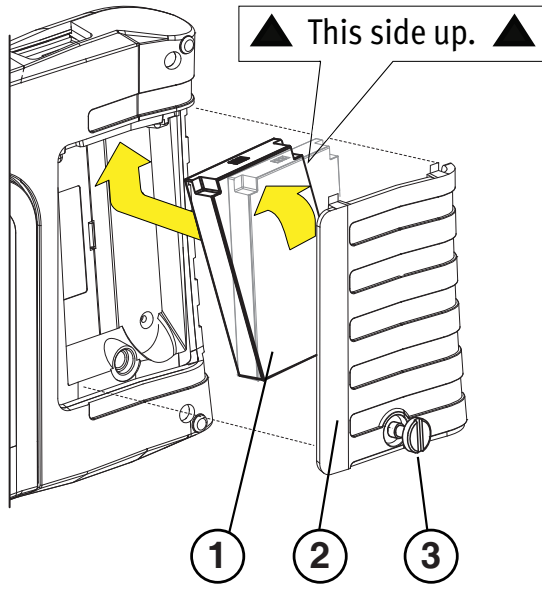

- 1— Battery Pack  
2— Cover  
3— Cover Screw

Figure 1-5

### 1.12.3 Charging

The diagnostic tool can be powered from the internal rechargeable battery pack. A fully charged battery pack provides sufficient power for about 3 hours of continuous operation. For battery pack removal and installation instructions see, [Removal / Installation](#) on page 8.

Battery charging occurs whenever the data cable is connected to a vehicle DLC. Battery charging also occurs when the AC power supply is connected to a live AC



power source, and connected to the diagnostic tool. Use the supplied AC power supply to charge the battery pack.



Insert the end of the AC power supply cable into the diagnostic tool power supply jack, then connect the AC power supply to an approved AC power source.

## IMPORTANT

**Only use the supplied AC power supply. Never connect the power supply to the diagnostic tool when the tool is communicating with a vehicle.**

The Battery Status Indicator LED (located next to the power supply jack) indicates battery status.

Battery Status LED (Top of Tool)	
	<b>Green</b> - Fully charged / power supplied by the AC power supply.
	<b>Red</b> - Charging
	<b>Amber</b> - Fault Mode, battery temperature above 104°F/ 40°C. Allow the tool and battery to cool down before continuing operation.

Battery Charge Status Indicator (Title Bar)	
	<b>Full Battery Charge Level</b> - Indicates power is being supplied by the internal battery pack. Horizontal bars diminish as the battery discharges.
	<b>Low Battery Charge Level</b> - Indicates the internal battery pack is low and needs to be recharged immediately. A warning message will also display on the screen when the battery gets low.
	<b>External Power Connected</b> - Indicates power is being supplied through the data cable connection to a vehicle or by the AC Power Supply and charging the battery pack.





## 1.12.4 Ordering a Replacement

If the battery pack needs to be replaced, contact your sales representative to order a new battery pack.

### IMPORTANT

***Only use the manufacturer recommended original equipment replacement battery pack.***

## 1.12.5 Disposal (North America)

Always dispose of the battery pack according to local regulations, which vary for different countries and regions. The battery pack, while non-hazardous waste, does contain recyclable materials. If shipping is required, ship the battery pack to a recycling facility in accordance with local, national, and international regulations.

### IMPORTANT

***Always dispose of materials according to local regulations.***

For additional information within the **United States of America** contact:

- Rechargeable Battery Recycling Corporation (RBRC) at [www.call2recycle.org](http://www.call2recycle.org)  
Phone - 800 822-8837

For additional information within **Canada** contact:

- Rechargeable Battery Recycling Corporation (RBRC) at [www.call2recycle.ca](http://www.call2recycle.ca)  
Phone - 888 224 9764

Products bearing the WEEE logo (*Figure 1-6*) are subject to European Union regulations.



Figure 1-6

Contact your sales representative for details.

## 1.13 Care and Cleaning

Periodically perform the following tasks to keep your diagnostic tool in proper working order:

- Check the housing, cables and connectors for dirt and damage before and after each use.
- At the end of each work day, wipe the diagnostic tool housing, cables and connectors clean with a water damped soft cloth.

Clean the touch screen and housing using mild soap and a water damped soft cloth.

### IMPORTANT

***Do not use any abrasive cleansers or automotive chemicals on the touch screen or housing.***

## 1.14 Accessories

Find diagnostic tool accessories using our Interactive Accessories Catalog:

visit <http://diagnostics.snapon.com> and enter "accessories catalog" in the Search field.

Additional accessory information is located in our Vehicle Application Guide:

visit <http://diagnostics.snapon.com> and enter "application guide" in the Search field.

Contact your sales representative to purchase product accessories.



## 1.15 Diagnostic Quick Tips - Video Series

Snap-on Diagnostic Quick Tips videos are available at no charge on our website and on our YouTube channel. These videos are developed from real repair case studies to help professional technicians use diagnostic tools to solve specific vehicle problems (e.g. performing a Ford Relative Injector Flow Test).

Additional videos are also available showing specific diagnostic tool features (e.g. ShopStream Connect - Software Updates).



Figure 1-7

Videos are available at:

<http://diagnostics.snapon.com> - Click on the "Training & Support" tab, select the applicable diagnostic tool, then select "See Quick Tips"

<https://www.youtube.com/user/snaponscanner/videos> - Use the search function to find a title, or enter "Diagnostic Quick Tips" in the search field to see a list of all applicable titles.

### NOTES

*URL links (above) and titles listed (below) are subject to change and may not be available in all markets.*

*A sample list of titles are listed below, other titles may be available.*

*Some videos may not applicable for use with all diagnostic tools.*

#### Snap-on® Training Solutions® - Diagnostic Quick Tips Videos (examples)

Air/Fuel Ratio Sensor Test	Fuel Injector Voltage and Current Tests (Scope)
Alternator Ripple Test (Scope)	Fuel Pump Current Ramp Test (Scope)
BMW® Rain Sensor Calibration	Harley-Davidson® ABS Brake Bleed
CAN Bus Diagnostics (Scope)	Harley-Davidson® Functional Tests
Chevrolet® Volt Coolant Pump Bleed	Harley-Davidson® Key Fob Programming
Chrysler HVAC Test	Hyundai Blind Spot Detection System Calibration
Chrysler VVT System Cleaning	Hyundai Occupant Detection System Reset
Chrysler Wheel & Tire Calibrations	Ignition Coil Current and Voltage Comparison
COP Ignition Test	Ignition Coil Current Ramp Test
Dual Screen Diagnostics: Scanner vs. Scope	Ignition Coil Primary Voltage Test
Electronic Throttle Control System Diagnostics	Ignition System Diagnostics Using the SIA2000 (Scope)
FIAT® 500 Proxi Alignment	MINI Battery Relearn
FIAT® 500 Throttle Body Relearn	Multi Channel Cam / Crank Correlation
Flex Ray Bus Diagnostics	OBD-II Mode 10 Permanent Codes
Ford Battery Monitor System	Oil Specs & Service Light Resets
Ford Coil Current RFI Test (Scope)	PID Trigger Functions (Scanner)
Ford Flash Reprogramming	Piezo Injectors Signature Test
Ford Misfire Monitor Neutral Profile Correction (Scanner)	Relative Compression Test (Scope)
Ford PATS Key Programming	ShopStream Connect - Data Manipulation
Ford Relative Compression Test	ShopStream Connect - Software Updates



Snap-on® Training Solutions® - Diagnostic Quick Tips Videos (examples)	
Ford Relative Injector Flow Test	Speed Up Your Diagnostics (Scanner)
Ford TPMS Reprogramming	The Power of Troubleshooter Tips (Scanner)
Ford® 6.7L Transmission Solenoid Characterization	Top Level Menus: Built In Scope Training
Ford® Diesel Injector Coding	Toyota EVAP Test
VW / Audi Flexible Service Reset (Scanner)	Toyota Multiple Freeze Frame (Scanner)
	Toyota Transmission Compensation Coding

## 1.16 Training Videos (Online)

Diagnostic tool specific training videos are available on our website (see [Website on page vii](#)). Follow along and learn the basics of diagnostic tool operation with our free training videos.

*Sample titles are listed below. Not all titles may be available for all diagnostic tools, and are subject to change.*

Snap-on® Training Solutions® - Training Videos (examples)	
Introduction and Navigation	Global OBD-II
Scanner Codes	Digital Multimeter
Scanner Data in PID View	Graphing Multimeter & Lab Scope
Scanner Data in Graphing View	Guided Component Tests
Fast-Track® Troubleshooter	Vehicle Specs & Resets
Functional Tests	SureTrack® & Wi-Fi

This section is intended as an introduction to the following applications that are available as a companion to your diagnostic tool. These applications may require you to have the current diagnostic software version installed, application authorization and additional setup information. For additional information, see the respective user manual / instructions on the product website (see [Customer Support / Links on page vii](#)).

## 2.1 Snap-on Cloud



For more information on the features and operation of the Snap-on Cloud, see the **Snap-on Cloud User's Guide** on the website, and visit [ALTUSDRIVE.com](http://ALTUSDRIVE.com)

### NOTE

**Wi-Fi Required** - Wi-Fi connection is required to use this application. See [Wi-Fi Connection / Troubleshooting](#) on page 127.

The Snap-on Cloud is a free mobile-friendly cloud-based application designed specifically for technicians to store, organize and share information. Typical screens shown in ([Figure 2-1](#) and [Figure 2-2](#)).

#### Key Features:

- Diagnostic tool automatically transfers code scan reports, ADAS reports and screen captures to the Snap-on Cloud.
- Access and manage your Snap-on Cloud account, using your mobile device or PC.
- Share/send files via e-mail, or other mobile apps.
- Tag files (attach a descriptive key-name) to help you organize and search files.

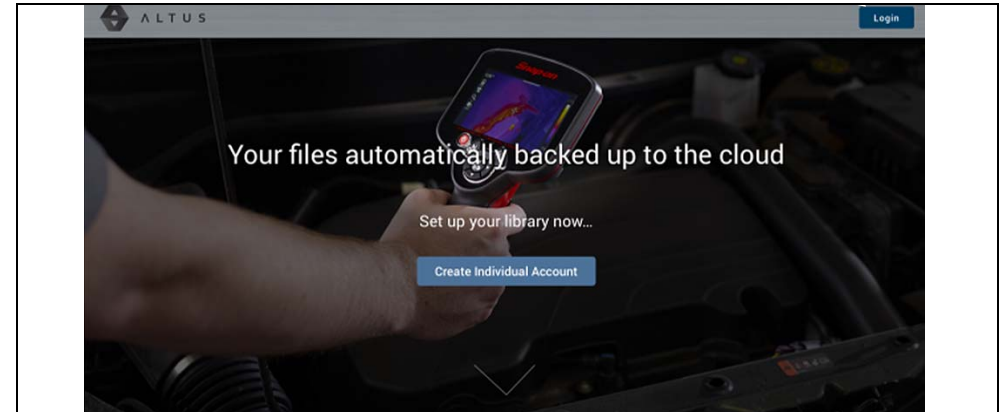

Figure 2-1

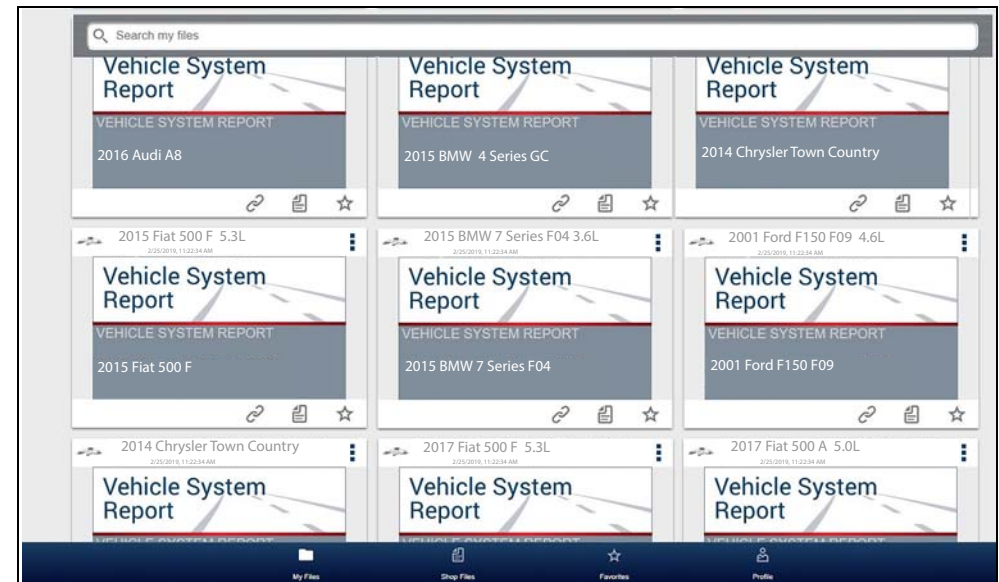

Figure 2-2



## 2.1.1 Authorization Codes

### Navigation

Home Screen: **Tools > Get Connected**

The authorization codes needed to register and use the Snap-on Cloud are located on the Get Connected screen ([Figure 2-3](#)).

### **i** NOTE

*It is normal operation for the PIN codes to change every time the page is refreshed.*

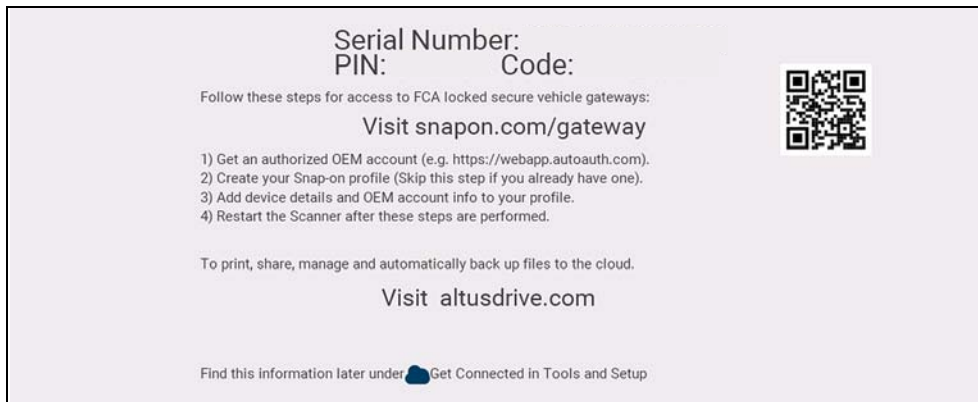

Figure 2-3

## 2.2 ShopStream Connect™ (Connecting to your PC)

For more information on ShopStream Connect, see the **ShopStream Connect User's Guide** on the product website (see [Customer Support / Links](#) on page vii).

### **i** NOTE

*This application requires USB connection of the diagnostic tool to a personal computer with Internet access.*

ShopStream Connect is a free PC application that allows you to:

- Transfer, print and edit (select fields) the (Code Scan) Vehicle System Report
- Transfer and print data files, and screenshots
- View, save and manage data files on your PC.
- Add or edit notes and comments to your data files.

### To Get ShopStream Connect (SSC):

1. Download and install SSC on your PC from:  
(see ShopStream Connect link on [Customer Support / Links](#) on page vii)
2. Connect the supplied USB cable from the USB jack on your diagnostic tool to your PC:
3. From the Home screen on the tool, select **Tools > Connect-to-PC**.

Once connected ShopStream Connect will open automatically on your PC.

Typical screens shown in ([Figure 2-4](#) and [Figure 2-5](#)).

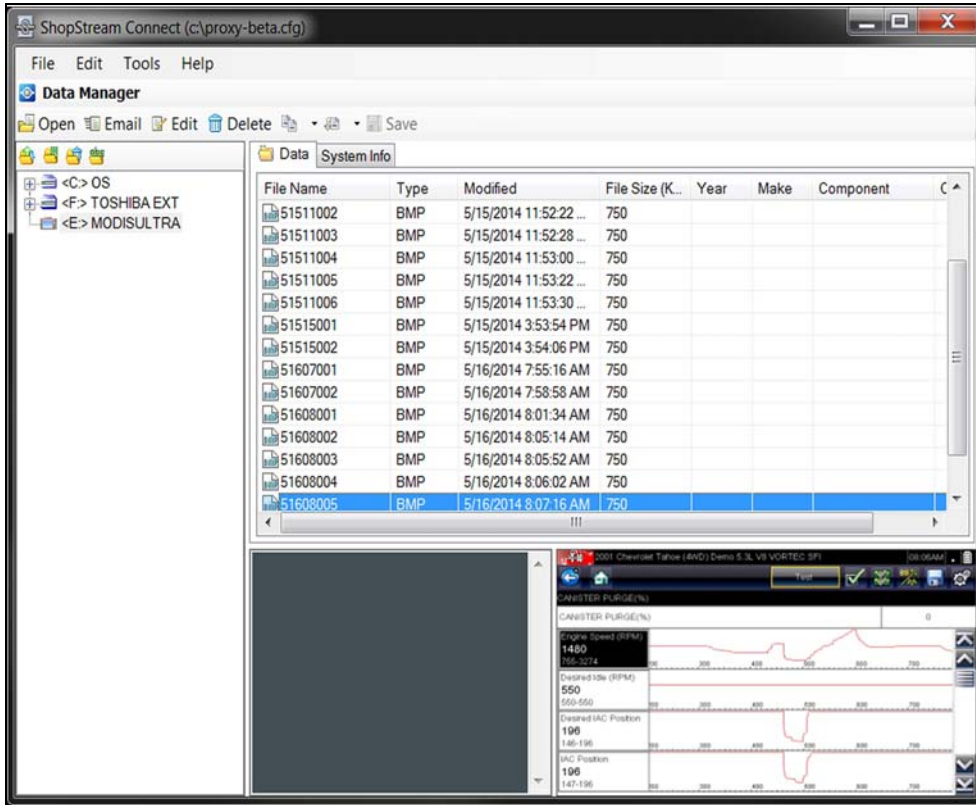

Figure 2-4

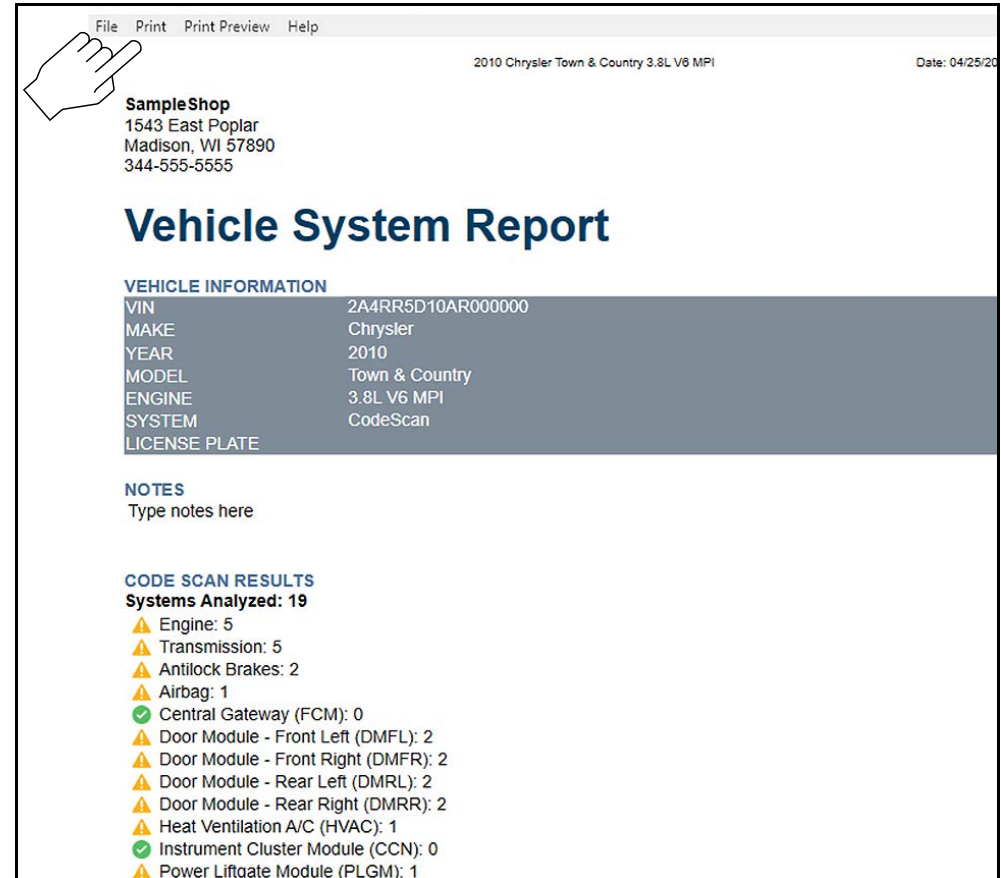

Figure 2-5



## 2.3 SureTrack® (On PC)

For more information on SureTrack, see the **Suretrack User's Guide** on the product website (see [Customer Support / Links](#) on page vii).

### **i** NOTE

*This application requires Internet access, via computer or mobile device.*

Your diagnostic tool may include authorization to access to the online SureTrack Community. You can use your PC to access the latest Real Fixes, Related Tips, and Common Repair Procedures information.

SureTrack is an evolving database of "real-world" automotive repair knowledge based on expert knowledge and millions of actual repair orders.

Typical login screen shown in ([Figure 2-6](#)).

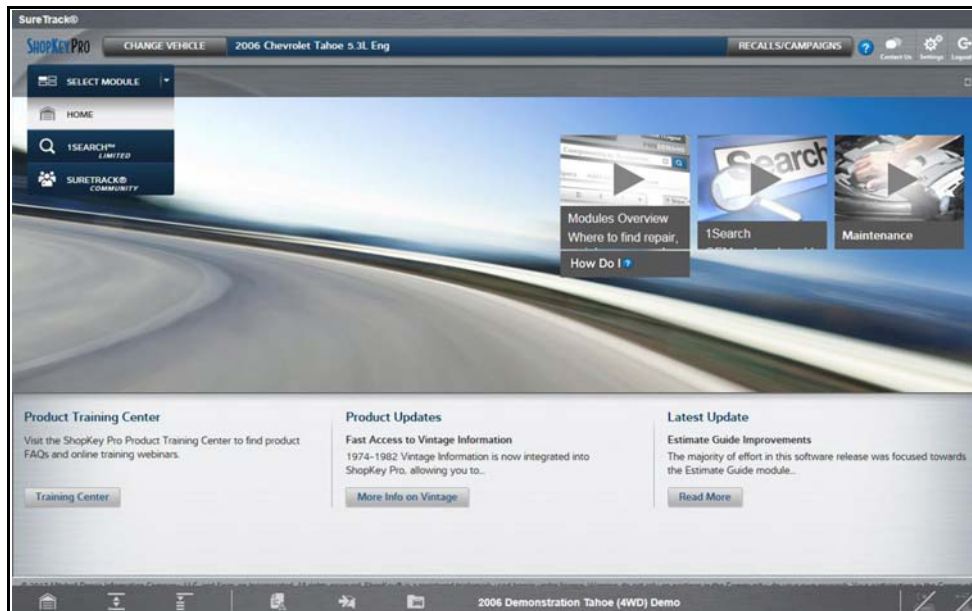

Figure 2-6



### 3.1 About Ethernet Equipped Vehicles and Data Cables

Automotive Ethernet can be thought of, as the physical networking architecture used to allow multiple vehicle controllers and components to communicate. Ethernet can transport data 100 times faster than CAN and is better suited for the needs of modern safety systems. Just as CAN Bus communications are monitored via the OBD-II diagnostic link connector, Ethernet Bus communications can be monitored in the same way.

Ethernet equipped vehicles use the standard 16 pin OBD-II diagnostic link connector for diagnostic tool connection, however the diagnostic tool data cable must be designed to support Ethernet communication.

This diagnostic tool has the ability to communicate with Ethernet equipped vehicles. In order to communicate via Ethernet, the data cable supplied with this tool (marked "DA-4E") must be used. Substituting a different data cable may result in no or an erroneous communication condition.

### 3.2 Data Cable Connection (OBD-II/EOBD Vehicles)

#### IMPORTANT

**Only use the supplied data cable, and/or original equipment accessory cables with your diagnostic tool. Total data cable length must not exceed 114.17 inches (2.9 meters).**

#### NOTE

*The diagnostic tool will automatically turn on when the Data Cable is connected to a vehicle that has 12VDC at the data link connector (DLC). An LED indicator on the DLC end of the data cable illuminates when power is being supplied. If the LED fails to illuminate, check the data cable connection and then the DLC power circuit.*

1. For OBD-II/EOBD compliant vehicles, connect the DA-4E data cable (26 pin end) to the diagnostic tool ([Figure 3-1](#)). Connect the cable with the arrow facing up (display side).

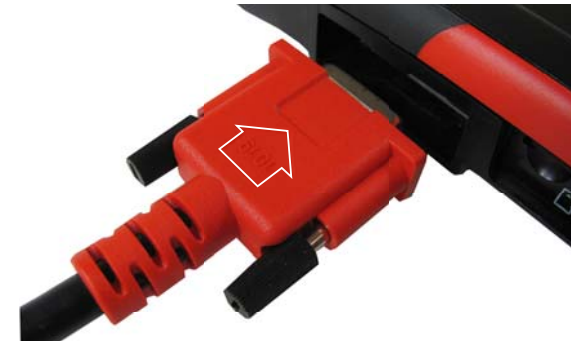

Figure 3-1 Arrow highlighted for illustration purposes only.





The supplied data cable, includes an LED flashlight on the vehicle DLC connector end (*Figure 3-2*). The LED flashlight is powered by the diagnostic tool battery, and is useful when locating the vehicle DLC.

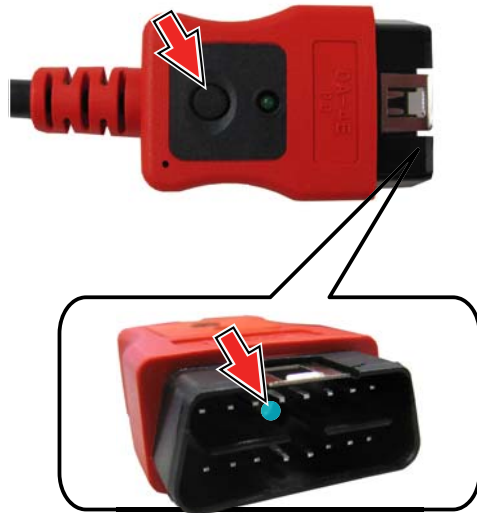

Figure 3-2

2. Connect the 16-pin (J-1962) end of DA-4E cable (*Figure 3-3*) to the vehicle DLC.

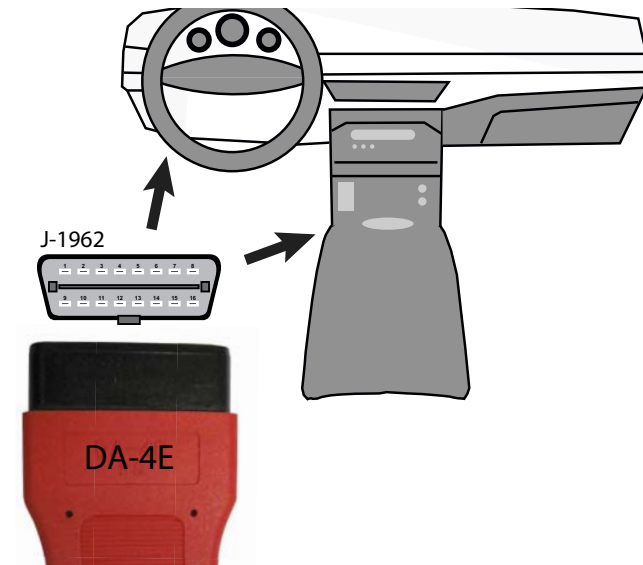

Figure 3-3

#### **i** NOTE

*During vehicle identification, on-screen cable connection instructions may be provided along with the location of the DLC.*

### 3.3 Data Cable Connection (OBD-I Vehicles)

For most OBD-I (non-OBD-II/EOBD) compliant vehicles you can use the supplied data cable with the optional DA-5 adapter, and an optional manufacturer specific OBD-I adapter (Figure 3-4).

- a. The 26-pin end "A" of the cable (Figure 3-4) connects to the diagnostic tool.
- b. The 16-pin end "B" of the cable (Figure 3-4) connects to the DA-5 adapter "C".
- c. One end of the manufacturer specific adapter "D" (Figure 3-4) connects to the DA-5 adapter.
- d. The other end of the manufacturer specific adapter "E" (Figure 3-4) connects to the vehicle.

OBD-I adapters with a power jack MUST be connected to the vehicle battery using an accessory power cable "F" (Figure 3-4). See Figure 3-5 for additional information.

If the OBD-I adapter does not have a power jack, an external power connection (accessory power cable) is not needed.

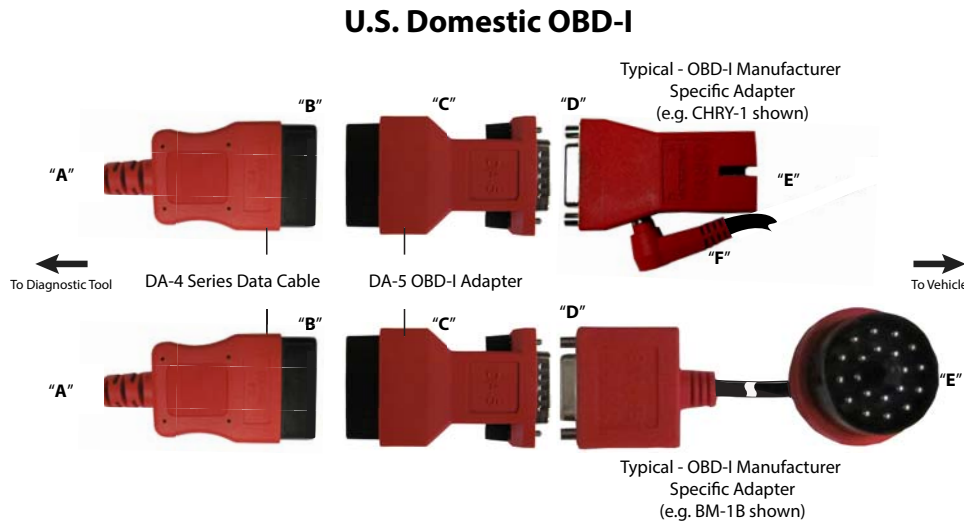

Figure 3-4

Figure 3-5 shows a typical OBD-I adapter (with power jack). This type of adapter MUST be connected to the vehicle battery, using either of the power cables shown.

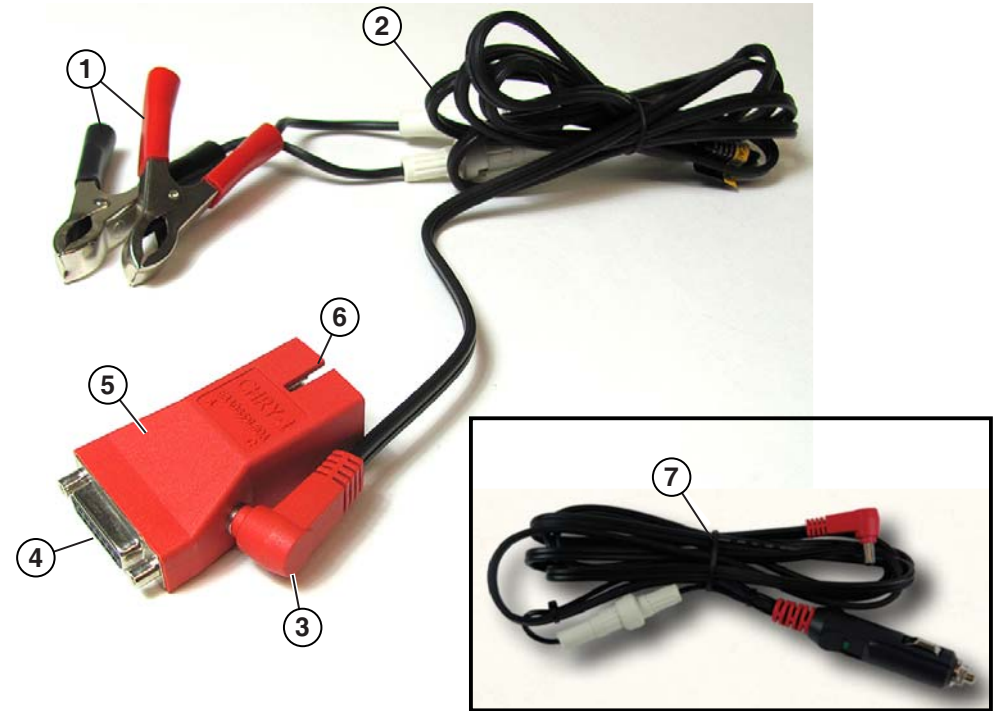

Figure 3-5

- 1— Connect Clamps to Vehicle Battery
- 2— Accessory Power Cable (Battery clamp type)
- 3— Power Cable Connection
- 4— Connects to DA-5 Adapter
- 5— Typical OBD-I Adapter (with power jack)
- 6— Connects to Vehicle
- 7— Accessory Power Cable (Power port type)

**NOTE**

Only use original Snap-on data cables and accessories with your diagnostic tool. Total data cable length must not exceed 114.17 inches (2.9 meters).



### 3.3.1 Optional OBD-I Data Cables and Adapters

- An optional **OBD-I data cable adapter (DA-5)** is available, which allows connection of the supplied DA-4E (OBD-II/EOBD) cable to the DA-5 adapter. The DA-5 adapter connects to the manufacturer specific OBD-I adapter. This may be used instead of the optional OBD-I data cable.
- An optional **OBD-I data cable** is available, which allows direct connection between the diagnostic tool and the manufacturer specific OBD-I adapter. This may be used instead of the optional DA-5 adapter.
- An optional **U.S. domestic and Asian vehicle OBD-I adapter kit** is available for select vehicles. The kit includes multiple manufacturer specific adapters and cables for OBD-I connection.
- An optional **European vehicle OBD-I adapter kit** is available for select vehicles. The kit includes multiple manufacturer specific adapters, cables and personality keys, providing OBD-I connection capabilities for select vehicles such as Mercedes Benz, VW and BMW. Depending on your diagnostic tool, optional European vehicle software may be required.

Contact your sales representative to purchase all optional accessories and software.



The Scanner function allows your diagnostic tool to communicate with the electronic control modules (ECMs) of a vehicle. This allows you to perform tests, view diagnostic trouble codes (DTCs), and data parameters from various vehicle systems such as the engine, transmission, antilock brake system (ABS) and more.

## NOTE

Scanner functionality, feature availability, navigation and terminology is vehicle manufacturer dependent, and will vary.

## 4.1 Quick Links

- [Basic Operations](#) page 23
- [Scanner Control Icons](#) page 21
- [Secured Vehicle Gateway™](#) page 22
- [Quick-Access Menu](#) page 22
- [Vehicle Voltage Readout](#) page 22
- [Scanner Overview](#) page 23
- [Vehicle Identification](#) page 23
- [Working with Trouble Codes](#) page 26
- [Codes Menu](#) page 26
- [Code Scan](#) page 26
- [Service Resets and Relearns](#) page 28
- [Working with Data \(PIDs\)](#) page 29
- [Data Menu](#) page 29
- [Custom Data Lists](#) page 29
- [Pausing and Reviewing Active Data](#) page 33
- [Using Zoom](#) page 36
- [Using Triggers](#) page 36
- [Functional Tests](#) page 39
- [Troubleshooter](#) page 40

## 4.2 General Information

### 4.2.1 Scanner Control Icons

Icon	Function	Icon	Function
	<b>Pause</b> - Pauses active data collection.		<b>Start (Capture)</b> - Resumes active data collection.
	<b>Clear</b> - Erases all the PID data in the buffer and restarts data collection.		<b>Custom Data List</b> - Allows you to choose which PIDs display.
	<b>Trigger</b> - Allows you to set, arm, and clear PID triggers		<b>Change View</b> - Toggle data display between list or graph.
	<b>Zoom</b> - Incrementally increases and decreases the scale of the data displayed.		<b>Lock</b> - Locks PIDs to the top of the list.
	<b>Step Forward</b> - Allows forward movement in singular steps. (Note: To quickly step forward during Scanner data review, press and hold )		<b>Sort</b> - Toggles the alpha order of a list.
	<b>Skip Forward</b> - Allows forward movement in multiple steps.		<b>Step Back</b> - Allows backward movement in singular steps. (Note: To quickly step backward during Scanner data review, press and hold )
	<b>Help</b> - Opens the Getting Started with Fast-Track® Intelligent Diagnostics slideshow.		<b>Skip Back</b> - Allows backward movement in multiple steps.

Icon	Function	Icon	Function
	<b>Diagnose</b> - Opens <a href="#">Fast-Track® Intelligent Diagnostics</a> for the selected code.		<b>Save</b> - Saves the active information to memory.
	<b>Automatic ID</b> - Automatically completes the identification process, once connected and make/year are entered.		<b>PID Alarm</b> - Display visual indicators for two state PIDs
	<b>Single Selection (List)</b> - Select / Deselect single item from list		<b>Multi-Selection (List)</b> - Select / Deselect all items in a list
	Next / Forward		Back / Last
	<b>Menu View</b> - Toggle between categorized / non-categorized list view		<b>Freeze Frame</b> - Display Freeze Frame data
	<b>Data List Selector</b> - Choose data list during functional test		<b>Tools</b> - Change units of measure

## 4.2.2 Secured Vehicle Gateway™

To protect against unauthorized vehicle network manipulation, many automobile manufacturers now **require special authorization** to allow the scan tool to communicate with select vehicle modules.

To learn more about how to connect this diagnostic tool to vehicles using a secured gateway. See [Customer Support / Links](#) on page vii for Secure Vehicle Gateway website link.

## 4.2.3 Quick-Access Menu

Selecting the **Home** icon opens the Quick-Access menu, depending on your location in the software. Use this feature as a shortcut to “jump” between functions, or to **Exit** the active vehicle. For additional information see [Quick-Access Menu](#) on page 5.

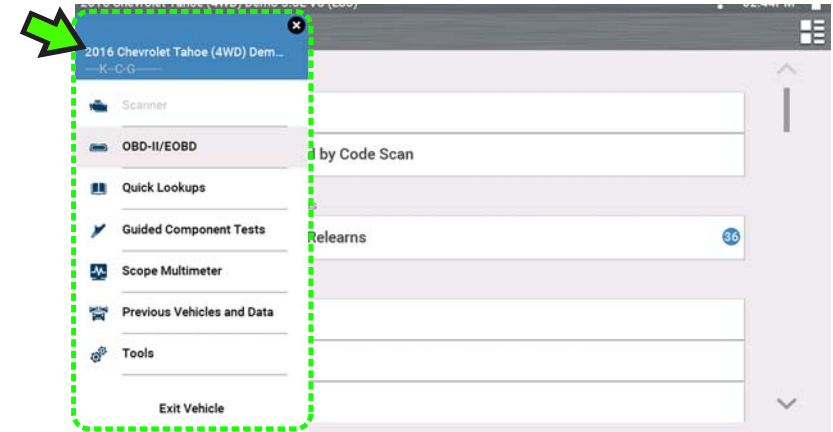

Figure 4-1

## 4.2.4 Vehicle Voltage Readout

When the data cable is connected to the vehicle, the vehicle's battery voltage (at the data link connector) is displayed on the top of the screen.

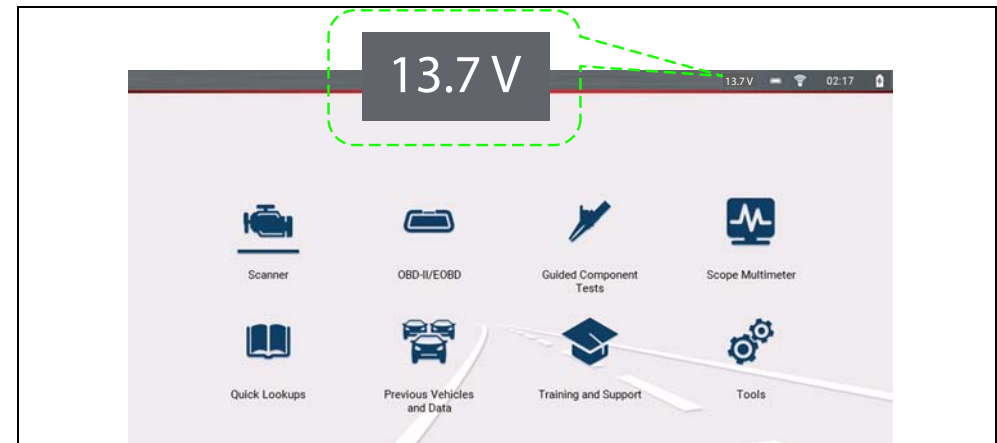

Figure 4-2



## 4.3 Basic Operations

### 4.3.1 Scanner Overview

#### Navigation

##### Home Screen: **Scanner**

1. Turn the vehicle ignition switch on.
2. Connect the data cable to the tool and vehicle. See [Data Cable / Connections on page 17](#)

The diagnostic tool will turn on automatically when connected to an OBD-II vehicle.

Depending on the vehicle, Instant ID may occur and the identification process automatically starts. See [Instant ID on page 24](#) for additional information.

If Instant ID is not supported, select **Scanner** and follow the screen prompts to identify the vehicle. See [Vehicle Identification on page 23](#) for additional information.

3. Select a **Vehicle System** (e.g. Engine, Transmission).
4. Select a **Vehicle System Test/Function** (e.g. Codes Menu) to perform. See [System and Test Selection on page 25](#).

#### IMPORTANT

**To avoid damage to the vehicle electronic control modules, never disconnect the data cable or disrupt the power supply during Scanner vehicle communication. Exit tests and stop Scanner vehicle communication before disconnecting the data cable or powering down the diagnostic tool.**

5. To exit Scanner vehicle communication, select the **Home** icon then select **Exit Vehicle** from the Quick-Access menu.

### 4.3.2 Vehicle Identification

#### NOTE

*Menus, options and procedures vary by vehicle. Not all vehicles support Auto ID and, or Instant ID.*

Depending on the vehicle, the vehicle identification process may require manual entry of the vehicle information, or it may be automated. The following functions are available to identify the vehicle:

**Instant ID** - See [Instant ID on page 24](#) for additional information.

**Manual ID** - Allows for manual entry of all required vehicle identification criteria, see [Manual ID on page 23](#).

**Auto ID** - Automatically completes the identification process after the vehicle make and year are manually entered. see [Manual ID on page 23](#).

**OBDII/EOBD ID** - See [Alternative Vehicle Identification on page 24](#) for additional information.

#### Manual ID

1. Turn the vehicle ignition switch on.
2. Connect the data cable to the tool and vehicle. See [Data Cable / Connections on page 17](#).
3. If required, turn the diagnostic tool on (the tool should automatically turn on when connected to the vehicle).
4. Select **Scanner** from the Home screen.
5. Follow the screen prompts to enter the vehicle make and year.
6. If prompted select, **Automatic ID** or **Manual ID**.



Selecting **Automatic ID** or the **Automatic ID icon** will start the automatic vehicle identification process.

Selecting **Manual ID** will allow you to continue manually identifying the vehicle.

7. Follow the screen prompts to complete the vehicle identification process .
8. The vehicle identification confirmation screen displays ([Figure 4-3](#)), select **Ok** to continue.

**NOTE**

Data cable location and connection information may be provided.



Figure 4-3

**Instant ID**

Instant ID automatically communicates with the vehicle to start the vehicle identification process.

**Operational Requirements:**

- **Vehicle requirements:**
  - Vehicle must support Mode \$09 VIN.
  - **Note:** Mode \$09 VIN is mandated on 2008 and newer vehicles.
  - Vehicle must be equipped with Hi Speed CAN or J1850 communication protocol.
- **Connection procedure requirements:**
  1. Turn vehicle ignition on.
  2. Connect data cable to the tool and then the vehicle.
    - An audible "beep" will sound approximately 6 seconds after boot-up, if the VIN is read.
  3. Vehicle identification confirmation displays, select **Ok** to continue.

**NOTE**

If the Scanner feature is exited during the session that Instant ID was used, selecting Scanner again, will not automatically ID the vehicle again. However, you can select the Automatic ID Icon to restart the identification. As an alternate method, you can select the vehicle from **Previous Vehicles and Data > Vehicle History**.

**Alternative Vehicle Identification**

If you have a vehicle that does not appear in the scanner list, you can try and establish communication by using the **OBDII/EOBD** function, see [OBD-II/EOBD](#) on page 113. Communication is limited to basic OBD-II or EOBD diagnostic functions.

### 4.3.3 System and Test Selection

#### Navigation

**Home Screen:** [Typical] Scanner (Vehicle Identification) > (Vehicle System Menu)

After the vehicle is identified, a menu of available systems and/or test options is displayed (*Figure 4-4*).



Use the **Menu View** icon (*Figure 4-4*) to toggle between a categorized and non-categorized list view.

Select a system/test option as applicable.

#### **i** NOTE

*Only the systems/ test options supported for the vehicle are displayed.*



Figure 4-4

Once a system/test option is selected, the available options for that system are displayed in the System Main Menu (*Figure 4-5*).

#### Navigation

**Home Screen:** [Typical] Scanner (Vehicle Identification) > (Vehicle System Menu) > (Vehicle System Main Menu)

See *Working with Trouble Codes* on page 26 for descriptions of typical System Main Menu options.

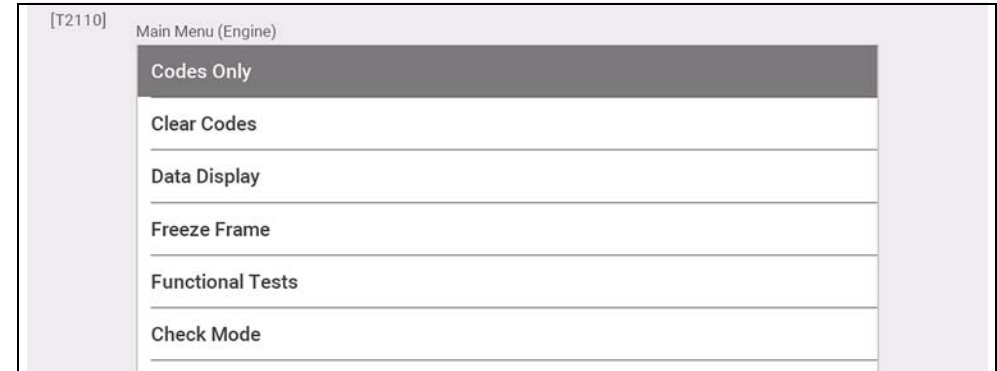

Figure 4-5



## 4.4 Working with Trouble Codes

The following sections describe a few trouble code functions found within a typical System Main Menu.

### **i** NOTE

*Trouble code functionality, availability, navigation and terminology is vehicle manufacturer dependent, and will vary.*

### 4.4.1 Code Scan

#### Navigation

**Home Screen:** [Typical] Scanner (Vehicle Identification) > (Vehicle System Menu) > (Code Scan)

**Code Scan** quickly scans all supported vehicle control modules for codes and OBD-II monitor readiness. See [Vehicle Code Scan on page 41](#) for information.

### 4.4.2 Codes Menu

#### Navigation

**Home Screen:** [Typical] Scanner (Vehicle Identification) > (Vehicle System Menu) > (Vehicle System Main Menu) > (Codes Menu)

To view trouble codes, select **Codes Menu** and then make any sub-menu selections as applicable (if available). Depending on the vehicle manufacturer, the “Codes Menu” and sub-menu selection names will vary (e.g Codes, Codes Menu, Codes Only, Codes (No Data), Service Codes, Display Codes, etc.).

### 4.4.3 Display Codes

#### Navigation

**Home Screen:** [Typical] Scanner (Vehicle Identification) > (Vehicle System Menu) > (Vehicle System Main Menu) > (Codes Menu) > (Display Codes)

Display Codes may be a sub-menu of the Codes Menu, and typically displays a list of the current trouble codes, however sub-menu selections may also be required ([Figure 4-6](#)).

### Fast-Track® Intelligent Diagnostics

Fast-Track® Intelligent Diagnostics may be available for a selected code from the Display Codes screen ([Figure 4-6](#)).



If active, select the **Diagnose** icon to open Fast-Track® Intelligent Diagnostics, see [Fast-Track® Intelligent Diagnostics on page 46](#) for additional information.

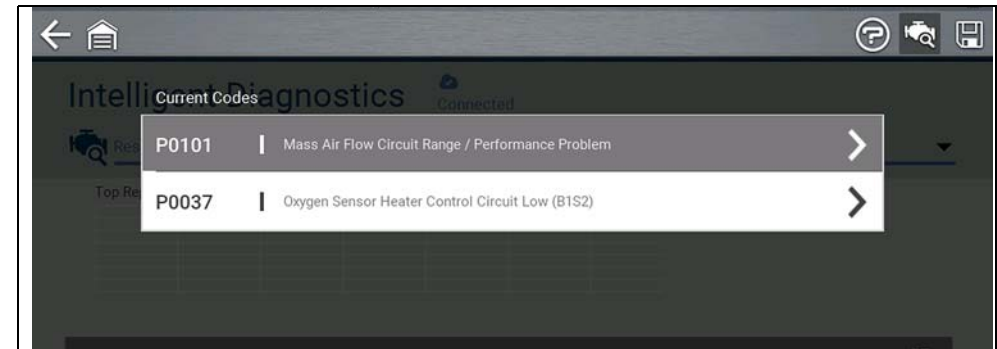

Figure 4-6



## 4.4.4 Freeze Frame/Failure Records

### Navigation

**Home Screen:** [Typical] **Scanner** (Vehicle Identification) > (Vehicle System Menu) > (Vehicle System Main Menu) > (Codes Menu) > (Display Codes) > (Freeze Frame/Failure Records)

**Freeze Frame/Failure Records.** may be a sub-menu of the Codes Menu and displays the last code that was set.



Selecting the **Freeze Frame** icon (*Figure 4-7*) displays the corresponding Freeze Frame data that was captured when the code was set.

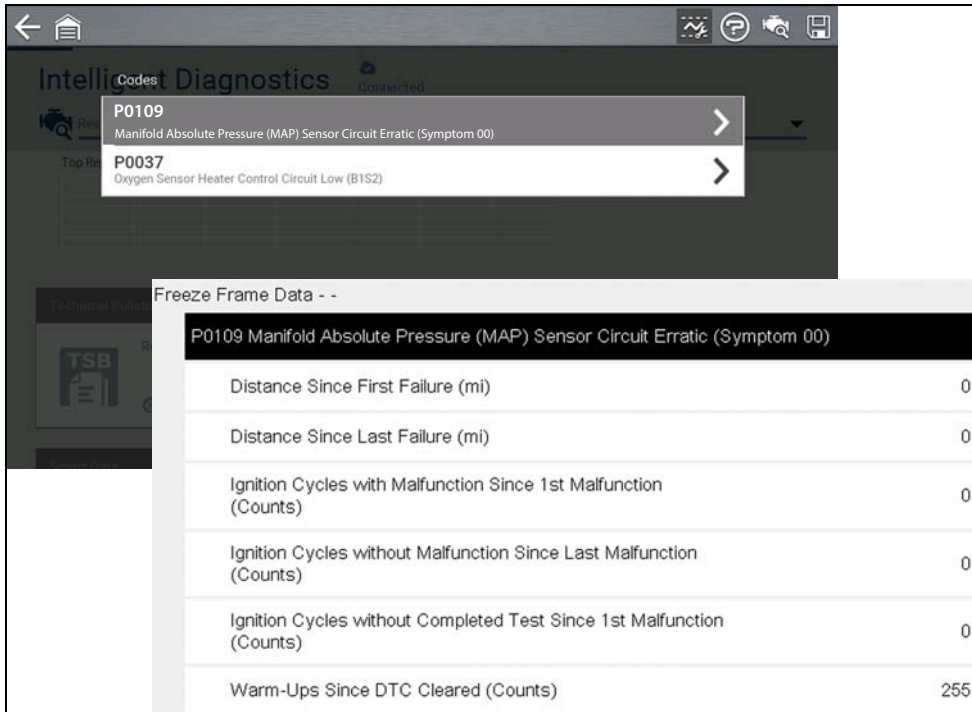

Figure 4-7

## 4.4.5 Clear Codes

### Navigation

**Home Screen:** **Scanner** (Vehicle Identification) > (Vehicle System Menu) > (Vehicle System Main Menu) > (Clear Codes)

**Clear Codes** allows you to erase codes from ECM memory.

### IMPORTANT

***Clearing codes erases all temporary ECM information, including Freeze Frame/Failure Records. Check and/or record all vital diagnostic information before clearing codes.***

## 4.5 Service Resets and Relearns

### Navigation

**Home Screen:** [Typical] Scanner (Vehicle Identification) > (Vehicle System Menu) > (Service Resets and Relearns)

The Service Resets and Relearns option, saves you time by providing you with a full menu of vehicle specific resets/relearns (functional tests) and related OEM information to help you successfully start and complete these services.

The number in the blue icon (*Figure 4-8*) indicates the number of resets and relearns supported for the vehicle.

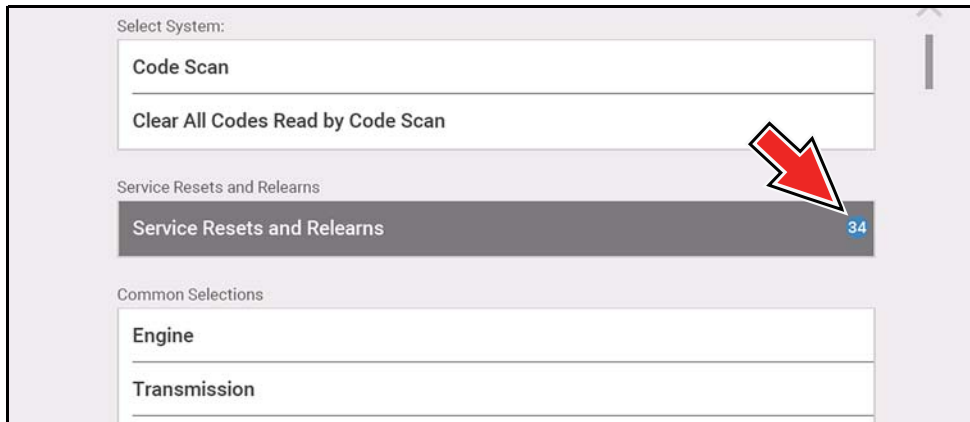

Figure 4-8

Selecting Service Resets and Relearns (from the System menu) (*Figure 4-8*), opens a categorized list of all the available resets and relearns (*Figure 4-9*).



Figure 4-9

Making a selection from the menu (*Figure 4-9*) opens the related information screen for that specific Reset/Relearn (*Figure 4-10*). The information provided may include:

- Top Repairs Graph - Shows the top repairs related to the selected Reset/Relearn
- TSB's and Safety Recall Links - (if available) provides links to related OEM service bulletins and safety recall information
- Functional Resets and Calibrations - Resets/Relearns that can be completed using the diagnostic tool

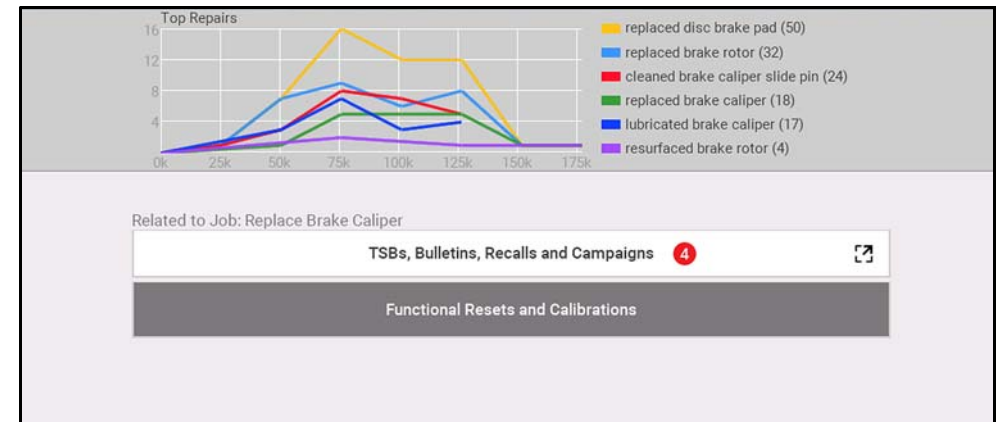

Figure 4-10

## 4.6 Working with Data (PIDs)

The following sections describe common data functions.

### NOTE

*Data functionality, availability, navigation and terminology is vehicle manufacturer dependent, and will vary.*

### 4.6.1 Data Menu

#### Navigation

**Home Screen:** **Scanner** (Vehicle Identification) > (Vehicle System Menu) > (Vehicle System Main Menu) > (Data)

To view Data, select **Data** and then make a sub-menu selection as applicable (if available). Depending on the vehicle manufacturer, the “Data” and sub-menu selection names will vary (e.g. Data, Data Menu, Data Only, Data Groups, Display Data, etc.).

The Data menu ([Figure 4-11](#)), displays available PID lists.

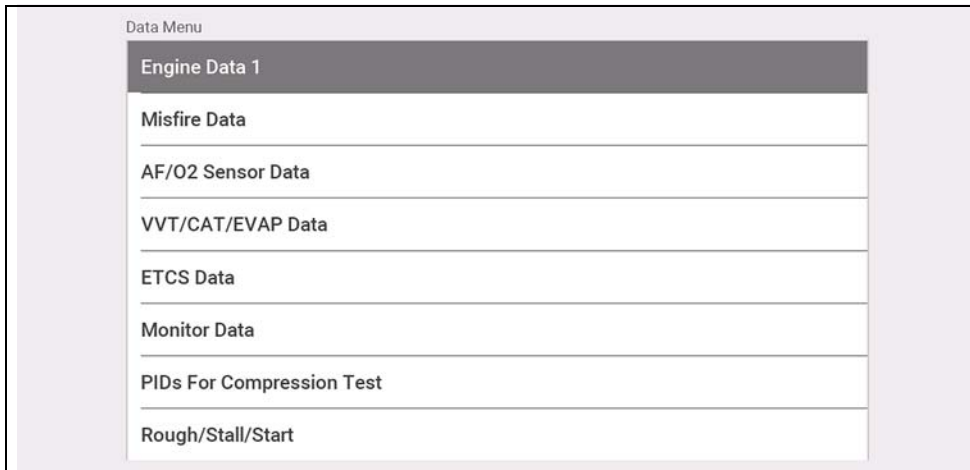

Figure 4-11

There are 3 basic PID list types:

- **All System Data** - display all available PIDs for that system. As an example from within an Engine system Data menu, the Engine Data option can be used to display all Engine related PIDs.
- **Related System Data** - display a list of PIDs that are related to the primary system (e.g. Misfire, EVAP, and Fuel Trim PID lists are related to the Engine system).
- **Custom Data** - user defined list of PIDs see [Custom Data Lists](#) on page 29.

### 4.6.2 Custom Data Lists

#### Navigation

**Home Screen:** **Scanner** (Vehicle Identification) > (Vehicle System Menu) > (Vehicle System Main Menu) > (Data) > (Specific Data List - e.g. Engine)



Select the **Custom Data List** icon to create a custom PID list ([Figure 4-12](#)) (add or remove PIDs from the list). Minimizing the number of PIDs displayed allows you to focus on specific data parameters and provides a faster refresh rate.



Figure 4-12

Check the parameters to display ([Figure 4-13](#)) and then select the **Accept** icon. The custom list displays ([Figure 4-14](#)).

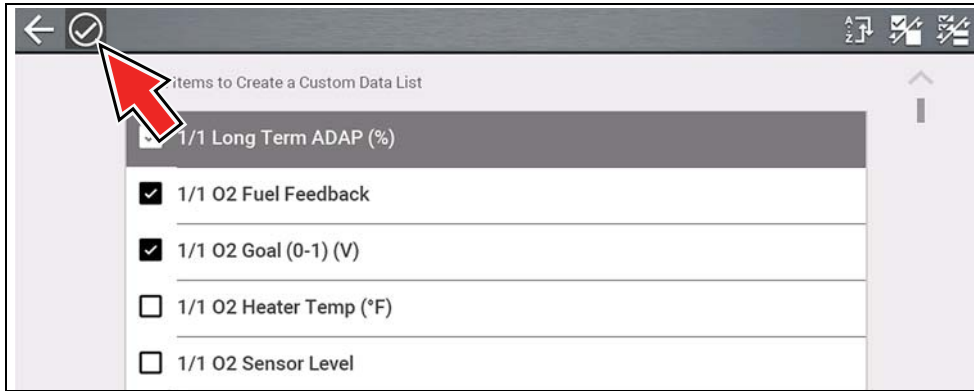

Figure 4-13

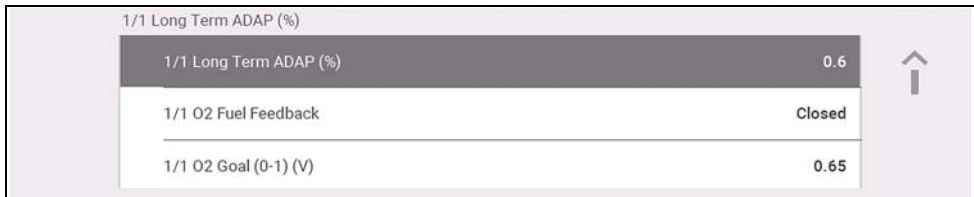

Figure 4-14

### 4.6.3 PID (Alarm) Indicator

Visual (alarm) indicators can be set for two state PIDs. Two state PIDs include components and circuits that only operate in two modes or “states” (e.g. solenoids, relays, and switches that are either, open/closed, on/off, true/false, etc.).



To set two state PID Indicators, select the **PID Alarm** icon.

Choose the PIDs indicators to display (*Figure 4-15*), then select the **Back** arrow. PID indicators are displayed in the data list (*Figure 4-16*), and change color as the states change.

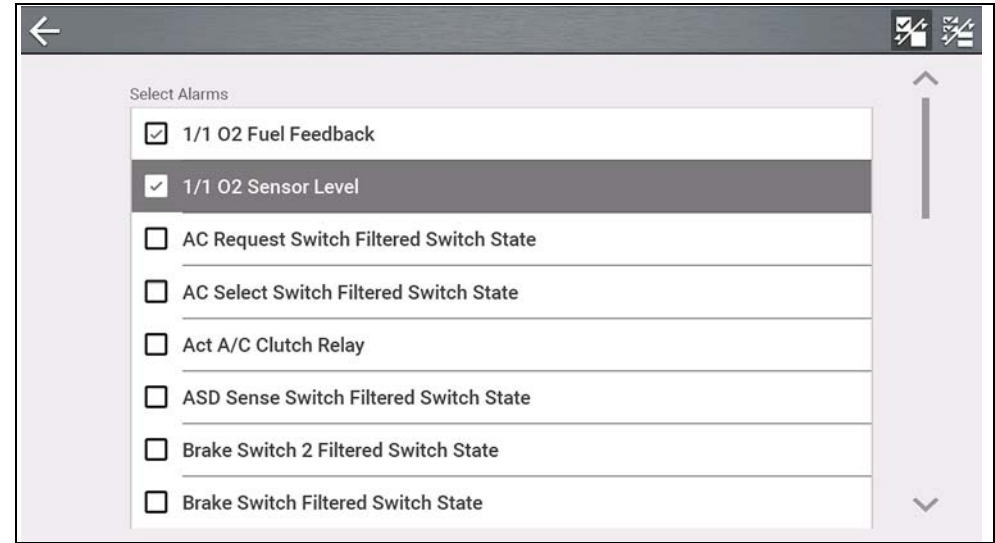

Figure 4-15

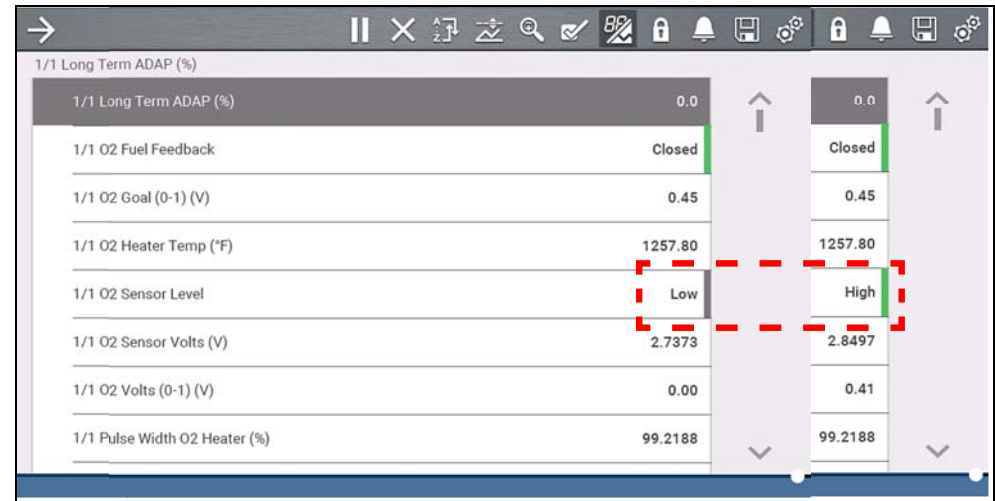

Figure 4-16

## 4.6.4 Data Views (List / Graph)

Data may be displayed in either list or graph form.

Figure 4-17 shows a four PID graph view (top) and PID list view (bottom).



To change the data display type, select the **View** icon.

In all views, the current parameter value or state is shown, and the PIDs are listed in the order in which they are transmitted by the ECM.



Select the **Right Arrow** to display the next data list when more than one list is available.

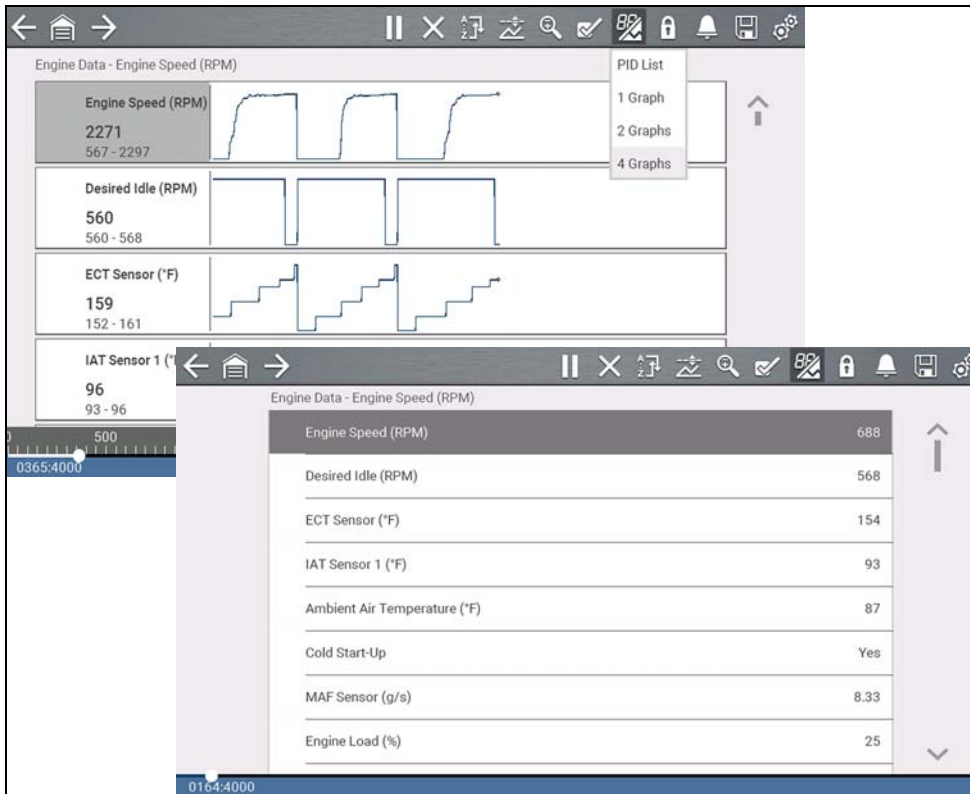

Figure 4-17

In graph view the text block (Figure 4-18) to the left of the graph displays:

- Top - PID description
- Middle - Current value or state

- Bottom - Active minimum and maximum values

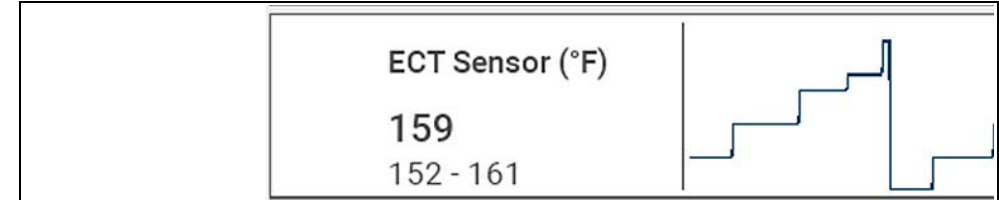

Figure 4-18

## 4.6.5 Locking PIDs (to always display at top)



Use the **Lock** icon to lock selected PIDs at the top of the list.

To lock or unlock a PID, highlight the parameter and select the **Lock** icon.

### NOTE

Only three parameters can be locked at one time. Once locked, a parameter remains locked until it is manually unlocked, or communication with the vehicle is stopped.

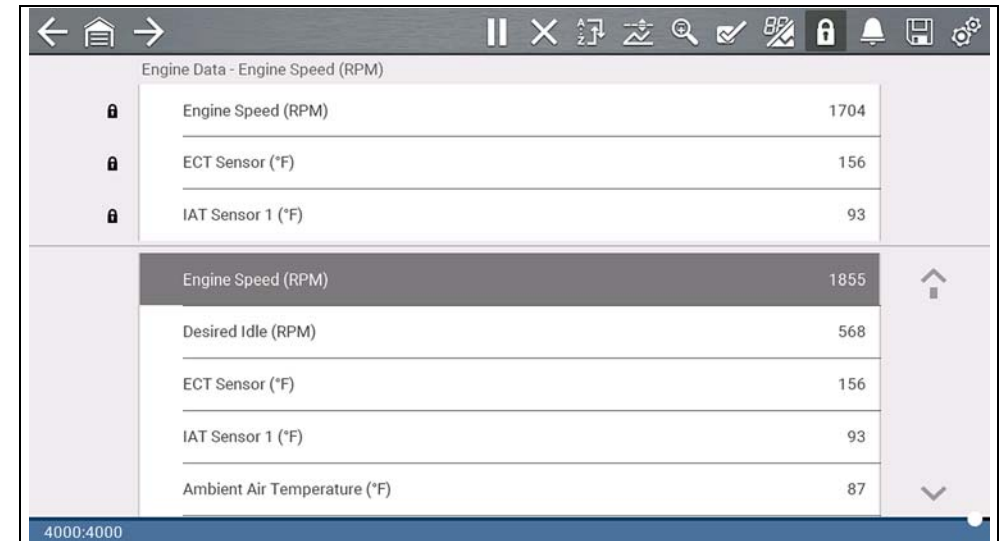

Figure 4-19

## 4.6.6 About the Data Buffer

The diagnostic tool has the capability to collect, store and save PID data utilizing internal buffer storage memory.

When data is displayed onscreen, it is automatically stored in buffer memory. The data buffer runs continuously (storing data) until the Pause, Clear, or Save icon is selected. All PIDs displayed in the list will be stored, not just those displayed.

Buffer memory is limited to a predetermined "total" size. When buffer memory reaches it's full capacity, the data buffer will continue to store new data, however earlier stored data will be removed to allow room for the new data being stored.

The most recent data is always available for review when Pause is pressed, and can be reviewed using the toolbar controls.

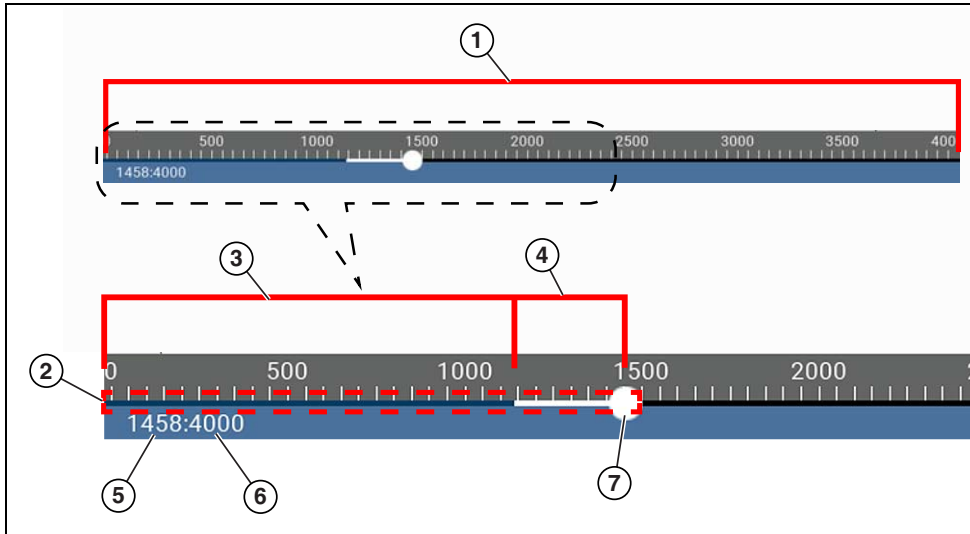

Figure 4-20

- 1— **Data Buffer Scale** - Displays maximum data buffer size (e.g. 4000) across screen
- 2— **Data Buffer Indicator** - Bar graph indicates total data stored in the memory buffer. Includes blue and white graph bars and active position indicator.
- 3— **Blue Graph Bar** - Stored data not displayed onscreen
- 4— **White Graph Bar** - Stored data displayed onscreen
- 5— **Active Data Position Counter** - the numerical position of the active (current) data point as displayed within buffer memory.

- 6— **Maximum Data Buffer Size** (Data Buffer Position Counter) - indicates the maximum data buffer size value (e.g. 4000)
- 7— **Active Data Position Indicator** - Round icon indicates active (current) position in the data, which is also denoted by the Active Data Position Counter.

Figure 4-21 shows the relationship between the (Blue) Current Position Cursor, Active Data Position Indicator and Active Data Position Indicator during data review.

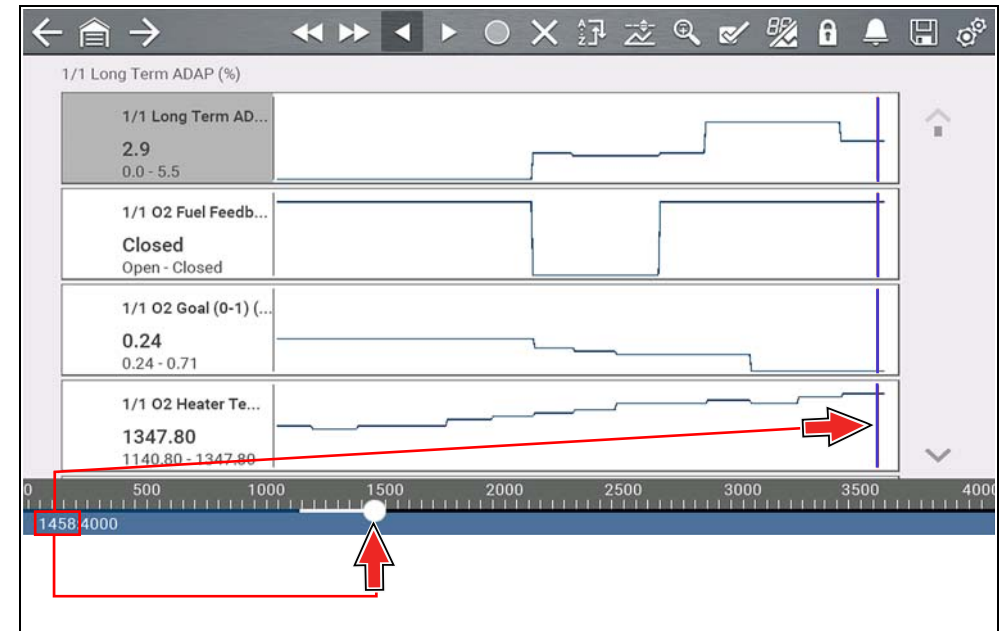

Figure 4-21

## 4.6.7 About Cursors

Vertical cursors are automatically displayed (in graphical PID views) to mark specific data reference points.

**Gray (Pause/Save)** - If you select Pause or Save while collecting data, a vertical gray cursor is automatically placed at that point in the data to indicate where the data was paused or saved.

- Each time Pause is pressed an additional cursor is added, and appears when Start is pressed to resume data collection.
- Each time Save is pressed an additional cursor is added, and appears when the data starts again after a slight pause to save the file.
- Cursors are displayed in all PIDs as reference markers.
- Cursors are retained and appear in saved data files.

**Blue (Current Position)** - If you select Pause while collecting data, a vertical blue cursor is displayed as an indicator to your position in the data and is denoted by the current position value in the counter display.

- Cursors are displayed in all PIDs as reference markers.
- Depending on the amount of data saved the blue cursor may be initially located on the far left next to the description, or the far right next to the scroll bar making it difficult to see. If this happens, use the control icons (Step/Skip) to move the data until you can see the cursor.

**Red (Triggered PID Activation Point)** - When using triggers, a vertical red cursor is displayed in the data of the triggered PID at the point where the trigger was activated.

- When multiple PIDs are armed, only the PID that is triggered first will display a red cursor.

**Green (Trigger Activation Reference Point)** - When using triggers, green vertical cursors are displayed in all PIDs (except the PID that was triggered) as reference to the triggered PID activation point.

- When a trigger is activated the displayed red and green cursors are all vertically aligned in the graphed data to show the relationship of the trigger point in all PIDs.

## 4.6.8 Pausing and Reviewing Active Data

During normal operation, data from the vehicle is continuously being stored in buffer memory as it is displayed onscreen. The Pause icon ([Figure 4-22](#)), allows you to temporarily pause data collection to review it in detail.

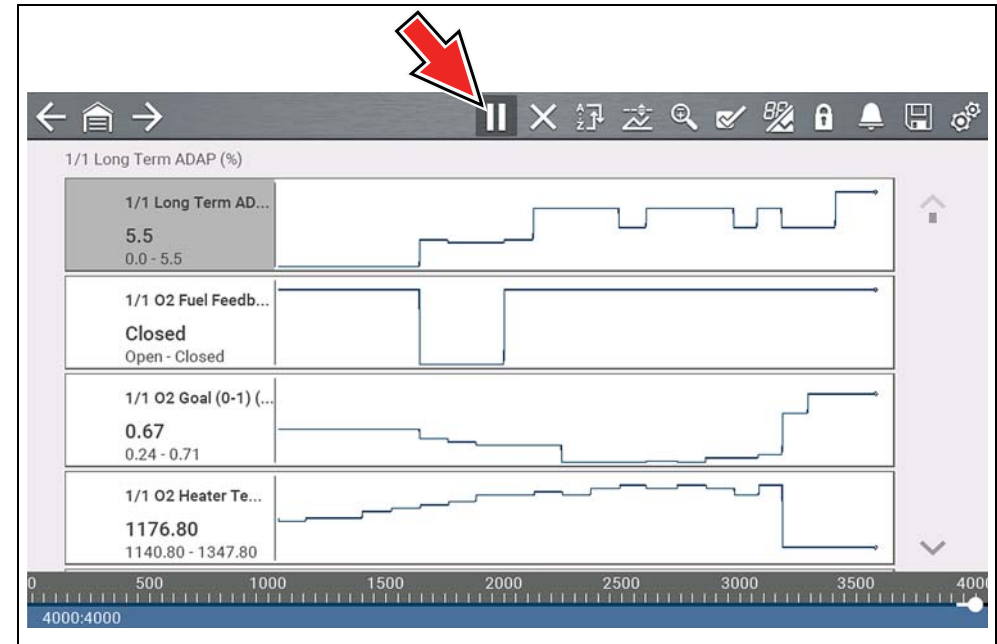

Figure 4-22

After Pause is pressed:

- Use the review control icons ([Figure 4-23](#)) to accurately move through the data.
- The blue (vertical cursor) ([Figure 4-23](#)) indicates your position in the data and is denoted by the current position value in the counter display. This cursor displays in all PIDs.



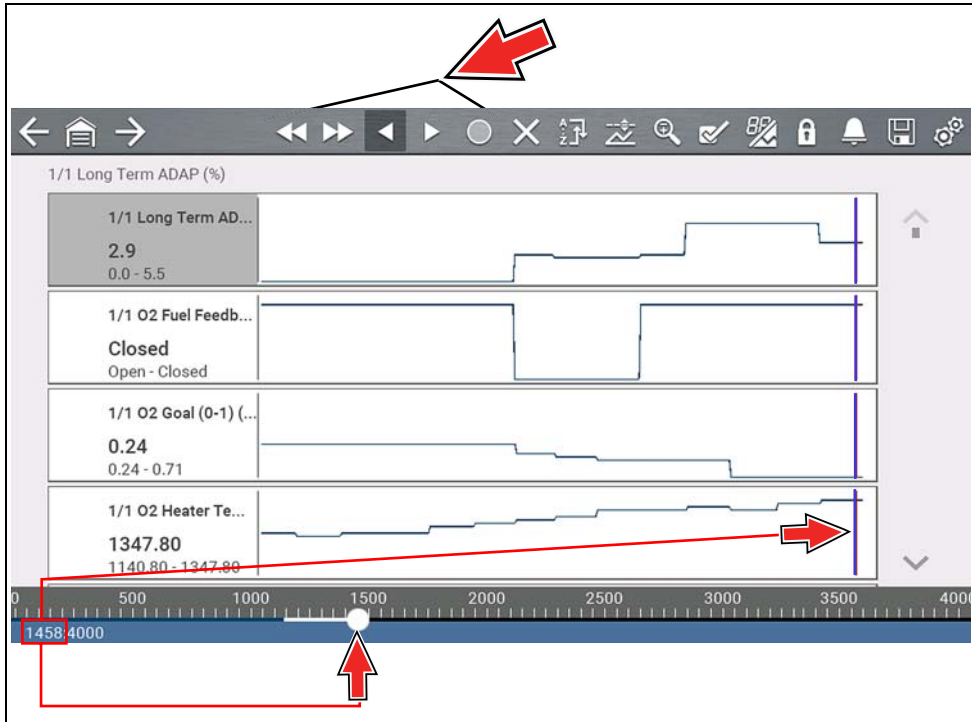



Figure 4-23

To resume data collection (after pausing), select the **Start** icon .

- The screen changes back to display data ([Figure 4-24](#)).
- A vertical gray cursor is displayed on all PIDs, indicating where the data was paused ([Figure 4-24](#)). If Pause occurred more than once, gray cursors will be used for each instance.

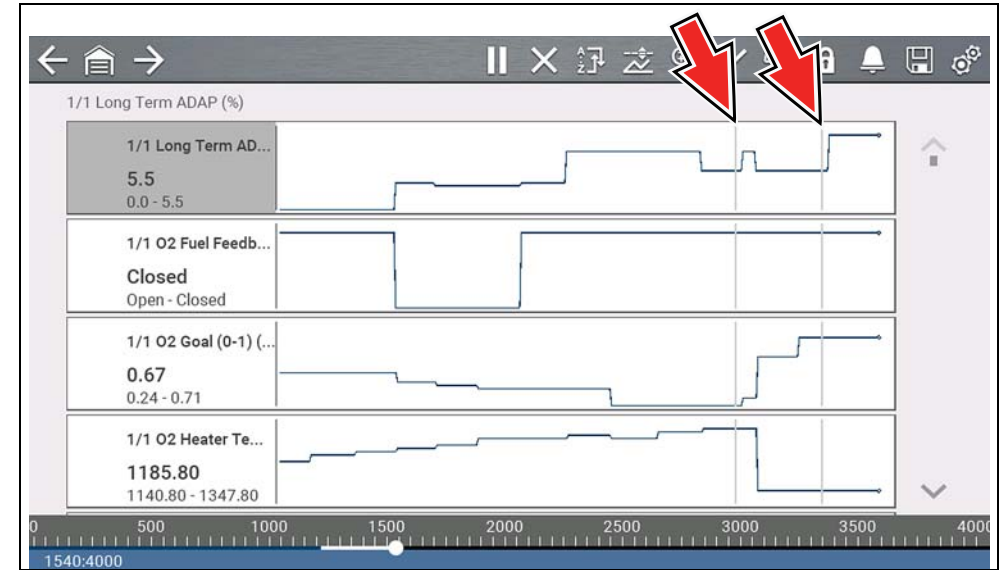

Figure 4-24

#### 4.6.9 Saving Data Files



Saving data is useful when trying to isolate an intermittent problem or to verify a repair. During normal operation, data from the vehicle is continuously being stored in buffer memory as it is displayed onscreen.

Selecting the **Save** icon writes stored buffer memory to a (.SCM) file.

#### **i** NOTE

The **Save icon** performs the same function as “Save Movie” function choice for the programmable **Shortcut** button, see [Configure Shortcut Key](#) on page 123 for details.

## 4.6.10 Viewing Data Files

### Viewing Data Files on the Tool

#### Navigation

**Home Screen:** Previous Vehicles and Data > Saved Data

1. Select the desired data file (.SCM file extension), see [Saved Data on page 121](#) for additional information.
2. Change the view type and zoom levels as needed.
3. In graph view, use the control icons to move through the data ([Figure 4-25](#)).

The blue (vertical cursor) ([Figure 4-25](#)) indicates your position in the data and is denoted by the current position value ([Figure 4-25](#)) in the counter display. The cursor displays in all PIDs.

Depending on the amount of data saved the cursor may be initially located on the far left next to the description, or the far right next to the scroll bar making it difficult to see. If this happens, use the control icons to move the data until you can see the cursor.

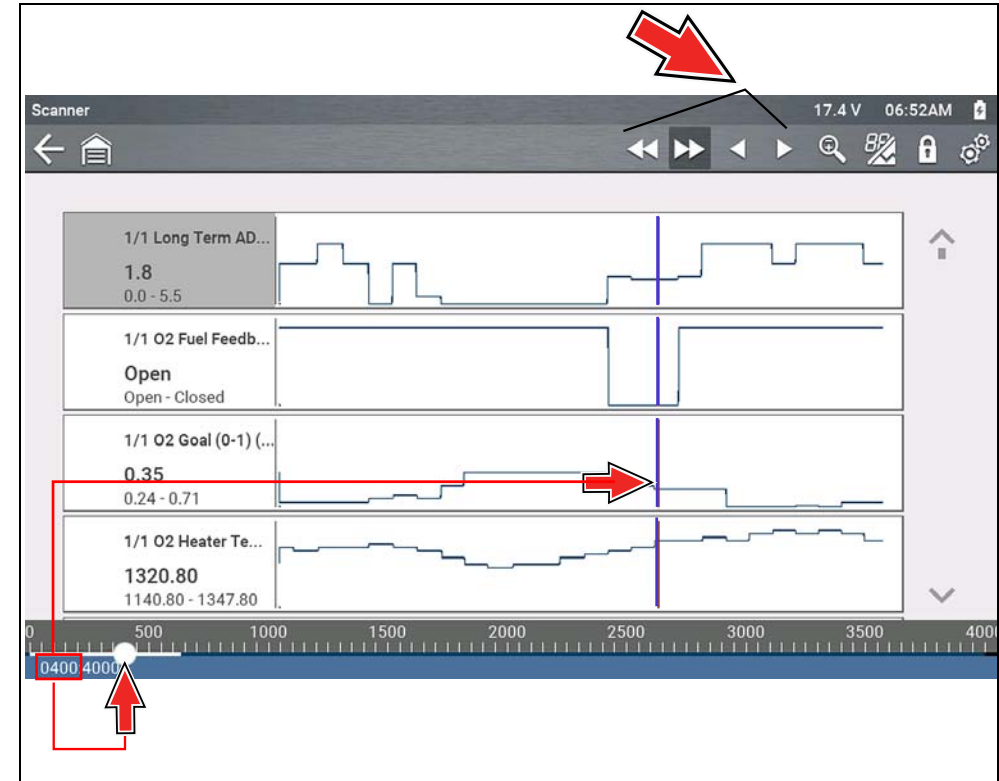

Figure 4-25

### Viewing Data Files on a PC

Saved data files can also be downloaded to a personal computer (PC) using the supplied USB cable and *ShopStream Connect™*. See [Connect-to-PC \(File Transfer\) on page 123](#).



## 4.6.11 Using Zoom



The zoom function allows you to change the magnification level of the graphed data during data collection and review. Changing magnification levels allows you to compress or expand the displayed data to quickly find glitches, or signal losses.

When the **Zoom** icon is selected the dropdown menu allows you to select the display magnification level from a range of -2X to +8X. The "Zoom Out" option displays up to half of the maximum amount of data that can be collected, on one screen. The default magnification level is 1x.

**Examples** *Figure 4-26*: Top (+4X), Middle (1X), Bottom (Zoom Out)

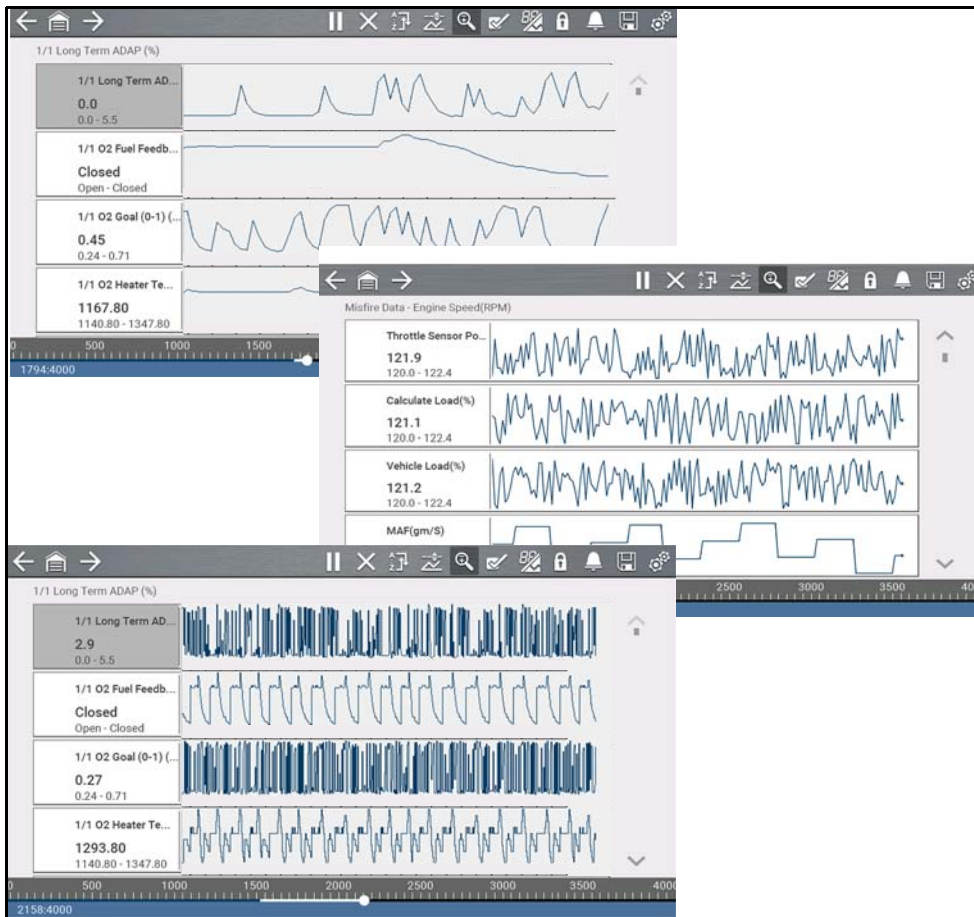

Figure 4-26

## 4.6.12 Using Triggers

### Trigger Description and Features



Setting PID triggers allows you to configure the diagnostic tool to automatically save PID data to a file when a PID value meets an upper/lower limit (trigger point).

When a PID value meets the trigger point it activates the trigger which captures a short recording of PID data (before and after the trigger event), and saves it as a data file.

You can then review the file to evaluate the PID that triggered the event, and all the PIDs collectively to determine what happened up to and just past when the event occurred.

Examples of the following trigger states (Armed / Not Activated - upper image) and (Activated - lower image) are shown in (Figure 4-27).

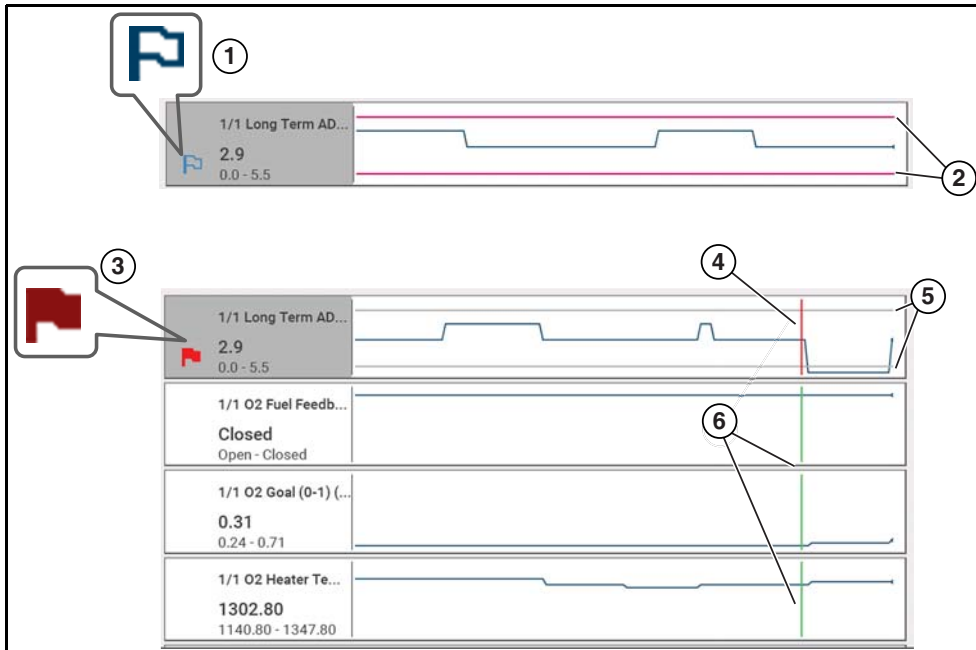



Figure 4-27

- 1— **Armed PID Trigger Indicator** - A blue outlined flag indicates the PID trigger is armed.
- 2— **Upper and Lower Limit Lines (Armed)** - Colored limit lines indicate the trigger is armed but not activated.
- 3— **Activated PID Trigger Indicator** - A red flag indicates the PID trigger has activated.
- 4— **Trigger Activation Point Cursor** - A red cursor line is displayed in the PID data where the trigger was activated.
- 5— **Upper and Lower Limit Lines (Not Armed and Activated)** - Gray limit lines are displayed when the trigger is armed but not activated and after the trigger has been activated.
- 6— **Trigger Activation Point Reference Cursor** - Green cursors lines are displayed on all the other PID graphs to indicate their relationship to where the trigger occurred.

### PID Trigger Status Icons

The icons (below) are used to help you quickly identify the status of individual PID triggers:

Icon	Description
Trigger Armed 	Trigger has been set (configured) and is armed.
Trigger Activated 	Trigger has been activated (upper or lower limit has been met).

### ▶ Setting triggers:

To use triggers, they must be turned on (set/configured), and then armed. Use the following procedures to setup PID triggers.

1. Highlight the PID to setup with a trigger.
2. Select the **Trigger** icon.

Selecting the **Trigger** icon (Figure 4-28) displays trigger menu options:

- **Set Trigger**—opens setup screen for upper/lower limits (trigger points)
- **Arm Trigger**—arms the trigger to capture data
- **Clear All Triggers**—deletes all previously set triggers

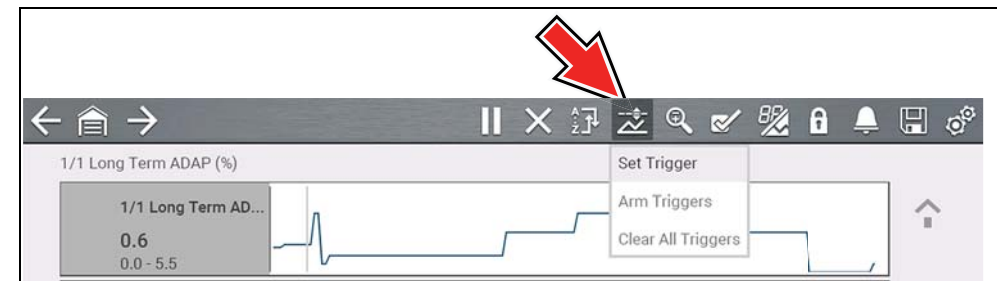

Figure 4-28

If triggers are already set, the menu options are:

- **Clear Trigger**—deletes the highlighted trigger
- **Disarm Trigger**—disarms the highlighted trigger
- **Clear All Triggers**—deletes all set triggers

3. Select **Set Trigger**.

A graph of the highlighted PID and setup icons display (*Figure 4-29*).

The upper trigger point must be set first. A red horizontal line is displayed across the data graph (*Figure 4-29*) representing the upper trigger point.

4. Use the lower toolbar arrow icons (*Figure 4-29*), or the up ▲ and down ▼ arrow buttons to change the position of the upper trigger point.
5. Select ✓, or press the **Y/✓** button, to set the upper trigger point.

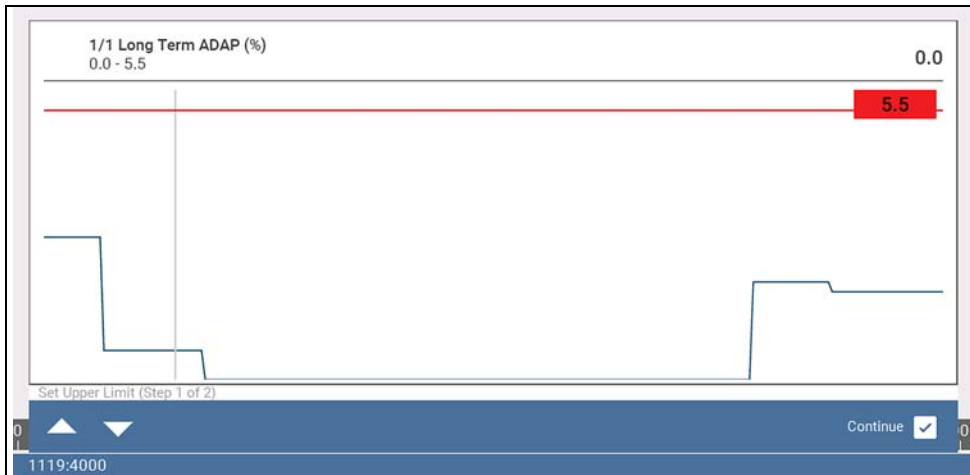

Figure 4-29

The upper trigger line changes color to gray and the lower trigger line displays in red (*Figure 4-30*).

6. Change the position of the lower trigger line in the same manner as the upper.
7. When finished, select ✓, or press the **Y/✓** button, to set the lower trigger level.

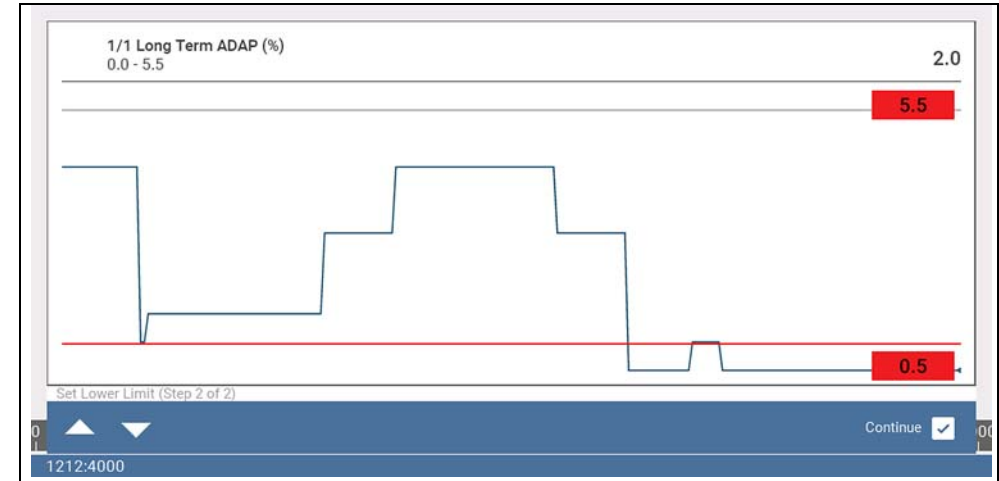

Figure 4-30

The display returns to the PID data view and the trigger points appear as horizontal lines across the designated graph (*Figure 4-31*). Repeat this procedure to establish trigger points for other parameters (up to three) if desired.

### **i** NOTE

*Only three parameters can have trigger levels set at one time, but only one of the conditions needs to be satisfied for triggering to occur.*



Figure 4-31



### Arming triggers:

1. Select the **Trigger** icon.
2. Select **Arm Triggers**.

The trigger point lines change color to indicate an armed condition (Figure 4-32).

All set PID triggers are armed simultaneously (if more that one is set). Once armed it remains armed until you clear it or the trigger is activated.

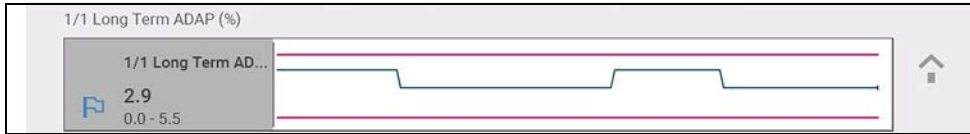

Figure 4-32

### About Activated Triggers

A trigger is activated (displays red flag)  when a PID value meets an upper/lower limit (trigger point).

When a trigger is activated:

- Data collection is briefly paused as the Scanner captures a short recording of PID data (before and after the trigger event), and saves it as a data file.
- A gray cursor line is displayed to indicate the point at which the data was paused or saved.
- An audible alarm is sounded
- A message displays indicating a data file was saved.
- Data collection continues.
- The activated PID trigger is disarmed. **Note** - if a different PID trigger is activated subsequently, an additional data file will be recorded.
- A red cursor line is displayed on the graph of the PID with the activated trigger to indicate where the trigger occurred. A green cursor line is displayed on all the other PID graphs to indicate their relationship to where the trigger occurred.
- The trigger menu options are:
  - **Clear Trigger**—deletes the highlighted trigger
  - **Arm Trigger**—arms the trigger to capture data
  - **Clear All Triggers**—deletes all set triggers

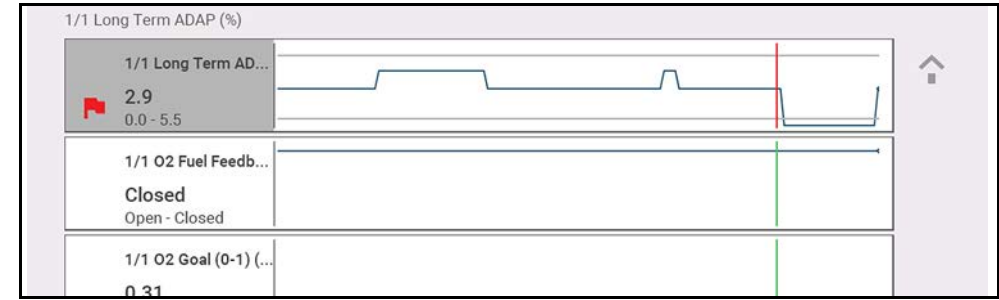

Figure 4-33

## 4.7 Functional Tests

### Navigation

**Home Screen:** **Scanner** (Vehicle Identification) > (Vehicle System Menu) > (Vehicle System Main Menu) > (Functional Tests)

**Functional Tests** provides access to vehicle-specific subsystem tests.

### NOTE

*Functional Test functionality, availability, navigation and terminology is vehicle manufacturer dependent, and will vary.*

Typical functional tests:

- **Information Tests**—read-only tests (i.e. selecting “VIN” to display the VIN of the vehicle).
- **Toggle Tests**—component state change tests (i.e. switching a solenoid, relay, or switch, between two operating states).
- **Variable Control Tests**—command variable value tests (i.e. varying spark timing in 1° increments or EGR valve duty cycle in 10% increments).
- **Reset Tests**—reset the adaptive, or learned, values that are stored in the vehicle electronic control module memory.
- **Scripted Tests**—preconfigured tests that are run when performing certain repairs (i.e. bleeding brakes with ABS).



## IMPORTANT

*Follow all screen instructions while performing tests.*

Different toolbar controls are used depending on the functional test. Some tests use a Test icon to switch actuators on/off, and some require variable controls selection to increase and decrease a testing value.

Some tests provide a Data List icon, which allows you to change which data displays.

Toggle and variable control tests often display functional test controls on the toolbar at the top of the screen with PID data in the main body.



## 4.8 Troubleshooter

### Navigation

**Home Screen:** **Scanner** (Vehicle Identification) > (Vehicle System Menu) > (Vehicle System Main Menu) > (Troubleshooter)

## IMPORTANT

*Troubleshooter information is only applicable for select vehicles up to and including the 2015 model year. Troubleshooter is dependent on the availability of information, and is not available for all vehicles.*

Troubleshooter provides reference information from actual repairs. Code tips, parameter descriptions, along with repair guidelines are some of the information that may be included.

Typical information:

- **Code Tips**—provides detailed information on setting conditions, testing, and interpreting test results for specific codes.
- **Symptom Tips**—provides diagnostic tests and procedures based on vehicle operation.
- **Time Savers**—provides supplemental information, such as firing order and #1 cylinder location, that may be needed to make a diagnosis.
- **Common Problems**—provides advice and remedies for certain “pattern failures” that have been experienced on vehicles of the same model.
- **Tests and Procedures**—explains how to perform certain tests on the specific test vehicle. Some tips provide specifications and installation information as well.
- **Data Scan**—contains information and guidelines on how to validate data readings for certain sensors and actuators, PID data values are provided.
- **Fixes**—provides actual repair information for related repairs.

# Section 5

# Vehicle Code Scan



Code Scan allows you to quickly scan all supported vehicle control modules for codes and monitor readiness.

## Wi-Fi Required



Wi-Fi connection is required to use certain functions of this feature. See [Wi-Fi Connection / Troubleshooting](#) on page 127.

## IMPORTANT

**PRE / POST Scan Importance - As many systems do not turn on the check engine light or other indicator, performing a vehicle code scan before making any repairs may help in troubleshooting, by identifying possible unknown issues that may be related to the present symptoms.**

**Performing pre and post scans also allows you to record in report format the pre-condition of the vehicle and compare the post scan after work is complete to confirm the repairs were completed properly.**

**Pre and post scan is required by some manufacturers for collision work as well as by some insurance companies.**

Page: 1 2016 Nissan Rogue 2.5L L4 MFI (QR25DE) Date: 04/01/2020 10:16AM

### Pre-Scan Vehicle System Report

2016 Nissan Rogue 2.5L

VEHICLE INFORMATION

VIN	JN8ASMT0FW000000
MAKE	Nissan
YEAR	2016
MODEL	Rogue
ENGINE	2.5L L4 MFI (QR25DE)
SYSTEM	CodeScan
LICENSE PLATE	
ODOMETER	

NOTES

CODE SCAN RESULTS

Systems Analyzed: 10

- Engine: 0
- Transmission: 0
- Antilock Brakes: 0
- Airbag: 0
- Body Control Module - Codes: 0
- Electronic Power Steering: 0
- Intelligent Power Distribution Module: 0
- Meter: 0
- Tire Pressure Monitor - Codes: 0
- OBDII: 0

Body Control Module - Codes

- C1704 | Low Pressure Left Front
- C1706 | Low Pressure Right Rear
- C1707 | Low Pressure Left Rear

Tire Pressure Monitor - Codes

- C1704 | Low Pressure Left Front
- C1706 | Low Pressure Right Rear
- C1707 | Low Pressure Left Rear

READINESS MONITORS

Tests Complete

- Misfire
- Fuel System
- Comprehensive Component
- EGR/VVT
- Catalyst
- Evaporative System
- Oxygen Sensor
- Oxygen Sensor Heater

Page: 1 2016 Nissan Rogue 2.5L L4 MFI (QR25DE) Date: 04/01/2020 2:14PM

### Post-Scan Vehicle System Report

2016 Nissan Rogue 2.5L

VEHICLE INFORMATION

VIN	JN8ASMT0FW000000
MAKE	Nissan
YEAR	2016
MODEL	Rogue
ENGINE	2.5L L4 MFI (QR25DE)
SYSTEM	CodeScan
LICENSE PLATE	
ODOMETER	

NOTES

CODE SCAN RESULTS

Systems Analyzed: 10

- Engine: 0
- Transmission: 0
- Antilock Brakes: 0
- Airbag: 0
- Body Control Module: 0
- Electronic Power Steering: 0
- Intelligent Power Distribution Module: 0
- Meter: 0
- Tire Pressure Monitor: 0
- OBDII: 0

READINESS MONITORS

Tests Complete

- Misfire
- Fuel System
- Comprehensive Component
- EGR/VVT
- Catalyst
- Evaporative System
- Oxygen Sensor
- Oxygen Sensor Heater

Figure 5-1



# 5.1 Using Code Scan

## NOTE

Code Scan is not supported on all vehicles.

## Navigation

Home Screen: **Scanner > (Identify Vehicle) > Code Scan (System Menu)**

Select **Code Scan** from the System menu (*Figure 5-2*).



Figure 5-2

Choose which type of **Code Scan**, **Pre** or **Post Scan** (*Figure 5-3*). This selection determines the type of report header that is displayed, see *Figure 5-1* for example.



Figure 5-3

**Code Scan** runs an active scan of vehicle control modules, and then displays the results (*Figure 5-4*).

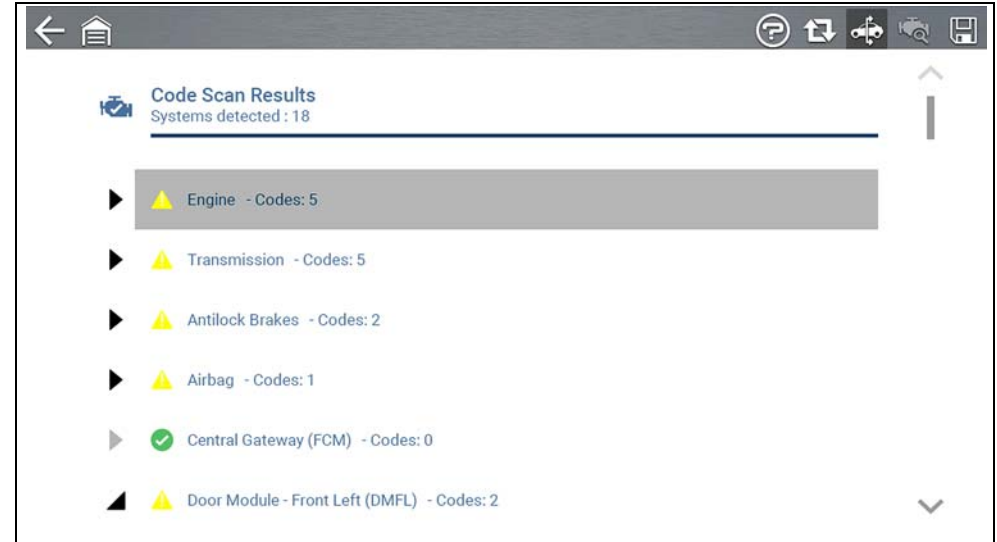

Figure 5-4

Code Scan result descriptions are provided in the following sections.





After the code scan has completed it is automatically saved as an .XML file on the diagnostic tool, and is uploaded to your Snap-on Cloud account.

- To view the report on the diagnostic tool, see [Viewing /Printing Saved Codes and Code Scan Results](#) on page 121.
- To view/print the report on the Snap-on Cloud, see [Vehicle System Report](#) on page 45.

## IMPORTANT

**Selecting *Clear All Codes Read by Code Scan* erases all DTCs from all vehicle system modules that were read by Code Scan. Selecting this function may not clear global OBD-II codes on some vehicles.**



Code Scan Icons	
	Refresh - Refreshes (restarts) the code scan
	System - Opens the main menu of the system selected (highlighted)
	Diagnose - Opens <a href="#">Fast-Track® Intelligent Diagnostics</a> for the code selected (highlighted)
	Save - Saves the code scan results as an (.XML) file. See <a href="#">Viewing /Printing Saved Codes and Code Scan Results</a> on page 121.
	Help - Opens the Getting Started with Fast-Track® Intelligent Diagnostics demonstration. See <a href="#">Demonstration</a> on page 46.

### 5.1.1 Total Number of Systems (modules) Analyzed

The total number of systems analyzed is actively displayed at the top of the screen as they are scanned.

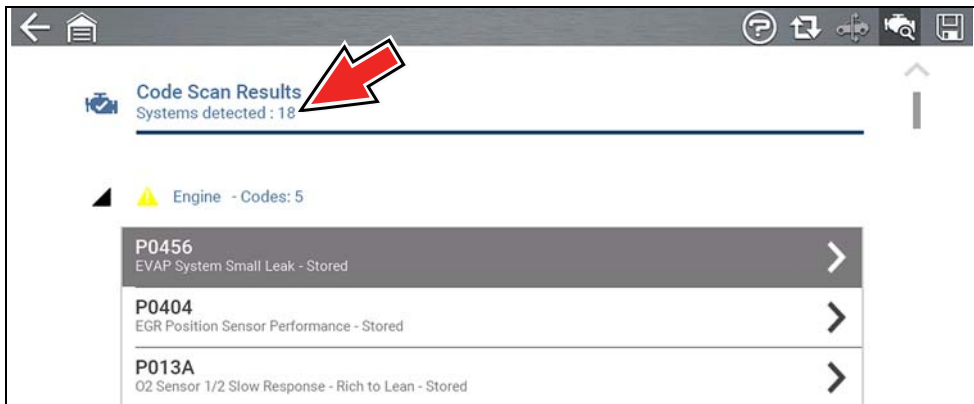

Figure 5-5

### 5.1.2 List of All the Systems Analyzed with DTCs Totals

A categorized system list with DTC totals is displayed in the order they are scanned. To view the main menu for a system in the list, select the system or select the **System** icon ([Figure 5-6](#)).

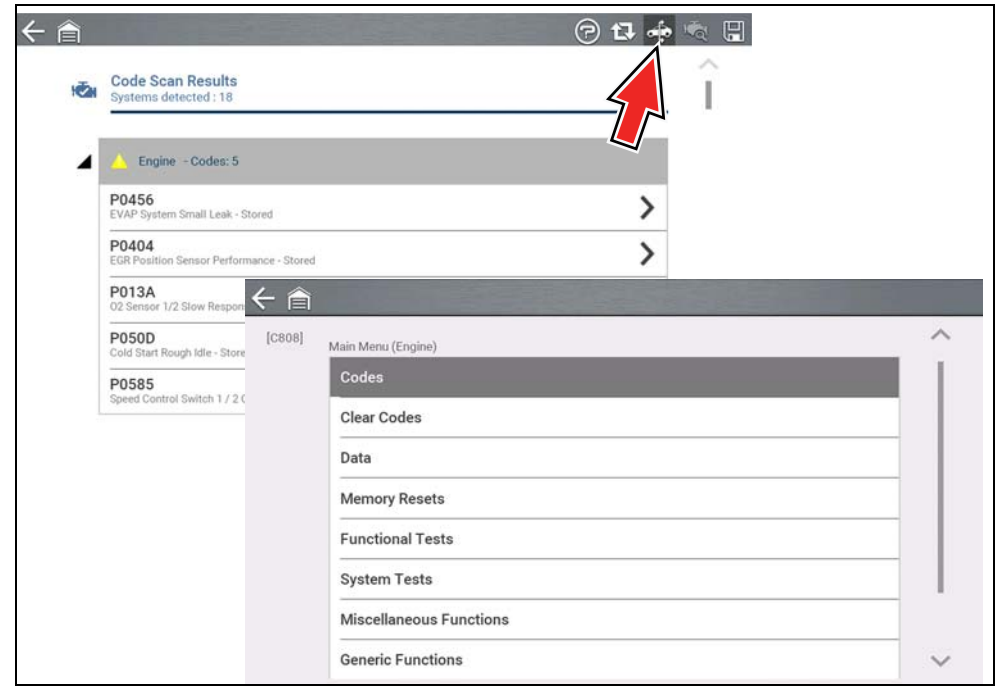

Figure 5-6

Select the **expand/collapse** icon (*Figure 5-7*) on the left side of a system category title to expand or collapse a systems' DTC list.

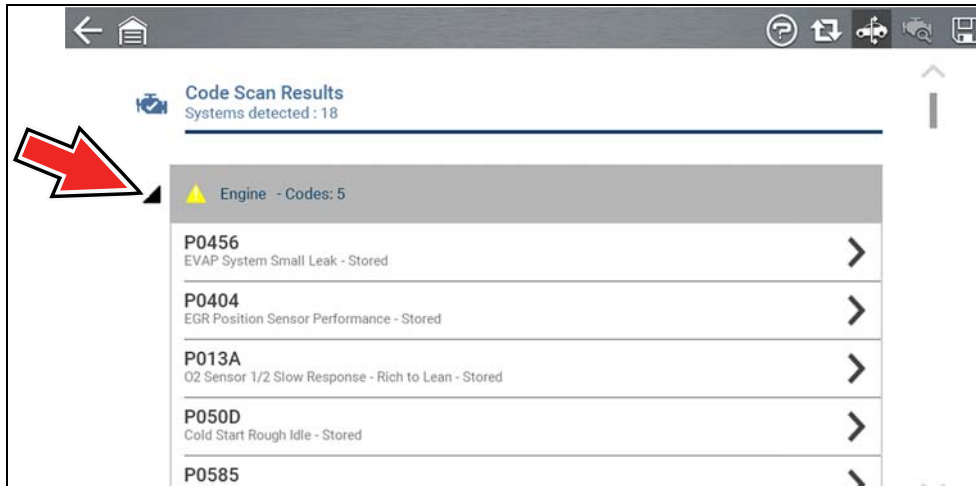

Figure 5-7

### 5.1.3 Global OBDII DTCs

Towards the end of the Code Scan list Global OBDII DTCs are displayed.

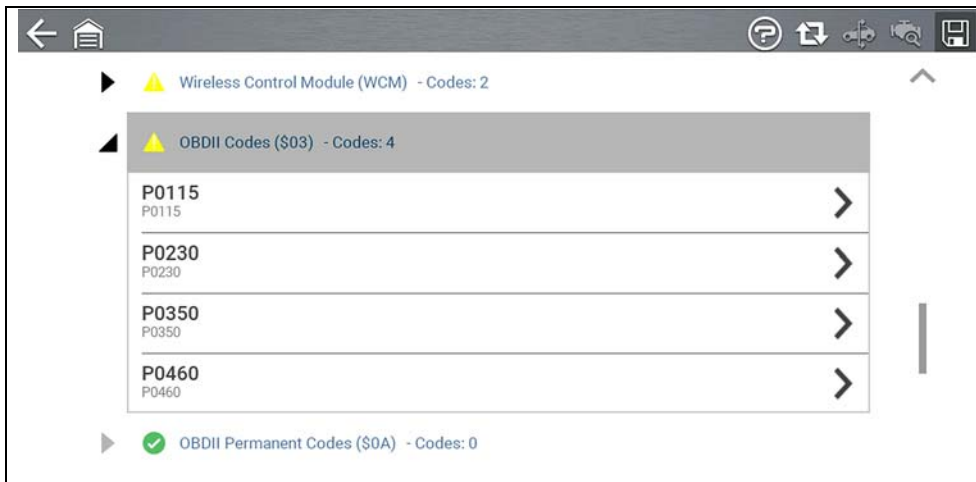

Figure 5-8

### NOTE

Some 2005 to 2008 vehicles may not display global OBD-II information in the Code Scan list. A message will be displayed to inform you the OBD-II - codes and monitors for this vehicle may be accessed using the global OBD-II function. See [OBD-II/EODB](#) on page 113.

### 5.1.4 Readiness Monitor Test Status

At the end of the Code Scan list, readiness monitor test results are displayed as "Tests Complete" or "Not Complete".

Quick reference indicators are used to show monitor status.

- Green icon "✓" mark - Monitor test is complete
- Grey icon "—" mark - Monitor test is not complete

Monitors that are not supported by the vehicle are not displayed in Code Scan.

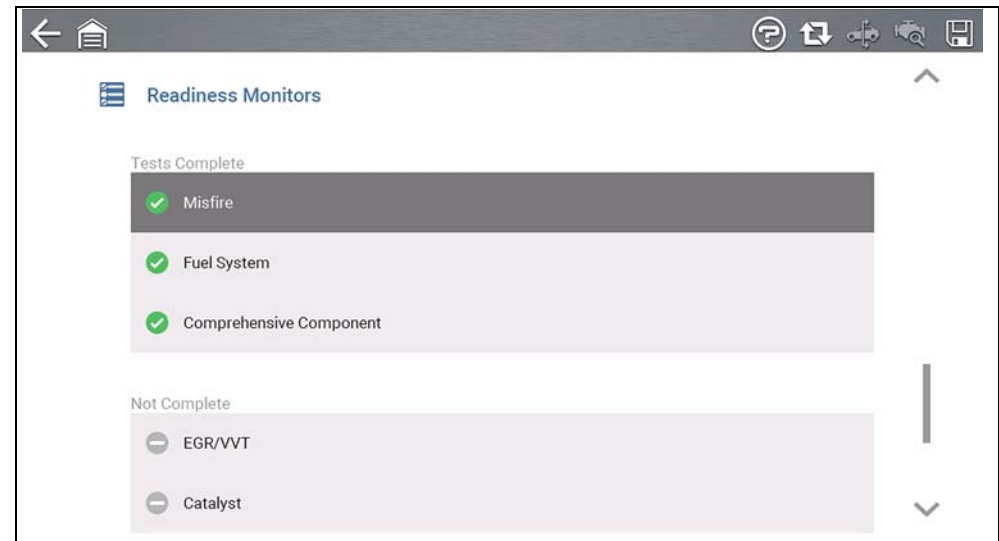

Figure 5-9



## 5.2 Vehicle System Report

After a code scan is completed the results of the scan are automatically configured into a Vehicle System Report that is uploaded and saved to your Snap-on Cloud account (if registered and connected). Report examples are shown in [Figure 5-1](#).

Using the Snap-on Cloud, the report can be printed, downloaded, attached to an e-mail or other social media app to share with others. For additional information on using the Snap-on Cloud, see [Snap-on Cloud on page 13](#).

### **i** NOTE

*Code scan reports are automatically saved each time a code scan is performed. The report is automatically uploaded to your Snap-on Cloud account, if registered and Wi-Fi is connected.*

The code scan/vehicle system report includes:

- Basic vehicle information
- A list of the code scan results by system
- Individual system DTCs with a brief description
- Global OBD codes
- Readiness monitor test status

### 5.2.1 Printing the Vehicle System Report

Use the Snap-on Cloud to print the vehicle system report from your PC or mobile device, see [Snap-on Cloud on page 13](#).

The vehicle system report can also be customized and printed using ShopStream Connect - See [ShopStream Connect™ \(Connecting to your PC\) on page 14](#).

## Introduction

Fast-Track® Intelligent Diagnostics saves you time by providing access to code related data, information, and tests, all from one screen. It allows you to quickly find TSB's, smart data PID lists, out-of-range PIDs, functional tests, Sure Track Top Repairs Graph and Real Fixes, and more all at a glance.

In addition, you can directly access all (not just code related) PIDs and functional tests from one place, as compared to accessing them separately through the individual system menus.

## Wi-Fi Required



Wi-Fi connection is required to use this application. See [Wi-Fi Connection / Troubleshooting](#) on page 127.

## 6.1 Demonstration



Selecting the **Help icon** ([Figure 6-1](#)), starts a Fast-Track® Intelligent Diagnostics slideshow demonstration describing the basic features of Fast-Track® Intelligent Diagnostics.

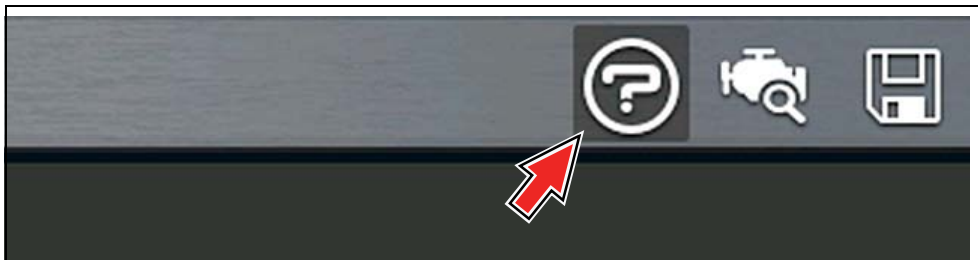

Figure 6-1

Demonstration example screens are shown in [Figure 6-2](#).

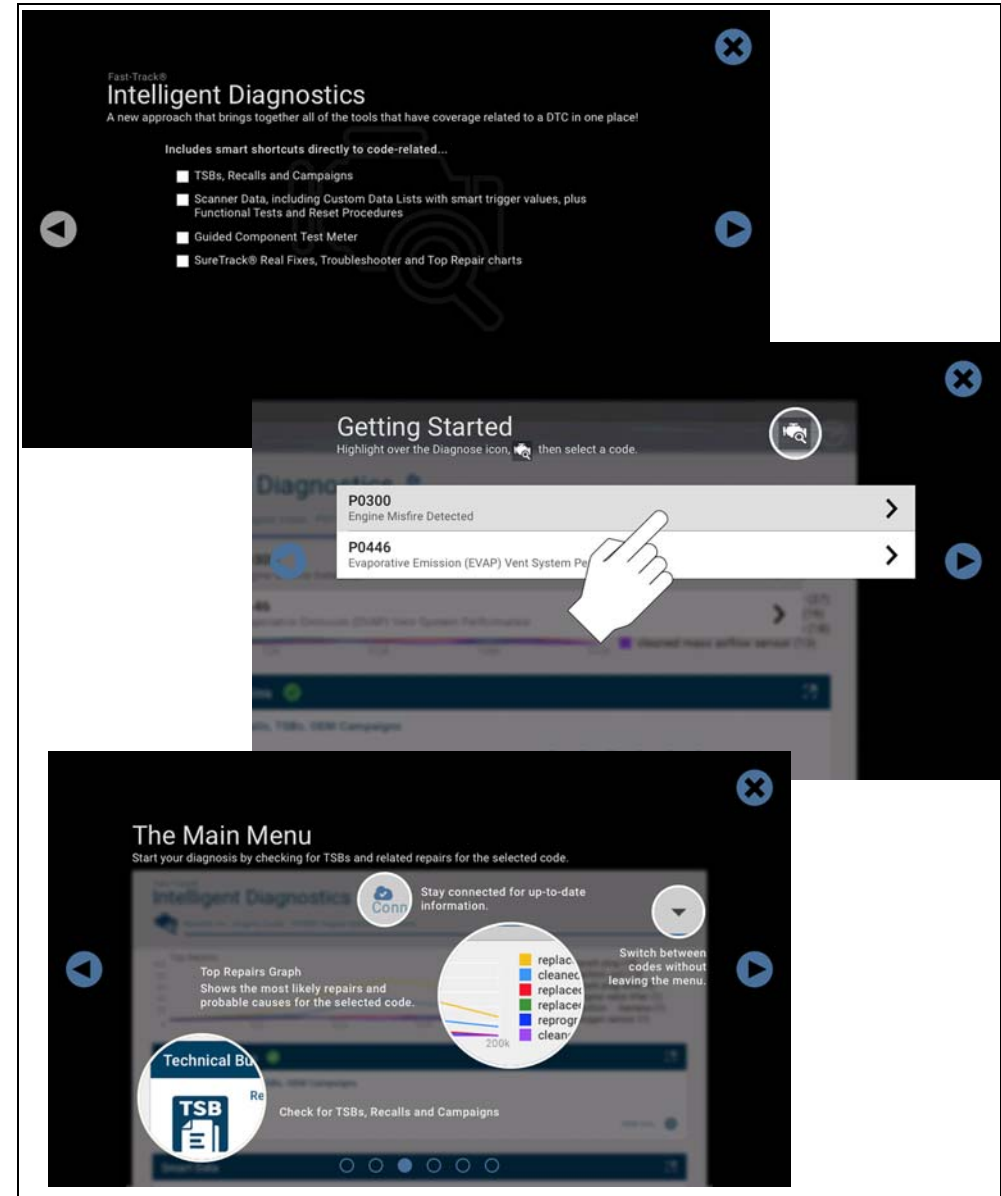

Figure 6-2

## 6.2 Accessing Fast-Track® Intelligent Diagnostics

To access Fast-Track® Intelligent Diagnostics, you must:

- have authorized access. Contact your sales representative for information.
- have a Wi-Fi connection. For Wi-Fi setup and connection see, [Wi-Fi Connection / Troubleshooting](#) on page 127.

### Navigation

**(Typical Navigation) Home Screen: Scanner (Vehicle Identification) > (Vehicle System Menu) > (Vehicle System Main Menu) > (Codes Menu) > (Code Results) Diagnose Icon**

Fast-Track® Intelligent Diagnostics may also be accessed when viewing codes in Code Scan or in individual systems.



Figure 6-3

## 6.3 Main Menu

Fast-Track® Intelligent Diagnostics functions are contained in a common multi-card main menu ([Figure 6-4](#)). Card functions are described in the following sections.

Fast-Track® Intelligent Diagnostics and Scanner share some common functions. Cross references are used in the following sections for the applicable common information.

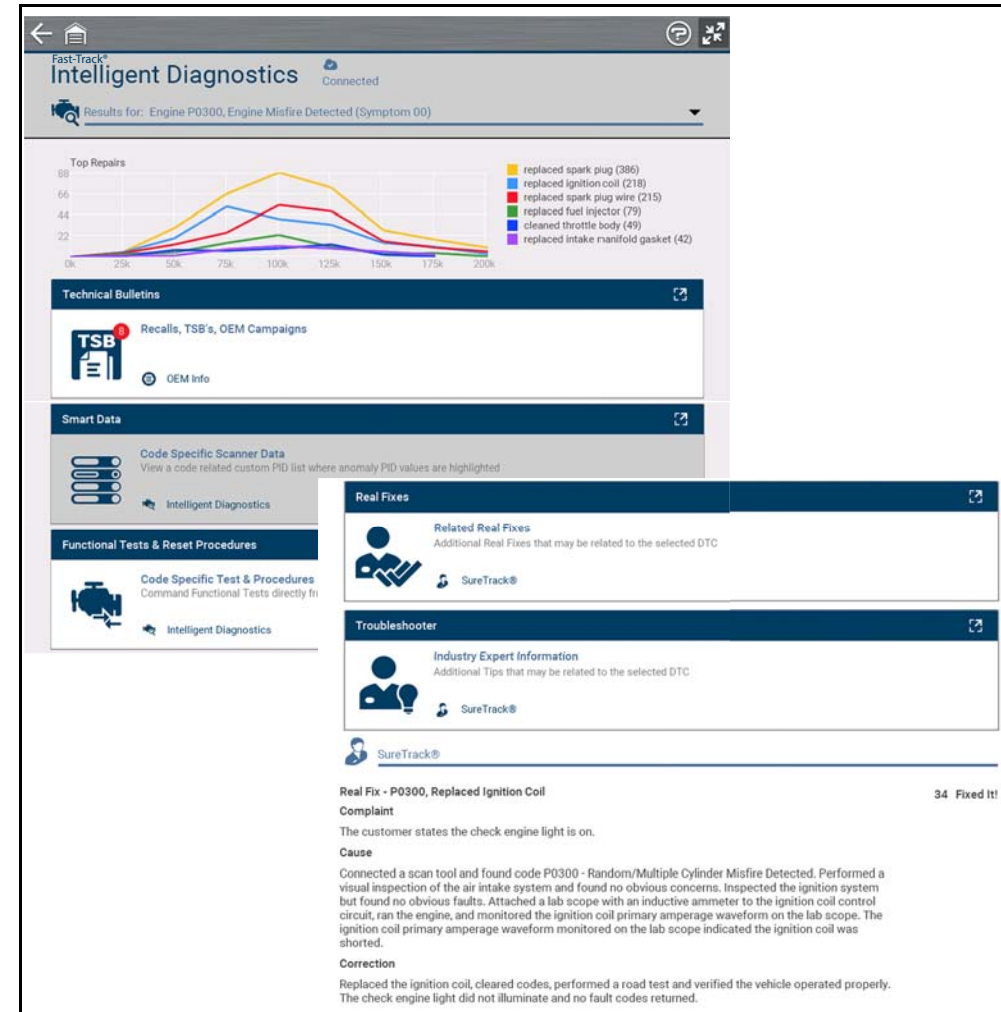

Figure 6-4

## 6.4 Wi-Fi Status Indicator

The cloud icon indicates Wi-Fi connection status (*Figure 6-4*). This icon is also used to indicate Fast-Track® Intelligent Diagnostics service expiration. The icon will change red in color and display “Expired” when your service has expired.

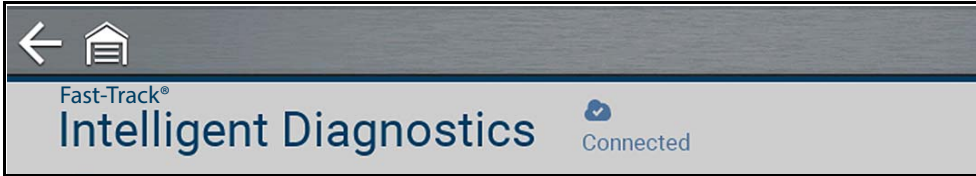

Figure 6-5

## 6.5 Code Results Dropdown Menu

The Code Results Dropdown menu allows you to quickly choose any of the scanned codes from the code results list. Select a code to view related information about that code within Fast-Track® Intelligent Diagnostics.

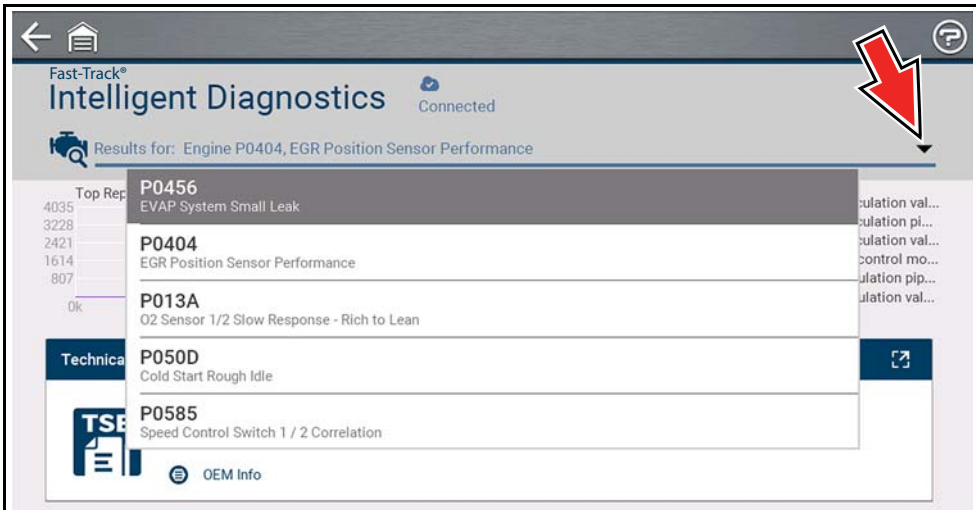

Figure 6-6

## 6.6 Top Repairs Graph

The Top Repairs Graph (*Figure 6-7*) shows the most common verified fixes and procedures for the selected code.

**Example** - In the graph shown below, the most common fix for the code was replacing the intake manifold gasket. This fix occurred 413 times, with the most occurrences (85) at 100k miles in vehicles with up to 200k miles.

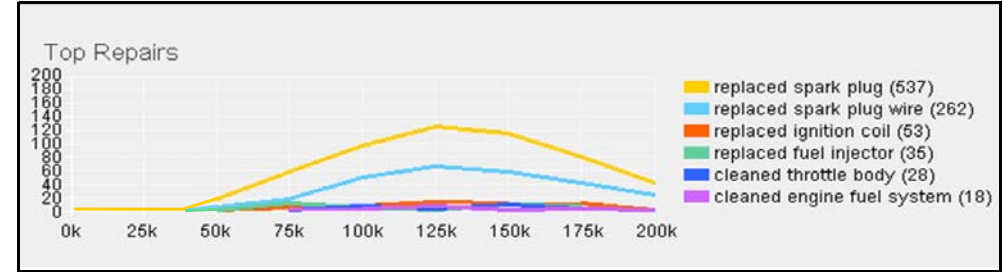

Figure 6-7

Depending on the information available, the graph may also include probable causes. See example in *Figure 6-8* “cleaned mass airflow sensor”.

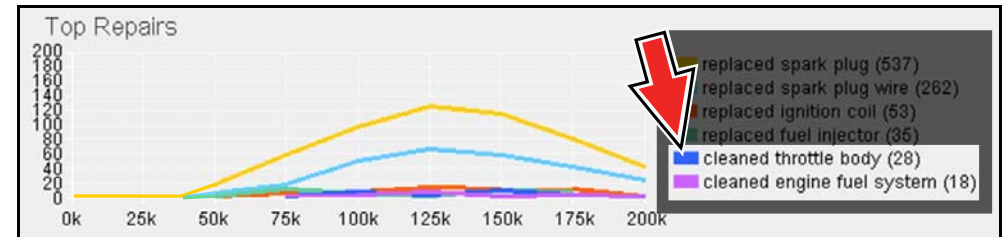

Figure 6-8

Select the Expand/Contract icon from the toolbar to change (toggle) the Top Repairs display mode. *Figure 6-9*.

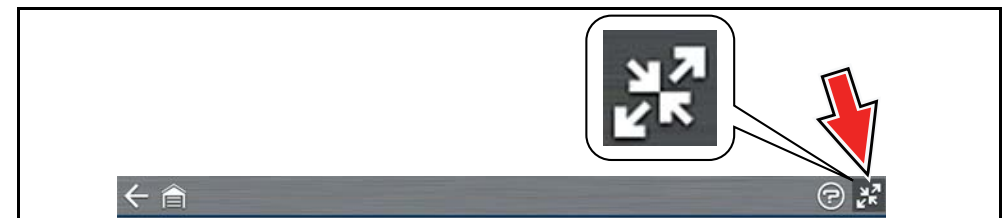

Figure 6-9

## 6.7 Technical Bulletins (OEM Information)

The Technical Bulletins card (*Figure 6-10*) provides a quick link to available OEM Recall, TSB and Campaign information that is code related.

A red icon (*Figure 6-10*) indicates the total number of Recalls, TSBs, and OEM Campaigns that have been found. Green check mark indicates no TSS's were found.

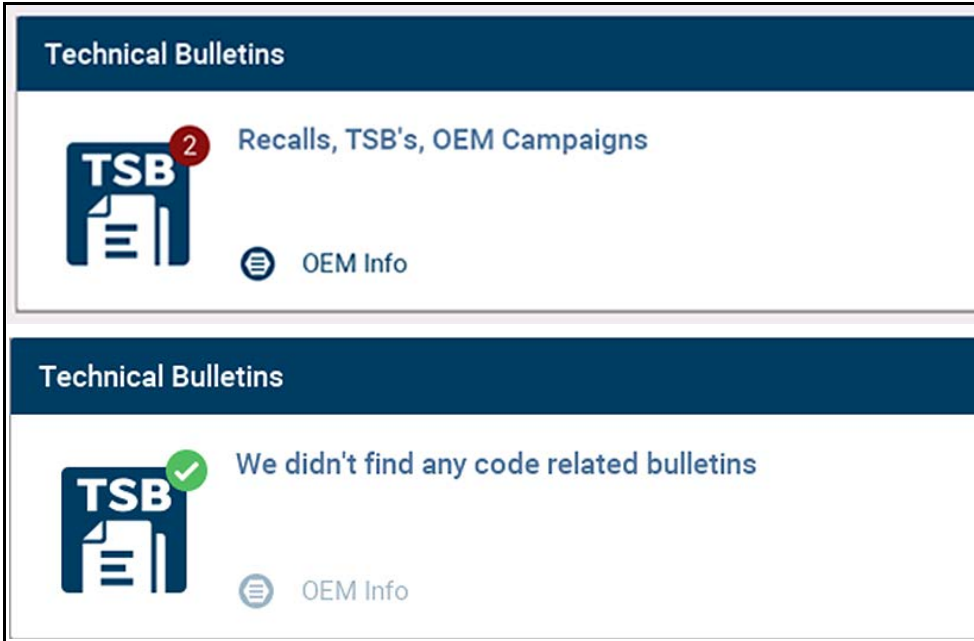

Figure 6-10

Select a topic from the list (*Figure 6-11*) to view detailed information on the topic (*Figure 6-12*).

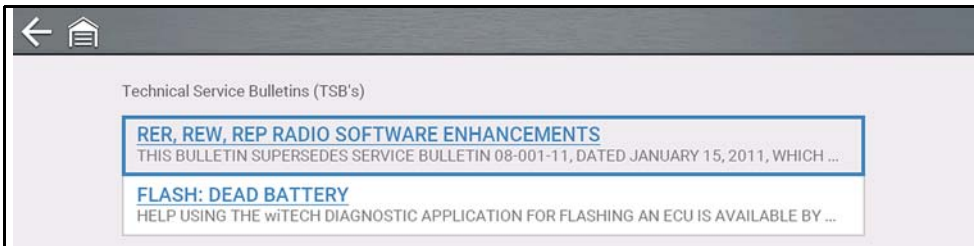

Figure 6-11

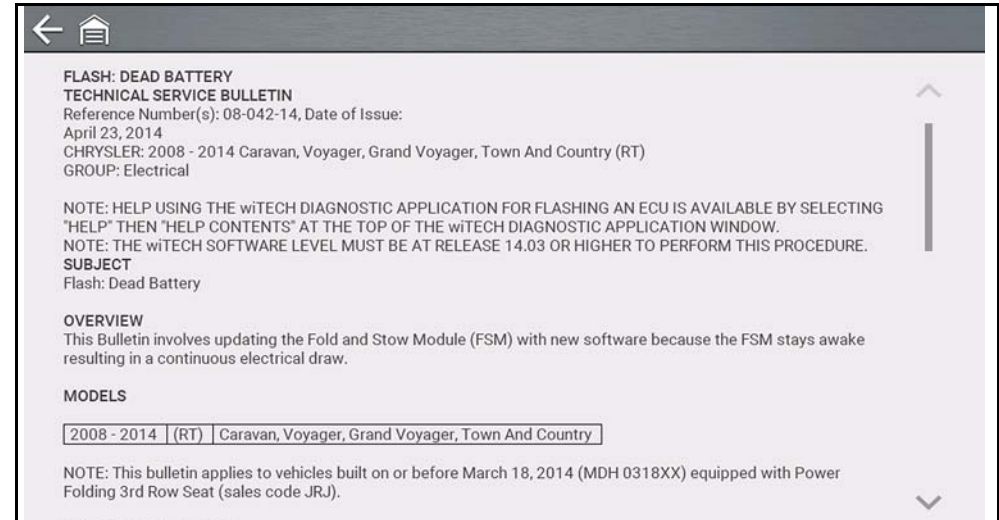

Figure 6-12



## 6.8 Smart Data

Smart Data automatically configures the data list to only show PIDs related to the selected code. Non-related PIDs are filtered out, to save you time. In addition, it highlights PIDs that are out of expected range.

As an added troubleshooting feature, you can also directly access all (not just code related) PIDs from one place, as compared to accessing them separately through the individual system menus.

### IMPORTANT

*Smart Data works best when the vehicle is idling at operating temperature with no load present. Always refer to OEM service information for specific PID range limit information.*

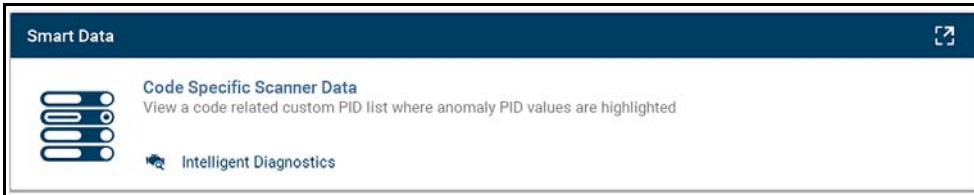

Figure 6-13

### PID List View (Figure 6-14)

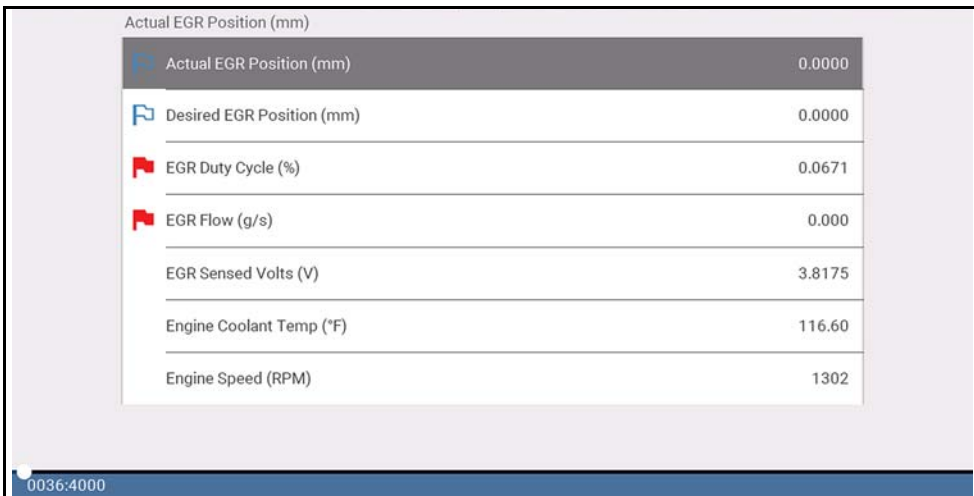

Figure 6-14

### PID Graph View (Figure 6-15)

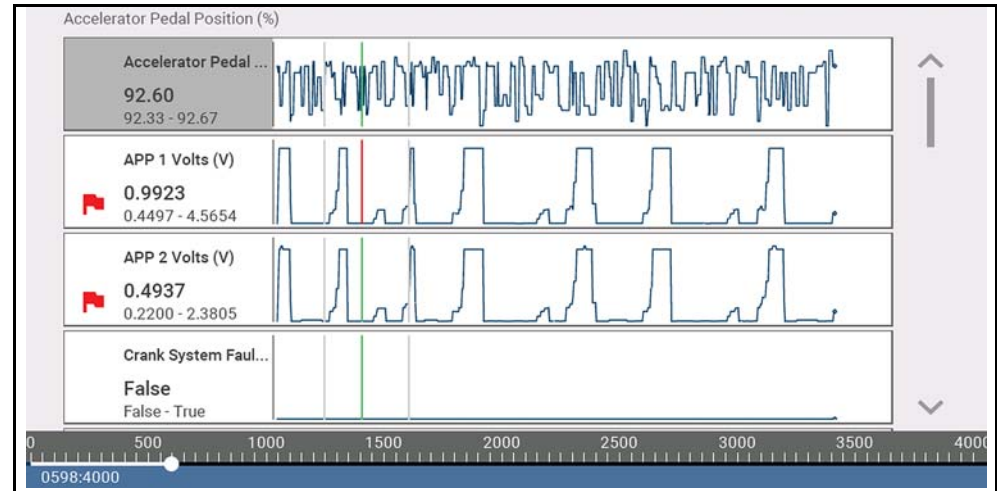

Figure 6-15

Selecting the **Back** icon opens the Smart Data main menu (Figure 6-16), which includes additional data list options (bottom of screen).

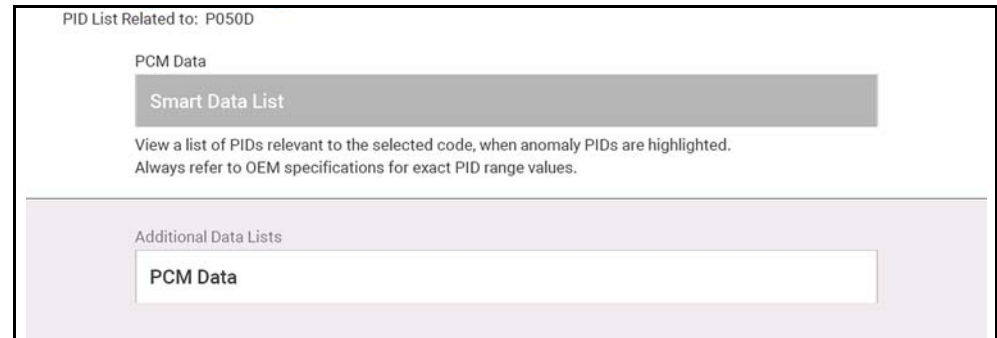



Figure 6-16



## 6.8.1 About Smart Data PIDs

### Features and operation of Smart Data PIDs:

- Any PID with a flag displayed has been preset and prearmed.
  - A red flag  indicates the PID trigger has been activated and is operating out of range.
  - A blue outlined flag indicates the PID is armed, and operating within its limits (trigger not activated).
- PID trigger points (upper/lower value limits) are automatically set using known-good upper/lower limit values.
  - **Note** - Upper/lower limit lines are not displayed on the graph, and values are not displayed in settings.
- Smart Data PID triggers can be (overridden) set manually, see [Using Triggers](#) on page 36 for instructions.
  - **Note** - Manually setting trigger values will override the preconfigured Smart Data values.
  - **Note** - Manually set triggers will display upper and lower trigger limit lines in the graph.

When a trigger is activated:

- Data collection continues briefly after the trigger point, then pauses as the Scanner captures a recording of the data. Data is saved leading up to and just past the trigger point.
- An audible alarm is sounded
- A message displays indicating a data file was saved.
- Data collection continues.
- The activated PID trigger is disarmed. **Note** - if a different PID trigger is activated subsequently, an additional data file will be recorded.
- A red cursor line is displayed on the graph ([Figure 6-17](#)) of the PID with the activated trigger to indicate where the trigger occurred.
- A green cursor line is displayed on all the other PID graphs to indicate their relationship to where the trigger occurred.
- A gray cursor line is displayed to indicate the point at which the data was paused to save the data file.

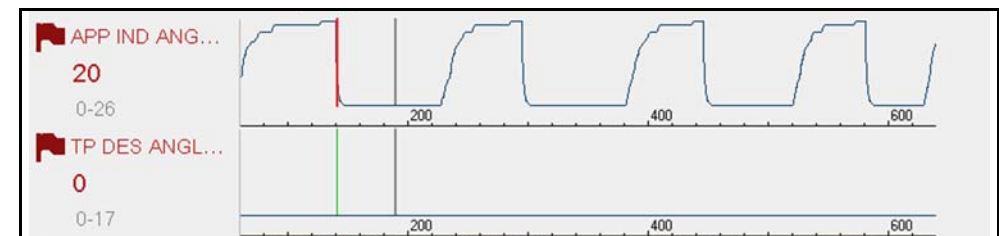

Figure 6-17 Triggers activated

## 6.9 Functional Tests and Reset Procedures

Functional Tests and Reset Procedures ([Figure 6-18](#)) provides access to supported code related bi-directional tests (to verify component operation) and reset procedures (to complete the repair).

In addition, you can directly access all (not just code related) functional tests from one place, as compared to accessing them separately through the individual system menus.

For additional information see [Functional Tests](#) on page 39.

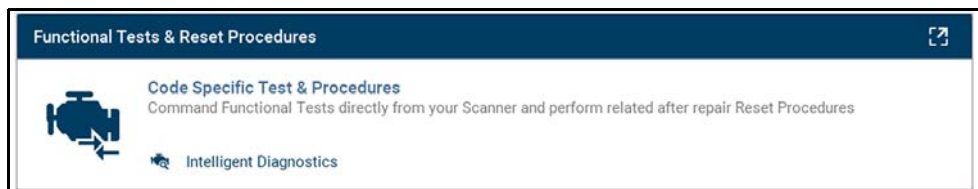

Figure 6-18

The upper list provides Functional Tests and Reset options related to the selected code. The lower list may provide additional Functional Tests and Reset options that are not code related, but are vehicle specific and may be useful in troubleshooting or validating repairs.

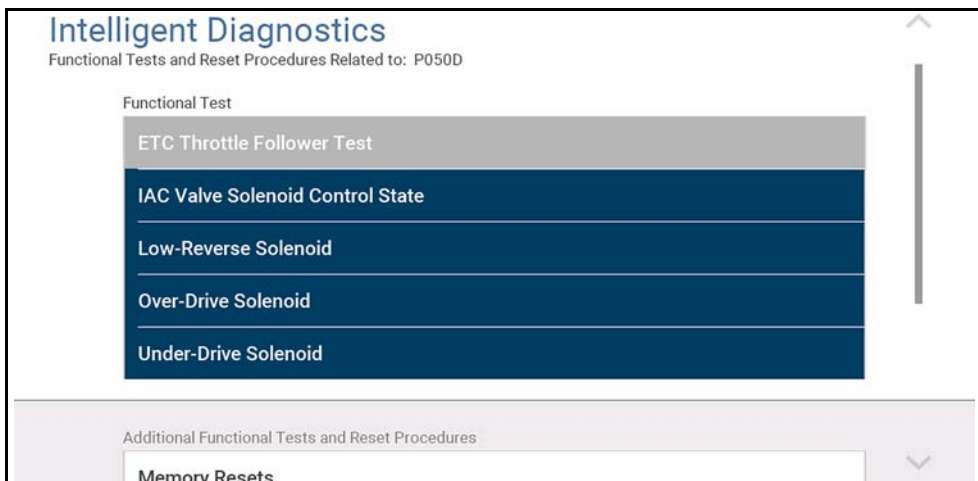

Figure 6-19

## 6.10 Real Fixes

The Real Fix displayed on the Main Menu ([Figure 6-20](#)) is the most common to date. The information is displayed in a Complaint - Cause - Correction format.

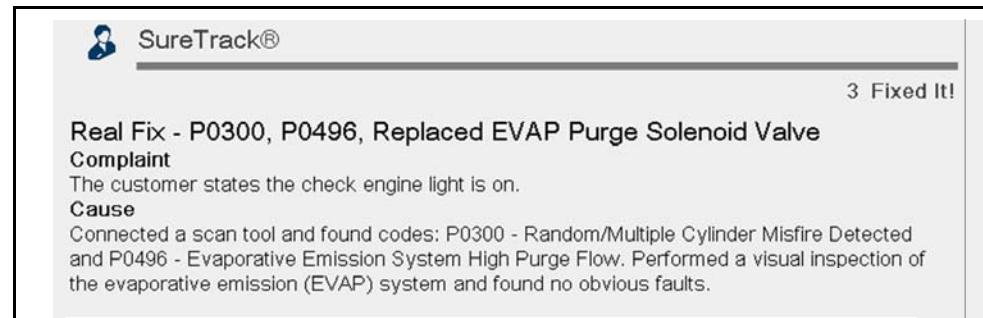

Figure 6-20

Real Fixes ([Figure 6-22](#)) provides a list of available code-related procedures, tests and repair tips (Real and Related Real Fixes) obtained from actual shop repairs.

Fixes may not be available for every vehicle and/or DTC.

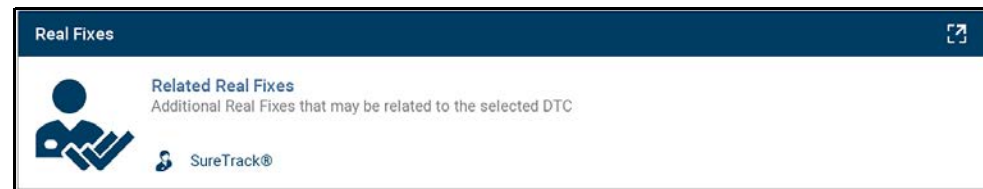

Figure 6-21

Select a **Related Real Fix** from the list ([Figure 6-22](#)) to view detailed information about the fix ([Figure 6-23](#)) in a Complaint - Cause - Correction format.



Figure 6-22



SureTrack®

---

**Real Fix - P0404, Replaced Exhaust Gas Recirculation Valve** 11510 Fixed It!

**Complaint**  
The customer states the check engine light is on.

**Cause**  
Connected a scan tool and found code P0404 - Exhaust Gas Recirculation "A" Control Circuit Range/Performance. At idle, monitored live scan tool data and observed the exhaust gas recirculation valve parameter was not within the specified range. Performed a road test while monitoring live scan tool data and observed the exhaust gas recirculation valve parameter was fixed. Performed an inspection of the exhaust gas recirculation system and detected no obvious faults. Removed the exhaust gas recirculation valve and a visual inspection revealed the pintle was damaged.

**Correction**  
Replaced the exhaust gas recirculation valve, cleared codes, performed a road test and verified the vehicle operated properly. The check engine light did not illuminate and no fault codes returned.

Figure 6-23

## 6.11 Troubleshooter

**Troubleshooter** (Figure 6-25) provides a list of available code-related tips gathered from industry professionals.

**NOTE**

*Troubleshooter Tips may not be available for every vehicle and/or DTC.*

Troubleshooter

**Industry Expert Information**

Additional Tips that may be related to the selected DTC

SureTrack®

Figure 6-24

Select a **Related Tip** from the list (Figure 6-25) to view the information (Figure 6-26).

Troubleshooter

**P0404**  
P0404: EGR Position Sensor Rationality Monitor State: Engine running. Code Set Condition: The ...

**P0404**  
P0404: EGR Position Sensor Performance Monitor State: The PCM performs two diagnostic ...

Figure 6-25

**Tip - P0404**

P0404: EGR Position Sensor Rationality Monitor State:  
Engine running.  
Code Set Condition:  
The EGR flow or valve movement is not what is expected. A rationality error has been detected from the EGR Close Position Performance. Two trip fault.  
Possible Causes:  
Excessive resistance in the egr sensor signal circuit  
Excessive resistance in the 5 volt supply circuit  
Excessive resistance in the egr solenoid control circuit  
Excessive resistance in the sensor ground circuit  
Egr solenoid ground circuit open  
Egr solenoid assembly  
PCM  
EBI (Tech Note):  
EGR position sensor is a 3 wire potentiometer similar to TPS. It is mounted on top of the EGR valve and measures pintle position.  
Use PID data to monitor EGR while driving

Figure 6-26



Quick Lookups provides access to vehicle manufacturer:

- Engine Oil Specifications and Reset Information
- Tire and Wheel Service Information and Reset Information

## Wi-Fi Required



Wi-Fi connection is required to use this application. See [Wi-Fi Connection / Troubleshooting](#) on page 127.

## Quick Links

- [Oil Specs and Resets](#) page 54
- [Tire and Wheel Service](#) page 57

## 7.1 Oil Specs and Resets

### Navigation

**Home Screen:** [Quick Lookups](#) > [Oil Specs and Resets](#)

The Oil Specs and Resets information service provides up-to-date OEM information on your diagnostic tool. Quick Lookups provides both OEM information and Scanner functions in one place.

Typical OEM information provided:

- Oil capacity and specifications
- Oil Service reset procedures and information
- Scanner Functional Resets

### NOTES

— *Oil Specs and Resets vehicle coverage is the same as the Scanner vehicle coverage.*

— *Not all vehicles may have on-board diagnostic tool reset capabilities, or have information available.*

— *To use the Oil Specs and Resets feature you must have authorized access, contact your sales representative for details.*

— *The diagnostic tool is equipped with the ability to connect to a Wi-Fi network, however the connection is solely dedicated to our Snap-on Information Service Network. Before you begin using an integrated Information Service you must connect to a wireless network. See [Wi-Fi Connection / Troubleshooting](#) on page 127 for instructions.*

— *If you experience a wireless network connection loss, Oil Specs and Resets information will not refresh and/or may cause the function to stop. To continue use, you must re-establish your Internet connection.*

— *Performance may vary depending on your wireless network equipment and ISP.*



## 7.1.1 Operation

There are two methods to access **Oil Specs and Resets**:

1. From the Home screen - select the **Quick Lookups** icon, then select Oil Specs and Resets.
2. From within a current Scanner session - select **Oil Specs and Resets** from the System menu (*Figure 7-1*).

Follow the screen prompts to ID the vehicle, then select an option:

- Perform a service interval reset using the diagnostic tool.
- View OEM service reset instructions and related information.

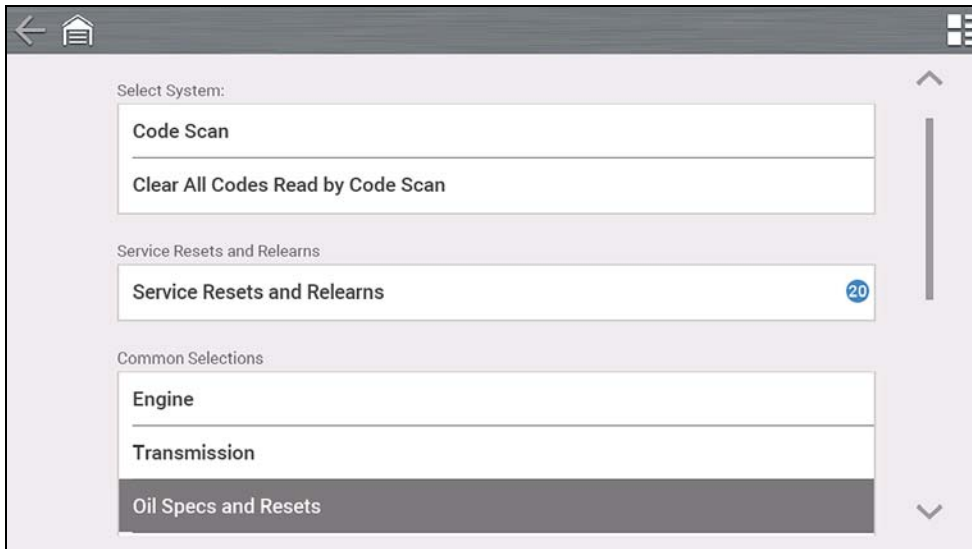

Figure 7-1

## 7.1.2 Fluid Capacity



Selecting the **Fluid Capacity** icon displays OEM recommended engine oil and capacity information (*Figure 7-2*).

Typical information may include:

- Vehicle application information
- Oil capacity specifications with or without oil filter
- Oil rating, weight and type
- Special notes

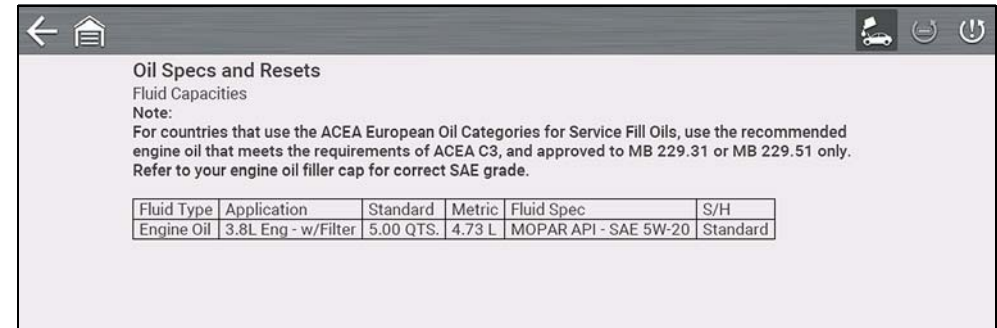

Figure 7-2



## 7.1.3 Functional Reset



Selecting the **Functional Reset** icon opens the service interval reset menu (within the Scanner function) for the selected vehicle, and includes functional resets for the oil service indicator and other supported resets.

Instructions may be provided, that are required to be performed before selecting or completing the reset function itself. Follow all instructions as written.

### NOTES

*Functional resets are not available for all vehicles, and will vary depending on vehicle support.*

*A “grayed out” or non-selectable icon indicates that functional resets are not available for the selected vehicle.*

*Service interval reset menus and selections, will vary by manufacturer.*

1. Select the **Functional Reset** icon.
2. Select the applicable menu option(s) to perform the functional reset.
3. Read and perform any instructions that are provided.
4. If applicable, once the reset has completed select **OK** or **Continue**.  
The following screen examples ([Figure 7-3](#)) illustrate typical indicator reset screens.

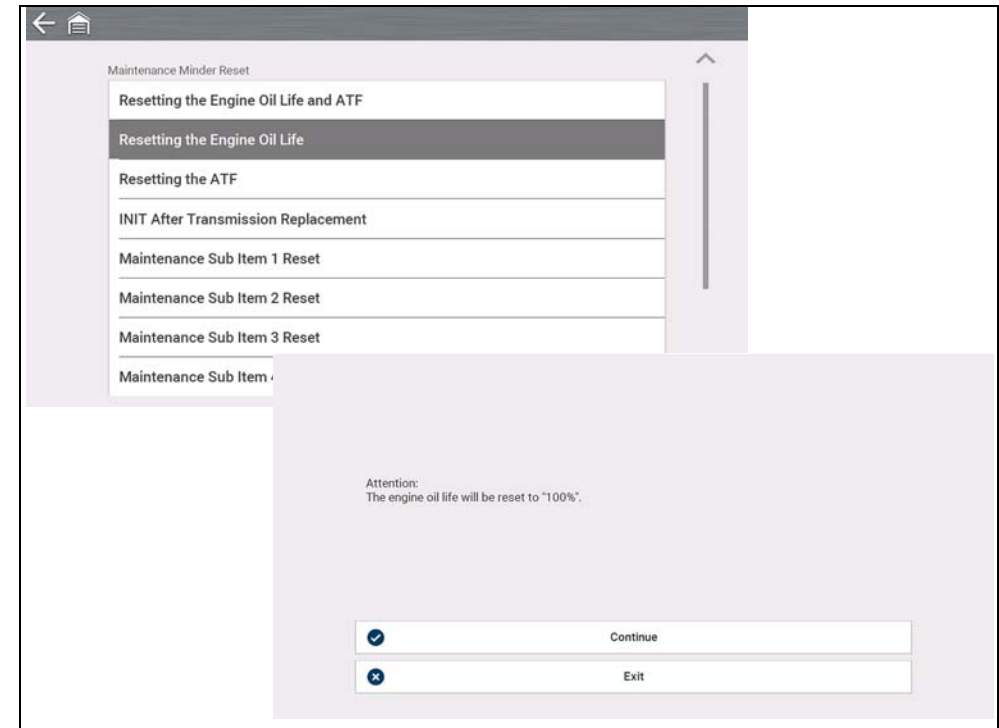

Figure 7-3

## 7.1.4 Reset Procedure



Selecting the **Reset Procedure** icon displays OEM oil service reset instructions.

Typical information may include:

- Step-by-step instructions for manually resetting the oil service reset indicator using on-board vehicle functionality (e.g. instrument cluster controls, accelerator pedal, information or media center controls, multi-function switch, etc.)
- Special notes, and/or instructions
- Theory of operation

The following are examples ([Figure 7-4](#)) of typical oil service reset instructions.

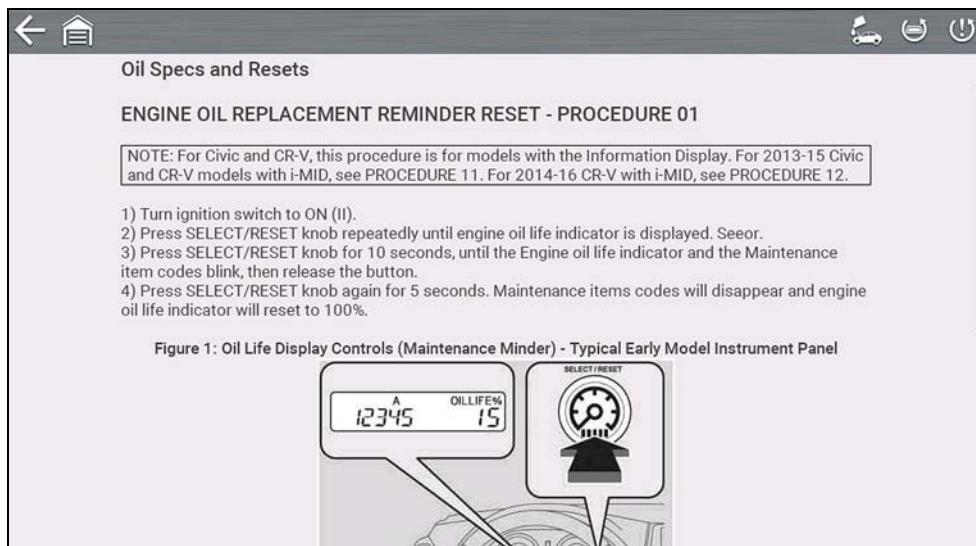

Figure 7-4

## 7.2 Tire and Wheel Service

### Navigation

**Home Screen:** Quick Lookups > Tire and Wheel Service

The Tire and Wheel Service Information Service provides up-to-date information on your diagnostic tool. This feature allows you quick access to the following information:

- Tire Pressure Monitoring System (TPMS) Indicator Reset Procedures
- TPMS Relearn Procedures
- Tire Pressure Sensor Removal/Installation Procedures
- Tire Fitment Specifications

The following may also be available when connected to a vehicle:

- View and Clear TPMS Related Codes
- View TPMS Related Data
- Perform TPMS Related Functional Tests
- View TPMS Troubleshooter Information

### NOTES

— *Tire and Wheel Service vehicle coverage is the same as the Scanner vehicle coverage.*

— *Not all vehicles may have on-board diagnostic tool reset capabilities, or have information available.*

— *To use the Tire and Wheel Service feature you must have authorized access, contact your sales representative for details.*

— *The diagnostic tool is equipped with the ability to connect to a Wi-Fi network, however the connection is solely dedicated to our Snap-on Information Service Network. Before you begin using an integrated Information Service you must connect to a wireless network. See [Wi-Fi Connection / Troubleshooting](#) on page 127 for instructions.*

— *If you experience a wireless network connection loss, Tire and Wheel Service information will not refresh and/or may cause the function to stop. To continue use, you must re-establish your Internet connection.*

— *Performance may vary depending on your wireless network equipment and ISP.*



## 7.2.1 Operation

There are two methods to access **Tire and Wheel Service**:

1. From the Home screen - select the **Quick Lookups** icon, then select **Tire and Wheel Service**.
2. From within a current Scanner session - select **Tire and Wheel Service** from the System menu ([Figure 7-5](#)).

Follow the screen prompts to ID the vehicle, then select an option.



Figure 7-5

## TPMS Indicator Reset



Selecting the **TPMS Indicator Reset** icon displays TPMS indicator reset instructions.

Typical information may include:

- Instructions for manually resetting the TPMS indicator using on-board vehicle functionality.
- Special notes, and/or instructions
- Theory of operation

The following example ([Figure 7-6](#)) shows typical TPMS indicator reset instructions.

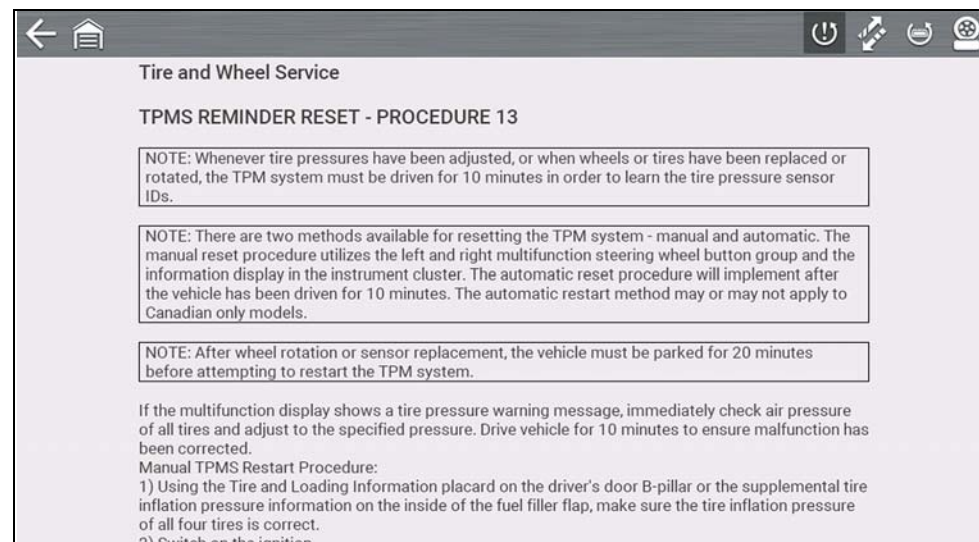

Figure 7-6



## TPMS Remove & Repair (TPMS Service)



Selecting the **Remove & Repair (TPMS Service)** icon displays TPMS service information.

Typical information may include:

- Removal and installation instructions.
- Relearn/enable procedures
- Diagnostic testing procedures
- Theory of operation

The following are examples (*Figure 7-7*) of typical TPMS service procedures.

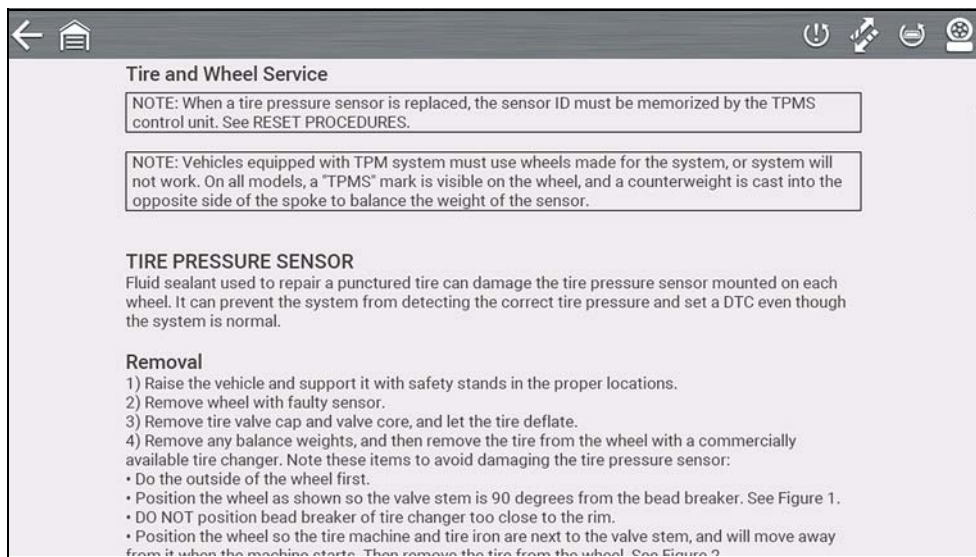

Figure 7-7

## Scanner Functions



Selecting the **Scanner Function** icon opens the TPMS Scanner test menu for the selected vehicle.

Options may include:

- View and Clear Codes
- View Data
- Perform TPMS Related Functional Tests/Resets
- View TPMS Troubleshooter Information

### IMPORTANT

**Functional test instructions may be provided, that are required to be performed before selecting or completing the function itself. Follow all instructions as written.**

### NOTES

*Scanner functions require connection and communication with the vehicle.*

*Functional tests/resets are not available for all vehicles, and will vary depending on vehicle support.*

*A “grayed out” or non-selectable icon indicates that functional resets/resets are not available for the selected vehicle.*

*Service test/reset menu titles will vary by manufacturer.*

The following screen examples (*Figure 7-8*) illustrate some typical TPMS functional test screens.

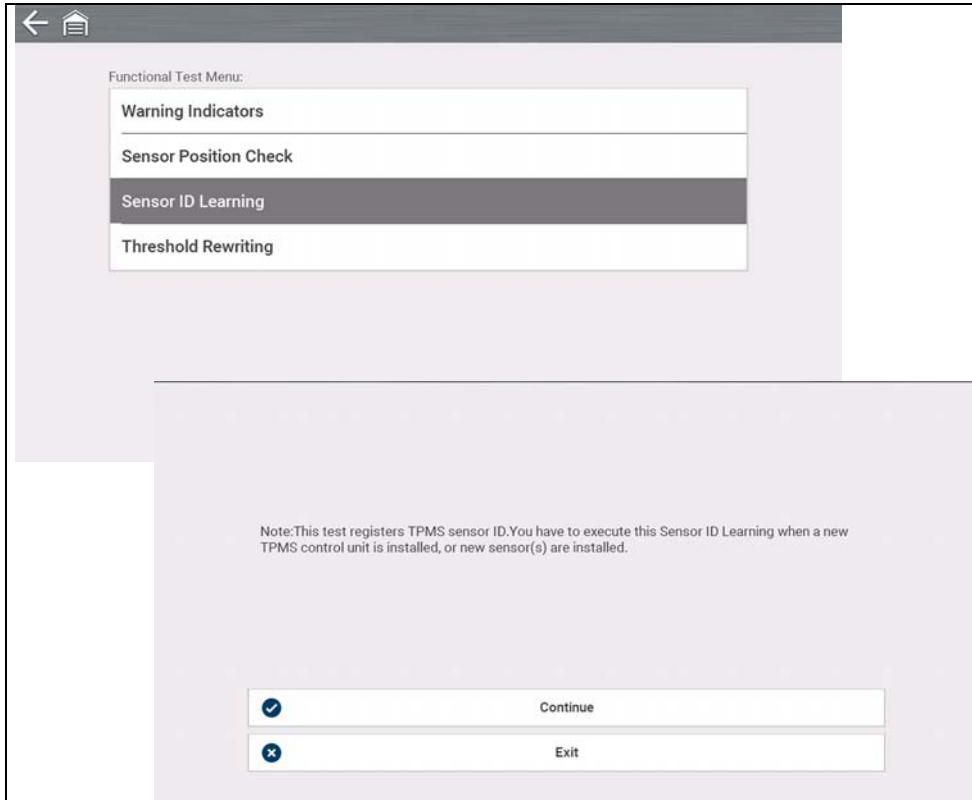

Figure 7-8

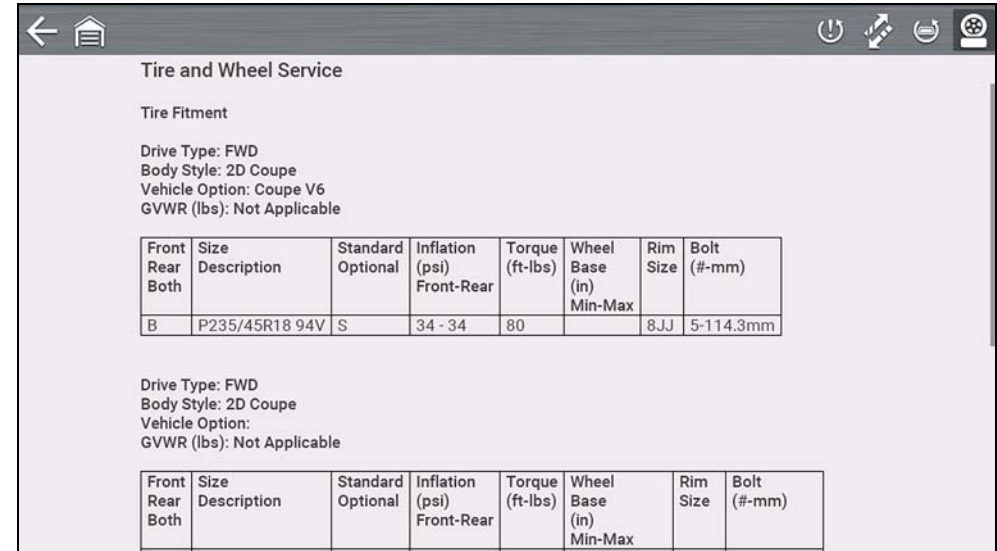

Figure 7-9

## Tire/Wheel Specifications (Fitment)



Selecting **Tire/Wheel Specifications** displays OEM tire and wheel specifications ([Figure 7-9](#)).

Typical information may include:

- Tire size and pressure
- Wheel hub stud size and lug torque
- Wheel size



The Guided Component Tests function provides you with an extensive collection of vehicle specific component tests and reference information. It is like having access to a complete library of automotive repair manuals for testing multiple vehicle components.

The preconfigured meter tests and reference information provided are vehicle specific and designed to help save you diagnostic time, verify faulty components, and verify the repair.

Detailed instructions and reference information are provided to guide you through the testing process, from locating the component, to selecting the appropriate test, showing test lead connections, and illustrating electrical connector and pin configurations. In addition, test results (including waveform examples), procedures, tips, and specifications may also be provided.

## **i** NOTE

*Availability of Guided Component Tests features will vary. Not all features/tests are available in all markets.*

As an added resource, the Training and Classes feature provides even more support by including (non-vehicle specific) tests and resources that allow you to quickly perform common tests, review basic reference information and more.

## Main Topic Links

- [Training and Classes](#) page 61
- [Screen Layout and Icons](#) page 64
- [Operation](#) page 65
- [Component Information](#) page 66
- [Tests](#) page 67
- [Saving and Reviewing Data Files](#) page 69

## 8.1 Training and Classes

Training and Classes is a companion feature to the Guided Component Tests function. This resource includes a wide collection of common (non-vehicle specific) reference information and tests, such as measuring fuel pump current ramp, and monitoring CKP and CMP signals simultaneously. Also included are, basic component operation and theory information, testing procedures, tips, definitions, illustrations, diagnostic tool feature descriptions and accessory information.

### Navigation

**Home Screen:** [Guided Component Tests > Training and Classes](#)

Selecting **Training and Classes** from the Vehicle Make menu ([Figure 8-1](#)) provides the following menu options:

- [Power User Tests](#)
- [Features and Benefits](#)
- [How To](#)

## **i** NOTE

*All features and information are subject to change. The following is for reference only.*

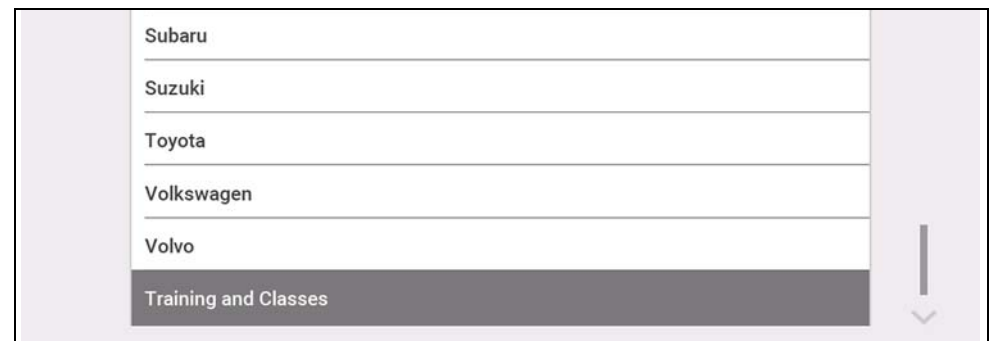

Figure 8-1



## 8.1.1 Power User Tests

### Navigation

**Home Screen:** [Guided Component Tests > Training and Classes > Power User Tests](#)

**Power User Tests** provide you quick access to preconfigured meter tests for a number of common automotive system tests. Most tests provide onscreen help and testing information along with a description of the test and the expected results, including known good waveforms.

Here is a sample listing of the types and specific tests that may be available within Power User Tests:

- **Current Probe Tests** - provides common tests configured to use the Snap-on Low Amp Current probes or generic Low Amp Current probes. Snap-on Low Amp Current Probe operation information is also provided within the *Snap-on Low Amp Probe Reference Manual* option.
  - Fuel Injector Current Ramp (multiple types)
  - Fuel Pump Current Ramp
  - Fuel Pump RPM Calculation
  - Ignition Coil Current Ramp (multiple types)
  - Parasitic Draw
  - Snap-on Low Amp Probe Reference Manual
- **Dual Channel Tests** - provides common tests configured to measure or compare two signals
  - CAN-BUS High/Low
  - CKP and CMP Relationship
  - EGR Solenoid and Position Sensor
  - EVAP Solenoid and Diagnostic Switch
  - FlexRay Bus
  - Injector and Oxygen Sensor
  - Knock Sensor and EST
  - MC Dwell and Oxygen Sensor
  - Pre and Post Cat Oxygen Sensors
  - Throttle Positions 1 & 2
  - WSS (Hall Effect Type)

- **Transducer Tests** - provides common single and dual channel tests configured to measure various types of pressures, voltage and current. Transducers are available as optional equipment.
  - A/T Line Pressure and Shift Solenoid
  - A/T Line Pressure Test
  - EGR Temperature Sensor and EGR Vacuum
  - Exhaust Back Pressure Test
  - Fuel Pressure and Fuel Pump Current and Voltage
  - Fuel Pressure Test

## 8.1.2 Features and Benefits

### Navigation

**Home Screen:** [Guided Component Tests > Training and Classes > Features and Benefits](#)

Selecting **Features and Benefits** provides basic feature description and operational information about the diagnostic tool. Additional information is provided for ShopStream Connect, optional waveform demonstration boards and optional accessories. Selections include:

- **5-Minute Walk Thru With Demo Board**—provides instructions on the operation of the optional waveform demonstration board(s) to sharpen your Lab Scope and Meter skills. Topics may include:
  - New Demo Board (PN) #EESX306A—provides functionality information and basic step-by-step demonstration information of multiple generated waveforms
  - Old Demo Board (PN) #SSP816—provides functionality information and basic step-by-step demonstration information for multiple generated waveforms

The optional demonstration board(s) generate various waveforms similar to signals commonly found on modern vehicle control systems. The demonstration board(s) not only help you learn how to use the Guided Component Tests software, it allows you to hone your skills and diagnostic techniques without connecting to an actual vehicle. Contact your sales representative for details.
- **Accessories**—provides descriptions for the optional accessories available for the diagnostic tool. Accessory topics may include:
  - Low Amp Probe
  - Pressure/Vacuum Transducers



- ShopStream Connect
- Test Leads and Clips
- **Product Description**—provides an overview of diagnostic tool capabilities and operations.

### 8.1.3 How To

#### Navigation

**Home Screen:** [Guided Component Tests > Training and Classes > How To](#)

The **How To** option provides multiple topics and references ranging from instructional and basic theory to troubleshooting and testing instructions. Menu options may include:

- **10-minute Electronic Classes**—provides basic electrical theory and testing information. Topics may include:
  - Ohm's Law
  - Variable Resistors
  - Amperage
  - Diode Continuity
  - Electrical Circuits
  - Guided Voltage Drop Test
  - Other Electrical Measurements
  - Resistance
  - Scientific Notation
  - Voltage
- **15-minute Ignition Class**—provides basic introductory ignition system information. Topics may include:
  - Introduction
  - Coil on Plug (COP)
  - Conventional
  - Waste Spark
- **Illustrated Terms & Definitions**—provides common term definitions, illustrations and tips associated with automotive component testing.
- **No-Start Basics**—provides basic step-by-step procedures for the diagnosis of a no-start condition on carbureted and fuel injected vehicles.

- **O2 Sensor & Feedback System Analysis**—provides basic definition and theory information for the following O2 sensor topics:
  - Air Fuel Ratio Sensors
  - Correct PCM Response (includes configured meter test)
  - Heated Oxygen Sensor
  - Non-Heated Oxygen Sensor
  - Open and Closed Loop
  - Oxygen Sensor Types
  - Understanding Oxygen Sensors (includes configured meter test)
- **Snap-on Automotive Theory**— provides basic theory information on multiple topics including:
  - Air Conditioning
  - Diagnosing Battery Draws
  - Diesel Particulate Filters
  - Electronic Parking Assistance
  - HID Headlights
  - Hybrid Vehicles
  - LIN-BUS
  - Supplemental Restraint Systems
  - Tire Pressure Monitoring (TPMS)
- **Test Tips**—provides basic testing information, tips and procedures for specific tests and meter operations. Topics may include:
  - Alternator Ripple Test
  - EVP Sensor Test
  - Frequency, Pulse Width and Duty Cycle Test
  - Graphing AC Voltage
  - Injector Pulse Width Test
  - Parasitic Draw Test
  - Reading Pulsed DTC's
  - TPS Sweep Test
  - Using Cursors
  - Using Pressure Transducers
  - Using Triggers
  - Wiggle Test
  - Zirconia Oxygen Sensor Rise Time



- Theory and Operation—provides basic theory information for the following topics:
  - Oxygen Sensors
  - Relays
- **20-minute Current Ramp Classes**—provides an introduction to current ramp testing using the Snap-on Low Amp Current Probes. Snap-on Low Amp Current Probe operation information is also provided within the *Snap-on Low Amp Probe Reference Manual* option. Topics may include:
  - Fuel Injector Current Ramp (multiple types)
  - Fuel Pump Current Ramp
  - Fuel Pump RPM Calculation
  - Ignition Coil Current Ramp (multiple types)
  - Parasitic Draw
  - Snap-on Low Amp Probe Reference Manual
  - Using Fuse Box for Current Test Hard to Reach Wiring

## 8.2 Screen Layout and Icons

This section describes the Guided Component Tests control icon functions and screen layout.

### 8.2.1 Screen Layout

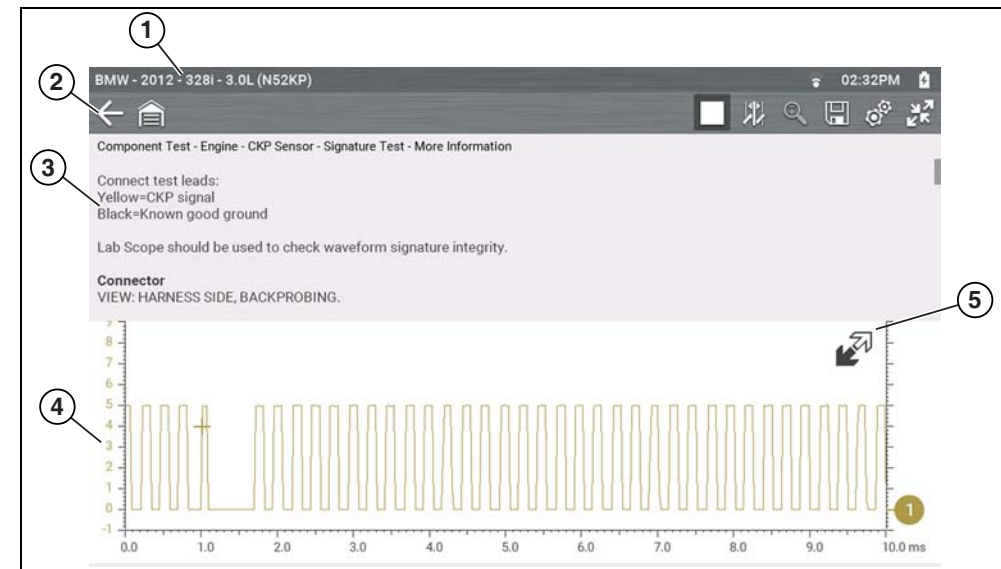

**1— Vehicle Identification**

**2— Toolbar**—contains control icons

**3— Information Panel**—displays test information

**4— Main Body**—displays menus, information, meter scales and signal traces

**5— Expand/Collapse icon**—expands and collapses the control panel on the screen

Figure 8-2







## Main Body

The main body of a Guided Component Test screen may display any of the following:

- **Selectable Menu** - Select menu options using the touch screen or control buttons.
- **Component Information** - Provides information to assist you with testing.
- **Test Meter** - The test meter can display up to two signals, simultaneously. Signal and display adjustments are made through the Control Panel. Signals are displayed using a grid with scales, both vertical (y axis), and horizontal (x axis).

### 8.2.2 Guided Component Tests Control Icons

Guided Component Tests toolbar control icons may vary depending on the active function or test. Other control icons (not shown) are described in [Icon Reference Table](#) on page 6.

Icon	Function
	<b>Stop</b> - Stops the data buffer.
	<b>Cursors</b> - Toggles cursors on/off.
	<b>Expand/Collapse Icon</b> - Toggles display of the control panel (Trace Detail).
	<b>Expand/Collapse Icon</b> - Toggles the Main body display between full and split screen.

## 8.3 Operation

As the information and tests provided within the Guided Component Test function is vehicle specific, the vehicle must first be identified in order to retrieve the correct data.



### To identify a vehicle:

The vehicle identification process is the same as the process used for the Scanner function, see [Vehicle Identification on page 23](#) for additional information. Once the vehicle is identified, a list of Systems is displayed.



### To select a system and component to test:

1. Select a system from the list ([Figure 8-3](#)).



Figure 8-3



A list of Components (and/or sub systems) is displayed ([Figure 8-4](#)).

2. Select a Component to continue.

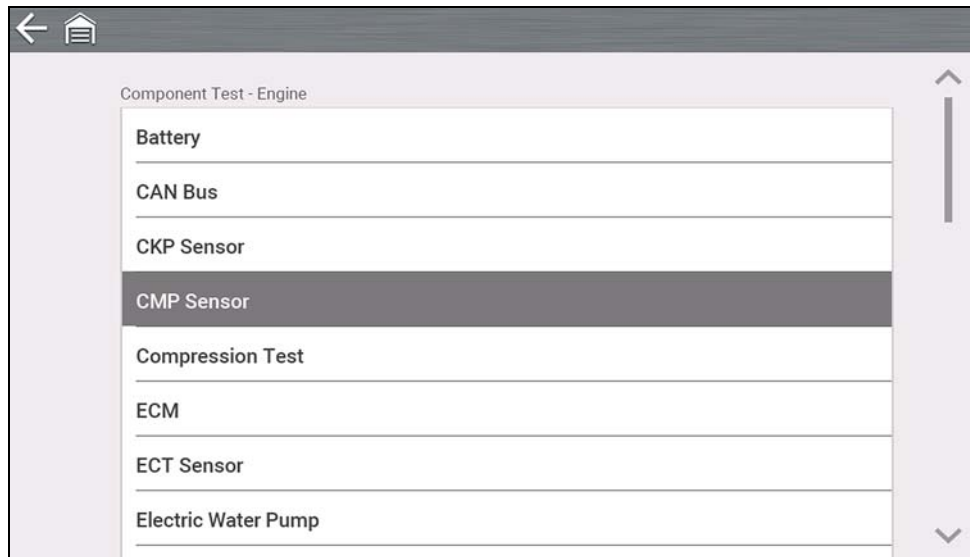

Figure 8-4

Depending on the vehicle and component selected, different options and sub-menus may be displayed. Information and tests may vary:

- **Component Information**— see [Component Information](#) on page 66.
- **Tests**— see [Tests](#) on page 67.
- **Reference Information**—provides identification of components, connector pin location and functions, and abbreviation reference.

### 8.3.1 Component Information

**Component Information** provides (if available) specific operational information on the selected component, and may also include electrical connector and pin location and function details



**To view component information:**

1. Select a component.
2. Select **Component Information** from the Component Test menu ([Figure 8-5](#)).

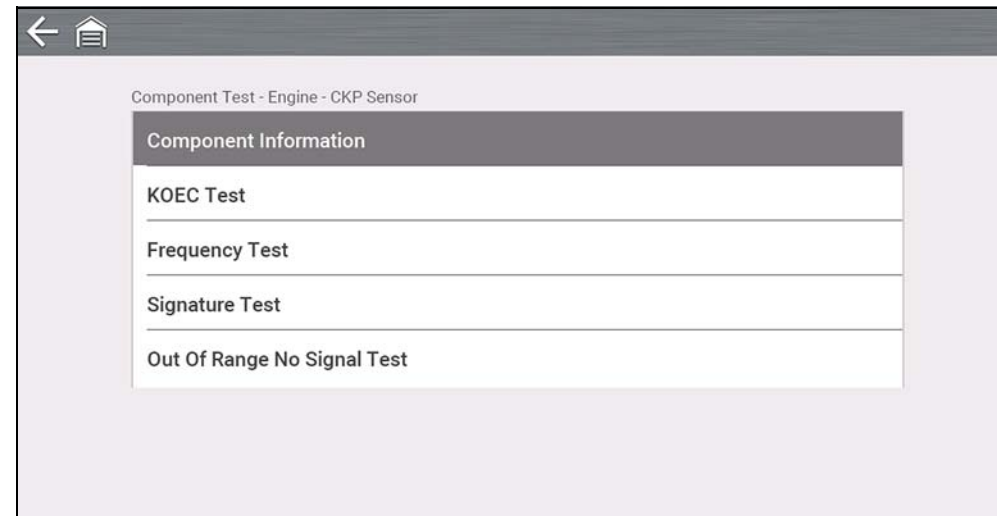

Figure 8-5

#### **i** NOTE

*An additional selection may be required for some components (e.g. selecting front or rear for an oxygen sensor (O2S)).*

Component Information is displayed (*Figure 8-6*).

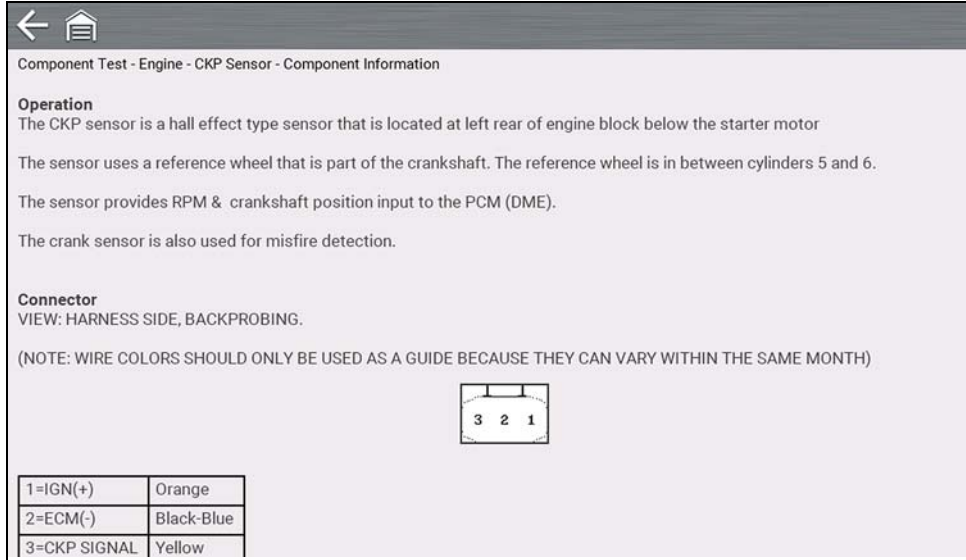

Figure 8-6

Screens are divided into sections to quickly guide you to the correct information (available sections and information will vary):

- **Operation**—provides a general description of component operation.
- **Tech note**—provides component related tips (e.g. common failures or faults), additional information may include OEM service updates and recall information.
- **Connector**—displays illustrated electrical connectors and socket/pin identification.
- **Location**—provides component locations, testing tips, and alternate testing locations if available.

Use the scroll bar to view additional information.

3. Select **Back** on the Toolbar, or press the **N/X** button, to return to the component menu.

## 8.3.2 Tests

**Tests** provides (if available) specific instructions to help you perform tests on components. Selecting a component test opens a preconfigured meter to start the test, and may also provide connection instructions, specifications and testing tips.



**To select a test:**

1. Select a component.
2. Select a **Test** from the Component Test menu (*Figure 8-7*).

The component test menu lists all of the tests available for the selected component. Choices vary by the type of component, as well as the make, model, and year of the vehicle.

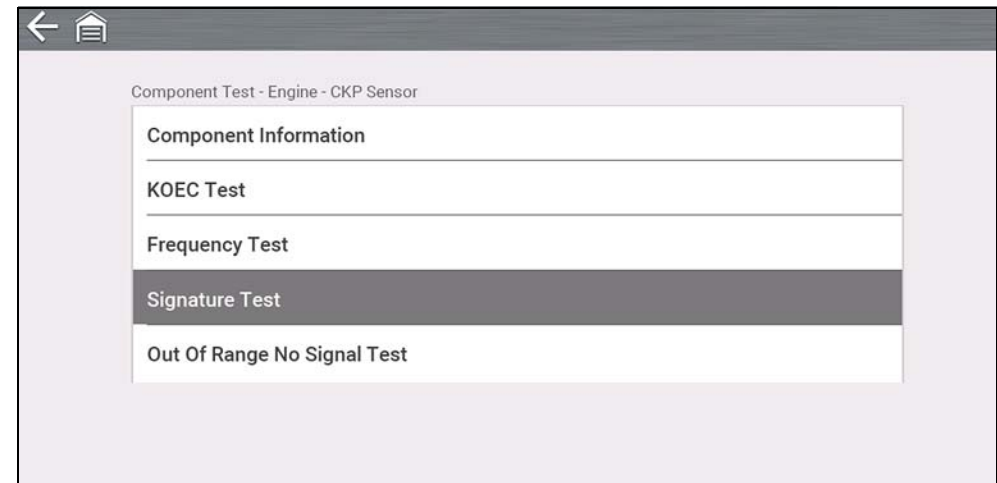

Figure 8-7

### **i** NOTE

*An additional selection may be required for some Component Tests (e.g. selecting front or rear for an oxygen sensor).*

The test connection information screen displays (*Figure 8-8*).

Use the scrollbar to display hidden information.

3. Select **View Meter** to display the meter display and to perform the test.

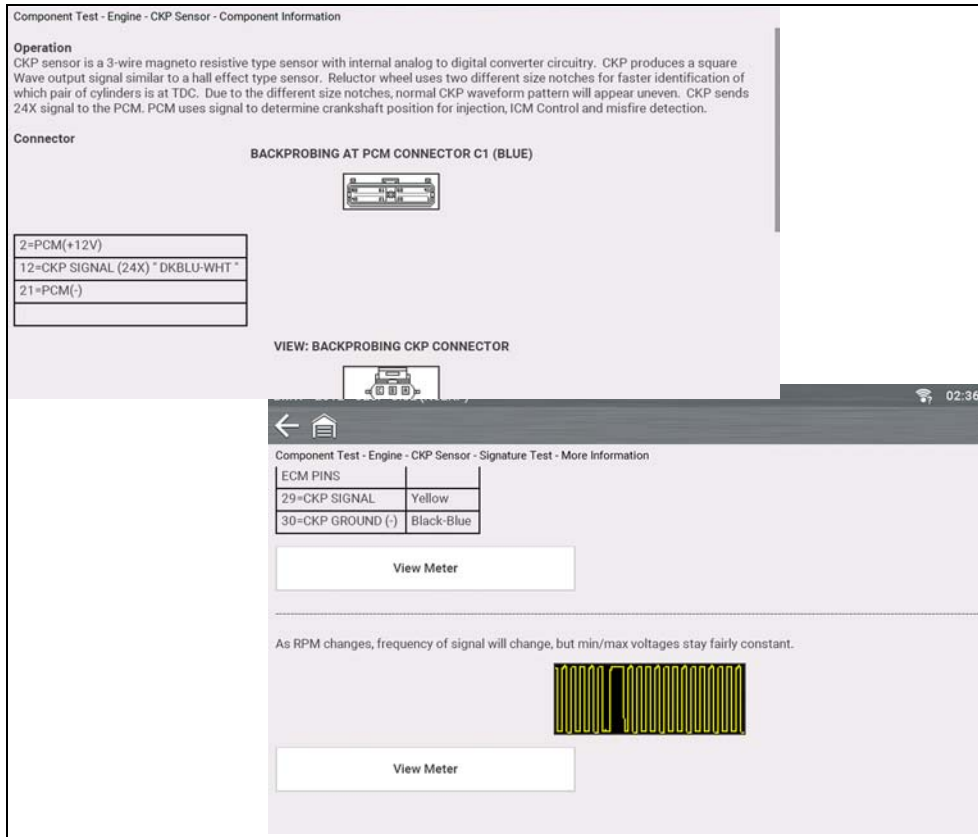

Figure 8-8

4. Use the **Expand/Collapse** icon to toggle through split and full screen views and to display the control panel (*Figure 8-9*).

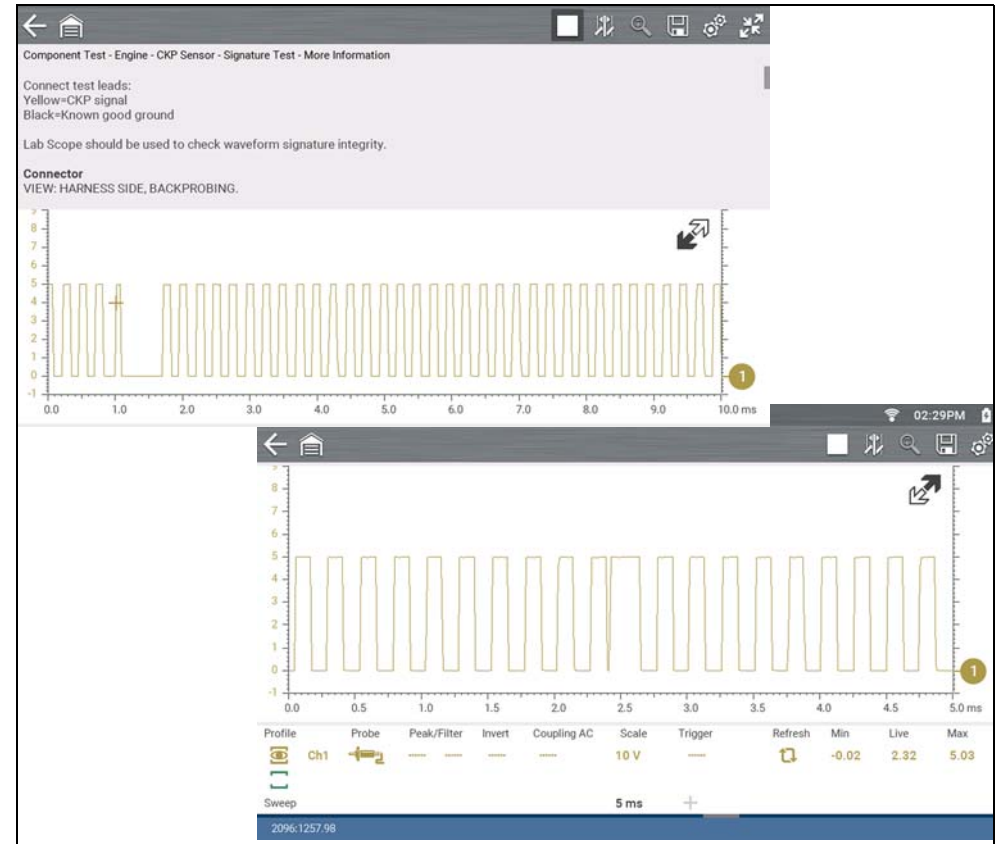

Figure 8-9

Some tests (e.g. signature integrity tests) may include waveform examples within the information panel. These waveform examples allow you to compare your test results for quick diagnosis (*Figure 8-10*).

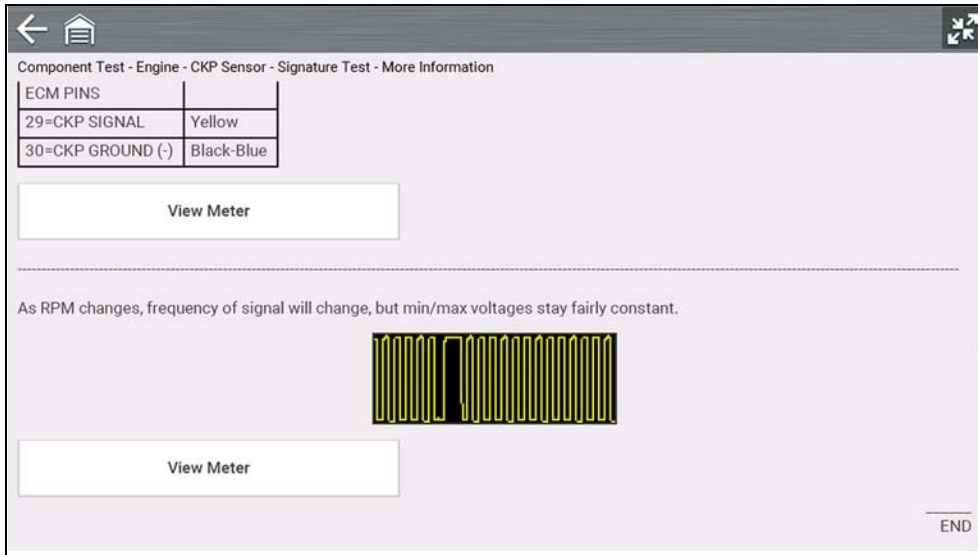

Figure 8-10

### Channel Settings

The test meter is preconfigured, for most of the component tests. However, if the need to change channel settings is needed, adjustments can be made by using the Control Panel (*Figure 8-11*). To access the Control Panel, use the **Expand/Collapse** icon to toggle the view. For additional information on channel settings, see *Control Panel and Settings on page 81*.

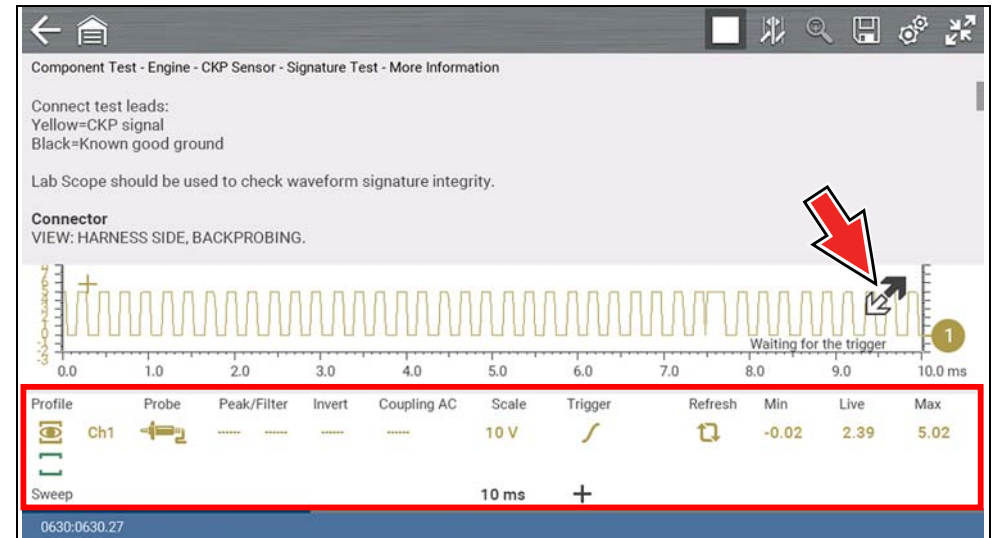

Figure 8-11

### 8.3.3 Saving and Reviewing Data Files

Save and Stop control icon operation and data review procedures are the same as used for the Scope/Multimeter function, see *Saving Data Files on page 102*.



The Scope Multimeter function allows you to perform multiple types of circuit and component measurement tests. This chapter includes general operation procedures, instructions for saving and reviewing test data, optional settings, and general reference information.

## Main Topic Links

- [Safety Information](#) page 70
- [Overview](#) page 71
- [Digital Multimeter \(DMM\)](#) page 71
- [Graphing Multimeter \(GMM\)](#) page 72
- [Lab Scope](#) page 73
- [Digital Multimeter \(DMM\)](#) page 71
- [Tests and Capabilities \(Quick Reference\)](#) page 74
- [General Information](#) page 78
- [Operation and Controls](#) page 80
- [Optional Settings](#) page 94
- [Capturing Data](#) page 97
- [Optional Settings](#) page 94
- [Reviewing Data and Using Zoom \(Review Mode\)](#) page 99
- [Saving Data Files](#) page 102
- [General Reference](#) page 103

## 9.1 Safety Information

### IMPORTANT

*Over Voltage Installation Category (CAT) - This Scope Multimeter is rated as a Category (CAT) 1 device. The maximum rated transient over voltage impulse is 500 volts, DO NOT exceed the rated transient over voltage.*



**! WARNING**

Risk of electrical shock.

- **Read the Safety Information** provided for important warnings on the use of this product
- **This product is intended for Measurement Category I** (for example, automotive 12V systems), do not use this product for Measurement Categories II, III, and IV.
- **Measurement Category I** is for performing measurements on circuits not directly connected to MAINS or MAINS circuits (an example of a MAINS circuit is 120V AC or 240V AC household or industrial electricity), do not connect this product to MAINS or MAINS circuits.
- **Do not apply the Black Ground Lead to test points other than ground/ system return/vehicle chassis.**

*Electrical shock can cause personal injury, equipment damage, and/or circuit damage.*

### 9.1.1 Measurement Out of Range Indicator

A group of arrows display when a measurement is out of range for the scale selected:

- Arrows pointing UP—measurement over maximum range
- Arrows pointing DOWN—measurement under minimum range

Voltage measurements also display arrows in place of live values when the voltage exceeds the input rating of the meter.

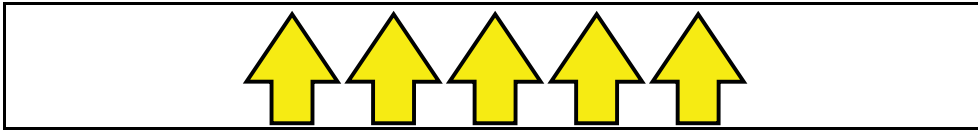

Figure 9-1



**WARNING**

Risk of electrical shock.

- Do not exceed voltage limits between inputs as indicated on the rating label.
- Use extreme caution when working with circuits that have greater than 40 volts AC or 24 volts DC.

Electrical shock can cause personal injury, equipment damage, and/or circuit damage.

**IMPORTANT**

*If arrows are displayed in the live voltage values, discontinue circuit testing.*

Correct an out-of-range condition by selecting a scale setting appropriate for the signal being sampled. See [Scale \(Vertical scale adjustment\)](#) on page 82 for more information.

## 9.2 Overview

The Scope Multimeter test functions are:

- Digital Multimeter (DMM)
- Graphing Multimeter (GMM)
- Lab Scope

**IMPORTANT**

*Over Voltage Installation Category (CAT) - This Scope Multimeter is rated as a Category (CAT) 1 device. The maximum rated transient over voltage impulse is 500 volts, DO NOT exceed the rated transient over voltage.*

### 9.2.1 Digital Multimeter (DMM)

The digital multimeter gives you the ability to quickly make precise common electrical measurements (e.g. DC and AC voltage, resistance and amperage) on circuits and components to verify operation. The meter displays measurements in a digital numerical format, and is typically used for measuring signals that are not rapidly changing.

The DMM is ideal for performing basic tests on most standard automotive circuits, and displays the results in a large easy to see format.

To use the DMM, select the **Scope Multimeter** icon from the home screen then select **Digital Multimeter** from the menu. See [Tests and Capabilities \(Quick Reference\)](#) on page 74 for a list of available testing functions.

#### Specifications

Function	Range	Accuracy/Comments
Signal Measurement	Ch. 1— (yellow jack)	Input is referenced to common ground (GND— (black jack)
VDC (Full Scale)	75VDC	Do not measure greater than 75VDC
VAC (Full Scale)	50VAC	Do not measure greater than 50VAC (rms)
Signal Measurement Input Impedance	10 MΩ	-
Ohm Measurement	Ch. 1— (yellow jack (-))	-
Diode Test	Ch. 2— (green jack (+))	-
Continuity Test		
Ohms	40 Ω—4 MΩ	Fixed scales or auto ranging
Glitch Capture	Approximately 50 μS	-
Diode test	2V scale	-



## 9.2.2 Graphing Multimeter (GMM)

Unlike the DMM, the graphing multimeter provides two channels for testing and plots a visual graphing line of the signal instead of displaying digital values. The GMM displays a signal's measurements over time on a two-dimensional grid. This plotted graph is basically a graphical history (histogram) of the signal's measurements over time.

The GMM uses a higher sample rate (than a DMM) to calculate signal measurements. This characteristic along with the visual graph, make the GMM ideal for finding intermittent dropouts or glitches that may not be obvious when viewing a digital value. A key advantage of the GMM is being able to capture a signal over a long time interval and then review it's graphical history, to visually see if and when dropouts have occurred.

In addition, the GMM uses a combination of filter and peak detect modes to provide a good balance between detecting fast glitches and preventing unwanted noise from displaying.

Unlike the lab scope, the sweep scales used with typical GMM tests are of longer time intervals, and may range from seconds to minutes, compared to the lab scope sweep scales that use relatively short time intervals (e.g. milli and micro seconds). This allows you to monitor a signal over a longer period of time when looking for erratic glitches or dropouts.

To use the GMM, select the **Scope Multimeter** icon from the home screen then select **Graphing Multimeter** from the menu. See [Tests and Capabilities \(Quick Reference\)](#) on page 74 for a list of available testing functions.

## Specifications

Function	Range	Accuracy/Comments
Signal Measurement	Ch. 1— (yellow jack) Ch. 2— (green jack)	Each channel input is referenced to common ground (GND— black jack)
Sample Rate	1.5 MSPS	Continuous sampling, MSPS = mega samples per second
Band Width	3 MHz	3 db point @ 3 MHz
Input Impedance	10 M $\Omega$ @ DC 4 k $\Omega$ @ 3 MHz	Channel 1 and 2
VDC (Full Scale)	75VDC	Do not measure greater than 75VDC
VAC (Full Scale)	50VAC	Do not measure greater than 50 VAC (rms)
Ohm Measurement Diode Test Continuity Test	Ch. 1— (yellow jack (-)) Ch. 2— (green jack (+))	-
Ohms	40 $\Omega$ —4 M $\Omega$	Fixed scales
Low Amp Probe	20A scale (100mV/Amp) 40A scale (10mV/Amp) 60A scale (10mV/Amp)	Connect the positive (+) Amp Probe lead to the yellow jack on the diagnostic tool for values on Ch.1, or to the green jack for values on Ch. 2. Connect the negative (-) lead to GND (black jack) <sup>1</sup> .
1. Do not use the Low Amp Probe to measure current on conductors at a potential greater than 46VAC peak or 70VDC.		



## 9.2.3 Lab Scope

Similar to the GMM, the lab scope (oscilloscope) plots a visual image line of a signal's measurements over time on a two-dimensional grid. The visual line that is displayed is commonly called a trace, and the graphical form created by a signal is called a waveform.

Unlike the DMM, the lab scope allows you to visually see a signals waveform, which in turn allows you to see the strength and shape of the signal, as well as any noise that may be occurring on the circuit. The lab scope also samples signals at a high rate, which allows you to see a higher level of detail in short samples of the signal, especially in signals that change rapidly. In addition, the lab scope also provides more control over the acquisition of the signal and in how it is displayed, through the use of triggers and channel controls. All of these features allow you to analyze signals in great detail when performing diagnostics.

To use the lab scope, select the **Scope Multimeter** icon from the home screen then select **Lab Scope** from the menu. See [Tests and Capabilities \(Quick Reference\)](#) on page 74 for a list of available testing functions.

## Specifications

Function	Range	Accuracy/Comments
Signal Measurement	Ch. 1— (yellow jack) Ch. 2— (green jack)	Each channel input is referenced to common ground (GND— black jack).
Sample Rate	For 50 $\mu$ S sweep 6 (MS/s) For 100 $\mu$ S sweep 3 (MS/s) For all other sweeps 1.5 (MS/s)	Continuous sampling, (MS/s) = mega samples per second
Band Width	3 MHz	3 db point @ 3 MHz
Input Impedance	10 M $\Omega$ @ DC 4 k $\Omega$ @ 3 MHz	Channel 1 and 2
VDC (Full Scale)	100mV–400V	Do not measure greater than 75VDC.
VAC (Full Scale)	100mV–400V	Do not measure greater than 50 VAC (rms).
Low Amp Probe	20A scale (100mV/Amp) 40A scale (10mV/Amp) 60A scale (10mV/Amp)	Connect the positive (+) Amp Probe lead to the yellow jack on the diagnostic tool for values on Ch.1, or to the green jack for values on Ch. 2. Connect the negative (–) lead to GND (black jack) <sup>1</sup> .
1. Do not use the Low Amp Probe to measure current on conductors at a potential greater than 46VAC peak or 70VDC.		





## 9.3 Tests and Capabilities (Quick Reference)

The following chart identifies and describes available tests by function.

### **i** NOTE

*Not all the tests listed are described in this manual. This list is intended as reference only.*

D M M	G M M	L S	Test	Function
		✓	Two Channel Lab Scope	Displays two Lab Scope channels automatically.
	✓		Dual Graphing Meter	Displays two Graphing Multimeter channels automatically.
		✓	Ignition Probe	Measures secondary Ignition voltage 2 to 50kV. Displays secondary ignition (kV) waveforms.
✓	✓	✓	Volts DC	Measures direct current voltage. DC voltage is measured through the two test leads connected to a DC circuit.
✓	✓		Volts DC - Average	Measures DC voltage using a filter to determine the average voltage over a period in time. DC voltage is measured through the two test leads connected to a DC circuit.
✓	✓		Volts AC RMS	Measures the effective AC voltage, not the peak voltage which results in measurements with higher accuracy. The AC RMS (root mean square) voltage value can be defined as the equivalent DC voltage of the AC voltage measured. RMS values are commonly used in AC electrical measurement, as they are more representative of DC measurements.
✓	✓		Ohms	Measures electrical resistance (opposition to current) 0 to 4 M Ohms. Scope supplied DC current is passed through the circuit to measure the resistance between the two connected test leads.

D M M	G M M	L S	Test	Function
✓			Diode/Continuity	Measures voltage drop across a diode and continuity through a diode. Scope supplied DC current is passed through the diode to measure the voltage drop between the two connected test leads. Typical setup for positive to negative current flow - positive lead (anode +/side) and negative (cathode -/side).
	✓		Frequency	Measures the number of times a signal repeats itself per second. Used to measure frequency of signals such as CKP, CMP and wheel speed sensors.
	✓		Pulse Width	Measures the on-time of various components (e.g. components that cycle on and off like the EGR, or canister purge).
	✓		Injector Pulse Width	Measures fuel injector on-time when checking for variances when engine load is changed and/or physical problems with the injector.
	✓		Duty Cycle	Measures the ratio of the pulse width to the complete cycle width, the on-time of components that cycle on and off like EGR, or canister purge from 0–100%.
✓	✓	✓	Low Amps (20)	Used to measure amperage of typical devices (e.g. ignition coils, injectors, fuel pumps) that may draw up to 20A peak (startup) when initially started. Also used to measure parasitic draw.
✓	✓	✓	Low Amps (40)	Used to measure amperage of typical motors and devices that may draw up to 40A peak (startup) when initially started.
✓	✓	✓	Low Amps (60)	Used to measure amperage of larger motors and devices that may draw up to 60A peak (startup) when initially started.
	✓		MC Dwell (60)	Measures carburetor Mixture Control Solenoids (0–60°). The duty cycle of the solenoid is expressed in the dwell angle of a 6 cylinder engine: 100% = 60 deg.
	✓		MC Dwell (90)	Measures fuel system Mixture Control Solenoids (0–90°). The duty cycle of the solenoid is expressed in the dwell angle of a 4 cylinder engine: 100% = 90 deg.
	✓	✓	100 PSI Vacuum	Used to measure vacuum up to 20 in.Hg, using the 0–100 psi transducer.



D M M	G M M	L S	Test	Function
	✓	✓	100 PSI Pressure	Used to measure pressures for typical systems such as, fuel, oil, EVAP, hydraulic/transmission fluid etc. up to 100 psi, using the 0–100 psi transducer.
	✓	✓	500 PSI Pressure	Used to measure pressures for typical systems such as, hydraulic/transmission fluid pressure, cylinder compression, and AC high side up to 500 psi, using the 0–500 psi transducer.
	✓	✓	5000 PSI Pressure	Used to measure pressures for typical systems such as, ABS, power steering, and heavy-duty hydraulic system fluid up to 5000 psi, using the 0–5000 psi transducer.
	✓	✓	MT5030 Vacuum	Used to measure vacuum up to 29 in.Hg, using the MT5030 pressure transducer adapter.
	✓	✓	MT5030 Pressure	Used to measure fluid and gas pressures up to 500 psi, using the MT5030 pressure transducer adapter.
	✓	✓	EEDM506D Temperature	Used to measure temperatures from -50° to 1800° F (-45 to 982° C), using the EEDM506D pressure transducer adapter.

## 9.4 Test Leads and Accessories

Some of the leads, probes and adapters supplied with or that may be available, are explained in the following section.

### NOTE

*Not all test leads and/or accessories may be available in all markets. Contact your sales representative for information, or to find out more about these and other available accessories.*

### IMPORTANT

**Avoid damaging test leads, do not pull on the wire when removing the leads from their jacks. Pull only on the lead terminal end.**

### 9.4.1 Channel 1 Lead

The shielded yellow lead is used with channel 1, and is color matched with the channel 1 jack on the diagnostic tool.

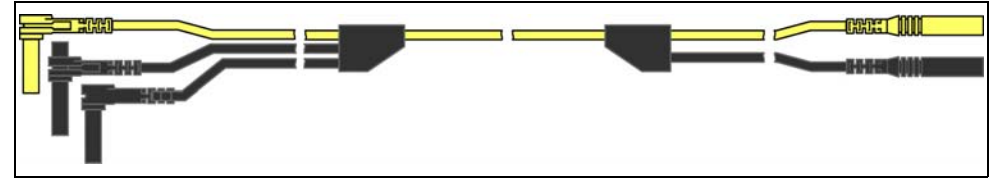

Figure 9-2 Yellow Channel 1 Lead

This lead also includes two black, right-angle common ground plugs. One plug is standard and the other is stackable. The standard ground plug should always be connected to the ground (GND) jack on the diagnostic tool.

The stackable ground plug is used for connecting additional ground leads, such as the Channel 2 or the Secondary Coil Adapter lead grounds. The stackable ground lead is internally connected to the standard ground lead, therefore it does not need to be connected to the diagnostic tool ground jack.

### 9.4.2 Channel 2 Lead

The shielded green lead is used with channel 2, and is color matched with the channel 2 jack on the diagnostic tool. This lead also includes a black, right-angle stackable ground plug.

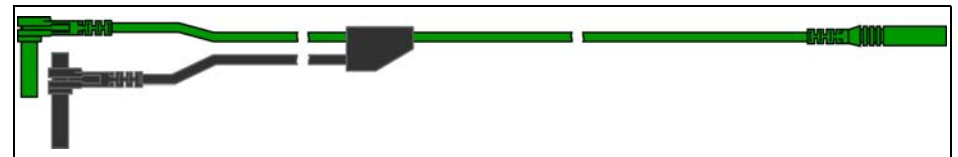

Figure 9-3 Green Channel 2 lead



### 9.4.3 Alligator Clips and Probes

Insulated alligator clips and probes (pointed type) can be attached to the end of the test leads. Each alligator clip is color matched with a test lead, and the probes are available in red and black.

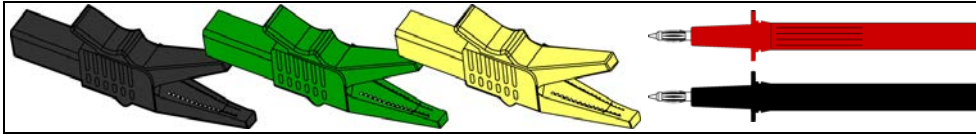

Figure 9-4 Alligator clips

### 9.4.4 Secondary Ignition Coil Adapter Lead and Clip-on Adapter (optional)

The secondary ignition adapter lead can be used with the secondary ignition clip-on wire adapter, coil-in-cap (CIC), or coil-on-plug (COP) secondary ignition adapters to display secondary ignition signals. The clip-on adapter clips over a secondary ignition wire to pickup a signal, and the CIC and COP adapters attach to the ignition coil. The coil adapter lead includes a black, right-angle stackable ground plug, and a RCA type connector that is used to connect the lead to a secondary ignition adapter. The spring clamp is used to connect to a ground.

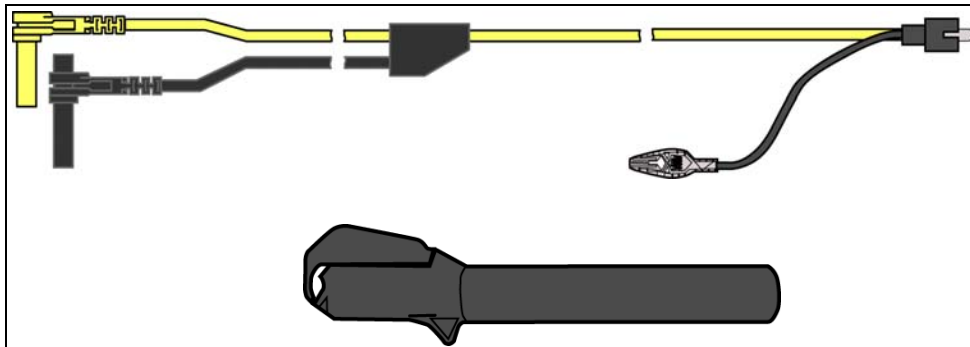

Figure 9-5 Secondary Ignition Coil Adapter Lead and Clip-on Wire Adapter

#### **i** NOTE

Contact your sales representative for additional information on OEM specific CIC and COP secondary ignition adapters.

### 9.4.5 Low Amp Current Probe (optional)

The Low Amp Current Probe is used measure AC or DC current up to 60A. This probe includes two scales (0 to 20A) and (0 to 60A) that can be used to provide accurate and reliable non-intrusive current measurement for components such as, ignition coils, fuel injectors, fuel pumps, relays, and electric motors.



Figure 9-6 Low Amp Current Probe

### 9.4.6 Temperature Probe Adapter (optional)

The temperature probe adapter can be used to measure temperatures ranging from  $-50^{\circ}\text{F}$  to  $1,800^{\circ}\text{F}$ . Different probes are available for surface, fluid and air temperature measurements.



Figure 9-7



### 9.4.7 Pressure Transducers and Adapters (optional)

Different pressure transducers and adapters are available for measuring positive and negative gas and liquid pressures. Depending on the adapter, measurement capabilities range from 1 to 5000 psi and up to 29 inHg. Measurement and application capabilities vary per device.



Figure 9-8

### 9.4.8 Waveform Demonstration Tools (optional)

To help you sharpen your lab scope and graphing multimeter skills, optional waveform demonstration tools are available as a training aid. These demonstration tools generate common waveforms, and allow you to vary their display characteristics by turning glitches on/off, helping you to become more familiar with the lab scope controls. Common waveforms include, AC sine wave, variable frequency and pulse, secondary ignition, and more. There are two tools currently available, the standard model (Figure 9-9 left) and the vehicle simulator model (Figure 9-9 right) which produces waveforms (e.g. Crankshaft Position Sensor (CKP), Camshaft Position Sensor (CMP), Accelerator Pedal Sensor (APP), Wheel Speed Sensor (WSS) Signals, and more) representative of a 2012 BMW 328i Sedan.

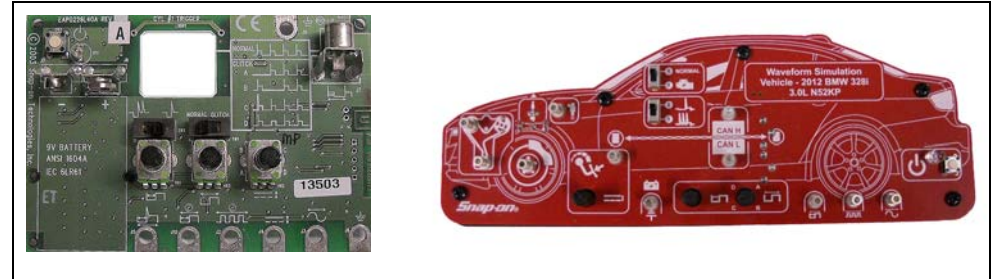

Figure 9-9

## 9.5 General Information

This section describes the general Scope Multimeter control icon functions, screen layout and optional settings. The screen layout and control icon functions are shared between the digital/graphing multimeters and lab scope.

### NOTE

*Scope and Multimeter tests are not vehicle specific, therefore vehicle identification is not required.*

### NOTE

*Images and screenshots in the following sections are provided as general reference only, and in some instances have been modified for clarity.*

### 9.5.1 Scope Multimeter Screen Layout and Features



- 1— **Toolbar**—contains navigational and control icons
- 2— **Main Body**—contains the meter/scope display
- 3— **Control Panel**—contains channel/trace controls
- 4— **Data Buffer Position Indicators**—graphical and numerical position indicators
- 5— **Expand/Collapse icon**—toggles display between split and full screen views including the control panel

Figure 9-10



## Scope Multimeter Control Icons

The following control icons are common across most Scope Multimeter functions, however use may vary depending on the active function or test. A yellow frame surrounding an icon (highlighted), indicates it is selected. Other control icons (not shown) are described in [Icon Reference Table on page 6](#).

Icon	Function
	<b>Pause</b> - Pauses the data buffer
	<b>Start (Capture)</b> - Resumes active data collection.
	<b>Zoom</b> - Increases and decreases screen magnification. The zoom function is only available during data review (scope paused).
	<b>Cursors</b> - Toggles cursors on/off.
	<b>Step Forward</b> - moves to the next point in the data. To quickly step forward, select this icon then press and hold the Y/✓ button.
	<b>Forward 1 Frame</b> - allows forward movement by one frame. To quickly skip forward, select this icon (yellow frame appears around icon) then press and hold the Y/✓ button
	<b>Step Back</b> - moves to the previous point in the data. To quickly step backward, select this icon then press and hold the Y/✓ button.
	<b>Back 1 Frame</b> - allows backward movement by one frame. To quickly skip backward, select this icon then press and hold the Y/✓ button.
	<b>Expand / Collapse</b> - Toggles display of the control panel (Trace Detail).

Icon	Function
	<b>Save</b> - Saves the data stored in buffer memory to a file.
	<b>Tools</b> - Open the Tools menu, providing options for scope and meter settings.

## Main Body

The main body may display the following:

- **Menu** - Select from a menu using the touch screen or the control buttons.
- **Meter/Scope Display** - Up to two signal traces can be displayed simultaneously. Each trace is displayed as voltage over time and the voltage level is recorded on the vertical, or “y”, axis and time is presented on the horizontal, or “x”, axis of the screen.

## Data Buffer Position Indicators

The graphing multimeter and lab scope functions have the capability to save, store and playback, data (signals) utilizing internal storage “buffer” memory.

The Data Buffer Position Indicators are used to visually see the overall amount and position of the of stored buffer data during saving and playback.

For additional information on the Data Buffer, Data Buffer Position Indicator and Saving, Storing and Reviewing Data files, see [About the Data Buffer on page 97](#).

## 9.6 Operation and Controls

This section describes the general operation and controls used to configure the scope or meter to perform testing. All three functions share similar control panel settings, see [Control Panel and Settings](#) on page 81 for additional information.

### NOTE

*The information in the following sections is intended as a guide and general overview of the controls and functions used within the Scope Multimeter. Not all the settings or controls described throughout this section are applicable with all functions.*



#### To open a scope multimeter function:

1. Select the **Scope Multimeter** icon from the home screen.
2. Select either **Lab Scope**, **Graphing Multimeter** or **Digital Multimeter** from the menu.

### 9.6.1 Test Lead / Probe Connection

Standard “safety type” test lead jacks are located on the top of the diagnostic tool, and are compatible with many test leads and probes ([Figure 9-11](#)). Insert the applicable test lead or probe terminal end into the jack to complete the connection.

### IMPORTANT

*To avoid damaging test leads, do not pull on the wire when removing the leads from their jacks. Pull only on the lead terminal end.*

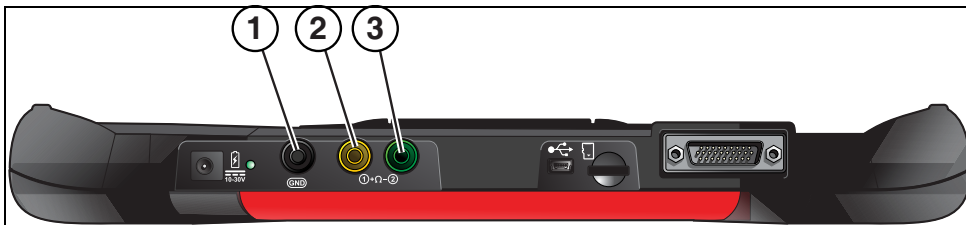

- 1— Ground Jack (Black)
- 2— Channel 1 Jack (Yellow)
- 3— Channel 2 Jack (Green)

Figure 9-11

### 9.6.2 Test Lead / Probe Calibration

Certain tests may display a confirmation prompt asking “Do you wish to calibrate this probe?” before continuing with the test. As general practice, it is important to ensure the test probe is calibrated before testing, to ensure accurate results.

Typical resistance, pressure, and vacuum tests will display the calibration message, reminding you to calibrate the probe. To perform the probe calibration, select **Yes** at the prompt and continue to follow the onscreen instructions to complete the calibration.

**Example:** For the ohms (resistance) calibration process, once completed, zero ohms should be displayed when the leads are connected together. When the leads are separated, the upward arrows on the display indicate infinite resistance or an open circuit.

### NOTE

*During an ohms test or a pressure test, a manual probe recalibration can be initiated by selecting the probe icon from the Control Panel to open the probe menu. Then select either the **Ohms** or **Pressure (100, 500, 5000)** items from the probe menu. The menu selections will display a graphic of a balance scale with an “X” through it (on right side) to indicate that probe is not calibrated ([Figure 9-12](#)).*

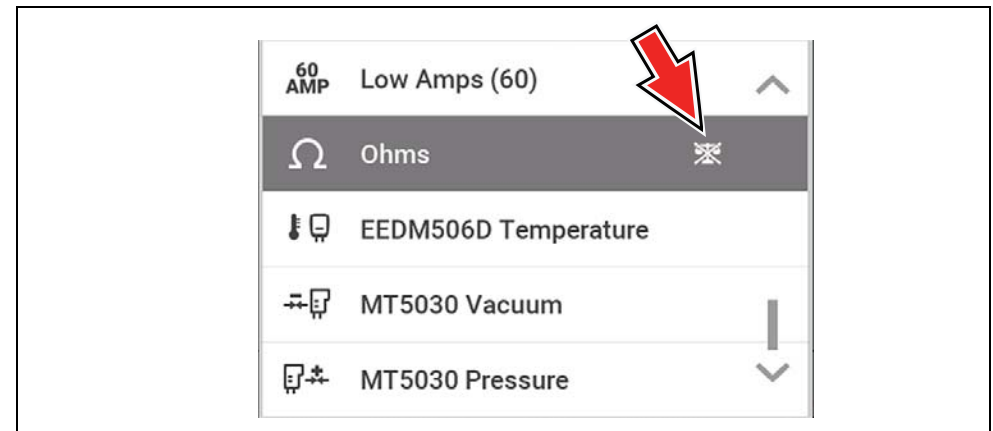

Figure 9-12

### 9.6.3 Control Panel and Settings

The control panel is common to all three Scope Multimeter functions, and contains the channel (or “trace”) settings and controls that are used to monitor and adjust the signal being measured. This section provides a general overview of all the channel settings and control features used across all three Scope Multimeter functions.

#### NOTE

*This section is intended as a general overview of the channel settings. Not all the settings or controls described in this section are applicable with all functions, some may be “grayed out” or not active (applicable) depending on the function or test. Function availability is noted as applicable.*

#### NOTE

*The control panel can be toggled on/off by selecting the Expand/Collapse Icon to switch the screen between full and split test meter views.*



- 1— Cursors
- 2— Cursors Icon
- 3— Zero Base Line Indicators
- 4— Control Panel—contains channel/trace controls and settings
- 5— Data Buffer Position Indicators—graphical and numerical position indicators

Figure 9-13



## Scale, Sweep and Probe Settings

The most common and typically the first adjustments made when performing tests are the setup or adjustment of the probes and scales. All three of these adjustments are made from the control panel and are described in the following sections.

The following illustration is for reference, and identifies key terms and features used throughout the following sections:

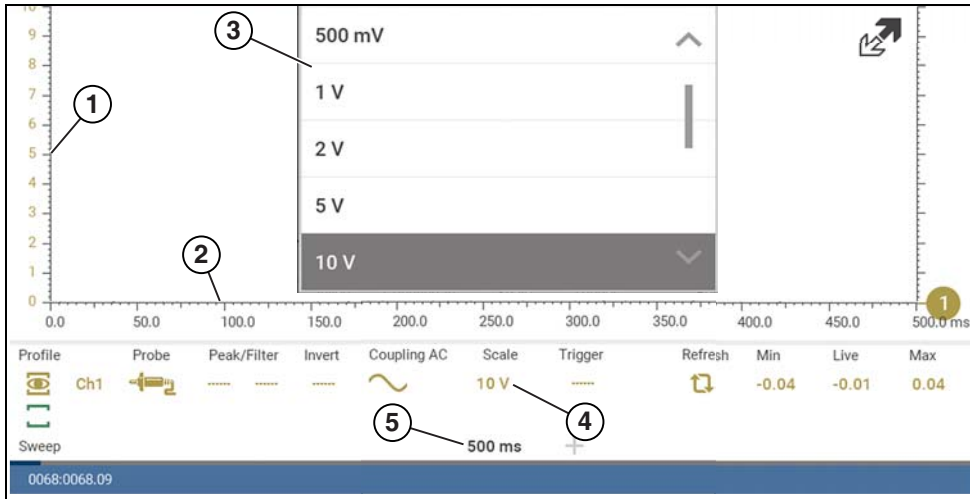

- 1— Vertical Scale - [Y axis]
- 2— Horizontal (sweep or time) Scale - [X axis]
- 3— Vertical Scale Menu
- 4— Vertical Scale Icon
- 5— Sweep Scale Icon

Figure 9-14

## Scale (Vertical scale adjustment)

The vertical scale (Y-axis) represents what is being measured (voltage, amperage, pressure etc.), and the unit of measurement it is being measured in. The vertical scale is “always” divided into 10 major divisions; how these divisions are defined, sets the scale of measurement.

### NOTE

Vertical scales (either channel) can be set independently.

### NOTE

Optional vertical scale preference settings are available. The Divisions option allow you to change (to your preference) how the vertical scale menu selections are represented, and the type of value that displays in the vertical scale icon. See [Trace Divisions](#) on page 95.

To adjust the vertical scale unit of measurement, select the **Vertical Scale** icon to open the vertical scale menu and select a value. The value displayed in the vertical scale icon indicates the active value.

**Example:** Selecting 10V, changes the vertical scale to a 10V volt scale. The scale is “always” divided by 10, therefore each division is incremented by 1V.

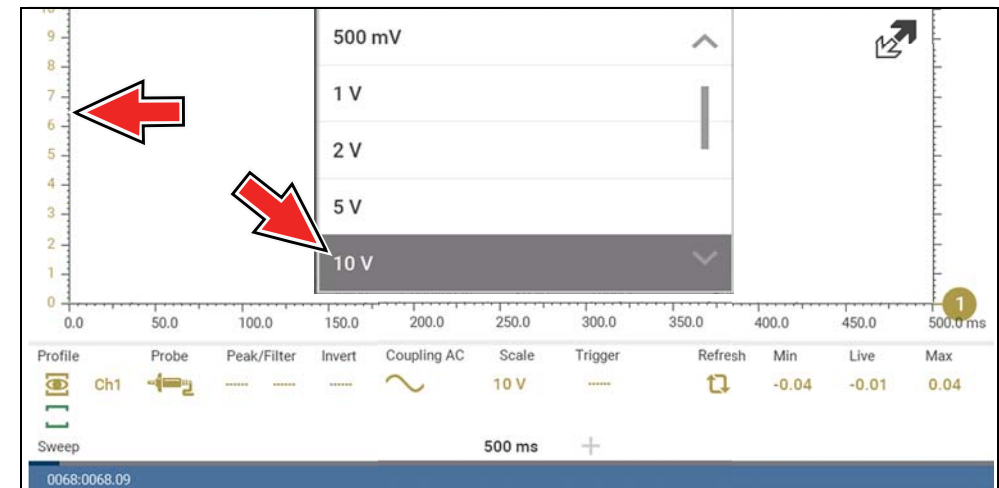

Figure 9-15

**Example:** Selecting 50 psi displays a 50 psi scale that is divided by 10, therefore each division is incremented by 5 psi.

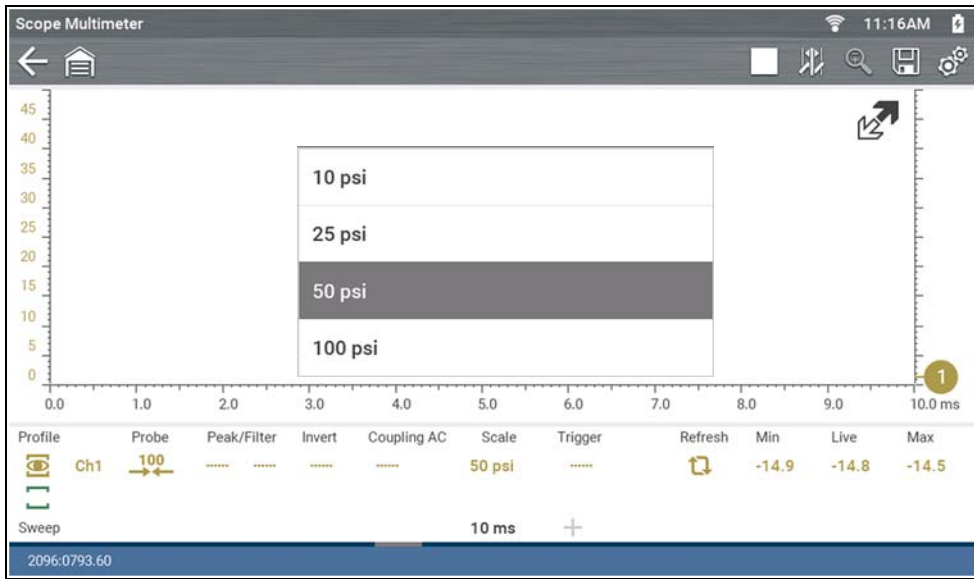

Figure 9-16

**Sweep (Horizontal or Time scale adjustment)**

The horizontal scale (X-axis) represents time, and the unit of measurement it is being measured in. The horizontal scale is “always” divided into 10 major divisions, how these divisions are defined, sets the scale of measurement. The value displayed in the sweep Scale icon indicates the active sweep setting.

**NOTE**

*The sweep setting applies to all channels and cannot be set independently per channel.*

To adjust the sweep scale unit of measurement value, select the Sweep Scale icon to open the sweep scale menu. Select a value then press the **N/X** button, to exit the menu.

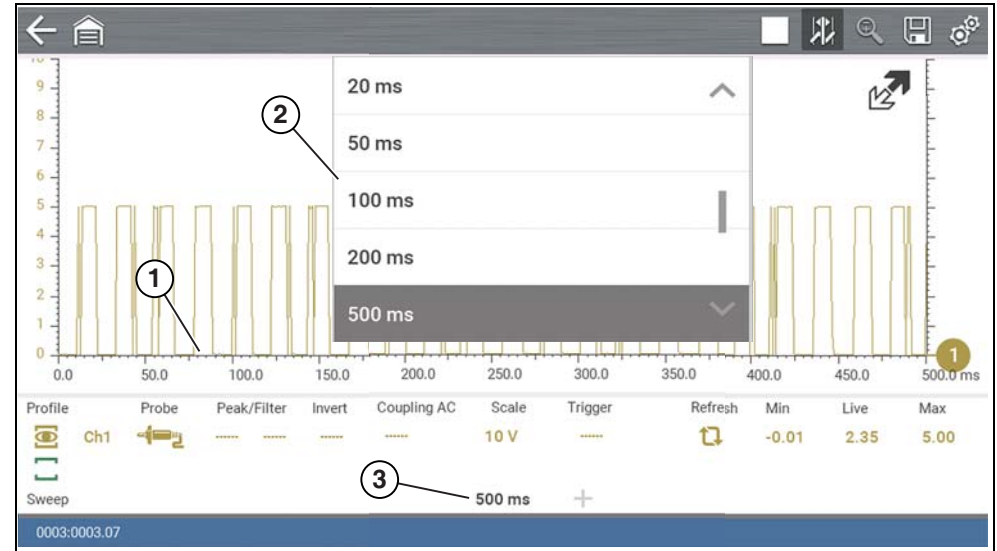

- 1— Sweep Scale
- 2— Sweep Scale Menu
- 3— Sweep Scale Icon

Figure 9-17

**Example:** Selecting 500ms, changes the sweep scale to a 500ms scale. The scale is “always” divided by 10, therefore each division is incremented by 50ms.

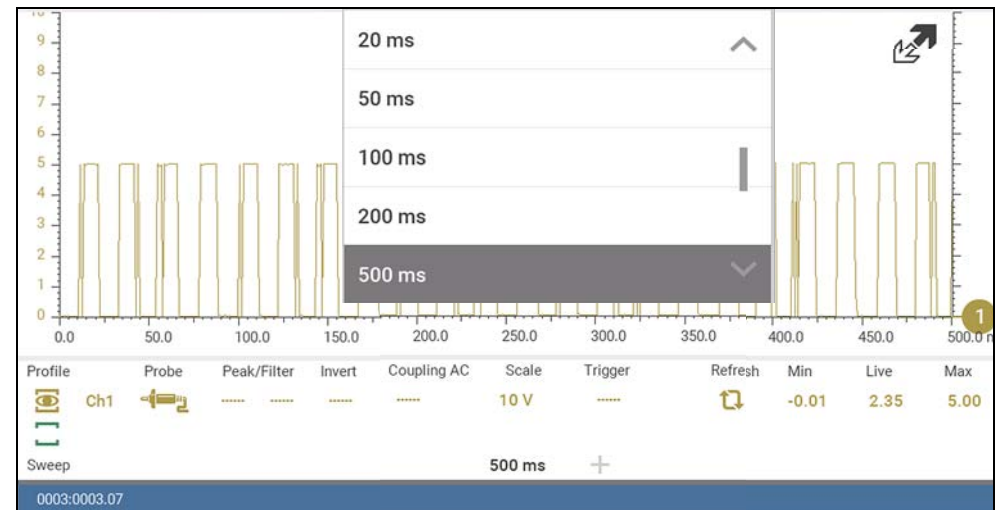

Figure 9-18



**Probe (Probe type “test” selection)**

Different types of Probes are available from the probe option menu, depending on which type of test you are performing. Changing the probe selection, also changes the vertical scale to the applicable type of measurement.

To select a Probe type, select the **Probe** icon to open the probe option menu, then select a probe. The probe icon will change to the selected probe. Select **Close** from the menu to close the menu.

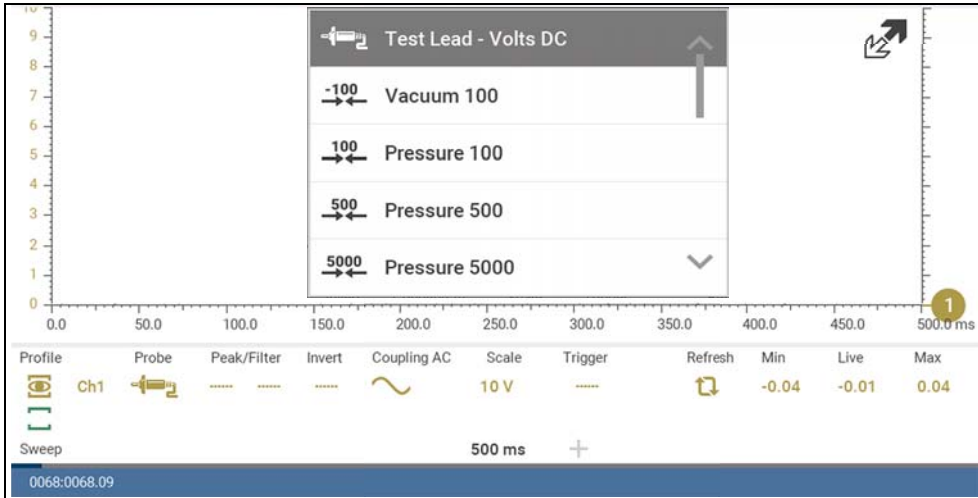

Figure 9-19

For probe calibration information, see [Test Lead / Probe Calibration](#) on page 80.

Probe “test” Options	
Menu Option	Probe / Device Used
Test Lead - Volts DC	Standard Channel 1 and 2 test leads with alligator clips or test probes
Vacuum 100	(optional) 0-100 psi pressure transducer with pressure adapter
Pressure 100	
Pressure 500	(optional) 0-500 psi pressure transducer with pressure adapter
Pressure 5000	(optional) 0-5000 psi pressure transducer with pressure adapter
Low Amps 20	(optional) Low Amp Probe
Low Amps 40	
Low Amps 60	
Ignition	(optional) Secondary ignition adapter lead with desired secondary ignition coil adapter
EEDM506D Temperature	(optional) Part number - EEDM506D temperature adapter
MT5030 Vacuum	(optional) Part number - EEDM5030 0-500 pressure adapter
MT5030 Pressure	

## Channel Settings

The majority of the channel (trace) settings and controls are located in the Control Panel. Each setting is represented by an icon, or a value. Icons are used to make adjustments, and the displayed values represent an individual characteristic. Depending on the test, applicable settings are displayed. The following image shows different views of the control panels to identify the different controls.

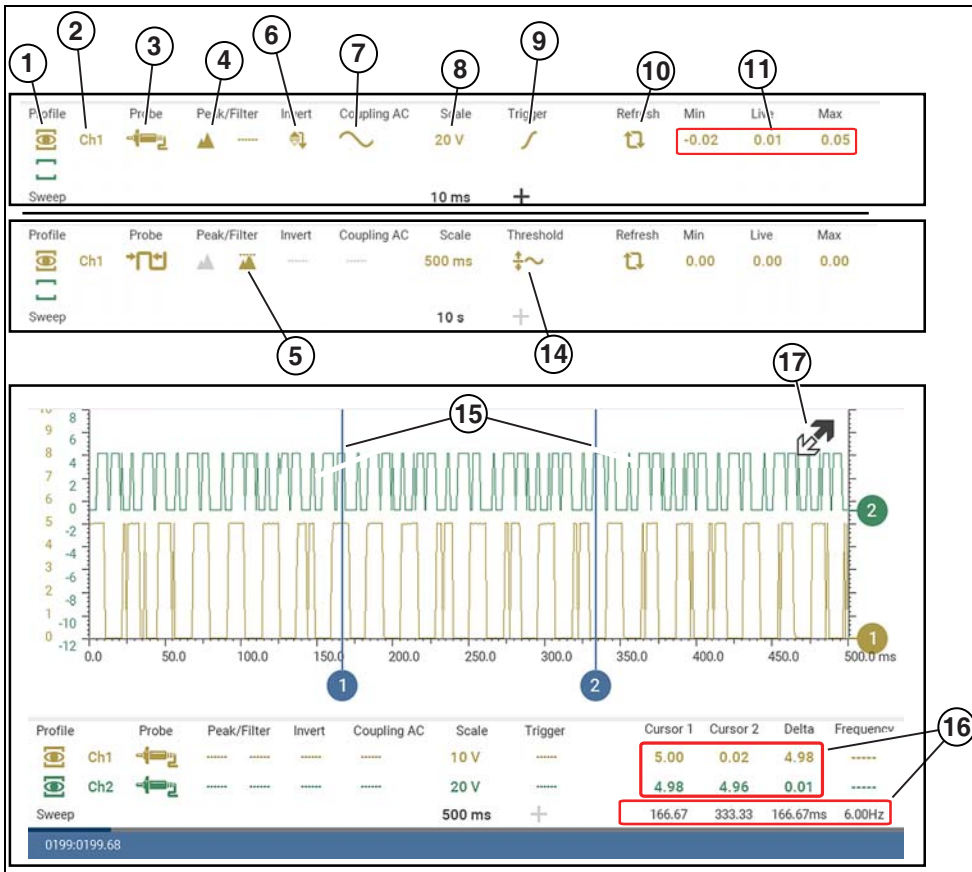

Figure 9-20



- 1— **Show/Hide (Channel display on/off)**—turns channel on/off
- 2— **Trace (Zero Baseline position adjustment)**—adjusts zero baseline position
- 3— **Probe (Probe type “test” selection)**—changes test probe function
- 4— **Peak Detect**—maximizes sampling rate
- 5— **Filter**—removes signal noise or interference
- 6— **Invert**—switches signal polarity
- 7— **Coupling AC**—blocks the DC portion of signal
- 8— **Scale (Vertical scale adjustment)**—adjusts vertical scale
- 9— **Trigger**—turns triggering on/off, and sets direction of trigger slope
- 10— **Refresh**—clears Min, Max and Live values and resets to zero
- 11— **Min, Live and Max Display Panel**—displays lowest, highest and current trace measurements set since the test was activated
- 12— **Sweep (Horizontal or Time scale adjustment)**—adjusts horizontal scale
- 13— **Trigger Position Icon**—opens trigger position control panel
- 14— **Threshold**—turns auto threshold on, to provide a more accurate measurement on select tests where noise is present (GMM only)
- 15— **Cursors**—used to measure time, amplitude and frequency
- 16— **Cursor Measurements Panel**—displays signal amplitude at cursor and cursor position in time
- 17— **Expand/Collapse Icon** - Toggles display of the control panel (Trace Detail)



### Show/Hide (Channel display on/off)

The Show/Hide icons allow you to turn the channels on and off.

To turn a channel on and off, select the applicable channel's **Show/Hide** icon.

Show/Hide Icons	
On (Channel displayed)	Off (Channel not displayed)
	

### Trace (Zero Baseline position adjustment)

The Trace icon identifies the channel number and is used to open the zero baseline adjustment controls.

To adjust the vertical position of the zero baseline (0 value) of a trace (for either channel), select the **Trace** icon or to open the zero baseline adjustment controls. Select the up/down arrows to make adjustments or press the up/down directional buttons. Tap the main body screen section or press the **N/X** button, to exit.

The zero baseline can also be repositioned by touching and dragging the baseline marker up/down on the screen.

Trace Icon

### Peak Detect

#### Peak Detect Off

When peak detect is off, the scope samples at a high rate but saves just enough sample points to the data buffer memory to plot a waveform across the screen. No preference is given to any point during the selection process.

#### NOTES

— Turning peak detect “off” is suitable for basic measurements, and viewing waveforms (e.g. oxygen (O<sub>2</sub>) or Cam sensor) when capturing fast events is not necessary.

— The longer the time sweep, the greater the chance a glitch could be missed because it occurred in between the sample points saved to the data buffer memory. To increase the chance of capturing a glitch with peak detect “off”, a shorter time sweep should be selected.

— Turning peak detect “off” avoids the need for an external filter to decrease the display of unwanted noise, which can make diagnosis more difficult.

**Example:** With a time sweep of 10 seconds on a screen 100 points wide, the effective sample rate would be 10 times a second. Decreasing the time sweep to 1 second, increases the effective sample rate to 100 times a second. At this time setting, a fast occurring event is more likely to be captured due to the increased rate. This is the standard mode of operation for many scopes.



## Peak Detect On

When peak detect is “on”, all sample points are evaluated. The points stored to the data buffer memory are intelligently selected to capture fast events that might be missed at slower effective sample rates. Peak Detect captures fast events, spikes and glitches for signals going in both positive and negative directions.



### NOTES

— Turn peak detect “on” when capturing fast events (e.g. ignition firing voltage, glitches, and intermittent events).

— Turning peak detect “on” may capture unwanted noise, therefore, using peak detect may not be suitable for some tests (e.g. oxygen (O<sub>2</sub>) sensor), as the waveform may be more difficult to evaluate due to the additional noise that may be displayed.

— Peak Detect decreases the possibility of waveform aliasing.

To turn peak detect on and off, select the **Peak Detect** icon.

Peak Detect Icons	
On (Sampling maximized)	Off (Sampling not maximized)
	

## Filter

Using the filter feature can minimize or smooth out signal spikes and fast variations, depending on which function is its used with.

### Filter - Lab Scope

Using the filter with the lab scope, suppresses fast spikes and unwanted noise.

Using the filter is useful when working with scales of 5 volts and below, as the lower the voltage scale, the more likely noise can occur.

**Example:** Using the filter is helpful when testing components such as, an O<sub>2</sub> sensor (1 or 2 volt scale), or when performing a throttle position (TP) sensor sweep test (5 volt scale).

In addition, the filter is also helpful for low amp probe tests, as a low voltage scale is used to measure the output of the probe (due to the conversion factors of the probe).



**Example:** For a probe with a conversion factor of 100 mV/A connected to a 2 amp load, the scope uses a 200 mV scale to measure the output of the probe. The scope converts the measured output to 2 amps for display on the screen.

### Filter - GMM

Using the filter with the GMM, the filter minimizes noise by ignoring or smoothing out fast signal spikes. **Note:** Using both Peak Detect and Filter provide a good balance between noise suppression and capturing spikes (glitches).

- For a direct measurement test, such as volts, amps, or pressure, the filter minimizes the display of very fast spikes by averaging the sampled data when filter is active.
- For a calculated measurement test, such as frequency, pulse width, dwell, or duty cycle, extremely fast spikes (20  $\mu$ S and faster) from sources like the ignition system are ignored when filter is active. **Note:** Peak is always on when displaying calculated measurements such as frequency

To turn the filter on and off, select the **Filter** icon.



Filter Icons	
On (Interference is suppressed)	Off (Interference is not suppressed)
	

## Invert

The Invert feature is used to switch signal polarity, so the trace appears upside down (inverted) on the screen. This is typically used when measuring amperage using the low amp probe, or high-voltage signals like, secondary ignition.

**Example:** A signal that normally rises from 0 to +5 volts, if inverted would show falling from 0 to -5 volts.

To turn inversion on/off, select the **Invert** icon.

Invert Icons	
On (Polarity is inverted)	Off (Polarity is not inverted)
	





## Coupling AC

Coupling AC subtracts the average value of a signal so that small variations can be displayed in the waveform. This is accomplished by blocking the direct current (DC) portions of a signal in order to amplify (show) the alternating current (AC) portions of the signal, without driving the trace off of the screen.

Using coupling AC can be helpful when testing and diagnosing alternator ripple or fuel pump amperage, by allowing you to see any abnormal small variations or events.

To turn coupling AC on and off, select the **Coupling AC** icon.

Coupling AC Icons	
On (DC signal portion blocked)	Off (DC signal portion not blocked)
	

## Trigger

### NOTE

*The Trigger feature is only available in the lab scope function.*

A trigger can be used to stabilize a changing or erratic signal (a signal that may flicker or drift as it refreshes), so that it is easier to view or diagnose. This stabilization effect is accomplished by basically displaying the same part of the trace repeatedly from the same starting point, thus the flicker or drift is minimized which makes the trace appear more consistent or static.

A trigger is basically a “specific point” on the display, at which a trace will start to display (start the sweep) if it crosses that point.

The trigger feature allows you to set the conditions of that “specific point” also called a “trigger point”. When the trigger conditions are set, and a trace “meets” those conditions (crosses the trigger point), the trace will start.

Trigger conditions:

- Vertical scale position (amplitude)
- Sweep position - the horizontal scale position, or position in time
- **Slope direction** - the direction the trace must be moving (up/rising or positive) or (down/falling or negative) when crossing the trigger point.

### NOTES

*Triggers can be set on any channel, however only one trigger can be activated (used) at a time.*

*If a trigger is set outside the range of the scales, a yellow marker (e.g. arrow with plus symbol) will be displayed (Figure 9-22) indicating the trigger is out of range and a confirmation screen will display.*



*When a trigger is set on a channel, and more than one channel is active (displayed), trigger conditions must be met for that channel in order to display all the other channels.*



### To turn a trigger on/off:

A trigger is activated by selecting the trigger icon from the control panel, which then automatically initiates trigger slope setup.

1. Select the desired channel's **Trigger** icon.  
Each tap of the icon sets the trigger to a different slope setting, or turns the trigger off.
2. Select the desired slope setting, to turn the trigger on.

Trigger Icon	Description
	<b>Rising (up or positive)</b> - Trigger is turned on to start the trace on the rising edge (as signal begins to rise)
	<b>Falling (down or negative)</b> - Trigger is turned on to start the trace on the falling edge (as signal begins to fall)
	<b>Off</b> - Trigger is turned off.

3. Proceed to **“To set trigger position”** next to complete the trigger set up.



### To set trigger position:

Trigger position (also called trigger level) can be adjusted in two ways:

- Dragging the trigger marker (*Figure 9-21*) on the touch screen - rough adjustment
- Using the trigger position control panel (*Figure 9-21*) - fine adjustment

The trigger marker is indicated by a plus symbol (+) on the display (*Figure 9-22*). The trigger marker represents the trigger point and is displayed on the screen when the trigger is turned on.

To roughly position the trigger marker, select and drag it into position using the touch screen.

- To more accurately position the trigger marker, select the **Trigger Position Control** icon (*Figure 9-22*).

The trigger position control panel opens.

- Use the directional controls provided, or the thumbpad directional controls to move the trigger marker into position (*Figure 9-21*). Sweep and vertical scale values are provided in the trigger position control panel, which gives you the precise position of the trigger marker.
- Press the **N/X** button, to exit.

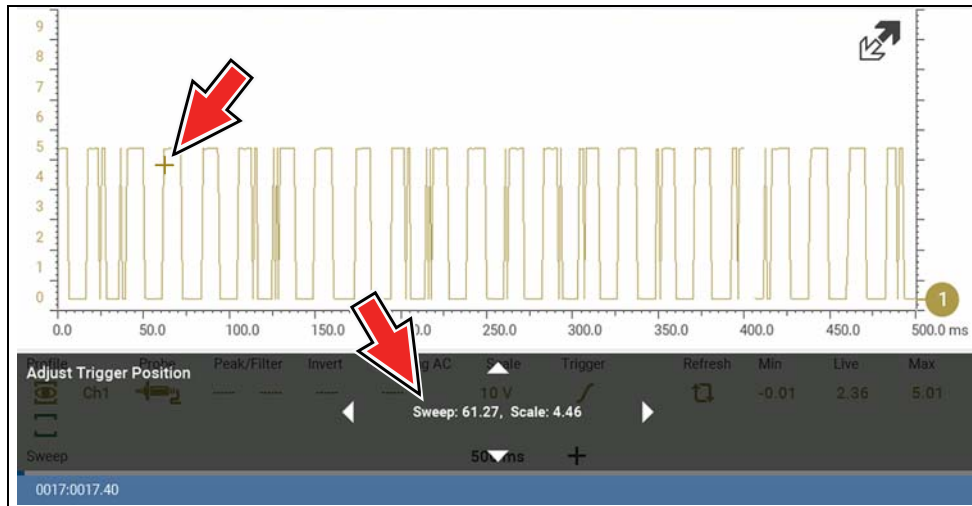

1— Trigger Marker

2— Trigger Position Control Panel

Figure 9-21

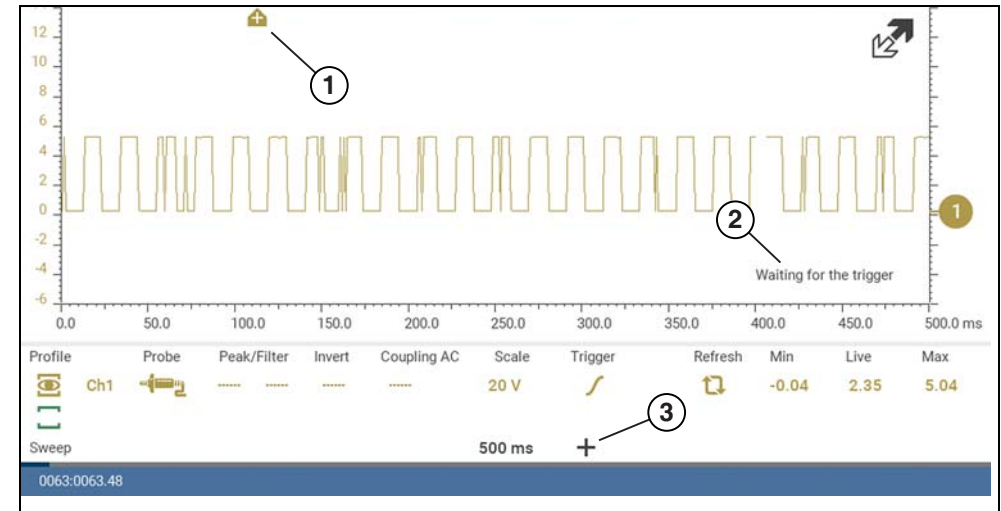

1— Trigger Marker (out of range symbol)

2— Waiting for Trigger Message

3— Trigger Position Control Icon

Figure 9-22





## Trigger Auto/Manual Mode (Optional Setting)

### NOTE

The Auto and Manual Trigger modes allow you to set the criteria used to display signals on the screen. To change the trigger mode, the trigger must be set on one of the channels.

In both Auto and Manual Trigger mode the screen is updated when the signal crosses the trigger point in the selected direction (rising or falling), however:

- **Auto Trigger**—(default mode)
  - when Auto Trigger is on, even if the signal does not cross the trigger point, the screen automatically updates after a short period (approximately 1/2 second) allowing you to see the waveform. When this occurs, the message "Waiting for the trigger" (Figure 9-22) is displayed on the screen. The trigger point can then be set to optimize viewing.
- **Manual Trigger**
  - when Manual Trigger is on, if the signal does not cross the trigger point the screen will not update. This allows you to capture intermittent events, as the screen only updates when the signal meets your trigger selection.

### NOTE

To use Manual Trigger, it may be easier to initially set the trigger point using Auto Trigger, as the screen will update regardless if the signal crosses the trigger point. Once the trigger point is set, then switch to Manual Trigger mode.



### Selecting Trigger Auto/Manual Mode:

1. From the Control Panel (on the test meter screen), turn the trigger on for the desired channel.
2. Select the **Settings** icon from the toolbar.

## Navigation

**Home Screen:** Settings > Configure Scope / Meter > Trigger Mode

3. Select either **Auto Trigger** or **Manual Trigger**.
4. Select **Back** or press the **N/X** button to navigate back to the test meter screen.

## Threshold

### NOTE

The Threshold function is only available in the Graphing Meter function for specific tests. This function may also be referred to as Auto Threshold Select (ATS).

The Threshold function can be used, to display and obtain a more accurate measurement when measuring signals (e.g. Frequency, Duty Cycle, MC Dwell and Pulse Width) that may be difficult to display or have noise or other undesirable variations in the signal. When selected, the Threshold function automatically sets a trigger and determines a threshold level in the middle of the signal range (calculated from the Min and Max measurements) to be used as a reference point to calculate the measurement. The falling edge (slope) of the signal is used in determining the threshold level.

To activate the Threshold function, select the **Threshold** icon, then select **Continue** from the confirmation screen (Figure 9-23). Once selected, the Threshold function remains active until the test is exited.

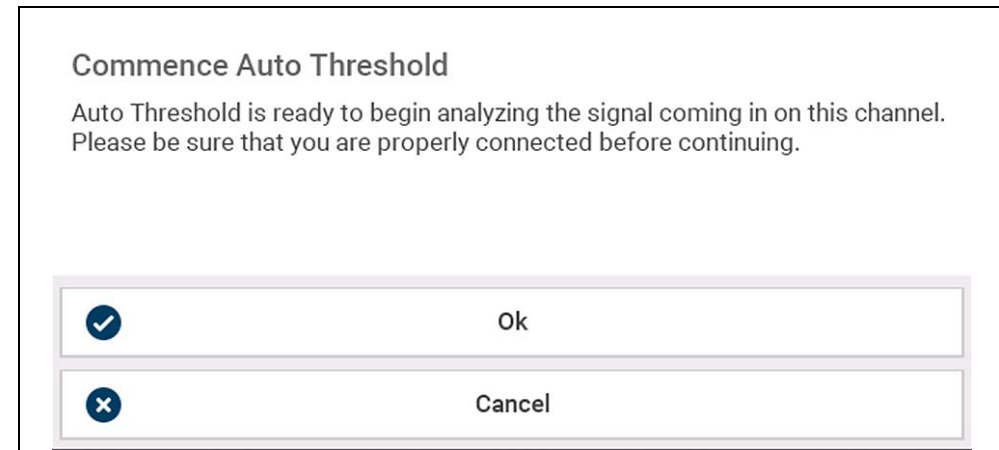

Figure 9-23

If after enabling the Threshold function, if the signal is still not displayed, reduce the vertical scale setting. Sometimes a low frequency signal may not display if the vertical scale is set too high. If the signal still seems incorrect use the lab scope to verify the signal integrity and signal spacing. Slow or unequal spacing will display as a band or ragged signal, depending on the sweep setting.



## Refresh

Selecting the **Refresh** icon ([Figure 9-24](#)) clears the digital values (minimum, maximum and live measurements) displayed and restarts from zero.

Use the Refresh feature to:

- Track the variation in a component or circuit under a certain condition. If the condition changes, Refresh lets you start tracking again to see the change.
- Verify that a connection problem you found by looking for a dropout or spike in min/max values has been fixed.

## Min, Live and Max Display Panel

The Min, Live and Max display panel ([Figure 9-24](#)) displays each channels active signal minimum and maximum recorded measurements and live measurement.

**Note:** When Cursors are turned on, the cursor measurements panel (values) replace the Min, Live and Max display panel.

- **Min** - lowest measurement recorded for the signal since the test was activated, or from the last time Refresh was selected
- **Max** - highest measurement recorded for the signal since the test was activated, or from the last time Refresh was selected
- **Live** - represents the “live” running average measurement of the signal being measured

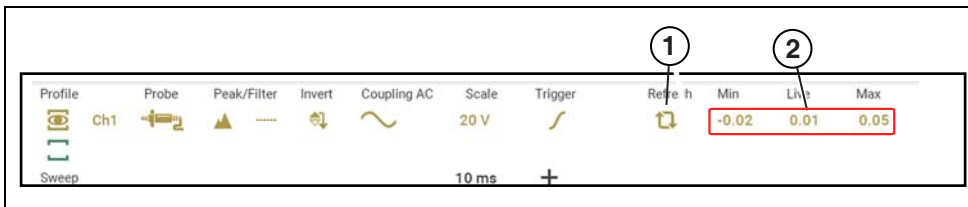

1— Refresh Icon

2— Min, Live, Max Display Panel

Figure 9-24

## Cursors

### NOTE

*The Cursors feature is only available in the lab scope and Graphing Meter functions.*

Two vertical cursors are provided that allow you to make precise signal measurements, when determining signal characteristics such as, amplitude at specific points, and cycle time (duration) or frequency.

Using cursors can also be helpful when performing certain diagnostic tests, such as:

- O2 sensor rich/lean switch time
- fuel injector pulse width frequency
- secondary ignition spark duration
- crankshaft position sensor frequency

Measurements can quickly be taken between the two cursors, when measuring a single cycle or across multiple cycles by positioning the cursors at the start and end of the cycle or multiple cycles.

The cursor measurements panel is displayed when using the cursors, providing you digital values of the cursor measurements. See [Cursor Measurements Panel](#) on page 92 for additional information on the values displayed in the cursor measurements panel.



### To turn the cursors on/off:

1. To turn the Cursors on (display), select the **Cursor** icon from the toolbar.

Two cursors are displayed on the test screen, and the Refresh, Min, Live, Max display panel is switched off and replaced by the cursor measurements panel. See [Cursor Measurements Panel](#) on page 92 for additional information on the cursor measurements panel.

To turn the Cursors off, select the **Cursor** icon again from the toolbar.

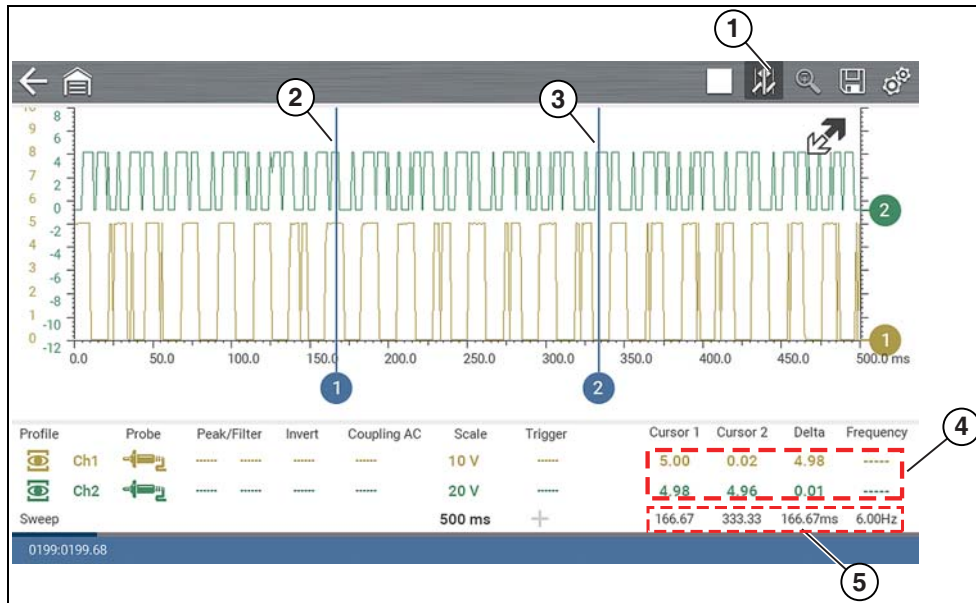

- 1— Cursors Icon
- 2— Cursor (no. 1)
- 3— Cursor Marker (no. 2)
- 4— Cursor Measurement Panel - amplitude and delta display
- 5— Cursor Measurement Panel - time and delta display

Figure 9-25



### To position the cursors:

The cursors can be positioned anywhere within the range of the sweep scale ([Figure 9-25](#)).

1. Turn the Cursors on.
2. Using the touch screen, select either cursor marker (base) and drag it to the desired position.

### Cursor Measurements Panel

When the cursors are turned on, the Refresh, Min, Live, Max display panel is switched off and replaced by the Cursor Measurements Panel.

The cursor measurements panel displays the following signal and cursor measurements:

- Signal amplitude at two points
- Signal amplitude difference (delta) between two points
- Cursor position in time at two points
- Difference (delta) in time between the cursors
- Frequency - frequency of the signal for the time period between cursor 1 and 2

The cursor measurements panel contains values for each channel in two displays.

The amplitude and delta display is provided in the channel specific color and includes:

- **Cursor 1** - signal amplitude at cursor 1 position
- **Cursor 2** - signal amplitude at cursor 2 position
- **Delta** - signal amplitude difference between cursor 1 and 2

The time and delta display is gray in color and includes:

- **Cursor 1** - cursor position in time at cursor 1
- **Cursor 2** - cursor position in time at cursor 2
- **Delta** - difference in time between cursor 1 and 2
- **Frequency** - the frequency value (Hz) of the signal for the time period between cursor 1 and 2

**NOTE**

Frequency is the number of times a signal repeats itself per second and is measured in hertz (Hz).

The frequency value displayed, is the inverse of the Delta value, and can also be calculated as 1 divided by Delta. The frequency value (Hz) shown is automatically calculated by the scope.

**Example 1:** Delta = 20.46ms, to get frequency divide 1 by .02046 (1/.02046 = 48.87Hz)

**Example 2:** Delta = 2.53ms, to get frequency divide 1 by .00253 (1/.00253 = 395.27Hz)

Use applicable decimal point placement during division as the Delta value changes.

## 9.6.4 Secondary Ignition Testing

The lab scope function can be used to display secondary ignition waveforms for many systems (distributor, CIC - Coil In Cap, Waste spark, COP - Coil On Plug). To display secondary ignition waveforms, optional secondary ignition coil adapter(s) and a coil adapter lead assembly are required.

Contact your sales representative to purchase the optional adapter leads and/or Secondary Ignition Clip-on or COP/CIC Adapters.

- Adapter lead assembly needed:
  - Secondary Coil Adapter Lead Assembly - connects the diagnostic tool to a secondary ignition adapter (yellow and black scope connectors and black RCA type adapter connector). See [Secondary Ignition Coil Adapter Lead and Clip-on Adapter \(optional\)](#) on page 76.

- Secondary Ignition Adapters available:
 

Different secondary ignition coil adapters are available as optional equipment. These adapters attach to either the secondary lead (spark plug lead) or directly to the secondary ignition coil in order to pick up the secondary ignition signal.

  - Universal kV Ignition Clip-on adapter - clips over a spark plug or coil lead. See [Secondary Ignition Coil Adapter Lead and Clip-on Adapter \(optional\)](#) on page 76.
  - Universal stick and flag type adapters - are loosely positioned next to or on a secondary ignition coil.
    - General purpose single flag pick-up.
    - General purpose stick pick-up.
  - Vehicle specific Clip-on adapters - are directly attached to (or next to) a secondary ignition coil (COP type) or to a distributor cap (CIC type). Secondary ignition coil-on-plug (COP) and coil-in-cap (CIC) adapters are available for universal and engine specific applications. All the adapters listed are available individually.
    - OEM specific COP adapters:
      - Ford (COP-1)
      - Chrysler (COP-2)
      - VW/Audi (COP-3)
      - Acura/Honda/Isuzu (COP-4)
      - Volvo/BMW (COP-5)
      - Mercedes-Benz (COP-6)
      - Mercedes-Benz Dual Type (COP-7)
      - BMW (COP-8)
      - Lexus (COP-9)
      - Chrysler/Jeep/Lexus/Toyota (COP-11)
    - OEM specific CIC adapters:
      - GM HEI (CIC-1)
      - Toyota/Honda (CIC-2)



### Connecting the Secondary Coil Adapter Leads:

1. Connect the black (ground) lead into the diagnostic tool test lead ground jack.
2. Connect the yellow lead into the diagnostic tool test lead channel 1 jack.
3. Connect the adapter lead ground clamp to vehicle ground. If a jumper wire is used to extend the length of the adapter lead ground clamp lead, keep it as short as possible.
4. Connect the adapter lead RCA plug into the secondary ignition "clip-on" or COP/CIC coil adapter as needed.
5. Clamp the secondary clip-on adapter over a spark plug or coil lead, or attach the applicable COP/CIC coil adapter to the vehicle ignition coil.
6. Isolate the leads from other components, to avoid any unwanted noise that could be induced onto the signal.
7. From the lab scope function, select the Ignition Probe (probe setting).
8. If needed, turn the Invert function on.

Once a signal is displayed, further channel settings may be required to display the pattern characteristics you are looking for.

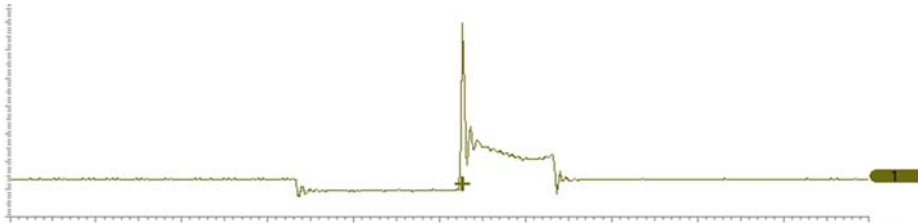

Figure 9-26 Typical Secondary Ignition Signal

## 9.7 Optional Settings

### Navigation

**Home Screen:** Tools > Settings > Configure Scope / Meter

The following optional Scope/Meter settings can be set to your preference:

- [Trigger Auto/Manual Mode \(Optional Setting\)](#) on page 90
- [Grid \(on/off\)](#) on page 94
- [Trace Divisions](#) on page 95
- [Display Settings](#) on page 96

### 9.7.1 Grid (on/off)

### Navigation

**Home Screen:** Tools > Settings > Configure Scope / Meter > Grid

The Grid option allows you to display or hide the screen grid lines.

- **Show Grid**—grid lines on
- **Hide Grid**—grid lines off



Figure 9-27



## 9.7.2 Trace Divisions

### Navigation

**Home Screen:** Tools > Settings > Configure Scope / Meter > Trace Divisions

The Trace Divisions option allows you to change how the vertical scale menu selections are represented.

- Trace Full Scale, or
- Trace Per Division

### NOTE

This setting *ONLY* changes the vertical scale, the sweep (horizontal) scale is *NOT* changed.

### NOTE

When adjusting the vertical scale setting, it is important to remember that the vertical scale is divided into 10 major divisions, and all scale adjustments reflect this factor of 10. The division set of 10 cannot be changed, divisions cannot be added or removed.

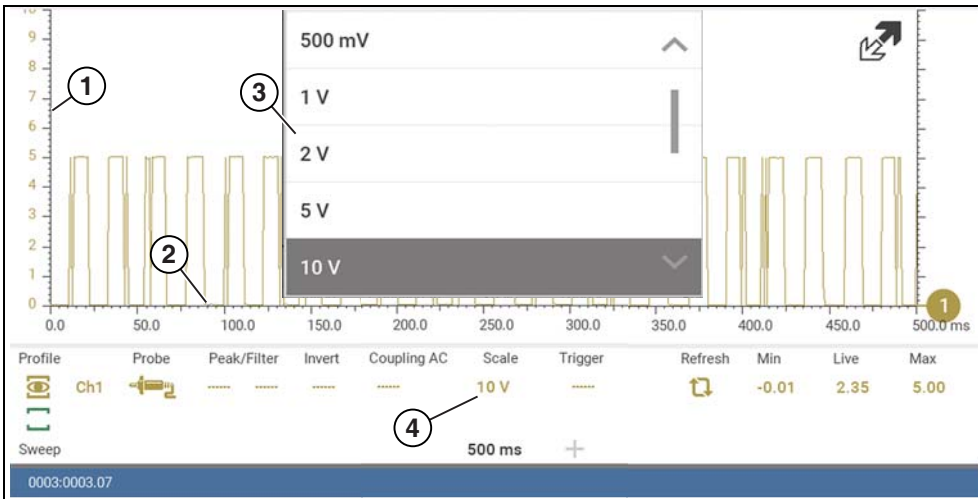

1— Vertical Scale

2— Sweep (horizontal or time) Scale

3— Vertical Scale Menu

4— Vertical Scale Icon

Figure 9-28

*Trace Full Scale* - changes the dropdown vertical scale menu selections to full scale mode, which represents the selected unit of measurement over the entire (full) scale.

**Example (Figure 9-29):** Selecting 10V, changes the vertical scale to a 10V volt scale. The vertical scale is “always” divided by 10, therefore each division is incremented by 1V.

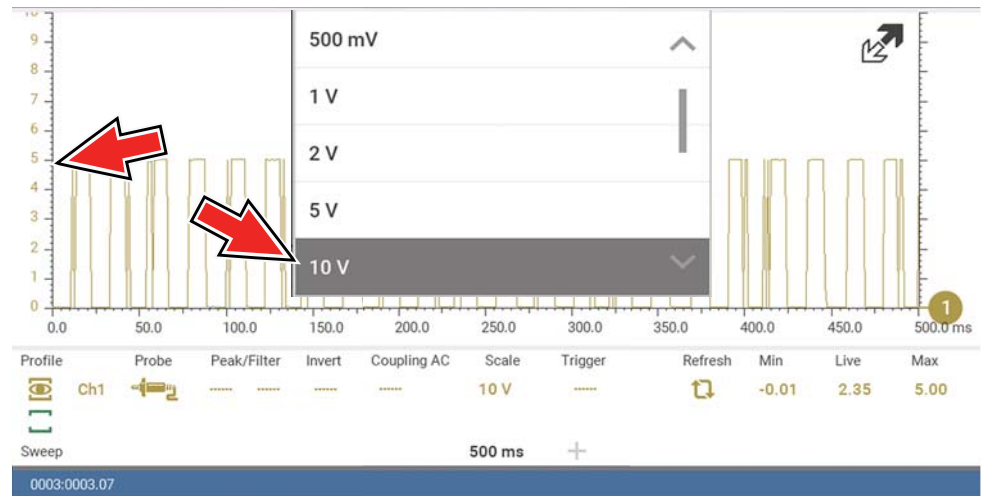

Figure 9-29

**Trace Per Division** - changes the dropdown vertical scale menu selections to ##/div mode, which in turn changes the vertical scale to represent ## by division.

**##** - represents (variable) what is being measured (voltage, amperage, pressure etc.)

**Example (Figure 9-30):** Selecting 1.0V/div, displays a vertical scale divided by 10. The vertical scale is “always” divided by 10, therefore each division is incremented by 1.0V, thus a 10V scale.

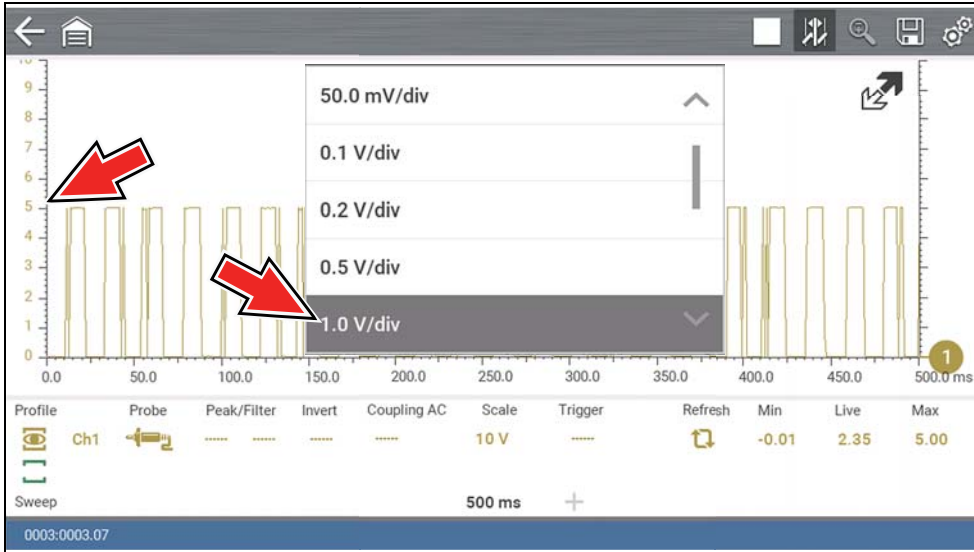

Figure 9-30

### 9.7.3 Display Settings

#### Navigation

**Home Screen:** Tools > Settings> Configure Scope / Meter

#### Display

- Display Full Scale
- Display Per Division

The Display setting allows you to change the displayed value in the Vertical Scale icon to your preference.

#### NOTE

This setting **ONLY** changes the value displayed in the Vertical Scale icon.

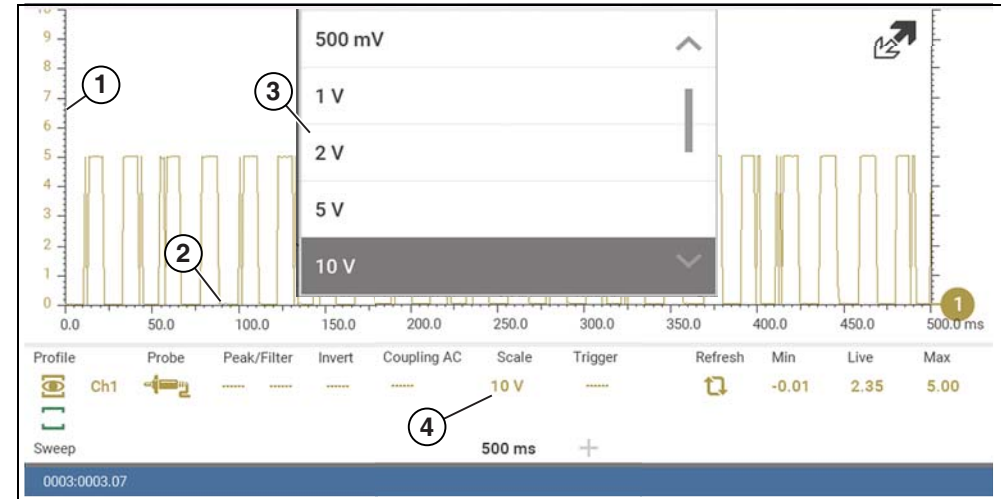

- 1— Vertical Scale
- 2— Sweep (horizontal or time) Scale
- 3— Vertical Scale Menu
- 4— Vertical Scale Icon

Figure 9-31

Display Full Scale - displays the value of the entire (full) scale

**Example (Figure 9-32):** If the vertical scale is set to 1V, the value displayed is 1V.

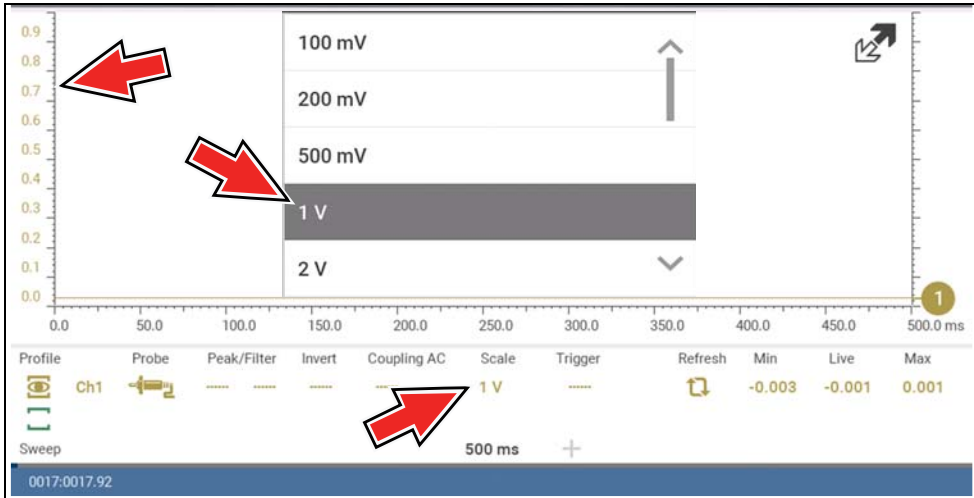

Figure 9-32

Display Per Division - displays the graduation value of the major scale divisions

**Example (Figure 9-33):** If the vertical scale is set to 1V, the value displayed is 0.1V.

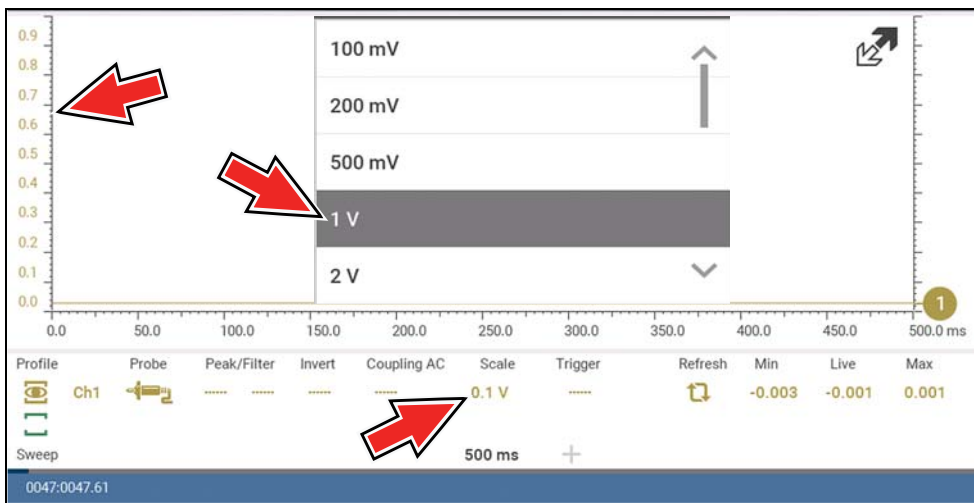

Figure 9-33

## 9.8 Capturing Data

The primary purpose and advantage of the Lab Scope and Graphing Multimeter, is their ability to capture, store and playback data (test signals). Having this ability can be invaluable when diagnosing intermittent issues, by providing you the ability to navigate through the data in detail to find events of interest, such as glitches and signal losses. The following sections describe the basics of the data buffer and the two basic modes of operation, Capture Mode and Review Mode.

### 9.8.1 About the Data Buffer

To gain a better understanding of the capabilities of the scope and the basics of capturing and reviewing data, understanding what the data buffer is and how it works is important.

The Lab Scope and Graphing Multimeter have the capability to capture, store and playback data (test signals) utilizing internal buffer storage memory. When a test function is selected (e.g. Lab Scope > DC Volts), the data is automatically stored in buffer memory, until the Pause icon is selected.

The amount of data you can capture is limited to a predetermined “total buffer memory” size. When the buffer memory reaches its full capacity, the data buffer will continue to store new data, however earlier stored data will be removed to allow room for the new data being stored. The most recent data is always available for review when the scope is paused, and can be reviewed using the toolbar controls

As a visual aid, a graphic Data Buffer Slider (Figure 9-34 (1)) is located at the bottom of the screen and indicates the position of the current displayed frame of data in relation to the entire buffer memory capacity.

In addition, a Data Buffer Position Counter (Figure 9-34 (2)) displays the numerical position of the Data Buffer Slider within buffer memory.



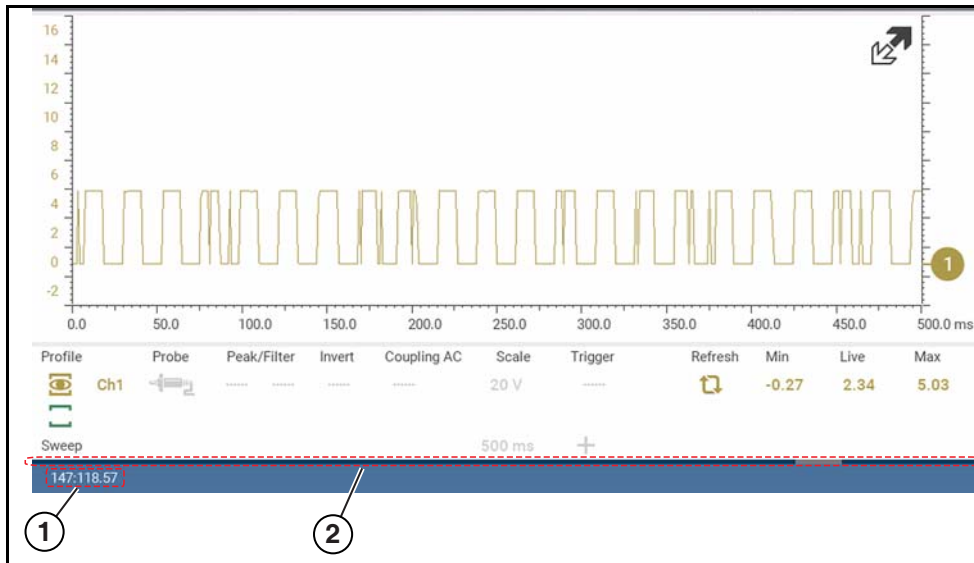

1— Data Buffer Position Counter (XXX (Total memory “frames” available):  
XXX (Whole frame number): XX (Fractional frame number))

2— Data Buffer Slider

Figure 9-34

## 9.8.2 Capturing Data (Capture Mode)

For control icon descriptions, see [Scope Multimeter Control Icons](#) on page 79.

Whenever you open Lab Scope or the Graphing Multimeter, the device is in Capture Mode. In Capture Mode, data is continuously being captured and stored in buffer memory at the same time it is being displayed onscreen.

### NOTE

*Data is continuously stored in buffer memory with or without an active input test signal or trigger.*

To help you understand how to work with captured data, an important concept to remember is that data is captured over a period of time. Therefore there is a direct relationship between the length of time the data is captured in, and the resultant level of detail you will have when reviewing it.

As every testing situation is different, the following is provided only as a guide when capturing data to provide the best flexibility when reviewing the data to find events.

In most situations if you start by using a sweep setting that is best suited for viewing the waveform “live”, or at a setting that provides the best detail to the naked eye, this will allow you to either see the event you are looking for “live”, or allow you to use the zoom feature (in Review Mode) to zoom out (2, 8, 32X etc.) and then search through the data buffer for events of interest.

It is important to remember that whatever sweep setting you use during data capture is what the 1X zoom level will be when you switch to Review Mode. Therefore, if you capture data using a sweep setting where the pattern displayed is tightly compacted (can’t visually see detail), then when you try to use zoom you will not be able to see any detail, as you will only be able to zoom out from the setting where you originally captured the data (displaying an even greater level of compacted data).

In other situations you may need to start at a faster sweep (shorter time) to capture more detail “live”, then zoom out (in Review Mode) to get a wider view and then zoom in at the points of interest where you need more detail. Using this strategy you will capture less total time, but be able to see more detail.

For some situations, if the sweep setting you are using is not fast enough to capture the event your looking for, turning Peak Detect on will increase the sample rate and may allow you to see the event.

Using peak detect can also help in avoiding aliasing if the sweep time is too great for the waveform being captured. Using peak detect is not appropriate for every instance, but when using longer sweep settings, it can help increase the capture time by allowing you to capture more than you could without it and still capture dropouts and points of interest. See [Peak Detect](#) on page 86 for more information.

For additional information on setup and capturing data (input signals) see [General Reference](#) on page 103.

### NOTE

*Glitches may cause drivability problems and may not turn on the MIL or set DTCs. As a general guide when looking for a suspected signal glitch, always try to verify the problem by duplicating the conditions while capturing data. Utilize the GMM to monitor the signal over longer time periods and review the histogram for possible faults.*

### 9.8.3 Pausing Data

Data continuously stores in buffer memory until the **Pause** icon is selected.

Selecting the **Pause** icon ([Figure 9-35](#)), allows you to temporarily pause the data (input test signal) to review it in detail. See [Reviewing Data and Using Zoom \(Review Mode\)](#) on page 99 for more information.

To resume data capture, select the **Start** icon.

For control icon descriptions, see [Scope Multimeter Control Icons](#) on page 79.

### 9.8.4 Reviewing Data and Using Zoom (Review Mode)

Review Mode allows you to search through the captured data in detail to find events of interest, such as glitches and signal losses.

Press the **Pause** icon ([Figure 9-35](#)) to open Review Mode.

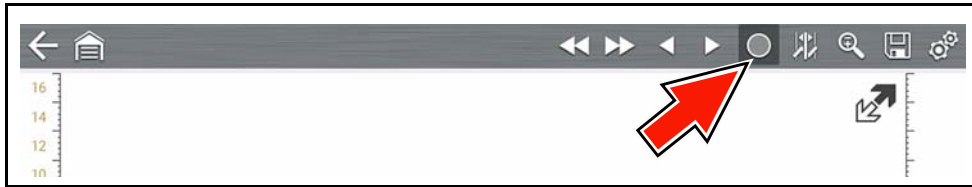

Figure 9-35

To search through the captured data, select the desired control icon to move forward or backward through the data ([Figure 9-36](#)).

#### **NOTE**

*You can also swipe the screen (side-to-side) to quickly scroll through the captured data.*

For control icon descriptions, also see [Scope Multimeter Control Icons](#) on page 79.

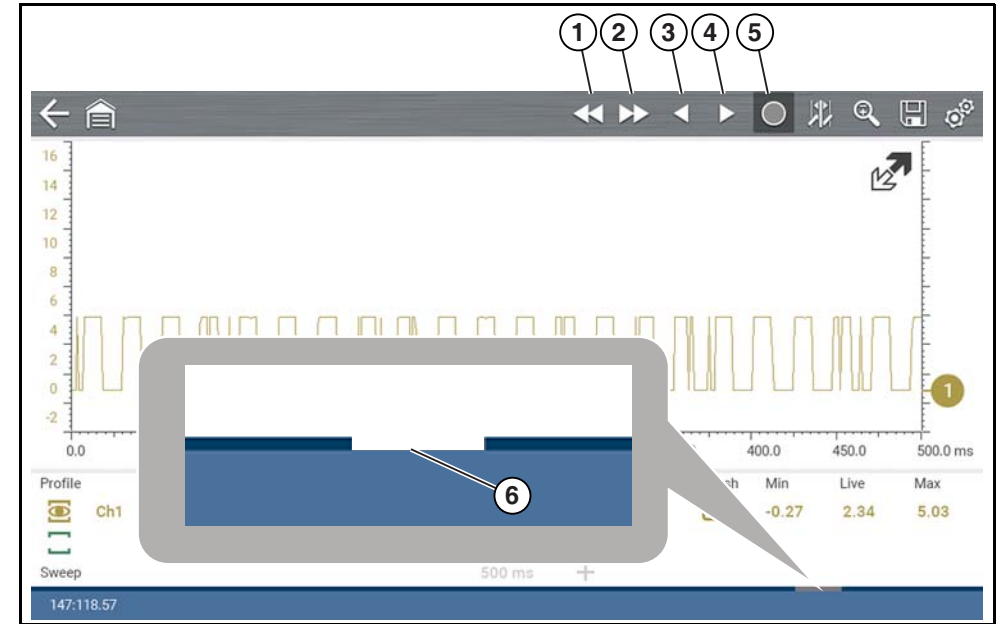

- 1— Back 1 Frame** Moves to the previous frame in the data
- 2— Forward 1 Frame** Moves to the next frame in the data
- 3— Step Back** Moves to the previous point in the data
- 4— Step Forward** Moves to the next point in the data
- 5— Start (Capture)** Resumes data capture
- 6— Data Buffer Slider**

Figure 9-36

## Using Zoom

For control icon descriptions, see [Scope Multimeter Control Icons](#) on page 79.

The zoom function is only available in Review Mode, and can be an invaluable tool when searching for events of interest within captured data. Zoom effectively gives you the ability to change the magnification level of the signal sweep during data review.

As zoom, allows you to change the magnification level of the signal sweep, this allows you to compress or expand multiple screens of data to quickly find glitches, or signal losses.

### NOTE

Control icon function is normal when using zoom, with the following exception:

**Forward 1 Frame / Back 1 Frame control icons** - (press once) moves multiple frames relative to the set magnification level (e.g. 2X setting, moves 2 frames; 16X setting, moves 16 frames).



When the **Zoom** icon is selected the display defaults to the "Max" magnification level and a dropdown scroll menu will display ([Figure 9-37](#)).

The dropdown menu allows you to select the display magnification level from a range of 1X to 256X (Max). The "Max" (maximum) option displays all data captured on one screen.

### NOTE

It is important to remember that whatever sweep setting you used during data capture is what the 1X zoom level will show.

### NOTE

The active zoom options (1X to 256X (Max)) that are selectable are dependent on the amount of data stored in the buffer. Less data captured = less zoom options. More data captured = more zoom options.

### NOTE

As there is a direct relationship between the length of time the data is captured in, and the resultant level of detail you will have when reviewing it, review the information in [Capturing Data](#) on page 97 for tips on capturing and reviewing data.

When zoom levels of 2X and higher are selected, a Zoom cursor (vertical dashed line) ([Figure 9-37](#)) displays onscreen. The cursor is used to quickly mark and navigate to points of interest or glitch in a captured waveform.

The Zoom cursor can be used to mark the approximate position of a glitch and can be manually dragged onscreen to the desired position. The new cursor position will be centered on the screen when a lower magnification level is selected.

[Figure 9-37](#) shows an example at Max with the Zoom cursor positioned in the area of a signal drop glitch.

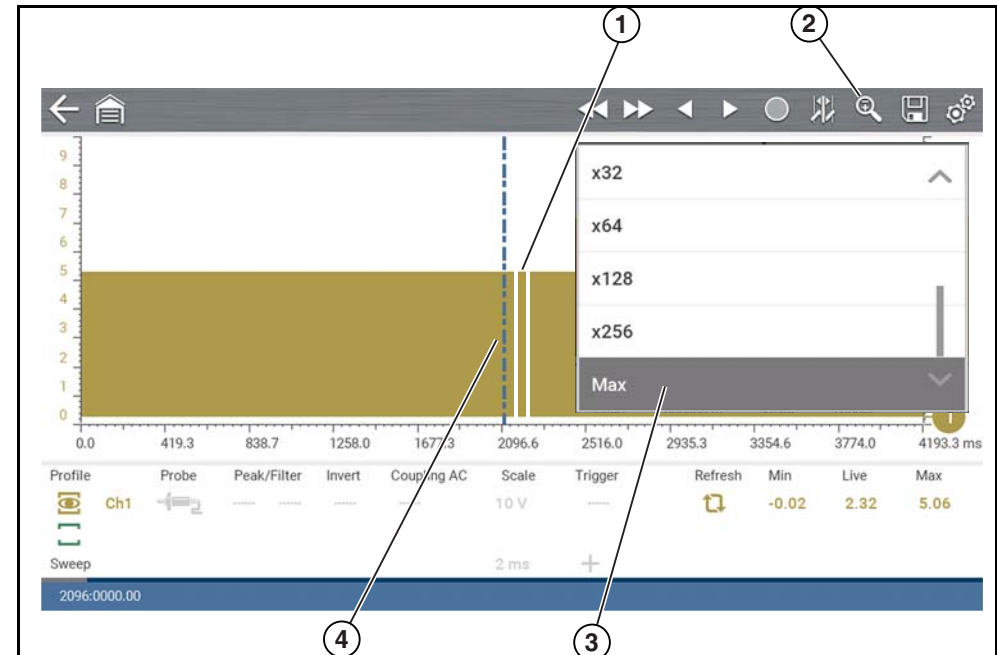

1. Glitch
2. Zoom Icon
3. Zoom Magnification Level (Max shown)
4. Zoom Cursor

Figure 9-37



**NOTE**

To quickly identify a glitch in a pattern, it may be easier to initially view the waveform at a higher magnification level (e.g. 256X or "Max") to display the entire captured waveform, find the area of interest and then lower the zoom level to 8X or 2X to review that area in detail. See the following figures and the [Zoom Example](#) on page 102.

Figure 9-38 shows an example at 16X of the same waveform shown in Figure 9-39. In Figure 9-38 at 16X, the glitch is easily seen as compared to higher magnification levels.

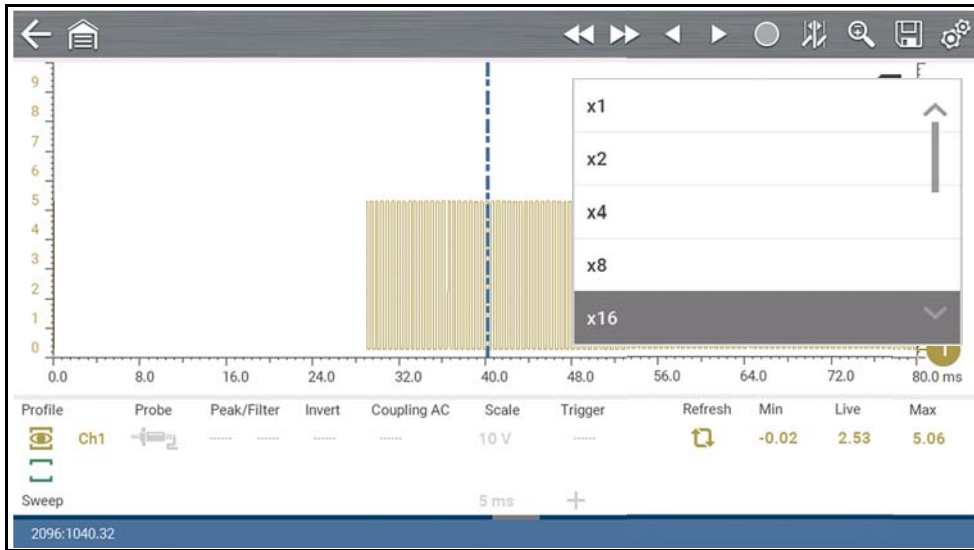

Figure 9-38

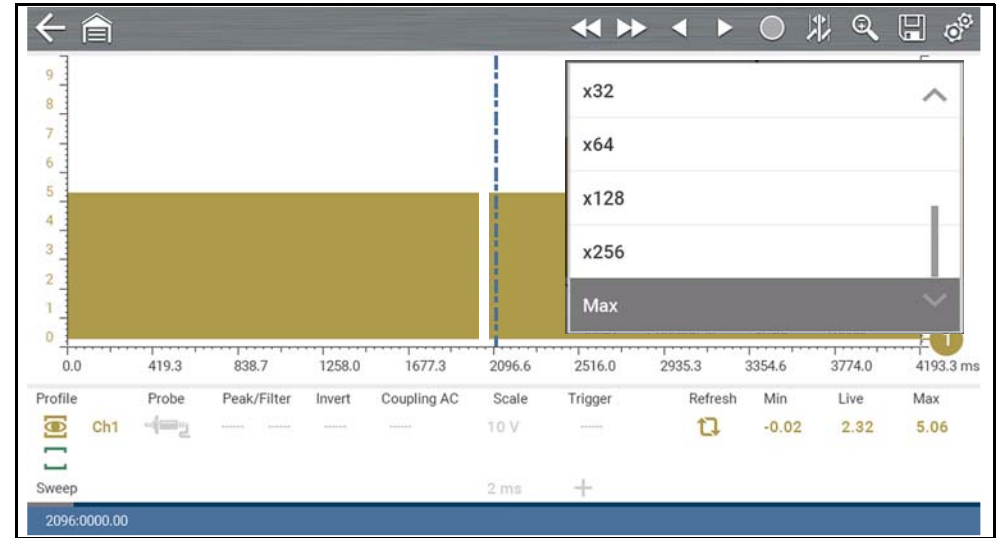

Figure 9-39

## Zoom Example

While monitoring a MAF (Mass Air Flow Sensor) signal, the waveform displays normally. As the signal is being monitored, an erratic “condition” suddenly develops, then goes away, but may have not been observed on the screen. Pausing the data capture (when such an event occurs) allows you to analyze the waveform using a higher zoom level (wider view) to look for a glitch in the signal.

The following **three** illustrations show a generic square waveform to illustrate this method.

**1** - Monitoring / Capturing waveform as it displays normally ([Figure 9-40](#)). You may not see a glitch, while monitoring at this setting.

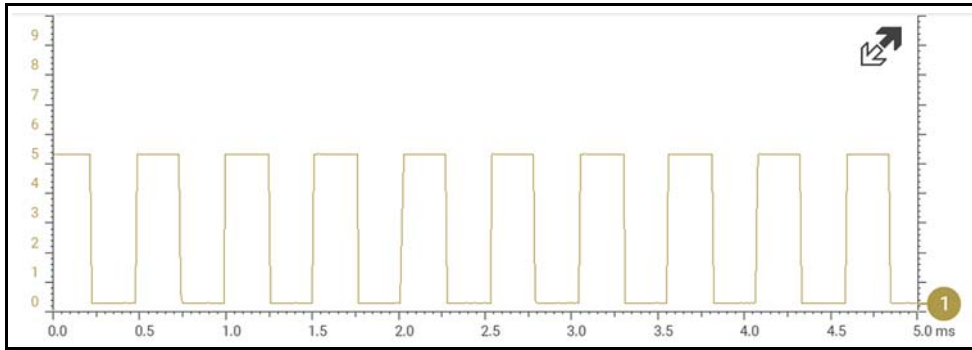

Figure 9-40

**2** - Pause data capture and then zoom out (this example is at 256X) to see more data and to possibly find a glitch ([Figure 9-41](#)). In this example the cursor has been placed on the right side of a glitch. The waveform is too compressed to see any detail, however the glitch stands out as a thin light area in the waveform.

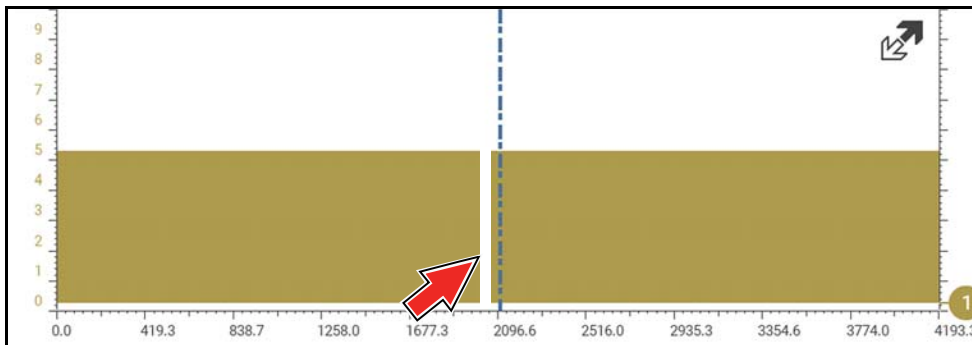

Figure 9-41

**3** - Zoom back in (this example is at 8X) to view more detail ([Figure 9-42](#)) in the area where the cursor was placed by the glitch.

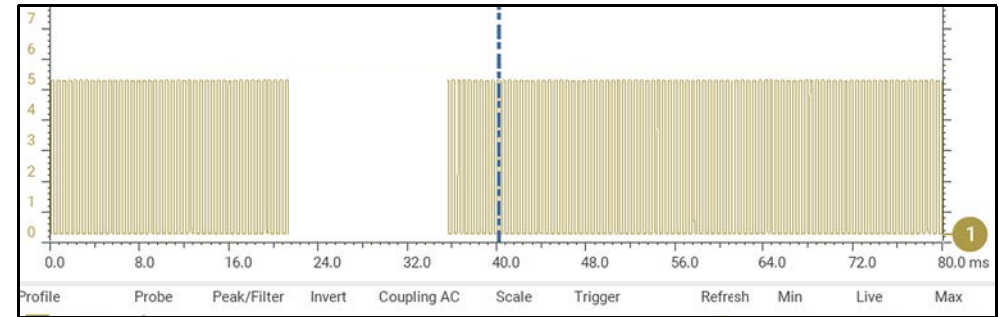

Figure 9-42

## 9.9 Saving Data Files

**File Save** - Selecting the **Save** icon writes the data stored in buffer memory to a file. Saving data files is useful when trying to isolate an intermittent problem or to verify a repair during a road test.

**File Playback** - The saved file can be played back (similar to a movie clip). See [Viewing Data Files](#) on page 35 for additional information.

### Navigation

**Home Screen:** [Previous Vehicles and Data > View Saved Data](#)

### NOTE

The **Save icon** performs the same function as “Save Movie” function choice for the programmable **Shortcut** button, see [Configure Shortcut Key](#) on page 123 for details.

The saved file can also be downloaded to a personal computer (PC) using the Mini USB jack. Once connected to the PC, the files can be printed, transferred, and copied using ShopStream Connect. ShopStream Connect is a companion application that interfaces the diagnostic tool with a PC. ShopStream Connect is available at no cost, and can be downloaded online. See the ShopStream Connect website information at the front of this manual for additional information.



The toolbar control icons are described in [Scope Multimeter Control Icons](#) on page 79 and [Icon Reference Table](#) on page 6.

-  **To save files:**
- Select the **Save** icon from the toolbar.  
A save dialog box displays while files are being saved. The file is saved when the message box disappears.

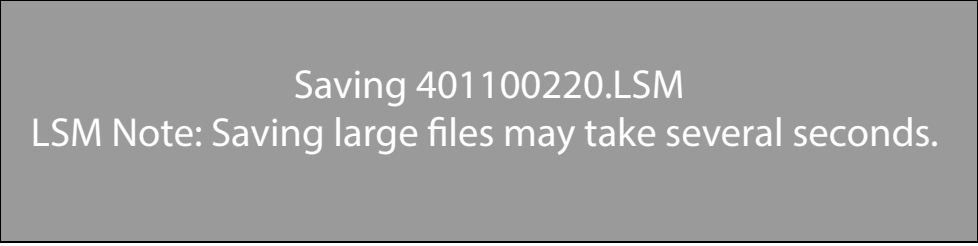

Saving 401100220.LSM  
LSM Note: Saving large files may take several seconds.

Figure 9-43

## 9.10 Saving Screens

The **Shortcut** button can be programmed to save a snapshot (screen shot) of a visible screen as a bitmap file, see [Configure Shortcut Key](#) on page 123 for details. The saved file can be viewed by selecting **Previous Vehicles and Data > View Saved Data**, see [Viewing /Printing Saved Codes and Code Scan Results](#) on page 121 for additional information.

## 9.11 General Reference

### 9.11.1 Basic Setup Tips (unknown signal type)

When conducting automotive diagnostics, situations may arise when you need to capture and analyze a signal that you are not familiar with, or know what the intended waveform pattern should look like, or even how to set the scope to acquire the signal.

The following tips are intended to provide guidance, at the most basic level to assist you in your lab scope diagnostics.

Testing information and/or procedures for testing certain components may be available in the Guided Component Test function, see [Guided Component Tests](#) on

page 61 for additional information. If you have already narrowed down the system and/or component to test, ID the vehicle within the Guided Component Test function, and check the available tests first, as this may save you some time.

If the Guided Component Test function, does not have the test you are looking for, you need to determine a few things about what you are testing to get the scope / meter set up to capture a signal or make a measurement.

### **i** NOTE

*Testing information and known good waveform libraries may also be available from other sources (e.g. SureTrack, ShopKey Pro or other online sources). Obtaining correct testing reference information can be a key advantage in making sound repair decisions.*

Listed below are a few basic questions to help narrow down the testing direction to follow.

- Are you looking to make or test a simple voltage or current level or maybe check resistance or continuity? Then you may want to use the DMM.
- Are you looking to check a circuit/component for an erratic dropout or make a frequency test? You may want to use the GMM.
- Do you need to see signal details (level, shape, frequency etc.)? The lab scope may be the best choice.
- Are you testing a DC or AC signal?
- What is the operating range of the circuit?
- Do you know what type or shape the intended waveform should be?

After answering the questions above, you need to determine which Scope / Multimeter test function you are going to use (e.g. Lab Scope, DMM or GMM). See [Tests and Capabilities \(Quick Reference\)](#) on page 74.

Once your test function is selected, you can now connect the test leads and select the applicable probe and scales:

Probe (test) type, see [Probe \(Probe type “test” selection\)](#) on page 84

Vertical scale, see [Scale \(Vertical scale adjustment\)](#) on page 82

Sweep scale, see [Sweep \(Horizontal or Time scale adjustment\)](#) on page 83

Connect the test leads or probe, to the applicable test point(s). Always use the correct lead or probe designed for the test and ensure the signal and ground connections are clean and secure.



For the initial setup, you may wish to turn other channel settings off (e.g. Peak, Filter, Invert, AC Coupling, Threshold etc.), as these may affect the signal display. See [Channel Settings](#) on page 85.

As a default setting, trigger is normally off. The scope/meter uses internal circuitry to display a signal if present. However, in certain circumstances additional channel adjustments may be required, or the trigger mode may have to be turned on, for a signal that is present but is not displayed. You may also need to readjust the vertical scale if set to low, in order to bring the signal into the viewable display area.

At this point you should have a visible signal on the screen. An ideal signal should be displayed within the area of the display.

- If the signal goes beyond the top and bottom of the display, try and readjust the vertical scale to a higher setting, to bring the signal into the viewable display area.

Use the zero baseline controls or move the zero baseline marker onscreen to move the zero baseline of the signal vertically on the screen to the desired position. See [Trace \(Zero Baseline position adjustment\)](#) on page 86.

- If the signal cycles are compressed (close to each other), try and readjust the sweep scale (horizontal scale) to a lower setting to display less cycles.

Once you have a usable signal displayed, if needed use the trigger function to stabilize a changing or erratic signal (a signal that may flicker or drift), so that it is easier to view. Try and set the trigger at the mid-point of the signal, and then adjust as needed from there. See [Trigger](#) on page 88.

As all signals are different, and due to other variables, additional adjustments may be needed to get the signal displayed exactly how you need. Review the channel settings section in this manual for additional information on using the settings. See [Channel Settings](#) on page 85.

At this point you should have a signal displayed that will allow you to see the overall signal characteristics, and allow you to begin your diagnosis.

Comparing your captured waveforms to known good waveforms, can be a time saver and provide supporting evidence when trying to determine a fault. See [Using Known Good Waveforms](#) on page 104 for additional information.

## 9.11.2 Using Known Good Waveforms

In some cases captured waveforms may not provide enough information to determine if a suspected sensor or circuit is at fault. Comparing the test vehicle waveforms to known good waveforms, can help to provide supporting evidence when trying to determine a fault.

Known good waveform examples may be available from different sources including the Guided Component Tests function, information services (e.g. SureTrack) or from other sources.

One of the many resources available within the optional online version of SureTrack is the comprehensive collection of known good component waveform examples gathered through actual vehicle tests. Waveform and PID graph screenshot examples are provided by fellow member technicians and shared with all members in a searchable (vehicle/component specific) database.

As good practice, capturing waveforms before and after the repair will help you to build your own library of waveforms for future troubleshooting.



### To find waveform examples within SureTrack (online version):

1. Visit the SureTrack website, and join SureTrack (if not already a member).
2. Sign in to SureTrack.
3. Enter (identify) the test vehicle details in the search field at the top of the screen ([Figure 9-44](#)).
4. Select the Dashboard tab (left side) ([Figure 9-44](#)).

If waveform and/or PID graph examples are available, the Library tab will be displayed at the top ([Figure 9-44](#)).

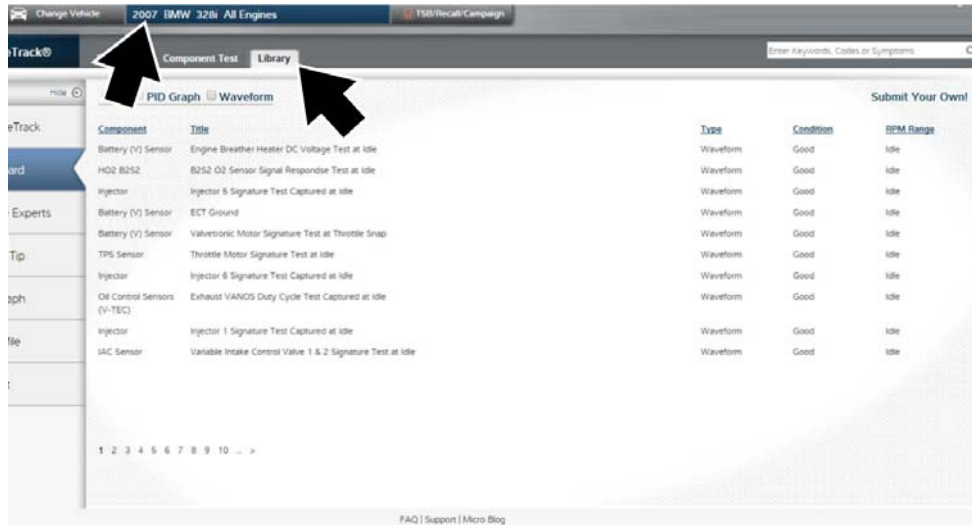

Figure 9-44 SureTrack - Library tab showing list of waveform examples

5. Select the **Library** tab (Figure 9-44). A list of examples is displayed and sortable by selecting the PID Graph and/or Waveform check boxes at the top.
6. Search through the list and select the desired example.  
Typical examples are displayed in Figure 9-45.

### NOTE

Examples may not be available for all vehicles or components and are supplied from various diagnostic tools. All examples are provided as reference only.

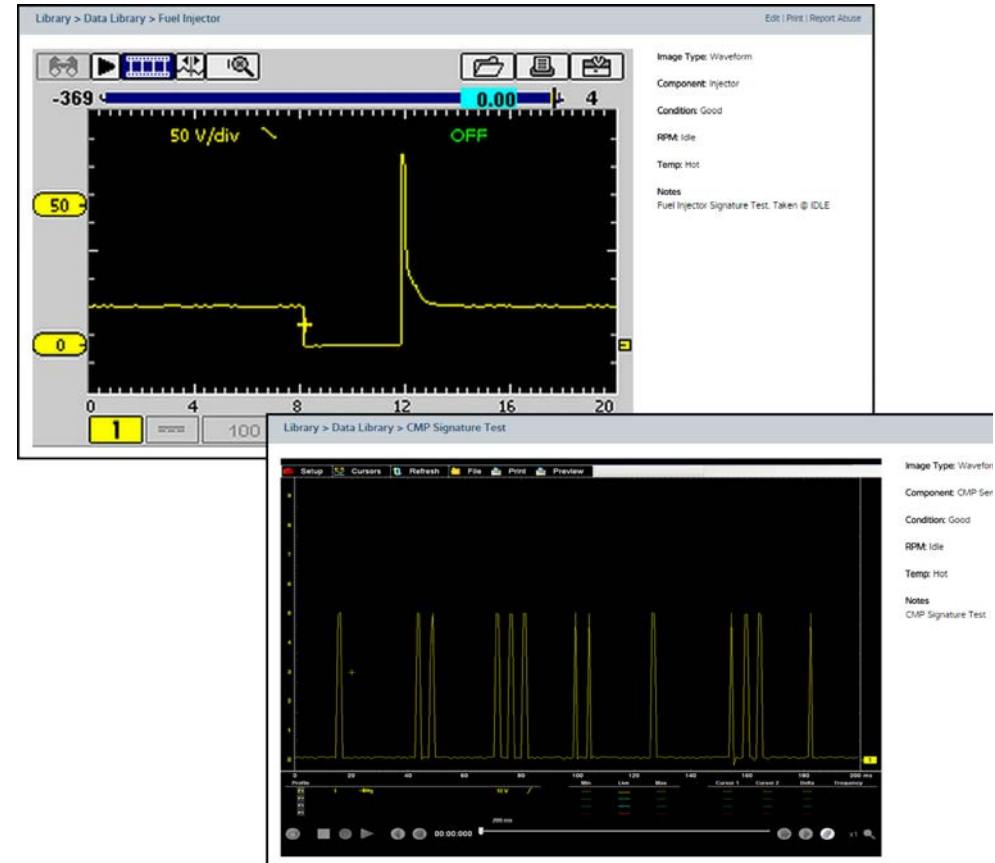

Figure 9-45 SureTrack - Waveform examples

For additional waveform reference information, visit the Snap-on Diagnostics forums to ask questions, and share information at: <http://productforum.autorepairedata.com>





### 9.11.3 Troubleshooting Signals

When capturing signals, you may occasionally encounter problems with the way the signal initially displays. Noise, hash, fuzz are some of the terms used to describe, unwanted signals displaying in or on the signal you are trying to capture, basically making the signal unclear. The following tips are intended to provide some basic guidance, to help resolve these types of issues if encountered.

- Make sure you have the correct test leads connected to the applicable test point(s) and test lead jacks on the diagnostic tool.
- Ensure the signal and ground connections are clean and secure, at the test points and diagnostic tool.
- Ensure the polarity of the test leads connections are correct.
- If using stackable connectors, try to isolate or only connect the leads being used to capture the signal.
- Make sure the ground lead is providing a direct ground from the circuit to the diagnostic tool test lead jack.
- Isolate the test leads from other components, leads, or systems that may induce unwanted noise into the signal being tested (e.g. electric motors, secondary ignition components, relays, alternators, etc.)
- Use the shortest test leads possible.
- Try different test leads, to verify the issue. Use the recommended snap-on leads or probes available for the diagnostic tool or equivalent. Shielded test leads are recommended.
- Check the test lead or probes for damage.
- Enable or disable channel controls also to help try and clean the signal:
  - [Peak Detect](#)—maximizes sampling rate, but may pickup unwanted noise
  - [Filter](#)—removes signal noise or interference
  - [Invert](#)—switches signal polarity
  - [Coupling AC](#)—blocks the DC portion of signal
  - [Threshold](#) —provides a more accurate measurement on select GMM tests where noise is present
  - [Scale \(Vertical scale adjustment\)](#)—adjusts vertical scale. Using a higher setting may provide a cleaner signal in some situations.

For signals that do not display or display off the screen, erratic, compressed etc.:

- Use a trigger to help stabilize the signal. Try and set the trigger at the mid-point of the signal, and then adjust as needed from there. See [Trigger on page 88](#).

- If the signal wraps off the top and bottom of the display, try and readjust the vertical scale to a higher setting, to bring the signal into the viewable display area. See [Scale \(Vertical scale adjustment\)](#).
- If the signal cycles are compressed (close to each other), try and readjust the sweep scale (horizontal scale) to a lower setting to display less cycles. Try a higher setting if the cycles are spread too far across the screen and seem flat. See [Sweep \(Horizontal or Time scale adjustment\) on page 83](#).
- Move the zero baseline marker to move the zero baseline of the signal vertically on the screen to the desired position. See [Trace \(Zero Baseline position adjustment\) on page 86](#).
- Check calibration of test leads or probe(s) if applicable. See [Test Lead / Probe Calibration on page 80](#).



## 9.11.4 Units of Measurement / Conversions

Base Units	
(Symbol) / Unit Prefix	Typical Expressions
(μ) micro	0.000001 or $10^{-6}$ or 1/1,000,000
(m) milli	0.001 or $10^{-3}$ or 1/1,000
(c) centi	0.01 or $10^{-2}$ or 1/100
(k) kilo	$10^3$ or 1,000
(M) mega	$10^6$ or 1,000,000

Electrical Units	
(Symbol) / Description	Equivalents
(V) Voltage	$V = I \times R$
(I) Current	$I = V \div R$
(R) or ( $\Omega$ ) Resistance	$R = V \div I$
(Hz) Frequency	$f(\text{freq.}) = 1 \div T(\text{time})$ or 1 cycle per second
Voltage	
(μV) microvolt	1 μV = 0.000001 V
(mV) millivolt	1 mV = 0.001 V
(V) volt	1 V = 1000 mV
(kV) kilovolt	1kV = 1,000 Volts.
Ohms	
(mΩ) milliohm	1 mΩ = 0.001 ohms
(Ω) ohm	1 Ω = 1000 mΩ
(kΩ) kiloohm	1 kΩ = 1000 Ω
(MΩ) megaohm	1 MΩ = 1,000,000 Ω
Amperes	
(μA) microamps	1 μA = 0.000001 amps
(mA) milliamps	1 mA = 0.001 amps
(A) amps	1A = 1000 mA
(ka) kiloamps	1 ka = 1000 amps
Frequency	
(MHz) megahertz	1 MHz = 1,000,000 Hertz
(kHz) kilohertz	1 kHz = 1000 Hertz

Pressure Units	
(Symbol) / Description	Equivalents
(psi) pounds per square inch	1 psi = 6894.757 Pa 1 psi = 0.06894757 bar 1 psi = 2.036021 inHg
(bar)	1 bar = 14.50377 psi 1 bar = 100000 Pa 1 bar = 29.52999 inHg
(Mbar) Millibar	1 Mbar = 0.001 bar
(Pa) pascal	1 Pa = 0.0001450377 psi 1 Pa = 0.00001 bar 1 Pa = 0.0002952999 inHg
(kPa) KiloPasca	1 kPa = 1000 Pa
(MPa) Megapascal	1 MPa = 1,000,000 Pa
(inHg) inches of mercury	1 inHg = 0.03386388 bar 1 inHg = 0.4911541 psi 1 inHg = 3386.388 Pa

Pressure Conversions	
psi x 0.0689 = bar	
psi x 6.8950 = kPa	
psi x 0.0703 = kg/cm <sup>2</sup>	
bar x 14.5030 = psi	
bar x 100.0000 = kPa	
bar x 29.5300 = inHg (60°F)	
kPa x 0.1450 = psi	
kPa x 0.0100 = bar	
kPa x 0.0102 = kg/cm <sup>2</sup>	
kPa x 0.295299 = inHg	
kg/cm <sup>2</sup> x 98.0700 = psi	
kg/cm <sup>2</sup> x 0.9807 = bar	
kg/cm <sup>2</sup> x 14.2200 = kPa	
inHg (60°) x 0.0333 = bar	
inHg (60°) x 3.3770 = kPa	
inHg (60°) x 0.0344 = kg/cm <sup>2</sup>	
inHg x 25.4 = mmHg	
mmHg x 0.003994 = inHg	

**Temperature Units**

(Symbol) / Description	Conversions
(°C) degree Celsius	$^{\circ}\text{C} = 0.556 \times (^{\circ}\text{F} - 32)$
(°F) degree Fahrenheit	$^{\circ}\text{F} = (1.8 \times ^{\circ}\text{C}) + 32$

**Time Units**

(Symbol) / Description	Equivalents
( $\mu\text{s}$ ) microsecond	1 $\mu\text{s}$ = 0.000001 of a second
(ms) millisecond	1 ms = 0.001 of a second
(s) second	1 s = 1000 ms

**Duty % to Dwell Conversions**

Duty Cycle	Dwell		
	4 cyl	6 cyl	8 cyl
%			
10	9.0	6.0	4.5
20	18.0	12.0	9.0
30	27.0	18.0	13.5
40	36.0	24.0	18.0
50	45.0	30.0	22.5
60	54.0	36.0	27.0
70	63.0	42.0	31.5
80	72.0	48.0	36.0
90	81.0	54.0	40.5
100	90.0	60.0	45.0



## 9.11.5 Glossary of Common Terms

Term / Abbreviation	Description
AC	Alternating Current - electrical current that switches polarity at regular intervals.
Aliasing	An effect that causes an incorrect signal to be displayed and/or causes a trigger to malfunction, due to the input signal exceeding the sample rate of the scope.
Amperage	The strength of an electric current, expressed in amperes
Amplitude	Vertical magnitude (level or position) of a signal, or the varying quantity from its zero value.
Buffer	An electronic reservoir for temporary storage of data
Cursor	Onscreen markers used to measure time, amplitude and frequency
Coupling AC	Function used to subtract the average value of a signal so that small variations can be displayed in the waveform.
DC	Direct Current - electrical current that flows in one direction only
Delta	Difference in time between two events.
Dropout	An intermittent or unwanted, vertical fall in a signal to zero that may cause an undesired result.
Duty cycle	Measurement of the length of a signals on time. Specified as a percentage (ratio), of the total cycle time.
Dwell	Used to measure a signals on time in degrees of dwell. Commonly used to measure mixture control solenoids on carbureted feedback engines and specified in duty cycle %.
Dwell 60	Measurement of the length of a signals on time displayed on a 0 to 60 degree scale. 0° = 0%; 30° = 50%; 60° = 100%.
Dwell 90	Measurement of the length of a signals on time displayed on a 0 to 90 degree scale. 0° = 0%; 45° = 50%; 90° = 100%.
Filter	Function used to filter or smooth out spikes and fast variations in signals.
Frequency	The number of times a signal repeats in one second. Measured in Hertz (cycles per second).
Glitch	An intermittent or unwanted, error in a signal that may cause a false or undesired result.
Grid	The graph displayed on the scope screen that is made up of the x and y axis scales that aid in the measuring of signal characteristics.
Horizontal Scale	See Sweep Scale
Invert	Function used to switch signal polarity,

Term / Abbreviation	Description
Lambda (λ)	Used to represent a numerical value denoting the actual measured air/fuel ratio with respect to the ideal air/fuel ratio at stoichiometry. Lambda equals one (1) when the actual air/fuel ratio is equal to the theoretical (stoichiometric) air/fuel ratio of 14.7 (14.66) to 1. Lambda less than 1 means excess fuel; greater than 1 means excess air.
Megasamples per second (MS/s)	Sample rate unit equal to one million samples per second
Noise or Hash	Unwanted voltage, current or signal interference that is imposed on a signal.
Parasitic Voltage	Trace voltage in a circuit after the main power source is disconnected.
Peak	The maximum amplitude value present in a varying or alternating voltage. This value may be either positive or negative.
Peak Detect	Peak detect captures and evaluates all signal sample points, in order to display fast occurring events or glitches.
Pressure Transducer	Electronic device that converts pressures (negative/positive) to electrical signals.
Pulse	A signal with abrupt (fast) signal direction changes in a positive or negative direction, with consistent level and duration.
Pulse Period	One complete on and off cycle or time period.
Pulse Train	Collection of signal pulses traveling together.
Pulse Width (duration)	Measurement of a signals on time in a circuit that pulses on and off. Specified in units of time.
Pulse Width Modulation (PWM)	A signal that continuously cycles on and off while the on-time varies within each cycle.
RMS	The RMS (root mean square) value of alternating currents and voltages is the effective current or voltage applied, rather than the peak current or voltage measurable. The AC RMS voltage value can be defined as the equivalent DC voltage of the AC voltage measured. RMS values are commonly used in AC electrical measurement, as they are more representative of DC measurements.
Sample Rate	Number of times (frequency) the scope/meter takes a sample of the signal. Specified in mega samples per second (MS/s).
Sampling	Process of obtaining a sequence of instantaneous values for a signal at regular or intermittent intervals. When a quantity of samples are collected the operational status of the device is determined.



Term / Abbreviation	Description
Screen Update Rate	How often the captured data is (updated) displayed on the screen.
Signal	Detectable voltage, current, or magnetic field, by which specific information is transmitted in an electronic circuit or system.
Square Wave	A square or rectangular waveform (digital) which alternately switches high to low (on/off) for specific lengths of time, that has very fast rise and fall times.
Sweep Scale	The horizontal scale on the grid. Also referred to as time scale or x axis.
Threshold	The threshold function automatically sets a trigger and determines a threshold level in the middle of the signal range (calculated from the Min and Max measurements) to be used as a reference point to calculate the measurement.
Trace	The actual visible line displayed on the scope screen.
Trigger	A conditional function that initiates if and when a trace is drawn on the screen.
Trigger Slope	The slope that a trigger source signal must reach before the trigger circuit initiates a sweep
VAC	Volts Alternating Current
VDC	Volts Direct Current
Vertical Scale	The vertical scale on the grid or (y-axis) represents what is being measured (voltage, amperage, pressure etc.), and the unit of measurement it is being measured in.
Volt	Unit of electric potential difference.
Voltage	Electromotive force or potential difference, expressed in volts.
Voltage (inductive) Kick	A voltage, many times higher than the applied voltage, produced by the collapsing magnetic field in a coil when the current through it is abruptly terminated.
Waveform	The graphic representation (form) of a signal over time, which the trace displays on the screen.
Zero Base Line	Reference setting or 0% level of a graph scale.



Training and Support provides short videos on how to setup and get started using select features of your diagnostic tool.

For diagnostic tool training videos and information see the product website. See [Customer Support / Links](#) on page vii for website

links.

## 10.1 Training and Support

### Navigation

**Home Screen:** [Training and Support](#)

The back arrow on the left side of the upper toolbar ([Figure 10-1](#)), or the “N” button can be used to stop playback and/or return to the main Training and Support menu.



Figure 10-1

### **i** NOTE

*The videos provided (at time of publishing) do not include audio, therefore the sound control in the upper right toolbar ([Figure 10-1](#)) is not functional.*

### 10.1.1 Setting up your Wi-Fi connection

Watch a short video tutorial on how to setup and turn on your diagnostic tool Wi-Fi. For additional information see, [Wi-Fi Connection / Troubleshooting](#) on page 127.



Figure 10-2



## 10.1.2 Setting up the Snap-on Cloud

Watch a short video tutorial on the basic setup and authorization steps required to get started using the Snap-on Cloud. For additional information see, [Snap-on Cloud](#) on page 13.



Figure 10-3

## 10.1.3 Sharing a pre and post scan report (Code Scan Report)

Watch a short video tutorial on how to share a pre/post scan report using your Snap-on Cloud account.



Figure 10-4

## 10.1.4 Upgrading your device (Software Upgrades)

Watch a short video tutorial on how to download and install software upgrades for your diagnostic tool.



Figure 10-5



The **OBD-II/EOBD** function allows you to access “generic” OBD-II/EOBD data, and data for some OBD-II/EOBD vehicles that are not included in the Scanner function databases.

Generic OBD-II/EOBD data is limited to emission related diagnostics, and can be used for the following, and more:

- Checking and clearing emissions-related trouble codes
- Checking the cause of the malfunction indicator lamp (MIL)
- Checking readiness monitor status prior to emissions certification testing
- Viewing Freeze Frame data
- Checking oxygen sensor data
- Checking pending and permanent trouble codes
- Performing bi-directional tests
- Check the number of times each of the monitor tests have been completed
- Check misfire, EVAP, and catalyst monitoring data

## 11.1 OBD Direct

### Navigation

**Home Screen:** OBD-II/EOBD > OBD Direct

**OBD Direct** provides access to all available OBD-II /EOBD control system services. Menu options are described in the following sections.

### 11.1.1 Start Communication

#### Navigation

**Home Screen:** OBD-II/EOBD > OBD Direct > OBD Diagnose > Start Communication

Start Communication establishes communication with the vehicle, and then displays available OBD-II /EOBD services (*Figure 11-1*). Menu options are described in the following sections.

#### **i** NOTE

*All service modes are not supported by all vehicles, available modes and options will vary.*

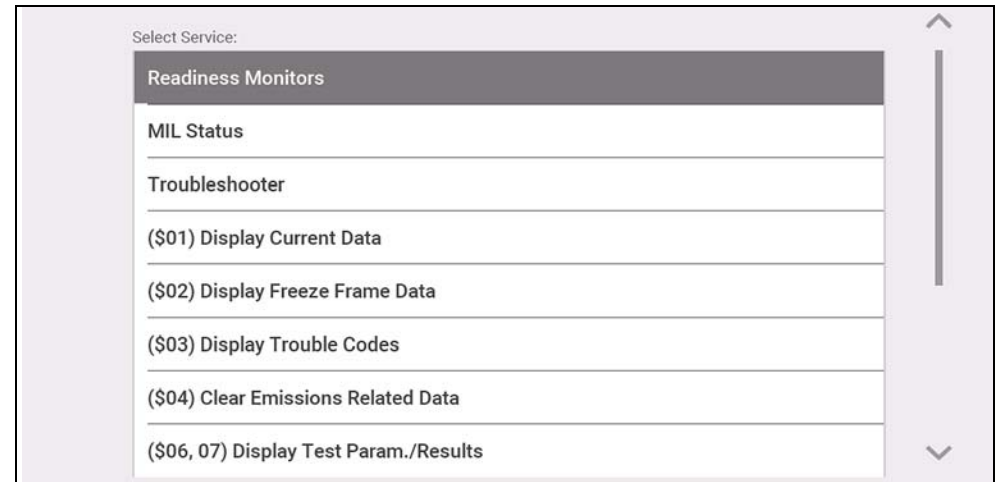

Figure 11-1





## Readiness Monitors

### Navigation

**Home Screen:** [OBD-II/EOBD > OBD Direct > OBD Diagnose > Start Communication > Readiness Monitors](#)

The readiness monitoring system is an OBD-II /EOBD control system that runs continuous and periodic integrity tests to check the status of emission-related controls and subsystems. Display options may include:

- **Monitors Complete Since DTC Cleared**—status of all monitors run since the last time ECM memory was erased.
- **Monitors Complete This Cycle**—status of the monitors that ran during the current drive cycle only.

Monitor Test reference indicators (*Figure 11-2*):

- **Green icon “✓” mark** - complete
- **Gray icon “—” mark** - not complete
- **Red icon “X” mark** - test not supported by vehicle

ID : \$	EB
✓ MISFIRE	TEST COMPLETE
✓ FUEL SYSTEM	TEST COMPLETE
✓ COMPONENTS	TEST COMPLETE
! CATALYST	NOT COMPLETE
✗ HEATED CATALYST	NOT SUPPORTED
! EVAPORATIVE SYSTEM	NOT COMPLETE
✗ SEC. AIR SYSTEM	NOT SUPPORTED

Figure 11-2

## MIL Status

### Navigation

**Home Screen:** [OBD-II/EOBD > OBD Direct > OBD Diagnose > Start Communication > MIL Status](#)

Mil Status checks the ECM commanded state on/off of the malfunction indicator lamp.

## Troubleshooter

### Navigation

**Home Screen:** [OBD-II/EOBD > OBD Direct > OBD Diagnose > Start Communication > Troubleshooter](#)

Troubleshooter provides reference information (e.g. code tips, parameter descriptions, and repair tips) from actual repairs.



**(\$01) Display Current Data**

**Navigation**

**Home Screen:** OBD-II/EOBD > OBD Direct > OBD Diagnose > Start Communication > (\$01) Display Current Data

This service displays current emission related PID descriptions and values.

ID: \$	E8
ENGINE SPEED(1/min)	2444
ABSOLUTE THROTTLE POSITION(%)	17.3
ABSOLUTE THROTTLE POSITION B(%)	17.3
RELATIVE THROTTLE POSITION(%)	7.1
COMMANDED THROTTLE ACT.CONTROL(%)	7.1
ACCELERATOR PEDAL POSITION D(%)	15.7
ACCELERATOR PEDAL POSITION E(%)	7.5

Figure 11-3

**(\$02) Display Freeze Frame Data**

**Navigation**

**Home Screen:** OBD-II/EOBD > OBD Direct > OBD Diagnose > Start Communication > (\$02) Display Freeze Frame Data

This service provides a “snapshot” of critical parameter values at the time an emission related DTC is set.

Typically the stored data frame is from the last DTC that occurred, however certain DTCs that have a greater impact on vehicle emissions will have a higher priority. In this situation, the freeze frame data for the DTC with the highest priority level will be retained.

**(\$03) Display Trouble Codes**

**Navigation**

**Home Screen:** OBD-II/EOBD > OBD Direct > OBD Diagnose > Start Communication > (\$03) Display Trouble Codes

This service displays a list of current emission related DTCs.

Select a code from the list below for code specific diagnostics	
P0115	Engine Coolant Temperature Sensor 1 Circuit
P0230	Fuel Pump Primary Circuit
P0350	Ignition Coil Primary/Secondary Circuit/Open
P0460	Fuel Level Sensor "A" Circuit

Figure 11-4

OBD-II/EOBD Codes have a priority according to their emission severity. The priority of the code determines the illumination of the MIL and the code erase procedure. Priority rankings vary across vehicle manufacturers, makes and models.



### (\$04) Clear Emissions Related Data

#### Navigation

**Home Screen:** [OBD-II/EOBD > OBD Direct > OBD Diagnose > Start Communication > \(\\$04\) Clear Emissions Related Data](#)

This service clears all emission related diagnostic data, such as DTCs, freeze frame data, and test results, from ECM memory.

#### IMPORTANT

*Clear Codes erases all stored data, including any enhanced codes and freeze frame information.*

### (\$05) Oxygen Sensor Monitoring

#### Navigation

**Home Screen:** [OBD-II/EOBD > OBD Direct > OBD Diagnose > Start Communication > \(\\$05\) Oxygen Sensor Monitoring](#)

This service provides access to the tests available for checking the integrity of the oxygen (O<sub>2</sub>) sensors. Making a selection displays all related O<sub>2</sub> sensor parameters for the specific test. The test identification (ID) displays at the top of the data list.

### (\$06) On-Board Monitored Systems

#### Navigation

**Home Screen:** [OBD-II/EOBD > OBD Direct > OBD Diagnose > Start Communication > \(\\$06, 07\) Display Test Param./Results > \(\\$06\) On-Board Monitored Systems](#)

This service provides access to monitored systems data. The available data is for specific systems and components that the on-board diagnostic system monitors continuously (e.g. misfires), or non-continuously (e.g. catalyst system).

### (\$07) DTCs Detected During Last Drive

#### Navigation

**Home Screen:** [OBD-II/EOBD > OBD Direct > OBD Diagnose > Start Communication > \(\\$06, 07\) Display Test Param./Results > \(\\$07\) DTCs Detected During Last Drive](#)

This service displays a list of “pending” or maturing DTCs. These are codes whose setting conditions were met during the last drive cycle, but need to be met on two or more consecutive drive cycles before the DTC actually sets.

#### NOTE

*Check pending codes to verify test results after a single drive cycle following a repair and code clear.*

- If a test failed during the drive cycle, the DTC associated with that test is reported. If the pending fault does not occur again within 40 to 80 warm-up cycles, the fault is automatically cleared from memory.
- Test results reported by this service do not necessarily indicate a faulty component or system. If test results indicate another failure after additional driving, then a DTC is set to indicate a faulty component or system, and the MIL is illuminated.

### (\$08) Request Control of On-board System

#### Navigation

**Home Screen:** [OBD-II/EOBD > OBD Direct > OBD Diagnose > Start Communication > \(\\$08\) Request Control of On-board System](#)

This service allows the diagnostic tool to control the operation of an on-board system, test, or component.



### (\$09) Read Vehicle Identification

#### Navigation

**Home Screen:** [OBD-II/E OBD](#) > [OBD Direct](#) > [OBD Diagnose](#) > [Start Communication](#) > [\(\\$09\) Read Vehicle Identification](#)

This service displays vehicle-specific information, such as the vehicle identification number (VIN), the calibration identification, and the calibration verification number (CVN), of the vehicle.

### (\$09) In-use Performance Tracking

#### Navigation

**Home Screen:** [OBD-II/E OBD](#) > [OBD Direct](#) > [OBD Diagnose](#) > [Start Communication](#) > [\(\\$09\) In-use Performance Tracking](#)

This service displays “In-use Performance Tracking” data. It is a record of the number of times each of the monitor tests have been completed.

### (\$0A) Display Permanent Trouble Codes

#### Navigation

**Home Screen:** [OBD-II/E OBD](#) > [OBD Direct](#) > [OBD Diagnose](#) > [Start Communication](#) > [\(\\$0A\) Display Permanent Trouble Codes](#)

This service displays a record of any “permanent” codes. A permanent status DTC is one that was severe enough to illuminate the MIL at some point, but the MIL may not be on at the present time.

Whether the MIL was switched off by clearing codes or because the setting conditions did not repeat after a specified number of drive cycles, a record of the DTC is retained by the ECM. Permanent status codes automatically clear after repairs have been made and the related system monitor runs successfully.

### 11.1.2 Connector Information

#### Navigation

**Home Screen:** [OBD-II/E OBD](#) > [OBD Direct](#) > [OBD Diagnose](#) > [Connector Information](#)

This function provides access to vehicle diagnostic connector locations for most makes and models.

### 11.1.3 Manual Protocol Selection

#### Navigation

**Home Screen:** [OBD-II/E OBD](#) > [OBD Direct](#) > [OBD Diagnose](#) > [Manual Protocol Selection](#)

Typically the communication protocol is automatically detected when establishing communication with a vehicle, this service allows you to manually select a protocol, if automatic detection fails.

Communication protocol is a standardized way of transferring data between an ECM and a diagnostic tool. Global OBD may use the following communication protocols ([Figure 11-5](#)):

- ISO 15765-4 (CAN)
- ISO 27145 (WWHOBD CAN)
- ISO J1939 (CAN)
- ISO 9141-2 (K-LINE)
- SAE J1850 PWM (Pulse Width Modulation)
- SAE J1850 VPW (Variable Pulse Width)
- ISO 14230-4 (Keyword Protocol 2000)
- SAE J2284/ISO 15765-4 (CAN)

#### IMPORTANT

**Using unsupported OBD communication protocols may activate warning lights and can set network related faults. Only use the manual selection option when OBD protocol is already known.**



Figure 11-5

## 11.2 OBD Training Mode

### Navigation

**Home Screen:** OBD-II/EOBD > OBD Direct > OBD Training Mode

This function allows you to familiarize yourself with the capabilities of OBD-II/EOBD while navigating through menus without being connected to a vehicle.

## 11.3 OBD-II Health Check

### Navigation

**Home Screen:** OBD-II/EOBD > OBD Health Check

OBD-II Health Check allows you to quickly check readiness monitors, view emissions-related diagnostic trouble codes (DTCs) and more (Figure 11-6).

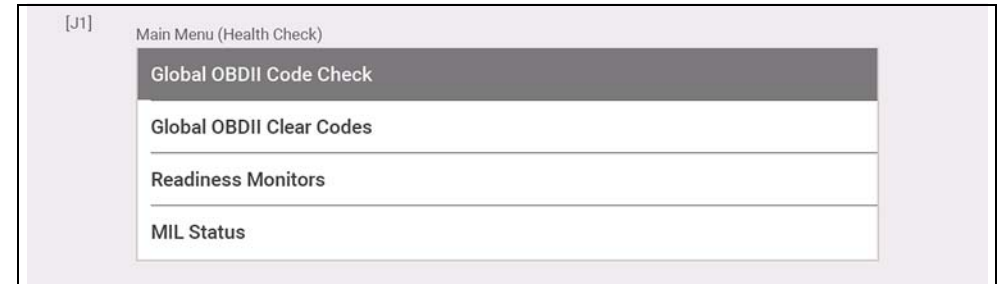

Figure 11-6

### 11.3.1 Global OBD-II Code Check

#### Navigation

**Home Screen:** OBD-II/EOBD > OBD Health Check > Global OBD-II Code Check

For Codes, see (\$03) *Display Trouble Codes* on page 115.

For Pending Codes, see (\$07) *DTCs Detected During Last Drive* on page 116.

### 11.3.2 Global OBD-II Clear Codes

#### Navigation

**Home Screen:** OBD-II/EOBD > OBD Health Check > Global OBD-II Clear Codes

See (\$04) *Clear Emissions Related Data* on page 116



### 11.3.3 Readiness Monitors

#### Navigation

**Home Screen:** [OBD-II/EOBD](#) > [OBD Health Check](#) > [Readiness Monitors](#)

---

See [Readiness Monitors](#) on page 114.

### 11.3.4 MIL Status

#### Navigation

**Home Screen:** [OBD-II/EOBD](#) > [OBD Health Check](#) > [MIL Status](#)

---

See [MIL Status](#) on page 114.



The **Previous Vehicles and Data** function allows you to reactivate previously identified vehicles for retesting, and access saved data files.

## 12.1 Vehicle History

### Navigation

**Home Screen:** Previous Vehicles and Data > Vehicle History

The last twenty-five vehicles identified are saved and available for retesting (*Figure 12-1*). The oldest vehicle record is deleted once twenty-five vehicles are saved.



Icons	
	<b>Activate Vehicle</b> - Select a previously identified vehicle ( <i>Figure 12-1</i> )
	<b>Delete</b> - Deletes selected attachment from a vehicle record, or the vehicle from history
	<b>Search</b> - Lists associated attachments for the selected vehicle (e.g. screen captures, code scans, data files, etc)



Figure 12-1

# 12.2 Saved Data

## Navigation

**Home Screen:** Previous Vehicles and Data > Saved Data

Exit vehicle communication before opening data files. Select a file to view it. The most recent files are listed first.

- **All Saved Data** - Lists all saved files (Figure 12-2)
- **Screenshots** - Lists all saved screenshot files
- **Scanner** - Lists all saved scanner data files
- **Scope** - Lists all saved Scope/Meter data files

### NOTE

A maximum of 50 files are displayed. To view all (if more than 50) files stored, transfer the files to a PC and use ShopStream Connect. See [Connect-to-PC \(File Transfer\)](#) on page 123 for additional information.

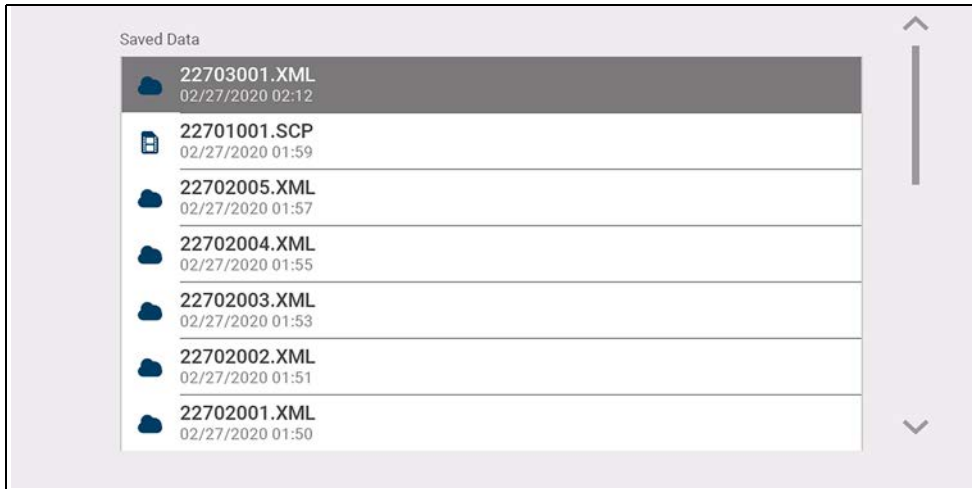

Figure 12-2

## 12.2.1 Viewing /Printing Saved Codes and Code Scan Results

Code scans and single system code results are saved as (.XML) files, and can be selected from the All Saved Data list or Scanner list (Figure 12-2).

To print:

- Transfer the files to ShopStream Connect, or
- Print from the Snap-on Cloud (if connected and authorized)

## 12.3 Delete Saved Data

### Navigation

**Home Screen:** Previous Vehicles and Data > Delete Saved Data



Select the file(s) to be permanently deleted, then select the **Delete** icon.



Use the **List** icon to select and deselect all files.



Figure 12-3





The **Tools** function allows you to configure diagnostic tool settings to your preferences.

## Quick Links

- [Tools Main Menu](#) page 122
- [Connect-to-PC \(File Transfer\)](#) page 123
- [Get Connected](#) page 123
- [Configure Shortcut Key](#) page 123
- [System Information](#) page 123
- [Brightness](#) page 124
- [Color Theme](#) page 124
- [High Contrast Toolbar](#) page 124
- [Font Type](#) page 124
- [Backlight Time](#) page 124
- [Time Zone](#) page 125
- [Clock Settings](#) page 125
- [Daylight Savings Time](#) page 125
- [24 Hour Format](#) page 125
- [Date Format](#) page 124
- [Auto VIN](#) page 125
- [Configure Scanner](#) page 125
- [Configure Scope / Meter](#) page 126
- [Auto VIN](#) page 125
- [Code Scan Generics](#) page 125
- [Configure Units](#) page 126

## 13.1 Tools Main Menu

### Navigation

**Home Screen:** [Tools](#)

The main Tools menu includes multiple sub-menus and settings, which are described throughout this section.

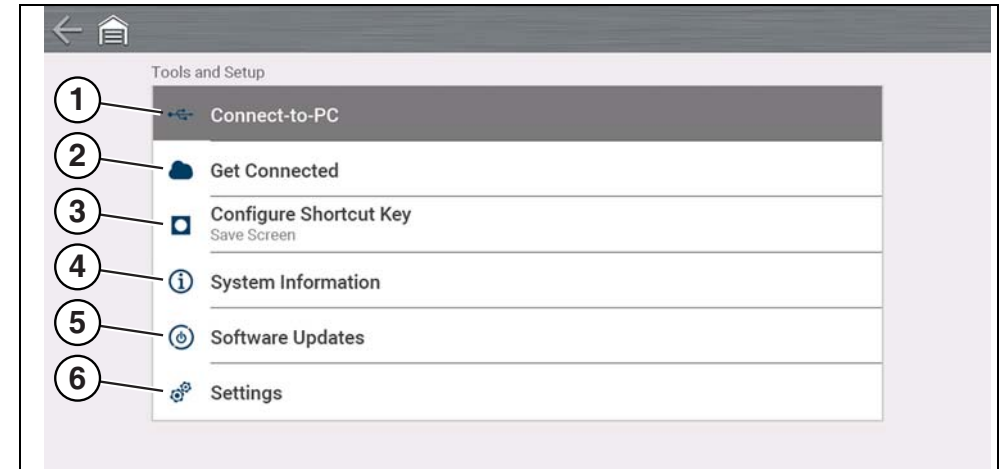

Figure 13-1

- 1— [Connect-to-PC \(File Transfer\)](#) on page 123
- 2— [Get Connected](#) on page 123
- 3— [Configure Shortcut Key](#) on page 123
- 4— [System Information](#) on page 123
- 5— [Software Updates](#) on page 123
- 6— [Settings](#) on page 124



## 13.2 Connect-to-PC (File Transfer)

### Navigation

**Home Screen:** [Tools > Connect to PC](#)

**Connect-to-PC** allows you to connect to your PC as an external drive, giving you the ability to transfer saved data files (using Windows® File Explorer) from your diagnostic tool to your PC.

Connect the supplied USB cable to the diagnostic tool and PC, then select **Connect-to-PC**.

### NOTE

*An alternative method of connecting your diagnostic tool to your PC is to use the companion application ShopStream Connect™ (SSC). SSC is a free application you install on your PC allowing you to view, print and save data files on your PC. See [ShopStream Connect™ \(Connecting to your PC\)](#) on page 14.*

## 13.3 Get Connected

### Navigation

**Home Screen:** [Tools > Get Connected](#)

**Get Connected** displays the diagnostic tool serial number, PIN and Code needed for Snap-on Cloud registration. See [Snap-on Cloud](#) on page 13 for instructions.

## 13.4 Configure Shortcut Key

### Navigation

**Home Screen:** [Tools > Configure Shortcut Key](#)

**Configure Shortcut Key** allows you to assign the function of the **Shortcut** button. Select an option to set the function:

- **Brightness**—opens the brightness setting

- **Save Screen**—saves a bitmap image of the visible screen.
- **Save Movie**—save PID data to a file
- **Show Shortcut Menu**—opens the Shortcut menu.

## 13.5 System Information

### Navigation

**Home Screen:** [Tools > System Information](#)

**System Information** displays various software and product information, such as the software version and serial number of the diagnostic tool.

## 13.6 Software Updates

### Wi-Fi Required



Wi-Fi connection is required to use this application. See [Wi-Fi Connection / Troubleshooting](#) on page 127.

### Navigation

**Home Screen:** [Tools > Software Updates](#)

**Software Updates** allows you to directly install software updates for your diagnostic tool. Follow the screen prompts to download and install updates. Also see the video tutorial information [Upgrading your device \(Software Upgrades\)](#) on page 112.



## 13.7 Settings

### Navigation

Home Screen: [Tools > Settings](#)

Settings provides the following sub-menus:

- [System Settings \(Display, Date & Time\)](#) on page 124
- [Configure Wi-Fi](#) on page 126
- [Configure Scanner](#) on page 125
- [Configure Units](#) on page 126
- [Configure Scope / Meter](#) on page 126

### 13.7.1 System Settings (Display, Date & Time)

System Settings provides sub-menus for various Display and Date and Time related settings. Descriptions are provided in the following sections.

### Navigation

Home Screen: [Tools > Settings > System Settings > Display](#)

### Brightness

### Navigation

Home Screen: [Tools > Settings > System Settings > Display > Brightness](#)

**Brightness** allows you to adjust brightness of the display back lighting.

### Color Theme

### Navigation

Home Screen: [Tools > Settings > System Settings > Display > Color Theme](#)

**Color Theme** allows you to select:

- **Day Theme** (white screen background)

- **Night Theme** (black screen background)

### High Contrast Toolbar

### Navigation

Home Screen: [Tools > Settings > System Settings > Display > High Contrast Toolbar](#)

**High Contrast Toolbar** allows you to select:

- **Light** - (lighter background, darker icons)
- **Dark** - (darker background, lighter icons)

### Font Type

### Navigation

Home Screen: [Tools > Settings > System Settings > Display > Font Type](#)

**Font Type** allows you to select **Normal** or **Bold** font for the display.

### Backlight Time

### Navigation

Home Screen: [Tools > Settings > System Settings > Display > Backlight Time](#)

**Backlight Time** allows you to set the inactivity backlight time (i.e. Always on, or off after 15, 30, 45, 60 seconds.)

### Date Format

### Navigation

Home Screen: [Tools > Settings > System Settings > Date & Time > Date Format](#)

**Date Format** allows you to set the date display format.

- **(MM\_DD\_YYYY)**—Month, Day, Year



- (DD\_MM\_YYYY)—Day, Month, Year
- (YYYY\_MM\_DD)—Year, Month, Day

## Clock Settings

### Navigation

**Home Screen:** [Tools > Settings > System Settings > Date & Time > Clock Settings](#)

**Clock Settings** allows you to set the internal clock time.

## Time Zone

### Navigation

**Home Screen:** [Tools > Settings > System Settings > Date & Time > Time Zone](#)

**Time Zone** allows you to set the internal clock time zone.

## Daylight Savings Time

### Navigation

**Home Screen:** [Tools > Settings > System Settings > Date & Time > Daylight Savings Time](#)

**Daylight Savings Time** allows you to adjust the internal clock for daylight savings time.

## 24 Hour Format

### Navigation

**Home Screen:** [Tools > Settings > System Settings > Date & Time > 24 Hour Format](#)

**24 Hour Format** allows you to set the internal clock format to either 12 or 24 hour.

## 13.7.2 Configure Scanner

### Navigation

**Home Screen:** [Tools > Settings > System Settings > Display > Brightness](#)

**Brightness** allows you to adjust brightness of the display back lighting.

## Graph Scale

### Navigation

**Home Screen:** [Tools > Settings > Configure Scanner > Graph Scale](#)

**Graph Scale** allows you to toggle the scales (On/Off) within Scanner. Scales are the graduations and values that display on the horizontal axis at the base of the parameter graphs. The waveform fills the entire graph area with scales switched off.

## Auto VIN

### Navigation

**Home Screen:** [Tools > Settings > Configure Scanner > Auto VIN](#)

**Auto VIN** allows you to turn (On/Off) the Instant Vehicle Identification feature.

## Code Scan Generics

### Navigation

**Home Screen:** [Tools > Settings > Configure Scanner > Code Scan Generics](#)

**Code Scan Generics** allows you to turn (On/Off) the scanning of OBD-II codes and monitors for Code Scan.



### 13.7.3 Configure Scope / Meter

#### Navigation

**Home Screen:** Tools > Settings > Configure Scope / Meter

The available menu options allow you to configure certain characteristics of the display screen to your preference when using the Scope / Meter, see [Optional Settings](#) on page 94.

### 13.7.4 Configure Wi-Fi

#### Navigation

**Home Screen:** Tools > Settings > Configure Wi-Fi

**Configure W-Fi** allows you to turn (On/Off) Wi-Fi, and configure Wi-Fi settings, see [Wi-Fi Connection / Troubleshooting](#) on page 127.

### 13.7.5 Configure Units

#### Navigation

**Home Screen:** Tools > Settings > Configure Units

**Configure Units** allows you to display either US customary or metric units of measure.

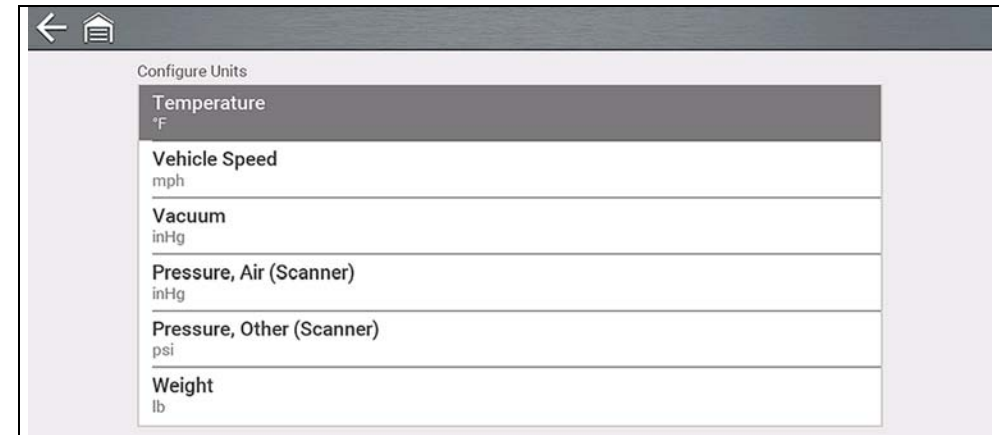

Figure 13-2



## Wi-Fi Required



A Wi-Fi connection is required to use various diagnostic tool features, (e.g. Fast-Track® Intelligent Diagnostics and the Snap-on Cloud). It is recommended that you keep Wi-Fi turned on and connected during operation to ensure you have access to the latest diagnostic information and updates.

## 14.1 Checking if Wi-Fi is On and Connected

The Wi-Fi indicator is displayed in the title bar when Wi-Fi is on.

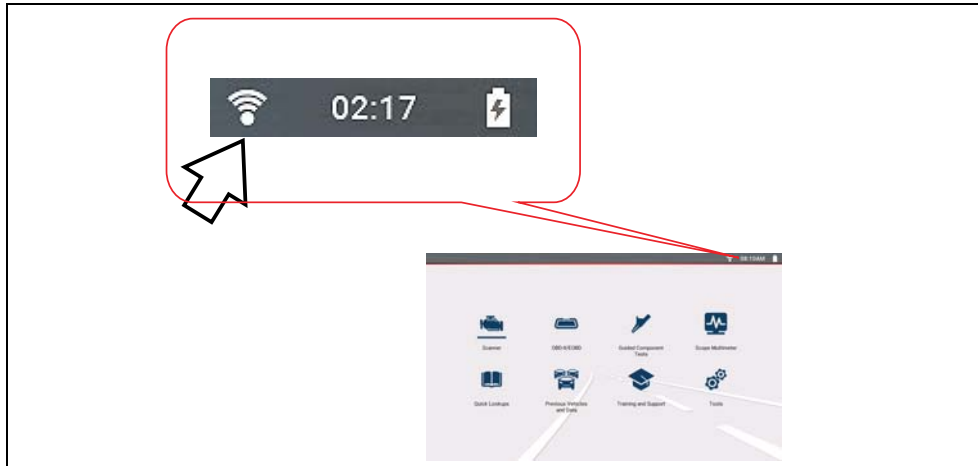

	<p>1 to 3 solid bars - Wi-Fi is on and connected to a network. Three bars indicates maximum strength signal.</p>
--	--

	<p>Flashing with “?” mark - Wi-Fi is on, but not connected. See <a href="#">Wi-Fi Troubleshooting and Status Messages</a> on page 129.</p>
	<p>No bars - No signal / out of range.</p>

## 14.2 Turning Wi-Fi On and Connecting to a Network

### Navigation

Home Screen: **Tools > Settings > Configure Wi-Fi**

1. To turn Wi-Fi on/off, select the **Wi-Fi power icon** ([Figure 14-1](#)).

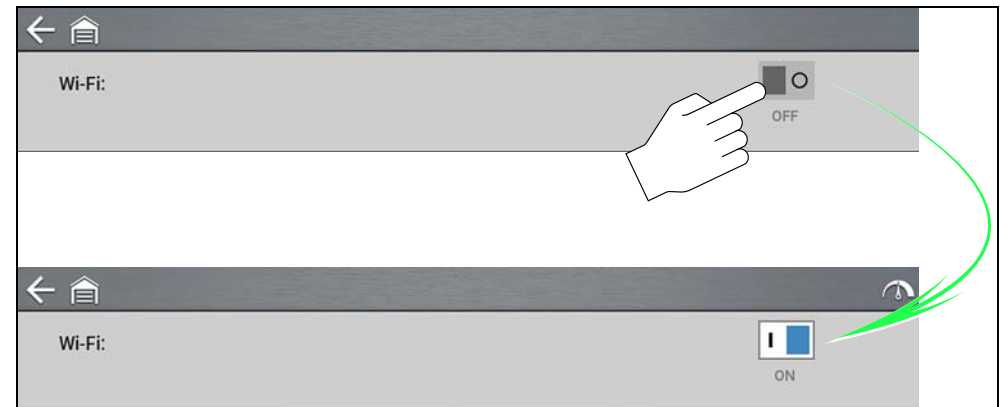

Figure 14-1

2. To connect, select your network from the available networks ([Figure 14-2](#)).

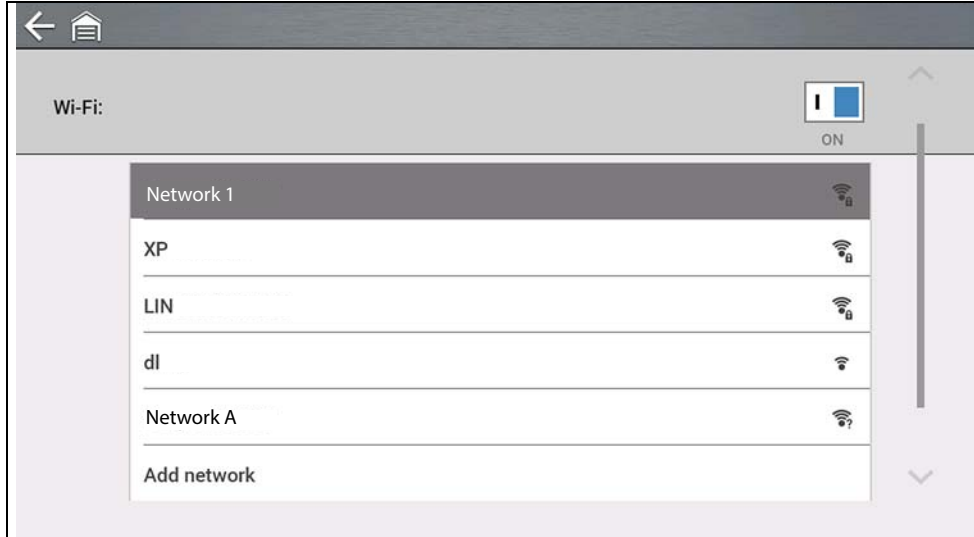

Figure 14-2

## NOTES

*A password is required when choosing a secured (protected) network.*

*Networks with a proxy, challenge page, or that require the user to accept terms of usage are not supported.*

*Wi-Fi performance varies depending on your wireless network equipment and ISP.*

3. Enter the required password and press **Next**, or select **Connect** to continue.
4. Select **OK** to connect, or **Forget** to cancel.
  - The Snap-on Cloud registration information is displayed. For Snap-on Cloud registration information see [Snap-on Cloud](#) on page 13.
  - If “Not Connected” is displayed, try to reconnect or see [“Wi-Fi Testing”](#) on page 129 for additional information.

## 14.3 Add Network Advanced (Connecting to a hidden network)

The Add Network selection allows you to connect to a network that is not broadcasting its name (not visible in the displayed network list). These networks are also known as “hidden” networks.

To connect to a hidden network you will first need to know the following:

- Network Security Type
  - Open (only need SSID)
  - WPA or WPA2 (Pre-shared key)
  - **Note - WEP encryption is NOT supported**
- Network name or SSID (Service Set Identifier)
- Network Password

### Navigation

Home Screen: [Tools](#) > [Settings](#) > [Configure Wi-Fi](#)

1. To connect, select **Add Network Advanced** from the available network list.
2. Select security type Open, WPA, or WPA2. Refer to the router user manual or your IT administrator to determine the type.
3. Enter the network name or SSID
4. Enter the network password and press **Next**.
5. Select **OK** to connect.

## 14.4 Wi-Fi Testing

If you are experiencing network connection issues, an automated testing feature is available to quickly test your network connection.

1. Turn off the diagnostic tool and then turn it on. This clears previous testing messages from memory.
2. Connect to your desired network, see [“Turning Wi-Fi On and Connecting to a Network” on page 127](#).
3. From the Wi-Fi configuration screen, select the **Wi-Fi Test** icon .

Three pass/fail connection tests are performed. If a connection issue(s) is present, select **View Summary** ([Figure 14-3](#)) to review the results for details.



Figure 14-3

## 14.5 Wi-Fi Troubleshooting and Status Messages

The following troubleshooting information is not inclusive and is meant as a guide only. Other issues and solutions may arise that are not stated here. The following description of terms are provided for reference as used in the following troubleshooting chart:

- **Router** - The data transmission device directly connected to your ISP.
- **Remote Wireless Access Point** - A wireless connection device between the router and your diagnostic tool.
- **Wi-Fi Radio** - The internal diagnostic tool radio transmitting and receiving Wi-Fi signals.
- **Network Connection** - Also called Wi-Fi connection. The configured Wi-Fi router connection the diagnostic tool connects to. This connection can be secured (password protected) or unsecured (open).

### Router Information

Router compatibility and setup are important factors to check when trying to determine connectivity problems. Although we have tested this device at the factory to verify connectivity, we cannot guaranty its connectivity with your specific equipment. There may be some situations that require your time for router connection troubleshooting and/or additional consultation and equipment. Snap-on Incorporated is not responsible for any costs incurred for any additional equipment, labor or consultation charges or any other costs that may result from correcting non-connectivity issues with this device.

### IMPORTANT

***WEP encryption technology is obsolete and not secure. Routers using WEP encryption are not supported and cannot be used.***





### Check Router Settings

Verify the following router settings **BEFORE** you begin troubleshooting a non-connectivity or “No Connection” problem. After each check, make any corrections as necessary then retest for connectivity. **Contact your IT administrator or ISP for assistance.**

1. Check your router connection and if applicable, the remote wireless access point connection.
2. Clear saved Wi-Fi networks, see [Clearing Wi-Fi Networks on page 130](#) below.
3. Verify:
  - (a). Router is configured to use Dynamic Host Configuration Protocol (DHCP), not a static IP address.
  - (b). Router and/or settings for this device are configured to 2.4GHz. 5GHz is supported, however 2.4GHz is the preferred setting as it provides greater range.
  - (c). Router is configured to B/G and/or N standard wireless networks to 2.4GHz. 5GHz is supported, however 2.4GHz is the preferred setting, as it provides more range.  
See your router "User Guide" for setup, connection and troubleshooting procedures.

### IMPORTANT

**Routers using WEP encryption are not supported and should not be used.**

4. Check for router firmware and update to current version, if applicable.
5. Restart or reset the router. See your router "User Guide" for procedures.
6. Connect to a different router.

### Clearing Wi-Fi Networks

1. Select the Wi-Fi network that you are trying to connect to from the list of saved networks on the Wi-Fi configuration menu.  
The Wi-Fi Summary page displays.
2. Select **FORGET**  
The Wi-Fi Configuration menu displays.
3. Repeat steps (1) and (2) for ALL saved Wi-Fi networks.
4. Once all saved Wi-Fi networks have been deleted (forgotten) turn off the diagnostic tool.

5. Turn on the diagnostic tool and connect to the desired Wi-Fi network, see [Turning Wi-Fi On and Connecting to a Network on page 127](#).

General -Troubleshooting		
Problem	Possible Cause	Corrective Action
Information Services are not available	Access has expired	Contact your sales representative.
	Access may be temporarily unavailable	Try to access the function at a later time as updates may be in process.
	Wi-Fi radio is turned Off	1. From the Home screen, navigate to <b>Tools &gt; Settings &gt; Configure Wi-Fi</b> . 2. Select the <b>Wi-Fi</b> icon and turn the Wi-Fi radio on. The Wi-Fi icon will change from a green check mark icon to red "X" mark icon indicating Wi-Fi radio is on. 3. Connect to a known good network.
	Not connecting to a network	1. Clear saved Wi-Fi networks, see <a href="#">Clearing Wi-Fi Networks on page 130</a> . 2. Connect to a network. 3. From the Configure Wi-Fi screen select the <b>Wi-Fi Test</b> icon and review the results. See <b>Connection Tests - Troubleshooting in the following table</b> .
Wi-Fi connection drops off or disconnects intermittently	Wi-Fi Signal strength insufficient	Check Wi-Fi signal strength - out of range or interference. Move closer (within 50 Ft. (15 M) or into a direct open sight-line of the router or if applicable, remote wireless access point. Eliminate interference from overhead lights, windows, walls, other wireless devices, metal objects and devices that emit electrostatic discharge. Configure router to 2.4GHz for extended range capability.
	Router overloaded	Disconnect/disable other Wi-Fi devices connected to the router.



Connection Tests - Troubleshooting		
Failed Test	Possible Cause (Displayed Tip Message*)	Corrective Action / Checks
Device	Wi-Fi radio not responding and/or will not turn on	Contact Customer Support for assistance.
	Wi-Fi radio not responding and/or will not initialize	
	Missing or corrupt firmware file(s)	
Network	This device is not connected to a router	Check Wi-Fi signal strength - out of range or interference. Move closer (within 50 Ft. (15 M) or into a direct open sight-line of the router or if applicable, remote wireless access point. Eliminate interference from overhead lights, windows, walls, other wireless devices, metal objects and devices that emit electrostatic discharge. Configure router to 2.4GHz for extended range capability.
		Check router connection and setup. See <a href="#">Check Router Settings on page 130</a> for procedure.
	This device is not connected to the Internet or has no DNS	Check router connection and setup. See <a href="#">Check Router Settings on page 130</a> for procedure.
Domain Name System (DNS) server not connected. Contact your Internet service provider (ISP).		
This device cannot communicate using HTTP	Check if your Internet access uses a "Proxy" or "Accepting terms in a browser" protocol, or uses a challenge page. These protocols are not supported by this device. Contact your IT administrator or ISP for options.	
Information Services are not available	Your access has expired	Contact your sales representative.
	Information Services may be temporarily unavailable or Not connecting to a network	Try to access at a later time as Information Services may be performing updates to the service. Check router connection and setup. See <a href="#">Check Router Settings on page 130</a> for procedure.



# Legal Information

## Trademarks

Snap-on, SureTrack and Fast-Track Intelligent Diagnostics are trademarks registered in the United States and other countries of Snap-on Incorporated. All other marks are trademarks or registered trademarks of their respective holders.

## Copyright Information

© 2021 Snap-on Incorporated. All rights reserved.

## Software License Information

Use of Software is governed by the terms and conditions of the End User License Agreement. The diagnostic tool should not be initially operated until the End User License Agreement is read. Use of the device acknowledges your acceptance of the End User License Agreement. The Snap-on Incorporated Software End User License Agreement may be provided with the diagnostic tool, and is available at: <https://eula.snapon.com/diagnostics>

## Patent Information

For a listing of Snap-on products that are protected by patents in the United States and elsewhere, visit: <https://patents.snapon.com>

## Disclaimer of Warranties and Limitation of Liabilities

All pictures and illustrations shown are for reference purposes only. All information, specifications and illustrations in this manual are based on the latest information available at the time of printing and are subject to change without notice. While the authors have taken due care in the preparation of this manual, nothing contained herein:

- Modifies or alters in any way the standard terms and conditions of the purchase, lease, or rental agreement under the terms of which the equipment to which this manual relates was acquired.
- Increases in any way the liability to the customer or to third parties.

Snap-on<sup>®</sup> reserves the right to make changes at any time without notice.

### IMPORTANT

***Before operating or maintaining this unit, please read this manual carefully paying extra attention to the safety warnings and precautions.***



## FCC Compliance Statement

This equipment has been tested and found to comply with the limits for a Class B digital device, pursuant to part 15 of the FCC rules. These limits are designed to provide reasonable protection against harmful interference in a residential installation. This equipment generates, uses and can radiate radio frequency energy and, if not installed and used in accordance with the instructions, may cause harmful interference to radio communications. However, there is no guarantee that interference will not occur in a particular installation. If this equipment does cause harmful interference to radio or television reception, which can be determined by turning the equipment off and on, the user is encouraged to try to correct the interference by one or more of the following measures:

- Reorient or relocate the receiving antenna.
- Increase the separation between the equipment and receiver.
- Connect the equipment into an outlet on a circuit different from that to which the receiver is connected.
- Consult the dealer or an experienced radio/TV technician for help.

### CAUTION

You are cautioned that changes or modifications not expressly approved by the party responsible for compliance could void your authority to operate the equipment.

### FCC RF Radiation Exposure Statement

1. This transmitter must not be co-located or operating in conjunction with any other antenna or transmitter.
2. This equipment complies with FCC RF radiation exposure limits set forth for an uncontrolled environment. This device was tested for typical lap held operations with the device contacted directly to the human body to the back side of the Display Unit. To maintain compliance with FCC RF exposure compliance requirements, avoid direct contact to the transmitting antenna during transmitting.
3. According to FCC 15.407(e), the device is intended to operate in the frequency band of 5.15GHz to 5.25GHz under all conditions of normal operation. Normal operation of this device is restricted to indoor use only to reduce any potential for harmful interference to co-channel MSS operations.