

SIEMENS



www.siemens.com/3TL

3TL Vacuum Contactors Selection and Ordering Data

Medium-Voltage Equipment · Catalog HG 11.21 · 2014

Answers for infrastructure and cities.



3TL Vacuum Contactors

Medium-Voltage Equipment Catalog HG 11.21 · 2014

Invalid:
Catalog HG 11.21 · 2007
Catalog HG 11.21 · 2008 (only PDF version)

Contents Page

Description	5
General	6
Construction and mode of operation	7
Switching duties	11
Standards and tests	14
Ambient conditions and dielectric strength	15
Comparison of contactors	16



Equipment Selection	17
Ordering data and configuration example	18
Selection of 3TL6	19
Selection of 3TL7	23
Selection of 3TL8	26
Accessories and spare parts	29



Technical Data	33
Electrical data, dimensions and weights	34
Dimension drawings	37
Circuit diagrams	39
Transport dimensions and weights	43



Annex	45
Inquiry form	46
Configuration instructions	47
Configuration aid	Foldout page



The products and systems described in this catalog are manufactured and sold according to a certified management system (acc. to ISO 9001, ISO 14001 and BS OHSAS 18001).

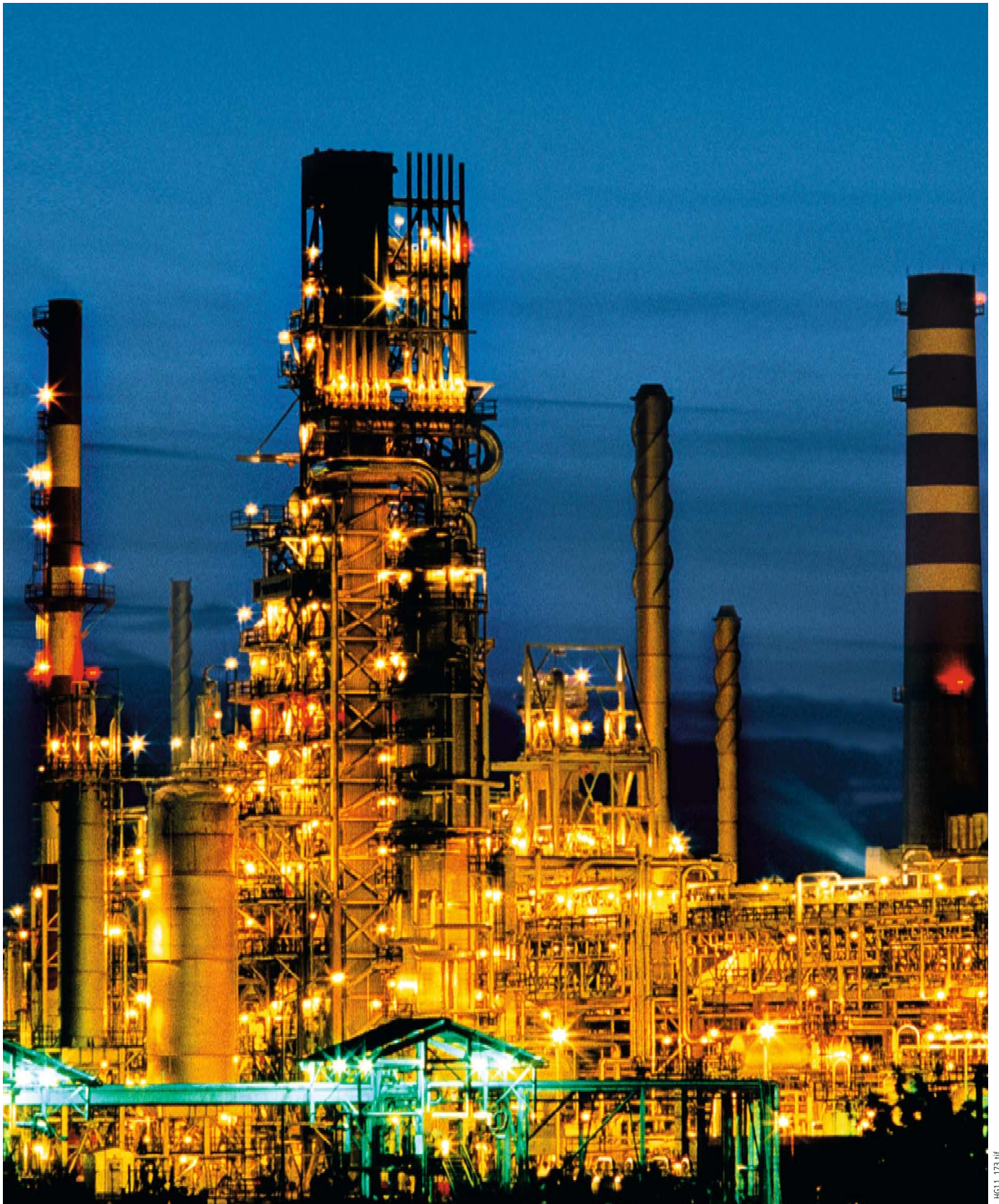

R_HG11_173.tif



Industrial application: Refinery

R-HIG1-174.tif

Contents	Page
Description	5
General	6
Application	7
Switching medium	7
Construction	7
Design	7
3TL6 vacuum contactor	
Mode of operation	8
Mechanical closing latch	8
Mechanical closing lockout	8
Built-on components	8
Installation position	8
Adjustment to the site altitude	9
3TL7 vacuum contactor	
Mode of operation	9
Built-on components	9
Installation position	9
Adjustment to the site altitude	9
3TL8 vacuum contactor	
Mode of operation	10
Mechanical closing latch	10
Built-on components	10
Installation position	10
Adjustment to the site altitude	10
Switching duties	
Utilization categories	11
Application examples	11
Switching of motors	12
Switching of transformers	12
Switching of capacitors	12
Surge protection via limiters	12
Short-circuit protection	12
Short-circuit protection via HV HRC fuses	13
Short-circuit protection via circuit-breakers	14
Standards and tests	14
Ambient conditions	15
Dielectric strength	15
Comparison of contactors	16
Contactor-fuse combinations 3TL62/63/66	16



1

3TL vacuum contactors – The Untiring

3TL vacuum contactors are three-pole contactors with electromagnetic operating mechanism for medium-voltage switchgear. They are load breaking devices with a limited short-circuit making and breaking capacity for applications

with high switching rates of up to 1 million electrical operating cycles or 3 million mechanical operating cycles.

3TL6 vacuum contactor – The Compact



As the operating mechanism is located at the rear, 3TL6 vacuum contactors have a very compact design. This arrangement also enables front access to the main conductor terminals as well as very variable installation options.

In 3TL7 (bottom-right illustration)/3TL8 (top-right illustration) contactors, the assemblies of the low-voltage part and of the medium-voltage part are not arranged one behind the other (3TL6), but one above the other. This provides a slim design which can easily be mounted on the different switchgear and frame structures.

3TL7/3TL8 vacuum contactors – The Slim



Application

The vacuum contactors are suitable for operational switching of alternating current consumers.

The contactors are used in conveying and elevator systems, pumping stations, air conditioning systems, as well as in systems for reactive power compensation, and can therefore be found in almost every industrial sector.

Switching medium

The vacuum switching technology, proven and fully developed for more than 40 years, serves as arc-quenching principle by using vacuum interrupters.

Construction

3TL vacuum contactors consist of a medium-voltage and a low-voltage part. Together with the main conductor terminals, the vacuum interrupters constitute the medium-voltage part. All components required to operate the vacuum interrupter, such as the operating mechanism, closing latch and control unit make up the low-voltage part. These assemblies can be arranged either one behind the other (3TL6) or one above the other (3TL7 and 3TL8).

Design

3TL vacuum contactors are designed as an open construction, with degree of protection IP00 according to DIN EN 60529 and IEC 60529.

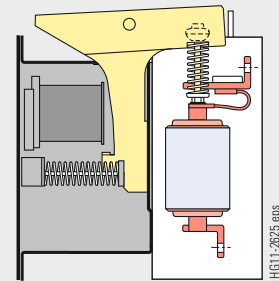

3TL6 vacuum contactor

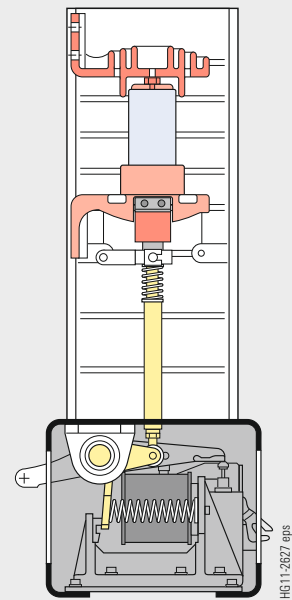

3TL7 vacuum contactor

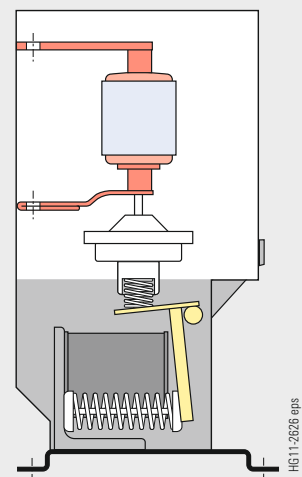

3TL8 vacuum contactor



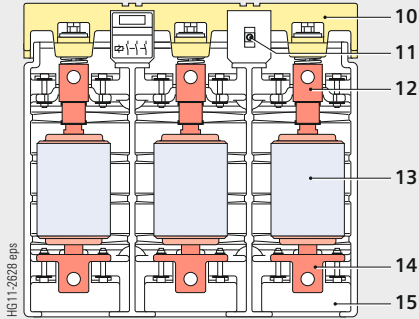

Construction of the 3TL6 vacuum contactor (front view)

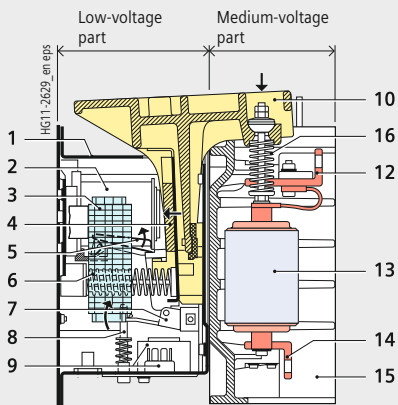

Construction of the 3TL6 vacuum contactor in "OPEN" position, side view from the left (section). The arrows show the moving direction for "CLOSE".

Legend

- | | |
|---|---|
| 1 Operating mechanism box | 9 Latch release solenoid with rectifier and varistor module |
| 2 Magnet system (magnet coil) with rectifier and economy resistor | 10 Integral rocker |
| 3 Terminal strip | 11 Position indicator O - I |
| 4 Magnet armature | 12 Upper main conductor terminal |
| 5 Mechanical closing latch | 13 Vacuum interrupter |
| 6 Opening spring | 14 Lower main conductor terminal |
| 7 Latch | 15 Molded-plastic housing |
| 8 Tripping bolt | 16 Contact pressure spring |

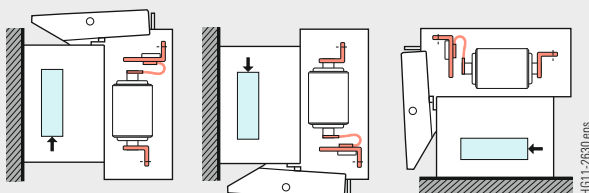

Wall mounting
Vertical arrangement

Wall mounting
Vertical arrangement (turned by 180°)

Floor mounting
Horizontal arrangement

The arrow shows the arrangement of the terminal strip

3TL6 vacuum contactor

Mode of operation

The atmospheric pressure exerts a force on the metal bellows of the vacuum interrupter. Without the influence of the operating mechanism, this would close the contact gap. The opening springs (6) keep the moving interrupter contact in open position via the integral rocker (10). To close the vacuum contactor, the compressive force of the opening springs (6) is overcome by the magnet system (2). The magnet armature (4) is attracted, thus moving the integral rocker (10), which closes the interrupter contact. The integral rocker (10) compresses the contact pressure springs (16), thus generating the necessary contact force. When the magnetic excitation is de-energized, the opening springs (6) open the contact gap via the integral rocker (10) and the moving interrupter contact. The DC magnet system operates as an economy circuit, providing a high mechanical endurance and a low holding power.

Mechanical closing latch

When the magnet system is energized, the integral rocker is latched mechanically in the "CLOSED" position through a lever and roller system. The latch (7) holds the vacuum contactor in closed position even without excitation of the magnet system. The vacuum contactor is released electrically by means of a latch release solenoid (9) or mechanically by the tripping bolt (8) (customer-side control).

Mechanical closing lockout

The mechanical closing lockout (5) prevents unintentional closing of the vacuum contactor, e.g. due to vibrations or while racking the withdrawable part. During operational switching, the closing lockout is inactive.

Built-on components

To interlock two contactors mutually for reversing duty, a mechanically operating blocking element is available on request (for 3TL61 only). The blocking element is fixed between the two contactors, blocking the movement of the operating rocker of the two contactors alternatively. This excludes a phase short circuit that could occur when the two senses of rotation are activated simultaneously as a result of mechanical impacts and electrical maloperation.

Installation position

3TL6 vacuum contactors can be installed in different positions. Besides wall mounting (vertical arrangement), they can also be mounted on the floor (horizontal arrangement).

3TL6 vacuum contactor (continuation)

Adjustment to the site altitude

At the factory, the vacuum contactor is adjusted to a site altitude of – 200 m to + 1250 m above sea level. For other site altitudes, the contactor must be adapted to the corresponding site altitude range by means of adjusters located on the rear side of the device (see illustration on the right).

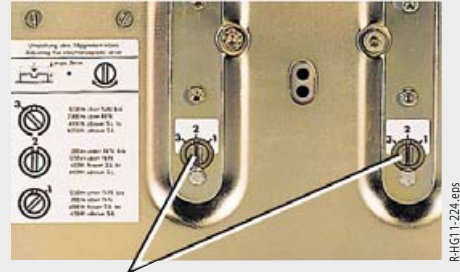

Adjusters (on the rear side of the device) to adapt the site altitude

Setting ranges above sea level:

- 1. + 1250 m to + 2500 m
- 2. – 200 m to + 1250 m
- 3. – 1250 m to + 200 m

3TL7 vacuum contactor

Mode of operation

The mode of operation of the 3TL7 is comparable to the mode of operation of the 3TL6. Instead of the integral rocker, the interrupters are operated via a linear mechanical connection (7). Due to the use of a special double coil, the magnetic drive is designed for the closing and holding process.

Built-on components

To implement a mechanical interlocking between the withdrawable part of the switchgear and the vacuum contactor, there is a lug (11) available on the operating shaft which transfers the signaling commands.

Installation position

Contrary to the 3TL6, the 3TL7 can only be installed in vertical position.

Adjustment to the site altitude

On the 3TL7, the site altitude is selected directly at the 14th position of the order number. The standard site altitude is between – 50 m and + 1250 m.

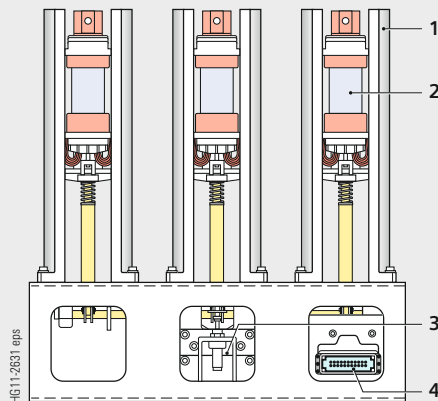

Construction of the 3TL7 vacuum contactor (front view)

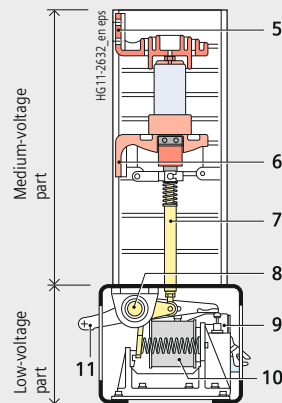

3TL7, side view from the left (section)

Legend

- 1 Pole half-shell
- 2 Vacuum interrupter
- 3 Mechanism section
- 4 Auxiliary plug connector
- 5 Upper main conductor terminal
- 6 Lower main conductor terminal
- 7 Mechanical connection between medium-voltage and low-voltage part
- 8 Operating shaft
- 9 Auxiliary switch block
- 10 Magnet system (magnet coil)
- 11 Lug for mechanical interlocking in the switchgear

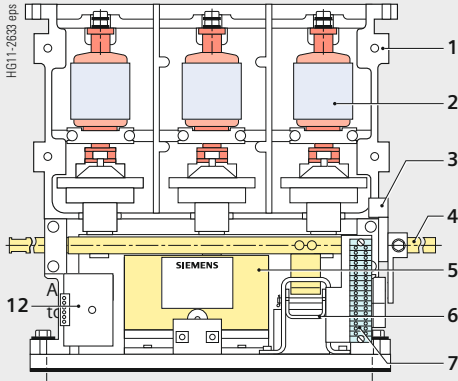

Construction of the 3TL8 vacuum contactor (front view)

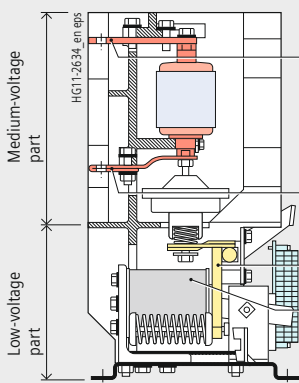

3TL8, side view from the left (section)

Legend

- 1 Molded-plastic housing
- 2 Vacuum interrupter
- 3 Position indicator O - I
- 4 Operating shaft (short or long version)
- 5 Drive lever
- 6 Mechanical closing latch with rectifier module for AC operation
- 7 Terminal strip
- 8 Upper main conductor terminal
- 9 Lower main conductor terminal
- 10 Mechanical connection between medium-voltage and low-voltage part
- 11 Magnet system (magnet coil)
- 12 Electronic module (electronic economy circuit) with connection terminals

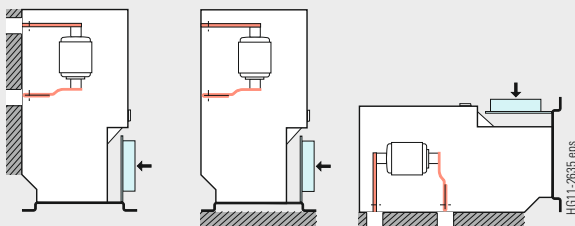

Wall mounting

Vertical arrangement

Floor mounting

Vertical arrangement

Horizontal arrangement

The arrow shows the arrangement of the terminal strip

3TL8 vacuum contactor

Mode of operation

The mode of operation of the 3TL8 is comparable to the mode of operation of the 3TL6. Due to the use of an electronic module (12), the magnet system (11) is to a large extent independent of the voltage type and level. The electronic module also takes over the economy circuit.

Mechanical closing latch

The mechanical closing latch (6) holds the vacuum contactor in closed position even without excitation of the magnet system (11). The latching module of the mechanical closing latch (6) is accommodated in the mechanism section. The vacuum contactor is released electrically by means of a latch release solenoid or mechanically by a tripping lever (customer control required).

Built-on components

For no-force components, a long operating shaft (4) is optionally available.

Installation position

3TL8 vacuum contactors can be installed in different positions. Besides wall mounting (vertical arrangement), they can also be mounted on the floor (vertical or horizontal arrangement).

Adjustment to the site altitude

The standard site altitude of the 3TL8 is between - 500 m and + 2000 m, and can be specified up to +4000 m at the 7th position of the order number.



Utilization categories

In IEC 62271-106, power contactors are divided into different utilization categories. According to these categories, 3TL vacuum contactors are dimensioned for different electrical consumers and operating conditions. The opposite table shows typical applications in accordance with the respective utilization category.

Utilization categories	Typical applications
AC-1	Non-inductive or slightly inductive loads, resistance furnaces
AC-2	Slip-ring motors: Starting, switching off
AC-3	Squirrel-cage motors: Starting, switching off during running
AC-4	Squirrel-cage motors: Starting, plugging ¹⁾ , reversing ¹⁾ , inching ²⁾

- 1) By plugging or reversing is understood stopping or reversing the motor rapidly by reversing motor primary connections while the motor is running
- 2) By inching is understood energizing a motor once or repeatedly for short periods to obtain small movements of the driven mechanism





Application examples

3TL vacuum contactors are three-pole contactors with electromagnetic operating mechanism for medium-voltage switchgear. They are load breaking devices with a limited short-circuit making and breaking capacity, and are used for high switching rates (> 10,000 operating cycles).

The vacuum contactors are suitable for operational switching of alternating current consumers in indoor switchgear, and can be used, e.g., for the following switching duties:

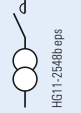
- Three-phase motor starting
- Plugging or reversing the direction of rotation of motors
- Switching of three-phase motors in AC-3 and AC-4 operation
- Switching of transformers
- Switching of reactors
- Switching of resistive consumers such as electrical furnaces
- Switching of capacitors.

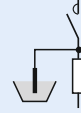
In contactor-type reversing starter combinations (reversing duty), only one contactor is required for each direction of rotation if HV HRC fuses are used for short-circuit protection.

Application, switching of consumers	Symbols	Application examples
Medium voltage three-phase motors		Conveyor and elevator systems, compressors, ventilation and heating
Transformers		Ring-main units, industrial system distributions
Reactors		Industrial system distributions, DC-link reactors, reactive power compensation systems
Resistive consumers		Heating resistors, electric furnaces
Capacitors		Reactive power compensation systems, capacitor banks

1

Circuit diagram	Mode of operation
	Switching of accelerated motors
	Occasional switching of just accelerated motors in case of fault ¹⁾
	Frequent switching in AC-4 operation ¹⁾

Circuit examples for surge protection of three-phase motors with a starting current ≤ 600 A

1) With surge limiter

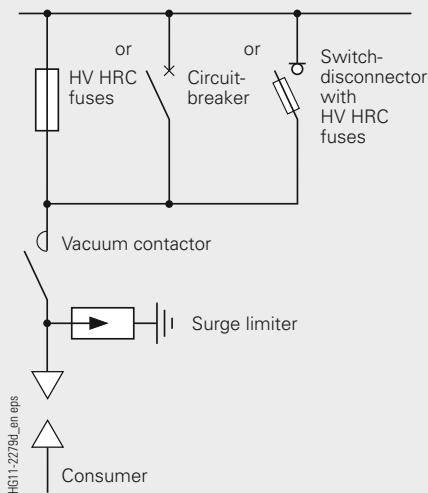

Switching devices in combination with a vacuum contactor

Switching of motors

3TL vacuum contactors are especially suitable for frequent operation of motors. As the chopping currents of the contactors are ≤ 5 A, no unpermissibly high overvoltages are produced when accelerated motors are switched during normal operation. However, when high-voltage motors with starting currents of ≤ 600 A are stopped during start-up, switching overvoltages may arise. The magnitude of these overvoltages can be reduced to harmless values by means of special surge limiters.

Switching of transformers

When inductive currents are interrupted, current chopping can produce overvoltages at the contact gap. As the chopping current of the Siemens vacuum contactor is less than 5 A, no dangerous overvoltages are produced when the unloaded transformer is switched off.

Switching of capacitors

3TL vacuum contactors can interrupt capacitive currents up to 400 A up to the rated voltage of 24 kV without restrikes, and thus without overvoltages.

Surge protection via limiters

Overvoltages can arise as a consequence of multiple re-strikes or by virtual current chopping, e.g. when motors are switched in braked condition or during start-up. Motors with a starting current ≤ 600 A are endangered. Safe protection against overvoltages is ensured by surge limiters 3EF. These can be arranged in parallel to the cable sealing ends, preferably in the cable compartment. The surge limiters consist of non-linear resistors (metal-oxide varistors SIOV) and a series-connected spark gap. During installation it must be observed that the surge limiter is flexibly mounted on one side for mechanical reasons.

Short-circuit protection

3TL vacuum contactors are not designed to switch short-circuit currents. It is therefore absolutely essential to provide short-circuit protection. The best protection is provided by HV HRC fuses, but circuit-breakers can also be used for this purpose.

Short-circuit protection via HV HRC fuses

At high short-circuit currents, HV HRC fuses have a current-limiting effect, i.e. the fuse limits the short-circuit current to the let-through current. When selecting the fuses, the type of consumer must be observed, e.g. motor, transformer, capacitor.

The opposite diagram shows an example for the coordination of a HV HRC fuse with an overcurrent-time protection.

Coordinating the components of the motor circuit:

- The time-current characteristic must be located on the right of the motor starting current (point A).
- The rated current of the HV HRC fuse-link must exceed the normal current of the motor.
- The current corresponding to the intersection B of the HV HRC fuse-link characteristic and the characteristic of the overcurrent-time protection must be higher than the minimum breaking current of the HV HRC fuse-link.
- If this is not feasible, it must be ensured that overload currents that are smaller than the minimum breaking current of the HV HRC fuse-link are interrupted by the switching device via the striker. This prevents thermal overloading of the HV HRC fuse-link, which would otherwise be destroyed.
- The selected HV HRC fuse-link limits the sustained symmetrical short-circuit current I_k to the let-through current I_D shown in the diagram for the current-limiting characteristics (I_D as a function of I_k for HV HRC fuse-links with different rated currents). The maximum permissible let-through current is $I_D = 50$ kA, however, only at 7.2 kV.

Requirements

- The let-through current I_D must not exceed 50 kA at 7.2 kV.
- In case of low-voltage supply via a control transformer, short-circuit currents ranging above the limit breaking capacity must be interrupted within 80 ms. This requirement does not apply if
 - a mechanical latch is provided, or
 - the opening times have been extended so much that – in the a.m. current range – the contactor can only open when the fuse has interrupted the current.
- Due to the arising motor starting current, the instant when the motor starts represents the maximum stress for the HV HRC fuse. This stress must neither operate nor pre-damage the fuse-link.
- Other factors of influence on the stress of the HV HRC fuses are the starting time and the starting frequency of the motors.

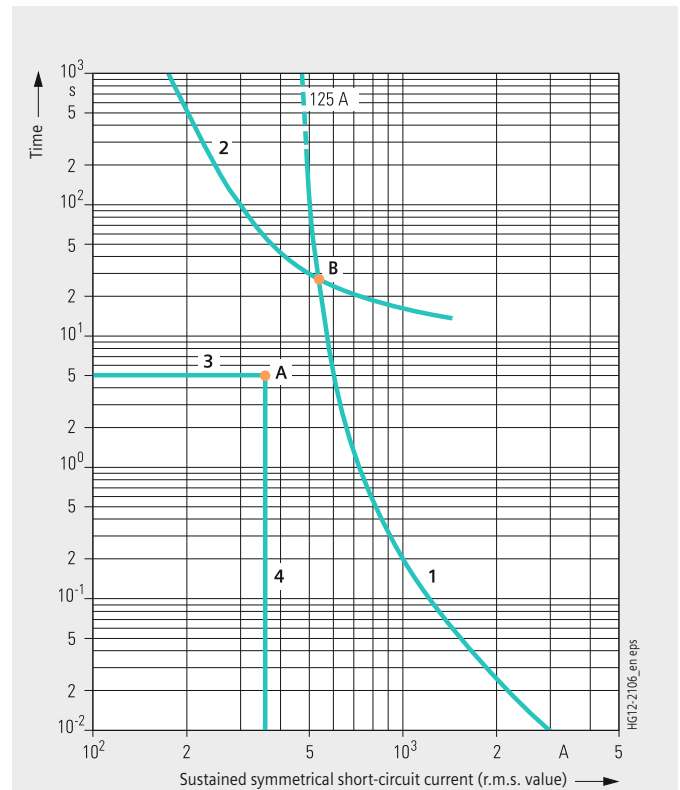

Example for the coordination of a HV HRC fuse characteristic 125 A with a motor characteristic

- 1 Characteristic of the HV HRC fuse (e.g. type 3GD2)
- 2 Characteristic of the overcurrent-time protection
- 3 Motor starting time
- 4 Motor starting current



Description

Switching duties, standards and tests

1

Short-circuit protection for “class E2 controllers” according to UL 347/CSA C22.2

For using 3TL6 and 3TL8 vacuum contactors as “class E2 controllers” for 7.2 kV, Siemens fuses of type 3GD2 150-4D (7.2 kV/250 A) or other fuses with a comparable current-time characteristic are specified for short-circuit protection. If two fuse-links are connected in parallel, the symmetrical short-circuit current determined has to be divided by two, and the associated let-through current for one fuse-link must be stated. This value must then be multiplied by two in order to obtain the total let-through current, which must not exceed the permissible value for the vacuum contactor. The parallel connection should ensure that the resistance values in the two branches are almost the same. When the fuses operate, the vacuum contactor must be switched off. A suitable device, actuated by the striker of the HV HRC fuse-link, has to be provided.

Fuse monitoring

To prevent a three-phase load (e.g. a motor) from being supplied only by two phases when a fuse has operated, the fuse-bases can be equipped with a “fuse trip indicator”. This device can be used either to energize a warning signal or to switch off the vacuum contactor.

Short-circuit protection via circuit-breakers

Consumers for which no suitable fuses are available can also be protected by circuit-breakers. Due to the longer break time of the circuit-breakers (max. permissible 120 ms), the symmetrical short-circuit current must not exceed the maximum permissible value (e.g. 20 kA at 7.2 kV for 3TL6 vacuum contactors). As a consequence of the longer break time, the interrupters should be replaced immediately by new ones after carrying the maximum permissible symmetrical short-circuit current, as their service life has been considerably reduced.

Overload protection

For protecting high-voltage motors against overload, it is possible to use thermally delayed overcurrent relays with suitable current transformers.

Trip-free mechanism

All contacts of the vacuum contactors are trip-free. The “OPEN” command interrupts the “CLOSE” command, i.e. the instant of the “OPEN” command determines whether the contacts will close or not.

Standards

3TL vacuum contactors are designed in open construction, with degree of protection IP00 according to IEC 60529 and DIN EN 60529. They conform to the standards for high-voltage alternating current contactors:

- IEC 62271-106
- UL Standard 347 (up to 15 kV)
- CSA C22.2 (up to 7.2 kV contactor).

Tests

For the development and type testing of power switching devices according to relevant standards, we have accredited testing laboratories at our disposal:

- Testing laboratories with a high electrical testing capacity
- Testing laboratories to prove the following features:
 - Mechanical operation
 - Reliability
 - Dielectric strength
 - Temperature-rise performance
 - Climatic resistance.

To obtain secure results, comprehensive test series are performed for the type tests defined in the standards.

Ambient conditions

The vacuum contactors are designed for the normal operating conditions defined in the standards.

Condensation can occasionally occur under the ambient conditions shown. Vacuum contactors are suitable for use in the following climatic classes according to IEC 60721:

- Climatic ambient conditions: Class 3K4 ¹⁾
Class 3K6 ²⁾
Class 3Z2
Class 3Z5
- Biological ambient conditions: Class 3B1
- Mechanical ambient conditions: Class 3M2
- Chemically-active substances: Class 3C2 ³⁾
- Mechanically-active substances: Class 3S2 ⁴⁾

- 1) Low temperature limit: -25 °C (-40 °C for 3TL7)
- 2) Without icing and wind-driven precipitation
- 3) Without appearance of saline fog and simultaneous condensation
- 4) Restriction: Clean insulation parts

Dielectric strength

The dielectric strength of air insulation decreases with increasing altitude due to low air density. According to IEC 62271-1, the values of the rated lightning impulse withstand voltage and the rated short-duration power-frequency withstand voltage specified in the chapter "Technical Data" apply to a site altitude of 1000 m above sea level. For an altitude above 1000 m, the insulation level must be corrected according to the opposite diagram.

The characteristic shown applies to both rated withstand voltages.

To select the devices, the following applies:

$$U \geq U_0 \times K_a$$

- U Rated withstand voltage under reference atmosphere
- U_0 Rated withstand voltage requested for the place of installation
- K_a Altitude correction factor according to the opposite diagram

Example

For a requested rated lightning impulse withstand voltage of 60 kV at an altitude of 2500 m, an insulation level of 72 kV under reference atmosphere is required as a minimum:

$$72 \text{ kV} \geq 60 \text{ kV} \times 1.2$$

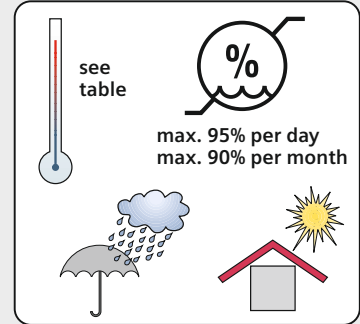

Temperature value	For vacuum contactor		
	3TL6	3TL7	3TL8
Maximum value	+80 °C	+55 °C	+65 °C
Maximum 24-hour mean value	+75 °C	+50 °C	+60 °C
Minimum value	-25 °C	-40 °C	-25 °C

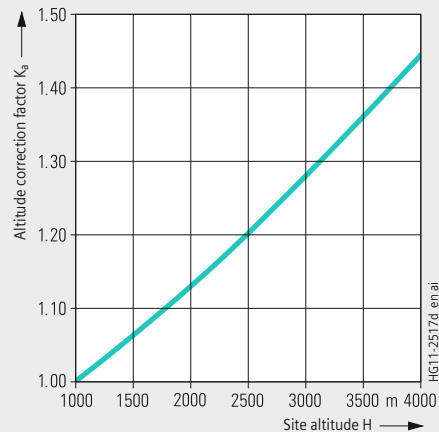

1

Comparison of contactors

Comparison of contactors	3TL61	3TL65	3TL68	3TL71	3TL81
Rated voltage	7.2 kV	12 kV	15 kV	24 kV	7.2 kV
Rated normal current	450 A	400 A	320 A	800 A	400 A
Thermal current	450 A	400 A	320 A	800 A	400 A
Rated operational current	450 A	400 A	320 A	450 A	400 A
Switching rate	1200 operating cycles/h	600 operating cycles/h	600 operating cycles/h	60 operating cycles/h	1200 operating cycles/h
Endurance - Contactor - Vacuum interrupter	Operating cycles Mech. endurance 3 mio. Mech. endurance 2 mio. Electr. endurance 1 mio.	Operating cycles Mech. endurance 1 mio. Mech. endurance 1 mio. Electr. endurance 0.5 mio.	Operating cycles Mech. endurance 1 mio. Mech. endurance 1 mio. Electr. endurance 0.25 mio.	Operating cycles Mech. endurance 1 mio. Mech. endurance 1 mio. Electr. endurance 0.5 mio.	Operating cycles Mech. endurance 1 mio. Mech. endurance 0.25 mio. Electr. endurance 0.25 mio.
Chopping current	< 5 A	< 5 A	< 5 A	< 5 A	≤ 0.6 A
Economy circuit	Via economy resistor	Via economy resistor	Via economy resistor	Via automatic coil changeover	Integrated in electronic module
Auxiliary contacts	Positively driven auxiliary switch 8 NO, 7 NC	Positively driven auxiliary contacts 8 NO, 7 NC	Positively driven auxiliary contacts 8 NO, 7 NC	Positively driven auxiliary contacts 8 NO, 7 NC	Positively driven auxiliary contacts 4 NO, 4 NC
Operating mechanism	At the rear of the vacuum interrupters	At the rear of the vacuum interrupters	At the rear of the vacuum interrupters	Below the vacuum interrupters	Below the vacuum interrupters
Type of construction	Compact	Compact	Compact	Slim	Slim
Main conductor terminals	At the front of the vacuum interrupters	At the front of the vacuum interrupters	At the front of the vacuum interrupters	At the rear of the vacuum interrupters	At the rear of the vacuum interrupters
Auxiliary conductor terminals	Terminal strip with testing possibilities in built-in condition (optionally withdrawable terminal strip)	Terminal strip with testing possibilities in built-in condition (optionally withdrawable terminal strip)	Terminal strip with testing possibilities in built-in condition (optionally withdrawable terminal strip)	Wiring of auxiliary contacts to central auxiliary plug connector	Direct tapping at the terminals (optionally wiring of auxiliary contacts to central terminal strip)
Additional components	Mechanical closing latch ¹⁾ , mechanical closing lockout, extension or reduction of opening time	Mechanical closing latch ¹⁾ , mechanical closing lockout, extension or reduction of opening time	Mechanical closing latch ¹⁾ , mechanical closing lockout, extension or reduction of opening time	Reduction of opening time	Mechanical closing latch ¹⁾ , long operating shaft for non-force external components, reduction of opening time

1) For operating voltages of the mechanical closing latch below 110 V, a stable voltage supply must be observed

Contactor-fuse combinations 3TL62/63/66

The contactor-fuse combinations 3TL62/63/66 are type-tested units of the 3TL6 contactors and HV HRC fuses.

A fuse holder for one or two fuses per phase and optionally a control transformer for power supply have been integrated. The type-tested unit enables frequent switching of high normal currents in a compact space.

The arrangement of the components on the base plate ensures optimum ventilation and thus a high normal current. This is supported by the specially designed fuse holder, which ensures uniform current distribution. Even a high dielectric strength as required in countries such as China are fulfilled with this construction. The 3TL6 fuse-link combination is suitable for applications in withdrawable modules and for fixed mounting. Bushings and different widths across flats are available for easy integration.

For selection, please use catalog HG 11.22 "Contactor-Fuse Combinations 3TL62/63/66".



R-HG11.22.tif



R-HG11-220.tif

3TL6 vacuum contactor



R-HG11-221.tif

3TL8 vacuum contactor

Contents Page

Equipment Selection 17

Ordering data and configuration example 18

Selection of 3TL6

Voltage level 7.2 kV 19

Voltage level 12 kV 19

Voltage level 15 kV 19

Terminal strip, auxiliary contacts 19

Additional components 20

Mode of operation for magnet system 21

Operating voltage for magnet system 21

Additional equipment 22

Selection of 3TL7

Voltage level 24 kV 23

Auxiliary switch 23

Mode of operation for magnet coil 23

Operating voltage for magnet coil 23

Language of operating instructions 24

Type of construction 24

Site altitude 24

Additional equipment 25

Selection of 3TL8

Voltage level 7.2 kV 26

Design 26

Auxiliary switch, wiring 26

Operating voltage for magnet coil 27

Operating voltage for closing latch 27

Opening time 27

Language of operating instructions/
routine test certificate 28

Additional equipment 28

Accessories and spare parts 29





9th/10th/11th position

Mode of operation and operating voltage
for magnet system and closing latch

		Position:	1	2	3	4	5	6	7	-	8	9	10	11	Order codes			
		Order No.:	3	T	L	6	■	■	■	-	■	■	■	■	■	■	■	■
DC operation with voltage	AC operation with voltage																	
24 V DC ¹⁾												B	B	4				
30 V DC ¹⁾												B	C	4				
48 V DC ¹⁾												B	W	4				
60 V DC ¹⁾												B	E	4				
110 V DC												B	F	4				
125 V DC												B	G	4				
220 V DC												B	M	4				
	100 V AC, 50/60 Hz											A	F	2				
	110 V AC, 50/60 Hz											A	G	2				
	115 V AC, 50/60 Hz											A	J	2				
	120 V AC, 50/60 Hz											A	K	2				
	230 V AC, 50/60 Hz											A	L	2				
	240 V AC, 50/60 Hz											A	P	2				

1) For operating voltages of the mechanical closing latch below 100 kV, a stable voltage supply must be observed

Voltage different from operating voltage
for closing latch and shunt release

		Position:	1	2	3	4	5	6	7	-	8	9	10	11	Order codes			
		Order No.:	3	T	L	6	■	■	■	-	■	■	■	■	■	■	■	■
DC operation with voltage	AC operation with voltage																	
24 V DC															-	Z	G 6 0	
30 V DC															-	Z	G 6 1	
48 V DC															-	Z	G 6 2	
60 V DC															-	Z	G 6 3	
110 V DC															-	Z	G 6 4	
125 V DC															-	Z	G 6 5	
220 V DC															-	Z	G 6 6	
	100 V AC, 50/60 Hz														-	Z	G 6 7	
	110 V AC, 50/60 Hz														-	Z	G 6 8	
	115 V AC, 50/60 Hz														-	Z	G 6 9	
	120 V AC, 50/60 Hz														-	Z	G 7 0	
	230 V AC, 50/60 Hz														-	Z	G 7 1	
	240 V AC, 50/60 Hz														-	Z	G 7 2	

Configuration example

3TL6 vacuum contactor
 $(U_r = 12 \text{ kV}, U_p \text{ (to earth)} = 75 \text{ kV}, U_p \text{ (open contact gap)} = 60 \text{ kV},$
 $U_d = 28 \text{ kV}, I_r = 400 \text{ A})$
 Mode of operation DC operation
 for magnet system and closing latch
 Operating voltage 60 V DC

3 T L 6

5 3 5 - 2

B

E 4

Example for Order No.: 3 T L 6 5 3 5 - 2 B E 4 - Z
 Order codes: E 1 3





12th position

Language of operating instructions

Option	1	2	3	4	5	6	7	-	8	9	10	11	12	-	13	14	Order codes			
German/English	3	T	L	7	■	■	■	-	■	■	■	■	■	-	■	■	-	■	■	■

13th position

Type of construction

Options	1	2	3	4	5	6	7	-	8	9	10	11	12	-	13	14	Order codes			
Version standard/industry (interrupters in vertical position)																				
Version with insulating plate (interrupters in vertical position)																				

14th position

Site altitude

Options	1	2	3	4	5	6	7	-	8	9	10	11	12	-	13	14	Order codes			
Site altitude -50 – 1250 m																				
Site altitude 1250 – 2500 m																				
Site altitude 2500 – 4000 m																				
Site altitude 4000 – 5000 m																				

Configuration example

3TL7 vacuum contactor
 $(U_r = 24 \text{ kV}, U_p \text{ (to earth)} = 125 \text{ kV}, U_p \text{ (open contact gap)} = 95 \text{ kV}, U_d = 50 \text{ kV}, I_r = 800 \text{ A})$

Language of operating instructions German/English
 Type of construction, version with insulating plate (interrupters in vertical position)
 Site altitude 0 – 1250 m

3	T	L	7																	
				1	2	8	-	0	A	G	2									
													0	-						
																			1	
																				A
Example for Order No.:	3	T	L	7	1	2	8	-	0	A	G	2	0	-	1	A				
Order codes:																				



Additional equipment

	Position:	1	2	3	4	5	6	7	-	8	9	10	11	12	-	13	14	Order codes					
Order No.:		3	T	L	7	■	■	■	-	■	■	■	■	■	-	■	■	-	★	■	■	■	
Options																							
Wiring, halogen-free and flame-retardant																			-	Z	A	1	0
Wiring cables, tinned																			-	Z	A	1	2
Additional rating plate, loose delivery																			-	Z	B	0	0
Silver-plated connecting surfaces																			-	Z	D	0	9
Seaworthy packing inside Germany																			-	Z	F	0	2
Routine test certificate in English enclosed																			-	Z	F	2	0
Routine test certificate in German enclosed																			-	Z	F	2	4
Routine test certificate in French enclosed																			-	Z	F	2	5
Routine test certificate in Spanish enclosed																			-	Z	F	2	6
Customer acceptance test																			-	Z	F	5	0
Special wiring for opening time ≤ 50 ms																			-	Z	G	0	1

Note on opening times:
 Standard 50 to 100 ms
 With special wiring G01 ≤ 50 ms



Configuration example

- 3TL7 vacuum contactor
- Rated voltage $U_r = 24 \text{ kV}$
- Rated lightning impulse withstand voltage U_p (to earth) = 125 kV
- Rated lightning impulse withstand voltage U_p (open contact gap) = 95 kV
- Rated power-frequency withstand voltage $U_d = 50 \text{ kV}$
- Rated normal current $I_r = 800 \text{ A}$
- Auxiliary switch 8 NO + 8 NC
- Mode of operation AC operation for magnet coil
- Operating voltage 110 V AC for magnet coil
- Language of operating instructions German/English
- Type of construction, version with insulating plate (interrupters in vertical position)
- Site altitude 0 – 1250 m
- Additional rating plate, loose delivery

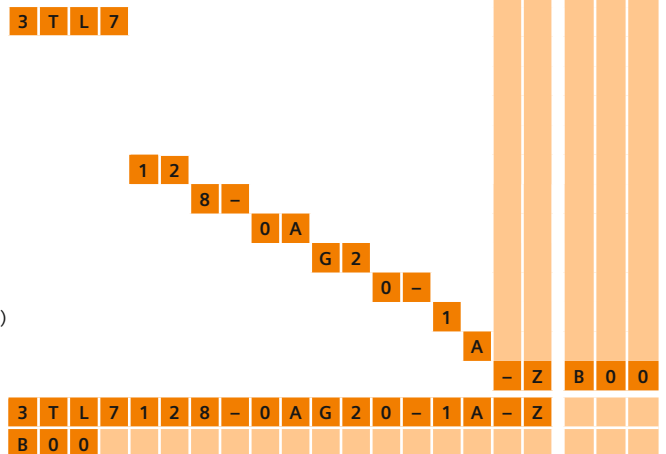

Example for Order No.: 3 T L 7 1 2 8 - 0 A G 2 0 - 1 A - Z
 Order codes: B 0 0



9th position
Operating voltage for magnet coil

Position:	1	2	3	4	5	6	7	-	8	9	10	11	12	Order codes	
Order No.:	3	T	L	8	■	■	■	-	■	■	■	■	■	■	■
Voltage											See page 28	See page 28	■		
110 V to 250 V AC/DC											B				

10th position
Operating voltage for closing latch

DC voltage	AC voltage	1	2	3	4	5	6	7	-	8	9	10	11	12	Order codes	
Without mechanical closing latch ¹⁾												A				
24 V DC ²⁾												B				
30 V DC												C				
48 V DC ²⁾												D				
60 V DC ²⁾												E				
110 V DC												F				
125 V DC												G				
220 V to 250 V DC												H				
	110 V – 115 V AC	50/60 Hz											L			
	120 V – 127 V AC	50/60 Hz											M			
	220 V – 240 V AC	50/60 Hz											N			

Other voltages on request

11th position
Opening time

Time	Remark	1	2	3	4	5	6	7	-	8	9	10	11	12	Order codes
250 ms to 400 ms	Without mechanical closing latch ¹⁾											0			
≤ 50 ms ³⁾	Without mechanical closing latch ¹⁾											2			
30 ms to 50 ms	With mechanical closing latch											5			

- 1) "Without mechanical closing latch" can only be selected if no latching option was selected at the 8th position either (0, 1, 5 or 6)
- 2) For operating voltages of the mechanical closing latch below 100 V, a stable voltage supply must be observed
- 3) Implementation by external circuit (see page 42)

Configuration example

3TL8 vacuum contactor
 $(U_r = 7.5 \text{ kV}, U_p(\text{to earth}) = 60 \text{ kV}, U_p(\text{open contact gap}) = 40 \text{ kV}, U_d = 20 \text{ kV}, I_r = 400 \text{ A})$
 Operating voltage of the magnet coil 110 to 250 V AC/DC
 Without mechanical closing latch
 Opening time 325 ms ± 75 ms without mechanical closing latch

3	T	L	8												
				1	0	0	-	1							
										B	A	0			
Example for Order No.:	3	T	L	8	1	0	0	-	1	B	A	0	■		
Order codes:															





12th position

Language of the operating instructions/ routine test certificate

		Position:	1	2	3	4	5	6	7	-	8	9	10	11	12	Order codes					
		Order No.:	3	T	L	8	■	■	■	-	■	■	■	■	■	■	-	★	■	■	■
Operating instructions	Routine test certificate																				
German/English	Without certificate															0					
French/Spanish	Without certificate															1					
German/English	German															4					
German/English	English															5					
French/Spanish	French															6					
French/Spanish	Spanish															7					

2

Additional equipment

		Position:	1	2	3	4	5	6	7	-	8	9	10	11	12	Order codes					
Options																					
Wiring, halogen-free and flame-retardant																	-	Z	A	1	0
Wiring cables, tinned																	-	Z	A	1	2
Additional rating plate, loose delivery																	-	Z	B	0	0
Cable harness with flexible tube																	-	Z	B	5	8
Seaworthy packing inside Germany																	-	Z	F	0	2
Routine test certificate (supplied with the delivery)																	-	Z	F	2	0
Routine test certificate (to orderer)																	-	Z	F	2	3
Customer acceptance test																	-	Z	F	5	0

Configuration example

3TL8 vacuum contactor
 Rated voltage $U_r = 7.2 \text{ kV}$
 Rated lightning impulse withstand voltage $U_p (\text{to earth}) = 60 \text{ kV}$
 Rated lightning impulse withstand voltage $U_p (\text{open contact gap}) = 40 \text{ kV}$
 Rated short-duration power-frequency withstand voltage $U_d = 20 \text{ kV}$
 Rated normal current $I_r = 400 \text{ A}$
 Design with short operating shaft
 Auxiliary switch 4 NO + 4 NC without additional components
 Operating voltage of the magnet coil 110 to 250 V AC/DC
 Without mechanical closing latch
 Opening time 325 ms ± 75 ms without mechanical closing latch
 Operating instructions in French/Spanish, without routine test certificate

Example for Order No.:

Order codes:

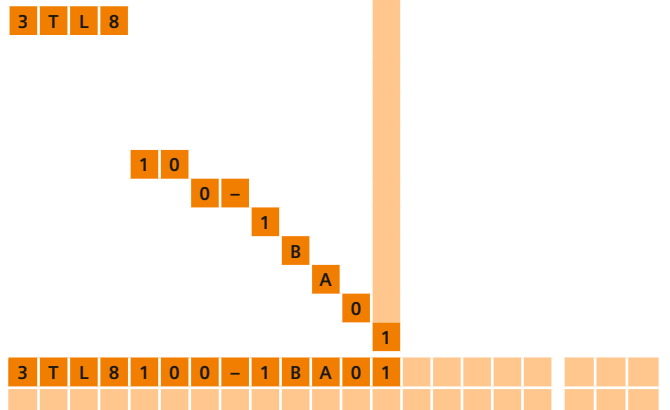

Remark for orders

The order numbers are applicable to contactors of current manufacture. When mounting parts or spare parts are being ordered for an existing vacuum contactor, always quote the

type designation, serial number and the year of manufacture of the contactor to be sure to get the correct delivery. This data is given on the rating plate.

Designation	Remark	Operating voltage	Order No.
Auxiliary switch block	For 3TL6		
	Left 2 NO + 2 NC ¹⁾		3TY7 561-1NA0
	Left 3 NO + 3 NC ¹⁾		3TY7 561-1QA0
	Left 7 NO + 7 NC ¹⁾		3TY7 561-1SA0
	Right 2 NO + 2 NC ¹⁾		3TY7 561-1PA0
	Right 3 NO + 3 NC ¹⁾		3TY7 561-1RA0
	Right 7 NO + 7 NC ¹⁾		3TY7 561-1TA0
	For 3TL7		
	4 NO + 4 NC		3SV9 894-2AA0
	8 NO + 8 NC		3SV9 896-2AA0
	For 3TL8		
	Top 2 NO + 2 NC		3TY7 561-1SA0
Bottom 2 NO + 2 NC		3TY7 561-1NA0	
Magnet coil	For 3TL6	100 V AC, 50/60 Hz	3TY5 651-0AF2
	(from year of manufact. 10/90, from serial no. 31 375 035)	110/115 V AC, 50/60 Hz	3TY5 651-0AG7
		120 V AC, 50/60 Hz	3TY5 651-0AL7
		125/127 V AC, 50 Hz	3TY5 651-0AL7
		220 V AC, 50/60 Hz	3TY5 651-0AN2
		230/240 V AC, 50/60 Hz	3TY5 651-0AN7
		24 V DC	3TY5 651-0BB4
		30 V DC	3TY5 651-0BC4
		48 V DC	3TY5 651-0BW4
		60 V DC	3TY5 651-0BE4
		110 V DC	3TY5 651-0BF4
		125 V DC	3TY5 651-0BG4
		220 V DC	3TY5 651-0BM4
	For 3TL7	110 V AC, 50/60 Hz	3TY5 741-0AG2
		120 V AC, 50/60 Hz	3TY5 741-0AK2
		230/240 V AC, 50/60 Hz	3TY5 741-0AL2
		110 V DC	3TY5 741-0BF4
		120/125 V DC	3TY5 741-0BG4
		220 V DC	3TY5 741-0BM4
	For 3TL8	110 V – 250 V AC/DC	3TY5 811-0BA0
	Resistor for economy circuit	For 3TL6	100 V AC, 50/60 Hz
(from year of manuf. 10/90, from serial no. 31 375 035)		110/115 V AC	3TY5 664-1DA0
		120/125/127 V AC	3TY5 664-1EA0
		220 V AC	3TY5 664-1FA0
		230/240 V AC	3TY5 664-1GA0
		24 V DC	3TY5 664-0AA0
		30 V DC	3TY5 664-0BA0
		48 V DC	3TY5 664-0WA0
		60 V DC	3TY5 664-0CA0
		110 V DC	3TY5 664-0DA0
		125 V DC	3TY5 664-0EA0
	220 V DC	3TY5 664-0FA0	

1) The information left/right applies when the vacuum interrupters are observed with the rocker at the top

2

Designation	Remark	Operating voltage	Order No.
Electronic module for economy circuit	For 3TL8	110 V – 250 V AC/DC	3TY5 812-0BA0
Auxiliary contactor	For 3TL6 (for economy circuit and closing latch)	24 V DC	3TY5 662-0BB4
		30 V DC	3TY5 662-0BC4
		48 V DC	3TY5 662-0BW4
		60 V DC	3TY5 662-0BE4
		110 V DC	3TY5 662-0BF4
		125 V DC	3TY5 662-0BG4
		220 V DC	3TY5 662-0BM4
		100 V AC, 50/60 Hz	3TY5 662-0AF2
		110 V AC, 50/60 Hz	3TY5 662-0AG2
		115 V AC, 50/60 Hz	3TY5 662-0AJ2
		120 V AC, 50/60 Hz	3TY5 662-0AK2
		230 V AC, 50/60 Hz	3TY5 662-0AL2
		240 V AC, 50/60 Hz	3TY5 662-0AP2
	For 3TL7	110 V DC	3RT1 526-1BF40
		120 V – 125 V DC	3RT1 325-1BG40
		220 V DC	3RT1 517-1BM40
		110/120 V AC, 50/60 Hz	3RT1 325-1AG40
		230 V AC, 50/60 Hz	3RT1 517-1AP00
Mechanical closing latch	For 3TL6	110/115 V AC, 50/60 Hz	3TY5 692-0AG7
		120/125/127 V AC, 50/60 Hz	3TY5 692-0AL7
		220/230/240 V AC, 50/60 Hz	3TY5 692-0AN2
		24 V DC	3TY5 692-0BB4
		30 V DC	3TY5 692-0BC4
		48 V DC	3TY5 692-0BW4
		60 V DC	3TY5 692-0BE4
		110 V DC	3TY5 692-0BF4
		125 V DC	3TY5 692-0BG4
		220/250 V DC	3TY5 692-0BM4
	For 3TL8	110 V – 115 V AC, 50/60 Hz	3TY5 892-0AG7
		120 V – 127 V AC, 50/60 Hz	3TY5 892-0AL7
		220 V – 240 V AC, 50/60 Hz	3TY5 892-0AN7
		24 V DC	3TY5 892-0BB4
		30 V DC	3TY5 892-0BC4
		48 V DC	3TY5 892-0BD4
		60 V DC	3TY5 892-0BE4
		110 V DC	3TY5 892-0BF4
		125 V DC	3TY5 892-0BG4
		220 V – 250 V DC	3TY5 892-0BM4
Mechanical closing lockout	For 3TL6		3TY5 693-0AA0
Blocking element	For 3TL61 for mechanical interlocking of two contactors	110/115 V AC, 50/60 Hz	3TX5 111-0AA0
Semiconductor components		Remark	
Rectifiers	For 3TL6 contactor coil	3TL6	3TY5 694-2AA0
Varistor module	For overvoltage protection in DC secondary circuit 3TL6/3TL7	3TL6, 3TL7	3AX15 26-0F
Rectifier element	For overvoltage protection in AC secondary circuit 3TL6/3TL7	3TL6, 3TL7	3AX15 25-1F
Adjustment parts	To replace 3TL50 and 3TL51 contactors by 3TL60 and 3TL61 (this does not apply to 8BD3 switchgear)		3TY5 610-1AA0

Designation	Remark	Operating voltage	Order No.	
Shunt release	For 3TL6	110/115 V AC, 50/60 Hz	3TY5695-0AG7	
		125/127 V AC, 50/60 Hz	3TY5695-0AL7	
		220 V AC, 50/60 Hz	3TY5695-0AN2	
		230/240 V AC, 50/60 Hz	3TY5695-0AN7	
		24 V DC	3TY5695-0BB4	
		30 V DC	3TY5695-0BC4	
		48 V DC	3TY5695-0BW4	
		60 V DC	3TY5695-0BE4	
		110/115 V DC	3TY5695-0BF4	
		125/127 V DC	3TY5695-0BG4	
Vacuum interrupter	For 3TL6	220 V DC	3TY5695-0BM4	
		VS 7202	7.2 kV, 450 A	3TY5 610-2AA0
		VS 12003	12 kV, 400 A	3TY5 650-1AA0
		VS 12003 SP	12 kV, 400 A ($U_d = 42$ kV)	3TY5 650-2AA0
		For 3TL8		
		Up to serial number 31 670 935		3TY5 810-0AA0
From serial number 31 670 936		3TY5 810-1AA0		



To select the correct spare vacuum interrupter, please specify the type designation, serial number and year of manufacture of the contactor. This data is given on the rating plate.

Vacuum interrupters and other spare parts must only be replaced by instructed personnel.

Data on the rating plate

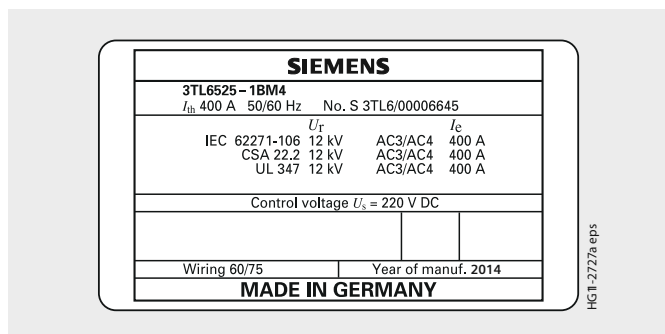

Note:

For any query regarding spare parts, subsequent deliveries, etc. the following details are necessary:

- Type designation
- Serial no. (**No. S**)
- Year of manufacture (**Year of manuf.**)

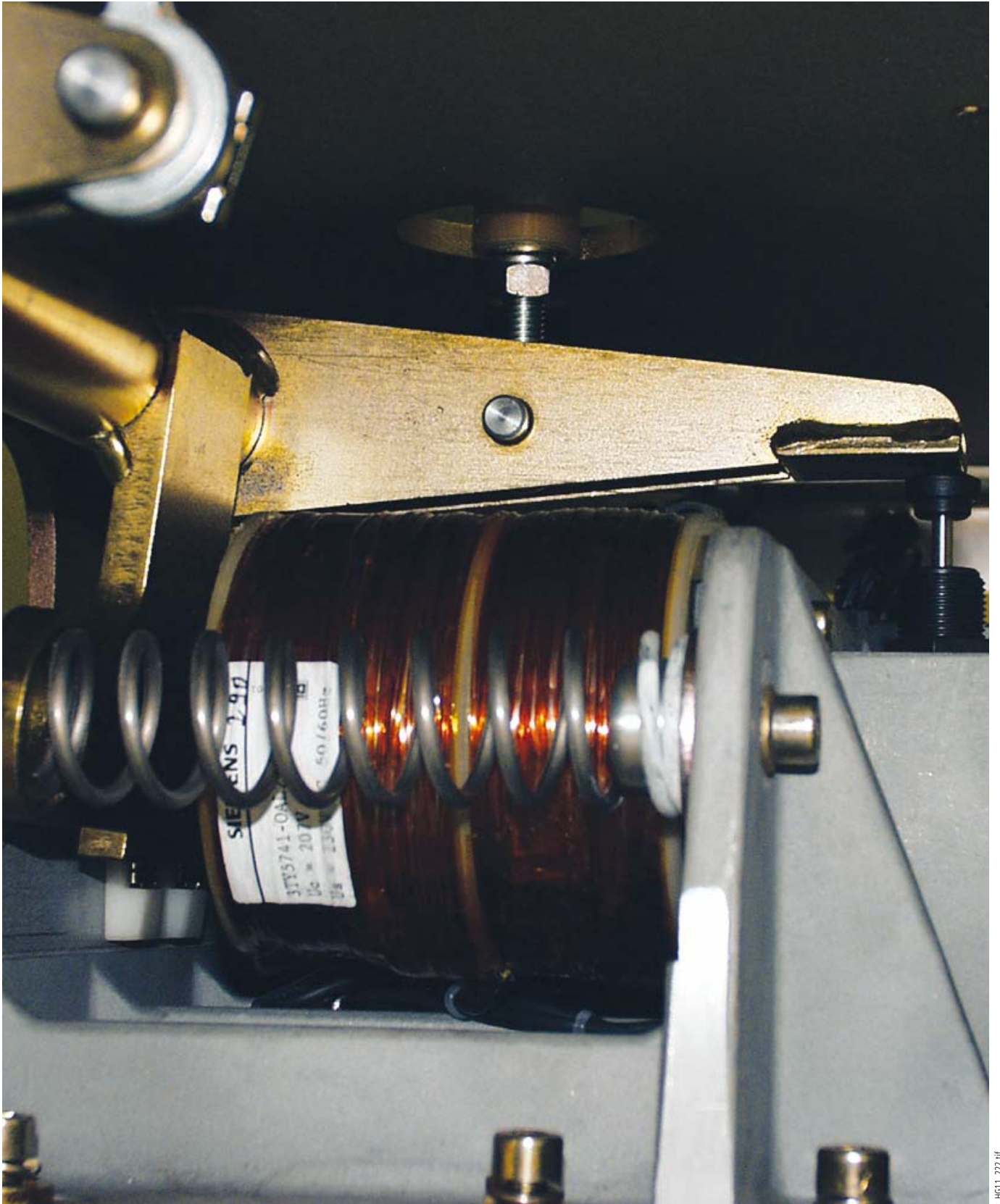

R_HG11_2022.tif



R-HG11-223.tif

Flexible connector

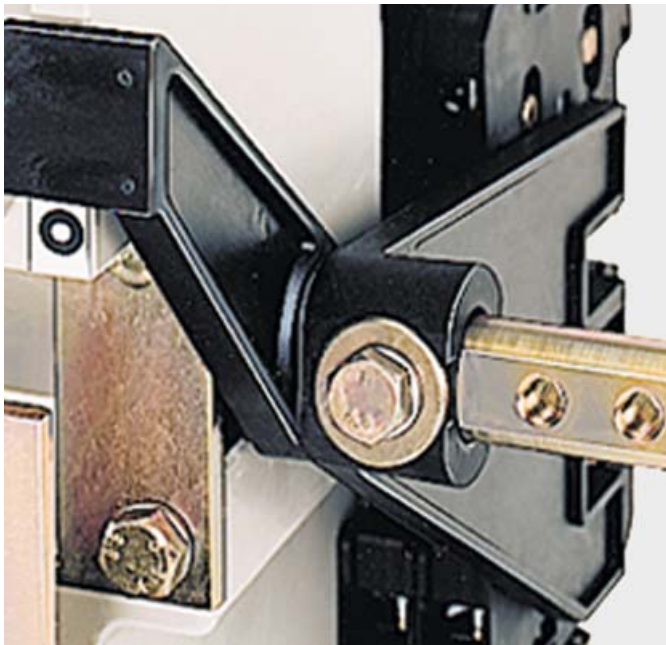

R-HG11-092.tif

Long operating shaft for 3TL8

Contents	Page
Technical Data	33
Electrical data, dimensions and weights	
Medium-voltage part	34
Low-voltage part	35
Short-time withstand current/ load time characteristic	36
Operating cycle diagrams	36
Dimension drawings	37
Auxiliary contacts	38
Ambient conditions	38
Circuit diagrams	
3TL6 vacuum contactor	39
3TL7 vacuum contactor	41
3TL8 vacuum contactor	42
Transport dimensions and weights	
Types of transport	43

Medium-voltage part

Order No.	Rated voltage U_r kV	Rated normal current I_r A	Rated continuous normal current ¹⁾ at ambient air temperature up to + 55 °C I_{th} A	Thermal current at ambient temperature up to + 80 °C I_e A	Rated operational current ¹⁾ I_m A	Switching capacity ²⁾ Rated making current I_c A	Switching capacity ²⁾ Rated breaking current I_{ba} kA	Rated short-circuit breaking current (limit switching capacity) I_k kA	Rated short-time withstand current (r.m.s. value) 1 s ³⁾ A	Rated single capacitor bank breaking current Rated normal current of capacitor kA	Rated making current for a parallel capacitor bank Oper. cycles/h	Switching rate Without mechanical closing latch Oper. cycles	Mechanical endurance of the contactor Oper. cycles	Mechanical endurance of the vacuum interrupter Oper. cycles	Electrical endurance (AC-1) while breaking the rated normal current Oper. cycles	Rated lightning impulse withstand voltage to earthed parts and between phases kV	Rated lightning impulse withstand voltage across the open contact gap kV	Rated short-duration power-frequency withstand voltage to earthed parts and between phases kV	Rated short-duration power-frequency withstand voltage across the open contact gap kV	Weight kg	Detailed dimension drawing (can be ordered) s_A7E_
3TL61 ...	7.2	450	450	360	450	4500	3600	5	8	250	10	1200	3 mio.	2 mio.	1 mio.	60	40	20	20	28	154 01503
3TL65 ...	12	400	400	315	400	4000	3200	4.5	8	250	10	600	1 mio.	1 mio.	0.5 mio.	75	60	28	28	30	154 01503
3TL68 ...	15	320	320	315	320	3200	2560	4.5	8	-	-	600	1 mio.	1 mio.	0.25 mio.	75	60	38	38	30	154 01504
3TL71 ...	24	800	800	630	450	4500	3600	7	8	400	5	60	1 mio.	1 mio.	0.5 mio.	125	95	50	50	80	154 02492
3TL81 ...	7.2	400	400	360 ⁴⁾	400	4000	3200	5	8	250	10	1200	1 mio.	0.25 mio.	0.25 mio.	60	40	20	20	30	154 02120

1) According to utilization category AC-1, AC-2, AC-3 and AC-4

2) According to utilization category AC-4 (cos φ = 0.35)

3) For short-time withstand current with longer durations, see short-time withstand current/load time characteristic

4) Ambient air temperature + 65 °C

Low-voltage part

Order No.	Power consumption of the drive solenoid Making capacity	Power consumption of the drive solenoid Holding power referred to 230 V AC	Voltage range of the drive solenoid Operating voltage	Minimum closing command for drive solenoid	Closing time (Interval of time between the command and the instant when the contacts touch in all poles)	Opening time (Interval of time between the command and the instant of the contact separation in the last pole) (without mechanical latch)	Opening time Mechanical closing latch	Mechanical closing latch Service life	Mechanical closing latch Switching rate	Mechanical closing latch Power consumption of the latch release solenoid	Mechanical closing latch Voltage range of the latch release solenoid	Mechanical closing latch Opening impulse
	W	W	V	ms	ms	ms	ms	Oper. cycles	Oper. cycles	W	V	s
3TL61 ... 3TL65 ... 3TL68 ...	650	90	0.8 to 1.1 U_a	100	80	75 to 100 ¹⁾	50 to 75	100,000	60	900	0.85 to 1.1 U_a	0.2 to max. 1
3TL71 ...	1200	200	0.85 to 1.1 U_a	100	40 to 60	50 to 100 ²⁾	–	–	–	–	–	–
3TL81 ...	600	90	0.85 to 1.1 U_a	300	150	250 to 400 ≤ 50 ³⁾	30 to 50	100,000	60	900	0.85 to 1.1 U_a	0.2 to max. 1

- 1) 3TL6 With special wiring G01 ≤ 50 ms
 With special wiring G02 100 to 180 ms
 With special wiring G03 180 to 320 ms
 With special wiring G08 Reconnectable: 100 to 180 ms and 50 to 75 ms
- 2) 3TL71 With special wiring G01 ≤ 50 ms
- 3) 3TL8 Implementation by external circuit (see page 42)



Short-time withstand current/load time characteristic

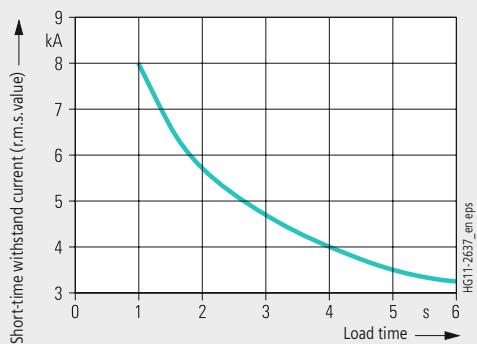

Operating cycle diagrams

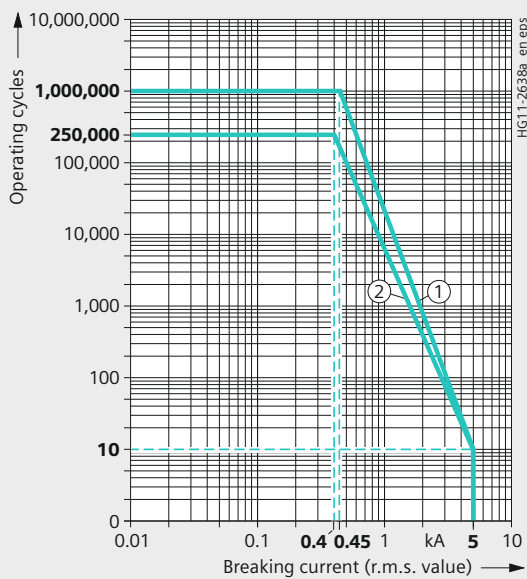

- 1) 3TL61
- 2) 3TL81

The permissible number of electrical operating cycles is shown as a function of the breaking current (r.m.s. value). The curve shape shows average values. The number of operating cycles that can actually be reached can be different depending on the respective application.

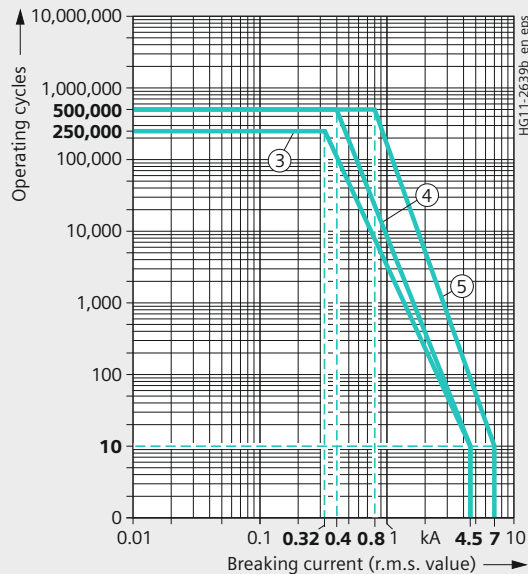

- 3) 3TL68
- 4) 3TL65
- 5) 3TL71

Dimension drawings

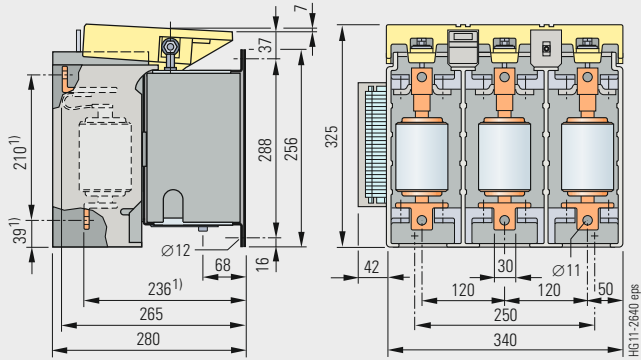

3TL61 dimension drawing

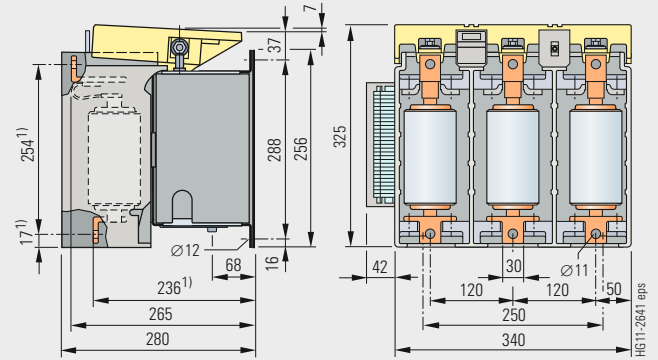

3TL65/68 dimension drawing

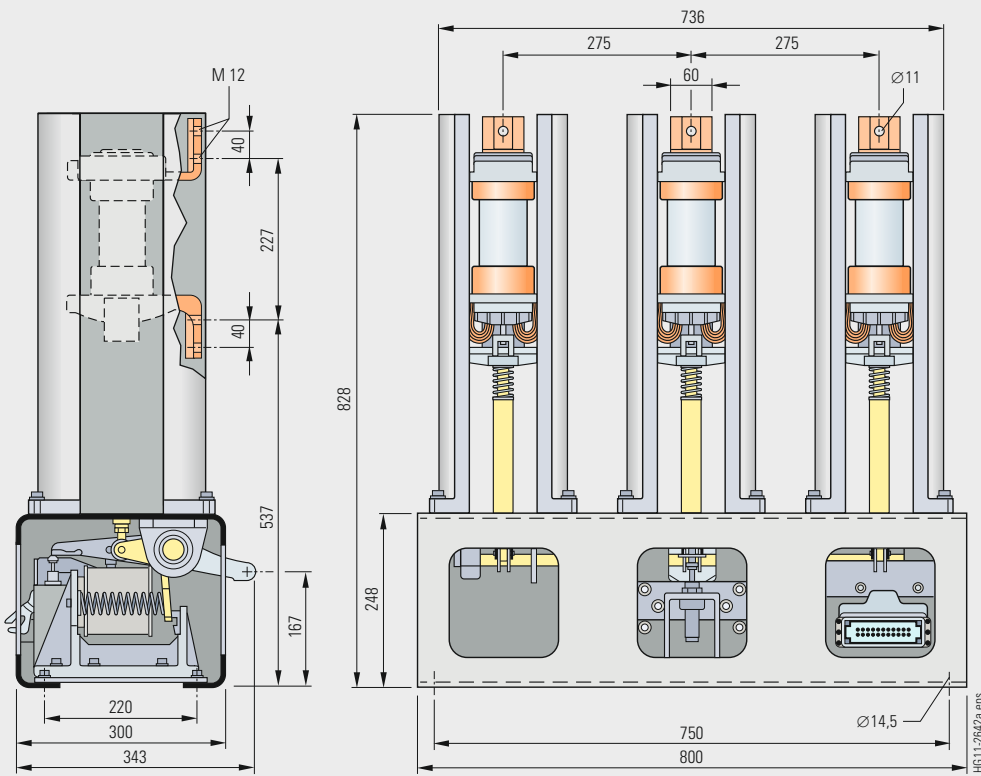

3TL7 dimension drawing

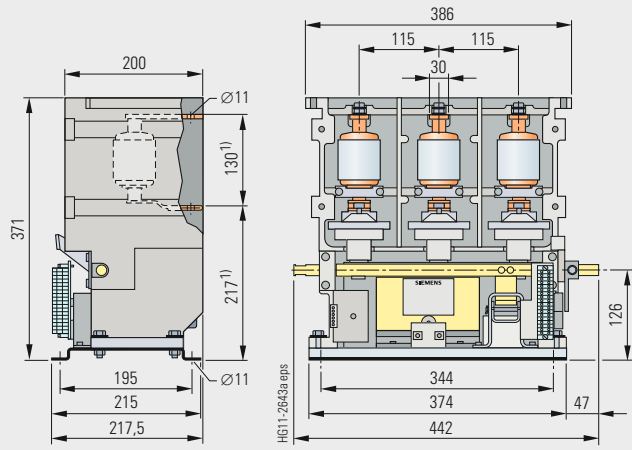

3TL8 dimension drawing

Values identified with 1) are connecting dimensions



Auxiliary contacts

Order No.	Number of auxiliary contacts	Rated continuous current A	Rated normal current Utilization category for AC voltage AC-14/15 at rated voltage							Rated normal current Utilization category for DC voltage DC-13 at rated voltage							Connection cross-sections of the auxiliary contacts acc. to DIN EN 60947 Part 1	
			110 V AC	115 V AC	120 V AC	125 V AC	220 V AC	230 V AC	240 V AC	24 V DC	30 V DC	48 V DC	60 V DC	110 V DC	125 V DC	220 V DC	Single wire mm ²	Finely stranded with wire end ferrule mm ²
			I_r	I_r	I_r	I_r	I_r	I_r	I_r	I_r	I_r	I_r	I_r	I_r	I_r	I_r		
3TL61 ...	4 NO + 3 NC 6 NO + 6 NC 8 NO + 7 NC	10	10	10	10	10	–	5.6	5.6	10	5	5	5	1.14	0.98	0.48	0.6 – 4	0.5 – 2.5
3TL65 ...	4 NO + 3 NC 6 NO + 6 NC 8 NO + 7 NC	10	10	10	10	10	–	5.6	5.6	10	5	5	5	1.14	0.98	0.48	0.6 – 4	0.5 – 2.5
3TL68 ...	4 NO + 3 NC 6 NO + 6 NC 8 NO + 7 NC	10	10	10	10	10	–	5.6	5.6	10	5	5	5	1.14	0.98	0.48	0.6 – 4	0.5 – 2.5
3TL71 ...	4 NO + 4 NC 8 NO + 8 NC	–	5	–	–	–	2.5	–	–	10	9	9	7	4	–	2	0.6 – 4	0.5 – 2.5
3TL81 ...	2 NO + 2 NC 4 NO + 4 NC	10	10	10	10	10	–	5.6	5.6	10	5	5	5	1.14	0.98	0.48	0.6 – 4	0.5 – 2.5

3

Ambient conditions

Order No.	Service life at ambient air temperature					Site altitude	Shock resistance	Degree of protection according to IEC 60529
	Storage at –40 °C to +65 °C	Operation at –5 °C to +55 °C	Operation at –5 °C to +65 °C	Operation at +55 °C to +80 °C	Operation at –25 °C to –5 °C			
3TL61 ...	20 years	3 mio. oper. cycles	–	1 mio. oper. cycles	0.5 mio. oper. cycles	1250 m below sea level to 5000 m above sea level	5 x g, 10 ms or 10 x g, 5 ms	IP00
3TL65 ...	20 years	1 mio. oper. cycles	–	1 mio. oper. cycles	0.25 mio. oper. cycles	1250 m below sea level to 5000 m above sea level	5 x g, 10 ms or 10 x g, 5 ms	IP00
3TL68 ...	20 years	1 mio. oper. cycles	–	1 mio. oper. cycles	0.25 mio. oper. cycles	1250 m below sea level to 5000 m above sea level	5 x g, 10 ms or 10 x g, 5 ms	IP00
3TL71 ...	20 years	–	1 mio. oper. cycles	–	0.5 mio. ¹⁾ oper. cycles	50 m below sea level to 5000 m above sea level	–	IP00
3TL81 ...	20 years	–	1 mio. oper. cycles	0.5 mio. oper. cycles	0.5 mio. oper. cycles	200 m below sea level to 5000 m above sea level	5 x g, 10 ms or 10 x g, 5 ms	IP00

1) Operation at –40 °C to –5 °C

3TL6 vacuum contactor

DC operation

- Voltage range 24 V to 220 V DC
- Opening time with latching 50 to 75 ms
- Opening time without latching depends on the G supplements (see page 40)
- Resistor for economy circuit
- Auxiliary contact block 4 NO + 3 NC, 6 NO + 5 NC (shown), or 8 NO + 7 NC
- Mechanical closing latch (optionally)

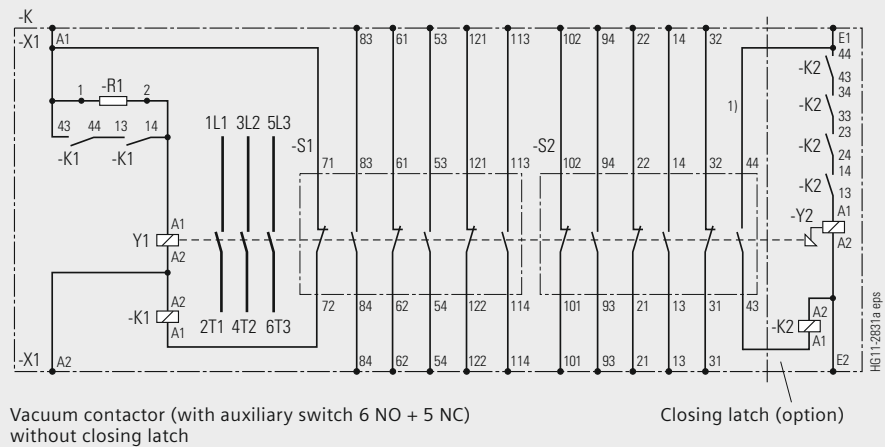

Vacuum contactor (with auxiliary switch 6 NO + 5 NC without closing latch

Closing latch (option)

1) In 3TL6133 and 3TL6135 contactors (with withdrawable terminal strip), the current must be deactivated externally via the unlatching coil.

AC operation

- Voltage range 110 V to 500 V AC, 50/60 Hz
- The wiring of the 3TL6 vacuum contactor with AC operation only differs by the upstream rectifier (circuit symbol G).

Legend

- K Vacuum contactor
- Y1 Magnetic drive
- K1 Contactor for economy circuit
- Y2 Latch release solenoid
- K2 Contactor for latch release
- R1 Resistor
- S1, S2 Auxiliary contact block
- X1 Terminal strip

Circuit examples

Standard opening time 75 to 100 ms (without G supplements and without latching)

- Opening time with G02: 120 to 180 ms
- Opening time with G03: 180 to 320 ms

Momentary-contact operation

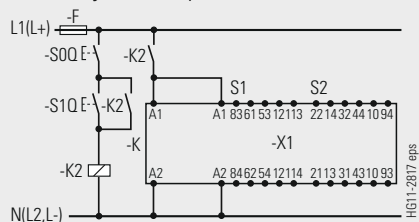

Maintained-contact operation

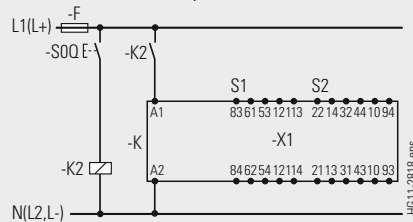

Opening time with G01: ≤ 50 ms

Momentary-contact operation

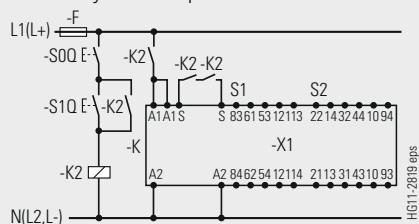

Maintained-contact operation

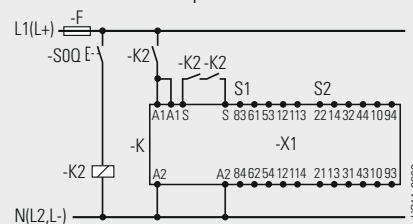

Opening time with G08: 100 to 180 ms // 50 to 75 ms reconnectable

Momentary-contact operation

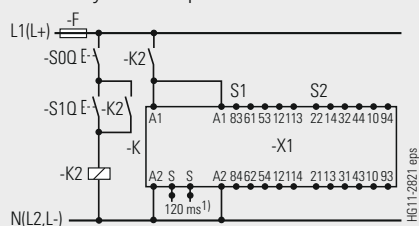

Maintained-contact operation

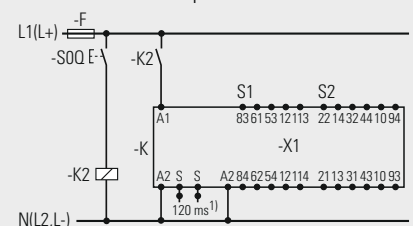

- 1) Bridge open: 50 ms to 75 ms
Bridge closed: 100 ms to 180 ms

Legend

- F Fuse
- K Vacuum contactor
- K2 External auxiliary contactor (e.g. Siemens 3RH2140)
- S1, S2 Auxiliary contact block
- S0Q External OFF pushbutton
- S1Q External ON pushbutton
- X1 Terminal strip
- 1) Bridge

3TL71 vacuum contactor

- Voltage range 110 V to 230 V AC, 50/60 Hz
- Standard opening time 50 to 100 ms (without G supplements)
- Voltage range 110 V to 220 V DC
- Opening time with G01: ≤ 50 ms

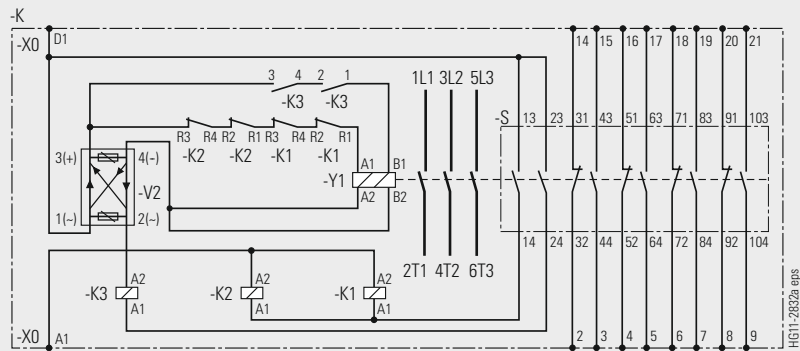

Circuit examples

Standard opening time 50 to 100 ms (without G supplements)

Momentary-contact operation

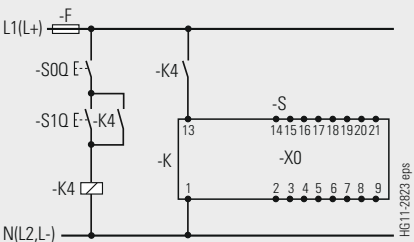

Maintained-contact operation

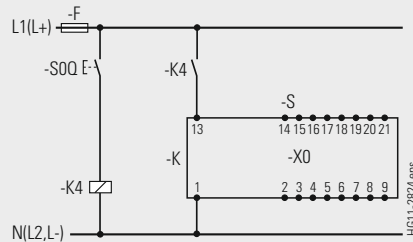

Opening time with G01: ≤ 50 ms

Momentary-contact operation

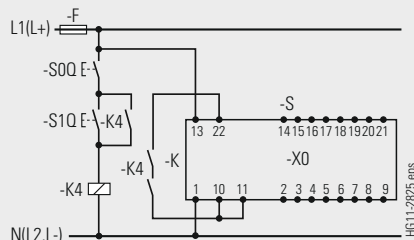

Maintained-contact operation

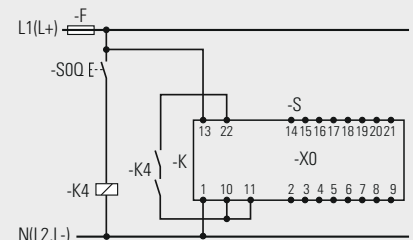

Legend

- | | | | |
|--------|-------------------------------------|-----|--|
| F | Fuse | S | Auxiliary switch |
| K | Vacuum contactor | S0Q | External OFF pushbutton |
| Y1 | Magnetic drive for vacuum contactor | S1Q | External ON pushbutton |
| K1, K2 | Contactors for pick-up coil | V2 | Rectifier module |
| K3 | Contactors for holding coil | X0 | Plug or terminal strip for auxiliary wire connection |
| K4 | External auxiliary contactor | | |

The circuit diagrams shown here are examples from the manifold possibilities of contactor wiring



3TL8 vacuum contactor

AC and DC operation

- Voltage range 110 V to 250 V AC/DC, 50/60 Hz
- Opening time with latching ≤ 50 ms
- Opening time without latching 250 ms to 400 ms
- Opening time with external circuit ≤ 50 ms
- Auxiliary contact block 2 NO + 2 NC, or 4 NO + 4 NC (option)
- With mechanical closing latch (-K2S) only with auxiliary contact block 4 NO + 4 NC

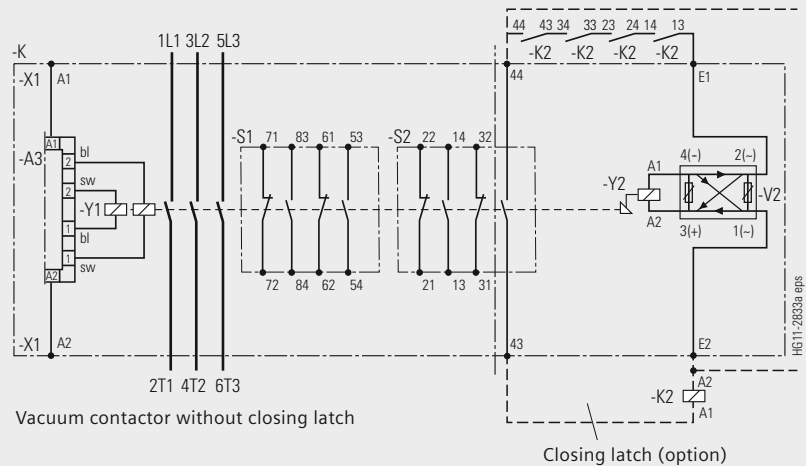

Circuit examples

Standard opening time 250 to 400 ms (without latching)

Momentary-contact operation

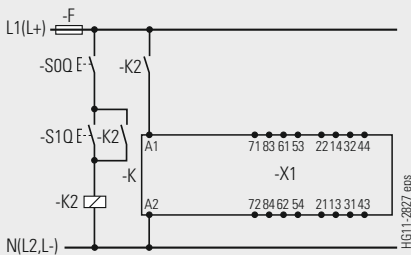

Maintained-contact operation

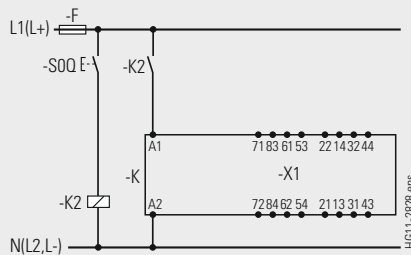

Opening time: ≤ 50 ms

Momentary-contact operation

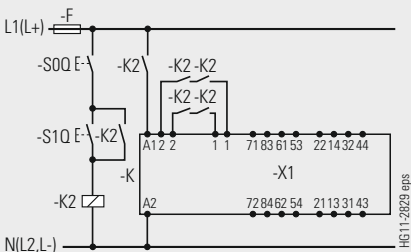

Maintained-contact operation

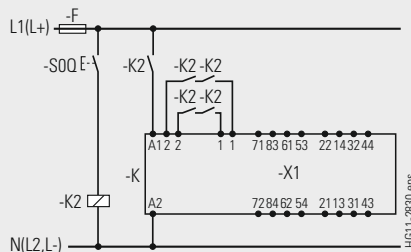

Legend

- | | | | |
|----|---|-----|--|
| A3 | Electronic module | SQ | External OFF pushbutton |
| F | Fuse | S1Q | External ON pushbutton |
| K | Vacuum contactor | V2 | Rectifier module |
| K2 | External auxiliary contactor (e.g. Siemens 3RH2140) | Y1 | Magnet drive |
| S1 | Auxiliary contact block, top | Y2 | Latch release solenoid (option) |
| S2 | Auxiliary contact block, bottom | X1 | Terminal strip for auxiliary wire connection |

The circuit diagrams shown here are examples from the manifold possibilities of contactor wiring

Transport by truck, rail, airfreight or ship

Packing type	3TL6 ²⁾			3TL8 ²⁾		
	For number of vacuum contactors	Dimensions length/width/height mm	Volume m ³	For number of vacuum contactors	Dimensions length/width/height mm	Volume m ³
Cardboard box or lattice box ¹⁾	1	600 x 500 x 500	0.150	1 – 2	600 x 500 x 550	0.165
	1 – 2	800 x 500 x 480	0.192	2	800 x 500 x 480	0.192
	2	920 x 640 x 780	0.459	2 – 3	920 x 640 x 780	0.459
	–	–	–	2 – 4	800 x 760 x 930	0.565
	4 – 8	1120 x 820 x 1130	1.038	5 – 10	1120 x 820 x 1130	1.038
	6 – 8	1140 x 1020 x 1020	1.186	10 – 14	1140 x 1020 x 1020	1.186
	16 – 18	1215 x 1040 x 1270	1.605	15 – 16	1215 x 1040 x 1270	1.605

1) Cardboard box with inside cardboard suiting the device, cardboard box with sealed packing and inside cardboard suiting the device, or lattice box with dust protection foil

2) Gross weight for 3TL6 with approx. 31 kg and 3TL8 with approx. 22 kg per device, depending on the equipment

Transport by truck, rail, airfreight or ship

Packing type	3TL71			
	For number of vacuum contactors	Dimensions length/width/height mm	Volume m ³	Gross weight kg
Cardboard box with inside cardboard suiting the device	1 – 2	1120 x 820 x 1130	1.038	150 – 293
	3	1140 x 1020 x 1020	1.186	286 – 400
	3 ¹⁾	1215 x 1040 x 1270	1.605	425 – 431
Lattice box with dust protection foil	1 – 2 ²⁾	1200 x 850 x 900	0.918	199 – 313

1) With partitions

2) Not stackable





Switchgear Factory, Berlin

R-HIG1-180.eps

Contents

Page

Annex

45

Inquiry form

46

Configuration instructions

47

Configuration aid

Foldout page

Inquiry form

Please copy, fill in and return to your Siemens partner

Inquiry concerning

- 3TL6 vacuum contactor
- 3TL7 vacuum contactor
- 3TL8 vacuum contactor

Please

- Submit an offer
- Call us
- Visit us

Your address

Company _____

Department _____

Name _____

Street _____

Zip code/City _____

Country _____

Phone _____

Fax _____

E-mail _____

Siemens AG

Department _____

Name _____

Street _____

Zip code/City _____

Country _____

Fax _____

Technical data

	Other values				
Rated voltage	<input type="checkbox"/> 7.2 kV <input type="checkbox"/> 24 kV	<input type="checkbox"/> 12 kV	<input type="checkbox"/> 15 kV	<input type="checkbox"/> ___ kV	
Rated lightning impulse-withstand voltage	to earth open contact gap	<input type="checkbox"/> 60 kV <input type="checkbox"/> 40 kV	<input type="checkbox"/> 75 kV <input type="checkbox"/> 60 kV	<input type="checkbox"/> 125 kV <input type="checkbox"/> 95 kV	
Rated short-duration power-frequency withstand voltage	<input type="checkbox"/> 20 kV	<input type="checkbox"/> 28 kV	<input type="checkbox"/> 38 kV	<input type="checkbox"/> 50 kV	<input type="checkbox"/> ___ kV
Rated normal current	<input type="checkbox"/> 320 A	<input type="checkbox"/> 400 A	<input type="checkbox"/> 450 A	<input type="checkbox"/> 800 A	<input type="checkbox"/> ___ A
Rated making current	<input type="checkbox"/> 3200 A	<input type="checkbox"/> 4000 A	<input type="checkbox"/> 4500 A	<input type="checkbox"/> ___ A	
Rated breaking current	<input type="checkbox"/> 2560 A	<input type="checkbox"/> 3200 A	<input type="checkbox"/> 3600 A	<input type="checkbox"/> ___ A	
Switching rate	<input type="checkbox"/> 60 oper. cycles/h	<input type="checkbox"/> 600 oper. cycles/h	<input type="checkbox"/> 1200 oper. cycles/h		
Mechanical endurance of the contactor	<input type="checkbox"/> 1 mio. oper. cycles	<input type="checkbox"/> 3 mio. oper. cycles	<input type="checkbox"/> ___ oper. cycles		
Mechanical endurance of the interrupter	<input type="checkbox"/> 0.25 mio. oper. cycles	<input type="checkbox"/> 1 mio. oper. cycles	<input type="checkbox"/> 2 mio. oper. cycles	<input type="checkbox"/> ___ oper. cycles	
Electrical endurance (AC-1)	<input type="checkbox"/> 0.25 mio. oper. cycles	<input type="checkbox"/> 0.5 mio. oper. cycles	<input type="checkbox"/> 1 mio. oper. cycles	<input type="checkbox"/> ___ oper. cycles	

Equipment

Contact elements	3TL6 3TL71 3TL8	<input type="checkbox"/> 4 NO + 4 NC <input type="checkbox"/> 4 NO + 4 NC <input type="checkbox"/> 2 NO + 2 NC	<input type="checkbox"/> 6 NO + 6 NC <input type="checkbox"/> 6 NO + 6 NC <input type="checkbox"/> 4 NO + 4 NC	<input type="checkbox"/> 8 NO + 8 NC <input type="checkbox"/> 8 NO + 8 NC	<input type="checkbox"/> ___
Operating voltage of the magnet coil	<input type="checkbox"/> ___ V DC		<input type="checkbox"/> ___ V AC, ___ Hz		
Mechanical closing latch	<input type="checkbox"/> with		<input type="checkbox"/> without		
Operating voltage of the closing latch	<input type="checkbox"/> ___ V DC		<input type="checkbox"/> ___ V AC, ___ Hz		
Operating instructions in	<input type="checkbox"/> German	<input type="checkbox"/> English	<input type="checkbox"/> French	<input type="checkbox"/> Spanish	

Application and other requirements

Please check off ___ Please fill in

You prefer to configure your 3TL vacuum contactor on your own?

Follow the steps to the configuration and enter the order number in the configuration help.

Instruction for configuration of the 3TL vacuum contactor

1st step: Definition of the primary part

<u>Please specify the following ratings:</u>	<u>Possible options:</u>
Rated voltage (U_r)	U_r : 7.2 kV to 24 kV
Rated lightning impulse withstand voltage (U_p)	U_p : 60 kV to 125 kV
Rated short-duration power-frequency withstand voltage (U_d)	U_d : 20 kV to 50 kV
Rated normal current (I_r)	I_r : 320 A to 800 A
Switching rate	60 operating cycles/h to 1200 operating cycles/h
Mechanical endurance of the contactor	1 mio. to 3 mio. operating cycles

2nd step: Definition of the equipment

<u>Please specify the following equipment features:</u>	<u>Possible options:</u>
Number of auxiliary contacts	2 NO + 2 NC to 8 NO + 8 NC
Operating voltage of the magnet coil	Operating voltages from 24 V DC to 240 V AC
Operating voltage of the closing latch	Operating voltages from 24 V DC to 240 V AC
Operating voltage of the shunt release	Operating voltages from 24 V DC to 230/240 V AC
Site altitude	-500 m below sea level to +5000 m above sea level

3rd step: Do you still have further requirements concerning the equipment?

Your Siemens sales partner will be pleased to support you.

1	2	3	4	5	6	7	-	8	9	10	11	12	-	13	14		
3	T	L	■	■	■	■	-	■	■	■	■	■	-	■	■	-	Z

3 T L - -

 + + +

 + + +

3 T L - -

 + + +

 + + +

3 T L - -

 + + +

 + + +

3 T L - -

 + + +

 + + +

3 T L - -

 + + +

 + + +

3 T L - -

 + + +

 + + +

3 T L - -

 + + +

 + + +

3 T L - -

 + + +

 + + +



Published by and copyright © 2014:
Siemens AG
Infrastructure & Cities Sector
Wittelsbacherplatz 2
80333 Munich, Germany

Siemens AG
Infrastructure & Cities Sector
Low and Medium Voltage Division
Nonnendammallee 104
13629 Berlin, Germany
www.siemens.com

All rights reserved.

If not stated otherwise on the individual pages of this catalog, we reserve the right to include modifications, especially regarding the stated values, dimensions and weights.

Drawings are not binding.

All product designations used are trademarks or product names of Siemens AG or other suppliers.

If not stated otherwise, all dimensions in this catalog are given in mm.

Subject to change without prior notice.

The information in this document contains general descriptions of the technical options available, which may not apply in all cases.

The required technical options should therefore be specified in the contract for the individual case.

For more information,
please contact our
Customer Support Center.
Tel.: +49 180 524 84 37
Fax: +49 180 524 24 71
(Charges depending on provider)
E-mail: support.ic@siemens.com

Order No. IC1000-K1511-A211-A5-7600

Printed in Germany

KG 11.13 1.0 50 En

7400/50897

Printed on elementary chlorine-free bleached paper.