

# SeaLife®

## REEFMMASTER® RM-4K



# Instruction Manual

ReefMaster RM-4K Underwater Camera (*Item SL350*)



## About this manual

- Francais, Deutsch, Italiano, Espanol and Nederlands manuals may be downloaded at: [www.sealife-cameras.com/service/manuals](http://www.sealife-cameras.com/service/manuals)
- This manual and specifications are subject to change without notice.
- Visit [SeaLife-Cameras.com](http://SeaLife-Cameras.com) for updates to this manual.
- Please register your product online at: [sealife-cameras.com/warranty](http://sealife-cameras.com/warranty).

## Important

- Do not directly or indirectly expose the underwater housing to spray-on sunscreens. Most spray-on sunscreens contain chemicals that may react with polycarbonate and other plastics, causing cracks that comprise the waterproof seal.
- Do not expose the inner camera to water, high temperatures, or direct sunlight for long duration. The inner camera is not waterproof.
- Soak the sealed underwater housing in fresh water for 20 minutes after each use. Push each button 20 times to flush out any trapped salt or debris. Fully dry the housing with clean towel before opening.
- Do not attempt to service the camera. Contact your local authorized SeaLife dealer if the camera requires service.

## Battery Information

- For airline travel, never put any Li-ion batteries in your checked baggage. Always put batteries in your carry-on bag. To prevent short-circuiting or fire, keep the battery away from other metal objects.
- When you are using a new battery or if the battery has not been used for an extended period, we recommend fully charging and discharging the battery once to maximize battery life.
- Only use the ReefMaster battery (item # SL3504) included. Using other batteries may cause damage and void the warranty.
- Remove the battery when storing the camera for more than a month.
- Replace battery if it becomes wet, deformed, or discolored.
- Extreme cold environments will shorten the battery life.
- Dispose old batteries according to your local recycling regulations.

I.	Package contents.....	4
II.	Optional accessories.....	5
III.	Getting to know the camera.....	6
IV.	Setting up the camera.....	8
	a. Inserting the memory card	
	b. Inserting the battery	
	c. Charging the Battery	
V.	Operating the camera.....	10
	a. Powering camera On/Off	
	b. Changing the modes	
	c. Setting the language	
	d. Setting the date/time	
	e. Formatting the memory card	
	f. Taking a photo and recording video	
	g. Navigating the menus	
	h. Playback photos and videos	
VI.	Downloading photos/videos to a computer.....	17
VII.	Camera settings and menus.....	18
	a. Photo settings	
	b. Video settings	
	c. System settings	
VIII.	WiFi connection to smartphone/tablet .....	29
IX.	Underwater housing setup and care.....	38
	a. Getting to know the underwater housing	
	b. Important and caution statements	
	c. Preparing the inner camera	
	d. Preparing the underwater housing	
	e. After underwater use	
	f. Quick waterproof test	
	g. Removing / Installing the O-ring	
X.	Great Underwater Pictures Made Easy.....	49
XI.	Troubleshooting, spare parts and repair service.....	50
XII.	Specifications.....	51
XIII.	FCC statement.....	52
XIV.	Limited Warranty statement.....	55

# I. Package contents



Inner camera



Underwater Housing



Li-ion battery



USB cable



Lanyard for UW housing



Instruction manual



Moisture Muncher 1-pack sampler

## Optional accessories (Sold separately)



Delkin 128GB V30 micro SDXC memory card (SLDK08)



Spare Li-ion battery (SL3504)  
900 mAh, 3.7V. 3.3Wh



Sea Dragon Photo-Video Light (Minimum 2000 lumens)  
See assortment at [sealife-cameras.com](http://sealife-cameras.com)



Super Macro Close-up Lens (SL571) and/or  
10X Close-Up Lens (SL572)

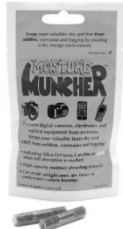

Moisture Muncher capsules 10-pack (SL911)



Screen Shield screen protector 2-pack (SL3506)  
Waterproof screen protector for ReefMaster

Visit your local authorized Sealife dealer or [www.sealife-cameras.com](http://www.sealife-cameras.com) for a complete listing of accessories.

## II. Getting to know the inner camera

(See page 38 for UW housing details)



- 1 – Lens
- 2 – Battery indicator LED
  - Blinks when charging
  - Solid when fully charged
- 3 – LCD Display

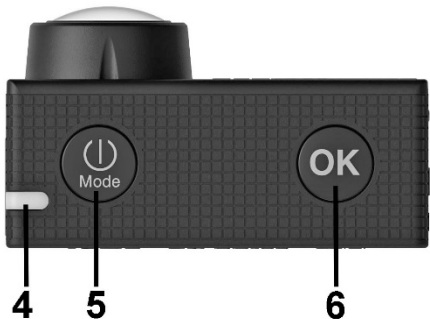

- 4 – Power ON indicator LED
- 5 – Power/Mode/Back 1-step button
- 6 – Shutter/OK button

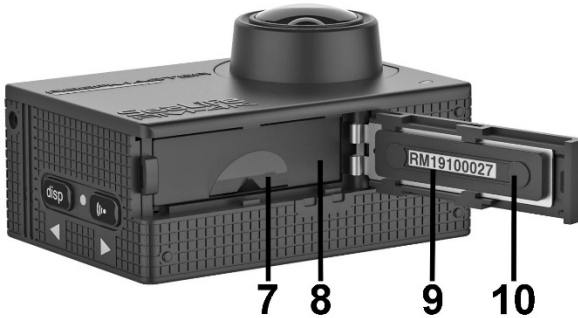

- 7 – Battery pull tab
- 8 – Li-ion battery
- 9 – Serial # (inner camera)
- 10 – Battery door
- 11 – Microphone
- 12 – UP/Display button
- 13 – WiFi indicator LED
- 14 – Down/WiFi button

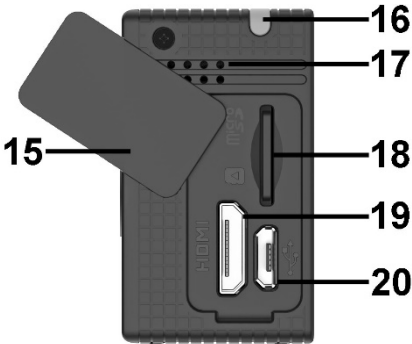

- 15 – USB/Memory Card cover(open)
- 16 – Power ON indicator LED
- 17 – Speaker
- 18 – MicroSD memory card slot
- 19 – Micro HDMI output
- 20 – Micro-B USB output



### III. Setting up the camera

#### Inserting the memory card

Recommend 128GB Micro SDXC with V30 (U3) Video Speed Class.

1. Open the USB/Memory Card cover and insert the memory card with contacts facing the lens.



2. Push down with fingernail or small coin until card locks into place.  
To remove the memory card, push down and release until card ejects.

#### Inserting the battery

1. Slide the battery door to the side until the spring-loaded door opens and insert the battery with contacts facing down nearest the lens.

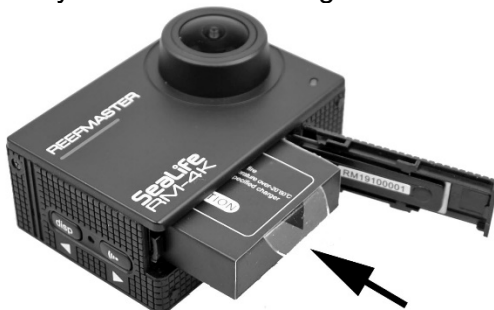

2. Close the battery door and slide inward to lock.

## Charging the battery

Fully charge the battery and discharge it for at least one complete cycle before use for optimal performance.

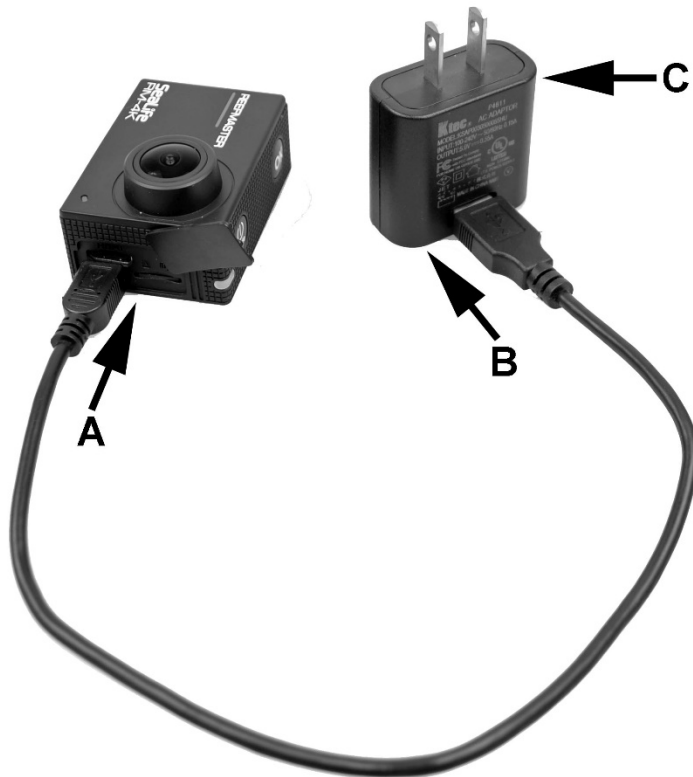

1. Insert the small end of the USB cable [A] into the USB output.
2. Insert the large end of the USB cable [B] into any 5V USB wall charger [C] or computer USB port. Note: 5V wall charger not included.
3. The blue status LED will blink when the battery is charging and turn solid when charging is complete. Full charge takes about 2.5 hours.

## IV. Operating the camera

### Powering On/Off

1. Push and hold the power button for 1 second to power ON.  
Note: The camera will be in Photo mode when powering on.



2. Push and hold camera for 2 seconds to power OFF.

**Note:** In the unlikely event the camera locks-up, push the power and shutter buttons at the same time to force off camera.

## Changing modes

Pushing the Power/Mode button will cycle through 3 primary modes:



1. Photo mode – for taking photos
2. Video mode – for recording video
3. Playback/Settings mode - for viewing photos and videos or changing camera settings.



Photo mode



Video mode



Playback/Settings mode

## Setting the language

Set the desired menu language as follows:

1. Push the Power/Mode button until you enter Playback/Settings mode.



2. Scroll to System settings using the up/down button and push Shutter/OK button.

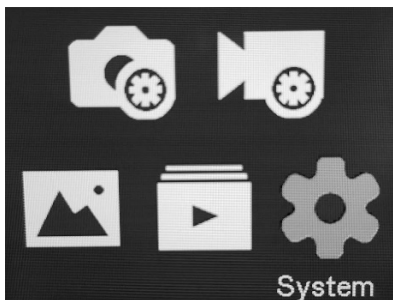

3. Scroll down to Language setting and push Shutter/OK button.

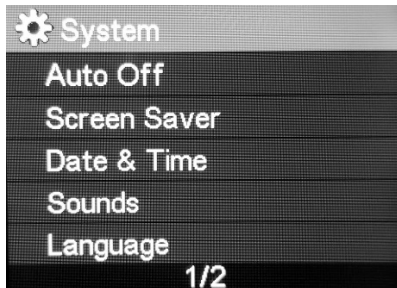

4. Scroll down to the desired language and push Shutter/OK button to confirm.
5. Push the Power/Mode button to go back 1 step and exit the System Settings menu.

## Setting the Date and Time

Set the desired menu language as follows:

1. Push the Power/Mode button until you enter Playback/Settings mode.
2. Scroll to System settings using the up/down button and push Shutter/OK button.
3. Scroll down to Date & Time setting and push Shutter/OK button.

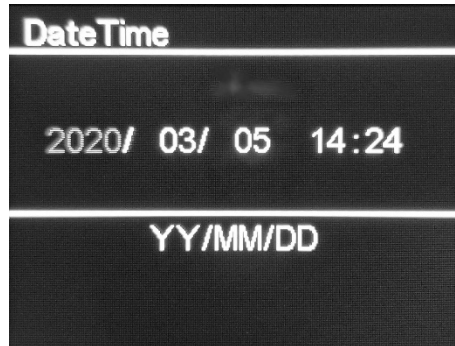

4. Use Up/Down keys to set the year and push OK. Do the same for the month, day, hours, minutes and date format, pushing OK after setting each value.
5. When finished, push the Power/Mode button to go back 1 step and exit the Date/Time menu.

## Formatting the memory card

Format the memory card in the camera upon initial use. Formatting the memory card every couple of months is recommended. Important: Formatting the memory card will erase all files saved on the card.

1. Push the Power/Mode button until you enter Playback/Settings mode.
2. Scroll to System settings using the up/down button and push Shutter/OK button.
3. Scroll down to Format setting and push Shutter/OK button.

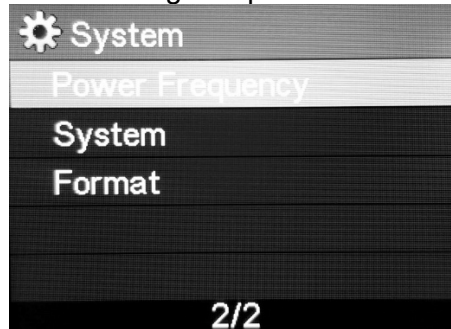

4. Select YES and push Shutter/OK button to confirm. Select NO to cancel format.
5. Push the Power/Mode button to go back 1 step and exit the System Settings menu

## Taking a photo and recording video

1. In Photo mode, push the shutter button to take a photo.
2. In Video mode, push the shutter button to start/stop video recording.



## Navigating the menus

1. In Playback and Settings modes, use the up and down buttons to scroll up/left or down/right.



2. Push the shutter button to enter a sub-menu or select setting.



## Playback photos and videos

Use the Photo and Video Playback menus to view thumbnails or single-view of the files saved on the memory card.

1. Push the Power/Mode button until you enter Playback/Settings mode.
2. Scroll to Photo Play or Video Play using the up/down button and push OK to enter the desired Playback menu.

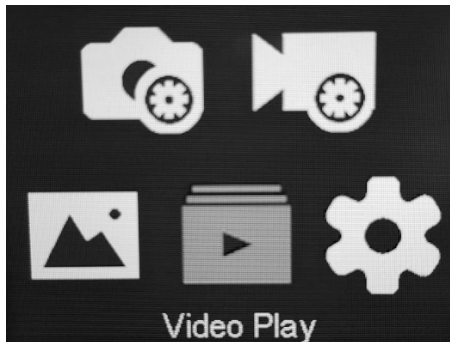
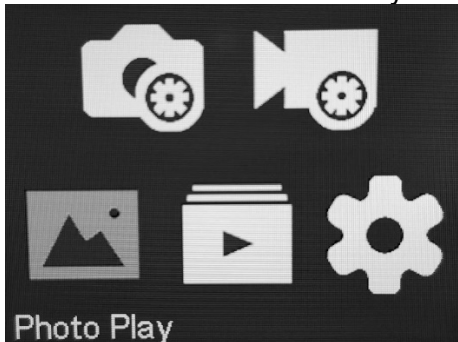

3. Push the OK to change from thumbnail to single view.



Thumbnail view



Single view

4. Scroll through files using the up/down button. Video clips will play automatically when in single view. In thumbnail view, push and hold the OK button for 2 seconds to delete the selected file.

## V. Downloading photos/videos to a computer

The camera uses a standard mass storage device computer connection protocol. Follow these steps to connect the camera to a computer and access your photos and videos.

1. Connect the camera to your computer using the provided USB cable.

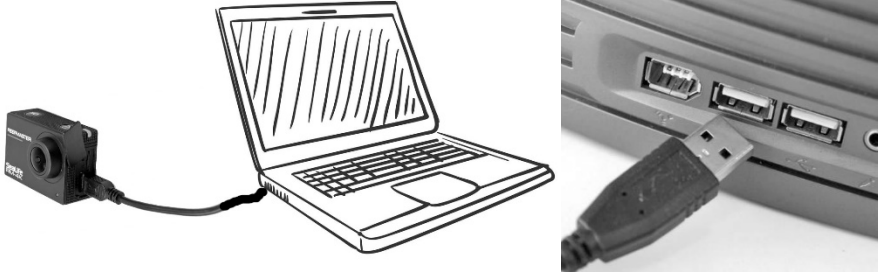

2. Power ON camera. “Connected” will appear on the camera display.
3. Open the file browser on your computer and locate the USB drive titled SDHC (\_:). A letter will be assigned to the drive.
4. Double-click on the SDHC (\_:) drive. Two folders will appear – the JPG folder contains photos and VIDEO folder contains videos.
5. Select the photos/videos you want to download and copy & paste to the desired folder on your computer.

**Note:** A memory card must be installed in the camera to a make computer connection. The file name format consists of the year, month, day, hour, minute and second the file was created. For example, IMG\_20200716120802.JPG was created July 16, 2020 at 12:08:02.

## VI. Camera settings and menus

In Playback/Settings mode, you can adjust the Photo settings, Video settings, System settings or playback photos and videos.

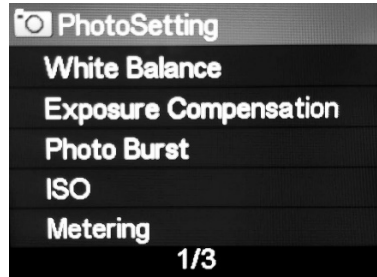
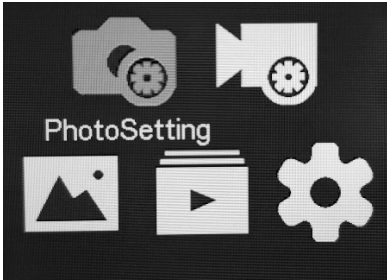

### **Photo settings**

This menu is used to change still photo settings. Some photo settings are also found in the Video settings menu. For example, the White Balance setting is in the Photo and Video settings menu. Changing one of these duplicate settings will apply to both photos and videos.

#### White Balance (WB)

Select from 8 different white balance settings depending on specific ambient lighting conditions to optimize the photo and video color reproduction.

- Auto: Automatically selects best white balance for land (not for underwater).
- Underwater Shallow: Ideal for shooting underwater images and videos at depths less than 25ft/8m.
- Underwater Deep: Ideal for shooting underwater images and videos at depths greater than 25ft/8m.
- Daylight: Ideal for shooting outdoors in sunny conditions.
- Cloudy: Ideal for shooting outdoors in cloudy conditions.
- Tungsten: Ideal for shooting indoors under tungsten lighting
- Fluorescent: Ideal for shooting indoors under fluorescent lighting

#### Exposure Compensation

This setting adjusts the camera's auto exposure program to be slightly overexposed or under-exposed. Increasing the value (+) results in a brighter image exposure. Decreasing the value (-) results in a darker image exposure. The Exposure Compensation values range from +2.0 to -2.0 in 0.3 step increments. Each step is equivalent to 1 exposure stop.

### Photo Burst

Use this setting to capture a series of photos with one push of the shutter button.

- Off: Photo Burst is disabled. Pushing the shutter will capture 1 photo.
- 3 Shots / 1 Sec: Shoots 3 photos in 1 second
- 7 Shots / 2 Sec: Shoots 7 photos in 2 second
- 15 Shots / 4 Sec: Shoots 15 photos in 4 seconds
- 30 Shots / 8 Sec: Shoots 30 photos in 8 seconds

### ISO

ISO adjusts how sensitive the image sensor is to light. Select between Auto, 100, 200, 400 or 800. The higher the ISO value, the more sensitive the camera will be to light. A higher ISO is useful when taking photos in low light conditions but will result in a grainier, less sharp picture. The lower the ISO value, the less sensitive the camera will be to light. A lower ISO value is useful for ideal for brighter light shooting conditions and results in the sharpest image quality. Selecting AUTO ISO automatically selects the optimal setting.

### Metering

This sets the area within the image frame that the camera uses to adjust photo and video exposure.

- Multi: The entire area of the image frame is measured to adjust exposure. Recommended setting.
- Center: The entire area of the image frame is measured to adjust exposure but greater weight is given to the subject area at the center.
- Spot: Only the center of the screen is measured to adjust exposure. Useful for optimal exposure of bright objects located in the center of

the image frame. Recommended when using an external photo-video light.

### Photo Time Lapse

Records a series of photos at pre-set time interval of 3 sec., 5 sec., 10 sec., 30 sec. or 1 min. Push the shutter button to start / stop photo time lapse capture. Turn Photo Time Lapse OFF to disable this feature.

Use Photo Time Lapse when trying to capture photos of subjects that won't allow you to get close. For example, a garden eel hiding in the sand. Place the camera where you last spotted the garden eel and start the time lapse sequence. Swim away from the camera and wait a minute until the garden eel reemerges. Now you have captured a photo of a garden eel that otherwise would be impossible with you behind the camera capturing the photo.

### Resolution Photo

Select among 5 different photo resolutions (sizes). The larger the megapixel (M) size, the higher the resolution and image quality, but the larger the file size will be.

- 14M: This is the largest size, highest resolution and best quality suitable for printing pictures. 14M is ideal for most purposes. The photo will have pixel dimension of 4320 x 3240 and aspect ratio of 4:3.
- 10M: This setting is considered high resolution and produces very good print quality. The wider 16:9 aspect ratio is suitable for landscapes where the subject matter is wider.
- 8M: This setting is considered good resolution and produces good print quality but with smaller file size than 10M and 14M. The wider 16:9 aspect ratio is suitable for landscapes where the subject matter is wider.
- 5M: This is a lower resolution photo with smaller file size suitable for emailing and sharing on social media where larger files sizes are difficult.

- 2M: This is the lowest resolution and equivalent to a single 1080p HD video frame. It is useful for time lapse photography where you want to stitch together the individual images into a video file. Most video editing software will allow you to import a sequence of photos and convert them to video.

### Lens Angle (Field of View)

This adjusts the camera's lens angle or field-of-view. Changing the field of view setting maintains the original video or picture resolution. Three lens angles are available:

- Ultra Wide 156°: Useful for shooting bigger subjects at close up range, so everything fits into the image frame. Not recommended for underwater because video clips will show vignette (black edges) when camera is inside the underwater housing.
- Wide 140°: Most common lens angle suitable for varying subject sizes and shooting distances. Will not vignette underwater inside the underwater housing.
- Narrow 100° Useful for smaller-sized subjects at close up shooting distance

### Art Effect

Select from 6 different artistic color effects for dramatic, creative Photos and Videos.

- Normal: This is the default suitable for most photos and videos.
- Black & White: Removes all colors
- Negative: Reverses colors. For example, red will be blue.
- Warm: Lowers color temperature
- High Contrast: Increases contrast.

### Delay Timer

Useful for self-portraits or videos. Delays image capture or video record start time by 2 sec. or 10 sec. after pushing shutter button.

## Date & Time Stamp Photo

When this setting is enabled, the Date or Date & Time will be imprinted on the bottom right corner of each photo. The date/time stamp format is YYYY/MM/DD HH:MM:SS. Refer to Video Settings for Date & Time Stamp Video.

## **Video settings**

This menu is used to change video recording settings. Some video settings are also found in the Photo settings menu. For example, the White Balance setting is in the Video and Photo settings menu. Changing one of these duplicate settings will apply to both videos and photos.

## White Balance (WB)

Select from 7 different white balance settings depending on specific ambient lighting conditions to optimize the photo and video color reproduction.

- Auto: Automatically selects best white balance for land (not for underwater).
- Underwater Shallow: Ideal for shooting underwater images and videos at depths less than 25ft/8m.
- Underwater Deep: Ideal for shooting underwater images and videos at depths greater than 25ft/8m.
- Daylight: Ideal for shooting outdoors in sunny conditions.
- Cloudy: Ideal for shooting outdoors in cloudy conditions.
- Tungsten: Ideal for shooting indoors under tungsten lighting
- Fluorescent: Ideal for shooting indoors under fluorescent lighting

## Exposure Compensation

This setting adjusts the camera's auto exposure program to be slightly overexposed or under-exposed. Increasing the value (+) results in a brighter image exposure. Decreasing the value (-) results in a darker image exposure. The Exposure Compensation values range from +2.0 to -2.0 in 0.3 step increments. Each step is equivalent to 1 exposure stop.

## Metering

This sets the area within the image frame that the camera uses to adjust photo and video exposure.

- Center: The entire area of the image frame is measured to adjust exposure but greater weight is given to the subject area at the center.
- Multi: The entire area of the image frame is measured to adjust exposure. Recommended setting.
- Spot: Only the center of the screen is measured to adjust exposure. Useful for optimal exposure of bright objects located in the center of the image frame. Recommended when using an external photo-video light.

## Time Lapse Video

Records video at very slow frame rate of 1, 3, 5 or 10 seconds and plays back at standard 30 frames per second. Useful for recording very slow moving subjects, like a sunset, crawling starfish, etc. A 30 minute time lapse video recorded at 1 second frame rate will play back in 1 minute. Push the shutter button to start / stop time lapse video. Turn Video Time Lapse OFF to disable this feature.

## Video Resolution

Select among 6 different video resolutions (sizes) and frame rate speeds depending on what you are recording and what you intend to do with the video clip.

- 4K 30fps: This is the highest quality video resolution recorded at 30fps. Each frame dimension is 3840 x 2160 pixels or 8 megapixels. This setting produces the sharpest video quality but uses the most memory storage. 1 minute of 4K video uses 440MB (0.44GB) of memory space. Recommended for professional and advanced videographers capable of managing and editing larger video files.
- 2.7K 30fps: This is a high quality video resolution recorded at 30fps. Each frame dimension is 2704 x 1520 pixels or 4 megapixels. This setting produces sharp video quality but also uses a lot of memory



storage. 1 minute of 2.7K video uses 220MB (0.22GB) of memory space. Recommended for professional and advanced videographers capable of managing and editing larger video files.

- 1080p 60fps: This is a good quality video resolution recorded at 60fps. Each frame dimension is 1920 x 1080 pixels or 2 megapixels. This setting produces sharp video quality at a higher frame rate, which also uses a lot of memory storage. 1 minute of 1080p 60fps video uses 220MB (0.22GB) of memory space. Recommended for fast moving subjects.
- 1080p 30fps: This is a good quality video resolution recorded at 30fps. Each frame dimension is 1920 x 1080 pixels or 2 megapixels. This setting produces sharp video quality at a standard frame rate. 1 minute of 1080p 30fps video uses about 110MB (0.11GB) of memory space. Recommended for most video shooting conditions.
- 720p 120 fps: This is a lower video resolution but with fastest frame rate of 120fps. Each frame dimension is 1280 x 720 pixels or 1 megapixel. This setting produces good video quality at a very fast frame rate. 1 minute of 720p 120fps video uses 220MB (0.22GB) of memory space. Recommended for action sports and fast moving subjects.
- 720p 60 fps: This is a lower video resolution but with fast frame rate. Each frame dimension is 1280 x 720 pixels or 1 megapixel. This setting produces good video quality at a fast frame rate. 1 minute of 720p 60fps video uses 110MB (0.1GB) of memory space. Recommended for fast moving subjects.

### Stabilization

Stabilization creates a smoother video recording by electronically adjusting the frames up, down, left, right position relative to small movements, like hand shake. This setting only applies to video mode. The video resolution is reduced slightly when stabilization is ON.

### Slow Motion Video

When this setting is turned ON, the video file is saved at slower playback frame rate of 30fps. This setting only works with video clips recorded at

60fps or 120fps. It is useful for fast moving subjects that you want to view in slow motion.

### Fast Motion Video

This setting will save video files at a faster playback frame rate of 2X, 4X or 6X speeds. For example, 1 minute of video at 2X speed will playback in 30 seconds. It is useful for slower moving subjects that you want to view in fast motion or for creative video playback effect.

### Mic Volume

The camera's microphone is located on the right-hand side of the camera just above the "Up" button and may be set to Off, Low, Medium and High. The microphone will be lower volume when the camera is inside the underwater housing. You may consider turning the Mic off and add music to your video production during post editing.

### Lens Angle (Field of View)

This adjusts the camera's lens angle or field-of-view. Changing the field of view setting maintains the original video or picture resolution. Three lens angles are available:

- Ultra-Wide 156°: Useful for shooting bigger subjects at close up range, so everything fits into the image frame. Not recommended for underwater because video clips will show vignette (black edges) when camera is inside the underwater housing.
- Wide 140°: Most common lens angle suitable for varying subject sizes and shooting distances. Will not vignette underwater inside the underwater housing.
- Narrow 100° Useful for smaller-sized subjects at close up shooting distance

## Power On Recording

When turned ON, the camera will automatically start recording video after powering on the camera. This setting is useful when you know you will be recording video and you want to save some time and button pushes to manually start the video. Push the Shutter button to stop video recording.

## Art Effect

Select from 6 different artistic color effects for dramatic, creative Photos and Videos.

- Normal: This is the default suitable for most photos and videos.
- Black & White: Removes all colors
- Negative: Reverses colors. For example, red will be blue.
- Warm: Lowers color temperature
- High Contrast: Increases contrast.

## Delay Timer

Useful for self-portraits or videos. Delays image capture or video record start time by 2 sec. or 10 sec. after pushing shutter button.

## Date & Time Stamp Video

When this setting is enabled, the Date or Date & Time will be imprinted on the top left corner of each video clip. The date/time stamp format is YYYY/MM/DD HH:MM:SS. Refer to Photo Settings for Date & Time Stamp Photo.

## Video File Length

This setting determines the maximum video clip time length. There are 3 options:

- Unlimited: There is no limit to the time length of the video recording. Manually stop recording video by pushing the shutter button.
- 1 Min: The video recording will automatically stop 1 minute after starting.

- 5 Min: The video recording will automatically stop 5 minutes after starting.

Note: When selecting Unlimited, you may continuously record video until pushing the shutter button to stop recording, memory card is full or battery is empty. Continuous video will be saved as a series of video clips with maximum file size of 3.9GB, which is about 9 minutes of 4K video resolution and 24 minutes of 1080p resolution.

## **System settings**

Set your camera's operating environment.

### Auto Off

Camera will power off at the selected time if no buttons have been pushed. Select Off if you don't want the camera to turn off automatically when no buttons have been pushed. Recommend selecting 3 minutes, to conserve battery power.

### Screen Saver

The LCD display will turn off at the selected time if no buttons have been pushed. The camera will still be powered on. Push any button to wake-up the camera from Screen Saver mode. Select off if you don't want the LCD display to automatically turn off if no buttons have been pushed. Recommend selecting 1 minute screen saver to conserve battery power.

### Date & Time

Set the camera's date and time in YYYY/MM/DD HH:MM format. The camera's date and time setting will be used to create the photo and video file name. It is also used for the Date & Time Stamp function.

Select Date & Time setting and push OK button. Use the up and down buttons to increase or decrease each date and time value. Push OK to change from year, month, day, hour, minute and date/time format. After setting the correct date, time and desired date/time format, push the power/mode button to exit.

## Sounds

This setting allows you to control the sound volume and turn on/off sounds for the shutter, start-up and menu scrolling beep.

## Language

Select from 8 different languages used for menu settings and on-screen messages. English, Spanish, Italian, French, German, Dutch, Simplified and traditional Chinese.

## Power Frequency

This setting helps to prevent horizontal lines from appearing in photos and videos when shooting under fluorescent lighting. Select 60Hz for the Americas and 50Hz for the rest of the world.

## System

The system setting is used to reset the camera to factory default settings. It also includes information about the firmware version installed on the camera and how much memory storage space is remaining.

## Format

This will delete all files in the internal memory. It is useful to format memory if the memory card has become corrupted by other files saved on the camera. It is recommended to format the memory card occasionally to refresh the memory's folder structure.

## VII. WiFi connection with SeaLife ReefMaster app

WiFi connection to smartphone or tablet

1. On your iOS or Android device, go to the Apple App Store or Google Play Store and download and install the free "ReefMaster" app. For iPads, select "iPhone Only" when searching for the app.



2. Power on the camera and push the Down/WiFi button to enable the WiFi. Allow about 15 seconds for the WiFi to start-up.



3. Go to the WiFi setting on your smart device and select "SeaLife\_xxxxxx" from the list of available hotspots. "\_xxxxxx" is the unique camera I.D. shown on the camera display. When prompted, enter password 1234567890.

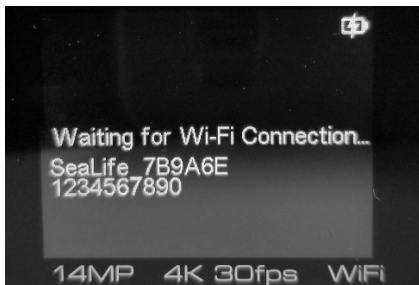

*Example of WiFi settings and camera display showing unique camera I.D. SeaLife\_7B9A6E*

4. Open the ReefMaster app. The app will show the start-up screen and then the home screen. If not, repeat the above steps.



Start-up screen



Home screen

From the Home screen, you may select Capture mode, Phone Gallery or Camera Gallery.

5. Capture mode is used to remotely take a photo or record a video clip. This feature is intended for land use only.





6. Camera Gallery shows all the photos and videos saved to the camera's memory card. Files are displayed in date order with the most recent date on top. Photos are displayed on top and Videos at the bottom.

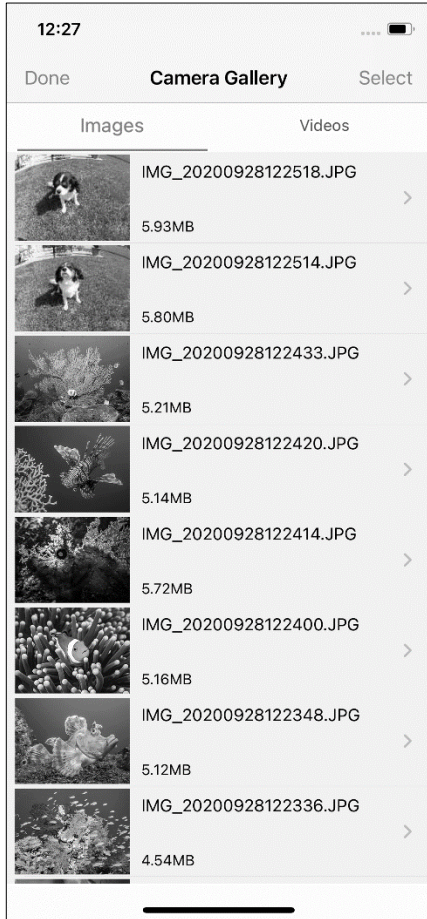

*Camera Gallery on iPhone*

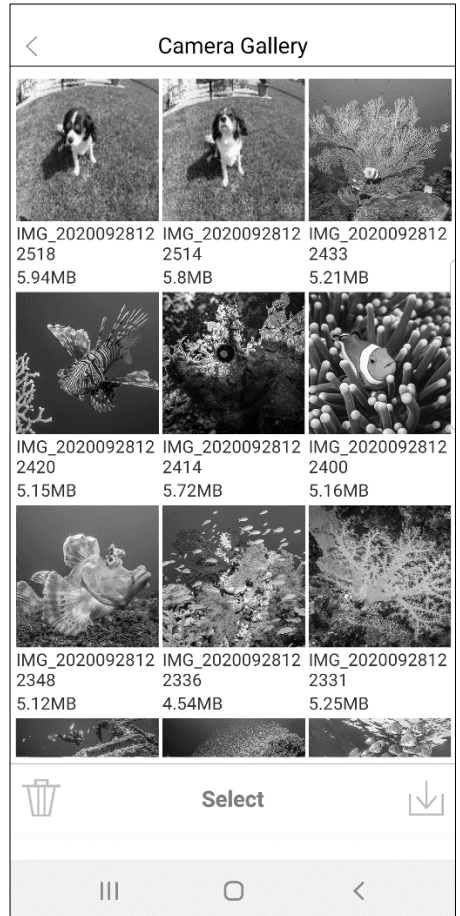

*Camera Gallery on Android phone*

7. Phone Gallery shows all the photos and videos that you have downloaded from your camera to your phone.

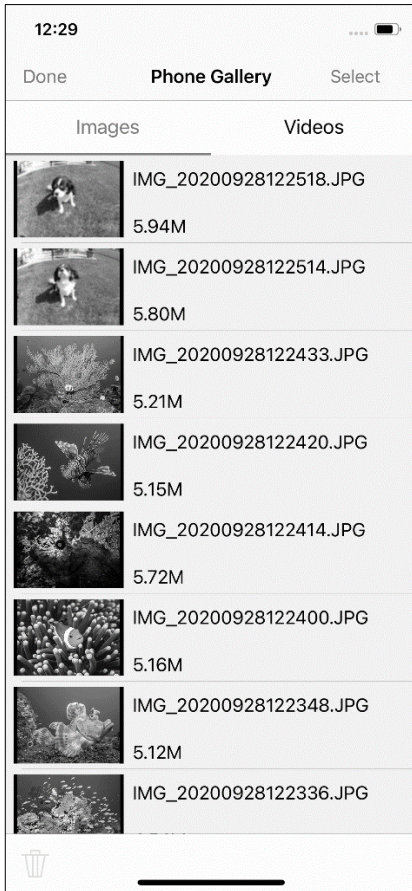

*Phone Gallery on iPhone*

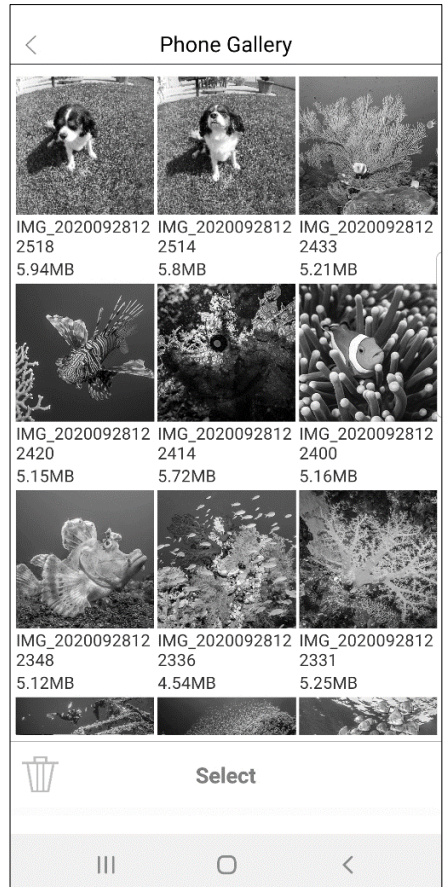

*Phone Gallery on Android phone*

8. To download files from the Camera Gallery to your Phone Gallery, touch “Select” (“A”) and touch the files you want to download (“B”). You may touch “Select All” to download all files. A green check mark will appear on the top right of each selected thumbnail.

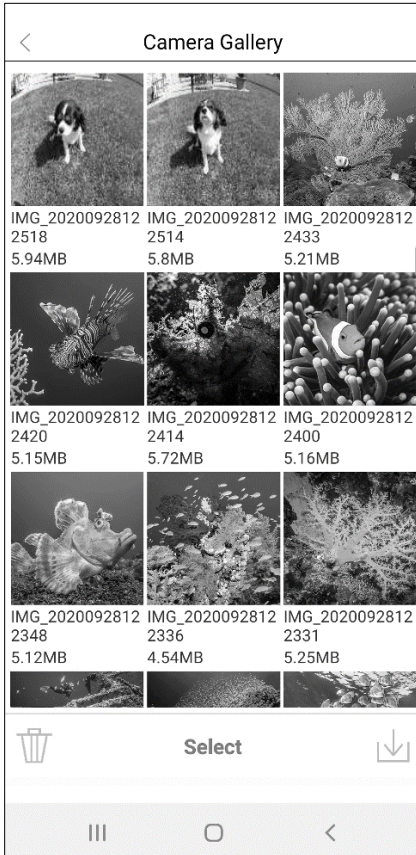

*A - Touch Select*

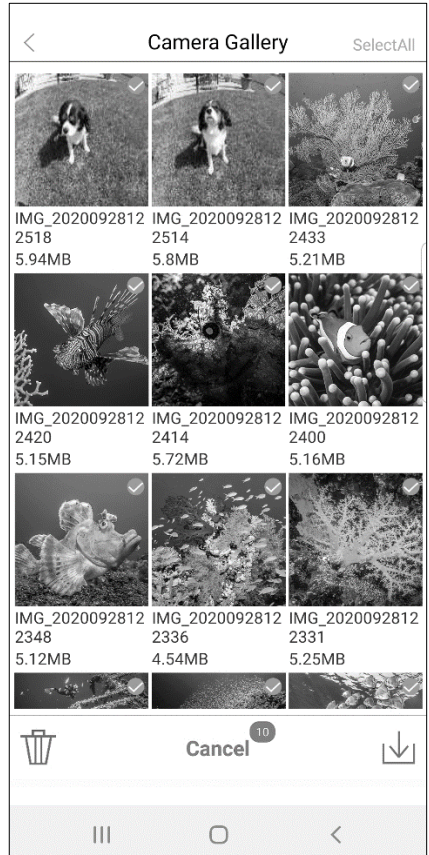

*B – Touch files you want to download*



9. After selecting the files you want to download, touch the download icon  on the bottom right. The download screen will appear and show the downloading progress.

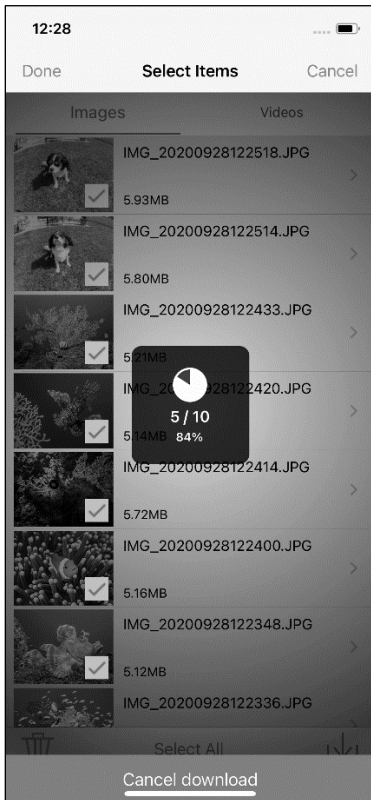

*Downloading on iPhone*

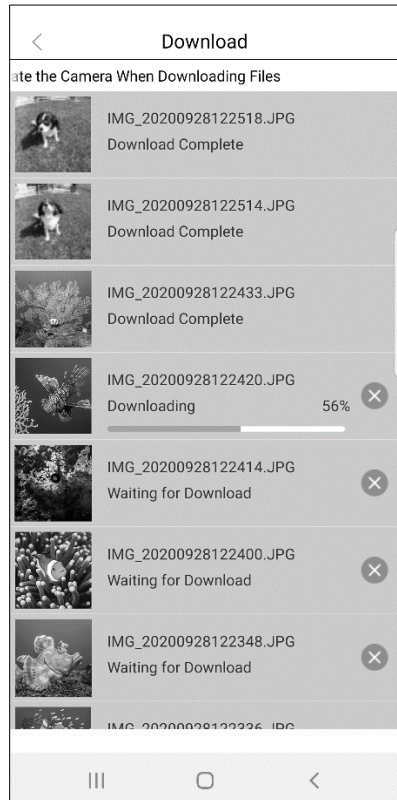

*Downloading on Android phone*

Note: You may also delete the selected files by touching the trashcan icon  on the bottom left of the previous selection screen.

10. Downloaded files will be saved to the app's Phone Gallery you're your phone's native photos app in a folder titled "ReefMaster".

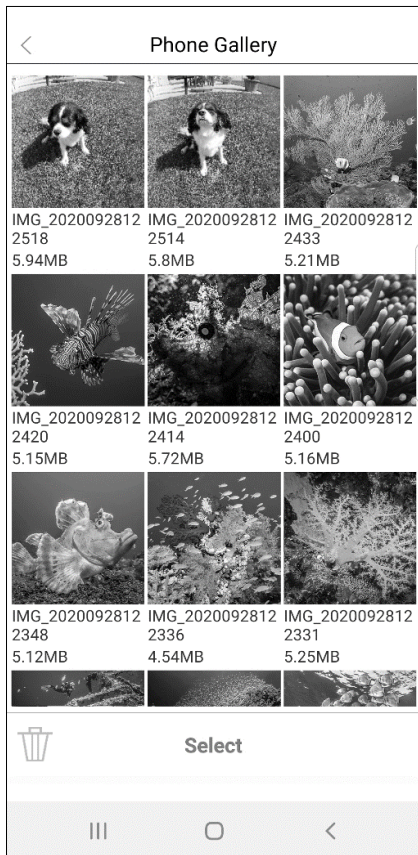

*App's Phone Gallery*

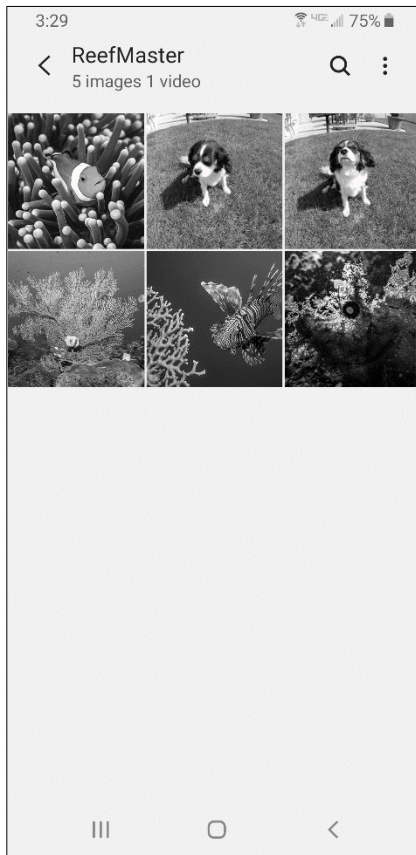

*Phone's native photo app*

11. Touching any thumbnail in Photo or Camera Gallery will display the file in single view. The file size and date created will be displayed above the single view image. You may delete the single-view file by touching the trashcan icon on the bottom left of the screen.

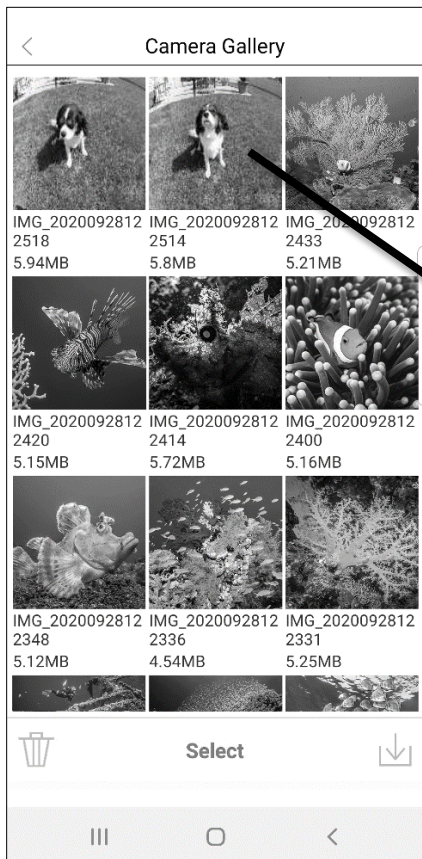

*Thumbnail view*

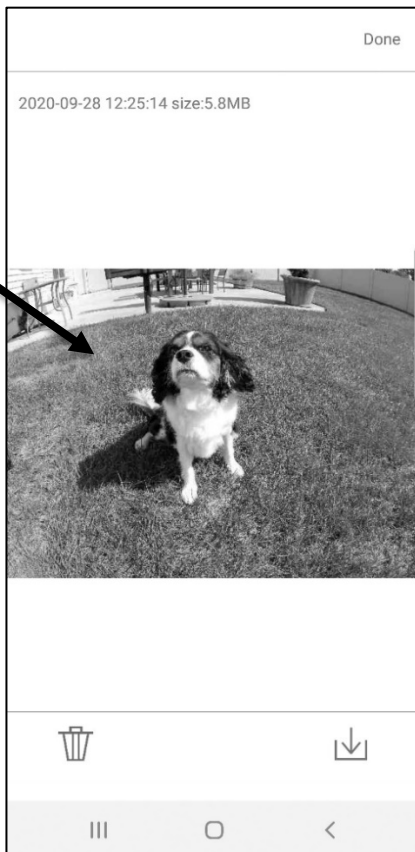

*Single view*

## VIII. Underwater housing setup and care



### **Overview**

The ReefMaster RM-4K Underwater Camera Housing is specifically designed to fit the RM-4K inner camera. The housing is depth rated to 130ft (40m) and constructed of fiber reinforced polycarbonate and 316 or 304 grade stainless steel hardware. Please carefully read the following information before using the camera underwater.

## Getting to know the underwater housing



- 1 – Lens port
- 2 – Lens adapter ring  
(For attaching lens accessory)

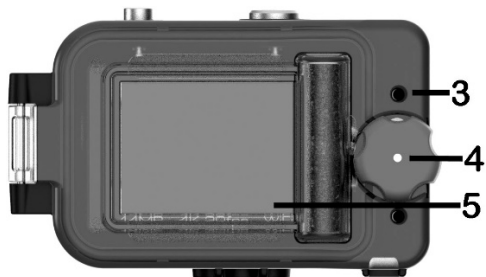

- 3 – Drainage hole
- 4 – Pressure locking thumbscrew
- 5 – LCD Display

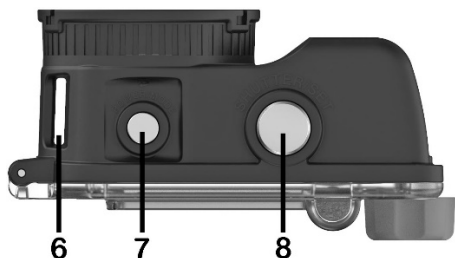

- 6 – Connect lanyard or retractor here
- 7 – Power/Mode/Back 1-step button
- 8 – Shutter/OK button



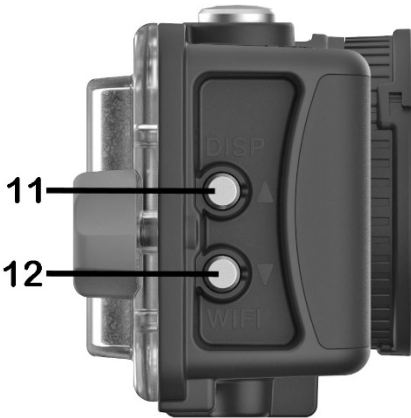
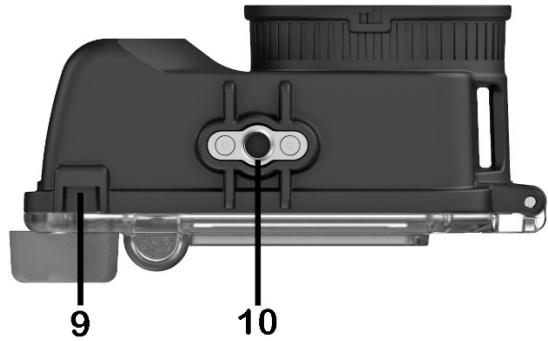

- 9 – Battery door
- 10 – Microphone
- 11 – UP/Display button
- 12 – Down/WiFi button
- 13 – Holding arm  
(Holds Moisture Muncher)
- 14 – Moisture Muncher location
- 15 – O-ring



### **Do not expose the UW housing to spray-on sunscreens**

Spray-on sunscreens contain chemicals that can damage plastics, like polycarbonate, which are commonly used to manufacture underwater camera housings and diving equipment. Test results confirm that spray-on sunscreens are particularly aggressive causing a chemical reaction making the material become brittle and crack.

SeaLife UW cameras/lights and some accessories are manufactured from a high-quality grade of polycarbonate. Polycarbonate is used in many products where high impact resistance and/or optical transparency is important. Such products include sports safety equipment, medical devices, automotive parts and electronic device housings, to name only a few. Despite polycarbonate's impressive engineering characteristics and expansive presence in modern life, it is unfortunately susceptible to damage from some sunscreens.

We recommend using sunscreens that are advertised as safe for oceans and reefs. If you use a spray-on sunscreen, never apply it around your diving equipment or UW cameras/lights. Always wash your hands after applying sunscreen to avoid contaminating plastic material.

### **Caution when connecting accessory to tripod mount**

Do not connect any accessory to the camera's 1/4-20 tripod mount where the screw length exceeds 0.3" (7.5mm). Using a 1/4-20 screw that is too long will bottom out in the tripod hole and create a high degree of stress to the camera housing material that may result in cracks and consequential flooding.

Also, never apply thread-locking compound or any chemicals to the tripod mount area. These compounds may cause chemical reaction that permanently damages the camera housing material and consequential flooding.

## Preparing the inner camera

1. Fully charge the camera battery and make sure a memory card is installed. Refer to pages 10 and 11 for details.
2. Clean the camera lens and LCD display using a micro-fiber lens cloth.
3. Make sure the USB/memory card cover on the side of the camera is fully seated.

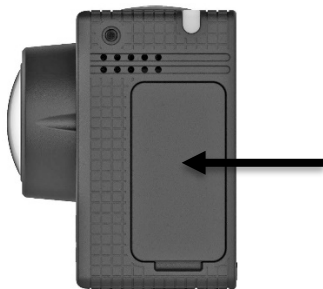

4. If you are NOT using an underwater photo-video light, set the camera's White Balance setting to Underwater Deep or Underwater Shallow depending on your depth. User Deep for depths greater than 25ft (8m) and Shallow for depths less than 25ft (8m) If you are using a photo-video light, set the White Balance to Auto.

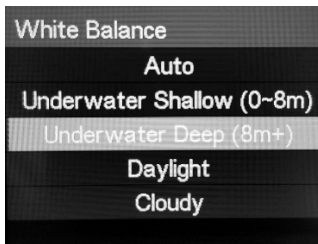

5. Check the other menu settings to make sure the camera is setup to your preference. Refer to the Photo Setting and Video Settings in this manual for more information about menu settings.

## Preparing the underwater housing



1. Inspect the O-ring and O-ring contact surfaces for damage, such as cuts (A), tears (B) and scratches (C). Replace the O-ring if it is damaged. If the O-ring contact surface is damaged, contact your local authorized SeaLife dealer or the service center in your country. Replacement O-rings are available at your local authorized SeaLife dealer or online at [sealifepartsdirect.com](http://sealifepartsdirect.com) (USA only). Note: Replace O-ring every year to ensure proper seal. Only use SeaLife O-ring designed for the ReefMaster RM-4K (Item # SL3517). See instructions below for removing / installing the O-ring.

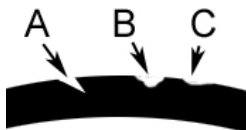

2. DO NOT lubricate the O-ring. Clean the O-ring and O-ring contact surfaces with a slightly-dampened, micro-fiber cloth. A slight-dampened cloth helps attract and remove hair (1), sand (2) and other fine particles.

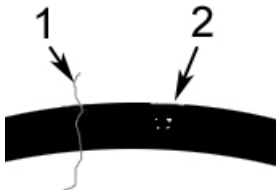

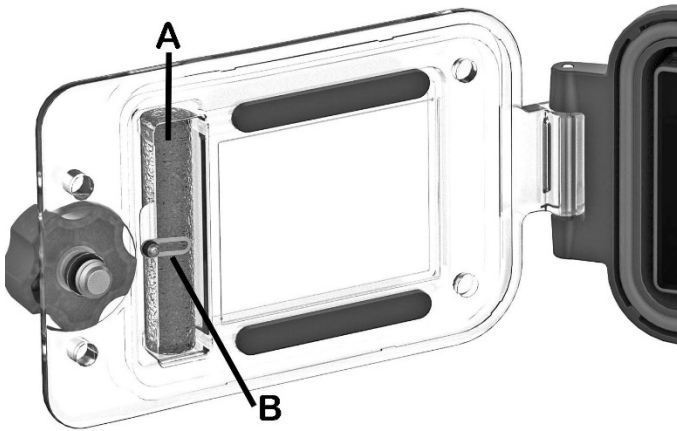

3. Insert one Moisture Muncher desiccant capsule into the housing as shown above (A). Rotate the holding arm (B) over the capsule to prevent it from falling out.

Moisture Muncher absorbs the humidity trapped inside the housing and prevents the optical lens port from fogging underwater. One Moisture Muncher capsule sample is included with the camera. Check with your local authorized SeaLife dealer to reorder (Item # SL911)





4. Insert the camera into the housing, making sure the camera is fully seated without any obstructions.



5. Make sure O-ring is completely seated into O-ring groove and not twisted before sealing housing. Close the waterproof door by pinching the door and body together and completely hand tighten the sealing screw. Do not use tools.



*Check O-ring seal is good*

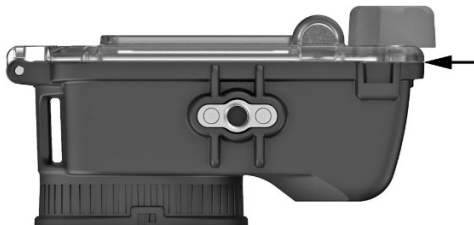

*There should be no gaps*

6. When the housing is sealed, you will see the O-ring pressed against the waterproof door. Check that there are no gaps in the O-ring seal.
7. Power on the camera and take a test picture to confirm everything is setup and functioning properly.

### **Quick Waterproof test before entering the water**

Perform a quick waterproof test before entering the water.

1. In a sink or fresh-water tub, hold the sealed housing underwater with for about 15 seconds and look at LCD display window for any water drops. If no leaks are detected, hold the sealed housing underwater for about 2 minutes and inspect for leaks.
2. If you detect any leaks, carefully dry and open the housing and inspect the O-ring sealing area. As described above.

### **Entering the water**

1. As you enter the water and submerge the camera, check the back of the underwater housing for any water drops entering the inside of the housing. If you see any water inside the housing, return the camera to the surface following safe diving practices.
2. Use the wrist lanyard or clip the camera to your BCD D-ring to avoid accidentally losing the camera while underwater.

## After underwater use

1. Soak and rinse the sealed underwater housing in fresh water for 20 minutes after each use. While holding the housing underwater, push each button 20 times to remove any sand or debris trapped under the buttons.
2. Towel-dry the housing. Make sure that you and the housing are dry before opening and the housing. It is recommended to open the housing when returning to a cool, dry environment, like an air-condition room. Do not allow the inside of the housing or the camera to get wet.
3. Store the camera and housing in a cool, dry environment with the waterproof door sealing screw untightened.

## Removing / Installing the O-ring

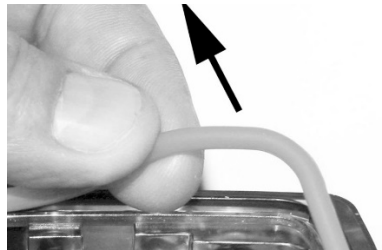
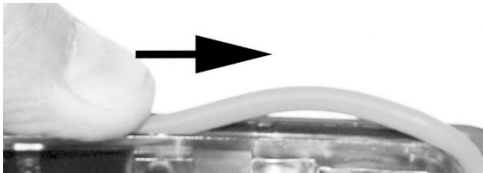

1. **DO NOT** use tools to remove the O-ring. To remove, push down on the O-ring with your fingertip and slide it parallel to the groove until it lifts up as shown above.



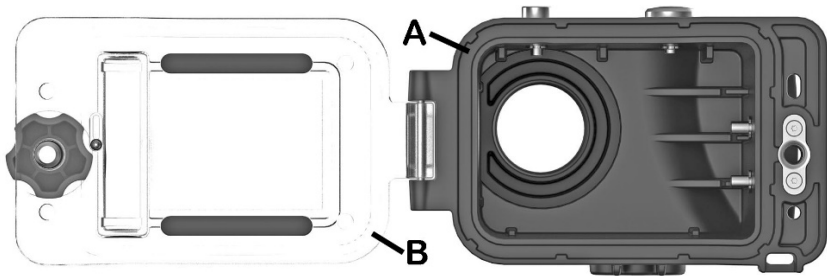

2. Clean the O-ring, O-ring groove (A) and apposing O-ring contact surface (B) using a slightly-dampened, micro-fiber cloth. **DO NOT LUBE THE O-RING.**



3. Place the O-ring over the groove, making sure the shape of the O-ring matches the shape the groove. Notice that one side has more rounded corners than the other side.
4. Push the O-ring down into the groove. The O-ring should be evenly seated without any twists. Close the housing door to firmly seat O-ring and open housing again to inspect that O-ring is completely seated into groove.

## **IX. Great underwater pictures made easy**

Please visit the SeaLife website for updates and how-to tutorials. Any updates to the manual or additional tips and advice can be found on the SeaLife website at [www.sealife-cameras.com](http://www.sealife-cameras.com).

### **Clear water visibility**

Clear water is essential for good results. Tiny particles floating in the water cause low visibility and poor image quality. Avoid stirring up the sea floor with your fins. Limit your shooting distance to 1/10 of the water visibility. For example, if the visibility is 40ft (12m), you should keep your shooting distance to within 4 feet (1.2m).

### **Keep close shooting distance**

The ideal shooting distance is within 6ft (1.8m), and the closer the better. The camera's minimum focus range is 12" (30cm). Use the optional Super Macro Lens (SL571) for closer underwater focus distance of 3.5" to 7" (9cm to 18cm), or the Close-up Lens (SL572) for closer underwater focus distance of 6" to 24" (15 to 60cm).

### **Move calmly and control your buoyancy**

It is very hard to take good photos or videos when you are moving or buoyancy is not controlled. Position yourself at the best angle and neutralize your buoyancy. Then, frame your subject, check your shooting distance and keep the camera steady. Don't chase the fish, let the fish come to you. Sometimes you have to wait a little bit for the fish return. Always observe safe-diving rules.

### **Take several photos and shoot upwards**

Shoot at least 3 photos of each subject. You can always delete the bad shots later. Try different shooting angles and shooting distances. Shoot upwards to capture some blue water in the background. Shooting downwards tends to result in poor composition and contrast.

## Avoiding blue photos and video

Water reduces light and filters out red/yellow colors resulting in darker, bluer ambient lighting. There are two ways to restore the lost colors:

- 1) Use one or two SeaLife Sea Dragon underwater photo-video lights (optional accessory) to enhance colors and photo/video quality.
- 2) When NOT using an underwater photo-video light, set the camera's White Balance setting to Underwater Deep or Underwater Shallow depending on your depth. If you are using a photo-video light, set the White Balance to Auto.

## **X. Troubleshooting tips, spare parts and repair service**

For updated troubleshooting, spare parts and repair service, please visit the SeaLife website at [www.sealife-cameras.com](http://www.sealife-cameras.com). Select the "Tech Support" section.

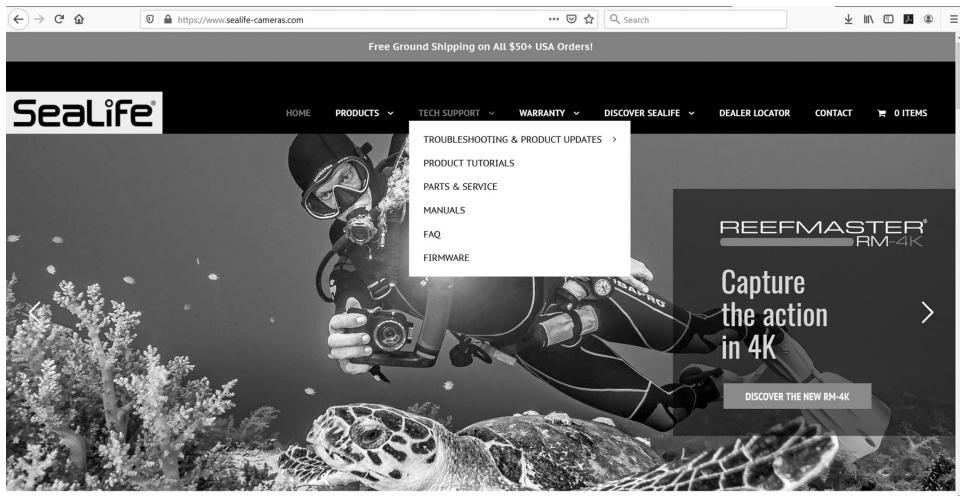

## **XI. Specifications**

For comprehensive product specifications, visit [www.sealife-cameras.com](http://www.sealife-cameras.com)

Image Sensor:	14 mega pixel Panasonic 1/2.3" CMOS sensor
Picture file format:	JPEG
Video Resolution:	4K (3840 x 2160) at 30fps
Video file format:	MPEG4 h.264 (.mp4)
Audio:	MPEG-4 AAC
Microphone/speaker:	Yes - Mono
Lens:	F2.8; 6 element, fully multi-coated, aspheric lens
Focal Length:	2.5 mm (35 film equivalent = 14mm)
Focus type:	Instant fixed-focus lens / 12" (30cm) to Infinity
Field of View:	Adjustable: 156°, 140° and 100° diagonal
Shutter speed:	1/25 to 1/2000 second
LCD	2.0" TFT LCD color display 230K resolution
Memory:	Sold separately Micro SDHC/SDXC memory card Recommend 128GB w/ Speed Class V30 (U3)
PC connection:	PC: Windows 7 and up / MAC: OS X and up
Output ports:	1x USB 2.0 out and 1x Micro HDMI out
Battery:	Removable Li-ion battery. 900 mAh, 3.8V. 3.42Wh.
Battery life:	Still images: 2+ hours (Approx. 500+ images) Video: 1.5 hours at 1080p and 1.2+ hours at 4K
Waterproof:	Individually depth tested to 130' (60 m)
Shockproof:	3ft / 1m
Operating temp:	0°F to 120°F (-18°C to 50°C)
Storage temp:	-20°F to +140°F(-29°C to +60°C)
Tripod mount:	Standard ¼-20 tripod threads
Certification:	CE, ROHS, FCC
Weight:	7.1 ounces (202 grams)
Dimensions:	1.9" x 4.1" x 2.6" (4.9cm x 10.5cm x 2.6cm)
Warranty:	1 year limited warranty
Country of Origin:	China

## **XII. FCC Statement**

### **Class B: Section 15.105**

#### **FEDERAL COMMUNICATIONS COMMISSION INTERFERENCE STATEMENT**

This equipment has been tested and found to comply with the limits for a Class B digital device, pursuant to part 15 of the FCC Rules. These limits are designed to provide reasonable protection against harmful interference in a residential installation. This equipment generates, uses and can radiate radio frequency energy and, if not installed and used in accordance with the instructions, may cause harmful interference to radio communications. However, there is no guarantee that interference will not occur in a particular installation. If this equipment does cause harmful interference to radio or television reception, which can be determined by turning the equipment off and on, the user is encouraged to try to correct the interference by one or more of the following measures:

-Reorient or relocate the receiving antenna.

-Increase the separation between the equipment and receiver.

-Connect the equipment into an outlet on a circuit different from that to which the receiver is connected.

-Consult the dealer or an experienced radio/ TV technician for help.

#### **Section 15.21**

##### **CAUTION:**

Any changes or modifications not expressly approved by the grantee of this device could void the user's authority to operate the equipment.

#### **Section 15.19(a)(3)**

This device complies with Part 15 of the FCC Rules. Operation is subject to the following two conditions: (1) this device may not cause harmful interference, and (2) this device must accept any interference received, including interference that may cause undesired operation.

#### **RF Exposure Information (SAR)**

This device meets the government's requirements for exposure to radio waves. This device is designed and manufactured not to exceed the emission limits for exposure to radio frequency (RF) energy set by the Federal Communications Commission of the U.S. Government.

The exposure standard employs a unit of measurement known as the Specific Absorption Rate, or SAR. The SAR limit set by the FCC is 1.6 W/kg. Tests for SAR are conducted using standard operating positions accepted by the FCC with the EUT transmitting at the specified power level in different channels.

The FCC has granted an Equipment Authorization for this device with all reported SAR levels evaluated as in compliance with the FCC RF exposure guidelines. SAR information on this device is on file with the FCC and can be found under the Display Grant section of

[www.fcc.gov/eot/ea/fccid](http://www.fcc.gov/eot/ea/fccid) after searching on FCC ID: 2AAD3AA2G1J1

#### **End Product Labeling**

This transmitter module is authorized only for use in device where the antenna may be installed such that 20cm may be maintained between the antenna and users. The final end product must be labeled in a visible area with the following: "Contains FCC ID: 2AAD3AA2G1J1 " and "Contains IC: 10290A-AA2G1J1 "

#### **Information for the OEMs and Integrators**

The following statement must be included with all versions of this document supplied to an OEM or integrator, but should not be distributed to the end user.

- 1) This device is intended for OEM integrators only.
- 2) Please see the full Grant of Equipment document for other restrictions.

#### **IC Statement**

**(RSS-Gen section 7.1.3)**

### **Canada, Industry Canada (IC) Notices**

This device complies with Canada license-exempt RSS standard(s).

Operation is subject to the following two conditions: (1) this device may not cause interference, and (2) this device must accept any interference, including interference that may cause undesired operation of the device.

### **Canada, avis d'Industry Canada (IC)**

Le présent appareil est conforme aux CNR d'Industrie Canada applicables aux appareils radio exempts de licence. L'exploitation est autorisée aux deux conditions suivantes :

(1) l'appareil ne doit pas produire de brouillage, et

(2) l'utilisateur de l'appareil doit accepter tout brouillage radioélectrique subi, même si le brouillage est susceptible d'en compromettre le fonctionnement.

### **Radio Frequency (RF) Exposure Information**

The radiated output power of the Wireless Device is below the Industry Canada (IC) radio frequency exposure limits. The Wireless Device should be used in such a manner such that the potential for human contact during normal operation is minimized.

This device has been evaluated for and shown compliant with the IC Specific Absorption Rate ("SAR") limits when operated in portable exposure conditions.

### **Informations concernant l'exposition aux fréquences radio (RF)**

La puissance de sortie émise par l'appareil de sans fil est inférieure à la limite d'exposition aux fréquences radio d'Industry Canada (IC). Utilisez l'appareil de sans fil de façon à minimiser les contacts humains lors du fonctionnement normal.

Ce dispositif a été évalué pour et démontré conforme à la Taux IC d'absorption spécifique ("SAR") des limites lorsqu'il est utilisé dans des conditions d'exposition portatifs.

### **CE**

"Hereby, Pioneer Research, declares that this device ReefMaster RM-4K is in compliance with the essential requirements and other relevant provisions of Directive 2014/53/EU."

## **XIII. Limited Warranty**

Manufacturer warrants to the original purchaser (the "Purchaser") of this product (the "Product"), provided the Product was at the time of purchase, new and unused and in its original packaging for a period of one (1) year from the date of purchase (the "Warranty Period"), that the Product is free from defects in workmanship and materials when used in accordance with Manufacturer's published specifications. In the event that the Purchaser believes the Product contains a defect, the Purchaser should seek troubleshooting advice from the SeaLife website at [www.sealife-cameras.com](http://www.sealife-cameras.com) or the importer of the Product in the country in which the Product was purchased by the Purchaser. The local authorized SeaLife Dealer can also assist with Product servicing and, in the event it is determined that the product requires servicing, can issue to Purchaser a return authorization number. To be entitled to any remedy hereunder, Purchaser must return the Product to Manufacturer within the Warranty Period, at the sender's risk, accompanied by the following (the "Claim Requirements"): (a) a Manufacturer issued return authorization number, (b) a letter describing in the defect in reasonable detail; (c) a valid address for the Purchaser; and (d) a copy of the original purchase receipt or proof of purchase specifying the purchase date of the Product For more information about repair service, or to locate a service center in your country, please visit the SeaLife website at [www.sealife-cameras.com](http://www.sealife-cameras.com).

**Important: The foregoing limited warranty applies only to the Product sold by Manufacturer. This limited warranty does not cover, and does not provide any remedy for damage to, any smart phones, other electronic devices, or other products, used in connection with the Product. Purchaser understand and agrees that while Manufacturer has undertaken commercially reasonable efforts to ensure that the Product functions in accordance with Manufacturer's applicable published specifications, some risk of flooding or other failure remains when the Product is used, which risk the Purchaser assumes.**

In the event Purchaser returns the Product to Manufacturer with the Claim Requirements, and Manufacturer is able to replicate the alleged defects or leaks, and determines in its reasonable discretion that the Product contains a defect in workmanship or materials, Manufacturer will, in its absolute and sole discretion, repair or replace this Product and return it to Purchaser free of charge. In the event that Manufacturer is unable to replicate alleged defects or leaks, or determines that the product does not contain a defect in workmanship or materials, Manufacturer will notify Purchaser and upon request by Purchaser Manufacturer will return the Product to Purchaser at Purchaser expense.

Excluded from this warranty are any damages caused by the failure to use the Product in accordance with Manufacturer's published specifications, cosmetic damages, damages caused by abuse, misuse, wear, tear, water damage caused by damaged O-ring or O-ring contact surfaces or debris trapped between the product housing and the O-ring, damages caused by exposure to sunscreens or other chemicals, repair or attempted repair by unauthorized persons, improper storage, non-performance of scheduled maintenance, and battery leakage.

THE FOREGOING IS PURCHASER'S SOLE AND EXCLUSIVE REMEDY, AND MANUFACTURER'S SOLE AND EXCLUSIVE OBLIGATION, WITH RESPECT TO A CLAIM THAT A PRODUCT IS DEFECTIVE. EXCEPT FOR THE LIMITED WARRANTY SET FORTH ABOVE, MANUFACTURER DISCLAIMS ALL WARRANTIES, EXPRESS OR IMPLIED, WITH RESPECT TO THE PRODUCT INCLUDING, WITHOUT LIMITATION, THE IMPLIED WARRANTIES OF MERCHANTABILITY, FITNESS FOR A PARTICULAR PURPOSE, AND NON-INFRINGEMENT. UNDER NO CIRCUMSTANCES SHALL MANUFACTURER BE LIABLE TO PURCHASER OR ANY THIRD PARTY FOR ANY SPECIAL, INCIDENTAL, INDIRECT, CONSEQUENTIAL OR PUNITIVE DAMAGES INCLUDING, WITHOUT LIMITATION, LOSS OF PROFITS, INJURIES TO PERSONS OR PROPERTY, OR DAMAGES FOR WHICH PURCHASER MAY BE LIABLE TO OTHER PERSONS OR ENTITIES, EVEN IF MANUFACTURER HAS BEEN ADVISED OF THE POSSIBILITY OF SUCH DAMAGES, AND WHETHER THE CLAIM IS FOR BREACH OR REPUDIATION OF CONTRACT, BREACH OF WARRANTY, TORT, NEGLIGENCE OR OTHERWISE. SOME JURISDICTIONS DO NOT ALLOW THE EXCLUSION OR LIMITATION OF INCIDENTAL OR CONSEQUENTIAL DAMAGES OR ALLOW LIMITATIONS ON HOW LONG AN IMPLIED WARRANTY LASTS, SO THE FOREGOING LIMITATIONS MAY NOT APPLY. ANY OF THE FOREGOING NOTWITHSTANDING, IN NO EVENT SHALL MANUFACTURER'S MAXIMUM AGGREGATE LIABILITY ARISING OUT OF OR RELATING

TO THE SALE OF THE PRODUCT EXCEED THE PURCHASE PRICE PAID TO MANUFACTURER FOR THE PRODUCT.

This limited warranty is governed by the laws of the State of New Jersey, U.S.A. Any warranty claim, or other dispute arising out of or related to this limited warranty or the Product, shall be brought exclusively in the state or federal courts located in the State of New Jersey, U.S.A., the exclusive jurisdiction and venue of which Purchaser and any party from which Purchaser purchased the Product, directly or indirectly, irrevocably consent to for this purpose.











# SeaLife®

## REEFMMASTER® RM-4K



SL35008 | March 2021

***Share your photos and videos with us on the web!***

sealife-cameras.com



SeaLifeCameras



SeaLifeCameras

Visit [sealife-cameras.com/manuals](https://sealife-cameras.com/manuals) for Español, Deutsch, Français, Italiano and Nederlands