

Agilent N4967A

Serial BERT System 44 Gb/s

User Guide

Notices

© Agilent Technologies, Inc. 2012

No part of this manual may be reproduced in any form or by any means (including electronic storage and retrieval or translation into a foreign language) without prior agreement and written consent from Agilent Technologies, Inc. as governed by United States and international copyright laws.

Manual Part Number

N4967-91021

Edition

Sixth edition, April 2014

Agilent Technologies, Deutschland GmbH

Herrenberger Str. 130

71034 Böblingen, Germany

For Assistance and Support

<http://www.agilent.com/find/assist>

Limitation of Warranty

The foregoing warranty shall not apply to defects resulting from improper or inadequate maintenance by Buyer, Buyer-supplied software or interfacing, unauthorized modification or misuse, operation outside of the environmental specifications for the product, or improper site preparation or maintenance. No other warranty is expressed or implied. Agilent Technologies specifically disclaims the implied warranties of Merchantability and Fitness for a Particular Purpose.

Warranty

The material contained in this document is provided “as is,” and is subject to being changed, without notice, in future editions. Further, to the maximum extent permitted by applicable law, Agilent disclaims all warranties, either express or implied, with regard to this manual and any information contained herein, including but not limited to the implied warranties of merchantability and fitness for a particular purpose. Agilent shall not be liable for errors or for incidental or consequential damages in connection with the furnishing, use, or performance of this document or of any information contained herein. Should Agilent and the user have a separate written agreement with warranty terms covering the material in this document that conflict with these terms, the warranty terms in the separate agreement shall control.

Technology Licenses

The hardware and/or software described in this document are furnished under a license and may be used or copied only in accordance with the terms of such license.

Restricted Rights Legend

If software is for use in the performance of a U.S. Government prime contract or subcontract, Software is delivered and licensed as “Commercial computer software” as defined in DFAR 252.227-7014 (June 1995), or as a “commercial item” as defined in FAR 2.101(a) or as “Restricted computer software” as defined in FAR 52.227-19 (June 1987) or any equivalent agency regulation or contract clause. Use, duplication or disclosure of Software is subject to Agilent Technologies’ standard commercial license terms, and non-DOD Departments and Agencies of the U.S. Government will receive no greater than Restricted Rights as defined in FAR 52.227-19(c)(1-2) (June 1987). U.S. Government users will receive no greater than Limited Rights as defined in FAR 52.227-14 (June 1987) or DFAR 252.227-7015 (b)(2) (November 1995), as applicable in any technical data.

Safety Notices

CAUTION

A **CAUTION** notice denotes a hazard. It calls attention to an operating procedure, practice, or the like that, if not correctly performed or adhered to, could result in damage to the product or loss of important data. Do not proceed beyond a **CAUTION** notice until the indicated conditions are fully understood and met.

WARNING

A **WARNING** notice denotes a hazard. It calls attention to an operating procedure, practice, or the like that, if not correctly performed or adhered to, could result in personal injury or death. Do not proceed beyond a **WARNING** notice until the indicated conditions are fully understood and met.

NOTE

A **NOTE** provides important or special information.

Safety Summary

General Safety Precautions

The following general safety precautions must be observed during all phases of operation of this instrument. Failure to comply with these precautions or with specific warnings elsewhere in this manual violates safety standards of design, manufacture, and intended use of the instrument.

Agilent Technologies Inc. assumes no liability for the customer's failure to comply with these requirements.

Before operation, review the instrument and manual for safety markings and instructions. You must follow these to ensure safe operation and to maintain the instrument in safe condition.

Initial Inspection

Inspect the shipping container for damage. If there is damage to the container or cushioning, keep them until you have checked the contents of the shipment for completeness and verified the instrument both mechanically and electrically. The Performance Tests give procedures for checking the operation of the instrument. If the contents are incomplete, mechanical damage or defect is apparent, or if an instrument does not pass the operator's checks, notify the nearest Agilent Technologies Sales/Service Office.

WARNING To avoid hazardous electrical shock, do not perform electrical tests when there are signs of shipping damage to any portion of the outer enclosure (covers, panels, etc.).

General

This product is a Safety Class 1 product (provided with a protective earthing ground incorporated in the power cord). The mains plug shall only be inserted in a socket outlet provided with a protective earth contact. Any interruption of the protective conductor, inside or outside of the instrument, will make the instrument dangerous. Intentional interruption is prohibited.

Environment Conditions

This instrument is intended for indoor use in an installation category II, pollution degree 2 environment per IEC 61010 Second Edition and 664 respectively. It is designed to operate within a temperature range of 10 to 40 °C at a maximum relative humidity of 80% for temperatures up to 31 °C, decreasing linearly to 50% relative humidity at 40 °C at an altitude of 2000 meters.

This module can be stored or shipped at temperatures between -40°C and +70°C. Protect the module from temperature extremes that may cause condensation within it.

Before Applying Power

Verify that all safety precautions are taken. The power cable inlet of the instrument serves as a device to disconnect from the mains in case of hazard. The instrument must be positioned so that the operator can easily access the power cable inlet. When the instrument is rack mounted the rack must be provided with an easily accessible mains switch.

Ground the Instrument

Install the instrument so that the ON / OFF switch is readily identifiable and is easily reached by the operator. The ON / OFF switch is the instrument disconnecting device. It disconnects the mains circuits from the mains supply before other parts of the instrument. Or the detachable power cord can be removed from the electrical supply. Alternately, an externally installed switch or circuit breaker which is readily identifiable and is easily reached by the operator may be used as a disconnecting device.

Do Not Operate in an Explosive Atmosphere

Do not operate the instrument in the presence of flammable gases or fumes.

Do Not Remove the Instrument Cover

Operating personnel must not remove instrument covers. Component replacement and internal adjustments must be made only by qualified personnel.

Instruments that appear damaged or defective should be made inoperative and secured against unintended operation until they can be repaired by qualified service personnel.

Symbols on Instruments



Indicates warning or caution. If you see this symbol on a product, you must refer to the manuals for specific Warning or Caution information to avoid personal injury or damage to the product.



C-Tick Conformity Mark of the Australian ACA for EMC compliance.



The CSA mark is a registered trademark of the CSA International. This instrument complies with Canada: CSA 22.2 No. 61010-1 -04.



Indicates that protective earthing ground is incorporated in the power cord.



This symbol indicates that internal circuits can be damaged by electrostatic discharge (ESD), therefore, avoid applying static discharges to the panel input connectors.



This mark indicates compliance with the Canadian EMC regulations.

ISM 1-A

This text denotes the instrument is an Industrial Scientific and Medical Group 1 Class A product.



China RoHS regulations include requirements related to packaging, and require compliance to China standard GB18455-2001. This symbol indicates compliance with the China RoHS regulations for paper/fiberboard packaging.



Indicates the time period during which no hazardous or toxic substance elements are expected to leak or deteriorate during normal use. Forty years is the expected useful life of the product.



This symbol indicates that the instrument requires alternating current (AC) input.

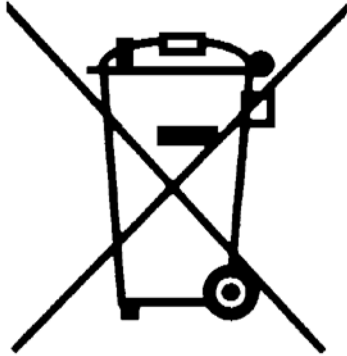


This symbol indicates that the power line switch is in the ON position.



This symbol indicates that the power line switch is in the OFF position.

Environmental Information



This product complies with the WEEE Directive (2002/96/EC) marketing requirements. The affixed label indicates that you must not discard this electrical/electronic product in domestic household waste.

Product category: With reference to the equipment types in the WEEE Directive Annexure I, this product is classed as a "Monitoring and Control instrumentation" product.

Do not dispose in domestic household waste.

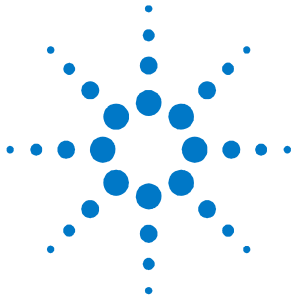
To return unwanted products, contact your local Agilent office, or see

www.agilent.com/environment/product/ for more information.

Contents

1	Setting Up the N4967A	9
1.1	Introduction	9
1.1.1	Features	9
1.2	Main Components and Accessories	10
1.3	Unpacking	13
1.4	Important Notes.....	13
1.5	Measurement Best Practices.....	14
1.6	General Specifications.....	14
1.7	Safety and Regulatory.....	15
1.8	Installation	16
2	Operation Overview	21
2.1	Modular Design	21
2.1.1	N4974A PRBS Generator 44 Gb/s.....	22
2.1.2	N4968A Clock and Data Demultiplexer 44 Gb/s.....	23
2.1.3	N4965A-CTR Multi-Channel BERT Controller.....	23
2.2	Control	23
3	Operation	25
3.1	Connector Care	25
3.2	Aligning the N4967A.....	26
3.2.1	Timing Alignment.....	26
3.3	DUT Setup.....	35
4	Applications	37
4.1	40 Gb/s Optical Receiver BER Setup.....	37

5	System Performance Specifications.....	39
5.1	N4974A-PRBS Source.....	39
5.2	N4968A Clock and Data Demultiplexer 44 GB/s.....	41
5.3	N4965A-CTR with N4956A-E12 and N4957A-C12.....	42
6	Returning the N4967A to Agilent Technologies.....	43



1 Setting Up the N4967A

1.1 Introduction

The Agilent Technologies N4967A serial BERT system 44 Gb/s is a modular system designed for device characterization, research and development testing, production testing, and general lab use.

1.1.1 Features







All features can be controlled through the front panel controls or through the N4980A multi-instrument BERT software running on a PC (refer to the N4980A multi-instrument BERT software user guide for system requirements).







- Operates at data rates from 22 to 44 Gb/s with external clock
 - True PRBS pattern generation at full data rate
 - Supports differential or single ended inputs and outputs
 - Remote control through USB or GPIB
 - Semi-automatic receiver clock phase alignment
 - Internal oscillator for operation at 40 Gb/s
 - Compact size
 - N4980A multi-instrument BERT software for quick and easy setup of multi-channel BER testing
-







1.2 Main Components and Accessories


The N4967A is shipped in protective boxes with all the accessories required for operation. The N4967A includes the components listed in Table 1.

Table 1. Main components and accessories

Component	Description
	N4965A-CTR multi-channel BERT controller
	N4956A-E12 12.5 Gb/s error detector remote head (4) with cable (4)
	5.5 inch blue 2.92 mm male-male cable (8)
	5.5 inch blue 2.92 mm male-female cable (8)
	50 Ω 18 GHz 1 W SMA male termination (4)
	N4957A-C12 clock doubler remote head with cable

Component	Description
	N4974A PRBS generator 44 Gb/s
	Type 1.85 mm 50 Ω terminator (1)
	Type 1.85 mm attenuator, -3 dB, DC – 60 GHz (1)
	Screwdriver .050 inch, B-Size (1)
	Loopback cable (1)
	Power supply (1)

Component	Description
     	<p>N4968A clock and data demultiplexer 44 Gb/s</p> <p>Type 1.85 mm 50 Ω terminator (1)</p> <p>50 Ω 18 GHz 1 W SMA male termination (4)</p> <p>2.92 mm female to 1.85 mm male adapters (2)</p> <p>Loopback cables (3)</p> <p>Power supply (1)</p>

Component	Description
<p>N4967A Accessory Kit</p> 	<p>16301 astro TC cable assembly – 36" (2)</p> <p>Minibend SMA male-male 12" (2)</p> <p>Minibend 1.85 mm male-male 5.5" (2)</p> <p>Directional coupler SMA 10 dB (1)</p> <p>Connector SMA male to male adapter (1)</p>

1.3 Unpacking

Carefully remove each instrument from its respective box in an ESD-safe environment.

1.4 Important Notes

- Use ESD protection at all times when using the system.
- Review min/max specifications before applying input signals.
- Use high quality SMA, 2.92 mm, and 1.85 mm connectors on all ports.
- Leave dust jackets on unused connectors.
- Situate the system away from heat sources, do not block the fans, and do not block the exhaust vents (minimum of 3 inches clearance).
- Do not modify the power plug or wall outlet to remove the third (ground) pin.
- Do not drop or shake the instrument, minimize vibration, and handle with care.

1.5 Measurement Best Practices

- When using differential-mode connections, ensure the cables are phase balanced for best performance.
 - Use high quality cables and connector savers (or adaptors).
 - Keep cable lengths short and minimize the number of cable bends.
 - Terminate unused outputs of a differential pair when a single ended signal is used.
 - Use an 8 in-lbs (90 N-cm) torque wrench when attaching connectors.
-

1.6 General Specifications

Before installing the N4967A, review the specifications in Table 2.

Table 2. Specification considerations before installation

Parameter	Specification
Temperature, operating	+10° to +40° C
Temperature, NON-OPERATING	–40° to +70° C
Dimensions (height, width, and depth)	
N4974A PRBS generator 44 Gb/s	63.5 mm (2.5 in) x 230.2 mm (8 in) x 254 mm (10 in)
N4968A clock and data demultiplexer 44 Gb/s	63.5 mm (2.5 in) x 254 mm (10 in) x 254 mm (10 in)
N4965A-CTR multi-channel BERT controller	100 mm (3.9 in) x 214 mm (8.4 in) x 425 mm (16.7 in)
N4956A-E12 12.5 Gb/s error detector remote head	33 mm (1.3 in) x 72 mm (2.8 in) x 130 mm (5.1 in)
N4957A-C12 clock doubler remote head	33 mm (1.3 in) x 72 mm (2.8 in) x 130 mm (5.1 in)

Parameter	Specification
Mass	
N4974A PRBS generator 44 Gb/s	2.7 kg (6 lbs)
N4968A clock and data demultiplexer 44 Gb/s	3.2 kg (7 lbs)
N4965A-CTR multi-channel BERT controller	3.3 kg (7.1 lbs)
N4956A-E12 12.5 Gb/s error detector remote head	0.38 kg (13.4 oz)
N4957A-C12 clock doubler remote head	0.38 kg (13.4 oz)

1.7 Safety and Regulatory

These products have been designed and tested in accordance with accepted industry standards, and have been supplied in a safe condition. The documentation contains information and warnings that must be followed by the user to ensure safe operation and to maintain the products in a safe condition.

WARNING

Do not remove instrument covers. There are no user serviceable parts within. Operation of the instrument in a manner not specified by Agilent Technologies may result in personal injury or loss of life.

WARNING

For continued protection against fire hazard, replace fuses, and or circuit breakers only with same type and ratings. The use of other fuses, circuit breakers or materials is prohibited.

WARNING

To prevent electrical shock, disconnect instrument from mains before cleaning. Use a dry cloth or one slightly dampened with water to clean the external case parts. Do not attempt to clean internally.

CAUTION

The Mains wiring and connectors shall be compatible with the connector used in the premise electrical system. Failure to ensure adequate earth grounding by not using the correct components may cause product damage, and serious injury.

CAUTION

Before switching on this instrument, make sure the supply voltages are in the specified range.

1.8 Installation

Figure 1 shows the instrument interconnections.

CAUTION

The output connectors of the N4974A and the input connectors of the N4968A are type 1.85 mm. These connectors are not compatible with type 2.92 mm or SMA connectors. To prevent damage to the connectors, do not attempt to connect cables with non-compatible connectors.

CAUTION

The instruments have autoranging line voltage inputs. Be sure the supply voltage is within the specified range.

WARNING

If these products are not used as specified, the protection provided by the equipment could be impaired. These products must be used in a normal condition (in which all means for protections are intact) only.

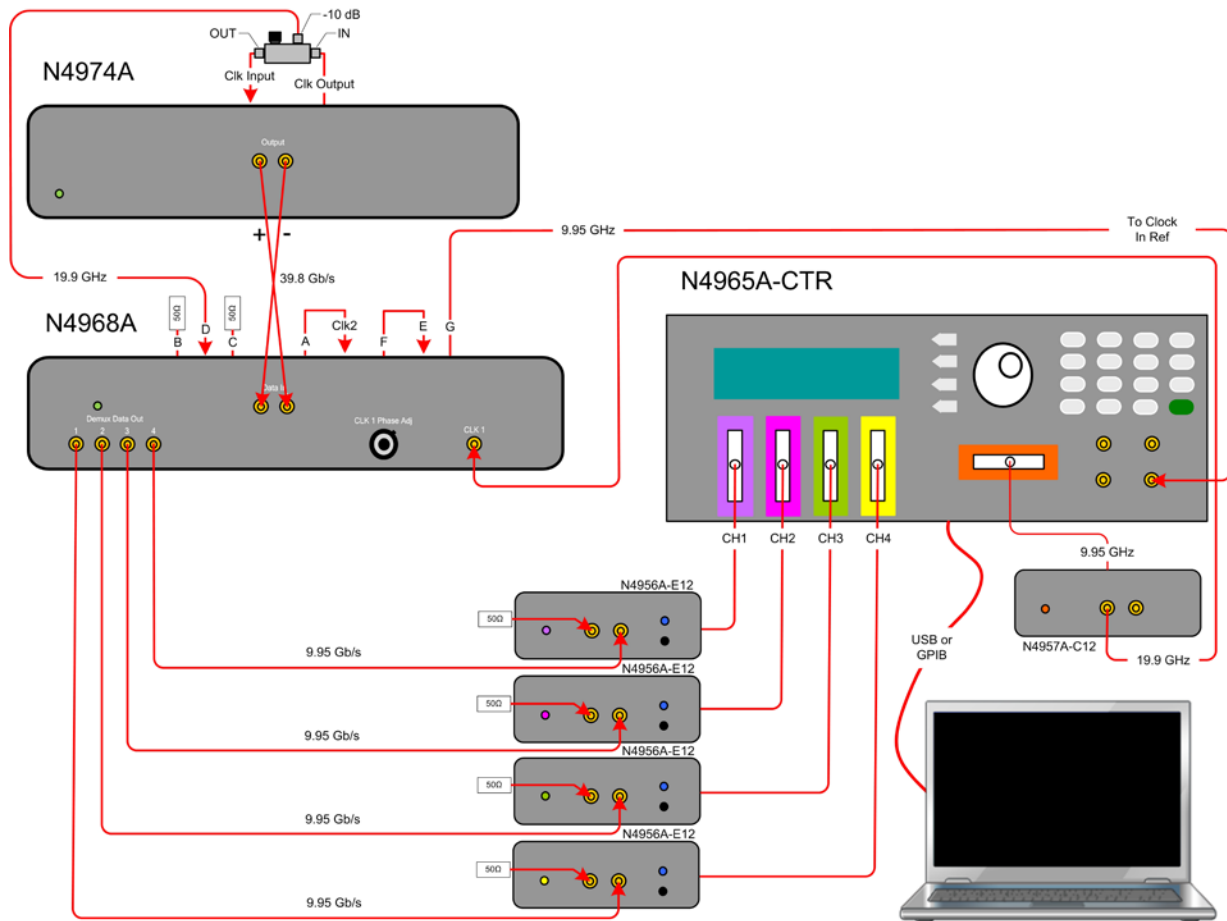


Figure 1. Hardware installation

NOTE

The setup shown here is for internal clock operation at 39.8 Gb/s. For additional information on internal and external clock operation (22 - 44 Gb/s), see section 2.

1. Remove the instruments from their boxes in an ESD-safe environment.
2. Install on a flat surface with unobstructed airflow to the back panels and side vents.
3. Place the N4974A on top of the N4968A and position them with the rear panels facing forward for easy access to rear panel connections.
4. In the N4967A accessory kit, locate the 10 dB directional coupler and the SMA male to male adapter.
5. Connect one end of the SMA male to male adapter to the IN port of the 10 dB directional coupler and the other end to the N4974A Clk output connector.
6. Connect the OUT port of the 10 dB directional coupler to the N4974A Clk input connector using a 10 inch blue SMA cable provided in the

- N4967A accessory kit.
7. Connect the -10 dB port of the 10 dB directional coupler to the N4968A D connector using a 5 inch blue 2.92 mm cable provided with a N4956A-E12.
 8. Terminate input B and output C on the rear panel of the N4968A with 50 Ω SMA terminations provided in the N4968A accessory kit.
 9. Loop E to F and A to Clk2 on the rear panel of the N4968A using the semi-rigid loopback cables provided in the N4968A accessory kit.
 10. On the rear panel of the N4974A, set the switches for a PRBS31 pattern (both switches in the “1” position).
 11. On the rear panel of the N4968A, set the switches as shown in Figure 2.



Switch Group	Switch#	Switch Position
1	1	1
	2	1
2	3	1
	4	1
3	5	0
	6	0
4	7	0
	8	0

Figure 2. Divider dip switches on N4968A

12. Position the N4974A and N4968A with their front panels facing forward.
13. Connect the N4974A outputs to the differential data inputs of the N4968A using the purple cables with 1.85 mm connectors provided in the N4967A accessory kit. Make sure the data polarities are matched. The N4974A has no polarity signs on the front panel.

NOTE

The N4974A outputs are “+” on the left and “-” on the right when viewed from the front panel. The N4968A inputs are “+” on the right and “-” on the left when viewed from the front panel.

14. Connect the 4x N4956A-E12 data receivers to aux channels 1 to 4 of the N4965A-CTR.
15. Connect the N4957A-C12 clock doubler to the reference channel of the N4965A-CTR.
16. Connect the demux data out outputs 1 through 4 of the N4968A to the data inputs of the N4956A-E12 using the 5 inch blue cables with 2.92 mm connectors provided with the N4956A-E12 accessory kits. Terminate the unused data/ inputs of each N4956A-E12 with 50 Ω SMA terminations provided in the N4956A-E12 accessory kit.
17. Connect the clock out of the N4957A-C12 to the CLK 1 input of the N4968A using a 10 inch blue SMA cable provided in the N4967A accessory kit.
18. Connect output G on the rear panel of the N4968A to the clock in ref of the N4965A-CTR using a 90 cm (36 inch) astro TC cable provided in the N4967A accessory kit.
19. Plug each instrument’s AC power cord into the instrument and then into a suitable wall socket (100-240 V AC, 50/60 Hz).
20. Tighten cables/connectors to 8 lbf-in (90 N-cm).
21. Connect the N4965A-CTR to a personal computer using a USB cable or a USB-GPIB adapter. The PC should have the Agilent Technologies N4980A multi-instrument BERT software installed.

NOTE

N4980A multi-instrument BERT software can be downloaded without charge from the Agilent Technologies Web site: www.agilent.com/find/N4980A. Follow the installation instructions provided on the web site. No additional drivers are required to interface with the instruments. If GPIB is used to control the system, any drivers required for the PC - GPIB adapter must be installed. This driver is provided by the GPIB adapter vendor.

Setting Up the N4967A



2 Operation Overview

2.1 Modular Design

Figure 3 shows how the N4967A instruments are configured in a typical test setup.

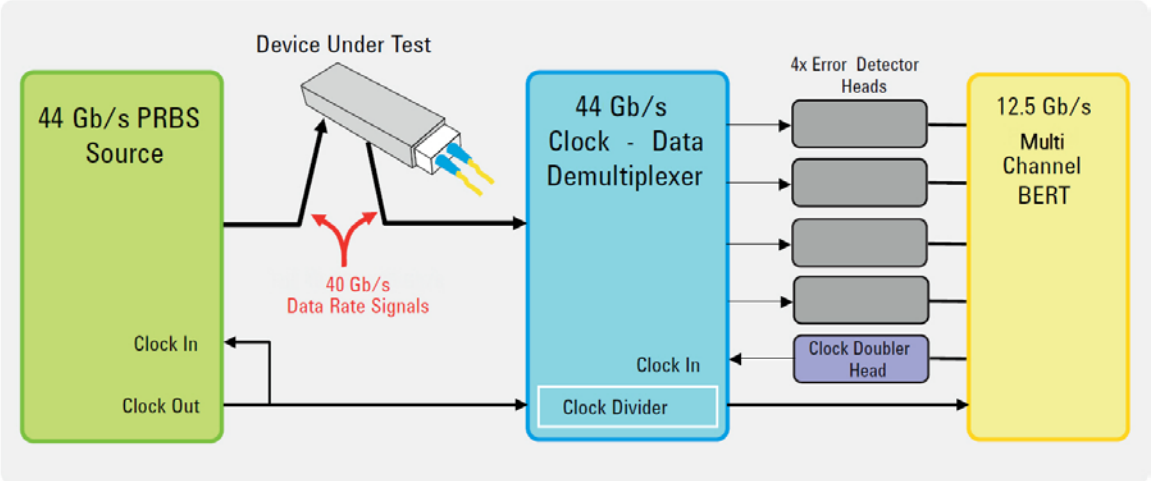


Figure 3. Typical test setup at 40 Gb/s using internal clock

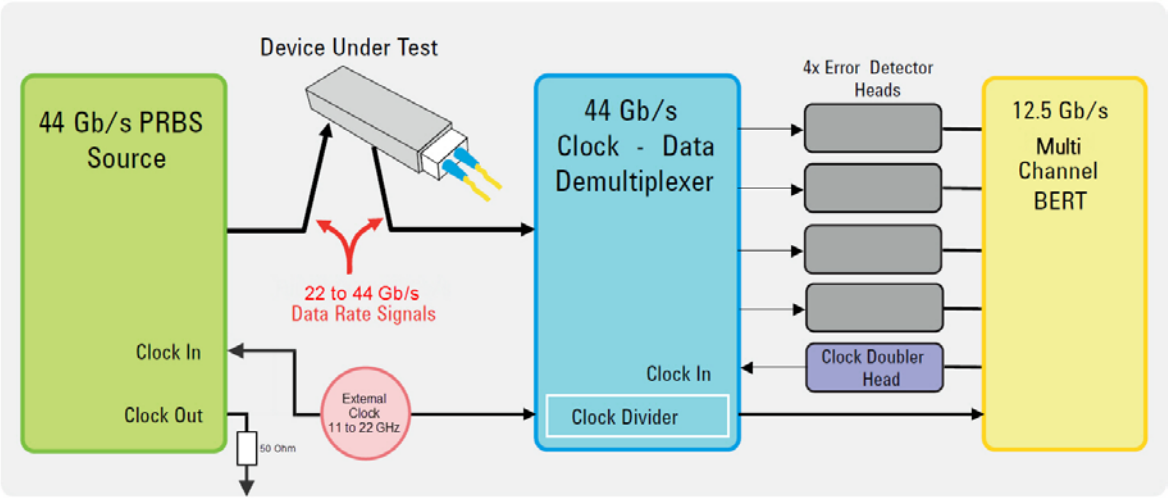


Figure 4. Typical test setup using external clock for 22 to 44 Gb/s operation

2.1.1 N4974A PRBS Generator 44 Gb/s

The N4974A produces the data patterns. This model operates over the frequency range of 22 to 44 Gb/s. The generator has a built in half-rate oscillator at 19.9 GHz for operation at 39.8 Gb/s ($2 \times 19.9 = 39.8$), as shown in Figure 3.

Alternatively the generator can be clocked from an external source, such as an Agilent N5183A with options 532 and 1EA, for operation at any rate between 22 and 44 Gb/s (half-rate clock required). For example, with a 22.0 GHz clock input the data output will be at $2 \times 22.0 = 44.0$ Gb/s. This setup is shown in Figure 4.

NOTE

See the N4974A and N4968A datasheets for clock input power requirements.

NOTE

When the data rate of the N4974A is changed, it may be necessary to adjust the phase re-timer. See the N4974A user guide for additional information.

Data outputs are differential, dc-coupled, and can also be used single-ended, terminating the unused output with 50 Ω . DC return paths are required at the outputs of the PRBS generator. This can be achieved by connecting directly to the DC coupled inputs of the device under test, or by using bias tees or 3 dB attenuators at the outputs of the generator.

CAUTION

To prevent damage to the DATA output stage, before switching on, ensure that the front panel DATA outputs are terminated to a 50 Ω load or equivalent circuit.

In an ESD-safe environment, carefully remove the N4974A from the packaging. Install on a flat surface with unobstructed air flow to the back panel. Make all RF connections between the N4974A and the DUT or test equipment BEFORE applying AC power by plugging the converter module into the N4974A. Also, remove AC power from the N4974A instrument before disconnecting any RF connections. Plug the AC power cord into the power converter module and a wall socket, then plug the converter module into the N4974A.

2.1.2 N4968A Clock and Data Demultiplexer 44 Gb/s

The N4968A is a versatile unit, containing both a 1:4 demultiplexer, clock phase shifter, and 4x programmable clock dividers. The demultiplexer requires a half-rate clock input. One of the programmable dividers is set to divide by 2 and provides a 10 GHz reference clock output for the N4965A-CTR multi-channel BERT controller. The N4968A has 4 data outputs so all 4x channels at 10 Gb/s can be measured for BER simultaneously.

2.1.3 N4965A-CTR Multi-Channel BERT Controller

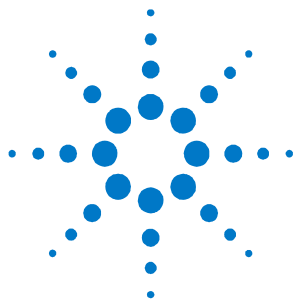
The N4965A-CTR is a modular system. The N4965A-CTR mainframe is used with 4x N4956A-E12 error detector remote heads to measure each N4968A 10 Gb/s data signal.

The N4957A-C12 is also used with the N4965A-CTR to enable programmable control of the phase shifter with the N4968A demultiplexer.

2.2 Control

N4965A-CTR configuration settings are all available through the local control panel interface, the remote GPIB (IEEE 488.2) interface, or the USB interface. Instrument status is conveyed on the front panel by the display.

The N4967A is supported by the N4980A multi-instrument BERT software, which provides a complete user control interface for performing multi-channel BER testing.



3 Operation

The following section provides detailed information regarding the use of the N4967A.

3.1 Connector Care

The N4967A features high-quality connectors for the front and rear panel input and output connections. Connector damage will degrade signal fidelity. Use high quality connectors on all ports. Always leave dust jackets on unused ports.

Refer to the N4960-90030 N495xA through N498xA Connector Care Reference Guide at www.agilent.com/find/N4967A.

CAUTION

The output connectors of the N4974A and the input connectors of the N4968A are type 1.85 mm. These connectors are not compatible with type 2.92 mm or SMA connectors. To prevent damage to the connectors, do not attempt to connect cables with non-compatible connectors.

Inspect the connectors for the following:

- Worn or damaged threads
- Scratches to mating surface
- Burrs and loose metal particles
- Ensure that female contacts are straight and aligned

Clean the connectors as described in the following procedure. Cleaning connectors with alcohol shall only be done with the instrument's power cord removed, and in a well-ventilated area. Allow all residual alcohol moisture to evaporate, and the fumes to dissipate prior to energizing the instrument.

1. Remove any loose particles using a low-pressure air source.
 2. Moisten a lint-free swab with isopropyl alcohol. Do not saturate the swab.
 3. Minimize the wicking of the alcohol into the connector structure.
 4. Clean the mating plane surfaces and threads.
 5. Allow alcohol to evaporate, and then use a low-pressure air source to blow surfaces clean.
 6. Make sure no particles or residue remains.
 7. Inspect connector for damage.
-

3.2 Aligning the N4967A

Two clock-data timing alignments need to be made before performing BER measurements. For example, at 40 Gb/s data rate, the 40 Gb/s clock-data timing at the N4968A input is adjusted first using the N4965A-CTR/N4957A-C12 delay parameter. The 10 Gb/s clock-data timing is then adjusted using the N4965A-CTR/N4956A-E12 delay parameter and the auto delay function to determine the best alignment for the 10 Gb/s signals.

3.2.1 Timing Alignment

The timing alignment procedure described below can be performed using the front panel of the N4965A-CTR multi-channel BERT controller or by using the N4980A multi-instrument BERT software running on a PC, connected via USB or GPIB to the N4965A-CTR multi-channel BERT controller.

The following procedure provides instructions for timing alignment using the N4980A multi-instrument BERT software.

NOTE

Auto phase adjustments are made for each 10 Gb/s channel.

1. Turn on the power on all N4967A instruments.
2. Start the N4980A multi-instrument BERT software on the PC.
3. When the Main Screen appears, click the **Discover** button. The discovered N4965A-CTR appears below its corresponding instrument image. If you have other instruments connected to the bus and their power is turned on, they will be discovered also.
4. Click the **Connect All** button to connect all listed instruments. A lightning bolt appears to the left of the instrument name.
5. In the main screen of the N4980A multi-instrument BERT software, right-click on the N4965A-CTR instrument name/address located below the image of the N4965A-CTR then select **Control** from the pop-up menu as shown in Figure 4. This accesses the N4965A-CTR control panel.

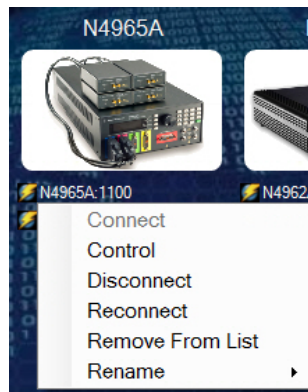


Figure 5. Accessing the N4965A-CTR control panel

6. In the N4965A-CTR control panel select the **N4957A-C12** tab. Refer to Figure 5.
7. Under **Input Clock**, ensure that the **Freq** is **10000 MHz**. Actual frequency is 9950 MHz. Refer to Figure 5.
8. Under **Output Clock**, ensure that the **Freq** is **20000 MHz**. Actual frequency is 19900 MHz. Refer to Figure 5.

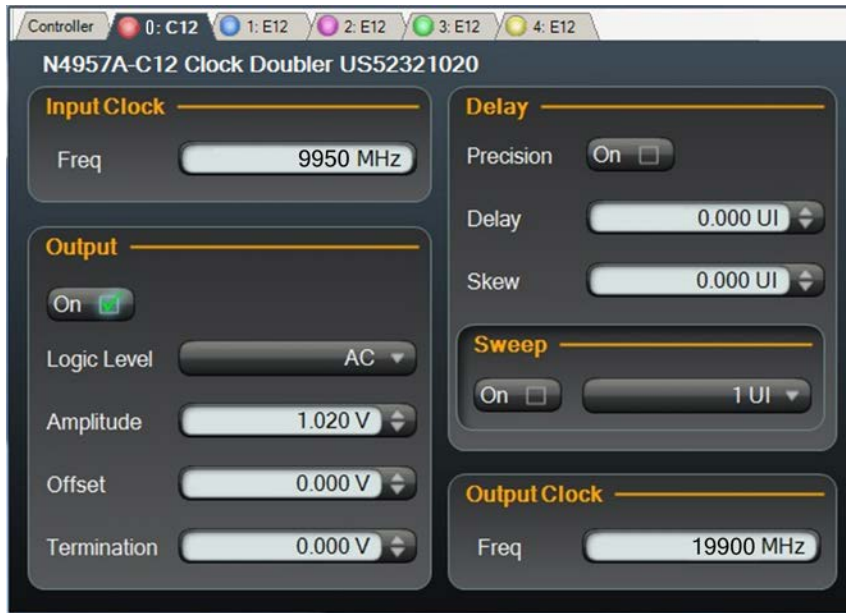


Figure 6. N4957A-C12 control panel

9. Under **Output**, click the **On** button to turn the output on (a green check appears in the button). Refer to Figure 5.
10. Select a **N4956A-E12** tab to display its control panel.
11. Under **Input**, click on the **Pattern** drop down list box and select the **PRBS 2³¹-1** pattern as shown in Figure 6.



Figure 7. Select the PRBS 2³¹-1 pattern

12. Right-click on the **Pattern** drop down list box and select **Apply To All** to set all error detectors to this pattern as shown in Figure 7.

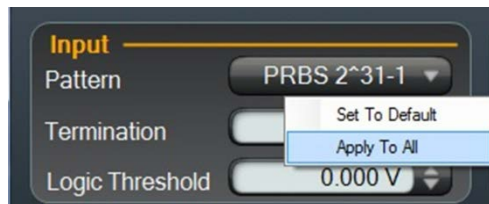


Figure 8. Apply pattern selection to all error detectors

13. Under **Alignment**, click on the **Auto** button. If the **Sync** light is on (green) and the **Error** light is off, proceed to the next step. If not, perform the following:
 - a. Select the **N4957A-C12** tab.
 - b. In the **Delay** numeric field, click the up arrow to increase or down arrow to decrease the delay by a few tenths of a UI.
 - c. Select the **N4956A-E12** tab corresponding to the error detector that has errors.
 - d. Under **Alignment**, click on the **Auto** button.
 - e. Repeat this procedure until the Error light is off.

NOTE

Each time the N4957A-C12 delay is changed, an auto alignment must be performed on all error detectors.

14. In turn, select a **N4956A-E12** tab to display its control panel and perform an auto alignment on each N4956A-E12 as described in the previous step.
15. Under the **Measurements** menu on the Main Screen, select **Multi-Channel BER** as shown in Figure 8.



Figure 9. Select Multi-channel BER

16. In the Multi-Channel BER screen, click the **Add** button four times to add four channels, one for each error detector.
17. Assign each error detector to a channel by clicking on the drop down list box next to **Det** in each channel and selecting the error detector from the list as shown in Figure 9. Ensure that you assign all four error detectors.



Figure 10. Adding error detectors to channels

- 18. Under **Meas Setup**, set the **Duration** to allow plenty of time to perform the following steps used to determine the optimal decision point in the eye.
- 19. Click on the play button to start the BER measurement.
- 20. Select the **N4957A-C12** tab.
- 21. Right-click in the **Delay** field, select **Step Size** then select **0.01 UI** to step in 0.01 UI steps as shown in Figure 10.

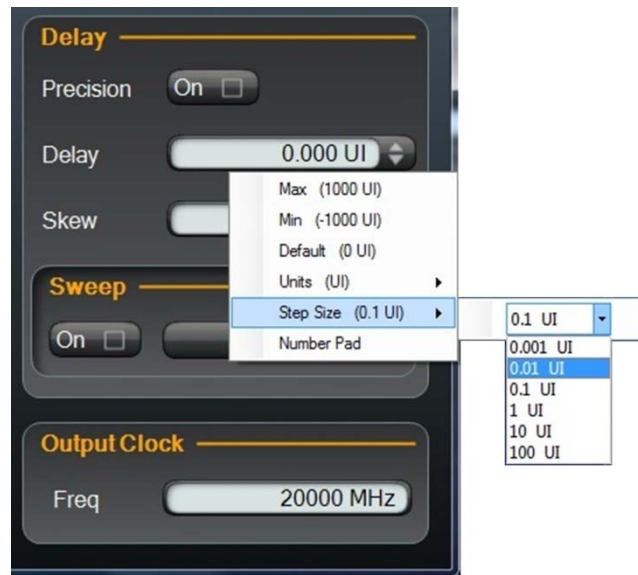


Figure 11. Setting delay step size

22. In the **Delay** numeric field in the **N4957A-C12** tab, increase the delay in 0.01 UI steps until the **Error** lights in the Multi-Channel BER screen begin to turn on and note the N4957A-C12 delay number. Refer to Figure 11.

NOTE

Alternately the 10 Gb/s output of the N4968A can be viewed on a scope, and a small shift in the dc level of the eye diagram will be observed at this point. This provides an alternative way of aligning the clock data, especially in situations when testing a DUT where error free signal fidelity may not be present.



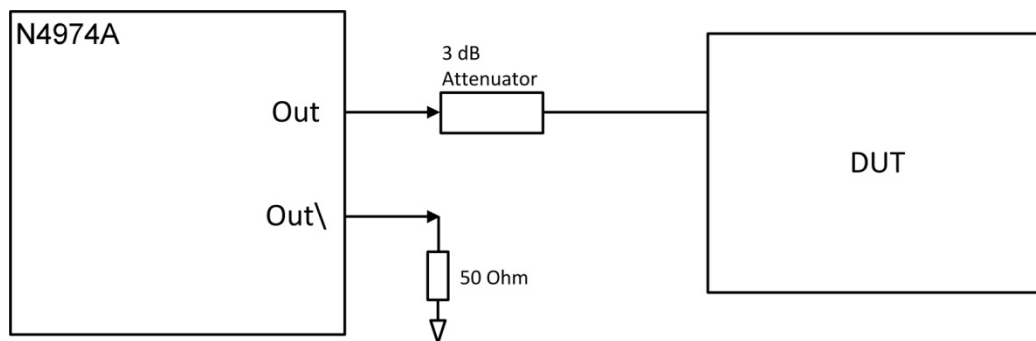
Figure 12. Increase delay until errors occur

23. In the **Delay** numeric field, decrease the delay in 0.01 UI steps until the Error lights turn off.
24. Continue decreasing the delay in 0.01 UI steps until the Error lights in the Multi-Channel BER screen begin to turn on again and note the N4957A-C12 delay number. Refer to Figure 12.

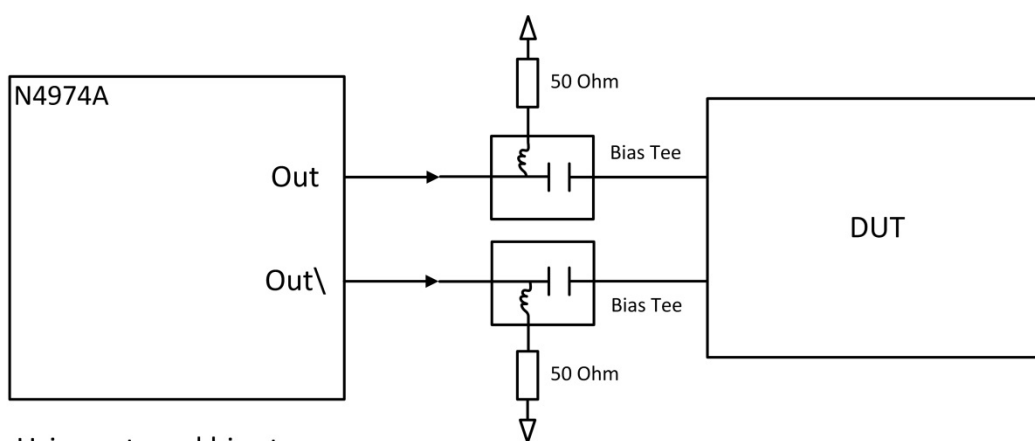


Figure 13. Decrease delay until errors occur

25. Adjust the N4957A-C12 delay to a position that corresponds to the middle of the two delay numbers noted above. The N4968A clock-data is now optimally aligned.
26. In the Multi-Channel BER screen, click on the stop button to stop the measurement.
27. Select the **N4956A-E12** tab in channel 1 to display its control panel.
28. Under **Alignment**, click on the **Auto** button.
29. Select the **N4956A-E12** tab in channel 2 to display its control panel.
30. Under **Alignment**, click on the **Auto** button.
31. Select the **N4956A-E12** tab in channel 3 to display its control panel.
32. Under **Alignment**, click on the **Auto** button.
33. Select the **N4956A-E12** tab in channel 4 to display its control panel.
34. Under **Alignment**, click on the **Auto** button.
35. After aligning all four error detectors, optimal clock-data alignment for each 10 Gb/s signal is now achieved.
36. In the Multi-Channel BER screen under **Meas Setup**, set the **Duration** to 10 seconds.
37. Click on the play button to start the BER measurement and verify that there are no errors.



Using a 3 dB attenuator



Using external bias tees

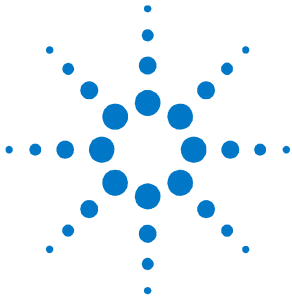
Figure 15. 50 Ω dc return to ground

NOTE

If the DUT is single-ended, then the unused N4974A output and N4968A input should be terminated in 50 Ω.

If the DUT output levels are not compatible with N4968A inputs, then dc-blocks should be used at the N4968A inputs.

The setup procedure is the same as before, except that zero BER may not be achieved, in which case either use the scope method to set the timing or run a series of short measurements on the N4965A-CTR/N4956A-E12 BERT as the N4957A-C12 phase delay is adjusted to determine the minimum BER points.



4 Applications

4.1 40 Gb/s Optical Receiver BER Setup

Figure 15 shows a setup for testing optical receivers. When testing optical receivers, it is often necessary to use an optical modulator with a laser as a data source. Modulator driver amplifiers increase the voltage of the PRBS Source output to allow driving Lithium Niobate MZ or Electro-Absorptive modulators.

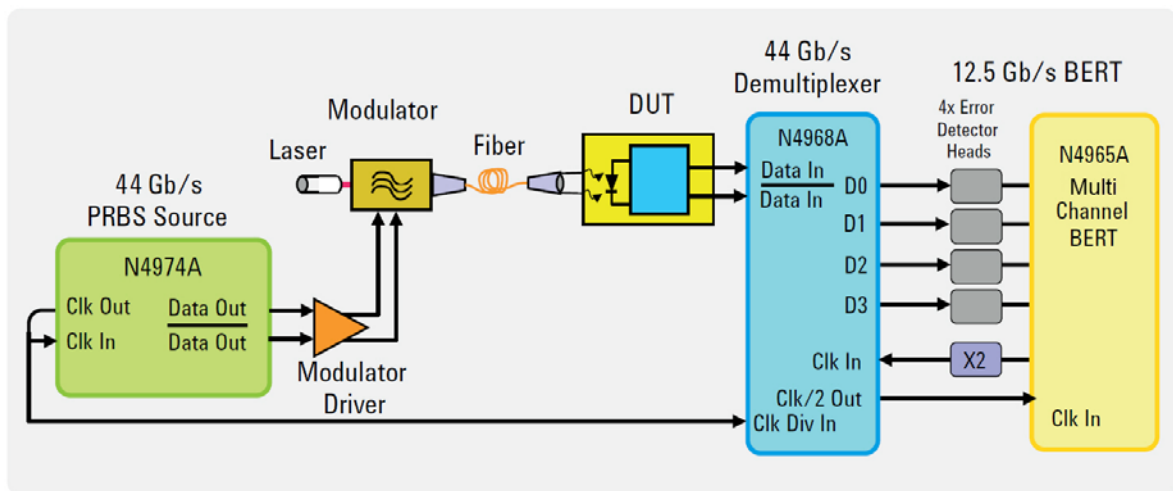
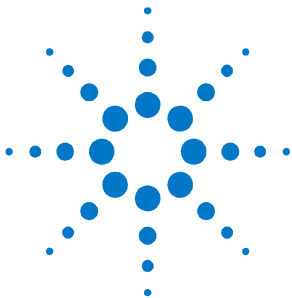


Figure 16. 40 Gb/s optical receiver BER test setup



5 System Performance Specifications

The following tables list specifications of the individual instruments relevant to application in the 40 Gb/s BERT system. For complete specifications relevant to other applications, refer to the individual product user guides.

5.1 N4974A-PRBS Source

Table 3. N4974A PRBS Source Specifications

Parameter	Specification
Data Output	
Data rate	22 to 44 Gb/s ¹ (option 001)
PRBS patterns	$2^7-1 : 1 + X^4 + X^7$ $2^{15}-1 : 1 + X^{14} + X^{15}$ $2^{31}-1 : 1 + X^{28} + X^{31}$
Output amplitude (single-ended)	> 500 mV p-p typical
Output level	High: 0 V nominal Low: -500 mV nominal
Jitter	500 fs rms typical ²
Rise/fall time (20% to 80%)	8 ps typical
Data crossover	55% typical
Data phase adjust range	30 ps nominal
External interface	Differential. DC coupled, 50 Ω nominal, 1.85 mm female connectors.
	<div style="background-color: #cccccc; padding: 2px; display: inline-block;">NOTE</div> Outputs are CML and must be externally DC terminated with 50 Ω to GND.

System Performance Specifications

Parameter	Specification
Clock input External half-rate clock input range External half-rate clock input power required External interface	11 to 22 GHz (option 001) +10 to +16 dBm Single-ended. AC coupled, 50 Ω nominal, 2.92 mm female connector.
Internal clock Internal half-rate clock frequency Output power External interface	Single frequency internal oscillator 19.90656 GHz (for 39.81312 Gb/s data rate) +16 dBm (4 V p-p) typical Single-ended. AC coupled, 50 Ω nominal, 2.92 mm female connector.
Clock trigger output Clock trigger (CLK/1) output power External interface	Nominally –16 dB less than Clock Input power Single-ended. AC coupled, 50 Ω nominal, 2.92 mm female connector. Terminate if not used.
Pattern trigger output³ Pulse width Repetition period Output amplitude External interface	64 * (1/Bit_rate) e.g. at 40 Gb/s pulse width = 1.6 ns 64 * (1/Bit_rate)*Pattern_length e.g. at 40 Gb/s, 2 ³¹ –1 pattern, period = 3.4 s 200 mV p-p typical Single-ended. DC coupled, 50 Ω nominal, SMA female connector
Power requirements	42 W external AC adapter, 100 to 240 V AC, 47 to 63 Hz

¹ With an external clock.

² At ≤ 40 Gb/s.

³ Pattern trigger specified at ≤ 40 Gb/s only. Remove termination from CLK/1 output when using the Pattern Trigger.

5.2 N4968A Clock and Data Demultiplexer 44 GB/s

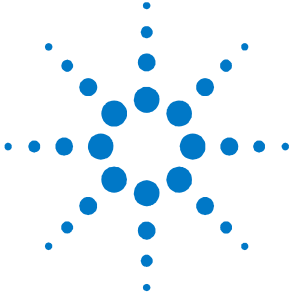
Table 4. N4968A clock and data demultiplexer specifications

Parameter	Specification
Data input	
Data rate	3.5 to 44 Gb/s
Data amplitude	150 to 1000 mV p-p single-ended Maximum DC voltage ± 0.5 V
Interface	Differential. DC coupled, 50 Ω nominal, 1.85 mm female connectors. Can be used single-ended if unused input is terminated with 50 Ω load.
Data output	
Data rate	0.875 to 11 Gb/s
Data amplitude	> 210 mV p-p typical
Interface	Single-ended outputs. AC coupled, 50 Ω nominal, 2.92 mm female connectors.
Clock input	
Type	Half-rate clock
Frequency	1.75 to 22 GHz
Clock amplitude	+2 to +10 dBm (0.8 to 2 V p-p)
Interface	Single-ended input. AC coupled, 50 Ω nominal, 2.92 mm female connector.
Divided clock outputs	
Division ratios	1, 2, 4, 8, 16, 32, and 64
Clock amplitude	> -5 dBm (355 mV p-p) typical
Interface	Differential outputs. AC coupled, 50 Ω nominal, SMA mm female connectors. Can be used single-ended if unused input is terminated with 50 Ω load.
Power requirements	42 W external AC adapter, 100 to 240 V AC, 47 to 63 Hz

5.3 N4965A-CTR with N4956A-E12 and N4957A-C12

Table 5. N4965A-CTR, N4956A-E12, and N4957A-C12 specifications

Parameter	Specification
Data rate	1.0 to 12.5 Gb/s (timing parameter determined by N4965A controller)
Data line coding	Non-return to zero (NRZ)
Data patterns	2^n-1 PRBS patterns (n = 7, 10, 15, 23, 31)
Data input sensitivity	< 0.1 V p-p single-ended
Data threshold adjustment	-1.0 to +1.0 V, 1mV steps
Data delay adjustment	-1000 to +1000 UI, 1 mUI steps (timing parameter determined by N4965A controller)
Autoalign	Set optimum 0/1 threshold and data delay Search step size range
Threshold	5 to 20 mV in 1 mV steps
Delay	5 to 20 mUI in 1 mUI steps
BER measurement period	0 to 99,999.999 seconds in 1 msec steps
BER results	Bit error rate, error count, bit count, measurement seconds
Phase margin	> 0.6 UI typical @ 10 Gb/s, $2^{31}-1$ PRBS
Data connectors	2.92 mm female
Remote control interface	IEEE-488 (GPIB) or USB2.0
Power requirements	100 to 240 VAC, 50 to 60 Hz, 170 W maximum



6 Returning the N4967A to Agilent Technologies

If the N4967A fails system verification and you cannot correct the problem, return it to Agilent Technologies for repair following the steps shown below.

1. Record all symptoms.
 2. Contact Agilent Technologies at <http://www.agilent.com/find/assist>.
 3. Use the original packing material or comparable packing material to ship the instrument to Agilent Technologies.
-

© Copyright Agilent Technologies 2012

Sixth edition, April 2014

Printed in Germany



N4967-91021

