



PresencePLUS[®] P4 OMNI/OMNI 1.3/OMNI Color User's Manual



Contents

Chapter 1: Product Support and Maintenance.....	7
1.1 Product Support.....	7
1.2 Maintenance.....	8
Chapter 2: System Description	9
2.1 P4 Vision Sensors.....	9
2.1.1 Typical P4 Vision Application.....	9
2.1.2 PresencePLUS® P4 Components.....	10
2.1.3 P4 Cable Connections.....	11
2.2 Software Overview.....	12
2.2.1 Main Menu Toolbar	12
2.2.2 Image Window.....	13
2.2.3 Navigation/Results Window.....	14
2.2.4 Configuration Window.....	16
2.2.5 Status Window.....	17
Chapter 3: Getting Started.....	19
3.1 Installing the PresencePLUS Software.....	19
3.1.1 Installing the Software.....	19
3.1.2 Starting Up the Software.....	19
3.2 Typical Setup and Startup Sequence.....	23
3.3 Startup and Troubleshooting.....	23
3.3.1 General Troubleshooting.....	24
3.4 Setting Up Hardware Parameters.....	25
3.5 Building an Inspection.....	25
Chapter 4: Setup.....	27
4.1 Setup Screen.....	27
4.2 Capturing a Reference Image.....	27
4.3 Focus Tab.....	27
4.3.1 Reference Image Source.....	28
4.3.2 Focus Value.....	29
4.3.3 Auto Exposure.....	29
4.4 Trigger Tab.....	30
4.4.1 Trigger Settings.....	31
4.4.2 Resolution.....	31
4.5 Advanced Tab.....	32
4.6 Considerations When Setting up Color Inspections.....	33
4.6.1 Primary Colors.....	33
4.6.2 Setting up a Color Inspection.....	34
Chapter 5: Tools Screen	39
5.1 Overview.....	39
5.2 Typical Build/Modify Procedure.....	39
5.2.1 Choosing a Tool.....	39
5.2.2 Adding a Tool.....	40
5.2.3 Adding a Test Tool.....	40
5.2.4 Renaming Tools.....	40
5.2.5 Removing a Tool.....	40
5.3 Quick Teach.....	40
5.4 Load Tab.....	41
5.4.1 Flexible Inspection Loading.....	42
5.4.2 Inspection Storage Capacity.....	43
5.4.3 Opening an Inspection from the Sensor or a Library.....	43

Chapter 6: System Setup Dialog	45
6.1 Sensor Select Tab.....	45
6.1.1 Change Sensor IP Address.....	46
6.1.2 PC (GUI) to Sensor Connection Setup.....	47
6.1.3 IP Address History.....	48
6.2 Communication Tab.....	49
6.2.1 Communication Setup.....	50
6.2.2 Remote Command Channel Configuration	54
6.2.3 PresencePLUS/Kawasaki Vision Guidance and Inspection.....	61
6.2.4 Using Custom_ASCII to Communicate with an External Device Over Ethernet.....	75
6.3 Input/Output Tab.....	76
6.3.1 P4 Input/Output Tab.....	78
6.4 Strobe Tab.....	80
6.4.1 Strobe Width.....	81
6.4.2 Level.....	82
6.5 Units Tab.....	82
6.5.1 Select Conversion Units.....	83
6.5.2 Configure with Known Distance.....	84
6.6 Reset Tab.....	86
6.7 Start-Up Inspection Tab.....	87
6.8 NTSC Tab.....	88
6.9 Language Tab.....	89
6.10 Tools Configuration.....	90
6.10.1 Standard Mode.....	91
6.10.2 Enhanced Mode.....	91
6.10.3 Custom Mode.....	91
6.10.4 Tool Licensing.....	92
Chapter 7: PresencePLUS Software Tools	93
7.1 ROI Types.....	93
7.1.1 Linear ROI.....	93
7.1.2 Area ROI.....	93
7.1.3 Search ROI.....	93
7.2 Location Tools.....	94
7.2.1 Locate Tool.....	94
7.2.2 Geometric Find Tool.....	101
7.2.3 Pattern Find Tool.....	108
7.2.4 Blob Find Tool.....	111
7.3 Vision Gray Scale Tools.....	122
7.3.1 Average Gray Scale Tool.....	122
7.3.2 Blob Detect Tool.....	125
7.3.3 Circle Detect Tool.....	137
7.3.4 Edge Tool.....	142
7.3.5 Geometric Count Tool	149
7.3.6 Line Detect Tool.....	155
7.3.7 Object Tool.....	158
7.3.8 Pattern Count Tool.....	167
7.4 Vision Color Tools.....	170
7.4.1 Average Color Tool.....	170
7.4.2 Color Blob Tool.....	174
7.4.3 Color Match Tool.....	187
7.5 Premium Vision Tools.....	190
7.5.1 Barcode Tool.....	190
7.5.2 Barcode Tool Advanced Tab.....	193
7.5.3 Barcodes Read by Banner BCR.....	196
7.5.4 Bead Tool.....	200
7.5.5 Optical Character Recognition (OCR) Tool.....	206
7.5.6 Trainer.....	208
7.5.7 Advanced Tab.....	223
7.5.8 Optical Character Verification (OCV) Tool.....	224
7.5.9 Trainer.....	227
7.5.10 Advanced Tab.....	242
7.5.11 OCV Tool and the Remote Command Channel.....	243
7.6 Analysis Tools.....	244

7.6.1 Communication Tool.....	244
7.6.2 Coordinate Tool.....	259
7.6.3 Math Tool.....	263
7.6.4 Measure Tool.....	268
7.6.5 String Tool.....	290
7.6.6 Test Tool.....	297
Chapter 8: Communication Tool Setup.....	317
8.1 Ethernet Connection.....	317
8.2 Serial Connection.....	318
8.3 Overview of Testing the Communication Tool.....	319
8.4 Detailed Steps for Testing the Communication Tool.....	319
8.4.1 Testing Ethernet Communications.....	319
8.4.2 Testing Serial Communications.....	320
8.5 Troubleshooting Ethernet Connections.....	320
8.6 Troubleshooting Serial Connections.....	321
8.7 Remote Command Channel Configuration	321
8.7.1 Remote Command Set	321
8.7.2 RCC Return Values.....	324
8.7.3 Frame Tag Numbers	325
8.7.4 Command Processing	325
8.7.5 RCC Log	326
8.7.6 Frame and Field Delimiters.....	326
Chapter 9: Teach.....	329
9.1 Quick Teach.....	329
9.2 Teach.....	329
9.3 Teach Screen.....	329
9.3.1 Teaching an Inspection.....	330
9.4 Remote Teach.....	332
9.4.1 Understanding Remote Teach.....	332
9.4.2 Remotely Teaching a Tool.....	332
9.4.3 Timing Sequence.....	332
9.4.4 Remote Teach Results.....	333
Chapter 10: Run Screen.....	335
10.1 Selected Inspection.....	336
10.2 Display.....	336
10.3 Capture Control.....	336
10.4 Results.....	337
10.5 Inputs.....	337
10.6 Outputs.....	337
10.7 Product Select.....	338
10.8 System.....	338
10.9 Start/Stop.....	338
10.10 Select Tab.....	338
10.11 Log Tab.....	339
10.12 Run Results.....	341
10.13 Run Player/Recorder.....	343
10.13.1 Record.....	345
10.13.2 Playback.....	347
Chapter 11: Product Change.....	349
11.1 Product Change Specifications.....	349
11.2 Product Select Input Specifications.....	350
Chapter 12: P4 Product Change and Product Select Timing.....	351
12.1 One Pulse Set Overview.....	351
12.1.1 Product Select in One-Pulse Configuration.....	352
12.2 Three Pulse Set Overview.....	352
12.2.1 Product Select in Three-Pulse Configuration.....	352
Chapter 13: Saving Inspections.....	355
13.1 Saving Inspections to a Vision Sensor.....	356

13.2 Saving Inspections to a PC or Network Drive.....	357
Chapter 14: Backing Up and Restoring Vision Sensor Data.....	359
14.1 Backing up Vision Sensor Data.....	359
14.2 Restoring Vision Sensor Data.....	363
Chapter 15: Dimensions and Specifications.....	367
15.1 Sensor Dimensions.....	367
15.1.1 Right-Angle Sensor Dimensions.....	367
15.1.2 Right-Angle Sensor Mounting Bracket Dimensions.....	367
15.1.3 In-Line Sensor Dimensions.....	368
15.1.4 In-Line Sensor Mounting Bracket Dimensions.....	368
15.2 Sensor Specifications.....	369
15.3 Monitor Specifications - 9" CRT.....	370
15.4 Monitor Specifications - Flat Panel 8" LCD Color.....	371
15.5 Ethernet Communication Specifications.....	372
15.6 Serial Port Communication Specifications.....	373
.....	375

Product Support and Maintenance Chapter 1

This section provides general Banner resources and specific documentation for installers and operators of this *PresencePLUS* Vision Sensor.



Attention: Not to be Used for Personal Protection.

Never use these products as sensing devices for personnel protection. Doing so could lead to serious injury or death.

These sensors do NOT include the self-checking redundant circuitry necessary to allow their use in personnel safety applications. A sensor failure or malfunction can cause either an energized or de-energized sensor output condition. Consult your current Banner Safety Products catalog for safety products which meet OSHA, ANSI, and IEC standards for personnel protection.

1.1 Product Support

Banner provides the following resources for quickly setting up and operating the sensor.

Documentation

Online Help

The *PresencePLUS* online help is available from the from the Help menu item within the *PresencePLUS* software. You can also get targeted help while on any system tab or dialog by pressing the <F1> key.

PDF Documentation

The *PresencePLUS* Sensor documentation is available in a convenient printable format (PDF) on the installation CD or on the [Banner Web site](#)

Banner Website

The most current *PresencePLUS* information, documentation, and software updates are available at the following Banner website page:

www.bannerengineering.com

Warranty Service

The *PresencePLUS* Vision Sensor is designed for reliability. Do not open the housing; it contains no field-replaceable components. If repair is necessary, do not attempt to repair the sensor yourself; return the unit to the factory. Should it become necessary to return a sensor to the factory, please do the following:

1. Contact the Banner Factory Application Engineering group at the address or numbers listed below. They will attempt to trouble shoot the system from your description of the problem. If they conclude that a component is defective, they will issue an RMA (Return Merchandise Authorization) number for your paperwork and give you the proper shipping address.
2. Pack the sensor carefully. Damage which occurs during return shipping is not covered by warranty.

Factory Support

Call, e-mail, fax, or write your local Banner representative or a Banner Applications Engineer for support. Applications Engineers are available from 8:00 A.M. to 5:00 P.M. Central Time, Monday through Friday, excluding holidays.

Phone	Local: 763.544.3164 Toll Free: 1.888.3.SENSOR (1.888.373.6767)
Fax	763.544.3213
E-mail	sensors@bannerengineering.com
Address	Banner Engineering Corp. 9714 10th Avenue North, Minneapolis, MN 55441 USA

To help Banner better assist you, be ready to provide the following information:

- PresencePLUS software version (to find version number, click Help in the Main Menu toolbar and choose About)
- Operating system of your PC
- Sensor Model Number and Date Code. Model Number is on top of Sensor, Date Code is either on the bottom or the side
- Exact wording of any messages that appeared on your screen
- A description of what you were doing and what happened
- A description of how you tried to solve the problem

See [Maintenance](#) on page 8

1.2 Maintenance

Maintenance tasks include keeping the hardware free of dust and dirt and possibly updating the PresencePLUS software as new versions become available.

Cleaning the Sensor

Regularly remove any dust or dirt from the Sensor using a soft cloth. If needed, slightly dampen the cloth with a weak solution of neutral detergent. Avoid getting dirt on the imager (the area behind the lens). If the imager is dirty, use anti-static compressed air to blow off the dust.

Cleaning the Lens

Regularly remove dust, dirt, or fingerprints from the lens. Use anti-static compressed air to blow off dust. If necessary, use a lens cloth and lens cleaner or window cleaner to wipe off remaining debris.

Do not use any other chemicals for cleaning.

Updating the PresencePLUS Software

The current version of PresencePLUS software is available for download from the Banner website. See [BannerWebsite](#) for the software downloads link.

The *PresencePLUS* ProII and P4 sensor families are easy-to-use camera systems with advanced visual inspection capability. With minimal knowledge of vision systems, a user can quickly set up a *PresencePLUS* ProII or P4 and run an inspection that tests products accurately, rejecting bad products on a production line.

Inspections are set up using a personal computer (PC). A digital camera inside the Vision sensor captures images, and the sensor software analyzes the images using one or more Vision tools to pass or fail the product. The PC is not required for running inspections after the inspection files have been stored in the sensor's memory.

Inspection setup involves focusing the camera and selecting the appropriate Location, Vision, and Analysis tools. The full range of inspection tolerances can be established either automatically or manually. The automatic Teach function eliminates the iterative process of determining correct tolerances.

The *PresencePLUS* ProII and P4 Sensor families accommodate both translational and rotational variation. Parts moving down a production line or web need not be oriented in exactly the same way.

The Sensor is easy to operate, with both basic and advanced options. New users can follow the guided Setup sequence. Advanced users can override automatic settings and create highly customized inspections.

2.1 P4 Vision Sensors

2.1.1 Typical P4 Vision Application

A typical *PresencePLUS* P4 application is shown below.

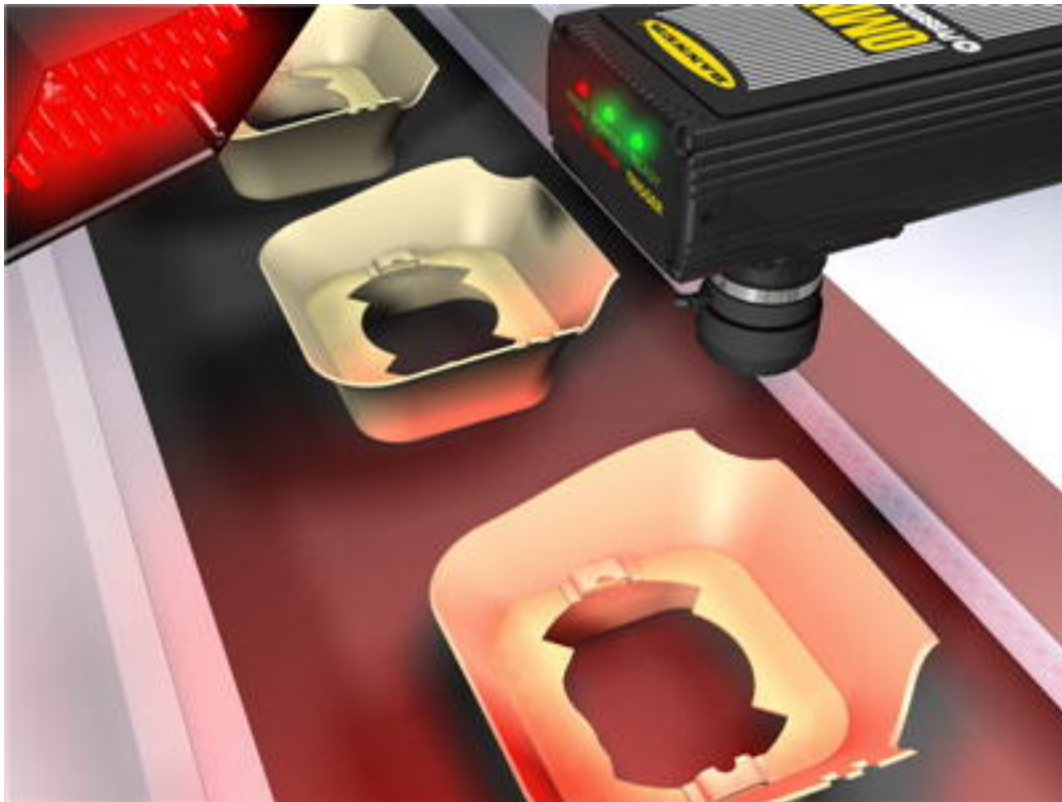

In the application shown above, as each plastic formed part comes past the Vision sensor, an inspection is performed. If the part is not shaped correctly as shown here, the inspection fails.

2.1.2 PresencePLUS® P4 Components

The *PresencePLUS* P4 system consists of the Sensor and a PC with *PresencePLUS* software and the appropriate connections. The Sensor requires lighting and a trigger device, and an optional video monitor can be connected.

 **Note:** The trigger device can be any 10-30V dc photoelectric sensor (PNP or NPN) or a device with a similar output.

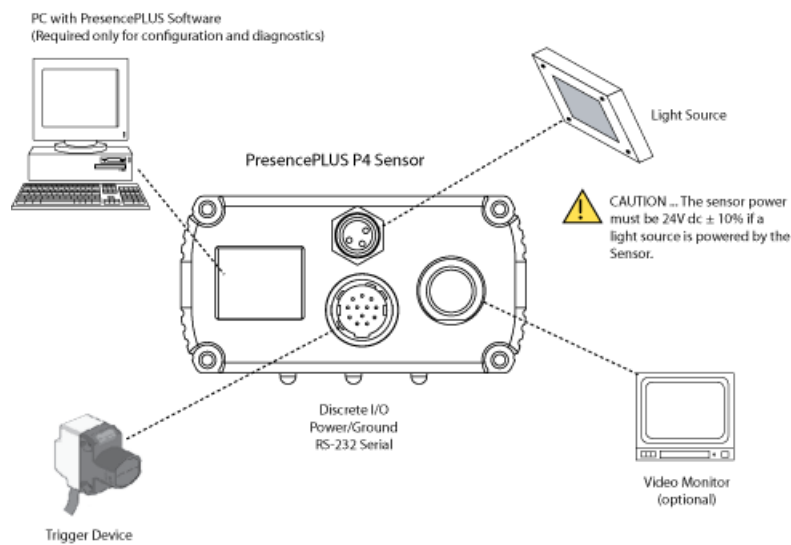

2.1.3 P4 Cable Connections

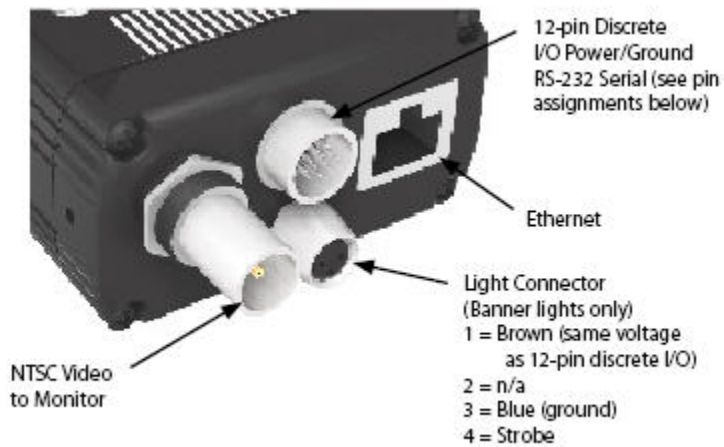

Note: The sensor power must be 24V dc \pm 10% if a light source is powered by the sensor.

Crossover Ethernet Cable (to PC Ethernet Port)*	Monitor Cable (to Video Monitor, optional)
STPX07 — 2.1 m (7')	BNC06 — 2 m (6')
STPX25 — 7.6 m (25')	BNC15 — 5 m (15')
or	BNC30 — 9 m (30')
Standard Ethernet Cable (to PC via Network Hub or Switch)	Serial Cable (to PC serial Port)*
STP07 — 2.1 m (7')	DB9P06 — 2 m (6')
STP25 — 7.6 m (25')	DB9P15 — 5 m (15')
	DB9P30 — 9 m (30')

*The Sensor can be connected to the PC via a serial cable or an Ethernet network; Ethernet provides faster communication.

Pin #	Wire Color	Description	Direction
1	Yellow	RS-232 TX**	Output
2	Gray	Remote Teach	Input
3	Orange	Product Change	Input
4	Pink	External Trigger	Input
5	Black	Discrete I/O #1	In/Out
6	Red	Discrete I/O #2	In/Out
7	White	Discrete I/O #3	In/Out
8	Light Blue	Discrete I/O #4	In/Out

Pin #	Wire Color	Description	Direction
9	Violet	RS-232 RX**	Input
10	Green	RS-232 Signal Ground**	Output
11	Blue	Common (Signal Ground)	Input
12	Brown	10-30V dc	Input

** These three wires make up the RS-232 serial connection.

 **Note:** All unused inputs and outputs should be connected to ground if configured as PNP, and connected to +24V dc if configured as NPN. Serial input pins should be connected to ground.

2.2 Software Overview

The *PresencePLUS* application window is shown below.



2.2.1 Main Menu Toolbar

Use the Main Menu toolbar to navigate between the Sensor options. Proceeding from left to right, the buttons in the Main Menu toolbar step through the process of creating and controlling an inspection. Each button is explained in the illustration below and in the table that follows.

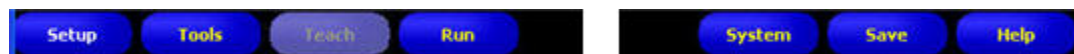

The following table describes the screen associated with each button in the Main Menu.



Inspection-Specific Screens	
Setup	Set up the camera, lens, trigger, and lighting to acquire images. Create a reference image to be used later.
Tools	Add tools to an inspection. Build the inspection from scratch, or load tools from a previous inspection file saved on the controller or a PC.
Teach	Teach the Sensor good products. This screen automatically configures the parameters chosen in the Tools screen.
Run	Choose which inspection file the Sensor will run, and view the results of the inspection
System-Wide Screens	
System	Set up the discrete inputs and outputs and communication configuration. This screen also has the Sensor diagnostic tools.
Save	Name the current inspection files and save them to the controller or a PC for future use.
Help	Call the Help window or the About window.

2.2.2 Image Window

The Image window, on the left side of the screen, displays images acquired from the camera or the reference image that is set for the current inspection. The toolbar buttons in the Image window are explained below.



 **Note:** The reference image is used as a template for developing an inspection; it establishes the initial values for the Vision tools. The reference image also is used by Quick Teach.

Icon	Description
	Zoom -- toggles zoom control. When enabled, click on the image window to zoom in and right-click to zoom out. This button is active when an image is displayed in the Image window.
	Expand Image -- toggles the size of the Image window between maximum and minimum.
	Selected ROI / ALL ROIs -- toggles between the currently S elected Region of Interest (ROI) and A ll ROIs.

2.2.3 Navigation/Results Window

The Navigation/Results window, at the bottom of the screen, displays tool navigation buttons or inspection results files.

Navigation Buttons

Clicking on the Tools button in the Main Menu toolbar brings up the tool navigation buttons in the Navigation/Results window. When setting up or using tools, click on any tool navigation button to get the corresponding tab in the Configuration window.



LOCATE_1 (or BLOB_1)	Tool name
A	Absolute
R	Relative
Locate (or Blob)	Tool type

Absolute and Relative Tools





An absolute tool's Region of Interest (ROI) does not move in the image window. A relative tool shifts the ROI from the previous tool, relative to the position of the part.

The Location tools (for example, Locate) track parts in the Image window, and the Vision tools that follow (for example, Average Gray Scale and Blob Detect) are relative. A Vision tool that precedes all Location tools will be absolute. Rules governing whether a tool is absolute or relative are as follows:

- The first Location tool is always absolute.
- All tools following a Location tool are relative to that tool unless they are made absolute themselves, in which case the chain is broken, and a new chain is started.
- For a Vision tool to be absolute, it must be placed before any Location tools.

Navigation/Results Toolbar Buttons

Using the Navigation/Results toolbar buttons, the Navigation/Results window size can be set, and tools can be deleted.

Icon	Description
	Expand Results -- toggles the size of the Navigation/Results window between maximum and minimum.
	Delete Selected Tool -- deletes the selected tool from the current inspection.
	Delete Selected Tools -- deletes the selected tool and all the tools to the right of the selected tool.
	Copy Selected Tool -- clones the selected tool.

Expand Button

Clicking on the Expand button () toggles the size of the Navigation/Results window to accommodate an expanded list of inspection results files, as shown below.

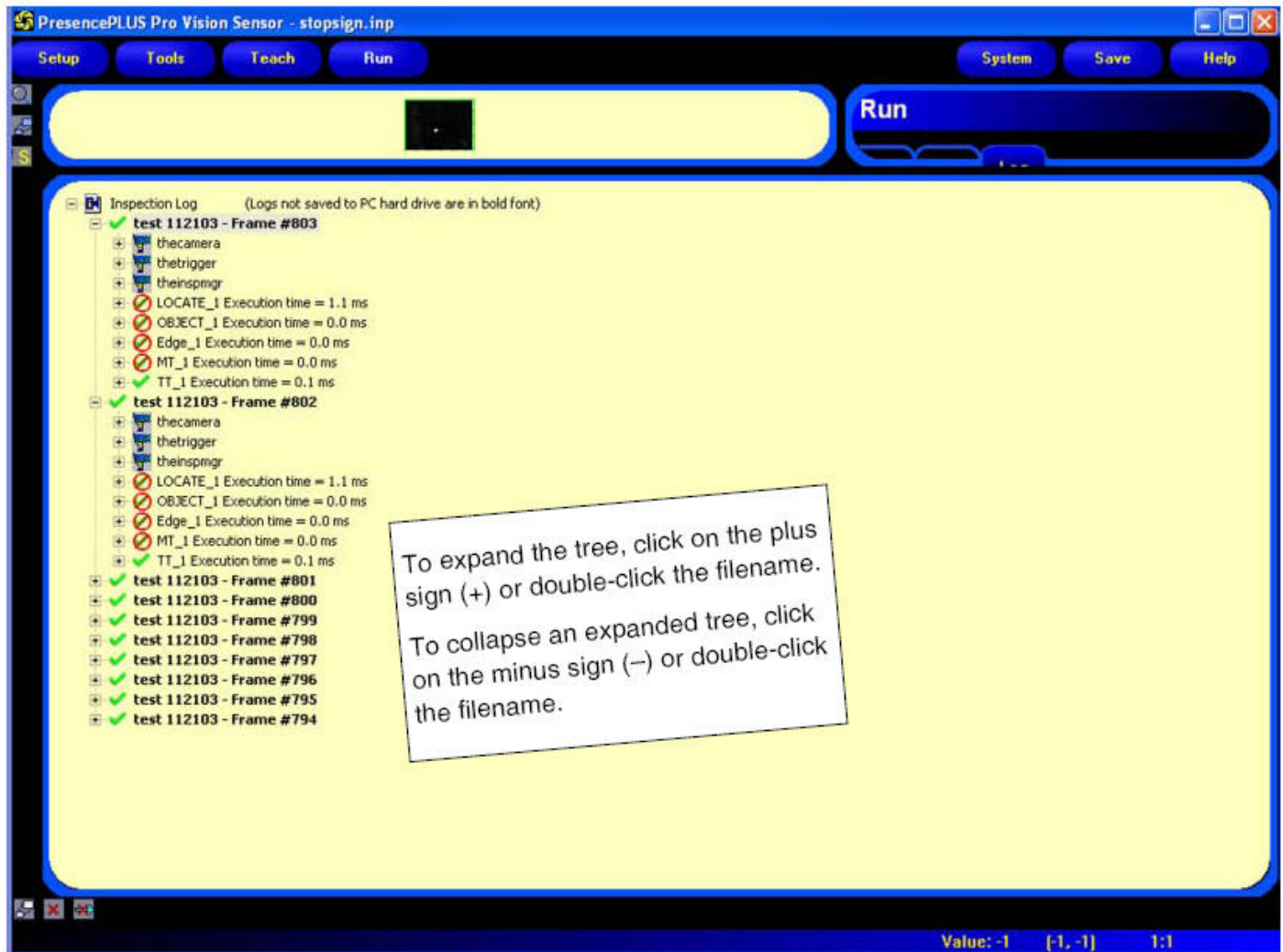

2.2.4 Configuration Window

The Configuration window, on the right side of the screen, displays the currently selected options with multiple tabs. Clicking the Setup, Tools, Teach, Run, System, Save, or Help buttons on the Main Menu toolbar changes the contents of the Configuration window accordingly.

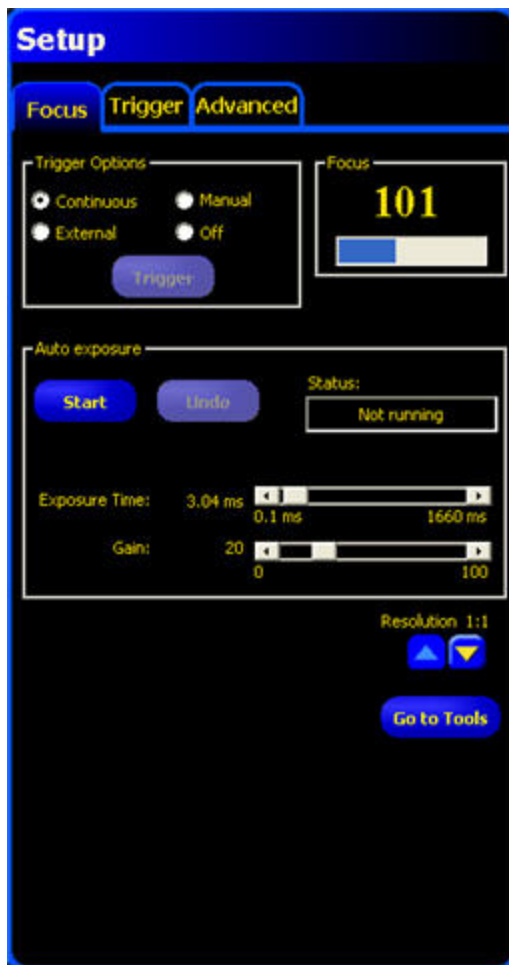

2.2.5 Status Window

The Status window, shown below, provides the following Sensor feedback.

Connection: Sensor 192.168.0.1 Zoom: 0.500 Value: 5 [950, 958] Res: 1:1

The following table provides descriptions of each region in the Status window:

Region	Description
Connection: Sensor 192.168.0.1	Connection info -- current sensor to which the PC is connected.
■■■■■■■■	Image update completion -- progress bar shows relative image update completion when an image is being transferred from the camera to the PC (this flickers, and is next to Connection: Sensor 192.168.0.1).
Zoom: 0.500	Current zoom value - works with the Zoom icon (magnifying glass).
Value: 8	Current grayscale value -- the 0-255 gray scale value of the pixel under the cursor.

Region	Description
(876, 604)	Cursor position -- displays the x, y coordinates of the pixel under the cursor relative to the upper-left corner (origin, which is 0,0) of the field of view. Note that you must have the mouse pointer hovering over the image to get this information, otherwise, it displays (-1,-1).
Res: 1:1	Current image display resolution -- displays the user-specified value, which can be from 1:1 to 64:1. Note that this does not affect how the sensor operates; it only affects sensor-to-GUI image communication speed, and is more useful when using Serial communication.

This section begins with some Vision basics, then provides a brief overview of how to install the software, and the general steps to creating an inspection.

3.1 Installing the *PresencePLUS* Software

The *PresencePLUS* software CD includes the sensor software and this documentation.

3.1.1 *Installing the Software*

To install the *PresencePLUS* software:

1. Close all active programs.
2. Make sure that no previous installations of *PresencePLUS* are installed.
3. Insert the *PresencePLUS* CD into the CD ROM drive of the personal computer. If you have auto-start enabled, the CD should automatically start. If it doesn't start --
 - a. Double-click on the **My Computer** icon on the desktop.
 - b. Double-click on the **CD Drive** in the list that appears.
 - c. Double-click on the **PresencePLUS** autorun file.
4. When the Install screen appears, click *PresencePLUS* PC Software.
5. Follow the instructions on the screen.
6. When the installation completes, reboot the PC.

3.1.2 *Starting Up the Software*

1. Power up the PC.
2. Install the software if it has not been installed. The installation screen of the *PresencePLUS* Pro software CD is shown below.



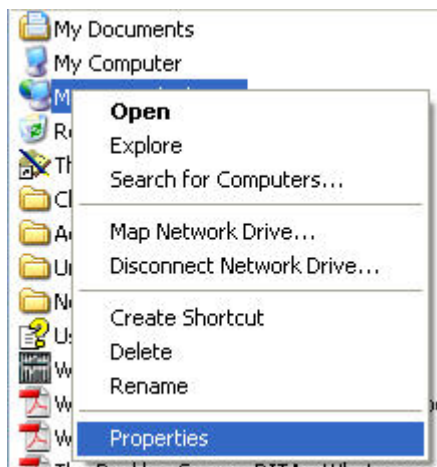

 **Note:** The following instructions assume you are installing the software on Windows XP.

3. If using an Ethernet communication cable, configure the IP address as follows:
 - a. Open **Network Properties** on the PC (right-click on the **Network Neighborhood** icon).

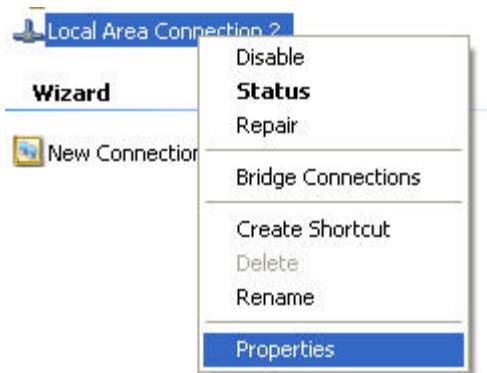

- b. On the Local Area Connection, right-click on **Properties**.



-  **Note:** The PC in the example above has a second network card which is used to connect to the camera so it is using **Local Area Connection 2**.

- c. In the dialog, click on **Internet Protocol (TCP/IP)** and click the **Properties** button.

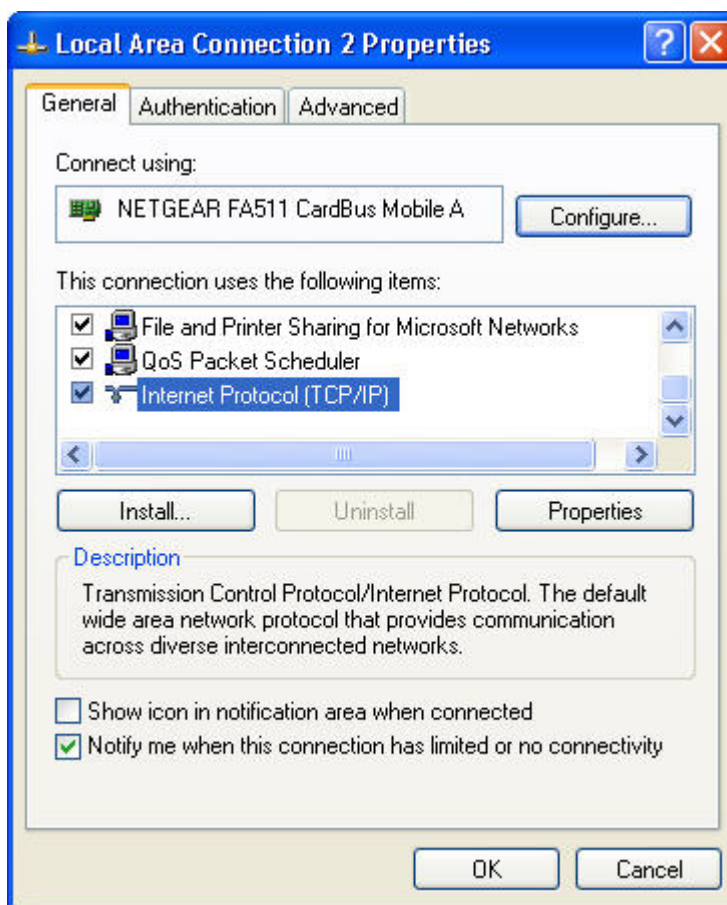

4. In the **Internet Protocol (TCP/IP) Properties** dialog, select **Use the following IP address** and make sure that the IP address is 192.168.0.2, and the subnet mask is 255.255.255.0.

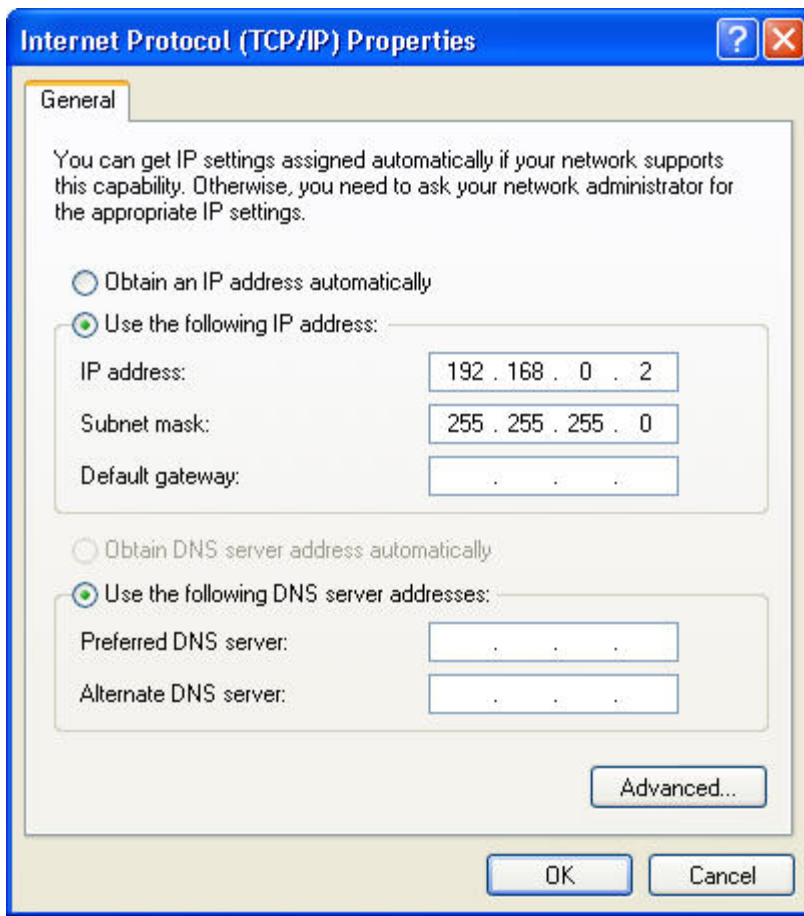

5. Start the software.
6. Upon initial startup, the software communication is not configured, and the following error message is displayed.

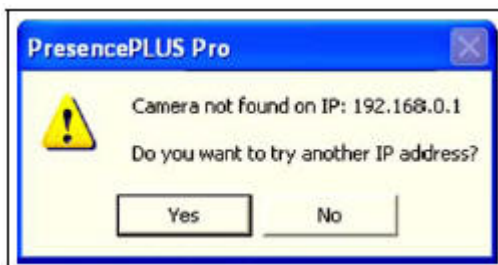

7. Click **Yes** to open the Communication screen.
8. Establish communications as follows:

Ethernet Connection

1. When the software is started for the first time, the IP address is "Localhost." Choose **Ethernet (RJ 45)**.
2. Change the IP address to 192.168.0.1 (default IP address of the sensor).
3. Click **OK**.

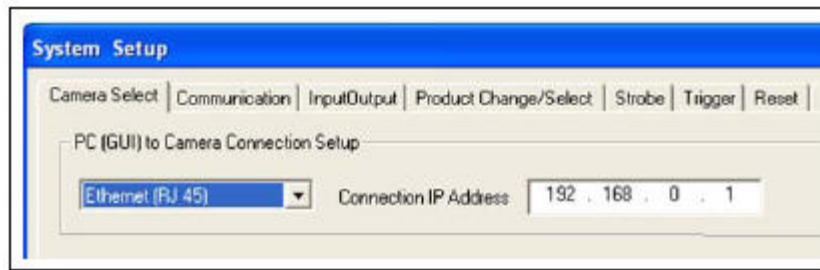

3.2 Typical Setup and Startup Sequence

The following subsections proceed through a typical Sensor setup and startup sequence

1. Connect and power up the hardware.
2. Start up the software.
3. Set up hardware parameters.
4. Build and run an inspection.

3.3 Startup and Troubleshooting

The following explains how to verify connections and start the *PresencePLUS* software.

1. Verify cable connections.
 - The sensor is connected to a PC with an Ethernet crossover cable or a serial cable.
 - The monitor, if used, is connected to the sensor's video port.
2. Thread the lens onto the sensor.
3. Verify electrical connections.
 - +V is connected to Pin 12, brown wire, 10-30V dc (24V dc \pm 10% if a light is powered by the sensor).
 - -V is connected to Pin 11, blue wire (dc common).
 - The trigger device is connected to Pin 4 (pink wire, Trigger In).
 - Any additional connections are made as required.
4. Verify power. Ensure that the sensor is powered by 10-30V dc (24V dc \pm 10% if a light is powered by the sensor).
5. Verify PC configuration.
 - **Ethernet connection:** IP address of PC is **192.168.0.2**.
 - **Serial connection:** A dial-up network has been established, and the network is a point-to-point protocol (PPP).
6. Power up the hardware and verify that the Error LED turns off.
 - During powerup, all the sensor LEDs illuminate for 15 to 20 seconds.
 - After the Red Error LED turns OFF, verify that the Green power LED is flashing.
7. Launch the Software.
 - Click Start > PresencePLUS to start the program.
 - If the sensor has a different IP address than the default address (192.168.0.1), or if it is connected through a serial connection, the following error message will display:

Sensor not found on specified IP address 192.168.0.1.

Do you want to try another IP address?

 - Click Yes to access the System Setup window.

- Click on the Sensor select tab, and change the connection setup as follows:

Ethernet Connection --

1. Select **Ethernet (RJ45)** in the drop-down menu.
2. Change the IP address to the address of the sensor to which the PC is connected.
3. Click **OK**.

Serial Connection --

1. Select **PC Serial** in the drop-down menu.
2. Click **OK**.

3.3.1 General Troubleshooting

The following table describes solutions to the most common problems in using the *PresencePLUS* software. For further assistance, contact Banner Engineering.

Problem	Cause/Solution
<ul style="list-style-type: none"> • Green Power LED on sensor is not ON. • Interface cannot connect to the sensor. • No image on the monitor. 	Sensor not getting enough power. <ul style="list-style-type: none"> • Check the connection to the power supply.
<ul style="list-style-type: none"> • No image on PC or monitor. • Green Ready LED on sensor is OFF. • The software seems to be working correctly, but the image is missing. 	Run display set to "None" <ul style="list-style-type: none"> • Ensure that the sensor is receiving trigger signals. Sensor not receiving triggers <ul style="list-style-type: none"> • If the connections are secure, call a Banner Applications Engineer.
<ul style="list-style-type: none"> • Error message "Failed to capture a full-resolution image. Please try again." • Image is frozen on the PC and monitor. • Green Ready LED on sensor is OFF 	Software restart needed or there are loose connections. <ul style="list-style-type: none"> • Restart the PresencePLUS software. • Check all connections. • If a software restart does not correct the problem and the connections are secure, call a Banner Applications Engineer.
<ul style="list-style-type: none"> • Error message "Failed to capture a full-resolution image. Please try again." • Image is frozen on PC, but image on monitor updates properly. Image is frozen on PC, but image on monitor updates properly. • Indicator lights on RJ-45 port are OFF. 	Ethernet connection lost. <ul style="list-style-type: none"> • Reconnect the cable. • Check the cable for breaks, then power down and back up. • Replace the cable. • Attempt to close and reopen PresencePLUS software. • If none of these actions fix the problem, call a Banner Applications Engineer.
<ul style="list-style-type: none"> • Focus number does not update. • QuickStart fails. • Errors when saving inspections to the sensor. 	FTP communications is blocked. <ul style="list-style-type: none"> • Disable TCP/IP Firewall software on the PC.
<ul style="list-style-type: none"> • Error code is displayed on PC. 	<ul style="list-style-type: none"> • A list of error codes and potential causes and solutions are available in the main help.

3.4 Setting Up Hardware Parameters

If the Sensor is being run for the first time, or if changes have been made to the hardware, then you may need to set or modify hardware parameters.

1. Click on **System** in the Main Menu toolbar.
2. Configure the Trigger parameter according to the trigger device being used. For example, if using the QS18V6ND as the trigger device, then select NPN.
3. Configure the six discrete inputs/outputs.
4. If the controller triggers a strobe light source, set the strobe trigger options.
5. If using the product select, configure the product select and product change lines to be NPN or PNP as required.
6. Click on **Setup** in the Main Menu toolbar, select **Trigger** tab, and configure the remaining parameters:
 - Polarity
 - Minimum Trigger Width
 - Trigger delay
 - Trigger Divide

3.5 Building an Inspection

The automatic screen sequence starts with the Setup screen, which results from the first button (Setup) in the Main Menu toolbar. Subsequent screens are shown below in the Main Menu toolbar layout.

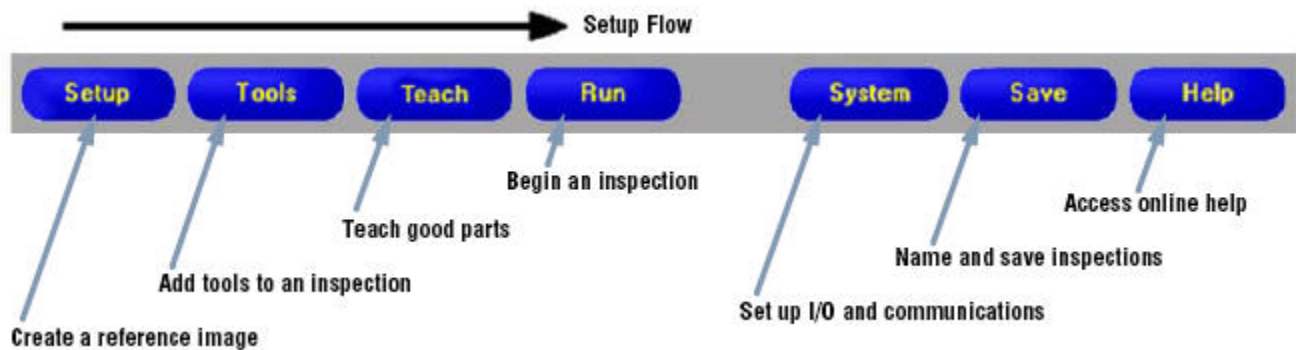

1. Setup screen:

- a. Set up the camera, lens, and lighting.
- b. Choose trigger option **Continuous** for a live image.
- c. Click **Auto-exposure** to adjust the image brightness.
- d. Focus the lens by turning the lens focusing ring until the focus value is maximized.
- e. When the desired image is shown, click **Next** to proceed to the Tools screen.

2. Tools screen:

- a. Add Location tool(s) to find the target to adjust the Regions of Interest (ROI) for translational and rotational changes.
- b. **Required:** Add Vision tool(s) to inspect the part.
- c. Add Measure tools(s) to create distance measurements from points found.
- d. **Required:** Add Test tool(s) to set the Pass/Fail criteria (Vision and Measure tools are inputs to the Test tool).
- e. Click **Quick Teach** to automatically set all the selected parameters in the Test tool and to proceed to the Run screen, or click Next to proceed to the Teach screen and to teach a sample set of good products.

 **Note:** To keep specific, user-defined parameters in a Test tool, skip Teach and go directly to Run.

3. **Teach screen:**

The Teach screen automatically configures the parameters chosen in the Tools screen.

- a. Choose the sample size.
- b. Click **Start**.
- c. Trigger the controller with the external trigger device.
- d. Click **Stop**.

 **Note:** Before entering Run, save inspection file to one of the memory locations on the controller.

- e. Click **Next** to proceed to the Run screen.

 **Note:** Save a backup copy of the inspection to the host PC.

4. **Run screen:**

Select an inspection to run, and review the results of the inspection.

- To select an inspection (in the **Select** tab), enable **Software Override**, and select the inspection file from the list of stored inspections on the camera.
- An alternate method is to use **Hardware input** to select an inspection via discrete inputs to the controller.

5. **Begin inspection:**

To begin inspecting, click the **Start** button in the Run screen.

4.1 Setup Screen

The Vision sensor has two modes: running and idle. If the sensor is idle when you start up the *PresencePLUS* software while your PC is connected, the software starts in the Setup screen. If the sensor is running, then the software starts in the Run screen.

4.2 Capturing a Reference Image

The reference image is used as a template for developing an inspection. The Vision tools use this image to acquire the critical information needed for the inspection.

Acquiring a quality image is crucial for a successful inspection. A quality image shows a measurable and repeatable difference between good products (which pass inspection) and bad products (which fail inspection). Most commonly, what determines the quality of the image is the illumination.

4.3 Focus Tab

The Focus tab on the Setup screen is used to:

- *Reference Image Source* on page 28
- *Focus Value* on page 29
- *Auto Exposure* on page 29

Focus tab



4.3.1 Reference Image Source

Before capturing an image, you need to determine what will trigger the Sensor to capture and image.



The Sensor can be triggered to capture an image in one of the following ways.

Trigger Option	Description
Continuous	The sensor will update continuously in Setup mode.

Trigger Option	Description
External	Images are acquired only in response to a signal from an external source as configured on the Trigger tab. Choose External if the part will be moving during the inspection to capture an image with the same conditions as the inspection conditions.
Manual	Images are acquired only when the Trigger button is clicked. The Trigger button is grayed out when any trigger option other than Manual is selected.
From Disk	If you check this option, the Trigger button allows you to browse for an image to load from disk.

 **Note:** The trigger options described above are used only in the Setup routine. Note, though, that Run mode does require an external trigger.

4.3.2 Focus Value

The Focus value on the Focus tab is a number between 1 and 255.

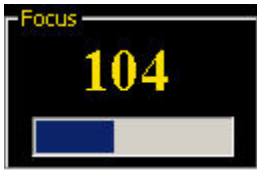

To focus the lens, place the target object so that the area to be focused appears on the center of the displayed image. You can use the image on the PC to determine when the image is sharp enough, or you can use this Focus value as a guide. Turn the focus ring on the lens until the Focus value is at the highest possible number between 1 and 255. Note there is no optimal value for this number, but it can be used as a guide if setting up more than one camera focused on the same target.

4.3.3 Auto Exposure

When you click Start in Auto Exposure, the exposure time and gain are optimized for the current inspection and the Status field provides feedback.

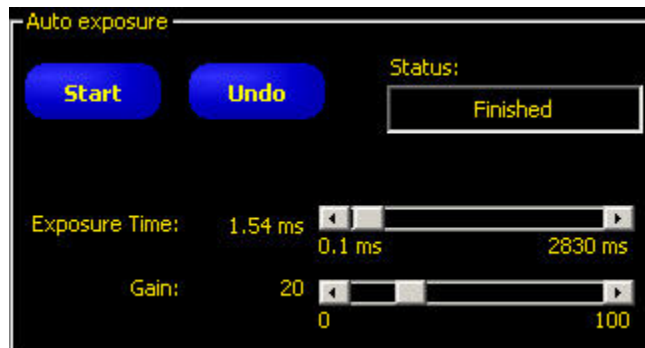

Field	Description
Status	<p>The following are status possibilities:</p> <ul style="list-style-type: none"> • Not running -- Auto exposure has not been activated since entering this screen. • Running -- Auto exposure is currently running. • Finished -- Auto exposure has run and is complete. • Image too dark -- Auto exposure could not brighten the image enough. Add more light to the inspection, or increase the exposure manually.

Field	Description
	<ul style="list-style-type: none"> • Image too bright -- Auto exposure could not darken the image enough. Remove light to the inspection, or decrease the exposure manually.
Exposure Time	Exposure time is the amount of time the camera allows light to energize the image chip. Increasing the exposure time (that is, moving the slider to the right) allows more light to energize the image chip, which brightens the image.
Gain	<p>Gain is an electronic boost to the image signal. Increasing gain (that is, moving the slider to the right) increases image brightness without increasing exposure time.</p> <p> Note: Gain brightens both the light pixels and dark pixels. High gain values will make the image appear grainy.</p>

4.4 Trigger Tab

An external trigger is used to tell the Sensor when to capture an image. You can modify the validity and timing of the trigger by setting the parameters on the Trigger tab.

 **Note:** Parameters set in the Trigger tab are stored in the inspection file and can be different for each inspection.

Trigger tab



4.4.1 Trigger Settings

Field	Description
Trigger Divide (range: 1-10,000 triggers)	Sets the sequence of valid triggers. If set to 1, an image is captured in response to every valid trigger; if set to 2, and image is captured in response to every second valid trigger, and so on.
Trigger Delay (range: 0-8,000 ms)	Fixed time (ms) from the instant the Sensor receives a valid trigger to the instant the Sensor captures the image.
Minimum Trigger Width (range: 1-8,000 ms)	Eliminates unwanted triggers by accepting triggers only if they are above a specified duration.
Polarity	Choose Leading Edge to capture images at the leading edge of a trigger signal. Choose Trailing Edge to capture images at the trailing edge of the trigger signal.

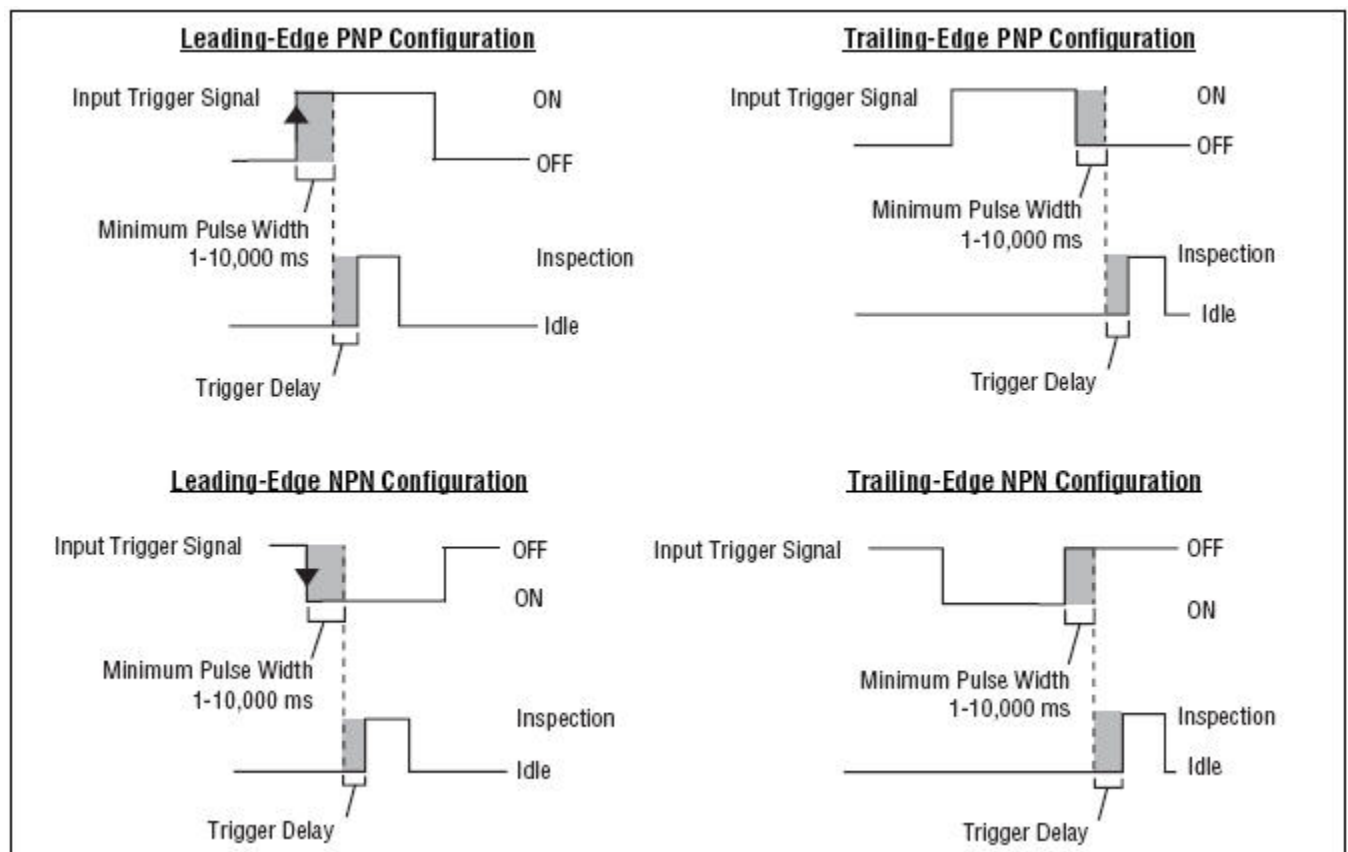

4.4.2 Resolution

Increases or decreases the resolution on the displayed image. A lower resolution will have a faster PC update. The resolution does not change the inspection. Resolution options are 1:1, 4:1, 16:1, and 64:1.



4.5 Advanced Tab

The Advanced tab on the Setup screen allows you to adjust the field of view (FOV). The FOV is the image area at the focal plane of a camera.

You can use the maximum FOV or adjust the FOV to improve performance. The FOV dimensions are shown in the Advanced tab.



Default Mode

The Default Mode determines whether to use the Current FOV or Maximum FOV by default.

Maximum and adjusted FOV

The FOV is denoted by the green box surrounding the image in the Setup screen. The maximum FOV is shown below.



To improve performance, reduce the size of the FOV either vertically, horizontally, or both, as shown below.



4.6 Considerations When Setting up Color Inspections

4.6.1 Primary Colors

A color Vision sensor has a color imaging chip that, rather than providing just a gray scale value along with the grid location, actually provides a color intensity value for each of the primary colors of light: red, green, and blue. Variations of color intensity for each of these primary colors provides all other shades of colors.

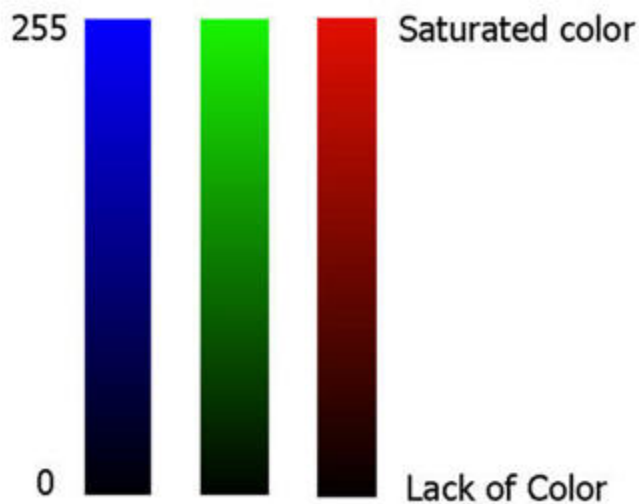

Red, Green, Blue (RGB)

Red, Green, and Blue (RGB) is a representation of additive color space where red, green and blue are combined to create other colors. This is the primary method for showing color on monitors and televisions.

The RGB color space is represented as a cube with the three primary colors whose axes are perpendicular to each other. Black is the absence of all primary colors; that is, the intensity of all three primary colors is zero [0,0,0]. White is the presence of all primary colors; that is the intensity of all three primary colors is 255 -- [255,255,255].

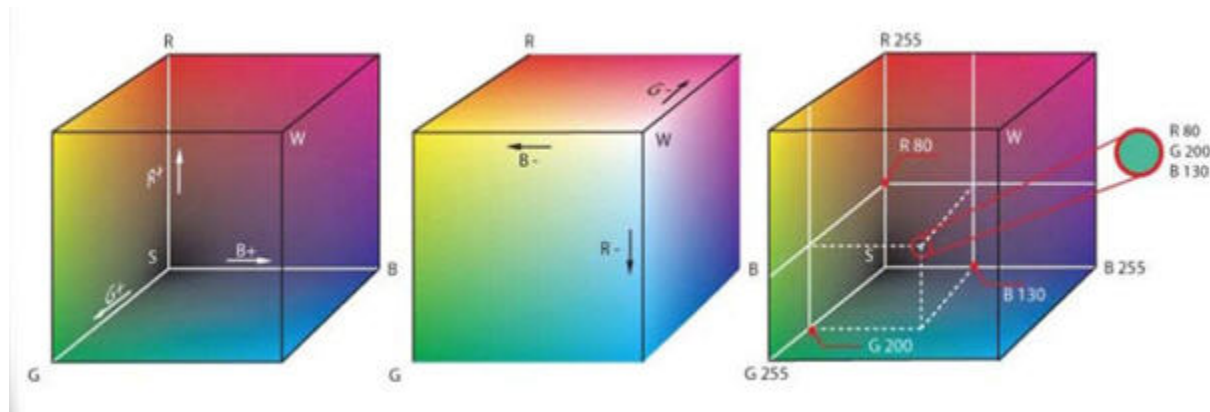

A color value is specified with three numbers between 0 - 255, each representing Red, Green and Blue. For example, the particular green shown above is [80,200,130].

Note: Typically, with a Color Vision sensor, none of the primary colors will be specified at either end of the Intensity range (0 or 255). The sensor has an optimum Intensity range and the predominant primary color will typically be around 200, and the other primary colors will be adjusted accordingly so that they do not fall out of this optimum Intensity range.

Hue, Saturation, and Intensity (HSI)

One way to look at color is not in terms of red, green, and blue, but as hue, saturation, and intensity (HSI). We generally do not see things as quantities of primary colors mixed in certain proportions. Rather, we see things as colors, or hues, that either are "washed-out" or vivid. This means having low or high saturation, respectively.

Hue, saturation, and intensity, then, are three dimensions that provide a representation of color space that is closer to human perception of color dynamics. "Colors" are defined as H, S, and I ratios are represented as a cone. The cone shape has one central axis representing intensity. Along this axis are all the gray values, with black at the pointed end of the cone and white at its base. The greater the distance along this line from the pointed end, or origin, the brighter or higher the intensity.

4.6.2 Setting up a Color Inspection

To set up a color inspection, you need to calibrate the color imager for existing lighting conditions.

Auto Exposure

In order to ensure that the image is bright enough to perform accurate color sensing when setting up a color inspection, the ROI should be placed over the color of interest:

1. Draw an ROI over the color in which you are interested.
2. Click the Start button.

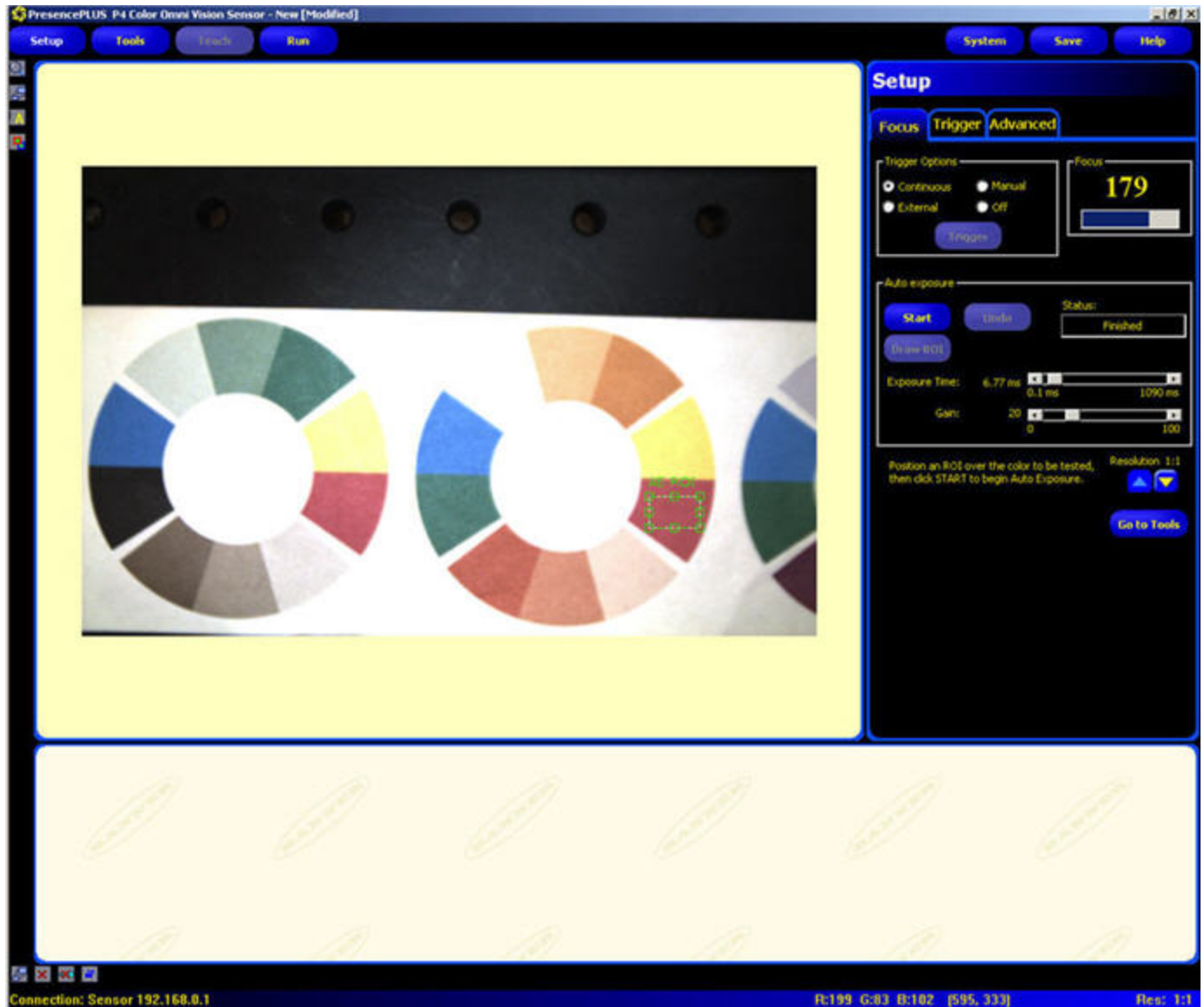

Practically speaking, auto-exposing in this way ensures that the camera is kept in the optimum range of the R-G-B scale.

White Balance

White balancing is the process by which a color imager is calibrated for existing lighting conditions. Due to the large variation in light sources and the fact that the R, G, and B channels on the imager are analyzed independently, a color sensor just out of the box may not have a true color image initially. The White Balance routine is found on the Advanced tab of the Setup menu.

1. Draw a ROI over a region on the image that is known to be white.



Draw the WB ROI on a region of the image known to be white. This routine will automatically adjust the gain for each of the R, G, and B channels in an effort to make the area in the WB ROI appear white. Strange effects can occur if the area in the WB ROI is not in fact white as shown below when white balancing on blue. This effects will carry over to the gray scale version of the image too.

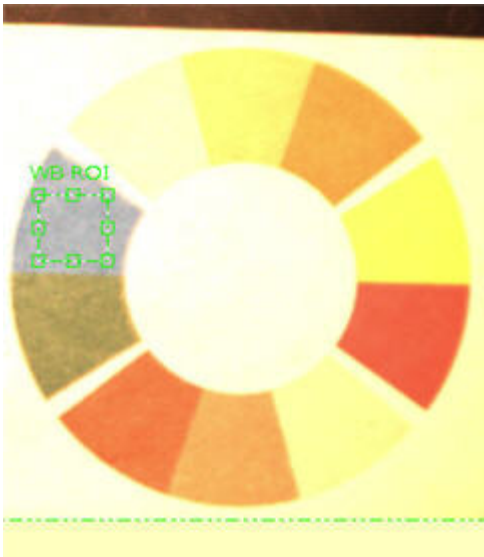

2. Click Start to calibrate the color settings.

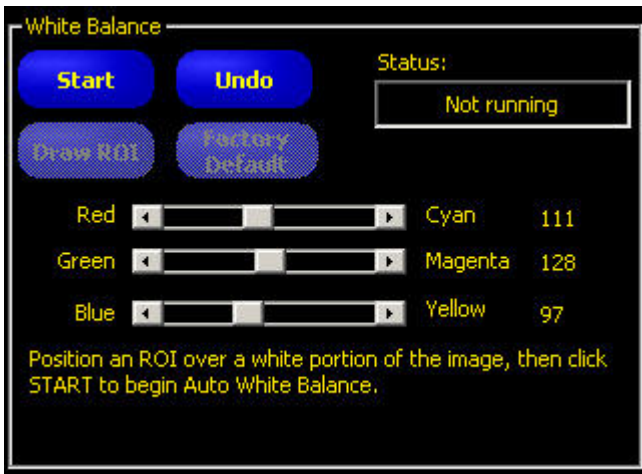

3. Click Next to go to the Tools tab.

5.1 Overview

Using the Tools screen, the user establishes the inspections that the Sensor will execute. Three sources of inspections are available:

1. **Building an inspection from scratch** is the typical method of establishing an inspection. The Tools screen is designed to aid the user in building an inspection. A typical inspection consists of Location Tools, followed by Vision Tools, Analysis Tools, and finally (if required) the Communication Tool. The Tools screen, shown below, supports this inspection organization.
2. **Existing inspections can be obtained from the sensor** (with or without the reference image) for execution or modification. This method is very useful if the user has an existing inspection on the controller and needs to make modifications to establish a new inspection.
3. Existing inspections also can be obtained from host resources using the Library. In this case, the sources of the inspections are the host's hard drive or network resources. This method provides access to an unlimited number of existing inspections (with or without the reference image) for execution or modification.

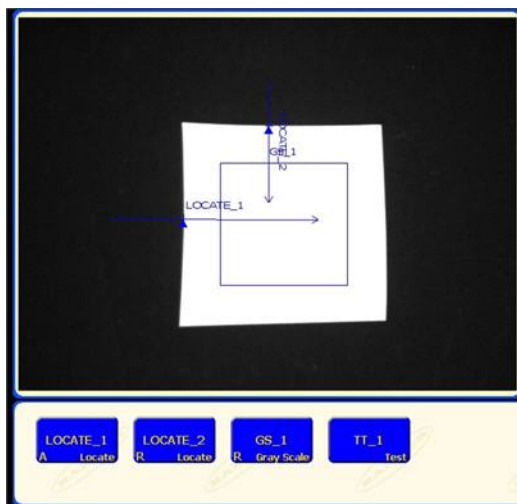

5.2 Typical Build/Modify Procedure

5.2.1 Choosing a Tool

To choose the right tools for an inspection, consider the tool's parameters and result options:

- Parameters are selected inputs for each tool (for example, relative threshold).
- Results are the information returned from the tool after it has executed.

Some tools perform evaluations, while others provide positional data for the tools that follow. Test tools evaluate, combine, or compare the results of other tools and determine a Pass-or-Fail judgment.

 **Note:** Test tool must be chosen to evaluate the results of each tool or set of tools.

5.2.2 Adding a Tool

The following steps provide an overview for setting up tools in an inspection. Steps not available for some of the Location or Analysis tools are noted.

1. Click the button of the tool to be added to the inspection.
2. Rename the tool.
3. Draw the ROI (not available for Analysis tools).
4. Set Input options to indicate the expected results (not available for the Test tool).
5. Add a Test tool.
6. Configure the Test tool inputs and, if desired, configure the desired results.
7. Set the judgment tolerances in one of three ways:
 - Use Quick Teach.
 - Use Teach.
 - Manually set the judgment tolerances.

5.2.3 Adding a Test Tool

The following steps provide an overview for adding a Test tool to an inspection.

1. Add a Test tool.
2. Configure the Test tool inputs.
3. Set the judgment tolerances.

5.2.4 Renaming Tools

The default name of each tool can be edited or replaced (examples: GS_1, TT_2). Each name must be unique.

To edit the tool name, click on the Name field (double-click to select the entire name), and type to change or replace the name.

- Enter up to 49 characters; only alphanumeric characters and underscores are valid.
- The button in the Navigation/Results window that appears will show the first nine characters after exiting the tool.

5.2.5 Removing a Tool

To remove a tool:

1. Choose the tool to be removed in the Navigation/Results window.
2. Click the Delete button in the lower-left corner of the screen.

5.3 Quick Teach

Quick Teach provides the fastest and easiest method of establishing an inspection. Quick Teach will use the reference image to establish Pass/Fail parameters of the Test tools.

Quick Teach does the following:

- Executes the inspection on the reference image.
- “Learns” the results of the Vision tools.
- Applies the applicable tolerances (user-determined, but default is 10%) to the selected parameters in the Test tool (these parameters determine the Pass/Fail criteria for each Test tool within the inspection).

 **Note:** Quick Teach discards any manually-entered values in the Test tool. Manually-entered values must be entered after Quick Teach has been performed, or they will be lost.

Click Quick Teach to:

- Run all the tools.
- Calculate the measurements.
- Add a percentage of tolerance around taught values.
- Save the inspection to the controller.
- Go to Run.

5.4 Load Tab

The Load provides a way to load a saved inspection and a reference image.

Load Tab

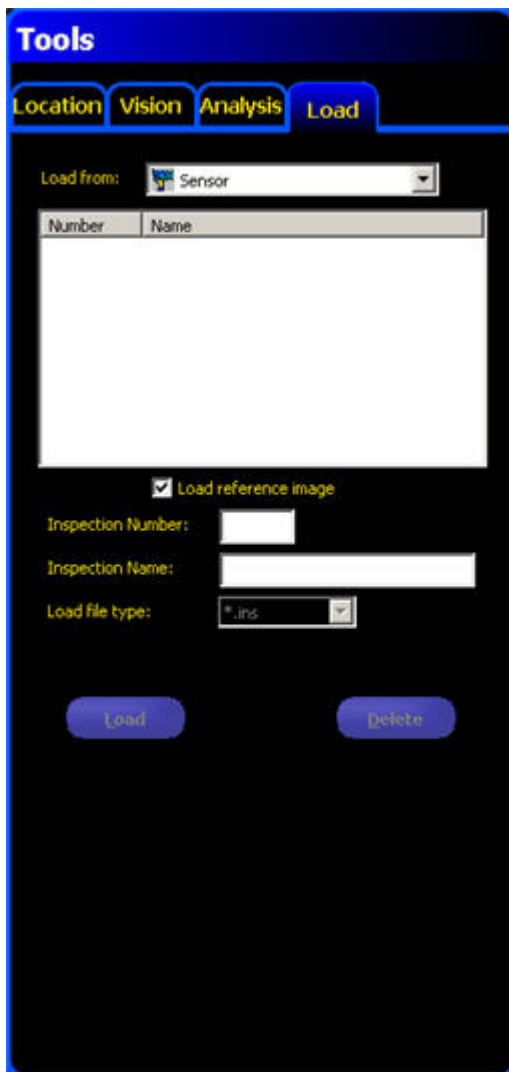

Tools

Location Vision Analysis **Load**

Load from: Sensor

Number	Name
--------	------

Load reference image

Inspection Number:

Inspection Name:

Load file type: *.ins

Load Delete

5.4.1 Flexible Inspection Loading

Release 2009R1B introduces a more flexible inspection loading capability that allows most inspections created by any *PresencePLUS* vision sensor to be loaded through the *PresencePLUS* software even if connected to a different type of *PresencePLUS* vision sensor. This means that you can now load, for example, an inspection created by an OMNI 1.3 into *PresencePLUS* software connected to a standard OMNI. Prior to Release 2009R1B, inspections could only be loaded into *PresencePLUS* software that was connected to the same type of *PresencePLUS* vision sensor that had created the inspection. In other words, a ProII camera could only load inspections created by another ProII camera, and an OMNI could only load an inspection saved from another OMNI, etc.

 **Note:** The one limitation that still exists occurs when trying to load an inspection that uses a tool that is unavailable (or unlicensed) for the currently connected sensor (for example, attempting to load to an inspection that uses a Geometric Count tool to a *PresencePLUS* AREA sensor will not work because the Geometric Count tool is not supported on the AREA sensor).

Inspection Source	Inspection Destination	Result	Possible Inspection Modifications
Color sensor (for example, a Color OMNI)	Standard grayscale sensor (for example, a standard OMNI)	A dialog indicates that the image color has changed and the inspection loads	None required
Grayscale sensor (for example, a standard OMNI)	Color sensor (for example, a Color OMNI)	A dialog indicates that the image color has changed and the inspection loads	None required
High Resolution (1.3) sensor (for example, an AREA 1.3 sensor)	Standard VGA sensor (for example, a standard AREA sensor)	A dialog indicates that the image/FOV has been adjusted and the image loads the image into the upper-left of the FOV. Note that the image may be cropped at the right and/or bottom and ROIs may be outside the image area	Reposition image, adjust ROIs and tools in the FOV, and possibly acquire a new reference image
Standard VGA sensor (for example, a standard AREA sensor)	High Resolution (1.3) sensor (for example, an AREA 1.3 sensor)	A dialog indicates that the FOV has been adjusted and the inspection loads with the image centered in the FOV	Possibly acquire a new reference image
Sensor with 6 I/O (for example, a ProII)	Sensor with 4 I/O (for example, an OMNI)	A dialog indicates that the inspection uses I/Os not available on the sensor and the inspection loads	Adjust I/O as appropriate
Sensor that supports a larger maximum trigger delay, trigger width, NTSC fail/hold time, or exposure time (for example, a ProII maximum trigger delay set to 10000 ms)	Sensor that supports a smaller maximum trigger delay, trigger width, NTSC fail/hold time, or exposure time (for example, a standard OMNI maximum trigger delay set to 8000 ms)	A dialog indicates that the timing was adjusted and the inspection loads with the timing(s) adjusted to the maximum time allowed on that sensor	Retest and modify timings as appropriate, and possibly acquire a new reference image

5.4.2 Inspection Storage Capacity

The INS file format allows for the storage of inspection files onboard every sensor. The table below shows the storage capacity for the various Vision sensors. Stored inspections can be modified, run, or deleted on the sensor.

Sensor Type	INS Storage Memory	Number of INS Files	Number of INS files without Reference Images*
Pro II	64MB	188	999
Pro II Color	64MB	160	999
Area/GEO/Edge	8MB	150	500+
OMNI	32MB	85	999
OMNI Color	32MB	72	999
Pro II 1.3	64MB	44	999
OMNI 1.3	64MB	44	999
BCR		8	400+
GEO/Edge/Area/BCR 1.3	32	20	999

*Not saving a reference image with the inspection frees up a lot of room onboard the sensor. However, inspections that include any of the following tools require a reference image to be saved:

- Geometric Find
- Geometric Count
- Pattern Find
- Pattern Count
- Color Match
- Color BLOB

5.4.3 Opening an Inspection from the Sensor or a Library

Inspections can be stored on the sensor or to a library of inspections stored on a PC or network drive. To select and open an inspection from the sensor or a library:

1. Click the Load tab.
2. From the **Load from** drop-down list, select the Sensor or a location on a PC or Network.
3. Select the desired inspection.
4. Click the Load button.

The tools from the selected inspection populate the Navigation/Results window. At this point, all tools in the inspection can be modified. If new tools are to be added, simply select the tool in the Tool screen. If tools are to be deleted, select the tool and click the Delete icon.

 **Note:** If you want to see the the image stored with the inspection, check the **Load reference image** box.

Tools

Location

Vision

Analysis

Load

Load from:  Sensor

Number	Name
1	new.ins
2	new1.ins

Load reference image

Inspection Number:

Inspection Name:

Load file type:

Load

Delete

This section describes how to configure the sensor and diagnose system errors in the System Setup window.

6.1 Sensor Select Tab

Use the Sensor Select tab to establish the Sensor connection with the PC.

 **Note:** An option box to open the Sensor Select tab is automatically displayed if the Sensor either is not connected or is connected but with the wrong IP Address selected.

Sensor Neighborhood Fields

The Sensor Neighborhood will list sensors in your environment. The following describes the fields in the Sensor Neighborhood.

Field	Description
Available	If the Icon is green (Yes), the sensor is available; if yellow, a connection can't be established for some reason; if red (No), the sensor is not available.  Note: The sensor to which you are currently connected will show up as unavailable (red icon).
Name	The name of the sensor.
IP Address	The IP address assigned to the sensor.
Product ID	The sensor model and type.
Sensor Version	The sensor version.
Running Inspection	Indicates whether the sensor is running or not.
Error	Indicates whether there is an error condition associated with the sensor.
MAC	The MAC address of the sensor.

PC (GUI) to Sensor Connection Setup

This selection is used to configure the communication link between the GUI (Graphical User Interface) and the sensor. There are two possible selections, Ethernet (RJ45) and Serial:

• Ethernet (RJ45)

This selection will configure the GUI to communicate with the sensor using the Ethernet (RJ45) connection. To establish communication you must enter the IP address of the sensor you would like to communicate with into the "Connection IP Address" edit box or select the desired Sensor from the Sensor Neighborhood results. Then, click on the "OK" button to connect.

• Serial

This selection will configure the GUI to communicate with a sensor via the Serial connection. To establish communication you must first start Dial-Up Networking (DUN) on the PC. Then, click on the "OK" button to connect.

Sensor Select Tab

System Setup

NTSC Language Tools Configuration

Sensor Select Communication InputOutput Product Change/Select Strobe Trigger Units Reset Start-Up

Sensor Neighborhood

Available	Name	IP Address	Product ID	Sensor Version	Running Inspection	Error	MAC
<input checked="" type="checkbox"/> No	ppvs	192.168.0.1	Pro II 1.3	2.2.0	No	No	00:D0:66:01:55:C1

Refresh Change Sensor IP Address

PC (GUI) to Sensor Connection Setup

Ethernet (RJ 45) Connection IP Address: 192 . 168 . 0 . 1 Address History Information

Automatically Connect To Selected IP Address Host PC IP Address: 192 . 168 . 0 . 2

OK

6.1.1 Change Sensor IP Address

To change a sensor's IP address:

1. Select the sensor in the **Sensor Neighborhood**
2. Click the **Change Sensor IP Address** button.

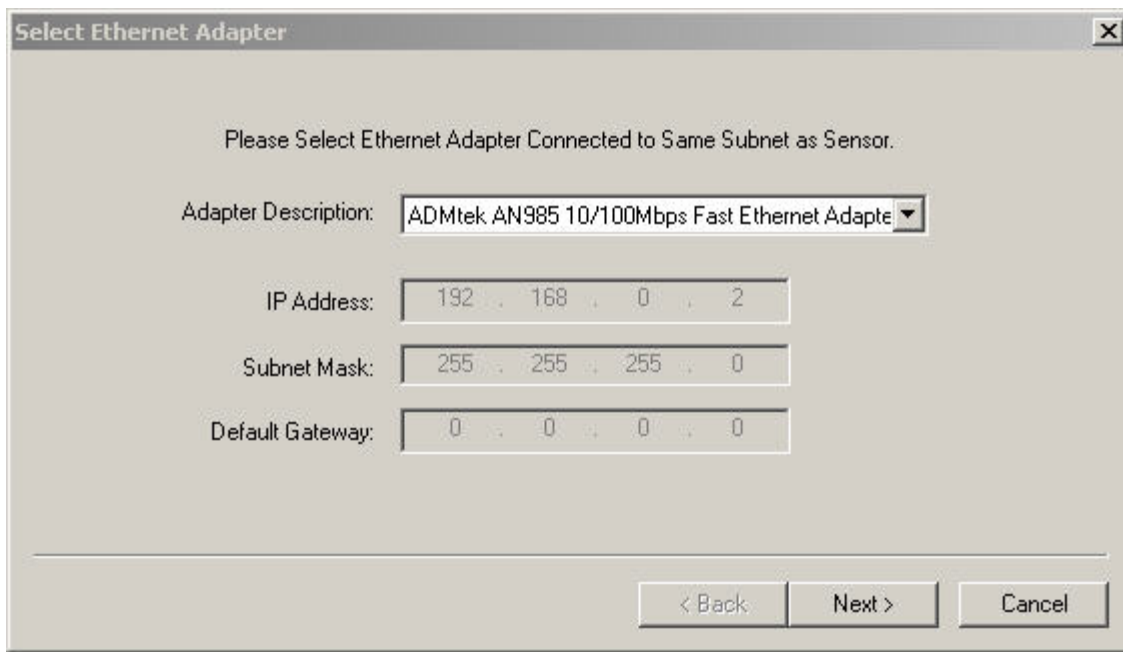

Select Ethernet Adapter

Please Select Ethernet Adapter Connected to Same Subnet as Sensor.

Adapter Description: ADMtek AN985 10/100Mbps Fast Ethernet Adapte

IP Address: 192 . 168 . 0 . 2

Subnet Mask: 255 . 255 . 255 . 0

Default Gateway: 0 . 0 . 0 . 0

< Back Next > Cancel

3. Click **Next**
4. Enter an appropriate sensor name in the **New Sensor Name** field.

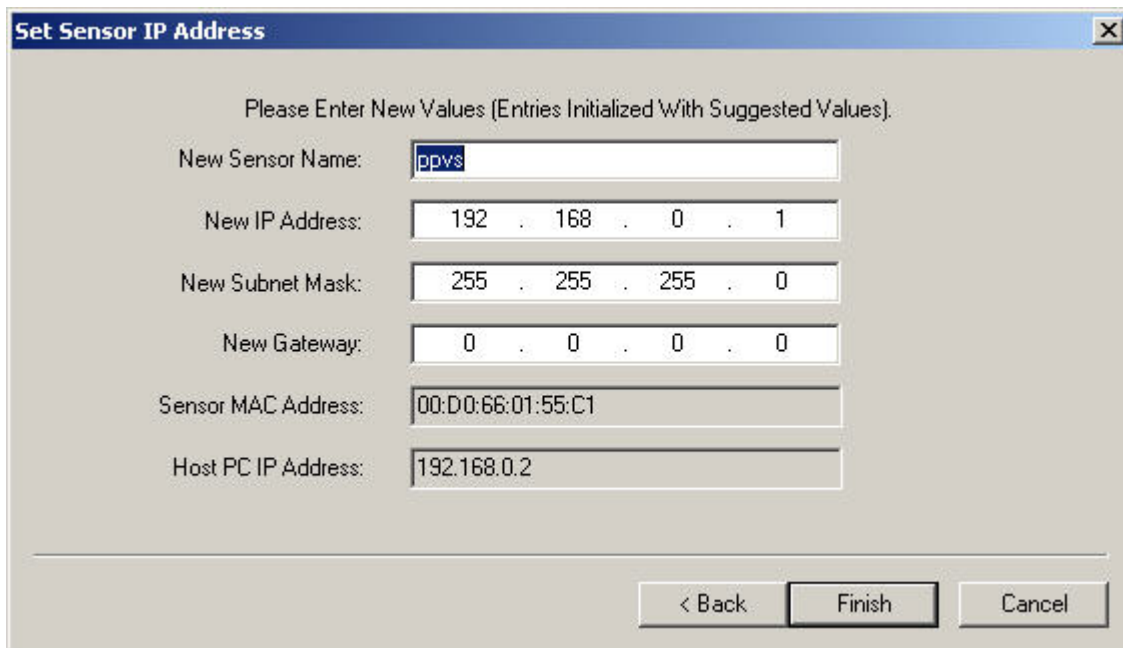

Set Sensor IP Address

Please Enter New Values (Entries Initialized With Suggested Values).

New Sensor Name: ppws

New IP Address: 192 . 168 . 0 . 1

New Subnet Mask: 255 . 255 . 255 . 0

New Gateway: 0 . 0 . 0 . 0

Sensor MAC Address: 00:D0:66:01:55:C1

Host PC IP Address: 192.168.0.2

< Back Finish Cancel

5. Click **Finish**.

6.1.2 PC (GUI) to Sensor Connection Setup

Use this field to select whether the Sensor will communicate via the Ethernet port or a serial connection.

System Setup

NTSC | Language | Tools Configuration

Sensor Select | Communication | InputOutput | Product Change/Select | Strobe | Trigger | Units | Reset | Start-Up In

Sensor Neighborhood

Available	Name	IP Address	Product ID	Sensor Version	Running Inspection	Error	MAC	
<input checked="" type="checkbox"/>	No	ppvs	192.168.0.1	Pro II 1.3	2.2.0	No	No	00:D0:66:01:55:C1
<input type="checkbox"/>								
<input type="checkbox"/>								
<input type="checkbox"/>								
<input type="checkbox"/>								

Refresh | Change Sensor IP Address

PC (GUI) to Sensor Connection Setup

Ethernet (RJ 45) | Connection IP Address: 192 . 168 . 0 . 1 | Address History | Information

Automatically Connect To Selected IP Address | Host PC IP Address: 192 . 168 . 0 . 2

OK

- If you select **Ethernet (RJ 45)**, the Connection IP Address shows the IP address for which the software is looking. Initially, the IP address should be 192.168.0.1, the default IP address of the sensor.
- If you select **Serial**, the IP address is not applicable.

6.1.3 IP Address History

Use this button to view previous IP Addresses and Subnet Masks.

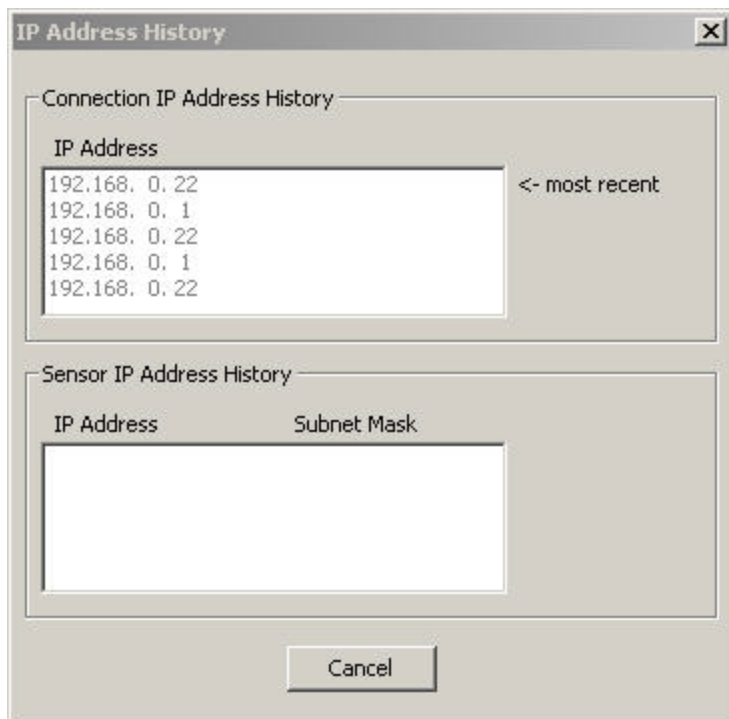

6.2 Communication Tab

The Communication tab is used to configure:

- General Communication Setup
- Remote Command Configuration (RCC)

Communication Tab

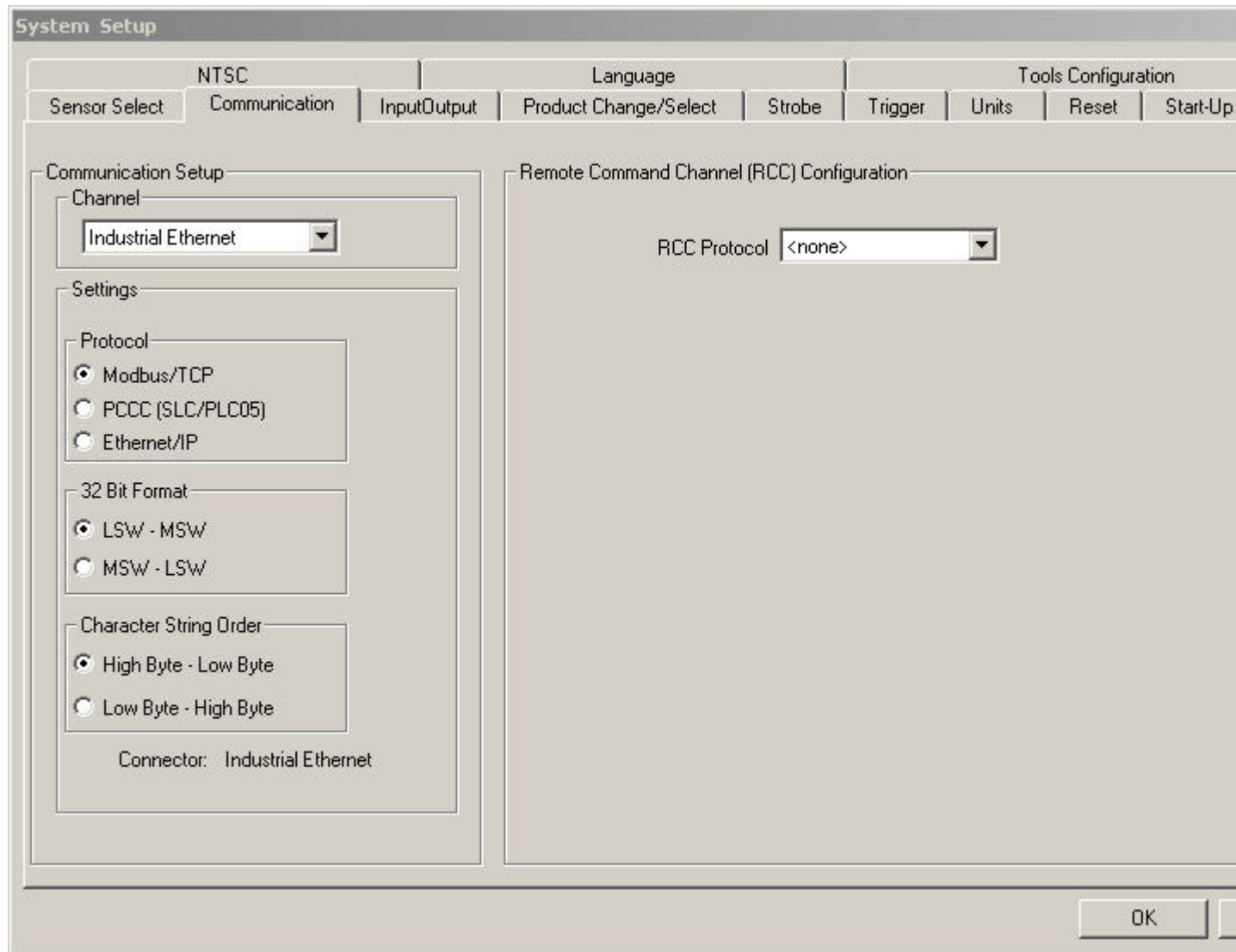

6.2.1 Communication Setup

Banner Vision sensors support the following communication options:

- Ethernet Sockets 1-10
- Serial 1
- Industrial Ethernet

Ethernet Connection

In order to establish an Ethernet connection, the external device must be directed to the correct IP address and the correct TCP port. In TCP/IP protocol, a TCP port number is used with the IP address to identify a specific path or socket. The sensor has sockets 1 to 10, and can send out unique sets of data to 10 different devices.

Valid user TCP/IP port numbers are in the range of 1024 through 65535. The PresencePLUS GUI provides automatic notification if you attempt to use a reserved port.

To view an Ethernet connection:

1. Click on the System button in the Main Menu toolbar to bring up the System Setup window.

- Click on the **Communication** tab.

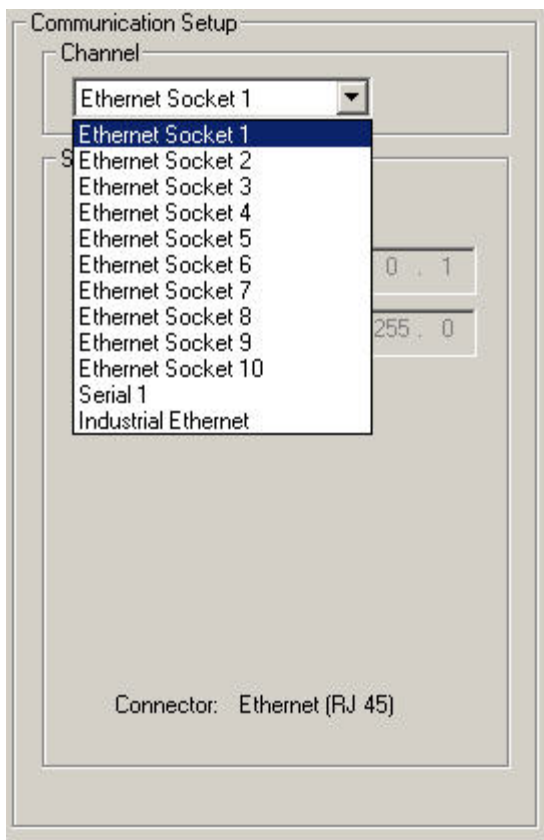

- Choose a connection from the fixed Connection drop-down list of the **Communication Tool Setup** field.

Each Ethernet socket has a unique TCP port number as shown below

 **Note:** The following addresses are defaults.

Socket	Default IP Address	Port
1	192.168.0.1	20000
2	192.168.0.1	20001
3	192.168.0.1	20002
4	192.168.0.1	20003
5	192.168.0.1	20004
6	192.168.0.1	20005
7	192.168.0.1	20006
8	192.168.0.1	20007
9	192.168.0.1	20008
10	192.168.0.1	20009

Serial Connection

The sensor has a single serial connection that you can configure, Serial 1:

- Serial 1 is the DB-9 connector.

 **Note:** The Pro has 2 serial connections. Serial 2 in the dropdown list is to support those sensors.

The sensor has one serial connection that can be configured: Serial 1 is pins 1, 9, and 10. Set up the serial communication options to match the receiving device. The following table shows the configuration options:

Attribute	Default Setting
Baud Rate	115200
Data Bits	8
Parity	None
Stop Bit	1
Flow Control	None

To setup a serial connection:

1. Click on the **System** button in the Main Menu toolbar to bring up the System Setup window.
2. Click on the **Communication** tab.
3. Choose Serial 1 from the Connection drop-down list of the **Communication Tool Setup** field.

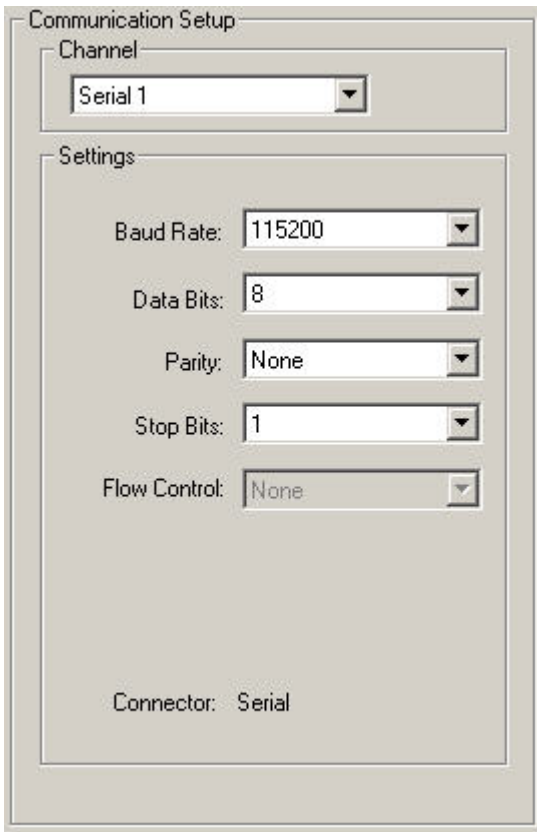

Communication Setup

Channel: Serial 1

Settings

Baud Rate: 115200

Data Bits: 8

Parity: None

Stop Bits: 1

Flow Control: None

Connector: Serial

 **Note:**

Because there is no flow control for the serial connections, the sensor will not detect or log a lost or broken connection

Industrial Ethernet

Protocol

Protocol selects which Industrial Ethernet protocol is being used. This changes the string format and the word/register values reported in the PLC Map.

32 bit Format

32 bit Format determines how 32 bit integers and floating point values are stored in sequential 16 bit registers (words) - least significant word first (LSW-MSW) or most significant word first (MSW-LSW).

Character String Order

For Modbus/TCP and PCCC protocols, characters in the string can be packed into registers according to either the Standard String format or the ControlLogix Format I:

- Standard String Format is used when the Character String Order option is set to “High Byte – Low Byte” selection.

Please note that the length of the string is stored in one 16-bit register:



- ControlLogix packing format is used to store characters into registers when the Character String Order option is set to “Low Byte – High Byte” selection.

Please note that in this particular case, the length of the string is still stored in one 16-bit register, and only the order of characters in each 16-bit register follows the ControlLogix format:



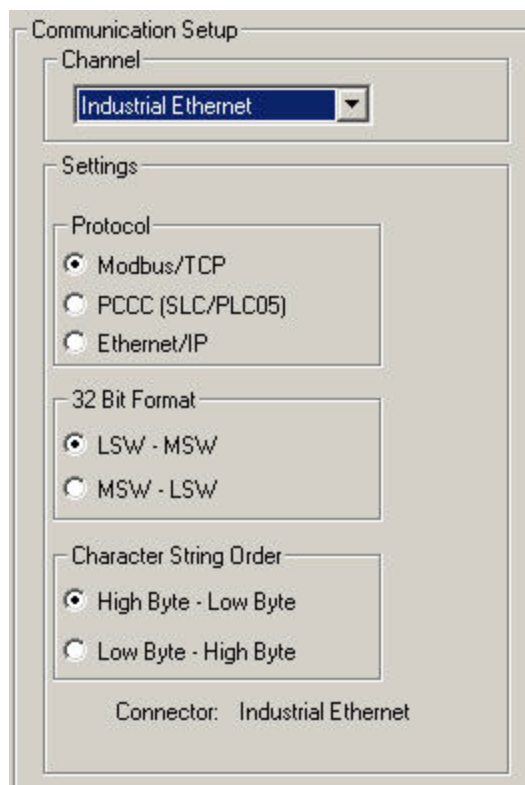

6.2.2 Remote Command Channel Configuration

This section describes the commands that are supported to communicate with a Vision sensor. All commands are case-insensitive

Remote Command Set

All RCC commands are case-insensitive. Valid characters for commands are 7-bit ASCII alphabetic or numeric characters (A-Z, a-z, 0-9), dash (-) and underscore (_).

All commands have the following structure:

ACTION OBJECT_IDENTIFIER QUALIFIER(S)

ACTION is an operation the user intends to perform on the *OBJECT_IDENTIFIER*. There are three possible actions available:

- **GET** — used to retrieve information associated with the named object. This information can be a Boolean value, and unsigned or signed number, a string or, for complex objects like the Communications tool, a field-delimited record that includes other data types.
- **SET** — used to assign a value to a named object.
- **EXEC** — used to execute a pre-defined functional object or activity in the sensor. Activities may take object identifiers as parameter qualifiers.

The table below identifies objects that are supported in the current RCC release, their identifiers, and the corresponding actions that they will support. Items highlighted in bold are command keywords. Flag objects are appended with the **FLG** suffix, status objects are appended with the **STS** suffix, and counters are appended with the **CNT** suffix.

System Object, Component, or Activity	Object or Activity Identifier	Support Actions	Required Qualifiers	Optional Qualifiers	Comments
Trigger	TRIGGER	EXEC	None	Timeout (msec) or NOWAIT	If no qualifiers are specified, a 30 second timeout is used.
Product Change	PRODCHANGE	EXEC	Numeric Inspection ID	Timeout (msec) or NOWAIT	By default, a 30 second timeout is used.
Counter or Flag Reset	RESET	EXEC	SYSERRFLG or PASSFAILCNT or MISSTRIGCNT	None	Reset either the System Error Flag, Pass and Fail counters, or Missing Trigger count.
Remote Teach	RTEACH	EXEC	None	TRIGGER or TRIGGER NOWAIT or TRIGGER Timeout (msec)	Enables remote teach. If no qualifiers are specified, remote teach will occur on the next trigger. If TRIGGER qualifier is specified, remote teach will occur immediately, and the command will block until a default 30-second timeout expires. If TRIGGER NOWAIT is specified, remote teach will occur immediately, and the command will return right away. If a timeout value is specified, the command will block until the specified timeout expires.
Online Status	ONLINESTS	GET	None	None	Retrieve the sensor online status.
Ready State	READYFLG	GET	None	None	Returns 1 if the camera is ready, 0 otherwise

System Object, Component, or Activity	Object or Activity Identifier	Support Actions	Required Qualifiers	Optional Qualifiers	Comments
Current Inspection Number	INSPNUM	GET	None	None	Retrieve currently running inspection
Communications Tool Results	COMMTOOL	GET	None	CommTool Number or CommTool Name	Retrieve comm tool results, either by specifying its sequential number in the inspection (1,2,...,n) or by specifying its name. By default, data for the first comm tool will be retrieved.
Pass/Fail flag	PASSFAILFLG	GET	None	None	Retrieve the value of the Pass/Fail flag - 1 if pass, 0 if fail
System Error	SYSERRFLG	GET	None	None	Retrieve the value of the System Error - either 0 or 1
Frame Number	FRAMENUM	GET	None	None	Retrieve the current frame number
Pass Count	PASSCNT	GET	None	None	Retrieve the pass count
Fail Count	FAILCNT	GET	None	None	Retrieve the failed count
Iteration Count	ITERCNT	GET	None	None	Retrieve the Iteration Count
System Error Count	SYSERRCNT	GET	None	None	Retrieve the system error count
Missed Trigger Count	MISSTRIGCNT	GET	None	None	Retrieve the missed trigger count
I/O Line Status	IOSTS	GET	I/O line id, numeric, either 1 through 4 or 1 through 6	None	Retrieve the cached status of the I/O line
Gain	GAIN	GET		None	Retrieve the gain
Gain	GAIN	SET	Positive Integer	None	Set the gain
Exposure	EXPOSURE	GET		None	Retrieve the camera exposure

System Object, Component, or Activity	Object or Activity Identifier	Support Actions	Required Qualifiers	Optional Qualifiers	Comments
Exposure	EXPOSURE	SET	Positive Number	None	Get the camera exposure
Frame Number Tag	FRAMETAG	SET	ENABLE	None	Enables frame number as command acceptance indicator
Frame Number Tag	FRAMETAG	SET	DISABLE	None	Disables frame number as command acceptance indicator
Frame Number Tag	FRAMETAG	GET	None	None	Retrieve the status of the frame tag indicator

Coordinate tool

Commands

Syntax	Description
set coordtool <i>tool_name tool_number x y angle</i>	Returns the specified Coordinate tool output.
get coordtool <i>tool_name tool_number x y angle</i>	Gets the value

Math tool and the Remote Command Channel

Commands

Syntax	Description
set mathtool <i>tool_name tool_number value operand_1 operand_2</i>	Sets the specified tool operand, if it is a constant. Value should be a floating number.
get mathtool <i>tool_name tool_number operand_1 operand_2</i>	Gets the value of the specified tool operand, if it is a constant.

String tool

Commands

Syntax	Description
set stringtool <i>tool_name tool_number operand_1 operand_2 value</i>	Sets the specified tool operand, if it is a constant. Value should be a quoted string (see Character Strings on page 327).
get stringtool <i>tool_name tool_number operand_1 operand_2</i>	Gets the value of the specified tool operand, if it is a constant.

OCV Tool and the Remote Command Channel

Commands

Syntax	Description
<code>set ocvtool <i>tool_name tool_number</i> <i>exp_string</i> <i>value</i></code>	Sets the expected string, if it is a constant. The Value should be a quoted string containing printable ASCII characters (see Character Strings on page 327).
<code>get ocvtool <i>tool_name tool_number</i> <i>exp_string</i></code>	Gets the value of the expected string.

Examples

Set Command Example Assuming that you have two OCV tools, `my_ocv_tool_1` and `my_ocv_tool_2`, each with their first operand configured as a constant. To set the constant of the second ocvtool to `foobar`, issue the following command:

```
set ocvtool my_ocv_tool_2 "foobar"
or
set ocvtool 2 "foobar"
```

Get Command Example To get the constant of the second ocvtool, issue the following command:

```
get ocvtool my_ocv_tool_2
or
get ocvtool 2
```

RCC Return Values

RCC return values are numeric, and are listed below:

- 0 - command accepted. This return code is generated when a valid SET, GET, and EXEC command has been completely handled by the sensor. It may be followed by a command-specific return value or a completion code.

If the frame tag is enabled, the current frame number will be returned instead of 0 as command acceptance indicator.

- -100 - Invalid command entered by the user.
- Trigger and Product Change error codes:
 - -201 - Product change command attempted in the middle of the inspection
 - -202 – Trigger command attempted in the middle of product change
 - -203 – Trigger command is attempted when the inspection is not executing (sensor is idle)
 - -204 – Specified inspection slot is out of range
 - -205 – Trigger command attempted in the middle of the inspection
 - -206 – Product change command attempted in the middle of a product change
 - -207 – Product change command attempted while the sensor is in the Teach mode
 - -208 – Product change attempted when the GUI is connected, and the inspection is not executing
- Comm tool error codes
 - -301 – get/set tool command attempted while the inspection is not executing
 - -302 – get command issued before inspection is triggered for the first time – tool results unavailable

- -303 – get/set tool command attempted in the middle of the inspection
- -304 – get/set tool command attempted in the middle of the product change
- -305 – Tool specified in get/set command not found in the inspection
- -306 – Requested comm tool is not configured for RCC
- -307 - Tool executed with an error or did not execute
- -308 - Specified tool operand is not a constant, and cannot be modified
- Reset command error codes
 - -401 – Reset command attempted in the middle of the inspection
 - -402 – Reset command attempted in the middle of the product change
- -500 – RCC commands are not accepted because the sensor is in the Playback mode
- Timeout error codes
 - -600 – Product change timeout occurred
 - -601 – Trigger timeout occurred
- -700 – Specified value is out of range
- -701 – Set Gain command attempted when the GUI is connected and the inspection is not executing
- -702 – Set Exposure command attempted when the GUI is connected and the inspection is not executing
- -800 – Product Change, Trigger or Get Commtool command attempted when either Product Change or Trigger Command timeout occurred, but the operation has not yet completed.

Frame Tag Numbers

RCC provides user with a debug facility that allows users to correlate command completion with current frame numbers. This facility is enabled by issuing a SET FRAMETAG ENABLE command. This command will cause RCC to send the current frame number as the command acceptance code. This will allow users to track when each command was issued, and which frame it applies to.

For EXEC TRIGGER command, returned number will be the frame number at the completion of the inspection execution.

For EXEC TRIGGER command, returned number will be the frame number at the completion of the inspection execution.

For all other commands, the returned number is the current frame number.

Command Processing

RCC commands are interpreted in the context of the running PPVS system. Due to the constantly changing system state caused either by external action or by previous RCC commands, certain rules are imposed on RCC command acceptance and processing. Please note that command acceptance does not constitute successful completion of the command.

1. EXEC TRIGGER command can be successfully accepted under the following conditions:
 - Inspection is Executing and is Ready
2. EXEC PRODCHANGE command can be successfully accepted under the following conditions:
 - Sensor is idle (inspection is not loaded), and the GUI is not connected
 - Inspection is Executing and is Ready
 - Sensor was previously product changed to an invalid slot
3. EXEC RESET command can be successfully accepted under the following conditions:
 - Sensor is idle (inspection is not loaded)
 - Inspection is Executing and is Ready
4. SET GAIN or SET EXPOSURE commands can be successfully accepted under the following conditions:

- Inspection is Executing and is Ready
5. GET status, counter or flag commands can be accepted at any time. If issued when inspection is Executing but is not Ready, these values may change as the inspection is executing.
 6. GET COMMTOOL command can be successfully accepted if the inspection has been loaded. However, RCC may not have valid data until the inspection has been triggered (executed) at least once.

Commands with timeouts, such as EXEC TRIGGER and EXEC PRODCHANGE, will block processing of additional commands while they are executing if they are invoked without the NOWAIT option. Additional commands that are issued while processing is blocked will be queued, and will be processed in the order that they were received when the blocking command finishes its execution.

When blocking commands, such as EXEC TRIGGER and EXEC PRODCHANGE, are invoked with the NOWAIT option, GET commands that retrieve flags and status are accepted for processing. All other commands are rejected with an appropriate error code.

RCC Log

RCC Log allows users to monitor and troubleshoot communication inputs and outputs.

Log consists of a circular buffer with up to 400 entries. These entries can be one of three types:

- IN – characters received in the input stream
- CMD – commands that were extracted after the frame start and frame end delimiters have been received
- OUT – formatted command output, with frame delimiters already included.

Log entries are time stamped with system time and sorted in the order they were received.

Non-displayable ASCII characters are shown in the ASCII Hex string form. The ASCII Hex strings are preceded by character sequence “\x” (backslash-lower-case-x). The ASCII Hex string will always be two characters long. For example, NULL will be converted to “\x00”, and carriage return will be converted to “\x0D”. To represent ASCII Hex digits, only upper case letters, A-F, are used.

Sample RCC log is given below:

```
0000000118.116 IN e
0000000118.116 IN x
0000000118.116 IN e
0000000118.116 IN c
0000000118.116 IN
0000000118.116 IN t
0000000118.116 IN r
0000000118.116 IN i
0000000118.116 IN g
0000000118.116 IN g
0000000118.116 IN e
0000000118.116 IN r
0000000118.116 IN \x0D
0000000118.116 IN \x0A
0000000118.116 CMD exec trigger
0000000118.483 OUT 0\x0D\x0A
```

In this example, command exec trigger was sent to RCC interface. The interface was configured to use no start frame delimiter, and carriage return (\x0D) and line feed (\x0A) as frame delimiters. As soon as valid frame delimiters were received, the command exec trigger was sent for processing, and the command response was sent back after inspection finished executing.

Frame and Field Delimiters

The PresencePLUS GUI includes a drop-down list of Frame delimiters as follows:

- <none> for no delimiter

- **\r** for carriage return (<CR>)
- **\n** for line feed (LF)
- **\r\n** for carriage return followed by a line feed (CR-LF)
- **\n\r** for line feed followed by a carriage return (LF-CR)

In addition to the above field delimiters, you can enter other delimiter types keeping in mind the following:

- ASCII hex format can be used as a delimiter
- a NULL character can be used as a delimiter (specified in ASCII hex format)
- Frame delimiters can be multi-character sequences up to 20 characters long

The PresencePLUS GUI includes a drop-down list of Field delimiters as follows:

- **<none>** for no delimiter
- **,** for comma
- **;** for semi-colon
- **:** for colon
- **<SPC>** for space
- **\t** for tab

In addition to the above field delimiters, you can enter other delimiter types keeping in mind the following:

- ASCII hex format can be used as a delimiter
- a NULL character can be used as a delimiter (specified in ASCII hex format)
- Field delimiters can be multi-character sequences up to 10 characters long

Character Strings

Communications Tool configured for Barcode or String Tool output may produce strings that contain non-printable ASCII characters, such as carriage returns, line feeds, and characters in the upper ASCII range.

To output these strings, the following encoding rules are used:

- Tool output strings will be enclosed in double quote characters, “.”
- Any non-printable ASCII character, including NULL, will be converted to its ASCII Hex equivalent. The ASCII Hex string will be preceded by character sequence “\x” (backslash-lower-case-x). The ASCII Hex string will always be two characters long. For example, NULL will be converted to “\x00”, and carriage return will be converted to “\x0D”. To represent ASCII Hex digits, only upper case letters, A-F, will be used.
- Any backslash encountered in the Barcode or String Tool data will be converted to its ASCII Hex equivalent, “\x5C”.
- Any double quote encountered in the Barcode or String Tool will be converted to its ASCII Hex equivalent, “\x22”.

For RCC input strings, the formatting rules are expanded to accommodate readability as follows:

- Carriage return can be specified as character sequence “\r” (backslash-r).
- Line feed can be specified as character sequence “\n” (backslash-n).
- Double quote can be specified as character sequence “\” (backslash-doublequote).
- Backslash can be specified as character sequence “\\” (backslash-backslash).
- tab can be specified as character sequence “\t” (backslash-t).
- Embedded NULL characters are not allowed.

6.2.3 PresencePLUS/Kawasaki Vision Guidance and Inspection

Integrating Banner Vision Sensors with Kawasaki Robot Controllers

Quick Start

This document describes how to integrate a Banner *PresencePLUS* sensor with Kawasaki Robot Controllers, and:

- includes instructions for establishing communications between the *PresencePLUS* sensor and a Kawasaki Robot Controller

- describes how to set up a sample *PresencePLUS* vision inspection
- provides a sample Kawasaki AS Language program

Below is a quick overview of the procedure for integrating *PresencePLUS* sensors with Kawasaki Robot Controllers and, where noted, more details are provided in the document subsections.

Main Steps	Tasks to Complete
Establish communication between the <i>PresencePLUS</i> sensor and the Kawasaki Robot Controller. See Establishing Sensor/Robot Communication on page 63	<ol style="list-style-type: none"> 1. Install and physically connect a Banner <i>PresencePLUS</i> Vision Sensor to a Kawasaki controller. 2. Configure <i>PresencePLUS</i> and Kawasaki controller IP addresses. 3. Configure the <i>PresencePLUS</i> Remote Command Channel.
Create and save a <i>PresencePLUS</i> Inspection. See Creating the PresencePLUS Inspection on page 65 for more details.	<ol style="list-style-type: none"> 1. Create a new inspection and configure Vision tools to produce the desired part location data that outputs it to the RCC interface. The sample inspection described in this document: <ul style="list-style-type: none"> • Locates a part • Tests for presence of the part • Outputs X, Y, and Rotation about the Z-axis offsets 2. Save and then start the inspection.
Program the Kawasaki controller to connect and issue commands to the <i>PresencePLUS</i> sensor. A Kawasaki AS Language Sample on page 70 is provided to get you started.	<ol style="list-style-type: none"> 1. Load the sample AS Language program onto robot controller. The sample program implements the following actions: <ul style="list-style-type: none"> • Connects to the RCC. • Triggers vision sensor and wait for inspection to complete. • Determines pass/fail condition of the inspection. • Gets the X, Y, and Rotation about Z-axis offsets. • Closes the connection to the RCC. 2. Run program. <p> Note: The IP address and port number within the sample AS Language program must be modified to match the IP address and port number of the <i>PresencePLUS</i> sensor.</p>

Overview

The *PresencePLUS* ProII and P4 sensor families are cost-effective, easy-to-use camera systems with advanced visual inspection capability. Where other vision systems can be difficult to configure, the *PresencePLUS* software is straight-forward. This enables users with minimal experience with vision systems to quickly set an inspection that inspects and accurately determines product position, and to integrate the *PresencePLUS* system into their environment.

To facilitate the implementation of *Presence PLUS* Vision Sensors with robots to provide vision guidance and/or product quality tests on a production line, *Presence PLUS* supports a user-configurable, ASCII-based, TCP /IP communications interface called the Remote Command Channel. The RCC supports a Kawasaki protocol specifically designed to communicate with Kawasaki C/D/D+ robot controllers.

Summary of Remote Command Channel Features

The RCC within the Banner *PresencePLUS* Sensor is configured as a Server device. This means that it does not initiate connections on its own, but instead waits for a client (robot controller) to connect to it. The *PresencePLUS* Remote Command Channel (RCC) supports the following features:

- Triggering the sensor and performing product changes
- Checking sensor status, such as pass, fail, and I/O line state
- Retrieving tool results, and sensor counters including pass/fail
- User-defined frame (command) delimiters and output field separators
- Logging input and output data to assist with RCC/MMI debugging

Prerequisites — Kawasaki Robot

This procedure assumes that you are using an Ethernet-enabled Kawasaki robot controller configuration such as:

- Kawasaki C Series Controller with a 1HA Ethernet board option
- Kawasaki D Series Controller with a 1KN or 1QN Ethernet board option
- Kawasaki D+ Series Controller with an integrated 1RA Ethernet board

Related Documentation

For more information relating to Banner's Vision Sensors and Kawasaki Robot Controllers, refer to the following sources:

- Kawasaki Robot TCP/IP Function Instruction Manual
- Kawasaki D Series Controller AS Language Reference Manual
- *PresencePLUS* electronic Help

Establishing Sensor/Robot Communication

Step 1	Main Tasks to Complete
Install and connect a <i>PresencePLUS</i> Vision Sensor	<ol style="list-style-type: none"> 1. Install Banner <i>PresencePLUS</i> Vision Sensor version 2009R1B or later. 2. Connect the Vision Sensor using one of the following approaches: <ul style="list-style-type: none"> • connect to an existing Ethernet network via a switch or hub using a straight-through Ethernet cable with RJ45 connectors • connect directly to the Kawasaki controller using a cross-over Ethernet cable with RJ45 connectors. 3. Configure both the <i>PresencePLUS</i> sensor and the Kawasaki controller with static IP addresses.
Step 2	Main Tasks to Complete
Configure <i>PresencePLUS</i> Ethernet ports: The	<ol style="list-style-type: none"> 1. Start the <i>PresencePLUS</i> software. 2. Connect to the sensor.

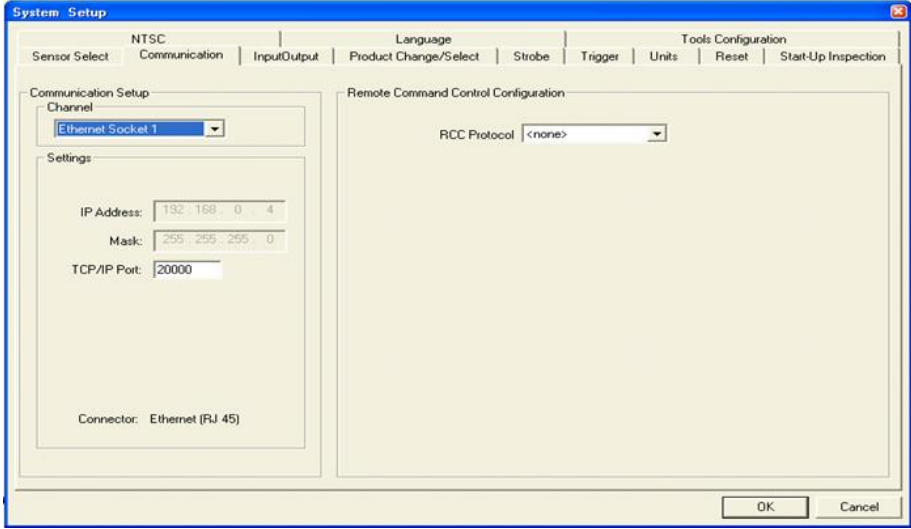
Step 2	Main Tasks to Complete
<p><i>PresencePLUS</i> Sensor supports user-assignable TCP/IP ports. This assignment is performed from the System Setup Dialog, Communications tab</p>	<ol style="list-style-type: none"> Click on the System button in the upper right corner of the <i>PresencePLUS</i> GUI to display the System Setup screen. Click on the Communication tab to display the Communication configuration dialog.  <p>The default Ethernet port assignments are from 20000 to 20009.</p>

 **Note:** Valid user TCP/IP port numbers for *PresencePLUS* sensors are in the range of 1024 through 65535. The *PresencePLUS* GUI will provide automatic notification if an attempt to use a reserved port is made. Any changes to the port assignment must be reflected in the AS Language program included in this document .

Step 3	Main Tasks to Complete
<p>Configure the <i>PresencePLUS</i> Remote Command Channel (RCC)</p>	<ol style="list-style-type: none"> Click on the RCC Protocol drop-down menu, and select "Kawasaki" from the menu. The default protocol configuration for Kawasaki robot is displayed.

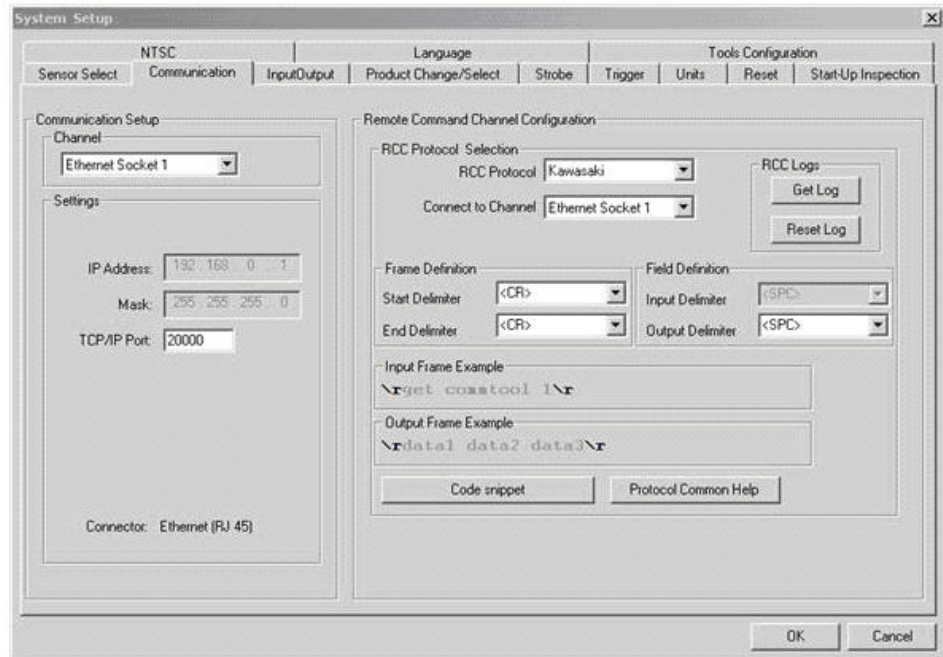
Step 3**Main Tasks to Complete**

2. Click the **OK** button to accept the configuration.

Kawasaki Protocol Defaults

The default Kawasaki protocol configuration parameters are:

- Ethernet Socket 1 configured for TCP/IP Port 20000 as the communications channel
- No Frame Start (Command Start) delimiter
- Carriage Return/Line Feed as Frame End (Command End) delimiter
- Space as the input command field separator
- Comma as the output field separator.

 **Note:** You can adjust each of these parameters as necessary, but corresponding adjustments will have to be made to the sample AS Language program provided to enable successful communication.

*Creating the PresencePLUS Inspection***Step 1****Main Tasks to Complete**

Enable the Coordinate Tool in the Tool Configuration dialog.

1. Click the **System** button in the upper-right corner of the *PresencePLUS* GUI.
2. Select the **Tools Configuration** tab.

Step 1**Main Tasks to Complete**

3. Scroll down to the **Coordinate Tool**, and then select the checkbox next to it, as shown below.
4. Click the **OK** button to close the Tool Configuration dialog.

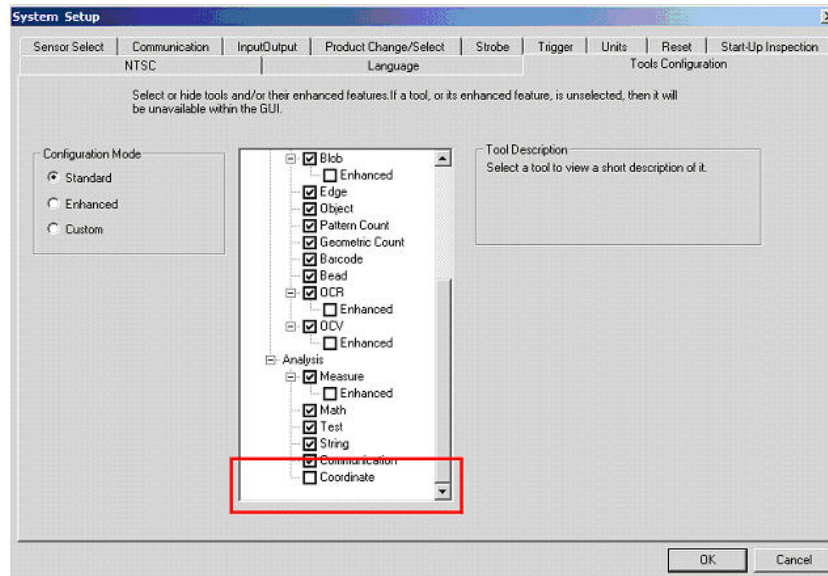
**Step 2****Main Tasks to Complete****Create a New Inspection using Setup.**

1. In the *PresencePLUS* GUI, create a new inspection by pressing the **Setup** button in the upper-left corner of the GUI.
2. Capture an image of the part to locate.
3. Press the **Goto Tools** button in the lower-right corner of the Setup tab.

Step 3**Main Tasks to Complete****Add a Geometric Find tool to locate the part within the field-of-view.**

1. In the *PresencePLUS* GUI, click the **Location Tools** tab.

Step 3**Main Tasks to Complete**

2. Click the **Geometric Find** button.
3. Draw the tool **ROI (Region of Interest)** to select the image feature of interest as shown below.



4. Click the **Apply** button to accept the ROI.
5. Click the **Next** button to return to the Tools menu.

Step 4**Main Tasks to Complete**

Add a Coordinate tool to provide locational data for the Robot.

1. In the *PresencePLUS* GUI, click the **Analysis Tools** tab.
2. Click the **Coordinate tool** button to create a Coordinate tool.

Step 4

Main Tasks to Complete

3. Select **Offset Only** from the **Tool List Filter** drop-down menu.

4. Click the **Next** button to return to the Tools menu.

 **Note:** The X, Y and Rotation selections will default to GF_1.

Step 5

Main Tasks to Complete

Add a **Test tool** to receive a positive confirmation that the

1. In the *PresencePLUS* GUI, click the **Analysis Tools** tab.
2. Click the **Test tool** button.
3. Select Coordinate Tool (COORD_1) from the Input 1 drop-down list.

Step 5**Main Tasks to Complete**

inspection ran successfully; that is, the part was found.

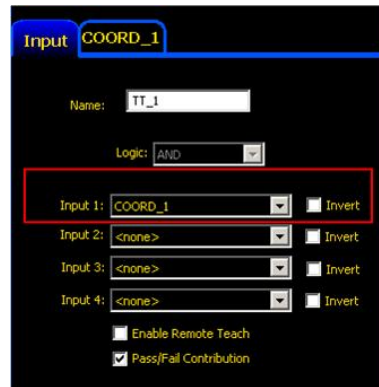

- Click on the Coordinate Tool (COORD_1) tab and make sure that the checkmark next to the X-Coordinate value checked. Enter 0 (zero) in the Min column and a large number (e.g., 1000) in the Max column.

 **Note:** These settings will cause the Test tool to pass all resulting X values, but fail if the X value is invalid (that is, if the part is not found).

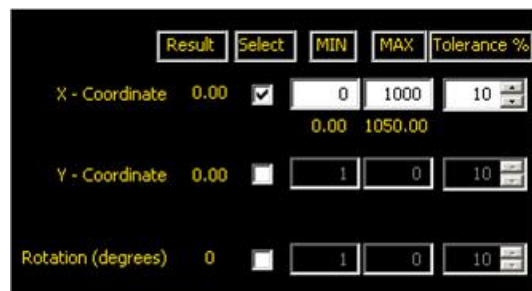

- Uncheck other values.
- Click the Back button.
- Click the Next button to exit the Test Tool configuration.

Step 6**Main Tasks to Complete****Save and Start Inspection**

In the *PresencePLUS* GUI, click the **Go To Run** button. When prompted to save the inspection:

- Enter a name in the **Inspection Name** field.

Step 6

Main Tasks to Complete

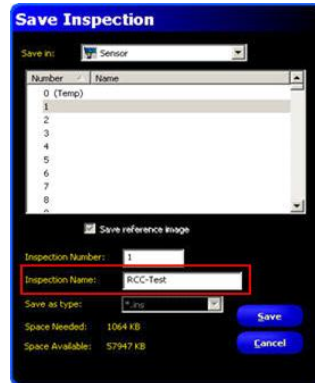

2. Click on the **Save** button.
3. Once the inspection is saved, click the **Start** button to start the inspection.

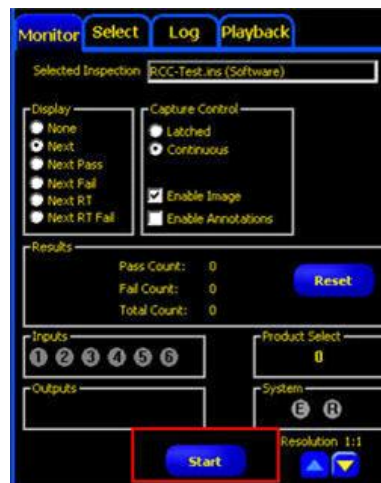

Kawasaki AS Language Sample

This sample AS Language code snippet will assist with the integration of a Banner PresencePLUS Vision Sensor and a Kawasaki C/D/D+ Series Robot Controller.

In this example, the Banner Remote Command Channel (RCC) has been configured to use the Kawasaki RCC Protocol with Ethernet Socket 1, all other settings are default (TCP port 20000, command and response frame start delimiter is empty string (<none>) with an end delimiter of carriage return-linefeed (\r\n), and the field output delimiter is comma (,).

This example assumes that a Banner PresencePLUS inspection that produces X, Y and Angle offsets has been loaded into the PresencePLUS Vision Sensor and has been started with the PresencePLUS GUI. These offsets will then be obtained and stored in the following variables:

- X_offset is the offset (in units set in camera) along the horizontal axis of the image, increases to the right
- Y_offset is the offset (in units set in camera) along the vertical axis of the image, increases downward
- Rz_offset is the angular offset (in degrees) about the Z-axis, increases clockwise

This program implements the following actions:

1. Connect to the RCC.
2. Issue EXEC TRIGGER and wait for inspection to complete.
3. Determine pass/fail condition of the inspection.
4. Get the X, Y, and Rotation about Z-axis offsets.
5. Close the connection to the RCC.

If any failure occurs, such as a TCP communications failure or a RCC command error, then the connection to the RCC will be severed within this example program.

```
.PROGRAM banner_vision()
  ; Global variables
  $cmd_del = $CHR(13)+$CHR(10)
  $coord_del = ","
  tcp_sock_id = -1      ; TCP/IP socket id for the camera

  ; Local variables
  .ret_val = -1
  .$cmd_str = ""       ; Used for commands to camera
  .$rcv_str = ""       ; Used for incoming data from camera
  .$rsp_str = ""       ; Used for response parsing from camera

  ;
  ; Open TCP socket and connect to RCC
  ;
  CALL tcp_open(.ret_val, 20000)
  IF .ret_val < 0 THEN
    PRINT "Unable to connect to RCC"
    RETURN
  END

  ;
  ; Trigger the camera and wait for the inspection to complete
  ;

  ; Send Trigger to camera and wait for the inspection to complete
  .$cmd_str = "EXEC TRIGGER"+$cmd_del
  CALL tcp_send(.ret_val, .$cmd_str)
  IF .ret_val < 0 GOTO tcp_error

  ; Read command response from camera
  .$rcv_str = ""
  CALL tcp_recv(.ret_val, .$rcv_str)
  IF .ret_val < 0 GOTO tcp_error

  ; Decode command response - a response of zero indicates that
  ; the command was accepted for processing, a negative value
  ; indicates that an error has occurred.
  .$rsp_str = $DECODE(.$rcv_str, $cmd_del, 0)
  .ret_val = VAL(.$rsp_str)
  IF .ret_val < 0 GOTO cmd_error      ; Trigger failed

  ;
```

```

; Determine whether the inspection passed or failed
;

; Send command to camera to determine if the inspection passed
; the inspection and found the desired part
.$cmd_str = "GET PASSFAILFLG"+$cmd_del
CALL tcp_send(.ret_val,.$cmd_str)
IF .ret_val < 0 GOTO tcp_error

; Read command response from camera
.$rcv_str = ""
CALL tcp_rcv(.ret_val, .$rcv_str)
IF .ret_val < 0 GOTO tcp_error          ; Get command failed

; Decode command response
.$rsp_str = $DECODE(.$rcv_str, $cmd_del, 0)
.ret_val = VAL(.$rsp_str)
IF .ret_val < 0 GOTO cmd_error          ; Get Pass/Fail failed
$stemp = $DECODE(.$rcv_str, $cmd_del, 1) ; Remove frame delimiter

; Decode the Pass/Fail status data returned by the Get command
.$rsp_str = $DECODE(.$rcv_str, $coord_del, 0)
.passfail = VAL(.$rsp_str)
IF .passfail <> 1 GOTO notfnd_error

;
; Obtain the X, Y, and Rz offset data
;

; Send command to camera to acquire the Communication Tool
; result data
.$cmd_str = "GET COORDTOOL"+$cmd_del
CALL tcp_send(.ret_val,.$cmd_str)
IF .ret_val < 0 GOTO tcp_error

; Read command response from camera
.$rcv_str = ""
CALL tcp_rcv(.ret_val, .$rcv_str)
IF .ret_val < 0 GOTO tcp_error

; Decode command response
.$rsp_str = $DECODE(.$rcv_str, $cmd_del, 0)
.ret_val = VAL(.$rsp_str)
IF .ret_val < 0 GOTO cmd_error          ; Get Commtool failed

$stemp = $DECODE(.$rcv_str, $cmd_del, 1) ; Remove frame delimiter

; Decode the X offset data
.$rsp_str = $DECODE(.$rcv_str, $coord_del, 0)
X_offset = VAL(.$rsp_str)
$stemp = $DECODE(.$rcv_str, $coord_del, 1) ; Remove field delimiter

; Decode the Y offset data
.$rsp_str = $DECODE(.$rcv_str, $coord_del, 0)
Y_offset = VAL(.$rsp_str)
$stemp = $DECODE(.$rcv_str, $coord_del, 1) ; Remove field delimiter

;Decode the Rz offset data -- rotation about the Z axis
.$rsp_str = $DECODE(.$rcv_str, $coord_del, 0)
O_offset = VAL(.$rsp_str)
$stemp = $DECODE(.$rcv_str, $coord_del, 1) ; Remove field delimiter

```



```

;
; Handle new coordinate offsets
;
PRINT X_offset, Y_offset, Rz_offset
POINT pick = frame1+TRANS(X_offset, Y_offset, ,Rz_offset)
HOME
LAPPRO pick,100
LMOVE pick
CLAMP 1
LDEPART 100
HOME

; Part not found error
notfnd_error:
  PRINT "The part was not found"
  GOTO all_done

; TCP error
tcp_error:
  PRINT "Error during send or receive via TCP:", .ret_val
  GOTO all_done

; RCC Command error
cmd_error:
  PRINT "Error during command to camera:", .ret_val
  GOTO all_done

; Done with program
all_done:
  CALL tcp_close
.END

;
; Open a TCP connection to the RCC using specified TCP port number
;
.PROGRAM tcp_open(.ret_val, .port)

  .ret_val = 0          ; Initialize the return value
  .retry_count = 0     ; Initialize the retry count

  ; Set the IP address to 192.168.0.1
  ip[1] = 192
  ip[2] = 168
  ip[3] = 0
  ip[4] = 1

connect:

  ; Connect to the RCC port
  TCP_CONNECT tcp_sock_id, .port, ip[1]

  ; Check whether connection was established
  IF tcp_sock_id < 0 THEN
    IF .retry_count >= 5 THEN
      ; Number of retries exceeds 5, exit with error
      PRINT "Unable to establish connection with camera"
      .ret_val = -1
      GOTO connect_error
    ELSE
      ; Increment the retry count and try again

```

```

        .retry_count = .retry_count + 1
        PRINT "TCP_CONNECT error - attempt #", .retry_count
        GOTO connect
    END
ELSE
    PRINT "Established connection, socket id = ", tcp_sock_id
END

; Error occurred during connection attempt(s)
connect_error:
    RETURN

.END

;
; Close the TCP connection
;
.PROGRAM tcp_close()

    .ret_val = 0                ; Initialize the return value

    TCP_CLOSE .ret_val, tcp_sock_id

    ; Check for errors
    IF (.ret_val < 0) THEN
        PRINT "Unable to close TCP connection, error id = ", .ret_val
    ELSE
        PRINT "TCP Connection has been closed"
    END
.END

;
; Receive data over TCP connection
;
.PROGRAM tcp_rcv(.ret_val, .$receive)

    .ret_val = 0                ; Initialize the return value
    .error_return = -99         ; Return value from TCP_RECV
    .timeout_rcv = 60           ; Timeout of 60 seconds
    .max_rcv_len = 255         ; Maximum length of single string element
    .$receive = ""             ; Empty the return string
    .num_elem_rcv = 0          ; Number of elements received

    ; Read the TCP socket
    TCP_RECV .error_return, tcp_sock_id, .$rcv_buf[1], .num_elem_rcv,
    .timeout_rcv, .max_rcv_len

    ; Process data
    IF .error_return < 0 THEN
        PRINT "Error receiving data, TCP_RECV error #", .error_return
        .ret_val = -1
    ELSE
        IF .num_elem_rcv > 0 THEN

            ; Ensure the combined return string element lengths do
            ; not exceed 255 (maximum allowed length of string) - the
            ; multiplication allows .max_rcv_len to be less than 255
            IF .num_elem_rcv * .max_rcv_len <= 255 THEN

                ; Copy all of the received elements into output buffer
                FOR .j = 1 TO .num_elem_rcv
                    .$receive = .$receive+.$rcv_buf[.j]
                END
            END
        END
    END
END

```

```

        ELSE
            PRINT "Received string too long"
            .ret_val = -1
        END
    ELSE
        PRINT "Invalid number of elements received"
        .ret_val = -1
    END
END
.END

;
; Send data over the TCP connection
;
.PROGRAM tcp_send(.ret_val, .$data)

.ret_val = 0           ; Initialize function return code
.$send_buf[1] = .$data ; Data to send
.buf_num = 1          ; Number of array elements
.send_timeout = 60    ; send timeout
.error_return = 0     ; send error return code

TCP_SEND .error_return, tcp_sock_id, .$send_buf[1], .buf_num, send_timeout

IF .error_return < 0 THEN
    .ret_val = -1
    PRINT "TCP SEND error in SEND, error = ", .error_return
END
.END

```

PresencePLUS Communication Testing

The RCC interface is not a true Telnet interface, although you can use Telnet to test it. Some of the control keys, such as Back Space and Delete will not cause mistyped characters to be erased. Instead, they will be passed on and consumed by the RCC interface. Other control characters will also be consumed by the interface without the usual Telnet actions.

However, you can test the RCC connection by using a Telnet application to connect to the sensor using the port that you configured for the RCC (20000 by default). To function correctly, you must set the Newline transmit value within the Telnet application to be the same as the Command Line End delimiter that you selected in the RCC configuration menu (Carriage Return/Line Feed by default).

After you have successfully connected to the RCC, you can enter RCC commands and observe responses. For example, you can enter *get onlinests* to retrieve the online status of the sensor. Another example is you can type in the command *exec trigger*, this will result in the sensor to be triggered, the inspection will be executed, and you should see the inspection output in the GUI. For a complete list of RCC commands and return codes, please refer to the *PresencePLUS* electronic documentation - accessible through the *PresencePLUS* GUI.

6.2.4 Using Custom_ASCII to Communicate with an External Device Over Ethernet

To select **Custom_ASCII**, click on the RCC Protocol pull-down menu, and select **Custom_ASCII** from the menu. The protocol configuration for **Custom_ASCII** is displayed as shown below. The default protocol configuration parameters are:

- Ethernet Socket 1 configured for TCP/IP 20000 as the communications channel
- No Frame Start (Command Start) Delimiter — <none>
- Carriage Return/Line Feed as Frame End (Command End) Delimiter — \r\n
- Comma as the Output Delimiter for the Field Definition — ,
- Space as the Input Delimiter for the Field Definition — <SPC>

The screenshot shows the 'Communication' tab of the 'System Setup Dialog'. The 'Communication Setup' section has a 'Channel' dropdown set to 'Ethernet Socket 1'. Under 'Settings', the 'IP Address' is '192.168.0.4', 'Mask' is '255.255.255.0', and 'TCP/IP Port' is '20000'. The 'Connector' is 'Ethernet (RJ 45)'. The 'Remote Command Channel (RCC) Configuration' section has 'RCC Protocol Selection' set to 'Custom_ASCII' and 'Connect to Channel' set to 'Ethernet Socket 1'. 'Frame Definition' shows 'Start Delimiter' as '<None>' and 'End Delimiter' as '<CR-LF>'. 'Field Definition' shows 'Input Delimiter' as '<SPC>' and 'Output Delimiter' as ','. 'Input Frame Example' is 'get commtool 1\r\n' and 'Output Frame Example' is 'data1,data2,data3\r\n'. There are 'Get Log' and 'Reset Log' buttons. An 'OK' button is at the bottom right.

6.3 Input/Output Tab

Use this tab to set the functionality of the four programmable I/O connections.

Inputs and Outputs You can select Trigger, Product Change, Remote Teach, and Discrete inputs and outputs as either NPN (current sourcing) or PNP (current sinking). Once NPN or PNP is selected, **all** inputs and outputs are either NPN or PNP.

I/O, Pin #, Function I/O 1 through 4 in the I/O column correspond to Pins 5 through 8 in the Pin # column.

Options from the drop-down list are:

- **General Input:** Input to the sensor.
- **General Output:** Output from the sensor that can be selected in a Test tool.
- **Pass:** Active when the entire inspection passes.
- **Fail:** Active when the inspection fails.
- **System Error:** Active when a system error occurs.
- **Ready:** Active when the sensor is ready to accept another trigger.
- **Product Select:** Used in conjunction with Product Change to select inspection locations at which to begin execution.

Normally Open/Closed Select the state (open or closed) that the output will take when not active.

- **Normally Open:** The output becomes **active** when the logic condition controlling the output becomes **True**.
- **Normally Closed:** The output becomes **inactive** when the logic condition controlling the output becomes **True**.

Output Delay Output Delay is the time from a trigger to start an inspection until the Sensor output turns ON. It is available only for general outputs.

-  **Note:** If processing time is longer than the output delay, the output will become active immediately after the processing is finished.

Output Duration This option is available only for the general outputs; the other outputs (Pass, Fail, System Error, and Ready) are latched only.

- **Latched:** Active until the condition changes.
- **Time:** Active for a specific length of time.

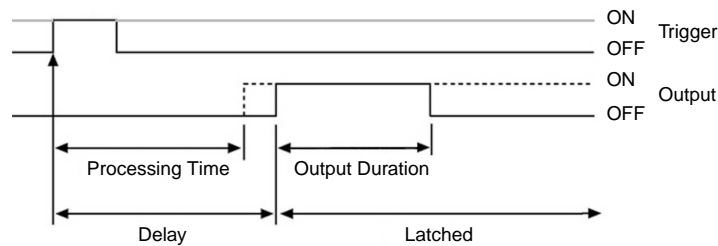

Input/Output Tab

P4 Input/Output Tab

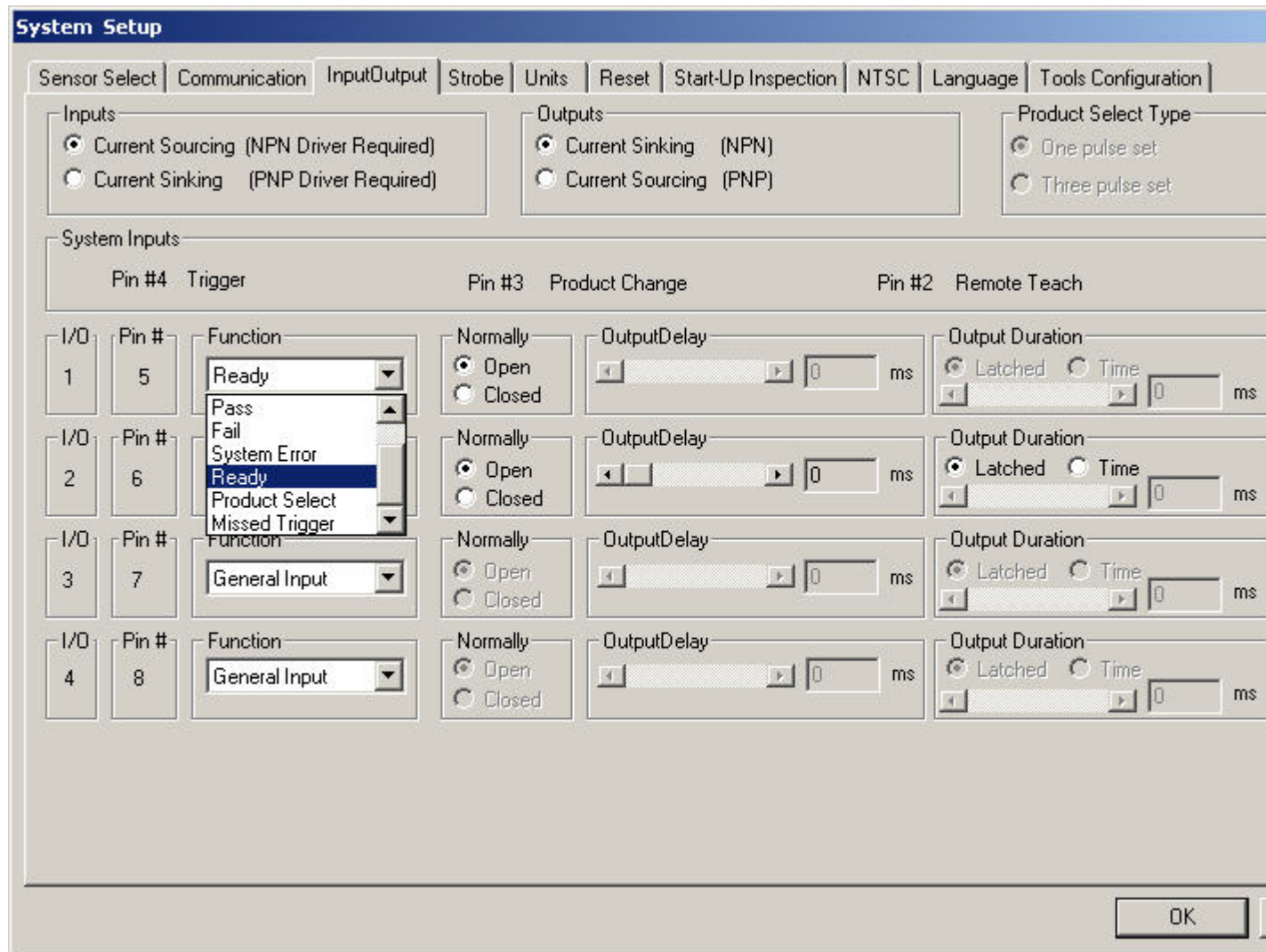

6.3.1 P4 Input/Output Tab

Use this tab to set the functionality of the four programmable I/O connections.

Inputs and Outputs You can select Trigger, Product Change, Remote Teach, and Discrete inputs and outputs as either NPN (current sourcing) or PNP (current sinking). Once NPN or PNP is selected, **all** inputs and outputs are either NPN or PNP.

I/O, Pin #, Function I/O 1 through 4 in the I/O column correspond to Pins 5 through 8 in the Pin # column.

Options from the drop-down list are:

- **General Input:** Input to the sensor.
- **General Output:** Output from the sensor that can be selected in a Test tool.
- **Pass:** Active when the entire inspection passes.
- **Fail:** Active when the inspection fails.
- **System Error:** Active when a system error occurs.
- **Ready:** Active when the sensor is ready to accept another trigger.
- **Product Select:** Used in conjunction with Product Change to select inspection locations at which to begin execution.

Normally Open/Closed Select the state (open or closed) that the output will take when not active.

- **Normally Open:** The output becomes **active** when the logic condition controlling the output becomes **True**.
- **Normally Closed:** The output becomes **inactive** when the logic condition controlling the output becomes **True**.

Output Delay Output Delay is the time from a trigger to start an inspection until the Sensor output turns ON. It is available only for general outputs.

- 👉 **Note:** If processing time is longer than the output delay, the output will become active immediately after the processing is finished.

Output Duration This option is available only for the general outputs; the other outputs (Pass, Fail, System Error, and Ready) are latched only.

- **Latched:** Active until the condition changes.
- **Time:** Active for a specific length of time.

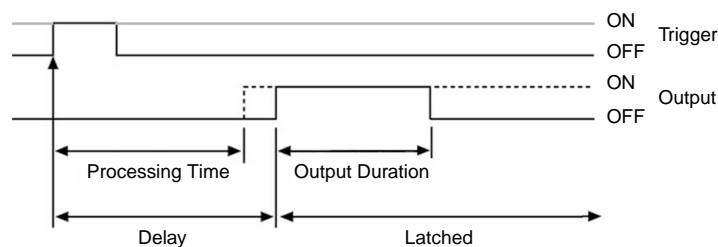

Input/Output Tab

P4 Input/Output Tab

System Setup

Sensor Select | Communication | InputOutput | **Strobe** | Units | Reset | Start-Up Inspection | NTSC | Language | Tools Configuration

Inputs

Current Sourcing (NPN Driver Required)
 Current Sinking (PNP Driver Required)

Outputs

Current Sinking (NPN)
 Current Sourcing (PNP)

Product Select Type

One pulse set
 Three pulse set

System Inputs

I/O	Pin #	Function	Normally	OutputDelay	Output Duration
	Pin #4	Trigger			
	Pin #3	Product Change			
	Pin #2	Remote Teach			
1	5	Ready	<input checked="" type="radio"/> Open <input type="radio"/> Closed	0 ms	<input checked="" type="radio"/> Latched <input type="radio"/> Time 0 ms
2	6	Ready	<input checked="" type="radio"/> Open <input type="radio"/> Closed	0 ms	<input checked="" type="radio"/> Latched <input type="radio"/> Time 0 ms
3	7	General Input	<input checked="" type="radio"/> Open <input type="radio"/> Closed	0 ms	<input checked="" type="radio"/> Latched <input type="radio"/> Time 0 ms
4	8	General Input	<input checked="" type="radio"/> Open <input type="radio"/> Closed	0 ms	<input checked="" type="radio"/> Latched <input type="radio"/> Time 0 ms

OK

6.4 Strobe Tab

Use the Strobe tab to set the strobe signal for a strobed light source. The strobe signal is a +5V dc TTL signal.

Fields in the System Setup window's Strobe tab are described below:

Strobe Tab

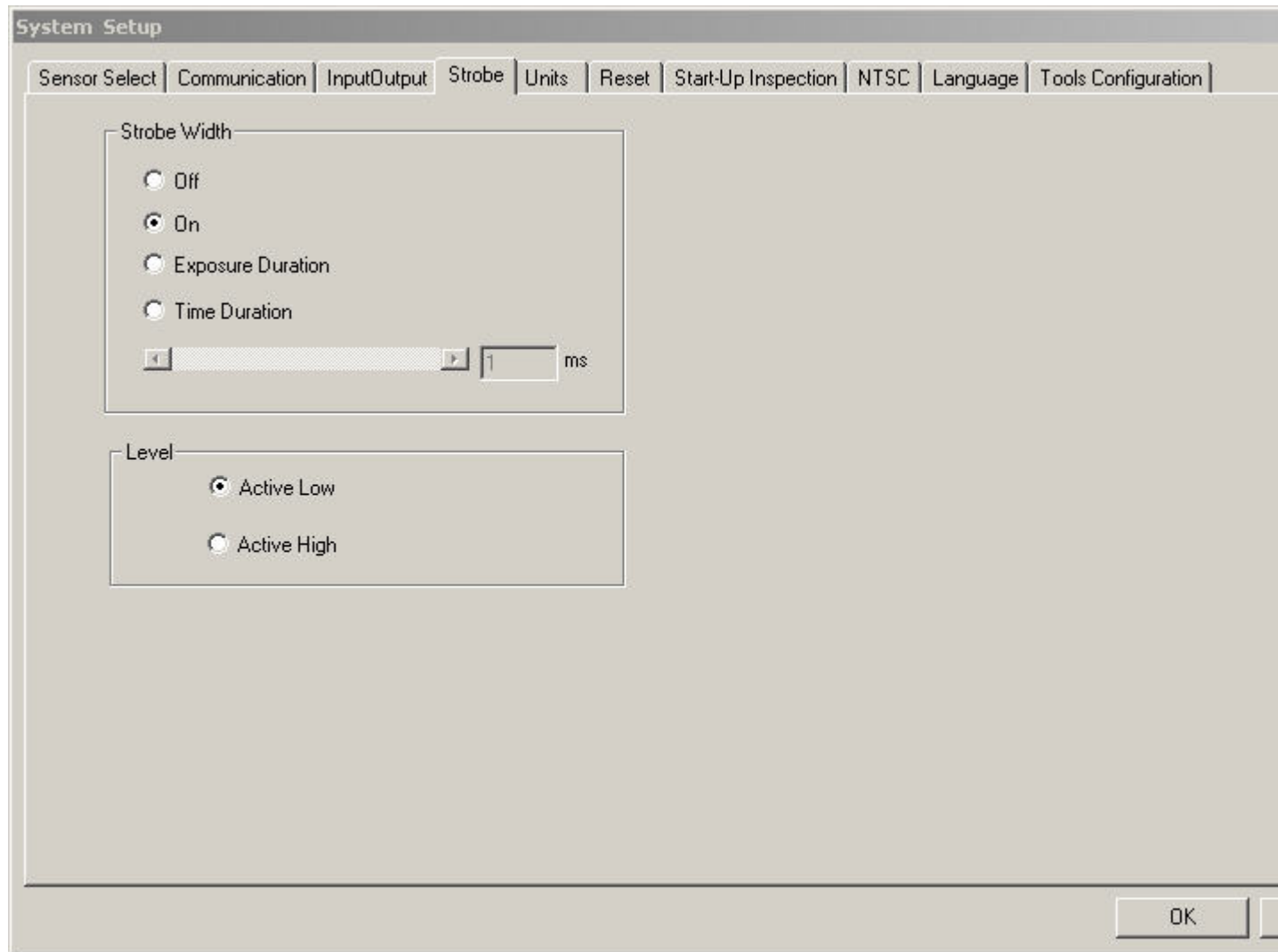

6.4.1 Strobe Width

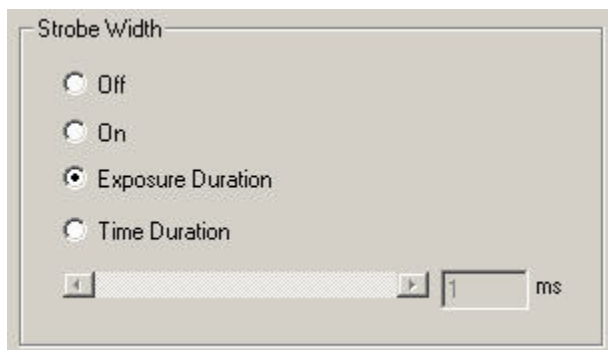

Strobe Width Option	Description
Off	The strobe output never becomes active (light off).

Strobe Width Option	Description
On	The strobe output remains active (light on).
Exposure Duration	The strobe output is active only while the sensor is acquiring an image. This is the default.
Time Duration	Sets the duration for active strobe output from the initial valid trigger (minimum pulse width has been satisfied) to the end of the duration. The range is from 0 to 4,000 ms.

6.4.2 Level

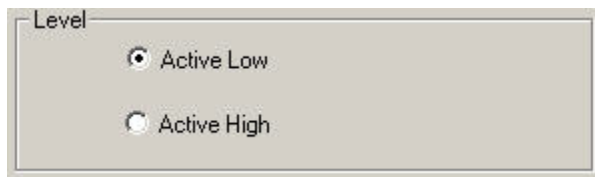

- **Active Low** -- When given a 0V dc signal, it turns on. This is the default.
- **Active High** -- When given a +5V dc signal, it turns on.

6.5 Units Tab

By default, the sensor expresses all distance calculations as pixels:

- Configure a scale value based on a known distance in user-selected units (for example, inches, millimeters, or centimeters) See [Configure with Known Distance](#) on page 84 for more information.

Units Tab

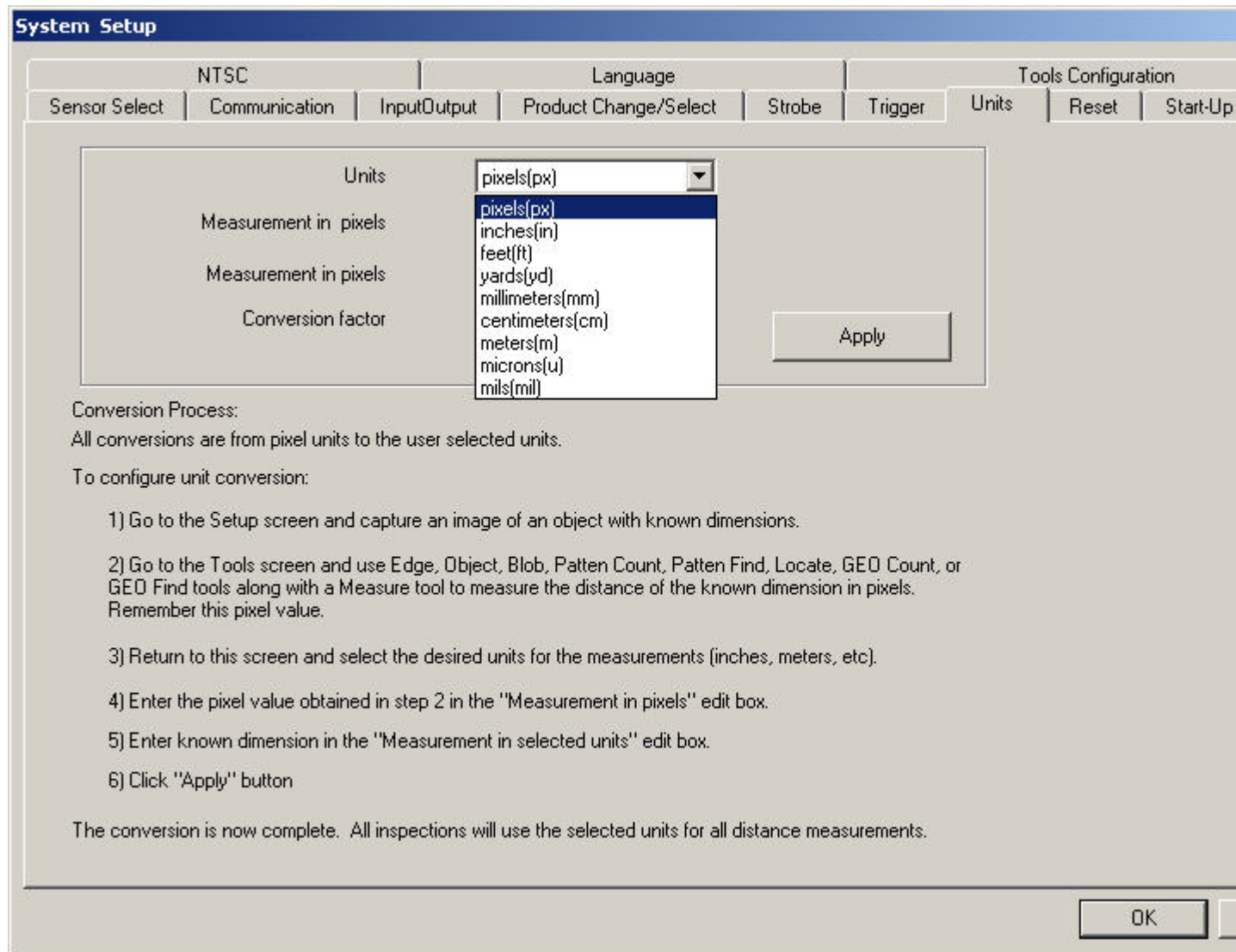

6.5.1 Select Conversion Units

From the Units drop-down list, select the units to in which to convert pixels. The options are:

- pixels (px)
- inches (in)
- feet (ft)
- yards (yd)
- millimeters (mm)
- centimeters (cm)
- meters (m)
- microns (u)
- mils (mil)

Additionally, select the decimal place precision using the arrow keys to select a value from 0 to 6.

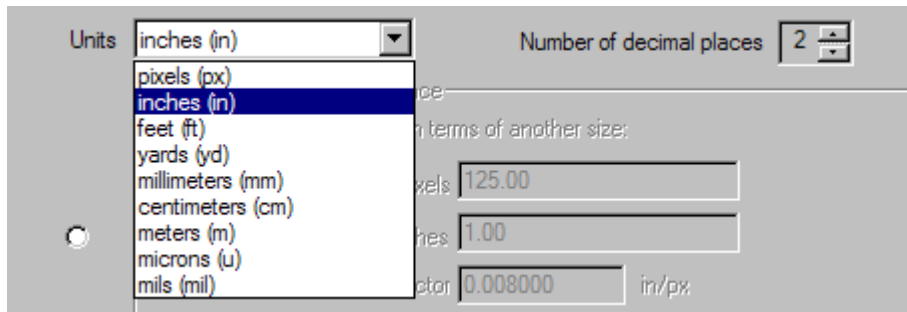

6.5.2 Configure with Known Distance

To configure how to scale pixel units for the PresencePLUS software, do the following:

1. Go to the Setup screen and capture an image of an object with known dimensions.

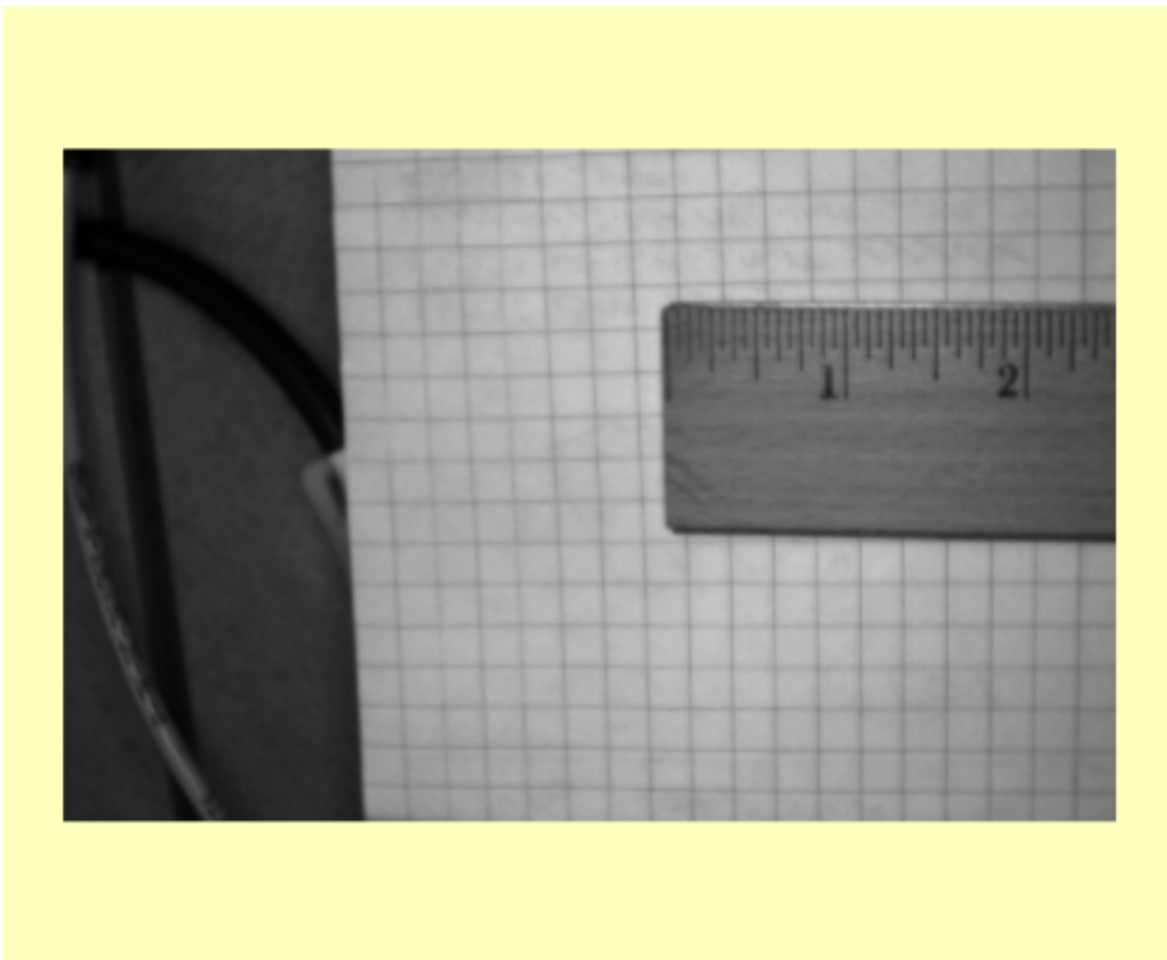

2. Go to the Tools screen and use a Location or Vision tool (for example, a Locate, Edge, or Object tool) and a Measure tool to measure the distance of the known dimension in pixels. The example below uses two Locate tools and a measure tool to determine the number of pixels in an inch.



3. In the Units tab, select the desired units and enter the pixel value in the **Measurement in pixels** field.

Configure with known distance

Establish the size of a pixel in terms of another size:

Measurement in pixels

Measurement in inches

Conversion factor in/px

Apply to

4. From the **Apply to** drop-down list, select either **Distances only** (default for backward compatibility), or **Distances offsets, and locations**.

Configure with known distance

Establish the size of a pixel in terms of another size:

Measurement in pixels

Measurement in inches

Conversion factor in/px

Apply to

Distances only

Distances, offsets, and locations

Configure with two known points

5. Click Apply.

6.6 Reset Tab

Use the Reset tab to read sensor error codes, clear system errors and reestablish Sensor communications.

Option	Description
Reset Error Flag	Click to clear the sensor's Red Error LED.
Reset Error Log	Click to clear the error log.
System Reset	Click to reboot the Sensor. (This is a system reboot and will take several seconds).
Get Error Log	Click to display the System Log icon in the Navigation/Results window. The System Log records information about all system failures (such as communication errors between the PC and the Sensor).

Reset Tab

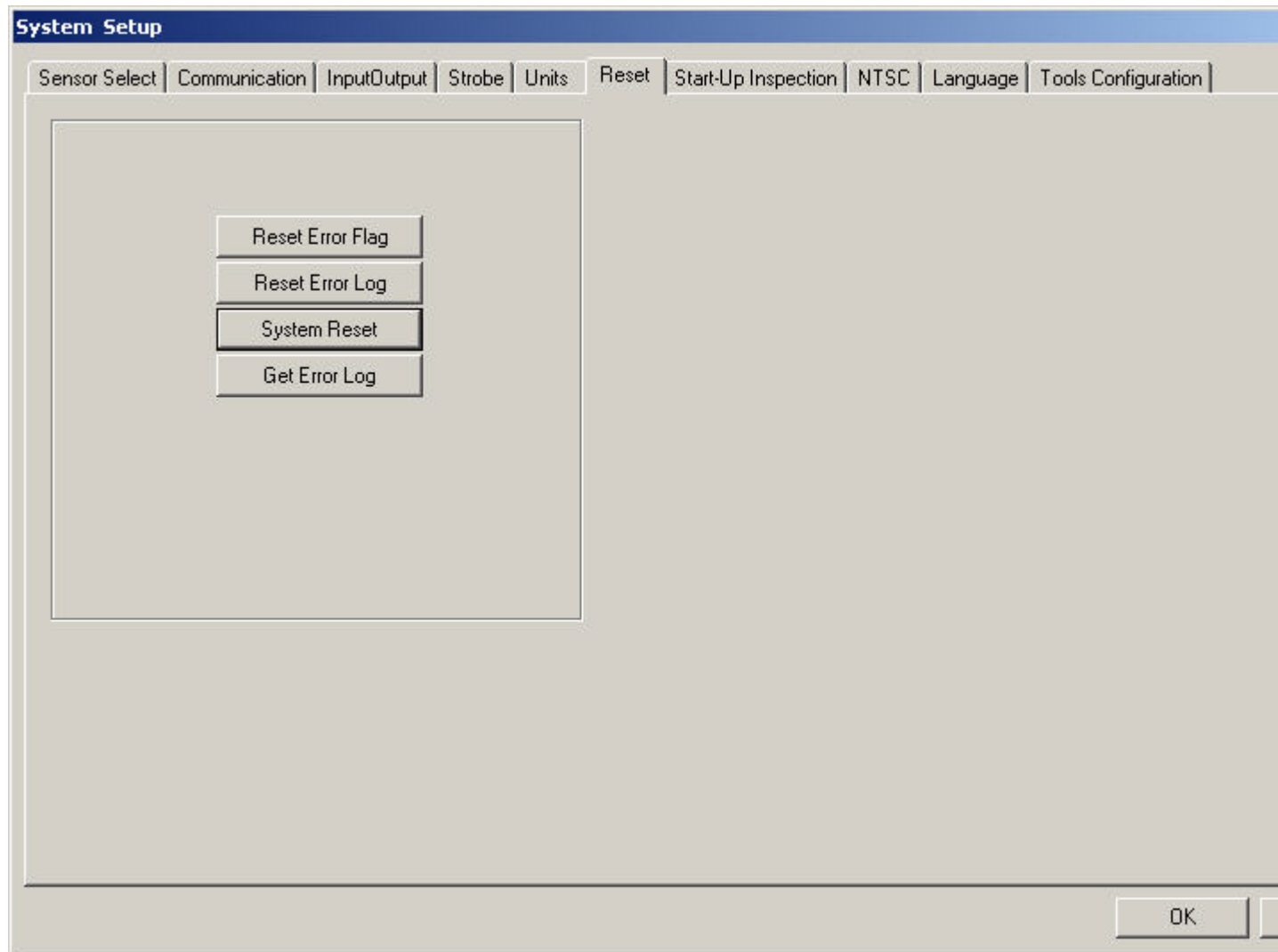

6.7 Start-Up Inspection Tab

The options on the Start-Up Inspection tab:

- Click on **Setup Mode** if you want the camera to start in Setup Mode after it is powered down.
- Click on **Inspection Name**, and select an inspection from the drop-down list to have the sensor start up to run.

Start-Up Inspection Tab

P4 Start-Up Inspection Tab

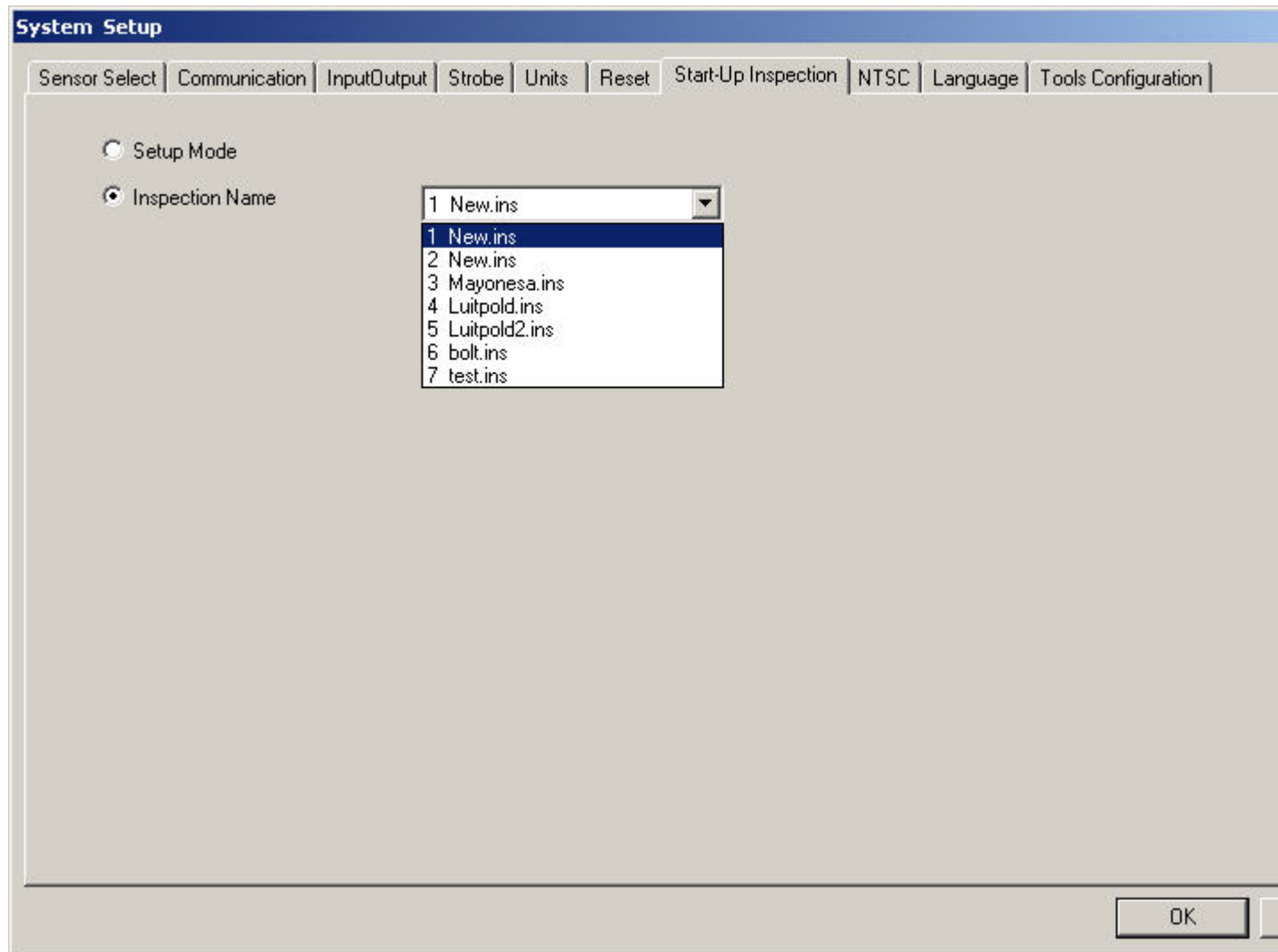

ProII Start-Up Inspection Tab

6.8 NTSC Tab

The **Zoom Level** adjustment on the NTSC tab is available only for single function, low-resolution sensors such as the Area and Geo. From the drop-down list, select the desired zoom level as it will appear on the optional NTSC video monitor that you can attach to the sensor. The default is 4:1.

NTSC Tab

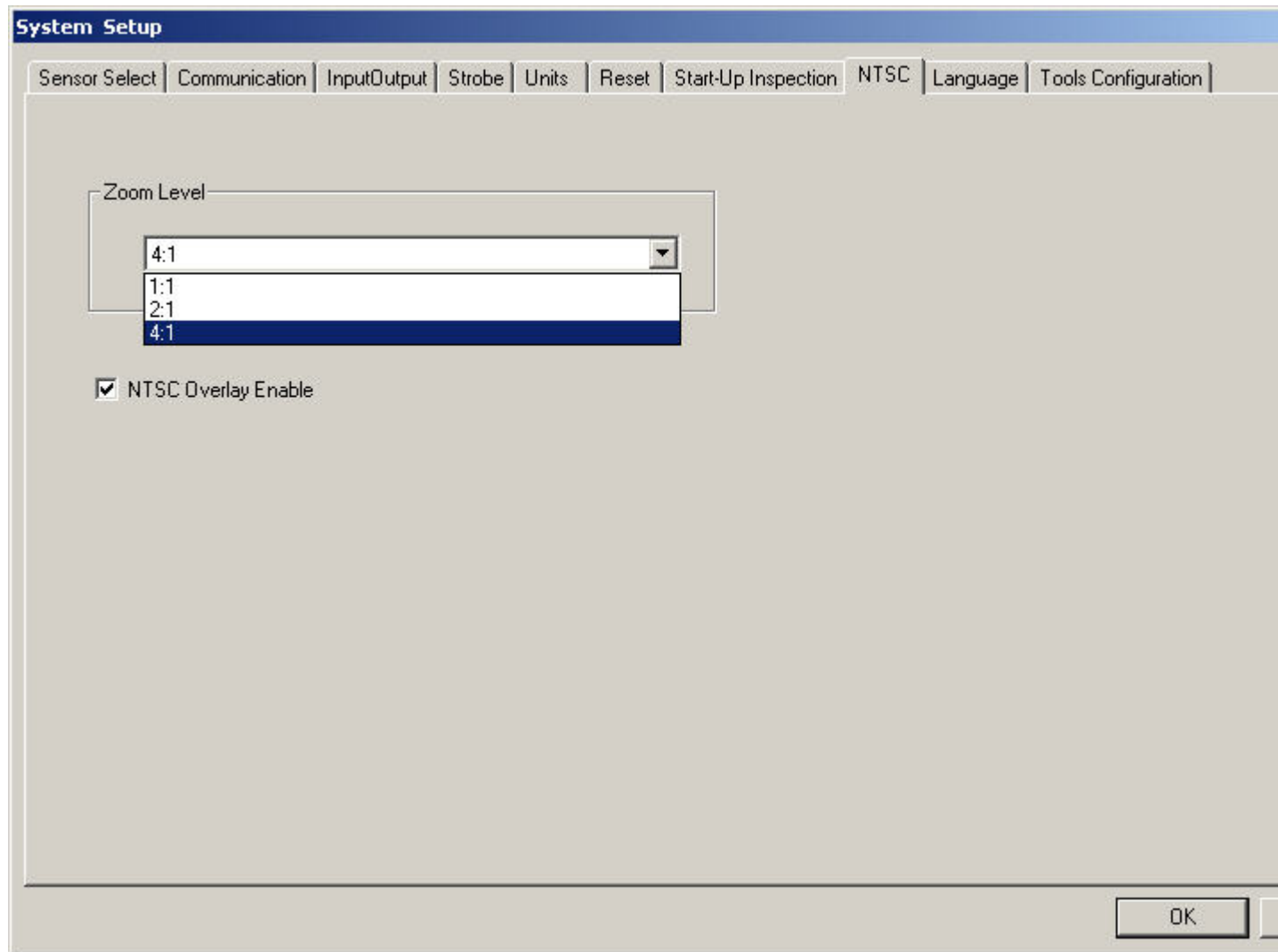

6.9 Language Tab

In the Languages tab, click on the down arrow for a drop-down list of the languages installed from the *PresencePLUS* software CD.

Click on the desired language, then click Apply. At the next start-up, the PresencePLUS software will use the selected language.

To save changes and exit the System Setup window, click OK. To exit the System Setup window without making any changes, click the X in the upper-right hand corner of the window.

Language Tab

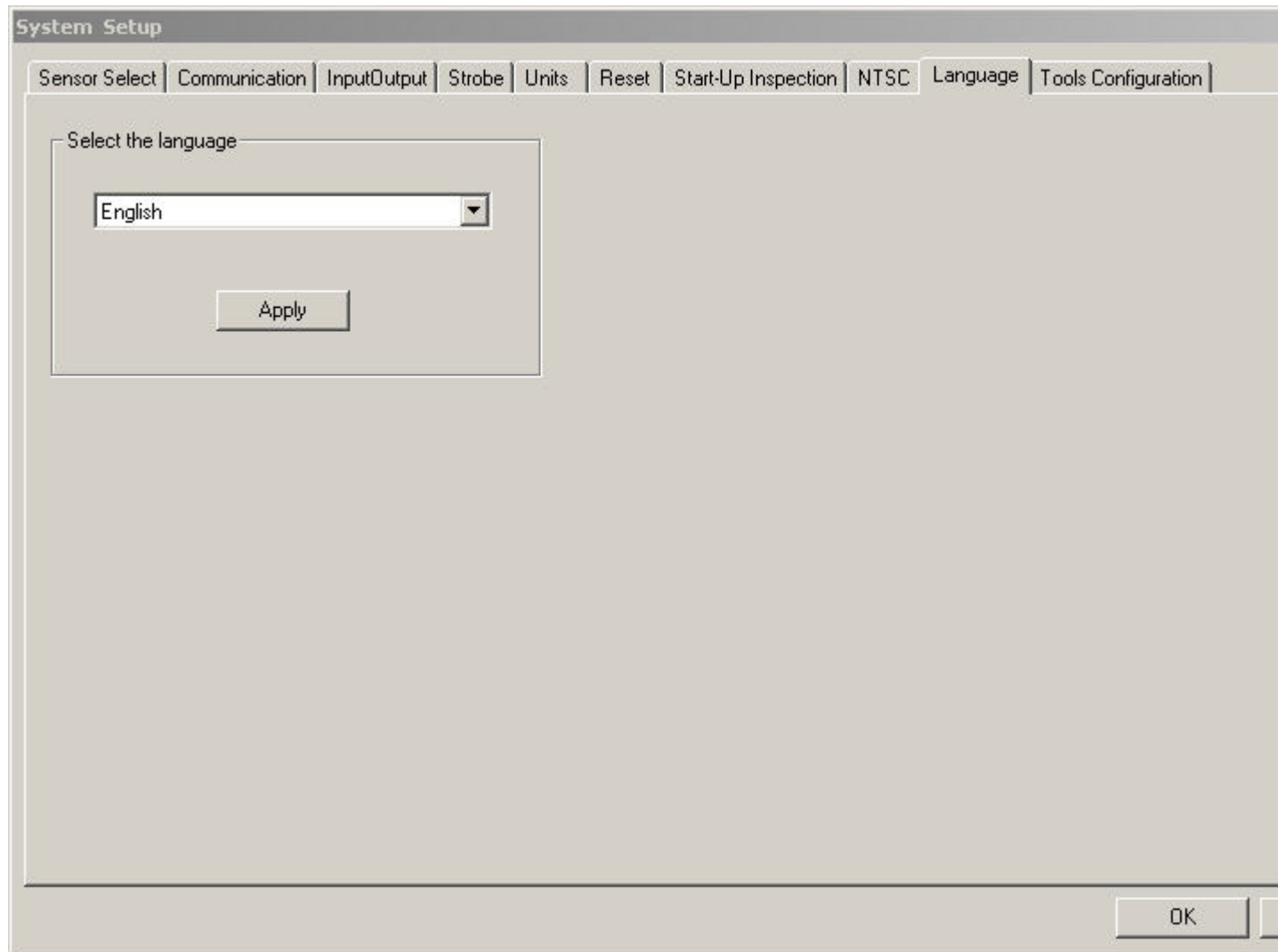

6.10 Tools Configuration

Tool Configuration provides the ability to customize the Tools page within the PresencePLUS software. Entire tools, or their enhanced features, can optionally be displayed or hidden. This provides the ability to configure the system to better support your application, thus further simplifying the creation and modification of inspections.

To assist with the customization, the list of tools for the connected sensor is displayed in a tree view. In this tree view, all tools which have a check mark are available for use in the inspection, and all tools that are unchecked are hidden. Similarly, a tool's enhanced feature will be available if checked, and unavailable if unchecked.

Tools Configuration

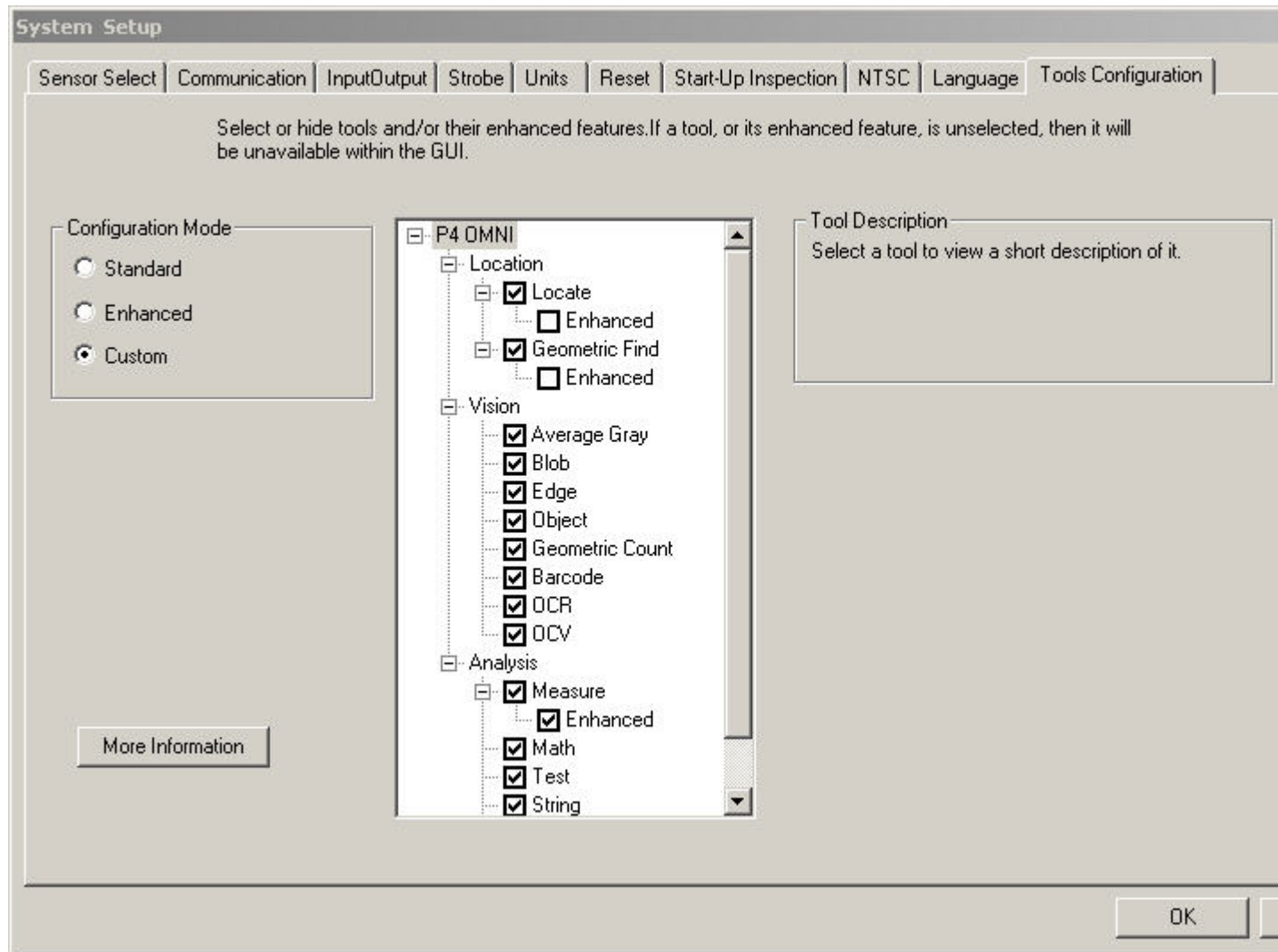

6.10.1 Standard Mode

Choose this option to reset all tool configuration settings for the connected sensor to the factory defaults.

6.10.2 Enhanced Mode

Choose this option to enable all tools and all tool's enhanced features for the connected sensor.

6.10.3 Custom Mode

Choose this mode to customize the tools configuration settings within the tree view. This mode is automatically selected when changes are made to the tree view.

The Tool Configuration settings will only affect the sensor that the PresencePLUS software is connected - these settings are stored with the sensor. Therefore, if the PresencePLUS software connects to a different sensor, then that sensor's tool configuration will be reflected within the *PresencePLUS* software.

This feature is available when connected to sensors with 2008R1 or newer versions of firmware.

6.10.4 Tool Licensing

Some tools (e.g., barcode and OCR/OCV) require a license to be registered within the sensor before they can be activated. To purchase a license key, contact Banner with the following information:

- MAC address of the sensor you wish to license
- Product Type of the sensor
- The tool(s) you wish to purchase licenses
- Your company information
- An e-mail address to receive the Key

Please use caution when providing this information, as a license issued for one sensor cannot be registered on a different sensor.

After receiving a license key, you may register the license key using two different methods:

Method 1 - Use the Firmware Updater (recommended)

- Run the Firmware Updater - version 2.0.4 (2008R1) or newer
- Select the 'Licensing' tab
- Connect to the sensor with the MAC address used for key
- Enter the license key received for the sensor - or browse for the license file
- Click on the 'Register' button
- If necessary, select the 'Update' tab and update the firmware to the latest version

Method 2 - Use the PresencePLUS GUI software

(Use this method if sensor has latest version of firmware)

- Start the PresencePLUS software - version 3.2.0 (2008R1) or newer
- Connect to the sensor with the MAC address used for key
- Click 'System' on the title bar and then select the 'Tool Configuration' tab
- Select the tool to activate
- Enter the license key received for the sensor
- Click on the 'Register' button

To view licenses currently registered within the sensor, click the 'Help' button on the title bar and select 'About' from the menu. The licenses are also displayed next to the product name in the title bar.

PresencePLUS Software Tools Chapter 7

7.1 ROI Types

ROI types include Area, Search, and Linear.

7.1.1 Linear ROI

Linear ROIs are used by tools that scan along a defined line in a defined direction. Data are averaged along a linear ROI wider than 1 pixel to provide accurate test results. You can adjust the ROI width in increments of 4; that is, 1, 5, 9, 13, and so on. The ROI is widened symmetrically.

 **Note:** Widening an ROI provides an average value/location, which results in improved repeatability.

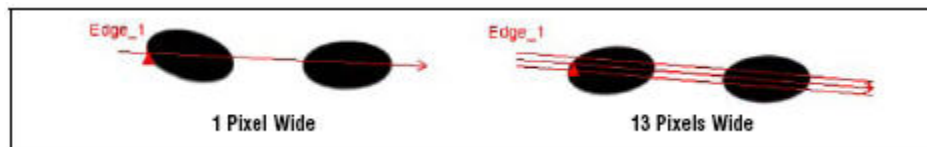

7.1.2 Area ROI

An Area ROI can be rectangular, elliptical, or circular. Click on Draw ROI in the input tab to expand the list of ROI shapes from which to select. The shapes are shown below.

 **Note:** An Area ROI can be as large as the entire Field of View (FOV).

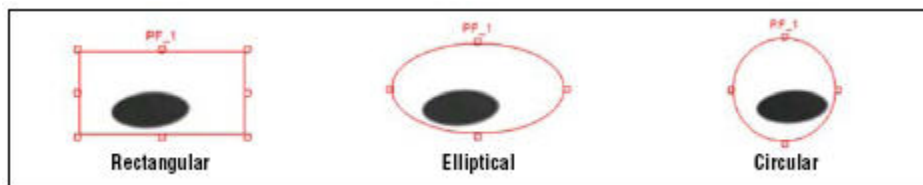

7.1.3 Search ROI

Geometric Find, Geometric Count, Pattern Find, and Pattern Count ROIs, like Area ROIs, can be rectangular, elliptical, or circular; however, these ROIs are also bounded by a Search ROI. The Search ROI is indicated by a yellow box that is always rectangular and, by default, is 20% to 30% larger than the Area ROI, which is red.

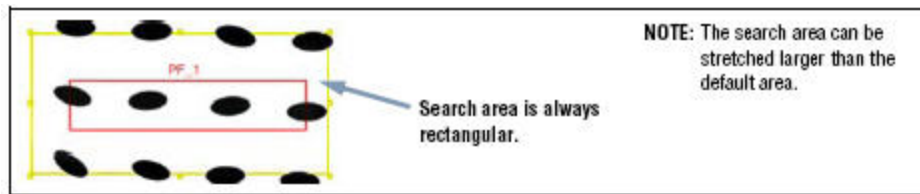

7.2 Location Tools

Location tools are used as a reference point to adjust the location of subsequent Regions of Interest (ROI) for translational and rotational variations of the target.

7.2.1 Locate Tool

The Locate tool locates the position of a target in a field of view. This tool finds and marks position of the first edge along the ROI line. Typically, tools, including additional Locate tools that follow, are relative to this point. Additionally, the software can calculate the angle at which the Locate tool intersects the feature's edge and rotates following tools Regions of Interest (ROIs) accordingly.

Usage

The Locate tool is used to align and position Vision tools consistently over the feature of interest.

Fields

The following are fields on the Locate tool Input tab:

- [Threshold Type](#) on page 96
- [Filters](#) on page 98
- [Results](#) on page 99
- [Select](#) on page 99

Supported Platforms

ProII Color	ProII/ProII 1.3	OMNI Color	OMNI/OMNI 1.3	AREA/AREA13	EDGE/EDGE 1.3	GEO/GEO 1.3	BCR/BCR 1.3
Yes	Yes	Yes	Yes	Yes	Yes	Yes	Yes

Locate Tool Tabs

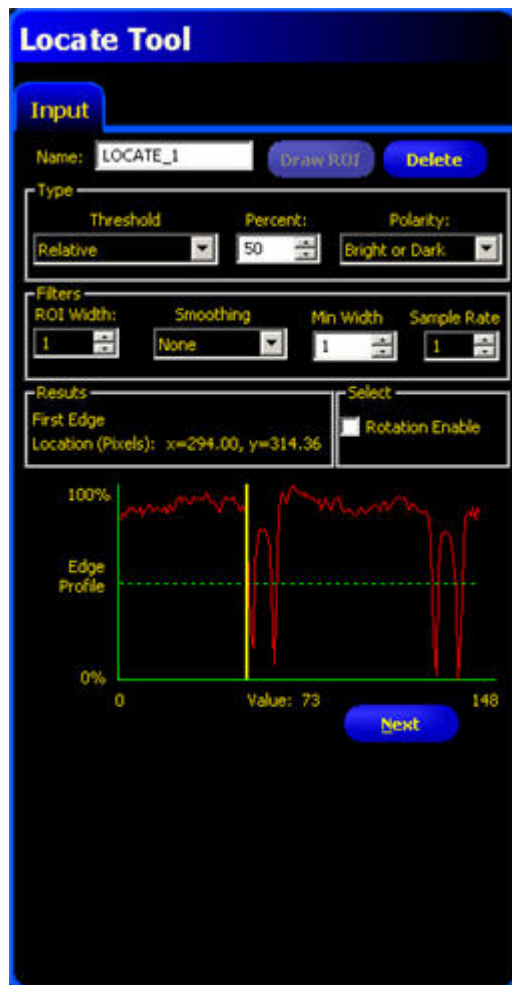

Adding a Locate Tool

To add a Locate tool to an inspection:

1. Click the button of the tool to be added to the inspection.
2. If desired, rename the tool.
3. Draw an ROI.

Field/Button	Description
	Use this field to rename the tool. The default is <i>tool_name_1</i> , <i>tool_name_2</i> , and so on, where the default <i>tool_name</i> depends on the tool being created (for example, locate, edge or the like). The name can have only alphanumeric characters and underscores with no spaces.
	Click this button to add an ROI to an image.
	Click this button to remove an ROI from an image.

Threshold Type

The threshold is used to mark the gray scale transition point. The tool marks the edge when the pixel intensity crosses the threshold level. From the dropdown list, select one of the following:

- Relative
- Absolute
- Edge Strength

Relative Threshold

Relative threshold is the default, and it finds an edge at a relative pixel intensity. The brightest gray scale level is 100% and the darkest is 0%. While Relative threshold is more tolerant of light fluctuations between inspections than other transition types, it may find false edges.



Field/Graph	Description
Percent	Percent is displayed when the Type is Relative. Choose the percentage value at which the edge should be marked.
Polarity	<ul style="list-style-type: none"> • Bright to Dark finds edges that start above the threshold value and cross below the threshold value. • Dark to Bright finds edges that start below the threshold value and cross above the threshold value. • Bright or Dark finds any edge.
Edge Profile Graph	<p>In the Edge Profile graph displayed when the Relative threshold is selected, the red line shows the percentage pixel intensity relative to the green threshold line. The threshold line will move up or down with the percent value.</p>

Absolute Threshold

Absolute threshold finds an edge at a specific gray scale level. While Absolute threshold is less likely to find a false edge than Relative Threshold, it may miss edges if the light level changes between inspections.



Field/Graph	Description
Value	Value is displayed when Type is Absolute. Enter a specific gray scale value from 0 to 255.
Polarity	<ul style="list-style-type: none"> • Bright to Dark finds edges that start above the threshold value and cross below the threshold value. • Dark to Bright finds edges that start below the threshold value and cross above the threshold value. • Bright or Dark finds any edge.
Edge Profile Graph	<p>In the Edge Profile graph displayed when the Absolute threshold is selected, the red line shows the percentage pixel intensity relative to the green threshold line. The threshold line will move up or down with the percent value.</p>

Edge Strength

Edge strength measures the rate of change of grayscale values and needs sharply-defined transitions. Edge strength is more tolerant of gradual changes in light levels across the tool than other transition types and it will filter out weak or gradual edges.



Field	Description
Edge	Enter an edge bandwidth value from 1 to 255.
Polarity	<ul style="list-style-type: none"> • Bright to Dark finds edges that start above the threshold value and cross below the threshold value. • Dark to Bright finds edges that start below the threshold value and cross above the threshold value. • Bright or Dark finds any edge.

Graph Tab

When Edge Strength is selected in the Input tab, the software displays the Graph tab. This tab provides similar information to the Input tab, but displays separate Edge Profile and Edge Strength graphs for easier viewing.

The Edge Profile graph represents the absolute gray scale level across the tool ROI.

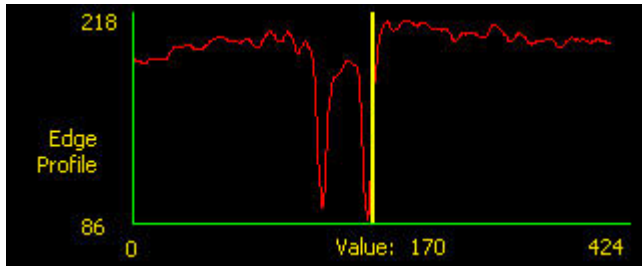

The Edge Strength graph represents the change in gray scale along the tool ROI. Edge Strength detects an edge when the rate of change (solid red line on the graph) crosses the selected intensity change amount (dashed green lines on the screen).

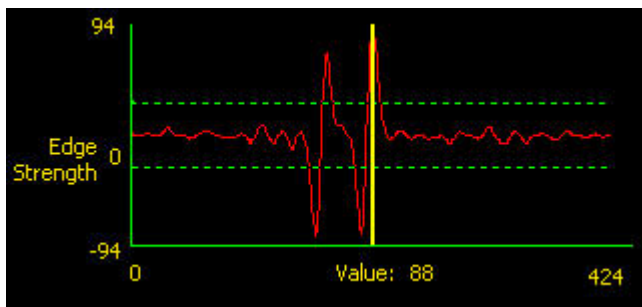

A bright-to-dark transition has a negative edge strength value, and a dark-to-bright transition has a positive edge strength value. When the Edge Strength level is adjusted, both the negative and positive green dotted lines will adjust together.

Filters



ROI Width

Increases in increments of 4 pixels (for example, 1, 5, 9, 13, ...) up to the total FOV size. Some things to note:

- Narrow ROIs execute faster but could miss the part.
- Wide ROIs are more consistent but don't execute as fast.
- The ROI must be 13 pixels or wider to calculate the rotation of a part.

Smoothing

Runs a rolling average along the ROI length. It filters out sharp changes in the edge profile.

 **Note:** A high filter number may miss the edge of a narrow line.

Min Width	Filters out small spike-of-intensity changes, and narrow dark or bright bands. It determines the distance (in pixels) before and after an edge that must be free from additional transitions or the end of the FOV before the edge is recognized.  Note: A high filter number may miss the edge of a narrow line.
Sample Rate	Determines the sub-pixel resolution, which increases the resolution of the tool, and increases the inspection time. <ol style="list-style-type: none"> 1. 1-pixel resolution 2. 1/2-pixel resolution 3. 1/3-pixel resolution 4. 1/4-pixel resolution

Results



The Results field provides the position of the first edge found. The position is expressed as X, Y coordinates in pixels, with the origin (0,0) at the upper-left corner of the screen.

Select

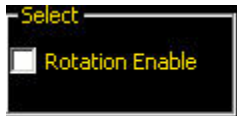

If you select Rotation Enable, the software Activates the rotation compensation calculation. ROIs that follow will rotate according to the difference between the reference image and the current inspection image.

 **Note:** ROI width must be 13 pixels or greater.

Advanced Tab

If you have enabled the Advanced Configuration in the System setup, the software displays and Advanced tab. This enables you to force any location tool to Absolute Positioning.



Graph Tab

When Edge Strength is selected, the Graph tab appears on the tool window. The graph for the Input tab overlays both the edge strength graph and the edge profile. In the Graph tab, the edge profile graph and the edge strength graph are separated for easier viewing.

The top graph, Edge Profile, represents the absolute gray scale level across the Edge tool.

The bottom graph, Edge Strength, represents the change in gray scale along the Edge tool.

Edge Strength detects an edge when the rate of change (solid red line on the screen) crosses the selected intensity change amount (dashed green lines on the screen).

A bright-to-dark transition has a negative edge strength value, and a dark-to-bright transition has a positive edge strength value. When the Edge Strength level is adjusted, both the negative and positive lines will adjust together.

Graph Tab

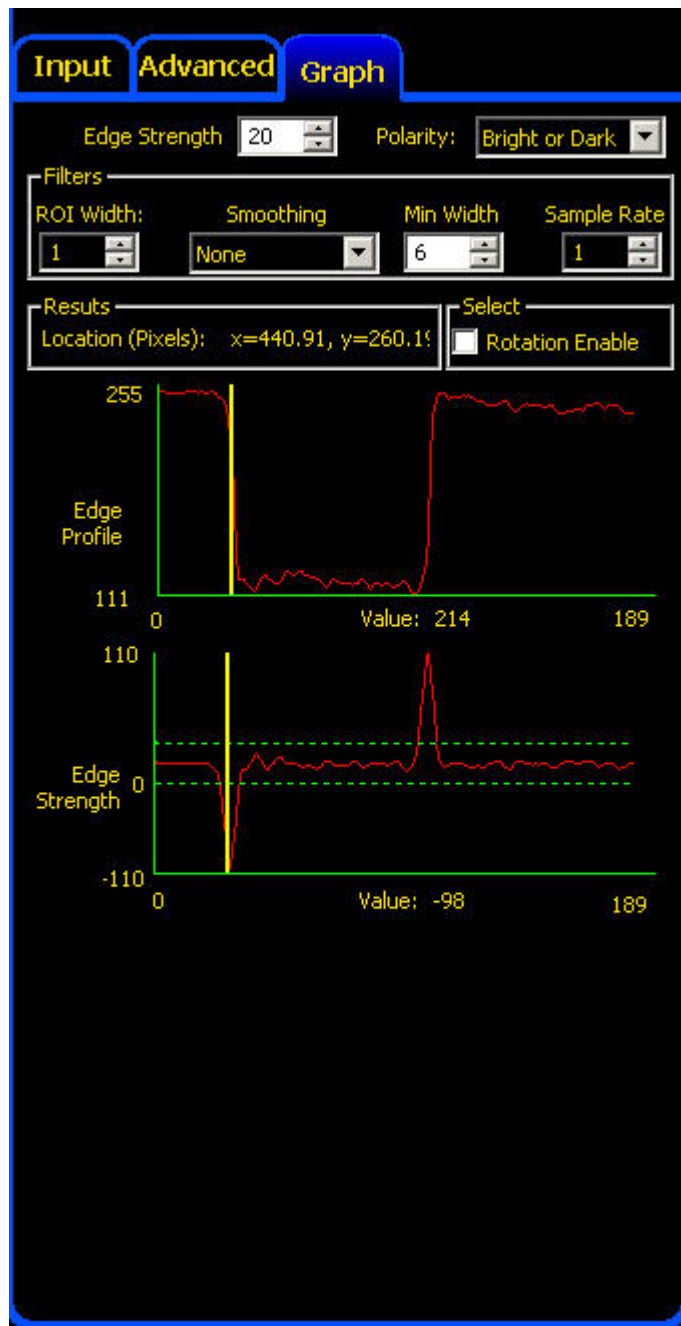

7.2.2 Geometric Find Tool

The Geometric Find tool uses edge content to locate the best matching shape in a search area of an image. During setup, you identify a reference shape within a search area for the Geometric Find tool. This reference shape is subsequently used to locate like shapes in new images by searching for shapes similar to the reference shape.

Tools that follow the Geometric Find tool translate and rotate their ROIs relative to positional information from the Geometric Find tool. Geometric Find returns the location of the best shape found.

Note: If the Geometric Find tool is preceded by a Location tool (for example, a Locate or another Geometric Find tool), the Search ROI will translate by the amount that the preceding Location tool found. However, even if the Location tool has rotation enabled, the Search ROI will not rotate.

 **Note:** The Geometric Find tool requires strong and repeatable edge content in the image.

Usage

- Locate the position of a label
- Locate electronic components on a circuit board
- Locate date/lot code for inspection

 **Note:** In general, the Geometric Find tool can be used to locate a rounded object or an object where large amounts of rotation are possible. In these types of applications, a linear Locate tool will not work as well.

Fields

The following are fields on the Geometric Find tool Input tab:

- [Threshold](#) on page 151
- [Edge Length](#) on page 152
- [Legend](#) on page 152
- [Results](#) on page 155

Supported Platforms

ProII Color	ProII/ProII 1.3	OMNI Color	OMNI/OMNI 1.3	AREA/AREA13	EDGE/EDGE 1.3	GEO/GEO 1.3	BCR/BCR 1.3
Yes	Yes	Yes	Yes	No	No	Yes	No



Geometric Find Input Tab





Adding a Geometric Find Tool

To add a Geometric Find tool to an inspection:

1. Click the button of the tool to be added to the inspection.
2. If desired, rename the tool.
3. Draw an ROI.

Field/Button	Description
	Use this field to rename the tool. The default is <i>tool_name_1</i> , <i>tool_name_2</i> , and so on, where the default <i>tool_name</i> depends on the tool being created (for example, locate, edge or the like). The name can have only alphanumeric characters and underscores with no spaces.
	Click this button to add an ROI to an image.
	Click this button to add a mask to an image. A mask is a way to remove some anomaly in the ROI that might deleteriously affect the inspection.

Field/Button	Description
	Click this button to remove an ROI or a mask from an image.
	Use this field to rotate the ROI. You can manually key in a rotation angle, or you can use the up or down arrow keys to rotate the ROI.

Threshold

Adaptive Threshold

Adaptive Threshold adjusts the edge threshold on each acquired image. The Sensor automatically sets the threshold and attempts to adjust for contrast variations.



Edge Strength

Edge Strength sets the edge threshold at a predetermined gray scale value from 0 to 127. Edge Strength provides more control over what gets to be considered an edge pixel.



Edge Length

The tool ignores target patterns with edges equal to or shorter than the specified number of pixels for edge length.



Legend

All edges found by the Geometric Find tool are color-coded in the Image window. Strong edges show up in green, and weak edges show up in red.

 **Note:** Both weak and strong edges in the pattern ROI are expected to be present in the inspection.



Results

The Results field returns the following:

- Total number of shapes above the minimum acceptance level.
- Position of each shape's center. The origin (0,0) is the upper-left corner of the screen.



Geometric Find Tool Advanced Tab

Fields in the Geometric Find Tool Advanced tab are described in the following subsections.

Fields

The following are fields on the Geometric Find tool Input tab:

- [Rotation Range](#) on page 153
- [Extra and Missing Edges](#) on page 153
- [Minimum Acceptance Level](#) on page 169
- [Reject Threshold](#) on page 154
- [Scaling Range](#) on page 155
- [Tool Timeout and Absolute Positioning](#) on page 108
- [Results](#) on page 155

Advanced Tab

Geometric Find Tool

Input **Advanced**

Rotation Range
 Clockwise (+) 45 Counterclockwise (-) 45

Extra and Missing Edges
 Check For Extra Edges
 Check For Missing Edges

Minimum Acceptance Level
 20 100 % 80

Reject Threshold
 Low 0 High 255

Scaling Range
 Low 1 High 1

Tool Timeout: 30000 ms
 Force To Absolute Positioning

Results
 Number Found 1 Best Match # 1
 1. x=558.00, y=572.00, angle=0.00, accept=100.00%

Apply **Back**



Rotation Range

These adjustments are used to set the maximum allowable rotation (0° to 180°) that a target pattern can have and still be identifiable.

Rotation Range
 Clockwise (+) 45 Counterclockwise (-) 45

Extra and Missing Edges

Extra and Missing Edges
 Check For Extra Edges
 Check For Missing Edges

Field	Description
Extra Edges	<p>If left unchecked (disabled), the Sensor will find a target shape that might have extra edges. If checked (enabled), the Sensor will not find a target shape that has extra edges of a specified length. The size of the minimum edge length is adjustable.</p> <p> Note: If checked, the application will not allow a minimum edge length to be set below the number specified for Minimum Edge Length (in the Input tab) for this tool.</p>
Missing Edges	<p>If left unchecked (disabled), then the Sensor will find a target shape, even if it is missing some edge content. If checked (enabled), then the Sensor will not find a target shape that is missing edges of a specified length. The size of the minimum edge length to check for is adjustable.</p> <p> Note: If checked, the application will not allow a minimum edge length to be set below the number specified for Minimum Edge Length (in the Input tab) for this tool.</p>

Minimum Acceptance Level

This adjustment sets the acceptance level for pattern matches.

- Decrease the Minimum Acceptance Level to allow more variations in matching patterns.
- Increase the Minimum Acceptance Level to filter out patterns that contain small defects.

Percent match is a value between 20% and 100% that indicates the quality of the match (100% is a perfect match; 20% is a slight match). The percent match can be used to detect large defects.

 **Note:** Banner does not recommend setting the Minimum Acceptance Level below 70%.



Reject Threshold

These adjustments allow the user to set the “band of gray scale values” the tool uses to determine the threshold when Adaptive Threshold is specified.

If the Low is set to zero (default) and the High is set to 255 (default), then all gray scale values within the acquired image are used to determine the threshold.

An example of narrowing the band of gray scale values is to set the Low at 50 and the High at 200. With these settings, only gray scale values from 50 to 200 will be used by the Geometric Find tool to determine the threshold when Adaptive Threshold is specified.

These controls allow the user to “block” dark spots or light spots from influencing the threshold in the image acquired by the Sensor.



Scaling Range

Scaling Range allows you to set a range from a low of 0.8 to a high of 1.2. In Run mode, this will enable matches to occur even with slight variations in shape from the reference shape.



Tool Timeout and Absolute Positioning

Set a timeout in milliseconds that determines how long the Geometric tool will attempt to determine whether a pattern is good or not.

Select **Force to Absolute Positioning** if you want to change the Geometric tool from relative positioning to absolute.



Results

The Results field returns the following:

- Total number of shapes above the minimum acceptance level.
- Position of each shape's center. The origin (0,0) is the upper-left corner of the screen.



7.2.3 Pattern Find Tool

The Pattern Find tool locates the first shape in a search area of the image. During setup, identify a section of the image containing the target shape, and assign that shape as the reference for the Pattern Find tool. This reference shape is subsequently used to locate the target shape in new images by searching for shapes very similar to the reference one. The shape is remembered by the sensor in full gray scale detail, and the search is conducted in a way that is “normalized” or indifferent to variations in the level of illumination.

Tools that follow the Pattern Find tool translate and rotate their ROIs relative to positional information from the Pattern Find tool. Pattern Find returns the location of the first shape found.

Usage

- Match letters and numbers
- Locate a fiducial on a circuit board
- Spot-check for an object

 **Note:** Only one target shape is found in the search area. Only the ROIs that follow a Location tool will move relative to the Location tools.

Fields

The following are fields on the Pattern Find tool Input tab:

- [Minimum Acceptance Level](#) on page 169
- [Rotation Enabled](#) on page 169
- [Selected Pattern](#) on page 170
- [Results](#) on page 111

Supported Platforms

ProII Color	ProII/ProII 1.3	OMNI Color	OMNI/OMNI 1.3	AREA/AREA13	EDGE/EDGE 1.3	GEO/GEO 1.3	BCR/BCR 1.3
Yes	Yes	Yes	Yes	No	No	No	No

Pattern Find Input Tab

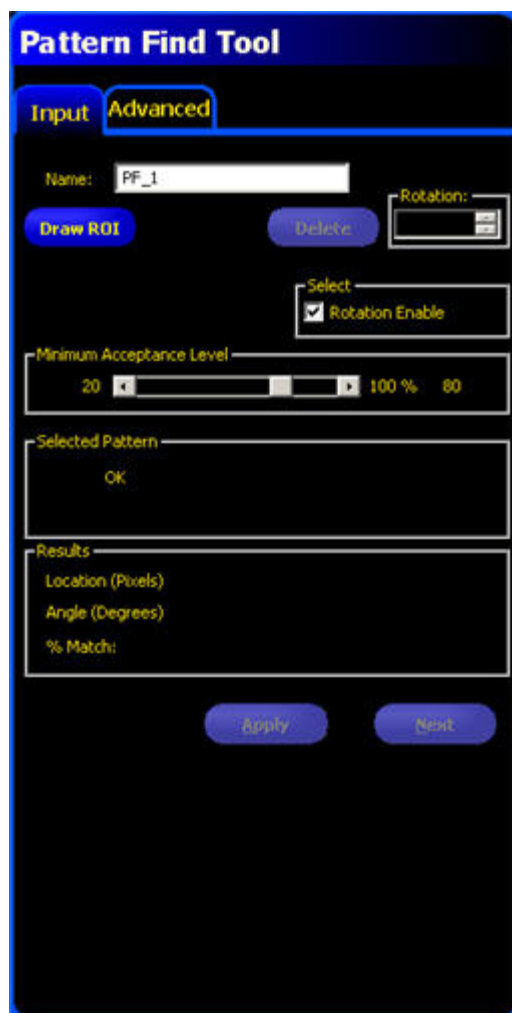





Adding a Pattern Find Tool

To add a Pattern Find tool to an inspection:

1. Click the button of the tool to be added to the inspection.

2. If desired, rename the tool.
3. Draw an ROI.

Field/Button	Description
	Use this field to rename the tool. The default is <i>tool_name_1</i> , <i>tool_name_2</i> , and so on, where the default <i>tool_name</i> depends on the tool being created (for example, locate, edge or the like). The name can have only alphanumeric characters and underscores with no spaces.
	Click this button to add an ROI to an image.
	Click this button to remove an ROI from an image.
	Use this field to rotate the ROI. You can manually key in a rotation angle, or you can use the up or down arrow keys to rotate the ROI.

Minimum Acceptance Level

This adjustment sets the acceptance level for pattern matches.

- Decrease the Minimum Acceptance Level to allow more variations in matching patterns.
- Increase the Minimum Acceptance Level to filter out patterns that contain small defects.

Percent match is a value between 20% and 100% that indicates the quality of the match (100% is a perfect match; 20% is a slight match). The percent match can be used to detect large defects.

 **Note:** Banner does not recommend setting the Minimum Acceptance Level below 70%.



Rotation Enabled

The Pattern Find tool has a +/- 10 degree rotation ability. All subsequent ROIs will rotate relative to the edge found. During setup, the tool calculates the angle of the pattern found. During inspection, the new angle is compared to the original angle. If there is any rotational change between the new angle and the original angle, all subsequent ROIs will rotate that amount.



Selected Pattern

The Selected Pattern field indicates whether the captured image is fine as it is or if there are potential issues. For example, in the display below, the image is marinal for both translational content and for rotational content.

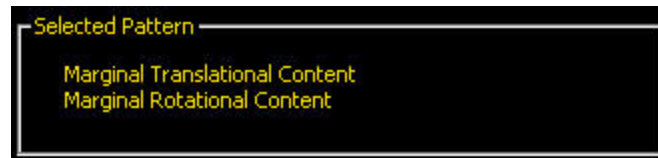

Results

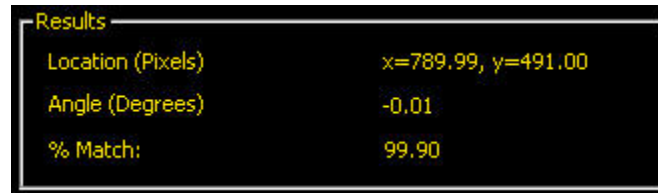

Pattern Find Advanced Tab

Select **Force to Absolute Positioning** if you want to change the Pattern tool from relative positioning to absolute.

7.2.4 Blob Find Tool

The Blob Find tool is a Location tool used to position other vision tools in reference to some object, or "Blob." In imaging, a group of adjacent, like-shaded pixels, is called a Blob, short for Binary Large Object. Unlike the Locate or Geometric Find tools, the Blob Find tool does not depend on strong and repeatable edges. Rather, Blob Find locates a Blob in the FOV quickly and is most useful in cases where an object does not need to be matched precisely, but does need to be identified speedily.

 **Note:** The Blob Find tool starts out disabled, and you need to enable it in the Tools Configuration tab of the System dialog.

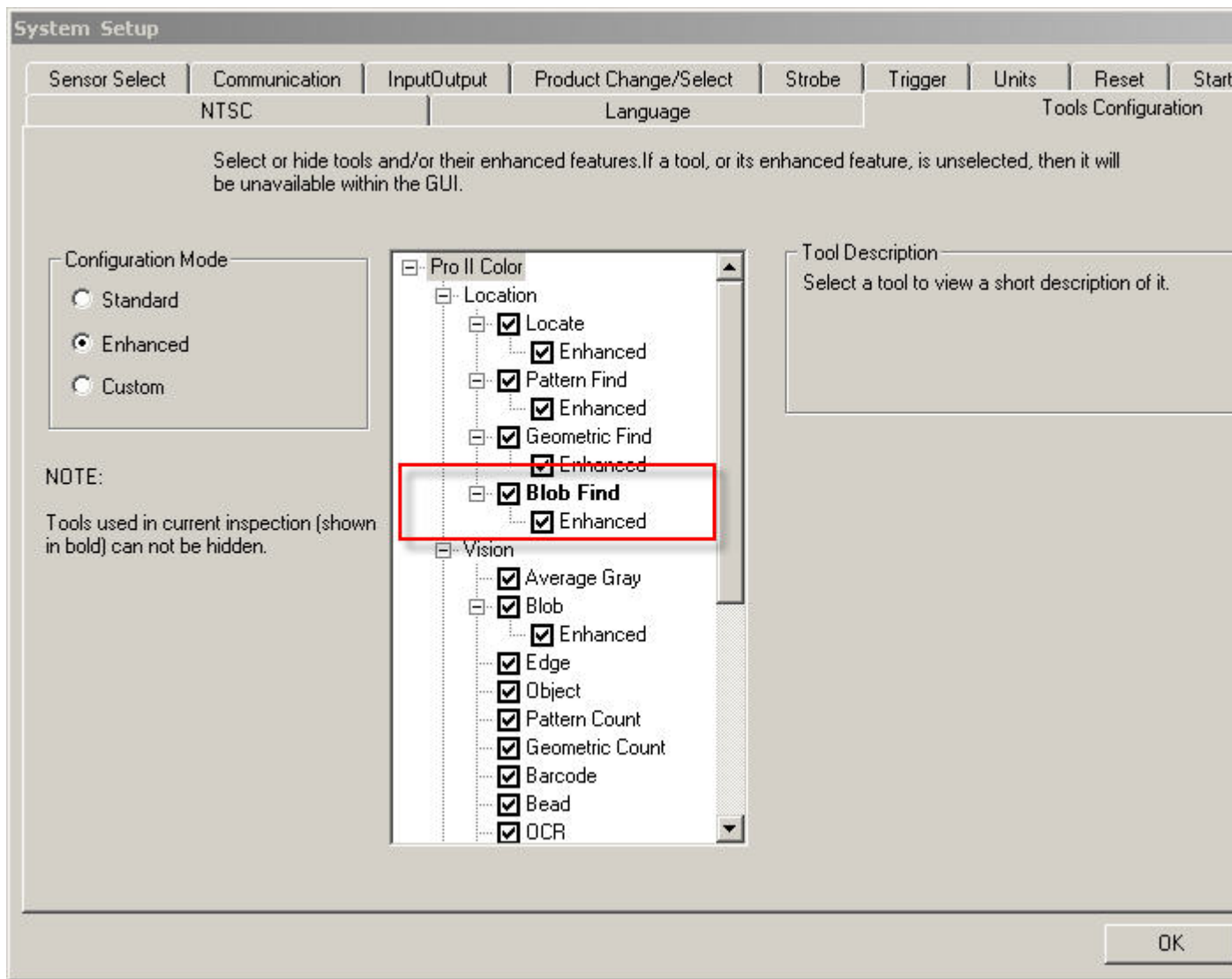

ProII Color	ProII/ProII 1.3	OMNI Color	OMNI/OMNI 1.3	AREA/AREA13	EDGE/EDGE 1.3	GEO/GEO 1.3	BCR/BCR 1.3
Yes	Yes	Yes	Yes	No	No	No	No

Fields

The following are fields on the Blob Find tool Input tab:

- [Threshold](#) on page 203
- [Blob Find Tool Input Tab Results](#) on page 115

Supported Platforms

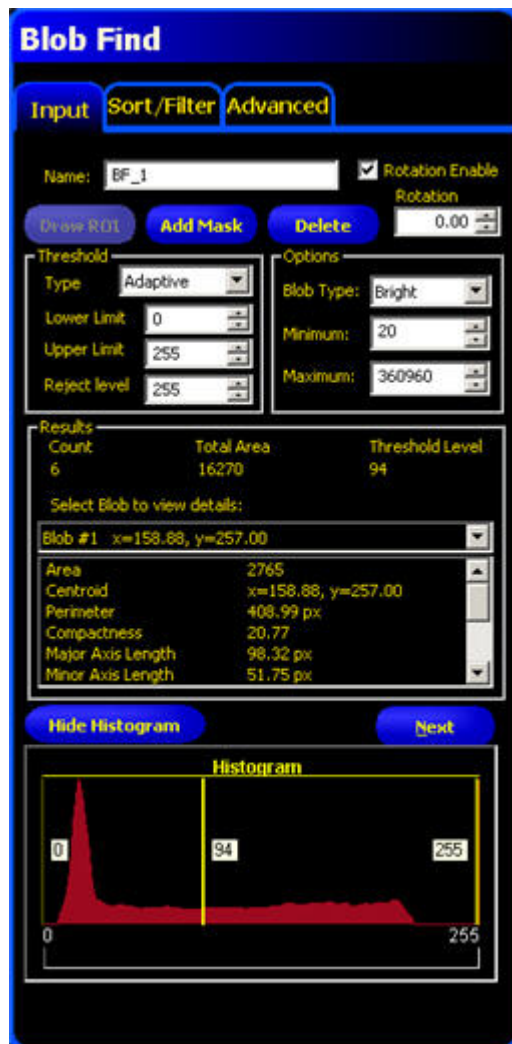

Blob Find Input Tab



Adding a Blob Find Tool

1. Click the button of the tool to be added to the inspection.
2. If desired, rename the tool.
3. Draw an ROI.

Control	Description
<p>Name: <input type="text" value="tool_name_1"/></p>	<p>Use this field to rename the tool. The default is <i>tool_name_1</i>, <i>tool_name_2</i>, and so on, where the default <i>tool_name</i> depends on the tool being created (for example, locate, edge or the like). The name can have only alphanumeric characters and underscores with no spaces.</p>
<p><input type="button" value="Draw ROI"/></p>	<p>Click this button to add an ROI to an image.</p>
<p><input type="button" value="Add Mask"/></p>	<p>Click this button to add a mask to an image. A mask excludes an area inside the ROI.</p>

Control	Description
	Click this button to remove an ROI or mask from an image.
	Use this field to rotate the ROI. You can manually key in a rotation angle, or you can use the up or down arrow keys to rotate the ROI.

 **Note:** The angle used in the Rotation calculation is the Major Axis angle, measured with respect to the horizontal plane. This angle is not reliable if the part rotates through ± 90 degrees because the Blob Find tool doesn't pay attention to what is "top" or "bottom" on the Blob.

Threshold

Type



Fixed

Select Fixed when the lighting and image content will remain relatively constant for all inspections.



If you select Fixed, you can also specify Threshold and Reject Levels.

Threshold Level

The Threshold Level (e.g., 141) defines the white/black cutoff point. Once a threshold is chosen, any pixels brighter than the threshold become pure white while those darker than the threshold become pure black.

Reject Level

The Reject Level field is for bright Blobs only, and is used to narrow the range of pixel intensities to consider in an inspection. Leaving the defaults at 0 for low and 255 for high will result in the tool taking into consideration all gray scale levels in the ROI from 0 (black) to 255 (white). Note that the Reject Level field is visible only when Bright bead type is selected.

Adaptive

Select Adaptive when there are lighting changes that cause the acquired image to change.



Adaptive thresholding is a technique that is used to adjust the threshold for the BLOB tool based upon lighting changes and image content within the ROI. It performs best if used with bi-modal images, which have a clear contrast in the ROI. Adaptive thresholding chooses the current threshold value by converging to a value based on the average value of the pixels above and below the previous threshold value; it will not move the value of the threshold above or below the upper or lower limits.

Low Limit: Enter a gray scale value in this field, and the tool will not allow the Adaptive threshold to go below this value.

Upper Limit: Enter a gray scale value in this field, and the tool will not allow the Adaptive threshold to go above this value.

Reject Level: The Reject Level field is for bright Blobs only, and is used to narrow the range of pixel intensities to consider in an inspection. Leaving the defaults at 0 for low and 255 for high will result in the tool taking into consideration all gray scale levels in the ROI from 0 (black) to 255 (white). Note that the Reject Level field is visible only when Bright bead type is selected.

Reject Level Example

Consider setting up an inspection for a relatively bright object that ranges from 180 to 200 in pixel intensity and takes up 15 percent of the Field of View; yet, the remaining 85 percent of the Field of View ranges from 230 to 255 in pixel intensity. Setting a Reject Level of 220 will allow the tool to “pay attention” to only the bright object being inspected. Further, masking the bright parts of the Field of View will not be necessary as only pixels whose intensity is less than the Reject Level will contribute to bright Blobs. Note that rejected pixels are colored orange in the histogram.

Blob Type

- Choose **Dark** if the part is darker than the background.
 - Choosing Dark with a Fixed threshold will cause the tool to fix the threshold at the level specified in the Threshold level field. The tool will choose as dark Blobs all grouped pixels below the specified threshold.
 - Choosing Dark with an Adaptive threshold type will cause the tool to limit the threshold to the range specified in the Threshold level Lower and Upper Limit fields. The tool will choose as dark Blobs all grouped pixels below the threshold chosen.
- Choose **Bright** if the part is lighter than the background.
 - Choosing Bright with a Fixed threshold type will cause the tool to fix the threshold at the Bright level specified in the Threshold level field. The tool will choose as bright Blobs all grouped pixels above the specified Bright threshold and less than or equal to the Reject level. Note: Pixels in the ROI which are brighter than the specified Reject level will turn orange in the Image window and be ignored during inspection.
 - Choosing Bright with an Adaptive threshold type will cause the tool to limit the threshold to the range specified in the Threshold level Lower and Upper Limit fields. The tool will choose as bright Blobs all grouped pixels above the specified Lower Limit and less than or equal to the Upper Limit. Note: Pixels in the ROI which are brighter than the specified Reject level will turn orange in the Image window and be ignored during inspection.

Blob Find Tool Input Tab Results

Results		
Count	Total Area	Threshold Level
6	15998	97
Select Blob to view details:		
Largest Blob x=475.76, y=256.26 (Blob #3)		
Blob #3	x=475.76, y=256.26	
Blob #4	x=159.02, y=256.60	
Blob #5	x=693.20, y=257.06	
Blob #6	x=583.61, y=257.04	
Smallest Blob	x=259.83, y=260.88 (Blob #1)	
Largest Blob	x=475.76, y=256.26 (Blob #3)	
MINOR AXIS LENGTH	52.33 px	

Count: The number of Blobs found.

Total Area: The total area (in pixels) of all the Blobs.

Threshold Level: The white/black cutoff point.

From the dropdown list of Blobs, you can select a specific Blob to get area and centroid information about that specific Blob.

Results	
Count	Total Area
6	15998
Select Blob to view details:	
Blob #6 x=583.61, y=257.04	
Area	2673
Centroid	x=583.61, y=257.04
Perimeter	446.02 px
Compactness	16.88
Major Axis Length	102.70 px
Minor Axis Length	58.38 px

Histogram

The Histogram is a display of the grayscale values on the "x" axis and the number of pixels on the "y" axis. The Histogram displays the amount of pixels for each grayscale value. The graph displays information for all grayscale values (0-255). Cursors, shown as vertical lines, represent minimum threshold, maximum threshold, threshold level and reject level. Corresponding cursor can be moved horizontally to adjust a value.

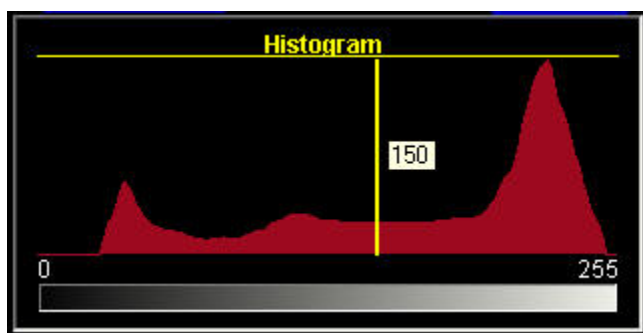

Blob Find Filter/Sort Tab

Blob Sort

The Sort drop-down list allows the user to select a sort method to determine which Blob the sensor labels as "Blob #1." By default, Blobs are numbered according to scan order; that is, the sensor numbers Blobs as it encounters them while scanning the FOV from top-to-bottom and then left-to-right. Select one of the computed statistics choices from the drop-down list to use for the sort:

- No sorting
- Position
- *Area* on page 183
- *Perimeter* on page 184
- *Compactness* on page 185
- *Major Axis Length, Minor Axis Length, and Major Axis Angle* on page 185
- *Eccentricity* on page 185
- *Min Radius and Min Radius Position* on page 187
- *Max Radius and Max Radius Position* on page 187

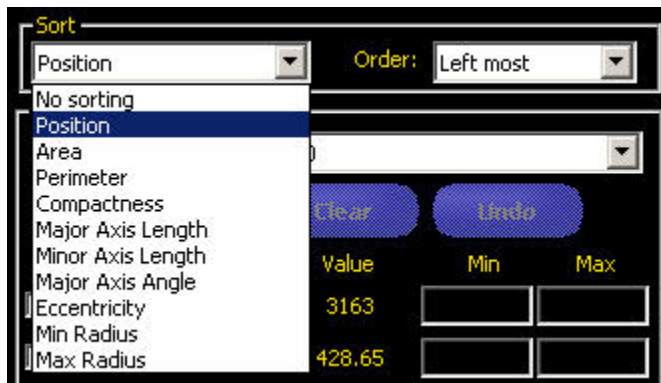

Blob Sort Order

Once you select a Sort method, you need to define a Sort Order:

- If Position is selected for the Sort method, then Blob order is based on the x,y coordinates of the centroids and the options are—
 - Left most
 - Top most
 - Right most
 - Bottom most
- For any of the other options, Blob order is based on Increasing or Decreasing value of the parameter selected. For example, if Perimeter and Increasing is selected, the smallest perimeter Blob will be Blob #1.

Blob Filter

The Blob filter allows you to more accurately select a specific Blob to locate and to use for positioning other Vision tools. Filter modifies the Blob count based on Computed Statistics criteria so that, for example, only circular Blobs (compactness) or symmetric Blobs (eccentricity) are included in the Blob count.

When you click the Preset button, the sensor uses the selected Blob to preset the filter values so that only the selected Blob will subsequently be identified by the sensor. This reduces the time it would take to manually enter values. When the sensor is in Run mode, you should use the runtime filter results to fine-tune these settings.

Statistic	Value	Min	Max
<input checked="" type="checkbox"/> Area	3163	2530	3796
<input checked="" type="checkbox"/> Perimeter (px)	428.65	342.92	514.38
<input checked="" type="checkbox"/> Compactness	21.63	17.30	25.96
<input checked="" type="checkbox"/> Major Axis Length (px)	104.30	83.44	125.16
<input checked="" type="checkbox"/> Minor Axis Length (px)	53.89	43.11	64.67
<input type="checkbox"/> Major Axis Angle	-1.52	-1.82	-1.22
<input checked="" type="checkbox"/> Eccentricity	1.94	1.55	2.33
<input checked="" type="checkbox"/> Min Radius (px)	2.81	2.25	3.37
<input checked="" type="checkbox"/> Max Radius (px)	53.20	42.56	63.84

Blob Find Tool Advanced Tab

Fields

The following are fields on the Blob Find Advanced tab:

- [Options](#) on page 133
- [Blob Find Tool Advanced Tab Results](#) on page 119

Options

Discard Boundary Blobs: The Discard Boundary Blobs checkbox, if selected, allows you to determine if you want blobs touching the perimeter of the search ROI to be included in your results.

Fill Holes: Fill Holes checkbox, if selected, allows you to ignore (by filling) small features such as scratches, glare and so on which might otherwise appear as small imperfections or non-blobs within a larger blob. If you select this option, you can specify the size of the largest hole to fill in the **Largest Hole to Fill** field.

Compute Statistics: The Compute Statistics checkbox, when selected, enables advanced results to be calculated and displayed when inspections are run.

Largest Hole to Fill: If you select **Fill Holes**, you must specify the size of the largest hole to fill in this field.

Blob Find Tool Advanced Tab Results

Area

The area (A) is just a count of the total number of pixels belonging to the blob.

Centroid

The centroid (x_c , y_c) is the point at the center of mass of the blob. For simple blobs like solid circles, ellipses, or rectangles, this is just the center of the shape. For more complicated shapes it is helpful to imagine a piece of cardboard cut out in the shape of the blob. The centroid is the point where you could balance the cardboard on the tip of a pencil. For complicated shapes-especially shapes with unfilled holes-the centroid might lie outside the shape.

The x coordinate of the centroid is calculated by adding up the x coordinates of each pixel in the blob and dividing by the area. The y coordinate is similar:

$$x_c = \frac{\sum_{i=1}^A x_i}{A} \qquad y_c = \frac{\sum_{i=1}^A y_i}{A}$$

Perimeter

The perimeter (P) gives an approximate measurement of the length of the circumference of the blob. Because blobs are built from individual pixels, it is most practical to estimate the perimeter by counting the contributions of individual pixels on the blob's boundary. The following table describes the exact values that are added to the perimeter for each possible pixel configuration. In each example, the description refers to the center pixel in the corresponding pictures.

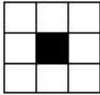
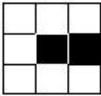
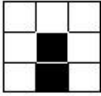
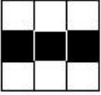
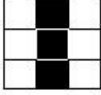
	<p>A pixel with no neighbors that belong to the same blob contributes (3.14) linear pixels to the perimeter of the blob. This can only happen in a blob that has an area of one. Since such small blobs are usually ignored, this circumstance is rare.</p>	
		<p>A pixel with one neighbor that belongs to the same blob contributes 2.571 linear pixels to the perimeter of the blob.</p>
		<p>A pixel with two neighbors that belong to the same blob, forming a straight line, contributes exactly 2 linear pixels to the perimeter of the blob.</p>

		A pixel with two neighbors that belong to the same blob, forming a corner, contributes 1.414 linear pixels to the perimeter of the blob.
		A pixel with three neighbors that belong to the same blob contributes exactly 1 linear pixel to the perimeter of the blob. A pixel with three neighbors that belong to the same blob contributes exactly 1 linear pixel to the perimeter of the blob.
		A pixel with four neighbors that belong to the same blob contributes nothing to the perimeter of the blob.

This method of counting tends to slightly overestimate the "true" perimeter. For example, a circle with a radius of 100 pixels will have a computed perimeter of approximately 660 pixels, compared with the expected value of 628 pixels.

If the camera is configured to convert pixel distances to other units, (e.g. inches), the perimeter will be given in those units. If the blob contains holes that have not been filled, the length of the perimeter will include the points on the perimeters of these holes.

Compactness

The compactness is high for blobs that are nearly circular and low for blobs that are elongated or complicated.

$$\text{compactness} = \frac{400\pi A}{P^2}$$

Where A is the area and P is the perimeter of the Blob in question. An idealized circle would have a compactness of 100, but because the perimeter is approximated (see above), the highest realistic value for most blobs is roughly 90. Very small blobs with just a handful of pixels may reach or even exceed the theoretical maximum of 100, again because of the approximations in the perimeter calculation.

Major Axis Length, Minor Axis Length, and Major Axis Angle

To understand Major Axis Length, Minor Axis Length, and Major Axis Angle, it is important to note that these are not measurements of the Blob itself because the Blob may be an irregular shape. Rather, these measurements are determined by a well-defined shape, a "best fit ellipse" as shown below.

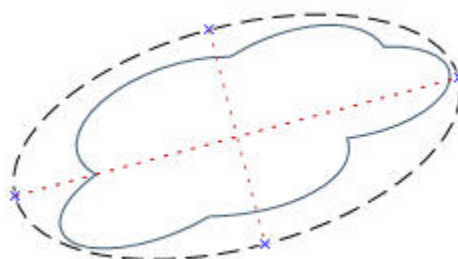

These three results combine to give information about the elongation and orientation of a blob . The equations used to compute these statistics are fairly complicated, but the results usually have an intuitively useful meaning, described below. The first step in computing these results is to compute the $M_{2,0}$, $M_{0,2}$ and $M_{1,1}$ statistical moments:

$$M_{2,0} = \frac{\sum_{i=1}^A (x_i - x_c)^2}{A}$$

$$M_{0,2} = \frac{\sum_{i=1}^A (y_i - y_c)^2}{A}$$

$$M_{1,1} = \frac{\sum_{i=1}^A ((x_i - x_c)(y_i - y_c))}{A}$$

where A is the area, (x_c, y_c) are the coordinates of the centroid and (x_i, y_i) are the coordinates of pixel i. These values represent the variance with respect to x, the variance with respect to y, and the covariance, respectively. The final results can be calculated as follows.

$$\text{Major Axis Length} = 2\sqrt{2\left(M_{2,0} + M_{0,2} + \sqrt{4M_{1,1}(M_{2,0} - M_{0,2})^2}\right)}$$

$$\text{Major Axis Length} = 2\sqrt{2\left(M_{2,0} + M_{0,2} - \sqrt{4M_{1,1}(M_{2,0} - M_{0,2})^2}\right)}$$

$$\text{Major Axis Angle} = \frac{\tan^{-1}\left(\frac{2M_{1,1}}{M_{2,0} - M_{0,2}}\right)}{2}$$

The table below gives a more practical perspective on how to interpret these results. If the camera is configured to convert pixels to other units, the major and minor axis lengths will be given in those units. The major axis angle is always given in degrees.

Blob Shape	Meaning of Major Axis Length	Meaning of Minor Axis Length	Meaning of Major Axis angle
circular, no holes	diameter of the circle	equal to the major axis length	unstable
elliptical, no holes	length of the ellipse	width of the ellipse	orientation of the ellipse
square, no holes	diameter of a circle that best approximates the square	equal to the major axis length	unstable
rectangular, no holes	length of an ellipse that best approximates the rectangle	width of an ellipse that best approximates the rectangle	orientation of the rectangle
complicated shape, no holes	length of an ellipse that best approximates the shape	width of an ellipse that best approximates the shape	orientation of the shape-unstable if length and width are nearly equal

any shape with holes	results vary depending on exact shape-experiment on your particular shape	results vary depending on exact shape-experiment on your particular shape	results vary depending on exact shape-experiment on your particular shape
----------------------	---	---	---

Eccentricity

The eccentricity of a blob is defined as the length of the major axis divided by the length of the minor axis. For circular regions and other regions with radial symmetry (like a square), the value will be very close to 1. For elongated regions, the value will grow, possibly becoming quite large.

Max Radius and Max Radius Position

These results are equivalent to those for the minimum radius, but they refer to the pixel on the perimeter of the blob that is farthest from the centroid .

Min Radius and Min Radius Position

The minimum radius of a blob is the distance from the centroid of the blob to the closest pixel on that blob's perimeter. The minimum radius position gives the pixel coordinates of that closest perimeter point. If the blob contains unfilled holes, the minimum radius position may be on the perimeter of a hole. If the camera is configured to convert pixels to other units, the minimum radius (but not the minimum radius position) will be given in those units.

7.3 Vision Gray Scale Tools

Vision tools analyze an image and extract information used for judgment criteria.

7.3.1 Average Gray Scale Tool

The Average Gray Scale tool calculates the average pixel intensity within the selected ROI. Each pixel has a gray scale intensity value from 0 to 255, where 0 is black and 255 is white. The Average Gray Scale tool records the gray scale value of each pixel in an ROI and averages them. With this information, the Average Gray Scale tool can detect changes in intensity that can indicate several conditions, such as missing objects, holes, texture changes, and possible color changes.

Using the Reject Level parameter, the tool can be set up to ignore pixel intensities that are not pertinent to an inspection

Usage

- Spot-check for holes
- Check for change in surface texture
- Check for color quality
- Check for presences/absence of a label or other objects

Fields

The following are fields on the Average Gray Scale tool Input tab:

- [Reject Level Example](#) on page 128
- [Average Gray Scale Results](#) on page 124
- [Histogram](#) on page 124

Supported Platforms

ProII Color	ProII/ProII 1.3	OMNI Color	OMNI/OMNI 1.3	AREA/AREA13	EDGE/EDGE 1.3	GEO/GEO 1.3	BCR/BCR 1.3
Yes	Yes	Yes	Yes	Yes	No	No	No

Average Gray Scale Input Tab





Adding an Average Gray Scale Tool

To add an area tool to an inspection:

1. Click the button of the tool to be added to the inspection.
2. If desired, rename the tool.
3. Draw an ROI.

Control	Description
	Use this field to rename the tool. The default is <i>tool_name_1</i> , <i>tool_name_2</i> , and so on, where the default <i>tool_name</i> depends on the tool being created (for example, locate, edge or the like). The name can have only alphanumeric characters and underscores with no spaces.
	Click this button to add an ROI to an image.
	Click this button to add a mask to an image. A mask excludes an area inside the ROI.

Control	Description
	Click this button to remove an ROI or a mask from an image.
	Use this field to rotate the ROI. You can manually key in a rotation angle, or you can use the up or down arrow keys to rotate the ROI.

Reject Level Example

Consider setting up an inspection for a relatively bright object that ranges from 180 to 200 in pixel intensity and takes up 15 percent of the Field of View; yet, the remaining 85 percent of the Field of View ranges from 230 to 255 in pixel intensity. Setting a Reject Level of 220 will allow the tool to “pay attention” to only the bright object being inspected. Further, masking the bright parts of the Field of View will not be necessary as only pixels whose intensity is less than the Reject Level will contribute to bright Blobs. Note that rejected pixels are colored orange in the histogram.

Average Gray Scale Results

The Results field returns the average gray scale value of the pixels in the ROI as well as the Standard Deviation.

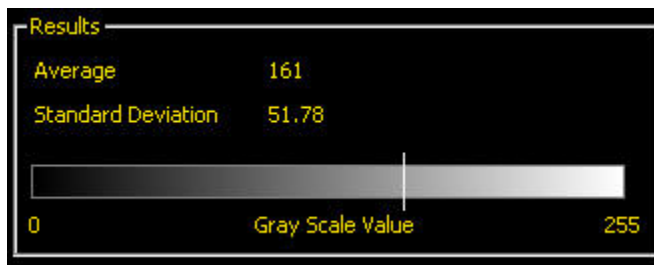

Histogram

The Average Gray Scale tool has an optional Histogram feature. The histogram below, corresponds to an Average Gray Scale tool ROI. The horizontal axis of the histogram is the individual pixel brightness values, the vertical axis is a count of how many pixels in the Average Gray Scale ROI have that brightness.

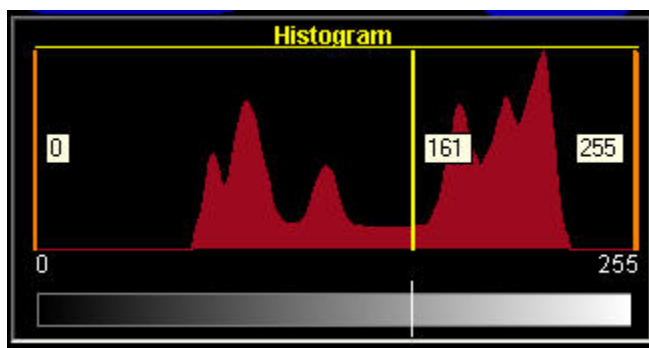

7.3.2 Blob Detect Tool

In imaging, a group of adjacent, like-shaded pixels, is called a Blob, short for Binary Large Object . The Blob tool separates selected pixels into two categories: black and white. After the pixels are separated into black and white, they are grouped and adjacent black or white pixels are seen as a dark or bright Blob.

Usage

- Count pills
- Measure hole size
- Verify the number of characters in date/lot code
- Detect LCD segments
- Detect missing products during packaging

Fields

The following are fields on the Blob Detect tool Input tab:

- [Threshold](#) on page 203
- [Blob Type](#) on page 128
- [Blob Detect Tool Input Tab Results](#) on page 128
- [Histogram](#) on page 132

Supported Platforms

ProII Color	ProII/ProII 1.3	OMNI Color	OMNI/OMNI 1.3	AREA/AREA13	EDGE/EDGE 1.3	GEO/GEO 1.3	BCR/BCR 1.3
Yes	Yes	Yes	Yes	Yes	No	No	No

Blob Tool Input Tab



Adding a Blob Detect Tool

1. Click the button of the tool to be added to the inspection.
2. If desired, rename the tool.
3. Draw an ROI.

Control	Description
Name: <input type="text" value="tool_name_1"/>	Use this field to rename the tool. The default is <i>tool_name_1</i> , <i>tool_name_2</i> , and so on, where the default <i>tool_name</i> depends on the tool being created (for example, locate, edge or the like). The name can have only alphanumeric characters and underscores with no spaces.
<input type="button" value="Draw ROI"/>	Click this button to add an ROI to an image.
<input type="button" value="Add Mask"/>	Click this button to add a mask to an image. A mask excludes an area inside the ROI.
<input type="button" value="Delete"/>	Click this button to remove an ROI or mask from an image.

Control	Description
	Use this field to rotate the ROI. You can manually key in a rotation angle, or you can use the up or down arrow keys to rotate the ROI.

Threshold

Type



Fixed

Select Fixed when the lighting and image content will remain relatively constant for all inspections.



If you select Fixed, you can also specify Threshold and Reject Levels.

Threshold Level

The Threshold Level (e.g., 141) defines the white/black cutoff point. Once a threshold is chosen, any pixels brighter than the threshold become pure white while those darker than the threshold become pure black.

Reject Level

The Reject Level field is for bright Blobs only, and is used to narrow the range of pixel intensities to consider in an inspection. Leaving the defaults at 0 for low and 255 for high will result in the tool taking into consideration all gray scale levels in the ROI from 0 (black) to 255 (white). Note that the Reject Level field is visible only when Bright bead type is selected.

Adaptive

Select Adaptive when there are lighting changes that cause the acquired image to change.



Adaptive thresholding is a technique that is used to adjust the threshold for the BLOB tool based upon lighting changes and image content within the ROI. It performs best if used with bi-modal images, which have a clear contrast in the ROI. Adaptive thresholding chooses the current threshold value by converging to a value based on the average value of the pixels above and below the previous threshold value; it will not move the value of the threshold above or below the upper or lower limits.

Low Limit: Enter a gray scale value in this field, and the tool will not allow the Adaptive threshold to go below this value.

Upper Limit: Enter a gray scale value in this field, and the tool will not allow the Adaptive threshold to go above this value.

Reject Level: The Reject Level field is for bright Blobs only, and is used to narrow the range of pixel intensities to consider in an inspection. Leaving the defaults at 0 for low and 255 for high will result in the tool taking into consideration all gray scale levels in the ROI from 0 (black) to 255 (white). Note that the Reject Level field is visible only when Bright bead type is selected.

Reject Level Example

Consider setting up an inspection for a relatively bright object that ranges from 180 to 200 in pixel intensity and takes up 15 percent of the Field of View; yet, the remaining 85 percent of the Field of View ranges from 230 to 255 in pixel intensity. Setting a Reject Level of 220 will allow the tool to “pay attention” to only the bright object being inspected. Further, masking the bright parts of the Field of View will not be necessary as only pixels whose intensity is less than the Reject Level will contribute to bright Blobs. Note that rejected pixels are colored orange in the histogram.

Blob Type

- Choose **Dark** if the part is darker than the background.
 - Choosing Dark with a Fixed threshold will cause the tool to fix the threshold at the level specified in the Threshold level field. The tool will choose as dark Blobs all grouped pixels below the specified threshold.
 - Choosing Dark with an Adaptive threshold type will cause the tool to limit the threshold to the range specified in the Threshold level Lower and Upper Limit fields. The tool will choose as dark Blobs all grouped pixels below the threshold chosen.
- Choose **Bright** if the part is lighter than the background.
 - Choosing Bright with a Fixed threshold type will cause the tool to fix the threshold at the Bright level specified in the Threshold level field. The tool will choose as bright Blobs all grouped pixels above the specified Bright threshold and less than or equal to the Reject level. Note: Pixels in the ROI which are brighter than the specified Reject level will turn orange in the Image window and be ignored during inspection.
 - Choosing Bright with an Adaptive threshold type will cause the tool to limit the threshold to the range specified in the Threshold level Lower and Upper Limit fields. The tool will choose as bright Blobs all grouped pixels above the specified Lower Limit and less than or equal to the Upper Limit. Note: Pixels in the ROI which are brighter than the specified Reject level will turn orange in the Image window and be ignored during inspection.

Blob Detect Tool Input Tab Results

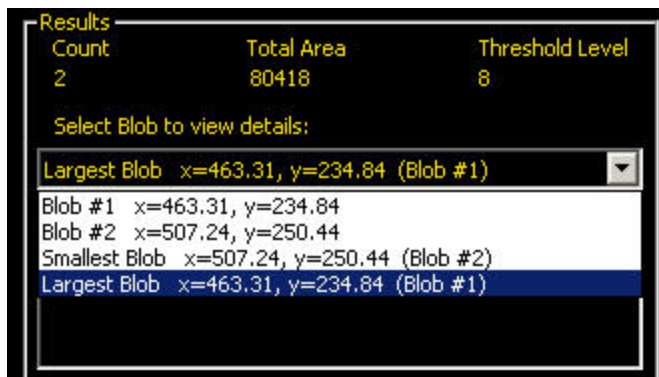

Count: The number of Blobs found.

Total Area: The total area (in pixels) of all the Blobs.

Threshold Level: The white/black cutoff point.

From the dropdown list of Blobs, you can select a specific Blob to get area and centroid information about that specific Blob.

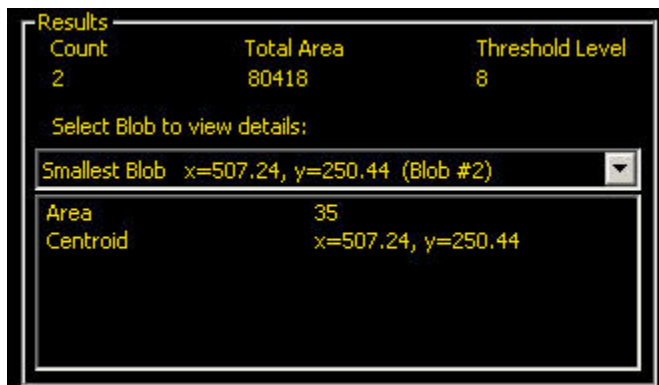

Blob Detect Filter/Sort Tab



Note: The Blob Detect Filter/Sort tab starts out disabled, and you need to enable it in the Tools Configuration tab of the System d

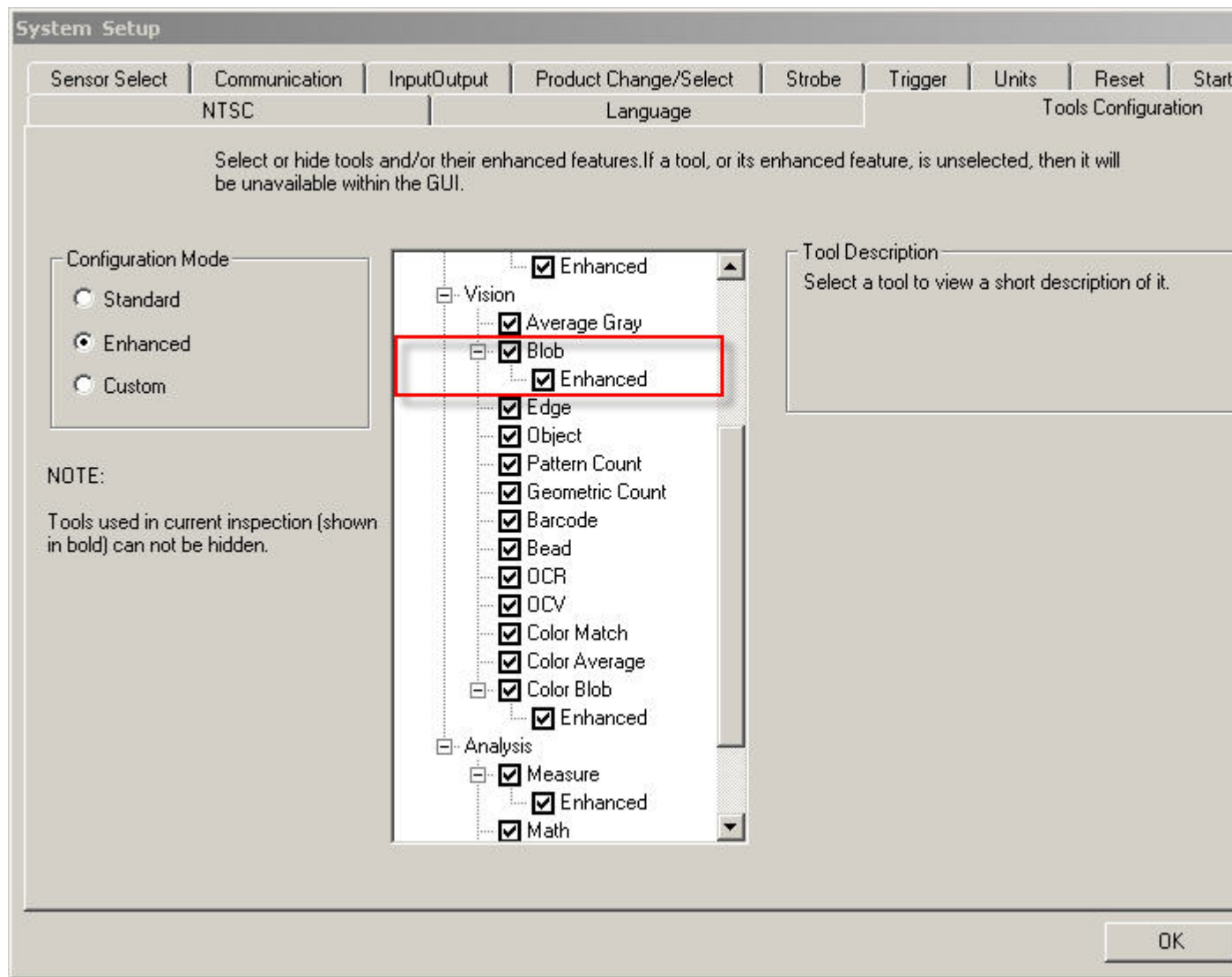

Blob Sort

The Sort drop-down list allows the user to select a sort method to determine which Blob the sensor labels as "Blob #1." By default, Blobs are numbered according to scan order; that is, the sensor numbers Blobs as it encounters them while scanning the FOV from top-to-bottom and then left-to-right. Select one of the computed statistics choices from the drop-down list to use for the sort:

- No sorting
- Position
- *Area* on page 183
- *Perimeter* on page 184
- *Compactness* on page 185
- *Major Axis Length, Minor Axis Length, and Major Axis Angle* on page 185
- *Eccentricity* on page 185
- *Min Radius and Min Radius Position* on page 187
- *Max Radius and Max Radius Position* on page 187

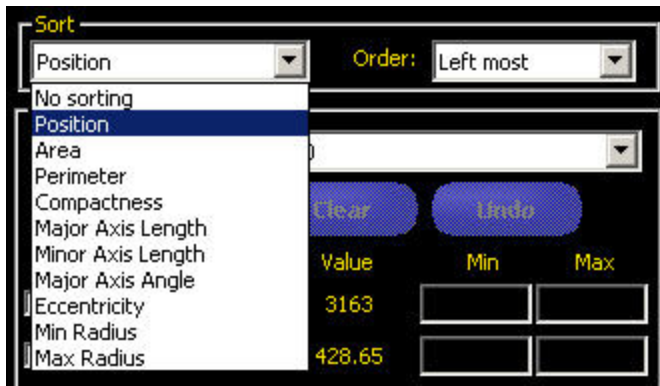

Blob Sort Order

Once you select a Sort method, you need to define a Sort Order:

- If Position is selected for the Sort method, then Blob order is based on the x,y coordinates of the centroids and the options are—
 - Left most
 - Top most
 - Right most
 - Bottom most
- For any of the other options, Blob order is based on Increasing or Decreasing value of the parameter selected. For example, if Perimeter and Increasing is selected, the smallest perimeter Blob will be Blob #1.

Blob Filter

The Blob filter allows you to more accurately select a specific Blob to locate and to use for positioning other Vision tools. Filter modifies the Blob count based on Computed Statistics criteria so that, for example, only circular Blobs (compactness) or symmetric Blobs (eccentricity) are included in the Blob count.

When you click the Preset button, the sensor uses the selected Blob to preset the filter values so that only the selected Blob will subsequently be identified by the sensor. This reduces the time it would take to manually enter values. When the sensor is in Run mode, you should use the runtime filter results to fine-tune these settings.

The screenshot shows the 'Advanced' tab of the Blob Detect Tool. At the top, there are three tabs: 'Input', 'Sort/Filter', and 'Advanced'. Below the tabs, there is a 'Sort' section with a dropdown menu set to 'Area' and an 'Order' dropdown set to 'Decreasing'. A 'Filter' section shows a dropdown menu with 'Blob 1 x=134.13, y=215.00' selected. Below the filter are three buttons: 'Preset', 'Clear', and 'Undo'. A table displays various statistics for the selected blob:

Statistic	Value	Min	Max
<input checked="" type="checkbox"/> Area	3163	2530	3796
<input checked="" type="checkbox"/> Perimeter (px)	428.65	342.92	514.38
<input checked="" type="checkbox"/> Compactness	21.63	17.30	25.96
<input checked="" type="checkbox"/> Major Axis Length (px)	104.30	83.44	125.16
<input checked="" type="checkbox"/> Minor Axis Length (px)	53.89	43.11	64.67
<input type="checkbox"/> Major Axis Angle	-1.52	-1.62	-1.22
<input checked="" type="checkbox"/> Eccentricity	1.94	1.55	2.33
<input checked="" type="checkbox"/> Min Radius (px)	2.81	2.25	3.37
<input checked="" type="checkbox"/> Max Radius (px)	53.20	42.56	63.84

Below the table are two buttons: 'Hide Histogram' and 'Back'. At the bottom, a histogram is displayed with a red area under the curve. The x-axis is labeled from 0 to 255. A vertical yellow line is positioned at 93. The histogram title is 'Histogram'.

Histogram

The Histogram is a display of the grayscale values on the "x" axis and the number of pixels on the "y" axis. The Histogram displays the amount of pixels for each grayscale value. The graph displays information for all grayscale values (0-255). Cursors, shown as vertical lines, represent minimum threshold, maximum threshold, threshold level and reject level. Corresponding cursor can be moved horizontally to adjust a value.

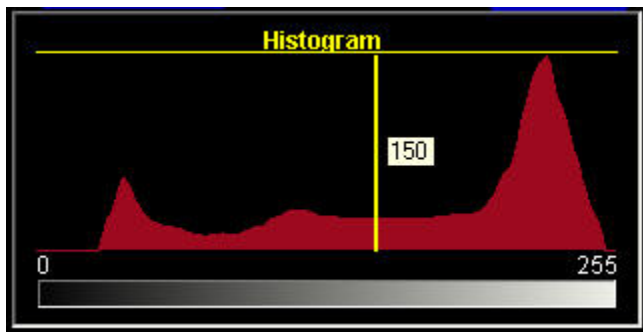

Blob Detect Tool Advanced Tab

Fields

The following are fields on the Blob Detect Advanced tab:

- *Options* on page 133
- *Blob Detect Tool Advanced Tab Results* on page 134

Blob Tool

Input **Advanced**

Options

- Discard Boundary Blobs
- Fill Holes
- Compute Statistics

Largest Hole to Fill: 37200

Results

Count	Total Area	Threshold Level
6	12032	150

Select Blob to view details:

Largest Blob x=222.62, y=272.64 (Blob #1)

Area	2297
Centroid	x=222.62, y=272.64
Perimeter	190.71 px
Compactness	79.36
Major Axis Length	74.88 px
Minor Axis Length	39.42 px
Major Axis Angle	4.52
Eccentricity	1.90
Min Radius	17.64 px
Max Radius	35.94 px
Min Radius Position	x=223.00, y=255.00
Max Radius Position	x=257.00, y=278.00

Hide Histogram Back

Histogram

0 150 255

Options

Options

- Discard Boundary Blobs
- Fill Holes
- Compute Statistics

Largest Hole to Fill: 37200

Discard Boundary Blobs: The Discard Boundary Blobs checkbox, if selected, allows you to determine if you want blobs touching the perimeter of the search ROI to be included in your results.

Fill Holes: Fill Holes checkbox, if selected, allows you to ignore (by filling) small features such as scratches, glare and so on which might otherwise appear as small imperfections or non-blobs within a larger blob. If you select this option, you can specify the size of the largest hole to fill in the **Largest Hole to Fill** field.

Compute Statistics: The Compute Statistics checkbox, when selected, enables advanced results to be calculated and displayed when inspections are run.

Largest Hole to Fill: If you select **Fill Holes**, you must specify the size of the largest hole to fill in this field.

Blob Detect Tool Advanced Tab Results

Area

The area (A) is just a count of the total number of pixels belonging to the blob.

Centroid



The centroid (x_c , y_c) is the point at the center of mass of the blob. For simple blobs like solid circles, ellipses, or rectangles, this is just the center of the shape. For more complicated shapes it is helpful to imagine a piece of cardboard cut out in the shape of the blob. The centroid is the point where you could balance the cardboard on the tip of a pencil. For complicated shapes-especially shapes with unfilled holes-the centroid might lie outside the shape.

The x coordinate of the centroid is calculated by adding up the x coordinates of each pixel in the blob and dividing by the area. The y coordinate is similar:

$$x_c = \frac{\sum_{i=1}^A x_i}{A} \qquad y_c = \frac{\sum_{i=1}^A y_i}{A}$$

Perimeter

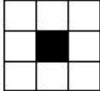
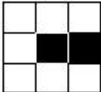
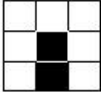
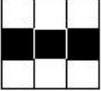
The perimeter (P) gives an approximate measurement of the length of the circumference of the blob. Because blobs are built from individual pixels, it is most practical to estimate the perimeter by counting the contributions of individual pixels on the blob's boundary. The following table describes the exact values that are added to the perimeter for each possible pixel configuration. In each example, the description refers to the center pixel in the corresponding pictures.

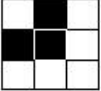
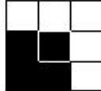
		A pixel with no neighbors that belong to the same blob contributes (3.14) linear pixels to the perimeter of the blob. This can only happen in a blob that has an area of one. Since such small blobs are usually ignored, this circumstance is rare.
		A pixel with one neighbor that belongs to the same blob contributes 2.571 linear pixels to the perimeter of the blob.
		A pixel with two neighbors that belong to the same blob, forming a straight line, contributes exactly 2 linear pixels to the perimeter of the blob.
		A pixel with two neighbors that belong to the same blob, forming a corner, contributes 1.414 linear pixels to the perimeter of the blob.

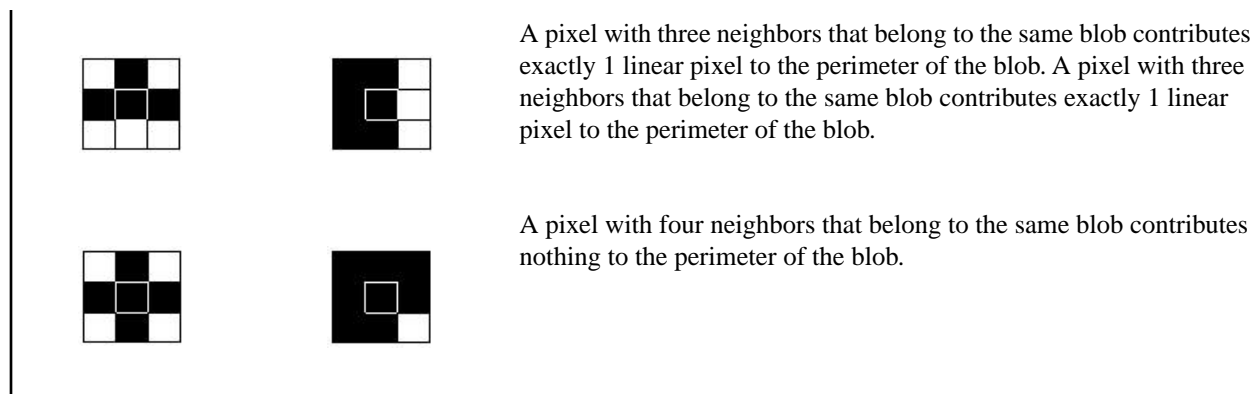

This method of counting tends to slightly overestimate the "true" perimeter. For example, a circle with a radius of 100 pixels will have a computed perimeter of approximately 660 pixels, compared with the expected value of 628 pixels.

If the camera is configured to convert pixel distances to other units, (e.g. inches), the perimeter will be given in those units. If the blob contains holes that have not been filled, the length of the perimeter will include the points on the perimeters of these holes.

Compactness

The compactness is high for blobs that are nearly circular and low for blobs that are elongated or complicated.

$$\text{compactness} = \frac{400 \pi A}{P^2}$$

Where A is the area and P is the perimeter of the Blob in question. An idealized circle would have a compactness of 100, but because the perimeter is approximated (see above), the highest realistic value for most blobs is roughly 90. Very small blobs with just a handful of pixels may reach or even exceed the theoretical maximum of 100, again because of the approximations in the perimeter calculation.

Major Axis Length, Minor Axis Length, and Major Axis Angle

To understand Major Axis Length, Minor Axis Length, and Major Axis Angle, it is important to note that these are not measurements of the Blob itself because the Blob may be an irregular shape. Rather, these measurements are determined by a well-defined shape, a "best fit ellipse" as shown below.

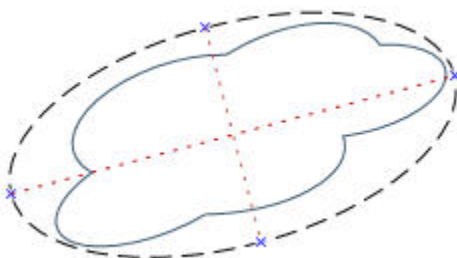

These three results combine to give information about the elongation and orientation of a blob. The equations used to compute these statistics are fairly complicated, but the results usually have an intuitively useful meaning, described below. The first step in computing these results is to compute the $M_{2,0}$, $M_{0,2}$ and $M_{1,1}$ statistical moments:

$$M_{2,0} = \frac{\sum_{i=1}^A (x_i - x_c)^2}{A}$$

$$M_{0,2} = \frac{\sum_{i=1}^A (y_i - y_c)^2}{A}$$

$$M_{1,1} = \frac{\sum_{i=1}^A ((x_i - x_c)(y_i - y_c))}{A}$$

where A is the area, (x_c, y_c) are the coordinates of the centroid and (x_i, y_i) are the coordinates of pixel i. These values represent the variance with respect to x, the variance with respect to y, and the covariance, respectively. The final results can be calculated as follows.

$$Major\ Axis\ Length = 2\sqrt{2\left(M_{2,0} + M_{0,2} + \sqrt{4M_{1,1}(M_{2,0} - M_{0,2})^2}\right)}$$

$$Major\ Axis\ Length = 2\sqrt{2\left(M_{2,0} + M_{0,2} - \sqrt{4M_{1,1}(M_{2,0} - M_{0,2})^2}\right)}$$

$$Major\ Axis\ Angle = \frac{\tan^{-1}\left(\frac{2M_{1,1}}{M_{2,0} - M_{0,2}}\right)}{2}$$

The table below gives a more practical perspective on how to interpret these results. If the camera is configured to convert pixels to other units, the major and minor axis lengths will be given in those units. The major axis angle is always given in degrees.

Blob Shape	Meaning of Major Axis Length	Meaning of Minor Axis Length	Meaning of Major Axis angle
circular, no holes	diameter of the circle	equal to the major axis length	unstable
elliptical, no holes	length of the ellipse	width of the ellipse	orientation of the ellipse
square, no holes	diameter of a circle that best approximates the square	equal to the major axis length	unstable
rectangular, no holes	length of an ellipse that best approximates the rectangle	width of an ellipse that best approximates the rectangle	orientation of the rectangle
complicated shape, no holes	length of an ellipse that best approximates the shape	width of an ellipse that best approximates the shape	orientation of the shape-unstable if length and width are nearly equal
any shape with holes	results vary depending on exact shape-experiment on your particular shape	results vary depending on exact shape-experiment on your particular shape	results vary depending on exact shape-experiment on your particular shape

Eccentricity

The eccentricity of a blob is defined as the length of the major axis divided by the length of the minor axis. For circular regions and other regions with radial symmetry (like a square), the value will be very close to 1. For elongated regions, the value will grow, possibly becoming quite large.

Max Radius and Max Radius Position

These results are equivalent to those for the minimum radius, but they refer to the pixel on the perimeter of the blob that is farthest from the centroid .

Min Radius and Min Radius Position

The minimum radius of a blob is the distance from the centroid of the blob to the closest pixel on that blob's perimeter. The minimum radius position gives the pixel coordinates of that closest perimeter point. If the blob contains unfilled holes, the minimum radius position may be on the perimeter of a hole. If the camera is configured to convert pixels to other units, the minimum radius (but not the minimum radius position) will be given in those units.

7.3.3 Circle Detect Tool

Test

The Circle Detect tool finds a single circle or piece of a circle. The tool works by first finding many edge points along the transitions between bright and dark pixels and then fitting a circular shape to some or all of those points. It can determine a bend radius, and the circumference of a circular part.

Place the Region of Interest (ROI) by clicking near the center of the circle you wish to find and dragging the cursor to the outside of that circle. The tool works best when the inner ring of the ROI is completely inside the circle being detected.

Usage

- Find flaws like chips or metal spurs along a punch or drilled hole
- Measure hole size
- Measure the size of a disk
- Verify that the neck on a vial or bottle is the correct size
- Measure the bend radius of an electronic component
- Find the radius of a circle that is too big to fit in the image

Fields

The following are fields on the Circle Detect tool Input tab:

- [Edges](#) on page 139
- [Search For Field](#) on page 139
- [Legend](#) on page 158
- [Results](#) on page 141

Supported Platforms

ProII Color	ProII/ProII 1.3	OMNI Color	OMNI/OMNI 1.3	AREA/AREA13	EDGE/EDGE 1.3	GEO/GEO 1.3	BCR/BCR 1.3
Yes	Yes	Yes	Yes	No	No	No	No

Circle Detect Tool Input Tab

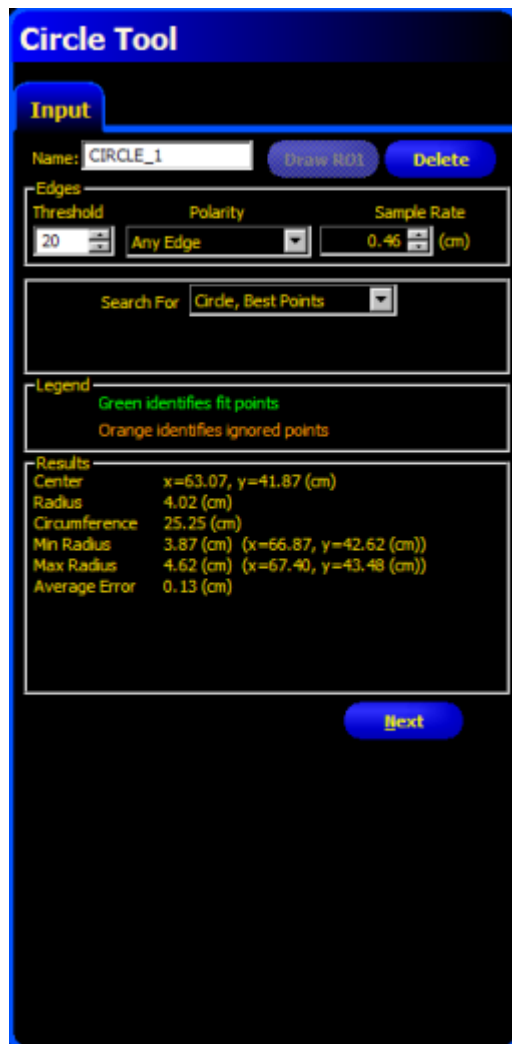

Adding an Circle Detect Tool

1. Click the button of the tool to be added to the inspection.
2. If desired, rename the tool.
3. Draw an ROI.

Field/Button	Description
<input type="text" value="tool_name_1"/>	Use this field to rename the tool. The default is <i>tool_name_1</i> , <i>tool_name_2</i> , and so on, where the default <i>tool_name</i> depends on the tool being created (for example, locate, edge or the like). The name can have only alphanumeric characters and underscores with no spaces.
<input type="button" value="Draw ROI"/>	Click this button to add an ROI to an image.
<input type="button" value="Delete"/>	Click this button to remove an ROI from an image.

When adding an ROI for a Circle Detect tool, click near the center of the circle you wish to inspect and drag to the outside of the circle. Adjust the inner and outer rings of the ROI by dragging the squares on the top, bottom, and sides. If using the "Circular, Arc" option, adjust the angular range by dragging the lines at the start and end of the arc.

Edges

Threshold measures the rate of change of grayscale values and needs sharply-defined transitions. The Circle Detect tool finds edge points by scanning along many invisible lines from inside of the ROI to the outside. Arrows on the ROI point outwards to indicate this direction. Three settings—Threshold, Polarity, and Sample Rate—give you control over how the edge scan works.

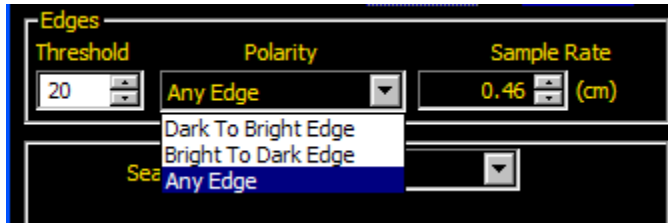

Field/Graph	Description
Threshold	Edges are selected by the edge strength method, which measures the rate of change from bright to dark or dark to bright. Enter an edge strength threshold in the range from 1 to 255. The default value is 20. As this value gets lower, the tool will find weaker, blurrier or more gradual edges.
Polarity	<ul style="list-style-type: none"> • Bright to Dark: Finds only the edges with their bright side towards the center of the ROI and their dark side towards the outside of the ROI. • Dark to Bright: Finds only the edges with their dark side towards the center of the ROI and their bright side towards the outside of the ROI • Bright or Dark finds all edges.
Sample Rate	The Sample Rate sets the spacing between the invisible scan lines at the midpoint between the inner and outer rings of the ROI. When the sample rate is raised, fewer edges will be found and they will be spaced more widely. When the sample rate is lowered, more edge will be found. This creates a tradeoff between speed and precision. Higher sample rates execute faster, and lower sample rates find more precision results and are capable of detecting smaller flaws.

Search For Field



The Search For offers three ways to fit a circle to the edge points the tool finds:

- "Circle, Best Points" is the most common choice. It automatically figures which edge points make the best circle and ignores the rest. The points that are being ignored will be shown on the image in orange. This mode is very tolerant of noise or extra edges in the ROI, but under some circumstances it may ignore edges you wish to include.
- "Circle, All Points" finds a circle that explains all the edges as well as possible without ignoring anything. This setting is the fastest, but it works poorly if there are any extra edges or noise within the ROI. This mode is useful if the circle being examined is irregular or elliptical.
- "Circular Arc" finds a piece of a circle. Using this setting to find the start or end angle of an arc or bend or to measure the angle subtended by a bend.

PresencePLUS P4 OMNI 1.3+BCR+OCR+BD Vision Sensor - Circle_Test2.ins [Modified]

Setup Tools Teach Run

CIRCLE_1
A Circle

CIRCLE_2
A Circle

Connection: Sensor 192.168.0.1 Zoom: 4

Legend

The Legend describes the pixel colors on the image.



Results

Using the Search For "Circle, Best Points" or "Circle, All Points" options will produce the following results.

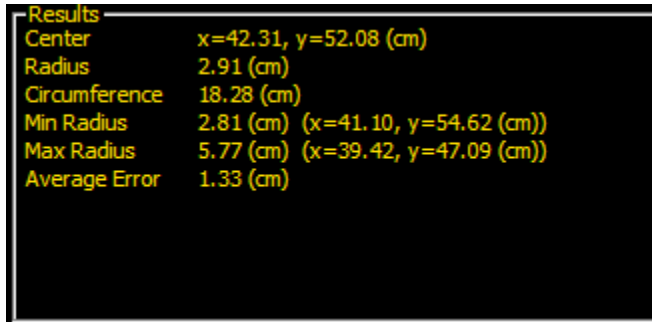

Result	Description
Center	The center point of the circle detected. A Measure tool can measure from this center point to other features.
Radius	The distance from the center of the detected circle to its edges. Use this value in a Test tool to determine if a circle is the correct size.
Circumference	The distance around the circle.
Min Radius	The distance from the center of the circle to the closest green edge point. Click on this result to see the location. Use this value in a Test tool to look for flaws like metal spurs on the inside of a drilled or punched hole.
Max Radius	The distance from the center of the circle to the farthest green edge point. Use the value in a Test tool to find flaws like chips or tearing on the outside of a punched or drilled hole.
Average Error	The average distance between green edge points and the circle found. Use this value in a Test tool to determine if a circle is squished (elliptical), poorly formed, or irregular.

Using the Search For "Circular Arc" option will produce the following additional results.

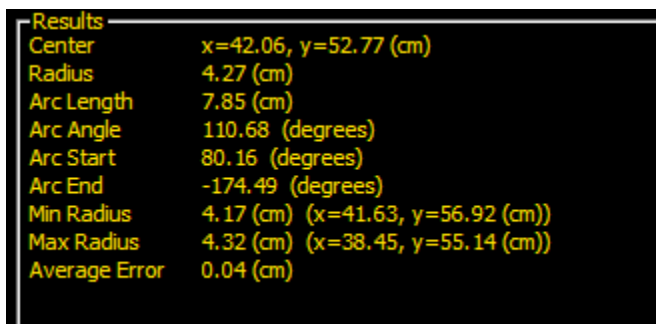

Result	Description
Arc Length	The distance along the arc.
Arc Angle	The angle between the start and end of the arc. This will be between 0 and 360 degrees.
Arc Start Angle	The angle between the x-axis and the beginning of the arc. This will be between -180 and +180 degrees.
Arc End Angle	The between the x-axis and the end of the arc. This will be between -180 and +180 degrees.

7.3.4 Edge Tool

The Edge tool finds and marks the position of all edges along an *ROI* line. It detects and counts transitions between bright and dark pixels. The total number of edges can be counted, and the position of each edge can be found. Edge position information can be used for distance or angle measurement.

Usage

- Measure the height and width of a part
- Count the pins on a resistor
- Measure the height of a needle
- Measure the deflection of an automotive gauge
- Detect the edge of a web
- Verify that a bottle cap is on completely

Fields

The following are fields on the Edge tool Input tab:

- *Threshold Type* on page 160
- *Filters* on page 165
- *Edge Tool Results* on page 147

Supported Platforms

ProII Color	ProII/ProII 1.3	OMNI Color	OMNI/OMNI 1.3	AREA/AREA13	EDGE/EDGE 1.3	GEO/GEO 1.3	BCR/BCR 1.3
Yes	Yes	Yes	Yes	No	Yes	No	No

Edge Tool Input Tab

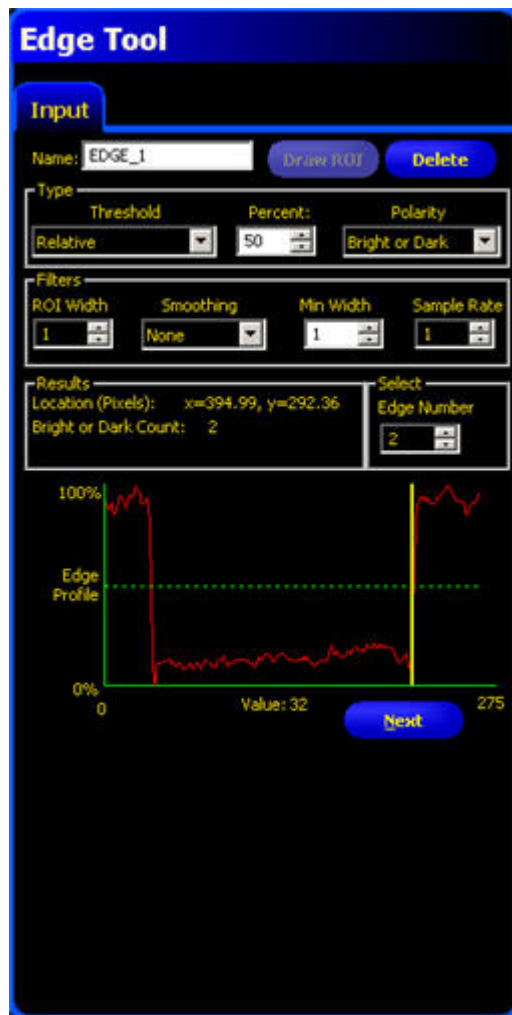

Adding an Edge Tool

1. Click the button of the tool to be added to the inspection.
2. If desired, rename the tool.
3. Draw an ROI.

Field/Button	Description
<input type="text" value="tool_name_1"/>	Use this field to rename the tool. The default is <i>tool_name_1</i> , <i>tool_name_2</i> , and so on, where the default <i>tool_name</i> depends on the tool being created (for example, locate, edge or the like). The name can have only alphanumeric characters and underscores with no spaces.
<input type="button" value="Draw ROI"/>	Click this button to add an ROI to an image.
<input type="button" value="Delete"/>	Click this button to remove an ROI from an image.

Threshold Type

The threshold is used to mark the gray scale transition point. The tool marks the edge when the pixel intensity crosses the threshold level. From the dropdown list, select one of the following:

- Relative
- Absolute
- Edge Strength

Relative Threshold

Relative threshold is the default, and it finds an edge at a relative pixel intensity. The brightest gray scale level is 100% and the darkest is 0%. While Relative threshold is more tolerant of light fluctuations between inspections than other transition types, it may find false edges.



Field/Graph	Description
Percent	Percent is displayed when the Type is Relative. Choose the percentage value at which the edge should be marked.
Polarity	<ul style="list-style-type: none"> • Bright to Dark finds edges that start above the threshold value and cross below the threshold value. • Dark to Bright finds edges that start below the threshold value and cross above the threshold value. • Bright or Dark finds any edge.
Edge Profile Graph	<p>In the Edge Profile graph displayed when the Relative threshold is selected, the red line shows the percentage pixel intensity relative to the green threshold line. The threshold line will move up or down with the percent value.</p>

Absolute Threshold

Absolute threshold finds an edge at a specific gray scale level. While Absolute threshold is less likely to find a false edge than Relative Threshold, it may miss edges if the light level changes between inspections.



Field/Graph	Description
Value	Value is displayed when Type is Absolute. Enter a specific gray scale value from 0 to 255.
Polarity	<ul style="list-style-type: none"> • Bright to Dark finds edges that start above the threshold value and cross below the threshold value. • Dark to Bright finds edges that start below the threshold value and cross above the threshold value. • Bright or Dark finds any edge.
Edge Profile Graph	<p>In the Edge Profile graph displayed when the Absolute threshold is selected, the red line shows the percentage pixel intensity relative to the green threshold line. The threshold line will move up or down with the percent value.</p>

Edge Strength

Edge strength measures the rate of change of grayscale values and needs sharply-defined transitions. Edge strength is more tolerant of gradual changes in light levels across the tool than other transition types and it will filter out weak or gradual edges.



Field	Description
Edge	Enter an edge bandwidth value from 1 to 255.
Polarity	<ul style="list-style-type: none"> • Bright to Dark finds edges that start above the threshold value and cross below the threshold value. • Dark to Bright finds edges that start below the threshold value and cross above the threshold value. • Bright or Dark finds any edge.

Graph Tab

When Edge Strength is selected in the Input tab, the software displays the Graph tab. This tab provides similar information to the Input tab, but displays separate Edge Profile and Edge Strength graphs for easier viewing.

The Edge Profile graph represents the absolute gray scale level across the tool ROI.

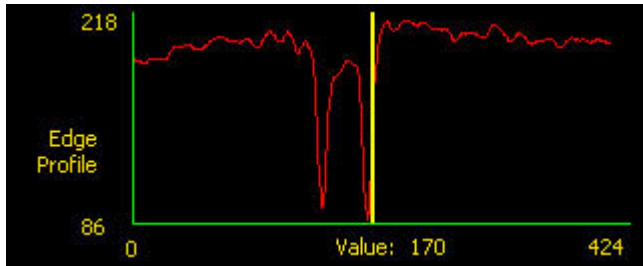

The Edge Strength graph represents the change in gray scale along the tool ROI. Edge Strength detects an edge when the rate of change (solid red line on the graph) crosses the selected intensity change amount (dashed green lines on the screen).

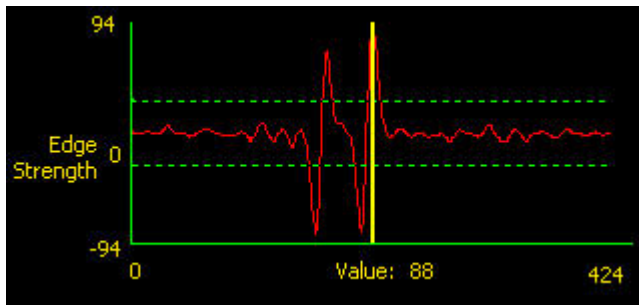



A bright-to-dark transition has a negative edge strength value, and a dark-to-bright transition has a positive edge strength value. When the Edge Strength level is adjusted, both the negative and positive green dotted lines will adjust together.

Filters



Field	Description
ROI Width	Increases in increments of 4 pixels (for example, 1, 5, 9, 13, ...) up to the total FOV size. Some things to note: <ul style="list-style-type: none"> • Narrow ROIs execute faster but could miss the edge. • Wide ROIs are more consistent but don't execute as fast. • The ROI must be 13 pixels or wider to calculate the rotation of a part.

Field	Description
Smoothing	Runs a rolling average along the ROI length. It filters out sharp changes in the edge profile.  Note: A high filter number may miss the edge of a narrow line.
Min Width	Filters out small spike-of-intensity changes, and narrow dark or bright bands. It determines the distance (in pixels) before and after an edge that must be free from additional transitions or the end of the ROI before the edge is recognized.  Note: A high filter number may miss the edge of a narrow line.
Sample Rate	Determines the sub-pixel resolution, which increases the resolution of the tool, and increases the inspection time. <ol style="list-style-type: none"> 1. 1-pixel resolution 2. 1/2-pixel resolution 3. 1/3-pixel resolution 4. 1/4-pixel resolution

Edge Tool Results

The Results field returns the following:

- X,Y coordinates of the current edge. The origin (0,0) is the upper-left corner of the screen.
- A **Edge Number** field for selecting an edge to analyze.
- Total number of bright-to-dark and dark-to-bright edges, depending on the **Polarity** option in effect.



Graph Tab

When Edge Strength is selected, the Graph tab appears on the tool window. The graph for the Input tab overlays both the edge strength graph and the edge profile. In the Graph tab, the edge profile graph and the edge strength graph are separated for easier viewing.

The top graph, Edge Profile, represents the absolute gray scale level across the Edge tool.

The bottom graph, Edge Strength, represents the change in gray scale along the Edge tool.

Edge Strength detects an edge when the rate of change (solid red line on the screen) crosses the selected intensity change amount (dashed green lines on the screen).

A bright-to-dark transition has a negative edge strength value, and a dark-to-bright transition has a positive edge strength value. When the Edge Strength level is adjusted, both the negative and positive lines will adjust together.

Graph Tab

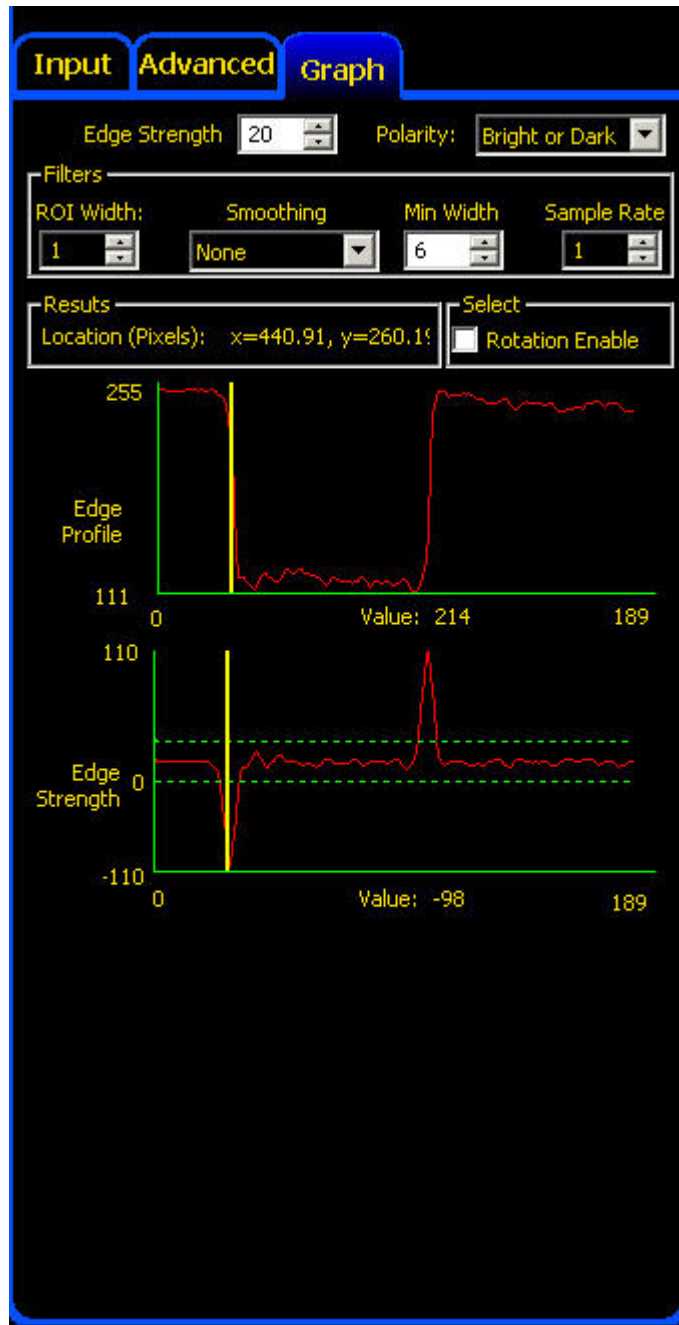

7.3.5 Geometric Count Tool

The Geometric Count tool uses edge content to find shapes in an image. During setup, the user identifies a section of the image containing the target shape and assigns that shape as the reference for the Geometric Count tool. This reference shape is subsequently used to locate all similar shapes in new images by searching inside the Search ROI. Geometric Count returns the following information:

- Number of shapes found
- Location of all shapes found

 **Note:** If the Geometric Count tool is preceded by a Location tool (for example, Locate or Geometric Find tool), then the Search ROI will only translate by the amount that the preceding Location tool found. Thus, even if the Location tool has rotation enabled, the Search ROI will not rotate.

 **Note:** The Geometric Count tool requires strong and repeatable edge content in the image.

Usage

- Verify date/lot codes
- Inspect electronic component assembly
- Inspect printing

Fields

The following are fields on the Geometric Count tool Input tab:

- [Threshold](#) on page 151
- [Enabling Remote Teach](#) on page 299
- [Count](#) on page 151
- [Edge Length](#) on page 152
- [Legend](#) on page 152
- [Results](#) on page 155

Supported Platforms

ProII Color	ProII/ProII 1.3	OMNI Color	OMNI/OMNI 1.3	AREA/AREA13	EDGE/EDGE 1.3	GEO/GEO 1.3	BCR/BCR 1.3
Yes	Yes	Yes	Yes	No	No	Yes	No

Geometric Count Tool Input Tab



Adding a Geometric Count Tool

To add a tool to an inspection:

1. Click the button of the tool to be added to the inspection.
2. If desired, rename the tool.
3. Draw an ROI.

Field/Button	Description
Name: <input type="text" value="tool_name_1"/>	Use this field to rename the tool. The default is <i>tool_name_1</i> , <i>tool_name_2</i> , and so on, where the default <i>tool_name</i> depends on the tool being created (for example, locate, edge or the like). The name can have only alphanumeric characters and underscores with no spaces.
<input type="button" value="Draw ROI"/>	Click this button to add an ROI to an image.
<input type="button" value="Add Mask"/>	Click this button to add a mask to an image
<input type="button" value="Delete"/>	Click this button to remove an ROI from an image.

Field/Button	Description
	Use this field to rotate the ROI. You can manually key in a rotation angle, or you can use the up or down arrow keys to rotate the ROI.

Threshold

Adaptive Threshold

Adaptive Threshold adjusts the edge threshold on each acquired image. The Sensor automatically sets the threshold and attempts to adjust for contrast variations.



Edge Strength

Edge Strength sets the edge threshold at a predetermined gray scale value from 0 to 127. Edge Strength provides more control over what gets to be considered an edge pixel.



Enabling Remote Teach

The Remote Teach function is a method of remotely updating inspection parameters in Run mode. Vision tools and Test tools can be selected to be taught or not taught. To remotely teach an inspection, the Remote Teach function must be enabled on each tool to be taught.

-  **Note:** Remote Teach in the Geometric Count tool will learn a new shape. Remote Teach in a Geometric Count Test tool will learn a new number of shapes.

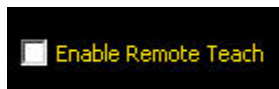

Count

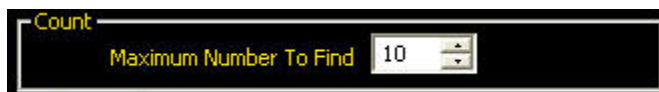

In the **Maximum Number to Find** field, enter the maximum number of outline patterns to find, or use the up and down arrow keys to change the number.

The lower the number you enter, the faster the inspection time because the inspection will stop once it reaches the selected number. The maximum number of outline patterns that the tool will find is 255.

Edge Length

The tool ignores target patterns with edges equal to or shorter than the specified number of pixels for edge length.



Legend

All edges found by the Geometric Find tool are color-coded in the Image window. Strong edges show up in green, and weak edges show up in red.

 **Note:** Both weak and strong edges in the pattern ROI are expected to be present in the inspection.



Results

The Results field returns the following:

- Total number of shapes above the minimum acceptance level.
- Position of each shape's center. The origin (0,0) is the upper-left corner of the screen.



Geometric Count Tool Advanced Tab

Fields in the Geometric Count Tool Advanced tab are described in the following.

Fields

The following are fields on the Geometric Count tool Advanced tab:

- [Rotation Range](#) on page 153
- [Extra and Missing Edges](#) on page 153
- [Minimum Acceptance Level](#) on page 169
- [Reject Threshold](#) on page 154
- [Scaling Range](#) on page 155
- [Results](#) on page 155

Advanced Tab

Geometric Count Tool

Input **Advanced**

Rotation Range
 Clockwise (+) 45 Counterclockwise (-) 45

Extra and Missing Edges
 Check For Extra Edges
 Check For Missing Edges

Minimum Acceptance Level
 20 100 % 80

Reject Threshold
 Low 0 High 255

Scaling Range
 Low 1 High 1

Tool Timeout 30000 ms

Results
 Number Found 0 Best Match #0

Apply Back



Rotation Range

These adjustments are used to set the maximum allowable rotation (0° to 180°) that a target pattern can have and still be identifiable.

Rotation Range
 Clockwise (+) 45 Counterclockwise (-) 45

Extra and Missing Edges

Extra and Missing Edges
 Check For Extra Edges
 Check For Missing Edges

Field	Description
Extra Edges	<p>If left unchecked (disabled), the Sensor will find a target shape that might have extra edges. If checked (enabled), the Sensor will not find a target shape that has extra edges of a specified length. The size of the minimum edge length is adjustable.</p> <p> Note: If checked, the application will not allow a minimum edge length to be set below the number specified for Minimum Edge Length (in the Input tab) for this tool.</p>
Missing Edges	<p>If left unchecked (disabled), then the Sensor will find a target shape, even if it is missing some edge content. If checked (enabled), then the Sensor will not find a target shape that is missing edges of a specified length. The size of the minimum edge length to check for is adjustable.</p> <p> Note: If checked, the application will not allow a minimum edge length to be set below the number specified for Minimum Edge Length (in the Input tab) for this tool.</p>

Minimum Acceptance Level

This adjustment sets the acceptance level for pattern matches.

- Decrease the Minimum Acceptance Level to allow more variations in matching patterns.
- Increase the Minimum Acceptance Level to filter out patterns that contain small defects.

Percent match is a value between 20% and 100% that indicates the quality of the match (100% is a perfect match; 20% is a slight match). The percent match can be used to detect large defects.

 **Note:** Banner does not recommend setting the Minimum Acceptance Level below 70%.



Reject Threshold

These adjustments allow the user to set the “band of gray scale values” the tool uses to determine the threshold when Adaptive Threshold is specified.

If the Low is set to zero (default) and the High is set to 255 (default), then all gray scale values within the acquired image are used to determine the threshold.

An example of narrowing the band of gray scale values is to set the Low at 50 and the High at 200. With these settings, only gray scale values from 50 to 200 will be used by the Geometric Find tool to determine the threshold when Adaptive Threshold is specified.

These controls allow the user to “block” dark spots or light spots from influencing the threshold in the image acquired by the Sensor.



Scaling Range

Scaling Range allows you to set a range from a low of 0.8 to a high of 1.2. In Run mode, this will enable matches to occur even with slight variations in shape from the reference shape.



Results

The Results field returns the following:

- Total number of shapes above the minimum acceptance level.
- Position of each shape's center. The origin (0,0) is the upper-left corner of the screen.



7.3.6 Line Detect Tool

The Line Detect tool finds a single, straight-line segment. The tool works by first finding many edge points along the transitions between bright and dark pixels and then fitting a line to some or all of those points. I can measure the length of a straight edge, find damage or flaws along an edge or offer a way to measure between a straight line and other points or lines in the image.

Place the Region of Interest (ROI) by clicking to one side of the line you wish to find and then dragging the cursor perpendicularly across that line before releasing. Adjust the width of the ROI by dragging either side.

Usage

- Measure the height and width of a part
- Measure the height of a needle
- Measure the deflection of an automotive gauge
- Detect the edge of a web
- Verify that a bottle cap is on completely
- Find chips, spurs, or other flaws along a straight edge
- Measure the angle between two lines

Fields

The following are fields on the Line Detect tool Input tab:

- [Edges](#) on page 157
- [Search For Field](#) on page 157
- [Legend](#) on page 158
- [Results](#) on page 158

Supported Platforms

ProII Color	ProII/ProII 1.3	OMNI Color	OMNI/OMNI 1.3	AREA/AREA13	EDGE/EDGE 1.3	GEO/GEO 1.3	BCR/BCR 1.3
Yes	Yes	Yes	Yes	No	No	No	No

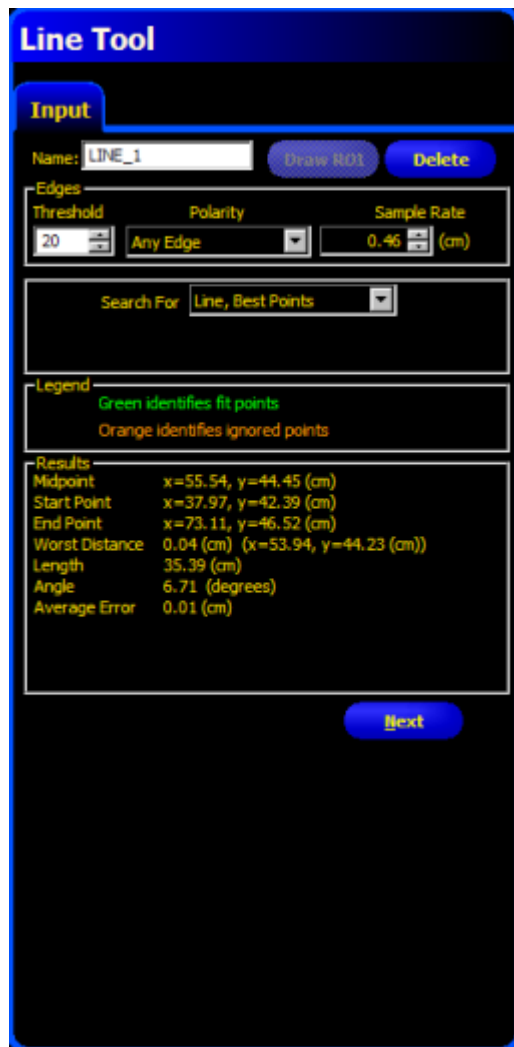

Line Detect Tool Input Tab



Adding an Line Detect Tool

1. Click the button of the tool to be added to the inspection.
2. If desired, rename the tool.
3. Draw an ROI.

Field/Button	Description
Name: <input type="text" value="tool_name_1"/>	Use this field to rename the tool. The default is <i>tool_name_1</i> , <i>tool_name_2</i> , and so on, where the default <i>tool_name</i> depends on the tool being created (for example, locate, edge or the like). The name can have only alphanumeric characters and underscores with no spaces.

Field/Button	Description
	Click this button to add an ROI to an image.
	Click this button to remove an ROI from an image.

When adding an ROI for a Line Detect tool, click to one side of the line you wish to find and drag the cursor perpendicularly across the line before releasing. Adjust the width of the ROI by dragging either side.

Edges

The Line Detect tool finds edge points by scanning along many invisible lines parallel to the arrows shown on the edges of the ROI. Three settings—Threshold, Polarity, and Sample Rate—give you control over how the edge scan works.

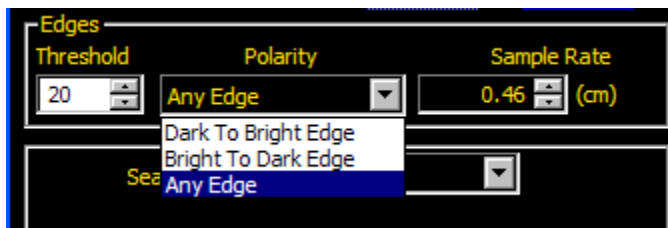

Field/Graph	Description
Threshold	Edges are selected by the edge strength method, which measures the rate of change from bright to dark or dark to bright. Enter an edge strength threshold in the range from 1 to 255. The default is 20. As this value gets lower, the tool will find weaker, blurrier or more gradual edges.
Polarity	<ul style="list-style-type: none"> • Bright to Dark: Finds only the edges with their bright side towards the center of the ROI and their dark side towards the outside of the ROI. • Dark to Bright: Finds only the edges with their dark side towards the center of the ROI and their bright side towards the outside of the ROI. • Bright or Dark: Finds all edges.
Sample Rate	The Sample Rate sets the spacing between invisible scan lines at the midpoint between the inner and outer part of the ROI. When the sample rate is raised, fewer edges will be found and they will be spaced more widely. When the sample rate is lowered, more edge will be found. This creates a trade-off between speed and precision. Higher sample rates execute faster, and lower sample rates find more precise results and are capable of detecting smaller flaws.

Search For Field

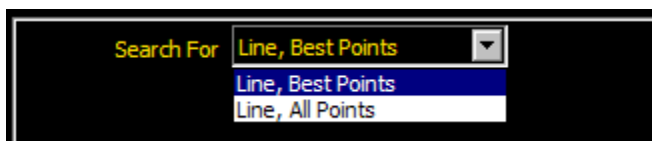

The Search For offers two ways to fit a line to the edge points the tool finds:

- "Line, Best Points" is the most common choice. It automatically figures which edge points make the best line and ignores the rest. The points that are being ignored will be shown on the image in orange. This mode is tolerant of

noise or extra edges in the ROI, but under some circumstances it may ignore edges you wish to include. Also, if the line in the image has gaps in it, this mode may produce lines that are shorter than you want.

- "Line, All Points" finds a line that explains all the edges as well as possible without ignoring anything. This setting is the fastest, but it works poorly if there are any extra edges or noise within the ROI. This mode can be useful if the line being examined is jagged, irregular, or curved.

Legend

The Legend describes the pixel colors on the image.

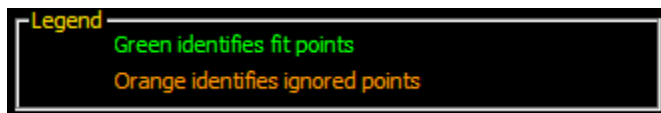

Results

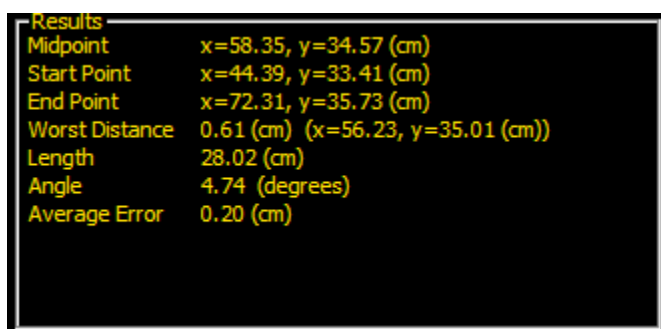

Result	Description
Start Point, Midpoint, End Point	The (x,y) coordinates of the start, middle, and end of the line found. Click on any of these results to see where they are in the image. By definition, the start point will be on the end of the line that is closer to the left side of the ROI, when viewed in the direction of the arrows. Use these values with a Measure tool.
Worst Distance	The distance from the line to the farthest green edge point. Click on this result to see the location. Use this value in a Test tool to look for damage or deviation along an edge. This result may be most useful when using the Search For "Line, All Points" option.
Length	The distance from the start point of the line to the end point.
Angle	The angle between the x-axis and the vector from the start of the line to the end of the line. This will be in the range from -180 to +180.
Average Error	The average distance between the green edge points and the line found. Use this value in a Test tool to determine whether a line is curved or irregular. This may be most useful when using the Search For "Line, All Points" option.

7.3.7 Object Tool

The Object tool detects the edges of dark and bright segments in an ROI. The Object tool measures the widths of every dark and light segment along the ROI. The Object tool calculates the midpoint for every object, and counts the total number of objects. The midpoint can be used to measure distances and angles. Each object can have unique size limit, or all objects may have the same size limit.

Usage

- Measure the width of a label
- Locate the center of a box on a conveyor
- Measure the gaps between stamped parts on a Web.

Fields

The following are fields on the Object tool Input tab:

- [Threshold Type](#) on page 160
- [Filters](#) on page 165
- [Object Tool Results](#) on page 166

Supported Platforms

ProII Color	ProII/ProII 1.3	OMNI Color	OMNI/OMNI 1.3	AREA/AREA13	EDGE/EDGE 1.3	GEO/GEO 1.3	BCR/BCR 1.3
Yes	Yes	Yes	Yes	No	Yes	No	No

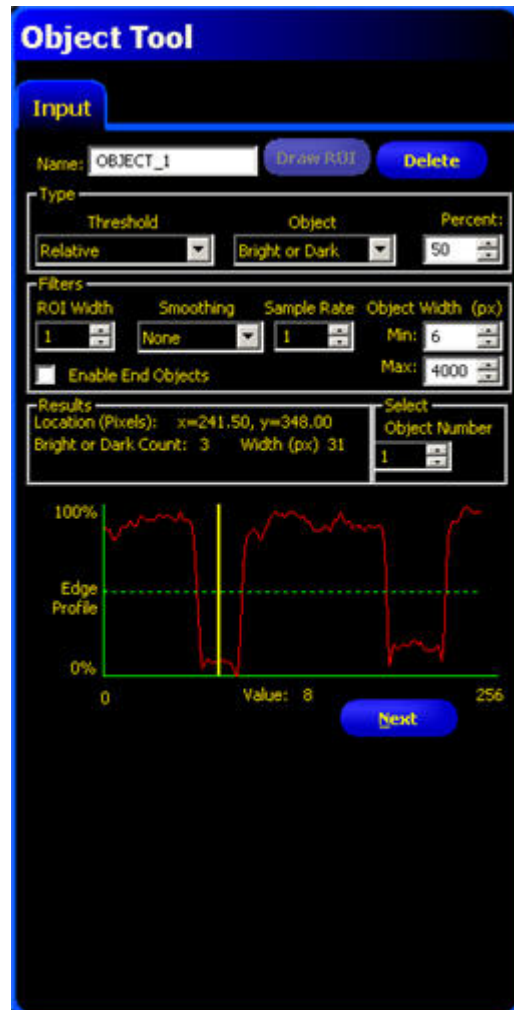

Object Tool Input Tab



Adding a Linear Tool

To add a tool to an inspection:

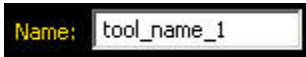
1. Click the button of the tool to be added to the inspection.
2. If desired, rename the tool.
3. Draw an ROI.

Field/Button	Description
	Use this field to rename the tool. The default is <i>tool_name_1</i> , <i>tool_name_2</i> , and so on, where the default <i>tool_name</i> depends on the tool being created (for example, locate, edge or the like). The name can have only alphanumeric characters and underscores with no spaces.
	Click this button to add an ROI to an image.
	Click this button to remove an ROI from an image.

Threshold Type

The threshold is used to mark the gray scale transition point. The tool marks the edge when the pixel intensity crosses the threshold level. From the dropdown list, select one of the following:

- Relative
- Absolute
- Edge Strength

Relative Threshold

Relative threshold is the default, and it finds an edge at a relative pixel intensity. The brightest gray scale level is 100% and the darkest is 0%. While Relative threshold is more tolerant of light fluctuations between inspections than other transition types, it may find false edges.

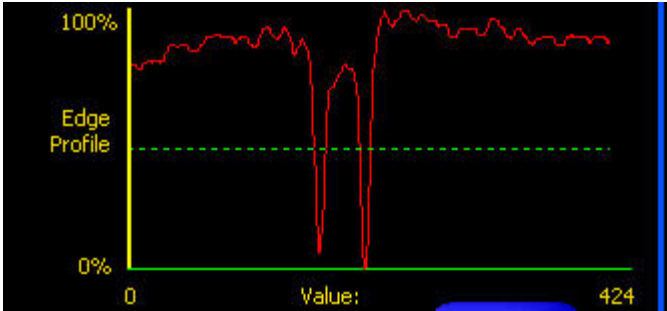

Field/Graph	Description
Percent	Percent is displayed when the Type is Relative. Choose the percentage value at which the edge should be marked.
Polarity	<ul style="list-style-type: none"> • Bright to Dark finds edges that start above the threshold value and cross below the threshold value. • Dark to Bright finds edges that start below the threshold value and cross above the threshold value. • Bright or Dark finds any edge.

Field/Graph	Description
Edge Profile Graph	<p>In the Edge Profile graph displayed when the Relative threshold is selected, the red line shows the percentage pixel intensity relative to the green threshold line. The threshold line will move up or down with the percent value.</p> 

Absolute Threshold

Absolute threshold finds an edge at a specific gray scale level. While Absolute threshold is less likely to find a false edge than Relative Threshold, it may miss edges if the light level changes between inspections.



Field/Graph	Description
Value	Value is displayed when Type is Absolute. Enter a specific gray scale value from 0 to 255.
Polarity	<ul style="list-style-type: none"> • Bright to Dark finds edges that start above the threshold value and cross below the threshold value. • Dark to Bright finds edges that start below the threshold value and cross above the threshold value. • Bright or Dark finds any edge.
Edge Profile Graph	<p>In the Edge Profile graph displayed when the Absolute threshold is selected, the red line shows the percentage pixel intensity relative to the green threshold line. The threshold line will move up or down with the percent value.</p> 

Edge Strength

Edge strength measures the rate of change of grayscale values and needs sharply-defined transitions. Edge strength is more tolerant of gradual changes in light levels across the tool than other transition types and it will filter out weak or gradual edges.



Field	Description
Edge	Enter an edge bandwidth value from 1 to 255.
Polarity	<ul style="list-style-type: none"> • Bright to Dark finds edges that start above the threshold value and cross below the threshold value. • Dark to Bright finds edges that start below the threshold value and cross above the threshold value. • Bright or Dark finds any edge.

Graph Tab

When Edge Strength is selected in the Input tab, the software displays the Graph tab. This tab provides similar information to the Input tab, but displays separate Edge Profile and Edge Strength graphs for easier viewing.

The Edge Profile graph represents the absolute gray scale level across the tool ROI.

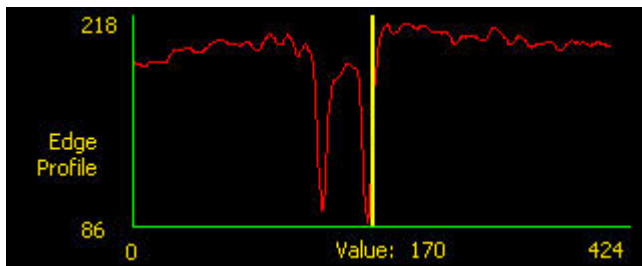

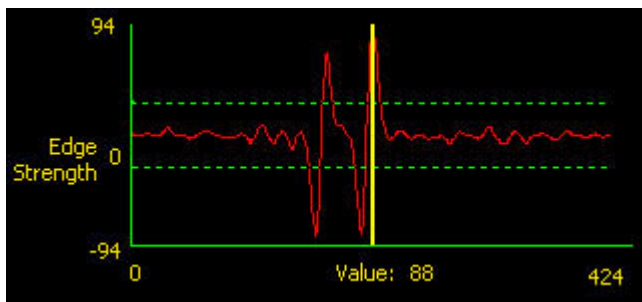

The Edge Strength graph represents the change in gray scale along the tool ROI. Edge Strength detects an edge when the rate of change (solid red line on the graph) crosses the selected intensity change amount (dashed green lines on the screen).



A bright-to-dark transition has a negative edge strength value, and a dark-to-bright transition has a positive edge strength value. When the Edge Strength level is adjusted, both the negative and positive green dotted lines will adjust together.

Filters



Field	Description
ROI Width	Increases in increments of 4 pixels (for example, 1, 5, 9, 13, ...) up to the total FOV size. Some things to note: <ul style="list-style-type: none"> • Narrow ROIs execute faster but could miss the edge. • Wide ROIs are more consistent but don't execute as fast. • The ROI must be 13 pixels or wider to calculate the rotation of a part.
Smoothing	Runs a rolling average along the ROI length. It filters out sharp changes in the edge profile. <p> Note: A high filter number may miss the edge of a narrow line.</p>
Min Width	Filters out small spike-of-intensity changes, and narrow dark or bright bands. It determines the distance (in pixels) before and after an edge that must be free from additional transitions or the end of the ROI before the edge is recognized. <p> Note: A high filter number may miss the edge of a narrow line.</p>
Sample Rate	Determines the sub-pixel resolution, which increases the resolution of the tool, and increases the inspection time. <ol style="list-style-type: none"> 1. 1-pixel resolution 2. 1/2-pixel resolution 3. 1/3-pixel resolution 4. 1/4-pixel resolution

Object Width

Object Width filters out objects and spaces that are smaller than the minimum and larger than the maximum values specified.



The minimum and maximum object width affects both objects and spaces between objects. Minimum object width can filter out objects and spaces.

Object Tool Results

The **Results** field returns the following:

- The position of the object midpoint. The origin (0,0) is the upper-left corner of the screen.
- A Select Object Number field for selecting an object to analyze.
- Total number of Bright, Dark, or All objects (depending on the Bright/Dark option in effect).
- Distance between the edges of the current object.



Graph Tab

When Edge Strength is selected, the Graph tab appears on the tool window. The graph for the Input tab overlays both the edge strength graph and the edge profile. In the Graph tab, the edge profile graph and the edge strength graph are separated for easier viewing.

The top graph, Edge Profile, represents the absolute gray scale level across the Edge tool.

The bottom graph, Edge Strength, represents the change in gray scale along the Edge tool.

Edge Strength detects an edge when the rate of change (solid red line on the screen) crosses the selected intensity change amount (dashed green lines on the screen).

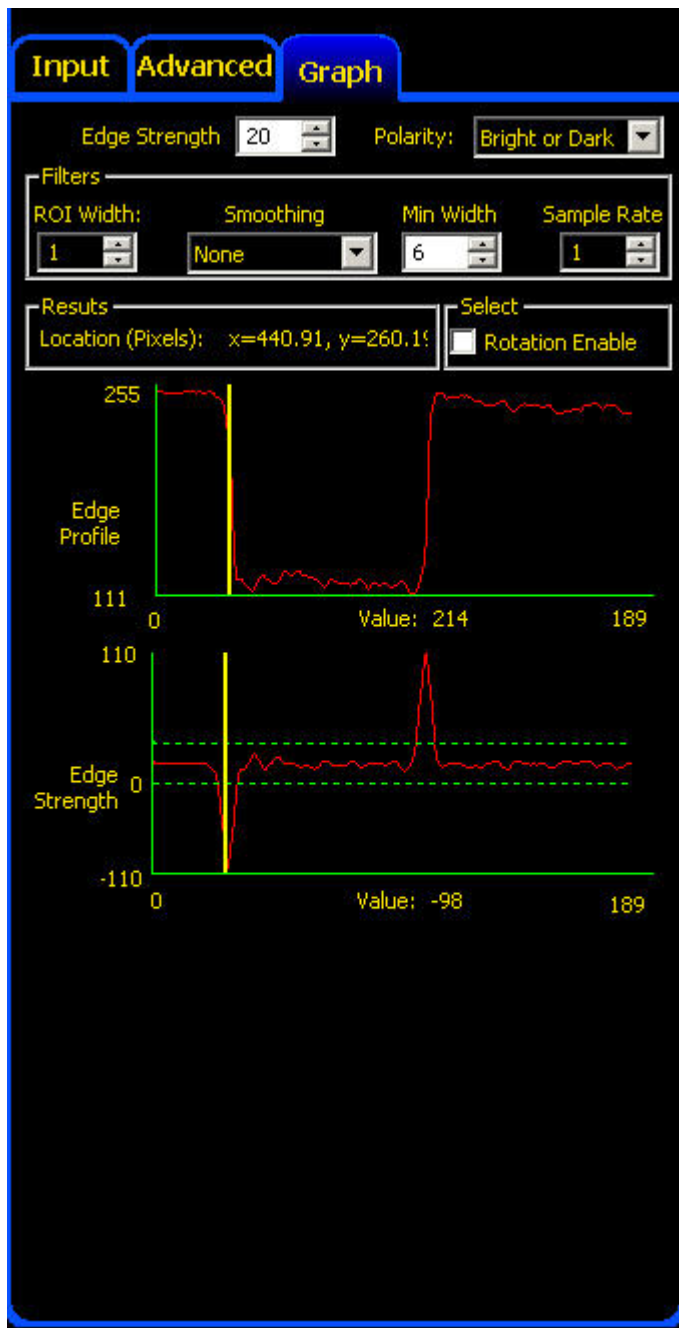

A bright-to-dark transition has a negative edge strength value, and a dark-to-bright transition has a positive edge strength value. When the Edge Strength level is adjusted, both the negative and positive lines will adjust together.

Graph Tab



Filters



Field	Description
ROI Width	Increases in increments of 4 pixels (for example, 1, 5, 9, 13, ...) up to the total FOV size. Some things to note: <ul style="list-style-type: none"> • Narrow ROIs execute faster but could miss the edge. • Wide ROIs are more consistent but don't execute as fast. • The ROI must be 13 pixels or wider to calculate the rotation of a part.
Smoothing	Runs a rolling average along the ROI length. It filters out sharp changes in the edge profile. <p> Note: A high filter number may miss the edge of a narrow line.</p>
Min Width	Filters out small spike-of-intensity changes, and narrow dark or bright bands. It determines the distance (in pixels) before and after an edge that must be free from additional transitions or the end of the ROI before the edge is recognized. <p> Note: A high filter number may miss the edge of a narrow line.</p>
Sample Rate	Determines the sub-pixel resolution, which increases the resolution of the tool, and increases the inspection time. <ol style="list-style-type: none"> 1. 1-pixel resolution 2. 1/2-pixel resolution 3. 1/3-pixel resolution 4. 1/4-pixel resolution

Object Width

Object Width filters out objects and spaces that are smaller than the minimum and larger than the maximum values specified.



The minimum and maximum object width affects both objects and spaces between objects. Minimum object width can filter out objects and spaces.

Object Tool Results

The **Results** field returns the following:

- The position of the object midpoint. The origin (0,0) is the upper-left corner of the screen.
- A Select Object Number field for selecting an object to analyze.
- Total number of Bright, Dark, or All objects (depending on the Bright/Dark option in effect).
- Distance between the edges of the current object.



7.3.8 Pattern Count Tool

The Pattern Count tool locates a pattern within a reference image, using and uses that pattern as a reference pattern to locate the same pattern in new images. A reference pattern is stored in memory. The tool searches for patterns that are very similar to the reference pattern. All patterns that match the reference pattern are counted and the center of the first pattern found is determined. The location of the first pattern found is returned to the user. This information can be used to measure distances and angles. The reference pattern is remembered by the sensor in full gray scale detail, so the tool can find patterns in various light levels.

Usage

- Verify fabric patterns
- Verify date/lot codes
- Inspect electronic component assembly

Fields

The following are fields on the Pattern Count tool Input tab:

- [Enabling Remote Teach](#) on page 299
- [Rotation Enabled](#) on page 169
- [Minimum Acceptance Level](#) on page 169
- [Patterns](#) on page 169
- [Selected Pattern](#) on page 170
- [Results](#) on page 170

Supported Platforms

ProII Color	ProII/ProII 1.3	OMNI Color	OMNI/OMNI 1.3	AREA/AREA13	EDGE/EDGE 1.3	GEO/GEO 1.3	BCR/BCR 1.3
Yes	Yes	Yes	Yes	No	No	No	No

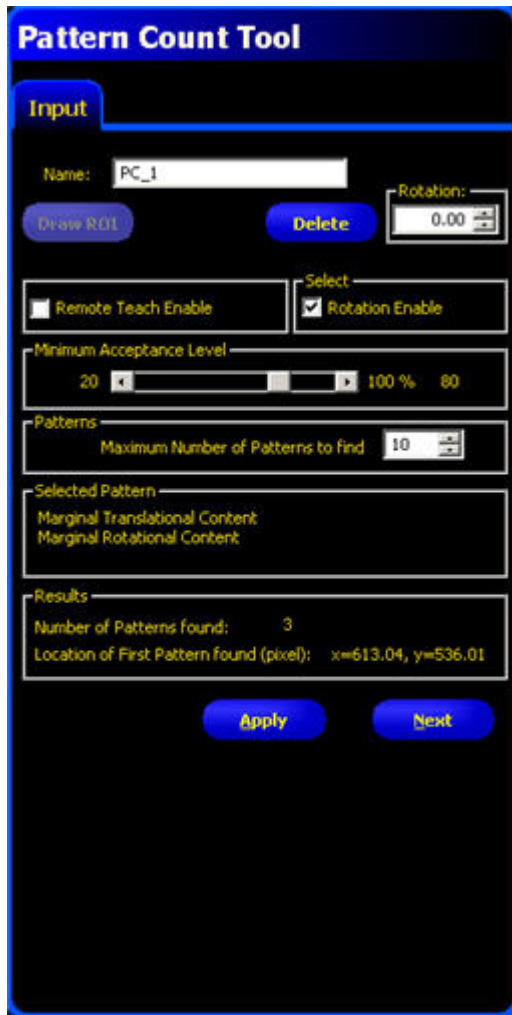

Pattern Count Input Tab





Adding a Pattern Count Tool

To add a tool to an inspection:

1. Click the button of the tool to be added to the inspection.
2. If desired, rename the tool.
3. Draw an ROI.

Field/Button	Description
	Use this field to rename the tool. The default is <i>tool_name_1</i> , <i>tool_name_2</i> , and so on, where the default <i>tool_name</i> depends on the tool being created (for example, locate, edge or the like). The name can have only alphanumeric characters and underscores with no spaces.
	Click this button to add an ROI to an image.
	Click this button to add a mask to an image

Field/Button	Description
	Click this button to remove an ROI from an image.
	Use this field to rotate the ROI. You can manually key in a rotation angle, or you can use the up or down arrow keys to rotate the ROI.

Enabling Remote Teach

The Remote Teach function is a method of remotely updating inspection parameters in Run mode. Vision tools and Test tools can be selected to be taught or not taught. To remotely teach an inspection, the Remote Teach function must be enabled on each tool to be taught.

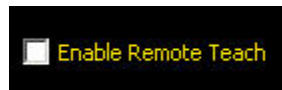

Rotation Enabled

The Pattern Find tool has a +/- 10 degree rotation ability. All subsequent ROIs will rotate relative to the edge found. During setup, the tool calculates the angle of the pattern found. During inspection, the new angle is compared to the original angle. If there is any rotational change between the new angle and the original angle, all subsequent ROIs will rotate that amount.

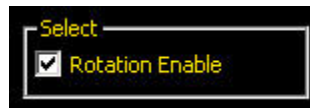

Minimum Acceptance Level

This adjustment sets the acceptance level for pattern matches.

- Decrease the Minimum Acceptance Level to allow more variations in matching patterns.
- Increase the Minimum Acceptance Level to filter out patterns that contain small defects.

Percent match is a value between 20% and 100% that indicates the quality of the match (100% is a perfect match; 20% is a slight match). The percent match can be used to detect large defects.

 **Note:** Banner does not recommend setting the Minimum Acceptance Level below 70%.



Patterns

In **Maximum Number of Patterns to find field**, manually key in a value or use the up or down arrow keys to specify the number of patterns to find.



Selected Pattern

The Selected Pattern field indicates whether the captured image is fine as it is or if there are potential issues. For example, in the display below, the image is marginal for both translational content and for rotational content.

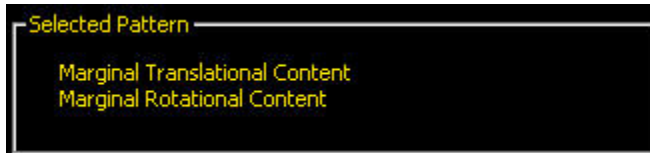

Results

Results indicate the following:

- **Number of patterns found:** The total number of patterns above the minimum acceptance level and below the maximum number of patterns.
- **Location of the first match:** The position of the pattern's center. The origin (0,0) is the upper-left corner of the screen.

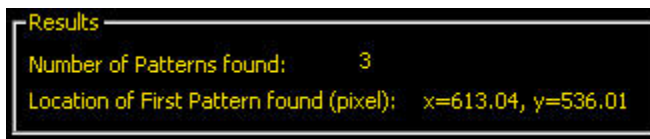

7.4 Vision Color Tools

Color tools include Average Color, Color Blob, and Color Match, where color is a discriminator between a good and bad condition.

7.4.1 Average Color Tool

The Average Color Tool can be used to visually inspect a part by analyzing all colors in a Region of Interest (ROI) and reducing them to a single set of color values, the *average* of the combined colors in the ROI.

Usage

The Average Color tool is used to analyze parts with subtle color variations that cannot accurately be detected by gray scale sensors. This is especially true when the parts are of similar colors.

In combination with a Test Tool, Average Color can be used to sort and verify parts by the presence or absence of a specified color.

With the use of a Communication Tool, Average Color can be used to measure colors and report what is seen.

- Differentiating yellow as opposed to gray caps on bottles of soda.
- Sorting between dark blue and light blue toys on an assembly line.
- Matching burgundy trim pieces in automotive assembly.

Fields

The following are fields on the Average Color tool Input tab:

- [Options](#) on page 172
- [Average Color Tool Results - HSI](#) on page 172
- [Average Color Tool Results - RGB Average](#) on page 173

Supported Platforms

ProII Color	ProII/ProII 1.3	OMNI Color	OMNI/OMNI 1.3	AREA/AREA13	EDGE/EDGE 1.3	GEO/GEO 1.3	BCR/BCR 1.3
Yes	No	Yes	No	No	No	No	No

Average Color Input Tab







Adding an Color Tool

To add an area tool to an inspection:

1. Click the button of the tool to be added to the inspection.
2. If desired, rename the tool.

3. Draw an ROI.

Control	Description
	Use this field to rename the tool. The default is <i>tool_name_1</i> , <i>tool_name_2</i> , and so on, where the default <i>tool_name</i> depends on the tool being created (for example, locate, edge or the like). The name can have only alphanumeric characters and underscores with no spaces.
	Click this button to add an ROI to an image.
	Click this button to add a mask to an image. A mask excludes an area inside the ROI.
	Click this button to remove an ROI from an image.
	Use this field to rotate the ROI. You can manually key in a rotation angle, or you can use the up or down arrow keys to rotate the ROI.

Options

The Options group lets you set the Color Space (HSI or RGB) and the intensity range.



Options	Description
Color Space	Use the drop-down to choose how to visualize and output the color values by either HSI or RGB.
Reject pixels brighter than	You can set intensity tolerances between 0 and 255. Pixels in the ROI that are brighter than the intensity value set here will not be included in the measurement.
Reject pixels darker than	You can set intensity tolerances between 0 and 255. Pixels in the ROI that are darker than the intensity value set here will not be included in the measurement.

Average Color Tool Results - HSI

Hue, Saturation, and Intensity (HSI) is a representation of color space that is closer to human perception of color dynamics.

The results are shown as an average for each value: hue, saturation, and intensity. In addition, the standard deviation is displayed so that you can test the variance of color. The greater the range of colors of the pixels within the ROI, the higher the standard deviation will be. If all pixels are uniformly the same color, the standard deviation will be zero.

Options

Color Space HSI

Reject pixels brighter than 230

Reject pixels darker than 20

Results

Average		Std. Deviation	
Hue	207 °	Hue	84.15 °
Saturation	7 %	Saturation	10.62 %
Intensity	134	Intensity	28.60

The table below describes the results and shows the color map. A color map is a visual legend showing the hue, saturation, and intensity:

- Hue and Saturation are represented in the circular color map, while Intensity is shown as a gradient bar.
- The crosshairs indicate the average hue and saturation, and the line on the intensity bar shows the average intensity.
- The irregular outline in the color map includes all the individual colors represented in the ROI from which the average color is derived.

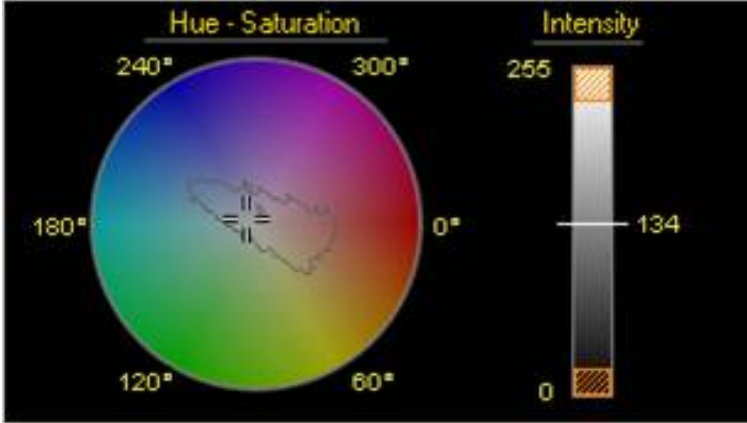
Value	Description	HSI Color Map
Hue	A representation of average hue as an angle in degrees around a circle, which will always be between 0 and 359°.	
Saturation	A representation of average saturation as a distance from the center of the circle where 0 is the center of the circle (and could include the colors black, white and gray) and 100 would be on the very edge of the color map circle. With a higher saturation number, the color represented is more vivid.	
Intensity	The average brightness of a color, represented in a number from 0 (black) to 255 (white).	

Average Color Tool Results - RGB Average

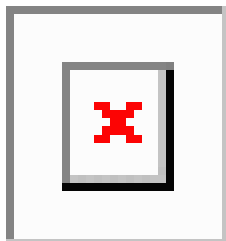

Red : The average of the red color component, represented as a number from 0 to 255. Fully saturated red is a [255, 0, 0].

Green : The average of the green color component, represented as a number from 0 to 255. Fully saturated green is a [0, 255, 0].

Blue : The average of the blue color component, represented as a number from 0 to 255. Fully saturated blue is a [0, 0, 255].

Intensity : The average brightness of a color, represented in a number from 0 (black) to 255 (white).

7.4.2 Color Blob Tool

One way to conduct a color inspection is to group adjacent pixels within the same color range together to form a Blob, or Binary Large Object .

The Color Blob Tool is used to separate same color Blobs from the larger scene and to analyze parts with color variations that cannot accurately be detected by gray scale sensors.

The Color Blob tool can be used to detect parts with either different or similar colors. In addition, the Color Blob tool can give area, shape and spatial content.

Usage

- Is the red trim in the correct position?
- Is that the fuse, and is it dark or light blue?
- Is the light blue fuse located next to the dark blue fuse?

Fields

The following are fields on the Color Blob tool Input tab:

- [Color Probes](#) on page 176
- [Options](#) on page 177
- [Color Blob Tool Color Map Visualization](#) on page 187

Supported Platforms

ProII Color	ProII/ProII 1.3	OMNI Color	OMNI/OMNI 1.3	AREA/AREA13	EDGE/EDGE 1.3	GEO/GEO 1.3	BCR/BCR 1.3
Yes	No	Yes	No	No	No	No	No

Color Blob Input Tab

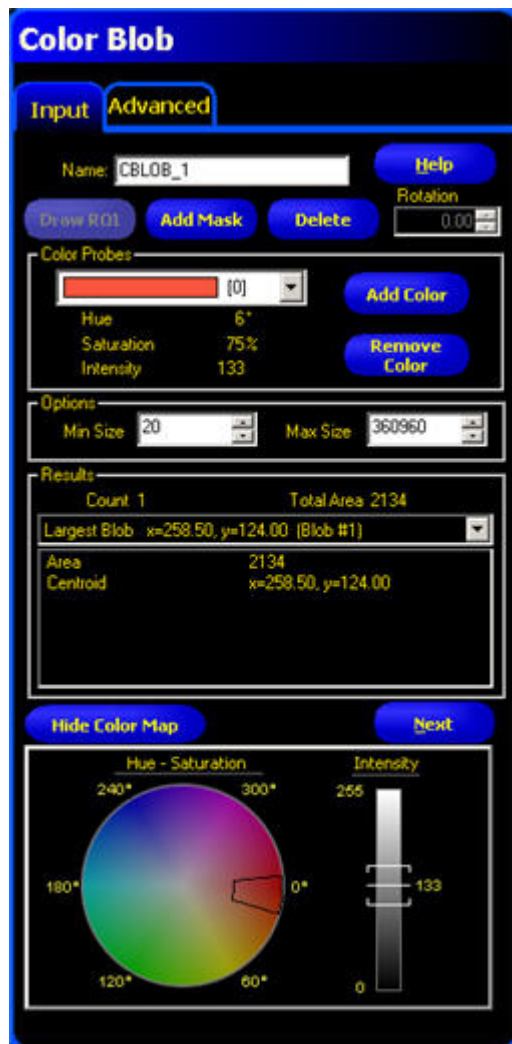



Adding an Color Tool

To add an area tool to an inspection:

1. Click the button of the tool to be added to the inspection.
2. If desired, rename the tool.
3. Draw an ROI.



Control	Description
<p>Name: <input type="text" value="tool_name_1"/></p> <p><input type="button" value="Draw ROI"/></p> <p><input type="button" value="Add Mask"/></p>	<p>Use this field to rename the tool. The default is <i>tool_name_1</i>, <i>tool_name_2</i>, and so on, where the default <i>tool_name</i> depends on the tool being created (for example, locate, edge or the like). The name can have only alphanumeric characters and underscores with no spaces.</p> <p>Click this button to add an ROI to an image.</p> <p>Click this button to add a mask to an image. A mask excludes an area inside the ROI.</p>

Control	Description
	Click this button to remove an ROI from an image.
	Use this field to rotate the ROI. You can manually key in a rotation angle, or you can use the up or down arrow keys to rotate the ROI.

Color Probes

In the Color Blob tool, you need to define the bright Blob/dark Blob threshold. The threshold for the Color Blob tool is not a specific gray scale value, but instead bright blobs are those that match the colors you define using Color Probes, and dark blobs are those colors that do not match.



Button	Description
	Used to identify a color value range that will be used to define a Blob. The probe identifies the color values within the selected area and groups together all adjacent pixels with that range of values.
	Used to select and remove a color probe.

 **Note:** The color probe may be created outside the ROI, but a BLOB of that color will only be detected within the ROI.

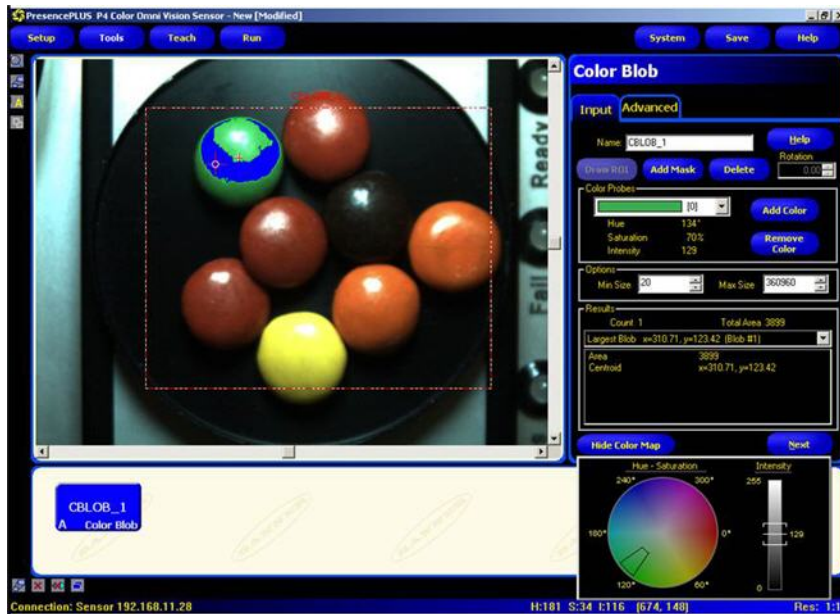

Note: The above has a single probe. Use more than one probe when the range of color to include in the Blob exceeds the range that a single probe can detect. Below additional probes have been added.

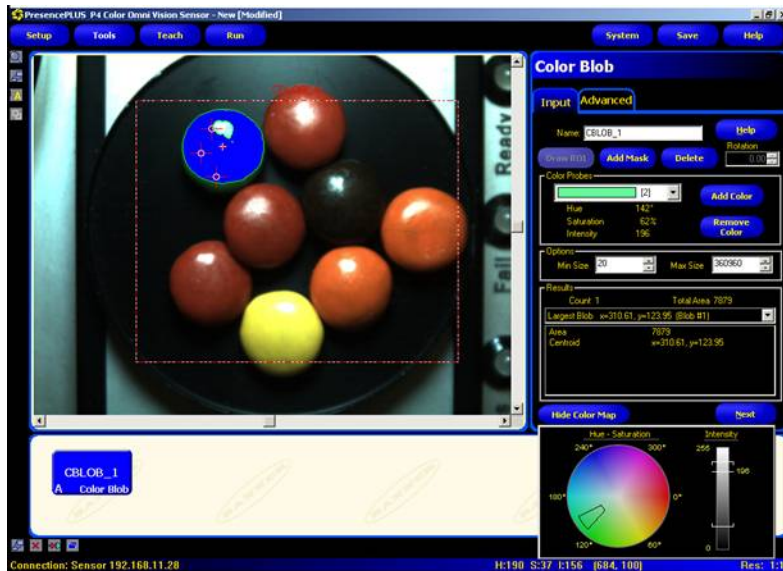

Options

Min/Max Size

Allows the user to determine what size object will be considered a Blob, thereby filtering other content as noise



- Note:** Use Grayscale Blob when trying to distinguish white, black and shades of gray. Using Color Blob for grayscale analysis is not as effective as using Grayscale Blob.

Color Blob Tool Color Map Visualization

Hue, Saturation, and Intensity is a representation of color space that is closer to human perception of color dynamics.

Hue and Saturation are represented in the circular color map, while Intensity is shown as a gradient bar.

The white outline in the color map includes the range of colors that would define a Blob, while the bars on the gradient bar includes the range of intensities.

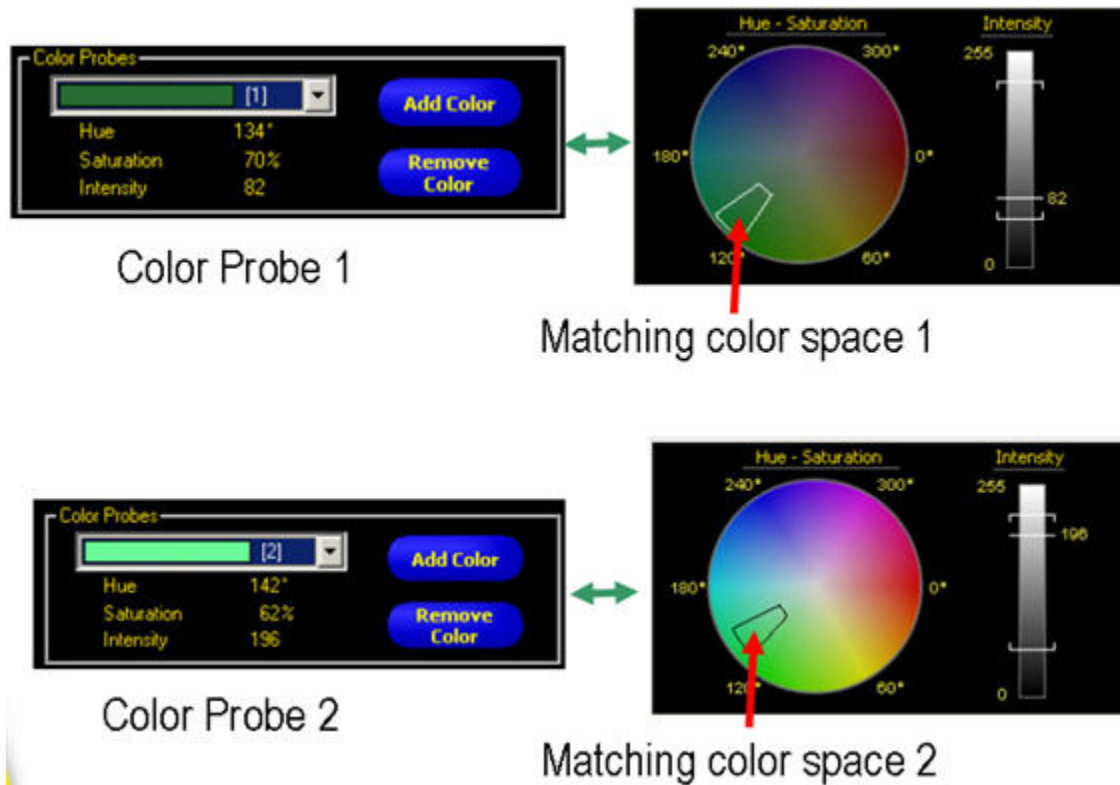

Color Blob Filter/Sort Tab

- Note:** The Color Blob Filter/Sort tab starts out disabled, and you need to enable it in the Tools Configuration tab of the System dialog.

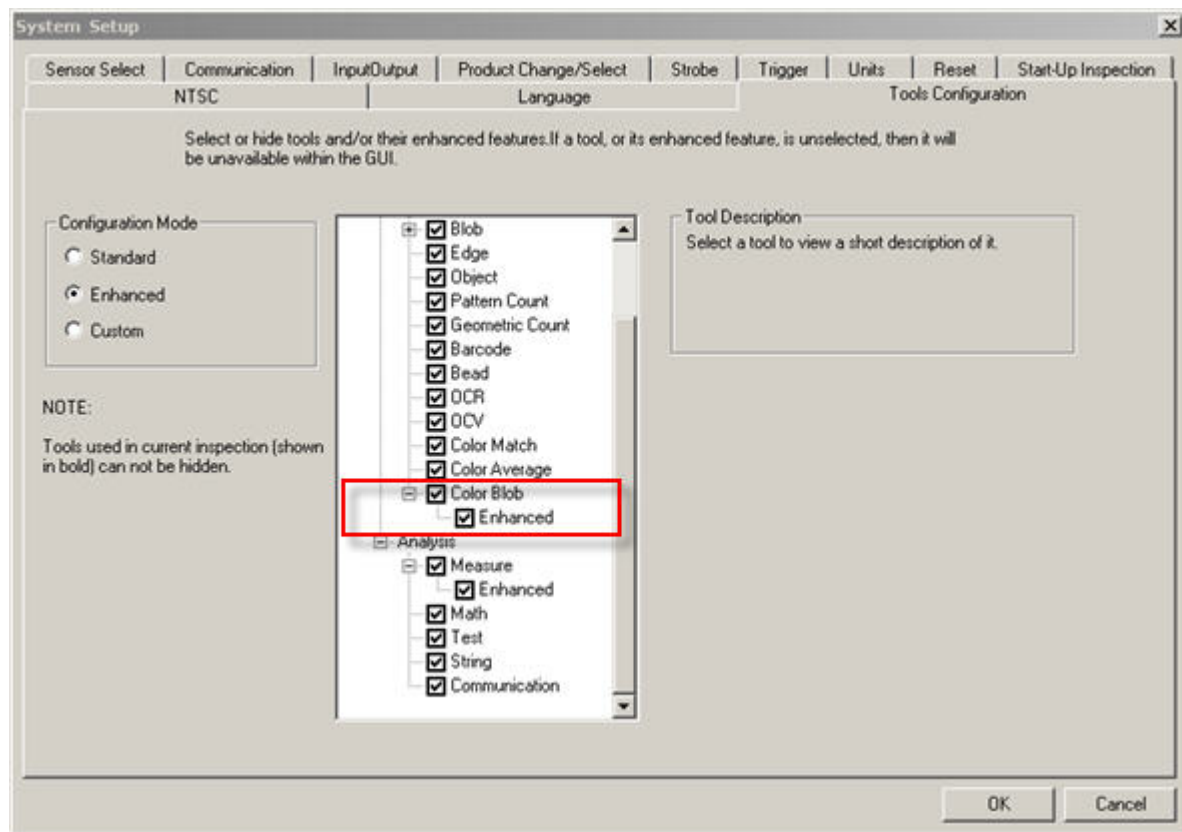

Blob Sort

The Sort drop-down list allows the user to select a sort method to determine which Blob the sensor labels as "Blob #1." By default, Blobs are numbered according to scan order; that is, the sensor numbers Blobs as it encounters them while scanning the FOV from top-to-bottom and then left-to-right. Select one of the computed statistics choices from the drop-down list to use for the sort:

- No sorting
- Position
- *Area* on page 183
- *Perimeter* on page 184
- *Compactness* on page 185
- *Major Axis Length, Minor Axis Length, and Major Axis Angle* on page 185
- *Eccentricity* on page 185
- *Min Radius and Min Radius Position* on page 187
- *Max Radius and Max Radius Position* on page 187

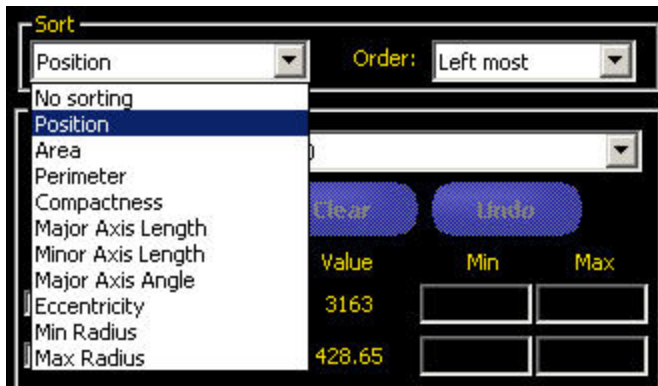

Blob Sort Order

Once you select a Sort method, you need to define a Sort Order:

- If Position is selected for the Sort method, then Blob order is based on the x,y coordinates of the centroids and the options are—
 - Left most
 - Top most
 - Right most
 - Bottom most
- For any of the other options, Blob order is based on Increasing or Decreasing value of the parameter selected. For example, if Perimeter and Increasing is selected, the smallest perimeter Blob will be Blob #1.

Blob Filter

The Blob filter allows you to more accurately select a specific Blob to locate and to use for positioning other Vision tools. Filter modifies the Blob count based on Computed Statistics criteria so that, for example, only circular Blobs (compactness) or symmetric Blobs (eccentricity) are included in the Blob count.

When you click the Preset button, the sensor uses the selected Blob to preset the filter values so that only the selected Blob will subsequently be identified by the sensor. This reduces the time it would take to manually enter values. When the sensor is in Run mode, you should use the runtime filter results to fine-tune these settings.

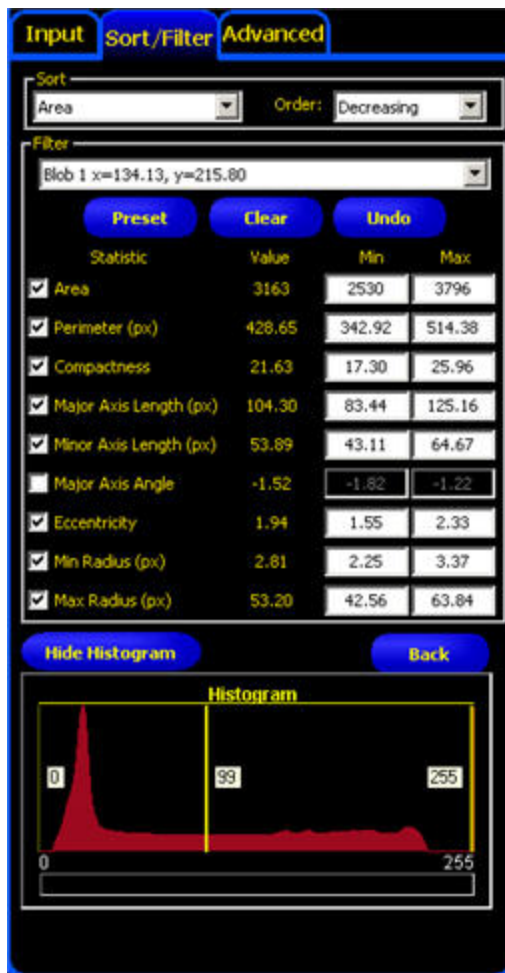

Color Blob Tool Advanced Tab

Fields

The following are fields on the Color Blob tool Advanced tab:

- [Advanced Options](#) on page 182
- [Range](#) on page 183
- [Color Blob Advanced Tab Results](#) on page 183

Below is the Color Blob tool Advanced tab .

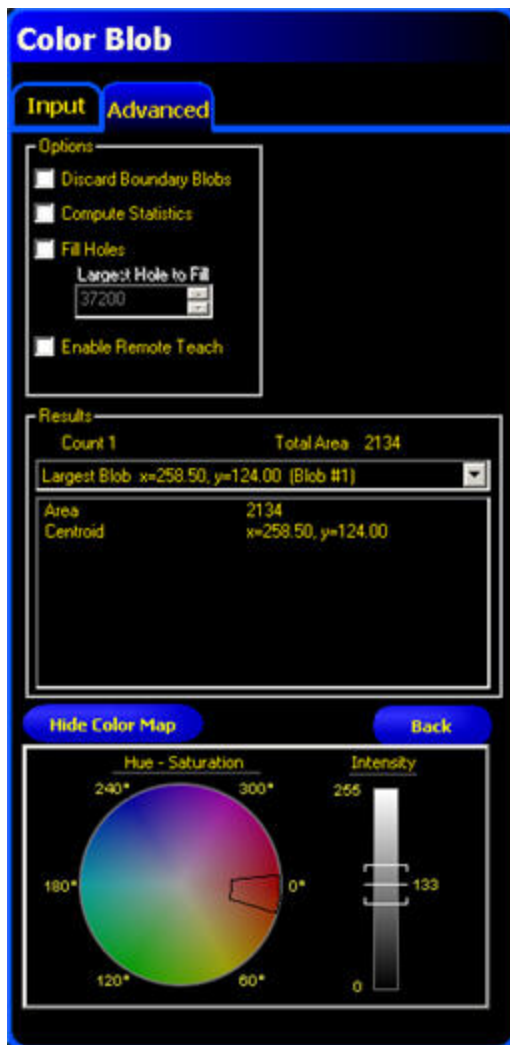

Advanced Options

Below are the Color Blob tool Advanced tab Options

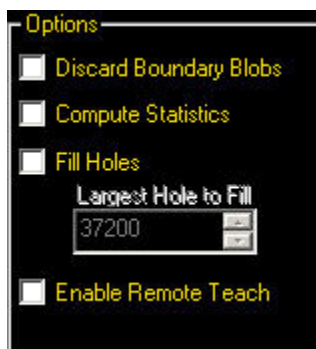

Option	Description
Discard Boundary Blobs	Use to determine whether Blobs found on the perimeter of the ROI should be included in the results.

Option	Description
Compute Statistics	Allows user to calculate and display advanced results.
Fill Holes	Allows user to ignore (by filling) small imperfections, or non-Blobs, within a larger Blob. Largest Hole to Fill allows users to specify the size of the imperfection so that valid non-Blobs are excluded.
Enable Remote Teach	Allows user to relearn the color identified by the color probe while the sensor is running.

Range

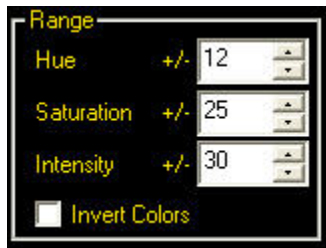

Enter a value or use the arrow keys to specify a tolerance for Hue and/or Saturation. As you adjust the tolerance, it is shown in the Color Map.

The brackets on the intensity bar will widen or narrow as you adjust the intensity tolerance up or down.

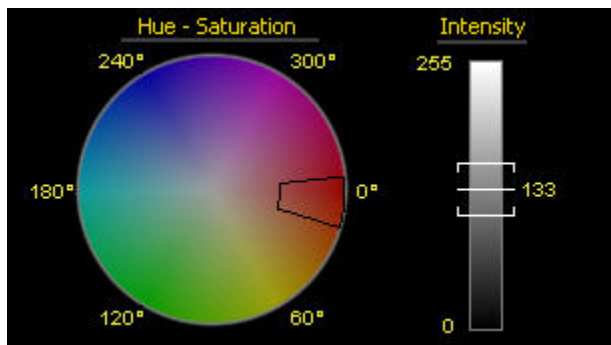

There are a couple of ways to use the **Invert Colors** option:

- Check the box while setting up a Color Blob inspection that involves a busy background in order to get a "negative effect" to see more easily if there are other color Blobs in the background that are the same as the one you specified with the color probe.
- You might check this box if there is a single dominant color in the item to be inspected but several different colors you that are important for the inspection. Rather than creating a probe for each of the minor colors, use the probe to specify the dominant color, then click **Invert Colors** to feature the other colors for the inspection.

Color Blob Advanced Tab Results

Area

The area (A) is just a count of the total number of pixels belonging to the blob.

Centroid

The centroid (x_c, y_c) is the point at the center of mass of the blob. For simple blobs like solid circles, ellipses, or rectangles, this is just the center of the shape. For more complicated shapes it is helpful to imagine a piece of cardboard cut out in the shape of the blob. The centroid is the point where you could balance the cardboard on the tip of a pencil. For complicated shapes-especially shapes with unfilled holes-the centroid might lie outside the shape.

The x coordinate of the centroid is calculated by adding up the x coordinates of each pixel in the blob and dividing by the area. The y coordinate is similar:

$$x_c = \frac{\sum_{i=1}^A x_i}{A} \qquad y_c = \frac{\sum_{i=1}^A y_i}{A}$$

Perimeter

The perimeter (P) gives an approximate measurement of the length of the circumference of the blob. Because blobs are built from individual pixels, it is most practical to estimate the perimeter by counting the contributions of individual pixels on the blob's boundary. The following table describes the exact values that are added to the perimeter for each possible pixel configuration. In each example, the description refers to the center pixel in the corresponding pictures.

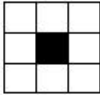
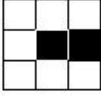
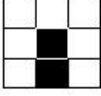
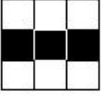
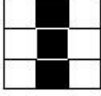
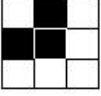
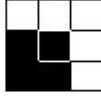
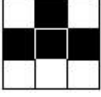
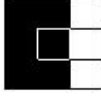
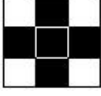
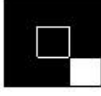
		A pixel with no neighbors that belong to the same blob contributes (3.14) linear pixels to the perimeter of the blob. This can only happen in a blob that has an area of one. Since such small blobs are usually ignored, this circumstance is rare.
		A pixel with one neighbor that belongs to the same blob contributes 2.571 linear pixels to the perimeter of the blob.
		A pixel with two neighbors that belong to the same blob, forming a straight line, contributes exactly 2 linear pixels to the perimeter of the blob.
		A pixel with two neighbors that belong to the same blob, forming a corner, contributes 1.414 linear pixels to the perimeter of the blob.
		A pixel with three neighbors that belong to the same blob contributes exactly 1 linear pixel to the perimeter of the blob. A pixel with three neighbors that belong to the same blob contributes exactly 1 linear pixel to the perimeter of the blob.
		A pixel with four neighbors that belong to the same blob contributes nothing to the perimeter of the blob.

This method of counting tends to slightly overestimate the "true" perimeter. For example, a circle with a radius of 100 pixels will have a computed perimeter of approximately 660 pixels, compared with the expected value of 628 pixels.

If the camera is configured to convert pixel distances to other units, (e.g. inches), the perimeter will be given in those units. If the blob contains holes that have not been filled, the length of the perimeter will include the points on the perimeters of these holes.

Compactness

The compactness is high for blobs that are nearly circular and low for blobs that are elongated or complicated.

$$\text{compactness} = \frac{400\pi A}{P^2}$$

Where A is the area and P is the perimeter of the Blob in question. An idealized circle would have a compactness of 100, but because the perimeter is approximated (see above), the highest realistic value for most blobs is roughly 90. Very small blobs with just a handful of pixels may reach or even exceed the theoretical maximum of 100, again because of the approximations in the perimeter calculation.

Eccentricity

The eccentricity of a blob is defined as the length of the major axis divided by the length of the minor axis. For circular regions and other regions with radial symmetry (like a square), the value will be very close to 1. For elongated regions, the value will grow, possibly becoming quite large.

Major Axis Length, Minor Axis Length, and Major Axis Angle

To understand Major Axis Length, Minor Axis Length, and Major Axis Angle, it is important to note that these are not measurements of the Blob itself because the Blob may be an irregular shape. Rather, these measurements are determined by a well-defined shape, a "best fit ellipse" as shown below.

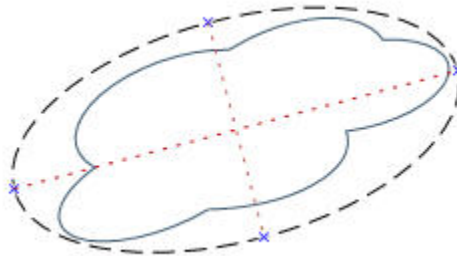

These three results combine to give information about the elongation and orientation of a blob. The equations used to compute these statistics are fairly complicated, but the results usually have an intuitively useful meaning, described below. The first step in computing these results is to compute the $M_{2,0}$, $M_{0,2}$ and $M_{1,1}$ statistical moments:

$$M_{2,0} = \frac{\sum_{i=1}^A (x_i - x_c)^2}{A}$$

$$M_{0,2} = \frac{\sum_{i=1}^A (y_i - y_c)^2}{A}$$

$$M_{1,1} = \frac{\sum_{i=1}^A ((x_i - x_c)(y_i - y_c))}{A}$$

where A is the area, (x_c, y_c) are the coordinates of the centroid and (x_i, y_i) are the coordinates of pixel i. These values represent the variance with respect to x, the variance with respect to y, and the covariance, respectively. The final results can be calculated as follows.

$$Major\ Axis\ Length = 2\sqrt{2\left(M_{2,0} + M_{0,2} + \sqrt{4M_{1,1}(M_{2,0} - M_{0,2})^2}\right)}$$

$$Major\ Axis\ Length = 2\sqrt{2\left(M_{2,0} + M_{0,2} - \sqrt{4M_{1,1}(M_{2,0} - M_{0,2})^2}\right)}$$

$$Major\ Axis\ Angle = \frac{\tan^{-1}\left(\frac{2M_{1,1}}{M_{2,0} - M_{0,2}}\right)}{2}$$

The table below gives a more practical perspective on how to interpret these results. If the camera is configured to convert pixels to other units, the major and minor axis lengths will be given in those units. The major axis angle is always given in degrees.

Blob Shape	Meaning of Major Axis Length	Meaning of Minor Axis Length	Meaning of Major Axis angle
circular, no holes	diameter of the circle	equal to the major axis length	unstable
elliptical, no holes	length of the ellipse	width of the ellipse	orientation of the ellipse
square, no holes	diameter of a circle that best approximates the square	equal to the major axis length	unstable
rectangular, no holes	length of an ellipse that best approximates the rectangle	width of an ellipse that best approximates the rectangle	orientation of the rectangle
complicated shape, no holes	length of an ellipse that best approximates the shape	width of an ellipse that best approximates the shape	orientation of the shape-unstable if length and width are nearly equal
any shape with holes	results vary depending on exact shape-experiment on your particular shape	results vary depending on exact shape-experiment on your particular shape	results vary depending on exact shape-experiment on your particular shape

Min Radius and Min Radius Position

The minimum radius of a blob is the distance from the centroid of the blob to the closest pixel on that blob's perimeter. The minimum radius position gives the pixel coordinates of that closest perimeter point. If the blob contains unfilled holes, the minimum radius position may be on the perimeter of a hole. If the camera is configured to convert pixels to other units, the minimum radius (but not the minimum radius position) will be given in those units.

Max Radius and Max Radius Position

These results are equivalent to those for the minimum radius, but they refer to the pixel on the perimeter of the blob that is farthest from the centroid.

Color Blob Tool Color Map Visualization

Hue, Saturation, and Intensity is a representation of color space that is closer to human perception of color dynamics.

Hue and Saturation are represented in the circular color map, while Intensity is shown as a gradient bar.

The white outline in the color map includes the range of colors that would define a Blob, while the bars on the gradient bar includes the range of intensities.

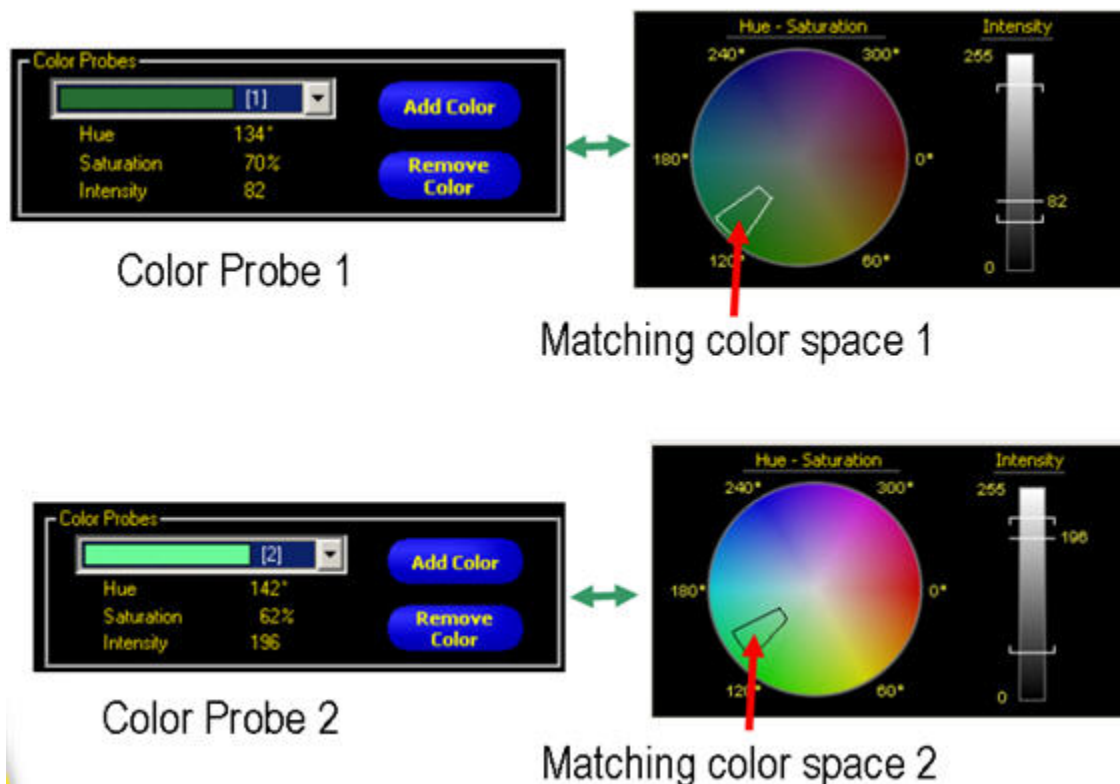

7.4.3 Color Match Tool

The Color Match tool behaves somewhat like the Average Grayscale tool; you simply draw an ROI over the color you wish to check for in future inspections.

The tool takes two inputs--Color Match Percent Threshold and Intensity Match Range--and will automatically generate a Color Map of Hue, Saturation, and Intensity.

Hue, Saturation, and Intensity is a representation of color space that is closer to human perception of color dynamics.

Hue and Saturation are represented in the circular color map, while Intensity is shown as a gradient bar.

The white outline in the color map includes the range of colors, while the bars on the gradient bar includes the range of intensities.

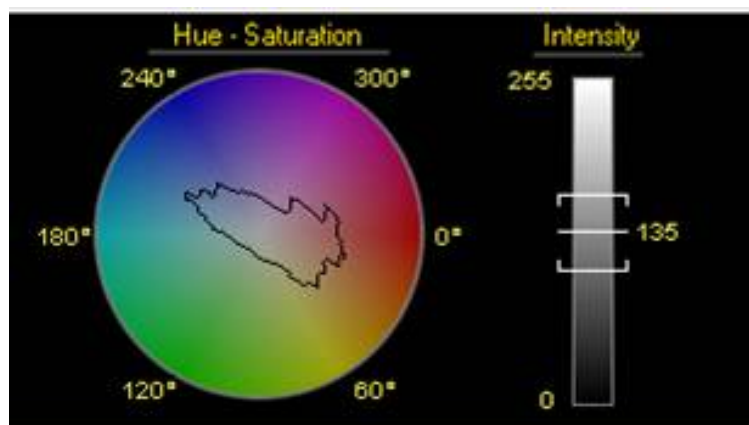

Usage

- Verify healthy fruit color and ripeness
- Verify stain color on wood
- Verify product color in packaging applications

Fields

The following are fields on the Color Match tool Input tab:

- [Color Match Percent Threshold](#) on page 189
- [Intensity Match Range](#) on page 189
- [Enabling Remote Teach](#) on page 299
- [Color Map Visualization](#) on page 190

Supported Platforms



ProII Color	ProII/ProII 1.3	OMNI Color	OMNI/OMNI 1.3	AREA/AREA13	EDGE/EDGE 1.3	GEO/GEO 1.3	BCR/BCR 1.3
Yes	No	Yes	No	No	No	No	No

Adding an Color Tool

To add an area tool to an inspection:

1. Click the button of the tool to be added to the inspection.
2. If desired, rename the tool.
3. Draw an ROI.

Control	Description
	Use this field to rename the tool. The default is <i>tool_name_1</i> , <i>tool_name_2</i> , and so on, where the default <i>tool_name</i> depends on the tool being created (for example, locate, edge or the like). The name can have only alphanumeric characters and underscores with no spaces.
	Click this button to add an ROI to an image.

Control	Description
	Click this button to add a mask to an image. A mask excludes an area inside the ROI.
	Click this button to remove an ROI from an image.
	Use this field to rotate the ROI. You can manually key in a rotation angle, or you can use the up or down arrow keys to rotate the ROI.

Color Match Percent Threshold

The first of two settable parameters for the Color Match tool, the Color Match Percent Threshold, controls the variation in the colors to be matched in the future.



Increasing this number will reduce the range of colors present on the Acceptable Colors map. When the Color Match Percent Threshold is set to 100, the map of Acceptable Colors will include only one hue. If this threshold is reduced to 0 the map of Acceptable Colors will start to look more like a rainbow, including a large number of hues. A typical setting for this threshold is around 90.

Intensity Match Range

As the Color Match Percent Threshold defines the specific hues which can be considered good, the Intensity Match Range defines the grayscale brightness level necessary to constitute a match. This value ranges from 0 to 255.



As the Tolerance value is changed, the acceptable Min and Max limits on either side of the Reference are calculated. When the number is set to 255, a full range of color shades are displayed on the map of Acceptable Colors; starting with black on the left and continuing to the fully saturated color on the right. When this tolerance is set to 0, only a single shade of each color is acceptable; that is, no change in the amount of black present in the color is allowed. Or, to say it another way, no changing the intensity of illumination for a given color target is allowed.

Enabling Remote Teach

The Remote Teach function is a method of remotely updating inspection parameters in Run mode. Vision tools and Test tools can be selected to be taught or not taught. To remotely teach an inspection, the Remote Teach function must be enabled on each tool to be taught.

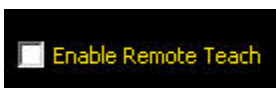

Color Map Visualization

Hue, Saturation, and Intensity is a representation of color space that is closer to human perception of color dynamics.

Hue and Saturation are represented in the circular color map, while Intensity is shown as a gradient bar.

The white outline in the color map includes the range of colors, while the bars on the gradient bar includes the range of intensities.

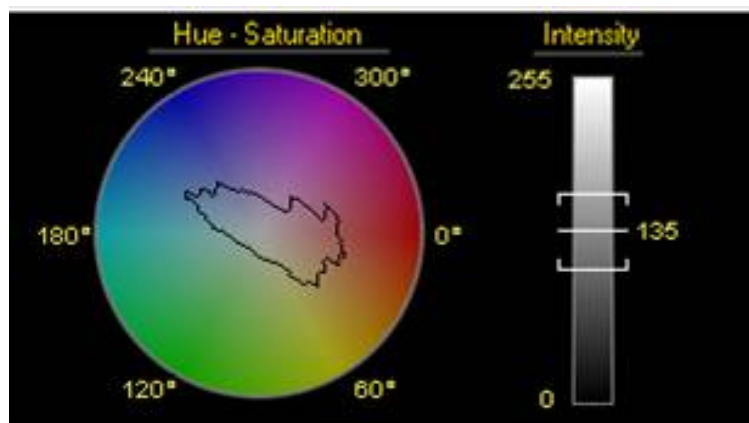

7.5 Premium Vision Tools

Premium Vision tools are advanced tools for specialty applications. These include Barcode, Bead, Optical Character Recognition (OCR) and Optical Character Verification (OCV) tools.

7.5.1 Barcode Tool

The Barcode tool is more of an appliance than a generic vision tool. The tool is easy to use: push one button and it just works. In addition to decoding the data present in the barcode symbol, the Barcode tool also grades the symbol according to ISO-specified quality parameters. These grades are meant to test whether the physical barcode symbol was printed correctly. Both linear codes and the 2D data matrix codes are graded-- each according to a different ISO standard. In the linear case, the spec is ISO 15416. For the Data Matrix, the relevant document is ISO 15415.

Fields

The following are fields on the Barcode tool Input tab:

- [Barcode Type](#) on page 191
- [Results](#) on page 192

Supported Platforms

ProII Color	ProII/ProII 1.3	OMNI Color	OMNI/OMNI 1.3	AREA/AREA13	EDGE/EDGE 1.3	GEO/GEO 1.3	BCR/BCR 1.3
Yes	Yes	Yes	Yes	No	No	No	Yes

Barcode Input Tab

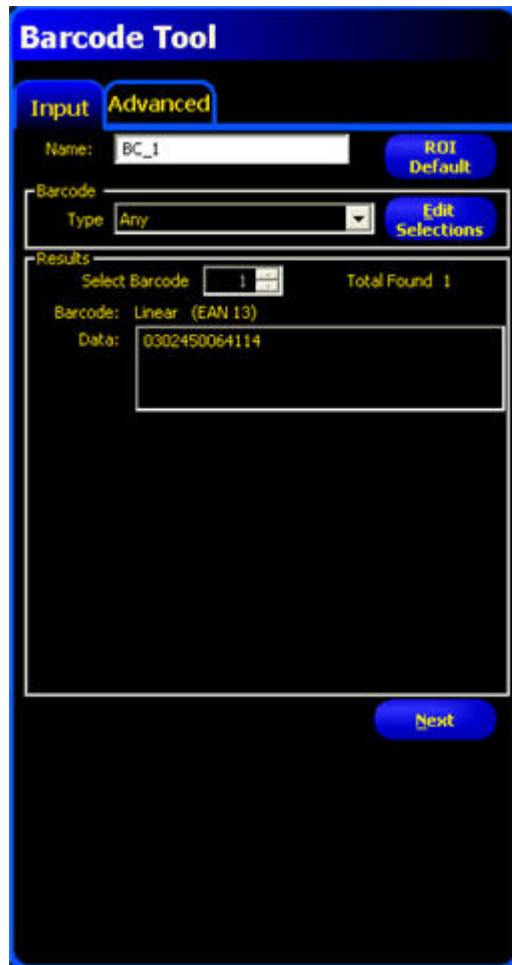

Barcode Type

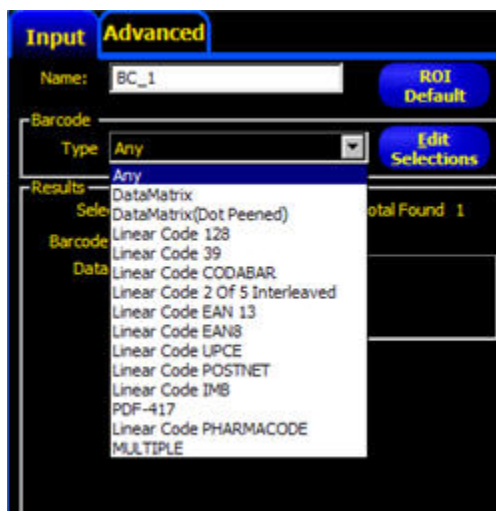

Select one of the following for the Barcode **Type**:

- Any -- Enables the Barcode tool to read any supported barcode type

- DataMatrix
- DataMatrix (Dot Peened)
- Linear Code 128
- Linear Code 39
- Linear Code CODABAR
- Linear Code 2 of 5 Interleaved
- Linear Code EAN 13
- Linear Code EAN8
- Linear Code UPCE
- Linear Code POSTNET
- Linear Code IMB
- PDF-417
- Linear Code PHARMACODE
- MULTIPLE -- When you select this option, you can select multiple barcode types you want the sensor to read

Click on the Edit Selections button to modify the list of available barcode types.

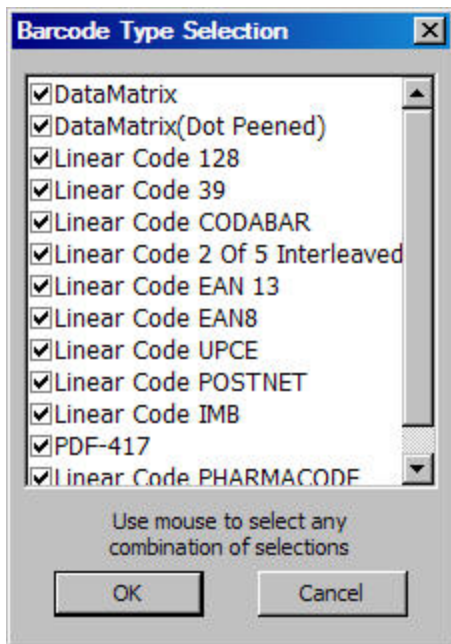

Results



The Results field provides the number of barcodes found, barcode type, data read, and quality parameters.

 **Note:** When the Barcode tool finds multiple barcodes, the **Select Barcode** field allows you to select each barcode individually. The multiple barcodes are arranged in order (with respect to image origin) from left to right, top to bottom, according to the location of the lower-left corner of the barcode.

7.5.2 Barcode Tool Advanced Tab

Fields

The following are fields on the Barcode tool Advanced tab:

- [All Barcodes Options](#) on page 194
- [Datamatrix Only Options](#) on page 195
- [Linear Only Options](#) on page 196

Barcode Tool

Input **Advanced**

All Barcodes Options

Color Scheme

View Scheme

Maximum To Find

Time Out ms

Enable Grades

Datamatrix Only Options

Decoder Mode

Linear Only Options

Check Sum Verify (Code 39 and Interleaved 2 of 5)

Relaxed Quietzone (Linear Only)

Direction (Pharmacode Only)

Back

All Barcodes Options

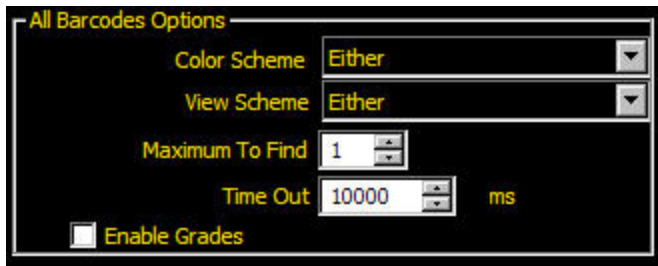

Color Scheme

The Color Scheme determines what color scheme of barcode the sensor will recognize. Of the three Color Scheme options, the default is **Either**.

Color Scheme Option	Description
Black on White	The sensor will recognize barcodes that are black (or dark) marked on a white (or light) background.
White on Black	The sensor will recognize barcodes that are white (or light) marked on a black (or dark) background.
Either	The sensor will recognize either barcodes that are black (or dark) marked on a white (or light) background or white (or light) marked on a black (or dark) background.

View Scheme

The View Scheme option determines which view of barcode the sensor will recognize. The default is **Either**.

View Scheme Option	Description
Normal	The sensor will recognize barcodes that are presented in the mirrored view.
Mirrored	The sensor will recognize barcodes that are presented in the mirrored view.
Either	The sensor will recognize barcodes that are presented in either the normal or mirrored view.

Maximum to Find

Use the arrow keys or enter the maximum number of barcodes to find.

Enable Grades

Check this box to get barcode grade information. Note that, while this is intended to provide useful information about a specific barcode, it is not intended to be used as a verifier.

Datamatrix Only Options



The Decoder Mode determines which decode algorithm to employ and how imperfections in barcode images are handled. Of the two options, **Robust** is preferred and is the default.

Decoder Mode Option	Description
Robust	When you select Robust, the sensor employs an algorithm that performs routines to correct for imperfections of the barcode image. This mode typically has the higher read rate.
Fast	When you select Fast, the sensor employs an algorithm that is "tailored" for speed. The algorithm does NOT correct for barcode image imperfections. The Fast setting has the best results on high-contrast images that contain high-quality DataMatrix barcodes. Fast should be used only when demanded by the desired read rates. If speed is not critical, select Robust for better results.

Linear Only Options

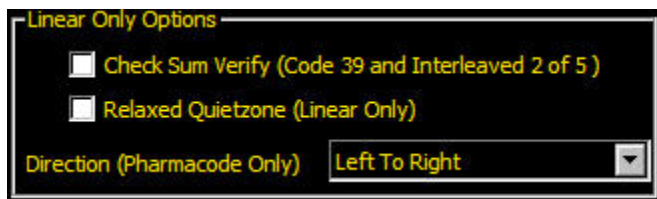

Check Sum Verify (Code 39 and Interleaved 2 of 5)

Check the box to use a checksum to verify the integrity of a Code 39 or Code 2 of 5 Interleaved linear barcodes.

Relaxed Quietzone (Linear Only)

Check the box to provide a greater tolerance with respect to the quiet zone required before and after the barcode.





Direction (Pharmacode Only)



From the drop-down list, select one of the following:



- Left To Right
- Right To Left
- Top To Bottom
- Bottom To Top

7.5.3 Barcodes Read by Banner BCR

Barcode	Date	Format	Industries	Notes	Example
Codabar (NW-7 in Japan, USD4, 2 of 7)	1972	linear	blood banks, cotton industry, libraries, photo labs, air parcel express, information processing industry	16-characters, self-checking, variable length, discrete, start/stop characters.	

Barcode	Date	Format	Industries	Notes	Example
(Code 25, ITF-14, ITF, "I" 2 of 5, I25) NOT included: 2 of 5 Industrial OR 2 of 5 Matrix	1972	linear	Distribution industry, warehousing, product/container identification, general industrial, automotive Can be printed directly on corrugated cartons	10 characters (numeric only), optional check-sum, variable length, continuous, start/stop characters.	 123 45670
Code 39 (USD-3, 3 of 9, LOGMARS) includes: Code 39 extended	1975	linear	LOGMARS (Department of Defense standard), HIBCC (health industry standard), AIAG (automotive industry standard), general industry	Most common non-UPC (i.e. non-retail) code. 43 characters, optional check-sum, variable length, discrete, start/stop characters.	 TEST8052
EAN-13 (UPC-A)	1976	linear	retail products worldwide (point-of-sale)	10 characters (numeric only), check-sum, continuous. Like an international UPC symbol, EAN-13 includes the UPC-A standard, fixed length (10 data digits plus 2 or 3-digit country code and 1 check digit). The only difference between UPC-A and EAN-13 is UPC-A has a single digit country (or product type) code.	 0188837367678
UPC-E	~1976	linear	small retail products in USA and Canada (point-of-sale)	6 characters (numeric only), check sum, continuous. Commonly called a "zerosuppressed" version of the standard UPC-A	 0 123456 5

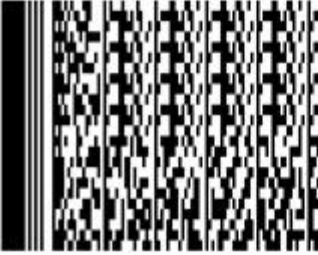
Barcode	Date	Format	Industries	Notes	Example
EAN-8	1976	linear	retail products worldwide (point-of-sale)	<p>symbol, this barcode is used on small items or crowded labels where space is at a premium.</p> <p>10 characters (numeric only), check-sum, continuous. A shortened version of EAN-13. Fixed length (5 data digits plus 2 flag digits and 1 check digit)</p>	
Code 128 (GS1-128, EAN-128, UCC-128, UCC/EAN-128) includes: Code 128/EAN 128 subsets A, B, & C	1981	linear	Retail distribution, carton tracking, inventory control, general industrial.	<p>Most compact linear code. All 128 printable ASCII characters, check-sum, variable length, continuous, start/stop characters.</p>	
Postnet includes: Delivery Point Barcode(DPBC)	1980	linear	Mail sorting for US Postal Service	<p>10 characters (numeric only), check-sum, discrete. Three main data strings are stored in Postnet codes: a 5 digit ZIP code (with check digit), a 9 digit ZIP+4 code (with check digit), and an 11 digit ZIP+4 plus delivery code (with check digit).</p>	

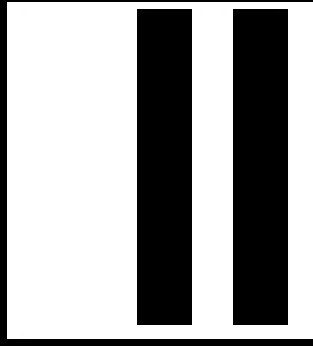
Barcode	Date	Format	Industries	Notes	Example
Data Matrix (ECC 200)	1990	2D	Integrated circuit, printed circuit boards and automotive, aerospace, electronics, semiconductor and medical device industries.	Stores up to 3116 numbers or 2335 ASCII characters. Banner supports only the latest version of this standard, ECC-200. (the older subset, including the ECC-000 to ECC-140 standards, will not be supported). This is the target market for the Banner BCR.	
PDF417		2D	Transport, identification cards, and inventory management.	Consists of 3 to 90 rows, each of which is like a small linear bar code.	
IMB	2006	linear	Mail sorting for US Postal Service	The Intelligent Mail barcode (IMB) replaces the POSTNET and PLANET barcodes. It is a 65-bar code for use on mail in the United States	
Pharmacode		linear	Pharmaceutical Binary Code and is used for packing control in the pharmaceutical industry.	Pharmacode can represent only a single integer from 3 to 131070.	

7.5.4 Bead Tool

The Bead tool is used to inspect parts on which an application of adhesives or sealant material has been placed. In an industrial setting, this "bead" of material is commonly applied in a strip on a known path. The Bead tool can look at this pre-defined path and verify whether the adhesive or sealant has been correctly applied.

For the purposes of this tool, a bead is any long, narrow strip of approximate consistent width and approximately consistent color. The bead must have sufficient contrast with its background so that a simple grayscale thresholding scheme, like that used in the Blob Tool, can separate the two. Background clutter and optical noise (i.e. shiny spots, holes in the bead) are permitted, but their presence may degrade the robustness of a bead inspection.

The Bead Tool also assumes that the bead material has been applied by a mechanized system and thus is quite consistent in location and direction. The tool does not attempt to detect, follow, or account for variations in bead location.

Usage

- Check for uniformity of a bead of adhesive.
- Check for the uniformity of a gap.

Fields

The following are fields on the Bead tool Input tab:

- [Drawing a Connected Line ROI](#) on page 201
- [Bead Type](#) on page 203
- [Threshold](#) on page 203
- [Filters](#) on page 205
- [Results](#) on page 205

Supported Platforms

ProII Color	ProII/ProII 1.3	OMNI Color	OMNI/OMNI 1.3	AREA/AREA13	EDGE/EDGE 1.3	GEO/GEO 1.3	BCR/BCR 1.3
Yes	Yes	Yes	Yes	No	No	No	No

Bead Tool Input Tab

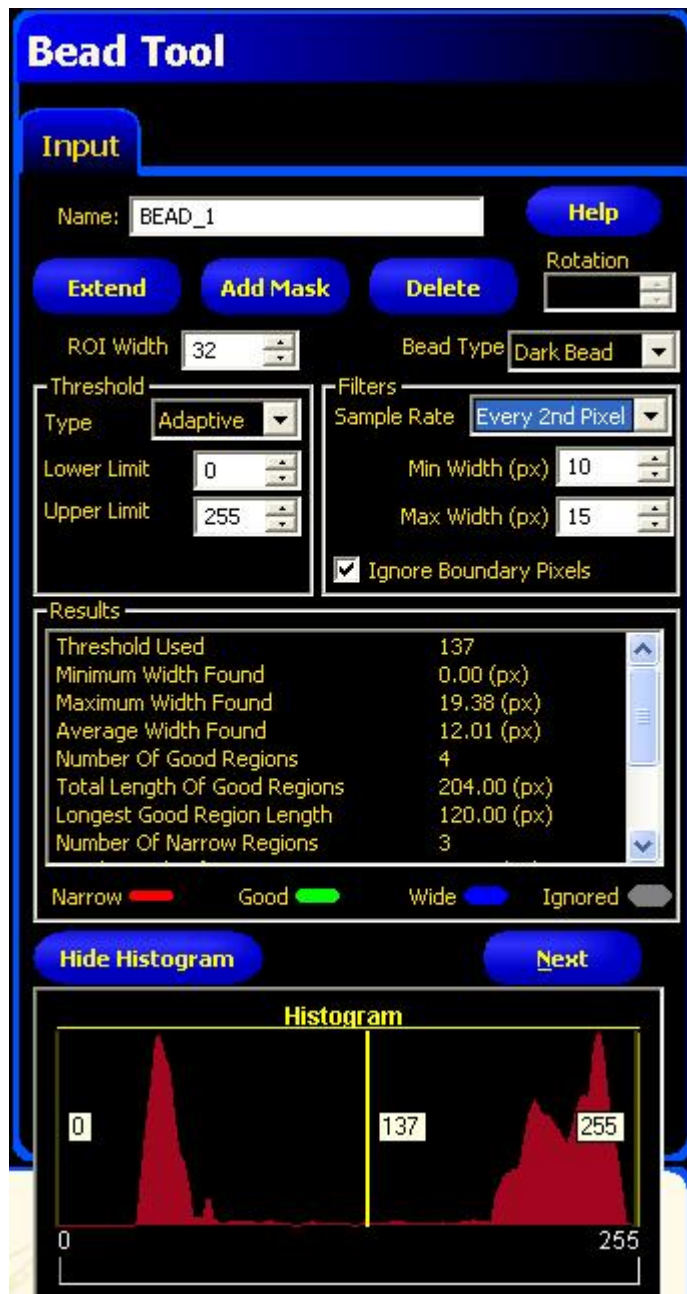



Drawing a Connected Line ROI

To begin defining the ROI:

1. Click on the **Draw ROI** button.
2. Click on the bead to mark a starting point. A small circle will mark this start point. As you move the mouse away from the start point, the software draws a dotted line following the mouse pointer.
3. Click on any part of the field of view, and a second point is drawn with a line connecting the two dots to define a line segment.
4. Add more segments as necessary. (Depending on the bends of the bead, you need more segments for better resolution.) Note that the dotted line is only displayed while the mouse pointer is in the FOV.
5. You can end creating the ROI by--

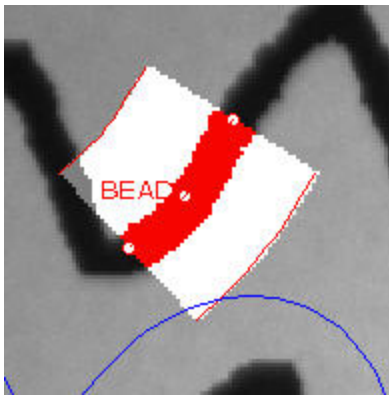
- clicking on the Done button.
 - pressing the ESC button on the keyboard.
6. When you are done, the ROI will look something like what is shown below.



-  **Note:** When drawing the connected line ROI, if the end point of one segment comes close the beginning of another segment, the tool will tend to automatically close the loop. Below the picture on the left shows the position just before the loop is closed, and the picture on the right shows the loop automatically closed.

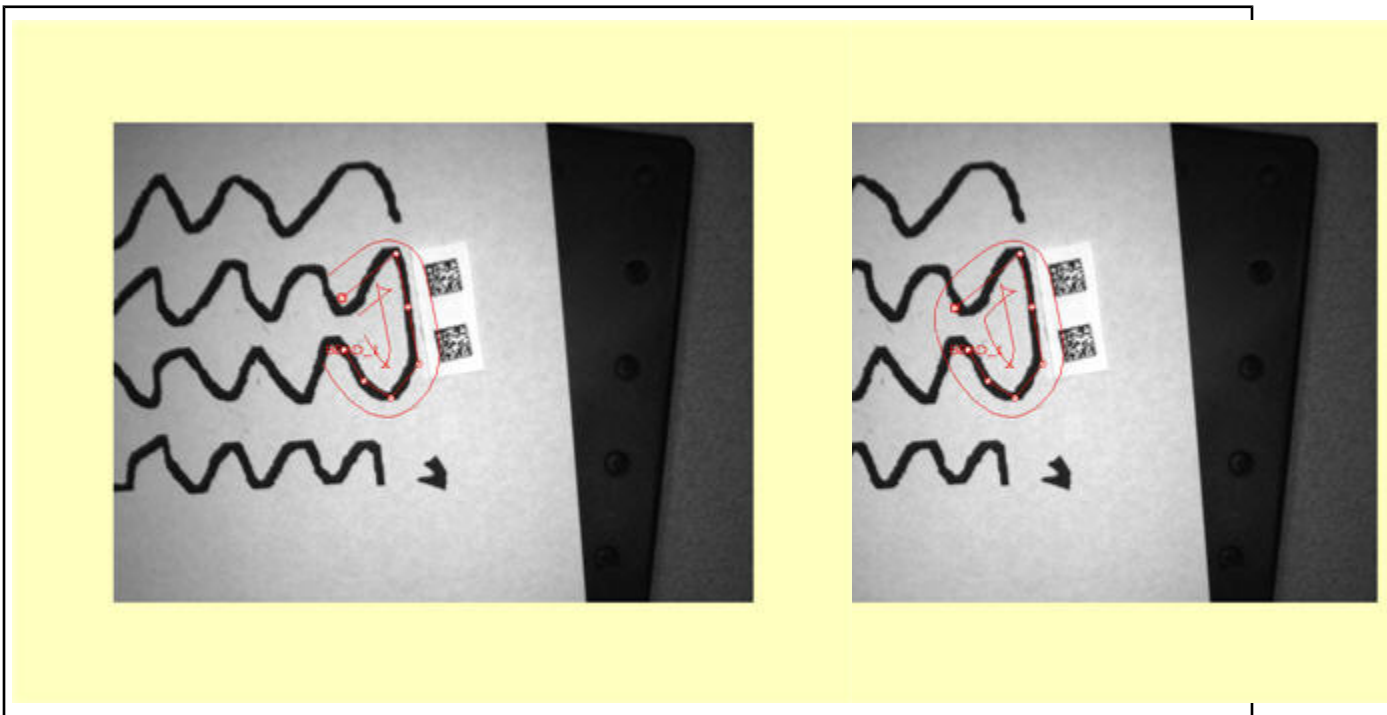

Modifying an ROI

To change the position of a point, select the point and drag with the cursor. You can add more points to the line by clicking on the line connecting different points.

To extend the ROI to more line segments, click the **Extend** button, and select from the beginning or the end of the existing ROI.

To delete a point on the ROI, select the point, and click the **Delete** button.

You can also change the ROI width:

- By changing the value in the ROI Width field.



- By clicking on the lines that define the ROI width, and dragging to modify the width.

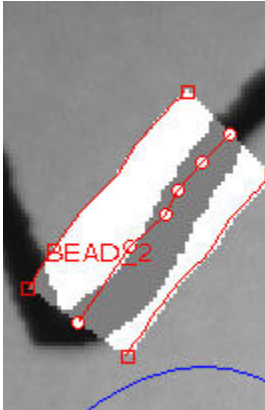

One-Shot

Once an ROI has been defined and terminated, the software performs a one-shot analysis of the existing image. The software sends the values of all the input parameters to the sensor where the sensor performs analysis on the reference image with those values, and computes initial values for number of good, narrow, and wide regions as well as other characteristics of the regions.

Bead Tool Inputs

Bead Type

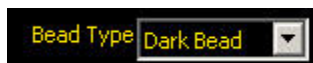

From the drop-down list, select **Dark Bead** or **Bright Bead** as appropriate for your application.

Threshold

Type



Adaptive

Select Adaptive when there are lighting changes that cause the acquired image to change.



Adaptive thresholding is a technique that is used to adjust the threshold for the BLOB tool based upon lighting changes and image content within the ROI. It performs best if used with bi-modal images, which have a clear contrast in the ROI. Adaptive thresholding chooses the current threshold value by converging to a value based on the average value of the pixels above and below the previous threshold value; it will not move the value of the threshold above or below the upper or lower limits.

Low Limit: Enter a gray scale value in this field, and the tool will not allow the Adaptive threshold to go below this value.

Upper Limit: Enter a gray scale value in this field, and the tool will not allow the Adaptive threshold to go above this value.

Reject Level: The Reject Level field is for bright Blobs only, and is used to narrow the range of pixel intensities to consider in an inspection. Leaving the defaults at 0 for low and 255 for high will result in the tool taking into consideration all gray scale levels in the ROI from 0 (black) to 255 (white). Note that the Reject Level field is visible only when Bright bead type is selected.

Fixed

Select Fixed when the lighting and image content will remain relatively constant for all inspections.



If you select Fixed, you can also specify Threshold and Reject Levels.

Threshold Level

The Threshold Level (e.g., 141) defines the white/black cutoff point. Once a threshold is chosen, any pixels brighter than the threshold become pure white while those darker than the threshold become pure black.

Reject Level

The Reject Level field is for bright Blobs only, and is used to narrow the range of pixel intensities to consider in an inspection. Leaving the defaults at 0 for low and 255 for high will result in the tool taking into consideration all gray scale levels in the ROI from 0 (black) to 255 (white). Note that the Reject Level field is visible only when Bright bead type is selected.

Filters



Samples Per Pixel

From the drop-down list select the pixels to sample: Every Pixel, Every 2nd Pixel or Every 4th Pixel.

Bead Width

Change the value for **Min** and **Max Bead Width** by using the arrow keys in each field, or by typing the desired value.

Ignore Boundary Pixels

Check this box if you want the software to ignore boundary pixels. Boundary pixels are bead pixels that touch the ROI. If you choose to ignore boundary pixels, you might ignore one or more segments.

Results

The full list of results for the following bead are noted in the table below.

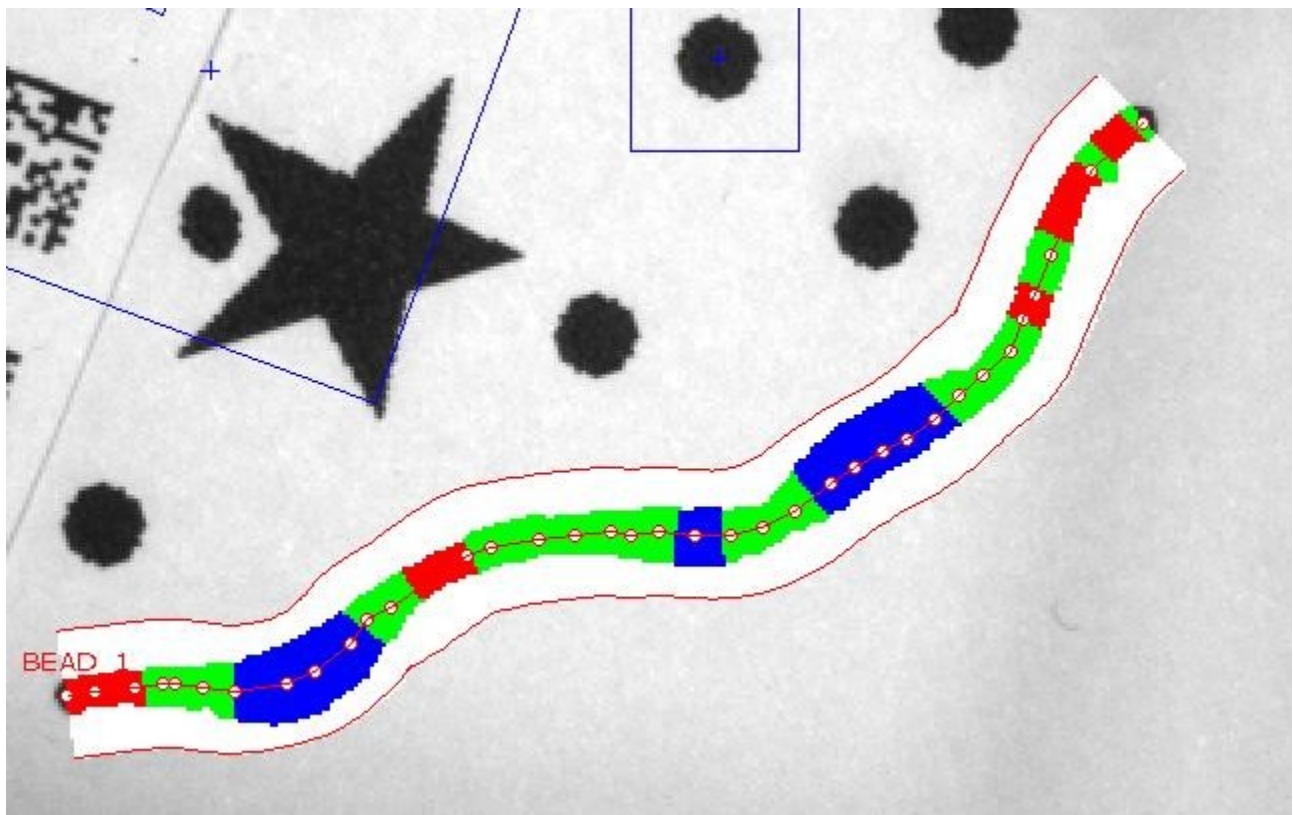



Result	Example Value
Threshold used	137
Minimum width found	8.20 (px)
Maximum width found	19.91 (px)
Average width found	12.58 (px)
Number of good regions	8
Total length of good regions	175.00 (px)
Longest good region length	53.00 (px)
Number of narrow regions	5
Total length of narrow regions	72.00 (px)
Longest narrow region length	20.00 (px)
Number of wide regions	3
Total length of wide regions	87.00 (px)
Longest wide region length	40.00 (px)

7.5.5 Optical Character Recognition (OCR) Tool

Optical character recognition (OCR) is the electronic interpretation of printed text that has been captured by a Vision Sensor. The OCR tool in the PresencePLUS software is used to train character patterns and their variations into the Vision Sensor's font library so that the Vision Sensor can recognize character patterns on labels and packages. Each character pattern is associated with a character ID so that the Sensor is able to identify character strings on a label or package. For example, you might train different fonts for the letter (*S* or **S**) and use the keyboard to associate these variations with the character ID "S".

Usage

The OCR Vision Sensor tool can be used:

- to ensure that the correct lot or date code is printed on a label or package.
- to ensure that the right labels are placed on the appropriate packages.
- with the Barcode tool to match strings and/or substrings with the human readable text.

Fields

The following are fields on the OCR tool Input tab:

- [Should I Use OCR or OCV?](#) on page 225
- [Decoded String Field](#) on page 226
- [Trainer](#) on page 227

Supported Platforms

ProII Color	ProII/ProII 1.3	OMNI Color	OMNI/OMNI 1.3	AREA/AREA13	EDGE/EDGE 1.3	GEO/GEO 1.3	BCR/BCR 1.3
Yes	Yes	Yes	Yes	No	No	No	Yes

OCR Tool Input Tab

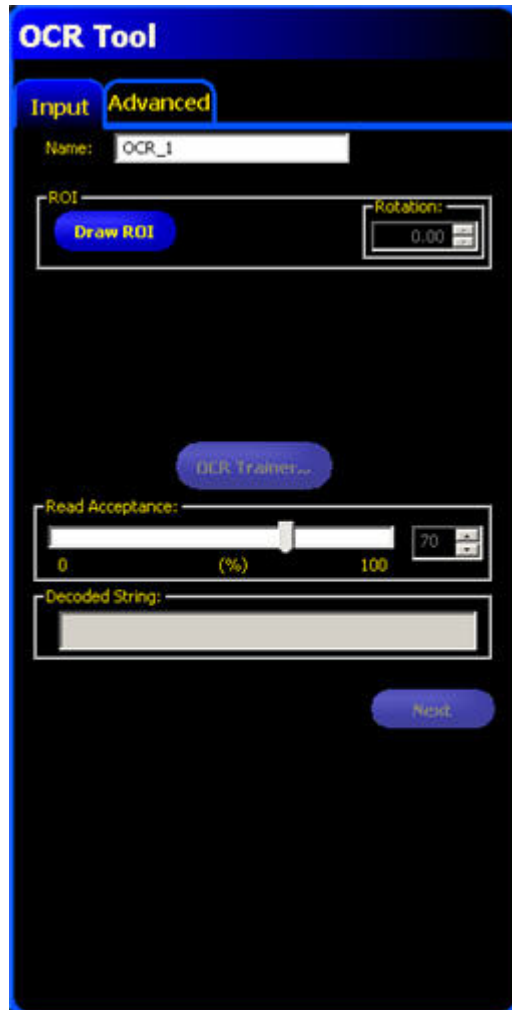

Decoded String Field

Once the Sensor has been trained, the Decoded String field should show the characters the software detects in the image area. If the Sensor does not correctly identify all the characters in the string, you may need to do some additional training.

 **Note:** The software ignores spaces.

 **Note:** For OCV, if the Decoded string does not match the Expected String, then the Decoded string will be displayed in red.



7.5.6 Trainer

The Box Tab

When you capture a reference image using the OCR or OCV tool, these tools use sophisticated pattern recognition algorithms to box what is estimated to be individual characters in a captured image. In the example below, the initial image capture finds all the individual characters except the 3 and the 4, which it has incorrectly boxed as a single character. In the Box tab, you can calibrate image settings so that the software will more accurately box the characters in a character string.



On the Box tab, you can calibrate the following:

- *Image Control Parameters* on page 228
- *ROI Control Calibration* on page 229
- *Character Settings Calibration* on page 231
- *Character Connectivity Calibration* on page 234

• [Thresholding Calibration](#) on page 236

Training List

You can add, load, or import images as a Training List to train character patterns into the Sensor.

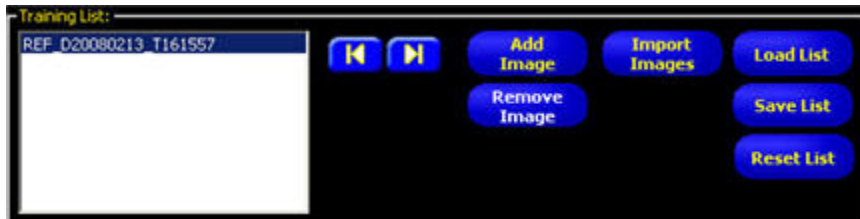









Button	Description
	Use the right arrow to cycle down through a list of images, and use the left arrow to cycle up through the list.
	Click this button to add the currently displayed image to the Training List.  Note: Use this button as Sensor images are being captured.
	Click this button to remove the currently selected image from the Training List.
	Click this button to import images from the player/recorder folder where bitmaps are saved.
	Click this button to select a .pbl file that has been previously saved with images.
	Click this button to save the current Training List.
	Click this button to clear the Training List.

Image Control Parameters

The Image Control parameters determine what image or images to use when fine-tuning how characters are boxed within the ROI.



Parameters

The following describe the image control parameters set in this group.

Image	Description	Additional Information
Reference Image	Boxing is first done using the Reference Image captured with the OCR or OCV tool.	
Training List	<p>Create or use a Training List (or Play List) of images previously saved, or by adding images currently displayed in the Image window to get some variants of character patterns.</p> <p>Note: For the best results when training the Sensor, you should capture several character string images to account for slight character pattern variations.</p>	
Sensor Images	Capture sensor images using either a Continuous , External , or Manual/Hold trigger.	

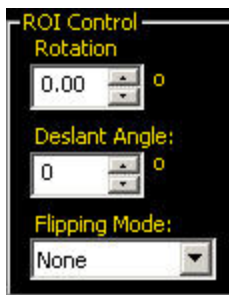

ROI Control Calibration

The ROI Control provides a way to adjust the image if it is not on a horizontal plane, if the characters are slanted so that the software cannot box them accurately, or if the camera is positioned in such a way that the captured image is backwards or upside down.

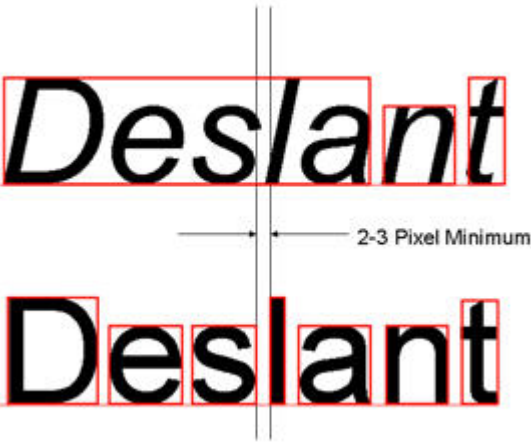

Parameters

The following are used to calibrate the ROI:

ROI Control	Description	Additional Information
Rotation	Use the up or down arrow controls to rotate the ROI clockwise, or counterclockwise so that the ROI aligns with the character string image.	
Deslant Angle	In order for the OCV/OCR Vision tool to box correctly, there must be a minimum of a 2 to 3 pixel-wide column between characters. If the characters are slanted in such a way that they overlap in this 2 to 3 pixel-wide column, then the image may need to be manipulated, or deslanted, so that the image can box correctly. Use the up or down arrow controls to adjust for the slant as appropriate.	
Flipping Mode	From the dropdown, select None , Horizontal , Vertical , or Both . <p> Note: Performance is reduced if you have to flip the image. If you can't re-orient the camera so that the character string in the captured image reads normally from left to right on a horizontal plane, consider assigning each character pattern as it appears to a character ID in the font library.</p>	

Character Settings Calibration

The Character Settings calibration group on the OCR or OCV Trainer is used to define characteristics of the string images captured by the Vision Sensor.



Standard Character Settings

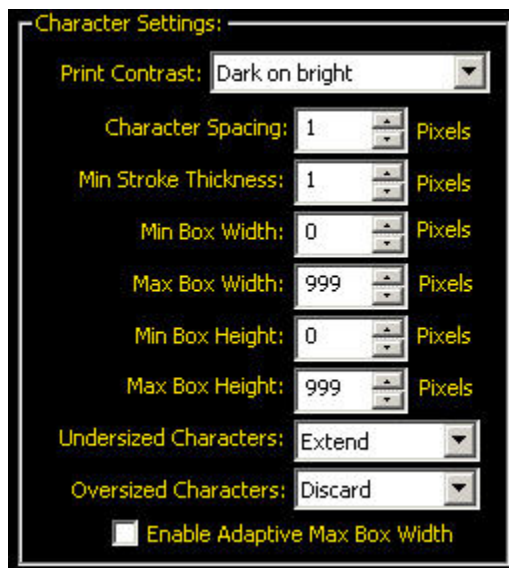

Enhanced Character Settings

Parameters

The following are parameters to used to calibrate character settings.

Character Settings	Description	Additional Information
Print Contrast	From the drop-down list, select Dark on bright or Bright on dark , which defines the relationship of the characters and the background; that is black on white or white on black.	
Character spacing	Use the up and down arrow controls to specify the number of pixels the	

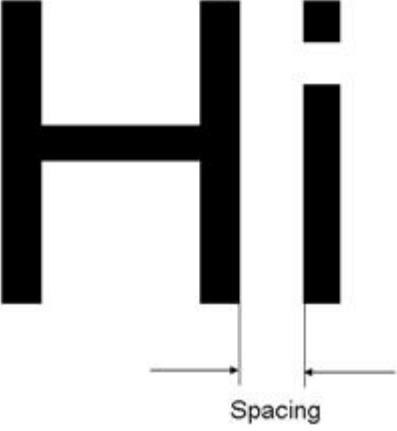
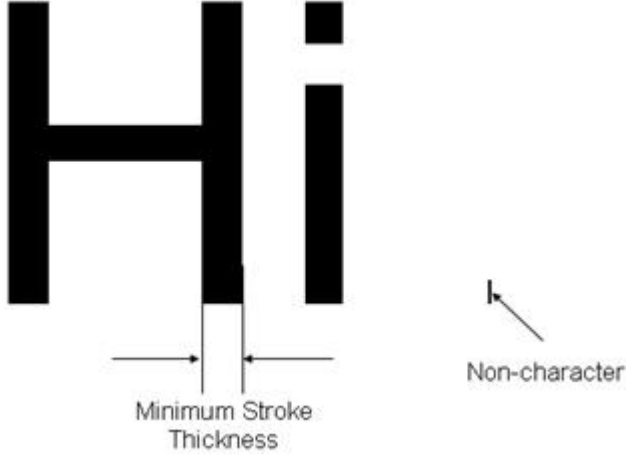



Character Settings	Description	Additional Information
	software should ignore where one character box ends and where the next character box begins.	 <p style="text-align: center;">Spacing</p>
Min Stroke Thickness	Use the up and down arrow controls to specify the stroke thickness of the characters. This is used to eliminate spurious marks that might result in false-positive identification of characters.	 <p style="text-align: center;">Minimum Stroke Thickness</p> <p style="text-align: right;">Non-character</p>

Enhanced Character Settings

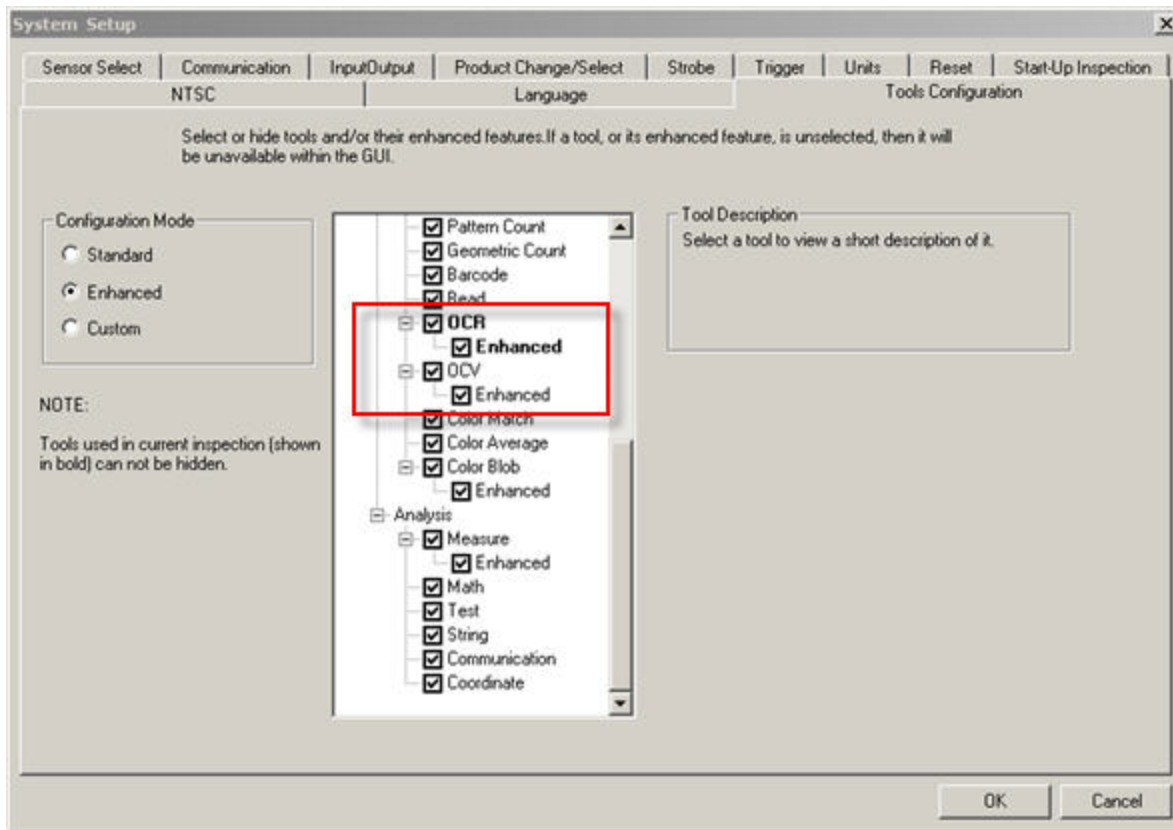
The enhanced OCR/OCV settings provide for fine-tuning how the sensor boxes characters. To enable Enhanced OCR/OCV tools:

1. Click the System button on the UI to display the System Setup dialog.
2. Select the Tools Configuration tab.
3. Check the box next to **Enhanced** under OCR and/or OCV.

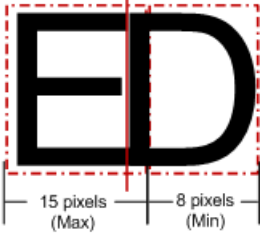

Enhanced Character Settings	Description	Additional Information	
Min Box Width Min Box Height	These values determine the minimum width and height allowed for the boxing around a character. Typically, these values will be the width (and height) of the smallest valid character. If a character is smaller than the Min Box Width setting, for example, the sensor will force the box to be the Min Box Width unless the Undersized characters has Discard selected, in which case, for example, a 10 pixel character will be ignored.	Auto Boxing (Default Settings) 	Min Box Width = 15 
Max Box Width Max Box Height	These values determine the maximum width and height allowed for the boxing around a character. Typically, these values will be the width (and height) of the largest valid character. If a character is larger than the Max Box Width setting, for example, the sensor will force the box to be the Max	Auto Boxing (Default Settings) 	Min Box Width = 5 

Enhanced Character Settings	Description	Additional Information
	Box Width unless the Oversized characters has Discard selected, in which case, for example, a 5 pixel character will be ignored.	
Enable Adaptive Max Box Width	If a box reaches the Max Box Width without finding a natural character ending, when Enable Adaptive Max Box Width is checked, the sensor will adjust the right edge of the box to find a most likely endpoint for a character.	<p data-bbox="761 436 1029 478">Enable Adaptive Max Box Width (right edge shifted back)</p> 
Undersized characters	<ul data-bbox="415 751 753 1014" style="list-style-type: none"> • When Discard is selected, the sensor will reject proposed boxes that do not meet the minimum requirements (see Minimum Box Width above). • When Extend is selected, the sensor will make the character fit the box. 	
Oversized characters	<ul data-bbox="415 1056 753 1350" style="list-style-type: none"> • When Discard is selected, the sensor will reject proposed boxes that do not meet the maximum requirements (see Maximum Box Width above) • When Split is selected, the sensor will split the character into multiple characters. 	

Character Connectivity Calibration

Intra-Character Connectivity defines the maximum number of pixel spaces between two character strokes so that both strokes will be considered part of the same character. In the example below, if the Horizontal Gap were defined too small, the "H" could be considered an **I - I**.

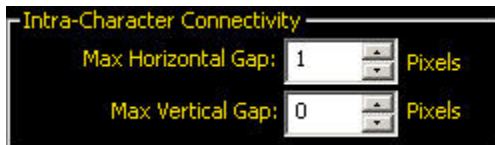
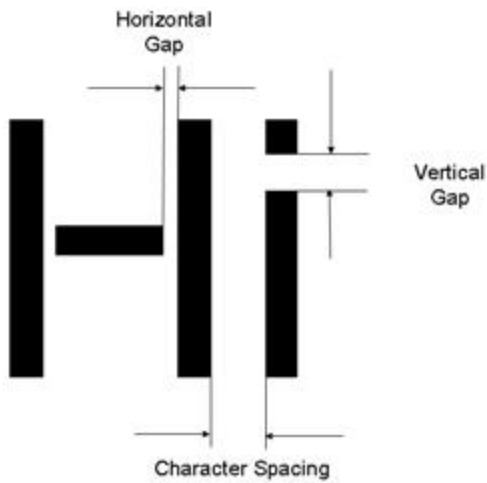

Note: Here "0" vertical gap really means "infinite" vertical gap (but bounded by the ROI); that is, all pixels in a vertical line can be considered part of the same character.

Parameters

The following are the parameters that you adjust to set Intra-Character Connectivity.

Intra-Character Connectivity	Description	Additional Information
Max Horizontal Gap	Use the up or down arrow controls to set the maximum number of pixel spaces that can exist between two horizontal character strokes so that the image is boxed as a single character image.	<p>The diagram shows a stylized black character 'H' with a label 'Horizontal Gap' and an arrow pointing to the space between the two vertical stems.</p>
Max Vertical Gap	Use the up or down arrow controls to set the maximum	

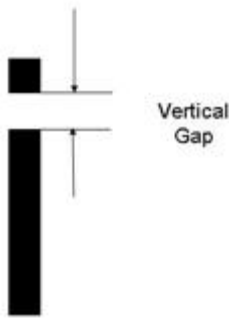
Intra-Character Connectivity	Description	Additional Information
	number of pixel spaces that can exist between two vertical character strokes so that the image is boxed as a single character image.	



Thresholding Calibration

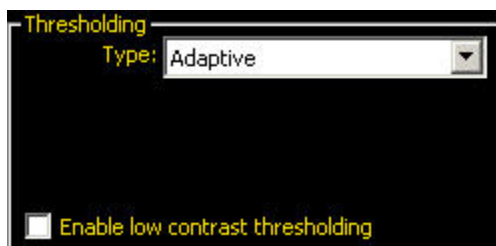

The Thresholding calibration group includes options for adjusting the grayscale threshold level for the image.

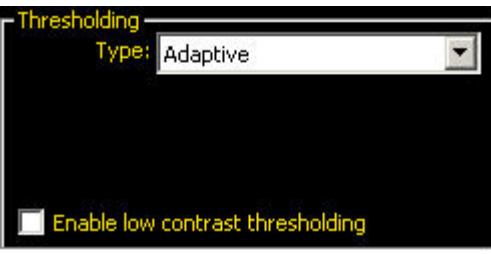

Parameters

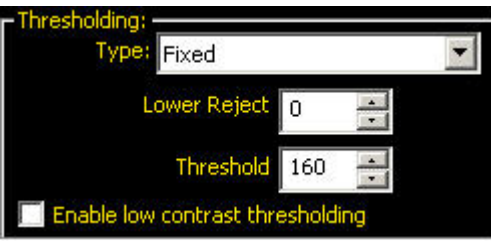
The following are the parameters that can be set for Thresholding.

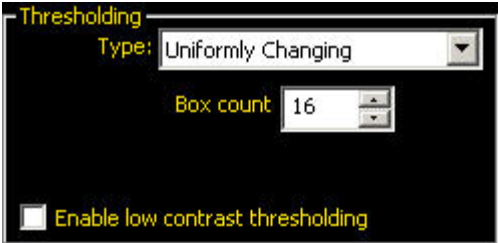
Thresholding Type	Description	Additional Information
Adaptive	<p>If you select Adaptive from the drop-down list, which is the default, the software automatically chooses the grayscale threshold level for the bimodal image.</p> <p> Note: this threshold assumes that the image is bimodal.</p>	
Fixed	<p>If you select Fixed from the drop-down list, you need to enter the Lower Reject and Threshold (see the example below).</p> <p> Note: If the Print Contrast is set to Bright on dark, then the Lower Reject and Thresholds will be the opposite.</p>	

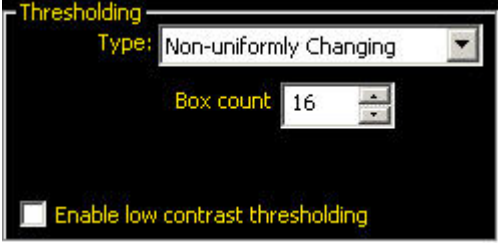
Thresholding Type	Description	Additional Information
Uniformly Changing	<p>If you select Uniformly Changing, then the grayscale contrast of the image changes along the read direction of the ROI in uniform increments (up or down) over the units indicated in the Box count field. The default box count is 16. Use the arrow controls to adjust as appropriate.</p> <p> Note: The Box count integer is close to the number of characters in the image. A good starting point is the number of characters in the image.</p>	
Non-uniformly Changing	<p>If you select Non-uniformly Changing, then the grayscale contrast of the image varies irregularly along the read direction of the ROI. The default box count is 16. Use the arrow controls to adjust as appropriate.</p> <p> Note: The Box count integer is close to the number of characters in the image. A good starting point is the number of characters in the image.</p>	
Enable low contrast thresholding	<p>Check the Enable low contrast thresholding if the contrast is not sufficient to allow characters to box correctly.</p>	

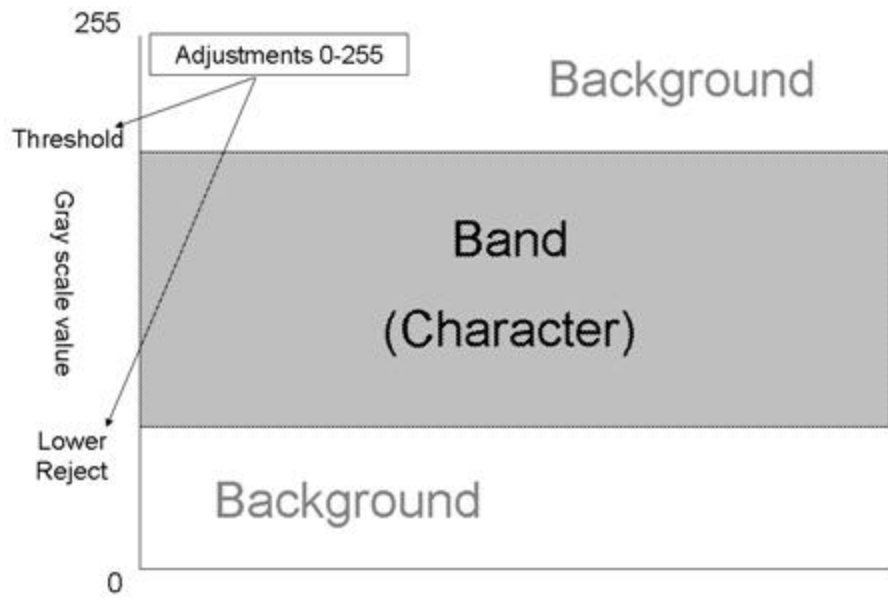

The Train Tab

The Train tab is where you train character patterns into the Font Library; that is, assign a character ID to each character pattern. As character patterns are trained into the Vision Sensor, the software will begin to recognize character patterns.



Read Acceptance

There are three levels of Read Acceptance, **Loose** (default), **Medium**, and **Strict**. Which you select will determine how forgiving the Sensor will be regarding character variability. In other words, the stricter you set Read Acceptance, the less forgiving the Sensor will be for variability, which might mean training more characters that will lead to a bigger library, and eventually some effect on performance. Also, a Font Library that gets too many characters may have an increased chance of false positive reads.



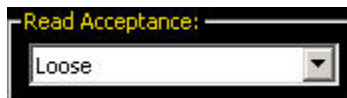



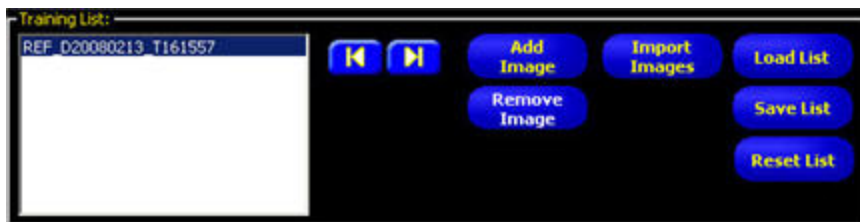

 **Note:** No matter the level Read Acceptance selected, the software always uses a slightly tighter tolerance when training the Sensor than when the Sensor is in Run mode.



Training List

You can add, load, or import images as a Training List to train character patterns into the Sensor.



Button	Description
	Use the right arrow to cycle down through a list of images, and use the left arrow to cycle up through the list.
	Click this button to add the currently displayed image to the Training List.  Note: Use this button as Sensor images are being captured.
	Click this button to remove the currently selected image from the Training List.
	Click this button to import images from the player/recorder folder where bitmaps are saved.
	Click this button to select a .pbl file that has been previously saved with images.
	Click this button to save the current Training List.
	Click this button to clear the Training List.

Font Library

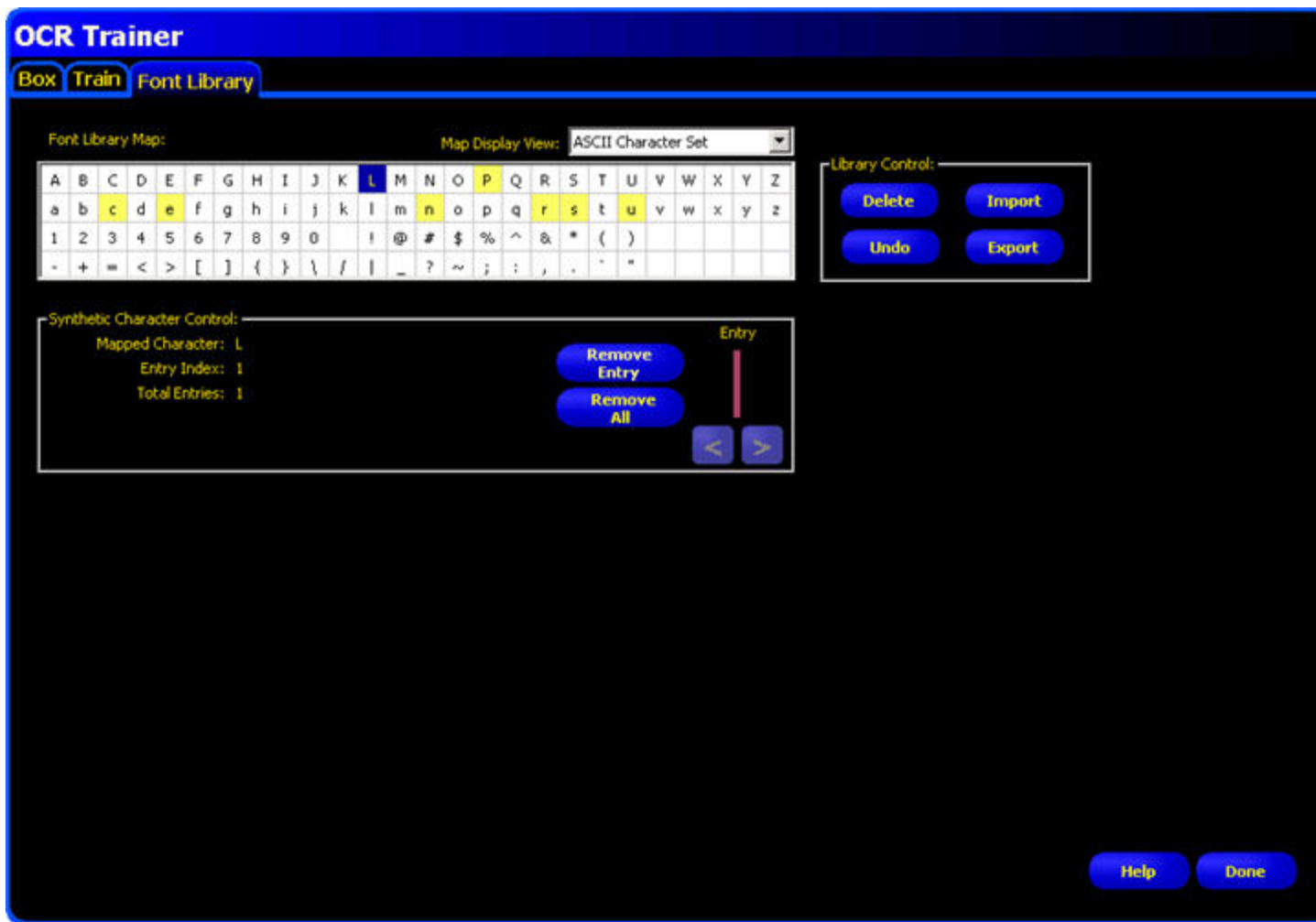

The Vision Sensor's Font Library shows trained fonts in yellow. It also provides for importing a Font Library from another tool and for reviewing the various character patterns trained into the Sensor.







Library Control

Library Control lets you manage the entire library. You can export a library, delete a library, or import a library; that is, import all trained characters from another tool.





Button	Description
	Click this button to delete all the trained characters from the current library.
	Click this button to undo the last operation.

Button	Description
	
	<p>Click this button to import a font library from another OCR or OCV tool. To be able to import the font library from another tool, you must first export the library from that tool and save the font library to a file. Then, you can import the font library into the current tool.</p> <p> Note: If a tool is copied, its font library is also copied.</p> <p>Click this button to export the current library so that it can be imported elsewhere.</p>
	

Synthetic Character Control

Synthetic Character Control lets you view all the character patterns associated with a particular character ID. You can remove any one character pattern or all the character patterns associated with a character ID.



Button	Description
	Use this button to remove the currently viewed character pattern in the Entry field.
	Use this button to remove all the entries for the character pattern currently viewed in the Entry field.
	Use the arrows to cycle through the character patterns for a particular character ID.

7.5.7 Advanced Tab

Use the up and down arrow controls on the Time out field to change the inspection timeout in milliseconds.

-  **Note:** When the tool times out, it may have decoded part of the string before the time ran out. This partial decoding is reported back as the Decoded String. In OCV, whenever a timeout occurs, it is considered NO MATCH even if the returned Decoded String matched Expected String.

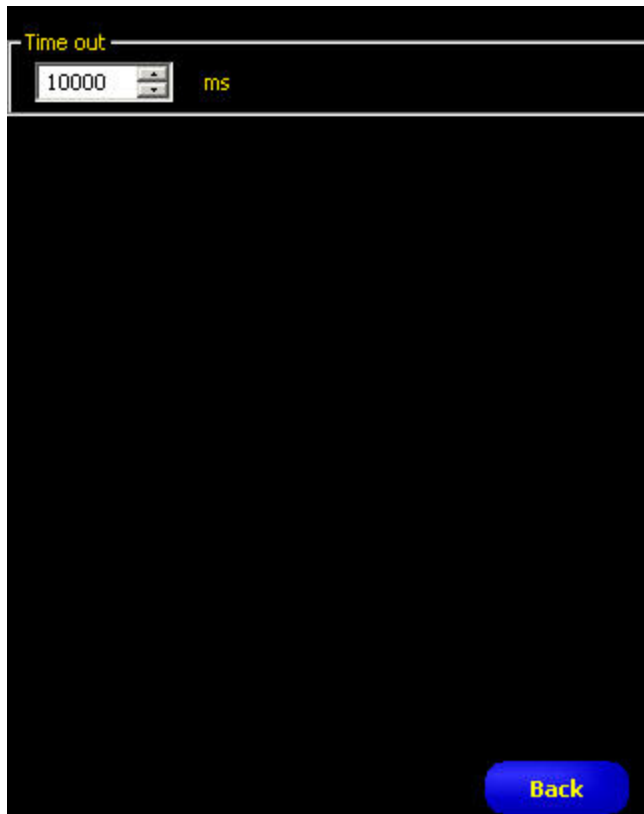

7.5.8 Optical Character Verification (OCV) Tool

Optical character verification (OCV) is very similar to the OCR tool regarding decoding an image and building the Font Library. However, where OCR always feeds back what it decodes, the OCV tool simply provides success/failure results; that is, OCV simply indicates whether or not an expected character string matches a decoded string. If the strings match, then the result is Success. If the strings do not match, then the result is Failure.

Usage

The OCV Vision Sensor tool can be used:

- to ensure that the correct lot or date code is printed on a label or package.
- to ensure that the right labels are placed on the appropriate packages.
- verify string with a string that is received from Industrial Protocols.

Fields

The following are fields on the OCV tool Input tab:

- [Should I Use OCR or OCV?](#) on page 225
- [Decoded String Field](#) on page 226
- [Trainer](#) on page 227

Supported Platforms

ProII Color	ProII/ProII 1.3	OMNI Color	OMNI/OMNI 1.3	AREA/AREA13	EDGE/EDGE 1.3	GEO/GEO 1.3	BCR/BCR 1.3
Yes	Yes	Yes	Yes	No	No	No	Yes

OCV Input Tab



Should I Use OCR or OCV?

Most applications should use OCR because it provides more information than simply a success/failure. However, there are times where you don't care about any additional information, but do require a bit better performance than OCR can provide.

With OCR, the Sensor has no idea what to expect at each character position so, when it decodes an image for each character pattern, it has to search the entire Font Library to find a character ID that matches.

For the OCV tool, on the other hand, each character position is filtered such that there are a finite number of character variants associated with a single character ID.

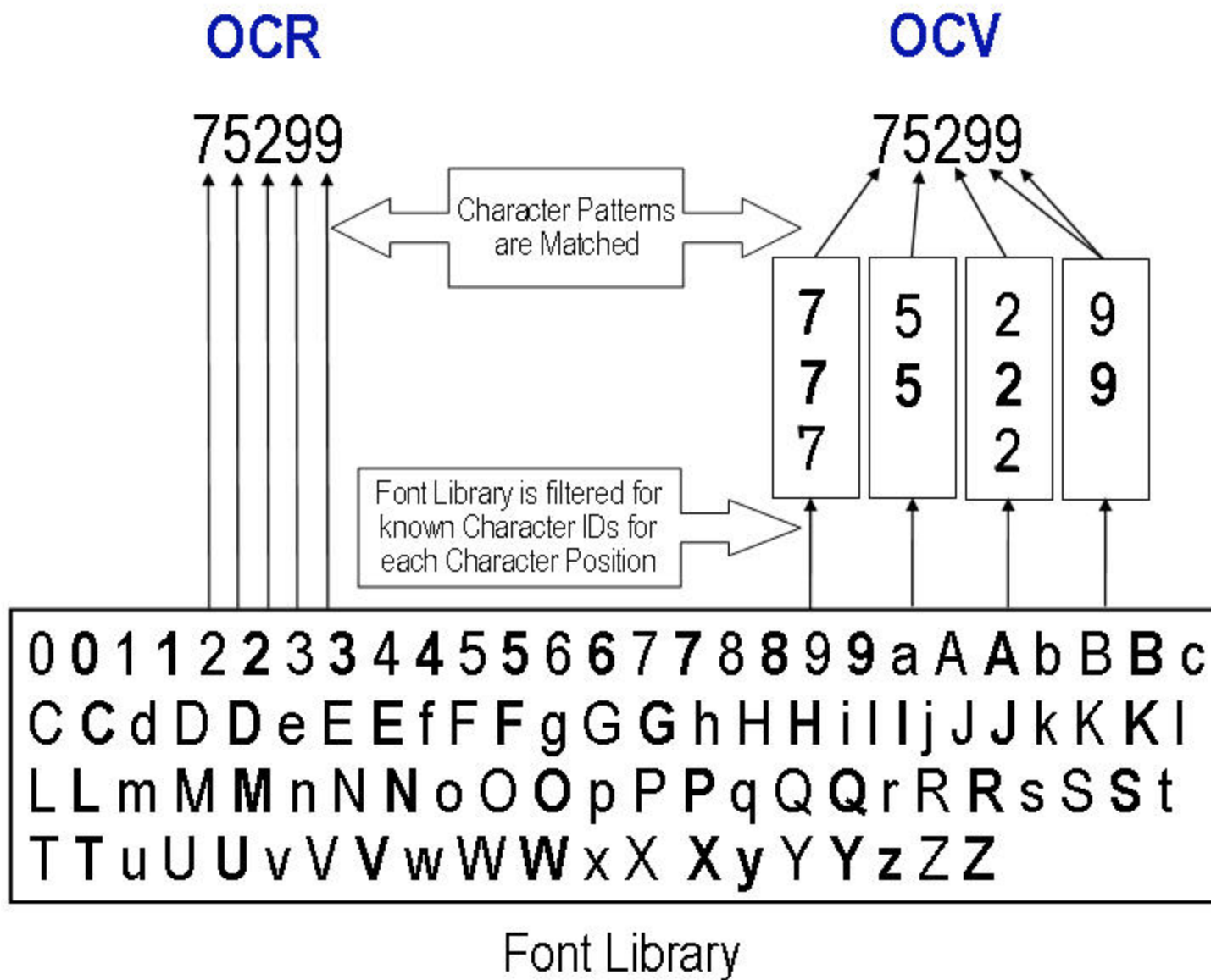

Decoded String Field

Once the Sensor has been trained, the Decoded String field should show the characters the software detects in the image area. If the Sensor does not correctly identify all the characters in the string, you may need to do some additional training.

Note: The software ignores spaces.

Note: For OCV, if the Decoded string does not match the Expected String, then the Decoded string will be displayed in red.



7.5.9 Trainer

The Box Tab

When you capture a reference image using the OCR or OCV tool, these tools use sophisticated pattern recognition algorithms to box what is estimated to be individual characters in a captured image. In the example below, the initial image capture finds all the individual characters except the 3 and the 4, which it has incorrectly boxed as a single character. In the Box tab, you can calibrate image settings so that the software will more accurately box the characters in a character string.



On the Box tab, you can calibrate the following:

- *Image Control Parameters* on page 228
- *ROI Control Calibration* on page 229
- *Character Settings Calibration* on page 231
- *Character Connectivity Calibration* on page 234
- *Thresholding Calibration* on page 236

Training List

You can add, load, or import images as a Training List to train character patterns into the Sensor.

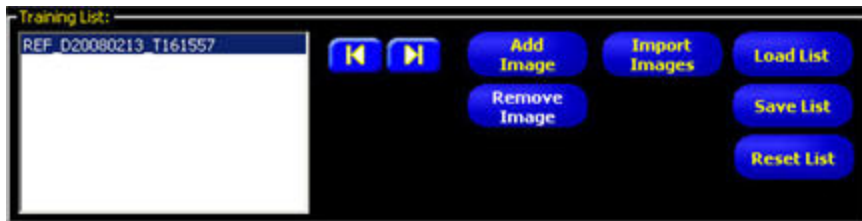

Button	Description
	Use the right arrow to cycle down through a list of images, and use the left arrow to cycle up through the list.
	Click this button to add the currently displayed image to the Training List. Note: Use this button as Sensor images are being captured.
	Click this button to remove the currently selected image from the Training List.
	Click this button to import images from the player/recorder folder where bitmaps are saved.
	Click this button to select a .pbl file that has been previously saved with images.
	Click this button to save the current Training List.
	Click this button to clear the Training List.



Image Control Parameters

The Image Control parameters determine what image or images to use when fine-tuning how characters are boxed within the ROI.



Parameters

The following describe the image control parameters set in this group.

Image	Description	Additional Information
Reference Image	Boxing is first done using the Reference Image captured with the OCR or OCV tool.	
Training List	<p>Create or use a Training List (or Play List) of images previously saved, or by adding images currently displayed in the Image window to get some variants of character patterns.</p> <p> Note: For the best results when training the Sensor, you should capture several character string images to account for slight character pattern variations.</p>	
Sensor Images	Capture sensor images using either a Continuous, External, or Manual/Hold trigger.	



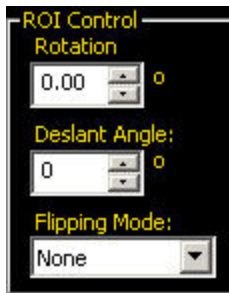

ROI Control Calibration

The ROI Control provides a way to adjust the image if it is not on a horizontal plane, if the characters are slanted so that the software cannot box them accurately, or if the camera is positioned in such a way that the captured image is backwards or upside down.

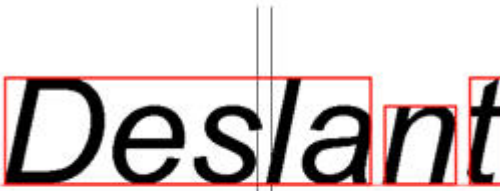

Parameters

The following are used to calibrate the ROI:

ROI Control	Description	Additional Information
Rotation	Use the up or down arrow controls to rotate the ROI clockwise, or counterclockwise so that the ROI aligns with the character string image.	
Deslant Angle	In order for the OCV/OCR Vision tool to box correctly, there must be a minimum of a 2 to 3 pixel-wide column between characters. If the characters are slanted in such a way that they overlap in this 2 to 3 pixel-wide column, then the image may need to be manipulated, or deslanted, so that the image can box correctly. Use the up or down arrow controls to adjust for the slant as appropriate.	 
Flipping Mode	From the dropdown, select None , Horizontal , Vertical , or Both . <p> Note: Performance is reduced if you have to flip the image. If you can't re-orient the camera so that the character string in the captured image reads normally from left to right on a horizontal plane, consider assigning each character pattern as it appears to a character ID in the font library.</p>	

Character Settings Calibration

The Character Settings calibration group on the OCR or OCV Trainer is used to define characteristics of the string images captured by the Vision Sensor.



Standard Character Settings

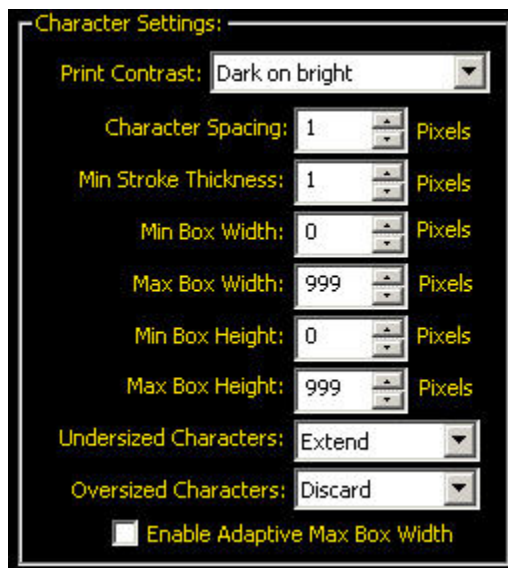

Enhanced Character Settings

Parameters

The following are parameters to used to calibrate character settings.

Character Settings	Description	Additional Information
Print Contrast	From the drop-down list, select Dark on bright or Bright on dark , which defines the relationship of the characters and the background; that is black on white or white on black.	
Character spacing	Use the up and down arrow controls to specify the number of pixels the	

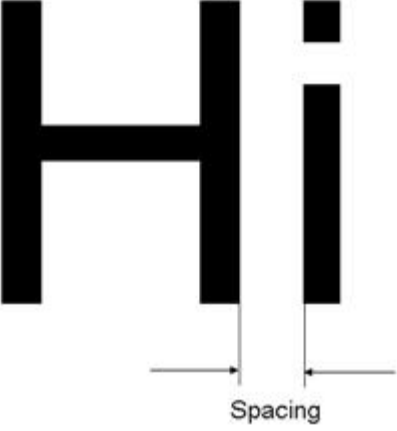
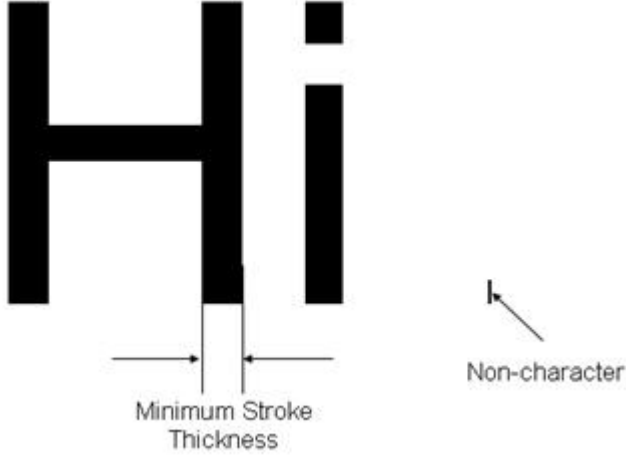



Character Settings	Description	Additional Information
	software should ignore where one character box ends and where the next character box begins.	
Min Stroke Thickness	Use the up and down arrow controls to specify the stroke thickness of the characters. This is used to eliminate spurious marks that might result in false-positive identification of characters.	

Enhanced Character Settings

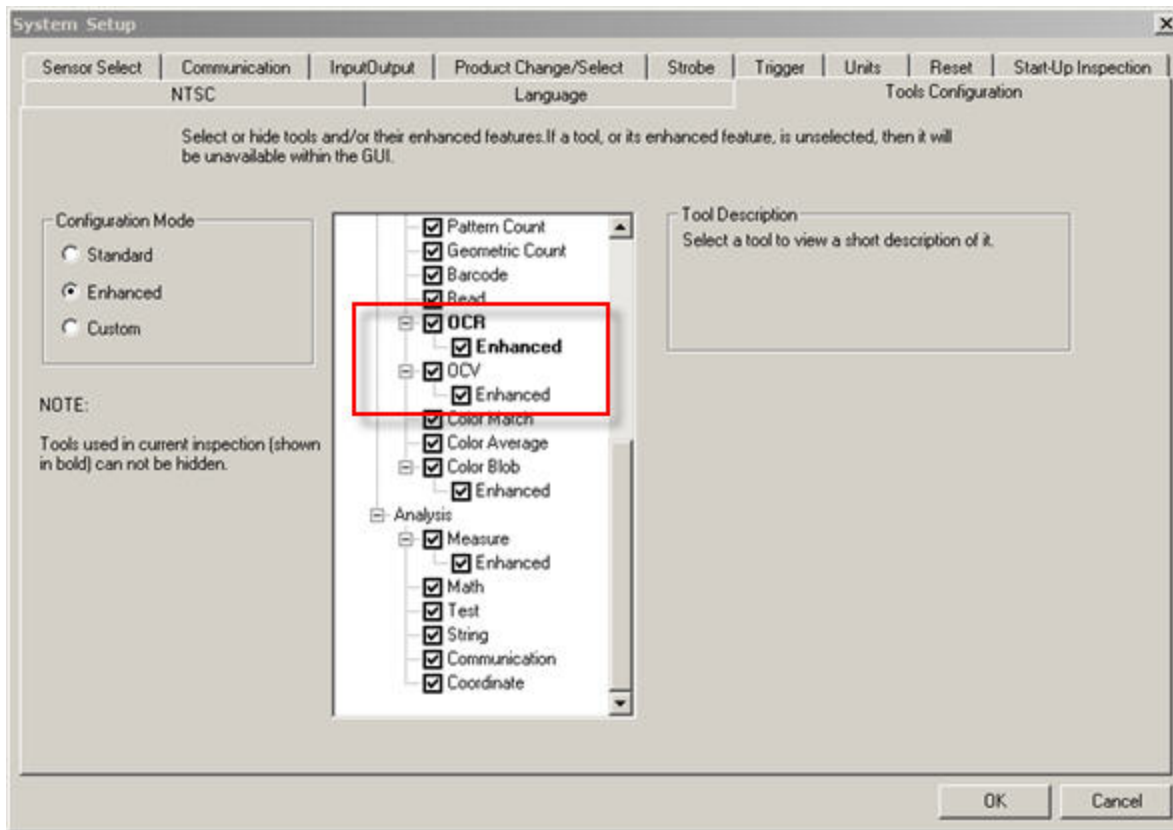
The enhanced OCR/OCV settings provide for fine-tuning how the sensor boxes characters. To enable Enhanced OCR/OCV tools:

1. Click the System button on the UI to display the System Setup dialog.
2. Select the Tools Configuration tab.
3. Check the box next to **Enhanced** under OCR and/or OCV.

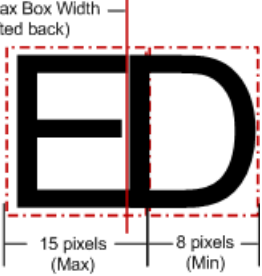

Enhanced Character Settings	Description	Additional Information	
Min Box Width Min Box Height	These values determine the minimum width and height allowed for the boxing around a character. Typically, these values will be the width (and height) of the smallest valid character. If a character is smaller than the Min Box Width setting, for example, the sensor will force the box to be the Min Box Width unless the Undersized characters has Discard selected, in which case, for example, a 10 pixel character will be ignored.	Auto Boxing (Default Settings) 	Min Box Width = 15 
Max Box Width Max Box Height	These values determine the maximum width and height allowed for the boxing around a character. Typically, these values will be the width (and height) of the largest valid character. If a character is larger than the Max Box Width setting, for example, the sensor will force the box to be the Max	Auto Boxing (Default Settings) 	Min Box Width = 5 

Enhanced Character Settings	Description	Additional Information
	<p>Box Width unless the Oversized characters has Discard selected, in which case, for example, a 5 pixel character will be ignored.</p>	
<p>Enable Adaptive Max Box Width</p>	<p>If a box reaches the Max Box Width without finding a natural character ending, when Enable Adaptive Max Box Width is checked, the sensor will adjust the right edge of the box to find a most likely endpoint for a character.</p>	<p>Enable Adaptive Max Box Width (right edge shifted back)</p> 
<p>Undersized characters</p>	<ul style="list-style-type: none"> • When Discard is selected, the sensor will reject proposed boxes that do not meet the minimum requirements (see Minimum Box Width above). • When Extend is selected, the sensor will make the character fit the box. 	
<p>Oversized characters</p>	<ul style="list-style-type: none"> • When Discard is selected, the sensor will reject proposed boxes that do not meet the maximum requirements (see Maximum Box Width above) • When Split is selected, the sensor will split the character into multiple characters. 	

Character Connectivity Calibration

Intra-Character Connectivity defines the maximum number of pixel spaces between two character strokes so that both strokes will be considered part of the same character. In the example below, if the Horizontal Gap were defined too small, the "H" could be considered an I - I.

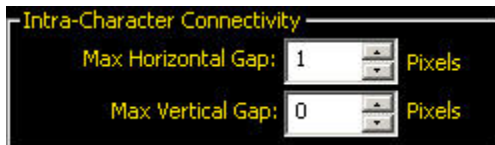
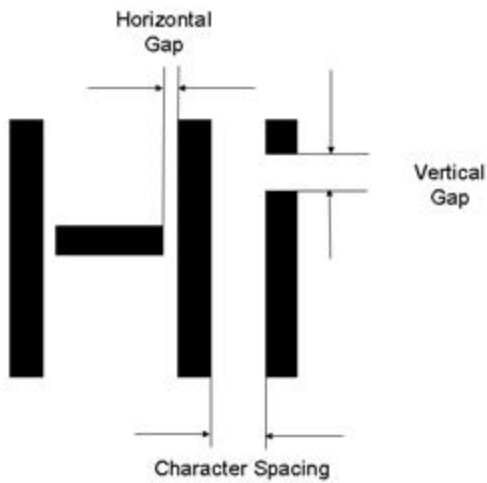

Note: Here "0" vertical gap really means "infinite" vertical gap (but bounded by the ROI); that is, all pixels in a vertical line can be considered part of the same character.

Parameters

The following are the parameters that you adjust to set Intra-Character Connectivity.

Intra-Character Connectivity	Description	Additional Information
Max Horizontal Gap	Use the up or down arrow controls to set the maximum number of pixel spaces that can exist between two horizontal character strokes so that the image is boxed as a single character image.	<p>The diagram shows a stylized black character 'H'. A vertical double-headed arrow between the two vertical stems is labeled 'Horizontal Gap'.</p>
Max Vertical Gap	Use the up or down arrow controls to set the maximum	

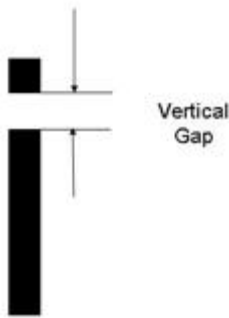
Intra-Character Connectivity	Description	Additional Information
	number of pixel spaces that can exist between two vertical character strokes so that the image is boxed as a single character image.	

Thresholding Calibration

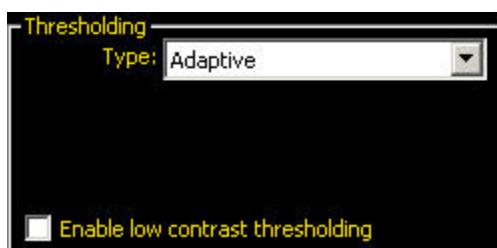

The Thresholding calibration group includes options for adjusting the grayscale threshold level for the image.

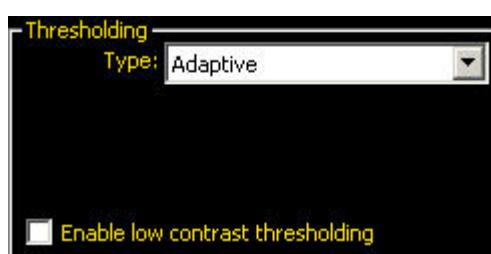
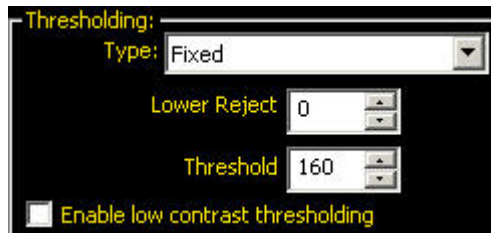

Parameters

The following are the parameters that can be set for Thresholding.

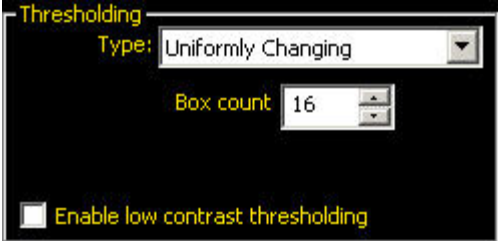
Thresholding Type	Description	Additional Information
Adaptive	<p>If you select Adaptive from the drop-down list, which is the default, the software automatically chooses the grayscale threshold level for the bimodal image.</p> <p>Note: this threshold assumes that the image is bimodal.</p>	
Fixed	<p>If you select Fixed from the drop-down list, you need to enter the Lower Reject and Threshold (see the example below).</p> <p>Note: If the Print Contrast is set to Bright on dark, then the Lower Reject and Thresholds will be the opposite.</p>	

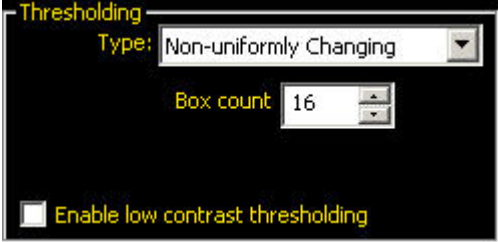
Thresholding Type	Description	Additional Information
Uniformly Changing	<p>If you select Uniformly Changing, then the grayscale contrast of the image changes along the read direction of the ROI in uniform increments (up or down) over the units indicated in the Box count field. The default box count is 16. Use the arrow controls to adjust as appropriate.</p> <p> Note: The Box count integer is close to the number of characters in the image. A good starting point is the number of characters in the image.</p>	
Non-uniformly Changing	<p>If you select Non-uniformly Changing, then the grayscale contrast of the image varies irregularly along the read direction of the ROI. The default box count is 16. Use the arrow controls to adjust as appropriate.</p> <p> Note: The Box count integer is close to the number of characters in the image. A good starting point is the number of characters in the image.</p>	
Enable low contrast thresholding	<p>Check the Enable low contrast thresholding if the contrast is not sufficient to allow characters to box correctly.</p>	

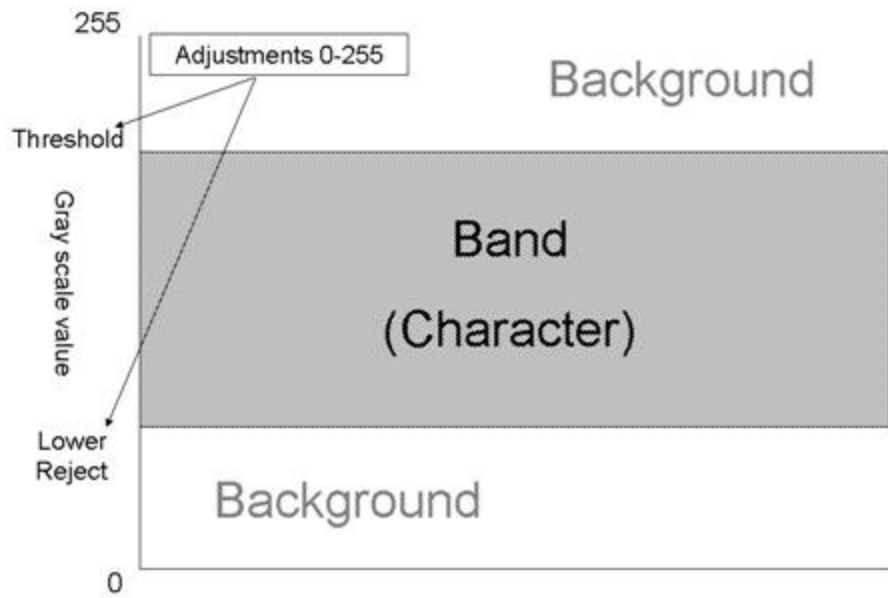

The Train Tab

The Train tab is where you train character patterns into the Font Library; that is, assign a character ID to each character pattern. As character patterns are trained into the Vision Sensor, the software will begin to recognize character patterns.



Read Acceptance

There are three levels of Read Acceptance, **Loose** (default), **Medium**, and **Strict**. Which you select will determine how forgiving the Sensor will be regarding character variability. In other words, the stricter you set Read Acceptance, the less forgiving the Sensor will be for variability, which might mean training more characters that will lead to a bigger library, and eventually some effect on performance. Also, a Font Library that gets too many characters may have an increased chance of false positive reads.







 **Note:** No matter the level Read Acceptance selected, the software always uses a slightly tighter tolerance when training the Sensor than when the Sensor is in Run mode.

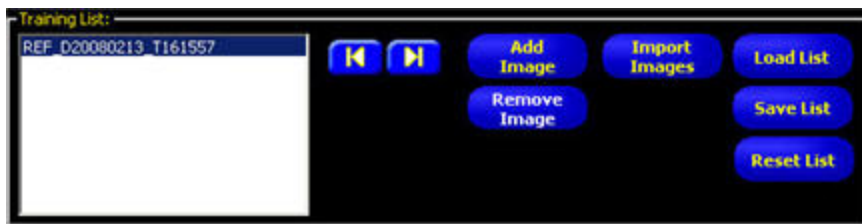

Training List

You can add, load, or import images as a Training List to train character patterns into the Sensor.



Button	Description
	Use the right arrow to cycle down through a list of images, and use the left arrow to cycle up through the list.
	Click this button to add the currently displayed image to the Training List. 🖱️ Note: Use this button as Sensor images are being captured.
	Click this button to remove the currently selected image from the Training List.
	Click this button to import images from the player/recorder folder where bitmaps are saved.
	Click this button to select a .pbl file that has been previously saved with images.
	Click this button to save the current Training List.
	Click this button to clear the Training List.



Font Library





The Vision Sensor's Font Library shows trained fonts in yellow. It also provides for importing a Font Library from another tool and for reviewing the various character patterns trained into the Sensor.

Library Control

Library Control lets you manage the entire library. You can export a library, delete a library, or import a library; that is, import all trained characters from another tool.





Button	Description
	Click this button to delete all the trained characters from the current library.
	Click this button to undo the last operation.

Button	Description
	
	<p>Click this button to import a font library from another OCR or OCV tool. To be able to import the font library from another tool, you must first export the library from that tool and save the font library to a file. Then, you can import the font library into the current tool.</p> <p> Note: If a tool is copied, its font library is also copied.</p>
	<p>Click this button to export the current library so that it can be imported elsewhere.</p>

Synthetic Character Control

Synthetic Character Control lets you view all the character patterns associated with a particular character ID. You can remove any one character pattern or all the character patterns associated with a character ID.



Button	Description
	Use this button to remove the currently viewed character pattern in the Entry field.
	Use this button to remove all the entries for the character pattern currently viewed in the Entry field.
	Use the arrows to cycle through the character patterns for a particular character ID.

7.5.10 Advanced Tab

Use the up and down arrow controls on the Time out field to change the inspection timeout in milliseconds.

-  **Note:** When the tool times out, it may have decoded part of the string before the time ran out. This partial decoding is reported back as the Decoded String. In OCV, whenever a timeout occurs, it is considered NO MATCH even if the returned Decoded String matched Expected String.

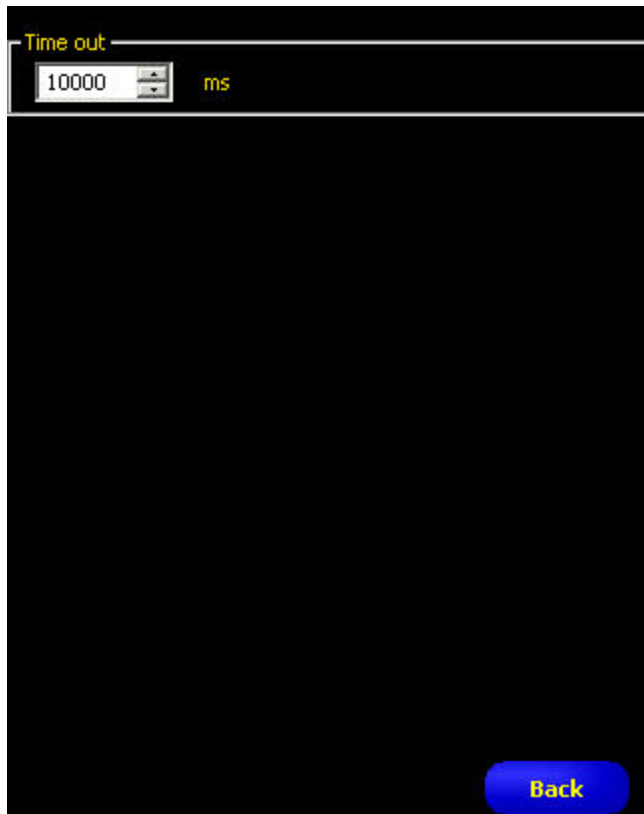

7.5.11 OCV Tool and the Remote Command Channel

Commands

Syntax	Description
set ocvtool <i>tool_name tool_number exp_string value</i>	Sets the expected string, if it is a constant. The Value should be a quoted string containing printable ASCII characters (see Character Strings on page 327).
get ocvtool <i>tool_name tool_number exp_string</i>	Gets the value of the expected string.

Examples

Set Command Example Assuming that you have two OCV tools, `my_ocv_tool_1` and `my_ocv_tool_2`, each with their first operand configured as a constant. To set the constant of the second ocvtool to foobar, issue the following command:

```
set ocvtool my_ocv_tool_2 "foobar"
or
```

```
set ocvtool 2 "foobar"
```

Get Command Example

To get the constant of the second ocvtool, issue the following command:

```
get ocvtool my_ocv_tool_2
or
get ocvtool 2
```

7.6 Analysis Tools

Analysis tools analyze the information gathered with the Vision tools to create measurements and tolerances for the Vision tools.

Analysis Tools

Location Tools	ProII Color	ProII/ProII 1.3	OMNI Color	OMNI/OMNI 1.3	AREA/AREA/B	EDGE/EDGE 1.3	GEO/GEO 1.3	BCR/BCR 1.3
Coordinate Tool on page 259	Yes	Yes	Yes	Yes	No	No	No	No
Communication Tool on page 244	Yes	Yes	Yes	Yes	Yes	Yes	Yes	Yes
Math Tool on page 263	Yes	Yes	Yes	Yes	Yes	Yes	Yes	Yes
Measure Tool on page 268	Yes	Yes	Yes	Yes	Yes	Yes	Yes	Yes
String Tool on page 290	Yes	Yes	Yes	Yes	No	No	No	Yes
Test Tool on page 297	Yes	Yes	Yes	Yes	Yes	Yes	Yes	Yes

7.6.1 Communication Tool

The Communication tool is used to conditionally export data from the Sensor to an external device. Results from Vision tools can be selected by the Communication tool and exported to an external device. The Sensor can export data over the Ethernet or via its serial channels.

Examples of exported results

- Execution times
- Whole-number counts
- Input and output values from a Test tool
- Success from Locate and Test tools
- Reference point-to-edge and rotation distances

Fields

The following are fields on the Communication tool Input tab:

- *Select* on page 246
- *Connections* on page 246
- *Format* on page 247
- *Output Filter* on page 247
- *Guidelines for Configuring the Communication Tool* on page 247

Supported Platforms

ProII Color	ProII/ProII 1.3	OMNI Color	OMNI/OMNI 1.3	AREA/AREA13	EDGE/EDGE 1.3	GEO/GEO 1.3	BCR/BCR 1.3
Yes	Yes	Yes	Yes	Yes	Yes	Yes	Yes

Communication Tool Input Tab

Adding a Communication Tool

Important: Add the Communication tool after the Vision tools that have data to be exported.

The Communication tool can export results data from the first Location, Vision, Analysis, and Test tools as follows:

- In the sequence that the tools are selected within the Communication tool.
- In the sequence that the options are listed within the tools for export

One inspection can have more than one Communication tool.

Use one Communication tool to:

- Export data out of one port (serial or Ethernet).
- Export identical data out of multiple ports at the same time.

Use multiple Communication tools to:

- Separate the data and export separate segments to unique external devices.
- Customize the order of the exported data.
- Export data from the Vision tools at different times during the inspection.
- Customize the “Start Strings” control characters to unique external devices.

 **Note:** The Test tool can have the Communication tool as one of its inputs. Therefore, if a Test tool is added after the Communication tool, a discrete output can be activated:

- If the TCP/IP connection is lost.
- If the external device fails to acknowledge it received data.

This output could contribute to an inspection Pass/Fail if it is an input to a Test tool. A Communication tool without a Test tool will not contribute to the inspection Pass/Fail.

Select

This field provides a drop-down list from which to select tools; select the results to export from the selected tool’s tab that appears in the configuration window.

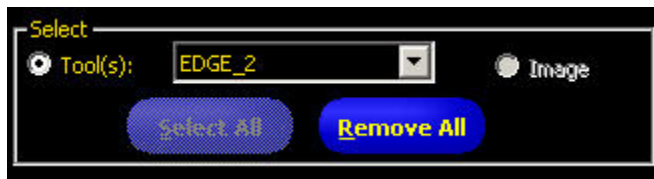

Connections

This field provides a drop-down list from which to select the communication connection(s) to export the data.

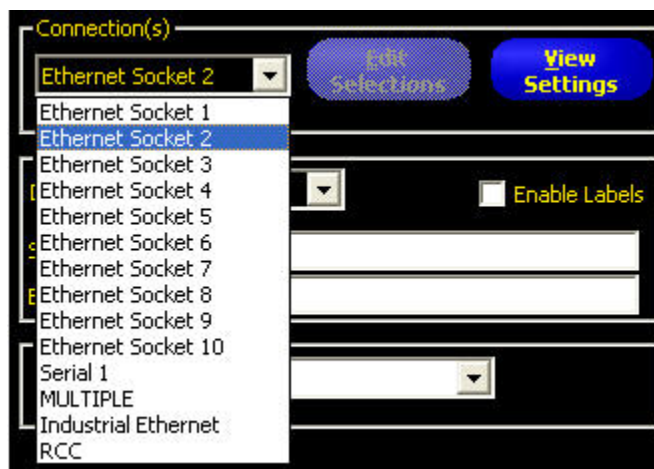

Format

This field provides options for formatting the ASCII string of data that will be exported.



Output Filter

This field provides a means to make specific output selections in order to avoid unwanted output information.



Guidelines for Configuring the Communication Tool

There are four main steps in configuring the Communication tool:

1. Select the Vision tools and their results to export (in the Select field).
 - When a tool is selected, the selected tool's tab appears in the Configuration window.
 - Click on the tab to select the data to be exported.
2. Select the communication connection(s) that will export the data (in the Connection field).
 - If MULTIPLE is chosen from the drop-down list, then click Edit Selections to select more than one port.
 - Click View Settings to display the configuration of the connection.
 - Data can be sent through 11 different communication connections: one connector for the serial connection, and 10 sockets (1 to 10) through the Ethernet connector.
 - The 10 Ethernet sockets are comprised of the Sensor IP address and port number. The table below lists the default Ethernet socket addresses.

Socket	Default IP Address	Port
1	192.168.0.1	20,000
2	192.168.0.1	20,001
3	192.168.0.1	20,002
4	192.168.0.1	20,003
5	192.168.0.1	20,004
6	192.168.0.1	20,005
7	192.168.0.1	20,006

Socket	Default IP Address	Port
8	192.168.0.1	20,007
9	192.168.0.1	20,008
10	192.168.0.1	20,009

- The serial port is the RS-232 connector (Pins 1, 9, and 10) on the Sensor. The default settings for the serial port are listed below.

Attribute	Default Setting
Baud Rate	115200
Data Bits	8
Parity	None
Stop Bit	1
Flow Control	None

3. Format the ASCII string of data (in the Format field).

- Choose a Delimiter and Start and End strings.
- Check the Enable Labels box to add the names for data being sent.

Allowable ASCII string options are shown below.

 **Note:** Start and End strings can now accept ASCII Hex values, and the following special characters: "\r", "\n", "\t".

Option Name	Values	Description
Delimiter	, <Comma> : <Colon> ; <Semicolon> \r\n <CR_LF> Carriage return and then line feed \n\r <LF-CR> Line feed then carriage return \r <CR> Carriage return only \n <LF> Line feed only	The delimiter is used to separate the individual pieces of data being sent. The delimiter will follow every individual segment of data, including start string and end string.
Start String	User-defined ASCII characters (limit of 75 characters)  Note: ASCII Hex characters are allowed. Special symbols such as \r, \n, and \t will cause a carriage return, new line, and tab to be output respectively.	This option is a mechanism for adding characters before a string of data.

Option Name	Values	Description
End String	User-defined ASCII characters (limit of 75 characters)  Note: ASCII Hex characters are allowed. Special symbols such as \r, \n, and \t will cause a carriage return, new line, and tab to be output respectively.	This option is a mechanism for adding characters after a string of data.
Enable Labels	Parameter labels	Check this box to add a label to the data before the data itself. Example: Dark Count = 3, where "Dark Count=" is the label.

4. Set conditions for conditionally exporting the selected data (in the Output Filter field).

- Select **Pass** to export the selected information on a passing Test tool.
- Select **Fail** to export the selected information on a failing Test tool.

Communication Tool Exportable Results

The Communication tool sends out the data in the same sequence that the tools appear in the inspection, and the result of transmitting this data will increase the inspection time.

The following shows the data sent out for each Communication tool.

Result	Value	Description
Success	1 = The connection is valid, and data will be sent.	Checks the connection (Ethernet only).
Execution time	Given in ms.	Processing time for the Sensor to send the data out.

The table below shows the format of the data.

Result*	Number	Format	Example
Point (X,Y)	Decimal	(0.00, 00.00)	(23.41, 156.52)
Distance	Decimal	00.00	99.00
Count	Whole	0	4

* Available data is tool and model-dependent.

Location Tools

- [Communication Tool Exportable Results: Locate Tool](#) on page 250
- [Communication Tool Exportable Results: Geometric Find Tool](#) on page 250
- [Communication Tool Exportable Results: Pattern Find Tool](#) on page 251

Gray Scale Tools

- [Communication Tool Exportable Results: Blob Detect Tool](#) on page 251
- [Communication Tool Exportable Results: Edge Tool](#) on page 252
- [Communication Tool Exportable Results: Geometric Count Tool](#) on page 252
- [Communication Tool Exportable Results: Object Tool](#) on page 253

- [Communication Tool Exportable Results: Pattern Count Tool](#) on page 253

Color Tools

- [Communication Tool Exportable Results: Average Color Tool](#) on page 254
- [Communication Tool Exportable Results: Color Blob Tool](#) on page 254
- [Communication Tool Exportable Results: Color Match Tool](#) on page 254

Premium Tools

- [Communication Tool Exportable Results: Barcode Tool](#) on page 255
- [Communication Tool Exportable Results: Bead Tool](#) on page 255
- [Communication Tool Exportable Results: OCR Tool](#) on page 256
- [Communication Tool Exportable Results: OCV Tool](#) on page 257

Analysis Tools

- [Communication Tool Exportable Results: Math Tool](#) on page 257
- [Communication Tool Exportable Results: Measure Tool](#) on page 257
- [Communication Tool Exportable Results: String Tool](#) on page 258
- [Communication Tool Exportable Results: Test Tool](#) on page 258

Communication Tool Exportable Results: Locate Tool

Data Label	Value	Description
Tool Name	string	User-defined name
Success	1 or 0	1 = Tool executed successfully 0 = Tool did not find a point to use as a reference
Execution Time	ms	Fastest recorded tool processing time since the start of the inspection or since power-up.
Execution Time Min	ms	Fastest recorded tool processing time for the current inspection or since power-up.
Execution Time Max	ms	Slowest recorded tool processing time since the start of the inspection or since power-up.
Edge Offset Point	pixels (X, Y)	Distance from the reference edge to the current edge.
Edge Location Point	pixels (X, Y)	X, Y coordinates of the current edge.
Rotation	degrees	Amount of rotation from the current edge to the reference edge.
Rotation Origin	pixels (X, Y)	X, Y coordinates of the point from which ROIs will rotate.

Communication Tool Exportable Results: Geometric Find Tool

Data Label	Value	Description
Tool Name	string	User-defined name
Success	1 or 0	1 = Tool executed successfully 0 = Tool did not find a point to use as a reference
Execution Time	ms	Tool processing time for the current inspection.
Execution Time Min	ms	Fastest recorded tool processing time since the start of the inspection or since power-up.

Data Label	Value	Description
Execution Time Max	ms	Slowest recorded tool processing time since the start of the inspection or since power-up.
Rotation Origin	pixels (X, Y)	X, Y coordinates of the point from ROIs will rotate.
Best Match Rotation	degrees	Rotational value of the first pattern found.
Best Match Location Point	pixels (X, Y)	X, Y coordinates of the first pattern found.
Best Match %	20-100%	Percent match of the first pattern found.

Communication Tool Exportable Results: Pattern Find Tool

Data Label	Value	Description
Tool Name	string	User-defined name
Success	1 or 0	1 = Tool executed successfully 0 = Tool did not find a point to use as a reference
Execution Time	ms	Tool processing time for the current inspection.
Execution Time Min	ms	Fastest recorded tool processing time since the start of the inspection or since power-up.
Execution Time Max	ms	Slowest recorded tool processing time since the start of the inspection or since power-up.
Match Acceptance Level Range Min	20 - 100%	Minimum percent the current pattern must match the reference pattern to be considered a match.
Match Acceptance Level Range Max	20 - 100%	Maximum percent the current pattern must match the reference pattern to be considered a match.
Rotation Origin	pixels (X,Y)	X, Y coordinates of the point from which ROIs will rotate.
First Match Rotation	degrees	Rotational value of the first pattern found.
First Match Location Point	pixels (X, Y)	X,Y coordinates of the first pattern found.
% Match of First Pattern Found	15 - 100%	Percent match of the first pattern found.

Communication Tool Exportable Results: Blob Detect Tool

Data Label	Value	Description
Tool Name	string	User-defined name
Execution Time	ms	Tool processing time for the current inspection.
Execution Time Min	ms	Fastest recorded tool processing time since the start of the inspection or since power-up.
Execution Time Max	ms	Slowest recorded tool processing time since the start of the inspection or since power-up.
Count	whole number	Number of Blobs found.
Total Area	pixels	Number of pixels when combining all Blobs found.
Largest Blob Area	pixels	Number of pixels in the largest Blob.

Data Label	Value	Description
Largest Location	pixels (X, Y)	Centroid of the largest Blob.
Smallest Blob Area	pixels	Number of pixels in the smallest Blob.
Smallest Location	pixels (X, Y)	Centroid of the smallest Blob.

Communication Tool Exportable Results: Edge Tool

Data Label	Value	Description
Tool Name	string	User-defined name
Execution Time	ms	Tool processing time for the current inspection.
Execution Time Min	ms	Fastest recorded tool processing time since the start of the inspection or since power-up.
Execution Time Max	ms	Slowest recorded tool processing time since the start of the inspection or since power-up.
Bright-to-Dark Count	whole number	Total number of bright-to-dark edges.
Dark-to-Bright Count	whole number	Total number of dark-to-bright edges.
Total Edge Count	whole number	Total number of all edges.
Location(s)	pixels (X, Y)	X, Y coordinates of all the edges found.

Communication Tool Exportable Results: Geometric Count Tool

Data Label	Value	Description
Tool Name	string	User-defined name
Success	1 or 0	1 = Tool executed successfully 0 = Tool did not find a point to use as a reference
Execution Time	ms	Tool processing time for the current inspection.
Execution Time Min	ms	Fastest recorded tool processing time since the start of the inspection or since power-up.
Execution Time Max	ms	Slowest recorded tool processing time since the start of the inspection or since power-up.
Match Count	whole number	Total number of patterns above the minimum acceptance level and below the maximum number of patterns.
Rotation Origin	pixels (X, Y)	X, Y coordinates of the point from ROIs will rotate.
Match Rotation	degrees	Rotational value of the first pattern found.
Best Match Location Point	pixels (X, Y)	X, Y coordinates of the first pattern found.
Best Match %	20-100%	Percent match of the first pattern found.

Communication Tool Exportable Results: Object Tool

Data Label	Value	Description
Tool Name	string	User-defined name
Execution Time	ms	Tool processing time for the current inspection.
Execution Time Min	ms	Fastest recorded tool processing time since the start of the inspection or since power-up.
Execution Time Max	ms	Slowest recorded tool processing time since the start of the inspection or since power-up.
Dark Count	whole number	Total number of dark objects.
Total Object Count	whole number	Total number of all objects.
Min Bright Object Width	pixels	Width of the smallest bright object found.
Max Bright Object Width	pixels	Width of the largest bright object found.
Min Dark Object Width	pixels	Width of the smallest dark object found.
Max Dark Object Width	pixels	Width of the largest dark object found.
Width(s)	pixels	Widths of all objects found.
Location(s)	pixels (X, Y)	Midpoint position of all the objects found.

Communication Tool Exportable Results: Pattern Count Tool

Data Label	Value	Description
Tool Name	string	User-defined name
Execution Time	ms	Tool processing time for the current inspection.
Execution Time Min	ms	Fastest recorded tool processing time since the start of the inspection or since power-up.
Execution Time Max	ms	Slowest recorded tool processing time since the start of the inspection or since power-up.
Match Count	whole number	Total number of patterns above the minimum acceptance level and below the maximum acceptance level.
Match Acceptance Level Range Min	20 - 100%	Minimum percent the current pattern must match the reference pattern to be considered a match.
Match Acceptance Level Range Max	20 - 100%	Maximum percent the current pattern must match the reference pattern to be considered a match.
Rotation Origin	pixels (X,Y)	X, Y coordinates of the point from which ROIs will rotate.
First Match Rotation	degrees	Rotational value of the first pattern found.
First Match Location Point	pixels (X, Y)	X,Y coordinates of the first pattern found.
% Match of Pattern(s) Found	15 - 100%	Percent match of the first pattern found.

Communication Tool Exportable Results: Average Color Tool

Data Label	Value	Description
Tool Name	string	User-defined name
Success	1 or 0	1 = Tool executed successfully 0 = Tool did not find a point to use as a reference
Execution Time	ms	Tool processing time for the current inspection.
Execution Time Min	ms	Fastest recorded tool processing time since the start of the inspection or since power-up.
Execution Time Max	ms	Slowest recorded tool processing time since the start of the inspection or since power-up.

Communication Tool Exportable Results: Color Blob Tool

Data Label	Value	Description
Tool Name	string	User-defined name
Success	1 or 0	1 = Tool overall results passed. 2 = Tool overall results failed.
Execution Time	ms	Tool processing time for the current inspection.
Execution Time Min	ms	Fastest recorded tool processing time since the start of the inspection or since power-up.
Execution Time Max	ms	Slowest recorded tool processing time since the start of the inspection or since power-up.
Threshold		
Threshold Min		
Threshold Max		
Count		
Areas		
Total Area	pixels	Total number of pixels in all the color Blobs.
Largest Blob Area	pixels	Number of pixels in the largest color Blob.
Largest Blob Location	pixels (X, Y)	Centroid of the largest color Blob.
Smallest Blob Area	pixels	Number of pixels in the smallest color Blob.
Smallest Blob Location	pixels (X, Y)	Centroid of the smallest color Blob.
Locations		

Communication Tool Exportable Results: Color Match Tool

Data Label	Value	Description
Tool Name	string	User-defined name

Data Label	Value	Description
Success	1 or 0	1 = Tool executed successfully 0 = Tool did not find a point to use as a reference
Execution Time	ms	Tool processing time for the current inspection.
Execution Time Min	ms	Fastest recorded tool processing time since the start of the inspection or since power-up.
Execution Time Max	ms	Slowest recorded tool processing time since the start of the inspection or since power-up.
Color Match Test Result		
Color Match Percent	%	
Match Percent Threshold	%	
Brightness	whole number	The grayscale brightness. This value ranges from 0 to 255.
Brightness Lower Limit	whole number	The grayscale brightness lower limit. This value ranges from 0 to 255.
Brightness Upper Limit	whole number	The grayscale brightness upper limit. This value ranges from 0 to 255.

Communication Tool Exportable Results: Barcode Tool

Data Label	Value	Description
Tool Name	string	User-defined name
Success		
Execution Time	ms	Tool processing time for the current inspection.
Execution Time Min	ms	Fastest recorded tool processing time since the start of the inspection or since power-up.
Execution Time Max	ms	Slowest recorded tool processing time since the start of the inspection or since power-up.
Max Time Exceeded		
Number Found	whole number	
Coordinates of Barcodes Found		
Barcode Type		
Symbol Type		
Number of Barcode Data Elements Read	whole number	
Barcode Data Read		
Barcode Read Status		
2-D Symbol Dimensions		

Communication Tool Exportable Results: Bead Tool

Data Label	Value	Description
Tool Name	string	User-defined name

Data Label	Value	Description
Success	1 or 0	1 = Tool overall results passed. 2 = Tool overall results failed.
Execution Time	ms	Tool processing time for the current inspection.
Execution Time Min	ms	Fastest recorded tool processing time since the start of the inspection or since power-up.
Execution Time Max	ms	Slowest recorded tool processing time since the start of the inspection or since power-up.
Threshold Used		
Minimum Width Found		
Maximum Width Found		
Average Width Found		
Number of Good Regions		
Total Length of Good Regions		
Good Region Lengths		
Longest Good Region Length		
Number of Narrow Regions		
Total Length of Narrow Regions		
Narrow Region Lengths		
Longest Narrow Region Length		
Number of Wide Regions		
Total Length of Wide Regions		
Wide Region Lengths		
Longest Wide Region Length		

Communication Tool Exportable Results: OCR Tool

Data Label	Value	Description
Tool Name	string	User-defined name
Success	1 or 0	1 = Tool overall results passed. 2 = Tool overall results failed.
Execution Time	ms	Tool processing time for the current inspection.
Execution Time Min	ms	Fastest recorded tool processing time since the start of the inspection or since power-up.
Execution Time Max	ms	Slowest recorded tool processing time since the start of the inspection or since power-up.
Max Time Exceeded		
String Read	string	
String Length	whole number	

Communication Tool Exportable Results: OCV Tool

Data Label	Value	Description
Tool Name	string	User-defined name
Success	1 or 0	1 = Tool overall results passed. 2 = Tool overall results failed.
Execution Time	ms	Tool processing time for the current inspection.
Execution Time Min	ms	Fastest recorded tool processing time since the start of the inspection or since power-up.
Execution Time Max	ms	Slowest recorded tool processing time since the start of the inspection or since power-up.
Max Time Exceeded		
String Read		
String Length		
OCV Result		
Expected String		

Communication Tool Exportable Results: Math Tool

Data Label	Value	Description
Tool Name	string	User-defined name
Success	1 or 0	1 = Tool overall results passed. 2 = Tool overall results failed.
Execution Time	ms	Tool processing time for the current inspection.
Execution Time Min	ms	Fastest recorded tool processing time since the start of the inspection or since power-up.
Execution Time Max	ms	Slowest recorded tool processing time since the start of the inspection or since power-up.
Output		

Communication Tool Exportable Results: Measure Tool

Data Label	Value	Description
Tool Name	string	User-defined name
Execution Time	ms	Tool processing time for the current inspection.
Execution Time Min	ms	Fastest recorded tool processing time since the start of the inspection or since power-up.
Execution Time Max	ms	Slowest recorded tool processing time since the start of the inspection or since power-up.
Distance	pixels	Total distance from the points selected for Tool One and Tool Two.î

Data Label	Value	Description
Distance X	pixels	Horizontal component (X) of the total distance.
Distance Y	pixels	Vertical component (Y) of the total distance.
Origin Point	pixels (X, Y)	X, Y coordinates of the origin point.
Measure Location Point 1	pixels (X,Y)	X,Y coordinates of the point selected for Tool One.
Measure Location Point 2	pixels (X,Y)	X,Y coordinates of the point selected for Tool Two.

Communication Tool Exportable Results: String Tool

Data Label	Value	Description
Tool Name	string	User-defined name
Success	1 or 0	1 = Tool overall results passed. 2 = Tool overall results failed.
Execution Time	ms	Tool processing time for the current inspection.
Execution Time Min	ms	Fastest recorded tool processing time since the start of the inspection or since power-up.
Execution Time Max	ms	Slowest recorded tool processing time since the start of the inspection or since power-up.
Max Time Exceeded		
Operand 1		
Operand 2		
Operation Result		

Communication Tool Exportable Results: Test Tool

Data Label	Value	Description
Tool Name	string	User-defined name
Success	1 or 0	1 = Tool overall results passed. 2 = Tool overall results failed.
Execution Time	ms	Tool processing time for the current inspection.
Execution Time Min	ms	Fastest recorded tool processing time since the start of the inspection or since power-up.
Execution Time Max	ms	Slowest recorded tool processing time since the start of the inspection or since power-up.
Input1	1, 0, or -1	1 = Input 1 results passed. 0 = Input 1 results failed. -1 = Input1 results not defined.

Data Label	Value	Description
Input2	1, 0, or -1	1 = Input 2 results passed. 0 = Input 2 results failed. -1 = Input2 results not defined.
Input3	1, 0, or -1	1 = Input 3 results passed. 0 = Input 3 results failed. -1 = Input3 results not defined.
Input4	1, 0, or -1	1 = Input 4 results passed. 0 = Input 4 results failed. -1 = Input4 results not defined.
Output	1 or 0	1 = Tool overall results passed. 0 = Tool overall results failed.

7.6.2 Coordinate Tool

The Coordinate tool takes coordinate values from different vision tools and combines them into a single output representing object x and y coordinates as well as a rotational offset from a default position defined in the inspection.

The Coordinate tool can accept x, y coordinates, and angle (Theta) data from any tool that produces locational information as part of the results:

- Locate tool
- Geometric Find tool
- Pattern Find tool
- Blob Find tool
- Blob Detect tool
- Color Blob tool
- Pattern Count tool
- Geometric Count tool
- Edge tool
- Object tool
- Barcode tool
- BCR tool
- Measure tool
- Math tool

 **Note:** The Coordinate tool also accepts user-defined constants for any of these values. Additionally, not all tools (for example, Barcode) produce angle data.

The Coordinate tool can be used with the PresencePLUS Remote Command Channel (RCC), which is used to interface and operate industrial robots.

Fields

The following are fields on the Coordinate tool Input tab:

- [Coordinate Tool Inputs](#) on page 260

Supported Platforms

ProII Color	ProII/ProII 1.3	OMNI Color	OMNI/OMNI 1.3	AREA/AREA13	EDGE/EDGE 1.3	GEO/GEO 1.3	BCR/BCR 1.3
Yes	Yes	Yes	Yes	No	No	No	No

Coordinate Tool Input Tab

Coordinate Tool

Input

Name:

Tool List Filter:

X - Coordinate

Tool:

Y - Coordinate

Tool:

Rotation (Degrees)

Tool:

Result

X Coordinate (px)	404.00
Y Coordinate (px)	115.00
Angle (Degrees)	-20.93

Coordinate Tool Inputs

Tool List Filter

The Tool List Filter helps to limit the input data available for x,y coordinates and angle data. From the drop-down, select either of the following:

- **Absolute**—this is the default, and enables x and y location data as well as angle information from any tools that provide this data.
- **Offset Only**—which enables the selection of location offsets of x and y coordinates and angle data from location tools.



X - Coordinate

From the drop-down list of available tools that provide x and y coordinate data, select a tool or, to enter a constant value, select CONSTANT.

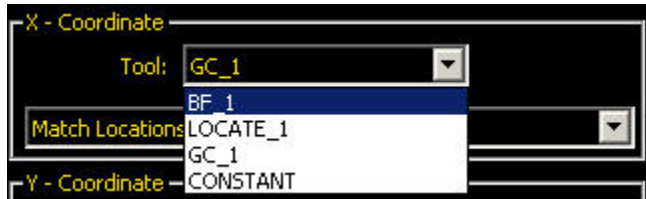

Select x or y coordinate information for that tool.

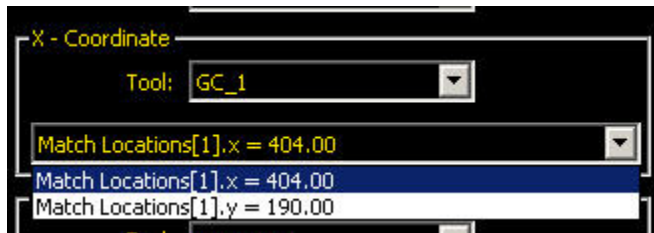

Y - Coordinate

From the drop-down list of available tools that provide x and y coordinate data, select a tool or, to enter a constant value, select CONSTANT.

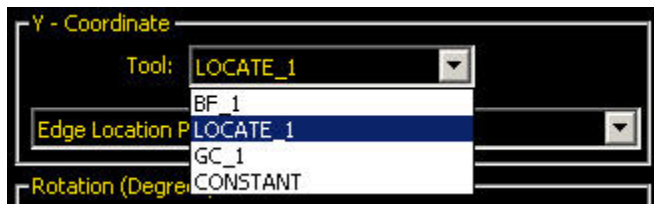

Select x or y coordinate information for that tool.

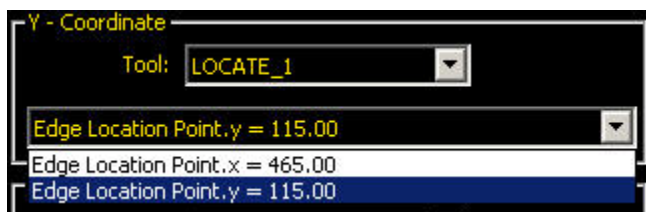

Rotation (Degrees)

From the drop-down list of available tools that provide angle data, select a tool or, to enter a constant value, select CONSTANT.

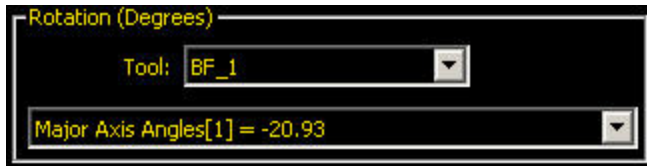

Result

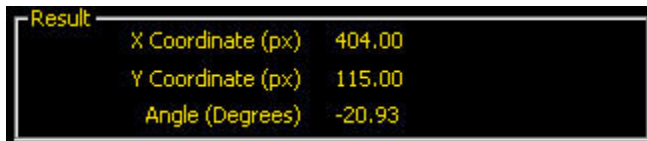

Coordinate Tool and the Remote Command Channel (RCC)

The Coordinate tool can be used with the PresencePLUS RCC to interface with industrial robots. The RCC can get or set x,y coordinates, angle information, or the entire set of Coordinate tool data:

- get *coordinate_tool_identifier* returns all the Coordinate tool outputs separated by the field delimiter and bounded by start and end frame delimiters (as configured for the RCC).
- get coordtool *coordinate_tool_identifier* [x | y | angle] returns the specified Coordinate tool output.
- set coordtool *coordinate_tool_identifier* [x | y | angle] sets value for the specified input.

 **Note:** The *coordinate_tool_identifier* can be a tool name or a tool number.

Examples

Set Command Example Assuming that you have two Coordinate tools, *my_coord_tool_1* and *my_coord_tool_2*, to set the x coordinate of the second coordtool to 50, issue the following command:

```
set coordtool my_coord_tool_2 x 50

or

set coordtool 2 x 50
```

Get Command Example To get the constant of the second coordtool, issue the following command:

```
get coordtool my_coordtool_tool_2 x

or

get coordtool 2 x
```

7.6.3 Math Tool

The Math tool provides basic arithmetic, inequality expressions, and statistical information for PresencePLUS inspections. In general, the Math tool takes one or more pieces of information from Vision tools and makes mathematical expressions out of them. The results of the Math tool's analysis are displayed in the Result windows at the bottom of the screen.

The inputs to the Math tool are called Operands. The Operation is the mathematical expression used to analyze the Operands.

Fields

The following are fields on the Math tool Input tab:

- [Math Tool Modes](#) on page 264
- [Use of Constants](#) on page 267
- [Results](#) on page 267

Supported Platforms

ProII Color	ProII/ProII 1.3	OMNI Color	OMNI/OMNI 1.3	AREA/AREA13	EDGE/EDGE 1.3	GEO/GEO 1.3	BCR/BCR 1.3
Yes	Yes	Yes	Yes	Yes	Yes	Yes	Yes

Math Tool Input Tab



Math Tool Modes

One Operand Operation

There is only one operation that requires a single Operand--Absolute Value. This Operator requires the user to provide only one Operand.

One Operand Functions

abs Abs (Absolute value) returns $Abs(X_1)$.

The absolute value of an operand is its unsigned magnitude. For example, $Abs(-1.5)$ and $Abs(1.5)$ both return 1.5

Two Operand Operations

Two Operand Operations require two inputs (Operand 1 and Operand 2). For each operand, you specify:

- the vision tool (or a constant)

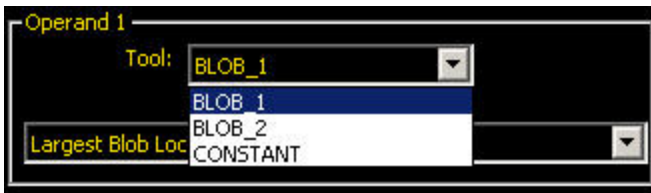

- a specific attribute of interest for that tool.

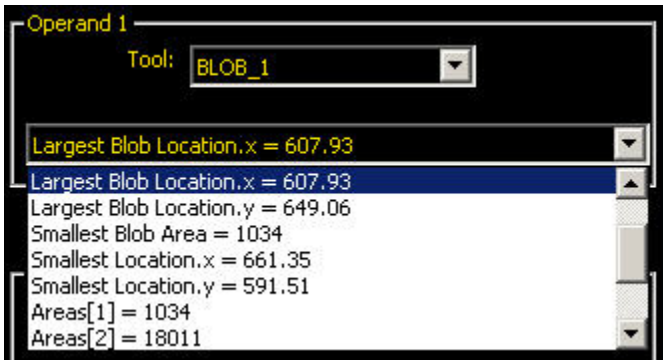

The following are classified as Two Operand Operations:

- Add
- Subtract
- Multiply
- Divide
- Greater Than
- Greater Than Equal To
- Less Than
- Less Than Equal To
- Equal To
- Diff
- Mod
- Div

Arithmetic Operations

Add	Returns $(X_1 + X_2)$
Subtract	Returns $(X_1 - X_2)$
Multiply	Returns $(X_1 * X_2)$
Divide	Returns (X_1 / X_2)

Relational Operations

Greater Than	If $(X_1 > X_2)$ returns True, else False.
Greater Than or Equal To	If $(X_1 >= X_2)$ returns True, else False.
Less Than	If $(X_1 < X_2)$ returns True, else False.
Less Than or Equal To	If $(X_1 >= X_2)$ returns True, else False.
Equal To	If $(X_1 = X_2)$ returns True, else False.

If the output of relational operation is used as an input for another Math Tool, True interpreted as 1 and False interpreted as 0.

Two Operand Functions

Diff (Difference)	Returns $Abs(X_1 - X_2)$. Returns the difference - absolute value of the difference between two operands.
Mod (Modulus)	Returns $Mod(X_1 / X_2)$. The modulus, or remainder, operator divides operand1 by operand2 and returns the remainder.
Div (Integer Division)	Returns $Div(X_1 \div X_2)$. Returns the integer part of division, remainder is discarded.

Multiple Operand Operations

Multiple Operand Operations allow the user to make a long list of input data. All of these pieces of information are inputs to the selected Operation.

For example, select Min as the Operation, and select an input tool. A tab is created for the input tool. Click on this tab to specify the attribute(s) of the vision tool that will be the Operands. Multiple tools can contribute multiple Operands to the list as shown in the examples below.

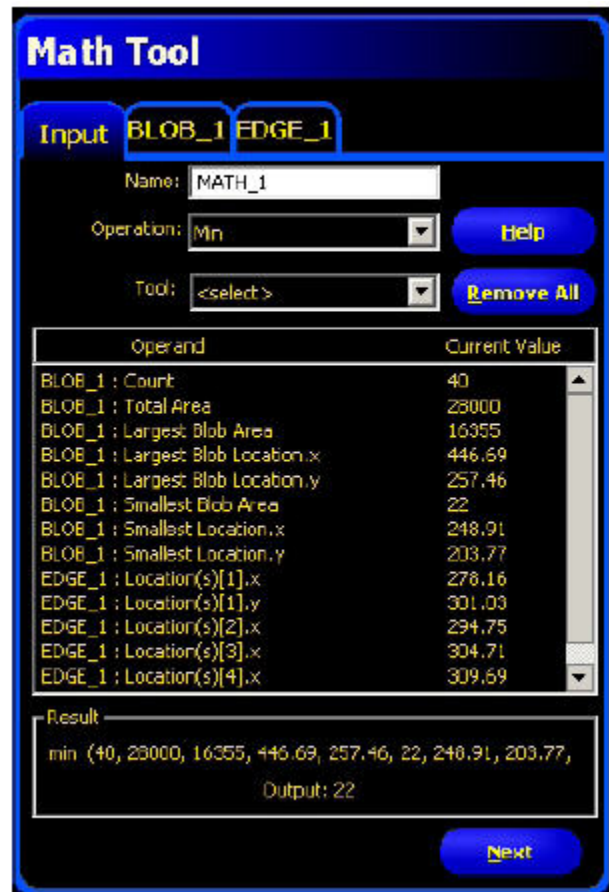
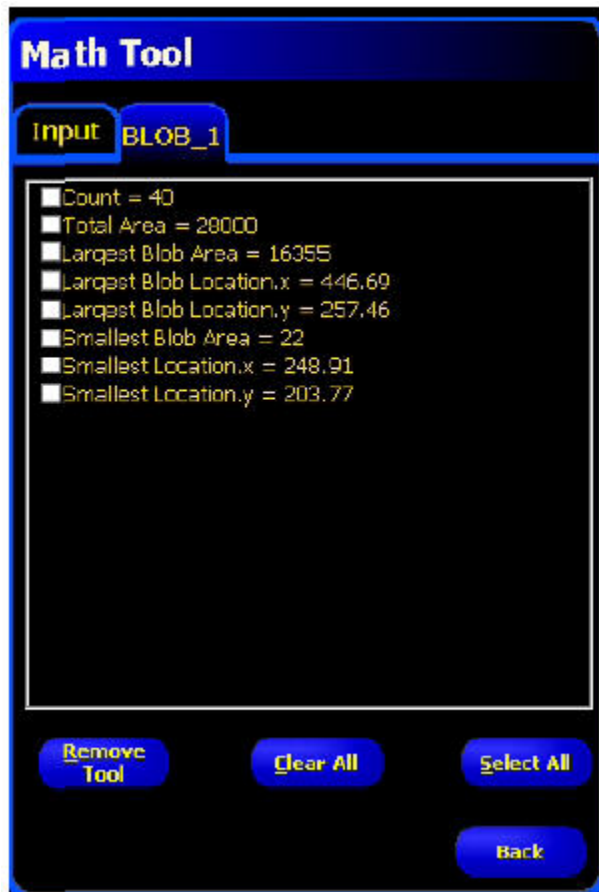

Math tool outputs can be sent out via a Communications tool and/or used as an input to a Test tool (or another Math tool).

Multiple Operand Functions

Min (Minimum)	Returns Min (X_1, X_2, \dots, X_n). Returns the operand with the lowest value.
Max (Maximum)	Returns Max (X_1, X_2, \dots, X_n). Returns the operand with the highest value.
Count	Returns Count (X_1, X_2, \dots, X_n). Returns the count of operands.
Sum	Returns Sum (X_1, X_2, \dots, X_n). Returns the arithmetic sum of operands.
Mean	Returns $\text{Sum} (X_1, X_2, \dots, X_n) \div \text{Count} (X_1, X_2, \dots, X_n)$. Returns the mean value of operands.
Median	The statistical median is middle number of a group of numbers that have been arranged in order by size. If there is an even number of terms, the median is the mean of the two middle numbers.
StdDev (Standard Deviation) and Variance	The standard deviation and variance are measures of how spread out operands values are.

Use of Constants

In general, a user-defined constant can be selected as one of the Operands for the Math tool. This allows for a number of things, including scaling the output of a vision tool in real units (by dividing that output by a known conversion factor). Along the same lines, dynamic scaling of outputs is also possible by dividing one Operand by another and then multiplying by a constant conversion factor. In this case, two Math tools would be used: one set for Division, the other for Multiplication. The output of the first Math tool would be an Operand for the second Math tool.

Results

The output of the math operation selected for the inputs is displayed in the results area of the Math tool Input tab.

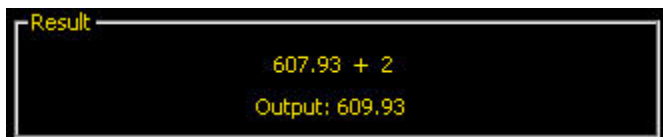

Math Tool and the Remote Command Channel (RCC)

Syntax	Description
set mathtool <i>tool_name tool_number value operand_1 operand_2</i>	Sets the specified tool operand, if it is a constant. Value should be a floating number.
get mathtool <i>tool_name tool_number operand_1 operand_2</i>	Gets the value of the specified tool operand, if it is a constant.

Examples

Set Command Example

Assuming that you have two Math tools, `my_math_tool_1` and `my_math_tool_2`, each with their first operand configured as a constant. To set the constant of the second mathtool to 100.5, issue the following command:

```
set mathtool my_math_tool_2 operand_1 100.5

or

set mathtool 2 operand_1 100.5
```

Get Command Example

To get the constant of the second mathtool, issue the following command:

```
get mathtool my_math_tool_2 operand_1

or

get mathtool 2 operand_1
```

7.6.4 Measure Tool

Measure tool can be used to measure distance, calculate angles, and create points and lines for use as inputs to other Measure Tools.

There are three Measure Tool operations:

- Measure from a point to a point
- Intersect two lines
- Measure from a line to a point
- Measure a curve to a point
- Measure a curve to a line

In these operations, points are generated by a variety of vision tools and lines are created by Coordinate tools, Line Detect tools, or other Measure tools.

Usage

- Determine the location of a Blob
- Determine the distance between Blobs
- Determine a distance between a Blob and a closest point on a bead
- Determine a distance between a Blob and a farthest point on a bead

Fields

The following are fields on the Measure tool Input tab:

- [Measure Tool Operations](#) on page 269
- [Measurement Type](#) on page 277

Supported Platforms

ProII Color	ProII/ProII 1.3	OMNI Color	OMNI/OMNI 1.3	AREA/AREA13	EDGE/EDGE 1.3	GEO/GEO 1.3	BCR/BCR 1.3
Yes	Yes	Yes	Yes	Yes	Yes	Yes	Yes

Measure Tool Input Tab

Measure Tool

Input **LOCATE_2** **COORD_1**

Name: MT_1

Operation: Measure Point to Point

Options

Absolute Relative

Preserve Sign

Tool One...

LOCATE_2

... to Tool Two

COORD_1

Result

Distance (px)	45.73
Distance X (px)	-45.73
Distance Y (px)	0.00
Angle (Degrees)	180.00
Midpoint Location (Pixels)	x=145.42, y=323.26

Next

Measure Tool Operations

Measure from a Point to a Point

In this operation, the distance between two points is calculated. In addition, the X and Y components of that distance calculation are returned.

Along with distance, the following results are generated in this operation:

- A line from point 1 to point 2
- The angle of that line (relative to the x-axis)
- The midpoint of point 1 and point 2

Intersect Two Lines

In this operation, the results of the intersection of two lines is generated. These results are:

- The angle of intersection between the two lines, measure from line 1 to line 2.
- The intersection point

Measure from a Line to a Point

In this operation, the software calculates the distance between a line and a point. This is the shortest distance from the line to the point, and is generated by creating a line perpendicular to the original line that intersects the point. In addition, it returns the distance calculations for the X and Y component.

Additionally, the following results are generated in this operation:

- The perpendicular line, which goes from the line to the point
- The angle of that line (relative to the x-axis)
- The intersection point between the original line and the perpendicular line

Measure from a Curve to a Point

This operation is available if a Bead Tool has been added to the inspection prior to the particular instance of the Measure Tool being edited. In this operation, the software calculates the distance between a curve and a point. This measurement can be from either the closest or the farthest point on the curve, and is selected in the Bead tab in the Measure Tool.

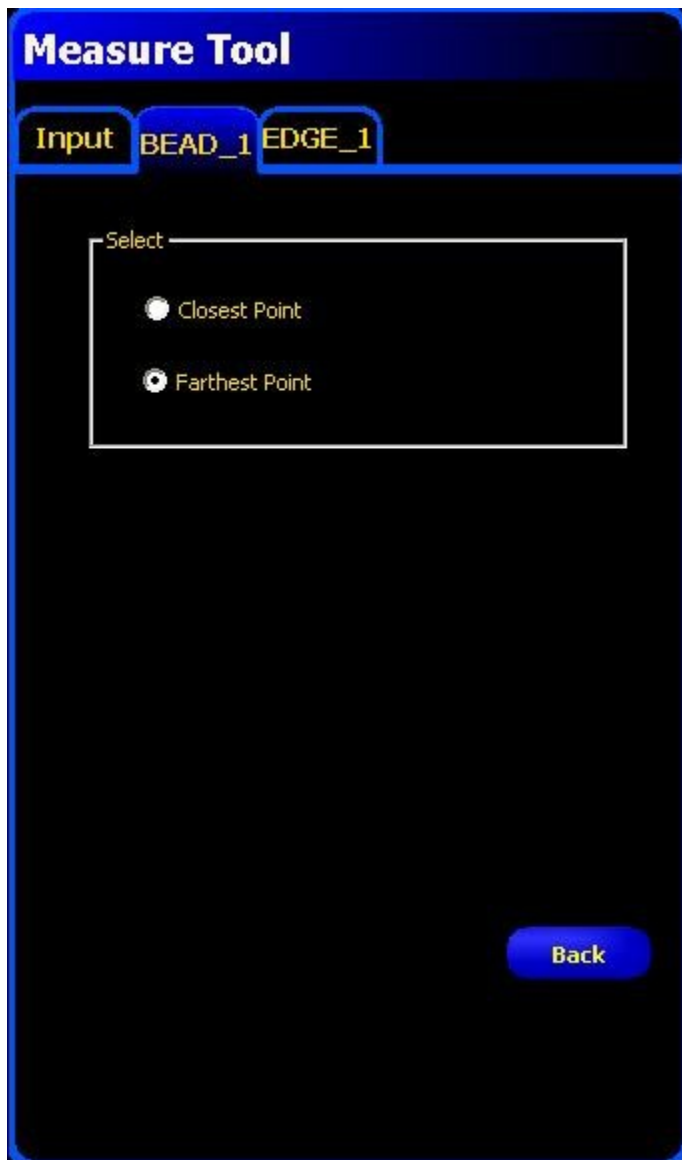

The curve, drawn in purple over the image of the bead, is an artifact generated by the bead tool. It shows the computed center spine of the bead detected by the Bead Tool within its ROI.

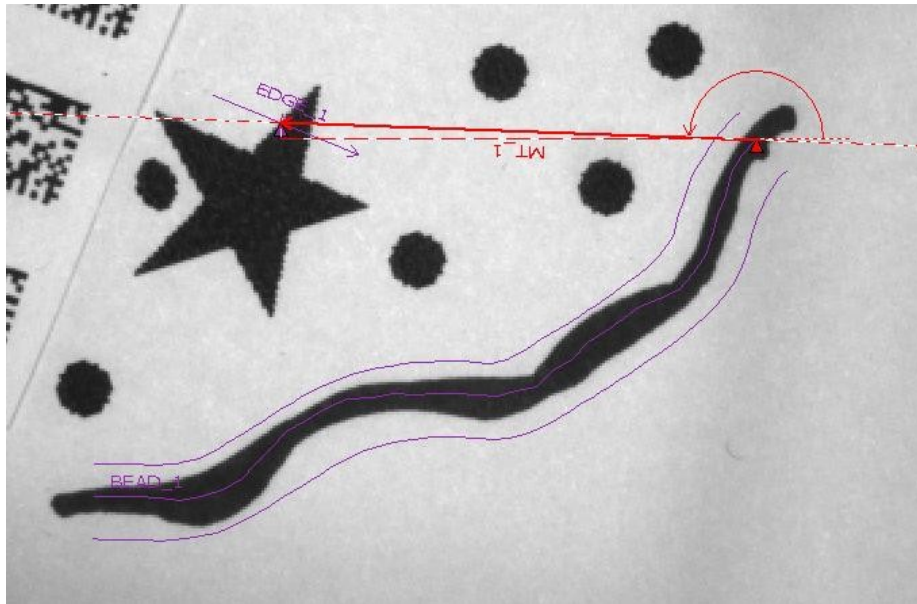

The tool returns the distance calculations for the X and Y component.

Additionally, the following results are generated in this operation:

- The line connecting the two points
- The angle of that line (relative to the x-axis)
- The coordinates of the selected (farthest or closest) point on the curve

Measure from a Curve to a Line

This operation is available if a Bead Tool has been added to the inspection prior to the particular instance of the Measure Tool being edited. In this operation, the software calculates the distance between a curve and a line produced by other Measure Tool.

This measurement is made from either the closest or the farthest point on the curve. It is the shortest distance from the line to the selected point, and is generated by creating a line perpendicular to the original line that intersects the selected point on the curve. The points are selected in the Bead tab in the Measure Tool.

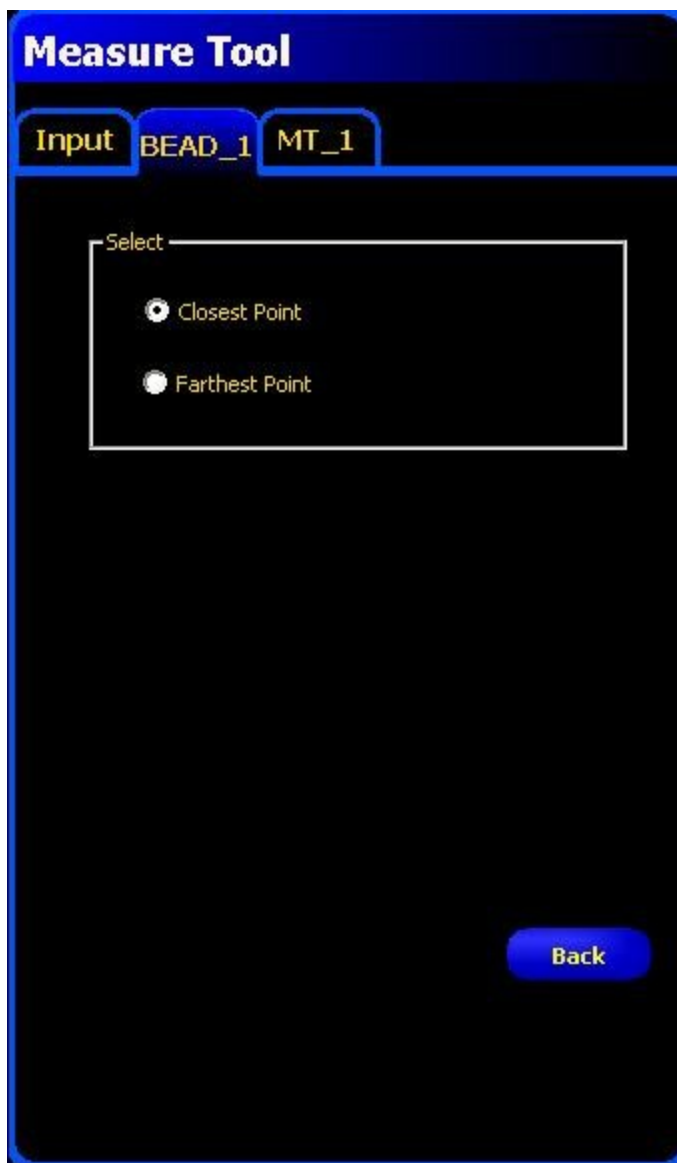

The curve, drawn in purple over the image of the bead, is an artifact generated by the bead tool. It shows the computed center spine of the bead detected by the Bead Tool within its ROI.

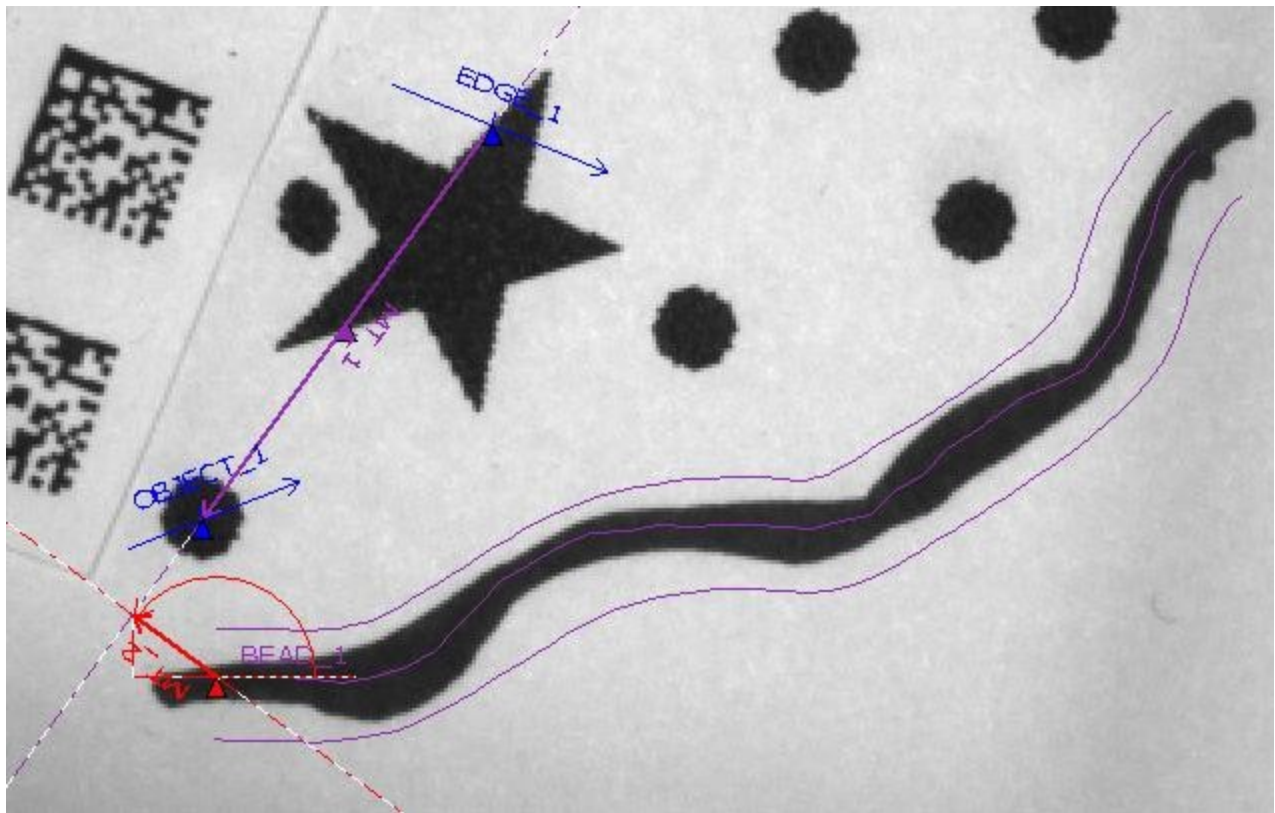

The tool returns the distance calculations for the X and Y component.

Additionally, the following results are generated in this operation:

- The line connecting the curve and the selected line
- The angle of that line (relative to the x-axis)
- The coordinates of the selected (farthest or closest) point on the curve

Conventions of the Measure Tool

The Measure tool reports an angle associated with every line it finds, according to the following conventions:

- For the line defined by two points, the tool measures the angle between the line and the horizontal axis. The tool assigns a positive or negative value to the angle, depending on the line's direction. Angles are positive if measured clockwise and negative if measured counterclockwise.

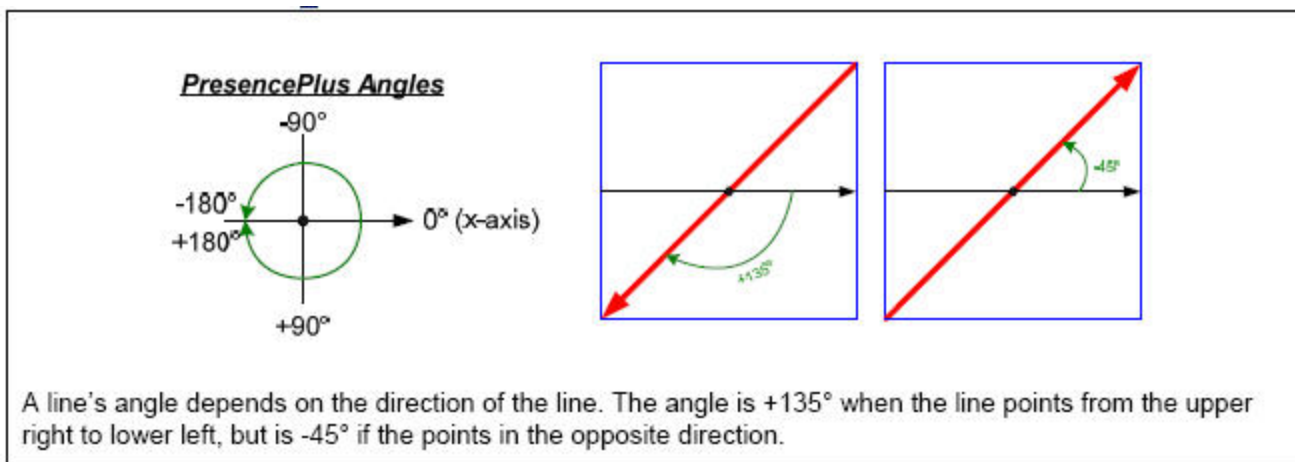

- When defining the angle between two lines, the Measure tool takes into account the order of the tool inputs. The sign of the angle from Line 1 to Line 2, for example, differs from the sign of the angle from Line 2 to Line 1. The tool detects the intersection point of two lines. Even if they intersect outside the viewable FOV (field of view), the resulting angle between the 2 lines is correct, and the intersection point created can be passed into other Measure tools for distance or other measurements. Note that the X or Y coordinates of the point in this case may be negative.

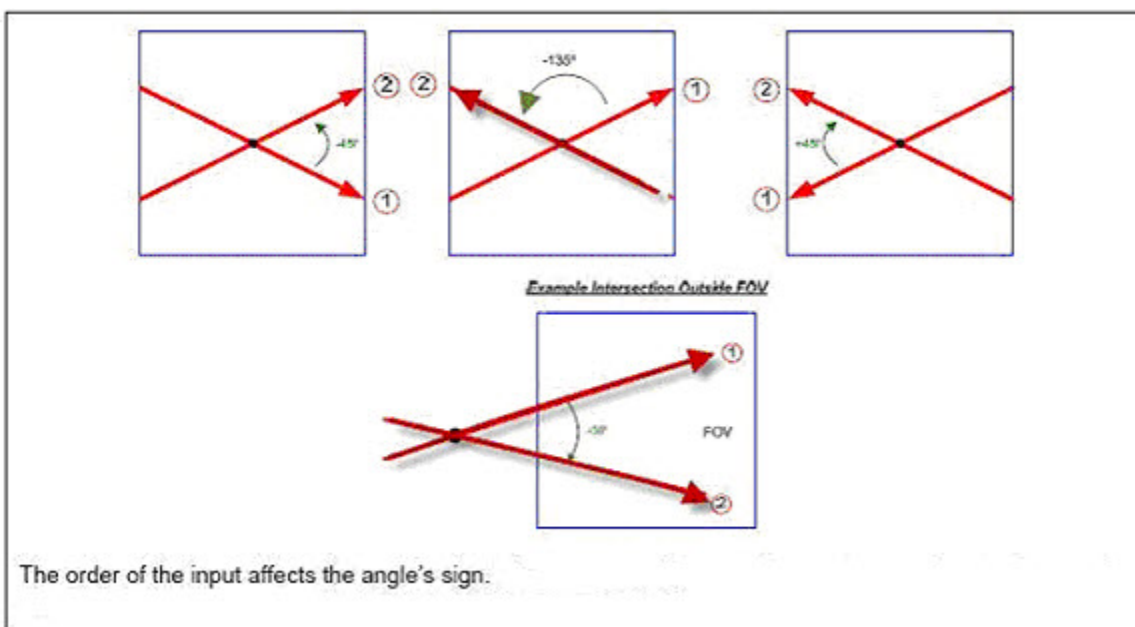

How the Tool Measures Two Points

The inputs to the Measure tool for measuring two points are any two points that vision tools generate. These can be an Edge transition, a Blob centroid, or a Geo pattern. The results include the total distance between the points and the x- and y-component distances. In addition to finding these distance values, the Measure tool also calculates the line between the two endpoints. The software reports the angle between this line and the camera's horizontal plane, as well as the coordinates for the line's midpoint.

As shown below, the Measure tool window shows the settings and results of the inspection. In the inspection image, the two points Edge_1 and Edge_2 define the dashed red line that runs from top left to bottom right. The actual measured distance between the points is the solid line labeled MT_1, and the solid red triangle is the line's midpoint. MT_1's direction is the direction of the measurement operation: from Edge_1 to Edge_2.

The two shorter dashed lines represent the x- and y-components. The angle between MT_1 and the horizontal plane is the curved clockwise arrow. In the Results section of the Measure Tool window, this angle is listed as +53.11 degrees.

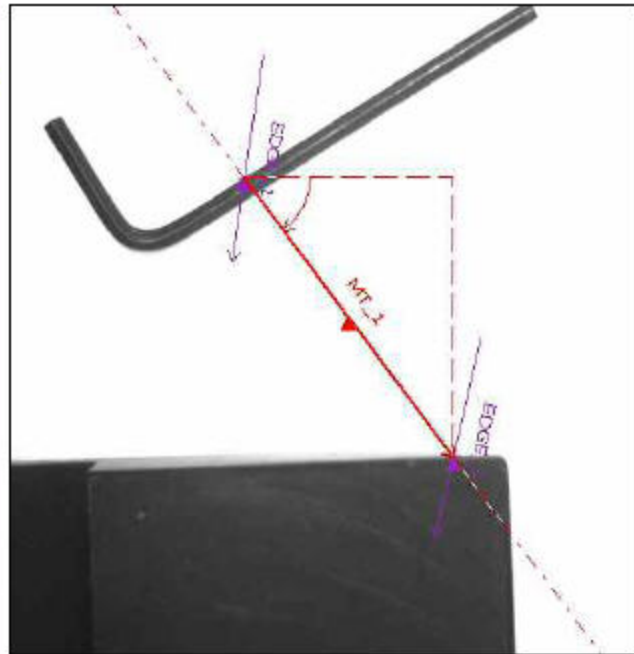
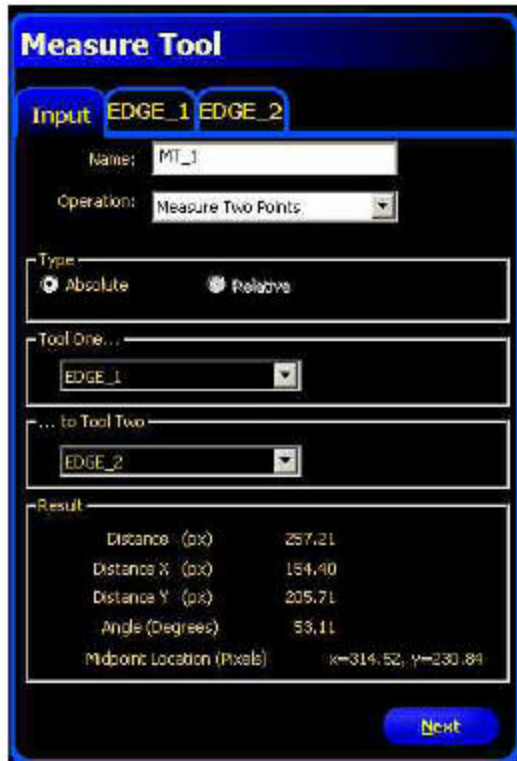

How the Tool Measures Two Lines

This mode finds the angle between two lines. Both inputs are existing Measure tools. The order in which these tools are input does matter.

The intersection point can well be off the screen. This angle gives the ability to measure two lines for parallelism.

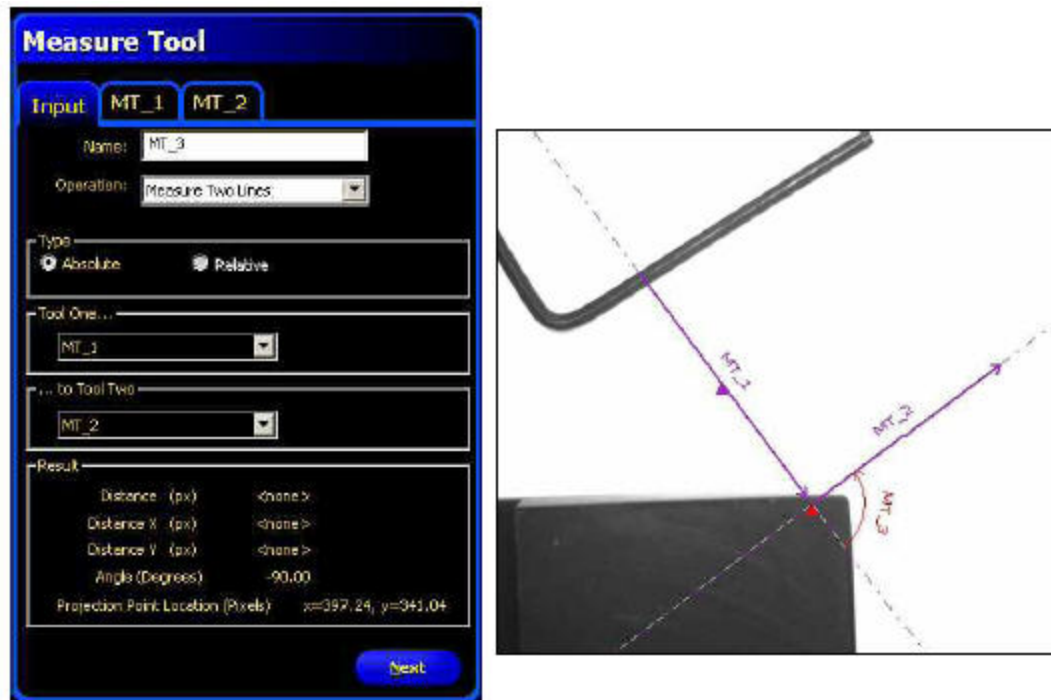

The Measure tool window to the left shows the settings and results of the inspection to the right.

The inputs are both existing Measure tools (MT_1 and MT_2). The output, called MT_3, is the angle between the lines of each of the inputs. MT_3 is a curved counterclockwise arrow from the first input, MT_1, towards the arrowhead of the second input, MT_2. The Results section of the measure Tool window lists this angle a -90.00 degrees. The only other piece of information reported is the intersection point of the two best fit lines, marked by a solid red triangle.

How the Tool Measures a Line and a Point

This mode finds the shortest distance between a point and a line. The two inputs to the Measure tool are:

- any point a vision tool generates
- any line another measure tool generates.

The shortest distance between a line and a point lies along another line. This new line is perpendicular to the original line, as shown below.

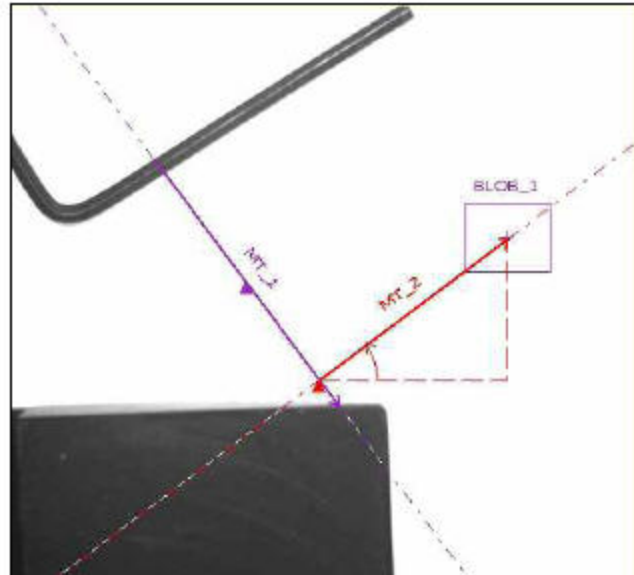
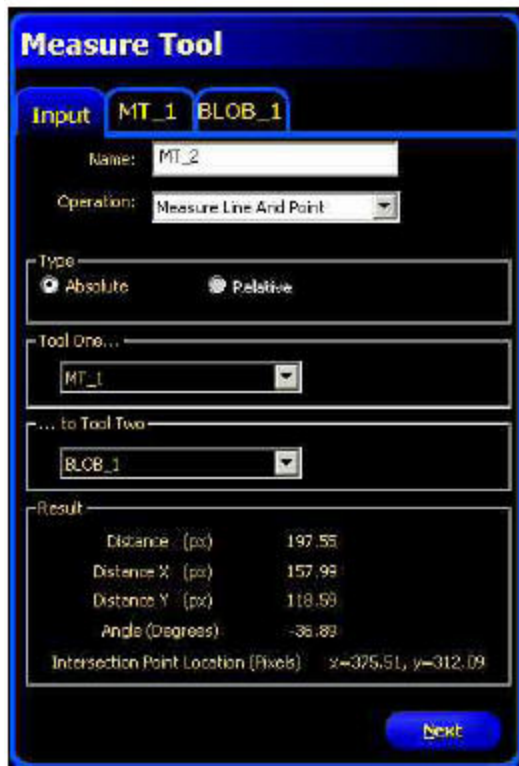

The Measure tool window to the left shows the settings and results of the inspection to the right.

In the Inspection image, the center point of BLOB_1 and the nearest point in the input line MT_1 define the dashed red line that runs from bottom left to top right. The actual measured distance between BLOB_1 and MT_1 is labeled MT_2. The solid red triangle shows where MT_1 and MT_2 intersect. The Results section of the Measure Tool window lists the distance between the intersection point and the Blob midpoint as 197.55 pixels.

The two shorter dashed lines represent the x- and y-components. The angle between MT_2 and the horizontal plane is the curved counterclockwise arrow. In the Results section of the Measure Tool window, this angle is listed as -36.89 degrees.

Measurement Type

The PresencePLUS software can perform all three Measure tool operations using the default Absolute type or the alternate Relative type. The types differ in how the Rotation Enable feature of a one of the Location tools—Locate, Geometric Find, and Pattern Find—affect the Measure tool.



Absolute

When the measurement type is set to Absolute, the x- and y-components of the measured distance use the absolute, or fixed, coordinate system of the camera's field of view (FOV). If a rotation enabled Location tool precedes the Measure tool in the order of operation (that is, if the Location tool is to the left of the Measure tool in the Navigation/Results window), then the x- and ycomponent values and the angle of the line change as rotation occurs.

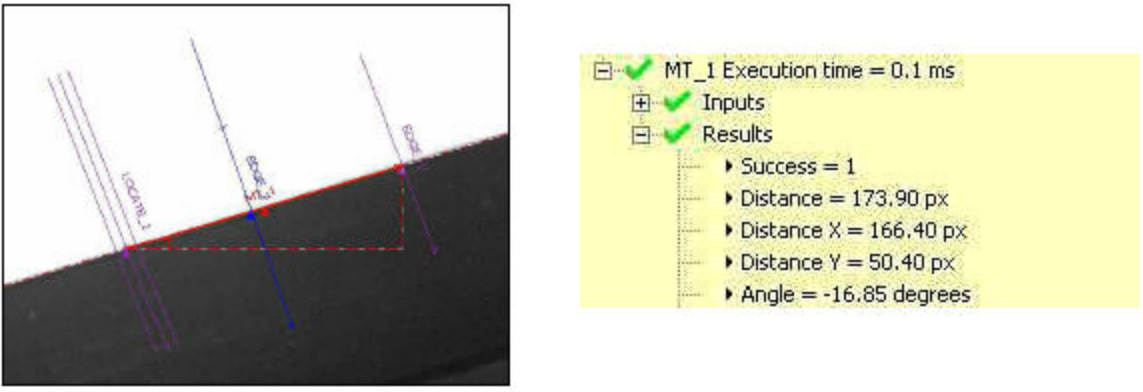

The screenshot shows a dark, slanted surface with several blue lines representing measurement tools. A red dashed line indicates the measurement path. The results panel on the right is highlighted in yellow and contains the following data:

```

MT_1 Execution time = 0.1 ms
Inputs
Results
  Success = 1
  Distance = 173.90 px
  Distance X = 166.40 px
  Distance Y = 50.40 px
  Angle = -16.85 degrees

```

The inspection on the left shows a rotation-enabled Location tool followed by a pair of Edge tools. The results of an Absolute measurement are on the right.

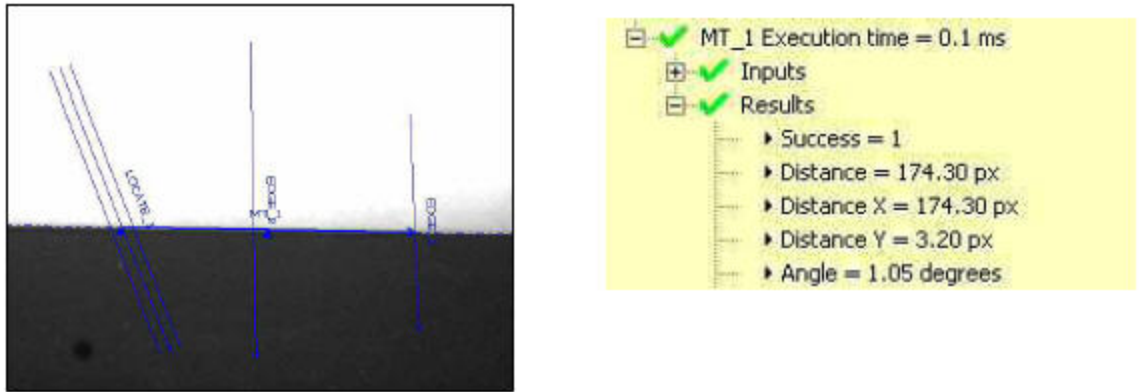

The screenshot shows the same dark surface as above, but now rotated. The blue lines representing measurement tools are now vertical. The results panel on the right is highlighted in yellow and contains the following data:

```

MT_1 Execution time = 0.1 ms
Inputs
Results
  Success = 1
  Distance = 174.30 px
  Distance X = 174.30 px
  Distance Y = 3.20 px
  Angle = 1.05 degrees

```

The part rotated. The x- and y-components and the angle of the measurement change, but the total distance remains the same.

Relative

For the Measurement type to be set to Relative, a Location-type tool must precede the Measure tool in the order of operation. When the user selects the Relative type, the window indicates to what Locate tool the measurement is relative.

The coordinate system of the Measure tool changes based on the rotation information the Location-type tool provides. The x- and y-components and the angle of the measurement remain constant even if the part rotates in the camera's FOV. The relative Measure tool is relative to the rotation-enabled Locate tool. The part has rotated, but the x- and y-distances and the angle of the line are largely unaffected.

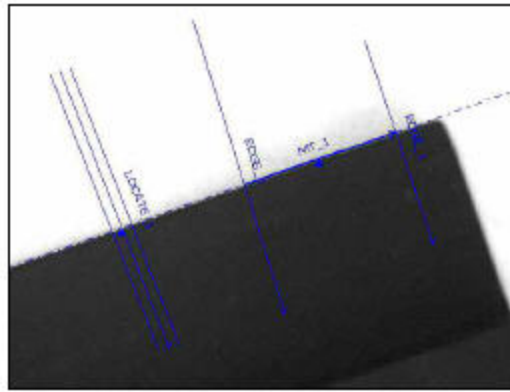

The relative Measure tool is relative to the rotation-enabled Locate tool.

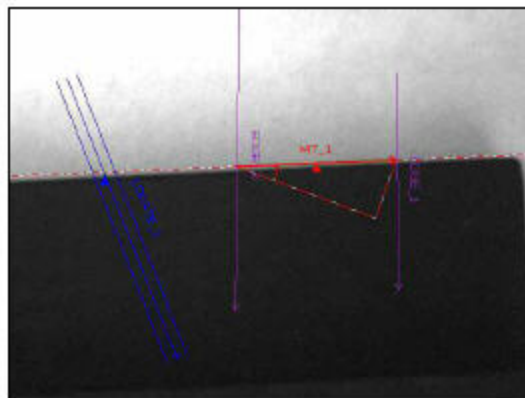

The part has rotated, but the x- and y-distances and the angle of the line are largely unaffected.

Preserve Sign

When this checkmark is set, the X and Y distances are computed as distance offsets. These distance offsets are represented by signed numbers. Negative numbers mean distance offset is toward the origin (0,0), positive numbers mean distance offset is away from origin.

Additional Measure Tool Tabs

Measure Tool Locate Tab

Use the drop-down list to select either to Measure From the Reference Point or the Current Point. Click [Measure Tool](#) on page 268 for more information about the Measure tool.

Locate Tab

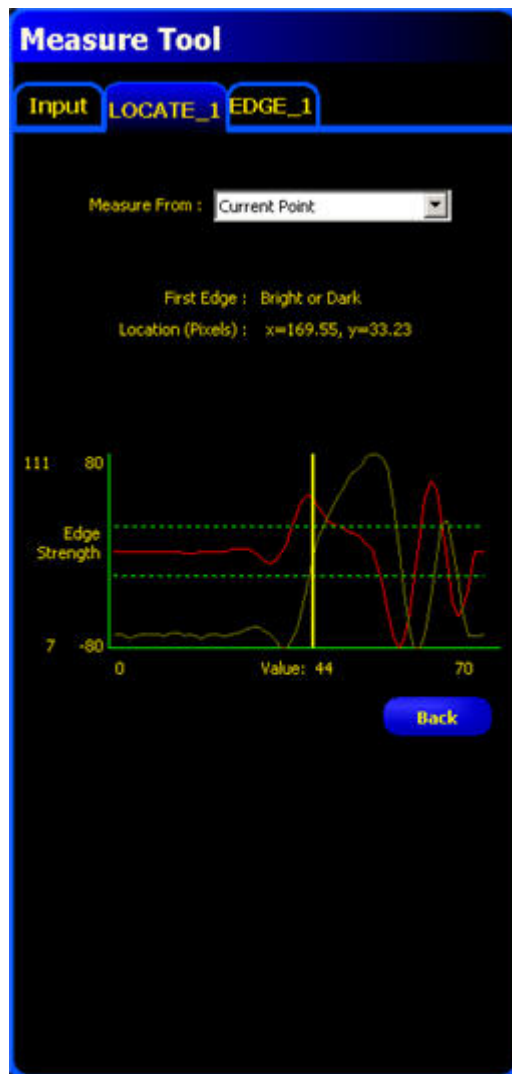

Measure Tool Geometric Find/Count Tab

On the Geometric Find tab, use the drop-down list to select either to Measure From the Reference Point or the Current Point.

On the Geometric Count tab, use the up or down arrow keys to select the Barcode to measure to. Click [Measure Tool](#) on page 268 for more information about the Measure tool.

Geometric Find and Geometric Count Tabs

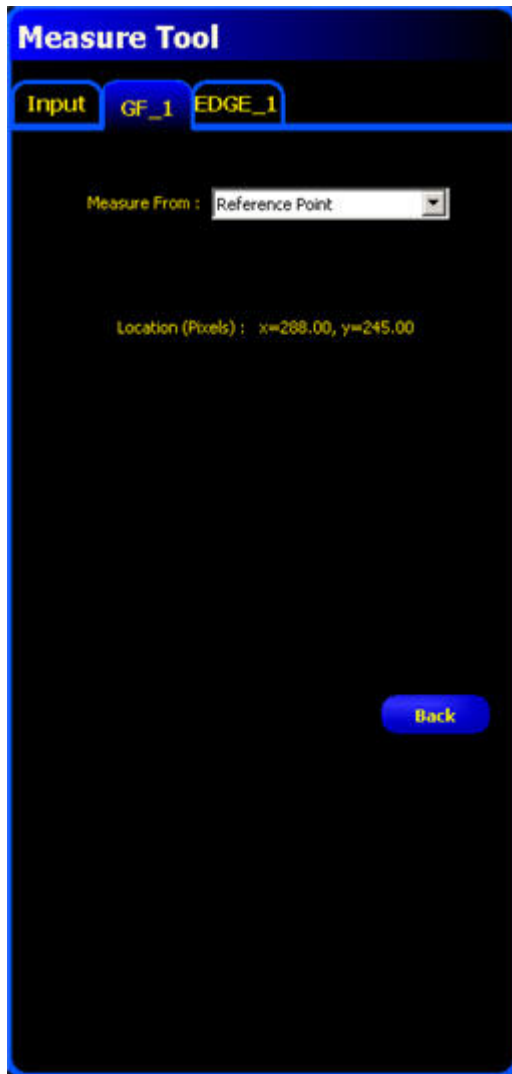

Geometric Count Tab

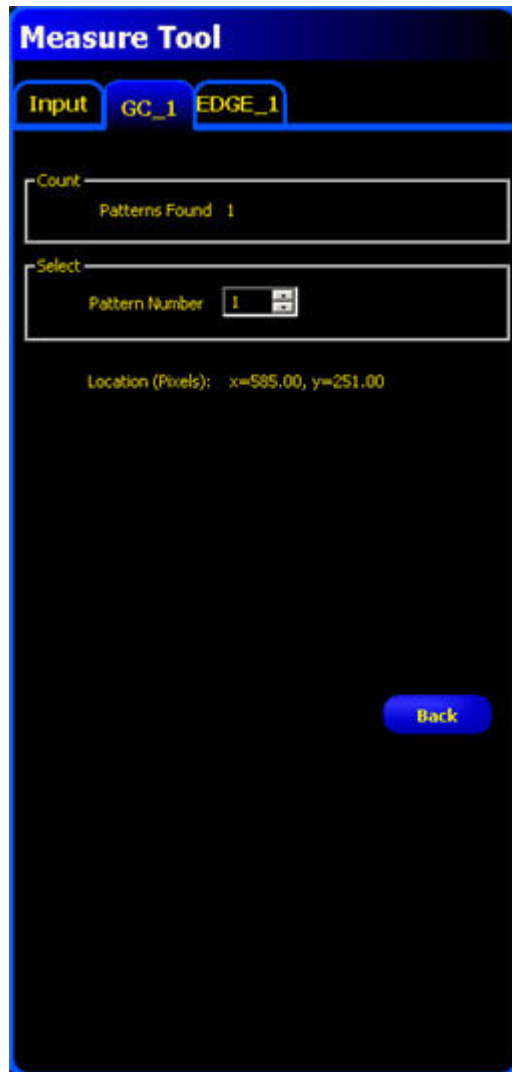

Measure Tool Pattern Find/Count Tab

On the Pattern Find tab, use the drop-down list to select either to Measure From the Reference Point or the Current Point.

The Pattern Count tab shows the location of the Pattern Location used in the measurement. Click [Measure Tool](#) on page 268 for more information about the Measure tool.

Pattern Find and Pattern Count Tabs

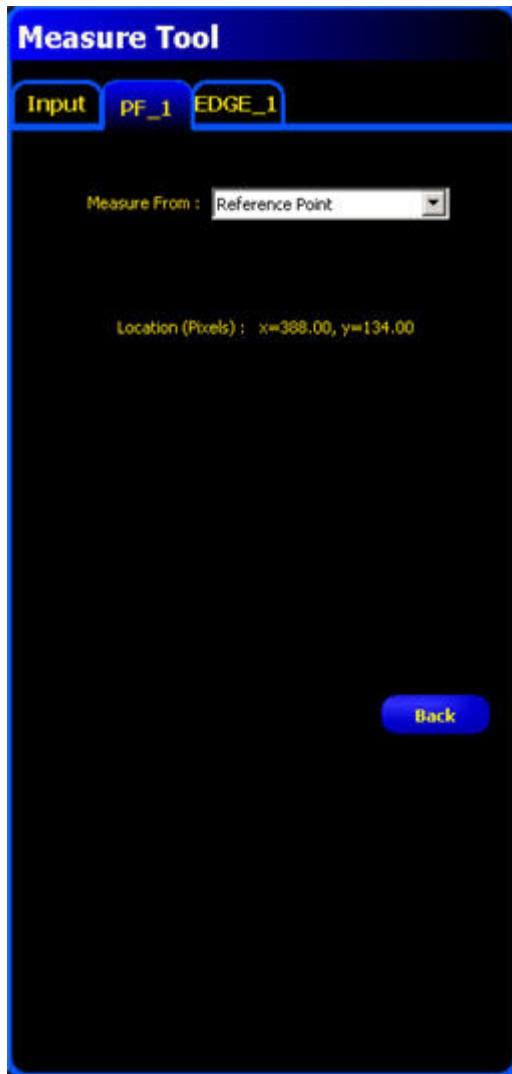

Pattern Count Tab

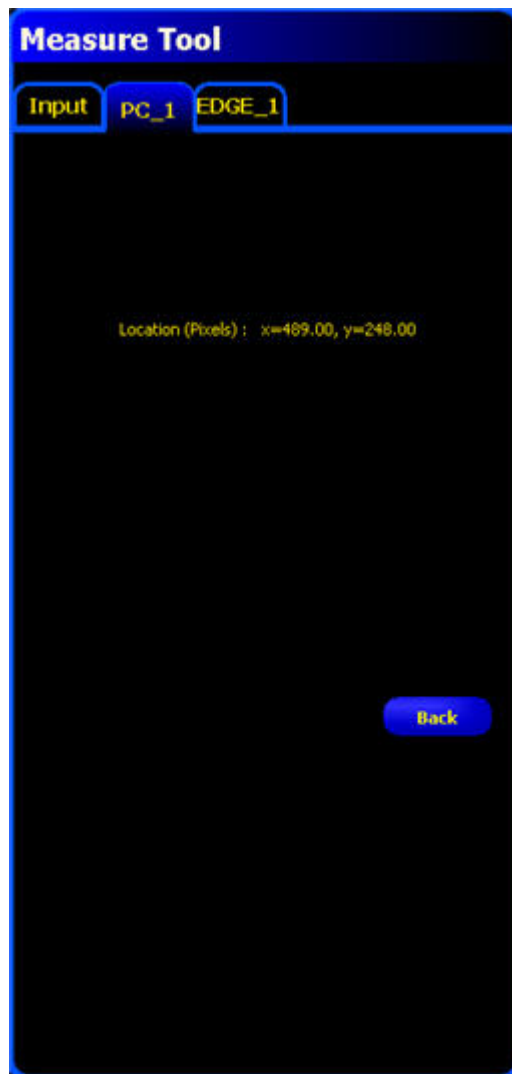

Measure Tool Blob and Color Blob Tab

From the dropdown list select the Blob #, Smallest or Largest Blob to measure to. Click [Measure Tool](#) on page 268 for more information about the Measure tool.

Blob or Color Blob Tab

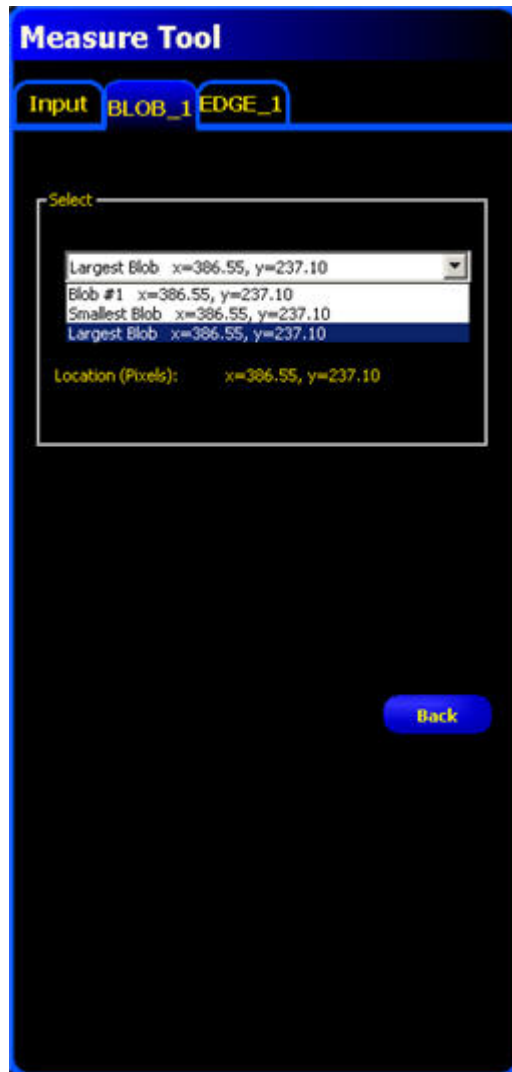

Measure Tool Circle Tab

The Circle tab for the selected Circle tool displays the coordinates of the circle center. Click [Measure Tool](#) on page 268 for more information about the Measure tool.

Circle Tab

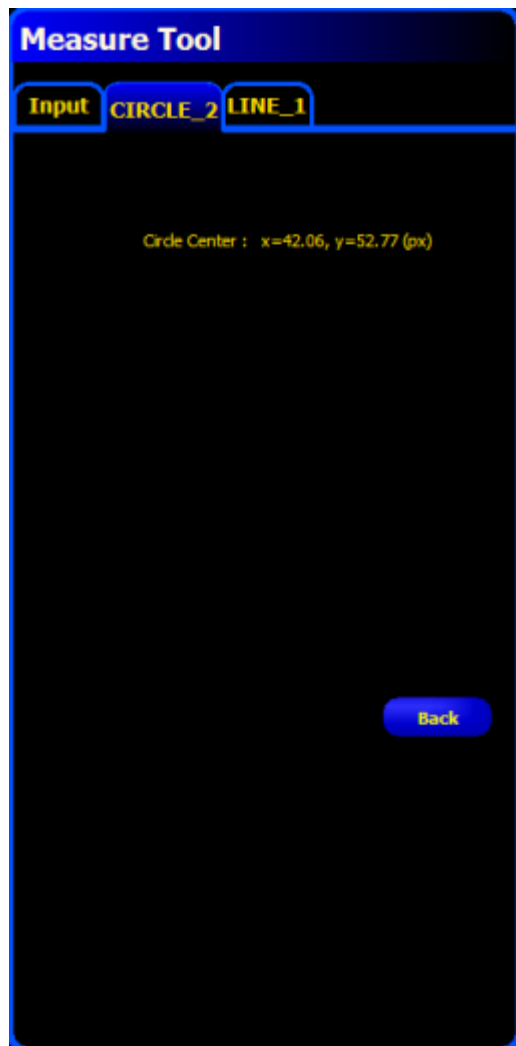

Measure Tool Edge Tab

Use the up or down arrow keys to select the Edge Number to measure to. Click [Measure Tool](#) on page 268 for more information about the Measure tool.

Edge Tab

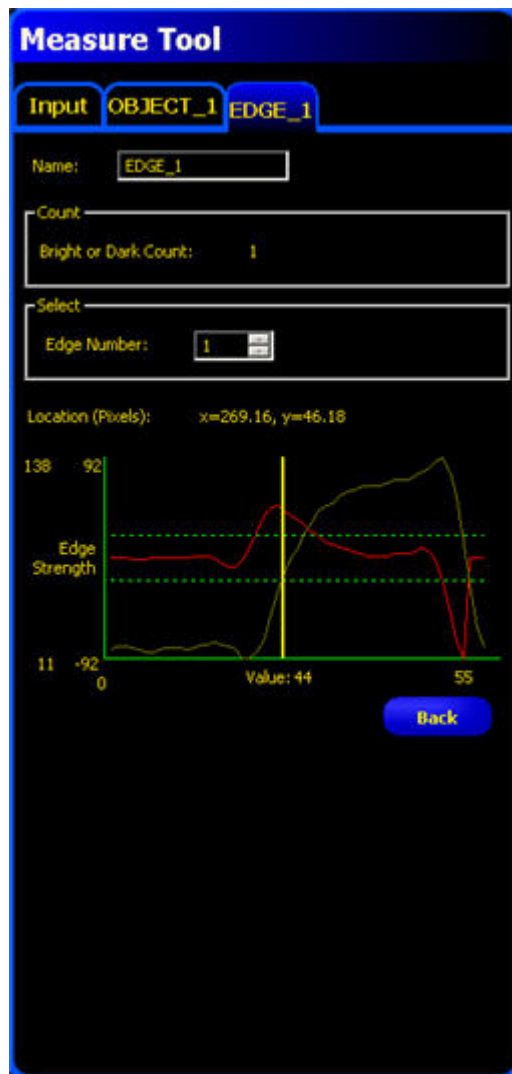

Measure Tool Line Tab

From the drop-down list, select one of the following to display the coordinates of the specific location:

- Midpoint
- Start Point
- End Point

Click [Measure Tool](#) on page 268 for more information about the Measure tool.

Line Tab

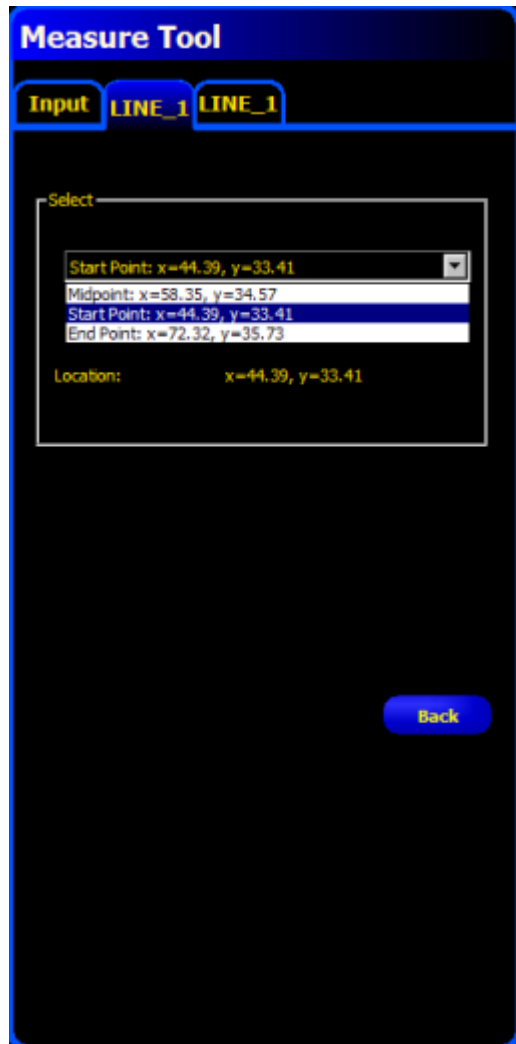

Measure Tool Object Tab

Use the up and down arrow keys to select the Object Number to use as a point to measure to. Click [Measure Tool](#) on page 268 for more information about the Measure tool.

Object Tab

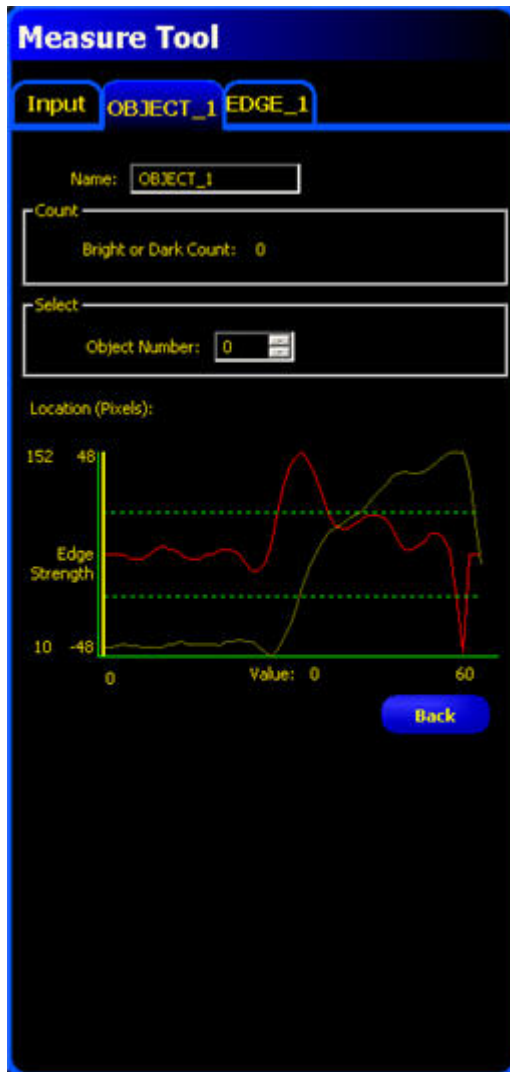

Measure Tool Barcode Tab

Use the up or down arrow keys to select the Barcode to measure to. Click [Measure Tool](#) on page 268 for more information about the Measure tool.

Barcode Tab

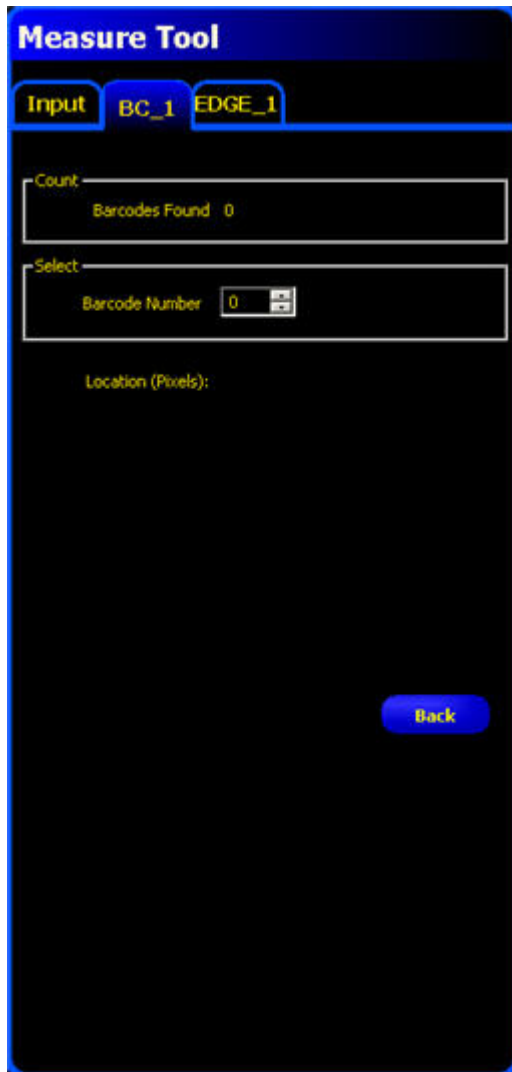

7.6.5 String Tool

String tool can be used to compare barcode and/or OCR strings with one and other, with Industrial protocol inputs, or with constants.

Fields

The following are fields on the String tool Input tab:

- *Operation Field* on page 291
- *Operand 1 Field* on page 292
- *Operand 2 Field* on page 292
- *Result Field* on page 293

Supported Platforms

ProII Color	ProII/ProII 1.3	OMNI Color	OMNI/OMNI 1.3	AREA/AREA13	EDGE/EDGE 1.3	GEO/GEO 1.3	BCR/BCR 1.3
Yes	Yes	Yes	Yes	No	No	No	Yes

String Tool Input Tab

Operation Field

There are three options you can select from the **Operation** drop-down list on the String tool Input tab:

- String Compare
- Masked String Compare
- Find Substring

Operation Option	Description
String Compare	Select String Compare from the drop-down list to compare the strings that you select in the <i>Operand 1 Field</i> on page 292 and <i>Operand 2 Field</i> on page 292 fields.

Operation Option	Description
Masked String Compare	If you select Masked String Compare, then the string defined in <i>Operand 2 Field</i> on page 292 must be a constant defined in the field or retrieved from Industrial Ethernet.
Find Substring	If you select Find Substring from the drop-down list, then the String tool will determine if the string specified in <i>Operand 1 Field</i> on page 292 is in the string defined in <i>Operand 2 Field</i> on page 292.

Operand 1 Field

Use the drop-down list in Operand 1 to select the first string for the comparison operation. The options are:

- one or more strings decoded by OCR tools (for example OCR_1, OCR_2, etc.)
- Barcode tools
- CONSTANT
- Industrial Ethernet



Operand 2 Field

Use the drop-down list in Operand 2 to select the first string for the comparison operation. The options depend on what you select for an *Operation Field* on page 291. If you select String Compare or Find Substring, then the options are:

- one or more strings decoded by OCR tools (for example OCR_1, OCR_2, etc.)
- Barcode tools
- CONSTANT
- Industrial Ethernet

If you select Masked String Compare, then you must use a CONSTANT value either entered in the field for coming from Industrial Ethernet. Masked String Compare does so on a positional basis; for example, it looks for characters a position 1, 2, and 3, and 4, 5, and 6 are ignored because they are masked. Sensor-decoded strings cannot be used because they can be of variable length.



Result Field

The Result field indicates whether or not the strings specified in Operand 1 and Operand 2 match.



Advanced Tab

Fields

The following are fields on the String tool Advanced tab:

- [Options](#) on page 294

The String tool Advanced tab provides the opportunity to refine the string matching characteristics; specifically, it provides the opportunity to ignore things like case, special characters, whitespace and the like.



Options

The Options on the Advanced tab provide for more fine-grained tuning of string matching parameters. You can select any or all of the options.



Option	Description	Match Results
Ignore Case	Match the same letters that are only different in their case.	<p>The screenshot shows the 'Match Results' for the 'Ignore Case' option. It includes a sub-screenshot of the 'Options' panel where 'Ignore Case' is checked. Below this, the 'OCR_1' field contains the text 'LOT1234567' and the 'CONSTANT' field contains 'lot1234567'. The final 'Result' field displays 'MATCH'.</p>
Ignore Special	Ignore special characters.	

Option	Description	Match Results
		<div style="border: 1px solid black; padding: 5px;"> <p>Options</p> <p><input type="checkbox"/> Ignore Case <input type="checkbox"/> Ignore Numbers</p> <p><input checked="" type="checkbox"/> Ignore Special <input type="checkbox"/> Ignore Alphabets</p> <p><input type="checkbox"/> Ignore Whitespace</p> </div> <div style="border: 1px solid black; padding: 5px; margin-top: 5px;"> <p>OCR_1</p> <p>LOT1234567</p> </div> <div style="border: 1px solid black; padding: 5px; margin-top: 5px;"> <p>CONSTANT</p> <p>LOT\$\$%&*1234567</p> </div> <div style="border: 1px solid black; padding: 5px; margin-top: 5px;"> <p>Result</p> <p style="text-align: center;">MATCH</p> </div>
<p>Ignore Whitespace Ignore whitespace.</p>		<div style="border: 1px solid black; padding: 5px;"> <p>Options</p> <p><input type="checkbox"/> Ignore Case <input type="checkbox"/> Ignore Numbers</p> <p><input type="checkbox"/> Ignore Special <input type="checkbox"/> Ignore Alphabets</p> <p><input checked="" type="checkbox"/> Ignore Whitespace</p> </div> <div style="border: 1px solid black; padding: 5px; margin-top: 5px;"> <p>OCR_1</p> <p>LOT1234567</p> </div> <div style="border: 1px solid black; padding: 5px; margin-top: 5px;"> <p>CONSTANT</p> <p>LOT 1234567</p> </div> <div style="border: 1px solid black; padding: 5px; margin-top: 5px;"> <p>Result</p> <p style="text-align: center;">MATCH</p> </div>
<p>Ignore Numbers Ignore any numbers</p>		

Option	Description	Match Results
		<div style="border: 1px solid black; padding: 5px;"> <p>Options</p> <p> <input type="checkbox"/> Ignore Case <input checked="" type="checkbox"/> Ignore Numbers <input type="checkbox"/> Ignore Special <input type="checkbox"/> Ignore Alphabets <input type="checkbox"/> Ignore Whitespace </p> <hr/> <p>OCR_1</p> <div style="border: 1px solid black; padding: 2px; margin: 2px;"> LOT1234567 </div> <hr/> <p>CONSTANT</p> <div style="border: 1px solid black; padding: 2px; margin: 2px;"> LOT7654321 </div> <hr/> <p>Result</p> <p style="text-align: center;">MATCH</p> </div>
<p>Ignore Alphabets</p>	<p>Ignore any alphabetic characters</p>	<div style="border: 1px solid black; padding: 5px;"> <p>Options</p> <p> <input type="checkbox"/> Ignore Case <input type="checkbox"/> Ignore Numbers <input type="checkbox"/> Ignore Special <input checked="" type="checkbox"/> Ignore Alphabets <input type="checkbox"/> Ignore Whitespace </p> <hr/> <p>OCR_1</p> <div style="border: 1px solid black; padding: 2px; margin: 2px;"> LOT1234567 </div> <hr/> <p>CONSTANT</p> <div style="border: 1px solid black; padding: 2px; margin: 2px;"> TOL1234567 </div> <hr/> <p>Result</p> <p style="text-align: center;">MATCH</p> </div>

String Tool and the Remote Command Channel (RCC)

Syntax	Description
set stringtool <i>tool_name tool_number operand_1 operand_2 value</i>	Sets the specified tool operand, if it is a constant. Value should be a quoted string (see Character Strings on page 327).
get stringtool <i>tool_name tool_number operand_1 operand_2</i>	Gets the value of the specified tool operand, if it is a constant.

Examples

Set Command

Example

Assuming that you have two String tools, `my_string_tool_1` and `my_string_tool_2`, each with their first operand configured as a constant. To set the constant of the second stringtool to `foobar`, issue the following command:

```
set stringtool my_string_tool_2 operand_1 foobar
or
set stringtool 2 operand_1 foobar
```

Get Command Example

To get the constant of the second stringtool, issue the following command:

```
get mathtool my_string_tool_2 operand_1
or
get stringtool 2 operand_1
```

7.6.6 Test Tool

The Test tool uses Boolean logic to combine or convert tool results. Its data can be used to evaluate the results of a single tool or multiple tools. The output of the Test tool can be used to input to another Test tool or to generate a discrete output. Additionally, a discrete input can be tied to a Test tool.

The Test tool displays the result ranges it is using as judgement criteria. Typically, these ranges are automatically set by Quick Teach or by teaching the inspection. Additionally, they can be manually set or modified either before or after teaching or running the inspection, in which case Quick Teach will discard any manually entered values. The Test tool also displays the results of the last image evaluated while setting up or running the inspection.

For inspections with many Vision tools, the Test tools can be linked together.

Usage

- Gather results from image processing tools and discrete inputs
- Establish parameters for desired inspection results
- Tie multiple results together with logic options
- Include results in the overall Pass/Fail criteria
- Activate an output based on the inspection results

Fields

The following are fields on the Test tool Input tab:

- [Logic](#) on page 298
- [Inputs](#) on page 299

- [Enabling Remote Teach](#) on page 299
- [Pass/Fail Contribution](#) on page 299
- [Tool Tabs in the Test Tool Window](#) on page 300

Supported Platforms

ProII Color	ProII/ProII 1.3	OMNI Color	OMNI/OMNI 1.3	AREA/AREA13	EDGE/EDGE 1.3	GEO/GEO 1.3	BCR/BCR 1.3
Yes	Yes	Yes	Yes	Yes	Yes	Yes	Yes

Test Tool Input Tab

Test Tool

Input **EDGE_1** **EDGE_2**

Name:

Logic:

Input 1: Invert

Input 2: Invert

Input 3: Invert

Input 4: Invert

Enable Remote Teach

Pass/Fail Contribution

Output

I/O:

Next

Logic

Use logic to combine multiple inputs to the Test tool. The results at the inputs and the logic option selected will determine whether the Test tool is True or False.



Inputs

Choose previous tools or external inputs that need to be evaluated to pass the Test tool. When a tool is chosen, another tab pops up in the Test tool window.



 **Note:** The tool to be evaluated must appear before the Test tool in the Navigation window.

Select Invert to invert the individual input. If the input is True, Invert reverses it to False. If the input is False, Invert reverses it to True.

Enabling Remote Teach

The Remote Teach function is a method of remotely updating inspection parameters in Run mode. Vision tools and Test tools can be selected to be taught or not taught. To remotely teach an inspection, the Remote Teach function must be enabled on each tool to be taught.

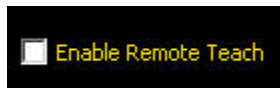

Pass/Fail Contribution

Check this box if the Test tool will influence the Pass/Fail status of the inspection. Do not check this box if the overall Pass/Fail status of the inspection is not dependent on the current Test tool. The Pass/Fail contribution influences the following:

- Discrete output Pass
- Discrete output Fail
- Pass/Fail results counter
- Pass (Green) and Fail (red) LEDs on the Sensor
- Freezing an image on the video monitor
- Display options on the PC



Tool Tabs in the Test Tool Window

For each tool selected in the Input tab as Input 1, 2, 3, or 4, the software displays a tab.

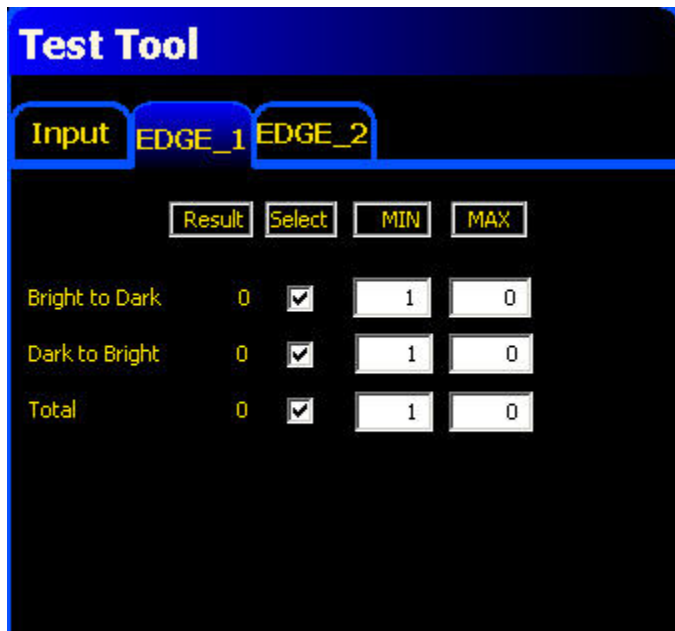

Tool Options

Tool	Values	Options
Locate	Not Available	
Pattern Find	Not Available	
Geometric Find	Not Available	
Average Gray Scale	Average Gray Scale	Min/Max/Tolerance % *
BLOB	Count	Min/Max
	Largest Area	Min/Max/Tolerance % *
	Smallest Area	Min/Max/Tolerance % *
	Total BLOB Area	Min/Max/Tolerance % *
Edge	Bright-to-dark (edge count)	Min/Max
	Dark-to-bright (edge count)	Min/Max
	All (edge count)	Min/Max
Object	Count	Min/Max
	• Bright object	
	• Dark object	
	• All (bright or dark)	
	Width (pixels)	Min/Max
	• Bright	
	• Dark	

Tool	Values	Options
Geometric Count	Match count	Min/Max
Measure	Distance	Min/Max/Tolerance % *
	Distance X	
	Distance Y	
Test	True/False value	Pass/Fail Contribution
Communication	Success/Fail	Pass/Fail
Discrete Inputs 1-6	ON/OFF	
System Error	True/Fale	

Test Tool Average Gray Scale Tab

Tool Options

Values	Options
Gray Scale	Min/Max/Tolerance % *
Deviation	Min/Max /Tolerance %

Test Tool Average Gray Scale Tab

The screenshot shows a software interface titled "Test Tool" with a dark blue header. Below the header, there are two tabs: "Input" and "GS_1". The "Input" tab is active. The interface contains several input fields and buttons:

Result	Select	MIN	MAX	Tolerance %	
Gray Scale	136	<input checked="" type="checkbox"/>	1	0	10
Toleranced Scale					
Deviation	50.90	<input type="checkbox"/>	1	0	10
Toleranced Deviation					

At the bottom right of the interface, there is a blue button labeled "Back".

Test Tool Blob and Color Blob Tab

Indicates if the result is a MATCH or NO MATCH.

Test Tool Color Blob Tab



Test Tool Circle Tab

Values	Options
Radius	Min/Max/Tolerance %
Radius Min	Min/Max/Tolerance %
Radius Max	Min/Max/Tolerance %
Circumference	Min/Max/Tolerance %

Values	Options
Average Error	Min/Max/Tolerance %

Test Tool Circle Tab



Test Tool Edge Tab

Values	Options
Bright to Dark	Min/Max
Dark to Bright	Min/Max
Total	Min/Max

Test Tool Edge Tab

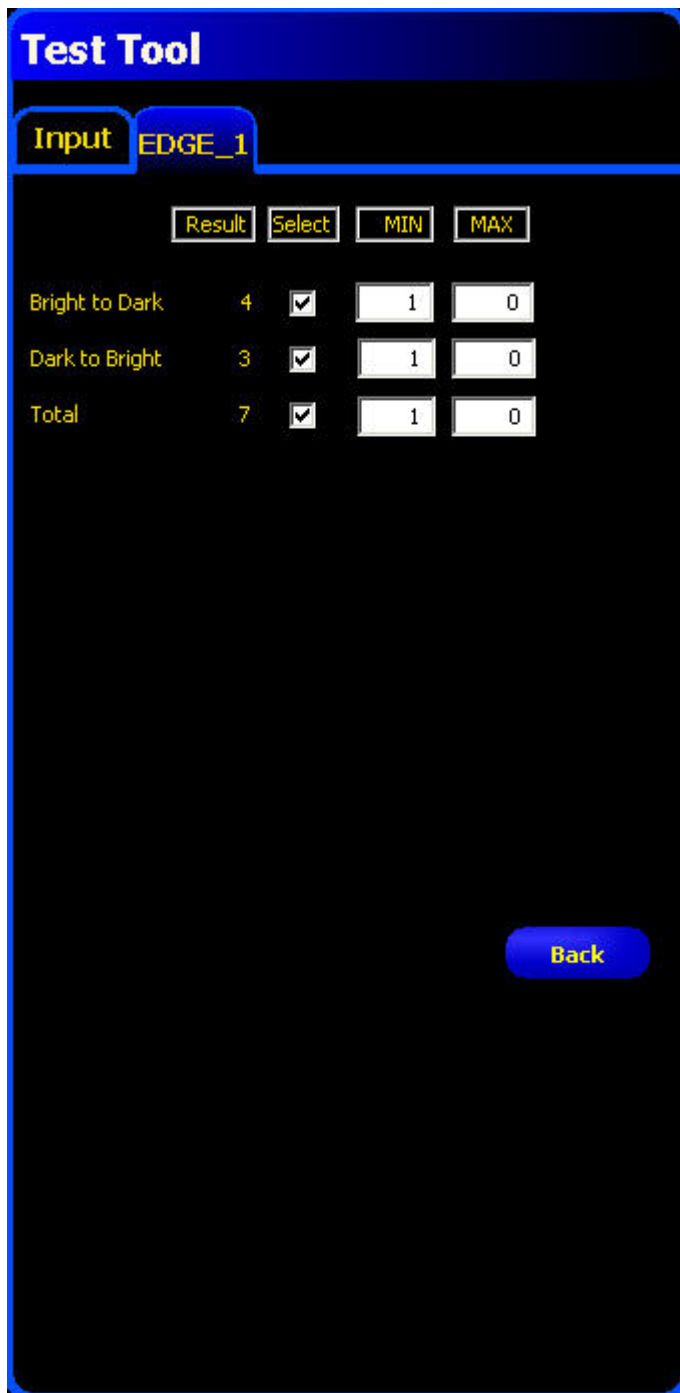

Test Tool Geometric Count Tab

Values	Options
Count	Min/Max

Test Tool Geometric Count Tab

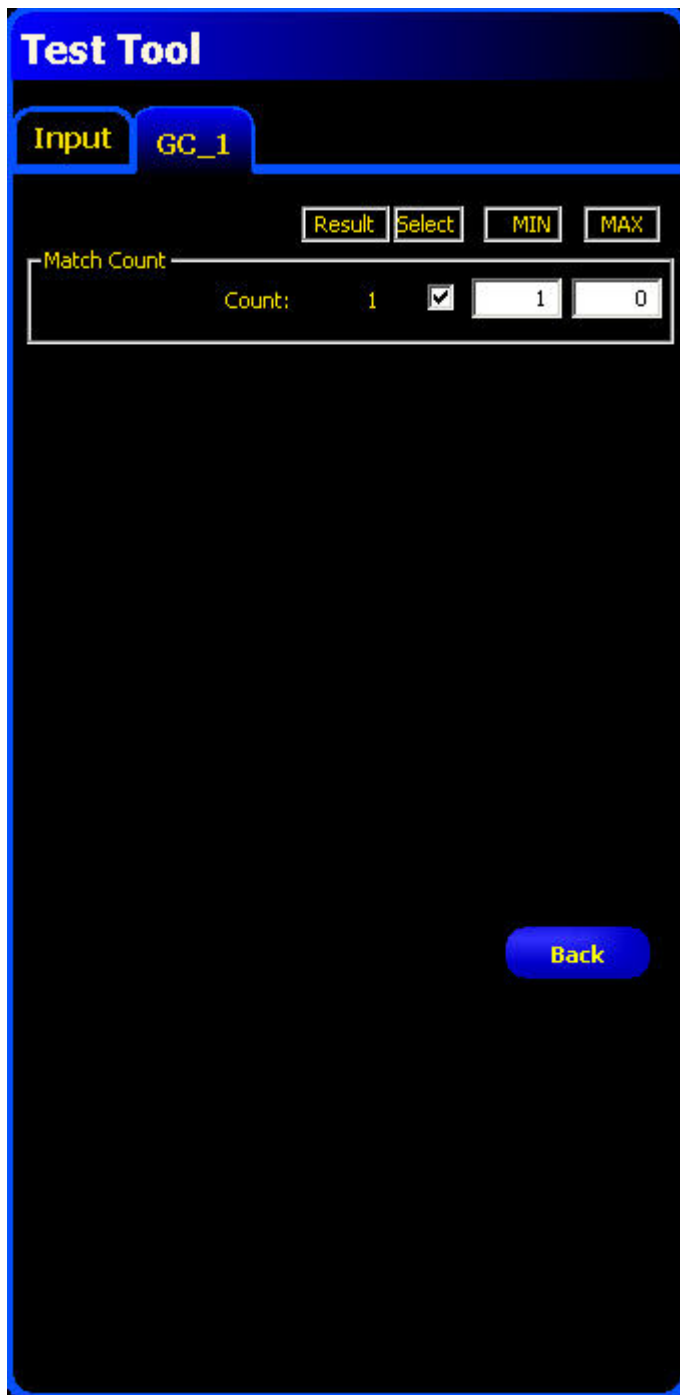

Test Tool Line Tab

Values	Options
Line Length	Min/Max/Tolerance %
Angle (Degrees)	Min/Max/Tolerance %
Worst Distance	Min/Max/Tolerance %
Average Error	Min/Max/Tolerance %

Test Tool Line Tab



Test Tool Pattern Count Tab

Test	Values	Options
Match Count	Count	Min/Max

Test Tool Pattern Count Tab

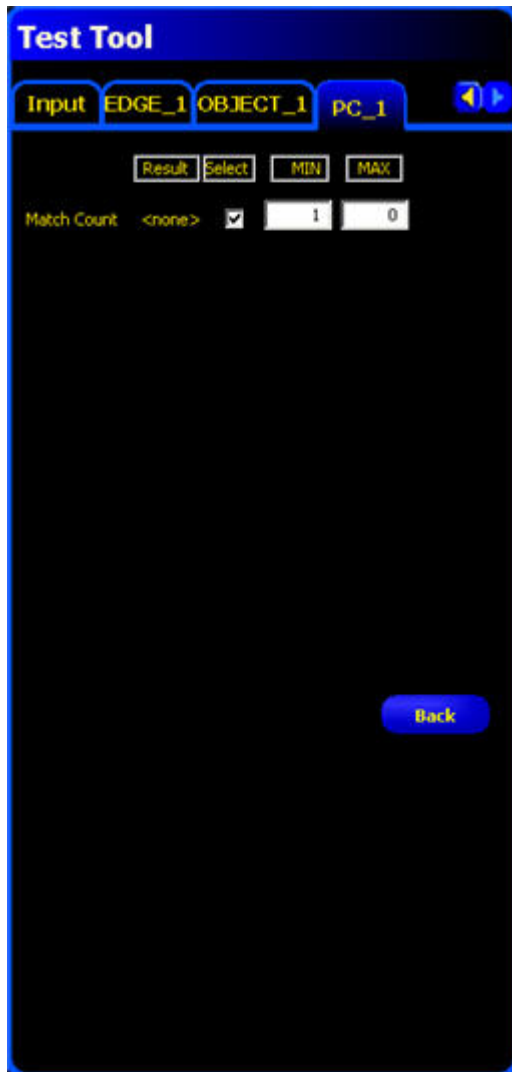

Test Tool Object Tab

Test	Values	Options
Count	Bright Object	Min/Max
	Dark Object	Min/Max
	Totabl Object	Min/Max
Select	Object	All
Width (px)	Object #	Min/Max/Tolerance %

Test Tool Object Tab

Test Tool

Input OBJECT_1

Result Select MIN MAX

Count

Bright Object: 1

Dark Object: 2

Total Object: 3

Select

Object All Dark Bright

Result Select MIN MAX Tolerance %

Width(px):

Object 1 82

Toleranced Width

Width test fails if object is not found [Back](#)

Test Tool Average Color Tab

Category	Values	Options
Averages	Hue	Begin/End/Tolerance %
	Saturation	Min/Max /Tolerance %
	Intensity	Min/Max /Tolerance %
Standard Deviations	Hue	Min/Max /Tolerance %

Category	Values	Options
	Saturation	Min/Max /Tolerance %
	Intensity	Min/Max /Tolerance %

Test Tool Average Color Tab

Test Tool

Input
AC_1

Averages

	Result	Select	Begin	End	Tolerance %
Hue	213°	<input checked="" type="checkbox"/>	<input type="text"/>	<input type="text"/>	3
Saturation	66%	<input checked="" type="checkbox"/>	<input type="text" value="1"/>	<input type="text" value="0"/>	10
Intensity	86	<input checked="" type="checkbox"/>	<input type="text" value="1"/>	<input type="text" value="0"/>	10

Standard Deviations

	Result	Select	Min	Max	Tolerance %
Hue	0,99°	<input type="checkbox"/>	<input type="text" value="1"/>	<input type="text" value="0"/>	10
Saturation	1,14%	<input type="checkbox"/>	<input type="text" value="1"/>	<input type="text" value="0"/>	10
Intensity	2,24	<input type="checkbox"/>	<input type="text" value="1"/>	<input type="text" value="0"/>	10

Hide Color Map
Back

Hue - Saturation

Intensity

Test Tool Color Match Tab

Indicates whether there is a color MATCH or NO MATCH.

Test Tool Color Match Tab



Test Tool OCR Tab

Test	Values	Options
String Length	Count	Min/Max
Data Read	String	

Test Tool OCR Tab

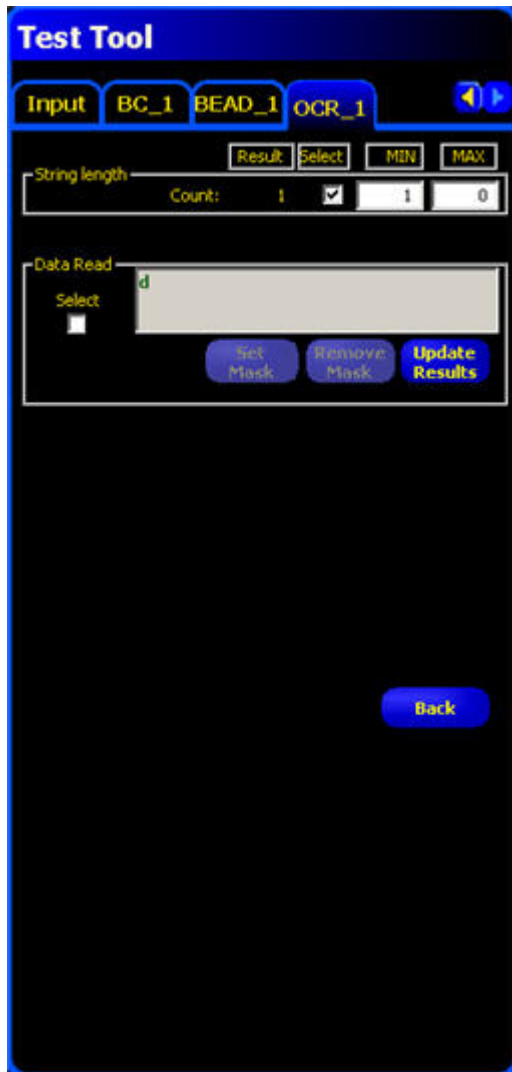

Test Tool OCV Tab

Indicates where the String matches or not.

Test Tool OCV Tab

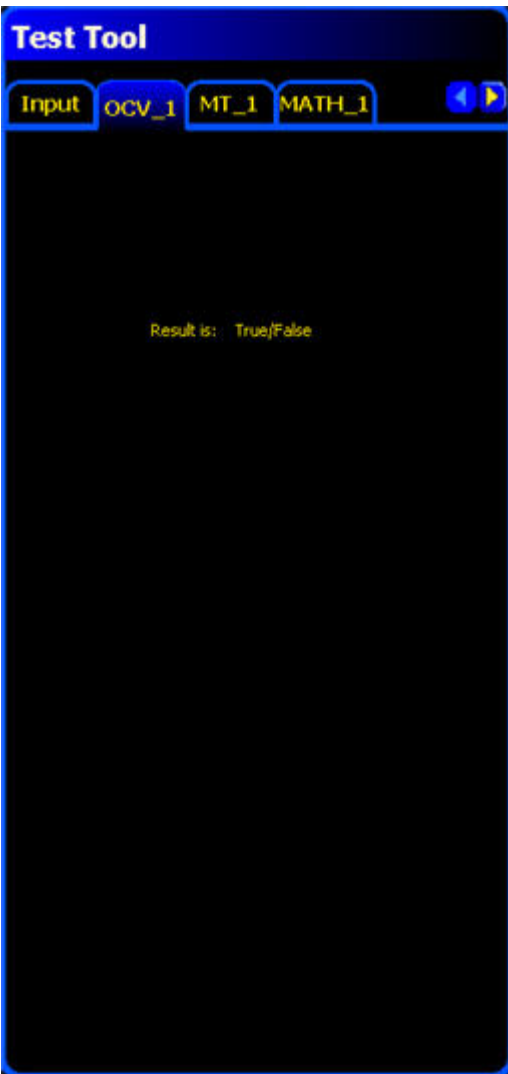

Test Tool Math Tab

Indicates where the String matches or not.

Test Tool MathTab

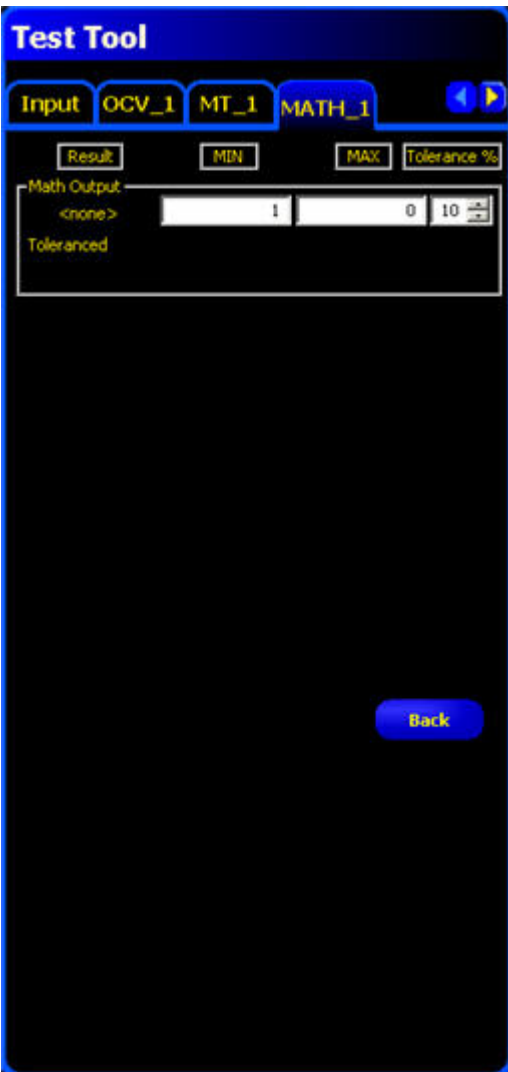

Test Tool Measure Tab

Indicates where the String matches or not.

Test Tool Measure Tab



Test Tool Test Tab

Indicates whether the test

Test Tool TestTab

Test Tool

Input MT_1 MATH_1 TT_1



Result is: TRUE/FALSE

Back

To set up the Communication tool, click on the System button in the Main Menu toolbar to bring up the System Setup window, then click on the Communication tab.

8.1 Ethernet Connection

In order to establish an Ethernet connection, the external device must be directed to the correct IP address and the correct TCP port. In TCP/IP protocol, a TCP port number is used with the IP address to identify a specific path or socket. The sensor has sockets 1 to 10, and can send out unique sets of data to 10 different devices.

Valid user TCP/IP port numbers are in the range of 1024 through 65535. The PresencePLUS GUI provides automatic notification if you attempt to use a reserved port.

To view an Ethernet connection:

1. Click on the System button in the Main Menu toolbar to bring up the System Setup window.
2. Click on the **Communication** tab.

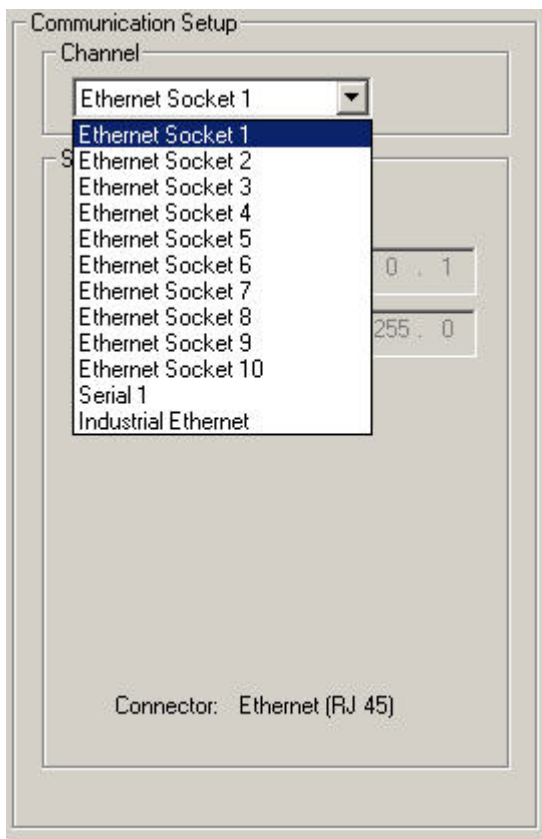

3. Choose a connection from the fixed Connection drop-down list of the **Communication Tool Setup** field.

Each Ethernet socket has a unique TCP port number as shown below

 **Note:** The following addresses are defaults.

Socket	Default IP Address	Port
1	192.168.0.1	20000
2	192.168.0.1	20001
3	192.168.0.1	20002
4	192.168.0.1	20003
5	192.168.0.1	20004
6	192.168.0.1	20005
7	192.168.0.1	20006
8	192.168.0.1	20007
9	192.168.0.1	20008
10	192.168.0.1	20009

8.2 Serial Connection

The sensor has a single serial connection that you can configure, Serial 1:

- Serial 1 is the DB-9 connector.

 **Note:** The Pro has 2 serial connections. Serial 2 in the dropdown list is to support those sensors.

The sensor has one serial connection that can be configured: Serial 1 is pins 1, 9, and 10. Set up the serial communication options to match the receiving device. The following table shows the configuration options:

Attribute	Default Setting
Baud Rate	115200
Data Bits	8
Parity	None
Stop Bit	1
Flow Control	None

To setup a serial connection:

1. Click on the **System** button in the Main Menu toolbar to bring up the System Setup window.
2. Click on the **Communication** tab.
3. Choose Serial 1 from the Connection drop-down list of the **Communication Tool Setup** field.

Communication Setup

Channel: Serial 1

Settings

Baud Rate: 115200

Data Bits: 8

Parity: None

Stop Bits: 1

Flow Control: None

Connector: Serial

 **Note:**

Because there is no flow control for the serial connections, the sensor will not detect or log a lost or broken connection.

8.3 Overview of Testing the Communication Tool

1. Connect the Sensor to a PC using a crossover Ethernet cable (STPX.) or the serial pins on the Sensor cable.
2. Start an inspection that has a configured Communication tool. For details about configuring the Communication.
3. Start HyperTerminal or Telnet.
4. Trigger the Sensor.
5. Look in HyperTerminal or Telnet to see if the data has updated.

8.4 Detailed Steps for Testing the Communication Tool

There are a number of software programs such as Telnet and HyperTerminal that can test the connection with the Communication tool.

- Telnet can test Ethernet communications and is relatively easy to set up.
- HyperTerminal can test both serial and Ethernet communications, but note that HyperTerminal for Windows NT does not have an Ethernet option.

8.4.1 Testing Ethernet Communications

To test Ethernet communications with Telnet:

1. Start an inspection that has a configured Communication tool.
2. Connect a PC to the controller using an Ethernet crossover cable.
3. From the Start menu, click Start > Run.
4. In the dialog box, type:

```
telnet controller_ip_address ip_port
```

Example: telnet 192.168.0.22 20000

5. Click **OK** to open a Telnet window.
6. Trigger the sensor.
7. View the results.

To test Ethernet communications with HyperTerminal:

1. Start an inspection that has a configured Communication tool.
2. Connect a PC to the controller using an Ethernet crossover cable.
3. Start a new connection with HyperTerminal.
4. Connect using TCP/IP (Winsock).
5. Configure HyperTerminal to talk with the controller. For example:
 - Host Address: 192.168.0.1
 - Port Number: 20000 (Ethernet Socket 1)
6. Trigger the sensor.
7. View the results.

8.4.2 Testing Serial Communications

To test serial communications with Telnet:

1. Start an inspection that has a configured Communication tool.
2. Connect a PC to the sensor using a serial cable.
3. Start a new connection with HyperTerminal.
4. Connect using COM1 (choose a serial COM port).
5. Configure HyperTerminal to talk with the sensor. For example:
 - Baud rate = 1155200 bits/sec (sensor default).
 - Data bits = 8 (sensor default)
 - Parity = None (sensor default)
 - Stop Bits = 1 (sensor default)
 - Flow Control = None
6. Trigger the sensor.
7. View the results.

8.5 Troubleshooting Ethernet Connections

1. Check the LEDs on the sensor's RJ-45 connector.
 - No LEDs are ON: the cable may not be the correct type (straight or crossover), or it could be broken.
 - Only the yellow LED is ON: the electrical connection is good, but the sensor device are not exchanging data.
 - Yellow LED is ON and the green LED is ON or flashing: data are being exchanged between the PC and the sensor.
2. Verify that the Communication tool is configured correctly.
 - The connection should be Ethernet socket 1 - 10.
 - Verify that you have selected the desired result data in the **Tool** tab.

3. Check the receiving device setup.
 - Check the IP address. The device IP subnet must match the sensor IP subnet.
 - Check the Port number: 20000 - 20009 (not 2000).
 - Check all firewall and anti-virus software to verify that it is not blocking the sensor's Ethernet socket.

8.6 Troubleshooting Serial Connections

1. Verify the hardware.
 - Check for breaks in the serial cable.
 - Use a straight serial cable from the sensor to the PC.
2. Verify that the Communication tool is configured correctly.
 - Verify that the desired result data has been checked.
3. Check the receiving device setup.
 - Check the receiving device setup.
 - Check that the COM port properties on the receiving device matches the System parameters in the sensor (baud rate, data bits, parity, stop bits, and flow control).

8.7 Remote Command Channel Configuration

This section describes the commands that are supported to communicate with a Vision sensor. All commands are case-insensitive

8.7.1 Remote Command Set

All RCC commands are case-insensitive. Valid characters for commands are 7-bit ASCII alphabetic or numeric characters (A-Z, a-z, 0-9), dash (-) and underscore (_).

All commands have the following structure:

ACTION OBJECT_IDENTIFIER QUALIFIER(S)

ACTION is an operation the user intends to perform on the *OBJECT_IDENTIFIER*. There are three possible actions available:

- **GET** — used to retrieve information associated with the named object. This information can be a Boolean value, and unsigned or signed number, a string or, for complex objects like the Communications tool, a field-delimited record that includes other data types.
- **SET** — used to assign a value to a named object.
- **EXEC** — used to execute a pre-defined functional object or activity in the sensor. Activities may take object identifiers as parameter qualifiers.

The table below identifies objects that are supported in the current RCC release, their identifiers, and the corresponding actions that they will support. Items highlighted in bold are command keywords. Flag objects are appended with the **FLG** suffix, status objects are appended with the **STS** suffix, and counters are appended with the **CNT** suffix.

System Object, Component, or Activity	Object or Activity Identifier	Support Actions	Required Qualifiers	Optional Qualifiers	Comments
Trigger	TRIGGER	EXEC	None	Timeout (msec) or NOWAIT	If no qualifiers are specified, a 30 second timeout is used.

System Object, Component, or Activity	Object or Activity Identifier	Support Actions	Required Qualifiers	Optional Qualifiers	Comments
Product Change	PRODCHANGE	EXEC	Numeric Inspection ID	Timeout (msec) or NOWAIT	By default, a 30 second timeout is used.
Counter or Flag Reset	RESET	EXEC	SYSERRFLG or PASSFAILCNT or MISSTRIGCNT	None	Reset either the System Error Flag, Pass and Fail counters, or Missing Trigger count.
Remote Teach	RTEACH	EXEC	None	TRIGGER or TRIGGER NOWAIT or TRIGGER Timeout (msec)	Enables remote teach. If no qualifiers are specified, remote teach will occur on the next trigger. If TRIGGER qualifier is specified, remote teach will occur immediately, and the command will block until a default 30-second timeout expires. If TRIGGER NOWAIT is specified, remote teach will occur immediately, and the command will return right away. If a timeout value is specified, the command will block until the specified timeout expires.
Online Status	ONLINESTS	GET	None	None	Retrieve the sensor online status.
Ready State	READYFLG	GET	None	None	Returns 1 if the camera is ready, 0 otherwise
Current Inspection Number	INSPNUM	GET	None	None	Retrieve currently running inspection

System Object, Component, or Activity	Object or Activity Identifier	Support Actions	Required Qualifiers	Optional Qualifiers	Comments
Communications Tool Results	COMMTOOL	GET	None	CommTool Number <i>or</i> CommTool Name	Retrieve comm tool results, either by specifying its sequential number in the inspection (1,2,...,n) or by specifying its name. By default, data for the first comm tool will be retrieved.
Pass/Fail flag	PASSFAILFLG	GET	None	None	Retrieve the value of the Pass/Fail flag - 1 if pass, 0 if fail
System Error	SYSERRFLG	GET	None	None	Retrieve the value of the System Error - either 0 or 1
Frame Number	FRAMENUM	GET	None	None	Retrieve the current frame number
Pass Count	PASSCNT	GET	None	None	Retrieve the pass count
Fail Count	FAILCNT	GET	None	None	Retrieve the failed count
Iteration Count	ITERCNT	GET	None	None	Retrieve the Iteration Count
System Error Count	SYSERRCNT	GET	None	None	Retrieve the system error count
Missed Trigger Count	MISSTRIGCNT	GET	None	None	Retrieve the missed trigger count
I/O Line Status	IOSTS	GET	I/O line id, numeric, either 1 through 4 or 1 through 6	None	Retrieve the cached status of the I/O line
Gain	GAIN	GET		None	Retrieve the gain
Gain	GAIN	SET	Positive Integer	None	Set the gain
Exposure	EXPOSURE	GET		None	Retrieve the camera exposure
Exposure	EXPOSURE	SET	Positive Number	None	Get the camera exposure

System Object, Component, or Activity	Object or Activity Identifier	Support Actions	Required Qualifiers	Optional Qualifiers	Comments
Frame Number Tag	FRAMETAG	SET	ENABLE	None	Enables frame number as command acceptance indicator
Frame Number Tag	FRAMETAG	SET	DISABLE	None	Disables frame number as command acceptance indicator
Frame Number Tag	FRAMETAG	GET	None	None	Retrieve the status of the frame tag indicator

8.7.2 RCC Return Values

RCC return values are numeric, and are listed below:

- 0 - command accepted. This return code is generated when a valid SET, GET, and EXEC command has been completely handled by the sensor. It may be followed by a command-specific return value or a completion code.

If the frame tag is enabled, the current frame number will be returned instead of 0 as command acceptance indicator.

- -100 - Invalid command entered by the user.
- Trigger and Product Change error codes:
 - -201 - Product change command attempted in the middle of the inspection
 - -202 – Trigger command attempted in the middle of product change
 - -203 – Trigger command is attempted when the inspection is not executing (sensor is idle)
 - -204 – Specified inspection slot is out of range
 - -205 – Trigger command attempted in the middle of the inspection
 - -206 – Product change command attempted in the middle of a product change
 - -207 – Product change command attempted while the sensor is in the Teach mode
 - -208 – Product change attempted when the GUI is connected, and the inspection is not executing
- Comm tool error codes
 - -301 – get/set tool command attempted while the inspection is not executing
 - -302 – get command issued before inspection is triggered for the first time – tool results unavailable
 - -303 – get/set tool command attempted in the middle of the inspection
 - -304 – get/set tool command attempted in the middle of the product change
 - -305 – Tool specified in get/set command not found in the inspection
 - -306 – Requested comm tool is not configured for RCC
 - -307 - Tool executed with an error or did not execute
 - -308 - Specified tool operand is not a constant, and cannot be modified
- Reset command error codes
 - -401 – Reset command attempted in the middle of the inspection
 - -402 – Reset command attempted in the middle of the product change
- -500 – RCC commands are not accepted because the sensor is in the Playback mode
- Timeout error codes

- -600 – Product change timeout occurred
- -601 – Trigger timeout occurred
- -700 – Specified value is out of range
- -701 – Set Gain command attempted when the GUI is connected and the inspection is not executing
- -702 – Set Exposure command attempted when the GUI is connected and the inspection is not executing
- -800 – Product Change, Trigger or Get Commtool command attempted when either Product Change or Trigger Command timeout occurred, but the operation has not yet completed.

8.7.3 Frame Tag Numbers

RCC provides user with a debug facility that allows users to correlate command completion with current frame numbers. This facility is enabled by issuing a SET FRAMETAG ENABLE command. This command will cause RCC to send the current frame number as the command acceptance code. This will allow users to track when each command was issued, and which frame it applies to.

For EXEC TRIGGER command, returned number will be the frame number at the completion of the inspection execution.

For EXEC TRIGGER command, returned number will be the frame number at the completion of the inspection execution.

For all other commands, the returned number is the current frame number.

8.7.4 Command Processing

RCC commands are interpreted in the context of the running PPVS system. Due to the constantly changing system state caused either by external action or by previous RCC commands, certain rules are imposed on RCC command acceptance and processing. Please note that command acceptance does not constitute successful completion of the command.

1. EXEC TRIGGER command can be successfully accepted under the following conditions:
 - Inspection is Executing and is Ready
2. EXEC PRODCHANGE command can be successfully accepted under the following conditions:
 - Sensor is idle (inspection is not loaded), and the GUI is not connected
 - Inspection is Executing and is Ready
 - Sensor was previously product changed to an invalid slot
3. EXEC RESET command can be successfully accepted under the following conditions:
 - Sensor is idle (inspection is not loaded)
 - Inspection is Executing and is Ready
4. SET GAIN or SET EXPOSURE commands can be successfully accepted under the following conditions:
 - Inspection is Executing and is Ready
5. GET status, counter or flag commands can be accepted at any time. If issued when inspection is Executing but is not Ready, these values may change as the inspection is executing.
6. GET COMMTOOL command can be successfully accepted if the inspection has been loaded. However, RCC may not have valid data until the inspection has been triggered (executed) at least once.

Commands with timeouts, such as EXEC TRIGGER and EXEC PRODCHANGE, will block processing of additional commands while they are executing if they are invoked without the NOWAIT option. Additional commands that are issued while processing is blocked will be queued, and will be processed in the order that they were received when the blocking command finishes its execution.

When blocking commands, such as EXEC TRIGGER and EXEC PRODCHANGE, are invoked with the NOWAIT option, GET commands that retrieve flags and status are accepted for processing. All other commands are rejected with an appropriate error code.

8.7.5 RCC Log

RCC Log allows users to monitor and troubleshoot communication inputs and outputs.

Log consists of a circular buffer with up to 400 entries. These entries can be one of three types:

- IN – characters received in the input stream
- CMD – commands that were extracted after the frame start and frame end delimiters have been received
- OUT – formatted command output, with frame delimiters already included.

Log entries are time stamped with system time and sorted in the order they were received.

Non-displayable ASCII characters are shown in the ASCII Hex string form. The ASCII Hex strings are preceded by character sequence “\x” (backslash-lower-case-x). The ASCII Hex string will always be two characters long. For example, NULL will be converted to “\x00”, and carriage return will be converted to “\x0D”. To represent ASCII Hex digits, only upper case letters, A-F, are used.

Sample RCC log is given below:

```
0000000118.116 IN e
0000000118.116 IN x
0000000118.116 IN e
0000000118.116 IN c
0000000118.116 IN
0000000118.116 IN t
0000000118.116 IN r
0000000118.116 IN i
0000000118.116 IN g
0000000118.116 IN g
0000000118.116 IN e
0000000118.116 IN r
0000000118.116 IN \x0D
0000000118.116 IN \x0A
0000000118.116 CMD exec trigger
0000000118.483 OUT 0\x0D\x0A
```

In this example, command exec trigger was sent to RCC interface. The interface was configured to use no start frame delimiter, and carriage return (\x0D) and line feed (\x0A) as frame delimiters. As soon as valid frame delimiters were received, the command exec trigger was sent for processing, and the command response was sent back after inspection finished executing.

8.7.6 Frame and Field Delimiters

The PresencePLUS GUI includes a drop-down list of Frame delimiters as follows:

- <none> for no delimiter
- \r for carriage return (<CR>)
- \n for line feed (LF)
- \r\n for carriage return followed by a line feed (CR-LF)
- \n\r for line feed followed by a carriage return (LF-CR)

In addition to the above field delimiters, you can enter other delimiter types keeping in mind the following:

- ASCII hex format can be used as a delimiter
- a NULL character can be used as a delimiter (specified in ASCII hex format)
- Frame delimiters can be multi-character sequences up to 20 characters long

The PresencePLUS GUI includes a drop-down list of Field delimiters as follows:

- <none> for no delimiter
- , for comma
- ; for semi-colon
- : for colon
- <SPC> for space
- \t for tab

In addition to the above field delimiters, you can enter other delimiter types keeping in mind the following:

- ASCII hex format can be used as a delimiter
- a NULL character can be used as a delimiter (specified in ASCII hex format)
- Field delimiters can be multi-character sequences up to 10 characters long

Character Strings

Communications Tool configured for Barcode or String Tool output may produce strings that contain non-printable ASCII characters, such as carriage returns, line feeds, and characters in the upper ASCII range.

To output these strings, the following encoding rules are used:

- Tool output strings will be enclosed in double quote characters, “.”
- Any non-printable ASCII character, including NULL, will be converted to its ASCII Hex equivalent. The ASCII Hex string will be preceded by character sequence “\x” (backslash-lower-case-x). The ASCII Hex string will always be two characters long. For example, NULL will be converted to “\x00”, and carriage return will be converted to “\x0D”. To represent ASCII Hex digits, only upper case letters, A-F, will be used.
- Any backslash encountered in the Barcode or String Tool data will be converted to its ASCII Hex equivalent, “\x5C”.
- Any double quote encountered in the Barcode or String Tool will be converted to its ASCII Hex equivalent, “\x22”.

For RCC input strings, the formatting rules are expanded to accommodate readability as follows:

- Carriage return can be specified as character sequence “\r” (backslash-r).
- Line feed can be specified as character sequence “\n” (backslash-n).
- Double quote can be specified as character sequence “\” (backslash-doublequote).
- Backslash can be specified as character sequence “\\” (backslash-backslash).
- tab can be specified as character sequence “\t” (backslash-t).
- Embedded NULLL characters are not allowed.

The inspection parameters can be taught automatically by using the Teach function. There are two Teach options: Quick Teach and Teach. The Quick Teach button is in the Tools window, and the Teach button is in the Main Menu toolbar.

9.1 Quick Teach

Use Quick Teach to set the Pass/Fail parameters based on the reference image. This is a fast way to start inspecting products with minimal effort. This method works best when the reference image is a good representation of all the parts. If the good parts can vary in appearance, standard Teach is a better option.

Click the **Quick Teach** button to trigger the following events:

1. The results calculated from the reference image are transferred to the minimum and maximum fields in the Test tool.
2. If a tool's Results field includes a tolerance (e.g., shortest distance), then the additional tolerance is calculated (default is 10%).
3. The Save window prompts the user to save the inspection on the Sensor.
4. The software proceeds to the Run screen.



Caution: Quick Teach will overwrite all the minimum and maximum values in the Test tool. If values were entered manually, or no changes are desired, go directly to Run without clicking Quick Teach.

9.2 Teach

Use **Teach** to automatically set the Pass/Fail parameters based on a sample of good parts. Instead of using the reference image as the good part, Teach uses new good parts that are presented to the sensor under running conditions.



Note: The Teach screen looks very similar to the Run screen. Verify that the sensor is at the Run screen and not the Teach screen before running an inspection.

There is no limit to the sample size during the Teach process. Teach will only expand the parameter window. If the current tolerances were greater than the sample set shown during the Teach process, then the Sensor will retain the old tolerances. Use Teach when there is a large part variation between the good parts.



Caution: Only use good parts with Teach. A taught bad part will pass the inspection.

9.3 Teach Screen

To display the Teach screen, click the Teach button on the Main Menu toolbar, or click the Next button on the Tools screen Build tab.

Use the Teach screen to automatically set judgment tolerances to accommodate all variations of good product. After teaching the inspection, typically proceed to the Run screen to run it.

- Note:** Before entering the Run screen, a pop-up prompts the user to save the inspection. Save the inspection to one of the memory locations on the Sensor. As an alternative to teaching, enter judgment tolerances in the Results tab in the Test tool, and run the inspection without teaching.

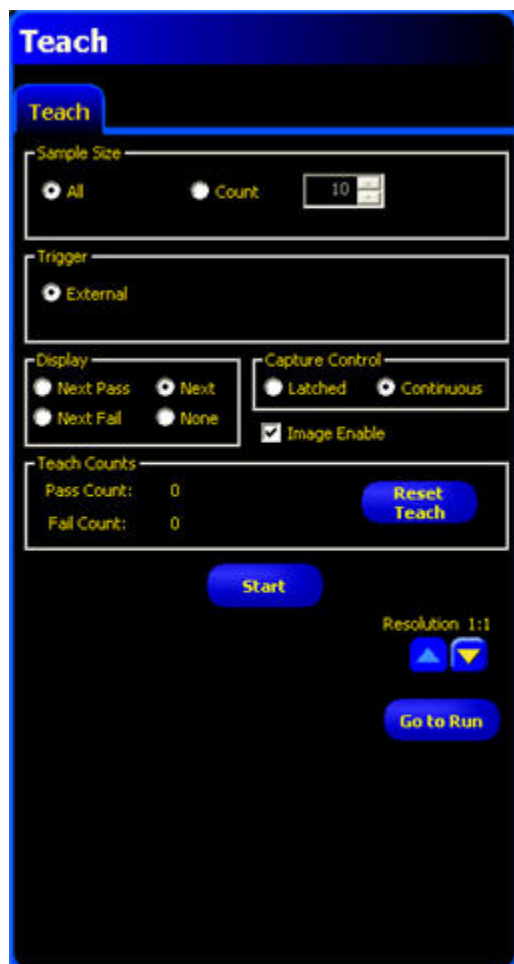





9.3.1 Teaching an Inspection

Teaching on a number of known good samples finds acceptable variations and automatically sets the judgment tolerances to accommodate the full range of acceptable results.

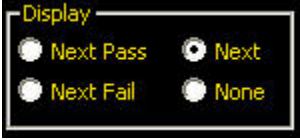
Several Teach parameters may be selected in the Teach tool's Teach tab, such as how many images to consider during a teaching session and what type of captured images to display.

Teach Screen Field/Button	Description
	<p>Use All to not limit the Teach sample size. All is the default.</p> <p>Use Count to have the Sensor automatically stop the Teach process after a set number of samples.</p> <p>Use the Count option when there is a known sample set size. Use the arrows to increase or decrease the sample size. When the sample size is reached, the Sensor will</p>

Teach Screen Field/Button	Description
	<p>stop the Teach process, and the Start/Stop button will return to displaying Start.</p> <p>The Sensor must receive an external trigger (pin 3) to accept a sample.</p>
	<p>Determines when information is updated on the PC.</p> <ul style="list-style-type: none"> • Next Pass: Display the next passing inspection. • Next Fail: Display the next failed inspection. • Next: Display the next available inspection. • None: Do not display inspections.
	<p>Capture Control determines how often information is updated on the PC.</p> <ul style="list-style-type: none"> • Latched: Sets the Display option to None after an inspection is displayed to prevent displaying additional inspections. • Continuous: Continuously updates the inspection information according to the display option. <p> Note: The display may not capture every inspection.</p> <ul style="list-style-type: none"> • Image Enable: Determines if the image is included in the result information. If checked, the inspection image and results will update upon capture. If unchecked, only the results will update upon capture. <p> Note: Displaying the image on the PC will add to the inspection time.</p>
	<p>Teach Counts tracks the number of samples used in each teach process. Teach ignores samples that fail. Samples fail for the following reasons:</p> <ul style="list-style-type: none"> • An Edge tool before the Test tool fails. • A Locate tool before the Test tool fails. • Measure tool fails to find two points. • Time-out error. • An ROI rotates or translates off the screen. <p>Click the Reset Teach button to clear all previously gathered data.</p>
<p>Start</p> <p>Stop</p> <p>Next</p>	<p>Click the Start button to start the Teach routine.</p> <p>Click the Start button to stop the Teach routine.</p> <p>When you click the Next button, the software prompts you to save the inspection, and then it continues on to the Run screen.</p>

9.4 Remote Teach

This section explains teaching inspections on good product using Remote Teach.

9.4.1 Understanding Remote Teach

The Remote Teach function is a method of remotely updating inspection parameters in Run mode. Vision tool(s) and Test tool(s) can each be selected to be taught. To remotely teach an inspection, the Remote Teach function must be enabled on each tool to be taught.

 **Note:** The Location tools, the Measure tool, and the Communication tool are not affected by Remote Teach.

The sequence of events in the sensor is as follows:

1. With the sensor in Run mode (and Ready), pulse the Remote Teach line (Pin 2, gray wire).
2. The sensor recognizes that the Remote Teach line is active and waits for the next valid trigger.
3. At the next valid trigger, Ready goes inactive (the Green Ready LED shuts OFF), and the sensor acquires a new image.
4. The sensor adjusts the ROI (if the inspection uses Location tools).
5. The Vision tool learns the new pattern and performs the analysis.
6. The sensor adjusts the minimums and maximums in the Test tool (if the Test tool is enabled for Remote Teach).
7. The inspection indicates Pass if the pattern meets the requirements of the Vision tool and (if the Test tool is enabled for Remote Teach) if the evaluation of the Test tool(s) passes with the adjusted minimums and maximums.
8. The inspection will Fail if the Vision tool(s) or the Test tool(s) fails. If the inspection fails, another Remote Teach sequence or user intervention is required.

9.4.2 Remotely Teaching a Tool

To remotely teach a tool, the user must enable Remote Teach on each tool to be taught. This can be accomplished by clicking on the Enable Remote Teach box in the tool window before running an inspection (typically performed when the inspection is created).

To perform a Remote Teach, do the following:

1. Verify that the correct tools are enabled for Remote Teach.
2. Verify that the sensor is in Run mode.
3. Verify that the Green Ready LED is ON.
4. Activate the Remote Teach input.
5. Position the target as desired.
6. Trigger the Sensor.

Following a Remote Teach, subsequent inspections will be performed with the newly learned parameters of the Vision tool(s) and the Test tool.

 **Caution:** A successful Remote Teach will occur **ONLY** if the new target is similar in contrast to the original target. The exposure time and gain are **NOT** modified during Remote Teach.

9.4.3 Timing Sequence

The timing for the Remote Teach sequence is shown below (the diagram assumes Remote Teach is enabled on the tools and that all signals meet minimum times).

It is important to note that the remotely taught parameters are not saved to non-volatile memory; hence, the remotely taught inspection is good only as long as Run mode is maintained and power to the Sensor is not lost.

To record the remotely taught inspection, the logging function must be used.

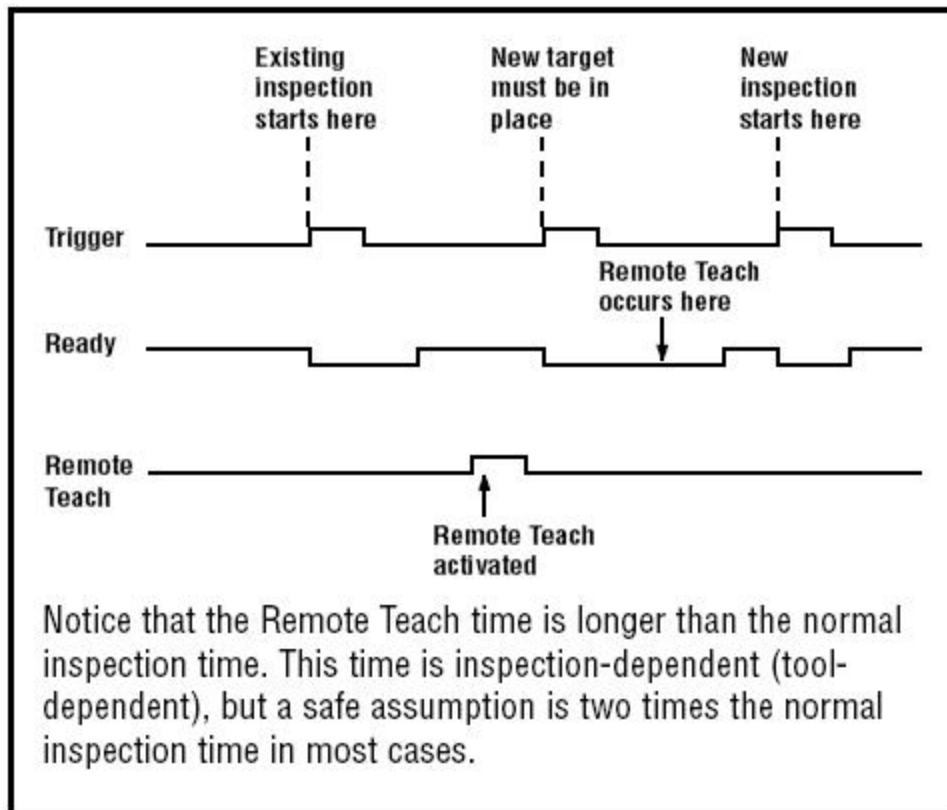

9.4.4 Remote Teach Results

Remote Teach will indicate normal Pass/Fail results. To clarify normal results, the rules are as follows:

- If Location tools were used in the inspection, then they must perform correctly; that is, the Locate tool must find an edge, and the Vision tool(s) must find a pattern. If they do not perform correctly, the Remote Teach will fail, and the inspection will indicate Fail.
 - 👉 **Note:** If the Remote Teach fails for this reason, then the new pattern will not be taught, and the previous inspection will still be valid.
- If Location tools were used and they performed correctly or if Location tools were not used, then the Remote Teach will attempt to update the Vision tool (if enabled). If the Vision tool fails, then the Remote Teach will fail, and the inspection will indicate Fail.
 - 👉 **Note:** If the Remote Teach fails for this reason, then the existing inspection is not valid. The Remote Teach inspection will continue to fail until a new inspection is taught or selected (via Product Change) or until the Sensor is taken out of Run mode.
- If the Remote Teach is successful, the inspection will indicate Pass, and the new inspection will perform with the new parameters.

Use the Run screen to start, stop, monitor, and log an inspection. To display the Monitor tab on the Run screen, click Run in the Main Menu toolbar. The Monitor tab is the default tab in the window.

To exit the Run screen, verify that Run is stopped, and click another destination on the Main Menu toolbar.

While running an inspection, you can monitor the following:

- Pass and Fail counts
- The status of inputs, outputs, Product Select System errors, and whether the Sensor is Ready
- Next Pass, Next Fail, Next Remote Teach, Next Remote Teach Fail, Next, None

To run an inspection, set options and preferences, and click the Start button.

Fields in the Monitor tab are explained below.

Run Screen Monitor Tab

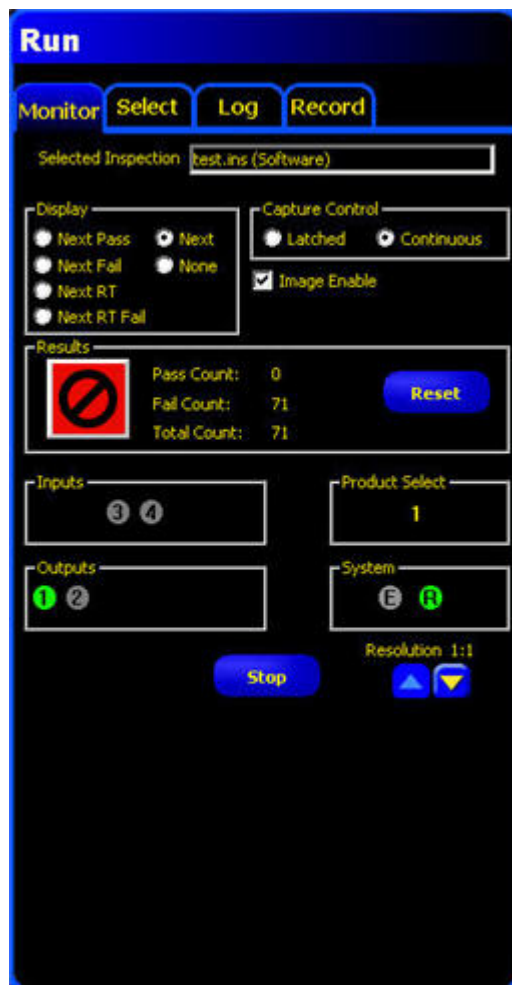

10.1 Selected Inspection



Displays the filename of the selected inspection. The default is the last saved inspection.

10.2 Display



Display Option	Description
Next Pass	Display next passed inspection.
Next Fail	Display next failed inspection.
Next RT	Display next remotely taught inspection.
Next FT Fail	Display next failed, remotely taught inspection.
Next	Display all inspections. The display is updated continuously, but because of transfer speed limits, not every image will be displayed. For faster image speed, reduce the resolution.
None	Display is not updated.

10.3 Capture Control



Capture Control Option	Description
Latched	The condition set in the Display field is displayed, or latched, until set.
Continuous	The condition set in the Display field is displayed.
Image Enable	Checked: The PC displays an image of the inspection. Unchecked: The PC will collect the inspection information without an image.

Capture Control Option	Description
	 Note: Capturing images slows sensor response. For highspeed applications where the PC remains connected to the sensor, you should uncheck Image Enable unless absolutely necessary.

10.4 Results

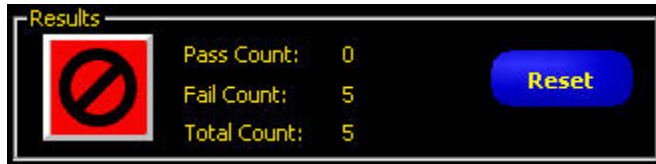

Results Field	Description
Pass Count	Number of passed inspections.
Fail Count	Number of failed inspections.
Total Count	Total number of inspections.
Reset Button	Clears the counts for the selected inspection.

 **Note:** Each of the stored inspections has its own Pass/Fail registers to store the Pass/Fail counts for that particular inspection.

10.5 Inputs



Each numbered circle represents an input and its current state.

The legend below applies to the colored circles in the Inputs:

- Gray = Inactive (not currently available)
- Red = Active (not currently available)
- Not Visible = Not selected as input/output

10.6 Outputs



Each numbered circle represents an output and its current state.

The legend below applies to the colored circles in the outputs:

- Gray = Inactive (not currently available)
- Red = Active (not currently available)
- Not Visible = Not selected as input/output

10.7 Product Select



Displays the last latched Product Select (binary encoded).

The legend below applies to the colored circles in the outputs:

- Gray = Inactive (not currently available)
- Red = Active (not currently available)
- Not Visible = Not selected as input/output

10.8 System



E = System error

R = Ready

 **Note:** The results of the discrete I/O are not displayed in real time. They update approximately 4 times per second.

10.9 Start/Stop

Click the Start button to start running the inspection and click Stop to stop running the inspection.

10.10 Select Tab

The fields on the Select tab of the Run screen are described below.

Product Select

- The **Hardware Input** option signals the sensor to run the product option currently selected by the Product and Product Select input lines (not necessarily what is shown in the drop-down list on the tab). With this option selected, then, the Product Change and Product Select input will change the inspection when signaled to do so.
- The **Software Override** option is typically used for troubleshooting a specific inspection and it signals the sensor that you will manually select an inspection to run. The inspection displayed in the field next to **Software Override** will be the inspection that runs.

Failed Image Hold Enter the number of seconds failed images should be displayed on the optional NTSC video monitor. The default is 1 second.

Trigger Delay Adjust Enter the number of milliseconds to delay the camera before it takes a picture after the sensor receives a valid trigger. The default is 0 milliseconds.

 **Note:** Using the Trigger Delay when a part is triggered too early may be easier than moving the sensor.

Select Tab

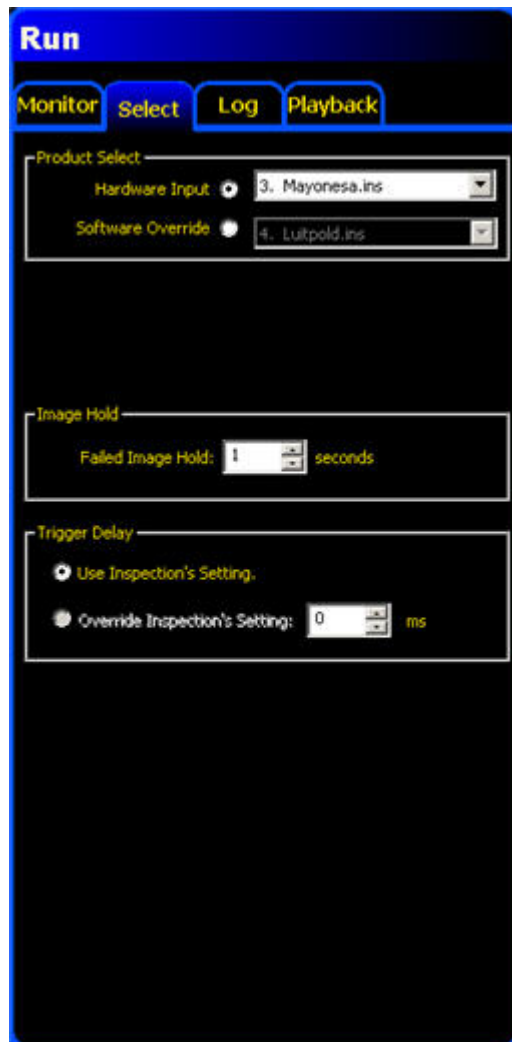

10.11 Log Tab

Fields in the Runs screen's Log tab are described below.

- Mode**
- **Pass**-Logs only passed inspections based on Strategy.
 - **Fail**-Logs only failed inspections based on Strategy.
 - **RT**-Log remotely-taught inspections based on Strategy.
 - **RT Fail**-Log failed, remotely-taught inspections based on Strategy.

- **Any**-Logs both passed and failed inspections based on Strategy.
- **None**-Log not updated.

Strategy

- **Last Ten**-Stores the previous 10 inspections that meet the Mode criteria (this is the default).
- **First Ten**-Stores the first 10 inspections that meet the Mode criteria.
- **First and Last Five**-Stores the first 5 and last 5 inspections that meet the Mode criteria.

Camera

Shows the number of stored inspections currently in the camera's memory.

- **Obtain** button-Moves the stored inspection data from the camera's memory to the GUI's memory.
- **Flush** button-Deletes all stored inspections from the camera's memory.

PC

- **Save All** button-Enables the user to write the log files from...
- **Save Selected** button-Enables the user to write the current log file from the GUI's memory onto a hard drive or other storage device.
- **Load** button-Enables the user to load a saved file from the computer's hard drive or other storage device into the GUI to be viewed.

Result View

- **Clear All** button-Deletes all inspections from the GUI's memory.
- **Clear Selected** button-Deletes the currently selected inspection from the GUI's memory.

Log Tab

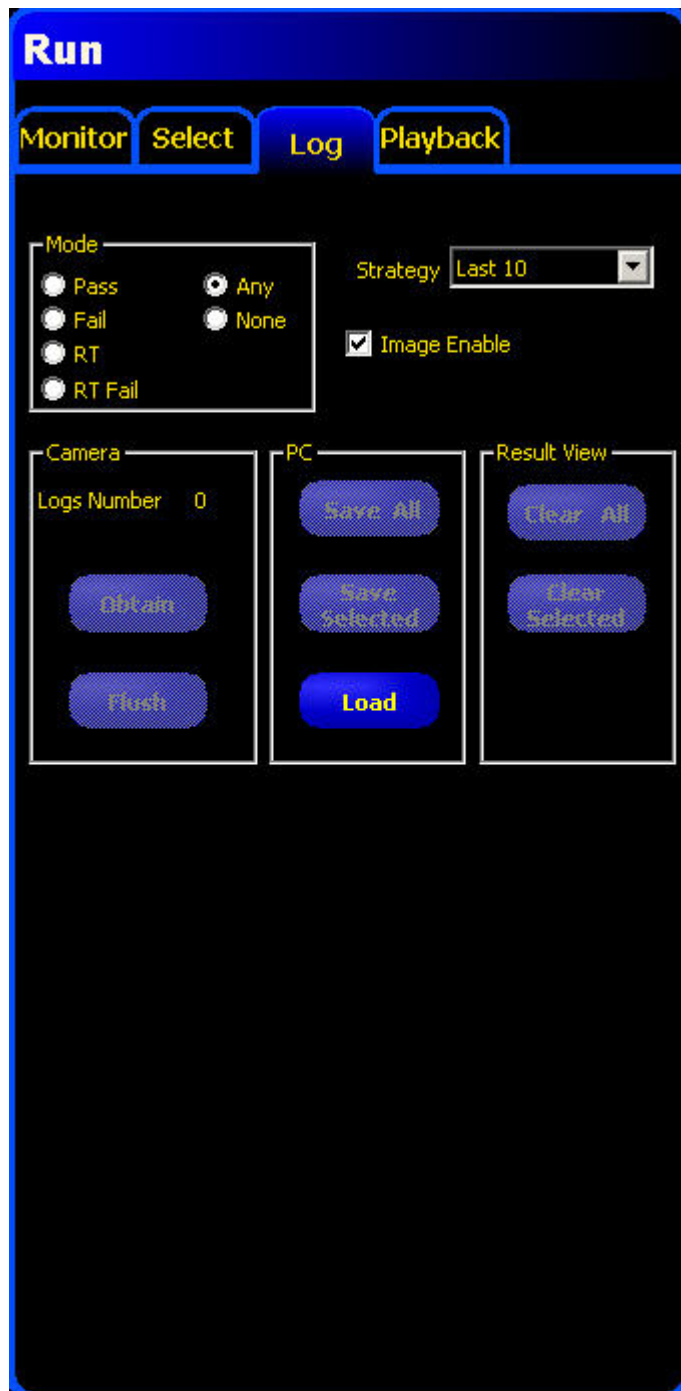

10.12 Run Results

In the Run screen, the Results/Navigation window at the bottom of the display defaults to the Results window shown below. The Results window provides information about the

last displayed inspection. Each tool in the list can be expanded to show its results. Each result shown indicates the tolerance assigned to the parameter and its current value.

- If the current value falls within the Test tool's set tolerance or if the tool executed properly, then a green checkmark symbol is shown beside that parameter.

- If the current value falls outside the Test tool's set tolerance or if the tool failed to execute properly, then a red failed symbol is shown beside that parameter.

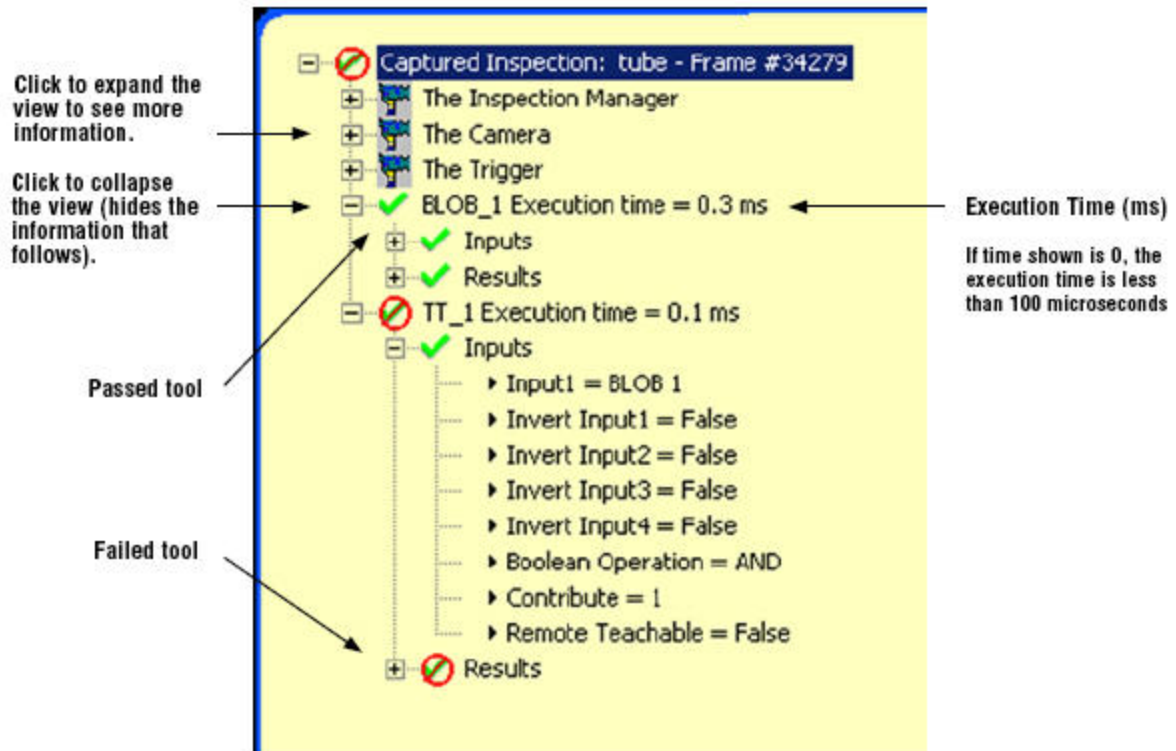

Name	Level	Parent Level	Description
Current Inspection	First	None	Name of currently running inspection.
The Camera	Second	Inspection Name	Sensor Information: <ul style="list-style-type: none"> • Gain • Exposure time (ms)
The Trigger	Second	Inspection Name	Trigger Input Information: <ul style="list-style-type: none"> • Divide • Delay • Width • Polarity
The Inspection Manager	Second	Inspection Name	General Inspection Information: <ul style="list-style-type: none"> • Fail hold time (ms): how long a failed image is displayed on the monitor • Power-up time: time since last shutdown (resolution = second) • Pass count • Fail count • Missed trigger count: total number of triggers missed because sensor was not Ready • Lifetime: ow long the sensor has been turned on (resolution = 1 hour)

Name	Level	Parent Level	Description
			<ul style="list-style-type: none"> • Total inspection time minimum (ms): minimum inspection time recorded (resolution = 0.1 ms) • Total inspection time maximum (ms): maximum inspection time recorded (resolution = 0.1 ms) • Total inspection time (ms)*: inspection time from trigger until the end of processing time for last inspection (resolution = 0.1 ms) (does not include inspection capture to PC*) • Config timestamp: when inspection was created <p>* Capturing an image on teh PC adds to the inspection time. Set display settings to None to decrease the inspection time to a minimum.</p>
Tools (tool name)	Second	Inspection Name	Information about current tool: <ul style="list-style-type: none"> • Execution time (resolution = 0.1 ms) • Inputs (parameters set for the current tool) • Results (results of the current tool)
System log	First	None	Not used

10.13 Run Player/Recorder

The Player/Recorder is typically used for troubleshooting and is actually two features in one—a bitmap Player and a bitmap Recorder. The Recorder can save image files from the camera to an external hard drive for later use. The Player can force the Vision sensor to run on these stored bitmaps rather than “live” pictures taken from the imager chip.

The Player/Recorder feature has two states, based on the status of the Start button. If the Start button has not been pressed, then the sensor can run on saved images. Once the Start button is pressed, then the sensor is evaluating live images and can't run on saved images.

For non-color cameras, the images which are saved by the Recorder feature are 8-bit grayscale bitmaps with the same resolution as the vision sensor they came from. A P4 Geo would generate 128x100 resolution BMP files (13.5 kB in size) while a P4 Omni would make 640x480 BMPs (302 kB) and a P4 BCR 1.3 make 1280x1024 BMPs (1282 kB). The Player feature will work only for the correct resolution images; but it does not care where those images come from originally. Anything that can generate an 8-bit grayscale bitmap of the correct resolution can be a source for Player images: a digital camera, a photo-editing software package, an image from another sensor, etc.

Playback Tab

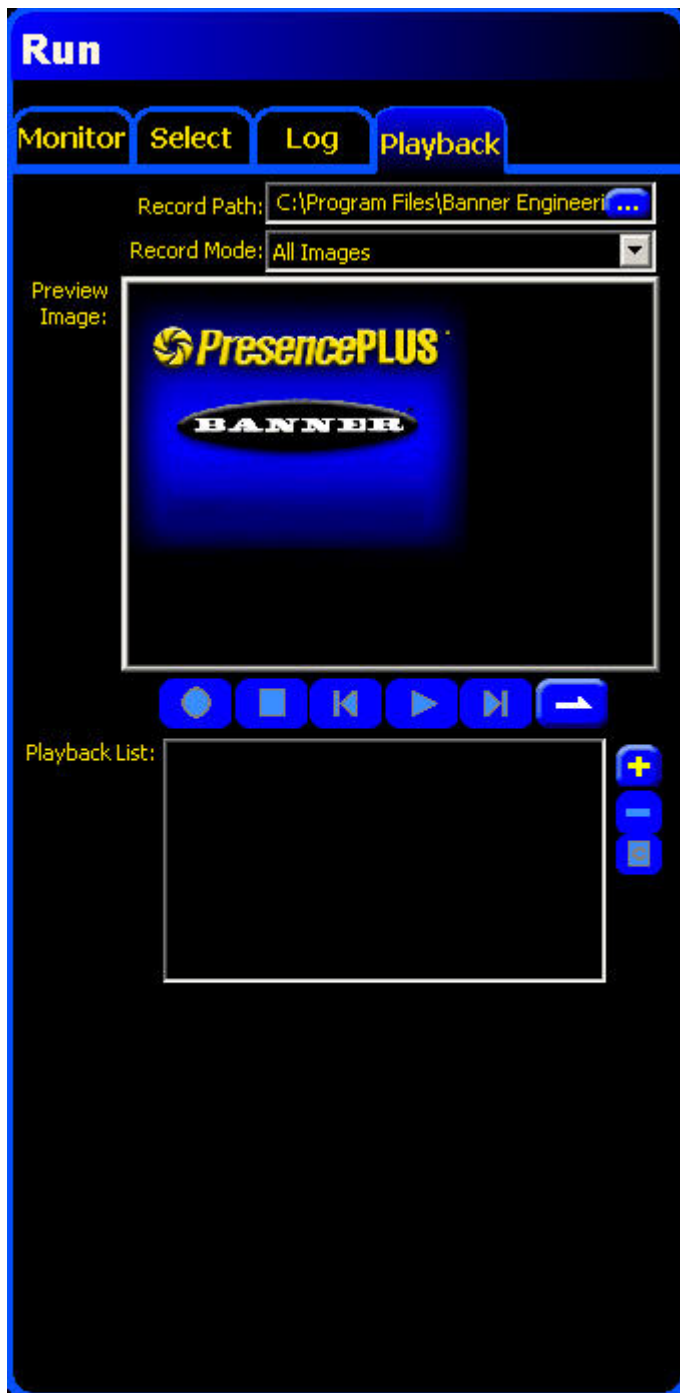

Record Tab



10.13.1 Record

The Record tab is present on the Run screen when the vision sensor is running on live images (that is, the Start button has been pressed).

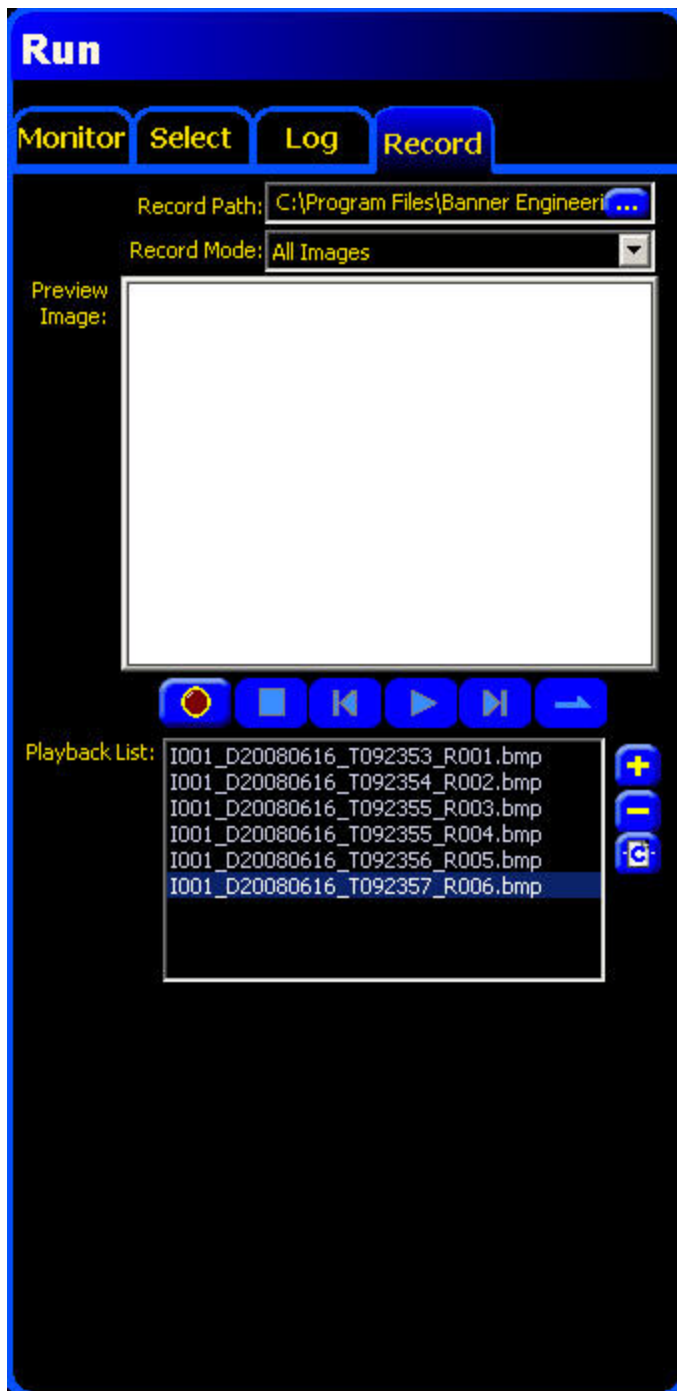

There are three steps to recording bitmap images using this feature:

1. **Choose a Record Path.** At the top of the tab, at the end of the line labeled Record Path, click the button. This will open up the Record to... window allowing you to browse for the folder where you want the images to be saved.
2. **Choose a Record Mode.** Right beneath the Record Path selection is the Record Mode drop down menu. This is where the user selects the conditions (if any) for saving images. The choices are similar to those for the Logging feature.
3. **Press Record.** After choosing which images to save and where to save them, the last step is to press the red Record button found midway down the page. As the images are saved, the file names will appear in the Playback List window. Press the record button or the square Stop button to stop recording.

10.13.2 Playback

The Playback feature is available whenever the vision sensor is in Run mode but the Start button has not been pushed. To enter Playback mode on a currently running sensor, hit the Stop button. Clicking on the Playback tab will bring up the screen shown below left. This screen is almost exactly the same as the Record screen shown earlier: the only differences are the title of the tab and the fact that the Record button is inactive.

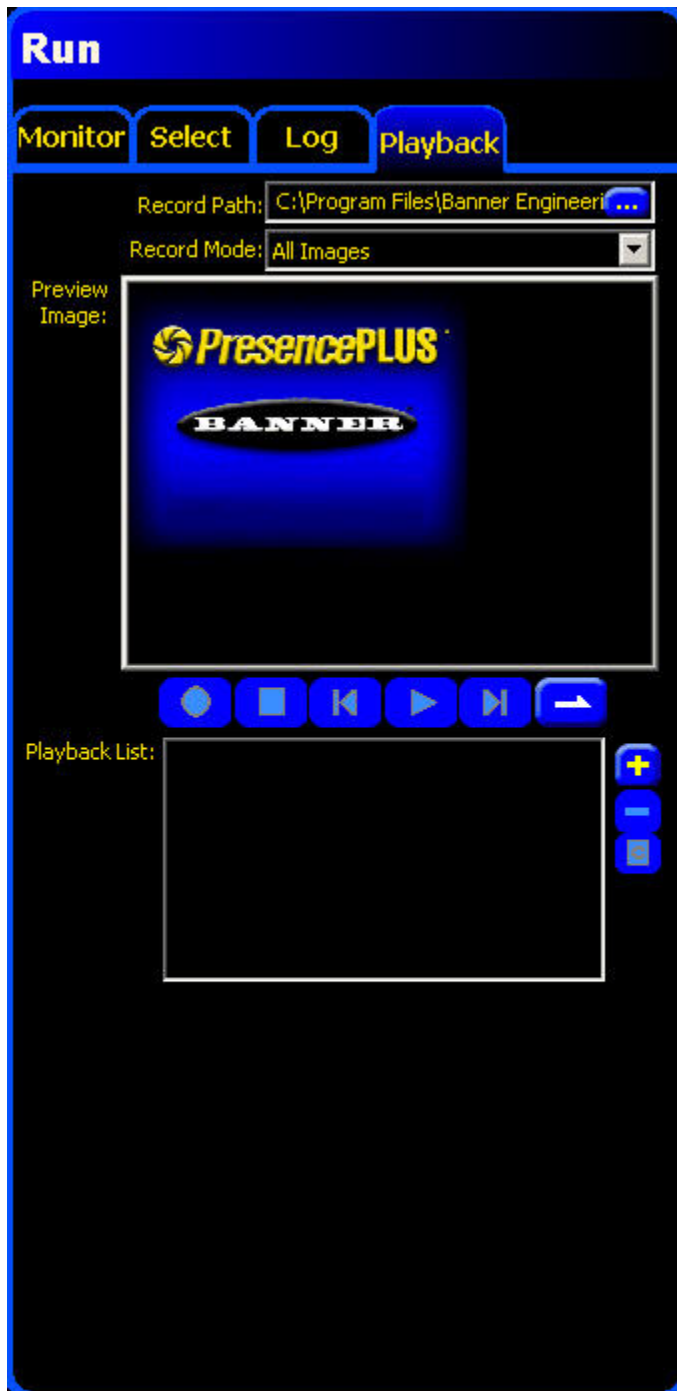

There are three steps to playing back bitmap images using this feature:

1. Load INP file. In Playback mode the vision sensor will be running off of stored images. These images will need to be evaluated in some way, using vision tools, etc. To begin the Playback process, load an INP file as if you are going to run the inspection on live images. When you get to the Run screen, however, hit Playback instead of Start.
2. Make a Playback List. At the bottom of the Playback screen is a box entitled Playback List. This is where you can see the collection of image files the Player will be feeding to the sensor. To add a new BMP file to the Playback List, click the plus button . This will bring up the Add Image(s) window allowing you to find the relevant files on your computer.
3. Click the Play button. Once the Playback List is populated with image file(s), the Play button becomes active. When the Play button is clicked, the Play button becomes to the Pause button and the images in the Playback List are inspected. Press the square Stop button or the Pause button to stop.

Other Playback Features

After files have been added to the Playback List, a couple of buttons become active:

- The minus button is used to remove the currently selected bitmap from the list.
- The Clear All Images button is used to erase all of the files on the list.

There are two Playback modes possible:

- Single Play Mode (the default). In this mode, the Player will run through all the files on the Playback List once and then stop.
- Repeated Play Mode is entered by clicking on the Single Play Mode button. Repeated Play puts the Player into a continuous loop inspecting the files on the Playback List over and over until the Stop or Pause buttons are clicked or the mode is changed back to Single Play.

Instead of running through all the files on the Playback List as fast as possible, the Player can be made to step through each image individually. Clicking on the file name in the list runs the inspection file once on that image. Using the Forward or Back buttons will allow you to step through the images one at a time.

This section explains the Product Change (pin 3) input.

The Product Change input is used in conjunction with one of the four I/O points programmed as Product Select lines. The inspection loaded will be executed following a valid trigger.

- The Product Change input responds to the leading edge transition of a pulse greater than 1 millisecond.
- The Product Select input is pulsed to correspond to a program location. For example, five pulses will load program #5.

11.1 Product Change Specifications

State	Current Sinking (NPN)	Current Sourcing (PNP)
ON	< 2V at 1 mA max.	> 8V at -7.5 mA max.
OFF	> 10 V at 4 mA max.	< 2V at -7.5 mA max.

One of the four I/O on the System Setup InputOutput tab must be programmed for Product Select if Product Change is to be used.

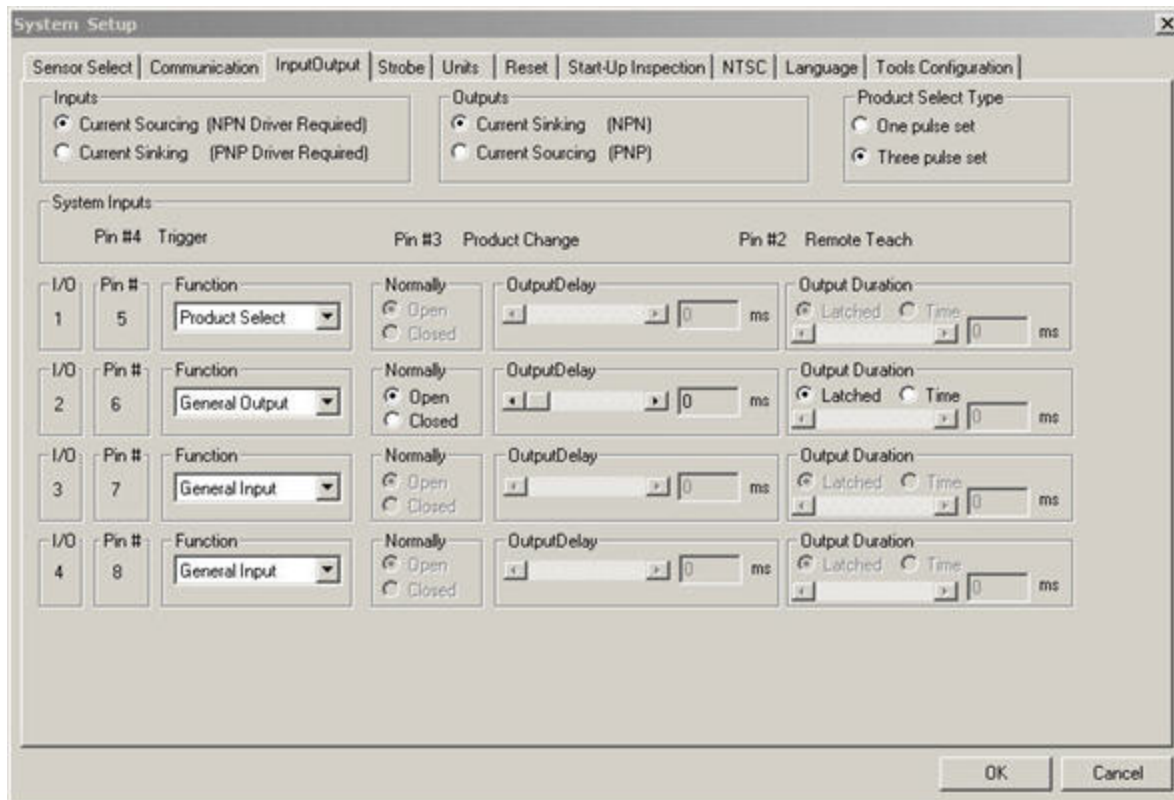

11.2 Product Select Input Specifications

State	Current Sinking (NPN)	Current Sourcing (PNP)
ON	< 2V at 1 mA max.	> 8V at -7.5 mA max.
OFF	> 10V at 4 mA max.	< 2V at -7.5 mA max.

P4 Product Change and Product Select Timing

12.1 One Pulse Set Overview

The Product Change line signals the Sensor to stop what it is doing and begin counting pulses on the Product Select line. The number of pulses indicates to the Sensor the inspection address at which to begin executing the inspection. The only pulses counted are those that occur when the Product Change input is active. As shown in the diagram below, a Product Select input pulse that occurs when the Product Change input is not active is NOT counted.

If the Sensor is in Run mode, the Product Change line should be activated only when the Sensor Green Ready LED is ON. If the Product Change line is activated when the Sensor is in Run mode but performing an inspection (not Ready), the current inspection will be aborted, and the Sensor will proceed to load the inspection at the indicated address.

If the Product Change line is activated when the Sensor is not in Run mode (Setup mode, for example), then the Sensor will go to the address indicated (address number four in this case) and begin executing. The maximum number of pulses is limited by the number of inspections possible on the Sensor.

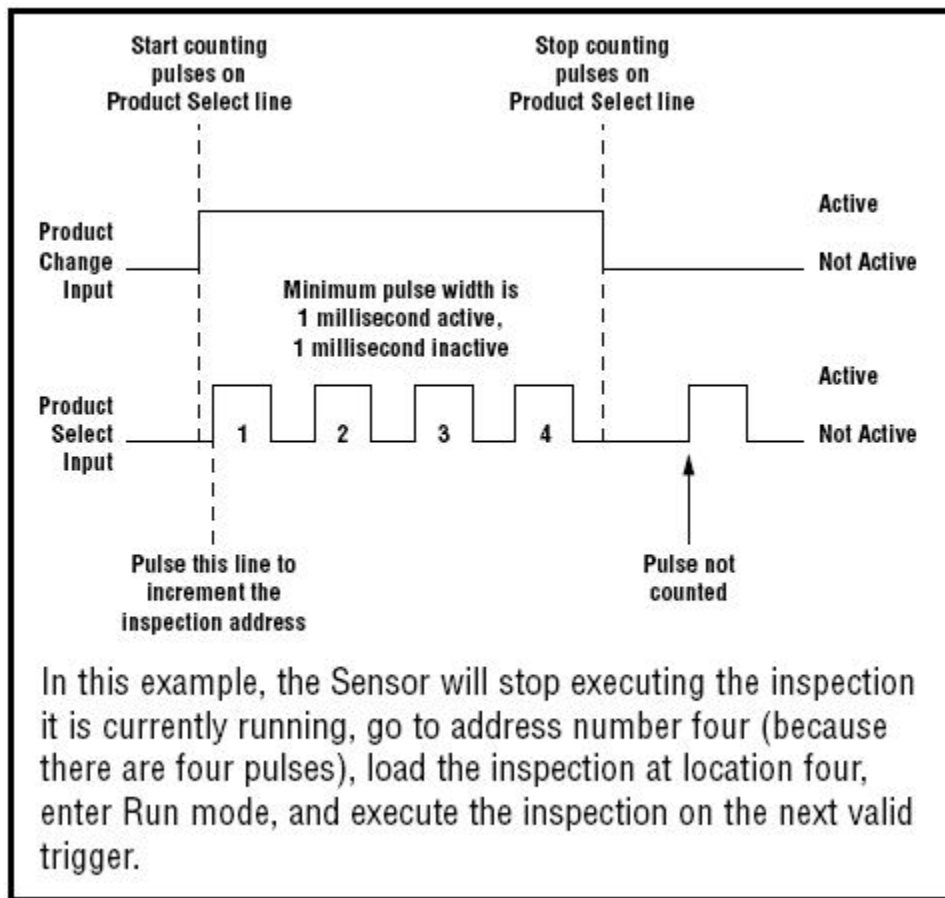

12.1.1 Product Select in One-Pulse Configuration

To use the product select option in the one-pulse configuration, follow these steps.

1. Select Hardware Input in the Select tab of the Run Screen.
2. Configure an I/O for Product Change in the System-Input/Output screen.
3. Set the Product Select Type to "One Pulse Set".
4. Assert the Product Change signal and then assert the number of pulse representing the inspection number to go to.
To do this the Product Change signal must be asserted and held while the pulses representing the digit.

The selected inspection is displayed in the Product Select box in the Monitor under the Run screen.

 **Note:** Note: If the GUI is connected to the sensor there must be an inspection running to perform Product Change.

12.2 Three Pulse Set Overview

The Three Pulse Set uses the same I/O configuration as the standard One Pulse Set, but requires a different timing scheme. Instead of a single product change pulse, three product change pulses will be required, one for 100's digit of the program number, one for the 10's digit, and another for the 1's digit. Corresponding sets of pulses on the Product Select line are also required, as shown below:

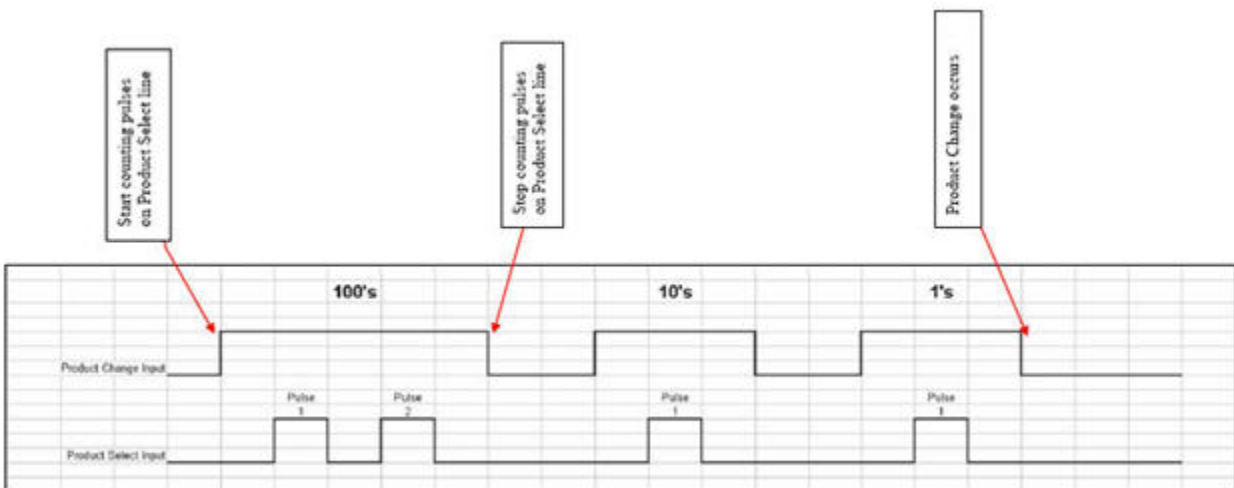

The timing diagram above shows the example for the product number 211. The minimum pulse width for all the timing is 1 ms to guarantee that the vision sensor will see the transitions. The valid number of pulses for each place is 0 – 9. If an invalid memory location is selected (or one which does not store a valid inspection file), the 'Current Inspection' number will be set to -1 and the sensor will be kicked out of Run mode. At this point, a Product Change to a correct inspection file will get the sensor back into Run mode and inspecting.

12.2.1 Product Select in Three-Pulse Configuration

To use the product select option in the 3-pulse configuration follow these steps.

1. Select Hardware Input in the Select tab of the Run Screen.
2. Configure an I/O for Product Change.
3. Select 3-Pulse set.
4. For the Input of Inspection to be selected, there are three sets of pulses and the pulses are setup in the following manner:

- First set of pulses are for the 100's digit.
- Second set of pulses are for the 10's digit.
- Third set of pulses are for the 1's digit.

The user will need to assert the Product Change signal for each set of pulses. To do this, the Product Change signal must be asserted and held while the pulses representing the digit are being sent, and released after the last pulse is given. Valid range of pulses for all digits is 0 - 9.

Inspection (.ins) files can be saved either to the sensor or to the PC. You need to save inspections to the sensor in order to run them; however, you can also save a copy to the PC or your network as a backup.

An inspection (.ins) file contains the image parameters, inspection parameters and, optionally, the reference image:

- Image parameters are the programmed values used by the sensor to acquire the inspection image. These values include gain, exposure time, and trigger setup.
- Inspection parameters include Location tools, Vision tools, and Analysis tools as well as their associated parameters.
- The reference image is the image selected in the Setup screen.

Use the Save window to save an inspection to the Sensor or to save to an Inspections folder on the PC or network.

To display the **Save** dialog, click the Save button in the Menu toolbar.

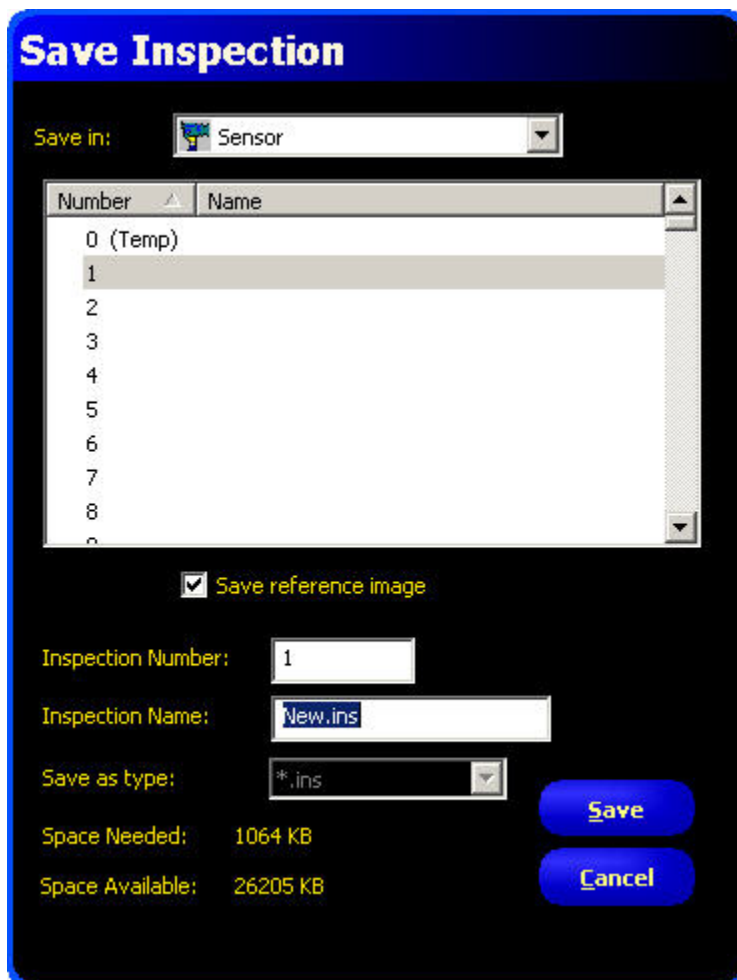

13.1 Saving Inspections to a Vision Sensor

To save an inspection to a Vision sensor:

1. Click on the Save button in the Menu toolbar to display the Save Inspection dialog.

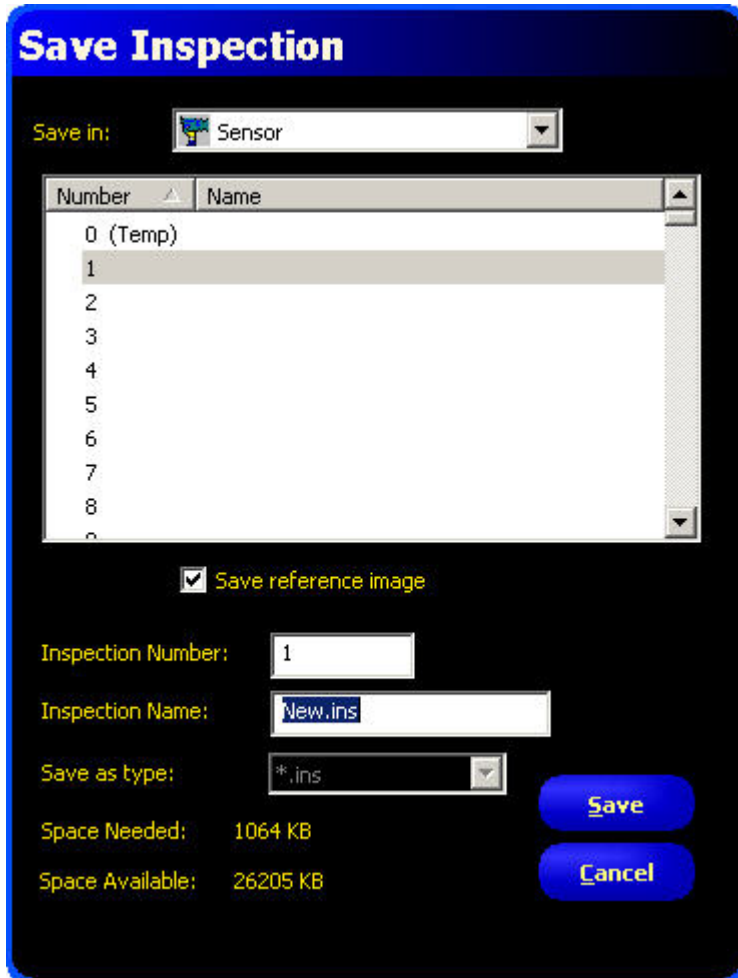

2. Use the scroll bar and select an Inspection Number by clicking in the dialog next to the number where you want to store the inspection, or enter a number in the **Inspection Number** field.
3. In the **Inspection Name** field, enter a name for the inspection.
4. Click the **Save** button in the dialog.

Note: Check the **Space Needed** and **Space Available** fields to ensure there is room to save an inspection. You can choose whether to save a reference image. Not saving a reference image with the inspection frees up a lot of room onboard the sensor. However, inspections that include any of the following tools require a reference image to be saved:

- Geometric Find
- Geometric Count
- Pattern Find
- Pattern Count
- Color Match
- Color BLOB

13.2 Saving Inspections to a PC or Network Drive

To save an inspection to a PC or network drive:

1. Click on the Save button in the Menu toolbar to display the Save Inspection dialog.

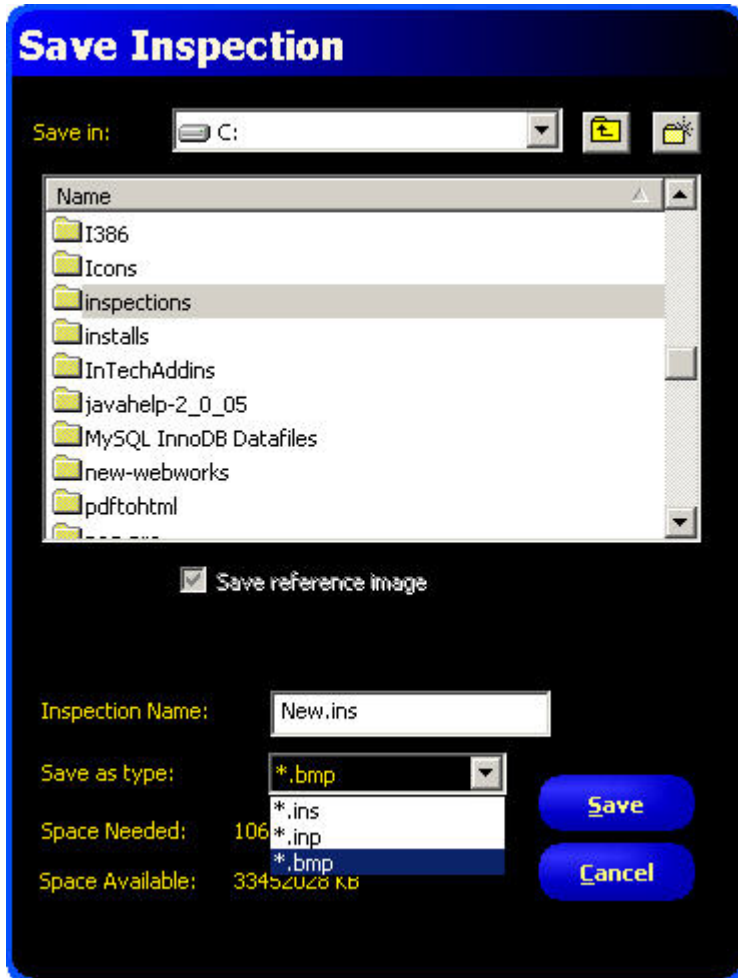

2. Select a disk drive from the **Save in** field.
3. Select a drive and a location for the stored inspection.
4. In the **Inspection Name** field, enter a name for the inspection.
5. From the Save as type drop-down, select:
 - *.ins to save as a standard format for Vision sensors
 - *.inp to save in an older format for compatibility with older sensors.
 - *.bmp to only save the current image.
6. Click the **Save** button in the dialog.

Backing Up and Restoring Vision Sensor Data

14.1 Backing up Vision Sensor Data

To back up Vision sensor data:

1. Insert the PresencePLUS installation CD into the CD-ROM drive, and launch the install program.
2. Click on **PresencePLUS Update Firmware**.

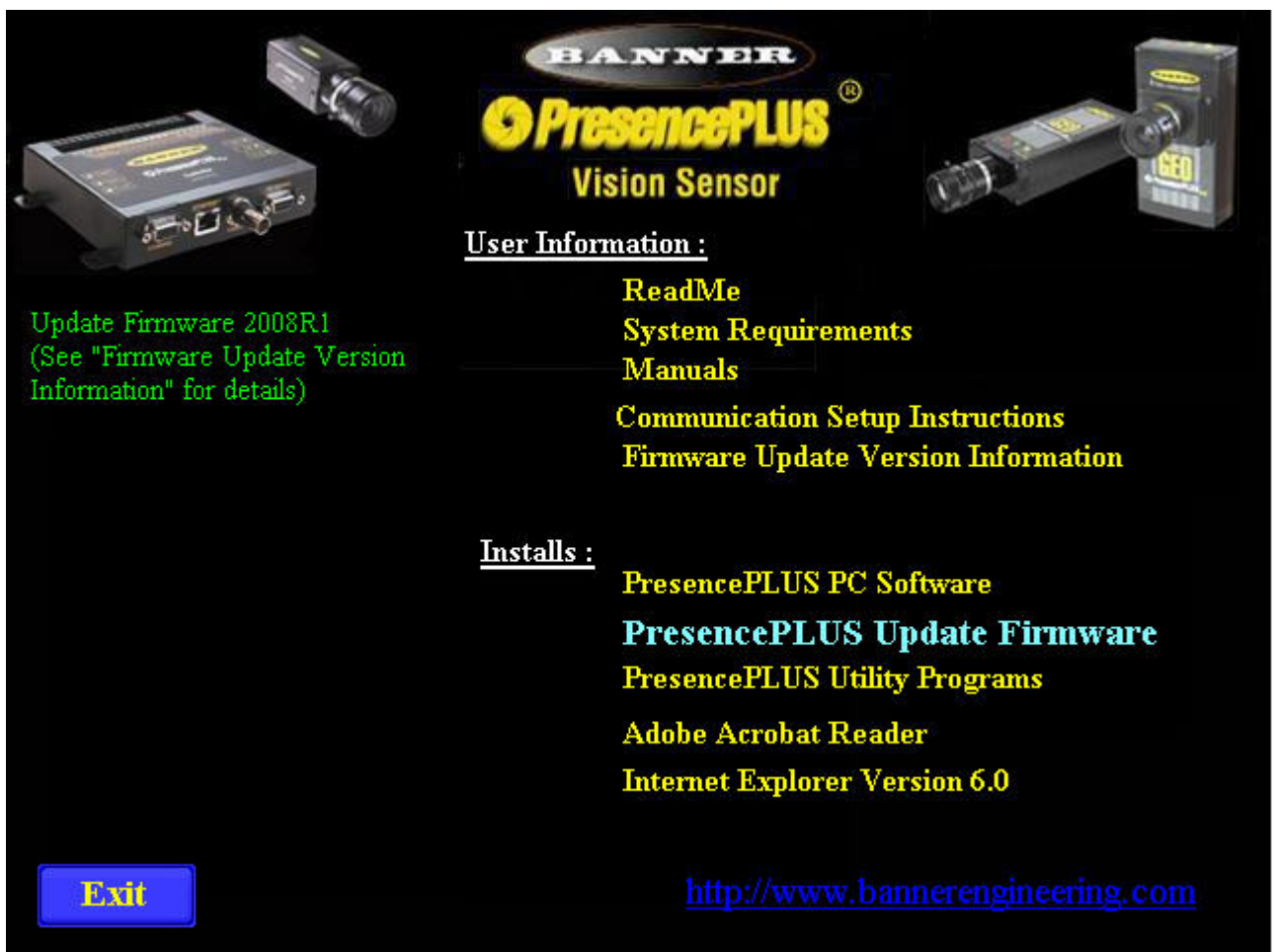

3. From the list of sensors in the **PresencePLUS Firmware Updater**, select the sensor you want to back up, and click **Connect**.
4. Click on the **Sensor Backup** tab.

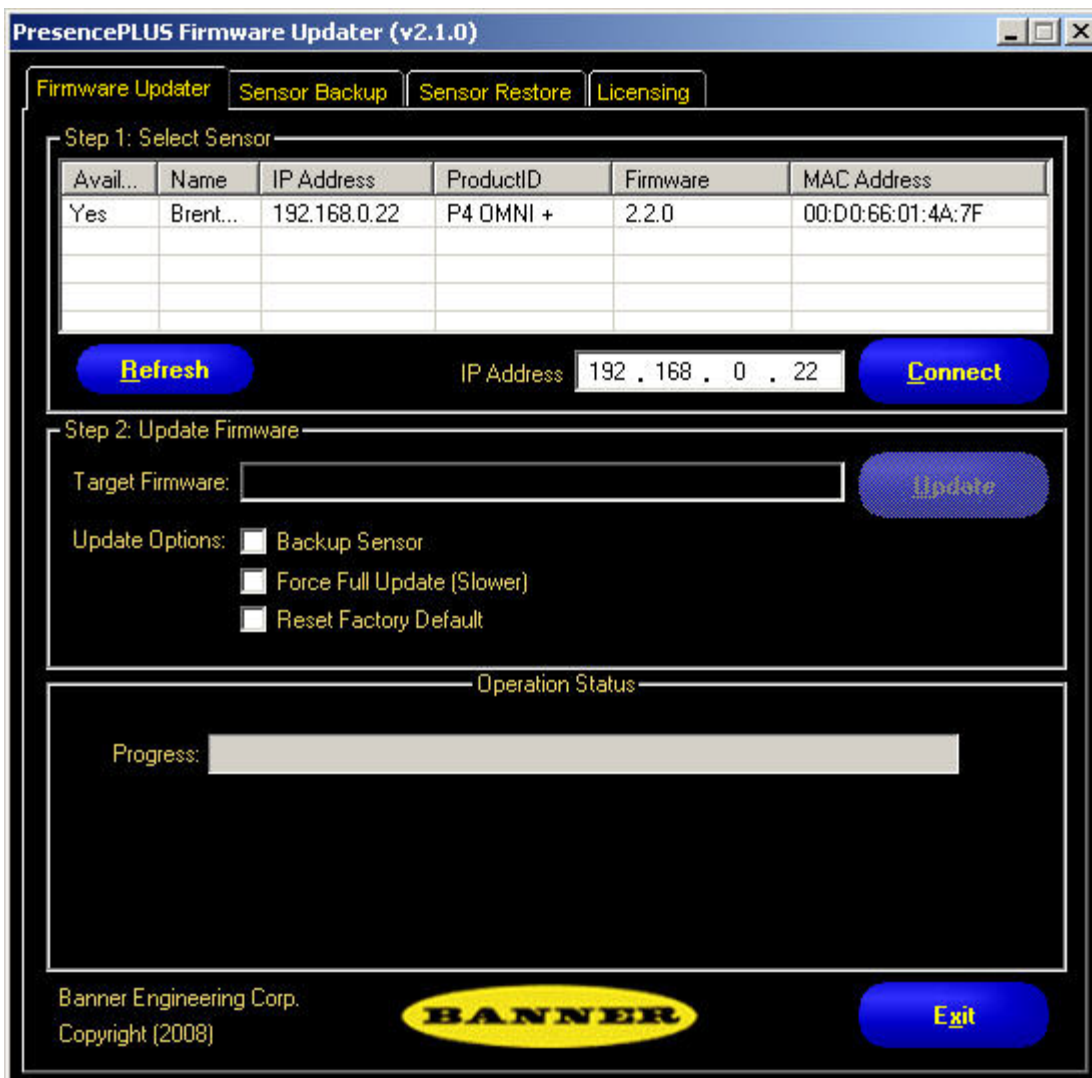

5. In the Create Backup section, click on the ellipses (...) button to select a filename for the backup file as well as a location for the backup on the local computer or on the network.

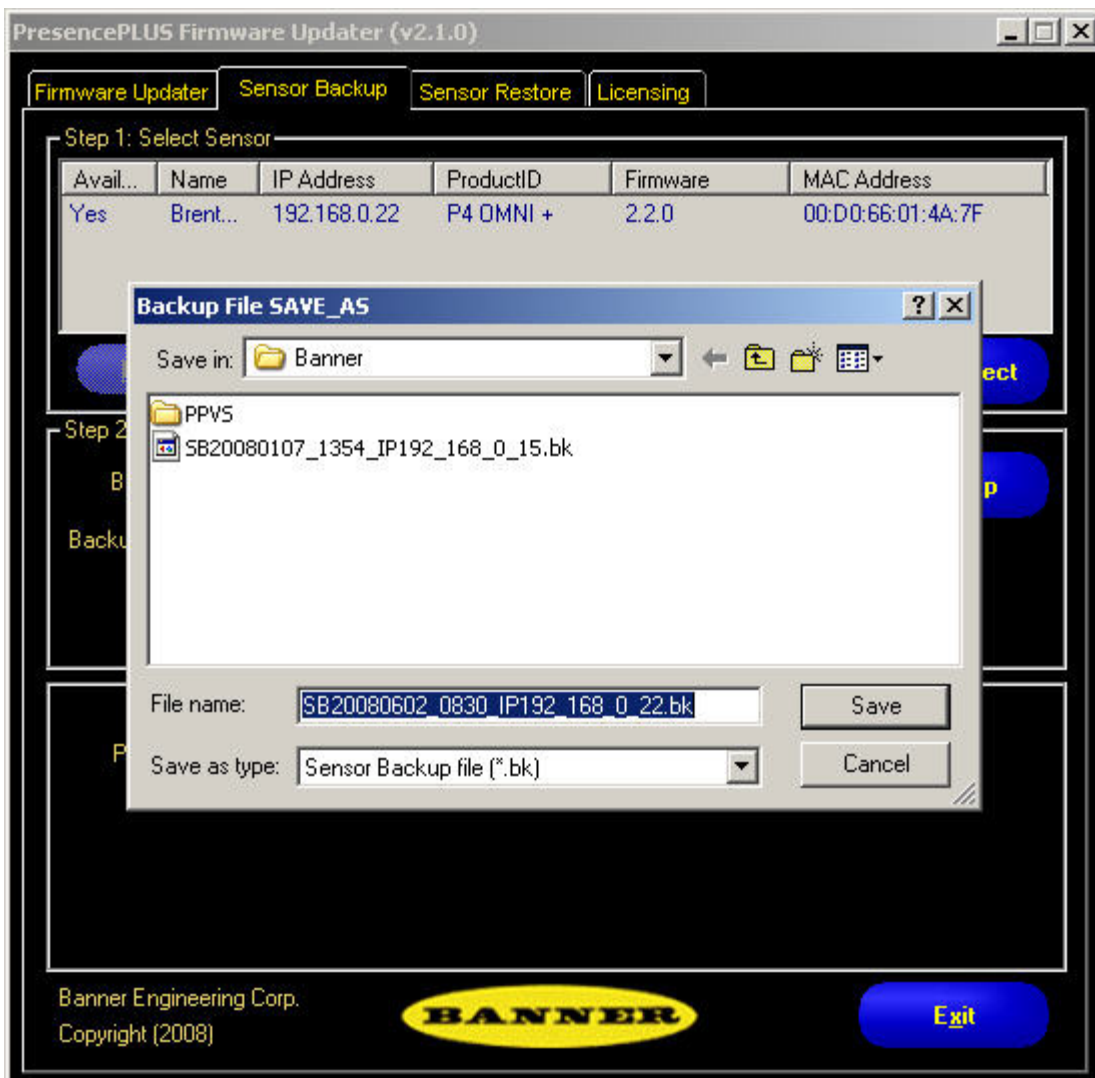

6. In the Backup Content field, select either of the following to backup:

- [Firmware] + [Configuration] + [Inspection(s)]
- [Configuration] + [Inspection(s)]

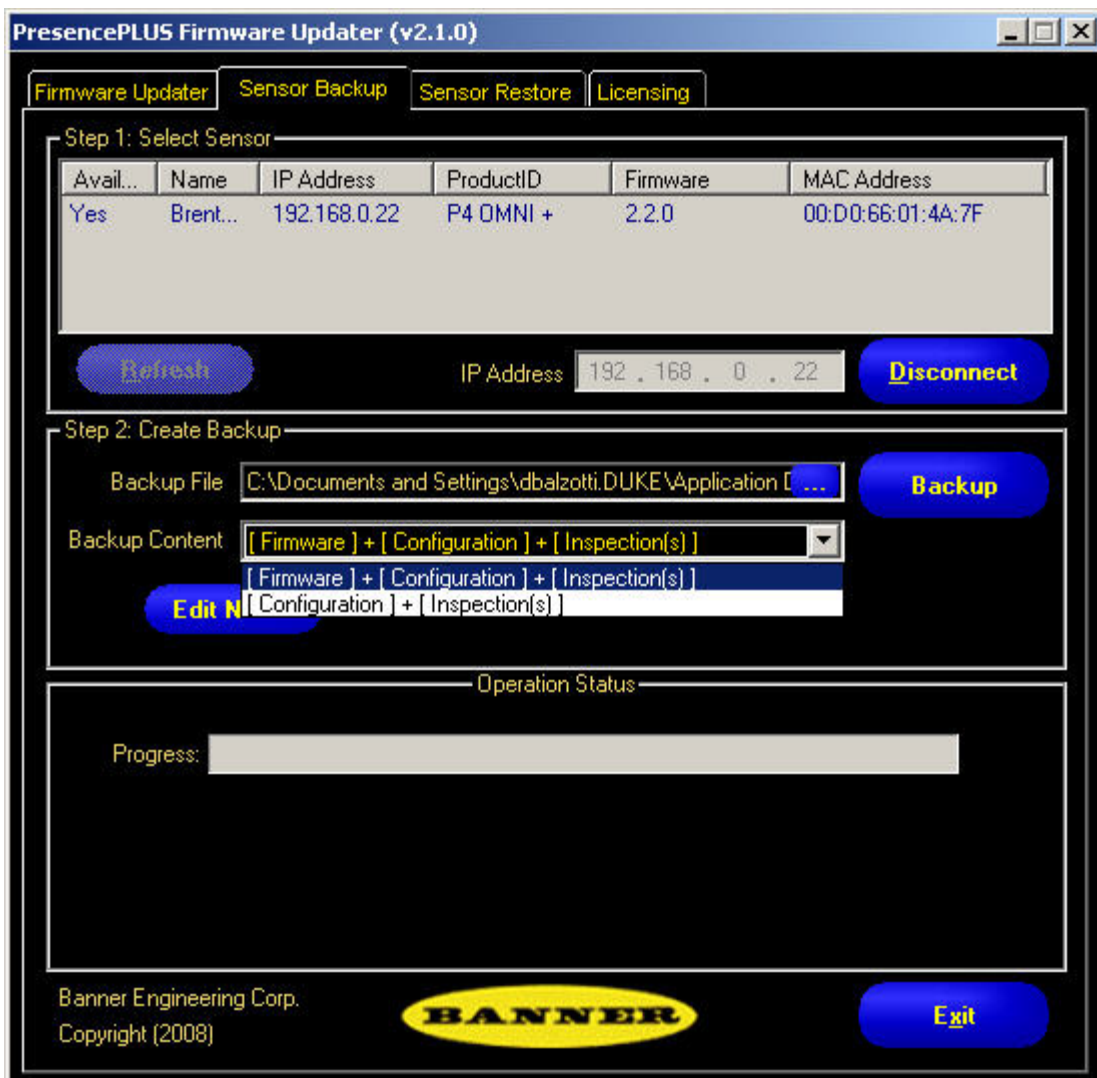

7. Optionally, click on the Edit Note button to add notes for the backup operation.



8. Click the **Backup** button to back up Vision sensor data.

14.2 Restoring Vision Sensor Data

To restore Vision sensor data:

1. Insert the PresencePLUS installation CD into the CD-ROM drive, and launch the install program.
2. Click on **PresencePLUS Update Firmware**.

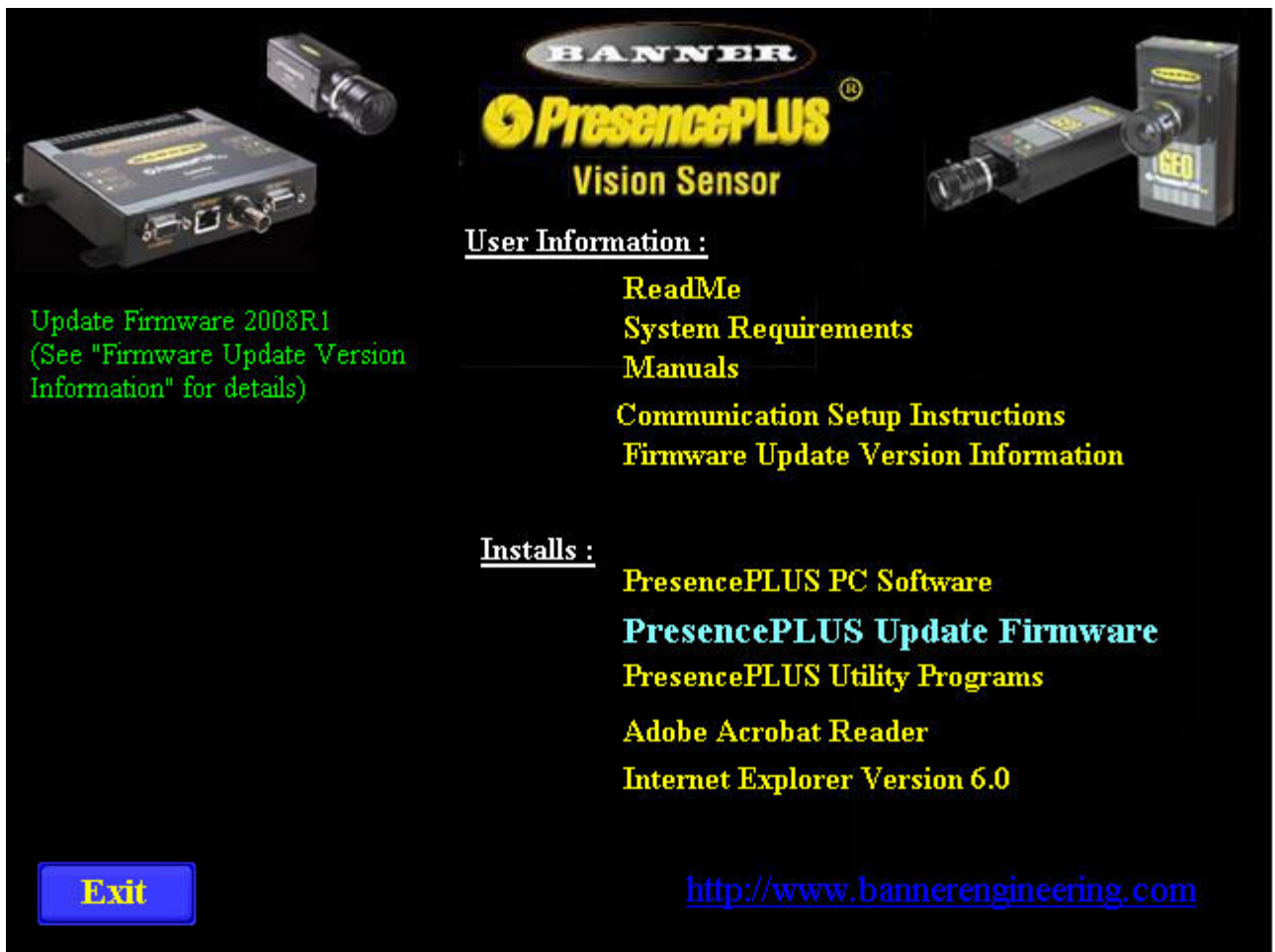

The image shows a software interface for Banner PresencePLUS Vision Sensors. At the top center, the logo reads "BANNER PresencePLUS Vision Sensor". To the left is a large black sensor unit with a lens, and to the right is a smaller, more compact sensor unit. The interface is divided into two main sections: "User Information" and "Installs".

User Information :

- ReadMe
- System Requirements
- Manuals
- Communication Setup Instructions
- Firmware Update Version Information

Installs :

- PresencePLUS PC Software
- PresencePLUS Update Firmware
- PresencePLUS Utility Programs
- Adobe Acrobat Reader
- Internet Explorer Version 6.0

On the left side, there is a green text box that says: "Update Firmware 2008R1 (See "Firmware Update Version Information" for details)".

At the bottom left, there is a blue button labeled "Exit". At the bottom right, there is a blue hyperlink: <http://www.bannerengineering.com>

3. In the **PresencePLUS Firmware Updater**, click on the **Restore** tab.
4. From the list of sensors, select the one you want to restore to, and click **Connect**.
5. In the Restore Sensor section, click on the ellipses (...) button to select a backup file from which to restore the Vision sensor data.

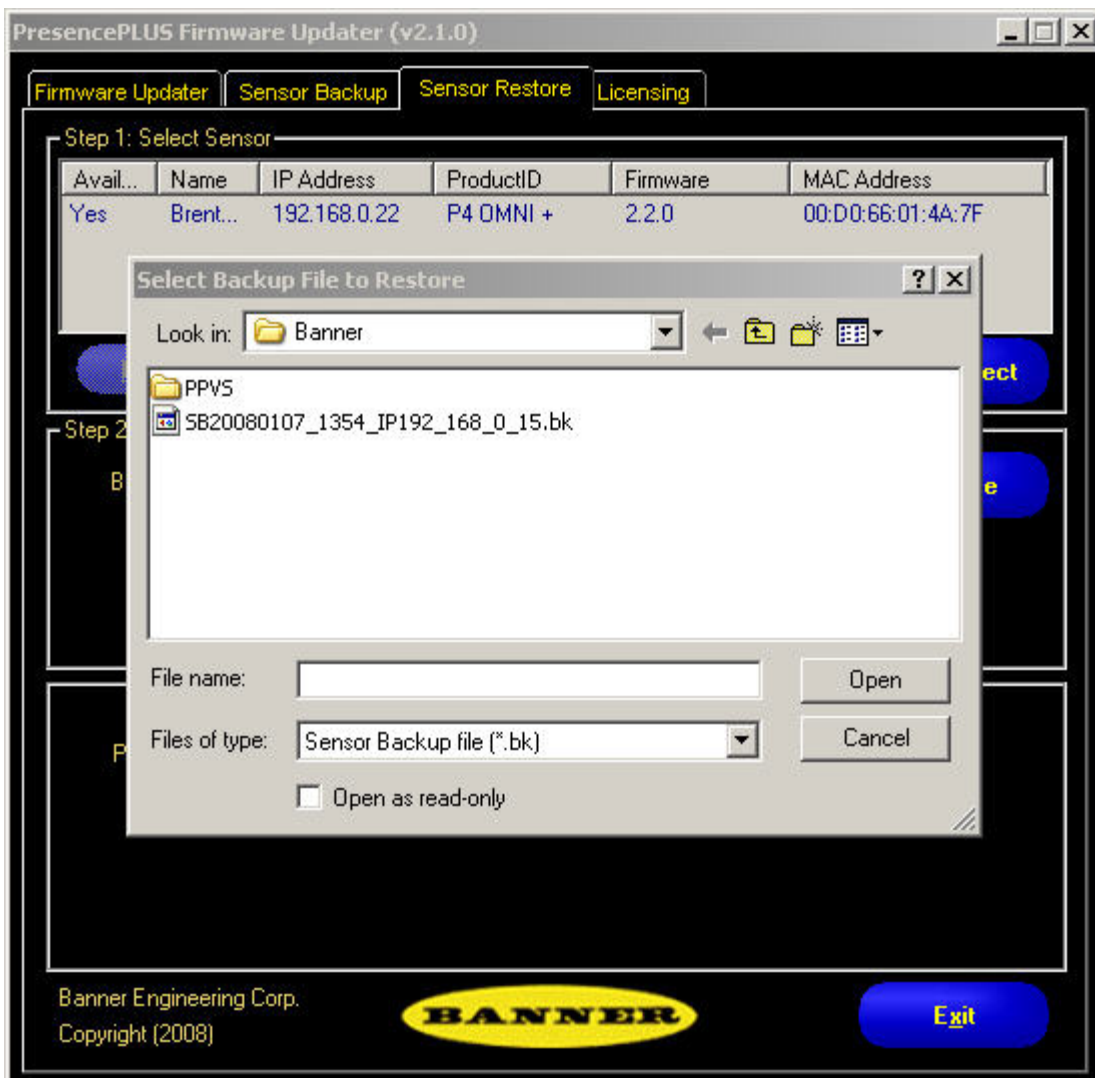

- Optionally, click the **Read Note..** button to get more information about the restore.

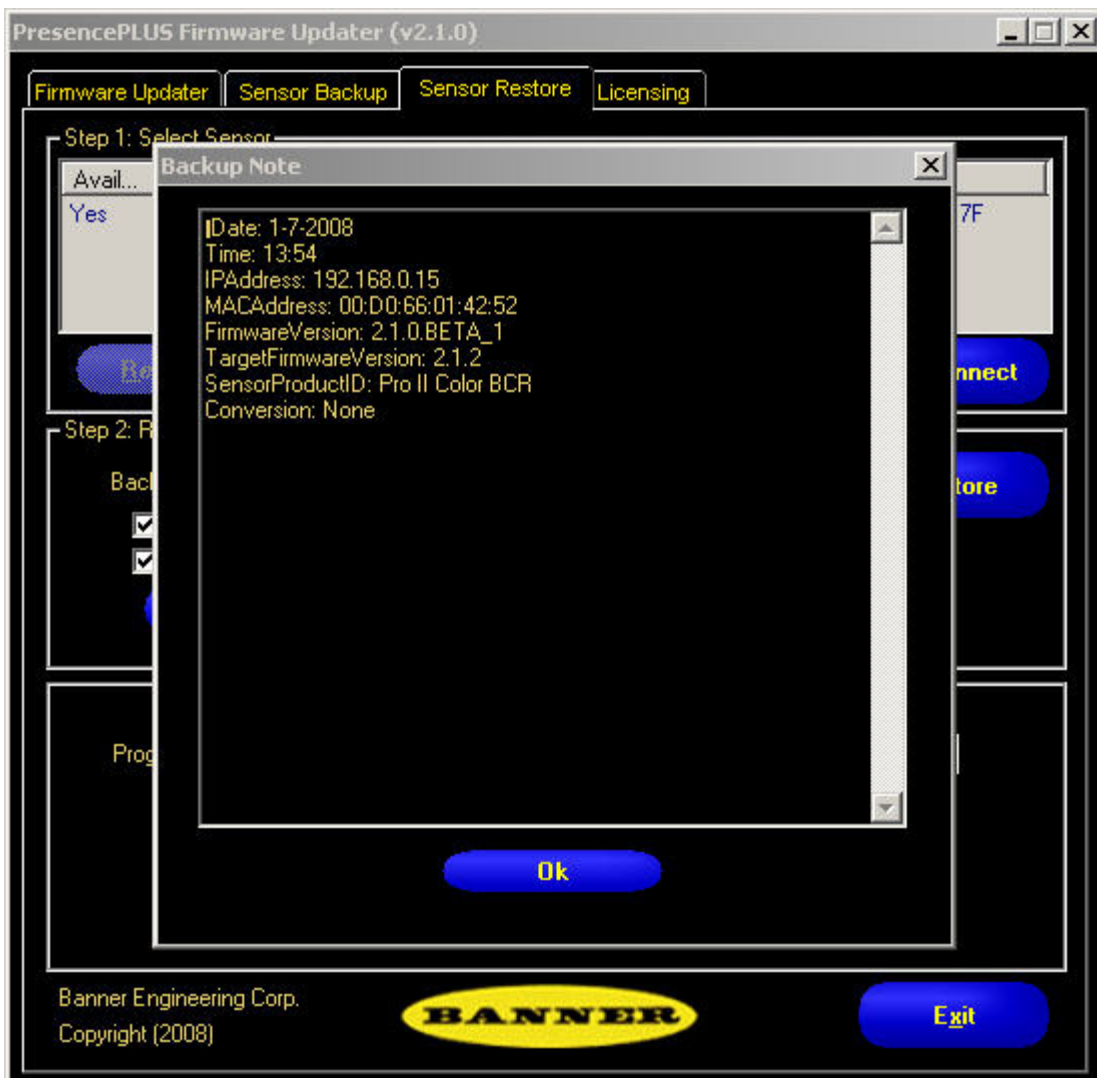

7. If desired, check the box next to **Restore Firmware** and/or **Optimized**.
8. Click the **Restore** button to restore Vision sensor data from the selected backup file.

Dimensions and Specification Chapter 15

15.1 Sensor Dimensions

15.1.1 Right-Angle Sensor Dimensions

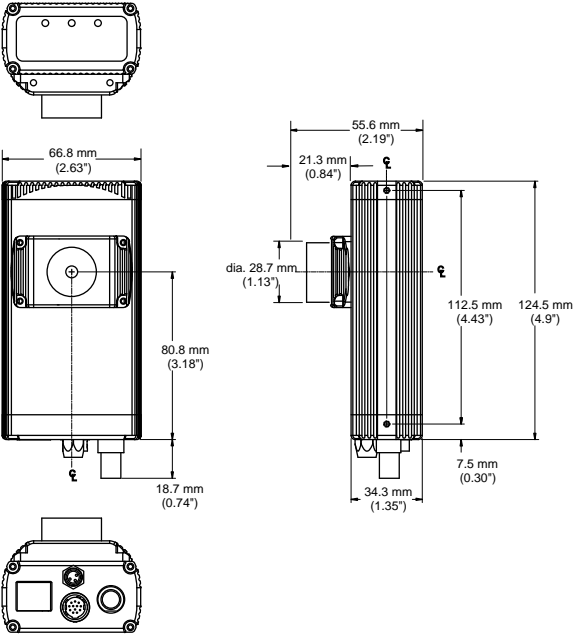

15.1.2 Right-Angle Sensor Mounting Bracket Dimensions

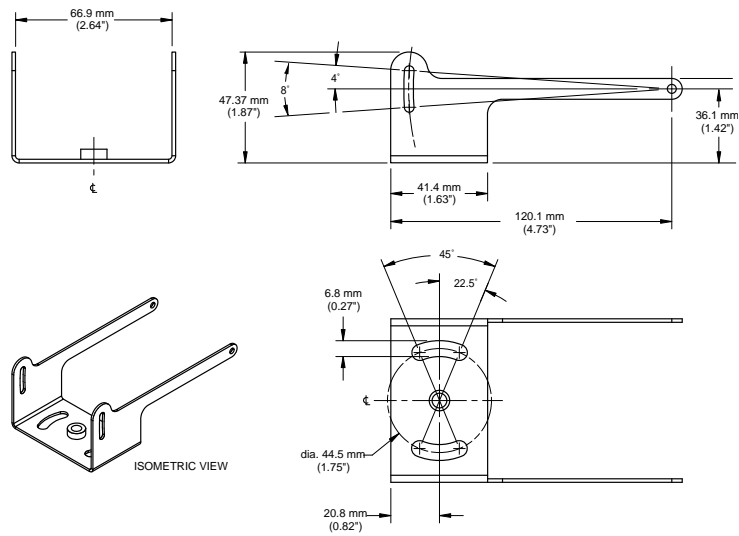

15.1.3 In-Line Sensor Dimensions

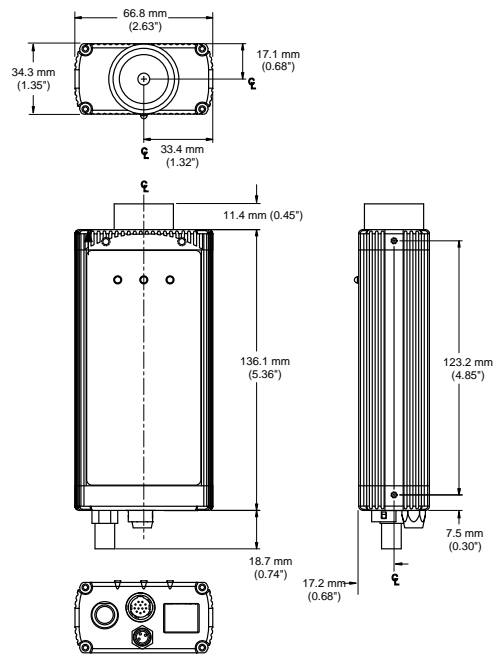

15.1.4 In-Line Sensor Mounting Bracket Dimensions

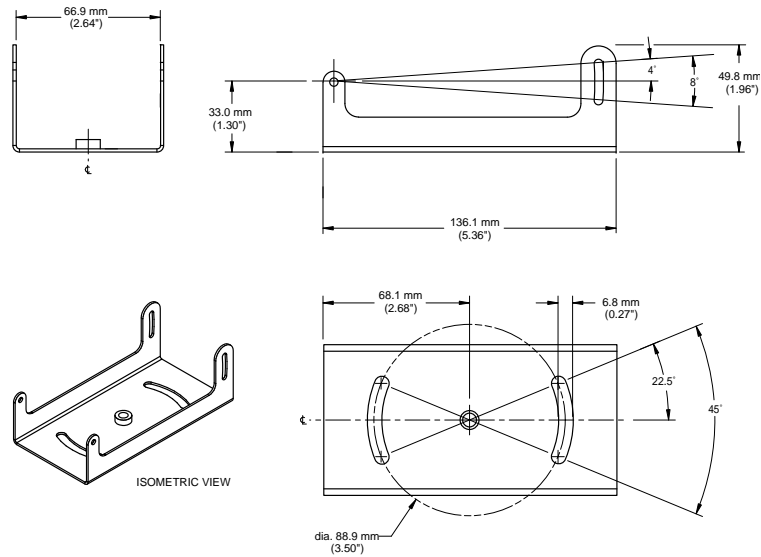

15.2 Sensor Specifications

Feature	Description
Model Numbers	<p>PresencePLUS P4 OMNI Right-Angle Sensor: P4OR P4 OMNI In-Line Sensor: P4OI</p> <p>PresencePLUS P4 OMNI 1.3 Right-Angle Sensor: P4O1.3R P4 OMNI 1.3 In-Line Sensor: P4O1.3I</p> <p>PresencePLUS P4 Color OMNI Right-Angle Sensor: P4COR P4 Color OMNI In-Line Sensor: P4COI</p>
Power	<p>Voltage: 10-30V dc (24V dc \pm 10% if a light source is powered by the Sensor)</p> <p>Current: P4 OMNI: 650 mA maximum (exclusive of I/O load and lights)</p> <p>Current: P4 Color OMNI: 550 mA maximum (exclusive of I/O load and lights)</p> <p>P4 OMNI 1.3: 550 mA maximum (exclusive of I/O load and lights)</p>
Discrete I/O	<p>1 Trigger IN</p> <p>1 Strobe OUT</p> <p>4 Programmable I/O</p> <p>1 Product Change</p> <p>1 Remote Teach</p>
Input/Output Configuration	NPN or PNP software selectable
Output Rating	<p>150 mA</p> <p>ON-State Saturation Voltage: <1V at 150 mA max. NpN; >V \pm 2V</p> <p>OFF-State Leakage Current: <100 microamps NPN or PNP</p>
Communication	<p>1 RJ-45 Ethernet</p> <p>RS-232 flying leads</p>

Feature	Description
Display Options	PC or NTSC video; 9 m (30') max. cable length
Memory	INS Storage Memory: 32 MB Number of INS Files: 999
Acquisition	Frames Per Second: P4 OMNI: 48 max. P4 Color OMNI: 17 max. P4 OMNI 1.3: 26.8 max Image Size: P4 OMNI: 640 X 480 P4 Color OMNI: 752 X 480 P4 OMNI 1.3: 1280 X 1024 Levels of Gray Scale: 256 Color OMNI: 256 Red, Green and Blue
Exposure Time	P4 OMNI: 0.1 to 2830 ms P4 OMNI 1.3: 0.1 to 1670 ms P4 Color OMNI: 0.1 to 1000 ms
Imager	P4 OMNI: 4.736 X 3.552 mm, 5.900 mm diagonal (1/3 inch CCD) P4 OMNI 1.3: 8.576 X 6.861 mm, 10.9829 mm diagonal (2/3 inch CMOS) P4 Color OMNI: 4.5 X 2.9 mm, 5.4 mm diagonal (1/3 inch CMOS)
Pixel Size	P4 OMNI: 7.4 X 7.4 microns P4 OMNI 1.3: 6.7 X 6.7 micrometers P4 Color OMNI: 7.4 X 7.4 microns
Lens Mount	C-mount
Construction	Black anodized aluminum sensor housing, glass lens. Weight: Approximately 0.29 kg (0.642 lb.)
Environmental Rating	IEC IP20; NEMA 1
Operating Conditions	Stable Ambient Temperature: 0° to + 50° C (+32° to + 122° F) Stable Ambient Lighting: No large, quick changes in light level; no direct or reflected sunlight Relative Humidity: 35-90%, non-condensing
Certifications	

15.3 Monitor Specifications - 9" CRT

Feature	Description
Model Number	PPM9

Feature	Description
Construction	Metal case, glass screen Dimensions: 220 X 240 X 267 mm (8.66" X 9.45" X 10.51") Weight: 6 kg (13.2 lb.)
Operating Conditions	Operating Temperature: -10° to +55° C (+14° to 130° F) Maximum Relative Humidity: 95%, non-condensing
Electrical	System: NTSC compatible Picture Tube: 9" measured diagonally Horizontal Resolution: > 1000 TV lines (center), > 800 TV lines (corners) Power Requirement: 110-240V ac, 50/60 Hz Power Consumption: 0.5A
Certifications	Listed TV/Video Product 8K37, E133441 
Controls/Connectors	Horizontal Hold (rotary knob) Vertical Hold (rotary knob) Brightness (rotary knob) Contrast (rotary knob) Video IN-OUT (BNC) Impedance High/Low switch (75 Ohms)

15.4 Monitor Specifications - Flat Panel 8" LCD Color

Feature	Description
Screen Size	8" diagonal
LCD Aspect Ratio	4:3
LCD Panel Type	TFT Active Matrix
Display Resolution	800(H) x 600(V)
Brightness (Central)	350 Nit
Viewing Angle	Left and Right 80° Down 35° Up 15°
Supply Voltage	12-24V dc Red Wire: +V Black Wire: -V
Current Draw	0.6 A @ 12V dc
Connections	Flying leads for power BNC for Video

Feature	Description
	BNC adaptor provided
Operating Temperature	0° C to +50° C (+32° F to +122° F)
Storage Temperature	-20° C to +60° C (-4° F to +140° F)
Video System	NTCS/PAL Auto Switching
Control	Selectable on monitor or via remote control (included) On-screen control: Bright, contrast, color, tint
Net Weight	1.2 lb

15.5 Ethernet Communication Specifications

Use a crossover Ethernet cable for communicating directly with a PC. Use a straight Ethernet cable for communicating with a network device, such as an Ethernet hub or switch.

Feature	Description
Protocol	TCP/IP
Data Transfer Rate	10/100 Mbps
Max Cable Length	120 m (393')
Recommended PC IP Address	192.168.0.2
PC Subnet Mask	255.255.255.0
Factory Default Sensor IP Address	192.168.0.1
Connector	RJ-45
Connector Pinout	Use RJ-45 network crossover cable for direct connection to a PC.

Pin	Name
Pin 1	TXD+
Pin 2	TXD-
Pin 3	RXD+
Pin 4	Not used
Pin 5	Not used
Pin 6	RXD-
Pin 7	Not used
Pin 8	Not used

15.6 Serial Port Communication Specifications

Feature	Description
Baud Rate	115K
Data Bits	Eight
Stop Bits	One
Parity	Odd
Flow Control	None
Connector	

A

A/D converter

Acronym for Analog-to-Digital Converter, an electronic device that converts data from analog form to digital representation.

Abs (Absolute Value)

Abs (Absolute value) returns Abs(X1). The absolute value of an operand is its unsigned magnitude. For example, Abs(-1.5) and Abs(1.5) both return 1.5

acquisition

The manner in which outside information is brought into an analysis system, as in an image acquisition. Generally involves A/D conversion.

adaptive threshold

A control method in which a threshold is adjusted based on scene content.

algorithm

A set of well-defined rules or procedures for solving a problem in a finite number of steps, or providing an output from a specific set of inputs. Usually implemented as a computer program.

ambient light

Light that is present in the environment but not provided by the sensing system.

angle of incidence

The angle between the axis of an impinging light beam and the axis perpendicular to the sample surface.

angle of view

1. The angle formed between two lines drawn from the most widely separated points in the object plane to the center of the lens.

2. The angle between the axis of observation and perpendicular to the specimen surface.

aperture

The size of a lens opening.

ASCII

Acronym for American Standard Code for Information Interchange. An 8-bit coded character set used to represent alphanumeric, punctuation, and certain special control characters.

B

backlighting

A condition where the light reaching the image sensor does not reflect from the surface of the object, but comes from behind the objects or area of interest. Backlighting produces a silhouette of the work piece.

band-eliminator filter

A filter that suppresses a given range of frequencies, transmitting only those above and below that band.

bandpass

The specific range of frequencies or wavelengths, passing through a device. Typically measured between points equal to 50% of maximum amplitude.

barrel distortions

An image appearing to bulge outward on all sides, like a barrel. This is caused by a decrease in effective magnification, as points in the image move a way from the image center.

beam splitter

A device for dividing a light beam into two or more separate beams.

bimodal

Histogram distribution of values with two peaks.

binary system

A vision system that creates a digitized image of an object in which each pixel can have one of only two values, such as light/dark, or zero/one.

Blob

cronym for Binary Large OBject. A connected region in a binary image.

blooming

The "smearing" of regions of the image where the detected brightness is at an excessive level for the receiving element, due to electronic contamination from neighboring bright pixels.

C

c-mount

Threaded lens mount developed from 16 mm movie work. used extensively for closed-circuit television. The threads have a major diameter of 1" and a pitch of 32 threads per inch. The flange focal distance is 0.69".

calibration

The relationship between the output of a measuring instrument and some fiducial mark, an accepted standard of measurement, or other reference datum for the purpose of reporting future results relative to the reference.

centroid

The X and Y pixel coordinates of the center of mass in a two dimensional Blob.

collimated

A beam of light in which all optical rays are parallel.

contrast

The range of difference between light and dark values in an image.

correlation

A process whereby two image segments are compared to determine their similarity, or to find the position at which optimal similarity exists.

D

dark field

An illumination technique supplying the illumination at a shallow (grazing) angle to the surface of the work piece. Ordinarily only a negligible amount of light reflects into the Sensor. Specular reflections occur off any abrupt surface irregularities, and are detectable in the image.

depth of field

The in-focus range of an imaging system. Measured from the distance behind an object to the distance in front of the object, with all objects appearing in focus.

depth of focus

The range of lens-to-image plane distance having the image formed by the lens appearing in focus.

deslant

In order for the OCV/OCR Vision tool to box correctly, there must be a minimum of a 1 pixel-wide column between characters. If the characters are slanted in such a way that they overlap in this 1 pixel-wide column, then the image may need to be manipulated, or deslanted, so that the image can box correctly.

diffuse

The process of redirecting incident light over a range of scattered angles, while reflecting from or transmitting through a material.

distortion

Undesired change in the shape of an image or waveform from the original object or signal.

edge

A change in pixel values exceeding some threshold between two adjacent regions of relatively uniform values. Edges correspond to changes in brightness corresponding to a discontinuity in surface orientation, reflectance, or illumination.

f/stop (or f/number)

Ratio of the focal length of a lens to the diameter of its opening. Increasing or decreasing an exposure by one f/stop doubles or halves the amount of light allowed through the lens.

feature

Any characteristic descriptive of an image or a region in an image.

feature extraction

The process of generating a set of descriptors or characteristic attributes from an image.

fiducial mark

A mark defining a datum point or standard of positional reference used as a basis for calculation or measurement.

field of view (FOV)

The area of object space imaged at the focal plane of a lens.

fluorescent lamp

A lamp that produces light by exciting a phosphor with a plasma, with the phosphor re-emitting the energy as light.

focal length

The distance from a lens' principal point to the corresponding focal point. Also referred to as the equivalent focal length and the effective focal length.

front lighting

An arrangement in which the object is illuminated and viewed from the same side.

G

gradient magnitude

The rate-of-change of pixel intensities over a small local neighborhood.

gray scale

Standardized variations of values from white, through shades of gray, to black in a digitized image with black assigned the value of zero and white the value of 255.

H

halogen

A gas, such as iodine, placed inside an incandescent lamp to gather the evaporated filament off the bulb and redeposit it back onto the filament.

high pass filter

A processing operation that enhances high frequencies (and attenuates low frequencies).

histogram

Frequency counts of the population of pixels of each intensity (gray level) or other characteristic populations in an image.

I

incandescent

Thermal generation of light, usually through radiant filaments in a bulb.

incident light

The light falling directly on an object.

inverse square law

The exponential relationship between increased distance and decreased light intensity.

iris

An adjustable aperture built into a Sensor lens to permit control of the amount of light passing through the lens.

L

LED

Acronym for Light-Emitting Diode.

M

mask

A pattern used to eliminate portions of another pattern. Regions of an image at a constant value, usually white or black, form the mask.

N

noise

Irrelevant or meaningless data resulting from various causes unrelated to the source of data being measured or inspected; random undesirable video signals.

O

ocr

Acronym for Optical Character Recognition. Recognition of each character in a string by a vision system.

ocv

Acronym for Optical Character Verification. Verify a string by a vision system.

P

parallax

The difference in appearance or position of an object when viewed from two different locations.

photon

A particle of light. A quantum of electromagnetic energy moving at the speed of light.

pincushion distortion

A visual effect where the sides of an image appear to bulge inward on all sides like a pincushion. Caused by an increase in effective magnification, as points in the image move away from the image center.

pixel

Acronym for picture element.

polarization

The restriction of the vibrations of light or magnetic field vectors to one plane.

polarized lighting

The use of polarizing filters to remove specular reflections from a scene to be viewed. Typically, one polarizing filter is placed in front of the light source and a second filter is placed over the receiver with the two filters offset in their polarizing direction by 90 degrees.

preprocessing

Enhancement, transformation, or filtering of images before processing.

R

recognition

A match between a description derived from an image and a description obtained from a stored model or feature set.

region of interest (ROI)

The Region of Interest (ROI) is the area to be analyzed inside user-defined boundaries.

repeatability

The degree to which repeated measurements of the same quantity vary about their mean.

resolution

1. The smallest detectable change in position or size of an object.
2. The closest distance between two objects (points) in an image, identifiable as two separate objects rather than one object.

S

shift register

An electronic circuit consisting of a series of storage locations (registers). During each clock cycle, the information in each location moves (shifts) into the adjacent location.

signal-to-noise ratio

The ratio of the maximum value of an output signal to the standard deviation amplitude of the noise on the signal.

strobe light

A pulsed illumination source that generates short bursts of high-intensity light.

sub-pixel resolution

Any technique resulting in a measurement with a resolution (interpolated position of change) of less than one pixel.

T

template matching

Comparing a template with an object in an image. Usually performed at the pixel level, as with a template correlation.

threshold

The intensity (specific pixel value) below which a stimulus produces no effect or response. Often used to convert a gray scale or analog image into a binary image.

thresholding

A scene segmentation process based on converting a gray scale image into a binary image by reassigning pixel gray levels to only two values. Regions of the binary image are separated, based on whether pixel values in the gray scale image were above or below a chosen intensity level.

throughput

The total capability of equipment to process or transmit data during a specified time period.

tolerance

The established range upon which to base the differentiation between good and bad products.

translation

Movement left or right, up or down, but not rotated; a geometrical operation that shifts the position of an image from its original position.

Z

zoom

Electronically or optically enlarging or reducing the size of an image.

Index

A

- absolute positioning 99
- absolute threshold 96, 144, 161
- adaptive threshold 104, 151
- adding an area tool 123, 171, 175, 188
- advanced tab
 - barcode tool 193
 - Blob Find tool 118
 - Blob tool 133
 - color Blob tool 181
 - geometric count tool 152
 - geometric find tool 105
 - string tool 293
- area 119, 134, 183
- area tools
 - adding 123, 171, 175, 188
 - mask 113, 123, 126, 172, 175, 189
- average color tool 170
- average gray scale
 - histogram 124
- average gray scale tool 122

B

- barcode tool 190
 - advanced tab 193
 - color scheme 195
 - decoder mode 195
- barcode type 191
- binary large object 174
- binary large object(s) 111, 125
- Blob 125
- Blob Find 111
- Blob Find tool 111
 - advanced tab 118
- Blob tool 125
 - advanced tab 133
 - histogram 116, 132

C

- centroid 119, 134, 184
- character ID 206
- character pattern 206
- character spacing 212, 231
- character strings 61, 327
- Circle Detect tool 137
- color Blob tool 174
 - advanced tab 181
- color inspections 34
 - white balancing 35
- color match tool 187

- color scheme 195
- command processing
 - EXEC PRODCHANGE 59, 325
 - EXEC RESET 59, 325
 - EXEC TRIGGER 59, 325
 - GET 60, 325
 - SET EXPOSURE 59, 325
- communication tool 244
 - Ethernet connection 50, 317
 - setup 317
- Communication tool error codes 58, 324
- compactness 120, 135, 185
- compute statistics 119, 134
- coordinate tool 259

D

- decoder mode 195
- deslant 211, 230
- discard boundary blobs 119, 133

E

- eccentricity 122, 137, 185
- edge length 104, 152
- edge profile graph 96, 97, 144, 145, 161
- edge strength 97, 104, 145, 151, 162
- edge tool 142
- error codes
 - Communication tool 58, 324
 - Reset command 59, 324
 - Trigger and Product Change 58, 324
- Ethernet connection 50, 317
- EXEC PRODCHANGE 59, 325
- EXEC RESET 59, 325
- EXEC TRIGGER 59, 325

F

- fill holes 119, 133
- filters 98, 146, 163, 165
- fixed threshold 114, 127, 204
- font library 221, 240
- Frame Tag Numbers 59, 325

G

- geometric count tool
 - advanced tab 152
- geometric find tool 101
- geometric count tool 149

geomtric find tool
 advanced tab 105
GET 60, 325
gray scale intensity 122

H

histogram 116, 124, 132
horizontal gap 216, 235
HSI 172

I

input tab
 locate tool 94
inspection storage capacity 43

L

largest hole to fill 119, 134
line detect 157
Line Detect tool 155
linear tools
 locate tool 94
locate tool 94
 filters 98, 146, 163, 165
 min width 99, 147, 163, 166
 ROI width 98, 146, 163, 166
 sample rate 99, 147, 163, 166
 smoothing 98, 147, 163, 166
 input tab 94
location tool
 rotation enable 99

M

major axis angle 120, 135, 185
major axis length 120, 135, 185
mask 113, 123, 126, 172, 175, 189
math tool 263
max radius 122, 137, 187
max radius position 122, 137, 187
measure tool 268
min radius 122, 137, 187
min radius position 122, 137, 187
min stroke thickness 213, 232
min width 99
minor axis length 120, 135, 185
monitor tab
 product select 338
 ready 338
 system error 338

O

optical character recognition (OCR) 206
optical character verification (OCV) 224

P

pattern count tool 167

pattern find tool 108
perimeter 119, 134, 184
polarity 96, 97, 139, 144, 145, 157, 160, 161, 162
print contrast 212, 231
product select 338

R

RCC log 60, 326
RCC return values 58, 324
ready 338
reference image 208, 227
region of interest (ROI) 210, 229
reject level 114, 115, 127, 128, 204
reject threshold 107, 154
relative threshold 96, 144, 160
remote teach 151, 169, 189, 299, 332
Reset command error codes 59, 324
RGB 34
ROI width 98, 146, 163, 166
rotation enable 99
rotation range 106, 153
run screen 335
 monitor tab 335

S

sample rate 99, 147, 163, 166
scaling range 108, 155
sensor select tab 45
SET GAIN 59, 325
smoothing 98, 147, 163, 166
storage capacity
 inspections 43
string tool 290
 advanced tab 293
system error 338
system setup 45
 sensor select tab 45

T

teach 329
teach screen 329
test tool 297
threshold 96, 139, 144, 160
 adaptive 104, 151
 reject 107, 154
threshold type
 absolute 96, 144, 161
 edge strength 97, 145, 162
 fixed 114, 127, 204
 relative 96, 144, 160
tools
 average color 170
 average gray scale 122
 barcode 190
 Blob 125
 Blob Find 111
 Circle 137
 color Blob 174
 color match 187

tools (*continued*)

- communication 244
- coordinate 259
- edge 142
- geometric count 149
- geometric find 101
- Line 155
- locate tool 94
- math 263
- measure 268
- string 290
- test 297

tools (*continued*)

- pattern find 108
- tools{pattern count} 167
- Trigger and Product Change error codes 58, 324

V

- vertical gap 216, 235

W

- white balancing 35

