

GE Healthcare

CardioSoft

Version 6.7

Operator's Manual

2060290-002 ENG Revision C



NOTE: The information in this manual only applies to system software version 6.7. It does not apply to earlier software versions.

Due to continuing product innovation, specifications in this manual are subject to change without notice.



GE Medical Systems
Information Technologies, Inc.
8200 West Tower Avenue
Milwaukee, WI 53223 USA
Tel: +1 414 355 5000
1 800 558 7044 (USA only)
1 800 668 0732 (Canada only)
Fax: +1 414 355 3790



GE Medical Systems
Information Technologies GmbH
Munzinger Straße 5
79111 Freiburg
GERMANY
Tel: +49 761 45 43-0
Fax: +49 761 45 43-233

CASE, MAC, MARS, and MUSE are trademarks owned by GE Medical Systems *Information Technologies GmbH*, a General Electric Company going to market as GE Healthcare.

© 2011-2014. General Electric Company. All rights reserved.

CE Marking Information



Compliance

The product CardioSoft bears the CE marking CE-0459, notified body GMED, indicating its conformity with the provisions of the Council Directive 93/42/EEC concerning medical devices and fulfills the essential requirements of Annex I of this directive.

The acquisition module is assigned to class IIa as specified in Annex IX of the Directive 93/42/EEC.

The CE marking only covers accessories listed in the Order Information chapter.

The acquisition module complies with the electromagnetic immunity requirements of standard IEC 60601-1-2 "Electromagnetic Compatibility - Medical Electrical Equipment".

The radio interference emitted by the acquisition module is within the limits specified in EN 55011 - class B.

Magnetic and electrical fields are capable of interfering with the proper performance of the device. For this reason make sure that all external devices operated in the vicinity of the system cart comply with the relevant EMC requirements. X-ray equipment, MRI devices, radio systems, cellular telephones, etc. are possible sources of interference as they may emit higher levels of electromagnetic radiation. Keep the PC away from these devices and verify the performance of CardioSoft before use.

The safety and effectiveness of this device has been verified against previously distributed devices. Although all standards applicable to presently marketed devices may not be appropriate for prior devices (i.e., electromagnetic compatibility standards), this device will not impair the safe and effective use of those previously distributed devices (see Operator's Manual).

The country of manufacture appears on the device label.

For your notes

Contents

CE Marking Information	CE-1
------------------------------	------

1

Introduction

License Agreement	1-3
About This Manual	1-4
Revision History	1-4
Manual Purpose	1-4
Intended Audience	1-4
Conventions	1-5
Styles	1-5
Illustrations	1-5
Safety Information	1-6
Intended Use	1-6
General Information	1-7
Definition	1-8
Classification	1-12
Equipment Symbols	1-13
Biocompatibility	1-14
Technical Maintenance	1-14
Legal Notice	1-15
Security Patches	1-15
Service Information	1-15
Service Requirements	1-15
Equipment Identification	1-15

2

Product Overview

PC / Server Setup	2-3
Minimum PC / Server Requirements	2-3
Peripheral Devices Connecting to the PC	2-3
MAC 500, MAC 600, MAC 800, MAC 1200, MAC 1600, MAC 3500, MAC 5000, MAC 5500	2-4
CardioSoft Client / CardioSoft Web Hardware Key	2-5
Installing CardioSoft	2-5
Putting the System Into Service	2-6
Mains Connection, Power Up, Functional Test	2-6
Initial Screen	2-7
Softkeys Controlling Exercise Tests	2-8

Viewing and Printing the Operator's Manual	2-9
Online Help	2-9
Software Options	2-10
Demo Version of CardioSoft	2-13

3 **Preparing the Patient**

Applying Electrodes - The Basics	3-3
Preparing the Patient's Skin	3-4
Applying Electrodes	3-5
Lead Labels on the Acquisition Module	3-5
Standard 12 Lead Electrode Placement	3-6
Standard 15 Lead Electrode Placement	3-7
MASON-LIKAR Lead Electrode Placement	3-8
(Modified Standard Leads for Exercise Tests)	3-8
FRANK X, Y, Z Lead Electrode Placement	3-9
NEHB Lead Electrode Placement	3-10
CM5, CC5, ML (CML) Auxiliary Lead Electrode Placement	3-11
CM5, CC5, CH (CMH) Auxiliary Lead Electrode Placement	3-12
Attaching the Acquisition Module	3-13

4 **Selecting a Patient Record and Test Type**

Selecting a Patient Record from the Local Database	4-3
Overview	4-3
Retrieving a Patient Record from the MUSE System Database	4-5
Orders from the MUSE System	4-6
Entering a New Patient	4-7
Patient Records of External Programs	4-8

5 **Resting ECG**

Entering Test Information	5-3
Overview	5-3
Patient Information Tab	5-3
Test / Personnel Tab	5-4
Medications Tab	5-5
Recording a Resting ECG	5-6

Overview	5-6
10-Second ECG with Analysis	5-7
Operating Steps	5-8
Full Disclosure ECG	5-10
Operating Steps	5-10
Post Test Review	5-11
Test Summary	5-11
ECG Traces	5-13
Zoom Mode	5-14
Measuring the ECG	5-15
Medians	5-16
Reanalysis	5-17
Performing Reanalysis	5-18
Arrhythmia Review	5-20
Determining the Heart Rate	5-21
Vector Loops	5-22
Full Disclosure ECG	5-23
Printing the Full Disclosure ECG	5-24
Enabling the Zoom Mode	5-24
Analyzing Full Disclosure ECG Segments, Save as Resting ECGs	5-25
Report Printout	5-26
Generating the Interpretation	5-27
Copying Diagnostic Statements Using Acronyms	5-28
Comparing Resting ECGs	5-29
Comparing Two Resting ECGs	5-29
Comparing Median Complexes from Multiple Resting ECGs	5-33

6 Exercise Test

Patient Education	6-3
Entering Test Information	6-4
Overview	6-4
Patient Information Tab	6-4
Test / Personnel Tab	6-6
Medications Tab	6-7
Calculating Patient Risk	6-7
Before the Test	6-9
Pre-Acquisition Screen	6-9
Overview	6-9
Operating Steps	6-12
During the Test	6-13
Acquisition Screen	6-13
Overview	6-13

Pretest Phase	6-15
Overview	6-15
Operating Steps	6-15
Exercise Phase	6-16
Overview	6-16
Operating Steps	6-16
Manual Control	6-17
ECG Data Windows	6-18
ST/Arrhy Window	6-18
Medians Window	6-19
Waterfall Window	6-20
Tabular Summary Window	6-21
METS Formula (Metabolic Equivalent)	6-22
Trends Window	6-23
ECG Strips Window	6-24
12SL Window	6-25
Interpretation Window	6-26
Comparing Previous Test Data	6-27
Recovery Phase	6-28
Overview	6-28
Test End Phase	6-29
Overview	6-29
Operating Steps	6-29
After the Test — Post Test Review	6-31
Test Summary	6-31
Overview	6-31
Tabular Summary	6-33
METS Formula	6-33
Graphic Trends	6-34
Overview	6-34
Viewing the Full Disclosure ECG	6-35
Viewing Medians, Replacing max. ST Changes	6-36
Viewing TWA Medians, Replacing max. TWA Values	6-37
Sample Cardiac Cycles	6-38
Overview	6-38
Reanalysis	6-39
Performing Reanalysis	6-40
Performing Measurements on the Median Complex	6-40
Sample TWA Cycles	6-41
Overview	6-41
ECG Strips	6-42
Arrhythmia Review	6-43
Full Disclosure ECG	6-45
Overview	6-45
Printing the Full Disclosure ECG	6-46
Enabling the Zoom Mode	6-47

Audio ECG	6-48
Waterfall	6-48
3D Graph	6-49
12SL	6-50
Vector Loops	6-51
Report Printout	6-52
Report Formats	6-53
In-Test Reports with Laser Printer	6-53
Final Reports	6-54
Monitoring of Remote Exercise Test Workstations	6-55

7 Ambulatory Blood Pressure Measurement

Ambulatory Blood Pressure Monitors	7-3
Connecting the Ambulatory BP Monitor	7-4
Setting Up the Ambulatory Blood Pressure Monitor	7-5
Acquisition Screen	7-5
Operating Steps	7-6
Post Test Review	7-8
Downloading Data	7-8
Test Summary	7-9
Patient Information	7-10
Test Information	7-10
Measurement Results	7-12
Generating or Editing the Interpretation	7-13
Graphics	7-14
Tabular Summary	7-15
Hourly Averages	7-16
Statistics Summary	7-16
Report Printout	7-17

8 Spirometry Test

Sensors	8-3
Entering Test Information	8-4
Overview	8-4
Patient Information Tab	8-4
Test / Personnel Tab	8-5
Medications	8-6
Conducting Spirometry Tests	8-7

Overview	8-7
Flow-Volume Measurement - Operating Steps	8-9
Bronchodilator Test	8-12
Spirometry Tests with the LF 501	8-12
Post Test Review	8-14
Test Summary	8-14
Patient Information	8-15
Test Information	8-15
FVC Measurement	8-15
Generating or Editing the Interpretation	8-16
Report Printout	8-17
Comparing Two Spirograms	8-18

9 File Management

Overview	9-3
Selecting Patient Records	9-4
Viewing, Editing, Printing Patient Records	9-6
Printing a Combined Report	9-6
Viewing and Printing Patient Records from the MUSE System	9-7
Sending, Exporting, Deleting Patient Records	9-8
Transfer to MUSE	9-8
Send	9-8
Export	9-9
Working Temporarily with the Local Database	9-11

10 Operation with Administrative Tools

Overview	10-3
Description	10-4

11 DICOM Interface

Overview	11-3
Performing Procedures with the Order List (Scheduled Procedures)	11-4
Elements of the Order List - Explanation	11-6
Performing Procedures without the Order List (Unscheduled Procedures) ...	11-6

12 System Settings

Resting ECG Setup	12-3
Acquisition Tab	12-3
Editing the Reason for Test Library	12-4
Editing the Interpretation Library	12-5
Editing Medication Groups, Assigning Drug Names	12-6
Lead Sequence Tab	12-7
Modifying the Lead Sequence	12-7
Configuring Leads Ex1, Ex2, Ex3	12-7
Miscellaneous Tab	12-8
Final Report Tab	12-9
Report Editor	12-10
Exercise Test Setup	12-12
Writer Tab	12-12
Screen Tab	12-13
Configuring the Tabular Summary	12-14
Configuring Trends	12-15
Configuring the Vital Signs	12-16
Lead Sequence Tab	12-17
Modifying the Lead Sequence	12-17
Configuring Leads Ex1, Ex2, Ex3	12-18
Protocol Editor Tab	12-19
Selecting the Default Protocol	12-19
Protocol Editor Screen	12-20
Creating a New Phase	12-22
Editing Stage or Phase Information	12-22
Final Report Tab	12-23
Miscellaneous 1 Tab	12-24
Miscellaneous 2 Tab	12-26
Editing the Comments, Test Types, Reason for Test, Reasons for Termination, Medications Library	12-26
Configuring the Measurement Results	12-26
Editing the Interpretation Library	12-27
Entering Extra Questions	12-28
Assigning Functions to the Function Keys	12-28
ST/Medians / 12SL Tab	12-29
TWA Tab	12-30
Ambulatory Blood Pressure Measurement Setup	12-31
Acquisition Tab	12-31
Editing the BP Protocol	12-32
Miscellaneous Tab	12-33
Editing the Reason for Test, Medication Library	12-33
Editing the Interpretation Library	12-34

Spirometry Setup	12-35
Acquisition Tab	12-35
Miscellaneous Tab	12-36
Editing the <i>Reason for Test, Medication</i> Library .	12-36
Editing the <i>Interpretation</i> Library	12-37
Custom Setups, Factory Setup	12-38
Save	12-38
Load or Delete	12-39
Load the Factory Setup	12-39
System Configuration	12-40
General Tab	12-40
Adjusting the Screen Size for Widescreen Monitors	12-42
User Administration	12-43
Receiving Resting ECGs from Other ECG Devices	12-45
Copying Patient Records	12-48
Archiving Patient Records	12-49
Compressing Patient Records	12-50
Changing System Date and Time	12-51
Procedure Statistics	12-52
Printer Settings	12-53
Devices Tab	12-54
Modem Tab	12-55
MUSE Tab	12-56
Option Code Tab	12-59
Country Settings Tab	12-60
EMR Tab	12-61
Connectivity Server Tab	12-62
Adding Inbound Connections	12-63
.....	12-63
DICOM Tab	12-64

A **Cleaning and Maintenance**

Cleaning, Disinfection, and Maintenance	A-3
Equipment Surface	A-3
Cables, Electrodes	A-3
Maintenance	A-4
Before Each Use	A-4
Technical Inspections	A-4
Disposal at the End of Its Service Life	A-4

B Miscellaneous

Connecting Peripheral Devices	B-3
Bicycle Ergometers	B-3
Connecting ERGOLINE 900/900 L/900 EL Ergometers to the System B-3	
Treadmills	B-3
Blood Pressure Monitor	B-4
Setting Up the SunTech 4240 BP Monitor	B-4
SpO2 Monitor	B-5
ECG Recorder	B-5
Modem	B-5
Laser Printer	B-5
Local Printer	B-5
Printers in a Network Environment	B-6
Application Tips	B-7
General Application	B-7
Recording ECGs of Pacemaker Patients	B-7
Recording ECGs During Defibrillation	B-7
Exercise Test Interpretation (XTI)	B-9
Duke Treadmill Score	B-10
References	B-10
Risk Factors	B-12
Spirometry Reference Value Equations, Interpretation Modes, Measurements	B-14
Reference Value Equations	B-14
ECCS/Zapletal	B-14
NHANESIII	B-14
Knudson	B-15
Forche	B-15
Finland	B-15
Brazil	B-16
Interpretation Modes	B-18
Europe	B-18
.....	B-20
CHS	B-21
Definition of Spirometry Test Values	B-22
CardioSoft Web	B-23
Points to Note	B-23
General	B-23
Exercise Tests	B-23
Spirometry Tests	B-23
Patient Administration	B-23
Displaying Tests	B-24

Installing the Program	B-24
Troubleshooting	B-25
Remote Service	B-27
System Maintenance	B-28
Data Backup	B-28
Virus Protection	B-28
Direct Fax Transmission of Printer Documents	B-29
Related Physician's Guides	B-30

C **Order Information**

Order Information	C-3
Accessories	C-3
Skin Prepping Items for Exercise Tests	C-6

1 Introduction

For your notes

License Agreement

Opening the envelope indicates acceptance of the license agreement. If you do not accept the terms of this agreement, please return the closed envelope including the documentation and supplied hardware to your vendor for a full refund.

The object of the agreement is to grant a license for the use of the software program and product documentation. GE Healthcare grants you the personal, non-exclusive and non-transferable right to use the software. The software and documentation are protected by copyright laws. The licensee agrees to observe the regulations stipulated by the copyright. The software and all rights to it remain the property of GE Healthcare. Therefore, the enclosed copy of the program may be installed on one PC only. You may not transfer the software via network or other communication channels to any other PC. The program and the accompanying documentation may not be modified, copied, merged with other programs or made available to third parties. The licensee is liable for any damage to the licensor resulting from infringement of the copyright as per this license agreement. The licensor notifies all users that the present state of the art does not allow for the creation of computer programs which run trouble-free in all applications and combinations. The licensor is not liable for product malfunctions. The licensor is not obliged to make program updates available to licensees who have not signed and returned the registration card.

© GE Medical Systems
Information Technologies GmbH, 2011-2014.
All rights reserved.
Munzinger Straße 5
79111 Freiburg, GERMANY
Tel: +49 761 4543-0
Fax: +49 761 4543-233

GE Medical Systems
Information Technologies, Inc.
8200 West Tower Avenue
Milwaukee, WI 53223 USA
Tel: +1 414 355 5000
800 558 7044 (USA only)
800 668 0732 (Canada only)
Fax: +1 414 355 3790

About This Manual

Revision History

This manual is subject to the GE Healthcare change order service. The revision code, a letter that follows the document part number, changes with every update of the manual.

Part No./ Revision	Date	Comment
2060290-002-A	2011-09-23	Initial release, corresponds with software version 6.7.
2060290-002-B	2013-02-25	Changes on pages T-2, 1-3, 1-4, 1-15, 6-56, 12-45, 12-49, 12-50, 12-59, 12-60, C-3 (v6.73).
2060290-002-C	2014-04-25	Removed references to CORINA and related parts. Added reference to Windows Server 2012 and Windows Server 2012 R2. Added references to CAM-USB v2.

Manual Purpose

This manual contains the instructions necessary to employ the product safely and in accordance with its function and intended use.

Where necessary the manual identifies additional sources of relevant information and/or technical assistance.

Intended Audience

This manual is geared for clinical professionals. Clinical professionals are expected to have working knowledge of medical procedures, practices, and terminology as required for completing these examinations.

Conventions

These are the conventions used in the manual:

Styles

- **Bold** text indicates keys on the keyboard, function keypad, text to be entered, or hardware items such as buttons or switches on the equipment.
- *Italicized* text indicates software terms that identify menu items, on-screen controls, buttons or options in various windows.
- To perform an operation which appears with a plus (+) sign between the names of the two keys, you press and hold the first key while pressing the second key once. This is called a keystroke combination. Example: "Press **Ctrl+Esc**" means to press and hold down the **Ctrl** key while pressing the **Esc** key.
- When instructions are given for typing a precise text string with one or more spaces, the point where the space bar must be pressed is indicated as **<space>**. The purpose is to ensure you press the spacebar when required.

Illustrations

All illustrations in this manual are provided as examples only. They may not necessarily reflect your equipment setup or data displayed.

All names appearing in examples and illustrations are fictitious. The use of any real person's name is purely coincidental.

Safety Information

Intended Use

- CardioSoft is intended to be used by trained operators under direct supervision of a licensed health care practitioner on adult and pediatric patients.
- CardioSoft is designed to acquire, process, record, archive, analyze and output ECG data (12 and 15 leads) during a period of physiologic stress or during a resting ECG test and acquire data from ancillary devices, such as spirometry and ambulatory blood pressure devices. Furthermore, it provides median morphology recordings and records ECG in real-time with and without arrhythmia detection.
- The arrhythmia detection algorithm of CardioSoft is provided to the user for the convenience of automatic detection of arrhythmias but does not provide alarms.
- CardioSoft provides the control of external devices. These are typically treadmills and bicycle ergometers. Additionally, CardioSoft communicates with centralized electronic/digital storage systems via data networks.

WARNING

Patient Hazard—Do not use the digital or analog outputs to control therapeutic devices such as defibrillators.

- CardioSoft provides a user-selectable option for printouts of prognostic scores on selected reports. Vector loops are also available.
- CardioSoft can be configured in a network environment for multiple CASE and CardioSoft/CS stations allowing the user to create a central database of patient demographics and collected patient physiological data.
- CardioSoft is intended to be used primarily in the hospital. However, it can also be used in clinics, physician offices, outreach centers or wherever exercise stress testing, ECG, spirometry or ambulatory blood pressure testing is performed.
- CardioSoft offers no diagnostic opinion to the user. Instead it provides interpretive statements of morphology, rhythm, and conduction for which the physician renders his/her own medical opinion.
- CardioSoft is not intended to be used as a transport device or for home use.
- CardioSoft is not intended for use as a vital signs physiological monitor.
- CardioSoft is not intended for intracardiac use.
- CardioSoft is not intended for use as an emergency device.
- CardioSoft will not cause abnormal operation of a patient's cardiac pacemaker or other electronic stimulators.

- CardioSoft is not intended for use with high frequency surgical units. Disconnect the patient from CardioSoft before using the high frequency surgical unit.

General Information

- This manual is an integral part of the product. It should always be kept near the PC. Close observance of the information given in the manual is a prerequisite for proper product performance and correct operation and ensures patient and operator safety. Please read the manual once in its entirety, because information pertinent to several chapters is given only once.
- To ensure maximum patient safety, interference-free operation and the specified measuring accuracy, we recommend using only original GE Healthcare accessories. The user is responsible for application of accessories from other manufacturers.
- The warranty does not cover damage resulting from the use of unsuitable accessories and consumables from other manufacturers.
- GE Healthcare is responsible for the effects on safety, reliability, and performance of the product, only if:
 - ◆ assembly operations, extensions, readjustments, modifications, or repairs are carried out by GE Healthcare or by persons authorized by GE Healthcare.
 - ◆ the electrical installation of the relevant room complies with the requirements of the appropriate regulations, and
 - ◆ the product is used in accordance with the instructions given in this manual.
- The acquisition module is protected against the effects of cardiac defibrillator discharge to ensure recovery as required by standards.
- Accuracy of the Input Signal Reproduction
 - ◆ Overall System Error is tested using the method described in AAMI EC11 3.2.7.1. The maximum overall system error is $\pm 5\%$.
 - ◆ Frequency Response is tested according to AAMI EC11 3.2.7.2, methods A and D.
- Modulating Effects in the Digital System

This device uses digital sampling techniques that may produce some variation in amplitude of Q, R, and/or S waves. This effect may be particularly noticeable in pediatric recordings. If this phenomenon is observed, the clinician should be aware that the origin of amplitude variations is not entirely physiologic. For measuring voltages of Q, R, and S waves, it is advisable to use the QRS complexes with the largest deflection of the particular waves.
- Contact GE Medical Systems *Information Technologies* for information before connecting any devices to this system that are not recommended in this manual.
- Parts and accessories used must meet the requirements of the applicable IEC 60601 series safety standards, and/or the system

configuration must meet the requirements of the IEC 60601-1-1 medical electrical systems standard.

- The use of accessories not complying with the equivalent safety requirements of this equipment may lead to a reduced level of safety of the resulting system. Considerations relating to the choice shall include:
 - ◆ use of the accessory in the patient vicinity and
 - ◆ evidence that the safety certification of the accessory has been performed in accordance to the appropriate IEC 60601-1 and/or IEC 60601-1-1 harmonized national standard.
- Throughout the document, the term *CAM-USB Interface Box* refers to both *CAM-USB Interface Box V1* and *CAM-USB Interface Box V2*.
- Throughout the document, the term *CAM-USB A/T Interface Box* refers to both *CAM-USB A/T Interface Box V1* and *CAM-USB A/T Interface Box V2*.
- Throughout the document, the term *CAM-USB A/T KISS Interface Box* refers to both *CAM-USB A/T KISS Interface Box V1* and *CAM-USB A/T KISS Interface Box V2*.

Definition

The terms Danger, Warning, and Caution are used throughout this manual to point out hazards and to designate a degree or level of seriousness. Familiarize yourself with their definitions and significance.

Hazard is defined as a source of potential injury to a person.

The safety statements presented in this chapter refer to the product in general.

The order in which safety statements are presented in no way implies order of importance.

Danger — indicates an imminent hazard which, if not avoided, will result in death or serious injury.

Warning — indicates a potential hazard or unsafe practice which, if not avoided, could result in death or serious injury.

Caution — indicates a potential hazard or unsafe practice which, if not avoided, may result in minor personal injury or product/property damage.

Danger

Explosion Hazard — The acquisition module is not designed for use in areas of medical locations where an explosion hazard may occur. An explosion hazard may result from the use of flammable anesthetics, skin cleansing agents and disinfectants. Furthermore, the device is suitable for application in an oxygen-enriched atmosphere only with certain restrictions. The atmosphere is considered to be oxygen-enriched when the room air contains more than 25% of oxygen or nitrous oxide.

Warning

Shock Hazard — Observe the following warnings. Failure to do so endangers the lives of the patient, the user, and other persons present.

- ◆ Before putting the device into operation, the operator is required to ascertain that it is in correct working order and operating condition. The cables, in particular, must be checked for damage. Damaged cables and connectors must be replaced immediately.
 - ◆ When disconnecting the device from the power line, remove the plug from the wall outlet, before disconnecting the cable from the device. Otherwise there is a risk of coming in contact with line voltage by inadvertently introducing metal parts in the socket of the power cord.
 - ◆ Do not use extension cables with multiple portable socket outlet (MPSO).
 - ◆ All devices of a system must be connected to the same power supply circuit. Devices that are not connected to the same circuit must be electrically isolated for operation (electrically isolated RS 232 interface); this requirement does not apply in the USA.
 - ◆ The PC must be installed outside the patient vicinity, if it does not meet the requirements of EN 60601-1.
 - ◆ The acquisition module is not intended for intracardiac use.
 - ◆ All bicycle ergometers and treadmills connected to the system must meet the requirements of IEC 60601-1. The CardioSoft PC and the connected bicycle ergometer or treadmill must be connected to the same electric circuit via separate wall outlets; this requirement does not apply in the USA.
-
-

Warning

Shock Hazard — Observe the following warnings. Failure to do so endangers the lives of the patient, the user, and other persons present.

- ◆ All modems connected to the system must meet the requirements of IEC 60950 or UL1950. The specific regulations valid in your country must also be observed.
 - ◆ The modem must be installed within the medical location, but not in the patient vicinity.
 - ◆ Disconnect the patient from the PC while sending data via the modem.
 - ◆ Devices may only be connected to each other or to parts of systems when it has been made certain that there is no danger to the patient, the operator, or the environment as a result. In those instances where there is any element of doubt concerning the safety of connected devices, the user must contact the manufacturers concerned or other informed experts as to whether there is any possible danger to the patient, the operator, or the environment as a result of the proposed combination of devices. Standards IEC 60601-1-1/EN 60601-1-1 must be complied with in all cases.
 - ◆ Liquids must not be allowed to enter the devices. If liquids have entered the devices, notify service to have them inspected for damage before using them again.
-
-

Warning

Patient Hazard — During exercise tests, a defibrillator and a pacemaker, both checked for proper functioning, should be kept at hand.

Patient Hazard — The operator must be capable of using the equipment properly.

Interpretation Hazard — A qualified physician must overread computer-generated tracings. Computerized interpretation is only significant when used in conjunction with clinical findings.

Risk of Suffocation — Dispose of the packaging material, observing the applicable waste-control regulations and keeping it out of children's reach.

Risk of Poisoning — Follow all manufacturer instructions for preparing and storing chemicals required for the application or maintenance of the device, and store all chemicals in their original containers to prevent poisoning risk.

RF Interference — Known RF sources, such as cell phones, radio or TV stations, and two-way radios, may cause unexpected or adverse operation of this device. Consult qualified personnel regarding system configuration.

Loss of Data — Improper shutdown of the CardioSoft system, e.g., turning the system off with the mains power switch before all programs are closed, may damage the databases

Caution

Equipment Damage — Before connecting the device to the power line, check that the voltage and frequency ratings of your power line match those indicated on the device label.

Loss of Data — To avoid loss of data, make a daily backup of the program and database folders (as determined during installation).

Restricted Sale — In the USA, U.S. Federal Law restricts this product to sale by or on the order of a physician.

Password Protection — If access to the system is protected with a password, the password must be stored in a secure place and made available to registered system users.

Acquisition Module — Use CardioSoft only in conjunction with the CAM-14 acquisition module.

Equipment Configuration — The equipment or system should not be used adjacent to, or stacked with other equipment. If adjacent or stacked use is necessary, test the equipment or system to verify normal operation.

The product is compliant with EN/IEC 60601-1-2 and applicable amendments. Refer to the Electromagnetic Immunity information in this product's service manual.

Classification

Type of protection against electrical shock	class II
Degree of protection against electrical shock	CAM USB / CAM-14: Type BF, defibrillation-proof
Degree of protection against harmful ingress of water	enclosed equipment without protection against ingress of water
Degree of safety of application in the presence of a flammable anesthetic mixture with air or with oxygen or nitrous oxide	Not suitable for use in the presence of a flammable anesthetic mixture with air or with oxygen or nitrous oxide.
Method(s) of sterilization or disinfection recommended by the manufacturer	sterilization: not applicable disinfection: see Appendix A
Mode of operation	continuous operation

Equipment Symbols

Note

Some of the symbols may not appear on all equipment.



Caution, consult accompanying documents.



Consult instructions for use.



Type CF signal input, defibrillation-proof



Type BF signal input, defibrillation-proof



Mains power switch (ON - OFF)



Potential equalization pin



Protective earth terminal



Caution! High Voltage!



Signal input



Signal output



Fuse

12V  12 V DC



The number found under this symbol is the date of manufacture in the YYYY-MM format.



Medical Equipment — Classified with respect to electric shock, fire and mechanical hazards only in accordance with UL 60601-1/CAN/CSA C22.2 No. 601.1, CAN/CSA C22.2 No. 601-2-25, IEC 60601-2-25, IEC 60601-1-1.



Authorized representative in the European Community.



CE marked per the Medical Device Directive 93/42/EEC of the European Union.



Manufacturer's identification



Order number



Revision letter



Serial number



Ident number



Lot number



Product ID (3 digits)



This symbol indicates that the waste of electrical and electronic equipment must not be disposed as unsorted municipal waste and must be collected separately. Please contact an authorized representative of the manufacturer for information concerning the decommissioning of your equipment.



China RoHS pollution control label



China RoHS Mobius loop symbol



This symbol indicates that the device was tested and certified according to the Russian safety standards specified by GOST.

Rx Only For use by or on the order of a physician, or persons licensed by U.S. law.

Biocompatibility

All parts of the product and all accessories described in this manual that come in contact with the patient during the intended use of the product, fulfill the biocompatibility requirements of the applicable standards. If you have questions in this matter, please contact GE Medical Systems *Information Technologies* or its representatives.

Technical Maintenance

For technical data and other detailed technical information, please refer to the Service Manual.

Legal Notice

Our equipment contains several fields which can be filled in before performing an ECG. Some of these fields must be filled in before performing an exam, some are optional and therefore left to the user to assess whether they are needed to perform the exam. A field RACE is one of these optional fields. It has been acknowledged by the medical profession as useful to analyze some pathologies. You should be aware that, in some jurisdictions, the processing of data revealing an individual's racial origin is subject to legal requirements, such as obtaining the patient's prior consent. If you elect to collect this type of data, it is your responsibility to ensure that you comply with all applicable legal requirements.

Security Patches

Please visit the GE Product Security Database regularly and search it for security patches for your product in order to keep the operating system up to date and ensure its integrity. Download the security patch compatible with your operating system and install it on your system.

Registration and download: <http://prodsecdb.gehealthcare.com>

Service Information

Service Requirements

Refer equipment servicing to GE Medical Systems *Information Technologies* authorized service personnel only. Any unauthorized attempt to repair equipment under warranty voids that warranty.

It is the user's responsibility to report the need for service to GE Medical Systems *Information Technologies* or to one of the authorized agents.

Equipment Identification

Every GE Medical Systems *Information Technologies* device has a unique serial number for identification. The serial number appears on the device label.

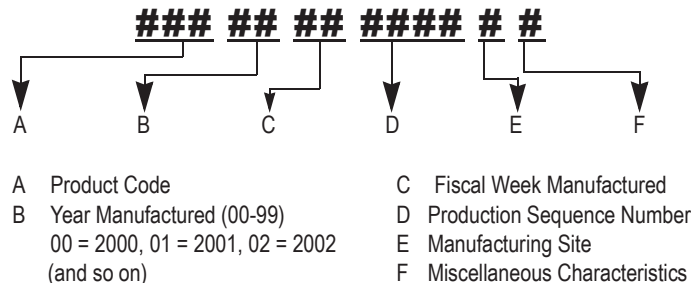

For your notes

2 Product Overview

For your notes

PC / Server Setup

Minimum PC / Server Requirements

For the minimum PC and server requirements, please refer to the Cardisoft Software Installation and Upgrade Guide.

Peripheral Devices Connecting to the PC

The illustration below shows the PC interfaces where peripheral devices can be connected.

WARNING

Radio Interference — In residential areas, devices and installations with radio-interference protection according to EN 55011, class A, may be disturbed by radiation emitted by the PC system. In this case, the user is required to take appropriate measures.

Refer to the Electromagnetic Immunity information in this product's service manual for EN 60601-1-2 (2001) Edition 2 compliance information and safety information for this product.

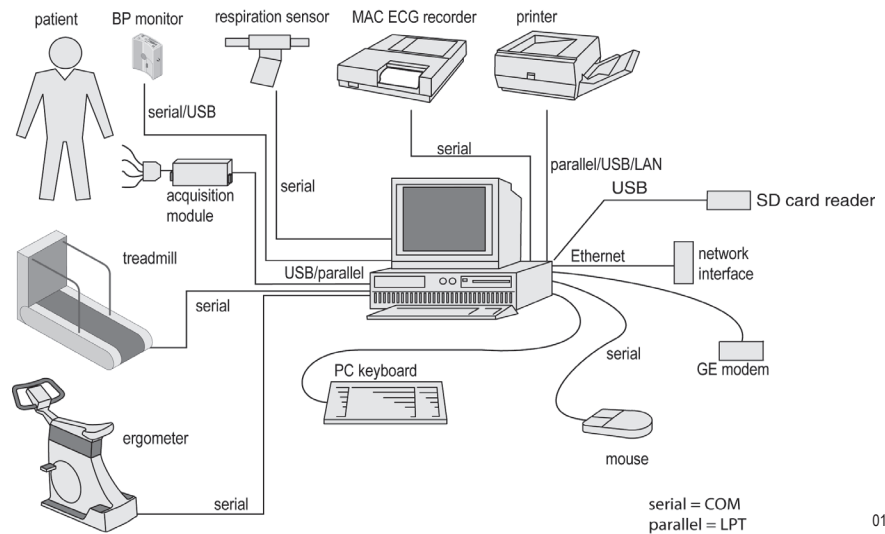

01A

MAC 500, MAC 600, MAC 800, MAC 1200, MAC 1600, MAC 3500, MAC 5000, MAC 5500

Via the serial interface, the ECG systems can be connected to a PC meeting the minimum GE Medical Systems *Information Technologies* requirements. Please contact the GE Medical Systems *Information Technologies* Customer Service for advice. This combination of devices allows you to transfer resting ECGs acquired in the automatic mode to the PC, including the pertinent data.

Be sure to observe the safety information given in section “**Safety Information**” on page 1-6. IEC standard 60601-1-1 must be complied with in any case.

For installation instructions, please refer to the Cardiosoft Software Installation and Upgrade Guide.

Caution

Patient Hazard — Always connect the CAM-14 acquisition module to the CAM-USB/CAM-USB A/T interface box, never directly to the PC.

Disconnecting Leadwires — Always attach the CAM-USB/CAM-USB A/T interface box to a suitable place (e.g. on the PC)

Shock Hazard / Equipment Damage — The patient signal input is a high-insulation port and it is defibrillation-proof (CAM-14, type BF). This type of input guarantees patient safety and protects the equipment during defibrillation and HF surgery. Nevertheless, extreme care should be exercised when a defibrillator or HF surgery equipment is used on a patient connected to other devices. As a general rule, the distance between the ECG electrodes and the defibrillation or HF surgery electrodes should not be less than 15 cm. If this is not ensured, temporarily disconnect the patient cables while using the defibrillator or the HF surgery equipment. It is very important that conductive parts, such as connectors, electrodes, or transducers, do not come into contact with other grounded, conductive parts when connected to the isolated patient input. Such contact would bridge the patient's isolation and cancel the protection provided by the isolated input. In particular, there must be no contact of the neutral electrode and ground.

NOTE

Before starting the CardioSoft program, verify that the acquisition module is connected to the PC and that the AC power adapter is connected, if required. If the acquisition module is not connected, the system cannot read the internal serial number and all option codes will become invalid.

NOTE

Set up the device so that the operator has a clear, unobstructed view of the control panel.

Only persons with the required training and expertise are authorized to use medical electrical equipment such as a PC with CardioSoft.

CardioSoft Client / CardioSoft Web Hardware Key

For use of the optional software packages

- CardioSoft Client
- CardioSoft Web

a hardware key is required for workstations that are integrated in the network and have no acquisition module. Depending on the hardware key used, it is connected either to the printer port or to a USB port.

Note

It is not possible to operate both the acquisition module and the hardware key at the same workstation.

When using the *Floating License/CardioSoft Web* software option, the hardware key must be installed at the server (in conjunction with Windows Server 2008 R2, Windows Server 2012, and Windows Server 2012 R2).

Installing CardioSoft

For CardioSoft installation instructions, please refer to the CardioSoft Software Installation and Upgrade Guide.

Putting the System Into Service

The software is a Windows-based program. Its scope can be expanded by activation of individual optional programs. This manual describes the program with all options included. If you have not purchased one or the other option, simply skip the corresponding sections.

Access to the program is restricted to registered users. At the time a user is registered, the password and privileges are assigned (technician, physician, with or without the right to edit data, etc.).

Mains Connection, Power Up, Functional Test

1. Before powering the system up for the first time, read the safety information in section “**Safety Information**” on page 1-6.
2. Turn on the PC, the monitor and, if used, the bicycle ergometer or treadmill, electrocardiograph and printer.
3. Double-click the CardioSoft icon to start the program.

When you see the initial screen (see “**Initial Screen**” on page 2-7) and no error message appears, the program is operational.

Note

- ◆ Do not run more than one additional Windows-based program at the same time as CardioSoft.
- ◆ The screen saver is automatically disabled during ECG acquisition.
- ◆ When using the program for the first time, select the size of your monitor screen (“**General Tab**” on page 12-40).
- ◆ Disable all energy save modes (BIOS, Windows).
- ◆ Unlock the purchased optional software programs as described in section “**Option Code Tab**” on page 12-59.
- ◆ Scan the hard drive for viruses once a week.
- ◆ Do not turn off the PC until you have properly exited from the program and shut down Windows.
- ◆ Run a functional test on a regular basis (about once a month); this includes an inspection of the cables and other accessories for signs of damage.







Caution

Simulated Patient Data — To avoid the possibility of misinterpreting patient information, enable the simulated Test Patient data for demonstration purposes only.

Initial Screen



06A

- A  *New Test* - Click to start a new test.
- B  *Local Database* - Click to display the contents of the local database for selection of a patient and test.
- C  *MUSE Browser* - Click to display the MUSE system database.
- D  *Operator's Manual* - Click to display the Operator's Manual (see [“Viewing and Printing the Operator's Manual”](#) on page 2-9).
- E  *System Configuration* - Click to display the *System Configuration* menu (see section [“System Configuration”](#) on page 12-40).
- F  *Remote View* - Click to view exercise tests performed at remote stations (see section [“Monitoring of Remote Exercise Test Workstations”](#) on page 6-55).
- G  *Quit Program* - Click to exit from the program.

Note

Refer to section [“Country Settings Tab”](#) on page 12-60 for information on selecting the language and on toggling between text labels and icons, or right-click any button to toggle between text labels and icons.

Softkeys Controlling Exercise Tests

Softkeys for control of the exercise test are displayed at the bottom of the screen; you activate these keys by clicking them with the mouse. Some of the softkeys can also be activated with the function keys **F1** through **F12** on the keyboard.

Following is a brief explanation of the key functions. For detailed information on running the exercise test, please refer to section “[Before the Test](#)” on page 6-9.

F1:pretest	F2:exercise	F3:recovery	F4:test end	arrhy doc	hold stage	F5:speed +	F7:grade up	F9:start tmill	F11:comment
12 lead	medians	rhythm	recall	stop writer	12SL analysis	F6:speed -	F8:grade down	F10:STOP tmill	F12:enter BP

062A

<i>F1: pretest</i>	initiates the pretest phase and advances through the pretest stages (to return to the preceding stage, press Shift + F1 or Shift + <i>F1:pretest</i>).
<i>F2: exercise</i>	initiates the exercise phase and advances through the individual stages of the exercise phase.
<i>F3: recovery</i>	initiates the recovery phase and advances through the individual stages of the recovery phase.
<i>F4: test end</i> <i>arrhy doc</i>	terminates the test and initiates the printout of the final reports. enables and disables automatic arrhythmia reporting (a one-page arrhythmia report is printed on the thermal writer on occurrence of an arrhythmia).
<i>hold stage</i>	maintains the current stage (automatic stage sequencing is stopped). Press again to turn off stage hold.
<i>F5: speed + or load +</i>	increases the treadmill speed or ergometer workload.
<i>F6: speed - or load -</i>	decreases the treadmill speed or ergometer workload.
<i>F7: grade up</i>	increases the treadmill grade.
<i>F8: grade down</i>	decreases the treadmill grade.
<i>F9: start tmill</i>	starts the belt. When restarted after FAST stop, the treadmill returns to the previous speed and grade.
<i>F10: stop tmill</i>	stops the belt.
<i>F11: comment</i>	enables entry of additional information and of values for the user-defined columns of the tabular summary (see “ Configuring the Tabular Summary ” on page 12-14).
<i>F12: enter BP</i>	enables entry of the patient's blood pressure readings.
<i>12 lead</i>	initiates recording of a 10-second ECG (5 seconds from memory, 5 seconds from when key was pressed).
<i>medians</i>	initiates printout of a medians report.
<i>rhythm</i>	initiates recording of a continuous, real-time ECG rhythm strip (terminate recording with <i>stop writer</i>).
<i>recall</i>	records a one-page rhythm strip of the previous 10 seconds.
<i>stop writer</i>	stops the thermal writer.
<i>12SL analysis</i>	initiates a 12SL report (includes measurement report and interpretation - only available during pretest and recovery phases).

Viewing and Printing the Operator's Manual

The CardioSoft operator's manual is available on the program CD-ROM.

Click *Operator's Manual* on the initial screen to display the document.

The system will load the *Acrobat Reader* program and display the title page of the operator's manual. Use the controls explained below to navigate through the document.

Note

Clicking a chapter headline in the operator manual's table of contents takes you directly to the corresponding chapter. Clicking an index entry will also display the corresponding page of the manual.

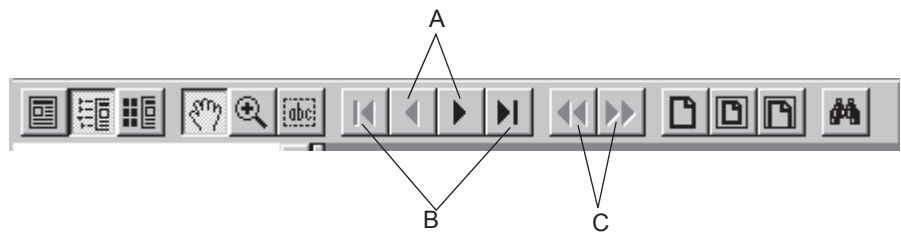

141A

- A Pages back or forward through the document.
- B Takes you directly to the first or last page of the document.
- C Undoes a change of page or view.

To print the document:

1. Select *File* in the menu bar, then *Print*.
2. In the print dialog, choose the print options:
 - ◆ the *Print Range* (all pages, the current page, or a section of the document)
 - ◆ the print quality
 - ◆ the number of copies.
3. Click *OK* to initiate the printout.

Online Help

On many screens you will find a *Help* button. Click the button to display a context-sensitive Help window.

Note

The online help implemented in the software provides information about using the program. For safety information, please refer to the Operator Manual and all other documents supplied with the product.

Software Options

Many features are available as options which can be unlocked to enhance the CardioSoft functionality. Following is a list of these optional features. For details, please contact your Sales Representative.

RESB (Basic Software Package)

- ◆ 12-lead/15-lead ECG acquisition (resting ECG)
- ◆ downloading of data from MAC electrocardiographs
- ◆ data management for all modalities

RESM (Resting ECG Measurement)

- ◆ measurement of 12/15 simultaneously acquired leads
- ◆ tabular presentation of measured values
- ◆ manual editing of measuring marks
- ◆ direct comparison of 2 resting ECGs

RESI (Resting ECG Interpretation)

- ◆ interpretation of the measured resting ECG with detailed explanations
- ◆ medication and patient's age are taken into account
- ◆ reanalysis after manual modification of the measuring marks

ERGM (Remote View)

- ◆ during an exercise test, data is continuously sent via the network
- ◆ the following information is available at any of the workstations in the network:
 - station name
 - 12-lead ECG, leads selectable
 - information on the exercise test and ergometer
 - HR and blood pressure

EGMO (Storage of the Full-Disclosure ECG)

- ◆ continuous storage of a maximum of 15 leads
- ◆ color-coded arrhythmias
- ◆ any segment of the full-disclosure ECG can be zoomed and stored

NETS (Data Storage on Network Server)

- ◆ storage of examination data on low-volume server (< 3000 examinations)
- ◆ storage of examination data in the MUSE database
- ◆ use of the MUSE patient list to retrieve data

NET2 (Data Storage on Network Server)

- ◆ storage of examination data on medium-volume server (< 15,000 examinations)
- ◆ pre-condition: NETS required

NET3 (Data Storage on Network Server)

- ◆ storage of examination data on high-volume server (unlimited number of examinations)
- ◆ pre-condition: NET2 required

ARRY (Arrhythmia Documentation)

- ◆ arrhythmia documentation during exercise tests

2DWF (2D Waterfall Display)

- ◆ waterfall display during exercise tests and in exercise test report

BRWS (MUSE Browser)

- ◆ Internet browser for access to the MUSE system

RISK (Risk Factors)

- ◆ calculation of coronary heart disease and stroke risk factors
- ◆ Duke Treadmill Score

EXPD (Data Export)

- ◆ export of examinations in XML or Excel file format

EPDF (Report Export as PDF File)

- ◆ export of report as a PDF formatted file (we recommend Acrobat V5.0 at minimum)

EWRD (Report Export as Word File)

- ◆ export of the configured report as a Word formatted file (we recommend MS Word 2000 at minimum)

DSPC (Display Configuration)

- ◆ configuration of the vital-signs window

ITBL (In-Test Tabular Summary)

- ◆ display of the tabular summary during exercise tests

ITRD (In-Test Trend)

- ◆ display of trends during exercise tests

PRVT (Previous Test Retrieval)

- ◆ display of the previous exercise test during an exercise test

TWAA (T-Wave Alternans)

- ◆ T-wave alternans analysis of an exercise test
- ◆ required option code: EGMO

ERG2 (Exercise Test AT)

- ◆ ST measurement, arrhythmia (6/12 leads)

ERG3 (Exercise Test Expert Mode)

- ◆ manual editing of the E, J, and post-J point
- ◆ direct cross-referencing from the trends to the full-disclosure ECG (final report)
- ◆ 15-lead exercise test

ECGH (ECG History - requires hardware key)

- ◆ display of the median beats from up to 5 selected resting ECGs for comparison or printout
- ◆ 3D presentation of the median beat for serial comparison

DICM (DICOM Interface)

- ◆ software package for communication with the DICOM interface

STHY (ST/HT Hysteresis)

- ◆ 4 more exercise stress test values (ST/HR hysteresis, HR recovery, HR reserve used, FVE recovery)

EXTI (Exercise Test Interpretation XTI)

- ◆ evaluation of the exercise stress test with respect to:
 - risk of mortality
 - functional capacity
 - coronary heart disease
- ◆ required option codes: ERG2, STHY
- ◆ recommended option codes: TWAA, RISK

CWEB (Web Interface)

- ◆ display of patient records via the internet (section “[CardioSoft Web](#)” on page B-23)

XEMR (EMR Interface)

- ◆ software package for communication with the EMR interface

FLLX (Floating License)

- ◆ software package required if more than one person will use the program at the same time; the number of licenses varies with the purchased option code; requires hardware key to be connected to the server

CardioSoft Client

- ◆ software version for editing of patient records at workstations without acquisition module

Demo Version of CardioSoft

When working with the demo version of CardioSoft, the following points should be noted:

- The Test Patient is always selected (artificial patient signals). The demo version is not intended for use on patients.
- The acquisition module, the respiration sensor and TONOPORT cannot be connected.
- All available software options are active.
- The functions *Copy Patient Records*, *Receive Data from ECG Device*, *Archive Patient Records* are not available.

For your notes

3 Preparing the Patient

For your notes

Applying Electrodes - The Basics

Careful application of the electrodes is a prerequisite for obtaining a noise-free ECG. In exercise testing, careful preparation of the patient's skin is a must (see “[Preparing the Patient's Skin](#)” on page 3-4).

For resting ECGs, use GE's electrode application system.

Use only the GE Medical Systems *Information Technologies*-recommended electrodes and contact agents.

The signal acquisition screen will show the applied electrodes and the signal quality after the right-arm electrode has been applied. When the right-arm electrode becomes detached, the system behaves as if all electrodes were disconnected.

Observe the information given in sections “[Recording ECGs of Pacemaker Patients](#)” on page B-7 and “[Recording ECGs During Defibrillation](#)” on page B-7.

WARNING

Strangulation Hazard — Route cables and tubes away from patient's throat to avoid possible strangulation.

Preparing the Patient's Skin

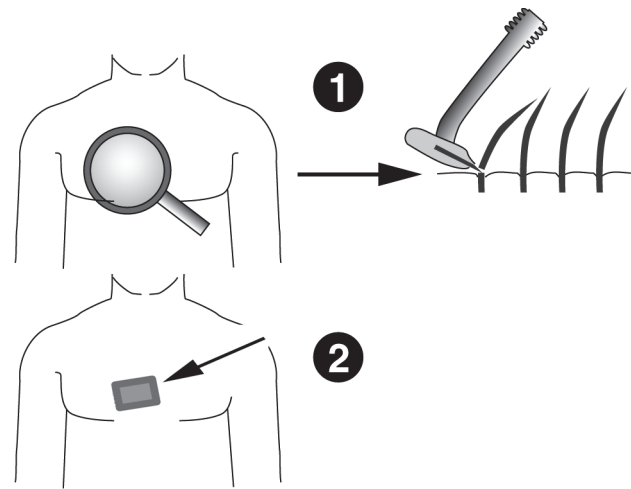

31A

1. Shave any hair from each electrode site and degrease each site with alcohol.
2. Remove the epidermal skin layer at each site. Use an abrasive pad or skin prep cream (for example, EPICONT, Part no. 217 083 12).

CAUTION

Skin Lesions — Do not rub the skin vigorously to avoid inflammation or bleeding.

Applying Electrodes

Lead Labels on the Acquisition Module

CAM 14	
AHA Label	IEC Label
RL	N
RA	R
LA	L
LL	F
V1	C1
V2	C2
V3	C3
V4	C4
V5	C5
V6	C6
A1	A1
A2	A2
A3	A3
A4	A4

CAUTION

Proper Leadwire Connection — Improper connection will cause inaccuracies in the ECG.

Trace each individual leadwire from its acquisition module label to the colored connector and then to the proper electrode to ensure that it is matched to the correct label location.

Standard 12 Lead Electrode Placement

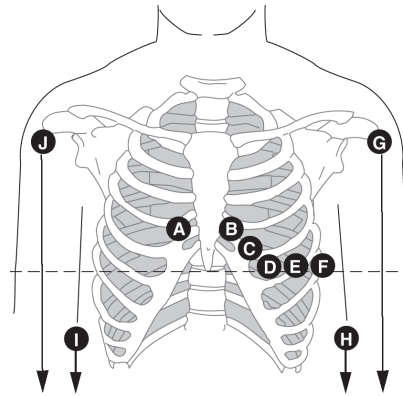

32A

	AHA Label	IEC Label	Electrode Placement
A	V1 red	C1 red	Fourth intercostal space at the right sternal border.
B	V2 yellow	C2 yellow	Fourth intercostal space at the left sternal border.
C	V3 green	C3 green	Midway between sites B and D.
D	V4 blue	C4 brown	Mid-clavicular line in the fifth intercostal space.
E	V5 orange	C5 black	Anterior axillary line on the same horizontal level as D.
F	V6 purple	C6 purple	Mid-axillary line on the same horizontal level as D.
G	LA black	L yellow	Left arm (resting ECG).
J	RA white	R red	Right arm (resting ECG).
H	LL red	F green	Left foot (resting ECG).
I	RL green	N black	Right foot (resting ECG).

Standard 15 Lead Electrode Placement

Standard leads + right, recommended for pediatric ECGs.

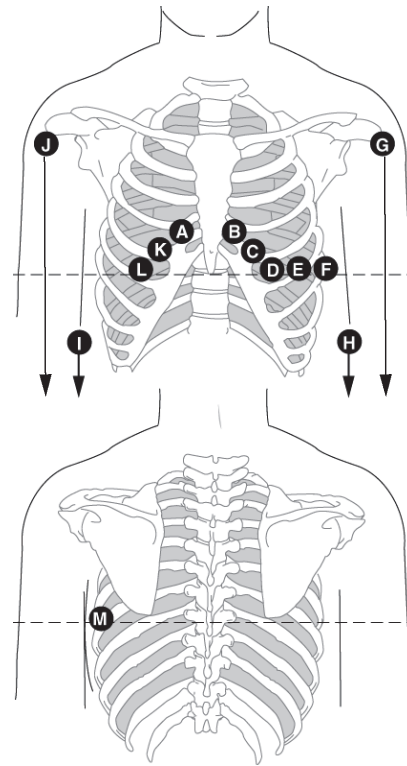

33A

	AHA Label	IEC Label	Electrode Placement
A	V1 red	C1 red	Fourth intercostal space at the right sternal border.
B	V2 yellow	C2 yellow	Fourth intercostal space at the left sternal border.
C	V3 green	C3 green	Midway between sites B and D.
D	V4 blue	C4 brown	Mid-clavicular line in the fifth intercostal space.
E	V5 orange	C5 black	Anterior axillary line on the same horizontal level as D.
F	V6 purple	C6 purple	Mid-axillary line on the same horizontal level as D.
G	LA black	L yellow	Left arm (resting ECG).
J	RA white	R red	Right arm (resting ECG).
H	LL red	F green	Left foot (resting ECG).
I	RL green	N black	Right foot (resting ECG).
K/A3	V3R gray	C3R gray	Opposite of C.
L/A2	V4R gray	C4R gray	Opposite of D.
M/A1	V7 gray	C7 gray	Left posterior axillary line at the level of D.

MASON-LIKAR Lead Electrode Placement

(Modified Standard Leads for Exercise Tests)

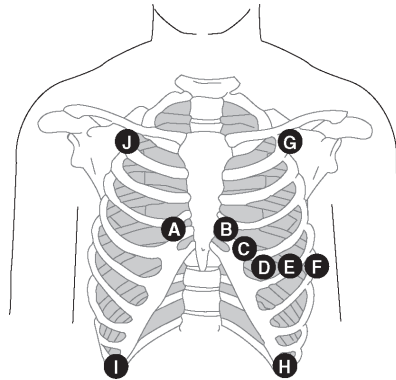

34A

AHA Label	IEC Label	Electrode Placement
A V1 red	C1 red	Fourth intercostal space at the right sternal border.
B V2 yellow	C2 yellow	Fourth intercostal space at the left sternal border.
C V3 green	C3 green	Midway between sites B and D.
D V4 blue	C4 brown	Mid-clavicular line in the fifth intercostal space.
E V5 orange	C5 black	Anterior axillary line on the same horizontal level as D.
F V6 purple	C6 purple	Mid-axillary line on the same horizontal level as D and E.
G LA black	L yellow	Slightly below the right and left clavicle.
J RA white	R red	
H LL red	F green	Lower edge of the rib cage, or at the level of the umbilicus at the left and right mid-clavicular lines.
I RL green	N black	

Note

The ECG recorded with the torso placement of the limb lead electrodes may differ from that recorded with the electrodes on the limbs. Affected characteristics are the Q-waves and the frontal axes, whereas ST levels are unlikely to change.

This lead placement is the preferred placement for exercise stress tests on treadmills or bicycles with patients in the supine or half-supine position.

For upright bicycle exercise stress tests it is recommended to apply the limb leads on the back, opposite the limb electrode positions shown above.

FRANK X, Y, Z Lead Electrode Placement

To record the orthogonal FRANK leads X, Y, and Z, apply electrodes G (A3), B (A2), J (A4) and I (A1) in addition to the standard lead electrodes.

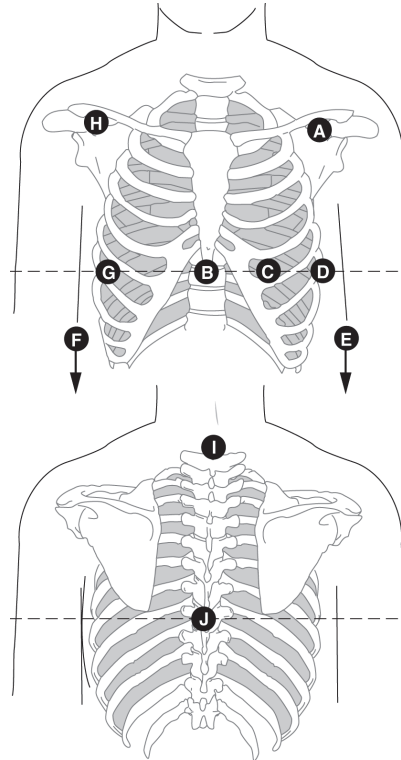

35A

	AHA Label	IEC Label	Electrode Placement
A	LA black	L yellow	Below the clavicle.
H	RA white	R red	
B/A2	E orange	E light blue	Sternum at the level of C and D.
C	V4 blue	C4 brown	Mid-clavicular line in the fifth intercostal space.
D	V6 purple	C6 purple	Left mid-axillary line on the same horizontal level as C.
E	LL red	F green	Right and left thighs.
F	RL green	N black	
G/A3	I orange	I light blue	Right mid-axillary line on the same horizontal level as C and D.
I/A1	H orange	H light blue	Neck, avoid carotid artery and jugular vein.
J/A4	M orange	M light blue	Center of spine on the same horizontal level as C and D.

NEHB Lead Electrode Placement

For acquisition of the NEHB leads electrodes A/A1 and B/A2 must be applied in addition to the standard lead electrodes (C equals V4/C4).

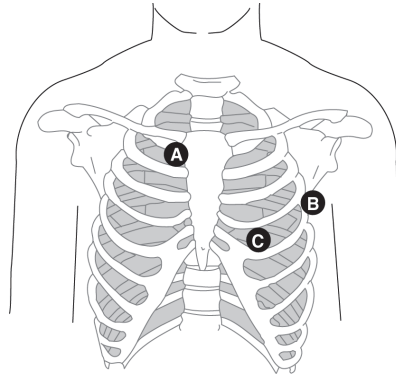

36A

	AHA Label	IEC Label	Electrode Placement
A/A1	A1 orange	Nst white	Attachment point of 2nd rib to right sternal edge.
B/A2	A2 orange	Nax white	Fifth intercostal space on the left posterior axillary line. (Same position as V7/C7.)
C	V4 blue	Nap white (C4)	Mid-clavicular line in the fifth intercostal space. (Same position as V4/C4.)

Depending on the selected number of leads the leads are recorded as follows (see section “[Modifying the Lead Sequence](#)” on page 12-7 or “[Modifying the Lead Sequence](#)” on page 12-17).

Lead	12-Lead Monitoring	15-Lead Monitoring
D	channel 7	channel 13
A	channel 8	channel 14
J	channel 9	channel 15

CM5, CC5, ML (CML) Auxiliary Lead Electrode Placement

In addition to the standard electrodes, apply one electrode on the sternum (A1) and one in location V5R/C5R (A2).

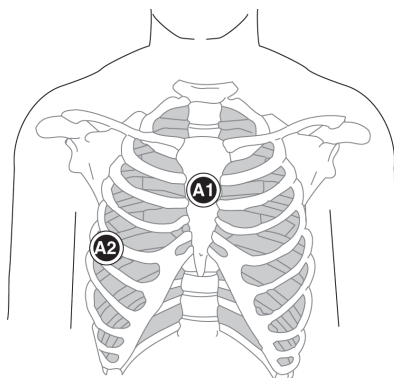

37A

Electrode	Electrode Placement
A1 (Nst)	Mid-sternum at the second intercostal space.
A2 (Nax)	In the fifth intercostal space in the right, anterior axillary line (V5F/C5R).

CM5, CC5, CH (CMH) Auxiliary Lead Electrode Placement

In addition to the standard electrodes, apply one electrode on the sternum (A1), one in location V5R/C5R (A2) and one on the neck (A3).

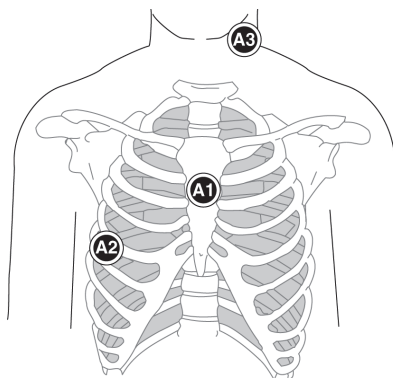

38A

Electrode	Electrode Placement
A1	Mid-sternum at the second intercostal space.
A2	In the fifth intercostal space in the right, anterior axillary line (V5F/C5R).
A3	On either side of the neck or anywhere above the shoulders.

Attaching the Acquisition Module

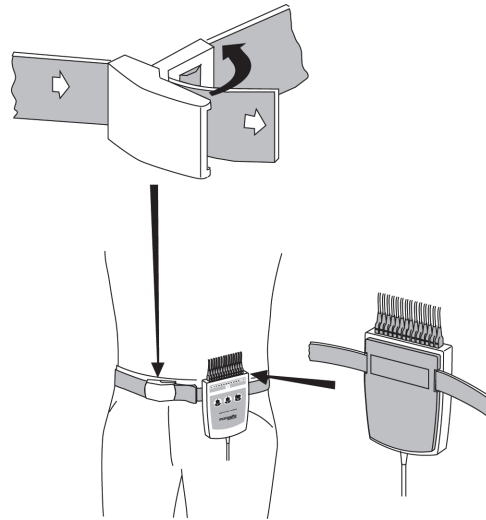

47A

Attach the acquisition module to the patient as shown above.

Open the buckle to loosen the belt.

Note

The functions of buttons 1 and 2 on the acquisition module vary with the test performed:

Resting ECG:

- ◆ Button 1: initiates ECG analysis
- ◆ Button 2: initiates a rhythm report
- ◆ Button 3: stops the writer

Exercise Test:

For exercise tests, different tasks can be assigned to the buttons (see “Miscellaneous 1 Tab” on page 12-24). The default functions of the buttons are:

- ◆ Button 1: initiates 12-lead report
- ◆ Button 2: initiates a rhythm report
- ◆ Button 3: stops the writer

For your notes

4 Selecting a Patient Record and Test Type

For your notes

Selecting a Patient Record from the Local Database

Overview

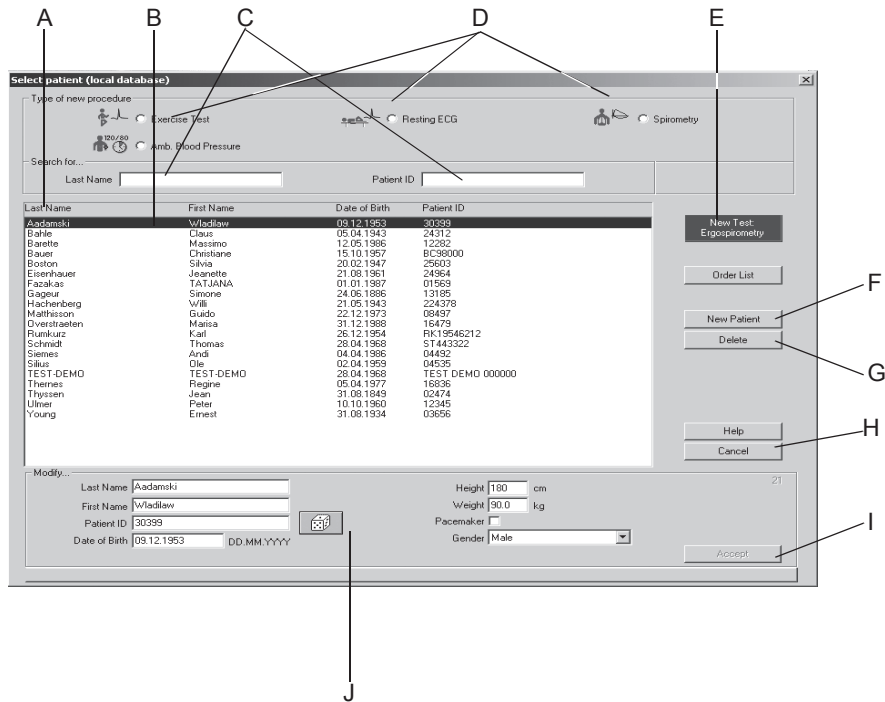

048A

Note

Before running a new test, you are required to select a patient record from the database or to enter a new patient. Depending on the system configuration you will be working with the local database of the system or with the database of the MUSE system. When you select *New Test* on the initial screen, a window opens where you select the patient record and test type or enter a new patient.

- A Click *next page/previous page* to display more patient records.
- B The bar cursor highlights a patient record.
- C Text boxes for the patient's Last Name / Patient ID.
- D Option buttons for selection of the test type (see "Devices Tab" on page 12-54).
- E Click *New Test* to select the highlighted patient and go to the acquisition screen of the selected test type.
- F Click *New Patient* to activate the area for entry of patient information.
- G Click *Delete* to delete the highlighted patient record from the database.
- H Click *Cancel* to clear the window.
- I Click *Accept* to save the new or edited patient information to the database.
- J Area for entry of patient information.

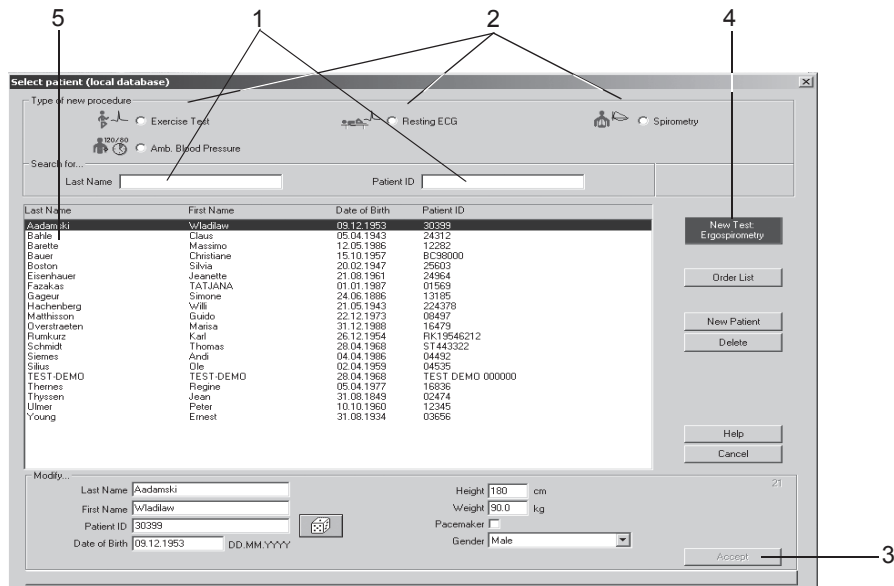

1. Enter the patient's last name or the patient ID to find a particular patient. It is sufficient to enter the first letters or numbers.

2. Select the test type.

3. Check the patient information. If it needs to be modified:

- a. Type over the current data and
- b. click *Accept*.

NOTE

Confirm that the correct patient has been selected before beginning a test. If the test is conducted with the wrong patient information, you will need to delete the test and perform a new test with the correct patient information.

4. Follow these steps to start a test with the selected patient:

- a. Click *New Test* or
- b. press **Enter**.

5. As an alternative you can select a patient by double-clicking the name.

6. If you are working with the keyboard only:

- a. Select the test type with the cursor keys
- b. press the **Tab** key
- c. enter the patient's name and
- d. confirm the selection with **Enter**.

Note

Once you have selected your patient, the acquisition screen for the new test will appear.

048A

Retrieving a Patient Record from the MUSE System Database

When you click *New Test* on the initial screen, the patient selection window will appear. Patient record and test type are basically selected in the same way as from the local database (see previous page).

The patient selection window has one additional button: *Order List* (see next page).

Note

- ◆ This is an optional feature.
- ◆ When you enter a new patient or edit patient information, the data is first saved to the local database. The data will appear in the MUSE system only after you have transferred the test to MUSE and confirmed the data there.
- ◆ Please refer to section “**MUSE Tab**” on page 12-56 for configuration of the system to communicate with MUSE.

Orders from the MUSE System

The *Order List* button allows you to view a list of orders for the previously selected patient. If a patient was not selected, you will see the requested orders for all patients.

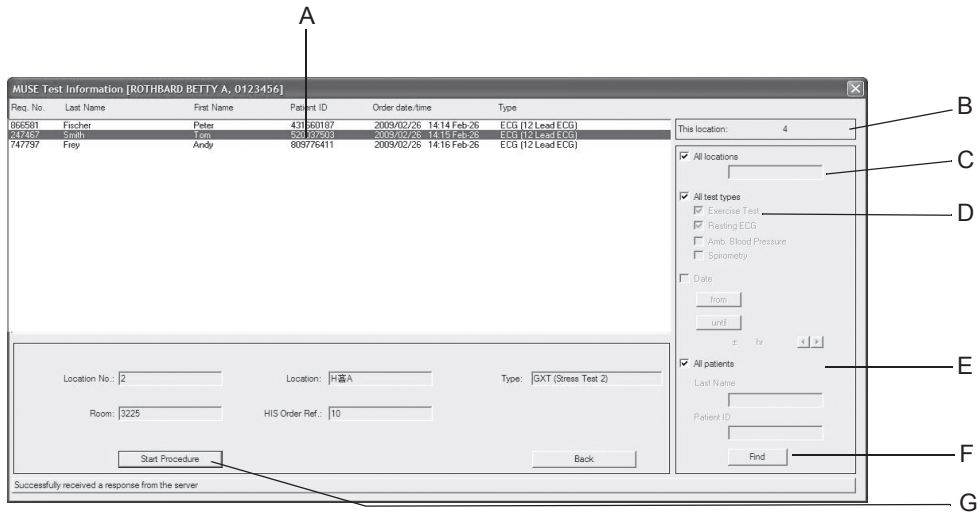

- A Requested orders.
- B Your location number.
- C The list only shows orders for your location .
The list shows orders for all locations .
- D The list only shows orders for the selected test type .
The list shows all orders .
- E The list only shows orders for the selected patient .
The list shows orders for all patients .
- F The list will be updated according to the current search criteria. After changing the search criteria, you can press the Enter key to start the search.
- G The test of the selected order will be started. If you do not change the search criteria, you can directly press the Enter key to start the search.

159A

Entering a New Patient

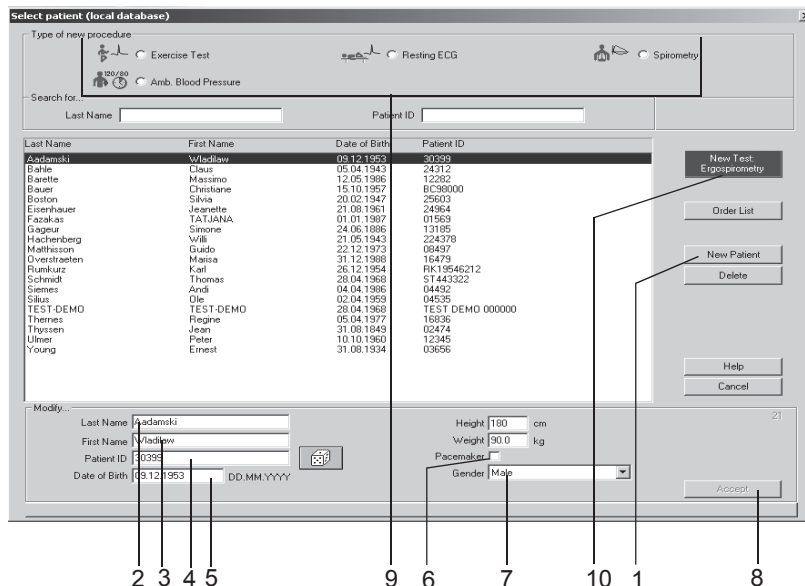

048A

1. Click *New Patient*.
2. Enter the patient's Last Name. Press the **Tab** key after each entry to move to the next text box.
3. Enter the patient's first name
4. Enter the Patient ID.
 - a. To do so, either use the keyboard or
 - b. instruct the system to generate a random number (select the dice with the **Tab** key and press the **spacebar**).
5. Enter the date of birth, height and weight.
6. If your patient is wearing a pacemaker, apply a check mark in the *Pacemaker* check box, using the **spacebar** (☑) (see also p. 6-11).
7. Enter the patient's gender with "m" (male) or "f" (female).
8. Click *Accept* to save the patient record to the database.
9. Select the test type.
10. Click *New Test*. The acquisition screen for the new test appears.

NOTE

- ◆ The system will automatically capitalize the first letter of the first and last names.
- ◆ The patient record cannot be created without an ID number. If at all possible, also enter the patient's last name, first name, date of birth and gender to allow the system to perform the necessary calculations when evaluating the test results.

Patient Records of External Programs

The system only supports the GE Medical Systems *Information Technologies* Holter ECG program MARS PC as well as ndd's external spirometry test program EasyWare.

Note

GE Medical Systems *Information Technologies* is not in a position to guarantee full compatibility of external programs with CardioSoft.

In conjunction with external programs, the patient record is always maintained in CardioSoft while the external program handles the test data. At the end of the test, CardioSoft will only receive a summary from the external program and save this summary with the patient record.

Before selecting the external program, choose a patient in CardioSoft. To change the selected patient you will have to exit the external program and select another patient in CardioSoft.

Dialog between CardioSoft and the external program:

1. Start CardioSoft.
2. Select patient.

NOTE

Confirm that the correct patient has been selected before beginning a test. If the test is conducted with the wrong patient information, you will need to delete the test and perform a new test with the correct patient information.

3. Select external program on procedure selection screen (the external program must already be configured).
4. Perform examination (e.g. Holter ECG).
5. Return to CardioSoft, summary and recording will be assigned to the patient record.

An external program can be activated only after it has been configured as described in section “[Devices Tab](#)” on page 12-54.

Note

When the configuration of external programs changes, maintain the compatibility to ensure that stored tests remain accessible.

5 Resting ECG

For your notes

Entering Test Information

Overview

Depending on your system configuration, the *Test Information* window will open automatically or you can display it with the *Test Information* button.

These are the tabs of the menu

- *Patient Information*
- *Test / Personnel*
- *Medications*

Closing a tab with *Cancel* or *OK* will bring up the acquisition screen.

Patient Information Tab

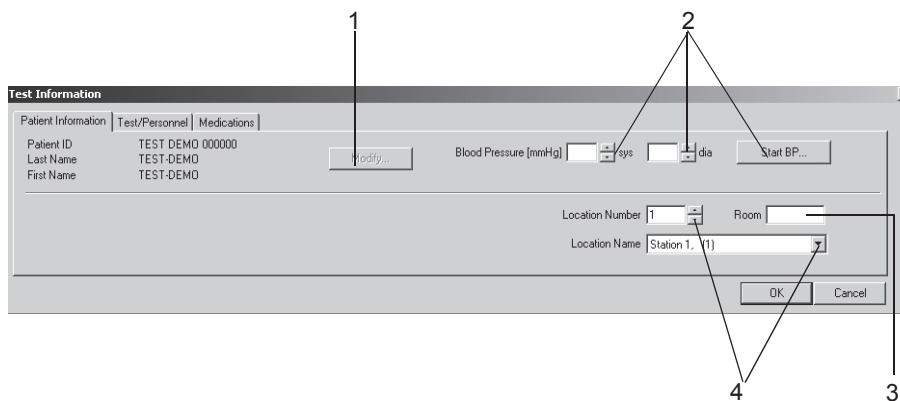

051A-R

The *Patient Information* tab is open.

1. Verify the patient's name and ID. If the data is incorrect, click *Modify* to change.
2. Enter the blood pressure readings or initiate a blood pressure measurement with *Start BP...*
3. Enter a designation for the Room (5 characters max.).
4. Select a *Location Number* or a *Location Name* (names can be configured on the *MUSE* tab, see “[MUSE Tab](#)” on page 12-56).

Note

You can assign a Location Name to the Location Number (see section “[MUSE Tab](#)” on page 12-56).

Note

The Patient Information can be assigned to the patient file or only to the pending test.

Test / Personnel Tab

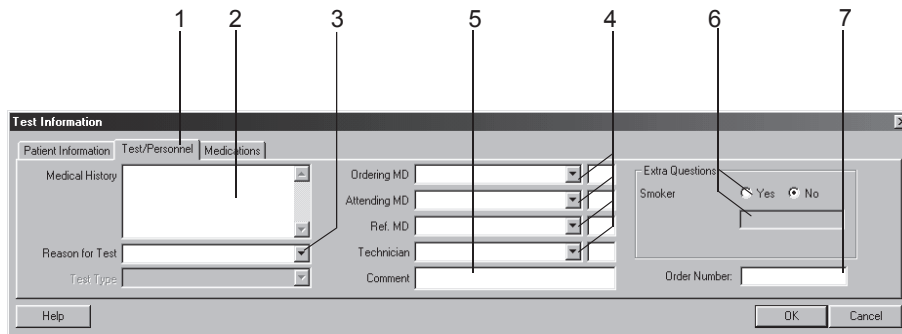

052A-R

1. Click the *Test / Personnel* tab.
2. Type the relevant information in the *Medical History* field.
3. Enter the *Reason for Test* or select one from the list box. Multiple selections are permitted.
4. Type the physicians' and technician's names or select them from the list boxes.
5. Type any *Comment* about the test.
6. Answer the *Extra Questions*.
7. Enter an Order Number. This number will appear on the printed reports and on the Test Summary.

Note

The *Reason for Test* library can be edited (see section “[Editing the Reason for Test Library](#)” on page 12-4).

You can define two Extra Questions as needed (see section “[Miscellaneous Tab](#)” on page 12-8).

You enter the names of the physicians and of the ECG technician in the *System Configuration* menu (see section “[General Tab](#)” on page 12-40).

Medications Tab

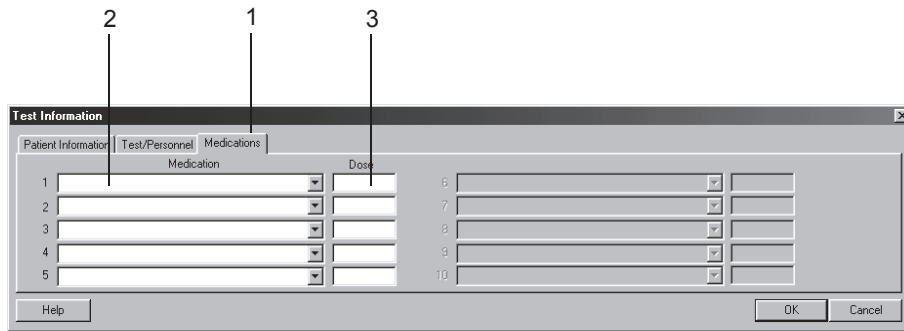

053A-R

1. Click the *Medications* tab.
2. Enter or choose a maximum of 5 medications.
3. Enter the medication dose.

Note

You can assign drugs to specific medication groups (see section [“Editing Medication Groups, Assigning Drug Names”](#) on page 12-6).

Note

Entering a medication will influence the analysis with the HEART ECG analysis program. The following medications may affect the diagnosis:

digitalis	antiarrhythmics Ic
diuretics	antiarrhythmics III
psychotropics	Ca channel antagonists Verapamil
steroids	Ca channel antagonists Nifedipin
beta-blockers II	nitrates
beta-blockers III	ACE
antiarrhythmics Ia	alpha-blockers
antiarrhythmics Ib	cytostatics

If one or more of these medications are used, a reanalysis may become necessary after changing the medication information.

Recording a Resting ECG

Overview

In the upper part of the screen you see the lead check information for verification of the ECG signal quality. All 12 or 15 leads are shown. The schematic lead check torso allows you to verify the applied electrodes. The actual waveform data appears in the area below.

With this modality you can acquire a 10-second resting ECG with subsequent analysis and/or you can record the full disclosure ECG for a period of up to 60 minutes.

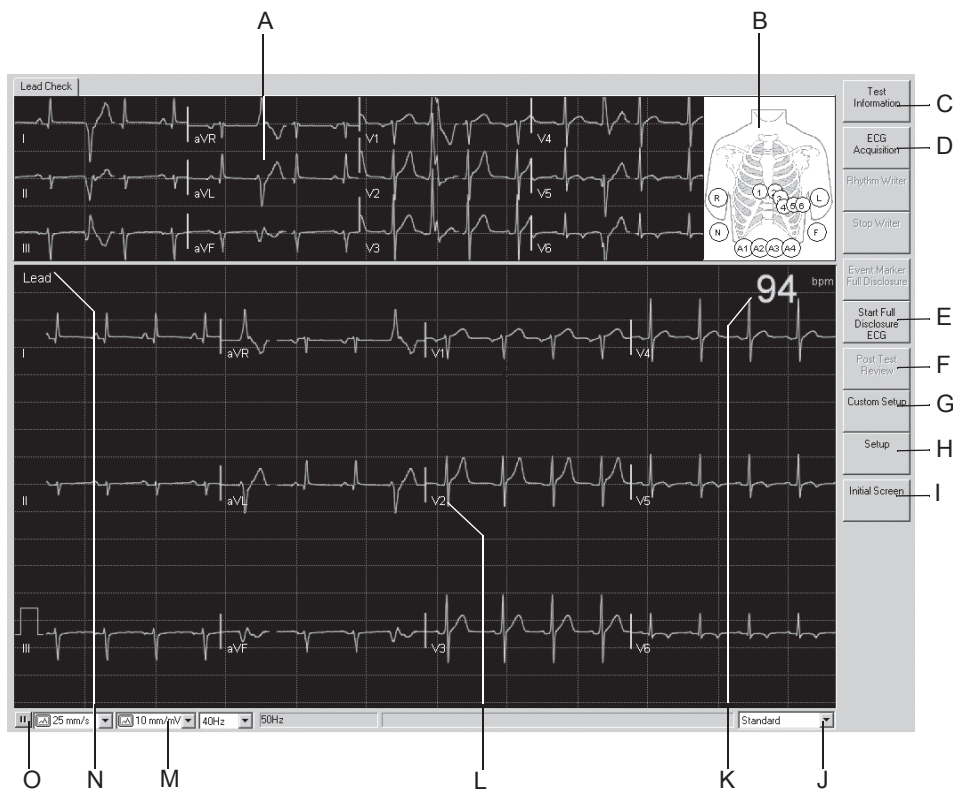





054A-R

- A Lead check window
- B Schematic representation of the applied electrodes:
green: correct, yellow: lead problem (high impedance), white: not used,
red: electrode disconnected or lead break (numbers indicate the impedance value in $k\Omega$).

C  Click to enter test information.

D  Click to start acquisition of the 10-second resting ECG.

- | | | |
|---|---|--|
| E |  | Click to start acquisition of the full disclosure ECG. |
| F |  | Click to terminate acquisition of the full disclosure ECG and/or to end the test and display the report. |
| G |  | Click to load system setups stored for different system users (see section “Custom Setups, Factory Setup” on page 12-38). |
| H |  | Click to display the resting ECG setup menu (see section “Resting ECG Setup” on page 12-3). |
| I |  | Click to return to the initial screen. |
| J | | Click to select a temporary lead sequence from the list. |
| K | | Heart Rate. |
| L | | Lead label: Click the label with the right mouse button to display an up/down arrow for adjustment of the ECG baseline. |
| M | | Status bar: controls for selection of speed / gain for writer and screen, filter frequency (current ECG), indication of AC line filter, Cubic Spline (if enabled). |
| N | | Selection of a temporary screen format: click with the right mouse button to open the list, select a format with the left mouse button. |
| O | | Click icon to freeze and release the ECG waveforms (except lead at the top). Measurements can be performed on frozen waveforms (see “Measuring the ECG” on page 5-15). |

Warning

Misinterpretation — Please bear in mind that filters might also suppress diagnostically relevant portions of the signal, as they limit the signal range. Therefore, filters should only be enabled if necessary.

10-Second ECG with Analysis

The system continuously saves 10-s segments of the incoming ECG signal. When you click *ECG Acquisition* the most recent 10 seconds will be stored as the patient's reference ECG and analyzed. You can repeat this operation as often as needed. The new ECG segment will always overwrite the previous reference ECG.

Operating Steps

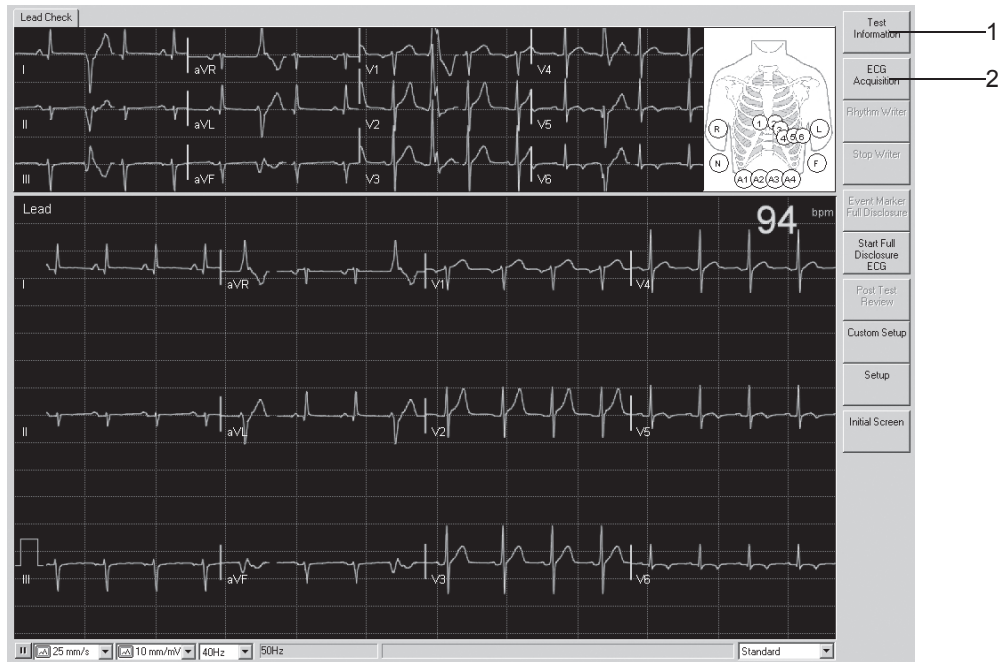

054A-R

1. Enter the *Test Information* or verify the data.
2. Click *ECG Acquisition* to initiate acquisition and analysis of the 10-second ECG.

Note

When you select *ECG Acquisition* before the system had time to save 10 seconds of ECG data, a bar graph will inform you of the ongoing storage process.

The analyzed 10-second ECG appears at the top of the screen. A new tab provides the corresponding interpretation.

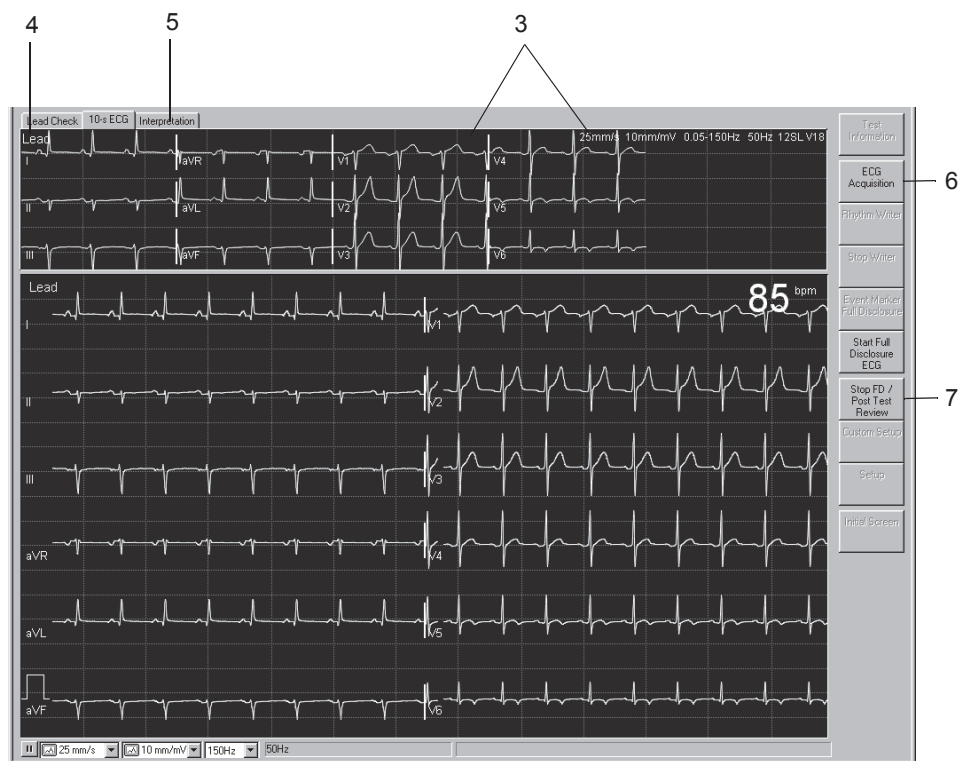

055A-R

3. Check the 10-second ECG and data.
4. Select a different screen format, if necessary.
5. Display the *Interpretation* and check the system evaluation and ECG measurement results.
6. If necessary, repeat the procedure with *ECG Acquisition*.
7. If you do not wish to record the ECG for a prolonged period of time (see next page), click *Stop FD/Post Test Review* to terminate signal acquisition.

NOTE

Clicking *Stop FD/Post Test Review* brings up the Test Summary (see “[Test Summary](#)” on page 5-11).

Full Disclosure ECG

You can acquire the full disclosure ECG over a maximum period of 60 minutes.

Operating Steps

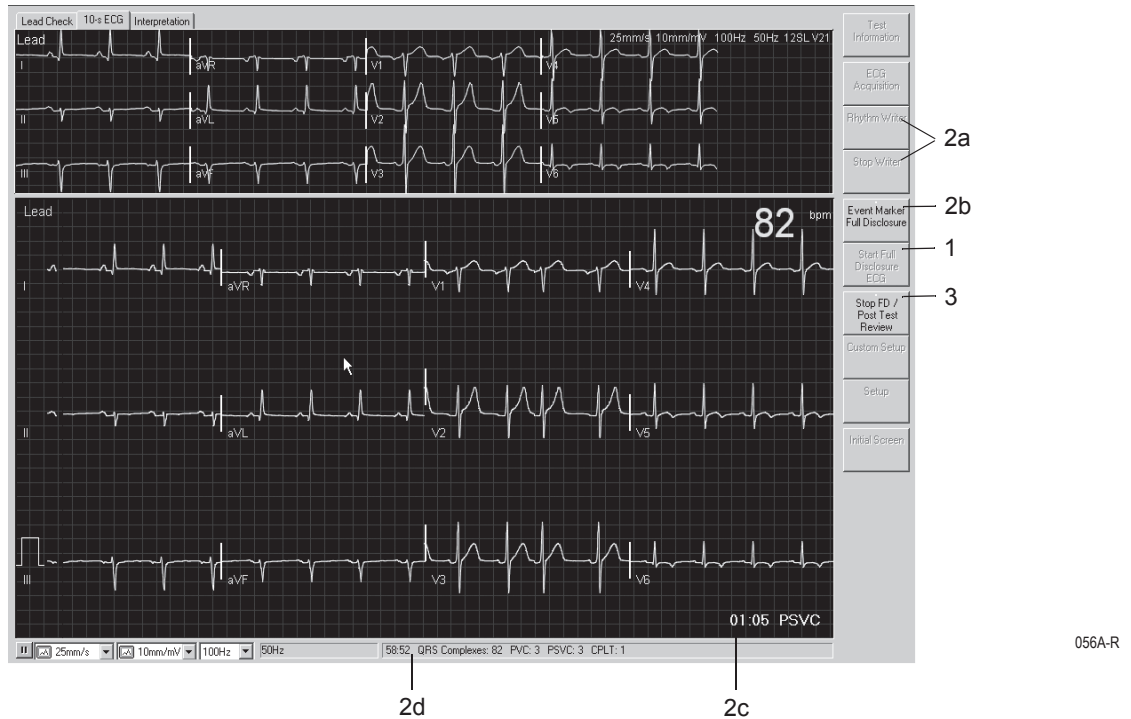

1. Click *Start Full Disclosure ECG* to initiate ECG storage.
2. While the full disclosure ECG is acquired:
 - a. You can make an ECG recording (*Rhythm Writer*, *Stop Writer*).
 - b. You can click *Event Marker Full Disclosure* to enter event marks (vertical line).
 - c. The most recent arrhythmia is always displayed.
 - d. The remaining storage time, the total number of stored QRS complexes and the number or arrhythmic events is displayed.
3. Click *Stop FD/Post Test Review* to terminate the procedure.

NOTE

Clicking *Stop FD/Post Test Review* brings up the Test Summary (see page 5-11).





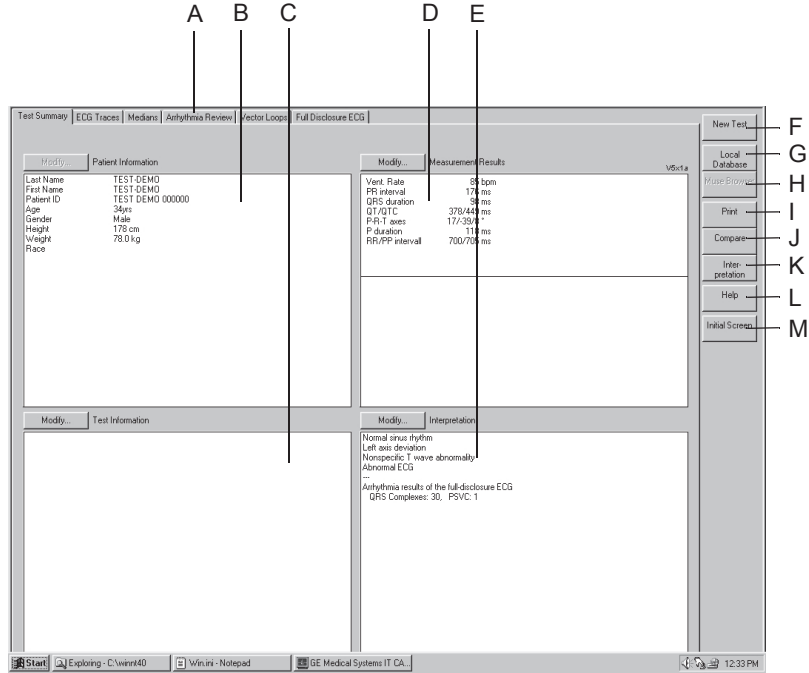



Post Test Review

Test Summary



057A-R

- A Click a tab to display the corresponding window.
- B Patient Information area.
- C Test Information area.
- D Measurement Results area.
- E Interpretation area.

- F  Click to display patient list for a new test.
- G  Click to display a list with more tests of the current patient (local database).
- H  Click to display a list with more tests of the current patient (MUSE database system).
- I  Click to display the print setup window.
- J  Click to display a list of tests to compare with the current test.
- K  Click to display the interpretation window where a detailed interpretation of the test can be generated.
- L  Click to activate the online Help program.
- M  Click to return to the initial screen.

The *Modify...* buttons allow you to edit or complete the data in the respective areas.

- *Patient Information*: The *Patient Information* window opens.
- *Test Information*: The *Test Information* window opens.
- *Measurement Results*: A window opens where you can edit the measurement results. Edited measurement results are identified with the * symbol. In the same window you can select and deselect the *View system evaluation* feature. This feature also affects the printout, the combined report, the transfer to MUSE and data export.
- *Interpretation*: A window opens where you can generate the test interpretation (see section “[Generating the Interpretation](#)” on page 5-27).

Note



Changes to the patient information will only affect the current test; previous tests of the same patient remain unaffected.

ECG Traces

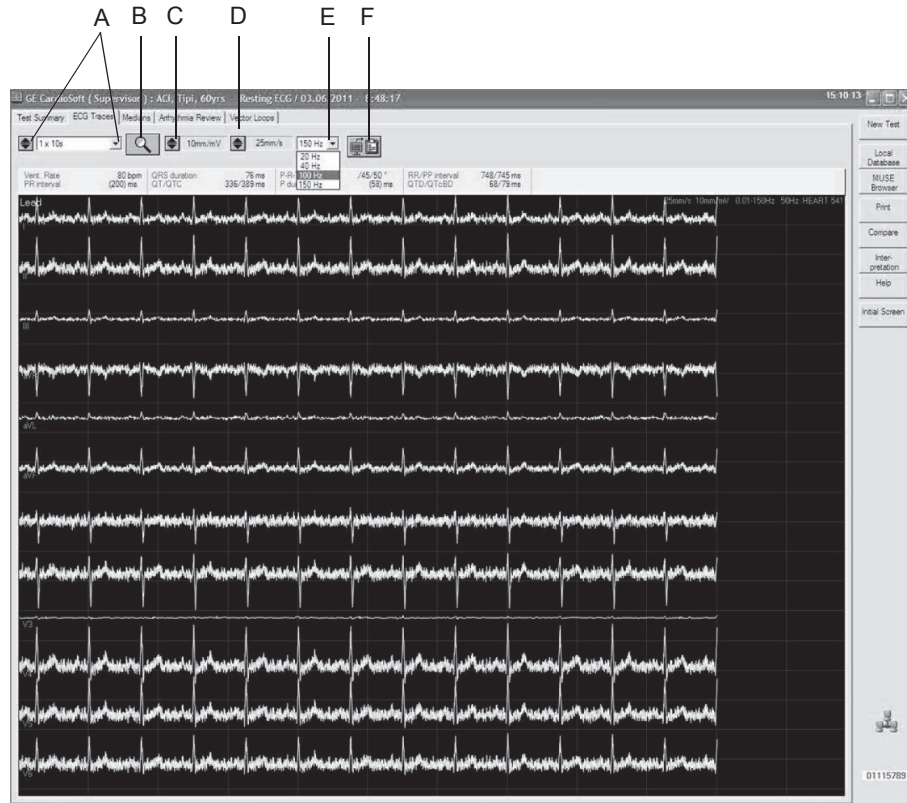
On this screen you see the reference ECG. Depending on the selected screen format and speed, the waveforms may take up several screens.



058A-R



- A Click to select the screen format:
With  you scroll through the formats,
with  you open the list.
Format *1 x 10s I ... aVF* displays 10 seconds of the first group of 6 standard leads,
format *1 x 10s V1 ... V6* displays the second group of 6 standard leads.
- B Click icon to activate the zoom function:
Position the magnifying glass on the region of interest and click. An enlarged view of the selected region appears (see next page "Zoom Mode").
- C Click to change the gain (amplitude).
- D Click to change the speed.
- E Click to select the frequency for re-filtering the 10-second ECG.
- F Click icon to copy waveforms to the Clipboard. From the Clipboard the data can be inserted in another application, e.g. in Word, with the shortcut Ctrl + V.

Zoom Mode

A zoom factor from 2 to 12 can be selected and the selected segment can be displayed in all leads.



059A-R

- A Click to select the lead:
With  you scroll through the leads,
with  you open the list.
- B Click icon to terminate the zoom function.
- C Click to select the zoom factor.
- D Click icon to print the segment.
- E Click icon to copy the segment to the Clipboard.
- F Cursor position in mV.

Measuring the ECG

Amplitudes (mV), intervals (ms) and slopes (mV/s) can be measured on all ECG waveforms.

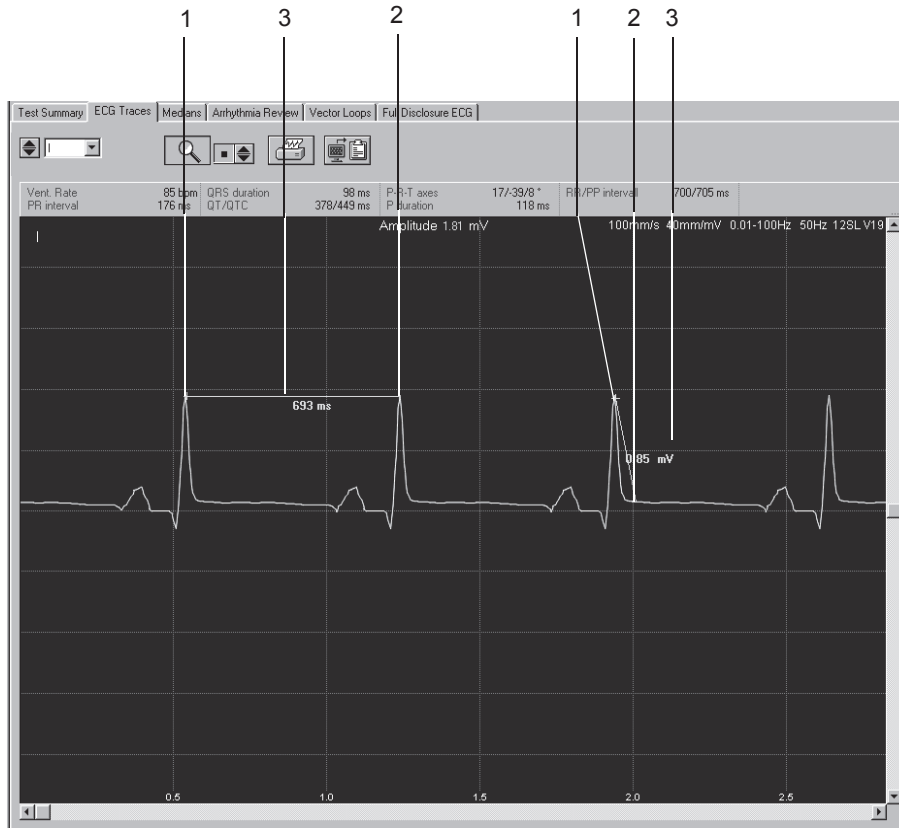

510-R

1. Position the cursor on the first measurement point and click. A caliper appears.
2. Position the cursor on the second measurement point and click. Now you will see
 - ◆ the second caliper
 - ◆ the measuring line and
 - ◆ the measurement results
3. Click the right mouse button to remove measurement points.

Medians

This screen shows the median complexes of all leads as well as the measurement marks that formed the basis for analysis. You are free to perform additional measurements, if needed.

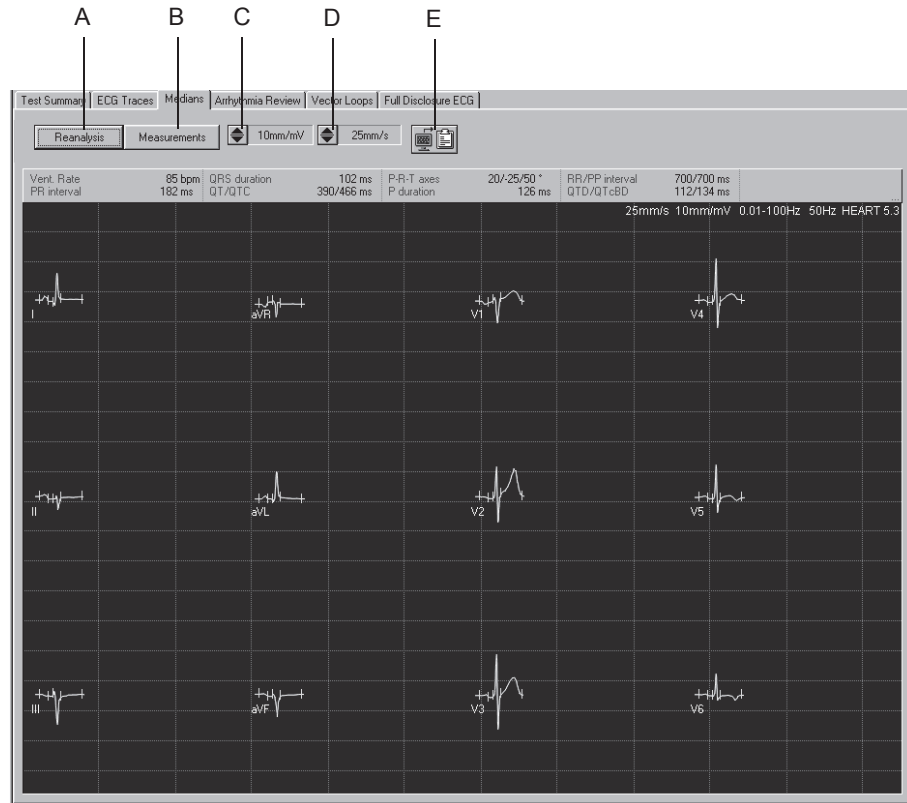

511A-R

- A Click button for a reanalysis (with the HEART ECG analysis program only, see next page).
- B Click button to display the tabular summary.
- C Click to select the gain (amplitude).
- D Click to select the speed.
- E Click icon to copy the waveform area to the Clipboard.

Reanalysis

Reanalysis allows you to manually change the position of the ST measurement marks. The reanalysis can only be performed on ECGs analyzed with the HEART program (see section “Miscellaneous Tab” on page 12-8).

On the reanalysis screen the medians of all leads are superimposed. The currently selected lead is highlighted. The measurement marks determined by the program are shown below the ECG baseline. The measurement marks above the baseline can be edited. The table in the top right-hand corner indicates the time intervals.

The T-offset measurement mark can be adjusted in each individual lead (see page after next).

Measurements can also be performed on the complex.

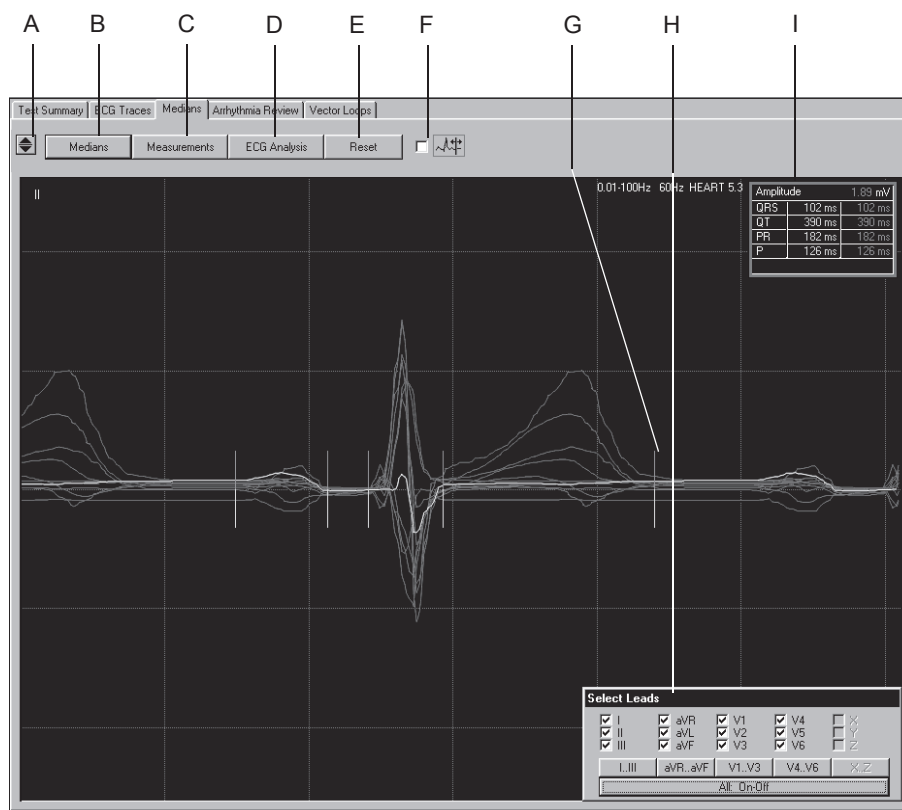

512A-R

- A Click to select the lead to be highlighted.
- B Click to display the medians window.
- C Click button to display the tabular summary.
- D Click button to perform the reanalysis.
- E Click to reset the measurement marks to their original positions.
- F Select if you wish to adjust the T-wave offset mark (see next page).

- G Measurement mark.
- H Menu for selection of the leads to be displayed.
- I Table showing time intervals and position of the cursor in mV.

Performing Reanalysis

1. Click the measurement mark and hold the mouse button depressed.
2. Move the measurement mark to its new position and release the mouse button.
3. Adjust the other marks in the same way.
4. Click *ECG Analysis*.
5. Click *Reset* and *ECG Analysis* if you wish to restore the previous analysis results.

Note

The P-onset and P-offset markers may be dashed, e.g. in the presence of atrial fibrillation. This indicates that the program was unable to locate the exact beginning and end of the P wave. In this case you can click the marks and drag them to the correct position; the marks are now solid instead of dashed. It is possible to restore the marks to the original position by clicking them again.

Adjusting the T-offset Mark

1. Select the check box.

The medians of all leads, except the selected lead, disappear.

2. Holding the mouse button depressed, move the T-offset mark to the correct position.
3. Click icon to select the leads whose T-offset marks you also wish to adjust.

Adjusting the T-offset mark on this screen (page 5-19) does not affect the position of the T-offset mark on the previous screen (page 5-17).

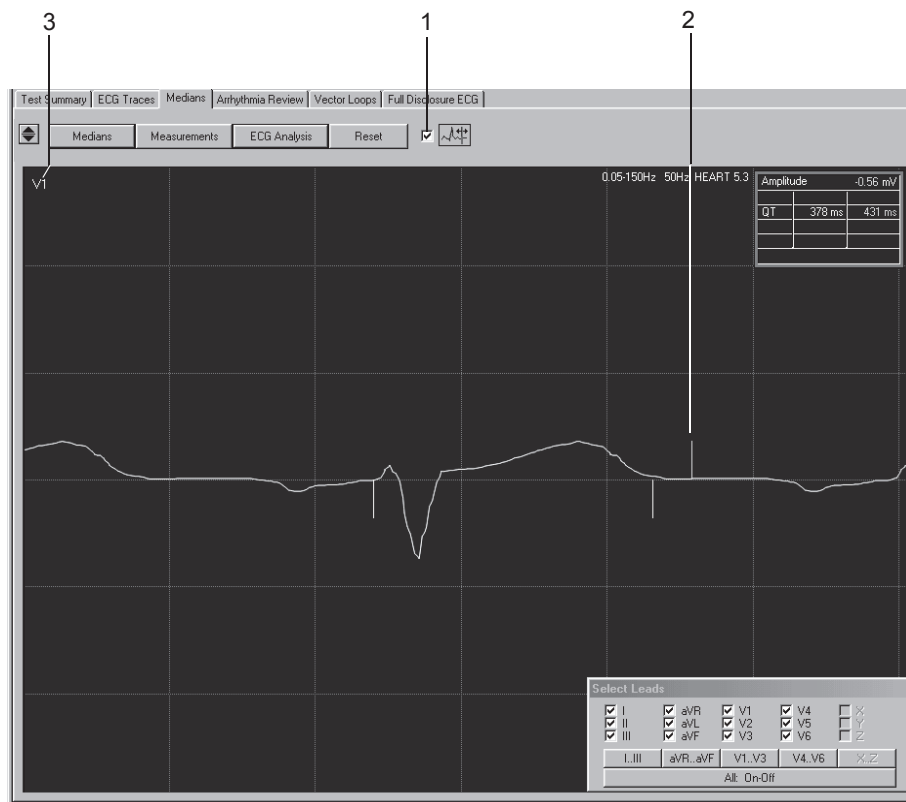

513A-R



Arrhythmia Review

This screen shows one lead of the reference ECG at a time. A bar diagram below the signal trace indicates, for each individual QRS complex, the deviation of the RR interval from the mean RR interval.

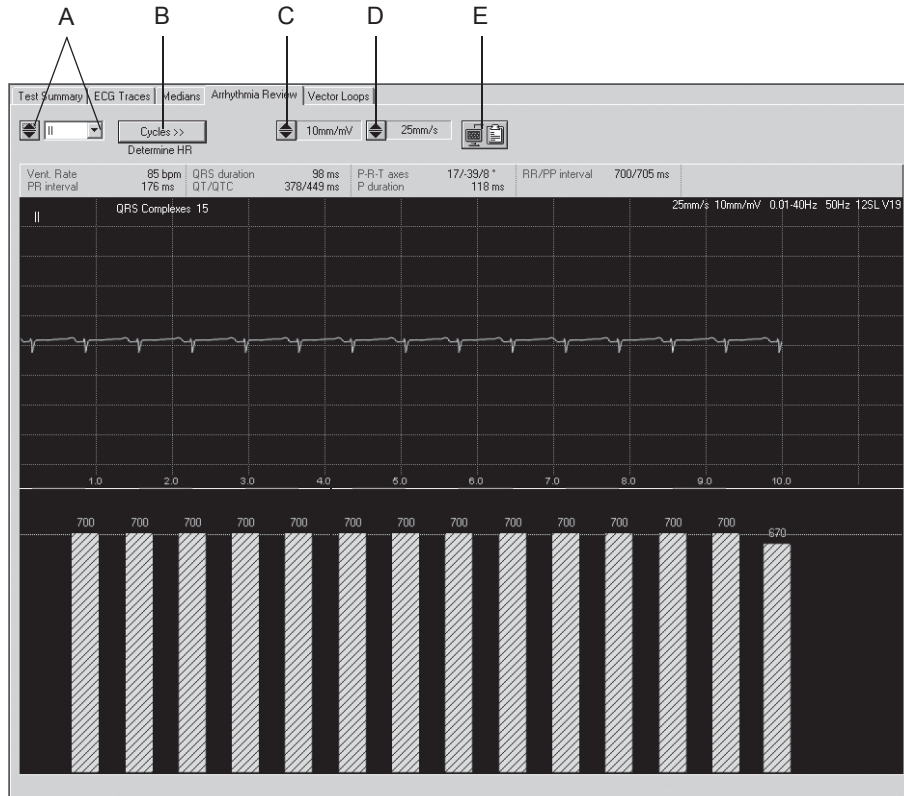
Furthermore, you can determine the HR over a selectable ECG segment.



514A-R

- A Click to select the lead:
With  you scroll through the leads,
with  you open the list.
- B Click to determine the number of cardiac cycles (only for atrial fibrillation or flutter).
- C Click to select the gain (amplitude).
- D Click to select the speed.
- E Click icon to copy the waveform area to the Clipboard.

Determining the Heart Rate

In a normal ECG:

1. Click on a point of the ECG to mark the beginning of the interval to be measured. A marker appears.
2. Click on the end of the interval. A line appears connecting the two end points and the corresponding heart rate is displayed.
3. Click the right mouse button to remove the markers and data.

In the presence of atrial fibrillation or flutter:

In this situation you will have to define a cardiac cycle yourself.

1. Click *Cycles* and select the number of cycles over which the HR is to be determined.
2. Click on a point of the ECG to mark the beginning of the interval to be measured. A marker appears.
3. Count the number of cardiac cycles and click again. A line appears connecting the two end points and the corresponding heart rate is displayed.

Vector Loops

This screen shows the median complexes of the orthogonal FRANK leads X, Y and Z as well as the vector loops in three planes.

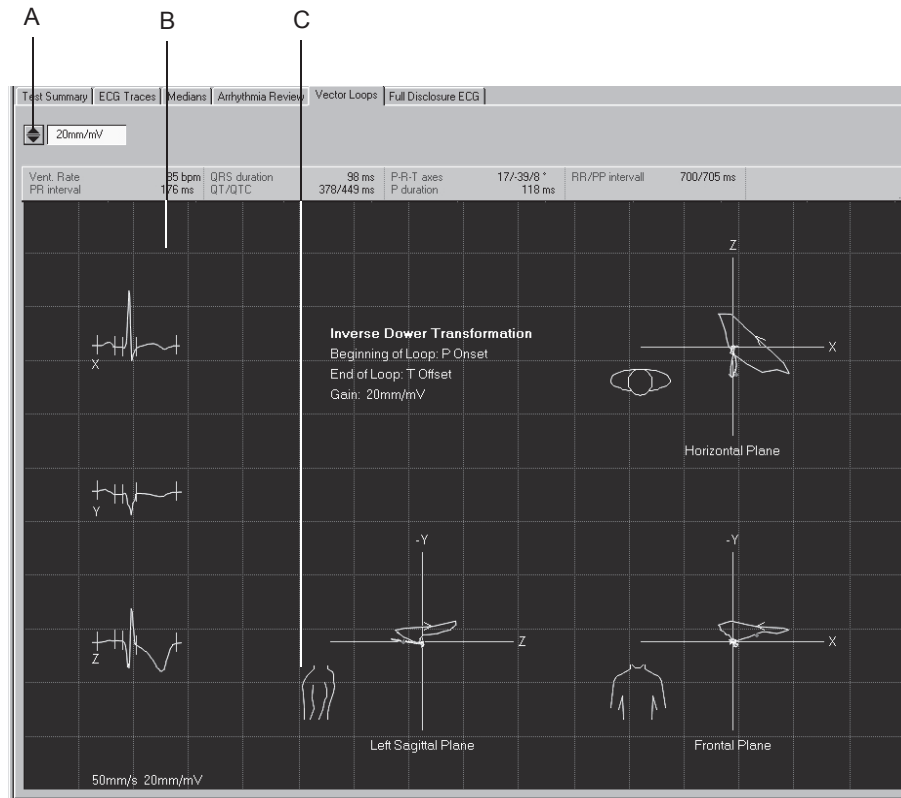

515A-R

- A Click to adjust the gain.
- B Median complex.
- C Click torso to toggle between right and left sagittal planes.

Full Disclosure ECG

On this screen you see one lead of the full disclosure ECG. The events identified by the rhythm analysis algorithm are color-coded. On the display you will also see when filter or cubic spline were enabled or disabled, e.g. in the form of Spline OFF = *Spline -*, Spline ON = *Spline +*.

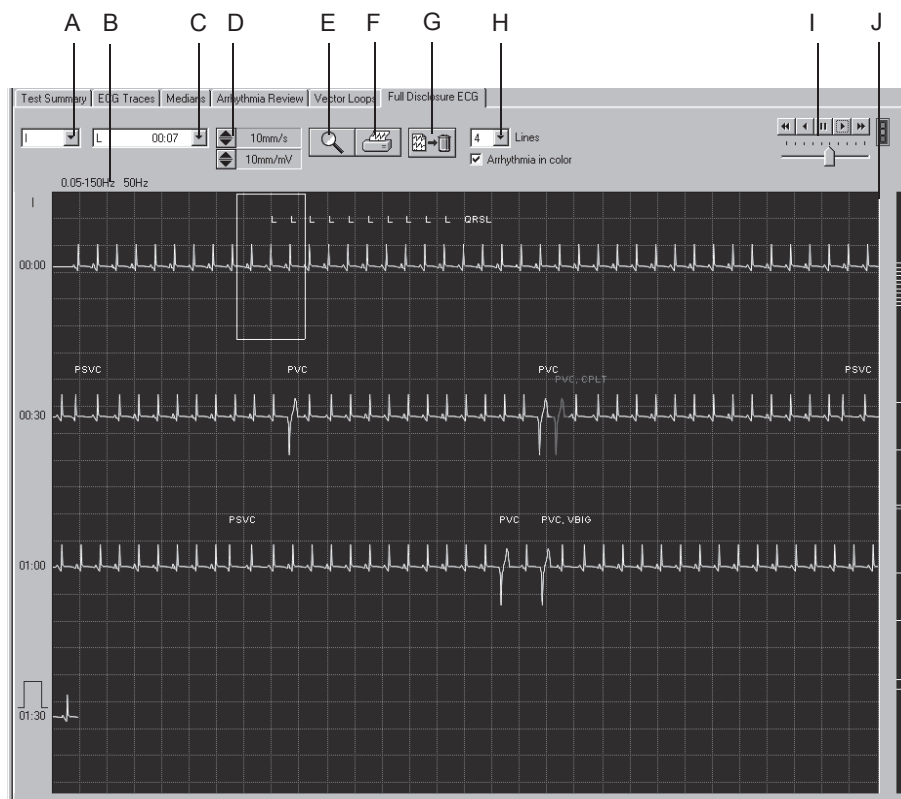

516A-R

- A Click to select the lead.
- B Information about filters, etc.
- C Click to open a list showing all identified arrhythmias.
- D Click to select gain and speed.
- E Click icon to activate the zoom function.
- F Click icon to print the entire full disclosure ECG or selected segments.
- G Click icon to delete the full disclosure ECG.
- H Select the number of lines and whether or not the events are to be color-coded.
- I Click icons for automatic scrolling of the ECG waveform, adjust the scroll speed with the slider below.
- J Scroll box to display different time windows. The markers to the right of the scroll bar allow direct access to the corresponding events.

Printing the Full Disclosure ECG

You can either print the entire full disclosure ECG or a selected segment.

Selecting an ECG Segment

1. Click to mark the beginning of the segment. A flag appears.
2. Click again to mark the end of the segment. A second flag appears.

Printing

1. Click the printer icon. The print setup window opens.

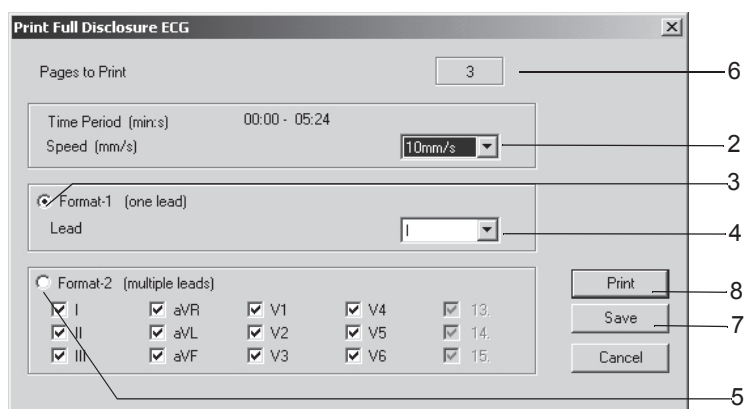

517A-R

2. Select the paper speed.
3. Click the Format-1 option button, if you wish to print only one lead.
4. Select the lead.
5. Click the Format-2 option button, if you wish to print multiple leads, and select the leads.
6. This box indicates the number of pages to print; check paper supply before printing.
7. Click the *Save* button to save the print setup.
8. Initiate the printout or close the window with *Cancel*.

Enabling the Zoom Mode

1. Click the zoom icon.
2. Position the magnifying glass on the region of interest and click.

An enlarged view of the selected region appears.

The operating controls basically remain the same. When you click the printer icon, however, only that page will be printed. Click the zoom icon again to exit the zoom mode.

Analyzing Full Disclosure ECG Segments, Save as Resting ECGs

You can select a segment in the full disclosure ECG and save this segment as an additional resting ECG in the procedure list.

1. Click the zoom icon.
2. Position the magnifying glass on the region of interest and click.
3. Click  : 10 s of the selected segment will be displayed at a larger scale.
4. Confirm the displayed question with "Yes" to save the segment in the box as a separate resting ECG.

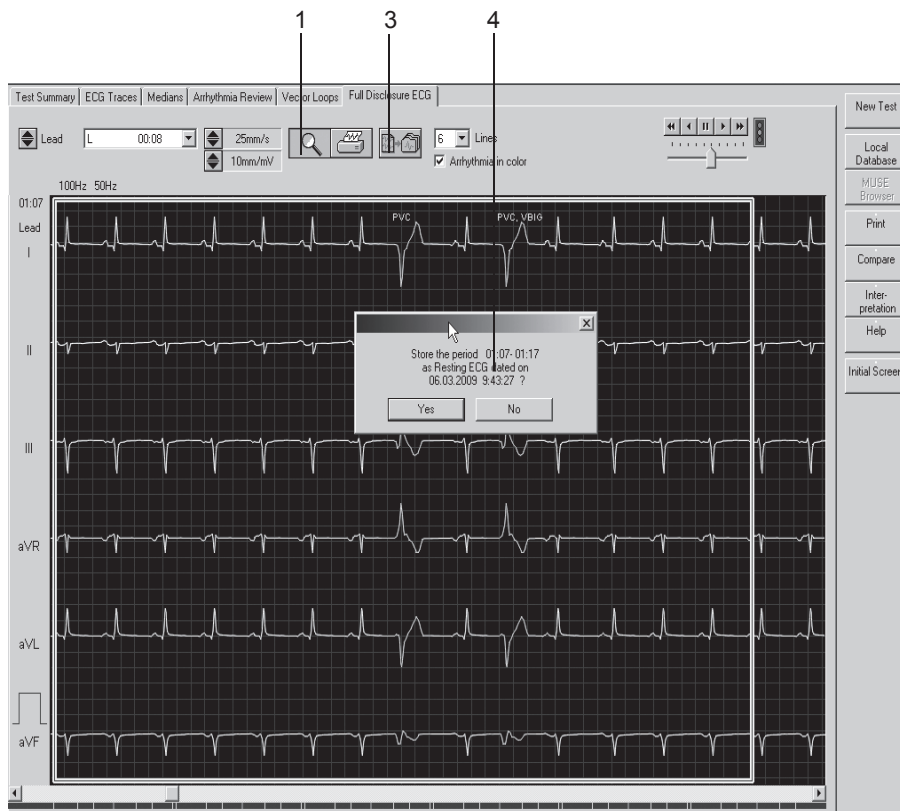

527A-R

Report Printout

Click the *Print* button to print the report. The print setup window opens where you can temporarily adjust the settings for the printout. Refer to section “**Final Report Tab**” on page 12-9 for details on changing the setup permanently.

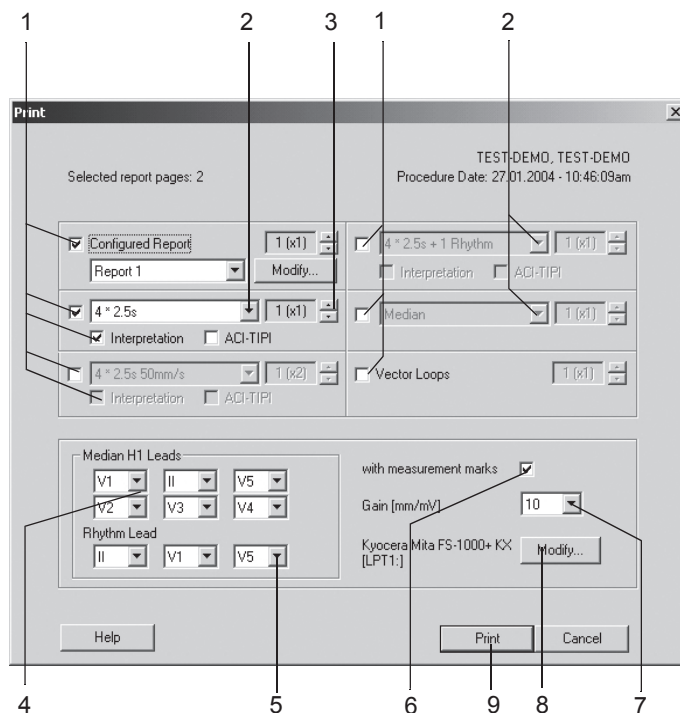

518A-R



1. Select the documents to be included in the report
 - ◆ *Configured Report*
 - ◆ 10-second ECG (up to 3 different formats, with or without *Interpretation* or *ACI-TIPI* score)
 - ◆ two more formats of the 10-second ECG
 - ◆ *Medians*
 - ◆ *Vector Loops*.
2. Select the lead format for the 10-second ECG.
3. Select the number of copies to print.
4. Choose the leads if you selected the Swedish *Median H1* format.
5. Select the rhythm leads.
6. Select whether or not the *Median H1* report is to include the measurement marks.
7. Select the gain.
8. Select the printer.
9. Click the *Print* button to initiate the printout.

Generating the Interpretation

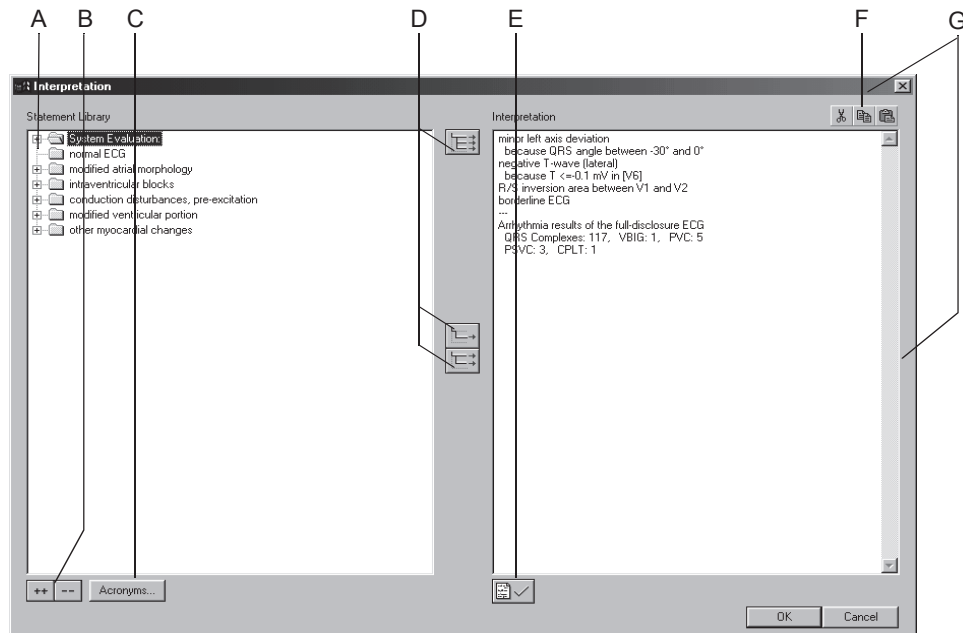
Click *Interpretation/Modify* to open the window. In the left part of the window you see a number of folders with standard interpretation texts. With the *Acronyms...* button you can open an acronym window. The actual interpretation is generated in the right part of the window. The system generated evaluation is already shown. The system supports the creation of an interpretation by providing standard texts and acronyms which can be copied to the Interpretation area on the right. In the Interpretation area you can edit the texts as needed (enter new text, copy, remove, etc.). Refer to section “[Editing the Interpretation Library](#)” on page 12-37 for information on editing the standard texts.



525A-R

- A Click icon to open folders individually.
- B Click icons to simultaneously open (++) or close (- -) all folders.
- C Click button to open a window with acronyms and the corresponding diagnostic findings.
- D Click icons to copy folders , individual lines , lines including the chapter .
- E Click icon to confirm the test results.
- F Click icons to cut, copy and paste text in the Interpretation area.
- G Click the window frame to resize or move the window.

Copying Diagnostic Statements Using Acronyms

1. Click *Acronyms...* to open the window.
2. Type the acronym.
3. Click *Insert>>* to copy the corresponding full text to the Interpretation.

Note

As an alternative you can double-click a text to copy it from left to right.

4. Select the check box if you wish to copy each text to a new line.

Note

Interpretative statements transferred to MUSE that are part of the acronym list will be replaced with the appropriate acronyms.

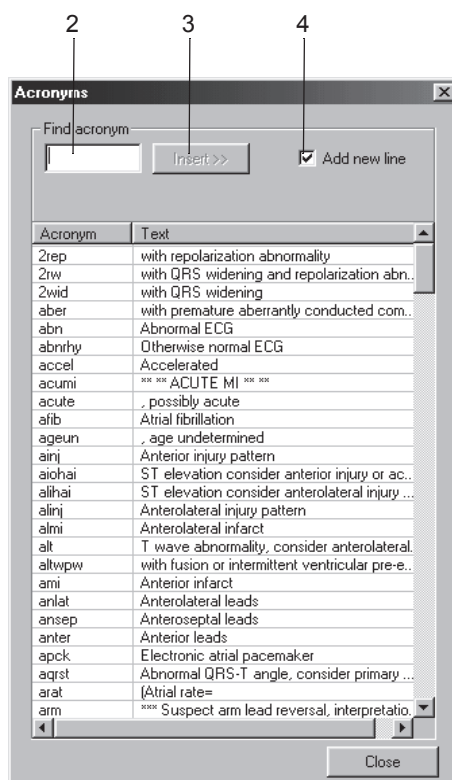

526A-R

Comparing Resting ECGs

You can compare the following details of two resting ECGs:

- the 10-second ECG
- the median complexes and
- the interpretation

It is also possible to compare the medians of at least 3 and up to 6 ECGs.

Comparing Two Resting ECGs

The system offers two alternatives: you can compare the present ECG with an earlier recording or you can retrieve a stored examination, as described in section “[Selecting Patient Records](#)” on page 9-4, and compare it with a second ECG.

1. Click *Compare*.

A window opens listing all the patient's resting ECGs.



2. Select an ECG.
3. Click *OK* to clear the window.

The comparison screen with the two 10-second ECGs appears.

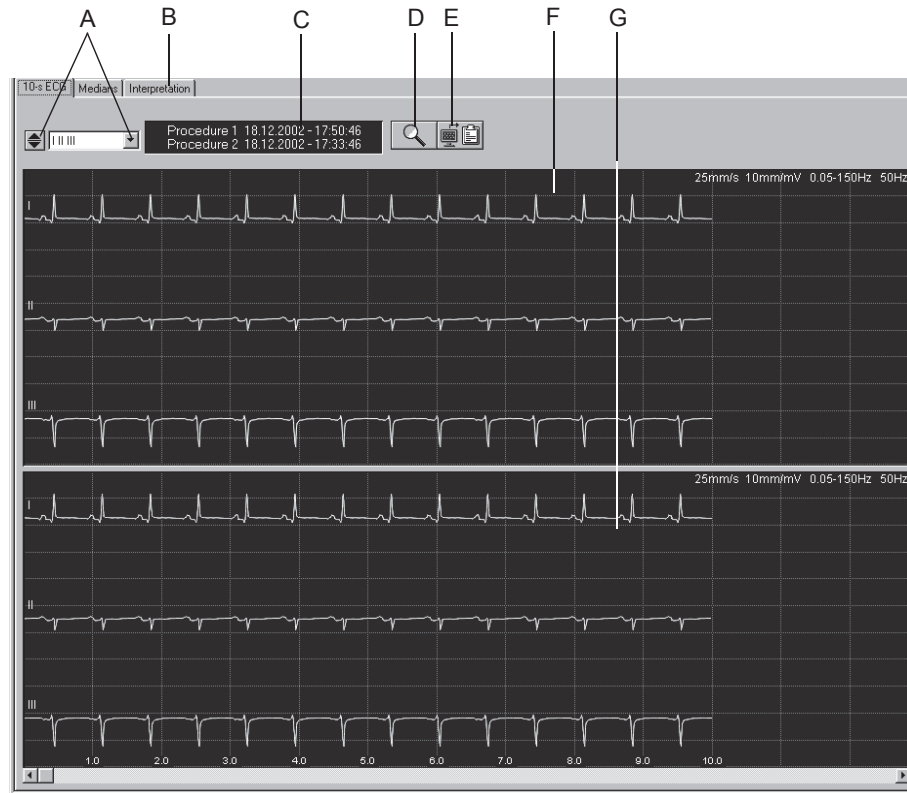
10-Second ECG



519A-R

- A Click to select the lead:
With  you scroll through the leads,
with  you open the list.
- B Click tabs to compare the *Medians* and the *Interpretation*.
- C Acquisition date and time.
- D Click icon to activate the zoom function.
- E Click icon to copy the waveform area to the Clipboard.
- F Procedure 1.
- G Procedure 2.

Zoom Mode –

Follow these steps to enable the zoom mode:

1. Click the zoom icon.
2. Position the magnifying glass on the region of interest and click.

Identical segments of the two procedures are superimposed. With the scroll boxes you can shift the segment of procedure 2 horizontally and vertically.

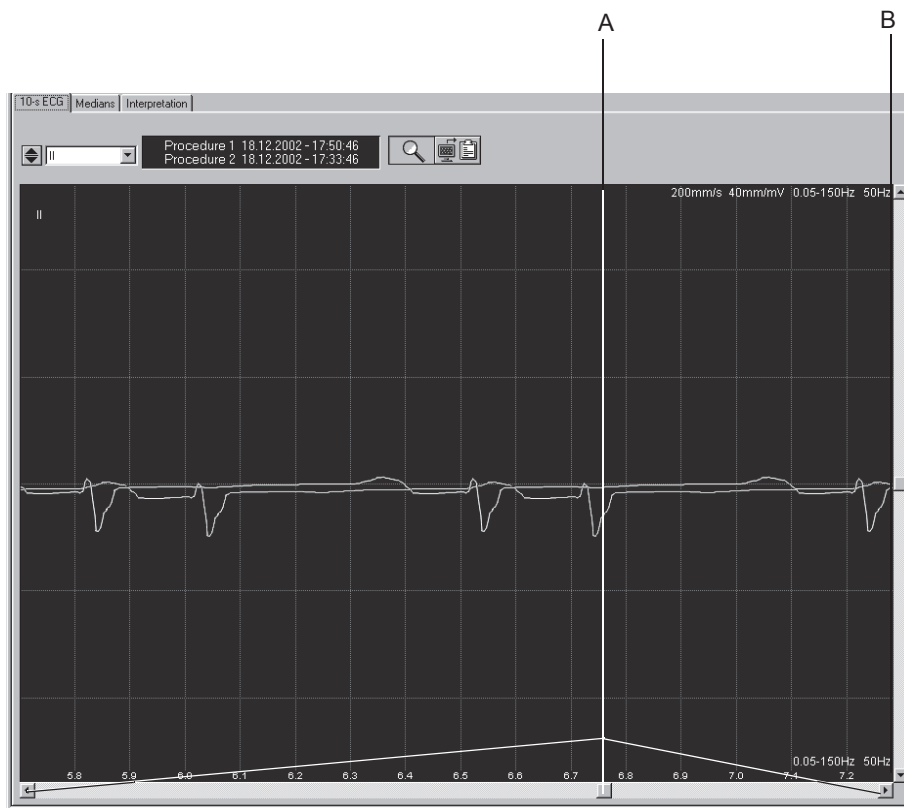

520A-R

- A Click scroll box to move the segment of procedure 2 to the right and left.
- B Click scroll box to move the segment of procedure 2 up and down.

Medians

Click the *Medians* tab to display the screen for comparison of the two median complexes. The scroll boxes also allow you to move the median of procedure 2 up and down and to the right and left.

Interpretation

Click the *Interpretation* tab to display the screen for comparison of the two interpretations.

The following details of the two procedures are displayed:

- the measurement results
- the system evaluation and
- the interpretation

Procedure 1: Measurement Results		Procedure 2: Measurement Results	
Vent. Rate	85 bpm	Vent. Rate	85 bpm
PR interval	182 ms	PR interval	176 ms
QRS duration	102 ms	QRS duration	98 ms
QT/QTc	390/456 ms	QT/QTc	378/449 ms
P/R-T axes	20/-25/50 °	P/R-T axes	17/-39/8 °
P duration	126 ms	P duration	118 ms
RR/PP interval	700/700 ms	RR/PP interval	700/705 ms
QTd/QTcBd	112/134 ms		
System Evaluation: minor left axis deviation because QRS angle between -30° and 0° negative T-wave (lateral) because T <= 0.1 mV in V6 R/S inversion area between V1 and V2 borderline ECG ... Arrhythmia results of the full-disclosure ECG QRS Complexes: 16		System Evaluation: Normal sinus rhythm Left axis deviation Nonspecific T wave abnormality Abnormal ECG ... Arrhythmia results of the full-disclosure ECG QRS Complexes: 42, PVC: 1, PSVC: 1	
Procedure 1: Interpretation		Procedure 2: Interpretation	
minor left axis deviation because QRS angle between -30° and 0° negative T-wave (lateral) because T <= 0.1 mV in V6 R/S inversion area between V1 and V2 borderline ECG ... Arrhythmia results of the full-disclosure ECG QRS Complexes: 16		Normal sinus rhythm Left axis deviation Nonspecific T wave abnormality Abnormal ECG ... Arrhythmia results of the full-disclosure ECG QRS Complexes: 42, PVC: 1, PSVC: 1	

521A-R

- A Measurement results of procedure 1.
- B Interpretation of procedure 1.
- C Measurement results of procedure 2.
- D Interpretation of procedure 2.

Comparing Median Complexes from Multiple Resting ECGs

It is possible to compare the medians of at least 3 and up to 6 ECGs.

Note

Software option ECGH is required for use of this functionality.

1. Click *Compare*.

A window opens listing all the patient's resting ECGs.

2. Holding the **Shift** key down, select the procedures.
3. Click *OK* to clear the window.

The comparison screen with the medians of the selected procedures appears.

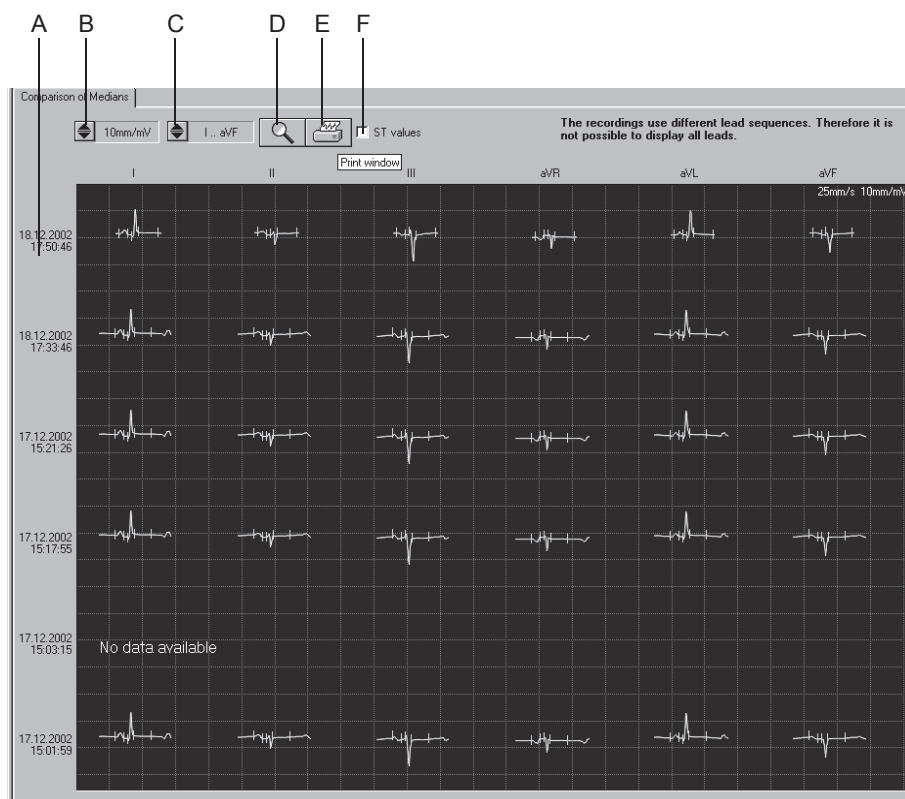

522A-R

- A Acquisition date.
- B Click to select the gain.
- C Click to select the leads.
- D Click icon to activate the zoom function.
- E Click icon to print the screen.
- F Click to select and deselect the ST values.

Zoom Mode

Follow these steps to enable the zoom mode:

1. Click the zoom icon.
2. Position the magnifying glass on the region of interest and click.

The selected median is displayed at a larger scale.



523A-R

- A Acquisition date.
- B Click to select the lead.
- C Click icon to terminate the zoom function.
- D Click icon to print the median.
- E Click button to display the 3D graph.

3D Graph

Click the *3D graph* button to display a three-dimensional representation of the medians from all selected procedures. The scroll boxes allow you to rotate the illustration horizontally and vertically.

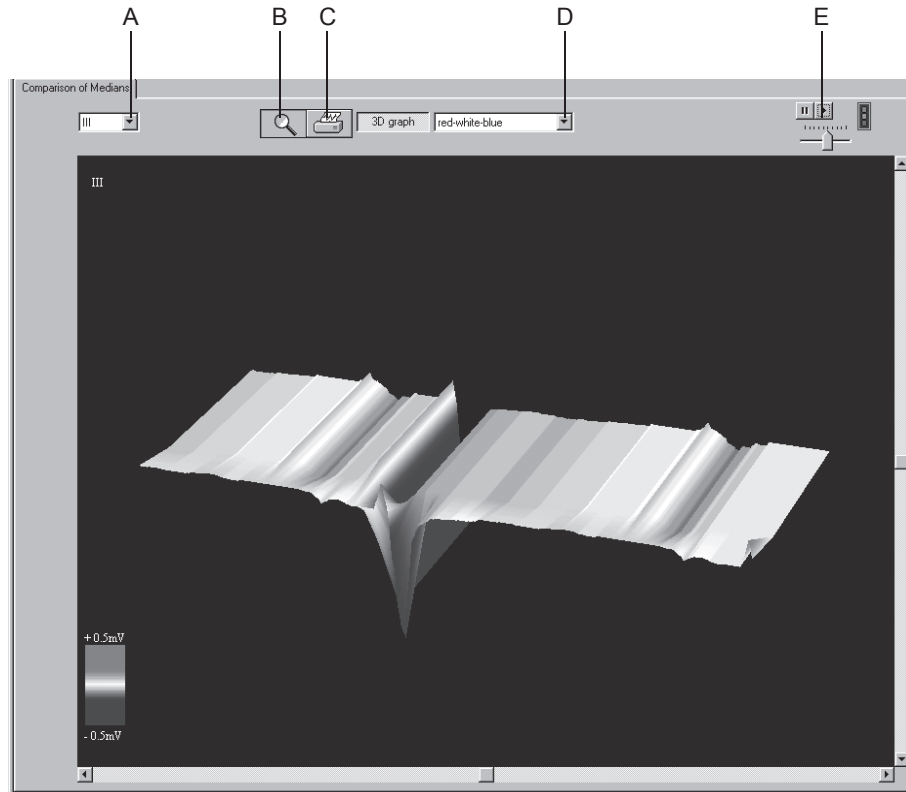

524A-R

- A Click to select the lead.
- B Click icon to terminate the zoom function.
- C Click icon to print the illustration.
- D Click to select the color.
- E Click to start and stop the continuous rotation of the illustration; set the speed with the slider below.

For your notes

6 Exercise Test

For your notes

Patient Education

Before the test you should give your patient some information about what will happen in the course of the test. Click the *Patient Education* button on the pre-acquisition screen to display a description of what the patient can expect to happen before, during, and after the exercise test.

Entering Test Information

Overview

Depending on your system configuration, the *Test Information* window will open automatically or you can display it with the *Test Information* button.

These are the tabs of the menu

- *Patient Information*
- *Test / Personnel*
- *Medications*
- *AHA Stroke Risk*
- *AHA CHD Risk*

Closing a tab with *Cancel* or *OK* will bring up the acquisition screen.

Patient Information Tab

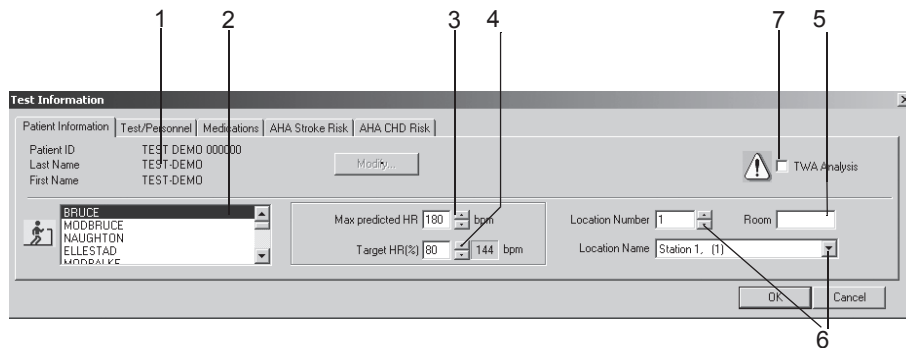

051A-S

The *Patient Information* tab is open.

1. Verify the patient's name and ID. If the data is incorrect, click *Modify* to change.
2. Select the protocol for the next test (refer to section “[Protocol Editor Tab](#)” on page 12-19 for information on changing the default protocol).
3. Confirm or change the *Max. predicted HR* for the exercise test (refer to section “[Miscellaneous 1 Tab](#)” on page 12-24 for information on changing the calculation method).
4. Enter the *Target HR (%)* of the *Max. predicted HR* (refer to section “[Miscellaneous 1 Tab](#)” on page 12-24 for information on changing the percentage permanently).
5. Enter a designation for the *Room* (5 characters max.).
6. Select a *Location Number* or a *Location Name* (names can be configured on the *MUSE* tab, see “[MUSE Tab](#)” on page 12-56).

Note

You can assign a Location Name to the Location number (see section “MUSE Tab” on page 12-56).

7. Enable or disable TWA analysis.

Note

The Patient Information can be assigned to the patient file or only to the pending test.

Note

Before initiating TWA analysis check that all TWA settings are correct (see “TWA Tab” on page 12-30) and that the electrodes are properly applied according to the instructions given in chapter “Preparing the Patient” on page 3-1.

Test / Personnel Tab

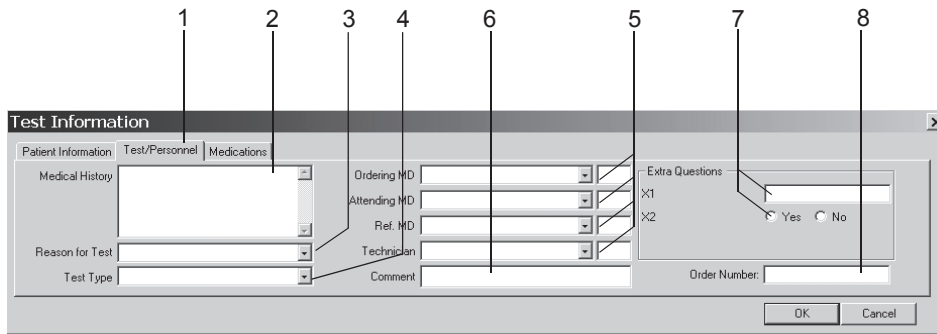

052A-S

1. Click the *Test / Personnel* tab.
2. Type the relevant information in the *Medical History* field.
3. Enter the *Reason for Test* or select one from the list box. Multiple selections are permitted.
4. Select the *Test Type*.
5. Type the physicians' and technician's names or select them from the list boxes.
6. Type any comment about the test.
7. Answer the *Extra Questions*.
8. Enter an *Order Number*. This number will appear on the printed reports and on the Test Summary.

Note

The *Reason for Test* library can be edited (see section “[Miscellaneous 2 Tab](#)” on page 12-26).

You can define two *Extra Questions* as needed (see section “[Entering Extra Questions](#)” on page 12-28).

You enter the names of the physicians and of the technician in the System Configuration (see section “[General Tab](#)” on page 12-40).

Medications Tab

053A-S

1. Click the *Medications* tab.
2. Enter or choose a maximum of 10 medications.
3. Enter the medication dose.

Note

You can edit the libraries (see section [“Editing the Comments, Test Types, Reason for Test, Reasons for Termination, Medications Library”](#) on page 12-26).

Calculating Patient Risk

To calculate the patient's risk for stroke and CHD you must enter the patient's age and gender. The system will assume some values for parameters that are unknown or out-of-range. Refer to [“Risk Factors”](#) on page B-12 for the table of values.

The risk calculations are a prediction of group incidence and may not apply to individual patients. Refer to the American Heart Association publication "Instructions for Using Coronary Risk and Stroke Prediction Charts and Worksheet" (1990) for details.

The system automates the manual calculation of risk. You can edit the values calculated by the system. Edited values are marked with an asteriks *.

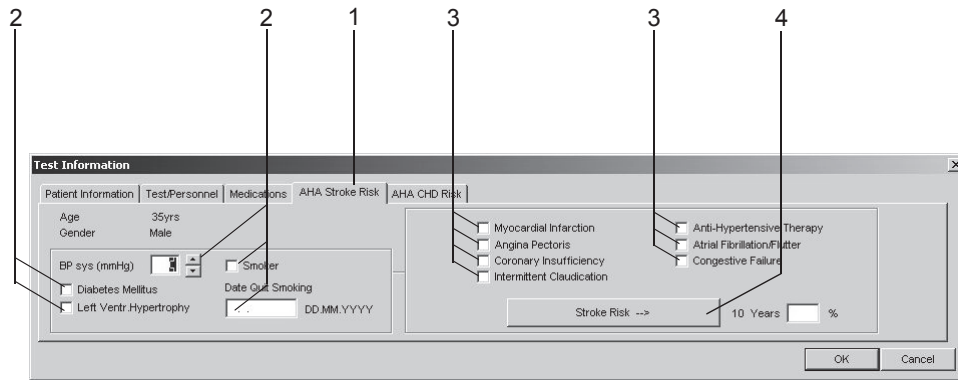

94A

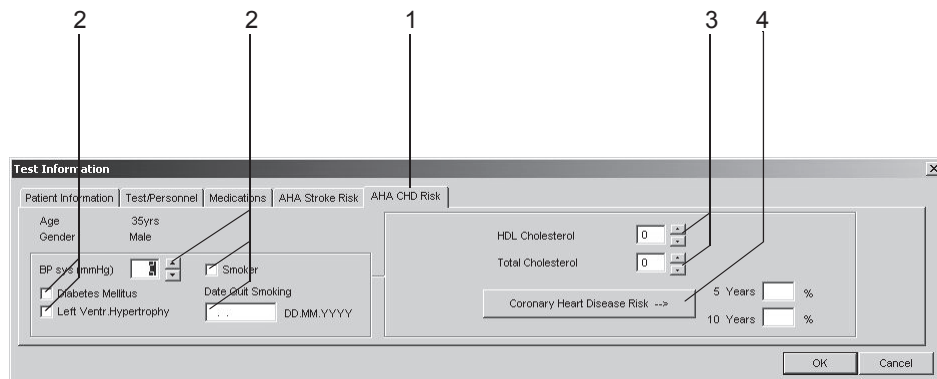

95A

1. Click the *AHA Stroke Risk* or the *AHA CHD Risk* tab.
2. Enter the factors that influence both coronary AND stroke risks.
3. Enter the factors that influence stroke OR coronary risk.
4. Click *Stroke Risk* or *Coronary Heart Disease Risk*.

Before the Test

Pre-Acquisition Screen

Overview

In the upper part of the screen you see the lead check information for verification of the ECG signal quality. All 12 or 15 leads are shown. The schematic lead check torso allows you to verify the applied electrodes. The actual waveform data appears in the area below.





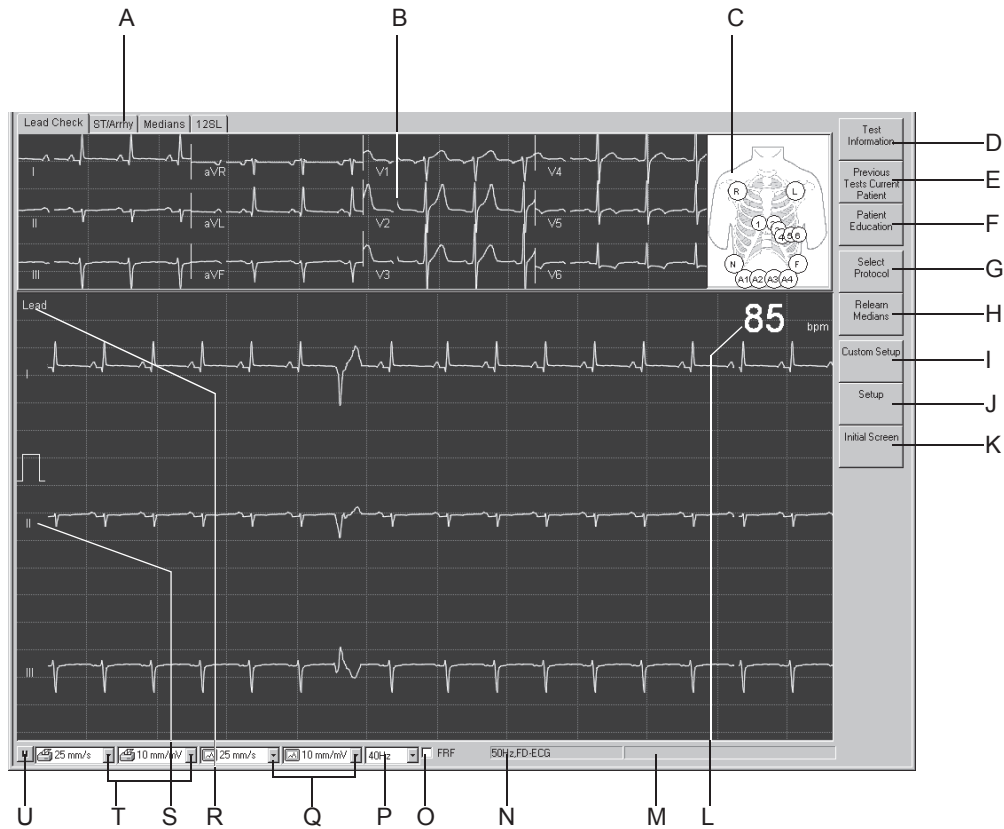



Note

The softkeys displayed at the bottom of the screen are used to control an exercise test. Their functions are explained in section “Softkeys Controlling Exercise Tests” on page 2-8.



056A-S

- A Tabs showing the different ECG analysis data.
- B Lead check status window (other tabs are explained in "During the Test" on page 6-18 (ST/Arrhy), 6-19 (Medians) and 6-25 (12SL).
- C Schematic representation of the applied electrodes:
green: correct, yellow: lead problem (high impedance), white: not used, red: electrode disconnected or lead break (numbers indicate the impedance value in kΩ).

- D  Click to enter or review test information.
- E  Click to select previous tests of the current patient.
- F  Click to display Patient Education.
- G  Click to select an exercise test protocol. A new protocol will become effective in the next phase.
- H  Click to relearn the median complex. With *Relearn Medians* you can also restart the learn phase when not all electrodes are applied.
- I  Click to load system setups stored for different system users.
- J  Click to edit the exercise test setup.
- K  Click to return to the initial screen.
- L Heart rate.
- M System messages window.
- N Indicates AC line filter and arrhythmia recording enabled.
- O Enable or disable FRF or Cubic Spline algorithm, see note below.
- P Select filter frequency (current ECG).
- Q Select screen gain and speed.
- R Click to change selected leads.
- S Lead label, click the label with the right mouse button to display an up/down arrow for adjustment of the ECG baseline.
- T Select writer gain and speed (for ECG recordings in real-time only).
- U Click icon to freeze and release the ECG waveforms (except lead at the top).

WARNING

Misinterpretation — Please bear in mind that muscle filters (20 Hz, 40 Hz, 100 Hz) might also suppress diagnostically relevant portions of the signal, as they limit the signal range. Therefore, muscle filters should only be enabled if necessary.

Note

Cubic Spline and FRF are algorithms that significantly reduce artifact and baseline fluctuations without adversely affecting the ECG signal as conventional filters do. Therefore, the system allows

you to enable and disable the algorithms before or during the test, as needed.

Note

During the exercise test, a new protocol selection with *Select Protocol* will become effective in the next phase.

Note

Pacemaker Patients — It is very important that you indicate on the first database screen, pictured below, whether your patient has a PACEMAKER implanted. A check indicates that the patient DOES have a pacemaker.

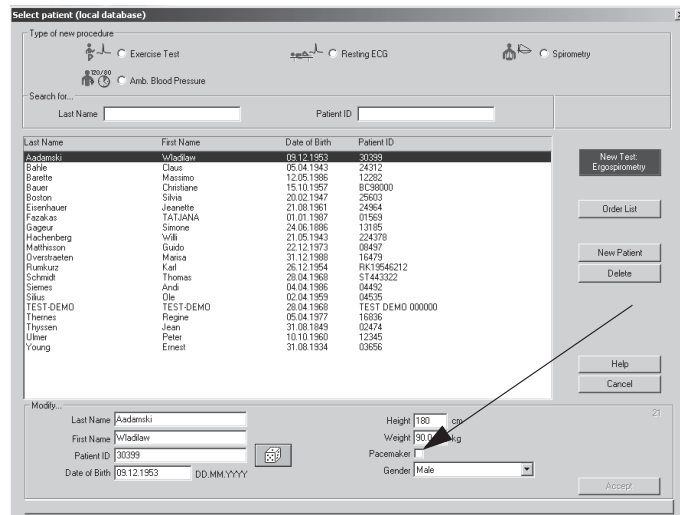

We recommend the following filter setting for exercise tests:

- FRF ON

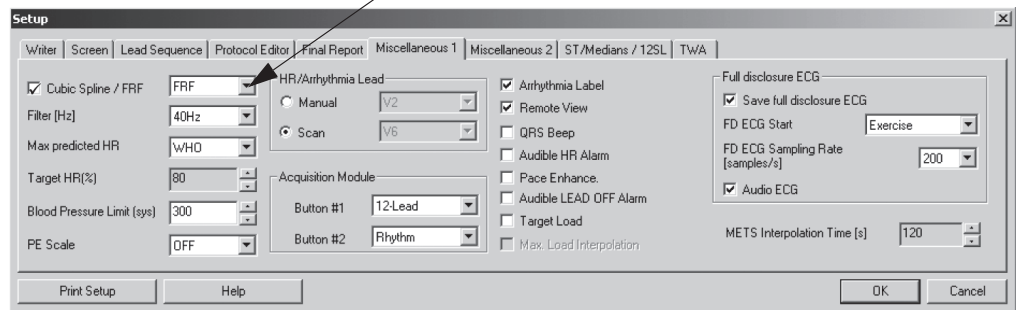

Operating Steps

1. Check the applied electrodes and verify the signal quality in all leads.

ST measurements and arrhythmia analysis will automatically be displayed when all necessary electrodes have been applied and signals of adequate quality are obtained (e.g. without major baseline fluctuations). If all electrodes are not being used, click *Relearn Medians* to manually activate ST measurement and arrhythmia analysis.

2. Click *Select Protocol* to verify that the appropriate test protocol is active or to select another protocol.
3. Click *Patient Education* to display the patient exercise test instructions.
4. Click *Custom Setup* to select and load user-specific test settings.
5. Click *Setup* to edit the exercise test setup.

NOTE

Once you initiate the pretest phase you can no longer change the test settings.

6. Press *pretest* to initiate the test. The pretest screen will appear and the pretest phase begins.

During the Test

Acquisition Screen

Overview

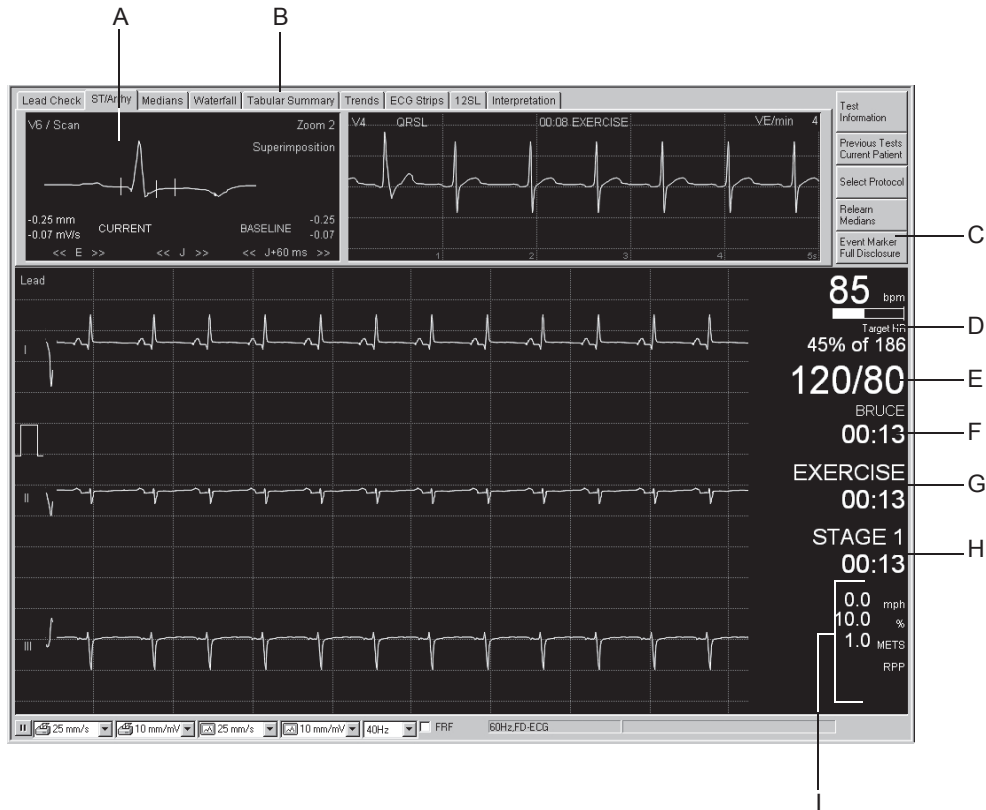

57A-S

Note

The acquisition screen has the same type of information in the pretest, exercise and recovery phases.

- A ST/Arrhy window (see section “ST/Arrhy Window” on page 6-18 for details).
- B Tabs to display windows with ECG test data (see “ST/Arrhy Window” on page 6-18 to “Interpretation Window” on page 6-26 for details).
- C  Button to mark and save ECG events (see section “Arrhythmia Review” on page 6-43).

- D Current heart rate and bar graph indicating percentage of max. predicted HR (see "Exercise Test Setup", "Miscellaneous 1 Tab" on page 12-24 and illustrations below). Turns red when max. HR is exceeded.
- E Most recent BP readings. Turn red when max. systolic BP is exceeded. Values older than 1 minute are dimmed.
- F Selected protocol, exercise clock - starts with the exercise phase and indicates its duration.
- G Current phase, phase clock - each new phase (pretest, exercise, recovery) resets the clock to zero.
- H Current stage, stage clock - restarts with each new stage.
- I Treadmill: belt speed and grade
bicycle ergometer: pedal speed (RPM) and load
METS (metabolic equivalents) see "METS Formula (Metabolic Equivalents)" on page 6-22
RPP (Rate Pressure Product).

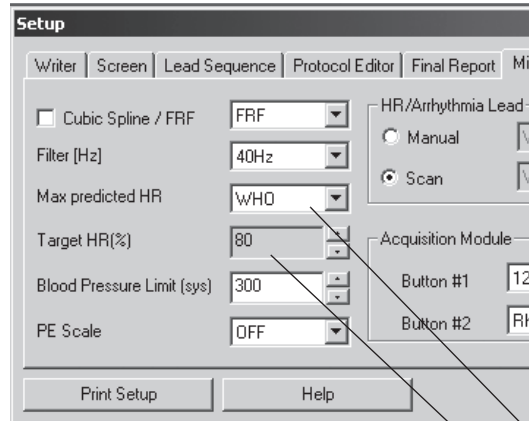

85A-S

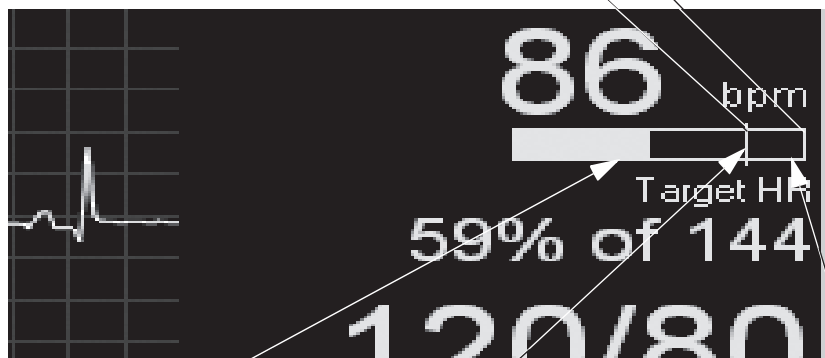

86A-S

Current HR

Target HR in %

Max. predicted HR

Pretest Phase

Overview

The pretest phase might consist of stages configured in each protocol. Commonly used stages are:

- Supine
- Standing
- Hyperventilation
- Warm-up

Blood pressure measurements can be taken manually or automatically as configured in the *Protocol Editor*. When manual entry is configured, the window for entry of BP values will appear automatically (see section “[Protocol Editor Tab](#)” on page 12-19).

The first QRS complex of the exercise phase is saved as the baseline complex.

Operating Steps

1. Wait until the message *Median update ceased... Relearn* disappears, the baseline ST measurement appears and the blood pressure has been taken.
2. Press
 - a. the *12 lead* button to initiate a recording on the thermal writer or laser printer
 - b. the *12SL analysis* button to acquire and analyze a baseline ECG
 - c. the *medians* button to print a baseline ECG on the thermal writer or laser printer.
3. Press *pretest* to advance to the next stage.

Note

When the TWA algorithm is enabled, ensure that the pretest phase is long enough (approx. 1 minute for update factor of 1/8).

Exercise Phase

Overview

The selected protocol will control the treadmill or bicycle ergometer. When you enter the exercise phase:

- the belt speed and grade or the bicycle load will change according to the selected protocol
- the exercise clock will start (phase and stage clocks restart at zero), and
- the system will start saving test data. This data can be viewed on the tabs at the top of the screen (see “[ST/Arrhy Window](#)” on page 6-18 to “[Interpretation Window](#)” on page 6-26).

Operating Steps

Treadmill

1. Press the *exercise* button to enter the exercise phase.
2. Press the *start tmill* button to start the treadmill.

WARNING

Fall Hazard — Your patient should wait until the treadmill belt is moving before stepping onto the belt. Otherwise severe injury could result from a fall. For the same reason, avoid rapid changes in belt speed.

If a higher load level is selected manually before the treadmill is started with the *start tmill* button, the treadmill will accelerate to the speed corresponding to the manually selected load level.

For a FAST stop of the treadmill in an emergency, press the *STOP tmill* button twice, waiting at least 1 second after the first press, or hit the emergency stop button on the treadmill. Please note that when restarted after FAST stop, the treadmill returns to the previous speed and grade.

Note

When the TWA algorithm is enabled, ensure that the patient does not run until the heart rate exceeds the TWA heart rate limit (default value: 125 BPM, see “[TWA Tab](#)” on page 12-30).

Bicycle

The exercise test starts automatically when the patient starts pedalling.

Manual Control

<i>comment</i>	Press to enter comments to appear in the <i>Tabular Summary</i> .
<i>enter BP</i>	Press to enter BP readings.
<i>12 lead</i>	Press to start an ECG recording (12 leads, 5 seconds from memory, 5 seconds of real-time data).
<i>recall</i>	Press to print a 10-second delayed recall report on the thermal writer.
<i>rhythm</i>	Press to start a continuous rhythm report on the thermal writer.
<i>stop writer</i>	Press to stop the writer or printer.
<i>medians</i>	Press to print a medians report.
<i>arrhy doc</i>	Press to enable or disable the automatic documentation of arrhythmias.

Note

Cubic Spline / FRF algorithms can delay the rhythm report by approximately 2 seconds when enabled.

<i>12SL analysis</i>	Press to acquire a 12SL resting ECG with measurements and interpretation (Pretest and Recovery phases only).
<i>grade up</i>	Press to change the elevation of the treadmill belt.
<i>grade down</i>	
<i>speed +</i>	Press to change the belt speed or ergometer load.
<i>speed -</i>	
<i>exercise</i>	Press to advance to the exercise phase.
<i>hold stage</i>	Press to hold the exercise test in the current stage.
<i>start tmill/ STOP tmill</i>	Press to start and stop the treadmill belt.

Note

In the pretest phase, **Shift + pretest** or **Shift + F1** allow you to return to the previous stage.

Note

If a bicycle ergometer test is initiated with the *exercise* button, the clock will start even when the patient has not yet begun to pedal.

Note

When the patient reaches the target HR, the HR reading turns red and an audio signal sounds (if configured, see section “[Miscellaneous 1 Tab](#)” on page 12-24).

Note

Using the treadmill speed and grade buttons during a protocol puts the treadmill in manual control. The system is no longer controlled automatically by the protocol. The system will enter a new stage and the phase name appearing in the Tabular Summary will be *Manual*.

ECG Data Windows

ST/Arrhy Window

The *ST/Arrhy* window displays the median complex (left) and the current arrhythmias (right). As soon as the exercise phase begins, the current median complex is superimposed on the baseline complex and both measurements are displayed.

The system chooses the two leads with the greatest amplitude for arrhythmia analysis (click E to select another lead). The system starts saving arrhythmias at the beginning of the pretest (20 arrhythmias max., following preset priorities, see section “*Arrhythmia Review*” on page 6-43).

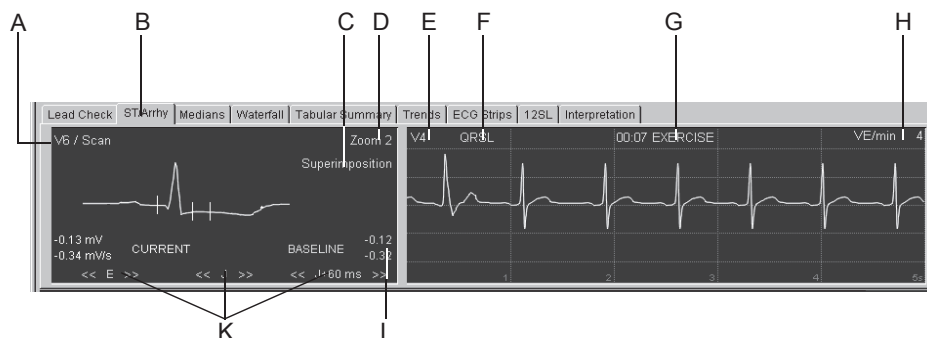

58A-S

- A Click the lead label to display the median complexes of other leads. The message *Scan* indicates that the system has chosen the lead with the most significant ST depression. (Leads aVR, aVL, V1 are not considered.)
- B Click the tab to display the *ST/Arrhy* window.
- C Click *Superimposition* to display the median complexes from all leads superimposed (click again to restore normal presentation).
- D Click *Zoom* to change the size of the median complex.
- E Click the lead label to open a window for manual selection of the arrhythmia lead (the system automatically selects the 2 leads with the greatest amplitudes).
- F Arrhythmia label.
- G Time at which arrhythmia occurred in the indicated phase.
- H Number of ventricular ectopics per minute.
- I ST measurements.
- K Click arrows to adjust the E, J and J+x reference points (only in "manual" mode, see section “*ST/Medians / 12SL Tab*” on page 12-29).

Note



Significant arrhythmias are displayed with red waveforms.

Medians Window

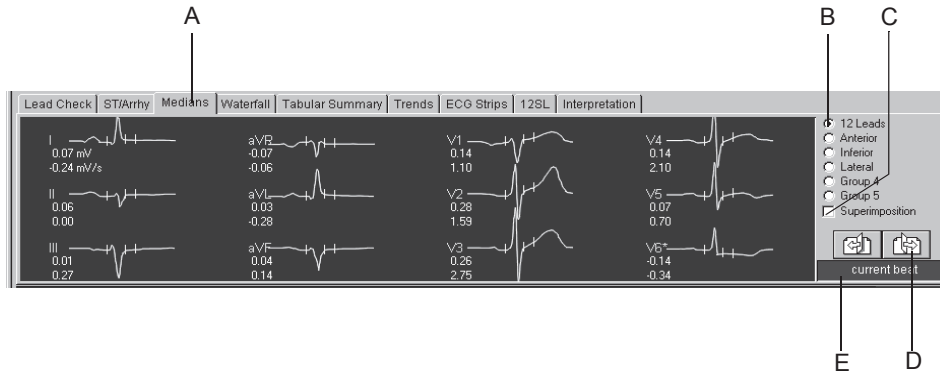
The *Medians* window displays the current median complex. The system saves new median beats at the time intervals selected in the *Protocol Editor* (see section “**Protocol Editor Tab**” on page 12-19).



59A-S

- A Click the tab to display the *Medians* window.
- B Click option button to select different lead groups (see “**Screen Tab**” on page 12-13 for information on how to assign the leads to the groups).
- C Click *Superimposition* to display the median complexes of the selected group superimposed (click again to restore normal presentation).
- D Display other median complexes.
 -  backward
 -  forward
- E Median label (the complex is updated at the time interval selected in the *Protocol Editor*).

Waterfall Window

This window displays a graphic color representation of the median beat changes in the course of the test (updated at 30 second intervals).

Click anywhere in the waterfall to display the median complex and measurement of the corresponding point in time (associated phase, stage, HR, BP, and METS appear at the right).

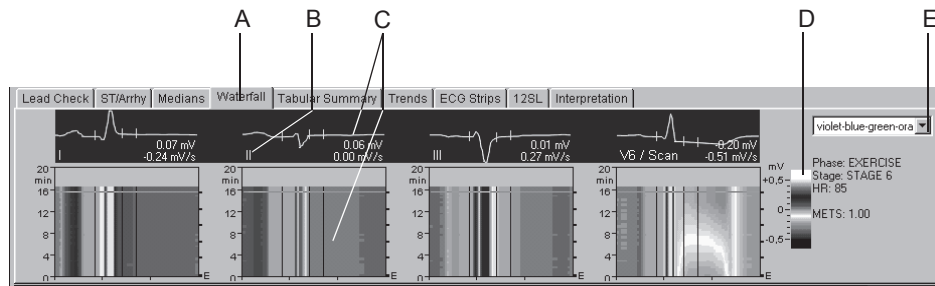

60A-S

- A Click the tab to display the *Waterfall* window.
- B Click the lead label to change the displayed leads.
- C Median complex, ST measurement and corresponding waterfall.
- D Color code of the different amplitudes in mV.
- E Click to select the color menu.

Tabular Summary Window

The *Tabular Summary* window displays test data in two tabular formats:

- stage format: 1 line per stage, or
- detailed format: 1 line minimum / 30 seconds

The *Tabular Summary* can be configured. See “[Configuring the Tabular Summary](#)” on page 12-14 for details.

Use the detailed format to enter or edit data.

1. Click the value to change.
2. Enter the new value. Edited values are bold.

To enter new data:

1. Click in an empty field.
2. Enter the new value.

The screenshot shows the 'Tabular Summary' window with the following data table:

	Phase Name	Stage Name	Time in Stage	Speed (km/h)	Grade (%)	Workload (METS)	HR	BP (mmHg)	RPP	VE (l/min)	ST Level (V5 mV)	Comment
1	PRETEST	SUPINE	01:47	0.00	0.00	1.0	85			5	-0.02	
2		STANDING	00:15	0.00	0.00	1.0	85			5	-0.03	
3		HYPERV.	00:19	0.00	0.00	1.0	85			5	-0.03	
4	EXERCISE	STAGE 1	03:00	2.70	10.00	4.6	85	125/85	10625	5	-0.07	
5		STAGE 2	03:00	4.00	12.00	7.0	86			5	-0.12	
6		STAGE 3	02:00	5.40	14.00	9.9	83	131/91	10873	5	-0.15	
7	RECOVERY		00:55	2.40	0.00	6.4	85			5	-0.17	

61A-S

- A Click *Tabular Summary* tab to display the window.
- B Select to display the stage format: 1 line/stage.
- C Select to display the detailed format: 1 line/30 seconds.

METS Formula (Metabolic Equivalents)

Treadmill

$$\text{METS} = \frac{(\text{speed} \times 26.8 \times 0.1) + (\text{grade} / 100 \times 1.8 \times \text{speed} \times 26.8) + 3.5}{3.5}$$

speed = miles per hour

grade = percent

$$\text{METS} = \frac{(\text{speed} \times 0.1) + (\text{grade} / 100 \times 1.8 \times \text{speed}) + 3.5}{3.5}$$

speed = meters per minute

grade = percent

Bicycle Ergometer

$$\text{METS} = \frac{12.3 \times \text{load} + 3.5 \times \text{weight}}{\text{weight} \times 3.5}$$

load = Watt

weight = kg

Between two stages, the METS value will be interpolated. The correct METS value of a stage is reached after a stage time of 60 seconds (default value, can be changed, see section “[Miscellaneous 1 Tab](#)” on page 12-24).

Trends Window

The *Trends* window displays graphic trends of different parameters. The trends are updated in 30 second intervals.

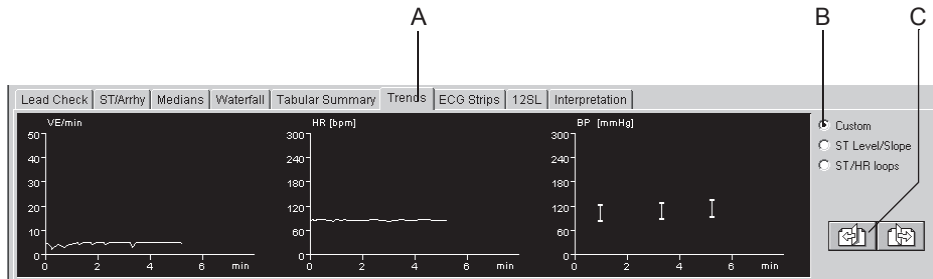

62A-S

- A Click the tab to display the *Trends* window.
- B Click an option button to display other trend formats.
Click *Custom* to display user configured trends.
Click *ST Level/Slope* to display the trend of ST level and slope versus time.
Click *ST/HR Loops* to display the 2-dimensional representation of ST level versus HR (see section “*Configuring Trends*” on page 12-15).

- C Click to display other trend displays



backward



forward

ECG Strips Window

The *ECG Strips* window displays 10-second ECG strips

- stored during the last 10 seconds of each stage
- acquired manually, or
- acquired automatically as configured (see section “[Protocol Editor Screen](#)” on page 12-20).

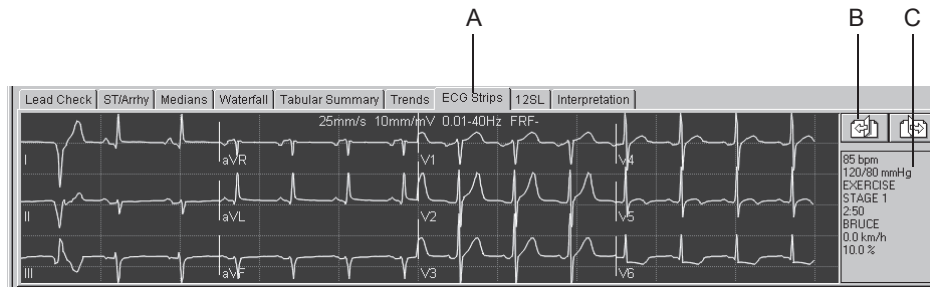

63A-S

A Click the tab to display the *ECG Strips* window.

B Click to display the other ECG strips.



backward



forward

C Test data of the ECG strip.

12SL Window

The *12SL* window displays the 12SL resting ECG measurements and interpretation acquired by pressing *12SL analysis* during preacquisition, pretest and recovery.

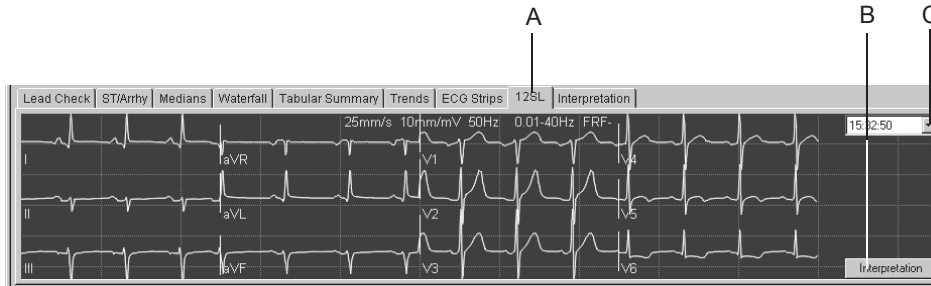

64A-S

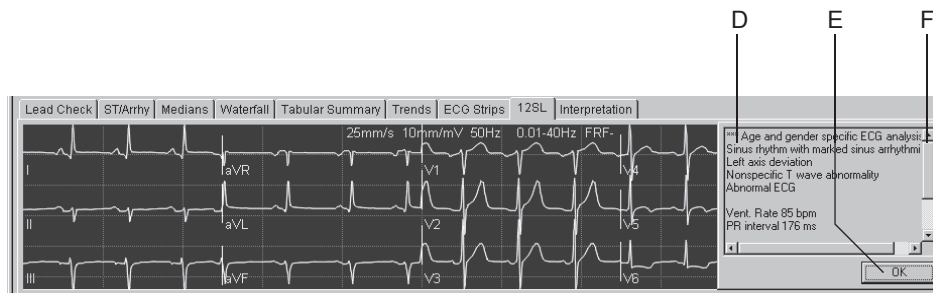

65A-S

- A Click the tab to display the 12SL window.
- B Click button to display the interpretation.
- C Click to select the recording.
- D 12SL measurements and interpretation.
- E Click to clear the Interpretation window.
- F Click arrows to display sections currently out of view.

Note

The vector loop is saved with the 12SL report only if the message *Median update ceased... Relearn* has disappeared from the *ST/Arrhy* window at the time the 12SL report is stored.

Note

The system stores up to five 12SL reports.

Interpretation Window

The *Interpretation* window allows the physician to enter an interpretation of the test.



66A-S

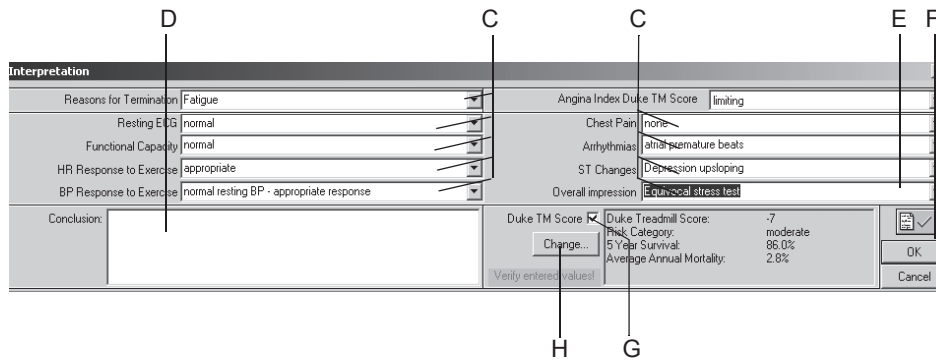

67A-S

- A Click the tab to display the *Interpretation* window.
- B Click to enter or edit the interpretation.
- C Enter or select summary statements for the different interpretation categories and for the Overall Impression.
- D Click to enter the Conclusion.
- E Click to confirm the test results.
- F Click to clear the window.
- G Select to include the Duke Treadmill Score in the Test Results and in the Final Report, or deselect.
- H Click to edit the Duke Treadmill Score.

Comparing Previous Test Data

At any point in the test you can compare the current data with that of a previous test:

1. Click *Previous Tests Current Patient*.
2. Double-click the test to review:

Page 1 of the median complexes will appear in the lower part of the screen for reference.



68A-S

- A Details of the displayed median complexes.
- B Click tabs to view other ECG data windows.
- C Click *Close* to clear the second test window.

- D Click to view more median complexes.



- E Click to display the baseline medians.
- F Click to display the peak exercise medians.
- G Click to display the medians with the most significant ST depression.

Recovery Phase

Overview

Press the *recovery* button to advance to the recovery phase.

The clock begins timing the recovery phase. In recovery, the treadmill speed and grade or the bicycle load will change according to the protocol configuration.

Test End Phase

Overview

1. Press the *test end* button to end the test and start the test end phase.
2. Click *Yes* to confirm the test end. The Interpretation window appears with the patient's ECG waveforms below.

NOTE

After you press the *test end* button, the following happens:

- ◆ The system no longer acquires and stores ECG measurement data.
- ◆ The clocks stop.
- ◆ Workload, speed, and grade no longer display.

67A-S

Operating Steps

1. Enter or select the *Reasons for Termination* (multiple selections are permitted).
2. Select the *Angina Index* which is necessary to calculate the Duke Treadmill Score.
3. Enter or select summary statements (multiple selections are permitted).
4. Enter the *Conclusion*.
5. Click *Modify...* to edit the Duke Treadmill Score (see “**Duke Treadmill Score**” on page B-10). Enable the Duke TM Score : to include it in the Test Results and in the Final Report.
6. Confirm the test results.
7. Click *OK* to clear the window. The Interpretation window and the test end menu tabs appear.

ST/Arrhy	Patient Information	Test Information	Measurement Results	Tabular Summary	Interpretation
Reasons for Termination:	Fatigue				
Summary:					
Resting ECG:	normal				
Functional Capacity:	normal				
HR Response to Exercise:	appropriate				
BP Response to Exercise:	normal resting BP - appropriate response.				
Chest Pain:	none				
Arrhythmias:	atrial premature beats				
ST Changes:	Depression upslowing				
Overall Impression:	Equivocal stress test.				
Prognosis:					
Duke Treadmill Score:	-7				

69A-S

Note

Real-time reports can be printed with the following buttons on the function keypad:

- ◆ *12 lead*
- ◆ *medians*
- ◆ *rhythm*
- ◆ *recall* (data is not saved).

8. Click the test end menu tabs to review and edit the data.
9. Click *Print* or *test end* to print the final report (see “**Report Printout**” on page 6-52).
10. Click *Post Test Review* to review the stored test information. This will end the display of the patient ECG waveforms.

Note

If you do not want to go to Post Test Review:

- ◆ Click *New Test* to start a new test, or
- ◆ click *Initial Screen* to end ECG display and go to the initial screen.

After the Test — Post Test Review





Test Summary



Overview

The screenshot shows the 'Test Summary' window for a patient named TEST-DEMO. The interface is divided into several sections:

- Section A:** Tabs at the top: Test Summary, Tabular Summary, Graphic Trends, Sample Card, Cycles, ECG Strips, Arrhythmia Review, Waterfall, 12-lead Report.
- Section B:** Patient Information area containing fields for Last Name, First Name, Patient ID, Age, Gender, Height, and Weight.
- Section C:** Test Information area containing Location Number and Station.
- Section D:** Measurement Results area containing various physiological data points such as Max HR, Max BP, Maximum Workload, Max ST, ST/HR slope, HR reserve used, Freq VE recovery, ST/HR hysteresis, and a detailed Exercise Test Interpretation (XTI) section.
- Section E:** Interpretation area containing Reasons for Termination, Summary, Resting ECG, Functional Capacity, HR Response to Exercise, BP Response to Exercise, Chest Pain, Arrhythmias, ST Changes, Overall Impression, Prognosis, Duke Treadmill Score, Risk Category, 5 Year Survival, and Average Annual Mortality.
- Section F-L:** A vertical toolbar on the right side with icons for New Test, Local Database, MUSE Browser, Print, Compare, Interpretation, Help, and Initial Screen.

70A-S

- A Click a tab to display the corresponding window.
- B Patient Information area.
- C Test Information area.
- D Measurement Results area: area for exercise measurements and machine “Exercise Test Interpretation (XTI)”.
- E Interpretation area: area for the physician’s interpretation.
- F  Click to display patient list for a new test.
- G  Click to display a list with more tests of the current patient (local database).
- H  Click to display a list with more tests of the current patient (MUSE database system).
- I  Click to display the print setup window.

- J  Click to display the interpretation window where a detailed interpretation of the test can be generated.
- K  Click to activate the online Help program.
- L  Click to return to the initial screen.

The *Modify...* buttons allow you to edit or complete the data in the respective areas.

- *Patient Information*: The *Patient Information* window opens.
- *Test Information*: The *Test Information* window opens.
- *Measurement Results*: A window opens where you can edit the measurement results. Edited measurement results are identified with the * symbol. You can also choose whether or not to display the system evaluation.

NOTE

After opening the edit window with *Modify...*, you can select a check box to remove the *Exercise Test Interpretation* from the *Measurement Results* window.

- *Interpretation*: A window opens where you can generate the test interpretation (“**Test End Phase**” on page 6-29).

Tabular Summary

The *Tabular Summary* window displays test data in three tabular formats:

- stage format: 1 line per stage, or
- detailed format: 1 line minimum / 30 seconds
- all entries

The *Tabular Summary* can be configured. See “[Configuring the Tabular Summary](#)” on page 12-14 for details.

Use *Detail* or *All entries* to enter or edit data.

1. Click the value to change.
2. Enter the new value. Edited values are bold.

To enter new data:

1. Click in an empty field.
2. Enter the new value.

The screenshot shows the 'Tabular Summary' window with a table of test data. Labels A, B, C, and D point to the following elements:

- A: The 'Stages' radio button.
- B: The 'Detail' radio button.
- C: The 'Tabular Summary' tab.
- D: The 'All Entries' radio button.

	Phase Name	Stage Name	Time in Stage	Speed (km/h)	Grade (%)	Workload (METS)	HR	BP (mmHg)	RPP	VE (/min)	ST Level (V6 mV)	Comment
1	PRETEST	SUPINE	01:47	0.00	0.00	1.0	85			5	-0.02	
2		STANDING	00:15	0.00	0.00	1.0	85			5	-0.03	
3		HYPERV.	00:19	0.00	0.00	1.0	85			5	-0.03	
4	EXERCISE	STAGE 1	03:00	2.70	10.00	4.6	85	125/85	10625	5	-0.07	
5		STAGE 2	03:00	4.00	12.00	7.0	86			5	-0.12	
6		STAGE 3	02:00	5.40	14.00	9.9	83	131/91	10873	5	-0.15	
7	RECOVERY		00:55	2.40	0.00	6.4	85			5	-0.17	

71A-S

- A Select to display the stage format (1 line/stage).
- B Select to display the detailed format (1 line minimum/30 seconds).
- C Click the *Tabular Summary* tab to display the stage format.
- D Select to display all entries.

Note

Only the stage format of the *Tabular Summary* is transferred to the MUSE system.

METS Formula

See “[METS Formula \(Metabolic Equivalents\)](#)” on page 6-22 for details of the METS formulas.



Between two stages, the METS value will be interpolated. The correct METS value of a stage is reached after a stage time of 60 seconds (default value, can be changed, see section “[Miscellaneous 1 Tab](#)” on page 12-24).

Graphic Trends

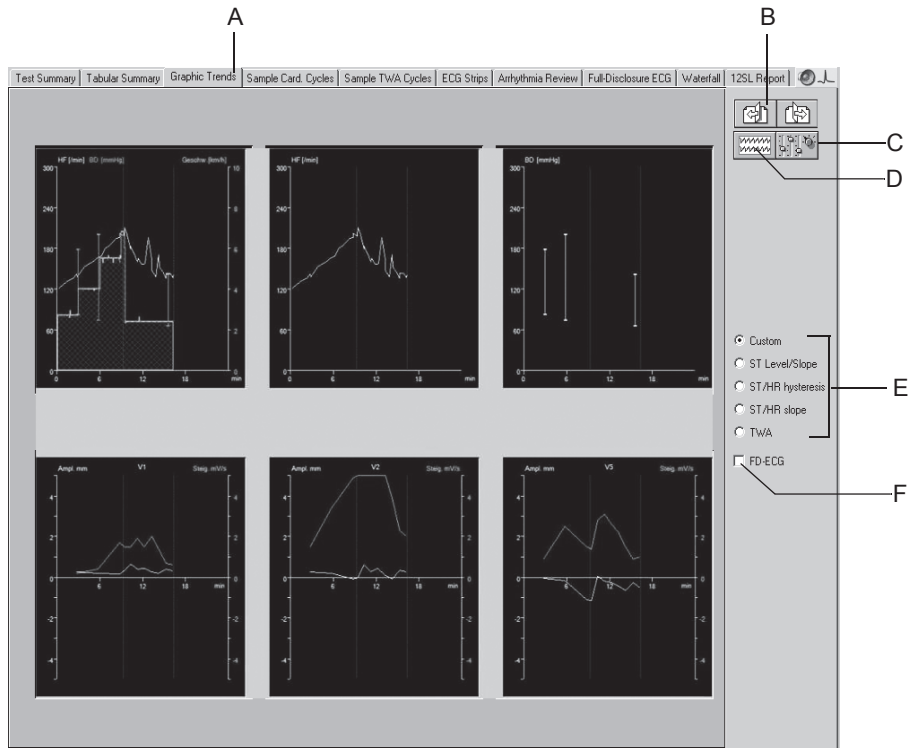
Overview



72A-S

- A Click to display the graphic trends.
- B Click to display other leads of the trends (not available on all screens).
 -  backward
 -  forward
- C Click icon to display the trend configuration window.
- D Click to jump to a separate full disclosure ECG window.
- E Click an option button to display other trend formats.
 - Click *Custom* to display user configured trends.
 - Click *ST Level/Slope* to display the trend of ST level and slope versus time.
 - Click *ST/HR Loops* to display the 2-dimensional representation of ST level versus HR. To expand the ST and HR axes, click *Auto Scale ST* and *Auto Scale HR* (see section “Configuring Trends” on page 12-15).
 - If you purchased the STHY option (ST/HT Hysteresis), *ST/HR Hysteresis* will be displayed here instead of *ST/HR Loop*.
 - Click *ST/HR Slope* to display the heart rate-adjusted slope for all leads.
 - Click *TWA* to display the TWA trends.
- F Click to display the full disclosure ECG (see next page).

Note

The system starts collecting trend data at the beginning of the exercise phase.

Viewing the Full Disclosure ECG

By selecting the Full disclosure option on the trend screen, you can view the full disclosure ECG. The operating controls in the full disclosure window are explained in section “Full Disclosure ECG” on page 6-45.

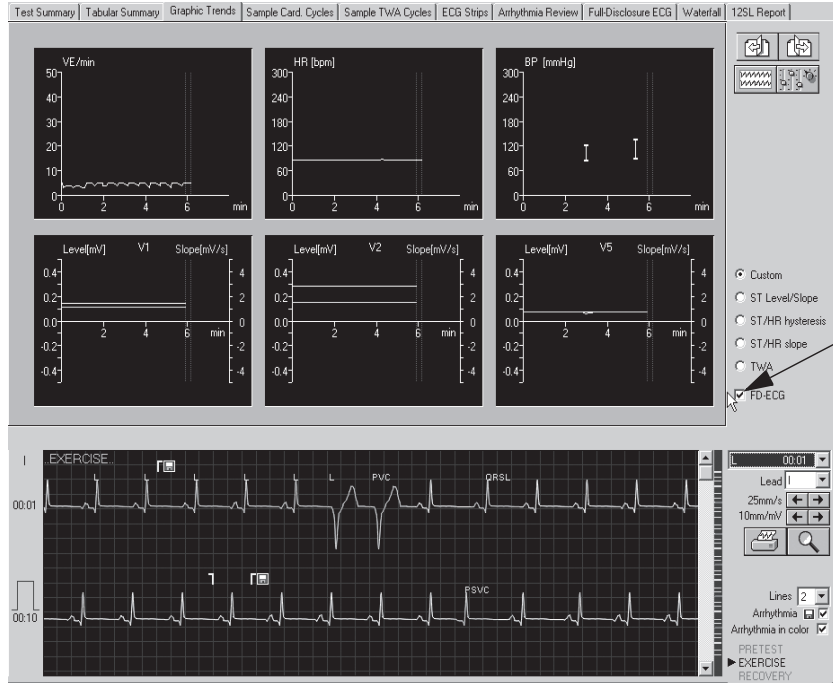

942A-S

Viewing Medians, Replacing max. ST Changes

1. Locate the ST value in the trend graph of interest and click: a new window with the corresponding median complex will open.
2. Click on the ST value in the median complex window: a new window with the new and old ST values appears.
3. Click *Yes* and the ST value will be changed.

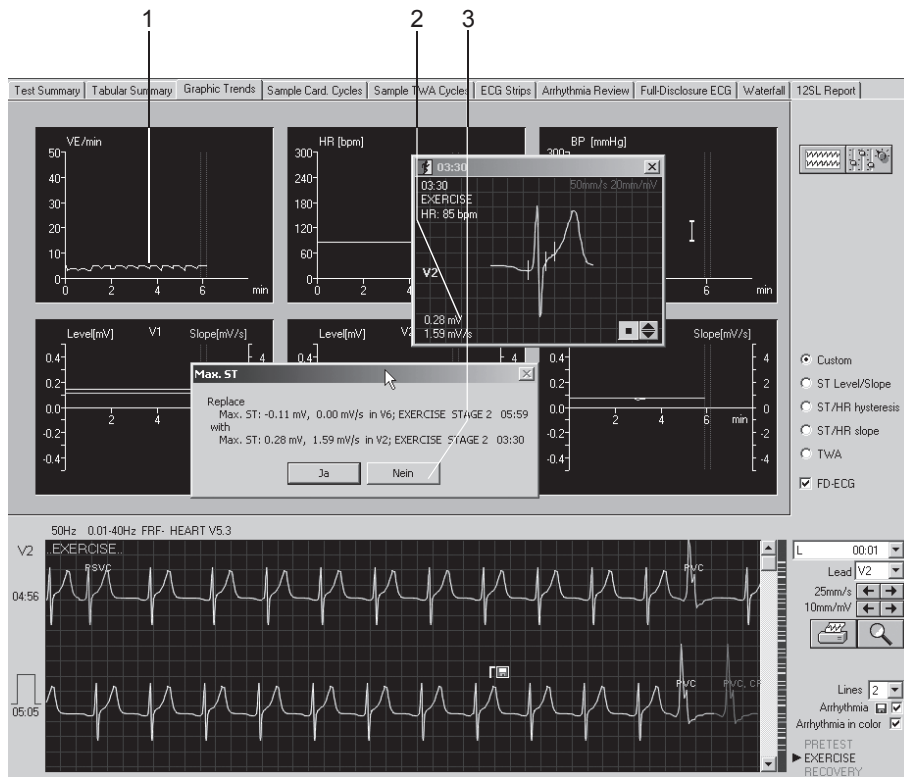

943A-S

Viewing TWA Medians, Replacing max. TWA Values

1. Locate the TWA value in the trend graph of interest and click.
2. A new window with the corresponding median complexes will open.
3. Click on the TWA value in the median complex window: a new window with the new and old TWA values appears.
4. Click *Yes* and the TWA value will be changed.

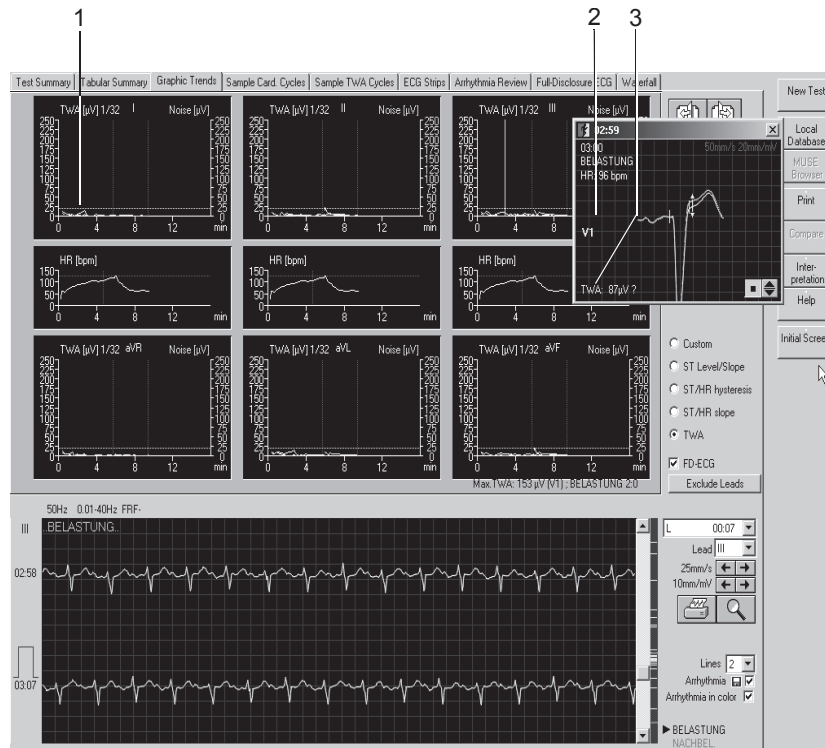

949A-S

Note

Dashed lines appear in case of noisy signal and/or when the heart rate is too high (see *TWA Heart Rate Limit* in Chapter 12, “[System Settings](#)” under “[TWA Tab](#)” on page 12-30).

Sample Cardiac Cycles

Overview

This screen shows the median complexes collected at each stage, beginning with the pretest phase.

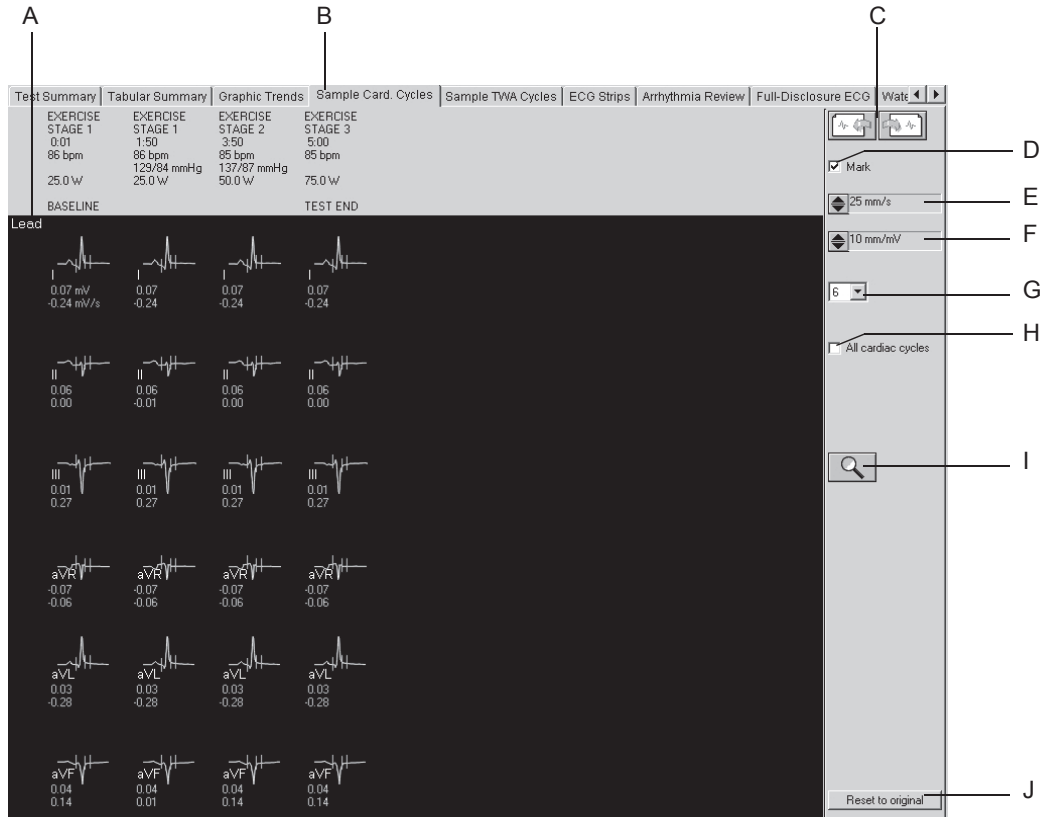

Note

Reanalyze the sample cardiac cycles as described under “**Reanalysis**” on page 6-39.

- A Click the lead label to change the displayed leads.
- B Click to display the *Sample Cardiac Cycles*.
- C Click to view more sample cardiac cycles.
- D Click to show and hide the measurement marks.
- E Select the speed of the displayed medians.
- F Select the gain for the displayed medians.
- G Select the number of lines (1, 3, 6).
- H Number of medians shown per stage:
 - All cardiac cycles (at intervals of 30 seconds)
 - only one cardiac cycle

- I Click icon to activate the zoom and reanalysis function (see next page).
- J Click *Reset to original* to discard the results of the reanalysis and return to the original measurements.

Reanalysis

Reanalysis allows you to manually change the position of the ST measurement marks. On the reanalysis screen the medians of all leads are superimposed. The currently selected lead is highlighted. The measurement marks determined by the system are indicated. The marks above the baseline can be edited.

To activate reanalysis

- ◆ Click the Zoom icon on the *Sample Cardiac Cycles* screen
- ◆ position it over a complex and click the left mouse button

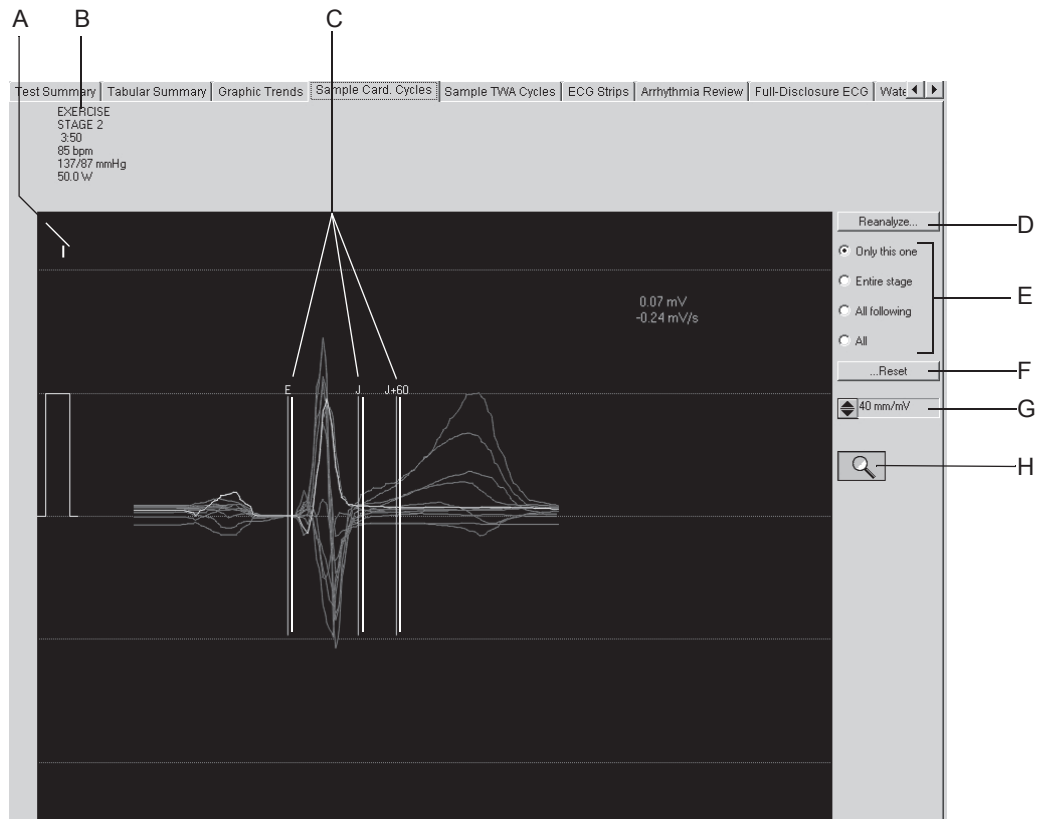

74A-S

- A Click to select another lead.
- B Details of the selected median complex.
- C Measurement marks determined by the system.
- D Click to *Reanalyze*.
- E Click an option button to select the complexes to reanalyze.
- F Click to reset the measurement marks to their original positions.

- G Click to change the gain.
- H Click icon to terminate the reanalysis function and return to the *Sample Cardiac Cycles* window.

Performing Reanalysis

1. Click a measurement mark above the baseline and hold the mouse button depressed.
2. Move the mark to its new position and release the mouse button.
3. Adjust the other marks in the same way.
4. Select the complexes to reanalyze.
5. Click the *Reanalyze* button.
6. Click *...Reset and Reanalyze...* to restore the original analysis results. (*Reset to original* restores the original results for all complexes of the entire exercise test).

Performing Measurements on the Median Complex

Amplitudes (mV), intervals (ms) and slopes (mV/s) can be measured on all sample cardiac cycles:

1. Position the cursor on the first measurement point and click. A caliper appears.
2. Position the cursor on the second measurement point and click. Now you will see
 - ◆ the second caliper
 - ◆ the measuring line
 - ◆ the measurement results
3. Click the right mouse button to remove the measurement points.

Sample TWA Cycles

Overview

This screen shows the Sample TWA Cycles. Questionable values are identified with a question mark ?. Two-headed arrows identify the position where the TWA value was determined. Individual leads can be excluded. You may then repeat the analysis without these leads. This method prevents false-positive TWA values, particularly when permanently disturbed leads are excluded.

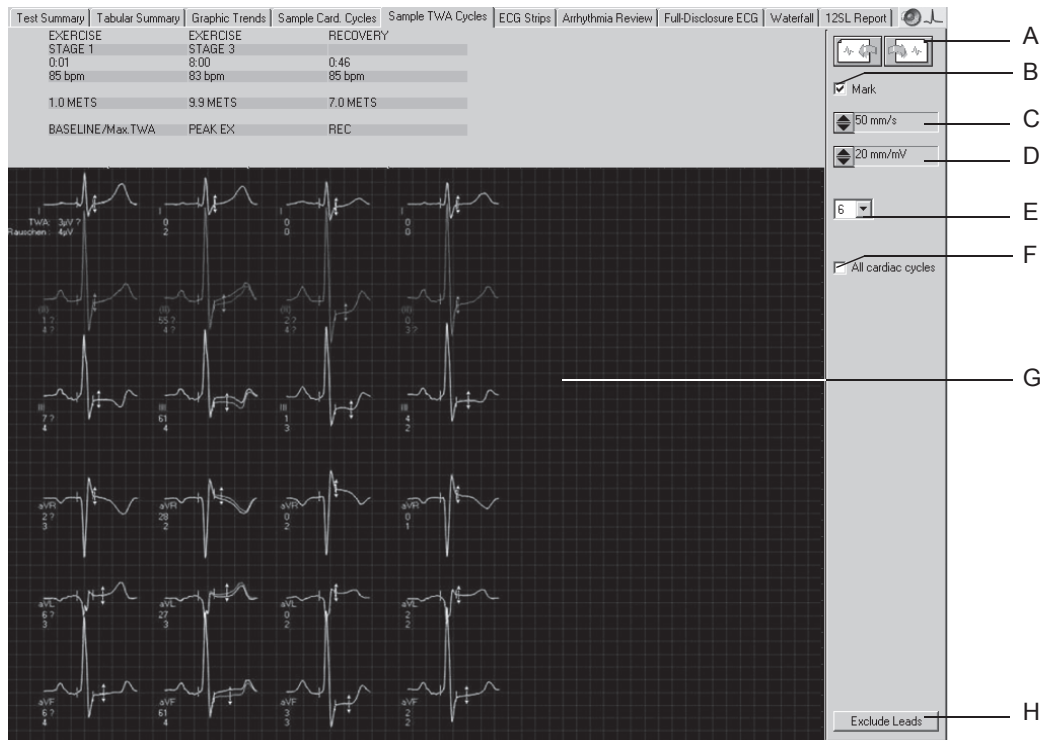

- A Click to view more sample TWA cycles.
- B Click to show and hide the measurement marks.
- C Select the speed of the displayed medians.
- D Select the gain for the displayed medians.
- E Select the number of lines (1, 3, 6).
- F Number of medians shown per stage:
 - All cardiac cycles (at intervals of 30 seconds)
 - only one cardiac cycle
- G Position where the TWA value was determined.
- H Click to exclude individual leads.

938A-S

ECG Strips

This screen displays 10-second ECG strips

- stored during the last 10 seconds of each stage
- acquired manually, or
- acquired automatically as configured in the *Protocol Editor*.

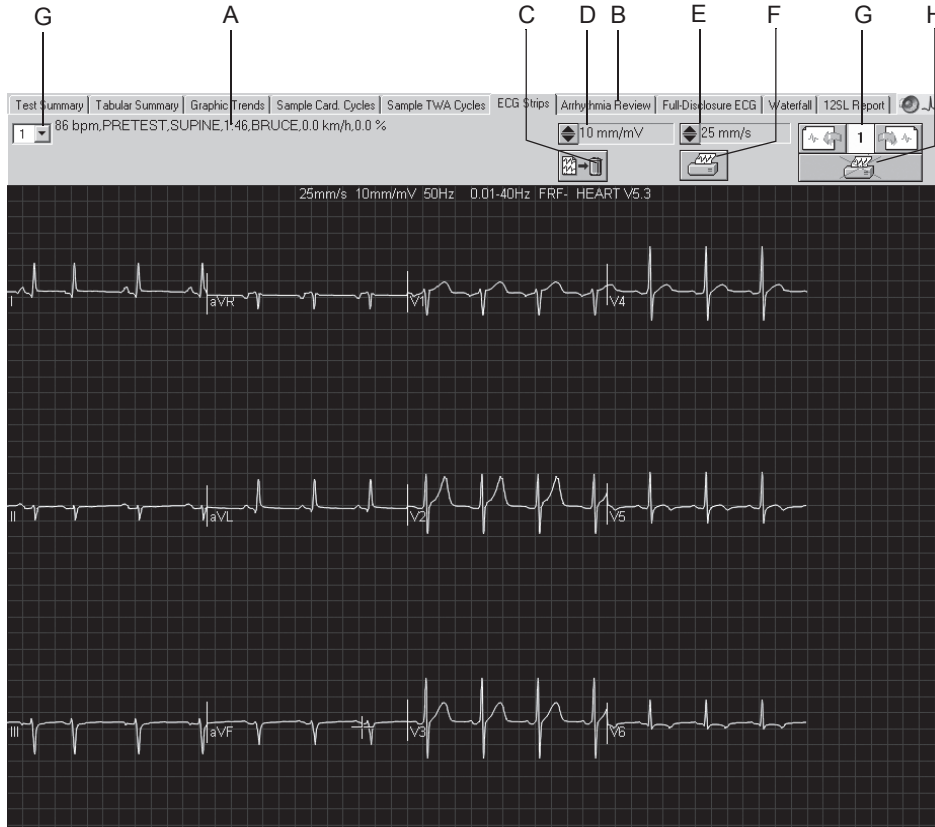

75A-S

- A Details of the selected ECG strip.
- B Click to display the *ECG Strips* window.
- C Click icon to delete the displayed ECG strip.
- D Click to change the gain.
- E Click to change the speed.
- F Click icon to print the displayed ECG strip.
- G Click to display the other ECG strips.
- H Click icon to include the ECG strip in the test report (check mark) or to exclude it from the test report (printer crossed out).

Note

You can perform measurements as described under “[Performing Measurements on the Median Complex](#)” on page 6-40.

Arrhythmia Review

The system will save a 10-second ECG strip each time an arrhythmia occurs and when the *Event Marker Full Disclosure* button is clicked on the acquisition screen (to a maximum of 20). When the event memory is full, the strips will be overwritten according to preset priorities.

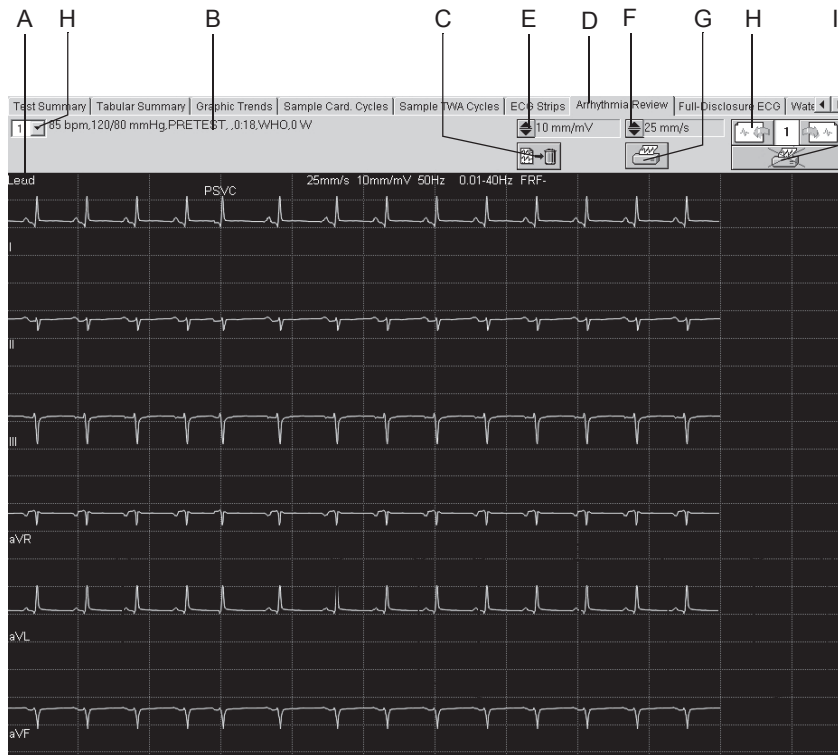

76A-S

- A Click to view other *Arrhythmia Review* leads.
- B Details of the displayed *Arrhythmia Review* strips.
- C Click icon to delete the displayed *Arrhythmia Review* strip.
- D Click to display the *Arrhythmia Review* window.
- E Click to change the gain.
- F Click to change the speed.
- G Click icon to print the displayed *Arrhythmia Review* strip.
- H Click to display the other *Arrhythmia Review* strips.
- I Click icon to include the *Arrhythmia Review* strip in the test report (check mark) or to exclude it from the test report (printer crossed out).

Note

You can perform measurements as described under “[Performing Measurements on the Median Complex](#)” on page 6-40.

Significant arrhythmias are displayed red.

Arrhythmias (descending priority)

- patient's learned typical QRS complex	QRSL
- asystole ¹ , limit value 3 s	ASYSTO
- ventricular fibrillation/flutter ¹	VFIB
- ventricular tachycardia ¹	VTAC
- ventricular run (minimum of 3 consecutive PVCs) ¹	RUN
- ventricular couplet (2 consecutive PVCs) ¹	CPLT
- atrial fibrillation	AFIB
- pause of 2 missed beats ²	PAU2
- pause of 1 missed beat ²	PAU1
- ventricular bigeminy	VBIG
- paroxysmal supraventricular tachycardia	PSVT
- pacemaker error	PERR
- ventricular escape beat	ESC
- premature ventricular contraction	PVC
- premature supraventricular contraction ²	PSVC
- pacemaker capture	PCAP
- absolute pause	PAUA
- artifact ³	A
- learn phase ³	L

1. significant arrhythmias

2. The arrhythmia analysis algorithm will not output these events in the presence of supraventricular arrhythmia (e.g. atrial fibrillation).

3. not in arrhythmia window, no arrhythmia strip (only full disclosure ECG)

Full Disclosure ECG

Overview

The system will save the full disclosure ECG only if configured (see section “Miscellaneous 1 Tab” on page 12-24). On this screen you see one lead of the full disclosure ECG. The events identified by the rhythm analysis algorithm may be color-coded. On the display you will also see when filter or cubic spline were enabled or disabled, e.g. in the form of FRF off = FRF-, Spline ON = Spline +.

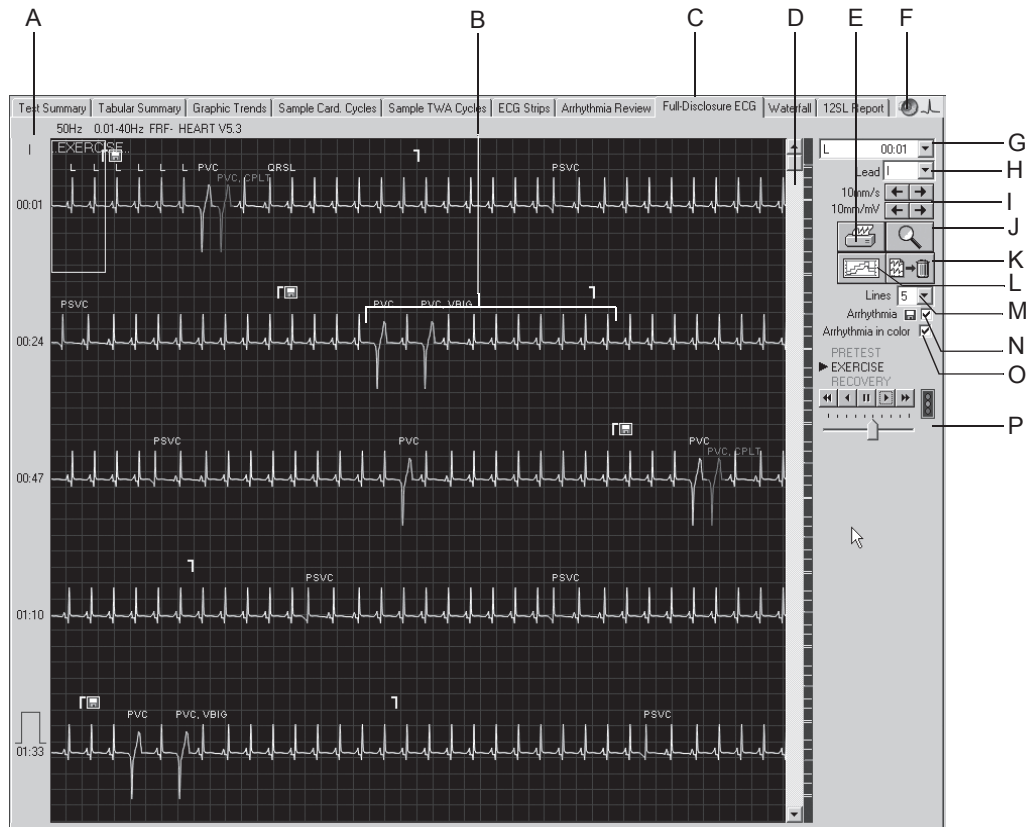

77A-S

- A Click lead label to change displayed lead.
- B Marks beginning and end of an arrhythmia.
- C Click to display the *Full Disclosure ECG* window.
- D Scroll box to display different time windows. The markers to the right of the scroll bar allow direct access to the corresponding events.
- E Click to open a list showing all identified arrhythmias.
- F Click to play the audio ECG.
- G Click to open a list with all leads.
- H Click to select gain and speed.

- I Click icon to activate the zoom function.
- J Click icon to print the entire full disclosure ECG or selected segments.
- K Click icon to go to the trend display.
- L Click icon to delete the full disclosure ECG.
- M Select the number of waveforms viewed.
- N Click to show and hide the arrhythmia strip markers (beginning/end).
- O Select or deselect the arrhythmia color coding.
- P Click icons for automatic scrolling of the ECG waveform, adjust the scroll speed with the slider below.

Printing the Full Disclosure ECG

You can either print the entire full disclosure ECG or a selected segment.

Selecting an ECG Segment

1. Click to mark the beginning of the segment. A flag appears.
2. Click again to mark the end of the segment. A second flag appears.

Printing

1. Click the printer icon. The print setup window opens.

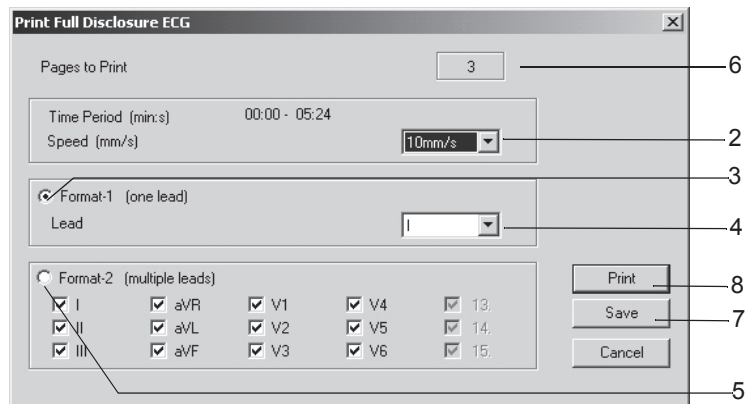

517A-R

2. Select the paper speed.
3. Click the Format-1 option button, if you wish to print only one lead.
4. Select the lead.
5. Click the Format-2 option button, if you wish to print multiple leads, and select the leads.
6. This box indicates the number of pages to print; check paper supply before printing.
7. Click the *Save* button to save the print setup.

- Initiate the printout or close the window with *Cancel*.

Note

To save or print a 12-lead ECG, enable the zoom function as described below. With button B you are then able to save or print the ECG strip.

Enabling the Zoom Mode

- Click the zoom icon.
- Position the magnifying glass on the region of interest and click.

An enlarged view of the selected region appears.

The operating controls basically remain the same. When you click the printer icon, however, only that page will be printed.



78A-S

- Click icon to print the displayed screen.
- Click icon to initiate one of the following actions
the ECG strip is saved
the ECG strip is printed, or
the ECG strip is saved and printed (see section “Writer Tab” on page 12-12).

Audio ECG

The audio ECG allows the medical staff to assess the exercise test quickly and easily.

The ECG is played back at 60 times the original speed, so that you can listen to a 10-minute recording in 10 seconds.

Playback of the recording is in stereo: lead V2 is assigned to the left channel, lead V5 to the right channel.

The continuously increasing heart rate corresponds to the exercise phase, the subsequent decrease, to the recovery phase. Arrhythmias can be heard very clearly.

Also refer to the Audio ECG Physician's Guide, Part No. 2051167-001.

Waterfall

The *Waterfall* display is a graphic color representation of the median beat changes in the course of the test (updated at 30 second intervals).

Click anywhere in the waterfall to display the median complex and measurement of the corresponding point in time (associated phase, stage, HR, BP, and METS appear at the right).

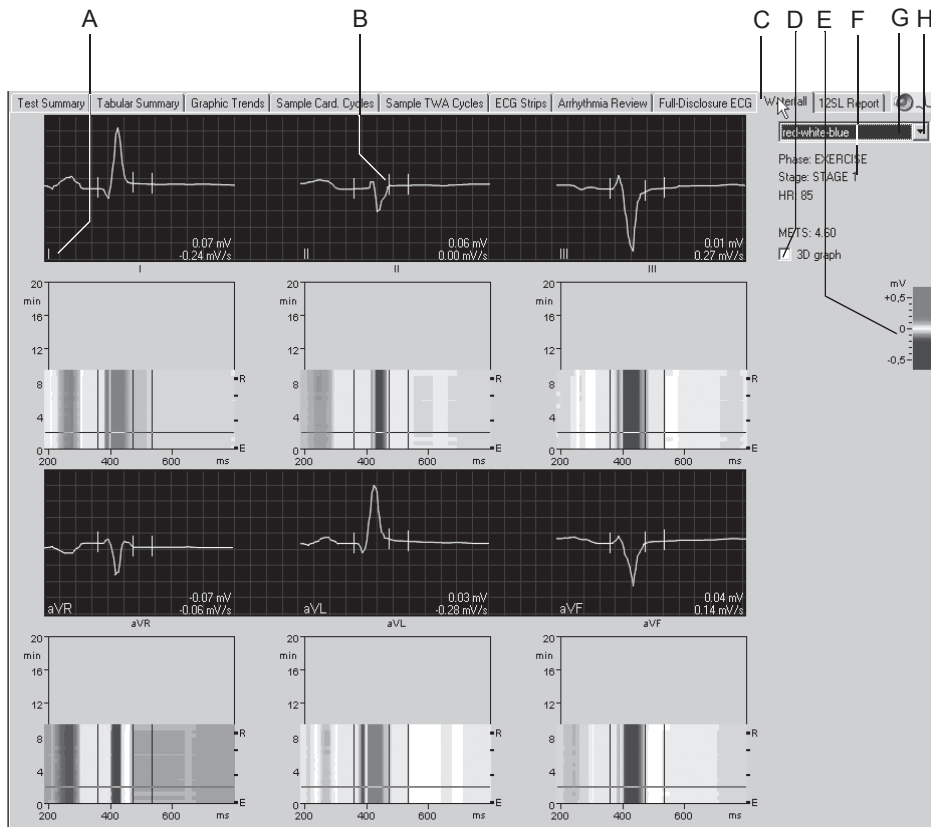

79A-S

- A Click the lead label to change the displayed leads.
- B Median complex selected in the waterfall.
- C Click to display the *Waterfall*.
- D Select check box to view the 3D graph (see next page).
- E Color code of the different amplitudes in mV.
- F Details of the selected median complex.
- G Click to play the audio ECG (see “Audio ECG” on page 6-48).
- H Click to select the color menu.

3D Graph

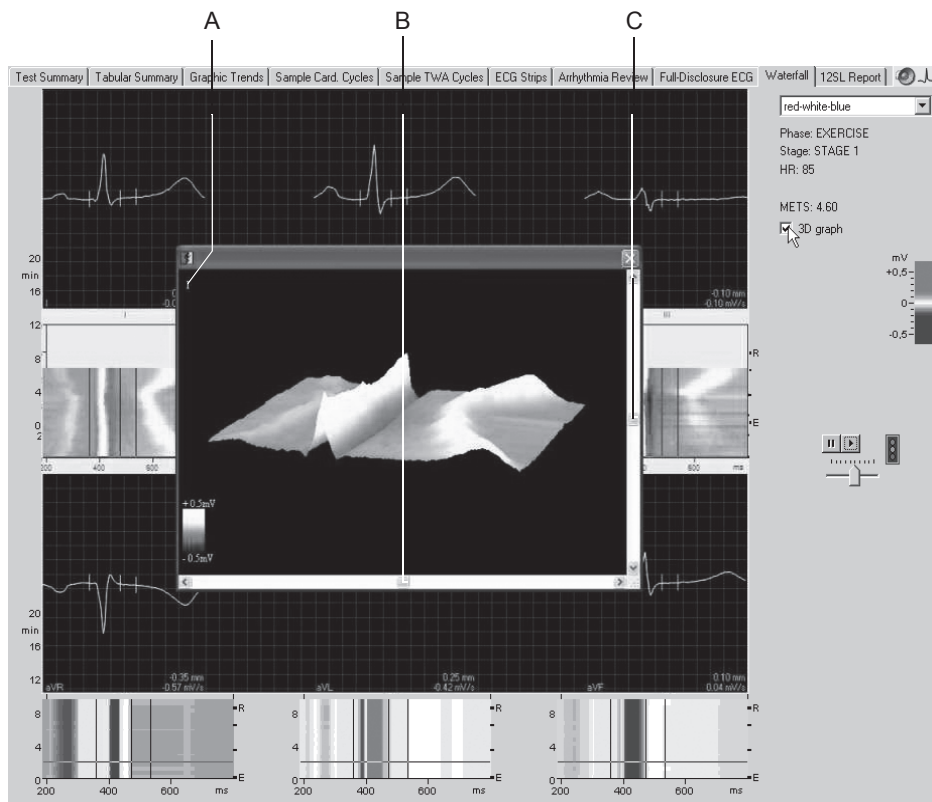

84A-S

- A Click to select another lead.
- B Click to rotate the display horizontally.
- C Click to rotate the display vertically.

12SL

This screen shows the measurements from the 12SL ECG analysis.

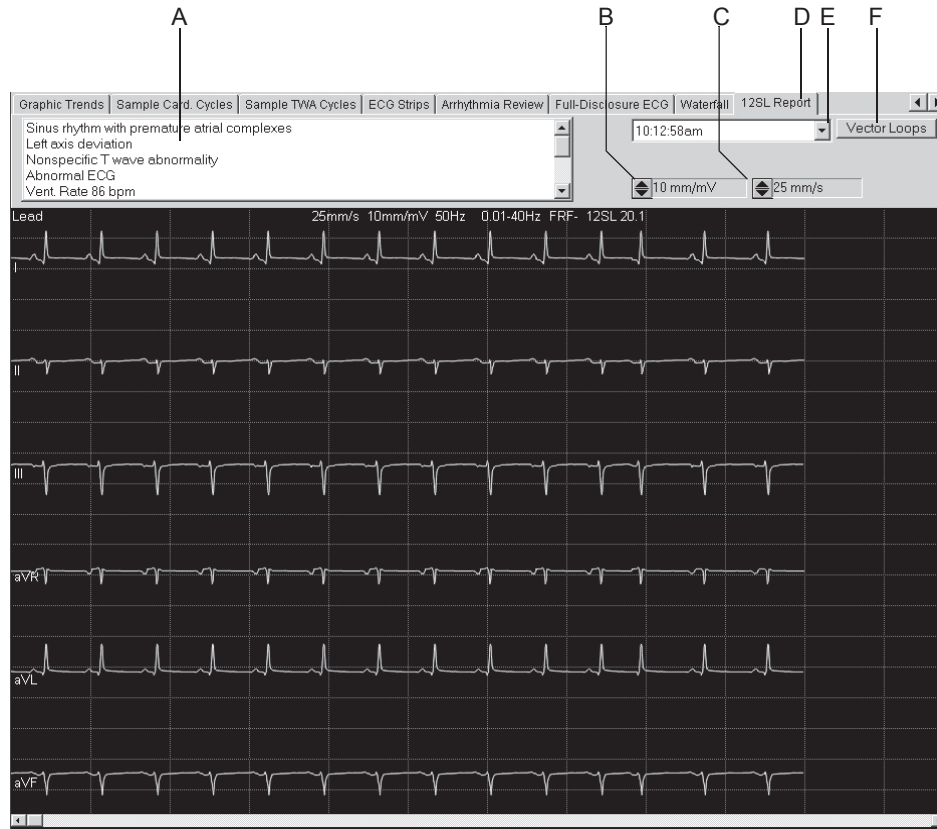

80A-S

- A Analysis results.
- B Click to change the gain.
- C Click to change the speed.
- D Click to display the 12SL Report.
- E Click to select another 12SL ECG.
- F Click to view the corresponding Vector Loops (see next page).

Vector Loops

This screen shows the median complexes of the orthogonal FRANK leads X, Y and Z as well as the vector loops in three planes.

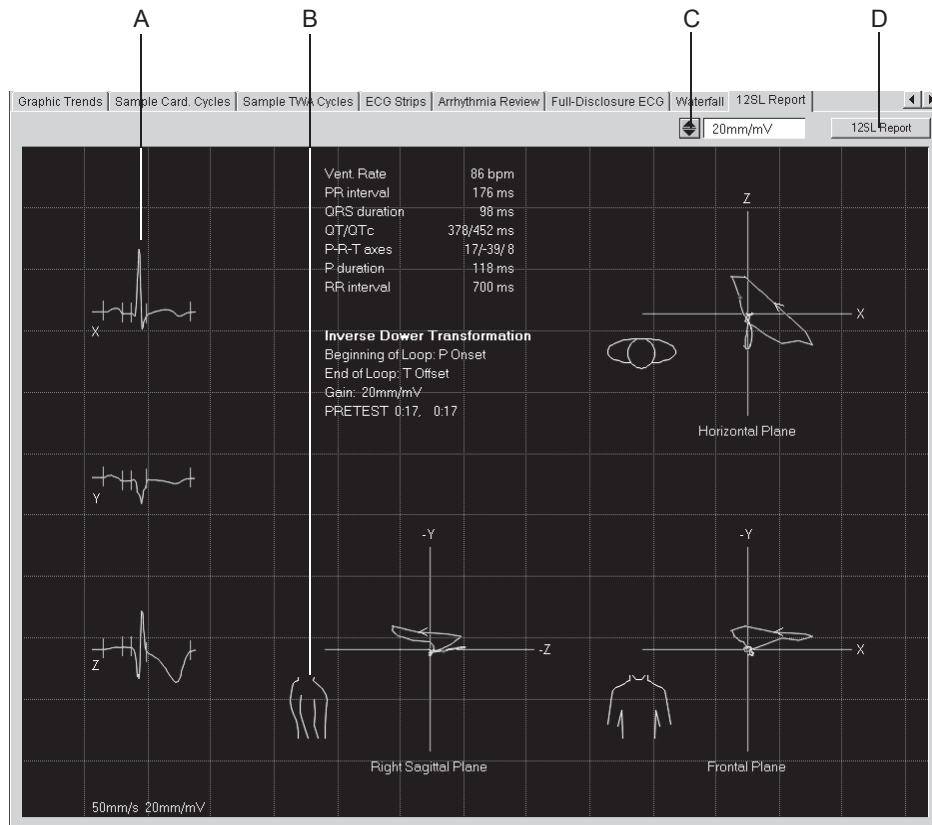

81A-S

- A Median complex.
- B Click torso to toggle between right and left sagittal planes.
- C Click to change the gain.
- D Click to return to the 12SL Report window.

Note

You can perform measurements as described in section “[Measuring the ECG](#)” on page 5-15.

The vector loop is saved with the 12SL report only if the message *Median update ceased... Relearn* has disappeared from the *ST/Arrhy* window at the time the 12SL report is stored.

Report Printout

Click the *Print* button to print the report. The print setup window opens where you can temporarily adjust the settings for the printout. Refer to section “**Final Report Tab**” on page 12-23 for details on changing the setup permanently.

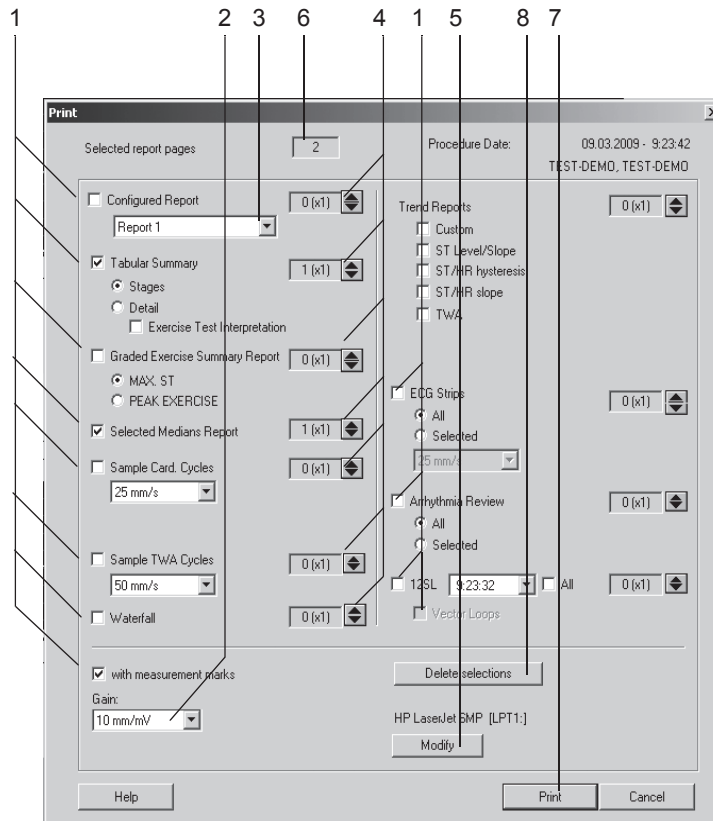

82A-S

1. Select the documents for the report (*Configured Report, Tabular Summary, Graded Exercise Summary Report* etc.): In the *Trend Reports* section, select the report formats to print.
2. Select the gain.
3. Select the *Configured Report* format (see section “**Report Editor**” on page 12-10).
4. Select the number of copies for each report section.
5. Select the printer.
6. Check the total number of pages.
7. Initiate the printout.
8. Click *Delete selections* to cancel the selections.

NOTE

Select the *ECG Grid* option if you print on plain paper.

Temporary changes to the selections will be lost when you close the window.

Report Formats

In-Test Reports with Laser Printer

Format	Description
12SL	Interpretative resting ECG with analytical statements on morphology, rhythm, and conduction. Measurements of rate, intervals and axes. Available before the test, in pretest and recovery. Formats include: 4 x 2.5; 4 x 2.5 +1, 2 x 5; H2 (5 s ECG at a speed of 50 mm/s x 6) and H1 (6-lead ECG at 12.5 mm/s, Medians at 50 mm/s).
3, 6, 12 or 15-Lead Report	Presents raw ECG data in various formats: 4 x 2.5 s ECG; 4 x 2.5 +1 (2.5 seconds of raw data plus 1 continuous 10 second recording of continuous rhythm); 2 x 5 (5 seconds of raw data); 1 x 10 (10 seconds of raw data); H2 format (5 seconds of raw data at a speed of 50 mm/s x 6).
Arrhythmia Report	Automatic 10-second documentation of arrhythmias showing 2.5 seconds of raw data prior to ectopic beat. Leads for arrhythmia report correspond to leads on the screen.
Recall Report	A delayed recording of raw data 10 seconds in duration: 3, 6, 12 leads.
Comparative Medians Report	Baseline and current medians followed by 2.5 seconds of real-time rhythm in 12 leads. ST level and ST slope reported for each lead. Also comes in H1 Medians format of 12 medians at 50 mm/s + 6 leads (selectable) of 10 seconds of rhythm at 12.5 mm/s.
Linked Medians Report	4 x 2.5 with rhythm lead. 3 channels of median beat which are linked together at the current heart rate with a fourth 10-second channel of raw, real-time rhythm.

Note

The formats may differ slightly when the *Swedish Reports* are selected.

Final Reports

Format	Description
Configured Report	User-configured portrait-style final report. User formats narrative text and selects data fields to create report template. Configured Report automatically merges text and data according to templates selected. For details on the Configured Report, refer to section “Report Editor” on page 12-10.
Tabular Summary	Tabular Summary of test by stage including time, speed, grade, workload, MET level, heart rate, blood pressure, comments, with optional selections for double product (RPP), ST level, SpO ₂ and user-configured entries. Can also be printed as Detailed Summary in minimum of 30 second intervals. For instructions on Tabular Summary configuration, see section “Configuring the Tabular Summary” on page 12-14.
Graded Exercise Summary Report	One page overview of entire test with median morphologies for 12 leads from baseline and either max. ST depression or peak exercise. For max. ST depression, report only prints when a minimum of -0.5 mm of ST depression occurs in one of the following leads: I, II, III, aVF, V2 to V6 (V1, aVR, aVL excluded; for ST elevation, -aVR is excluded).
Selected Medians Report	Records median morphologies at baseline, max. ST depression, peak exercise and test end for 12 leads. For max. ST medians, column only prints when a minimum of -0.5 mm of ST depression occurs in one of the following leads: I, II, III, aVF, V2-V6. (V1, aVR, aVL excluded; for ST elevation, -aVR is excluded).
Sample Cardiac Cycles	Records median morphologies for 12 leads at user-defined intervals. Intervals defined in <i>Protocol Editor</i> for each protocol by configuration of Store Median interval; 25 or 50 mm/s.
Trend Reports	Records plots of PVCs, heart rate and blood pressure or any custom combination of parameters (Trends: Custom). Also produces trend report of ST level and slope versus time (Trends: ST Level/Slope, Trends: TWA). For details on the Trend Graphs, refer to section “Configuring Trends” on page 12-15.
ST/HR Hysteresis	A two-dimensional representation of ST level versus heart rate in exercise and recovery phases.
ST/HR Slope	Records linear regression of heart rate-adjusted slope for all leads, plus median morphology of lead with highest slope.
ECG Strips	Report of all 12 leads (also medians and recall stored in 12-lead format) stored during the tests (manual or automatic). User can select all or some of the 12 leads to be printed.
Arrhythmia Review	Report of 20 stored arrhythmias showing 2.5 seconds of raw data prior to the ectopic beat through 2.5 seconds after the last. User can select all or some arrhythmias to be printed.
Vector Loops	Report showing Y, X, Z leads and three-plane vector loop display of horizontal, frontal and sagittal planes using Frank X, Y, Z lead set. Derived from associated 12SL report.
Sample TWA Cycles	TWA medians report (see “Sample TWA Cycles” on page 6-41).
Waterfall	Waterfall display report of all leads.
Swedish Median Report	Special medians format for Sweden. Only if <i>Swedish Reports</i> are enabled.



Monitoring of Remote Exercise Test Workstations

The program allows you to monitor an exercise test performed at remote stations from your PC. However, only one station can be viewed by one other station at a time. The data in the vital signs window reflect the settings at the remote station. Conditions for the remote view function:

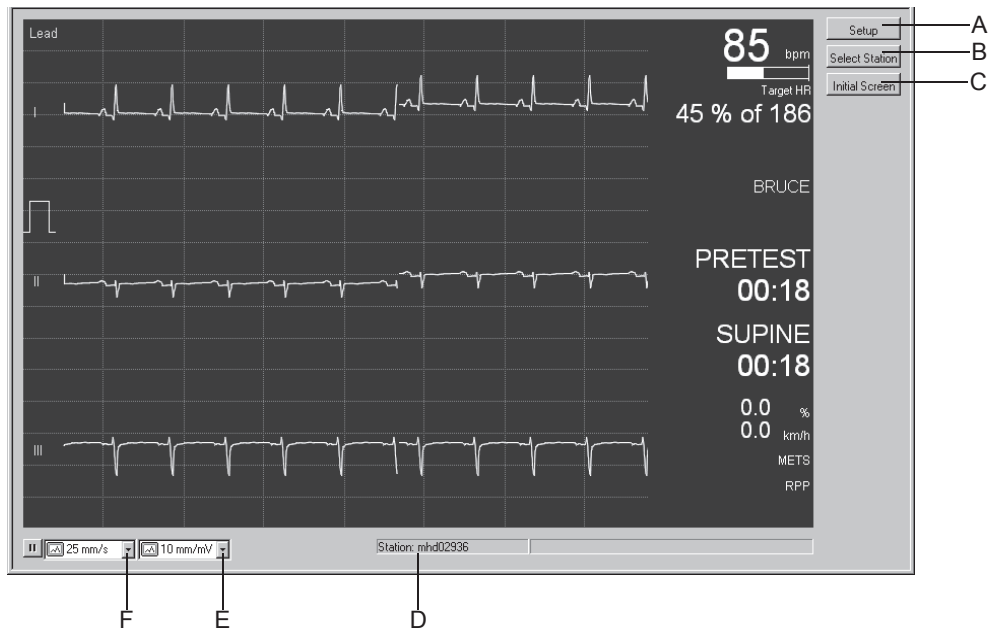
- The *Remote View* function is enabled at the remote station (see section “Miscellaneous 1 Tab” on page 12-24).
 - The *pretest* phase has already started.
1. Click *Remote View* on the initial screen to view the remote exercise test screen.
 2. Click the *Setup* button and enter the PC names in the left column of the window.
 3. Click the arrow buttons to enter the corresponding IP address automatically. If the system does not find the IP address, you can enter the address manually.
 4. Click *OK* to clear the window.
 5. Click the *Select Station* button and select the station.



83A-S

- A  Click to enter the names and IP addresses of the remote stations.
- B  Click to select the station.

- C  Click to return to the initial screen.
- D Name of the remote station.
- E Click to change the gain.
- F Click to change the speed.

7 Ambulatory Blood Pressure Measurement

For your notes

Ambulatory Blood Pressure Monitors

The following ambulatory blood pressure monitors can be connected to the system:

- TONOPORT V: blood pressure only, oscillometric method
- TONOPORT IVa: blood pressure, oscillometric and auscultatory method, as well as ECG

For information on setup and operation of the ambulatory blood pressure monitor, please refer to the TONOPORT Operator's Manual.

CAUTION

Patient Hazard — Disconnect TONOPORT from the patient when it is connected to the PC.

NOTE

Check that the correct port for the ambulatory blood pressure monitor is configured (see section “[Devices Tab](#)” on page 12-54).

The blood pressure can be measured in kPa or mmHg. For selection of the blood pressure unit, see “[Country Settings Tab](#)” on page 12-60.

TONOPORT V devices, version 2.0 and later, can be connected to the serial port (RS232) or to the USB port. If the USB port is used, the required driver must be installed. Please refer to the Software Installation chapter of the TONOPORT V Operator Manual for instructions.

Connecting the Ambulatory BP Monitor

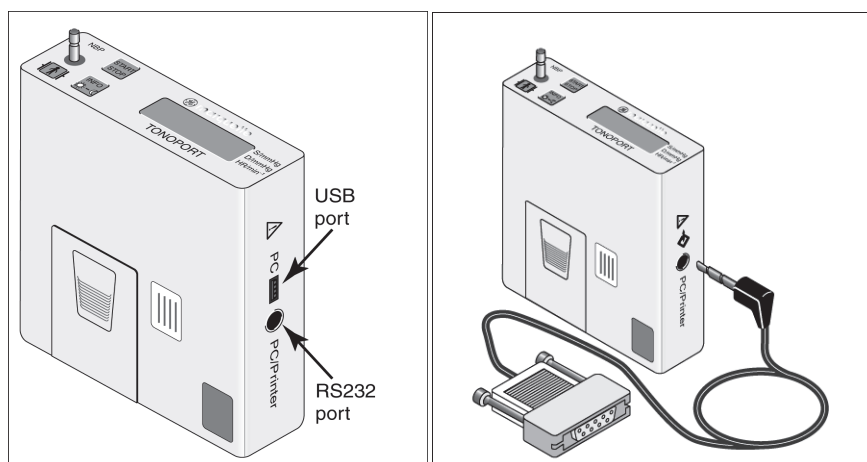

TONOPORT V, version 2.0 and later

180A-







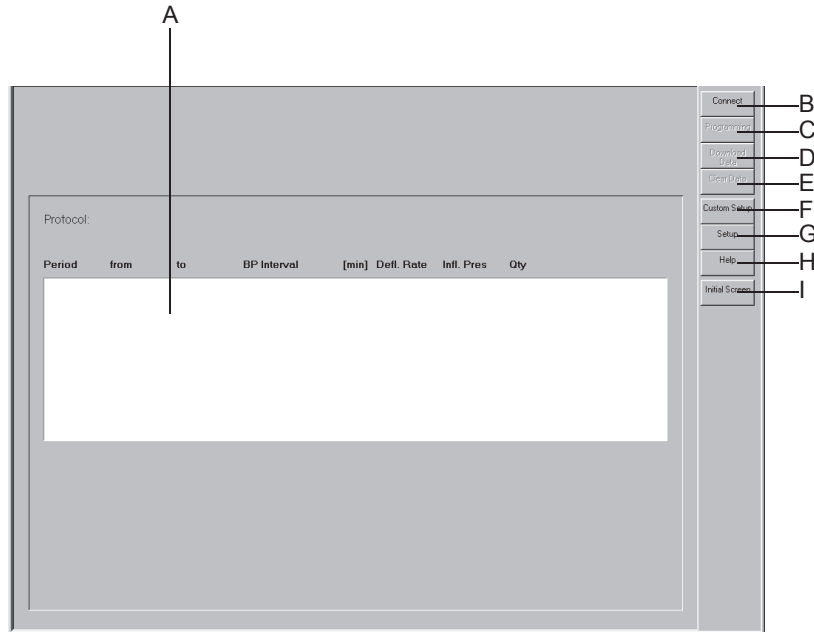

1. Turn the monitor off and on again.
2. Wait for the time to be displayed, then connect the monitor to the PC.

Setting Up the Ambulatory Blood Pressure Monitor

Acquisition Screen



181A-BP

- A  Measurement protocol details.
- B  Click to connect the ambulatory blood pressure monitor to the system.
- C  Click to activate the programming mode. If a patient is selected first, TONOPORT V devices of version 2.0 and later will automatically copy that patient's ID number from the CardioSoft database.
- D  Click to download the stored data to the system.
- E  Click to delete the data stored in the ambulatory blood pressure monitor.
- F  Click to load system setups stored for different system users.
- G  Click to display the setup menu for ambulatory blood pressure measurements (see section “[Ambulatory Blood Pressure Measurement Setup](#)” on page 12-31).
- H  Click to activate the online Help program.
- I  Click to return to the initial screen.

Operating Steps

1. Turn the monitor off and on again.
2. Wait for the time to be displayed, then connect the monitor to the PC.
3. Click *Connect*.

The acquisition screen indicates the memory status of the ambulatory blood pressure monitor.

- A: Date and time of the monitor.
- B: Measurement protocol.
- C: Number of BP measurements and the duration of the protocol.
- D: Information whether or not data is stored in the monitor.

With TONOPORT V, version 2.0 and later:

- E: Patient ID stored in the TONOPORT device.
- F: Patient data from the CardioSoft database assigned to the patient ID.

Ambulatory BP Device Memory Status

Patient ID in ambulatory BP device:
Corresponding patient information from database:
Date / Time:

234-TEST0111
Caldwell, Walter S., 16 08 1942
14.11.2005 / 16:34:00

Data stored in ambulatory BP device

Protocol:

Period	from	to	BP Interval	[min]	Defl. Rate	Infl. Pres	Qty
1	7:00:00	21:59:00	approx.	2	3	250	450
2	22:00:00	6:59:00	exact	15	3	250	36

Duration: 24:00 h

Number of BP Measurements: 486

Connect
Programming
Download Data
Clear Data
Custom Setup
Setup
Help
Initial Screen

182A-BP

4. Click the *Clear Data* button to delete data stored in the monitor (with TONOPORT V devices, version 2.0 and later, this command will also clear the patient ID).

NOTE

If the stored data has not been transferred to the system, download it as described in the next section.

5. Click *Programming* to select the protocol.

6. Select the protocol and click *Programming*. You can choose between two protocols. Refer to section “**Editing the BP Protocol**” on page 12-32 for information on configuring the protocols.

NOTE

If you are using TONOPORT V devices, version 2.0 and later, check the displayed patient data to avoid data mismatch.

7. Turn the monitor off and disconnect it from the PC.
8. Connect the monitor to the patient (see TONOPORT Operator's Manual).

Post Test Review

Downloading Data

1. Turn the monitor off and on again.
2. Wait for the time to be displayed, then connect the monitor to the PC.
3. Select the patient.

NOTE

If the patient ID has been stored in TONOPORT V devices of version 2.0 and later, you are not required to select the patient. Simply click *Select* and you will see the acquisition screen.

Be sure to download the data to the same database from which you read the patient ID.

4. Click *Connect*.
5. Click *Download Data*. After the download, the *Test Summary* tab appears.

NOTE





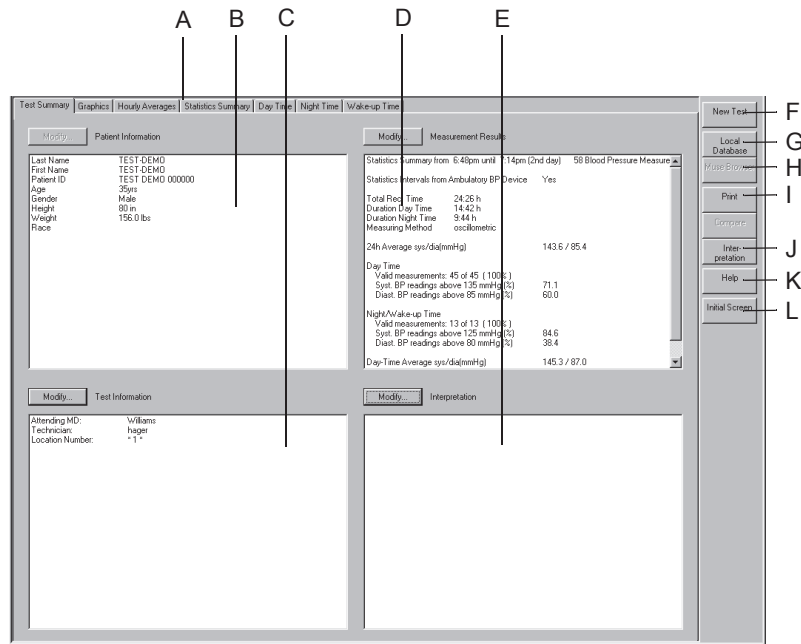

Do not forget to delete the data stored in the monitor. This is to ensure that the monitor does not contain data from a previous test when used on a new patient.

When the message *Inconsistent data in ambulatory BP device! Procedure cannot be saved!* appears, turn the monitor briefly off and on again.

Test Summary



183A-BP

- A Click a tab to display the corresponding window.
- B Patient Information area.
- C Test Information area.
- D Measurement Results (Statistics Summary).
- E Interpretation.
- F  Click to display patient list for a new test.
- G  Click to display a list with more tests of the current patient (local database).
- H  Click to display a list with more tests of the current patient (MUSE database system).
- I  Click to display the print setup window.
- J  Click to display the interpretation window where a detailed interpretation of the test can be generated.
- K  Click to activate the online Help program.
- L  Click to return to the initial screen.

The *Modify...* buttons allow you to edit or complete the data in the respective areas, as described below:

Patient Information

The Patient Information window opens. You can edit or complete the data. Any changes you make will be assigned to this procedure, not to the patient.

Note

The Patient Information can be assigned to the patient file or only to the pending test.

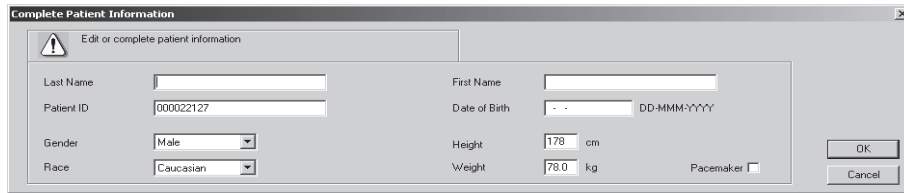

184A-BP

Test Information

The *Test Information* window opens.

These are the tabs of the menu

- *Patient Information*
- *Test / Personnel*
- *Medications*

You can edit the data (the changes you make will be assigned to this procedure, not to the patient) or display the other tabs by clicking the tab headers.

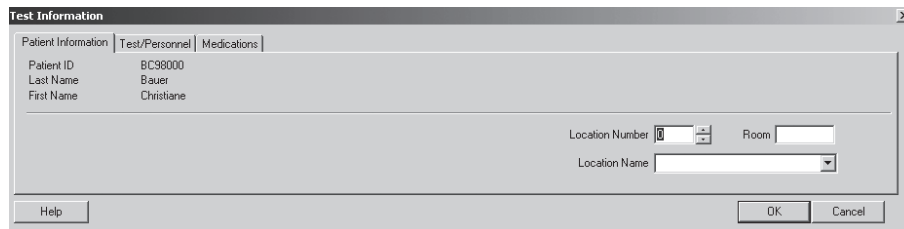

185A-BP

Test / Personnel

052A-R

1. Type the relevant information in the *Medical History* field.
2. Enter the *Reason for Test* or select one from the list box. Multiple selections are permitted.
3. Type the physicians' and technician's names or select them from the list boxes.
4. Type any *Comment* about the test.
5. Answer the *Extra Questions*.
6. Enter an *Order Number*. This number will appear on the printed reports and on the Test Summary.

Note

The *Reason for Test* library can be edited (see section “**Miscellaneous Tab**” on page 12-33).

You can define two Extra Questions as needed (see section “**Miscellaneous Tab**” on page 12-33).

You enter the names of the physicians and of the technician in the System Configuration (see section “**General Tab**” on page 12-40).

Medications

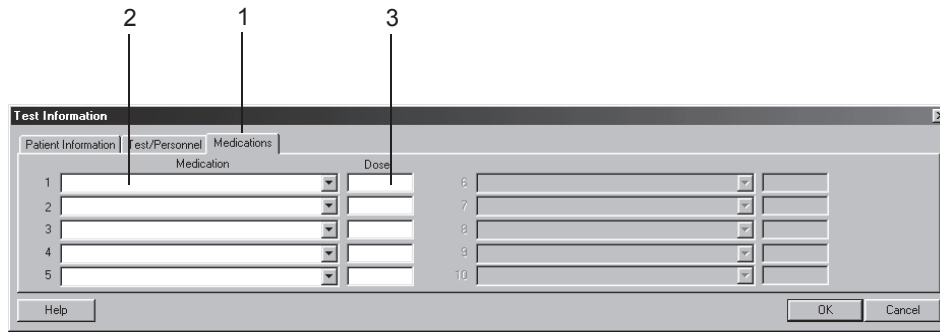

053A-R

1. Click the *Medications* tab.
2. Enter or choose a maximum of 5 medications.
3. Enter the medication dose.

Note

You can edit the medication library (see section “[Editing the Reason for Test, Medication Library](#)” on page 12-36).

Measurement Results

In this window you can temporarily modify the statistics intervals and the blood pressure limits for this report.

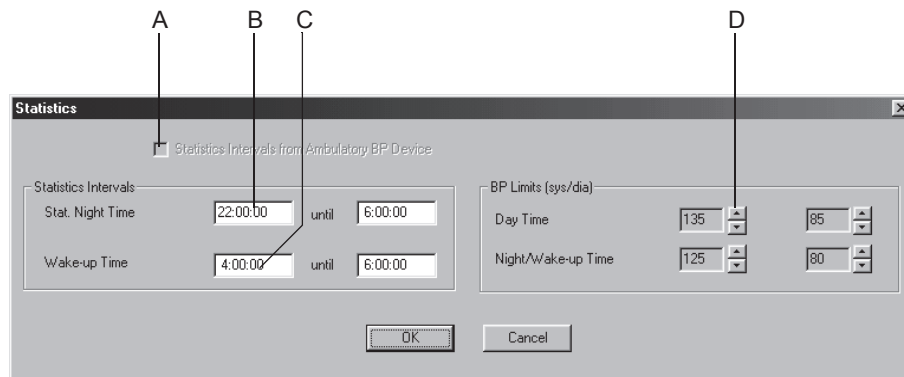

193A-BP



- A Select to perform the statistical analysis with the Statistics Intervals from the ambulatory BP device; otherwise the intervals set in the system will be used (see section “[Editing the BP Protocol](#)” on page 12-32). The check box is accessible only when 1 or 2 BP periods have been selected at TONOPORT V.
- B Select box to change the statistical night time.
- C Select box to change the statistical wake-up time.
- D Click buttons to change the blood pressure limits.

Generating or Editing the Interpretation

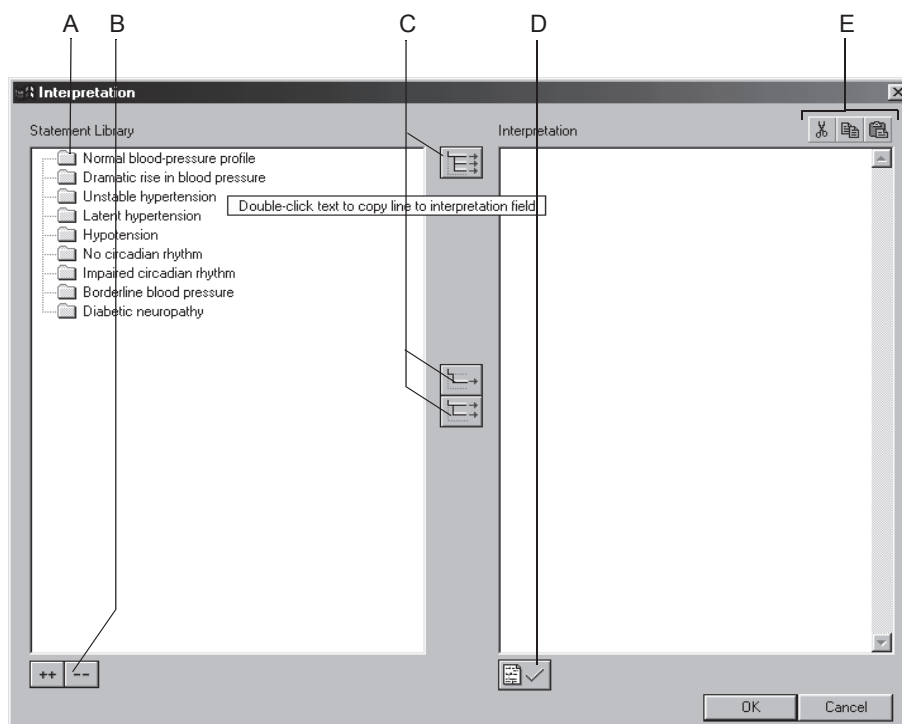
Click *Interpretation* or *Modify...* to open the window. In the left part of the window you see a number of folders with standard interpretation texts. The system supports the creation of an interpretation by providing standard texts which can be copied to the Interpretation area on the right. In the Interpretation area you can edit the texts as needed (enter new text, copy, cut, paste, etc.). Refer to section “[Editing the Interpretation Library](#)” on page 12-34 for information on editing the standard texts.



186A-BP

- A Click icon to open folders individually.
- B Click icons to simultaneously open (++) or close (- -) all folders.
- C Click icons to copy folders , individual lines , lines including the chapter .
- D Click icon to confirm the test results.
- E Click icons to cut, copy and paste text in the Interpretation area.

Note

As an alternative you can double-click a text to copy it from left to right.

Graphics

The Graphics screen shows all BP values acquired over the monitoring period. The blood pressure values are shown at the top, the pulse pressure values (systolic pressure minus diastolic pressure) below. You can show or hide the pulse pressure values (see “[Ambulatory Blood Pressure Measurement Setup](#)” on page 12-31).

You can choose between display formats 1, 2 and 3. This format can be preset in the System Settings and is saved as a user-specific configuration. The selected format will also be used for printouts.

A small window with the values corresponding to the measurement will be displayed as you move the mouse over the diagram.

For measurements taken with TONOPORT IVA, the ECG strips are also displayed.

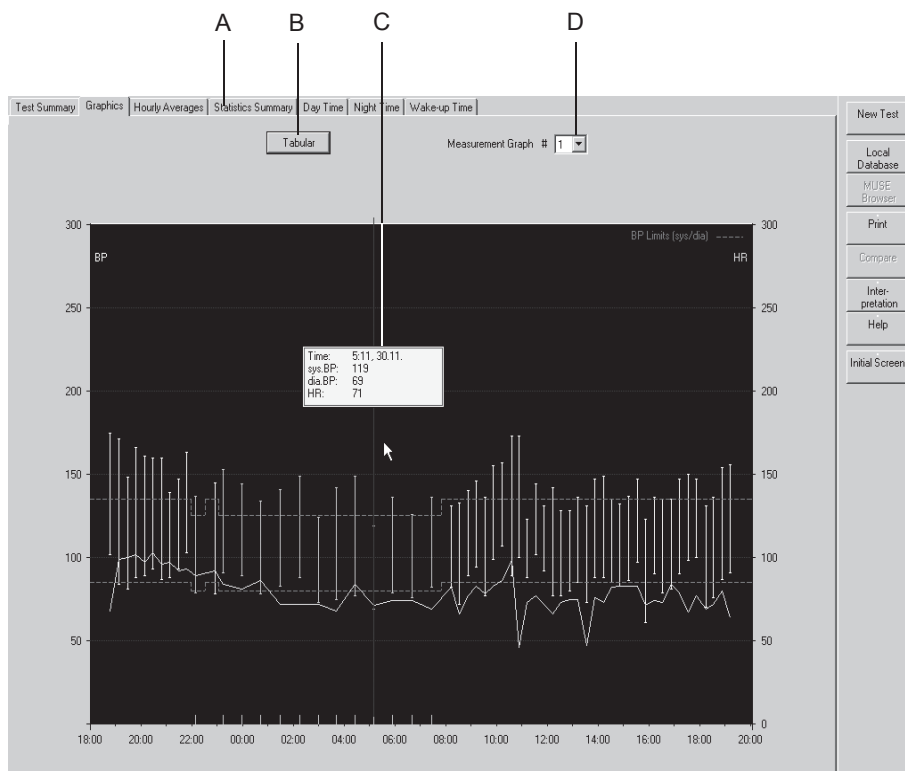

187A-BP

- A Click a tab to display the corresponding window.
- B Click button to display the tabular summary.
- C Window with measuring values at the cursor position.
- D Click down arrow to select the display format (the same format is used for the printout).

Tabular Summary

Note

Individual measurements in the Tabular Summary can be suppressed by double-clicking or by clicking with the right mouse button; they can be restored in the same way. Suppressed measurement data are excluded from the statistical analysis.

Test Summary Graphics Hourly Averages Statistics Summary Day Time Night Time Wake-up Time					
Return					
Measuring Interval from 18:48 until 19:14 (oscillometric)					
Time	HR	sys BP	dia BP	mn BP	Comment
18:48	68	175!	102!	126	
19:09	99	171!	84	113	
19:29	100	148!	81	103	
19:49	102	166!	88!	114	
20:09	97	161!	89!	113	
20:29	103	160!	93!	115	
20:49	96	160!	87!	111	
21:09	97	139!	88!	105	
21:29	92	147!	93!	111	
21:48	93	163!	103!	123	
22:09*	89	137!	79	98	
22:55	92	145!	78	100	
23:15*	84	153!	91!	111	
23:59*	81	144!	89!	107	
0:43*	86	134!	78	96	
1:29*	72	141!	83!	102	
2:15*	72	149!	88!	108	
2:59*	72	124	73	90	
3:43*	68	142!	75	97	
4:27*	84	149!	77	101	
5:11*	71	119	69	85	
5:54*	74	136!	79	98	
6:40*	74	126!	76	92	
7:27*	69	136!	82!	100	
8:13	82	131	82	98	
8:33	66	133	72	92	
8:53	77	140!	89!	106	
9:13	83	146!	94!	111	
9:33	78	136!	77	96	
9:53	83	155!	99!	117	
10:13	86	157!	107!	123	
10:36	98	173!	89!	117	
10:53	46	173!	100!	124	
--	--	--	--	--	

BP Limits [sys/dia] Day Time : 135 / 85 Night/Wake-up Time : 125 / 80 ! : Limit exceeded * : Night Time + : Manual Measurement

188A-BP

Hourly Averages

The diagram shows the *Hourly Averages* of all measurements taken during the monitoring period. Click *Tabular* to view the same values in tabular format.

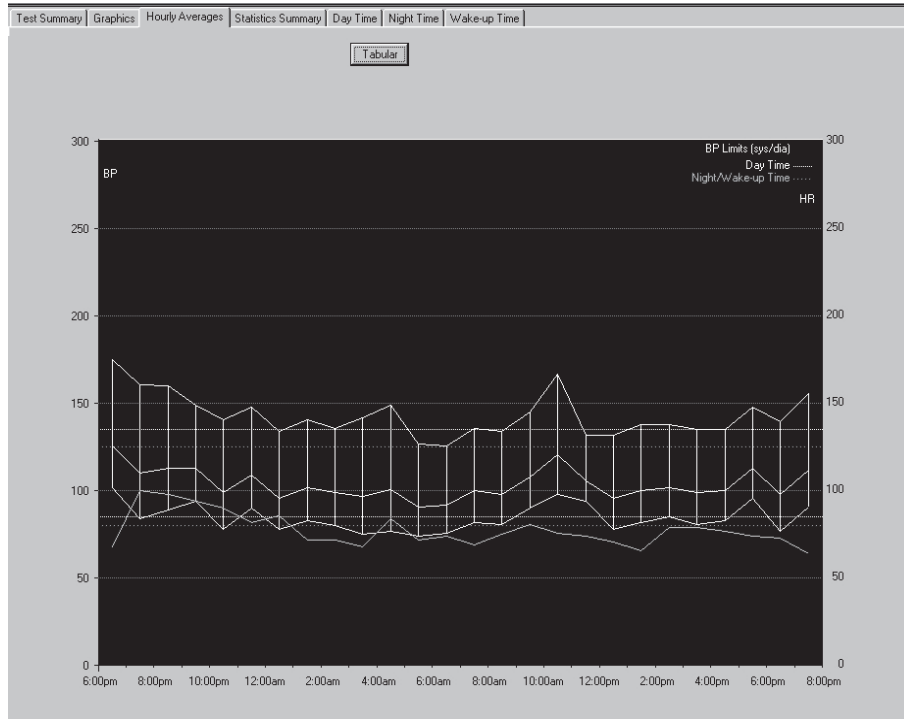

189A-BP

Statistics Summary

The *Statistics Summary* shows one histogram each for the systolic values (left) and the diastolic values (right) as well as the frequency distribution given as a percentage.

The table below indicates the maximum, minimum and mean values as well as the standard deviations.

The percentage of readings that exceeded the set limits is shown at the bottom.

Similar report pages exist for the day time, the night time and the wake-up time.

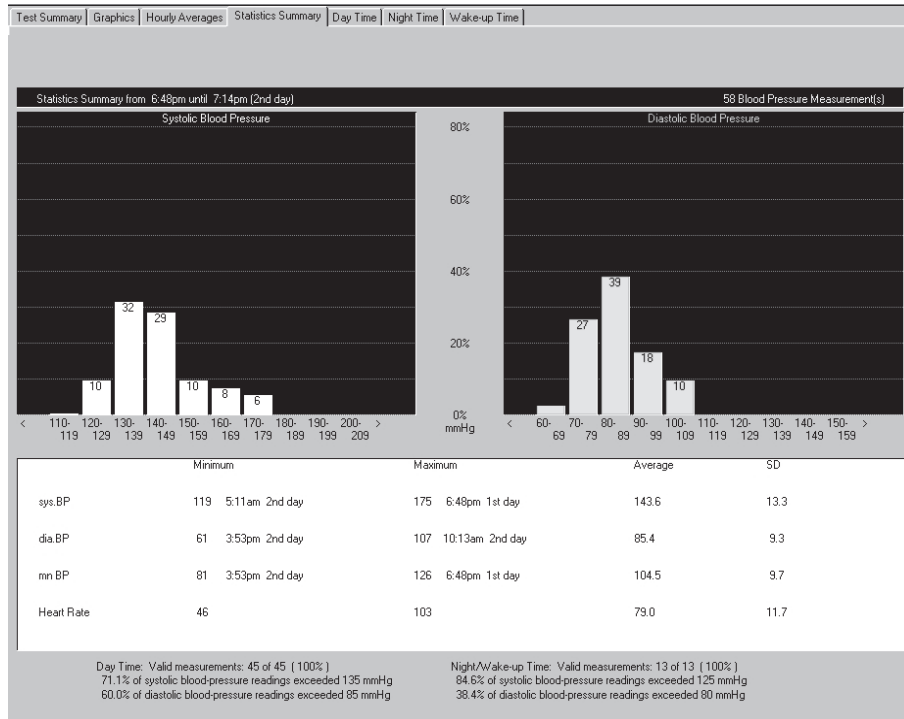

190A-BP

Report Printout

Click the *Print* button to print the report. The print setup window opens where you can temporarily adjust the settings for the printout. Refer to section “Miscellaneous Tab” on page 12-33 for details on changing the setup permanently.

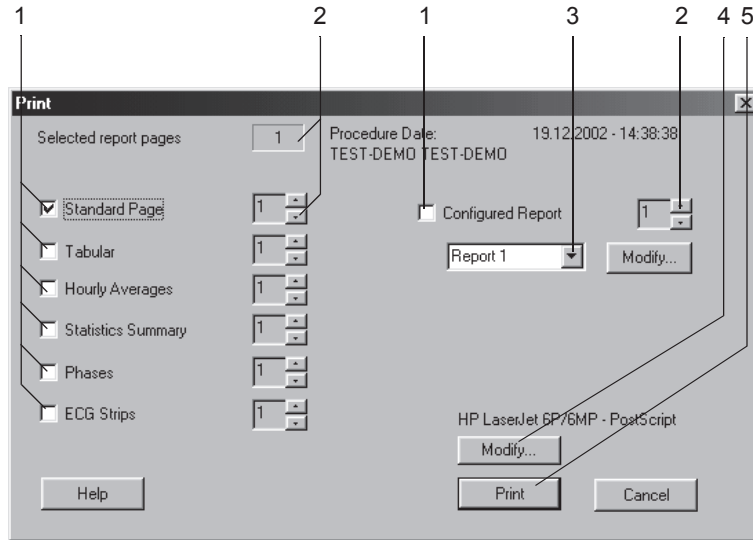

191A-BP

1. Select the documents to be included in the report
 - ◆ *Standard Page* (Test Information, Statistics Summary, Graphics)
 - ◆ *Tabular* (all measured values in tabular format)
 - ◆ *Hourly Averages* (tabular and graphics format)
 - ◆ *Statistics Summary* (Statistics Summary as histogram, minimum, maximum and mean values, standard deviation)
 - ◆ *Phases* (same as Statistics Summary, but divided into day time, wake-up time and night time)
 - ◆ *ECG Strips* (all ECG strips in chronological order, TONOPORT IVa)
 - ◆ *Configured Report*
2. Select the number of copies to print.
3. Select a report format (click *Modify...* to display the Report Editor, see section “**Report Editor**” on page 12-10).
4. Select the printer.
5. Click the *Print* button to initiate the printout.

8 Spirometry Test

For your notes

Sensors

- SpiroSoft respiration flow sensor for FVC measurements
- LF 501 respiration flow sensor for VC and FVC measurements

For information on setup and operation of the sensors, refer to the separate operator manuals.

Check whether the system is set up for the correct sensor (see section “**Devices Tab**” on page 12-54) and connect the sensor to the configured port.

Entering Test Information

Overview

Depending on your system configuration, the *Test Information* window will open automatically or you can display it with the *Test Information* button.

These are the tabs of the menu

- *Patient Information*
- *Test / Personnel*
- *Medications*

Closing a tab with *Cancel* or *OK* will bring up the acquisition screen.

Patient Information Tab

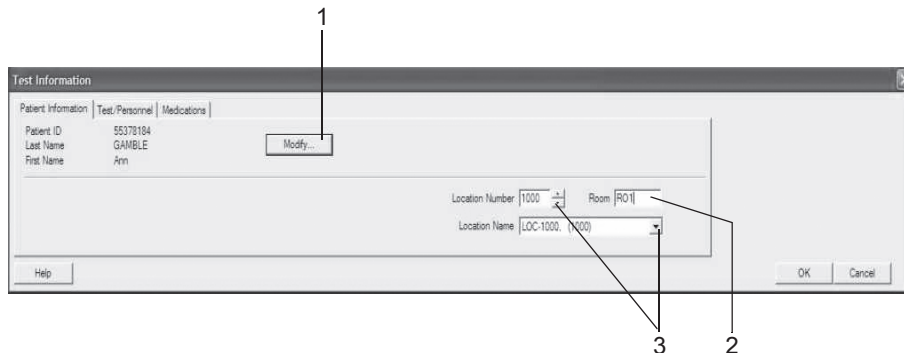

101A-SP

The *Patient Information* tab is open.

1. Verify the patient's name and ID. If the data is incorrect, click *Modify* to change.
2. Enter a designation for the *Room* (5 characters max.).
3. Select a *Location Number* or a *Location Name* (names can be configured on the *MUSE* tab, see “*MUSE Tab*” on page 12-56).
4. Check that the patient information is complete.

Note

Depending on the selected reference value equation, the program requires the gender, height, weight, date of birth, and race data for calculation of the spirometry reference value (see section “*Spirometry Reference Value Equations, Interpretation Modes, Measurements*” on page B-14).

You can assign a location name to the location number (see section “*MUSE Tab*” on page 12-56).

The Patient Information can be assigned to the patient file or only to the pending test.

Test / Personnel Tab

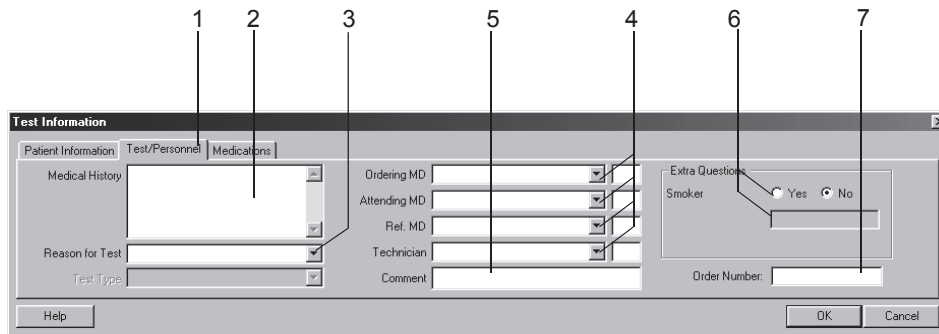

52A-R

1. Click the *Test / Personnel* tab.
2. Type the relevant information in the *Medical History* field.
3. Enter the *Reason for Test* or select one from the list box. Multiple selections are permitted.
4. Type the physicians' and technician's names or select them from the list boxes.
5. Type any *Comment* about the test.
6. Answer the *Extra Questions*.
7. Enter an *Order Number*. This number will appear on the printed reports and on the Test Summary.

Note

The *Reason for Test* library can be edited (see section “[Editing the Reason for Test, Medication Library](#)” on page 12-36).

You can define two Extra Questions as needed (see section “[Miscellaneous Tab](#)” on page 12-36).

You enter the names of the physicians and of the technician in the System Configuration (see section “[General Tab](#)” on page 12-40).

Medications

The screenshot shows a window titled "Test Information" with three tabs: "Patient Information", "Test/Personnel", and "Medications". The "Medications" tab is selected. It contains a table with 10 rows. The first five rows have a "Medication" dropdown menu and a "Dose" text field. The last five rows have a "Medication" dropdown menu and an empty text field. Numbered callouts 1, 2, and 3 point to the "Medications" tab, the first "Medication" dropdown, and the first "Dose" field respectively. At the bottom of the window are "Help", "OK", and "Cancel" buttons.

53A-R

1. Click the *Medications* tab.
2. Enter or choose a maximum of 5 medications.
3. Enter the medication dose.

Note

You can edit the medication library (see section [“Editing the Reason for Test, Medication Library”](#) on page 12-36).

Conducting Spirometry Tests

Overview

We will explain a spirometry test with the SpiroSoft respiration flow sensor. The operating steps for spirometry tests with the LF 501 sensor follow next.

The flow-volume loop is recorded in the spirometry test; all diagnostically relevant values for forced inspiration and expiration can be derived from the flow-volume loop (see section “[Definition of Spirometry Test Values](#)” on page B-22). You can choose between two measurement modes:

- *Envelope*
- *ATS*

The *Envelope* mode permits multiple maneuvers to be performed in a test. When you terminate the test, the system will determine the envelope waveform and derive the measuring values. If several tests exist, the system will determine the best measurement, which is the measurement with the largest sum of FVC + FEV1.

With the *ATS* mode (American Thoracic Society), the program will first determine the best expiratory and inspiratory curves of a test, based on the largest sum of FVC + FEV1 or FIVC + FIV1. Then the system will determine the test acceptability, using the ATS criteria (see “[Acceptability Criteria](#)” on page 8-10). The best three tests are sorted according to the largest sum of FVC + FEV1 and stored (see *ATS Summary* table). In the next step, the program will determine whether the best two tests meet the ATS reproducibility criteria (see “[Reproducibility Criteria](#)” on page 8-10). The displayed overall measurement reflects the flow-volume loop of the best test. The FVC and FEV1 values are the best values from all tests; similar to the flow-volume loop, the other values are taken from the best test.

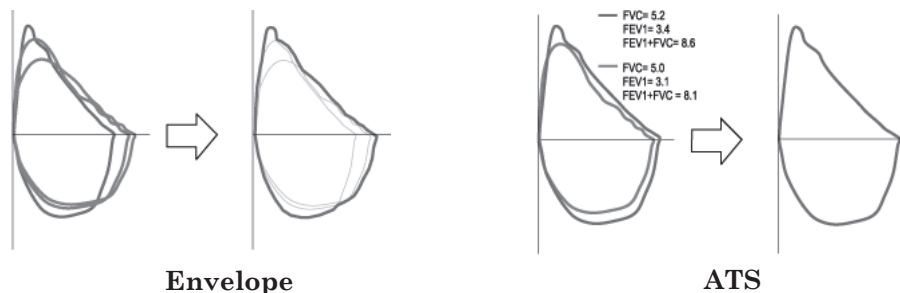

210A-SP

The system offers a number of equations for calculation of the reference values (see section “[Spirometry Reference Value Equations, Interpretation Modes, Measurements](#)” on page B-14); you can also choose between two interpretation modes (see section “[Interpretation Modes](#)” on page B-18).





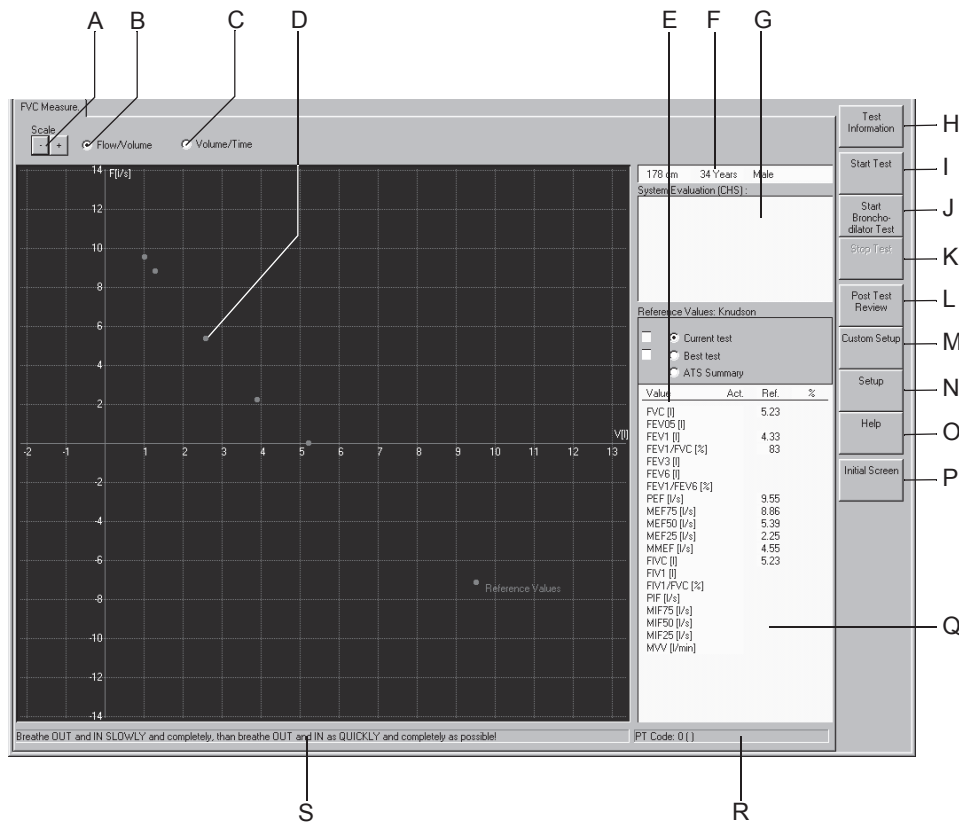



Note

- ◆ For flow-volume measurements, the patient's cooperation is essential.
- ◆ The ambient conditions should be checked every day before performing spirometry tests; the room temperature is the factor with the most impact on the test results (see section “Acquisition Tab” on page 12-35).
- ◆ Refer to section “Acquisition Tab” on page 12-35 for information on selecting the *Measurement Mode*, the *Interpretation Mode*, or the *Equation for Reference Value Calculation* or on entering the *PT Code*.



201A-SP

- A Click buttons to change the waveform scale.
- B Click option button to display the flow-volume loop.
- C Click option button to display the volume-time curve.
- D Reference curve.
- E Table with actual and reference values.
- F Patient data.
- G System evaluation area (MILLER square only with LF 501).
- H  Click to enter test information.

- I  Click to start the test.
- J  Click to start the bronchodilator test.
- K  Click to terminate the test.
- L  Click for the post test review.
- M  Click to load system setups stored for different system users (see section “[Custom Setups, Factory Setup](#)” on page 12-38).
- N  Click to display the spirometry setup menu (see section “[Spirometry Setup](#)” on page 12-35).
- O  Click to activate the online Help program.
- P  Click to return to the initial screen.
- Q ATS acceptance of the current test, ATS statement.
- R PT code information (for information on entering the PT code, refer to section “[Acquisition Tab](#)” on page 12-35).
- S Status line with information on the test procedure.

Flow-Volume Measurement - Operating Steps

WARNING

Incorrect Measurements, Risk of Infection — The pneumotach including its mouth piece is designed for single use. Use a new pneumotach for each patient. Check that the PT code on the pneumotach is the same as the PT code (**R**) shown on the acquisition screen.

Clean the nose clip after each patient and attach new foam pads.

With the LF 501, use a fresh mouthpiece for each new patient.

1. Explain the test procedure to the patient.
2. Attach nose clip to ensure that the entire respiratory volume passes through the sensor.
3. During the measurement, the patient should sit straight and hold the SpiroSoft sensor in a horizontal position.
4. Click *Start Test*, then click *OK* to confirm that the patient is not yet breathing through the sensor.

5. Wait for the status line to turn green.
6. Have the patient close the lips around the mouthpiece and perform the following maneuver through the sensor:
 - a. Exhale completely.
 - b. Slowly inhale completely.
 - c. Exhale as vigorously and for as long as possible (forced expiratory parameters; in the *ATS* mode, the expiration should last 6 seconds (see information on the *ATS* mode)).
 - d. Inhale as vigorously and deeply as possible (forced inspiratory parameters).
7. Click *Stop Test* (beep). The system also emits the beep when SpiroSoft terminates the measurement automatically.
8. Repeat the test several times, because the patient's cooperation is essential for the quality of the test.
9. Click *Best test* to display the new best test (including system evaluation) of the tests completed so far.

Note

The flow-volume measurements in the *ATS* mode must meet specific criteria:

Acceptability Criteria

- ◆ The exhalation in the FEV1 maneuver must be longer than 6 seconds (configurable beep, see section “**Acquisition Tab**” on page 12-35). Otherwise you will see the message *Exhalation too short*.
- ◆ An expiratory plateau must be achieved, i.e., the expiratory volume must not vary more than 30 ml within the last second. Otherwise you will see the message *No endexpiratory plateau*.
- ◆ The forced expiration must start as quickly as possible. The parameter used to determine the correct start is the back-extrapolated volume. The volume must be less than 150 ml or less than 5% of the FVC. Otherwise the message *High back-extrapolated volume* will appear.

Reproducibility Criteria

- ◆ A minimum of three accepted trials is required; two of these must be reproducible. The reproducibility criterion is a maximum variation of 200 ml of FEV1 and FVC between the two best tests. Otherwise you will see the message *High FEV1 variability* or *High FVC variability*.

The flow-volume loop of the current test and of the best test are displayed. The table shows the measuring values (*Act.*), the reference values and the percentage deviation of the current test.

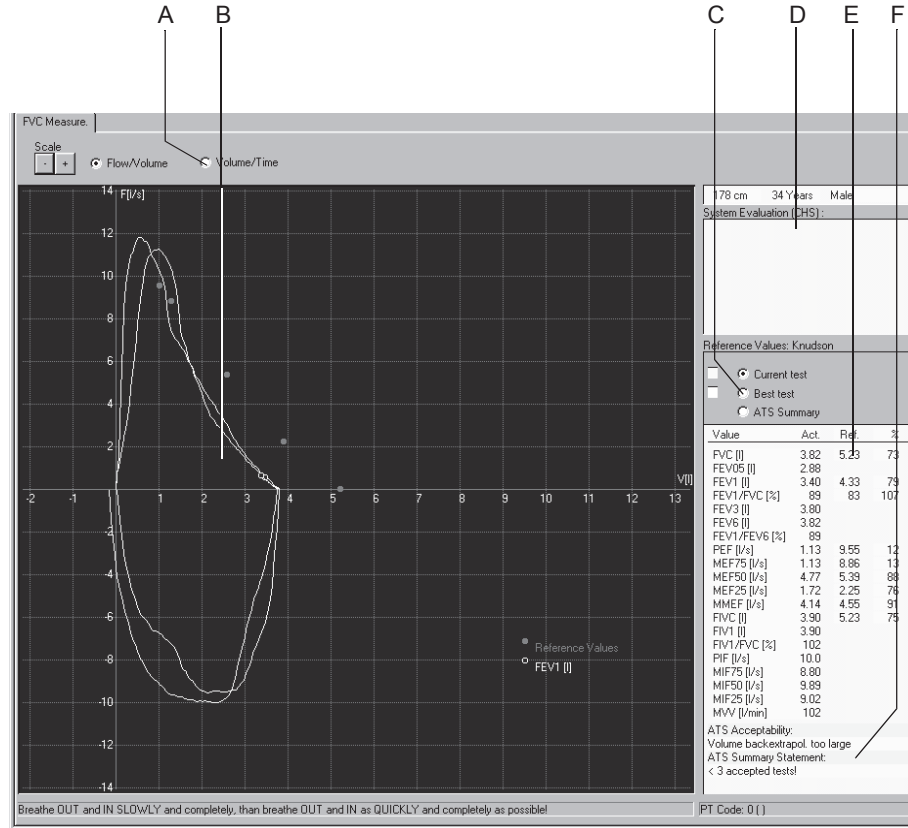

202A-SP

- A Click option button to display the volume-time curve.
- B FEV1 value.
- C Click option button to display the Current test, the Best test or the ATS Summary.
- D System evaluation according to the selected interpretation mode (for *Best test* only).
- E Measuring values, reference values and percentage deviation according to the selected equation for calculation of the reference values.
- F ATS acceptance of the current test, ATS statement below.

Bronchodilator Test

The bronchodilator test always consists of two measurements: one before and one after medication. After medication, measure the dilatation as follows:

1. Click *Start Bronchodilator Test* to start the measurement.
2. The system asks whether the previous measurement is to be the pre-dilation test (*Before Bronchodilation* test); the question appears only if a spirogram of this patient has been recorded earlier the same day.
3. Answer the question with *OK*.
4. Conduct the test as a normal flow-volume measurement.

When you select the Post Test Review, you have another opportunity to select a pre-dilation test for comparison with the current test.

Spirometry Tests with the LF 501

The LF 501 also supports VC measurements. The *ATS* and *Envelope* measurement modes are not available.

VC Measurement

1. Explain the test maneuver to the patient.
2. Attach nose clip to ensure that the entire respiratory volume passes through the sensor.
3. Click *Start Test* and ask your patient to perform the following maneuver when the orange indicator on the sensor lights up:
 - ◆ Inhale, exhale and inhale again completely through the sensor. Then your patient may resume normal breathing.

Note

- ◆ The maneuver must be concluded within 20 seconds of clicking *Start Test*.
- ◆ The program terminates the measurement when it does not detect a flow reversal within 4 s of two identified inversion points, or after 5 full breaths.

The curve window shows the volume-time curve (expiration only) and the table indicates the measuring values and the percentage deviation from the reference values.

Click *Start Test* to initiate additional measurements. The next curve is represented with a different color and superimposed on the first one. The best results for EVC and IVC, which are not necessarily taken from the same test, give VCmax.

FVC Measurement





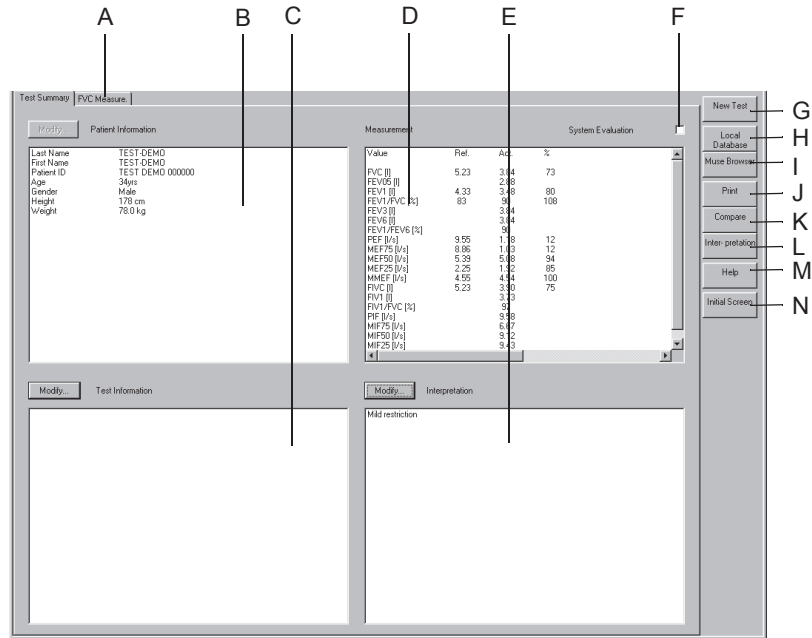

1. On the acquisition screen click *FVC Measure..*
2. Explain the test maneuver to the patient.
3. Check the nose clip.
4. Click *Start Test* and ask your patient to perform the following maneuver when the orange indicator on the sensor lights up:
 - ◆ Inhale completely through the sensor. Exhale maximally and as quickly as possible, then inhale again completely and as quickly as possible. Then your patient may resume normal breathing.

Post Test Review

Test Summary



203A-SP

- A Click tab to display the flow-volume loop and tabular data.
- B Patient Information area.
- C Test Information area.
- D Measurement Results area.
- E Interpretation.
- F Select to display and print the system evaluation, or deselect .
- G  Click to display patient list for a new test.
- H  Click to display a list with more tests of the current patient (local database).
- I  Click to display a list with more tests of the current patient (MUSE database system).
- J  Click to display the print setup window.
- K  Click to display a list of tests to compare with the current test.
- L  Click to display the interpretation window where a detailed interpretation of the test can be generated.

M  Click to activate the online Help program.

N  Click to return to the initial screen.

The *Modify...* buttons allow you to edit or complete the data in the respective areas, as described below:

Patient Information

The Patient Information window opens. You can only enter or correct data that does not affect the calculation of reference values.

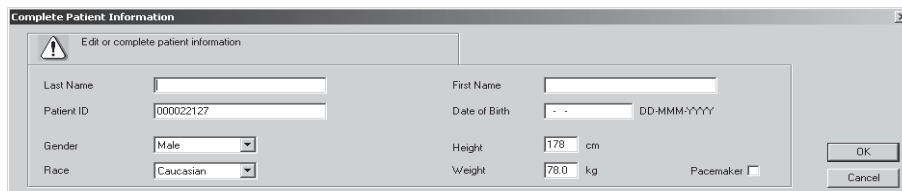

184A-BP

Test Information

The *Test Information* window opens (see “[Entering Test Information](#)” on page 8-4).

Note

The Test Information is not assigned to the patient, but to the test data.

FVC Measurement



Click the *FVC Measure*. tab to display the acquisition screen with the corresponding flow-volume loop and the measuring values. The status line indicates the ambient conditions set at the time of the measurement.

Generating or Editing the Interpretation

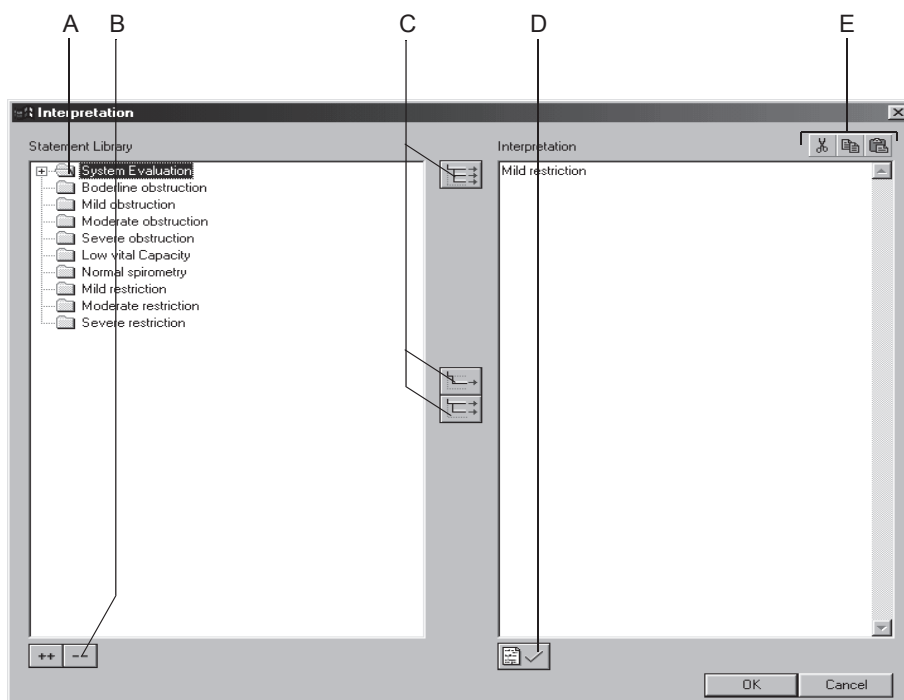
At the end of the test the system evaluation is automatically entered in the interpretation window. Click *Interpretation* or *Modify...* to open the window. In the left part of the window you see a number of folders with standard interpretation texts. The system supports the creation of an interpretation by providing standard texts which can be copied to the Interpretation area on the right. In the Interpretation area you can edit the texts as needed (enter new text, copy, cut, paste, etc.). Refer to section “[Editing the Interpretation Library](#)” on page 12-37 for information on editing the standard texts.



206A-SP

- A Click icon to open folders individually.
- B Click icons to simultaneously open (++) or close (--) all folders.
- C Click icons to copy folders , individual lines , lines including the chapter .
- D Click icon to confirm the test results.
- E Click icons to cut, copy and paste text in the Interpretation area.

Note

As an alternative you can double-click text to copy it from left to right.

Report Printout

Click the *Print* button to print the report. The print setup window opens where you can temporarily adjust the settings for the printout. Refer to section “[Miscellaneous Tab](#)” on page 12-36 for details on changing the setup permanently.

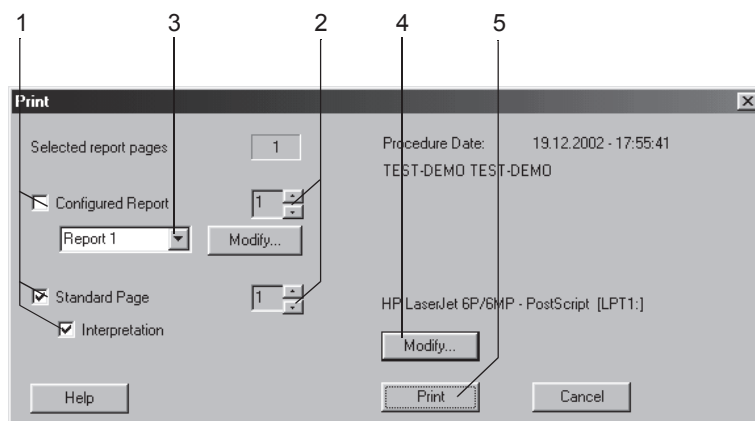

207A-SP

1. Select the documents to be included in the report
 - ◆ *Configured Report*
 - ◆ *Standard Page* with Flow-Volume Loop, Volume-Time Curve, Measurements
 - ◆ *Interpretation* (appears on the Standard Page)
2. Select the number of copies to print.
3. Select a format for the Configured Report (click *Modify...* to display the Report Editor, see section “[Report Editor](#)” on page 12-10).
4. Select the printer.
5. Click the *Print* button to initiate the printout.

Comparing Two Spirograms

You can compare the present spirogram with another one of the same patient recorded earlier.

1. Click *Compare*.
A window opens listing all the patient's spirograms.
2. Select a test.
3. Click *OK* to clear the window.

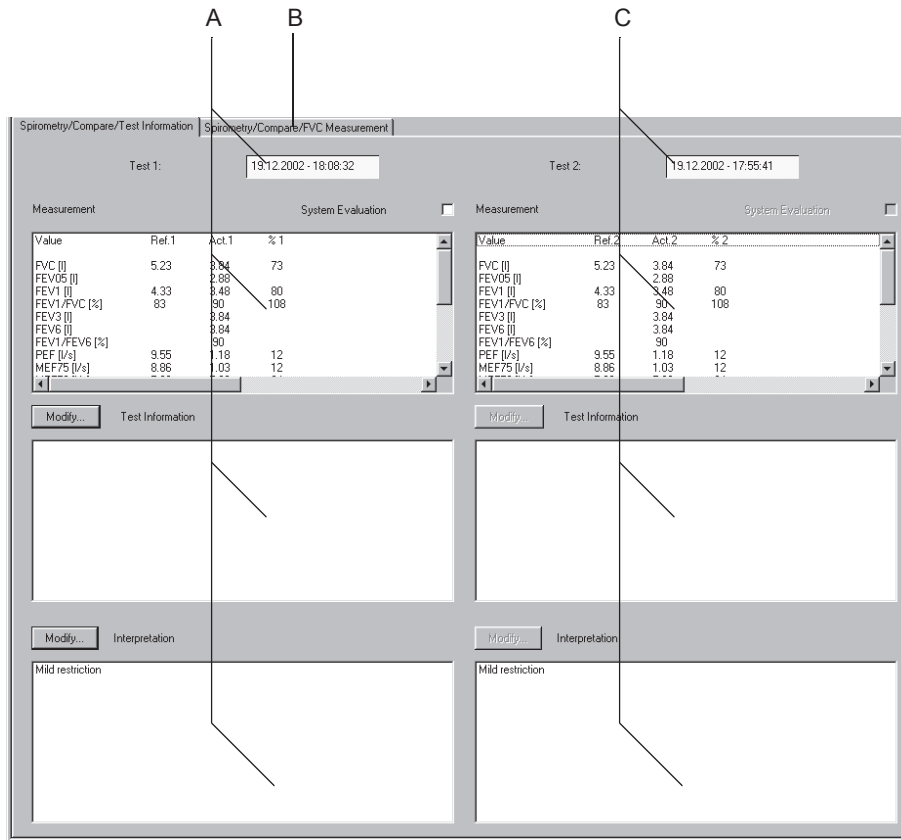

204A-SP

- A Data relating to test 1 (reference test, test selected first).
- B Click tab to display the flow-volume loops and tabular data.
- C Data relating to test 2.

Click *Spirometry/Compare/FVC Measurement* to display the comparison screen with the flow-volume loop. The screen shows the two curves and the percentage deviation from the reference values or the percentage of the reference values attained.

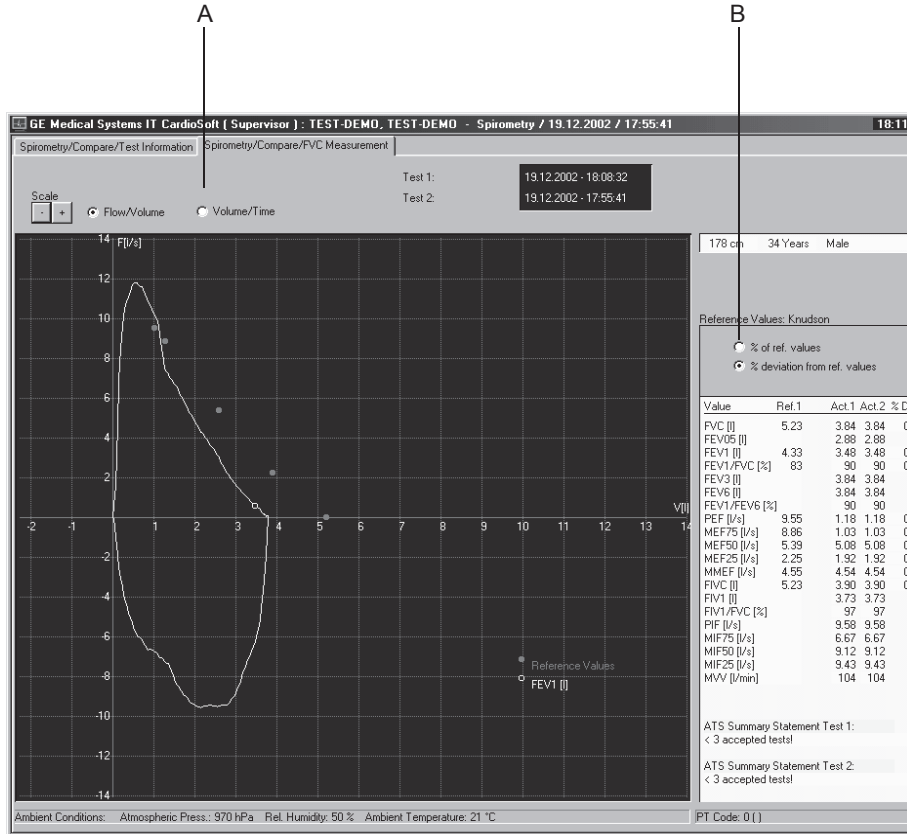

- A Click option button to display the volume-time curve.
- B Change the tabular display from *% of ref. values* to *% deviation from ref. values*.

209A-SP

For your notes

9 File Management

For your notes

Overview

All patient records are saved to the local database. The patient records can be

- viewed, edited, printed
- exported to another storage medium
- transferred to the MUSE database system or
- deleted

Click *Local Database* to open the window with the names of all stored patients.

In this window, you can

- click *Test* to view all tests
- select a patient and then click *Test* to view only this patient's tests

Selecting Patient Records

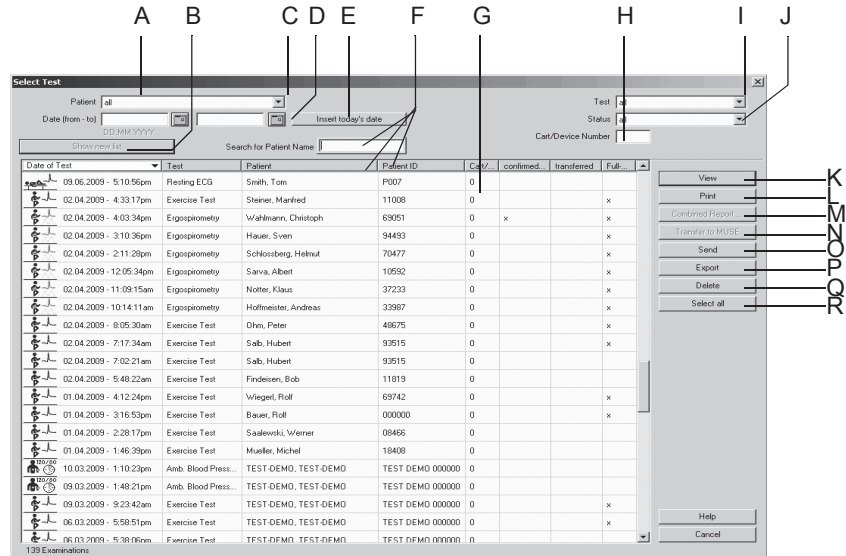

101A

- A Selected patient (only this patient's records are shown).
- B Click button to update the current list according to the selection criteria.
- C Click down arrow to open the list box with the option *all* (i.e., all records stored in the database will be shown).
- D Enter dates, if you wish to view only the patient records acquired in that time period.
- E Click button to insert the current date at D.
- F Search for patient by name or ID (depending on whether the *Patient* or the *Patient ID* column is selected).
- G Columns with details of the patient records: *Cart/Device Number*: ID number of the acquisition device, *confirmed*: the test results have been reviewed and confirmed by a physician, *transferred*: the patient record was transferred to the MUSE system, *Full disclosure ECG*: the full disclosure ECG has been stored, *Patient*: patient's name when *all* tests in the database are listed. The list can be sorted by columns. To do so, click on a column header with the left mouse button. The right mouse button is used to restore the original width of a column.
- H Enter a *Cart/Device Number*, if you wish to see only the patient records acquired with the specific cart/device.
- I Click down arrow to display a list with all test types and select.
- J Click down arrow to display a list with the different test statuses and select: *confirmed* or *unconfirmed* patient records only, or *all* patient records.
- K Click button to view the selected patient record.
- L Click button to print the final report of the selected patient record.
- M Click button to generate a Combined Report for the current patient (see section "Printing a Combined Report" on page 9-6).

- N Click button to transfer the selected patient record(s) to the MUSE database system.
 - O Click button to send the selected patient record(s) via modem or to save it to another directory.
 - P Click button to export the selected patient record(s), using file formats PDF, Word, Excel or XML.
 - Q Click button to delete the selected patient record(s).
 - R Click button to select all displayed patient records.
1. Select *all* in the *Patient* list box, if you would like to see all stored patient records and not just those of the selected patient.
 2. To reduce the number of displayed patient records
 - ◆ enter a *Cart/Device Number* to view only those patient records acquired with that cart/device
 - ◆ enter a time period at *Date (from - to)* to view only those patient records acquired in that period
 - ◆ click *Insert today's date* to view only today's patient records
 - ◆ select a specific test type (e.g. exercise tests only) from the *Test* list
 - ◆ select a test status (confirmed, unconfirmed) from the *Status* list
 3. Click *Show new list* to update the list according to your selections.
 4. Select a patient record by clicking.

Note

Patient records marked with an asterisk * are stored on an external medium.

You can select multiple patient records, holding the **Shift** key depressed.

Click *Select all* to select all displayed patient records.

In a network environment, do not review a patient's test at more than one workstation at a time.

Viewing, Editing, Printing Patient Records

Click *View*.

The *Test Summary* will appear first.

You can edit the information. Changes are saved automatically to the local database when you exit the screen. To print the displayed patient record, click the *Print* button.

Note

You can also display a patient record by double-clicking.

When working in a network environment, it is not possible to view the same patient record at multiple workstations.

When selecting a patient record stored on an external medium, the system asks if you want to view the record only (in that case it remains on the external medium) or if you want to restore it to your PC.

Patient records transferred to the MUSE system database can be viewed and printed with the MUSE Browser.

When you have selected the option *Delete local test data after transfer to MUSE* on the *MUSE* tab (see section “**MUSE Tab**” on page 12-56), all test data will be automatically deleted from the local database. Only the patient demographics remain stored.

Printing a Combined Report

For the selected patient, you can generate and print a Combined Report covering multiple records.

1. Select the patient.
2. Select a record (or select multiple records, holding the **Shift** key depressed).
3. Click *Combined Report*.

The Combined Report is displayed.

The Combined Report can be edited and printed, but it cannot be saved.

Viewing and Printing Patient Records from the MUSE System

1. Click the *MUSE Browser* button on the initial screen.
2. Enter the MUSE password, if prompted. The MUSE web page will appear.
3. Select *Display with Frame* or *Display without Frame*.
4. Submit query or identify the patient record to be retrieved by patient ID or name.
5. Display the individual documents of the patient record.
6. Print reports using the Acrobat Reader printer tools on screen (tool bar directly above the report page).

DO NOT use the Internet Explorer printer tools (toolbar at the top of the screen).

Sending, Exporting, Deleting Patient Records

First select the patient record(s).

- To select a series of consecutive records, hold down the **Shift** key and click the first and last file name of the series.
- To select individual records, hold down the **Ctrl** key and click on each single record you wish to select.
- To select all displayed patient records, click *Select all*.

Transfer to MUSE

To transfer the patient record(s) to a MUSE system, click the *Transfer to MUSE* button.

NOTE

This button is enabled only if the data transfer to the MUSE system has been enabled on the *MUSE* tab (see section “**MUSE Tab**” on page 12-56).

Data sent to the MUSE system can be edited only when the program is configured accordingly (see “**MUSE Tab**” on page 12-56).

Data sent to the MUSE system can be viewed and printed with the MUSE Browser. Please note: Select the *Landscape* format before each printout.

Send

Click the *Send* button to send the patient record(s) via modem or save them to a storage medium.

To send records via modem

- click *Transmission via modem*
- enter telephone number, name and password of the workstation at the receiving end
- click *OK* to clear the window

To save records to a storage medium

- click *Save procedure to storage medium*
- click *OK* to clear the window

Export

Click the *Export* button to export patient record(s) using different file formats.

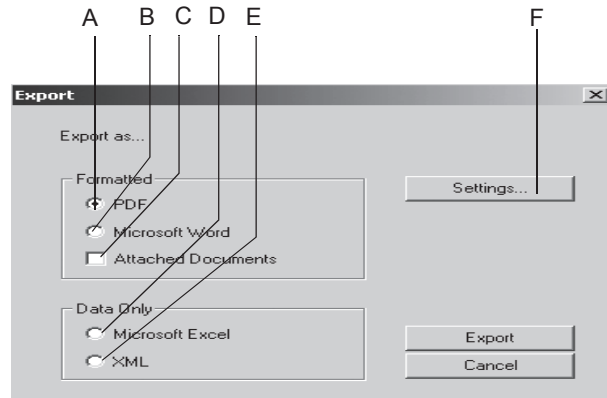

102A

- A Select option button to export data as a *PDF* file.
- B Select option button to export data as a *Microsoft Word* file.
- C Select option button to export the attached documents (ergospirometry).
- D Select option button to export data as a *Microsoft Excel* file.
- E Select option button to export data as an *XML* file.
- F Click button to display the setup screen.

1. Select the export format (A, B, D, or E).
2. Configure the export settings, if needed (see next page).
3. Click the *Export* button to export the data.

For the *PDF* format, select the documents to print in the *Print* window.

Settings

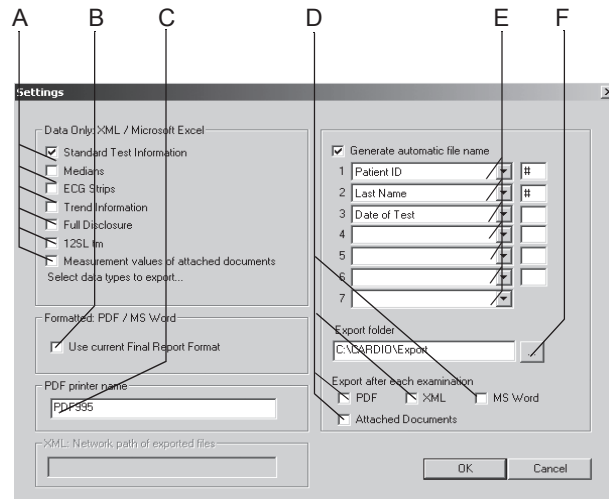

102A

- A Select the data to export as XML/Excel files.
- B Select check box if you wish to use the settings from the Final Report tab (see “Final Report Tab” on page 12-9 and “Final Report Tab” on page 12-23). Otherwise the setup screen for configuration of the final report will appear.
- C Enter the printer driver for PDF files.
- D Select check box if you wish to automatically export each test after completion as a PDF, XML or Word file and with the name selected at E, and whether the attached documents are to be included in the export.
- E Select the patient and/or test information to be included in the file name that the system will generate automatically:
 - test type
 - date
 - patient's last name
 - patient's first name
 - patient's date of birth
 - patient ID
 - patient record no.
 - export date
- F Select the target folder for the data export.

Note

If you do not use the PDF995 *PDF printer driver* to export data in the PDF format, you must set the export folder in the corresponding PDF writer application.

Working Temporarily with the Local Database

If you wish to work temporarily with the offline (local) database (house call), you can copy the patient list (without any examinations) to the local database. This can be done manually or automatically.

Manual

1. Connect the PC to the data network.
2. Click *System Configuration* to display the system configuration menu.
3. Click *Database...*
4. In the *Database Setup* window select *use offline database*.

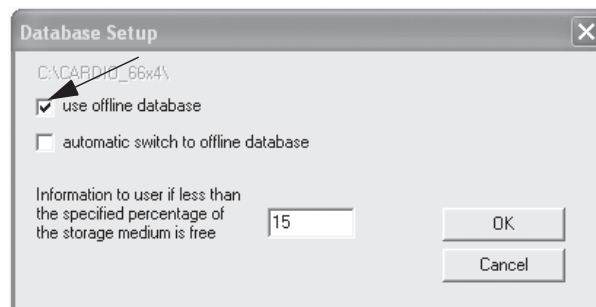

162A

The patient list without the corresponding examinations will be copied to the local database.

Now you can disconnect the PC from the data network and continue working with the local database as usual, i.e., you can select a patient and perform a test or admit a new patient to perform a test.

When you have finished working with the local database, reconnect the PC to the network and deselect the *use offline database* check box: new tests as well as new patients for whom tests exist will be copied to the database on the server.

Automatic

If you select the *automatic switch to offline database* check box in the *Database Setup* window, an additional button will be displayed when you shut down the program: *Use Offline Database*.

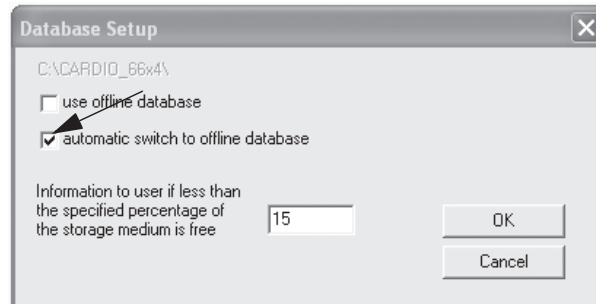

163A

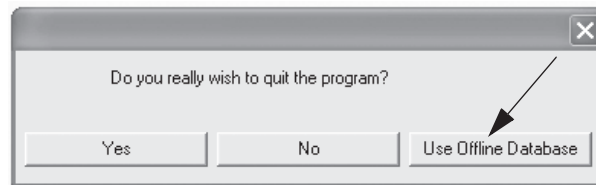

164A

When you terminate the program with this button, the patient list will be copied to the local database. Continue working with your PC as usual.

When you have finished working with the local database, exit the program, reconnect the PC to the network and start the program. New tests as well as new patients for whom tests exist will automatically be copied to the database on the server. A message informs you of the copy procedure.

10 Operation with Administrative Tools

For your notes

Overview

The program can be used in combination with the following administrative tools:

- medical reimbursement program
- hospital information system (HIS)
- EMR system (electronic medical records)

Description

The CardioSoft program supports communication with administrative tools via the following interfaces:

- GDT (German medical device data standard)
- BDT (German medical data standard)
- HL7 (requires XEMR option)

Note

Please refer to the separate descriptions supplied.

If the program is used in conjunction with an administrative tool, the patient file is always managed in the administrative tool while the test data are managed in the CardioSoft program. In this case you will also select the patient in the administrative tool and enter height and weight.

After selecting the patient, you choose the test type. This will automatically transfer you to CardioSoft which you operate as usual. If you wish to select another patient, you will have to exit the examination program and choose the patient in the administrative tool.

After ending the test and terminating the examination program, the most important data, but no curves, will be transferred to the administrative tool.

Dialog between the administrative tool and CardioSoft:

- start of the administrative tool
- selection of the patient
- display of the patient's medical record
- selection of an examination (start of CardioSoft)
- acquisition of a new test (ECG, spirogram, etc.)
- termination of the examination program
- transfer of test data to the administrative tool

When running the CardioSoft program in conjunction with an administrative tool, the functions *selecting another patient*, *admitting a new patient* are not available.

The patient is admitted to the administrative tool with last name, first name, patient ID, date of birth, height and weight.

Note

GE Healthcare is not in a position to guarantee full compatibility of administrative tool with CardioSoft in all situations.

11 DICOM Interface

For your notes

Overview

DICOM (**D**igital **I**maging and **C**ommunications in **M**edicine) is an open data exchange standard for medical information.

DICOM standardizes both the file format for data storage as well as the communications protocol for the exchange of these data.

The following functions are supported:

- performing procedures on the basis of the order list (scheduled examinations)
- performing procedures without the order list (unscheduled examinations)
- sending procedure data to the archiving system

Note

A valid DICOM option code will activate the DICOM interface as well as the *DICOM* tab.

Configurations on the *DICOM* tab should be referred to IT/Service staff (see Field Service Manual).

Performing Procedures with the Order List (Scheduled Procedures)

1. Click *New Test*.
2. Select the patient and click *Order List*.

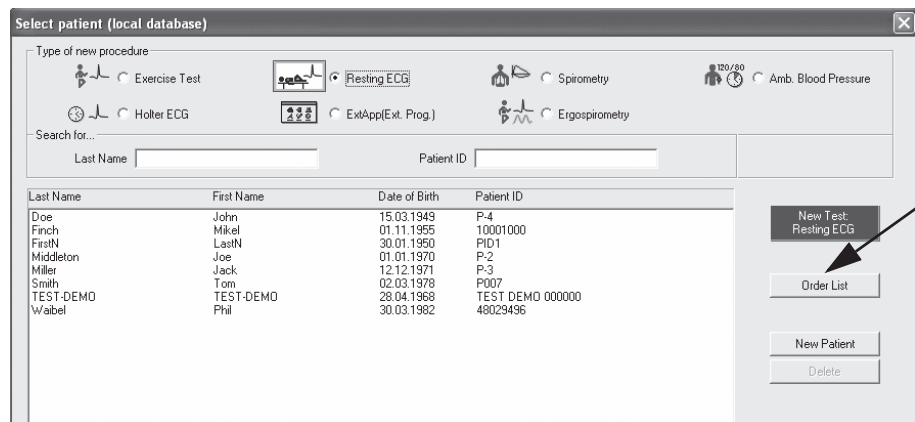

104A

An order list query is automatically sent via the network. These are the default search criteria:

- orders for the selected patient
- orders for the present day (today)
- orders assigned to this workstation

Note

It is also possible to view the order list without selecting a patient first. An order list query is automatically sent via the network. These are the default search criteria:

- ◆ orders for all patients
 - ◆ orders for the present day (today)
 - ◆ orders assigned to this workstation
3. If required, you can changed these default settings. Then click *Find* to start the query.
 4. Select the order from the list. More details can be found below the order list.
 5. Click *Start Procedure*.

The procedure with the patient data of the selected order will start. For exercise stress tests, a test protocol assigned to the order will automatically be selected (see Field Service Manual).

If present, the following data will be saved with the test.

- Order number (configurable source, see Field Service Manual)
- Name of the requesting physician

- Name of the performing physician
6. Perform the examination according to the user instructions.
 7. At the end of the examination you will be asked whether the test is a valid or an invalid test. If invalid, you must state a reason.
 8. Confirm your entries.

Once the test has been successfully terminated (or after it has been analyzed, see Field Service Manual), the data will be sent to the archiving system.

Depending on the DICOM configuration, only the ECG waveforms (for exercise stress tests only) or the ECG waveforms and the test report (as configured for the printout) will be sent to the archive. After a successful transfer the exam is labelled *Transferred (DCM)* in the examination list.

When the data were successfully archived (this may take more or less time, depending on the archiving system used), the exam is labelled *Archived (DCM)* in the examination list. Depending on the configuration, it may not be possible to edit the archived exam.

Elements of the Order List - Explanation

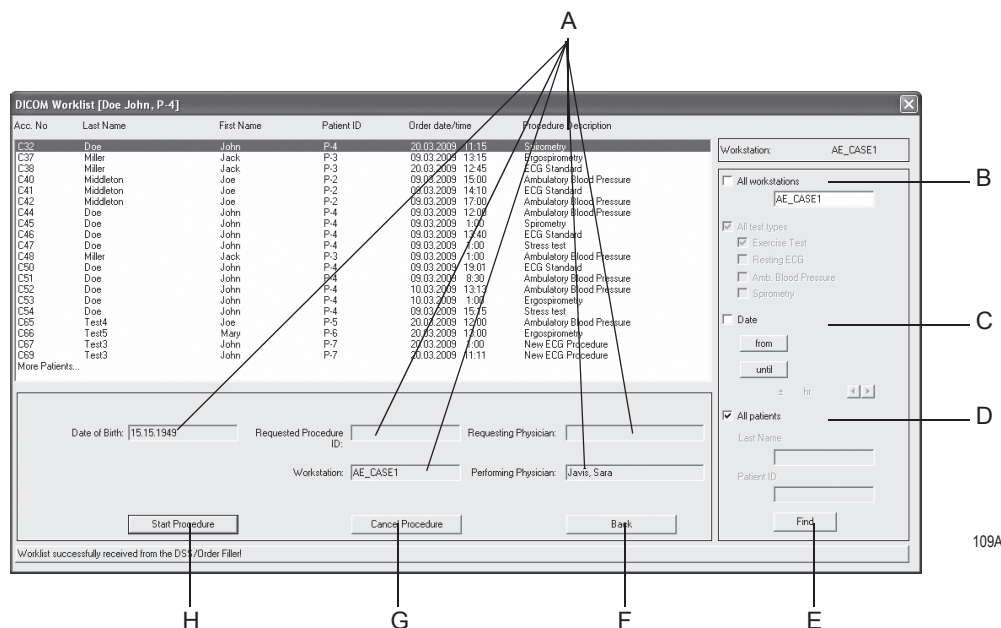

- A The content of these fields depends on the program configuration.
- B Search criterion for the workstation: find orders for a specific workstation or find orders for all workstations.
- C Search criterion date: find orders for the selected time period or find orders irrespective of a time period.
- D Search criterion patient name/patient ID: find orders for patients with a given last name or patient ID or find orders for all patients.
- E Click to find orders that match the specified search criteria.
- F Click to quit the dialog window.
- G Click to reject the order, stating the reason.
- H Click to initiate the procedure of the selected order.

Performing Procedures without the Order List (Unscheduled Procedures)

- Click *New Test*.
- Select a patient or admit a new one.
- Select the test type.
- Start the test.
- The procedure is performed and archived as described in the previous section.

12 System Settings

For your notes

Resting ECG Setup

The settings specific to the resting ECG modality can be entered either from the resting ECG acquisition screen where you click *Setup* to display the setup menu, or from the *General* tab of the System Configuration (see “*General Tab*” on page 12-40).

Acquisition Tab

The *Acquisition* tab with the acquisition settings is already on top.

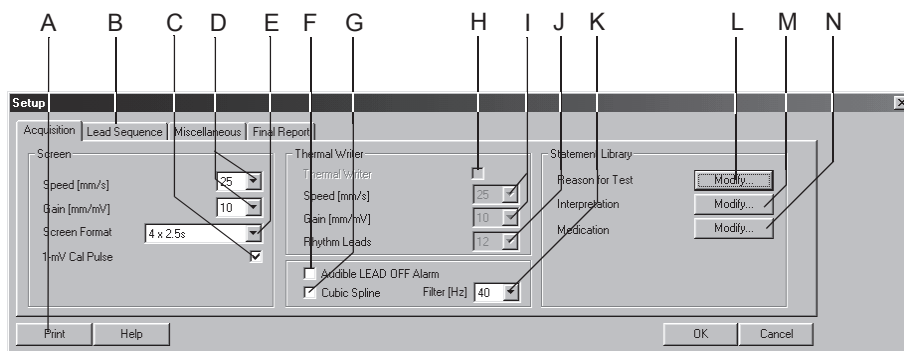

91A-R

- A Click to print the resting ECG setup.
- B Click to display the other setup tabs.
- C Select or deselect display of the 1-mV calibration pulse.
- D Select the speed and gain (screen).
- E Select the screen format.
- F Select to hear the lead off alarm. If selected, the system will emit a beep when an electrode becomes disconnected.
- G Select to enable the Cubic Spline algorithm (automatic compensation of baseline fluctuation). Cubic Spline causes a signal delay of approx. 2. seconds.
- H Click to enable the thermal writer.
- I Select the thermal writer speed and gain.
- J Select the number of rhythm leads to be recorded with the thermal writer.
- K Select filter frequency (ECG).
- L Click to edit the *Reason for Test* library (see next page).
- M Click to edit the *Interpretation* library.
- N Click to edit the *Medications* library.





Editing the Reason for Test Library

In this window you can edit the library for the Reason for Test list box. You can enter a maximum of 12 statements.

1. Click *Modify...* to display the *Reason for Test* library.
2. Select a blank line.
3. Enter the text.

Editing the Interpretation Library

In this window you can edit the library of interpretative statements.

1. Click *Modify...* to display the *Interpretation* library.
2. Click a line to highlight it.
3. Click a second time to enable the edit mode and enter your changes.
4. With the icons at the bottom of the window you can
 - ◆ open (++) or close (- -) folders
 - ◆ insert chapters 
 - ◆ insert lines 
 - ◆ delete chapters 
 - ◆ sort texts alphabetically 

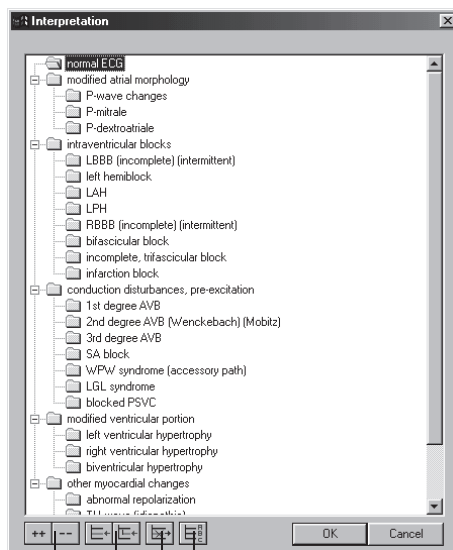

A B C D

- A Click icon to open (++) or close (- -) folders.
- B Click icon to insert chapters or lines.
- C Click icon to delete chapters.
- D Click icon to sort texts alphabetically.

92A-R

Editing Medication Groups, Assigning Drug Names

1. Click *Modify...* to display the *Medications* library.
2. Click down arrow to open the list.
3. Select the medication group.
4. Click the *Drug Name* box and enter the medication name.

Note

Assigning the correct names to the groups is the responsibility of the physician.

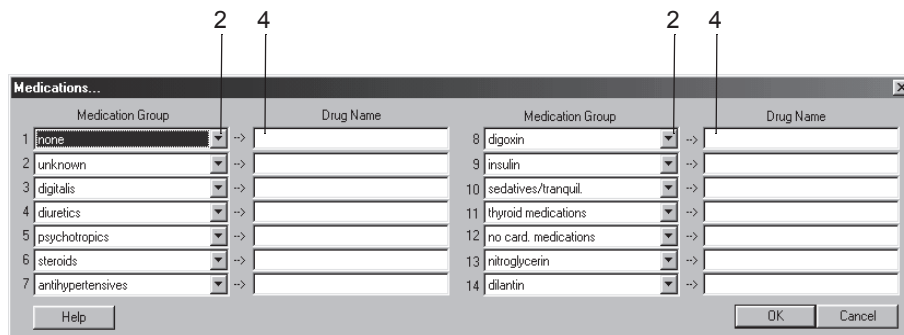

93A-R

Lead Sequence Tab

Click the *Lead Sequence* tab to open the window.

Lead sequence is the assignment of ECG leads to the writer or screen channels.

You can change the lead sequences according to your needs and save them under the same name or under a new name. You may also create new lead sequences.

Note

The *Standard* and *Cabrera* lead sequences cannot be modified.

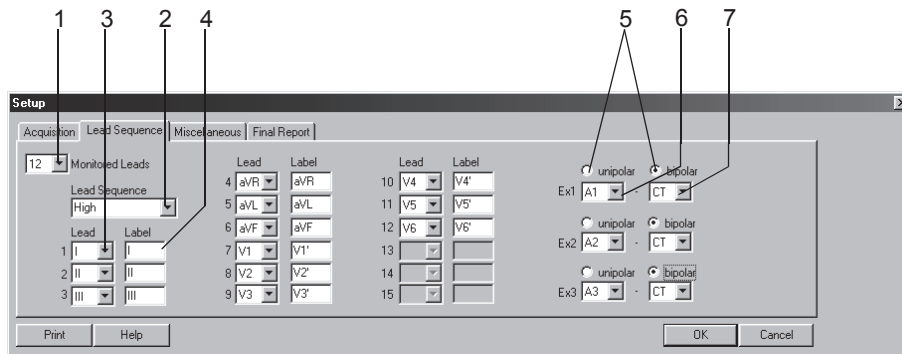

94A-R

Modifying the Lead Sequence

1. Select the number of monitored leads. These are the leads to be recorded.
2. Select a *Lead Sequence*.
3. Open the list box of the channel where you want to record another lead and select.
4. Enter the lead label.

Configuring Leads Ex1, Ex2, Ex3

5. Choose unipolar or bipolar.
6. Choose the 1st electrode site for Ex1.
7. Select the 2nd electrode site for Ex1 (*bipolar*) (the 2nd site for *unipolar* leads is always CT).
8. If required, change the name of the lead sequence (step 2) and click *OK* to save.

If you change any of the selections of an "Ex" lead, the sequence name is given as "?"

Miscellaneous Tab

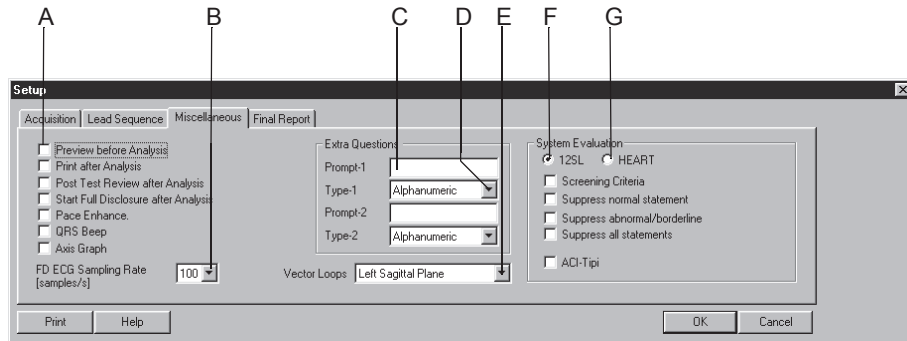

95A-R

- A Select the check boxes to enable the following functions:
- Preview before Analysis:* Full-screen display of the 10-second ECG, analysis only after confirmation.
 - Print after Analysis:* Automatic printout after acquisition of the 10-second ECG.
 - Post Test Review after Analysis:* Automatic display of the test report after acquisition and analysis of the 10-second ECG.
 - Start Full Disclosure after Analysis:* After acquisition of the 10-second ECG the system starts saving the full disclosure data.
 - Pace Enhancement:* All pacer pulses will be displayed with an amplitude of 0.5 mV.
 - QRS Beep:* The system emits a beep each time it detects a QRS complex (only with CAM-14 acquisition module).
 - Axis Graph:* An axis graph is shown in *Tabular Summary* and in the *Median Report*.
- B Select sampling rate for full disclosure ECG.
- C Enter prompt for Extra Question 1 (appears in *Test Information*, *Test/Personnel*).
- D Select answer format for prompt 1.
- E Select sagittal plane (right/left) for vector loop display.
- F 12SL analysis program:
Select check box to display the corresponding statements in the Test Summary (ACI-TIPI (**A**cute **C**ardiac **I**schemia - **T**ime **I**nsensitive **P**redictive **I**nstrument)) is a mathematically-based decision aid which has been shown to be useful in critical care situations where speed of diagnosis can be crucial).
- G HEART analysis program.

Final Report Tab

Click the *Final Reports* tab for configuration of the report printout.

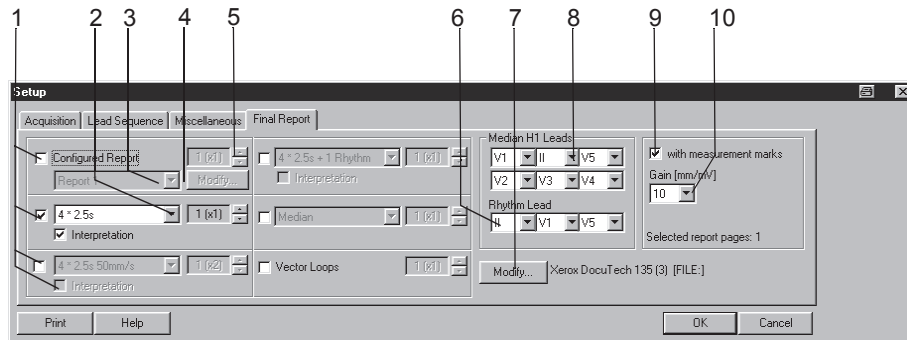

96A-R

1. Select the documents to be included in the report
 - ◆ *Configured Report*
 - ◆ 10-second ECG (up to 3 different formats, with or without *Interpretation*)
 - ◆ *Medians*
 - ◆ *Vector Loops*.
2. Select the screen format for the 10-second ECG. You can choose two more formats.
3. Select a report format.
4. Click *Modify...* to edit the report or create a new Configured Report (see “[Report Editor](#)” on page 12-10).
5. Select the number of copies to print.
6. Select the rhythm leads.
7. Select the printer.
8. Choose the leads if you selected the *Swedish H1* format.
9. Select check box if you wish to print the measurement marks.
10. Select the gain.

Report Editor

The Configured Report Editor allows you to create a maximum of 10 templates (e.g. letter to referring physician). Two templates (Reports 1 and 2) are preconfigured and cannot be changed.

Click *Modify...* on the *Final Report* tab to display the *Configured Report Editor* window.

You can enter text and insert report items from a list (e.g., patient name, heart rate). At the time the report is printed the program will replace these report items with the actual data.

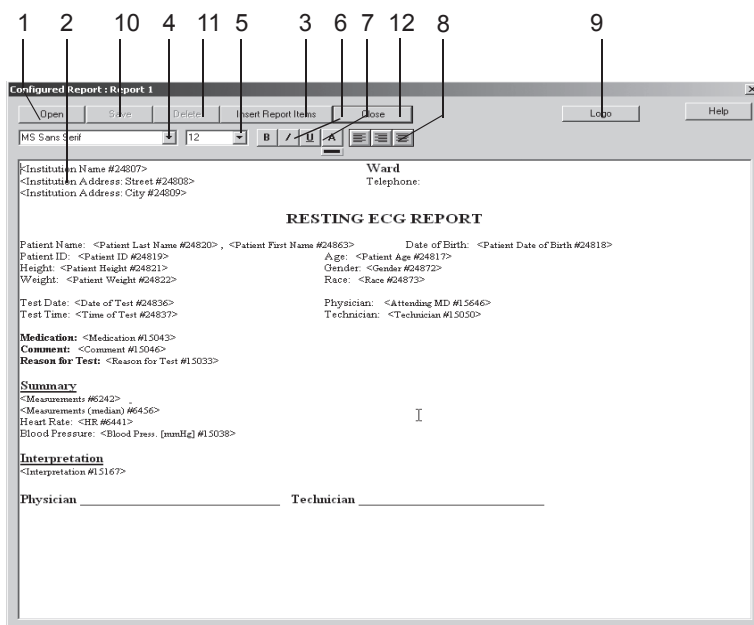

97A-R

1. Click to select and open a report template.
2. Click in the window and type the text.
3. Click *Insert Report Items* to open the list of available data fields and select an item by double-clicking.
4. Highlight the text and select the font.
5. Select the font size.
6. Select the font format: **bold**, *italics* or underlined.
7. Select a color from the color palette *A* and click the colored bar.
8. Select the paragraph format: left flush, right flush, or centered.

9. Click *Logo* to open the logo window.

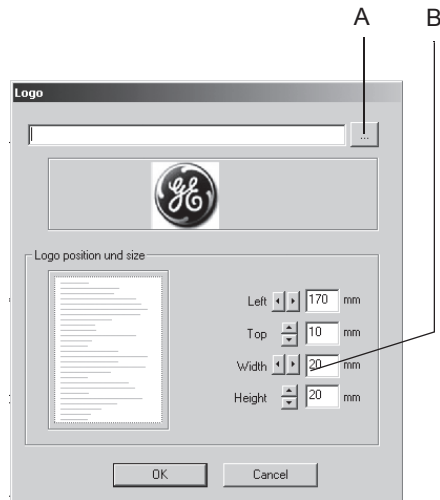

944A

- A Click to select the logo.
 - B Use arrow buttons or text fields to define the size and position of the logo.
10. Click button to save the template. To do so, enter the template name first. This name will allow you to select the template later on when configuring the printed report. If edited, Reports 1 and 2 must be saved under a new name.
 11. Click to delete the template.
 12. Close the *Configured Report* window.

Exercise Test Setup

The settings specific to the exercise test modality can be entered either from the exercise test pre-acquisition screen where you click *Setup* to display the setup menu, or from the *General* tab of the System Configuration (see “[General Tab](#)” on page 12-40).

Writer Tab

The *Writer* tab with the writer settings is already on top.

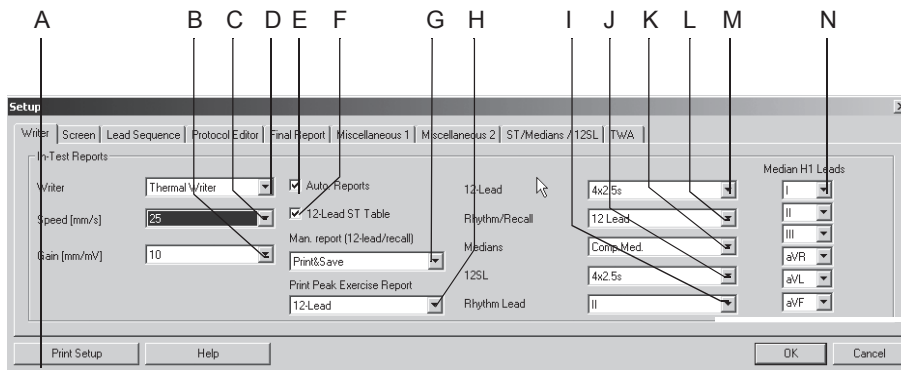

98A-S

- A Click to print the exercise test setup.
- B Click to select the writer gain.
- C Click to select the writer speed.
- D Click to select writer for In-Test Reports.
- E Select or deselect automatic in-test reports configured in the *Protocol Editor* (see “[Protocol Editor Tab](#)” on page 12-19).
- F Select or deselect display of the ST Table in the 12-lead reports.
- G Define output of manually acquired in-test reports: *Print*, *Print&Save* or *Save*.
- H Select peak exercise report type: *none*, *Medians*, *12-Lead ECG*.
- I Select rhythm lead for viewing and recording.
- J Select 12SL report format.
- K Select *Medians* report:
 - Select the rhythm lead for Linked Medians at I.
 - Select the leads for Median H1 at N.
- L Select *Rhythm/Recall* report format.
- M Select *12-Lead* report format.
- N Select *H1 ECG* leads.

Screen Tab

Click the *Screen* tab to open the window.

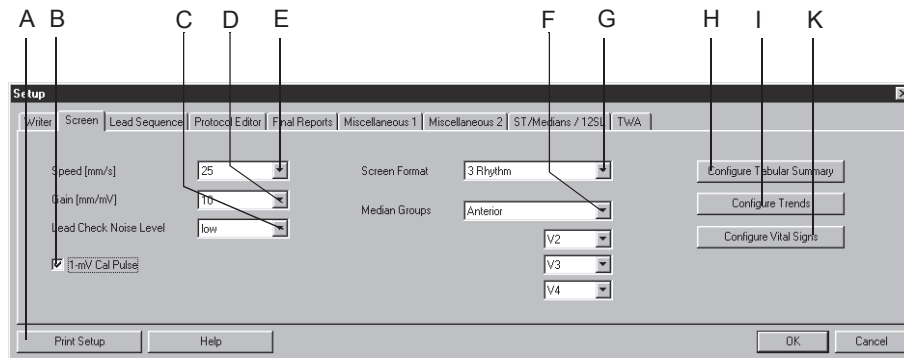

99A-S

- A Click to print the exercise test setup.
- B Select or deselect display of the 1-mV calibration pulse.
- C Select the sensitivity level to noise (noise/signal ratio): low, middle, high (electrodes with a high impedance are shown yellow).
- D Select the gain for the displayed ECGs.
- E Select the speed for the displayed ECGs.
- F Select a median group. Then select the leads for this group.
- G Select the ECG format for the screen display.
- H Click to configure the *Tabular Summary* (see next page).
- I Click to configure the *Trends* (see “Configuring Trends” on page 12-15).
- K Click to configure the *Vital Signs* window (see “Configuring the Vital Signs” on page 12-16).

Configuring the Tabular Summary

You can define up to 5 columns of data in the Tabular Summary in addition to the standard 8.

Select preconfigured data types or create new column headings.

Click *Configure Tabular Summary* on the “Screen Tab” on page 12-13 to display the configuration window.

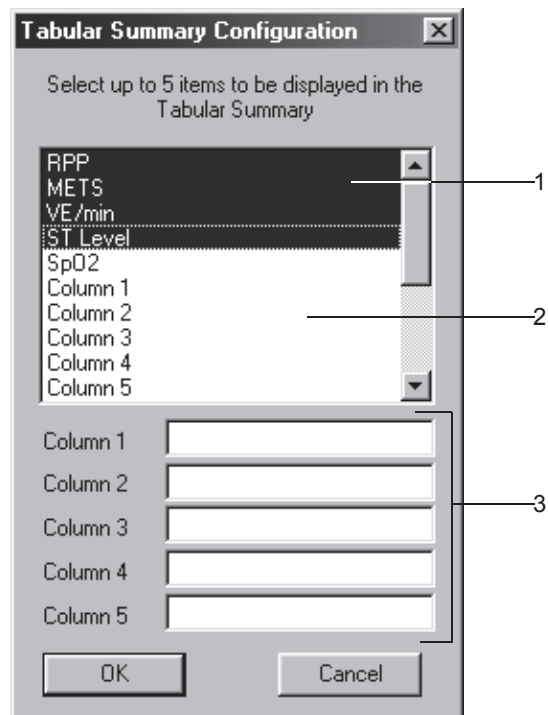

910A-S

The highlighted items are selected for display.

1. Click a highlighted item to deselect it.
2. Click a deselected item to select it.
3. To create your own column headings:
 - a. Type the new column heading.
 - b. Click a heading to select it.

Note

You can enter the values for columns 1 through 5 either directly in the Tabular Summary or use *F11:comment*.

Configuring Trends

Click *Configure Trends* on the “Screen Tab” on page 12-13 to display the configuration window.

You can choose the parameters for 6 graphic trends.

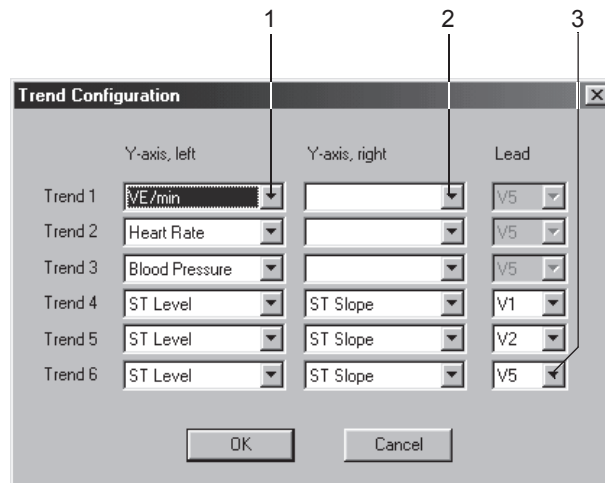

911A-S

1. Select the parameter for the left Y axis.
2. Select the parameter for the right Y axis.
3. Choose the ECG lead for the ST-related graphic trends.

Configuring the Vital Signs

Click *Configure Vital Signs* on the “Screen Tab” on page 12-13 to display the configuration window. You can choose

- the vital signs to be displayed
- the order in which they are presented
- the font size

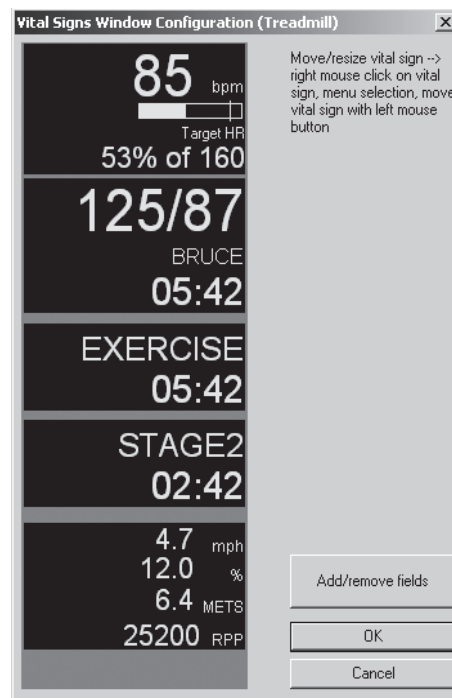

912A-S

1. Click *Add/remove fields* to select the vital signs to display.
2. Right-click a window item to choose a different font size or move the item.

These are the choices in the menu:

- ◆ move
 - ◆ bigger font
 - ◆ smaller font
3. Click the appropriate item in the menu to change the font size.
 4. Click *Move* to choose another location for the item. A box appears around the selected item.
 5. Click in the box and, holding the mouse button down, move it to its new position.

Note

You can define different setups for bicycle ergometers and treadmills.

Lead Sequence Tab

Click the *Lead Sequence* tab to open the window.

Lead sequence is the assignment of ECG leads to the writer or screen channels.

You can change the lead sequences according to your needs and save them under the same name or under a new name. You may also define different lead sequences for the screen display and the printouts.

Note

The first two lead sequences are fixed and cannot be modified.

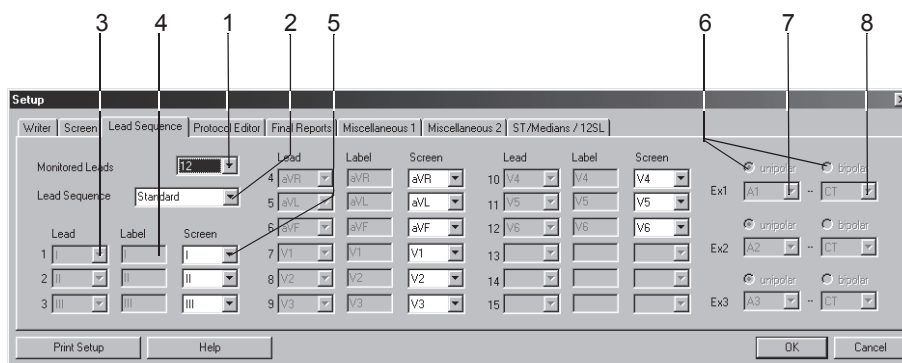

913A-S

Modifying the Lead Sequence

1. Select the number of monitored leads. These are the leads to be recorded.
2. Select a *Lead Sequence*.
3. Open the list box of the channel where you want to record another lead and select.
4. Enter the lead label.
5. Select the lead for screen display (only possible after definition of the lead sequence).

Configuring Leads Ex1, Ex2, Ex3

6. Choose *unipolar* or *bipolar*.
7. Choose the 1st electrode site for *Ex1*.
8. Select the 2nd electrode site for *Ex1 (bipolar)* (the 2nd site for *unipolar* leads is always CT).
9. If required, change the name of the lead sequence (step 2) and click *OK* to save.

If you change any of the selections of an *Ex* lead, the sequence name is given as ???.

Protocol Editor Tab

Click the *Protocol Editor* tab to open the window.

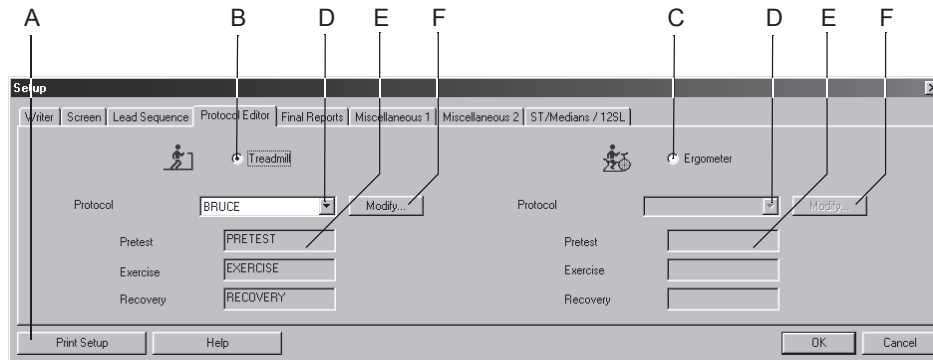

914A-S

- A Click to print the exercise test setup.
- B Click option button to select the treadmill exercise testing device.
- C Click option button to select the bicycle ergometer exercise testing device.
- D Click down arrow to select a protocol.
- E Phase names of the protocol.
- F Click to modify or delete protocols (see “Protocol Editor Screen” on page 12-20).

Selecting the Default Protocol

1. Choose the treadmill B or bicycle ergometer C exercise testing device.
2. Select the default protocol D.
 - ◆ You can either select an existing protocol (e.g. *BRUCE*) and edit the parameters, or
 - ◆ You can create a new protocol from a blank template (e.g. *TEST 14*).
3. Click *Modify* F to edit existing protocols or create new ones. This displays the *Protocol Editor* window.

Note

You can select protocols for pharmacological tests (e.g. Dobutamine) at D.

Protocol Editor Screen

Phase	Stage	Stage Time	Speed (k/h/h)	Grade (%)	12 Lead Report First	12 Lead Report Repeat	Median Report First	Median Report Repeat	BP First	BP Repeat	Stage Median First	Stage Median Repeat
PRE-TEST	Ramping off	99:00	0.0	0.0	---	---	---	---	---	---	---	---
	SUPINE	99:00	0.0	0.0	---	---	---	---	---	---	---	---
	STANZING	99:00	0.0	0.0	---	---	---	---	---	---	---	---
	HYPERIV	99:00	0.0	0.0	---	---	---	---	---	---	---	---
	WARM-UP	99:00	1.6	0.0	---	---	---	---	---	---	---	---
EXERCISE	Ramping off	03:00	2.7	10.0	02:50	03:00	---	---	02:00	03:00	02:50	03:00
	STAGE 1	03:00	4.0	12.0	02:50	03:00	---	---	02:00	03:00	02:50	03:00
	STAGE 2	03:00	5.4	14.0	02:50	03:00	---	---	02:00	03:00	02:50	03:00
	STAGE 3	03:00	6.7	16.0	02:50	03:00	---	---	02:00	03:00	02:50	03:00
	STAGE 4	03:00	8.0	18.0	02:50	03:00	---	---	02:00	03:00	02:50	03:00
	STAGE 5	03:00	8.8	20.0	02:50	03:00	---	---	02:00	03:00	02:50	03:00
	STAGE 6	03:00	9.6	22.0	02:50	03:00	---	---	02:00	03:00	02:50	03:00
RECOVERY	Ramping off	99:00	2.4	0.0	00:50	01:00	---	---	02:00	03:00	00:50	01:00

915A-S

Note

The *12 lead* and *Median* report formats are selected on the *Writer* tab.

The medians saved with *Store Median* are included in the *Medians* report.

- A Phase name.
- B Selected protocol.
- C Stage name.
- D Select or deselect a ramping phase (= continuous speed/load increase; selectable only when phase name, e.g. BRUCE, is highlighted; separately adjustable for each phase).

- E Parameter fields (corresponding to the columns from left to right).
 - Phase/Stage name.*
 - Stage Time.*
 - Speed.*
 - Grade.*
 - 12 Lead Report: First* = time of first 12-lead report.
 - 12 Lead Report: Repeat* = print interval after first report.
 - Median Report: First* = time of first median report.
 - Median Report: Repeat* = print interval after first report.
 - BP: First* = time of first BP prompt or measurement.
 - BP: Repeat* = interval after first BP prompt or measurement.
 - Store Median: First* = time first median stored.
 - Store Median: Repeat* = interval after first stored median.
- F Click a button to add a new protocol, delete or print an existing protocol.
- G Click button to reset changes.
- H Click a button to add a phase or a graded phase.
- I Click button to delete the selected phase.
- J Click a button to add or delete a stage.

Caution

Bruise Hazard — DO NOT specify BP intervals shorter than 2 minutes. The BP readings may be incorrect and the tissue might be damaged.

Creating a New Phase

The screenshot shows the 'Protocol Editor' window with the protocol name 'BRUCE'. The main table lists stages for PRETEST, EXERCISE, and RECOVERY. The control panel at the bottom includes input fields for Stage Time, Speed, and Grade, and buttons for 'New protocol', 'Delete protocol', 'Print protocol', 'Reset protocol', 'Add phase', 'Add graded phase', 'Delete phase', and 'Add stage'. Numbered callouts 2 through 8 point to these various controls.

Phase	Stage	Stage Time	Speed (km/h)	Grade (%)	12 Lead Report		Median Report		BP	Repeat	Store Median	
					First	Repeat	First	Repeat			First	Repeat
PRETEST	Ramping: off											
	SUPINE	99:00	0.0	0.0	---	---	---	---	---	---	---	---
	STANDING	99:00	0.0	0.0	---	---	---	---	---	---	---	---
	HYPERV.	99:00	0.0	0.0	---	---	---	---	---	---	---	---
	WARM-UP	99:00	1.6	0.0	---	---	---	---	---	---	---	---
EXERCISE	Ramping: off											
	STAGE 1	03:00	2.7	10.0	02:50	03:00	---	---	02:00	03:00	02:50	03:00
	STAGE 2	03:00	4.0	12.0	02:50	03:00	---	---	02:00	03:00	02:50	03:00
	STAGE 3	03:00	5.4	14.0	02:50	03:00	---	---	02:00	03:00	02:50	03:00
	STAGE 4	03:00	6.7	16.0	02:50	03:00	---	---	02:00	03:00	02:50	03:00
	STAGE 5	03:00	8.0	18.0	02:50	03:00	---	---	02:00	03:00	02:50	03:00
	STAGE 6	03:00	8.8	20.0	02:50	03:00	---	---	02:00	03:00	02:50	03:00
	STAGE 7	99:00	9.6	22.0	02:50	03:00	---	---	02:00	03:00	02:50	03:00
RECOVERY	Ramping: off											
		99:00	2.4	0.0	00:50	01:00	---	---	02:00	03:00	00:50	01:00

1. Select a blank protocol (e.g. *TEST 14*).
2. Click the *New Protocol* button to display the window with all protocol templates.
3. Select a template from the list.

Editing Stage or Phase Information

4. Click on a stage or phase to display the active data fields.
5. Enter new data for the stage or phase.
6. To delete this stage or phase, click the *Delete stage* or *Delete phase* button.
7. To add a stage, click *Add stage*.
8. To add a phase, select a phase. Then click *Add phase* or *Add graded phase*. The new phase is inserted below the selected phase.

Note

New protocols can be created only when the displayed protocol is blank or was deleted.

New phases can be created only when an existing phase is deleted first and when the protocol has less than three phases.

If the stage time in pretest is 0, the pretest phase will automatically begin when the patient starts pedalling.

Final Report Tab

Click the *Final Report* tab for configuration of the report printout.

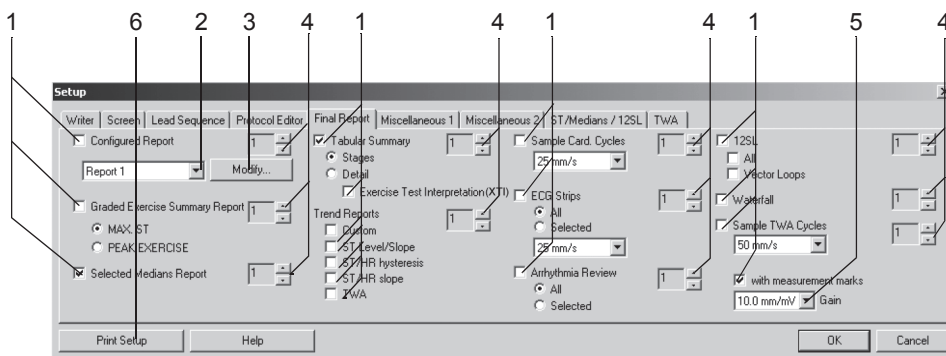

916A-S

1. Select the documents to be included in the report
 - ◆ *Configured Report*
 - ◆ *Graded Exercise Summary Report*
 - ◆ *Selected Medians Report*
 - ◆ *Tabular Summary (stage/detail)*
 - ◆ *Trend Reports* (only the selected graphs will be printed)
 - ◆ *Exercise Test Interpretation (XTI)*
 - ◆ *Sample Cardiac Cycles*
 - ◆ *ECG Strips / Arrhythmia Review:*
All: prints all stored strips or arrhythmias;
Selected: prints ECG strips or arrhythmias from the post test review.
 - ◆ *12SL / Vector Loops*
 - ◆ *Waterfall*
 - ◆ *Sample TWA Cycles*
 - ◆ *with measurement marks:* median complexes with ST measurement marks.
2. Select a report format.
3. Click *Modify...* to edit the report or create a new Configured Report (see “[Report Editor](#)” on page 12-10).
4. Select the number of copies.
5. Select the gain.
6. Click button to print the exercise test settings.

Miscellaneous 1 Tab

Click the *Miscellaneous 1* tab to open the window.

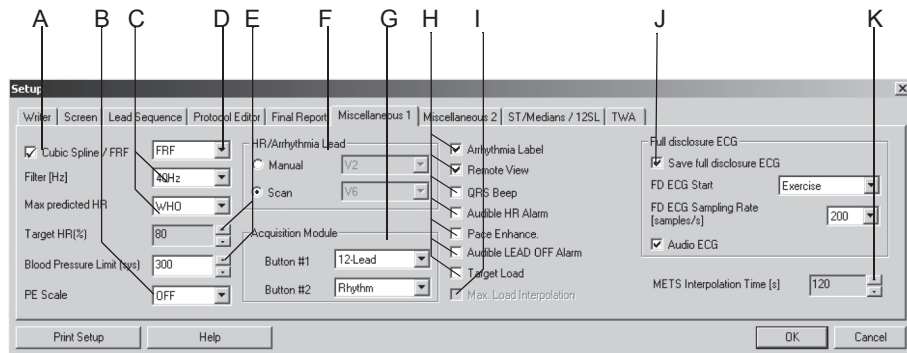

917A-S

- A Select or deselect FRF (Finite Residual Filter algorithm = filtering of high and low-frequency components without altering the QRS complexes, signal delay of 1 s) or Cubic Spline (compensation of baseline fluctuation, signal delay 2 s); see section “[Application Tips](#)” on page B-7.
- B Select the PE Scale (Perceived Exertion). The selected scale will appear in the event list box.
- C Select the muscle filter frequency and the method for calculation of the *Max. predicted HR*.
- WHO: max. predicted HR = 220 - age
 - AHA: max. predicted HR for age < 25: 160, for age > 75: 115, for age between 25 and 75: 160 - (age - 25) x 45/50.
- D Select FRF or Cubic Spline (see A).
- E Select the *Target HR (%)* as a percentage of the max. predicted heart rate and the max. blood pressure.
- F Choose the arrhythmia lead selection mode: Scan or Manual (if Manual: select leads).
- G Select the reports to be initiated with buttons 1 and 2 on the CAM-14 acquisition module.
- H Select or deselect the following functions:
- display of *Arrhythmia Labels*
 - *Remote View*
 - *QRS Beep*
 - *Audible HR Alarm* (alert when target HR is exceeded)
 - display of *Pace Enhancement* markers
 - *Audible LEAD OFF Alarm* (alert when an electrode becomes disconnected)
 - *Target Load* (value will be calculated and indicated, for bicycle ergometer protocols only)

- I Select the *Max. Load Interpolation* function (only possible when the exercise test is performed on a bicycle ergometer). The maximum load is the load of the last completed stage plus the duration of the last stage x load increase/stage time.
Example:
load of the last completed stage: 125 Watts
last stage aborted after 1 minute
load increase: 25 Watts
stage time: 2 minutes
 $125\text{ W} + 1 \times 25/2 = 137.5\text{ W}$
This value is also used to determine the percentage of the target load.
- J Select *Save full disclosure ECG*, then choose the phase when storage of the full disclosure ECG should start, and the sampling rate.
- K Select the *METS Interpolation Time*.

Miscellaneous 2 Tab

Click the *Miscellaneous 2* tab to open the window.

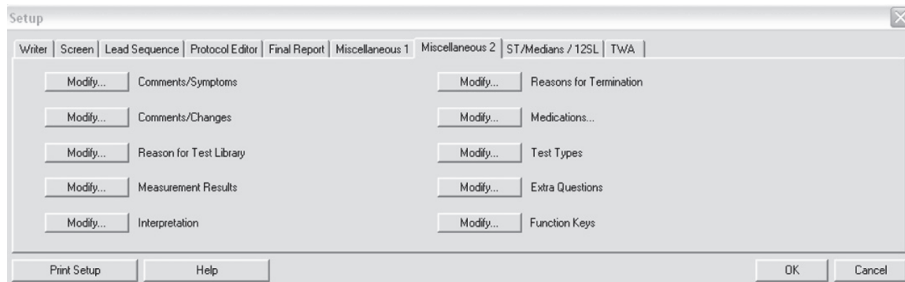

918A-S

Editing the Comments, Test Types, Reason for Test, Reasons for Termination, Medications Library

1. Click *Modify...* to open the edit window.
2. Edit, delete or add new statements.

Configuring the Measurement Results

1. Click *Modify...* to display the *Measurement Results* window.
2. Select the parameters to be included in the Measurement Results (Test Summary).

Note

ST/HR Index is the maximal change in ST depression as a function of change in heart rate during recovery.

Selection of multiple parameters may cause report header to continue on second page.

Editing the Interpretation Library

Click *Modify...* to open the *Interpretation Library* window.

Note

You can edit the eight preset topics in the window on the left. Do not edit the topics, if data will be sent to MUSE. Additional statements can be entered in the window on the right. To do so, click in the blank space below the last statement.

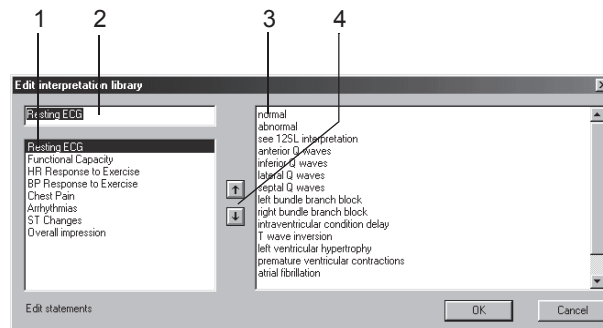

919A-S

1. Select the topic to edit.
2. Click in the text box and edit the text.
3. Delete or change existing statements or add new ones (a maximum of 20 statements can be entered for each topic).
4. Click the up/down arrows to change the order of topics and statements.

Entering Extra Questions

Click *Modify...* to open the *Extra Questions* window.

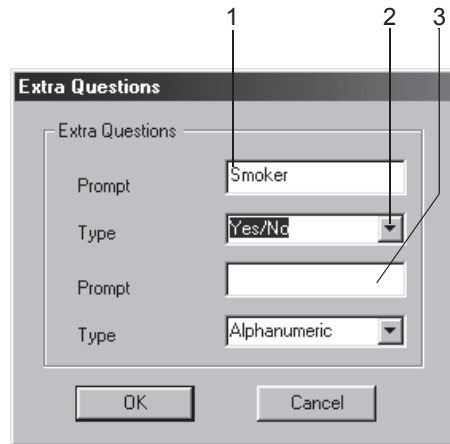

920A-S

1. Click in the text box for the first question and type a text (20 characters max.).
2. Select the answer format: *Alphanumeric*, *Numeric*, *Yes/No*.
3. Enter the second question in the same way.

Assigning Functions to the Function Keys

You can assign different functions to function keys F1 through F12 of the PC keyboard. Click *Modify...* to open the *Assign function to keys F1 through F12* window. The text boxes display the currently assigned functions.

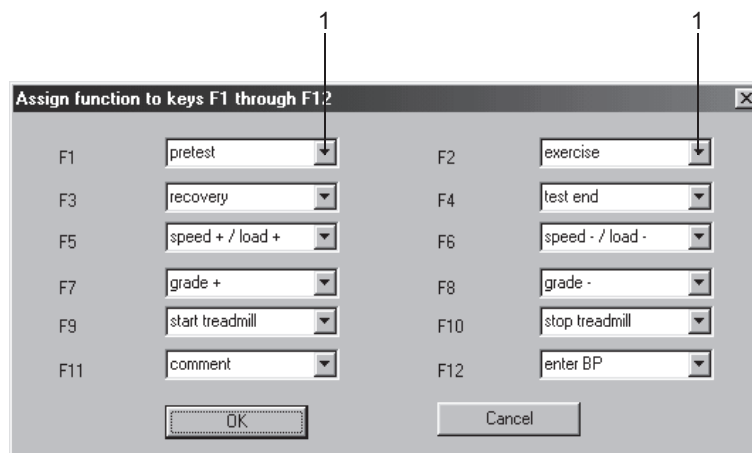

921A-S

1. Click on the down arrow of the function key whose function you wish to change.
2. Select a function from the list.

ST/Medians / 12SL Tab

Click the *ST/Medians / 12SL* tab to display the window for setup of ST measurement and 12SL.

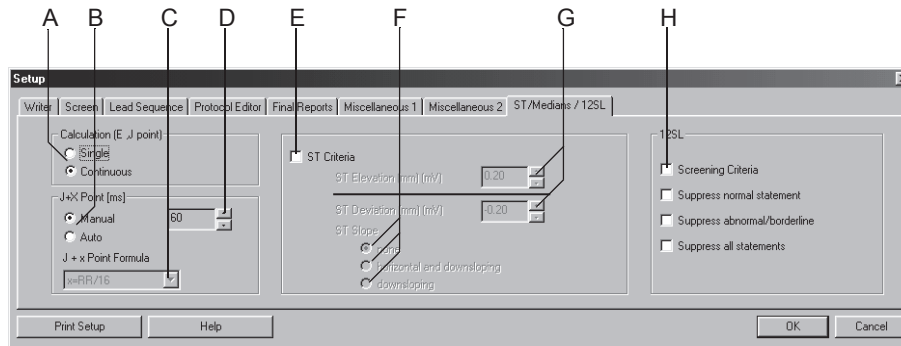

922A-S

- A Click option button to select calculation method for E and J points.
- B Click option button to select calculation method for post-J point.
Manual: set post-J point at D
Auto: select formula at C.
- C Select formula for calculation of post-J point.
- D Manually select post-J value.
- E Select or deselect the ST Criteria.
- F Click option button to select ST Slope criteria.
- G Select the max. ST elevation / depression (when the limit is reached, a message appears on the acquisition screen).
- H Select or deselect the 12SL Criteria.

TWA Tab

Click the *TWA* tab to open the window.

During the exercise test the TWA algorithm analyzes the data in the background. In each of the selected leads, the algorithm calculates the even and odd medians, the TWA value and the noise limit. The data is saved at intervals of 15 seconds. Verify the TWA settings on this tab before the test.

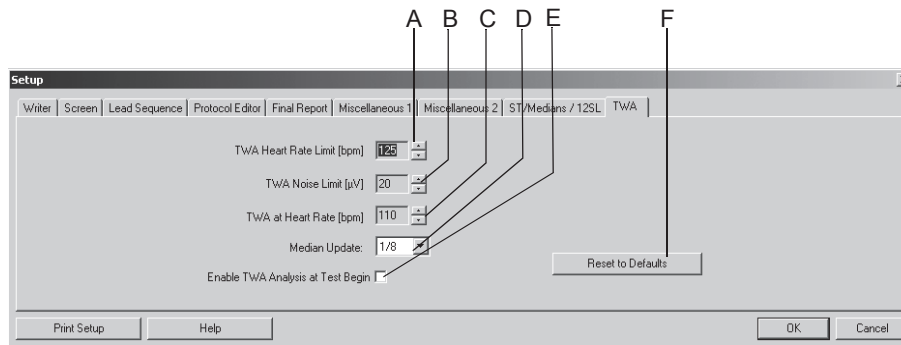

923A-S

- A Select the *TWA Heart Rate Limit* (TWA values whose HR exceeds this limit are excluded from calculation of the maximum TWA value and are identified with a question mark on the display).
- B Select the *TWA Noise Limit* (TWA values whose noise value exceeds this limit are excluded from calculation of the maximum TWA value and are identified with a question mark on the display).
- C Heart rate: when first reached, the corresponding TWA value is stored separately.
- D Click down arrow to select the update factor.
- E Select the check box to enable TWA analysis at test begin, or deselect.
- F Click to reset the values to the defaults.

Note

During the test, TWA data records are saved at given points in time. Each TWA data record provides the following information:

- ◆ time it was saved
- ◆ heart rate
- ◆ TWA and noise values for each lead

Ambulatory Blood Pressure Measurement Setup

The settings specific to the ambulatory blood pressure measurement modality can be entered either from the ambulatory blood pressure acquisition screen where you click *Setup* to display the setup menu, or from the *General* tab of the System Configuration (see “*General Tab*” on page 12-40).

Acquisition Tab

The *Acquisition* tab is already on top.

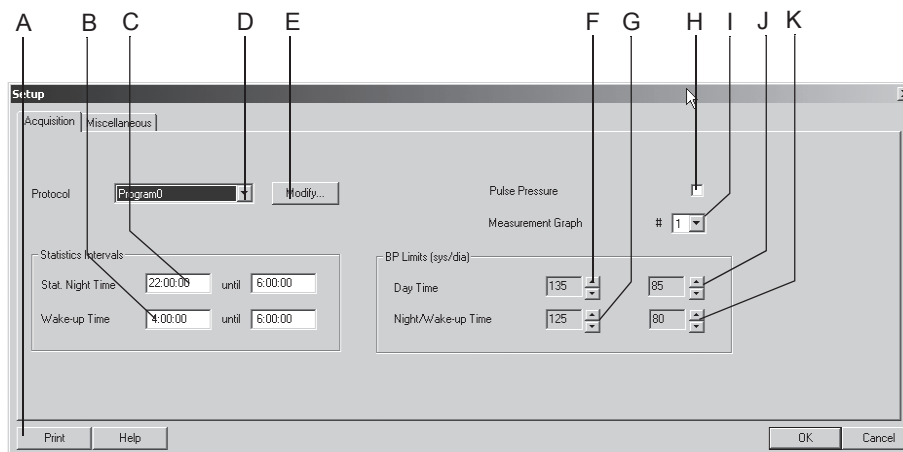

192A-BP

- A Click to print the ambulatory blood pressure measurement setup.
- B Select box to change the statistical wake-up time.
- C Select box to change the statistical night time.
- D Click to select the measurement protocol.
- E Click to edit the protocol (see next section).
- F Click to change the systolic blood pressure limit for the day time.
- G Click to change the systolic blood pressure limit for the night/wake-up time.
- H Select check box to add the pulse pressure value (systolic pressure minus diastolic pressure) to the following report formats on the display and on the printout: measurement results, graphics, statistics summary, day phase, night phase and wake-up phase.
- I Click to select the graphics display format for the display and the printout: 1 = line chart, 2 = area chart, 3 = limit value chart.
- J Click to change the diastolic blood pressure limit for the day time.
- K Click to change the diastolic blood pressure limit for the night/wake-up time.

Editing the BP Protocol

Click *Modify* to display the configuration menu.

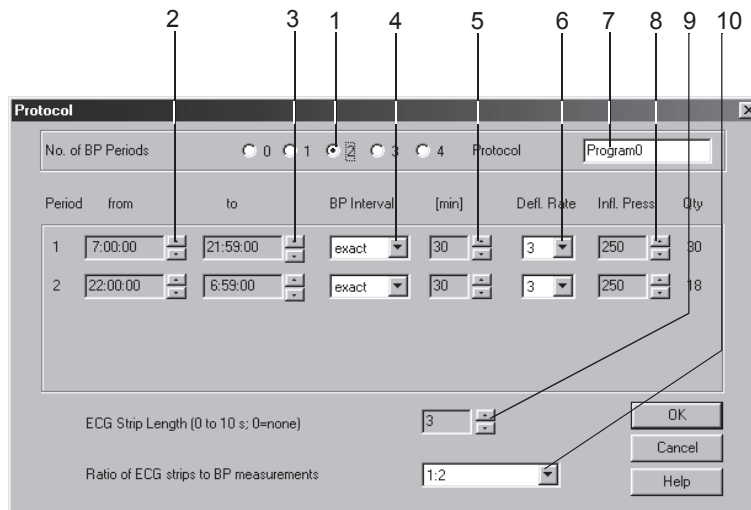

194A-BP

1. Select the number of BP periods.
2. Select the beginning of the period.
3. Select the end of the period.
4. Choose whether measurements are to be taken at exactly or at approximately the selected intervals.
5. Select the BP interval.
6. Select the deflation rate.
7. Enter a name for the protocol.
8. Select the inflation pressure for the first measurement.
9. Select the length of ECG strips (TONOPORT IVa only).
10. Select whether you wish to record an ECG with each, with every second or with every third BP measurement (TONOPORT IVa only).
11. Click *OK* to clear the window.

Miscellaneous Tab

Click the *Miscellaneous* tab to open the window.

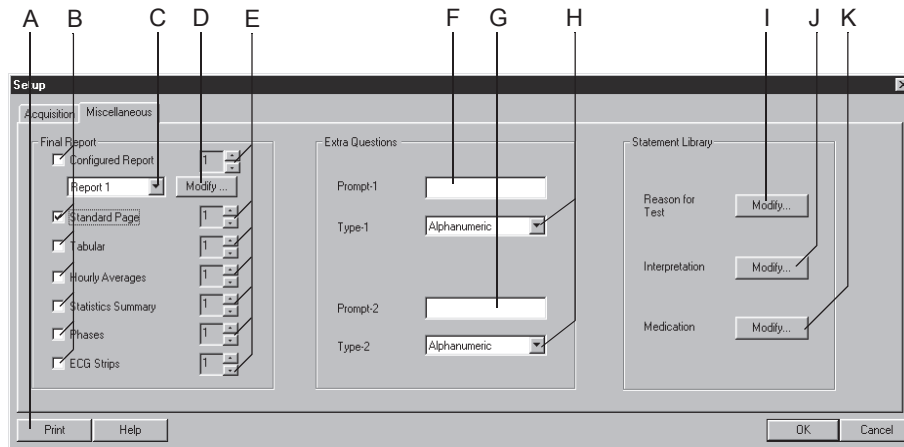

195A-BP





- A Click to print the ambulatory blood pressure measurement setup.
- B Select documents to be included in the report.
- C Select the Configured Report format.
- D Click button to edit the Configured Report or create a new one (see [“Report Editor”](#) on page 12-10).
- E Select number of copies.
- F Enter Extra Question 1 (20 characters max.).
- G Enter Extra Question 2 (20 characters max.).
- H Select the answer format for the Extra Questions.
- I Click to edit the *Reason for Test* library.
- J Click to edit the *Interpretation* library.
- K Click to edit the *Medication* library.

Editing the Reason for Test, Medication Library

1. Click *Modify...* to display the edit window.
2. Edit, delete or add new statements.

Editing the Interpretation Library

In this window you can edit the library of interpretative statements. You can enter a maximum of 12 statements.

1. Click *Modify...* to display the *Interpretation* library.
2. Click a line to highlight it.
3. Click a second time to enable the edit mode and enter your changes.
4. With the icons at the bottom of the window you can
 - ◆ open (++) or close (- -) folders
 - ◆ insert chapters 
 - ◆ insert lines 
 - ◆ delete chapters 
 - ◆ sort texts alphabetically 

Spirometry Setup

The settings specific to the spirometry modality can be entered either from the spirometry acquisition screen where you click *Setup* to display the setup menu, or from the *General* tab of the System Configuration (see “*General Tab*” on page 12-40).

Acquisition Tab

The *Acquisition* tab is already on top.

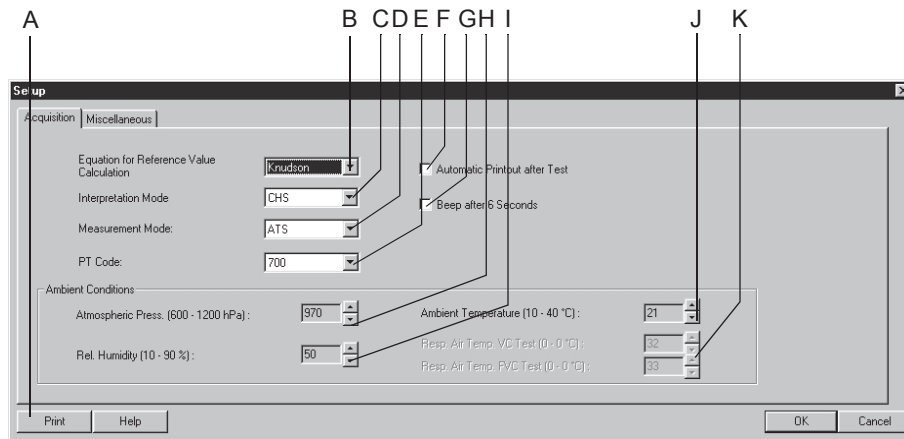

205A-SP

- A Click to print the spirometry test setup.
- B Select the Equation for Reference Value Calculation.
- C Select the Interpretation Mode.
- D Select the Measurement Mode.
- E Select the PT Code.
- F Select to print the report automatically after the test.
- G Select if you want to hear a beep at the end of expiration in the ATS mode.
- H Enter the atmospheric pressure.
- I Enter the relative air humidity.
- J Enter the ambient temperature (SpiroSoft only).
- K Enter the respiratory air temperature for the VC/FVC test (LF 501 only).

Note

Check the entered ambient conditions each day. The program needs this information for BTPS correction (Body Temperature Pressure Saturated), i.e., the measuring values are referred to an ambient pressure and saturation with water vapor at a body temperature of 37° C.

Note

Exiting the spirometry setup menu with *OK* confirms all data and the PT code. At the same time, date and time in the PT Code line on the acquisition screen will be updated.

Miscellaneous Tab

Click the *Miscellaneous* tab to open the window.

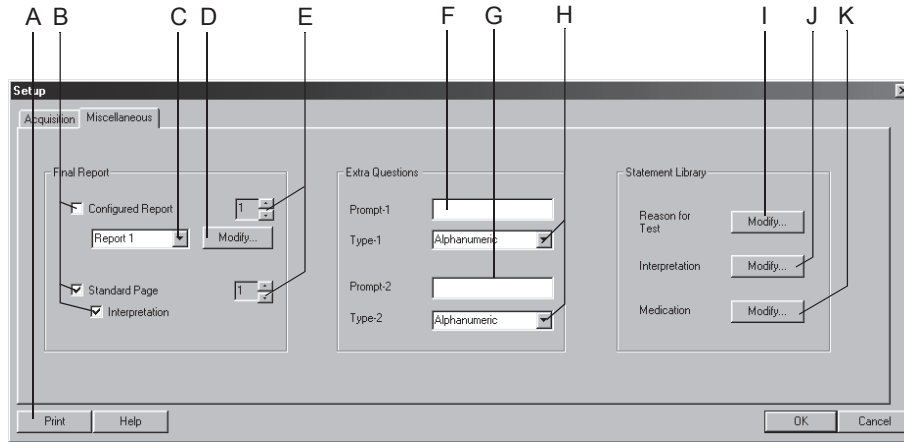

208A-SP





- A Click to print the spirometry test setup.
- B Select documents to be included in the report.
- C Select the Configured Report format.
- D Click button to edit the Configured Report or create a new one (see “[Report Editor](#)” on page 12-10).
- E Select number of copies.
- F Enter Extra Question 1 (20 characters max.).
- G Enter Extra Question 2 (20 characters max.).
- H Select the answer format for the Extra Questions.
- I Click to edit the *Reason for Test* library.
- J Click to edit the *Interpretation* library.
- K Click to edit the *Medication* library.

Editing the *Reason for Test*, *Medication* Library

1. Click *Modify...* to display the edit window.
2. Edit, delete or add new statements.

Editing the *Interpretation* Library

In this window you can edit the library of interpretative statements. You can enter a maximum of 12 statements.

1. Click *Modify...* to display the *Interpretation* library.
2. Click a line to highlight it.
3. Click a second time to enable the edit mode and enter your changes.
4. With the icons at the bottom of the window you can
 - ◆ open (++) or close (- -) folders
 - ◆ insert chapters 
 - ◆ insert lines 
 - ◆ delete chapters 
 - ◆ sort texts alphabetically 

Custom Setups, Factory Setup

The program allows you to save, load, and delete your personal settings for the different test modalities. From the same menu, you can restore the factory defaults.

You access the setup menu by clicking the *Custom Setup* button on the acquisition or pre-acquisition screen, or from the the *General* tab of the System Configuration (see “**General Tab**” on page 12-40).

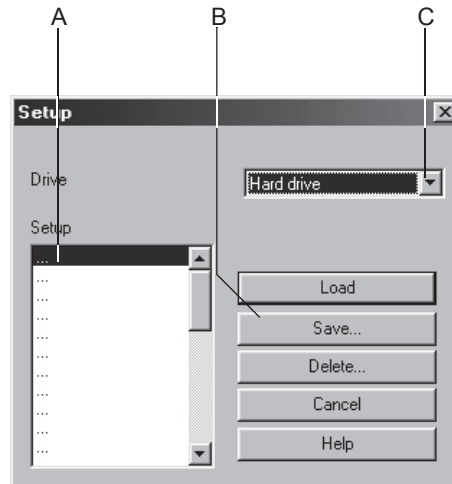

924A

- A Names of stored custom setups.
- B Click a button to load, save or delete a setup.
- C Click to select the drive.

Save

1. Click the *Save* button.
2. In the *Save Setup* window, select the target drive from the list.
 - ◆ Hard drive
 - ◆ Disk drive A
3. Select a line in the *Setup* window A.
4. In the *Save As* box, enter a name.
5. Click *Save....*

Note

With this command you save the setups of all modalities, not just of the selected modality.

Load or Delete

1. Select the drive.
2. Select the name.
3. Click *Load* to load the setup, or click *Delete* to delete the setup.

Note

Be sure to save the current setup BEFORE loading one of the stored setups, or your modifications will be lost.

With some bicycle ergometers, restoring the Factory Setup will delete your own exercise test protocols and phases.

The following parameters cannot be loaded, stored or reset to the factory defaults.

Exercise Tests

- ◆ Remote View
- ◆ thermal writer port

Spirometry Tests

- ◆ ambient conditions

System Configuration

- ◆ all settings on the *General* tab

Load the Factory Setup

1. Click the *Custom Setup* button on the acquisition or pre-acquisition screen, or on the *General* tab of the System Configuration.
2. Scroll to the bottom of the list box.
3. Select *Factory Setup*.
4. Click *Load* to load the setup.

System Configuration

Click the *System Configuration* button on the initial screen to display the menu.

General Tab

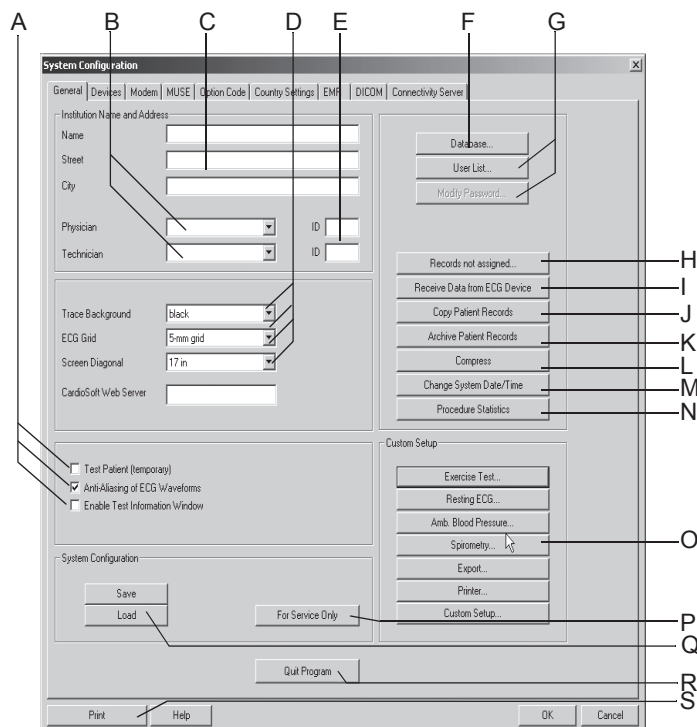

925A

- A ■ **Test Patient:** Select check box to run a test using simulated patient data. Select the function each time before starting a simulated test.

WARNING

Interpretation Hazard—Select the simulated patient data for demonstration purposes only to avoid misinterpretation of the data.

- **Anti-Aliasing:** Select check box to smooth the ECG signal traces.
 - **Enable Test Information Window:** Select check box to automatically display the *Test Information* window on the acquisition or pre-acquisition screen.
- B Enter or select the default physician and technician names (the names will appear on the *Test/Personnel* tab).
- C Enter the name and address of the hospital or practice (information appears on the printed reports).

- D
 - *Trace Background*: Click to select the background for the signal traces.
 - *ECG Grid*: Select the grid format for the displayed ECG.
 - *Report ECG Grid*: Select the grid format for the printed ECG.
 - *Screen Diagonal*: Select the size of your PC monitor (*custom*, see [“Adjusting the Screen Size for Widescreen Monitors”](#) on page 12-42).
- E Enter the physician and technician IDs. When sending data to a MUSE system, be sure to match User ID numbers assigned at the MUSE system to User ID numbers assigned in CardioSoft.
- F Settings for temporary use of the offline (local) database (see [“Working Temporarily with the Local Database”](#) on page 9-11).
Click to enter a percentage value for the minimum free hard drive storage capacity. You will be alerted when the capacity drops below this value.
- G
 - *User List*: Click to define the users, groups and privileges for individuals working with the system (see next page).
 - *Modify Password*: Click to modify the current user's password (not with Windows user list).
- H Click to display the assignment list (available only when unassigned tests exist, see [“Assignment List”](#) on page 12-47).
- I Click to transfer resting ECGs (see [“Receiving Resting ECGs from Other ECG Devices”](#) on page 12-45).
- J Click to copy patient records to another medium. The patient records remain stored in the local database (see [“Copying Patient Records”](#) on page 12-48).
- K Click to archive patient records not currently used on an external medium (see [“Archiving Patient Records”](#) on page 12-49).
- L Click to compress patient records (see [“Compressing Patient Records”](#) on page 12-50).
- M Click to change the system date and time (see [“Changing System Date and Time”](#) on page 12-51).
- N Click to perform a statistical analysis of all tests performed with the system (see [“Procedure Statistics”](#) on page 12-52).
- O Click to display the *Custom Setup* screens for
 - Resting ECG (see [“Resting ECG Setup”](#) on page 12-3)
 - Exercise Test (see [“Exercise Test Setup”](#) on page 12-12)
 - Spirometry (see [“Spirometry Setup”](#) on page 12-35)
 - Ambulatory Blood Pressure (see [“Ambulatory Blood Pressure Measurement Setup”](#) on page 12-31)
 - Export (see [“Settings”](#) on page 9-10)
 - Printer (see [“Printer Settings”](#) on page 12-53)
 - Custom Setup (see [“Custom Setups, Factory Setup”](#) on page 12-38).
- P Click to access the service screen (requires Service password).
- Q Click to save or load the System Configuration.
- R Click to quit the program.
- S Click to print the System Configuration.

Note

If you cannot remember the supervisor password, please contact the GE Healthcare Technical Support or your local Service Representative.

Adjusting the Screen Size for Widescreen Monitors

1. Select *custom*.
2. Click .
3. Adjust the height of the displayed window to 10 cm, using a ruler.
4. Adjust the width in the same way.
5. Clear the window.

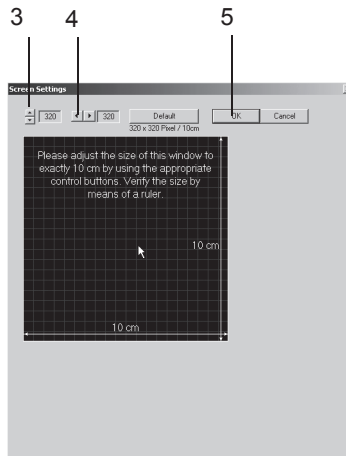

945A

User Administration

User List (**G** on the *General* tab, on page 12-40) displays the list of all registered system users if you select the *Enable Password Function* check box in the preceding window. You can edit user data with *Modify...* (select name first), delete a user with *Delete...* or register a new user with *New...*

If you enable *Use Windows User List*, the user list of the specified *Windows domain* will appear.

Windows User List

This feature allows you to display the user list of the Windows domain and authorize these users to access the system. The local user list will be deleted.

1. Click *Set Administrator User Name* to log on as administrator.
2. Select a user from the list.
3. Register the user with the appropriate privileges.

Note

Note down the administrator's user name and assign all privileges to the administrator.

Call up the capture settings from the *User List*. The selected events will be captured. The records are saved to the *Event Log*. You invoke the *Event Log* with *Start ->Programs ->General Administration ->Event Log*. Select the capture item in the *Event Log*. The source for all entries from this application is *CARDIO*. These details are shown after double-clicking the entry:

- ◆ event category
- ◆ user
- ◆ cart/device number
- ◆ patient ID
- ◆ test type
- ◆ test date
- ◆ test time

Note

Only the System Administrator is authorized to perform these administrative tasks.

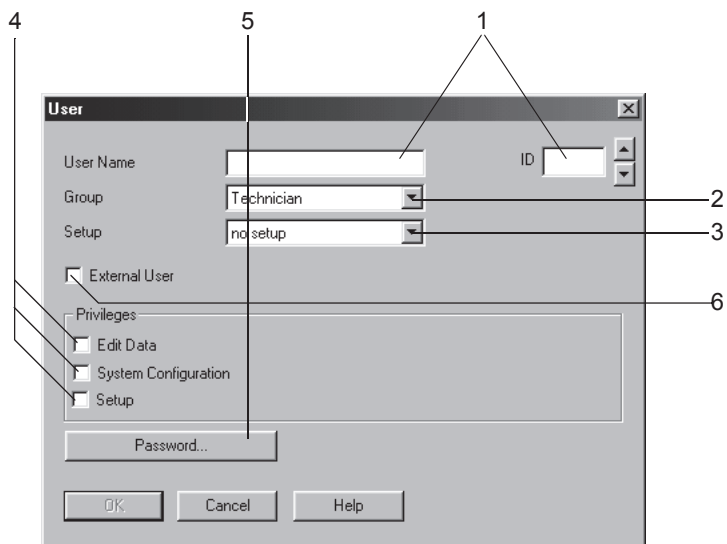

926A

Click *New...* to display the user registration window.

1. Enter the user name and ID number. If you enter the last name before the first name, insert a comma in between. Otherwise the name entered first becomes the first name and the name entered second becomes the last name, when the user is registered in the MUSE system. Please note that MUSE accepts first names with a maximum length of 10 characters, last names must not be longer than 16 characters. When sending data to a MUSE system, be sure to match User ID numbers assigned at the MUSE system to User ID numbers assigned in CardioSoft.
2. Select the user group.
3. Select the user's custom setup (see “[Custom Setups, Factory Setup](#)” on page 12-38).
4. Select the user's privileges.
 - Edit Data:* user is authorized to edit test and patient data.
 - System Configuration:* user is authorized to edit the *System Configuration*.
 - Setup:* user is authorized to edit the test settings.
5. Enter a password. Be sure to remember the password. If you forget it, you will have to contact GE Medical Systems *Information Technologies* Technical Support or your local Service Representative.
6. Select the *External User* check box if you wish to receive data from remote test stations (at the sending stations, enter the addressee's name and password).

Note

Do not use any special characters in your passwords. The minimum length of a password is 6 characters.

Receiving Resting ECGs from Other ECG Devices

With the *Receive Data from ECG Device* function, resting ECGs acquired with other GE Healthcare ECG devices can be transferred to the local database.

Note

If an ECG is received without patient ID (not even blanks), it will automatically appear in the list for manual assignment with the special patient ID "000000".

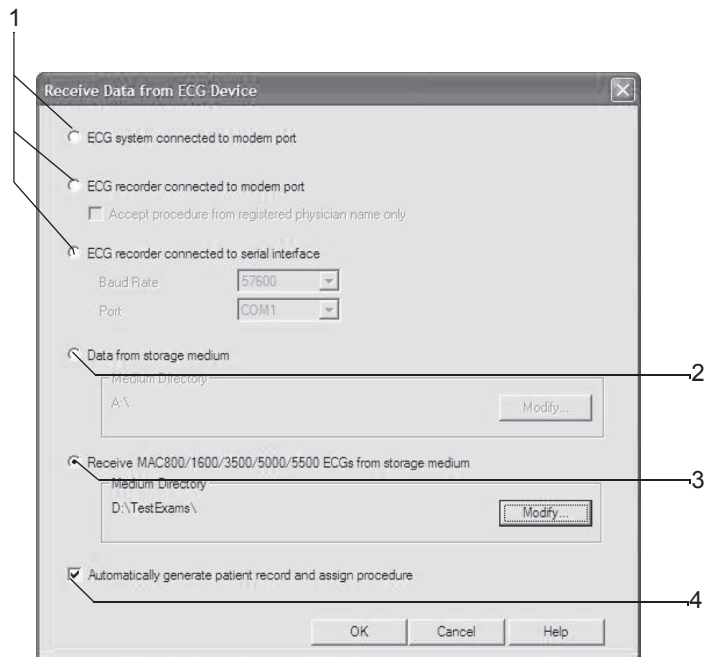

927A

Click *Receive Data from ECG Device* (I on the *General* tab) to display the setup window.

1. Select the transmission modality.
 - ◆ ECG system connected to modem port = CardioSoft
 - ◆ ECG recorder connected to modem port = MAC ECG recorder. If you wish to accept only procedures from registered physicians, select the check box. The physician's last name must be entered at the MAC 1200 and MAC 1600 before acquisition of the resting ECG. The same physician's name must be registered in the user list in the physician group.
 - ◆ MAC ECG recorder connected to serial interface: Enter the baud rate (19200 is preferred; see Technical Specifications of the equipment used) and the port.

Note

Sometimes, when a patient ID has not been entered, ECG recorders may send a series of blanks instead of a patient ID.

A device number (e.g. 12) can be entered at the ECG recorder: to do so type hospital %12% at Hospital/Practice Name.

2. Select this option button to receive data from a storage medium and specify the directory.
3. Select this option button to receive MAC ECGs from a disk or memory card (SD card) and specify the directory.
4. Select to automatically assign tests to a patient, or deselect to enter tests in a list from which they can be assigned manually.

Conditions for automatically assigning tests to patients:

- ◆ The patient ID is new and is transferred to the database together with the patient data of the incoming test.
- ◆ The patient ID already exists and last name, first name as well as the date of birth are identical with the information of the incoming test. Blank data fields are considered as identical.

If these conditions are not met, the test will appear in the list for manual assignment, even though automatic assignment has been selected (see next page).

5. Click *OK* to initiate the transfer.

A progress indicator appears. Observe the instructions displayed on screen.

6. Push the **Copy** key on the ECG recorder or send stored ECGs (see separate Operator Manuals that come with the ECG recorder).
7. Click *Cancel* to terminate the transfer.

Note

It is possible to simultaneously send the ECGs from up to 4 ECG recorders via modem to the system. To utilize this feature, an extra PC is required as the communications server. This server is part of a network through which the ECG can be routed to the system or to a MUSE system database. For details, please contact GE Medical Systems *Information Technologies* Technical Support or your local Service Representative.

Assignment List

In the assignment list, you will find all tests that were not automatically assigned to a patient record. This list appears whenever incoming ECGs cannot be assigned, or you can display it manually from the *General* tab (see “*General Tab*” on page 12-40).

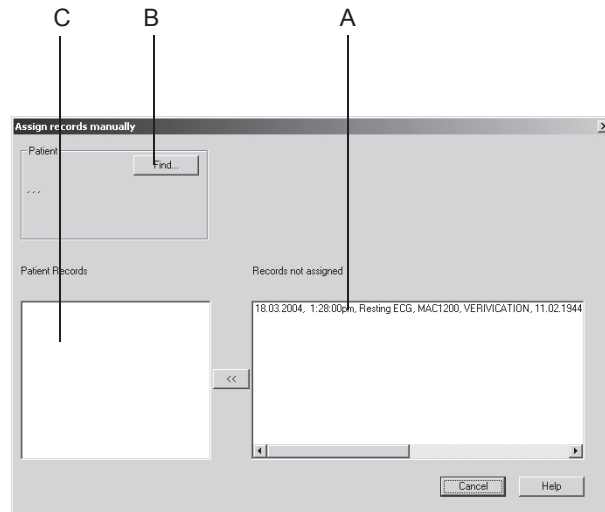

940A

- A These tests could not be assigned.
- B Click button to select the correct patient for the test to be assigned.
- C Existing tests of the selected patient.

1. Click the patient record.
2. Click *Find...* to select the patient or enter a new patient.
3. Click << to assign the patient record to the patient.

Copying Patient Records

With the *Copy Patient Records* function, patient records can be copied from the local database to a removable media or a network drive, or they can be moved from a removable media or network drive to the local database. When “moved“, the data record will be deleted from the source medium.

Click *Copy Patient Records* (**J** on the *General* tab) to display the setup window.

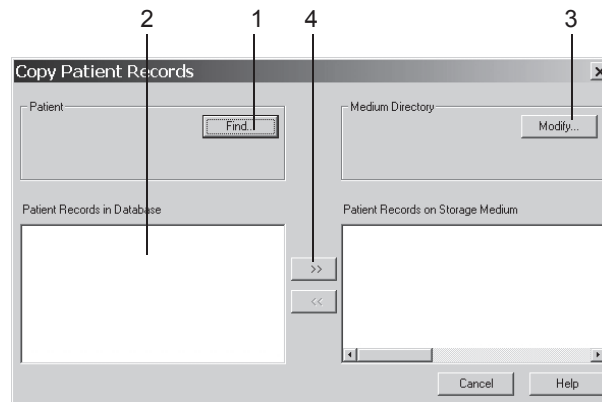

928A

1. Select the patient.
2. Select the patient records to copy.
3. Select the target drive and/or directory.
4. Click >> to copy patient records TO a disk.
5. Click << to move patient records FROM a disk.

Archiving Patient Records

With the *Archive Patient Records* function you can export patient records not currently used to an external medium. The date and test type remain included in the patient record list. An asterisk * identifies archived patient records.

Do not copy the data to the root directory (e.g. d:\), create a subdirectory (e.g. d:\data\).

If you want to view an archived patient record, the system will indicate the storage medium. Archived patient records can be transferred to the MUSE database system only after they have been restored.

Click *Archive Patient Records* (**K** on the *General* tab) to display the setup window.

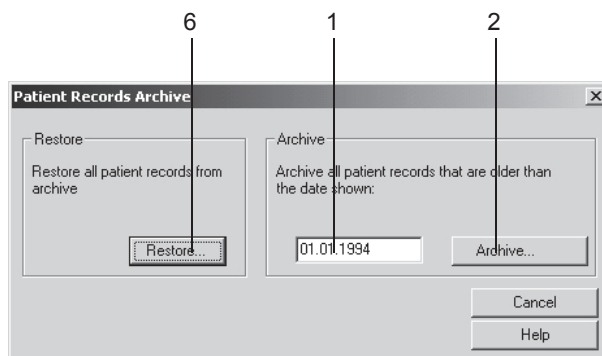

929A

1. Enter a date: patient records older than this date will be archived.
2. Click the *Archive...* button.
3. Insert the storage medium and, after archiving, label it with the number displayed.
4. Select the target drive or directory.
5. Click *OK*. Observe the instructions displayed on screen.
6. Proceed in a similar way to restore archived patient records.

Compressing Patient Records

Older patient records that are seldom used can be compressed with the *Compress* function to free storage capacity for new data. If you select compressed patient records for viewing, they uncompress automatically.

Click *Compress* (**L** on the *General* tab) to display the setup window.

1. Enter a date: patient records older than this date will be compressed.
2. Click the *Compress...* button.

Changing System Date and Time

Click *Change System Date/Time* (M on the *General* tab) to display the setup window.

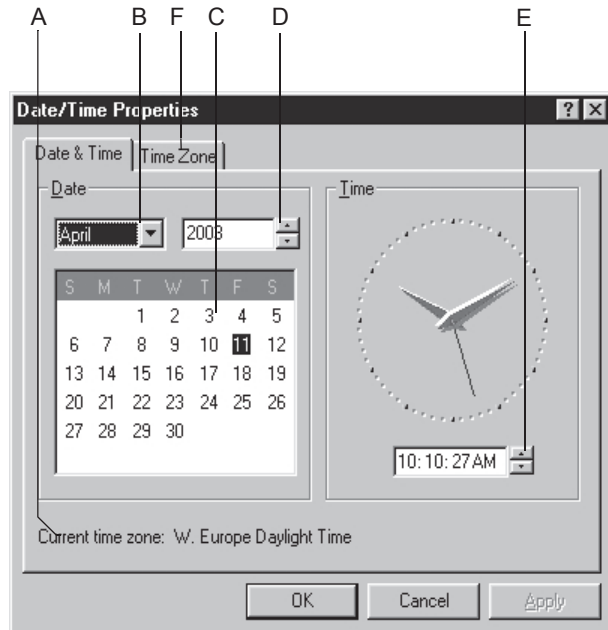

930A

- A Selected time zone.
- B Click to select the month.
- C Click to select the day.
- D Click to select the year.
- E Click to change the system time.
- F Click to select the *Time Zone*.

Note

Access to the *Date/Time Properties* dialog is restricted to authorized system users.

Procedure Statistics

Click *Procedure Statistics* (N on the *General* tab) to display the setup window.

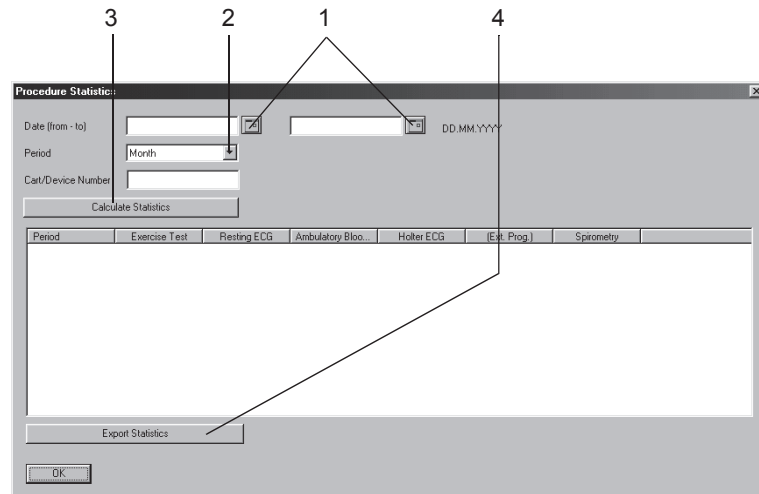

932A

1. Enter the date range for the statistical analysis.
2. Select the period (month, quarter, year).
3. Click to calculate the statistics.
4. Click to export the data to Microsoft Excel.

Printer Settings

Click *Printer* (O on the *General* tab, page12-40) to display the setup window.

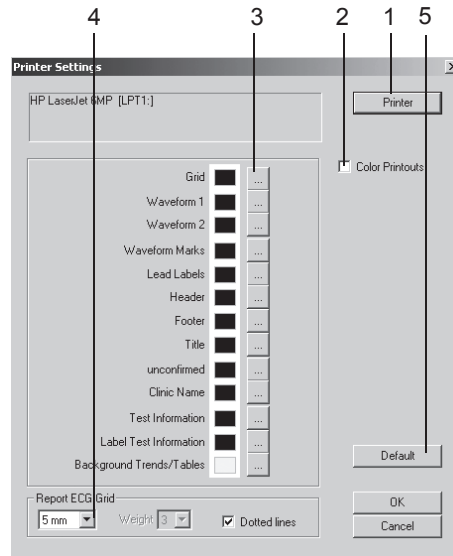

946A

1. Select the printer.
2. Select the *Color Printouts* check box, if desired.
3. Define the colors.
4. Select the ECG grid format.
5. Click *Default* to restore the initial settings.
6. Click *OK* to clear the window.

Devices Tab

Click the *Devices* tab to open the window.

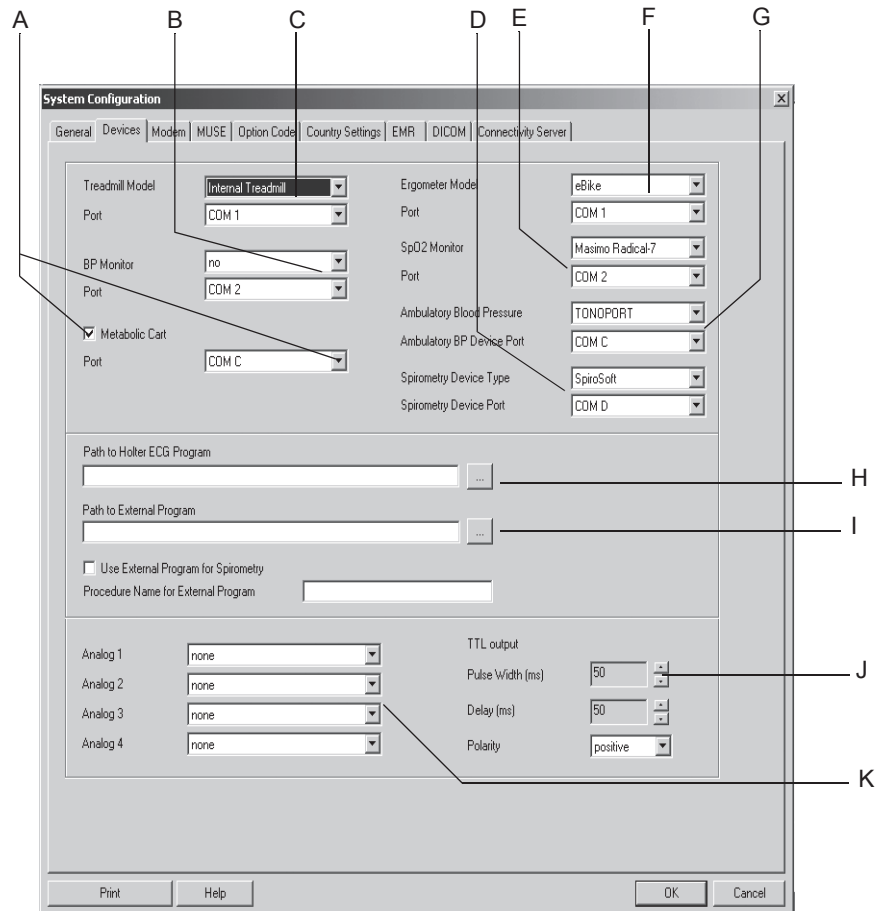

933A

- A Select check box, then select a port for the metabolic cart.
- B Click to select the BP monitor model and the port.
- C Click to select the treadmill model and the port.
- D Click to select the spirometry device type and the port (*none* indicates that the modality is inactive).
- E Click to select the SpO₂ monitor model and the port.
- F Click to select the ergometer model and the port.
- G Click to select the ambulatory BP device and the port (*none* indicates that the modality is inactive).
- H Enter or select the path to the Holter ECG program.
- I Select/deselect an external program for spirometry, enter or select the path.
- J Specify the TTL output signal characteristics.
- K Select up to 4 analog signals of the CAM-USB A/T interface. The selections become effective only after you have started the exercise test mode.

Modem Tab

Click the *Modem* tab to open the window.

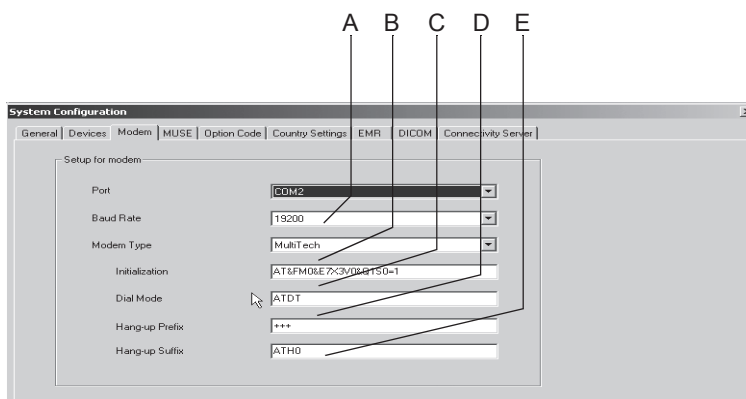

934A

- A Select modem port and baud rate (same baud rate at sending and receiving units).
- B Select the modem type.
- C Field for entry of the initialization string (entered automatically for *MultiTech* and *ELSA* modems).
initialization string for other modem types (e.g. MultiTech 56K):
AT&FM0&E7<3V0&S0=1
- D Field for entry of the dial mode (pulse / touch tone dialing).
- E Field for entry of the *Hang-up Prefix* and *Hang-up Suffix*.

Warning

Patient Hazard — All modems connected to the system must meet the requirements of IEC 60950 or UL1950. The specific regulations valid in your country must also be observed. The modem must be installed within the medical location, but not in the patient vicinity.

Note

For *Dial Mode*, *Hang-up Prefix* and *Hang-up Suffix*, please refer to the user manual of your modem.

MUSE Tab

Click the *MUSE* tab to open the window.

Note

CardioSoft is compatible with the following versions of the MUSE system: Pre 5C, 5C to 7.1 or 7.2 and above.

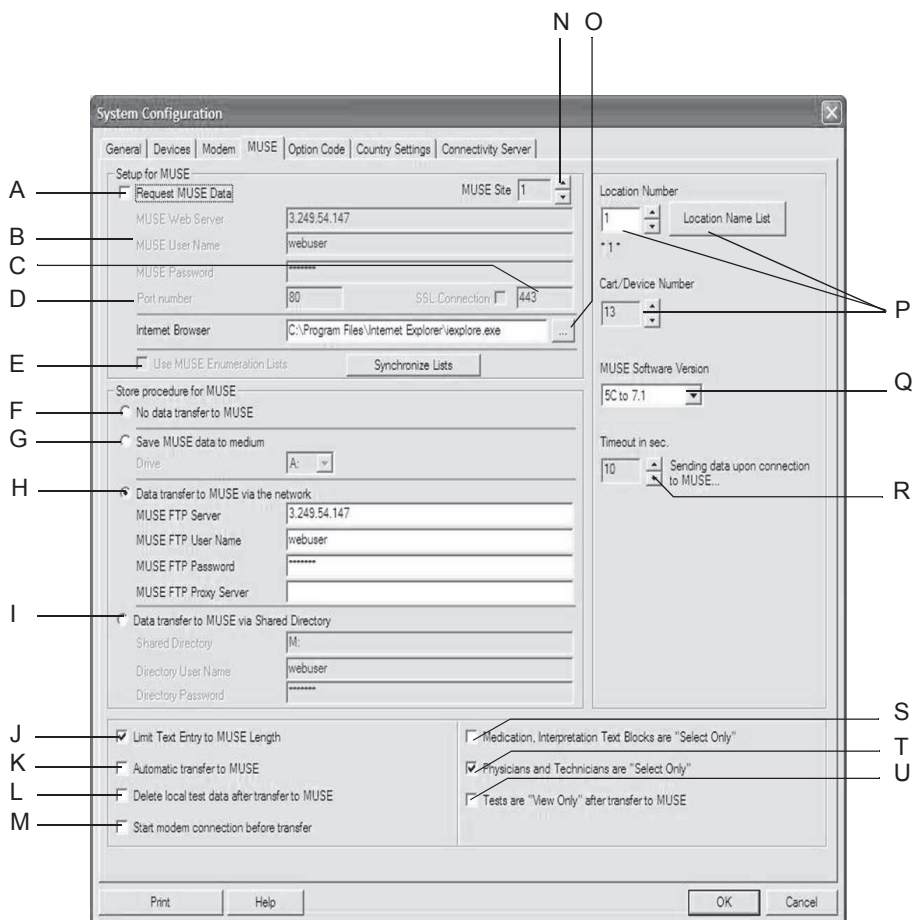

- A Select to retrieve patient data and orders from the MUSE system.
- B Enter information required for communication with the MUSE web system.
- C Select, if SSL is configured at the MUSE Web server.
- D Box for entry of the port number.
- E MUSE exercise test lists (comments, reason for test, interpretation, etc.) are used: Yes/No. Click *Synchronize Lists* to load the lists from the MUSE Web server.
- F Select when data is not transferred to a MUSE system.
- G Select to transfer data to a MUSE system via disk.
- H Select to transfer data to a MUSE system via a network. Enter MUSE FTP server information (MUSE version 5A and above).

935A

- I Select to transfer data to a MUSE system via a network, using a shared directory (allows transfer of data to older MUSE versions via the network, a separate shared directory is required for each workstation).
- J Select to limit entered texts, such as in *Patient Information*, *Test Information*, to the maximum length accepted by MUSE.
- K Select to automatically transfer each test or each modification to a test to the MUSE system.
- L Select to automatically delete patient records from the local database after transfer to a MUSE system.
- M Select to start the modem connection before the transfer.
- N Enter the MUSE Site number.
- O Click to configure the Internet browser. Enter the path to the Internet browser to start the MUSE Browser. Both the Internet browser (Internet Explorer, version 4.0 and later) and the Acrobat Reader program must already be installed. The Internet browser must be set up for proper communication (web address of the MUSE system, etc.). Contact GE Medical Systems *Information Technologies Service* for details.
- P Enter location and cart/device number. Display the location name list.
- Q Select the software version of the receiving MUSE system. *Pre 5C, 5C to 7.1 or 7.2 and above*. Versions V5C and above send a more detailed data record.
- R Set the maximum permitted transmission time.
- S Select to prevent adding of new texts in the *Medication* and *Interpretation* windows. If deselected, texts can be added.
- T Select to prevent adding of new texts in the *Physicians* and *Technicians* windows. If deselected, texts can be added.
- U Select to prevent editing of tests after transfer to the MUSE system.

Note

Use the GE Healthcare network installation kit to ensure all patient isolation requirements are met.

A GE Healthcare Service Representative is required to configure the MUSE system.

Only resting ECGs and exercise tests can be transferred to the MUSE system.

The following resting ECG information is not transferred to the MUSE system, because MUSE does not support this type of data:

- ◆ hospital name, street, QT dispersion
- ◆ arrhythmia labels for each QRS complex
- ◆ vector loops
- ◆ lead-related measuring values (Tabular Summary)
- ◆ Full Disclosure ECG

The following exercise test information is not transferred to the MUSE system, because MUSE does not support this type of data:

- ◆ Sokolov index, QT dispersion

- ◆ full disclosure ECG
- ◆ arrhythmia review
- ◆ ST/HR slope
- ◆ ST/HR index
- ◆ waterfall
- ◆ TWA trends
- ◆ TWA medians

Option Code Tab

Click the *Option Code* tab to open the option code window. If you have purchased additional software options, enter the option codes to activate the software options. The code numbers are given on the supplied option code sheets or on a disk.

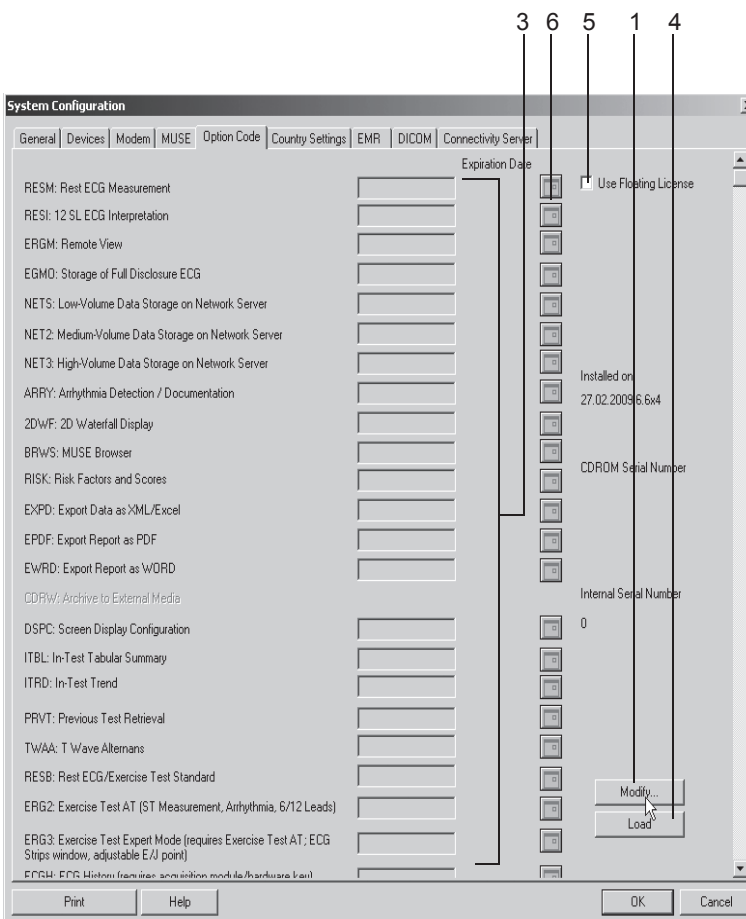

936A

1. Click *Modify...*
2. When asked *Change software option. Are you sure?*, click *Yes* to clear the window.
3. Enter the option code in the appropriate field, or
4. Click *Load* to load the option code from disk.
5. Select this check box, when using the *Floating License* option.
6. To enable an option for a limited period of time, click the icon and enter the expiration date (if not yet displayed).

Note

If you are working with the simulated test data *Test Patient* you can activate all options with the code number "123".

Country Settings Tab

Click the *Country Settings* tab to open the window.

Note

After selecting the language, first load the factory settings to set all text libraries to the new language (*Custom Setup — Factory Settings — Load*).

Select Chinese, Japanese, Korean or Russian only when the operating system of your computer supports the required character sets.

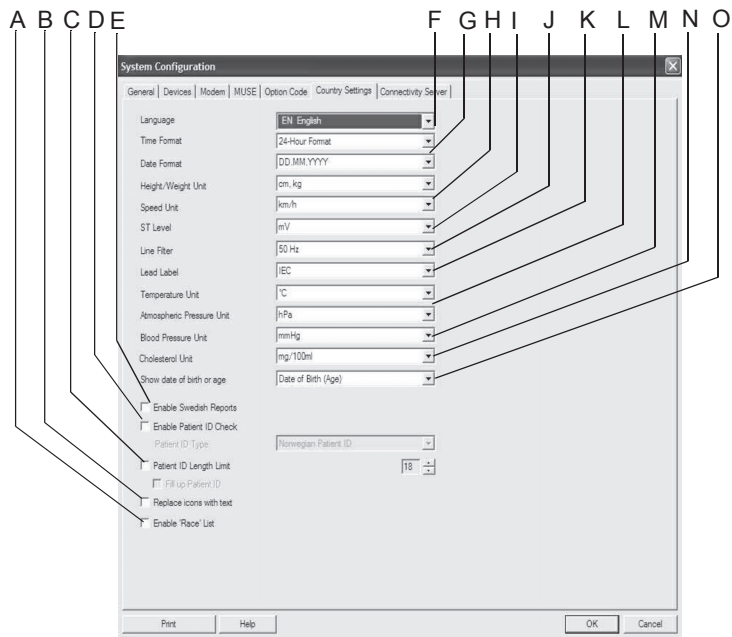

937A

- A Select to enable the race list on the patient information screen.
- B Select to replace the icons on the control buttons with text labels.
- C Select to limit the length of patient IDs (3 to 29 digits).
- D Select to enable the Patient ID Check feature (select patient ID type).
- E Select to enable the Swedish report formats.
- F Select the language.
- G Select the time and date format.
- H Select the units for weight, height and speed (the same speed unit must be selected at the treadmill).
- I Select the ST level unit.
- J Select the AC line filter frequency (off = filter off).
- K Select the ECG lead labels (IEC, AAMI).
- L Select the units for temperature and atmospheric pressure (for spirometry).
- M Select the blood pressure unit.
- N Select the cholesterol unit.
- O Select whether you wish to see the patient's date of birth or age.

EMR Tab

Click the *EMR* tab to open the window (with XEMR option only).

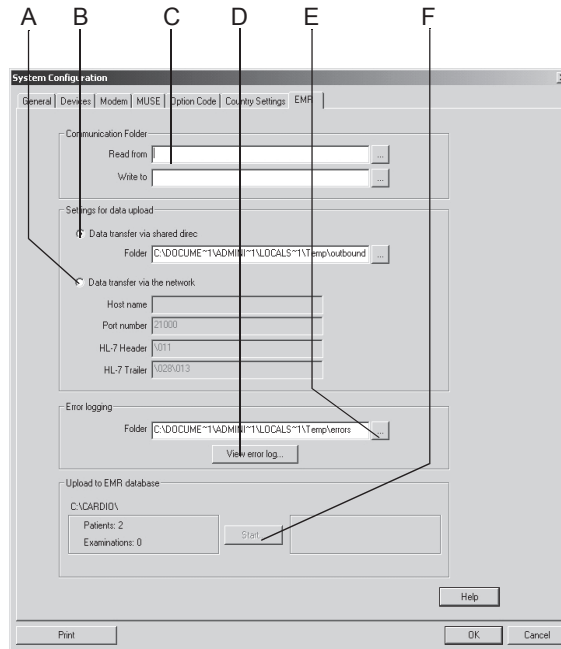

941A

- A Select to transfer data to the EMR interface via a network.
- B Select to transfer data to the EMR interface via a shared directory.
- C Set or select the communication folders (read orders from the EMR interface, write data to the EMR interface).
- D Click to view the error log.
- E Set or select the error log folder.
- F Click to start data transfer (patient data, test data) from CardioSoft to the EMR interface directories selected at A or B.

Connectivity Server Tab

Note

Information about installing the connectivity server can be found in the CardioSoft Software Installation and Upgrade Guide.

Click the *Connectivity Server* tab to open the window.

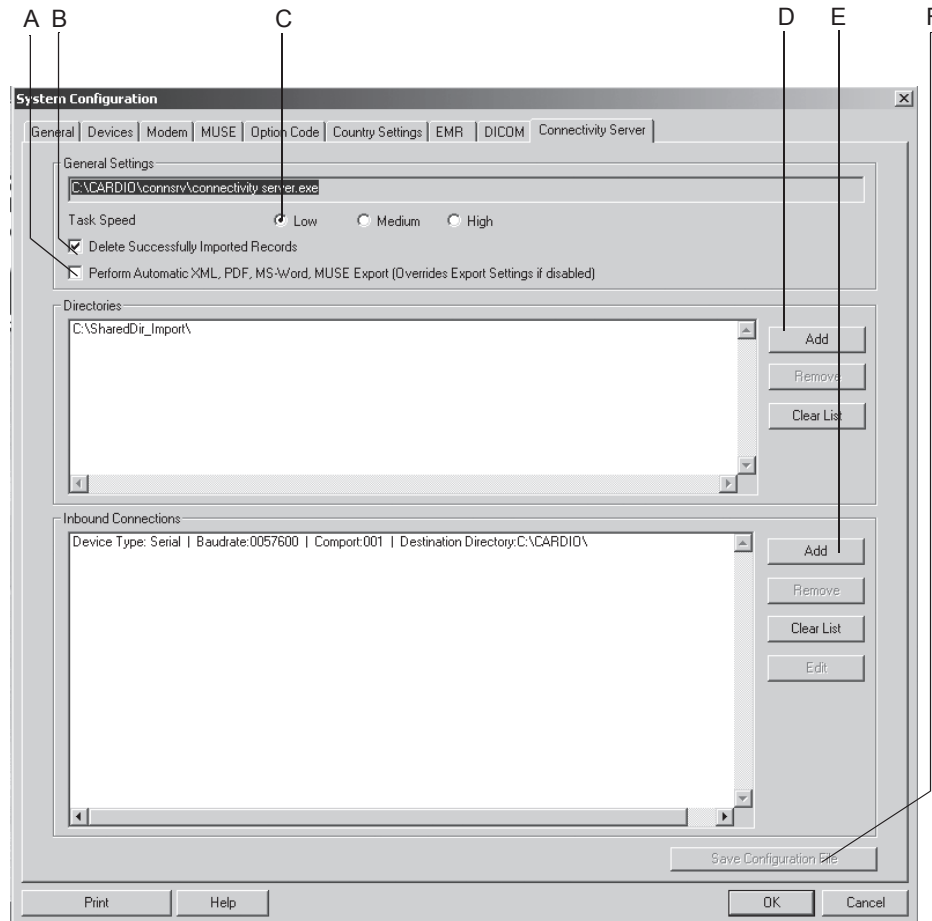

947A

- A Select to automatically export data in Word, XML or PDF format as configured in the System Configuration (see “[System Configuration](#)” on page 12-40 and “[Export](#)” on page 9-9). The selection is also valid for data export to the MUSE system (see “[MUSE Tab](#)” on page 12-56). If deselected, the system settings defined for export and for MUSE apply.
- B Select to delete patient records that were successfully imported to the CardioSoft database from a remote folder.
- C Query speed - Low: long pause between query cycles, High: short pause.

- D Click to open a dialog to add shared directories. You select a folder for which you have permission to save data. Normally, a user will be created and the rights needed to save data are assigned to this user. On the cart, this user is used to log onto the system. After this, the folder is regularly checked and existing data records are transferred.
- E Click to open a dialog to add inbound connections (see below).
- F Click to save the settings.

Adding Inbound Connections

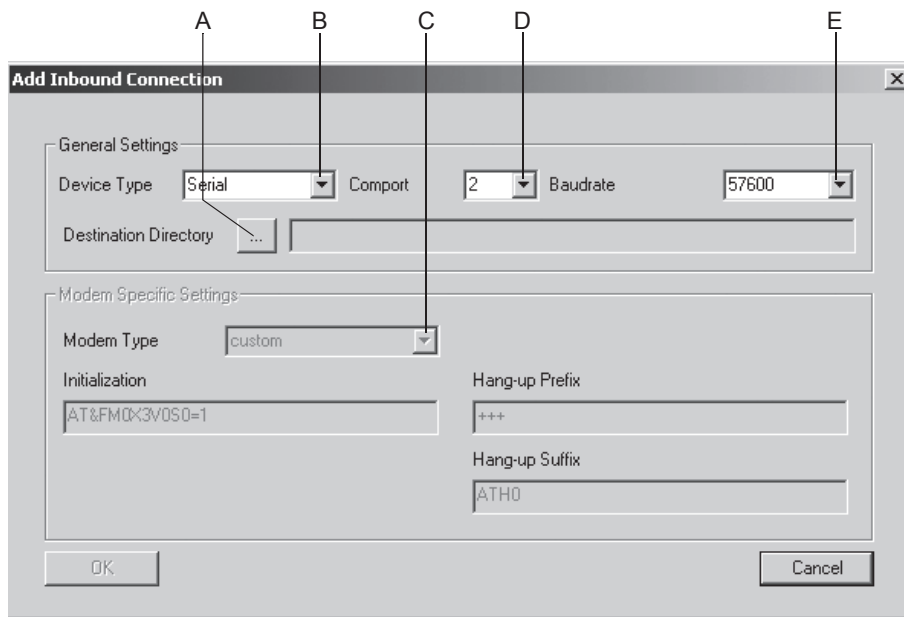

948A

- A Click to select the target directory (the existing directory where the incoming data are stored will be added here). The connectivity server will monitor this directory and the data received will be downloaded.
- B Click to select the type of connection: *Serial* or *Modem*.
- C Click to select the modem type (see “Modem Tab” on page 12-55).
- D Click to select the port for the connectivity server. The server will receive data via this port (usually in conjunction with serial/IP software which provides virtual COM ports and is able to map TCP/IP (LAN) links to COM ports).
- E Click to select the baud rate. For modems, a maximum baud rate of 57600 is supported, for serial connections, a maximum baud rate of 115200.

DICOM Tab

Note

A valid DICOM option code will activate the DICOM interface as well as the *DICOM* tab.

Configurations on the *DICOM* tab should be referred to IT/Service staff (see Field Service Manual).

A Cleaning and Maintenance

For your notes

Cleaning, Disinfection, and Maintenance

Equipment Surface

Warning

Shock Hazard — Disconnect the power cord from the wall outlet before cleaning or disinfecting the system.

- Use a moist cloth to wipe the surface clean; do not allow liquids to enter the system. All cleaning agents and disinfectants commonly used in hospitals and containing up to 70% alcohol are suitable. If liquids have entered the system, notify service to have the system inspected for damage before it is used again.
- DO NOT use disinfectants with a phenol base or peroxide compounds to disinfect the external surfaces.

Cables, Electrodes

- Disconnect the cable from the system before cleaning or disinfection. To disconnect cables, always pull on the plug, not on the cable.
- Rub the cables clean with soap water, use a disinfectant for disinfection. All cleaning agents and disinfectants commonly used in hospitals and containing up to 70% alcohol are suitable. Do not immerse the cables in liquids.
- Discard single-use adhesive electrodes immediately after removing them from the patient to prevent that they are reused.
- Immediately after removing them from the patient, clean reusable electrodes as described in the instructions for use.

Maintenance

Before Each Use

Before each use, visually inspect the equipment, the cables and the electrodes for signs of mechanical damage.

If you detect damage or impaired functions which may result in a hazard to the patient or the operator, the items must be repaired or replaced before use.

The system does not require other regular maintenance.

Technical Inspections

For safety, the devices require regular maintenance. To ensure functional and operational safety of this system, Technical Inspections should be carried out on an annual basis.

These checks should be referred to individuals with adequate training and experience.

The inspections can be carried out by GE Healthcare Service within the framework of a service agreement. The Technical Inspections include:

- Visual inspection of the device and of the accessories for mechanical damage that may impair their function.
- Verification of the safety-related labeling for legibility.
- A function test.
- Measurement of the leakage current and of the resistance of the protective conductor according to local regulations.

The system does not require other regular maintenance.

Disposal at the End of Its Service Life



This symbol indicates that the waste of electrical and electronic equipment must not be disposed as unsorted municipal waste and must be collected separately. Please contact an authorized representative of the manufacturer for information concerning the decommissioning of your equipment.

B Miscellaneous

For your notes

Connecting Peripheral Devices

Note

Ergometers and treadmills must be calibrated before being used with the system. Refer to the appropriate service manuals for calibration information.

Bicycle Ergometers

Connect bicycle ergometers to the COM ports.

Model	Configuration
Ergoline 900 / 900 L / 900 EL ¹), variobike 500	Ergoline 900
eBike PC, eBike PCplus, eBike L, eBike EL	eBike

1. See [“Connecting ERGOLINE 900/900 L/900 EL Ergometers to the System”](#) on page B-3

Connecting ERGOLINE 900/900 L/900 EL Ergometers to the System

Set the following parameters at the ergometer:

- ECG type: P10
- Baud rate: 4800

The ergometer software must be version V436 or V236; ergometers with a 4-button control panel must be software version 752 or M343.

Plug the round connector of the connecting cable into the **J10 / RS 232** port of the ergometer and the other end into one of the **COM** ports of the system.

Treadmills

Connect treadmills to the COM ports.

Model	Configuration
Treadmills without digital communication interface	internal treadmill
GE Medical Systems <i>Information Technologies</i> treadmills	Series 2000
■ 1800	
■ 1900	
■ T2000/T2100	
■ T2100	T2100

Note

Other bicycle ergometers and treadmill models with an analog port can be connected to the analog output of the system.

Blood Pressure Monitor

Connect blood pressure monitors to the COM ports.

Model	Configuration
integrated in the ergometer	integrated in the ergometer
no BP monitor (with prompt to take BP measurement)	none
SunTech 4240 and 2120 (Tango), Tango+	Suntech 4240
bosotron 2 / BP 511	Bosotron

The BP monitor must be ready for operation before the exercise test is activated. Otherwise the system will not recognize it and prompt the user to take manual BP measurements.

If a measurement takes more than 60 seconds to complete, the values may appear in the tabular data for the next stage or phase.

If no external BP monitor is connected, the system defaults to the BP monitor integrated in or connected to the ergometer.

Note

If the systolic pressure is expected to exceed 200 mmHg, select a higher deflation rate at the BP monitor to expedite the measurement. The bosotron 2 will terminate the measurement after approx. 90 seconds.

If the bosotron 2 identifies problems while taking a measurement, the values will be displayed on the Bosotron 2, but they will not be accepted by the program.

Always use the SunTech ECG electrodes, when taking BP measurements with the SunTech 4240 during exercise tests.

Setting Up the SunTech 4240 BP Monitor

This BP monitor needs to be configured once:

1. On the program screen select *Change Test Parameters*.
Move the cursor with the *LAST* and *NEXT* keys.
2. Confirm selections with *YES*.
3. Select *Set BP Reading Interval* and press *YES* to confirm the selection.
4. Select *MAN* for *PRE*, *TEST* and *POST* (with *YES* or *NO*, 1 to 90 min, *MAN*).
5. Display the program screen again by pressing *OK* twice and select *Utilities*.

6. Confirm the selection with *YES*.
7. Choose *Select System Interface* and press *YES* to confirm the selection.
8. Select *SUNTECH* with *YES* or *NO*.
9. Display the program screen again by pressing *OK* twice.

The setup is now complete. From now on the system will start the BP monitor.

SpO₂ Monitor

Connect SpO₂ monitors to the COM ports.

Model	Configuration
Masimo Radical-7	Masimo Radical-7
Tango+	in BP monitor

The system only indicates the current SpO₂ level.

Configurations are performed directly at the SpO₂ monitor.

ECG Recorder

Connect MAC 1200 (V5.21 or later) to a COM port, using a serial cable.

Connect MAC 500 (V2.22 or later) to a serial port via an IR converter.

Connect MAC 600, MAC 800, MAC 1600, MAC 3500, MAC 5000, MAC 5500 to LAN, serial port (RS232), modem.

Modem

Connect the modem to a COM port, using a serial cable.

Laser Printer

Local Printer

WARNING

Patient Hazard — Do not set up the printer in the patient vicinity (1.5 m).

- GE Healthcare recommends the printer model HP LaserJet P3015dn.

- Observe the installation instructions supplied with the printer.

Note

For printer selection information, please refer to Chapter 12, “System Settings” .

Printers in a Network Environment

WARNING

Patient Hazard — As stipulated in IEC 60601-1, printers operated in the patient environment must be connected via an isolation transformer or to a potential equalization system (protective earth conductor).

- Recommended storage capacity: 8 MB
- Recommended printer: HP LaserJet P3015dn

Application Tips

General Application

When operating the system in a network environment, periodically scan the system for viruses. The anti-virus software should be updated on a weekly basis. Customers are responsible for installation and maintenance of anti-virus software.

Recording ECGs of Pacemaker Patients

It is not possible to display pacing pulses directly in all situations. At a sweep speed or writer speed of 50 mm/s and a pulse duration of just 0.5 ms, the width of the recorded pacing pulse would be a mere 0.025 mm. When the pace enhancement is enabled (see “Miscellaneous Tab” on page 12-8), a 6-ms impulse with the correct polarity and with an amplitude of 0.5 mV replaces the pacer pulse. Depending on the polarity of the pacer pulse in leads I and II, the pacer pulse in lead III may be suppressed.

Note

- ◆ The Cubic Spline and the FRF algorithm cause a signal delay of approx. 2 seconds; therefore they should be disabled for adjustment of the pacemaker parameters.
- ◆ If several adverse conditions exist at once, the possibility of pacer pulses being interpreted as QRS complexes should be considered. At the same time, however, QRS complexes might be suppressed in certain situations. For safety, always watch pacemaker patients closely.

Recording ECGs During Defibrillation

The patient signal input is defibrillation-proof. Therefore, it is not necessary to remove the ECG electrodes prior to defibrillation.

When using stainless steel or silver electrodes a defibrillator discharge current may cause the electrodes to retain a residual charge causing a polarization or DC offset voltage at the electrode/skin interface. This electrode polarization will block acquisition of the ECG signal for several minutes. To avoid this condition, use silver-silver chloride electrodes.

If other electrodes are used, we recommend disconnecting the patient cable from the system before delivering the defibrillation shock.

The Cubic Spline and the FRF algorithm cause a signal delay of approx. 2 seconds; therefore they should be disabled if the patient has to be defibrillated while the ECG is being recorded (“Acquisition Tab” on page 12-3).

We recommend using non-polarizing disposable electrodes with defibrillation recovery ratings as specified in AAMI EC 12.3.2.2.4 (MMS P/N 900703 Silver Trace). AAMI EC12 requires that the polarization potential of an electrode pair does not exceed 100 mV 5 seconds after a defibrillation discharge.

Note

If excessive DC voltages are present at the electrode, then a message will appear indicating a Lead Off condition.

Exercise Test Interpretation (XTI)

An exercise test on a treadmill or a bicycle delivers a large number of measurements that are valuable in predicting morbidity/mortality, in detecting coronary artery disease and in describing the functional exercise response of a patient.

However, it is very difficult to have a comprehensive knowledge of all measurements and their thresholds, especially of the new ones, namely HR recovery, FVE recovery, ST/HR hysteresis, and HR reserve used.

The Exercise Test Interpretation (XTI) program compares the exercise measurements against established thresholds and provides statements and reasoning texts (explanation of the statements) when thresholds are exceeded.

Following is an example of a statement with the accompanying reasoning text:

Ischemia, probably caused by coronary artery disease

because ST/HR hysteresis > 0.02 mV in [V5 V6] and

HR reserve used < 70%

The intention of the statements and reasoning texts is to provide a short, clear, and accurate overview of the results of an exercise test.

For more details, please refer to the Physician's Guide to GE Stress Systems, Part No. 2009352-001, Revision E.

Duke Treadmill Score

1. The system automatically generates the Duke Treadmill Score using the following standard computation.

$$\text{Duke Treadmill Score} = \frac{\text{(Bruce) Exercise Time (minutes)}}{\text{maximum ST deviation (mm)}} - 5 \left\{ \begin{array}{l} \text{maximum} \\ \text{ST deviation} \\ \text{(mm)} \end{array} \right\} - 4 \text{ (Angina Index)}$$

Angina-Index 0 = none, 1 = non-limiting, 2 = limiting

NOTE

Maximum ST deviation refers to the amount of exercise-induced ST segment deviation, i.e., the largest elevation or depression after baseline ST levels have been subtracted.

- ◆ The calculated ST deviation value depends on the J+x setting (default: J+60 ms). High heart rates may affect the accuracy of this value.
- ◆ The calculated ST deviation does not differentiate between horizontal, downsloping and upsloping ST segments, nor is Q wave significance considered.

NOTE

The user must verify and possibly correct the system-calculated value.

2. Duke Treadmill Score Risk Categories are assigned according to the following ranges:
 - ◆ $\geq (+5)$ low
 - ◆ (-10 to +4.9) intermediate
 - ◆ $< (-10)$ high
3. Prognosis percentages for 5-year survival and average annual mortality are calculated from the nomogram of the prognostic relations embodied in the Duke Treadmill Score.
4. Exercise time using the Bruce Protocol is standard. Equivalent measures in multiples of resting oxygen consumption (METs) from an alternative protocol can be used.

References

Study the following publications for a correct understanding of the Duke Treadmill Score:

Gibbons et al.: ACC / AHA Guidelines For Exercise Testing. JACC, 30 (1):260 - 315, July 1997.

Mark, D.B.; Shaw, L.; Harrell, F. E.; Lee, K. L.; Bengton, J.R.; McCants, C.B.; Califf, R.M.; Pryor, D.B.: Prognostic value of a

treadmill exercise score in outpatients with suspected coronary artery disease. *The New England Journal of Medicine*. 325 (12): 849 - 853 (Sept. 1991)

Mark, D.B. An overview of risk assessment in coronary artery disease. *The American Journal of Cardiology*. 73: 19B - 25B (March 1994)

Mark, D.B.; Hatky, M.A.; Harrell, F.E.; Lee, K.L.; Bengton, J.R.; Califf, R.M.; Pryor, D.B. Exercise treadmill score for predicting prognosis in coronary artery disease. *Annals of Internal Medicine*. 106 (6): 793 - 800 (June 1987)

Risk Factors

According to the "Instructions of Using Coronary Risk and Stroke Risk Prediction Charts and Worksheet" proposed by the American Heart Association (AHA) (see also Physician's Guide to GE Stress Systems) the system automatically calculates the risk factors for coronary heart disease and myocardial infarction. If an input value is unknown or out-of-range, the system uses the following risk factor values:

Table 2. Coronary Heart Disease Risk Factor Values for Unknown or Out-of range Parameters

Parameter	Value	Value Used
Age (female) unknown	unknown	40
	< 30 years	30
	> 74 years	74
Age (male) unknown	unknown	33
	< 30 years	30
	> 74 years	74
Age (gender unknown)	all values	33
HDL-Cholesterol	unknown	50
	< 25	25
	> 96	96
Total-Cholesterol	unknown	199
	< 139	139
	> 330	330
Systolic Blood Pressure	unknown	120
	< 98	98
	> 185	185
Smoker	unknown	no
Diabetic (male or female)	unknown	no
Diabetic (gender unknown)	all values	no
ECG-LVH (ECG indicative of left-ventricular hypertrophy)	unknown	no

Table 3. Male Stroke Risk Factor Values for Unknown or Out-of range Parameters

Parameter	Value	Value Used
Age	unknown	56
	< 54 years	54
	> 86 years	86
Systolic Blood Pressure	unknown	105
	< 95	95
	> 213	213
HYP RX (anti-hypertensive medication)	unknown	no

Table 3. Male Stroke Risk Factor Values for Unknown or Out-of range Parameters

Parameter	Value	Value Used
Diabetes	unknown	no
Smoker (cigarettes)	unknown	no
CVD (cardiovascular disease)	unknown	no
AF (atrial fibrillation)	unknown	no
LVH (left-ventricular hypertrophy)	unknown	no

Table 4. Female Stroke Risk Factor Values for Unknown or Out-of range Parameters

Parameter	Value	Value Used
Age	unknown	56
	< 54 years	54
	> 86 years	86
Systolic Blood Pressure	unknown	104
	< 95	95
	> 204	204
HYP RX (anti-hypertensive medication)	unknown	no
Diabetes	unknown	no
Smoker (cigarettes)	unknown	no
CVD	unknown	no
AF	unknown	no
LVH	unknown	no

Spirometry Reference Value Equations, Interpretation Modes, Measurements

Reference Value Equations

ECCS/Zapletal

This equation uses reference values developed by QUANJER (ECCS93) and ZAPLETAL.

The ECCS reference values were published 1993 (ISBN 87-16-15024-4).

The reference values are height and gender-related and are defined for patients aged 19 to 70 years.

NOTE

- ◆ Patients between 19 and 25 years of age are assumed to be 25.
- ◆ A range for height is not defined.

The ZAPLETAL reference values were published 1987. (Progress of Respiration Research Vol 22 (1987): Lung function in Children and Adolescents; ISBN: 3-8055-4495-2).

The reference values are height and gender-related and are defined for patients aged 5 to 18 years.

NOTE

- ◆ Height range from 107 cm to 182 cm.
- ◆ For patients exceeding the range limits, the limit values will be used.

The equation defines the following reference values: FEV1/FVC (calculated from single values), FEV1, FVC, MEF25, MEF50, MEF75, MMEF, PEF, VC (same as FIVC).

NHANESIII

This reference value equation was published 1999 (AM J RESPIR CRIT CARE MED 1999; 159:179-187).

The reference values are height and gender-related and are defined for patients aged 8 to 80 years from the ethnic groups Caucasian (Race selection: *Caucasian*), African American (Race selection: *Black*), Mexican American (Race selection: *Hispanic*).

NOTE

- ◆ Height range from 110 cm to 200 cm.
- ◆ Age range from 8 to 80 years.
- ◆ For patients exceeding the range limits, the limit values will be used.

The equation defines the following reference values: FEV1, FEV6, FVC, PEF, MMEF, FEV1/FEV6, FEV1/FVC.

Knudson

This reference value equation was published 1983 (KNUDSON et al. Am Rev Respir Dis 127 (1983) 725-734).

The reference values are height and gender-related and are defined for patients aged 5 to 90 years from the ethnic groups Caucasian (Race selection: *Caucasian*), African American (Race selection: *Black*).

NOTE

- ◆ Age range from 5 to 90 years.
- ◆ For patients exceeding the range limits, the limit values will be used.
- ◆ A range for height is not defined.

The equation defines the following reference values: VC (same as FIVC), MEF75, MEF50, MEF25, PEF, MMEF, FVC, FEV1, FEV1/FVC.

Forche

This reference value equation was published 1994 (Sollwerte für die Lungenfunktion; Arbeitskreis für die Standardisierung der Österreichischen Gesellschaft für Lungenerkrankungen und Tuberkulose 1994).

The reference values are height and gender-related and are defined for patients aged 5 to 90 years, for adolescents the values are also weight-related.

NOTE

- ◆ Age range from 5 to 90 years.
- ◆ For patients exceeding the range limits, the limit values will be used.
- ◆ A range for height is not defined.

The equation defines the following reference values: VC (same as FIVC), MEF75, MEF50, MEF25, PEF, FVC, FEV1, FEV1/FVC.

Finland

The equation combines the reference value developed by VILJANEN and WANNE.

The reference values by VILJANEN were published 1982 (Scand. J. clin. Invest. Vol. 452 Suppl. 159 1982).

The reference values are height and gender-related and are defined for patients aged 18 to 65 years.

NOTE

- ◆ Age range from 18 to 65 years.
- ◆ For patients older than 65 years, the age is set to 65.
- ◆ A range for height is not defined.

The equation defines the following reference values: MEF25, MEF50, PEF, FVC, FEV1, FEV1/FVC, VC (same as FIVC).

The reference values by WANNE are height and gender-related and are defined for patients aged 6 to 17 years.

NOTE

- ◆ Age range from 6 to 17 years.
- ◆ For patients younger than 6 years, the age is set to 6.
- ◆ A range for height is not defined.

The equation defines the following reference values: MEF50, PEF, FVC, FEV1, FEV1/FVC, VC (same as FIVC).

Brazil

The *Brazil* equation is based on the reference values by PEREIRA and MALLOZI.

The reference values by PEREIRA were published 1992 (Jornal de Pneumologia 1992; 18:10-22).

The reference values are height and gender-related and are defined for men aged 25 to 78 years and women aged 20 to 78 years.

NOTE

- ◆ Age range 25 to 78 years for men and 20 to 78 years for women.
- ◆ For patients older than the upper limit, the upper limit will be used.
- ◆ A range for height is not defined.

The equation defines the following reference values: PEF, FVC, FEV1, FEV1/FVC, MMEF.

The reference values by MALLOZI were published 1995 (Tese, Doutorado, Escola Paulista de Medicina, 1995; 116p.).

The reference values are height and gender-related and are defined for men aged 6 to 24 years and women aged 6 to 19 years.

NOTE

- ◆ Age range 6 to 24 years for men and 6 to 19 years for women.
- ◆ For patients younger than the lower limit, the lower limit will be

used.

- ◆ A range for height is not defined.

The equation defines the following reference values: PEF, FVC, FEV1, FEV1/FVC, MMEF.

Interpretation Modes

Note

The authors of the reference values developed the interpretation modes for the reference value equations. Other reference value equations may lead to different interpretations.

Europe

An interpretation mode on the basis of the ECCS reference values. The flow-volume loop is analyzed according to these criteria:

1. Expiratory flow limitation?
2. Curve typical of restriction?
3. Expiratory stenoses?
4. Impaired peripheral respiration?

Expiratory flow limitation

Possible causes	increased airway resistance (e.g. asthma), reduced pulmonary elasticity (e.g. emphysema), airway obstruction
Criterion	MEF50 % VC Ref.
Definition	Interpretative Statement
> 70 %	normal*
50 ... 70 %	mild expiratory flow limitation
35 ... 49 %	moderate expiratory flow limitation
< 35 %	severe expiratory flow limitation
if < 70 %	further lung function measurement recommended

* If all four interpretation criteria are *normal*, the interpretative statement *Normal lung function values* is displayed.

Curve typical of restriction

Possible causes	reduced lung volume (restriction), elevated pulmonary elasticity (fibrosis)
Criterion	FVC Act. < xx % FVC Ref. and (VC MAX / (2 x MEF50) < 0.8)
Definition	Interpretative Statement
> 70 %	normal*
50 ... 70 %	curve typical of mild restriction
< 49 %	curve typical of moderate to severe restriction
if < 70 %	further lung function measurement recommended

Expiratory stenoses

Possible causes	Stenoses in the large airways, extrathoracic flow obstruction, expiratory tracheal stenosis
Criterion	FVC Act. / PEF > 0.8
Definition	Interpretative Statement
< 0,8	normal*
> 0,8	Further examination for extrathoracic flow obstruction and expiratory tracheal stenosis recommended. Watch patient cooperation.

* If all four interpretation criteria are *normal*, the interpretative statement *Normal lung function values* is displayed.

Impaired peripheral respiration

Possible causes	reduced pulmonary elasticity (emphysema), impaired ventilatory distribution, peripheral airway obstruction
Criterion	VC MAX / (2 x MEF50)
Definition	Interpretative Statement
T50 % = < 0.8 s	normal*
T50 % = 0.8 - 1 s	mild expiratory flow limitation at deep expiration
T50 % = > 1 s	moderate to severe expiratory flow limitation at deep expiration
if > 0.8 s	further lung function measurement recommended

* If all four interpretation criteria are *normal*, the interpretative statement *Normal lung function values* is displayed.

CHS

Interpretation mode based on the "American Thoracic Society recommendations for disability testing." The most important criterion used is the FEV1 / FVC ratio; the changes of FEV 1 and FVC are also considered. The underlying reference values are those published by KNUDSON.

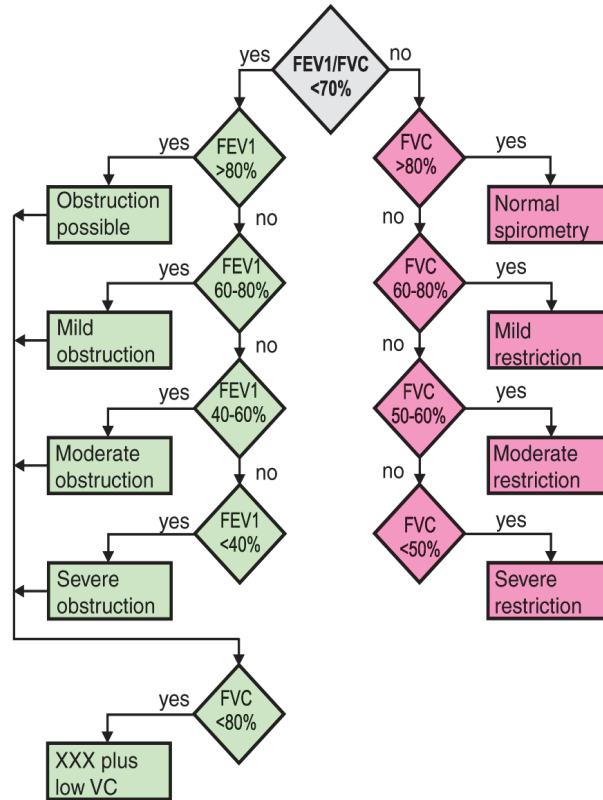

XXX = "Obstruction possible" or "Mild" or "Moderate" or "Severe obstruction"

211A

Definition of Spirometry Test Values

FVC	forced expiratory vital capacity
FEV05	forced expiratory volume in the first 0.5 seconds
FEV1	forced expiratory volume in the first second (same as FVC, if exhalation time < 1 second)
FEV1/FVC	FEV1 as a percentage of FVC
FEV3	forced expiratory volume in the first 3 seconds (same as FVC, if exhalation time < 3 seconds)
FEV6	forced expiratory volume in the first 6 seconds (same as FVC, if exhalation time < 6 seconds)
FEV1/FEV6	FEV1 as a percentage of FEV6
PEF	peak expiratory flow
MEF75	maximal expiratory flow when 75% of FVC remain to be exhaled
MEF50	maximal expiratory flow when 50% of FVC remain to be exhaled
MEF25	maximal expiratory flow when 25% of FVC remain to be exhaled
MMEF	maximal mid-expiratory flow (between 25 and 75% of FVC)
FIVC	forced inspiratory vital capacity
FIV1	forced inspiratory volume in the first second
FIV1/FVC	FIV1 as a percentage of FVC
PIF	maximal inspiratory flow
MIF25	maximal inspiratory flow when 25% of FIVC have been inhaled
MIF50	maximal inspiratory flow when 50% of FIVC have been inhaled
MIF75	maximal inspiratory flow when 75% of FIVC have been inhaled
MVV(ind)	maximal expiratory ventilation volume in one minute (indirectly determined: 30*FEV1)

CardioSoft Web

CardioSoft Web allows you to retrieve tests via the Internet for display on any PC.

Note

For CardioSoft Web installation instructions, please refer to the CardioSoft Software Installation and Upgrade Guide.

Points to Note

General

- The ECG traces are superimposed on a grid pattern that neither adapts to the monitor size nor to the display resolution. The grid is designed for a 17-inch monitor with a resolution of 1024 x 768 pixels.

Exercise Tests

- ST/HR Slope is not shown.

Spirometry Tests

- The comparison of two spirometry tests is not shown.

Patient Administration

- Archived patient records do not appear in the patient record list.
- The patient record list informs about
 - ◆ test type
 - ◆ date and time
 - ◆ cart/device number
 - ◆ confirmed (yes/no)
 - ◆ transferred (yes/no)
- The patient list only indicates last name, first name, date of birth, and patient ID.

Displaying Tests

1. Enter the patient's last name or the first letter of the name and click *Find...*
2. The patient list will be displayed.
3. As an alternative you can click the initial letter in the alphabet to display the patient list (e.g., click s to find the patient named Saunders).
4. Select the patient whose records you wish to see.
This will bring up the list with the patient's records.
5. Select the record you would like to review.

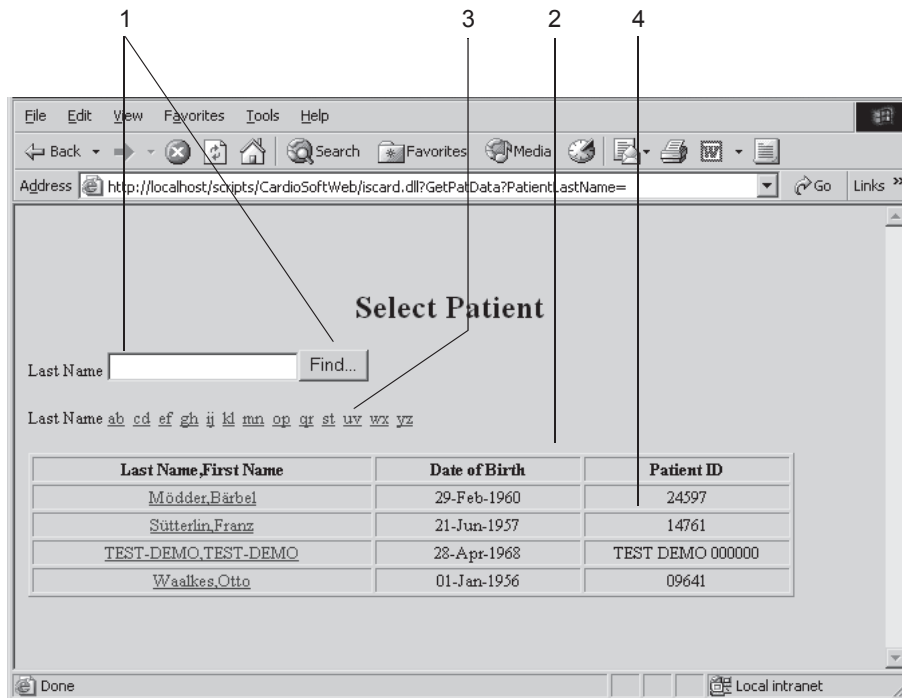

210A

Installing the Program

Note

For CardioSoft installation instructions, please refer to the CardioSoft Software Installation and Upgrade Guide.

Troubleshooting

Problem	Remedy
Installation of acquisition module not possible, module has problems sending data, red bar on ECG	<p>CAM-USB or CAM-USB A/T:</p> <ul style="list-style-type: none"> ■ green LED ON, yellow LED OFF: signal transmission in progress ■ green LED ON, yellow LED ON: ready to send ECG signals (e.g., no communication with CAM14) ■ green LED OFF, yellow LED OFF: no power ■ green LED ON, yellow LED blinking: communication with CAM14 interrupted (e.g., CAM14 not connected) ■ When a communication problem between the CAM-USB interface box and the PC occurs (due to a program crash), the box will emit a continuous tone and both LEDs will be ON. ■ If the installed manufacturer's printer driver has a spooler or print status indicator (e.g. HP), this driver must be uninstalled and all pertinent entries must be removed from the registry, if applicable. This should be referred to an authorized system administrator, because incorrect entries in the registry may cause the system to break down. Please install a standard printer driver, e.g. the Windows driver HP LaserJet 4 for laser printers.
<i>Send exercise test data</i> not possible	<ul style="list-style-type: none"> ■ Check network address of the remote PC on your local PC and correct, if necessary. ■ Check option code and correct, if necessary. ■ Enable the <i>Remote View</i> function.
Exercise test analysis does not start	<ul style="list-style-type: none"> ■ Not all required electrodes are applied. If you wish to initiate the analysis all the same, click the <i>Relearn medians</i> button.
Incorrect heart rate or arrhythmia results	<ul style="list-style-type: none"> ■ The program may have selected two unsuitable leads. Manually select two good leads (see section "Miscellaneous 1 Tab" on page 12-24).
Displayed data are incomplete.	<ul style="list-style-type: none"> ■ The screen diagonal entered in the System Configuration (section "General Tab" on page 12-40) is incorrect. ■ For screens below 17 inches: the Windows taskbar is always on top (Windows settings - Taskbar). ■ Wrong screen resolution in Windows. Please use <i>Small Fonts</i>.
The message <i>The following software options are not available:</i> appears, although all option codes were entered correctly	<ul style="list-style-type: none"> ■ The CAM-USB interface box was not connected when the program was started. Connect the CAM-USB interface box, exit the program and restart.
System does not identify ergometer.	<ul style="list-style-type: none"> ■ Incorrect ergometer model / port selected (section "Devices Tab" on page 12-54). ■ Check connection cable and connectors. ■ Turn ergometer off and on again. Restart CardioSoft.

Problem	Remedy
No communication with MUSE.	<ul style="list-style-type: none"> ■ Incorrect network address of the MUSE server or shared directory (section “MUSE Tab” on page 12-56). ■ Required options <i>Request MUSE Data</i> or <i>Send Data to MUSE</i> not enabled (section “MUSE Tab” on page 12-56). ■ Incorrect network configuration (system administrator). ■ Incorrect Internet Explorer setup (version >4.0 is required, also for sending data to MUSE).
The ECG grid is not visible in the PDF file.	<ul style="list-style-type: none"> ■ Set up Acrobat Distiller as follows <p>Acrobat V6.0:</p> <ul style="list-style-type: none"> ■ <i>Start -> Settings -> Printer -> Adobe PDF -> menu Printer -> Document Defaults -> menu Adobe PDF Settings -> disable do not send fonts to distiller;</i> ■ <i>menu Paper/Quality -> button Advanced -> Graphic and select the field Download True Type Font as Softfont.</i> <p>Acrobat V5.0:</p> <ul style="list-style-type: none"> ■ <i>Start -> Settings -> Printer -> Acrobat Distiller -> menu Printer -> Document Defaults -> menu Adobe PDF Settings -> disable do not send fonts to distiller;</i> ■ <i>menu Paper/Quality -> button Advanced -> Graphic and select the field Download True Type Font as Softfont.</i> ■ If these steps do not correct the problem, change the grid format: <i>System Configuration -> General tab -> Printer -> deselect Dotted line -> select grid format.</i> Tip: If the grid lines appear too strong, select a shade of gray rather than black.
Message <i>Not enough free memory on hard drive!</i>	<ul style="list-style-type: none"> ■ Free storage capacity on the hard drive where your database is stored, e.g., by compressing exercise test data or by deleting examinations. Also ensure that there is enough free storage capacity on the hard drive where your operating system is located and in the temporary directories (100 MB minimum).
After connection of the CAM-USB interface box to the PC, no ECGs are displayed	<ul style="list-style-type: none"> ■ Remove connector of the CAM-USB interface box from the PC, wait about 10 seconds, then reconnect. When prompted to install a new USB device, clear the prompt or any other message with <i>Cancel</i>.
Patient record cannot be opened and is reported to be locked.	<ul style="list-style-type: none"> ■ In a network environment, the currently open patient record may be locked following the crash of the client or server (e.g. due to power failure). Please contact Customer Service for advice.

Note

You can send a screenshot to GE Healthcare.

- ◆ Using the **Print** key on the keyboard, copy the screen to the Clipboard.
- ◆ Open *WordPad* by selecting *Start -> Programs -> Accessories*.
- ◆ Insert the screen from the Clipboard with *Edit -> Paste*.
- ◆ Select the page orientation, using *File -> Print setup -> Landscape*.
- ◆ Print the page and fax it to GE Healthcare or save the page as a *WordPad* document and send it via e-mail.

Remote Service

In conjunction with the InSiteExC application, CardioSoft is a system with remote service capability. For InSiteExC installation instructions, please refer to the CardioSoft Software Installation and Upgrade Guide. You must have access to the internet to be able to use the remote service capability.

WARNING

Patient Hazard — Disconnect the patient from the system during remote servicing.

System Maintenance

Data Backup

We recommend making one backup of the operating system, and daily backups of the CardioSoft software and of the patient data.

Virus Protection

To protect the CardioSoft system from viruses, the appropriate anti-virus software should be installed. Keep the virus definitions current to avoid virus infections.

CAUTION

Program Disturbance—Be sure to disable (turn off) the anti-virus software auto-protect option during use of the CardioSoft software. This will prevent the virus protection program from interfering with the CardioSoft application while a patient test is running.

Note

It is advised that you initiate a manual virus scan weekly—at a time when a patient test is NOT running.

Automatic online updates should be disabled. Instead, we recommend periodically updating the virus definition database via modem or TCP/IP network, using the manual Live Update feature (once a week, if possible).

WARNING

Patient Hazard—Disconnect the patient from the system when the modem is connected.

Direct Fax Transmission of Printer Documents

Instead of sending documents to the printer, they can be directly routed to another PC or to a fax machine. A modem with a serial port is required for this purpose. The modems recommended by GE Healthcare include the FAX software.

When installing the fax software from the original media, you can configure the fax port as the standard printer. With this setting, every print command is sent to the fax program. Enter frequently used fax numbers in the *Telephone Directory*. Select the *high* printer resolution and the landscape format. If the same image is transferred more than twice between two PCs, you must select the portrait orientation after the second transfer.

Sending a Fax

1. Display the screen to print.
2. Select the fax as the printer (e.g. fax printer CAPTURE FAX BVZP).

The program converts the ECG to an image file. Depending on computer power, this may take a few minutes. The status indicator shows the page being converted. The fax software is activated automatically after the conversion.

3. Select the addressee (from the telephone directory).
4. Select *Send*. The status window and the audible signal from the modem indicate the transfer.

Note

All modems connected to the system must meet the requirements of IEC 60950 or UL1950. Furthermore, the regulations valid in the respective countries must be observed. The modem must be set up within the medical location, but not in the patient vicinity.

WARNING

Patient Hazard — Disconnect the patient from the system when the modem is connected.

Related Physician's Guides

For detailed information on specific topics, we recommend that you refer to these physician's guides:

- Stress Test Physician's Guide, Part No. 2051167-001
- TWA Physician's Guide, Part No. 2020044-067
- Audio ECG Physician's Guide, Part No. 2051167-001
- HEART Resting ECG Interpretation Program, Part No. 22747702
- 12 SL Physician's Guide, Part No. 416791-001

C Order Information

For your notes

Order Information

Subject to change. Always refer to latest list of accessories.

2060450-001	CardioSoft standard software package for ECG analysis, including acquisition module
2060452-001	CardioSoft Client software package for ECG analysis, including hardware dongle
2060451-001	CardioSoft Viewer software package, including hardware dongle
2060629-001	Electrode application system KISS

Accessories

Optional Software Programs

45502401	Resting ECG Interpretation (RESI)
45502901	Remote View (ERGM)
45502701	Storage of the Full-Disclosure ECG (EGMO)
45503001	Data Storage on Network Server, < 3,000 tests (NETS)
2014659-001	Data Storage on Network Server, < 15,000 tests (NET2)
2014659-002	Data Storage on Network Server, unlimited number of tests (NET3)
2014659-014	Arrhythmia Detection / Documentation (ARRY)
2014659-003	2D Waterfall Display (2DWF)
2014659-004	MUSE Browser (BRWS)
2014659-005	Risk Factors (RISK)
2014659-006	Data Export in Excel or XML Format (EXPD)
2014659-007	Report Export as PDF File (EPDF)
2014659-008	Report Export as Word File (EWRD)
2014659-009	Display Configuration (DSPC)
2014659-010	In-Test Tabular Summary (ITBL)
2014659-011	In-Test Trend (ITRD)
2014659-012	Previous Test Retrieval (PRVT)
2014659-013	T-Wave Alternans (TWAA)

2014659-020	EMR Interface (XEMR)
2014659-021	Floating License (FLLX)
45502301	Resting ECG Measurement (RESM)
45502601	ST Measurement, Arrhythmia, 6/12-Lead Exercise Test (ERG2)
45503201	Exercise Test Expert Mode (ERG3)
45505101	CardioSoft Web (CWEB)
45504001	ECG History - requires hardware key (ECGH)
2014659-026	DICOM Interface (DICM)
2014659-028	ST/HR Hysteresis (STHY)
2014659-029	Exercise Test Interpretation (EXTI)

Cables

223 362 03	Connection cable for Bosotron BP monitor or variobike 500 / MAC 1200
223 380 01	Connection cable for all ergoline and eBike bicycle ergometers
223 381 01	Connection cable for SunTech 4240
700609-002	Connection cable for T2000/T2100 (RS232), ROHS
700607-001	Connection cable for treadmill models 1800 / 1900 / T2000/T2100 (RS422)

Acquisition Modules

200995-001/002	CAM-14 acquisition module
901142-005	CAM-14 acquisition module with AHA electrode connectors (requires 2009000-001 or 2009500-001 or 2009500-009)
901142-008	CAM-14 acquisition module with IEC electrode connectors (requires 2009000-001 or 2009500-001 or 2009500-009)
303 443 77	Swivel arm for KISS
384 015 84	Table-top clamp with pole
384 013 30	Wall fixture for swivel arm
2040437-001	CAM-USB Interface Box V2 , required for the CAM-14 acquisition module (901142-005, 901142-008).

2040438-001	CAM-USB A/T Interface Box V2 with analog and trigger output, required for the CAM-14 acquisition module (901142-005, 901142-008).
2040438-009	CAM-USB A/T KISS Interface Box V2 with analog and trigger output and suction pump for KISS multi-lead, required for the CAM-14 acquisition module (901142-005, 901142-008).
2024264-001	AC power adapter for CAM-USB A/T interface box or CAM USB A/T KISS interface box

CAM-14 Accessories

2016560-002	Connection cable, Device to CAM-14
420101-001	14 leadwire set
420101-002	10 leadwire set
900178-003	Grabber adapter set (10) AHA
900179-203	Grabber adapter set (14) AHA
900178-103	Grabber adapter set (10) IEC
900178-203	Grabber adapter set (14) IEC
2001926-001	Blank plugs (set of 4)
405185-001	Belt, black
419456-001	Belt clip CAM-14
401089-003	Kit AM3 leadwire separator

Electrodes

217 320 01	Adhesive electrode for children, 22 mm diameter, press stud, fixation with adesive rings 217 123 01
217 321 01	Adhesive electrode for adults, 35 mm diameter, press stud, fixation with adesive rings 927 223 00
217 194 01	Chest electrode for chest belt, 30 mm diameter
217 196 01	Chest belt for electrodes 217 194 01 and 301 340 00
9033-015	Suction electrode, small, German silver
9623-003P	Tab electrode SILVER MACTRODE plus, pkg. of 1000
9490-210	Clip adapter for SILVER MACTRODE, pkg. of 10
919 202 32	Clamp electrode for limbs, pkg. of 4 (red, yellow, green black)

Consumables

217 083 18	Electrode creme, 250-ml refill bottle
930 115 82	Dispenser, 30 ml
217 307 01	Electrode contact spray, 200-ml can
217 307 05	Electrode contact spray, 2-1 refill

Electrode Application Systems for CAM-USB A/T-KISS*

2024037-001	Set KISS standard electrodes
2024038-001	Additional electrodes for FRANK leads
2024039-001	Additional electrodes for NEHB leads
2024040-001	Additional electrodes for leads A1 to A4
303 443 77	Swivel arm for KISS
384 015 84	Table-top clamp with pole
384 013 30	Wall fixture for swivel arm
303 444 21	Clip adapter for adhesive electrodes
303 444 20	KISS support to mount on ergometer

* Not for use in the U.S. and Canada.

Spirometry Tests

2030430-100	EasyOne-CS spirometer
-------------	-----------------------

Ambulatory Blood Pressure Measurement

2001762-100	TONOPORT V ambulatory BP measurement system
-------------	---

Modem

2245794	Global Modem Kit
---------	------------------

Skin Prepping Items for Exercise Tests

9612-002	Skin prep analyzer
3704-901	Disposable razors (100 per pack)
4828-004	Alcohol pumice pad (100 pads)
4828-005	Sandpaper strips (100 per pack)

Order Information

9612-002	Skin prep analyzer
4828-006	Adhesive remover pad (100 per pack)
9386-001	Pot scrubber (200 pads/box)

For your notes



GE Medical Systems
Information Technologies, Inc.
8200 West Tower Avenue
Milwaukee, WI 53223 USA
Tel: + 1 414 355 5000
1 800 437 1171 (US Only)
Fax: + 1 414 355 3790



GE Medical Systems
Information Technologies GmbH
Munzinger Straße 3-5
D-79111 Freiburg
Germany
Tel: + 49 761 45 43 - 0
Fax: + 49 761 45 43 - 233

Asia Headquarters

GE Medical Systems
Information Technologies Asia; GE (China) Co., Ltd.
No. 1 Huatuo Road,
Zhangjiang Hi-tech Park Pudong
Shanghai, People's Republic of China 201203
Tel: + 86 21 5257 4650
Fax: + 86 21 5208 2008

www.gehealthcare.com

