

VIZIO

E421VL
E470VL
E551VL

LCD **HDTV**

www.VIZIO.com



Dear VIZIO Customer,

Congratulations on your new VIZIO E421VL, E470VL, or E551VL television purchase. To get the most out of your new VIZIO HDTV, read these instructions before making any adjustments, and retain them for future reference. We hope you will experience many years of enjoyment from your new VIZIO HDTV High Definition Television.

For assistance, call **877-MYVIZIO** (877-698-4946) or e-mail us at www.VIZIO.com.

To purchase or inquire about accessories and installation services for your VIZIO HDTV, visit our website at www.VIZIO.com or call toll free at **(888) 849-4623**.

We recommend you register your VIZIO HDTV either at our website www.VIZIO.com or fill out and mail your registration card. For peace of mind and to protect your investment beyond the standard warranty, VIZIO offers on-site extended warranty service plans. These plans give additional coverage during the standard warranty period. Visit our website or call us to purchase a plan.

Write down the serial number located on the back of your HDTV for easy reference when obtaining warranty support:

Serial #: _____	Purchase Date _____
-----------------	---------------------

VIZIO is a registered trademark of VIZIO, Inc. dba V, Inc.

HDMI logo and "High Definition Multimedia Interface" are registered trademarks of HDMI Licensing LLC.

Manufactured under license from Dolby Laboratories.



Dolby and the double-D symbol are trademarks of Dolby Laboratories.



TruSurround HD and TruVolume are trademarks of SRS Labs, Inc.

TruSurround HD and TruVolume technologies are incorporated under license from SRS Labs, Inc.



This product qualifies for ENERGY STAR in the "factory default (Home Use)" setting and this is the setting in which power savings will be achieved. Changing the factory default picture setting or enabling other features will increase power consumption that could exceed the limits necessary to qualify for Energy Star rating.

THE TRADEMARKS SHOWN HEREIN ARE THE PROPERTY OF THEIR RESPECTIVE OWNERS; IMAGES USED ARE FOR ILLUSTRATION PURPOSES ONLY. VIZIO, THE V LOGO, WHERE VISION MEETS VALUE AND OTHER VIZIO TRADEMARKS ARE THE INTELLECTUAL PROPERTY OF VIZIO INC. PRODUCT SPECIFICATIONS ARE SUBJECT TO CHANGE WITHOUT NOTICE. © 2010 VIZIO INC. ALL RIGHTS RESERVED.

Important Safety Instructions

Your HDTV is designed and manufactured to operate within defined design limits. Misuse may result in electric shock or fire. To prevent your HDTV from being damaged, the following rules should be observed for the installation, use, and maintenance of your HDTV. Read the following safety instructions before operating your HDTV. Keep these instructions in a safe place for future reference.

- To reduce the risk of electric shock or component damage, switch off the power before connecting other components to your HDTV.
- Unplug the power cord before cleaning your HDTV. A damp cloth is sufficient for cleaning your HDTV. Do not use a liquid or a spray cleaner for cleaning your HDTV. Do not use abrasive cleaners.
- Always use the accessories recommended by the manufacturer to insure compatibility.
- When moving your HDTV from an area of low temperature to an area of high temperature, condensation may form in the housing. Wait before turning on your HDTV to avoid causing fire, electric shock, or component damage.
- Use only with the cart, stand, tripod, bracket, or table specified by manufacturer or sold with your HDTV. When a cart is used, use caution when moving the cart/HDTV combination to avoid injury from tip-over. Do not place your HDTV on an unstable cart, stand, or table. If your HDTV falls, it can injure a person and cause serious damage to your HDTV. Use only a cart or stand recommended by the manufacturer or sold with your HDTV.
- A distance of at least three feet should be maintained between your HDTV and any heat source, such as a radiator, heater, oven, amplifier etc. Do not install your HDTV close to smoke. Operating your HDTV close to smoke or moisture may cause fire or electric shock.
- Slots and openings in the back and bottom of the cabinet are provided for ventilation. To ensure reliable operation of your HDTV and to protect it from overheating, be sure these openings are not blocked or covered. Do not place your HDTV in a bookcase or cabinet unless proper ventilation is provided.
- Never push any object into the slots and openings on your HDTV cabinet. Do not place any objects on the top of your HDTV. Doing so could short circuit parts causing a fire or electric shock. Never spill liquids on your HDTV.
- Your HDTV should be operated only from the type of power source indicated on the label. If you are not sure of the type of power supplied to your home, consult your dealer or local power company.
- Do not apply pressure or throw objects at your HDTV. This may compromise the integrity of the display. The manufacturer's warranty does not cover user abuse or improper installations.
- The power cord must be replaced when using different voltage than the voltage specified. For more information, contact your dealer.
- Your HDTV is equipped with a **three-pronged grounded plug (a plug with a third grounding pin)**. This plug will fit only into a grounded power outlet. This is a safety feature. If your outlet does not accommodate the three-pronged, have an electrician install the correct outlet, or use an adapter to ground your HDTV safely. **Do not defeat the safety purpose of the grounded plug.**
- When connected to a power outlet, power is always flowing into your HDTV. To totally disconnect power, unplug the power cord.



- The lightning flash with arrowhead symbol within an equilateral triangle is intended to alert the user to the presence of un-isolated, dangerous voltage within the inside of your HDTV that may be of sufficient magnitude to constitute a risk of electric shock to persons.
- The exclamation point within an equilateral triangle is intended to alert the user to the presence of important operating and servicing instructions in the literature accompanying your HDTV.
- Do not overload power strips and extension cords. Overloading can result in fire or electric shock.



- The wall socket should be installed near your HDTV and easily accessible.
- Only power of the marked voltage can be used for your HDTV. Any other voltage than the specified voltage may cause fire or electric shock
- Do not touch the power cord during lightning. To avoid electric shock, avoid handling the power cord during electrical storms.
- Unplug your HDTV during a lightning storm or when it will not be used for long period of time. This will protect your HDTV from damage due to power surges.
- Do not attempt to repair or service your HDTV yourself. Opening or removing the back cover may expose you to high voltages, electric shock, and other hazards. If repair is required, contact your dealer and refer all servicing to qualified service personnel.
- Keep your HDTV away from moisture. Do not expose your HDTV to rain or moisture. If water penetrates into your HDTV, unplug the power cord and contact your dealer. Continuous use in this case may result in fire or electric shock.
- Do not use your HDTV if any abnormality occurs. If any smoke or odor becomes apparent, unplug the power cord and contact your dealer immediately. Do not try to repair your HDTV yourself.
- Avoid using dropped or damaged appliances. If your HDTV is dropped and the housing is damaged, the internal components may function abnormally. Unplug the power cord immediately and contact your dealer for repair. Continued use of your HDTV may cause fire or electric shock.
- Do not install your HDTV in an area with heavy dust or high humidity. Operating your HDTV in environments with heavy dust or high humidity may cause fire or electric shock.
- Follow instructions for moving your HDTV. Ensure that the power cord and any other cables are unplugged before moving your HDTV.
- When unplugging your HDTV, hold the power plug, not the cord. Pulling on the power cord may damage the wires inside the cord and cause fire or electric shock. When your HDTV will not be used for an extended period of time, unplug the power cord.
- To reduce risk of electric shock, do not touch the connector with wet hands.
- Insert batteries in accordance with instructions. Incorrect polarities may cause the batteries to leak which can damage the remote control or injure the operator.
- If any of the following occurs, contact the dealer:
 - The power cord fails or frays.
 - Liquid sprays or any object drops into your HDTV.
 - Your HDTV is exposed to rain or other moisture.
 - Your HDTV is dropped or damaged in any way.
 - The performance of your HDTV changes substantially.

Television Antenna Connection Protection

External Television Antenna Grounding

If an outside antenna/satellite dish or cable system is to be connected to the TV, make sure that the antenna or cable system is electrically grounded to provide some protection against voltage surges and static charges.

Article 810 of the National Electrical Code, ANSI/NFPA 70, provides information with regard to proper grounding of the mast and supporting structure, grounding of the lead-in wire to an antenna discharge unit, size of the grounding conductors, location of antenna discharge unit, connection to grounding electrodes, and requirements of the grounding electrode.

Lightning Protection

For added protection of the TV during a lightning storm or when it is left unattended or unused for long periods of time, unplug the TV from the wall outlet and disconnect the antenna or cable system.

Power Lines

Do not locate the antenna near overhead light or power circuits, or where it could fall into such power lines or circuits.

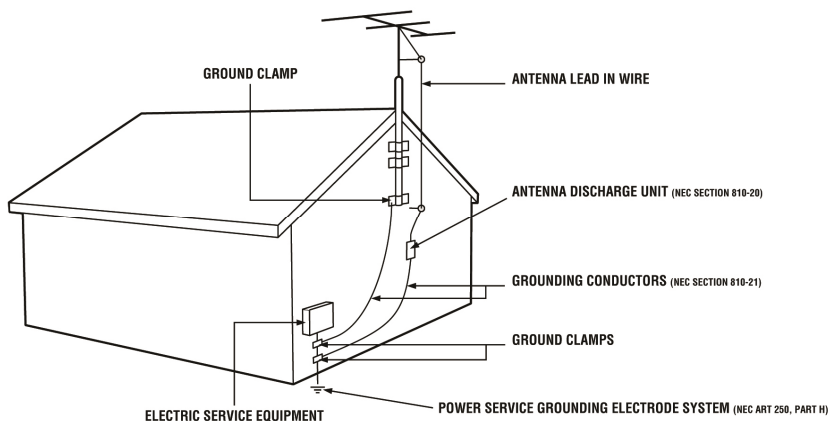

Remember, the screen of the coaxial cable is intended to be connected to earth in the building installation.

Advisory of the DTV Transition

The nationwide switch to digital television broadcasting will be complete on June 12, 2009, but your local television stations may switch sooner. After the switch, analog-only television sets that receive TV programming through an antenna will need a converter box to continue to receive over-the-air TV. Watch your local stations to find out when they will turn off their analog signal and switch to digital-only broadcasting. Analog-only TVs should continue to work as before to receive low power, Class A or translator television stations and with cable and satellite TV services, gaming consoles, VCRs, DVD players, and similar products.

For additional information, contact the parties listed below, as appropriate:

FCC (US Federal Communications Commission)

<http://www.fcc.gov/>

Phone: 1-888-CALL-FCC (1-888-225-5322)

TTY: 1-888-TELL-FCC (1-888-835-5322)

Fax: 1-866-418-0232

E-mail: fccinfo@fcc.gov

NTIA (National Telecommunications and Information Administration)

<http://www.ntia.doc.gov/>

1-888-DTV-2009

Listings of US Television Stations

<http://www.high-techproductions.com/usTVstations.htm>

Note: Your VIZIO HDTV is capable of receiving Digital Broadcasts, and no Digital Converter Box is required.

Table of Contents

Important Safety Instructions..... 2
 Television Antenna Connection Protection 4
 Advisory of the DTV Transition..... 5

CHAPTER 1 SETTING UP YOUR HDTV 10

Attaching the E421VL TV Stand..... 11
 Attaching the E470VL TV Stand..... 12
 Wall Mounting your HDTV 13

CHAPTER 2 BASIC CONTROLS AND CONNECTIONS 14

Front Panel..... 14
 Side Panel Controls..... 14
 Side Panel Connection..... 14
 Rear Panel Connections..... 15

CHAPTER 3 VIZIO REMOTE CONTROL 16

Installing the Batteries 16
 Remote Control Range..... 16
 VIZIO Remote Control Precautions..... 16
 E421VL Remote Control Buttons 17
 E470VL & E551VL Remote Control Buttons..... 18

CHAPTER 4 GETTING STARTED 19

CHAPTER 5 USING YOUR HDTV FOR THE FIRST TIME 20

Select Input Source 20
 Watching a TV Program 20
 Viewing Digital TV Program Information 21

CHAPTER 6 CONNECTING EQUIPMENT 22

Which Video Connection Should I Use? 22
 Connecting Your Cable or Satellite Box..... 23
 Using HDMI (Best)..... 23
 HDMI Connections for Cable or Satellite Boxes with DVI 23
 Using Component Video (Better)..... 24
 Using Composite Video (Good)..... 24
 Using Coaxial (Antenna) (Good)..... 24
 Connecting Your DVD Player..... 25
 Using HDMI (Best)..... 25
 HDMI Connections for DVD Players with DVI 25
 Using Component Video (Better)..... 26
 Using Composite (AV) Video (Good)..... 26
 Connecting Coaxial (RF)..... 27
 Using Your Antenna or Digital Cable for Standard or Digital TV 27
 Connecting Your VCR or Video Camera..... 27
 Connecting a Home Theater System 28
 Using RCA..... 28
 Using Optical (S/PDIF) 28
 Connecting a Computer..... 29
 Using RGB (VGA)..... 29
 Using HDMI..... 29

CHAPTER 7 VIEWING PICTURES 30

Viewing Pictures 30

Slideshow Mode.....	31
Repeat.....	31
Sort By	31
Duration	31
Slideshow Effect	31
Thumbnail Size	31
Info	31
CHAPTER 8 ADJUSTING YOUR HDTV SETTINGS.....	32
Using the On-screen Display (OSD)	32
Input Menu.....	32
Wide Menu	33
Normal.....	33
Wide.....	33
Zoom.....	33
Panoramic.....	33
Stretch.....	33
CC (Closed Caption) Menu	34
Analog Closed Caption	34
Digital Closed Caption	34
Digital CC Style.....	34
Sleep Timer Menu	34
Picture Menu	34
Picture Mode.....	34
Backlight	34
Brightness	34
Contrast	35
Color.....	35
Tint.....	35
Sharpness.....	35
More	35
PIP Menu.....	37
PIP Mode	37
Source.....	37
Position	37
Size	37
Audio.....	37
Settings Menu.....	38
Audio Menu	38
Tuner.....	40
Name Input	41
Parental Controls	41
Menu Language	43
Time & Local Settings	43
CEC.....	44
Media Menu.....	44
Slideshow Mode.....	44
Repeat.....	44
Sort By	44
Duration	45
Slideshow Effect	45
Thumbnail Size	45
Info	45
Help Menu	45
System Info	45
Reset TV Settings.....	45

Clear Memory (Factory Default)	45
Start Setup Wizard	45
CHAPTER 9 PROGRAMMING THE VIZIO UNIVERSAL REMOTE CONTROL	46
Using a Cable or Satellite Box Remote	46
Programming other devices	46
Programming your Blu-Ray or DVD Player	46
Programming your Home Theater System	46
Programming your Cable or Satellite Set-Top Box	47
Searching for Device Codes	47
Reset Remote to Factory Settings	47
Remote Control Codes	48
Television Codes	48
Cable Box Codes	50
*****Converters. (.....)	50
*****Decoders	50
IPTV	50
Satellite Receiver Codes	50
PVR Codes	51
Blu-Ray DVD Codes	51
DVD/VCR Player Codes	51
DVD Player Codes	51
Amplifier / Receiver / Tuner Codes	52
Satellite Receiver Codes	53
Audio Accessory Codes	53
Video Accessory Codes	54
VCR Codes	54
CHAPTER 10 MAINTENANCE AND TROUBLESHOOTING	56
Cleaning the TV and Remote Control	56
Troubleshooting Guide	56
Telephone & Technical Support	59
Compliance	59
FCC Class B Radio Interference Statement	59
CHAPTER 11 SPECIFICATIONS	60
E421VL Specifications	60
E470VL Specifications	61
E551VL Specifications	62
Preset PC Resolutions	64
Resolution through RGB Input	64
WARRANTY	65
INDEX	66

Opening the Package

Your HDTV and its accompanying accessories are carefully packed in a cardboard carton that has been designed to protect it from transportation damage. After you have opened the carton, check that your HDTV is in good condition and that all of the contents are included.

The glass surface can easily be scratched or broken, so handle your HDTV gently and never place your HDTV with the glass facing downwards on a surface without protective padding.

IMPORTANT: Save the carton and packing material for future shipping.

Package Contents

- VIZIO E421VL or E470VL or E551VL
- VIZIO remote control VR15 (E421VL only)
- VIZIO remote control VUR13M (E470VL and E551VL only)
- AA batteries for the VR15 remote control (2)
- AAA batteries for the VUR13M remote control (2)
- Power cord
- Detachable base with thumbscrew (E421VL and E470VL only)
- Quick Setup Guide
- Registration Card



HDTV Accessories and Services

Additional certified accessories for your HDTV are sold separately, including:

- Wall mounts
- High Definition cables
- Extra or replacement remote controls
- Sound Bars
- Blu-ray DVD Players

VIZIO also offers installation services and extended warranty services for your HDTV.

To purchase or inquire about additional accessories and services for your VIZIO HDTV, visit our website at www.VIZIO.com or call us toll free at **877-MYVIZIO** (877-698-4946).

Caution: Do not apply pressure or throw objects at your HDTV (including game controllers). This may compromise the integrity of the display. The manufacturer's warranty does not cover user abuse or improper installations.

Chapter 1 Setting Up Your HDTV

- Read this user manual carefully before installing your HDTV.
- The power consumption of your HDTV is about 111W (E421VL); 134W (E470VL); 155W (E551VL) average. Use the included AC/DC power adapter. When an extension cord is required, use one with the correct power rating. The cord must be grounded and the grounding feature must not be compromised.
- Install your HDTV on a flat surface to avoid tipping.
- For proper ventilation, you must allow a 1" space between the back of your HDTV and the wall.
- Avoid installing your HDTV in places with high humidity, dust, or smoke so you do not shorten the service life of the electronic components.
- Install your HDTV in a level, landscape orientation, with the VIZIO logo at the bottom to prevent poor ventilation and excessive component damage.
- If you want to mount your HDTV on the wall, see below for additional information.
- Read this user manual carefully before installing your HDTV.

VIZIO offers professional installation services including home networking. Contact VIZIO for more information on these services at **877-MYVIZIO** (877-698-4946) or www.VIZIO.com.

Attaching the E421VL TV Stand

Note: We strongly recommend that two people perform the setup and assembly due to the weight and size of the TV.

Unpack the TV and stand base:

1. Remove the remote control, batteries, and power cord from the foam end caps.
2. Remove the two top foam end caps.
3. Remove the stand base from the packaging.
4. Remove the TV from the box and lay it face down on a clean, flat surface.

Note: Make sure that the surface is free of debris to prevent the TV screen from getting scratched.

Attach the TV stand base:

1. Push the stand base onto the stand neck (already connected to TV).
2. On the bottom of the base, insert the thumb screw and tighten. Move the TV into an upright position.

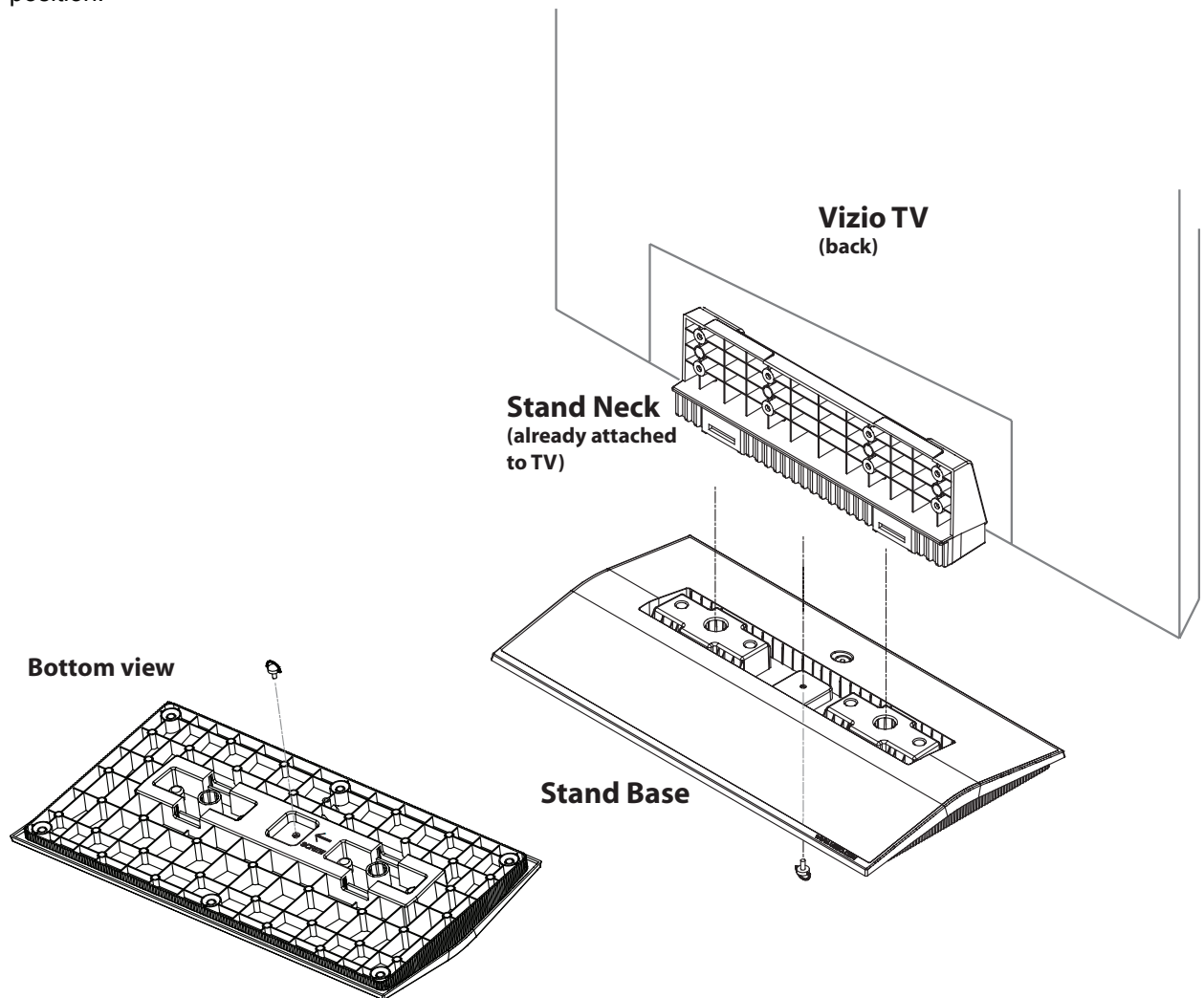

Attaching the E470VL TV Stand

Note: We strongly recommend that two people perform the setup and assembly due to the weight and size of the TV.

Unpack the TV and stand base:

1. Remove the remote control, batteries, and power cord from the foam end caps.
2. Remove the two top foam end caps.
3. Remove the stand base from the packaging.
4. Remove the TV from the box and lay it face down on a clean, flat surface.

Note: Make sure that the surface is free of debris to prevent the TV screen from getting scratched.

Attach the TV stand base:

1. Align the stand base to the back of the TV.
2. Insert the four screws provided and tighten.

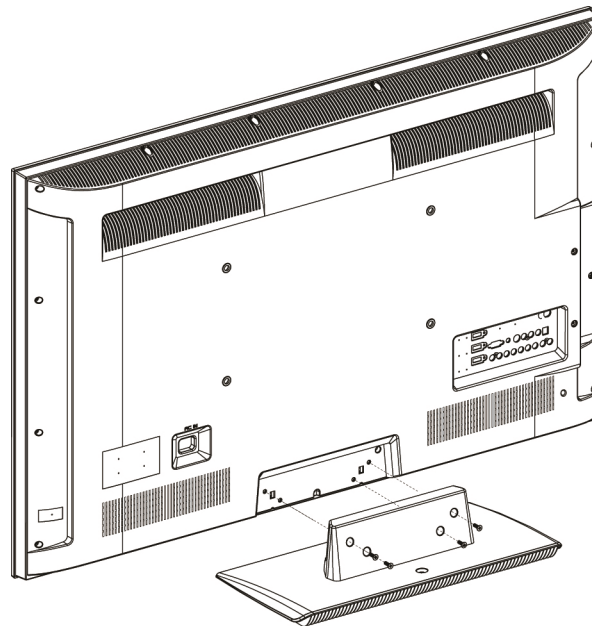

Wall Mounting your HDTV

Your HDTV can be mounted on the wall for viewing. If you choose to mount your HDTV on the wall, follow the instructions below.

1. Write down the serial number located on the back of your HDTV in the space provided on page 1 to have it handy if you need to call for support.
2. Remove the stand base and neck:
 - a. Disconnect the cables from your HDTV.
 - b. Place your HDTV face down on a soft, flat surface to prevent damage to the screen.
 - c. Remove the six (6) screws holding the stand neck, and then remove the neck and base.

Note: To remove the base from the neck, unscrew thumbscrew on bottom.

3. Mount your HDTV on the wall:
 - a. Attach your HDTV to a wall mount (sold separately) using the mounting holes in the back panel of your HDTV.
 - b. Read the instructions that came with your specific wall mount to properly hang your HDTV.

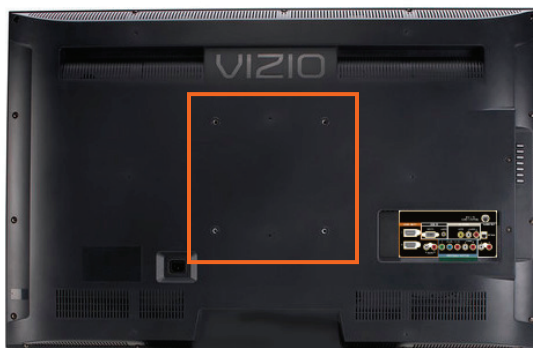

Wall Mounting Specifications (E421VL & E470VL)	
Screw Size	M6
Screw Length	20.0 mm
Screw Pitch	1.0 mm
Hole Pattern	VESA standard 200 x 200 mm spacing

Wall Mounting Specifications (E551VL)	
Screw Size	M8
Screw Length	25 mm
Screw Pitch	1.25 mm
Hole Pattern	VESA standard 400 x 200 mm spacing

Chapter 2 Basic Controls and Connections

Front Panel

1. **Remote Control Sensor**—Point the remote control directly at this window on the lower left corner of your HDTV for the best response to the remote signal.
2. **POWER 'VIZIO' LIGHT**—The VIZIO name lights white when powered on and orange when powered off.



Side Panel Controls

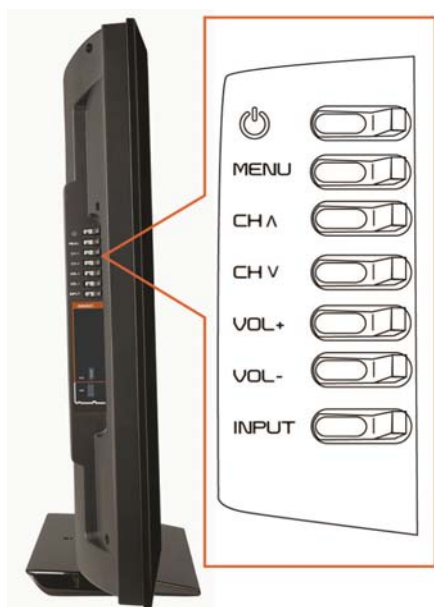

POWER ()—Turn your HDTV on by pressing the button once. Press the button again to turn your HDTV off.

MENU—Press to launch the on-screen menu. If a sub-menu is active, this button will proceed to the next level.

CH ▲/▼—Press to change the channels up or down. While the menu is active, these buttons function as up and down controls.

VOL + / -—Press to increase or decrease the speaker volume. While the menu is active, these buttons function as left and right controls.

INPUT (ENTER) —Press to cycle through the various devices connected to your TV (called Inputs). The inputs cycle in the following sequence: TV, AV, Comp, HDMI-1, HDMI-2, HDMI SIDE, RGB, and Media. After you have stepped through the entire sequence, you will return to the beginning.

Additionally, when the OSD is active, this button confirms the menu function to be adjusted.

Side Panel Connection

HDMI—Connect digital video devices such as a DVD player or Set-Top Box through this all digital connector. There are additional HDMI connectors on the back.

USB:

- Insert a FAT/FAT32 formatted USB drive to view pictures.
- Service port for use by a professional service technician.

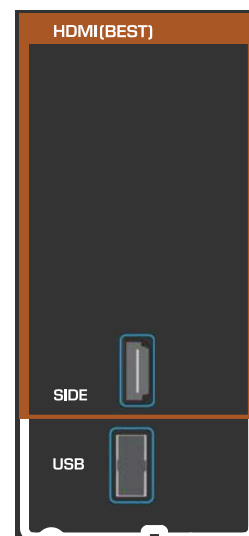

Rear Panel Connections

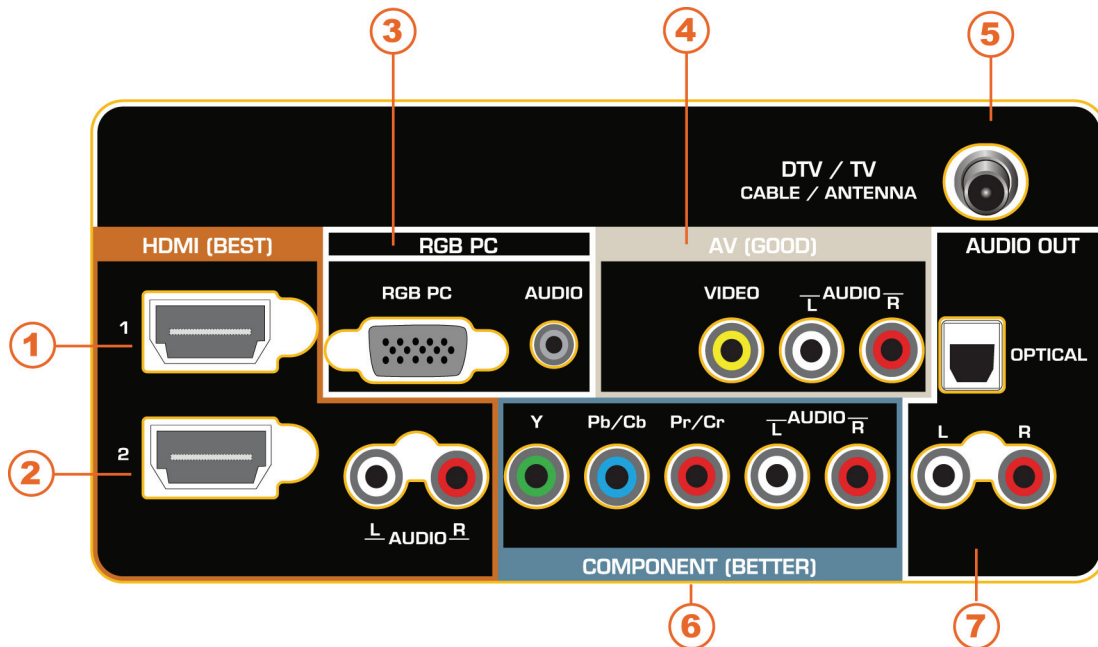

1. **HDMI 1**—Connect digital video devices such as a DVD player or Set-Top Box through this all digital connector. There is an additional HDMI connector on the side.
2. **HDMI 2 with L/R Audio**—Connect another digital video device such as a DVD player or Set-Top Box through this all digital connector. For users who want to connect to a DVI enabled device, use a DVI-HDMI cable and connect the analog audio output of the device to the **L / R AUDIO** here. Your VIZIO Certified HDMI-DVI cables are available for purchase from www.VIZIO.com or by calling **877-MYVIZIO** (877-698-4946).
3. **RGB PC**—Connect the video and audio from a computer here. Connect a 1/8" mini plug stereo connector from the computer to the TV if you want the sound to come from the HDTV speakers.
4. **AV**—Connect composite video devices, such as a VCR or game console. Use the white and red connectors to connect the external audio from the same source.
5. **DTV/TV**— Connect to an antenna or digital cable source. For digital TV stations in your area visit www.antennaweb.org. For cable and satellite Set-Top boxes, we recommend that you use a HDMI or component cable connection for high definition image quality.
6. **COMPONENT (Y Pb/Cb Pr/Cr with L/R Audio)**—Connect component video devices such as a DVD Player or set top box here.
7. **AUDIO OUT:**
 - **OPTICAL**—When digital TV is selected for viewing, the audio associated with the programming will be available on the S/PDIF Optical connector for connection to a VIZIO Sound Bar or your Home Theater system.
 - **ANALOG L/R**—Connect the audio from the HDTV to an external device, such as a home theater system, external amplifier, or stereo. Speakers cannot be connected directly here.

Chapter 3 VIZIO Remote Control

Installing the Batteries

1. Remove the battery cover.
2. Insert the batteries into the remote control. Make sure that you match the (+) and (-) symbols on the batteries with the (+) and (-) symbols inside the battery compartment.
3. Replace the battery cover.



Precautionary Tips for Inserting the Batteries:

- Do not mix new and old batteries. This may result in cracking or leakage that may cause a fire or lead to personal injury.
- Inserting the batteries incorrectly may also result in cracking or leakage that may cause a fire or lead to personal injury.
- Dispose of batteries according to local hazardous waste regulations.
- Keep the batteries away from children and pets.

Remote Control Range

- Point the remote control directly at this sensor for the best response to the remote signal.
- Do not place any obstacles between the remote control and the remote control sensor.
- The effective range of the remote control is approximately 22 feet (7 meters) from the front of the remote control sensor, 30° to the left and right, 20° up and down.



VIZIO Remote Control Precautions

- The remote control should be kept dry and away from heat sources. Avoid humidity.
- If the TV responds erratically to the remote control or does not respond at all, check the batteries. If the batteries are low or exhausted, replace them with fresh batteries.
- When not using the remote control for a long period of time, remove the batteries.
- Do not take the batteries apart, heat them, or throw them into a fire.
- Do not subject the remote control to undue physical stress, such as striking or dropping it.
- Do not attempt to clean the remote control with a volatile solvent. Wipe it with a clean, damp cloth.

E421VL Remote Control Buttons

POWER ()—Press to turn the TV on from the Standby mode. Press it again to return to the Standby mode.

CEC-Supported Buttons:

CEC needs to be set up and enabled for these buttons to work. See *CEC* on page 44 for more information.

- (Record)—Press to begin recording on your CEC-supported device.
- ⏸ (Pause)—Press to pause playback on your CEC-supported device.
- ▶ (Play)—Press to start Playback on your CEC-supported device.
- (Stop)—Press to stop playback/recording on your CEC-supported device.
- ⏮ (Previous)—Press to skip the previous track on your CEC-supported device.
- ◀ (Reverse)—Press to reverses playback on your CEC-supported device.
- ▶▶ (Fast Forward)—Press to fast forward playback on your CEC-supported device.
- ▶▶ (Next)—Press to skip to the next chapter on your CEC-supported device.

EXIT—Press to exit from open menus.

MENU—Press to open the On-Screen Display (OSD) menu.

OK—Press this button to display the Channel List. Press to confirm selections for On-Screen Display (OSD) menus.

Silver Diamond (represented by ▲▼◀▶ in the manual instructions)—Pressing up, down, left, or right on the points of the diamond are used to navigate the OSD menu. They will also be used as value settings when the slide bar is shown on the screen and option settings to turn a feature off or on.

BACK—Press to return to a previous OSD menu.

GUIDE—Press to display detailed program information when viewing a digital TV program.

Color Buttons (Yellow, Blue, Red, & Green)—These buttons currently do not operate any functions on your HDTV.

VOL +/- —Press to turn the volume up or down.

MEDIA – Use this button to access the USB drive to view your pictures.

MUTE—Press to turn the sound on and off.

LAST— Press to recall the previously viewed channel.

CH +/- —Press to change the channels up or down

HDMI—Press to select the HDMI input. Press repeatedly to cycle between both HDMI inputs.

AV—Press to select the AV input.

TV—Press to select the TV input.

Number Button Pad—Press to select a channel or enter a password.

INPUT—Press to cycle through the various devices connected to your TV (called Inputs). The inputs cycle in the following sequence: TV, AV, Comp, HDMI-1, HDMI-2, HDMI SIDE, RGB, and Media. After you have stepped through the entire sequence, you will return to the beginning.

- (**DASH**)—Press to insert a dash between the main and sub-channels. For example, channel 28-2 would be selected by the button sequence 2, 8, DASH, 2.



E470VL & E551VL Remote Control Buttons

POWER ()—Press to turn the TV on from the Standby mode. Press it again to return to the Standby mode.

Device Buttons:

- **DVD**—Press to select a DVD player that has been programmed to work with this remote. See page 46 to program your remote control.
- **AUDIO**—Press to select a Home Theater System or Audio Amplifier that has been programmed to work with this remote. See page 46 to program your remote control.
- **CABLE**—Press to select a cable or satellite Set-Top box that has been programmed to work with this remote. See page 46 to program your remote control.
- **TV**—Press to return to TV mode. If the remote is not working, press this button to return the functions back to TV.

CEC-Supported Buttons:

CEC needs to be set up and enabled for these buttons to work. See *CEC* on page 44 for more information.

- (Record)—Press to begin recording on your CEC-supported device.
- **II** (Pause)—Press to pause playback on your CEC-supported device.
- **▶** (Play)—Press to start Playback on your CEC-supported device.
- **■** (Stop)—Press to stop playback/recording on your CEC-supported device.
- **⏮** (Previous)—Press to skip the previous track on your CEC-supported device.
- **⏪** (Reverse)—Press to reverses playback on your CEC-supported device.
- **⏩** (Fast Forward)—Press to fast forward playback on your CEC-supported device.
- **⏭** (Next)—Press to skip to the next chapter on your CEC-supported device.

EXIT—Press to exit from open menus.

MENU—Press to open the On-Screen Display (OSD) menu.

OK—Press this button to display the Channel List. Press to confirm selections for On-Screen Display (OSD) menus.

Silver Diamond (represented by **▲ ▼ ◀ ▶** in the manual instructions)—Pressing up, down, left, or right on the points of the diamond are used to navigate the OSD menu. They will also be used as value settings when the slide bar is shown on the screen and option settings to turn a feature off or on.

BACK—Press to return to a previous OSD menu.

GUIDE—Press to display detailed program information when viewing a digital TV program.

Color Buttons (Yellow, Blue, Red, & Green)—These buttons currently do not operate any functions on your HDTV.

VOL +/- —Press to turn the volume up or down.

MEDIA – Use this button to access the USB drive to view your pictures.

MUTE—Press to turn the sound on and off.

LAST— Press to recall the previously viewed channel.

CH +/- —Press to change the channels up or down

HDMI—Press to select the HDMI input. Press repeatedly to cycle between both HDMI inputs.



AV—Press to select the AV input.

TV—Press to select the TV input.

Number Button Pad—Press to select a channel or enter a password.

INPUT—Press to cycle through the various devices connected to your TV (called Inputs). The inputs cycle in the following sequence: TV, AV, Comp, HDMI-1, HDMI-2, HDMI SIDE, RGB, and Media. After you have stepped through the entire sequence, you will return to the beginning.

- (**DASH**)—Press to insert a dash between the main and sub-channels. For example, channel 28-2 would be selected by the button sequence 2, 8, DASH, 2.



Chapter 4 Getting Started

Your HDTV has a built-in setup App that runs when you turn on your TV for the first time. Follow the on-screen directions to easily setup your new HDTV.

1. Insert the batteries into the remote control.
2. Connect the power cord to the power cord connector on the back of your HDTV, and then plug the power cord into an AC wall socket.
3. Connect your devices to your HDTV (see Chapter 6 for detailed steps).
4. Turn on your TV. The Setup App will automatically play and guide you thru the initial setup of your HDTV. Use the Arrow and OK buttons to navigate through the setup App. During the setup process you will:
 - Choose your Menu language
 - Set the TV to Home Mode for the best picture and most efficient energy usage.
 - Set your Time Zone and Daylight Savings preferences
 - Add your TV channels (unless you have a Cable/Satellite Set-Top Box)

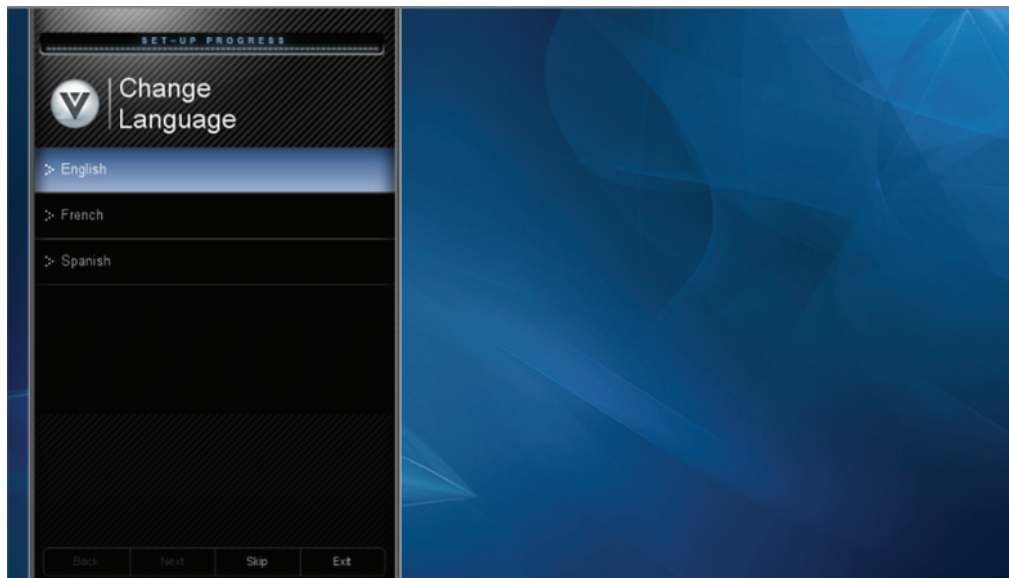

Chapter 5 Using your HDTV for the first time

Select Input Source

Select the input source for your HDTV by pressing the **INPUT** button on the remote control or the side of your TV. Pressing this button will cycle you through the following options: TV, AV, Comp, HDMI-1, HDMI-2, HDMI SIDE, RGB, and Media.

Turn on your device and you will see a picture on your HDTV. If there is no picture, make sure you have selected the correct input on your HDTV.

Note: If the selected device is RF connected, your HDTV needs to be in **TV** mode and on either channel 3 or channel 4 matching the channel which has been selected on the back of the VCR, Cable Box, External TV Tuner or Satellite Receiver. Refer to Owner or User's Manual of such equipment for details.

Watching a TV Program

Before you start watching TV, make sure that any cable, satellite or off-air antenna connections are secure. Also, verify that the AC/DC power adapter is plugged into a correctly grounded electrical outlet or surge protector.

1. Press the power button on the remote control. The VIZIO logo on the front will light up white.
2. Select the input to which your device is connected that provides TV programming (i.e. TV, HDMI, COMP).

Note: You should be able to see a picture. If you do not, make sure that all of your HDTV connections are secure and you have selected the correct video input source. Each press of the **INPUT** button on the remote control will cycle through the available inputs. Press the button until the input associated with the device you want to view is shown.

3. When using the TV input, press the channel buttons on the remote control or the TV to change the channel. The channel buttons will not work if you are watching a program using HDMI, Component, or AV inputs.

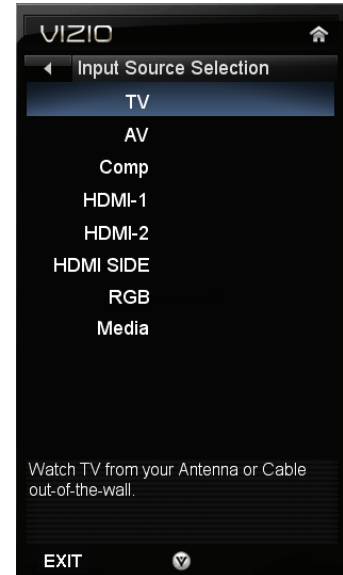

Viewing Digital TV Program Information

When the channel is changed or when you press the **GUIDE** button, an information header is shown over the picture for a few seconds. Each press of the **GUIDE** button will display more information about the program:





Time Warp: Mouse Trap			Ch 50-123	KCAL DTV	CABLE
11:00 AM - 12:00 AM	TV-PG (V)	CC-OFF	ENGLISH	DOLBY 5.1	720p HD
In this hour-long special, the Time Warp team runs off to join the circus with trap-testing Rev. Tommy Gunn and with high-flying Cirque du Soleil, explore their inner stuntmen, and put everything but wood in a chipper.					



Chapter 6 Connecting Equipment

Which Video Connection Should I Use?

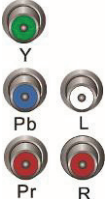
You have six options for connecting your video equipment box to your HDTV from a basic connection to the most advanced for digital displays. Based on your Home Theater configuration, you can decide which option is the right one for you.

Connection Quality (type)	Connector	Description
Best (digital)	 HDMI	HDMI delivers the best image quality of any of the cable types available and it's all done over one cable. You get a great picture and cut down on your cable clutter. HDMI provides digital quality and amazing sound so if your TV has HDMI, this is the connection type you should be using.
Best (digital) ----- Good (analog)		Connect your antenna or coaxial cable to watch TV programming. This cable usually comes from your cable box or right out of the wall.
Best (analog)	 VGA	The RGB (VGA) port allows you to connect your computer so you can use the TV as your monitor.
Better (analog)	 Y Pb L Pr R	Component consists of three cables for transmitting video and two cables for transmitting audio: one red and one white. Component video provides a sharper image than Composite video and should be used instead of composite when possible. However, because it is still an analog connection, it won't provide the high-quality video and audio that HDMI can produce.
Good (analog)	 VIDEO L R	Composite consists of one yellow cable for transmitting video and two cables for transmitting audio: one red and one white. It is capable of transmitting stereo sound and standard definition video (480i). While it provides a good image, it has lower image quality than HDMI or Component. So try to use one of those connections first.

Note: To maintain the display quality, use a VIZIO certified HDMI cable. This cable is available in 6, 8, and 12 foot lengths. Visit www.vizio.com or call 1-888-VIZIOCE (1-888-849-4623) for details.

Connecting Your Cable or Satellite Box

Using HDMI (Best)

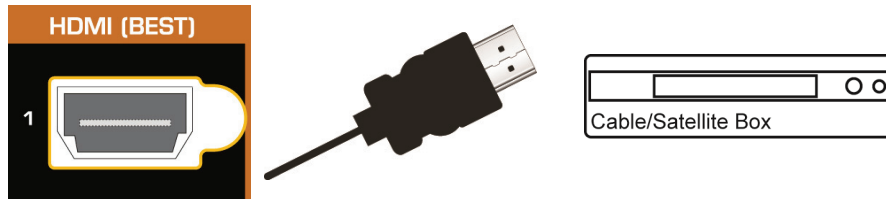

Cable and Satellite Boxes that have a HDMI digital interface should be connected using HDMI for optimal results. To maintain image quality, use a VIZIO certified HDMI cable. This cable is available in 6, 15, and 30 foot lengths. Visit www.VIZIO.com or call **877-MYVIZIO** (877-698-4946) for details.

1. Turn off your HDTV and cable/satellite box.
2. Connect an HDMI cable to the **HDMI** output of your cable/satellite box and the other end to the **HDMI 1** or **2** jack on your HDTV.
3. Turn on the power to your HDTV and your cable/satellite box.
4. Select **HDMI-1**, **HDMI-2**, or **HDMI SIDE** using the **INPUT** button on the remote control or side of the TV.

Note:

- The HDMI input on your HDTV supports High-bandwidth Digital Content Protection (HDCP). HDCP encrypts the transmission between the video source and the digital display for added security and protection.
- Refer to your cable/satellite Set-Top box user manual for more information about the video output requirements of the product or consult your cable or satellite operator.

HDMI Connections for Cable or Satellite Boxes with DVI

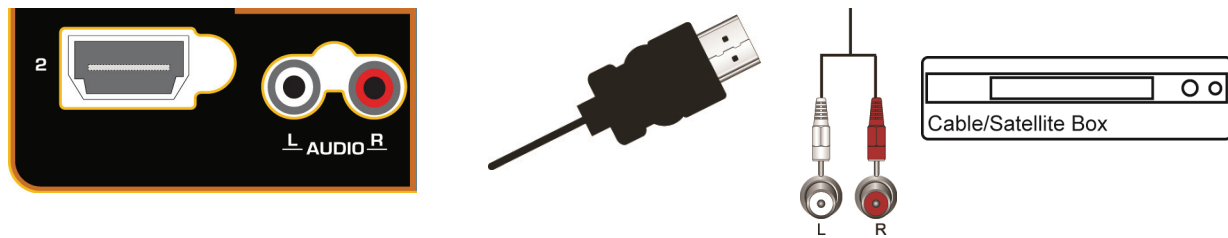

1. Turn off the power to your HDTV and HDTV cable/satellite box.
2. Using a HDMI-DVI cable, connect the DVI end to your cable/satellite box and the HDMI end to the **HDMI 2** jack on your HDTV.
3. Connect the audio cables (white and red) from the DVI audio output jacks on the cable/satellite box to the **HDMI 2 L** and **R AUDIO** jacks on your HDTV.
4. Turn on the power to your HDTV and your cable/satellite box.
5. Select **HDMI-2** using the **INPUT** button on the remote control or side of the TV.

Using Component Video (Better)

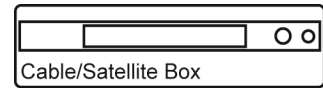
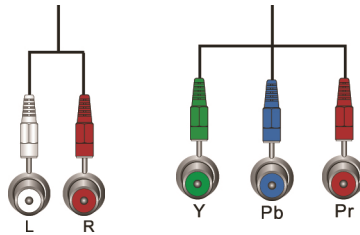
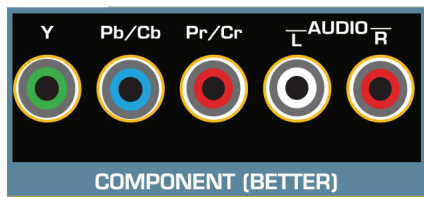

1. Turn off your HDTV and cable/satellite box.
2. Connect the component cables (green, blue, and red) from your cable/satellite box to the **COMPONENT** jacks on your HDTV.
3. Connect the audio cables (white and red) from your Set-Top box to the **COMPONENT L** and **R AUDIO** jacks on your HDTV.
4. Turn on your HDTV and cable/satellite box.
5. Select **Comp** using the **INPUT** button on the remote control or side of the TV.

Using Composite Video (Good)

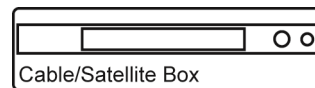
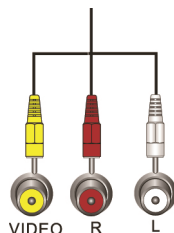
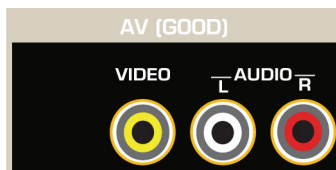

1. Turn off your HDTV and Set-Top box.
2. Connect the video cable (yellow) from your Set-Top box to the **AV** jack (yellow) on your HDTV.
3. Connect the audio cables (white and red) on your Set-Top box to the **AV L** and **R AUDIO** jacks on your HDTV.
4. Turn on your HDTV and Set-Top box.
5. Select **AV** using the **INPUT** button on the remote control or side of the TV.

Using Coaxial (Antenna) (Good)



COAXIAL

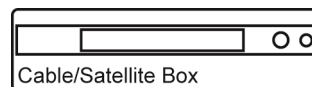

1. Turn off the power to your HDTV.
2. Connect the coaxial (RF) connector from your antenna or digital cable to the **DTV/TV CABLE/ANTENNA** connector on your HDTV.
3. Turn on the power to your HDTV.
4. Select **TV** using the **INPUT** button on the remote control or side of the TV.
5. Search for new channels. See *Auto Channel Scan* on page 24 for more information on scanning for channels.

Connecting Your DVD Player

Using HDMI (Best)

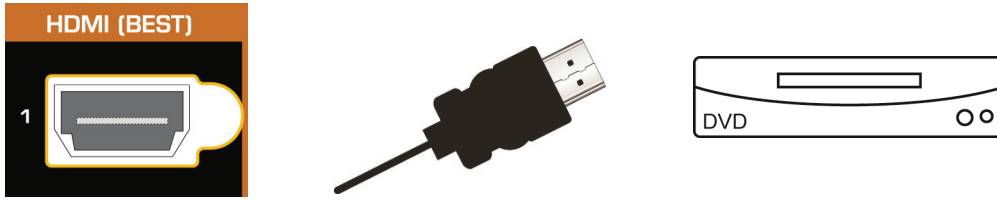

DVD players that have a HDMI digital interface should be connected using HDMI for optimal results. To maintain image quality, use a VIZIO certified HDMI cable. This cable is available in 6, 15, and 30 foot lengths. Visit www.VIZIO.com or call **877-MYVIZIO** (877-698-4946) for details.

1. Turn off your HDTV and DVD player.
2. Connect a HDMI cable to the HDMI output of your DVD player and the other end to the **HDMI 1** or **2** jack on your HDTV.
3. Turn on the power to your HDTV and your DVD player.
4. Select **HDMI-1**, **HDMI-2**, or **HDMI SIDE** using the **INPUT** button on the remote control or side of the TV.

Note:

- The HDMI input on your HDTV supports High-bandwidth Digital Content Protection (HDCP). HDCP encrypts the transmission between the video source and the digital display for added security and protection.
- Refer to your DVD player user manual for more information about the video output requirements.

HDMI Connections for DVD Players with DVI

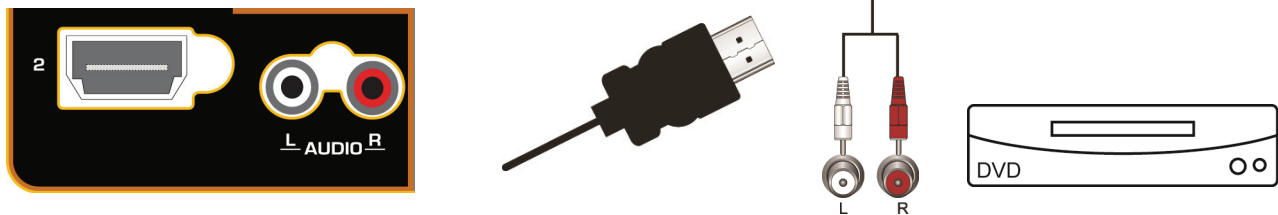

1. Turn off your HDTV and DVD player.
2. Using a HDMI-DVI cable, connect the DVI end to your DVD player and the HDMI end to the **HDMI 2** Jack on your HDTV.
3. Connect the audio cables (white and red) from the DVI audio output jacks on the DVD player to the **HDMI 2 L** and **R AUDIO** jacks on your HDTV.
4. Turn on the power to your HDTV and your DVD player.
5. Select **HDMI-2** using the **INPUT** button on the remote control or side of the TV.

Using Component Video (Better)

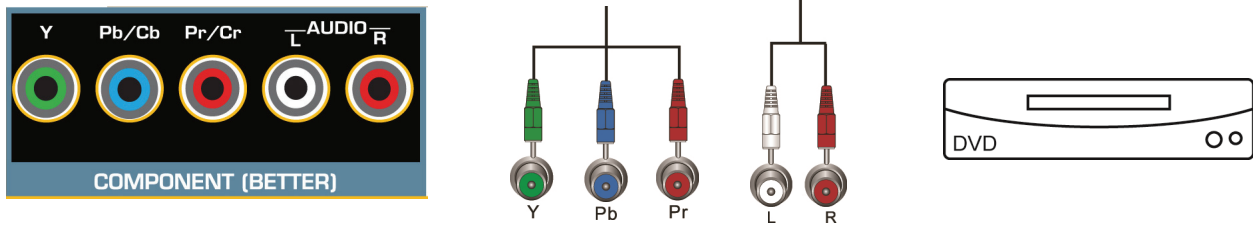

1. Turn off the power to your HDTV and DVD player.
2. Connect the component cable (green, blue, and red) from your DVD player to the **COMPONENT** jacks on your HDTV.
3. Connect the audio cables (white and red) from your DVD player to the **COMPONENT L and R AUDIO** jacks on your HDTV.
4. Turn on the power to your HDTV and DVD player.
5. Select **COMP** using the **INPUT** button on the remote control or side of the TV.

Using Composite (AV) Video (Good)

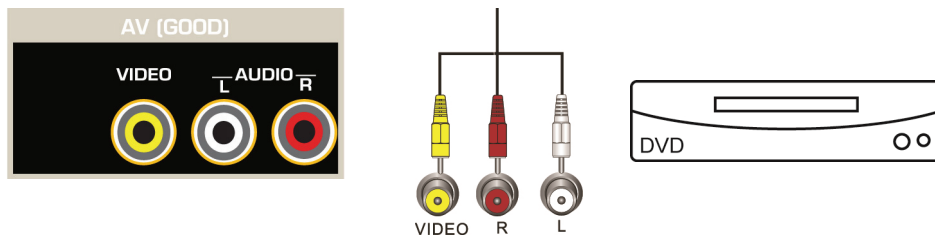

1. Turn off the power to your HDTV and DVD player.
2. Connect the Video cable (yellow) from your DVD player to the **AV** jack on your HDTV.
3. Connect the audio cables (white and red) on your DVD player to the **AV L and R AUDIO** jacks on your HDTV.
4. Turn on the power to your HDTV and DVD Player.
5. Select **AV** using the **INPUT** button on the remote control or side of the TV.

Connecting Coaxial (RF)

Using Your Antenna or Digital Cable for Standard or Digital TV



COAXIAL

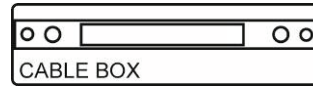

1. Turn off the power to your HDTV.
2. Connect the coaxial (RF) connector from your antenna or cable to the **DTV/TV CABLE/ANTENNA** connector on your HDTV.
3. Turn on the power to your HDTV.
4. Select **TV** using the **INPUT** button on the remote control or side of the TV.
5. Search for new channels. See *Auto Channel Scan* on page 40 for more information on scanning for channels.

Connecting Your VCR or Video Camera

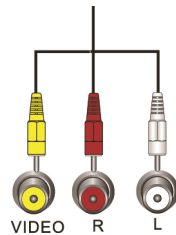
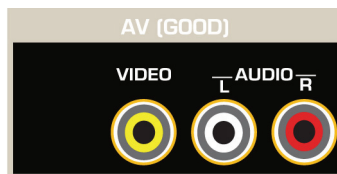

Note: Refer to your VCR or Video Camera user manual for more information about the video output requirements of the product.

1. Turn off the power to your HDTV and VCR or video camera.
2. Connect the yellow AV cable from your VCR or video camera to the **AV** jack on your HDTV.
3. Connect the audio cables on your VCR or video camera to the corresponding **L** and **R AUDIO** jacks on your HDTV.
4. Turn on the power to your HDTV and VCR or video camera.
5. Select **AV** using the **INPUT** button on the remote control or side of the TV.

Connecting a Home Theater System

Using RCA

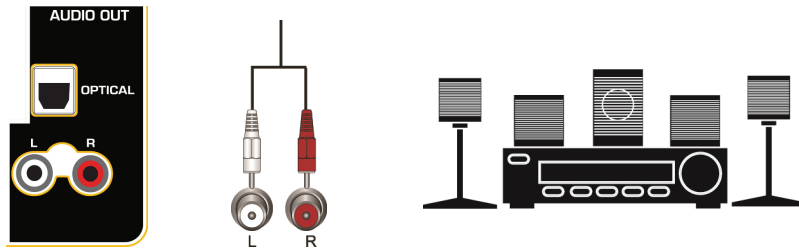

1. Turn off the power to the HDTV and Receiver/Amp.
2. Using an audio cable (white and red connectors), connect the cable to the audio input connectors on the Receiver/Amp and connect the other end to the **AUDIO OUT** audio connectors on the back of the HDTV.
3. Turn on the power to the HDTV and Receiver/Amp.
4. Press the **MENU** button on the remote control to open the On-Screen Display (OSD) menu.
5. Press **▼** on the remote control to highlight the Audio menu, and then press **OK** to select.
6. Press **▼** on the remote control to select **TV SPEAKERS**.
7. Press **▶** on the remote control to select **OFF** so the sound from the HDTV will be routed through your Receiver/Amp system.

Notes:

- Refer to your Receiver/Amp user manual to select the corresponding audio input.
- The audio output is not amplified and cannot be connected directly to external speakers.

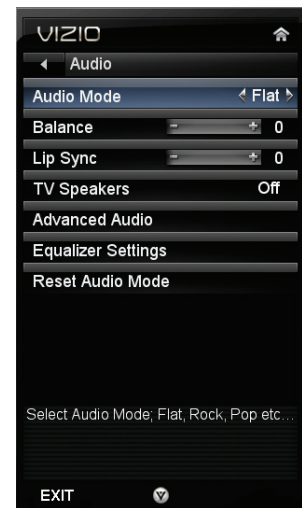

Using Optical (S/PDIF)

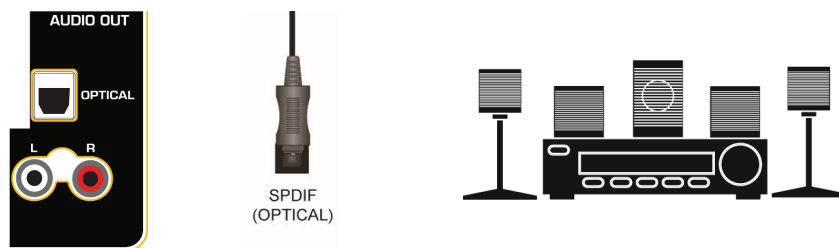

If your sound system has a S/PDIF (optical) digital audio input you can connect it from your sound system to the **OPTICAL** digital audio out on your HDTV. This is active when receiving audio with the programs being viewed no matter what input is being used.

1. Connect one end of the optical cable to optical connectors on the home theater and the other end to the **OPTICAL** jack on your HDTV.
2. Turn on the power to your HDTV and home theater.
3. Change the input on your home theater to optical. See your home theater user manual for more information.

Connecting a Computer Using RGB (VGA)

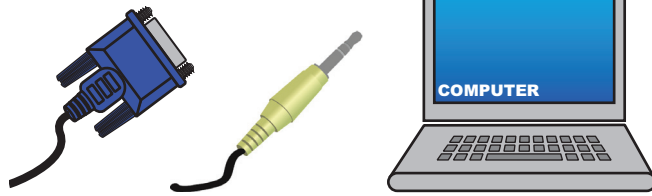
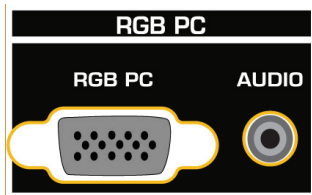

1. Set computer to a resolution supported by your HDTV (see *Preset PC Resolutions* on page 70). If your computer supports it, we recommend 1920x1080.
2. Turn off the power to your HDTV and computer.
3. Connect the RGB (VGA) cable from your computer to the **RGB PC** jack on of your HDTV.
4. Connect the 1/8-inch audio cable from your computer to the **RGB PC Audio** jack on your HDTV. This step is optional and only needed if you want to transmit audio from the computer through the TV.
5. Turn on the power to your HDTV and computer.
6. Select **RGB** (VGA) using the **INPUT** button on the remote control or side of the TV.

Note: Refer to your PC computer user manual for more information about the video output requirements.

Using HDMI

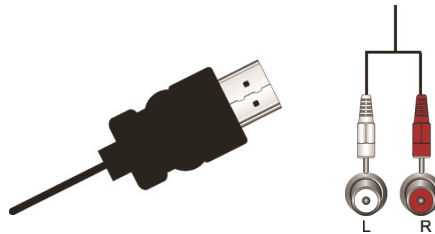
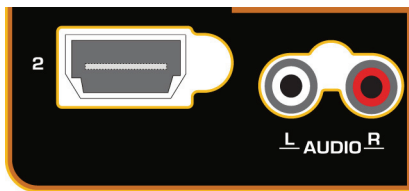

1. Turn off your HDTV and computer.
2. Connect a HDMI cable to the HDMI output of your computer and the other end to the **HDMI 3** jack on your HDTV.
3. Connect the audio cables (white and red) from the audio output jacks on the computer to the **HDMI 2 L** and **R AUDIO** jacks on your HDTV.
4. Turn on the power to your HDTV and your computer.
5. Select **HDMI-2** using the **INPUT** button on the remote control or side of the TV.

Chapter 7 Viewing Pictures

Connect a USB flash drive to the USB port on your HDTV to view pictures.

- USB drives that are USB 2.0 and FAT or FAT32 are supported. The USB Port does not support external hard drives or USB hubs.
- If your USB drive is oversized and does not physically fit in the USB port, use a USB extension cable. Connect one end of the cable to your USB drive and the other end to the USB port.
- Supported file extensions include .jpg and .jpeg.

Note: Even the supported format files listed above may or may not play properly or completely, depending on the USB device, bit rate stream, and other content characteristics, as well as other factors.

Viewing Pictures

1. Insert a USB device with digital content containing photos into the USB port on the side of your HDTV. If a USB device is already connected, press **MENU** on the remote control and select *Media*. A message will appear asking if you want to play multimedia content.
2. Press ◀ or ▶ to highlight **OK**, and then press **OK** to select it. The *Picture* folder will be displayed.
3. Press **OK** to select it. A menu will be displayed showing the folders and files that are on your USB device.
4. Press ◀ or ▶ to highlight the folder or file you want to play, and then press **OK** to select it. The file will play. See *Adjusting Photo Settings* on page 31 below to adjust various settings including setting up a slideshow and setting picture duration.
5. When finished, press **MEDIA** once to return to the previous screen or repeatedly to return to the main menu.

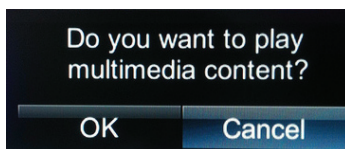

Adjusting Photo Settings

When viewing pictures you can adjust various settings, including slideshow, picture duration, etc.

1. Insert a USB device containing pictures and select the folder or files that you want to play.
2. Press **MENU**. The Picture menu will be displayed.
3. Press **▲** or **▼** on the remote control to highlight a Picture menu option, and then press **◀** or **▶** to adjust the setting.
4. Press **MENU** once to close the menu.

Slideshow Mode

Choose from **Shuffle**, **Single**, and **Sequence** to set the slideshow mode. Press **OK** to start and stop the slideshow.

- **Single** will display one picture selected from the thumbnails for the interval set in the *Duration* option and return to the thumbnails. If the *Repeat* option is set to **On**, the selected picture will be displayed until you press **EXIT**.
- **Sequence** will show your pictures in the order they are listed on your USB device until you stop the slideshow.
- **Shuffle** will show your pictures in random order until you stop the slideshow.

Repeat

Choose from **On** or **Off** to repeat the slideshow.

Sort By

You can choose to sort the pictures on the USB device by **Photo Date**, **File Date**, or alphabetically (**File A-Z**).

Duration

Set the amount of time the picture will remain on the screen during the slideshow. Choose a time between 5 seconds and 32 seconds.

Slideshow Effect

Choose from **Random**, **Dissolve**, **Wipe Right**, **Wipe Left**, **Wipe Up**, **Wipe Down**, **Box In**, or **Box Out** to set the transition type when changing from one picture to another during a slideshow.

Thumbnail Size

Set the size of the preview pictures (thumbnails) in the menu. Choose from **Small**, **Medium**, or **Large**.

Info

When set to **On**, information about the picture briefly appears on your HDTV.

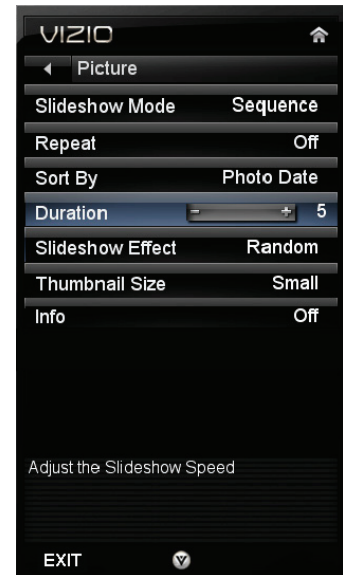

Chapter 8 Adjusting Your HDTV Settings

Using the On-screen Display (OSD)

The remote control or the control buttons on the side of the TV can control all the function settings. The *OSD* allows you to adjust contrast, brightness and other settings. The TV will save changes made to the settings, even if the TV is turned off.

The OSD consists of several menu options. The main menu options may vary depending on your selected input source.

Note: Some of the main menu options may have additional submenus, for example, the TV Rating submenu for Parental Controls.

1. Press **MENU**. The *OSD* opens.
2. Press **◀**, **▶**, **▲**, or **▼** on the remote control to select one of the menu options:
 - Input
 - Wide
 - CC
 - Sleep Timer
 - Picture
 - PIP
 - Settings
 - Media
 - Help
3. Press **OK** to select the option or feature you want to adjust.
4. After the menu option is displayed, press **▲** or **▼** on the remote control to select one of the items to adjust.
5. Press **OK** to select it, and then press **◀**, **▶**, **▲**, or **▼** to adjust the selection.
6. Press **BACK** once to return to the previous screen. To return to your program once adjustments have been completed, you can do one of the following:
 - a. Press the **EXIT** button on the remote control.

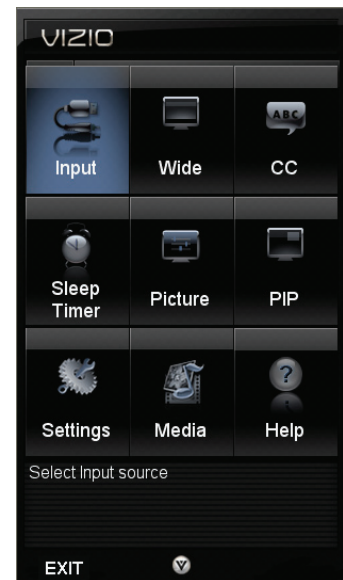

Input Menu

Select the Input Source for your HDTV. Choose from *TV*, *AV*, *Comp*, *HDMI-1*, *HDMI-2*, *HDMI SIDE*, *RGB*, and *Media*.

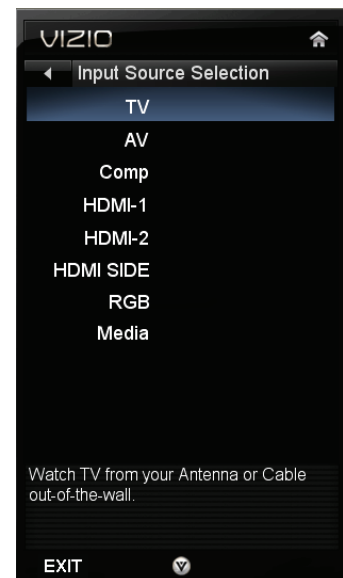

Wide Menu

Select how the picture displays on the screen. As you select an option, you will see the screen adjusting to the different sizes. The options vary depending on the selected input and the TV program:

Normal

The original 4:3 aspect ratio (1.33:1 source) is preserved, so black bars are added to the left and right of the display image. Standard TV broadcasts are displayed with a 4:3 Aspect Ratio. Movies in 4:3 Aspect Ratio may be referred to as pan-and-scan or full frame. These movies were originally filmed in 16:9 (widescreen), and then modified to fit a traditional TV screen (4:3).

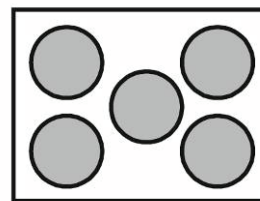

Wide

Wide mode allows you to view the entire picture. This is recommended for HDMI and RGB (Computer) viewing so you can see the complete picture without the image overstretching beyond the viewing area. For 720p, 1080i, 1080p only.

Zoom

Zoom mode will "zoom in" to the center of the image, allowing 4:3 images to be viewed in original aspect ratio without stretching the black bars. The top and the bottom of the image are cropped out, though.

Panoramic

When watching a standard broadcast or full frame movie in this mode, the 4:3 Aspect Ratio (1.33:1 source) display image is stretched horizontally on the left and right sides to fill the TV screen. The center of the image is not stretched.

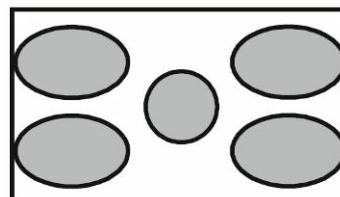

Stretch

When watching a widescreen program (1.78:1 source) with black bars on the sides, the display image will stretch to fill the TV screen. People will appear wider than they really are. If you are watching a widescreen (1.85:1 or 2.35:1 source) program or movie, there will still be black bars at the top and bottom. This mode is available only when watching a widescreen program.

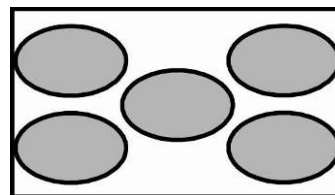

CC (Closed Caption) Menu

Adjust closed caption options.

Analog Closed Caption

The CC feature is available when watching regular analog TV. Select from **Off**, **CC1**, **CC2**, **CC3**, and **CC4**. Closed Caption for regular TV is usually **CC1** or **CC2**.

Digital Closed Caption

The CC feature is available when watching digital TV. Select from **CC1**, **CC2**, **CC3**, **CC4**, or **CS1**, **CS2**, **CS3**, **CS4**, **CS5**, **CS6**, or **Off**.

Digital CC Style

The Digital CC Style feature is available when watching digital TV.

- **Caption Style:** Select either **As Broadcaster** or **Custom**. If Custom is selected you can customize the way Closed Caption is displayed. The options available are:
 - **Text Size:** Make CC text larger or smaller.
 - **Color:** Choose a text color for CC display
 - **Opacity:** Make text more or less transparent.
 - **BG Color:** Choose a background color for CC text.
 - **BG Opacity:** Make the background for CC text more or less transparent.
 - **Window Color:** Choose a text frame color for CC text.
 - **Window Opacity:** Make the text frame for CC text more or less transparent.

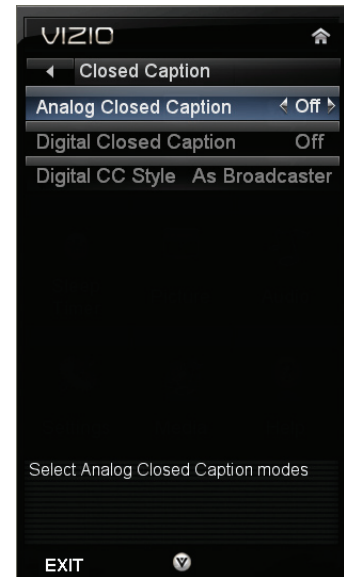

Sleep Timer Menu

Select the timer to turn off the TV in **30**, **60**, **90**, **120** or **180** minutes.

Picture Menu

Adjust picture options including brightness, contrast, and advanced picture settings.

Picture Mode

Choose from **Standard**, **Movie**, **Game**, **Vivid**, **Football**, **Golf**, **Basketball**, or **Custom**. Each input (i.e. HDMI, COMP, etc) remembers the custom setting you created. Select **Custom** to manually adjust *Backlight*, *Brightness*, *Contrast*, *Color*, *Tint*, *Sharpness*, and to access the *More* menu where further adjustments can be made.

Backlight

Adjust the brightness to affect the overall brilliance of the picture not the Brightness (black level) or Contrast (white level) of the picture.

Brightness

Adjust black levels in the picture. If the brightness is too low you will not be able to see the detail in darker parts of the picture and if the brightness is too high the picture will look washed out.

Note: Brightness is only available when *Picture Mode* is set to **Custom**.



Contrast

Adjust the white levels in the picture. If the contrast is too low the picture will look washed out and if the contrast is too high you will not be able to see any detail in the bright parts of a picture.

Note: Contrast is only available when *Picture Mode* is set to **Custom**.

Color

Adjust the amount of color in the picture.

Note: Color is only available when *Picture Mode* is set to **Custom**.

Tint

Adjust the hue of the picture. The easiest way to set tint is to look at flesh tones and adjust for a realistic appearance. In most cases, the default middle position is correct. If people's faces look too orange try reducing the level of color first.

Note: Tint is only available when *Picture Mode* is set to **Custom**.

Sharpness

Adjust the sharpness of the edges of elements in the picture. It does not produce detail that otherwise does not exist. This adjustment is helpful when viewing Standard Definition sources.

Note: Sharpness is only available when *Picture Mode* is set to **Custom**.

More

Select **More** to adjust advanced options for fine tuning the picture.

Note: The *More* menu is only available when *Picture Mode* is set to **Custom**.

Size & Position

To select the options in the Size & Position sub-menu, press **OK**. A new menu will be displayed showing the following Size & Position settings:

- **Horiz. Position**
Adjust the horizontal position of the picture.
- **Vertical Position**
Adjust the vertical position of the picture.
- **Horizontal Size**
Adjust the horizontal size of the picture.
- **Vertical Size**
Adjust the vertical size of the picture.

Note: The Size & Position function is only available in HDMI, Component, or RGB modes.

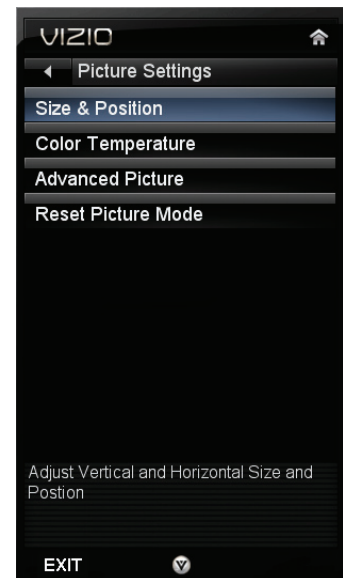

Color Temperature

Color Temperature is the “warmness” or “coolness” of the white areas of the picture. Choose from **Custom**, **Cool**, **Normal**, or **Computer**. **Normal** is the setting for television broadcasting. **Custom** allows you to set a preset calibrated for a white point to suit individual preferences. **Cool** produces a blue-hued image. **Computer** sets the white point at the established setting for a computer display (9300K). Each preset may also be adjusted for a customized setting.

Advanced Picture

To select the options in the Advanced Picture sub-menu, press **OK**. A new menu will be displayed showing the advanced functions available for fine tuning of the picture.

- **Smooth Motion Effect**

The Smooth Motion™ Effect option activates Motion Estimation/Motion Compensation (ME/MC), which suppresses motion judder, or “stuttering” of the image when the camera pans across a scene, or there is horizontal motion in the scene. Choose from **Off**, **Low**, **Middle**, or **High**.

- **Real Cinema Mode**

The Real Cinema Mode option allows selection of the type of compensation used for the Smooth Motion™ Effect option. Choose from **Off**, **Precision** and **Smooth**.

- **Noise Reduction**

This feature diminishes picture artifacts caused by the digitizing of image motion content that may be present in the picture. Choose from **Off**, **Low**, **Medium**, or **High**.

- **MPEG NR**

Reduces white areas between color boundaries. Choose from **Off**, **Low**, **Medium** or **Strong**.

- **Color Enhancement**

This feature increases the picture reproduction performance of the picture by reducing oversaturation of certain colors and improving flesh tones. Choose from **Off**, **Normal**, **Rich Color**, **Grn/Flesh**, and **Grn/Blue**.

- **Adaptive Luma**

Large areas of brightness in the picture will result in a higher Average Picture Level (APL) and the overall picture will look too light. This feature will lower the APL to counteract this effect. Choose from **Off**, **Low**, **Medium**, **Strong**, or **Extend**.

- **Film Mode**

Choose from **Off** or **Auto**. When set to **Off** it will stay at 60 fps. When set to **Auto**, the TV will detect the cadence (for example at 24 frames/second for film, or normal video at 60 fps).

- **Backlight Control**

Set this feature to **OFF**, **DCR**, or **OPC**. **DCR** (Dynamic Contrast Ratio) improves the black level performance and increases contrast ratio. **OPC** (Optimum Power Control) Reduces power consumption while maintaining the same picture brightness.

- **Ambient Light Sensor**

Choose **Off**, **Low**, **Medium**, or **High**. When set to **Low**, **Medium**, or **High**, your HDTV will automatically adjust to light changes in the room.

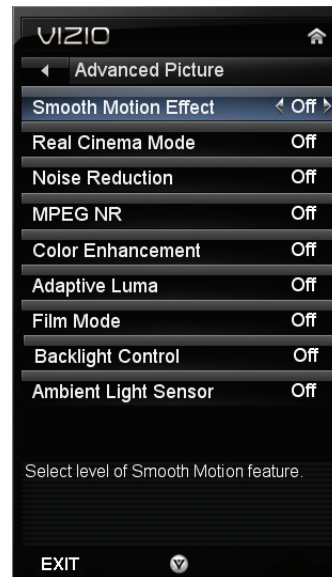

Reset Picture Mode

Return all Picture settings to factory default. A screen will come up to confirm your selection or to cancel it. Press ◀ or ▶ to make the selection, and then press **OK** to accept it.

Note: Only settings under the Picture will be reset.

PIP Menu

Your TV features PIP mode so you can watch two pictures at the same time. One picture is displayed as the full screen (main screen) and the other picture is displayed in a small window (sub screen).

Note: PIP is only available when the *Rating Enable* option in *Parental Controls* is set to **Off**.

PIP Mode

Select from **Off**, **PIP** (Picture-inside-picture) or **POP** (Picture-outside-picture). In **PIP** mode a smaller sub-screen is displayed on top of the main screen. In **POP** mode the main screen and sub-screen are of equal size and are positioned side-by-side.

Source

Select the input source for the sub-screen. The input sources available will vary according to which input is used for the main screen.

“✓” – Indicates which inputs are available for PIP and POP modes.

SUB \ MAIN	SUB				
	TV	AV (Composite)	Component	HDMI-1 HDMI-2 HDMI SIDE	RGB (Computer)
TV			✓	✓	✓
AV (Composite)			✓	✓	✓
Component	✓	✓		✓	
HDMI-1	✓	✓	✓		✓
HDMI-2	✓	✓	✓		✓
HDMI Side	✓	✓	✓		✓
RGB (Computer)	✓	✓		✓	

Position

Select where you want the PIP screen positioned over the main screen. Choose from **Top Left**, **Top Right**, **Bottom Left**, and **Bottom Right**.

Size

Set the size of the PIP window. Choose from **Small**, **Medium** or **Large**.

Audio

Select which source will play the audio. Choose from the **Main** screen or the **PIP** (sub) screen.

Settings Menu

Adjust various options including audio settings, scanning for channels, parental controls, date and time, and more.

Audio Menu

Adjust audio options including balance, equalizer, and advanced audio settings.

Audio Mode

Choose from Flat, Rock, Pop, Classic or Jazz.

Balance

Adjust the sound to the left or the right.

Lip Sync

Lip Sync is designed to adjust the audio of the program being viewed so that it matches the movement of the lips of someone talking on the screen.

TV Speakers

Turn the internal speakers On or Off. You may want to turn the internal speakers off when listening to the audio through your Home Theater System.

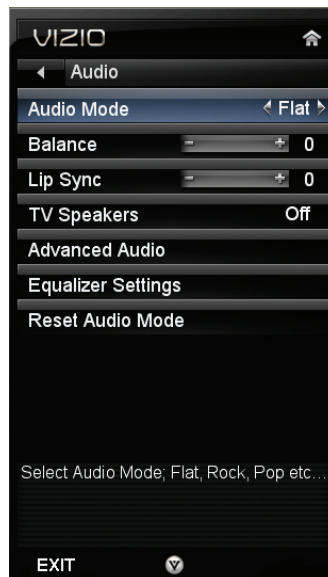
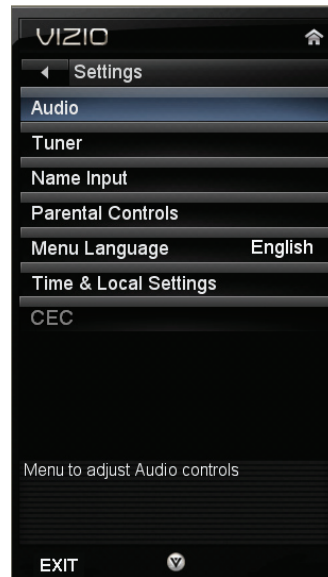

Advanced Audio

To select the options in the Advanced Audio sub-menu, press **OK**. A new menu will be displayed showing the advanced functions available for fine tuning of the audio.

- **SRS TruSurround HD**

When watching TV or a movie, TruSurround HD™ creates an immersive surround sound experience from only two speakers and provides rich bass, clear dialog and high frequency detail.

- **SRS TruVolume**

When the programming switches to a commercial or when changing from channel to channel, volume fluctuations occur. When turned ON, TruVolume™ provides the listener with a comfortable and consistent volume level.

- **Digital Audio Out**

This option allows selection of the type of processing for the S/PDIF (Optical connector) when used with a Receiver/Amplifier/Home Theater system. Choose from OFF, Dolby Digital or PCM.

- **Analog Audio Out**

This option sets the volume control properties when using the RCA (white and red) connectors as audio line out to connect a Receiver/Amplifier/Home Theater system. Choose from Fixed or Variable. When set to Variable, volume from the external speakers will change according to the volume setting on the TV. If it is set to Fixed, the volume can only be changed by the settings on the external stereo system.

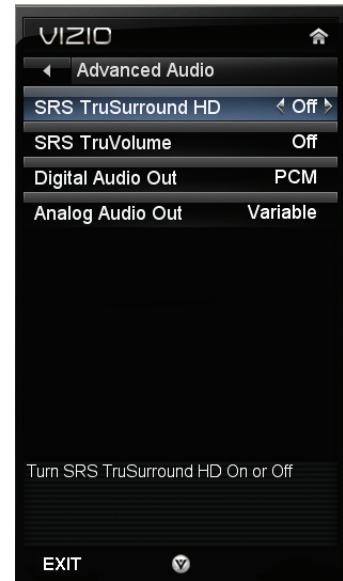

Equalizer Settings

To select the options in the Equalizer Settings sub-menu, press **OK**. A new menu will be displayed showing the available equalizer functions. Press **◀** or **▶** to select *Basic* or *Advanced*.

- **EQ Mode (Basic)**

Adjust Bass and Treble.

- **EQ Mode (Advanced)**

Adjust volumes of different frequencies.

Starting from lowest to the highest, they are 120 Hz, 500Hz, 1.5 kHz, 5 kHz and 10 kHz.

1. Press **◀** or **▶** to select the frequency to be adjusted.
2. Use **▲** or **▼** to adjust the selected frequency to your preference. Values above 0 will boost the frequency and values below 0 will attenuate the frequency.

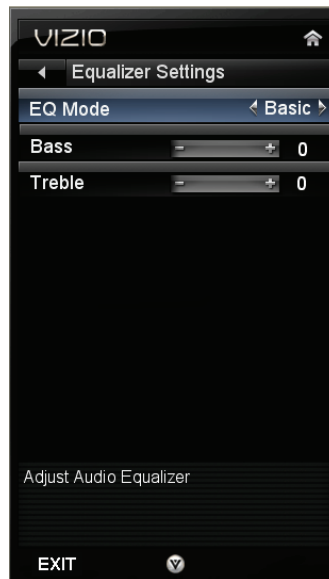

Note: The Equalizer adjustment will only be available when SRS TSHD is set to Off.

Reset Audio Mode

Return all Audio settings to factory default. A screen will come up to confirm your selection or to cancel it. Press ◀ or ▶ to make the selection, and then press OK to accept it.

Note: Only settings under the Audio menu will be reset.

Tuner

Note: The tuner option can only be selected when your HDTV is in TV input mode.

Tuner Mode

Select Cable or Antenna depending upon which you have attached to the DTV / TV Input.

Auto Channel Scan

Automatically search for TV channels that are available in your area. Be sure to first select the correct tuner mode above. The TV will search for analog and digital channels. When the search is done, press **OK** to begin watching your programs.

Partial Channel Search

If you believe channels are missed from the auto search, you can do a partial channel search to look for channel in a certain channel range again. Select to scan for Analog, Digital, or both Analog/Digital channels, then press ▼ to highlight the “From” and “To” selection. Press ▶ to select the range of channel numbers you want to start searching in. Press **OK** to start channel search.

Add Analog Channel

If your are in fringe/marginal reception areas or you want to receive local broadcasts where *Auto Channel Search* may not pick up the signals you can manually add channels. Press **OK** and a new menu will open. Enter the channel number, press ▼ to select *Add Channel*, and then press **OK** to add the channel.

Skip Channel

After the TV has stored all of the available digital channels in memory you will find that some channels are too weak to watch comfortably or they may be channels you do not want to see. Press **OK** to select the channel to be skipped when using the CH▲ or CH▼ button. An X will appear in channels you have selected to skip. You will still be able to select this channel using the number buttons on the remote control.

Analog MTS

This feature allows you to select the different languages the broadcaster is transmitting the audio with the program you are watching. This signal is usually Spanish. Choose from **Mono**, **Stereo**, or **SAP**.

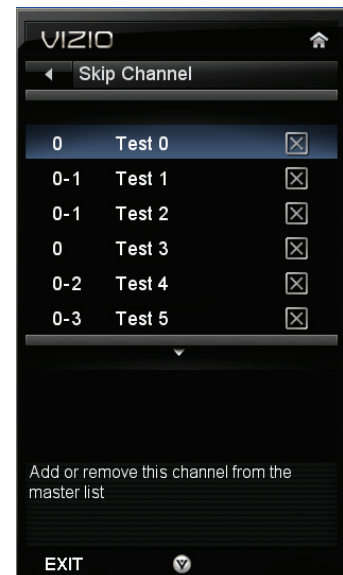
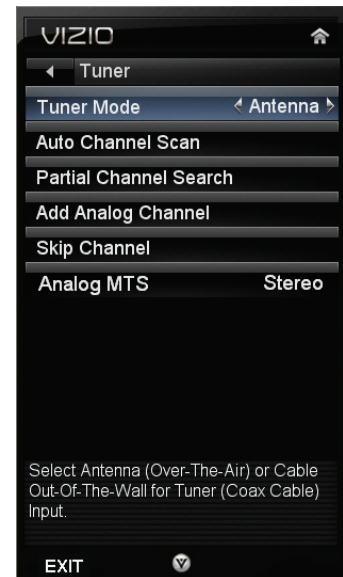

Name Input

This feature makes it easier for you to recognize the devices you have connected to your HDTV when you press **INPUT**. For example, if you have a Blu-Ray DVD player connected to the HDMI-1 input, you can have the input label read *HDMI-1 BluRay* instead of just *HDMI-1*. You can select from 10 preset labels.

To use one of the 10 preset labels:

1. Select *Input Source*, and then press **OK** to show the list of inputs.
2. Press **▼** to select the input label you want to change, and then press **OK**.
3. Press **▼** to select *Input Labels*, and then press **OK** to show the list of 10 preset labels.
4. Press **▼** to select the new input label name, and then press **OK**.

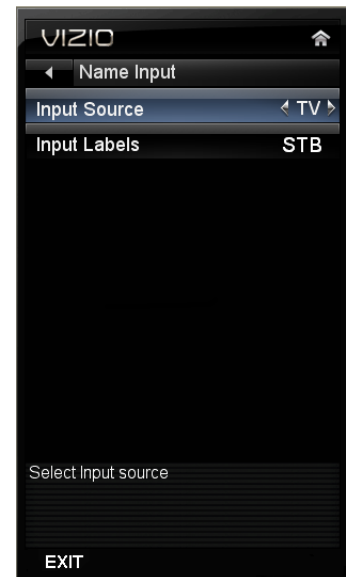

Parental Controls

If you want to restrict certain channel and program viewing, you can do this by turning on the Parental Control. Selected programs, movies and channels can then be made available only after an authorized password has been entered and accepted by the TV.

Note: The Parental Controls are divided into **LOCK** and **UNLOCK** menus. To activate or lock parental controls, use the **LOCK** menu. To deactivate or unlock parental controls, use the **UNLOCK** menu.

Navigating Lock and Unlock Menus

To access or navigate the **LOCK** menu, you must use the **Channel Up/Down** and **INPUT** buttons on the side of the TV. **The remote control buttons do not control the LOCK menu.**

To access or navigate the **UNLOCK** menu, you can use the **Arrow** and **OK** buttons on the remote. Enter your PIN when prompted.

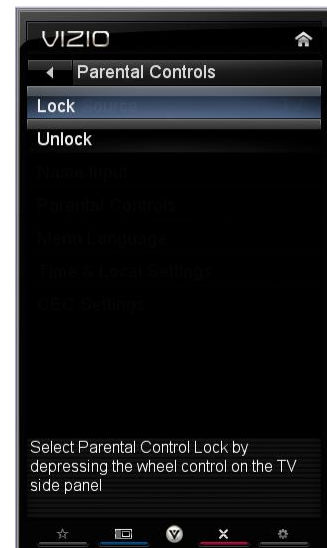

Lock and Unlock Menu Functions

Rating Enable

Select **ON** or **OFF**. If set to **OFF**, you will not be able to set the US TV, US Movie, Canadian English, or Canadian French Ratings.

Channel Locks

Block individual channels from being displayed.

USA-TV

Note: When Rating Enable is **OFF**, the USA-TV Rating adjustments are not available.

- TV-Y** – All children
- TV-Y7** – Older children
- TV-G** – General audience
- TV-PG** – Guidance suggested
- TV-14** – Strongly cautioned
- TV-MA** – Mature audience

You can also customize the TV ratings for the following content:

- A** – All sub-ratings
- FV** – Fantasy violence
- D** – Sexual dialog
- L** – Adult language
- S** – Sexual situations
- V** – Violence

USA-Movie

Note: When Rating Enable is **OFF**, USA-Movie Rating adjustments are not available.

- G** – General audience
- PG** – Parental guidance suggested
- PG-13** – Recommended for children 13 years of age or older
- R** – Mature audience
- NC-17** – No one under 17 years of age
- X** – No one under 17 years of age

CAN-English

Note: When Rating Enable is **OFF**, Canadian English Rating adjustments are not available.

- C** – Children
- C8+** – Children 8 years or older
- G** – General Programming, suitable for all audiences
- PG** – Parental guidance
- 14+** – Viewers 14 years or older
- 18+** – Adult programming

CAN-French

Note: When Rating Enable is **OFF**, Canadian French Rating adjustments are not available.

- G** – General audience
- 8 ans+** – General – not recommended for young children
- 13 ans+** – Not suitable for children under 13 years of age
- 16 ans+** – Not suitable for under 16 years of age
- 18 ans+** – Adults only

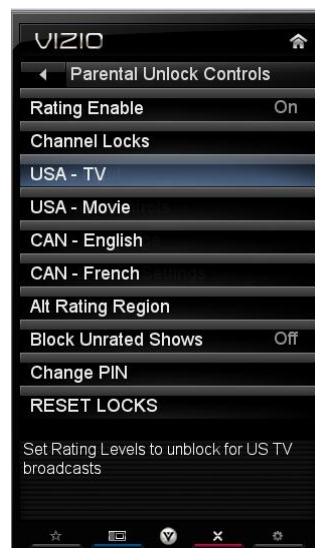
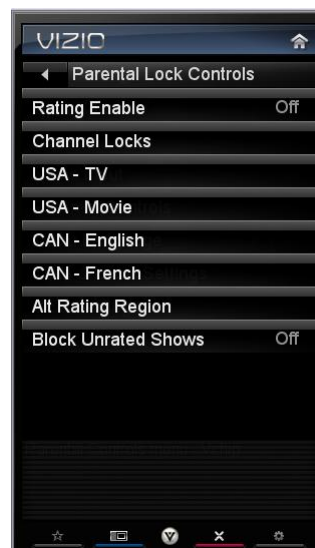

Alt Rating Region

This setting is not used. It is reserved for future rating systems.

Block Unrated TV

Block programming that does not have a rating.

Change PIN (UNLOCK Menu Only)

Enter a new, 4-digit password using the number buttons on the remote control. Enter it a second time to confirm you entered it correctly.

Note: Make sure you write down and store the new password in a secure place. The *Reset Locks* feature does NOT reset the password.

RESET LOCKS (UNLOCK Menu Only)

Return all Parental Control lock settings to factory default. A screen will come up to confirm your selection or to cancel it. Press ◀ or ▶ to make the selection, and then press **OK** to accept it.

Menu Language

Select to change the language of the menu. The default is **English**. You can also select **French** or **Spanish**.

Time & Local Settings

Time Zone

Setting the correct Time Zone for your area will ensure that the correct time is shown after pressing the **GUIDE** button on the remote control.

Daylight Saving

Setting the daylight saving time for your area will ensure that the correct time is shown after pressing the **GUIDE** button on the remote control.

CEC

Consumer Electronics Control allows you to control other devices using your HDTV remote control when those devices are connected via HDMI. For example, if a CEC-supported Blu-ray DVD player is connected to your HDTV through HDMI-2 and that player is powered on, your HDTV will automatically change to the HDMI-2 input. Similarly, if your HDTV is powered on first and you change the input to HDMI-2, your Blu-ray player will automatically power on.

Also, you can control your CEC-supported device using the transport keys on your HDTV remote control (e.g. Play, Stop, Prev, etc.). When you press one of the buttons on your HDTV, the action will occur on your device.

Contact your devices' user manual or manufacturer to check whether your device supports CEC.

CEC Function

Turn CEC On or Off. When set to Off, your HDTV will not send or receive any CEC commands.

Device Discovery

Register device with TV. Before CEC will work, perform a Device Discovery to see if there are any CEC supported devices connected to your HDTV.



Media Menu

When viewing pictures you can adjust various settings, including slideshow, picture duration, etc.

1. Insert a USB device containing pictures and select the folder or files that you want to play.
2. Press **MENU**. The Picture menu will be displayed.
3. Press **▲** or **▼** on the remote control to highlight a Picture menu option, and then press **◀** or **▶** to adjust the setting.
4. Press **MENU** once to close the menu.

Slideshow Mode

Choose from **Shuffle**, **Single**, and **Sequence** to set the slideshow mode. Press **OK** to begin the slideshow. Press **EXIT** to stop the slideshow.

- **Single** will display one picture selected from the thumbnails for the interval set in the *Duration* option and return to the thumbnails. If the *Repeat* option is set to **On**, the selected picture will be displayed until you press **EXIT**.
- **Sequence** will show your pictures in the order they are listed on your USB device until you stop the slideshow.
- **Shuffle** will show your pictures in random order until you stop the slideshow.

Repeat

Choose from **On** or **Off** to repeat the slideshow.

Sort By

You can choose to sort the pictures on the USB device by **Photo Date**, **File Date**, or alphabetically (**File A-Z**).

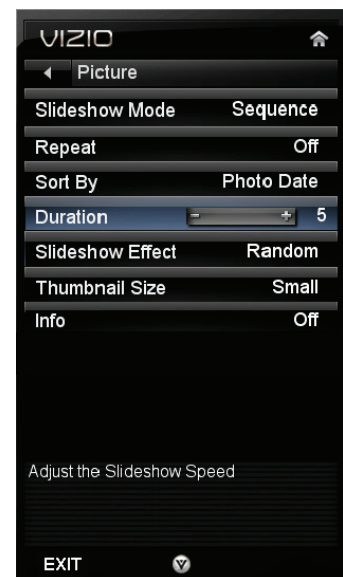

Duration

Set the amount of time the picture will remain on the screen during the slideshow. Choose a time between 5 seconds and 32 seconds.

Slideshow Effect

Choose from **Random**, **Dissolve**, **Wipe Right**, **Wipe Left**, **Wipe Up**, **Wipe Down**, **Box In**, or **Box Out** to set the transition type when changing from one picture to another during a slideshow.

Thumbnail Size

Set the size of the preview pictures (thumbnails) in the menu. Choose from **Small**, **Medium**, or **Large**.

Info

When set to **On**, information about the picture briefly appears on your HDTV.

Help Menu

System Info

Display the technical information including model name, version and revision of firmware, source type, and resolution.

Reset TV Settings

Return all Picture and Audio settings to factory default. A screen will come up to confirm your selection or to cancel it. Press Left or Right Navigation buttons to make the selection, and then press **OK** to accept it.

Note: This does **NOT** reset the Parental Control Password.

Clear Memory (Factory Default)

Use this function to reset the TV to the default factory settings. The screen will display a message to confirm that you want to reset the values to factory settings. Press ◀ or ▶ to make the selection, and then press **OK** to accept it.

Note: This does **NOT** reset the Parental Control Password.

Start Setup Wizard

Use this function to return to the Initial Setup menu. Use this function if you want to have a guided setup when you move your TV.

Note: Previously scanned channels will be removed.



Chapter 9 Programming the VIZIO Universal Remote Control

Program your E470VL and E551VL remote control to work with other devices.

Using a Cable or Satellite Box Remote

Your VIZIO remote uses codes 000, 047, 050, 067, 329, 331 and 339 to work your HDTV. To use a Cable or Satellite remote to work the HDTV, refer to your Cable or Satellite remote user guide for more information on how to program the remote.

If your Cable or Satellite remote uses a 5-digit code (like most Direct TV units), first try 11758 and then, if that does not work, 10178. If your Cable or Satellite remote uses a 4-digit code, try 1758 and then 0178 as an alternative. If your Cable or Satellite remote uses a 3-digit code (Echostar or Dish Network for example), use code 627.

Note: Some buttons may not function as expected on your Cable or Satellite remote. Typically power, volume and mute will work.

Programming other devices

Your remote control is programmable and supports up to three different devices. Listed below are the steps for programming your DVD player, Home Theater System, and a Cable or Satellite box. After you find your codes, write them in the table provided.

Programming your Blu-Ray or DVD Player

1. Turn on the DVD player.
2. Press and release the **DVD** button on your VIZIO universal remote control.
3. Press and hold the **SET** button until the LED flashes twice.
4. Find the programming code for your DVD player in the code list below and enter it using the number buttons. If the code is accepted, the LED flashes twice after the last digit is entered. If the LED does not flash twice, repeat Steps 2 through 4 with the next code listed.
5. Point the remote control at the DVD player and press **POWER**. The DVD player will turn off. If the DVD player does not turn off, repeat Steps 2 through 4 with the next code listed for the component and manufacturer.

Notes:

- If the codes do not work or your brand is not listed, see *Searching for Device Codes* on page 48.
- Sometimes a code listed will only include limited functions. Try other codes that may include more functionality.

Programming your Home Theater System

1. Turn on the Home Theater System.
2. Press and release the **AUDIO** button on your VIZIO universal remote control.
3. Press and hold the **SET** button until the LED flashes twice.
4. Find the programming code for your Home Theater System and enter it using the number buttons. If the code is accepted, the LED flashes twice after the last digit is entered. If the LED does not flash twice, repeat Steps 2 through 4 with the next code listed.
5. Point the remote control at the Home Theater System and press **POWER**. The Home Theater System will turn off. If the Home Theater System does not turn off, repeat Steps 2 through 4 with the next code listed for the component and manufacturer.

Notes:

- If the codes do not work or your brand is not listed, see *Searching for Device Codes* on page 48.
- Sometimes a code listed will only include limited functions. Try other codes that may include more functionality.

Programming your Cable or Satellite Set-Top Box

1. Turn on the Cable or Satellite Set-Top Box.
2. Press and release the **CABLE** button on your VIZIO universal remote control.
3. Press and hold the **SET** button until the LED flashes twice.
4. Find the programming code for your Cable or Satellite Set-Top Box and enter it using the number buttons. If the code is accepted, the LED flashes twice after the last digit is entered. If the LED does not flash twice, repeat Steps 2 through 4 with the next code listed.
5. Point the remote control at the Cable or Satellite Set-Top Box and press **POWER**. The Cable or Satellite Set-Top Box will turn off. If the Cable or Satellite Set-Top Box does not turn off, repeat Steps 2 through 4 with the next code listed for the component and manufacturer.

My Codes	
DVD Player	
Home Theater	
Cable Box	
Satellite Box	
VCR	
Other	
Other	
Other	

Notes:

- If the codes do not work or your brand is not listed, see *Searching for Device Codes* on page 48
- Sometimes a code listed will only include limited functions. Try other codes that may include more functionality.

Searching for Device Codes

If you cannot find the manufacturer in the list or the program code does not work, you can use the remote control to search for the correct device code.

1. Turn on the device.
2. Press the matching device button on your VIZIO universal remote control.
3. Press and hold **SET** until the LED flashes twice.
4. Press **9 9 1**. The LED flashes twice.
5. Point the remote control at the device and then press and hold **POWER** until the device turns off.

Reset Remote Control to Factory Settings

1. Press and hold **SET** until the LED flashes twice.
2. Press **9 1 9 1 9**. The LED flashes twice.

Remote Control Codes

Television Codes

(Including TV/DVD, TV/VCR, and TV/DVD/VCR)

3M 1655	Chun Yun 0706, 1687, 1756, 1834, 2230	Emerson 1864, 0154, 0451, 0236, 0463, 0180, 0178, 0171, 1661, 0623, 1394, 1913, 1929, 1944, 1963, 0002, 0479, 0593, 1479, 0675, 1268, 2212, 0821	Helios 0865
Admiral 0093, 0463	Citizen 0060, 0030, 0092, 1669, 1671, 1672, 1935, 0695	Emprex 1422, 1546, 1765	Hello Kitty 0451
Advent 0761, 0783, 0815, 0817, 0842	Clarion 0180	Envision 0030, 0813, 1365, 1589, 2014, 2087	Heran 1826, 1852, 2305, 2356
Aiko 0092	Coby 1538, 1634, 2017, 2306, 2315, 2338, 2340, 2343, 2344, 2345, 2347, 2348, 2350, 2495, 2535, 2536, 2537, 2538, 2540	Epson 0833, 0840, 1122	Herosonic 1826
Akai 0812, 1675, 0702, 0030, 0672, 1207, 1935, 2232, 0143, 0695, 2439	Colt 0072	ESA 0812, 0171, 1944, 1963, 1268, 0821	Hewlett Packard 1642, 1494, 1502
Albatron 0700, 0843	Commercial Solutions 1447, 0047	Esonic 2221, 2229, 2234	HiPlus 1420, 1435, 2113, 2224, 2225, 2226, 2230, 2235
America Action 0180, 0278	Contec 0180	Fisher 0154	Hisense 0748, 1314, 1660, 2098, 2183, 2355, 2419
Anam 0180	Craig 0180	Frigidaire 1597, 1826, 2231	Hitachi 1643, 1145, 0145, 1445, 1904, 0000
AOC 0030, 1365, 1589, 1590, 2014, 2087, 2402	Crosley 0000, 0054	Fujimaru 1687	HP 1642, 1494, 1502
Aomni 1623	Crown 0180	Fujitsu 0809, 0683, 0853	Humax 1501
Apex Digital 0748, 0879, 0765, 0767, 0890, 1217, 2397	Curtis 2352, 2466, 2660	Funai 0000, 0180, 0171, 1271, 1904, 1963, 1268	Hyundai 0849
Astar 1531, 1548, 1738	Curtis Mathes 0047, 0054, 0154, 0451, 0093, 0060, 0702, 0030, 0145, 0166, 1661, 1147, 1347	Futuretech 0180	I-Inc 1746
Asus 2175	CXC 0180	Gateway 1755, 1756	iLo 1286, 1603, 1684, 1990, 1472
Audiovox 0451, 0180, 0092, 0623, 0802, 0846, 0875, 1284, 1937, 1951, 1952, 0278, 1071, 1121, 1122	Daewoo 0154, 0451, 0092, 1661, 0623, 0661, 0672	GE 1447, 0047, 0051, 0451, 0178, 1347, 1922, 2359, 0240, 1060	Infinity 0054
AUO 1591	Dell 1264, 1080, 1178, 1403, 1863	GFM 0171, 1963, 2167, 1268	InFocus 2024, 2199
Aventura 0171	Delta 1369	Gibraltar 0017, 0030	Initial 1603, 1990, 1472
Axion 1937, 1071	Denon 0145	Gibson 1597, 1826, 1834, 2305	Insignia 1423, 1564, 0171, 1204, 1517, 1641, 1660, 1710, 1780, 1892, 1963, 2002, 2049, 2088, 2417, 1013, 1268, 2255, 2620
Bell & Howell 0154	Diamond Vision 1996, 1609	Go Video 0886, 1823, 1831	Inteq 0017
BenQ 1032, 1715, 1853	Digisonic 1826	Go Vision 1071	iRIS 2189
Boxlight 0893	Digital Lifestyles 1765, 1822	GoldStar 0178, 0030	JBL 0054
Bradford 0180	Digital Projection Inc. 1750	Goodmans 0360, 2274	JCB 0000
Brandt Plus 1851	DirecTV 1501	Grundig 0683	Jensen 0761, 0815, 0817, 1299
Brilliant 1007	Disney 2152, 2356	Grunpy 0180	JVC 0463, 0053, 0650, 0731, 1253, 1601, 1774, 1923, 2271, 1067, 2472
Broksonic 0236, 0463, 1929, 1935, 1938, 0002, 0479, 1479, 0695, 0868	Dream Vision 1297	Haier 1034, 1748, 1749, 1753, 2309, 2099, 2500	KDS 1498, 1687
byd:sign 1309	Dumont 0017	Hallmark 0178	KEC 0180
Candle 0030	Durabrand 0463, 0180, 0178, 0171, 1034	Hanns.G 1783	Kenwood 0030
Canon 1396	Dynex 1463, 1780, 1785, 1810, 2049, 2184, 2255, 2388	Hannspree 1348, 1351, 1745, 1783, 1826	KLH 0765, 0767
Carnivale 0030	Electroband 0000	Harley Davidson 0000, 1904	Kolin 1610, 1755, 0150, 1240, 1837
Carver 0054	Electrograph 1755, 1623	Harman/Kardon 0054	Konka 0748, 1831
Celebrity 0000	Electrohome 0463, 1670, 1672, 1607	Harsper 1206	KTV 0180, 0030
Celera 0765	Element 1687, 2183	Harvard 0180	
Changhong 0765		Havermy 0093	
Chimei 1837, 1852, 2072			

LG 1423, 0017, 1265, 0178,
 0700, 0856, 1178, 1768,
 1934, 1993, 2358, 2424,
 0480, 1037, 2485
 Lloyd's 1904, 0000
 Loewe 0136
 LXI 0047, 0054, 0154, 0156,
 0178
 MAG 1498, 1687
 Magnasonic 1913, 0593
 Magnavox 1454, 1866, 0054,
 0051, 0030, 0706, 0802,
 1012, 1198, 1254, 1365,
 1525, 1904, 1913, 1931,
 1944, 1963, 1990, 2372,
 0000, 0593, 1781, 1268,
 1472, 2229, 2632, 0821
 Magnin 0240
 Marantz 1454, 0054, 0030,
 0704, 0855, 1154, 1398,
 2445, 2447
 Matsushita 0250, 0650
 Maxent 1755, 1714, 1757
 Megapower 0700
 Megatron 0178, 0145
 Memorex 0154, 0463, 0150,
 0178, 1670, 1892, 1924,
 0162, 1037, 1162, 1262,
 1607
 MGA 0150, 0178, 0030,
 0240
 Midland 0047, 0017, 0051
 Mintek 1603, 1990, 1472
 Mitsubishi 1250, 0093, 0150,
 0178, 0836, 0868, 1522,
 2010
 Monivision 0700, 0843
 Motorola 0093
 MTC 0060, 0030
 Multitech 0180
 NAD 0156, 0178, 0866,
 1156
 NEC 0030, 0497, 0704,
 0882, 1398, 1546, 1704,
 1797, 1852, 2026, 2144
 NetTV 1755
 NewSonic 1826
 Nexus Electronics 2183
 Nikko 0178, 0030, 0092
 Niko 1581, 1618
 Norcent 0748, 0824, 1365,
 1589, 1590, 1591, 2110
 Norwood Micro 1286, 1303
 NTC 0092
 NuVision 1657, 2158
 Olevia 1610, 1144, 1240,
 1331
 Onwa 0180
 Optimus 0250, 0154, 0166,
 0650, 1913, 1924, 0162,
 0593, 1162, 1262
 Optoma 0887, 1348, 1622,
 2161
 Optonica 0093
 Orion 0236, 0463, 1463,
 1929, 0002, 0479, 1479
 Panasonic 1480, 0250,
 1457, 0051, 0650, 1271,
 1291, 1410, 1924, 1941,
 1946, 1947, 0162, 1162,
 1262, 1490, 1362, 1462
 PARK 2104, 2194, 2202
 Penney 0047, 0156, 0051,
 0060, 0178, 0030, 1347,
 0240
 Petters 1523
 Philco 0054, 0030, 0171,
 1271, 1394, 1963
 Philips 1454, 1866, 0054,
 0690, 1154, 1744, 1850,
 1867, 1961, 2227, 2372,
 2374, 1260
 Pilot 0030
 Pioneer 1457, 0166, 0679,
 0866, 1260, 1398
 Polaroid 1523, 0765, 2425,
 2121, 2120, 2119, 2063,
 2002, 1992, 1769, 1767,
 1766, 1687, 1538, 1498,
 1314, 1286, 1276, 0865,
 1013, 2110, 2140, 1482
 Polyvision 0889, 1144
 Portland 0451, 0092, 1661
 Prima 0761, 0783, 0815,
 0817, 1785
 Princeton 0700
 Prism 0051
 Projectiondesign 1750
 Proscan 1447, 0047, 0030,
 1347, 1922, 2147, 2256,
 2450
 Proton 0178, 1546, 1834,
 1874
 Proview 1498, 1687
 Proxima 1896
 Pulsar 0017
 Puneet 1546
 Quasar 0250, 0051, 0650,
 1924, 0162, 1162
 Radio Shack 0047, 0154,
 0180, 0178, 0030, 1904,
 0000, 1037
 RCA 1547, 1447, 0047,
 0051, 0093, 0090, 0679,
 1047, 1147, 1247, 1347,
 1781, 1922, 1953, 2002,
 2187, 2247, 2434, 0240,
 1060, 1013, 2392, 1132
 Realistic 0154, 0180,
 0178, 0030
 Relon 1826
 RevolutionHD 1623
 Runco 0017, 0030, 0497,
 0603, 1398, 1629, 2444
 Sampo 1755, 0030, 1597,
 1618, 2238
 Samsung 0812, 0060,
 0702, 0178, 0030, 0587,
 0650, 0766, 0814, 1060,
 1618, 1632, 1959, 2051,
 1014
 Sansui 0463, 0171, 1409,
 1670, 1892, 1904, 1929,
 1935, 0000, 0479, 1479,
 0695, 1607
 Sanyo 0054, 0154, 0088,
 0799, 0842, 0893, 1142,
 2115, 2236, 2237, 2238,
 2448, 2452, 0240
 Sceptre 0878, 1217, 1360,
 1599
 Scotch 0178
 Scott 0236, 0180, 0178,
 1711
 Sears 0047, 0054, 0154,
 0156, 0178, 0171, 1007,
 1904, 0000
 Seleco 1297, 1351
 Sharp 0818, 0093, 0491,
 0688, 0851, 1602, 2360,
 2561, 0630
 Sheng Chia 0093
 Sherwood 1399
 SIM2 Multimedia 1297
 Sole 1623, 2075, 2076
 Sony 0810, 0000, 0834,
 1685, 1904, 1925, 2054,
 1232
 Soundesign 0180, 0178
 Sova 1952, 1122
 SOYO 1520, 1546,
 1746, 1826, 1828,
 1829, 1830, 1831,
 1832, 1834
 Spectroniq 1498, 1687
 Squareview 0171
 SSS 0180
 Starlite 0180
 Studio Experience
 0843
 SunBrite 1420, 1435,
 2337
 SuperScan 0093,
 0864, 1944, 0821
 Supreme 0000
 SVA 0748, 0587, 0865,
 0870, 0871, 0872,
 1963
 Sylvania 1864, 0054,
 0030, 0171, 0587,
 1271, 1314, 1394,
 1886, 1913, 1931,
 1944, 1963, 1781,
 0675, 1268, 2194,
 2212, 0821
 Symphonic 0180,
 0171, 1904, 1913,
 1944, 0000, 0593,
 0821
 Synco 1755, 1826
 Syntax 1610, 1144,
 1240, 1331
 Tandy 0093
 Tatung 1156, 1254,
 1286, 1687, 1719,
 1756, 1839, 1857
 Technics 0250, 0051
 Techview 0847, 2004
 Techwood 0051
 Teco 0053, 0092,
 1687, 1834, 1838,
 2114
 Teknika 0054, 0180,
 0150, 0060, 0092
 Telefunken 0702
 Thomas 1904, 0000
 TMK 0178
 TNCi 0017

Toshiba 1524, 0154, 0156,
1256, 1265, 0060, 2233,
2006, 1945, 1936, 1935,
1704, 1656, 1635, 1369,
1356, 1156, 0845, 0832,
0650, 1145, 0695, 1606,
2165, 1045
Trutech 1723, 2066, 2264
TVS 0463
US Logic 1286, 1303
UTI Technology 2244
Vector Research 0030
Venturer 1865, 2195
VEOS 1007
Victor 0053
Vidikron 0054, 1398, 1629
Vidtech 0178
Viore 1207, 1684, 1811,
2104, 2352, 2154, 2300,
2580
Vision 1826, 2305
Vistron 2142
Vito 1852, 2365, 2375, 2376,
2377, 2378, 2379, 2380,
2381
Vizio 1758, 0864, 0885,
1756, 2116
Wards 0054, 0178, 0030,
0866, 1156
Waycon 0156
Westinghouse 1712, 1755,
0451, 0885, 0889, 0890,
1282, 1300, 1577, 1597,
1826, 1834, 2293, 2305,
2513
White Westinghouse 0463,
1661, 0623
Wyse 1365
Yamaha 0030, 0769, 0833,
0839
Zenith 0000, 1423, 0047,
0017, 0463, 1265, 0178,
0030, 1145, 0145, 0092,
1661, 1904, 1929, 0479,
1479
Zinwell 2116, 2281

Cable Box Codes

(Including Cable / PVR Boxes)

Amino 1602, 1822
Bright House 1376, 1877
Cable One 1376, 1877
Cablevision 1376, 1877,
1006
Charter 1376, 1877, 2187
Cisco 1877, 0877, 1982
CNS 2350
Comcast 1376, 1877, 1982,
2576
Cox 1376, 1877
Digeo 1187, 2187
Director 0476
General Instrument 0476
Homecast 2301
i3 Micro 1602
Insight 1376, 1877
Jerrold 0476
Knology 1877
Mediacom 1376, 1877
Motorola 1376, 0476, 1187,
1982
Myrio 1602, 1822
Pace 1376, 1877, 1982
Panasonic 1982
Pioneer 1877, 0877
Prime 2340
Rogers 1877
Scientific Atlanta 1877,
0877
Sejin 1602
Shaw 1376
Sony 1006
Suddenlink 1376, 1877
Thomson 1982
Time Warner 1376, 1877,
2187
Tivo 2576
WideOpenWest 1877

Converters

(Including Digital-to-Analog and HDTV)

Access HD 2185
Airlink 101 2491
Alpha Digital 2185
AMTC 2185
Apex Digital 2478
Artec 2490
CASTi 2305
Channel Master 2365
Coby 2667
Coship 2487
Daewoo 2338
Daytek 2305
Digital Stream 2303
Dish Network 0775, 2470
Echostar 2470
GE 2360, 2450
Goodmind 2450
Gridlink 2348
Insignia 1415
Lasonic 2348
Magnavox 1563
Memorex 2486
MicroGEM 2489
Motorola 1982
Pace 1982
Philco 1563
RCA 2325, 2454
Samsung 2592
Sansonic 2348
Sunkey 2695
Sylvania 1563
Thomson 1982
Tivax 2185
Ventura 2454
Venturer 2454
Wineward 2454
Zenith 1415
Zentech 2491
Zinwell 2488

Decoders

(Including Digital-to-Analog and HDTV)

DirecTV 0392
Dish Network 0775
Epson 1563
LG 1414, 1415
Panasonic 1120, 1190,
1490
Samsung 1190, 1276,
1490
Sylvania 1563
Sony 1006
Tivo 0739
Zenith 1856

IPTV

Motorola 1376, 0476
ADB 2254
Amino 1481, 1615,
1673, 2482
AT&T 0858
Chunghwa 1917
Cisco 2345, 2517
Motorola 0858, 2378
Scientific Atlanta 0858,
2345, 2517
SetaBox 1917
Verizon 2378

Satellite Receiver Codes

(Including Sat / PVR Boxes)

Amino 1615
Bell ExpressVu 0775,
1170
Coolsat 2147
Crossdigital 1109
DirecTV 1377, 0392,
0566, 0639, 1639,
1142, 0247, 0749,
1749, 1856, 1076,
1109, 1414, 1442,
1443, 1444, 1609,
0739, 0740
Dish Network System
0775, 1505, 1170,
1775
Dishpro 0775, 1505,
1775
Echostar 0775, 1505,
1170, 1775

Expressvu 0775, 1775
 Fortec Star 1948
 GE 0566
 General Instrument 0869
 GOI 0775, 1775
 HTS 0775, 1775
 Hughes Network 1142, 0749, 1749, 1442, 1443, 1444, 0740
 Jerrold 0869
 JVC 0775, 1170, 1775
 LG 1414
 Mitsubishi 0749
 Motorola 0869
 Next Level 0869
 Panasonic 0247, 0701
 Pansat 1807
 Philips 1142, 0749, 1749, 1076, 1442
 Proscan 0392, 0566
 RadioShack 0869
 RCA 0392, 0566, 0855, 0143
 Samsung 1377, 1276, 1109, 1442, 1609
 Sonicview 2373, 2374
 Sony 0639, 1639
 Star Choice 0869
 Tivo 1142, 1442, 1443, 1444, 0740
 Toshiba 0749, 1749, 0790
 Viewsat 1994
 Voom 0869
 Zenith 1856

PVR Codes

Amino 1673
 ABS 1972
 Alienware 1972
 CyberPower 1972
 Dell 1972
 DirecTV 0739, 0740
 Gateway 1972
 Go Video 0614
 Hewlett Packard 1972
 Howard Computers 1972
 HP 1972
 Hughes Network Systems 0740
 Humax 0739, 1797, 1988

Hush 1972
 iBUYPOWER 1972
 Linksys 1972
 Media Center PC 1972
 Microsoft 1972
 Mind 1972
 Niveus Media 1972
 Northgate 1972
 Panasonic 0614, 0616, 1807, 1777
 Philips 0739, 0618, 1818
 Pioneer 1803
 RCA 0880
 ReplayTV 0614, 0616
 Sharp 1893
 Sonic Blue 0614, 0616
 Sony 0636, 1886, 1972
 Stack9 1972
 Sylvania 0000
 Systemax 1972
 Tagar Systems 1972
 Tivo 0739, 0618, 0636, 0740
 Toshiba 1008, 1972, 1988, 1996
 Touch 1972
 Viewsonic 1972
 Voodoo 1972
 ZT Group 1972

Blu-Ray DVD Codes

Denon 2258
 Insignia 0675, 2428, 2596
 Integra 1769, 2147
 JVC 2365
 LG 0741, 1602
 Magnavox 0675
 Marantz 2414
 Microsoft 2083
 NAD 2572
 Olevia 2331
 Onkyo 1769, 2147
 Oppo 2545, 2546, 2547
 Panasonic 1641, 2518
 Philips 2084, 2434
 Pioneer 0142, 2442
 RCA 1769
 Samsung 0199, 0298
 Sharp 2250, 2561
 Sony 1516, 2504

Sylvania 0675, 2194
 Toshiba 1769, 1515, 2705
 Viore 2553
 Vizio 2563
 Xbox 2083
 Yamaha 2298

DVD/VCR Player Codes

Accurian 0000, 0675
 Allegro 0869
 Apex Digital 1061
 Broksonic 0695
 CineVision 0869
 Daewoo 0869
 Emerson 1593, 0675
 Funai 1593, 0675
 GFM 1593, 0675
 Go Video 0744, 0715, 0741, 0869, 1044, 1075
 GoldStar 0741
 Hitachi 0000, 0664
 JVC 1707, 0867, 1164, 1550, 1602
 LG 0741
 LiteOn 1656
 Magnavox 0000, 1593, 0675
 Memorex 0695
 Panasonic 1762
 Philips 0675, 1267
 Pioneer 1460
 Polaroid 1061
 Presidian 0000, 1593, 0675
 RCA 0060, 0522, 0822
 Rio 2002
 Samsung 0820, 1044, 1075, 2489
 Sansui 0695
 Sanyo 0104, 0670, 0873
 Sharp 0848, 1893, 0630
 Sonic Blue 2002
 Sony 1702, 1896, 0864, 1033, 1070, 1431
 Sylvania 0000, 0593, 1593, 0675
 Symphonic 0000, 1593, 0675
 Toshiba 0503, 1854
 Zenith 0741, 0869

DVD Player Codes

Accurian 0675, 0675
 Aiwa 0641, 1912
 Akai 0143, 0695, 0770, 1975, 2439
 Alco 0790
 Allegro 0869
 Amphion Media Works 2001, 2016
 AMW 2001, 2016
 Anam 1913
 Apex Digital 0672, 0755, 0794, 0796, 0797, 1004, 1020, 1056, 1061, 1100, 1833, 1915, 1937
 Arrgo 1023
 Audio Authority 2555
 Audiovox 0790, 1041, 1071, 1121, 1122
 Axion 1071
 B & K 0662
 BBK 1224
 Bel Canto Design 1571
 Blue Parade 0571
 Bose 1895, 2023
 Boston Acoustics 1856
 Broksonic 0695, 0868
 California Audio Labs 0490
 Cambridge Sound Works 1916
 Cinea 0831
 CineVision 0869
 Citizen 0695, 2116
 Classic 1917
 Coby 0778, 0852, 1086, 1107, 1165, 1177, 1351, 1628, 1923, 2495, 2535, 2536, 2537, 2538, 2540
 Craig 0831
 Criterion 2007
 Curtis 2660
 Curtis Mathes 1087
 CyberHome 0816, 1023, 1024, 1129, 1502

Daewoo 0784, 0869, 1169, 1172, 1918	Koss 1980	Presidian 0675, 1738	Urban Concepts 0503
Denon 0490, 0634, 1634, 2258, 2270	Lennox 1127, 1938	Proceed 0672	Venturer 0790, 2195
Diamond Vision 1609	LG 0591, 074 1, 0869, 1602, 1906, 2002, 2485, 2568	Proscan 0522, 2450	Viore 2154, 2300, 2553, 2580
DigitalMax 1738	Liquid Video 1980	ProVision 0778	Vizio 1064, 1226, 2563
Disney 0675, 1270, 2356	LiteOn 1058, 1656, 1738	RCA 0522, 0571, 1769, 0790, 0822, 1013, 1132, 1913, 1965, 1974, 2213, 2392	Westinghouse 2513
Durabrand 1023, 1127	Logitech 2639	Regent 1938	Xbox 0522, 2083
DVD2000 0521	Magnavox 0503, 0539, 0646, 0675, 0821, 1177, 1268, 1354, 1472, 1506, 1914, 1976, 2229, 2632	Rio 0869, 2002	Yamaha 0490, 0539, 0646, 0545, 0497, 0817, 1840, 2298, 2558
Dynex 2255, 2388	Marantz 0539, 2414	Rotel 0623	Zenith 0503, 0591, 0741, 0869, 1906
Electrohome 1607, 1729, 2116	Mclntosh 1273	Saba 1977	
Emerson 0591, 0675, 0821, 1268, 2212	Memorex 0695, 0831, 12 70, 1607, 2213	Sampo 0752	Amplifier / Receiver / Tuner Codes
Enterprise 0591	Messiah Entertainment 2396	Samsung 0490, 0573, 0199, 0298, 0820, 1044, 1075, 1470, 1932, 1979, 2069, 2329, 2369, 2489, 2556	Adcom 1100
ESA 0821, 1268	Microsoft 0522, 2083	Sansui 0695, 1607	Aiwa 1405, 1388, 1641, 2298
Fisher 0670, 1919	Mintek 1472	Sanyo 0670, 0695, 0873, 1919, 1967	Akai 1512
Funai 0675, 1268	Mitsubishi 1521, 0521	Schmartz 2367	Alco 1390
Gateway 1077	NAD 0741, 2572	Schneider 0646	AMC 1077
GE 0522, 0815	NexxTech 1830	Sharp 1893, 0630, 0675, 0752, 1256, 2250, 2561	Amphion Media Works 1563, 1615
GFM 0675, 1268	Norcent 1107, 1830, 1923	Sherwood 0633, 0770, 1043, 1077, 1889	AMW 1563, 1615
Go Video 0744, 0715, 0741, 0869, 1044, 1075, 1970	Nova 1923	Sherwood Newcastle 1077	Anam 1609, 1074
Go Vision 1071	Nyko 2340	Shinsonic 0533, 1931	Anthem 2220
GoldStar 0741, 0869	Olevia 2331	Sonic Blue 0869, 1970, 2002	Apex Digital 1257, 1430, 1774
Goodmans 2274	Onkyo 0503, 1769, 0627, 1924, 1985, 2147	Sony 1702, 1896, 1633, 0533, 0864, 0772, 1033, 1070, 1431, 1516, 1536, 1824, 1903, 1904, 1934, 1981, 2020, 2132, 2504	Arcam 1189
Grundig 0539	Oppo 0575, 1224, 1525, 2185, 2545, 2546, 2547	Sova 1122	Audiotronic 1189
Haier 2099, 2500	Oritron 1980	Superscan 0821	Audiovox 1390, 1627
Harman/Kardon 0582, 0702, 1229	Panasonic 0490, 0503, 2967, 2518, 2017, 1990, 1925, 1909, 1908, 1907, 1762, 1641, 1579, 1490, 1462, 1362, 0703, 0632, 0458	Sylvania 0675, 0821, 1268, 2194, 2212	B & K 0820
Helios 2080, 2192	Philco 0675	Symphonic 0675, 0821	Bose 1229, 0639, 1253, 1629, 1841, 1933
Hello Kitty 0831	Philips 0503, 0539, 2056, 2084, 0646, 2531, 2526, 2434, 1914, 1911, 1846, 1506, 1354, 1340, 1267, 1260, 0675	Teac 0790, 1984	Boston Acoustics 1840, 1847, 2162, 2232
Hitachi 0573, 0664, 1919	PianoDisc 1024	Technics 0490, 0703	Brix 1602
Hiteker 0672	Pioneer 0525, 0571, 0142, 0631, 0632, 1460, 1512, 1531, 1571, 1902, 1965, 2442	Terapin 1031	Cambridge Soundworks 1370, 2297
Humax 1500, 1588	Polaroid 1013, 1020, 1061, 1086, 1482, 1998, 2110, 2140	Theta Digital 0571	Cary Audio Design 1879
iLo 1348, 1472	Polk Audio 0539	Tivo 1503, 1512	Carver 1189
Initial 1472, 1931	Portland 0770	Toshiba 0503, 1769, 0695, 1045, 1154, 1503, 1510, 1515, 1588, 1606, 1608, 1854, 2006, 2165, 2277, 2705	Classic 1352
Insignia 0675, 1013, 1268, 1712, 1830, 2095, 2150, 2255, 2428, 2596, 2620		Trutech 2264	Coby 1389, 2127
Integra 0571, 1769, 0627, 1634, 1924, 2147			Cox Cable 1517
iSymphony 1792			Criterion 1420
JBL 0702, 1926			Curtis 1596
JVC 0558, 0623, 0867, 1164, 1275, 1550, 1602, 1863, 1901, 1940, 2365, 2472			
Kawasaki 0790			
Kenwood 0490, 0534			
KLH 0790, 1020, 1149, 1939			
Konka 0711			

- Daewoo 1250
 Delphi 1414, 1846
 Denon 2134, 2857, 1360, 1142, 2230, 2263, 2279, 2861, 2862
 DirecTV 1517
 Dish Network 1517
 Electrohome 2026
 Emerson 1659
 Fisher 1801
 Flextronics 1879
 Gateway 1517
 Go Video 1532
 GPX 2319
 Halcro 1934
 Harman/Kardon 0892
 Harman/Kardon 0891, 1304, 1306, 2241, 2443
 Hitachi 1801
 iHome 2435
 iLive 2013
 Initial 1426
 Insignia 1030, 1077, 1751, 1893, 2126, 2169, 2175, 2472, 2474, 2545
 Integra 1298, 1320, 1805, 2989, 2993
 iSymphony 2018, 2258, 2442
 Jamo 2160
 JBL 1306
 JVC 1374, 1495, 1534, 1560, 1643, 1676, 1811, 1871, 1894, 2040, 2161, 2239, 2299, 2331, 2456
 Kenwood 1313, 1570, 1569, 1770
 KLH 1390, 1412, 1428
 Koss 1366, 1497
 Krell 1837, 2463
 Lasonic 1798
 Lennox 1437
 LG 1293, 2197, 2284
 Liquid Video 1497
 Logitech 2217
 Left Coast 0892
 Magnavox 1189, 1269, 1514
 Marantz 0892, 1189, 1269, 1289, 1892, 2114, 2117, 2118, 2138
 Mark Levinson 2405
 McIntosh 1289
 Memorex 1596
 Micromega 1189
 Mitsubishi 1393
 Myryad 1189
 NAD 1989, 1995, 2457
 Nakamichi 1313
 NexxTech 1751
 Norcent 1389, 1751
 Nova 1389
 Onkyo 0842, 1298, 1320, 1531, 1805, 2259, 2451, 2989, 2993
 Optimus 1023, 1074
 Oritron 1366, 1497
 Panasonic 1308, 1518, 1275, 1288, 1316, 1548, 1633, 1763, 1764, 1807, 2221, 2452, 2549, 2967, 2968
 Parasound 1934, 2245
 Philips 0892, 1189, 1269, 0891, 1266, 1538, 1831, 2029, 2311, 2459, 2461
 Pioneer 1023, 1384, 1459, 1935
 Polaroid 1508
 Polk Audio 0892, 1289, 1414, 1988, 2115, 2242, 2244, 2270
 Primare 1851, 2479
 Proscan 1254
 RCA 1023, 1609, 1254, 1074, 1390, 1459, 1511, 2041
 Regent 1437
 Rio 1869
 Rotel 2003
 Saba 1519
 Samsung 1295, 1304, 1500, 1868
 Sangean 1888, 2165, 2296
 Sanyo 1251, 1469, 1801
 Sharp 1286
 Sherwood 1077, 1517, 1653, 1905, 2169
 Sherwood Newcastle 2169
 Shinsonic 1426
 Sirius 1602, 1627, 1770, 1811, 1987, 1988, 2124
 Sonic Blue 1532, 1869
 Sony 1759, 1058, 1441, 1258, 1622, 2522, 2320, 2216, 2172, 1858, 1822, 1758, 1658, 1558, 1547, 1529, 1406
 Stereophonics 1023
 Sunfire 1313, 1521, 1931
 Super Atlas 1517
 Teac 1074, 1390, 1528, 2261, 2363
 Technics 1308, 1518
 Thorens 1189
 Thule Audio 1851
 Toshiba 1788
 Venturer 1390
 Vizio 1517
 XACT 2124
 XM 1406, 1414, 1846
 Yamaha 0176, 0376, 1176, 1276, 1331, 1375, 1376, 1476, 1815, 2061, 2455, 2467, 2469, 2471
 Zenith 1293
 ZVOX 2332
- Game Console Codes**
 Audio Authority 2555
 Logitech 2639
 Messiah Entertainment 2396
 Microsoft 0522, 2083
 Nyko 2340
 Schmartz 2367
 Sony 0533, 0772
 Xbox 0522, 2083
- Audio Accessory Codes (Including CD Players and Soundbars)**
 Accurian 1106
 Acoustic Research 2226
 Aiwa 0157
 Altec Lansing 0607, 1056, 2251
 Apple 1115
 Arcam 0157
 ASI 2454
 B&W 2441
 Bryston 2368
 Burmester 0420
 California Audio Labs 0029, 0303
 Cambridge Audio 1731
 Carver 0157, 0179
 Classe 2046
 Creative 2288
 D-Link 1522
 Denon 0003, 0034, 2502, 2815
 DKK 0000
 DLO 1155
 DMX Electronics 0157
 Fisher 0179
 Garrard 0393, 0420
 Genexxa 0032
 GPX 2113
 Griffin 1891
 Harman/Kardon 0157
 Hitachi 0032
 iDeck 1106
 iHome 2152
 iLive 2113
 Integra 0101
 JVC 0072, 1294
 Kenwood 0626, 0028, 0190
 KLH 1318, 1372, 1373, 1711
 Klipsch 2553
 Krell 0157, 2464
 Linn 0157
 Logitech 2182
 Magnavox 0157, 0038
 Marantz 0626, 0029, 0157, 0038, 0180, 0435
 Mark Levinson 1484
 McIntosh 0256, 0290, 0660, 1703
 MCS 0029
 Memorex 2119
 Miro 0000
 Mission 0157
 Monitor Audio 1106
 MTC0420
 Myryad 0157
 NAD 2096
 Netgear 1785
 NSM 0157

Nyko 2231
 Onkyo 1327, 0101
 Optimus 0000, 0032, 0087, 0179, 0420, 0468
 Panasonic 0029, 0303, 0388, 0752
 Parasound 0420
 Philips 0626, 0157, 0274
 Pioneer 1062, 0032, 1087, 0468, 2327
 Polk Audio 0157, 2228
 Primare 2480
 Proceed 0420
 Proton 0157
 QED 0157
 Quad 0157
 Quasar 0029
 RCA 1062, 0032, 0053, 0179, 0420, 0468
 Realistic 0179, 0180, 0420
 Rotel 0157, 0420, 2046
 Roku 1828
 SAE 0157
 Sansui 0157
 Sanyo 0087, 0179
 Sharp 0180
 Sherwood 0180, 1950
 Sonic Frontiers 0157
 Sony 0490, 0000, 0100, 1364, 0185
 SSI 1522
 TAG McLaren 0157
 Tascam 0420
 Teac 0180, 0378, 0393, 0420
 Technics 0029, 0303
 Tivoli Audio 1553, 2158
 Victor 0072
 Vizio 2454
 Wards 0157, 0053
 Yamaha 0490, 0036, 1292, 1797, 2021, 2116, 2458

Video Accessory Codes

Access HD 2185
 ADB 2254
 Airlink 101 2491
 Alpha Digital 2185
 Amino 1481, 1615, 1673, 2482

AMTC 2185
 Apex Digital 2478
 Artec 2490
 AT&T 0858
 CASTi 2305
 Channel Master 2365
 Chunghwa 1917
 Cisco 2345, 2517
 Coby 2667
 Coship 2487
 Daewoo 2338
 Daytek 2305
 Digital Stream 2303
 Dish Network 2470
 Echostar 2470
 Epson 1563
 GE 2360, 2450
 Goodmind 2450
 Gridlink 2348
 Insignia 1415
 KoolConnect 1481
 Lasonic 2348
 LG 1415
 Magnavox 1563
 Memorex 2486
 MicroGEM 2489
 Motorola 0858, 2378
 Panasonic 1120
 Philco 1563
 RCA 2325, 2454
 Samsung 1190, 1490, 2592
 Sansonic 2348
 Scientific Atlanta 0858, 2345, 2517
 SetaBox 1917
 Sunkey 2695
 SureWest 1481
 Sylvania 1563
 Tivax 2185
 Ventura 2454
 Venturer 2454
 Verizon 2378
 Winegard 2454
 Zenith 1415
 Zentech 2491
 Zinwell 2488

VCR Codes

ABS 1972
 Accurian 0000
 Admiral 0048, 0209, 0020, 0479
 Adventura 0000
 Aiko 0278
 Aiwa 0037, 0000, 0307
 Akai 0041, 0061, 0106
 Alienware 1972
 Allegro 0039
 America Action 0278
 American High 0035
 Asha 0240
 Audiovox 0037, 0278
 Beaumark 0240
 Bell & Howell 0104
 Broksonic 0184, 0121, 0209, 0002, 0479, 1479
 Calix 0037
 Canon 0035
 Capehart 0020
 Carver 0081
 CCE 0072, 0278
 Citizen 0037, 0278
 Colt 0072
 Craig 0037, 0047, 0240, 0072, 0271
 Crosley 0081, 0000
 Curtis Mathes 0060, 0035, 0162, 0240, 0041, 0278, 0760
 Cybernex 0240
 CyberPower 1972
 Daewoo 0045, 0278, 0020, 0561
 Daytron 0020
 Dell 1972
 Denon 0042
 DIRECTV 0739, 0740
 Durabrand 0039, 0038
 Dynatech 0000
 Electrohome 0037, 0043
 Electrophonic 0037
 Emerex 0032
 Emerson 0037, 0184, 0000, 0121, 0043, 0209, 0002, 0278, 0061, 0208, 0479, 0561, 0593, 1479, 1593

Fisher 0047, 0104
 Fuji 0035, 0033
 Funai 0000, 0593, 1593
 Garrard 0000
 Gateway 1972
 GE 0060, 0035, 0240, 0202, 0760, 0761, 1060
 GFM 1593
 Go Video 0240, 0432, 0526, 0614
 GoldStar 0037, 0038, 0480
 Harley Davidson 0000
 Harman/Kardon 0081, 0038
 Harwood 0072
 Headquarter 0046
 Hewlett Packard 1972
 HI-Q 0047
 Hitachi 0000, 0042, 0041, 0105
 Howard Computers 1972
 HP 1972
 Hughes Network Systems 0042, 0740
 Humax 0739, 1797, 1988
 Hush 1972
 iBUYPOWER 1972
 Instant Replay 0035
 Jensen 0041
 JVC 0067, 0041, 0008, 1067, 1707
 KEC 0037, 0278
 Kenwood 0067, 0041, 0038
 KLH 0072
 Kodak 0035, 0037
 LG 0480, 1037, 1720
 Linksys 1972
 Lloyd's 0000, 0208
 Logik 0072
 LXI 0037
 Magnasonic 0593
 Magnavox 0035, 0039, 0081, 0000, 0149, 0563, 0593, 1593, 1781
 Magnin 0240

Marantz 0035, 0081, 0062	Pulsar 0039	Teknika 0035, 0037, 0000
Marta 0037	Quarter 0046	Thomas 0000
Matsushita 0035, 0162, 1162	Quartz 0046	Tivo 0739, 0618, 0636, 0740, 1996
Media Center PC 1972	Quasar 0035, 0162, 1162	TMK 0240, 0208
MEI 0035	RadioShack 0000, 1037	Toshiba 0045, 0043, 0209, 0041, 1008, 1145, 1972, 1988, 1996
Memorex 0035, 0162, 0037, 0048, 0039, 0047, 0240, 0000, 0104, 0209, 0046, 0307, 0479, 1037, 1162, 1262	Radix 0037	Unitech 0240
MGA 0240, 0043, 0061	Randex 0037	Vector 0045
MGN Technology 0240	RCA 0060, 0240, 0042, 0149, 0105, 0106, 0202, 0760, 0761, 0880, 1060	Vector Research 0038
Microsoft 1972	Realistic 0035, 0037, 0048, 0047, 0000, 0104, 0046, 0062	Video Concepts 0045, 0061
Mind 1972	ReplayTV 0614, 0616	Videomagic 0037
Minolta 0042, 0105	Ricavision 1972	Videosonic 0240
Mitsubishi 0067, 0043, 0061	Runco 0039	Viewsonic 1972
Motorola 0035, 0048	Samsung 0240, 0045, 1014	Voodoo 1972
MTC 0240, 0000	Sanky 0048, 0039	Wards 0060, 0035, 0048, 0047, 0081, 0240, 0000, 0042, 0072, 0149, 0062, 0760
Multitech 0000, 0072	Sansui 0000, 0067, 0209, 0041, 0271, 0479, 1479	White Westinghouse 0209, 0072
NEC 0104, 0067, 0041, 0038	Sanyo 0047, 0240, 0104, 0046	XR-1000 0035, 0000, 0072
Nikko 0037	Sceptre 0104	Yamaha 0038
Niveus Media 1972	Scott 0184, 0045, 0121, 0043	Zenith 0037, 0039, 0033, 0000, 0209, 0479, 1139, 1479
Noblex 0240	Sears 0035, 0037, 0047, 0000, 0042, 0104, 0046, 0105	ZT Group 1972
Northgate 1972	Sharp 0048, 0062, 0848, 1893	
Olympus 0035	Shintom 0072	
Optimus 1062, 0162, 0037, 0048, 0104, 0432, 0593, 1048, 1162, 1262	Shogun 0240	
Optonica 0062	Singer 0072	
Orion 0184, 0209, 0002, 0479, 1479	Sonic Blue 0614, 0616	
Panasonic 1062, 0035, 0162, 0614, 0616, 1162, 1262, 1807, 1777	Sony 1232, 0032, 0035, 0033, 0000, 0636, 1032, 1702, 1886, 1896, 1972	
Penney 0035, 0037, 0240, 0042, 0038	Stack9 1972	
Pentax 0042, 0105	STS 0042	
Philco 0035	Sylvania 0035, 0081, 0000, 0043, 0593, 1593, 1781	
Philips 0739, 0035, 0081, 0062, 0618, 1081, 1181, 1818	Symphonic 0000, 0593, 1593	
Pilot 0037	Systemax 1972	
Pioneer 0067, 1803	Totevision 0037, 0240	
Polk Audio 0081	Touch 1972	
Portland 0278, 0020	Tagar Systems 1972	
Presidian 1593	Tashiko 0037	
Profitronic 0240	Tatung 0041	
Proscan 0060, 0202, 0760, 0761, 1060	Teac 0000, 0041	
Protec 0072	Technics 0035, 0162	

Chapter 10 Maintenance and Troubleshooting

Cleaning the TV and Remote Control

1. Remove the power adapter cable from the TV.
2. Use a soft cloth moistened with diluted neutral cleaner to clean the TV and remote control. VIZIO recommends using an HDTV cleaning solution which can be purchased at any major retailer.
3. Wring liquid out of the cloth before cleaning to prevent water from penetrating into the housing.
4. Wipe the TV and remote control with a dry cloth after cleaning.

Important:

- Do not use volatile solvent (such as toluene, rosin and alcohol). Such chemicals may damage the housing, screen glass, and remote control, and cause labeling to peel.
- The screen glass is very fragile. Do not scrape it with any sharp object.
- Do not press or tap the screen to avoid cracking.

Troubleshooting Guide

If the TV fails or the performance changes dramatically, check the following troubleshooting guide for possible solutions. Remember to check the peripherals to pinpoint the source of the failure. If the display still fails to perform as expected, contact the VIZIO for assistance by calling 1-877-MYVIZIO (877-698-4946) or e-mail us at techsupport@vizio.com.

General TV Problems	Solution
Receive the error message "No Signal."	<ul style="list-style-type: none"> • Press the INPUT button on the remote control to select a different input source. • If you are using cable connected directly to the TV or an antenna, scan for channels from the Tuner menu in the OSD. • Press the TV button on the top of the remote to return to the TV mode.
No power.	<ul style="list-style-type: none"> • Make sure the power button is ON (VIZIO logo glows white). • Make sure the AC power cord is securely connected to the AC socket. • Plug another electrical device to the power outlet to verify that the outlet is working.
No sound.	<ul style="list-style-type: none"> • Press Volume + (Up) on the remote control. • Press MUTE on the remote control to make sure that MUTE is not ON. • Check your audio settings. The audio may be set to SAP, or the speakers are set to off. • Check the audio connections of external devices that may be connected to the HDTV. • If you are using an antenna, the signal strength of the channel may be low. Make sure your antenna is connected securely to the TV and move the antenna around the room or close to a window.
If the screen is black.	<ul style="list-style-type: none"> • Make sure the power button is ON (VIZIO Logo glows white). • Press the INPUT button on the remote control to select a different input source. • Check the connections of external devices that may be connected to the HDTV. • Press the TV button on the top of the remote to return to the TV mode.

General TV Problems	Solution
Power is ON but there is no image on the screen.	<ul style="list-style-type: none"> • Make sure all cables attached to the HDTV are connected to the correct output on the external device. • Adjust brightness, contrast or backlight. • Press the INPUT button on the remote control to select a different input source. • Press the TV button on the top of the remote to return to the TV mode.
Wrong or abnormal colors appear.	<ul style="list-style-type: none"> • Check Color and Tint settings in Picture Menu. • Reset Picture settings. • Check the video cables to make sure they are securely connected. • If you are using an antenna, the signal strength of the channel may be low. Make sure your antenna is connected securely to the TV and move the antenna around the room or close to a window.
Control buttons do not work.	<ul style="list-style-type: none"> • Press only one button at a time. • Press the TV button on the top of the remote to return to the TV mode.
Remote control does not work.	<ul style="list-style-type: none"> • Point the remote control directly at the remote sensor on your TV. • Remove any obstacles between the remote control and the remote sensor. • Replace dead batteries with new ones. • Press the TV button on the top of the remote to return to the TV mode.
There appear to be image quality issues.	<ul style="list-style-type: none"> • If you are using an antenna, the signal strength of the channel may be low. Make sure your antenna is connected securely to the TV and move the antenna around the room or close to a window. • For best image quality, view HD wide-screen programs where possible. • If HD content is not available view "Standard Definition" from a digital source. • Standard, analog TV will always be noticeably inferior to HD because your digital flat panel TV has video that is many times better than old TV so you will see interference and deficiencies you did not know you had.
You cannot see a picture.	<ul style="list-style-type: none"> • Make sure the power button is ON (VIZIO logo glows white). • Make sure the AC power cord is securely connected to the AC socket. • Press the INPUT button on the remote control to select a different input source. • Press the TV button on the top of the remote to return to the TV mode. • Check the connections of external devices that may be connected to the HDTV. • If your HDTV is connected to a computer, press any button on your keyboard to "wake" your computer. • If you are using an antenna, the signal strength of the channel may be low. Make sure your antenna is connected securely to the TV and move the antenna around the room or close to a window.
You see a distorted picture or hear unusual sound.	<ul style="list-style-type: none"> • You may be getting interference from electrical appliances, cars, motorcycles, or fluorescent lights. If you have not mounted it on the wall, try moving your HDTV to another location to see if this is the cause of the problem.
The picture has abnormal patterns.	<ul style="list-style-type: none"> • Check the connections of external devices that may be connected to the HDTV. • Make sure the specifications of external devices meet the specifications of your HDTV (like resolution). • If you are using an antenna, the signal strength of the channel may be low. Make sure your antenna is connected securely to the TV and move the antenna around the room or close to a window.

General TV Problems	Solution
The display image does not cover the entire screen.	<ul style="list-style-type: none"> • If you are in RGB mode (Computer), make sure that H-Size and V-Position in the On Screen Display (OSD) are set correctly. • If you are using TV, AV1, AV2 or Component with 480i input, press the WIDE button on the remote control to scroll through various screen modes.
You can see a picture but you cannot hear sound.	<ul style="list-style-type: none"> • Press Volume + (Up) on the remote control. • Press MUTE on the remote control to make sure that MUTE is not ON. • Check your audio settings. The audio may be set to SAP, or the speakers are set to off. • Check the audio connections of external devices that may be connected to the HDTV.
The TV has pixels (dots) that are always dark or colored.	<ul style="list-style-type: none"> • Your HDTV is manufactured using an extremely high level of precision technology, however, sometimes some pixels of your HDTV may not display. Pixel defects within industry specifications are inherent to this type of product and do not constitute a defective product.
You see “noise” or “trash” on the screen.	<ul style="list-style-type: none"> • When your HDTV’s digital capabilities exceed a digital broadcast signal, the signal is up-converted (increased) to match your TV’s display capabilities. Up-converting can cause noise or trash. • If you are using an antenna, the signal strength of the channel may be low. Make sure your antenna is connected securely to the TV and move the antenna around the room or close to a window.
You switch to a different input and the volume changes.	<ul style="list-style-type: none"> • The TV remembers the volume level from the last time you adjusted it. If the sound level is higher or lower from another source, then the volume will change.
You switch to a different input and the screen size changes.	<ul style="list-style-type: none"> • The TV remembers the viewing mode from the last time you used a particular input (AV-1, AV-2, Component, HDMI and TV).
Tips for High-Definition Users.	<ul style="list-style-type: none"> • Your HDTV is an ideal platform for viewing High Definition Content. • Best image quality will be achieved by HDMI. The next best is Component, followed by Composite. • Due to variances in broadcast practices, it is possible some image distortions can occur.
Tips for Letterbox Content Users.	<ul style="list-style-type: none"> • Some Letterboxed (or “Widescreen”) versions of DVD movies are formatted for standard 4:3 Televisions. Your HDTV has the ability to expand this content so the entire screen is filled at the expense of image accuracy. To use this function, press ZOOM on the remote control to cycle among the options.

Media Viewer Problems	Solution
USB device is not recognized.	<ul style="list-style-type: none"> • Make sure the device is correctly inserted. • Make sure the device is FAT or FAT32 • Make sure it contains the supported files.
Image or sound is interrupted or distorted.	<ul style="list-style-type: none"> • Make sure the device is correctly inserted. • Make sure that the file complies with the supported format, bit rate and/or profile. Also check the file for damage. • Some files that comply with the supported format may not play back or display properly.
Slideshow doesn’t start.	<ul style="list-style-type: none"> • Make sure the viewer isn’t in pause, rotation, or zoom mode.

Telephone & Technical Support

Products are often returned due to a technical problem rather than a defective product that may result in unnecessary shipping charges billed to you. Our trained support personnel can often resolve the problem over the phone. For more information on warranty service or repair, after the warranty period, contact our Support Department at the number below.

Customer support and quality service are integral parts of VIZIO's commitment to service excellence. For technical assistance contact our VIZIO Technical Support Department via email or phone.

Email: techsupport@VIZIO.com

(877) 698-4946 Fax: (949) 585-9563

Hours of operation: Monday - Friday: 6 am to 9 pm

Saturday – Sunday: 8 am to 4 pm

Have your VIZIO model number, serial number, and date of purchase available before you call.

VIZIO

Address:

39 Tesla

Irvine, CA 92618, USA

Telephone: (888) 849-4623 (949) 428-2525 Fax: (949) 585-9514

Web: www.VIZIO.com

Compliance

Caution: Always use a power cable that is properly grounded. Use the AC cords listed below for each area.

USA: UL

Canada: CSA

Germany: VDE

UK: BASE/BS

Japan: Electric Appliance Control Act

FCC Class B Radio Interference Statement

NOTE: This equipment has been tested and found to comply with the limits for a Class B digital device, pursuant to Part 15 of the FCC Rules. These limits are designed to provide reasonable protection against harmful interference in a residential installation. This equipment generates, uses and can radiate radio frequency energy, and if not installed and used in accordance with the instructions, may cause harmful interference to radio communications. However, there is no guarantee that interference will not occur in a particular installation. If this equipment does cause harmful interference to radio or television reception, which can be determined by turning the equipment off and on, the user is encouraged to try to correct the interference by one or more of the following measures:

1. Reorient or relocate the receiving antenna.
2. Increase the separation between the equipment and receiver.
3. Connect the equipment into an outlet on a circuit different from that to which the receiver is connected.
4. Consult the dealer or an experienced radio/TV technician for help.

Notice:

1. The changes or modifications not expressly approved by the party responsible for compliance could void the user's authority to operate the equipment.
2. Shielded interface cables and AC AC/DC power adapter, if any, must be used in order to comply with the emission limits.
3. The manufacturer is not responsible for any radio or TV interference caused by unauthorized modification to this equipment. It is the responsibilities of the user to correct such interference.

Chapter 11 Specifications

Product specifications may change without notice or obligation.

E421VL Specifications

E421VL Specifications	
Panel	42.02" Diagonal, 16:9 Aspect Ratio
Resolution	1920 x 1080 pixels
Pixel (Dot) Pitch	0.4845mm (H) x 0.4845mm (H)
Display Compatibility	1080P (FHDTV)
Colors	1.06 billion @ 10 bit
Brightness cd/m2 (typical)	500nits
Contrast	Dynamic Contrast Ratio: 100,000:1
Response Time	5ms (typical)
Viewing Angle	178° (horizontal/vertical)
Inputs	3 x HDMI with HDCP (1 with L/R audio inputs) 1 x RF (F connector for internal tuner) 1x Composite Video and Stereo Audio 1x Component YPbPr plus Stereo Audio 1x Computer RGB plus Stereo Audio 1x USB (side)
Outputs	1x 5.1 S/PDIF Optical Digital Audio, 1x Stereo Audio
Features	MEMC, 1080P FHDTV, 120Hz PANEL, 10-BIT VIDEO PROCESSING, MTS STEREO DECODER, HDMI v1.3, 3D COMB FILTER, DIGITAL AUDIO AMPLIFIER, DYNAMIC CONTRAST RATIO TECHNOLOGY, ZERO BRIGHT PIXEL GUARRANTEE, HD GAME PORT, DIGITAL AUDIO AMPLIFIER, NOISE REDUCTION, DOLBY DIGITAL FOR ATSC/QAM, SIGNAL COMPATIBILITY: 480I(SDTV), 480P(EDTV), 720P(HDTV), 1080I(HDTV), 1080P(FHDTV), CHANNEL SKIP/ADD, FAVORITE CHANNEL, VIDEO/INPUT NAMING CAPABILITY, CLOSED CAPTION, PARENTAL CONTROL/V-CHIP 2.0, PROGRAMMABLE TIMER, PIP/POP, SRS TSHD, SRS TruVolume, VESA MOUNT COMPATIBLE, MULTIMEDIA.
Special Features	<ul style="list-style-type: none"> • 120Hz panel W/O scanning backlight • Multimedia(JPEG) • HDMI CEC • Ambient light sensor • 1080 FHDTV • HDMI v1.3 • DYNAMIC CONTRAST RATIO TECHNOLOGY • DOLBY DIGITAL FOR ATSC/QAM
	<ul style="list-style-type: none"> • 480I(SDTV), 480P(EDTV), 720P(HDTV), 1080I(HDTV), 1080P (FHDTV) • CHANNEL SKIP VIDEO/INPUT NAMING CAPABILITY • CLOSED CAPTION • PARENTAL CONTROL/V-CHIP 2.0 • PROGRAMMABLE TIMER • SRS TSHD • SRS TruVolume • DETACHABLE BASE
Speakers	2xBuilt-in, 10W Speakers
Panel Life	50,000 hours to half the original brightness

Power	
Input	IEC Connector for direct power line connection
Voltage Range	100~240Vac at 50/60Hz
Power Consumption	111W (Avg), 0.37W standby
Environmental Conditions	
Operating	Temperature: 5°C~35°C, Relative Humidity: 20~80%, Altitude: 0~14,000 ft
Non-Operating	Temperature: -20°C~50°C, Relative Humidity: 10~70%, Altitude: 0~40,000 ft
Dimensions	40.26" W x 27.48" H x 8.99" D with stand; 40.26" W x 25.91" H x 3.51" D without stand 1023 x 698 x 228.4 mm with stand; 1023x 658 x 89.3 mm without stand
Net Weight	32.85 lbs with stand; 31.09 lbs without stand 14.9 kg with stand; 14.1 kg without stand
Gross Weight	42.99 lbs; 19.50 kg
Certifications	CSA, CSA-US, FCC Class B
Compliances	Energy Star 4.0. ATSC Spec A/65, EIA/CEA-766-A

E470VL Specifications

E470VL	Specifications
Panel	46.96" Diagonal, 16:9 Aspect Ratio
Resolution	1920 x 1080 pixels
Pixel (Dot) Pitch	0.5415mm (H) x 0.5415mm (V)
Display Compatibility	1080P (FHDTV)
Colors	1.06 Billion @ 10 bit color depth
Brightness cd/m2 (typical)	500nits
Contrast	Dynamic Contrast Ratio: 100,000:1
Response Time	5ms (typical)
Viewing Angle	178° (horizontal/vertical)
Inputs	3 x HDMI with HDCP (1 with L/R audio inputs) 1 x RF (F connector for internal tuner) 1x Composite Video and Stereo Audio 1x Component YPbPr plus Stereo Audio 1x Computer RGB plus Stereo Audio 1x USB (side)
Outputs	1x 5.1 S/PDIF Optical Digital Audio, 1x Stereo Audio
Features	MEMC, 1080P FHDTV, 120Hz PANEL, 10-BIT VIDEO PROCESSING, MTS STEREO DECODER, HDMI v1.3, 3D COMB FILTER, DIGITAL AUDIO AMPLIFIER, DYNAMIC CONTRAST RATIO TECHNOLOGY, ZERO BRIGHT PIXEL GUARRANTEE, HD GAME PORT, DIGITAL AUDIO AMPLIFIER, NOISE REDUCTION, DOLBY DIGITAL FOR ATSC/QAM, SIGNAL COMPATIBILITY: 480I(SDTV), 480P(EDTV), 720P(HDTV), 1080I(HDTV), 1080P(FHDTV), CHANNEL SKIP/ADD, FAVORITE CHANNEL, VIDEO/INPUT NAMING CAPABILITY, CLOSED CAPTION, PARENTAL CONTROL/V-CHIP 2.0,

	PROGRAMMABLE TIMER, PIP/POP, SRS TSHD, SRS TruVolume, VESA MOUNT COMPATIBLE, MULTIMEDIA.	
Special Features	<ul style="list-style-type: none"> • 120Hz panel W/O scanning backlight • Multimedia(JPEG) • HDMI CEC • Ambient light sensor • 1080 FHDTV • HDMI v1.3 • DYNAMIC CONTRAST RATIO TECHNOLOGY • DOLBY DIGITAL FOR ATSC/QAM 	<ul style="list-style-type: none"> • 480I(SDTV), 480P(EDTV), 720P(HDTV), 1080I(HDTV), 1080P (FHDTV) • CHANNEL SKIP VIDEO/INPUT NAMING CAPABILITY • CLOSED CAPTION • PARENTAL CONTROL/V-CHIP 2.0 • PROGRAMMABLE TIMER • SRS TSHD • SRS TruVolume • DETACHABLE BASE
Speakers	2xBuilt-in, 10W Speakers	
Panel Life	50,000 hours to half the original brightness	
Power		
Input	IEC Connector for direct power line connection	
Voltage Range	100~240Vac at 50/60Hz	
Power Consumption	134W (Avg), 0.37W standby	
Environmental Conditions		
Operating	Temperature: 5°C~35°C, Relative Humidity: 20~80%, Altitude: 0~14,000 ft	
Non-Operating	Temperature: -20°C~50°C, Relative Humidity: 10~70%, Altitude: 0~40,000 ft	
Dimensions	44.65" W x 29.99" H x 10.43" D with stand; 44.65" W x 28.44" H x 3.66" D without stand 1134 x 761.8 x 265 mm with stand; 1134 x 722.4 x 93.1 mm without stand	
Net Weight	44.75 lbs with stand; 39.68 lbs without stand; 20.3 kg with stand; 18 kg without stand	
Gross Weight	58.86 lbs; 26.7 kg	
Certifications	CSA, CSA-US, FCC Class B	
Compliances	Energy Star 4.0. ATSC Spec A/65, EIA/CEA-766-A	

E551VL Specifications

E551VL	Specifications
Panel	54.64" Diagonal, 16:9 Aspect Ratio
Resolution	1920 x 1080 pixels
Pixel (Dot) Pitch	0.630 mm (H) x 0.630 mm (V)
Display Compatibility	1080P (FHDTV)
Colors	1.06 Billion @ 10 bit color depth
Brightness cd/m2 (typical)	500nits
Contrast	Dynamic Contrast Ratio: 100,000:1
Response Time	5ms (typical)
Viewing Angle	178° (horizontal/vertical)

Inputs	3 x HDMI with HDCP (1 with L/R audio inputs) 1 x RF (F connector for internal tuner) 1x Composite Video and Stereo Audio 1x Component YPbPr plus Stereo Audio 1x Computer RGB plus Stereo Audio 1x USB (side)
Outputs	1x 5.1 S/PDIF Optical Digital Audio, 1x Stereo Audio
Features	MEMC, 1080P FHDTV, 120Hz PANEL, 10-BIT VIDEO PROCESSING, MTS STEREO DECODER, HDMI v1.3, 3D COMB FILTER, DIGITAL AUDIO AMPLIFIER, DYNAMIC CONTRAST RATIO TECHNOLOGY, ZERO BRIGHT PIXEL GUARANTEE, HD GAME PORT, DIGITAL AUDIO AMPLIFIER, NOISE REDUCTION, DOLBY DIGITAL FOR ATSC/QAM, SIGNAL COMPATIBILITY: 480I(SDTV), 480P(EDTV), 720P(HDTV), 1080I(HDTV), 1080P(FHDTV), CHANNEL SKIP/ADD, FAVORITE CHANNEL, VIDEO/INPUT NAMING CAPABILITY, CLOSED CAPTION, PARENTAL CONTROL/V-CHIP 2.0, PROGRAMMABLE TIMER, PIP/POP, SRS TSHD, SRS TruVolume, VESA MOUNT COMPATIBLE, MULTIMEDIA.
Special Features	<ul style="list-style-type: none"> • 120Hz panel W/O scanning backlight • Multimedia(JPEG) • HDMI CEC • Ambient light sensor • 1080 FHDTV • HDMI v1.3 • DYNAMIC CONTRAST RATIO TECHNOLOGY • DOLBY DIGITAL FOR ATSC/QAM
	<ul style="list-style-type: none"> • 480I(SDTV), 480P(EDTV), 720P(HDTV), 1080I(HDTV), 1080P (FHDTV) • CHANNEL SKIP VIDEO/INPUT NAMING CAPABILITY • CLOSED CAPTION • PARENTAL CONTROL/V-CHIP 2.0 • PROGRAMMABLE TIMER • SRS TSHD • SRS TruVolume
Speakers	2xBuilt-in, 15W Speakers
Panel Life	50,000 hours to half the original brightness
Power	
Input	IEC Connector for direct power line connection
Voltage Range	100~240Vac at 50/60Hz
Power Consumption	155W (Avg), 0.37W standby
Environmental Conditions	
Operating	Temperature: 5°C~35°C, Relative Humidity: 20~80%, Altitude: 0~14,000 ft
Non-Operating	Temperature: -20°C~50°C, Relative Humidity: 10~70%, Altitude: 0~40,000 ft
Dimensions	52.13" W x 34.44" H x 13.15" D with stand; 52.13" W x 32.56" H x 4.95" D without stand 1324 x 875 x 334 mm with stand; 1324 x 827 x 125.7 mm without stand
Net Weight	78.71 lbs with stand; 67.68 lbs without stand 35.7 kg with stand; 30.7 kg without stand
Gross Weight	95.9 lbs; 43.5 kg
Certifications	CSA, CSA-US, FCC Class B
Compliances	Energy Star 4.0. ATSC Spec A/65, EIA/CEA-766-A

Preset PC Resolutions

If connecting to a PC through the RGB PC input, set the TV timing mode to VESA 1920x1080 at 60Hz for best picture quality (refer to the graphic card's user guide for questions on how to set this timing mode). See the table below for the factory preset resolutions.

Mode No.	Resolution	Refresh Rate (Hz)	Horizontal Frequency (KHz)	Vertical Frequency (Hz)	Horizontal Sync Polarity (TTL)	Vertical Sync Polarity (TTL)	Pixel Rate (MHz)	Remark
1	640 x 480	60	31.469	59.941	N	N	25.175	Windows
2	640 x 480	75	37.500	75.000	N	N	31.500	Windows
3	800 x 600	60	37.879	60.317	P	P	40.000	Windows
4	800 x 600	72	48.077	72.188	P	P	50.000	Windows
5	800 x 600	75	46.875	75.000	P	P	49.500	Windows
6	1024 x 768	60	48.363	60.004	N	N	65.000	Windows
7	1024 x 768	70	56.476	70.069	N	N	75.000	Windows
8	1024 x 768	75	60.023	75.029	P	P	78.750	Windows
9	720 x 400	70	31.469	70.087	N	P	28.322	DOS
10	Ⓢ1920 x 1080	60	66.587	59.934	P	N	138.50	Windows

Note: P: positive, N: negative, Ⓢ: Primary mode

Resolution through RGB Input

If your PC supports VESA Reduce Blanking timing via the VGA card drive program (usually offered by the VGA Card Manufacturer), your TV set is equipped to have the 1920x1080 resolution display through this connection using the following timing 138.5MHz. The following parameters are often the values required by the software or programs to set up the display:

Parameters	Horizontal Values (Pixels)	Vertical Values (Lines)
Address	1920	1080
Front Porch	48	3
Sync Width	32	5
Back Porch	80	23
Total	2080	1111
Frequency	66.587 KHz	59.934 Hz
Sync Polarity	P	N
Pixel Rate (MHz)	138.5	
Refresh Rate (Hz)	60	

Warranty

ONE-YEAR LIMITED WARRANTY ON PARTS AND LABOR

(Covers units purchased as new in United States and Puerto Rico Only)

VIZIO provides a warranty to the original purchaser of its products against defects in materials and workmanship for a period of one year of non-commercial usage and ninety (90) days of commercial use. If a VIZIO product is defective within the warranty period, VIZIO will either repair or replace the unit at its sole option and discretion.

To obtain warranty service, contact VIZIO Technical Support via email: TechSupport@VIZIO.com or via phone at 877 MY VIZIO (877.698.4946) from 6:00AM to 9:00PM Monday through Friday and 8:00AM to 4:00PM Saturday and Sunday, Pacific Time, or visit www.VIZIO.com. Proof of purchase in the form of a purchase receipt or copy thereof is required.

Parts and Labor

There will be no charge for parts or labor during the warranty period. Replacement parts and units may be new or recertified at VIZIO's option and sole discretion. Replacement parts and units are warranted for the remaining portion of the original warranty or for ninety (90) days from warranty service or replacement, whichever is later.

Types of Service

Units 30" or larger will usually be serviced in-home. In-home service requires complete and easy access to the unit and does not include de-installation or re-installation of the product. However, in some cases, it may be necessary to send the unit to a VIZIO service center. VIZIO will cover the transportation charges to and from the same customer location.

Units less than 30" must be sent to a VIZIO service center. VIZIO is not responsible for transportation costs to the service center, but VIZIO will cover return shipping to the customer. **PRE-AUTHORIZATION IS REQUIRED BEFORE SENDING ANY UNIT IN FOR SERVICE.**

Any returns to VIZIO's service centers must utilize either the original carton box and shipping material or a replacement box and material provided by VIZIO. VIZIO technical support will provide instructions for packing and shipping the unit to the VIZIO service center.

Limitations and Exclusions

VIZIO's one-year limited warranty only covers defects in materials and workmanship. Items not covered include but are not limited to cosmetic damage, normal wear and tear, misuse, signal issues, power surges, and damages from shipping, acts of God, any sort of customer misuse, installation, customer modifications, adjustments, and set-up issues. Units with unreadable or removed serial numbers, "image burn-in", and routine maintenance are not covered. This warranty does not cover products sold "AS IS", "FACTORY RECERTIFIED", or by a non-authorized reseller.

THERE ARE NO EXPRESS WARRANTIES OTHER THAN THOSE LISTED OR DESCRIBED ABOVE. ANY IMPLIED WARRANTIES, INCLUDING ANY IMPLIED WARRANTY OF MERCHANTABILITY AND FITNESS FOR A PARTICULAR PURPOSE, SHALL BE LIMITED IN DURATION TO THE PERIOD OF TIME SET FORTH ABOVE. VIZIO'S TOTAL LIABILITY FOR ANY AND ALL LOSSES AND DAMAGES RESULTING FROM ANY CAUSE WHATSOEVER SHALL IN NO EVENT EXCEED THE PURCHASE PRICE OF THE DISPLAY. VIZIO SHALL NOT BE RESPONSIBLE FOR LOSS OF USE, COMMERCIAL LOSS, LOST REVENUE OR LOST PROFITS, OR OTHER INCIDENTAL OR CONSEQUENTIAL DAMAGES. SOME STATES DO NOT ALLOW LIMITATIONS ON HOW LONG AN IMPLIED WARRANTY LASTS OR THE EXCLUSION OF INCIDENTAL OR CONSEQUENTIAL DAMAGES, SO THE ABOVE LIMITATIONS OR EXCLUSIONS MAY NOT APPLY TO YOU. THIS WARRANTY GIVES YOU SPECIFIC LEGAL RIGHTS, AND YOU MAY ALSO HAVE OTHER RIGHTS, WHICH VARY FROM STATE TO STATE. THIS WARRANTY IS SUBJECT TO CHANGE WITHOUT NOTICE. CHECK www.VIZIO.com FOR THE MOST CURRENT VERSION.

Personal Data

If your VIZIO product is capable of storing personal data and other information, **ALL CONTENTS AND INFORMATION WILL BE DELETED IN THE COURSE OF SOME IN-HOME AND ALL SHIP-IN WARRANTY SERVICE.** If this occurs, your product will be restored to you configured **as originally purchased.** You will be **responsible for restoring all applicable data and passwords.** Recovery and reinstallation of user data is not covered under this Limited Warranty. **In order to protect your personal information, VIZIO recommends that you always clear all personal information from the unit before it is serviced, regardless of the servicer.**

ZERO BRIGHT PIXEL DEFECT GUARANTEE

This policy covers "zero bright pixel" defects for the duration of the limited "ONE YEAR WARRANTY" on select new product purchases. To determine if this guarantee applies to your product, refer to the "DETAILS" tab of the model's product information page (www.VIZIO.com) or look for the "zero bright pixel" guarantee on the box.

Index

- 16:9 33
- 4:3 33
- Accessories 9
- Adjustments
 - Advanced 32
 - Volume 14
- Advanced Adjustments 32
- Ambient Light Sensor 36
- Antenna 22
- Aspect Ratio 33
- Audio Menu
 - Advanced Audio 39
 - Analog Audio Out 39
 - Audio Mode 38
 - Balance 38
 - Digital Audio Out 39
 - Equalizer adjustments 39
 - Lip Sync 38
 - Reset Audio Mode 40
 - SRS TruSurroundHD 39
 - SRS TruVolume 39
 - TV Speakers 38
- AV connector 22
- Bass 39
- Blackbars 33
- Blocking Channels 41
- Brightness 34
- Cable Box
 - Connecting 23
- CC Closed Caption 34
- CEC 44
- Cleaning 62
- Coaxial connection
 - Satellite box 27
- Coaxial Connection
 - Cable TV 27
- Color 35
- Component Connector 22
- Composite Connector 22
- Computer
 - Connecting 29
 - Preset Resolutions 70
 - Resolution through RGB 70
- Connecting
 - Computer 29
 - RGB 29
 - VGA 29
- Connecting Equipment
 - Cable 23
 - DVD 25
 - Home Theater 28
 - Rear Panel Connections 15
 - Satellite Box 23
 - Sound system 28
 - Stereo 28
 - VCR 27
 - Video Camera 27
- Contents 9
- Contrast 35

- Controls
 - Front Panel 14
 - Side Panel 14
- Daylight Savings setting 43
- DTV Transition 5
- DVD Player
 - Connecting 25
- DVI
 - Cable Box 23
 - DVD Player 25
 - Satellite Box 23
- EPG 21
- Equalizer Settings 39
- Getting Started 19
- Grounding 4
- GUIDE Button 21
- HDMI 22
- Help Menu
 - Reset All Settings 45
 - Setup Wizard 45
 - System Info 45
- Help Menu 45
- Home Theater
 - Connecting 28
- Horizontal/Vertical Position adjustments 35
- Input Source
 - Choosing 20
- Inputs
 - Antenna 4
 - Connectors 22
- Maintenance of TV 62
- Media Menu
 - Duration 31, 45
 - Info 31, 45
 - Repeat 31, 44
 - Slideshow 31, 44
 - Slideshow Effect 31, 45
 - Sort By 31, 44
 - Thumbnail Size 31, 45
- Menu Language 43
- Name Input 41
- OSD 32
 - CC Menu 34
 - Help Menu 45
 - Input Menu 32
 - Photo Menu 44
 - Picture Menu 34
 - PIP Menu 37
 - Settings Menu 38
 - Sleep Timer Menu 34
 - Wide Menu 33
- Parental Controls
 - Alt Rating Region 43
 - Block Unrated TV 43
 - Canadian English Rating 42
 - Canadian French Rating 43
 - Change the Password 43
 - Channel Block 41
 - Rating Enable 41

Reset Locks	43	All TV Settings.....	45
USA Movie Rating	42	Audio Settings.....	40
USA TV Rating	42	Factory Default.....	45
Parental Controls	41	Picture Settings.....	37
Password	43	RGB	22
Photo Menu.....	44	Safety Instructions.....	2
Photos		Satellite Box	
Adjusting Settings	31	Connecting.....	23
Viewing	30	Search for channels	40
Picture		Setting Up	10
Reset Picture Mode.....	37	Settings Menu	
Picture Menu.....	34	Audio.....	38, 41
Adaptive Luma	36	CEC	44
Ambient Light Sensor.....	36	Menu Language	43
Backlight	34	Parental Controls Menu	41
Backlight Control.....	36	Time & Local Settings	43
Brightness	34	Setup Wizard.....	19
Color	35	Sharpness.....	35
Color Enhancement	36	Skip Channel.....	40
Color Temperature.....	36	Slideshow	
Contrast	35	Duration	31, 45
Film Mode	36	Effect.....	31, 45
MPEG NR	36	Mode	31, 44
Noise Reduction.....	36	Repeat	31, 44
Picture Mode.....	34	Specifications.....	66
Real Cinema	36	Stereo	
Sharpness.....	35	Connecting.....	28
Smooth Motion.....	36	Surround Sound.....	39
Tint.....	35	System Information	45
Pictures		Technical Support	65
Adjusting Settings	31	Time Zone setting	43
Create Slideshow.....	31, 44	Tint.....	35
Info	31, 45	Treble.....	39
Sort	31, 44	Troubleshooting	62
Thumbnail Size	31, 45	Tuner Menu	
Viewing	30	Analog MTS	40
PIP	37	Auto Search	40
Audio.....	37	Skip Channel.....	40
Mode	37	Tuner Mode.....	40
Position	37	TV Menu	32
Size	37	Partial Channel Search	40
Source.....	37	USB Port	30
Remote		VCR	
Programming Cable Box.....	47	Connecting.....	27
Programming DVD Player.....	46	Video Camera	
Programming Home Theater System.....	46	Connecting.....	27
Programming Satellite Box.....	47	Wall mounting	13
Remote Control.....	16	Warranty	71
Batteries.....	16	Watching TV	
Buttons	17, 18	Getting your Programs	20
Precautions	16	Program Information	21
Range	16	Wide.....	33
Reset		Wizard.....	45

VIZIO

TRADEMARKS SHOWN ARE THE PROPERTY OF THEIR RESPECTIVE OWNERS. IMAGES USED ARE FOR ILLUSTRATION PURPOSES ONLY. VIZIO, THE V LOGO, WHERE VISION MEETS VALUE AND OTHER VIZIO TRADEMARKS ARE THE INTELLECTUAL PROPERTY OF VIZIO INC. PRODUCT FEATURES AND SPECIFICATIONS ARE SUBJECT TO CHANGE WITHOUT NOTICE. © 2010 VIZIO INC. ALL RIGHTS RESERVED.

www.vizio.com

