

Contents

Product Offering	7-2
Decision Tree	7-3
Piston Seal Profiles	
BP	7-5
PSP	7-8
CC	7-11
OK	7-13
PIP.....	7-15
B7	7-19
UP	7-23
E4	7-26
BMP.....	7-29
TP	7-31
S5	7-35
R5	7-39
CT	7-43
CQ.....	7-48
OE	7-53
CP	7-62
OA	7-68
OQ.....	7-74

Piston Seal Profiles

Parker offers the most comprehensive range of piston seals in the market today. A variety of profiles such as lip seals, cap seals and squeeze seals are manufactured from proprietary rubber, thermoplastic and PTFE compounds to meet the broad demands of the fluid power industry. The highest quality materials and manufacturing processes are utilized to ensure the best performance possible. Parker's piston seal profiles are available for both uni-directional and bi-directional applications. When combined with wear rings, Parker piston seals have proven to provide long life and leak free performance.











































Piston Seal Product Offering

Catalog EPS 5370/USA

Profiles

Table 7-1: Product Profiles

Series	Description	Application (Duty)				Page	Series	Description	Application (Duty)				Page
		Light	Medium	Heavy	Pneumatic				Light	Medium	Heavy	Pneumatic	
BP	Premium TPU Cap Seal					7-5	TP	Compact Seal with Anti-Extrusion Technology					7-31
PSP	TPU Piston Cap Seal					7-8	S5	Square PTFE Cap Seal					7-35
CC	High Pressure, Step Cut Cap Piston Seal					7-11	R5	Rectangular PTFE Cap Seal					7-39
OK	High Pressure, Step Cut Cap Piston Seal					7-13	CT	Premium PTFE Cap Seal with Anti-Extrusion Technology					7-43
PIP	Loaded Lip Seal with Pressure Inverting Pedestal					7-15	CQ	Premium PTFE Cap Seal with Anti-Drift Technology					7-48
B7	U-cup Piston Seal					7-19	OE	PTFE Piston Cap Seal					7-53
UP	Industrial U-cup Piston Seal					7-23	CP	PTFE Piston Cap Seal to Retrofit O-ring Gland					7-62
E4	Premium Rounded Lip U-cup Piston Seal					7-26	OA	Compact PTFE Piston Cap Seal					7-68
BMP	Rounded Lip Seal with Bumper Cushion					7-29	OQ	Rotary PTFE Cap Seal					7-74

7

09/01/07



Piston Seal Decision Tree

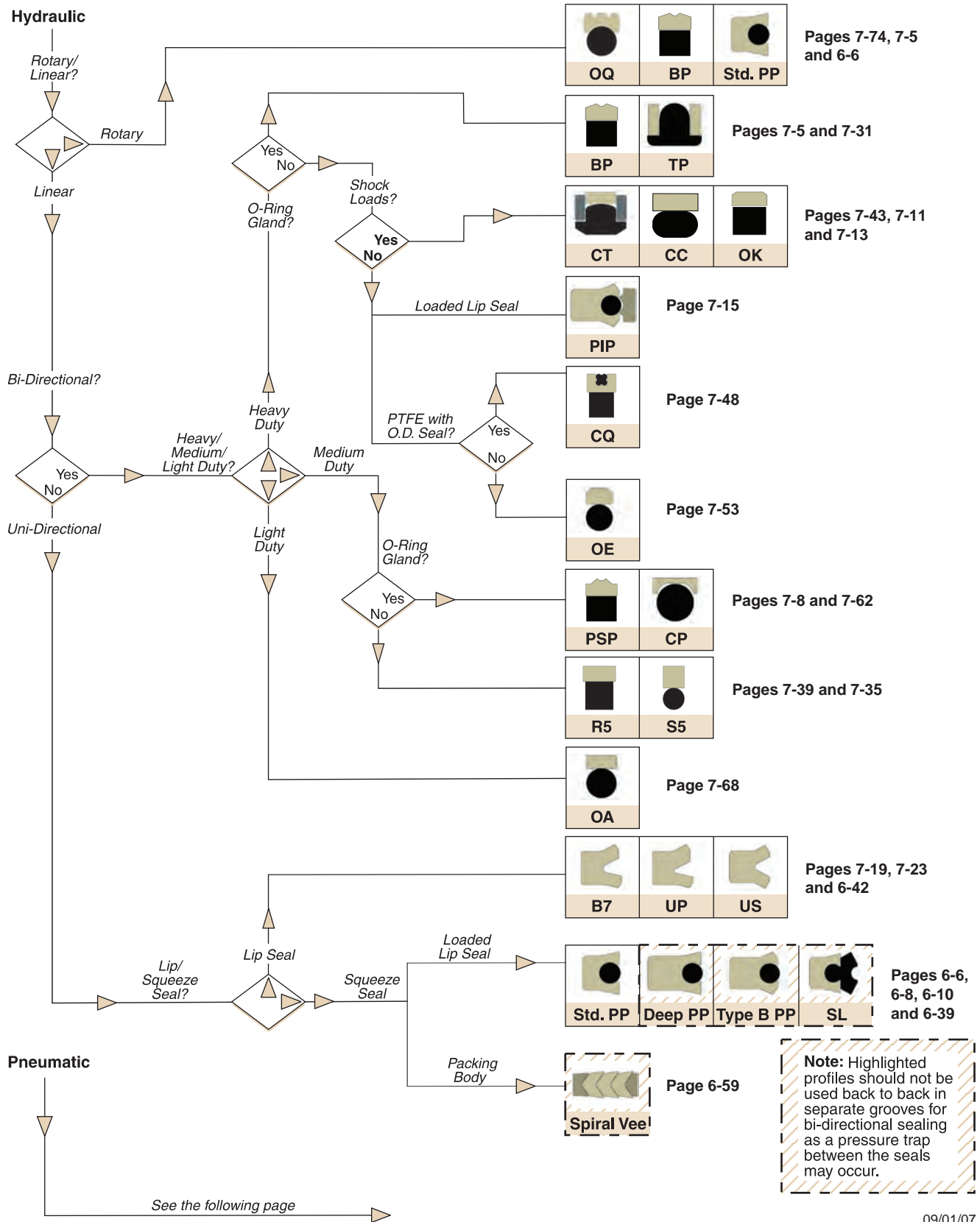

Piston Seal Decision Tree (Continued)

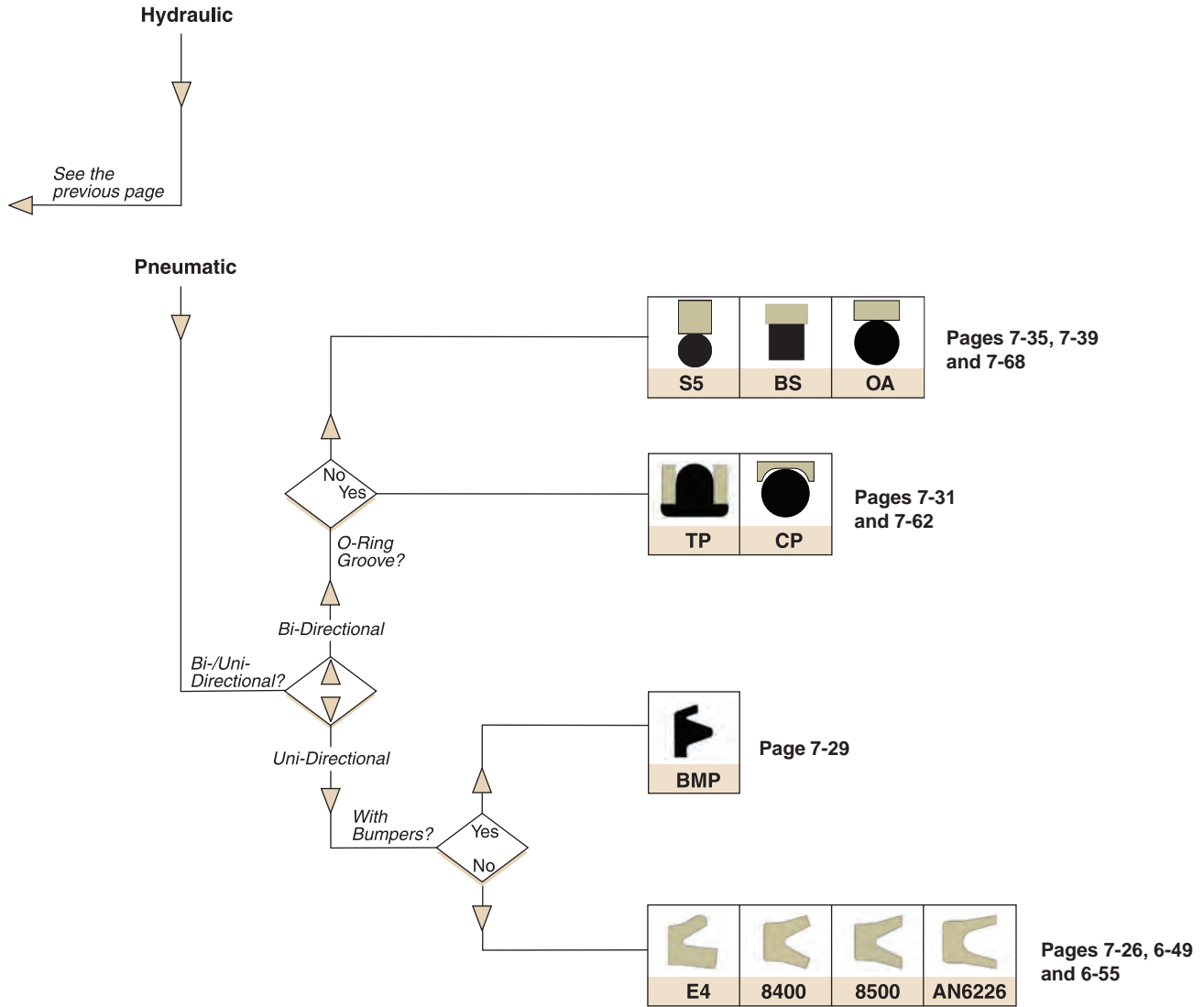

7

Piston Seal BP Profile

Catalog EPS 5370/USA



BP Profile, Premium TPU Cap Seal

Parker's BP profile is a squeeze type, bi-directional piston seal for use in medium to heavy duty hydraulic applications. This seal is primarily designed for linear applications but has been successfully used as a low speed rotary seal. The standard material for this profile is Resilon® 4304 polyurethane, compound P4304. This is a proprietary Parker polyurethane offering higher wear resistance, extrusion resistance, and extended temperature range. The Resilon® 4304 cap is energized using a resilient nitrile elastomer offering low compression set. The BP seal's geometry provides a fluid reservoir between the two sealing lips which holds system fluid, resulting in reduced breakaway and running friction. The BP is offered in two styles, standard and narrow, with the standard style designed to retrofit O-ring grooves. The BP profile is easy to install and will resist rolling and twisting in long stroke applications.

The BP profile is sold only as an assembly (seal and energizer). See part number nomenclature.

Technical Data

Standard Materials*	Temperature Range	Pressure Range†	Surface Speed
Cap P4304D60	-65°F to 275°F (-54°C to 135°C)	7,000 psi (482 bar)	< 1.6 ft/s (0.5 m/sec)
Energizer A 70A Nitrile	-30°F to 250°F (-34°C to 121°C)		

***Alternate Materials:** For applications that may require an alternate material, please contact your local Parker Seal representative.

†**Pressure Range** without wear rings (see Table 2-4, page 2-5).



BP Cross-Section

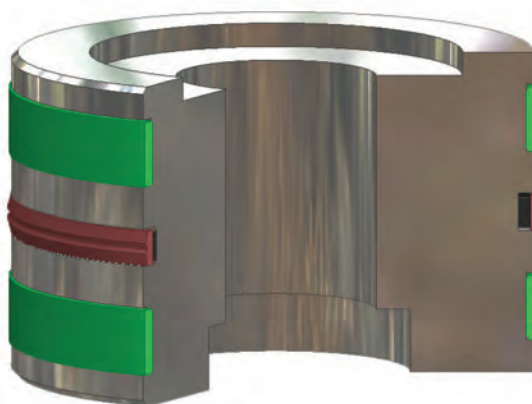

BP installed in Piston Gland

7

09/01/07

BP Profile

Part Number Nomenclature — BP (Standard Style) Profile

Table 7-2. BP (Standard Style) Profile — Inch

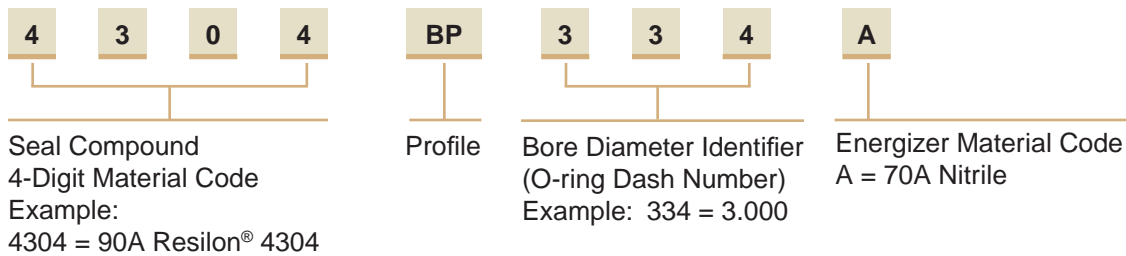

Gland Dimensions — BP Profile

Please refer to Engineering Section 2, Page 2-8 for surface finish and additional hardware considerations.

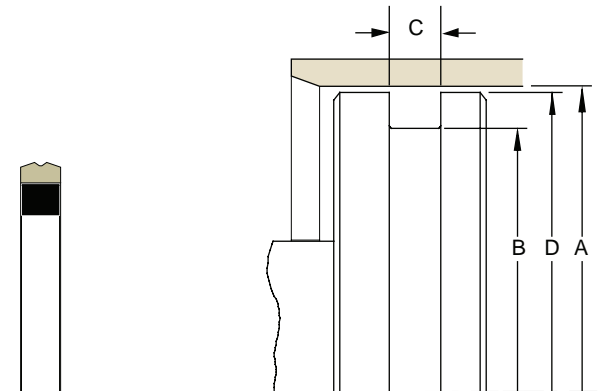

Table 7-3. BP Gland Dimensions (Standard Size)

A Bore Diameter	B Groove Diameter	C Groove Width	D Piston Diameter*	Part Number
+0.002/-0.000	+0.000/-0.002	+0.005/-0.000	+0.000/-0.001	
0.562	0.320	0.187	0.559	4304BP203A
0.625	0.383	0.187	0.662	4304BP204A
0.687	0.445	0.187	0.684	4304BP205A
0.750	0.508	0.187	0.747	4304BP206A
0.812	0.570	0.187	0.809	4304BP207A
0.875	0.633	0.187	0.872	4304BP208A
0.937	0.695	0.187	0.934	4304BP209A
1.000	0.758	0.187	0.997	4304BP210A
1.062	0.820	0.187	1.059	4304BP211A
1.125	0.833	0.187	1.122	4304BP212A
1.187	0.945	0.187	1.184	4304BP213A
1.250	1.008	0.187	1.247	4304BP214A
1.312	1.070	0.187	1.309	4304BP215A
1.375	1.133	0.187	1.372	4304BP216A
1.437	1.195	0.187	1.434	4304BP217A
1.500	1.258	0.187	1.497	4304BP218A
1.562	1.320	0.187	1.559	4304BP219A
1.625	1.383	0.187	1.622	4304BP220A
1.687	1.445	0.187	1.684	4304BP221A
1.750	1.508	0.187	1.747	4304BP222A
1.875	1.505	0.281	1.872	4304BP325A
2.000	1.630	0.281	1.997	4304BP326A
2.125	1.755	0.281	2.122	4304BP327A
2.250	1.880	0.281	2.247	4304BP328A

*If used with wear rings, refer to wear ring piston diameter, see Section 9.

A Bore Diameter	B Groove Diameter	C Groove Width	D Piston Diameter*	Part Number
+0.002/-0.000	+0.000/-0.002	+0.005/-0.000	+0.000/-0.001	
2.375	2.005	0.281	2.372	4304BP329A
2.500	2.130	0.281	2.497	4304BP330A
2.625	2.255	0.281	2.622	4304BP331A
2.750	2.380	0.281	2.747	4304BP332A
2.875	2.505	0.281	2.872	4304BP333A
3.000	2.630	0.281	2.997	4304BP334A
3.125	2.755	0.281	3.122	4304BP335A
3.250	2.880	0.281	3.247	4304BP336A
3.375	3.005	0.281	3.372	4304BP337A
3.500	3.130	0.281	3.497	4304BP338A
3.625	3.255	0.281	3.622	4304BP339A
3.750	3.380	0.281	3.747	4304BP340A
3.875	3.505	0.281	3.872	4304BP341A
4.000	3.630	0.281	3.997	4304BP342A
4.125	3.755	0.281	4.122	4304BP343A
4.250	3.880	0.281	4.247	4304BP344A
4.375	4.005	0.281	4.372	4304BP345A
4.500	4.130	0.281	4.497	4304BP346A
4.625	4.255	0.281	4.622	4304BP347A
4.750	4.380	0.281	4.747	4304BP348A
4.875	4.505	0.281	4.872	4304BP349A
5.002	4.630	0.281	4.997	4304BP350A
5.127	4.653	0.375	5.123	4304BP426A
5.252	4.778	0.375	5.248	4304BP427A

*If used with wear rings, refer to wear ring piston diameter, see Section 9.

09/01/07



Table 7-3. BP Gland Dimensions — Inch (Continued)

A Bore Diameter	B Groove Diameter	C Groove Width	D Piston Diameter*	Part Number
+0.002/ -0.000	+0.000/ -0.002	+0.005/ -0.000	+0.000/ -0.001	
5.377	4.903	0.375	5.373	4304BP428A
5.502	5.028	0.375	5.498	4304BP429A
5.627	5.153	0.375	5.623	4304BP430A
5.752	5.278	0.375	5.748	4304BP431A
5.877	5.403	0.375	5.873	4304BP432A
6.002	5.528	0.375	5.998	4304BP433A

A Bore Diameter	B Groove Diameter	C Groove Width	D Piston Diameter*	Part Number
+0.002/ -0.000	+0.000/ -0.002	+0.005/ -0.000	+0.000/ -0.001	
6.127	5.653	0.375	6.123	4304BP434A
6.252	5.778	0.375	6.248	4304BP435A
6.502	6.028	0.375	6.498	4304BP437A
6.752	6.278	0.375	6.748	4304BP438A
7.002	6.528	0.375	6.998	4304BP439A

*If used with wear rings, refer to wear ring piston diameter, see Section 9.

*If used with wear rings, refer to wear ring piston diameter, see Section 9.

NOTE: For sizes larger than those shown in the table, please contact your local Parker Seal representative.

Part Number Nomenclature — BP (Narrow Style) Profile

Table 7-4. BP (Narrow Style) Profile — Inch

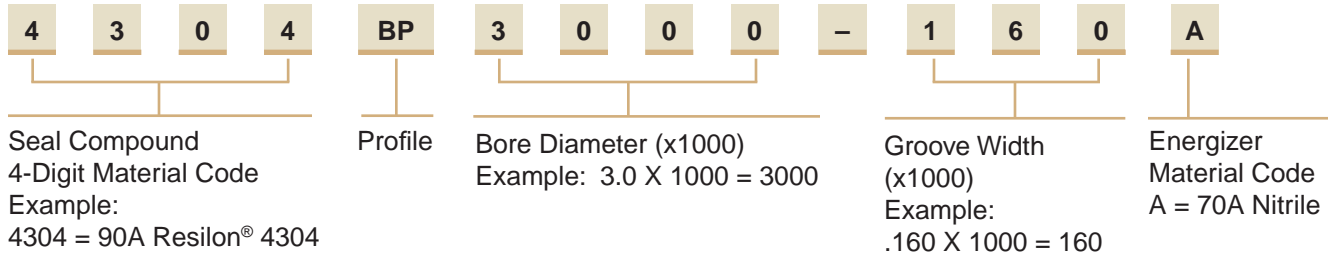

Gland Dimensions — BP Profile

Please refer to Engineering Section 2, Page 2-8 for surface finish and additional hardware considerations.

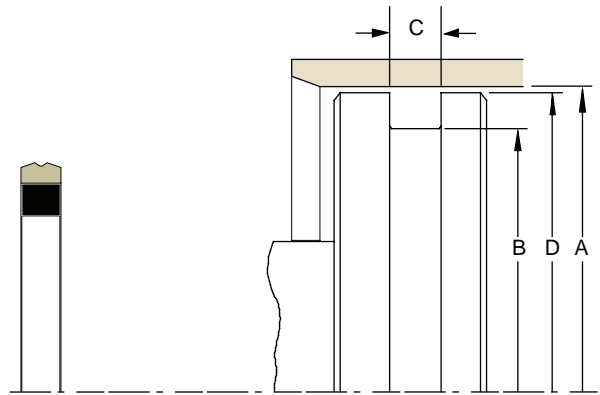

Table 7-5. BP Gland Dimensions (Narrow Size)

A Bore Diameter	B Groove Diameter	C Groove Width	D Piston Diameter*	Part Number
+0.002/ -0.000	+0.000/ -0.002	+0.002/ -0.000	+0.000/ -0.001	
1.750	1.473	0.130	1.747	4304BP1750-130A
2.000	1.582	0.175	1.997	4304BP2000-175A
2.250	1.973	0.130	2.247	4304BP2250-130A
2.500	2.223	0.130	2.497	4304BP2500-130A
2.500	2.082	0.175	2.497	4304BP2500-175A
2.750	2.348	0.160	2.747	4304BP2750-160A
3.000	2.598	0.160	2.997	4304BP3000-160A

A Bore Diameter	B Groove Diameter	C Groove Width	D Piston Diameter*	Part Number
+0.002/ -0.000	+0.000/ -0.002	+0.002/ -0.000	+0.000/ -0.001	
3.250	2.848	0.160	3.247	4304BP3250-160A
3.500	3.098	0.160	3.497	4304BP3500-160A
3.750	3.348	0.160	3.747	4304BP3750-160A
4.000	3.598	0.160	3.997	4304BP4000-160A
4.250	3.848	0.160	4.247	4304BP4250-160A
4.500	4.098	0.160	4.497	4304BP4500-160A
5.000	4.598	0.160	4.997	4304BP5000-160A

*If used with wear rings, refer to wear ring piston diameter, see Section 9.

*If used with wear rings, refer to wear ring piston diameter, see Section 9.

NOTE: For sizes larger than those shown in the table, please contact your local Parker Seal representative.

Piston Seal PSP Profile

Catalog EPS 5370/USA



PSP Profile, TPU Piston Cap Seal

Parker's PSP seal is a squeeze type, bi-directional piston seal for use in light to medium duty hydraulic applications. Available from proprietary Parker polyurethanes, the PSP offers low friction, abrasion and extrusion resistance. The nitrile elastomer energizer ensures resistance to compression set to increase seal life. The PSP seal's geometry provides a fluid reservoir between the two sealing lips which holds system fluid, resulting in reduced breakaway and running friction. Designed to retrofit grooves for a single O-ring or an O-ring with two back-ups, the PSP profile is easy to install and resist rolling and twisting in long stroke applications.

The PSP profile is sold only as an assembly (seal and energizer). See part number nomenclature.

Technical Data

Standard Materials*	Temperature Range	Pressure Range†	Surface Speed
Cap			
P4622A90	-65°F to 225°F (-54°C to 107°C)	5000 psi (344 bar)	< 1.6 ft/s (0.5 m/sec)
P4300A90	-65°F to 275°F (-54°C to 135°C)	5000 psi (344 bar)	< 1.6 ft/s (0.5 m/sec)
Energizer			
A 70A Nitrile	-30°F to 250°F (-34°C to 121°C)		

*Alternate Materials: For applications that may require an alternate material, please contact your local Parker Seal representative.

†Pressure Range without wear rings (see Table 2-4, page 2-5).

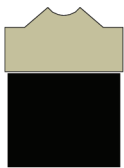

PSP Cross-Section

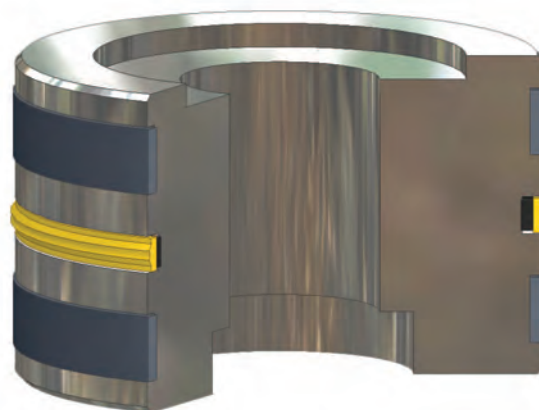

PSP installed in Piston Gland

09/01/07

Part Number Nomenclature — PSP Profile

Table 7-6. PSP Profile — Inch

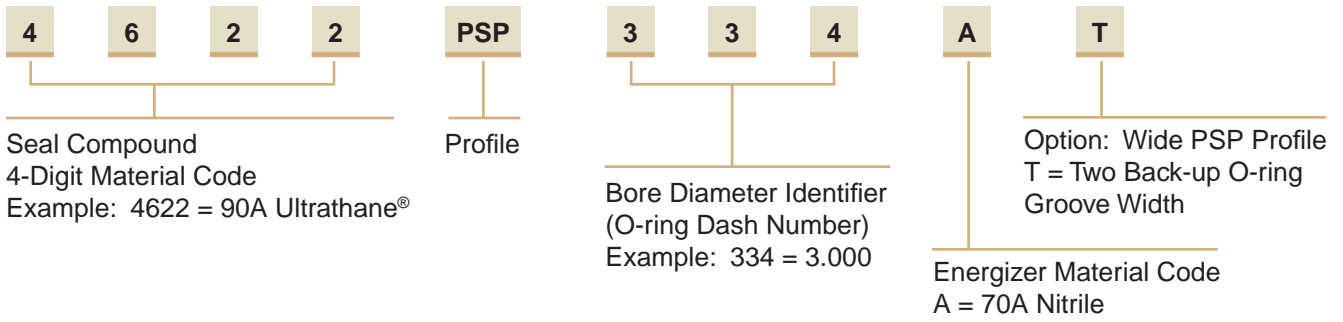

Gland Dimensions — PSP Profile

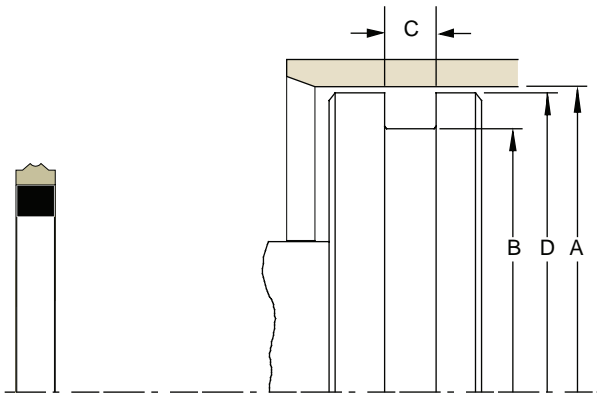

Please refer to Engineering Section 2, Page 2-8 for surface finish and additional hardware considerations.

Table 7-7. PSP Gland Dimensions

A Bore Diameter	B Groove Diameter	C Groove Width	D Piston Diameter*	Compound (X = Standard Offering)			Part Number	
				PSP		Wide PSP	Compound Code	
				4622	4300	4300		
+0.002/-0.000	+0.000/-0.002	+0.005/-0.000	+0.000/-0.001					
0.625	0.383	0.187	0.662		X		XXXX	PSP204A
0.750	0.508	0.187	0.747		X		XXXX	PSP206A
1.000	0.758	0.187	0.997	X	X		XXXX	PSP210A
1.250	1.008	0.187	1.247	X	X		XXXX	PSP214A
1.500	1.258	0.187	1.497	X	X		XXXX	PSP218A
1.500	1.258	0.275	1.497			X	XXXX	PSP218AT
1.750	1.508	0.187	1.747	X			XXXX	PSP222A
1.750	1.508	0.275	1.747			X	XXXX	PSP222AT
1.875	1.633	0.187	1.872		X		XXXX	PSP223A
2.125	1.833	0.187	2.122		X		XXXX	PSP225A
2.250	2.008	0.187	2.247		X		XXXX	PSP226A
1.875	1.505	0.281	1.872				XXXX	PSP325A
2.000	1.630	0.281	1.997	X	X		XXXX	PSP326A
2.000	1.630	0.410	1.997			X	XXXX	PSP326AT
2.250	1.880	0.281	2.247	X	X		XXXX	PSP328A
2.500	2.130	0.281	2.497	X	X		XXXX	PSP330A
2.500	2.130	0.410	2.497			X	XXXX	PSP330AT
2.625	2.255	0.281	2.622		X		XXXX	PSP331A
2.750	2.380	0.281	2.747	X	X		XXXX	PSP332A
3.000	2.630	0.281	2.997	X	X		XXXX	PSP334A

*If used with wear rings, refer to wear ring piston diameter, see Section 9.



PSP Profile

Table 7-7. PSP Gland Dimensions — Inch (Continued)

A Bore Diameter	B Groove Diameter	C Groove Width	D Piston Diameter*	Compound (X = Standard Offering)			Part Number	
				PSP		Wide PSP	Compound Code	
				4622	4300	4300		
+ .002/- .000	+ .000/- .002	+ .005/- .000	+ .000/- .001					
3.000	2.630	0.410	2.997			X	XXXX	PSP334AT
3.125	2.755	0.281	3.122		X		XXXX	PSP335A
3.250	2.880	0.281	3.247	X	X		XXXX	PSP336A
3.500	3.130	0.281	3.497	X	X		XXXX	PSP338A
3.500	3.130	0.410	3.497			X	XXXX	PSP338AT
3.625	3.255	0.281	3.622	X			XXXX	PSP339A
4.000	3.630	0.281	3.997	X	X		XXXX	PSP342A
4.000	3.630	0.410	3.997			X	XXXX	PSP342AT
4.500	4.130	0.281	4.497	X			XXXX	PSP346A
4.500	4.130	0.410	4.497			X	XXXX	PSP346AT
5.002	4.630	0.281	4.997	X			XXXX	PSP350A
5.002	4.528	0.538	4.997			X	XXXX	PSP425AT
5.502	5.028	0.375	5.498	X			XXXX	PSP429A
5.502	5.028	0.538	5.498			X	XXXX	PSP429AT
6.002	5.528	0.375	5.998	X			XXXX	PSP433A
6.002	5.528	0.538	5.998			X	XXXX	PSP433AT
6.502	6.028	0.375	6.498		X		XXXX	PSP437A
7.002	6.528	0.538	6.998			X	XXXX	PSP439AT
8.002	7.528	0.375	7.998		X		XXXX	PSP443A
12.002	11.528	0.375	11.998		X		XXXX	PSP452A

*If used with wear rings, refer to wear ring piston diameter, see Section 9.

NOTE: For sizes larger than those shown in the table, please contact your local Parker Seal representative.

Piston Seal OK Profile

Catalog EPS 5370/USA



OK Profile, High Pressure Split Cap Piston Seal

The OK profile is a bi-directional piston seal designed for heavy duty hydraulic applications. Its durable, two-piece design installs easily onto a solid piston without the necessity of auxiliary tools. When installed into the bore, the diameter of the OK profile is compressed to close the step cut in the cap to provide excellent, drift free sealing performance. The glass-filled nylon sealing surface handles the toughest applications. It will resist shock loads, wear, contamination, and will resist extrusion or chipping when passing over cylinder ports. The rectangular nitrile energizer ring ensures resistance to compression set to increase seal life.

The OK profile is sold only as an assembly. See part number nomenclature.

Technical Data

Standard Materials	Temperature Range	Pressure Range†	Surface Speed
Cap W4650NHH	-65°F to 275°F (-54°C to 135°C)	7250 psi (500 bar)	< 3.3 ft/s (1.0 m/sec)
Energizer A 70A Nitrile	-40°F to 250°F (-40°C to 121°C)		

†Pressure Range without wear rings (see Table 2-4, page 2-5).

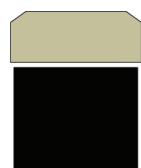

OK Cross-Section

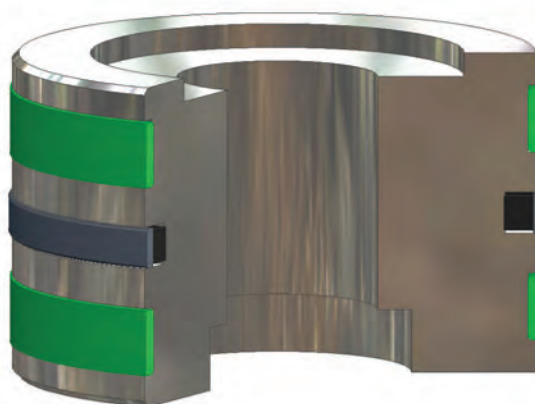

OK installed in Piston Gland

7

09/01/07

OK Profile

Part Number Nomenclature — OK Profile

Table 7-9. OK Profile — Inch

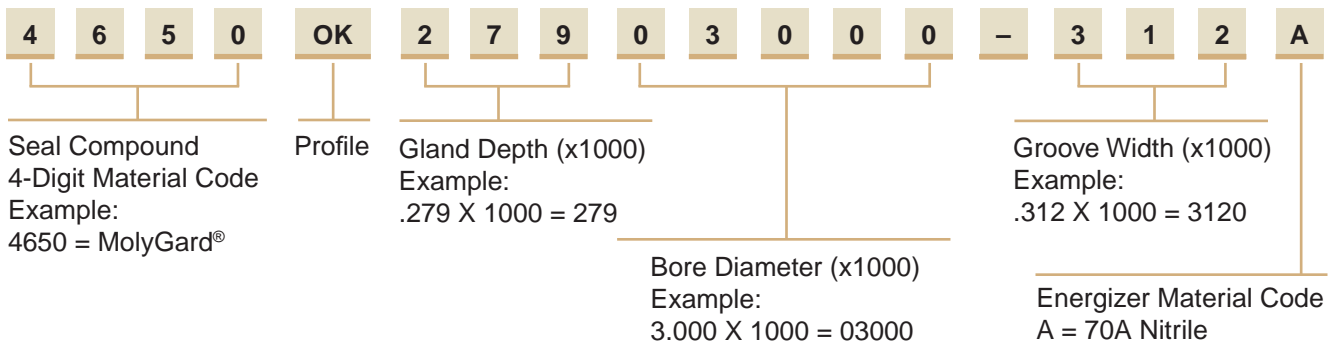

Gland Dimensions — OK Profile

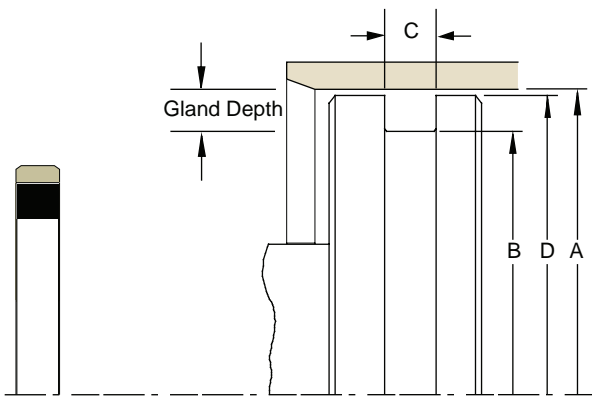

Please refer to Engineering Section 2, Page 2-8 for surface finish and additional hardware considerations.

Table 7-10. OK Gland Dimensions — Inch

A Bore Diameter +.005/-.000	B Groove Diameter +.000/-.005	C Groove Width +.005/-.000	D Piston Diameter* +.000/-.001	Part Number
1.500	0.962	0.282	1.435	4650OK26901500-282A
2.000	1.462	0.282	1.935	4650OK26902000-282A
2.500	1.962	0.282	2.435	4650OK26902500-282A
2.500	1.962	0.312	2.435	4650OK26902500-312A
2.750	2.192	0.282	2.670	4650OK27902750-282A
3.000	2.442	0.312	2.920	4650OK27903000-312A
3.250	2.692	0.312	3.170	4650OK27903250-312A
3.500	2.942	0.282	3.420	4650OK27903500-282A
3.500	2.942	0.312	3.420	4650OK27903500-312A
3.750	3.192	0.282	3.670	4650OK27903750-282A
4.000	3.442	0.282	3.920	4650OK27904000-282A
4.000	3.402	0.315	3.920	4650OK29904000-315A
4.500	3.942	0.282	4.420	4650OK27904500-282A
5.000	4.442	0.282	4.920	4650OK27905000-282A
5.500	4.740	0.377	5.400	4650OK38005500-377A
6.000	5.240	0.377	5.900	4650OK38006000-377A
7.000	6.240	0.377	6.900	4650OK38007000-377A
8.000	7.240	0.377	7.900	4650OK38008000-377A

*If used with wear rings, refer to wear ring piston diameter, see Section 9.

NOTE: For sizes larger than those shown in the table, please contact your local Parker Seal representative.

Piston Seal PIP Profile

Catalog EPS 5370/USA

PIP Ring® Profile, Loaded Lip Seal with Pressure Inverting Pedestal



The Parker PIP Ring® profile combines a “Pressure Inverting Pedestal” with a Type B PolyPak® to provide excellent, bi-directional piston sealing in hydraulic applications. The PIP Ring conforms to the beveled sealing lips of the Type B PolyPak to provide extrusion resistance when pressure is applied to the heel side of the seal. The PIP Ring profile requires only a single seal groove for installation. This eliminates the use of two PolyPaks on the piston to save space and increase bearing length.

Note: The PIP Ring profile may be purchased as an assembly (Type B PolyPak and PIP ring) or separately as a PIP Ring only. If purchasing as an assembly, the standard material is a 4615 Type B PolyPak with 4617 PIP Ring. If you desire alternate material combinations, please order the PIP Ring and Type B PolyPak separately. Call your Parker Seal representative for details.



PIP Cross-Section

Technical Data

Standard Materials*	Temperature Range	Pressure Range†	Surface Speed
Type B PolyPak P4615A90	-65°F to 200°F (-54°C to 93°C)	5,000 psi (344 bar)	< 1.6 ft/s (0.5 m/s)
PIP Ring P4617D65	-65°F to 250°F (-54°C to 121°C)	5,000 psi (344 bar)	< 1.6 ft/s (0.5 m/s)
Optional Materials			
PIP Ring Z4652D65	-65°F to 275°F (-54°C to 135°C)	10,000 psi** (689 bar)	
W4685R119	-65°F to 500°F (-54°C to 260°C)	10,000+ psi (689 bar)	

***Alternate Materials:** For applications that may require an alternate material, please contact your local Parker Seal representative.

†Pressure Range without wear rings (see Table 2-4, page 2-5).

****Pressure rating** dependant on entire assembly of PolyPak shell/energizer and PIP ring.

Note: The PIP may be ordered separately. Please contact your local Parker Seal representative.

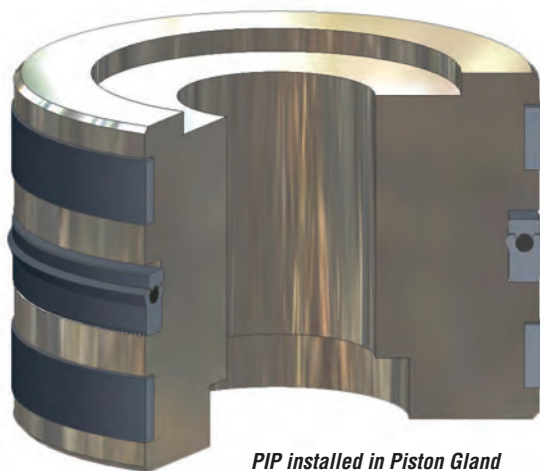

PIP installed in Piston Gland



PIP Profile

Part Number Nomenclature — PIP Assembly Profile

Table 7-11. PIP Assembly Profile — Inch

4	6	1	5	2	5	0	0	2	5	0	0	P	3	7	5	B
Seal Compound 4-Digit Material Code Example: 4615 = 90A Molythane®				Gland Depth (x1000) or Seal Nominal Radial Cross-Section Example: .250 x 1000 = 250			Seal Nominal I.D. (x1000) Example: 2.500 x 1000 = 02500				Cap Profile PIP 4617 is standard for assemblies only		Base Profile Type B PolyPak® Axial Width			

Part Number Nomenclature — PIP Ring Only Profile

Table 7-12. PIP Ring Only Profile — Inch

4	6	1	7	2	5	0	0	2	5	0	0	PR
PIP Ring Compound 4-Digit Material Code Example: 4617 = 90A Molythane® 4652 = Polymyte® 4685 = UltraCOMP™				Gland Depth (x1000) or Seal Nominal Radial Cross-Section Example: .250 x 1000 = 250			Seal Nominal I.D. (x1000) Example: 2.500 x 1000 = 02500				Profile	

Gland Dimensions — PIP Profile

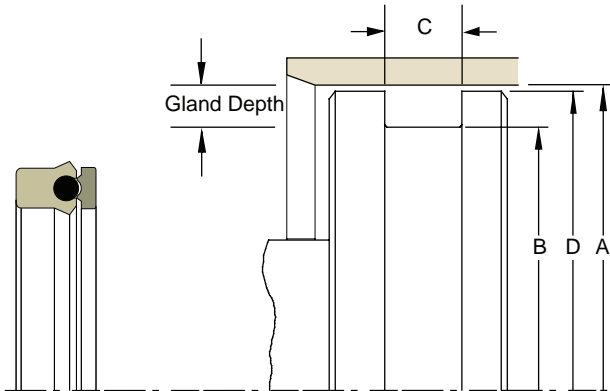

Please refer to Engineering Section 2, Page 2-8 for surface finish and additional hardware considerations.

Table 7-13. Gland Dimension Tolerances

Nominal Gland Depth	A Bore Diameter	B Groove Diameter	C Groove Width	D Piston Diameter
1/8	+0.002/-0.000	+0.000/-0.002	+0.015/-0.000	+0.000/-0.001
3/16	+0.002/-0.000	+0.000/-0.002		+0.000/-0.002
1/4	+0.003/-0.000	+0.000/-0.003		+0.000/-0.002
5/16	+0.003/-0.000	+0.000/-0.004		+0.000/-0.002
3/8	+0.004/-0.000	+0.000/-0.005		+0.000/-0.002
7/16	+0.005/-0.000	+0.000/-0.006		+0.000/-0.002
1/2	+0.005/-0.000	+0.000/-0.007		+0.000/-0.003
9/16	+0.006/-0.000	+0.000/-0.008		+0.000/-0.003
5/8	+0.006/-0.000	+0.000/-0.009		+0.000/-0.003
3/4	+0.007/-0.000	+0.000/-0.010		+0.000/-0.004
7/8	+0.008/-0.000	+0.000/-0.011	+0.000/-0.005	
1	+0.009/-0.000	+0.000/-0.012	+0.000/-0.005	

Table 7-14. PIP Gland Dimensions — Inch

A Bore Diameter	B Groove Diameter	C Groove Width	D Piston Diameter*	Part Number
1.250	0.875	0.453	1.249	461518700875P312B
1.250	1.000	0.340	1.249	461512501000P250B
1.500	1.000	0.550	1.499	461525001000P375B
1.500	1.125	0.453	1.498	461518701125P312B
1.500	1.250	0.340	1.499	461512501250P250B
1.562	1.312	0.271	1.561	461512501312P187B

*If used with wear rings, refer to wear ring piston diameter, see Section 9.

A Bore Diameter	B Groove Diameter	C Groove Width	D Piston Diameter*	Part Number
1.625	1.375	0.340	1.624	461512501375P250B
1.687	1.437	0.340	1.686	461512501437P250B
1.750	1.250	0.550	1.749	461525001250P375B
1.750	1.375	0.453	1.749	461518701375P312B
1.750	1.500	0.340	1.749	461512501500P250B
2.000	1.500	0.550	1.999	461525001500P375B

*If used with wear rings, refer to wear ring piston diameter, see Section 9.

09/01/07



Table 7-14. PIP Gland Dimensions — Inch (Continued)

A Bore Diameter	B Groove Diameter	C Groove Width	D Piston Diameter*	Part Number	A Bore Diameter	B Groove Diameter	C Groove Width	D Piston Diameter*	Part Number
2.000	1.625	0.453	1.999	461518701625P312B	5.000	4.500	0.550	4.999	461525004500P375B
2.000	1.625	0.523	1.999	461518701625P375B	5.000	4.500	0.688	4.999	461525004500P500B
2.125	1.750	0.523	2.124	461518701750P375B	5.000	4.500	0.756	4.999	461525004500P562B
2.250	1.750	0.550	2.249	461525001750P375B	5.125	4.500	0.853	5.123	461531204500P625B
2.250	1.875	0.523	2.249	461518701875P375B	5.125	4.625	0.756	5.124	461525004625P562B
2.250	2.000	0.271	2.249	461512502000P187B	5.250	4.750	0.756	5.249	461525004750P562B
2.375	2.000	0.523	2.374	461518702000P375B	5.375	4.875	0.756	5.374	461525004875P562B
2.500	1.875	0.715	2.499	461531201875P500B	5.500	4.750	0.895	5.498	461537504750P625B
2.500	2.000	0.550	2.499	461525002000P375B	5.500	5.000	0.550	5.499	461525005000P375B
2.500	2.125	0.523	2.499	461518702125P375B	5.500	5.000	0.756	5.499	461525005000P562B
2.625	2.250	0.523	2.624	461518702250P375B	5.750	5.000	0.895	5.748	461537505000P625B
2.750	2.250	0.550	2.749	461525002250P375B	5.750	5.250	0.550	5.749	461525005250P375B
2.750	2.375	0.403	2.749	461518702375P266B	5.750	5.250	0.756	5.749	461525005250P562B
2.750	2.375	0.523	2.749	461518702375P375B	6.000	5.000	1.100	5.998	461550005000P750B
2.875	2.250	0.715	2.873	461531202250P500B	6.000	5.250	0.758	5.998	461537505250P500B
2.875	2.500	0.523	2.874	461518702500P375B	6.000	5.250	0.895	5.998	461537505250P625B
3.000	2.250	0.895	2.998	461537502250P625B	6.000	5.500	0.550	5.999	461525005500P375B
3.000	2.375	0.715	2.998	461531202375P500B	6.000	5.500	0.756	5.999	461525005500P562B
3.000	2.500	0.413	2.999	461525002500P250B	6.125	5.500	0.853	6.123	461531205500P625B
3.000	2.500	0.550	2.999	461525002500P375B	6.250	5.250	0.825	6.248	461550005250P500B
3.000	2.625	0.523	2.999	461518702625P375B	6.250	5.250	1.100	6.248	461550005250P750B
3.125	2.750	0.523	3.124	461518702750P375B	6.250	5.500	0.895	6.248	461537505500P625B
3.250	2.500	0.895	3.248	461537502500P625B	6.375	5.625	0.895	6.373	461537505625P625B
3.250	2.625	0.715	3.248	461531202625P500B	6.500	5.750	0.895	6.498	461537505750P625B
3.250	2.750	0.550	3.249	461525002750P375B	6.500	6.000	0.550	6.499	461525006000P375B
3.250	2.875	0.523	3.249	461518702875P375B	6.500	6.000	0.618	6.499	461525006000P437B
3.375	2.875	0.550	3.374	461525002875P375B	6.500	6.000	0.756	6.499	461525006000P562B
3.375	3.000	0.523	3.374	461518703000P375B	6.750	6.250	0.756	6.749	461525006250P562B
3.500	3.000	0.550	3.499	461525003000P375B	7.000	6.250	0.895	6.998	461537506250P625B
3.500	3.125	0.523	3.499	461518703125P375B	7.000	6.500	0.550	6.999	461525006500P375B
3.625	3.125	0.550	3.624	461525003125P375B	7.000	6.500	0.756	6.999	461525006500P562B
3.750	3.250	0.550	3.749	461525003250P375B	7.250	6.500	0.895	7.248	461537506500P625B
3.875	3.375	0.550	3.874	461525003375P375B	7.250	6.750	0.756	7.249	461525006750P562B
4.000	3.250	0.895	3.998	461537503250P625B	7.500	6.750	0.895	7.498	461537506750P625B
4.000	3.375	0.715	3.998	461531203375P500B	7.500	7.000	0.756	7.499	461525007000P562B
4.000	3.500	0.550	3.999	461525003500P375B	8.000	7.000	1.100	7.998	461550007000P750B
4.000	3.625	0.523	3.999	461518703625P375B	8.000	7.250	0.895	7.998	461537507250P625B
4.250	3.750	0.550	4.249	461525003750P375B	8.000	7.500	0.756	7.999	461525007500P562B
4.250	3.875	0.523	4.249	461518703875P375B	8.250	7.750	0.756	8.249	461525007750P562B
4.375	4.000	0.523	4.374	461518704000P375B	8.500	7.750	0.895	8.498	461537507750P625B
4.500	3.750	0.895	4.498	461537503750P625B	9.000	8.000	1.100	8.998	461550008000P750B
4.500	4.000	0.550	4.499	461525004000P375B	9.250	8.500	0.895	9.248	461537508500P625B
4.500	4.000	0.756	4.499	461525004000P562B	9.875	9.250	0.853	9.873	461531209250P625B
4.750	4.000	0.895	4.748	461537504000P625B	10.000	9.000	1.100	9.998	461550009000P750B
4.750	4.250	0.550	4.749	461525004250P375B	10.375	9.750	0.853	10.373	461531209750P625B
4.750	4.250	0.756	4.749	461525004250P562B	10.500	9.500	1.100	10.498	461550009500P750B
4.875	4.250	0.783	4.873	461531204250P562B	11.000	10.000	1.100	10.998	461550010000P750B
5.000	4.000	1.100	4.998	461550004000P750B	11.500	10.500	1.100	11.498	461550010500P750B
5.000	4.250	0.895	4.998	461537504250P625B	12.000	11.000	1.100	11.998	461550011000P750B
5.000	4.375	0.783	4.998	461531204375P562B	12.250	11.250	1.100	12.248	461550011250P750B

*If used with wear rings, refer to wear ring piston diameter, see Section 9.

*If used with wear rings, refer to wear ring piston diameter, see Section 9.

7

09/01/07



Table 7-14. PIP Gland Dimensions — Inch (Continued)

A Bore Diameter	B Groove Diameter	C Groove Width	D Piston Diameter*	Part Number
12.500	11.500	1.100	12.498	461550011500P750B
12.875	11.875	1.100	12.873	461550011875P750B
13.000	12.000	1.100	12.998	461550012000P750B
13.000	12.250	0.895	12.998	461537512250P625B
14.000	13.500	0.756	13.998	461525013500P562B
15.000	14.000	1.100	14.998	461550014000P750B
15.000	14.250	0.895	14.998	461537514250P625B
15.750	14.750	1.100	15.748	461550014750P750B

*If used with wear rings, refer to wear ring piston diameter, see Section 9.

A Bore Diameter	B Groove Diameter	C Groove Width	D Piston Diameter*	Part Number
16.000	14.500	1.788	15.997	461575014500P1250B
16.000	15.000	1.100	15.998	461550015000P750B
20.000	19.000	1.100	19.998	461550019000P750B
21.250	20.250	1.100	21.248	461550020250P750B
22.000	21.000	1.100	21.998	461550021000P750B
25.500	24.500	1.100	25.498	461550024500P750B
39.250	38.250	1.100	39.248	461550038250P750B
43.000	42.000	1.100	42.998	461550042000P750B

*If used with wear rings, refer to wear ring piston diameter, see Section 9.

NOTE: For sizes larger than those shown in the table, please contact your local Parker Seal representative.

Piston Seal

B7 Profile

Catalog EPS 5370/USA



B7 Cross-Section

B7 Profile, U-cup Piston Seal

The B7 profile is a non-symmetrical, hydraulic cylinder piston seal. The knife trimmed, beveled lip contacts the bore to provide enhanced low to high pressure sealing and wiping action. When installed, the diameter of the B7 profile is stretched slightly to fit the gland. This ensures a tight static seal with the gland and improves stability in application. The B7 profile is available in Parker proprietary urethane compounds providing excellent wear, extrusion and compression set resistance. The B7 profile is a uni-directional seal. Two seals can be placed on a piston, back to back, in separate glands offering bi-directional fluid sealing.

Technical Data

Standard Materials*	Temperature Range	Pressure Range†	Surface Speed
P4300A90	-65°F to 275°F (-54°C to 135°C)	5,000 psi (344 bar)	< 1.6 ft/s (0.5 m/s)
P4301A90	-65°F to 275°F (-54°C to 135°C)	5000 psi (344 bar)	< 1.6 ft/s (0.5 m/s)
P4700A90	-65°F to 200°F (-54°C to 93°C)	5,000 psi (344 bar)	< 1.6 ft/s (0.5 m/s)
P5065A88	-70°F to 200°F (-57°C to 93°C)	3,500 psi (241 bar)	< 1.6 ft/s (0.5 m/s)

***Alternate Materials:** For applications that may require an alternate material, please contact your local Parker Seal representative.

†**Pressure Range** without wear rings (see Table 2-4, page 2-5).

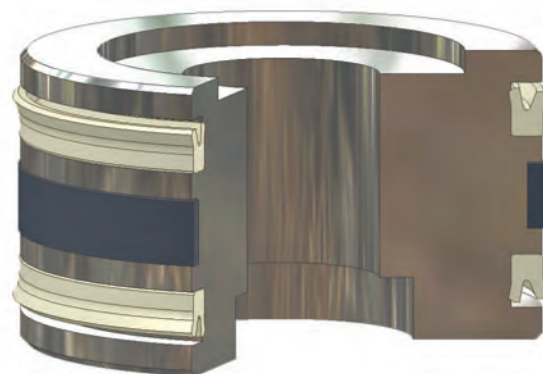

B7 installed in Piston Gland



09/01/07

B7 Profile

Part Number Nomenclature — B7 Profile

Table 7-15. B7 Profile — Inch

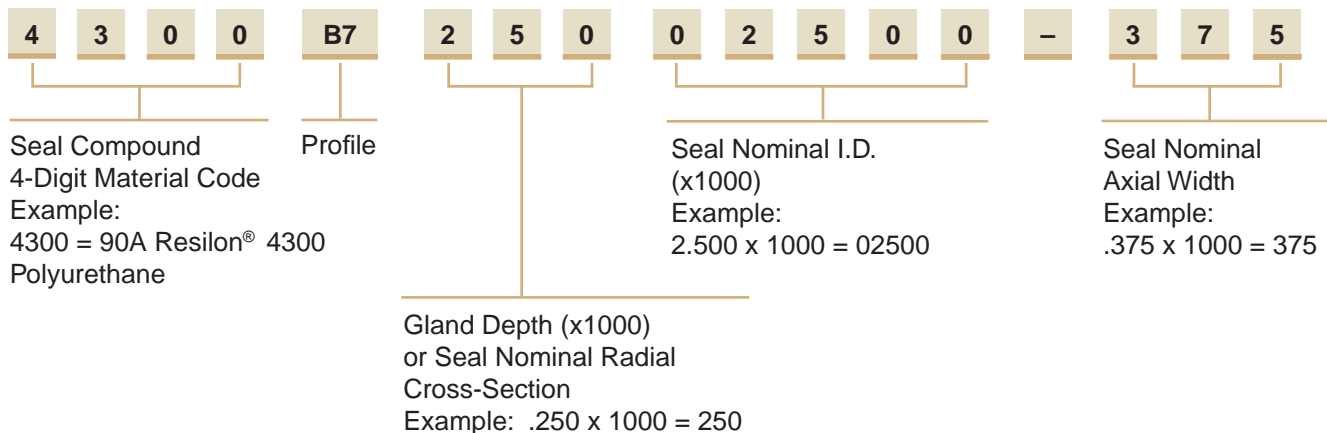

Gland Dimensions — B7 Profile

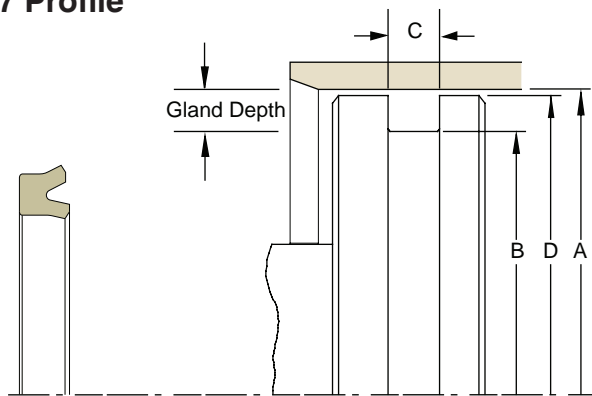

Table 7-16. Gland Dimension Tolerances

Nominal Gland Depth	A Bore Diameter	B Groove Diameter	C Groove Width	D Piston Diameter
1/8	+0.002/-0.000	+0.000/-0.002	+0.015/-0.000	+0.000/-0.001
3/16	+0.002/-0.000	+0.000/-0.002		+0.000/-0.002
1/4	+0.003/-0.000	+0.000/-0.003		+0.000/-0.002
5/16	+0.003/-0.000	+0.000/-0.004		+0.000/-0.002
3/8	+0.004/-0.000	+0.000/-0.005		+0.000/-0.002

Please refer to Engineering Section 2, Page 2-8 for surface finish and additional hardware considerations.

Table 7-17. B7 Gland Dimensions — Inch

A Bore Diameter	B Groove Diameter	C Groove Width	D Piston Diameter*	Compound Code (X = Standard Offering)			Part Number		
				4300	4700	5065	Compound Code	Profile Code	
1.125	0.750	0.206	1.124	X		X	XXXX	B7	18700750-187
1.375	0.875	0.275	1.374	X		X	XXXX	B7	25000875-250
1.500	1.250	0.206	1.499	X		X	XXXX	B7	12501250-187
1.625	1.125	0.343	1.624		X	X	XXXX	B7	25001125-312
1.625	1.250	0.343	1.624	X		X	XXXX	B7	18701250-312
1.750	1.375	0.206	1.749	X		X	XXXX	B7	18701375-187
1.875	1.500	0.413	1.874	X		X	XXXX	B7	18701500-375
2.000	1.625	0.343	1.999	X		X	XXXX	B7	18701625-312

*If used with wear rings, refer to wear ring piston diameter, see Section 9.

Table 7-17. B7 Gland Dimensions — Inch (Continued)

A Bore Diameter	B Groove Diameter	C Groove Width	D Piston Diameter*	Compound Code (X = Standard Offering)			Part Number		
				4300	4700	5065	Compound Code	Profile Code	
2.250	2.000	0.275	2.249	X		X	XXXX	B7	12502000-250
2.375	2.000	0.343	2.374	X		X	XXXX	B7	18702000-312
2.500	2.000	0.413	2.499	X		X	XXXX	B7	25002000-375
2.625	2.000	0.275	2.624	X		X	XXXX	B7	25002125-250
2.750	2.250	0.413	2.749	X		X	XXXX	B7	25002250-375
3.000	2.250	0.413	2.998		X	X	XXXX	B7	37502250-375
3.000	2.625	0.343	2.999	X		X	XXXX	B7	18702625-312
3.125	2.625	0.275	3.124	X		X	XXXX	B7	25002625-250
3.250	2.500	0.481	3.248		X	X	XXXX	B7	37502500-437
3.250	2.750	0.413	3.249	X		X	XXXX	B7	25002750-375
4.000	3.250	0.413	3.998		X	X	XXXX	B7	37503250-375
4.000	3.500	0.413	3.999	X		X	XXXX	B7	25003500-375
4.500	3.750	0.550	4.498		X	X	XXXX	B7	37503750-500
6.000	4.250	0.550	5.998		X	X	XXXX	B7	37505250-500

*If used with wear rings, refer to wear ring piston diameter, see Section 9.

NOTE: For sizes larger than those shown in the table, please contact your local Parker Seal representative.

Part Number Nomenclature — B7 Profile

Table 7-18. B7 Profile — Metric

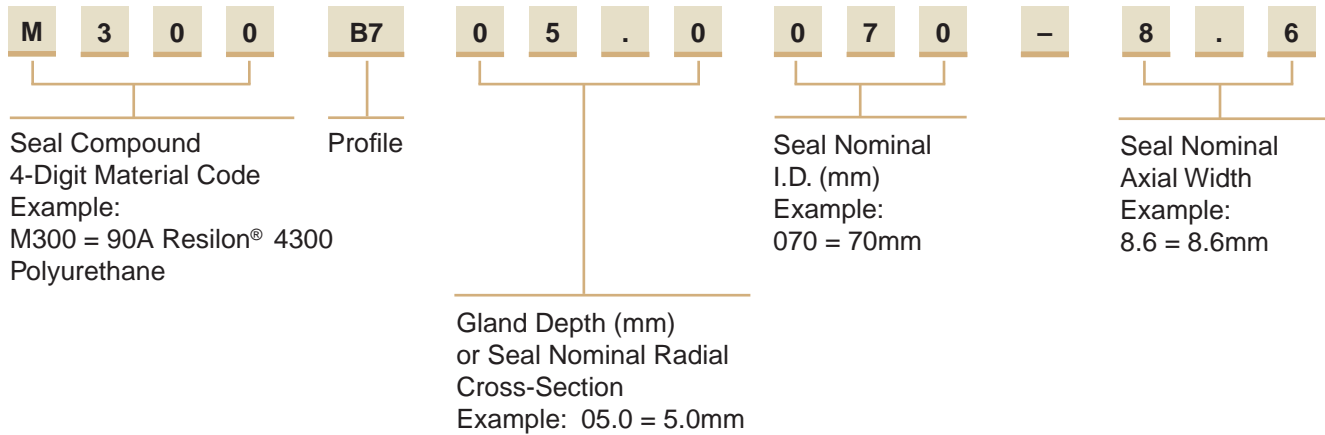

B7 Profile

Gland Dimensions — B7 Profiles

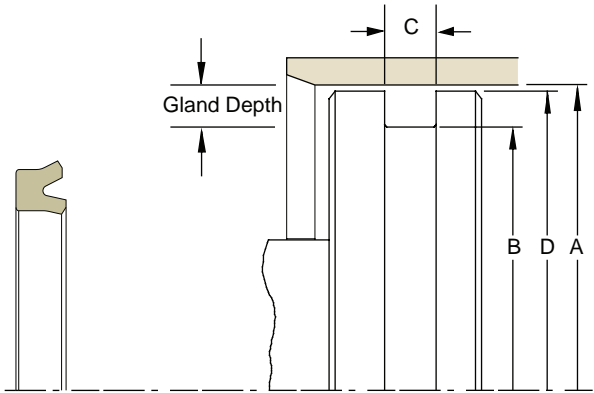

Please refer to Engineering Section 2, Page 2-8 for surface finish and additional hardware considerations.

Table 7-19. B7 Gland Dimensions — Metric (mm)

A Bore Diameter	B Groove Diameter	C Groove Width	D Piston Diameter*	Compound Code (X = Standard Offering)			Part Number		
				M300	M700	M065	Compound Code	Profile Code	
H9	h9	+ .25/- .00	f8						
For ISO tolerances refer to Appendix F.									
40	30	8	40	X		X	XXXX	B7	05.0030-7.3
43	35	10	43	X		X	XXXX	B7	04.0035-9
45	34	8	45		X	X	XXXX	B7	05.5034-7.3
45	35	8	45	X		X	XXXX	B7	05.0035-7.3
50	40	8	50	X		X	XXXX	B7	05.0040-7.3
55	45	8	55	X		X	XXXX	B7	05.0045-7.3
60	50	7	60	X		X	XXXX	B7	05.0050-6
60	50	8	60	X		X	XXXX	B7	05.0050-7.3
60	50	8	60		X	X	XXXX	B7	05.0050-7.3
65	55	7.6	65	X		X	XXXX	B7	05.0055-7
70	60	8	70	X		X	XXXX	B7	05.0060-7.3
75	63	8	75	X		X	XXXX	B7	06.0063-7.3
80	65	12.5	80	X		X	XXXX	B7	07.5065-11.4
80	70	7.6	80	X		X	XXXX	B7	05.0070-7.0
80	70	9.5	80	X		X	XXXX	B7	05.0070-8.6
120	100	16	120	X		X	XXXX	B7	10.0100-14.5

*If used with wear rings, refer to wear ring piston diameter, see Section 9.

NOTE: For sizes larger than those shown in the table, please contact your local Parker Seal representative.

Piston Seal

UP Profile

Catalog EPS 5370/USA

UP Profile, Industrial U-cup Piston Seal

The UP profile is a non-symmetrical, hydraulic piston seal. The knife trimmed, beveled lip faces the bore to provide enhanced low to high pressure sealing and wiping action. The UP profile is a uni-directional seal. Two UP seals can be used, back to back, in separate grooves to provide bi-directional pressure sealing. The UP profile is an economical choice, available in Parker's wear and extrusion resistant Molythane® compound.



Technical Data

Standard Materials*	Temperature Range	Pressure Range†	Surface Speed
P4615A90	-65°F to 200°F (-54°C to 93°C)	5,000 psi (344 bar)	< 1.6 ft/s (0.5 m/s)

***Alternate Materials:** For applications that may require an alternate material, please contact your local Parker Seal representative.

†**Pressure Range** without wear rings (see Table 2-4, page 2-5).



UP Cross-Section

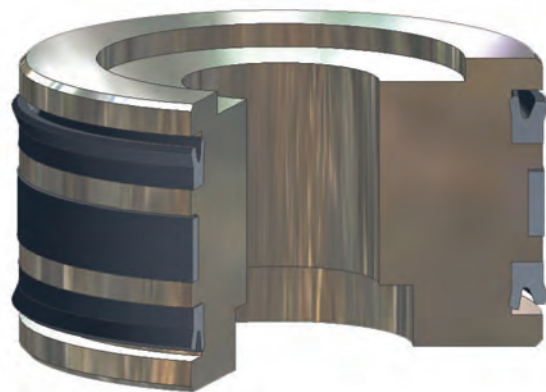

UP installed in Piston Gland

7

09/01/07

UP Profile

Part Number Nomenclature — UP Profile

Table 7-20. UP Profile — Inch

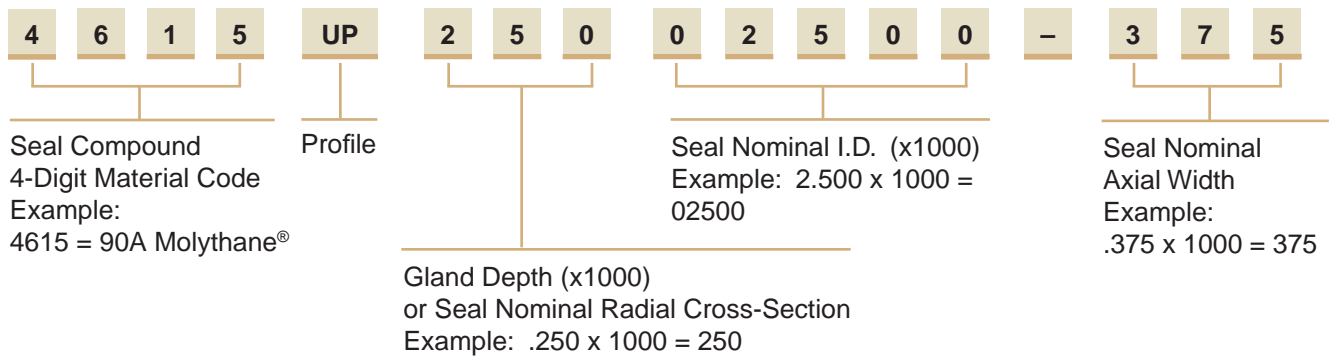

Gland Dimensions — UP Profile

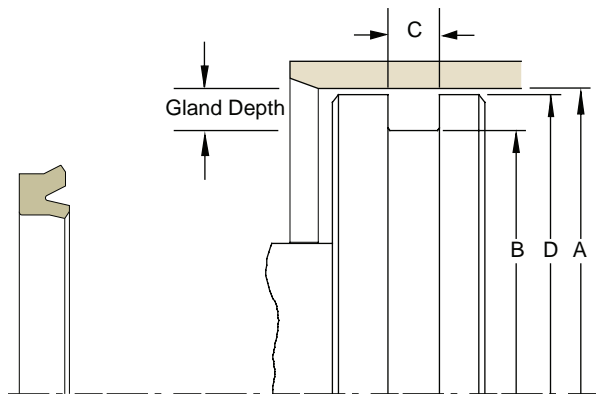

Table 7-21. Gland Dimension Tolerances

Nominal Gland Depth	A Bore Diameter	B Groove Diameter	C Groove Width	D Piston Diameter
1/8	+0.002/-.000	+0.000/-.002	+0.015/-.000	+0.000/-.001
3/16	+0.002/-.000	+0.000/-.002		+0.000/-.002
1/4	+0.003/-.000	+0.000/-.003		+0.000/-.002
5/16	+0.003/-.000	+0.000/-.004		+0.000/-.002
3/8	+0.004/-.000	+0.000/-.005		+0.000/-.002

Please refer to Engineering Section 2, Page 2-8 for surface finish and additional hardware considerations.

Table 7-22. UP Gland Dimensions — Inch

A Bore Diameter	B Groove Diameter	C Groove Width	D Piston Diameter*	Part Number
0.750	0.500	0.206	0.749	4615UP12500500-187
0.750	0.500	0.275	0.749	4615UP12500500-250
1.250	1.000	0.206	1.249	4615UP12501000-187
1.500	1.000	0.413	1.499	4615UP25001000-375
1.625	1.250	0.343	1.624	4615UP18701250-312
1.750	1.250	0.413	1.749	4615UP25001250-375
2.000	1.500	0.413	1.999	4615UP25001500-375
2.000	1.625	0.343	1.999	4615UP18701625-312
2.000	1.625	0.413	1.999	4615UP18701625-375
2.500	1.875	0.550	2.498	4615UP31201875-500
2.500	2.000	0.413	2.499	4615UP25002000-375
2.500	2.125	0.343	2.499	4615UP18702125-312
2.500	2.125	0.413	2.499	4615UP18702125-375
2.625	2.125	0.413	2.624	4615UP25002125-375
2.750	2.250	0.413	2.749	4615UP25002250-375
3.000	2.375	0.550	2.998	4615UP31202375-500

*If used with wear rings, refer to wear ring piston diameter, see Section 9.

Table 7-22. UP Gland Dimensions — Inch (Continued)

A Bore Diameter	B Groove Diameter	C Groove Width	D Piston Diameter*	Part Number
3.000	2.500	0.413	2.999	4615UP25002500-375
3.250	2.750	0.413	3.249	4615UP25002750-375
3.250	2.875	0.413	3.249	4615UP18702875-375
3.500	2.875	0.550	3.498	4615UP31202875-500
3.500	3.000	0.413	3.499	4615UP25003000-375
3.750	3.000	0.688	3.748	4615UP37503000-625
3.750	3.125	0.550	3.748	4615UP31203125-500
3.750	3.250	0.413	3.749	4615UP25003250-375
4.000	3.250	0.688	3.998	4615UP37503250-625
4.000	3.375	0.550	3.998	4615UP31203375-500
4.000	3.500	0.413	3.999	4615UP25003500-375
4.000	3.625	0.413	3.999	4615UP18703625-375
4.250	3.750	0.413	4.249	4615UP25003750-375
4.500	3.750	0.688	4.498	4615UP37503750-625
4.500	4.000	0.413	4.499	4615UP25004000-375
5.000	4.250	0.688	4.998	4615UP37504250-625
5.000	4.375	0.618	4.998	4615UP31204375-562
5.000	4.500	0.413	4.999	4615UP25004500-375
5.000	4.500	0.618	4.999	4615UP25004500-562
5.500	5.000	0.413	5.499	4615UP25005000-375
5.500	5.000	0.618	5.499	4615UP25005000-562
6.000	5.250	0.688	5.998	4615UP37505250-625
6.000	5.500	0.413	5.999	4615UP25005500-375
6.500	5.750	0.688	6.498	4615UP37505750-625
7.000	6.250	0.688	6.998	4615UP37506250-625
7.500	6.750	0.688	7.498	4615UP37506750-625
9.000	8.250	0.688	8.998	4615UP37508250-625

*If used with wear rings, refer to wear ring piston diameter, see Section 9.

NOTE: For sizes larger than those shown in the table, please contact your local Parker Seal representative.

Piston Seal E4 Profile

Catalog EPS 5370/USA

E4 Profile, Premium Rounded Lip U-cup Piston Seal



Parker's E4 profile is a non-symmetrical piston seal designed to seal both lubricated and non-lubricated air. To ensure that critical surfaces retain lubrication, the radius edge of the lip is designed to hydroplane over pre-lubricated surfaces. The standard compound for the E4 profile is Parker proprietary Nitroxile® Extreme Low Friction ("ELF") compound N4274A85. This compound is formulated with proprietary internal lubricants to provide extreme low friction and excellent wear resistance. This compound provides extended cycle life over standard nitrile and carboxylated nitrile compounds.

Technical Data

Standard Materials*	Temperature Range	Pressure Range†	Surface Speed
N4274A85	-10°F to 250°F (-23°C to 121°C)	250 psi (17 bar)	< 3 ft/s (1 m/s)
N4180A80	-40°F to 250°F (-40°C to 121°C)	250 psi (17 bar)	< 3 ft/s (1 m/s)
V4208A90	-5°F to 400°F (-21°C to 204°C)	250 psi (17 bar)	< 3 ft/s (1 m/s)
P5065A88	-70°F to 200°F (-57°C to 93°C)	250 psi (17 bar)	< 3 ft/s (1 m/s)

***Alternate Materials:** For applications that may require an alternate material, please contact your local Parker Seal representative.

†**Pressure Range** without wear rings (see Table 2-4, page 2-5).



E4 Cross-Section

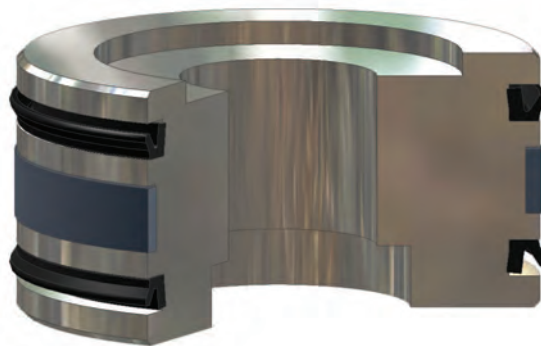

E4 installed in Piston Gland

09/01/07

Part Number Nomenclature — E4 Profile

Table 7-23. E4 Profile — Inch

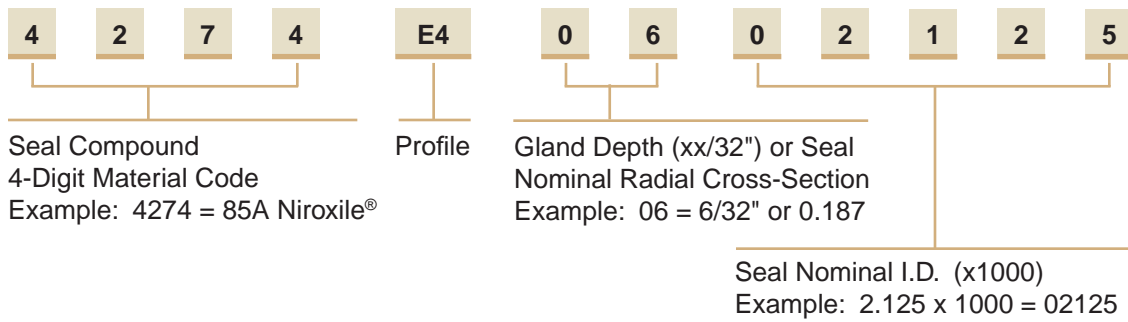

Gland Dimensions — E4 Profile

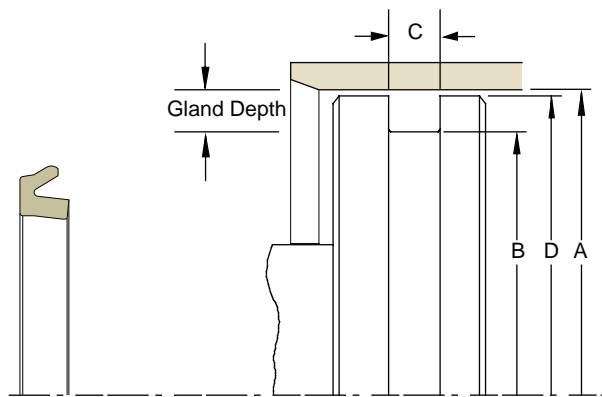

Please refer to Engineering Section 2, Page 2-8 for surface finish and additional hardware considerations.

Table 7-24. Gland Dimension Tolerances

Nominal Gland Depth	A Bore Diameter	B Groove Diameter	C Groove Width	D Piston Diameter
1/8	+0.002/-0.000	+0.000/-0.002	+0.015/-0.000	+0.000/-0.001
3/16	+0.002/-0.000	+0.000/-0.002		+0.000/-0.002
1/4	+0.003/-0.000	+0.000/-0.003		+0.000/-0.002
5/16	+0.003/-0.000	+0.000/-0.004		+0.000/-0.002
3/8	+0.004/-0.000	+0.000/-0.005		+0.000/-0.002
7/16	+0.005/-0.000	+0.000/-0.006		+0.000/-0.002
1/2	+0.005/-0.000	+0.000/-0.007		+0.000/-0.003
9/16	+0.006/-0.000	+0.000/-0.008		+0.000/-0.003
5/8	+0.006/-0.000	+0.000/-0.009		+0.000/-0.003
3/4	+0.007/-0.000	+0.000/-0.010		+0.000/-0.004
7/8	+0.008/-0.000	+0.000/-0.011		+0.000/-0.005
1	+0.009/-0.000	+0.000/-0.012		+0.000/-0.005

Table 7-25. E4 Gland Dimensions — Inch

A Bore Diameter	B Groove Diameter	C Groove Width	D Piston Diameter*	Compound Code				Part Number	
				4180	4274	4208	5065	Compound Code	
0.625	0.375	0.156	0.623	X	X		X	XXXX	E40400375
0.750	0.500	0.156	0.748	X	X			XXXX	E40400500
0.875	0.625	0.156	0.873	X	X			XXXX	E40400625
1.000	0.750	0.156	0.998	X	X		X	XXXX	E40400750
1.062	0.812	0.156	1.060	X				XXXX	E40400812
1.125	0.875	0.156	1.123	X	X			XXXX	E40400875
1.500	1.250	0.156	1.498		X			XXXX	E40401250
1.500	1.187	0.188	1.498	X	X	X	X	XXXX	E40501187
1.500	1.000	0.281	1.497		X			XXXX	E40801000
1.625	1.312	0.188	1.623		X			XXXX	E40501312
1.750	1.375	0.219	1.748	X	X			XXXX	E40601375
1.813	1.500	0.188	1.811	X				XXXX	E40501500
2.000	1.625	0.219	1.998	X	X	X	X	XXXX	E40601625
2.125	1.750	0.219	2.123		X			XXXX	E40601750
2.500	2.125	0.219	2.498	X	X	X	X	XXXX	E40602125
3.000	2.562	0.250	2.998	X	X	X	X	XXXX	E40702562
3.250	2.812	0.250	3.248	X	X	X		XXXX	E40702812
4.000	3.500	0.281	3.997	X	X		X	XXXX	E40803500

*If used with wear rings, refer to wear ring piston diameter, see Section 9.



E4 Profile

Table 7-25. E4 Gland Dimensions — Inch (Continued)

A Bore Diameter	B Groove Diameter	C Groove Width	D Piston Diameter*	Compound Code				Part Number	
				4180	4274	4208	5065	Compound Code	
5.000	4.500	0.281	4.997	X		X		XXXX	E40804500
5.000	4.437	0.312	4.997		X			XXXX	E40904437
6.000	5.500	0.281	5.997		X			XXXX	E40805500
6.000	5.437	0.312	5.997		X			XXXX	E40905437
6.000	5.375	0.344	5.997		X			XXXX	E41005375
8.000	7.375	0.344	7.997		X			XXXX	E41007375
8.000	7.250	0.406	7.997		X			XXXX	E41207250
10.000	9.312	0.375	9.997		X			XXXX	E41109312

*If used with wear rings, refer to wear ring piston diameter, see Section 9.

NOTE: For sizes larger than those shown in the table, please contact your local Parker Seal representative.

Part Number Nomenclature — E4 Profile

Table 7-26. E4 Profile — Metric

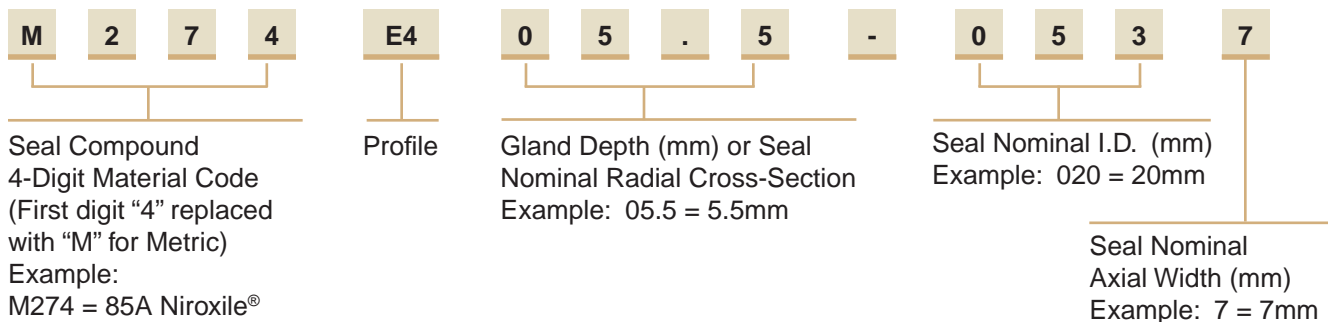

7

Gland Dimensions — E4 Profile

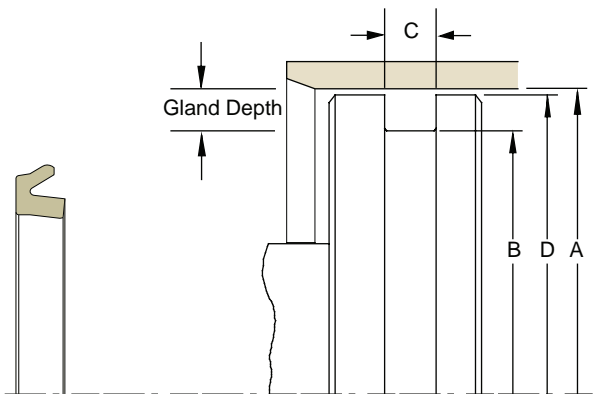

Please refer to Engineering Section 2, Page 2-8 for surface finish and additional hardware considerations.

Table 7-27. E4 Gland Dimensions — Metric (mm)

A Bore Diameter	B Groove Diameter	C Groove Width	D Piston Diameter*	Compound Code				Part Number	
				4180	4274	4208	5065	Compound Code	
H11	h9	+0.20/-0.00	f8						
43	33	7.5	43		X			XXXX	E405.0033-7
45	37	4.5	45		X			XXXX	E404.0037-4
63	53	7.5	63		X			XXXX	E405.0053-7
200	190	15	200			X		XXXX	E405.0190-14

*If used with wear rings, refer to wear ring piston diameter, see Section 9.

NOTE: For sizes larger than those shown in the table, please contact your local Parker Seal representative.

Piston Seal BMP Profile

Catalog EPS 5370/USA



BMP Profile, Rounded Lip Seal with Bumper Cushion

The Parker BMP profile is a low friction bumper and seal providing quiet deceleration and reduced end stroke noise in pneumatic piston applications. Designed to mount on the ends of the piston and to be used along with Parker's V6 profile cushion seal, the bumper pad absorbs the final inertia which prevents contact between the piston and tube ends. The BMP profile can also be used without cushion seals in less critical applications. The BMP profile has a rounded sealing edge which hydroplanes over pre-lubricated surfaces extending cycle life and reducing friction. The BMP profile is available in Parker proprietary Nitroxile compound, offering low friction and wear resistance, as well as fluorocarbon for extended temperature range.

Technical Data

Standard Materials*	Temperature Range	Pressure Range†	Surface Speed
N4274A85	-10°F to 250°F (-23°C to 121°C)	250 psi (17 bar)	< 3 ft/s (1 m/s)
V4208A90	-5°F to 400°F (-21°C to 204°C)	250 psi (17 bar)	< 3 ft/s (1 m/s)

***Alternate Materials:** For applications that may require an alternate material, please contact your local Parker Seal representative.

†**Pressure Range** without wear rings (see Table 2-4, page 2-5).



BMP Cross-Section

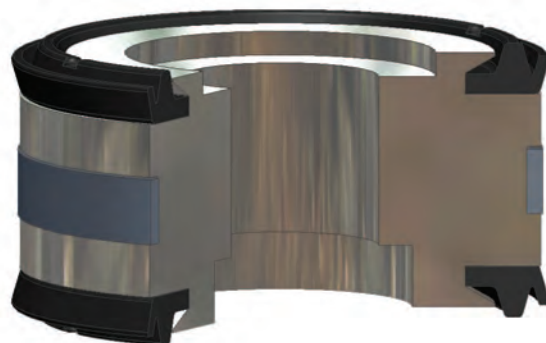

BMP installed in Piston Gland

7

09/01/07

BMP Profile

Part Number Nomenclature — BMP Profile

Table 7-28. BMP Profile — Inch

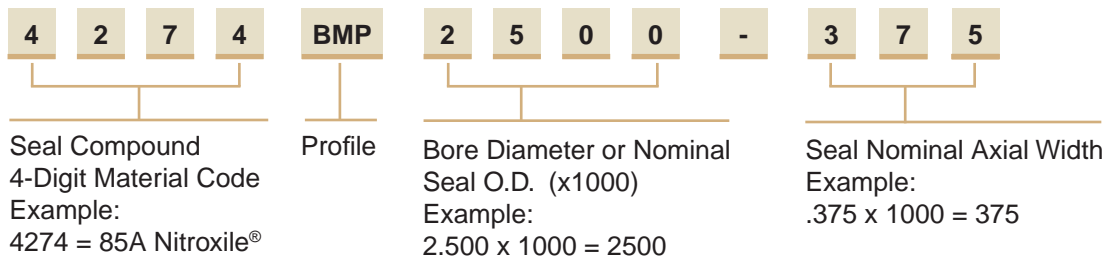

Gland Dimensions — BMP Profile

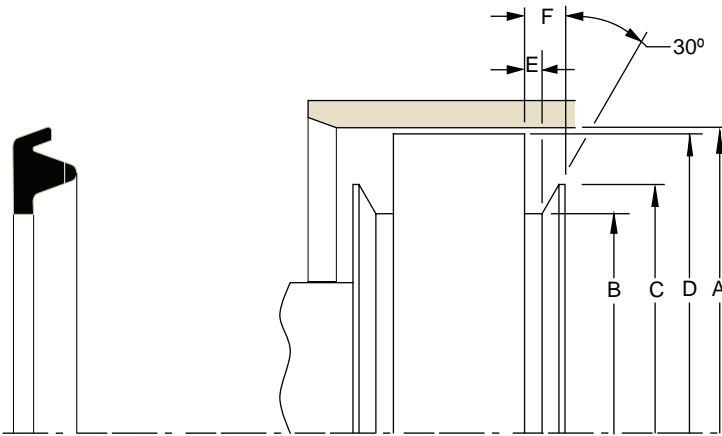

Please refer to Engineering Section 2, Page 2-8 for surface finish and additional hardware considerations.

Table 7-29. BMP Gland Dimensions — Inch

A Bore Diameter	B Groove Diameter	C Shoulder Diameter	D Piston Diameter*	E Groove Width	F Shoulder Height	Compound Codes		Part Number	
						4274	4208	Compound Code	
+ .002/- .000	+ .000/- .005	+ .000/- .005	+ .000/- .002	+ .005/- .000	+ .005/- .000				
1.125	0.639	0.851	1.123	0.110	0.204	X	X	XXXX	BMP1125-312
1.500	0.810	1.050	1.498	0.138	0.256	X	X	XXXX	BMP1500-312
2.000	1.202	1.440	1.998	0.138	0.256	X	X	XXXX	BMP2000-312
2.500	1.640	1.925	2.498	0.157	0.315	X	X	XXXX	BMP2500-375
3.250	2.150	2.550	3.248	0.157	0.315	X	X	XXXX	BMP3250-375
4.000	2.810	3.268	3.998	0.157	0.315	X	X	XXXX	BMP4000-375
5.000	3.525	4.095	4.998	0.157	0.315	X	X	XXXX	BMP5000-500

*If used with wear rings, refer to wear ring piston diameter, see Section 9.

NOTE: For sizes larger than those shown in the table, please contact your local Parker Seal representative.

Piston Seal TP Profile

Catalog EPS 5370/USA



TP Profile (Piston T-seal), Compact Seal with Anti-Extrusion Technology

Parker's Piston T-seal is designed to retrofit O-rings in no back-up, single back-up and two back-up standard industrial reciprocating glands. Its compact design provides improved stability and extrusion resistance in dynamic fluid sealing applications. The flange or base of the T-seal forms a tight seal in the gland and supports the anti-extrusion back-up rings. When energized, the back-up rings bridge the extrusion gap to protect the rubber sealing element from extrusion and system contamination. The Piston T-seal eliminates the spiral or twisting failure that can occur when O-rings are used against a dynamic surface. Parker offers the Piston T-seal in a variety of elastomer and back-up ring compounds to cover a wide range of fluid compatibility, pressure and temperature.

Profile **TP0** for **no** back-up O-ring gland (standard offering)

Profile **TPS** for **single** back-up O-ring gland

Profile **TPT** for **two** back-up O-ring gland

The TP profile is sold only as an assembly (elastomer and back-up).

Technical Data

Standard Materials

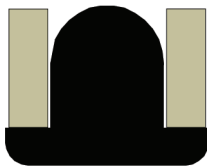

TP Cross-Section

Base

Elastomer*	Temperature Range	Surface Speed
N4115A75	-40°F to 225°F (-40°C to 107°C)	< 1.6 ft/s (0.5 m/s)
N4274A85	-10°F to 250°F (-23°C to 121°C)	< 1.6 ft/s (0.5 m/s)
V4205A75	-20°F to 400°F (-29°C to 204°C)	< 1.6 ft/s (0.5 m/s)
E4259A80	-65°F to 300°F (-54°C to 149°C)	< 1.6 ft/s (0.5 m/s)

***Alternate Materials:** For applications that may require an alternate material, please see Section 3 for alternate elastomer materials.

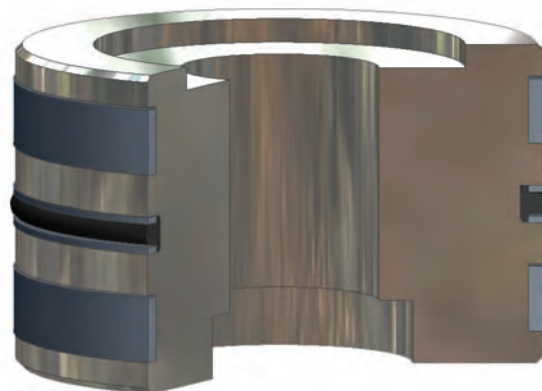

TP installed in Piston Gland

7

09/01/07

Technical Data (Continued)

Standard Materials

Back-up Rings**

	Temperature Range	Pressure Range†
B001 Nylatron	-65°F to 250°F (-54°C to 121°C)	5,000 psi (344 bar)
B011 Virgin PTFE	-20°F to 250°F (-29°C to 121°C)	3,000 psi (206 bar)
B085 PEEK	-65°F to 500°F (-54°C to 260°C)	10,000 psi (689 bar)

****Alternate Materials:** For applications that may require an alternate material, please see Section 3 for T-seal back-up materials.

†**Pressure Range** without wear rings (see Table 2-4, page 2-5).

Part Number Nomenclature — T-seal Profile

Table 7-30. T-seal Profile — Inch

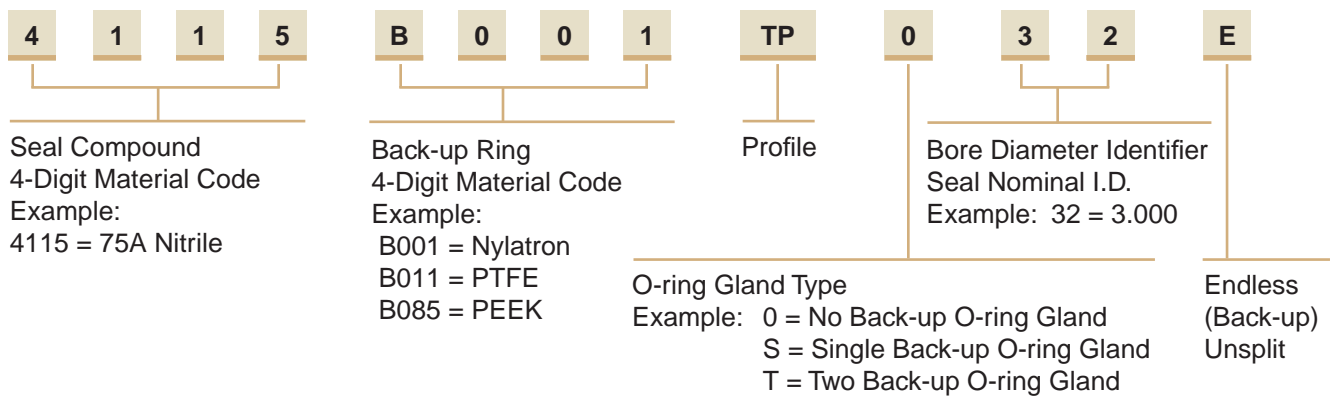

7

Gland Dimensions — TP Profile

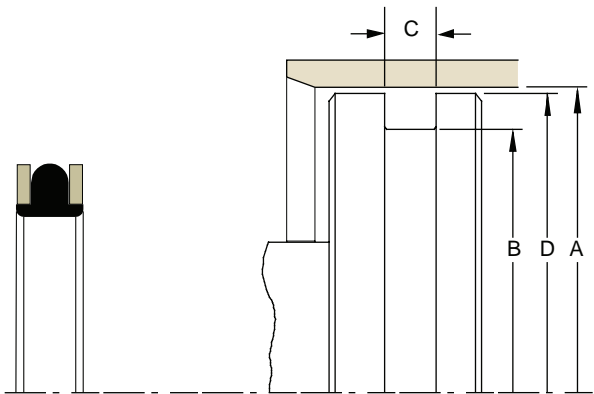

Please refer to Engineering Section 2, Page 2-8 for surface finish and additional hardware considerations.

Table 7-31. TP Gland Dimensions — Inch

A Bore Diameter	B Groove Diameter	C			D Piston Diameter*	Ref. O-ring Dash Number	Compound Code				Part Number				
		TP0 Groove Width	TPS Groove Width	TPT Groove Width			4115	4274	4205	4259	Compound Code	Back-up Ring Code	Groove Width Code**	Size Code	
+0.002/ -0.000	+0.000/ -0.002	+0.005/ -0.000	+0.005/ -0.000	+0.005/ -0.000	+0.000/ -0.001										
0.374	0.198	0.140	0.171	0.238	0.372	106	X		X		XXXX	B0xx	TP0	01	
0.437	0.261	0.140	0.171	0.238	0.435	108	X		X		XXXX	B0xx	TP0	02	
0.499	0.323	0.140	0.171	0.238	0.497	109	X		X		XXXX	B0xx	TP0	03	
0.562	0.320	0.187	0.208	0.275	0.559	203	X		X		XXXX	B0xx	TP0	04	

* If used with wear rings, refer to wear ring piston diameter, see Section 9.

**Chart reflects availability for TP0 only. For availability of TPS and TPT contact your local Parker Seal representative.

Table 7-31. TP Gland Dimensions — Inch (Continued)

A Bore Diameter	B Groove Diameter	C			D Piston Diameter*	Ref. O-ring Dash Number	Compound Code				Part Number			
		TP0 Groove Width	TPS Groove Width	TPT Groove Width			4115	4274	4205	4259	Compound Code	Back-up Ring Code	Groove Width Code**	Size Code
+0.002/ -0.000	+0.000/ -0.002	+0.005/ -0.000	+0.005/ -0.000	+0.005/ -0.000	+0.000/ -0.001									
0.625	0.383	0.187	0.208	0.275	0.662	204	X		X		XXXX	B0xx	TP0	05
0.687	0.445	0.187	0.208	0.275	0.684	205	X		X		XXXX	B0xx	TP0	06
0.750	0.508	0.187	0.208	0.275	0.747	206	X		X	X	XXXX	B0xx	TP0	07
0.812	0.570	0.187	0.208	0.275	0.809	207	X		X		XXXX	B0xx	TP0	08
0.875	0.633	0.187	0.208	0.275	0.872	208	X		X	X	XXXX	B0xx	TP0	09
0.937	0.695	0.187	0.208	0.275	0.934	209	X				XXXX	B0xx	TP0	10
1.000	0.758	0.187	0.208	0.275	0.997	210	X	X	X	X	XXXX	B0xx	TP0	11
1.062	0.820	0.187	0.208	0.275	1.059	211	X		X	X	XXXX	B0xx	TP0	12
1.125	0.833	0.187	0.208	0.275	1.122	212	X	X	X	X	XXXX	B0xx	TP0	13
1.187	0.945	0.187	0.208	0.275	1.184	213	X		X		XXXX	B0xx	TP0	14
1.250	1.008	0.187	0.208	0.275	1.247	214	X		X		XXXX	B0xx	TP0	15
1.312	1.070	0.187	0.208	0.275	1.309	215	X		X		XXXX	B0xx	TP0	16
1.375	1.133	0.187	0.208	0.275	1.372	216	X		X	X	XXXX	B0xx	TP0	17
1.437	1.195	0.187	0.208	0.275	1.434	217	X		X		XXXX	B0xx	TP0	18
1.500	1.258	0.187	0.208	0.275	1.497	218	X	X	X	X	XXXX	B0xx	TP0	19
1.562	1.320	0.187	0.208	0.275	1.559	219	X				XXXX	B0xx	TP0	20
1.625	1.383	0.187	0.208	0.275	1.622	220	X	X	X		XXXX	B0xx	TP0	21
1.750	1.508	0.187	0.208	0.275	1.747	222	X	X	X	X	XXXX	B0xx	TP0	22
1.875	1.505	0.281	0.311	0.410	1.872	325	X	X	X	X	XXXX	B0xx	TP0	23
2.000	1.630	0.281	0.311	0.410	1.997	326	X	X	X	X	XXXX	B0xx	TP0	24
2.125	1.755	0.281	0.311	0.410	2.122	327	X		X	X	XXXX	B0xx	TP0	25
2.250	1.880	0.281	0.311	0.410	2.247	328	X		X		XXXX	B0xx	TP0	26
2.375	2.005	0.281	0.311	0.410	2.372	329	X		X		XXXX	B0xx	TP0	27
2.500	2.130	0.281	0.311	0.410	2.497	330	X	X	X	X	XXXX	B0xx	TP0	28
2.625	2.255	0.281	0.311	0.410	2.622	331	X		X	X	XXXX	B0xx	TP0	29
2.750	2.380	0.281	0.311	0.410	2.747	332	X		X		XXXX	B0xx	TP0	30
2.875	2.505	0.281	0.311	0.410	2.872	333	X		X	X	XXXX	B0xx	TP0	31
3.000	2.630	0.281	0.311	0.410	2.997	334	X	X	X		XXXX	B0xx	TP0	32
3.125	2.755	0.281	0.311	0.410	3.122	335	X		X		XXXX	B0xx	TP0	33
3.250	2.880	0.281	0.311	0.410	3.247	336	X	X	X	X	XXXX	B0xx	TP0	34
3.500	3.130	0.281	0.311	0.410	3.497	338	X	X	X	X	XXXX	B0xx	TP0	35
3.625	3.255	0.281	0.311	0.410	3.622	339	X		X		XXXX	B0xx	TP0	36
3.750	3.380	0.281	0.311	0.410	3.747	340	X		X		XXXX	B0xx	TP0	37
3.875	3.505	0.281	0.311	0.410	3.872	341	X		X		XXXX	B0xx	TP0	38
4.000	3.630	0.281	0.311	0.410	3.997	342	X	X	X	X	XXXX	B0xx	TP0	39
4.125	3.755	0.281	0.311	0.410	4.122	343	X		X	X	XXXX	B0xx	TP0	40
4.250	3.880	0.281	0.311	0.410	4.247	344	X	X	X		XXXX	B0xx	TP0	41
4.375	4.005	0.281	0.311	0.410	4.372	345	X		X		XXXX	B0xx	TP0	42
4.500	4.130	0.281	0.311	0.410	4.497	346	X	X	X	X	XXXX	B0xx	TP0	43
4.625	4.255	0.281	0.311	0.410	4.622	347	X				XXXX	B0xx	TP0	44
4.750	4.380	0.281	0.311	0.410	4.747	348	X	X	X	X	XXXX	B0xx	TP0	45
4.875	4.505	0.281	0.311	0.410	4.872	349	X		X		XXXX	B0xx	TP0	46
5.002	4.630	0.281	0.311	0.410	4.997	350	X	X	X		XXXX	B0xx	TP0	47
5.127	4.653	0.375	0.408	0.538	5.123	426	X		X		XXXX	B0xx	TP0	48
5.252	4.778	0.375	0.408	0.538	5.248	427	X	X	X		XXXX	B0xx	TP0	49
5.377	4.903	0.375	0.408	0.538	5.373	428	X	X	X		XXXX	B0xx	TP0	50

* If used with wear rings, refer to wear ring piston diameter, see Section 9.

**Chart reflects availability for TP0 only. For availability of TPS and TPT contact your local Parker Seal representative.

7

Table 7-31. TP Gland Dimensions — Inch (Continued)

A Bore Diameter	B Groove Diameter	C			D Piston Diameter*	Ref. O-ring Dash Number	Compound Code				Part Number			
		TP0 Groove Width	TPS Groove Width	TPT Groove Width			4115	4274	4205	4259	Compound Code	Back-up Ring Code	Groove Width Code**	Size Code
+0.002/ -0.000	+0.000/ -0.002	+0.005/ -0.000	+0.005/ -0.000	+0.005/ -0.000	+0.000/ -0.001									
5.502	5.028	0.375	0.408	0.538	5.498	429	X	X		X	XXXX	B0xx	TP0	51
5.627	5.153	0.375	0.408	0.538	5.623	430	X				XXXX	B0xx	TP0	52
5.752	5.278	0.375	0.408	0.538	5.748	431	X	X	X	X	XXXX	B0xx	TP0	53
5.877	5.403	0.375	0.408	0.538	5.873	432	X				XXXX	B0xx	TP0	54
6.002	5.528	0.375	0.408	0.538	5.998	433	X	X	X		XXXX	B0xx	TP0	55
6.127	5.653	0.375	0.408	0.538	6.123	434	X				XXXX	B0xx	TP0	56
6.252	5.778	0.375	0.408	0.538	6.248	435	X				XXXX	B0xx	TP0	57
6.502	6.028	0.375	0.408	0.538	6.498	437	X		X		XXXX	B0xx	TP0	58
6.752	6.278	0.375	0.408	0.538	6.748	438	X		X		XXXX	B0xx	TP0	59
7.002	6.528	0.375	0.408	0.538	6.998	439	X		X		XXXX	B0xx	TP0	60
7.252	6.778	0.375	0.408	0.538	7.248	440	X		X		XXXX	B0xx	TP0	61
7.502	7.028	0.375	0.408	0.538	7.498	441	X			X	XXXX	B0xx	TP0	62
7.752	7.278	0.375	0.408	0.538	7.748	442	X				XXXX	B0xx	TP0	63
8.002	7.528	0.375	0.408	0.538	7.998	443	X	X	X		XXXX	B0xx	TP0	64
8.252	7.778	0.375	0.408	0.538	8.248	444	X				XXXX	B0xx	TP0	65
8.502	8.028	0.375	0.408	0.538	8.498	445	X		X		XXXX	B0xx	TP0	66
9.002	8.528	0.375	0.408	0.538	8.998	446	X				XXXX	B0xx	TP0	67
9.502	9.028	0.375	0.408	0.538	9.498	447	X				XXXX	B0xx	TP0	68
10.002	9.528	0.375	0.408	0.538	9.998	448	X				XXXX	B0xx	TP0	69
10.502	10.028	0.375	0.408	0.538	10.498	449	X				XXXX	B0xx	TP0	70
11.002	10.528	0.375	0.408	0.538	10.998	450	X				XXXX	B0xx	TP0	71
11.502	11.028	0.375	0.408	0.538	11.498	451	X				XXXX	B0xx	TP0	72
12.002	11.528	0.375	0.408	0.538	11.998	452	X		X		XXXX	B0xx	TP0	73
14.002	13.528	0.375	0.408	0.538	13.998	456	X			X	XXXX	B0xx	TP0	77
15.502	15.028	0.375	0.408	0.538	15.498	459	X				XXXX	B0xx	TP0	80
16.002	15.528	0.375	0.408	0.538	15.998	460	X			X	XXXX	B0xx	TP0	81
17.002	16.528	0.375	0.408	0.538	16.998	462	X				XXXX	B0xx	TP0	83
17.502	17.028	0.375	0.408	0.538	17.498	463	X				XXXX	B0xx	TP0	84
24.002	23.528	0.375	0.408	0.538	23.998	N/A	X		X	X	XXXX	B0xx	TP0	97

* If used with wear rings, refer to wear ring piston diameter, see Section 9.

**Chart reflects availability for TP0 only. For availability of TPS and TPT contact your local Parker Seal representative.

NOTE: For sizes larger than those shown in the table, please contact your local Parker Seal representative.

Piston Seal

S5 Profile

Catalog EPS 5370/USA



S5 Profile, Square PTFE Cap Seal

The Parker S5 profile is a bi-directional piston seal for use in low to medium duty hydraulic actuators and is suitable for sealing against hardened surfaces in pneumatic applications. The S5 profile is a two piece design comprised of a standard size Parker O-ring energizing a glass-filled PTFE cap. The S5 profile offers long wear, low friction and because of its short assembly length requires minimal gland space on the piston. The seal is commonly used in applications such as agriculture hydraulics, mobile hydraulics, machine tools, and hydraulic presses. Parker's S5 profile will retrofit non-Parker seals of similar design and is an updated version of the Parker S5000 piston seal.

The S5 profile may be ordered without the energizer by omitting the energizer code. See part number nomenclature.

Technical Data

Standard Materials*		Temperature Range	Pressure Range†	Surface Speed
Cap				
0203	15% fiberglass filled PTFE	-200°F to 575°F (-129°C to 302°C)	3500 psi (241 bar)	< 13 ft/s (4 m/sec)
Energizer				
A	70A Nitrile	-30°F to 250°F (-34°C to 121°C)		

***Alternate Materials:** For applications that may require an alternate material, please see Section 3 for alternate PTFE (Table 3-4) and energizer (Table 3-5) materials.

†Pressure Range without wear rings (see Table 2-4, page 2-5).



S5 Cross-Section

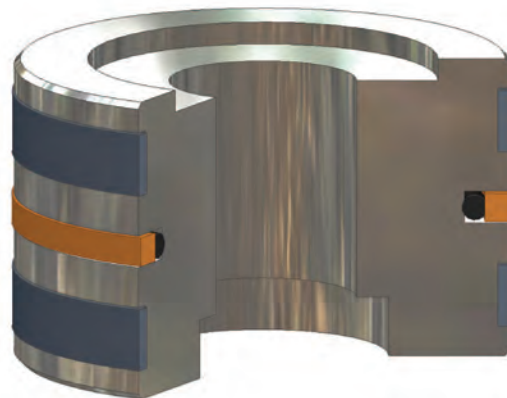

S5 installed in Piston Gland

7

09/01/07

S5 Profile

Technical Data (Continued)

Options

Split Rings: To aid in installation, the PTFE ring can be supplied in one of the following split configurations. To indicate that the S5 profile is to be split, add the appropriate split type indicator to the end of the part number.

- S = Step Cut
- T = Butt Cut
- V = Bevel cut

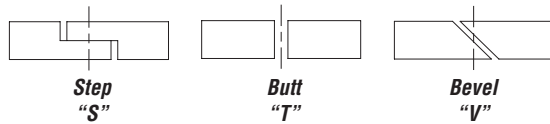

Metric: To configure metric part numbering, see Table 7-34 on page 7-38, and call your local Parker Seal representative for availability.

Part Number Nomenclature — S5 Profile

Table 7-32. S5 Profile — Inch

0	2	0	3	S5	1	9	6	0	3	5	0	0	-	1	2	9	A
Seal Compound 4-Digit Material Code Example: 0203 = 15% Fiberglass-filled PTFE				Profile	Gland Depth (x1000) Example: .196 X 1000 = 196				Bore Diameter (x1000) Example: 3.500 X 1000 = 03500					Groove Width (x1000) Example: .129 X 1000 = 129			Energizer Material Code A = 70A Nitrile Omit = No energizer See Table 3-5, page 3-18

- Option: Split Ring Options
- S = Step Cut
 - T = Butt Cut
 - V = Bevel Cut

7

Gland Dimensions — S5 Profile

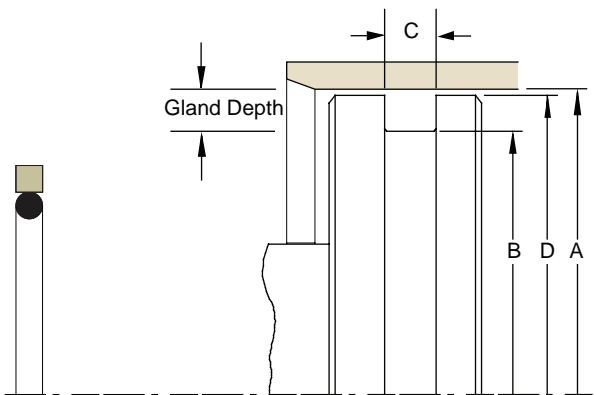

Please refer to Engineering Section 2, Page 2-8 for surface finish and additional hardware considerations.

Table 7-33. S5 Gland Dimensions — Inch

A Bore Diameter	B Groove Diameter	C Groove Width	D Piston Diameter*	O-ring Dash Number	Part Number
+0.002/-0.000	+0.001/-0.001	+0.002/-0.002	+0.000/-0.002		
0.500	0.240	0.083	0.499	009	0203S513000500-083A
0.625	0.365	0.083	0.624	011	0203S513000625-083A
0.750	0.490	0.083	0.749	013	0203S513000750-083A

*If used with wear rings, refer to wear ring piston diameter, see Section 9.

09/01/07



Table 7-33. S5 Gland Dimensions — Inch (Continued)

A Bore Diameter	B Groove Diameter	C Groove Width	D Piston Diameter*	O-ring Dash Number	Part Number
+0.002/-0.000	+0.001/-0.001	+0.002/-0.002	+0.000/-0.002		
0.875	0.615	0.083	0.874	016	0203S513000875-083A
1.000	0.740	0.083	0.999	017	0203S513001000-083A
1.125	0.865	0.083	1.124	019	0203S513001125-083A
1.250	0.990	0.083	1.249	022	0203S513001250-083A
1.375	1.115	0.083	1.374	022	0203S513001375-083A
1.500	1.240	0.083	1.499	025	0203S513001500-083A
+0.002/-0.000	+0.002/-0.002	+0.002/-0.002	+0.000/-0.002		
1.625	1.233	0.122	1.624	123	0203S519601625-122A
1.750	1.358	0.122	1.749	125	0203S519601750-122A
1.875	1.483	0.122	1.874	127	0203S519601875-122A
+0.003/-0.000	+0.002/-0.002	+0.003/-0.003	+0.000/-0.003		
2.000	1.608	0.130	1.999	129	0203S519602000-130A
2.125	1.733	0.130	2.14	131	0203S519602125-130A
2.250	1.858	0.130	2.249	133	0203S519602250-130A
2.375	1.983	0.130	2.374	135	0203S519602375-130A
2.500	2.108	0.130	2.499	137	0203S519602500-130A
2.625	2.233	0.130	2.624	139	0203S519602625-130A
2.750	2.358	0.130	2.749	141	0203S519602750-130A
2.875	2.483	0.130	2.874	143	0203S519602875-130A
3.000	2.608	0.130	2.999	145	0203S519603000-130A
3.250	2.858	0.130	3.249	149	0203S519603250-130A
3.375	2.983	0.130	3.374	150	0203S519603375-130A
3.500	3.108	0.130	3.499	151	0203S519603500-130A
3.625	3.233	0.130	3.624	152	0203S519603625-130A
3.750	3.358	0.130	3.749	152	0203S519603750-130A
4.000	3.608	0.130	3.999	153	0203S519604000-130A
4.250	3.858	0.130	4.249	154	0203S519604250-130A
4.500	4.108	0.130	4.499	155	0203S519604500-130A
4.750	4.358	0.130	4.749	156	0203S519604750-130A
4.875	4.483	0.130	4.874	156	0203S519604875-130A
5.000	4.608	0.130	4.999	157	0203S519605000-130A
5.250	4.858	0.130	5.249	158	0203S519605250-130A
5.500	5.108	0.130	5.499	159	0203S519605500-130A
+0.004/-0.000	+0.003/-0.003	+0.004/-0.004	+0.000/-0.003		
5.750	5.232	0.160	5.748	251	0203S525905750-160A
5.875	5.357	0.160	5.873	252	0203S525905875-160A
6.000	5.482	0.160	5.998	253	0203S525906000-160A
6.250	5.732	0.160	6.248	255	0203S525906250-160A
6.500	5.982	0.160	6.498	257	0203S525906500-160A
6.750	6.232	0.160	6.748	258	0203S525906750-160A
7.000	6.482	0.160	6.998	259	0203S525907000-160A
7.125	6.607	0.160	7.123	260	0203S525907125-160A
7.250	6.732	0.160	7.248	260	0203S525907250-160A
7.500	6.982	0.160	7.498	261	0203S525907500-160A
7.750	7.232	0.160	7.748	262	0203S525907750-160A
8.000	7.482	0.160	7.998	263	0203S525908000-160A
8.250	7.732	0.160	8.248	264	0203S525908250-160A
8.500	7.982	0.160	8.498	265	0203S525908500-160A
8.750	8.232	0.160	8.748	266	0203S525908750-160A
9.000	8.482	0.160	8.998	267	0203S525909000-160A

*If used with wear rings, refer to wear ring piston diameter, see Section 9.

09/01/07



S5 Profile

Table 7-33. S5 Gland Dimensions — Inch (Continued)

A Bore Diameter	B Groove Diameter	C Groove Width	D Piston Diameter*	O-ring Dash Number	Part Number
+ .004/- .000	+ .003/- .003	+ .004/- .004	+ .000/- .003		
9.250	8.732	0.160	9.248	268	0203S525909250-160A
9.500	8.982	0.160	9.498	269	0203S525909500-160A
9.750	9.232	0.160	9.748	270	0203S525909750-160A
10.000	9.482	0.160	9.998	271	0203S525910000-160A
10.250	9.732	0.160	10.248	272	0203S525910250-160A
10.500	9.982	0.160	10.498	273	0203S525910500-160A
10.750	10.232	0.160	10.748	274	0203S525910750-160A
11.000	10.482	0.160	10.998	275	0203S525911000-160A
11.500	10.982	0.160	11.498	276	0203S525911500-160A
12.000	11.482	0.160	11.998	277	0203S525912000-160A
12.500	11.982	0.160	12.498	278	0203S525912500-160A
13.000	12.482	0.160	12.998	278	0203S525913000-160A
14.000	13.482	0.160	13.998	279	0203S525914000-160A
15.000	14.482	0.160	14.998	280	0203S525915000-160A
16.000	15.482	0.160	15.998	281	0203S525916000-160A

*If used with wear rings, refer to wear ring piston diameter, see Section 9.

NOTE: For sizes larger than those shown in the table, please contact your local Parker Seal representative.

Part Number Nomenclature — S5 Profile

Table 7-34. S5 Profile — Metric (mm)

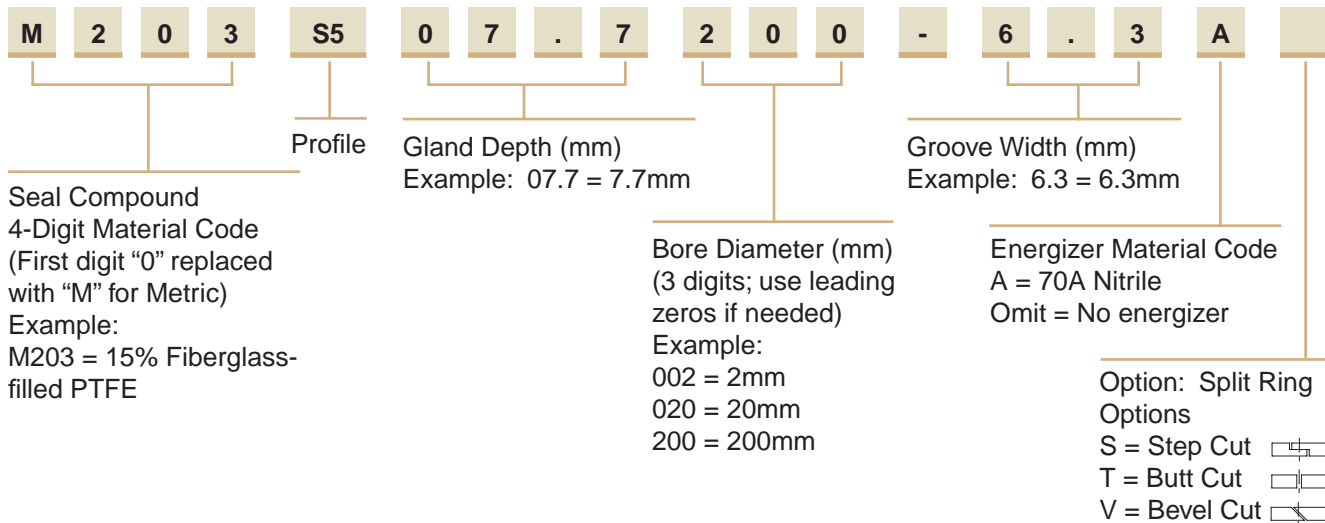

Piston Seal R5 Profile

Catalog EPS 5370/USA



R5 Profile, Rectangular PTFE Cap Seal

The Parker R5 profile is a bi-directional piston seal for use in medium to heavy duty hydraulic actuators and is suitable for sealing against hardened surfaces in pneumatic applications. The R5 profile is a two piece design comprised of a standard size rubber square ring energizing a rectangular shaped PTFE cap. The R5 profile offers excellent stability, long wear, low friction and extrusion protection. The seal is commonly used in applications such as agriculture hydraulics, mobile hydraulics, machine tools and hydraulic presses. Parker's R5 profile will retrofit non-Parker seals of similar design and is an updated version of the Parker R5100 piston seal.

The R5 profile may be ordered without the energizer by omitting the energizer code. See part number nomenclature.

Technical Data

Standard Materials*		Temperature Range	Pressure Range†	Surface Speed
0203	15% fiberglass filled PTFE	-200°F to 575°F (-129°C to 302°C)	3500 psi (241 bar)	< 13 ft/s (4 m/sec)
Energizer				
A	70A Nitrile	-30°F to 250°F (-34°C to 121°C)		

****Alternate Materials:** For applications that may require an alternate material, please see Section 3 for alternate PTFE (Table 3-4) and energizer (Table 3-5) materials.

†**Pressure Range** without wear rings (see Table 2-4, page 2-5).



R5 Cross-Section

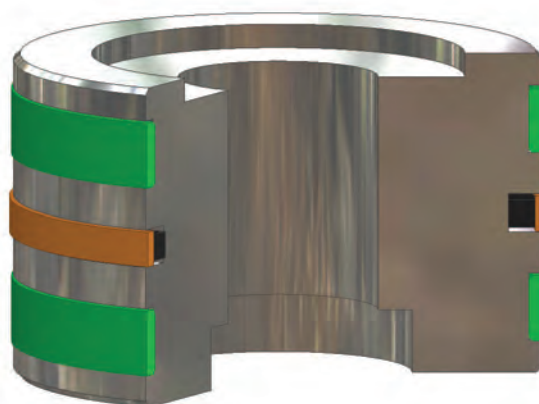

R5 installed in Piston Gland

7

09/01/07

R5 Profile

Technical Data (Continued)

Options

Split Rings: To aid in installation, the PTFE ring can be supplied in one of the following split configurations. To indicate that the R5 profile is to be split, add the appropriate split type indicator to the end of the part number.

- S = Step Cut
- T = Butt Cut
- V = Bevel cut

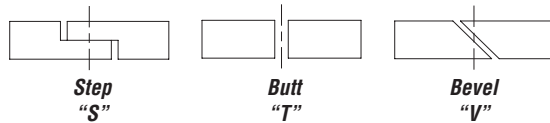

Metric: To configure metric part numbering, see Table 7-37 on page 7-42, and call your local Parker Seal representative for availability.

Part Number Nomenclature — R5 Profile

Table 7-35. R5 Profile — Inch

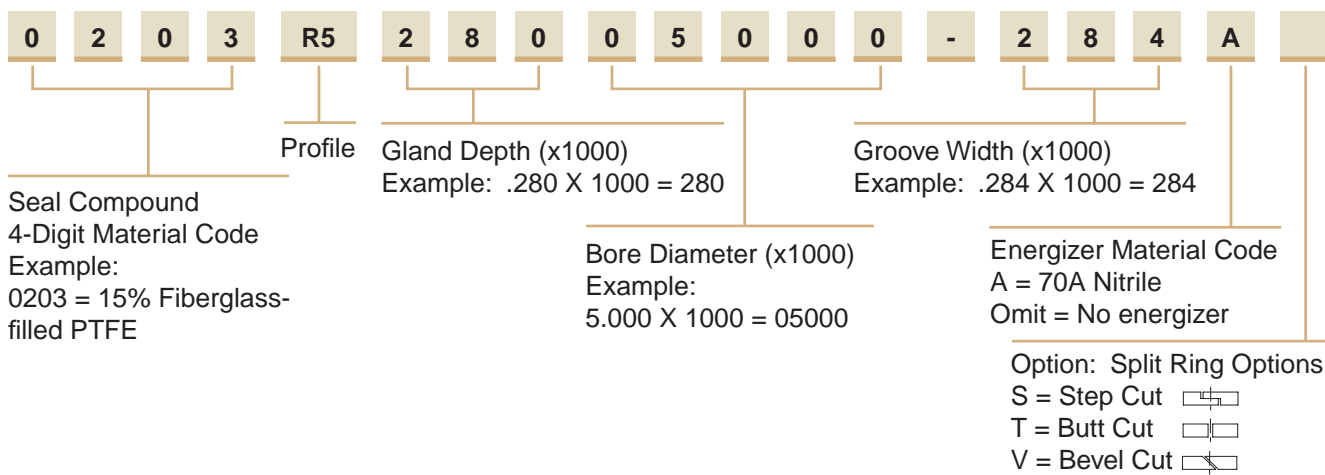

Gland Dimensions — R5 Profile

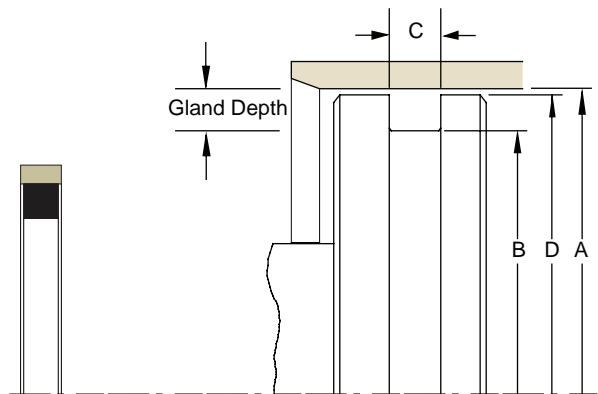

Please refer to Engineering Section 2, Page 2-8 for surface finish and additional hardware considerations.

Table 7-36. R5 Gland Dimensions — Inch

A Bore Diameter	B Groove Diameter	C Groove Width	D Piston Diameter*	Square Ring Number	Part Number
+0.002/-0.000	+0.001/-0.001	+0.002/-0.002	+0.000/-0.001		
1.000	0.692	0.129	0.999	115	0203R515501000-129A
1.250	0.942	0.129	1.249	119	0203R515501250-129A
1.500	1.192	0.129	1.499	123	0203R515501500-129A

*If used with wear rings, refer to wear ring piston diameter, see Section 9.

Table 7-36. R5 Gland Dimensions — Inch (Continued)

A Bore Diameter	B Groove Diameter	C Groove Width	D Piston Diameter*	Square Ring Number	Part Number
+ .002/- .000	+ .001/- .001	+ .002/- .002	+ .000/- .001		
1.750	1.442	0.129	1.749	127	0203R515501750-129A
2.000	1.692	0.129	1.999	131	0203R515502000-129A
2.250	1.942	0.129	2.249	135	0203R515502250-129A
2.500	2.192	0.129	2.499	139	0203R515502500-129A
2.750	2.442	0.129	2.749	143	0203R515502750-129A
+ .003/- .000	+ .002/- .002	+ .003/- .003	+ .000/- .002		
3.000	2.444	0.284	2.998	333	0203R528003000-284A
3.250	2.694	0.284	3.248	335	0203R528003250-284A
3.500	2.944	0.284	3.498	337	0203R528003500-284A
3.750	3.194	0.284	3.748	339	0203R528003750-284A
4.000	3.444	0.284	3.998	341	0203R528004000-284A
4.125	3.569	0.284	4.123	342	0203R528004125-284A
4.250	3.694	0.284	4.248	343	0203R528004250-284A
4.500	3.944	0.284	4.498	345	0203R528004500-284A
4.750	4.194	0.284	4.748	347	0203R528004750-284A
5.000	4.444	0.284	4.998	349	0203R528005000-284A
+ .004/- .000	+ .003/- .003	+ .004/- .004	+ .000/- .003		
5.250	4.488	0.379	5.247	425	0203R538105250-379A
5.500	4.738	0.379	5.497	427	0203R538105500-379A
5.750	4.988	0.379	5.747	429	0203R538105750-379A
6.000	5.238	0.379	5.997	431	0203R538106000-379A
6.250	5.488	0.379	6.247	433	0203R538106250-379A
6.500	5.738	0.379	6.497	435	0203R538106500-379A
6.750	5.988	0.379	6.747	437	0203R538106750-379A
7.000	6.238	0.379	6.997	438	0203R538107000-379A
7.250	6.488	0.379	7.247	439	0203R538107250-379A
7.500	6.738	0.379	7.497	440	0203R538107500-379A
7.750	6.988	0.379	7.747	441	0203R538107750-379A
8.000	7.238	0.379	7.997	442	0203R538108000-379A
8.250	7.488	0.379	8.247	443	0203R538108250-379A
8.500	7.738	0.379	8.497	444	0203R538108500-379A
+ .004/- .000	+ .004/- .004	+ .004/- .004	+ .000/- .004		
9.000	8.122	0.379	8.996	445	0203R543909000-379A
9.500	8.622	0.379	9.496	446	0203R543909500-379A
10.000	9.122	0.379	9.996	447	0203R543910000-379A
11.000	10.122	0.379	10.996	449	0203R543911000-379A
12.000	11.122	0.379	11.996	451	0203R543912000-379A
13.000	12.122	0.379	12.996	453	0203R543913000-379A
14.000	13.122	0.379	13.996	455	0203R543914000-379A

*If used with wear rings, refer to wear ring piston diameter, see Section 9.

NOTE: For sizes larger than those shown in the table, please contact your local Parker Seal representative.

7

R5 Profile

Part Number Nomenclature — R5 Profile

Table 7-37. R5 Profile — Metric (mm)

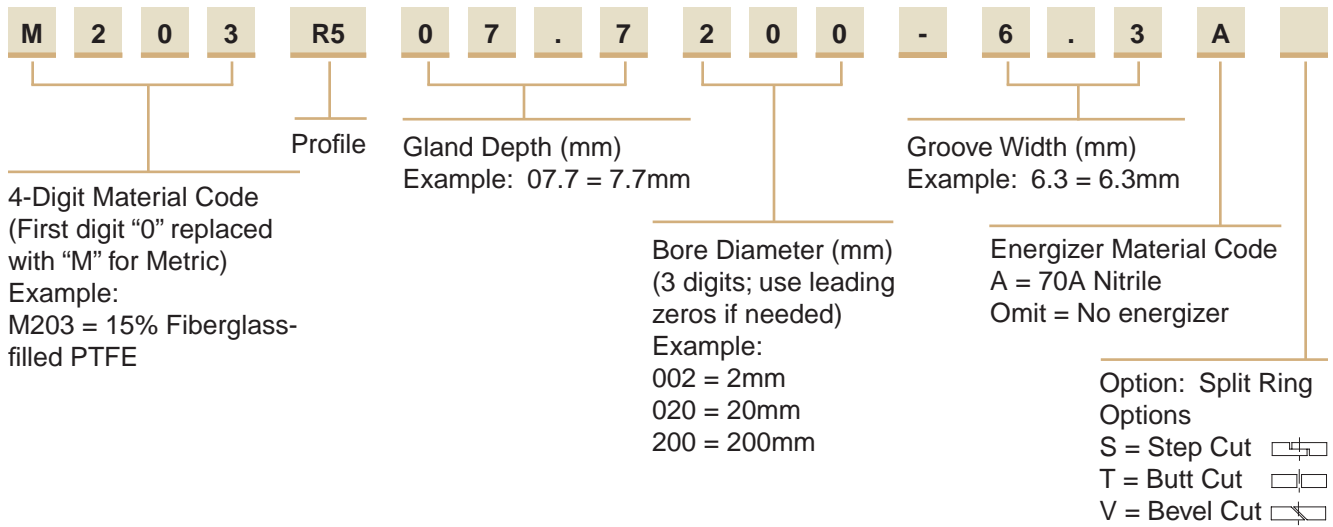

Piston Seal CT Profile

Catalog EPS 5370/USA

CT Profile, Premium PTFE Cap Seal with Anti-Extrusion Technology



The Parker CT Profile is a robust design for heavy duty hydraulic applications. The CT Profile is an excellent choice for sealing mobile hydraulic applications that experience shock loads. The CT profile is a four piece assembly made up of a rubber energizer, PTFE cap and two back-up rings. In application, fluid pressure forces the rubber energizer to apply increased load against the PTFE cap and back-up rings. This results in increased sealing force against the bore and allows the back-up rings to close off the extrusion gap between the piston and the bore. Once activated by pressure, the back-up rings protect the seal from extruding and keep internal contamination away from the PTFE cap. Parker's CT profile will retrofit non-Parker seals of similar design.

The CT Profile is sold only as an assembly (seal and energizer). See part number nomenclature.

Technical Data

Standard Materials*	Temperature Range**	Surface Speed
Cap 0401 40% bronze filled PTFE	-200°F to 575°F (-129°C to 302°C)	< 5 ft/s (1.5 m/sec)
Energizer A 70A Nitrile	-30°F to 250°F (-34°C to 121°C)	

***Alternate Materials:** For applications that may require an alternate material, please see Section 3 for alternate PTFE, energizer and back-up materials.

****The temperature range of the CT profile is limited to the energizer.** A wider temperature range can be achieved by using alternate energizer and back-up ring compounds.



CT Cross-Section Standard

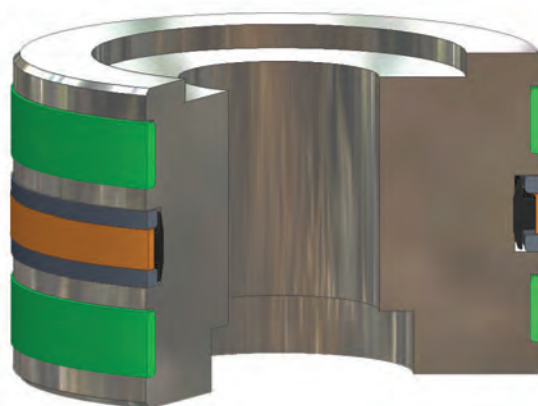

CT installed in Piston Gland

7

09/01/07

CT Profile

Technical Data (Continued)

Standard Materials*

Back-up Rings	Temperature Range	Pressure Range†
B001 Nylatron	-65°F to 250°F (-44°C to 121°C)	7,500 psi (500 bar)

***Alternate Materials:** For applications that may require an alternate material, please see Section 3 for alternate PTFE, energizer and back-up materials.

†**Pressure Range** without wear rings (see Table 2-4, page 2-5).

Options

Metric: To configure metric part numbering, see Table 7-41 on page 7-47, and call your local Parker Seal representative for availability.

Part Number Nomenclature — CT Profile

Table 7-38. CT Profile — Inch

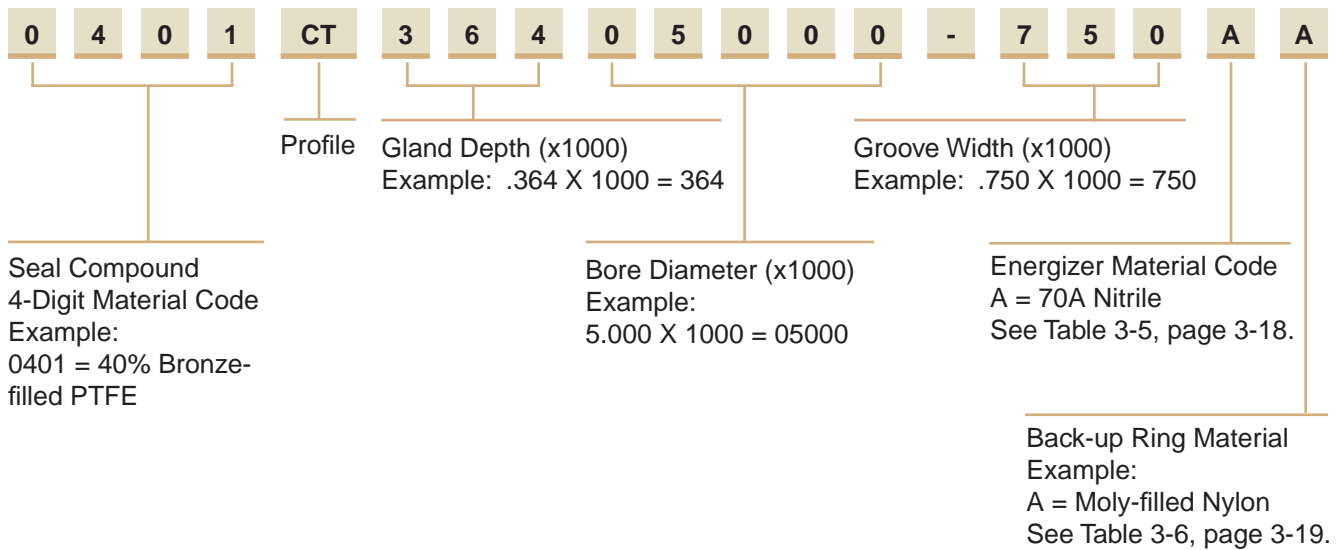

7

Gland Dimensions — CT Profile

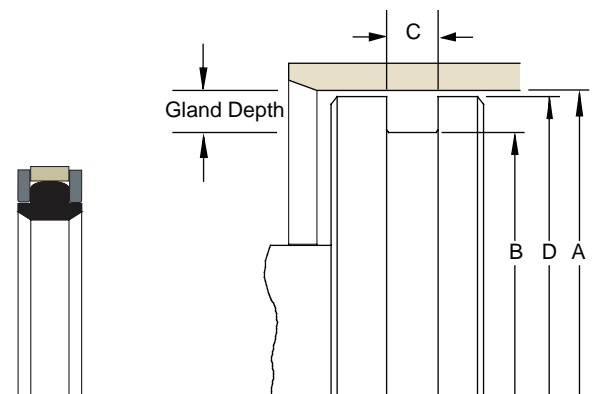

Please refer to Engineering Section 2, Page 2-8 for surface finish and additional hardware considerations.

Table 7-39. CT Gland Dimensions (Narrow Style) — Inch

A Bore Diameter	B Groove Diameter	C Groove Width	D Piston Diameter*	Part Number (Narrow Style)
+ .002/- .000	+ .000/- .002	+ .010/- .000	+ .000/- .002	
1.500	0.942	0.295	1.499	0401CT27901500-295AA
2.000	1.442	0.295	1.999	0401CT27902000-295AA
2.250	1.692	0.295	2.249	0401CT27902250-295AA
2.500	1.942	0.295	2.499	0401CT27902500-295AA
2.750	2.192	0.295	2.749	0401CT27902750-295AA
+ .003/- .000	+ .000/- .002	+ .010/- .000	+ .000/- .002	
3.000	2.442	0.420	2.998	0401CT27903000-420AA
3.250	2.692	0.420	3.248	0401CT27903250-420AA
3.500	2.942	0.420	3.498	0401CT27903500-420AA
3.750	3.192	0.420	3.748	0401CT27903750-420AA
4.000	3.442	0.420	3.998	0401CT27904000-420AA
4.250	3.692	0.420	4.248	0401CT27904250-420AA
4.500	3.942	0.420	4.498	0401CT27904500-420AA
4.750	4.192	0.420	4.748	0401CT27904750-420AA
5.000	4.442	0.420	4.998	0401CT27905000-420AA

*If used with wear rings, refer to wear ring piston diameter, see Section 9.

NOTE: For sizes larger than those shown in the table, please contact your local Parker Seal representative.

Table 7-40. CT Gland Dimensions (Standard Style) — Inch

A Bore Diameter	B Groove Diameter	C Groove Width	D Piston Diameter*	Part Number (Standard Style)
+ .002/- .000	+ .000/- .002	+ .010/- .000	+ .000/- .002	
1.000	0.628	0.424	0.999	0401CT18601000-424AA
1.063	0.691	0.424	1.062	0401CT18601063-424AA
1.125	0.753	0.424	1.124	0401CT18601125-424AA
1.188	0.816	0.424	1.187	0401CT18601188-424AA
1.250	0.878	0.424	1.249	0401CT18601250-424AA
1.313	0.941	0.424	1.312	0401CT18601313-424AA
1.375	1.003	0.424	1.374	0401CT18601375-424AA
1.438	1.066	0.424	1.437	0401CT18601438-424AA
1.500	1.128	0.424	1.499	0401CT18601500-424AA
1.563	1.191	0.424	1.562	0401CT18601563-424AA
1.625	1.253	0.424	1.624	0401CT18601625-424AA
1.688	1.316	0.424	1.687	0401CT18601688-424AA
1.750	1.378	0.424	1.749	0401CT18601750-424AA
1.875	1.503	0.424	1.874	0401CT18601875-424AA

*If used with wear rings, refer to wear ring piston diameter, see Section 9.



Table 7-40. CT Gland Dimensions (Standard Style) — Inch (Continued)

A Bore Diameter	B Groove Diameter	C Groove Width	D Piston Diameter*	Part Number (Standard Style)
+0.003/-0.000	+0.000/-0.003	+0.010/-0.000	+0.000/-0.003	
2.000	1.628	0.424	1.999	0401CT18602000-424AA
2.125	1.753	0.424	2.124	0401CT18602125-424AA
2.250	1.878	0.424	2.249	0401CT18602250-424AA
2.375	2.003	0.424	2.374	0401CT18602375-424AA
2.500	2.128	0.424	2.499	0401CT18602500-424AA
2.625	2.253	0.424	2.624	0401CT18602625-424AA
2.750	2.378	0.424	2.749	0401CT18602750-424AA
2.875	2.503	0.424	2.874	0401CT18602875-424AA
+0.004/-0.000	+0.000/-0.003	+0.010/-0.000	+0.000/-0.003	
3.000	2.522	0.579	2.998	0401CT23903000-579AA
3.125	2.647	0.579	3.123	0401CT23903125-579AA
3.250	2.772	0.579	3.248	0401CT23903250-579AA
3.375	2.897	0.579	3.373	0401CT23903375-579AA
3.500	3.022	0.579	3.498	0401CT23903500-579AA
3.625	3.147	0.579	3.623	0401CT23903625-579AA
3.750	3.272	0.579	3.748	0401CT23903750-579AA
3.875	3.397	0.579	3.873	0401CT23903875-579AA
4.000	3.522	0.579	3.998	0401CT23904000-579AA
4.125	3.647	0.579	4.123	0401CT23904125-579AA
4.250	3.772	0.579	4.248	0401CT23904250-579AA
4.375	3.897	0.579	4.373	0401CT23904375-579AA
4.500	4.022	0.579	4.498	0401CT23904500-579AA
4.625	4.147	0.579	4.623	0401CT23904625-579AA
4.750	4.272	0.579	4.748	0401CT23904750-579AA
4.875	4.397	0.579	4.873	0401CT23904875-579AA
5.000	4.272	0.750	4.998	0401CT36405000-750AA
5.125	4.397	0.750	5.123	0401CT36405125-750AA
5.250	4.522	0.750	5.248	0401CT36405250-750AA
5.375	4.647	0.750	5.373	0401CT36405375-750AA
+0.004/-0.000	+0.000/-0.004	+0.010/-0.000	+0.000/-0.004	
5.500	4.772	0.750	5.497	0401CT36405500-750AA
5.625	4.897	0.750	5.622	0401CT36405625-750AA
5.750	5.022	0.750	5.747	0401CT36405750-750AA
5.875	5.147	0.750	5.872	0401CT36405875-750AA
6.000	5.272	0.750	5.997	0401CT36406000-750AA
6.125	5.397	0.750	6.122	0401CT36406125-750AA
6.250	5.522	0.750	6.247	0401CT36406250-750AA
6.375	5.647	0.750	6.372	0401CT36406375-750AA
6.500	5.772	0.750	6.497	0401CT36406500-750AA
6.750	6.022	0.750	6.747	0401CT36406750-750AA
7.000	6.272	0.750	6.997	0401CT36407000-750AA
+0.005/-0.000	+0.000/-0.004	+0.010/-0.000	+0.000/-0.004	
7.250	6.522	0.750	7.247	0401CT36407250-750AA
7.500	6.772	0.750	7.497	0401CT36407500-750AA
7.750	7.022	0.750	7.747	0401CT36407750-750AA
+0.005/-0.000	+0.000/-0.005	+0.010/-0.000	+0.000/-0.005	
8.000	7.272	0.750	7.996	0401CT36408000-750AA
8.250	7.522	0.750	8.246	0401CT36408250-750AA
8.500	7.772	0.750	8.496	0401CT36408500-750AA

*If used with wear rings, refer to wear ring piston diameter, see Section 9.



Table 7-40. CT Gland Dimensions (Standard Style) — Inch (Continued)

A Bore Diameter	B Groove Diameter	C Groove Width	D Piston Diameter*	Part Number (Standard Style)
+ .005/- .000	+ .000/- .005	+ .010/- .000	+ .000/- .005	
8.750	8.022	0.750	8.746	0401CT36408750-750AA
9.000	8.272	0.750	8.996	0401CT36409000-750AA
9.500	8.772	0.750	9.496	0401CT36409500-750AA
10.000	9.272	0.750	9.996	0401CT36410000-750AA
10.500	9.772	0.750	10.496	0401CT36410500-750AA
11.000	10.272	0.750	10.996	0401CT36411000-750AA
11.500	10.772	0.750	11.496	0401CT36411500-750AA
12.000	11.272	0.750	11.996	0401CT36412000-750AA
+ .006/- .000	+ .000/- .005	+ .010/- .000	+ .000/- .005	
12.500	11.772	0.750	12.496	0401CT36412500-750AA
13.000	12.272	0.750	12.996	0401CT36413000-750AA
+ .006/- .000	+ .000/- .006	+ .010/- .000	+ .000/- .006	
13.500	12.772	0.750	13.495	0401CT36413500-750AA
14.000	13.272	0.750	13.995	0401CT36414000-750AA
14.500	13.772	0.750	14.495	0401CT36414500-750AA
15.000	14.272	0.750	14.995	0401CT36415000-750AA
15.500	14.772	0.750	15.495	0401CT36415500-750AA
16.000	15.272	0.750	15.995	0401CT36416000-750AA
16.500	15.772	0.750	16.495	0401CT36416500-750AA
17.000	16.272	0.750	16.995	0401CT36417000-750AA
17.500	16.772	0.750	17.495	0401CT36417500-750AA
18.000	17.272	0.750	17.995	0401CT36418000-750AA
18.500	17.772	0.750	18.495	0401CT36418500-750AA
19.000	18.272	0.750	18.995	0401CT36419000-750AA
19.500	18.772	0.750	19.495	0401CT36419500-750AA
20.000	19.272	0.750	19.995	0401CT36420000-750AA

*If used with wear rings, refer to wear ring piston diameter, see Section 9.

NOTE: For sizes larger than those shown in the table, please contact your local Parker Seal representative.

Part Number Nomenclature — CT Profile

Table 7-41. CT Profile — Metric (mm)

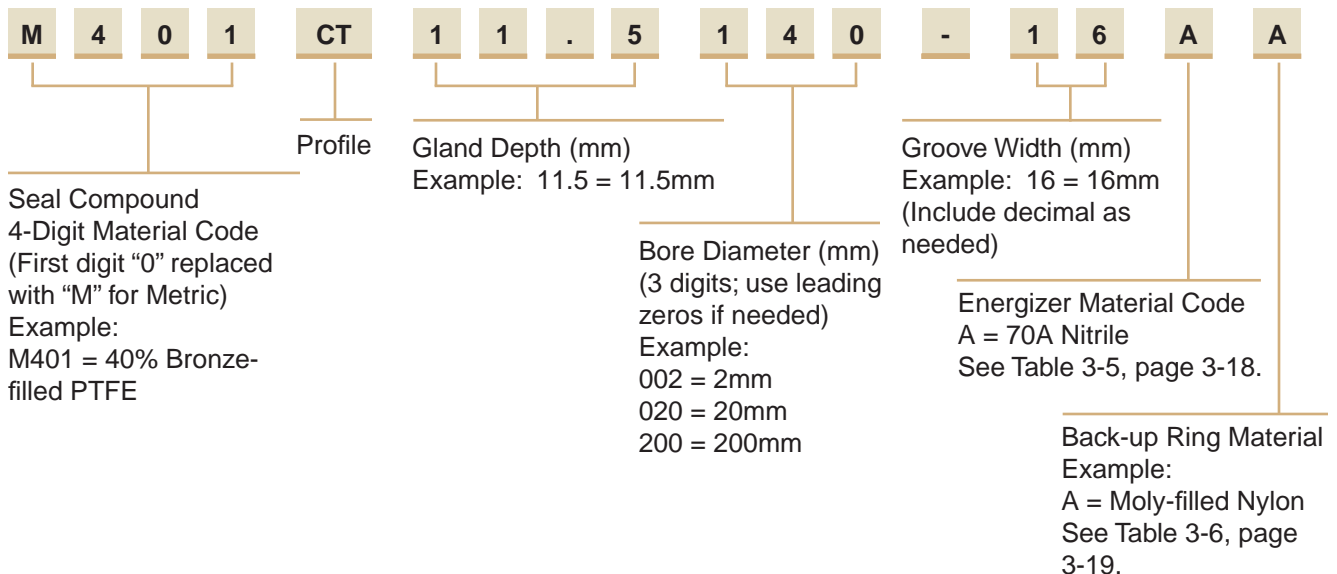

Piston Seal CQ Profile

Catalog EPS 5370/USA

CQ Profile, Premium PTFE Cap Seal with Anti-Drift Technology



The Parker CQ profile is a bi-directional piston seal for use in medium to heavy duty hydraulic applications. The CQ profile is a unique seal design that includes a rubber quad seal in the PTFE cap to ensure drift free performance. The PTFE cap is a stable rectangular shape and is energized, depending on its cross section, by a single square energizer or dual Parker O-rings. The CQ piston seal is commonly used in applications such as mobile hydraulics, lift trucks, standard cylinders and piston accumulators. Parker's CQ profile will retrofit non-Parker seals of similar design.

The CQ profile may be ordered without the energizer and quad seal by omitting the energizer/quad seal code. See part number nomenclature.

Technical Data

Standard Materials*	Temperature Range	Pressure Range†	Surface Speed
Cap 0401 40% bronze filled PTFE	-200°F to 575°F (-129°C to 302°C)	5000 psi (344 bar)	< 9.8 ft/s (3 m/sec)
Energizer/Quad Seal A 70A Nitrile	-30°F to 250°F (-34°C to 121°C)		

***Alternate Materials:** For applications that may require an alternate material, please see Section 3 for alternate PTFE (Table 3-4) and energizer (Table 3-5) materials.

†**Pressure Range** without wear rings (see Table 2-4, page 2-5).

Options

Notched Walls: Adding an "N" to the end of the part number indicates that notches are to be added to the side walls of the PTFE cap. Notches can help optimize the seal's response to fluid pressure. In application, the void created by the notch allows fluid pressure to fill the cavity between the side face of the gland and the seal. Consult your local Parker Seal representative for the availability and cost to add side notches to the CQ profile.

N = Notched walls 

Metric: To configure metric part numbering, see Table 7-45 on page 7-52, and call your local Parker Seal representative for availability.

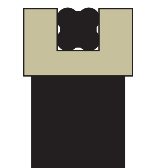

CQ Cross-Section Square Ring

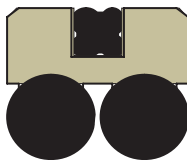

CQ Cross-Section dual O-ring

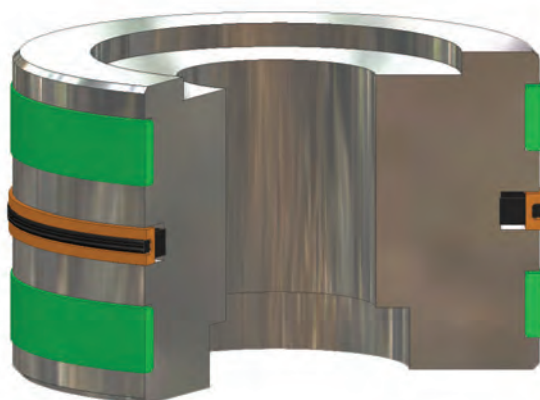

CQ installed in Piston Gland

02/15/08

Part Number Nomenclature — CQ Profile

Table 7-42. CQ Profile — Inch

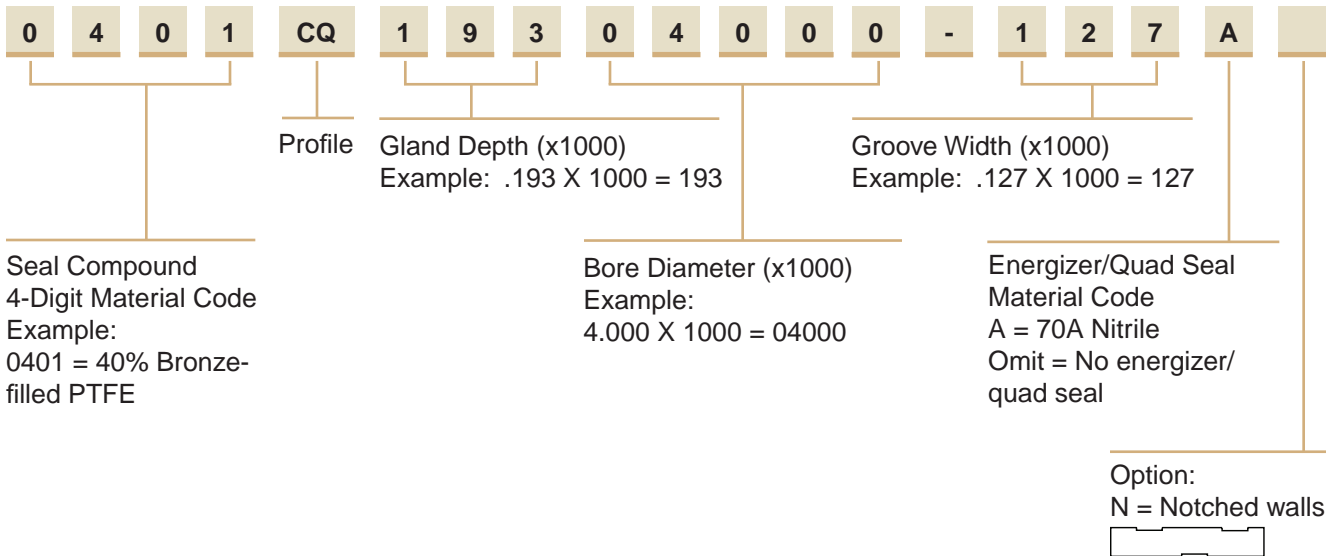

Gland Dimension — CQ Profile — Square Ring

Please refer to Engineering Section 2, Page 2-8 for surface finish and additional hardware considerations.

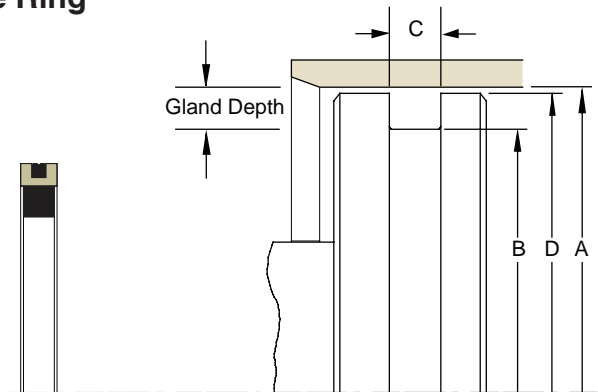

Table 7-43. CQ Gland Dimensions (Square Ring) — Inch

A Bore Diameter	B Groove Diameter	C Groove Width	D Piston Diameter*	Quad Seal Dash Number	Square Ring Number	Part Number (Square Ring)
+.002/-0.000	+.000/-0.003	+.005/-0.000	+.000/-0.002			
1.500	0.884	0.288	1.499	125	316	0401CQ30801500-288A
2.000	1.384	0.288	1.999	133	324	0401CQ30802000-288A
2.250	1.634	0.288	2.249	136	326	0401CQ30802250-288A
2.500	1.884	0.288	2.499	140	328	0401CQ30802500-288A
2.750	2.134	0.288	2.749	145	330	0401CQ30802750-288A
3.000	2.384	0.288	2.999	148	332	0401CQ30803000-288A
3.250	2.634	0.288	3.249	151	334	0401CQ30803250-288A
3.500	2.884	0.288	3.499	152	336	0401CQ30803500-288A
3.750	3.134	0.288	3.749	153	338	0401CQ30803750-288A
4.000	3.384	0.288	3.999	154	340	0401CQ30804000-288A
4.250	3.634	0.288	4.249	155	342	0401CQ30804250-288A
4.500	3.884	0.288	4.499	156	344	0401CQ30804500-288A
4.750	4.134	0.288	4.749	157	346	0401CQ30804750-288A

*If used with wear rings, refer to wear ring piston diameter, see Section 9.

Table 7-43. CQ Gland Dimensions (Square Ring) — Inch (Continued)

A Bore Diameter	B Groove Diameter	C Groove Width	D Piston Diameter*	Quad Seal Dash Number	Square Ring Number	Part Number (Square Ring)
+0.004/-0.000	+0.000/-0.006	+0.005/-0.000	+0.000/-0.004			
5.000	4.384	0.288	4.998	158	348	0401CQ30805000-288A
5.250	4.542	0.288	5.248	159	350	0401CQ30805250-288A
5.500	4.660	0.375	5.498	160	426	0401CQ42005500-375A
5.750	4.910	0.375	5.748	161	428	0401CQ42005750-375A
6.000	5.160	0.375	5.998	162	430	0401CQ42006000-375A
6.500	5.660	0.375	6.498	164	434	0401CQ42006500-375A
7.000	6.160	0.375	6.998	166	437	0401CQ42007000-375A
7.500	6.660	0.375	7.498	168	439	0401CQ42007500-375A
8.000	7.160	0.375	7.998	170	441	0401CQ42008000-375A
9.000	8.160	0.375	8.998	174	445	0401CQ42009000-375A
10.000	9.160	0.375	9.998	178	447	0401CQ42010000-375A

*If used with wear rings, refer to wear ring piston diameter, see Section 9.

NOTE: For sizes larger than those shown in the table, please contact your local Parker Seal representative.

Gland Dimension — CQ Profile — Dual O-ring

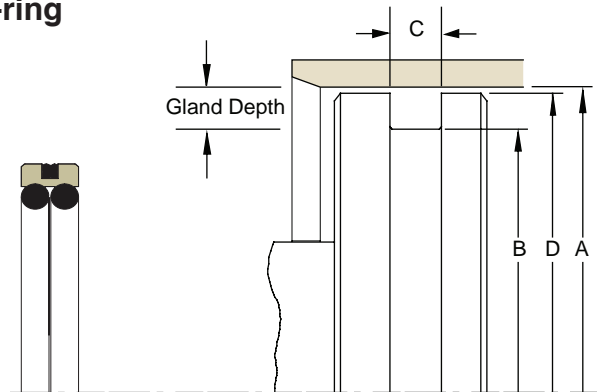

Please refer to Engineering Section 2, Page 2-8 for surface finish and additional hardware considerations.

Table 7-44. CQ Gland Dimensions (Dual O-ring) — Inch

A Bore Diameter	B Groove Diameter	C Groove Width	D Piston Diameter*	Quad Seal Dash Number	Dual O-ring Number	CQ Part Number (Dual O-ring)
+0.002/-0.000	+0.000/-0.003	+0.005/-0.000	+0.000/-0.002			
1.500	1.106	0.248	1.499	028	121	0401CQ19701500-248A
1.562	1.168	0.248	1.561	028	122	0401CQ19701562-248A
1.625	1.231	0.248	1.624	029	123	0401CQ19701625-248A
1.687	1.293	0.248	1.686	029	124	0401CQ19701687-248A
1.750	1.356	0.248	1.749	030	125	0401CQ19701750-248A
1.875	1.481	0.248	1.874	031	127	0401CQ19701875-248A
2.000	1.606	0.248	1.999	032	129	0401CQ19702000-248A
2.125	1.731	0.248	2.124	033	131	0401CQ19702125-248A
2.250	1.856	0.248	2.249	034	133	0401CQ19702250-248A
2.375	1.981	0.248	2.373	035	135	0401CQ19702375-248A
2.500	2.106	0.248	2.498	036	137	0401CQ19702500-248A
2.625	2.231	0.248	2.623	037	139	0401CQ19702625-248A
2.750	2.356	0.248	2.748	038	141	0401CQ19702750-248A
2.875	2.481	0.248	2.873	039	143	0401CQ19702875-248A
3.000	2.488	0.326	2.998	149	229	0401CQ25603000-326A

*If used with wear rings, refer to wear ring piston diameter, see Section 9.

Table 7-44. CQ Gland Dimensions (Dual O-ring) — Inch (Continued)

A Bore Diameter	B Groove Diameter	C Groove Width	D Piston Diameter*	Quad Seal Dash Number	Dual O-ring Number	CQ Part Number (Dual O-ring)
+0.002/-0.000	+0.000/-0.003	+0.005/-0.000	+0.000/-0.002			
3.125	2.613	0.326	3.123	150	230	0401CQ25603125-326A
3.250	2.738	0.326	3.248	151	231	0401CQ25603250-326A
3.375	2.863	0.326	3.373	151	232	0401CQ25603375-326A
3.500	2.988	0.326	3.498	152	233	0401CQ25603500-326A
3.625	3.113	0.326	3.623	152	234	0401CQ25603625-326A
3.750	3.238	0.326	3.748	153	235	0401CQ25603750-326A
3.875	3.363	0.326	3.873	153	236	0401CQ25603875-326A
4.000	3.488	0.326	3.998	154	237	0401CQ25604000-326A
4.125	3.613	0.326	4.123	154	238	0401CQ25604125-326A
4.250	3.738	0.326	4.248	155	239	0401CQ25604250-326A
4.375	3.863	0.326	4.373	155	240	0401CQ25604375-326A
4.500	3.988	0.326	4.498	156	241	0401CQ25604500-326A
4.625	4.113	0.326	4.623	156	242	0401CQ25604625-326A
4.750	4.238	0.326	4.748	157	243	0401CQ25604750-326A
4.875	4.363	0.326	4.873	157	244	0401CQ25604875-326A
+0.004/-0.000	+0.000/-0.006	+0.005/-0.000	+0.000/-0.004			
5.000	4.292	0.484	4.998	248	346	0401CQ35405000-484A
5.125	4.417	0.484	5.123	249	347	0401CQ35405125-484A
5.250	4.542	0.484	5.248	250	348	0401CQ35405250-484A
5.375	4.667	0.484	5.373	251	349	0401CQ35405375-484A
5.500	4.792	0.484	5.498	252	350	0401CQ35405500-484A
5.625	4.917	0.484	5.623	253	351	0401CQ35405625-484A
5.750	5.042	0.484	5.748	254	352	0401CQ35405750-484A
5.875	5.167	0.484	5.873	255	353	0401CQ35405875-484A
6.000	5.292	0.484	5.998	256	354	0401CQ35406000-484A
6.250	5.542	0.484	6.248	258	356	0401CQ35406250-484A
6.500	5.792	0.484	6.498	259	358	0401CQ35406500-484A
6.750	6.042	0.484	6.748	260	360	0401CQ35406750-484A
7.000	6.292	0.484	6.998	261	361	0401CQ35407000-484A
7.250	6.542	0.484	7.248	262	362	0401CQ35407250-484A
7.500	6.792	0.484	7.498	263	363	0401CQ35407500-484A
7.750	7.042	0.484	7.748	264	364	0401CQ35407750-484A
8.000	7.292	0.484	7.998	265	365	0401CQ35408000-484A
8.250	7.542	0.484	8.248	266	366	0401CQ35408250-484A
8.500	7.792	0.484	8.498	267	367	0401CQ35408500-484A
8.750	8.042	0.484	8.748	268	368	0401CQ35408750-484A
9.000	8.292	0.484	8.998	269	369	0401CQ35409000-484A
9.250	8.542	0.484	9.248	270	370	0401CQ35409250-484A
9.500	8.792	0.484	9.498	271	371	0401CQ35409500-484A
9.750	9.042	0.484	9.748	272	372	0401CQ35409750-484A
10.000	9.292	0.484	9.998	273	373	0401CQ35410000-484A
10.500	9.792	0.484	10.498	274	375	0401CQ35410500-484A
11.000	10.292	0.484	10.998	275	377	0401CQ35411000-484A
11.500	10.792	0.484	11.498	276	378	0401CQ35411500-484A
+0.006/-0.000	+0.000/-0.008	+0.005/-0.000	+0.000/-0.006			
12.000	10.780	0.642	11.998	380	450	0401CQ61012000-642A
12.500	11.280	0.642	12.498	381	451	0401CQ61012500-642A
13.000	11.780	0.642	12.998	381	452	0401CQ61013000-642A
13.500	12.280	0.642	13.498	382	453	0401CQ61013500-642A
14.000	12.780	0.642	13.998	382	454	0401CQ61014000-642A

*If used with wear rings, refer to wear ring piston diameter, see Section 9.

09/01/07

CQ Profile

Table 7-44. CQ Gland Dimensions (Dual O-ring) — Inch (Continued)

A Bore Diameter	B Groove Diameter	C Groove Width	D Piston Diameter*	Quad Seal Dash Number	Dual O-ring Number	CQ Part Number (Dual O-ring)
14.500	13.280	0.642	14.498	383	455	0401CQ61014500-642A
15.000	13.780	0.642	14.998	383	456	0401CQ61015000-642A
15.500	14.280	0.642	15.498	384	457	0401CQ61015500-642A
16.000	14.780	0.642	15.998	384	458	0401CQ61016000-642A
16.500	15.280	0.642	16.498	385	459	0401CQ61016500-642A
17.000	15.780	0.642	16.998	385	460	0401CQ61017000-642A
17.500	16.280	0.642	17.498	386	461	0401CQ61017500-642A
18.000	16.780	0.642	17.998	386	462	0401CQ61018000-642A
18.500	17.280	0.642	18.498	387	463	0401CQ61018500-642A
19.000	17.780	0.642	18.998	387	464	0401CQ61019000-642A
19.500	18.280	0.642	19.498	388	465	0401CQ61019500-642A
20.000	18.780	0.642	19.998	388	466	0401CQ61020000-642A

*If used with wear rings, refer to wear ring piston diameter, see Section 9.

NOTE: For sizes larger than those shown in the table, please contact your local Parker Seal representative.

Part Number Nomenclature — CQ Profile

Table 7-45. CQ Profile — Metric (mm)

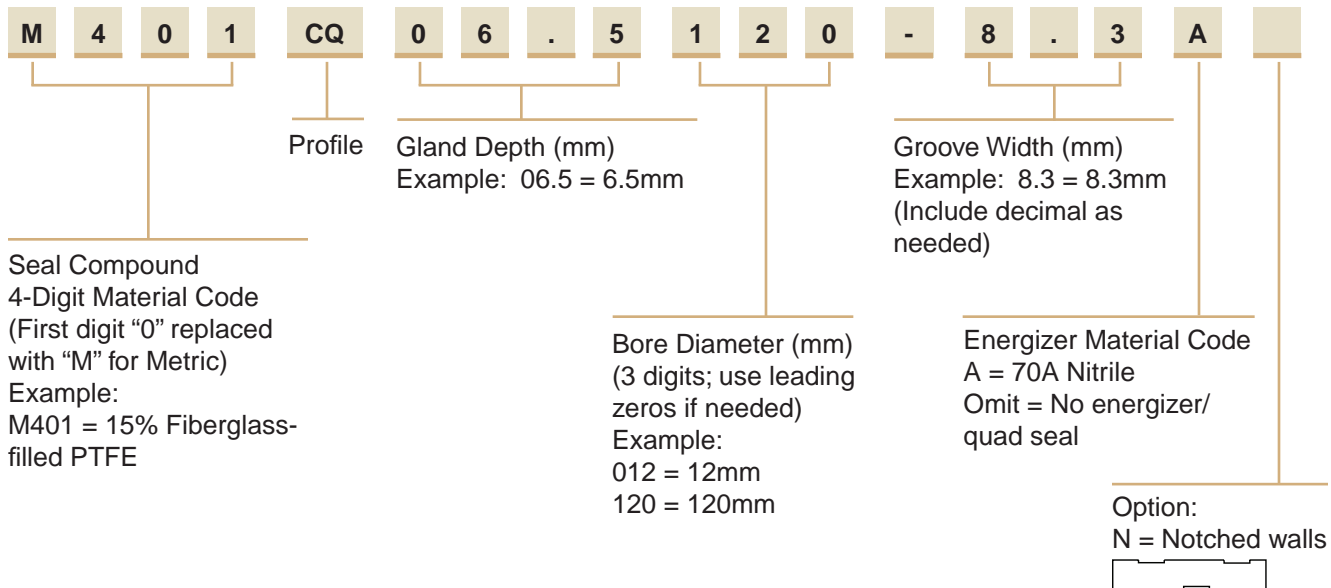

7

Piston Seal OE Profile

Catalog EPS 5370/USA

OE Profile, PTFE Piston Cap Seal



The Parker OE profile is a bi-directional piston seal for use in low to medium duty hydraulic applications. The OE profile is a two piece design comprised of a standard size Parker O-ring energizing a wear resistant PTFE cap. The OE profile offers long wear, low friction and because of its short assembly length requires minimal gland space on the piston. The seal is commonly used in applications such as mobile hydraulics, machine tools, injection molding machines and hydraulic presses. Parker's OE profile will retrofit non-Parker seals of similar design.

The OE profile may be ordered without the energizer by omitting the energizer code. See part number nomenclature.

Technical Data

Standard Materials*	Temperature Range	Pressure Range†	Surface Speed
Cap			
0401 40% bronze filled PTFE	-200°F to 575°F (-129°C to 302°C)	5000 psi (344 bar)	< 13 ft/s (4 m/sec)
Energizer			
A 70A Nitrile	-30°F to 250°F (-34°C to 121°C)		

***Alternate Materials:** For applications that may require an alternate material, please see Section 3 for alternate PTFE (Table 3-4) and energizer (Table 3-5) materials.

†Pressure Range without wear rings (see Table 2-4, page 2-5).

Options

Notched side walls: Adding an "N" to the end of the part number indicates that notches are to be added to the side walls of the PTFE cap. Notches can help optimize the seal's response to fluid pressure.

In application, the void created by the notch allows fluid pressure to fill the cavity between the side face of the gland and the seal. Consult your local Parker Seal representative for the availability and cost to add side notches to the OE profile.

N = Notched walls 



OE Cross-Section

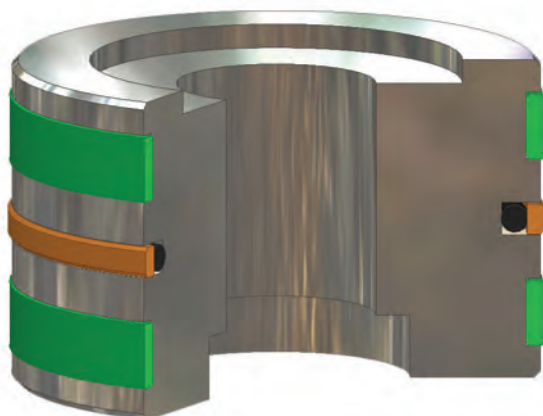

OE installed in Piston Gland

7

09/01/07

OE Profile

Part Number Nomenclature — OE Profile

Table 7-46. OE Profile — Inch

0	4	0	1	OE	1	9	3	0	4	0	0	0	-	1	2	7	A
Seal Compound 4-Digit Material Code Example: 0401 = 40% Bronze-filled PTFE				Profile	Gland Depth (x1000) Example: .193 X 1000 = 193			Bore Diameter (x1000) Example: 4.000 X 1000 = 04000					Groove Width (x1000) Example: .127 X 1000 = 127				Energizer Material Code A = 70A Nitrile Omit = No energizer See Table 3-5, page 3-18.
Option: N = Notched walls																	

Gland Dimension — OE Profile

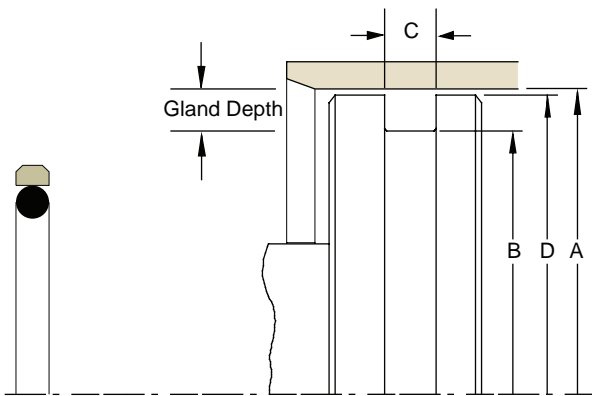

Please refer to Engineering Section 2, Page 2-8 for surface finish and additional hardware considerations.

Table 7-47. OE Gland Dimensions — Inch

A Bore Diameter	B Groove Diameter	C Groove Width	D Piston Diameter*	O-ring Dash Number	Part Number
+.001/-.000	+.000/-.001	+.005/-.000	.000/-.002		
0.500	0.326	0.081	0.499	011	0401OE08700500-081A
0.562	0.388	0.081	0.561	012	0401OE08700562-081A
0.625	0.451	0.081	0.624	013	0401OE08700625-081A
0.687	0.513	0.081	0.686	014	0401OE08700687-081A
0.750	0.576	0.081	0.749	015	0401OE08700750-081A
0.812	0.638	0.081	0.811	016	0401OE08700812-081A
0.875	0.701	0.081	0.874	017	0401OE08700875-081A
0.937	0.763	0.081	0.936	018	0401OE08700937-081A
1.000	0.826	0.081	0.999	019	0401OE08701000-081A
1.062	0.888	0.081	1.061	020	0401OE08701062-081A
1.125	0.951	0.081	1.124	021	0401OE08701125-081A
1.187	1.013	0.081	1.186	022	0401OE08701187-081A
1.250	1.076	0.081	1.249	023	0401OE08701250-081A
1.312	1.138	0.081	1.311	024	0401OE08701312-081A
1.375	1.201	0.081	1.374	025	0401OE08701375-081A
1.437	1.263	0.081	1.436	026	0401OE08701437-081A
1.500	1.326	0.081	1.499	027	0401OE08701500-081A

*If used with wear rings, refer to wear ring piston diameter, see Section 9.

Table 7-47. OE Gland Dimensions — Inch (Continued)

A Bore Diameter	B Groove Diameter	C Groove Width	D Piston Diameter*	O-ring Dash Number	Part Number
+.002/-.000	+.000/-.002	+.005/-.000	+.000/-.002		
0.500	0.244	0.081	0.499	010	0401OE12800500-081A
0.562	0.306	0.081	0.561	011	0401OE12800562-081A
0.625	0.369	0.081	0.624	012	0401OE12800625-081A
0.687	0.431	0.081	0.686	013	0401OE12800687-081A
0.750	0.494	0.081	0.749	014	0401OE12800750-081A
0.812	0.556	0.081	0.811	015	0401OE12800812-081A
0.875	0.619	0.081	0.874	016	0401OE12800875-081A
0.937	0.681	0.081	0.936	017	0401OE12800937-081A
1.000	0.744	0.081	0.999	018	0401OE12801000-081A
1.062	0.806	0.081	1.061	019	0401OE12801062-081A
1.125	0.869	0.081	1.124	020	0401OE12801125-081A
1.187	0.931	0.081	1.186	021	0401OE12801187-081A
1.250	0.994	0.081	1.249	022	0401OE12801250-081A
1.312	1.056	0.081	1.311	023	0401OE12801312-081A
1.375	1.119	0.081	1.374	024	0401OE12801375-081A
1.437	1.181	0.081	1.436	025	0401OE12801437-081A
1.500	1.244	0.081	1.499	026	0401OE12801500-081A
+.002/-.000	+.000/-.003	+.005/-.000	+.000/-.002		
0.750	0.452	0.126	0.749	111	0401OE14900750-126A
0.812	0.514	0.126	0.811	112	0401OE14900812-126A
0.875	0.577	0.126	0.874	113	0401OE14900875-126A
0.937	0.639	0.126	0.936	114	0401OE14900937-126A
1.000	0.702	0.126	0.999	115	0401OE14901000-126A
1.062	0.764	0.126	1.061	116	0401OE14901062-126A
1.125	0.827	0.126	1.124	117	0401OE14901125-126A
1.187	0.889	0.126	1.186	118	0401OE14901187-126A
1.250	0.952	0.126	1.249	119	0401OE14901250-126A
1.312	1.014	0.126	1.311	120	0401OE14901312-126A
1.375	1.077	0.126	1.374	121	0401OE14901375-126A
1.437	1.139	0.126	1.436	122	0401OE14901437-126A
1.500	1.202	0.126	1.499	123	0401OE14901500-126A
1.562	1.264	0.126	1.561	124	0401OE14901562-126A
1.625	1.327	0.126	1.624	125	0401OE14901625-126A
1.687	1.389	0.126	1.686	126	0401OE14901687-126A
1.750	1.452	0.126	1.749	127	0401OE14901750-126A
1.875	1.577	0.126	1.874	129	0401OE14901875-126A
2.000	1.702	0.126	1.999	131	0401OE14902000-126A
2.125	1.827	0.126	2.124	133	0401OE14902125-126A
2.250	1.952	0.126	2.249	135	0401OE14902250-126A
2.375	2.077	0.126	2.374	137	0401OE14902375-126A
2.500	2.202	0.126	2.499	139	0401OE14902500-126A
2.625	2.327	0.126	2.624	141	0401OE14902625-126A
2.750	2.452	0.126	2.749	143	0401OE14902750-126A
1.562	1.176	0.120	1.561	123	0401OE19301562-120A
1.625	1.239	0.120	1.624	124	0401OE19301625-120A
1.687	1.301	0.120	1.686	125	0401OE19301687-120A
1.750	1.364	0.120	1.749	126	0401OE19301750-120A
1.875	1.489	0.120	1.874	128	0401OE19301875-120A
2.000	1.614	0.127	1.999	130	0401OE19302000-127A
2.125	1.739	0.127	2.124	132	0401OE19302125-127A
2.250	1.864	0.127	2.249	134	0401OE19302250-127A

*If used with wear rings, refer to wear ring piston diameter, see Section 9.

09/01/07



Table 7-47. OE Gland Dimensions — Inch (Continued)

A Bore Diameter	B Groove Diameter	C Groove Width	D Piston Diameter*	O-ring Dash Number	Part Number
+0.002/-0.000	+0.000/-0.003	+0.005/-0.000	+0.000/-0.002		
2.375	1.989	0.127	2.374	136	0401OE19302375-127A
2.500	2.114	0.127	2.499	138	0401OE19302500-127A
2.625	2.239	0.127	2.624	140	0401OE19302625-127A
2.750	2.364	0.127	2.749	142	0401OE19302750-127A
2.875	2.489	0.127	2.874	144	0401OE19302875-127A
3.000	2.614	0.127	2.999	146	0401OE19303000-127A
3.125	2.739	0.127	3.124	148	0401OE19303125-127A
3.250	2.864	0.127	3.249	150	0401OE19303250-127A
3.375	2.989	0.127	3.374	151	0401OE19303375-127A
3.500	3.114	0.127	3.499	151	0401OE19303500-127A
3.625	3.239	0.127	3.624	152	0401OE19303625-127A
3.750	3.364	0.127	3.749	152	0401OE19303750-127A
3.875	3.489	0.127	3.874	153	0401OE19303875-127A
4.000	3.614	0.127	3.999	153	0401OE19304000-127A
4.125	3.739	0.127	4.124	154	0401OE19304125-127A
4.250	3.864	0.127	4.249	154	0401OE19304250-127A
4.375	3.989	0.127	4.374	155	0401OE19304375-127A
4.500	4.114	0.127	4.499	155	0401OE19304500-127A
4.625	4.239	0.127	4.624	156	0401OE19304625-127A
4.750	4.364	0.127	4.749	156	0401OE19304750-127A
4.875	4.489	0.127	4.874	157	0401OE19304875-127A
5.000	4.614	0.127	4.999	157	0401OE19305000-127A
5.125	4.739	0.127	5.124	158	0401OE19305125-127A
5.250	4.864	0.127	5.249	158	0401OE19305250-127A
5.375	4.989	0.127	5.374	159	0401OE19305375-127A
5.500	5.114	0.127	5.499	159	0401OE19305500-127A
+0.003/-0.000	+0.000/-0.004	+0.005/-0.000	+0.000/-0.003		
1.562	1.138	0.166	1.561	217	0401OE21201562-166A
1.625	1.201	0.166	1.624	218	0401OE21201625-166A
1.687	1.263	0.166	1.686	219	0401OE21201687-166A
1.750	1.326	0.166	1.749	221	0401OE21201750-166A
1.875	1.451	0.166	1.874	222	0401OE21201875-166A
2.000	1.576	0.166	1.999	223	0401OE21202000-166A
2.125	1.701	0.166	2.124	224	0401OE21202125-166A
2.250	1.826	0.166	2.249	225	0401OE21202250-166A
2.375	1.951	0.166	2.374	226	0401OE21202375-166A
2.500	2.076	0.166	2.499	227	0401OE21202500-166A
2.625	2.201	0.166	2.624	228	0401OE21202625-166A
2.750	2.326	0.166	2.749	229	0401OE21202750-166A
2.875	2.451	0.166	2.874	230	0401OE21202875-166A
3.000	2.576	0.166	2.999	231	0401OE21203000-166A
3.125	2.701	0.166	3.124	232	0401OE21203125-166A
3.250	2.826	0.166	3.249	233	0401OE21203250-166A
3.375	2.951	0.166	3.374	234	0401OE21203375-166A
3.500	3.076	0.166	3.499	235	0401OE21203500-166A
3.625	3.201	0.166	3.624	236	0401OE21203625-166A
3.750	3.326	0.166	3.749	237	0401OE21203750-166A
3.875	3.451	0.166	3.874	238	0401OE21203875-166A
4.000	3.576	0.166	3.999	239	0401OE21204000-166A

*If used with wear rings, refer to wear ring piston diameter, see Section 9.

Table 7-47. OE Gland Dimensions — Inch (Continued)

A Bore Diameter	B Groove Diameter	C Groove Width	D Piston Diameter*	O-ring Dash Number	Part Number
+ .003/- .000	+ .000/- .004	+ .005/- .000	+ .000/- .003		
4.125	3.701	0.166	4.124	240	0401OE21204125-166A
4.250	3.826	0.166	4.249	241	0401OE21204250-166A
4.375	3.951	0.166	4.374	242	0401OE21204375-166A
4.500	4.076	0.166	4.499	243	0401OE21204500-166A
4.625	4.201	0.166	4.624	244	0401OE21204625-166A
4.750	4.326	0.166	4.749	245	0401OE21204750-166A
4.875	4.451	0.166	4.874	246	0401OE21204875-166A
5.000	4.576	0.166	4.999	247	0401OE21205000-166A
5.125	4.701	0.166	5.124	248	0401OE21205125-166A
5.250	4.826	0.166	5.249	249	0401OE21205250-166A
5.375	4.951	0.166	5.374	250	0401OE21205375-166A
5.500	5.076	0.166	5.499	251	0401OE21205500-166A
+ .003/- .000	+ .000/- .005	+ .005/- .000	+ .000/- .003		
5.625	5.109	0.157	5.623	251	0401OE25805625-157A
5.750	5.234	0.157	5.748	252	0401OE25805750-157A
5.875	5.359	0.157	5.873	253	0401OE25805875-157A
6.000	5.484	0.157	5.998	254	0401OE25806000-157A
6.125	5.609	0.157	6.123	255	0401OE25806125-157A
6.250	5.734	0.157	6.248	256	0401OE25806250-157A
6.375	5.859	0.157	6.373	257	0401OE25806375-157A
6.500	5.984	0.157	6.498	258	0401OE25806500-157A
6.750	6.234	0.157	6.748	259	0401OE25806750-157A
7.000	6.484	0.157	6.998	260	0401OE25807000-157A
7.250	6.734	0.157	7.248	261	0401OE25807250-157A
7.500	6.984	0.157	7.498	262	0401OE25807500-157A
7.750	7.234	0.157	7.748	263	0401OE25807750-157A
8.000	7.484	0.157	7.998	264	0401OE25808000-157A
8.250	7.734	0.157	8.248	265	0401OE25808250-157A
8.500	7.984	0.157	8.498	266	0401OE25808500-157A
9.000	8.484	0.157	8.998	268	0401OE25809000-157A
9.500	8.984	0.157	9.498	270	0401OE25809500-157A
10.000	9.484	0.157	9.998	272	0401OE25810000-157A
10.500	9.984	0.157	10.498	274	0401OE25810500-157A
11.000	10.484	0.157	10.998	275	0401OE25811000-157A
11.500	10.984	0.157	11.498	276	0401OE25811500-157A
12.000	11.484	0.157	11.998	277	0401OE25812000-157A
+ .003/- .000	+ .000/- .006	+ .005/- .000	+ .000/- .003		
3.125	2.509	0.247	3.123	333	0401OE30803125-247A
3.250	2.634	0.247	3.248	334	0401OE30803250-247A
3.375	2.759	0.247	3.373	335	0401OE30803375-247A
3.500	2.884	0.247	3.498	336	0401OE30803500-247A
3.625	3.009	0.247	3.623	337	0401OE30803625-247A
3.750	3.134	0.247	3.748	338	0401OE30803750-247A
3.875	3.259	0.247	3.873	339	0401OE30803875-247A
4.000	3.384	0.247	3.998	340	0401OE30804000-247A
4.125	3.509	0.247	4.123	341	0401OE30804125-247A
4.250	3.634	0.247	4.248	342	0401OE30804250-247A
4.375	3.759	0.247	4.373	343	0401OE30804375-247A
4.500	3.884	0.247	4.498	344	0401OE30804500-247A

*If used with wear rings, refer to wear ring piston diameter, see Section 9.

7

Table 7-47. OE Gland Dimensions — Inch (Continued)

A Bore Diameter	B Groove Diameter	C Groove Width	D Piston Diameter*	O-ring Dash Number	Part Number
+0.003/-0.000	+0.000/-0.006	+0.005/-0.000	+0.000/-0.003		
4.625	4.009	0.247	4.623	345	0401OE30804625-247A
4.750	4.134	0.247	4.748	346	0401OE30804750-247A
4.875	4.259	0.247	4.873	347	0401OE30804875-247A
5.000	4.384	0.247	4.998	348	0401OE30805000-247A
5.125	4.509	0.247	5.123	349	0401OE30805125-247A
5.250	4.634	0.247	5.248	350	0401OE30805250-247A
5.375	4.759	0.247	5.373	351	0401OE30805375-247A
5.500	4.884	0.247	5.498	352	0401OE30805500-247A
5.625	5.009	0.247	5.623	353	0401OE30805625-247A
5.750	5.134	0.247	5.748	354	0401OE30805750-247A
5.875	5.259	0.247	5.873	355	0401OE30805875-247A
6.000	5.384	0.247	5.998	356	0401OE30806000-247A
6.125	5.509	0.247	6.123	357	0401OE30806125-247A
6.250	5.634	0.247	6.248	358	0401OE30806250-247A
6.375	5.759	0.247	6.373	359	0401OE30806375-247A
6.500	5.884	0.247	6.498	360	0401OE30806500-247A
6.750	6.134	0.247	6.748	361	0401OE30806750-247A
7.000	6.384	0.247	6.998	362	0401OE30807000-247A
7.250	6.634	0.247	7.248	363	0401OE30807250-247A
7.500	6.884	0.247	7.498	364	0401OE30807500-247A
7.750	7.134	0.247	7.748	365	0401OE30807750-247A
8.000	7.384	0.247	7.998	366	0401OE30808000-247A
8.250	7.634	0.247	8.248	367	0401OE30808250-247A
8.500	7.884	0.247	8.498	368	0401OE30808500-247A
9.000	8.384	0.247	8.998	370	0401OE30809000-247A
9.500	8.884	0.247	9.498	372	0401OE30809500-247A
10.000	9.384	0.247	9.998	374	0401OE30810000-247A
10.500	9.884	0.247	10.498	376	0401OE30810500-247A
11.000	10.384	0.247	10.998	377	0401OE30811000-247A
11.500	10.884	0.247	11.498	378	0401OE30811500-247A
12.000	11.384	0.247	11.998	379	0401OE30812000-247A
+0.004/-0.000	+0.000/-0.007	+0.005/-0.000	+0.000/-0.004		
5.375	4.545	0.320	5.373	425	0401OE41505375-320A
5.500	4.670	0.320	5.498	426	0401OE41505500-320A
5.625	4.795	0.320	5.623	427	0401OE41505625-320A
5.750	4.920	0.320	5.748	428	0401OE41505750-320A
5.875	5.045	0.320	5.873	429	0401OE41505875-320A
6.000	5.170	0.320	5.998	430	0401OE41506000-320A
6.125	5.295	0.320	6.123	431	0401OE41506125-320A
6.250	5.420	0.320	6.248	432	0401OE41506250-320A
6.375	5.545	0.320	6.373	433	0401OE41506375-320A
6.500	5.670	0.320	6.498	435	0401OE41506500-320A
6.750	5.920	0.320	6.748	436	0401OE41506750-320A
7.000	6.170	0.320	6.998	437	0401OE41507000-320A
7.250	6.420	0.320	7.248	438	0401OE41507250-320A
7.500	6.670	0.320	7.498	439	0401OE41507500-320A
7.750	6.920	0.320	7.748	440	0401OE41507750-320A
8.000	7.170	0.320	7.998	441	0401OE41508000-320A
8.250	7.420	0.320	8.248	442	0401OE41508250-320A

*If used with wear rings, refer to wear ring piston diameter, see Section 9.

Table 7-47. OE Gland Dimensions — Inch (Continued)

A Bore Diameter	B Groove Diameter	C Groove Width	D Piston Diameter*	O-ring Dash Number	Part Number
8.500	7.670	0.320	8.498	443	0401OE41508500-320A
9.000	8.170	0.320	8.998	445	0401OE41509000-320A
9.500	8.670	0.320	9.498	446	0401OE41509500-320A
10.000	9.170	0.320	9.998	447	0401OE41510000-320A
10.500	9.670	0.320	10.498	448	0401OE41510500-320A
11.000	10.170	0.320	10.998	449	0401OE41511000-320A
11.500	10.670	0.320	11.498	450	0401OE41511500-320A
12.000	11.170	0.320	11.998	451	0401OE41512000-320A
12.500	11.670	0.320	12.498	452	0401OE41512500-320A
13.000	12.170	0.320	12.998	453	0401OE41513000-320A
13.500	12.670	0.320	13.498	454	0401OE41513500-320A
14.000	13.170	0.320	13.998	455	0401OE41514000-320A
14.500	13.670	0.320	14.498	456	0401OE41514500-320A
15.000	14.170	0.320	14.998	457	0401OE41515000-320A
15.500	14.670	0.320	15.498	458	0401OE41515500-320A
16.000	15.170	0.320	15.998	459	0401OE41516000-320A

*If used with wear rings, refer to wear ring piston diameter, see Section 9.

NOTE: For sizes larger than those shown in the table, please contact your local Parker Seal representative.

Part Number Nomenclature — OE Profile

Table 7-48. OE Profile — Metric (mm)

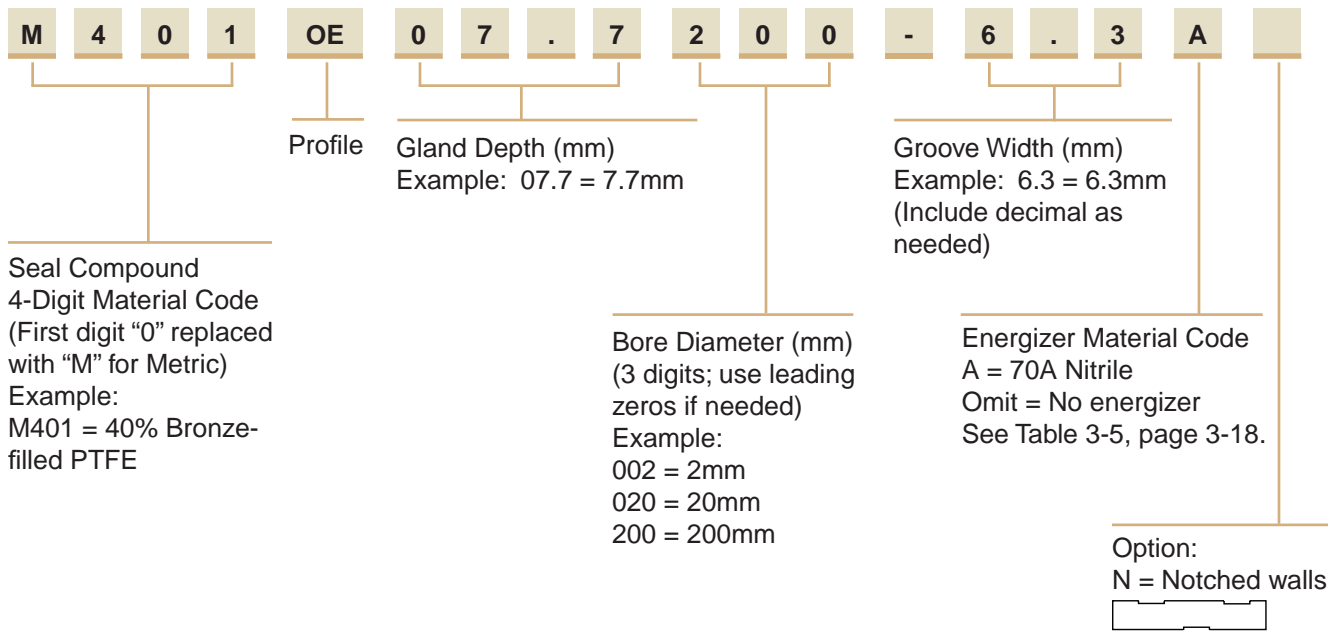

Gland Dimension — OE Profile

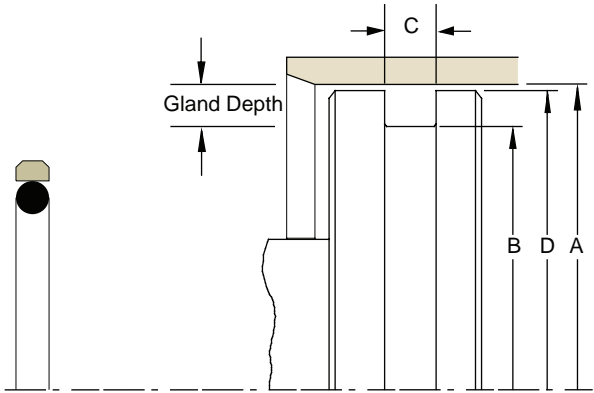

Please refer to Engineering Section 2, Page 2-8 for surface finish and additional hardware considerations.

Table 7-49. OE Gland Dimensions — Metric (mm)

A Bore Diameter H9	B Groove Diameter h9	C Groove Width +02/-00	D Piston Diameter* h8	O-ring Dash Number	Part Number
8.00	3.00	2.20	7.97	005	M401OE02.5008-2.2A
10.00	5.00	2.20	9.97	010	M401OE02.5010-2.2A
11.00	6.00	2.20	10.97	010	M401OE02.5011-2.2A
12.00	7.00	2.20	11.97	010	M401OE02.5012-2.2A
13.00	8.00	2.20	12.97	011	M401OE02.5013-2.2A
14.00	9.00	2.20	13.97	011	M401OE02.5014-2.2A
16.00	8.50	3.20	15.94	109	M401OE03.7016-3.2A
18.00	10.50	3.20	17.94	110	M401OE03.7018-3.2A
20.00	12.50	3.20	19.94	112	M401OE03.7020-3.2A
22.00	14.50	3.20	21.94	113	M401OE03.7022-3.2A
24.00	16.50	3.20	23.94	114	M401OE03.7024-3.2A
25.00	17.50	3.20	24.94	115	M401OE03.7025-3.2A
28.00	20.50	3.20	27.94	117	M401OE03.7028-3.2A
30.00	22.50	3.20	29.94	118	M401OE03.7030-3.2A
32.00	24.50	3.20	31.94	119	M401OE03.7032-3.2A
35.00	27.50	3.20	34.94	121	M401OE03.7035-3.2A
36.00	28.50	3.20	35.94	122	M401OE03.7036-3.2A
38.00	30.50	3.20	37.94	123	M401OE03.7038-3.2A
40.00	32.50	3.20	39.94	124	M401OE03.7040-3.2A
25.00	14.00	4.20	24.94	207	M401OE05.5025-4.2A
32.00	21.00	4.20	31.94	211	M401OE05.5032-4.2A
40.00	29.00	4.20	39.94	216	M401OE05.5040-4.2A
45.00	34.00	4.20	44.94	219	M401OE05.5045-4.2A
50.00	39.00	4.20	49.94	222	M401OE05.5050-4.2A
55.00	44.00	4.20	54.94	224	M401OE05.5055-4.2A
60.00	49.00	4.20	59.94	225	M401OE05.5060-4.2A
63.00	52.00	4.20	62.94	226	M401OE05.5063-4.2A
65.00	54.00	4.20	64.94	227	M401OE05.5065-4.2A
70.00	59.00	4.20	69.94	228	M401OE05.5070-4.2A
75.00	64.00	4.20	74.94	230	M401OE05.5075-4.2A
80.00	69.00	4.20	79.94	231	M401OE05.5080-4.2A
100.00	89.00	4.20	99.94	238	M401OE05.5100-4.2A
50.00	34.50	6.30	49.90	324	M401OE07.7050-6.3A
63.00	47.50	6.30	62.90	328	M401OE07.7063-6.3A
70.00	54.50	6.30	69.90	330	M401OE07.7070-6.3A
80.00	64.50	6.30	79.90	333	M401OE07.7080-6.3A
85.00	69.50	6.30	84.90	335	M401OE07.7085-6.3A
90.00	74.50	6.30	89.90	336	M401OE07.7090-6.3A
95.00	79.50	6.30	94.90	338	M401OE07.7095-6.3A
100.00	84.50	6.30	99.90	339	M401OE07.7100-6.3A

*If used with wear rings, refer to wear ring piston diameter, see Section 9.

Table 7-49. OE Gland Dimensions — Metric (Continued)

A Bore Diameter	B Groove Diameter	C Groove Width	D Piston Diameter*	O-ring Dash Number	Part Number
H9	h9	+0.02/-0.00	h8		
105.00	89.50	6.30	104.90	341	M401OE07.7105-6.3A
110.00	94.50	6.30	109.90	342	M401OE07.7110-6.3A
115.00	99.50	6.30	114.90	344	M401OE07.7115-6.3A
120.00	104.50	6.30	119.90	345	M401OE07.7120-6.3A
125.00	109.50	6.30	124.90	347	M401OE07.7125-6.3A
130.00	114.50	6.30	129.90	349	M401OE07.7130-6.3A
132.00	116.50	6.30	131.90	349	M401OE07.7132-6.3A
135.00	119.50	6.30	134.90	350	M401OE07.7135-6.3A
140.00	124.50	6.30	139.90	352	M401OE07.7140-6.3A
145.00	129.50	6.30	144.90	353	M401OE07.7145-6.3A
160.00	144.50	6.30	159.90	358	M401OE07.7160-6.3A
200.00	184.50	6.30	199.90	366	M401OE07.7200-6.3A
135.00	114.00	8.10	134.90	425	M401OE10.5135-8.1A
140.00	119.00	8.10	139.90	426	M401OE10.5140-8.1A
145.00	124.00	8.10	144.90	428	M401OE10.5145-8.1A
150.00	129.00	8.10	149.90	430	M401OE10.5150-8.1A
155.00	134.00	8.10	154.90	431	M401OE10.5155-8.1A
160.00	139.00	8.10	159.90	433	M401OE10.5160-8.1A
165.00	144.00	8.10	164.90	434	M401OE10.5165-8.1A
170.00	149.00	8.10	169.90	435	M401OE10.5170-8.1A
175.00	154.00	8.10	174.90	437	M401OE10.5175-8.1A
180.00	159.00	8.10	179.90	438	M401OE10.5180-8.1A
185.00	164.00	8.10	184.90	438	M401OE10.5185-8.1A
190.00	169.00	8.10	189.90	439	M401OE10.5190-8.1A
195.00	174.00	8.10	194.90	440	M401OE10.5195-8.1A
200.00	179.00	8.10	199.90	441	M401OE10.5200-8.1A
205.00	184.00	8.10	204.90	442	M401OE10.5205-8.1A
210.00	189.00	8.10	209.90	443	M401OE10.5210-8.1A
215.00	194.00	8.10	214.90	443	M401OE10.5215-8.1A
220.00	199.00	8.10	219.90	444	M401OE10.5220-8.1A
225.00	204.00	8.10	224.90	445	M401OE10.5225-8.1A
230.00	209.00	8.10	229.90	445	M401OE10.5230-8.1A
235.00	214.00	8.10	234.90	445	M401OE10.5235-8.1A
240.00	219.00	8.10	239.90	446	M401OE10.5240-8.1A
245.00	224.00	8.10	244.90	446	M401OE10.5245-8.1A
250.00	229.00	8.10	249.90	447	M401OE10.5250-8.1A

*If used with wear rings, refer to wear ring piston diameter, see Section 9.

NOTE: For sizes larger than those shown in the table, please contact your local Parker Seal representative.

Piston Seal CP Profile

Catalog EPS 5370/USA



CP Profile, PTFE Piston Cap Seal

The Parker CP profile is a cap seal with anti-extrusion, low friction and low wear features. The CP profile is a bi-directional piston seal for use in low to medium duty applications. The CP profile retrofits into a standard size O-ring groove without modification. There are three CP profiles to match the groove width for a single O-ring, O-ring with one back-up, or an O-ring with two back-up rings. Because of the unique design of the filled PTFE cap, the CP profile offers long wear, low friction and anti-extrusion. Because of its short assembly length, only minimal gland space is needed to fit the seal on the piston. Parker's CP profile will retrofit non-Parker seals of similar design.

- CP0 — a standard O-ring groove.
- CP1 — an O-ring groove designed for one back-up ring.
- CP2 — an O-ring groove designed for two back-up rings.

The CP profile may be ordered without the energizer by omitting the energizer code. See part number nomenclature.

Technical Data

Standard Materials*	Temperature Range	Pressure Range†	Surface Speed
Cap			
0401 40% bronze filled PTFE	-200°F to 575°F (-129°C to 302°C)	3,500 psi (240 bar)	< 13 ft/s (4 m/sec)
Energizer			
A 70A Nitrile	-30°F to 250°F (-34°C to 121°C)		

***Alternate Materials:** For applications that may require an alternate material, please see Section 3 for alternate PTFE (Table 3-4) and energizer (Table 3-5) materials.

†**Pressure Range** without wear rings (see Table 2-4, page 2-5).



CP Cross-Section

Options

Notched side walls: Adding an "N" to the end of the part number indicates that notches are to be added to the side walls of the PTFE cap. Notches can help optimize the seal's response to fluid pressure. In application, the void created by the notch allows fluid pressure to fill the cavity between the side face of the gland and the seal. Consult your local Parker Seal representative for the availability and cost to add side notches to the CP profile.

N = Notched walls 

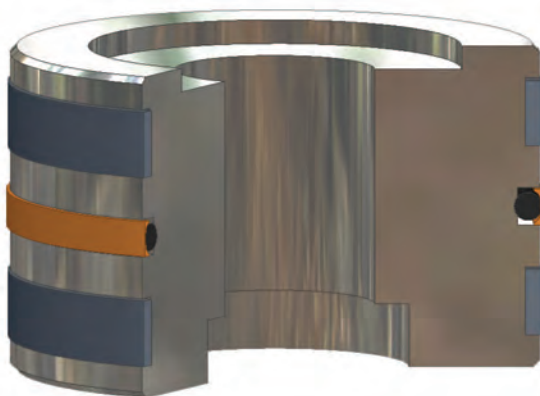

CP installed in Piston Gland

09/01/07

Part Number Nomenclature — CP Profile

Table 7-50. CP Profile — Inch

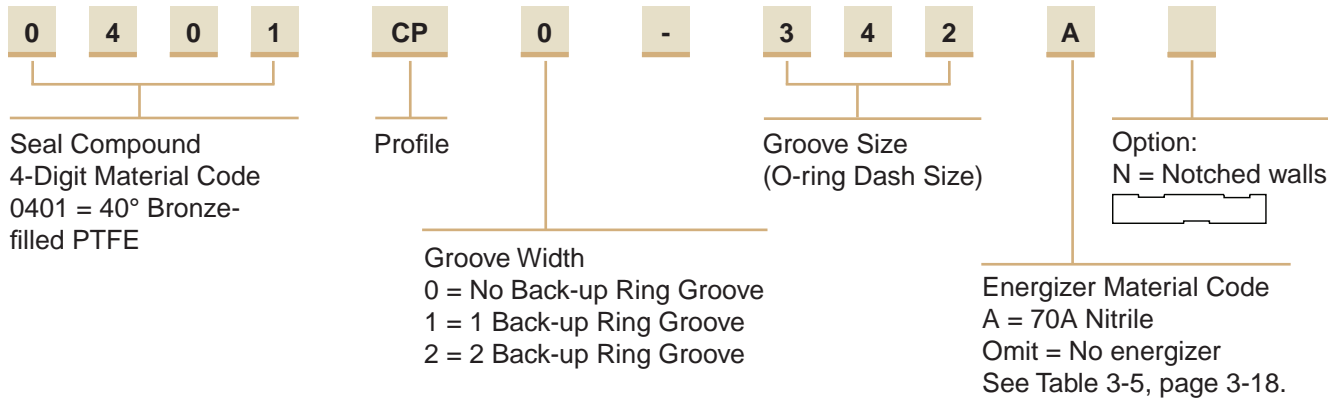

Gland Dimension — CP Profile

Please refer to Engineering Section 2, Page 2-8 for surface finish and additional hardware considerations.

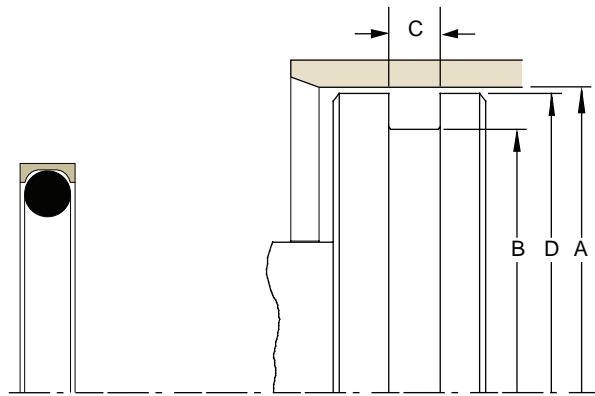

Table 7-51. CP Gland Dimensions — Inch

A Bore Diameter	B Groove Diameter	C Groove Width (CP0)	C Groove Width (CP1)	C Groove Width (CP2)	D Piston Diameter* 5000 psi (345 bar)	O-ring Dash Number	CP Part Number (X = Groove Width of 0, 1 or 2)
+0.002/-0.000	+0.000/-0.002	+0.005/-0.000	+0.005/-0.000	+0.005/-0.000	+0.000/-0.001		
0.250	0.140	0.093	0.138	0.205	0.249	006	0401CPX-006A
0.281	0.171	0.093	0.138	0.205	0.280	007	0401CPX-007A
0.312	0.202	0.093	0.138	0.205	0.311	008	0401CPX-008A
0.344	0.234	0.093	0.138	0.205	0.343	009	0401CPX-009A
0.375	0.265	0.093	0.138	0.205	0.374	010	0401CPX-010A
0.437	0.327	0.093	0.138	0.205	0.436	011	0401CPX-011A
0.500	0.390	0.093	0.138	0.205	0.499	012	0401CPX-012A
0.562	0.452	0.093	0.138	0.205	0.560	013	0401CPX-013A
0.625	0.515	0.093	0.138	0.205	0.623	014	0401CPX-014A
0.687	0.577	0.093	0.138	0.205	0.685	015	0401CPX-015A
0.750	0.640	0.093	0.138	0.205	0.748	016	0401CPX-016A
0.812	0.702	0.093	0.138	0.205	0.810	017	0401CPX-017A
0.875	0.765	0.093	0.138	0.205	0.873	018	0401CPX-018A
0.937	0.827	0.093	0.138	0.205	0.935	019	0401CPX-019A
1.000	0.890	0.093	0.138	0.205	0.998	020	0401CPX-020A
1.062	0.952	0.093	0.138	0.205	1.060	021	0401CPX-021A
1.125	1.015	0.093	0.138	0.205	1.123	022	0401CPX-022A
1.187	1.077	0.093	0.138	0.205	1.185	023	0401CPX-023A
1.250	1.140	0.093	0.138	0.205	1.248	024	0401CPX-024A

*If used with wear rings, refer to wear ring piston diameter, see Section 9.

CP Profile

Table 7-51. CP Gland Dimensions — Inch (Continued)

A Bore Diameter	B Groove Diameter	C Groove Width (CP0)	C Groove Width (CP1)	C Groove Width (CP2)	D Piston Diameter* 5000 psi (345 bar)	O-ring Dash Number	CP Part Number (X = Groove Width of 0, 1 or 2)
+0.002/-0.000	+0.000/-0.002	+0.005/-0.000	+0.005/-0.000	+0.005/-0.000	+0.00/-0.001		
1.312	1.202	0.093	0.138	0.205	1.310	025	0401CPX-025A
1.375	1.265	0.093	0.138	0.205	1.373	026	0401CPX-026A
1.437	1.327	0.093	0.138	0.205	1.435	027	0401CPX-027A
1.500	1.390	0.093	0.138	0.205	1.498	028	0401CPX-028A
+0.002/-0.000	+0.000/-0.002	+0.005/-0.000	+0.005/-0.000	+0.005/-0.000	+0.000/-0.002		
0.312	0.136	0.140	0.171	0.238	0.311	104	0401CPX-104A
0.343	0.167	0.140	0.171	0.238	0.342	105	0401CPX-105A
0.375	0.199	0.140	0.171	0.238	0.374	106	0401CPX-106A
0.406	0.230	0.140	0.171	0.238	0.405	107	0401CPX-107A
0.437	0.261	0.140	0.171	0.238	0.436	108	0401CPX-108A
0.500	0.324	0.140	0.171	0.238	0.499	109	0401CPX-109A
0.562	0.386	0.140	0.171	0.238	0.561	110	0401CPX-110A
0.625	0.449	0.140	0.171	0.238	0.624	111	0401CPX-111A
0.687	0.511	0.140	0.171	0.238	0.686	112	0401CPX-112A
0.750	0.574	0.140	0.171	0.238	0.749	113	0401CPX-113A
0.812	0.636	0.140	0.171	0.238	0.811	114	0401CPX-114A
0.875	0.699	0.140	0.171	0.238	0.874	115	0401CPX-115A
0.937	0.761	0.140	0.171	0.238	0.936	116	0401CPX-116A
1.000	0.824	0.140	0.171	0.238	0.999	117	0401CPX-117A
1.062	0.886	0.140	0.171	0.238	1.061	118	0401CPX-118A
1.125	0.949	0.140	0.171	0.238	1.124	119	0401CPX-119A
1.187	1.011	0.140	0.171	0.238	1.186	120	0401CPX-120A
1.250	1.074	0.140	0.171	0.238	1.249	121	0401CPX-121A
1.312	1.136	0.140	0.171	0.238	1.311	122	0401CPX-122A
1.375	1.199	0.140	0.171	0.238	1.374	123	0401CPX-123A
1.437	1.261	0.140	0.171	0.238	1.436	124	0401CPX-124A
1.500	1.324	0.140	0.171	0.238	1.499	125	0401CPX-125A
1.562	1.386	0.140	0.171	0.238	1.561	126	0401CPX-126A
1.625	1.449	0.140	0.171	0.238	1.624	127	0401CPX-127A
1.687	1.511	0.140	0.171	0.238	1.686	128	0401CPX-128A
1.750	1.574	0.140	0.171	0.238	1.749	129	0401CPX-129A
1.812	1.636	0.140	0.171	0.238	1.810	130	0401CPX-130A
1.875	1.699	0.140	0.171	0.238	1.873	131	0401CPX-131A
1.937	1.761	0.140	0.171	0.238	1.935	132	0401CPX-132A
2.000	1.824	0.140	0.171	0.238	1.998	133	0401CPX-133A
2.062	1.886	0.140	0.171	0.238	2.060	134	0401CPX-134A
2.125	1.949	0.140	0.171	0.238	2.123	135	0401CPX-135A
2.187	2.011	0.140	0.171	0.238	2.185	136	0401CPX-136A
2.250	2.074	0.140	0.171	0.238	2.248	137	0401CPX-137A
2.312	2.136	0.140	0.171	0.238	2.310	138	0401CPX-138A
2.375	2.199	0.140	0.171	0.238	2.373	139	0401CPX-139A
2.437	2.261	0.140	0.171	0.238	2.435	140	0401CPX-140A
+0.002/-0.000	+0.000/-0.002	+0.005/-0.000	+0.005/-0.000	.005/-0.000	+0.000/-0.003		
2.500	2.324	0.140	0.171	0.238	2.498	141	0401CPX-141A
2.562	2.386	0.140	0.171	0.238	2.560	142	0401CPX-142A
2.625	2.449	0.140	0.171	0.238	2.623	143	0401CPX-143A
2.687	2.511	0.140	0.171	0.238	2.685	144	0401CPX-144A
2.750	2.574	0.140	0.171	0.238	2.748	145	0401CPX-145A
2.812	2.636	0.140	0.171	0.238	2.810	146	0401CPX-146A

*If used with wear rings, refer to wear ring piston diameter, see Section 9.



Table 7-51. CP Gland Dimensions — Inch (Continued)

A Bore Diameter	B Groove Diameter	C Groove Width (CP0)	C Groove Width (CP1)	C Groove Width (CP2)	D Piston Diameter* 5000 psi (345 bar)	O-ring Dash Number	CP Part Number (X = Groove Width of 0, 1 or 2)
+0.002/-0.000	+0.000/-0.002	+0.005/-0.000	+0.005/-0.000	.005/-0.000	+0.000/-0.003		
2.875	2.699	0.140	0.171	0.238	2.873	147	0401CPX-147A
2.937	2.761	0.140	0.171	0.238	2.935	148	0401CPX-148A
3.000	2.824	0.140	0.171	0.238	2.998	149	0401CPX-149A
+0.002/-0.000	+0.000/-0.002	+0.005/-0.000	+0.005/-0.000	+0.005/-0.000	+0.000/-0.002		
0.437	0.195	0.187	0.208	0.275	0.436	201	0401CPX-201A
0.500	0.258	0.187	0.208	0.275	0.499	202	0401CPX-202A
0.562	0.320	0.187	0.208	0.275	0.561	203	0401CPX-203A
0.625	0.383	0.187	0.208	0.275	0.624	204	0401CPX-204A
0.687	0.445	0.187	0.208	0.275	0.686	205	0401CPX-205A
0.750	0.508	0.187	0.208	0.275	0.749	206	0401CPX-206A
0.812	0.570	0.187	0.208	0.275	0.811	207	0401CPX-207A
0.875	0.633	0.187	0.208	0.275	0.874	208	0401CPX-208A
0.937	0.695	0.187	0.208	0.275	0.936	209	0401CPX-209A
1.000	0.758	0.187	0.208	0.275	0.999	210	0401CPX-210A
1.062	0.820	0.187	0.208	0.275	1.061	211	0401CPX-211A
1.125	0.883	0.187	0.208	0.275	1.124	212	0401CPX-212A
1.187	0.945	0.187	0.208	0.275	1.186	213	0401CPX-213A
1.250	1.008	0.187	0.208	0.275	1.249	214	0401CPX-214A
1.312	1.070	0.187	0.208	0.275	1.311	215	0401CPX-215A
1.375	1.133	0.187	0.208	0.275	1.374	216	0401CPX-216A
1.437	1.195	0.187	0.208	0.275	1.436	217	0401CPX-217A
1.500	1.258	0.187	0.208	0.275	1.499	218	0401CPX-218A
1.562	1.320	0.187	0.208	0.275	1.561	219	0401CPX-219A
1.625	1.383	0.187	0.208	0.275	1.624	220	0401CPX-220A
1.687	1.445	0.187	0.208	0.275	1.686	221	0401CPX-221A
1.750	1.508	0.187	0.208	0.275	1.749	222	0401CPX-222A
1.875	1.633	0.187	0.208	0.275	1.873	223	0401CPX-223A
2.000	1.758	0.187	0.208	0.275	1.998	224	0401CPX-224A
2.125	1.883	0.187	0.208	0.275	2.123	225	0401CPX-225A
2.250	2.008	0.187	0.208	0.275	2.248	226	0401CPX-226A
2.375	2.133	0.187	0.208	0.275	2.373	227	0401CPX-227A
+0.002/-0.000	+0.000/-0.002	+0.005/-0.000	+0.005/-0.000	+0.0005/-0.000	+0.000/-0.003		
2.500	2.258	0.187	0.208	0.275	2.498	228	0401CPX-228A
2.625	2.383	0.187	0.208	0.275	2.623	229	0401CPX-229A
2.750	2.508	0.187	0.208	0.275	2.748	230	0401CPX-230A
2.875	2.633	0.187	0.208	0.275	2.873	231	0401CPX-231A
3.000	2.758	0.187	0.208	0.275	2.998	232	0401CPX-232A
3.125	2.883	0.187	0.208	0.275	3.123	233	0401CPX-233A
3.250	3.008	0.187	0.208	0.275	3.248	234	0401CPX-234A
3.375	3.133	0.187	0.208	0.275	3.373	235	0401CPX-235A
3.500	3.258	0.187	0.208	0.275	3.498	236	0401CPX-236A
3.625	3.383	0.187	0.208	0.275	3.623	237	0401CPX-237A
3.750	3.508	0.187	0.208	0.275	3.748	238	0401CPX-238A
3.875	3.633	0.187	0.208	0.275	3.873	239	0401CPX-239A
4.000	3.758	0.187	0.208	0.275	3.998	240	0401CPX-240A
4.125	3.883	0.187	0.208	0.275	4.123	241	0401CPX-241A
4.250	4.008	0.187	0.208	0.275	4.248	242	0401CPX-242A
4.375	4.133	0.187	0.208	0.275	4.373	243	0401CPX-243A
4.500	4.258	0.187	0.208	0.275	4.497	244	0401CPX-244A

*If used with wear rings, refer to wear ring piston diameter, see Section 9.

Table 7-51. CP Gland Dimensions — Inch (Continued)

A Bore Diameter	B Groove Diameter	C Groove Width (CP0)	C Groove Width (CP1)	C Groove Width (CP2)	D Piston Diameter* 5000 psi (345 bar)	O-ring Dash Number	CP Part Number (X = Groove Width of 0, 1 or 2)
+0.002/-0.000	+0.000/-0.002	+0.005/-0.000	+0.005/-0.000	+0.0005/-0.000	+0.000/-0.003		
4.625	4.383	0.187	0.208	0.275	4.622	245	0401CPX-245A
4.750	4.508	0.187	0.208	0.275	4.747	246	0401CPX-246A
4.875	4.633	0.187	0.208	0.275	4.872	247	0401CPX-247A
5.000	4.758	0.187	0.208	0.275	4.997	248	0401CPX-248A
+0.002/-0.000	+0.000/-0.002	+0.005/-0.000	+0.005/-0.000	+0.005/-0.000	+0.000/-0.002		
0.812	0.442	0.281	0.311	0.410	0.810	309	0401CPX-309A
0.875	0.505	0.281	0.311	0.410	0.873	310	0401CPX-310A
0.937	0.567	0.281	0.311	0.410	0.935	311	0401CPX-311A
1.000	0.630	0.281	0.311	0.410	0.998	312	0401CPX-312A
1.062	0.692	0.281	0.311	0.410	1.060	313	0401CPX-313A
1.125	0.755	0.281	0.311	0.410	1.123	314	0401CPX-314A
1.187	0.817	0.281	0.311	0.410	1.185	315	0401CPX-315A
1.250	0.880	0.281	0.311	0.410	1.248	316	0401CPX-316A
1.312	0.942	0.281	0.311	0.410	1.310	317	0401CPX-317A
1.375	1.005	0.281	0.311	0.410	1.373	318	0401CPX-318A
1.437	1.067	0.281	0.311	0.410	1.435	319	0401CPX-319A
1.500	1.130	0.281	0.311	0.410	1.498	320	0401CPX-320A
1.562	1.192	0.281	0.311	0.410	1.560	321	0401CPX-321A
1.625	1.255	0.281	0.311	0.410	1.623	322	0401CPX-322A
1.687	1.317	0.281	0.311	0.410	1.685	323	0401CPX-323A
1.750	1.380	0.281	0.311	0.410	1.748	324	0401CPX-324A
1.875	1.505	0.281	0.311	0.410	1.873	325	0401CPX-325A
2.000	1.630	0.281	0.311	0.410	1.998	326	0401CPX-326A
2.125	1.755	0.281	0.311	0.410	2.123	327	0401CPX-327A
2.250	1.880	0.281	0.311	0.410	2.248	328	0401CPX-328A
2.375	2.005	0.281	0.311	0.410	2.373	329	0401CPX-329A
+0.002/-0.000	+0.000/-0.002	+0.005/-0.000	+0.005/-0.000	+0.005/-0.000	+0.000/-0.003		
2.500	2.130	0.281	0.311	0.410	2.498	330	0401CPX-330A
2.625	2.255	0.281	0.311	0.410	2.623	331	0401CPX-331A
2.750	2.380	0.281	0.311	0.410	2.748	332	0401CPX-332A
2.875	2.505	0.281	0.311	0.410	2.873	333	0401CPX-333A
3.000	2.630	0.281	0.311	0.410	2.998	334	0401CPX-334A
3.125	2.755	0.281	0.311	0.410	3.123	335	0401CPX-335A
3.250	2.880	0.281	0.311	0.410	3.248	336	0401CPX-336A
3.375	3.005	0.281	0.311	0.410	3.373	337	0401CPX-337A
3.500	3.130	0.281	0.311	0.410	3.498	338	0401CPX-338A
3.625	3.255	0.281	0.311	0.410	3.623	339	0401CPX-339A
3.750	3.380	0.281	0.311	0.410	3.748	340	0401CPX-340A
3.875	3.505	0.281	0.311	0.410	3.873	341	0401CPX-341A
4.000	3.630	0.281	0.311	0.410	3.998	342	0401CPX-342A
4.125	3.755	0.281	0.311	0.410	4.123	343	0401CPX-343A
4.250	3.880	0.281	0.311	0.410	4.247	344	0401CPX-344A
4.375	4.005	0.281	0.311	0.410	4.372	345	0401CPX-345A
+0.002/-0.000	+0.000/-0.002	+0.005/-0.000	+0.005/-0.000	+0.005/-0.000	+0.000/-0.003		
4.500	4.130	0.281	0.311	0.410	4.497	346	0401CPX-346A
4.625	4.255	0.281	0.311	0.410	4.622	347	0401CPX-347A
4.750	4.380	0.281	0.311	0.410	4.747	348	0401CPX-348A
4.875	4.505	0.281	0.311	0.410	4.872	349	0401CPX-349A
5.000	4.630	0.281	0.311	0.410	4.997	350	0401CPX-350A

*If used with wear rings, refer to wear ring piston diameter, see Section 9.

Table 7-51. CP Gland Dimensions — Inch (Continued)

A Bore Diameter	B Groove Diameter	C Groove Width (CP0)	C Groove Width (CP1)	C Groove Width (CP2)	D Piston Diameter* 5000 psi (345 bar)	O-ring Dash Number	CP Part Number (X = Groove Width of 0, 1 or 2)
+ .002/- .000	+ .000/- .002	+ .005/- .000	+ .005/- .000	+ .005/- .000	+ .000/- .004		
5.000	4.526	0.375	0.408	0.538	4.997	425	0401CPX-425A
5.125	4.651	0.375	0.408	0.538	5.122	426	0401CPX-426A
5.250	4.776	0.375	0.408	0.538	5.247	427	0401CPX-427A
5.375	4.901	0.375	0.408	0.538	5.372	428	0401CPX-428A
5.500	5.026	0.375	0.408	0.538	5.497	429	0401CPX-429A
5.625	5.151	0.375	0.408	0.538	5.622	430	0401CPX-430A
5.750	5.276	0.375	0.408	0.538	5.747	431	0401CPX-431A
5.875	5.401	0.375	0.408	0.538	5.872	432	0401CPX-432A
6.000	5.526	0.375	0.408	0.538	5.997	433	0401CPX-433A
6.125	5.651	0.375	0.408	0.538	6.122	434	0401CPX-434A
6.250	5.776	0.375	0.408	0.538	6.247	435	0401CPX-435A
6.375	5.901	0.375	0.408	0.538	6.372	436	0401CPX-436A
6.500	6.026	0.375	0.408	0.538	6.497	437	0401CPX-437A
6.750	6.276	0.375	0.408	0.538	6.747	438	0401CPX-438A
7.000	6.526	0.375	0.408	0.538	6.997	439	0401CPX-439A
7.250	6.776	0.375	0.408	0.538	7.247	440	0401CPX-440A
7.500	7.026	0.375	0.408	0.538	7.497	441	0401CPX-441A
7.750	7.276	0.375	0.408	0.538	7.747	442	0401CPX-442A
8.000	7.526	0.375	0.408	0.538	7.997	443	0401CPX-443A
8.250	7.776	0.375	0.408	0.538	8.247	444	0401CPX-444A
8.500	8.026	0.375	0.408	0.538	8.497	445	0401CPX-445A
9.000	8.526	0.375	0.408	0.538	8.996	446	0401CPX-446A
9.500	9.026	0.375	0.408	0.538	9.496	447	0401CPX-447A
10.000	9.526	0.375	0.408	0.538	9.996	448	0401CPX-448A
10.500	10.026	0.375	0.408	0.538	10.496	449	0401CPX-449A
11.000	10.526	0.375	0.408	0.538	10.996	450	0401CPX-450A
11.500	11.026	0.375	0.408	0.538	11.496	451	0401CPX-451A
12.000	11.526	0.375	0.408	0.538	11.996	452	0401CPX-452A
12.500	12.026	0.375	0.408	0.538	12.496	453	0401CPX-453A
13.000	12.526	0.375	0.408	0.538	12.996	454	0401CPX-454A
13.500	13.026	0.375	0.408	0.538	13.496	455	0401CPX-455A
14.000	13.526	0.375	0.408	0.538	13.996	456	0401CPX-456A
14.500	14.026	0.375	0.408	0.538	14.496	457	0401CPX-457A
15.000	14.526	0.375	0.408	0.538	14.996	458	0401CPX-458A
15.500	15.026	0.375	0.408	0.538	15.496	459	0401CPX-459A
16.000	15.526	0.375	0.408	0.538	15.996	460	0401CPX-460A

*If used with wear rings, refer to wear ring piston diameter, see Section 9.

NOTE: For sizes larger than those shown in the table, please contact your local Parker Seal representative.

7

Piston Seal OA Profile

Catalog EPS 5370/USA



OA Profile, Compact PTFE Piston Cap Seal

The Parker OA profile is a bi-directional piston seal for use in pneumatic and low to medium duty hydraulic applications. The OA profile is a two piece design utilizing a rectangular PTFE cap and standard size O-ring. The OA profile is an excellent choice for applications requiring a compact design. The unique properties of the modified PTFE provide added wear resistance for improved cycle life. Parker's OA profile will retrofit non-Parker seals of similar design.

The OA profile may be ordered without the energizer by omitting the energizer code. See part number nomenclature.

Technical Data

Standard Materials*	Temperature Range	Pressure Range†	Surface Speed
Cap			
0102 Modified PTFE	-320°F to 450°F (-195°C to 282°C)	1,500 psi (103 bar)	< 13 ft/s (4 m/sec)
Energizer			
A 70A Nitrile	-30°F to 250°F (-34°C to 121°C)		

***Alternate Materials:** For applications that may require an alternate material, please see Section 3 for alternate PTFE and energizer materials.

†**Pressure Range** without wear rings (see Table 2-4, page 2-5).

Options

Notched side walls: Notches can be added to the side walls of the PTFE cap. This can help to optimize the seal's response to fluid pressure. Notched side walls help ensure that fluid pressure fills the cavity between the side face of the seal and the side face of the seal gland. Consult your local Parker Seal representative for the availability and cost to add side notches to the OA profile.

N = Notched walls 

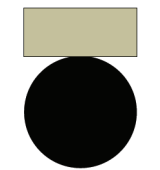

OA Cross-Section

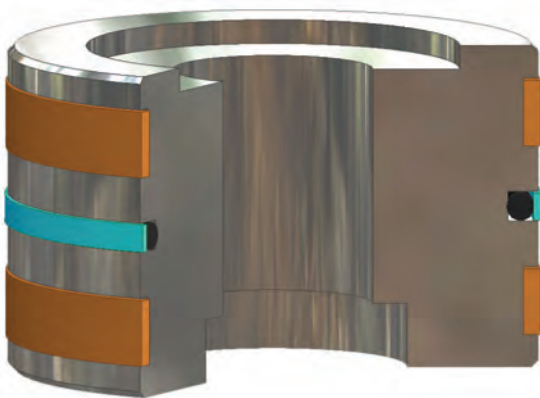

OA Installed in Piston Gland

09/01/07

Part Number Nomenclature —OA Profile

Table 7-52. OA Profile — Inch

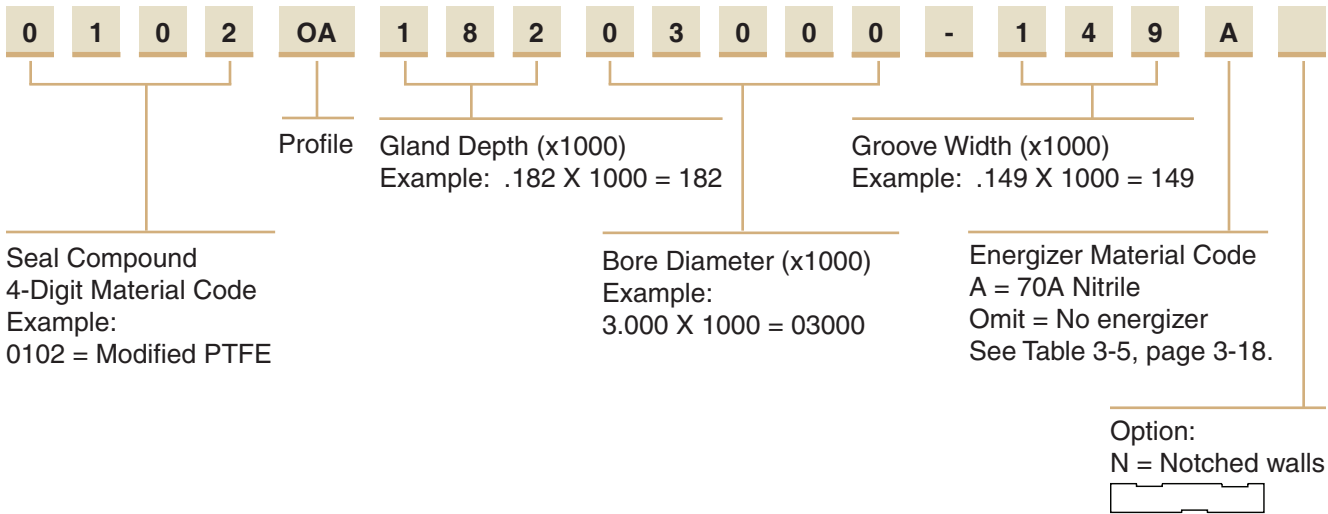

Gland Dimensions — OA Profile

Please refer to Engineering Section 2, Page 2-8 for surface finish and additional hardware considerations.

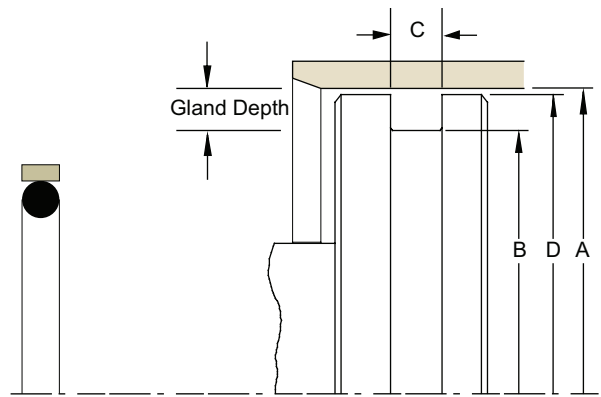

Table 7-53. OA Profile — Inch

A Bore Diameter	B Groove Diameter	C Groove Width	D Piston Diameter*	Max Radius	O-ring Dash Number	Part Number
+ .001/- .000	+ .000/- .001	+ .005/- .000	+ .000/- .001			
0.281	0.139	0.079	0.277	0.020	006	0102OA07200281-079A
0.312	0.169	0.079	0.308	0.020	007	0102OA07200312-079A
0.344	0.200	0.079	0.340	0.020	008	0102OA07200344-079A
0.375	0.231	0.079	0.371	0.020	009	0102OA07200375-079A
0.437	0.263	0.079	0.433	0.020	010	0102OA08700437-079A
0.500	0.326	0.079	0.496	0.020	011	0102OA08700500-079A
+ .002/- .000	+ .000/- .002	+ .005/- .000	+ .000/- .001			
0.562	0.388	0.079	0.557	0.020	012	0102OA08700562-079A
0.625	0.452	0.079	0.620	0.020	013	0102OA08700625-079A
0.687	0.515	0.079	0.682	0.020	014	0102OA08700687-079A
0.750	0.577	0.079	0.745	0.020	015	0102OA08700750-079A
0.812	0.640	0.079	0.807	0.020	016	0102OA08700812-079A
0.875	0.702	0.079	0.870	0.020	017	0102OA08700875-079A
0.937	0.765	0.079	0.932	0.020	018	0102OA08700937-079A
1.000	0.827	0.079	0.995	0.020	019	0102OA08701000-079A

*If used with wear rings, refer to wear ring piston diameter, see Section 9.

Table 7-53. OA Gland Dimensions — Inch (Continued)

A Bore Diameter	B Groove Diameter	C Groove Width	D Piston Diameter*	Max Radius	O-ring Dash Number	Part Number
+0.002/-0.000	+0.000/-0.002	+0.005/-0.000	+0.000/-0.001			
1.062	0.890	0.079	1.057	0.020	020	0102OA08701062-079A
1.125	0.952	0.079	1.120	0.020	021	0102OA08701125-079A
1.187	1.015	0.079	1.182	0.020	022	0102OA08701187-079A
1.250	1.078	0.079	1.245	0.020	023	0102OA08701250-079A
1.312	1.140	0.079	1.307	0.020	024	0102OA08701312-079A
1.375	1.202	0.079	1.370	0.020	025	0102OA08701375-079A
1.437	1.265	0.079	1.432	0.020	026	0102OA08701437-079A
1.500	1.327	0.079	1.495	0.020	027	0102OA08701500-079A
+0.003/-0.000	+0.000/-0.003	+0.005/-0.000	+0.000/-0.002			
0.625	0.388	0.112	0.620	0.020	110	0102OA11800625-112A
0.687	0.451	0.112	0.682	0.020	111	0102OA11800687-112A
0.750	0.513	0.112	0.745	0.020	112	0102OA11800750-112A
0.812	0.576	0.112	0.807	0.020	113	0102OA11800812-112A
0.875	0.638	0.112	0.870	0.020	114	0102OA11800875-112A
0.937	0.701	0.112	0.932	0.020	115	0102OA11800937-112A
1.000	0.763	0.112	0.995	0.020	116	0102OA11801000-112A
1.062	0.826	0.112	1.057	0.020	117	0102OA11801062-112A
1.125	0.888	0.112	1.120	0.020	118	0102OA11801125-112A
1.187	0.951	0.112	1.182	0.020	119	0102OA11801187-112A
1.250	1.013	0.112	1.245	0.020	120	0102OA11801250-112A
1.312	1.076	0.112	1.307	0.020	121	0102OA11801312-112A
1.375	1.138	0.112	1.370	0.020	122	0102OA11801375-112A
1.437	1.201	0.112	1.432	0.020	123	0102OA11801437-112A
1.500	1.263	0.112	1.495	0.020	124	0102OA11801500-112A
1.562	1.326	0.112	1.557	0.020	125	0102OA11801562-112A
1.625	1.388	0.112	1.620	0.020	126	0102OA11801625-112A
1.687	1.451	0.112	1.682	0.020	127	0102OA11801687-112A
1.750	1.513	0.112	1.745	0.020	128	0102OA11801750-112A
1.812	1.576	0.112	1.807	0.020	129	0102OA11801812-112A
1.875	1.638	0.112	1.870	0.020	130	0102OA11801875-112A
1.937	1.701	0.112	1.932	0.020	131	0102OA11801937-112A
2.000	1.763	0.112	1.995	0.020	132	0102OA11802000-112A
2.062	1.826	0.112	2.057	0.020	133	0102OA11802062-112A
2.125	1.888	0.112	2.120	0.020	134	0102OA11802125-112A
2.187	1.951	0.112	2.182	0.020	135	0102OA11802187-112A
2.250	2.013	0.112	2.245	0.020	136	0102OA11802250-112A
2.312	2.076	0.112	2.307	0.020	137	0102OA11802312-112A
2.375	2.138	0.112	2.370	0.020	138	0102OA11802375-112A
2.437	2.201	0.112	2.432	0.020	139	0102OA11802437-112A
2.500	2.263	0.112	2.495	0.020	140	0102OA11802500-112A
2.562	2.326	0.112	2.557	0.020	141	0102OA11802562-112A
2.625	2.388	0.112	2.620	0.020	142	0102OA11802625-112A
2.687	2.451	0.112	2.682	0.020	143	0102OA11802687-112A
2.750	2.513	0.112	2.745	0.020	144	0102OA11802750-112A
2.812	2.576	0.112	2.807	0.020	145	0102OA11802812-112A
2.875	2.638	0.112	2.870	0.020	146	0102OA11802875-112A
2.937	2.701	0.112	2.932	0.020	147	0102OA11802937-112A
3.000	2.763	0.112	2.995	0.020	148	0102OA11803000-112A

*If used with wear rings, refer to wear ring piston diameter, see Section 9.

Table 7-53. OA Gland Dimensions — Inch (Continued)

A Bore Diameter	B Groove Diameter	C Groove Width	D Piston Diameter*	Max Radius	O-ring Dash Number	Part Number
+ .004/- .000	+ .000/- .004	+ .005/- .000	+ .000/- .002			
1.062	0.762	0.149	1.056	0.030	210	0102OA15001062-149A
1.125	0.824	0.149	1.119	0.030	211	0102OA15001125-149A
1.187	0.887	0.149	1.181	0.030	212	0102OA15001187-149A
1.250	0.950	0.149	1.244	0.030	213	0102OA15001250-149A
1.312	1.012	0.149	1.306	0.030	214	0102OA15001312-149A
1.375	1.074	0.149	1.369	0.030	215	0102OA15001375-149A
1.437	1.137	0.149	1.431	0.030	216	0102OA15001437-149A
1.500	1.199	0.149	1.494	0.030	217	0102OA15001500-149A
1.562	1.262	0.149	1.556	0.030	218	0102OA15001562-149A
1.625	1.324	0.149	1.619	0.030	219	0102OA15001625-149A
1.687	1.387	0.149	1.681	0.030	220	0102OA15001687-149A
1.750	1.450	0.149	1.744	0.030	221	0102OA15001750-149A
1.875	1.512	0.149	1.869	0.030	222	0102OA18201875-149A
2.000	1.637	0.149	1.994	0.030	223	0102OA18202000-149A
2.125	1.762	0.149	2.119	0.030	224	0102OA18202125-149A
2.250	1.887	0.149	2.244	0.030	225	0102OA18202250-149A
2.375	2.012	0.149	2.369	0.030	226	0102OA18202375-149A
2.500	2.137	0.149	2.494	0.030	227	0102OA18202500-149A
2.625	2.262	0.149	2.619	0.030	228	0102OA18202625-149A
2.750	2.387	0.149	2.744	0.030	229	0102OA18202750-149A
2.875	2.512	0.149	2.869	0.030	230	0102OA18202875-149A
3.000	2.637	0.149	2.994	0.030	231	0102OA18203000-149A
3.125	2.762	0.149	3.119	0.030	232	0102OA18203125-149A
3.250	2.887	0.149	3.244	0.030	233	0102OA18203250-149A
3.375	3.012	0.149	3.369	0.030	234	0102OA18203375-149A
3.500	3.137	0.149	3.494	0.030	235	0102OA18203500-149A
3.625	3.262	0.149	3.619	0.030	236	0102OA18203625-149A
3.750	3.387	0.149	3.744	0.030	237	0102OA18203750-149A
3.875	3.512	0.149	3.869	0.030	238	0102OA18203875-149A
4.000	3.637	0.149	3.994	0.030	239	0102OA18204000-149A
4.125	3.762	0.149	4.119	0.030	240	0102OA18204125-149A
4.250	3.887	0.149	4.244	0.030	241	0102OA18204250-149A
4.375	4.012	0.149	4.369	0.030	242	0102OA18204375-149A
4.500	4.137	0.149	4.494	0.030	243	0102OA18204500-149A
4.625	4.262	0.149	4.619	0.030	244	0102OA18204625-149A
4.750	4.387	0.149	4.744	0.030	245	0102OA18204750-149A
4.875	4.512	0.149	4.869	0.030	246	0102OA18204875-149A
5.000	4.637	0.149	4.994	0.030	247	0102OA18205000-149A
+ .005/- .000	+ .000/- .005	+ .005/- .000	+ .000/- .002			
2.000	1.509	0.221	1.993	0.050	325	0102OA24602000-221A
2.125	1.634	0.221	2.118	0.050	326	0102OA24602125-221A
2.250	1.759	0.221	2.243	0.050	327	0102OA24602250-221A
2.375	1.884	0.221	2.368	0.050	328	0102OA24602375-221A
2.500	2.009	0.221	2.493	0.050	329	0102OA24602500-221A
2.625	2.134	0.221	2.618	0.050	330	0102OA24602625-221A
2.750	2.259	0.221	2.743	0.050	331	0102OA24602750-221A
2.875	2.384	0.221	2.868	0.050	332	0102OA24602875-221A
3.000	2.509	0.221	2.993	0.050	333	0102OA24603000-221A

*If used with wear rings, refer to wear ring piston diameter, see Section 9.

Table 7-53. OA Gland Dimensions — Inch (Continued)

A Bore Diameter	B Groove Diameter	C Groove Width	D Piston Diameter*	Max Radius	O-ring Dash Number	Part Number
+0.005/-0.000	+0.000/-0.005	+0.005/-0.000	+0.000/-0.002			
3.125	2.634	0.221	3.118	0.050	334	0102OA24603125-221A
3.250	2.759	0.221	3.243	0.050	335	0102OA24603250-221A
3.375	2.884	0.221	3.368	0.050	336	0102OA24603375-221A
3.500	3.009	0.221	3.493	0.050	337	0102OA24603500-221A
3.625	3.134	0.221	3.618	0.050	338	0102OA24603625-221A
3.750	3.259	0.221	3.743	0.050	339	0102OA24603750-221A
3.875	3.384	0.221	3.868	0.050	340	0102OA24603875-221A
4.000	3.509	0.221	3.993	0.050	341	0102OA24604000-221A
4.125	3.634	0.221	4.118	0.050	342	0102OA24604125-221A
4.250	3.759	0.221	4.243	0.050	343	0102OA24604250-221A
4.375	3.884	0.221	4.368	0.050	344	0102OA24604375-221A
4.500	4.009	0.221	4.493	0.050	345	0102OA24604500-221A
4.625	4.134	0.221	4.618	0.050	346	0102OA24604625-221A
4.750	4.259	0.221	4.743	0.050	347	0102OA24604750-221A
4.875	4.384	0.221	4.868	0.050	348	0102OA24604875-221A
5.000	4.509	0.221	4.993	0.050	349	0102OA24605000-221A
+0.006/-0.000	+0.000/-0.006	+0.005/-0.000	+0.000/-0.002			
5.125	4.532	0.297	5.117	0.060	425	0102OA29705125-297A
5.250	4.657	0.297	5.242	0.060	426	0102OA29705250-297A
5.375	4.782	0.297	5.367	0.060	427	0102OA29705375-297A
5.500	4.907	0.297	5.492	0.060	428	0102OA29705500-297A
5.625	5.032	0.297	5.617	0.060	429	0102OA29705625-297A
5.750	5.157	0.297	5.742	0.060	430	0102OA29705750-297A
5.875	5.282	0.297	5.867	0.060	431	0102OA29705875-297A
6.000	5.407	0.297	5.992	0.060	432	0102OA29706000-297A
6.125	5.532	0.297	6.117	0.060	433	0102OA29706125-297A
6.250	5.657	0.297	6.242	0.060	434	0102OA29706250-297A
6.375	5.782	0.297	6.367	0.060	435	0102OA29706375-297A
6.500	5.907	0.297	6.492	0.060	436	0102OA29706500-297A
6.750	6.032	0.297	6.742	0.060	437	0102OA35906750-297A
7.000	6.282	0.297	6.992	0.060	438	0102OA35907000-297A
7.250	6.532	0.297	7.242	0.060	439	0102OA35907250-297A
7.500	6.782	0.297	7.492	0.060	440	0102OA35907500-297A
7.750	7.032	0.297	7.742	0.060	441	0102OA35907750-297A
8.000	7.282	0.297	7.992	0.060	442	0102OA35908000-297A
8.250	7.532	0.297	8.242	0.060	443	0102OA35908250-297A
8.500	7.782	0.297	8.492	0.060	444	0102OA35908500-297A
9.000	8.032	0.297	8.992	0.060	445	0102OA48409000-297A
9.500	8.532	0.297	9.492	0.060	446	0102OA48409500-297A
10.000	9.032	0.297	9.992	0.060	447	0102OA48410000-297A
+0.003/-0.000	+0.000/-0.003	+0.005/-0.000	+0.000/-0.002			
10.500	9.532	0.297	10.492	0.060	448	0102OA48410500-297A
11.000	10.032	0.297	10.992	0.060	449	0102OA48411000-297A
11.500	10.532	0.297	11.492	0.060	450	0102OA48411500-297A
12.000	11.032	0.297	11.992	0.060	451	0102OA48412000-297A
12.500	11.532	0.297	12.492	0.060	452	0102OA48412500-297A
13.000	12.032	0.297	12.992	0.060	453	0102OA48413000-297A
13.500	12.532	0.297	13.492	0.060	454	0102OA48413500-297A
14.000	13.032	0.297	13.992	0.060	455	0102OA48414000-297A

*If used with wear rings, refer to wear ring piston diameter, see Section 9.

Table 7-53. OA Gland Dimensions — Inch (Continued)

A Bore Diameter	B Groove Diameter	C Groove Width	D Piston Diameter*	Max Radius	O-ring Dash Number	Part Number
+ .003/- .000	+ .000/- .003	+ .005/- .000	+ .000/- .002			
14.500	13.532	0.297	14.492	0.060	456	0102OA48414500-297A
15.000	14.032	0.297	14.992	0.060	457	0102OA48415000-297A
15.500	14.532	0.297	15.492	0.060	458	0102OA48415500-297A
16.000	15.032	0.297	15.992	0.060	459	0102OA48416000-297A

*If used with wear rings, refer to wear ring piston diameter, see Section 9.

NOTE: For sizes larger than those shown in the table, please contact your local Parker Seal representative.

Piston Seal

OQ Profile

Catalog EPS 5370/USA



OQ Profile, Rotary PTFE Cap Seal

The Parker OQ profile is a bi-directional piston seal for use in low to medium duty rotary or oscillating applications. The OQ profile is a two piece design comprised of a standard size O-ring energizing a wear resistant PTFE cap. The OQ profile offers long wear and low friction, without stickslip. The PTFE inner diameter is designed with a special interference with the O-ring to eliminate spinning between the O-ring and seal. Special grooves are designed into the PTFE outer diameter to provide lubrication and create a labyrinth effect for reduced leakage. Parker's OQ profile will retrofit non-Parker seals of similar design.

The OQ profile may be ordered without the energizer by omitting the energizer code. See part number nomenclature.

Technical Data

Standard Materials*	Temperature Range	Pressure Range†	Surface Speed
Cap 0205 15% fiberglass-, 5% molybdenum disulfide-filled PTFE	-200°F to 575°F (-129°C to 302°C)	3000 psi (206 bar)	< 3.3 ft/s (1.0 m/sec)
Energizer A 70A Nitrile	-30°F to 250°F (-34°C to 121°C)		

***Alternate Materials:** For applications that may require an alternate material, please see Section 3 for alternate PTFE (Table 3-4) and energizer (Table 3-5) materials.

†**Pressure Range** without wear rings (see Table 2-4, page 2-5).

Options

Metric: For metric part numbering and availability, see Tables 7-56 and 7-57 on pages 7-77 through 7-79.



OQ Cross-Section

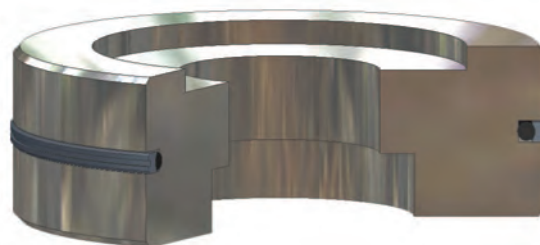

OQ installed in Rotary Gland

09/01/07

Part Number Nomenclature — OQ Profile

Table 7-54. OQ Profile — Inch

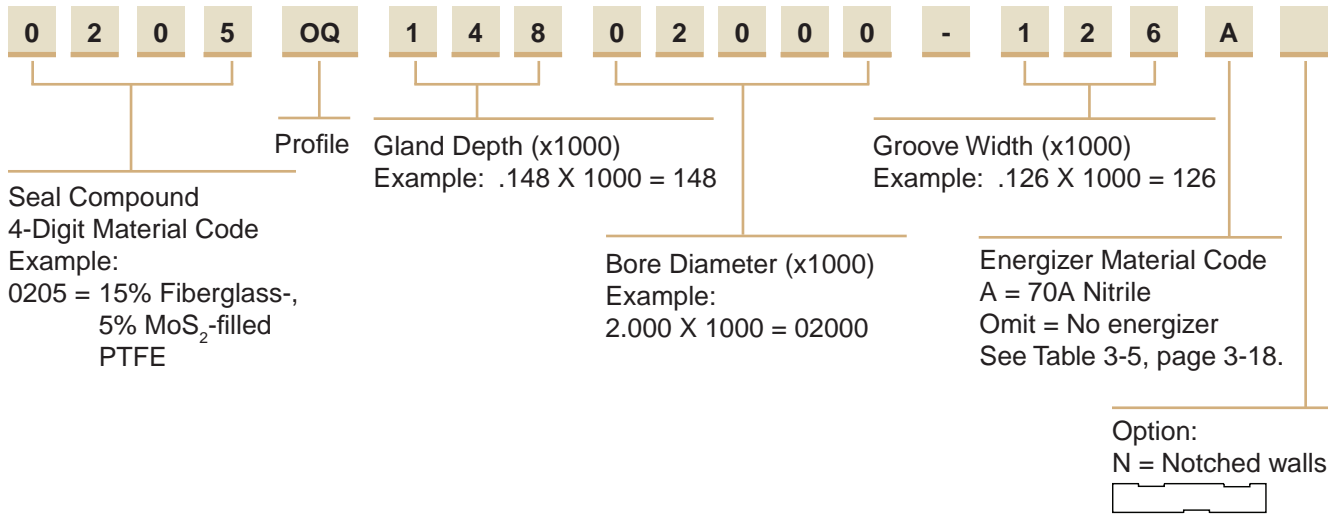

Gland Dimensions — OQ Profile

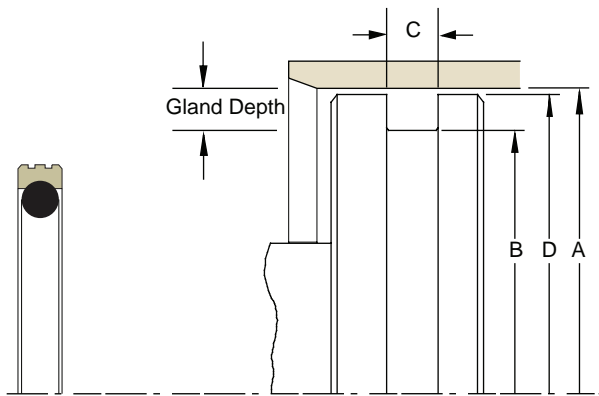

Please refer to Engineering Section 2, Page 2-8 for surface finish and additional hardware considerations.



Table 7-55. OQ Profile — Inch

A Bore Diameter	B Groove Diameter	C Groove Width	D Piston Diameter*	O-ring Dash Number	Part Number
+ .001/- .000	+ .000/- .001	+ .008/- .000	+ .000/- .002		
0.375	0.182	0.087	0.374	008	0205OQ09700375-087A
+ .002/- .000	+ .000/- .002	+ .008/- .000	+ .000/- .002		
0.438	0.245	0.087	0.437	010	0205OQ09700438-087A
0.500	0.307	0.087	0.499	011	0205OQ09700500-087A
0.563	0.370	0.087	0.562	012	0205OQ09700563-087A
0.625	0.432	0.087	0.624	013	0205OQ09700625-087A
0.688	0.495	0.087	0.687	014	0205OQ09700688-087A
0.750	0.557	0.087	0.749	015	0205OQ09700750-087A
0.813	0.620	0.087	0.812	016	0205OQ09700813-087A
0.875	0.682	0.087	0.874	017	0205OQ09700875-087A
0.938	0.745	0.087	0.937	018	0205OQ09700938-087A
1.000	0.807	0.087	0.999	019	0205OQ09701000-087A
1.125	0.932	0.087	1.124	021	0205OQ09701125-087A
1.250	1.057	0.087	1.249	023	0205OQ09701250-087A
1.375	1.182	0.087	1.374	025	0205OQ09701375-087A

*If used with wear rings, refer to wear ring piston diameter, see Section 9.

Table 7-55. OQ Gland Dimensions — Inch (Continued)

A Bore Diameter	B Groove Diameter	C Groove Width	D Piston Diameter*	O-ring Dash Number	Part Number
+ .002/- .000	+ .000/- .002	+ .008/- .000	+ .000/- .002		
1.500	1.205	0.126	1.499	123	0205OQ14801500-126A
1.625	1.330	0.126	1.624	125	0205OQ14801625-126A
1.750	1.455	0.126	1.749	127	0205OQ14801750-126A
1.875	1.580	0.126	1.874	129	0205OQ14801875-126A
+ .003/- .000	+ .000/- .003	+ .008/- .000	+ .000/- .002		
2.000	1.705	0.126	1.999	131	0205OQ14802000-126A
2.125	1.830	0.126	2.124	133	0205OQ14802125-126A
2.250	1.955	0.126	2.249	135	0205OQ14802250-126A
2.375	2.080	0.126	2.374	137	0205OQ14802375-126A
2.500	2.205	0.126	2.499	139	0205OQ14802500-126A
2.625	2.330	0.126	2.624	141	0205OQ14802625-126A
2.750	2.455	0.126	2.749	143	0205OQ14802750-126A
2.875	2.580	0.126	2.874	145	0205OQ14802875-126A
+ .003/- .000	+ .000/- .003	+ .008/- .000	+ .000/- .003		
3.000	2.567	0.165	2.999	230	0205OQ21703000-165A
3.125	2.692	0.165	3.124	231	0205OQ21703125-165A
3.250	2.817	0.165	3.249	232	0205OQ21703250-165A
3.375	2.942	0.165	3.374	233	0205OQ21703375-165A
3.500	3.067	0.165	3.499	234	0205OQ21703500-165A
3.625	3.192	0.165	3.624	235	0205OQ21703625-165A
3.750	3.317	0.165	3.749	236	0205OQ21703750-165A
3.875	3.442	0.165	3.874	237	0205OQ21703875-165A
4.000	3.567	0.165	3.999	238	0205OQ21704000-165A
4.125	3.692	0.165	4.124	239	0205OQ21704125-165A
4.250	3.817	0.165	4.249	240	0205OQ21704250-165A
4.375	3.942	0.165	4.374	241	0205OQ21704375-165A
4.500	4.067	0.165	4.499	242	0205OQ21704500-165A
4.625	4.192	0.165	4.624	243	0205OQ21704625-165A
+ .004/- .000	+ .000/- .004	+ .008/- .000	+ .000/- .003		
4.750	4.317	0.165	4.749	244	0205OQ21704750-165A
4.875	4.442	0.165	4.874	245	0205OQ21704875-165A
5.000	4.567	0.165	4.999	246	0205OQ21705000-165A
5.125	4.692	0.165	5.124	247	0205OQ21705125-165A
5.250	4.817	0.165	5.249	248	0205OQ21705250-165A
5.375	4.942	0.165	5.374	249	0205OQ21705375-165A
5.500	5.067	0.165	5.499	250	0205OQ21705500-165A
5.625	5.192	0.165	5.624	251	0205OQ21705625-165A
5.750	5.317	0.165	5.749	252	0205OQ21705750-165A
5.875	5.442	0.165	5.874	253	0205OQ21705875-165A
+ .004/- .000	+ .000/- .004	+ .008/- .000	+ .000/- .004		
6.000	5.390	0.248	5.999	355	0205OQ30506000-248A
6.250	5.640	0.248	6.249	357	0205OQ30506250-248A
6.500	5.890	0.248	6.499	359	0205OQ30506500-248A
6.750	6.140	0.248	6.749	361	0205OQ30506750-248A
7.000	6.390	0.248	6.999	362	0205OQ30507000-248A
+ .005/- .000	+ .000/- .005	+ .008/- .000	+ .000/- .004		
7.250	6.640	0.248	7.248	363	0205OQ30507250-248A
7.500	6.890	0.248	7.498	364	0205OQ30507500-248A
7.750	7.140	0.248	7.748	365	0205OQ30507750-248A

*If used with wear rings, refer to wear ring piston diameter, see Section 9.

Table 7-55. OQ Gland Dimensions — Inch (Continued)

A Bore Diameter	B Groove Diameter	C Groove Width	D Piston Diameter*	O-ring Dash Number	Part Number
+ .005/- .000	+ .000/- .005	+ .008/- .000	+ .000/- .004		
8.000	7.390	0.248	7.998	366	0205OQ30508000-248A
8.250	7.640	0.248	8.248	367	0205OQ30508250-248A
8.500	7.890	0.248	8.498	368	0205OQ30508500-248A
8.750	8.140	0.248	8.748	369	0205OQ30508750-248A
9.000	8.390	0.248	8.998	370	0205OQ30509000-248A
9.250	8.640	0.248	9.248	371	0205OQ30509250-248A
9.500	8.890	0.248	9.498	372	0205OQ30509500-248A
9.750	9.140	0.248	9.748	373	0205OQ30509750-248A
10.000	9.390	0.248	9.998	374	0205OQ30510000-248A
10.500	9.890	0.248	10.498	376	0205OQ30510500-248A
11.000	10.390	0.248	10.998	377	0205OQ30511000-248A
11.500	10.890	0.248	11.498	378	0205OQ30511500-248A
+ .006/- .000	+ .000/- .006	+ .008/- .000	+ .000/- .005		
12.000	11.173	0.319	11.998	451	0205OQ41412000-319A
12.500	11.673	0.319	12.498	452	0205OQ41412500-319A
13.000	12.173	0.319	12.998	453	0205OQ41413000-319A
13.500	12.673	0.319	13.498	454	0205OQ41413500-319A
14.000	13.173	0.319	13.998	455	0205OQ41414000-319A
14.500	13.673	0.319	14.498	456	0205OQ41414500-319A
15.000	14.173	0.319	14.998	457	0205OQ41415000-319A
15.500	14.673	0.319	15.498	458	0205OQ41415500-319A
16.000	15.173	0.319	15.998	459	0205OQ41416000-319A
16.500	15.673	0.319	16.498	460	0205OQ41416500-319A
17.000	16.173	0.319	16.998	461	0205OQ41417000-319A
17.500	16.673	0.319	17.498	462	0205OQ41417500-319A
18.000	17.173	0.319	17.998	463	0205OQ41418000-319A
18.500	17.673	0.319	18.498	464	0205OQ41418500-319A
19.000	18.173	0.319	18.998	465	0205OQ41419000-319A
19.500	18.673	0.319	19.498	466	0205OQ41419500-319A
+ .007/- .000	+ .000/- .007	+ .008/- .000	+ .000/- .005		
20.000	19.173	0.319	19.998	467	0205OQ41420000-319A

*If used with wear rings, refer to wear ring piston diameter, see Section 9.

NOTE: For sizes larger than those shown in the table, please contact your local Parker Seal representative.

Part Number Nomenclature —OQ Profile

Table 7-56. OQ Profile — Metric

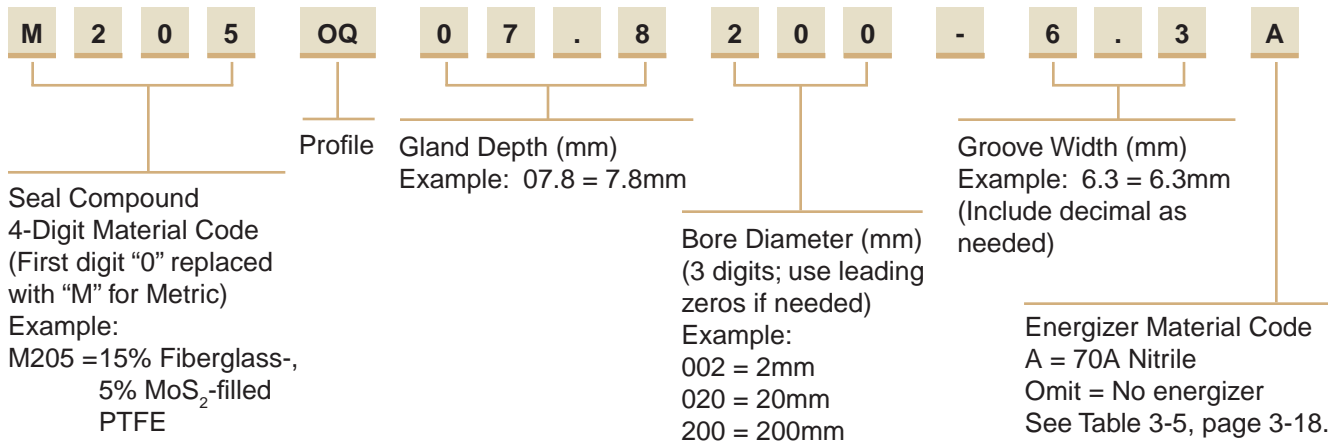

09/01/07



Gland Dimensions — OQ Profile

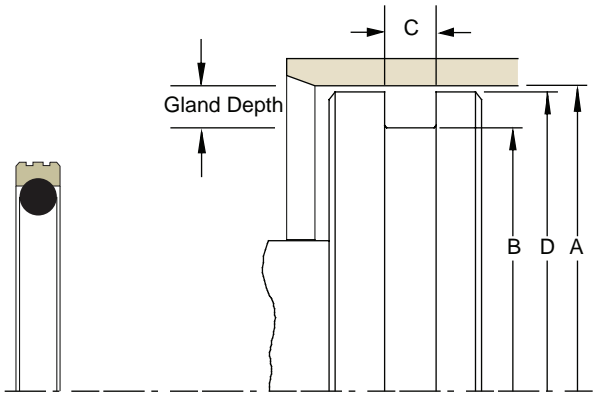

Please refer to Engineering Section 2, Page 2-8 for surface finish and additional hardware considerations.

Table 7-57. OQ Profile — Metric

A Bore Diameter	B Groove Diameter	C Groove Width	D Piston Diameter*	O-ring Dash Number	Part Number
H9	h9	+0.20/-0.00	h8		
8.00	3.10	2.20	7.97	006	M205OQ02.5008-2.2A
10.00	5.10	2.20	9.97	008	M205OQ02.5010-2.2A
12.00	7.10	2.20	11.97	010	M205OQ02.5012-2.2A
16.00	11.10	2.20	15.97	016	M205OQ02.5016-2.2A
20.00	15.10	2.20	19.97	015	M205OQ02.5020-2.2A
22.00	17.10	2.20	21.97	016	M205OQ02.5022-2.2A
25.00	20.10	2.20	24.97	018	M205OQ02.5025-2.2A
30.00	25.10	2.20	29.97	021	M205OQ02.5030-2.2A
32.00	27.10	2.20	31.97	023	M205OQ02.5032-2.2A
40.00	32.50	3.20	39.94	124	M205OQ03.8040-3.2A
45.00	37.50	3.20	44.94	127	M205OQ03.8045-3.2A
50.00	42.50	3.20	49.94	130	M205OQ03.8050-3.2A
55.00	47.50	3.20	54.94	133	M205OQ03.8055-3.2A
63.00	55.50	3.20	62.94	138	M205OQ03.8063-3.2A
70.00	62.50	3.20	69.94	143	M205OQ03.8070-3.2A
80.00	69.00	4.20	79.90	231	M205OQ05.5080-4.2A
90.00	79.00	4.20	89.90	234	M205OQ05.5090-4.2A
100.00	89.00	4.20	99.90	237	M205OQ05.5100-4.2A
110.00	99.00	4.20	109.90	241	M205OQ05.5110-4.2A
120.00	109.00	4.20	119.90	244	M205OQ05.5120-4.2A
125.00	114.00	4.20	124.90	245	M205OQ05.5125-4.2A
130.00	119.00	4.20	129.90	247	M205OQ05.5130-4.2A
140.00	124.50	6.30	139.90	352	M205OQ07.8140-6.3A
150.00	134.50	6.30	149.90	355	M205OQ07.8150-6.3A
160.00	144.50	6.30	159.90	358	M205OQ07.8160-6.3A
200.00	184.50	6.30	199.90	366	M205OQ07.8200-6.3A
220.00	204.50	6.30	219.90	369	M205OQ07.8220-6.3A
230.00	214.50	6.30	229.90	370	M205OQ07.8230-6.3A
240.00	224.50	6.30	239.90	372	M205OQ07.8240-6.3A
250.00	234.50	6.30	249.90	374	M205OQ07.8250-6.3A
300.00	284.50	6.30	299.90	379	M205OQ07.8300-6.3A
320.00	304.50	6.30	319.90	381	M205OQ07.8320-6.3A
400.00	379.00	8.10	399.90	458	M205OQ10.5400-8.1A
500.00	479.00	8.10	499.90	467	M205OQ10.5500-8.1A
600.00	579.00	8.10	599.90	472	M205OQ10.5600-8.1A

*If used with wear rings, refer to wear ring piston diameter, see Section 9.

NOTE: For sizes larger than those shown in the table, please contact your local Parker Seal representative.