

tekmar[®]

tekmarNet[®]2 Thermostat 528

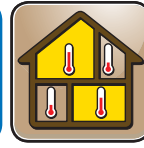

Zoning

D528

12/11

Replaces:08/10

Installation & Operation Manual

Introduction

The tekmarNet[®]2 Thermostat 528 provides operation for:

- One Stage Heat

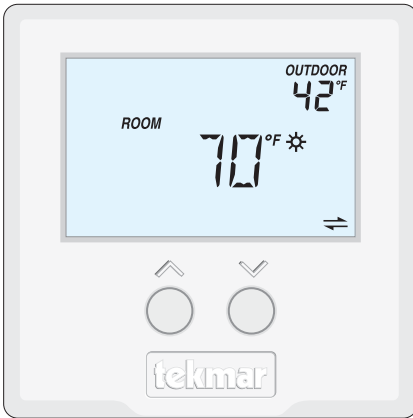

Features

- Zone Synchronization
- Zone Post Purge
- Intelligent Setback (Timer 033)
- One touch overrides (User Switch)
- Auto Heating Cycle
- tN2 Communication compatible
- Room temperature limiting
- Requires 2 Wires
- Pulse Width Modulation
- CSA C US Approved for use in USA and Canada
- Outdoor Temperature Display
- Air Group Member
- Backlight
- Freeze Protection
- Equipment Exercising
- Floor Warming (Slab Sensor 079)
- 1 Auxiliary Sensor input
- Supports Radiant Floor Cooling

Note

- tN2 Zone Manager, Expansion Module, Wiring Center or House Control required for operation
- tN2 Zone Manager, Expansion Module, Wiring Center or House Control required for operation

Table of Contents

Getting Started	2	Settings	8-14
Installation	2	Sequence of Operation.....	15
Caution.....	2	Heating Operation	15
Preparation.....	2	Air Group Operation	16
Removing The Thermostat Base...	3	Floor Cooling.....	16
Mounting The Thermostat Base...	3	Schedules	17
Thermostat Wiring.....	4	Scenes (System Override)	17
Testing the Thermostat Wiring	5	Troubleshooting	18
Mounting the Thermostat	5	Error Messages.....	18-21
Cleaning the Thermostat.....	6	Frequently Asked Questions	22
Switch Settings	6	Job Record.....	23
User Interface.....	7	Technical Data.....	23
Display.....	7	Limited Warranty and Product	
Button Operation	7	Return Procedure	24
Symbols Description	7		

Getting Started

Congratulations on the purchase of your new tekmar thermostat.

This manual will step through the complete installation, programming and sequence of operation for this control. At the back, there are tips for control and system troubleshooting.

Installation

Caution

Improper installation and operation of this control could result in damage to the equipment and possibly even personal injury or death. It is your responsibility to ensure that this control is safely installed according to all applicable codes and standards. This electronic control is not intended for use as a primary limit control. Other controls that are intended and certified as safety limits must be placed into the control circuit.

Preparation

Tools Required

- tekmar or jeweller screwdriver
- Phillips head screwdriver
- Wire Stripper

Materials Required

- 2, #6 x 1" Wood Screws
- 18 AWG LVT Solid Wire (Low Voltage Connections)
- Optional Adapter Plate 007 (for installation on 2" x 4" gang box)

Installation Location

Choose the placement of the thermostats early in the construction process to enable proper wiring during rough-in.

Consider the following:

- Interior Wall.
- Keep dry. Avoid potential leakage onto the control.
- Relative Humidity max 80% up to 88°F (31°C) decreasing linearly to 50% RH at 104°F (40°C). Non-condensing environment.
- No exposure to extreme temperatures beyond 32-122°F (0-50°C).
- No draft, direct sun, or other cause for inaccurate temperature readings.
- Away from equipment, appliances, or other sources of electrical interference.
- Easy access for wiring, viewing, and adjusting the display screen.
- Approximately 5 feet (1.5 m) off the finished floor.
- The maximum length of wire is 1000 feet (300 m).
- Strip wire to 3/8" (10 mm) for all terminal connections.
- Use standard 18 AWG wire for the tN2 connections.

Removing The Thermostat Base

To remove the thermostat base:

- Place a small slot screwdriver or similar tool into the slot located on the top of the thermostat.
- While pushing down against the plastic tab, pull the thermostat away from the thermostat's base.

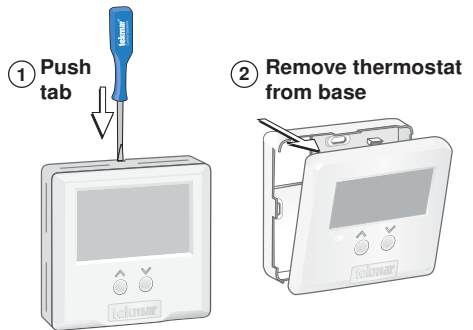

Mounting The Thermostat Base

If a single gang switch box is used, an Adaptor Plate 007 is required to mount the thermostat to the box.

- Fasten the base of the thermostat to the adaptor plate.
- Feed the wiring through the openings in the back of the adaptor plate and thermostat.
- Use the upper and lower screw holes to fasten the adaptor plate to the box.

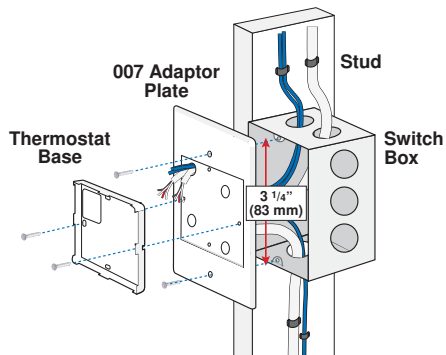

Mounted on switch box

If a switch box was not used, mount the thermostat directly to the wall.

- Feed the wiring through the openings in the back of the thermostat.
- Use screws in the screw holes to fasten the thermostat to the wall. At least one of the screws should enter a wall stud or similar rigid material.

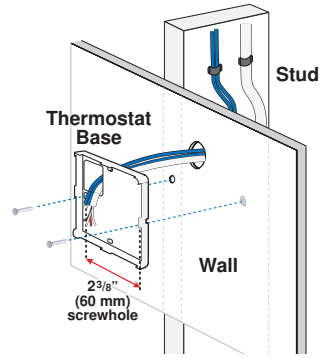

Mounted on wallboard

Thermostat Wiring

The thermostat operates a single heating system zone.

Power and communication are provided to the thermostat by connecting the tN2 terminals on the thermostat to the tN2 terminals on a tN2 Wiring Center, House Control, Zone Manager or Expansion Module. tN2 terminals are not polarity sensitive.

Connect the optional auxiliary sensor wires to the sensor terminals 3 and 4.

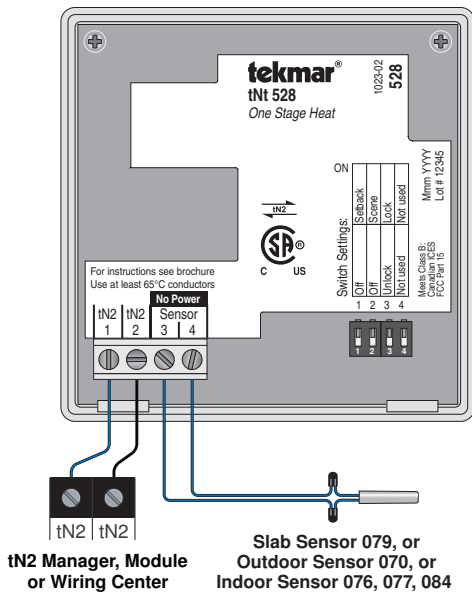

Testing the Thermostat Wiring

Testing the Power

If the thermostat display turns on, this indicates that the thermostat is operating correctly and there are no electrical issues. In the event that the display is off, or the display is cycling on and off:

1. Remove the tN2 wires from the thermostat.
2. Use an electrical meter to measure DC voltage between the tN2 terminals.
 - If the DC voltage is 0 V (dc) for 20 seconds, then there is an open or short circuit in the tN2 wires.
 - If the DC voltage is 0 V (dc) for 10 seconds and then is 23 to 24 V (dc) for 5 seconds, this indicates the wiring is correct.
3. Connect the thermostat to the tN2 wires connected to a zone on a House Control, Wiring Center, or Zone Manager.
4. If the thermostat display is off, or is cycling on and off, move the thermostat to the next available zone on the House Control, Wiring Center, or Zone Manager.
 - If the thermostat display remains permanently on, there may be a fault with the previously tried zone on the House Control, Wiring Center, or Zone Manager.
 - If the thermostat display continues to be off, or is cycling on and off, there may be a fault on the thermostat.

If a fault is suspected, contact your tekmar sales representative for assistance.

Testing the Heat Zone Output

1. Press the **^** button and set the heating temperature above the current room temperature. Make sure the display does not show “WWSD” or “Floor Max”.
2. When the H1 symbol appears on the display, use an electrical meter to check for voltage on the House Control, Wiring Center, or Zone Manager relay. The voltage is 24 V (ac) for zone valves, and 120 V (ac) for zone pumps when operating correctly.

Mounting the Thermostat

To place the thermostat back on the mounting base:

- Place thermostat bottom tabs on matching mounting base notches.
- Pivot top of the thermostat towards wall, ensuring wires clear obstructions.
- The top clasp makes a clicking sound when properly closed.

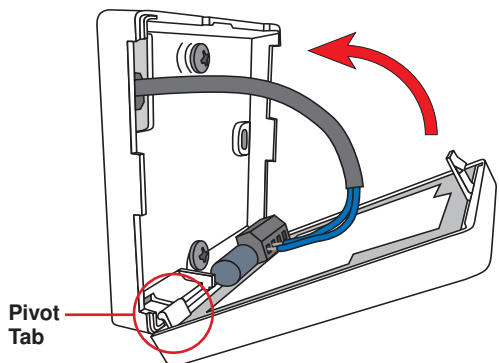

Cleaning the Thermostat

The thermostat's exterior can be cleaned using a damp cloth. Moisten the cloth with water and wring out prior to wiping the control. Do not use solvents or cleaning solutions.

Switch Settings

Switches are set to "On" position from the factory, and do not require changing for most applications.

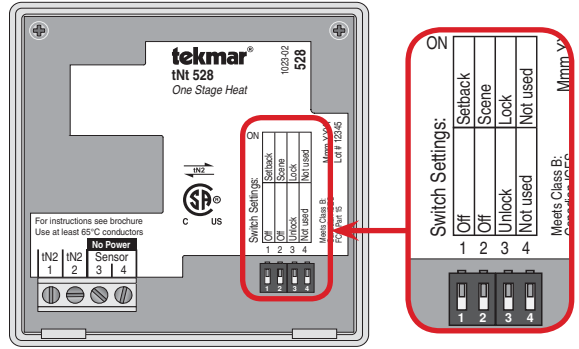

Switch Position Action

1	ON	SETBACK The thermostat follows a programmable setback schedule as a schedule member if available. Requires the installation of a Timer 033 to use this feature.
	OFF	OFF The thermostat does not follow a programmable setback schedule.
2	ON	SCENE The thermostat responds to changes in the scene (system wide manual overrides). Requires the installation of a User Switch 479 to use this feature.
	OFF	OFF The thermostat does not respond to scenes.
3	ON	LOCK ACCESS LEVEL Locked to 'User' access level. Set to Lock when installation completed.
	OFF	UNLOCK ACCESS LEVEL Unlock to allow 'User' and "Installer" access level. Set to Unlock during installation process. tekmarNet® reset control must also be set to Unlocked (Installer access level).
4	ON	Not used
	OFF	Not used

User Interface

Display

MAIN DISPLAY



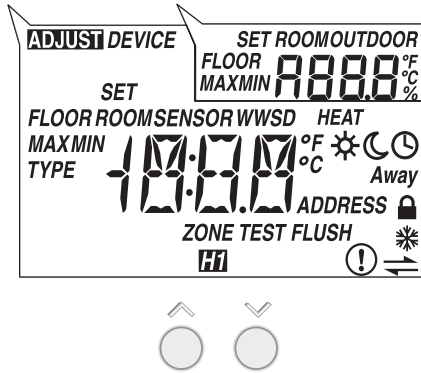





SECONDARY DISPLAY



Button Operation

Press the **^** or the **v** button to select the room temperature.

Symbols Description

	HEAT Heat is turned on.		LOCK Locked to 'User' access level.
	SUN Operating at the occupied (day) temperature.		CLOCK Operating on a programmable schedule.
	MOON Operating at the unoccupied (night) temperature.		tekmarNet® Communication is present.
<i>Away</i>	AWAY Operating at the <i>Away</i> scene temperature.		WARNING SYMBOL Indicates an error is present.
	AIR GROUP The air group is cooling. Heating can start once the cooling is finished.	WWSD	WARM WEATHER SHUT DOWN The heating system has been shut off for the summer.

Settings (1 of 7)

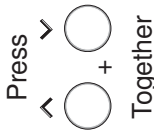

- Press and hold down both the ▲ and ▼ buttons for 2 seconds to change from one step to the next.
- Release both buttons once the step has been reached.
- Press the ▲ or the ▼ button to change the setting, if available.
- Press and hold down both the ▲ and ▼ buttons for 2 seconds to go to the next step, OR
- After 10 seconds of no button activity, the display goes back to normal operation.
- **Note:** Set switch setting #3 and tekmarNet® system control to Unlock to change Access level to Installer.

Display	Range	Access	Description	Set to
	40 to 95°F (4.5 to 35.0°C) Default = 70°F (21.0°C)	Installer User	SET ROOM HEAT ☀ Set the room heating temperature while in the ☀ event.	
	40 to 95°F (4.5 to 35.0°C) Default = 65°F (18.5°C)	Installer User	SET ROOM HEAT ☾ Set the room heating temperature while in the ☾ event.	
	40 to 95°F (4.5 to 35.0°C) Default = 62°F (16.5°C)	Installer	SET ROOM HEAT AWAY Set the room heating temperature while in the <i>Away</i> scene.	

Continued on next page.

Settings (2 of 7)

Display	Range	Access	Description	Set to
<p>The display shows the text 'ADJUST SET FLOOR' on the left and '72 HEAT °F *' on the right.</p>	<p>40 to 122°F (4.5 to 50.0°C) Default = 72°F (22.0°C)</p>	<p>Installer User</p>	<p>SET FLOOR HEAT * Set the floor heating temperature while in the * event. Available when: • A slab sensor is installed on the auxiliary sensor input AND Sensor setting in the Adjust menu is set to Floor AND Room Sensor setting in the Adjust menu is set to Off.</p>	
<p>The display shows the text 'ADJUST SET FLOOR' on the left and '65 HEAT °F ☾' on the right.</p>	<p>40 to 122°F (4.5 to 50.0°C) Default = 65°F (18.5°C)</p>	<p>Installer User</p>	<p>SET FLOOR HEAT ☾ Set the floor heating temperature while in the ☾ event. Available when: • A slab sensor is installed on the auxiliary sensor input AND Sensor setting in the Adjust menu is set to Floor AND Room Sensor setting in the Adjust menu is set to Off.</p>	
<p>The display shows the text 'ADJUST' on the left and '11:11 30' on the right.</p>	<p>Off, 30 sec, On, On + * Default = 30 sec</p>	<p>Installer User</p>	<p>BACKLIGHT Select the backlight operation. Off = Permanently Off 30 = Temporary on for 30 seconds On = Permanently On On + * = On during * and off during ☾</p>	

Continued on next page.

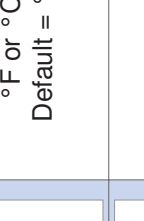
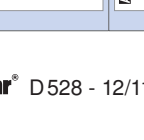
Settings (3 of 7)	Display	Range	Access	Description	Set to
ADJUST		°F or °C Default = °F	Installer User	TEMPERATURE UNITS Press the ^ or the v button to change from °F to °C and vice versa.	
ADJUST/DEVICE		Device Type with Software Version, Address	Installer User	DEVICE TYPE Display alternates between the Device Type (large number) with Software Version (upper right corner) and the thermostat address.	
ADJUST		40 to 95°F (4.5 to 35.0°C) Default = 85°F (29.5°C)	Installer	MAXIMUM SET ROOM HEAT ☀ Set the maximum room heating limit while in the ☀ event.	
ADJUST		40 to 95°F (4.5 to 35.0°C) Default = 85°F (29.5°C)	Installer	MAXIMUM SET ROOM HEAT ☾ Set the maximum room heating limit while in the ☾ event.	
ADJUST		40 to 95°F (4.5 to 35.0°C) Default = 45°F (7.0°C)	Installer	MINIMUM SET ROOM HEAT Set the minimum room heating limit.	

Continued on next page.

Settings (4 of 7)



Display	Range	Access	Description	Set to
<p>The display shows 'FLOOR 70°F' at the top. Below it, 'SET FLOOR MIN' is displayed on the left, and '72°F *' is displayed in large digits on the right.</p>	<p>Off, 40 to 122°F (Off, 4.5 to 50.0°C) Default = 72°F (22.0°C)</p> <p>Installer User</p>	<p>SET FLOOR MINIMUM *</p> <p>Set the floor minimum temperature while in the * event. The floor minimum heats the floor even when the room temperature is satisfied.</p> <p>The measured floor temperature is shown in the upper right hand corner of the display.</p> <p>Available when:</p> <ul style="list-style-type: none"> Room Sensor setting in the Adjust menu is set to On AND A slab sensor is installed on the auxiliary sensor input AND Sensor setting in the Adjust menu is set to Floor. 	<p>On AND</p>	
<p>The display shows 'FLOOR 70°F' at the top. Below it, 'SET FLOOR MIN' is displayed on the left, and 'OFF' is displayed in large digits on the right. A moon icon is visible in the top right corner of the display area.</p>	<p>Off, 40 to 122°F (Off, 4.5 to 50.0°C) Default = Off</p> <p>Installer User</p>	<p>SET FLOOR MINIMUM ☾</p> <p>Set the floor minimum temperature while in the ☾ event. The floor minimum heats the floor even when the room temperature is satisfied.</p> <p>The measured floor temperature is shown in the upper right hand corner of the display.</p> <p>Available when:</p> <ul style="list-style-type: none"> Room Sensor setting in the Adjust menu is set to On AND A slab sensor is installed on the auxiliary sensor input AND Sensor setting in the Adjust menu is set to Floor. 	<p>On AND</p>	

Continued on next page.

Settings (5 of 7)			
Display	Range	Access	Description
	40 to 122 °F, Off (4.5 to 50.0 °C, Off) Default = 85 °F (29.5 °C)	Installer	FLOOR MAXIMUM Set the floor maximum temperature in order to protect the floor covering. Available when: <ul style="list-style-type: none"> • Room Sensor setting in the Adjust menu is set to On AND • A slab sensor is installed on the auxiliary sensor input AND • Sensor setting in the Adjust menu is set to Floor.
	1, 2, 3, 4 Default = 1	Installer	SCHEDULE Thermostat can follow schedule master 1, 2, 3, or 4. Available when: <ul style="list-style-type: none"> • Switch setting 1 is set to Setback (On Position).
	OFF or On Default = On	Installer	HEAT SUPPLY PUMP During heating, select whether or not the system supply pump should turn on or be off to allow a zone group pump per manifold. Available when: <ul style="list-style-type: none"> • A reset control is present on the tekmarNet® system.

Continued on next page.

Settings (6 of 7)

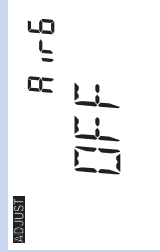
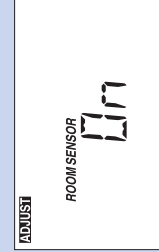
Display	Range	Access	Description	Set to
	<p>OFF or On Default = OFF</p>	<p>Installer</p>	<p>HEAT SUPPLY PUMP DELAY During heating, select whether or not the system supply pump should be delayed by 3 minutes before coming on (for thermal motor or wax actuator). Available when: • A reset control is present on the tekmarNet® system.</p>	
	<p>Auto, SYn(Synchronize) Default = Synchronize</p>	<p>Installer</p>	<p>HEAT CYCLES PER HOUR Select either Auto cycle or Synchronize with other thermostats on the tekmarNet® system. Choose Synchronize when zone heated using a boiler. Choose Auto when zone is non-hydrionic heating. Available when: • No reset control on the tekmarNet® system.</p>	
	<p>OFF, 1 to 16</p>	<p>Installer</p>	<p>AIR GROUP Select if this thermostat should be an air group member. Select off if the thermostat is not an air group member. Select 1 through 16 to select the air group number. Available when: • The thermostat is connected to other thermostats using tekmarNet®.</p>	
	<p>On or Off Default = On</p>	<p>Installer</p>	<p>ROOM SENSOR Select whether the built-in air temperature sensor is on or off. Available when: A floor sensor or room sensor is installed on the auxiliary sensor input.</p>	

Continued on next page.

Settings (7 of 7)

Display	Range	Access	Description	Set to
	Off, Room, Outdoor, Floor, Floor dSP	Installer	<p>AUXILIARY SENSOR</p> <p>Select the type of auxiliary sensor.</p> <p>Off = no auxiliary sensor, Room = Indoor Sensor, Outdoor = Outdoor Sensor, Floor = Slab Sensor, Floor dSP = Floor sensor reading in upper number field.</p> <p>Available when:</p> <ul style="list-style-type: none"> Auxiliary sensor automatically detected. 	
	01 to 24 (no reset control), b:01 to b:24 (reset control - boiler), 1:01 to 1:24 (reset control - mixing)	Installer	<p>tekmarNet® ADDRESS</p> <p>The address is shown in the large number field. "Auto" is shown in the upper number field when using automatic addressing.</p> <p>Press the ∧ or the ∨ button to manually select an address.</p> <p>The address can be returned to automatic "Auto" addressing when address set above 24.</p>	
	OFF or On Default = OFF	Installer	<p>FLOOR COOLING</p> <p>Select if the thermostat should operate the heating relay W for radiant floor cooling.</p> <p>Available when:</p> <ul style="list-style-type: none"> Connected to a tekmarNet® heat pump or chiller system control. 	
	None	Installer User	<p>ESCAPE</p> <p>Press the ∧ or the ∨ button to return to normal operation.</p>	

Sequence of Operation

Heating Operation

Section A

When using only a room temperature sensor, the thermostat operates the heating system to maintain the Set Room Heat temperature.

When using only a floor temperature sensor, the thermostat operates the heating system to maintain the Set Floor Heat temperature. In this case, the thermostat does not try to control the air temperature. This is ideal for bathrooms and some kitchen applications where the customer wants their feet to feel warm on the floor. This is also ideal for garages so that the heating system is not affected by the opening of the garage door in cold outdoor weather.

When using both a room temperature sensor and a floor temperature sensor, the thermostat always maintains the Floor Minimum temperature, even when the air temperature is satisfied. When the air temperature is below the Set Room Heat temperature, the thermostat operates the heating system to maintain the Set Room Heat temperature. The floor is never heated above the Floor Maximum setting in order to protect the floor covering.

The H1 symbol is shown on the display when the thermostat is heating. The heat can cycle on and off within +/- 1.5°F (1°C) of the Set Room Heat temperature.

Freeze Protection

The thermostat operates the heat whenever the room or floor temperature falls below 40°F (4.5°C).

Exercising

When connected to a tekmarNet® reset control, the thermostat exercises the heat relay for 10 seconds every 3 days. Exercising helps prevent zone valves or zone pumps from failing due to precipitate buildup. During exercising, the thermostat shows "TEST" on the display.

Flushing

The flushing feature is for open-loop systems that use a domestic hot water tank as a heat source. Flushing ensures that fresh potable water is circulated through the system once each day. If the thermostat is connected to a tekmarNet® reset control with the Flushing feature turned on, the thermostat display will display the "FLUSH" icon for the duration of the flushing operation.

Hydronic System Supply Pump

When connected to a tekmarNet® system control, the thermostat's Heat Supply Pump setting affects how the primary pump or mix pump on the system control operates. When connected to the boiler bus, the boiler system or primary pump is operated. When connected to the mix bus, the mix system pump is operated.

If the thermostat operates a motorized or thermal motor zone valve, the Heat Supply Pump setting should be set to On.

If the thermostat operates a thermal motor (wax actuator) zone valve, set the Heat Supply Pump Delay setting to On. This provides a three minute delay to allow the zone valve to open before the primary or mix pump is turned on.

In special applications with multiple zoning manifolds, the Heat Supply Pump setting can be set to Off. This allows a Zone Group Pump located on the Zone Manager, or Wiring Center to operate the pump for the manifold.

DHW Tank Priority

When a tekmarNet® reset control is heating an indirect Domestic Hot Water (DHW) tank, the thermostat may shut off the heating zones to allow the DHW tank to recover quickly. This is determined by the DHW priority of the tekmarNet® reset control.

Warm Weather Shut Down

When the outdoor air temperature exceeds the Warm Weather Shut Down (WWSD) setting on the tekmarNet® reset control, the heating system is shut off.

Air Group Operation Section B

In order to prevent heating and cooling at the same time, this thermostat can operate together with other thermostats on a tekmarNet® system to form an air group.

In an air group, one thermostat is assigned as the air group master. The air group master operates the cooling equipment for the group. This thermostat can be set to be a member of the air group.

When operating as an air group, the air temperature readings of all the air group member thermostats are communicated to the air group master and a temperature average is determined.

When the air group master is in cooling operation, the air group member thermostats do not operate the heating system for air heating.

If the Set Room Heat temperature is adjusted while the air group is cooling, the snowflake icon is flashed to alert the user that the cooling is presently on. Once the cooling shuts off, the heating can start operation.

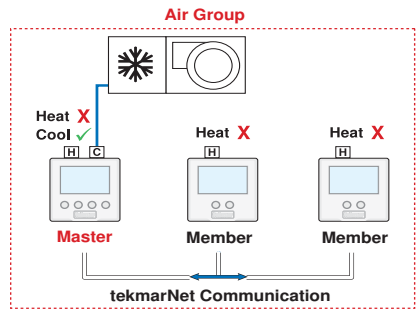

Floor Cooling Section C

The thermostat has the option to support radiant floor cooling when connected to a heat pump control using tekmarNet® communication. The floor cooling setting must be set to On and the heating system must be in Warm Weather Shut Down (WWSD). When the heat pump system control operates in cooling mode, all thermostats set for floor cooling on the tekmarNet® bus all activate the first stage heating contact (H1) at the same time to allow chilled water into the system. The thermostat continues to operate the cooling until either the room temperature reaches the Set Heat temperature plus 3°F (Set Heat+1.5°C) or reaches a minimum temperature of 74°F. If only a floor sensor is installed, the floor cooling setpoint is 67°F (19.5°C).

Lowering the room temperature setting reduces the amount of fuel required to heat the building resulting in energy savings.

This thermostat can follow a programmable schedule in order to automatically lower the room temperature setting. A schedule master such as a Timer 033 is required in order to gain programmable schedule functionality.

When operating on a programmable schedule, a ☀ symbol is shown, as well as a ☀ or a ☾. The ☀ or ☾ indicates the current operating temperature.

If a ☀ symbol does not appear, there is no schedule available.

Display	Action
☀	Occupied temperature. No schedule.
☾	Unoccupied temperature. No schedule.
☀ ☀	Programmable schedule at occupied temperature.
☀ ☀	Programmable schedule at unoccupied temperature.

When a programmable schedule is selected, there is a time delay for the temperature to change from the ☾ temperature to the ☀ temperature.

The thermostat uses Optimum Start to predict the heat up and cool off rate of the room. The optimum start feature allows the room to reach the set room ☀ temperature by the time set in the programmable schedule. This applies for both heating and cooling.

Scenes provide an easy way to save energy while away on vacation, or override a pre-set schedule when plans change. tekmarNet® devices such as a User Switch 479 provide scene adjustment.

This thermostat responds to the following scenes:

Scene	Display	Room Temperature Setting
1	☀ or ☀ ☀ or ☀ ☀	Follows programmable schedule or operates at the occupied ☀ temperature.
2	Away	Away temperature.
3	☾	Unoccupied ☾ temperature.

While in the *Away* scene, the room temperature cannot be changed using the ^ or v buttons. Change the scene from *Away* to ☀ or ☾ to change the temperature.

Troubleshooting

Error Messages (1 of 4)

Error Message

Description

CONTROL ERROR

The thermostat was unable to correctly read settings from memory and has reloaded the factory default settings. The thermostat does not operate the heating, cooling, or the fan while this error message is present.

Error clears once all adjust menu settings in the Installer access level (unlocked) have been checked. Set thermostat's switch setting #3 to unlock and unlock the tekmarNet® system control. Then press and hold **▲** and **▼** buttons together for 2 seconds to enter the adjust menu. Continue until all settings have been reviewed.

PORT ERROR

Thermostat has been connected to a tN2 Zone already in use by a 2-stage device. A 2-stage device requires two tN2 ports to operate. This device may be connected to one such port. Move the thermostat's tN2 wires to an unused tN2 port on the control.

BUS ERROR

The tekmarNet®4 communication bus has either an open or a short circuit. The result is that there are no communications. Check for loose wires. Check for short circuits between the tN4 and C wires on the House Control, Wiring Center, or Zone Manager. Check for correct polarity between the C and R wires.

Error clears automatically once wiring fault has been corrected. If the thermostat is intentionally removed from the tekmarNet®4 bus, press the **▲** and **▼** buttons together to clear the error message.

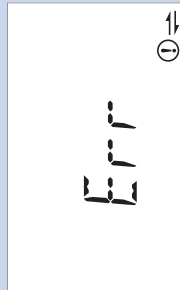
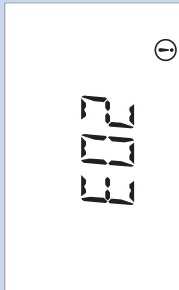
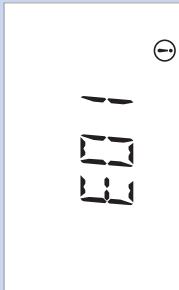

Error Messages (2 of 4)

Error Message

Description

DEVICE

L M
L 111

①

DEVICE LIMIT

The number of devices on the tekmarNet® bus has exceeded 24. Devices include tekmarNet® Thermostats and Setpoint Controls. The device count must be lowered to 24 or less. If possible, move devices to other tekmarNet® buses.

Error clears automatically once the number of devices on the tekmarNet® bus is at 24 or lower.

Err
ADDRESS

①

ADDRESS ERROR

This thermostat and another device have been manually given the same tekmarNet® address.

Error clears automatically once this thermostat is given a new manually set address or if the thermostat is set to automatic addressing.

ROOMSENSOR

SH-

①

ROOM SENSOR SHORT CIRCUIT

The built-in air temperature sensor has a short circuit fault. Do not confuse this error with the auxiliary room sensor short circuit error.

This error cannot be field repaired.

Contact your wholesaler or tekmar sales representative for details on repair procedures.

ROOMSENSOR

OP-

①

ROOM SENSOR OPEN CIRCUIT

The built-in air temperature sensor has an open circuit fault. Do not confuse this error with the auxiliary room sensor short circuit error.

This error cannot be field repaired.

Contact your wholesaler or tekmar sales representative for details on repair procedures.

Error Messages (3 of 4)

Error Message

Description

Err
Member
cool ⓘ

AIR GROUP MEMBER ERROR

The thermostat has been selected to join an air group as a member, yet there is no air group master thermostat.

Error clears once the thermostat detects an air group master or the air group is set to OFF.

FLOOR
SENSOR
SHR ⓘ

FLOOR SENSOR SHORT CIRCUIT

The auxiliary floor sensor has a short circuit. Check for damaged wires. Locate and repair the problem as described in the Data Brochure D072 or D079.

Error clears once the floor sensor fault is corrected.

FLOOR
SENSOR
OPN ⓘ

FLOOR SENSOR OPEN CIRCUIT

The auxiliary floor sensor has an open circuit. Check for loose or damaged wires. Locate and repair the problem as described in the Data Brochure D072 or D079.

Error clears once the floor sensor fault is corrected.

If the floor sensor was intentionally removed, locate the Room Sensor setting in the Adjust menu and set to On. Power the thermostat down and up to clear the error.

OUTDOOR
SENSOR
SHR ⓘ

OUTDOOR SENSOR SHORT CIRCUIT

The auxiliary outdoor sensor has a short circuit. Check for damaged wires. Locate and repair the problem as described in the Data Brochure D070.

Error clears after the outdoor sensor fault is corrected.

Error Messages (4 of 4)

Error Message

Description

OUTDOOR SENSOR OPEN CIRCUIT

The auxiliary outdoor sensor has an open circuit. Check for loose or damaged wires. Locate and repair the problem as described in the Data Brochure D070.
Error clears once the outdoor sensor fault is corrected.

If the outdoor sensor was intentionally removed, power the thermostat down and up to clear the error.



AUXILIARY ROOM SENSOR SHORT CIRCUIT

The auxiliary room sensor has a short circuit. Check for damaged wires. Locate and repair the problem as described in the Data Brochure D076, D077, or D084.
Error clears after the auxiliary room sensor fault is corrected.

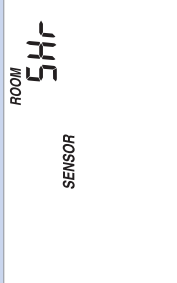

AUXILIARY ROOM SENSOR OPEN CIRCUIT

The auxiliary room sensor has an open circuit. Check for loose or damaged wires. Locate and repair the problem as described in the Data Brochure D076, D077, or D084.
Error clears once the auxiliary room sensor fault is corrected.

If the auxiliary room sensor was intentionally removed, power the thermostat down and up to clear the error.

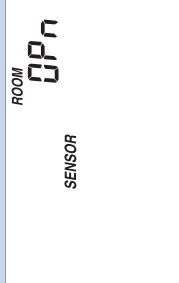

Frequently Asked Questions

Symptom	Look for...	Corrective Action
No Heat	H1 Symbol	H1 symbol indicates heat is on. Check if zone valve or zone pump is operating.
	Flashing WWSD	Increase WWSD setting on tekmarNet® reset control.
	Flashing Away	Change User Switch to Normal scene 1.
Heat on before scheduled time		Optimum start “learns” the heat up and cool off rate of the room and starts the heating or cooling early so that the room is comfortable at the scheduled time.
Pressing ^ button does not increase temperature	Flashing Max	Installer can increase the Maximum Set Room Heat.
	Flashing Floor Max	Floor temperature has reached the Floor Maximum setting. If the floor is not heated, then the floor sensor may be faulty and require replacement.
Pressing v button does not decrease temperature	Flashing Min	Installer can decrease the Minimum Set Room Heat.
	Floor Min	Floor minimum takes priority over the air heating temperature. Recommend turning down the floor minimum temperature setting.

Job Record

Jobsite Location _____

Thermostat Location _____

Item	Setting	Item	Setting
Set Room Heat ☼		Set Floor Min ☾	
Set Room Heat ☾		Set Floor Max	
Set Room Heat Away		Schedule Member	
Set Floor Heat ☼		Heat Supply Pump	
Set Floor Heat ☾		Heat Supply Pump Delay	
Backlight		Heat Cycles Per Hour	
Units		Air Group	
Max Set Room Heat ☼		Room Sensor	
Max Set Room Heat ☾		Sensor	
Min Set Room Heat		tekmarNet® Address	
Set Floor Min ☼		Floor Cooling	

Technical Data

tekmarNet® 2 Thermostat 528; *One Stage Heat*

Packaged weight	0.8 lb. (380 g)
Enclosure	White PVC plastic, NEMA Type 1
Dimensions	2-7/8" H x 2-7/8" W x 13/16" D (73 x 73 x 21 mm)
Approvals	CSA C US, meets Class B: ICES and FCC Part 15
Ambient conditions	Indoor use only, 32 to 122° F (0 to 50° C).
	RH max 80% up to 88° F (31° C) decreasing linearly to 50% RH at 104° F (40° C)
	Altitude 0 - 6560 feet (2000 m), Installation Category II, Pollution Category 2
Power supply	Provided by tekmarNet® 2 Control, 1.3 VA
Sensors:	NTC thermistor, 10 kΩ @ 77° F (25° C ± 0.2° C) β = 3892
– Optional	tekmar type # 070, 072, 073, 076, 077, 079, 084

Limited Warranty and Product Return Procedure

Limited Warranty *The liability of tekmar under this warranty is limited. The Purchaser, by taking receipt of any tekmar product ("Product"), acknowledges the terms of the Limited Warranty in effect at the time of such Product sale and acknowledges that it has read and understands same.*

The tekmar Limited Warranty to the Purchaser on the Products sold hereunder is a manufacturer's pass-through warranty which the Purchaser is authorized to pass through to its customers. Under the Limited Warranty, each tekmar Product is warranted against defects in workmanship and materials if the Product is installed and used in compliance with tekmar's instructions, ordinary wear and tear excepted. The pass-through warranty period is for a period of twenty-four (24) months from the production date if the Product is not installed during that period, or twelve (12) months from the documented date of installation if installed within twenty-four (24) months from the production date.

The liability of tekmar under the Limited Warranty shall be limited to, at tekmar's sole discretion: the cost of parts and labor provided by tekmar to repair defects in materials and / or workmanship of the defective product; or to the exchange of the defective product for a warranty replacement product; or to the granting of credit limited to the original cost of the defective product, and such repair, exchange or credit shall be the sole remedy available from tekmar, and, without limiting the foregoing in any way, tekmar is not responsible, in contract, tort or strict product liability, for any other losses, costs, expenses, inconveniences, or damages, whether direct, indirect, special, secondary, incidental or consequential, arising from ownership or use of the product, or from defects in workmanship or materials, including any liability for fundamental breach of contract.

The pass-through Limited Warranty applies only to those defective Products returned to tekmar during the warranty period. This Limited Warranty does not cover the cost of the parts or labor to remove or transport the defective Product, or to reinstall the repaired or replacement Product, all such costs and expenses being subject to Purchaser's agreement and warranty with its customers.

Any representations or warranties about the Products made by Purchaser to its customers which are different from or in excess of the tekmar Limited Warranty are the Purchaser's sole responsibility and obligation. Purchaser shall indemnify and hold tekmar harmless from and against any and all claims, liabilities and damages of any kind or nature which arise out of or are related to any such representations or warranties by Purchaser to its customers.

The pass-through Limited Warranty does not apply if the returned Product has been damaged by negligence by persons other than tekmar, accident, fire, Act of God, abuse or misuse; or has been damaged by modifications, alterations or attachments made subsequent to purchase which have not been authorized by tekmar; or if the Product was not installed in compliance with tekmar's instructions and / or the local codes and ordinances; or if due to defective installation of the Product; or if the Product was not used in compliance with tekmar's instructions.

THIS WARRANTY IS IN LIEU OF ALL OTHER WARRANTIES, EXPRESS OR IMPLIED, WHICH THE GOVERNING LAW ALLOWS PARTIES TO CONTRACTUALLY EXCLUDE, INCLUDING, WITHOUT LIMITATION, IMPLIED WARRANTIES OF MERCHANTABILITY AND FITNESS FOR A PARTICULAR PURPOSE, DURABILITY OR DESCRIPTION OF THE PRODUCT, ITS NON-INFRINGEMENT OF ANY RELEVANT PATENTS OR TRADEMARKS, AND ITS COMPLIANCE WITH OR NON-VIOLATION OF ANY APPLICABLE ENVIRONMENTAL, HEALTH OR SAFETY LEGISLATION; THE TERM OF ANY OTHER WARRANTY NOT HEREBY CONTRACTUALLY EXCLUDED IS LIMITED SUCH THAT IT SHALL NOT EXTEND BEYOND TWENTY-FOUR (24) MONTHS FROM THE PRODUCTION DATE, TO THE EXTENT THAT SUCH LIMITATION IS ALLOWED BY THE GOVERNING LAW.

Product Warranty Return Procedure All Products that are believed to have defects in workmanship or materials must be returned, together with a written description of the defect, to the tekmar Representative assigned to the territory in which such Product is located. If tekmar receives an inquiry from someone other than a tekmar Representative, including an inquiry from Purchaser (if not a tekmar Representative) or Purchaser's customers, regarding a potential warranty claim, tekmar's sole obligation shall be to provide the address and other contact information regarding the appropriate Representative.



tekmar Control Systems Ltd., Canada
tekmar Control Systems, Inc., U.S.A.
Head Office: 5100 Silver Star Road
Vernon, B.C. Canada V1B 3K4
(250) 545-7749 Fax. (250) 545-0650
Web Site: www.tekmarcontrols.com

Product design, software and literature
are Copyright © 2011 by:
tekmar Control Systems Ltd. and tekmar
Control Systems, Inc.