



# Dionex Eluent Generator Cartridges

065018 Revision 08 • May 2020

**thermo**scientific

*For Research Use Only. Not for use in diagnostic procedures.*

# Product Manual

for

## Dionex Eluent Generator Cartridges

(Dionex EGC)

### Dionex EGC III KOH

(Potassium Hydroxide Cartridge, Item # 074532)

### Dionex EGC 400 KOH

(Potassium Hydroxide Cartridge, Item # 302766)

### Dionex EGC 500 KOH

(Potassium Hydroxide Cartridge, Item # 075778)

### Dionex EGC-KOH (Capillary)

(Capillary Potassium Hydroxide Cartridge, Item # 072076)

### Dionex EGC III NaOH

(Sodium Hydroxide Cartridge, Item # 074533)

### Dionex EGC III LiOH

(Lithium Hydroxide Cartridge, Item # 074534)

### Dionex EGC 500 K<sub>2</sub>CO<sub>3</sub>

(Potassium Carbonate Cartridge, Item # 088453)

### Dionex EPM 500

(Electrolytic pH Modifier, Item # 088471)

### Dionex EGC 500 Carbonate Mixer

(4 mm, Item # 088468; 2 mm, Item # 088467)

### Dionex EGC III MSA

(Methanesulfonic Acid Cartridge, Item # 074535)

### Dionex EGC 400 MSA

(Methanesulfonic Acid Cartridge, Item # 302767)

### Dionex EGC 500 MSA

(Methanesulfonic Acid Cartridge, Item # 075779)

### Dionex EGC-MSA (Capillary)

(Capillary Methanesulfonic Acid Cartridge, Item # 072077)

© 2020 Thermo Fisher Scientific Inc. All rights reserved.

All trademarks are the property of Thermo Fisher Scientific Inc. and its subsidiaries.

Thermo Fisher Scientific Inc. provides this document to its customers with a product purchase to use in the product operation. This document is copyright protected and any reproduction of the whole or any part of this document is strictly prohibited, except with the written authorization of Thermo Fisher Scientific Inc.

The contents of this document are subject to change without notice. All technical information in this document is for reference purposes only. System configurations and specifications in this document supersede all previous information received by the purchaser.

Thermo Fisher Scientific Inc. makes no representations that this document is complete, accurate or error-free and assumes no responsibility and will not be liable for any errors, omissions, damage or loss that might result from any use of this document, even if the information in the document is followed properly.

This document is not part of any sales contract between Thermo Fisher Scientific Inc. and a purchaser. This document shall in no way govern or modify any Terms and Conditions of Sale, which Terms and Conditions of Sale shall govern all conflicting information between the two documents.

Revision History:

Revision 04, November 2012, Rebranded as Thermo Scientific. Added EGC 500.

Revision 05, June 2014, Removed EGC III K<sub>2</sub>CO<sub>3</sub> and EPM III. Added EGC 500 K<sub>2</sub>CO<sub>3</sub> and EPM 500.

Revision 06, February 2018, Added EGC 400 KOH and EGC 400 MSA.

Revision 07, October 2019, Removed references to the EG40.

Revision 08, May 2020, Updated references to Dual EG Degasser.

## Safety and Special Notices

Make sure you follow the precautionary statements presented in this guide. The safety and other special notices appear in boxes.

Safety and special notices include the following:



**SAFETY**

*Indicates a potentially hazardous situation which, if not avoided, could result in death or serious injury.*



**WARNING**

*Indicates a potentially hazardous situation which, if not avoided, could result in damage to equipment.*



**CAUTION**

*Indicates a potentially hazardous situation which, if not avoided, may result in minor or moderate injury. Also used to identify a situation or practice that may seriously damage the instrument but will not cause injury.*



**NOTE**

*Indicates information of general interest.*

**IMPORTANT**

*Highlights information necessary to prevent damage to software, loss of data, or invalid test results; or might contain information that is critical for optimal performance of the system.*

**Tip**

*Highlights helpful information that can make a task easier.*

# Contents

<b>1. Introduction</b> .....	<b>8</b>
1.1 Dionex EGC 500 KOH, Dionex EGC 400 KOH, Dionex EGC III KOH, NaOH and LiOH, and Dionex EGC-KOH (Capillary) Principle of Operation .....	10
1.2 Dionex EGC 500 MSA, Dionex EGC 400 MSA, Dionex EGC III MSA, and Dionex EGC-MSA (Capillary) Principle of Operation.....	11
1.3 Dionex EGC 500 K <sub>2</sub> CO <sub>3</sub> Principle of Operation .....	13
1.4 Dionex EPM 500 Principle of Operation .....	14
1.5 Dual EGC Principle of Operation .....	15
1.6 Differences between Dionex EGC III / Dionex EPM III, and Dionex EGC 500 / Dionex EPM 500 .....	16
1.7 Differences between Dionex EGC 500, Dionex EGC 400 and Dionex EGC (Capillary).....	17
1.8 System Flow Diagram.....	17
1.8.1 Eluent Generator module with hydroxide or MSA eluent and Dionex CR-TC Trap Column .....	17
1.8.2 Eluent Generator module with hydroxide or MSA eluent and Dionex ATC-HC 500 or Dionex CTC 500. ....	20
1.8.3 Eluent Generator module with hydroxide or MSA eluent and UltraViolet (UV) Detection. ....	20
1.8.4 Eluent Generator module with hydroxide or MSA eluent and Amperometric Detection. ....	21
1.8.5 Eluent Generator Module with Carbonate Eluent .....	21
1.8.6 Eluent Generator Module with Carbonate/Bicarbonate Eluent .....	22
1.8.7 Eluent Generator Module with Dual EGC KOH/KMSA Eluents .....	22
1.9 Dionex EGC 500, Dionex EGC 400, Dionex EGC III, and Dionex EGC (Capillary) Operational Lifetime.....	25
1.9.1 Dionex EGC 500 and Dionex EGC III KOH and NaOH .....	25
1.9.2 Dionex EGC III LiOH.....	25
1.9.3 Dionex EGC 500 and Dionex EGC III MSA .....	25
1.9.4 Dionex EGC 500 K <sub>2</sub> CO <sub>3</sub> and Dionex EPM 500.....	26
1.9.5 Dionex EGC-KOH (Capillary) and Dionex EGC-MSA (Capillary) .....	26
1.9.6 Dionex EGC 400 KOH .....	26
1.9.7 Dionex EGC 400 MSA .....	26
<b>2. Installation</b> .....	<b>27</b>
2.1 Procedure for Dionex EGC Installation .....	27
2.1.1 Preparation for Installation .....	27
2.1.2 Conditioning the Dionex EGC (except Capillary models) .....	28
2.2 Conditioning the Capillary Dionex EGC Cartridges.....	30
2.2.1 Installing the Dionex Continuously Regenerated Trap Column (Dionex CR-TC 600 or Dionex CR-TC 500) .....	30
2.2.2 Optional Pressure Restrictor Tubing .....	36
2.3 Preparation for Installation of Dionex EGC 500 K <sub>2</sub> CO <sub>3</sub> Cartridge.....	38
2.4 Conditioning the Dionex EGC 500 K <sub>2</sub> CO <sub>3</sub> .....	38
2.5 Filling the Dionex EGC 500 Carbonate Mixer with K <sub>2</sub> CO <sub>3</sub> Eluent of Desired Concentration.....	39
2.6 Operation of the High-Pressure Electrolytic K <sub>2</sub> CO <sub>3</sub> Eluent Generator for Ion Chromatographic Application .....	40
2.7 Preparation for Installation of Dionex EGC 500 K <sub>2</sub> CO <sub>3</sub> Cartridge and Dionex EPM 500 .....	41
2.8 Conditioning the Dionex EGC 500 K <sub>2</sub> CO <sub>3</sub> Cartridge and Dionex EPM 500 .....	41

## Contents

2.9	Filling the Dionex EGC 500 Carbonate Mixer with the $K_2CO_3$ / $KHCO_3$ Eluents of Desired Concentration	43
2.10	Operation of the Electrolytic $K_2CO_3/KHCO_3$ Eluent Generator for Ion Chromatographic Application	44
2.11	Preparation and Conditioning of Dionex EGC 400 cartridges for operation in Dual EGC Mode	45
2.12	Operation of Dionex EGC 400 KOH and Dionex EGC 400 MSA in Dual EGC Mode	47
2.13	Replacing a Dionex EGC 400 MSA Cartridge in Dual EGC Mode	47
2.14	Replacing a Dionex EGC 400 KOH Cartridge in Dual EGC Mode	48
2.15	Preparation and Conditioning of Dionex EGC (Capillary) cartridges for operation in Dual EGC Mode	49
2.16	Operation of Dionex EGC-KOH (Capillary) and Dionex EGC-MSA (Capillary) in Dual EGC Mode	51
2.17	Replacing a Dionex EGC-MSA (Capillary) Cartridge in Dual EGC Mode	51
2.18	Replacing a Dionex EGC-KOH (Capillary) Cartridge in Dual EGC Mode	52
<b>3.</b>	<b>Operation</b>	<b>54</b>
3.1	Routine Operation for Analytical Scale Systems	54
3.2	Routine Operation for Capillary Scale Systems	54
3.3	Operating Precautions	54
3.4	System Shutdown	56
3.4.1	Short-Term Shutdown	56
3.4.2	Long-Term Shutdown	57
3.4.3	Dual EG Mode Re-start	57
<b>4.</b>	<b>Example Applications</b>	<b>59</b>
4.1	Principles of Operation	59
4.1.1	Hydroxide based Applications	59
4.1.2	Carbonate-based Applications	59
4.1.3	Methanesulfonic acid-based Applications	59
4.1.4	Dionex EGC and Dionex EPM Operating Conditions	60
4.1.5	Verifying the System Configuration	61
4.2	Comparison of Eluent Generation with Dionex IonPac ATC-HC and Dionex CR-ATC for Dionex IonPac AS11 Gradient	62
4.3	Using the Dionex EGC III KOH or Dionex EGC 500 KOH Cartridge for Dionex IonPac AS15 Isocratic Elution	63
4.4	Comparison of Conventional Eluent System and RFIC-EG System	65
4.5	Large Loop Injection for $\mu\text{g/L}$ (ppb) Level Analysis on a 2 mm Dionex IonPac AS15	66
4.6	Comparison of Conventional Eluent System and RFIC-EG System for Gradient Elution on the Dionex IonPac AS16	67
4.7	Using an RFIC-EG System for KOH Elution of Inorganic Anions, Oxyhalides, and Organic Acids on the Dionex IonPac AS17	69
4.8	Using the Dionex EGC 500 MSA or Dionex EGC III MSA Cartridge for Isocratic MSA Elution on the Dionex IonPac CS12A	71
4.9	Using the Dionex EGC 500 MSA or Dionex EGC III MSA Cartridge for Dionex IonPac CS12A MSA Gradient	72
4.10	Comparison of Eluent Generation using a Dionex IonPac CTC-1 and a Dionex CR-CTC for Dionex IonPac CS12A Gradient	74
4.11	Glycoconjugate Monosaccharide Analysis with the Dionex EGC 500 KOH or Dionex EGC III KOH Cartridge	75

## Contents

4.12	Analysis of Mono- and Disaccharides Found in Foods and Beverages Using Dionex EGC Generated KOH as Eluent .....	76
4.13	Analysis of Carbohydrates using both EGC Generated KOH and Manually Prepared NaOH or KOH as Eluent .....	77
4.14	Determination of Trace Perchlorate Using the Dionex IonPac Cryptand C1 Concentrator Column .....	79
4.15	Dual Dionex EGC III NaOH and Dionex EGC III LiOH Applications .....	81
4.15.1	System Requirements .....	81
4.16	Separation of Ten Anions on a 4 mm Dionex IonPac AS9-HC Column using a Dionex EGC K <sub>2</sub> CO <sub>3</sub> .....	82
4.17	Determination of Trace Bromate in Drinking Water Using a 4 mm Dionex AS9-HC Column and a Dionex EGC K <sub>2</sub> CO <sub>3</sub> .....	82
4.18	Separation of Seven Anions on a 4 mm Dionex IonPac AS12A Column using a Dionex EGC K <sub>2</sub> CO <sub>3</sub> and Dionex EPM .....	83
4.19	Separation of Ten Anions on a 2 mm Dionex IonPac AS12A Column Using a Dionex EGC K <sub>2</sub> CO <sub>3</sub> and Dionex EPM .....	83
4.20	Separation of Eight Anions on a 3 mm Dionex IonPac AS14A Column Using a Dionex EGC K <sub>2</sub> CO <sub>3</sub> and Dionex EPM .....	84
4.21	Example of Dual EGC Application – Fetuin Oligosaccharide Alditol Profiling .....	84
<b>5.</b>	<b>Maintenance .....</b>	<b>85</b>
5.1	Replacing the Dionex EGC III or Dionex EGC 500 Cartridge .....	85
5.2	Replacing the Dionex EGC III Outlet Frit .....	87
<b>6.</b>	<b>Troubleshooting Guide .....</b>	<b>88</b>
6.1	Dionex ICS-3000, Dionex ICS-5000, Dionex ICS-5000 <sup>+</sup> , Dionex ICS-6000 EG Error Messages and Troubleshooting .....	88
6.1.1	EG1 Cartridge Disconnected and EG2 Cartridge Disconnected .....	88
6.1.2	EG1 Invalid Concentration and EG2 Invalid Concentration .....	88
6.1.3	EG1 Invalid Flow and EG2 Invalid Flow .....	88
6.1.4	EG1 Invalid Flow Rate-Concentration and EG2 Invalid Flow Rate-Concentration .....	89
6.1.5	EG1 over Current, EG2 over Current, EG1 over Power, and EG2 over Power .....	89
6.1.6	EG1 over Voltage and EG2 over Voltage .....	89
6.2	EG Alarm Light is Lit .....	90
6.3	EG Power LED Fails to Light .....	91
6.4	Liquid Leaks in the EG .....	91
6.5	No Flow .....	91
6.6	EG Stops Operation .....	92
6.7	Excessive System Backpressure .....	93
6.8	No Peaks .....	93
6.9	Peak Retention Times are Too Short .....	93
6.10	Peak Retention Times are Too Long .....	93
6.11	Low System Backpressure .....	93
<b>Appendix A</b>	<b>.....</b>	<b>94</b>

# 1. Introduction

A Reagent-Free™ Ion Chromatography system with Eluent Generation (RFIC™-EG) is capable of generating high purity acid, base, and salt eluents online at the point of use utilizing only deionized (DI) water as the carrier. The use of Eluent Generation (EG) in Ion Chromatography (IC) offers several significant advantages. Mainly, separations can be performed using only DI water as the carrier and the need to prepare eluent is eliminated. RFIC-EG systems produce high purity, contaminant-free eluents online. The use of these high purity eluents can significantly improve the performance of IC methods.

An important advantage of EG is that gradient separations can be performed using electrical current to generate gradients with minimal delay. In addition, the use of EG can reduce the maintenance costs of a pumping system since the pump only comes in contact with DI water instead of corrosive acids or bases.

Thermo Scientific offers 12 Thermo Scientific™ Dionex™ Eluent Generator Cartridges (Dionex EGC). Six are high purity hydroxide eluent cartridges used for anion separations with hydroxide selective columns:

1. Thermo Scientific™ Dionex™ EGC III KOH cartridge for the generation of potassium hydroxide (KOH) at flow rates between 0.10 and 3.0 mL/min and pressures up to 3,000 psi.
2. Thermo Scientific™ Dionex™ EGC III NaOH cartridge for the generation of sodium hydroxide (NaOH) at flow rates between 0.10 and 3.0 mL/min and pressures up to 3,000 psi.
3. Thermo Scientific™ Dionex™ EGC III LiOH cartridge for the generation of lithium hydroxide (LiOH) at flow rates between 0.10 and 3.0 mL/min and pressures up to 3,000 psi.
4. Thermo Scientific™ Dionex™ EGC 500 KOH cartridge for the generation of potassium hydroxide (KOH) at flow rates between 0.10 and 3.0 mL/min and pressures up to 5,000 psi.
5. Thermo Scientific™ Dionex™ EGC 400 KOH cartridge for the generation of potassium hydroxide (KOH) at flow rates between 0.02 and 0.20 mL/min and pressures up to 5,000 psi.
6. Thermo Scientific™ Dionex™ EGC-KOH (Capillary) cartridge for the generation of potassium hydroxide (KOH) at flow rates between 0.001 and 0.030 mL/min and pressures up to 5,000 psi.



## NOTE

***EGC 400 KOH cartridge has to be used in combination with EGC 400 MSA cartridge in order to be recognized by Chromeleon***

In addition, Thermo Scientific offers a high purity carbonate eluent cartridge and an Electrolytic pH Modifier for use with anion separations with carbonate eluent-based columns:

1. Thermo Scientific™ Dionex™ EGC 500 K<sub>2</sub>CO<sub>3</sub> cartridge for the generation of potassium carbonate (K<sub>2</sub>CO<sub>3</sub>) in traditional RFIC-EG systems up to 3,000 psi as well as high-pressure IC (HPIC) systems at pressures up to 5,000 psi.
2. Thermo Scientific™ Dionex™ EPM 500 eluent pH modifier for the in-line titration of potassium carbonate to potassium bicarbonate (KHCO<sub>3</sub>) in traditional RFIC-EG systems up to 3,000 psi as well as high-pressure IC (HPIC) systems at pressures up to 5,000 psi.



Finally, Thermo Scientific offers four high purity methanesulfonic acid cartridges for use with cation separations:

1. Thermo Scientific™ Dionex™ EGC III MSA cartridge for the generation of methanesulfonic acid ( $\text{CH}_3\text{SO}_3\text{H}$ ) at flow rates between 0.10 and 3.0 mL/min and pressures up to 3,000 psi.
2. Thermo Scientific™ Dionex™ EGC 500 MSA cartridge for the generation of methanesulfonic acid ( $\text{CH}_3\text{SO}_3\text{H}$ ) at flow rates between 0.10 and 3.0 mL/min and pressures up to 5,000 psi.
3. Thermo Scientific™ Dionex™ EGC 400 MSA cartridge for the generation of methanesulfonic acid ( $\text{CH}_3\text{SO}_3\text{H}$ ) at flow rates between 0.02 and 0.20 mL/min and pressures up to 5,000 psi.

**NOTE**

*EGC 400 KOH cartridge has to be used in combination with EGC 400 MSA cartridge in order to be recognized by Chromeleon.*

4. Thermo Scientific™ Dionex™ EGC-MSA (Capillary) cartridge for the generation of methanesulfonic acid ( $\text{CH}_3\text{SO}_3\text{H}$ ) at flow rates between 0.001 and 0.030 mL/min and pressures up to 5,000 psi.

To support the analysis of complex carbohydrates, the Dual EGC mode of operation can be used to generate potassium methanesulfonate (KMSA) salts. This mode of operation is only available on systems that support Dual EGC, such as the Dionex ICS-6000. In this mode a Dionex EGC 400 MSA can be connected in series to a Dionex EGC 400 KOH to generate KOH/KMSA eluents up to 200 mM at flow rates of 20 – 63  $\mu\text{L}/\text{min}$ , and up to 63 mM at flow rates up to 200  $\mu\text{L}/\text{min}$ . A Dionex EGC-KOH (Capillary) can be connected in series to a Dionex EGC-MSA (Capillary) to generate KOH/KMSA up to 200 mM at flow rates of 1 – 10  $\mu\text{L}/\text{min}$ , and up to 100 mM at flow rates up to 20  $\mu\text{L}/\text{min}$ .

Thermo Scientific also offers a Thermo Scientific™ Dionex™ Continuously Regenerated Trap Column (Dionex CR-TC 600). A Dionex CR-TC 600 removes any extraneous contaminants from the DI water source. The Dionex CR-TC 600 is electrolytically regenerated, thus eliminating the need for offline chemical regeneration. A Thermo Scientific™ Dionex™ CR-ATC 600 Trap Column is used for anion exchange applications while a Thermo Scientific™ Dionex™ CR-CTC 600 Trap Column is used for cation exchange applications. A Dionex CR-TC 600 can be used at pressures up to 5,000 psi and is only compatible with high-pressure IC systems equipped with the Consumables Monitoring capability such as the Thermo Scientific Dionex ICS-6000 or Thermo Scientific Dionex Integrion.

The Thermo Scientific Dionex CR-TC 500 offers compatibility with systems not equipped with Consumables Monitoring such as the Thermo Scientific Dionex ICS-5000<sup>+</sup> or Thermo Scientific Dionex ICS-2100. In all other respects, the Dionex CR-TC 500 is identical to the Dionex CR-TC 600.

## 1.1 Dionex EGC 500 KOH, Dionex EGC 400 KOH, Dionex EGC III KOH, NaOH and LiOH, and Dionex EGC-KOH (Capillary) Principle of Operation

**Figure 1** Dionex EGC 500 KOH, Dionex EGC 400 KOH, Dionex EGC III KOH, NaOH, LiOH or Dionex EGC-KOH (Capillary) Cartridge for generation of KOH, NaOH or LiOH eluent.

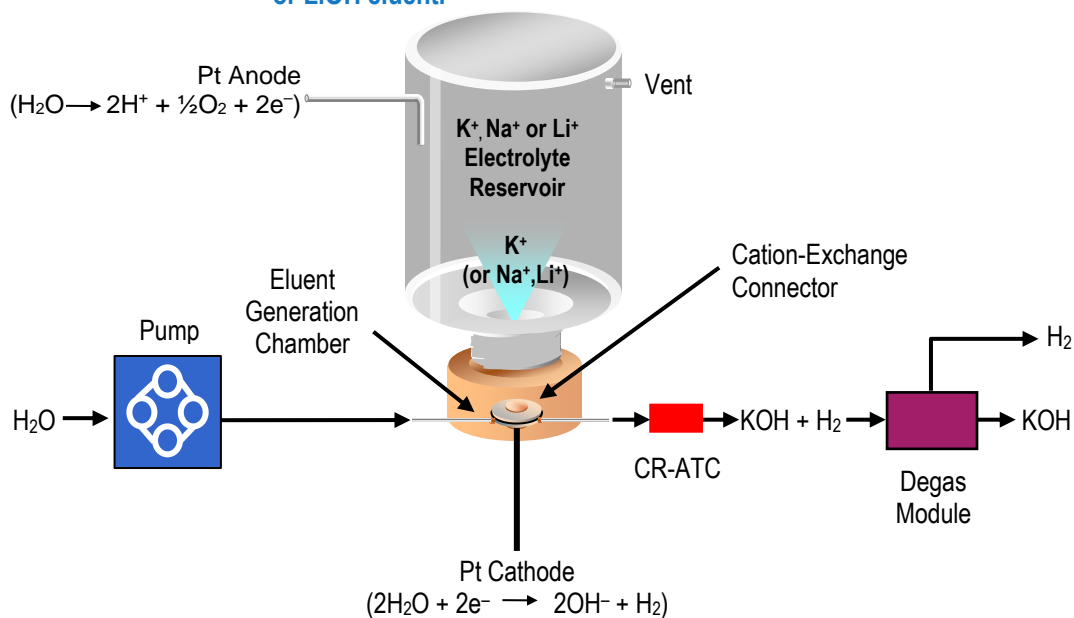

14538-05

Figure 1 illustrates the operation principle of a Dionex EGC 500 KOH, Dionex EGC 400 KOH, Dionex EGC III KOH, NaOH, LiOH or Dionex EGC-KOH (Capillary). The cartridge consists of a high-pressure eluent generation chamber and a low-pressure  $K^+$ ,  $Na^+$  or  $Li^+$  ion electrolyte reservoir. The eluent generation chamber contains a perforated platinum (Pt) cathode where hydroxide ions are formed. The  $K^+$ ,  $Na^+$  or  $Li^+$  ion electrolyte reservoir contains a Pt anode and an electrolyte solution of  $K^+$ ,  $Na^+$  or  $Li^+$  ions. The eluent generation chamber is connected to the electrolyte reservoir by means of a cation exchange connector which permits the passage of ions from the electrolyte reservoir into the high-pressure generation chamber while preventing the passage of anions from the electrolyte reservoir into the generation chamber. The cation exchange connector also serves the critical role of a high-pressure physical barrier between the low-pressure electrolyte reservoir and the high-pressure generation chamber.

To generate a KOH, NaOH or LiOH eluent, deionized water is pumped through the eluent generation chamber and a DC current is applied between the anode and cathode of the Dionex EGC. Under the applied field, the electrolysis of water occurs at both the anode and cathode of the device. As shown below, water is oxidized to form  $H^+$  ions and oxygen gas at the anode in the  $K^+$ ,  $Na^+$  or  $Li^+$  electrolyte reservoir.

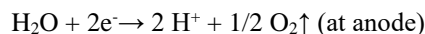

Water is reduced to form  $OH^-$  ions and hydrogen gas at the cathode in the KOH, NaOH or LiOH generation chamber.



As  $H^+$  ions, generated at the anode, displace  $K^+$ ,  $Na^+$  or  $Li^+$  ions in the electrolyte reservoir, the displaced ions migrate across the cation exchange connector into the eluent generation chamber.

These ions combine with  $\text{OH}^-$  ions generated at the cathode to produce the KOH, NaOH or LiOH solution, which is used as the eluent for anion exchange chromatography. The concentration of generated KOH, NaOH or LiOH is determined by the current applied to the generator and the carrier water flow rate through the generation chamber. Therefore, given the carrier flow rate, the EG module will precisely control the applied current to accurately and reproducibly generate KOH, NaOH or LiOH at the desired concentration.

In the case of the Dionex EGC 500 KOH, two EGC pods are connected in series to provide sufficient capacity while maintaining high-pressure capability.

## 1.2 Dionex EGC 500 MSA, Dionex EGC 400 MSA, Dionex EGC III MSA, and Dionex EGC-MSA (Capillary) Principle of Operation

**Figure 2** Dionex EGC 500 MSA, Dionex EGC 400 MSA, Dionex EGC III MSA or Dionex EGC-MSA (Capillary) Cartridge for generation of MSA eluent.

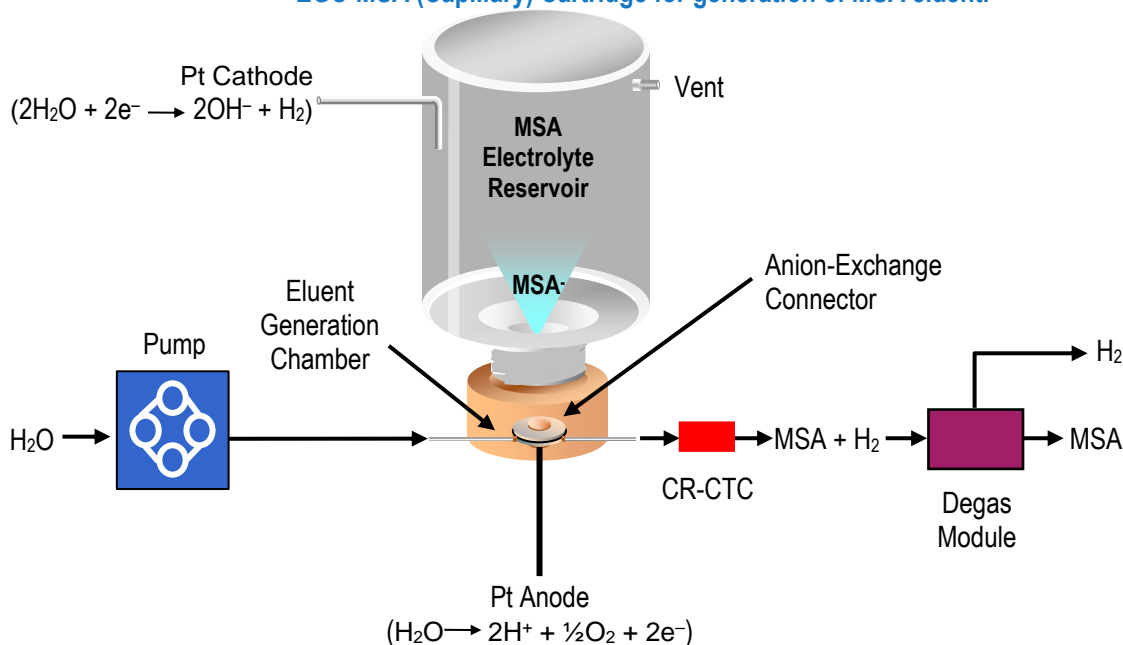

14538-

The concept described for the generation of hydroxide can be applied to the generation of acid. Figure 2 illustrates the operation principle of a Dionex EGC 500 MSA, Dionex EGC 400 MSA, Dionex EGC III MSA or Dionex EGC-MSA (Capillary) cartridge. The cartridge consists of a high-pressure eluent generation chamber and a low-pressure methanesulfonate ( $\text{MSA}^-$ ) ion electrolyte reservoir. The eluent generation chamber contains a perforated platinum (Pt) anode. The electrolyte reservoir contains a Pt cathode and an electrolyte solution of  $\text{MSA}^-$  ions. The eluent generation chamber is connected to the  $\text{MSA}^-$  ion electrolyte reservoir using an anion exchange connector which permits the passage of  $\text{MSA}^-$  ions from the electrolyte reservoir into the high-pressure generation chamber, while preventing the passage of cations.

The anion exchange connector also serves the critical role of a high-pressure physical barrier between the low-pressure electrolyte reservoir and the high-pressure eluent generation chamber.

To generate an MSA eluent, deionized water is pumped through the MSA generation chamber and a DC current is applied between the anode and cathode of the eluent generator cartridge.

Under the applied field, the electrolysis of water occurs at the anode and cathode of the device. Water is oxidized to form  $H^+$  ions and oxygen gas at the anode in the MSA generation chamber as shown below.

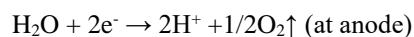

Water is reduced to form  $OH^-$  ions and hydrogen gas at the cathode in the  $MSA^-$  electrolyte reservoir.



As the  $OH^-$  ions, generated at the cathode, displace  $MSA^-$  ions in the electrolyte reservoir,  $MSA^-$  ions migrate across the anion exchange connector into the MSA electrolysis chamber. The  $MSA^-$  ions combine with  $H^+$  ions generated at the anode to produce a methanesulfonic acid (MSA) solution, which is used as the eluent for cation exchange chromatography. The concentration of MSA generated is determined by the current applied to the MSA generator and the carrier flow rate through the MSA generation chamber. Therefore, given the carrier flow rate, the EG module will control the applied current in order to accurately and reproducibly generate MSA at the desired concentration.

In the case of the Dionex EGC 500 MSA, two EGC pods are connected in series to provide sufficient capacity while maintaining high pressure capability.

### 1.3 Dionex EGC 500 K<sub>2</sub>CO<sub>3</sub> Principle of Operation

Figure 3 Dionex EGC 500 K<sub>2</sub>CO<sub>3</sub> Cartridge for Generation of Carbonate Eluents.

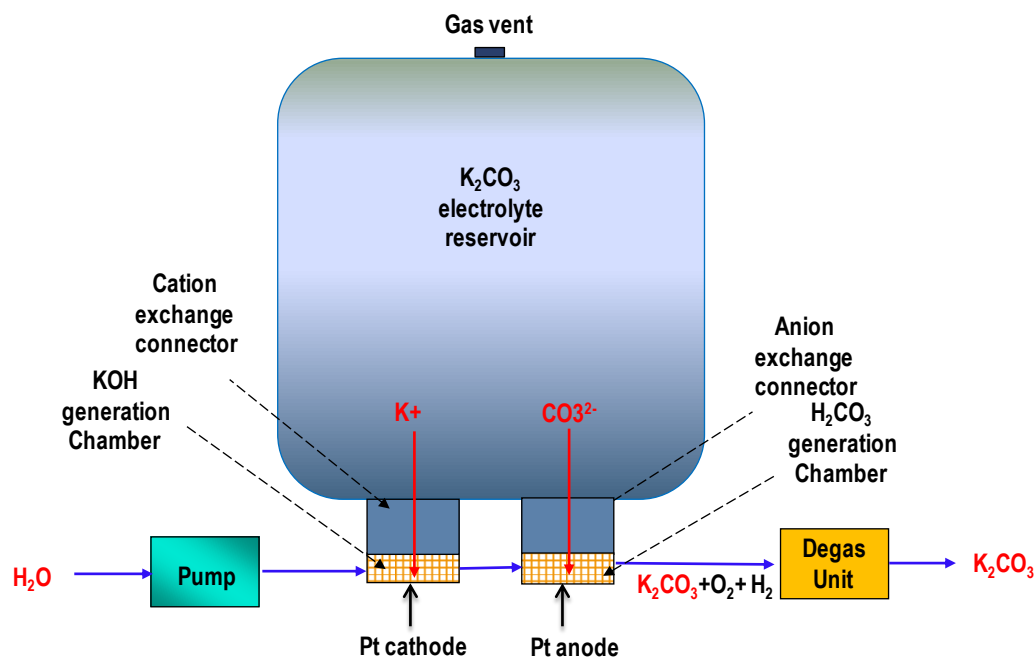

The Potassium Carbonate Eluent Generator Cartridge (Dionex EGC 500 K<sub>2</sub>CO<sub>3</sub>) is the heart of the electrolytic carbonate eluent generation process. Figure 3 shows the principle of electrolytic generation of carbonate eluents. Carbonate eluents are generated by using a Dionex EGC 500 K<sub>2</sub>CO<sub>3</sub> cartridge. The Dionex EGC 500 K<sub>2</sub>CO<sub>3</sub> cartridge consists of an electrolyte reservoir and two high-pressure eluent generation chambers, which are connected in series. The ion exchange connector sections in these two chambers are cation exchange section and anion exchange section, respectively.

In the first-generation chamber, the cation exchange section is located directly above the cathode and the anion exchange section is located directly above the anode in the second-generation chamber. To generate a potassium carbonate solution, deionized water is pumped into the eluent generation chambers and a DC electrical current is applied to the anode and cathode of the device. Water is reduced to form OH<sup>-</sup> ions and hydrogen gas at the cathode.



Water is oxidized to form H<sup>+</sup> ions and oxygen gas at the anode.

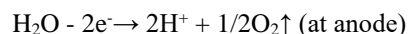

Under the applied electrical field, potassium ions in the electrolyte reservoir migrate across the cation exchange connector and combine with the hydroxide ions produced at the cathode through the reduction of water to form a KOH solution. In the meantime, carbonate ions migrate across the anion exchange connector and combine with  $H^+$  ions produced at the anode through the oxidation of water to form a carbonic acid solution. The potassium hydroxide solution reacts with the carbonic acid solution to form potassium carbonate ( $K_2CO_3$ ) solution, which can be used as the eluent in ion chromatography. The concentration of  $K_2CO_3$  formed is directly proportional to the applied DC current and inversely proportional to the flow rate of DI water going through the eluent generation chamber.

## 1.4 Dionex EPM 500 Principle of Operation

**Figure 4** Electrolytic Generation of  $K_2CO_3/KHCO_3$  eluents using a Dionex EGC 500  $K_2CO_3$  cartridge and Dionex EPM 500.

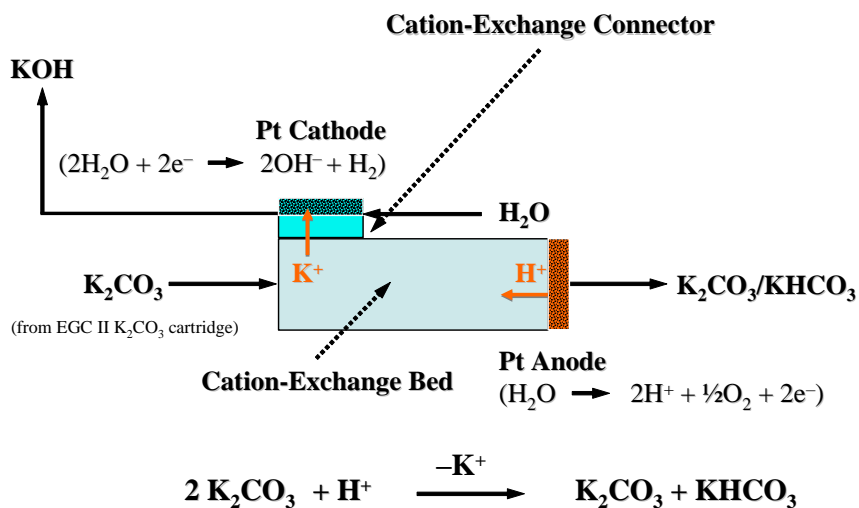

When the Dionex EGC 500  $K_2CO_3$  cartridge is combined with an Electrolytic pH Modifier (Dionex EPM 500), eluents of carbonate and bicarbonate can be generated electrolytically. The Dionex EPM 500 consists of a cation exchange bed that is fitted with an anode at its outlet. The inlet end of the device is connected to a cathode through the cation exchange connector. A DC current is applied to the Dionex EPM 500 to remove a controlled amount of potassium ions which are forced to migrate across the cation exchange connector. The displaced potassium ions move toward the cathode and combine with hydroxide ions to form a solution of potassium hydroxide, which is directed to waste. In the meantime, hydronium ions generated at the anode converts carbonate into bicarbonate. The net reaction is shown in Figure 4. Therefore, by controlling the applied current, the pH of the incoming potassium carbonate eluent can be modified to form a potassium carbonate and bicarbonate solution for use as the eluent in IC separations.

## 1.5 Dual EGC Principle of Operation

The Dual EGC mode of operation is available on supported instrument such as the Dionex ICS-6000 to support the analysis of complex carbohydrates using RFIC-EG generated eluent. In this mode a pair of EGC's are connected in series to generate KOH/KMSA eluents ranging from KOH alone, MSA alone, excess KOH with KMSA, and excess MSA with KMSA.

For 1 mm operation a Dionex EGC 400 MSA is connected in series to a Dionex EGC 400 KOH to generate KOH/KMSA eluents at concentrations up to 200 mM at flow rates of 20 – 63  $\mu\text{L}/\text{min}$ , and up to 63 mM at flow rates up to 200  $\mu\text{L}/\text{min}$ . For capillary operation a Dionex EGC-MSA (Capillary) is connected in series to a Dionex EGC-KOH (Capillary) to generate KOH/KMSA eluents at concentrations up to 200 mM at flow rates of 1 – 10  $\mu\text{L}/\text{min}$ , and up to 100 mM at flow rates up to 20  $\mu\text{L}/\text{min}$ .

Deionized water is pumped first into the EGC MSA cartridge to generate MSA. The MSA solution is then passed into the EGC KOH cartridge to form KMSA. By balancing the concentration of the two cartridges pure KOH/KMSA can be generated. By generating an excess of KOH compared to MSA, a basic solution of KMSA plus KOH can be generated (Basic Eluent Mode). By generating an excess of MSA compared to KOH, an acidic solution of KMSA plus MSA can be generated (Acidic Eluent Mode). The system can be switched between the two modes as needed.



### NOTE

*Oligosaccharide analysis applications typically require an excess of potassium hydroxide for operation; this is achieved by operating in Basic Eluent Mode. Column cleaning processes may require an excess of methanesulfonic acid; this is achieved by operating in Acidic Eluent Mode.*

When operated in Basic Eluent Mode pure KMSA can be generated, or an excess of KOH to create a basic eluent. In this mode the concentrations of generated eluent species are governed by the formulas:

$$\begin{aligned} MSA_{act} &= KMSA_{prog} \\ KOH_{act} &= KOH_{prog} + KMSA_{prog} \end{aligned}$$

When operated in Acid Eluent Mode pure KMSA can be generated, or an excess of MSA to create an acidic eluent. In this mode the concentrations of generated eluent species are governed by the formulas:

$$\begin{aligned} KOH_{act} &= KMSA_{prog} \\ MSA_{act} &= MSA_{prog} + KMSA_{prog} \end{aligned}$$

Where:

- $KMSA_{prog}$  is the concentration of potassium methanesulfonate that has been programmed by the operator
- $KOH_{prog}$  is the concentration of potassium hydroxide that has been programmed by the operator; this is zero in Acidic Eluent Mode
- $MSA_{prog}$  is the concentration of methanesulfonic acid that has been programmed by the operator; this is zero in Basic Eluent Mode
- $MSA_{act}$  is the concentration of methanesulfonic acid generated by the EGC MSA cartridge
- $KOH_{act}$  is the concentration of potassium hydroxide generated by the EGC KOH cartridge.

The Dionex Chromeleon CDS or IC System front panel will automatically calculate the  $MSA_{act}$  and  $KOH_{act}$  values based on input  $KMSA_{prog}$ ,  $MSA_{prog}$  and  $KOH_{prog}$  values. By setting the  $KMSA_{prog}$  value to zero it is possible to control each cartridge individually and generate pure KOH or MSA.

**Tip**

*By setting the  $KMSA_{prog}$  value to zero it is possible to control each cartridge individually and generate almost pure KOH or MSA. A trace level of cross-contamination is expected.*

## 1.6 Differences between Dionex EGC III / Dionex EPM III, and Dionex EGC 500 / Dionex EPM 500

With the exception of the Dionex EGC  $K_2CO_3$ , the Dionex EGC 500 is not a direct replacement for the Dionex EGC III. The Dionex EGC 500 is designed to enable high-pressure operation in High-Pressure RFIC-EG systems such as the Dionex ICS-6000 and Dionex Integriion RFIC. In order to operate above 3,000 psi, a High-Pressure RFIC-EG system must be fitted with a Dionex EGC 500.

The Dionex EGC 500  $K_2CO_3$  is a direct replacement for the Dionex EGC III  $K_2CO_3$  and the Dionex EPM 500 is a direct replacement for the Dionex EPM III. The Dionex EGC 500  $K_2CO_3$  and Dionex EPM 500 are designed to enable high-pressure operation in High-Pressure RFIC-EG systems (HPIC systems) such as the Dionex ICS-5000<sup>+</sup>. The Dionex EGC 500  $K_2CO_3$  and Dionex EPM 500 are compatible with non-HPIC RFIC-EG systems such as the Dionex ICS-2100, but the backpressure will be limited to 3,000 psi in these systems.

The following table outlines the equivalent Dionex EGC III and Dionex EGC 500 products:

Dionex EGC III Products		Dionex EGC 500 Products	
Item #	Description	Item #	Description
074532	Dionex EGC III KOH	075778	Dionex EGC 500 KOH
074535	Dionex EGC III MSA	075779	Dionex EGC 500 MSA
074534	Dionex EGC III LiOH	088453	Dionex EGC 500 $K_2CO_3$
074533	Dionex EGC III NaOH	088471	Dionex EPM 500

**NOTE**

*With the exception of the Dionex EGC  $K_2CO_3$ , the Dionex EGC 500 is not compatible with non-High Pressure RFIC systems and modules such as the Dionex ICS-5000, or Dionex ICS-2100. If a Dionex EGC 500 KOH or Dionex EGC 500 MSA is installed into a non-High Pressure RFIC system, the cartridge will not be recognized.*



## 1.7 Differences between Dionex EGC 500, Dionex EGC 400 and Dionex EGC (Capillary)

The Dionex EGC 400 is a complementary product to the Dionex EGC 500 and Dionex EGC (Capillary). The Dionex EGC 400 is designed to enable operation at flow rates between 20  $\mu\text{L}/\text{min}$  and 200  $\mu\text{L}/\text{min}$ . This fills the flow rate gap between the Dionex EGC (Capillary) (1  $\mu\text{L}/\text{min}$  – 30  $\mu\text{L}/\text{min}$ ) and the Dionex EGC 500 (100  $\mu\text{L}/\text{min}$  – 3,000  $\mu\text{L}/\text{min}$ ), see Figure 5. For example, the flow rate of the Thermo Scientific Dionex CarboPac PA200 (1 mm) column that is used for Dual EGC applications falls directly into this flow rate range (63  $\mu\text{L}/\text{min}$ ).

**Figure 5** Dionex EGC 500 and EGC (Capillary) cover the flow rate range 1 – 30  $\mu\text{L}/\text{min}$  and 100 to 3000  $\mu\text{L}/\text{min}$  respectively. The EGC 400 covers the gap (20 – 200  $\mu\text{L}/\text{min}$ ) required for some Dual EGC applications.

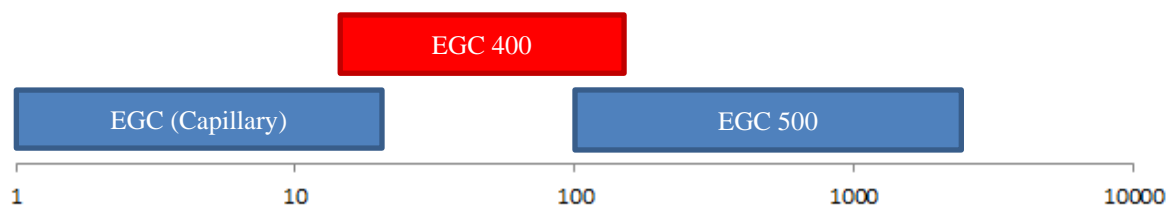

## 1.8 System Flow Diagram

### 1.8.1 Eluent Generator module with hydroxide or MSA eluent and Dionex CR-TC Trap Column

Figure 6 shows the configuration of a typical RFIC-EG system. The EG Module is placed between the outlet of the pump and the inlet of the sample injector. Deionized water is used as the carrier for the EG. For anion analysis, a Dionex Continuously Regenerated Anion Trap Column (Dionex CR-ATC 600, Item # 088662), should be placed at the Dionex Eluent Generator Cartridge (Dionex EGC) outlet to remove dissolved carbon dioxide and other anionic contaminants from the deionized water. For cation analysis, a Dionex Continuously Regenerated Cation Trap Column (Dionex CR-CTC 500, Item # 088663) should be placed at the Dionex EGC outlet to remove cationic contaminants such as ammonium from the acidic eluent.

The high pressure degas tubing assembly is located between the outlet of the Dionex CR-TC 600 and the inlet of the sample injector to remove electrolysis gases generated during the eluent generation process. After exiting the degas tubing assembly, the high purity eluent passes through the injector, column, suppressor, and finally to the detector. Depending on the pressure drop across the guard and analytical column, an optional pressure restrictor can be installed between the outlet of the high pressure degas tubing assembly and the inlet of the sample injector for optimal system performance. A total backpressure of 2,300 psi is ideal. When using suppressed conductivity detection, the suppressor regenerant effluent is directed to flow through the degas tubing assembly to remove any released hydrogen or oxygen gas as shown in Figure 6.

**Figure 6 Standard Pressure System Flow Diagram for a typical RFIC-EG application using hydroxide or MSA eluent.**



**NOTE**

*This flow diagram is not applicable when using EGC 400 cartridges for carbohydrate applications. Please refer to section 1.8.7 for more information.*

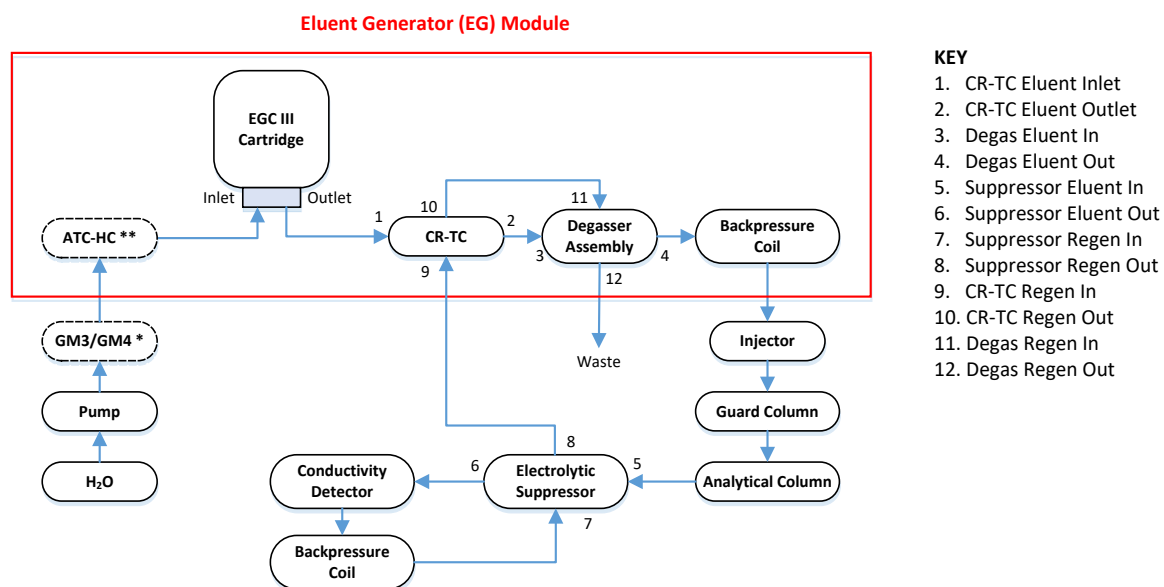

\* Use with CR-TC.  
 \*\* Remove for CR-TC use.

**Figure 7 High-Pressure System Flow Diagram for a Typical RFIC-EG Application Using Hydroxide or MSA Eluent.**

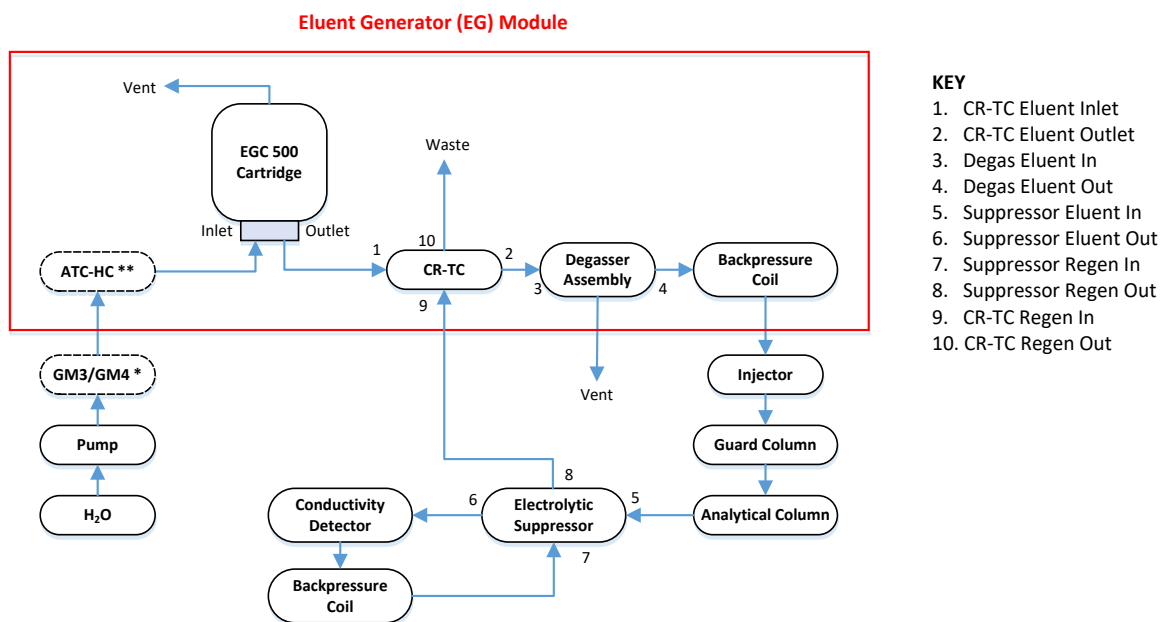

\* Use with CR-TC.  
 \*\* Remove for CR-TC use.

**1.8.2 Eluent Generator module with hydroxide or MSA eluent and Dionex ATC-HC 500 or Dionex CTC 500.**

As an alternative to the Dionex CR-ATC 500, the Thermo Scientific™ Dionex™ IonPac™ ATC-HC 500 (Item # 075978) can be used for anion exchange applications. The Thermo Scientific™ Dionex™ IonPac™ CTC 500 (Item # 075977) can be used as an alternative to the Dionex CR-CTC 600 Trap Column for cation applications. See Appendix A.

**1.8.3 Eluent Generator module with hydroxide or MSA eluent and UltraViolet (UV) Detection.**

When using UV detection, the detector effluent is directed to flow through the degas tubing assembly to remove any released hydrogen gas, as shown in Figure 7.

**Figure 8 High-Pressure System Flow Diagram for a Typical RFIC-EG Application Using Hydroxide or MSA Eluent and UV Detection.**

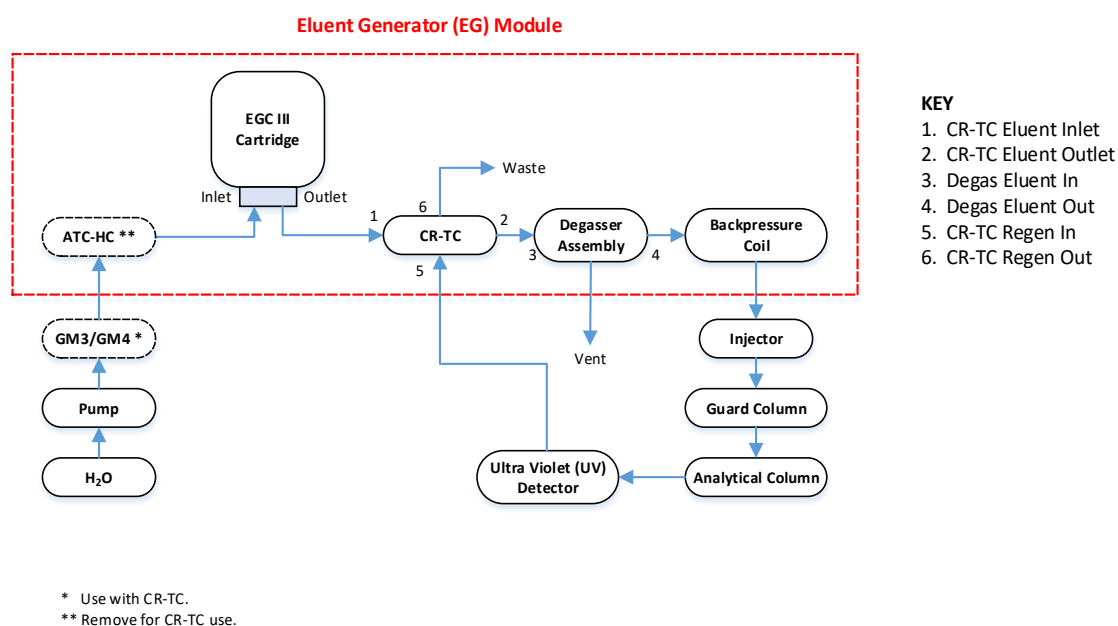

### 1.8.4 Eluent Generator module with hydroxide or MSA eluent and Amperometric Detection.

Because the hydrogen and oxygen gasses generated by the electrolytic reactions in the Dionex EGC cartridges are electroactive, they must be removed with greater efficiency for Amperometric Detection compared to other detection methods such as suppressed conductivity. To achieve this, it is necessary to pull a vacuum on the Dionex EG Degas module.

To increase the gas removal efficiency, the cell effluent is directed to the Dionex CR-ATC REGEN IN and then diverted to waste, see Figure 9. A Dionex VP Vacuum Pump Kit (Item # 066463) or the Dionex EG/DP/SP Vacuum Degas Conversion Kit (Item # 063353) is installed to vacuum degas the EG eluent prior to operation.

The Dionex VP Vacuum Pump Kit contains a stand-alone vacuum pump with all the components required to connect the pump and to remove H<sub>2</sub> gas from the Dionex EG Degas module.

The EG/DP/SP Vacuum Degas Conversion Kit contains all components required to convert the Dionex ICS-3000/5000/5000<sup>+</sup>/6000 DP or SP vacuum degas pump to remove H<sub>2</sub> gas from EG Degas module. A Dionex ICS-3000/5000/5000<sup>+</sup>/6000 DP or SP with vacuum degas option is required.

**Figure 9 High-Pressure System Flow Diagram for Carbohydrate Applications Using an Eluent Generator Module.**

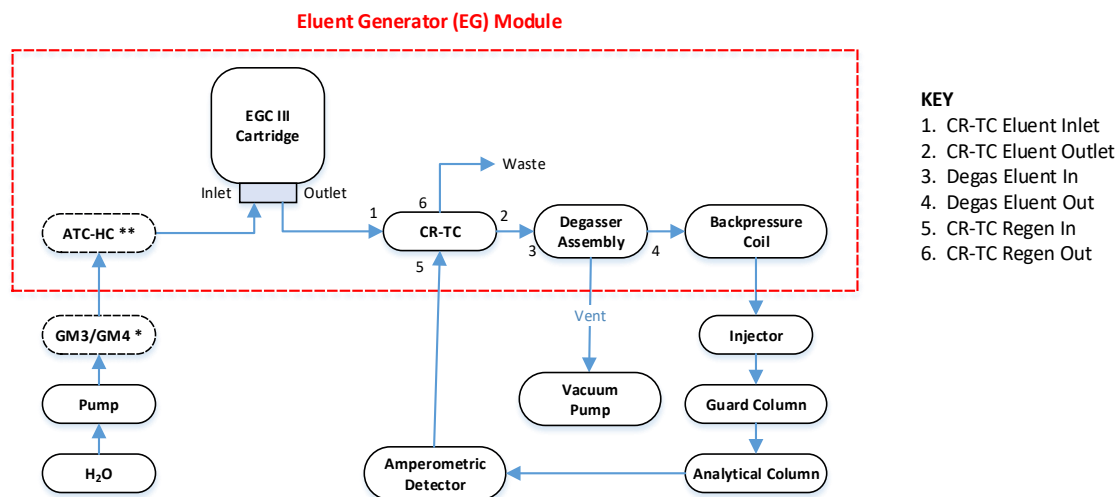

\* Use with CR-TC.

\*\* Remove for CR-TC use.

### 1.8.5 Eluent Generator Module with Carbonate Eluent

Figure 10 shows the plumbing schematic for electrolytic generation of carbonate only eluent using a Dionex EGC 500 K<sub>2</sub>CO<sub>3</sub> cartridge in a Dionex RFIC-EG system. The Dionex EGC 500 K<sub>2</sub>CO<sub>3</sub> Cartridge and EGC 500 Carbonate Mixer are shipped in separate boxes. The EGC 500 Carbonate Mixer is used to provide sufficient mixing of the KOH and H<sub>2</sub>CO<sub>3</sub> formed from the cation pod and anion pod of the Dionex EGC 500 K<sub>2</sub>CO<sub>3</sub> cartridge, respectively. The Dionex EGC degas assembly is installed inside the EG module at the factory.

**Figure 10** Plumbing Schematic for Electrolytic Generation of Carbonate Only Eluent Using a Dionex EGC 500 K<sub>2</sub>CO<sub>3</sub> Cartridge in an RFIC-EG System.

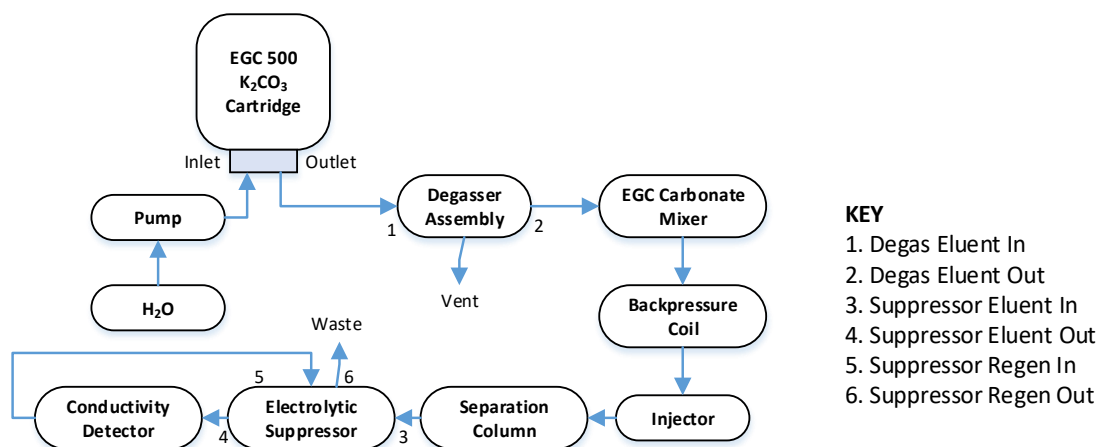

### 1.8.6 Eluent Generator Module with Carbonate/Bicarbonate Eluent

To generate eluents of carbonate and bicarbonate, a Dionex EPM 500 is installed in the system alongside the Dionex EGC 500 K<sub>2</sub>CO<sub>3</sub>. The system flow diagram is shown in Figure 11.

**Figure 11** Plumbing Schematic for Electrolytic Generation of Carbonate and Bicarbonate Mixed Eluents Using a Dionex EGC 500 K<sub>2</sub>CO<sub>3</sub> Cartridge and Dionex EPM 500 in an RFIC-EG System.

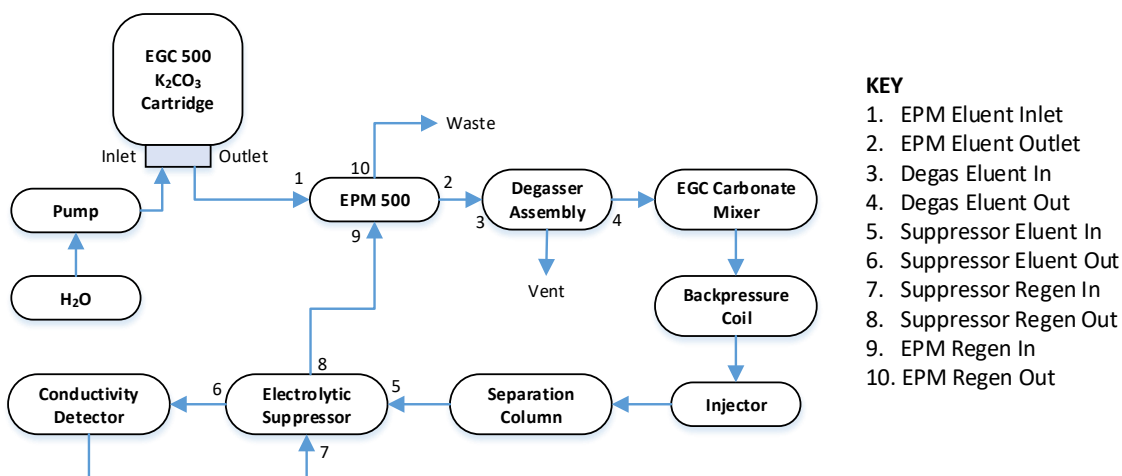

### 1.8.7 Eluent Generator Module with Dual EGC KOH/KMSA Eluents

To generate eluents of potassium methanesulfonate with optional excess potassium hydroxide or methanesulfonic acid, a Dionex EGC 400 MSA is paired with a Dionex EGC 400 KOH, or a Dionex EGC-MSA (Capillary) is paired with a Dionex EGC-KOH (Capillary). The system flow diagram for an analytical system is shown below in Figure 12, the flow diagram for a capillary system is shown in Figure 13.



*Oligosaccharide analysis applications typically require an excess of potassium hydroxide for operation. Column cleaning procedures may require an excess of methanesulfonic acid. The plumbing schematics below are suited to both modes of operation.*

**Figure 12 Plumbing Schematic for Electrolytic Generation of Potassium Hydroxide/ Potassium Methanesulfonate Eluents Using a Dionex EGC 400 KOH and Dionex EGC 400 MSA Cartridge in an RFIC-EG System**

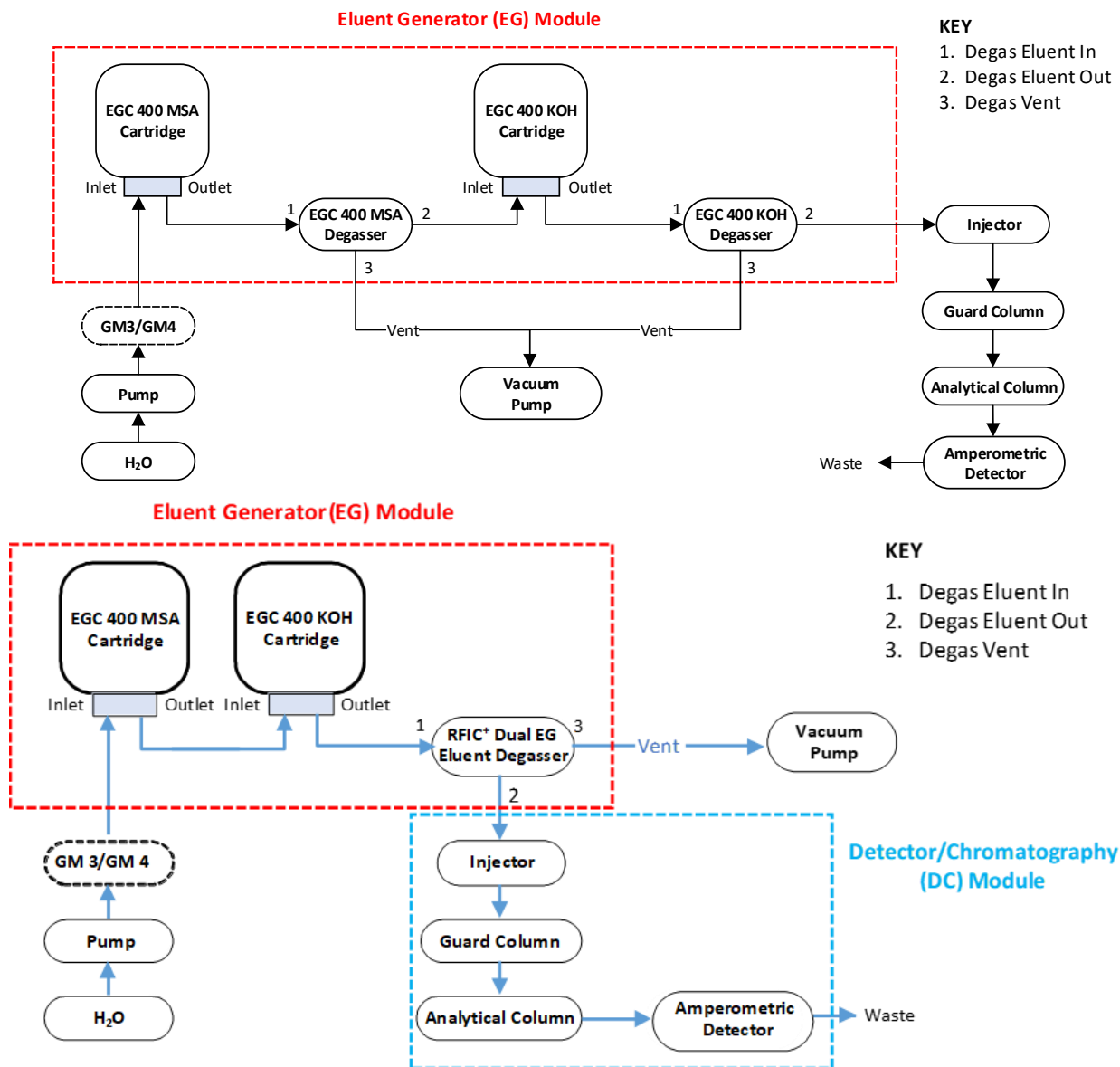

**Figure 13 Plumbing Schematic for Electrolytic Generation of Potassium Hydroxide/ Potassium Methanesulfonate Using a Dionex EGC-MSA (Capillary) and Dionex EGC-KOH (Capillary) Cartridge in an RFIC-EG System**

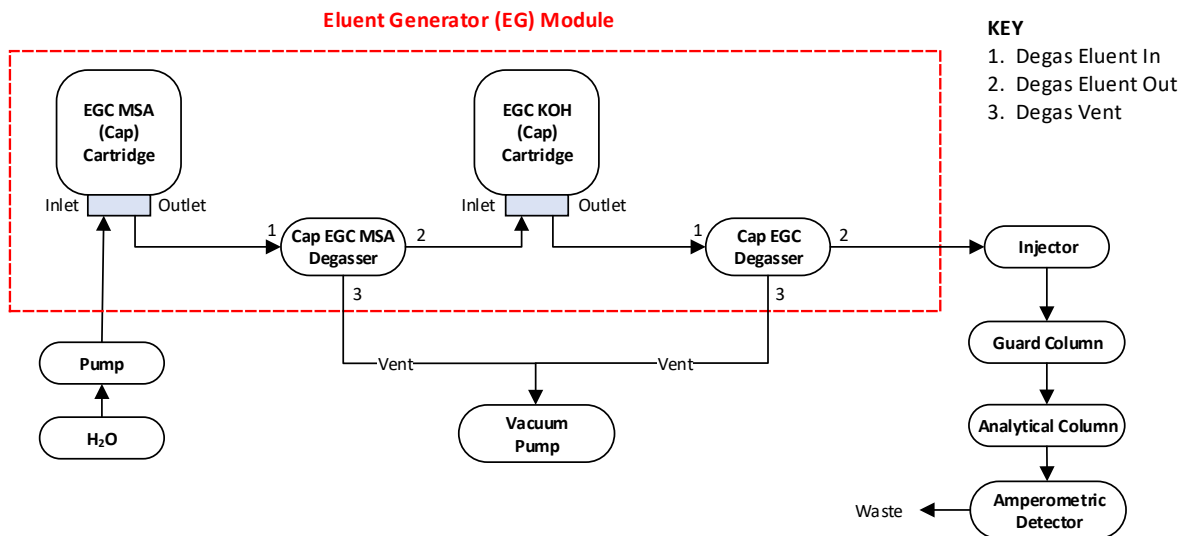



## 1.9 Dionex EGC 500, Dionex EGC 400, Dionex EGC III, and Dionex EGC (Capillary) Operational Lifetime

The life expectancy of an analytical Dionex EGC cartridge is a function of a number of user-selectable parameters. Based on eluent concentration and flow rate, the number of expected operating hours for the cartridge can be determined. The Dionex EGC 500 has identical operational lifetime than the Dionex EGC III. But with higher flow rates, HPIC systems typically can run more samples in the same period of time. This gives the Dionex EGC 500 cartridge a cost of ownership advantage over the Dionex EGC III.

The EGC 400 will typically last for 18 months of cumulative operation at 55 mM and 63  $\mu\text{L}/\text{min}$ , although at higher flow rates or eluent concentrations may last shorter.

Under most conditions, the Dionex EGC (Capillary) will last 18 months regardless of use, allowing the Always on operation without concern for accelerated consumption of the Dionex EGC cartridge.

### 1.9.1 Dionex EGC 500 and Dionex EGC III KOH and NaOH

The KOH and NaOH versions of the Dionex EGC 500 and Dionex EGC III have a lifetime of 2,500 hours at 1.0 mL/min and 20 mM. Increasing the flow rate or eluent concentration will accelerate the consumption of the Dionex EGC III or Dionex EGC 500 proportionately. Decreasing the flow rate or eluent concentration will decelerate the consumption of the Dionex EGC III or Dionex EGC 500 proportionately.

$$\text{lifetime} = \frac{50,000}{\text{flowrate} \cdot \text{concentration}} \text{ hours}$$

The Dionex EGC 500 and EGC III are not consumed while they are turned off. However, there is a 2 year best if used by date. The cartridge can be used beyond this date, but the generated eluent concentration should be re-validated.

### 1.9.2 Dionex EGC III LiOH

The LiOH version of the Dionex EGC III has a lifetime of 2,000 hours at 1.0 mL/min and 20 mM. Increasing the flow rate or eluent concentration will accelerate the consumption of the Dionex EGC III proportionately. Decreasing the flow rate or eluent concentration will decelerate the consumption of the Dionex EGC III proportionately.

$$\text{lifetime} = \frac{40,000}{\text{flowrate} \cdot \text{concentration}} \text{ hours}$$

The Dionex EGC III is not consumed while it is turned off. However, there is a 2 year best if used by date. The cartridge can be used beyond this date, but the generated eluent concentration should be re-validated.

### 1.9.3 Dionex EGC 500 and Dionex EGC III MSA

The MSA versions of the Dionex EGC 500 and Dionex EGC III have a lifetime of 1,250 hours at 1.0 mL/min and 20 mM. Increasing the flow rate or eluent concentration will accelerate the consumption of the Dionex EGC III or Dionex EGC 500 proportionately. Decreasing the flow rate or eluent concentration will decelerate the consumption of the Dionex EGC III or Dionex EGC 500 proportionately.

$$\text{lifetime} = \frac{25,000}{\text{flowrate} \cdot \text{concentration}} \text{ hours}$$

The Dionex EGC 500 and EGC III are not consumed while they are turned off. However, there is a 2 year best if used by date. The cartridge can be used beyond this date, but the generated eluent concentration should be re-validated.

#### 1.9.4 Dionex EGC 500 K<sub>2</sub>CO<sub>3</sub> and Dionex EPM 500

The K<sub>2</sub>CO<sub>3</sub> version of the EGC 500 has a lifetime of 1,500 hours at 1.0 mL/min and 9.0 mM. Increasing the flow rate or eluent concentration will accelerate the consumption of the Dionex EGC 500 proportionately. Decreasing the flow rate or eluent concentration will decelerate the consumption of the Dionex EGC 500 proportionately.

$$lifetime = \frac{13,500}{flowrate \cdot concentration} \text{ hours}$$

The Dionex EGC 500 is not consumed while it is turned off. However, there is a 2 year best if used by date. The cartridge can be used beyond this date, but the generated eluent concentration should be re-validated.

The Dionex EPM 500 has no expiration lifetime built in. It is recommended to replace the Dionex EPM 500 with every third Dionex EGC 500 K<sub>2</sub>CO<sub>3</sub>.

#### 1.9.5 Dionex EGC-KOH (Capillary) and Dionex EGC-MSA (Capillary)

Both the KOH and MSA versions of the Dionex EGC (Capillary) have an 18-month lifetime from the day they are first turned on. The Dionex EGC (Capillary) is consumed while it is turned off once it has been placed into a system and turned on. The counter is inactive when the Dionex EGC (Capillary) is shipped; the cartridge can be stored indefinitely without activating the 18-month counter. As soon as the Dionex EGC (Capillary) is installed in a system and turned on, the 18-month counter begins regardless of use.

There is also a 2 year best if used by date. The cartridge can be used beyond this date, but the generated eluent concentration should be re-validated.

#### 1.9.6 Dionex EGC 400 KOH

The Dionex EGC 400 KOH has a lifetime of 18 months at 0.63 μL/min and 55 mM. Increasing the flow rate or eluent concentration will accelerate the consumption of the Dionex EGC 400 KOH proportionately. The Dionex EGC 400 KOH also has a maximum limit of 18 months cumulative use; turning off the EGC 400 KOH will pause this counter. Operation at flow rates or concentrations less than 0.63 μL/min and 55 mM will not extend the 18-month counter.

There is also a 2 year best if used by date. The cartridge can be used beyond this date, but the generated eluent concentration should be re-validated.

#### 1.9.7 Dionex EGC 400 MSA

The Dionex EGC 400 MSA has a lifetime of 18 months at 0.63 μL/min and 32 mM. Increasing the flow rate or eluent concentration will accelerate the consumption of the Dionex EGC 400 MSA proportionately. The Dionex EGC 400 MSA also has a maximum limit of 18 months cumulative use; turning off the EGC 400 MSA will pause this counter. Operation at flow rates or concentrations less than 0.63 μL/min and 55 mM will not extend the 18-month counter.

There is also a 2 year best if used by date. The cartridge can be used beyond this date, but the generated eluent concentration should be re-validated.

## 2. Installation

The Dionex Eluent Generator Cartridges (Dionex EGC) are designed to be used with Dionex EG modules including the Dionex EG50, Dionex, Dionex ICS-2000, Dionex ICS-2100, Dionex ICS-3000 EG, Dionex ICS-5000 EG, Dionex ICS-5000<sup>+</sup> EG, Dionex ICS-6000 EG and Dionex Integrion RFIC modules. For details regarding the operation of these modules please refer to their respective operating manuals.

The Dionex Potassium Carbonate Eluent Generator Cartridges (Dionex EGC 500 K<sub>2</sub>CO<sub>3</sub>) and Dionex Electrolytic pH Modifier (Dionex EPM 500) are not compatible with the Dionex EG50 modules and require Thermo Scientific™ Dionex™ Chromeleon™ Chromatography Management System, version 6.7 or higher. For details regarding their operation, please refer to the EG module operation manual.

The Dionex EGC-KOH (Capillary) and Dionex EGC-MSA (Capillary) cartridges are designed to be used with a Dionex Capillary Ion Chromatography system such as the Dionex ICS-4000, Dionex ICS-5000, Dionex ICS-5000<sup>+</sup> or Dionex ICS-6000 with IC Cube and Capillary pump heads. These cartridges are not compatible with analytical scale instruments.

The Dionex EGC 400 KOH and Dionex EGC 400 MSA cartridges are designed to be used with Dionex RFIC-EG systems that are compatible with the Dual EGC mode of operation such as the Dionex ICS-6000. These cartridges are not compatible with other instruments.



NOTE

*The EGC-1 port of a Dionex ICS-6000, Dionex ICS-5000<sup>+</sup>, Dionex ICS-5000 EG, Dionex ICS-3000 EG, Dionex ICS-2100 or Dionex ICS-2000 is assigned to control the Dionex EGC 500 K<sub>2</sub>CO<sub>3</sub> cartridge, and the EGC-2 port is designed to control the Dionex EPM 500.*



NOTE

*Either port of a Dionex Integrion RFIC system can be assigned to control the Dionex EGC 500 K<sub>2</sub>CO<sub>3</sub> cartridge, or Dionex EPM 500.*

### 2.1 Procedure for Dionex EGC Installation

#### 2.1.1 Preparation for Installation

- A. Remove the Dionex EGC from the box. Save the box and foam for future storage.
- B. If required, configure the EG module to operate the cartridge by entering the cartridge serial number. Please refer to the EG Module and Chromeleon user manuals for detailed procedures for entering the cartridge serial number.



NOTE

- *The Dionex ICS-6000 EG, Dionex ICS-5000<sup>+</sup> EG, Dionex ICS-5000 EG, Dionex ICS-4000 and Dionex Integrion RFIC modules will automatically detect the cartridge type and do not require the serial number to be entered manually.*
- *The Dionex ICS-6000 EG, Dionex ICS-5000<sup>+</sup> EG, Dionex ICS-5000 EG, Dionex ICS-4000 and Dionex Integrion RFIC modules will not recognize Dionex EGC III, Dionex EGC, and Dionex EPM cartridges.*

- C. Place the Dionex EGC on a flat surface in front of the EG module with the Eluent Generation Chamber and INLET and OUTLET fittings facing up.
- D. Remove the plugs from the Dionex EGC INLET and OUTLET fittings.
- E. Turn over the Dionex EGC cartridge (fittings facing down). Shake the Dionex EGC cartridge vigorously and tap it with the palm of your hand 10 to 15 times to dislodge the air bubbles that may be trapped in the electrolysis chamber.



### NOTE

*Be sure to repeat Step E each time the eluent generation chamber is turned upward.*

- F. Connect the pump outlet to the Dionex EGC INLET port of the cartridge and the OUTLET port of the cartridge to the ELUENT IN port of the RFIC Eluent Degasser Assembly.
- G. Orient the cartridge with the cable aligned with the slot in the holder of the EG enclosure and then slide the cartridge down into the holder until secured.
- H. Connect the cartridge electrical cable to the EGC port of the EG module.
- I. Connect the ELUENT OUT port of the RFIC Eluent Degasser Assembly to a yellow PEEK backpressure restrictor tubing (Item # 053765) with 2,000 psi backpressure at 1.0 mL/min.

### 2.1.2 Conditioning the Dionex EGC (except Capillary models)

- A. Fill a 2 L eluent reservoir bottle with ASTM filtered, Type I (18-megohm) deionized water. Connect the reservoir to the eluent inlet line of the pump.
- B. Prime the pump as instructed by the system operation manual.
- C. Set the pump flow rate to 1.0 mL/min.
- D. Unscrew and remove the plug from the vent opening on the side of the cartridge (Dionex EGC III) or loosen the plug on the top of the cartridge (Dionex EGC 500 or Dionex EGC 400).
- E. Direct the outlet of the yellow PEEK backpressure tubing to a waste container.
- F. Turn on the pump and pump DI water through the cartridge for 10 minutes at the eluent flow rate given in Table 1.
- G. Set the concentration to the value listed in Table 1 from the front control panel of the Chromeleon Chromatography Data System and turn on the Dionex EGC.
- H. Run the Dionex EGC for the duration listed in Table 1.
- I. Turn off the pump.

**Table 1** Dionex EGC Conditioning Conditions.

Dionex EGC Type	Eluent Flow Rate	Eluent Concentration	Duration
Dionex EGC 500 K <sub>2</sub> CO <sub>3</sub>	1.0 mL/min	9 mM	30 minutes
Dionex EGC 500 KOH, Dionex EGC III KOH, Dionex EGC III NaOH, Dionex EGC III LiOH, Dionex EGC 500 MSA, Dionex EGC III MSA	1.0 mL/min	50 mM	30 minutes
Dionex EGC 400 KOH, Dionex EGC 400 MSA	0.1 mL/min	100 mM	30 minutes

J. Disconnect the backpressure restrictor tubing from the Dionex EGC outlet tubing.

If installing a Dionex EGC 500 K<sub>2</sub>CO<sub>3</sub>, proceed to Section 2.3. If installing a new Dionex Continuously Regenerated Trap Column (Dionex CR-TC 600) proceed to Section 2.2.1. If the Dionex CR-TC 600 is already installed, proceed to Section 2.2.2.

## 2.2 Conditioning the Capillary Dionex EGC Cartridges

- A. Fill a 2 L eluent reservoir bottle with ASTM filtered, Type I (18 megohm) deionized water. Connect the reservoir to the eluent inlet line of the pump.
- B. Prime the pump as instructed by the system operation manual.
- C. Pump DI water through the Dionex EGC (Capillary) cartridge at 0.1 mL/min for 30 minutes (use the capillary pump in the prime mode to perform this step).
- D. Connect the outlet port of the Dionex EGC (Capillary) cartridge to a PEEK backpressure tubing that generate 2000 psi at 30 uL/min
- E. Set the pump flow rate to 30 uL/min and the EGC concentration to 50 mM and condition the cartridge for 30 minutes.
- F. Direct the EGC effluent to a waste container.
- G. Turn off the pump.
- H. Disconnect the backpressure restrictor tubing from the EGC outlet tubing.

### 2.2.1 Installing the Dionex Continuously Regenerated Trap Column (Dionex CR-TC 600 or Dionex CR-TC 500)



#### NOTE

- *For analytical scale anion exchange applications use Dionex CR-ATC 600 Item # 088662 or Dionex CR-ATC 500 Item # 075550.*
- *For capillary scale anion exchange applications use Dionex CR-ATC (Capillary) Item # 072078.*
- *For analytical scale, cation exchange applications use Dionex CR-CTC 600 Item # 088663 or Dionex CR-CTC 500 Item # 075551.*
- *For capillary scale, cation exchange applications use Dionex CR-CTC (Capillary) Item # 072079.*
- *When making final plumbing connections all fittings should be finger tight plus ¼ turn.*
- *The Dionex CR-ATC 600 and Dionex CR-ATC 500 are not compatible with a Dionex EGC 500 K<sub>2</sub>CO<sub>3</sub> or Dual EGC applications.*
- *The guidelines here are intended to supplement, not to replace the information in the Dionex CR-TC manual.*

- A. Turn off power to the pump, Dionex EGC, Dionex CR-TC, and the suppressor (Dionex ERS/AES/CES).
- B. Disconnect the following:
  - i. Continuously regenerated trap columns (Dionex CR-ATC 600/500 or Dionex CR-CTC 600/500) installed between the EG and the Degas Assembly.
  - ii. Trap columns (Dionex IonPac ATC-HC 500 or Dionex IonPac CTC 500) installed between the pump and the EG module.
- C. Remove the plugs on the Dionex CR-TC ports.
- D. Find the tubing with the red label on one end and a white label on the other end (supplied with the EG module).
- E. Connect the end with the white label to the Eluent Out port of the Dionex EGC.
- F. Connect the end with the red label to the Eluent In port of the Dionex CR-TC.
- G. Connect the tubing with the orange label to the Regen In port of the Dionex CR-TC.
- H. Connect the tubing with the blue label to the blue Regen Out port of the Dionex CR-TC.
- I. Connect the tubing with the yellow label to the yellow Eluent Out port of the Dionex CR-TC.



*The Dionex CR-TC should be hydrated after the first installation before the operation, or after long-term storage. The process ensures the Dionex CR-TC resin and membranes are fully hydrated and ready for operation.*

- J. Disconnect the ELUENT OUT line protruding from the Degas Assembly at the end labeled TO INJECTION VALVE IN-P.
- K. If hydrating a Dionex CR-TC 500/600 connect this end to a 10-32 to 1/4-28 coupler (Item # 042806).
- L. If hydrating a Dionex CR-TC 500/600:
  - i. Connect the free end of the tubing, labeled TO ERS/AES REGEN OUT, to the 1/4-28 end of the coupler.
- M. If hydrating a Dionex CR-TC (Capillary):
  - i. Connect 2.1 m (7 ft) of 1-58 mm (0.062 in) ID clear Tefzel tubing to the REGEN OUT port of the Dionex CR-TC (Capillary). Direct the other end of the tubing to waste.
- N. Ensure that the current to the Dionex EGC cartridge and suppressor are turned off.
- O. If hydrating a Dionex CR-TC 500/600:
  - i. From the pump front panel, turn on the pump flow rate to hydrate the Dionex CR-TC by pumping DI water at the flow rate of your application for at least 10 minutes.
  - ii. Turn off the pump flow.
  - iii. Disconnect the coupler.
- P. If hydrating a Dionex CR-TC (Capillary):
  - i. Set the pump flow rate to 0.1 mL/min and flush the Dionex CR-TC for 3 minutes.
  - ii. Change the pump flow rate to 0.03 mL/min.
  - iii. Set the EGC concentration to 50 mM and turn on the Dionex EGC and Dionex CR-TC power for 30 minutes.
  - iv. Turn off the Dionex EGC and Dionex CR-TC power.
  - v. Turn off the pump flow.

**Figure 14** Dionex CR-TC 500/600 Plumbing Diagram for Hydration.

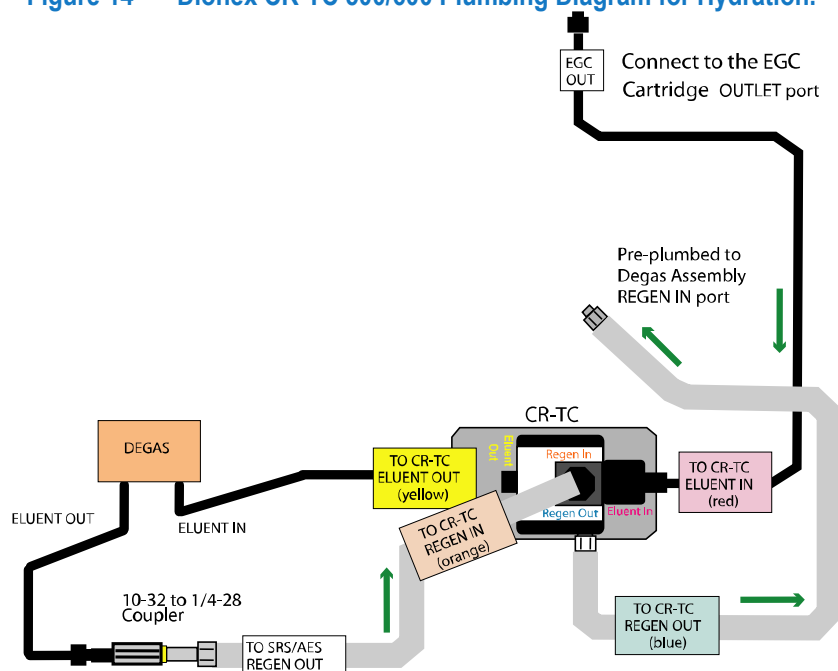
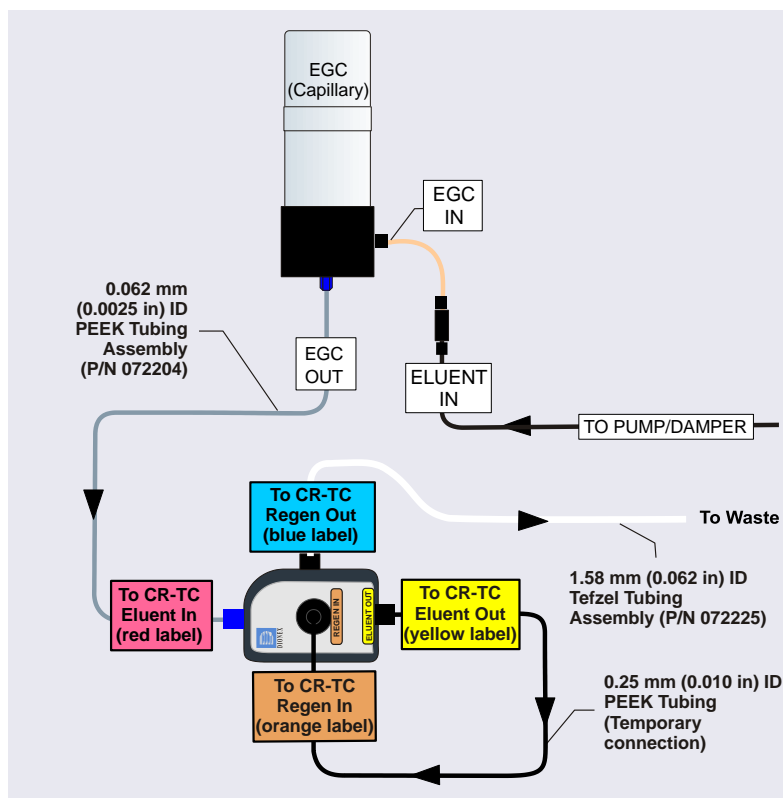

Figure 15 Dionex CR-TC (Capillary) Plumbing Diagram for Hydration.



- A. Verify the tubing labeled “TO INJECTION VALVE IN-P” is connected to the injection valve.
- B. Verify that the tubing with the Red label (TO CR-TC ELUENT IN) is connected to the Eluent In port of the CR-TC.
- C. Verify that the other end of this tubing with the White label (EGC OUT) is connected to the OUTLET port of the EGC.
- D. Verify that the tubing with the Yellow label (TO CR-TC ELUENT OUT) is connected to the CR-TC Eluent Out port.
- E. Verify that the tubing with the Orange label (TO CR-TC REGEN-IN) is connected to the CR-TC Regen In port.
- F. Connect the other end of this tubing with the White label (TO ERS/AES, REGEN OUT) to the suppressor REGEN OUT port.
- G. Verify that the tubing with the Blue label (TO CR-TC REGEN-OUT) is connected to the Dionex CR-TC Regen Out port.
- H. Mount the Dionex CR-TC.

**NOTE**

*The Dionex CR-TC is mounted onto the mounting plate or underneath the Dionex EGC Cartridge Holder by aligning the hole on the Dionex CR-TC backplate with the ball stud on the mounting plate and pushing the Dionex CR-TC firmly onto the mounting ball stud. The Dionex CR-TC will click into place when properly installed.*



Figure 16 Plumbing schematic for the Dionex EGC III with Dionex CR-TC on a 3000 psi System.

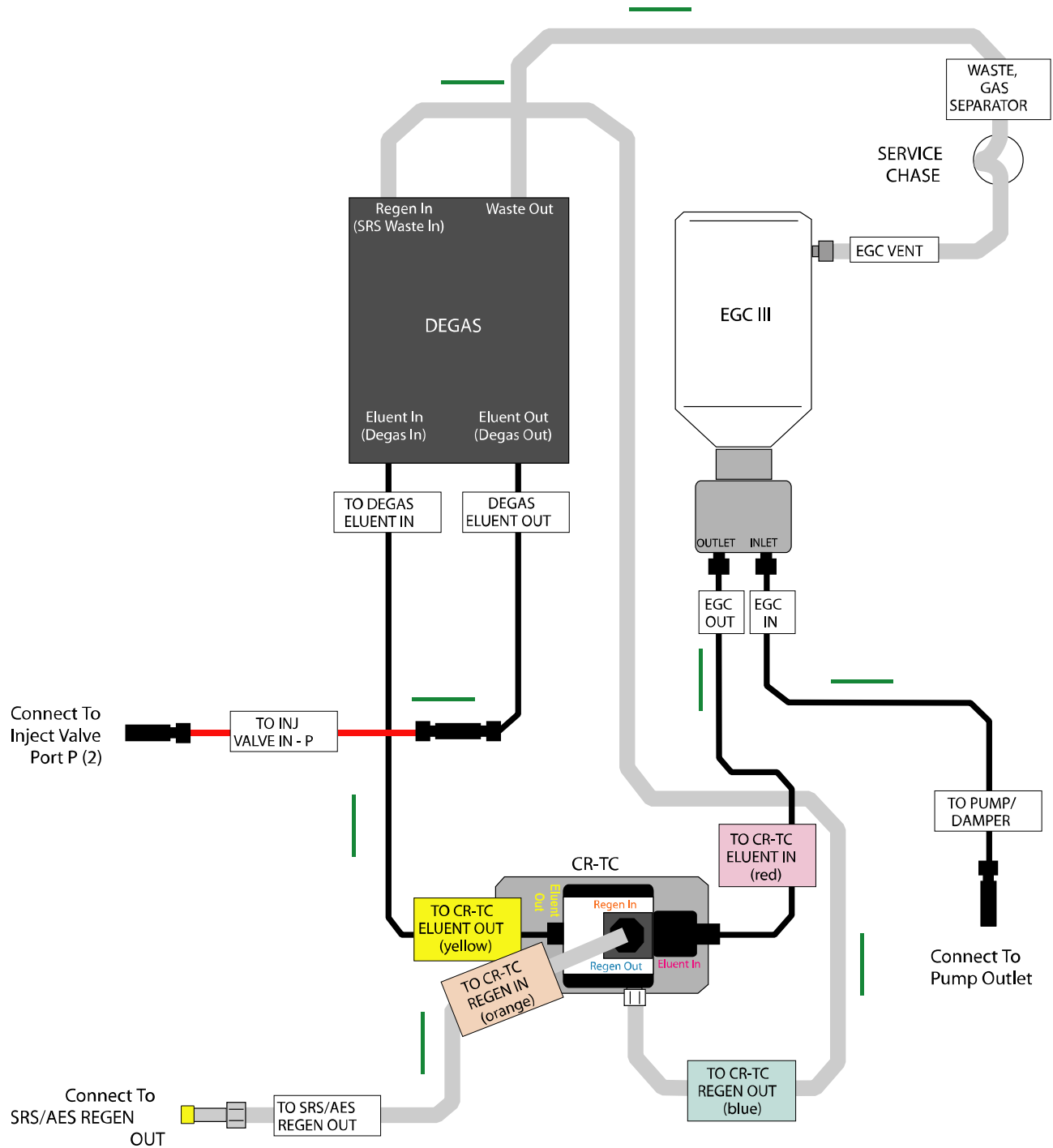

Figure 17 Plumbing schematic for the Dionex EGC (Capillary) with Dionex CR-TC (Capillary).

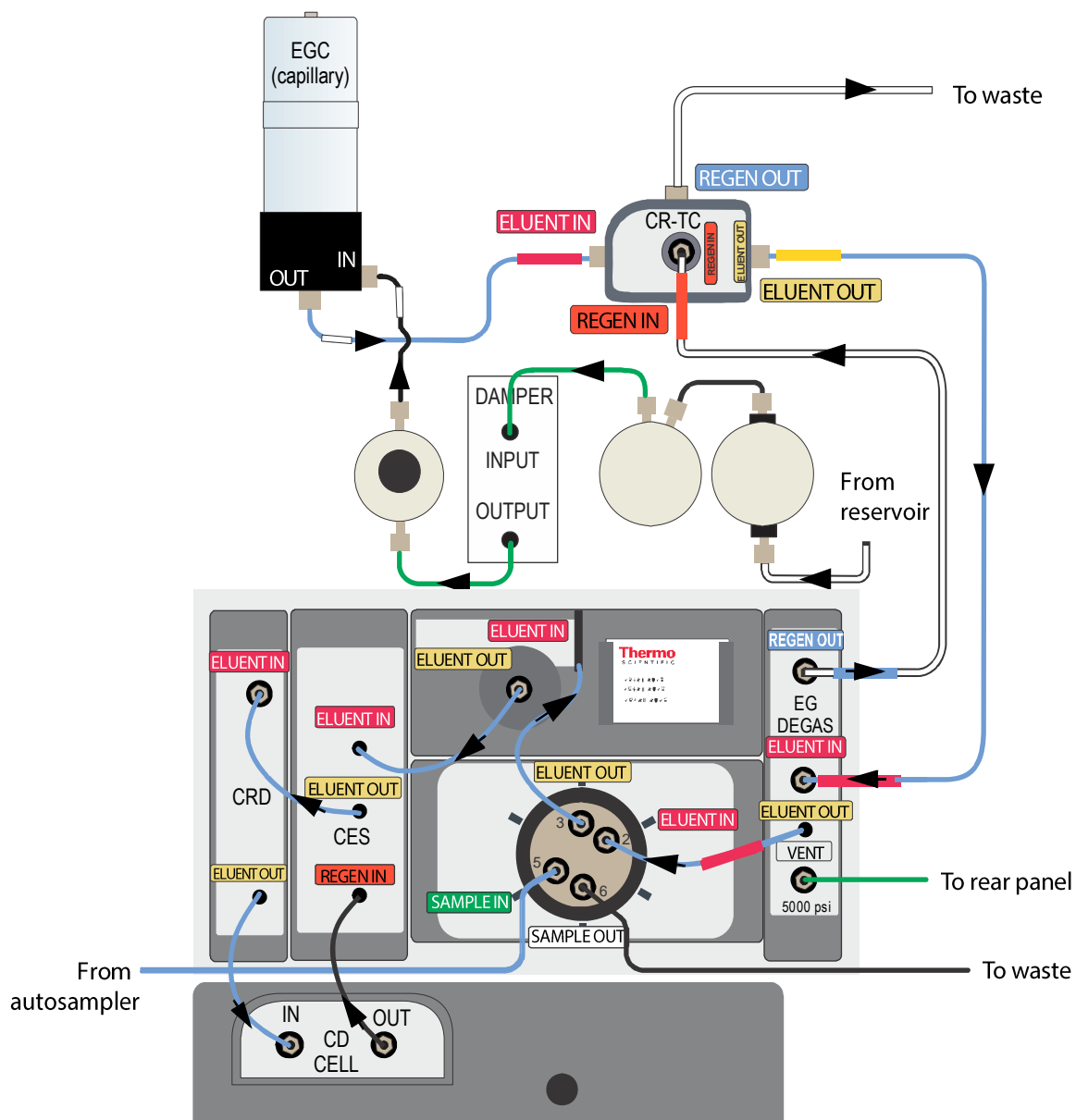
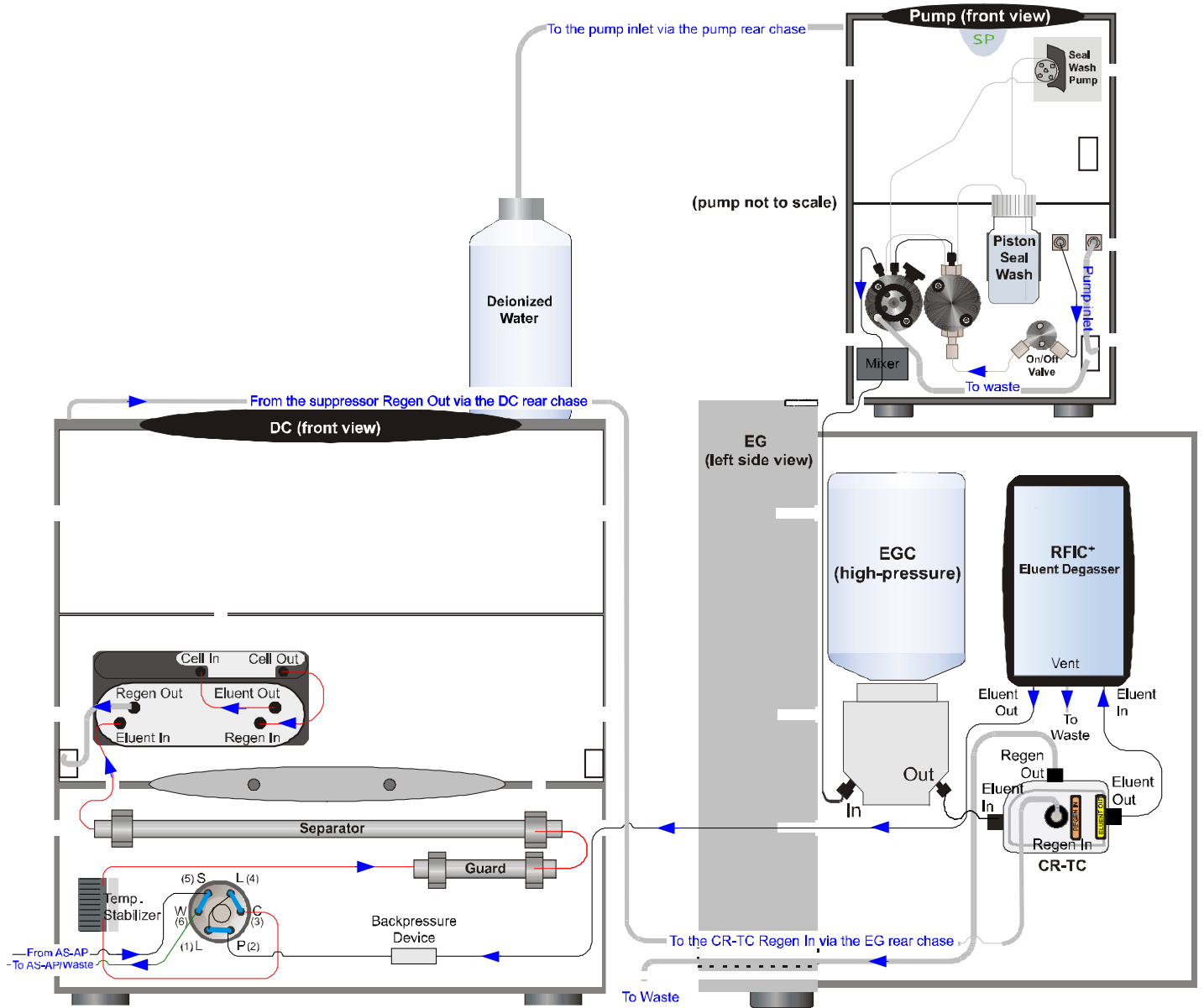

Figure 18 Plumbing schematic for the Dionex EGC 500 with Dionex CR-TC 500/600 on a 5000 psi System.



## 2.2.2 Optional Pressure Restrictor Tubing

The degas tubing assembly requires at least 2,000 psi (14 MPa) of back pressure for optimal removal of electrolysis gas from the eluent produced by the Dionex EGC III, Dionex EGC 400 or Dionex EGC 500. A system backpressure of 2,300 psi is ideal. The degas tubing is functional at pressures below 2,000 psi (14 MPa); however, this low system pressure may result in high baseline noise as the eluent concentration increases in the gradient. If a restrictor is required, the following procedure will assist in determining the correct back pressure restrictor tubing to use.



NOTE

*The capillary degas tubing assembly requires only 1,000 psi (7 MPa) of backpressure for optimal removal of electrolysis gas. Pressure restrictor tubing is thus not required for systems using a Dionex EGC (Capillary) with a capillary degas module. The minimum backpressure value applies during normal operation and during standby. Do not operate the EGC for an extended period of time below the minimum backpressure value, even when the system is not being used.*

- A. Turn the pump flow on.
- B. Confirm the eluent flows at the desired flow rate.



NOTE

*If the method is a gradient method, it should be run to completion.*

- C. Monitor the pump pressure and note the maximum and minimum system pressures for the duration of the method.
- D. If the maximum and minimum pressures are between 2,000 and 3,000 psi (Dionex EGC III) or between 2,000 and 5,000 psi (Dionex EGC 400 and Dionex EGC 500), the system back pressure is adequate.
- E. If the maximum pressure exceeds 3,000 psi (Dionex EGC III) or 5,000 psi (Dionex EGC 400 and Dionex EGC 500), the method will terminate prematurely.
  - i. Locate the source of the excessive pressure and eliminate it.



NOTE

*Several analytical and guard columns generate system pressures above 3,000 psi, especially when solvents are used in the eluent or the column uses 4µm particles. A Dionex EGC III cannot be used with these columns unless the flow rate is reduced so that the maximum system pressure is between 2,000 and 3,000 psi.*

- F. If the minimum system pressure is below 2,000 psi, a pressure restrictor should be used (except capillary systems). Table 2 can be used to determine the appropriate pressure restrictor to adjust the system pressure between 2,000 to 3,000 psi (14-21 MPa) or 2,000 to 5,000 psi (14 - 34.5 MPa). A system back pressure of 2,300 psi is ideal.
- G. The backpressure restrictors listed in Table 2 are supplied in the EG Module ship kit. If necessary, trim a back-pressure coil to the desired length to provide adequate backpressure restriction.
  - i. Install the back-pressure restrictor between the degas assembly "ELUENT OUT" port and the injection valve.

**NOTE**

*The back-pressure restrictor tubing may be installed directly into the injection valve "IN" port.*

- ii. Secure the back-pressure restrictor coils to the two coil clips that are provided in the EG Module.

**Table 2** Optional Back Pressure Restrictors.

Part Number	Description	Flow Rate	Approx. Back Pressure Added	Flow Rate	Approx. Back Pressure Added
AAA-053763	4 mm Pressure Restrictor	2.0 mL/min	1,000 psi (7 MPa)	1.0 mL/min	500 psi (3.5 MPa)
AAA-053762	4 mm Pressure Restrictor	2.0 mL/min	500 psi (3.5 MPa)	1.0 mL/min	250 psi (1.75 MPa)
053765	2 mm Pressure Restrictor	0.5 mL/min	1,000 psi (7 MPa)	0.25 mL/min	500 psi (3.5 MPa)
053764	2 mm Pressure Restrictor	0.5 mL/min	500 psi (3.5 MPa)	0.25 mL/min	250 psi (1.75 MPa)

### 2.3 Preparation for Installation of Dionex EGC 500 K<sub>2</sub>CO<sub>3</sub> Cartridge

If installing a Dionex EGC 500 and Dionex EPM 500 proceed to section 2.7.

- A. Remove the EGC from the box. Save the box and foam for future storage.
- B. Configure the EG module to operate the cartridge by entering the cartridge serial number. Please refer to the EG Module and Chromeleon user manuals for detailed procedures for entering the cartridge serial number.



#### NOTE

*The Dionex ICS-6000, Dionex ICS-5000+ EG, Dionex ICS-5000 EG and Dionex Integriion RFIC modules will automatically detect the cartridge type and do not require the serial number to be entered manually.*

- C. Place the EGC on a flat surface in front of the EG module with the Eluent Generation Chamber and INLET and OUTLET fittings facing up.
- D. Remove the plugs from the EGC INLET and OUTLET fittings.
- E. Turn over the EGC cartridge (fittings facing down). Shake the EGC cartridge vigorously and tap it with the palm of your hand 10 to 15 times to dislodge the air bubbles that may be trapped in the electrolysis chamber.



#### NOTE

*Be sure to repeat Step E each time the eluent generation chamber is turned upward.*

- F. Connect the pump outlet to the EGC INLET port of the cartridge and the OUTLET port of the cartridge to the ELUENT IN port of the RFIC Eluent Degasser Assembly.
- G. Orient the cartridge with the cable aligned with the slot in the holder of the EG enclosure and then slide the cartridge down into the holder until secured.
- H. Connect the cartridge electrical cable to the EGC-1 port of the EG module.
- I. Connect the ELUENT OUT port of the RFIC Eluent Degasser Assembly to a yellow PEEK backpressure restrictor tubing (Item # 053765) with 2,000 psi backpressure at 1.0 mL/min.

### 2.4 Conditioning the Dionex EGC 500 K<sub>2</sub>CO<sub>3</sub>

- A. Fill a 2 L eluent reservoir bottle with ASTM filtered, Type I (18-megohm) deionized water. Connect the reservoir to the eluent inlet line of the pump.
- B. Prime the pump as instructed by the system operation manual. Set the pump flow rate to 1.0 mL/min.
- C. Unscrew and remove the plug from the vent opening on top of the cartridge.
- D. Direct the outlet of the yellow PEEK backpressure tubing to a waste container.
- E. Turn on the pump. Set the concentration to 9 mM from the front control panel of the Chromeleon Chromatography Data System or system control panel and turn on the EGC.
- F. Run the EGC for 30 minutes.
- G. Turn off the pump.
- H. Disconnect the backpressure restrictor tubing from the EGC outlet tubing.

**Figure 19** Plumbing Diagram for Conditioning the Dionex EGC 500  $K_2CO_3$  Cartridge

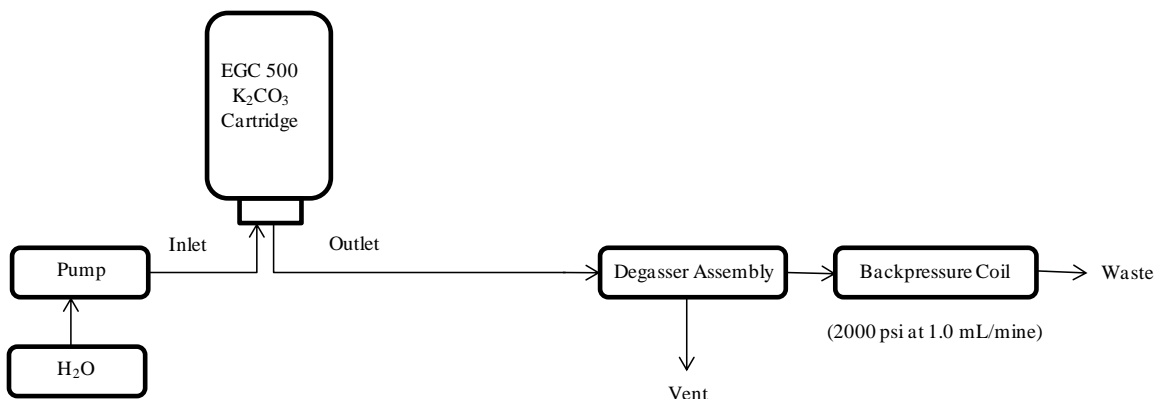

## 2.5 Filling the Dionex EGC 500 Carbonate Mixer with $K_2CO_3$ Eluent of Desired Concentration

- Connect the outlet of the yellow pressure restrictor tubing (Item # 053765) to the union attached to the INLET port of the Dionex EGC 500 Carbonate Mixer (Item # 088468 for 4 mm columns or Item # 088467 for 2 mm columns) as shown in Figure 20.
- Install the EGC Carbonate Mixer in the system enclosure by pushing the mixer onto the mixer holder clip. The OUTLET of the EGC Carbonate Mixer must point upward to ensure sufficient mixing of the eluents generated.
- Set the pump flow rate at 1.0 mL/min and turn on the pump.
- Set the desirable  $K_2CO_3$  concentration on EGC-1 (e.g., 9 mM for AS9-HC columns) and turn on EGC-1 current control.
- Operate EGC 500  $K_2CO_3$  cartridge to generate carbonate eluents. The main purpose of this step is to fill the Dionex EGC 500 Carbonate Mixer with the electrolytic eluents having the desired carbonate concentration (e.g. 9 mM  $K_2CO_3$  for Dionex IonPac AS9-HC columns) for your application.
- The 4 mm Dionex EGC 500 Carbonate Mixer has a void volume of about 16 mL. At 1.0 mL/min, it will take about 16 minutes to fill the Mixer with the  $K_2CO_3$  eluent of the set concentration upon initial installation. The 2 mm Dionex EGC 500 Carbonate Mixer has a void volume of about 5.0 mL. At 1.0 mL/min, it will take about 5 minutes to fill the mixer with the  $K_2CO_3$  eluent of the set concentration upon initial installation.

**Figure 20** Plumbing Diagram for Filling the EGC 500 Carbonate Mixer with the  $K_2CO_3$  Eluents of Desired Concentration

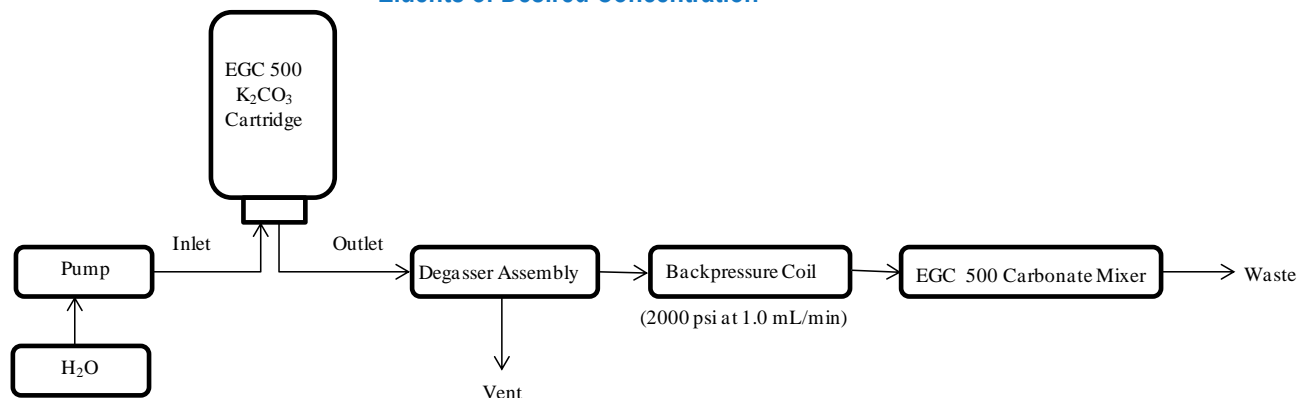

## 2.6 Operation of the High-Pressure Electrolytic $K_2CO_3$ Eluent Generator for Ion Chromatographic Application

- Complete the entire system plumbing as shown in Figure 21 for your application.
- Adjust the length of the backpressure tubing between the INLET of the injection valve and the OUTLET of the Dionex EGC 500 Carbonate Mixer if needed to ensure the system backpressure is adjusted between 2000 – 2300 psi at the system operation flow rate.
- Make sure to connect the REGEN OUT port of the suppressor to the REGEN IN port of the Dionex EPM 500.
- Turn on the pump at the flow rate recommended for your application.

**Figure 21** Plumbing Diagram for Electrolytic Generation of Carbonate Eluents Using Dionex EGC 500  $K_2CO_3$  with Electrolytic Suppressor Operated in Recycle Mode

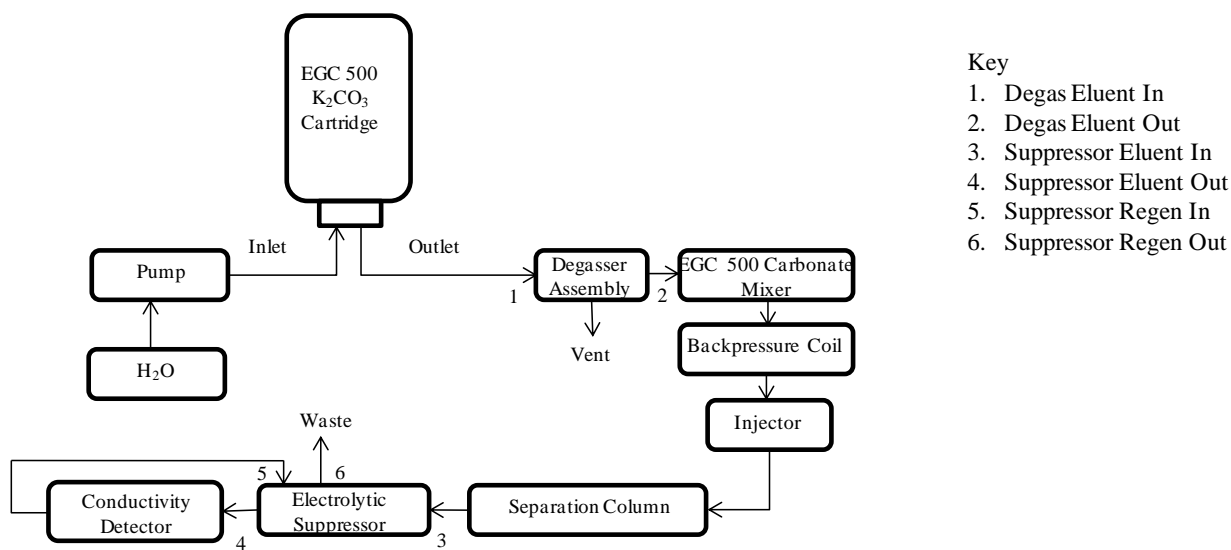

### Key

- Degas Eluent In
- Degas Eluent Out
- Suppressor Eluent In
- Suppressor Eluent Out
- Suppressor Regen In
- Suppressor Regen Out



## 2.7 Preparation for Installation of Dionex EGC 500 K<sub>2</sub>CO<sub>3</sub> Cartridge and Dionex EPM 500

- A. Remove the Dionex EGC 500 K<sub>2</sub>CO<sub>3</sub> cartridge (Item # 088453) from the shipping box. Save the box and the foam for future storage.
- B. Remove the Dionex EPM 500 (Item # 088471) from the shipping box.
- C. Configure the EG module to operate the Dionex EGC 500 K<sub>2</sub>CO<sub>3</sub> cartridge and the Dionex EPM 500 by entering the serial numbers for the cartridge and the EPM. Please refer to the EG or System and Chromeleon user manuals for detailed procedures for entering the cartridge and EPM serial numbers.



### NOTE

*The Dionex ICS-6000 EG, Dionex ICS-5000<sup>+</sup> EG, Dionex ICS-5000 EG and Dionex Integriion RFIC modules will automatically detect the cartridge type and do not require the serial number to be entered manually.*

- D. Place the Dionex EGC 500 K<sub>2</sub>CO<sub>3</sub> cartridge on a flat surface in front of the EG module with the Eluent Generator Chamber and the EGC INLET and OUTLET fittings facing up.
- E. Remove the plugs from the EGC INLET and OUTLET fittings.
- F. Remove the plugs from the EPM ELUENT and REGEN liquid fittings.
- G. Turn over the Dionex EGC 500 K<sub>2</sub>CO<sub>3</sub> cartridge (fittings facing down). Shake the Dionex EGC 500 K<sub>2</sub>CO<sub>3</sub> cartridge vigorously and tap it with the palm of your hand 10 to 15 times to dislodge any air bubbles that may be trapped in the electrolysis chamber.
- H. Connect the pump outlet to the EGC INLET port of the Dionex EGC 500 K<sub>2</sub>CO<sub>3</sub> cartridge.
- I. Connect the OUTLET port of the Dionex EGC 500 K<sub>2</sub>CO<sub>3</sub> cartridge to the ELUENT IN port of the Dionex EPM 500.
- J. Connect the ELUENT OUTLET port of the Dionex EPM 500 to the ELUENT IN port of the RFIC Eluent Degasser Assembly.
- K. Connect the ELUENT OUT port of the RFIC Eluent Degasser Assembly to a yellow PEEK backpressure restrictor tubing (Item # 053765).
- L. Orient the Dionex EGC 500 K<sub>2</sub>CO<sub>3</sub> cartridge with the cable aligned with the slot in the holder of the EG enclosure or ICS system and then slide the Dionex EGC 500 K<sub>2</sub>CO<sub>3</sub> down into the holder until secured.
- M. Connect the Dionex EGC 500 K<sub>2</sub>CO<sub>3</sub> cartridge electrical cable to the EGC-1 port of the EG enclosure or ICS system.
- N. Connect the Dionex EPM 500 electrical cable to the EGC-2 port of the EG enclosure or ICS system.

## 2.8 Conditioning the Dionex EGC 500 K<sub>2</sub>CO<sub>3</sub> Cartridge and Dionex EPM 500

- A. Fill a 2 L eluent reservoir bottle (Item # 044129) with deionized water. Use ASTM filtered, Type I (18 megohm) deionized water. Connect the reservoir to the eluent inlet line of the pump.
- B. Prime the pump as instructed by the system operation manual. Set the pump flow rate to 1.0 mL/min.
- C. Unscrew and remove the plug from the vent opening on the side of the Dionex EGC 500 K<sub>2</sub>CO<sub>3</sub> cartridge.
- D. Connect the outlet of the yellow PEEK backpressure restrictor tubing (Item # 053765) to the REGEN IN port of the Dionex EPM 500.
- E. Connect the REGEN OUT port of the Dionex EPM 500 to the REGEN IN port of the RFIC Eluent Degasser Assembly and connect the WASTE OUT port of the RFIC Eluent Degasser Assembly to waste.
- F. Complete the system plumbing as shown in Figure 22.



*The system plumbing shown in Figure 22 is a temporary connection which is only used during the EGC 500 K<sub>2</sub>CO<sub>3</sub> and EPM 500 conditioning step.*

- G. Set the pump flow rate at 1.0 mL/min.
- H. Turn on the pump for 5 min to hydrate the EPM 500.
- I. Set 9 mM for EGC 500 K<sub>2</sub>CO<sub>3</sub> (EGC-1) and 1 mM for EPM 500 (EGC-2) from the control panel and turn on the EGC-1 and EGC-2 current controls.
- J. Run the Dionex EGC 500 K<sub>2</sub>CO<sub>3</sub> and Dionex EPM 500 under these conditions for 30 min.
- K. Turn off the EGC-1 and EGC-2 current controls, and then turn off the pump.

**Figure 22** Plumbing Diagram for Conditioning the Dionex EGC 500 K<sub>2</sub>CO<sub>3</sub> Cartridge and Dionex EPM 500.

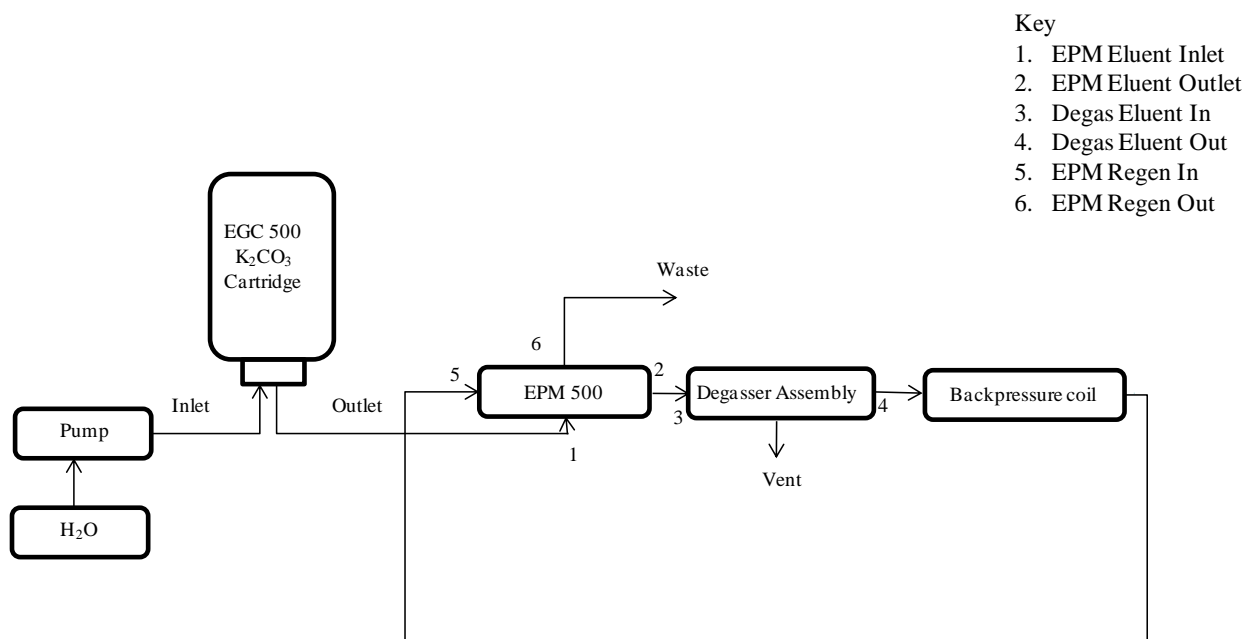

## 2.9 Filling the Dionex EGC 500 Carbonate Mixer with the $K_2CO_3$ / $KHCO_3$ Eluents of Desired Concentration

- A. Install the Dionex EGC 500 Carbonate Mixer in the EG enclosure or the side of the EGC cartridge holder by pushing the mixer onto the Mixer holder clip. The outlet of the Dionex EGC 500 Carbonate Mixer must point upward to ensure thorough mixing of the eluent.
- B. Disconnect the pump outlet from the INLET of the Dionex EGC 500  $K_2CO_3$  cartridge.
- C. Connect the pump outlet to the inlet of Dionex EGC 500 Carbonate Mixer and fill the Dionex EGC 500 Carbonate Mixer with deionized water by operating the pump at 5.0 mL/min. Operate the pump for 5 minutes to fill a 4 mm Dionex EGC 500 Carbonate Mixer and 2 minutes to fill a 2 mm Dionex EGC 500 Carbonate Mixer or until there is a consistent flow of water coming out the outlet of the Mixer.



### WARNING

*Please ensure that both EGC-1 and EGC-2 current controls are turned off in this step.*

- D. Disconnect the pump outlet from the inlet of the Dionex EGC 500 Carbonate Mixer.
- E. Connect the pump outlet to the INLET of the Dionex EGC 500  $K_2CO_3$  cartridge.
- F. Connect the outlet of the yellow PEEK backpressure restrictor tubing (Item # 053765) to the union attached to the inlet of the Dionex EGC 500 Carbonate Mixer.
- G. Connect the OUTLET of the mixer to the REGEN IN port of the Dionex EPM 500. Divert the REGEN OUT port of the Dionex EPM 500 to waste.
- H. Complete the system plumbing as shown in Figure 23.
- I. Operate both the Dionex EGC 500  $K_2CO_3$  cartridge and Dionex EPM 500 under the conditions to generate carbonate and bicarbonate eluent of desired  $K_2CO_3$  /  $KHCO_3$  concentration. The main purpose of this step is to fill the Dionex EGC Carbonate Mixer with the eluent of the desired concentration (e.g. 4.5 mM  $K_2CO_3$ /1.4 mM  $KHCO_3$  for Dionex IonPac AS22 columns) for your application.
- J. The 4 mm Dionex EGC 500 Carbonate Mixer has a void volume of about 16 mL. At 1.0 mL/min, it will take about 45 minutes to displace the deionized water and fill the mixer with the  $K_2CO_3$  /  $KHCO_3$  eluent having the desired concentration upon initial installation. The 2 mm Dionex EGC Carbonate Mixer has a void volume of approximately 5.0 mL. At 1.0 mL/min, it will take about 15 minutes to displace the deionized water and fill the Mixer with the  $K_2CO_3$  /  $KHCO_3$  eluents of the set concentration upon initial installation.



### NOTE

*The system backpressure should be adjusted between 2000 – 2300 psi at a flow rate of 1 mL/min. This step is very important to ensure fast system equilibration and startup.*

- K. Turn off the EGC-1 and EGC-2 current controls, and then turn off the pump.
- L. Replace the yellow backpressure tubing with a piece of 0.010-inch ID black PEEK tubing of appropriate length to connect between the ELUENT OUT port of the RFIC Eluent Degasser Assembly to the union attached to the inlet port of the Dionex EGC 500 Carbonate Mixer.

**Figure 23** Plumbing Diagram for Filling the EGC 500 Carbonate Mixer with the  $K_2CO_3$  /  $KHCO_3$  Eluents of Desired Concentration

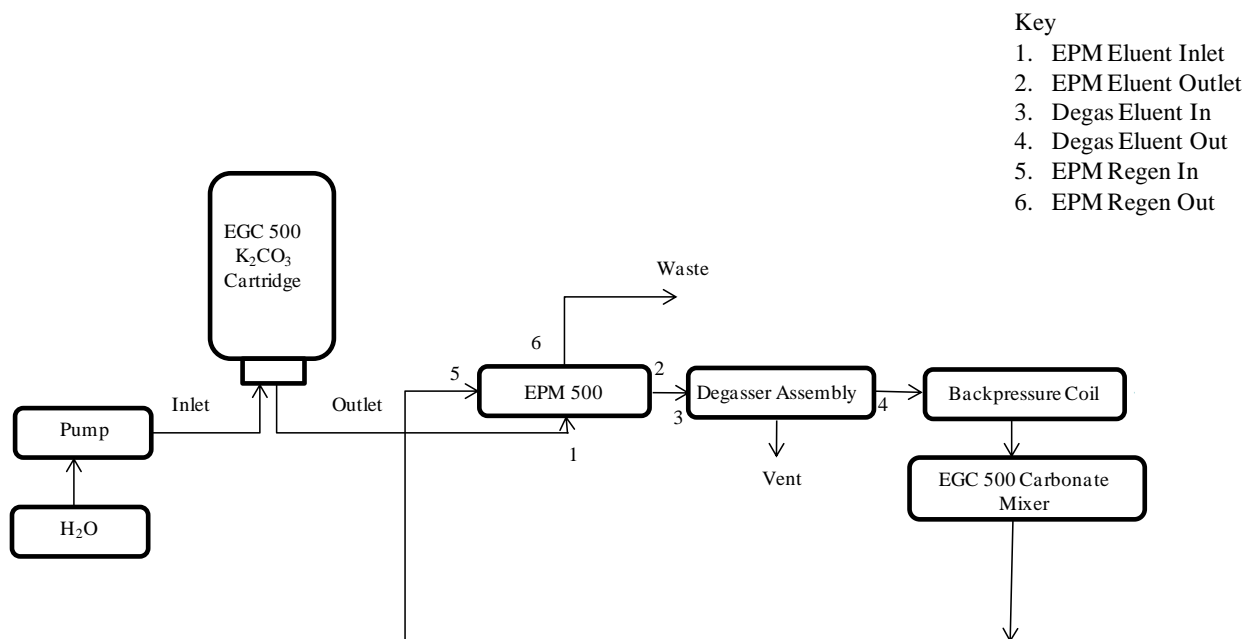

## 2.10 Operation of the Electrolytic $K_2CO_3$ / $KHCO_3$ Eluent Generator for Ion Chromatographic Application

- A. Complete the entire system plumbing as shown in Figure 24 for your application.
- B. Adjust the length of the backpressure tubing between the INLET of the injection valve and the OUTLET of the Dionex EGC 500 Carbonate Mixer if needed to ensure the system backpressure is adjusted between 2000 – 2300 psi at the system operation flow rate.
- C. Make sure to connect the REGEN OUT port of the suppressor to the REGEN IN port of the EPM 500.
- D. Turn on the pump at the flow rate recommended for your application.

**Figure 24 Plumbing Diagram for Electrolytic Generation of Carbonate / Bicarbonate Eluents Using a Dionex EGC 500  $K_2CO_3$  Cartridge and a Dionex EPM 500 with Electrolytic Suppressor Operated in Recycle Mode.**

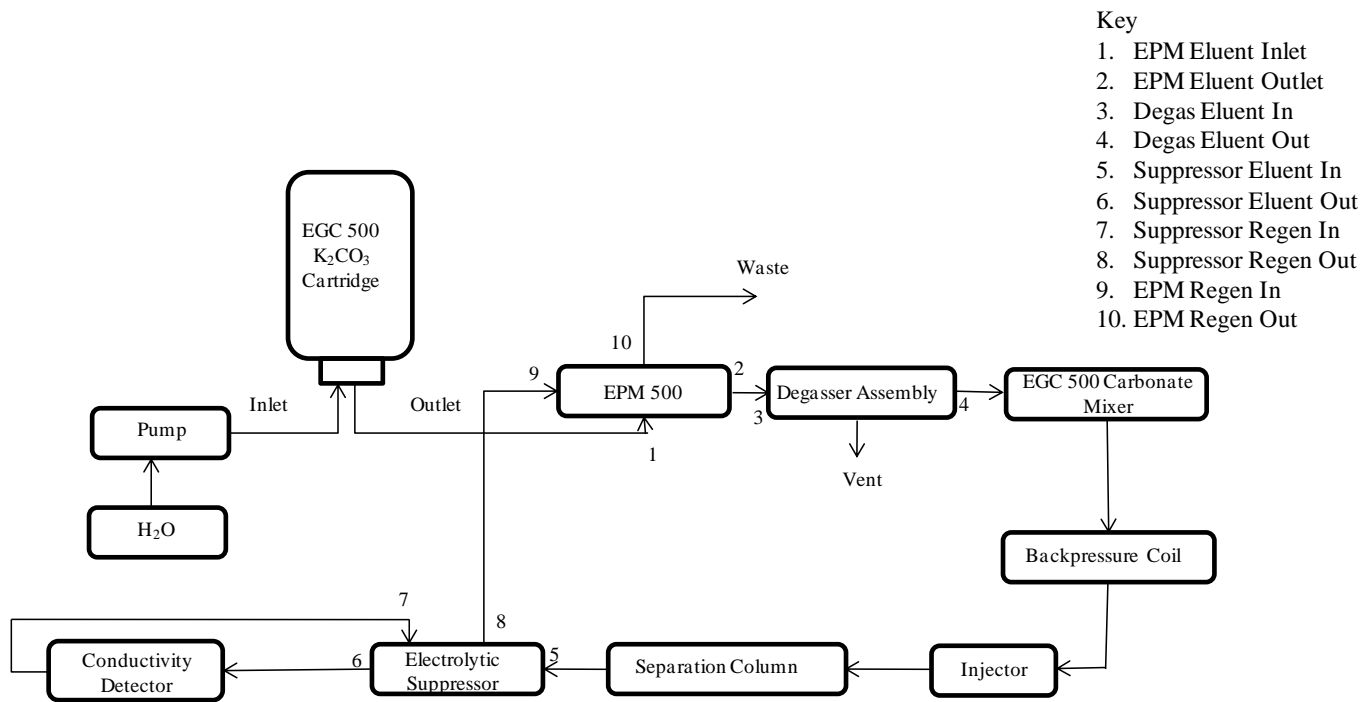

## 2.11 Preparation and Conditioning of Dionex EGC 400 cartridges for operation in Dual EGC Mode



**NOTE**

*To ensure stable baseline and low background noise, it is crucial to have sufficient removal of the hydrogen and oxygen gas formed with the EGC generated eluents. Connect the vent of the Dionex RFIC<sup>+</sup> Dual EG Eluent Degasser to the Vacuum Port located at the back of the Dionex DP module. Make sure all connections and fittings for the vacuum degas are vacuum-tight before using the system.*



**NOTE**

*Only turn on the EGC power when the system pressure reaches above 3000 psi at a flow rate of 0.063 mL/min. This step is very important to ensure best system performance.*

If replacing an existing Dionex EGC 400 cartridge in a Dual EGC system, see Section 2.13 or Section 2.14.

- A. Remove the Dionex EGC MSA from the box. Save the box and foam for future storage.
- B. Place the Dionex EGC MSA on a flat surface in front of the EG module with the Eluent Generation Chamber and INLET and OUTLET fittings facing up.
- C. Remove the plugs from the Dionex EGC MSA INLET and OUTLET fittings.
- D. Turn over the Dionex EGC MSA cartridge (fittings facing down). Shake the Dionex EGC MSA cartridge vigorously and tap it with the palm of your hand 10 to 15 times to dislodge the air bubbles that may be trapped in the electrolysis chamber.



## NOTE

*Be sure to repeat Step D each time the eluent generation chamber is turned upward.*

- E. Follow steps A-D to prepare the Dionex EGC 400 KOH.
- F. Orient the Dionex EGC 400 MSA and Dionex EGC 400 KOH cartridges with the cables aligned with the slots in the holders of the EG enclosure and then slide the cartridges down into the holders until secured.
- G. Connect the electrical cable of the Dionex EGC 400 MSA to the EGC1 port and the electrical cable of the Dionex EGC 400 KOH to the EGC2 port of the EG module.
- H. In the Chromeleon Instrument Configuration Manager, check the Dionex EGC 400 MSA and the Dionex EGC 400 KOH, and set the pump link of both cartridges to the same pump. This setting enables the configuration to enter “Dual EGC” mode.
- I. Fill a 2 L eluent reservoir bottle with ASTM filtered, Type I (18-megohm) degassed deionized water. Connect the reservoir to the eluent inlet line of the pump. Keep the water blanketed under an inert gas (helium or nitrogen).
- J. Prime the pump as instructed by the system operation manual.
- K. Remove the vent plug on the top of the Dionex EGC 400 MSA cartridge (please refer to Dionex Eluent Generator Cartridges Manual Document No. 065081 for details about the preparation of the Dionex EGC cartridges).
- L. Install the Dionex EGC 400 MSA cartridge on the right side (labeled “System 2”) of the panel in the EG module.
- M. Connect the pump outlet to the INLET port of the Dionex EGC 400 MSA cartridge and direct the OUTLET port of the cartridge to waste.
- N. Turn on the pump and pump DI water through the Dionex EGC 400 MSA cartridge for 15 minutes at the flow rate of 1 mL/min (prime mode).
- O. Connect the OUTLET port of the Dionex EGC 400 MSA cartridge to a PEEK backpressure tubing (Item # 22181-20031). Direct the backpressure tubing to waste.
- P. Set the pump flow rate to 0.1 mL/min.
- Q. On the E-Panel, under Eluent Generator Tab, set the Eluent Polarity to Acidic Eluents. Set MSA<sub>prog</sub> to 100 mM. Turn on the Dionex EGC power.
- R. Condition the Dionex EGC 400 MSA cartridge for 30 min.
- S. Turn off the pump.
- T. Remove the PEEK backpressure tubing from the OUTLET port of the Dionex EGC 400 MSA cartridge.
- U. Remove the vent plug on the top of the Dionex EGC 400 KOH cartridge.
- V. Install the Dionex EGC 400 KOH cartridge on the left side of the panel (labeled “System 1”) in the EG module.
- W. Connect the OUTLET port of the Dionex EGC 400 MSA cartridge to the INLET port of the Dionex EGC 400 KOH cartridge. Direct the OUTLET port of the cartridge to waste.
- X. Turn on the pump and pump DI water through the Dionex EGC 400 KOH cartridge for 15 minutes at the flow rate of 1 mL/min.
- Y. Connect the OUTLET port of the Dionex EGC 400 KOH cartridge to a PEEK backpressure tubing (Item # 22181-20031). Direct the backpressure tubing to waste.
- Z. Set the pump flow rate to 0.1 mL/min.

- AA. On the E-Panel, under Eluent Generator Tab, set the Eluent Polarity to Basic Eluents. Set  $\text{KOH}_{\text{prog}}$  to 100 mM. Turn on the Dionex EGC power.
- BB. Condition the Dionex EGC 400 KOH cartridge for 30 min.
- CC. Remove the backpressure tubing from the OUTLET port of the Dionex EGC 400 KOH cartridge.
- DD. Connect the OUTLET port of the Dionex EGC 400 KOH cartridge to the ELUENT IN port of the Dionex RFIC<sup>+</sup> Dual EG Eluent Degasser (Item # 22181-60951).
- EE. Direct the ELUENT OUT port of the Dionex RFIC<sup>+</sup> Dual EG Eluent Degasser (Item # 22181-60951) to waste.
- FF. With EGC power OFF, turn on the pump at the flow rate of 0.2 mL/min. Flush the Dionex RFIC<sup>+</sup> Dual EG Eluent Degasser (Item # 22181-60951) for 15 min.
- GG. Turn off the pump.
- HH. Remove the PEEK backpressure tubing (Item # 22181-20031) from the ELUENT OUT port of the Dionex RFIC<sup>+</sup> Dual EG Eluent Degasser (Item # 22181-60951).

### 2.12 Operation of Dionex EGC 400 KOH and Dionex EGC 400 MSA in Dual EGC Mode

- A. Complete the entire system plumbing as shown in Figure 12 for your application.
- B. Turn on the pump at the flow rate recommended for your application.

### 2.13 Replacing a Dionex EGC 400 MSA Cartridge in Dual EGC Mode

- A. Remove the Dionex EGC MSA from the box. Save the box and foam for future storage.
- B. Place the Dionex EGC MSA on a flat surface in front of the EG module with the Eluent Generation Chamber and INLET and OUTLET fittings facing up.
- C. Remove the plugs from the Dionex EGC MSA INLET and OUTLET fittings.
- D. Turn over the Dionex EGC MSA cartridge (fittings facing down). Shake the Dionex EGC MSA cartridge vigorously and tap it with the palm of your hand 10 to 15 times to dislodge the air bubbles that may be trapped in the electrolysis chamber.



#### NOTE

*Be sure to repeat Step D each time the eluent generation chamber is turned upward.*

- E. Disconnect the old Dionex EGC 400 MSA cartridge from the EGC1 port. Slide the cartridge up until it is clear of the cartridge holder and remove the cartridge from the EG module. Drain and dispose of the cartridge according to local Hazmat regulations.
- F. Orient the new Dionex EGC 400 MSA cartridge with the cables aligned with the slot in the holder of the EG enclosure and slide the cartridge down into the holder until secured.
- G. Connect the electrical cable of the Dionex EGC 400 MSA cartridge to the EGC1 port.
- H. Remove the plug on the top of the Dionex EGC 400 MSA cartridge.
- I. Connect the pump outlet to the INLET port of the Dionex EGC 400 MSA cartridge and direct the OUTLET port of the cartridge to waste.
- J. Turn on the pump and pump DI water through the Dionex EGC 400 MSA cartridge for 15 minutes at the flow rate of 1 mL/min (prime mode).
- K. Connect the OUTLET port of the Dionex EGC 400 MSA cartridge to a PEEK backpressure tubing (Item # 22181-20031). Direct the backpressure tubing to waste.

- L. Set the pump flow rate to 0.1 mL/min.
- M. On the E-Panel, under Eluent Generator Tab, set the Eluent Polarity to Acidic Eluents. Set MSA<sub>prog</sub> to 100 mM. Turn on the Dionex EGC power.
- N. Condition the Dionex EGC 400 MSA cartridge for 30 min.
- O. Turn off the pump.
- P. Remove the PEEK backpressure tubing from the OUTLET port of the Dionex EGC 400 MSA cartridge.
- Q. Connect the OUTLET port of the Dionex EGC 400 MSA cartridge to the INLET port of the Dionex EGC 400 KOH cartridge
- R. With EGC power OFF, turn on the pump and set to the recommended flow rate for the column.
- S. After the system pressure reach 3000 psi, with Eluent Polarity set to Basic Eluents, set KMSA<sub>prog</sub> and KOH<sub>prog</sub> to the desired concentrations for the applications. Turn on the Dionex EGC power and let the system equilibrate for 60 min.

### IMPORTANT

*If the system pressure is lower than 3000 psi, install backpressure tubing (P/N 22181-20038 for 500 psi back pressure, P/N 22181-20039 for 1000 psi backpressure) between the ELUENT OUT of the Dionex RFIC<sup>+</sup> Dual EG Eluent Degasser and the C port of the injection valve if necessary, to achieve a system pressure of 3000 psi or above. Please refer to Document No. 155052-01 enclosed with the separation column for flow diagram.*

### IMPORTANT

*To prevent backpressure tubing (P/N 22181-20038 for 500 psi back pressure, P/N 22181-20039 for 1000 psi backpressure, P/N 22181-20031 backpressure tubing) from clogging, for future use, please rinse the tubing with DI water after each use.*

## 2.14 Replacing a Dionex EGC 400 KOH Cartridge in Dual EGC Mode

- A. Remove the Dionex EGC KOH from the box. Save the box and foam for future storage.
- B. Place the Dionex EGC KOH on a flat surface in front of the EG module with the Eluent Generation Chamber and INLET and OUTLET fittings facing up.
- C. Remove the plugs from the Dionex EGC KOH INLET and OUTLET fittings.
- D. Turn over the Dionex EGC KOH cartridge (fittings facing down). Shake the Dionex EGC KOH cartridge vigorously and tap it with the palm of your hand 10 to 15 times to dislodge the air bubbles that may be trapped in the electrolysis chamber.



### NOTE

*Be sure to repeat Step D each time the eluent generation chamber is turned upward.*

- E. Disconnect the old Dionex EGC 400 KOH cartridge from the EGC2 port. Slide the cartridge up until it is clear of the cartridge holder and remove the cartridge from the EG module. Drain and dispose of the cartridge according to local Hazmat regulations.
- F. Orient the new Dionex EGC 400 KOH cartridge with the cables aligned with the slot in the holder of the EG enclosure and slide the cartridge down into the holder until secured.



- G. Connect the electrical cable of the Dionex EGC 400 KOH cartridge to the EGC2 port.
- H. Remove the plug on the top of the Dionex EGC 400 KOH cartridge.
- I. Connect the OUTLET port of the Dionex EGC 400 MSA cartridge to the INLET port of the Dionex EGC 400 KOH cartridge. Direct the OUTLET port of the cartridge to waste.
- J. Turn on the pump and pump DI water through the Dionex EGC 400 KOH cartridge for 15 minutes at the flow rate of 1 mL/min (prime mode).
- K. Connect the OUTLET port of the Dionex EGC 400 KOH cartridge to a PEEK backpressure tubing (Item # 22181-20031). Direct the backpressure tubing to waste.
- L. Set the pump flow rate to 0.1 mL/min.
- M. On the E-Panel, under Eluent Generator Tab, set the Eluent Polarity to Basic Eluents. Set  $\text{KOH}_{\text{prog}}$  to 100 mM. Turn on the Dionex EGC power.
- N. Condition the Dionex EGC 400 KOH cartridge for 30 min.
- O.
- P. Turn off the pump.
- Q. Remove the PEEK backpressure tubing from the OUTLET port of the Dionex EGC 400 KOH cartridge.
- R. Connect the OUTLET port of the Dionex EGC 400 KOH cartridge to the ELUENT IN port of the Dionex RFIC<sup>+</sup> Dual EG Eluent Degasser (Item # 22181-60201).
- S. With EGC power OFF, turn on the pump at the recommended flow rate for the column.
- T. After the system pressure reach 3000 psi, with Eluent Polarity set to Basic Eluents, set  $\text{KMSA}_{\text{prog}}$  and  $\text{KOH}_{\text{prog}}$  to the desired concentrations for the applications. Turn on the Dionex EGC power and let the system equilibrate for 60 min.

### IMPORTANT

*If the system pressure is lower than 3000 psi, install backpressure tubing (P/N 22181-20038 for 500 psi back pressure, P/N 22181-20039 for 1000 psi backpressure) between the ELUENT OUT of the Dionex RFIC<sup>+</sup> Dual EG Eluent Degasser and the C port of the injection valve if necessary, to achieve a system pressure of 3000 psi or above. Please refer to Document No. 155052-01 enclosed with the separation column for flow diagram.*

### IMPORTANT

*To prevent backpressure tubing (P/N 22181-20038 for 500 psi back pressure, P/N 22181-20039 for 1000 psi backpressure, P/N 22181-20031 backpressure tubing) from clogging, for future use, please rinse the tubing with DI water after each use.*

## 2.15 Preparation and Conditioning of Dionex EGC (Capillary) cartridges for operation in Dual EGC Mode



### NOTE

*To ensure stable baseline and low background noise, it is crucial to have sufficient removal of the hydrogen and oxygen gas formed with the EGC generated eluents. Connect the vents of the Dionex RFIC Capillary EGC MSA Degasser and the Dionex RFIC Capillary Eluent Degasser to the Vacuum Port located at the back of the Dionex DP module. Make sure all connections and fittings for the vacuum degas are vacuum-tight before using the system.*

**NOTE**

*Only turn on the EGC power when the system pressure reaches above 2600 psi at a flow rate of 0.010 mL/min. This step is very important to ensure best system performance.*

- A. Remove the Dionex EGC-MSA (Capillary) from the box. Save the box and foam for future storage.
- B. Place the Dionex EGC-MSA (Capillary) on a flat surface in front of the EG module with the Eluent Generation Chamber and INLET and OUTLET fittings facing up.
- C. Remove the plugs from the Dionex EGC-MSA (Capillary) INLET and OUTLET fittings.
- D. Turn over the Dionex EGC-MSA (Capillary) cartridge (fittings facing down). Shake the Dionex EGC-MSA (Capillary) cartridge vigorously and tap it with the palm of your hand 10 to 15 times to dislodge the air bubbles that may be trapped in the electrolysis chamber.

**NOTE**

*Be sure to repeat Step D each time the eluent generation chamber is turned upward.*

- E. Follow steps A-D to prepare the Dionex EGC-KOH (Capillary).
- F. Orient the Dionex EGC-MSA (Capillary) and Dionex EGC-KOH (Capillary) cartridges with the cables aligned with the slots in the holders of the EG enclosure and then slide the cartridges down into the holders until secured.

**Tip**

*If using a Dionex ICS-6000 system, position the Dionex EGC 400 KOH cartridge into the holder that is closer to the DC module, i.e., if the EG module is on the right of the DC, position the Dionex EGC 400 KOH in the left side holder.*

- G. Connect the electrical cable of the Dionex EGC-MSA (Capillary) to the EGC1 port and the electrical cable of the Dionex EGC-KOH (Capillary) to the EGC2 port of the EG module.
- H. In the Chromeleon Instrument Configuration Manager, check the Dionex EGC-MSA (Capillary) and the Dionex EGC-KOH (Capillary), and set the pump link of both cartridges to the same pump. This setting enables the configuration to enter “Dual EGC” mode.
- I. Fill a 2 L eluent reservoir bottle with ASTM filtered, Type I (18-megohm) degassed deionized water. Connect the reservoir to the eluent inlet line of the pump. Keep the water blanketed under an inert gas (helium or nitrogen).
- J. Prime the pump as instructed by the system operation manual.
- K. Remove the vent plug on the top of the Dionex EGC-MSA (Capillary) cartridge (please refer to Dionex Eluent Generator Cartridges Manual Document No. 065081 for details about the preparation of the Dionex EGC cartridges).
- L. Connect the pump outlet to the EGC IN port of the Dionex EGC-MSA (Capillary) cartridge and direct the EGC OUT port of the cartridge to waste.
- M. Turn on the pump and pump DI water through the Dionex EGC-MSA (Capillary) for 15 minutes at the flow rate of 0.1 mL/min (prime mode).
- N. Connect the EGC OUT port of the Dionex EGC-MSA (Capillary) cartridge to a PEEK backpressure tubing (Item # 22181-20032). Direct the backpressure tubing to waste.
- O. Set the pump flow rate to 0.020 mL/min.
- P. On the E-Panel, under Eluent Generator Tab, set the Eluent Polarity to Acidic Eluents. Set MSA<sub>prog</sub> to 100 mM. Turn on the Dionex EGC power.

- Q. Condition the Dionex EGC-MSA (Capillary) for 30 min.
- R. Turn off the pump.
- S. Remove the PEEK backpressure tubing from the EGC OUT port of the Dionex EGC-MSA (Capillary).
- T. Connect the EGC OUT port of the Dionex EGC-MSA (Capillary) to the ELUENT IN port of the Dionex RFIC Capillary EGC MSA Degasser (Item # 22181-60211). Direct the ELUENT OUT to waste.
- U. Set the pump flow rate to 0.05 mL/min and turn the pump on for 10 min.
- V. Remove the vent plug on the top of the Dionex EGC-KOH (Capillary) cartridge.
- W. Connect the ELUENT OUT port of the Dionex RFIC Capillary EGC MSA Degasser (Item # 22181-60211) and the EGC IN port of the Dionex EGC-KOH (Capillary) cartridge. Direct the EGC OUT port of the cartridge to waste.
- X. Turn on the pump and pump DI water through the Dionex EGC-KOH (Capillary) for 15 minutes at the flow rate of 0.1 mL/min.
- Y. Connect the EGC OUT port of the Dionex EGC-KOH (Capillary) cartridge to a PEEK backpressure tubing (Item # 22181-20032). Direct the backpressure tubing to waste
- Z. Set the pump flow rate to 0.020 mL/min.
- AA. On the E-Panel, under Eluent Generator Tab, set the Eluent Polarity to Basic Eluents. Set  $\text{KOH}_{\text{prog}}$  to 100 mM. Turn on the Dionex EGC power.
- BB. Condition the Dionex EGC-KOH (Capillary) for 30 min.
- CC. On the E-Panel, turn the Dionex EGC power OFF and keep the pump running at 0.02 mL/min for 10 min.
- DD. Turn off the pump.
- EE. Remove the PEEK backpressure tubing from the EGC OUT port of the Dionex EGC-KOH (Capillary) cartridge.
- FF. Connect the EGC OUT port of the Dionex EGC-KOH (Capillary) cartridge to the ELUENT IN port of the Dionex RFIC Capillary Eluent Degasser (Item # 22181-60202).
- GG. Connect the ELUENT OUT port of the Dionex Capillary RFIC Eluent Degasser (Item # 22181-60202) to a PEEK backpressure tubing (Item # 22181-20032). Direct the backpressure tubing to waste.
- HH. With EGC power OFF, turn on the pump at the flow rate of 0.020 mL/min. Flush the Dionex RFIC Capillary Eluent Degasser (Item # 22181-60202) for 15 min.
- II. Turn off the pump.
- JJ. Remove the PEEK backpressure tubing (Item # 22181-20032) from the ELUENT OUT port of the Dionex RFIC EGC Capillary Eluent Degasser (Item # 22181-60202).

### 2.16 Operation of Dionex EGC-KOH (Capillary) and Dionex EGC-MSA (Capillary) in Dual EGC Mode

- A. Complete the entire system plumbing as shown in Figure 13 for your application.
- B. Turn on the pump at the flow rate recommended for your application.

### 2.17 Replacing a Dionex EGC-MSA (Capillary) Cartridge in Dual EGC Mode

- A. Remove the Dionex EGC-MSA (Capillary) from the box. Save the box and foam for future storage.

- B. Place the Dionex EGC-MSA (Capillary) on a flat surface in front of the EG module with the Eluent Generation Chamber and INLET and OUTLET fittings facing up.
- C. Remove the plugs from the Dionex EGC-MSA (Capillary) INLET and OUTLET fittings.
- D. Turn over the Dionex EGC-MSA (Capillary) cartridge (fittings facing down). Shake the Dionex EGC-MSA (Capillary) cartridge vigorously and tap it with the palm of your hand 10 to 15 times to dislodge the air bubbles that may be trapped in the electrolysis chamber.

**NOTE**

*Be sure to repeat Step D each time the eluent generation chamber is turned upward.*

- E. Disconnect the old Dionex EGC-MSA (Capillary) cartridge from the EGC1 port. Slide the cartridge up until it is clear of the cartridge holder and remove the cartridge from the EG module. Drain and dispose of the cartridge according to local Hazmat regulations.
- F. Orient the new Dionex EGC-MSA (Capillary) cartridge with the cables aligned with the slot in the holder of the EG enclosure and slide the cartridge down into the holder until secured.
- G. Connect the electrical cable of the Dionex EGC-MSA (Capillary) cartridge to the EGC1 port.
- H. Remove the plug on the top of the Dionex EGC-MSA (Capillary) cartridge.
- I. Connect the pump outlet to the EGC IN port of the Dionex EGC-MSA (Capillary) cartridge and direct the EGC OUT port of the cartridge to waste.
- J. Turn on the pump and pump DI water through the Dionex EGC-MSA (Capillary) cartridge for 15 minutes at the flow rate of 0.1 mL/min (prime mode).
- K. Connect the OUTLET port of the Dionex EGC-MSA (Capillary) cartridge to a PEEK backpressure tubing (Item # 22181-20032). Direct the backpressure tubing to waste.
- L. Set the pump flow rate to 0.010 mL/min.
- M. On the E-Panel, under Eluent Generator Tab, set the Eluent Polarity to Acidic Eluents. Set  $MSA_{prog}$  to 100 mM. Turn on the Dionex EGC power.
- N. Condition the Dionex EGC-MSA (Capillary) cartridge for 30 min.
- O. Turn off the pump.
- P. Remove the PEEK backpressure tubing from the EGC OUT port of the Dionex EGC-MSA (Capillary) cartridge.
- Q. Connect the EGC OUT port of the Dionex EGC-MSA (Capillary) to the ELUENT IN port of the Dionex RFIC Capillary EGC MSA Degasser (Item # 22181-60211). Direct the ELUENT OUT to waste.
- R. With EGC power OFF, turn on the pump at the flow rate of 0.063 mL/min. Keep the pump on for 15 min.
- S. With Eluent Polarity set to Basic Eluents, set  $KMSA_{prog}$  and  $KOH_{prog}$  to the desired concentrations for the applications. Turn on the Dionex EGC power for 60 min.

## 2.18 Replacing a Dionex EGC-KOH (Capillary) Cartridge in Dual EGC Mode

- A. Remove the Dionex EGC-KOH (Capillary) from the box. Save the box and foam for future storage.
- B. Place the Dionex EGC-KOH (Capillary) on a flat surface in front of the EG module with the Eluent Generation Chamber and INLET and OUTLET fittings facing up.
- C. Remove the plugs from the Dionex EGC-KOH (Capillary) INLET and OUTLET fittings.

- D. Turn over the Dionex EGC-KOH (Capillary) cartridge (fittings facing down). Shake the Dionex EGC-KOH (Capillary) cartridge vigorously and tap it with the palm of your hand 10 to 15 times to dislodge the air bubbles that may be trapped in the electrolysis chamber.

**NOTE**

*Be sure to repeat Step D each time the eluent generation chamber is turned upward.*

- E. Disconnect the old Dionex EGC-KOH (Capillary) cartridge from the EGC2 port. Slide the cartridge up until it is clear of the cartridge holder and remove the cartridge from the EG module. Drain and dispose of the cartridge according to local Hazmat regulations.
- F. Orient the new Dionex EGC-KOH (Capillary) cartridge with the cables aligned with the slot in the holder of the EG enclosure and slide the cartridge down into the holder until secured.
- G. Connect the electrical cable of the Dionex EGC-KOH (Capillary) cartridge to the EGC2 port.
- H. Remove the plug on the top of the Dionex EGC-KOH (Capillary) cartridge.
- I. Connect the ELUENT OUT port of the Dionex RFIC Capillary EGC MSA Degasser (Item # 22181-60211) and the EGC IN port of the Dionex EGC-KOH (Capillary) cartridge. Direct the EGC OUT port of the cartridge to waste.
- J. Turn on the pump and pump DI water through the Dionex EGC-KOH (Capillary) for 15 minutes at the flow rate of 0.1 mL/min.
- K. Connect the EGC OUT port of the Dionex EGC-KOH (Capillary) cartridge to a PEEK backpressure tubing (Item # 22181-20032). Direct the backpressure tubing to waste.
- L. Set the pump flow rate to 0.010 mL/min.
- M. On the E-Panel, under Eluent Generator Tab, set the Eluent Polarity to Basic Eluents. Set  $\text{KOH}_{\text{prog}}$  to 100 mM. Turn on the Dionex EGC power.
- N. Condition the Dionex EGC-KOH (Capillary) for 30 min.
- O. On the E-Panel, turn the Dionex EGC power OFF and keep the pump running at 0.02 mL/min for 10 min.
- P. Turn off the pump.
- Q. Remove the PEEK backpressure tubing from the EGC OUT port of the Dionex EGC-KOH (Capillary) cartridge.
- R. Connect the EGC OUT port of the Dionex EGC-KOH (Capillary) cartridge to the ELUENT IN port of the Dionex RFIC Capillary Eluent Degasser (Item # 22181-60202).
- S. With EGC power OFF, turn on the pump at the flow rate of 0.063 mL/min. Keep the pump on for 15 min.
- T. With Eluent Polarity set to Basic Eluents, set  $\text{KMSA}_{\text{prog}}$  and  $\text{KOH}_{\text{prog}}$  to the desired concentrations for the applications. Turn on the Dionex EGC power for 60 min.

## 3. Operation

### 3.1 Routine Operation for Analytical Scale Systems

For analytical scale operation ( $\geq 1$  mm), the recommended system backpressure is 2,000 – 3,000 psi (14 - 21 MPa) for the Dionex EGC III, or 2,000 - 5,000 psi (14 - 34.5 MPa) for the Dionex EGC 400 and Dionex EGC 500; a system back pressure of 2,300 psi is ideal. If necessary, add a backpressure restrictor to increase the pressure. The pressure restrictor tubing is located in the Eluent Generator Module or System ship kit. See Section 2.1 for instructions.

### 3.2 Routine Operation for Capillary Scale Systems

For capillary scale operation ( $< 1$  mm), the recommended system backpressure is 1,000 – 5,000 psi (7 - 35 MPa); a system back pressure of 2,000 psi is ideal. Backpressure restrictor tubing is not recommended for capillary systems.

### 3.3 Operating Precautions



CAUTION

*The EG Module generates eluent by means of electrolysis which results in the production of small amounts of oxygen or hydrogen gas. Ensure that the Gas Separator Waste Tube, provided with your conductivity detector, is installed.*



CAUTION

*Operate the EG in properly ventilated areas only.*



CAUTION

*Ensure a vent line is attached to the Dionex EGC vent port. The end of the vent line should be placed in a waste container in case of electrolyte overflow.*



NOTE

*Under certain conditions it is normal for the Dionex EGC electrolyte level to increase or decrease over time.*



SAFETY

***DO NOT CAP THE WASTE RESERVOIR! The small amount of gas generated by the EG and the Electrolytic Suppressor (Dionex DRS, Dionex ERS or Dionex CES) is not dangerous unless the gas is trapped in a closed container and allowed to accumulate. The Gas Separator Waste Tube must be open to the atmosphere in order to operate properly.***



CAUTION

*Do not operate a modular chromatography system where the Eluent Generator (EG) is plumbed into the system, but not software controlled. The excessive pressures that are allowed in systems without an EG can damage components.*



NOTE

*In the case of the Dionex EGC 500, two EGC pods are connected in series to provide sufficient capacity while maintaining high-pressure capability.*



CAUTION

*For analytical scale operation ( $\geq 1$  mm), the maximum operating pressure for the EG Module is 3,000 psi (21 MPa) for the Dionex EGC III or 5,000 psi (34.5 MPa) for the Dionex EGC 400 and Dionex EGC 500; however, 2,300 psi is ideal.*



CAUTION

*For capillary scale operation ( $< 1$  mm), the maximum operating pressure for the EG Module is 5,000 psi (34.5 MPa).*



NOTE

*Due to the high backpressure, exercise care when using solvents with the following columns: Thermo Scientific™ Dionex™ IonPac™ AS11-HC or Thermo Scientific™ Dionex™ CarboPac™ PA10.*



NOTE

*For analytical scale operation ( $\geq 1$  mm), solvents may be used if the flow rate is reduced sufficiently to reduce the system pressure to less than 3,000 psi (21 MPa) for the Dionex EGC III or 5,000 psi (34.5 MPa) for the Dionex EGC 400 and Dionex EGC 500.*



CAUTION

*Due to potential high backpressure, do not operate the EG with the following columns: Thermo Scientific™ Dionex™ IonPac™ AS5A, Thermo Scientific™ Dionex™ IonPac™ AS10, Thermo Scientific™ Dionex™ OmniPac™ PAX-100, or Thermo Scientific™ Dionex™ OmniPac™ PAX-500 unless the flow rate has been reduced to lower the system pressure to less than 3,000 psi (21 MPa) for a Dionex EGC III or 5,000 psi (35 MPa) for a Dionex EGC 500. Excessive backpressure can damage components.*



NOTE

*Do not operate the Dionex EGC 500 KOH, Dionex EGC 400 KOH, Dionex EGC III KOH, Dionex EGC III NaOH, Dionex EGC III LiOH or Dionex EGC-KOH (Capillary) with solvents other than methanol (up to a maximum of 25%).*



NOTE

*Do not operate the Dionex EGC 500 K<sub>2</sub>CO<sub>3</sub>, Dionex EGC 500 MSA, Dionex EGC 400 MSA, Dionex EGC III MSA, Dionex EGC-MSA (Capillary) or Dionex EPM 500 with any solvent content.*



CAUTION

*To prevent the buildup of hydrogen and oxygen gases, install the EG Module in a well-ventilated site.*

**CAUTION**

*Make sure the Suppressor Gas Separator Waste Tube (Item # 045460) is correctly installed. The tube is used to dissipate the small amounts of hydrogen and oxygen gases that are generated during EG and Suppressor operation.*

**IMPORTANT**

*Do not allow the flow rate of the Dionex EGC 500, Dionex EGC 400 or Dionex EGC III to drop to a level where the backpressure can fall below 2,000 psi (14 MPa). The degas assembly will not properly degas the eluent if the system pressure is below 2,000 psi and gas will build up on the analytical column.*

**Tip**

*For anion exchange separations, carbonate may accumulate on the columns at low hydroxide concentrations. This accumulated carbonate will elute from the column when the hydroxide concentration is increased.*

## 3.4 System Shutdown

### 3.4.1 Short-Term Shutdown

Thermo Scientific recommends continuous operation of your IC system for the most trouble-free operation. For analytical scale operation ( $\geq 1$  mm), a microbore system will provide the most economical operation. Capillary scale systems ( $< 1$  mm) are designed to be operated non-stop for months at a time and provide the ultimate in economical operation.

The Dionex EGC 500, Dionex EGC 400, Dionex EGC III, and Dionex EGC (Capillary) may be left in the EG Module for short-term storage up to three months. The system should be shut down using the following methods:

- A. Turn System OFF Completely:
  - i. Turn the pump, EGC, CR-TC, and Suppressor off.
  - ii. Check that the current to the EGC, CR-TC, and Suppressor are off.

**NOTE**

*The suppressor should only be stored for up to 1 week with eluent in the chambers. See the suppressor user's guide for further instructions.*

- B. To restart the system:
  - i. Apply the required system settings.
  - ii. Allow the system to equilibrate for 30-45 minutes prior to collecting data.

**NOTE**

*If the system has been shut down for more than 3-4 days, the Suppressor should be rehydrated prior to starting pump flow.*

See the appropriate Suppressor manual for Suppressor start-up details.



#### 3.4.2 Long-Term Shutdown

For long-term storage, the Dionex EGC 500, Dionex EGC 400, Dionex EGC III, and Dionex EGC (Capillary) may be left in the EG module, but the EGC cable should be disconnected. If you need to remove the cartridge and store it, follow the directions in Section 5.1 (a-f). Cap all vents and liquid connections. The pump may be used for conventional delivery of eluents by connecting the outlet of the pump pressure transducer to the INJ IN port on the Rheodyne injection valve.

#### 3.4.3 Dual EG Mode Re-start

*Note: The systems under Dual EG mode are designed to be operated non-stop for months at a time. If the system has been shut down for more than 5 days, the system should be restarted using the following procedure:*

##### 3.4.3.1 Re-Start Procedure for Dionex EGC 400 cartridges for operation in Dual EGC Mode

- A. Disconnect all the components after the Dionex EGC 400 KOH cartridge from the system.
- B. Direct the OUTLET of the Dionex EGC 400 KOH cartridge to waste.
- C. Set the flow rate to 0.2 mL/min. Turn the pump and EGC power on. With Eluent Polarity set to Basic Eluents, set  $KMSA_{prog}$  to 5 mM and  $KOH_{prog}$  to 5 mM. Allow the system to run for 20 min.
- D. Turn the pump off.
- E. Connect the OUTLET of the Dionex EGC 400 KOH cartridge to the ELUENT IN of the Dionex RFIC<sup>+</sup> Dual EG Eluent Degasser (Item # 22181-60951). Direct the ELUENT OUT of the Dionex RFIC<sup>+</sup> Dual EG Eluent Degasser to waste.
- F. Set the flow rate to 0.2 mL/min and turn the pump on for 15 min. Keep EGC power off.
- G. Turn the pump off.
- H. Connect the ELUENT OUT of the Dionex RFIC<sup>+</sup> Dual EG Eluent Degasser to P port of the injection valve.
- I. Disconnect the outlet of the column from the ED cell. Direct the outlet of the column to waste.
- J. Set the flow rate to recommended flow rate of the column (e.g. 0.063 mL/min). After the system pressure reaches 3000 psi, turn on EGC power.
- K. With Eluent Polarity set to Basic Eluents, set  $KMSA_{prog}$  and  $KOH_{prog}$  to the desired concentrations for the applications. Turn on the Dionex EGC power for 60 min.
- L. Connect the outlet of the separator column to the ED cell.
- M. Direct the outlet of the ED cell to waste.
- N. Turn the pump and EGC power on. Set to the required application condition.
- O. When the pH reading of the ED detector shows  $pH > 11$ , turn the ED cell on.
- P. Allow the system to equilibrate for 30-45 minutes prior to collecting data.

### 3.4.3.2 Re-Start Procedure for Dionex EGC (Capillary) cartridges for operation in Dual EGC Mode

- A. Disconnect all the components after the Dionex EGC-KOH (Cap) cartridge from the system.
- B. Direct the EGC OUT of the Dionex EGC-KOH (Cap) cartridge to waste.
- C. Set the flow rate to 0.02 mL/min. Turn the pump and EGC power on. With Eluent Polarity set to Basic Eluents, set  $KMSA_{prog}$  to 50 mM and  $KOH_{prog}$  to 20 mM. Allow the system to run for 30 min.
- D. Turn the EGC power off.
- E. Keep the pump on at 0.02 mL/min for 10 min.
- F. Turn the pump off.
- G. Connect the EGC OUT of the Dionex EGC-KOH (Cap) cartridge to the ELUENT IN of the Dionex RFIC capillary eluent degasser (Item # 22181-60202). Direct the ELUENT OUT of the Dionex RFIC capillary eluent degasser to waste.
- H. Set the flow rate to 0.02 mL/min and turn the pump on for 10 min. Keep EGC power off.
- I. Turn the pump off.
- J. Connect the ELUENT OUT of the Dionex RFIC Capillary Eluent Degasser (Item # 22181-60202) to port 2 of the injection valve.
- K. Install the guard column and the separator column to port 3 of the injection valve. Direct the OUTLET of the column to waste.
- L. Set the flow rate to 0.01 mL/min With EGC power off, pump DI water through the system for 10 min.
- M. Turn the pump off.
- N. Connect the outlet of the separator column to the ED cell.
- O. Direct the outlet of the ED cell to waste.
- P. Turn the pump and EGC power on. Set to the required application condition.
- Q. When the pH reading of the ED detector shows  $pH > 11$ , turn the ED cell on.
- R. Allow the system to equilibrate for 30-45 minutes prior to collecting data.

## 4. Example Applications

### 4.1 Principles of Operation

#### 4.1.1 Hydroxide based Applications

The Eluent Generator Cartridges – Dionex EGC 500 KOH, EGC 400 KOH, Dionex EGC III KOH, Dionex EGC III NaOH, Dionex EGC III LiOH and Dionex EGC-KOH (Capillary) – may be used to generate isocratic or gradient eluents. The Dionex EGC 500 KOH, Dionex EGC III KOH and Dionex EGC III NaOH can generate up to 100 mM KOH or NaOH at 1.0 mL/min. The Dionex EGC III LiOH can generate up to 80 mM LiOH at 1.0 mL/min. The Dionex EGC 400 KOH can generate up to 200 mM KOH at 0.063 mL/min. The Dionex EGC-KOH (Capillary) cartridge may be used to generate up to 200 mM KOH at 0.010 mL/min.

- Dionex EGC 500 and Dionex EGC III: Eluent concentrations up to 50 mM KOH or NaOH can be produced at 2.0 mL/min.
- Dionex EGC III: Eluent concentrations up to 40 mM LiOH can be produced at 2.0 mL/min.
- Dionex EGC 400: Eluent concentrations up to 63 mM KOH can be produced at 0.20 mL/min.
- Dionex EGC (Capillary): Eluent concentrations up to 100 mM KOH can be produced at 0.020 mL/min.
- All KOH, NaOH and LiOH EGCs: Up to 25% methanol may be used in the eluent.

#### 4.1.2 Carbonate-based Applications

The Eluent Generator Cartridges – Dionex EGC 500 K<sub>2</sub>CO<sub>3</sub> and Dionex EPM 500 – may be used to generate isocratic eluents; gradient eluents are not supported. The Dionex EGC 500 K<sub>2</sub>CO<sub>3</sub> can generate up to 15 mM K<sub>2</sub>CO<sub>3</sub> at 1.0 mL/min. The Dionex EPM 500 can convert up to 10 mM K<sub>2</sub>CO<sub>3</sub> to KHCO<sub>3</sub> at 1.0 mL/min.

Eluent concentrations up to 7.5 mM K<sub>2</sub>CO<sub>3</sub> can be produced at 2.0 mL/min. Up to 5.0 M K<sub>2</sub>CO<sub>3</sub> can be converted to KHCO<sub>3</sub> at 2.0 mL/min.

No solvents can be used in the eluent with a Dionex EGC 500 K<sub>2</sub>CO<sub>3</sub> or Dionex EPM 500.

#### 4.1.3 Methanesulfonic acid-based Applications

The Eluent Generator Cartridges – Dionex EGC 500 MSA, Dionex EGC 400 MSA, Dionex EGC III MSA and Dionex EGC-MSA (Capillary) – may be used to generate isocratic or gradient eluents. The Dionex EGC 500 MSA and Dionex EGC III MSA can generate up to 100 mM MSA at 1.0 mL/min. The Dionex EGC 400 MSA can generate up to 200 mM MSA at 0.063 mL/min. The Dionex EGC-MSA (Capillary) cartridge may be used to generate up to 200 mM MSA at 0.010 mL/min.

- Dionex EGC 500 and Dionex EGC III: Eluent concentrations up to 50 mM MSA can be produced at 2.0 mL/min.
- Dionex EGC 400: Eluent concentrations up to 100 mM MSA can be produced at 0.20 mL/min.
- Dionex EGC (Capillary): Eluent concentrations up to 100 mM MSA can be produced at 0.020 mL/min.
- All MSA EGCs: No solvents can be used in the eluent at any concentration.

#### 4.1.4 Dionex EGC and Dionex EPM Operating Conditions

The Dionex EGC and Dionex EPM products may be used with the columns and eluent conditions listed below. Verify the performance of the entire system by duplicating the column test chromatogram.

##### A. EGC General Operating Conditions:

Maximum Flow Rate (4 mm operation):	3.0 mL/min.
Maximum Flow Rate (2 mm operation):	0.75 mL/min.
Maximum Flow Rate (1 mm operation):	0.20 mL/min.
Maximum Flow Rate (Capillary operation):	0.030 mL/min.
Maximum System Pressure (Dionex EGC III):	3,000 psi (21 MPa).
Maximum System Pressure (Dionex EGC 500, Dionex EGC 400 and Dionex EGC (Capillary)):	5,000 psi (35 MPa).
Minimum Recommended System Pressure (Dionex EGC 500, Dionex EGC 400 and Dionex EGC III):	2,000 psi (14 MPa); use optional Pressure Restrictor as required.
Minimum Recommended System Pressure Dionex EGC (Capillary):	1,000 psi (7 MPa); Pressure Restrictor is not recommended.

##### B. Anion Exchange with Dionex EGC 500 KOH, Dionex EGC 400 KOH, Dionex EGC III KOH, Dionex EGC III NaOH or Dionex EGC-KOH (Capillary):

Concentration Range for 4 mm operation:	Up to 100 mM KOH or NaOH at 1.0 mL/min; 50 mM at 2.0 mL/min.
Concentration Range for 2 mm operation:	Up to 100 mM KOH or NaOH at 0.25 mL/min.
Concentration Range for 1 mm operation:	Up to 200 mM KOH at 0.063 mL/min; 63 mM at 0.20 mL/min.
Concentration Range for capillary operation:	Up to 200 mM KOH at 0.010 mL/min; 100 mM at 0.020 mL/min.
Solvent Concentration Range:	Up to 25% Methanol.
Columns:	All hydroxide selective columns.



#### NOTE

*In most cases, the Dionex EGC III NaOH can be used with equivalent results to the Dionex EGC III KOH.*

##### C. Anion Exchange with Dionex EGC III LiOH:

Concentration Range for 4 mm operation:	Up to 80 mM LiOH at 1.0 mL/min; 40 mM at 2.0 mL/min.
Concentration Range for 2 mm operation:	Up to 80 mM LiOH at 0.25 mL/min.
Solvent Concentration Range:	Up to 25% Methanol.
Columns:	All hydroxide selective columns.

D. Anion Exchange with Dionex EGC 500 K<sub>2</sub>CO<sub>3</sub>:

Concentration Range for 4 mm operation:	Up to 15 mM K <sub>2</sub> CO <sub>3</sub> at 1.0 mL/min; 7.5 mM at 2.0 mL/min.
Concentration Range for 2 mm operation:	Up to 15 mM K <sub>2</sub> CO <sub>3</sub> at 0.25 mL/min.
Solvent Concentration Range:	Not compatible with any solvents.
Columns:	All carbonate-based anion exchange columns.

## E. Anion Exchange with Dionex EPM 500:

Concentration Range for 4 mm operation:	Convert up to 10 mM K <sub>2</sub> CO <sub>3</sub> to KHCO <sub>3</sub> at 1.0 mL/min; 5.0 mM at 2.0 mL/min.
Concentration Range for 2 mm operation:	Convert up to 10 mM K <sub>2</sub> CO <sub>3</sub> to KHCO <sub>3</sub> at 0.25 mL/min.
Solvent Concentration Range:	Not compatible with any solvents.
Columns:	All carbonate-based anion exchange columns.

## F. Cation Exchange with Dionex EGC 500 MSA, Dionex EGC 400 MSA, Dionex EGC III MSA or Dionex EGC-MSA (Capillary)

Concentration Range for 4 mm operation:	Up to 100 mM MSA at 1.0 mL/min; 50 mM at 2.0 mL/min.
Concentration Range for 2 mm operation:	Up to 100 mM MSA at 0.25 mL/min.
Concentration Range for 1 mm operation:	Up to 200 mM MSA at 0.063 mL/min; 63 mM MSA at 0.20 mL/min
Concentration Range for capillary operation:	Up to 200 mM MSA at 0.010 mL/min; 100 mM at 0.020 mL/min.
Solvent Concentration Range:	Not compatible with any solvents.
Columns:	All cation exchange columns compatible with MSA eluents.

## G. Carbohydrate Analysis with Dionex EGC 400 KOH and Dionex EGC 400 MSA, or Dionex EGC-KOH (Capillary) and Dionex EGC-MSA (Capillary) in Dual EGC Mode

Concentration Range for 1 mm operation:	Up to 200 mM KMSA at 0.063 mL/min; 63 mM KMSA at 0.20 mL/min
Concentration Range for capillary operation:	Up to 200 mM KMSA at 0.010 mL/min; 100 mM at 0.020 mL/min.
Solvent Concentration Range:	Not compatible with any solvents.
Columns:	All Thermo Scientific Dionex CarboPac 1 mm and 0.4 mm columns.

## 4.1.5 Verifying the System Configuration

After configuring the system, run the standard chromatogram for your column. Be sure to run the analysis at the temperature given for the chromatogram if one is listed. If no temperature is listed, the chromatogram should be run at room temperature. If the chromatogram obtained matches the test chromatogram included with the column, the system is operating correctly for that set of system operating parameters. If the chromatogram obtained does not match the sample chromatogram, see Section 6 for troubleshooting information.

## 4.2 Comparison of Eluent Generation with Dionex IonPac ATC-HC and Dionex CR-ATC for Dionex IonPac AS11 Gradient

This set of chromatograms demonstrates the decrease in baseline shift during a gradient when the Dionex IonPac ATC-HC or Dionex CR-ATC is used. The Dionex CR-ATC does not require off-line chemical regeneration.

Column: Dionex IonPac AS11 Analytical (4 mm)  
 Eluent: Dionex EGC generated KOH  
 Flow Rate: 2.0 mL/min  
 Inj. Volume: 10 µL  
 Detection: Suppressed Conductivity  
 Temperature: 30°C  
 Suppressor: Dionex Electrolytic Suppressor (4 mm), Recycle Mode

**Figure 25 Comparison of Dionex EGC with Dionex IonPac ATC-HC and Dionex CR-ATC for Dionex IonPac AS11 Gradient**

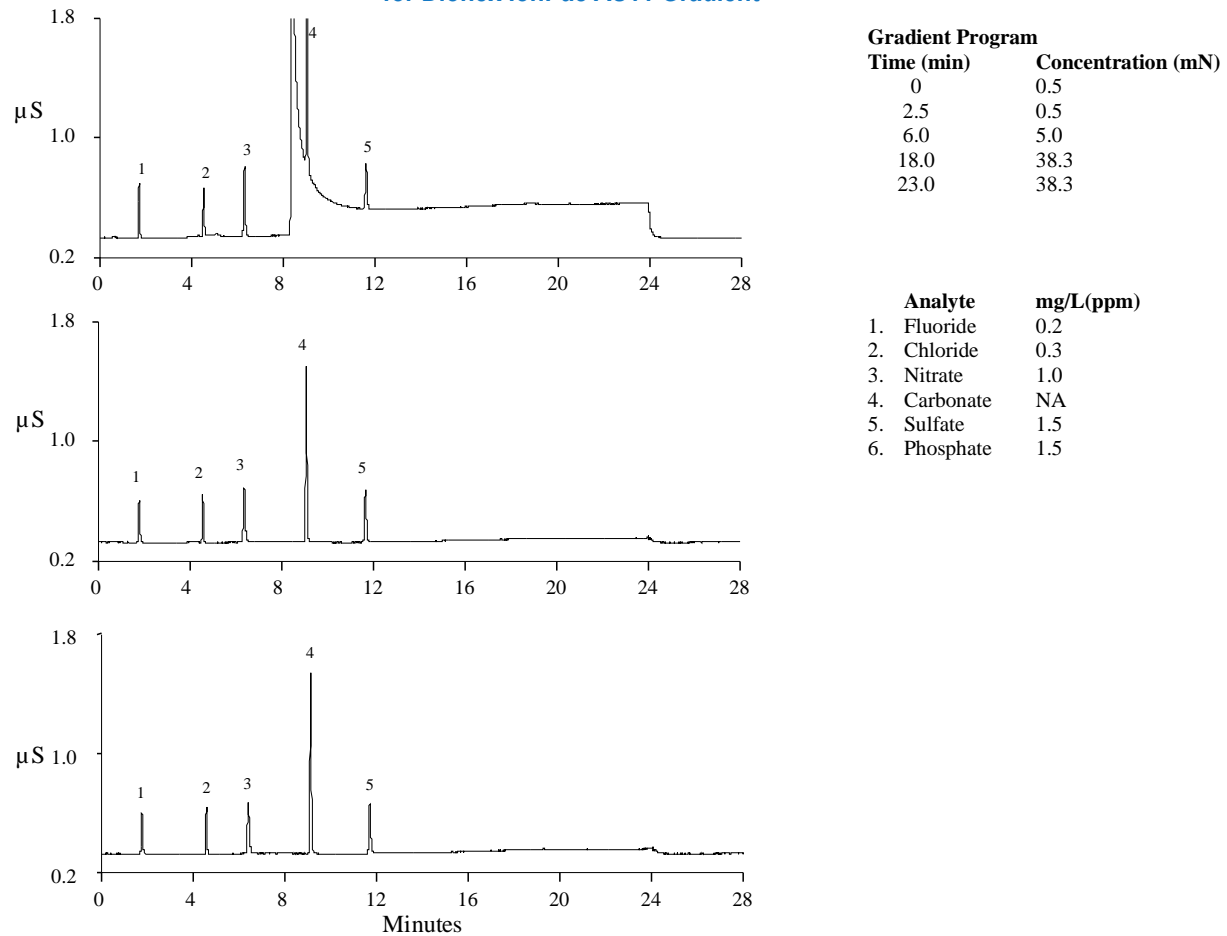

Background (µS/cm)	Start	End	Drift
Dionex EGC	0.33	0.56	0.23
Dionex IonPac ATC-HC	0.32	0.36	0.04
Dionex CR-ATC	0.32	0.36	0.04

### 4.3 Using the Dionex EGC III KOH or Dionex EGC 500 KOH Cartridge for Dionex IonPac AS15 Isocratic Elution

This application demonstrates the comparison of a Thermo Scientific™ Dionex™ IonPac™ AS15 isocratic separation using conventional pump delivery to Dionex EGC eluent delivery. Figure 26, “Conventional Hydroxide Eluent on the Dionex IonPac AS15,” illustrates the use of a conventional method. Figure 27, “Dionex EGC KOH Eluent on the Dionex IonPac AS15,” illustrates the use of the Dionex EGC with an identical isocratic program. In Figure 26, the chromatogram generated with conventional delivery of KOH was contaminated from carbonate in the DI reagent water used to make the KOH eluent. This contamination decreases the pH of the eluent and causes phosphate to co-elute with nitrate. Use of the Dionex EGC eliminates the eluent contamination problem, resulting in baseline resolution of nitrate and phosphate.

Sample Volume:	25 µL
Column:	Dionex IonPac AS15 analytical (4 mm) and Thermo Scientific™ Dionex™ IonPac™ AG15 guard (4 mm)
Eluent:	40 mM KOH
Eluent Flow Rate:	2.0 mL/min
Suppressor:	Dionex Electrolytic Suppressor (4 mm), AutoSuppression Recycle Mode
Temperature:	30°C
Expected Background Conductivity:	0.8-1.2 µS (Dionex EGC)    2-3 µS (Conventional Delivery)
Typical Operating Back Pressure:	2100 psi (Dionex EGC)    1700 psi (Conventional Delivery)
	Back pressure restrictor was not used with the Dionex EGC

**Figure 26 Conventional Hydroxide Eluent on the Dionex IonPac AS15**

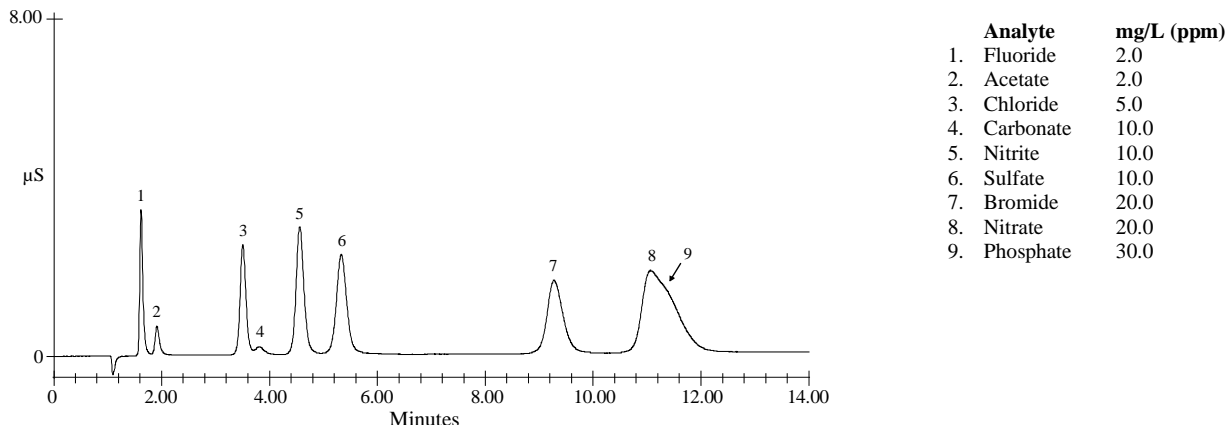
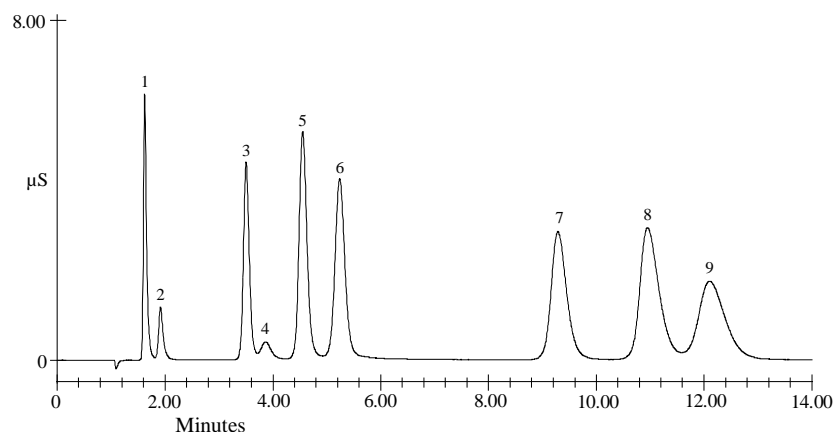

Figure 27 Dionex EGC KOH Eluent on the Dionex IonPac AS15





### 4.4 Comparison of Conventional Eluent System and RFIC-EG System

The following example illustrates a comparison of a gradient delivered using conventional pump delivery and using a Dionex EGC. When using the conventional gradient delivery, dissolved carbonate causes a baseline shift of approximately 1  $\mu\text{S}$ . The carbonate-free potassium hydroxide gradient produced by the Dionex EGC results in a very low baseline shift ( $< 0.1 \mu\text{S}$ ). This low baseline shift allows easy integration of trace components.

Sample Loop Volume: 2 mL  
 Trap Columns: Dionex CR-ATC Continuously Regenerated Trap Column. The Dionex CR-ATC is located after the Dionex EGC KOH cartridge.  
 Column: Dionex IonPac AS15 + Dionex IonPac AG15 (4 mm)  
 Eluent: See Chromatogram  
 Eluent Source: See chromatogram  
 Eluent Flow Rate: 1.6 mL/min.  
 Temperature: 30° C  
 ERS Suppressor: Thermo Scientific™ Dionex™ Anion Electrolytic Suppressor, AutoSuppression Recycle Mode  
 CRS Suppressor: Thermo Scientific™ Dionex™ Anion Chemically Regenerated Suppressor  
 CRS Regenerant: 50 mN H<sub>2</sub>SO<sub>4</sub>  
 Expected Background Conductivity: Dionex EGC eluent: 0.8-1.2  $\mu\text{S}$   
 Bottle eluent: 2-3  $\mu\text{S}$

**Figure 28 Comparison of RFIC-EG System and Conventional Eluent System**

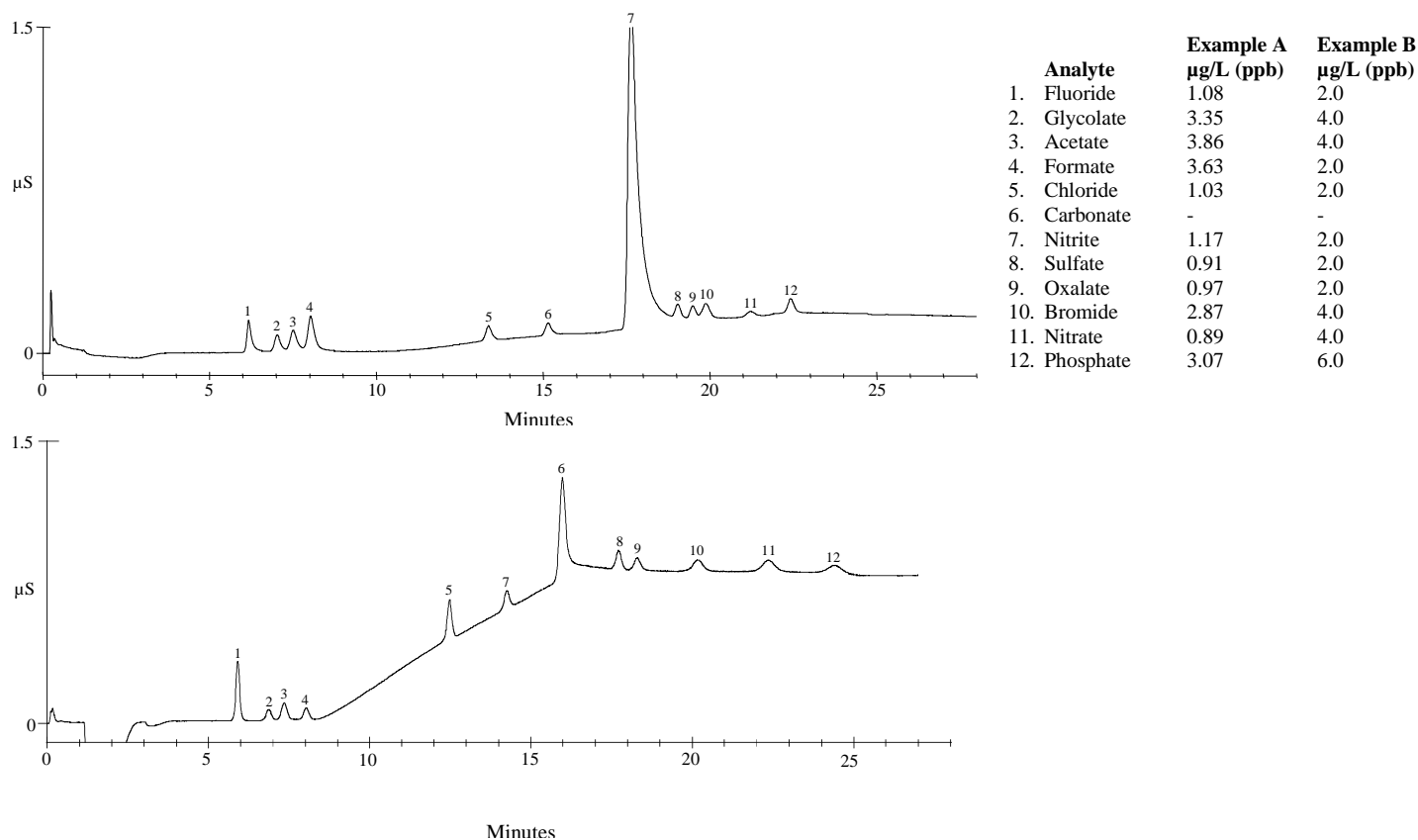

### 4.5 Large Loop Injection for µg/L (ppb) Level Analysis on a 2 mm Dionex IonPac AS15

The high capacity of the Dionex IonPac AS15 column allows for the determination of trace inorganic anions and low molecular weight organic acids in high purity water matrices using a large loop injection. This chromatogram illustrates the separation of inorganic anions and low molecular weight organic acids in a high purity water sample using a large loop injection with a hydroxide linear gradient coupled with suppressed conductivity detection. Low ppb levels of these analytes can easily be determined using a 1 mL injection loop on a 2 mm Dionex IonPac AS15 column. Notice the much lower baseline shift produced when using the Dionex EGC as the eluent source. To ensure reproducible retention times, the Dionex IonPac AS15 column must be operated at an elevated temperature (30° C).

Sample Loop Volume: 1 mL  
 Trap Columns: CR-ATC continuously Generated Trap Column. The Dionex CR-ATC is located after the Dionex EGC KOH cartridge.  
 Column: Dionex IonPac AS15 + Dionex IonPac AG15 (2 mm).  
 Eluent Source: Dionex EGC KOH  
 Eluent: 8 mM KOH (0-6 min.)  
 8-60 mM KOH (6-16 min.)  
 Eluent Flow Rate: 0.5 mL/min.  
 Temperature: 30° C  
 ERS Suppressor: Dionex Anion Electrolytic Suppressor, AutoSuppression Recycle Mode  
 or CRS Suppressor: Dionex Anion Chemically Regenerated Suppressor  
 CRS Regenerant: 50 mN H<sub>2</sub>SO<sub>4</sub>  
 Expected Background Conductivity: 0.8-1.2 µS

**Figure 29 Large Loop Injection for µg/L (ppb) analysis on 2 mm Dionex IonPac AS15**

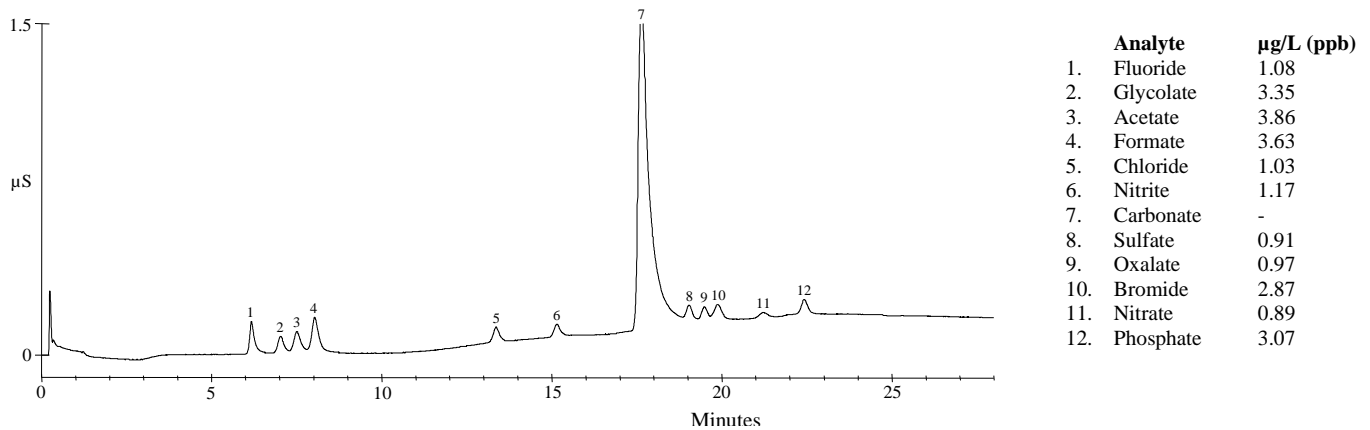

## 4.6 Comparison of Conventional Eluent System and RFIC-EG System for Gradient Elution on the Dionex IonPac AS16

Figure 30, “Separation of Polarizable Anions and Inorganic Anions using Gradient Elution,” illustrates the separation of a wide variety of inorganic anions including polarizable anions. Weakly retained anions such as acetate, propionate, and formate are resolved using an isocratic hydroxide eluent and the highly retained anions such as thiosulfate, thiocyanate, and perchlorate are eluted with a hydroxide gradient. Peak shape and efficiency are greatly improved for the polarizable anions on the Thermo Scientific™ Dionex™ IonPac™ AS16 column.

The following example also illustrates a comparison of a gradient delivered using a bottle eluent system and using an RFIC-EG system. When using the conventional bottle eluent delivery, dissolved carbonate causes a baseline shift of approximately 1  $\mu\text{S}$ . The carbonate free potassium hydroxide gradient produced by the Dionex EGC results in a very low baseline shift (<0.3  $\mu\text{S}$ ). This low baseline shift allows easy integration of trace components.

Trap Column:	Bottle Eluent System: Dionex IonPac ATC-3 (4 mm) Trap Column (Item # 059660). EG system: Dionex CR-ATC continuously Generated Trap Column. The Dionex CR-ATC is located after the Dionex EGC KOH cartridge.
Sample Volume:	10 $\mu\text{L}$
Column:	Dionex IonPac AS16 (4 mm) analytical and Thermo Scientific™ Dionex™ IonPac™ AG16 (4 mm) guard
Eluent:	E1: 5.0 mM NaOH E2: Deionized water E3: 100 mM NaOH
Eluent Flow Rate:	1.5 mL/min
Operating Temperature:	30° C
ERS Suppressor:	Dionex Anion Electrolytic Suppressor (4 mm) suppressor, AutoSuppression Recycle Mode
or CRS Suppressor:	Dionex Anion Chemically Regenerated Suppressor (4 mm) suppressor
CRS Regenerant:	50 mN H <sub>2</sub> SO <sub>4</sub>
Expected Background Conductivity:	1.5 mM NaOH: 1 $\mu\text{S}$ 55 mM NaOH: 2.5 - 3.5 $\mu\text{S}$
Typical Operating Back Pressure:	2,300 psi (15 MPa)

Analyte	mg/L (ppm)	Time (min)	%E1	%E2	%E3	Comments
1. Fluoride	2.0					
2. Acetate	10.0					
3. Propionate	10.0					
4. Formate	10.0					
5. Chlorite	10.0					
6. Bromate	10.0					
7. Chloride	5.0					
8. Nitrite	10.0					
9. Nitrate	10.0					
10. Selenite	10.0					
11. Carbonate	20.0					
12. Sulfate	10.0					
13. Selenate	10.0					
14. Iodide	20.0					
15. Thiosulfate	10.0					
16. Chromate	20.0					
17. Phosphate	20.0					
18. Arsenate	20.0					
19. Thiocyanate	20.0					
20. Perchlorate	30.0					

Gradient Conditions with bottle eluent system					
Time (min)	%E1	%E2	%E3	Comments	
<b>0</b>	30	70	0	1.5 mM NaOH for 7 min.	
<b>7.0</b>	30	70	0		
<b>Analysis</b>					
<b>7.1</b>	30	70	0	Start isocratic analysis	
<b>7.5</b>	30	70	0	Inject Valve to Load Position	
<b>14.0</b>	30	70	0	End Isocratic analysis, Begin Gradient analysis	
<b>20.0</b>	0	90	10		
<b>30.0</b>	0	45	55		

## 4 – Example Applications

**Dionex EGC Conditions**

Eluent: Deionized water  
Offset volume = 0.0  $\mu$ L

Time (min)	Eluent Conc. (mM)	Comments
<b>Equilibration</b>		
0	1.5	1.5 mM KOH for 7 min
7.0	1.5	
<b>Analysis</b>		
7.1	1.5	Start isocratic analysis
7.5	1.5	Inject Valve to Load Position
15.3	1.5	End Isocratic analysis, Begin Gradient analysis
21.3	10.0	
31.3	55.0	

**Figure 30 Separation of Polarizable Anions and Inorganic Anions Using Gradient Elution**

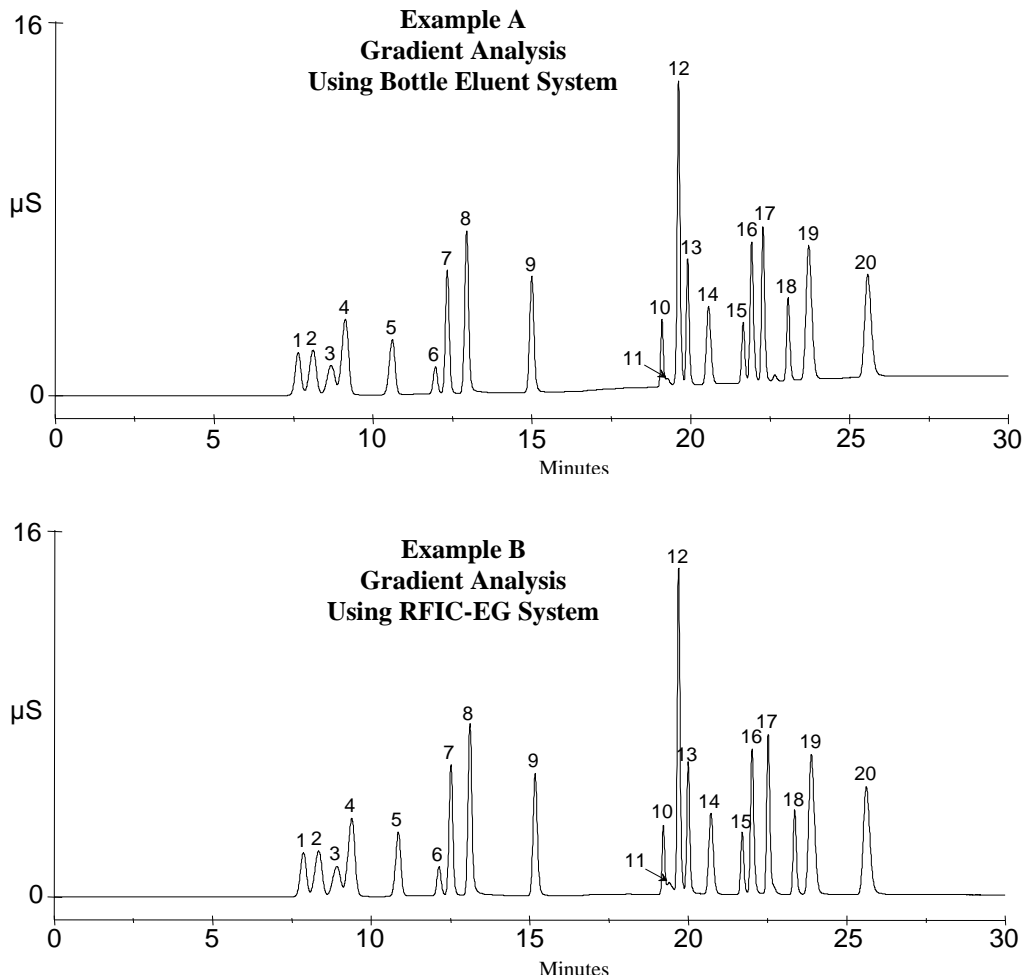

## 4.7 Using an RFIC-EG System for KOH Elution of Inorganic Anions, Oxyhalides, and Organic Acids on the Dionex IonPac AS17

The following chromatograms compare the Dionex EGC eluent delivery system with the bottle eluent delivery system at room temperature (22°C) for the determination of inorganic anions, oxyhalides, and organic acids on the Thermo Scientific™ Dionex™ IonPac™ AS17 column. Notice, due to the large system void volume with the bottle eluent system, a longer equilibration time is required before injection.

Trap Column: Bottle Eluent System: Dionex IonPac ATC-3 (4 mm) Trap Column (Item # 059660).  
 RFIC-EG System: Dionex CR-ATC 500 continuously Generated Trap Column. The Dionex CR-ATC 500 is located after the Dionex EGC KOH cartridge.

Sample Volume: 4 mm: 10 µL Loop + 0.8 µL Injection valve dead volume

Column: Dionex IonPac AS17, Thermo Scientific™ Dionex™ IonPac™ AG17 4 mm

Eluent Source: See table

Eluent: See table

Eluent Flow Rate: 1.5 mL/min (4 mm)

Temperature: Room temperature (22°C)

ERS Suppressor: Dionex Anion Electrolytic Suppressor (4 mm), AutoSuppression Recycle Mode

CRS Suppressor: Dionex ACRS 500 (4 mm) suppressor

CRS Regenerant: 50 mN H<sub>2</sub>SO<sub>4</sub>

Expected Background Conductivity: 0.5-1.0 µS

Storage Solution: Eluent

Eluent: Deionized water  
 Offset volume = 0.0 µL

Analyte	mg/L(ppm)
1. Fluoride	2.0
2. Acetate	5.0
3. Propionate	5.0
4. Formate	5.0
5. Chlorite	5.0
6. Bromate	5.0
7. Chloride	3.0
8. Nitrite	5.0
9. Bromide	10.0
10. Nitrate	10.0
11. Chlorate	10.0
12. Carbonate	20.0
13. Sulfate	5.0
14. Oxalate	5.0
15. Phosphate	10.0

Time (min)	Eluent Conc. (mM)	Comments
<b>Equilibration</b>		
-4.0	1.0	1.0 mM KOH for 4 min
0	1.0	
<b>Analysis</b>		
0	1.0	Start isocratic analysis
0	1.0	Inject valve to load position
0	1.0	Begin gradient analysis
7.0	10.0	
11.0	35.0	End gradient

**Gradient Conditions:**  
 E1: 5 mM NaOH  
 E2: DI water  
 E3: 100 mM NaOH

Time (min)	%E1	%E2	%E3	Comments
<b>Equilibration</b>				
-5.0	20	80	0	1.0 mM NaOH for 5 min
0	20	80	0	
<b>Analysis</b>				
0	20	80	0	Start isocratic analysis
0	20	80	0	Inject valve to load position
0	20	80	0	Begin gradient analysis
7.0	0	90	10	
11.0	0	65	35	End gradient

**Figure 31** Determination of Inorganic Anions, Oxyhalides, and Organic Acids at Room Temperature

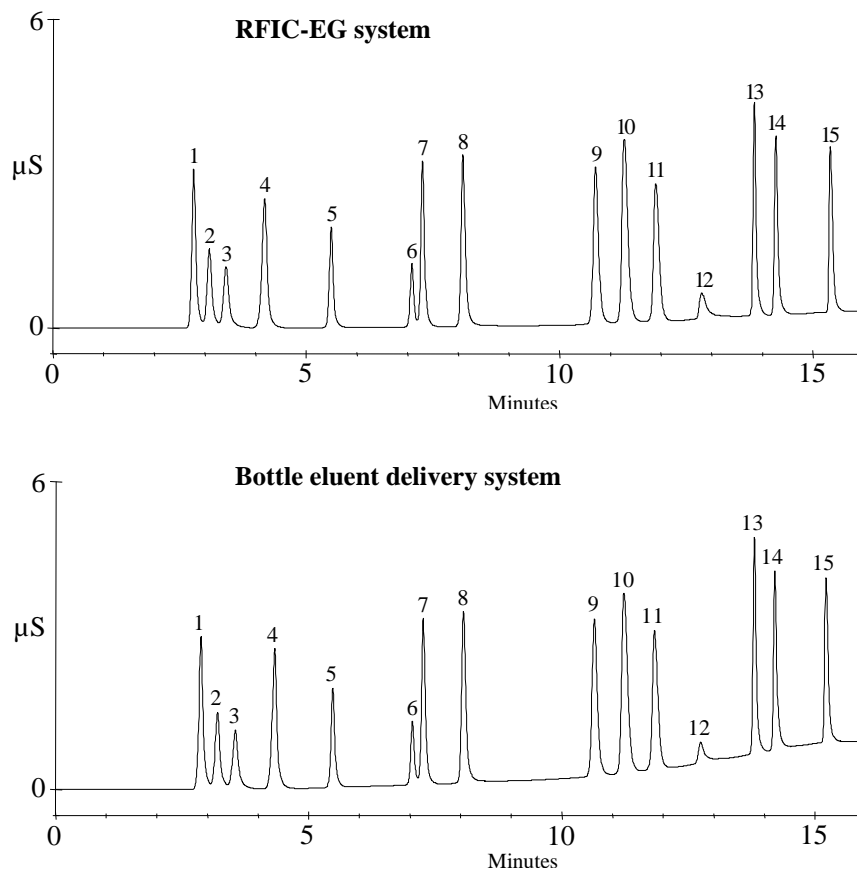

### 4.8 Using the Dionex EGC 500 MSA or Dionex EGC III MSA Cartridge for Isocratic MSA Elution on the Dionex IonPac CS12A

This application demonstrates the comparison of a Thermo Scientific™ Dionex™ IonPac™ CS12A isocratic separation using conventional isocratic pump delivery with Dionex EGC isocratic delivery. Figure 32, “Conventional MSA Isocratic Elution on the Dionex IonPac CS12A,” illustrates the use of a conventional pump method. Figure 33, “Dionex EGC MSA Isocratic Elution on the Dionex IonPac CS12A,” illustrates the use of a Dionex EGC.

Sample Volume: 25 µL  
 Column: Dionex IonPac CS12A analytical (4 mm) and Thermo Scientific™ Dionex™ IonPac™ CG12A guard (4 mm)  
 Eluent: 18 mM MSA  
 Eluent Flow Rate: 1.0 mL/min  
 Oven Temperature: 30° C  
 Cell Temperature: 35° C  
 Suppressor: Thermo Scientific™ Dionex™ Cation Electrolytic Suppressor (4 mm), AutoSuppression Recycle Mode  
 Expected Background Conductivity: 0.3 µS (Dionex EGC) 0.4 µS (Conventional Gradient)  
 Typical Operating Back Pressure: 1980 psi (Dionex EGC) 970 psi (Conventional Gradient)  
 Back pressure restrictor (Item # 053763) was used with the Dionex EGC

**Figure 32 Conventional MSA Isocratic Elution on the Dionex IonPac CS12A.**

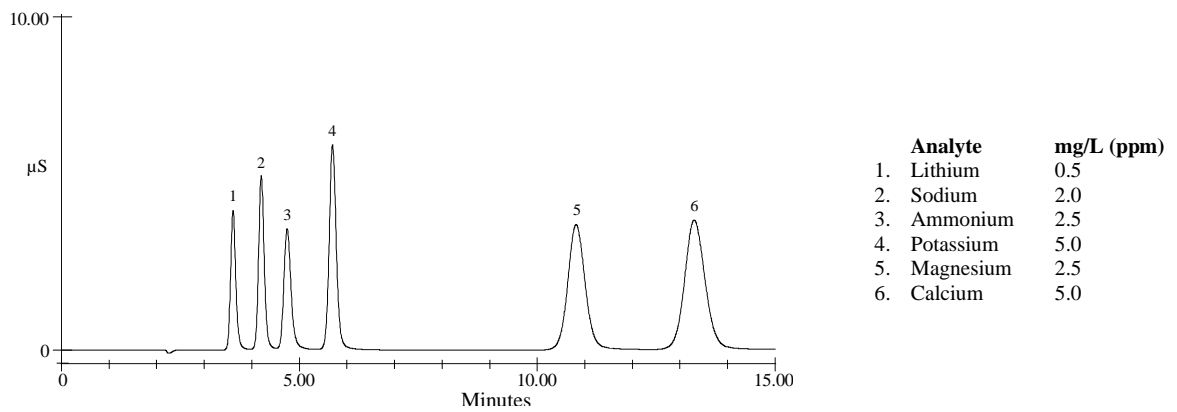

**Figure 33 Dionex EGC MSA Isocratic Elution on the Dionex IonPac CS12A.**

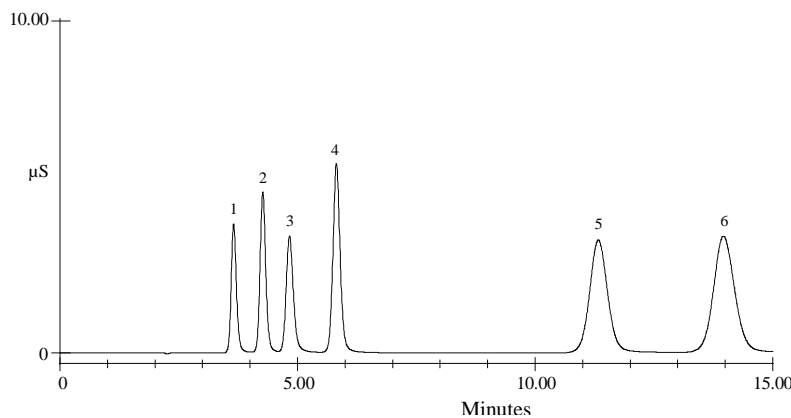

## 4.9 Using the Dionex EGC 500 MSA or Dionex EGC III MSA Cartridge for Dionex IonPac CS12A MSA Gradient

This application demonstrates the comparison of a Dionex IonPac CS12A gradient separation using conventional gradient pump delivery to the gradient separation using Dionex EGC gradient delivery. Figure 34, “Conventional MSA Linear Gradient on the Dionex IonPac CS12A,” illustrates the use of a conventional pump method. Figure 35, “Dionex EGC MSA Linear Gradient on the Dionex IonPac CS12A,” illustrates the use of a Dionex EGC. Note the smaller baseline shift during the gradient when using the Dionex EGC. Since the Dionex EGC delivers the gradient with a much smaller delay volume, the peaks elute more quickly.

**NOTE: Solvents should not be used with a Dionex EGC MSA cartridge.**

Sample Volume:	25 $\mu$ L
Column:	Dionex IonPac CS12A analytical and Thermo Scientific™ Dionex™ IonPac CG12A guard (4 mm)
Eluent:	See table of conditions
Eluent Flow Rate:	1.0 mL/min
Cell Temperature:	35° C
Oven Temperature:	30° C
Suppressor:	Dionex Cation Electrolytic Suppressor (4 mm), AutoSuppression Recycle Mode
Expected Background Conductivity:	(Conventional Gradient) 11 mM MSA: 0.4 $\mu$ S, 57 mM MSA: 0.8 $\mu$ S (Dionex EGC) 11 mM MSA: 0.4 $\mu$ S, 57 mM MSA: 0.44 $\mu$ S
Typical Operating Back Pressure:	(Conventional Gradient) 960 psi (6.6 MPa) (Dionex EGC) 1880 psi (13 MPa) Pressure Restrictor, (Item # 053763) was used with the Dionex EGC

Conventional Gradient Conditions				Analytes	mg/L (ppm)	
E1:	Deionized water			1. Lithium	0.5	
E2:	100 mM MSA			2. Sodium	2.0	
	<b>Time</b> (min)	<b>%E1</b>	<b>%E2</b>	<b>Comments</b>		
	<b>Equilibration</b>					
	-7.0	89	11	11 mM MSA for 7 min.	3. Ammonium	5.0
	0	89	11		4. Potassium	5.0
	<b>Analysis</b>				5. 5-Amino-1-pentanol	20.0
	0.0	89	11	11 mM MSA	6. Morpholine	15.0
	0.0	89	11	Inject Valve to Load Position	7. Magnesium	2.5
	9.0	55	45	Step change to 45 mM MSA	8. Calcium	5.0
	14.0	55	45	45-57 mM MSA in 3.0 min.	9. 3-Dimethylamino-propylamine	10.0
	17.0	43	57	57 mM MSA		
	20.0	43	57	57 mM MSA (end)		

Dionex EGC Conditions			
E1:	Deionized water		
	<b>Time</b> (min)	<b>Eluent</b> conc. (mM)	<b>Comments</b>
	<b>Equilibration</b>		
	-7.0	11	11 mM MSA for 7 min.
	0	11	
	<b>Analysis</b>		
	0.0	11	11 mM MSA
	0.0	11	Inject Valve to Load Position
	9.0	45	Step change to 45 mM MSA
	14.0	45	45-57 mM MSA in 3.0 min.
	17.0	57	57 mM MSA
	20.0	57	57 mM MSA (end)



Figure 34 Conventional MSA Linear Gradient on the Dionex IonPac CS12A.

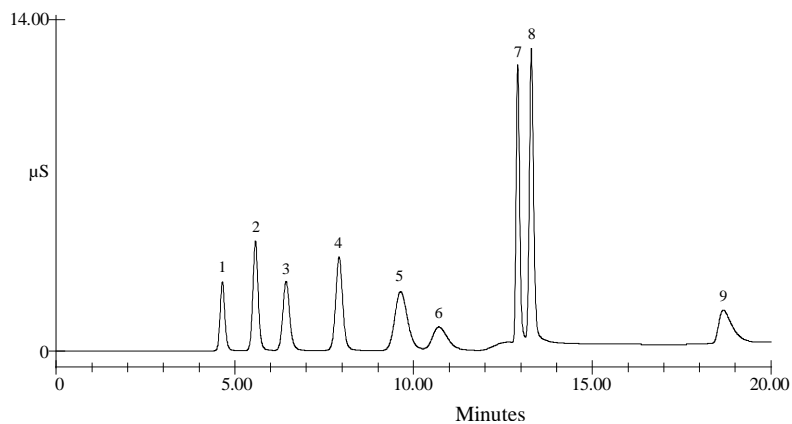
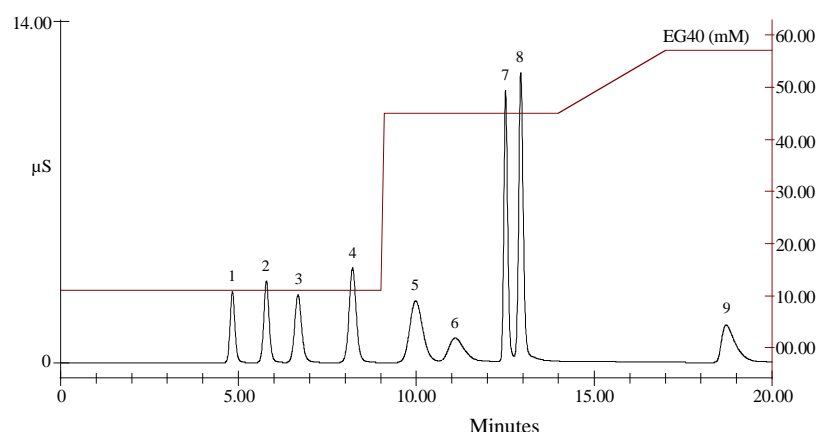

Figure 35 Dionex EGC MSA Linear Gradient on the Dionex IonPac CS12A.



### 4.10 Comparison of Eluent Generation using a Dionex IonPac CTC-1 and a Dionex CR-CTC for Dionex IonPac CS12A Gradient

The set of chromatograms in Figure 36 demonstrates the decrease in baseline shift during a gradient when the Thermo Scientific™ Dionex™ IonPac™ CTC-1 or Dionex CR-CTC is used. The Dionex CR-CTC does not require off-line chemical regeneration.

Column: Dionex IonPac CS12A (4 mm)  
 Eluent: Dionex EGC generated MSA  
 Flow Rate: 1.0 mL/min  
 Inj. Volume: 10 µL  
 Detection: Suppressed Conductivity  
 Temperature: 30°C  
 Suppressor: Dionex Cation Electrolytic Suppressor (4 mm), Recycle Mode

**Figure 36 Comparison of the Dionex EGC Using a Dionex IonPac CTC and a Dionex CR-CTC Trap Column with Dionex IonPac CS12A Gradient**

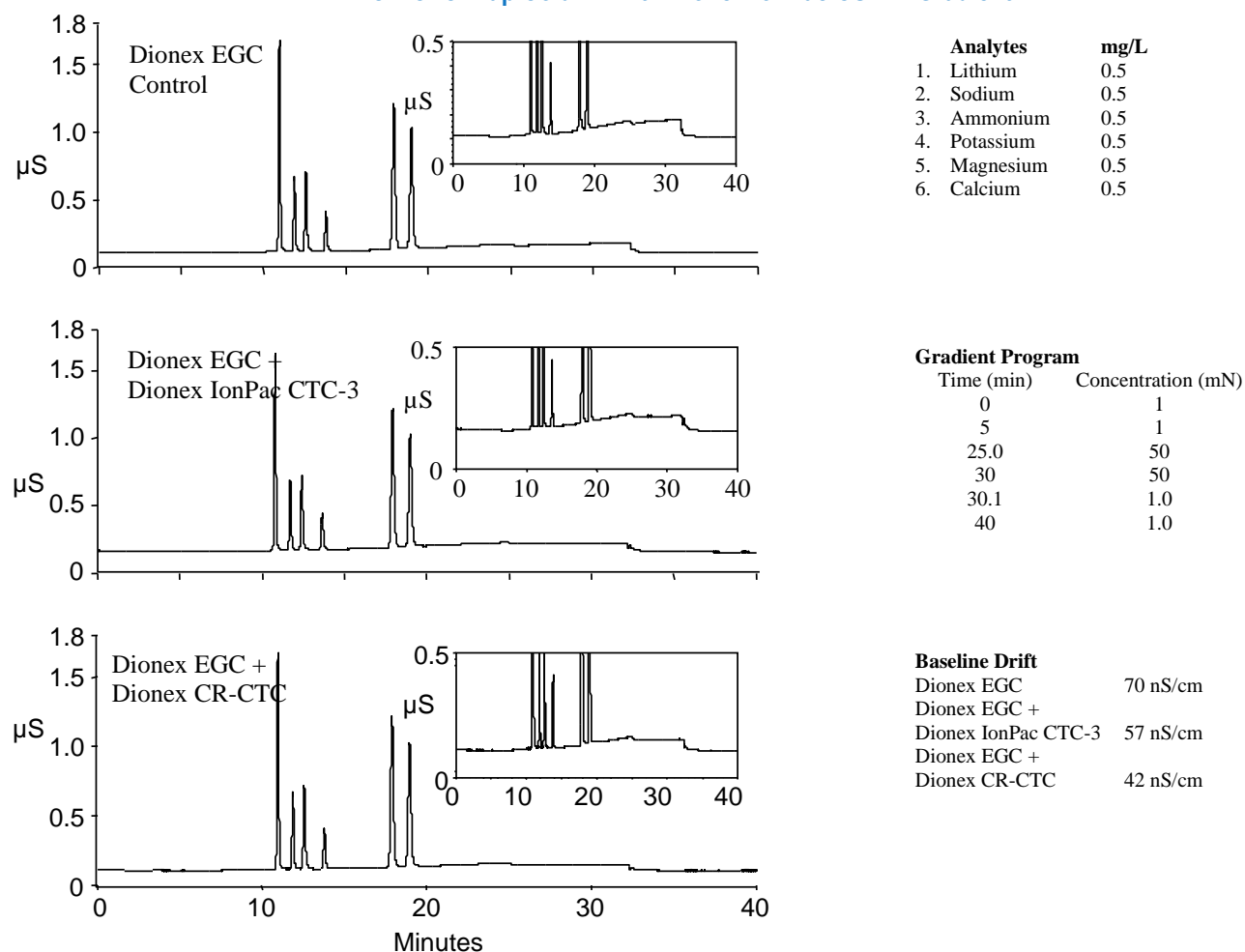

## 4.11 Glycoconjugate Monosaccharide Analysis with the Dionex EGC 500 KOH or Dionex EGC III KOH Cartridge

This application demonstrates the use of the Dionex EGC KOH generator for resolving glycoconjugate-derived monosaccharides in the Biotechnology and Pharmaceutical industries. The conventional method, using manual or pump-generated eluent, requires a step to 200 mM NaOH for 10 minutes to remove carbonate from the column, followed by a 15-minute re-equilibration to force a 50-minute cycle time. The Dionex EGC KOH method, (see Figure 37, “Analysis of Monosaccharide Standards Showing a Fast Cycle Time with Dionex EGC-Generated Carbonate-Free Eluent”) employs a 5-minute step at 80 mM to remove amino acids or late eluting components, and a short re-equilibration to support a 30-minute cycle time. This demonstrates that control of carbonate anion results in a 40% gain in throughput for this application.

Sample: 10  $\mu$ L, 20  $\mu$ M standards  
 Eluent: Deionized Water  
 Column: Thermo Scientific™ Dionex™ CarboPac™ PA10 (Analytical) and Thermo Scientific™ Dionex™ AminoTrap™  
 Flow: 1.0 mL/min  
 Pressure: 2,800 psi

**Figure 37 Analysis of Monosaccharide Standards Showing a Fast Cycle Time with Dionex EGC-Generated Carbonate-Free Eluent**

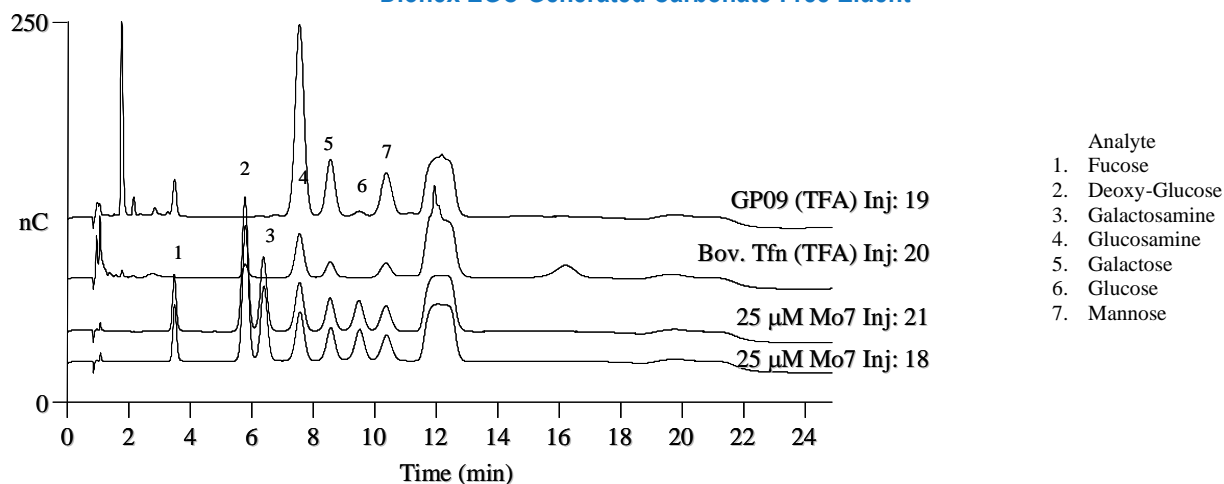

## 4.12 Analysis of Mono- and Disaccharides Found in Foods and Beverages Using Dionex EGC Generated KOH as Eluent

This application demonstrates the use of the Dionex EGC KOH cartridge for resolving carbohydrates found in foods and beverages (Figure 38, “Analysis of Monosaccharides in Foods and Beverages with the Dionex EGC Generated Carbonate-Free Eluent”). Resolution of galactose, glucose, mannose, and xylose, as well as other carbohydrates, is impacted by carbonate ion. This divalent anion is present to varying degrees in hydroxide-containing eluents due to the dissolution of carbon dioxide in the basic eluent. Use of KOH generated electrolytically at the time of use, prevents the accumulation of carbonate on the column. When hydroxide-containing eluents in system reservoirs are used, separation of these carbohydrates can only be accomplished following the completion of the following steps: (1) 15 min wash with 300 mM NaOH to remove carbonate from the column, (2) 15 min rinse with DI water. The sample can then be injected.

When 2.3 mM KOH is generated by the Dionex EGC KOH cartridge, these carbohydrates are well resolved by a system that requires neither post-column base addition nor preparation of caustic eluents. A 5 min step to 100 mM KOH at the end of the carbohydrate elution window is employed to remove organic acids and other late eluting compounds. With the step and time for equilibration, the cycle time is reduced from 80 min to 60 min, demonstrating that control of carbonate results in a 33% gain in throughput.

Sample: 10  $\mu$ L, 20  $\mu$ M standards  
 Eluent: Deionized Water  
 Column: Dionex CarboPac PA10 (4 mm) + Dionex AminoTrap (4-mm)  
 Flow: 1.0 mL/min  
 Pressure: 2,800 psi

**Figure 38 Analysis of Monosaccharides in Foods and Beverages with Dionex EGC Generated Carbonate-Free Eluent**

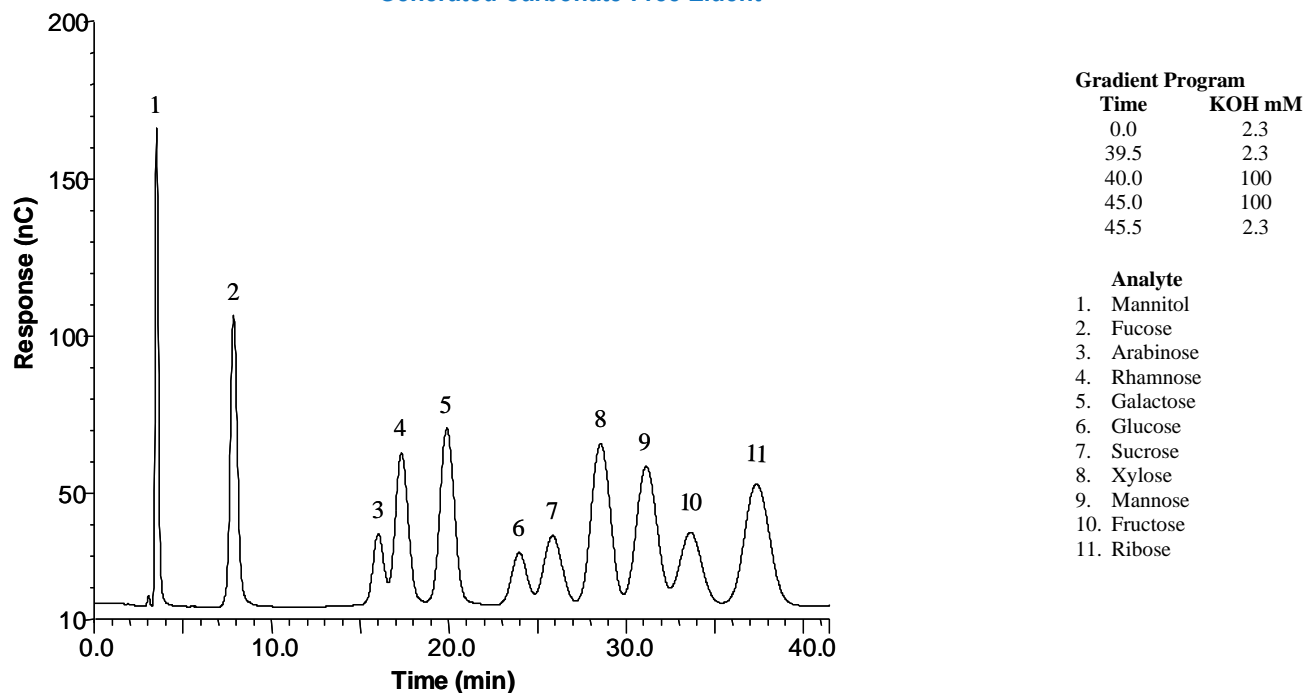

### 4.13 Analysis of Carbohydrates using both EGC Generated KOH and Manually Prepared NaOH or KOH as Eluent

This application demonstrates the use of the Dionex EGC KOH generator with manually prepared 200 mM NaOH eluent for resolving carbohydrates found in foods, beverages, lignocellulosic hydrolysates where the determination of more strongly retained carbohydrates or more effective column washing is desired. Figure 39, "Analysis of carbohydrates in corn stover hydrolysate with Dionex EGC Generated Carbonate-Free and Manually Prepared Eluent" shows the resolution of arabinose, galactose, glucose, xylose, mannose, fructose using Dionex EGC generated 0.5 mM KOH, and the rapid elution of cellobiose and other more strongly retained carbohydrates using manually prepared 200 mM NaOH eluents. Carbohydrate applications that require greater than 100 mM (the upper concentration limit for the Dionex EGC), but less than 200 mM KOH or NaOH eluent concentration may use manually prepared eluent to supplement the hydroxide produced by the Dionex EGC. For example, the Dionex EGC can be used to produce 0.5 to 20 mM concentrations of hydroxide eluent, used to separate weakly retained carbohydrates or alter their selectivity, and then change the proportioning valve on the pump to use another eluent channel (other than water) that contains manually prepared 200 mM KOH or NaOH to elute the more highly retained carbohydrates or other substances. The combined use of Dionex EGC and manually prepared eluent enable many of the benefits of eluent generation, and also provide the ability to rapidly elute highly retained compounds and more effectively clean the column. When manually prepared eluent is allowed to pass through the Dionex EGC cartridge and the Dionex CR-ATC, the Dionex EGC must be left on at low eluent concentration (e.g., 0.5 mM) to ensure polarization of the Dionex EGC cartridge membranes and ensure the longevity of the device. The use of combined Dionex EGC and manually prepared eluent does not require any additional plumbing or system configuration but does require a gradient pump with two or more eluent channels and a proportioning valve. The manually prepared eluents should be prepared following the procedures described in Thermo Scientific™ Dionex™ Technical Note 71.

Sample:	1) Carbohydrate standards, 0.2 µL				
	2) Undiluted corn stover acid hydrolysate, 0.2 µL				
Eluent:	A: Water				
	B: 200 mM NaOH				
Column:	Thermo Scientific™ Dionex™ CarboPac™ PA1 (4 mm)				
Flow:	1.0 mL/min				
Pressure:	1400 psi				
Gradient Program:	<b>Time</b>	<b>%A</b>	<b>%B</b>	<b>mM KOH (EG)</b>	<b>mM NaOH*</b>
	0.0	100	0	0.50	0
	35.0	100	0	0.50	0
	35.1	0	100	0.50	200
	50.0	0	100	0.50	200
	50.1	100	0	0.00	0
	55.0	100	0	0.00	0
	55.1	100	0	0.50	0

**Analyte:**

1. Arabinose
  2. Galactose
  3. Glucose
  4. Xylose
  5. Mannose
  6. Fructose
  7. Cellobiose
- \* Manually prepared eluent

**Figure 39 Analysis of Carbohydrates in Corn Stover Hydrolysate with Dionex EGC Generated Carbonate-Free and Manually Prepared Eluent**

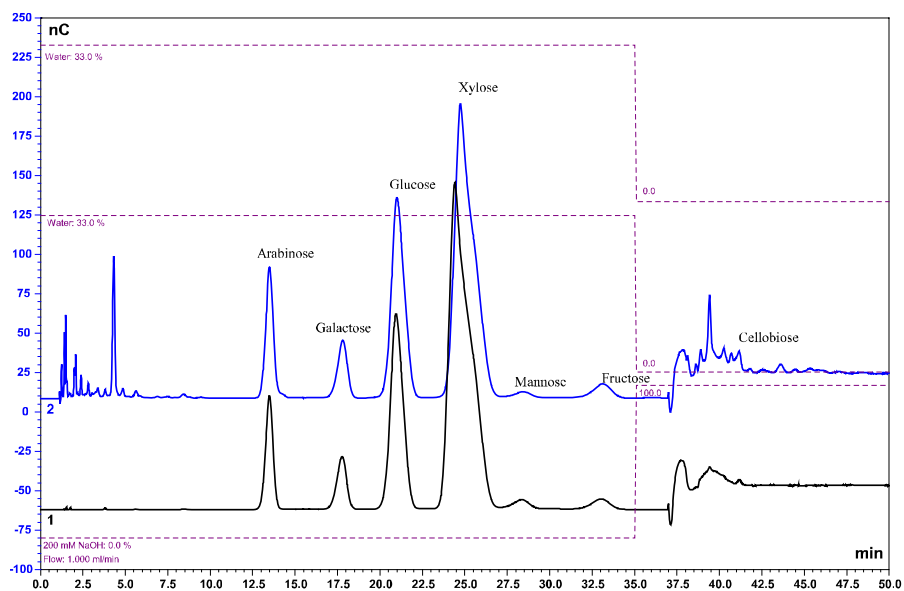

#### 4.14 Determination of Trace Perchlorate Using the Dionex IonPac Cryptand C1 Concentrator Column

Figure 40 illustrates the basic system configuration for the determination of trace perchlorate using a Dionex IonPac Cryptand C1 concentrator column, 2 mm Dionex IonPac AS16 separation column, and a Dionex EGC III NaOH. In this system, the deionized water is pumped into the Dionex EGC III NaOH cartridge where a high-purity NaOH eluent is generated electrolytically. The Dionex CR-ATC and the degas unit serve the same functions as described previously. A 5 mL aqueous sample containing trace perchlorate is first loaded onto a Dionex IonPac Cryptand C1 concentrator (Item # 062893) to concentrate perchlorate from the sample matrix using a Dionex AS-DV autosampler which comes in two versions (5 mL vials Item # 046029- and 0.5-mL vials Item # 046028). The AS-DV autosampler is then used again to deliver 1.0 mL of 10 mM NaOH to rinse the majority of matrix ions off the concentrator column. After the rinse, the concentrator column is switched on-line with the 2 mm Dionex IonPac AS16 separation column where perchlorate is separated from the matrix ions using the NaOH eluent.

Figure 40 System Configuration for Determination of Trace Perchlorate

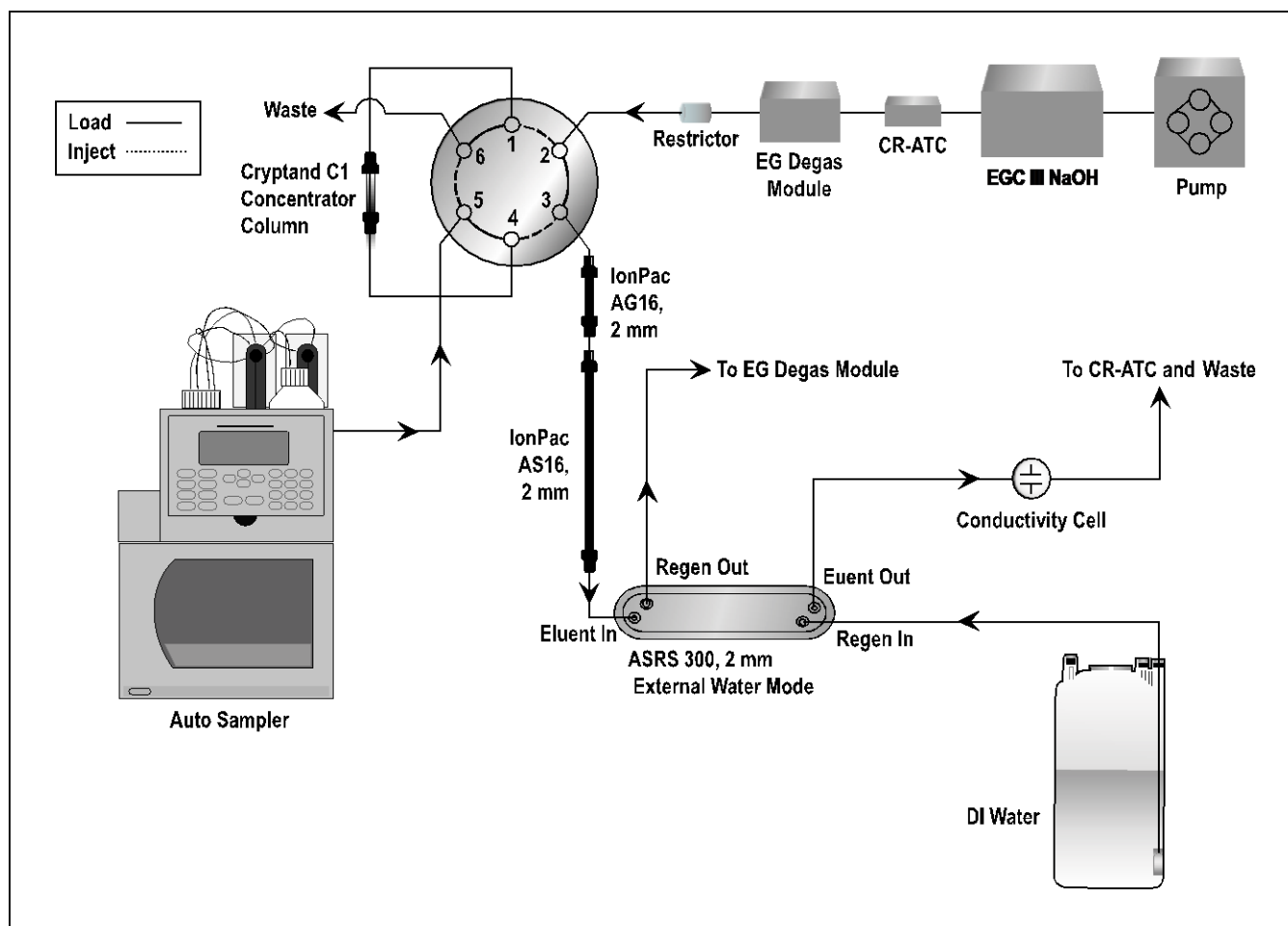

## 4 – Example Applications

This example demonstrates the determination of trace perchlorate in a synthetic water sample using the Dionex IonPac Cryptand C1 concentrator column, 2 mm Dionex IonPac AS16 separation column, and Dionex EGC III NaOH cartridge. In this example, 5 mL of the sample, which contains 5 µg/L perchlorate in 1000 mg/L (each) chloride, sulfate, and bicarbonate, is first loaded onto a Dionex IonPac Cryptand C1 concentrator (Item # 062893) to concentrate perchlorate from the sample matrix. The concentrator column is then rinsed with 1.0 mL of 10 mM NaOH. The concentrator column then is switched on-line with the 2 mm Dionex IonPac AS16 separation column. The Dionex EGC III NaOH cartridge is programmed to generate a 0.5 mM NaOH for 12 minutes and the concentration of the eluent is increased to 60 mM to elute perchlorate from the AS16 column as shown in Figure 41.

Column: Dionex IonPac AG16/AS16, 2 x 250 mm  
Concentrator: Dionex IonPac Cryptand C1 Concentrator  
Eluent: 0.5 mM sodium hydroxide step to  
60 mM sodium hydroxide at 12 min  
Eluent Source: Dionex EGC III NaOH with a Dionex CR-ATC 500  
Flow Rate: 0.25 mL/min  
Inj. Volume: 5 mL concentrated on Dionex IonPac Cryptand C1 concentrator  
Rinse: 1 mL of 10 mM NaOH  
Temperature: 35 °C  
Detection: Suppressed conductivity, Dionex ASRS 300 (2 mm), recycle mode  
Sample: Cl<sup>-</sup>, SO<sub>4</sub><sup>2-</sup>, HCO<sub>3</sub><sup>-</sup>

**Figure 41** Determination of Trace Perchlorate

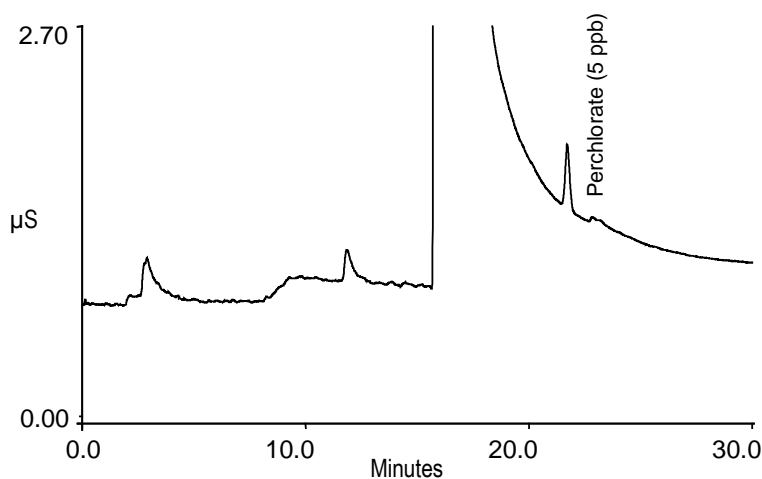



## 4.15 Dual Dionex EGC III NaOH and Dionex EGC III LiOH Applications

### 4.15.1 System Requirements

Figure 42 illustrates the system setup for electrolytic generation of dual component hydroxide eluents using Dionex EGC III NaOH and Dionex EGC III LiOH cartridges. In this system, the deionized water from the pump is first split equally into two flowing streams through the use of the "Dionex Dual EG Splits/Mixing Tee" kit (Item # 063049). One deionized (DI) water stream goes through the Dionex EGC III NaOH cartridge to generate NaOH eluent and the other stream goes through the Dionex EGC III LiOH cartridge to generate LiOH eluent. The two hydroxide streams are recombined using another Dual EG Splits/Mixing Tee kit to form a dual cation hydroxide eluent. The Dionex CR-ATC 500 and the degas unit serve the same functions as described previously.

**Figure 42 Electrolytic Generation of NaOH/LiOH Eluents**

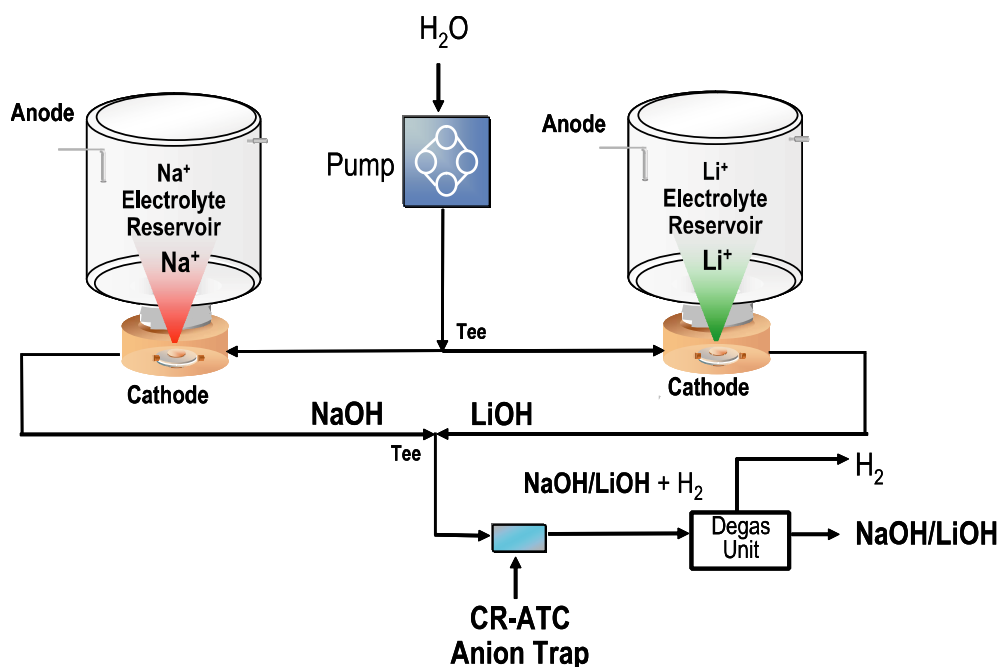

### 4.16 Separation of Ten Anions on a 4 mm Dionex IonPac AS9-HC Column using a Dionex EGC K<sub>2</sub>CO<sub>3</sub>

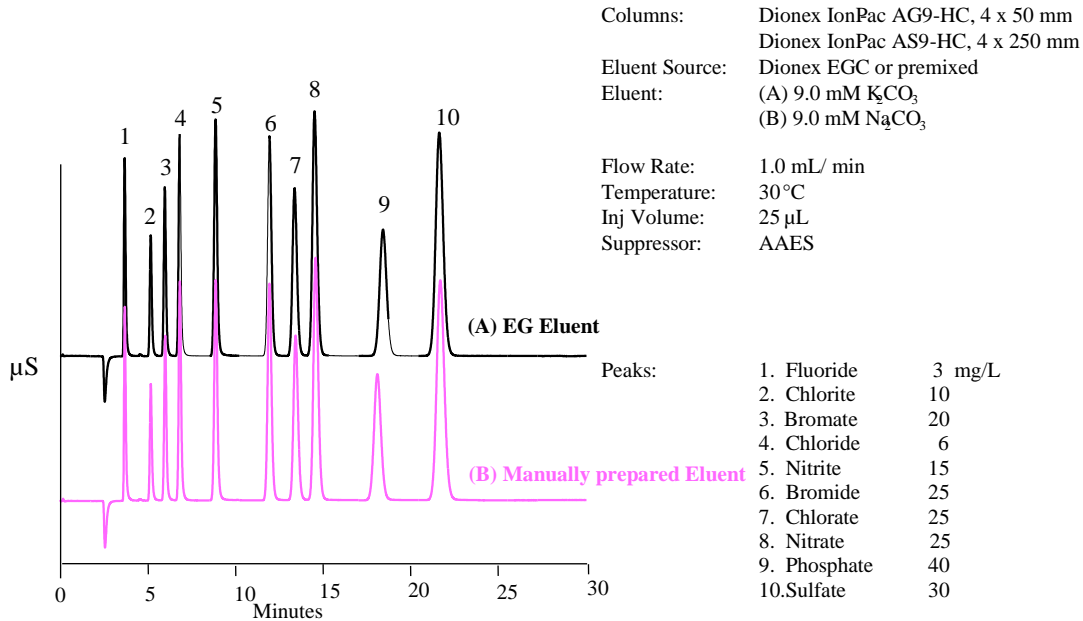

### 4.17 Determination of Trace Bromate in Drinking Water Using a 4 mm Dionex AS9-HC Column and a Dionex EGC K<sub>2</sub>CO<sub>3</sub>

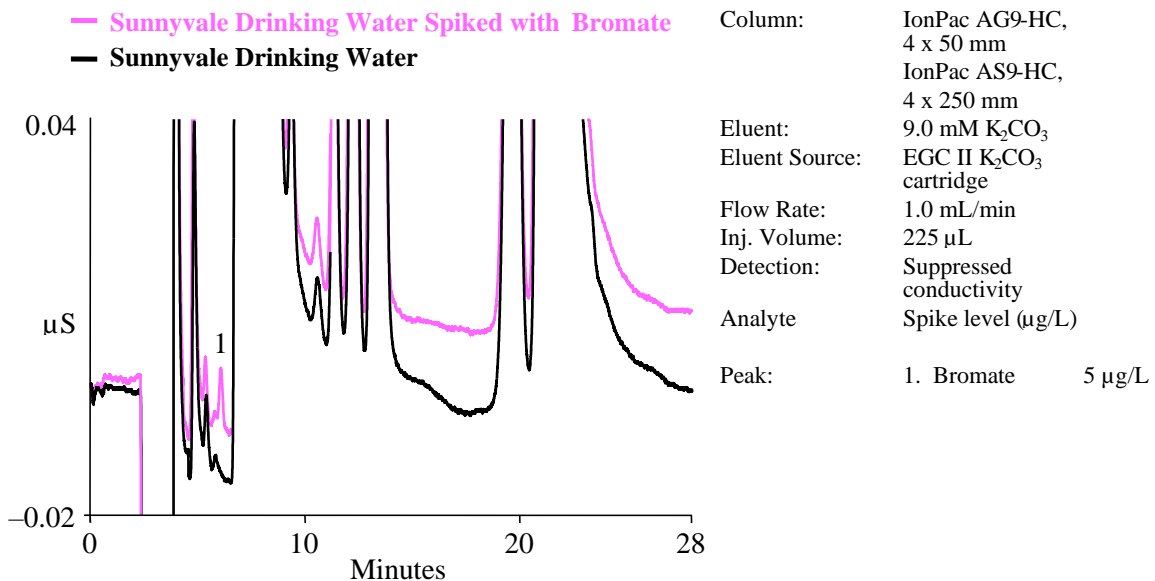

### 4.18 Separation of Seven Anions on a 4 mm Dionex IonPac AS12A Column using a Dionex EGC K<sub>2</sub>CO<sub>3</sub> and Dionex EPM

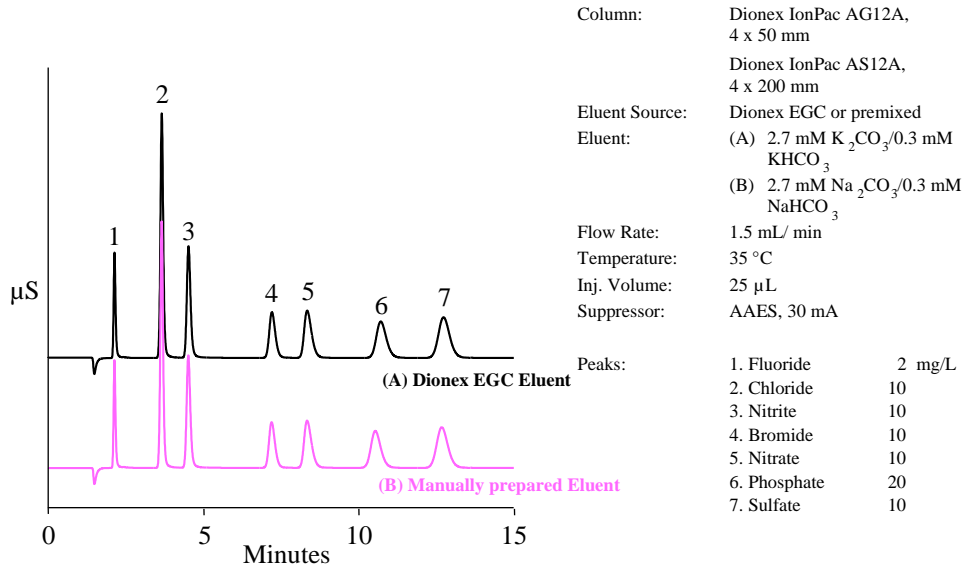

### 4.19 Separation of Ten Anions on a 2 mm Dionex IonPac AS12A Column Using a Dionex EGC K<sub>2</sub>CO<sub>3</sub> and Dionex EPM

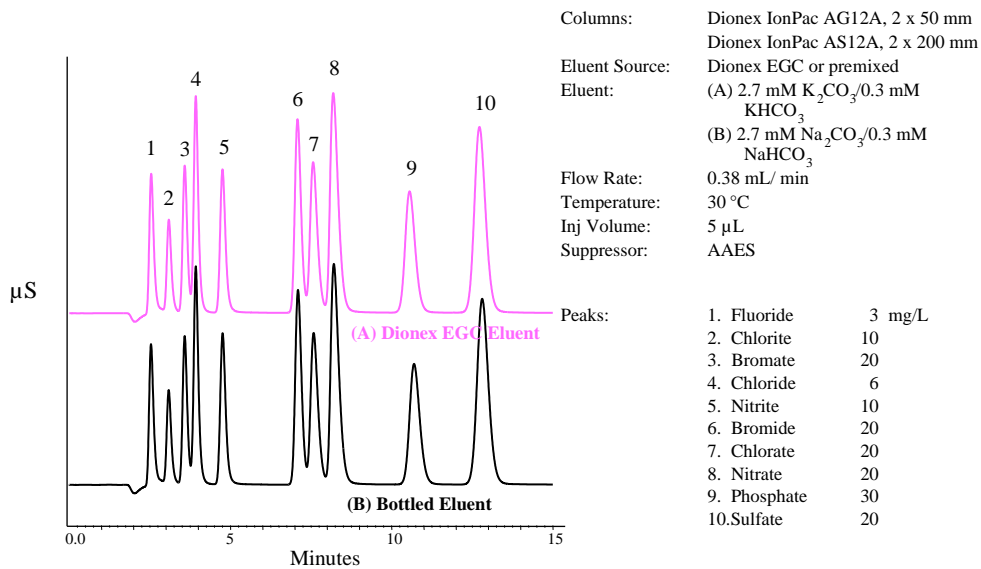

### 4.20 Separation of Eight Anions on a 3 mm Dionex IonPac AS14A Column Using a Dionex EGC K<sub>2</sub>CO<sub>3</sub> and Dionex EPM

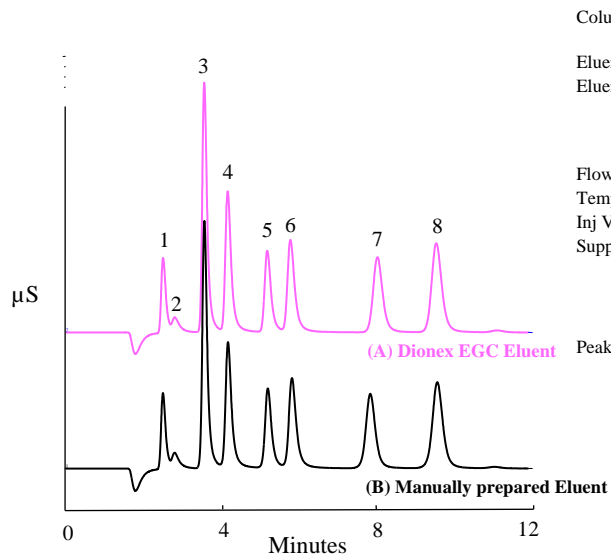

Column: Dionex IonPac AG14A, 3 x 30 mm  
 Dionex IonPac AS14A, 3 x 150 mm  
 Eluent Source: Dionex EGC or premixed  
 Eluent: (A) 8.0 mM K<sub>2</sub>CO<sub>3</sub>/1.0 mM KHCO<sub>3</sub>  
 (B) 8.0 mM Na<sub>2</sub>CO<sub>3</sub>/1.0 mM NaHCO<sub>3</sub>  
 Flow Rate: 0.5 mL/min  
 Temperature: 30 °C  
 Inj Volume: 5 µL  
 Suppressor: AAES

Peaks:	1. Fluoride	2 mg/L
	2. Acetate	10
	3. Chloride	10
	4. Nitrite	10
	5. Bromide	10
	6. Nitrate	10
	7. Phosphate	20
	8. Sulfate	10

### 4.21 Example of Dual EGC Application – Fetuin Oligosaccharide Alditol Profiling

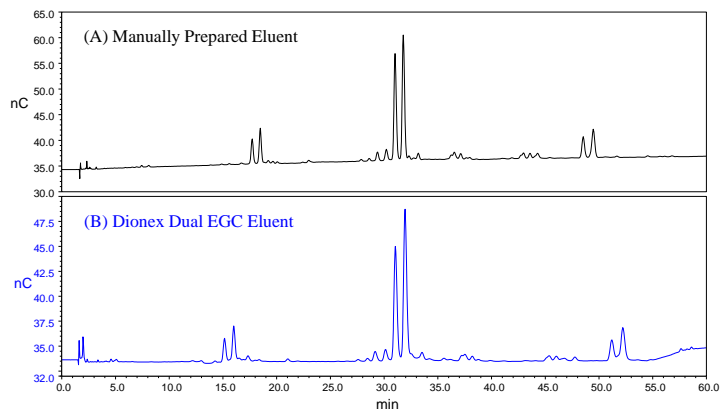

Column: (A) Dionex CarboPac PA200 3 x 50 mm  
 Dionex CarboPac PA200 3 x 250 mm  
 (B) Dionex CarboPac PA200 1 x 50 mm  
 Dionex CarboPac PA200 1 x 250 mm  
 Eluent Source: (A) premixed manually-prepared eluent  
 (B) Dionex EGC 400 MSA cartridge in series with  
 Dionex EGC 400 KOH cartridge  
 Eluent: (A) 20 mM NaOAc/100 mM NaOH to 150 mM  
 NaOAc/100 mM NaOH during 0-60 min  
 (B) 15 mM KMSA/136 mM KOH to 64 mM  
 KMSA/136 mM KOH during 0-50 min, 80 mM  
 KMSA/90 mM KOH during 50-60 min  
 Flow Rate: (A) 0.5 mL/min  
 (B) 0.063 mL/min  
 Temperature: 30 °C  
 Inj. Volume: (A) 5 µL  
 (B) 0.4 µL  
 Detection: (A) PAD, Au on PTFE, 2 mil gasket, Ag/AgCl ref.  
 (B) PAD, Au on PTFE, 1 mil gasket, Ag/AgCl ref.

## 5. Maintenance

### 5.1 Replacing the Dionex EGC III or Dionex EGC 500 Cartridge

The Dionex EGC III or Dionex EGC 500 must be replaced when the cartridge is expended when it leaks, or in order to switch between anion and cation separations with a single Dionex Eluent Generator (EG) Module.



**NOTE**

*When switching between anion and cation separations on the same system, flush the entire system (excluding the Dionex EGC, column, and suppressor, but including the high pressure degas tubing assembly) with 5 to 10 mL of DI water at 1.0 or 2.0 mL/min before connecting the new cartridge, column, and suppressor.*

To remove the old cartridge:

- A. Turn off the pump flow either manually or via direct control in the Dionex PeakNet or Dionex Chromeleon software. The power to the Dionex EGC III, Dionex EGC 500, Dionex CR-TC 500, Dionex EPM 500 and Dionex ERS suppressor will automatically shut off.
- B. The electrical connector cable for the cartridge is plugged into a connector. Unscrew the plug counterclockwise and pull it straight out of the connector.
- C. Unscrew the Luer lock from the Luer adaptor at the top corner of the Dionex EGC III or top of the Dionex EGC 500 and detach the gas vent line.
- D. Install the plastic plug in the gas vent port. Use the plug removed from the port during initial installation of the Dionex EGC.
- E. With the eluent lines still attached, and the electrical contacts facing you, lift the Dionex EGC from the shelf and turn it so that the electrolysis chamber and liquid line fittings are upward.
- F. Unscrew the cartridge inlet line from the Dionex EGC INLET fitting. This line leads to the pump transducer (or to the anion trap column, if present). Unscrew the cartridge outlet line from the OUTLET fitting on the Dionex EGC.
- G. Prepare an expended Dionex EGC III or Dionex EGC Capillary cartridge for disposal by completing the following:
  - i. Hold the cartridge with the generator chamber upward.
  - ii. Unscrew the eluent generation chamber from the electrolyte reservoir.
  - iii. Pour the remaining electrolyte solution into an appropriate hazardous waste container.



**NOTE**

*Refer to the Material Safety Data Sheet (MSDS) shipped with the Dionex EGC III or Dionex EGC 500 for the chemical description.*

- iv. Rinse the electrolyte reservoir and membranes with DI water three times.

- H. Prepare an expended Dionex EGC 500 cartridge for disposal by completing the following:
- i. Wear protective laboratory gloves and remove two 10-32 fittings from eluent inlet and outlet ports as shown in Figure H1.
  - ii. Use a Philips screwdriver to remove the two screws used to attach the Dionex EGC pod cover to the Dionex EGC reservoir as shown in Figure H2. Detach the pod cover from the reservoir.
  - iii. Use a Philips screwdriver to detach the Dionex EGC cable clamp from the reservoir as shown in Figure H3.
  - iv. Use a Philips screwdriver to remove the three screws used to attach one of the pods to the reservoir in Figure H4 and Figure H5. Either pod can be removed.
  - v. Detach the pod from the reservoir as shown in Figure H6. Dispose of the electrolyte solution into an appropriate hazardous waste container following the local hazard material disposable procedures.

**Figure H1**

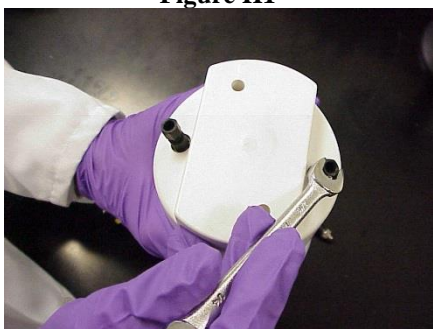

**Figure H2**

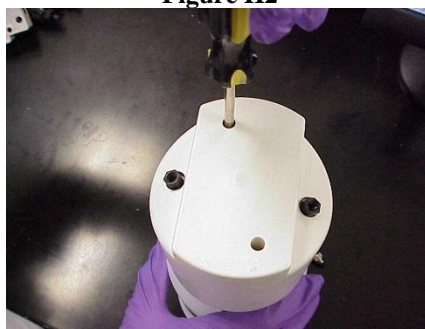

**Figure H3**



**Figure H4**

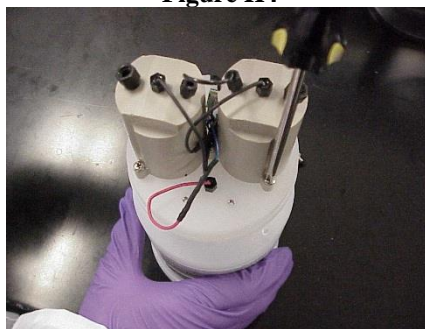

**Figure H5**

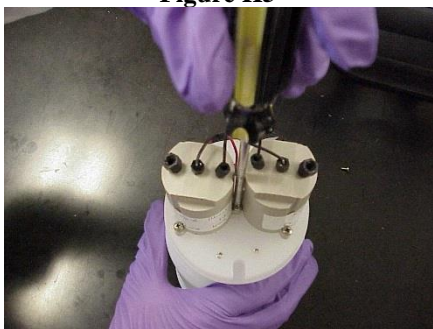

**Figure H6**

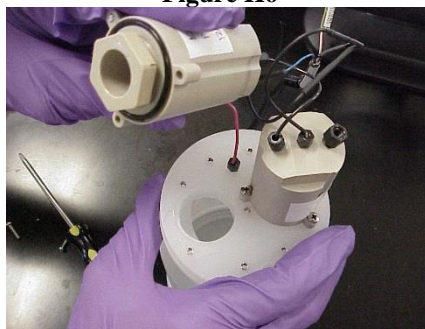



NOTE

*Rinsing should render the reservoir and the membranes nonhazardous; however, check with local, state, and federal regulatory agency regulations for proper disposal.*

- I. If the cartridge is not expended, plug all fittings.
- J. Store the cartridge in a standing position (with the electrolyte reservoir at the top) at 4 to 40°C (39 to 104°F) until its next use. The original shipping container is ideal for storage. The cartridge may be stored for up to two years.
- K. To install a new cartridge, follow the procedure in Section 2.



NOTE

*It is recommended the Dionex EPM 500 should be replaced with each third Dionex EGC 500 K<sub>2</sub>CO<sub>3</sub>.*

## 5.2 Replacing the Dionex EGC III Outlet Frit

If the source of the system high backpressure is isolated to the Dionex EGC III, the outlet frit should be replaced. The Dionex EGC III should add < 100 psi of backpressure.

- A. Unscrew the Luer lock from the Luer adaptor at the top corner of the Dionex EGC III electrolyte reservoir and detach the gas vent line.
- B. Install the plastic plug in the gas vent port. Use the plug removed from the port during initial installation of the Dionex EGC III.
- C. Turn off the pump flow.
- D. With the eluent lines and electrical connects still attached, lift the Dionex EGC III from the cartridge shelf, and turn it so the eluent generation chamber and liquid line fittings are upward.
- E. Unscrew the cartridge outlet line from the outlet fitting on the Dionex EGC III.



NOTE

*The outlet frit is located in the electrolysis chamber at the base of this fitting.*

- F. Using a sharp or pointed tool, such as the mini screwdriver (Item # 046985), carefully puncture and remove the frit body and seal ring.
- G. Replace with a new frit assembly (Item # 042310) provided with the Dionex EGC III.
- H. Reattach the outlet line.



NOTE

*Invert the Dionex EGC III with the Eluent Generation (EG) Chamber downward. Shake the Dionex EGC III vigorously and tap the eluent generation chamber with the palm of your hand 10 to 15 times. Watch to be sure all bubbles trapped in the electrolysis chamber are dislodged. Be sure to repeat this process each time the Dionex EGC III is turned with the eluent generation chamber upward.*

- I. Position the Dionex EGC III in the eluent generator controller Module with the eluent generation chamber downward by positioning the Dionex EGC chamber just below the shelf and sliding the cartridge through the opening in the shelf.

## 6. Troubleshooting Guide

The purpose of the Troubleshooting Guide is to help solve operating problems that may arise while using the Eluent Generator (EG). For more information on problems that originate with the Ion Chromatograph (IC), column, or suppressor, refer to the Troubleshooting Guide in the appropriate operator's manual. If you cannot solve the problem on your own, contact the Thermo Scientific North America Technical Call Center at 1-800-DIONEX-0 (1-800-346-6390) or the nearest Dionex Office (see "Thermo Scientific Worldwide Offices" on the Reference Library CD-ROM).

### 6.1 Dionex ICS-3000, Dionex ICS-5000, Dionex ICS-5000+, Dionex ICS-6000 EG Error Messages and Troubleshooting

#### 6.1.1 EG1 Cartridge Disconnected and EG2 Cartridge Disconnected

This error occurs if Dionex Chromeleon sends a command to set an EG parameter when the cartridge is disconnected. To troubleshoot: (1) Connect the cartridge and (2) If the error message appears again, contact Dionex for assistance. The cartridge control electronics may have malfunctioned.



NOTE

*The Dionex ICS-3000, Dionex ICS-5000, Dionex ICS-5000+ and Dionex ICS-6000 EG Ion Chromatography System electronics components cannot be serviced by the user.*

#### 6.1.2 EG1 Invalid Concentration and EG2 Invalid Concentration

This error occurs if the eluent concentration is outside the concentration range allowed for the type of cartridge used. This may be a user setting error. This may also indicate corrupted memory or a problem in the EG Moduleware (the instrument control firmware installed in the EG). To troubleshoot: set the correct EG concentration. If failed with correct concentration settings, contact Dionex for assistance.



NOTE

*The Dionex ICS-3000, Dionex ICS-5000 and Dionex ICS-5000+, Dionex ICS-6000 EG Ion Chromatography System electronics components and Moduleware cannot be serviced by the user.*

This error may also occur due to the incorrect linking of the EG to the correct pump in the Chromeleon server configuration. To troubleshoot, re-link the EG to the correct pump using the Chromeleon server configuration.

#### 6.1.3 EG1 Invalid Flow and EG2 Invalid Flow

This error occurs if the flow rate is set to a value not supported by the EG. The DP/SP flow rate range is 0.001 to 10.0 mL/min; however, when a Dionex EGC 500 or Dionex EGC III is installed, the allowed range is 0.01 to 3.00 mL/min. The recommended operating range is 0.25 to 2.00 mL/min. To troubleshoot: set the flow rate to a value within the allowed range.

When a Dionex EGC 400 is installed, the allowed range is 0.020 to 0.200 mL/min. The recommended operating range is 0.020 to 0.200 mL/min. To troubleshoot: set the flow rate to a value within the allowed range.

When a Dionex EGC (Capillary) is installed, the allowed range is 0.001 to 0.030 mL/min. The recommended operating range is 0.005 to 0.020 mL/min. To troubleshoot: set the flow rate to a value within the allowed range.



This error may also occur due to the incorrect linking of the EG to the correct pump in the Chromeleon server configuration. To troubleshoot, re-link the EG to the correct pump using the Chromeleon server configuration.

### 6.1.4 EG1 Invalid Flow Rate-Concentration and EG2 Invalid Flow Rate-Concentration

This error occurs if the selected concentration is too high for the set flow rate. To troubleshoot: set the flow rate to a value within the allowed range. The allowable eluent concentration for a particular application depends on several factors: the flow rate, suppressor type, cartridge type, and cartridge configuration.

This error may also occur due to the incorrect linking of the EG to the correct pump in the Chromeleon server configuration. To troubleshoot, re-link the EG to the correct pump using the Chromeleon server configuration.

### 6.1.5 EG1 over Current, EG2 over Current, EG1 over Power, and EG2 over Power

This error occurs when the current applied to the cartridge exceeds the maximum current allowed. (The current is automatically turned off to prevent damage to the cartridge). If the error message appears, contact Thermo Scientific for assistance. The cartridge control electronics may have malfunctioned.



**NOTE**

*The Dionex ICS-3000, Dionex ICS-5000, Dionex ICS-5000+ and Dionex ICS-6000 EG Ion Chromatography System electronics components and Moduleware cannot be serviced by the user.*

### 6.1.6 EG1 over Voltage and EG2 over Voltage

This error occurs when the cartridge is not connected properly to the EG1 and EG2 current source. To troubleshoot: check the cartridge cable connection to the electrical bulkhead. If the error message appears again, contact Dionex for assistance. The cartridge or Dionex ICS-3000, Dionex ICS-5000, Dionex ICS-5000+ or Dionex ICS-6000 EG control electronics may have malfunctioned.



**NOTE**

*The Dionex ICS-3000, Dionex ICS-5000, Dionex ICS-5000+ and Dionex ICS-6000 EG Ion Chromatography System electronics components and Moduleware cannot be serviced by the user.*

This error may also occur when air bubbles are trapped in the electrolytic chamber. To correct the problem, turn over the Dionex EGC Cartridge (eluent fitting facing down). Shake the Dionex EGC Cartridge vigorously and tap it with the palm of your hand 10 to 15 times, to dislodge the gas bubbles that may be trapped in the electrolytic chamber.

## 6.2 EG Alarm Light is Lit

- CAUSE:** Leaking fitting.  
**ACTION:** Locate the source of the leak. Tighten or replace liquid line connections as needed.
- CAUSE:** Blocked or improperly installed waste line.  
**ACTION:** Check the EG waste lines to be sure they are not crimped or otherwise blocked. Ensure the lines are not elevated at any point after they exit the EG.
- CAUSE:** Cartridge leaks.  
**ACTION:** Replace the cartridge.
- CAUSE:** RFIC Eluent Degasser leaks.  
**ACTION:** Replace the RFIC Eluent Degasser.
- CAUSE:** Cartridge electrical connection is open.  
**ACTION:** Tug gently on the cartridge electrical cable; the locking connector should hold the cable in place. If the cable is fully seated and the problem persists, the cartridge is defective and must be replaced.
- CAUSE:** Cartridge input electrical connection has shorted out.  
**ACTION:** Replace the cartridge.
- CAUSE:** Cartridge input electrical connection has shorted out.  
**ACTION:** Replace the cartridge.
- CAUSE:** Electrical error. The EG current and/or voltage may have become unstable.  
**ACTION:** Contact Dionex for assistance.



### NOTE

*The Dionex ICS-3000, Dionex ICS-5000, Dionex ICS-5000<sup>+</sup> and Dionex ICS-6000 EG Ion Chromatography System electronics components cannot be serviced by the user.*

### 6.3 EG Power LED Fails to Light

**CAUSE:** No power

**ACTION:** Check that the POWER button on the front of the EG is turned on. Check that the EG main power switch (on the rear panel) is turned on. Check that the main power cord is plugged into both the EG rear panel connector and the power source. Check that the wall outlet has power. If the POWER LED still fails to light, contact Dionex for assistance.

### 6.4 Liquid Leaks in the EG

**CAUSE:** Leaking fitting

**ACTION:** Locate the source of the leak. Tighten or replace liquid line connections as needed.

**CAUSE:** Blocked or improperly installed waste line.

**ACTION:** Check the EG waste lines to be sure they are not crimped or otherwise blocked. Make sure the lines are not elevated at any point after they exit the EG.

**CAUSE:** Cartridge leaks.

**ACTION:** Replace the Cartridge.

**CAUSE:** RFIC Eluent Degasser leaks.

**ACTION:** Replace the RFIC Eluent Degasser.

### 6.5 No Flow

**CAUSE:** DP/SP power is off. Turning off the DP/SP automatically turns off the EG and the suppressor.

**ACTION:** Check that the power to the DP/SP is turned on. Prime the pump and then resume operation.

**CAUSE:** DP/SP pressure limit tripped. When a system includes an EG, the high-pressure limit for the DP/SP is 21 MPa (3000 psi) and the low-pressure limit is 1.4 MPa (200 psi).

**ACTION:** Check that the Current Pressure (under Pressure Display on the pump Control panel) is within this range.



#### NOTE

***Dionex EGC 500, Dionex EGC 400 and Dionex EGC III cartridges require at least 14 MPa (2000 psi) of backpressure for optimal removal of electrolysis gas from the eluent produced by the cartridge. A system backpressure of 16 MPa (2300 psi) is ideal.***

**CAUSE:** RFIC Eluent Degasser tubing is ruptured. If the flow from the EG waste line is normal, but there is no flow through the columns, the tubing assembly inside the RFIC Eluent Degasser has ruptured.

**ACTION:** Replace the degasser.

## 6.6 EG Stops Operation

- CAUSE:** DP/SP power is off. Turning off the DP/SP automatically turns off the EG and the suppressor.
- ACTION:** Check that the power to the DP/SP is turned on. Prime the pump and then resume operation.
- CAUSE:** DP/SP pressure limit tripped. When a system includes an EG, the high-pressure limit for the DP/SP is 21 MPa (3000 psi) and the low-pressure limit is 1.4 MPa (200 psi).
- CAUSE:** DP/SP flow rate is too low or too high.
- ACTION:** Select a flow rate between 0.1 and 3.0 mL/min.
- CAUSE:** Electrical error detected (Alarm LED is lighted). To prevent damage to the Cartridges, the DP/SP automatically turns off electrical power to the cartridge when excessive current or voltage is detected.
- ACTION:** Ensure the Cartridge electrical cable is properly connected to the ICS 3000 EG module. If failure persists, contact Dionex for assistance.



### NOTE

*The Dionex ICS-3000, Dionex ICS-5000, Dionex ICS-5000+ and Dionex ICS-6000 EG Ion Chromatography System electronics components cannot be serviced by the user.*

- CAUSE:** Cartridge is expended.
- ACTION:** Replace the cartridge.
- CAUSE:** No communication with Chromeleon or Chromeleon Xpress.
- ACTION:**
1. Check that the POWER button on the front of the EG is turned on.
  2. Check that the EG main power switch (on the rear panel) is turned on.
  3. Check that the main power cord is plugged into both the EG rear panel connector and the power source.
  4. Check that the wall outlet has power.
  5. Check the USB connections. The EG should be connected to the DP/SP (or other ICS-3000 EG module) via a USB cable (Item # 960777). In addition, one module in the system must be connected to the PC on which Dionex Chromeleon or Dionex Chromeleon Xpress is installed.
  6. Check that the EG is configured in the software and assigned to a timebase.

## 6.7 Excessive System Backpressure

*CAUSE:* Restriction in the liquid line plumbing.

*ACTION:*

1. Begin pumping eluent through the system (including the columns) at the flow rate normally used.
2. Work backward through the system, beginning at the cell exit. One at a time, loosen each fitting and observe the pressure. The connection at which the pressure drops abnormally indicates the point of restriction.
3. If the Dionex EGC III Cartridge is identified as the source of the high backpressure, the outlet frit should be replaced. A restriction often causes such high pressure that the entire system cannot be operated. In that case, work forward through the system starting at the Dionex EGC III, adding parts one at a time until an abnormal pressure increase (and hence, the restriction) is found.

## 6.8 No Peaks

*CAUSE:* Dionex EGC current may not be on. The Chromeleon program may not be started.

*ACTION:* Make sure EG current is applied. Configure Dionex EGC correctly using Dionex Chromeleon software.

## 6.9 Peak Retention Times are Too Short

*CAUSE:* Concentration settings are too high. Pump flow rate is low.

*ACTION:* Check the Chromeleon program for correct concentration and flow rate combinations. Check the pump flow rate.

## 6.10 Peak Retention Times are Too Long

*CAUSE:* Concentration settings are too low. Pump flow rate is high. The OFFSET VOLUME in the EG program is too large.

*ACTION:* Check the Dionex Chromeleon program for correct concentration and flow rate combinations. Check the pump flow rate.

## 6.11 Low System Backpressure

*CAUSE:* Loose fitting. High pressure degas tubing assembly ruptured. Internal Dionex EGC leak in the membrane barrier. (This leak will not be detected immediately by the EG Module leak sensor since the liquid leak will pass out through the vent line)

*ACTION:* Check all system fittings. If there is no flow through the columns, although flow from the waste line remains normal, the degas tubing assembly has ruptured and must be replaced. This type of leak may trip the pump pressure limit and the pump will shut off. The cartridge must be replaced.

## Appendix A

### Optional Anion Trap Column – High Capacity (Dionex IonPac ATC-HC) or Cation Trap Column (Dionex IonPac CTC-1)

As an alternative to the Dionex CR-ATC 500 and Dionex CR-ATC 600, the Dionex IonPac ATC-HC 500 can be used for anion applications (Dionex EGC 500 KOH, Dionex EGC III KOH, Dionex EGC III NaOH or Dionex EGC III LiOH). The Dionex IonPac ATC-HC 500 will require regular offline chemical regeneration. See the Dionex IonPac ATC-HC 500 Trap Column Product Manual (Item # 032697) for details.

The Dionex IonPac CTC 500 can be used an alternative to the Dionex CR-CTC 500 and Dionex CR-CTC 600 for cation applications (Dionex EGC 500 MSA and Dionex EGC III MSA). The Dionex IonPac CTC 500 will require regular off-line chemical regeneration. See the Dionex IonPac CTC 500 Trap Column Product Manual (Item # 031910) for details.



#### NOTE

***Do not use the Dionex IonPac ATC-HC 500 or Dionex IonPac CTC 500 for capillary applications. Capillary RFIC-EG systems are only compatible with the Dionex CR-TC (Capillary) trap columns.***

- A. Prepare the Dionex IonPac ATC-HC 500 (Item # 075978) for use by flushing the trap column with 200 mL of 2.0 M NaOH or KOH at 2 mL/min. Alternatively, prepare the Dionex IonPac CTC 500 (Item # 075977) for use by flushing the trap column with 200 mL of 1.0 M H<sub>2</sub>SO<sub>4</sub> or 2.0 M MSA at 2 mL/min.
- B. Rinse the Dionex IonPac ATC-HC 500 or Dionex IonPac CTC 500 with degassed DI water for 20 minutes at 2 mL/min.
- C. Attach the Dionex IonPac ATC/CTC Bracket (Item # 046384) found in the EG Ship Kit.
- D. Connect the pump pressure transducer outlet to the Dionex IonPac ATC-HC 500 or Dionex IonPac CTC 500 inlet using the tubing connected to the exit of the pump pressure transducer.
- E. Connect the outlet of the Dionex IonPac ATC-HC 500 or Dionex IonPac CTC 500 to the inlet of the EGC using the tubing labeled TO PUMP OUT / DAMPER at one end and Dionex EGC IN at the other end.
- F. Connect the tubing, labeled, DEGAS ELUENT IN, extending from the Degas Assembly to the outlet of the Dionex EGC labeled EGC OUT.