

LOCTITE



Teroson

Product Selector

Industrial Adhesives, Sealants
and Surface Treatment Solutions



Henkel

Henkel

Nowadays, if you want to create added value, an excellent product portfolio simply is not good enough. You need a partner who understands your business and your products, who develops new production techniques, optimises your processes together with you and designs tailor-made system solutions.

A partner who can make a real contribution to long-lasting value creation for you:
Henkel – the worldwide market leader in adhesives, sealants and surface treatment. Get access to our unique and comprehensive product portfolio, benefit from our expertise and guarantee your highest process reliability. The General Industry Business fulfils specific industry and maintenance needs from one source.



The formula for efficient cleaning



Innovative pretreatment technology to improve your production process



High performance engineering adhesives and sealants



Advanced flexible bonding and sealing solutions

Partner

- Experienced sales and technical engineers are available around the clock
- Extensive technical support and certified testing methods provide the most effective and reliable solutions
- Advanced training programmes tailored to your specific needs will help you become the expert
- A strong distribution network puts our complete product range close to your operation, ensuring a high level of worldwide product availability
- Identify potential cost savings and process improvements for your operations

Innovation

- Advanced solutions to increase your innovation power
- Set new industry standards for sustainability and health and safety in your processes
- Create the basis for the development of new product design opportunities



Empowering your business



Technology

- Access to a complete product portfolio delivering superior performance for an extensive number of applications
- Use products that have been designed to meet the specific challenges of your industry
- Trust in state-of-the-art technologies and sustainable products

Brands

- The preferred global brands for high-performance adhesive, sealant and surface treatment solutions in industrial manufacturing and maintenance
- Loctite®, Teroson and Bonderite are known all over the world for proven high reliability and performance



Table of Contents

Engineering Applications

6 Threadlocking

12 Thread Sealing

18 Gasketing

24 Retaining

Bonding

30 Instant Bonding

38 Light Cure Adhesives

46 Hotmelt Adhesives

50 Solvent-based / Water-based Adhesives

Structural Bonding

52 Structural Bonding

54 Epoxies

58 Acrylics

62 Polyurethanes

68 Silicones

72 Silane Modified Polymers

Sealing

76 Sealing – Butyls

82 Casting Resins



Filling & Coating

84 **Acoustic Coatings**

86 **Metal-filled Compounds**

90 **Wearing Compounds**

Cleaning

96 **Parts and Maintenance Cleaning**

Lubrication

104 **Lubrication and Protection**

106 Anti-Seize

108 Dry Film and Oils

110 Greases

112 Cutting Fluids

Surface Treatment & Corrosion Protection

114 **Surface Treatment**

120 **Mould Release Agents**

Equipment

128 **Equipment**

128 Manual hand-held applicators

130 Manual dispensers

132 Semi-automatic dispensing systems

133 Hand-held dispensing systems

134 Light curing equipment

136 **Index**

Threadlocking

Locking of Threaded Fasteners

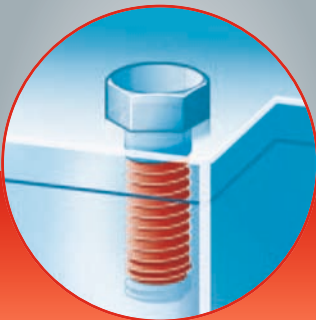

Why use a Loctite® Threadlocker?

Loctite® threadlocking products prevent self-loosening and secure any threaded fastener against vibration and shock loads. They are easy-flowing liquids which completely fill the gaps between mating threads. When used to assemble threaded fasteners, Loctite® Threadlockers permanently secure threaded assemblies and eliminate fretting corrosion by creating a unitised assembly.

Loctite® Threadlockers are much superior to traditional mechanical locking methods:

- Mechanical devices, e.g. split pins, tab washers: Only used to prevent the loss of nuts and bolts
- Friction devices: add to absolute elasticity and/or increase friction; but will not ensure permanent threadlocking under dynamic loads
- Locking devices, like tooth flanged and ribbed flanged bolts, nuts and washers: They prevent self-loosening, but are expensive and need larger flange-bearing surfaces; and they may damage the surfaces.

Loctite® Threadlockers are single-component liquid and semi-solid adhesives. They cure at room temperature to a hard solid thermoset plastic when applied between steel, aluminium, brass and most other metal surfaces. They cure in the absence of air. The adhesive completely fills the gaps between mating threads to lock threads and joints.

Advantages of Loctite® Threadlockers as compared to traditional mechanical locking devices:

- Prevent unwanted movement, loosening, leaks, and corrosion
- Resist vibration
- Single-component – clean and easy to apply
- Can be used on all sizes of fasteners – reduces inventory costs
- Seal threads – allow through-hole tapping

Choose the right Loctite® Threadlocker for your application:

Loctite® Threadlockers are available in varying viscosities and strengths and can be used for a wide range of applications.

Low Strength:

Removable with standard hand tools, good for adjustment screws, calibration screws, meters and gauges, for thread size up to M80.

Medium Strength:

Removable with hand tools, but more difficult to disassemble; good for machine tools and presses, pumps and compressors, mounting bolts, gear boxes, for thread size up to M80.

High Strength:

Very difficult to disassemble with standard hand tools; may require localised heat for removal. Good for permanent assemblies at heavy equipment, studs, motor and pump mounts, for thread size up to M80.



Wicking:

Very difficult to disassemble with standard hand tools; may require localised heat for removal. For preassembled fasteners, instrumentation or carburettor screws.



Non-liquids (semi-solid):

Medium and high strength semi-solid Threadlocker Sticks that can be used on thread size up to M50.



Surface Preparation

Correct surface preparation is the most important factor to assure the total success of any adhesive performance.

- Degrease, clean and dry threads prior to applying the adhesive – use Loctite® 7063 (see Cleaning on page 96)
- If the parts were in contact with aqueous washing solutions or cutting fluids which leave a protective layer on the surface, wash with hot water
- If the adhesive is applied below 5 °C, pre-treatment with Loctite® 7240 or Loctite® 7649 is advised (see Surface Treatment on page 114)
- For locking of plastic fasteners: see Instant Bonding on pages 30–37



Dispensing Equipment

Loctite® products are used for a wide variety of threadlocking applications. For some jobs it is sufficient to dispense adhesives and sealants manually from the bottle or cartridge onto the surfaces to be joined. In other cases, however, more precise hand-held or stationary automated dispensing is required. Loctite® dispensing equipment is specially designed to make application and use of our products fast, precise, clean and economical:

Semi-Automatic Dispensing Equipment

Loctite® 97009 / 97121 / 97201

Loctite® Semi-Automatic Dispensing Equipment combines a controller and reservoir into a single unit for valve dispensing of many Loctite® Threadlockers. Provides digital timing control, empty and end-of-cycle signal. Pinch Valve suitable for stationary or hand-held mode. The reservoirs are large enough to accept up to 2kg bottles, and units can be equipped with low level sensing.

97009 / 97121 / 97201



Hand-Held Applicator

Loctite® 98414 Peristaltic Hand Pump, 50ml bottle

Loctite® 97001 Peristaltic Hand Pump, 250ml bottle

These hand-held applicators mount easily on any anaerobic Loctite® 50 ml or 250 ml bottle, converting the bottle into a portable dispenser. They are designed to dispense at any angle in drop sizes from 0.01 to 0.04 ml, without leaks or product waste (suitable for viscosities up to 2,500 mPa·s).

97001 / 98414



For information on semi or fully-automatic dispensing equipment, available valves, spare parts, accessories and dispensing tips, please refer to page 128 or the Loctite® Equipment Sourcebook.

Threadlocking

Product table

Are the metal parts already assembled?

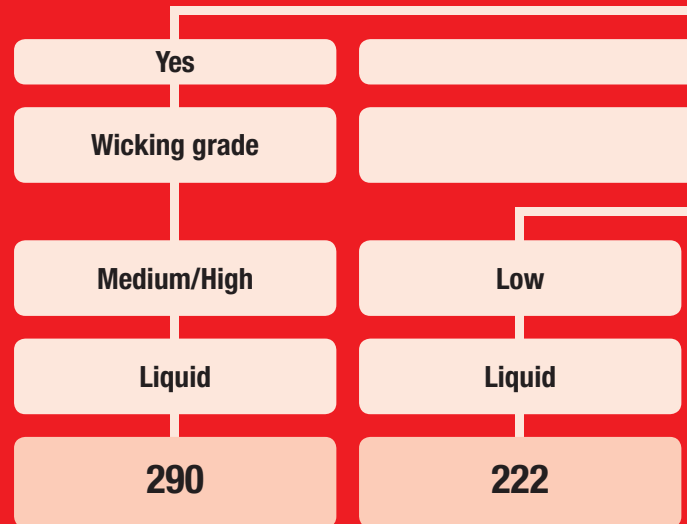

Solution

	290	222
Size of thread	Up to M6	Up to M36
Functional strength after ¹	3 h	6 h
Breakaway torque M10 bolts	10 Nm	6 Nm
Service temperature range	-55 to +150 °C	-55 to +150 °C
Pack sizes	10ml, 50ml, 250ml, 2 lt	10ml, 50ml, 250ml
Equipment ²	97001, 98414	97001, 98414

Handy Hints:

- Degrease, clean and dry surfaces prior to applying the adhesive – use Loctite® 7063 (see Cleaning on page 96)
- If the adhesive is applied below 5 °C, pre-treatment with Loctite® 7240 or Loctite® 7649 is advised (see Surface Treatment on page 114)
- For plastic part(s) please refer to Instant Bonding on pages 30–37



Loctite® 290

- Ideal for locking preassembled fasteners, e.g. instrumentation screws, electrical connectors and set screws



Loctite® 222

- Ideal for low-strength threadlocking of adjusting screws, countersunk head screws and set screws
- Good on low strength metals which could break during disassembly, e.g. aluminium or brass

P1 NSF Reg. No.: 123002

¹ Typical value at 22 °C

² For detailed information see pages 128–135

No

What strength do you require?

Medium

High

Liquid

Liquid

Liquid

Liquid

243

2400

270

2700

Up to M36

Up to M36

Up to M20

Up to M20

2 h

2 h

3 h

3 h

26 Nm

20 Nm

33 Nm

20 Nm

-55 to +180 °C

-55 to +150 °C

-55 to +180 °C

-55 to +150 °C

10ml, 50ml, 250ml, 2 lt

50ml

10ml, 50ml, 250ml, 2 lt

50ml

97001, 98414

97001, 98414

97001, 98414

97001, 98414



NEW FORMULA



NEW FORMULA



Loctite® 243

- Works on all metals, including passive substrates (e.g. stainless steel, aluminium, plated surfaces)
- Proven to tolerate slight contaminations of industrial oils, e.g. engine oils, corrosion prevention oils and cutting fluids
- Prevents loosening on vibrating parts, e.g. pumps, gear boxes or presses
- Permits disassembly with hand tools for servicing

P1 NSF Reg. No.: 123000

Loctite® 2400

- Leading in health and safety
- No hazard symbols, no risk phrases & no safety phrases
- “White” Material Safety Data Sheet – no entries in sections 2, 3, 15 and 16 of MSDS acc. to (EC) No. 1907/2006 – ISO 11014-1
- Excellent chemical and thermal resistance of cured product
- Permits disassembly with hand tools for servicing.

Loctite® 270

- Suitable for all metal fasteners, including stainless steel, aluminium, plated surfaces and chrome-free coatings
- Tolerates slight contaminations of industrial oils, e.g. engine oils, corrosion prevention oils, cutting fluids
- Ideal for permanently locking studs on engine blocks and pump housings
- For applications where disassembly is not required.

P1 NSF Reg. No.: 123006

Loctite® 2700

- Leading in health and safety
- No hazard symbols, no risk phrases & no safety phrases
- “White” Material Safety Data Sheet – no entries in sections 2, 3, 15 and 16 of MSDS acc. to (EC) No. 1907/2006 – ISO 11014-1
- Excellent chemical and thermal resistance of cured product
- For applications where disassembly is not required

Threadlocking

Product list

Product	Chemical basis	Max. thread size	Service temperature range	Strength	Breakaway torque	Thixotropy	Viscosity in mPa·s
Loctite® 221	Methacrylate	M12	-55 to +150 °C	Low	8.5 Nm	No	100 – 150
Loctite® 222		M36	-55 to +150 °C	Low	6 Nm	Yes	900 – 1,500
Loctite® 241		M12	-55 to +150 °C	Medium	11.5 Nm	No	100 – 150
Loctite® 242		M36	-55 to +150 °C	Medium	11.5 Nm	Yes	800 – 1,600
Loctite® 243		M36	-55 to +180 °C	Medium	26 Nm	Yes	1,300 – 3,000
Loctite® 245		M80	-55 to +150 °C	Medium	13 Nm	Yes	5,600 – 10,000
Loctite® 248 Stick		M50	-55 to +150 °C	Medium	17 Nm	N.A.	Semi-solid
Loctite® 262		M36	-55 to +150 °C	Medium/High	22 Nm	Yes	1,200 – 2,400
Loctite® 268 Stick		M50	-55 to +150 °C	High	17 Nm	N.A.	Semi-solid
Loctite® 270		M20	-55 to +180 °C	High	33 Nm	No	400 – 600
Loctite® 271		M20	-55 to +150 °C	High	26 Nm	No	400 – 600
Loctite® 272		M80	-55 to +200 °C	High	23 Nm	Yes	4,000 – 15,000
Loctite® 275		M80	-55 to +150 °C	High	25 Nm	Yes	5,000 – 10,000
Loctite® 276		M20	-55 to +150 °C	High	60 Nm	No	380 – 620
Loctite® 277		M80	-55 to +150 °C	High	32 Nm	Yes	6,000 – 8,000
Loctite® 278		M36	-55 to +200 °C	High	42 Nm	No	2,400 – 3,600
Loctite® 290		M6	-55 to +150 °C	Medium/ High	10 Nm	No	20 – 55
Loctite® 2400		M36	-55 to +150 °C	Medium	20 Nm	Yes	225 – 475
Loctite® 2700		M20	-55 to +150 °C	High	20 Nm	No	350 – 550
Loctite® 2701		M20	-55 to +150 °C	High	38 Nm	No	500 – 900

	Fixture time steel	Fixture time brass	Fixture time stainless steel	Pack sizes	Comments
	25 min.	20 min.	210 min.	250ml	Low strength, low viscosity, small threads
	15 min.	8 min.	360 min.	10ml, 50ml, 250ml	Low strength, general purpose
	35 min.	12 min.	240 min.	250ml	Medium strength, low viscosity, small threads
	5 min.	15 min.	20 min.	250ml	Medium strength, medium viscosity, general purpose
	10 min.	5 min.	10 min.	10ml, 50ml, 250ml, 2 lt	Medium strength, general purpose
	20 min.	12 min.	240 min.	50ml, 250ml	Medium strength, medium viscosity, large threads
	5 min.	–	20 min.	9g, 19g	Medium strength, positioning: MRO/distribution
	15 min.	8 min.	180 min.	250ml	Medium/high strength, general purpose
	5 min.	–	5 min.	19g	High strength, positioning: MRO/distribution
	10 min.	10 min.	150 min.	10ml, 50ml, 250ml, 2lt	High strength, general purpose
	10 min.	5 min.	15 min.	50ml	High strength, low viscosity
	40 min.	–	–	50ml, 250ml	High strength, high temperature resistant
	15 min.	7 min.	180 min.	250 ml, 2 lt	High viscosity, high strength, large threads
	3 min.	3 min.	5 min.	50ml	High strength, especially for nickel surfaces
	30 min.	25 min.	270 min.	50ml, 250ml	High viscosity, high strength, large threads
	20 min.	20 min.	60 min.	50ml, 250ml	High strength, high temperature resistant
	20 min.	20 min.	60 min.	10ml, 50ml, 250ml, 2 lt	Medium/high strength, wicking grade
	10 min.	8 min.	10 min.	50ml	Medium strength, no risk or safety labelling, white MSDS
	5 min.	4 min.	5 min.	50ml	High strength, no risk or safety labelling, white MSDS
	10 min.	4 min.	25 min.	10ml, 50ml, 250ml, 2 lt	High strength, especially for chromated surfaces



Thread Sealing

Sealing of Threaded Components

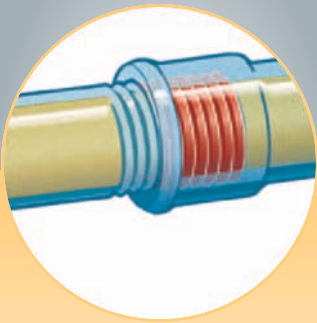

Why use a Loctite® Thread Sealant?

Loctite® Thread Sealants, available in liquid form or as sealing cord, prevent leakage of gasses and liquids. Designed for low and high pressure applications, they fill the space between threaded parts and provide an instant, low pressure seal. When fully cured, they seal to the burst pressure of most pipe systems.

Loctite® Sealants are much superior to traditional sealant types:

- Solvent-based sealing compounds: Shrink during cure as solvents evaporate. Fittings must be re-torqued to minimise voids. They lock the assembly by a combination of friction and deformation.
- PTFE tape: Lubricates in off direction, allowing fittings to loosen under dynamic loads and resulting in loss of clamping force and leakage. Dynamic loads may accelerate creep, causing leakage over time. The lubricating effect of PTFE frequently results in over-tightening of fasteners, adding stress or causing breakage of parts. Application requires good professional skills to avoid stressing fittings or castings.
- Hemp & Paste: are slow to apply and require a lot of expertise, are messy to assemble, and interfere with the torque needed to obtain the correct pre-stress. Frequently require re-work to achieve a 100 % seal of the assembly.

Advantages of Loctite® Thread Sealants as compared to traditional sealant types:

- Single-component – clean and easy to apply
- Does not creep, shrink or block systems
- Can be used on any size of pipe fitting
- Replaces all types of tape and hemp/paste sealants
- The seal resists vibration and shock loads
- Grades with several approvals, e.g. Loctite® 55 Sealing Cord: Potable water (KTW) and Gas (DVGW) approvals
- Protect mated threaded areas against corrosion

Choose the right Loctite® Thread Sealants for your application:

Sealants must be chosen for reliable long-term sealing performance. Pipes must remain leak-free under the severest vibration, chemical attack, heat or pressure surges. When choosing a thread sealant, the substrates to be sealed are a key criterion. Are we dealing with plastic threads, metal threads or a combination of both? Plastic threads usually require a different sealant than metal threads. The following explanations should help you identify which technology should be selected for each type of pipe fitting material:

Anaerobic:

Technology: Loctite® anaerobic thread sealants cure in the absence of air and by contact with metals when confined within the threads of pipe connections. Application area: Any type of metal fittings.



Silicone:

Technology:

Loctite® silicone thread sealant polymerises at room temperature, reacting with ambient moisture (RTV = Room Temperature Vulcanising)

Application area:

Ideal for use on threaded plastic or plastic/metal substrate combinations



Sealing cord – Loctite® 55:

Technology:

Loctite® 55 Sealing Cord is a non-curing, coated multifilament cord that seals out water, gas and most industrial oils. (Potable water (KTW) and gas (DVGW) approvals)

Application area:

Recommended for sealing metal and plastic tapered threads. Loctite® 55 allows for post assembly adjustments.



Surface Preparation

Correct surface preparation is the most important factor to assure the total success of any sealant performance. Without suitable surface preparation, Loctite® thread sealing applications can fail.

- Degrease, clean and dry surfaces prior to applying the sealant – use Loctite® 7063 (See Cleaning – page 96)
- If anaerobic sealants are applied below 5 °C, pre-treatment with Activator Loctite® 7240, Loctite® 7471 or Loctite® 7649 is required (see page 114)
- For Sealing Cord Loctite® 55: Clean parts with Loctite® 7063 and roughen smooth threads



Dispensing Equipment

Anaerobic Sealants:

Loctite® anaerobic sealants can be applied by hand or with automatic or semi-automatic equipment. Excess material can be wiped away.

Hand-Held Applicator:

Loctite® 98414 Peristaltic Hand Pump with stand for the Loctite® 50 ml bottle, and Loctite® 97001 Peristaltic Hand Pump for the Loctite® 250 ml bottle. They are designed to dispense at any angle in drop sizes from 0.01 to 0.04 ml with viscosities up to 2,500 mPa-s, without post-dripping or product waste.



Loctite® 97002 Pneumatic Cartridge Dispenser

Hand-held unit for 300ml cartridges and 250ml squeeze tubes. With integrated pressure regulator and quick pressure relief valve. No-run-on.



For information on semi or fully-automatic dispensing equipment, available valves, spare parts, accessories and dispensing tips, please refer to page 128 or the Loctite® Equipment Sourcebook.

Thread Sealing

Product table

Are the parts metal or plastic?

Metal, plastic or a combination of both

Do you need to make post assembly adjustments?

Yes

No

Cord

Gel

Solution

55

5331

Substrate to be sealed	Metal, plastic or both	Metal, plastic or both
Maximum pipe size	Tested to 4"	3"
Disassembly strength	Low	Low
Instant low pressure seal	Yes (full pressure)	Yes
Service temperature range	-55 to +130 °C	-50 to +150 °C
Pack sizes	50m, 150m cord	100ml
Equipment ¹	N.A.	N.A.

Handy Hints:

- Degrease, clean and dry surfaces prior to applying the adhesive – use Loctite® 7063 (See Cleaning on page 96)
- If the anaerobic sealant (Loctite® 542, 561, 572, 577 or 586) is applied below 5° C, pre-treatment with Loctite® 7240 or Loctite® 7649 is advised (See Surface Treatment on page 114)



Loctite® 55

- General purpose, threaded pipe and fitting sealant
 - Non curing, immediate, full pressure seal
 - For a quick, easy and reliable seal
- DVGW/KTW approval for gas and potable water**

Tested in accordance with EN 751-2 Class ARp and DIN 30660

Certified to NSF/ANSI, Standard 61



Loctite® 5331

- Ideal for use on threaded plastic or plastic/metal fittings carrying hot or cold water e.g. industrial and agricultural plastic water pipe systems or drainage systems

DVGW approval, tested in accordance with EN 751-1

P1 NSF Reg. No.: 123620

¹ For detailed information see pages 128-135

Metal

Are the threads fine or coarse?

Fine

Medium

Coarse

Liquid

Gel

Gel

Gel

542

586

577

572

Metal	Metal	Metal	Metal
3/4"	2"	3"	3"
Medium	High	Medium	Medium
No	No	Yes	Yes
-55 to +150 °C	-55 to +150 °C	-55 to +150 °C	-55 to +150 °C
10ml, 50ml, 250ml	Not available in the UK	50ml, 250ml, 2 lt	50ml, 250ml
97001, 98414	N.A.	97002	97002



Loctite® 542

- Ideal for fine threads as used in hydraulic, pneumatic & general fittings

DVGW approval (EN 751-1):
NG-5146AR0855



Loctite® 586

- Slow curing, high strength sealant
- Especially suitable for copper and brass fittings



Loctite® 577

- General purpose sealant for all coarse metal threads
- Suitable for fast applications at low temperatures, e.g. outdoor plant maintenance

DVGW approval (EN 751-1)
P1 NSF Reg. No.: 123001



Loctite® 572

- Suitable for coarse metal threads
- Ideal where slow cure is required for adjusting the alignment of fittings

Thread Sealing

Product list

Product	Chemical basis	Max. thread size	Service temperature range	Disassembly strength	Breakaway torque	Viscosity in mPa-s
Loctite® 511	Methacrylate	M80/R3"	-55 to +150 °C	Low	6 Nm	9,000 – 22,000
Loctite® 5331	Silicone	M80/R3"	-55 to +150 °C	Low	1.5 Nm	50,000
Loctite® 542	Methacrylate	M26/R3/4"	-55 to +150 °C	Medium	15 Nm	400 – 800
Loctite® 549	Methacrylate	M80/R3"	-55 to +150 °C	High	20 Nm	20,000
Loctite® 55	PA-multi-filament	R4"	-55 to +130 °C	N.A.	N.A.	Cord
Loctite® 561 Stick	Methacrylate	M80/R3"	-55 to +150 °C	Low	2 Nm	Semi-solid
Loctite® 567	Methacrylate	M80/R3"	-55 to +150 °C	Low	1.7 Nm	280,000 – 800,000
Loctite® 570	Methacrylate	M80/R3"	-55 to +150 °C	Low	5.5 Nm	16,000 – 24,000
Loctite® 572	Methacrylate	M80/R3"	-55 to +150 °C	Medium	7 Nm	14,400 – 28,600
Loctite® 577	Methacrylate	M80/R3"	-55 to +150 °C	Medium	11 Nm	16,000 – 33,000
Loctite® 582	Methacrylate	M56/R2"	-55 to +150 °C	Medium	8.5 Nm	4,500 – 5,500
Loctite® 586	Methacrylate	M56/R2"	-55 to +150 °C	High	15 Nm	4,000 – 6,000
Loctite® 5772	Methacrylate	M80/R3"	-55 to +150 °C	Medium	11 Nm	16,000 – 33,000

* For detailed information see www.loctite.co.uk

	Thixotropy	Approval*	Pack sizes	Comments
	Yes	DVGW	50ml, 250ml	For metal, low strength, general purpose
	Yes	NSF	100ml	For plastic and metal
	No	–	10ml, 50ml, 250ml	For metal, esp. hydraulic pipes
	Yes	–	250ml	For metal, high strength, slow curing
	–	KTW, NSF	50m, 150m cord	For plastic and metal, esp. gas and water pipes, not curing
	–	NSF	19g stick	Stick, for metal threads, MRO/Distribution
	Yes	UL	50ml, 250ml	For metal, low strength, coarse threads
	Yes	–	Not available in the UK	For metal, low strength, very slow curing
	Yes	–	50ml, 250ml	For metal, slow curing
	Yes	NSF	50ml, 250ml, 2 lt	For metal, general purpose
	No	–	Not available in the UK	For metal, medium strength, fast curing
	Yes	BAM	Not available in the UK	For metal, high strength, excellent on brass
	Yes	PMUC	50ml	For metal, especially for nuclear power plants



Gasketing

Sealing of Flanges

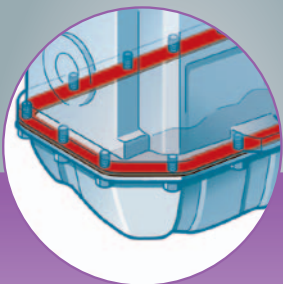
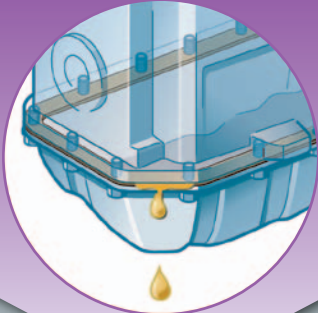

Why use a Loctite® Gasketing Product?

Gaskets are used to prevent leakage of fluids or gases by forming impervious barriers. For successful gasketing, it is necessary that the seal must remain intact and leak-free over a long period of time. The gasket must be resistant to fluids and/or gasses, and withstand the operating temperatures and pressures to which it is subjected. Loctite® gasketing products are self-forming gaskets that provide a perfect seal between components, with maximum face-to-face contact, eliminating flange face corrosion. A low-pressure seal is formed immediately on assembly, with full cure in 24 hours giving a joint that won't shrink, crack or relax.

Loctite® Gasketing products offer a much higher performance and provide numerous benefits over traditional sealing systems such as pre-cut gaskets:

The major causes of failure and leakage of compression gaskets are:

- Surface contact: Compression gaskets do not provide total contact between the gasket and the flange surfaces. Therefore minor leakages may always occur (weeping rate).
- Compression set: Compression gaskets relax under dynamic loads and decrease in thickness, with subsequent loss of bolt tension in the flange joint resulting in leakage
- Extrusion: Gaskets can be squeezed out between flanges
- Bolt hole distortion: High stresses are transferred to the gasket material under the bolt head, causing the gasket to crack, tear, rupture or extrude.

Advantages of Loctite® Gasketing products as compared to conventional pre-cut compression gaskets:

- Single-component - easy and clean to apply
- Replace conventional gaskets – reduce inventory
- Fills all voids
- No need for retorquing
- Excellent instant seal
- High resistance to solvents
- Resists high pressure when fully cured

Choose the right Loctite® Gasket for your application:

Many factors influence gasket choice. Henkel offers a variety of gasketing materials:

Anaerobic products for rigid flanges:

They remain liquid when exposed to air, but cure when confined between mating flanges. Loctite® anaerobic gasketing products are best suited for rigid metal-to-metal assemblies where the sealing gap is zero or small.



Silicone products for flexible flanges:

Loctite® silicone gasketing materials include products with specific properties including excellent fluid resistance and formulations for high operating temperatures. They are best suited for large gap applications and assemblies where flange movement occurs.



Loctite® Gasketing products:

Loctite® gaskets can be used on almost every flange type. They are applied as a liquid sealant to one of the flange surfaces before the parts are assembled. After assembly the gasket spreads and cures between the flanges, filling gaps, scratches, and surface irregularities to provide a durable seal.

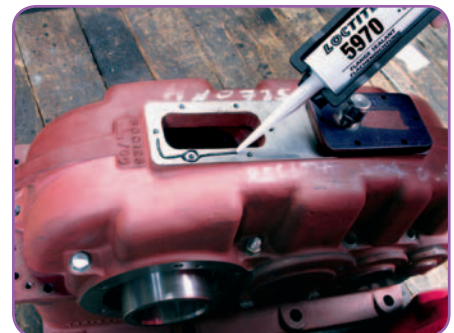

Surface Preparation

Components should be clean and free from contamination such as grease, oil, gasket and sealant residues, etc.

- Degrease, clean and dry surfaces prior to applying the sealant – use Loctite® 7063 (See Cleaning on page 96)
- For maintenance and repair, remove residues of old gaskets with Loctite® 7200 Gasket Remover and clean surfaces with Loctite® 7063 (see Cleaning on page 96)
- If the anaerobic sealant is applied below 5 °C, pre-treatment with Loctite® 7240, Loctite® 7471 or Loctite® 7649 is advised (see Surface Treatment on page 114)



Dispensing Equipment

Loctite® Cartridge Dispensers are ergonomically designed for the hand application of Loctite® sealants. Whether manual or pneumatic, each item is designed for simple, clean, hand-held dispensing of Loctite® gasketing products:

Cartridge Gun

Loctite® 142240 Cartridge Gun for 50ml and 300ml cartridges

- Hand-held, manually operated dispenser for all standard 150ml and 300ml cartridges
- Rapid loading system to make cartridge changes clean and easy



Cartridge Gun

Loctite® 97002 Pneumatic Cartridge Dispenser

- Hand-held unit for 300ml cartridges and 250ml squeeze tubes
- Integrated pressure regulator
- Quick pressure relief, to minimise run-on effect



For information on semi or fully-automatic dispensing equipment, available valves, spare parts, accessories and dispensing tips, please refer to page 128 or the Loctite® Equipment Sourcebook.

Gasketing

Product table

What gap must the sealant fill?

Up to 0.1 mm

Metals

Paste

Paste

Gel

Solution

573

574

518

Flange type	Rigid	Rigid	Rigid
Cure method	Anaerobic	Anaerobic	Anaerobic
Oil resistance	Excellent	Excellent	Excellent
Water/Glycol resistance	Excellent	Excellent	Excellent
Service temperature range	-55 to +150 °C	-55 to +150 °C	-55 to +150 °C
Pack size	250ml	50ml, 160ml cartridge, 250ml, 2 lt	50ml, 65ml, 300ml, 850ml cartridge
Equipment ¹	97002	97002	142240, 97002

Handy Hints:

- Remove residues of old gaskets with Loctite® 7200 Gasket Remover
- Degrease, clean and dry surfaces prior to applying the adhesive – use Loctite® 7063 (See Cleaning on page 96)
- If the anaerobic sealant is applied below 5 °C, pre-treatment with Loctite® 7240 or Loctite® 7649 is advised (See Surface Treatment on page 114)



Loctite® 573

Ideal for sealing large, rigid metal flanges or flanges where assembly may take up to several hours.



Loctite® 574

Ideal for use on rigid metal parts, e.g. cast iron components and pump housings.



Loctite® 518

Ideal for use on rigid iron, steel and aluminium flanges.

P1 NSF Reg. No.: 123758

¹ For detailed information see pages 128-135

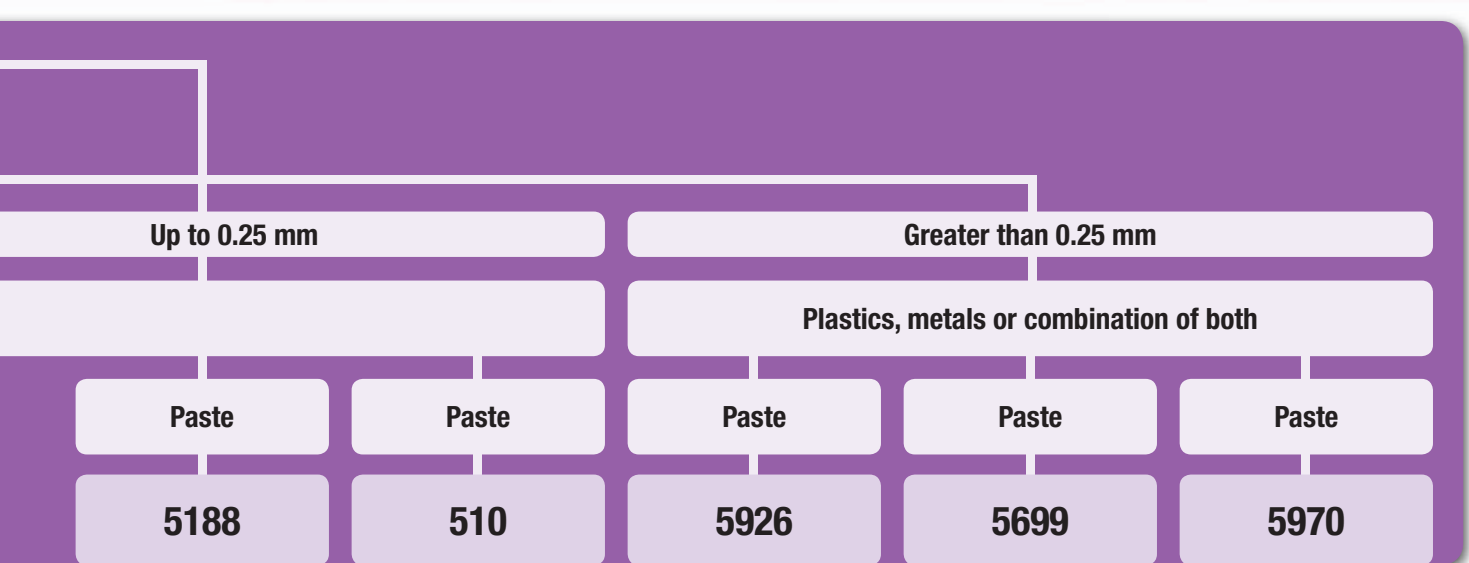

Rigid	Rigid	Flexible	Flexible	Flexible
Anaerobic	Anaerobic	Moisture	Moisture	Moisture
Excellent	Excellent	Good	Good	Excellent
Excellent	Excellent	Good	Excellent	Good
-55 to +150 °C	-55 to +200 °C	-55 to +150 °C	-60 to +200 °C	-60 to +200 °C
50ml, 300ml, 850ml, 2 lt	50ml, 160ml, a 250ml cartridge	40ml tube	80ml, 300ml cartridge, 20 lt	300ml cartridge, 20 lt
142240, 97002	142240, 97002	142240, 97002	142240, 97002	142240, 97002



Loctite® 5188

Ideal for sealing all kinds of rigid metal flanges, especially aluminium flanges. Excellent in demanding applications, excellent chemical resistance, resist flexing. Superior adhesion, can tolerate slight oil contamination on the flange surface.



Loctite® 510

Ideal for use on rigid flanges where high temperature and chemical resistance is necessary.
P1 NSF Reg. No.: 123007



Loctite® 5926

Multi-purpose flexible silicone sealant. Can be used on metal, plastic and painted parts. Resists vibration, thermal expansion and contraction.



Loctite® 5699

Ideal for sealing all types of flanges including stamped sheet metal where water glycol resistance is required. Tack free after 10 min.
P1 NSF Reg. No.: 122998



Loctite® 5970

Replacement for cork and paper cut gaskets on flanges and stamped sheet metal covers. Ideal for use where high vibration or flexing occurs. Can be used with plastic and painted parts. Tack free after 25 min.

Gasketing

Product list

Product	Chemical basis	Colour	Service temperature range	Strength	Fluorescent	Viscosity in mPa·s	Tensile shear strength in N/mm ²	
Loctite® 510	Methacrylate	Pink	-55 to +200 °C	Medium	No	40,000 – 140,000	5	
Loctite® 515		Dark purple	-55 to +150 °C	Medium	Yes	150,000 – 375,000	6	
Loctite® 518		Red	-55 to +150 °C	Medium	Yes	500,000 – 1,000,000	7.5	
Loctite® 5188		Red	-55 to +150 °C	Medium	Yes	11,000 – 32,000	7	
Loctite® 573		Green	-55 to +150 °C	Low	Yes	13,500 – 33,000	1.3	
Loctite® 574		Orange	-55 to +150 °C	Medium	Yes	23,000 – 35,000	8.5	
Loctite® 5203		Red	-55 to +150 °C	Very low	Yes	50,000 – 100,000	1	
Loctite® 5205		Red	-55 to +150 °C	Medium	Yes	30,000 – 75,000	3	
Loctite® 5208		Red	-55 to +150 °C	Medium	Yes	12,000 – 27,000	6	
Loctite® 128068		Dark purple	-55 to +150 °C	Medium	Yes	300,000 – 1,000,000	6	
						Extrusion rate in g/min		
Loctite® 5699	Silicone	Grey	-60 to +200 °C	Low	No	200	1.7	
Loctite® 5900		Black	-55 to +200 °C	Low	No	20 – 50	1.2	
Loctite® 5910		Black	-60 to +200 °C	Low	No	300	1.2	
Loctite® 5920		Copper	-60 to +350 °C	Low	No	275	1.4	
Loctite® 5926		Blue	-60 to +200 °C	Low	No	550	–	
Loctite® 5970		Black	-55 to +200 °C	Low	No	40 – 80	1.5	
Loctite® 5980		Black	-55 to +200 °C	Low	No	120 – 325	1.5	

	Max. gap in mm	Fixture time steel	Fixture time aluminum	Pack sizes	Comments
	0.25	25 min.	45 min.	50ml, 160ml, 250ml	For machined, rigid metal flanges – high temperature resistance
	0.25	30 min.	30 min.	50ml, 300ml	For machined, rigid metal flanges – medium cure speed
	0.3	25 min.	20 min.	50ml, 65ml, 300ml, 850ml	For machined, rigid metal flanges – semi-flexible
	0.25	25 min.	10 min.	50ml, 300ml, 850ml, 2 lt	For machined, rigid metal flanges – highly flexible
	0.1	9 h	12 h	250ml	For machined, rigid metal flanges – slow curing
	0.25	15 min.	45 min.	50ml, 160ml, 250ml, 2 lt	For machined, rigid metal flanges – general purpose
	0.125	10 min.	20 min.	300ml	For machined, rigid metal flanges – easy disassembly
	0.25	25 min.	25 min.	50ml, 300ml, 850ml	For machined, rigid metal flanges – semi-flexible
	0.125	12 min.	30 min.	250ml	For machined, rigid metal flanges – semi-flexible
	0.1	1 h	3 h	300ml, 850ml	For machined, rigid metal flanges – semi-flexible, very slow curing
		Skin over time	Cure through volume in 24 h		
	1	30 min.	2.5 mm	80ml, 300ml, 20 lt	For flexible flanges, machined or casted surfaces, metal or plastic, excellent in water/Glycol
	1	15 min.	2.5 mm	50ml, 300ml 20 lt	Thixotropic paste, black, excellent in engine oils
	1	40 min.	2.75 mm	300ml cartridge, 80ml tube, 20 lt	For flexible flanges, machined or casted surfaces, metal or plastic
	1	40 min.	2.5 mm	80ml tube, 300ml cartridge, 20 lt	For flexible flanges, machined or casted surfaces, high temperature resistant
	1	60 min.	2.5 mm	40ml tube	For flexible flanges, machined or casted surfaces, metal or plastic
	1	25 min.	2.5 mm	300ml cartridge, 20 lt	For flexible flanges, machined or casted surfaces, metal or plastic
	1	30 min.	1 mm	200ml rocep can	Flange sealant, black, big gaps, label free



Retaining

Cylindrical Assemblies



Why use a Loctite® Retaining Compound?

Loctite® Retaining Compounds secure bearings, bushes and cylindrical parts into housings or onto shafts. They achieve maximum load transmission capability and uniform stress distribution and eliminate fretting corrosion. Applied as a liquid, they form 100 % contact between mating metal surfaces, eliminating the need for expensive replacement parts, time consuming machining or the use of mechanical methods.

Loctite® Retaining Compounds fill the inner space between components and cure to form a strong precision assembly.

Loctite® Retaining Compounds are much superior to conventional assembly methods:

- Pins, key/keyway assemblies: Have uneven distribution of mass, an imbalance that can lead to vibration at high speeds
- Splines: They cause high stresses due to the "notch effect" that occurs. High machining costs. Backlash between drive and over run.
- Clamp rings, press fits, shrink fits, and taper fits: They rely on friction alone to transmit torque, therefore they are limited by material, surfaces and design. Close tolerances are needed to obtain specific load capacities, leading to higher production costs. Interference fitting creates stresses in the components that can lead to failure, particularly when combined with operational stresses.
- Welding and soldering: Only compatible metals can be joined, the parts can be distorted by the high temperatures required. Heating of the material can lead to residual stresses and structural degradation and distortion. Disassembly can also be difficult or impossible.

Advantages of Loctite® Retaining Compounds as compared to conventional assembly methods:

- High-strength products can carry high loads
- Fill all voids to prevent corrosion and fretting
- 100 % contact – load and stress is distributed evenly over the joint

Advantages of Loctite Retaining Compounds in combination with shrink fits or press fits:

- Higher load transmission and performance with existing design and geometry solutions
- Equal performance by lower interference / lighter construction

Key factors to consider when choosing the right Loctite® Retaining Compound:

1. Gap size between parts:

Typically, low viscosity retaining compounds (125 to 2,000 mPa·s) are used for gaps up to 0.15 mm. For gaps greater than 0.15 mm, retaining compounds with higher viscosities (>2,000 mPa·s) should be used.

2. Temperature resistance:

Most Loctite® Retaining Compounds are capable of withstanding temperatures up to 150 °C. For applications that require resistance to higher temperatures, Henkel has developed a special range of retaining products that can withstand up to 230 °C.



3. Bond strength:

A high-strength retaining compound is recommended for applications that require a permanent bond. If parts need to be taken apart for maintenance, it is better to use a medium strength product because shear strength is lower.



4. Cure speed:

Many production applications require retaining compounds with fast cure speed to optimise production rates. On the other hand, some applications call for a slower cure so that adjustments can be made after the parts have been assembled. Our range of Loctite® Retaining Compounds offers a wide choice of cure speed options.



Surface Preparation

Components should be clean and free from contamination such as grease, oil, cutting fluids, protective coatings, etc.

- Degrease, clean and dry surfaces prior to applying the sealant – use Loctite® 7063 (See Cleaning on page 96)
- If the adhesive is applied below 5 °C, pre-treatment with Activator Loctite® 7240 or Loctite® 7649 is advised (see Surface Preparation on page 114)
- The cure speed of the retaining compound can be increased by use of Activator Loctite® 7649 or Loctite® 7240 (see Surface Treatment on page 114).



Dispensing Equipment

Formulated in a wide variety of viscosities, gap-filling capabilities, flexibility and strength characteristics, Loctite® Retaining Compounds can be applied with automated process equipment or dispensed manually.

Semi-Automatic Dispensing Equipment

Loctite® 97009 / 97121 / 97201

Loctite® Semi-Automatic Dispensing Equipment combines a controller and reservoir into a single unit for valve dispensing of many Loctite® products. Provides digital timing control, empty and end-of-cycle signal. Pinch Valve suitable for stationary or hand-held setup mode. The reservoirs are large enough to accept 2kg bottles, and units can be equipped with low level sensing.

97009 / 97121 / 97201



Hand-Held Applicator

Loctite® 98414 Peristaltic Hand Pump, 50ml bottle

Loctite® 97001 Peristaltic Hand Pump, 250ml bottle

These hand-held applicators mount easily on any anaerobic Loctite® 50 ml or 250 ml bottle, converting the bottle into a portable dispenser. They are designed to dispense at any angle in drop sizes from 0.01 to 0.04 ml, without leaks or product waste (suitable for viscosities up to 2,500 mPa·s).

97001/98414



For information on semi or fully-automatic dispensing equipment, available valves, spare parts, accessories and dispensing tips, please refer to page 128 or the Loctite® Equipment Sourcebook.

Retaining

Product table

Is the assembly very loose or badly worn?

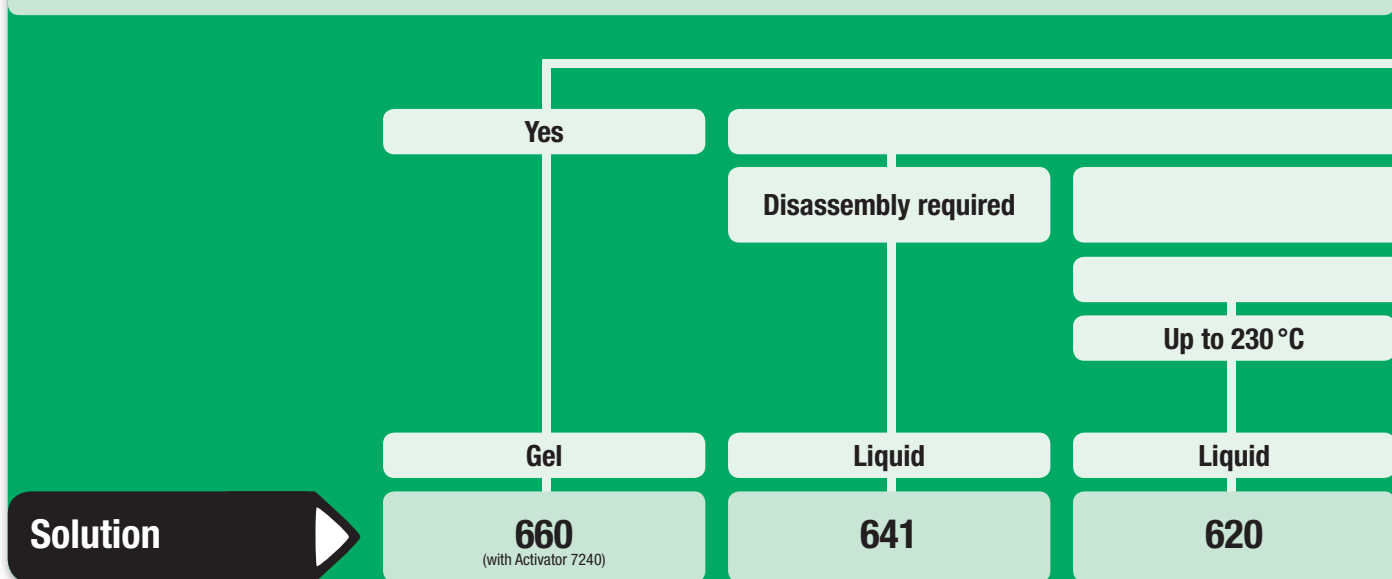

Solution

	Gel	Liquid	Liquid
Diametrical clearance	Up to 0.5 mm	Up to 0.1 mm	Up to 0.2 mm
Strength required	High	Medium	High
Handling strength after¹	15 min.	25 min.	80 min.
Service temperature range	-55 to +150 °C	-55 to +150 °C	-55 to +230 °C *
Pack size	50ml	10ml, 50ml, 250ml	250ml
Equipment²	N.A.	97001, 98414	97001, 98414

Handy Hints:

- Degrease, clean and dry surfaces prior to applying the adhesive – use Loctite® 7063 (See Cleaning on page 96)
- If the adhesive is applied below 5 °C, pre-treatment with Loctite® 7240 or Loctite® 7649 is advised (See Surface Treatment on page 114)
- Use in conjunction with existing designs to increase their strength



Loctite® 660

- Ideal for repairing worn coaxial parts without remachining
- Enables re-use of worn bearing seats, keys, splines or tapers
- Suitable for retaining shims

P1 NSF Reg. No.: 123704



Loctite® 641

- Ideal for parts that need subsequent dismantling, i.e. retention of bearings onto shafts and into housings



Loctite® 620

- High temperature resistance
- Ideal for retaining pins in radiator assemblies, sleeves into pump housings and bearings in auto transmissions

DVGW approval (EN 751-1):
NG-5146AR0622

¹ At room temperature on steel joints.

² For detailed information see page 128

* After heat cure 180 °C for 30 min.

No

No disassembly required

What service temperature is required?

Up to 175 °C

Up to 150 °C

Gap ≤ 0.25 mm

Gap ≤ 0.1 mm

Liquid

Liquid

Liquid

Liquid

648

640

638

603

Up to 0.15 mm	Up to 0.1 mm	Up to 0.25 mm	Up to 0.1 mm
High	High	High	High
3 min.	24 h	4 min.	8 min.
-55 to +175 °C	-55 to +175 °C	-55 to +150 °C	-55 to +150 °C
50 ml, 250 ml, 2 lt	250ml	3ml, 50ml, 250ml, 2 lt	10 ml, 50 ml, 250 ml, 1 lt
97001, 98414	97001, 98414	97001, 98414	97001, 98414



Loctite® 648

- Increased temperature resistance
- Ideal for retaining of parts with a clearance or interference fit, e.g. retaining bushes, bearings, seals, fans, and liners

WRC Approval (BS 6920):
0808532



Loctite® 640

- Slow cure
- Ideal for parts with longer positioning time, e.g. larger diameters
- Also for active metals, like brass components



Loctite® 638

- Best resistance to dynamic, axial and radial loads
- Ideal for shafts, gears, pulleys and similar cylindrical parts

P1 NSF Reg. No.: 123010
DVGW Approval (EN 751-1): NG-5146AR0619
WRC Approval (BS 6920):
0511518



Loctite® 603 (improved Loctite® 601)

- Ideal for retaining close fitting cylindrical parts
- For use on cylindrical fitting parts where thorough degreasing is not possible
- Approved for use on bearings

P1 NSF Reg. No.: 123003
WRC Approval (BS 6920):
0910511

Retaining

Product list

Product	Chemical basis	Colour	Service temperature range	Tensile shear strength in N/mm ²	Thixotropy	Viscosity in mPa-s	
Loctite® 601	Methacrylate	Green	-55 to +150 °C	> 15	No	100 – 150	
Loctite® 603		Green	-55 to +150 °C	> 22.5	No	100 – 150	
Loctite® 620		Green	-55 to +230 °C	> 24	Yes	5,000 – 12,000	
Loctite® 638		Green	-55 to +150 °C	> 25	No	2,000 – 3,000	
Loctite® 640		Green	-55 to +175 °C	22	No	450 – 750	
Loctite® 641		Yellow	-55 to +150 °C	> 6.5	No	400 – 800	
Loctite® 648		Green	-55 to +175 °C	> 25	No	400 – 600	
Loctite® 649		Green	-55 to +175 °C	> 15	No	550 – 950	
Loctite® 660		Silver	-55 to +150 °C	> 17	Yes	150,000 – 350,000	
Loctite® 661		Amber	-55 to +175 °C	> 15	No	400 – 600	
Loctite® 662		Amber	-55 to +150 °C	> 25	No	1,750 – 3,250	
Loctite® 675		Green	-55 to +150 °C	20	No	100 – 150	
Loctite® 121078		Green	-55 to +175 °C	> 20	Yes	3,000 – 5,000	

* In combination with activator

	Fixture time on steel	Maximum diametrical clearance	Pack sizes	Comments
	25 min.	0.1 mm	250ml	High strength, low viscosity, small gaps
	8 min.	0.1 mm	10ml, 50ml, 250ml, 1 lt	High strength, oil tolerant
	80 min.	0.2 mm	250ml	High strength, high temperature resistance
	4 min.	0.25 mm	3ml, 50ml, 250ml, 2 lt	High strength, general purpose
	2 h	0.1 mm	250 ml	High strength, good temperature resistance, slow curing
	25 min.	0.1 mm	10ml, 50ml, 250ml	Medium strength, if disassembly is required
	3 min.	0.15 mm	50ml, 250ml, 2 lt	High strength, good temperature resistance
	10 min.	0.1 mm	250ml	High strength, no acrylic acid
	15 min.	0.5 mm*	50ml	High strength, gap fill for repair
	4 min.	0.15 mm	250ml	High strength, low viscosity, also UV-curing
	7 min.	0.25 mm	Not available in the UK	High strength, medium viscosity, also UV-curing
	45 min.	0.1 mm	250ml, 2 lt	High strength, slow curing
	3 min.	0.25 mm	250ml, 1 lt, 2 lt	High strength, good temperature resistance, high viscosity



Instant Bonding

For small to medium size parts

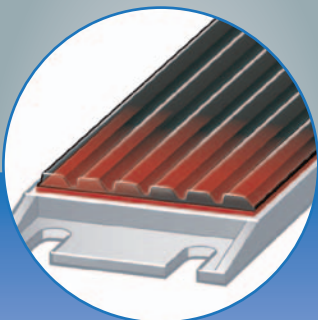
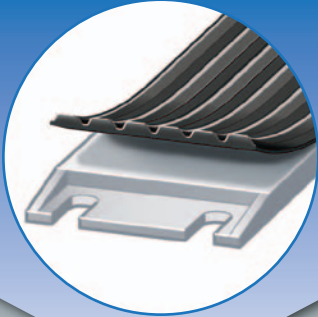

Why use a Loctite® Instant Adhesive?

Instant adhesives, or cyanoacrylates, cure very quickly when confined between surfaces. Surface humidity on the substrates triggers the cure reaction, which moves from the substrate surfaces towards the middle of the adhesive joint. Cyanoacrylates are chosen for bonding small parts to achieve extremely fast fixturing. Due to their limited gap filling capacity they require close fitting surfaces. Their adhesion to most substrates is excellent and the bonding strength in shear and tensile mode is very good. They should not be used on float glass or glazed ceramics, but can be used on GRP plastics. Bonds continuously exposed to water need proper adhesive selection and ageing evaluation.

Advantages of Loctite® Instant Adhesives:

- Clean and easy to apply
- Very fast positioning and fixturing of parts
- Joining a wide variety of dissimilar materials
- Excellent adhesion on a wide range of substrates, especially plastics and rubbers. Special formulations are available for bonding metals or porous substrates. Primer Loctite® 770 offers to improve adhesion on difficult-to-bond materials such as PP, PE, POM, PTFE, or silicone
- High strength on very small bond faces
- Free of solvents
- Do not require complex part geometries, e.g. for snap-fits

Choosing the right Loctite® Instant Adhesive:

Loctite® Instant Adhesives come in a variety of types optimised for specific application requirements, e.g. the parts to be bonded, the loads to be resisted, the joint geometry, the process parameters, etc.

The following explanations should help you identify which technology is best suited for any particular application.

Instant adhesives for bonding porous or acidic substrates:

These formulations are specially tailored to porous and acidic substrates, e.g. paper or galvanised metals, to achieve fast cure and fixturing.

Shock and impact resistant instant adhesives:

Elastomer-modified instant adhesives achieve very good shock and impact resistance. In addition, they offer improved thermal performance and resistance of metal bonds in humid environments.

High temperature instant adhesives:

These instant adhesives are resistant to temperatures up to 120 °C and for short periods even up to 140 °C.

Flexible instant adhesives:

Where bonded components are subjected to bending loads, flexible instant adhesives will reduce localised stress concentrations or encourage a more homogeneous deformation.

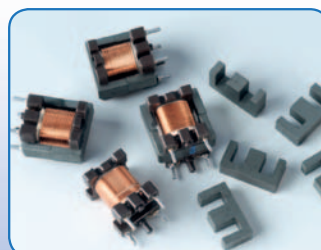

Low bloom, low odour instant adhesives:

Specially formulated low-bloom instant adhesives are recommended for cosmetically sensitive applications and/or very low odour.



2-component instant adhesives:

Innovative, two-component technology provides fast cure independent of gap. This applies especially for assemblies which are not a perfect fit, or where excess adhesive may be present.

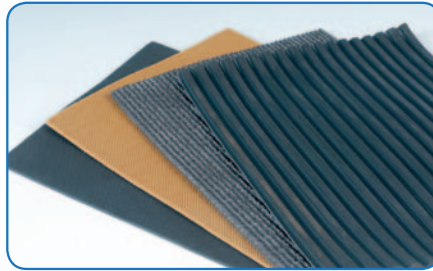

Light curing instant adhesives:

Light curing formulations are recommended for bonding clear and transparent substrates with good aesthetic finish, or for curing of excess fillets (see Light Cure Adhesives on page 38).



Surface Preparation

Correct surface preparation is a key factor to assure the total success of any adhesive performance.

- The surfaces to be bonded should be clean, dry and free of grease. If necessary, clean the parts with Loctite® 7063 or Loctite® 7070 and allow to dry (see Cleaning on page 96)
- For faster fixture time, apply Loctite® Activator to one of the mating surfaces (see Surface Preparation on page 114)
- To improve adhesion to difficult-to-bond materials (PP, PE, PTFE, etc.), coat these bond faces completely with Primer Loctite® 770 (see Surface Preparation on page 114)



Dispensing Equipment

Loctite® Instant Adhesives are used for a wide variety of bonding applications. For some jobs it is sufficient to dispense the product manually from bottles designed specifically for easy and accurate dispensing.

In other cases, however, more precise hand-held or stationary automated dispensing is required. Loctite® dispensing equipment is designed to make application and use of our products fast, precise, clean and economical:

Peristaltic Dispenser Loctite® 98548

The peristaltic motion of the rotor provides volumetric dispensing of the adhesive directly from the bottle. The unit is designed mainly for manual work stations but can also be integrated into automatic production lines. A precise amount of product can be set and high repetition accuracy is ensured.



Semi-Automatic Dispensing System Loctite® 1388646

The system is suitable for dispensing dots or beads of low to medium viscosity Loctite® Instant Adhesives. It is designed for integration into automated assembly lines. The diaphragm valve provides high-resolution stroke adjustment and achieves no-drip dispensing. The controller actuates valve, reservoir and start of operation via footswitch, keyboard or higher ranking PLC.



For information on semi or fully-automatic dispensing equipment, available valves, spare parts, accessories and dispensing tips, please refer to page 128 or the Loctite® Equipment Sourcebook.

Instant Bonding

Product table

Are you bonding “difficult to bond” rubbers or plastics, e.g. PE, PP, PTFE, silicone?

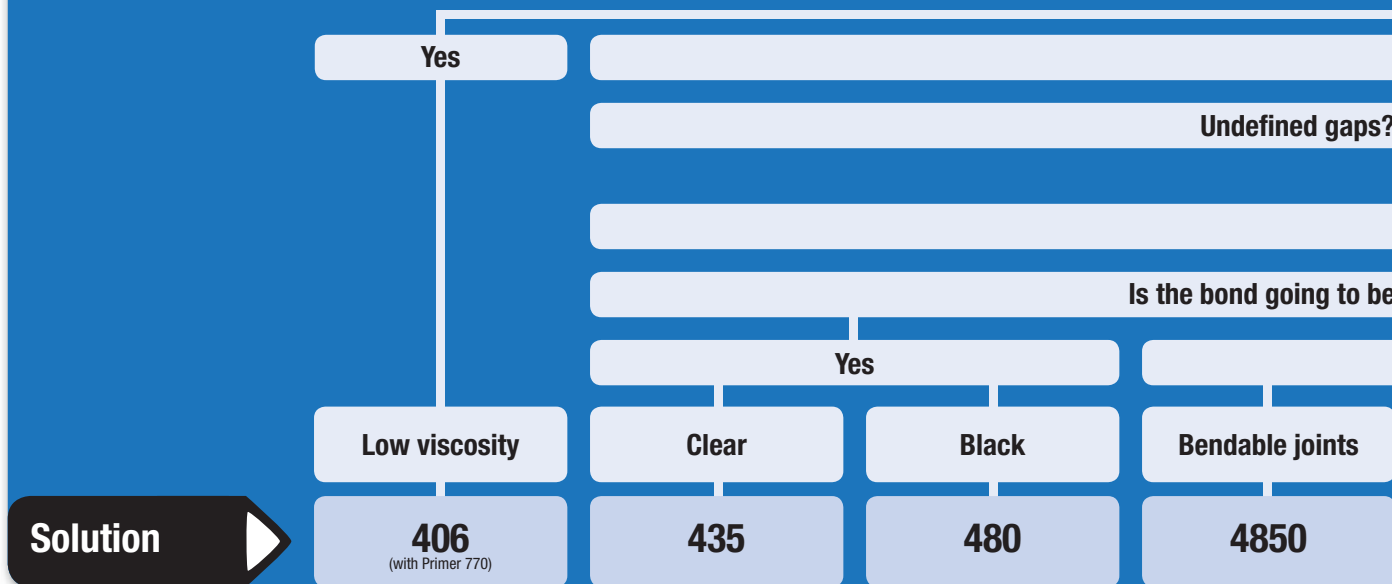

	406 (with Primer 770)	435	480	4850
Fixture time	2 – 10 sec.	10 – 20 sec.	20 – 50 sec.	3 – 10 sec.
Viscosity	20 mPa-s	200 mPa-s	150 mPa-s	400 mPa-s
Colour	Colourless	Colourless	Black	Colourless
Service temperature range	-40 to +80 °C	-40 to +100 °C	-40 to +100 °C	-40 to +80 °C
Pack sizes	20g, 50g, 500g, 2kg	20g, 500g	20g, 500g	20g, 500g

Handy Hints:

- In combination with Loctite® Instant Adhesives:
 - to improve adhesion of difficult-to-bond materials use Primer Loctite® 770
 - to increase cure speed use Activator Loctite® 7458, 7455, 7452 or 7457 (see Surface Treatment on page 114)
- For difficult-to-bond plastics (PE and PP) see also Loctite® 3030 or Loctite® 3038 on page 60



Loctite® 406

- Rapid bonding of plastics, rubbers, including EPDM, and elastomers
- Loctite® 770 Polyolefin Primer improves bonding on difficult to bond substrates



Loctite® 435

- High resistance to impact and shock loads, high peel strength
- Bonding of plastics, rubber, metals, porous and absorbent substrates and acidic surfaces
- Good resistance in humid environments



Loctite® 480

- For applications where shock resistance is required or shock or peel loads are present
- Ideal for bonding metal to metal, to rubber or magnets
- Good resistance in humid environments



Loctite® 4850

- For bonding materials subjected to bending or distortion, as well as flexible components
- For porous and adsorbent substrates and acidic surfaces

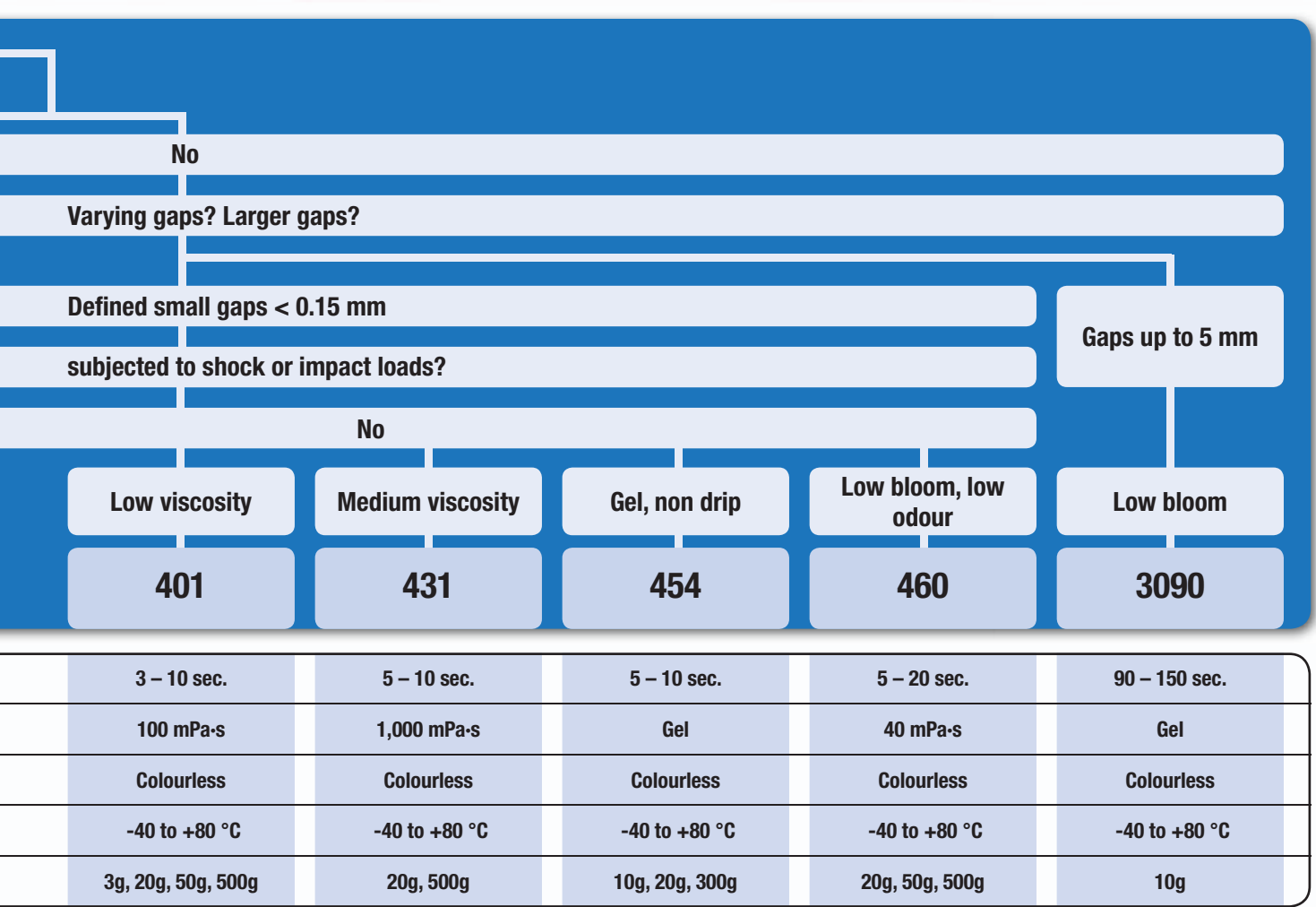

Loctite® 401

- General purpose
- For acidic surfaces such as chromated or galvanised surfaces
- For porous substrates such as wood, paper, leather, cork and fabric

P1 NSF Reg. No.: 123011



Loctite® 431

- General purpose
- For acidic surfaces such as chromated or galvanised surfaces
- For porous substrates such as wood, paper, leather, cork and fabric



Loctite® 454

- General purpose gel
- Ideal when non-dripping is required, or for use on vertical or overhead surfaces
- Bonding paper, wood, cork, foam, leather, card, metals and plastics

P1 NSF Reg. No.: 123009



Loctite® 460

- For applications where cosmetic aspects and low bloom are required
- For low odour during use
- For porous substrates such as wood, paper, leather, cork and fabric



Loctite® 3090

- For applications with gaps up to 5 mm or where excess of adhesive is present
- For applications where cosmetic aspects and low bloom are required
- For porous substrates such as wood, paper, leather, cork and fabric

Instant Bonding

Product list

Product	Chemical basis	Viscosity in mPa-s	Colour	Fixture time	Substrates		
					Plastics/Polyolefins	Rubbers	Metals
Loctite® 382	Ethyl	6,000	Colourless transparent	20 – 40 sec.	● / ●*	●	●
Loctite® 401	Ethyl	100	Colourless transparent	3 – 10 sec.	● / ●*	●	●
Loctite® 403	Alkoxy ethyl	1,200	Colourless transparent	5 – 20 sec.	● / ●*	●	●
Loctite® 406	Ethyl	20	Colourless transparent	2 – 10 sec.	●● / ●●*	●●	●
Loctite® 407	Ethyl	30	Colourless transparent	5 – 20 sec.	● / ●*	●	●●
Loctite® 408	Alkoxy ethyl	5	Colourless transparent	5 – 10 sec.	● / ●*	●	●
Loctite® 409	Ethyl	Gel	Colourless transparent	20 – 60 sec.	● / ●*	●	●
Loctite® 410	Ethyl	3,000	Black	30 – 60 sec.	● / ●*	●	●
Loctite® 414	Ethyl	90	Colourless transparent	2 – 10 sec.	● / ●*	●	●
Loctite® 415	Methyl	1,200	Colourless transparent	20 – 40 sec.	● / ●*	●	●●
Loctite® 416	Ethyl	1,200	Colourless transparent	20 – 40 sec.	● / ●*	●	●
Loctite® 420	Ethyl	2	Colourless transparent	5 – 20 sec.	●● / ●*	●	●
Loctite® 422	Ethyl	2,300	Colourless transparent	20 – 40 sec.	● / ●*	●	●
Loctite® 424	Ethyl	100	Colourless transparent	2 – 10 sec.	●● / ●●*	●●	●
Loctite® 431	Ethyl	1,000	Colourless transparent	5 – 10 sec.	● / ●*	●	●
Loctite® 435	Ethyl	200	Colourless transparent	10 – 20 sec.	●● / ●*	●●	●●
Loctite® 438	Ethyl	200	Black	10 – 20 sec.	● / ●*	●	●●
Loctite® 454	Ethyl	Gel	Colourless transparent	5 – 10 sec.	● / ●*	●	●
Loctite® 460	Alkoxy ethyl	40	Colourless transparent	5 – 20 sec.	● / ●*	●	●
Loctite® 480	Ethyl	200	Black	20 – 50 sec.	● / ●*	●●	●●
Loctite® 493	Methyl	3	Colourless transparent	10 – 30 sec.	● / ●*	●	●●
Loctite® 495	Ethyl	30	Colourless transparent	5 – 20 sec.	● / ●*	●	●
Loctite® 496	Methyl	125	Colourless transparent	10 – 30 sec.	● / ●*	●	●●
Loctite® 3090	Ethyl	Gel	Colourless transparent	90 – 150 sec.	● / ●*	●●	●
Loctite® 4011 ^{Med}	Ethyl	100	Colourless transparent	3 – 10 sec.	● / ●*	●	●
Loctite® 4014 ^{Med}	Ethyl	2	Colourless transparent	10 – 30 sec.	● / ●●*	●	●

Med = Certified according to ISO 10993 for medical device manufacturing

●● Highly Recommended

● Recommended

* In combination with Primer Loctite® 770

	Porous and/or acidic surfaces	Service temperature range	Properties		Pack sizes	Comments
			Low odour/cosmetic appearance	Flexible/impact resistance		
		-40 to +80 °C		- / ●	Kit	General purpose, gel
	● ●	-40 to +80 °C			3g, 20g, 50g, 500g	Universal, low viscosity
	● ●	-40 to +80 °C	● ● / ● ●		20g, 50g, 500g	Low bloom, low odour, medium viscosity
		-40 to +80 °C			20g, 50g, 500g, 2kg	Plastics & rubber, low viscosity
		-40 to +100 °C			50g	High temperature, low viscosity
	● ●	-40 to +80 °C	● ● / ● ●		20g, 500g	Low bloom, low odour, capillary
		-40 to +80 °C			20g	General purpose, gel
		-40 to +80 °C		● / ● ●	20g	Toughened, black, high viscosity
		-40 to +80 °C			20g	General purpose, low viscosity
		-40 to +80 °C			20g, 50g, 500g	Metals, medium viscosity
		-40 to +80 °C			20g, 50g, 500g	General purpose, medium viscosity
		-40 to +80 °C			20g, 500g, 2kg	General purpose, capillary
		-40 to +80 °C			20g, 50g, 500g	General purpose, high viscosity
		-40 to +80 °C			20g, 500g	Plastics & rubber, low viscosity
	● ●	-40 to +80 °C			20g, 500g	Universal, medium viscosity
	● ●	-40 to +100 °C		● / ● ●	20g, 500g	Toughened, clear
	● ●	-40 to +100 °C		● / ● ●	20g	Toughened, black, fast
	● ●	-40 to +80 °C			10g, 20g, 300g	Universal, gel
	● ●	-40 to +80 °C	● ● / ● ●		20g, 50g 500g	Low bloom, low odour, low viscosity
		-40 to +100 °C		● / ● ●	20g, 500g	Toughened, black, slow
		-40 to +80 °C			50g	Metals, capillary
		-40 to +80 °C			20g, 50g, 100g, 500g	General purpose, low viscosity
		-40 to +80 °C			20g, 50g, 100g, 500g	Metals, low viscosity
	● ●	-40 to +80 °C	● / ● ●		10g	Gap filling, 2-component, low bloom
	● ●	-40 to +80 °C			20g, 454g	Universal, low viscosity
		-40 to +80 °C			20g	Plastics & rubber, capillary

Instant Bonding

Product list

Product	Chemical basis	Viscosity in mPa-s	Colour	Fixture time	Substrates		
					Plastics/ Polyolefines	Rubbers	Metals
Loctite® 4031 ^{Med}	Alkoxy ethyl	1,200	Colourless transparent	20 – 60 sec.	● / ●*	●	●
Loctite® 4061 ^{Med}	Ethyl	20	Colourless transparent	2 – 10 sec.	●● / ●●*	●●	●
Loctite® 4062	Ethyl	2	Colourless transparent	2 – 5 sec.	●● / ●●*	●●	●
Loctite® 4204	Ethyl	4,000	Colourless transparent	10 – 30 sec.	● / ●*	●	●●
Loctite® 4601 ^{Med}	Alkoxy ethyl	40	Colourless transparent	20 – 60 sec.	● / ●*	●	●
Loctite® 4850	Ethyl	400	Colourless transparent	3 – 10 sec.	●● / ●*	●●	●
Loctite® 4860	Ethyl	4,000	Colourless transparent	3 – 10 sec.	● / ●*	●	●

Med = Certified according to ISO 10993 for medical device manufacturing

- Highly Recommended
- Recommended
- * In combination with Primer Loctite® 770

	Porous and/or acidic surfaces	Service temperature range	Properties		Pack sizes	Comments
			Low odour/cosmetic appearance	Flexible/impact resistance		
		-40 to +80 °C	●●/●●		454g	Low bloom, low odour, medium viscosity
		-40 to +80 °C			20g, 454g	Plastics & rubber, low viscosity
		-40 to +80 °C			20g, 50g, 500g	Plastics & rubber, capillary
		-40 to +120 °C		●/●●	20g, 500g	High temperature, good impact resistance
		-40 to +80 °C	●●/●●		20g	Low bloom, low odour, low viscosity
	●●	-40 to +80 °C		●●/-	20g, 500g	Flexible, bendable, low viscosity
	●●	-40 to +80 °C		●●/-	20g, 500g	Flexible, bendable, high viscosity



Light Cure Adhesives

For fast processing

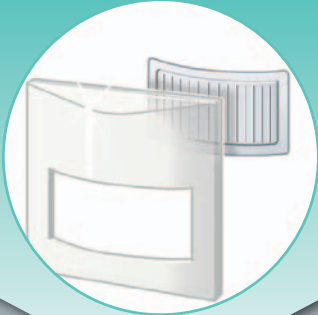

Why use a Loctite® Light Cure Adhesive?

In addition to their excellent bonding characteristics and transparency, light cure adhesives also provide unique processing advantages and compelling process cost reduction benefits. When exposed to sufficient light of the appropriate wavelength, they cure very rapidly and allow fast production cycles, in-line quality control and fast cycling to subsequent process steps. For best performance, light cure adhesives are available in various adhesive families. Loctite® Light Cure Equipment is engineered to match the adhesives with respect to intensity and radiation spectrum, and suit specific part size and manufacturing process requirements.

Advantages of Loctite® Light Cure Adhesives:

Light cure technology offers a unique combination of performance, design and processing benefits:

Cure on demand

- Material remains liquid until exposed to light systems, then cures in seconds
- Allows time to align parts precisely prior to cure
- Choice of cure system determines cure time

High speed of cure

- Achieves high process speeds for maximum throughput
- Fast cycling to subsequent process steps

Optical clarity

- Ideal for bonding clear and transparent substrates with perfect aesthetic finish
- Greatly expands the design options

Quality assurance

- Product presence monitoring by fluorescence
- Fast snap cure allows 100% in-line inspection
- Monitoring functions for cure parameters such as intensity, exposure time, etc.

One part systems

- Automated accurate dispensing
- No need to measure or mix, no pot life concerns
- Solvent-free

Choosing the right Loctite® Light Cure Adhesive:

To ensure reliable cure it is essential that the light reaches the adhesive. At least one of the bonded parts must be transparent to the curing wavelength of the adhesive selected. For UV-stabilised plastics, for example, visible light or INDIGO curing adhesives should be chosen.

Dual cure, initiated by heat or activator, moisture or anaerobic cure, can also be provided to cure adhesives in shadowed areas. Dual cure expands the benefits of light cure technology to non-transparent substrates, other adhesive technologies and application areas.

The targeted radiation wavelength is another key factor. Visible light offers a safer working environment. Especially the INDIGO light cure adhesives are designed to cure solely with low energy light in the visible spectrum. This eliminates the need for ventilation, reduces energy usage, and saves money due to fewer replacements, as well as reduced maintenance and repair.

Last but not least, adhesive performance is an important factor to consider. Loctite® Light Cure Adhesives cover the broadest range of adhesive technologies:

Loctite® Light Cure Adhesive Technologies

- Light cure acrylics offer the most extensive variety of properties of all light cure chemistries. A transparency equal to glass and clear plastics, as well as versatile adhesion characteristics are their most notable properties
- Light cure silicones, which cure into soft, flexible thermoset elastomers, are excellent for elastic bonding, sealing and leak proofing
- Light cure cyanoacrylates offer outstanding plastic bonding capabilities combined with rapid cure at low intensity light irradiation
- Light cure anaerobics show excellent metal bonding capabilities and offer outstanding chemical resistance combined with shadow cure



Surface Preparation

Correct surface preparation is a key factor to assure the total success of any adhesive performance.

- The surfaces to be bonded should be clean, dry and free of grease. If necessary, clean the parts with Loctite® 7063 or Loctite® 7070 and allow to dry (see Cleaning on page 96)

Dispensing Equipment and Light Cure Systems

For some jobs it is sufficient to dispense the product manually from the bottle onto the parts to be bonded. In other cases, however, more precise hand-held or stationary automated dispensing is required. Loctite® dispensing equipment is specially designed to make application and use of our products fast, precise, clean and economical:

Semi-Automatic Dispensing System Loctite® 1388647

The system is suitable for dispensing dots or beads of low to medium viscosity Loctite® light cure adhesives, and is designed for integration into automated assembly lines. The valve is a modular design used to facilitate field repairs. The reservoir accommodates up to 1.0 litre Loctite® bottles. The controller actuates valve, reservoir and start of operation via footswitch, keyboard or higher ranking PLC. An airline filter/regulator is included to provide filtered air supply.

Light Cure Systems

Loctite® Light Cure Systems are available for manual workstations as well as for production line integration. Various bulb and LED technologies ensure the proper wavelength adapted to the adhesive selected and the transparency of the parts to be bonded (for more details see Light Cure Equipment on page 134).

For information on semi or fully-automatic dispensing equipment, available valves, spare parts, accessories and dispensing tips, please refer to page 128 or the Loctite® Equipment Sourcebook.

1388647



97055



Light Cure Adhesives

Product table

Is a shadow area created by a non-transparent substrate? Is a secondary cure needed for shadow areas?

No

Are you bonding glass?

Glass and other substrates

Capillary

Ultra clear

Fast cure

High strength &

Low viscosity

Solution

3081

3491

3494

3922

Chemistry	Acrylic	Acrylic	Acrylic	Acrylic
Viscosity	100 mPa·s	1,100 mPa·s	6,000 mPa·s	300 mPa·s
Colour	Clear	Clear	Clear	Transparent, colourless
Fluorescence	Yes	No	No	Yes
Service temperature range	-40 to +120 °C	-40 to +130 °C	-40 to +120 °C	-40 to +130 °C
Pack sizes	25ml, 1 lt	25ml, 1 lt	25ml, 1 lt	25ml, 1 lt



Loctite® 3081

- UV-light curing acrylic
- Low viscosity, wicking grade for post assembly applications
- For bonding glass, plastics, metals, etc.



Loctite® 3491

- UV-light curing acrylic
- Low yellowing in sunlight environment
- For bonding glass, plastics, metals, etc.



Loctite® 3494

- UV-light and/or visible light curing acrylic
- Low yellowing in sunlight environment
- For bonding glass, plastics, metals, etc.

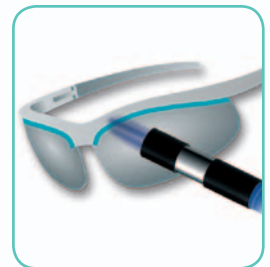

Loctite® 3922

- UV-light and/or visible light curing acrylic
- Low yellowing in sunlight environment
- For bonding plastics, metals, etc.

* more products with secondary cure mechanism, please see table on page 42

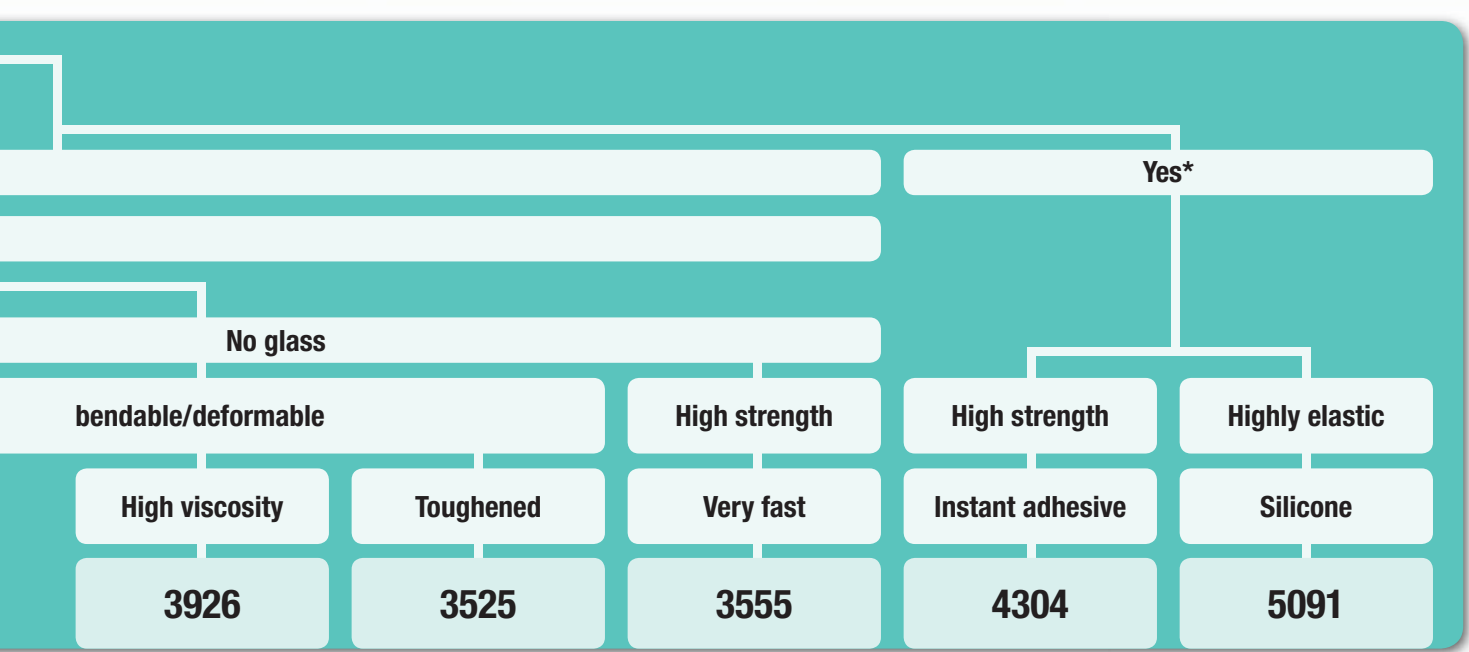

Acrylic	Acrylic	Acrylic	Cyanoacrylate	Silicone
5,500 mPa·s	15,000 mPa·s	1,000 mPa·s	20 mPa·s	5,000 mPa·s
Transparent, colourless	Clear	Transparent, yellow	Transparent, pale green	Translucent, slightly milky
Yes	No	Yes	No	No
-40 to +150 °C	-40 to +140 °C	-40 to +100 °C	-40 to +100 °C	-60 to +180 °C
25ml, 1 lt	25ml, 1 lt	25ml, 1 lt	28g, 1 lb	300ml



Loctite® 3926

- UV-light and/or visible light curing acrylic
- Low yellowing in sunlight environment
- For bonding plastics, metals, etc.



Loctite® 3525

- UV-light and/or visible light curing acrylic
- Low yellowing in sunlight environment
- For bonding plastics, metals, etc.



Loctite® 3555

- Very fast light cure acrylic
- Cures with UV-light, visible light and INDIGO light
- For bonding plastics, metals etc.

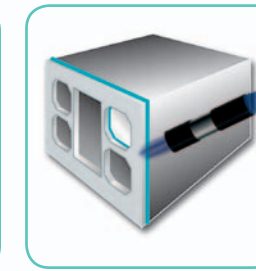

Loctite® 4304

- UV-light and/or visible light curing cyanoacrylate
- Cures in bond gaps by surface humidity
- For bonding plastics, metals, paper etc.

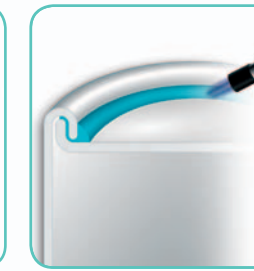

Loctite® 5091

- UV-light curing silicone with secondary RTV cure
- For elastic sealing and bonding applications
- Good adhesion on metals, glass and most plastics

Light Cure Adhesives

Product list

Product/grade	Chemical basis	Suitable wavelengths for cure	Secondary cure system	Viscosity in mPa·s	Service temperature range °C	Depth of cure in mm	Colour	Fluorescence
Loctite® 322	Acrylic	UV	No	5,500	-40 to +100	4	Transparent, light amber	No
Loctite® 350	Acrylic	UV	No	4,500	-40 to +120	4	Transparent, light amber	No
Loctite® 352	Acrylic	UV	Activator 7075	15,000	-40 to +150	4	Transparent, amber	No
Loctite® 3011 ^{Med}	Acrylic	UV	No	110	-40 to +100	4	Transparent, light amber	No
Loctite® 3081 ^{Med}	Acrylic	UV	No	100	-40 to +120	4	Clear	Yes
Loctite® 3211 ^{Med} Loctite® 3103	Acrylic	UV/VIS	No	10,000 thixo.	-40 to +140	>13	Transparent, amber	No
Loctite® 3301 ^{Med}	Acrylic	UV/VIS	No	160	-40 to +130	>13	Transparent, colourless	No
Loctite® 3311 ^{Med} Loctite® 3105	Acrylic	UV/VIS	No	300	-40 to +130	>13	Transparent, colourless	No
Loctite® 3321 ^{Med} Loctite® 3106	Acrylic	UV/VIS	No	5,500	-40 to +150	>13	Transparent, light yellow	No
Loctite® 3341 ^{Med}	Acrylic	UV/VIS	No	500	-40 to +100	>13	Transparent, light yellow	Yes
Loctite® 3345 ^{Med}	Acrylic	UV	No	1,500	-40 to +120	4	Transparent, light amber	No
Loctite® 3381 ^{Med}	Acrylic	UV	No	5,100	-40 to +130	4	Translucent, colourless	No
Loctite® 3491	Acrylic	UV	No	1,100	-40 to +130	4	Clear	No
Loctite® 3494	Acrylic	UV/VIS	No	6,000	-40 to +120	>13	Clear	No
Loctite® 3525	Acrylic	UV/VIS	No	15,000	-40 to +140	>13	Clear	Yes
Loctite® 3526	Acrylic	UV/VIS	Heat, 120 °C @ 15 min.	17,500	-40 to +140	>13	Transparent, amber	Yes
Loctite® 3554 ^{Med}	Acrylic	UV/VIS/INDIGO	No	300	-40 to +100	>13	Transparent, yellow	Yes

Med = Certified according to ISO 10993 for medical device manufacturing

* Cured with Loctite® 97055, 100 mW/cm² at 365 nm

** Irradiated with 6 mW at 365 nm

	Tack free time* in sec.	Fixturing time** in sec.	Shore hardness	Substrates				Pack sizes	Comments
				Glass	Plastics	Metals	Ceramics		
	4	10	D 68		••	•	•	250ml, 1 lt	Fast surface cure
	20	15	D 70	••	•	••	•	50ml, 250ml	High humidity and chemical resistance
	17	10	D 60	••		••	••	50ml, 250ml	High humidity and chemical resistance, toughened
	8	10	D 68		••	•	•	Not available in the UK	Fast surface cure
	8	10	D 74	••	••	•	•	25ml, 1 lt	Fast surface cure
	>30	12	D 51	•	••	••	•	25ml, 1 lt	For stress-sensitive plastics
	>30	12	D 69	•	••	••	•	25ml	For stress-sensitive plastics
	>30	12	D 64	•	••	••	•	25ml, 1 lt	For stress-sensitive plastics
	>30	12	D 53	•	••	••	•	25ml, 1 lt	For stress-sensitive plastics
	15	8	D 27		••	•	•	1 lt	Highly flexible, for soft PVC
	30	15	D 70	••	•	••	•	Not available in the UK	High humidity and chemical resistance
	>30	30	A 72	•	••	•	•	25ml, 1 lt	Highly flexible, high thermal cycle resistance
	15	12	D 75	••	••	••	•	25ml, 1 lt	High transparency, low yellowing
	>30	8	D 65	••	••	••	•	25ml, 1 lt	High transparency, low yellowing
	10	5	D 60	•	••	••	•	25ml, 1 lt	High strength, toughened
	<5	5	D 62	••	••	••	••	25ml, 1 lt	Glass and plastic bonder, with heat cure
	10	5	D 75		••	•	•	25ml, 1 lt	Fast cure, for coloured transparent substrates

•• Highly recommended
• Recommended

Light Cure Adhesives

Product list

Product/grade	Chemical basis	Suitable wavelengths for cure	Secondary cure system	Viscosity in mPa-s	Service temperature range °C	Depth of cure in mm	Colour	Fluorescence
Loctite® 3555 ^{Med}	Acrylic	UV/VIS INDIGO	No	1,000	-40 to +100	>13	Transparent, yellow	Yes
Loctite® 3556 ^{Med}	Acrylic	UV/VIS/INDIGO	No	5,000	-40 to +100	>13	Transparent, yellow	Yes
Loctite® 3921 ^{Med}	Acrylic	UV/VIS	No	150	-40 to +130	>13	Transparent, colourless	Yes
Loctite® 3922 ^{Med}	Acrylic	UV/VIS	No	300	-40 to +130	>13	Transparent, colourless	Yes
Loctite® 3926 ^{Med}	Acrylic	UV/VIS	No	5,500	-40 to +150	>13	Transparent, colourless	Yes
Loctite® 3936 ^{Med}	Acrylic	UV/VIS	No	11,000	-40 to +140	>13	Transparent, colourless	Yes
Loctite® 4304 ^{Med}	Cyano-acrylate	UV/VIS	Surface moisture	20	-40 to +100	>13	Transparent, pale green	No
Loctite® 4305 ^{Med}	Cyano-acrylate	UV/VIS	Surface moisture	900	-40 to +100	>13	Transparent, pale green	No
Loctite® 5083	Silicone	UV	Atmospheric moisture	Thixo. paste	-60 to +200	5	Translucent, colourless	No
Loctite® 5088 / Loctite® 5248 ^{Med}	Silicone	UV	Atmospheric moisture	65,000	-60 to +200	1.5	Translucent, straw coloured	No
Loctite® 5091	Silicone	UV	Atmospheric moisture	5,000	-60 to +180	4	Translucent, slight milky	No

Med = Certified according to ISO 10993 for medical device manufacturing

* Cured with Loctite® 97055, 100 mW/cm² at 365 nm

** Irradiated with 6 mW at 365 nm

Tack free time* in sec.	Fixturing time** in sec.	Shore hardness	Substrates				Pack sizes	Comments
			Glass	Plastics	Metals	Ceramics		
10	5	D 77		••	•	•	25ml, 1 lt	Fast cure, for coloured transparent substrates
10	5	D 68		••	•	•	25ml, 1 lt	Fast cure, for coloured transparent substrates
>30	3	D 67	•	••	•	•	25ml, 1 lt	For stress-sensitive plastics
>30	5	D 66	•	••	•	•	25ml, 1 lt	For stress-sensitive plastics
>30	3	D 57	•	••	•	•	25ml, 1 lt	For stress-sensitive plastics
>30	12	D 55	•	••	•	•	25ml, 1 lt	For stress-sensitive plastics
<5	2	D 72		••	•	•	28g, 1 lb	High plastic adhesion, low intensity cure
<5	2	D 77		••	•	•	28g, 454g	High plastic adhesion, low intensity cure
20	>30	A 55	••	•	••	••	10.8oz, 18kg	Highly flexible, acetoxy silicone
>30	>30	A 30	••	•	••	••	Not available in the UK	Highly flexible, alkoxy silicone
30	>30	A 34	••	•	••	••	300ml	Highly flexible, acetoxy silicone

•• Highly recommended
 • Recommended



Hotmelt Adhesives

Solutions for fast processing applications



Why use a Henkel Hotmelt Adhesive?

Hotmelt adhesives are available in solid form as granules, cubes or sticks. They are based on various raw material groups, such as ethylene vinyl acetate copolymer (EVA), polyamide (PA), polyolefin copolymer (APP).

Reactive hotmelt adhesives based on polyurethane (PUR hotmelts) undergo an additional crosslinking reaction after cooling.

- Hotmelts are: used for rapid initial strength
- Are applied by means of special equipment or hot melt guns

Hotmelt adhesives were developed to bond a variety of substrates, including difficult-to-bond plastics. These adhesives can handle today's toughest applications in a broad range of industries. Hotmelts are ideal for applications that require high-speed manufacturing, bonding versatility, very large gap filling, fast green strength, and minimal shrinkage.

Hotmelt adhesives offer many benefits – from open times ranging from seconds to minutes, eliminating the need for clamps or fixtures, to long-term durability and excellent resistance to moisture, chemicals, oils, and temperature extremes.

Hotmelt products are solvent-free.

Advantages Hotmelt in general

- High manufacturing speed (short setting time)
- Process can be easily automated
- Combination of adhesives and sealants

Advantages Polyamide Hotmelts

- Good resistance to oils
- High temperature resistance
- Good flexibility at lower temperatures

Advantages Pressure sensitive Hotmelts

- Permanently tacky
- Self adhesive coating
- Coating and assembly can be separated

Advantages Polyolefin Hotmelts

- Good adhesion to PP (without corona or similar pretreatment)
- Good chemical resistance to acids, alcohols
- Higher temperature resistance than EVA

Advantages Polyurethane Hotmelts

- Low application temperature
- Long open time
- MicroEmission products available

Advantages Ethylene vinylacetate Hotmelts

- Low viscosity
- Fast melting
- High application speed

Key factors to consider when choosing the right product

Temperature resistance

Different hotmelt systems covering different service temperature ranges. Temperature resistance up to 150 °C can be achieved.

Adhesion to different substrates

There are hotmelt systems providing adhesion to polar and/or non-polar substrates. They will bond different plastics, metals, wood and paper.

Chemical resistance

Hotmelt systems also differ with respect to chemical resistance. Products are available for use in contact with oils, cleaners and even battery acid.

Strengths

Thermoplastic hotmelts reach their final strength immediately after cooling. At elevated temperatures they soften again. In addition, they can be used as resins in hotmelt moulding processes. Polyurethane hotmelts are cross-linked by moisture to form a thermoset plastic that cannot be melted and re-shaped after it is cured.

Product safety of reactive Hotmelts

Purmelt ME (MicroEmission) is a PUR hotmelt adhesive innovation. **These products do not need to be labeled as hazardous material.**

They contain less than < 0.1 % of monomeric isocyanate. This is below the limit currently specified as harmful to human health under legislation of the EU member states.

Purmelt ME is a new PUR hotmelt adhesive product line.



Surface Preparation

Surfaces should be clean and free from grease. Corona or plasma pre-treatment will improve adhesion to plastic substrates. Metal substrates can be preheated to improve adhesion.

Equipment

Glue guns for processing sticks, cartridges or granules offer simple hand-held application solutions. A wide range of different melting units is available for semi or fully-automated production environments. Drum unloaders and adhesive extruders are recommended for very high volume applications. Roller coaters are suitable for applying hotmelt coatings.

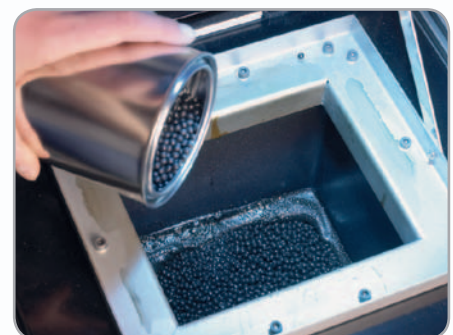

Hotmelt Adhesives

Product table

Thermoplastic setting

Chemical base

Rubber

Polyamide

Polyolefin

Pressure sensitive

Broad adhesion spectrum

Macromelt moulding

Primerless PP adhesion

Solution

Technomelt Q 8707

Macromelt 6238

Macromelt OM 657

Technomelt Q 5374

Density	1.0 g/cm ³	0.98 g/cm ³	0.98 g/cm ³	0.95 g/cm ³
Softening temperature	105 to 115 °C	133 to 145 °C	150 to 165 °C	92 to 104 °C
Application temperature range	150 to 180 °C	180 to 220 °C	180 to 230 °C	160 to 200 °C
Open time	Pressure sensitive	Short	Short	Medium
Melt viscosity in mPa-s @ 130°C	-	-	-	-
Melt viscosity in mPa-s @ 160 °C	-	21,000 – 33,000	-	-
Melt viscosity in mPa-s @ 180 °C	3,200 – 4,800	10,000 – 16,000	8,600	2,250 – 2,950
Pack sizes	approx. 15kg X-tra (cushion)	20kg granules	20kg granules	approx. 13.5kg X-tra (cushion)

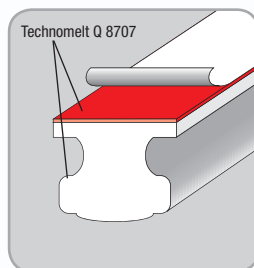

Technomelt Q 8707

- Solvent-free
- Permanently tacky
- Good adhesion to a variety of substrates
- Good temperature resistance

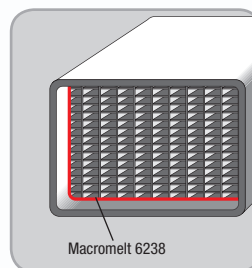

Macromelt 6238

- Solvent-free
- Good adhesion to metals and plastics
- Suitable for plasticised PVC
- Oil resistance

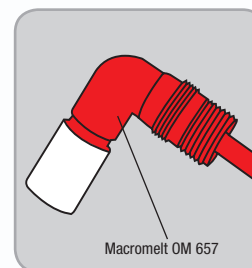

Macromelt OM 657

- Solvent-free
- Macromelt moulding
- Oil resistance
- High service temperature

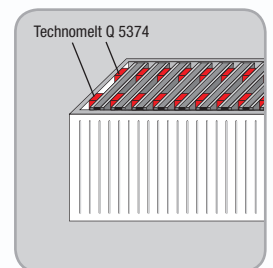

Technomelt Q 5374

- Solvent-free
- PP bonder
- Long open time

* MicroEmission (ME), contains less than 0,1 % isocyanate monomer and reduces isocyanate vapours up to 90 %

Thermoplastic setting + Chemical post cure

Chemical base

Ethylene vinyl acetate

Polyurethane

Long open time

Short open time

Micro-emission

Standard

Granules

Sticks

Multi-purpose

Multi-purpose

Fast-setting

**Technomelt
Q 3113**

**Technomelt
Q 9268H**

**Purmelt
ME 4663***

**Purmelt
QR 4663**

**Purmelt
QR 3460**

1.0 g/cm³

1.0 g/cm³

1.15 g/cm³

1.13 – 1.23 g/cm³

1.18 g/cm³

99 to 109 °C

82 to 90 °C

–

–

–

160 to 180 °C

170 to 190 °C

110 to 140 °C

110 to 140 °C

100 to 140 °C

Very short

Short

4 – 8 min.

4 – 8 min.

1 min.

17,000 – 23,000

–

5,000 – 13,000

6,000 – 12,000

6,000 – 15,000

6,600 – 8,800

24,000 – 30,000

–

–

–

3,800 – 5,800

–

–

–

–

25kg granules

10kg sticks

2kg candles,
190kg drums

2kg candles, 20kg pails,
190kg drums

300g cartridge,
2kg candles, 20kg pails,
190kg drums

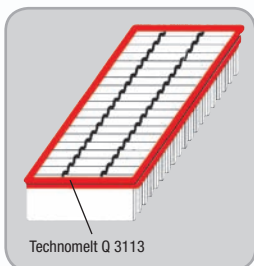

Technomelt Q 3113

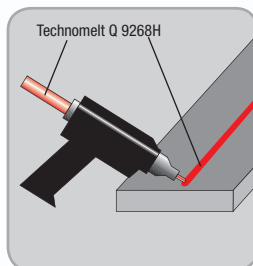

Technomelt Q 9268H

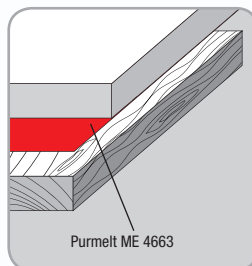

Purmelt ME 4663

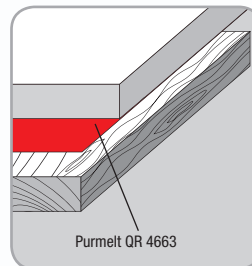

Purmelt QR 4663

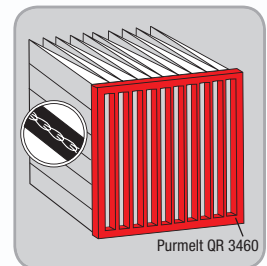

Purmelt QR 3460

Technomelt Q 3113

- Solvent-free
- BHT-free
- Low fogging
- Short setting time
- Low shrinkage on cooling

Technomelt Q 9268H

- Solvent-free
- Hotmelt sticks
- Wide range of adhesion
- Long open time
- Good impact strength

Purmelt ME 4663

- Solvent-free
- Long open time
- Low application temperature
- High temperature resistance

Purmelt QR 4663

- Solvent-free
- Long open time
- Low application temperature
- High temperature resistance
- Flame retardant (IMO FTCP Part 5)

Purmelt QR 3460

- Solvent-free
- Medium open time
- Low application temperature
- High temperature resistance

Solvent-based / Water-based Adhesives

Contact adhesive with good initial strength

Solvent-based adhesives

Solvent-based adhesives (polychloroprene) are formulated with different raw material groups including natural and synthetic rubbers and suitable resin combinations (naphthas, ketones, esters or aromatics). Adhesive films will be formed upon evaporation of solvents. Assemblies may be made by contact bonding (adhesive application to both surfaces) or wet bonding (applied to one of the bond faces). Most of the contact adhesives are based on polychloroprene rubber. They display good initial strength and achieve high strengths on numerous substrates.

Terokal 2444

Terokal 2444 can be applied by brush and spatula. It is used to bond rubber to different surfaces e.g. metal, wood, and to itself. Terokal 2444 offers high initial bond strength and contactability. The bondline is flexible and provides good heat resistance.



Macroplast B 2140

Macroplast B 2140 is a solvent-based contact adhesive based on polychloroprene. The product exhibits good high-temperature strength and the ability to bond various substrates to one another. Macroplast B 2140 is suitable for spray application and is particularly useful when bonds have to withstand temperatures up to 120 °C.

Water-based products with improved bonding characteristics

Water based or “dispersion” adhesives contain insoluble resins which are finely distributed as solid particles in water. These adhesives set by evaporation of water. Cross-linking of the dispersed particles is achieved by adding mainly basic catalysts. As a result, the resistance of the bonded joint to water and heat is greatly improved.

Generally, dispersion adhesives do not contain solvents or other problematic chemicals, they are not harmful to the environment and less critical with regard to health and safety at work. Dispersion adhesives are applied by means of rollers or handguns. Setting of the adhesives can be accelerated by applying additional heat incl. air ventilation.

Adhesin A 7088

Adhesin A 7088 is a water-based dispersion. It is used for bonding plasticised PVC films and painted surfaces to paper and cardboard. Good bonding properties on alu-laminated PVDC-coated surfaces as well as polystyrene films.



Adhesin J 1626

Adhesin J 1626 is a water-based dispersion based on acrylic ester. It is a highly concentrated, fast setting dispersion adhesive and therefore suitable for high line speeds. Adhesin J 1626 is used for applying pressure-sensitive adhesives to paper, fabric and plastics films/sheets, for coating aluminium and plastics signboards, screens and indicating dials for the electrical/phono industries and bonding aluminium foil to aluminium sheet.

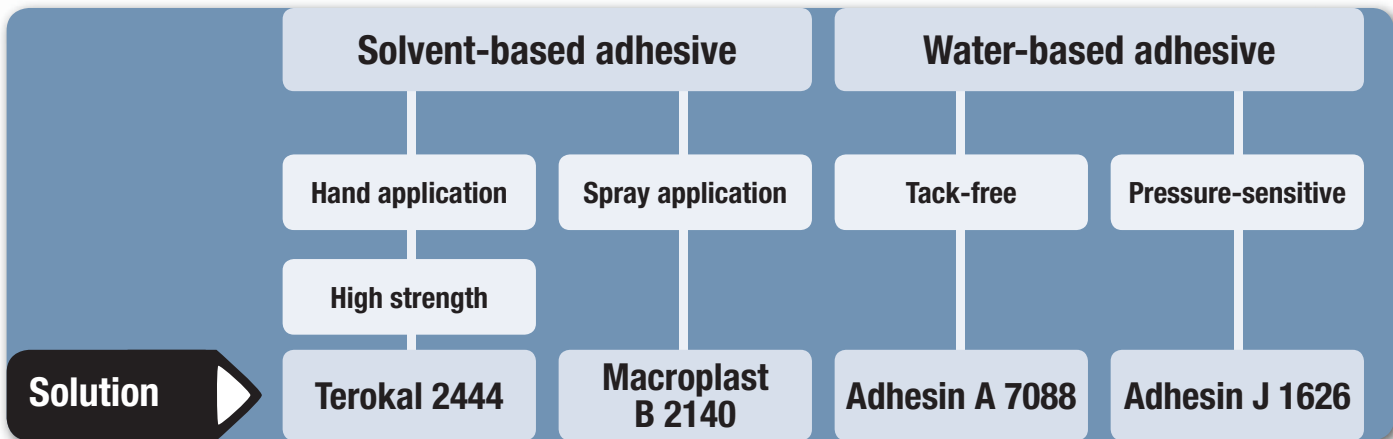

Technology	Solvent-based adhesive	Solvent-based adhesive	Water-based adhesive	Water-based adhesive
Chemical base	Polychloroprene	Polychloroprene	Dispersion	Acrylate dispersion
Solids contents	approx. 30 %	15 – 18 %	57 – 61 %	65.5 – 68.5 %
Viscosity	approx. 3,000 mPa·s	approx. 140 – 300 mPa·s	4,000 – 6,000 mPa·s	2,000 – 3,400 mPa·s
pH-value	–	–	3 – 5	6 – 8
Service temperature range	-30 to +90 °C (100 °C)	-30 to +120 °C (130 °C)	–	–
Usage	150 – 300 g/m ²	150 – 250 g/m ²	–	–
Density	approx. 0.89 g/cm ³	0.78 – 0.88 g/cm ³	–	approx. 1.0 g/cm ³
Colour	Beige	Beige	White	White
Pack sizes	340g, 5kg	Not available in the UK	30kg	Not available in the UK

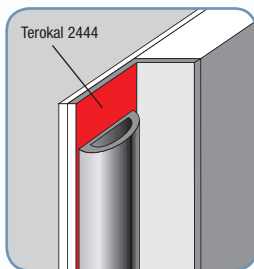

- Terokal 2444**
- Good adhesion to rubber
 - High strength
 - High contactability

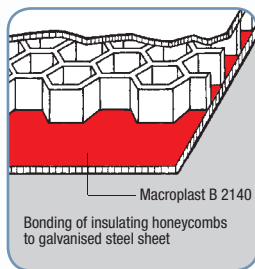

- Macroplast B 2140**
- Good sprayability
 - High temperature resistance

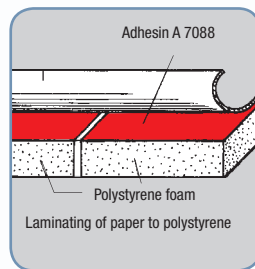

- Adhesin A 7088**
- Good adhesion to plasticised PVC and polystyrene foils
 - Soft elastic dry film

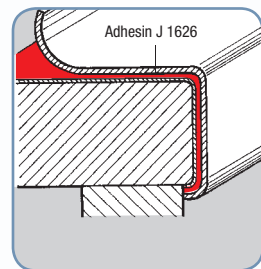

- Adhesin J 1626**
- Good surface tackiness
 - High cohesion

Structural Bonding

For demanding requirements

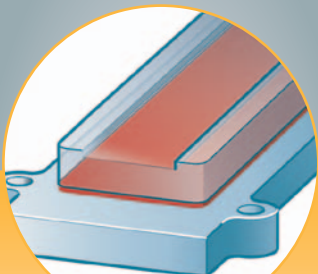
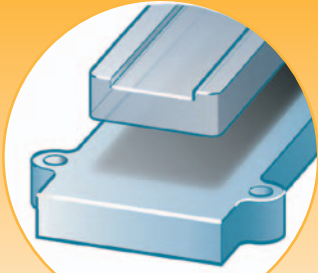

Why use a Henkel Adhesive for Structural Bonding?

The Henkel range of Structural Bonding products offers a wide choice of solutions to meet the different requirements and conditions that apply to industrial design and construction.

Bonding:

Adhesive bonding is a process in which two similar or dissimilar materials are permanently joined. Adhesives build "bridges" between the surfaces of substrates to be joined.

To achieve the optimal bonding result, the following prerequisites must be met:

- Compatibility of the adhesive with the materials to be bonded
- Compatibility of the adhesive with the specified requirements
- Correct application of the adhesive

Advantages of adhesive bonding compared to conventional joining methods:

More uniform stress distribution over the entire bond face:

This has a very positive effect on the static and dynamic strength achieved. Where welding and riveting result in localised stress peaks, adhesive bonding achieves uniform distribution and absorption of stress loads.

No change in surface and texture of the joined materials:

Welding temperatures may change the texture and therefore the mechanical properties of materials. In addition, welding, riveting and bolting all affect the visual appearance of the parts.

Weight saving:

Adhesives are particularly popular for light-weight constructions, where thin-walled parts (wall thickness < 0.5 mm) must be joined.

Sealed joints:

Adhesives also act as sealants, preventing loss of pressure or liquids, blocking the penetration of condensation water and protecting against corrosion.

Joining dissimilar materials and reducing the risk of corrosion:

The adhesive forms an insulating film to prevent contact corrosion when different types of metals are joined. It also acts as electrical and thermal insulator.

Choosing the right Henkel Structural Bonding Adhesive:

The following key points should be observed for the design of bonded joints:

- The surfaces to be joined should be as large as possible for maximum load transmission capability
- Forces acting on the joint should be distributed across the entire bond line

Joint designs suitable for adhesive bonding:

All design with shear, tensile or compressive load e.g. single and double lap joint, single and double cover plate, tapered overlap and double overlapping.

Joint designs not suited for adhesive bonding:

Butt joint, cleavage loading and peel loading.

Rigid Bonding

Rigid adhesives are mainly used for high load transmission to replace common mechanical joining methods. Two parts bonded with such an adhesive could be considered as structurally linked. Mechanical characteristics like high strength, high modulus and high adhesion have proven to be effective for customer applications in demanding industries like aerospace and automotive.

Rigid bonding offers significant benefits:

- Simplifies construction by increasing strength/rigidity for load transmission
- Prevents material fatigue and failure by achieving uniform transmission of loads (stress distribution) and by maintaining the structural integrity (no thermal or mechanical weakening of parts)
- Saves production costs by replacing conventional mechanical fasteners (screws, rivets or welding)
- Saves material cost and saves weight by reducing material thickness while maintaining load transmission characteristics
- Allows the most varied substrate combinations, e.g. metal/plastics, metal/glass, metal/wood etc.

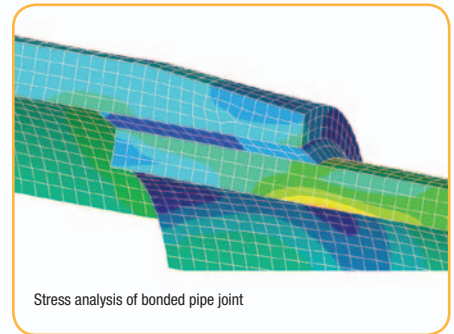

Stress analysis of bonded pipe joint

Elastic Bonding

Elastic adhesives are selected mainly for their capability to elastically absorb and/or compensate dynamic stresses, in addition to the load transmission properties of the adhesive assembly. Besides their elastic properties, many elastic adhesives from Henkel exhibit a high inherent strength (cohesion) and a relatively high modulus, achieving friction-locked joints which, at the same time, have elastic properties.

Elastic bonding offers significant benefits:

- Simplifies construction by increasing strength/rigidity to withstand dynamic loads
- Prevents material fatigue and failure by achieving uniform transmission of the load (stress distribution) and by maintaining the structural integrity (no thermal or mechanical weakening of parts)
- Saves production costs by replacing conventional mechanical fasteners (screws, rivets or welding)
- Allows the most varied substrate combinations, e.g. metal/plastics, metal/glass, metal/wood etc.
- Reduces and/or compensates stress caused by differential thermal expansion of joint substrates

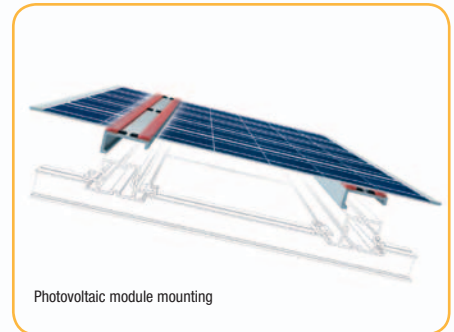

Photovoltaic module mounting

Available Technologies

Epoxies

- Rigid bonding
- 1- or 2-component solution
- Capability to fill large gap
- Very high strength
- For small to medium surfaces
- Very good chemical resistance

Acrylics

- Rigid to slightly flexible bonding
- 1- or 2-component solution
- For small surfaces
- Very high strength
- Good chemical resistance

Polyurethanes

- Slightly flexible bonding
- 2-component solution
- Capability to fill large gap
- High strength
- For medium to large surfaces
- Good chemical resistance

Silicones

- Flexible bonding
- 1- or 2-component solution
- Very high temperature resistance
- Very good chemical resistance

Silane modified Polymers

- Flexible bonding
- 1- or 2-component solution
- Bond most substrates

Structural Bonding – Epoxies

Product table

What is your focus?

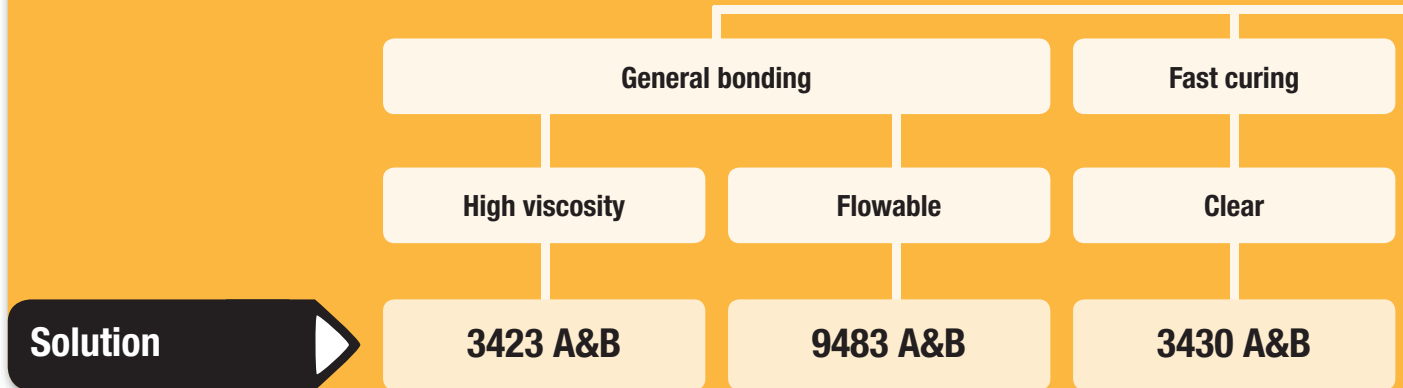

Description	2K-Epoxy	2K-Epoxy	2K-Epoxy
Mix ratio by volume (A:B)	1:1	2:1	1:1
Mix ratio by weight (A:B)	100:70	100:46	100:100
Working life	45 min.	30 min.	7 min.
Fixture time	180 min.	210 min.	15 min.
Colour	Grey	Ultra clear	Ultra clear
Viscosity	300 Pa·s	7 Pa·s	23 Pa·s
Shear strength (GBMS)	17 N/mm ²	23 N/mm ²	22 N/mm ²
Peel strength (GBMS)	2.7 N/mm	1.5 N/mm	3 N/mm
Service temperature range	-55 to +120 °C	-55 to +150 °C	-55 to +100 °C



Loctite® Hysol® 3423 A&B

- Non-sag paste
- Medium working life
- Excellent chemical resistance

Loctite® Hysol® 3423 A&B is a general purpose, 2K-Epoxy adhesive, suitable for gap filling and vertical applications. Ideal for bonding metal components.



Loctite® Hysol® 9483 A&B

- Flowable
- Ultra clear
- Low moisture absorption

Loctite® Hysol® 9483 A&B is a general purpose, 2K-Epoxy adhesive, suitable for bonding and potting where optical clarity and high strength are required. Ideal for bonding decorative panels and displays.



Loctite® Hysol® 3430 A&B

- Medium viscosity
- Ultra clear
- Toughened
- Water resistant

Loctite® Hysol® 3430 A&B is a five-minute, 2K-Epoxy adhesive, suitable for applications requiring an optically clear bond line. Ideal for bonding glass, decorative panels and displays and general DIY applications.

* Gel time @ 120 °C
 ** Cure time @ 120 °C or higher:
 see technical data sheet

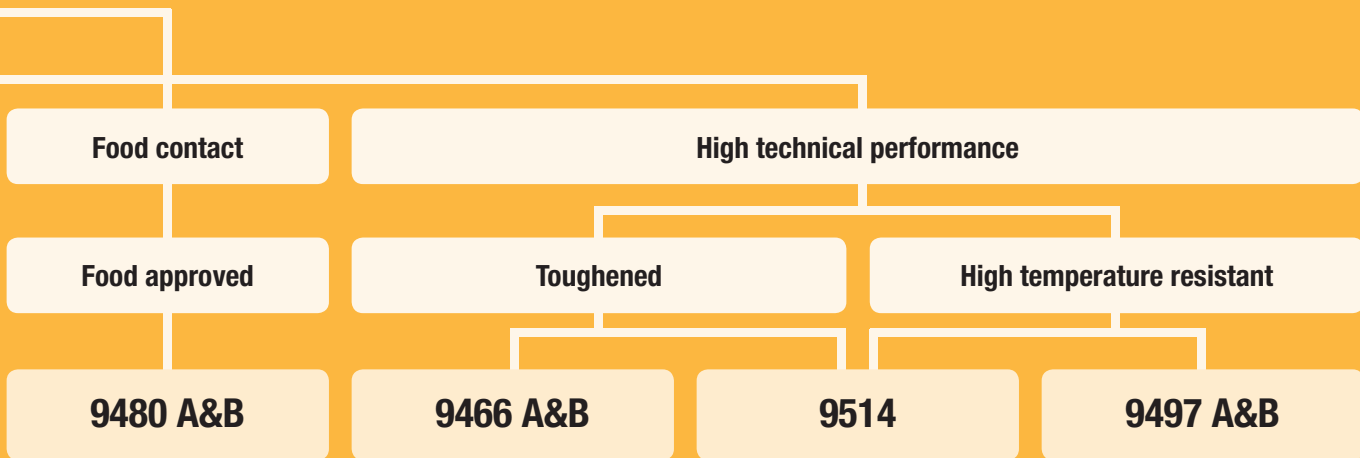

9480 A&B	9466 A&B	9514	9497 A&B
2K-Epoxy	2K-Epoxy	1K-Epoxy	2K-Epoxy
2:1	2:1	–	2:1
100:46.5	100:50	–	100:50
110 min.	60 min.	5 min.*	3 h
270 min.	180 min.	30 min.**	8 h
Off-white	Off-white	Grey	Grey
8.7 Pa-s	35 Pa-s	45 Pa-s	12 Pa-s
24 N/mm ²	37 N/mm ²	46 N/mm ²	20 N/mm ²
0.4 N/mm	8 N/mm	9.5 N/mm	–
-55 to +120 °C	-55 to +120 °C	-55 to +200 °C	-55 to +180 °C



Loctite® Hysol® 9480 A&B

- Good chemical resistance
- Toughened
- Good adhesion on stainless steel

Loctite® Hysol® 9480 A&B is a food approved 2K-Epoxy adhesive, suitable for bonding metals and most of plastic parts in and around food processing area.



Loctite® Hysol® 9466 A&B

- Medium viscosity
- Low density – SG = 1,0
- High strength

Loctite® Hysol® 9466 A&B is a toughened, 2K-Epoxy adhesive, suitable for multi-purpose applications requiring long open time and high bonding strength. Ideal for a wide variety of substrates like metals, ceramic and most plastics.



Loctite® Hysol® 9514

- Suitable for induction curing
- High shear and peel strength
- Excellent chemical resistance
- High temperature resistant (200 °C)

Loctite® Hysol® 9514 is a toughened, 1K-Epoxy adhesive, suitable for gap filling and resistance to high operating temperatures. Ideal for applications requiring toughness such as filter and magnet bonding.



Loctite® Hysol® 9497 A&B

- Medium viscosity
- High thermal conductivity
- High compression strength
- High temperature resistant (180 °C)

Loctite® Hysol® 9497 A&B is a thermally conductive, 2K-Epoxy adhesive for high temperature filling and bonding applications. Ideal for heat dissipation.

Structural Bonding – Epoxies

Product list

Product	Technology	Colour mix	Viscosity in Pa-s	Mix ratio by volume	Working life	Fixture time	Service temperature range
Loctite® Hysol® 3421	2K-Epoxy	Clear amber	37	1:1	30 – 150 min.	240 min.	-55 to +120 °C
Loctite® Hysol® 3423	2K-Epoxy	Grey	300	1:1	30 – 60 min.	180 min.	-55 to +120 °C
Loctite® Hysol® 3425	2K-Epoxy	Yellow / white	1,350	1:1	55 – 105 min.	240 min.	-55 to +120 °C
Loctite® Hysol® 3430	2K-Epoxy	Ultra clear	23	1:1	5 – 10 min.	15 min.	-55 to +100 °C
Loctite® Hysol® 3450	2K-Epoxy	Grey	35	1:1	4 – 6 min.	15 min.	-55 to +100 °C
Loctite® Hysol® 3455	2K-Epoxy	Grey	Pasty	1:1	40 min.	120 min.	-55 to +100 °C
Loctite® Hysol® 9450	2K-Epoxy	Translucent	200	1:1	2 – 7 min.	13 min.	-55 to +100 °C
Loctite® Hysol® 9461	2K-Epoxy	Grey	72	1:1	40 min.	240 min.	-55 to +120 °C
Loctite® Hysol® 9464	2K-Epoxy	Grey	96	1:1	10 – 20 min.	180 min.	-55 to +120 °C
Loctite® Hysol® 9466	2K-Epoxy	Off-white	35	2:1	60 min.	180 min.	-55 to +120 °C
Loctite® Hysol® 9480	2K-Epoxy	Off-white	8.7	2:1	110 – 190 min.	270 min.	-55 to +120 °C
Loctite® Hysol® 9483	2K-Epoxy	Ultra clear	7	2:1	25 – 60 min.	210 min.	-55 to +150 °C
Loctite® Hysol® 9489	2K-Epoxy	Grey	45	1:1	60 – 120 min.	300 min.	-55 to +120 °C
Loctite® Hysol® 9492	2K-Epoxy	White	30	2:1	15 min.	75 min.	-55 to +180 °C
Loctite® Hysol® 9497	2K-Epoxy	Grey	12	2:1	165 – 255 min.	480 min.	-55 to +180 °C
Loctite® Hysol® 9514	1K-Epoxy	Grey	45	–	–	Heat curing	-55 to +200 °C
Macroplast EP 3004 / 5004	2K-Epoxy	Grey	100	1:1	8 min.	240 min.	-55 to +70 °C
Macroplast EP 3032 / 5032	2K-Epoxy	Grey	80	1:1	120 min.	480 min.	-55 to +80 °C
Macroplast EP 3250 / 5250	2K-Epoxy	White	45	3:1	9 min.	12 min.	-55 to +150 °C
Macroplast EP 3640 / 5640	2K-Epoxy	Light yellow	3	2.3:1	120 min.	480 min.	-55 to +80 °C
Macroplast ESP 4108	1K-Epoxy	Silver	170	–	–	Heat curing	-55 to +180 °C
Macroplast ESP 4110	1K-Epoxy	Silver	400	–	–	Heat curing	-55 to +180 °C

	Tensile strength N/mm ²	Peel strength N/mm	Pack sizes	Comments
	28	2 – 3	50ml, 200ml, 1kg	Structural adhesive, general purpose, long open time
	24	2 – 3	50ml, 1kg	Multiple purpose, excellent for metal, good humidity resistance
	27	1.5 – 2.5	50ml, 200ml	Multiple purpose bonder, excellent for bonding metals, for large surfaces, thixotropic
	36	3	24ml, 50ml, 200ml, 400ml	Multiple purpose bonder, fast, ultra clear
	–	–	25ml	Structural adhesive, fast cure, ideal for metal repair
	–	–	Not available in the UK	Structural adhesive, fast (5 min.), high viscosity
	17	0.6	50ml, 200ml, 1kg	Multiple purpose bonder, fast (5 min.), gap filling, translucent
	30	10	50ml, 400ml, 1kg, 20kg	Structural adhesive, toughened, gap filling
	–	7 – 10	50ml, 400ml, 1kg	Structural adhesive, toughened, gap filling, fast cure
	32	8	50ml, 400ml	Toughened multiple purpose bonder, high bonding strength for all substrates
	47	0.4	50ml, 400ml	Multiple purpose bonder, food contact approved
	47	1.5	50ml, 400ml, 1kg	Multiple purpose bonder, ultra clear, excellent for panels and displays
	14	2.2	50ml	Structural adhesive, general purpose, extended working life
	31	1.6	50ml, 400ml	Structural adhesive, high temperature resistant
	52.6	–	50ml, 400ml	High temperature resistant, thermally conductive, excellent for bonding metal components (thixotropic)
	44	9.5	300ml, 1kg	High temperature resistant, heat resistant bonding, toughened, high mechanical resistance
	–	–	50ml	General purpose, thixotropic epoxy, bonds to wide variety of substrates, Lloyds approved
	–	–	25kg, 30kg, 250kg	Multiple purpose bonder, suitable for contact with potable water (approved to the Waters Byelaws Scheme)
	–	–	40kg, 300kg	Thixotropic, high temperature resistant, good chemical resistance, cream coloured, fast set
	–	–	Not available in the UK	Multiple purpose bonder, long pot life, low viscosity, clear
	–	–	7kg	Free flowing, high chemical resistance, looks like silver solder
	–	–	30kg	Thixotropic, high temperature resistant, high strength

Structural Bonding – Acrylics

Product table

1-component acrylic

General purpose

General purpose

High temperature

Solution

330

F246

3342

Description	No mix	No mix	No mix
Activator	7388 or 7386	Ini No. 1, No. 5	7386
Mix ratio by volume (A:B)	–	–	–
Colour	Pale yellow	Off-white	Yellow opaque
Viscosity	67,500 mPa-s	30,000 mPa-s	90,000 mPa-s
Working life	–	–	–
Fixture time	3 min.	0.5 – 1 min.	1 – 1.5 min.
Shear strength (GBMS)	15 – 30 N/mm ²	35 N/mm ²	15 – 30 N/mm ²
Service temperature (up to)	100 °C	120 °C	180 °C
Pack sizes	50ml kit, 50ml tube, 315ml, 5 lt, 200 lt	50ml kit, 320ml, 5 lt	300ml



Loctite® 330

- General purpose product
- Good impact resistance
- Ideal for bonding dissimilar substrates, like PVC, phenolic and acrylic compounds



Loctite® F246

- General purpose product
- Very fast curing with Ini. No.5
- High strength



Loctite® 3342

- High temperature resistance
- Good impact resistance
- Good humidity resistance

2-component acrylic

Glass bonding

Magnet bonding

General purpose

Clear bond line

Polyolefin bonder

3298

326

3295

V5004

3038

No mix	No mix	Premix	Premix	Premix
7386	7649	–	–	–
–	–	1:1	1:1	1:10
Green-grey	Yellow to amber	Green	Pale mauve, clear	Yellow
29,000 mPa-s	18,000 mPa-s	17,000 mPa-s	18,000 mPa-s	12,000 mPa-s
–	–	4 min.	0.5 min.	4 min.
3 min.	3 min.	5 – 10 min.	3 min.	> 40 min.
26 – 30 N/mm ²	15 N/mm ²	25 N/mm ²	12 N/mm ²	13 N/mm ² (PBT)
120 °C	120 °C	120 °C	80 °C	100 °C
Not available in the UK	50ml, 250ml	50ml, 600ml	50ml, 20 lt	490ml



Loctite® 3298

- Very good adhesion on glass
- High strength
- Good impact resistance



Loctite® 326

- Product for magnet bonding
- Medium viscosity (thixotropic)
- Good adhesion to different types of ferrites



Loctite® 3295

- 2-comp. general purpose product
- Good impact resistance
- Bonding of metals, ceramics and plastics



Loctite® V5004

- Clear bond line after curing
- Fast curing
- Medium strength
- Good adhesion to metals and plastics



Loctite® 3038

- Very good adhesion to polyolefin substrates (PP, PE)
- Good impact resistance
- Good adhesion to e-coated metals

Structural Bonding – Acrylics

Product list

Product	Description	Activator	Mix ratio by volume (A:B)	Colour	Viscosity in mPa-s	Working life in min.	
Loctite® 319	No mix	Loctite® 7649	–	Light amber	2,750	–	
Loctite® 326	No mix	Loctite® 7649	–	Yellow to amber	18,000	–	
Loctite® 329	No mix	Loctite® 7386	–	Light straw	26,500	–	
Loctite® 330	No mix	Loctite® 7388	–	Pale yellow	67,500	–	
Loctite® 366	No mix	Loctite® 7649	–	Yellow to amber	7,500	–	
Loctite® 3030	Premix	–	1:10	Clear yellow	6,500	3	
Loctite® 3038	Premix	–	1:10	Yellow	12,000	4	
Loctite® 3295	Premix	–	1:1	Green	17,000	4	
Loctite® 3298	No mix	Loctite® 7386	–	Green-grey	29,000	–	
Loctite® 3342	No mix	Loctite® 7386	–	Yellow opaque	90,000	–	
Loctite® 3504	No mix	Loctite® 7649	–	Amber	1,050	–	
Loctite® F245	No mix	Ini No. 1, No. 5	–	Off-white	50,000	–	
Loctite® F246	No mix	Ini No. 1, No. 5	–	Off-white	30,000	–	
Loctite® QB533	No mix	Loctite® 534	–	Light blue	15,000	–	
Loctite® V1305	Premix	–	1:1	Off-white	Thixotropic	N.A.	
Loctite® V1315	Premix	–	1:1	Off-white	Thixotropic	N.A.	
Loctite® V5004	Premix	–	1:1	Pale mauve, clear	18,000	0.5	

Fixture time in min.	Shear strength (GBMS) N/mm ²	Service temperature (up to) °C	Pack sizes	Comments
1	10	120	Not available in the UK	Glass-metal bonder
3	15	120	50ml, 250ml	Magnet bonder
1	20	100	315ml, 1 lt, 5 lt,	Fast fixture
3	15 – 30	100	50ml kit, 50ml tube, 315ml, 5 lt, 200 lt	General purpose
N.A.	13.5	120	250ml	Additional UV cure
10	9 (PBT)	65	35ml	PO bonder
> 40	13 (PBT)	100	490ml	PO bonder
5 – 10	25	120	50ml, 600ml	General purpose
3	26 – 30	120	Not available in the UK	Glass bonding
1 – 1.5	15 – 30	180	300ml	High temperature
N.A.	22	120	50ml, 250ml	Additional UV cure
0.5 – 1	25	100	320ml, 5 lt	Low odour
0.5 – 1	35	120	50ml kit, 320ml, 5 lt	General purpose
0.25 – 0.5	22	160	Not available in the UK	Very fast curing
5	21	120	50ml	Faster version of Loctite® V1315
15	15	120	50ml	Composite/pastic bonding
3	12	80	50ml, 20 lt	Clear bondline



Structural Bonding – Polyurethanes

Product table

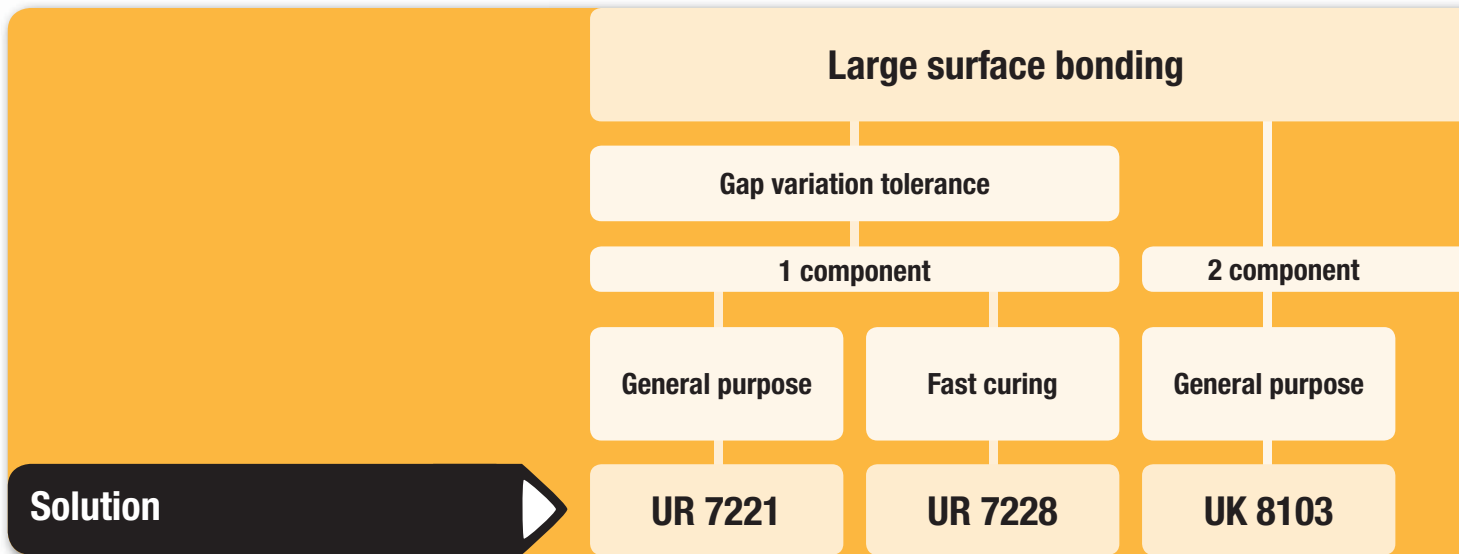

Technology	1K-PU	1K-PU	2K-PU
Viscosity	5,500 – 10,500 mPa·s	5,500 – 10,500 mPa·s	8,000 – 10,000 mPa·s
Initial strength	2 – 4 h	10 – 15 min.	5 – 8 h
Curing time	2 d	1 d	5 – 7 d
Tensile shear strength	> 6 N/mm ²	> 6 N/mm ²	> 9 N/mm ²
Service temperature range (short exposure)	-40 to +80 °C (100 °C)	-40 to +80 °C (100 °C)	-40 to +80 °C (150 °C)
Pack sizes	Not available in the UK	30kg jerry can	24kg pail



Macroplast UR 7221

- Long open time
- Multi-purpose
- Foaming
- IMO

A 1K-PU adhesive which cures with humidity from the air or fine water spray to bond PVC and PU rigid foams to lacquered or (Epoxy - primer) coated metal sheets. It has a good open time to press time relation.

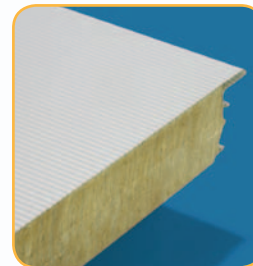

Macroplast UR 7228

- Short fixture time
- Foaming
- IMO

A 1K-PU adhesive which cures with humidity from the air or fine water spray to bond PVC and PU rigid foams to lacquered or (Epoxy-primer) coated metal sheets. It provides very fast processing in panel bonding.



Macroplast UK 8103

- Multi-purpose
- Different acceleration levels available
- Good flow properties
- Wheelmark (including IMO)

A general purpose 2K-PU adhesive, easy to spread on big surfaces for bonding coated metals and PU foams especially in the shipbuilding industry.

* Drive away time

Structural bonding

Gap filling

1 component

2 component

Low temperature resistance

Elastic bonding

Primerless adhesion

Good adhesion to plastics

High strength

UK 8202

Terostat 8597 HMLC

UK 8326 B30

UK 1366 B10

UK 1351 B25

2K-PU	1K-PU	2K-PU	2K-PU	2K-PU
8,000 – 10,000 mPa·s	Pasty	250,000 – 310,000 mPa·s	400,000 – 500,000 mPa·s	400,000 – 500,000 mPa·s
8 – 10 h	2 h*	3 – 4 h	40 – 60 min.	1 – 2 h
5 – 7 d	5 – 7 d	5 – 7 d	2 – 3 d	2 – 3 d
> 12 N/mm ²	> 5 N/mm ² at 5 mm layer	> 12 N/mm ²	> 10 N/mm ²	> 20 N/mm ²
-190 to +80 °C (150 °C)	-40 to +90 °C (120 °C)	-40 to +80 °C (150 °C)	-40 to +80 °C (100 °C)	-40 to +120 °C (150 °C)
24kg pail	310ml cartridge, 400ml foil, 570ml foil	3.6kg combi pack	415ml twin cartridge	400ml twin cartridge



Macroplast UK 8202

- Good flexibility at low temperatures
- High strength
- ABS approval

A low viscous 2K- PU adhesive suitable for the construction of panels for LNG/LPG tank ships complying with the regulations of American Bureau of Shipping (ABS).



Terostat 8597 HMLC

- High modulus
- Low conductivity
- Elastic
- Stress compensation

An elastic 1K-PU adhesive which cures by moisture from the air. Used for direct glazing in automotive industry and in joints where tension should be leveraged by the adhesive (elastic bonding).



Macroplast UK 8326 B30

- Primerless metal adhesion
- Good ageing stability
- Sag resistant

A sag-resistant 2K- PU adhesive which is suitable for vertical application combining primerless metal adhesion with good elastic and shock absorbent properties for use in trailer production.



Macroplast UK 1366 B10

- Short fixture time
- Good adhesion to plastics and metal
- Shock absorbent

A multi-purpose, sag-resistant cartridge grade 2K-PU adhesive with a very good extrusion rate and outstanding adhesion to metals and plastics. Slightly elastic for good shock absorbance.



Macroplast UK 1351 B25

- GL approved
- High strength
- No tempering required

A cartridge grade 2K- PU adhesive with high strength and stiffness and good compression strength. It is certified by Germanischer Lloyd for bonding in wind power applications.

Structural Bonding – Polyurethanes

Product list (2 components)

Product	Technology	Viscosity in mPa-s	Mix ratio by weight	Pot life at 20 °C in min.	Initial strength	Tensile shear strength in N/mm ²
Macroplast UK 1351 B25	2K-PU	400,000 – 500,000	2:1 vol.	20 – 30	1 – 2 h	> 20
Macroplast UK 1366 B10	2K-PU	400,000 – 500,000	4:1 vol.	7 – 13	40 – 60 min.	> 10
Macroplast UK 8101*	2K-PU	Liquid	4:1	50 – 70	5 – 8 h	> 9
Macroplast UK 8103*	2K-PU	8,000 – 10,000	5:1	40 – 70	5 – 8 h	> 9
Macroplast UK 8115-23*	2K-PU	700 – 1,200	5:1	80 – 105	6 – 8 h	> 6
Macroplast UK 8126*	2K-PU	300 – 900	100:65	45 – 70	–	> 15
Macroplast UK 8160*	2K-PU	Pasty	5:1	60 – 90	5 – 8 h	> 7
Macroplast UK 8202*	2K-PU	8,000 – 10,000	4:1	80 – 120	8 – 10 h	> 12
Macroplast UK 8303 B60*	2K-PU	200,000 – 300,000	6:1	60 – 75	4 – 5 h	> 12
Macroplast UK 8306 B60*	2K-PU	250,000 – 310,000	5:1	55 – 65	4 – 5 h	> 12
Macroplast UK 8309*	2K-PU	850,000	5:1	40 – 60	3,5 – 4 h	> 9
Macroplast UK 8326 B30*	2K-PU	250,000 – 310,000	5:1	25 – 35	3 – 4 h	> 12
Macroplast UK 8436*	2K-PU	500 – 900	2:1	90 – 130's	50 – 60 min.	–
Macroplast UK 8445 B1 W*	2K-PU	Liquid	100:22	70 – 74's	–	> 6
Teromix 6700	2K-PU	Pasty	1:1 vol.	10	30 min.	> 12
Terostat 8630 2K HMLC	2K-PU	Pasty	100:0.3 vol.	25 min.	2 h***	> 4 at 5 mm layer

* Macroplast UK 8XXX resins are generally used with hardener component Macroplast UK 5400 or Macroplast UK 5401. For more information, please refer to the TDS.

** Combi packs include hardener component Macroplast UK 5400

*** Drive away time (NCAP)

Consumption per m ²	Service temperature range (short exposure)	Pack sizes	Comments
–	-40 to +120 °C (150 °C)	400ml twin cartridge	GL approved as Duromeric Adhesive according to Rules for Classification and Construction, II, Part 2, high strength, high compression strength, no tempering necessary
–	-40 to +80 °C (100 °C)	415ml twin cartridge	Short fixture time, cartridge grade, good adhesion to plastics and metal, shock absorbent
200 – 400g	-40 to +80 °C (150 °C)	Not available in the UK	Low viscous
200 – 400g	-40 to +80 °C (150 °C)	24kg pail	Multi-purpose, different acceleration levels available, good flow properties
200 – 500g	-40 to +80 °C (150 °C)	Not available in the UK	Very long open time, hydrophobic, for large panel applications
–	-40 to +80 °C (150 °C)	Not available in the UK	Good penetration properties for laminates e.g. in the ski and snowboard industry
200 – 500g	-190 to +80 °C (150 °C)	Not available in the UK	Very pasty, certified in accordance with IMO 653, Part 5 / IMO MSC 61, Part 2 for shipbuilding
200 – 400g	-190 to +80 °C (150 °C)	24kg pail	Good flexibility at low temperatures, high strength, certified according to IMO 653, Part 5 / DIN 4102, Part 1 for shipbuilding, ABS type approval
200 – 500g	-40 to +80 °C (150 °C)	Not available in the UK	Certified in accordance with IMO 653, Part 5 / DIN 4102, Part 1 for shipbuilding
200 – 500g	-40 to +80 °C (150 °C)	Not available in the UK	High strength and good elasticity, different pot life versions available
200 – 500g	-40 to +80 °C (150 °C)	30kg pail	Pasty, good workability used for truck bodies assembly
200 – 500g	-40 to +80 °C (150 °C)	3.6 kg combi pack**	Primerless metal adhesion, good ageing stability, sag resistant
–	-40 to +80 °C (120 °C)	Not available in the UK	Good adhesion properties and excellent flowability
–	-40 to +80 °C (150 °C)	Not available in the UK	Liquid, fast setting for top lid bonding
–	-40 to +80 °C (140 °C)	50ml (2 x 25 ml) cartridge	Easy to use
–	-40 to +90 °C (120 °C)	310ml cartridge	Warm applied, high modulus, low conductivity, 2 component material, 2 hours drive away time acc. EURO NCAP

Structural Bonding – Polyurethanes

Product list (1 component)

Product	Technology	Viscosity in mPa·s	Open time at 23 °C, 50 % rh	Initial strength	Curing time	Tensile shear strength in N/mm ²
Macroplast UR 7220	1K-PU	5,500 – 10,500	4 – 6 h	6 – 10 h	3 d	> 6
Macroplast UR 7221	1K-PU	5,500 – 10,500	40 – 60 min.	2 – 4 h	2 d	> 6
Macroplast UR 7225	1K-PU	5,500 – 10,500	20 – 25 min.	50 – 70 min.	1 d	> 6
Macroplast UR 7228	1K-PU	5,500 – 10,500	7 – 9 min.	10 – 15 min.	1 d	> 6
Macroplast UR 7388	1K-PU	3,000 – 5,000	7 – 9 min.	10 – 15 min.	1 d	> 6
Macroplast UR 7395 B-21	1K-PU	2,000 – 4,000	12 – 15 min.	20 – 30 min.	1 d	> 7
Macroplast UR 7396	1K-PU	2,000 – 4,000	25 – 35 min.	60 – 90 min.	1 d	> 7
Terostat 8596	1K-PU	Pasty	25 min.	6 h*	5 – 7 d	> 5 at 5 mm layer
Terostat 8597 HMLC	1K-PU	Pasty	25 min.	2 h*	5 – 7 d	> 5 at 5 mm layer
Terostat 8599 HMLC	1K-PU	Pasty	15 min.	15 min.*	5 – 7 d	> 4 at 5 mm layer
Terostat 9096 PL	1K-PU	Pasty	25 min.	4 h*	5 – 7 d	> 5 at 5 mm layer
Terostat 9097 PL HMLC	1K-PU	Pasty	25 min.	1 h*	5 – 7 d	> 5 at 5 mm layer

* Drive away time (FMVSS)

Consumption per m ²	Service temperature range (short exposure)	Pack sizes	Comments
100 – 200g	-40 to +80 °C (100 °C)	Not available in the UK	Very long open time for large panel applications, certified in accordance with IMO, FTPC, Part 2
100 – 200g	-40 to +80 °C (100 °C)	Not available in the UK	Long open time, certified according to IMO, FTPC, Part 5
100 – 200g	-40 to +80 °C (100 °C)	1,000kg	Medium open time
100 – 200g	-40 to +80 °C (100 °C)	30 kg jerry can	Short fixture time, foaming, certified in accordance with IMO, FTPC, Part 2 + Part 5
100 – 200g	-40 to +80 °C (100 °C)	Not available in the UK	Low viscous, fast setting
100 – 200g	-40 to +80 °C (100 °C)	Not available in the UK	Low viscous, thermally accelerated, certified according to IMO, FTPC, Part 2
100 – 200g	-40 to +80 °C (100 °C)	Not available in the UK	Low viscous, thermally accelerated, medium open time
–	-40 to +90 °C (120 °C)	310ml cartridge, set	6 hours drive away time acc. FMVSS
–	-40 to +90 °C (120 °C)	310ml cartridge, 400ml foil, 570ml foil	High modulus, low conductivity, 2 hours drive away time acc. FMVSS
–	-40 to +90 °C (120 °C)	310ml cartridge, set	Warm applied, high modulus, low conductivity, 15 minutes drive away time acc. FMVSS
–	-40 to +90 °C (120 °C)	Not available in the UK	Primerless adhesion, 4 hours drive away time acc. FMVSS
–	-40 to +90 °C (120 °C)	310ml cartridge, set	Primerless adhesion, high modulus, low conductivity, 1 hour drive away time acc. FMVSS



Structural Bonding – Silicones

Product table

Do you need a fast fixture / fast cure adhesive?

Yes

Fast cure

Medium cure

Higher temperature resistance

Solution

5615 A&B

5607 A&B

5612 A&B

Description	2K alkoxy silicone	2K alkoxy silicone	2K alkoxy silicone
Mix ratio by volume (A:B)	2:1	2:1	4:1
Colour	Black	Grey	Red
Mix tip pot life (static mixer)	2 – 3 min.	5 – 7 min.	4 – 5 min.
Skin formation time	–	–	–
Fixture time	10 – 15 min.	50 min.	25 – 30 min.
Elongation at break	230 %	140 %	180 %
Hardness shore A	34	43	45
Shear strength (GBMS)	1.3 N/mm ²	1.55 N/mm ²	2 N/mm ²
Service temperature (up to)	180 °C	180 °C	220 °C
Pack sizes	400ml, 17 lt	400ml, 17 lt	400ml, 17 lt



Loctite® 5615 A&B

- Fast cure 2-component silicone
- Suitable mix ratio 2:1
- Good adhesion to a wide range of substrates



Loctite® 5607 A&B

- Medium cure 2-component silicone
- Suitable mix ratio 2:1
- Can be applied with manual hand gun



Loctite® 5612 A&B

- Higher temperature resistant 2-component silicone
- Fast cure
- High elongation

No

General purpose

Electrical components

Oil resistance

High temperature resistance

5366

5145

5970

5399

1K acetoxy silicone

1K alkoxy silicone

1K alkoxy silicone

1K acetoxy silicone

–

–

–

–

Clear

Clear

Black

Red

–

–

–

–

5 min.

70 min.

25 min.

5 min.

–

–

–

–

530 %

500 %

200 %

500 %

25

25

44

33

2.5 N/mm²

3.5 N/mm²

1.5 N/mm²

3.3 N/mm²

250 °C

200 °C

200 °C

300 °C

310ml

40ml

300ml, 20 lt

310ml



Loctite® 5366

- General purpose 1-component silicone
- Clear colour
- Suitable for glass, metal, ceramics, etc.



Loctite® 5145

- Neutral curing 1-component silicone
- Non corrosive
- Especially for sealing and protecting electrical components

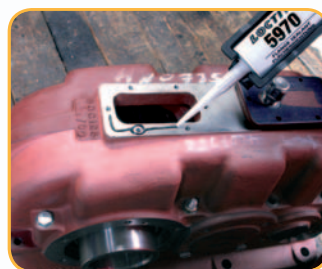

Loctite® 5970

- 1-component silicone with very good oil resistance
- Neutral curing
- Also used for gasketing applications (flange sealing)



Loctite® 5399

- High temperature resistant 1-component silicone
- For bonding and sealing glass, metal and ceramics e.g. industrial ovens, stove flues, etc.

Structural Bonding – Silicones

Product list

Product	Description	Mix ratio by volume A:B	Colour	Mix tip pot life (static mixer) min.	Skin formation time min.	Fixture time min.
Loctite® 5145	1K alkoxy silicone	–	Clear	–	5	–
Loctite® 5366	1K acetoxy silicone	–	Clear	–	5	–
Loctite® 5367	1K acetoxy silicone	–	White	–	5	–
Loctite® 5368	1K acetoxy silicone	–	Black	–	5	–
Loctite® 5398	1K acetoxy silicone	–	Red	–	8	–
Loctite® 5399	1K acetoxy silicone	–	Red	–	5	–
Loctite® 5404	1K heat curing silicone	–	White to grey	–	–	–
Loctite® 5607	2K alkoxy silicone	2:1	Grey	5 – 7	–	50
Loctite® 5610	2K alkoxy silicone	2:1	Black	1 – 2	–	5 – 7
Loctite® 5612	2K alkoxy silicone	4:1	Red	4 – 5	–	25 – 30
Loctite® 5615	2K alkoxy silicone	2:1	Black	2 – 3	–	10 – 15
Loctite® 5616	2K alkoxy silicone	2:1	White	2 – 3	–	10 – 15
Loctite® 5940	1K acetoxy silicone	–	Black	–	14	–
Loctite® 5970	1K alkoxy silicone	–	Black	–	25	–
Terostat 33	1K amine silicone	–	Transparent, grey, black, white	–	10	–
Terostat 58	1K oxime silicone	–	Black	–	6	–
Terostat 63	1K acetoxy silicone	–	Dark red	–	10	–
Terostat 140	1K alkoxy silicone	–	White	–	10	–

	Elongation at break %	Hardness shore A	Shear strength (GBMS) N/mm ²	Service temperature (up to) °C	Pack sizes	Comments
	500	25	3.5	200	40ml	For electrical components
	530	25	2.5	250	310ml	General purpose
	500	20	2	250	310ml	General purpose
	435	26	2.2	250	310ml	General purpose
	200	35	2	300	310ml	Flowable
	500	33	3.3	300	310ml	High temperature resistance
	65	60	1.3	N.A.	300ml	Thermal conductive
	140	43	1.55	180	400ml, 17 lt	Medium curing speed
	210	40	1.35	180	400ml	Very fast curing
	180	45	2	220	400ml, 17 lt	Higher temperature resistance
	230	34	1.3	180	400ml, 17 lt	Fast curing
	200	30	1	180	Not available in the UK	White version of Loctite® 5615
	500	22	1.8	200	40ml, 100ml	High elongation
	200	44	1.5	200	300ml, 20 lt	Very good oil resistance
	250	22	1.2	150	310ml	Primerless on metals
	250	40	2	200	Not available in the UK	Fast skin formation
	430	35	2.8	250	Not available in the UK	High temperature resistance
	750	10	N.A.	-50 to +120	Not available in the UK	Fungicidal properties

Structural Bonding – Silane Modified Polymers

Product table

What main function are you looking for?

Elastic sealing

General purpose

High/medium resistance

Solution

Terostat MS 930

Terostat MS 510

Terostat MS 935

Colour	White, grey, black	Black	White, grey, black
Consistency	Pasty, thixotropic	Pasty, thixotropic	Pasty, thixotropic
Hardness shore A (DIN EN ISO 868)	30	45	50
Depth of cure after 24 h	4 mm	3 – 4 mm	3 mm
Skin formation time	25 – 40 min.	10 – 20 min.	10 – 15 min.
Tensile strength (DIN 53504)	1.0 MPa	1.6 MPa	2.8 MPa
Elongation at break (DIN 53504)	250 %	210 %	230 %
Service temperature range	-50 to +80 °C	-50 to +100 °C	-40 to +100 °C
Pack sizes	310ml, 570ml	Not available in the UK	310ml

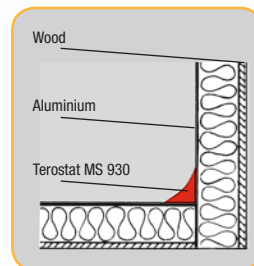

Terostat MS 930

- Soft-elastic
- UV and weathering resistant sealant
- Multi-purpose
- FDA status
- BSS 7239

FDA Status, Germanischer Lloyd (sensoric test), BSS 7239

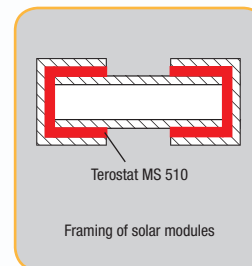

Terostat MS 510

- Fast processing especially with accelerator Terostat MS 9371
- Meets damp heat test for solar industry

Meets damp heat test according IEC 61215/61646

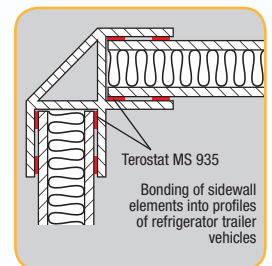

Terostat MS 935

- Elastic sealant/adhesive
- Easy smoothing
- Good environmental resistance
- Good overpaintability

**Sensoric test acc. to DIN 10955
Declaration of no objection acc. to ISEGA DIN 1846 fungus resistance**

Elastic bonding

Self spreading

General purpose

Flame retardant

High modulus

Two component rapid cure

Terostat MS 931

Terostat MS 939

Terostat MS 939 FR

Terostat MS 9380

Terostat MS 9399

White, grey, black	White, off-white, grey, black	Black	White, grey	White, grey, black
Self-levelling	Pasty, thixotropic	Pasty, thixotropic	Pasty, thixotropic	Pasty, thixotropic
25	55	> 50	> 65	60
3 – 4 mm	3 mm	3 mm	3 mm	2K-system
15 – 20 min.	10 min.	20 min.	5 – 10 min.	30 min. (black) 20 min. (white, grey)
0.8 MPa	3.0 MPa	3.5 MPa	4.0 MPa	3.0 MPa
100 %	250 %	180 %	120 %	150 %
-40 to +100 °C	-40 to +100 °C	-40 to +100 °C	-40 to +100 °C	-40 to +100 °C
Not available in the UK	310ml, 570ml, 25kg	310ml, 570ml, 25kg	310ml, 25kg	2 x 200ml

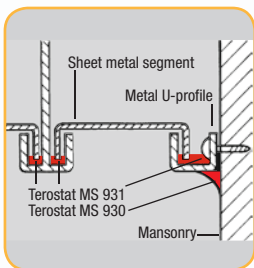

Terostat MS 931

- Self-levelling/pourable
- Sprayable

Sensoric test acc. to DIN 10955

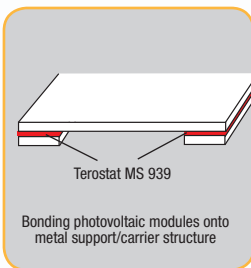

Terostat MS 939

- Very versatile
- Elastic bonding adhesive
- High strength
- Good elasticity
- Meets damp heat test for solar industry

UL Listing for electrical equipment

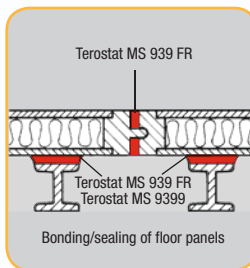

Terostat MS 939 FR

- Elastic bonding adhesive
 - High strength
 - Good elasticity
 - Flame retardant
- DIN 5510 S3 NF P 92507, M1 NF F 16-101, NF P 92-512-M1**

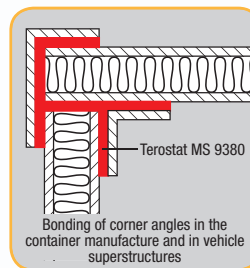

Terostat MS 9380

- High modulus
- Fast skin formation
- Gap filling
- High initial strength
- GL (Germanischer Lloyd) approved elastomeric adhesive

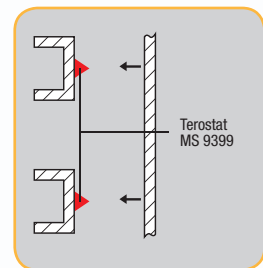

Terostat MS 9399

- 2-component cartridge grade
- High initial strength
- Short tack free time
- Independent from air/humidity
- Easy handling 2K-system

Structural Bonding – Silane Modified Polymers

Product list

Product	Colour	Consistency	Hardness shore A (DIN EN ISO 868)	Depth of cure in mm after 24 h	Skin formation time in min	Tensile strength (DIN 53504) in MPa
Terostat MS 930	White, grey, black	Pasty, thixotropic	30	4	25 – 40	1.0
Terostat MS 931	White, grey, black	Self-levelling	25	3 – 4	15 – 20	0.8
Terostat MS 935	White, grey, black	Pasty, thixotropic	50	3	10 – 15	2.8
Terostat MS 937	White, grey, black	Pasty, thixotropic	50	4	10 – 15	3.0
Terostat MS 939	White, off-white, grey, black	Pasty, thixotropic	55	3	10	3.0
Terostat MS 939 FR	Black	Pasty, thixotropic	> 50	3	20	3.5
Terostat MS 9302	Grey, brown	Thixotropic	30	3 – 4	10	1.1
Terostat MS 9360	Black	Pasty, thixotropic	> 50	3	10	3.5
Terostat MS 9380	White, grey	Pasty, thixotropic	> 65	3	5 – 10	4.0
Terostat MS 9399	White, grey, black	Pasty, thixotropic	60	2K-system	30 (black) 20 (white, grey)	3.0
Terostat MS 510	Black	Pasty, thixotropic	45	3 – 4	10 – 20	1.6

Cleaner:

Terostat 450 – alcoholic solution designed for cleaning and to improve adhesion (thin fluid, colorless)

B-Component (Hardener) for 2-component curing:

Terostat MS 9371 B – accelerator paste for Terostat MS adhesives and sealants (pasty, thixotropic, white)

	Elongation at break (DIN 53504) in %	Service temperature range	Pack sizes	Comments / speciality
	250	-50 to +80 °C	310ml, 570ml	FDA Status, Germanischer Lloyd (sensoric test), BSS 7239
	100	-40 to +100 °C	Not available in the UK	Sensoric test acc. to DIN 10955
	230	-40 to +100 °C	310ml	Sensoric test acc. to DIN 10955, Declaration of no objection acc. to ISEGA DIN 1846 fungus resistance
	220	-40 to +100 °C	310ml, 570ml, 18 lt	DIN EN ISO 846 (VDI 6022)
	250	-40 to +100 °C	310ml, 570ml, 25kg	UL Listing
	180	-40 to +100 °C	310ml, 570ml, 25kg	DIN 5510 S3 NF P 92-152-M1, M1 NF F 16-101
	250	-50 to +100 °C	Not available in the UK	DIN EN ISO 846 (VDI 6022)
	200	-40 to +100 °C	310ml, 25kg	ASTM E 662 ASTM E 162 BSS 7239
	120	-40 to +100 °C	310ml, 25kg	Germanischer Lloyd (elastomeric adhesive)
	150	-40 to +100 °C	2 x 200ml	NF P 92507, M1 NF F 16-101
	210	-50 to +100 °C	Not available in the UK	Fulfil damp heat test according IEC 61215/61646



Sealing – Butyls

Plastic sealants in different shapes



Why use a Henkel Butyl?

Plastic sealants

Like adhesives, sealants are employed in diverse areas of industry and occupations. Modern sealants ideally complement traditional joining and sealing techniques, such as the use of solid gaskets, and can often even replace them.

Fundamentals

Butyl and polyisobutylene (PIB) sealants have different chemical structures, but users will detect practically no differences in their properties when using them. Both groups of plastic sealants are 1-component products. As they need no hardener and no time to cure, their final properties are evident immediately after application. This, and the characteristics below, make butyl and PIB sealants interesting solutions for production and processing tasks in industry and professional occupations.

Properties

- Excellent adhesion to almost all substrates
- Final properties directly upon application
- Low permeability to water vapour and gases
- Good resistance to water and aging
- High flexibility even at low temperatures
- Self-welding

Due to their inherent tackiness, butyl and PIB sealants adhere to metals, glass, ceramics, mineral substrates, wood, PS, EPDM and other plastics. They even achieve excellent adhesion to substrates which are generally difficult to bond, such as PE, PP and POM.

Plastic vs. elastic

An important criterion in the selection of sealants is their mechanical behaviour under deformation. When exposed to forces, each sealant shows both a plastic (i.e. deformable) and an elastic (i.e. rubber-like) reaction. If the plastic reaction is dominant, the sealant is referred to as plastic. Two important groups of these plastic sealants are the products based on butyl rubber and/or polyisobutylene.

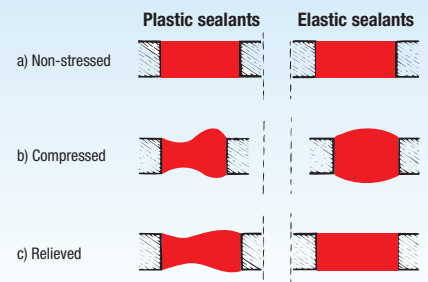

Plastic sealants

Wherever the term plastic sealants is used on the following pages, it refers to butyl and PIB sealants. Henkel breaks the plastic sealants down as follows:

- Profiles and extruded parts
- Putties
- Hotmelt butyls
- Gun-grade sealants

Profiles

Butyl adhesives their different profiles by means of extrusion at temperatures between 60 and 80 °C. They are subsequently applied to backing paper and coiled. The backing paper is removed immediately before the profile is used. Profiles come in the form of flat(tapes) or round (cords) with a great variety of dimensions. They are either wound on reels or cut to length (pre-cut profiles). In order to increase their longitudinal dimensional stability, flat and round profiles are also available with a core made of cotton or synthetic yarn or with a fabric sheath. Laminating one side of the tapes to plastic films/sheets, nonwovens or aluminium composite foils achieves further special properties such as UV and weathering stability, tear resistance, or compatibility with plasters or paints. No application equipment or particular precautions are required for handling the profiles. They are easy, safe and clean to use. Thanks to our long experience and the excellent reliability of our production processes, profiles from Henkel have outstanding dimensional accuracy. This is ensured by uniform application of material during production, a feature which is constantly monitored by our Quality Assurance.



Putties

Putties are easily shapeable sealants based on polyisobutylene. The required shape is achieved by hand and then pressed into gaps, joints or openings. Putties from Henkel easily mould themselves to any kind of surface geometry. Having good adhesion as well as easy shapeability, they provide an excellent seal against water, moisture, gases and dust.



Hotmelt butyls

At room temperature, hotmelt butyl sealants are highly viscous and very tacky. For processing, they are heated to 80 to 120 °C, which considerably reduces their viscosity. As a result, they process easily and at high speed when applied using heatable equipment. Moreover, hotmelt butyls can be applied in very thin layers. As highly tacky sealants, these products can be used on a wide variety of profiles, tapes, foils/films and mouldings. Once applied, the sealant can be covered with a release paper for transport and storage. Hotmelt butyls remain highly tacky even at low temperatures, allowing them to be processed at near to freezing point. The products are available in hobbocs and drums. They can be applied from these containers using equipment with screw extruders, piston pumps, gear pumps or rotary pumps.



Gun-grade butyl sealants

Gun-grade butyl sealants are 1-component cold-processable sealants based on butyl rubber. They can be applied at room temperature. These sealants are available in cartridges or foil cartridges for pressure guns, or in drums requiring suitable applicators. A distinction is made between solvent-free and solvent-based products. Solvent-based products release their organic solvent after application. During this process, they set physically, forming a plastic butyl sealant which is resistant to aging. The solvent-free products cure when exposed to heat.



Sealing – Butyls

Product table

How do you want to apply the product?

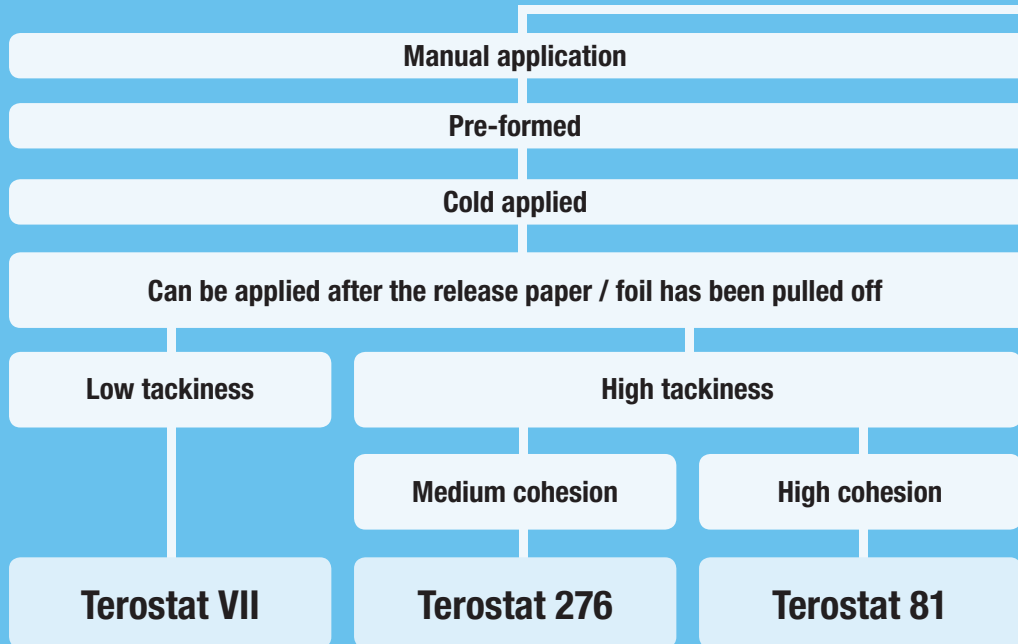

Solution

	Terostat VII	Terostat 276	Terostat 81
Density	1.69 g/cm ³	1.41 g/cm ³	1.26 g/cm ³
Solids content	100 %	100 %	100 %
Adhesion strength	Low	Very high	Very high
Processing temperature	Room temperature	Room temperature (hot applied: 120 to 140 °C)	Room temperature
Service temperature range	-40 to +80 °C	-40 to +80 °C	-40 to +80 °C

Pack sizes on request

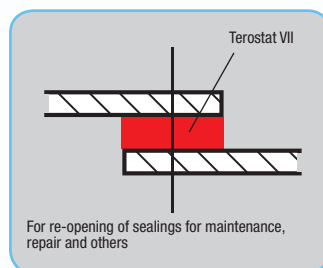

Terostat VII

- Easy to remove
- Very good water and aging resistance
- Good for spacing
- Sound insulation
- Can be overpainted

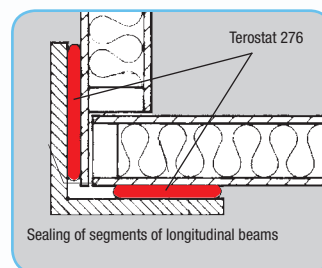

Terostat 276

- High tackiness
- Pumpable at elevated temperatures and also available as profiled grade

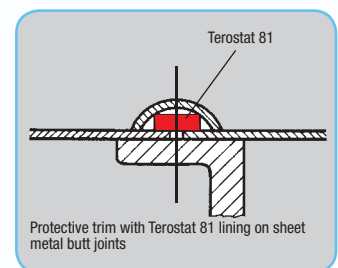

Terostat 81

- High quality sealing tape
- High tackiness and self-welding
- Very good water and aging resistance
- No corrosive constituents

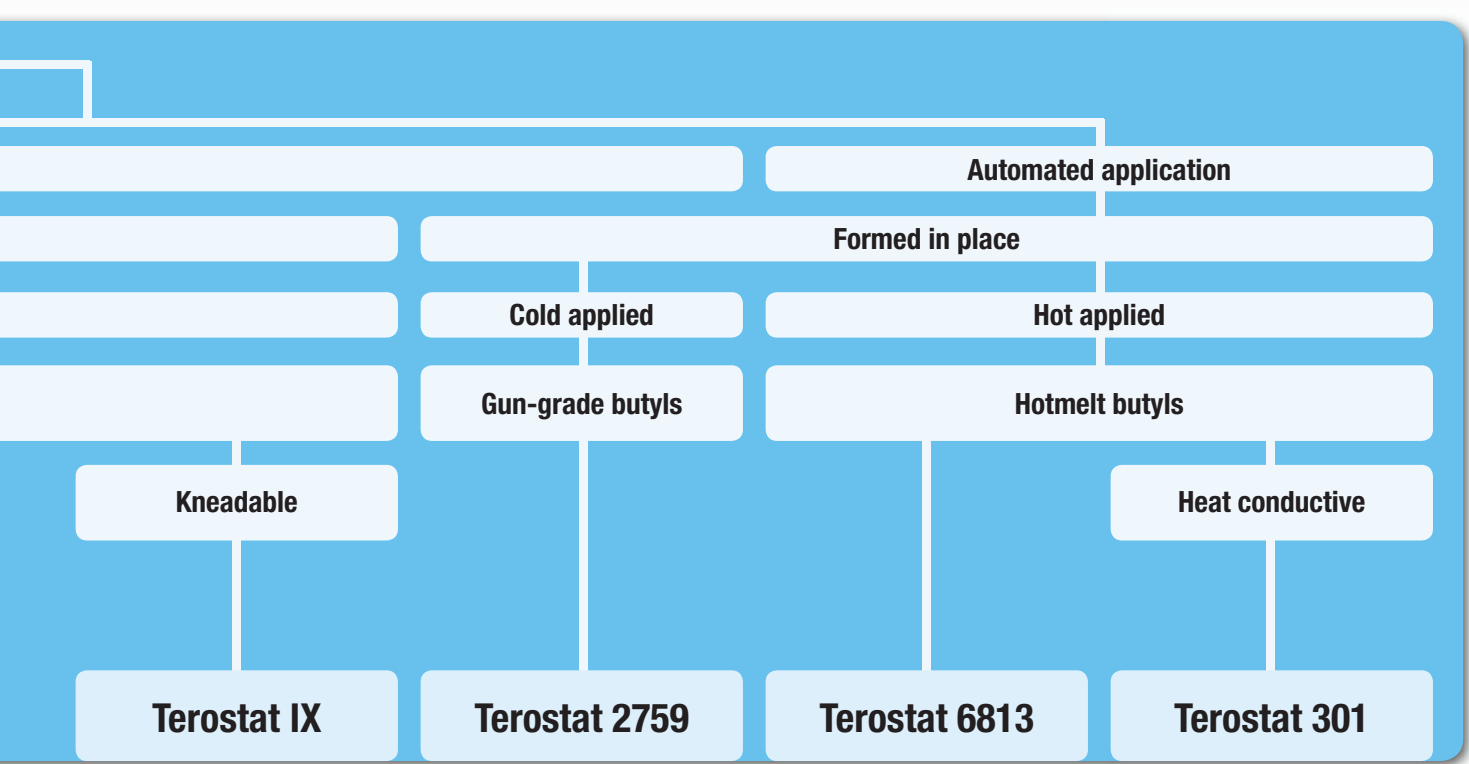

Terostat IX	Terostat 2759	Terostat 6813	Terostat 301
1.7 g/cm ³	1.37 g/cm ³	1.18 g/cm ³	1.25 g/cm ³
100 %	85 %	100 %	100 %
Low	Medium	Very high	Very high
Room temperature	Room temperature	80 to 160 °C	120 to 140 °C
-30 to +80 °C	-30 to +80 °C	-40 to +80 °C	-40 to +80 °C

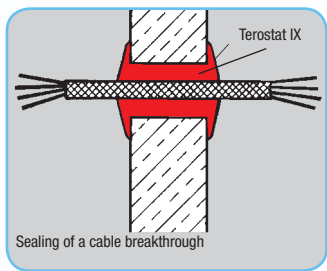

- Terostat IX**
- Slight tackiness
 - Very good water and aging resistance
 - Good for spacing
 - Sound insulation
 - Can be overpainted

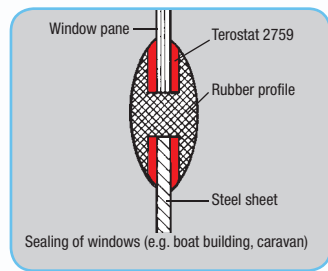

- Terostat 2759**
- Easy to dab off
 - Very good water and aging resistance
 - Elasto-plastic

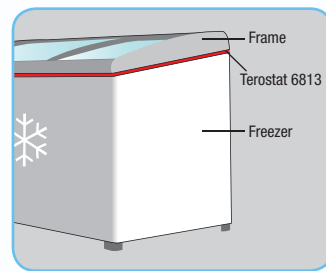

- Terostat 6813**
- High tackiness
 - Pumpable
 - Soft plastic

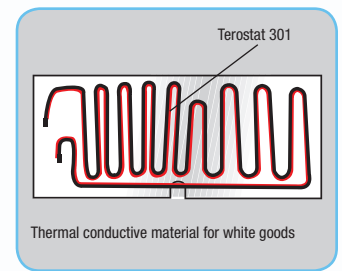

- Terostat 301**
- High thermal conductivity
 - Soft formable and hot extrudable
 - Pumpable and also available as profiled grade

Sealing – Butyls

Product list

Product	Characteristic	Colour	Density in g/cm ³	Solids content in %	Adhesion strength	Processing temperature in °C
Terostat VII	Putty	Light grey	1.69	100	Low	Room temperature
Terostat IX	Putty	Light grey	1.7	100	Low	Room temperature
Terostat 81	Pre-formed (and hot applied) butyl	Black	1.26	100	Very high	Room temperature
Terostat 276	Pre-formed and hot applied butyl	Grey and black	1.41	100	Very high	Pre-formed: room temperature hot applied: 120 to 140
Terostat 276 Alu	Composite	Silver black	1.41	100	High	Room temperature
Terostat 279	Hot applied butyl	Black	1.4	100	Very high	80 to 160
Terostat 285	Hot applied butyl	Grey, black	1.4	100	Very high	80 to 160
Terostat 301	Hot applied butyl	Anthracite	1.25	100	Very high	120 to 140
Terostat 2759	Cartridge grade, room temperature extrudable	Grey	1.37	85	Medium	Room temperature
Terostat 2761	Pre-formed butyl	Black	1.3	100	high	Room temperature
Terostat 2780	Hot applied butyl	Black	1.14	100	Low	130 to 200
Terostat 2785	Hot applied butyl	Black	1.05	>98	Very high	90 to 130
Terostat 3631 FR	Pre-formed parts	Black	1.4	100	Medium	Room temperature
Terostat 4006	Cartridge grade, room temperature extrudable	Grey	1.4	83	Low	Room temperature
Terostat 6813	Hot applied butyl	Grey	1.18	100	Very high	80 to 160

	Service temperature range in °C	Penetration 1/10 mm	Comments
	-40 to +80	56	Sealing of overlapping metal sheet
	-30 to +80	75	Kneadable sealant for gap and cable breakthrough sealing
	-40 to +80	65	Very high tackiness, improved performance
	-40 to +80	55	Multi-purpose, high strength
	-40 to +80	N.A.	Laminated with an aluminium composite foil for excellent weathering and UV resistance, water vapour diffusion (DIN 53 122): $\mu = 645\ 000$
	-40 to +80	85	Excellent pumpable hot butyl with high adhesion strength
	-40 to +80	105	Fungus resistant pumpable hot butyl
	-40 to +80	70	High thermal conductivity, pumpable hot butyl
	-30 to +80	N.A.	Gun-grade, solvent-based, excess material can easily be dabbed off
	-40 to +80	50	Vacuum bagging tape for infusion processes up to 80 °C mould temperature
	-30 to +105	N.A.	High strength, suitable for tank melter application
	-40 to +100	55	Good adhesion, high temperature resistance, suitable for flexible photovoltaic modules
	-40 to +105	45	Flame retardant tape, high temperature resistance
	-20 to +80	N.A.	Gun-grade, solvent-based sag-resistant sealant
	-40 to +80	86	High performance pumpable hot butyl

Casting Resins

Product table

What kind of Casting?



Technology	2K-PU	2K-PU	2K-PU
Hardener (Part B)	Macroplast UK 5400/ Macroplast UK 5401	Macroplast UK 5400/ Macroplast UK 5401	Macroplast CR 4200
Mixed colour	White/Beige	Beige	Yellowish
Mix ratio by weight	5:2	5:3	100:75
Pot life	4 – 5 min.	4 – 6 min.	23 – 29 min.
Viscosity mixture	800 mPa·s	850 mPa·s	1,300 mPa·s
Service temperature range	-40 to +80 °C	-40 to +100 °C	50 °C in process
Short exposure (1h)	150 °C	150 °C	70 °C
Pack sizes	Part A: 190 kg drum / Part B: 30 kg pail, 250 kg drum	Part A: 200 kg drum, 1.000 kg container / Part B: 30 kg pail, 250 kg drum, 1.250 kg container	Part A: 25 kg pail, 180 kg drum / Part B: 30 kg pail, 240 kg drum

Casting resins based on epoxy and polyurethane

Possessing versatile characteristics, casting resins based on epoxy and polyurethane have been steadily gaining ground over the past decades. They can be chemically engineered to be very hard and impact resistant or soft and elastic. A casting resin usually consists of two basic components which are mixed and react with each other to form a cross-linked product. Systems of this kind generally display high strength, are easy to apply, and have very good gap filling properties. Polyurethane casting resins are compatible with a broad range of materials and withstand temperatures of up to 120 °C (with brief peaks up to 150 °C). If higher temperatures are required (up to 180 °C), epoxy casting resins are used.



Macroplast UK 8439-21

- Self levelling
 - Fast setting
 - Broad adhesion spectrum
- Macroplast UK 8439-21 has very good workability and self levelling properties. It is designed for the manufacturing of particulate air filters. The product meets the requirements in HEPA filter industry.

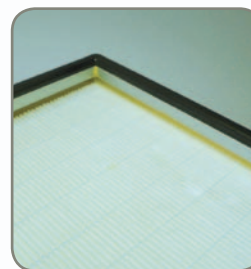

Macroplast UK 8180 N

- Fast built-in thixotropy
 - Short processing time
 - Good penetration into filter media
- Macroplast UK 8180 N forms a chemical thixotropy which allows to have a very fast inline processing for the assembly of filter elements. The product is suitable for clean room applications.



Macroplast CR 3525

- Fast setting
 - Easy processibility
- Macroplast CR 3525 has low exothermic reaction and therefore allows fast processing.
KTW approval
EG 1935 2004, direct food contact approval
2002/72/EG approval for the plastic industry

Filter application

Electrical application

Medical

Oil

Wet substrates

Medium pot life

Long pot life

EP 3299

CR 3502

EP 3030

EP 3430

CR 6127

2K-EP	2K-PU	2K-EP	2K-EP	2K-PU
Macroplast EP 5299	Macroplast CR 4100	Macroplast EP 5030	Macroplast EP 5430	Macroplast CR 4300
Amber	Yellowish/Transparent	Purple	Amber	White
100:35	100:59	100:29	10:1	85:15
6 h	5 – 7 min.	60 min.	16 h	70 – 110 min.
Liquid	1,000 mPa-s	600 mPa-s	8,000 mPa-s	2,600 mPa-s
80 °C in process	40 °C in process	-55 to +80 °C	-55 to +100 °C	-40 to +80 °C
200 °C	120 °C	200 °C	200 °C	150 °C
Part A: 180 kg drum / Part B: 180 kg drum	Part A: 180 kg drum / Part B: 30 kg pail, 250 kg drum	Part A: 20 kg pail, 230 kg drum / Part B: 20 kg pail	Part A: 20 kg pail / Part B: 18 kg pail	Part A: 35 kg pail / Part B: 6 kg pail, 30 kg pail



Macroplast EP 3299

- Good adhesion properties
 - High processing temperature resistance
- Macroplast EP 3299 has a very good chemical resistance and good adhesion properties to wet fibres in the production process. The product has KTW approval.



Macroplast CR 3502

- Allows steam, ETO or gamma ray sterilisation
 - Very good adhesion
- Macroplast CR 3502 has very good penetration properties during centrifuging. The product is ISO 10993 compliant for medical equipment and approved for dialysers.



Macroplast EP 3030

- Multi-purpose filter applications
 - High chemical resistance
 - Low viscosity
- Macroplast EP 3030 has low viscosity and controlled exothermic reaction in the process. It is well-proven in the production of membrane filters.



Macroplast EP 3430

- Long pot life
 - High temperature stability
 - Low shrinkage
- Macroplast EP 3430 has a very good resistance to hydraulic fluids, fuel and chemicals. Due to its long open time it can also be used for large potting applications e.g. in gas separation filters.

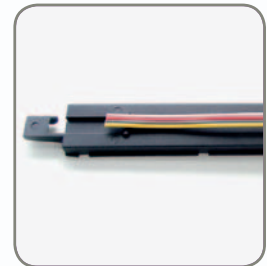

Macroplast CR 6127

- Flame retardant acc. to UL 94 V0
 - Elastic properties
 - Very good electrical properties e.g. dielectric strength or constant
- Macroplast CR 6127 is qualified for the casting of telecommunication articles, transformers or other electrical/electronic devices.

Acoustic Coatings

Soundproofing



Why use Teroson Acoustic Coatings?

Basically, there are two options for controlling noise: It can be insulated or absorbed. As both options can be applied to airborne and to structure-borne sound, there are in fact four different types of noise control:

1. Absorption of structure-borne sound

Absorption of structure-borne sound is achieved by converting part of the sound energy into thermal energy while the sound travels through homogeneous materials attached or bonded to a solid body. In this way, the structure-borne sound is absorbed before it generates air-borne sound. The better the absorption properties of such damping materials, the better the structure-borne sound absorption. The "loss factor" is a parameter for measuring this effect.

2. Insulation against structure-borne sound

Insulation against structure-borne sound is achieved by attenuating the propagation of sound by using a flexible material for sound insulation. The softer and more voluminous this material, the better the structure-borne sound insulation.

3. Absorption of air-borne sound

Absorption of air-borne sound is achieved by converting part of the air-borne sound energy into thermal energy as the sound penetrates into fibrous or foam materials. The thicker the fibrous or foam materials, the better the air-borne sound absorption.

4. Insulation against air-borne sound

Insulation against air-borne sound is achieved when part of the sound energy is reflected by a wall. The remaining sound energy is transmitted through the wall and re-radiated on the opposite side in the form of air-borne sound. The heavier and more flexible the partitioning wall, the better the air-borne sound insulation.

Sound Measurement and Evaluation:

The pressure of air-borne sound waves is measured by means of a sound level meter with a microphone. Sound levels are measured in units of decibels (dB). As the subjective response to noise as perceived by the human ear is largely dependent on the frequency or the frequency spectrum of a sound, level meters are provided with weighting filters for equalisation. The A-weighted sound level, expressed as dBA, will be sufficiently accurate for most comparative noise measurements.

Loss factor "d":

The acoustic loss factor "d" is used as a measure of the noise absorption capability of a material. This factor indicates how much of the sound energy propagated in the form of flexural waves will be absorbed and converted into heat energy. The loss factor of a material depends on frequency and temperature. It does not, however, provide a meaningful indication of the actual reduction of noise level which can be achieved. It must therefore be measured on site. Striking a reasonable compromise between economic cost and benefit, a loss factor of approx. 0.1 has been found acceptable for a wide range of applications.

Air-borne sound absorption coefficient α :

The absorption capability of a material is expressed as air-borne sound absorption coefficient α . It describes the percentage of incident sound energy which is absorbed and converted into heat energy. The absorption coefficient α depends to a great extent on frequency. The lower (deeper) the frequency, the thicker the absorbent material to be used!

Soundproofing

- Highly efficient paste-type soundproofing materials
- Offer outstanding absorption capabilities
- Reduction of structure-borne noise
- Can be coated in any thickness to meet the most exacting requirements for universal structure-borne sound absorption
- Can be applied by spatula or spray gun

Solution

Terophon 112 DB

Terophon 123 WF

Chemical base	Aqueous synthetic resin dispersion	Aqueous synthetic resin dispersion
Density wet/dry	1.4 g/cm ³ / 1.2 g/cm ³	1.4 g/cm ³ / 1.2 g/cm ³
Solids contents	65 %	73 %
Drying time (4 mm wet film) (DIN 50014)	24 h	15 h
Temperature resistance	-50 to +120 °C	-50 to +120 °C
Pack sizes	40kg	Not available in the UK

Handy Hints:

- Never apply Terophon water-based products to bare steel sheets because there is a serious risk of corrosion while the aqueous product cures on the steel face and afterwards, when humidity migrates into the Terophon coating. Non-galvanized steel sheets or non-anodised aluminium substrates always require a water-impermeable primer protection
- The Henkel range includes other soundproofing products which are available on request

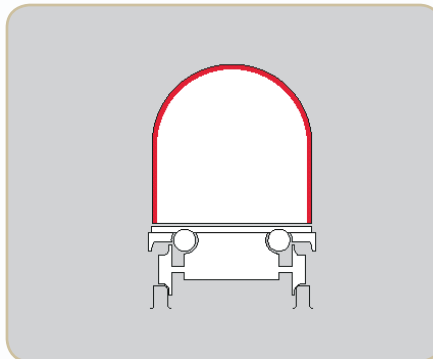

Terophon 112 DB

- Solvent-free
- Ready to apply from spray guns
- Excellent fire resistance
- Low flammability
- Good thermal insulation properties

Terophon 112 DB is used for secondary noise and vibration control on thin walled sheet metal constructions in the manufacture of vehicles, railway carriages, ship building as well as plant and equipment building. In addition, the product is also applied to ventilation ducts, fan housings, lifts, waste disposal units, to the rear side of facade elements as well as to container buildings. Coatings with Terophon 112 DB must not be subjected to standing water or direct weathering.

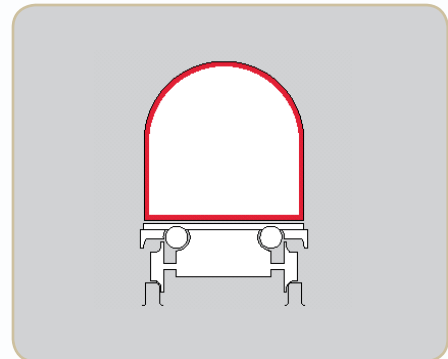

Terophon 123 WF

- Solvent-free
- Ready to apply from spray guns
- Moisture resistant
- Low flammability
- Good thermal insulation properties

Terophon 123 WF is used for secondary noise and vibration control on thin walled sheet metal constructions in the manufacture of vehicles, railway carriages, ship building as well as plant and equipment building. Coatings with Terophon 123 WF can be subjected to standing water for a longer period of time.

Metal-filled Compounds

To repair metal parts



Why use a Loctite® Hysol® Metal-filled Compound?

Loctite® Hysol® Metal-filled Compounds offer maintenance solutions to the problems caused by erosion and mechanical damage, including cracks in housings, worn keyways in shafts and collars, worn cylindrical shafts, etc.

Loctite® Hysol® Metal-filled Compounds repair, rebuild and restore damaged machinery and equipment permanently and without the need of heat or welding.

Traditional methods vs modern solutions:

Traditional repair methods such as hard face welding are time consuming and expensive. Alternatively, Loctite® Hysol® Metal-filled Compounds are easily applied and offer superior compressive strength and protection qualities.

Loctite® Hysol® Metal-filled Compounds and Loctite® Nordbak® Wearing Compounds help you restore and rebuild a wide variety of worn parts and put them back in serviceable condition.

Key benefits of Loctite® Hysol® Metal-filled Compounds are:

- Fast repair
- Low shrinkage to reduce stress on components
- Easy to apply
- No need to heat parts
- Make repairs right on the production line
- Match metal colour
- Can be drilled, tapped or machined after cure
- Good adhesion to metal, ceramic, wood, glass and some plastics
- Excellent resistance to aggressive chemicals to increase part life
- Choice of mild steel, aluminium or non-metallic fillers
- Create durable repairs
- High compression strength for mechanical applications

Key factors to consider when choosing the right Loctite® Hysol® Metal-filled Compound

Metal to repair

Loctite® Hysol® products for metal repair use steel or aluminium fillers to obtain properties as close as possible to the part being repaired. Non-metal filled products can be used to rebuild worn areas constantly subjected to cavitation and wear.

Consistency

Product viscosity must be formulated to meet customer needs. The range of Loctite® Hysol® Metal-filled range includes pourable, putty or kneadable products to answer your requirements.

Special requirements

As some applications are extremely demanding, Henkel has developed special products to resist to high compression loads, high temperature or abrasion.

Surface Preparation

Correct surface preparation is vital for the successful application of these products.

Good surface preparation will:

- Improve adhesion of Loctite® Hysol® Metal-filled Compounds to parts
- Prevent corrosion between the metal surface and the Loctite® Hysol® Metal-filled Compound
- Extend part life

After surface preparation, parts must be:

- Clean and dry
- Without surface or internal chemical contamination
- Without corrosion
- With a surface profile of 75 µm minimum



Product application

Loctite® Hysol® Metal-filled Compounds are two component epoxies. Products must be mixed correctly before application, using the proper mixing ratio, until a uniform colour is achieved.

Putty products should be applied in thin layers. Press in place firmly and build up to the required thickness to fill the gap. Particular attention must be taken to prevent air bubbles forming.

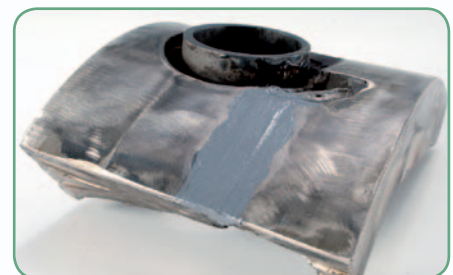

Shaft repair

Use Loctite® Hysol® 3478 for shaft-repair and to rebuild bearing seats. Please contact your local Technical Support to obtain specific recommendations for shaft repair solutions.



Metal-filled Compounds

Product table

Repair or rebuild metal damaged parts?

Steel

Kneadable

High compressive strength

Putty

Solution

3463

(Metal Magic Steel™ stick)

3478 A&B

(Superior Metal)

3471 A&B

(Metal Set S1)

Description	2K-Epoxy	2K-Epoxy	2K-Epoxy
Mix ratio by volume / weight:	N/A	7.25:1	1:1
Working life	3 min.	20 min.	45 min.
Fixture time	10 min.	180 min.	180 min.
Shear strength (GBMS)	≥6 N/mm ²	17 N/mm ²	20 N/mm ²
Compressive strength	82.7 N/mm ²	125 N/mm ²	70 N/mm ²
Service temperature range	-30 to +120 °C	-30 to +120 °C	-20 to +120 °C
Pack sizes	114g	453g	500g tub kit



Loctite® 3463

- Emergency sealing of leaks in pipes and tanks
- Smooths welds
- Repairs small cracks in castings

Sets in 10 minutes. Steel filled kneadable Stick. Adheres to damp surfaces and cures under water. Chemical and corrosion resistant. Can be drilled, filed and painted.

ANSI/NSF Standard 61



Loctite® Hysol® 3478 A&B

- Rebuilding keyways and spline assemblies
 - Rebuilding of bearings, clamp connections, tensioning elements, gear wheels or bearing seats
- Ferro-silicon filled with outstanding compression strength. Ideal for renewing surfaces subjected to compression, thrust, impact and harsh environments.



Loctite® Hysol® 3471 A&B

- Seal cracks in tanks, castings, vessels and valves
 - Patch non-structural defects in steel casings
 - Resurface worn air seals
 - Repair pitting caused by cavitation and/or corrosion
- General purpose steel-filled, non-sagging 2K-Epoxy. Used to rebuild worn metal parts.

What material are you filling?

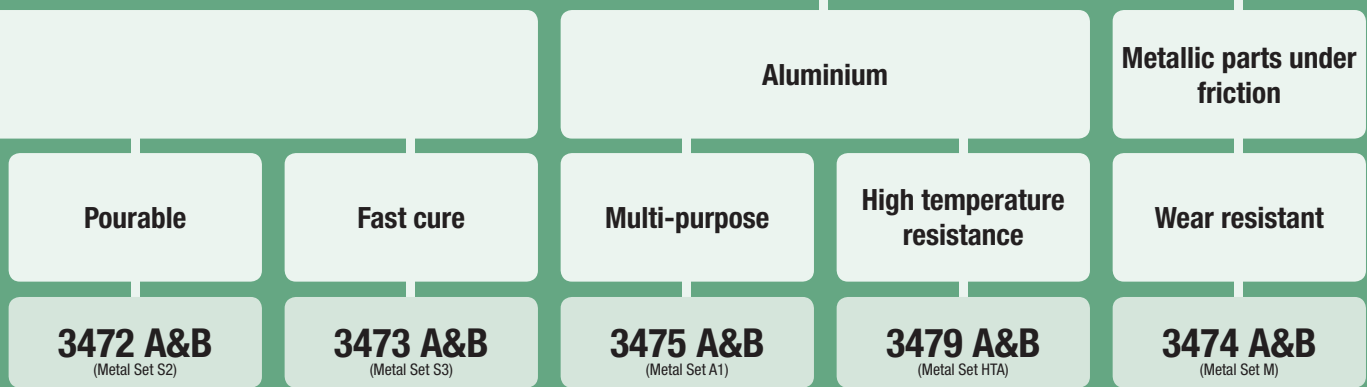

2K-Epoxy	2K-Epoxy	2K-Epoxy	2K-Epoxy	2K-Epoxy
1:1	1:1	1:1	1:1	1:1
45 min.	6 min.	45 min.	40 min.	45 min.
180 min.	15 min.	180 min.	150 min.	180 min.
25 N/mm ²	20 N/mm ²	20 N/mm ²	20 N/mm ²	20 N/mm ²
70 N/mm ²	60 N/mm ²	70 N/mm ²	90 N/mm ²	70 N/mm ²
-20 to +120 °C	-20 to +120 °C	-20 to +120 °C	-20 to +190 °C	-20 to +120 °C
500g tub kit	500g tub kit	500g tub kit	500g tub kit	Not available in the UK



Loctite® Hysol® 3472 A&B

- Form moulds, fixtures and prototypes
 - Repair threaded parts, pipes and tanks
- Pourable, steel-filled, self levelling. Recommended for casting into hard to reach areas, anchoring and levelling, forming moulds and parts.



Loctite® Hysol® 3473 A&B

- Repair holes in tanks, leaks in pipes and elbows
 - Renew stripped threads
 - Rebuild worn steel parts
- Fast curing, steel filled, nonsagging. Ideal for emergency repair and repairing worn metal parts to prevent downtime.



Loctite® Hysol® 3475 A&B

- Repair aluminium castings, cracked or worn aluminium parts and stripped aluminium threads
- A non sagging, heavily reinforced, aluminium powder filled 2K-Epoxy. Easily mixed and moulded to form odd shapes if required. Cures to a non-rusting, aluminium-like finish.



Loctite® Hysol® 3479 A&B

- Rebuilding and repairing worn metal parts in high operating temperature applications.
- A non sagging, heavily reinforced, aluminium powder filled 2K-Epoxy. Easily mixed and moulded to form odd shapes if required. Cures to a non-rusting, aluminium-like finish.



Loctite® Hysol® 3474 A&B

- Ideal for repairing metallic surfaces under friction
- Steel putty, high wear resistant. Forms a self-lubricating surface to reduce sliding wear on moving parts.

Wearing Compounds

Protection of parts against external attack

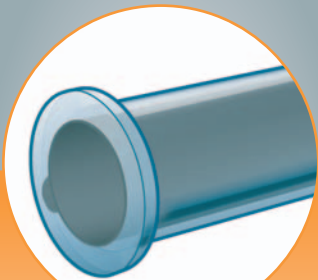
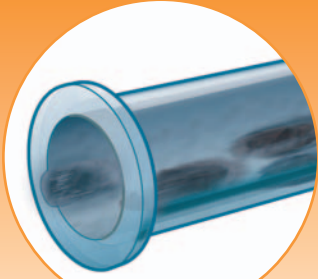

Why use a Loctite® Nordbak® Wearing Compound?

Loctite® Wearing Compounds offer maintenance solutions to the problems caused by wear, abrasion, chemical attack, cavitation and erosion.

Typical applications for this product range include air ducts, pumps, impellers, fan blades, propellers, cyclones, etc.

With extremely hard fillers, Loctite® Nordbak® Wearing Compound have excellent wear resistance and superior adhesion. They are designed for specific service conditions and to protect and extend the service life of a wide range of plant areas and plant equipment. Their key advantage is their capability to create a sacrificial and renewable working surface, protecting the structural integrity of the original substrate.

Available in trowelable, brushable and sprayable formulations with special fillers for tough conditions, Loctite® Nordbak® Wearing Compounds stand up to every corrosion, abrasion, and wear problem you can encounter, and are ideal for all those large-scale repairs that have to last.

Traditional methods vs modern solutions:

Traditional repair methods such as hard metal welding or flame spraying are expensive and difficult to use for large surfaces. Alternatively, Loctite® Nordbak® Wearing Compounds are easily applied on all surface sizes and offer the extra benefit of corrosion protection.

Loctite® Hysol® Metal-filled and Loctite® Nordbak® Wearing Compounds help you restore and rebuild a wide variety of worn parts and put them back in serviceable condition.

Key benefits of Loctite® Nordbak® Wearing Compounds:

- Restore worn surfaces and extend part life
- Save cost by avoiding part replacement
- Reduce spare part inventories
- Protect parts against corrosion
- Non-shrinking and non-sag formulations for large or vertical applications
- Good chemical resistance for effective protection of assemblies
- Wide range tailored to specific applications
- Extend life of new parts
- Increase part efficiency

Key factors to consider when choosing the right Loctite® Nordbak® Wearing Compound

Particle size

To improve abrasion resistance, particle sizes of the abrasive materials and of the Loctite® Nordbak® Wearing Compound should be similar. The range of Loctite® Nordbak® Wearing Compounds offers grades for coarse particles as well as fine particle protection. A special product offering high impact resistance is also included in the range.

Temperature resistance

Operating temperatures of Loctite® Nordbak® Wearing Compounds range from -30 °C to +120 °C. Some special grades, e.g. Loctite® Nordbak® 7230 or Loctite® Nordbak® 7229, can be used up to +230 °C. These special grades require post curing to achieve their ultimate high temperature performance.

Chemical resistance

Thanks to the special epoxy matrix of Loctite® Nordbak® Wearing Compounds, this range of products is resistant to most types of chemical attack. The products offer good protection against fresh water and sea water, ammonium sulphate and sodium hydroxide. Please contact your local Technical Support for specific chemicals requirements.

Surface Preparation

Correct surface preparation is vital for the successful application of these products.

Good surface preparation will:

- Improve adhesion of the Loctite® Nordbak® Wearing Compound to parts.
- Prevent corrosion between the metal surface and the Loctite® Nordbak® Wearing Compound
- Extend maintenance intervals.

After surface preparation parts, must be:

- Clean and dry
- Without surface or internal chemical contamination
- Without corrosion
- With a surface profile of 75 µm minimum
- With a blast profile of class 2.5

For large surfaces, an anticorrosion coating compatible with Loctite® Nordbak® Wearing Compounds could be applied to avoid flash rusting.



Product application

Loctite® Nordbak® Wearing Compounds are two component epoxies. Products must be mixed correctly before application, using the proper mixing ratio, until a uniform colour is achieved.

To insure good wettability of Loctite® Nordbak® Wearing Compound product, it is recommended to apply a brushable product like Loctite® Nordbak® 7117 as a primer prior to use coarse particle reinforced Loctite® Nordbak® Wearing Compound product.

For coating thicker than 25 mm, apply material in layers of 25 mm at a time, allowing the layer to cool before applying the next layer.



Wearing Compounds

Product table

What type of abrasive particle wear to be resisted?

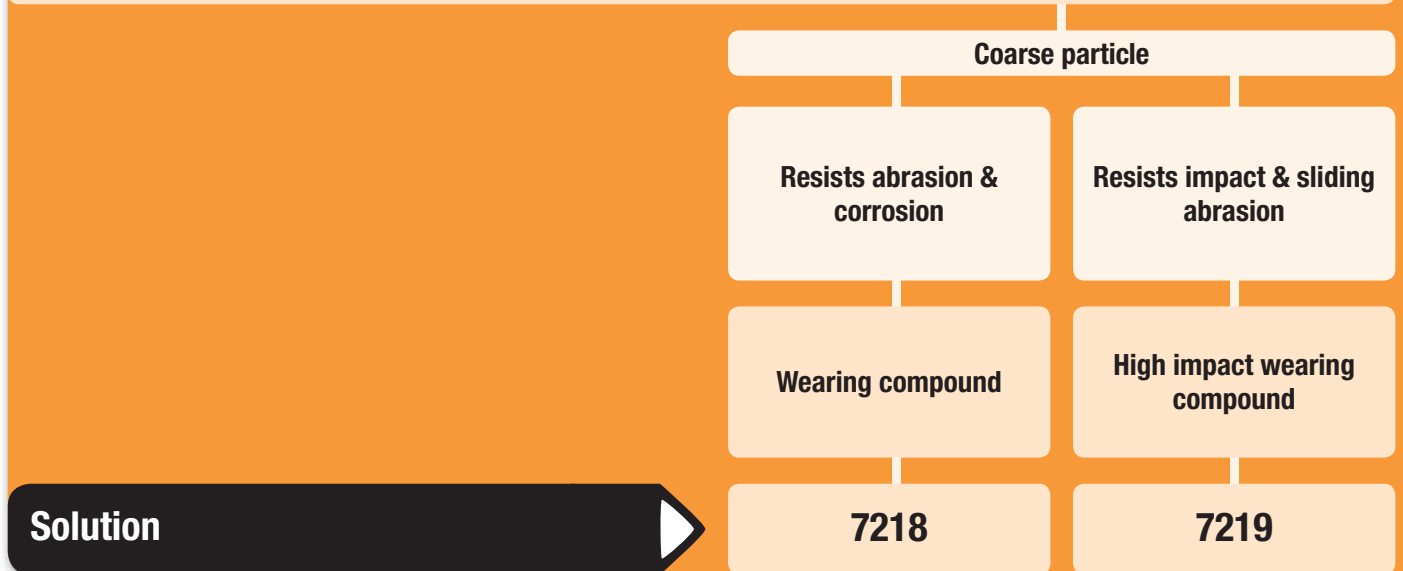

Colour	Grey	Grey
Service temperature range	-30 to +120 °C	-30 to +120 °C
Mix ratio by volume	2:1	2:1
Working life	30 min.	30 min.
Cure time	7 h	6 h
Recommended layer thickness	min. 6 mm	min. 6 mm
Pack sizes	1kg, 10kg	1kg, 10kg

Badly worn surfaces are rebuilt using Loctite® Nordbak® 7222 Wear Resistant Putty or Loctite® Nordbak® 7232 High Temperature Wear Resistant Putty, prior to applying protective Loctite® Nordbak® composite coatings.



Loctite® Nordbak® 7218

- Cyclone and separator bodies
 - Dust collectors and exhausters
 - Pump liners and impellers
 - Fan blades and housings
 - Chutes and hoppers
 - Elbows and transition points
- Trowelable, ceramic filled epoxy designed to protect, rebuild and repair high wear areas of processing equipment. Suitable for overhead applications and irregular surfaces.



Loctite® Nordbak® 7219

- Dredge pump liners
 - Flumes and troughs
 - Pump impellers
 - Vibrating feeders
 - Chutes/hoppers
- Rubber modified, ceramic filled epoxy that offers high impact resistance. Ideal for areas exposed to abrasion and impact. Nonsagging and suitable for overhead applications and irregular surfaces.

Fine particle

Resists fine particle abrasion	Sprayable protective coating	Brushable protective coating	Brushable protective coating at high temperature
Pneu-wear	Sprayable ceramic	Brushable ceramic	High temperature brushable ceramic
7226	7255	7117	7234

Grey	Green	Grey	Grey
-30 to +120 °C	-30 to +95 °C	-29 to +95 °C	-29 to +205 °C
4:1	2:1	3.38:1	2.6:1
30 min.	40 min.	60 min.	30 min.
6 h	4 h	3.5 h	8 h + 3 h post cure
min. 6 mm	min. 0.5 mm	min. 0.5 mm	min. 0.5 mm
1kg, 10kg	900g, 30kg	1kg	1kg



Loctite® Nordbak® 7226

- Dredge pump liners
- Flumes and troughs
- Pump impellers
- Vibrating feeders
- Chutes/hoppers

Carbid-filled epoxy for protecting processing equipment from fine particle abrasion. This trowelable and non-sag epoxy is suitable for overhead and vertical surfaces.



Loctite® Nordbak® 7255

- Lining tanks and chutes
 - Rudders and pintle housings
 - Heat exchangers
 - Condensers
 - Cooling pump impellers
- Ultra-smooth, ceramic reinforced epoxy that provides a high gloss, low friction coating to protect against turbulence and abrasion. Seals and protects equipment from corrosion and wear.



Loctite® Nordbak® 7117 Replacement of Loctite® Nordbak® 7227 offering improved abrasion resistance

- Impellers, butterfly valves
 - Pump housings
 - Cyclones
 - Lining tanks
- Brushable two-part epoxy that provides a high gloss, low friction coating to protect equipment from wear abrasion and corrosion.



Loctite® Nordbak® 7234

- Exhausters
 - Heat exchangers and condensers
 - Lining tanks and chutes
 - Butterfly valves
- Brushable two-part epoxy designed to protect against turbulence and abrasion under extreme heat.

Wearing Compounds

Product list

Product	Product description	Particle size	Colour	Mix ratio by volume	Working life	Cure time	Recommended layer thickness
Loctite® Nordbak® 7117	Ceramic filled epoxy	Fine	Grey	3.38:1	60 min.	3.5 h	min. 0.5 mm
Loctite® Nordbak® 7204	Quartz filled epoxy – Concrete repair	Small	Grey	1.66:1	45 min.	24 h	min. 6 mm
Loctite® Nordbak® 7218	Ceramic filled epoxy	Large	Grey	2:1	30 min.	7 h	min. 6 mm
Loctite® Nordbak® 7219	Ceramic filled epoxy	Large	Grey	2:1	30 min.	6 h	min. 6 mm
Loctite® Nordbak® 7221	Ceramic filled epoxy	Fine	Grey	2.3:1	20 min.	16 h	min. 0.5 mm
Loctite® Nordbak® 7222	Ceramic filled epoxy	Small	Grey	2:1	30 min.	6 h	–
Loctite® Nordbak® 7226	Ceramic filled epoxy	Fine	Grey	4:1	30 min.	6 h	min. 6 mm
Loctite® Nordbak® 7227	Ceramic filled epoxy	Fine	Grey	2.75:1	30 min.	6 h	min. 0.5 mm
Loctite® Nordbak® 7228	Ceramic filled epoxy	Fine	White	2.8:1	15 min.	5 h	min. 0.5 mm
Loctite® Nordbak® 7229	Ceramic filled epoxy	Small	Grey	4:1	30 min.	6 h + 2 h post cure	min. 6 mm
Loctite® Nordbak® 7230	Ceramic filled epoxy	Large	Grey	4:1	30 min.	7 h + 2 h post cure	min. 6 mm
Loctite® Nordbak® 7232	Ceramic filled epoxy	Large and fine	Grey	4:1	45 min.	8 h + 3 h post cure	min. 6 mm
Loctite® Nordbak® 7234	Ceramic filled epoxy	Fine	Grey	2.6:1	30 min.	8 h + 3 h post cure	min. 0.5 mm
Loctite® Nordbak® 7255	Ceramic filled epoxy	Fine	Green	2:1	40 min.	4 h	min. 0.5 mm
Loctite® Nordbak® 7256	Ceramic tile bonding epoxy	Fine	Off-white	1:1	60 min.	12 h	–
Loctite® Nordbak® 7257	Concrete repair – Magnesium phosphate	Small	Grey	1:5	3 min.	22 min.	min. 6 mm

	Hardness shore D	Compressive strength N/mm ²	Shear strength N/mm ²	Service temperature range	Pack sizes	Comments
	87	105	23.2	-28 to +95 °C	1kg	Brushable protective coating
	–	82.7	–	-29 to +66 °C	19kg	Chemically resistant floor protection
	90	110.3	–	-28 to +120 °C	1kg, 10kg	Resists abrasion & corrosion
	85	82.7	–	-30 to +120 °C	1kg, 10kg	High impact & abrasion resistance
	83	69	17.2	-30 to +65 °C	5.4 kg	Chemically resistant coating
	89	80	10	-29 to +107 °C	1.3 kg	Wear resistant putty
	85	103.4	34.5	-29 to +120 °C	1kg, 10kg	Protection from fine particle abrasion
	85	86.2	24.2	-29 to +95 °C	1kg	Old brushable protective coating
	85	86	24	-29 to +95 °C	1kg	White brushable protective coating
	85	103.4	34.5	-28 to +230 °C	10kg	High temperature protection from fine particle abrasion
	90	103.4	–	-28 to +230 °C	10kg	High temperature & abrasion resistance
	90	103	59	-29 to +205 °C	1kg	High temperature wear resistant putty
	–	–	–	-29 to +205 °C	1kg	High temperature brushable coating
	86	106	31	-30 to +95 °C	900g, 30kg	Sprayable wear resistant coating
	88	96.6	34	-29 to +93 °C	9kg	Bonding of ceramic tiles for wear protection
	–	up to 90	–	-26 to +1,090 °C	4.53kg, 24kg	Fast concrete repair solution



Cleaning

Parts and maintenance cleaning



Why use a Loctite® Cleaner?

Loctite® Cleaners and Degreasers are highly effective and are available in both aqueous and solvent-based formulations. When choosing a cleaner or degreaser, the major factors to consider are drying time, residue, odour, and substrate compatibility. Residue is a particularly important concern: if there is any secondary processing of the part, e.g. painting or bonding, a residue could interfere with that process. Substrate compatibility is a common concern when dealing with plastics and solvent-based cleaners.

The following chart will help you to select the appropriate cleaner for your application.

- Cleaning of components before applying Loctite® adhesives/sealants
- Cleaning and degreasing of worktops and parts
- Removing cured sealant residue

The product line includes:

- Two highly effective gentle and biodegradable hand cleaners
- Electrical contact cleaner
- Food grade cleaner (NSF A7)





Why use a P3 Cleaner?

P3 cleaners are mainly used for cleaning parts and assemblies in the metal working industry, in workshops, in the railway and boat industry and for maintenance applications. P3 cleaners are also suitable for removing paint from surfaces (graffiti), cleaning hands, floors, car bodies, track vehicles, boats, awnings, tanks, pipes and many other applications.

- P3 combines high quality water-based alkaline, acidic and neutral cleaners. P3 cleaners are suitable for metal substrates, plastics, concrete, stone, ceramics, glass, painted surfaces etc.
- P3 cleaners can be applied by spraying, dipping, high pressure, ultrasonic, manually or with a machine as final or intermediate cleaning process
- Good cleaning results can be achieved at temperatures of 5 °C up to 100 °C
- P3 cleaners are available as concentrate (mix with water) or as ready-to-use products
- In addition cleaners with corrosion protection properties are available

The cleaning function is removal of contaminants from the surface to prepare it for subsequent operations. These are materials left on the surface from previous operations as cutting, stamping, drilling, drawing, grinding, etc. or the surface condition of incoming stock.

Contamination can may generally be divided into three categories:

- Organic - are typically the lubricants used in metal forming and machining operations or corrosion preventive compounds. Mainly alkaline cleaners are suitable
- Inorganic - include rust, heat and weld scale, smuts and oxides. Acids or acidic cleaners are designed to remove such kind of soils. Acidic cleaners are also used to clean injection-moulded thermoset plastic
- Miscellaneous - include shop dirt, inks, glove and finger prints. Alkaline or neutral cleaners could be applied

Neutral cleaners are suitable for sensitive surfaces, especially self demulsifying cleaners

Cleaning

Product table

Do you need a hand cleaner or a parts/surface cleaner?

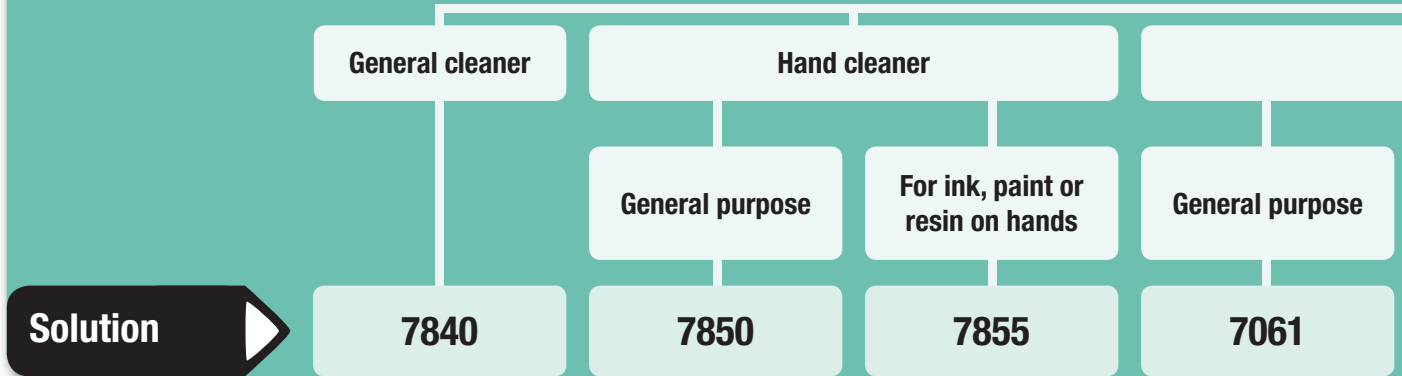

Description	Cleaner & degreaser	Hand cleaner	Hand cleaner	Cleaner & degreaser
Pack sizes	750ml trigger spray, 5 lt can, 20 lt drum	400ml bottle, 3 lt pump dispenser, 10 lt drum	400ml bottle, 1.75 lt pump dispenser	400ml aerosol



Loctite® 7840 Cleaner & degreaser

- Biodegradable
- Solvent-free, non-toxic, non-flammable
- Diluted with water
- Removes grease, oil, cutting fluids and workshop grime



Loctite® 7850 Hand cleaner

- Natural extract base
- Free from mineral oils
- Biodegradable
- Contains premium skin conditioners
- Works with or without water
- Removes ground-in dirt, grease, grime, and oil



Loctite® 7855 Hand cleaner

- Biodegradable
- Non toxic
- Removes paint, resin and adhesives



Loctite® 7061 Cleaner & degreaser

- Solvent-based (acetone) general parts cleaner
- Very fast evaporation
- Removes dirt, resins, lacquer, oils and greases

Parts, machines and surface cleaners

General purpose	Plastic parts	Low VOC	Gasket remover	Electrical contact
7063	7070	7066	7200	7039

Cleaner & degreaser	Cleaner & degreaser	Cleaner & degreaser	Gasket remover	Contact cleaner spray
400ml aerosol, pump, 10 lt can, 200 lt	400ml aerosol, pump, 10 lt	Not available in the UK	400ml aerosol	400ml aerosol



Loctite® 7063
Cleaner & degreaser

- Solvent-based general parts cleaner
- Leaves no residue
- Ideal for use prior to adhesive bonding and sealing applications
- Removes most greases, oils, lubrication fluids, metal cuttings and fines from all surfaces



Loctite® 7070
Cleaner & degreaser

- Solvent-based general parts cleaner
- Usable as spray or in immersion cleaning process at room temperature
- Removes special heavy oils
- For most plastic parts without the risk of stress cracks



Loctite® 7066
Cleaner & degreaser

- Water-based emulsion with low VOC
 - Use for metals and plastics
- A7 NSF Reg.No.: 138407**



Loctite® 7200
Gasket remover

- Removes cured gasket sealants and traditional gaskets in 10 to 15 minutes
- Minimal scraping
- Usable on most types of surfaces



Loctite® 7039
Contact cleaner spray

- For cleaning electrical contacts exposed to moisture or other contaminations
- Does not affect insulating varnishes
- Typical application: Cleaning of electrical contacts, relays, switch-gear etc.

Cleaning

Product list

Product	Application	Cleaner type	pH-value	Working temperature in °C	Application concentration in g/l
Loctite® 7061	Spray	Parts	N.A.	N.A.	Ready-to-use
Loctite® 7039	Spray	Electronic parts	N.A.	N.A.	Ready-to-use
Loctite® 7063	Spray/wipe	Parts	N.A.	N.A.	Ready-to-use
Loctite® 7066	Spray	Parts	N.A.	N.A.	Ready-to-use
Loctite® 7070	Spray/wipe/dip	Parts	N.A.	N.A.	Ready-to-use
Loctite® 7200	Spray	Parts/maintenance	N.A.	N.A.	Ready-to-use
Loctite® 7840	Spray/wipe/dip	Parts	10 – 11	N.A.	Ready-to-use/ diluted with water
Loctite® 7850	Manual	Hand cleaner	5 – 8	N.A.	Ready-to-use
Loctite® 7855	Manual	Hand cleaner	5 – 8	N.A.	Ready-to-use

Application area	Substrates to clean	Short description
Metal working industry, workshops, machines	General purpose	General purpose parts cleaner and degreaser (based on acetone) prior to bonding
Electronics	Electrical contacts	Cleaner spray for cleaning electrical contacts exposed to moisture or other contaminations
Metal working industry, workshops, machines	General purpose	General purpose parts cleaner and degreaser prior to bonding, which leaves no residue (solvent-based)
Metal working industry, workshops, machines	Metal, plastic	Low VOC cleaner and degreaser for use with metal and plastic, NSF approved
Metal working industry, workshops, machines	Plastic	Cleaner and degreaser for plastic parts prior to bonding, without risk of stress cracks
Metal working industry, workshops, machines	Gaskets	Gasket remover, which removes gasket sealants in 10–15 minutes
Metal working industry, workshops, machines, floors, store rooms, staff areas	General purpose	Biodegradable cleaner and degreaser for removing grease, oil cutting fluids and workshop grime
Metal working industry, workshops	Skin	General purpose hand cleaner based on natural extract
Metal working industry, workshops	Skin	Hand cleaner for removing paint, resin and adhesive



Cleaning

Product list

Product	Application	Cleaner type	pH-value	Working temperature in °C	Application concentration in g/lt
P3 Chemacid 3500	Spray/dip	Parts	1.5	50 – 90	20 – 450
P3 Croniclean 300	Spray/dip	Maintenance	11.0	15 – 35	10 – 20
P3 Emulpon 6776	Spray/dip	Parts	9.1	40 – 80	5 – 20
P3 Galvaclean 20	Dip/ultra sonic	Parts	8.6	40 – 90	20 – 80
P3 Gero Cor 3	Spray/dip	Parts	N.A.	15 – 30	Ready-to-use
P3 Glin Floor	Manual/machine	Maintenance	9.9	15 – 35	25 – 100
P3 Glin Plus	High pressure/manual	Maintenance	10.0	5 – 80	30 – 100
P3 Grato 12	(Spray)/dip/manual	Maintenance	9.1	5 – 80	Mixable in all ratios
P3 Grato 80	Spray/high pressure	Maintenance	12.0	15 – 100	5 – 20
P3 Manuvo	Manual	Maintenance	9.5	15 – 35	Ready-to-use
P3 Neutracare 3300	Spray/high pressure	Parts	9.1	30 – 80	10 – 30
P3 Neutrapon 5088	Spray/dip/ultra sonic	Parts	8.6	50 – 80	5 – 30
P3 Prevox 7400	Spray/dip	Parts	10.1	15 – 80	5 – 30
P3 Rimol 768	Spray/dip/manual	Maintenance	8.7	30 – 80	Mixable in all ratios
P3 Scribex 400	Manual	Maintenance	3.7	10 – 40	Ready-to-use
P3 Solvclean 102	Spray/dip/manual	Maintenance	N.A.	10 – 40	Ready-to-use
P3 Ultraperm 075	Spray/dip	Maintenance	1.1	50 – 60	5 – 10
P3 Ultraperm 091	Spray/dip	Maintenance	12.8	50 – 70	10 – 20
P3 Upon 5800	Spray	Parts	12.0	40 – 80	40 – 80
Plastiwash 1939	Spray	Parts	2.4	40 – 65	10 – 30

	Application area	Substrates to clean	Short discription
	Metal working industry	Steel, iron	Acid cleaner, pickle for heavy duty operations
	Metal working industry, paint shops	Paint application area/ equipments: guns, bells, nozzles	Waterbased cleaner to remove uncured water-born paint systems, overspray
	Metal working industry	Steel, cast iron	Corrosion protection emulsion (3–4 months)
	Metal working, electronic industry, hardening plants	Multi metal	All-purpose alkaline cleaner with corrosion protection (leaves hydrophobic surface, for final and intermediate cleaning, excellent for removing of polishing pastes)
	Metal working industry	Steel, cast iron	Corrosion protection oil (6–12 months)
	Metal working industry, work shops, store/social rooms	Tiles, concrete, synthetic material	Floor cleaner, applicable by floor cleaning machines, manual by wipes or brush
	Metal working industry, work shops, machines, floors, store/social rooms	Multi metal, plastic, painted surfaces	Multi-purpose cleaner, self-demulsifying, manual with sponge, brush or rag
	Railway carriages, boats, engines, repair parts, tanks, pipes, floors	Multi metal	Alkaline cleaner, cold applicable, for nearly all surfaces and substrates
	Metal working industry, car bodys, engines, repair parts	Steel, non-ferrous metals	Steam high pressure cleaner
	Metal working industry	Dirty hands	Hand cleaner
	Metal working industry, manufactures of engines	Steel, aluminum	Self-demulsifying neutral cleaner
	Metal working industry, manufactures of engines	Multi metal	Salt-free neutral cleaner with corrosion protection
	Metal working industry	Steel, cast iron	Aqueous corrosion protection (2–3 days)
	Metal working industry, cleaning of painted surfaces, facades, work shops, all kind of plastics	Multimetal, plastics, natural stone, concrete	High performance neutral cleaner for all substrates
	External bodies/carriages, smooth, non absorbing surfaces	Painted surfaces, glass, ceramics	Graffiti remover free of chlorinated solvents and mineral oil distillates
	Industrial cleaning plants, processing of high precision parts	Multi metal	Solvent containing cleaner, free of halogenated hydrocarbons, flash point >100 °C
	Metal working industry	Acid resistant membranes	Acidic membrane cleaner
	Metal working industry	Alkali resistant membranes	Alkaline membrane cleaner
	Metal working industry	Steel, plastic	Alkaline spray cleaner suitable for metals and all kind of plastics
	Mould and cast plastic manufactures	S.M.C., R.I.M., R-TPU, PC	Acidic cleaner for all kind of plastics prior painting

Lubrication

Lubrication and Protection

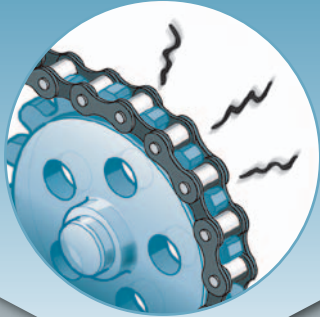

Why use a Loctite® Lubricant?

Loctite® Lubricants offer protection for industrial plant and equipment. This range includes organic, mineral and synthetic based products meeting the requirements of industrial applications.

What is the function of a lubricant?

The typical function of a lubricant is to protect against friction and wear. Lubricants are also used to protect against corrosion by displacing moisture and leaving a continuous coating on the part.

What considerations are important when choosing a lubricant?

When choosing a lubricant, it is important to consider the intended application as well as the environmental conditions to which the assembly will be exposed. Environmental conditions are critical to the successful selection of the right lubricant product. Factors including high temperature, harsh chemicals and contaminants may have an adverse effect on the expected lubricant performance.

Loctite® Anti-Seize

Loctite® Anti-Seize products provide protection in harsh environments and operating conditions, e.g. extreme temperatures and corrosive attack. They prevent fretting and galvanic corrosion, and can also be used as running-in lubricant for new equipment.



Loctite® Dry Film Lubricants

MoS₂ and PTFE based Loctite® Dry Film Lubricants reduce friction, prevent seizing, ensure protection against corrosion and enhance the performance of oils and greases.



Loctite® Lubricating Oils

Loctite® lubricating Oils have been developed for moving parts in equipment ranging from big plants to smaller machines. Flowability and surface adhesion ensure good lubrication at both high and low speeds within the specified temperature range.



Loctite® Lubricating Greases

Loctite® Lubricating Greases have been developed to offer the following performance benefits:

- Protect against friction
- Reduce wear
- Prevent overheating

Carefully balanced formulations and high-quality ingredients help Loctite® lubricants meet the requirements of a wide range of applications. To match specific requirements, Loctite® Greases are made of mineral or synthetic based oils combined with a thickening agent, e.g. lithium soap or inorganic material such as silica gel. Loctite® Greases protect against corrosion and withstand extreme pressures.



Multan® Cutting Fluid Emulsions – New biostable cutting fluids

Henkel patented emulsifier technology

Excellent wetting properties result in:

- High cleanliness of machined parts, machines and tools
- Good run-off characteristics and low drag-out rates
- Minimised replenishment rates
- Excellent anti-corrosion behaviour
- Bactericide-free cutting fluids without bacterial growth – even the addition of bactericides is unnecessary
- No bactericide costs – even during replenishment / stable also during long idle periods / Self repairing – Fill the system, maintain 5 % fill concentration
- Bactericide-free formulation ensures very good skin compatibility
- Remarkable little foam formation
- Milky white cutting fluids used for drilling, turning, milling, grinding
- Multi-metal applications (cast iron, steel, aluminium, non-ferrous metals, etc.)
- Multi-machining characteristics (turning, drilling, milling, tapping, grinding, etc.)
- Multifunctional – A true all-rounder-generalist Multan 71-2
- High performance cutting fluid for aluminium/stainless steel machining where high lubricity is required: Specialist Multan 77- 4

Multan 71-2



Multan 77-4



Lubrication – Anti-Seize

Product table

High performance applications

High water
resistance

High purity

Long term
protection

Solution

8023

8013

8009

Colour	Black	Dark grey	Black
Solid lubricating agent	Graphite, calcium, boron nitride & rust inhibitors	Graphite & calcium oxide	Graphite & calcium fluoride
N.L.G.I. class	–	–	–
Service temperature range	-30 to +1,315 °C	-30 to +1,315 °C	-30 to +1,315 °C
Pack sizes	454g brush top	454g brush top	454g brush top, 3.6kg can

Handy Hints:

- Loctite® 8065 now offers the same trusted performance in a semi-solid stick formula, but clean, fast and easy to apply.
- Special equipment available on request



Loctite® 8023 brush top

- Anti-Seize with ultimate wash out resistance
- For stainless steel
- Metal free

American Bureau of Shipping certified



Loctite® 8013 brush top

- High purity metal free Anti-Seize
- Excellent chemical resistance
- For stainless steel
- Ideal for use in the nuclear industry

PMUC



Loctite® 8009 brush top

- Metal free Anti-Seize
- Provides long term lubrication
- For all metals including stainless steel and titanium

Standard applications



Black	Copper	Grey	Black	White
MoS ₂ & rust inhibitors	Copper & graphite	Aluminium, graphite, extreme pressure (EP) additives	MoS ₂	White oil and extreme pressure (EP) additives
1	-	1	1	-
-30 to +400 °C	-30 to +980 °C	-30 to +900 °C	-30 to +450 °C	-30 to +400 °C
454g brush top	400ml aerosol, 113g, 454g brush top, 3.6kg can, 20g stick	500g, 1kg, 400ml aerosol	400ml aerosol	907g can



Loctite® 8012 brush top

- MoS₂ assembly paste ensures maximum lubricity
- Gives good resistance to extremely high loads
- Ideal for protection of parts during running in or cold start



C5-A®

Loctite® 8007 aerosol Loctite® 8008 brush top Loctite® 8065 stick

- Copper based Anti-Seize
- Typical applications: screws, nuts, pipes, exhaust bolts, brake caliper bolts



Loctite® 8150 can

Loctite® 8151 aerosol

- Protects threaded connections
- Prevents seizing and corrosion
- Typical applications: screws, nuts, pipes, heat exchangers and fittings of oil and gas burners



Loctite® 8154 aerosol

- Assembly paste with MoS₂
 - Facilitates assembly and disassembly of cylindrical parts
 - Withstands heavy operation conditions
 - Lubricates and seals cylindrical parts, bearings, gearwheels at low speed
- H2 NSF Reg. Nr.: 122982**



Loctite® 8014

- Food grade metal free Anti-Seize
- For stainless steel components
- Suitable for wet environments

H1 NSF Reg. Nr.: 123004

Lubrication – Dry Film and Oils

Product table

Solution	Dry film lubricant		
	General purpose	Non metal surface	Penetrating oil
	8191	8192	8001
Appearance	Black	White	Colourless
Base	MoS ₂	PTFE	Mineral oil
Viscosity	11 s (Cup 4)	11 s (Cup 4)	4 cSt
Service temperature range	-40 to +340 °C	-180 to +260 °C	-20 to +120 °C
Load test 4 ball N (Weld load)	N.A.	N.A.	1,200
Pack sizes	400ml aerosol	400ml aerosol	400ml aerosol



Loctite® 8191

- MoS₂ Anti-friction coating – aerosol
- Quick drying
- Surface protection against corrosion
- Enhances the performance of oils and greases



Loctite® 8192

- PTFE coating
 - For non-metal and metal surfaces
 - Creates sliding surface for free movement
 - Prevents dust/dirt accumulation
 - Protection against corrosion
 - For conveyor belts, slideways and cams
- H2 NSF Reg. No.: 122980**



Loctite® 8001

- Penetrating mineral oil spray
 - Multi-purpose penetrating oil for micro mechanisms
 - Penetrates inaccessible mechanisms
 - Lubricates valve seats, collars, chains, hinges and cutting knives
- H1 NSF Reg. No.: 122999**

Oil

Chain lubricant	Freeing parts	Silicone oil	Cutting oil	General purpose
8011	8040	8021	8030/8031	8201
Yellow	Amber	Colourless	Dark yellow	Light yellow
Synthetic oil	Mineral oil	Silicone oil	Mineral oil	Mineral oil
11.5 cSt	5 mPa.s	350 mPa.s	170 cSt	17.5 cSt (50°C)
-20 to +250 °C	N.A.	-30 to +150 °C	-20 to +160 °C	-20 to +120 °C
2,450	N.A.	N.A.	8,000	N.A.
400ml aerosol	400ml aerosol	400ml aerosol	8030: 250ml bottle 8031: 400ml aerosol	400ml aerosol



Loctite® 8011

- High temperature chain oil spray
 - Oxidation resistance prolongs lubricant service life
 - Lubricates open mechanisms, conveyors and chains at elevated temperatures up to 250 °C
- H2 NSF Reg. No.: 122978**



Loctite® 8040 Freeze & Release

- Releases rusted, corroded and seized components by the shock-freezing effect
- Wicks directly into the rust by capillary action
- Released parts remain lubricated and protected from corrosion



Loctite® 8021

- Silicone oil
 - Lubricates metal and non-metal surfaces
 - Suitable as release agent
- H1 NSF Reg.No.: 141642**



Loctite® 8030 bottle Loctite® 8031 aerosol

- Cutting oil
- Protects cutting tools in operation
- Improves surface finish
- Increases tool life
- For drilling, sawing or tapping steel, stainless steel and most non-ferrous metals



Loctite® 8201 Five way spray

- Frees assemblies
- For light lubrication of metals
- Cleans parts
- Displaces moisture
- Prevents corrosion

Lubrication – Greases

Product table

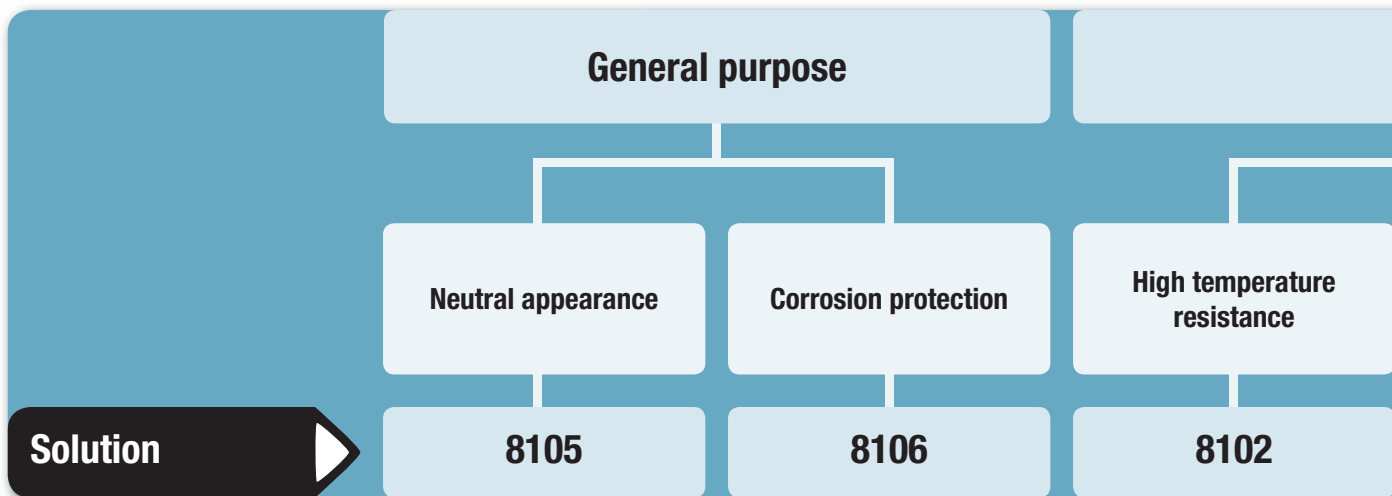

	8105	8106	8102
Appearance	Colourless	Light brown	Light brown
Base oil and additives	Mineral	Mineral	Mineral, EP
Thickener	Inorganic gel	Lithium soap	Lithium soap complex
Drop point	None	> 230 °C	> 250 °C
N.L.G.I. class	2	2	2
Service temperature range	-20 to +150 °C	-30 to +160 °C	-30 to +200 °C
Load test 4 ball N (Weld load)	1,300	2,400	3,300
Pack sizes	400ml cartridge, 1 lt can	400ml cartridge, 1 lt can	400g cartridge, 1 lt can

Handy Hints:

- Special equipment available on request



Loctite® 8105

- Mineral grease
- Lubricates moving parts
- Colourless
- Odourless
- Ideal for bearings, cams, valves and conveyors

H1 NSF Reg. No.: 122979



Loctite® 8106

- Multi-purpose grease
- Lubricates moving parts
- Provides corrosion protection
- For rolling, plain bearings and slideways



Loctite® 8102

- High temperature grease
- Prevents wear and corrosion
- Suitable in humid environmental conditions
- Withstands heavy loads at medium and high speeds
- Lubricates rolling, plain bearings, open gears and slideways

High performance

Special purpose

Heavy load applications

Plastic part applications

Food processing applications

Chains, gears

8103

8104

8108

8101

Black

Colourless

Creamy

Amber

Mineral oil, MoS₂

Silicone

Polyalphaolefin (PAO)

Mineral oil, E.P.

Lithium soap

Silica gel

Calcium sulfonate

Lithium soap

> 250 °C

N.A.

> 315 °C

> 250 °C

2

2/3

2

2

-30 to +160 °C

-50 to +200 °C

-40 to +200 °C

-30 to +170 °C

3,600

N.A.

N.A.

3,900

400g cartridge, 1 lt can

75ml tube, 1 lt can

400 ml (286.3 g)

400ml aerosol



Loctite® 8103

- MoS₂ grease
- For moving parts at all speeds
- Withstands vibration and heavy loads
- For highly stressed joints, plain and roller bearings, socket joints and slideways



Loctite® 8104

- Silicone grease
 - Valve and packing grease
 - Wide temperature range
 - Lubricates most plastic and elastomeric components
- H1 NSF Reg. No.: 122981**



Loctite® 8108

- Synthetic grease (aerosol)
- For use on food processing equipment as a lubricant and protective anti-rust film
- Long life lubricant for superior protection in industrial processes



Loctite® 8101

- Chain lubricant
- Adhesive grease for open mechanical systems with anti-filing properties
- Protects against water ingress
- Excellent wear and high pressure resistance
- Lubricates chains, open gears and worm screws

Lubrication – Cutting Fluids

Product table

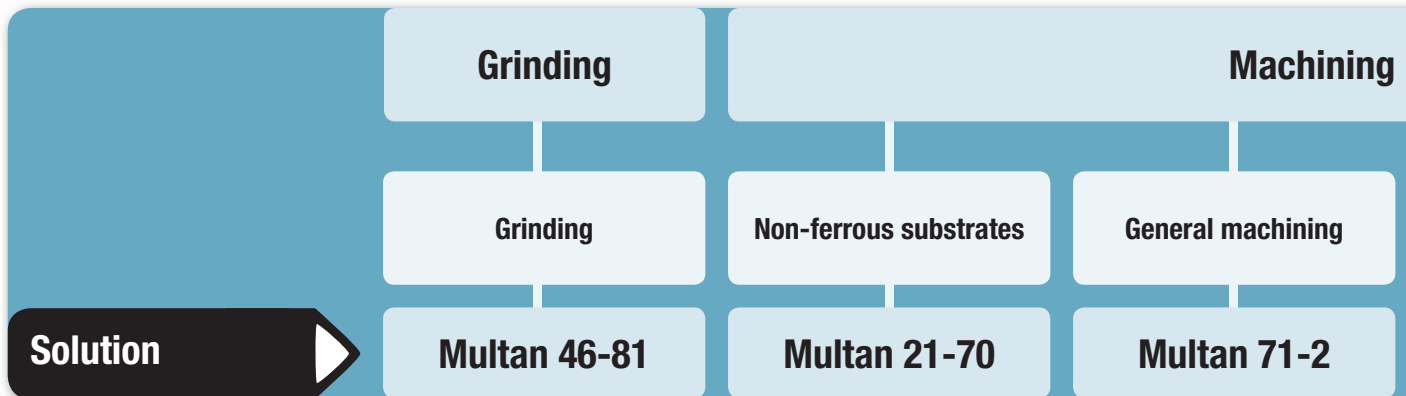

Type	Synthetic	Semi-synthetic	Semi-synthetic
Appearance	Transparent	Emulsion	Transparent
Aluminum	Suitable	Suitable	Suitable
Steel	Preferred	Suitable	Preferred
Cast Iron	Preferred	Suitable	Preferred
Stainless steel	Suitable	Suitable	Suitable
Non-ferrous metals	Suitable	Preferred	Suitable
Make-up concentration	3 – 4 %	5 – 20 %	4 – 8 %

Handy Hints:

Additives for lubricant systems:

- Multan S: System cleaner to extend the lifetime of emulsions
- Multan AS: Defoamer for emulsions



Multan 46-81

- Wide range of grinding operations
- Mineral oil-free
- Excellent foam control
- pH-value: 9.3
- Inhibited against attack on copper alloys
- Resistant against bacteria growth
- No formation of Nitrosodiethanolamines



Multan 21-70

- Drilling, turning, milling, threading, grinding operations
- Boron and amine free
- Free of EP-additives (chlorine, sulphur, phosphorus)
- pH-value: 9.1
- Mineral oil based
- No staining on aluminium and non-ferrous metals
- Resistant against bacteria growth
- Suitable for moderate to extreme water hardness – 20–150 GH



Multan 71-2

- Drilling, turning, milling, threading, reaming, grinding
- Bactericide-free
- pH-value: 9.2
- Low replenishment rates
- Highly resistant to micro-organisms, bacteria, fungi
- Extremely efficient lubrication resulting in longer tool life and excellent cooling performance

Stamping and drawing

Sophisticated machining

Heavy duty machining

Stamping

Drawing

Multan 77-4

Multan 233-1

Multan F AFS 105

Multan F 7161

Semi-synthetic	Vegetable oil	Oil	Oil
Milky	Emulsion	Transparent	Transparent
Preferred	Suitable	Preferred	Preferred
Preferred	Preferred	Suitable	Preferred
Suitable	Suitable	Suitable	Preferred
Preferred	Suitable	Suitable	Suitable
Suitable	Suitable	Suitable	Suitable
4 – 8 %	2 – 10 % (in addition to semi-synthetic emulsions)	Ready-to-use	Ready-to-use



Multan 77-4

- Drilling, turning, milling, threading, grinding operations
- Bactericide-free
- pH-value: 9.4
- Novel lubricating component
- Highly resistant to micro-organisms, bacteria, fungi
- High performance cutting fluid
- Extremely efficient lubrication resulting in longer tool life
- Contains aluminium inhibitors



Multan 233-1

- Enables the most difficult machining work, e.g. deep hole drilling, cutting, drilling
- Part of the HD-System
- Dispersible in cutting fluids: e.g. Multan 71-2
- Mineral oil-free
- Contains EP-additives with excellent lubricating performance
- Biodegradable vegetable oils, good oxidation resistance



Multan F AFS 105

- Low-viscosity for low and medium stamping operations
- Rolling, dipping, spraying, pour application
- Aluminium fin and hair pin manufacturing
- Evaporating type product
- Easy to clean
- No staining on aluminium and copper
- Suitable in manufacturing parts of air-conditioners



Multan F 7161

- Water-miscible
- Rolling, spraying, brush, pour application
- Compatible with downstream processes as cleaning, pretreatment, paint systems

Surface Treatment

Preparation & Protection

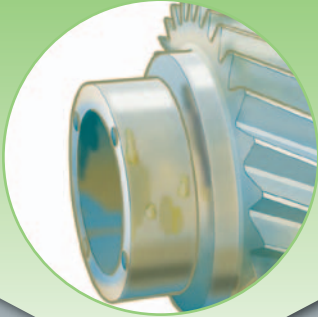

Why use a Loctite® Surface Treatment product?

The Loctite® portfolio of Surface Treatment products offers solutions for all types of surface treatments or preparations:

1. Belt dressing

Prevent slippage and increase friction for all types of belts

2. Rust treatment and corrosion protection

Protect surfaces against corrosion by converting rust into a stable base – restoring the protective coating on galvanised parts – coating parts with a non drying, tack free product

3. Leak detection

Detect leaks in gas handling systems

4. Tamper proofing

Visually detect movements in adjusted parts

5. Repair tape

Repair, reinforce, fix, seal and protect with a fabric reinforced tape

All products are easy to use. Some of them are recommended for emergency repairs where fast and efficient help is needed. Ideal also for maintenance and line production.





Why use a Loctite® Activator or Primer?

1. Loctite® Activators / Primers for Instant Bonding (Cyanoacrylate)

Loctite® Primers are used for improving adhesion to substrates. They are applied before the adhesive. For low surface energy plastic substrates, e.g. polyolefin, PP, PE, best adhesion will be achieved with Loctite® 770 / 7701.

Loctite® Activators are used to increase cure speed. Like the primers, activators are mostly applied before the adhesive. Heptane based activators have well "on part life" and provide good aesthetic appearance of the bond line. They are also suitable for stress cracking sensitive plastics. Activators can also be post applied after the adhesive, e.g. for curing residual adhesive. They provide excellent cosmetic appearance by avoiding white staining of instant adhesives.

2. Loctite® Activators for Modified Acrylics

Loctite® Activators for modified acrylics are needed to initiate the curing process. Usually, the activator is applied to one part and the modified acrylic to the other part. The curing process starts when the two parts are assembled. Fixture time is dependent on the adhesive, on the substrate and on the cleanliness of the surfaces.

3. Loctite® Activators for Threadlocking, Pipe and Thread Sealing, Gasketing, Retaining and Anaerobic Acrylics

Loctite® Activators for this group of adhesives are used to increase the cure speed of the products. They are recommended for applications on passive metals such as stainless steel, plated or passivated surfaces. Activators are available as solvent-based or solvent-free formulations.

Surface Treatment

Product table

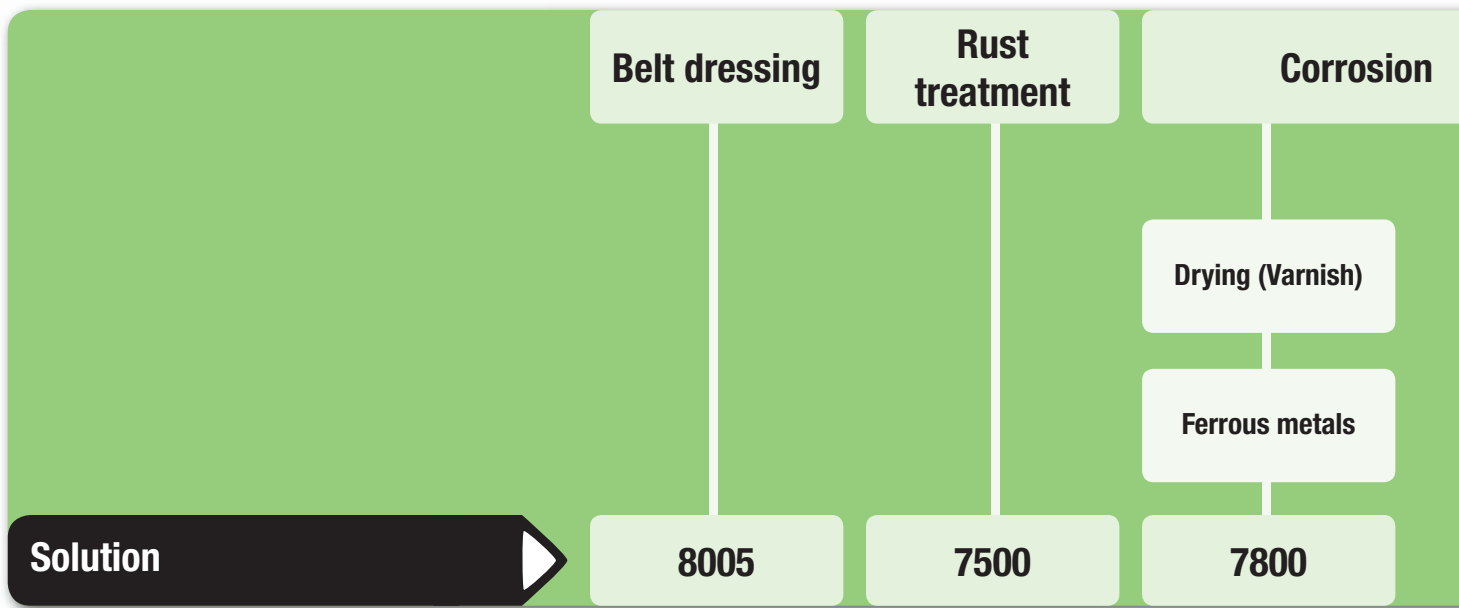

Description	Liquid spray	Rust treatment	Zinc spray
Colour	Clear yellow	Matt black	Grey
Service temperature range	N.A.	N.A.	-50 to +550 °C
Pack sizes	Not available in the UK	1 lt can	Not available in the UK



Loctite® 8005
Belt dressing

- Prevents slippage
- Increases friction for all types of belts
- Extends belt life

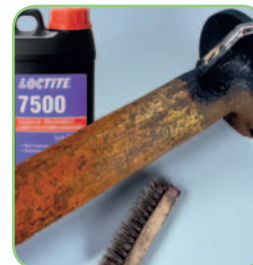

Loctite® 7500
Rust treatment

- Converts existing rust into a stable base
- Protects surfaces from corrosion
- Cured product acts as a primer ready for painting
- For metal pipes, valves, fittings, storage tanks, fences, guard rails, conveyors, construction and agricultural equipment



Loctite® 7800
Zinc spray

- Excellent cathodic corrosion protection on ferrous metals
- Restores protection to galvanised parts
- Typical applications: Touching-up of metal parts after welding, long term protection of metal assemblies

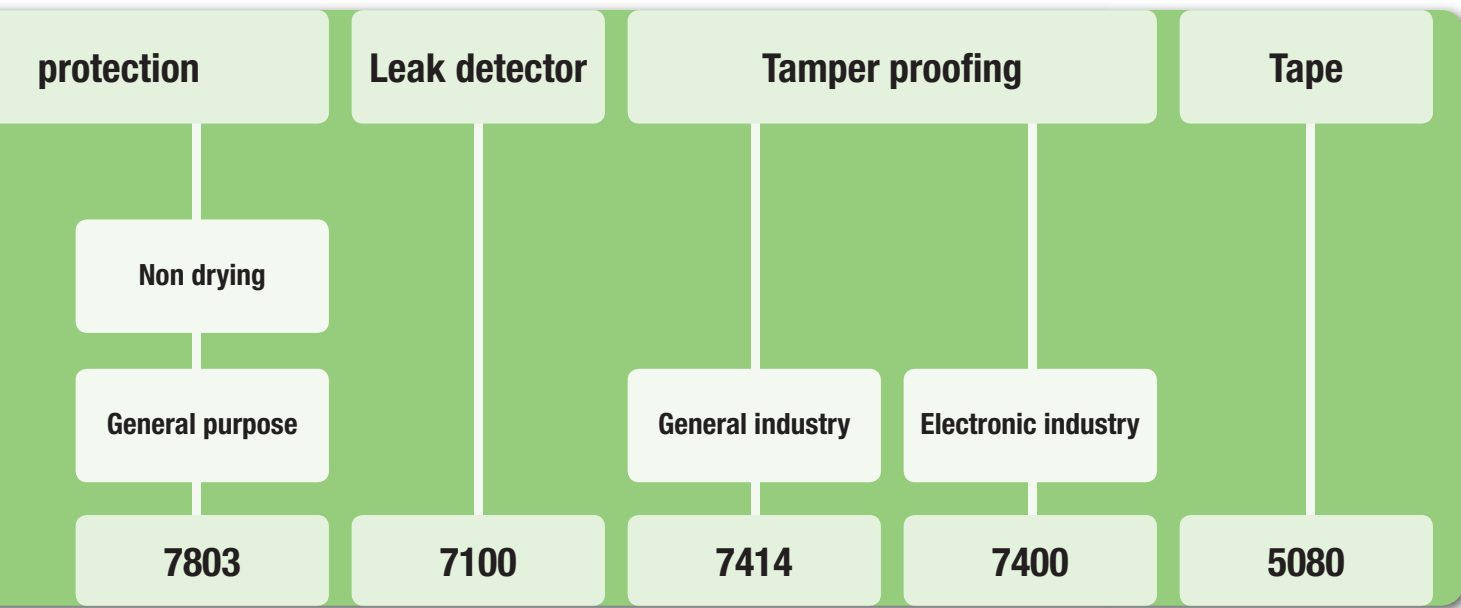

Metal protection coating	Detection of micro and larger leaks	Detect movements of parts	Detect movements of parts	Fabric reinforced tape
White	Colourless	Blue	Red	Metallic grey
-30 to +60 °C	+10 to +50 °C	-35 to +145 °C	-35 to +145 °C	Up to 70 °C
Not available in the UK	Not available in the UK	50ml	20ml, 500ml	Not available in the UK



Loctite® 7803
Metal protection coating spray

- Non drying, tack free coating
- Provides long term corrosion protection
- For iron, steel, sheet steel, pipes, moulds, machines and installations that have to be stored outdoors



Loctite® 7100
Leak Detector

- Produces bubbles at areas where a leak is present
- Non toxic
- Non flammable
- For use with all gases and gas mixtures except pure oxygen. Use also for iron, copper and plastic piping



Loctite® 7414
Tamper Proofing

- Visually detect movement of adjusted parts
- Use for fittings, studs, nuts etc.
- Good adhesion to metals
- Non-corrosive
- Also for outdoor applications



Loctite® 7400
Tamper Proofing

- Visually detect movement of adjusted parts, mark adjustment points, or mark components that have been set or tested
- Use for electronic equipment
- Good adhesion to a wide range of substrates



Loctite® 5080
Fix & Repair Tape

- Pressure resistance up to 4 bar (pipe leakage)
- The tape is easy to tear by hand
- For repairing, reinforcing, fixing, sealing and protecting

Surface Treatment

Product table

What is your application?

Instant bonding

What do you want to do?

Improve adhesion

Accelerate

General purpose

General purpose

Solution

7239

770/7701*

7458

7455

Description	Primer	Primer	Activator	Activator
Colour	Colourless	Colourless	Colourless	Colourless
Solvent	Heptane	Heptane	Heptane	Heptane
Application method	Pre-applied	Pre-applied	Pre- or post-applied	Post-applied
Pack sizes	Not available in the UK	10g, 300g, 16 oz	500ml	25ml, 150ml, 500ml, 20 lt



Loctite® 7239 Plastic Primer

- General purpose
- Suitable for use on all industrial plastics
- Improves the adhesion of instant adhesives on polyolefins and other low surface energy plastics



Loctite® 770 Polyolefin Primer

- Only for difficult to bond plastics
- Provides (best) adhesion of instant adhesives to polyolefins and other low surface energy plastics



Loctite® 7458

- General purpose
- For all substrates
- Good on part life – can be pre- or post-applied
- Low odour
- Minimises post cure white discolouring
- Provides good aesthetic appearance of the bondline



Loctite® 7455

- General purpose
- For all substrates
- Fast fixturing between close fitting parts
- For post application

* For medical applications

Modified acrylics
(329, 3298, 330,
3342)

Threadlocking, Pipe and Thread Sealing,
Gasketing, Retaining and Anaerobic
Acrylics

What activator is preferred?

Best cosmetic
appearance

Ideal for use on
stress cracking
sensitive plastics

Solvent-based

Solvent-based

Solvent-free

7452

7457

7386

7471/7649

7240

Activator	Activator	Activator	Activator	Activator
Transparent, light amber	Colourless	Transparent, yellow	Transparent, green	Blue-green, blue
Acetone	Heptane	Heptane	Acetone	Solvent-free
Post-applied	Pre- or post-applied	Pre-applied	Pre-applied	Pre-applied
500ml	150ml, 500ml	7386: 500ml	150ml, 500ml	90ml



Loctite® 7452

- Cures excess adhesive
- Provides excellent cosmetic appearance avoiding white discolouring of instant adhesive
- Not recommended on stress cracking sensitive plastics



Loctite® 7457

- Good on part life – can be pre- or post-applied
- Recommended for use on stress cracking sensitive plastics



Loctite® 7386

- Initiate the cure of modified acrylic adhesives
- Fixture time and cure speed depends on adhesive, bonded substrate and surface cleanliness



Loctite® 7471 Loctite® 7649

- Speed up cure on passive and inactive surfaces
- For large bond gaps
- On part life of:
Loctite® 7649: ≤ 30 days
Loctite® 7471: ≤ 7days



Loctite® 7240

- Increases cure speed on passive and inactive surfaces
- For large bond gaps
- For low (< 5 °C) temperature curing

Mould Release Agents

Semi-permanent Mould Release Technology

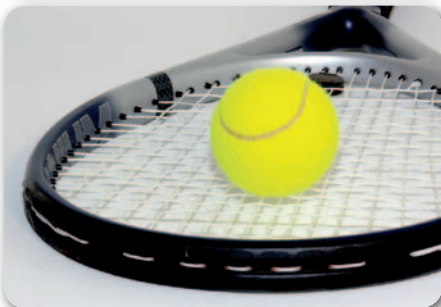

World standard products for release application

Henkel offers highly effective solutions for tough moulding and application challenges. Customers around the globe turn to Frekote® not just for our unique mould release products, but also for our expertise in developing “customised” solutions. We take pride in our knowledge, experience, and responsiveness in providing the best technical service to our customers around the globe.

The Frekote® line offers the broadest range of semi-permanent release agents, mould sealers and cleaners in the industry. Frekote® mould release agents, backed by over 50 years of research and development, are the global industry standard for performance, quality and value. By pioneering release solutions for many of the world’s largest manufacturing organisations, Henkel understands what it takes to release the most complex materials in the most demanding applications.

Lowest cost per release – Frekote® semi-permanent release agents minimise fouling and ensure the highest number of releases possible per application. Our customers realise higher productivity and profitability through reduced downtime; lower reject rates, and higher quality products. Frekote® products are the industry standard replacement for sacrificial release agents. Unlike sacrificial waxes or silicones, Frekote® semi-permanent mould release agents do not transfer to your parts; instead they chemically bond with the mould surface and they provide multiple releases. The parts release cleanly, and will not stick to low energy film. Only one touch-up coat is necessary to refresh the mould after multiple releases. Frekote® products are designed to save your money.

Henkel has designed mould release agents for virtually all composite, plastic and rubber moulding operations. From airliners to tennis rackets, truck tyres to O-rings, bathtubs to custom yachts, we have the release agent to fulfill your requirements.

Markets Served

For an initial market overview

Thermoset Plastics

Advanced Composites Epoxy Systems

- **Renewable energies**
Wind rotor blades
- **Aerospace**
Aircraft, helicopters, etc.
- **Recreational**
Bicycles, skis, rackets, etc.
- **Special**
Racing parts, medicals, electronics, filament windings, etc.

GRP Composites Polyester, Vinyl Ester

- **Marine GRP**
Boats, yachts, jet-skis, etc.
- **Transportation GRP**
Panels, roofs, spoilers, etc.
- **Construction GRP**
Wind rotor blades, cultured marble sinks & countertops, bathtubs, etc.

Thermoplastics

Rotational Moulding

- **Recreational**
Kayaks, pedal boats, etc.
- **Construction**
Containers, tanks, chairs, waste bins, etc.

Rubbers

Rubber Industry

- **Tyre**
Treads/side walls
- **Technical Rubber**
Vibration dampers, roller blade wheels, footwear, custom moulding, etc.

How Frekote® release agents work

Solvent-based semi-permanent Frekote® products are moisture curing, while the resins used in the Aqualine range are heat or room temperature cured. Frekote® release agents can be wiped on or sprayed on. Cured Frekote® release coatings form a solid, non-greasy, durable film which withstands the shear forces encountered in moulding and demoulding operations. The maximum film thickness is 5µm. This prevents mould build-up to minimize costly mould cleaning while achieving excellent part detail and mould geometry retention. Special Frekote® release agents are available that allow post-mould painting or bonding without the need for any cleaning of the released parts.

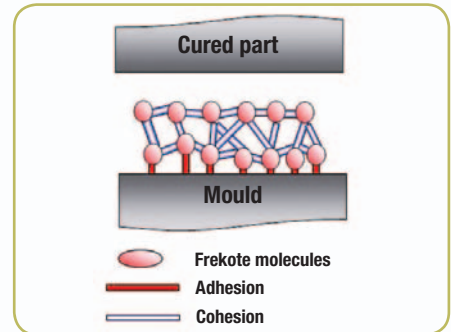

Semi-permanent technology coats the mould with a low energy film.

Sealing

Frekote® sealers are used prior to application of mould release coats to seal mould micro-porosity and provide a uniform, stable base coat for the release agent. Sealers also improve the durability of the Frekote® film, ensuring the maximum number of releases per application. Some release agents contain a mould sealer, for example the water-based Frekote® Aqualine C-600. Previous release contamination, e.g. sacrificial or semi-permanent release agents, should be removed before the sealer coat is applied.

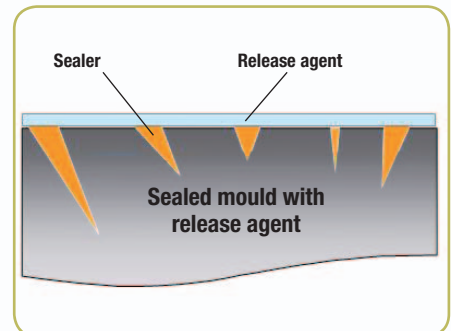

Sealers seal micro-porosity to achieve a uniform release coating

Cleaning

For maximum performance, Frekote® release agents should be applied to a completely cleaned mould. Therefore, mould cleaning is an important preparatory step to ensure that all cured release agent and other unwanted contaminants left on the mould are removed. Frekote® water based and solvent-based cleaners remove all contaminants from composite and metal moulds.

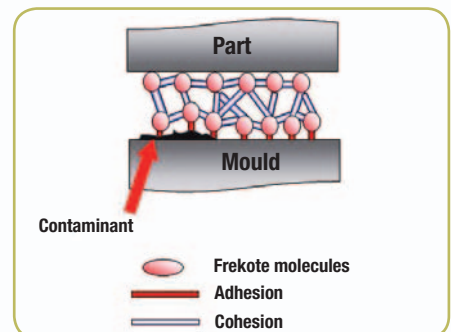

Unwanted contaminants may impair adhesion of the Frekote® release agent to the mould.

Frekote® Features – Benefits

- Semi-permanent technology – multiple release performance
- Quick room temperature cure, heat accelerated cure – reduces process down time
- Spray on, wipe on – easy to apply with cloth or spray gun
- Low or no transfer – reduces post part cleaning
- 5 µm film ensures low mould build-up – reduces post mould cleaning
- Form a hard durable and dry thermoset film – extended mould life
- Reduced cleaning and application time – lower cost per parts

Mould Release Agents

Product table

Are you releasing composites or rubber?

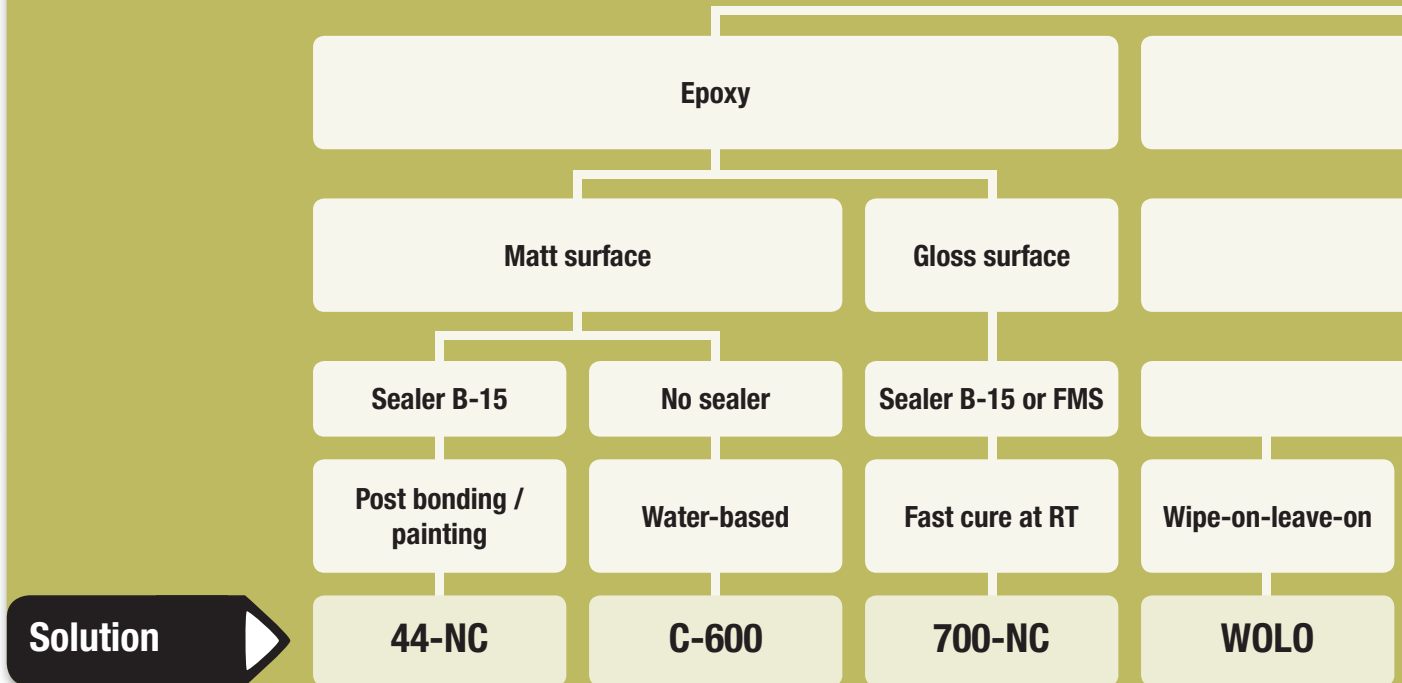

Description	Release agent	Release agent	Release agent	Release agent
Appearance	Clear liquid	White emulsion	Clear liquid	Clear liquid
Application temperature	15 to 60 °C	20 to 40 °C	15 to 135 °C	15 to 45 °C
Dry time between coats	15 min. / RT	15 min. / RT	5 min. / RT	5 min. / RT
Cure time after final coat	3 h / RT	40 min. / RT	15 – 20 min. / RT	15 min. / RT
Thermal stability	up to 400 °C	up to 315 °C	up to 400 °C	up to 400 °C



Frekote® 44-NC

- No mould build-up
- No contaminating transfer
- High thermal stability



Frekote® C-600

- Fast RT application and cure
- Large parts
- Non flammable



Frekote® 700-NC

- Fast RT cure
- High gloss and high slip
- Releases most polymers



Frekote® WOLO

- Easy application
- Multiple releases
- High gloss finish

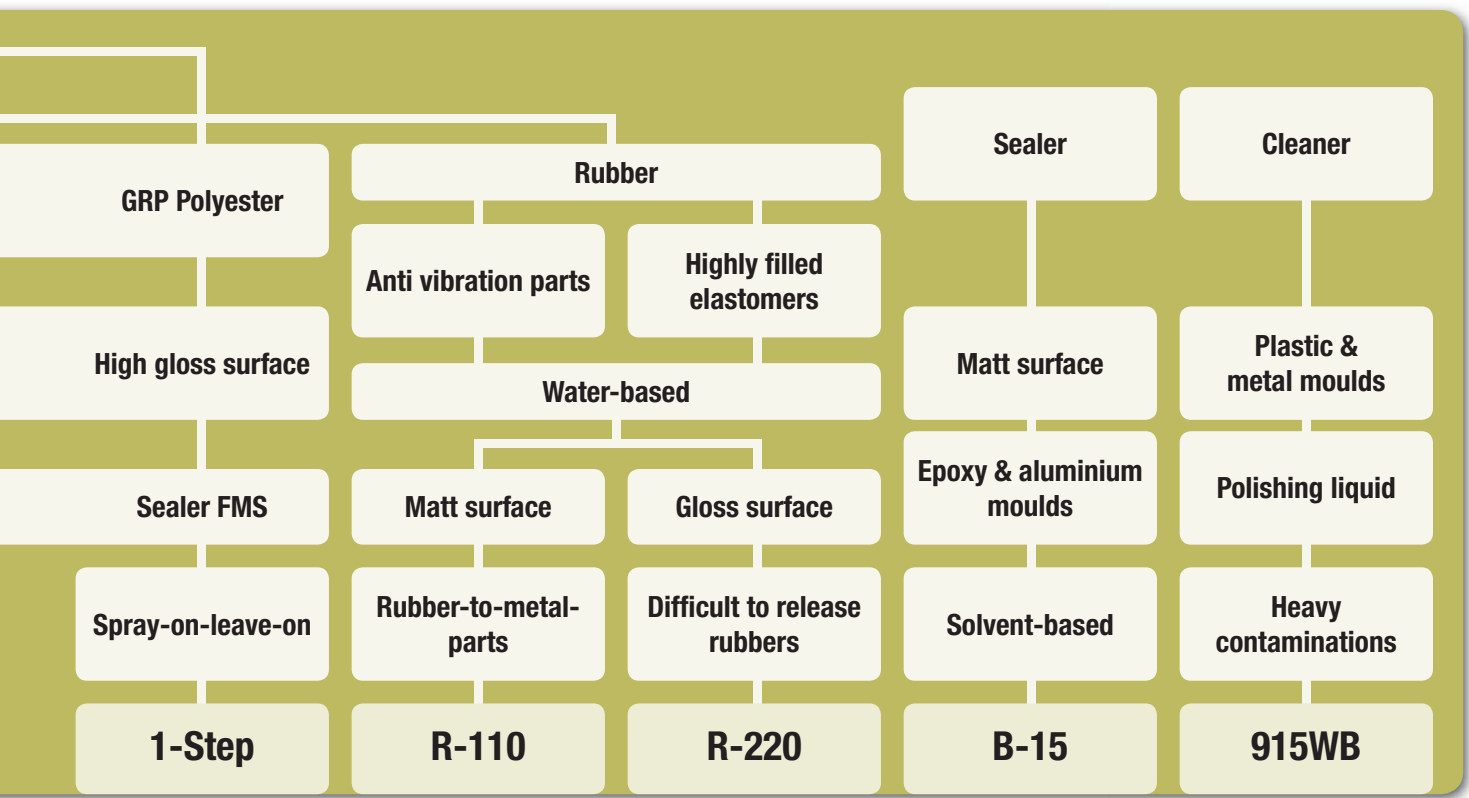

1-Step	R-110	R-220	B-15	915WB
Release agent	Release agent	Release agent	Seals porosities	Pre-cleaning
Clear liquid	White emulsion	White emulsion	Clear liquid	Beige pasty liquid
15 to 45 °C	60 to 205 °C	60 to 205 °C	15 to 60 °C	10 to 40 °C
Immediate RT	Immediate @ 60 °C	Immediate @ 60 °C	30 min. / RT	5 min. / RT
30 min. / RT	10 min. @ 90 °C 4 min. @ 150 °C	10 min. @ 90 °C 4 min. @ 150 °C	24 h / RT	N.A.
up to 400 °C	up to 315 °C	up to 315 °C	up to 400 °C	N.A.



Frekote® 1-Step

- Easy to use
- High gloss finish
- Minimal mould build-up



Frekote® R-110

- Fast cure
- No transfer
- For standard rubbers



Frekote® R-220

- Fast cure
- High slip
- For difficult to release rubbers



Frekote® B-15

- Easy to apply
- Seals mould porosity
- High thermal stability



Frekote® 915WB

- Water-based
- Polishing liquid
- Removes cured release agents

Mould Release Agents

Product list

Product Frekote®		Description	Chemical basis	Mould temperature	Cure system	Dry time between coats at		Cure time after final coat			
						20 °C	60 °C	20 °C	60 °C	100 °C	150 °C
1-Step	■	FRP Polyester parts	Solvent	15 to 40 °C	Moisture	*	N.A.	30 min.	N.A.	N.A.	N.A.
44-NC	■	Advanced composites	Solvent	20 to 60 °C	Moisture	15 min.	5 min.	3 h	30 min.	15 min.	N.A.
55-NC	■	Advanced composites, FRP polyester parts	Solvent	15 to 60 °C	Moisture	5 min.	3 min.	30 min.	10 min.	N.A.	N.A.
700-NC	■	Advanced composites	Solvent	15 to 135 °C	Moisture	5 min.	3 min.	20 min.	8 min.	5 min.	N.A.
770-NC	■	Advanced composites, FRP polyester parts	Solvent	15 to 60 °C	Moisture	5 min.	1 min.	10 min.	5 min.	N.A.	N.A.
909WB	▲	Pre-cleaner	Water	10 to 40 °C	N.A.	1 h	N.A.	N.A.	N.A.	N.A.	N.A.
913WB	▲	Post cleaner	Water	10 to 40 °C	N.A.	*	N.A.	N.A.	N.A.	N.A.	N.A.
915WB	▲	Pre-cleaner	Water	10 to 40 °C	N.A.	5 min.	N.A.	N.A.	N.A.	N.A.	N.A.
Aqualine C-200	■	Advanced composites	Water	60 to 205 °C	Heat cure	1 min.	*	N.A.	40 min.	20 min.	10 min.
Aqualine C-600	■	Advanced composites	Water	20 to 40 °C	Evaporation	15 min.	1 min.	40 min.	10 min.	N.A.	N.A.
Aqualine PUR-100	■	Special product	Water	60 to 205 °C	Heat cure	N.A.	*	N.A.	30 min.	10 min.	4 min.
Aqualine R-100	■	Rubber releasing	Water	60 to 205 °C	Heat cure	N.A.	*	N.A.	30 min.	10 min.	4 min.
Aqualine R-110	■	Rubber releasing	Water	60 to 205 °C	Heat cure	N.A.	*	N.A.	30 min.	10 min.	4 min.
Aqualine R-120	■	Rubber releasing	Water	60 to 205 °C	Heat cure	N.A.	*	N.A.	30 min.	10 min.	4 min.
Aqualine R-150	■	Rubber releasing	Water	60 to 205 °C	Heat cure	N.A.	*	N.A.	30 min.	10 min.	4 min.
Aqualine R-180	■	Rubber releasing	Water	60 to 205 °C	Heat cure	N.A.	*	N.A.	30 min.	10 min.	4 min.
Aqualine R-220	■	Rubber releasing	Water	60 to 205 °C	Heat cure	N.A.	*	N.A.	30 min.	10 min.	4 min.

■ Release agent

● Mould sealer

▲ Mould cleaner

* Immediate

	Resulting surface	Type of polymer/ elastomer	Application technique	Pack sizes							Comments		
				1 lt	3.7 lt	5 lt	10 lt	18.7 lt	25 lt	208 lt		210 lt	
	High gloss	Gel-coat, polyester resins	Spray-on	●		●				●			Spray-on-leave-on, no sealer required, high gloss gel-coat parts
	Matt	Epoxies, PA	Wipe-on, spray-on	●		●				●	●		No mould-build up, non-contaminating transfer, minimised cleaning before bonding and painting
	Satin matt	Epoxies, polyester non-gelcoat, PA	Wipe-on, spray-on	●		●				●	●		No mould-build up, non-contaminating transfer
	Gloss	Epoxies	Wipe-on, spray-on	●		●				●	●		High slip, universal for most composites, also for polyester resins
	High gloss	Epoxies, polyester non-gelcoat, PE	Wipe-on, spray-on	●		●				●	●		High slip, high gloss, fast curing, universal for most composites
	All	Steel, nickel, stainless steel	Wipe-on	●									Alkalic foam cleaner, removes cured release agents and other contaminations
	All	Esters, epoxies, steel, nickel, aluminium	Wipe-on	●									Antistatic mould cleaner, prevents dust re-contamination, removes fingerprints
	All	Esters, epoxies, steel, nickel	Wipe-on	●			●						Removes cured release agents and other contaminations
	Matt	Epoxies, PA, PP, PE	Spray-on			●	●						Low mould build up, non-contaminating transfer
	Matt	Epoxies	Wipe-on, spray-on			●	●					●	Integrated sealer, room temperature curing
	Matt	Rigid PUR	Spray-on		●				●		●		For rigid PUR materials
	Matt	NR, SBR, HNBR, CR	Spray-on				●					●	High slip, difficult to release rubbers, synthetic rubbers
	Matt	NR, SBR, HNBR	Spray-on			●	●					●	Low slip, low mould build up, standard rubbers
	Matt	NR, SBR, HNBR	Spray-on			●	●					●	Low slip, low mould build up, standard rubbers
	Matt	NR, SBR, HNBR, CR	Spray-on			●	●					●	Low slip, low mould build up, standard rubbers, rubber to metal
	Satin matt	NR, SBR, HNBR, CR, EPDM	Spray-on			●	●					●	High slip, difficult to release rubbers
	Gloss	NR, SBR, HNBR, CR, EPDM	Spray-on			●		●			●		High slip, most difficult to release rubbers, for highly filled elastomers, synthetic rubbers

Mould Release Agents

Product list

Product Frekote®		Description	Chemical basis	Mould temperature	Cure system	Dry time between coats at		Cure time after final coat			
						20 °C	60 °C	20 °C	60 °C	100 °C	150 °C
B-15	●	Mould preparation	Solvent	15 to 60 °C	Moisture	30 min.	5 min.	24 h	120 min.	N.A.	N.A.
FMS	●	Mould preparation	Solvent	15 to 35 °C	Moisture	15 min.	N.A.	20 min.	N.A.	N.A.	N.A.
Frewax	■	FRP Polyester parts	Solvent	15 to 35 °C	Moisture	5 min.	N.A.	10 min.	N.A.	N.A.	N.A.
FRP-NC	■	FRP Polyester parts	Solvent	15 to 40 °C	Moisture	15 min.	N.A.	20 min.	N.A.	N.A.	N.A.
PMC	▲	Post cleaner	Solvent	15 to 40 °C	N.A.	*	N.A.	N.A.	N.A.	N.A.	N.A.
S-50 E	■	Special product	Water	100 to 205°C	Heat cure	N.A.	N.A.	N.A.	N.A.	*	*
WOLO	■	FRP Polyester parts	Solvent	15 to 40 °C	Moisture	5 min.	N.A.	15 min.	N.A.	N.A.	N.A.

■ Release agent

● Mould sealer

▲ Mould cleaner

* Immediate

Resulting surface	Type of polymer/ elastomer	Application technique	Pack sizes							Comments	
			1 lt	3.7 lt	5 lt	10 lt	18.7 lt	25 lt	208 lt		210 lt
Matt	Epoxies	Wipe-on	●		●						Seals microporosities, provides uniform release agent coating
High gloss	Polyester, vinylester	Wipe-on	●		●						Seals microporosities, provides uniform release agent coating
High gloss	Gel-coat, polyester resins	Wipe-on	●		●						Easy to use, visible, no sealer required, high gloss gel-coat parts
High gloss	Gel-coat, polyester resins	Wipe-on	●		●			●			Low mould build up, high gloss gel-coat parts
All	Esters, epoxies, steel, nickel, aluminium	Wipe-on	●		●						Removes dust, dirt fingerprints, oil
Matt	Silicone rubber	Spray-on			●	●					For silicone elastomers
High gloss	Gel-coat, polyester resins	Wipe-on	●		●			●			Wipe-on-leave-on, no sealer required, high gloss gel-coat parts,



Equipment

Manual hand-held applicators

Manual hand-held applicators for 1-component cartridges

Cartridge size	Technology	Mechanical applicator	Pneumatic applicator
30ml	All, including acrylics and Light cure adhesives	98026 (IDH 476902)	See Syringe dispenser page 130
50ml	Elastic adhesives and sealants, gasketing products	96005 (IDH 363544)	
250ml Squeeze tubes, 300ml	Elastic adhesives and sealants, gasketing products		97002 (IDH 88632)
300ml, 310ml	Elastic adhesives and sealants, e.g. silicones, silane modified polymers	142240 (IDH 142240)	97046 (IDH 1047326) Electrical
310ml	Very high viscosity elastic adhesives and sealants, e.g. Terostat 1K-PU		PowerLine II (IDH 960304)
310ml	Spraying of Terostat 9320* or Terostat MS 9302*		Multi-Press (IDH 142241)
Foilpack 400ml, 570ml	Silane modified polymers, polyurethanes		Softpress (IDH 250052)

* Special spray nozzle set IDH 200257

Manual hand-held applicators for 2-component cartridges



Cartridge size	Mix ratio	Technology	Mechanical applicator	Pneumatic applicator
37ml 50ml	10:1 1:1, 2:1	Epoxies, polyurethanes, acrylics and silane modified polymers	96001 (IDH 267452)	97042 (IDH 476898)
50ml	10:1	Acrylics	IDH 1034026	
200ml	1:1, 2:1	Epoxies	96003 (IDH 267453)	983437 (IDH 218315)
400ml, 415ml	1:1, 2:1	Epoxies, acrylics, silicones, polyurethanes and silane modified polymers	983438 (IDH 218312)	983439 (IDH 218311)
	4:1	Polyurethanes	+ Conversion Kit 984211 (IDH 478553)	+ Conversion Kit 984210 (IDH 478552)
490ml	10:1	Acrylics	985246 (IDH 524579)	985249 (IDH 470572)
2 x 300ml	1:1	Loctite® 3295	2022315 (IDH 88747)	SYS 00706 (IDH 307418)
2 x 310ml	1:1	Teromix 6700		IDH 439869
900ml	2:1	Loctite® Nordbak® 7255*		97048 (IDH 1175530)

* For spray application with Hand-Held Applicator, preheat product to T= 50 °C. Use heating box IDH 796993

Equipment

Manual dispensers

Peristaltic dispensers

Pack size	Technology	Mechanical	Electrical
50ml	Anaerobic Threadlockers, Anaerobic Thread Sealants, Retaining Compounds	98414 (IDH 608966)	
250ml	Anaerobic Threadlockers, Anaerobic Thread Sealants, Retaining Compounds	97001 (IDH 88631)	
All pack sizes	All 1K-technologies*		98548 (IDH 769914) 

* Anaerobic Threadlockers, Anaerobic Thread Sealants, Anaerobic Gasketing, RTV Gasketing, Retaining Compounds, Cyanoacrylates, Gel-Cyanoacrylates, Acrylics, Light Cure Adhesives











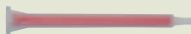





Syringe dispensers

Pack size	Technology	Mechanical	Pneumatic
10ml or 30ml	All 1K-technologies	See Hand-held applicators for 1-component cartridges, page 128	97006 (IDH 88633) 

Accessories – Syringes

Pack size	Item no.	Product	Description
10ml	97207 (IDH 88656)		Clear Syringe Barrel Kit
30ml	97244 (IDH 88677)		
10ml	97263 (IDH 218287)		Black Syringe Barrel Kit for UV and INDIGO adhesives
30ml	97264 (IDH 218286)		
10ml	97208 (IDH 88657)		Syringe Airline Adapter
30ml	97245 (IDH 88678)		



Accessories – Mixers and Nozzles

Pack size	Mix	Technology	Item no.	Product
37ml	10:1	Acrylics	98463 (IDH 720221)	
50ml	1:1, 2:1	Epoxies, polyurethanes and silane modified polymers	984569 (IDH 478562)	
50ml	1:1	Acrylics	5289010 (IDH 545996)	
50ml	10:1	Acrylics	IDH 1034575	
2 x 125ml	1:1	Polyurethanes	IDH 780805	
200ml 400ml	1:1 2:1	Epoxies	984570 (IDH 478563)	
400ml	1:1, 2:1, 4:1	Silicones	98457 (IDH 720174)	
400ml	1:1	Silane modified polymers	IDH 367545	
400ml 415ml	2:1 4:1	Polyurethanes	IDH 639381	
490ml	10:1	Acrylics	8953187 (IDH 1104047)	
2 x 300ml	1:1	Acrylics	IDH 545967*	
2 x 310 ml	1:1	Polyurethanes	Not available in the UK	
900ml	2:1	Epoxies	IDH 1248606	
310ml	Silane modified polymers		IDH 200257	
310ml	Silane modified polymers, polyurethanes		IDH 581582	
310ml	Silane modified polymers, polyurethanes		IDH 200259	
Foilpack 400ml, 570ml	Silane modified polymers, polyurethanes		IDH 582416	

* Manifold IDH 398158

Accessories – Dispense needles

Dispense tips are colour coded to indicate the inner diameter of the needle. All dispensing tips have a helical thread and can be attached to all Loctite® valves via 97233 (IDH 88672) Luer-Lock® Adapter.

Needle size	 Flexible dispensing tips Polypropylene (PPF)	 Tapered dispensing tips (PPC)	 Stainless steel dispensing tips standard (SSS)
15GA (= Amber) ID 1.37 mm	97229 (IDH 142640)		97225 (IDH 88664)
16GA (= Grey) ID 1.19 mm		97221 (IDH 88660)	
18GA (= Green) ID 0.84 mm	97230 (IDH 142641)	97222 (IDH 88661)	97226 (IDH 88665)
20GA (= Pink) ID 0.61 mm	97231 (IDH 142642)	97223 (IDH 88662)	97227 (IDH 88666)
22GA (= Blue) ID 0.41 mm		97224 (IDH 88663)	
25GA (= Red) ID 0.25 mm	97232 (IDH 142643)		97228 (IDH 88667)
Kit containing 2 each of the above tips		97262 (IDH 218288)	

Equipment

Semi-automatic dispensing systems

The systems are designed for integration into automated assembly lines and can be actuated by a PLC. They are suitable for dispensing microdots, dots, drops or beads of low to high viscosity products. Each system is equipped with Controller 97152, Reservoir 97108 accommodating up to 1.0 lt Loctite® bottles, Footswitch 97201 and Airline Filter / Regulator 97120 for combination with the appropriate valve. The valve is selected to suit the viscosity of the product and the amount to be dispensed. Please see table below.

Viscosity		● Microdot	● Dot	● Dot
		Micro bead	Medium bead	Bead
Low*	—	IDH 1388647 IDH 1388646	IDH 1388648 IDH 1388647 IDH 1388646	IDH 1388648
Medium**	▬	IDH 1388647 IDH 1388646	IDH 1388648 IDH 1388649 IDH 1388651	IDH 1388651
High***	▬▬	On request	On request	IDH 1388650

* Low viscosity up to 2.500 mPa-s

** Medium viscosity approx. 2.500 – 7.500 mPa-s

*** High viscosity over 7.500 mPa-s



IDH 1388651

- Includes: 97113 Stationary Applicator Valve ¼")
- Suitable for all 1-component technologies



IDH 1388650

- Includes: 97114 Stationary Applicator Valve 3/8"
- Suitable for all 1-component technologies



IDH 1388647

- Includes: 98009 Light Cure Dispensing Valve
- Suitable for light cure adhesives



IDH 1388648

- Includes: 97135 Diaphragm Valve
- Suitable for all low viscosity methacrylates and acrylic adhesives



IDH 1388649

- Includes: 97136 Diaphragm Valve
- Suitable for all low to medium viscosity methacrylates and acrylic adhesives



IDH 1388646

- Includes: 98013 (Cyanoacrylate Dispensing Valve) - not UVCA
- Suitable for all 1-component technologies except light cure adhesives

1-component technologies: e.g. methacrylates, acrylics, light cure acrylics and cyanoacrylates. For other technologies please contact us.

Hand-held dispensing systems

The systems are designed for single user manual workstations. They are suitable for dispensing dots, drops or beads of low to medium viscosity products.

The systems comprise an integrated Controller & Reservoir 97009, Footswitch 97201 and Airline Filter / Regulator 97120 for combination with the appropriate valve. The valve is selected to suit the viscosity of the product and the amount to be dispensed. Please see table below.

Viscosity		Microdot	Dot	Drop
		Micro bead	Medium bead	Bead
Low*		On request	IDH 1388652	IDH 1388652
Medium**		On request	IDH 1388653	IDH 1388653
High***		On request	IDH 1388653	On request

* Low viscosity up to 2,500 mPa-s

** Medium viscosity approx. 2,500 – 7,500 mPa-s

*** High viscosity over 7,500 mPa-s



IIDH 1388652

- Includes: 97121 Pinch Valve Applicator
- Suitable for all 1-component adhesive technologies



IDH 1388653

- Includes: 97130 LV Hand-Held Applicator
- Suitable for all 1-component adhesives technologies, except light cure adhesives

Customised systems

Henkel offers a wide range of stand alone dispensing equipment and turnkey packages for all adhesive and sealant dispensing needs. Systems range from built sealant dispensing pumps to custom built UV cure systems to fully integrated robot and special machine systems.

Henkel engineers can support customers with recommendations and specifications for custom built equipment.

Contact the Henkel equipment team on: 01442 278100



Equipment

Light curing equipment

Four major effects must be taken into consideration when designing a successful light cure application: emission spectrum of the cure system, light intensity, transmission properties of substrate and required cure characteristics. As a manufacturer of both the chemistry and the curing equipment, Henkel knows how to match light cure adhesives to the correct dispensing and curing system.

Flood cure systems

Bulb technology

Loctite® 97055 / 97056

1000 W

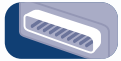

- Loctite® 97055 high intensity light cure chamber system for manual loading
 - Loctite® 97056 tunnel version designed for integration into automated lines
- Three different bulbs are available for appropriate emission spectrums



Bulb	IDH No.	UV	UV/Visible	INDIGO
Loctite® 97346	870098	☀☀☀	☀	☀
Loctite® 97347	870097	☀☀☀	☀☀☀	☀
Loctite® 97348	870096	☀	☀☀☀	☀☀☀

LED technology

Loctite® 97070 / 97071

LED

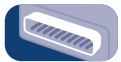

- Loctite® 97070 high intensity, cool radiation LED system, designed to emit UVA light
 - Loctite® 97071 high intensity, cool radiation LED system, designed to emit visible light
- Mounting stand available on request.



LED head	IDH No.	UV	UV/Visible	INDIGO
Loctite® 97070	1427234	☀☀☀	—	—
Loctite® 97071	1427233	—	☀☀☀	—

☀ Medium intensity

☀☀ High intensity

☀☀☀ Very high intensity

1000 W Energy consumption of bulb

Emission spectrum contains UV light

Emission spectrum contains UV / Visible light

Emission spectrum contains visible INDIGO light

LED LED system

Exposure timer

Interface for PLC connection, e.g. external start

Internal intensity monitoring

Spot cure system

Flood cure system

Spot cure systems

Bulb technology



Loctite® 97057 (IDH 941764)

High intensity light guide system emitting UVA, UV/Visible and INDIGO light. To be combined with appropriate light guide.

Loctite® 97323: Ø 5 x 1,500 mm (IDH 376720), Loctite® 97324: Ø 8 x 1,500 mm (IDH 298849),

Loctite® 97318: 2x Ø 3 x 1,500 mm (IDH 951637)

Loctite® 97034 (IDH 331219)

High intensity light guide system emitting UVC, UVA, UV/Visible and INDIGO light. To be combined with appropriate light guide.

Loctite® 97326: Ø 5 x 1,000 mm (IDH 329278), Loctite® 97327: Ø 8 x 1,000 mm (IDH 376721),

Loctite® 97328: 2x Ø 3 x 1,000 mm (IDH 352194)



LED technology

Loctite® 97069 (IDH 1305340)



High intensity, long lifetime system designed for curing Loctite® UV adhesives and coatings with UV light. Modern LED technology provides "cool" radiation at narrow bandwidth.



Accessories

Product	Item no.	IDH no.	Description
	Loctite® 98727 Loctite® 98770	1390323 1265282	The Dosimeter-Radiometer measures light dose (energy) and light intensity of the UV curing equipment and is a self-contained one channel device. Loctite® 98727 for UV light, Loctite® 98770 for UV / visible light.
	Loctite® 98002	1406024	The Loctite® Spot Radiometer 7020 is a self-contained, electro-optic instrument designed to measure and display the UV power density (irradiance) emitted by a UV light guide. For light guides Ø 3 mm, Ø 5 mm and Ø 8 mm.
	Loctite® 8953426 Loctite® 8953427	1175127 1175128	UV protection glasses Loctite® 8953426: protection glasses grey, best to use for UV light Loctite® 8953427: protection glasses orange, best to use for UV / Visible and INDIGO light.

Index

Product No.	Pack size	Page
Adhesin A 7088	30kg	51
Adhesin J 1626	Not available in the UK	51
Frekote® 1-Step	1 lt, 5 lt, 25 lt	123
Frekote® 44-NC	1 lt, 5 lt, 25 lt, 208 lt	122
Frekote® 55-NC	1 lt, 5 lt, 25 lt, 208 lt	124
Frekote® 700-NC	1 lt, 5 lt, 25 lt, 208 lt	122
Frekote® 770-NC	1 lt, 5 lt, 25 lt, 208 lt	124
Frekote® 909WB	1 lt	124
Frekote® 913WB	1 lt	124
Frekote® 915WB	1 lt, 10 lt	123
Frekote® Aqualine C-200	5 lt, 10 lt	124
Frekote® Aqualine C-600	5 lt, 10 lt, 210 lt	122
Frekote® Aqualine PUR-100	3.7 lt, 18.7 lt, 208 lt	124
Frekote® Aqualine R-100	10 lt, 210 lt	124
Frekote® Aqualine R-110	5 lt, 10 lt, 210 lt	123
Frekote® Aqualine R-120	5 lt, 10 lt, 210 lt	124
Frekote® Aqualine R-150	5 lt, 10 lt, 210 lt	124
Frekote® Aqualine R-180	5 lt, 10 lt, 210 lt	124
Frekote® Aqualine R-220	5 lt, 18.7 lt, 208 lt	123
Frekote® B-15	1 lt, 5 lt	123
Frekote® FMS	1 lt, 5 lt	126
Frekote® Frewax	1 lt, 5 lt	126
Frekote® FRP-NC	1 lt, 5 lt, 25 lt	126
Frekote® PMC	1 lt, 5 lt	126
Frekote® S-50 E	5 lt, 10 lt	126
Frekote® WOLO	1 lt, 5 lt, 25 lt	122
Loctite® 121078	250ml, 1 lt, 2 lt	28
Loctite® 128068	300ml, 850ml	22
Loctite® 221	250ml	10
Loctite® 222	10ml, 50ml, 250ml	8
Loctite® 2400	50ml	9
Loctite® 241	250ml	10
Loctite® 242	250ml	10
Loctite® 243	10ml, 50ml, 250ml, 2 lt	9
Loctite® 245	50ml, 250ml	10
Loctite® 248 Stick	9g, 19g	10
Loctite® 262	250ml	10
Loctite® 268 Stick	19g	10
Loctite® 270	10ml, 50ml, 250ml, 2 lt	9
Loctite® 2700	50ml	9
Loctite® 2701	10ml, 50ml, 250ml, 2 lt	10
Loctite® 271	50ml	10
Loctite® 272	50ml, 250ml	10
Loctite® 275	50ml, 250ml, 2 lt	10
Loctite® 276	50ml	10
Loctite® 277	50ml, 250ml	10
Loctite® 278	50ml, 250ml	10
Loctite® 290	10ml, 50ml, 250ml, 2 lt	8
Loctite® 3011 ^{Med}	Not available in the UK	42
Loctite® 3030	35ml	60
Loctite® 3038	490ml	59

Product No.	Pack size	Page
Loctite® 3081 ^{Med}	25ml, 1 lt	40
Loctite® 3090	10g	33
Loctite® 3103	25ml, 1 lt	42
Loctite® 3105	25ml, 1 lt	42
Loctite® 3106	25ml, 1 lt	42
Loctite® 319	Not available in the UK	60
Loctite® 3211 ^{Med}	25ml, 1 lt	42
Loctite® 322	250ml, 1 lt	42
Loctite® 326	50ml, 250ml	59
Loctite® 329	315 ml, 1 lt, 5 lt,	60
Loctite® 3295	50ml, 600ml	59
Loctite® 3298	Not available in the UK	59
Loctite® 330	50ml kit, 50ml tube 315ml, 1 lt, 5 lt, 200 lt	58
Loctite® 3301 ^{Med}	25ml	42
Loctite® 3311 ^{Med}	25ml, 1 lt	42
Loctite® 3321 ^{Med}	25ml, 1 lt	42
Loctite® 3341 ^{Med}	1 lt	42
Loctite® 3342	300ml	58
Loctite® 3345 ^{Med}	Not available in the UK	42
Loctite® 3381 ^{Med}	25ml, 1 lt	42
Loctite® 3463	114g	88
Loctite® 3471 A&B	500g tub kit	88
Loctite® 3472 A&B	500g tub kit	89
Loctite® 3473 A&B	500g tub kit	89
Loctite® 3474 A&B	Not available in the UK	89
Loctite® 3475 A&B	500g tub kit	89
Loctite® 3478 A&B	453g	88
Loctite® 3479 A&B	500g tub kit	89
Loctite® 3491	25ml, 1 lt	40
Loctite® 3494	25ml, 1 lt	40
Loctite® 350	50ml, 250ml	42
Loctite® 3504	50ml, 250ml	60
Loctite® 352	50ml, 250ml	42
Loctite® 3525	25ml, 1 lt	41
Loctite® 3526	25ml, 1 lt	42
Loctite® 3554 ^{Med}	25ml, 1 lt	42
Loctite® 3555 ^{Med}	25ml, 1 lt	41
Loctite® 3556 ^{Med}	25ml, 1 lt	44
Loctite® 366	250ml	60
Loctite® 382	Kit	34
Loctite® 3921 ^{Med}	25ml, 1 lt	44
Loctite® 3922 ^{Med}	25ml, 1 lt	40
Loctite® 3926 ^{Med}	25ml, 1 lt	41
Loctite® 3936 ^{Med}	25ml, 1 lt	44
Loctite® 401	3g, 20g, 50g, 500g	33
Loctite® 4011 ^{Med}	20g, 454g	34
Loctite® 4014 ^{Med}	20g	34
Loctite® 403	20g, 50g, 500g	34
Loctite® 4031 ^{Med}	454g	36
Loctite® 406	20g, 50g, 500g, 2kg	32
Loctite® 4061 ^{Med}	20g, 454g	36
Loctite® 4062	20g, 50g, 500g	36

Product No.	Pack size	Page
Loctite® 407	20g	34
Loctite® 408	20g, 500g	34
Loctite® 409	20g	34
Loctite® 410	20g	34
Loctite® 414	20g	34
Loctite® 415	20g, 50g, 500g	34
Loctite® 416	20g, 50g, 500g	34
Loctite® 420	20g, 500g, 2kg	34
Loctite® 4204	20g, 500g	36
Loctite® 422	20g, 50g, 500g	34
Loctite® 424	20g, 500g	34
Loctite® 4304 ^{Med}	28g, 1 lb	41
Loctite® 4305 ^{Med}	28g, 454g	44
Loctite® 431	20g, 500g	33
Loctite® 435	20g, 500g	32
Loctite® 438	20g	34
Loctite® 454	10g, 20g, 300g	33
Loctite® 460	20g, 50g, 500g	33
Loctite® 4601 ^{Med}	20g	36
Loctite® 480	20g, 500g	32
Loctite® 4850	20g, 500g	32
Loctite® 4860	20g, 500g	36
Loctite® 493	50g	34
Loctite® 495	20g, 50g, 100g, 500g	34
Loctite® 496	20g, 50g, 100g, 500g	34
Loctite® 5080	Not available in the UK	117
Loctite® 5083	10.8 oz, 18kg	44
Loctite® 5088	Not available in the UK	44
Loctite® 5091	300ml	41
Loctite® 510	10ml, 160ml, 250ml	21
Loctite® 511	50ml, 250ml	16
Loctite® 5145	40ml	69
Loctite® 515	50ml, 300ml	22
Loctite® 518	65ml, 300ml, 850ml	20
Loctite® 5188	50ml, 300ml, 850ml, 2 lt	21
Loctite® 5203	300ml	22
Loctite® 5205	50ml, 300ml, 850ml	22
Loctite® 5208	250ml	22
Loctite® 5248 ^{Med}	Not available in the UK	44
Loctite® 5331	100ml	14
Loctite® 5366	310ml	69
Loctite® 5367	310ml	70
Loctite® 5368	310ml	70
Loctite® 5398	310ml	70
Loctite® 5399	310ml	69
Loctite® 5404	300ml	70
Loctite® 542	10ml, 50ml, 250ml	15
Loctite® 549	250ml	16
Loctite® 55	50m, 150m cord	14
Loctite® 5607	400ml, 17 lt	68
Loctite® 561 Stick	19g stick	16

Product No.	Pack size	Page
Loctite® 5610	400ml	70
Loctite® 5612	400ml, 17 lt	68
Loctite® 5615	400ml, 17 lt	68
Loctite® 5616	Not available in the UK	70
Loctite® 567	50ml, 250ml	16
Loctite® 5699	80ml, 300ml, 20 lt	21
Loctite® 570	Not available in the UK	16
Loctite® 572	50ml, 250ml	15
Loctite® 573	250ml	20
Loctite® 574	50ml, 160ml, 250ml, 2 lt	20
Loctite® 577	50ml, 250ml, 2 lt	15
Loctite® 5772	50ml	16
Loctite® 582	Not available in the UK	16
Loctite® 586	Not available in the UK	15
Loctite® 5900	50ml, 300ml, 20 lt	22
Loctite® 5910	300ml cartridge, 80ml tube, 20 lt	22
Loctite® 5920	80ml tube, 300ml cartridge, 20 lt	22
Loctite® 5926	40ml tube	21
Loctite® 5940	40ml, 100ml	70
Loctite® 5970	300ml, 20 lt	21, 69
Loctite® 5980	200ml rocep can	22
Loctite® 601	250ml	28
Loctite® 603	10ml, 50ml, 250ml, 1 lt	27
Loctite® 620	250ml	26
Loctite® 638	3ml, 50ml, 250ml, 2 lt	27
Loctite® 640	250ml	27
Loctite® 641	10ml, 50ml, 250ml	26
Loctite® 648	50ml, 250ml, 2 lt	27
Loctite® 649	250ml	28
Loctite® 660	50ml	26
Loctite® 661	250ml	28
Loctite® 662	Not available in the UK	28
Loctite® 675	250ml, 2 lt	28
Loctite® 7039	400ml aerosol	99
Loctite® 7061	400ml aerosol	98
Loctite® 7063	400ml aerosol, pump, 10 lt can, 200 lt	99
Loctite® 7066	Not available in the UK	99
Loctite® 7070	400ml aerosol, 400ml pump, 10 lt	99
Loctite® 7091	90ml	119
Loctite® 7100	Not available in the UK	117
Loctite® 7200	400ml aerosol	99
Loctite® 7239	Not available in the UK	118
Loctite® 7240	90ml	119
Loctite® 7386	500ml	119
Loctite® 7388	150ml	119
Loctite® 7400	20ml, 500ml	117
Loctite® 7414	50ml	117

Index

Product No.	Pack size	Page
Loctite® 7452	500ml	119
Loctite® 7455	25ml, 150ml, 500ml, 20 lt	118
Loctite® 7457	150ml, 500ml	119
Loctite® 7458	500ml	118
Loctite® 7471	150ml, 500ml	119
Loctite® 7500	1 lt can	116
Loctite® 7649	150ml, 500ml	119
Loctite® 770 / 7701	10g, 300g, 16 oz	118
Loctite® 7800	Not available in the UK	116
Loctite® 7803	Not available in the UK	117
Loctite® 7840	750ml trigger spray, 5 lt can, 20 lt drum	98
Loctite® 7850	400ml bottle, 3 lt pump dispenser, 10 lt drum	98
Loctite® 7855	400ml bottle, 1.75 lt pump dispenser	98
Loctite® 8001	400ml aerosol	108
Loctite® 8005	Not available in the UK	116
Loctite® 8007 aerosol	400ml aerosol	107
Loctite® 8008 brush top	113g, 454g brush top, 3.6 kg can	107
Loctite® 8009	454g brush top, 3.6 kg can	106
Loctite® 8011	400ml aerosol	109
Loctite® 8012	454g brush top	107
Loctite® 8013	454g brush top	106
Loctite® 8014	907g can	107
Loctite® 8021	400ml aerosol	109
Loctite® 8023	454g brush top	106
Loctite® 8030	250ml bottle	109
Loctite® 8031	400ml aerosol	109
Loctite® 8040	400ml aerosol	109
Loctite® 8065 stick	20g stick	107
Loctite® 8101	400ml (286.3) gaerosol	111
Loctite® 8102	400ml cartridge, 1 lt can	110
Loctite® 8103	400ml cartridge, 1 lt can	111
Loctite® 8104	75ml tube, 1 lt can	111
Loctite® 8105	400ml cartridge, 1 lt can	110
Loctite® 8106	400ml cartridge, 1 lt can	110
Loctite® 8108	280g	111
Loctite® 8150 can	500g, 1 kg	107
Loctite® 8151 aerosol	400ml aerosol	107
Loctite® 8154	400ml aerosol	107
Loctite® 8191	400ml aerosol	108
Loctite® 8192	400ml aerosol	108
Loctite® 8201	400ml aerosol	109
Loctite® F245	320ml, 5 lt	60

Product No.	Pack size	Page
Loctite® F246	320ml	58
Loctite® Hysol® 3421	50ml, 200ml, 1 kg	56
Loctite® Hysol® 3423	50ml, 200ml 1 kg	54
Loctite® Hysol® 3425	50ml, 200ml	56
Loctite® Hysol® 3430	24ml, 50ml, 200ml, 400ml	54
Loctite® Hysol® 3450	25ml	56
Loctite® Hysol® 3455	Not available in the UK	56
Loctite® Hysol® 9450	50ml, 200ml, 1 kg	56
Loctite® Hysol® 9461	50ml, 400ml, 1 kg, 20 kg	56
Loctite® Hysol® 9464	50ml, 400ml, 1 kg	56
Loctite® Hysol® 9466	50ml, 400ml	55
Loctite® Hysol® 9480	50ml, 400ml	55
Loctite® Hysol® 9483	50ml, 400ml, 1 kg	54
Loctite® Hysol® 9489	50ml	56
Loctite® Hysol® 9492	50ml, 400ml	56
Loctite® Hysol® 9497	50ml, 400ml	55
Loctite® Hysol® 9514	300ml, 1kg	55
Loctite® Nordbak® 7117	1kg	93
Loctite® Nordbak® 7204	19kg	94
Loctite® Nordbak® 7218	1kg, 10kg	92
Loctite® Nordbak® 7219	1kg, 10kg	92
Loctite® Nordbak® 7221	5.4kg	94
Loctite® Nordbak® 7222	1.3kg	94
Loctite® Nordbak® 7226	1kg, 10kg	93
Loctite® Nordbak® 7227	1kg	94
Loctite® Nordbak® 7228	1kg	94
Loctite® Nordbak® 7229	10kg	94
Loctite® Nordbak® 7230	10kg	94
Loctite® Nordbak® 7232	1kg	94
Loctite® Nordbak® 7234	1kg	93
Loctite® Nordbak® 7255	900g, 30kg	93
Loctite® Nordbak® 7256	9kg	94
Loctite® Nordbak® 7257	4.53g, 24kg	94
Loctite® QB533	Not available in the UK	60
Loctite® V1305	50ml	60
Loctite® V1315	50ml	60
Loctite® V5004	50ml, 20 lt	59
Macromelt 6238	20kg granules	48
Macromelt OM 657	20kg granules	48
Macroplast B2140	Not available in the UK	51
Macroplast CR 3502	Part A: 180kg drum / Part B: 30kg pail, 250kg drum	82
Macroplast CR 3525	Part A: 25kg pail, 180kg drum/ Part B: 30kg pail, 240kg drum	82
Macroplast CR 6127	Part A: 35kg pail / Part B: 6kg pail, 30kg pail	82

Product No.	Pack size	Page
Macroplast EP 3004 / 5004	50ml	56
Macroplast EP 3030	Part A: 20kg pail, 230kg drum / Part B: 20kg pail	82
Macroplast EP 3032 / 5032	23kg, 30kg, 250kg	56
Macroplast EP 3250 / 5250	40kg, 300kg	56
Macroplast EP 3299	Part A: 180kg drum / Part B: 180kg drum	82
Macroplast EP 3430	Part A: 20kg pail / Part B: 18kg pail	82
Macroplast EP 3640 / 5640	Not available in the UK	56
Macroplast ESP 4108	7kg	56
Macroplast ESP 4110	30kg	56
Macroplast UK 1351 B25	400ml twin cartridge	63
Macroplast UK 1366 B10	415ml twin cartridge	63
Macroplast UK 8101	Not available in the UK	64
Macroplast UK 8103	24kg pail	62
Macroplast UK 8115-23	Not available in the UK	64
Macroplast UK 8126	Not available in the UK	64
Macroplast UK 8160	Not available in the UK	64
Macroplast UK 8180 N	Part A: 200kg drum, 1,000kg container / Part B: 30kg pail, 250kg drum, 1,250kg container	82
Macroplast UK 8202	24kg pail	63
Macroplast UK 8303 B60	Not available in the UK	64
Macroplast UK 8306 B60	Not available in the UK	64
Macroplast UK 8309	30 kg pail	64
Macroplast UK 8326 B30	3.6kg combi pack	63
Macroplast UK 8436	Not available in the UK	64
Macroplast UK 8439-21	Part A:190kg drum / Part B: 30kg pail, 250kg drum	82
Macroplast UK 8445 B1 W	Not available in the UK	64
Macroplast UR 7220	Not available in the UK	66

Product No.	Pack size	Page
Macroplast UR 7221	Not available in the UK	62
Macroplast UR 7225	1,000kg	66
Macroplast UR 7228	30kg jerry can	62
Macroplast UR 7388	Not available in the UK	66
Macroplast UR 7395 B-21	Not available in the UK	66
Macroplast UR 7396	Not available in the UK	66
Multan 21-70	On request	112
Multan 233-1	On request	113
Multan 46-81	On request	112
Multan 71-2	On request	112
Multan 77-4	On request	113
Multan F 7161	On request	113
Multan F AFS 105	On request	113
P3 Chemacid 3500	On request	102
P3 Croniclean 300	On request	102
P3 Emulpon 6776	On request	102
P3 Galvaclean 20	On request	102
P3 Gero Cor 3	On request	102
P3 Glin Floor	On request	102
P3 Glin Plus	On request	102
P3 Grato 12	On request	102
P3 Grato 80	On request	102
P3 Manuvo	On request	102
P3 Neutracare 3300	On request	102
P3 Neutracon 5088	On request	102
P3 Prevox 7400	On request	102
P3 Rimol 768	On request	102
P3 Scribex 400	On request	102
P3 Solvclean 102	On request	102
P3 Ultraperm 075	On request	102
P3 Ultraperm 091	On request	102
P3 Upon 5800	On request	102
Plastiwash 1939	On request	102
Purmelt ME 4663	2kg candles, 190kg drums	49
Purmelt QR 3460	300g cartridge, 2kg candles, 20kg pail, 190kg drums	49
Purmelt QR 4663	2kg candles, 20kg pails, 190kg drums	49
Technomelt Q 3113	25kg granules	49
Technomelt Q 5374	ca. 13.5 kg X-tra (cushion)	48
Technomelt Q 8707	ca. 15kg X-tra (cushion)	48
Technomelt Q 9268H	10kg sticks	49
Terokal 2444	5kg, 340kg	51

Index

Product No.	Pack size	Page
Teromix 6700	50ml (2 x 25ml) cartridge	64
Terophon 112 DB	40kg	85
Terophon 123 WF	Not available in the UK	85
Terostat 140	Not available in the UK	70
Terostat 2759	On request	79
Terostat 276	On request	78
Terostat 276 Alu	On request	80
Terostat 2761	On request	80
Terostat 2780	On request	80
Terostat 2785	On request	80
Terostat 279	On request	80
Terostat 285	On request	80
Terostat 301	On request	79
Terostat 33	310ml	70
Terostat 3631 FR	On request	80
Terostat 4006	On request	80
Terostat 58	Not available in the UK	70
Terostat 63	Not available in the UK	70
Terostat 6813	On request	79
Terostat 81	On request	78

Product No.	Pack size	Page
Terostat 8596	310ml cartridge, set	66
Terostat 8597 HMLC	310ml cartridge, 400ml foil, 570ml foil	63
Terostat 8599 HMLC	310ml cartridge, set	66
Terostat 8630 2K HMLC	310ml cartridge, set	64
Terostat 9096 PL	Not available in the UK	66
Terostat 9097 PL HMLC	310ml cartridge, set	66
Terostat IX	On request	79
Terostat MS 510	Not available in the UK	72
Terostat MS 930	310ml, 570ml	72
Terostat MS 9302	Not available in the UK	74
Terostat MS 931	Not available in the UK	73
Terostat MS 935	310ml	72
Terostat MS 9360	310ml, 25kg	74
Terostat MS 937	310ml, 570ml, 18 lt	74
Terostat MS 9380	310ml, 25kg	73
Terostat MS 939	310ml, 570ml, 25kg	73
Terostat MS 939 FR	310ml, 570ml, 25kg	73
Terostat MS 9399	2 x 200ml	73
Terostat VII	On request	78

Equipment

Product	Page
Manual hand-held applicators	
For 1-component cartridges	128
For 2-component cartridges	129
Manual dispensers	
Peristaltic dispensers	130
Syringe dispensers	130
Accessories – Syringes	130
Accessories – Mixers and Nozzles	131
Accessories – Dispensing needles	131
Semi-automatic dispensing systems	132

Product	Page
Hand-held dispensing systems	
Customized systems	133
Light curing equipment	
Flood cure systems	
Bulb technology	134
LED technology	134
Spot cure systems	
Bulb technology	135
LED technology	135
Accessories	135



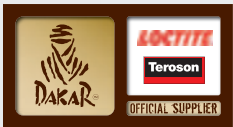

The data contained herein are intended as reference only. Please contact your local Henkel Technical Support Group for assistance and recommendation on specifications for these products.

Henkel Ltd
Wood Lane End
Hemel Hempstead
Hertfordshire HP2 4RQ
Tel: 01442 278100
Fax: 01442 278071
www.loctite.co.uk

® designates a trademark of Henkel AG & Co. KGaA or its affiliates, registered in Germany and elsewhere © Henkel AG & Co. KGaA, 2010