



Manual



Application Configurator for CCU



Contents

1	General information.....	8
1.1	About this documentation	8
1.2	Design of the safety notes	8
1.2.1	Meaning of signal words	8
1.2.2	Structure of section-related safety notes.....	8
1.2.3	Structure of embedded safety notes	9
1.3	Right to claim under warranty	9
1.4	Exclusion of liability.....	9
1.5	Copyright notice	10
1.6	Product names and trademarks.....	10
1.7	Other applicable documentation	10
2	Safety notes	12
2.1	General	12
2.2	Target group	12
2.3	Designated use	13
2.4	Bus systems.....	13
2.5	Short designation	13
3	System description	14
3.1	Fields of application	14
3.2	Performance classes of the configurable CCU application controller	14
3.2.1	CCU standard performance class	14
3.2.2	CCU advanced performance class	14
3.3	Functions	15
3.4	Benefits	15
3.5	System structure	16
3.6	System components and interfaces.....	16
3.7	Operating principle.....	17
3.8	Process data	19
3.9	Program identification	20
4	Functional description of the application modules.....	21
4.1	Transparent.....	21
4.1.1	Area of application	21
4.1.2	Scope of functions of the process data profiles	21
4.1.3	Approved unit combinations	21
4.1.4	Process data assignment	22
4.2	Velocity control.....	22
4.2.1	Area of application	22
4.2.2	Scope of functions of the process data profiles	22
4.2.3	Approved unit combinations	22
4.2.4	Process data assignment.....	24
4.3	Rapid/creep speed positioning.....	24
4.3.1	Area of application	24
4.3.2	Scope of functions of the process data profiles	25

22295410/EN – 11/2015

4.3.3	Approved device combinations	25
4.3.4	Process data assignment	25
4.4	Bus positioning.....	26
4.4.1	Area of application	26
4.4.2	Scope of functions of the process data profiles	26
4.4.3	Approved unit combinations	26
4.4.4	Process data assignment	27
4.5	Universal module	28
4.5.1	Area of application	28
4.5.2	Scope of functions of the process data profiles	28
4.5.3	Approved unit combinations	29
4.5.4	Process data assignment	29
4.6	Universal Module Technology 10 PD.....	30
4.6.1	Area of application	30
4.6.2	Scope of functions of the process data profiles	30
4.6.3	Approved unit combination.....	30
4.6.4	Process data assignment.....	31
4.7	Energy recovery.....	32
4.7.1	Area of application	32
4.7.2	Scope of functions of the process data profiles	32
4.7.3	Approved unit combination.....	32
4.7.4	Process data assignment.....	32
4.8	Application modules for SNI I/O systems.....	33
4.8.1	Area of application	33
4.8.2	Scope of functions of the process data profiles	33
4.8.3	Approved unit combinations	34
4.8.4	Process data assignment	34
4.9	Energy-efficient SRS.....	35
4.9.1	Area of application	35
4.9.2	Scope of functions of the process data profiles	35
4.9.3	Approved unit combinations	35
4.9.4	Process data assignment.....	36
4.10	Winder.....	36
4.10.1	Area of application	36
4.10.2	Scope of functions of the process data profiles	36
4.10.3	Approved unit combination.....	36
4.10.4	Process data assignment.....	36
4.11	HandlingKinematics	37
4.11.1	Areas of application.....	37
4.11.2	Scope of functions of the process data profiles	37
4.11.3	Approved unit combination.....	38
4.11.4	Process data assignment.....	38
5	Project planning.....	39
5.1	Requirements.....	39
5.1.1	Technology level	39
5.1.2	PC and software.....	39

5.1.3	Configurable application controller (CCU).....	39
5.1.4	Correctly configured units	39
5.2	Controller	40
5.2.1	Process data assignment.....	40
5.2.2	Fieldbus input data.....	41
5.2.3	Fieldbus output data.....	42
5.3	Transparent.....	42
5.3.1	Update rate of the process data.....	42
5.4	Velocity control.....	43
5.4.1	Velocity control 1 PD.....	43
5.4.2	Velocity control 2 PD.....	44
5.4.3	Velocity control 3 PD.....	45
5.4.4	Velocity control 4 PD.....	45
5.4.5	Velocity control 6 PD.....	46
5.4.6	Input terminal assignment	47
5.5	Repower.....	47
5.5.1	Fieldbus input data	47
5.5.2	Fieldbus output data.....	47
6	Startup	48
6.1	Requirements.....	48
6.2	Startup procedure	48
6.3	Axis configuration.....	49
6.3.1	Starting Application Configurator (Online).....	49
6.3.2	Creating a new configuration	52
6.3.3	Setting "Velocity control" application module	54
6.3.4	Advanced configuration settings	56
6.4	Controller configuration.....	57
6.4.1	Setting the configuration	57
6.4.2	Setting options	58
6.5	Download	59
6.5.1	Saving the complete configuration	60
6.5.2	Downloading the configuration	60
6.6	Opening an existing configuration.....	61
6.6.1	Anne Opening a configuration from the computer	61
6.6.2	Opening the configuration from the SD card of the controller	61
7	Operation and diagnostics	62
7.1	Overview: Initial screen of diagnostics.....	62
7.1.1	Monitor mode and control mode	64
7.1.2	Module diagnostics	66
7.2	PD monitor	72
7.2.1	Operating the PD monitor	74
7.3	Trace.....	75
7.3.1	Starting and editing the recording	76
7.4	Extended diagnostics.....	78
8	Diagnostic messages	80

8.1	Display in the PD monitor	80
8.2	Priority of the displayed messages	82
8.3	Error messages of the application modules	82
8.4	Error messages of the function modules	85
8.5	Controller messages	86
9	12-byte MOVILINK® parameter channel	90
9.1	Parameter setting procedure	90
9.2	Structure of the 12-byte MOVILINK® parameter channel	90
9.3	Parameter access to lower-level devices (sub-routing)	92
9.3.1	Function chart	92
9.3.2	Routing information subsystem 1 (bytes 8 - 9).....	93
9.3.3	Routing information subsystem 2 (bytes 10 - 11).....	93
9.3.4	Sample routing	93
9.3.5	Parameter list	93
9.4	Management byte 0	94
9.4.1	Response	94
9.5	Description of the parameter services	95
9.5.1	No service	95
9.5.2	Read parameter	95
9.5.3	Write parameter	95
9.5.4	Write parameter volatile	95
9.5.5	Read minimum	95
9.5.6	Read maximum	95
9.5.7	Read default.....	95
9.5.8	Read Scale.....	95
9.5.9	Read attribute.....	96
9.6	Return codes for parameterization.....	98
9.6.1	Error class	98
9.6.2	Error code	98
9.6.3	Additional code.....	99
9.7	Examples	101
9.7.1	1. Reading the firmware part number via the READ service.....	101
9.7.2	2. Writing the fixed setpoint (n_{11}) with the WRITE service.....	104
10	Appendix	106
10.1	Electrical installation	106
10.2	DHR21B/41B	107
10.2.1	Terminal assignment and DIP switches	107
10.2.2	LED L5	108
10.3	DHF21B/41B.....	109
10.3.1	Terminal assignment and DIP switches	109
10.3.2	Setting the DIP switches in DeviceNet operation	111
10.3.3	LED L5	111
10.4	MOVIDRIVE® B	112
10.4.1	Overview	112
10.4.2	Terminal assignment and DIP switches	113

10.5	MOVIAXIS®	116
10.5.1	Overview	116
10.5.2	Terminal assignment of an axis module.....	117
10.5.3	Address and baud rate at power supply module.....	118
10.6	MOVITRAC® B	120
10.6.1	Overview	120
10.6.2	Terminal assignment of the basic unit.....	121
10.6.3	Terminal assignment and DIP switches for FSC11B	122
10.7	MOVITRAC® LTX/LTP-B	123
10.7.1	Overview	123
10.7.2	Prefabricated cable with RJ45 connector on one end.....	124
10.7.3	Prefabricated cable with RJ45 connector on both ends.....	124
10.7.4	Cable splitter: 1 to 2	124
10.7.5	SBus terminating connector	124
10.7.6	Terminal assignment.....	125
10.8	MOVIFIT® FDC-SNI	126
10.8.1	EBOX "MTC...-R9...-00"	126
10.8.2	Terminal assignment of the standard ABOX "MTA...-S04.-...-00"	126
10.8.3	DIP switch S12.....	131
10.8.4	DIP switch S3.....	132
10.8.5	"USR" LED	133
10.9	MOVIGEAR® B / DRC DSC	134
10.9.1	Installation topology example	134
10.9.2	Terminal assignment.....	135
10.9.3	Setting of the bus terminating resistor.....	137
10.9.4	Description of the DIP switches	137
10.9.5	Assignment of the optional plug connector X5131.....	139
10.10	MOVIGEAR® B / DRC SNI	142
10.10.1	Installation topology (example)	142
10.10.2	Terminal assignment.....	143
10.10.3	Description of the DIP switches	144
10.10.4	Assignment of the optional plug connector X5131.....	145
10.11	Application Configurator part number	147
	Index	148

1 General information

1.1 About this documentation

The documentation is part of the product and contains important information. The documentation is for everyone who works with this product.

The documentation must be accessible and legible. Make sure that persons responsible for the system and its operation as well as persons who work independently with the software and the connected units of SEW-EURODRIVE have read through the manual carefully and understood it. If you are unclear about any of the information in this documentation or if you require further information, please contact SEW-EURODRIVE.

1.2 Design of the safety notes

1.2.1 Meaning of signal words

The following table shows the grading and meaning of the signal words for safety notes.

Signal word	Meaning	Consequences if disregarded
▲ DANGER	Imminent hazard	Severe or fatal injuries.
▲ WARNING	Possible dangerous situation	Severe or fatal injuries.
▲ CAUTION	Possible dangerous situation	Minor injuries
NOTICE	Possible damage to property	Damage to the drive system or its environment.
INFORMATION	Useful information or tip: Simplifies handling of the drive system.	

1.2.2 Structure of section-related safety notes

Section-related safety notes do not apply to a specific action but to several actions pertaining to one subject. The hazard symbols used either indicate a general hazard or a specific hazard.

This is the formal structure of a safety note for a specific section:



SIGNAL WORD

Type and source of hazard.





Possible consequence(s) if disregarded.

- Measure(s) to prevent the hazard.

Meaning of the hazard symbols

The hazard symbols in the safety notes have the following meaning:

Hazard symbol	Meaning
	General hazard

Hazard symbol	Meaning
	Warning of dangerous electrical voltage
	Warning of hot surfaces
	Warning of risk of crushing
	Warning of suspended load
	Warning of automatic restart

1.2.3 Structure of embedded safety notes

Embedded safety notes are directly integrated into the instructions just before the description of the dangerous action.

This is the formal structure of an embedded safety note:

▲ SIGNAL WORD! Type and source of hazard. Possible consequence(s) if disregarded. Measure(s) to prevent the hazard.

1.3 Right to claim under warranty

A requirement of fault-free operation and fulfillment of any rights to claim under limited warranty is that you adhere to the information in the documentation at hand. Therefore, read the documentation before you start working with the software and the connected units from SEW-EURODRIVE.

Make sure that the documentation is available to persons responsible for the machinery and its operation as well as to persons who work independently on the units. Also ensure that the documentation is legible.

1.4 Exclusion of liability

Please observe this documentation as well as the documentation for the software used and the SEW-EURODRIVE devices connected. This documentation must be observed to ensure that the devices operate safely and that the specified product properties and performance characteristics are achieved.

SEW-EURODRIVE assumes no liability for injury to persons or damage to equipment or property resulting from non-observance of the documentation. In such cases, SEW-EURODRIVE assumes no liability for defects.

1.5 Copyright notice

© 2015 SEW-EURODRIVE. All rights reserved.

Unauthorized reproduction, modification, distribution or any other use of the whole or any part of this documentation is strictly prohibited.

1.6 Product names and trademarks

The brands and product names in this documentation are trademarks or registered trademarks of their respective titleholders.

1.7 Other applicable documentation

Observe the following applicable documentation for the controller and software:

- Manual "Controller DHE21B / DHF21B / DHR21B (standard)",
DHE41B / DHF41B / DHR41B (advanced)"
- Communication manuals for the respective fieldbuses:
 - MOVI-PLC® advanced DHF41B Fieldbus Interfaces DeviceNet™ and PROFIBUS DP-V1
 - MOVI-PLC® advanced DHR41B Fieldbus Interfaces EtherNet/IP™, Modbus/TCP and PROFINET IO
- "MOVIPRO® ADC Decentralized Drive and Position Controller" operating instructions
- "MOVIPRO® ADC-SNI Decentralized Drive and Position Controller" operating instructions
- "MOVIFIT® FDC-SNI" operating instructions
- Manuals for the application modules that are used:
 - CCU "Rapid/Creep Speed Positioning" application module
 - CCU "Bus Positioning" application module
 - CCU "Universal Module" application module
 - CCU "Universal Module Technology 10 PD" application module
 - CCU "Energy-Efficient SRS" application module
 - CCU "HandlingKinematics" application module
 - CCU "Winder" application module
 - CCU "SNI I/O Systems" application modules
- Latest edition of the documentation (online help or manual) for MOVITOOLS® MotionStudio

Also observe the following applicable documentation depending on the connected drive technology:

- "MOVIDRIVE® MDX Drive Inverters" operating instructions
- "MOVITRAC® MC07 Frequency Inverters" operating instructions
- "MOVITRAC® LTX Frequency Inverters" operating instructions
- "MOVITRAC® LTP-B Frequency Inverters" operating instructions
- "MOVIGEAR® Mechatronic Drive System" operating instructions

- "MOVIAXIS® MX Multi-Axis Servo Inverter" operating instructions
- "CMP ELVCD Decentralized Extra-Low Voltage Servo Drive" operating instructions
- "MOVIAXIS® Multi-Axis Servo Inverter – MXR80 Supply and Regenerative Module" manual
- "MOVIAXIS® Multi-Axis Servo Inverter – MXR81 Supply and Regenerative Module" manual

2 Safety notes

2.1 General

The following basic safety notes are intended to prevent injury to persons and damage to property. The user must ensure that the basic safety notes are read and observed.

Ensure that persons responsible for the machinery and its operation as well as persons who work independently have read through the documentation carefully and understood it. If you are unclear about any of the information in this documentation or if you require further information, please contact SEW-EURODRIVE.

The following safety notes refer to the use of the software. Also observe the supplementary safety notes in this documentation and in the documentation for the connected units from SEW-EURODRIVE.

This document does not replace the detailed documentation for the connected units. This documentation assumes that the user has access to and is familiar with the documentation for all connected units from SEW-EURODRIVE.

Never install or operate damaged products. Report any damage to the shipping company immediately.

Depending on the degree of protection, units may have live, uninsulated, and sometimes moving or rotating parts, as well as hot surfaces during operation.

Removing required covers without authorization, improper use or incorrect installation and operation may result in severe injury to persons, or damage to machinery. Consult the documentation for further information.

2.2 Target group

Work with the software in this solution may only be performed by adequately qualified personnel. Qualified personnel in this context are persons who have the following qualifications:

- Appropriate training in their relevant field.
- Knowledge of this documentation and other applicable documentation.
- SEW-EURODRIVE recommends additional product training for products that are operated using this software.

All mechanical work on connected units is to be performed exclusively by adequately qualified personnel. Qualified personnel in the context of this documentation are persons familiar with the design, mechanical installation, troubleshooting and servicing of the product, who possess the following qualifications:

- Training in mechanical engineering, e.g. as a mechanic or mechatronics technician (final examinations must have been passed).
- Knowledge of this documentation and other applicable documentation.

All electrical work on connected units is to be performed exclusively by adequately qualified electricians. Qualified electricians in the context of this documentation are persons familiar with electrical installation, startup, troubleshooting and servicing of the product, who possess the following qualifications:

- Training in electrical engineering, e.g. as an electrician or mechatronics technician (final examinations must have been passed).
- Knowledge of this documentation and other applicable documentation.

- Knowledge of the relevant safety regulations and laws.
- Knowledge of all other standards, directives and laws named in this documentation.

The above-mentioned persons must have the express authorization of the company to operate, program, configure, label and ground units, systems and circuits in accordance with the standards of safety technology.

All work in the areas of transportation, storage, operation and waste disposal must be carried out by persons who are trained appropriately.

2.3 Designated use

SEW-EURODRIVE offers various standardized control programs, so-called application modules.

The application modules run on the controller and are independent of the connected drive electronics.

The Application Configurator is a unit-independent software that helps you to start up a suitable application module for each axis, to configure it, and to download it to the controller.

Depending on the lower-level devices, you can realize a variety of single- and multi-axis applications.

When testing the parameterized functions with the Application Configurator, you can directly access the drive functions in control mode. The limiting and locking specified in the higher-level controller can become ineffective. Suitable precautionary measures must therefore be taken when using control mode. Using control mode is the sole responsibility of the user.

▲ CAUTION

Using control mode is the sole responsibility of the user.



2.4 Bus systems

A bus system makes it possible to adapt frequency inverters and/or motor starters to the particulars of the machinery within wide limits. This results in the risk that a change of parameters that cannot be detected externally can result in unexpected, though not uncontrolled, system behavior.

2.5 Short designation

The following short designations are used in this documentation.

Type designation	Short designation
Higher-level controller	PLC
Controller in CCU design	Controller

3 System description

3.1 Fields of application

The Application Configurator can be used for:

- Single-axis applications
- Multi-axis applications

Depending on the application, there are the following selection criteria:

- Performance class of the configurable application controller:
 - CCU standard
 - CCU advanced
- Performance characteristics of the lower-level devices
- Application module used

The following sections illustrate the assignment of the two performance classes to the controller types.

3.2 Performance classes of the configurable CCU application controller

The following table provides an overview of the assignment of performance classes and controller types.

Performance class	Controller type
CCU standard	DHF21B
	DHR21B
	MOVIFIT® FDC-SNI standard
CCU advanced	DHF41B
	DHR41B
	MOVIPRO® ADC
	MOVIFIT® FDC-SNI advanced

3.2.1 CCU standard performance class

The "CCU standard" performance class is intended for application modules with single-axis functionality and medium response times. A maximum of 16 axes can be connected to a configurable controller.

You can only operate application modules with technology level T0.

3.2.2 CCU advanced performance class

The "CCU advanced" performance class is intended for application modules with single-axis and multi-axis functionality and fast response times. A maximum of 16 axes can be connected to a configurable controller.

You can operate application modules with technology level T0 or higher.

3.3 Functions

The application controller provides the following functions:

- Startup and configuration of application modules
- Diagnostics of application modules

3.4 Benefits

The application controller provides the following benefits:

- The process data monitor visualizes the data exchange between the parameterized application modules and the higher-level controller.
- Data is managed using an SD card for the entire application module and all drive parameters.
- The simulation mode allows for diagnostics of configurations without devices and motors connected.
- A detailed module diagnostics function allows for a simple testing of the application module.
- Variables (e.g. travel profiles) are recorded over the time for simple error detection.
- You can update the software of the Application Configurator on the SD card when you download the application data.
- The application modules run centrally on the controller, thus they are drive-independent.

3 System description

System structure

3.5 System structure

The following figure illustrates the system structure required in order to configure and operate your application modules with a configurable CCU controller.

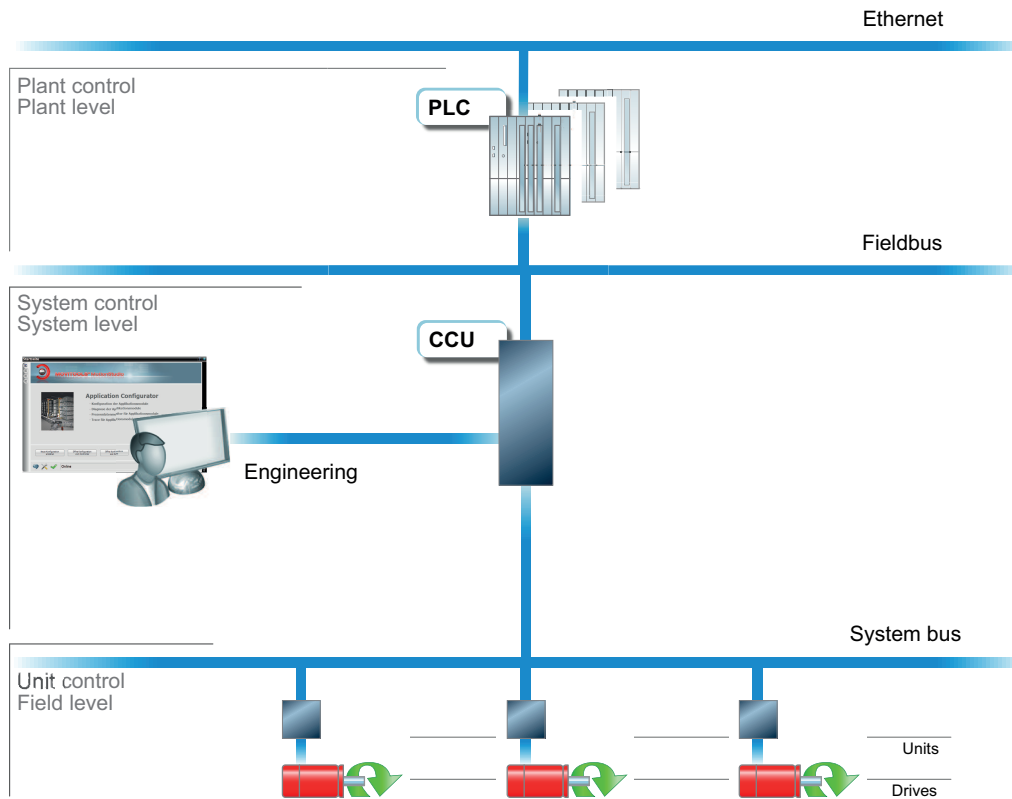

9007202422106251

3.6 System components and interfaces

The configurable CCU controller has various communication interfaces.

The engineering PC is connected to the CCU controller directly via the USB interface or via the Ethernet service interface.

The system bus interfaces CAN 1/CAN 2 or the SNI interface are predominantly used for connecting and controlling several inverters.

You can operate this machine module via the PLC using the integrated fieldbus interface.

Device	SBus 1	SBus 2	SNI	COM2	PROFIBUS Devi- ceNet™	PROFINET Modbus/TCP EtherNet/IP™
(CCU_)DHFX1B	1 – 16	1 – 16	-	-	X	-
(CCU_)DHRX1B	1 – 16	1 – 16	-	-	-	X
(CCU_)MTC_R9X	-	1 – 21	1 – 9	-	-	X

22295410/EN – 11/2015

Device	SBus 1	SBus 2	SNI	COM2	PROFIBUS Devi- ceNet™	PROFINET Modbus/TCP EtherNet/IP™
(CCU_)PFH_E2E3	1 (I/O modules) 20 – 23 (MDX) 31 – 34 (CanToCom) 41 (Energy storage unit)	1 – 63	-	1 (MOVIMOT®)	-	x
(CCU_)PFH_E2E3_ SNI	1 (I/O modules) 20 – 23 (MDX) 31 – 34 (CanToCom) 41 (Energy storage unit)	1 – 63	1 – 9	1 (MOVIMOT®)	-	x
(CCU_)PFH_P1D1	1 (I/O modules) 20 – 23 (MDX) 31 – 34 (CanToCom) 41 (Energy storage unit)	1 – 63	-	1 (MOVIMOT®)	x	-
(CCU_)PFH_P1D1 _SNI	1 (I/O modules) 20 – 23 (MDX) 31 – 34 (CanToCom) 41 (Energy storage unit)	1 – 63	1 – 9	1 (MOVIMOT®)	x	-

3.7 Operating principle

The Application Configurator is installed on the engineering PC. You can use this configuration software to select the suitable application module for each axis of your application (single- or multi-axis application) that runs independent of the connected drive electronics. The required parameters are entered in the assistant of the respective application module. Then the entire configuration is transferred to the CCU controller.

You can still integrate all the IPOS^{plus}®-based application modules or technology functions that run directly on the inverter. Select the "Transparent" application module to do so. This will forward the unmodified process input and output data from the controller. In this case, the parameterization in the Application Configurator is not required. Instead, parameterize IPOS^{plus}®-based application modules with the corresponding tool provided via MOVITOOLS® MotionStudio.

3 System description

Operating principle

The following figure illustrates the processing of axes with drive-independent application modules compared to an axis with IPOS^{plus}[®]-based application module.

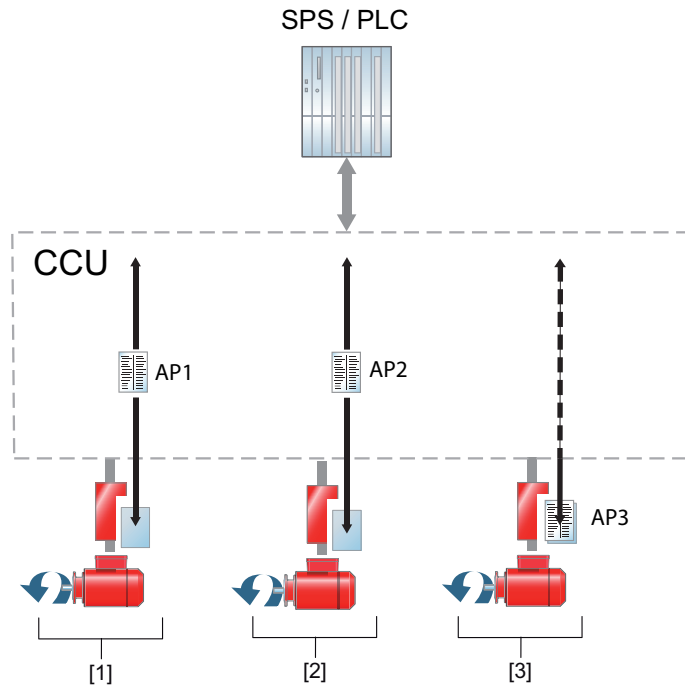

9007202367088011

No.	Description
[1]	AP1 The application module 1 (e.g. velocity control 1 PD) runs on the CCU controller independent of the drive.
[2]	AP2 The application module 2 (e.g. rapid/creep speed positioning 6 PD) runs on the CCU controller independent of the drive.
[3]	AP3 The application module 3 is an IPOS ^{plus} [®] -based application module (e.g. winder) and runs on the inverter. For integration, the application module "Transparent" is stored on the CCU controller.

3.8 Process data

The controller receives fieldbus input data (I) from the PLC and sends fieldbus output data to the PLC (O).

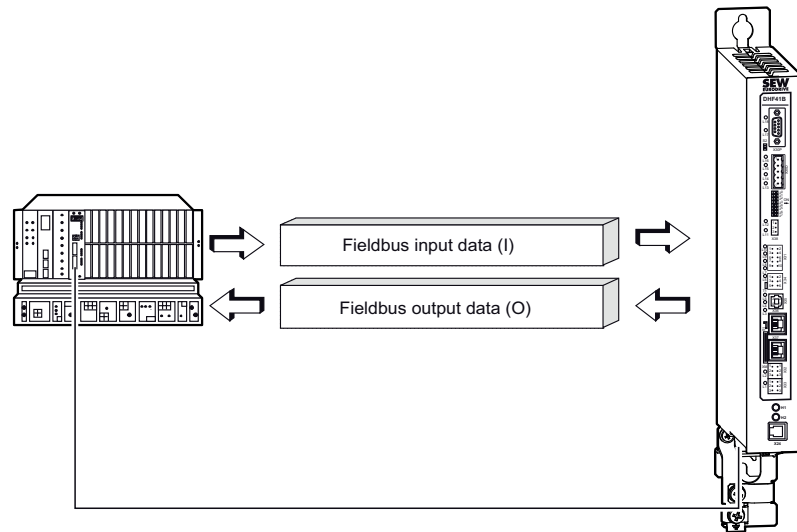

18014401631607691

The maximum number of process data is 120 PD. The process data consist of the process data of the application controller and the sum of the process data for each axis.

- Number of Controller PD:
 - 2 PD without parameter channel
 - 8 PD with parameter channel
- Number of axis PD:
 - 1 PD – 10 PD per axis (depending on the application module/profile)

The following example is to illustrate this relation. It shows the process data of 2 axes with different application modules/profiles and the process data of the application controller with deactivated parameter channel.

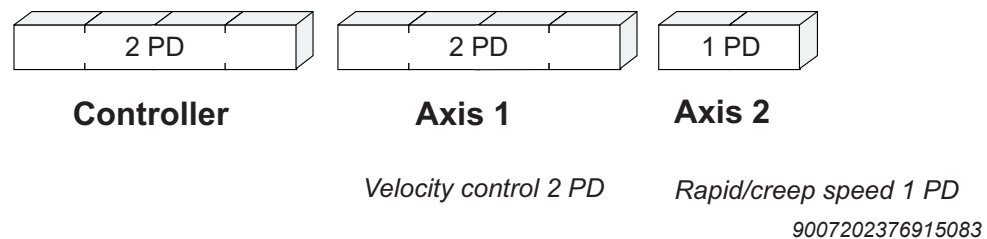

3.9 Program identification

You can use the MOVITOOLS® MotionStudio engineering software to identify the program last loaded into the controller.

Proceed as follows:

1. Start MOVITOOLS® MotionStudio.
2. Select the controller in the network view.
3. Right-click to open the context menu of the controller.
4. Choose the command [Startup] > [Parameter tree].
5. In the parameter tree, select the node "Unit data" [1] in the "Display values" folder.

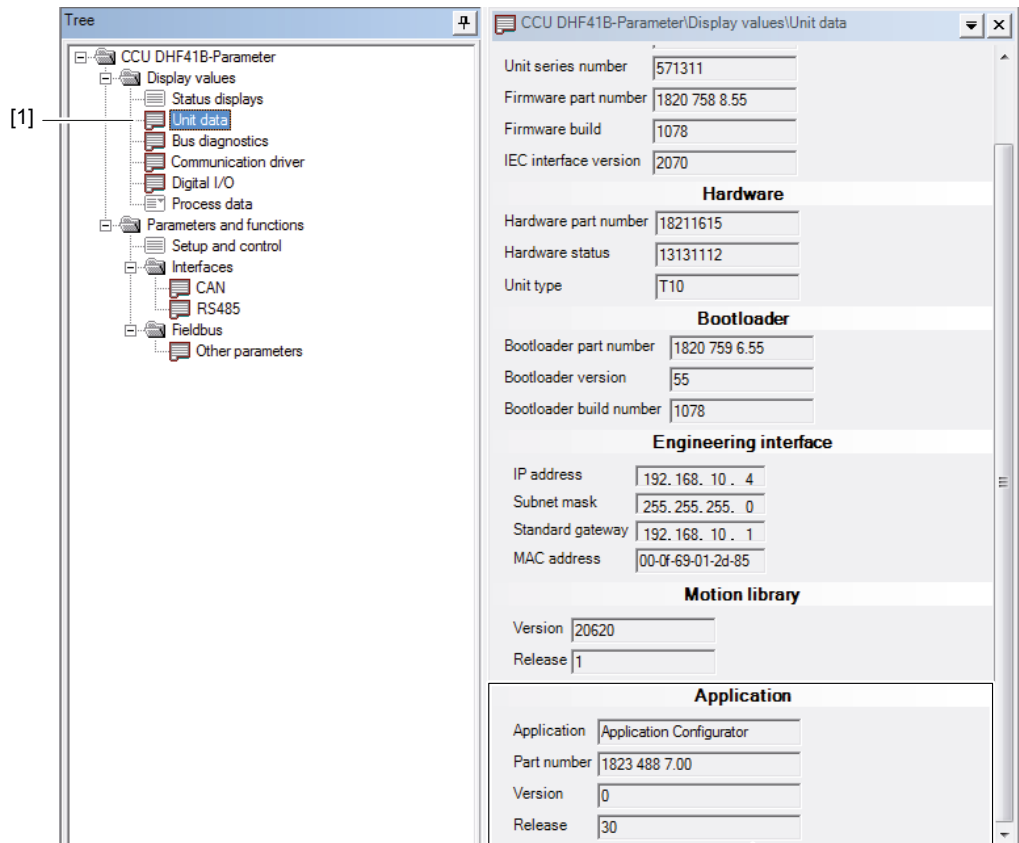

9007202600296715

- ⇒ The version information of the installed program is listed in the "Application" group [2] in the lower section of the window.

4 Functional description of the application modules

The following sections provide an overview of all application modules including the areas of application, the functionality, the permitted unit combinations and the process data assignment depending on the profile used.

For a detailed description of the process data assignment for the "Velocity control" and "Repower" application module, refer to the end of chapter "Project planning". For the other application modules, this information is included in the corresponding documentation of the individual application modules.

4.1 Transparent

4.1.1 Area of application

The "Transparent" application module is used when the fieldbus output data from the PLC is to be sent via the controller directly to the lower-level units. The same applies to the process data communication in the opposite direction. The fieldbus input data from the lower-level units is forwarded to the PLC via the controller.

The "Transparent" application module supports all the (IPOS^{plus}-based) application modules running directly on the inverter.

4.1.2 Scope of functions of the process data profiles

The "Transparent" application module has the following profiles.

Profile	Scope of functions
3 PD	3 process data words, control signals are forwarded to/from the inverter without being interpreted.
6 PD	6 process data words, control signals are forwarded to/from the inverter without being interpreted.
10 PD	10 process data words, control signals are forwarded to/from the inverter without being interpreted.

4.1.3 Approved unit combinations

The following table lists the permitted combinations of controller types and lower-level units.

CCU	Devices
DHF21B DHR21B	MOVIDRIVE [®] B MOVITRAC [®] B (only Transparent 3 PD) MOVITRAC [®] LTX (only Transparent 3 PD)
DHF41B DHR41B	MOVIDRIVE [®] B MOVITRAC [®] B (only Transparent 3 PD) MOVITRAC [®] LTX (only Transparent 3 PD) MOVIAXIS [®]
MOVIPRO [®] ADC	MOVIPRO [®] power section at SBus 1 (only 3 or 6 PD)
MOVIFIT [®] FDC-SNI MOVIPRO [®] ADC-SNI	MOVIFIT [®] FC slave (only Transparent 3 PD)

4 Functional description of the application modules

Velocity control

4.1.4 Process data assignment

The process data assignment depends on the application module running on the inverter.

4.2 Velocity control

4.2.1 Area of application

The "Velocity control" application module is used for speed-controlled applications without positioning.

4.2.2 Scope of functions of the process data profiles

The "Velocity control" application module has the following profiles.

Profile	Scope of functions
1 PD	1 process data word. All speeds and ramps are specified via the configuration interface and can be selected bit-coded. It is possible to specify 6 different speeds and 4 different ramps in the controller.
2 PD	2 process data words, like 1 PD profile, however, you can use the existing digital inputs/outputs of the device as additional process data word.
3 PD	3 process data words. The speeds and the ramps are specified dynamically via the process data. This profile is recommended for applications that require more than 6 different speeds or 4 different ramps, as well as for applications with speeds that are stored centrally in a PLC for many products (e.g. food industry).
4 PD	4 process data words, like the 3 PD profile, however, the existing digital inputs/outputs of the device can be evaluated via the process data.
6 PD	6 process data words, like the 4 PD profile, however, the existing analog inputs/outputs of the device can be evaluated via the process data.

4.2.3 Approved unit combinations

The following table lists the permitted combinations of controller types and lower-level units.

CCU	Devices
DHF21B DHR21B	MOVIDRIVE® B MOVITRAC® B MOVIGEAR® DSC-B MOVITRAC® LTX
DHF41B DHR41B	MOVIDRIVE® B MOVITRAC® B MOVIGEAR® DSC-B MOVITRAC® LTX MOVIAXIS®

22295410/EN – 11/2015

CCU	Devices
MOVIPRO® ADC	MOVIPRO® power section at SBus 1 (only velocity control 1, 3 PD) MOVIGEAR® DSC-B on SBus 2
MOVIFIT® FDC-SNI MOVIPRO® ADC-SNI	MOVIGEAR® SNI-B MOVIGEAR® DSC-B on SBus 2

4 Functional description of the application modules

Rapid/creep speed positioning

4.2.4 Process data assignment

The following table lists the process data assignment depending on the selected profile.

Profile	Process data assignment	
	Fieldbus input data	Fieldbus output data
1 PD	I1 = Control word	O1 = Status word
2 PD	I1 = Control word I2 = Digital outputs	O1 = Status word O2 = Digital inputs
3 PD	I1 = Control word I2 = Setpoint speed ¹⁾ (× 0.2) I3 = Ramp	O1 = Status word O2 = Actual speed ¹⁾ (× 0.2) O3 = Output current
4 PD	I1 = Control word I2 = Setpoint speed ¹⁾ (× 0.2) I3 = Ramp I4 = Digital outputs	O1 = Status word O2 = Actual speed ¹⁾ (× 0.2) O3 = Output current O4 = Digital inputs
6 PD	I1 = Control word I2 = Setpoint speed ¹⁾ (× 0.2) I3 = Ramp I4 = Digital outputs I5 = Analog output 1 I6 = Analog output 2	O1 = Status word O2 = Actual speed ¹⁾ (× 0.2) O3 = Output current O4 = Digital inputs O5 = Analog input 1 O6 = Analog input 2

¹⁾In order to ensure compliance with the MOVILINK[®] protocol, the following conversion applies to the entered/displayed speed value: 1 digit = 0.2 min⁻¹.

4.3 Rapid/creep speed positioning

4.3.1 Area of application

The "Rapid/creep speed positioning" application module is used for simple positioning tasks in materials handling technology.

This includes the following typical applications:

- Roller and chain conveyors
- Lifting table applications
- Rotary table applications

Positioning is carried out via 2 initiators with 2 speeds. The first initiator determines the switching point from rapid to creep speed, the second one determines the stop position.

Applications that must position in 2 directions require 4 initiators.

The following operating modes are supported:

- Jog
- Feed-in (positioning)

- Feed-out
- Lifting/rotating

4.3.2 Scope of functions of the process data profiles

The "Rapid/creep speed positioning" application module has the following profiles.

Profile	Scope of functions
1 PD	1 process data word. Control via one control word with this profile. You define all speeds and ramps via the configuration interface. SEW-EURODRIVE recommends this profile if you do not have to adjust speed and ramp to the product.
3 PD	3 process data words. This profile is used for example for conveying products with changing weight and for medium positioning accuracy. The rapid speed and the ramps can be defined using the bus. The digital inputs of the device can be evaluated via the process data.
6 PD	6 process data words. This profile is required e.g. for conveying products with varying weight, where the rapid speed as well as the creep speed can be set via the bus in order to achieve a high positioning accuracy. As opposed to the 3 PD profile, the ramp for acceleration and deceleration, as well as the stop ramp can be specified independently. The digital inputs of the device can be evaluated via the process data. The actual position can be reset. For this purpose, select operating mode = 0 and set the start bit.

4.3.3 Approved device combinations

The following table lists the permitted combinations of controller types and lower-level units.

CCU	Devices
DHF21B, DHR21B	MOVIDRIVE® B MOVIGEAR® DSC-B
DHF41B, DHR41B	MOVIDRIVE® B MOVIGEAR® DSC-B
MOVIPRO® ADC	MOVIPRO® power section on SBus 1 MOVIGEAR® DSC-B on SBus 2
MOVIFIT® FDC-SNI MOVIPRO® ADC-SNI	MOVIGEAR® SNI-B MOVIGEAR® DSC-B on SBus 2

4.3.4 Process data assignment

For the process data assignment, refer to the documentation of the respective application module, see chapter "Other applicable documentation".

22295410/EN – 11/2015

4 Functional description of the application modules

Bus positioning

4.4 Bus positioning

4.4.1 Area of application

The "bus positioning" application module is used for variable positions in conjunction with different speeds and ramps.

Positioning is carried out via the built-in motor encoder or an optional distance encoder. Only linear, absolute positioning is supported. You can work with user units.

The following operating modes are supported:

- Jog
- Referencing
- Positioning

INFORMATION



If you use this application module for positioning tasks, you require a drive with encoder.

4.4.2 Scope of functions of the process data profiles

The "Bus positioning" application module has the following profile.

Profile	Scope of functions
6 PD	6 process data words to control position, speed, acceleration and deceleration.

4.4.3 Approved unit combinations

The following table lists the permitted combinations of controller types and lower-level units.

CCU	Devices
DHF21B DHR21B	MOVIDRIVE® B MOVIGEAR® DSC-B MOVITRAC® LTX MOVITRAC® B
DHF41B DHR41B	MOVIDRIVE® B MOVIGEAR® DSC-B MOVITRAC® LTX MOVITRAC® B MOVIAXIS®
MOVIPRO® ADC	MOVIPRO® power section on SBus 1 MOVIGEAR® DSC-B on SBus 2
MOVIFIT® FDC-SNI MOVIPRO® ADC-SNI	MOVIGEAR® SNI-B MOVIGEAR® DSC-B on SBus 2

22295410/EN – 11/2015

4.4.4 Process data assignment

For the process data assignment, refer to the documentation of the respective application module, see chapter "Other applicable documentation".

4 Functional description of the application modules

Universal module

4.5 Universal module

4.5.1 Area of application

The "Universal module" application module is used for all speed-controlled and positioning applications in user units. Functional extensions such as synchronization or Touchprobe evaluation allow for a wide range of possible applications.

The application module is equipped with a consistent process data interface that is simply extended with increasing functionality. Thus the profiles of the universal module are downward compatible.

INFORMATION



If you use this application module for positioning tasks, you require a drive with encoder.

4.5.2 Scope of functions of the process data profiles

The "Universal module" application module has the following interrelated process data profiles.

Profile	Scope of functions
4 PD	Operating modes: <ul style="list-style-type: none">• Speed mode• Jog mode Functions: <ul style="list-style-type: none">• Speed and dynamics parameters in user units• INFORMATION: Motors without encoder are only supported in this profile.
6 PD	Operating modes (in addition to 4 PD profile): <ul style="list-style-type: none">• Referencing mode• Absolute positioning mode – linear and modulo
7 PD	Operating modes (in addition to 6 PD profile): <ul style="list-style-type: none">• Speed synchronism• Relative positioning mode – linear and modulo
10 PD	Operating mode (in addition to 7 PD profile): <ul style="list-style-type: none">• Positioning mode – Touchprobe (TP) with sensor-based positioning – linear and modulo Functions: <ul style="list-style-type: none">• Torque limitation• Reading the Touchprobe position• Digital inputs and digital outputs

22295410/EN – 11/2015

4.5.3 Approved unit combinations

The following table lists the permitted combinations of controller types and lower-level units.

CCU	Devices
DHF21B DHR21B	MOVIDRIVE® B MOVIGEAR® DSC-B MOVITRAC® LTX CMP ELVCD (in preparation)
DHF41B DHR41B	MOVIDRIVE® B MOVIGEAR® DSC-B MOVITRAC® LTX MOVIAXIS® CMP ELVCD (in preparation)
MOVIPRO® ADC	MOVIPRO® power section on SBus 1 MOVIGEAR® DSC-B on SBus 2 CMP ELVCD at SBus 2 (in preparation)
MOVIFIT® FDC-SNI MOVIPRO® ADC-SNI	MOVIGEAR® SNI-B MOVIGEAR® DSC-B on SBus 2

4.5.4 Process data assignment

For the process data assignment, refer to the documentation of the respective application module, see chapter "Other applicable documentation".

4.6 Universal Module Technology 10 PD

4.6.1 Area of application

The *universal module Technology 10 PD* expands the scope of functions of the *universal module Standard* (see "CCU – Universal Module Application Module" manual) by additional angle-synchronous applications in operating mode 8 "Gearing".

4.6.2 Scope of functions of the process data profiles

The *Universal module Technology 10 PD* supports linear axes and modulo axes and has the following profile.

Profile	Scope of functions
10 PD	<p>Operating modes:</p> <ul style="list-style-type: none"> • Speed mode • Jog mode • Referencing mode • Positioning mode • Synchronous angle mode (operating mode 8 "Gearing") <p>Functions:</p> <ul style="list-style-type: none"> • Touchprobe • Adjustment (operating mode 8 "Gearing") • Offset (operating mode 8 "Gearing")

4.6.3 Approved unit combination

Controller

You need one of the following controllers with technology level T2 or higher to use the application module.

CCU	Firmware version	Technology level
DHF41B	1115 or higher	T2 or higher
DHR41B		

For further information for technology activation, refer to the "Controller DHE21B / DH-21B / DHR21B (standard), DHE41B / DHF41B / DHR41B (advanced)" manual.

Inverter

To use the application module, you need one of the following inverters.

Inverter	Firmware version
MOVIDRIVE® B	xxx.16 or higher
MOVIAXIS®	xxx.29 or higher
CMP ELVCD (in preparation)	3.4 280.1.29 or higher

Compatibility

The *Universal Module Technology 10 PD* application module is downward compatible with the *Universal module standard* application module.

INFORMATION



Except for "speed synchronism" mode, the *universal module Technology 10 PD* offers all operating modes and functions included in the *universal module Standard*.

Control mode

The slave axis is synchronized with the setpoints of the master axis. This has the advantage that the slave axis runs smoothly because it does not follow every slightest control movement of the master axis. Consequently, a maximum lag distance might occur between the master axis and a slave axis resulting from the total of all lag distances configured for the master and slave inverters. You find more details in the manual of the inverter in use.

4.6.4 Process data assignment

For the process data assignment, refer to the documentation of the respective application module, see chapter "Other applicable documentation".

4 Functional description of the application modules

Energy recovery

4.7 Energy recovery

4.7.1 Area of application

The "Repower" application module is used to control the regenerative power supply unit. It can be enabled via the process data interface or via the digital inputs.

4.7.2 Scope of functions of the process data profiles

The "Repower" application module has the following profile.

Profile	Scope of functions
1 PD	1 process data word for enable and status messages of the regenerative power supply unit.

4.7.3 Approved unit combination

The following table lists the permitted combinations of controller types and lower-level units.

CCU	Devices
DHF41B, DHR41B	MOVIAXIS® MXR
MOVIPRO® ADC, MOVIPRO® ADC-SNI	MOVIPRO® with regenerative power supply unit (R15)

4.7.4 Process data assignment

Refer to the following table for the process data assignment of the profile.

Profile	Process data assignment	
	Fieldbus input data	Fieldbus output data
1 PD	I1 = Control word	O1 = Status word

4.8 Application modules for SNI I/O systems

4.8.1 Area of application

I/O application module

The *I/O* application module with the respective fieldbus interface makes the signals of the SNI I/O system available to the higher-level controller.

I/O logic application module

The *I/O logic* application module is used for the decentralized logical link of input signals to control a digital output signal. This allows for an independence of the bus runtime of the SNI bus. Digital input signals can be linked logically. Analog signals and counter values are linked with comparison operations. If the input signals are assigned to one direction of movement, a direction-dependent control of the output signal is possible by transfer of the direction of movement. Each link is controlled as independent function.

I/O positioning application module

The *I/O positioning* application module is an extension of the *I/O logic* application module. It is used for controlling the positioning procedure of an independent motion. One application example is the enable control of an EMS rail element.

The application modules are equipped with a consistent process data interface that is simply extended with increasing functionality. Thus the profiles of the application module are downward compatible.

4.8.2 Scope of functions of the process data profiles

I/O application module

The *I/O* application module has the following profiles.

Profile	Scope of functions
2 PD	2 process data words for controlling the SNI I/O system and the image of the digital inputs and outputs.
6 PD	6 process data words for controlling the SNI I/O system and in addition to the 2 PD profile for 4 counter values.
10 PD	10 process data words for controlling the SNI I/O system and in addition to the 6 PD profile for 4 analog values.

I/O logic application module

The *I/O logic* application module has the following profiles.

Profile	Scope of functions
10 PD	10 process data words for controlling the SNI I/O system and for controlling the logic functions.

4 Functional description of the application modules

Application modules for SNI I/O systems

I/O positioning application module

The *I/O positioning* application module has the following profiles.

Profile	Scope of functions
5 PD	5 process data words for controlling the SNI I/O system and for controlling the logic and positioning functions. A maximum of 3 function control words can be used.
10 PD	10 process data words for controlling the SNI I/O system and for controlling the logic and positioning functions. A maximum of 8 function control words can be used.

4.8.3 Approved unit combinations

The following table lists the permitted combinations of controller types and lower-level units.

CCU	Units
MOVIFIT® FDC-SNI MOVIPRO® ADC-SNI	SNI I/O system

4.8.4 Process data assignment

For the process data assignment, refer to the documentation of the respective application module, see chapter "Other applicable documentation".

22295410/EN – 11/2015

4.9 Energy-efficient SRS

4.9.1 Area of application

The "energy-efficient SRS" application module was developed to operate energy-efficient high-bay warehouses. The application module allows for energy savings of up to 25% due to optimized travel cycles of vertical lifting drive and horizontal travel drive. A simple interface allows for specifying the target positions and dynamic parameters for the lifting and travel axes. Integrated functions for buffer travel and slack rope detection.

The IEC program controls up to 3 axes and is used for the following devices:

- MOVIAxis® (with MXR supply und regenerative module)
- MOVIDRIVE®

INFORMATION



If you use this application module for positioning tasks, you require a drive with encoder.

4.9.2 Scope of functions of the process data profiles

Depending on the number of configured axes, there are the following profiles:

- **Simplified process data profile:**

If only **one** travel axis and **one** lifting axis is used, you can use the simplified process data profile.

- **Advanced process data profile:**

A soon as **two** synchronized travel or hoist axes are used, the advanced process data profile applies automatically.

4.9.3 Approved unit combinations

The following table lists the permitted combinations of controller types and lower-level units.

CCU	Devices	
	Main axes	Auxiliary axes
DHF41B DHR41B (Technology level T2)	MOVIDRIVE® B MOVIAxis®	MOVIDRIVE® B (with transparent, rapid/creep speed, velocity control, bus positioning or universal module) MOVIAxis® B (with transparent, velocity control, bus positioning or universal module) MOVITRAC® B (with transparent (only 3 PD), velocity control or universal module) MOVITRAC® LTX (with transparent (only 3 PD), velocity control, bus positioning or universal module) MOVIGEAR® DSC-B (with rapid/creep speed, velocity control, bus positioning or universal module)

4 Functional description of the application modules

Winder

4.9.4 Process data assignment

For the process data assignment, refer to the documentation of the respective application module, see chapter "Other applicable documentation".

4.10 Winder

4.10.1 Area of application

The "winder" application module is used for applications that require winding or unwinding of material with constant tension or constant path velocity.

The diversity of materials and different mechanical conditions require different winding techniques. The application module offers the following standard processes:

Tension determining winder

- Torque control (optional higher-level tension control)
- Dancer position control
- Tension control

Speed determining winder

- Speed controller
- Speed control

4.10.2 Scope of functions of the process data profiles

The "Winder" application module has the following process data profile.

Profile	Scope of functions
10 PD	<p>To control the standard procedure described above, the jog mode and the determination of the friction coefficient, 6 process data words are used.</p> <p>For further input parameters such as <i>digital outputs</i>, <i>actual diameter</i>, <i>actual path velocity</i> and for further output parameters such as <i>digital inputs</i> or <i>material length</i> 3 process data words are used.</p> <p>With the process data words I10 and O10 <i>position</i>, the referenced winder axis can be absolutely positioned in the range of 0 to 360°.</p>

4.10.3 Approved unit combination

The following table lists the permitted combinations of controller types and lower-level units:

CCU	Devices
DHF41B, DHR41B	MOVIDRIVE®, MOVIAXIS®

4.10.4 Process data assignment

For the process data assignment, refer to the documentation of the respective application module, see chapter "Other applicable documentation".

4.11 HandlingKinematics

4.11.1 Areas of application

The "HandlingKinematics" application module is controlled by the higher-level controller via fieldbus.

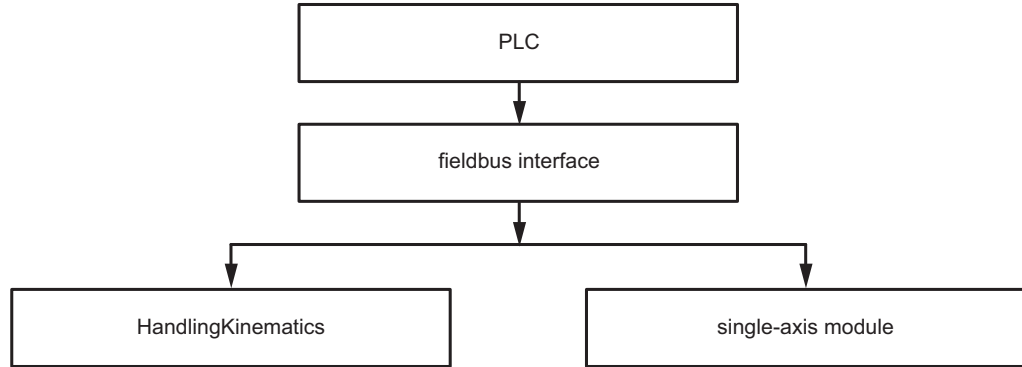

13943506059

The application module allows for a path control for kinematics that cannot be realized in this quality with direct fieldbus control of the single axes via the PLC due to the worse and irregular response time to process information. The following tasks are taken from the PLC.

- Interpolation in space
- Transformation into motion profiles of axes
- Controlling the drives/inverters
- Sequence control of entire paths of motion

As the tasks are solved by the independent and reliable "HandlingKinematics" application module, programming errors are avoided.

During startup, the mechanical data and the motion parameters are entered once. During operation, only the positions of the path when the motion starts must be transmitted to the controller. The application module coordinates the required path movements in real time. If you define a wait point in the path, the controller continues the motion only if it is allowed. During palletizing and piling, the target position must often be adjusted in ongoing operation. The integrated Touchprobe function can do this in real time without intervention of the PLC.

4.11.2 Scope of functions of the process data profiles

The "HandlingKinematics" application module has the following profiles.

Profile	Scope of functions
32 PD	6 process data words for general control signals, 26 process data words for up to 5 path segments.
60 PD	60 process data words, same as the 32 PD profile, but 10 path segments are supported.
88 PD	88 process data words, same as the 60 PD profile, but 15 path segments are supported.
116 PD	116 process data words, same as the 88 PD profile, but 20 path segments are supported.

4.11.3 Approved unit combination

The following table lists the permitted combinations of controller types and lower-level units:

CCU	Devices
DHF41B, DHR41B	MOVIDRIVE®, MOVIAxis®, MOVITRAC® LTX

4.11.4 Process data assignment

For the process data assignment, refer to the documentation of the respective application module, see chapter "Other applicable documentation".

5 Project planning

5.1 Requirements

5.1.1 Technology level

To execute the application module, a certain technology level is required. The technology level depends on the used application module.

The required technology level is T0, unless otherwise specified in the documentation of the respective application module.

5.1.2 PC and software

The Application Configurator is part of the MOVITOOLS® MotionStudio engineering software.

In order to use the Application Configurator, you require a PC with a Windows®-based operating system and MOVITOOLS® MotionStudio **Version 5.6 SP 2 complete** or higher.

For information regarding the installation requirements for the engineering software, refer to the documentation (online help or manual) of MOVITOOLS® MotionStudio.

5.1.3 Configurable application controller (CCU)

Use the Application Configurator with an CCU controller of the performance class "Standard" or "Advanced".

The controller is used as configurable application controller if you use SD cards of the type OMC41B. Only standardized application modules created by SEW-EURODRIVE can be executed.

5.1.4 Correctly configured units

Correct configuration and flawless installation of the units are the prerequisites for successful startup and operation of the application modules with the Application Configurator.

The appendix of this documentation provides wiring diagrams and terminal assignments of all units you can configure axes for with the Application Configurator.

For detailed configuration information, refer to the documentation of the respective unit (see chapter "Other applicable documentation").

5.2 Controller

5.2.1 Process data assignment

The following table lists the process data assignment of the controller.

Profile	Process data assignment	
	Fieldbus input data	Fieldbus output data
2 PD without parameter channel	I1 = Control word controller I2 = Digital outputs	O1 = Controller status word O2 = Digital inputs
8 PD with parameter channel ¹⁾	I1 = Subindex/control word of parameter channel I2 = Index I3 = Data (high word) I4 = Data (low word) I5 = Subchannel1/Subaddress1 I6 = Subchannel2/subaddress2 I7 = Controller control word I8 = Digital outputs	O1 = Subindex/status word of parameter channel O2 = Index O3 = Data (high word) O4 = Data (low word) O5 = Subchannel1/Subaddress1 O6 = Subchannel2/subaddress2 O7 = Controller status word O8 = Digital inputs

1) For information on the parameter channel, refer to chapter "12-Byte MOVILINK® parameter channel".

5.2.2 Fieldbus input data

The following table shows the fieldbus input data assignment from the PLC to the controller for fieldbus control with 2 process data words.

Word		Bit	Function			
Control word	I1	0	Download data set	You have to enable these data management functions in order to control them via the process data: In MOVITOOLS® MotionStudio select [Startup] > [Data management] and activate option "Enable data management function control via process data".		
		1	Upload data set			
		2	Upload data set and auto-reload ¹⁾			
				3	Simulation mode off	Physically non-existent axes that have been configured for simulation purposes can be enabled subsequently (without a new configuration). To do so, switch off the simulation mode with bit 3 via the fieldbus. This state remains until the Controller is "restarted". Then the axes are simulated again.
				4	Auto configuration off (see setting note)	
				5	Reserved (restart of the application)	
				6	Reboot system	
				7	Reserved	
				8 – 15	Reserved	
Digital outputs	I2	0 – 15	DO00-DO15 ²⁾			

1) Any unit replacement is detected when the controller is started up. If there has been a replacement, the parameter sets are transferred from the controller to the replaced units.

2) The actually used digital outputs depend on the respective controller type, as well as on the assignment of the digital input and output terminals (Refer to setting options in chapter "Controller configuration").

Setting note regarding bit 4 *auto configuration off*

This setting option refers to MOVIFIT® FDC-SNI in conjunction with MOVIGEAR® SNI slave units.

In delivery state, 10 preconfigured MOVIGEAR® SNI slave units are preconfigured. This means that the fieldbus is searched cyclically for all 10 units (SNI address 0 to 9). Proceed as follows to reduce the fieldbus load:

- In the PLC, evaluate as to whether all required MOVIGEAR® units signal in the status word that they are ready for operation.
- Once you have received the ready signal from all the required MOVIGEAR® units, set signal I1:4 *Auto configuration off* to "1".

If, for example, 3 units are connected, the controller only communicates with those units (SNI address 0 – 2).

5.2.3 Fieldbus output data

The following table shows the fieldbus output data assignment from the controller to the PLC for fieldbus control with 2 process data words.

Word		Bit	Function	
Status word	O1	0	Maintenance switch ¹⁾	0: Supply voltage of the drive = "ON" 1: Supply voltage of the drive = "OFF"
		1	Toggle	
		2	Reserved	
		3	Reserved	
		4	Data set available	
		5	Auto-reload configured	
		6	Warning	
		7	Error	
		8 – 15	Code for status/warning/error of the controller Refer to chapter "Diagnostic messages" (→ 80) for a detailed description of the errors, warnings and the statuses.	
Digital inputs	O2	0 – 15	DI00 – DI15	

1) For units without maintenance switch, the signal is "1" permanently.

5.3 Transparent

5.3.1 Update rate of the process data

The update rate of the process data can be adjusted via "Advanced configuration settings" (→ 56).

The default value is 5 ms. Depending on the specified time, the following minimum value applies to MOVIDRIVE® B with transparent 6 PD or 10 PD:

Update rate PD = number of MDX B in transparent 6 PD / 10 PD x 10 ms

5.4 Velocity control

5.4.1 Velocity control 1 PD

Fieldbus input data

The following table shows the fieldbus input data assignment from the PLC to the controller for fieldbus control with 1 process data word.

Word	Bit	Function
Control word I1	0	Controller inhibit
	1	Enable/Rapid stop The drive stops after the time specified in parameter "Deceleration enable/rapid stop".
	2	Enable/stop The drive stops after the time specified in parameter "Deceleration enable/stop".
	3	Reserved
	4	Reserved
	5	Reserved
	6	Error reset
	7	Reserved
	8	Reserved
	9	Fixed speed 2 ⁰
	10	Fixed speed 2 ¹
	11	Fixed speed 2 ²
	12	Direction of rotation reversal
	13	Reserved
	14	Ramp set 2 ⁰
15	Ramp set 2 ¹	

Fieldbus output data

The following table shows the fieldbus output data assignment from the controller to the PLC for fieldbus control with 1 process data word.

Word		Bit	Function
Status word	O1	0	Motor is running
		1	Inverter ready
		2	Drive referenced
		3	Setpoint speed reached
		4	Brake released
		5	Failure/warning
		6	Inverter error
		7	Internal error in application program Refer to chapter "Diagnostic messages" (→ 80) for a detailed description of the errors.
		8 – 15	Inverter state/error code

5.4.2 Velocity control 2 PD

Fieldbus input data

The following table shows the fieldbus input data assignment from the PLC to the controller for fieldbus control with 2 process data words.

Word		Bit	Function
Control word	I1	0 – 15	Assignment like 1 PD
Digital out-puts	I2	0 – 7	DO00 – DO07
		8 – 15	DO10 – DO17

Fieldbus output data

The following table shows the fieldbus output data assignment from the controller to the PLC for fieldbus control with 2 process data words.

Word		Bit	Function
Status word	O1	0 – 15	Assignment like 1 PD
Digital inputs	O2	0 – 7	DI00 – DI07
		8 – 15	DI10 – DI17

5.4.3 Velocity control 3 PD

Fieldbus input data

The following table shows the fieldbus input data assignment from the PLC to the controller for fieldbus control with 3 process data words.

Word	Bit	Function	
Control word	I1	0	Controller inhibit
		1	Enable/Rapid stop The drive stops after the time specified in parameter "Deceleration enable/rapid stop".
		2	Enable/stop The drive stops after the time specified in parameter "Deceleration enable/stop".
		3	Reserved
		4	Reserved
		5	Reserved
		6	Error reset
		7	Reserved
		8 – 15	Reserved
Setpoint speed	I2	0 – 15 [min ⁻¹] (1 digit = 0.2 min ⁻¹)	
Ramp	I3	0 – 15 [ms]	

Fieldbus output data

The following table shows the fieldbus output data assignment from the controller to the PLC for fieldbus control with 3 process data words.

Word	Bit	Function
Status word	O1	0 – 15 Assignment like 1 PD
Actual speed	O2	0 – 15 [min ⁻¹] (1 digit = 0.2 min ⁻¹)
Output current	O3	0 – 15 The unit depends on the device and can be gathered from the parameter tree of the respective device.

5.4.4 Velocity control 4 PD

Fieldbus input data

The following table shows the fieldbus input data assignment from the PLC to the controller for fieldbus control with 4 process data words.

Word	Bit	Function
Control word	I1	0 – 15 Assignment like 3 PD
Setpoint speed	I2	0 – 15 Assignment like 3 PD
Ramp	I3	0 – 15 [ms], assignment like 3 PD
Digital outputs	I4	0 – 15 Assignment like 2 PD

Fieldbus output data

The following table shows the fieldbus output data assignment from the controller to the PLC for fieldbus control with 4 process data words.

Word		Bit	Function
Status word	O1	0 – 15	Assignment like 1 PD
Actual speed (× 0.2)	O2	0 – 15	Assignment like 3 PD
Output current	O3	0 – 15	Assignment like 3 PD
Digital inputs	O4	0 – 15	Assignment like 2 PD

5.4.5 Velocity control 6 PD

Fieldbus input data

The following table shows the fieldbus input data assignment from the PLC to the controller for fieldbus control with 6 process data words.

Word		Bit	Function
Control word	I1	0 – 15	Assignment like 4 PD
Setpoint speed	I2	0 – 15	Assignment like 4 PD
Ramp	I3	0 – 15	Assignment like 4 PD
Digital outputs	I4	0 – 15	Assignment like 4 PD
Analog output 1	I5	0 – 15	Analog output 1
Analog output 2	I6	0 – 15	Analog output 2

Fieldbus output data

The following table shows the fieldbus output data assignment from the controller to the PLC for fieldbus control with 6 process data words.

Word		Bit	Function
Status word	O1	0 – 15	Assignment like 1 PD
Actual speed	O2	0 – 15	Assignment like 3 PD
Output current	O3	0 – 15	Assignment like 3 PD
Digital inputs	O4	0 – 15	Assignment like 2 PD
Analog input 1	O5	0 – 15	Analog input 1
Analog input 2	O6	0 – 15	Analog input 2

5.4.6 Input terminal assignment

The following table shows the terminal assignment of the respective unit with default assignment.

Input terminal	Default assignment	
	MOVITRAC® B	Other units
DI00	Input not used	All inputs not used
DI01	CW/stop (fix wiring to DC 24 V)	
DI02	Input not used	

5.5 Repower

5.5.1 Fieldbus input data

The following table shows the fieldbus input data assignment from the PLC to the controller for fieldbus control with 1 process data word.

Word	Bit	Function
Control word I1	0	Reserved
	1	Enable
	2	Reserved
	3	Reserved
	4	Reserved
	5	Reserved
	6	Error reset
	7 – 15	Reserved

5.5.2 Fieldbus output data

The following table shows the fieldbus output data assignment from the controller to the PLC for fieldbus control with 1 process data word.

Word	Bit	Function
Status word O1	0	Reserved
	1	Ready for operation
	2	Ready for power on
	3	Reserved
	4	Enable output stage
	5	Reserved
	6	Error
	7	Reserved
	8 – 15	Status/error code

6 Startup

6.1 Requirements

Check the inverter installation, the encoder connection and the controller installation based on the installation notes in the operating instructions, the fieldbus manuals and the appendix of this manual.

6.2 Startup procedure

You need the MOVITOOLS® MotionStudio engineering software for startup.

The scope of delivery comprises the technology editor **Drive Startup for MOVI-PLC®** and the **Application Configurator**. Both tools are required for startup. The following figure shows the entire procedure.

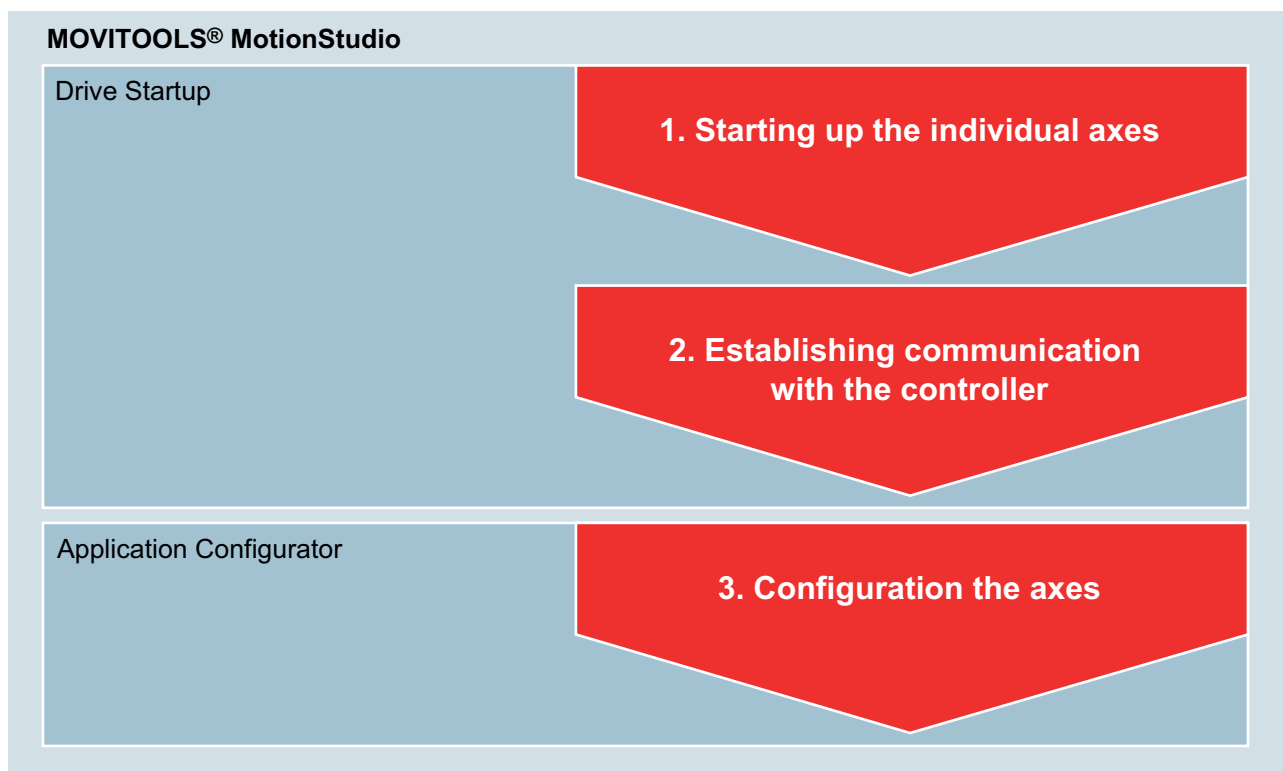

9007202421855371

INFORMATION



- Depending on the respective unit, you may have to perform the communication settings directly on the unit instead of using Drive Startup for MOVI-PLC® (e.g. MOVIGEAR® B). Refer to the appendix of this manual for detailed information on the communication settings (addressing, baud rate etc.).
- Ideally, you should use Drive Startup for MOVI-PLC® in conjunction with an interface adapter. This way, you make sure that communication can be re-established in the event of an incorrect addressing or baud rate setting.

In steps 1, 2:

1. Select the **inverter** you want to start up in the network view of MOVITOOLS® MotionStudio.
2. Right-click to open the context menu of the inverter.
3. Select the menu command [Technology editor] > [Drive Startup for MOVI-PLC®/CCU].
⇒ Drive Startup for MOVI-PLC®/CCU is started.
4. Follow the instructions of the wizard.

Step 3 is described in detail below.

6.3 Axis configuration

6.3.1 Starting Application Configurator (Online)

Proceed as follows:

1. **▲ WARNING!**
Make sure that the machine/system is in a safe state and that the DEFAULT operating mode is selected in MOVITOOLS® MotionStudio. In this operating mode, the permitted configurations are displayed.
2. Start the MOVITOOLS® MotionStudio engineering software.
3. **INFORMATION:** For a detailed description of the following steps, refer to the MOVITOOLS® MotionStudio documentation (manual or online help).
4. Set up a suitable communication channel (e.g. Ethernet).
5. Click on the [Network scan] icon [1] in the toolbar.



[1]

18014399642202507

6. Select the controller in the network view.
7. Right-click to open the context menu of the controller.
8. Select [Application modules] > [Application Configurator].
⇒ The initial screen of the Application Configurator opens.

Initial screen

The initial screen of the Application Configurator provides the following functions.



18014401530753291

No.	Description
[1]	Click this button to open the configuration interface in order to create a new configuration in the Application Configurator and transfer it to the SD card of the controller.
[2]	The tooltip shows the version of the Application Configurator interface when moving the mouse over it.
[3]	Use this icon to open the "settings" (→ 51) menu.
[4]	The communication status is displayed here: <ul style="list-style-type: none"> • Online: The communication to the controller has been established successfully (green tick) • Offline: The communication to the controller has failed (red X) INFORMATION: Successful communication with the controller requires the connection mode in MOVITOOLS® MotionStudio set to "online".
[5]	Use this button to load a configuration from the SD card of the controller to edit it in the Application Configurator. INFORMATION: This function is not available during the first use.
[6]	Use this button to open a dialog for selecting an existing configuration from a file *.AppConfig.zip.

No.	Description
[7]	<p>Click this button to open the diagnostics interface with the following functions:</p> <ul style="list-style-type: none"> • Overview (statuses of the inverter/controller and module diagnostics) • PD monitor (process data monitor) • Trace (Recording of variables) • Extended diagnostics (current state of important data structures)

"Settings" menu

The "settings" menu comprises the following functions.

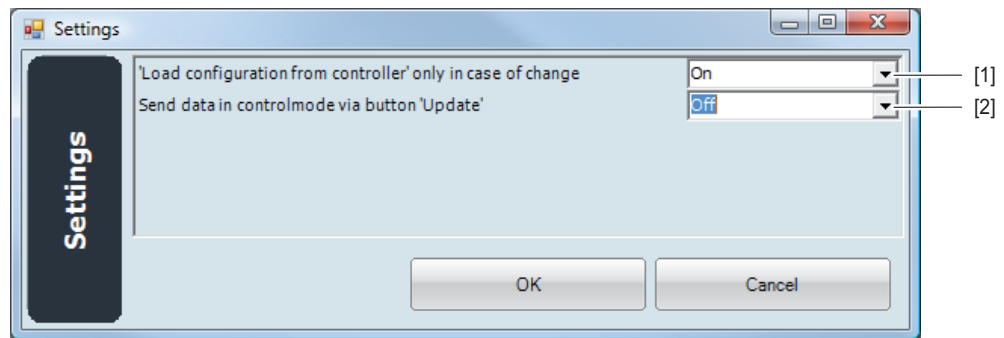

9007202341092235

No.	Function
[1]	<p>This is where you specify how the configuration is loaded:</p> <ul style="list-style-type: none"> • On: Configuration is only loaded in the event of any change (recommended for fast operation) • Off: Configuration is always loaded
[2]	<p>This is to specify how entered process input data are sent in control mode:</p> <ul style="list-style-type: none"> • On: All entered process input data are sent at the same time when you click on [Update]. • Off: Each input is sent immediately without clicking [Update].



INFORMATION

SEW-EURODRIVE recommends to configure the units in the MotionStudio project.

This results in significantly reduced upload and download times to the units as the unit data is stored in the MotionStudio project and is only downloaded to the unit if needed. This offers significant advantages for the access of an controller via fieldbus.

6.3.2 Creating a new configuration

Proceed as follows:

✓ The initial screen of the Application Configurator is displayed.

1. Click the [Create new configuration] button.

⇒ The configuration interface opens.

2. You should first become familiar with the configuration interface.

3. Proceed with step "Adding axes" (→ 53).

Configuration interface

The configuration interface of the Application Configurator provides the following functions.

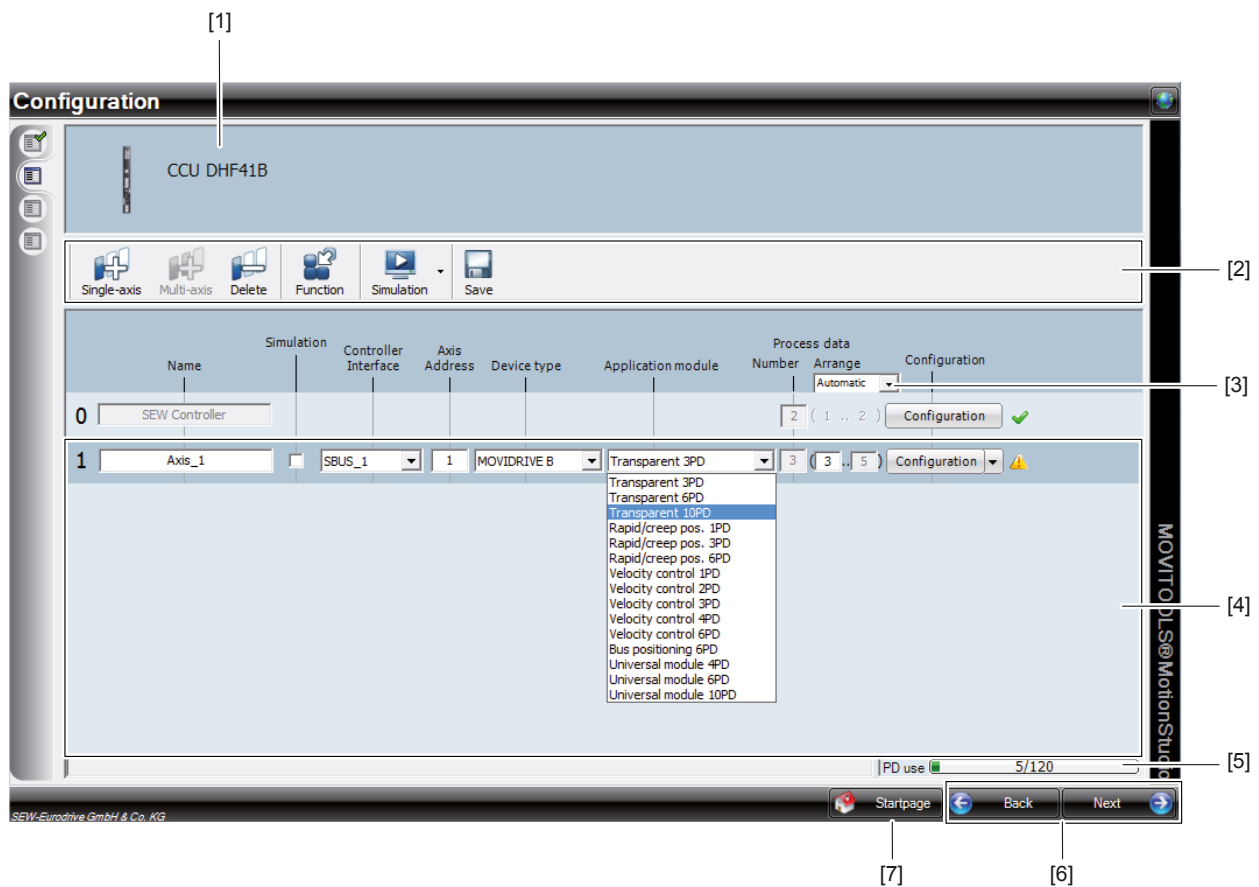

18014401538275083

No.	Description
[1]	This is where the respective controller type is displayed.
[2]	In this toolbar, you can find the icons for the following tasks: <ul style="list-style-type: none"> • Add single axes • Add multi-axis applications • Delete axes • Select axis-/device-independent functions (e.g. brake test) • Simulation (all axes/no axis) • Save complete configuration (all axes)

No.	Description
[3]	This is where you determine how the process data of the units are arranged: <ul style="list-style-type: none"> • Automatically: The units are addressed sequentially. • Manually: You can address the units manually, thus providing for gaps in the addressing. This setting is for users that are experienced in addressing process data.
[4]	This axes section displays the added axes in individual lines.
[5]	This section displays the used/free process data words.
[6]	Use these buttons to navigate back and forth between the individual program sections.
[7]	Use this button to go back to initial screen.

Adding axes

You can add individual axes or multi-axis applications.

Make sure that you always start with the multi-axis module, if you configure a combination of single and multi-axis modules.

The following section describes the procedure for individual axes. The procedure for multi-axis applications (e.g. energy-efficient SRS) is identical.

Adding a single-axis module in the axis configuration

Proceed as follows:

1. Click the "Single axis" icon in the configuration interface.
 - ⇒ A new line appears in the axis section.

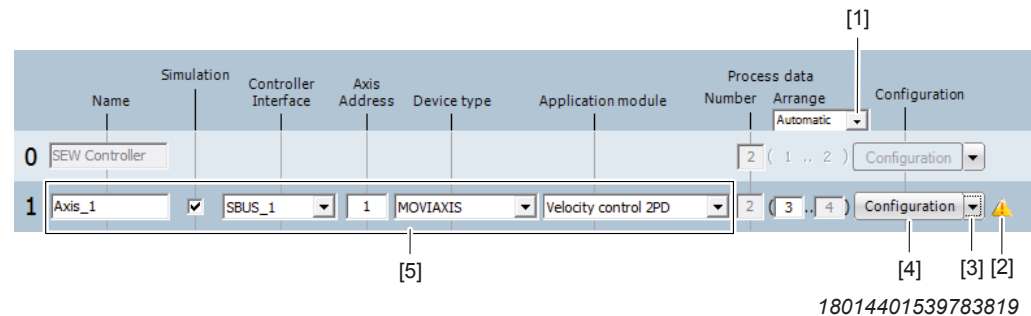

2. Configure the axis [5] according to your requirements:
 - ⇒ Enter an axis name.
 - ⇒ Activate the "Simulation" checkbox" if the axis is physically not available yet but you intend to perform diagnostics nonetheless.
 - ⇒ Select the interface that connects the controller to the unit (inverter).
 - ⇒ Enter the same axis address as at the unit.
 - ⇒ Select the device type.
 - ⇒ Select the required application module with the suitable profile.
3. Click the button [4] to configure the axis.
 - ⇒ A software wizard for configuring the selected application module appears.

INFORMATION



Some application modules do not require the user to perform any settings as the wizard assigns default values to the required parameters.

4. Follow the instructions of the wizard as described in the next chapter.
 - ⇒ Once you have configured an axis, the yellow warning symbol [2] turns into a green check. If required, you can undo this step by selecting "Reset the configuration" from the drop-down list [3].
5. Add more axes and repeat the previous steps.

INFORMATION



The process data words used are displayed for each axis and are arranged in sequential order.

6. Click [Next].
 - ⇒ The "Download" (→ 59) window is displayed.

6.3.3 Setting "Velocity control" application module

Setting the "Velocity control" application module is supported by a wizard and differs slightly depending on the respective process data profile.

Selecting an application module

Proceed as follows:

1. Select the "Velocity control .. PD" application module with the respective process data profile (PD 1 – 6) from the drop-down list [1].

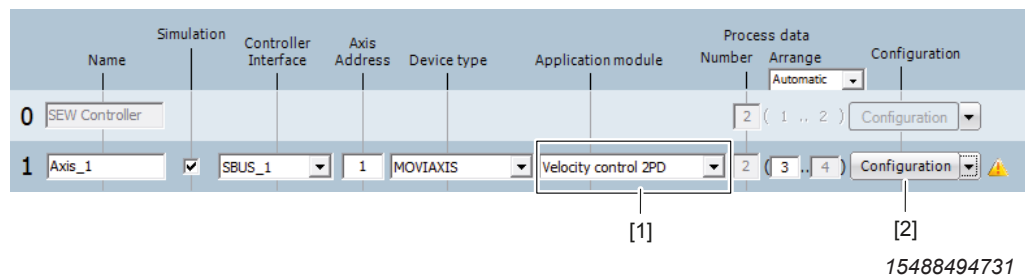

2. Click the button [2] to configure the axis.
 - ⇒ A software wizard for configuring the selected application module appears.
3. Adhere to the process that corresponds to your process data profile:
 - ⇒ 1 and 2 PD
 - ⇒ 3, 4, 5 and 6 PD

Velocity control 1 – 2 PD

The following functions are available for process data profiles 1 and 2.

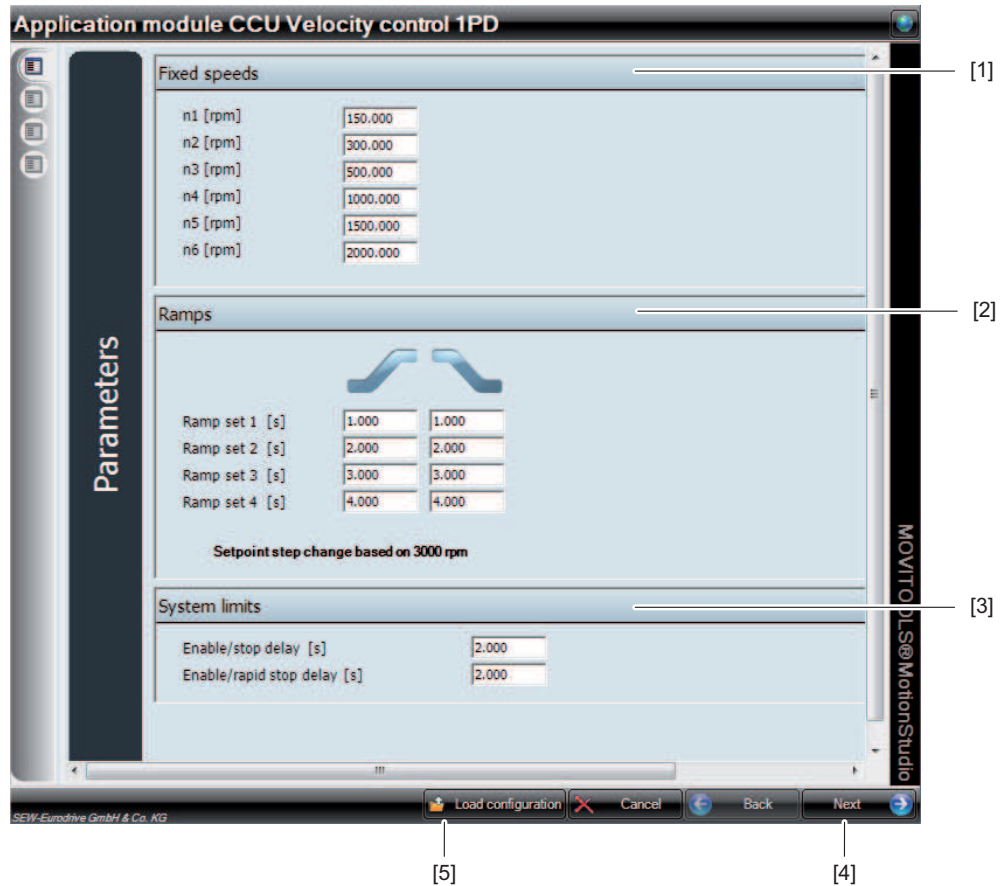

9007202290720139

No.	Description
[1]	Set the fixed speed n1 – n6 here.
[2]	Set the ramp sets 1 – 6 here.
[3]	Set the two following system limits here: <ul style="list-style-type: none"> • Enable/stop delay • Enable/rapid stop delay
[4]	Use this button to go to the next configuration page. On the last configuration page, the [Next] button changes to [Finish]. Use the [Finish] button to save the axis configuration. INFORMATION: Use the [Export configuration] button on the last configuration page to save frequently used axis configurations in a configuration file (*.XML) in order not to have to enter the values in the wizard again.
[5]	Use this button to load an already saved axis configuration.

1. Make the required settings.

2. To save the settings, click the [Next] button.
 - ⇒ The wizard switches to the program section for saving the axis configuration.
3. To exit the wizard, click the [Finish] button.
 - ⇒ Now the axis is configured with the "Velocity control 1 and 2 PD" application module.

Velocity control 3 – 6 PD

The following functions are available for process data profiles 3 – 6.

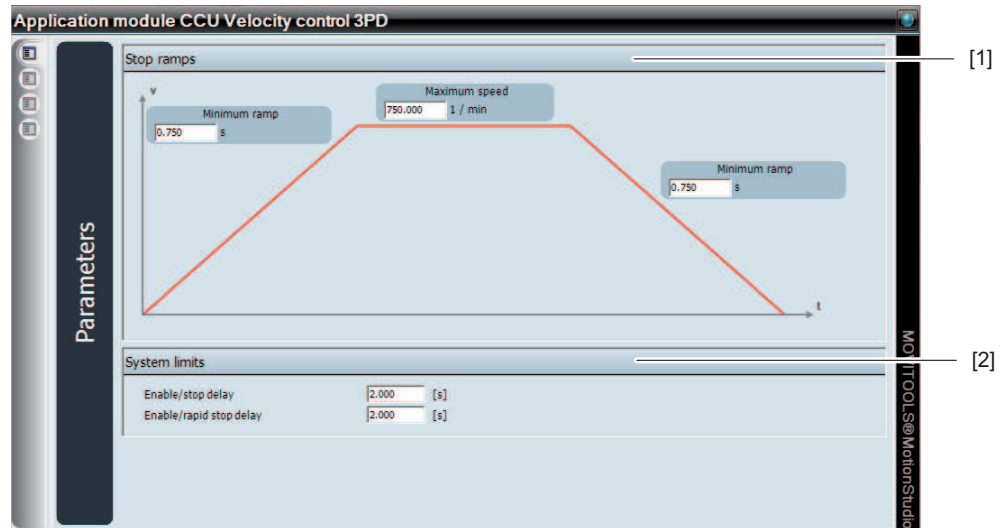

3789194379

No.	Description
[1]	Set the following limits here: <ul style="list-style-type: none"> • Minimum ramp (up) • Maximum speed • Minimum ramp (down)
[2]	Set the following system limit values here: <ul style="list-style-type: none"> • Enable/stop delay • Enable/rapid stop delay

1. Make the required settings.
2. Follow the instructions of the wizard as described in the chapter "Velocity control 1 – 2 PD" (→ 55).

6.3.4 Advanced configuration settings

Any available specific settings for the application module are provided under "Advanced configuration". This includes, for example, the update rate of the process data for the "Transparent" application module see chapter "Update rate of the process data" (→ 42).

Proceed as follows:

1. Open the configuration interface.
2. In the axis section, select the line of the respective axis.

- Click on the [Configuration] drop-down list at the end of the line.

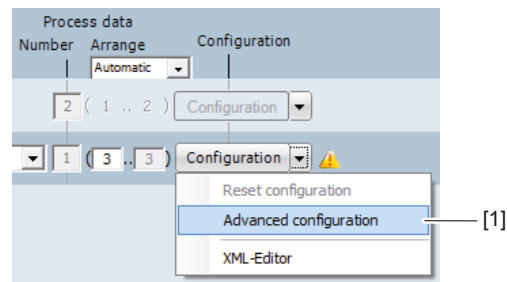

18014401579692555

- Select "Advanced configuration" [1].
⇒ A window with the setting options opens.
- Make the required settings.
- Click [Finish] to close the window.

6.4 Controller configuration

6.4.1 Setting the configuration

Proceed as follows:

- Open the configuration interface.
- Select line 0 (controller).
- Click on button [1] at the end of the line.

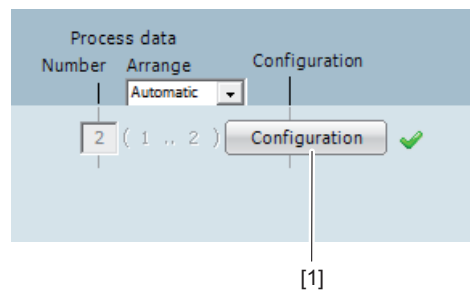

9007203045432203

- ⇒ A window with the described setting options (→ 58) described in the following chapter opens.

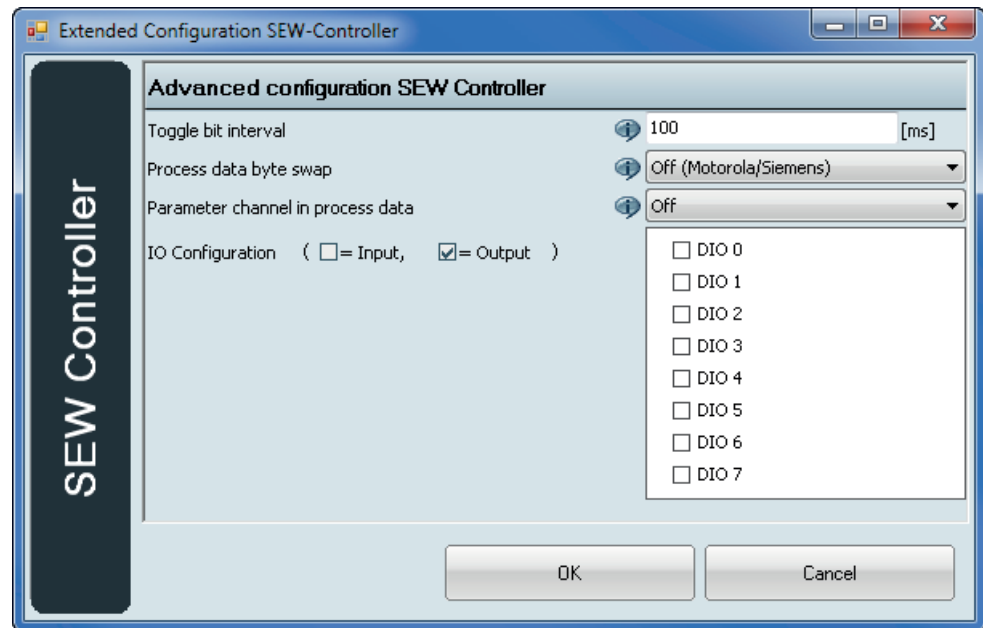

15801577099

4. Make the required settings.
5. Click [OK] to close the window.

6.4.2 Setting options

The controller configuration provides the following setting options:

- Toggle bit interval
- Byte swap of the fieldbus process data:
 - **Off:** Big-Endian (Motorola processors, such as e.g. in controllers by Siemens)
 - **On:** Little-Endian (Intel processors, such as e.g. in controllers by Rockwell)
- INFORMATION:** The setting applies to the complete process data range, i.e. for all axes.
- Parameter channel:
 - **On:** activated
 - **Off:** deactivated
- IO configuration: Assignment of the digital input and output terminals of the controller.
- Maintenance switch monitoring: only applies to units with maintenance switch.
 - **On:** activated
 - **Off:** deactivated

6.5 Download

The "Download" user interface of the Application Configurator provides the following functions.

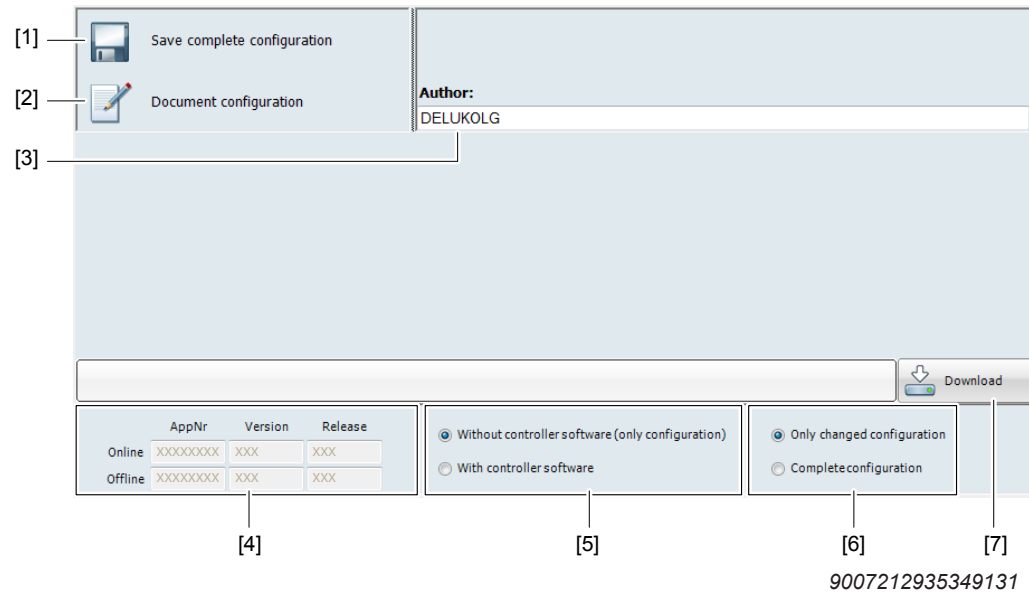

No.	Description
[1]	Use this button the save the configuration in an configuration file *.AppCon-fig.zip on your computer. This way, you do not have to enter the values again for future startups with the same configuration.
[2]	Use this button to create a PDF file with a configuration report.
[3]	If you enter a name in this input field, it will be listed in the report.
[4]	In this section, you see the information on the application module that is installed offline on your computer and online on the controller: <ul style="list-style-type: none"> • Part number • Version • Release
[5]	Use the radio buttons to choose if you want to download the configuration with or without controller software.
[6]	Use the radio buttons to choose if you want to download the changed or the entire configuration.
[7]	Use this button to download the configuration.

6.5.1 Saving the complete configuration

You can save the configuration on your computer in a configuration file *.AppConfig.zip.

Proceed as follows:

1. Click the button [1].
 - ⇒ A window with the directory structure of your computer is displayed.
2. Search for the corresponding storage location in the folder structure.
3. Enter a random name for the Configuration.
4. Click [Save] to close the dialog box.
 - ⇒ The configuration is saved.

6.5.2 Downloading the configuration



▲ CAUTION

Download while the system is running.

Injury and damage to property.

- Set the system to a safe state.

You can save the configuration for the axes on the SD card of the controller. The following procedure assumes first-time use.

Proceed as follows:

1. Perform the configuration.
2. Open the "Download" section.
3. Check the pre-selection of the radio button [5].

INFORMATION



If "Download **with** controller software" is set, the Application Configurator replaces the existing controller software with the new one (software update).

- ⇒ The software update can take several minutes. With "Download **with** controller software", use the local engineering interface (Ethernet or USB) in order to accelerate the process.
 - ⇒ Directly after this process, the configuration data of all axes are transferred to the SD card.
4. Click on the [Download] button [7].
 - ⇒ The configuration is saved on the SD card of the controller.
 - ⇒ The controller has to be restarted to process the new configuration data after the download.
 - ⇒ The initial screen is displayed if the download and the controller restart have been successful.

6.6 Opening an existing configuration

6.6.1 Anne Opening a configuration from the computer

Proceed as follows:

1. Go to the initial screen.
2. Click the [Open configuration from file] button.
 - ⇒ A window opens with the folder structure of your computer.
3. In the folder structure, search for the *.AppConfig.zip file with the required configuration.
4. Click the [Open] button.
 - ⇒ **INFORMATION:** If the selected configuration was created with a higher authorization level, the following message is displayed.

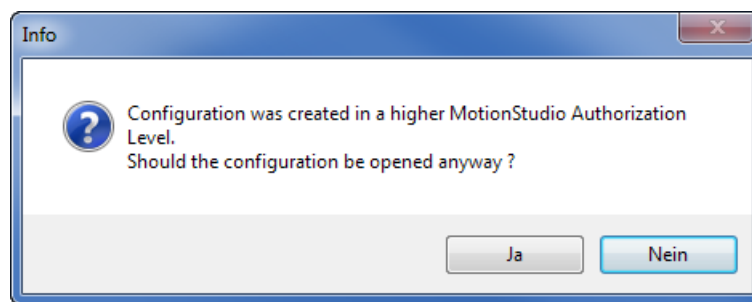

15357102219

5. Confirm the message with [Yes] and check the configuration.
 - ⇒ The configuration interface opens and shows the configured axes.

6.6.2 Opening the configuration from the SD card of the controller

Proceed as follows:

1. Go to the initial screen.
2. Click [Open configuration from controller].
 - ⇒ The configuration is transferred from the SD card of the controller to the configuration interface of the Application Configurator.
 - ⇒ Depending on the configuration, this process can take a few minutes.

7 Operation and diagnostics

To test the functionality the application modules and for error diagnostics, the Application Configurator provides the following functions:

- **Overview** (Initial screen of diagnostics)
Detail diagnostics of the individual application modules
- **PD monitor** (Process data monitor)
Fieldbus interface diagnostics, see chapter "PD monitor" (→ 72)
- **Trace**
Recording of various process signals such as velocity, position of the axis, etc., see chapter "Trace" (→ 75)
- **Advanced diagnostics**
The advanced diagnostics serves as "expert diagnostics" (→ 78)

7.1 Overview: Initial screen of diagnostics

Calling up diagnostics

Proceed as follows:

1. Switch to the initial screen of the Application Configurator.



[1]

15978960139

2. Click the button [1].

⇒ The configuration of the axes is transferred from the SD card of the controller to the diagnostics interface. This may take a few seconds.

⇒ The initial screen of diagnostics opens.

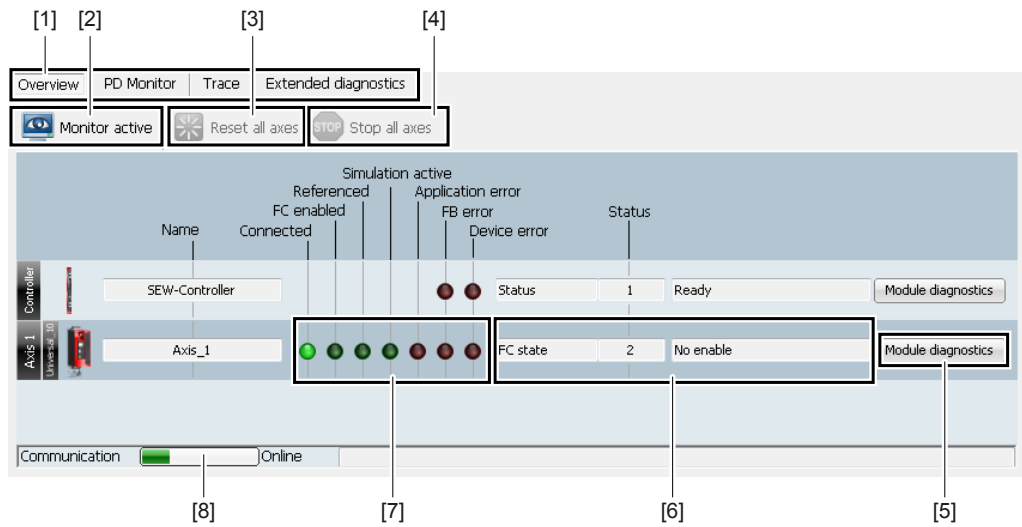

18014401551960075

No.	Description
[1]	Use these buttons to access the following diagnostic sections: <ul style="list-style-type: none"> • Overview (Initial screen of diagnostics) Detail diagnostics of the individual application modules. • PD monitor (Process data monitor) Fieldbus interface diagnostics, see chapter "PD monitor" (→ 72) • Trace Recording of various process signals such as velocity, position of the axis, etc., see chapter "Trace" (→ 75) • Extended diagnostics The extended diagnostics serves as "expert diagnostics" (→ 78).
[2]	Use this button to switch to "monitor or control mode" (→ 64). Observe the safety note in the chapter "Switching to control mode" (→ 64). <ul style="list-style-type: none"> • In monitor mode, you monitor the functions of the application module. • In control mode, you control the functions of the application module. <p>INFORMATION: The control mode of the PD monitor must not be activated simultaneously with the control mode.</p>
[3]	Use this button to acknowledge the errors of all axes.
[4]	Use this button to stop all configured axes (e.g. in case of danger). Deceleration is carried out via the emergency stop ramps. <p>INFORMATION: This button is only enabled in control mode and does not replace the emergency stop switch on the machine/system.</p>
[5]	Use this button to open the module diagnostics of the application module (=specific diagnostics for the application module).
[6]	The operating state and the inverter fault is displayed in plain text here.



No.	Description
[7]	<p>Here, the following information is displayed:</p> <ul style="list-style-type: none"> • Operating states of the inverter (highlighted in "green") <ul style="list-style-type: none"> – Connected – FI enabled – Referenced • Error states (highlighted in "red") <ul style="list-style-type: none"> – Application error: Internal error – FB error (function block error): Internal error – FI error (frequency inverter error)
[8]	<p>The communication status of the controller is displayed here. For successful diagnostics and control, the "online" must be displayed and the green progress bar must be completed.</p>

7.1.1 Monitor mode and control mode

In the diagnostics interface, you can choose between monitor mode (default setting) and control mode:

- In **monitor mode** the *higher-level controller* controls the system/machine via fieldbus.
- In **control mode**, *you* control the system/machine. The process data of the higher-level controller are ignored in this case.

The buttons [Monitor active] and [Control active] to switch between monitor mode and control mode are displayed in the following 3 sections of the diagnostics interface:

- "Initial screen of diagnostics" (→  62)
- "Module diagnostics" (→  66)
- "PD monitor" (→  72)

INFORMATION



- Note that switching to monitor mode or control mode will affect **all** axes.

Switching to control mode



⚠ DANGER

Unexpected movement of the machine.

Severe or fatal injuries.

Unexpected movement of the machine is possible in the following situations:

- When switching from monitor mode [Monitor active] to control mode [Control active] and vice versa.
 - After clearing the fieldbus input data.
- Make sure that an automatic restart or stop of the machine represents no danger to people or equipment.
- Make sure that the machine is in a safe state.

Proceed as follows:

1. Click on the [Monitor active] button.
 - ⇒ The program prompts you to set a time for the timeout [1].

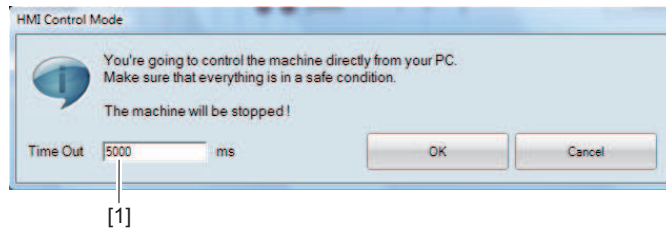

3166053387

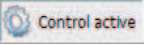
2. Enter a correct timeout value.
3. Confirm with [OK].
 - ⇒ The button  indicates the control mode.

Timeout

If communication is interrupted, the drive stops after the timeout interval set here.

The correct value depends on the following factors:

- **Dynamics properties of the application** (maximum value)
Servo applications require less timeout in order to stop the drive in time in the event of danger.
- **Processing power and utilization of your PC** (minimum value)
The longer response times of PCs with low processing power/high utilization require a longer timeout delay.

7.1.2 Module diagnostics

For many application modules, the Application Configurator provides a module diagnostics function with specific setting options for startup assistance.

Opening module diagnostics

Proceed as follows:

✓ Diagnostics interface is open.

1. Make sure that the controller communicates with the axes.
2. Select the tab [1].

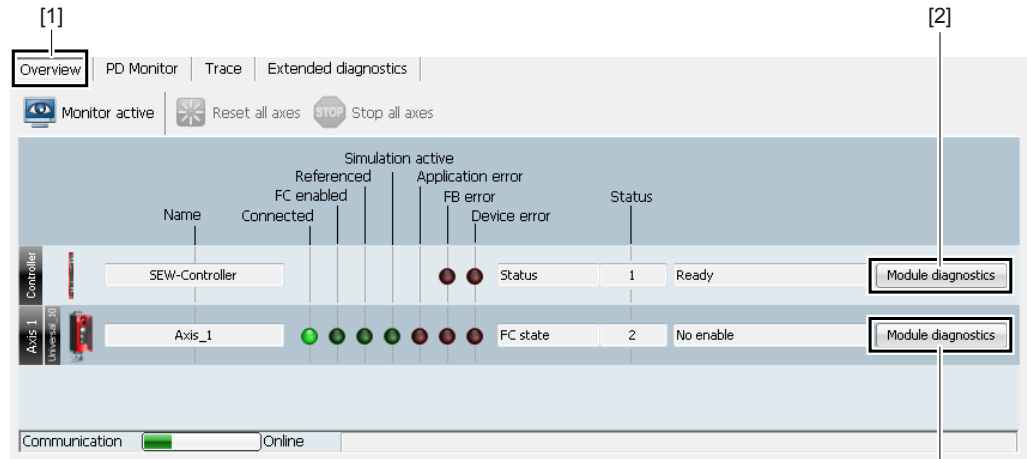

[3]
15531597835

3. Click the button [2] to open module diagnostics of the controller.
4. Click the button [3] to open module diagnostics of an application module.
⇒ The module diagnostics view opens.

Module diagnostics of application module (Example: velocity control)

The module diagnostics interface of the "Velocity control" application module provides the following functions.

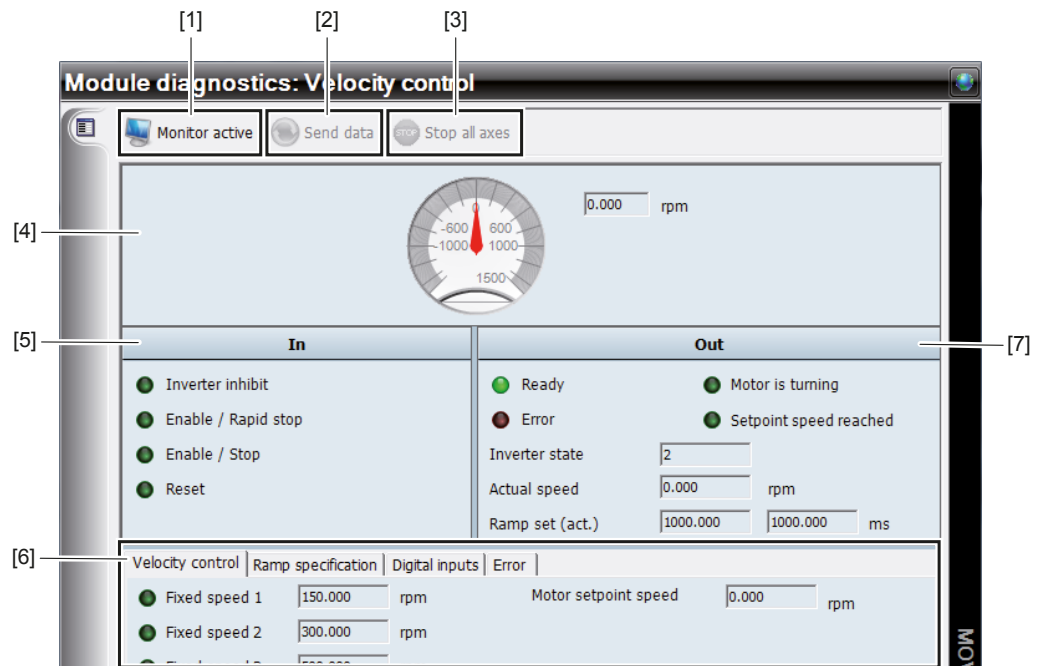

9007202299346699

No.	Description
[1]	Use this button to switch to "monitor or control mode" (→ 64). Observe the safety note in the chapter "Switching to control mode" (→ 64). <ul style="list-style-type: none"> In monitor mode, you monitor the functions of the application module. In control mode, you control the functions of the application module. <p>INFORMATION: The control mode of the application module must not be activated simultaneously with the control mode of the PD monitor.</p>
[2]	Click this button to transfer the input data to the controller. The button is only enabled in control mode. <p>INFORMATION: In the configuration settings of the controller, you can adjust the settings so that the button is no longer displayed. This way, each change of input data in control mode is transmitted directly to the controller.</p>
[3]	Use this button to stop all configured axes (e.g. in case of danger). Deceleration is carried out via the emergency stop ramps. <p>INFORMATION: This button is only enabled in control mode and does not replace the emergency stop switch on the machine/system.</p>
[4]	In this section, you monitor the operation of the selected operating mode.

No.	Description
[5]	<p>In this section, the following input data that are independent of operating mode and function are displayed.</p> <ul style="list-style-type: none"> • Controller inhibit: Has the same function as the controller inhibit of the unit. • Enable/rapid stop/emergency stop: Drive stops with emergency stop ramp. • Enable/stop: Drive stops with stop ramp. • Reset: Resets pending errors. <p>You can activate the control signals of the inverter by clicking on the LEDs:</p> <ul style="list-style-type: none"> • Off: Inactive • Lights up green: Active <p>INFORMATION: Clicking the LEDs is only possible in control mode.</p>
[6]	<p>Input and output information is displayed in these tabs:</p> <ul style="list-style-type: none"> • Velocity control Select from 6 fixed speeds or specify a variable value for the speed here. • Ramp specification Select from 4 ramp sets (ascending and descending ramps) or specify a variable value for the ramp. • Digital inputs Display of digital inputs. • Error If a group error displayed, click on this tab for a detailed error description.
[7]	<p>In this section, general output data that are independent of operating mode and function are displayed:</p> <ul style="list-style-type: none"> • Ready: Displays readiness for operation • Motor turning: Indicates that the motor is turning • Group fault: Indicates an error (see "Error" tab) • Setpoint speed reached: Indicates that the setpoint speed has been reached. • Inverter state: Displays the inverter state. For details on the inverter state, refer to the operating instructions / system manual of the inverter. • Actual speed: Displays the actual speed • Ramp set (act.): Displays the current ramp set <p>In this section, the module diagnostics report the inverter status:</p> <ul style="list-style-type: none"> • Off: Inactive • Lights up green: Active • Lights up red: Group error

Activating control signals and specifying values

Proceed as follows:

1. Click on the [Monitor active] button [1]. Observe the safety note in the chapter "Switching to control mode" (→ 64).
 - ⇒ Control mode is active.
2. Activate the control signals in group "In" [5] by clicking on the LEDs:
 - ⇒ Off: Inactive
 - ⇒ Lights up green: Active
3. Enter the required values for speed and ramps in the tabs [6].
4. Click on the [Send data] button [2] to apply your entries. In group "Out" [6], the module diagnostics report the inverter status:
 - ⇒ Off: Inactive
 - ⇒ Lights up green: Active
 - ⇒ Lights up red: Group error
5. To return to the diagnostics interface, click on the [Control active] button [1].
 - ⇒ Control mode is deactivated.

Letting the drive turn

Proceed as follows:

1. Enable the unit.
2. Observe the assignment of the corresponding input terminal of the respective unit.
 - ⇒ E.g. for MOVIDRIVE® B: the input terminal X13:1 (DI00 /controller inhibit)
3. Call up the module diagnostics" " (→ 66) for the respective axis.
4. Click on the [Monitor active] button [1]. Observe the safety note in the chapter "Switching to control mode" (→ 64).
 - ⇒ Control mode is active.
5. To enable the drive, click on the signals *Enable/rapid stop/emergency stop* [1] and *Enable/stop* [2] in the "In" section:

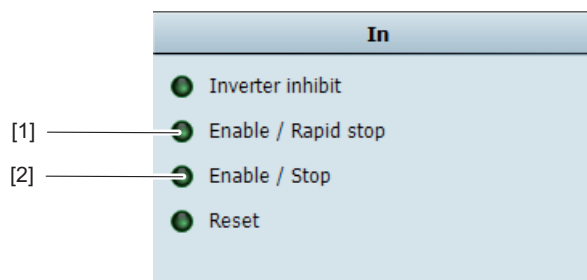

3132738699

6. Enter the required values for speeds and ramps.
7. Click on the [Send data] button [2] to apply your entries.
8. Make sure that the machine/plant is in a safe state when you want to exit control mode.
9. Click on the [Control active] button [1].
 - ⇒ Control mode is deactivated.

⇒ The following message appears.

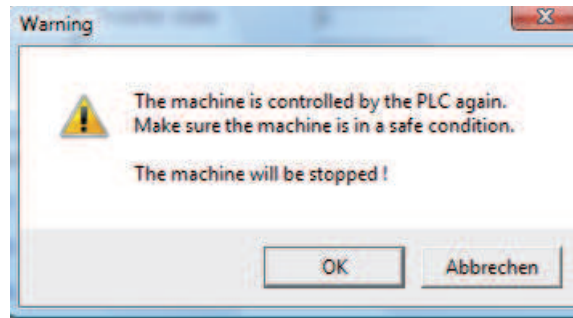

3168025611

10. To return to the initial screen of diagnostics, confirm the message.

Module diagnostics of the controller

The module diagnostics interface of the controller provides the following functions.

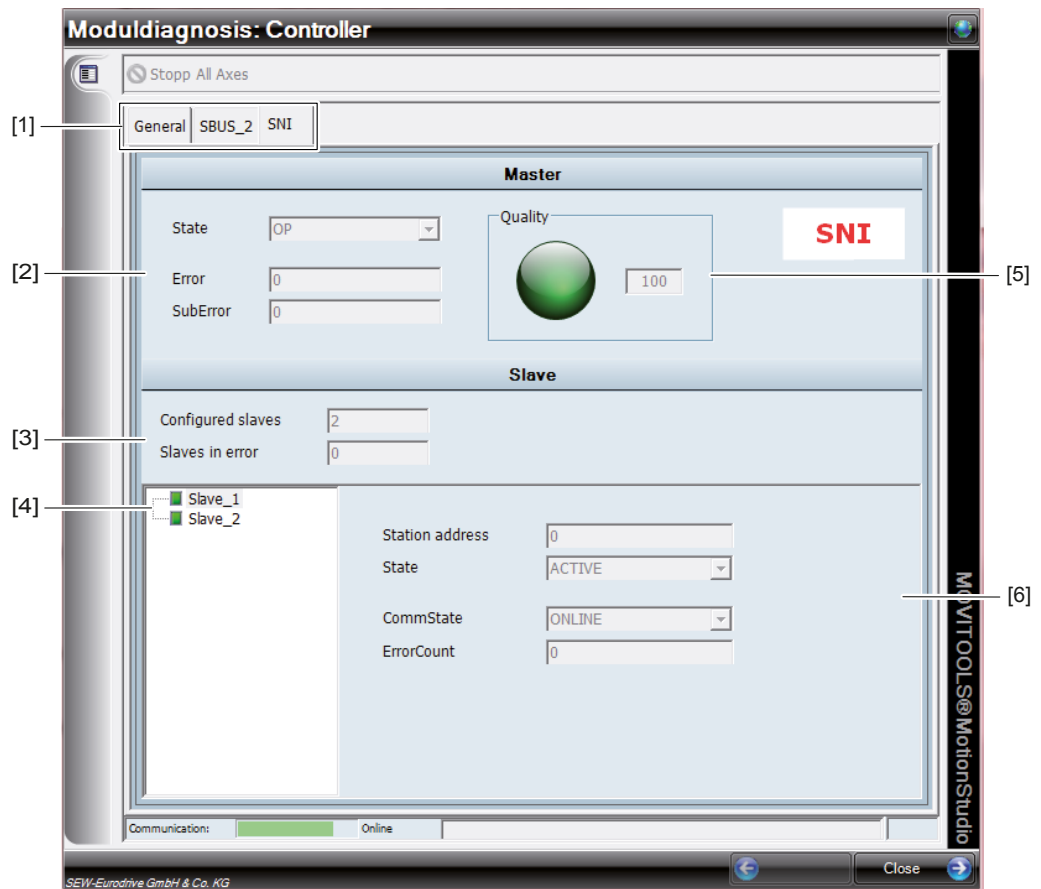

9007202399865355

No.	Description
[1]	The following tabs are displayed here: <ul style="list-style-type: none"> • For each bus system the controller supports. • General <ul style="list-style-type: none"> – Digital inputs – Digital outputs – Data management – Error
[2]	The following status information of the master is displayed here: <ul style="list-style-type: none"> • State • Error • Suberror
[3]	The number of configured and faulty slaves is displayed here.
[4]	The present slaves are displayed here. Click on one of the slaves to display the corresponding status information in section [6].

No.	Description
[5]	<p>The quality of bus communication is displayed here:</p> <ul style="list-style-type: none"> • Red: Insufficient quality • Yellow: Medium quality • Green: Good quality <p>INFORMATION: An insufficient bus communication indicates an inadequate installation.</p>
[6]	<p>The following status information of the slave marked in section [4] is displayed here:</p> <ul style="list-style-type: none"> • Station address • State • Communication status • Error counter

7.2 PD monitor

The PD monitor (process data monitor) is used for diagnostics and for introduction of the fieldbus interface. The content of the PD monitor is based on the data from the content and the configured application module. The PD monitor only accesses data of the fieldbus interface and displays fieldbus input data and output data that are exchanged between the controller and the higher-level controller.

Opening PD monitor

Proceed as follows:

✓ Diagnostics interface is open.

1. Make sure that the controller communicates with the axes.
2. Select the tab [1].

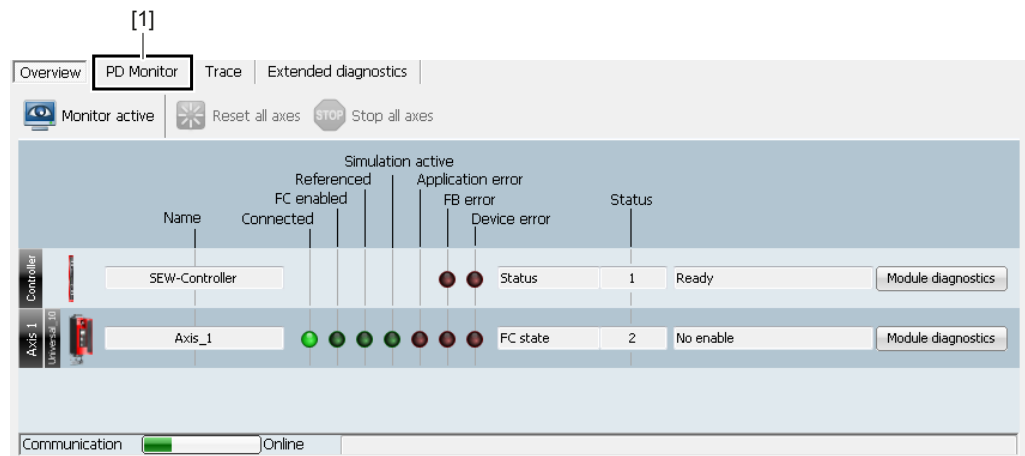

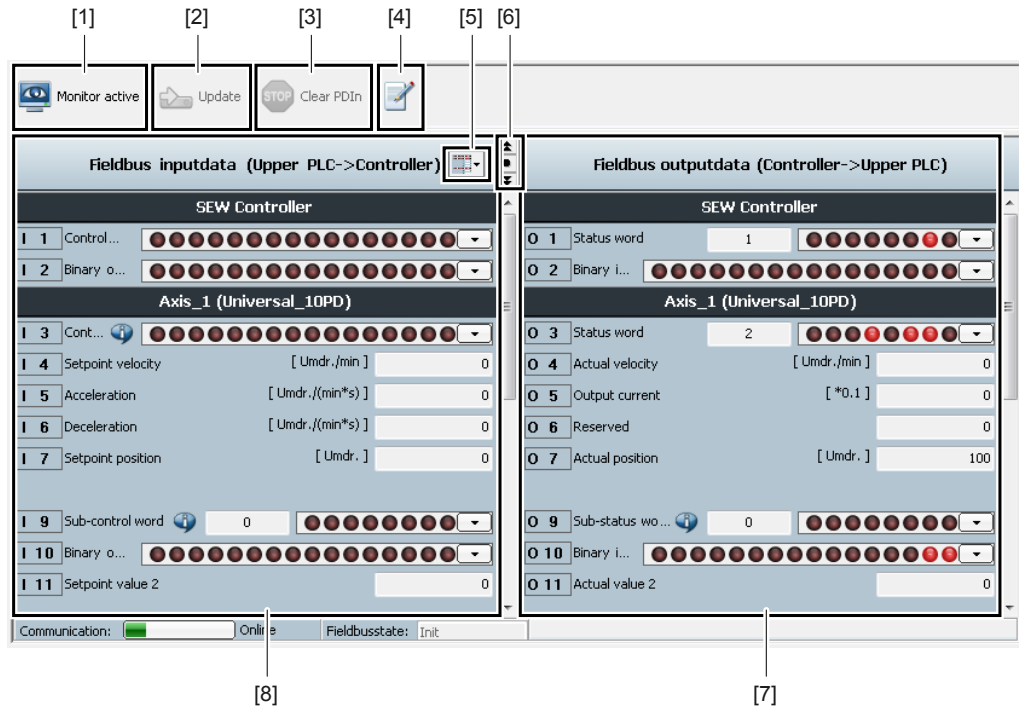

15531604747

- ⇒ The PD monitor is displayed.
- ⇒ An overview of the process data of all units is displayed.



15321799179

No.	Description
[1]	<p>Use this button to switch to monitor or control mode. Observe the safety note in the chapter "Switching to control mode" (→ 64).</p> <ul style="list-style-type: none"> In monitor mode, you monitor the functions of the application module. In control mode, you control the functions of the application module. <p>INFORMATION: The control mode of the PD monitor must not be activated simultaneously with the control mode.</p>
[2]	<p>Click this button to transfer the input data to the controller. The button is only enabled in control mode.</p> <p>INFORMATION: In the configuration settings of the controller, you can adjust the settings so that the button is no longer displayed. This way, each change of input data in control mode is transmitted directly to the controller.</p>
[3]	<p>Use this button to reset all input data or set all input data to zero.</p> <p>▲ DANGER Unexpected motion after clearing the fieldbus input data.</p> <p>In most applications, clearing the input data will make all axes stop using the emergency stop ramp as desired. However, a different response is possible depending on the PLC programming.</p> <ul style="list-style-type: none"> Use a suitable PLC programming to make sure that the system/machine switches to a safe state when the fieldbus input data is cleared. This button is only enabled in control mode and does not replace the emergency stop switch on the machine/system.
[4]	<p>Use this button to create a PDF file with the process data (e.g. for the programmer of the PLC).</p>
[5]	<p>Click this icon to save or download the current input data assignment for later use. Click this icon and select the desired option.</p>

No.	Description
[6]	<p>Use these icons to navigate between the axes:</p> <ul style="list-style-type: none">  : Navigate to the previous axis  : Navigate to the next axis  : Drop-down list to directly go to one specific axis
[7]	<p>This section displays the output data.</p> <p>INFORMATION: The output data are only displayed and cannot be changed in the user interface.</p>
[8]	<p>This section displays the input data.</p> <p>INFORMATION: In control mode you can change the input data.</p>

7.2.1 Operating the PD monitor

Proceed as follows:

- Click on the [Monitor active] button [1]. Observe the safety note in the chapter "Switching to control mode" (→ 64).
 - ⇒ Control mode is active.
- Activate the control signals in group "In" [6] by clicking on the LEDs:
 - ⇒ Off: Inactive
 - ⇒ Lights up green: Active
- Click on the [Update] button [2] to apply your entries.
 - ⇒ The fieldbus output data [7] change accordingly.
- To document the process data in a PDF file, click the button [4].
- To return to the diagnostics interface, click on the [Control active] button [1].
 - ⇒ Control mode is deactivated.

7.3 Trace

On the trace interface, the variables over time are recorded (e.g. travel profiles of axes).

Opening trace

Proceed as follows:

- ✓ Diagnostics interface is open.
- 1. Make sure that the controller communicates with the axes.
- 2. Select the tab [1].

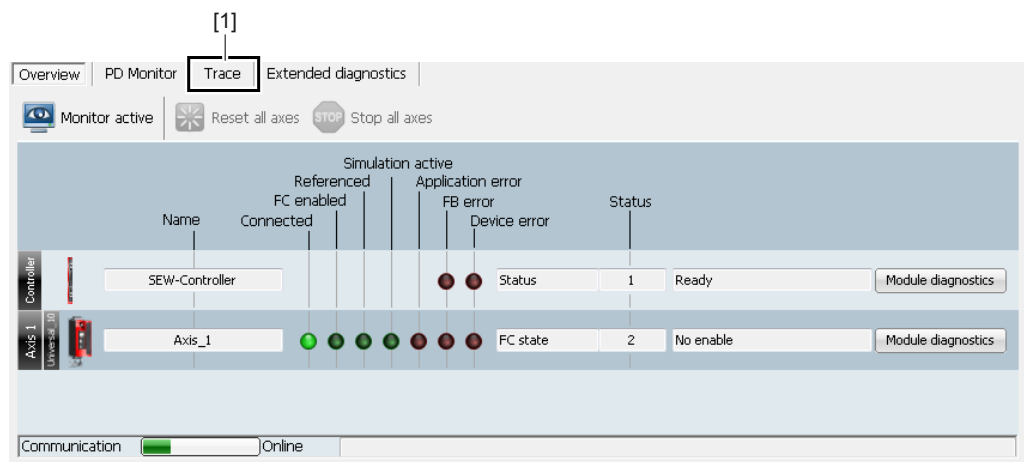

15531608203

⇒ The trace interface is displayed.

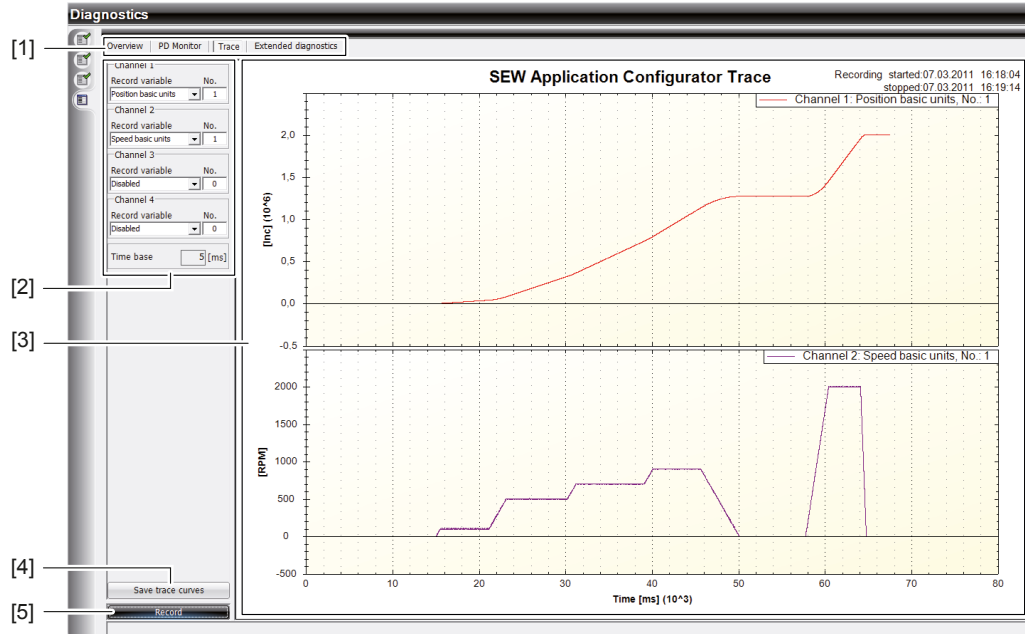

18014401655298315

No.	Description
[1]	Use these buttons to access the following diagnostic sections: <ul style="list-style-type: none"> • Overview (statuses of the inverter/controller and module diagnostics) • PD monitor (process data monitor) • Trace (Recording of variables) • Extended diagnostics (current state of important data structures)
[2]	Here you can select the display of specific signals for 4 channels: <ul style="list-style-type: none"> • Record variable: This is where you select the required variable to record, e.g. position or velocity. • No.: This is where you select the number of the required axis (with process data the number of the process data word). • Time base: Here you can see the sample rate for the recording the channels.
[3]	This recording window graphically displays up to 4 channels with the selected signals.
[4]	Use this button to save all recorded channels in a ZIP folder. There is a text file for each recorded channel. It contains the data in CSV format (semicolon as separator) that can be opened in a spreadsheet program.
[5]	Use this button to start and stop recording.

7.3.1 Starting and editing the recording

Proceed as follows:

1. In section [2], select the record variables for the channels such as position, velocity, etc.
2. Click [Record] [5].
 - ⇒ Recording starts.
 - ⇒ The record variables are displayed in the recording window [3].

3. To define the values for the record variables, switch to the PD monitor" " (→ 62) or to module diagnostics" " (→ 66).
4. Click on the [Monitor active] button. Observe the safety note in the chapter "Switching to control mode" (→ 64).
 - ⇒ Control mode is active.
5. Enter the required values.
6. Click on the [Update] button to apply your entries.
7. Click on the "Trace" tab.
8. Click on the [Record] button [5] again.
 - ⇒ Recording is completed.
9. To edit the recording, right-click in the recording window [3].
10. Select the required function from the context menu:
 - ⇒ Copy
 - ⇒ Print
 - ⇒ Reset scaling
11. To move the displayed section of the curve to the right or the left, use the scroll wheel.
12. To scale the recording, draw a box with the left mouse button.



INFORMATION

- The maximum recording time is limited to 10 minutes.
- The trace function can only be used when you are connected to the controller via USB or the Ethernet.

7.4 Extended diagnostics

"Extended diagnostics" displays the current state of important data structures.

INFORMATION



The extended diagnostics serves as expert diagnostics.

- Use the advanced diagnostics only after consultation with SEW-EURODRIVE.

Opening extended diagnostics

Proceed as follows:

- ✓ Diagnostics interface is open.

1. Make sure that the controller communicates with the axes.
2. Select the tab [1].

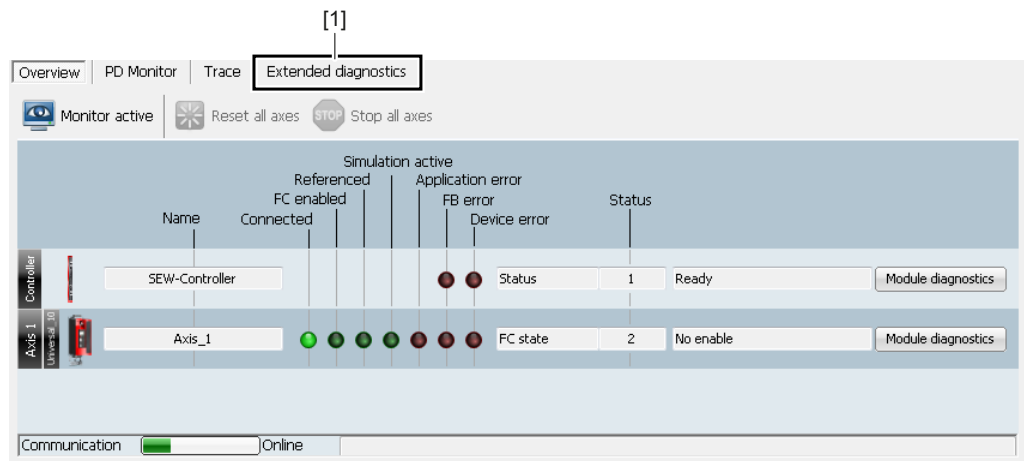

15530467723

⇒ Extended diagnostics is displayed.

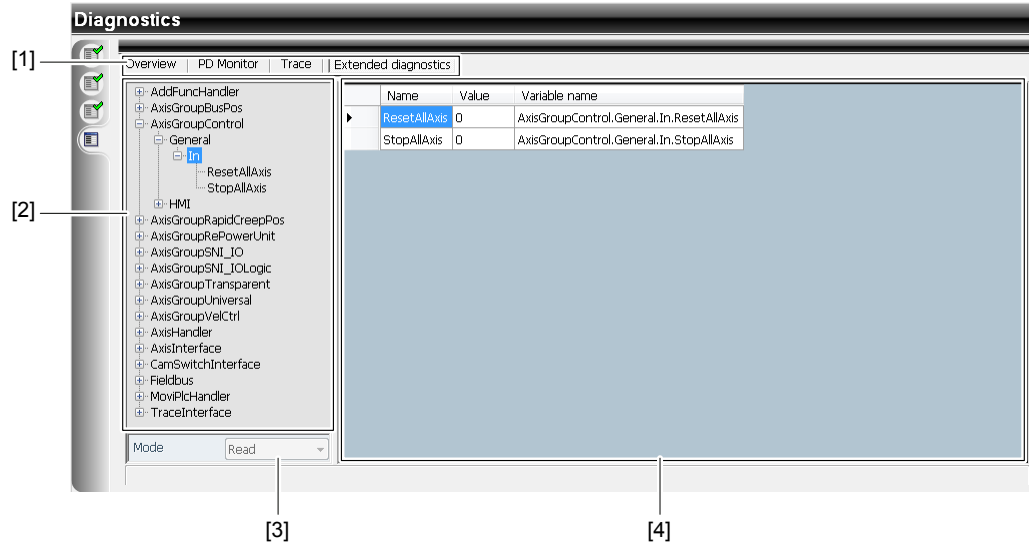

9007202399873547

No.	Description
[1]	Use these buttons to access the following diagnostic sections: <ul style="list-style-type: none"> • Overview (statuses of the inverter/controller and module diagnostics) • PD monitor (process data monitor) • Trace (Recording of variables) • Extended diagnostics (current state of important data structures)
[2]	In this overview bar all variables of the application modules are displayed: <ul style="list-style-type: none"> • AxisGroupBusPos • AxisGroupControl • AxisGroupRapidCreepPos • AxisGroupTransparent • AxisGroupVelCtrl • ... Further, all variables are displayed in the following structures: <ul style="list-style-type: none"> • AxisInterface • Fieldbus • MoviPLCHandler • TraceInterface • User
[3]	The "Read" button can be reconfigured to a "Write" button. The write function is used for diagnostics purposes and is only used after consultation with SEW-EURODRIVE.
[4]	In this section, the variables of the global interfaces are displayed with the entered values.

8 Diagnostic messages

The diagnostic messages you receive from the Application Configurator are grouped based on their source:

- **Controller**
- **Function module**
 - A function module provides functionality **for all axes**. The brake test is an example. It can be carried out by any configured axis.
- **Application module**
 - An application module provides functionality for **one axis**. The bus positioning is an example. It allows for positioning of a specific axis via fieldbus.
- **Inverter**

There are the following categories depending on the source: Error, warning and status.

A code is issued for all messages. The plain text is described in the tables of this chapter.

An exception are device-specific messages. You find the plain texts of these messages in the documentation of the connected units.

8.1 Display in the PD monitor

The display fields of the codes are listed under the fieldbus output data of the PD monitor.

The category (error, warning or status) of the displayed code [1] to [3] is determined in conjunction with the respective status bit [A] to [E]. This is illustrated in the following table.

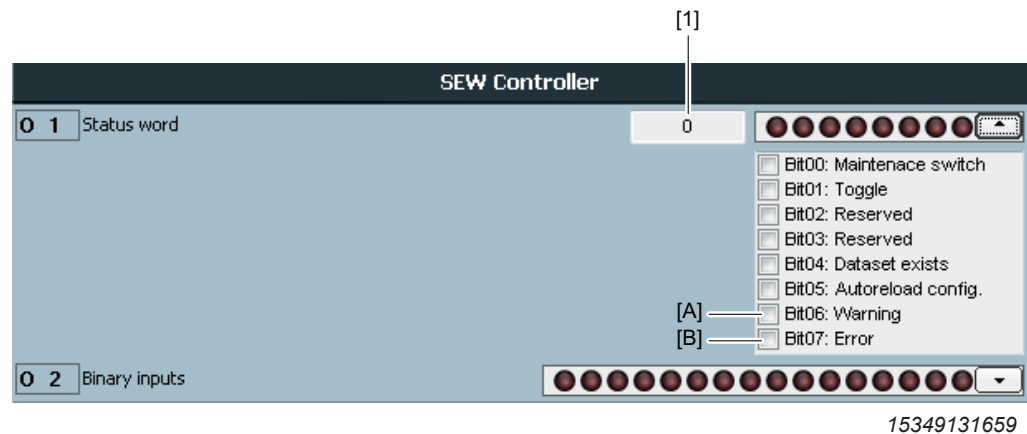

No.	Origin of the message	Category	Status bit
[1]	Controller	Error	[B]: Error = "1"
		Warning	[A]: Warning = "1" [B]: Error = "0"
		Status	[B]: Error = "0" [A]: Warning = "0"

No.	Origin of the message	Category	Status bit
[2]	Function module	Error	[C]: Diagnostics error = "1"
		Status	[C]: Diagnostics error = "0"

No.	Origin of the message	Category	Status bit
[3]	Application module ¹⁾	Inverter status	[F]: Error application = "0" [E]: Warning = "0" [D]: Error FU = "0"
		Inverter error	[D]: Error FU = "1"
		Application error	[F]: Error application = "1" [D]: Error FU = "0"

1) The position of [D], [E], and [F] may vary and depends on the configured application module.

8.2 Priority of the displayed messages

If several messages are pending, the one with the highest priority is displayed. The following table lists the priority. The highest priority is designated with "1".

Source of the message	Category	Priority
Controller	Error	1
	Warning	2
	Status	3
Function module	Error	1
	Status	2
Application module	Inverter error ¹⁾	1
	Application error	2
	Drive status inverter (see following table)	3

1) For a detailed description of the errors and statuses, refer to the documentation of the respective unit.

INFORMATION



Acknowledging error message

- Eliminate the error.
- Acknowledge the error message. Only error 010 "No connection to unit" and warning messages do not have to be acknowledged.

8.3 Error messages of the application modules

Code	Meaning	Possible cause	Measure
001	Timeout sensor check: Start rapid/creep speed	<ul style="list-style-type: none"> • Rapid/creep speed switch defective • Transported material blocked • Set time is too short 	<ul style="list-style-type: none"> • Check and eliminate the cause of error.
002	Timeout sensor check: Start – Stop	<ul style="list-style-type: none"> • Rapid/creep speed switch defective • Transported material blocked • Set time is too short 	<ul style="list-style-type: none"> • Check and eliminate the cause of error.
003	Speed too high when reaching the stop switch (in seldom cases: too low)	The speed is outside the configured speed hysteresis.	<ul style="list-style-type: none"> • The stop switch is too close to the rapid/creep speed switch. • Extend the speed hysteresis in the configuration.
004	Monitor timeout in control mode	Connection between controller and PC interrupted.	<ul style="list-style-type: none"> • Check the connection cable. • Adjust the time for monitor timeout.

Code	Meaning	Possible cause	Measure
010	No connection to the device	The controller is unable to establish a connection with the configured device.	<ul style="list-style-type: none"> • Check the connection cable. • Check the communication settings: <ul style="list-style-type: none"> – Is the SBus address correct? – Has the proper interface (SNI, SBus) been set? – Has "Drive Startup for MOVI-PLC®" been performed?
011	Axis without encoder: AxisMode is not supported	Attempt to perform a function that requires a drive with encoder. Example: Positioning or referencing a MOVIGEAR® without encoder.	<ul style="list-style-type: none"> • Use/check the encoder. • Select the function without positioning.
012	Invalid configuration parameters sent via MOVILINK®.	Configuration parameters with invalid values were sent to the inverter. Values that exceed the permitted minimum or maximum values are invalid for the MOVILINK® protocol. Example: Wrong settings for the system limits (e.g. rapid stop ramp too high).	<ul style="list-style-type: none"> • Adjust the configuration parameters.
018	Insufficient technology level	Not enough technology points enabled for the required function of the controller.	<ul style="list-style-type: none"> • Contact SEW-EURODRIVE to order additional technology points.
019	Invalid values in the configuration	The maximally permitted values of the axis have been exceeded.	<ul style="list-style-type: none"> • Check the configuration.
020	Travel command without sufficient parameters	Required parameters missing when starting a travel command (velocities, acceleration ramp, etc.).	<ul style="list-style-type: none"> • Specify all required parameters before you start the travel process.
021	Input variable too large or too small	The command cannot be executed as the control signals are invalid. Example: Operating mode 7 is selected although only modes 1 to 6 are available.	<ul style="list-style-type: none"> • Check the control signals.
022	File cannot be written or read	A corrupt file is stored on the controller.	<ul style="list-style-type: none"> • Contact SEW-EURODRIVE.
030	Hardware limit switch positive	Hardware limit switch reached	<ul style="list-style-type: none"> • Check the travel range. • Check wiring (hardware limit switches must be parameterized as NC contacts)
031	Hardware limit switch negative		
032	Software limit switch positive	Software limit switch reached	<ul style="list-style-type: none"> • Check the travel range. • Adjust the setting of the software limit switches.
033	Software limit switch negative		

22295410/EN – 11/2015

Code	Meaning	Possible cause	Measure
034	Target position outside the valid range	The target position of a positioning command is outside the range specified via software limit switches.	<ul style="list-style-type: none"> Check the calculation of the target position in the PLC. Check configured values for the software limit switches of the respective axis.
035	Start condition for operating mode missing	Not all conditions for executing the command have been met. Example: An axis is to execute a positioning command without being referenced.	<ul style="list-style-type: none"> Check all required conditions for command execution. For detailed information, refer to the manual for the respective application module.
040	"Operating mode selection" error	<ul style="list-style-type: none"> Combination of operating mode and sub-mode selection is not permitted. Selection is not permitted with current axis configuration. 	<ul style="list-style-type: none"> Check the control signals (process data).
041	"Slave not ready" error	One of the selected synchronization axes is in error state.	<ul style="list-style-type: none"> Check the slave state (there must not be any axis errors).
042	"Operating mode selection initialization" error	Incorrect initialization during operating mode selection.	<ul style="list-style-type: none"> Check the startup parameters.
043	"Positioning calculation" error	<ul style="list-style-type: none"> An error has occurred calculating the target position. The target position exceeds the permitted range of values. 	<ul style="list-style-type: none"> Check the target position.
044	Function has not been configured	<ul style="list-style-type: none"> A function was selected that has not been configured. A function was selected that is not supported. <p>Example: The Touchprobe function has not been configured but it is activated via the process data.</p>	<ul style="list-style-type: none"> Configure the function. Select the application module with this function.
045	Slave error	The master stops because of an slave error.	<ul style="list-style-type: none"> Reset the slave. Deactivate the function in the master configuration.
047	Function not available	The master stops because of an slave error.	<ul style="list-style-type: none"> Expand the axis by this function. Change the axis type.
050	No encoder signal	Faulty evaluation of the encoder signal	<ul style="list-style-type: none"> Check the encoder and the wiring.
051	Wrong direction of encoder rotation	Faulty evaluation of the encoder signal	<ul style="list-style-type: none"> Check the encoder and the wiring.
052	Reference is missing	Attempt to position an unreferenced axis.	<ul style="list-style-type: none"> Reference the axis.
061	Lag Error of external encoder (axis X1)	Lag error occurred between motor encoder and external encoder.	<ul style="list-style-type: none"> Check the encoder. Check the mechanics.
062	Lag Error of external encoder (axis X2)	Lag error occurred between motor encoder and external encoder.	<ul style="list-style-type: none"> Check the encoder. Check the mechanics.

Code	Meaning	Possible cause	Measure
063	Lag Error of external encoder (axis Y1)	Lag error occurred between motor encoder and external encoder.	<ul style="list-style-type: none"> • Check the encoder. • Check the mechanics.
064	Lag Error of external encoder (axis Y2)	Lag error occurred between motor encoder and external encoder.	<ul style="list-style-type: none"> • Check the encoder. • Check the mechanics.
099	General FB error	<p>Error occurs during internal sequence of the controller software.</p> <p>Refer to the module diagnostics for detailed information on the FB error:</p> <ul style="list-style-type: none"> • Select the "Overview" tab on the diagnostics interface. • Click on [Details] to start the module diagnostics of the respective axis. • Switch to the "Errors" tab. 	<ul style="list-style-type: none"> • Contact SEW-EURODRIVE.
200 – 250	Error in AppModCustom	A customer-specific application module is used.	Refer to the documentation of the customer-specific application module for information on the procedure.

8.4 Error messages of the function modules

Code	Meaning	Possible cause	Measure
01	Motor torque insufficient for diagnostics.	Motor is unable to provide the required test torque.	<ul style="list-style-type: none"> • Check input values of brake diagnostics and at frequency inverter. • Check to test direction in the hoist. • Check the test environment (base load). • Drive/frequency inverter must be dimensioned larger.
02	Movement in step 1 not sufficient.	Drive could not be moved sufficiently.	<ul style="list-style-type: none"> • Check whether motor is supplied. • Check if drive runs freely. • Check if brake is released.
		Adapt parameterization.	<ul style="list-style-type: none"> • Increase acceleration. • Increase maximum travel distance. • Reduce velocity.
03	Positional tolerance in step 2 exceeded.	Positional tolerance in step 2 was exceeded.	<ul style="list-style-type: none"> • Check if brake closes. • Check whether the brake lining is worn or dirty. • Check mechanical backlash of application and adapt parameters if necessary.

22295410/EN – 11/2015

Code	Meaning	Possible cause	Measure
04	Positional tolerance in step 3 exceeded.	Positional tolerance in step 3 was exceeded.	<ul style="list-style-type: none"> Check whether the brake lining is worn or dirty. Brake maintenance is required.
		The actual test torque was too low (< 90%).	<ul style="list-style-type: none"> Check input values at the frequency inverter. Was frequency inverter switched off during active brake diagnostics?
05	Invalid configuration.	Configuration is not plausible.	Positional tolerance must be smaller than $0.9 \times$ maximum travel distance.
06	Drive in wrong operating mode.	Operating mode of frequency inverter is not compatible.	CFC or SERVO operating mode required.
09	Maximum braking distance exceeded.	Only with dynamic brake diagnostics. The maximum braking distance was exceeded.	<ul style="list-style-type: none"> Check diagnostics conditions (speed, load) Check whether the brake lining is worn or dirty. If required, perform brake maintenance.
10	Brake diagnostics was canceled.	Active brake diagnostics was canceled.	-
11	Axis is not referenced.	The axis to be tested is not referenced.	-
12	Diagnostics result could not be saved.	The diagnostics result could not be saved on the SD card.	Check if write protection is active on SD card.
21	Type of diagnostics not configured.	The selected type of diagnostics is not configured.	-
22	Type of diagnostics not implemented.	The selected type of diagnostics is not implemented.	-
240	Controller inhibit required.	To activate brake diagnostics, the axis must be in "controller inhibit" state.	-
241	No communication with axis.	No communication between controller and frequency inverter of axis.	-
242	The selected axis is not supported by brake diagnostics.	Frequency inverter or application module is not compatible to brake diagnostics.	-

8.5 Controller messages

Error messages

Code	Meaning	Possible cause	Measure
001	Configuration: no connection to internal power section	No connection can be established with the internal power section (for example with MOVIPRO® SDC).	Contact SEW-EURODRIVE.

Code	Meaning	Possible cause	Measure
002	"External IO" error	Short circuit or overload of the digital inputs/outputs of the device.	Check the cabling and project planning for the system.
003	Configuration: no IPOS ^{plus} ® present	An IPOS ^{plus} ® program, which had not been released, was loaded to the internal power section.	Perform startup again with released IPOS ^{plus} ® application module.
005	Process data communication stopped to lower-level devices (GATEWAY)	Process data communication to lower-level devices was stopped.	<ul style="list-style-type: none"> • Check the connection cable. • Check the communication settings: <ul style="list-style-type: none"> – Is the SBus address correct? – Has the proper interface (SNI, SBus) been set? – Has "Drive Startup for MOVI-PLC[®]" been performed?
006	Parameter channel: Error reading/writing parameter from device	An error occurred while reading/writing parameters via the parameter channel.	<p>Check the control signals (see chapter "Process data of the controller"):</p> <ul style="list-style-type: none"> • Are subChannel and subAddress correct? • Is the index of the parameter correct?
010	Configuration: no configuration available	No configuration files were found on the controller.	Create a new configuration and transfer it to the controller.
011	Configuration: Connection to configured units could not be established	The controller is unable to establish a connection with the configured device.	<ul style="list-style-type: none"> • Check the connection cable. • Check the communication settings: <ul style="list-style-type: none"> – Is the SBus address correct? – Has the proper interface (SNI, SBus) been set? – Has "Drive Startup for MOVI-PLC[®]" been performed?
012	Insufficient technology points	SD card with insufficient technology points	SD card with more technology points required.
013	Configuration file too large	A configuration file is too large and cannot be read.	Reduce the size of the configuration file.
020	Data management: Upload failed	Unable to transfer datasets from the devices to the controller because the connection with one or several devices was lost.	Check whether all devices that are selected for data transmission in the data management tool are accessible.
021	Data management: Upload failed → SD card write protection active	<p>Unable to write datasets to the SD card.</p> <p>The reason might be that write protection of the SD card was activated or that the memory is full.</p>	<ul style="list-style-type: none"> • Deactivate the write protection of the SD card. • Check memory requirement.

Code	Meaning	Possible cause	Measure
022	Data management: Download failed	Unable to transfer the datasets from the controller to the devices because the connection was lost.	Check whether all devices that are selected for data transmission in the data management tool are accessible.
023	Data management: safe stop/controller inhibit required	Unable to transfer (save) datasets because "Controller inhibit"/"Safe stop" condition is required.	Stop the device and set to "Controller inhibit"/"Safe stop".
099	Internal system error	Device signals a general system error.	To rectify the error, refer to the notes about the inverter state, online device status in MOVITOOLS® MotionStudio, and the information provided in the documentation of the concerned device.
100	Undervoltage 24 V (MOVIFIT®)	Value falls below the lower limit for the actuator voltage at outputs DO00 through DO03.	<ul style="list-style-type: none"> • Ensure sufficiently high voltage supply at the outputs. • Check the cabling.
101	Inverter voltage not applied (+24V-P) (MOVIFIT®)	Missing 24V_P for the integrated power section (FC) or for the lower-level MOVIMOT®.	<ul style="list-style-type: none"> • Check the cabling and project planning for the system. • Check if the unit is possibly in safe stop state.
110	Actuator voltage overload DO00 (MOVIPRO®)	The device connected to the digital output exceeds the permitted values of the specification.	<ul style="list-style-type: none"> • Check the cabling and project planning for the system. • Check the specifications in the documentation of the units.
111	Actuator voltage overload DO00 (MOVIFIT®)		
112	Actuator voltage overload DO01 (MOVIFIT®)		
113	Actuator voltage overload DO02 (MOVIFIT®)		
114	Actuator voltage overload DO03 (MOVIFIT®)		
120	Sensor voltage overload Group1 (MOVIFIT® / MOVIPRO®)	Short circuit / overload of digital inputs/outputs	Check the cabling and project planning for the system.
121	Sensor voltage overload Group2 (MOVIFIT® / MOVIPRO®)		
122	Sensor voltage overload Group 3		
123	Sensor voltage overload Group 4		
130	SNI fuse tripped	The SNI fuse has tripped.	Check the SNI fuse.

Status messages

Code	Meaning	Possible cause	Measure
000	System startup	The controller boots.	Wait for the boot process to complete.
001	Ready for operation	OK	-
010	Data management: Upload active	The devices are sending datasets to the controller.	Wait (the process may take several minutes).
011	Data management: Upload finished	All datasets have been sent to the controller.	-
012	Data management: Download active	The controller is sending datasets to the devices.	Wait (the process may take several minutes).
013	Data management: Download finished	All datasets have been sent to the devices.	-
014	Data management: Control via inactive process data detected.	You have to enable the data management functions in order to control them via the process data.	<ul style="list-style-type: none"> Select [Startup] > [Data management] in MOVITOOLS® MotionStudio. Enable the option "Enable control of the data management function via process data".
015	Data management: Process active	A data management process is active (e.g. triggered via the data management interface or the auto-reload function)	Wait (the process may take several minutes).
016	Data management: Axes not connected yet	The data management is waiting for all configured axes to be connected.	<ul style="list-style-type: none"> Wait (the process may take several minutes). Check the configuration (Are all configured axes connected?)
020	Auto configuration is being executed	Refer to the setting information for bit 4 in chapter "Process data of the controller".	

Warnings

Code	Meaning	Possible cause	Measure
000	No warning	OK	-
001	Simulation active	During configuration in the Application Configuration, axes were configured with enabled "Simulation" check box. Consequently, the axes are not controlled for real operation.	If the drives should turn, deactivate the simulation using the check box in the axis range. Or disable simulation until the next restart by means of the control bit in the process data.
002	Control mode via PD monitor active	The axes connected to the controller are no longer controlled via the process data of the PLC.	For ending control mode, refer to the chapter "Monitor mode and control mode".
003	Simulation active and control mode via PD monitor	See codes 001 and 002	

9 12-byte MOVILINK® parameter channel

The drive parameters of the SEW controller are usually accessed using the bus-specific READ and WRITE services. Additional services can be executed for all bus system using the 12-byte MOVILINK® parameter channel. This parameter channel is available in all bus systems and is explained in detail below.

Also refer to the documentation for the fieldbus option card to obtain additional programming information on using the MOVILINK® parameter channel with the various bus systems.

9.1 Parameter setting procedure

The parameters of the SEW controller are usually set based on a client/server model. This means the controller provides the requested information only when prompted by the higher-level programmable controller. Thus the SEW controller usually only has server functionality.

9.2 Structure of the 12-byte MOVILINK® parameter channel

The 12-byte MOVILINK® parameter channel enables access to all parameters, regardless of the bus in use. Special services are available within this parameter channel to being able to read or write various parameter information.

The 12-byte MOVILINK® parameter channel is structured as follows:

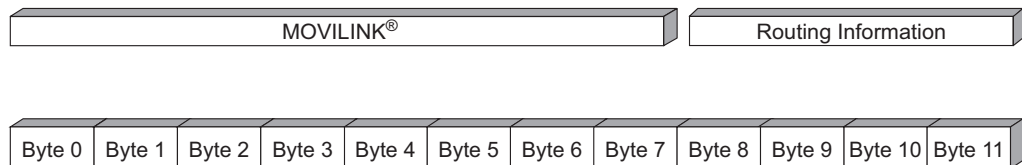

15394395531

Byte	Designation	Meaning
0	Management	–
1	Subindex	–
2	High index	Parameter index
3	Low index	
4	MSB data	4 byte data
5	Data	
6	Data	
7	LSB data	
8	Subaddress 1	Routing information (subrouting)
9	Subchannel 1	
10	Subaddress 2	
11	Subchannel 2	

Management of the parameter channel (byte 0)

The entire parameterization sequence is coordinated with byte 0 "Management". This byte provides important service parameters such as service identification, data length, execution and status of the service performed.

Index addressing (bytes 1 – 3)

Byte 2 "index high", byte 3 "index low", and byte 1 "subindex" determine the parameter to be read or written via the fieldbus system. Each parameter is assigned a special number (index). For information on how to determine the indexes easily with MOVITOOLS® MotionStudio, refer to "1. Reading the firmware part number via the READ service" (→  101).

Data range (bytes 4 – 7)

The data is located in byte 4 – 7 of the parameter channel. This means 4 bytes of data can be transmitted per service. The data is always entered with right-justification; that is, byte 7 contains the least significant data byte (Data LSB) whereas byte 4 is the most significant data byte (Data MSB).

Routing information (bytes 8 – 11)

You can use the routing information to access the controller from SEW-EURODRIVE as well as lower-level devices. For information on how to use the routing information, refer to "2. Writing the fixed setpoint (n11) with the WRITE service" (→  104).

9.3 Parameter access to lower-level devices (sub-routing)

9.3.1 Function chart

The following illustration shows the two levels (subsystems) that must be routed in order to realize the parameter access. The communication interfaces (with the lower-level communication interfaces) of the controllers represent the top level (subsystem 1). The second level (subsystem 2) comprises the lower-level devices.

The values you assign for *SubChannel 1/SubAddress 1* and *SubChannel 2/SubAddress 2* determine the actual lower-level device the parameterization data is routed to.

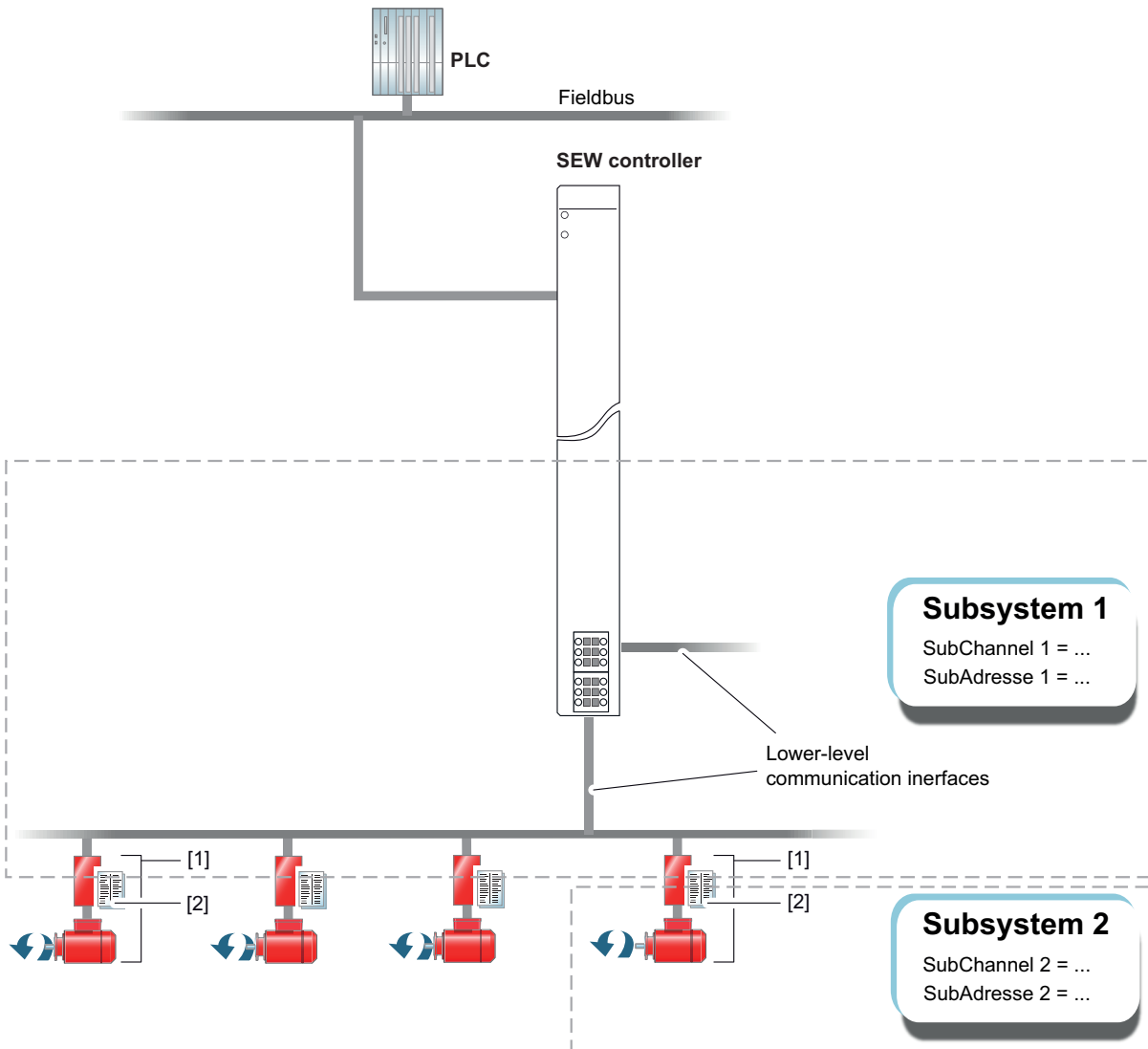

9007203334377995

- [1] Inverter with communication interface (e.g. SNI, EtherCAT®, SBus) from SEW-EURODRIVE
[2] Index and parameter list of the device

9.3.2 Routing information subsystem 1 (bytes 8 - 9)

The following table shows the routing information for subsystem 1 (bytes 8 – 9).

Subsystem 1		
	SubChannel 1 (byte 9)	SubAddress 1 (byte 8)
SEW controller	0	0
Inverter via DPRAM	1	0
EtherCAT®	2	0 – 99 (the EtherCAT® address is calculated from: sub-address 1 + 1001)
SNI		0 – 9
SBus1	3	1 – 63
SBus2	4	1 – 63
RS485_1	5	1 – 99
RS485_2	6	1 – 99

9.3.3 Routing information subsystem 2 (bytes 10 - 11)

The following table shows the routing information for subsystem 2 (bytes 10 – 11).

Subsystem 2			
System bus	Participants	SubChannel 2 (byte 10)	SubAddress 2 (byte 11)
EtherCAT®	DFE24B gateway	0	0
	Nodes downstream the DFE24B gateway	2	SBus address
SNI	MOVIGEAR® power section	1	1
	MOVIGEAR® control section	0	0

9.3.4 Sample routing

This example shows you how to address subsystem 1 and 2 in order to route to a lower-level device.

This example uses the MOVIGEAR® SNI-B inverter from SEW-EURODRIVE. The routing target is the power section of a lower-level SNI slave (with address 3).

- Routing information subsystem 1 shows:
 - SubChannel 1 = 2 (SNI)
 - SubAddress 1 = 3 (SNI slave, address 3)
- Routing information subsystem 2 shows:
 - SubChannel 2 = 1 (power section)
 - SubAddress 2 = 1 (power section, address 1)

9.3.5 Parameter list

For detailed information on coding and access attributes of all parameters, refer to the parameter list in the device documentation.

9.4 Management byte 0

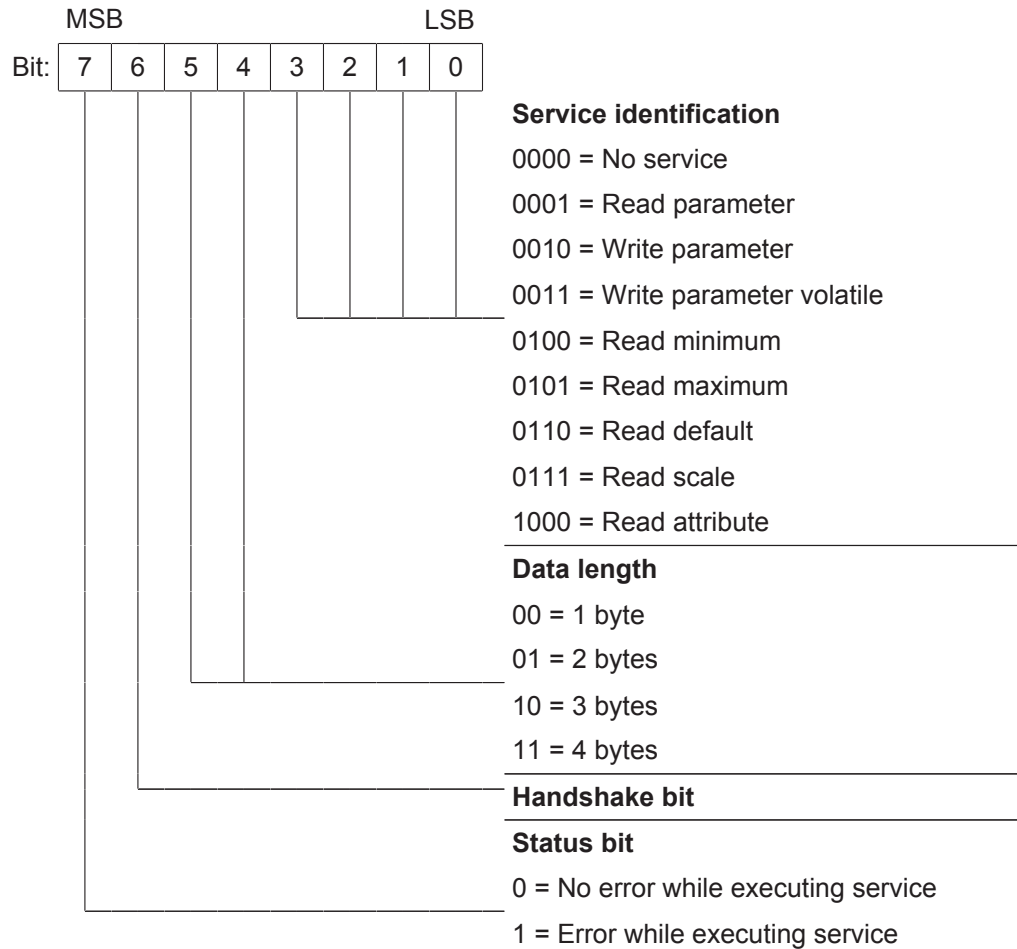

Bits 0 – 3 contain the service identification and define the service to be executed.

Bits 4 – 5 specify the data length in bytes; should be set to 4 bytes for all drive inverters from SEW-EURODRIVE.

The **handshake bit 6** is used as acknowledgement bit between client and server. As the parameter channel in this variant is transmitted cyclically, the service execution must be triggered by edge control via the handshake bit 6. For this purpose, the value of this bit is toggled for each new service to be executed. The inverter uses the handshake bit to signal whether the service has been executed or not. The service was executed if the handshake bit received in the controller is identical with the transmitted handshake bit.

Status bit 7 indicates whether the service was executed properly or whether errors occurred.

9.4.1 Response

The response to a parameterization request is structured as follows:

- The management byte of the response message is structured like that in the request message.
- The status bit indicates whether the service was executed successfully:
 - If the status bit is set to "0", bytes 4 – 7 of the response telegram will contain the requested data.

- If the status bit is set to "1", an error code is indicated in the data area (bytes 4 – 7), see section "Return codes for parameterization" (→ 98).

9.5 Description of the parameter services

Bits 0 – 3 of the management byte "0" are used to define the individual parameter services. The following parameter services are supported.

9.5.1 No service

This coding indicates that there is no parameter service.

9.5.2 Read parameter

This parameter service is used to read a drive parameter.

9.5.3 Write parameter

This parameter service is used for non-volatile writing of a drive parameter. The written parameter value is stored non-volatile (e.g. in EEPROM). This service should not be used for cyclic write accesses because the memory modules allow for only a limited number of write cycles.

9.5.4 Write parameter volatile

This parameter service is used to write a drive parameter volatile, if the parameter permits this. The written parameter value is only stored in the non-volatile RAM of the inverter, which means it is lost when the inverter is switched off. The value written last with write parameter is still available when the inverter is switched back on.

9.5.5 Read minimum

This service can be used to determine the smallest value (minimum) that can be set for a drive parameter. The coding corresponds to the parameter value.

9.5.6 Read maximum

This service can be used to determine the largest drive parameter value (maximum) that can be set. The coding corresponds to the parameter value.

9.5.7 Read default

This service can be used to determine the factory setting (default) of a drive parameter. The coding corresponds to the parameter value.

9.5.8 Read Scale

This service can be used to determine the scaling of a parameter. The inverter provides a quantity index and a conversion index.

Byte 4	Byte 5	Byte 6	Byte 7
MSB data	Data	Data	LSB data

Byte 4	Byte 5	Byte 6	Byte 7
Reserved		Quantity index	Conversion index

Quantity index

The quantity index is used for coding physical values. This index provides a communication partner with information about which physical quantity is involved with the corresponding parameter value. Coding takes place according to the "sensor/actuator" profile of the German PROFIBUS user organization (PNO). The entry FF_{hex} means that no measurement index is specified. You can also gather the measurement index from the parameter list of the inverter.

Conversion index

The conversion index is used for converting the transmitted parameter value into a basic SI unit. Coding takes place according to the "sensor/actuator" profile of the German PROFIBUS user organization (PNO).

Example	
Drive parameters	P131 ramp t11 down CW
Quantity index	4 (= time with second as measurement unit)
Conversion index	-3 (10^{-3} = milli)
Transmitted numerical value	3000 dec

The controller interprets the numerical value received via fieldbus as follows: $3000 \text{ s} \times 10^{-3} = 3 \text{ s}$

9.5.9 Read attribute

This service can be used for reading the access attributes and the index of the next parameter. The following table shows the coding of the data for this parameter service.

Byte 4	Byte 5	Byte 6	Byte 7
MSB data	Data	Data	LSB data
Next available index		Access attributes	

The coding of the access attributes is unit-specific. For SEW-EURODRIVE drive inverters, the attribute definition derives from the following table.

Byte 6	Byte 7	Meaning
Bit	Bit	
	0	1 = Parameter allows write access
	1	1 = Parameter is permanently saved on EEPROM
	2	1 = Factory setting overwrites RAM value
	3	1 = Factory setting overwrites EEPROM value
	4	1 = EEPROM value is valid after initialization
	5	1 = Controller inhibit condition not necessary for write access
	6	1 = Password required

Byte 6	Byte 7	Meaning
Bit	Bit	
8	7	00 = Parameter is generally valid 01 = Parameter is assigned to parameter set 1 10 = Parameter is assigned to parameter set 2 11 = Parameter is assigned to both parameter sets
9 – 15		Reserved

9.6 Return codes for parameterization

In the event of an incorrect parameterization, the drive inverter sends back various return codes to the parameterized master. These codes provide detailed information about the cause for error. All of these return codes are structured in accordance with EN 50170. We distinguish between the elements:

- *Error class*
- *Error code*
- *Additional code*

9.6.1 Error class

The *error class* element provides a more exact classification of the error type. The following error classes are distinguished in accordance with EN 50170.

Class (hex)	Designation	Meaning
1	vfd state	Status error of the virtual field device
2	Application reference	Error in application program
3	definition	Definition error
4	resource	Resource error
5	service	Error during execution of service
6	access	Access error
7	ov	Error in the object list
8	other	Other error (see additional code)

The *error class* is generated by the communication software of the fieldbus interface if there is an error in communication. This statement does not apply to *Error class 8 = Other error*. Return codes that are provided by the drive inverter system fall under the category *error class 8 = other error*. The error can be identified more precisely using the *additional code* element. The Ethernet *error code* is "0".

9.6.2 Error code

The *error code* element allows for a more detailed identification of the error cause within the *error class* and is generated by the communications software of the fieldbus interface in the event of faulty communication.

9.6.3 Additional code

The *additional code* contains SEW-EURODRIVE-specific return codes for faulty parameterization of the drive inverter. They are returned to the master under *Error class 8 = other error*. The following table shows all coding possibilities for the *Additional code*.

MOVILINK®			
Error class	Additional code		Description
	High	Low	
0x05	00	0x00	Unknown error
		0x01	Illegal Service
		0x02	No Response
		0x03	Different Address
		0x04	Different Type
		0x05	Different Index
		0x06	Different Service
		0x07	Different Channel
		0x08	Different Block
		0x09	No Scope Data
		0x0A	Illegal Length
		0x0B	Illegal Address
		0x0C	Illegal Pointer
		0x0D	Not enough memory
		0x0E	System Error
		0x0F	Communication does not exist
		0x10	Communication not initialized
		0x11	Mouse conflict
		0x12	Illegal Bus
0x13	FCS Error		
0x14	PB Init		
0x15	SBUS - Illegal Fragment Count		
0x16	SBUS - Illegal Fragment Type		
0x17	Access denied		
		Not used	

MOVILINK®			
Error class	Additional code		Description
	High	Low	
0x08	00	0x00	No error
		0x10	Illegal Index
		0x11	Not yet implemented
		0x12	Read only
		0x13	Parameter Blocking
		0x14	Setup runs
		0x15	Value too large
		0x16	Value too small
		0x17	Required Hardware does not exist
		0x18	Internal Error
		0x19	Access only via RS485 (via X13)
		0x1A	Access only via RS485 (via XT)
		0x1B	Parameter protected
		0x1C	"Controller inhibit" required
		0x1D	Value invalid
		0x1E	Setup started
		0x1F	Buffer overflow
		0x20	"No enable" required
		0x21	End of File
		0x22	Communication Order
0x23	"IPOS Stop" required		
0x24	Autosetup		
0x25	Encoder Nameplate Error		
0x29	PLC State Error		

Example: Parameterization error

An incorrect index was entered when executing a read or write service.

Element	Code (hex)	Meaning
Error class	0x08	Other
Error code	0x00	-
Additional code high	0x00	-
Additional code low	0x10	Illegal Index

9.7 Examples

9.7.1 1. Reading the firmware part number via the READ service

The example illustrates how to read the firmware part number of an controller from SEW-EURODRIVE. You use the READ service that is provided in the management byte 0 of the parameter channel.

Before you start reading an index, determine the number of the index in MOVITOOLS® MotionStudio.

Determining the number of the index for the firmware part number of the controller

Proceed as follows:

1. Start MOVITOOLS® MotionStudio.
2. Open the parameter tree of the controller.
3. Open parameter group "Display values/unit data".
4. Move the cursor over the display field "Firmware part number".

⇒ A tooltip with "Index (8300,0) ..." is displayed.

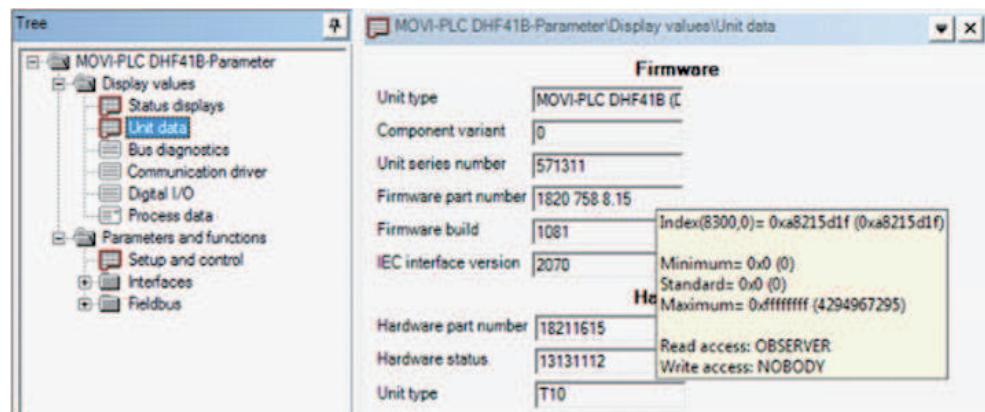

4083367307

⇒ That means that the number of the index is "8300" and the number of the sub-index is "0".

Reading index 8300 (firmware part number of controller) via the READ service

Proceed as follows:

1. Enter the following values in the parameter channel:

- **Byte 0: Management**

These settings are the prerequisite for the controller to process the READ service.

Bit: 7 6 5 4 3 2 1 0

0	0/1	1	1	0	0	0	1
---	-----	---	---	---	---	---	---

Service identification

0001 = Read parameter

Data length

11 = 4 bytes

Handshake bit

Must be changed (toggled) with every new order.

Status bit

0 = No error while executing service

1 = Error while executing service

- **Bytes 1 – 3: Index**

Byte 1	Byte 2	Byte 3
Subindex	High index	Low index
0	8300	

- **Bytes 8 – 11: Routing information**

Enter value "0" in bytes 8 – 11. This will only affect the controller and no lower-level devices.

Byte 8	Byte 9	Byte 10	Byte 11
SubAddress 1	SubChannel 1	SubAddress 2	SubChannel 2
0	0	0	0

The read value is in the data bytes 5 – 7.

As confirmation of the READ service, the controller provides the handshake bit with the same value that it received. For a new order, the handshake bit must be changed (toggled). In the management byte 0, the status bit is set to "1" in the event of a faulty service execution. In this case, an error code (= parameterization return code) is signaled in the data bytes 5 – 7.

The following procedure illustrates the parameterization between higher-level controller and controller using the READ service as an example.

Parameterization procedure between higher-level controller and controller from SEW-EURODRIVE

Using the READ service as an example, the illustration shows the parameterization procedure between the higher-level controller and the controller from SEW-EURODRIVE. To simplify the sequence, only the management byte 0 of the parameter channel is shown here.

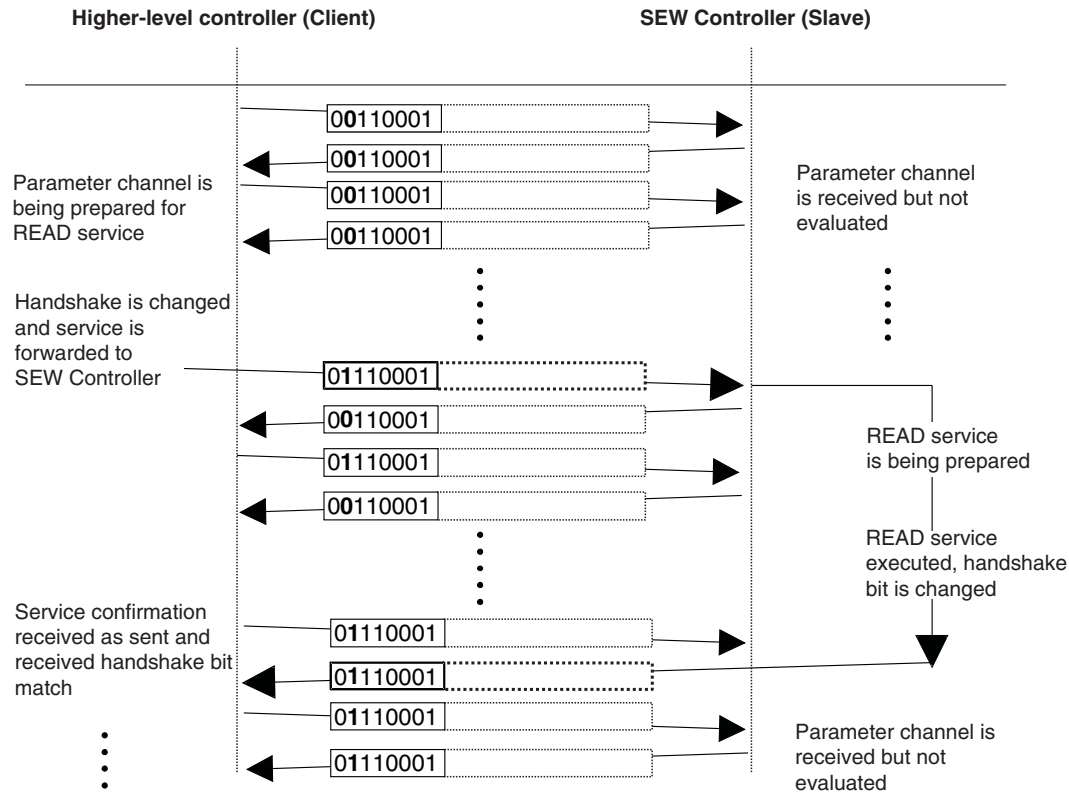

4083879179

While the parameter channel is being prepared for the READ service by the higher-level controller (client), the controller only receives and returns it. The service is not activated until the moment when the handshake bit is changed (in this example, when it changes from 0 to 1). The controller now interprets the parameter channel and processes the READ service; however, it continues to respond to all telegrams with handshake bit = 0. Confirmation that the service has been executed occurs when the handshake bit in the response telegram of the controller is set to the same value. The higher-level controller (client) now detects that the received handshake bit is once again the same as the one that was sent. It can now prepare another parameterization.

If the status bit 7 in the response telegram is "0", the service has been executed correctly.

9.7.2 2. Writing the fixed setpoint (n_{11}) with the WRITE service

This example is to illustrate how to route to a lower-level device in order to parameterize the fixed setpoint (n_{11}) with the WRITE service.

The higher-level controller routes the telegram to a lower-level SNI-node through the controller from SEW-EURODRIVE.

This example uses the MOVIGEAR® SNI-B controller. The parameterization target is the power section of a lower-level SNI slave (with address 3).

1. Determine the number for the index as shown in the example above.

⇒ You will receive index 8489.0 for the fixed setpoint (n_{11}).

2. Enter the following values in the parameter channel:

- **Byte 0: Management**

These settings are the prerequisite for the controller from SEW-EURODRIVE to process the WRITE service.

Bit: 7 6 5 4 3 2 1 0

0	0/1	1	1	0	0	1	0
---	-----	---	---	---	---	---	---

Service identification

0010 = Write parameter

Data length

11 = 4 bytes

Handshake bit

Must be changed (toggled) with every new order.

Status bit

0 = No error while executing service

1 = Error while executing service

- **Bytes 1 – 3: Index**

Byte 1	Byte 2	Byte 3
Subindex	High index	Low index
0	8489	

- **Bytes 4 – 7: Data byte**

Enter the fixed setpoint (e.g. $n_{11} = 123 \text{ 1/min}$) in data bytes 4 – 7.

Byte 4	Byte 5	Byte 6	Byte 7
MSB data	Data	Data	LSB data
123000			

In this example, the conversion index is -3 for factor $\times 10^{-3}$.

- **Bytes 8 – 11: Routing information**

Enter the routing information in bytes 8 – 11 so that parameter n_{11} is written on the power section of the lower-level SNI slave.

Byte 8	Byte 9	Byte 10	Byte 11
SubAddress 1	SubChannel 1	SubAddress 2	SubChannel 2

Byte 8	Byte 9	Byte 10	Byte 11
3	2	1	1

10 Appendix

10.1 Electrical installation

The following sections illustrate how to connect the lower-level units to the controller and set the address and baud rate.

The information in this chapter are excerpts from the installation chapters of the enclosed documents and are merely to provide an overview. They represent the technical status at the time of the publication of the present document. For detailed information refer to the documentation of the units and controllers.

10.2 DHR21B/41B

10.2.1 Terminal assignment and DIP switches

Front view MOVIPLC® ad- vanced DHR41B controller	Designation	LED DIP switch Terminal	Function
	Terminal X30-1: Ethernet 1 (fieldbus)	X30-1	Standard Ethernet assignment
	Terminal X30-2: Ethernet 2 (fieldbus)	X30-2	
	DIP switch	2 ⁰ = ON	Resets the axis parameters to their default values and deactivates DHCP: <ul style="list-style-type: none"> IP address: 192.168.10.4 Subnet mask: 255.255.255.0 Gateway: 192.168.10.4
		2 ¹ = ON	EtherNet/IP™ and Modbus TCP/IP protocol is active
		2 ¹ = OFF	PROFINET protocol is active
	Terminal X38: SafetyBus (plug-in terminals)	X38	Reserved
	Connector X31: Digital inputs and out- puts (plug-in terminals)	X31:1 +24 V input X31:2 REF24V X31:3 DIO 0 X31:4 DIO 1 X31:5 DIO 2 X31:6 DIO 3 X31:7 DIO 4 X31:8 DIO 5 X31:9 DIO 6 X31:10 DIO 7	Voltage input DC+24 V Reference potential for binary signals Digital input/output Digital input/output Digital input/output Digital input/output Digital input/output Digital input/output Digital input/output Digital input/output
	Connector X34: RS485 interfaces COM1, COM2 (plug-in terminals)	X34:1 RS+ X34:2 RS+ insulated X34:3 RS- X34:4 RS- insulated X34:5 DGND X34:6 GND insulated	Signal RS485+ (COM 1) Signal RS485+ insulated (COM 2) Signal RS485- (COM 1) Signal RS485- insulated (COM 2) Reference potential (COM 1) Reference potential (COM 2)
	Connector X35: USB connection	X35	

22295410/EN – 11/2015

Front view MOVIPLC® ad- vanced DHR41B controller	Designation	LED DIP switch Terminal		Function
	Terminal X36: Ethernet 1 (system bus)	X36		Standard Ethernet assignment
	Connector X37: Ethernet 2 (engineer- ing)	X37		
	Connector X32: CAN 2 system bus (electrically isolated) (plug-in terminals)	X32:1 X32:2 X32:3	REF_CAN 2 CAN 2H CAN 2L	Reference potential for system bus CAN 2 System bus CAN 2 high System bus CAN 2 low
	Connector X33: CAN 1 system bus (plug-in terminals)	X33:1 X33:2 X33:3	DGND CAN 1H CAN 1L	Reference potential for system bus CAN 1 System bus CAN 1 high System bus CAN 1 low
	DIP switch S1	S1	Up Down	Default IP address (192.168.10.4) Ethernet -2 connection
	Reset button T1	T1		Reset

INFORMATION



The Application Configurator works on SBus 1/2 with the baud rates 500 Baud or 1 MBaud.

10.2.2 LED L5

LED L5 indicates the state of the communication between the controller and the diagnostics interface of the Application Configurator:

L5 status	Meaning
Flashing green (4 Hz)	Diagnostics interface in control mode.
Flashing red (4 Hz)	Diagnostics interface in control mode. However, the communication between the controller and the diagnostics interface is interrupted and a timeout is triggered.
Off	Normal operation: Diagnostics interface closed or in monitor mode.

10.3 DHF21B/41B

10.3.1 Terminal assignment and DIP switches

Front view MOVIPLC® ad- vanced DHF41B controller	Designation	LED	DIP switch	Terminal	Function	
	Connector X30P: PROFIBUS (Sub-D9)			X30P		
	Terminal X30D: DeviceNet™ (plug-in terminals)	X30D:1	V-		0V24	
		X30D:2	CAN_L		CAN_L	
		X30D:3	DRAIN		DRAIN	
		X30D:4	CAN_H		CAN_H	
		X30D:5	V+		24 V	
	DIP switch S2 Switching between PROFIBUS and Devi- ceNet™	S2	Up	Down		Fieldbus interface PROFIBUS (X30P) active Fieldbus interface DeviceNet™ (X30P) active
	PROFIBUS operation: Setting the PROFIBUS Station address	2 ⁰ 2 ¹ 2 ² 2 ³ 2 ⁴ 2 ⁵ 2 ⁶				Significance: 1 Significance: 2 Significance: 4 Significance: 8 Significance: 16 Significance: 32 Significance: 64
DeviceNet™ opera- tion: Setting the MAC ID and baud rate	2 ⁰ 2 ¹ 2 ² 2 ³ 2 ⁴ 2 ⁵				The DIP switches 2 ⁰ – 2 ⁵ are used to set the MAC-ID (Media Access Con- trol Identifier). The MAC ID repres- ents the node address (address range 0 – 63)	
DeviceNet™ opera- tion: Setting the baud rate	2 ⁶ 2 ⁷				Setting the baud rate Setting the baud rate	
Terminal X38: SafetyBus (plug-in terminals)				X38	Reserved	

22295410/EN – 11/2015

Front view MOVIPLC® ad- vanced DHF41B controller	Designation	LED DIP switch Terminal	Function
Connector X31: Digital inputs and out- puts (plug-in terminals)	X31:1	+24 V input	Voltage input DC+24 V
	X31:2	REF24V	Reference potential for binary sig- nals
	X31:3	DIO 0	Digital input/output
	X31:4	DIO 1	Digital input/output
	X31:5	DIO 2	Digital input/output
	X31:6	DIO 3	Digital input/output
	X31:7	DIO 4	Digital input/output
	X31:8	DIO 5	Digital input/output
	X31:9	DIO 6	Digital input/output
	X31:10	DIO 7	Digital input/output
Connector X34: RS485 interfaces COM1, COM2 (plug-in terminals)	X34:1	RS+	Signal RS485+ (COM 1)
	X34:2	RS+ insulated	Signal RS485+ insulated (COM 2)
	X34:3	RS-	Signal RS485- (COM 1)
	X34:4	RS- insulated	Signal RS485- insulated (COM 2)
	X34:5	DGND	Reference potential (COM 1)
	X34:6	GND insulated	Reference potential (COM 2)
Connector X35: USB connection	X35		
Terminal X36: Ethernet 1 connection System bus	X36		Standard Ethernet assignment
Connector X37: Ethernet 2 connection (Engineering)	X37		
Connector X32: CAN 2 system bus (electrically isolated) (plug-in terminals, color: YE/BK)	X32:1	REF_CAN 2	Reference potential for system bus CAN 2
	X32:2	CAN 2H	System bus CAN 2 high
	X32:3	CAN 2L	System bus CAN 2 low
Connector X33: CAN 1 system bus (plug-in terminals, color: YE/BK)	X33:1	DGND	Reference potential for system bus CAN 1
	X33:2	CAN 1H	System bus CAN 1 high
	X33:3	CAN 1L	System bus CAN 1 low
DIP switch S1	S1	Up Down	Default IP address (192.168.10.4) Ethernet -2 connection
Reset button T1	T1		Reset

INFORMATION



The Application Configurator uses the set baud rate of 500 kBaud for the system bus CAN1/CAN2.

10.3.2 Setting the DIP switches in DeviceNet operation

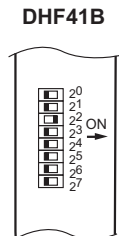

$2^0 - 2^5$ = MAC-ID setting

$2^6 - 2^7$ = baud rate setting

Setting the MAC ID

The MAC ID (**M**edia **A**ccess **C**ontrol **I**dentifier) is set on the DHF41B option using DIP switches $2^0 - 2^5$ in a binary coded manner. The MAC-ID represents the node address of the DHF41B. The DHF41B supports the address range 0 – 63.

Setting the baud rate

The baud rate is set using DIP switches 2^6 and 2^7 .

DIP switch		Baud rate
2^6	2^7	
0	0	125 kBaud
1	0	250 kBaud
0	1	500 kBaud
1	1	Invalid

10.3.3 LED L5

LED L5 indicates the state of the communication between the controller and the diagnostics interface of the Application Configurator:

L5 status	Meaning
Flashing green (4 Hz)	Diagnostics interface in control mode.
Flashing red (4 Hz)	Diagnostics interface in control mode. However, the communication between the controller and the diagnostics interface is interrupted and a timeout is triggered.
Off	Normal operation: Diagnostics interface closed or in monitor mode.

10.4 MOVIDRIVE® B

10.4.1 Overview

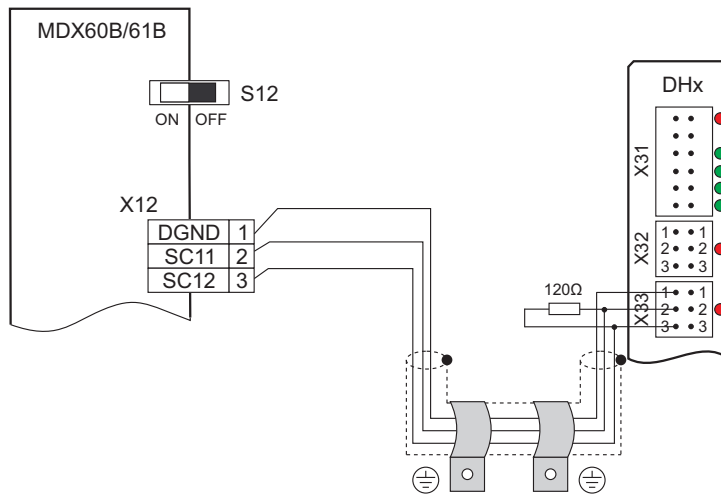

3354647179

10.4.2 Terminal assignment and DIP switches

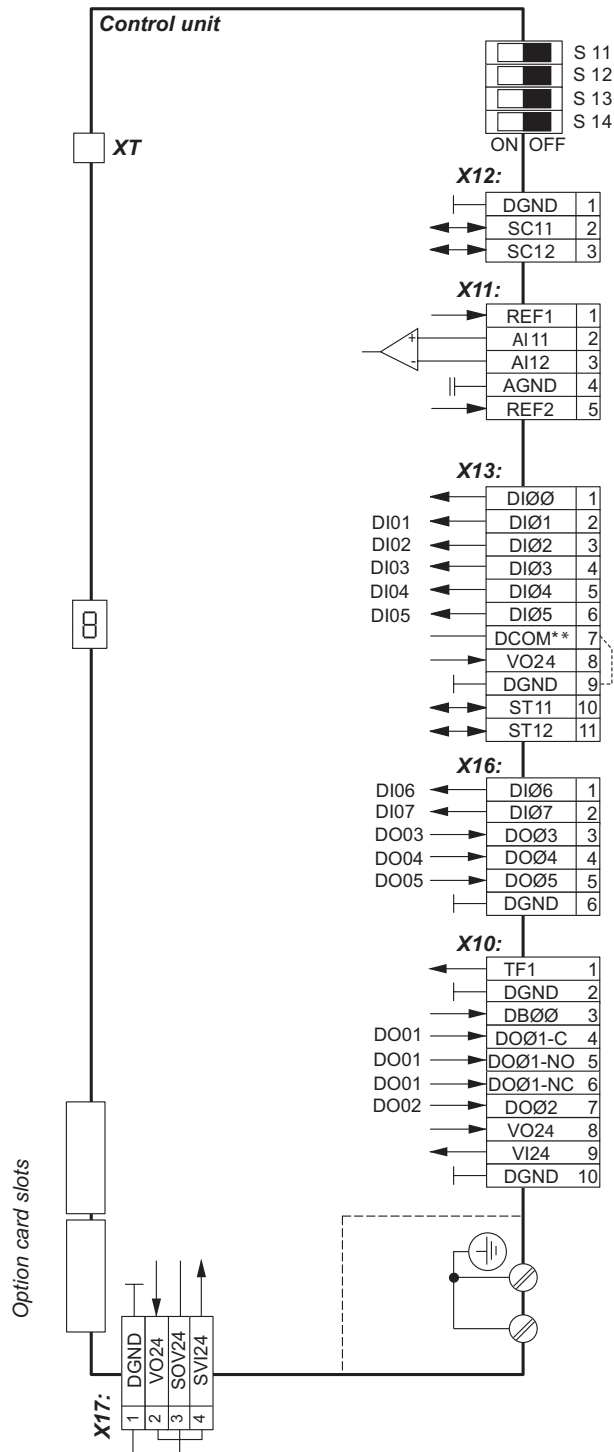

3236270859

** If the digital inputs are connected to the DC 24 V voltage supply X13:8 "VO24", install a jumper between X13:7 (DCOM) and X13:9 (DGND) on MOVDRIVE®.

DGND (X10, X12, X13, X16, X17) is connected with PE as standard (tapped hole, see chapter "Unit structure" in the operating instructions). You can establish electrical isolation by removing the M4 × 14 grounding screw.

22295410/EN – 11/2015

Terminal		Function
S11:		Change I-signal DC (0(4)...20 mA) ↔ V-signal DC (-10 V...0...10 V, 0...10 V), factory setting to V signal.
S12:		Switching system bus terminating resistor on/off; factory set to OFF. Set baud rate for the RS485 interface XT.
S13:		Either 9.6 or 57.6 baud, factory set to 57.6 baud.
S14:		Switch frequency input on or off, factory set to off.
X12:1	DGND	Reference potential system bus
X12:2	SC11	System bus high
X12:3	SC12	System bus low
X13:1	DIØØ	Fixed assignment "Controller inhibit"
X13:2	DIØ1	Digital input 1, freely programmable
X13:3	DIØ2	Digital input 2, freely programmable
X13:4	DIØ3	Digital input 3, freely programmable
X13:5	DIØ4	Digital input 4, freely programmable
X13:6	DIØ5	Digital input 5, freely programmable
X13:7	DCOM	Reference for digital inputs X13:1 to X13:6 (DIØØ – DIØ5) and X16:1/X16:2 (DIØ6 – DIØ7)
X13:8	VO24	Auxiliary voltage output DC+24 V
X13:9	DGND	Reference potential for binary signals
X13:10	ST11	RS485+ (baud rate has a fixed setting of 9.6 kBaud)
X13:11	ST12	RS485-
X16:1	DIØ6	Digital input 7, freely programmable
X16:2	DIØ7	Digital input 8, freely programmable
X16:3	DOØ3	Digital output 3, freely programmable
X16:4	DOØ4	Digital output 4, freely programmable
X16:5	DOØ5	Digital output 5, freely programmable
X16:6	DGND	Reference potential for binary signals Do not connect external voltage to digital outputs X16:3 (DO03) – X16:5 (DO05).
X10:1	TF1	KTY+/TF/TH connection
X10:2	DGND	Reference potential for binary signals / KTY–
X10:3	DBØØ	Digital output DBØØ fixedly assigned "/Brake"
X10:4	DOØ1-C	Common contact digital output 1, freely programmable
X10:5	DOØ1-NO	NO contact digital output 1, freely programmable
X10:6	DOØ1-NC	NC contact digital output 1, freely programmable
X10:7	DOØ2	Digital output DBØ2, freely programmable

Terminal		Function
X10:8	VO24	Auxiliary voltage output DC+24 V
X10:9	VI24	Input 24 V voltage supply input
X10:10	DGND	Reference potential for binary signals Note regarding X:10.9: Only connect external backup voltage DC +24 V to sizes 0 – 6. With size 7, the DC power supply unit must be connected to the supply system.
X17:1	DGND	Reference potential for X17:2
X17:2	VO24	Auxiliary voltage output DC+24 V, only to supply X17:4 on the same unit
X17:3	SOV24	Reference potential for DC+24 V "safe stop" input (safety contact)
X17:4	SVI24	DC+24 V "safe stop" input (safety contact)
XT		Only service interface. Option slot: DBG60B / UWS21B / USB11A

INFORMATION



- Set the SBus address (*P881*) and baud rate (*P884*) in MOVITOOLS® MotionStudio engineering software.
- Make sure that the baud rate is set to 500 kBaud.
- Option DIO11B provides additional inputs/outputs.

10.5 MOVIAXIS®

10.5.1 Overview

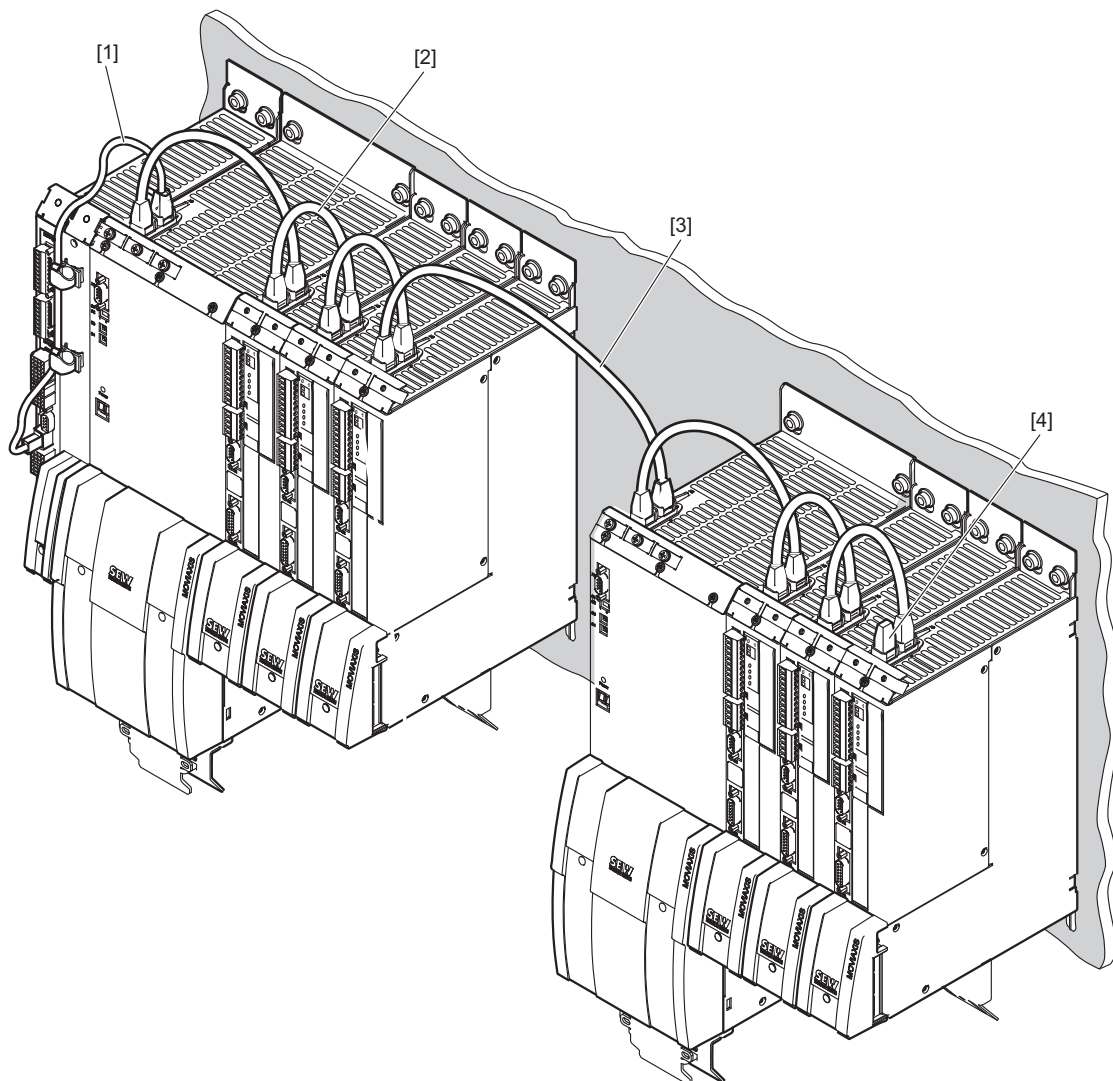

3346416779

- [1] Connection cable CAN master module
- [2] Cable of the CAN-based system bus (SBus)
- [3] System bus connection cable
- [4] Terminating resistor

10.5.2 Terminal assignment of an axis module

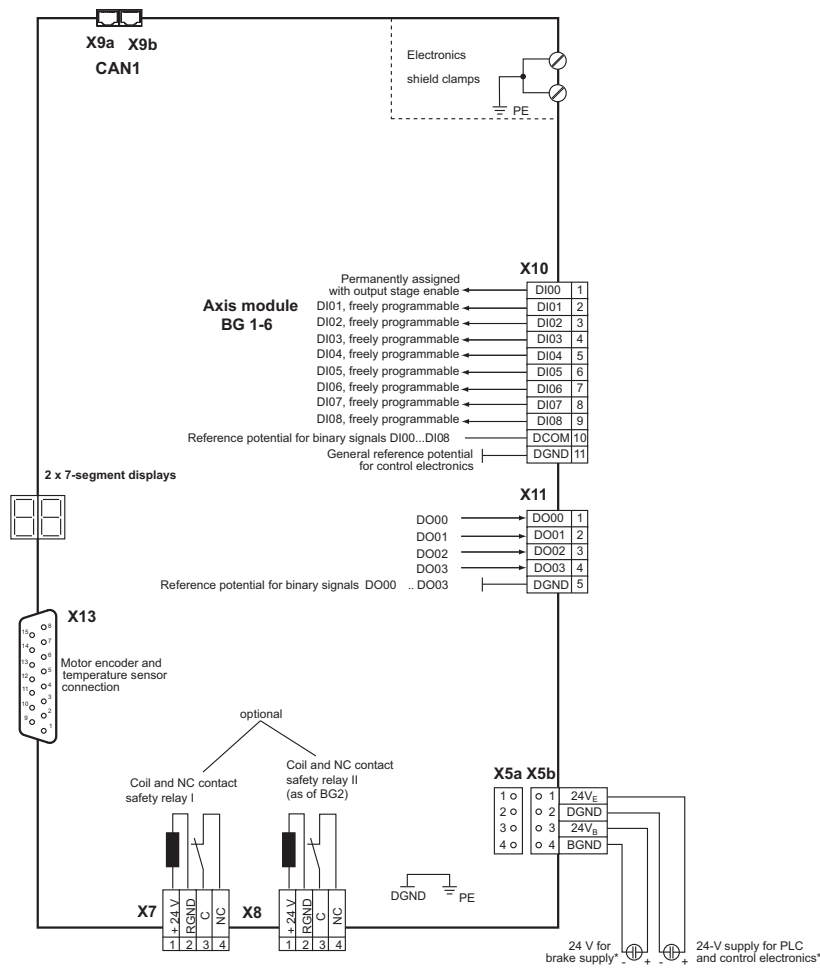

18014401746070923

* Connection via supplied prefabricated cables

Terminal	Function
X10:1 (DI00)	fixedly assigned /Controller inhibit
X10:2 (DI01)	Digital input 1, freely programmable
X10:3 (DI02)	Digital input 2, freely programmable
X10:4 (DI03)	Digital input 3, freely programmable
X10:5 (DI04)	Digital input 4, freely programmable
X10:6 (DI05)	Digital input 5, freely programmable
X10:7 (DI06)	Digital input 6, freely programmable
X10:8 (DI07)	Digital input 7, freely programmable
X10:9 (DI08)	Digital input 8, freely programmable

Terminal	Function
X11:1 (DO00)	Digital output 0, freely programmable
X11:2 (DO01)	Digital output 1, freely programmable
X11:3 (DO02)	Digital output 2, freely programmable
X11:4 (DO03)	Digital output 3, freely programmable
X11:5	Reference potential digital signals DO00 – DO03

10.5.3 Address and baud rate at power supply module

The following settings are required:

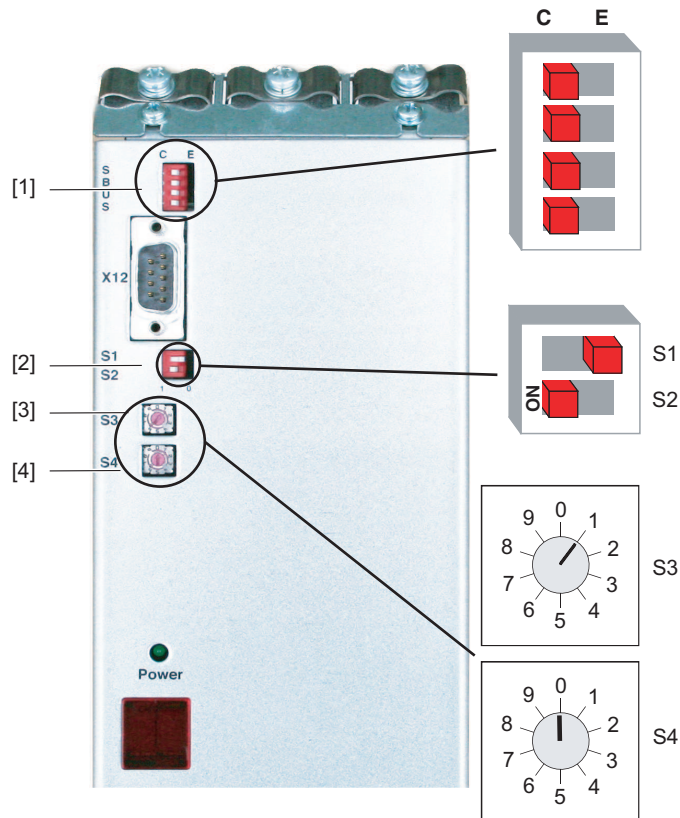

- The baud rate of CAN is set using the two address switches S1 and S2 on the power supply module.
- The 4 DIP switches for setting the system bus are set to "C".
- The axis address is set using the two address switches S3 and S4 on the power supply module. The next axis address will be set automatically based on the first address.



3243479819

- | | |
|--|------------------------------------|
| [1] DIP switch system bus | [3] S3: Axis address switch 10^0 |
| [2] S1, S2: DIP switches for CAN transmission rate | [4] S4: Axis address switch 10^1 |

Setting the CAN baud rate

	125 kBit/s	250 kBit/s	500 kBit/s	1 Mbit/s
S1				
S2				

INFORMATION



The default setting upon delivery is 500 kbit/s and must not be changed.

Setting the CAN axis address

Use these rotary switches to set a decimal address between 0 and 99.

S3 rotary switch

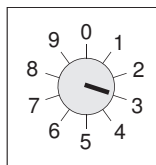

10⁰ = units digit

S4 rotary switch

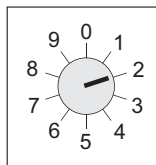

10¹ = tens digit

Axis address "23" is set as an example in the illustration above.

INFORMATION



The default factory setting is "1".

The addresses within the axis system are assigned as follows:

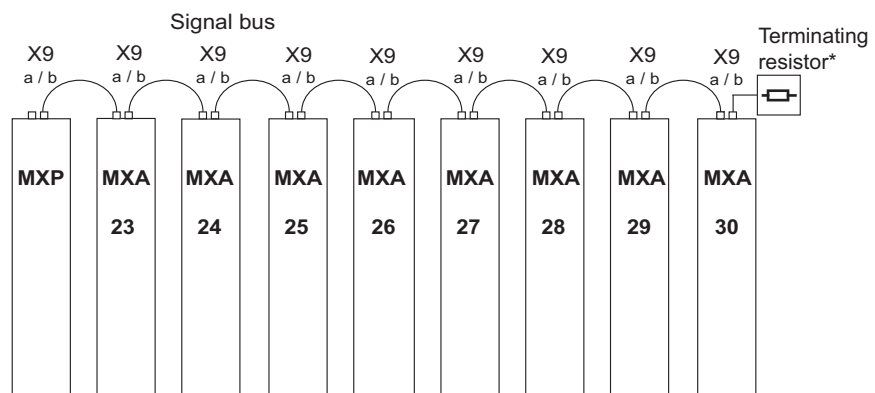

3243507211

In the example, the address of the first axis module is "23". The other axes are assigned addresses in ascending order.

INFORMATION



- Option XIO11A provides additional inputs/outputs.

10.6 MOVITRAC® B

10.6.1 Overview

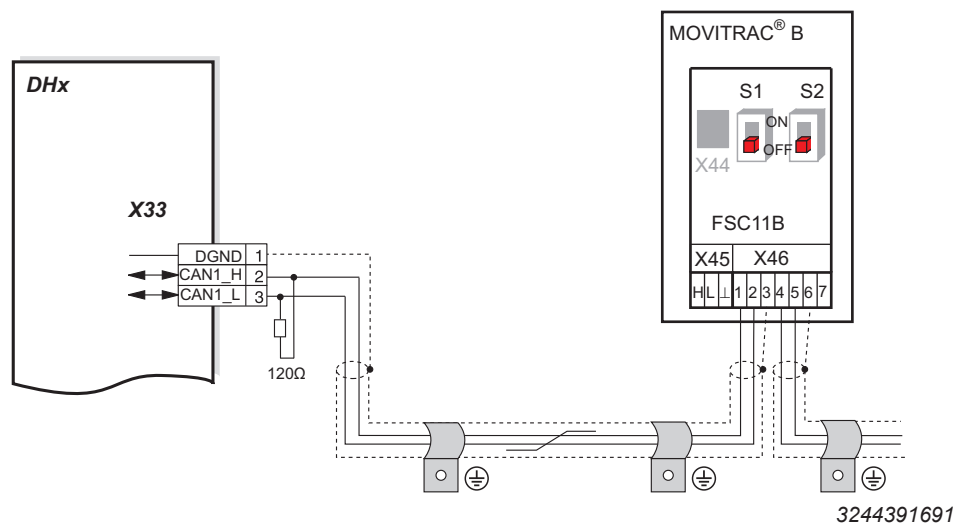

10.6.2 Terminal assignment of the basic unit

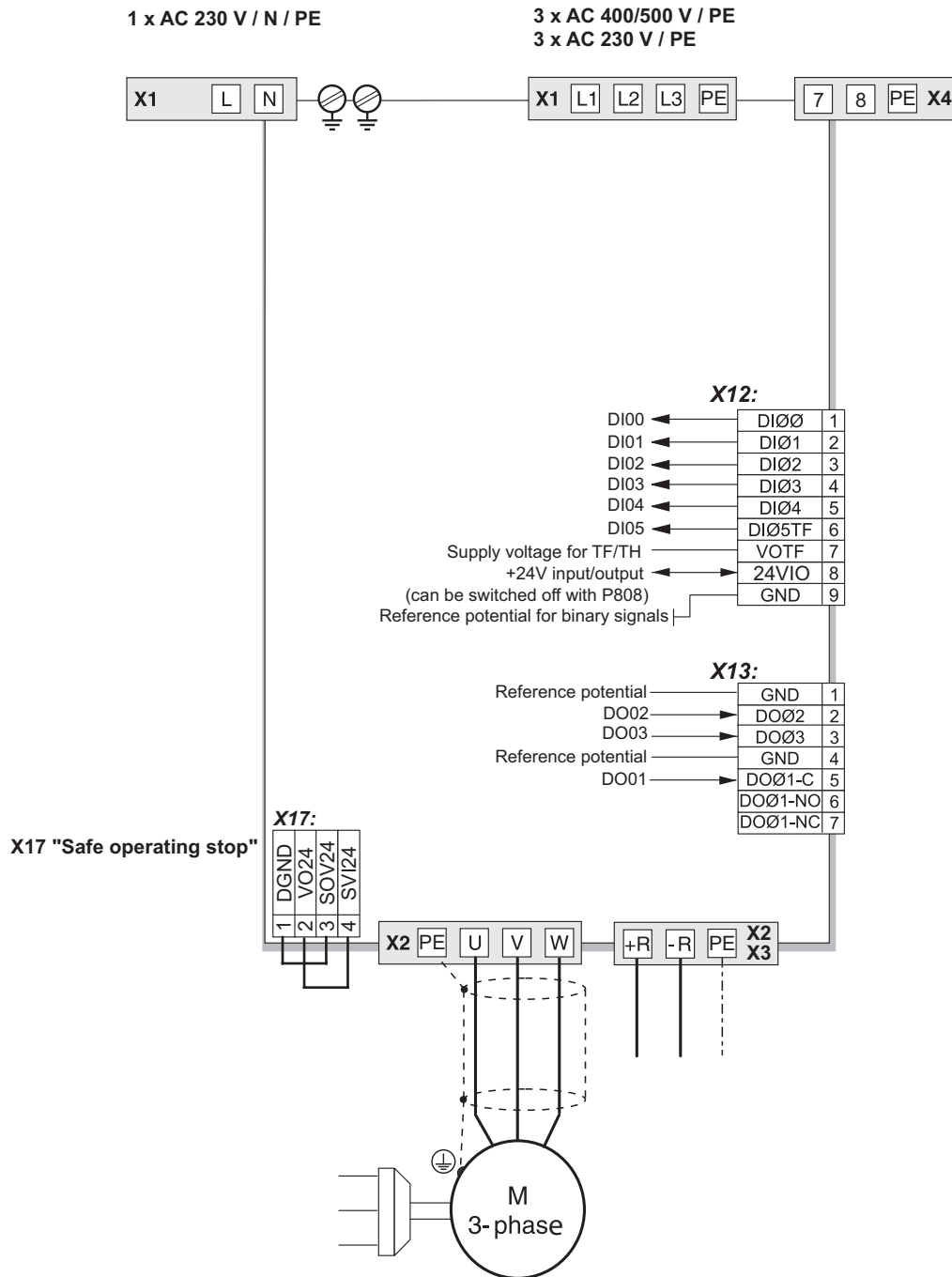

3237169675

Terminal	Function
X12:1 (DI00)	Digital input 0, freely programmable
X12:2 (DI01)	Digital input 1 CW/stop (fix wiring to DC 24 V)
X12:3 (DI02)	Digital input 2, freely programmable
X12:4 (DI03)	Digital input 3, freely programmable
X12:5 (DI04)	Digital input 4, freely programmable
X12:6 (DI05)	Digital input 5, freely programmable
X12:7	Supply voltage for TF/TH
X12:8	+24 V input/output
X12:9	Reference potential for binary signals
X13:1	Reference potential
X13:2 (DO02)	Digital output 2, freely programmable
X13:3 (DO03)	Digital output 3, freely programmable
X13:4	Reference potential
X13:5 (DO01)	Digital output 1, freely programmable

10.6.3 Terminal assignment and DIP switches for FSC11B

- Expand the basic unit with the FSC11B communication module

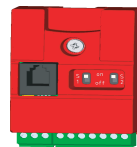
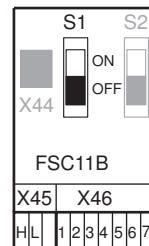

3237061003

Terminal	Function
X44	RJ10 plug connector
X45:H	ST11: RS-485+
X45:L	ST12: RS-485-
X45:'	GND: Reference potential
X46:1	SC11: SBus high
X46:2	SC12: SBus low
X46:3	GND: Reference potential
X46:4	SC21: SBus high
X46:5	SC22: SBus low
X46:6	GND: Reference potential

Terminal	Function
X46:7	24VIO: Auxiliary voltage/external voltage supply
DIP switch	S1: Terminating resistor CAN (ON/OFF) S2: Reserved (fixedly set to OFF)

The DC 24 V function of X46:7 is identical to X12:8 of the basic unit. All GND terminals of the unit are connected to each other and to PE.

INFORMATION



- Set the SBus address (*P881*) and baud rate (*P884*) in MOVITOOLS® MotionStudio engineering software.
- Make sure that the baud rate is set to 500 kBaud.
- Option FIO21B provides additional inputs/outputs.

10.7 MOVITRAC® LTX/LTP-B

10.7.1 Overview

The following figure shows a drive network with 3 MOVITRAC® LTX/LTP-B and one controller.

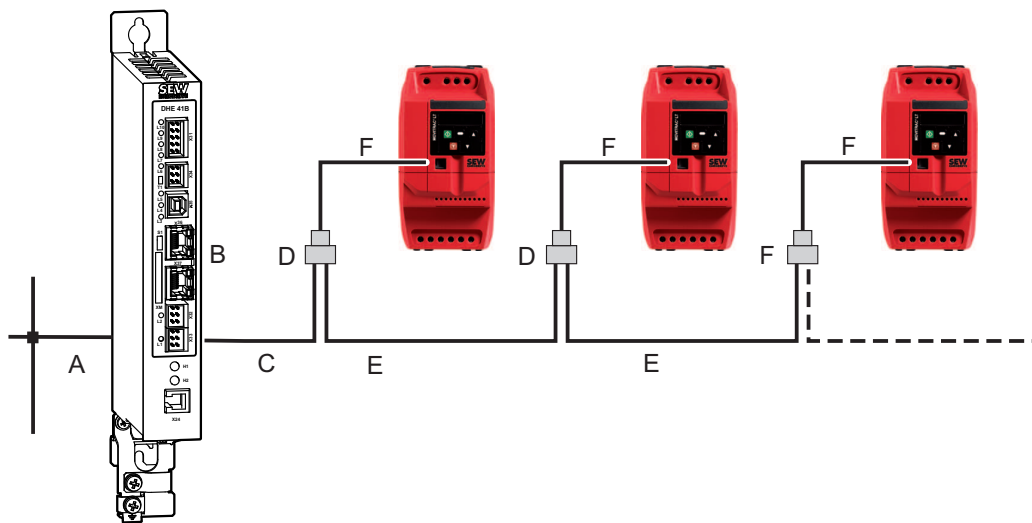

3121681419

- [A] Connection cable to the bus
- [B] CCU controller
- [C] Prefabricated cable with RJ45 connector on one end
- [D] Cable splitter: 1 to 2
- [E] Prefabricated cable with RJ45 connector on both ends
- [F] SBus terminating plug

10.7.2 Prefabricated cable with RJ45 connector on one end

The prefabricated cable has the following order information.

Cable length	Type	Part number
0.3 m unshielded	LT K-RJ-003-B	18218210
1.0 m unshielded	LT K-RJ-010-B	18218229
3.0 m unshielded	LT K-RJ-030-B	18218237

10.7.3 Prefabricated cable with RJ45 connector on both ends

The prefabricated cable has the following order information.

Cable length	Type	Part number
0.5 m unshielded	LT KR J0E 005 B	18218245

10.7.4 Cable splitter: 1 to 2

The cable splitter: 1 to 2 has the following order information.

Type	Part number
LT-RJ-CS-21-B	18218253

To connect multiple MOVITRAC® LTX/LTP-B and connect them to the SBus interface of the controller, the cable splitter: 1 to 2 is required.



3121678859

10.7.5 SBus terminating connector

The SBus terminating connector has the following order information.

Type	Part number
LT-CS-TR-B	18218261

The SBus terminating connector is required if MOVITRAC® LTX/LTP-B is used with a controller or the Dfx gateway from SEW-EURODRIVE. In this case, the last MOVITRAC® LTX/LTP-B in the network must be connected using this terminating connector.



3121688203

10.7.6 Terminal assignment

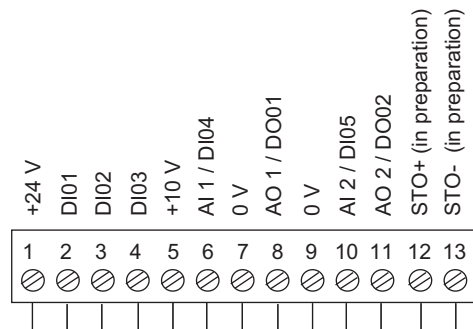

3238197515

INFORMATION



- You can set the SBus address (P1 – 19) and the baud rate (P1 – 20) with the keypad directly on the MOVITRAC® LTX/LTP-B.
- Make sure that the baud rate is set to 500 kBaud.

10.8 MOVIFIT® FDC-SNI

10.8.1 EBOX "MTC...-R9...-00"

Plug connector positions

The following figure depicts the EBOX "MTC...-R9...-00":

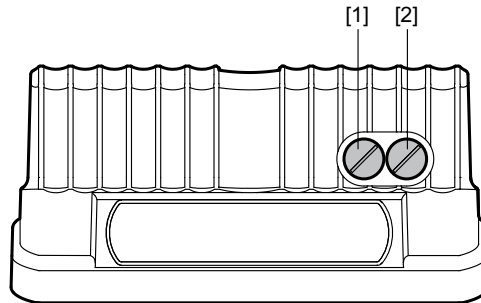

3239810699

- | | | | |
|-----|-----|--|-------------------|
| [1] | X51 | USB interface (underneath the screw plug) | USB socket type B |
| [2] | X52 | Ethernet service interface
(underneath the screw fitting) | RJ45 |
- Standard IP address: 192.168.10.4
 - Subnet mask: 255.255.255.0

10.8.2 Terminal assignment of the standard ABOX "MTA...-S04.-...-00"

▲ WARNING



Electric shock due to dangerous voltages present in the ABOX.

The maintenance switch only disconnects the connected drive units from the power supply system. Voltage is still present on the X1 terminals of the MOVIFIT® unit. Voltage is still present on the X8 terminals for up to 1 minute after having actuated the maintenance switch.

- Switch off the power to the MOVIFIT® using a suitable external disconnecting device, and wait at least 1 minute before opening the wiring space.

X1: Line terminals (power bus)

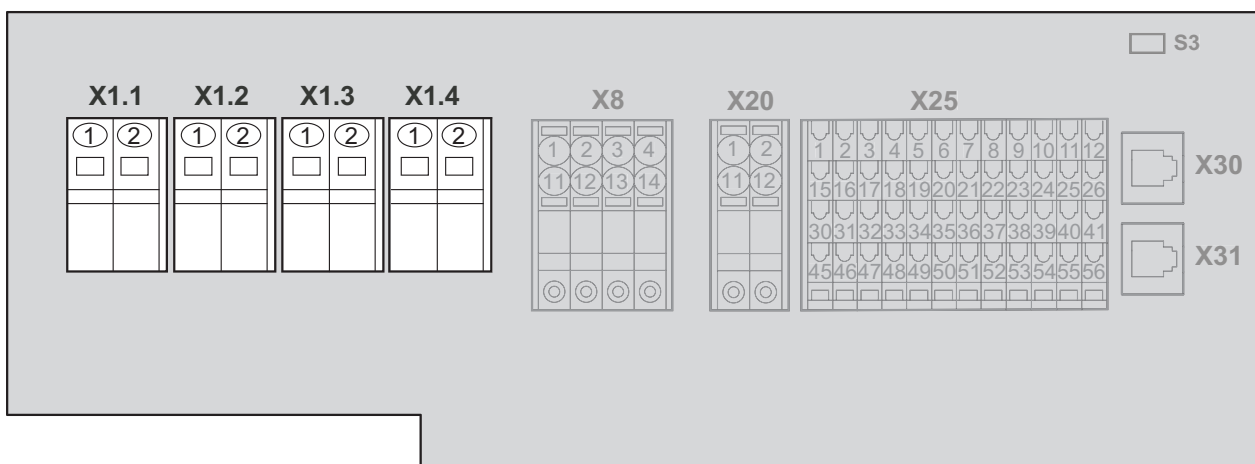

9007202494625803

22295410/EN – 11/2015

Line terminal (power bus)			
No.		Name	Function
X1.1	1	L1	Line connection phase 1 (IN)
	2	Res.	Reserved
X1.2	1	L2	Line connection phase 2 (IN)
	2	Res.	Reserved
X1.3	1	L3	Line connection phase 3 (IN)
	2	Res.	Reserved
X1.4	1	PE	PE connection (IN)
	2	PE	PE connection (OUT)

X20: 24 V supply terminal (24 V power bus)

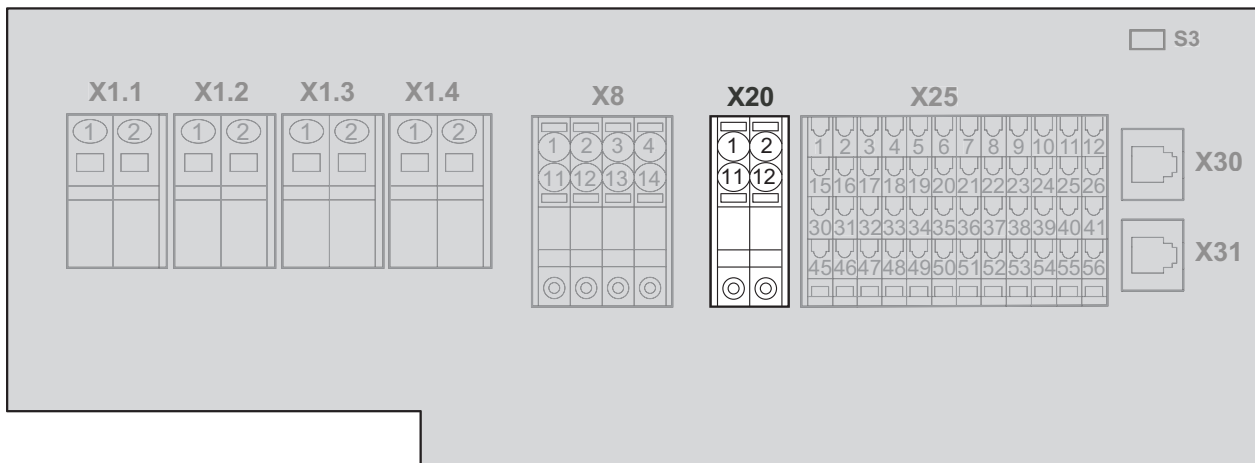

9007202495281291

Terminal for external DC 24 V supply			
No.		Name	Function
X20	1	+24 V	DC 24 V voltage (IN)
	2	0V24	0V24 reference potential for DC 24 V voltage (IN)
	11	Res.	Reserved
	12	Res.	Reserved

X8: Connecting terminals of MOVIGEAR® drive units (SNI cable)

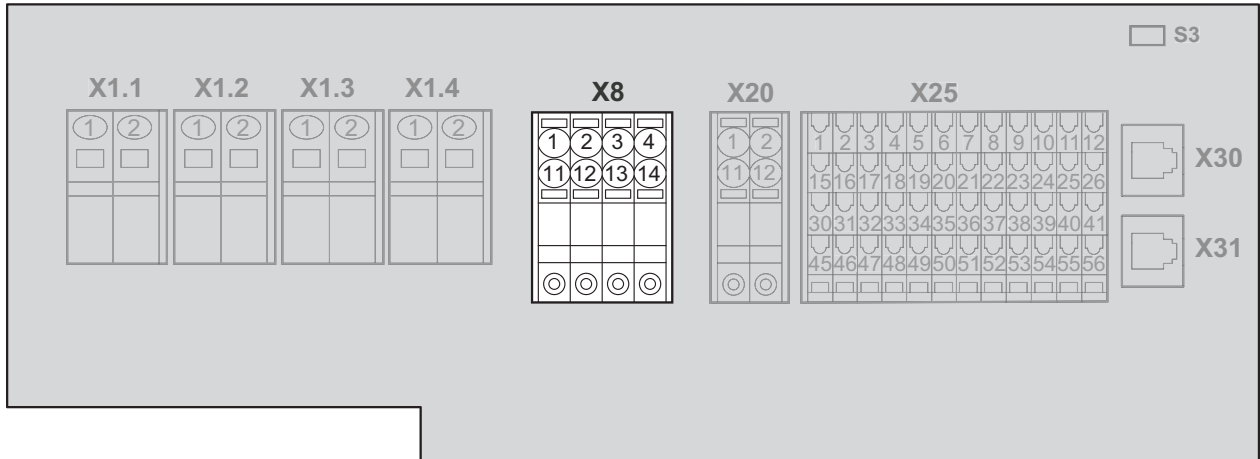

9007202495309323

Connecting terminal of drive units (SNI cable)

No.		Name	Function
X8	1	L1_SNI	Actuator supply phase L1 with SNI communication
	2	L2_SNI	Actuator supply phase L2 with SNI communication
	3	L3_SNI	Actuator supply phase L3 with SNI communication
	4	PE	PE connection drive unit
	11	Res.	Reserved
	12	Res.	Reserved
	13	Res.	Reserved
	14	Res.	Reserved

X25: I/O SBus RS485 terminals

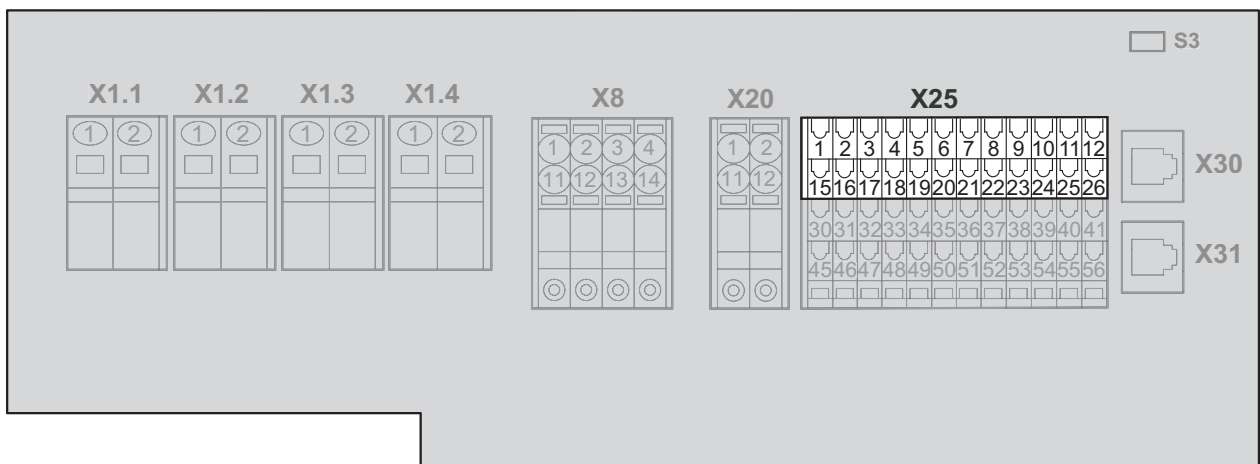

9007202495376011

22295410/EN – 11/2015

I/O terminals (connection of sensors + actuators)

SBus terminal (CAN)

RS-485 terminals

No.	Name	Function	
X25	1	DI00 / DO00	Digital input DI00 (switching signal) and digital output DO00
	2	DI02 / DO02	Digital input DI02 (switching signal) and digital output DO02
	3	DI04	Digital input DI04 (switching signal)
	4	D06	Digital input DI06 (switching signal)
	5	DI08	Digital input DI08 (switching signal)
	6	DI10	Digital input DI10 (switching signal)
	7	DI12	Digital input DI12 (switching signal)
	8	DI14	Digital input DI14 (switching signal)
	9	CAN_H	CAN data line (high)
	10	CAN_GND	Reference potential for CAN data line
	11	RS+	RS-485 data line (+)
	12	Res.	Reserved
	15	DI01 / DO01	Digital input DI01 (switching signal) and digital output DO01
	16	DI03 / DO03	Digital input DI03 (switching signal) and digital output DO03
	17	DI05	Digital input DI05 (switching signal)
	18	DI07	Digital input DI07 (switching signal)
	19	DI09	Digital input DI09 (switching signal)
	20	DI11	Digital input DI11 (switching signal)
	21	DI13	Digital input DI13 (switching signal)
	22	DI15	Digital input DI15 (switching signal)
	23	CAN_L	CAN data line (low)
	24	Res.	Reserved
	25	RS-	RS-485 data line (-)
	26	Res.	Reserved

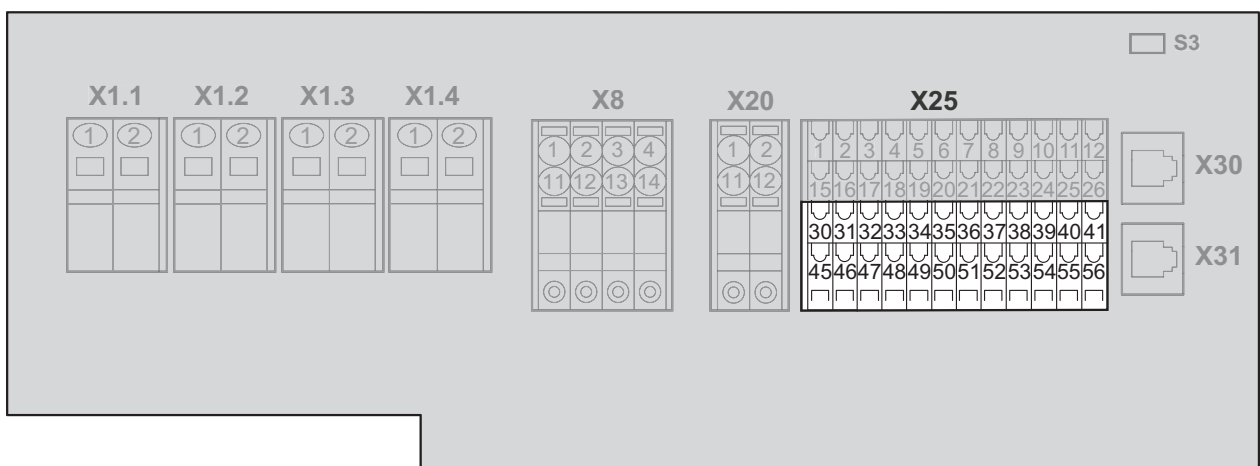

3326704779

22295410/EN – 11/2015

I/O terminals (connection of sensors + actuators)**SBus terminal (CAN)****RS-485 terminals**

No.	Name	Function	
X25	30	+24 V	DC 24 V output
	31	+24 V	DC 24 V output
	32	+24 V	DC 24 V output
	33	+24 V	DC 24 V output
	34	+24 V	DC 24 V output
	35	+24 V	DC 24 V output
	36	+24 V	DC 24 V output
	37	+24 V	DC 24 V output
	38	CAN_H	CAN data line (high)
	39	CAN_GND	Reference potential for CAN data line
	40	+5 V	DC 5 V output (supply of RS-485 interface)
	41	Res.	Reserved
	45	GND	Reference potential
	46	GND	Reference potential
	47	GND	Reference potential
	48	GND	Reference potential
	49	GND	Reference potential
	50	GND	Reference potential
	51	GND	Reference potential
	52	GND	Reference potential
	53	CAN_L	CAN data line (low)
	54	Res.	Reserved
	55	Res.	Reserved
56	Res.	Reserved	

10.8.3 DIP switch S12

Overview

The following figure shows the position of DIP switch S12 on the EBOX:

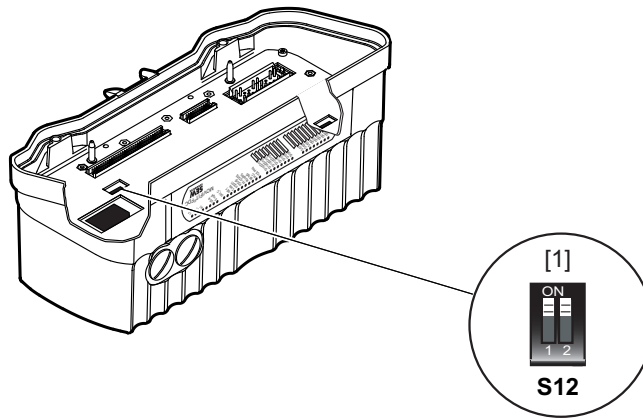

4275490059

Function

The following table shows the functions of DIP switch S12:

DIP switch	S12	
	1	2
	IP address allocation	
ON	DHCP / saved IP parameters	PROFINET IO
OFF	Default values	EtherNet/IP™ or Modbus/TCP

DIP switch S12/1

Default IP

DIP switch S12/1 of the EBOX is used to set the type of IP address allocation.

- DIP switch S12/1 = ON: The saved IP parameters are used in PROFINET IO operation.

In Modbus/TCP and EtherNet/IP™ operation, the IP parameters are taken from a DHCP server (default) or from the address parameter of MOVIFIT® FDC (see "DHCP start from configuration" parameter).
- DIP switch S12/1 = OFF: The IP parameters are set to the following default values:

IP address:	192.168.10.4
Subnet mask:	255.255.255.0
Gateway:	192.168.10.4

DIP switch S12/2**Ethernet protocol**

DIP switch S12/2 is used to select the Ethernet protocol of the connection between higher-level controller and MOVIFIT®.

- DIP switch S12/2 = ON: PROFINET IO
- DIP switch S12/2 = OFF: EtherNet/IP™ or Modbus/TCP

10.8.4 DIP switch S3

The following figure shows the position of DIP switch S3 [1] on the ABOX:

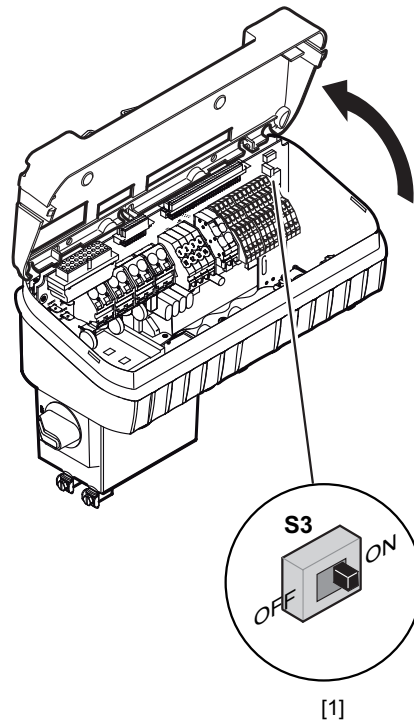

4280144523

[1] DIP switches S3 for bus termination SBus

10.8.5 "USR" LED

This chapter describes the "USR" LED. It is displayed in a dark color in the following figure:

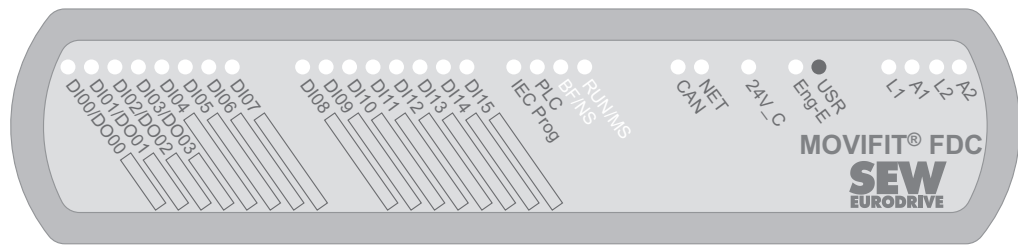

4878011915

The "USR" LED indicates the state of the communication between the controller and the diagnostics interface of the Application Configurator:

"USR" LED state	Meaning
Flashing green (4 Hz)	Diagnostics interface in control mode.
Flashing red (4 Hz)	Diagnostics interface in control mode. However, the communication between the controller and the diagnostics interface is interrupted and a timeout is triggered.
Off	Normal operation: Diagnostics interface closed or in monitor mode.

10.9 MOVIGEAR® B / DRC DSC

10.9.1 Installation topology example

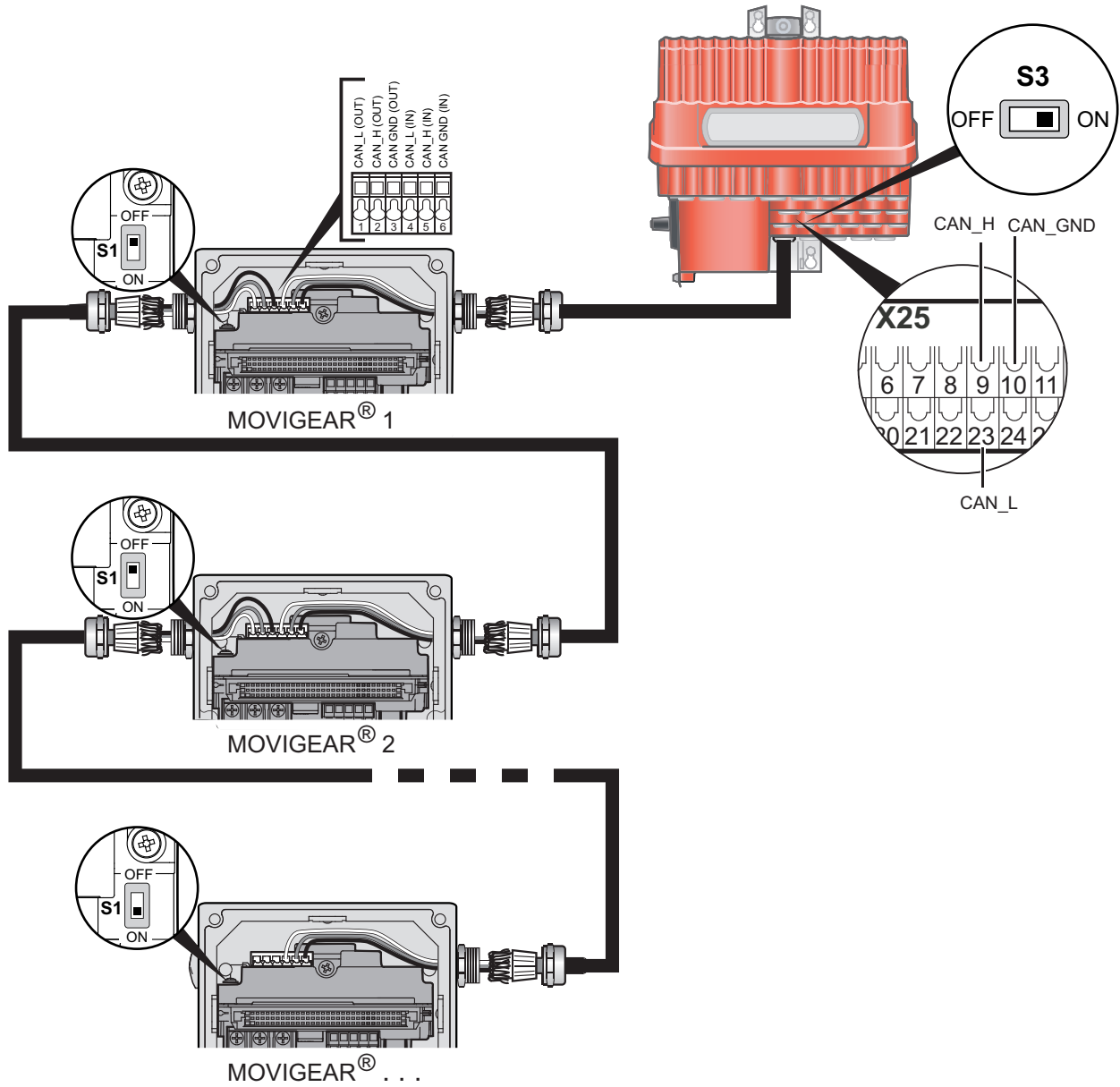

18014401865553931

22295410/EN – 11/2015

10.9.2 Terminal assignment

▲ WARNING



The drive is operated as a generator when the hollow shaft is turned.
Severe or fatal injuries from electric shock.

- Secure the output shaft against rotation when the electronics cover is removed.

The following figure shows the terminal assignment of MOVIGEAR® DSC.

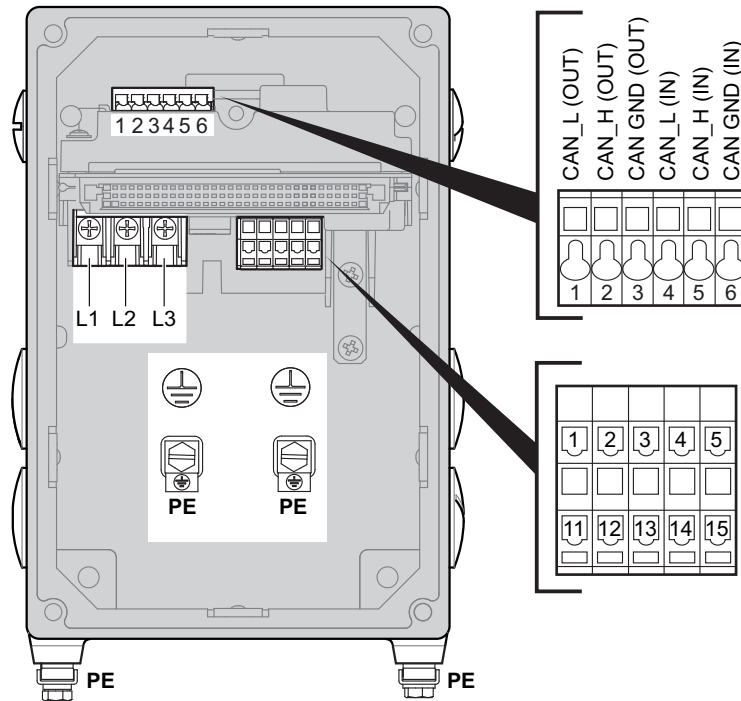

3246917003

Assignment				
Terminal	No	Name	Color	Function (permitted tightening torque)
Supply system terminals	–	L1	Brown	Line connection phase L1 (1.2 to 1.4 Nm)
	–	L2	Black	Line connection phase L2 (1.2 to 1.4 Nm)
	–	L3	Gray	Line connection phase L3 (1.2 to 1.4 Nm)
y	–	PE	–	PE connection (2.0 to 3.3 Nm)

Assignment				
Terminal	No	Name	Color	Function (permitted tightening torque)
Control terminals	1	STO +	Yellow	STO + input
	2	STO –	Yellow	Input STO –
	3	+24 V_SEN	–	Input for DC 24 V voltage supply for sensors The sensor supply voltage is then available at the optional plug connector
	4	0V24_SEN	–	Input for 0V24 reference potential for sensors
	5	24V_O	–	DC 24 V output
	11	STO +	Yellow	Output STO + (to loop through)
	12	STO –	Yellow	Output STO – (to loop through)
	13	+24 V_SEN	–	Looping of the DC 24 V voltage supply for sensors
	14	0V24_SEN	–	Looping of the 0V24 reference potential for sensors
	15	0V24_O	–	0V24 reference potential output
Communication terminals	1	CAN_L (OUT)	–	CAN bus data line low – outgoing
	2	CAN_H (OUT)	–	CAN bus data line high – outgoing
	3	CAN_GND (OUT)	–	Reference potential CAN bus – outgoing
	4	CAN_L (IN)	–	CAN bus data line low – incoming
	5	CAN_H (IN)	–	CAN bus data line high – incoming
	6	CAN_GND (IN)	–	Reference potential CAN bus – incoming

10.9.3 Setting of the bus terminating resistor

INFORMATION



Final CAN stations must terminate the bus with a resistance of 120 Ω. The resistor can be activated via DIP switch S1 on the connection board.

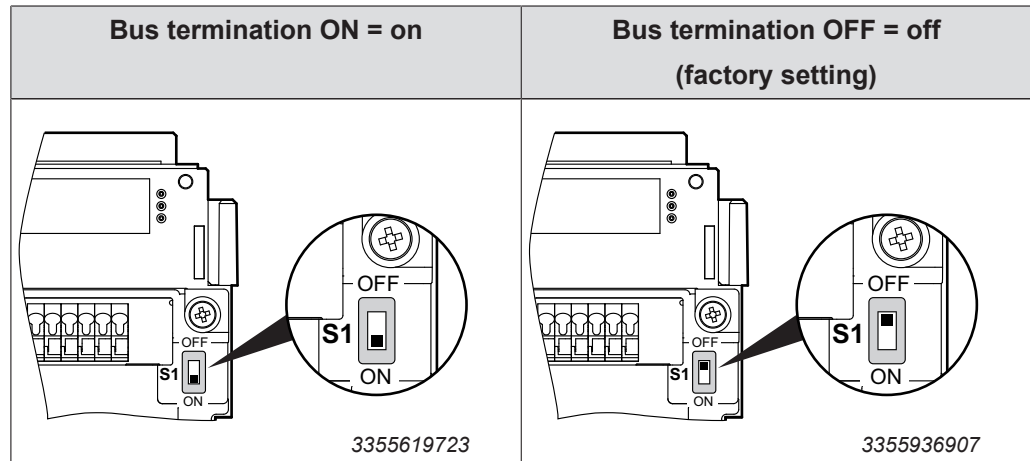

10.9.4 Description of the DIP switches

Overview

The following figure shows the DIP switches S1 and S2.

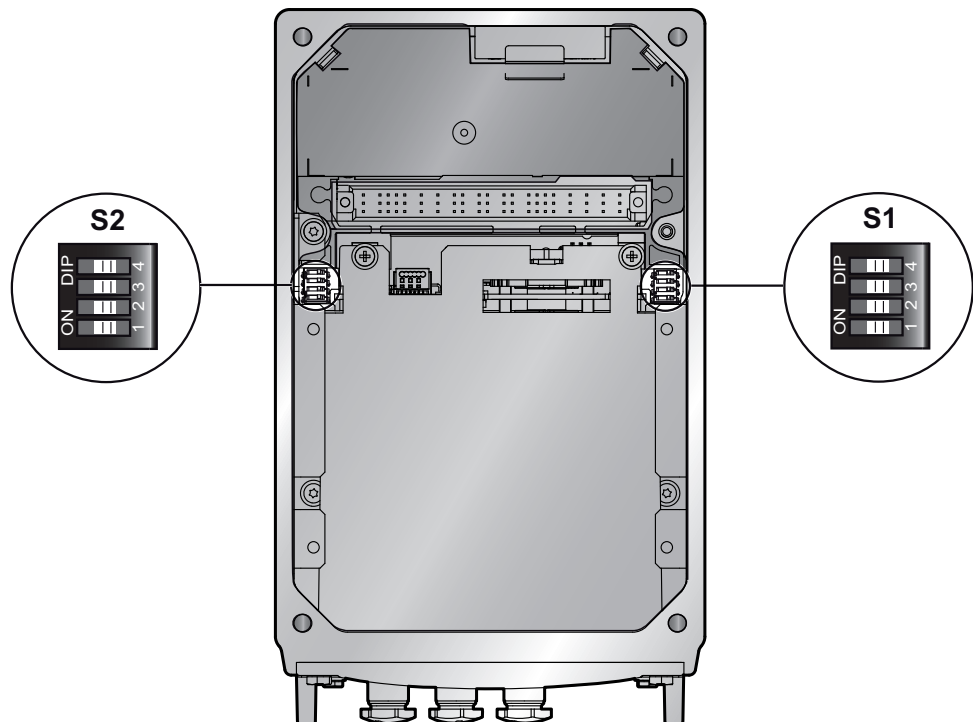

3248052235

DIP switch S1

The following table shows the functions of DIP switch S1.

DIP switch	S1			
	1	2	3	4
	Binary coding SBus unit address			
ON	Bit 2 ⁰	Bit 2 ¹	Bit 2 ²	Bit 2 ³
OFF				

DIP switch S2

The following table shows the functions of DIP switch S2.

DIP switch	S2			
	1	2	3	4
	Binary coding SBus unit address	Baud rate	Use of the motion control inputs	Addressing mode
ON	Bit 2 ⁴	1 MBaud	Local mode	Mode 2
OFF		500 kBaud	Sensors	Mode 1

- The following settings are **recommended** for the DIP switch (S2/3 and S2/4):
 - S2/3 to OFF (sensors)
 - S2/4 to ON (mode 2)
- The following settings are **compulsory** for the DIP switch (S2/2):
 - S2/2 to OFF (500 kBaud)

DIP switches S1/1 – S1/4 and S2/1**Setting the SBus address with addressing mode 2 (S2/4 = ON)**

- You can set the SBus addresses of MOVIGEAR® via DIP switches S1/1 – S1/4 and S2/1.
- In addressing mode 2 (DIP switch S2/4 = ON), the SBus address is calculated as follows:
 - **Power section address: Significance of the DIP switches + fixed offset of 1**
 - Address of command level: Significance of the DIP switches + fixed offset of 32
- This means you can set addresses from 1 – 31 (power section) and 32 – 62 (command level):

Addressing mode 2 (S2/4 = ON)																
SBus address command level	32	33	34	35	36	37	38	39	40	41	42	43	44	45	46	47
SBus address power section	1	2	3	4	5	6	7	8	9	10	11	12	13	14	15	16
S1/1	–	X	–	X	–	X	–	X	–	X	–	X	–	X	–	X
S1/2	–	–	X	X	–	–	X	X	–	–	X	X	–	–	X	X

Addressing mode 2 (S2/4 = ON)																
SBus address command level	32	33	34	35	36	37	38	39	40	41	42	43	44	45	46	47
SBus address power section	1	2	3	4	5	6	7	8	9	10	11	12	13	14	15	16
S1/3	-	-	-	-	X	X	X	X	-	-	-	-	X	X	X	X
S1/4	-	-	-	-	-	-	-	-	X	X	X	X	X	X	X	X
S2/1	-	-	-	-	-	-	-	-	-	-	-	-	-	-	-	-

Addressing mode 2 (S2/4 = ON)																
SBus address command level	48	49	50	51	52	53	54	55	56	57	58	59	60	61	62	
SBus address power section	17	18	19	20	21	22	23	24	25	26	27	28	29	30	31	
S1/1	-	X	-	X	-	X	-	X	-	X	-	X	-	X	-	
S1/2	-	-	X	X	-	-	X	X	-	-	X	X	-	-	X	
S1/3	-	-	-	-	X	X	X	X	-	-	-	-	X	X	X	
S1/4	-	-	-	-	-	-	-	-	X	X	X	X	X	X	X	
S2/1	X	X	X	X	X	X	X	X	X	X	X	X	X	X	X	

X = ON
- = OFF

INFORMATION





- In the configuration of the Application Configurator, enter the address of the power section as SBus address.

10.9.5 Assignment of the optional plug connector X5131

Connection cables

The following table shows the cables available for this connection.

Connection cable	Length/ Installation type
<p>Part number 1174 1457</p>  <p>M23, 12-pin, 0°-coded, open</p>	<p>Variable</p> 

Connection of cables with open end

The following table shows the conductor assignment of the cable with part number **11741457**.

Signal name	Color coding
DI01	Pink
DI02	Gray
DI03	Red
DI04	Blue
Reserved	Yellow
Reserved	Green
Reserved	Purple
+24V_O	Black
0V24_O	Brown
0V24_SEN	White
+24 V_SEN	Gray/pink
FE	Red/blue

X5131: Digital inputs/outputs

The following table shows information about this connection.

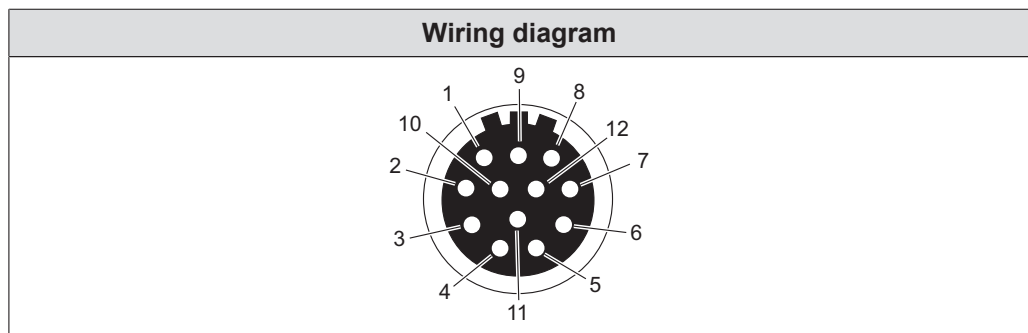

Assignment		
No.	Name	Function motion control inputs DIP switch S2/3 = OFF
1	DI01	DI01 sensor input
2	DI02	DI02 sensor input
3	DI03	DI03 sensor input
4	DI04	DI04 sensor input
5	n.c.	Not connected
6	n.c.	Not connected
7	n.c.	Not connected
8	+24V_O	Reserved
9	0V24V_O	Reserved

Assignment		
No.	Name	Function motion control inputs DIP switch S2/3 = OFF
10	0V24V_SEN	0V24 reference potential ¹⁾ must be supplied via terminals.
11	+24 V_SEN	DC 24 V sensor supply ²⁾ must be supplied via terminals.
12	FE	Equipotential bonding / functional earth

1) See operating instructions, chapter "MOVIGEAR® connection"

2) See operating instructions, chapter "MOVIGEAR® connection"

INFORMATION



- Use actuator/sensor distributors with 4 slots for the sensor inputs.
- Use the DC 24 V output only for local mode.
- Options GIO12A and GIO13A provide additional inputs/outputs.

10.10 MOVIGEAR® B / DRC SNI

10.10.1 Installation topology (example)

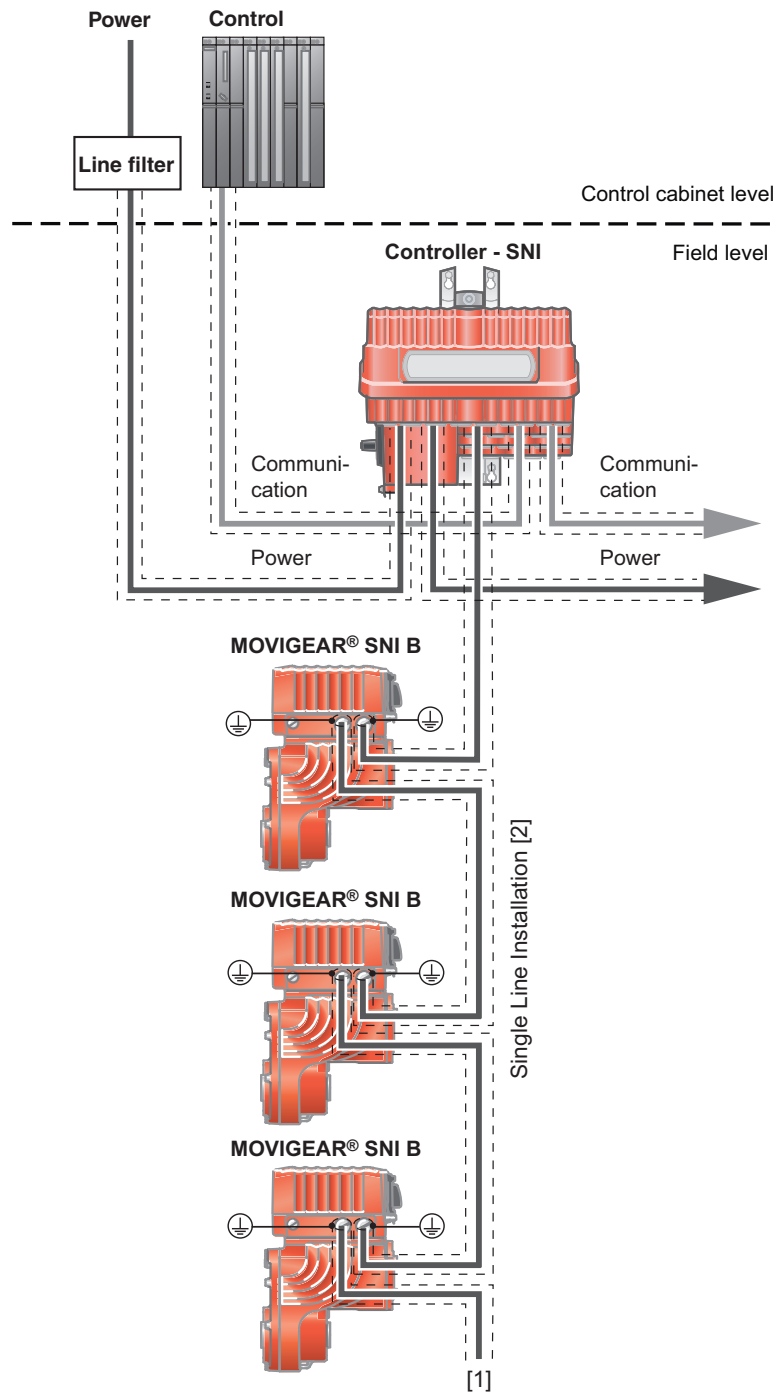

3248705931

[1] Max. 10 × MOVIGEAR® in total

[2] Permitted cable length between controller and last MOVIGEAR® max. 100 m

10.10.2 Terminal assignment

▲ WARNING



The drive is operated as a generator when the hollow shaft is turned.
Severe or fatal injuries from electric shock.

- Secure the output shaft against rotation when the electronics cover is removed.

The following figure shows the terminal assignment of MOVIGEAR® SNI:

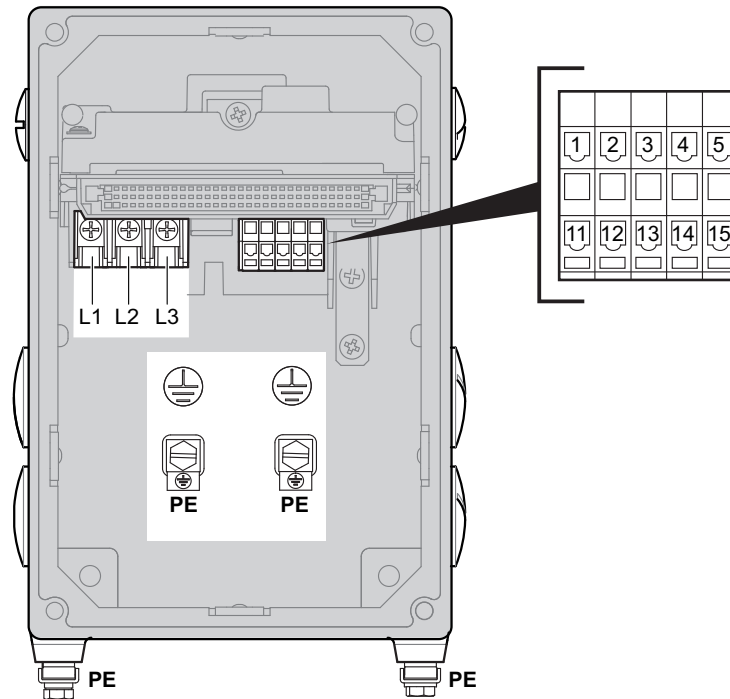

3249026699

Assignment				
Terminal	No	Name	Color	Function (permitted tightening torque)
Supply system terminals	–	L1	Brown	Actuator supply phase L1 with SNI communication (1.2 to 1.4 Nm)
	–	L2	Black	Actuator supply phase L2 with SNI communication (1.2 to 1.4 Nm)
	–	L3	Gray	Actuator supply phase L3 with SNI communication (1.2 to 1.4 Nm)
y	–	PE	–	PE connection (2.0 to 3.3 Nm)

INFORMATION



The communication method requires that you must observe the order of the line phases L1, L2, L3 between SNI controller and MOVIGEAR® SNI 1 – 10.

Assignment				
Terminal	No	Name	Color	Function
Control terminals	1	STO +	Yellow	STO + input
	2	STO -	Yellow	Input STO -
	3	+24 V_SEN	-	Input for DC 24 V voltage supply for sensors The sensor supply voltage is then available at the optional plug connector
	4	0V24_SEN	-	Input for 0V24 reference potential for sensors
	5	24V_O	-	DC 24 V output
	11	STO +	Yellow	Output STO + (to loop through)
	12	STO -	Yellow	Output STO - (to loop through)
	13	+24 V_SEN	-	Looping of the DC 24 V voltage supply for sensors
	14	0V24_SEN	-	Looping of the 0V24 reference potential for sensors
	15	0V24_O	-	0V24 reference potential output

10.10.3 Description of the DIP switches

Overview

The following figure shows the DIP switches S1 and S2.

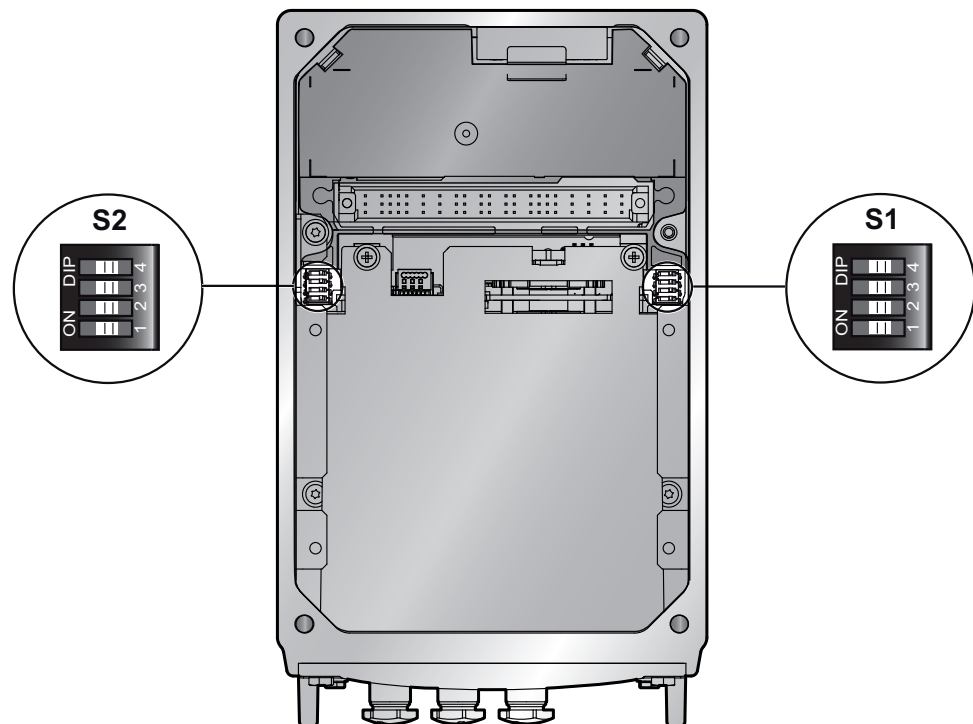

3248052235

22295410/EN – 11/2015

DIP switch S1

The following table shows the functions of DIP switch S1.

DIP switch	S1			
	Binary coding SNI unit address			
	1	2	3	4
ON	Bit 2 ⁰	Bit 2 ¹	Bit 2 ²	Bit 2 ³
OFF				

DIP switch S2

The following table shows the functions of DIP switch S2.

DIP switch	S2			
	1	2	3	4
	Binary coding operating mode		Use of the motion control inputs	Reserved
Bit 2 ⁰	Bit 2 ¹			
ON	1	1	Local mode	Reserved
OFF	0	0	Sensors	Reserved

- The following settings are **recommended** for the DIP switch S2/3:
 - S2/3 to OFF (sensors)
- The following settings are **compulsory** for the DIP switches S2 (S2/1 and S2/2):
 - S2/1 to ON ("Variable" mode)
 - S2/2 to ON ("Variable" mode)

10.10.4 Assignment of the optional plug connector X5131

Connection cables

The following table shows the cables available for this connection.

Connection cable	Length/ Installation type
<p>Part number 1 174 145 7</p>  <p>M23, 12-pin, 0°-coded, open</p>	<p>Variable</p>

Connection of cables with open end

The following table shows the conductor assignment of the cable with part number **11741457**.

Signal name	Color coding
DI01	Pink
DI02	Gray
DI03	Red
DI04	Blue
Reserved	Yellow
Reserved	Green
Reserved	Purple
+24V_O	Black
0V24_O	Brown
0V24_SEN	White
+24 V_SEN	Gray/pink
FE	Red/blue

X5131: Digital inputs/outputs

The following table shows information about this connection.

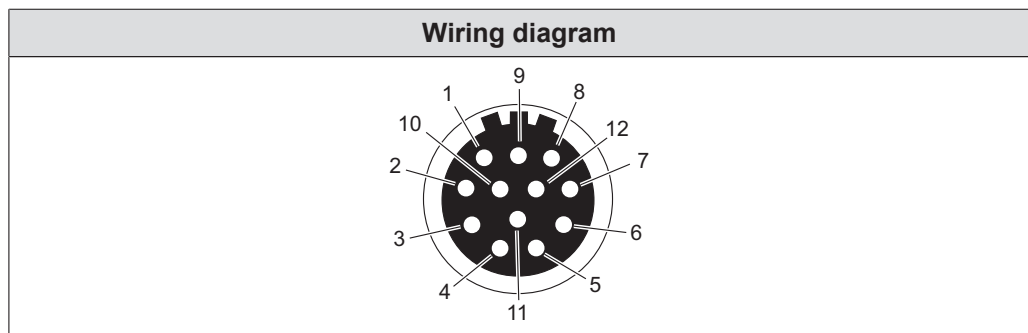

Assignment		
No.	Name	Function
Motion control inputs		
DIP switch S2/3 = OFF		
1	DI01	DI01 sensor input
2	DI02	DI02 sensor input
3	DI03	DI03 sensor input
4	DI04	DI04 sensor input
5	n.c.	Not connected
6	n.c.	Not connected
7	n.c.	Not connected
8	+24V_O	Reserved
9	0V24V_O	Reserved

Assignment		
No.	Name	Function
		Motion control inputs DIP switch S2/3 = OFF
10	0V24V_SEN	0V/24 reference potential for sensors Must be supplied via terminals
11	+24 V_SEN	DC 24 V sensor supply Must be supplied via terminals
12	FE	Equipotential bonding / functional earth



INFORMATION

- Use actuator/sensor distributors with 4 slots for the sensor inputs.
- Use the DC 24 V output only for local mode.
- Options GIO12A and GIO13A provide additional inputs/outputs.

10.11 Application Configurator part number

Projects	Axis driver	Part number
Application Configurator (Standard)	Decentrally calculated MultiMotion Light	18234887
Application Configurator (Technology)	Decentrally calculated MultiMotion	28206592
effiSRS		18230652
Kinematics		18242081
Winder		28210786

Index

A

Adding	
Axes	53
Adding axes	53
Appendix	
Error list	85
Application controller, configurable	39
Application module	
Area of application	37
Application modules	
Bus positioning	26
Functional description	21
Process data assignment	19
Rapid/creep speed	24
Transparent	21
Universal module	28
Velocity control	22, 43
Application program, display version	59
Area of application	36
Energy recovery	32
Transparent	21
Velocity control	22
Axis section	52

B

Bus system	13
------------------	----

C

CCU	39
Communication interfaces	16
Compatibility	30
Configurable controllers	
Performance class CCU advanced	14
Performance class CCU standard	14
Configuration	
Create new	52
Document	59
Loading from controller	61
Loading from the computer	61
Saving on the computer	60
Saving on the controller	60
Settings	51
Single axes	53
User interface	52

Configuration requirements	39
Control	39
Control mode	64
Controller, types	14
Copyright notice	10
Creating a project	49

D

Danger	
Change to control mode	65
DH.21B/41B Controller	
Configurable application controller (CCU)	39
DHF21B/41B	109
DHR21B/41B	107
Diagnostic procedure	
Application Configurator	62
Diagnostics	
Application modules	62
Data structure	78
Display errors/warnings/statuses	80
Initial screen	62
Letting the drive turn	69
Module diagnostics	66
Monitor and control mode	64
Trace recording	75
User interface	78
DIP switch	106
S12	131
S3	132
Display	
Communication status	50, 62
Device status	62
Version information	50
Version information, application program	59
Display unit status	62
Display version information, application program	59
Documentation	
Other applicable documentation	10
Download	59
Downloading the configuration to the controller	59, 60

E

Embedded safety notes	9
-----------------------------	---

Engineering software		MOVIGEAR® B / DRCSBus.....	134
MOVITOOLS® MotionStudio	49	MOVITOOLS® MotionStudio.....	49
Requirement.....	39	MOVITRAC® B.....	120
Start application configurator.....	49	MOVITRAC® LTX/LTP-B	123
Error codes		N	
Application.....	82	Network scan.....	49
Controller.....	86	Notes	
Error list	85	Designation in the documentation	8
Exclusion of liability	9	Meaning of the hazard symbols	8
F		O	
Field of application	30	Open settings	50
Functional description	14	Operating principle	17
Application modules	21	Operation.....	62
H		P	
Hazard symbols		Parameter channel	19
Meaning.....	8	Part number.....	147
I		PD monitor	72
I/O application module		Opening.....	72
Area of application.....	33	Operating.....	74
Profiles	33	Performance class CCU advanced	14
I/O logic application module		Performance class CCU standard.....	14
Area of application.....	33	Process data	
Profile	33	Assignment.....	19
I/O positioning application module		Communication	19
Area of application.....	33	Energy recovery	32
Profiles	33	Layout.....	52
Input terminal assignment	47	Parameter channel	19
Input terminal, device-dependent assignment.....	47	Transparent.....	22
L		Universal Module Technology 10 PD	30
Liability	9	Utilization.....	52
Liability for defects.....	9	Velocity control	24
M		Winder	36
Module diagnostics		Process data assignment	
Controller.....	71	Controller.....	40
Start.....	66	Velocity control	43
User interface	67, 71	Product names	10
Velocity control	66	Profile, application module	19
Monitor mode	64	Profiles	
MOVIAXIS®.....	116	Bus positioning	26
MOVIDRIVE® B	112	Energy recovery	32
MOVIFIT® FDC-SNI.....	126	HandlingKinematics.....	37
MOVIGEAR® B / DRC SNI	142	Rapid/creep speed positioning	25
		Transparent.....	21

Universal module.....	28	Tension determining winder	36
Velocity control	22	Start	
Program identification.....	20	Application Configurator	50
Project planning information		Configuration	52
Control mode.....	31	Diagnostics.....	62
Project planning notes		Module diagnostics.....	66
Controller	30	MOVITOOLS® MotionStudio	49
Inverter	30	Startup	
Purpose	14	Procedure.....	48
R		Requirements	48
Requirements		Startup requirements.....	000
Configuration.....	39	Status codes, controller.....	86
Startup.....	48	System components	16
Return codes for parameterization		System description	14
Additional code.....	99	System structure	16
Error class	98	T	
Error code.....	98	Target group	12
S		Technology level, requirements	39
Safety notes	12	Terminal assignment.....	106
Designation in the documentation	8	Topology.....	14
General.....	12	Trace recording	75
Meaning of the hazard symbols	8	Trademarks	10
Structure of embedded.....	9	Transparent	42
Structure of the section-related	8	Troubleshooting, trace.....	75
Saving the configuration on the computer	60	U	
Scaling of the parameters	96	Unintended start-up of the machine	65
Scanning the units, network scan.....	49	Unit combination	
SD card		Application modules for SNI I/O systems	34
Loading the configuration	61	Bus positioning	26
Saving the configuration.....	60	Energy recovery	32
Section-related safety notes.....	8	Energy-efficient SRS.....	35
Setting the inverter parameters		HandlingKinematics.....	38
Return code.....	98	Rapid/creep speed positioning.....	25
Structure of the MOVILINK® parameter channel .	90	Transparent.....	21
Settings	51	Universal module.....	29
Signal words in the safety notes.....	8	Velocity control	22
Software		Winder	36
Advantages	14, 15	Uploading the configuration from the controller...	61
Description	14	Use, designated	13
Requirements	39	User interface	
Software characteristics	14	Configuration	52
Standard procedure		Diagnostics.....	78
Speed determining winder.....	36	Download	59
		Module diagnostics.....	67, 71

Trace	75	Profiles	43
V		W	
<hr/>		<hr/>	
Velocity control		Warning codes	
Areas of application	22	Controller	86
Module diagnostics	66	Wiring diagrams	106
Process data assignment	43		

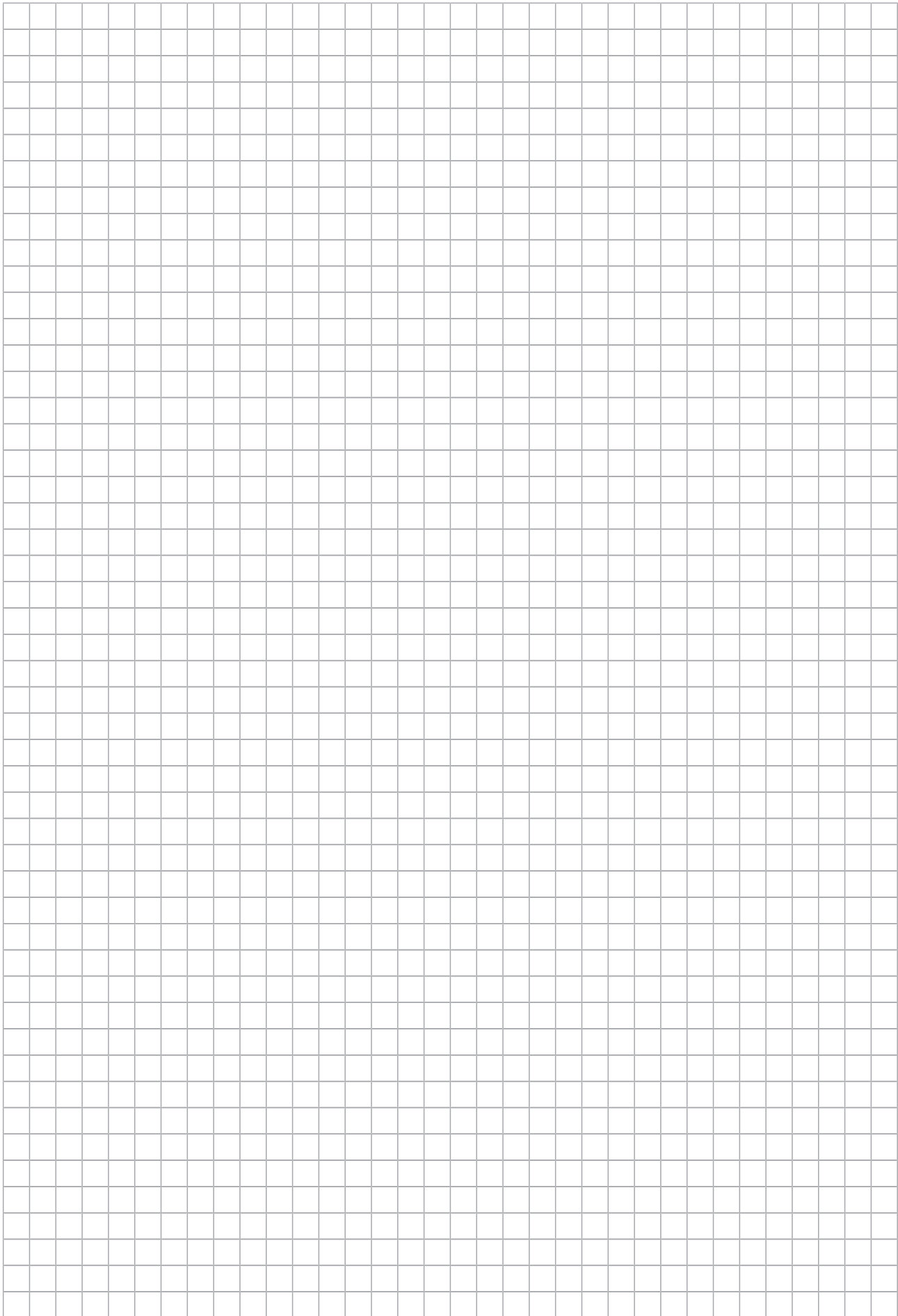

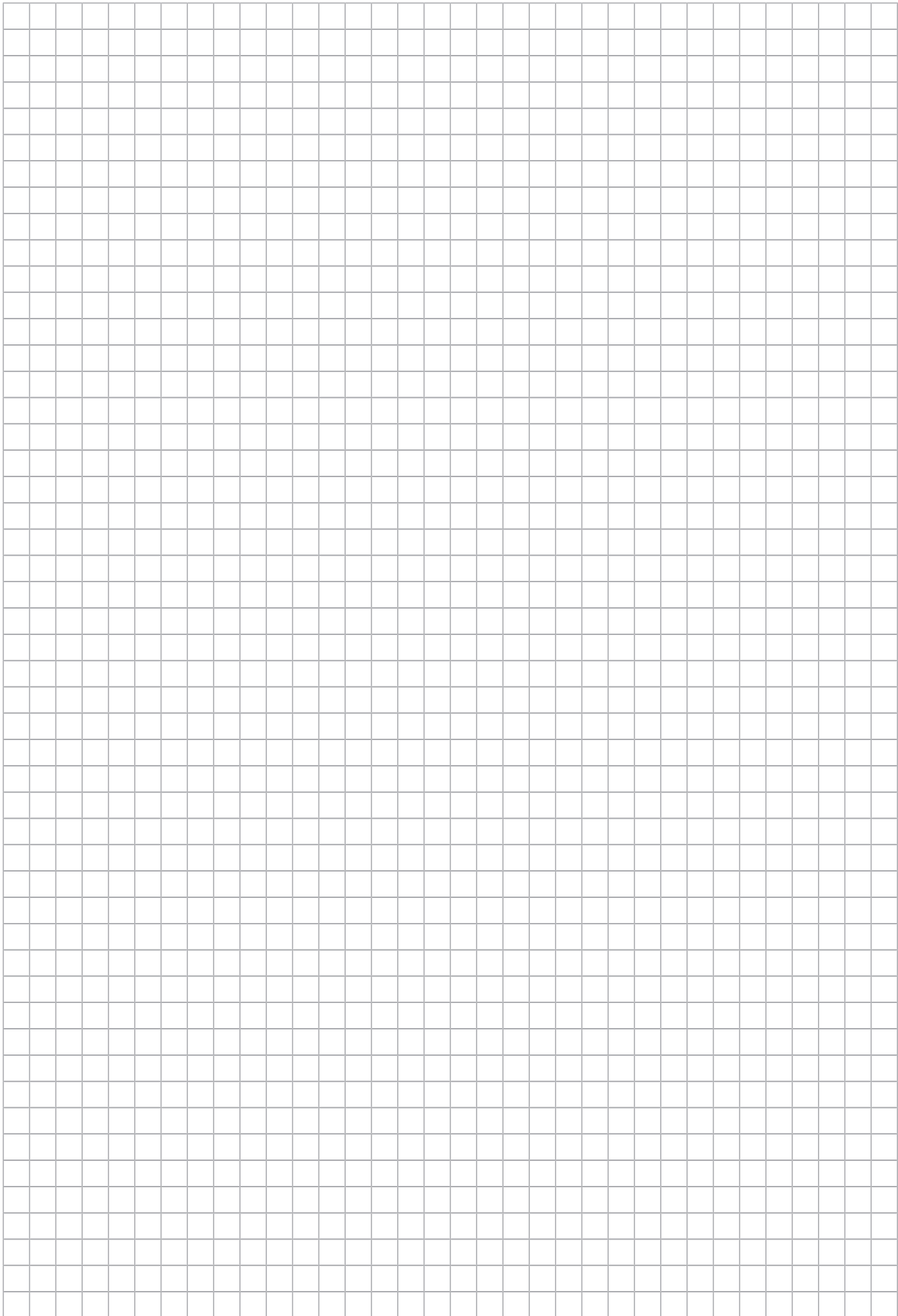

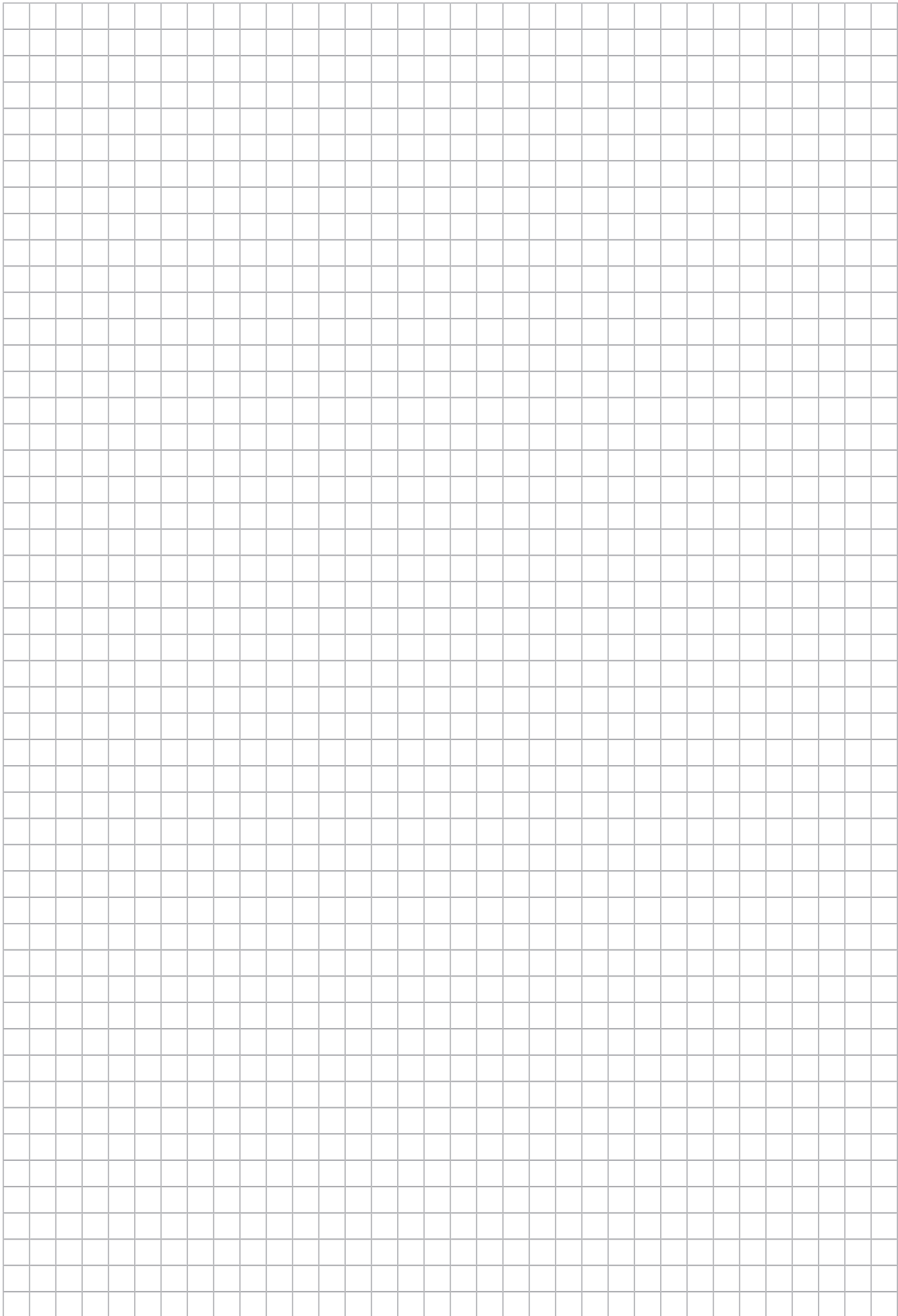

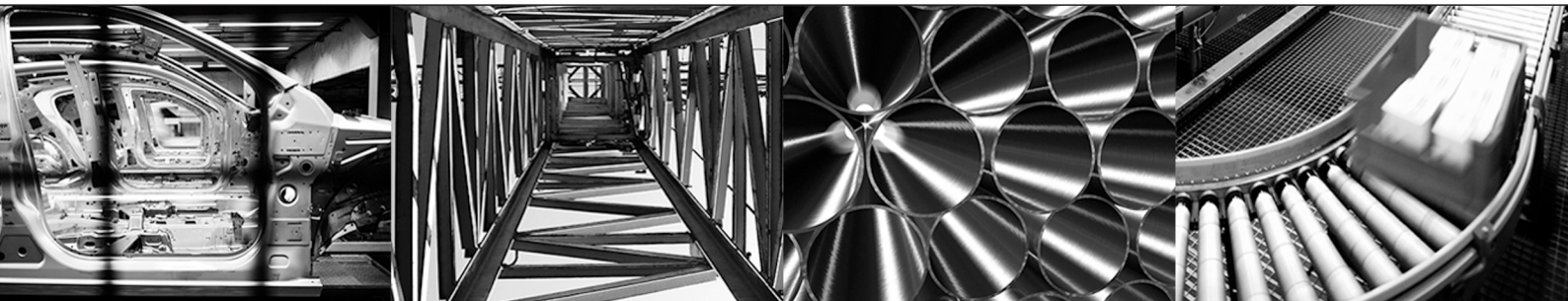

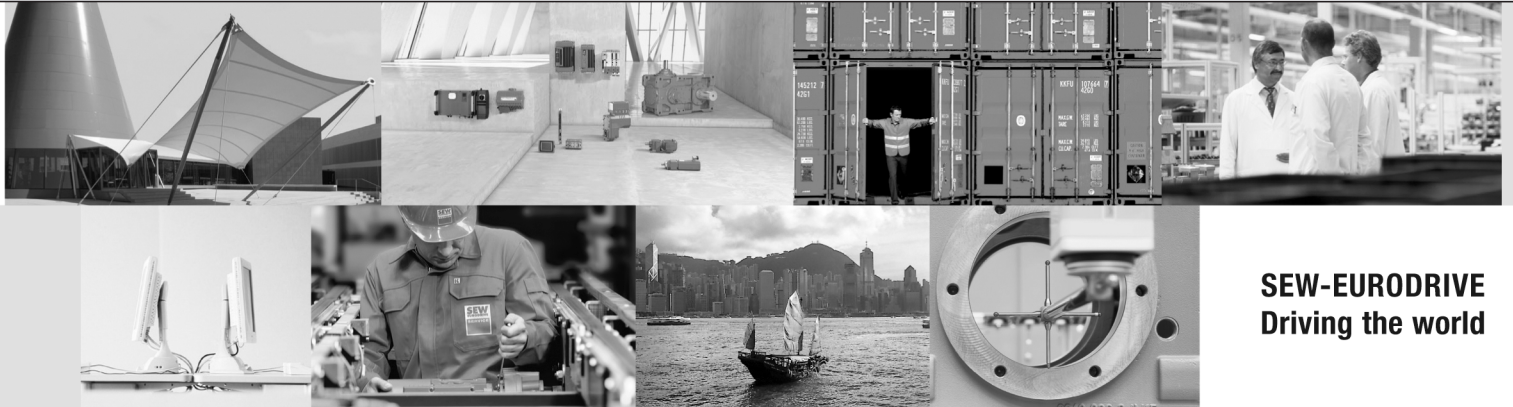

SEW-EURODRIVE
Driving the world

SEW
EURODRIVE

SEW-EURODRIVE GmbH & Co KG
P.O. Box 3023
76642 BRUCHSAL
GERMANY
Phone +49 7251 75-0
Fax +49 7251 75-1970
sew@sew-eurodrive.com
→ www.sew-eurodrive.com