



Weather Monitoring Instruments & Systems

2013 Catalog



www.novalynx.com

Applications	3	200-85000 Ultrasonic Anemometer	54
System Design	4	200-7000 WindSonic Ultrasonic Anemometer	55
Site Considerations	5	200-1390 WindObserver II Ultrasonic Anemometer	56
Typical System Drawings	6	200-101908 Current Loop Wind Sensors	57
Typical System Drawings	7	200-102083 Wind Mark III Wind Sensors	58
Typical System Drawings	8	200-2020 Micro Response Wind Sensors	59
Weather Stations	9	200-2030 Micro Response Wind Sensors	60
110-WS-16 Modular Weather Station	10	200-WS-21-A Dual Set Point Wind Alarm	61
110-WS-16 Modular Weather Station	11	200-WS-23 Current Loop Wind Sensor	62
110-WS-18 Portable Weather Station	12	200-455 Totalizing Anemometer with 10-Min Timer	63
110-WS-18 Portable Weather Station	13	200-WS-25 Wind Logger with Real-Time Display	64
110-WS-16SML Display Software	14	200-2520 Wind Meter	65
110-WS-16STR Graphical Display Software	15	200-2530 Wind Speed Indicator	65
110-WS-16SMM Met Manager Software	16	200-960 Handheld Anemometer	66
Davis Vantage Pro2 Weather Station	17	Kestrel 1000 Pocket Wind Meter	67
Kestrel 3000 & 4000 Pocket Weather Meters	18	La Crosse EA-3010U Anemometer	67
Data Acquisition	19	Calibration Accessories	68
195-WS-16 Data Logger	20	Calibration Accessories	69
195-WS-16 Data Logger	21	Wind Direction Calibrators	70
195-WS-16AD Automatic Voice Dialers	22	Wind Speed Calibrators	70
140-400 Spread Spectrum Radio	23	200-2620 Wind Sock	71
195-26800 Meteorological Display	24	200-2510-A 260-2511-A Totalizing Anemometer	72
Signal Conditioning	25	Temperature & Humidity	73
130-200 Series Signal Conditioners	26	225-5020-A Hygrothermograph	74
135-100 Series Signal Conditioning Translator Boards	27	220-730 Dial Hygrometer	75
135-104 General Purpose Translator Board	28	225-930 Dial ThermoHygrometer	75
Group 395 Enclosures	29	210-4410 Standard Thermometer	76
Analog Look-up Table	30	210-4420 Min-Max Thermometer Set	76
Analog & Digital Displays	31	225-520 Pocket Sling Psychrometer	77
Analog Displays	32	225-570 Sling Psychrometer	77
Digital Displays	32	225-564 Fan Psychrometer	78
Upper Air	33	225-566 Battery Psychrometer	78
Meteorological Balloons	34	225-5230 Assmann Psychrometer	79
Meteorological Balloons	35	225-569 Pocket Psychrometric Slide Rule	80
400-2090 Sight Clinometer	36	225-HMP60 Humidity/Temp	81
400-2095 Ceiling Light Projector	36	225-HMP155 Humidity/Temp	81
Visibility	37	210-4470 & 210-4480 Temperature Sensors	82
400-SVS1 Sentry Visibility Sensor	38	210-201, 210-301, & 201-600 Temperature Sensors	83
400-6000 Visibility Sensor	39	210-TP1 Temperature Sensor	84
400-CBME40/80 Cloud Ceilometer	40	210-WE700 Temperature Sensor	85
Lightning Detection	41	225-THT-1 Temperature & Humidity Sensor	86
410-SKYSCAN Hand-Held Lightning Detector	42	210-41342 Temp & 225-41382 T/RH	87
Wind	43	225-42603 Temp Tracker	87
WeatherPort General Purpose Wind Sensors	44	210-5320 Series Dew Cell	88
WeatherPort High Sensitivity Wind Sensors	45	Fuel Moisture Sticks & Scale	89
NovaVane Wind Speed & Direction Sensors	46	250-124 Soil Moisture Sensor	89
200-2218 Analog Indication Wind System	47	210-421-A General Purpose Temperature Alarm	90
200-05103 Wind Monitor	48	210-EC Series Frost Alarms	91
200-05305 Wind Monitor - Air Quality	49	225-HM34 Relative Humidity & Temperature Indicator	92
200-27005 Gill UVW Anemometer	50	225-RH520A RH/Temp Digital Chart Recorder	93
200-06201 Wind Tracker Display	51	225-445703 Big Digit Hygro-Thermometer	94
200-03002 Wind Sentry	52	380-280 Radiation Shield	95
200-81000 Ultrasonic Anemometer	53	380-281 Radiation Shield	95

380-41003 Radiation Shield	96	260-2597 Pocket Counter	142
380-43408 Radiation Shield	97	Evaporation	143
380-43502 Radiation Shield	97	Group 255 Evaporation Stations	144
380-600 Thermometer Shelter	98	Group 255 Evaporation Stations	145
380-601 Small Instrument Shelter	98	255-212 Min-Max Thermometer	146
380-605 Large Instrument Shelter	99	255-200 Evaporation Pan	146
220-HMK15 Humidity Calibrator	100	255-100 Analog Output Evaporation Gauge	147
220-HMK41 Calibration Kit	100	255-110 Evaporation Gauge Tester	147
Barometric Pressure	101	255-620-A Automatic Refill System	148
230-P111 Dial Barometer	102	255-704-B Evaporation Logger	149
230-600 Series Barometric Pressure Sensors	103	255-250 Evaporation Pan Platform	150
230-PTB110 Series Analog Barometers	104	Water Level & Flow	151
230-278 Barometric Pressure Transducer	105	280-FP Flow Probes	152
230-276 Barometric Pressure Sensor	106	280-330 Submersible Pressure Transducer	153
110-WS-16BP Barometric Pressure Sensor	107	280-IRU-9400 Ultrasonic Sensor	154
230-WE100 Barometric Pressure Sensor	108	Water Quality	155
230-M202 Handheld Barometer-Altimeter	109	270-WQ Water Quality Sensors	156
230-044 Handheld Barometer-Altimeter-Compass	110	270-WQ Water Quality Sensors	157
Solar Radiation	111	Towers & Lightning Protection	159
240-8101 Star Pyranometer	112	Tripod Towers	160
240-152 Shadow Band	113	Aluminum Towers	160
240-200SZ Silicon Pyranometer	114	Mounting Hardware & Accessories	161
240-120 SP-Lite Silicon Pyranometer	115	Tower Lightning Protection	162
240-140 & 240-150 Silicon Cell Pyranometer	116	Sensor Line Lightning Protection	162
240-6450 Solar Radiation Sensor	117	Power Supplies	163
240-CMP3 Pyranometer	118	310-120 Series Rechargeable Batteries	164
240-8104 Albedometer	119	Group 310 AC Power Supplies	165
240-8111 Pyrradiometer	120	Group 320 Solar Panel Battery Chargers	166
240-8110 Net Radiometer	121	Pens, Ink, Clocks, & Charts	167
240-100 Net Radiometer	122	Pens and Ink	168
240-110 NR-Lite Net Radiometer	123	Replacement Clocks	169
240-CUV4 Broadband UV Radiometer	124	Chart Paper	170
240-1070 Sunshine Recorder	125	Chart Paper	171
240-CSD3 Sunshine Duration Sensor	126	Chart Paper Examples	172
Precipitation	127	Reference	173
260-2500 Tipping Bucket Rain Gauges	128	Conversion Factors	174
260-2501-A Tipping Bucket Rain Gauge	129	Wind Conversion Table	175
260-2505 Tipping Bucket Rain Gauge	130	Temperature Conversion Table	176
260-52202 Tipping Bucket Rain Gauge	131	Relative Humidity Table	177
260-7852 Rain Collector	132	Pressure Conversion Table	178
260-2530 Fence Post Rain Gauge	133	Glossary of Meteorological Terms	179
260-2531 Plastic Rain Gauge	133	Index	210
260-2510 NWS Type Rain Gauge	134	Ordering Information	220
260-2520 Forestry Rain Gauge	135		
260-700 Ultrasonic Snow Depth Sensor	136		
260-2590 Precipitation Detector	137		
260-2591 Leaf Wetness Sensor	137		
260-2101 Rain Logger	138		
260-2103 Rain Logger	139		
260-952 Rain Gauge Wind Screen	140		
260-950 Mounting Plate	140		
260-2595 Rain Gauge Calibrator	141		
260-2696 Digital Event Counter	142		

Applications

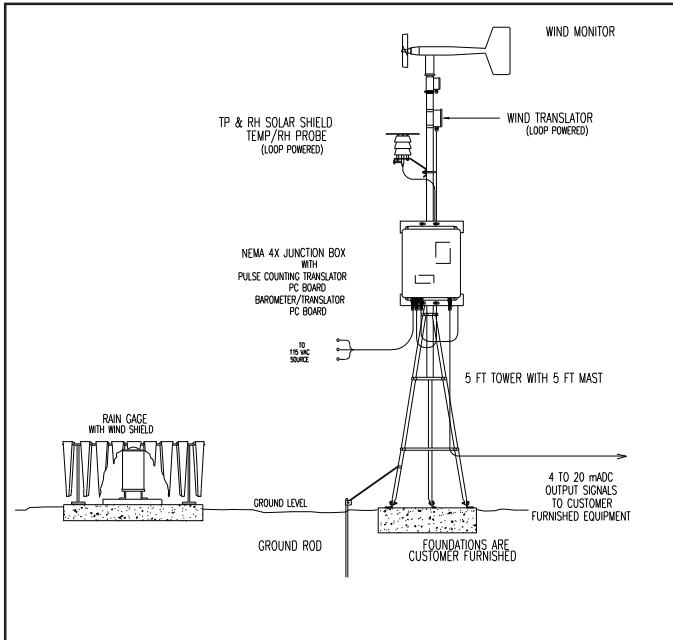

Tripod Tower Weather Station with 4-20 mA Outputs

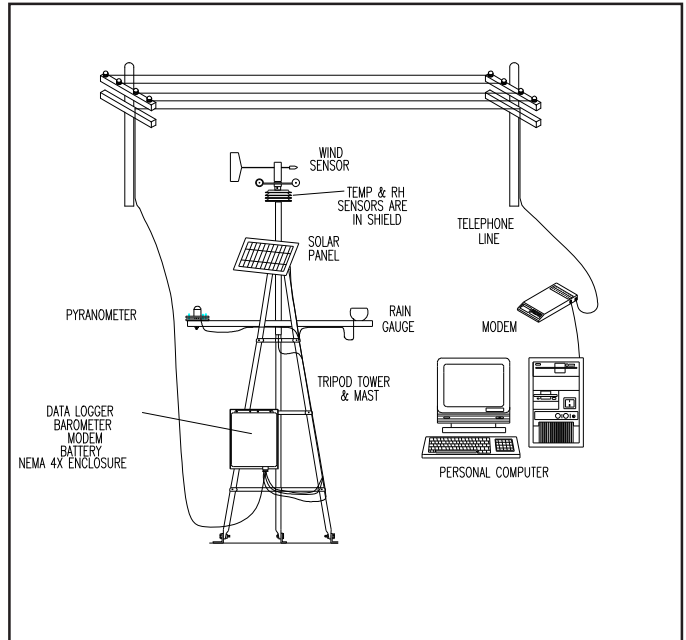

Remote Weather Station with Telephone Communications

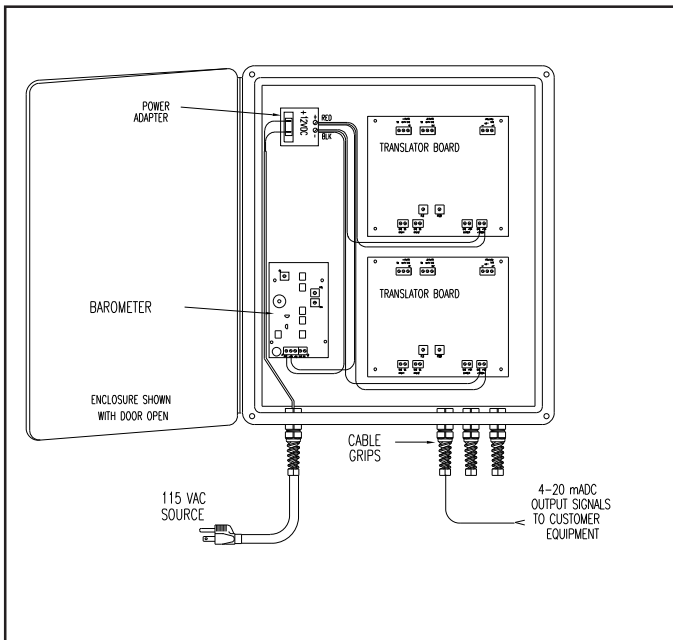

NEMA-4X Enclosure with Two Translator Boards and Analog Barometer

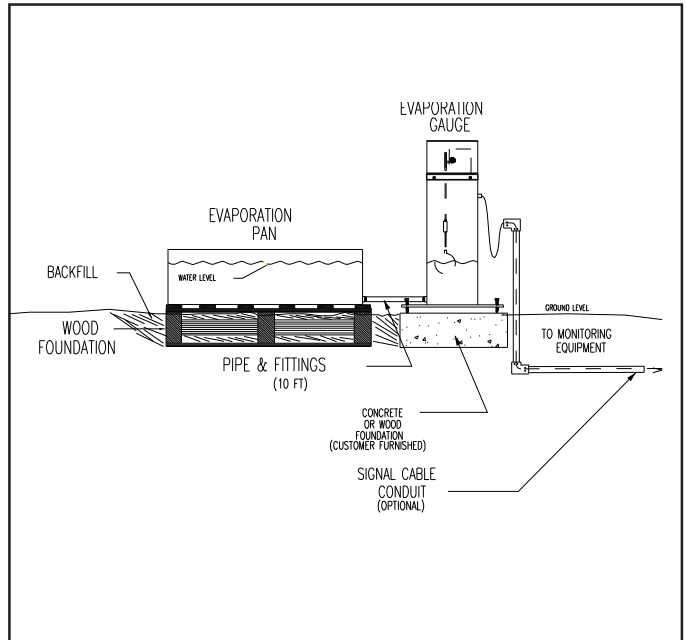

Typical Analog Output Evaporation Station

System Design

NovaLynx is an industry leader in the design, fabrication, and integration of meteorological systems. Using the best possible combination of sensors, signal conditioning, and data acquisition technologies, NovaLynx can customize and fit any combination of meteorological sensors and signal processing equipment to customer applications.

Sensors with signal translators provide a variety of systems supporting analog signal displays, digital panel meter displays, and strip chart recordings. NovaLynx also provides several data logger based systems for digital signal acquisition, display, and storage, with additional data processing using personal computers. Telemetry systems for either analog or digital data allow transmission of data to locations at some distance from the sensors.

In addition to the standard array of meteorological sensors, signal conditioners, data loggers, and recorders, NovaLynx provides towers, sensor masts and mast adapters, cables, solar radiation shields with or without fans, and installation assistance.

Special system hardware not shown in this catalog can be provided. NovaLynx can design and manufacture custom mounting hardware such as sensor mounting fixtures, enclosures, and panels, as well as configure standard products to meet unique requirements. Additional information is provided in the catalog sections covering specific system components. Custom system quotations with descriptive literature are available upon request.

Regulation Conforming Systems: NovaLynx can configure custom systems to meet strict governmental regulations. Government agencies such as the U.S. Environmental Protection Agency (EPA) and Department of Energy (DOE) require certain manufacturers and industries to monitor pollution generating processes by using meteorological monitoring equipment to track pollution dispersion. These special systems require specific meteorological instrumentation, installed with specific hardware at exact elevations and in some cases at more than one location. The sensors and signal conditioning equipment provided by NovaLynx allows easy configuration in order to meet the rigid requirements involved in these strict applications.



Tower-Mounted Meteorological Monitoring System

Site Considerations

Selecting the proper site for weather station sensors is just as important as selecting the proper sensor for a particular application. Siting standards should be given first consideration in sensor placement, however, unusual requirements may call for special siting techniques. The discussion below refers to installations in the northern hemisphere.

Wind Speed and Direction

The quality of wind sensors can be diminished by poor exposure to local topography. Placement of the wind sensors should follow standards established by agencies such as the World Meteorological Organization (WMO) and the United States National Weather Service (NWS).

The standard exposure of wind instruments over level, open terrain is 33' (10 meters) above the ground (WMO 1971). Open terrain means the distance between the wind sensors and the nearest obstruction is at least ten times the height of that obstruction.

For roof-mounted sensors, the exposure should be at a height that is at least 1.5 times the height of the building. For extremely tall buildings this rule can be difficult to follow. For tall buildings, the sensors should be at least 33' (10 meters) above the roof or above the tallest obstruction on the roof. Whenever possible the sensors should be placed on the upwind side of the building. Ventilation and exhaust vents must be avoided.

For ground-mounted sensors near a building, the upwind side of the building is preferred, with the sensors located at a distance that is at least one times the height of the building. The downwind side of the building requires that the sensors be located at a distance of five to ten times the height of the building. When wind sensors are located too close to a building "wind-milling" of the direction vane will occur and the speed sensor will measure artificial gustiness. The sensors are actually monitoring the wind turbulence created by the building.

While the WMO standard for siting wind sensors at ten meters above ground level provides ambient wind monitoring, in micrometeorology wind sensors are often placed closer to the ground. This allows for wind monitoring in the environment of interest. Multiple levels of sensors may be used to provide more detailed wind information.

Preliminary studies of the sensor location should be performed using flags, smoke, or by temporary installation of the sensors.

If wind sensors must be located amid vegetation, pick a spot that is about equidistant from the tallest trees or shrubs. A clearing with a diameter at least ten times the height of the tallest tree or shrub would be ideal. Even with the best possible location amid vegetation, it is sometimes necessary to add some height to the sensor mast in order to get better exposure.

Relative Humidity, Air Temperature, and Dew Point Temperature

These sensors should be installed in a properly ventilated solar radiation shield for accurate ambient measurements. Cotton region type instrument shelters provide the standard aspiration and solar protection for these sensors. Mast-mounted self aspirated and motor aspirated shields may provide adequate exposure as well, depending on the application. Mast-mounted sensors are usually positioned at "shelter" height, or about four feet above ground level, on the north side of the mast.

Solar Radiation

Solar radiation sensors may be mast or pole mounted. They should always be located in an open area, in full view of the sun at all times. When mast mounting or placing in an area where nearby obstructions are present, locate the sensor to the south of all obstacles. This will prevent shadows created by the nearby obstacles from passing over the sensor. These sensors are usually mounted approximately two meters above ground level.

Precipitation

Whether heated or unheated, rain and snow sensors should always be located in a relatively flat, open area. Some obstructions can be helpful to block the wind for more accurate catch. However, leaves from trees can cause increased gauge maintenance. If natural wind breaks are not available, a wind screen accessory is recommended.

Typical System Drawings

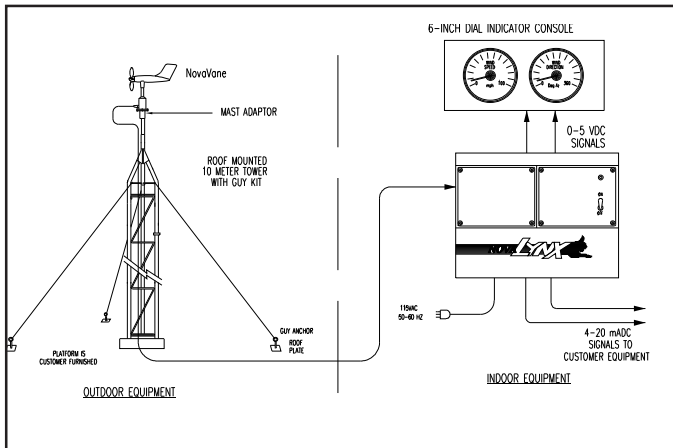

Indicating Wind Station

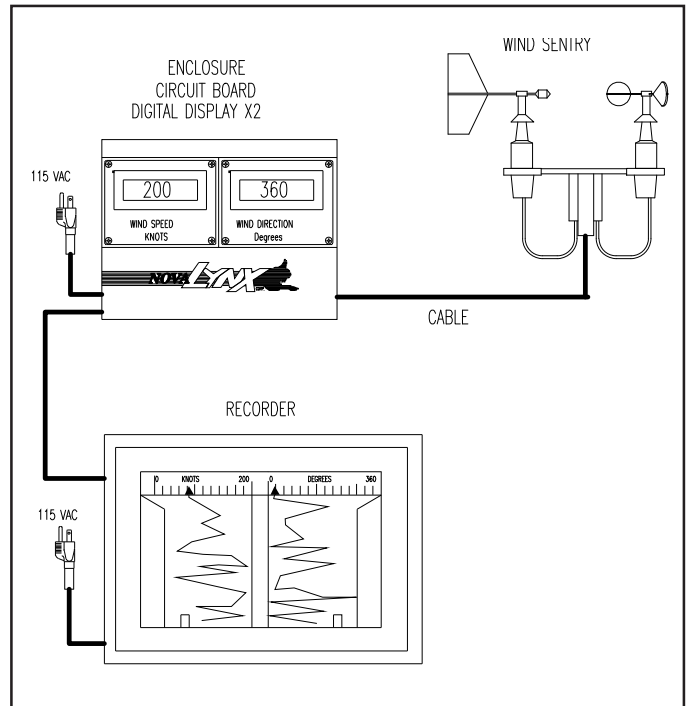

Recording and Indicating Wind Station

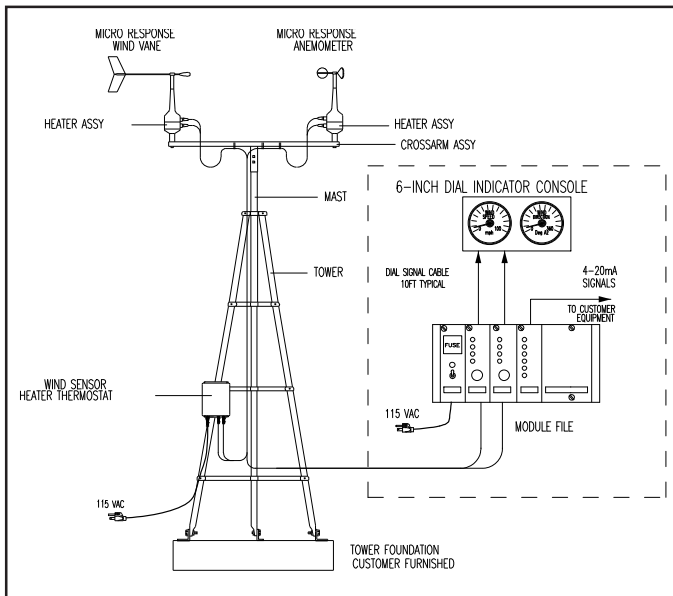

Indicating Wind Station with 4-20 mA Outputs

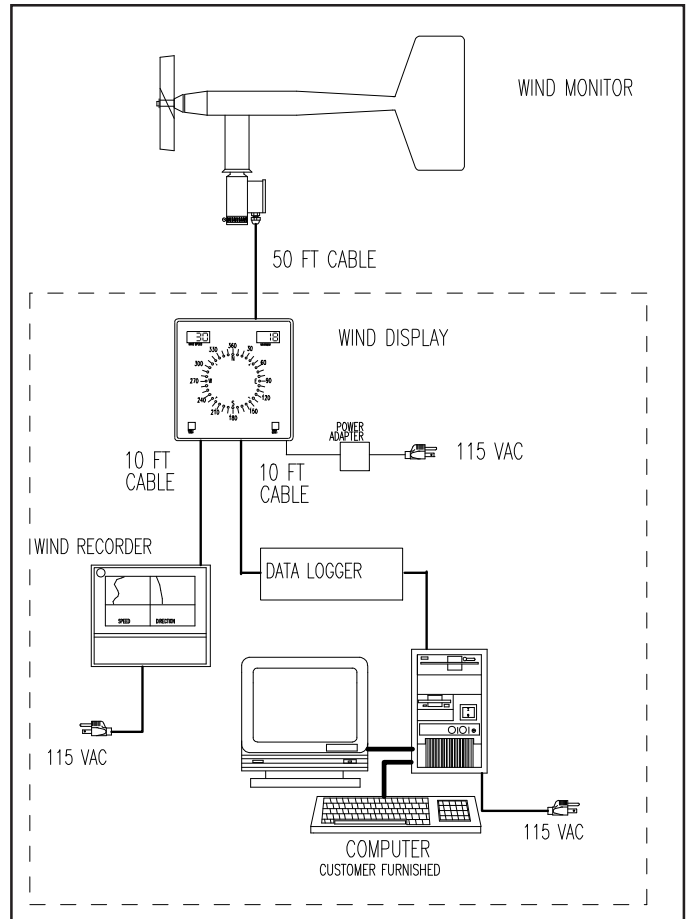

Recording, Indicating, and Logging Wind Station

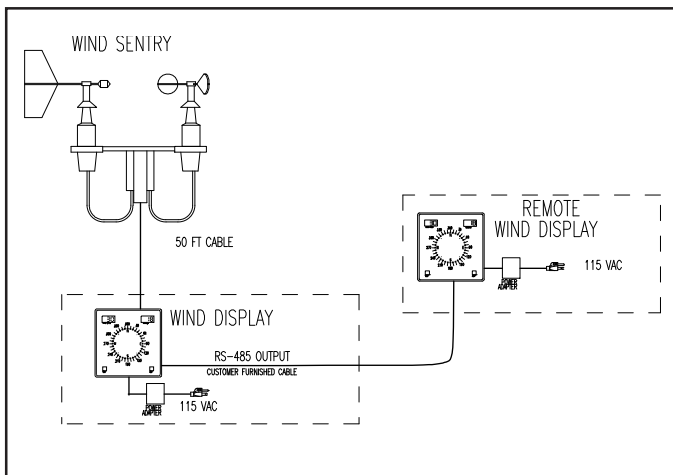

Wind Station with Wind Tracker Displays

Typical System Drawings

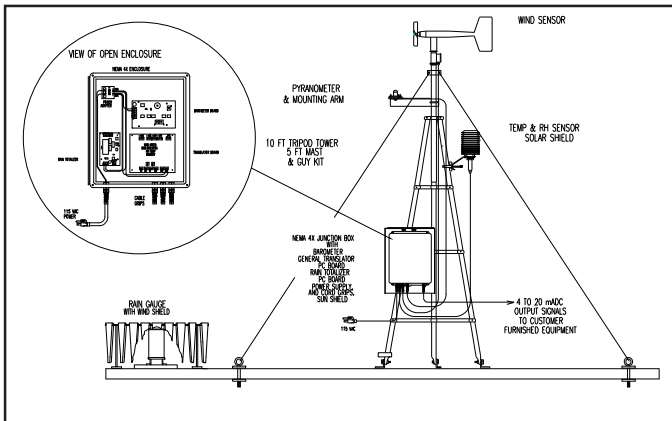

Roof Mounted Weather Station

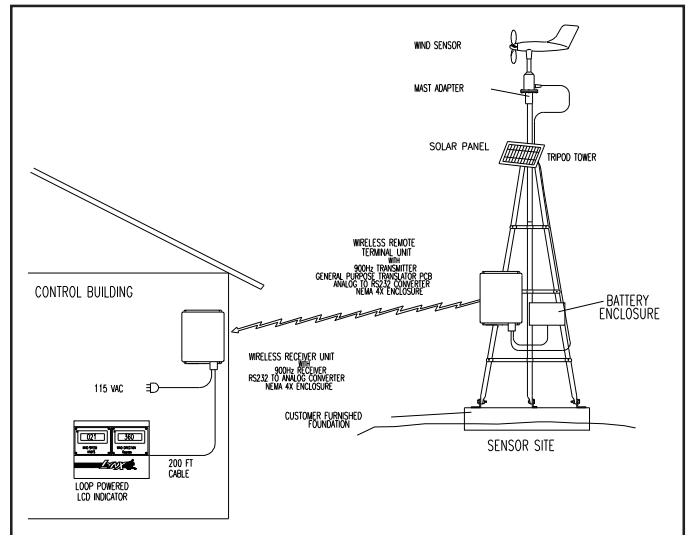

Indicating Wind Station with Wireless Data Transmission System

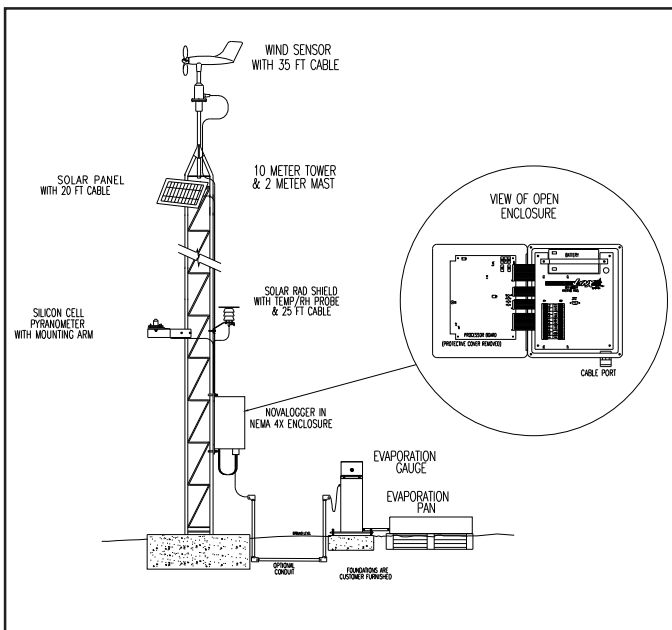

Ten Meter Tower Weather Station

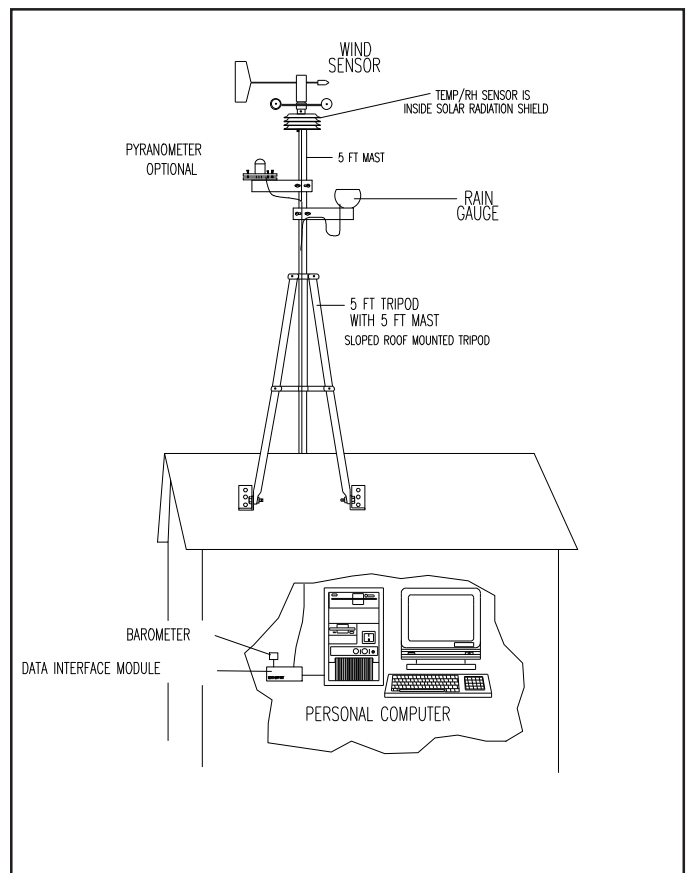

PC-Based Weather Station

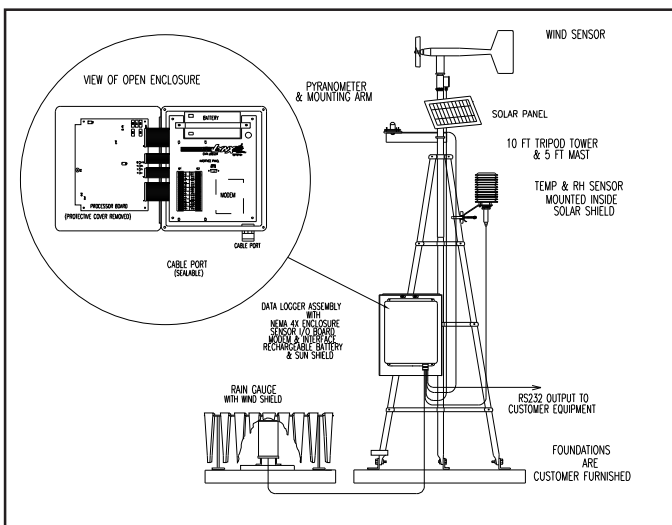

Data Logger Weather Station

Typical System Drawings

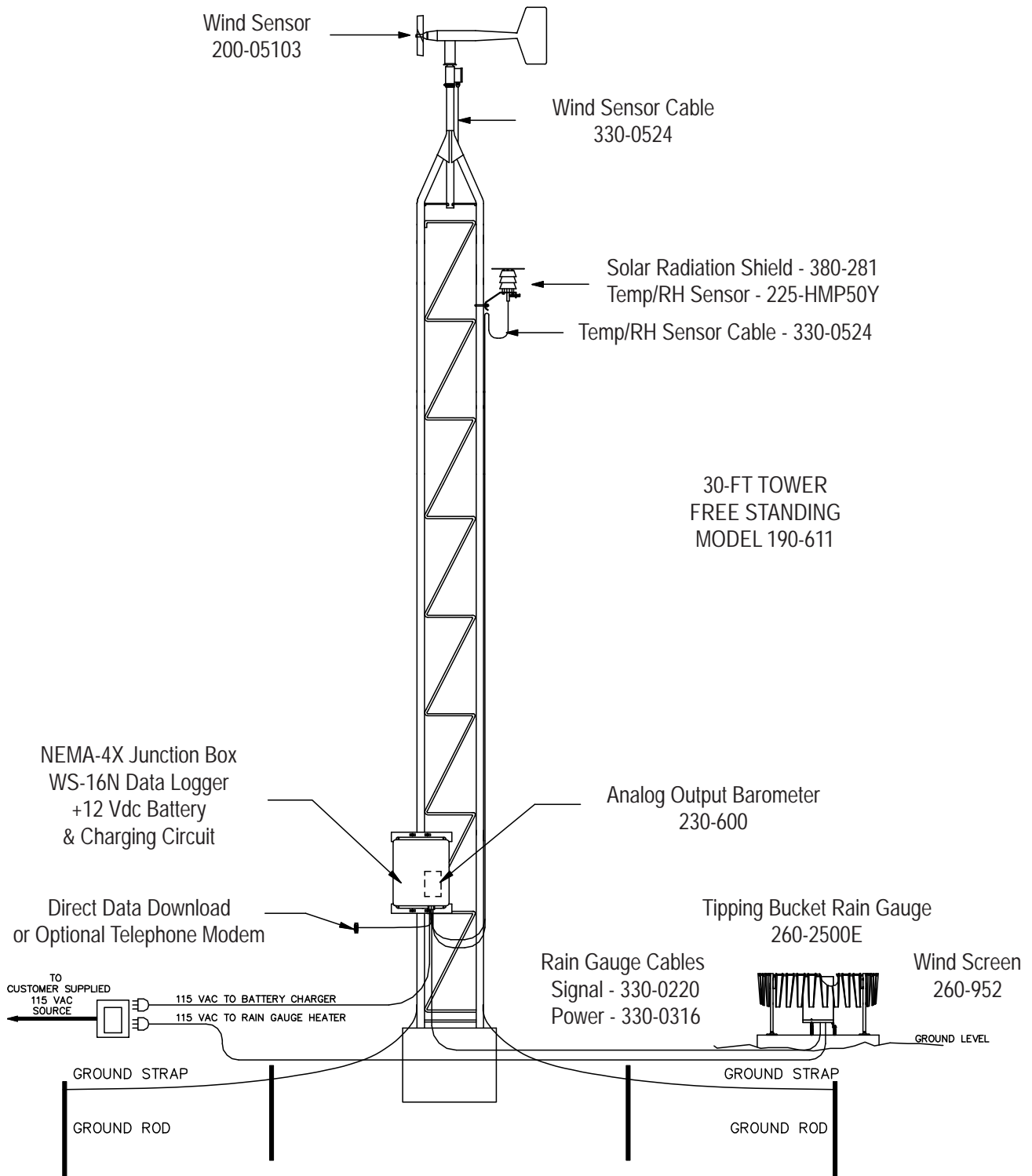

Weather Stations

110-WS-16 Modular Weather Station	10
110-WS-16 Modular Weather Station	11
110-WS-18 Portable Weather Station	12
110-WS-18 Portable Weather Station	13
110-WS-16SML Display Software	14
110-WS-16STR Graphical Display Software	15
110-WS-16SMM Met Manager Software	16
Davis Vantage Pro2 Weather Station	17
Kestrel 3000 & 4000 Pocket Weather Meters	18

110-WS-16 Modular Weather Station

The **Model 110-WS-16 Modular Weather Station** is a computer-based meteorological system designed as a “user friendly” solution for data storage and real-time monitoring of weather conditions. The standard package includes:

- Wind Speed
- Wind Direction
- Air Temperature
- Relative Humidity
- Barometric Pressure
- Precipitation
- Data Logger
- Tripod & Mast
- Radiation Shield for temp/humidity
- Cables & Mounts
- Set-Up Disk

Additional sensor options include solar radiation, water or soil temperature, auxiliary air temperature, rain gauge upgrade, wind sensor upgrade, evaporation, soil moisture, water level, gas detection, and others.

The unique modular system design provides simple menu selections for adding or replacing sensors. The 110-WS-16D Data Acquisition Module features nonvolatile memory, selectable averaging intervals, 12 bit analog conversion, 0.1% F.S. accuracy, two alarm outputs, and optional modem communications.

The WS-16 is supplied with an attractive desktop data acquisition module with a memory capacity of 128KB RAM (approximately 45 days at 15 minute intervals with 6 sensors). The standard system includes a 120Vac power adaptor and RS232 serial port for connection to a personal computer. For outdoor or remote applications, two enclosure options are available. One is for sites with AC power and the other utilizes a solar panel. Both options include a NEMA-4X enclosure and rechargeable battery to allow continued operation in the event of power failure.

Data can be viewed using Windows HyperTerminal or other terminal programs such as Procomm. A one page real-time text display, an ASCII row and column format, or ALOHA format may be selected. A menu is provided for setting the date and time, alarms, logging interval, etc. Optional graphical display software is available for viewing real-time and historical data charts and graphs.



110-WS-16 Modular Weather Station with optional NEMA-4X enclosure & solar panel



110-WS-16SMM Met Manager Software

110-WS-16 Modular Weather Station

Specifications

Data Acquisition Module

Reporting units: Selectable, °F, °C, mph, knots, m/s, km/hr
 Operating power: 10-16 Vdc
 Power consumption: 60 mA maximum, w/o power saver enabled
 < 5 mA, with power saver enabled
 Serial port: 9-pin d-sub connector, selectable baud rate, flow control
 Memory: 128KB RAM, nonvolatile (45 days at 15 minute intervals with 6 sensors). Expandable to 640KB.

Operating Temperature

Transducers: -40° to 140° F (-40° to 60° C)
 Data acquisition module: -40° to 140° F (-40° to 60° C)

Timekeeping

Format: MM/DD and HH:MM
 Accuracy: ± 30 seconds/month

Barometric Pressure

Range: 28.25 to 30.75 inHg (965 to 1041 mb)
 Measurement span: 2.50 inHg (85 mb)
 Resolution: ± 0.01 inHg or ± 0.3 mb
 Altitude offset: 0 to +10,000 feet, screwdriver adjustable
 Absolute Accuracy: 0.05 inHg

Wind Speed

Range: 0 to 125 mph (0-57 m/s)
 Resolution: > 0.1 mph
 Accuracy: ± 1 mph
 Starting threshold: 0.8 mph
 Time constant: 2 seconds

Temperature

Range: -40° to +140° F
 Resolution: > 0.1° F
 Accuracy: ± 1° F

Relative Humidity

Range: 0-100% RH
 Accuracy: ± 3% (10-90%)

Wind Direction

Range: 0-360°
 Resolution: > 1°
 Accuracy: ± 3°
 Starting threshold:
 200-WS-02E: 1.2 mph
 200-WS-05E: 0.5 mph

Rain Gauge

Resolution: 0.01"/tip
 Accuracy: ± 4% up to 3"/hour
 Max rate: Unlimited

Solar Radiation (optional)

Sensor: Silicon pyranometer
 Spectral range: 0.4 to 1.1 microns
 Sensitivity: 80mV / 1000w/m² approx
 Accuracy: ± 5%

Wireless radio communication packages are available for use with the WS-16. See the Model 140-400 Spread Spectrum Radio or call us for more information.

Ordering Information

110-WS-16

110-WS-16D

200-WS-02E

110-WS-16TH-B

110-WS-16THS

110-WS-16BP

110-WS-16RC

110-WS-16TM

110-WS-16P

110-WS-16EPA

200-WS-05E

Options:

110-WS-16N-A

110-WS-16N-A33

110-WS-16N-B

110-WS-16CC

110-WS-16HHD

110-WS-16M6

110-WS-16M

110-WS-16M-DC

110-WS-16PE

110-WS-16PBU

110-WS-16SML

110-WS-16SMM

110-WS-16STR

110-WS-16STR-H

110-WS-16SR

110-WS-16SRD

110-WS-16T

110-WS-16TWS

110-WS-16USB

1205-05/xxx

330-0220

330-0424

330-0524

Modular Weather Station

includes the following components:

Data Acquisition Module in Desktop Enclosure, includes set-up disk and 6' serial cable
 Wind Speed/Direction Sensor, 40' cable
 Outdoor Temperature & Relative Humidity Sensor, 40' cable
 Radiation Shield for temp/rh sensor
 Barometric Pressure Sensor, 18" cable
 Rain Gauge, includes mounting arm and 40' cable
 5' Tripod & 5' Sensor Mast (8' total)
 Power Supply, for desktop enclosure, 120Vac

High Sensitivity Modular Weather Station

same as above but with:

High Sensitivity Wind Sensor, 40' cable

Data Acquisition Module in NEMA Enclosure includes 7AH battery, 20W solar panel, mast mounting hardware, 6' serial cable and set-up disk
 Same as above but 33AH battery, 20W solar panel
 Data Acquisition Module in NEMA Enclosure includes 7AH battery, 110-200Vac charger, mast mounting hardware, 6' serial cable and set-up disk
 Waterproof Carrying Case, 33" x 20" x 12"
 Does not hold tripod & mast.
 Hand Held PC for local display of real time data
 Memory Expansion to 640KB
 Telephone Modem
 Telephone Modem, 12 Vdc
 Power Supply, for desktop enclosure, 220Vac
 Battery Backup for WS-16D
 Display Software
 Met Manager Software
 Graphical Display Software
 HTML Option
 Solar Radiation Sensor, incl mtg arm and 40' cable
 Solar Radiation Sensor, incl mtg bkt and 40' cable
 Auxiliary Air Temperature Sensor, 40' cable
 Water or Soil Temperature Sensor, 40' cable
 USB to DB9 Serial Adapter
 Serial Cable, specify 25', 50', 100', or call for longer
 Additional Cable for rain, per foot
 Additional Cable for wind, per foot
 Additional Cable for temp/humidity, per foot



Windows HyperTerminal Display



110-WS-16SML Display Software



110-WS-16STR Graphical Display Software

110-WS-18 Portable Weather Station

The **Model 110-WS-18 Portable Weather Station** is designed for application in which weather data is required for a temporary period. The complete system is housed in a weatherproof case weighing approximately 20 pounds and can be deployed by one man in less than five minutes without the use of tools. Sensors are pre-wired for quick deployment and ease of installation. Just turn on the power switch and the unit is operating.

Applications include hazmat/emergency management situations, fire management, and temporary meteorological surveys. The system is compatible with NOAA designed CAMEO/ALOHA Plume Modeling Software.

The basic system includes sensors for wind speed, wind direction, and temperature. Various other sensor options include, but are not limited to, relative humidity, barometric pressure, solar radiation, and precipitation. Two auxiliary channels are available for integration with gas monitoring sensors or other non-meteorological parameters.

The data logger includes 128KB RAM (approximately 45 days at 15 minutes intervals. Additional memory is available. The system is 12V battery powered with a 7AH battery that will operate for approximately five days between charging. A 110V battery charger/power supply is included. An optional solar panel is available. The data logger will communicate with Windows HyperTerminal Software for real-time monitoring of data and for data downloading. NovaLynx also offers several graphical display software programs.



110-WS-18 Portable Weather Station (shown without temperature sensor)



110-WS-18 Carrying Case



110-WS-18SMM Met Manager Software

110-WS-18 Portable Weather Station

Specifications

Data Logger

Reporting units: English or Metric, all measurements
 Operating power: 10-16 Vdc
 Power consumption: 60 mA maximum
 Serial port: 9-pin d-sub connector, selectable baud rate, flow control
 Memory: 128KB RAM nonvolatile (45 days at 15 minute intervals with 6 sensors). Expandable to 640KB.

Operating Temperature

Transducers: -40° to 140° F (-40° to 60° C)
 Data acquisition module: -40° to 140° F (-40° to 60° C)

Timekeeping

Format: MM/DD and HH:MM
 Accuracy: ± 30 seconds/month

Wind Speed

Range: 0 to 125 mph (0-57 m/s)
 Resolution: > 0.1 mph
 Accuracy: ± 1 mph
 Starting threshold: 0.8 mph
 Time constant: 2 seconds

Wind Direction

Range: 0-360°
 Resolution: > 1°
 Accuracy: ± 3°
 Starting threshold: 1.2 mph

Temperature

Range: -40° to +140° F
 Resolution: > .1° F
 Accuracy: ± 1° F

Relative Humidity

Range: 0-100% RH
 Accuracy: better than ± 3%

Carrying Case

Size: 20" x 17" x 8"
 Weight: 20 lbs

Tripod

Height: 36" (with mast 8')
 Weight: 12 lbs

Optional Sensors

Barometric Pressure

Range: 28.25 to 30.75 inHg (965 to 1041 mb)
 Measurement span: 2.50 inHg (85 mb)
 Resolution: ± 0.01 inHg or ± 0.3 mb
 Altitude offset: 0 to +10,000 feet, screwdriver adjustable
 Absolute Accuracy: .05 inHg

Rain Gauge

Resolution: 0.02"/tip
 Accuracy: ± 4% up to 3"/hour
 Max rate: Unlimited

Solar Radiation

Sensor: Silicon Pyranometer
 Spectral range: 0.4 to 1.1 microns
 Sensitivity: 80mV / 1000w/m² approx
 Accuracy: ± 5%

Ordering Information

110-WS-18-A Portable Weather Station (ws/wd/t)
 110-WS-18-B Portable Weather Station (ws/wd/trh)

Options

- 110-WS-18BP Barometric Pressure Sensor
- 110-WS-18H Relative Humidity Sensor
- 110-WS-18RG Rain Gauge, 0.02"/tip, 25' cable
- 110-WS-18SR Solar Radiation Sensor
- 110-WS-18TH Temp/Humidity Sensor
- 110-WS-18TWS Water/Soil Temperature Sensor
- 110-WS-18M6 Memory Expansion to 640KB
- 110-WS-18HHD Hand Held PC for local display of real time data
- 110-WS-18USB USB to DB9 Serial Adapter
- 110-WS-18SML Display Software
- 110-WS-18SMM Met Manager Software
- 110-WS-18STR Graphical Display Software
- 110-WS-18STR-H HTML Option
- 110-WS-18SP Solar Panel, 10 watt (will not fit in carrying case)



Windows HyperTerminal Display



110-WS-18SML Display Software

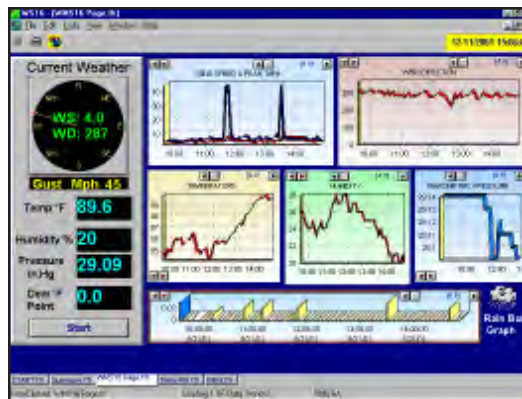

110-WS-18STR Graphical Display Software

110-WS-16SML Display Software

The Model 110-WS-16SML Display Software is a graphical Windows application for viewing and storing data from your WS-16 meteorological Station. With the WS-16SML software you can connect to your station to view real-time data or to download data logged in the WS-16 memory. The connection can be made over a direct wire link or via a dial-up modem. Real-time data received by the software are processed according to algorithms recommended by the U.S. National Weather Service and the World Meteorological Organization. The processed results can be viewed on the display page as numeric data or on the charts page in strip chart graphs. The terminal page can be used to communicate directly with the WS-16's on-board user interface (menus) for setting up the station or view raw data.

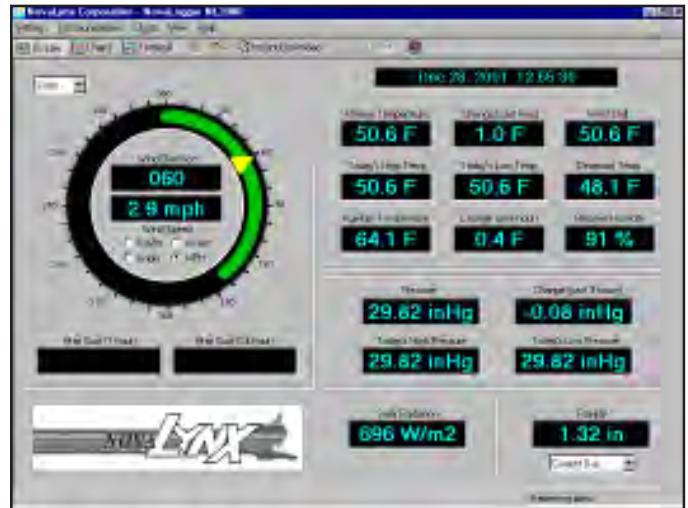

110-WS-16SML Display Software - Real Time Display

Features include:

- Connects to WS-16 station by direct wire link or dial-up modem.
- Received data from WS-16 in real-time (every 5 seconds).
- Performs error checking on all transferred data.
- Processes Data in large format Characters with high color contrast for viewing at a distance.
- Provides strip-chart graphs of real time data. The graphs have auto-scaling Y-axes, adjustable time base, direct readout cursors, zoom, and scroll.
- Equipped with an ANSI terminal emulator for communication with the WS-16's user interface menus.
- Provides "one click" command for downloading logged data from the WS-16.
- Logs and stores on computer hard disk over 50 user-selected parameters, such as hourly and daily wind gust, rainfall totals, high and low temperature, etc.

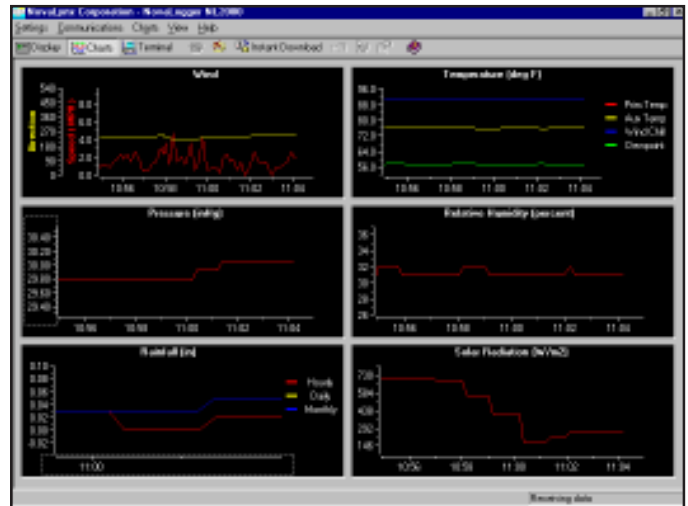

110-WS-16SML Display Software - Graphs

System requirements:

- Microsoft Windows 98/Me/XP, Windows NT 4.0, or Windows 2000
- SVGA video capability with 800 x 600 pixels and 256 colors (minimum)
- 10 MB space on hard disk for program storage

Ordering Information

110-WS-16SML Display Software

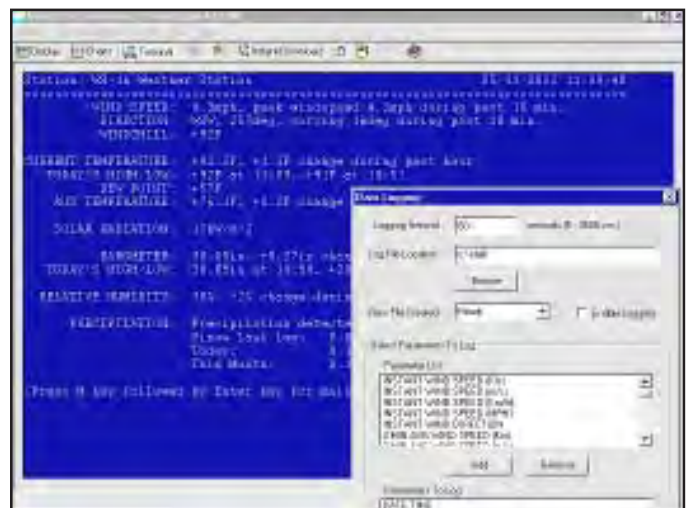

110-WS-16SML Display Software - Terminal

110-WS-16STR Graphical Display Software

The **Model 110-WS-16STR Graphical Display Software** is a Windows software program for data logger applications. It communicates with WS-16 data loggers for monitoring and display of sensors and devices.

WS-16STR includes the graphical design and terminal software runtime interface in one package. There are no limits on the number of loggers or sensor data points you can set or use. The standard Windows interface and setup tools make it easy to design new screens with graphs and indicators for your application.

Data that has been stored in the WS-16 can be downloaded and the historical trend graph charts can be analyzed for daily or monthly highs and lows.

With the optional HTML output, screens can be sent to a shared network drive on a timed basis, allowing anyone to view the various pages using an internet browser.

Features include:

- Real-time graphical software
- Powerful data presentation
- Supports real-time and stored archived data
- Built-in terminal program, direct connect and dial-up
- Scheduled automatic downloading
- Can display minimum, maximum, averages, graphs, alarms, time of min-max, etc.
- Calculated outputs, e.g. albedo, daily evaporation, delta temperature, etc.
- Your own images can be added
- Can be customized for special applications
- All types of graphs, line, bar, area, 3-D
- Full color and font support
- Can easily be set-up and customized with a little typing and a few clicks of the mouse

System requirements:

- Runs on Windows 98/ME/XP/NT/2000
- Requires a minimum of 32MB RAM
- For use with the WS-16 Data Logger

Ordering Information

110-WS-16STR Graphical Display Software, on compact disc
 110-WS-16STH HTML Option

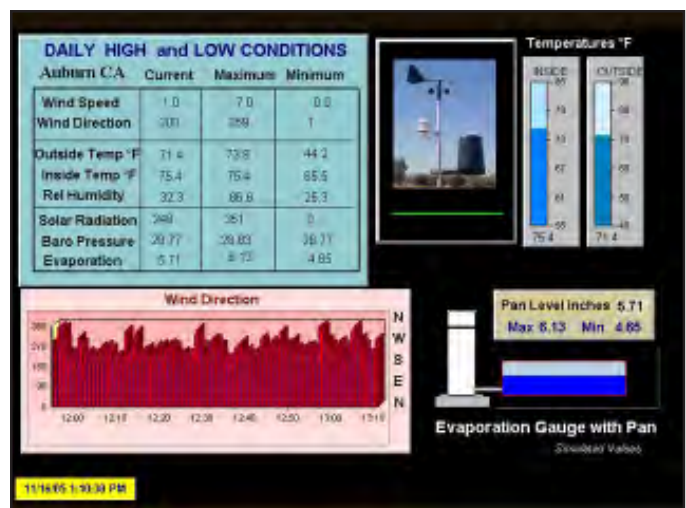
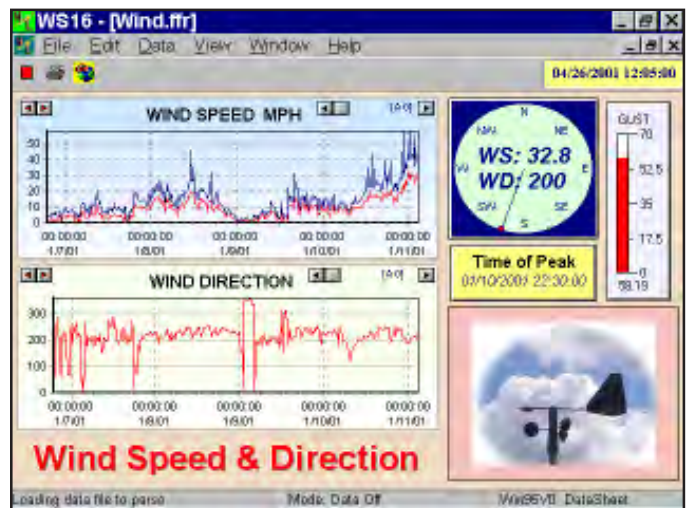

110-WS-16SMM Met Manager Software



110-WS-16SMM Met Manager Software

The **Model 110-WS-16SMM Met Manager Software** provides a powerful and easy way to acquire and view weather data in a variety of ways. This data may include any combination of wind speed, wind direction, temperature, humidity, pressure, and precipitation. Additional data may include solar radiation, soil moisture, soil temperature, evaporation, and others.

Some features of the Met Manager software include:

- Acquires data in real-time or from the internal memory of the datalogger.
- Acquired data is stored in a database on the local PC, or on a Microsoft®-compatible network file server.
- Stores and presents acquired data into database tables at user-selected intervals of 1, 5, 10, 15, 20, and 30 minutes and hourly. The data can represent averages, totals (for example rain), minimums, maximums, standard deviations, rates of change, etc.
- Data records in each data table can be kept indefinitely or can be automatically deleted from the database.
- Calculates derived parameters such as resultant vector horizontal wind speed, resultant vector horizontal wind direction, unit vector horizontal wind direction, Sigma Theta (from horizontal wind direction), Sigma Phi (from vertical wind direction), peak wind speed, dewpoint, wet bulb temperature, relative humidity, heat index, wind chill, solar energy from solar radiation (W/m^2), growing degrees (hours and days), heating or cooling degrees (hours and days), chill hours, reference evapotranspiration, etc.
- Makes extensive use of graphics. The user can setup named trend charts with multiple traces per chart, use of

dual y-axis, and so on. These graphs can be printed or copied to the clipboard.

- Generates a number of very useful reports including various data log reports, daily summary report, rainfall report, wind frequency distribution report, monthly parameter report, monthly data recovery, etc.
- And has many other features including data export to another drive path in comma-delimited, dBase, and Paradox formats.

Runs on Windows 95/98/NT/2000/XP and Win 7 in x86 mode. Met Manager can run on a desktop or notebook computer, or on a workstation of a Microsoft-compatible network. Network architectures include peer-to-peer and file-server.

Met Mirror™ software allows you to create and maintain a mirror image of data tables on a network file-server from a database managed by Met Manager on a workstation.

Met Viewer™ software is useful for allowing other network users to have access to the weather database. In a peer-to-peer or file-server network, Met Viewer attaches to the database maintained by Met Manager, or to a replicated database maintained by Met Mirror. With Met Viewer, you can recall, graph, view, report, and export the data in a variety of ways, and in the same way as Met Manager. The Met Viewer software product is purchased separately from Met Manager.

Ordering Information

110-WS-16SMM Met Manager Software

110-WS-16SMV Met Viewer Software, available for 1, 5, 10, 20, or unlimited users.

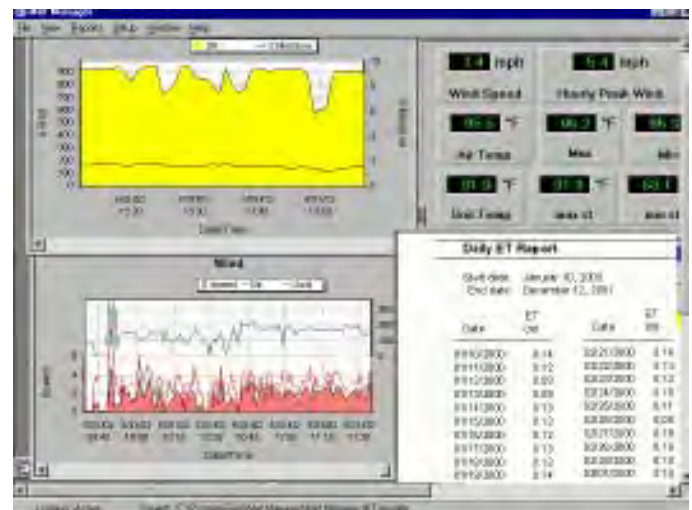

Davis Vantage Pro2 Weather Station



Vantage Pro2 Weather Station

The **100-6152C Vantage Pro2 Weather Station** offers forecasting, on-screen graphing, and much more, all on a large 3-1/2" x 6" (90 x 150 mm) LCD display. Quick view icons show the forecast at a glance, sunny, partly sunny, cloudy, rain, or snow, while a moving ticker-tape display gives more details. Mostly clear with little temperature change? Increasing clouds and cooler with precipitation within four to six hours? Whatever the forecast, Vantage Pro2 will let you know. Backlit display for easy viewing. Mounts on desk, shelf, or wall. US and metric units of measure. Optional data logger must be ordered separately.

Sensor Suite

The Vantage Pro2 includes an innovative integrated sensor suite, which combines rain collector, temperature and humidity sensors, and wind speed and direction sensors all into one package, making setup easier than ever and improving performance and reliability. Wind sensor is detachable for ultimate flexibility. Mount with integrated sensor suite, or mount separately using the included 40' (12 m) cable. Rain collector with self-emptying tipping bucket is exceptionally accurate. Read rainfall amounts in 0.01" or 0.25 mm increments. Temperature and humidity sensors are located inside the radiation shield. The shield protects the sensors from solar radiation and other sources of radiated and reflected heat. The optional tripod (must be ordered separately) makes installation even easier. Brackets on the legs tilt to mount on roof or uneven terrain.



Vantage Pro2 Console

Optional 100-6450 Solar Radiation Sensor

Diffuser element and housing are carefully designed for accurate cosine response. Silicon photo diode provides good match to solar spectrum. Includes built-in level and 3' (0.9 m) cable.

Optional 100-6490 UV Sensor

Measures the sunburning portion of the UV spectrum. Allows you to display UV index, dose rate, and daily and accumulated dose. Includes 3' (0.9 m) cable.

Optional 100-6510 WeatherLink Data Logger

For weather data collection, analysis, and display, connect Vantage Pro2 to your personal computer. The WeatherLink data logger fits neatly into the Vantage Pro console, storing your weather data even when the computer is off. Transfer data to the PC when you like. Later, use the software to create graphs, generate summaries, and more, all with your own weather database. WeatherLink lets you share your weather with the world on your own weather web site. WeatherLink software establishes the Internet connection and transfers the files using FTP.

Ordering Information

100-6152C	Vantage Pro2 Weather Station, includes console with AC-power adapter, integrated sensor suite with 40' (12 m) anemometer cable, mounting hardware, and a 100' (30 m) cable connecting the console to the sensor suite. Console may be powered using the included AC-power adapter or with three C batteries.
100-6450	Solar Radiation Sensor with 3' (0.9 m) cable
100-6490	UV Sensor with 3' (0.9 m) cable
100-6510USB	WeatherLink for Vantage Pro2, Windows USB Version
100-6510SER	WeatherLink for Vantage Pro2, Windows Serial Version
100-6520	WeatherLink for Vantage Pro2, Mac OS X
100-6510X	Extra User License Kit
100-7716	Mounting Tripod, includes 2 3' swaged masts, u-bolts
100-7717	Mounting Pole Kit, consists of 2 2' swaged masts, u-bolts

Kestrel 3000 & 4000 Pocket Weather Meters

The Kestrel® Tracker is the next generation of weather monitoring. You can now measure every major environmental condition, easily and accurately, right in the palm of your hand. The chart mode allows users to recall and graph up to 2,000 measurements, along with the date and time of storage. Barometric Pressure, Altitude, Density Altitude, Temperature, Humidity, Wind Speed, Wind Chill, Dew Point, Wet Bulb, and Heat Index... all in one pocket sized instrument.

The Kestrel® 4000 features

- Current, Maximum, and Average Wind Speeds
- Air, Water, and Snow Temperature
- Wind Chill
- Relative Humidity
- Dewpoint
- Heat Stress Index
- Barometric Pressure
- Altitude
- Density Altitude
- Wet Bulb Temperature
- Graph and recall trends
- Easy to read, backlit display
- Time and date
- Customize screens to display user-selected measurements
- Flip-top impeller cover allows use of other functions while protecting the impeller (hard cases available.)
- Automatically store measurements, even when the unit is turned off
- Manually store measurements with the press of a button
- Chart up to 2,000 measurements
- Impeller can be replaced without tools
- Exterior temperature, humidity, and pressure sensors for fast and accurate readings
- Humidity sensor can be recalibrated in the field
- Includes neck and wrist lanyards, protective pouch and 2 AAA batteries
- Waterproof and floats
- 2-year warranty
- Assembled in the USA



100-3000 Pocket Wind Meter



200-4000 Pocket Wind Meter

The Kestrel® 3000 measures

- Current Wind Speed
- Maximum Wind Gust
- Average Wind Speed
- Air, Water, and Snow Temperature
- Wind Chill
- Relative Humidity
- Heat Stress Index
- Dewpoint

Ordering Information

100-0830	Kestrel 3000 Pocket Weather Meter, red
100-0840GRY	Kestrel 4000 Pocket Weather Tracker, dark gray <i>also available in safety orange and olive drab</i>
100-0802	RH Calibration Kit
100-0804SER	PC Interface, serial port
100-0804USB	PC Interface, USB port
100-0805	Kestrel Carrying Case, black
200-0801	Replacement Impeller

Data Acquisition

195-WS-16 Data Logger	20
195-WS-16 Data Logger	21
195-WS-16AD Automatic Voice Dialers	22
140-400 Spread Spectrum Radio	23
195-26800 Meteorological Display	24

195-WS-16 Data Logger

The **195-WS-16N Data Logger** is designed specifically for collecting meteorological data. It has a versatile processor that can be used in systems from portable stations to networks. It is a complete package with sensor interfaces, data processing and logging, communications interfaces, and software for display, reporting, and data retrieval via a standard RS232 cable. Two independent user programmable alarms are supplied.

The 195-WS-16N supports a large variety of sensors. A 30-pin terminal strip is supplied for directly connecting analog and digital sensors without the need for external signal conditioning components or special programming. Sensor data are sampled every 2 seconds and logged at intervals selected by the user. The averaging period and logging interval can also be changed by the user. Each data record is logged with time and date. Data memory is backed with a 7 year lithium battery. Wind data are calculated in vector and scalar forms. The internal microprocessor determines weather parameters, generates standard reports, handles communications, and performs self-diagnostic tests.

The 195-WS-16N is typically powered by 12 Vdc. Operating current is less than 55 mA at 12 Vdc. An optional low power version is available for remote battery operated stations.

The 195-WS-16N is a completely self-contained data collector and processor for automatic stations. It is designed to withstand exposure to severe outdoor weather conditions. All components are contained in the rugged NEMA-4X weatherproof fiberglass enclosure. Internal circuit boards have surface mounted components for improved reliability. Three stages of lightning and transient protection are included on all signal and power connections. A desktop version is available for indoor use.

Data can be viewed using Windows HyperTerminal or other terminal programs such as Procomm. A one page real-time text display or an ASCII row and column format may be selected. A menu is provided for setting the date and time, alarms, logging interval, etc. Optional graphical display software is available for viewing real-time and historical data charts and graphs.

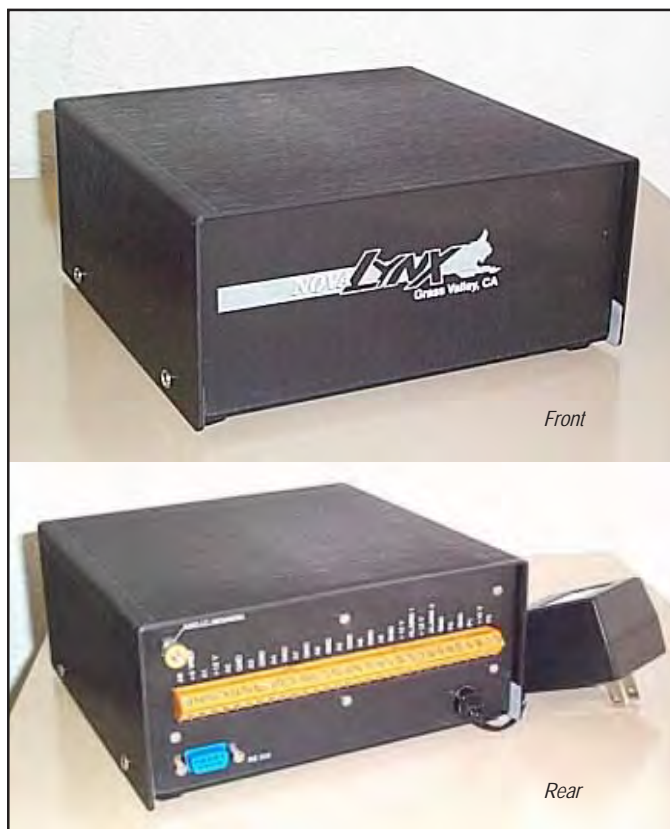

195-WS-16D Data Logger in Desktop Enclosure (power supply sold separately)



195-WS-16N Data Logger in NEMA-4X Enclosure (shown with optional accessories)

195-WS-16 Data Logger

Specifications

Analog Inputs

Number of channels: 7 voltage inputs, 3 inputs for 10K thermistor
 Input ranges: 100 mV, 1.0 V, 2.0 V, 5.0 V
 Accuracy: 0.1% F.S., 5 V range (-40 to 60 °C)
 Sample rate: 1 KHz maximum
 Resolution: 12 bit

Digital Inputs/Outputs

Frequency inputs: 3 counters, 16-bit each independent of processor
 Maximum count rate: 10 KHz
 Input modes: 2 high speed inputs for sine wave or square wave anemometers, 1 input for contact closure rain gauges
 Alarm outputs: 2 open collector @ 2 A max for high or low threshold events

Serial Channels

RS232C port: 1 port with hardware and software handshaking, baud rates 110 bps to 56 Kbps, 9 pin d-sub connector

Processor Functions

Configuration: Stored in non-volatile EEPROM
 Standard data memory: 128 KB SRAM with battery backup
 Optional data memory: 640 KB
 Calendar clock: Date, time, leap year, accuracy ±30 sec/month
 Backup battery: For memory and clock, 7 year life

Power Requirements

Input voltage: +7 to 40 Vdc
 Operating current: < 55 mA @ 12 Vdc
 Power saver mode: .5 mA @ 12 Vdc
 Input protection: Fuse, surge protection, reverse polarity, and over-voltage
 Supply sources: Battery, solar power, unregulated DC

Environmental Characteristics

Operating temperature: -40 to 60 °C
 Humidity: 0-90% RH non-condensing

Construction

Circuit boards: approx 90% surface mounted components, internal power and ground planes, and built-in EMI and ESD protection
 Lightning protection: Minimum 2 stages of protection devices on all signal and power lines when connected to an external earth ground.
 Includes MOVs on wind sensor input.
 Connections: User interface PCB 30-pin screw terminal, ground lug
 NEMA-4X enclosure: 13" x 11" x 6" fiberglass
 Desktop enclosure: 7" x 7" x 3-3/4" aluminum

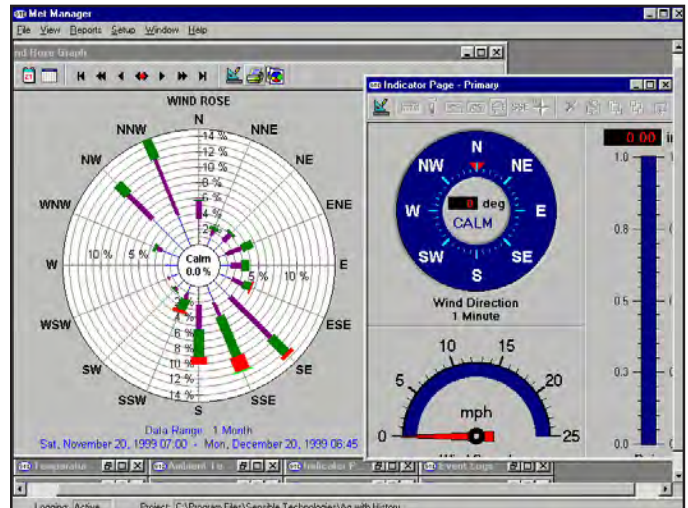

195-WS-16SMM Met Manager Software

Ordering Information

- 195-WS-16N Data Logger in NEMA-4X Fiberglass Enclosure, with 6' serial cable, no power supply (order below)
- 195-WS-16D Data Logger Desktop Enclosure, with 6' serial cable, no power supply (order below)
- 195-WS-16A Audible Alarm Option
- 195-WS-16HHD Hand Held PC for local display of real time data
- 195-WS-16M Telephone Modem
- 110-WS-16MDC Telephone Modem, 12 Vdc
- 195-WS-16M6 Optional Memory Expansion to 640KB
- 195-WS-16P AC Power Supply, for desktop enclosure, 120V
- 195-WS-16PE AC Power Supply, for desktop enclosure, 220V
- 195-WS-16SML Display Software
- 195-WS-16SMM Met Manager Software
- 195-WS-16STR Graphical Display Software
- 195-WS-16USB USB to DB9 Serial Adapter
- 320-600 Solar Panel Battery Charger, 10W
- 395-A Tower or Mast Mount Hardware Assy
- 395-C 12Vdc Power Supply/Battery Charger Assy, for NEMA enclosure, 100-240Vac (battery not included)
- 395-E Sunshield Assy
- 395-H 7AH Battery Assy

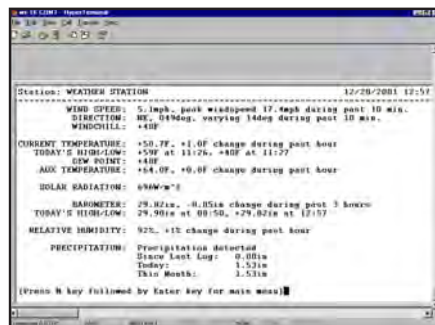

Windows HyperTerminal Display



195-WS-16SML Display Software



195-WS-16STR Graphical Display Software

195-WS-16AD Automatic Voice Dialers



The **195-WS-16AD Series Automatic Voice Dialers** are compatible with continuous, momentary, normally closed (NC) and normally open (NO) dry contact or voltage sensors. They can be programmed to sequentially dial any combination of four standard telephone, most cellular telephones, alpha voice pagers and/or numeric pagers. The dialer features busy-line and no answer detection to ensure timely transmissions of the recorded message. EEPROM and non-volatile memory for complete programming retention in the event of extended power loss.

195-WS-16AD21 Features

- Sends two messages to up to four telephone numbers or delivers numeric code to four local pagers or any combination of both (two zones, four numbers, 51 second message maximum)
- Automatically skips to next number when line is busy or no answer
- Dialing is continuous and stops when alarm input resets
- Can be configured for line seizure
- Listen-in and two-way voice capabilities
- Playback voice message through internal speaker
- Remote turn-off feature
- User-friendly function keys to program numbers and voice programming
- LED display to show keyed-in telephone numbers when programming
- Two programmable alarm inputs: NC, NO or voltage
- Aux output, switched 12V for sirens or buzzers

195-WS-16AD45 Features

- Dials up to 4 different numbers (one zone, one message, 16 second message maximum)
- Transmits either voice or numeric messages (for pagers)
- Automatically redials busy or unanswered numbers (up to 10 times for each number)
- Internal 9V battery provides 4 hours of stand-by power (195-WS-16AD45 only)
- Works alone or in conjunction with remote alarm

Dimensions

Size: 6.0" x 4.0" x 1.5" (152.4 x 101.6 x 38.1 mm)
Weight: 10 oz (283.5 g)

Ordering Information

195-WS-16AD21	Automatic Voice Dialer
195-WS-16AD21P	AC Power Supply 120V
195-WS-16AD45	Automatic Voice Dialer
195-WS-16AD45P	AC Power Supply 120V

140-400 Spread Spectrum Radio

- Ideal for remote weather station applications
- Long range, low power, low cost, wireless serial communication
- Plug-and-Play (no configuration required)
- Transparent operation supports existing software & systems
- Retries & acknowledgements for guaranteed packet delivery
- Low power modes include shutdown pin, cyclic sleep, & serial port sleep for current consumption as low as 1 mA
- Signal strength register for link quality monitoring & debugging



The **Model 140-400 Spread Spectrum Radio** was designed to provide end users with an easy to install wireless serial communication link. Used with the WS-16 Data Logger and a high-gain antenna, it provides data communication up to 20 miles. When configured as an addressable unit, it is suitable for use in a network of up to four weather stations.

Functionality is provided by the serial connection, power switch, indicator lights, high quality antenna, mounting plates, and power source inputs.

The 140-400 has the best sensitivity in the industry, making it one of the longest range low-cost radio modems available to date. It provides high performance and dependable operation.

The 140-400 requires no configuration to operate, simply plug-and-communicate. Output serial data from any RS232 port into the radio to send FCC & ETSI approved, frequency hopping spread spectrum data to the receiver.

Ordering Information

140-400	900 MHz Spread Spectrum Radio (2 required) Includes Stand-Alone Radio Modem 1/2 Wave Dipole Antenna (0-2 miles) DB-9 Male to DB-9 Female Serial Cable Null Modem Adapter AC Power Adapter 115V
140-400A11	Yagi Antenna 11dB (0-11 miles)
140-400A15	Yagi Antenna 15 dB (0-20 miles)
140-400A8	Yagi Antenna 8 dB (0-7 miles)
140-400C20	Dipole Antenna Extension Cable 20'
140-400C20Y	Yagi Antenna Cable 20'
140-400C40	Dipole Antenna Extension Cable 40'
140-400C40Y	Yagi Antenna Cable 40'
140-400C6Y	Yagi Antenna Cable 6'

Specifications

General

Frequency: 902-928 MHz
Spreading spectrum type: Frequency hopping, direct FM
Serial data interface: RS232/422/485
I/O data rate: Software selectable 1,200-57,000 bps

Power Requirements

Supply voltage: 7-18 Vdc
Transmit current: 200 mA
Receive current: 70 mA
Power down current: < 1 mA

Physical Properties

Enclosure type: Extruded aluminum, black anodized
Enclosure size: 2.75" x 5.50" x 1.124" (7.90 x 13.90 x 3.80 cm)
Weight: 7.1 oz (200 g)
Operating temperature: -40° to +85° C

Antenna

Type: 1/2 wave dipole whip
Gain: 2.1 dB
Length: 6.75" (17.1 cm)
Impedance: 50 ohms unbalanced

Performance

Indoor/Urban range: Up to 1,500' (457 m)
Outdoor LOS range: Up to 7 mi (11 km) with dipole, up to 20 mi (32 km) with hi-gain antenna

195-26800 Meteorological Display

The **195-26800 Meteorological Display** offers a unique and flexible solution for meteorological data measurement, recording and display. Advanced design has features and flexibility to perform a wide variety of monitoring tasks. From simple display of a single variable to recording data from a complete sensor suite, the 26800 can satisfy countless measurement needs.

High Resolution Display: The 26800 features a large, high-contrast LCD screen. The display text and layout are fully programmable so measured data can be displayed in a wide variety of formats. Up to 8 screens may be used. Display illumination is easily adjusted for best viewing in any light.

Fully Programmable: The real strength of the 26800 is the ability of the user to custom program the device to perform virtually any task. A user-friendly PC program allows easy formatting of the program parameters, display screens and recording functions. Programming is also possible using front panel controls when a PC is unavailable.

Data Storage: The 26800 has built-in memory for storage of large amounts of recorded data. More than 2 million data points may be stored. Data retrieval is simplified by the handy communication program provided.

Wide Variety of Inputs: The 26800 is supplied with a large selection of sensor inputs. Wind, temperature, precipitation, humidity, and other sensors are easily connected through the back-panel terminals. Frequency, voltage, current-loop, and serial inputs are provided. All values are completely scalable in the program.

Useful Outputs: Many output options are available from the 26800. Terminals are available for calibrated voltage outputs and current outputs as well as serial outputs. Switched outputs provide alarm capability.

Practical Design: Compact configuration is easily panel mounted. Adjustable stand permits table top use as well.

Specifications

Dimensions: 200 mm (7.8 in) x 144 mm (5.7 in) x 54 mm (2.1 in)

Panel cutout: 194 mm (7.6 in) x 138 mm (5.4 in)

Weight: 0.8 kg (1.8 lb)

Operating temperature: 0° to 50° C

Storage temperature: -30° to 50° C

Display

Adjustable high-brightness, high-contrast with 8 user programmable screens. Large font capacity: 3 rows x 20 characters per screen. Small font capacity: 6 rows x 40 characters per screen. Both font sizes may be used together on the same screen.



Power

Nominal 12 Vdc at 250 mA with maximum backlight.

10 to 30 Vdc at 4 W max

Terminals or coaxial jack for included AC-power adapter

Memory

2,162,688 single-precision floating point values for data records.

256 temporary floating point values for user program

1 to 512 user program instructions

Voltage Input

Channels: 8 different or 16 single-ended inputs in any combination.

Measurement range: 4 Channels 0 to 5 Vdc, 12 Channels -2.5 to 5 Vdc

Resolution: 16 bit minimum.

Conversion rate: 6 Hz to 3.5 kHz in 10 steps.

50/60 Hz Rejection: Greater than 95 dB at 6 Hz sampling rate

Accuracy: 0.1% from 0° to 40° C

Pulse/Frequency Input

Channels: 4 Inputs. Each may be configured for Low Level AC or Switch Closure/TTL with built-in debounce.

Range: 0 to 2500 Hz

Threshold: 30 mVp-p for Low Level AC input. 2.5VDC for Switch Closure/TTL

Excitation

Channels: 2 outputs regulated 5Vdc at 10mA for potentiometer or RTD excitation

Voltage/Current Output

Channels: 4 outputs. Each channel may be configured as a voltage or current output.

Range: Voltage 0 to 5Vdc. Current 0 to 20mA

Resolution: 12-bits (1.25 mV or 0.005 mA)

Serial I/O

Channels: 2 ports. One for RS232, one for RS485. Both channels are full duplex with no handshaking, 1 start, 8 data, 1 stop, no parity.

Baud rate: 1200 to 230,400 baud

Switch Output

Channels: 4 solid state switch outputs

Voltage/Current: Each switch can handle 60Vdc at 5A. Switched line must be referenced to ground.

Ordering Information

195-26800

Meteorological Translator, 115V, 50-60 Hz

195-26800H

Meteorological Translator, 230V, 50-60 Hz

195-26880

Rack Mounting Panel (19")

195-00811

Custom Programming for 195-26800

Signal Conditioning

130-200 Series Signal Conditioners	26
135-100 Series Signal Conditioning Translator Boards	27
135-104 General Purpose Translator Board	28
Group 395 Enclosures	29
Analog Look-up Table	30

130-200 Series Signal Conditioners

The **130-200 Series Signal Conditioners** is a full line of field configurable conditioners useful for transmitting process control setpoints to remote PID controllers or interfacing position sensors to data acquisition and control systems. Individual modules mount on DIN rails and provide 1800 Vdc isolation between input, output, and power. The field configurable input and output offers flexible, wide range capability for DC currents, AC/DC voltage, frequency, and RTD signals. Most NovaLynx sensors will directly connect to the conditioners and provide an isolated output as selected; 4 to 20 mA, 0 to 5 or 10 Vdc, 0 to 1 mA. The Q2 version provides a two channel isolated 4-20 mA current loop in proportion to two DC inputs. The 4-20mA output is loop powered from 12 to 35 Vdc, selectable input 0-.5V, 1V, 5V, 100V, 1 mA. Signal conditioners are available for the following inputs:

- DC voltage
- AC voltage
- DC output proportional to a potentiometer input
- Frequency
- Platinum and copper RTDs
- Specific for high density applications

Specifications

Input power: 9 to 30 Vdc, 1.5 W typical, 2.5 W maximum
Accuracy: including linearity and hysteresis $\pm 0.1\%$ @ 25°C
Stability: Temp $< \pm 0.025\%/^{\circ}\text{C}$
Isolation: 1800 Vdc between input, output and power
Dimensions: 4.4" (112 mm) H x 3" (76 mm) D x 0.5" (12 mm) W
Operating temperature range: 0 to 55°C (32 to 131°F)
Storage temperature range: -25 to +70°C (-13 to +158°F)
Operating humidity: 15 to 95% @ 45°C
Voltage output: 0-5 V, 0-10 V (selectable)
Impedance: <10 ohms
Drive: 10 mA, max
Current output: 0-1 mA, 4-20 mA, 0-20 mA (selectable)
Impedance: >100 Kohm
Compliance: 0-1 mA: 7.5 V, max (7.5K ohm) 4-20 mA: 12 V, max (600 ohm) 0-20 mA: 12 V, max (600 ohm)
Input: Each conditioner supports a wide range of specific inputs that support most of the NovaLynx sensors. Consult a sales rep for specific input specifications for each unit.
Mounting: Horizontal din rail mounting is recommended
Size: 3.54"W x 4.34"D x .50"H

Ordering Information

130-205	DC Voltage Input (Relative Humidity, Barometric Pressure, Solar Radiation)
130-205Q2	Loop-Powered Signal Conditioner, 2 ch (Solar Rad)
130-206	RTD Input (Temperature, Dew Point)
130-207	Potentiometer Input (Wind Direction, Evaporation)
130-208	Frequency Input (Wind Speed)
130-209	AC Voltage Input (Power Line)
130-H902	DIN Rail Power Supply, 115 Vac 24 Vdc @ 200 mA
130-H910	DIN Rail Power Supply, 115 Vac 24 Vdc @ 1000 mA

Note: All units supplied with a section of DIN rail for mounting. Refer to section on power supplies for other suitable power sources. Refer to page on enclosures for suitable desktop or NEMA enclosures.



130-200 Series Signal Conditioners



130-205Q2 Loop-Powered Signal Conditioner

135-100 Series Signal Conditioning Translator Boards

- 12 Vdc Input Power
- Wind Speed & Direction
- Rainfall Accumulation
- Analog Outputs

The **135-100 Series Translator Boards** are a complete line of analog signal conditioning interfaces for almost any sensor input and desired output. Circuit boards utilize the latest technology in low-power solid-state components. They can be used individually or in combinations to create customized systems. NEMA-4X, mast mount, 19" rack mount, and desktop enclosures are available.

The **Model 135-100 Wind Translator Board** provides signal conditioning for wind speed and direction with voltage or current output. The circuit provides a regulated voltage to the wind direction potentiometer and converts wind speed pulse, AC or switch closure sensor outputs to a DC output. 0-100 mph and 0-360° typically = 0-5 Vdc outputs.

Specifications

Power: 12 Vdc \pm 20%
Power consumption: 20 mA nominal
Inputs: Wind speed sensor (frequency), Wind direction sensor (potentiometer)
Outputs: 0 to 5 Vdc or 0 to 1 mA (open collector)
Overall accuracy: 0.5%
Operating temperature: -30° to +60°C
Storage temperature: -40° to +80°C
Relative humidity: 0-100% non-condensing
Connectors: Screw terminals
Size: 3-1/2" x 2-1/2"
Weight/shipping: 4 oz/1 lb

Ordering Information

135-100	Wind Speed/Wind Direction Translator PCB, 0-5 Vdc or 0-1 mA
350-290	Transient Protection, per input channel

The following must be specified when ordering:
 Wind sensor model number
 Wind speed range, mph, knots, m/s, or kmh
 Wind speed full scale unit (0-100 mph is standard)
 Output type, 0-5 Vdc or 0-1 mA

395-301	NEMA Enclosure
395-A-003	Mast Mounting Hardware

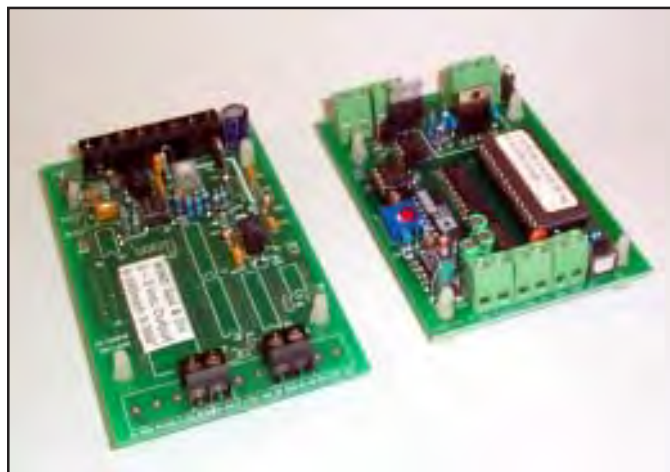

135-100 WS/WD Translator PCB

135-102 Digital-to-Analog Conversion PCB

The **Model 135-102 Precipitation D to A Conversion Board** converts digital pulses to voltage or current output. Use with tipping bucket rain gauges or other pulse output devices like contact anemometers or flow sensors. The circuit accumulates switch closure events and converts the events into a linear increasing DC output. When the circuit accumulates it's maximum count the output resets to zero and starts the process over again.

Specifications

Power: 12 Vdc \pm 20%
Power consumption: 15-20 mA nominal
Inputs: Two wire switch closure
Inputs: 0-1000 counts (10 bit resolution), other ranges are available (0-10, 0-100, 0-500, etc.)
Outputs: 0-1 or 4-20 mA, or 0-5 Vdc
Zero reset: on-board or external
Operating temperature: -30° to +60°C
Storage temperature: -40° to +80°C
Relative humidity: 0-100% non-condensing
Connectors: Screw terminals
Size: 3-1/2" x 2-1/2"
Weight/shipping: 4 oz/1 lb

Ordering Information

135-102	Digital to Analog Conversion PCB, 10 bit resolution, 0-1 or 4-20 mA, or 0 5 Vdc
350-290	Transient Protection, per input channel

The following must be specified when ordering:
 Number of events required for full scale (0-1000 is standard)
 DC Output, 0-1 or 4-20 mA, or 0-5 Vdc

135-104 General Purpose Translator Board

The **Model 135-104 General Purpose Translator Board** is designed to support up to three separate analog sensors and one wind speed sensor, producing four independent analog output signals, one for each sensor. The board is designed for applications requiring either desktop enclosures, rack mounted enclosures, or outdoor box mounted enclosures. A +12 Vdc power source is required for circuit operation. Typical power consumption for the translator board is approximately 30 mA.

The translator board can be configured to provide one of three difference types of output signals; 0-5 Vdc, 0-1 mA, or 4-20 mA, 400 ohms maximum load. Sensors can be configured for any one of the three types of output signals or all three sensors can be set for the same type of output signal. All sensor input wiring and output signal wiring is accomplished using circuit board terminal blocks.

The circuit board has been designed to eliminate customer calibration of the circuitry. On most of the printed circuit boards manufactured by NovaLynx, there are no potentiometers for adjusting input or output signal levels. All board calibration is accomplished by selecting precision resistors to set the output span and zero to match the characteristics of the sensor as well as to meet the requirements of the user.

The Models 135-114 and 135-115 have additional alarm circuitry for applications requiring relay contact outputs to turn on and/or off weather sensitive equipment or for storm warnings. External relays can be provided to drive alarm equipment.

Specifications

Power: 12 Vdc \pm 20%

Power consumption: 20 mA nominal

Inputs: 1 each frequency (to 1 KHz), switch closure, ac voltage, 3 each voltage, resistance, current

Outputs: 4 each, specify one: 0-5 Vdc, 0-1 mA, 4-20 mA (into 400 ohms max), 4 each alarm 12 Vdc @ 100 mA (current source, 135-114/115 only), 12 Vdc battery voltage

Overall accuracy: 0.5%

Controls: Alarm set points adjustable with on-board or off-board potentiometer (135-114/115 only)

Operating temperature: -30° to +60°C

Storage temperature: -40° to +80°C

Relative humidity: 0-100% non-condensing

Connectors: Screw terminals

Size: 5.8" x 5.1"

Weight/shipping: 8 oz/1 lb

Ordering Information

135-104	General Purpose Translator PCB, 4 channels, 0-5 Vdc, 0-1 mA, or 4-20 mA
135-114	General Purpose Translator PCB, 1 channel and 1 alarm output
135-115	General Purpose Translator PCB, 4 channels with alarms on 4 channels
350-290	Transient Protection, per input channel

The following must be specified when ordering:

Sensor model number for each input channel

Full scale values and units (example 0-100 mph, -40° to +120°F)

Desired output on each channel, 0-5 V, 0-1 mA, or 4-20 mA

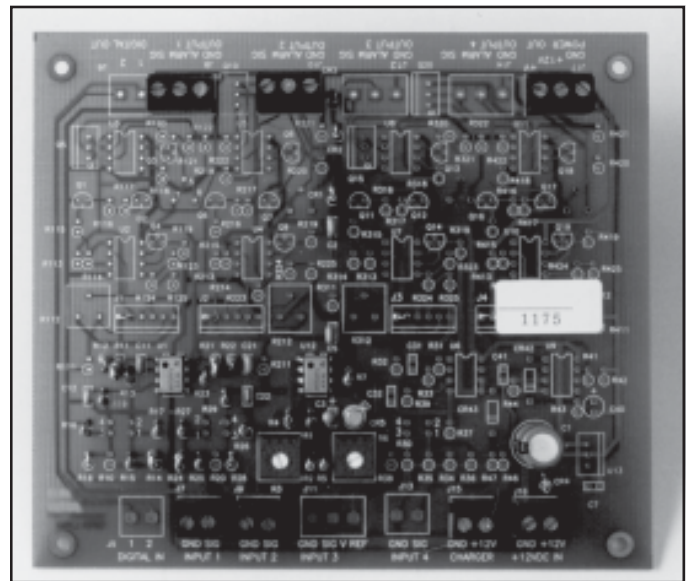

Model 135-104 General Purpose Translator Board

Group 395 Enclosures

NovaLynx provides an assortment of enclosures which can be used to mount various translator boards and other devices such as meters, relays, thermostats, radios, lightning protection devices, and terminal strips. Standard enclosures are desktop, rack mount, NEMA polycarbonate weathertight, and NEMA-4X fiberglass weatherproof. Custom enclosures are also available. Consult NovaLynx for more information.

Specifications

395-110 Series Small Desktop Enclosures

Case: Blue anodized aluminum with clear anodized panels, terminal strip on back
 Power: Input 115 Vac, Output 12 Vdc @ 300mA
 Size: 5"H x 7"W x 11"D
 Weight/shipping: 5 lbs/7 lbs

395-120 Series Large Desktop Enclosures

Case: Blue anodized aluminum with clear anodized panels, terminal strip on back
 Power: Input 115 Vac, Output 12 Vdc @ 300mA
 Size: 5"H x 13"W x 11"D
 Weight/shipping: 7 lbs/9 lbs

395-123 Series Rack Mount Enclosures

Front panel: Clear anodized aluminum with rack handles
 Power: Input 115 Vac, Output 12 Vdc @ 300mA
 Size: 5" or 7" or 9"H x 19"W x 8"D
 Note: Most rack mount enclosures require custom machining and silkscreening.

395-300 Series NEMA Polycarbonate Enclosures

Light gray polycarbonate with screw-down lid, includes backplate
 395-301 size: 4.5"H x 3.88"W x 1.89"D
 395-302 size: 4.5"H x 6.95"W x 2.68"D

395 Series NEMA-4X Fiberglass Reinforced Polyester Enclosures come standard with aluminum backplate, hinged door with latches, and desiccant pack. Most are gray. The 395-1210 is white.

Sizes available (UL/CSA inside dimensions):

- 395-0604: 6"H x 4"W x 4.45"D
- 395-0806: 8"H x 6"W x 4.15"D
- 395-1008: 10"H x 8"W x 4.64"D
- 395-1210: 12"H x 10"W x 4.79"D
- 395-1412: 14"H x 12"W x 5.79"D
- 395-1614: 16"H x 14"W x 5.79"D



395-300 Series Polycarbonate Enclosures



395-1210 with mounting hardware

Ordering Information

395-110	Small Desktop Enclosure, 115 Vac
395-120	Large Desktop Enclosure, 115 Vac
395-123-#	Rack Mount Enclosure, specify 5", 7", or 9"
395-301	Small NEMA Polycarbonate Enclosure
395-302	Large NEMA Polycarbonate Enclosure
395-A-003	Tower or Mast Mounting Hardware
395-0604	NEMA-4X Fiberglass Enclosure with backplate
395-0806	NEMA-4X Fiberglass Enclosure with backplate
395-1008	NEMA-4X Fiberglass Enclosure with backplate
395-1210	NEMA-4X Fiberglass Enclosure with backplate
395-1412	NEMA-4X Fiberglass Enclosure with backplate
395-1614	NEMA-4X Fiberglass Enclosure with backplate
395-A	Tower or Mast Mounting Hardware, for mid-size boxes (0806, 1008, 1210)
395-B	Unistrut Tower or Mast Mounting Hardware, for large boxes (1412, 1614)
395-C	12Vdc Power Supply/Battery Charger Assy, 100-240Vac input (battery not included)
Note:	Solar chargers can be used in place of ac chargers. See 320 Series Solar Panels.
395-E	Sunshield, for midsize boxes (0806, 1008, 1210)
395-F	Sunshield, for large boxes (1412, 1614)
395-G	4AH Battery Assy
395-H	7AH Battery Assy
395-I	12AH Battery Assy
Note:	Battery assemblies include battery, mounting hardware, and battery cable. Order ac or solar panel battery charger separately, see above. Larger batteries are available on special order.
395-240	MS Type Quick Release Connector
395-250	Termination Strip, 12 position
395-990	Desiccant (2 packs)



395-123 Rack Mount Enclosure



395-120 Large Desktop Enclosure, optional meters

Analog Look-up Table

mA 0-1	mA 4-20	VOLTS 0-1	VOLTS 0-5	MPH 0-100	DIR 0-360°	TEMP 0-128°	BP 950-1050 mb	BP In Hg
0.00000	4.0	0.00000	0.000	0.000	0.00	0	950	28.05
0.03125	4.5	0.03125	0.156	3.125	11.25	4	953	28.15
0.06250	5.0	0.06250	0.313	6.250	22.50	8	956	28.24
0.09375	5.5	0.09375	0.469	9.375	33.75	12	959	28.33
0.12500	6.0	0.12500	0.625	12.500	45.00	16	963	28.42
0.15625	6.5	0.15625	0.781	15.625	56.25	20	966	28.51
0.18750	7.0	0.18750	0.938	18.750	67.50	24	969	28.61
0.21875	7.5	0.21875	1.094	21.875	78.75	28	972	28.70
0.25000	8.0	0.25000	1.250	25.000	90.00	32	975	28.79
0.28125	8.5	0.28125	1.406	28.125	101.25	36	978	28.88
0.31250	9.0	0.31250	1.563	31.250	112.50	40	981	28.98
0.34375	9.5	0.34375	1.719	34.375	123.75	44	984	29.07
0.37500	10.0	0.37500	1.875	37.500	135.00	48	988	29.16
0.40625	10.5	0.40625	2.031	40.625	146.25	52	991	29.25
0.43750	11.0	0.43750	2.188	43.750	157.50	56	994	29.35
0.46875	11.5	0.46875	2.344	46.875	168.75	60	997	29.44
0.50000	12.0	0.50000	2.500	50.000	180.00	64	1000	29.53
0.53125	12.5	0.53125	2.656	53.125	191.25	68	1003	29.62
0.56250	13.0	0.56250	2.813	56.250	202.50	72	1006	29.71
0.59375	13.5	0.59375	2.969	59.375	213.75	76	1009	29.81
0.62500	14.0	0.62500	3.125	62.500	225.00	80	1013	29.90
0.65625	14.5	0.65625	3.281	65.625	236.25	84	1016	29.99
0.68750	15.0	0.68750	3.438	68.750	247.50	88	1019	30.08
0.71875	15.5	0.71875	3.594	71.875	258.75	92	1022	30.18
0.75000	16.0	0.75000	3.750	75.000	270.00	96	1025	30.27
0.78125	16.5	0.78125	3.906	78.125	281.25	100	1028	30.36
0.81250	17.0	0.81250	4.063	81.250	292.50	104	1031	30.45
0.84375	17.5	0.84375	4.219	84.375	303.75	108	1034	30.55
0.87500	18.0	0.87500	4.375	87.500	315.00	112	1038	30.64
0.90625	18.5	0.90625	4.531	90.625	326.25	116	1041	30.73
0.93750	19.0	0.93750	4.688	93.750	337.50	120	1044	30.82
0.96875	19.5	0.96875	4.844	96.875	348.75	124	1047	30.91
1.00000	20.0	1.00000	5.000	100.000	360.00	128	1050	31.01

Analog & Digital Displays

Analog Displays	32
Digital Displays	32

Analog Displays

A complete line of **Analog Display Dials** is available to provide an indication of the output signal from signal conditioning modules or data loggers. Each dial is 6" in diameter and includes a black bezel. A lance-type pointer moves over the scale's 250° arc. The galvanometric meter has a linearity of ± 2%. Mounting hardware is provided to install the dials in a customer-supplied panel. A standard two-dial indicator console is available. Custom panels are also available. Consult NovaLynx for details and prices.

Specifications

Dials

Meter: 0-1 mA
 Impedance: 250 ohms typical
 Linearity: ± 2%
 Scale length: 10.5" over 250° arc
 Zero adjust: Mechanical
 Mounting: Flush, 3 threaded studs
 Size: 6" Dia x 2.5" D (152 mm x 64mm)
 Weight/shipping: 1.25 lbs/3 lbs

Standard Console

Input: 0 to 5 Vdc (passive circuit)
 Impedance: 5,000 ohms typical
 Enclosure: Slope front painted aluminum
 Size: 14" W x 7.75" H x 6.75" D
 Weight/shipping: 5 lbs/9 lbs

Ordering Information

300-1172 Wind Speed Dial, 0-100 mph
 300-11722 Wind Speed Dial, 0-120 mph
 300-11725 Wind Speed Dial, 0-120 knots
 300-1173 Wind Direction Dial, 0-360°
 300-1174 Wind Direction Dial, 0-540°
 300-11761 Temperature Dial, -40 to +120°F
 300-11763 Temperature Dial, 0 to +120°F
 300-1178 Relative Humidity Dial, 0-100%
 300-1180 Barometric Pressure Dial, 945-1045 mb
 300-11800 Barometric Pressure Dial, 27.5-31.5" Hg

300-400 Series Dual Analog Display Console includes two 300-1170 series meters and two 5 Vdc to 1 mA passive circuits. Specify meter range and parameters.

Other parameters and ranges are available.

A small setup and artwork charge will be added for custom ranges.



300-11725 Analog Display

Digital Displays

NovaLynx offers both **LCD and LED Digital Displays**. LCD (Liquid Crystal Display) is selected for ease of reading in bright light or sunlight. LED (Light Emitting Diode) displays are usually preferred in most other applications where their red display can be easily observed. Like analog displays, digital displays may be used in conjunction with signal conditioners and data loggers. Desktop displays and custom panels for 19" rack mount are available. Consult NovaLynx for more information.

Specifications

Small Meters

LCD: 4.5 to 5.5 Vdc at 5 mA
 LED: 4.5 to 5.5 Vdc at 200 mA
 Range: 0-5 Vdc standard (4-20 mA optional)
 Display: 0.48" LCD, 0.56" LED
 Overall size: 2.7" W x 1.1" H x 4.03" D (meter only)

Large Displays (3", 5", 9", 12")

Custom, consult NovaLynx for details

Enclosures

Custom, consult NovaLynx for details.

Ordering Information

300-550 LED Meter, specify range, 3-1/2 digit
 300-650 LCD Meter, specify range, 3-1/2 digit
 300-50XXX Large Digital Displays



395-120 Desktop Enclosure with LED Display



300-50XXX Custom Large Digital Display

Upper Air

Meteorological Balloons	34
Meteorological Balloons	35
400-2090 Sight Clinometer	36
400-2095 Ceiling Light Projector	36

Meteorological Balloons

The **400 Series Meteorological Balloons** are produced by rotational molding of natural rubber. Their uniform wall thickness prevents premature blowouts, and they are ozone resistant. Reinforced necks allow use in strong winds without tearing. These balloons are not recommended for tethering.

Each balloon is inflated, inspected, and tested before being dusted and sealed in a moistureproof polyethylene bag. They may be stored up to seven years if kept in a cool, dark room. No preflight conditioning is required.

Two basic types of balloons are available. The smaller **pilot (or ceiling) balloons** are usually tracked with a theodolite. These balloons are not designed to carry a payload. Three different colors provide easier sighting

under varying weather conditions. The natural color has the greatest visibility on clear days; red is easiest to see in scattered clouds; and black is best for overcast conditions. Small lights can be used to illuminate pilot balloons for easier sighting during nighttime observations. Balloon weight is chosen based on the altitude and ascent rate required. The larger **sounding balloons** are designed to carry a radiosonde aloft, and these balloons are usually used in conjunction with a rawinsonde tracking station. They can also carry other types of payload, such as radar targets. The burst altitude required should be used to determine the balloon weight needed.

Specifications are based on performance tests conducted at the factory. They are taken from hydrogen-inflated balloons. Helium inflation may provide different results.

Specifications and Ordering Information

Model	Nominal Weight gm	Color	Neck Dia in (mm)	Uninflated Dia in (cm)	Std Inflated Dia ft (cm)	Burst Dia ft (cm)
Pilot Balloons:						
400-8210	10	red	0.9 (23)	3.2 (8)	1.5 (46)	2.0 (60)
400-8230	30	red	0.6 (14)	7.1 (18)	2.1 (64)	3.3 (102)
400-8231	30	black	0.6 (14)	7.1 (18)	2.1 (64)	3.3 (102)
400-8232	30	natural	0.6 (14)	7.1 (18)	2.1 (64)	3.3 (102)
400-8233	100	red	0.6 (14)	13.8 (35)	2.4 (74)	4.4 (133)
400-8234	100	black	0.6 (14)	13.8 (35)	2.4 (74)	4.4 (133)
400-8235	100	natural	0.6 (14)	13.8 (35)	2.4 (74)	4.4 (133)
400-8236	200	natural	1.3 (32)	18.9 (48)	3.9 (118)	8.9 (270)
Sounding Balloons:						
400-8237	300	natural	1.3 (32)	23.6 (60)	5.0 (154)	12.8 (390)
400-8239	500	natural	1.3 (32)	32.7 (83)	5.7 (175)	17.7 (540)
400-8242	800	natural	1.3 (32)	42.5 (108)	6.1 (185)	22.3 (680)
Options:						
400-8260-10	10G Balloon Filling System, includes pressure hose, valve, and 10gm weighted nozzle					
400-8266	Helium Tank Regulator					
400-8318	Pilot Balloon Light, 2.5 volt, 0.3 amp bulb, water-activated battery, weight 0.34 oz (no longer available)					

Performance Test Specifications

Results

Weight gm	Free Lift gm	Payload gm	Gross Lift gm	Inflation Vol cu ft (cu M)	Inflation Dia ft (M)	Ascent Rate M/Min	Altitude at Burst Mi (Km)
Pilot Balloons:							
10	50	—	60	1.9 (0.05)	1.5 (0.5)	150	4.3 (7)
30	140	—	170	5.5 (0.16)	2.2 (0.7)	200	7.8 (12.5)
100	160	—	260	8.4 (0.24)	2.5 (0.8)	200	9.3 (15)
200	850	—	1050	33.9 (0.96)	4.0 (1.2)	350	11.8 (19)
Sounding Balloons:							
300	1400	630	2330	75.2 (2.1)	5.2 (1.6)	400	13.0 (21)
500	1700	1150	3350	108.1 (3.1)	5.9 (1.8)	400	15.2 (24.5)
800	2000	1150	3950	127.4 (3.6)	6.2 (1.9)	400	17.4 (28)

Meteorological Balloons

Sounding balloons can carry payloads greater than those listed in the chart if the gross lift of the balloon is increased. This is done by increasing the inflation volume. (Note the burst diameter of the balloon to avoid overfilling.) The ascent rate and burst altitude will vary from the values given. The following formulas can be used to calculate approximate values. Experimentation will probably be required.

$$\text{Gross lift (gm)} = \text{Free lift (gm)} + \text{Balloon weight (gm)} + \text{Payload (gm)}$$

$$\text{Inflated volume (ft}^3\text{)} = \frac{\text{Gross lift (gm)}}{31 \text{ gm/ft}^3}$$

where 31 gm/ft³ is the lifting force of hydrogen at 1013 mb, 25°C.

$$\text{Inflated diameter (ft)} = 2 \sqrt[3]{\frac{\text{Inflated volume (ft}^3\text{)}}{4.189}}$$

$$\text{Ascent rate (m/min)} = K \frac{\sqrt{\text{Free lift (gm)}}}{\sqrt[3]{\text{Gross lift (gm)}}}$$

where K is a factor dependent on the drag coefficient of the balloon.

K = 142 for 300-1500 gm balloons

K = 151 for 2000 gm balloons

K = 158 for 3000 gm balloons

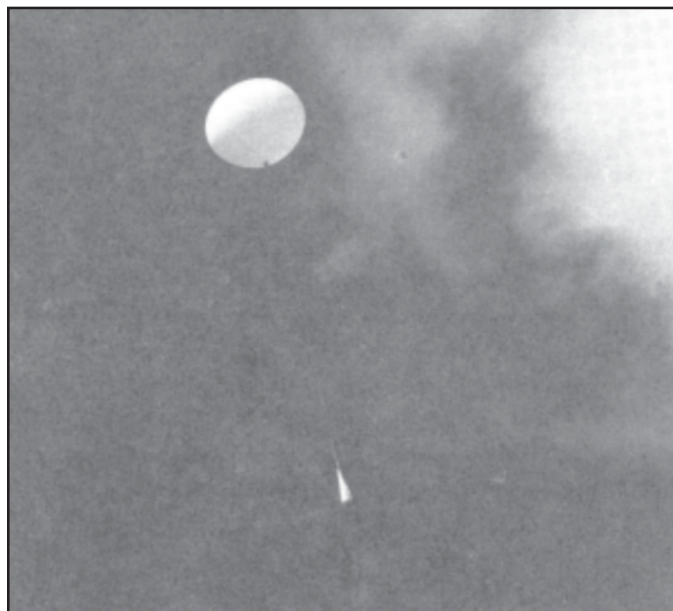

Meteorological Balloon



400-8318 Pilot Balloon Light (no longer available)

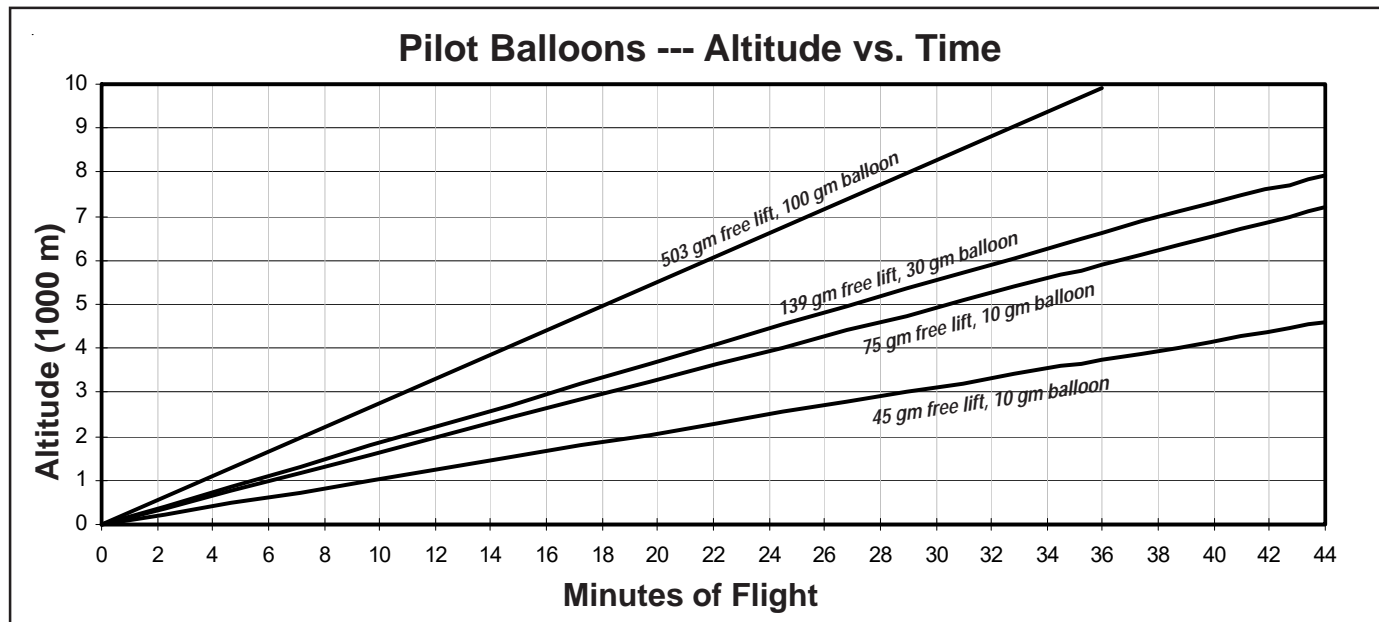

400-2090 Sight Clinometer

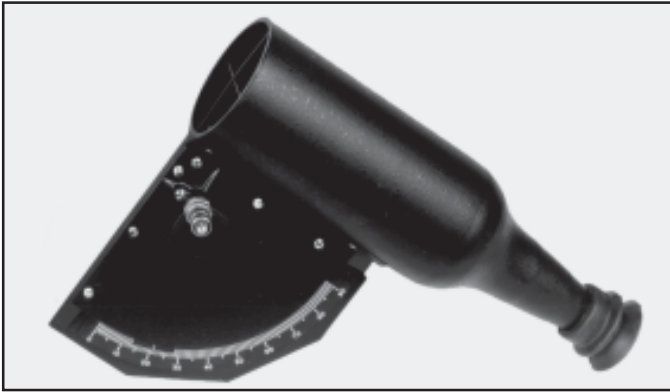

400-2090 Sight Clinometer

Sight clinometers are used to measure the angle of elevation between a viewer and the light generated by a ceiling light projector when reflected on to a base of a cloud. This information, together with a knowledge of the base line distance between the observer and the projector, is used to determine the cloud height - using simple trigonometric tables supplied with the sight clinometer.

The **Model 400-2090 Sight Clinometer** is designed to conform to U.S. National Weather Service Specification K110-SP001. The Sight Clinometer consists of a bottle shaped sighting tube, complete with a 1/4" peep-sight and soft rubber eye shield, cross wires, a quadrant scale graduated into one degree intervals from 0-90 degrees, and a pendant arm, complete with index line, clamped into position by a clutch.

The outer end of the sighting tube is three inches in diameter to permit a wide view of the projector light spot, as well as of the surrounding dark sky. Cross wires aid the observer in centering the sight clinometer onto the light spot. The instrument is supplied complete with carrying case and instructions for operation and maintenance.

Specifications

Weight: 2 lbs
Shipping: 6 lbs

Ordering Information

400-2090 Sight Clinometer

400-2095 Ceiling Light Projector

This National Weather Service pattern Ceiling Light Projector is a small, compact device that measures cloud height to approximately 3,000 feet with the use of a 6 volt, 100 watt, sealed beam lamp powered from a built-in step-down transformer operating on 120 Vac at 50/60 Hz. The transformer can be easily rewired for 220 Vac use.

Lamp life is limited to 50 hours and the projector is provided with a three-minute limit switch for connecting to a power source to conserve lamp life. Silicone gaskets permit quick and trouble-free lamp replacement.

The **Model 400-2095 Ceiling Light Projector** is supplied with one lamp installed, one spare lamp, a timer switch, a 3" test level and complete instructions for installation, operation, and maintenance - ready for mounting onto a user-furnished 2" o.d. support pipe. All hardware items are of stainless steel and the housing is of cast aluminum.

Specifications

Size: 9" diameter, 13" high
Weight: 18 lbs
Shipping: 25 lbs

Ordering Information

400-2095	Ceiling Light Projector
400-15-45	Replacement Lamp (6 V, 100 watt)
400-15-187	Replacement Transformer
400-50-209P3	Replacement Silicone Sealing Ring (2 required)



400-2095 Ceiling Light Projector

Visibility

400-SVS1 Sentry Visibility Sensor	38
400-6000 Visibility Sensor	39
400-CBME40/80 Cloud Ceilometer	40

400-SVS1 Sentry Visibility Sensor



The **Model 400-SVS1 Sentry Visibility Sensor** measures atmospheric visibility, also known as meteorological optical range (MOR), by determining the amount of light scattered by particles (smoke, dust, haze, fog, rain, and snow) in the air that passes through the optical sample volume. A 42-degree forward scatter angle is used to ensure performance over a wide range of particle sizes.

Performance in all weather conditions was a design prerequisite for the Sentry. An integrated, one-piece housing design keeps all cabling internal to the sensor for the ultimate protection against the elements. The sensor housing is made from anodized aluminum and the enclosures are rugged, UV-resistant fiberglass rated to IP66. Based on the proven experience of the NWS and FAA, the sensor uses a “look down” geometry to reduce window contamination and clogging from blowing snow. The windows use continuous duty anti-dew heaters and thermostatically controlled external hood heaters are offered for protection in extreme environments. All power and signal lines to the Sentry are protected with surge and EMI filtering to help guarantee uninterrupted service for the life of the sensor.

Installation and maintenance effort is minimal for the Sentry. A flange located on the bottom of the sensor signal processing box mates with a user supplied 1-1/2 inch IPS pipe. Power and signal connections are made through waterproof cable glands to terminal boards in the signal processing box. Cables are not included.

Calibration of the Sentry in the field is as simple as connecting a factory supplied calibration fixture and following a simple procedure that takes less than 30 minutes. Semiannual calibration is recommended.

Specifications

Performance

Range: 30 m to 16 km (other ranges available)
 Accuracy: $\pm 10\%$
 Time Constant: 60 sec
 Scatter Angle: 42 deg nominal
 Source: 880 nm LED

Power

AC Version: 100-240 Vac, 14 VA; 75 VA with hood heaters
 DC Version: 10-36 Vdc, 6 VA; 18 VA with hood heaters

Environmental

Temperature: -40 to 60 °C
 Humidity: 0-100%
 Protection: IP66 (NEMA-4X)

Physical

Dimensions: 889 mm W x 292 mm H x 305 mm D (35" x 11.5" x 12")
 Weight: 8 kg (18 lb)
 Mounting: Nominal 40 mm pipe, 48.3 mm o.d. max
 (1-1/2" IPS pipe, 1.9" o.d. max)

Data Outputs

Standard: 0-10 Vdc analog
 Optional:
 0-5 Vdc analog
 4-20 mA single ended or isolated
 Serial RS232, RS422, RS485
 Wireless RF modem

Ordering Information

400-SVS1-xx-y-H-P	Sentry Visibility Sensor, specify:
-xx	(AC) 100-240Vac or (DC) 10-36 Vdc
-y = analog output	(1) 0-10 Vdc, (2) 0-5 Vdc, or (A) 4-20 mA single-ended, (B) 4-20 mA isolated
-y = serial output	(MA) RS232 serial data, (MB) RS422 serial data, or (MF) RS485 serial data
-H	(H) hood heaters or (blank) no heaters
-P	(P) 1" pipe flange or (blank) standard 1-1/2" size
400-SVS1-20004	Calibration Fixture
400-SVS1-20007	Day/Night Photometer (for MA, MB, MF options)
400-SVS1-20014	Mounting Bracket
400-SVS1-20016	Hood Extensions (2/set) for areas with severe lens contamination
400-SVS1-30023	Serial RS232 Test Cable (for MA, MB, MF options)
400-SVS1-70009	AC Power Cable 3C 18AWG 3M
400-SVS1-70010-xx	Signal Cable 1 Twisted Pair 22AWG Shielded Specify xx length of cable in meters
400-SVS1-70011-xx	DC Power Cable 2C 20AWG Shielded Specify xx length of cable in meters
400-SVS1-70015	RF Modem, RS232 (for MA, MB, MF options)
400-SVS1-70016	RF Modem, USB (for MA, MB, MF options)

400-6000 Visibility Sensor



The **Model 400-6000 Visibility Sensor** is designed to monitor visibility conditions over a range of 0-50 miles (0-80 km). The 400-6000 includes both analog and digital outputs. Analog output ranges of 0-1, 0-5, or 0-10 volts and 4-20 mA are available. Also included are alarm outputs, which can be adjusted to alarm at user preset visibility thresholds. Two alarm channels are standard, making it possible to indicate good/medium/poor visibility by setting the appropriate thresholds. Digital RS232 and RS485 output at 300-38,400 Baud can be used to indicate the present visibility and provide diagnostic information.

These sensors are designed to provide both accuracy and reliability in a cost effective package. Applications include lighthouses, highways, resort areas, as well as shipboard and other marine platforms.

Visibility is detected using widely accepted principles of forward scattering. A high output infrared LED transmitter projects light into a sample volume, and light scattered in a forward direction is collected by the receiver. The light source is modulated to provide excellent rejection of background noise and natural variations in background light intensity. The sensor's analog output signal is proportional to visibility. Visibility is also compared to the preset alarm thresholds, so that when alarm conditions are reached, the outputs are switched. Visibility thresholds can be set to any value within the instrument range. Alarm outputs are toggled from 0 to 5 V, or from 5 to 0 V, when the alarm condition is satisfied.

- Uses proven optical geometry
- U-bolt mounting for simple installation
- 110 Vac, 220/240 Vac, 12 Vdc
- Low power consumption
- Dual alarm settings
- User configurable analog output
- CE approved
- 47 CFR 15

The sensors are assembled around a compact, lightweight housing, which can be installed on a simple pipe mast. They are constructed entirely of corrosion resistant materials for durability. The standard unit includes small heaters to prevent condensation on the optics. Optional hood heaters are available for areas where the sensor will operate in freezing weather. Transmitter and receiver hoods are designed to divert precipitation away from the optical paths. Calibration is possible under most weather conditions. The wide range of output options allows the sensor to conform to most installation requirements.

Specifications

Range: 20 feet - 50 miles (6 m - 80 km)

Accuracy: $\pm 10\%$ or 10 feet (3m)

Scatter angle: 42° nominal

Source: Infrared LED

Outputs:

Analog: 0-1, 0-5, or 0-10 Volts

Alarms: 2 channels, TTL Hi/Lo

Digital: RS232, RS422, 300 to 38,400 baud

Environmental:

Temperature: -40° to +130° F (-40° to +55° C)

Humidity: 0-100%

Power requirements: 17 W

Heater power: 25 W

Dimensions: 41" W x 11" H x 21" D

Weight: 20 lbs

Mounting: U-bolts for 1-1/4" to 2"

Ordering Information

400-6000-1	Visibility Sensor, 110 Vac
400-6000-2	Visibility Sensor, 220 Vac
400-6000-3	Visibility Sensor, 12 Vdc
400-6000CK	Calibration Kit

Unless otherwise specified, standard configuration will be: miles, RS232, 9600 baud, N, 8, 1, 0-10 volts, 4-20 mA, analog limit 10 miles

400-CBME40/80 Cloud Ceilometer



400-CBME40A Cloud Ceilometer

- *Reliable operation*
- *Easy installation and maintenance*
- *Very long laser life (calc 10 year)*
- *12,500 and 25,000 feet measuring range capability*
- *Low weight and low power consumption*

The **Model 400-CBME40 Cloud Ceilometer** is a stand-alone instrument designed for fixed and mobile installations where accurate and reliable cloud height information is required. The design is based on the LIDAR principle. The light emitting component is a low power diode laser with the output power limited to an eye-safe level. Real time digitizing technique is employed in signal detection and the powerful INTEL 80186 microprocessor is used in signal processing.

The 400-CBME40 has outputs for different types of display and recording units. An RS232 interface supports local control, test, and data acquisition. For remote control and data acquisition, there is an FSK modem.

A built-in test system indicates failures in the event of a malfunction. The electronics are located in two easily replaceable subunits, i.e. a power supply module and printed circuit board. The subunits, as well as the laser diode which is placed on the printed circuit board, can be replaced by spare parts without adjustments or recalibration.

Specifications

Range: 30-12,500 feet and 30-25,000 feet
 Resolution: 20 feet
 Accuracy: 20 feet or 2%, whichever is greater
 Measuring interval: Selected ranges
 Outputs: RS232C, V.23 alt. V.21, Bell 103 alt. Bell 212
 Output data: Cloud height (multiple bases)
 Monitoring data
 Back scatter signal profile
 Operating temperature: -40° to +50°C
 Power supply: 120/230V, 50 Hz, 25 VA, 200 VA (heater)
 Color: White
 Weight: 14 kg without stand
 Laser safety: Class 1 laser product SSIFS 1980:2 (SS-EN60825)

Options

Mobile version with local display
 Stand for permanent installation
 12 Vdc (not connected to heater)
 Green color

Accessories

Graphic program with storing functions, for IBM-PC (DOS 5)
 Display unit, chart recorder
 Demodulator V.23 - RS232

Ordering Information

400-CBME40	Cloud Ceilometer, 12,500 feet detection Specify 110Vac or 220Vac operation Specify RS232 or FSK output
400-CBME80	Cloud Ceilometer, 25,000 feet detection Specify 110Vac or 220Vac operation Specify RS232 or FSK output
400-CHI-BE	Digital Display
400-CHI-BL	Blower Option
400-CHI-DM	FSK Modem
400-CHI-S	Support Stand
400-CHI-SS	Sun Shutter
400-CHI-SW	Display Software, for Windows

Lightning Detection

410-SKYSCAN Hand-Held Lightning Detector 42

410-SKYSCAN Hand-Held Lightning Detector

The **Model 410-SKYSCAN Lightning Detector** is a hand-held instrument used to detect lightning as far as 40 miles away and accurately range its approach, by both an audible tone and by four LEDs which are ranged in miles (20-40, 8-20, 3-8, 0-3). This feature tells the user if the storm is moving towards, away, or parallel to their position.

ACCURACY: State-of-the-art electronics and full digital microprocessor ensures accuracy and reliability.

POWER: SkyScan can be powered by two 9V batteries, 120Vac adapter, or by a 12Vdc cigarette lighter adapter. Unit has automatic shut-off after five hours of continuous operation for extended battery life.

RANGE SELECT: Allows user to choose range at which detected lightning strokes will sound audible alarm.

TONE ON/OFF: Permits user to turn on/off the audible tone, permitting operation in situations where a distinctive audible warning alarm would be intrusive.

STORM DISTANCE: Indicates range of detected lightning strokes by lighting high-intensity LEDs and sounding audible alarm. One LED will light for a lightning strike 20-40 miles away, two for a lightning strike 8-20 miles away, three for a lightning strike 3-8 miles away (highly dangerous situation), and all four for a lightning strike within three miles.

BATTERY SAVE: This mode deactivates all LEDs except battery save. SkyScan still provides audible warning of lightning strikes, while extending battery life from 40-50 hours to as much as 75+ hours.

LOW BATTERY: Lights when SkyScan has approx five hours of operational life remaining in the batteries.

SEVERE STORM WARNING: Warns users of especially strong thunderstorms or squall lines which might produce especially strong winds, heavy rains, or even tornados. SkyScan will sound a continuous alarm for fifteen seconds and lights the severe storm warning LED for a minimum of fifteen minutes. The unit will repeat the process every fifteen minutes until the severe weather activity has cleared.

SKYSCAN CASE: Electronics are protected by a rugged, weather-resistant plastic case, permitting use in any typical outdoor application.

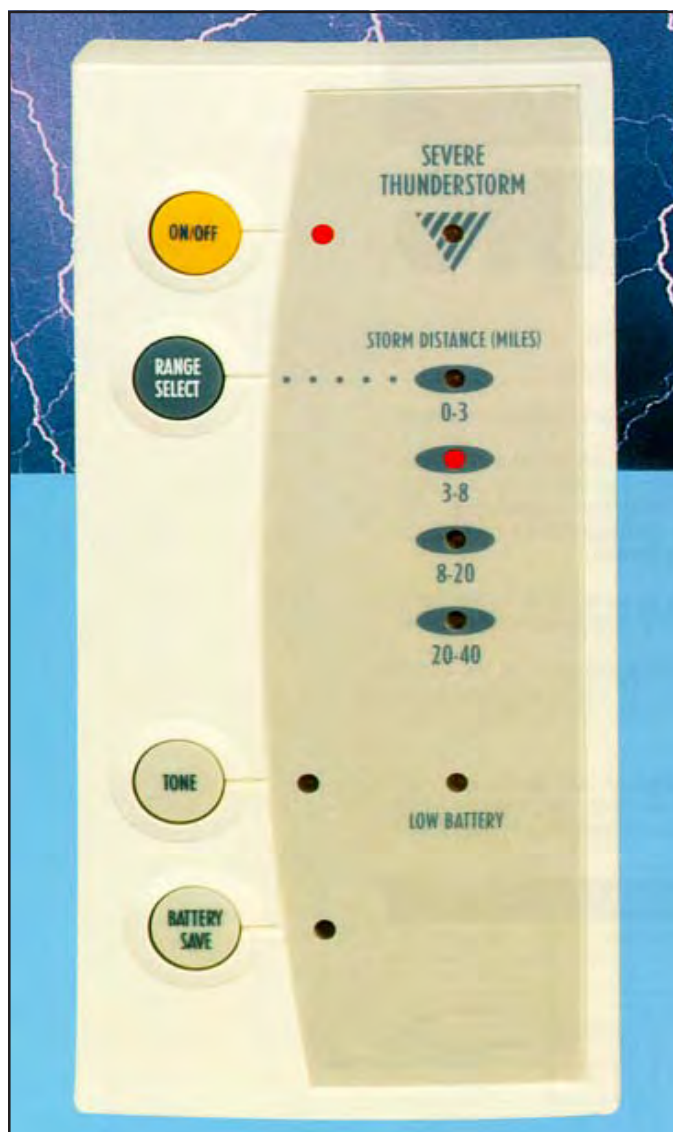

410-SkyScan Hand-Held Lightning Detector

Specifications

Dimensions: 6.5"H x 3.1"W x 1.5"D
Weight: 10.8 oz without batteries

Ordering Information

410-SKYSCAN	SkyScan Hand-Held Lightning Detector Faceplate in kilometers is available on request.
410-SKAC	AC Adapter 120V/60Hz
410-SKAC-220	AC Adapter 220V
410-SKDC	Cigarette Lighter Adapter
410-SKLC	Carrying Case
410-SKMB	Wall Mounting Bracket

Wind

WeatherPort General Purpose Wind Sensors	44
WeatherPort High Sensitivity Wind Sensors	45
NovaVane Wind Speed & Direction Sensors	46
200-2218 Analog Indication Wind System	47
200-05103 Wind Monitor	48
200-05305 Wind Monitor - Air Quality	49
200-27005 Gill UVW Anemometer	50
200-06201 Wind Tracker Display	51
200-03002 Wind Sentry	52
200-81000 Ultrasonic Anemometer	53
200-85000 Ultrasonic Anemometer	54
200-7000 WindSonic Ultrasonic Anemometer	55
200-1390 WindObserver II Ultrasonic Anemometer	56
200-101908 Current Loop Wind Sensors	57
200-102083 Wind Mark III Wind Sensors	58
200-2020 Micro Response Wind Sensors	59
200-2030 Micro Response Wind Sensors	60
200-WS-21-A Dual Set Point Wind Alarm	61
200-WS-23 Current Loop Wind Sensor	62
200-455 Totalizing Anemometer with 10-Min Timer	63
200-WS-25 Wind Logger with Real-Time Display	64
200-2520 Wind Meter	65
200-2530 Wind Speed Indicator	65
200-960 Handheld Anemometer	66
Kestrel 1000 Pocket Wind Meter	67
La Crosse EA-3010U Anemometer	67
Calibration Accessories	68
Calibration Accessories	69
Wind Direction Calibrators	70
Wind Speed Calibrators	70
200-2620 Wind Sock	71
200-2510-A 260-2511-A Totalizing Anemometer	72

WeatherPort General Purpose Wind Sensors

This series of **WeatherPort Wind Sensors** are moderately priced quality transducers designed for general application. A combination of injection molded thermoplastic, anodized aluminum, and stainless steel parts contribute to reliable operation in adverse environments.

These sensors are easy and inexpensive to maintain. The combination three cup anemometer and wind vane units utilize an in-line configuration, eliminating the need for a crossarm.

The anemometer produces a series of output pulses having a frequency directly proportional to wind speed. Wind direction is measured by a balanced vane coupled to a 20k ohm conductive plastic potentiometer. With a constant excitation voltage of less than 15 volts, the output from the wiper arm is proportional to the wind azimuth angle.

Specifications

Model 200-WS-01 Wind Speed Sensor

Turning radius: 4.25"	Accuracy: 0.5 mph or $\pm 3\%$
Speed threshold: 0.8 mph	Size: 4.5" H x 8.5" W
Transducer: Magnetic reed switch	Mounting: 1" o.d. pipe
Speed constant: 1.25 mph=1 pps	Cable: 40', 2 conductor, 24 AWG
Measurement range: 0-99 mph	Weight/shipping: 1 lb/2 lbs

Model 200-WS-04 Wind Direction Sensor

Azimuth accuracy: $\pm 3^\circ$	Resolution: $< 1^\circ$
Transducer: 20K ohm pot, single wiper	Time constant: 2 sec
Potentiometer gap: 5°	Turning radius: 6"
Distance constant: 1.5'	Size: 12-1/2" H x 8" W
Damping ratio: 0.4	Mounting: 1" o.d. pipe
Vane threshold: 1.2 mph	Cable: 40', 3 conductor, 24 AWG
Measurement range:	Weight/shipping: 1 lb/2 lbs
0-360° mechanical, 355° electrical	

Model 200-WS-02 Wind Speed & Direction Sensor

The 200-WS-02 is a combination of the above sensors, mounted in an in-line configuration.

Cable: 40', 5 conductor, 24 AWG
Weight/Shipping: 2 lbs/3 lbs

Environmental

Operating temperature: -40° to $+60^\circ\text{C}$
Relative humidity: 0-100%

Ordering Information

200-WS-01	Wind Speed Sensor, 40' cable
200-WS-02	Wind Speed & Direction Sensors, 40' cable
200-WS-04	Wind Direction Sensor, 40' cable
200-600	Crossarm, 24" wide, without sensors
200-601	Wind Speed & Direction Sensors on Crossarm, 40' cable
330-0224	Additional Cable, per foot (WS-01)
330-0324	Additional Cable, per foot (WS-04)
330-0524	Additional Cable, per foot (WS-02)



200-WS-01 Wind Speed Sensor



200-WS-04 Wind Direction Sensor

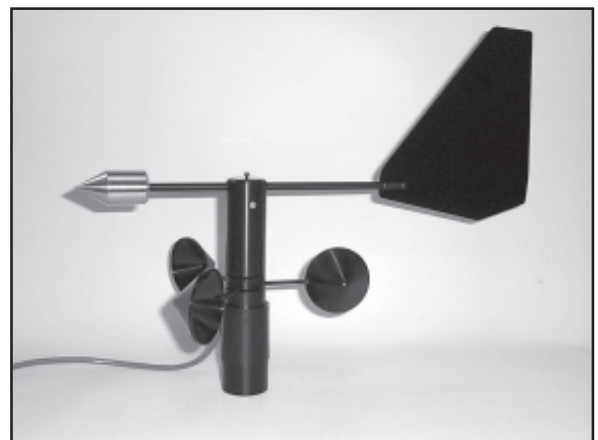

200-WS-02 Combination Wind Speed & Direction Sensor

WeatherPort High Sensitivity Wind Sensors

The **WeatherPort High Sensitivity Wind Sensors** are similar to those shown on the previous page, but they are specially configured to meet U.S. Environmental Protection Agency requirements for PSD (Prevention of Significant Deterioration).

Specifications

Speed

Turning radius: 4.25"
 Speed threshold: 0.8 mph
 Transducer: Magnetic reed switch
 Speed Constant: 1.25 mph = 1 pps
 Measurement range: Speed 0-99 mph
 Accuracy: 0.5 mph or $\pm 3\%$

Direction

Azimuth accuracy: $\pm 3^\circ$
 Transducer type: 20K ohm potentiometer, single wiper
 Potentiometer gap: 5°
 Measurement range: 0-360°
 Linearity: 1%
 Distance constant: 2.6'
 Damping ratio: 0.4
 Vane threshold: 0.8 mph
 Turning radius: 12.5"

Overall

Dimensions:
 WS-04H: 12-1/2" H x 16-1/2" L x 1-1/2" W
 WS-05: 12-1/2" H x 16-1/2" L x 8" W
 Mounting: 1.07" i.d. fits over 1" o.d. (3/4" i.d.) pipe
 Cable: 40', 5 conductor, 24 AWG, shielded
 Weight/shipping: 2 lbs/4 lbs

Ordering Information

- 200-WS-04H High Sensitivity Wind Direction Sensor, 40' cable
- 200-WS-05 High Sensitivity Wind Speed & Direction Sensors, 40' cable
- 200-605 High Sensitivity Wind Speed & Direction Sensors on Crossarm, 40' cable
- 330-0324 Additional Cable, per foot (WS-04H)
- 330-0524 Additional Cable, per foot (WS-05)

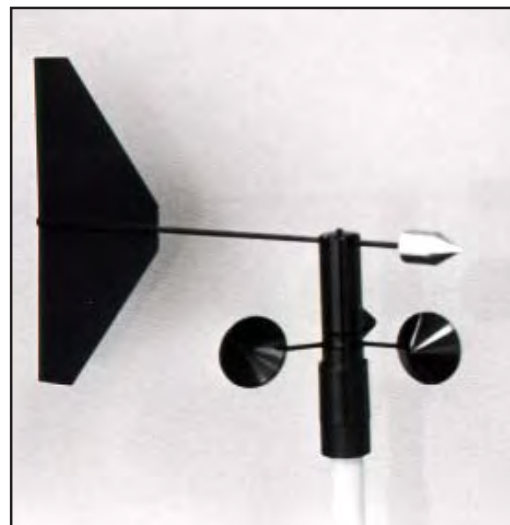

200-WS-05 High Sensitivity Wind Sensor

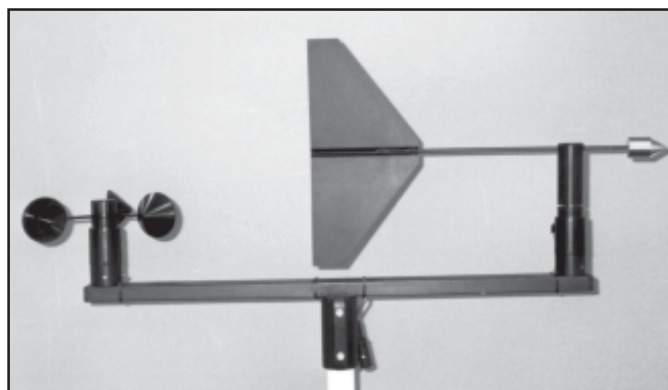

200-605 High Sensitivity Wind Speed & Direction Sensors on crossarm



200-601 General Purpose Wind Speed & Direction Sensors on crossarm

NovaVane Wind Speed & Direction Sensors



200-2201 NovaVane Wind Speed & Direction Sensor

The **NovaVane Wind Speed and Direction Sensor** is designed for use in high wind and marine environments. It features a sensitive four-blade propeller made of high impact plastic to withstand gale force winds. The body of the sensor is constructed of aluminum and high impact plastic. The base is aluminum with a mounting hole pattern that matches other marine style sensors. The NovaVane provides a single sensor design to measure both wind speed and wind direction. The use of internal wiring and slip rings enables speed and direction transducers to operate inside the same housing. The aerodynamic design of the housing and the materials used in the fabrication of the instrument contribute to the durability and the responsiveness of the sensor.

Wind speed is measured by the response of the propeller to the wind. The propeller is coupled directly to a precision-built four-pole AC generator which produces an alternating current with a voltage that is proportional to the wind velocity. The generator is brushless, providing long life and reliable performance at low temperatures.

Wind direction is measured by the response of the aerodynamic body which aligns itself with the direction of the horizontal wind. The sensor shaft is attached directly to the wind direction transducer, producing an output signal which varies in proportion to the horizontal angle of the wind.

Specifications

Wind Speed

Sensor: 4-blade propeller, 13.78" (350 mm) diameter
 Transducer: AC generator, 4-pole
 Range: 0-200 mph (0-90 m/s)
 Output signal: 20 Vac 84 Hz, typical at 100 mph
 Accuracy: ± 0.3 m/s for winds less than 10 m/s, $\pm 3\%$ for winds greater than 10 m/s (with 1.1K ohm load)
 Starting speed threshold: 1.5 mph (0.7 m/s)
 Distance constant: 9.9 ft (3 m)

Wind Direction

Sensor: aerodynamic counter-balanced body
 Transducer:
 200-2201: 1K ohm potentiometer, single-wiper
 200-2206: AC synchro, 115 Vac primary, 90 Vac secondary
 Range: 0-360° azimuth
 Resolution: 1° (depends upon monitoring device)
 Output signal: potentiometer 0-1000 ohms typical, synchro 90 Vac, three phase
 Accuracy: potentiometer linearity $\pm 2^\circ$, synchro ± 2 degrees
 Threshold: 1.5 mph (0.7 m/s)
 Damping ratio: 0.36
 Power consumption
 Wind speed: none, self-generating
 Wind direction: potentiometer 0.1 VA, synchro 25 VA

General

Operating temperature: -50° to $+60^\circ$ C
 Dimensions:
 Height: 26.4" (670 mm)
 Body length: 27.2" (690 mm)
 Base diameter: 5.9" (150 mm)
 Weight/shipping: 11.5 lbs/22 lbs (5.2 kg/10 kg)

Ordering Information

200-2201	NovaVane Wind Speed & Direction Sensor, AC generator and potentiometer
200-2206	NovaVane Wind Speed & Direction Sensor, AC generator and synchro
200-21101	Mast Adaptor, for mounting NovaVane to 1.66" (42 mm) o.d. mast
200-03631	Current Loop Converter 4-20 mA
395-304	Termination J-Box
330-0524	Signal Cable for 200-2201, per foot
330-0820	Signal Cable for 200-2206, per foot

200-2218 Analog Indication Wind System

The **Model 200-2218 Analog Indicating Wind System** consists of a rugged sensor capable of withstanding hurricane force winds and a console for remote display of wind speed and direction. The sensor is a Model 200-2206 NovaVane which measures wind speed using a four-blade propeller coupled to an ac generator transducer. Wind direction is monitored by a counter-balanced tail which drives a synchro transducer.

The indicator console includes electronics to condition the sensor signals for display. The ac voltage representing wind speed is converted to a dc voltage and scaled. The resulting signal is displayed on a jewel and pivot type galvanometric dial. The standard indicating ranges are 0-120 mph, 0-120 knots, or 0-45 m/s. Other ranges are available on special order.

The rotation of the direction sensor synchro is received by an identical synchro in the console. The attached wind direction needle travels proportionally over the 6" diameter dial. Because the synchro output has no discontinuity at north, indication is continuous over the complete 0-360° range. Four cardinal points are noted on the dial.

The indicator console should be installed indoors and may be located up to 1000 feet from the sensor. Two indicator consoles may be used to display the output of a single sensor. In this case the Model 200-22152 Master Indicator Console is connected to the sensor and provides an output signal to the Model 200-22155 Slave Indicator Console. Special order synchro to analog outputs are available.

Specifications

Indicator Console

Input transducers: Speed: ac generator; Direction: synchro
 Indicators: Speed: pivot and jewel meter, 6" diameter dial
 Direction: synchro receiver, 6" diameter dial
 Indicating range: Speed: 0-120 mph, 0-120 knots, or 0-45 m/s,
 must be specified at time of order; Direction: 360° continuous
 Graduations: Speed: 1 mph, 1 knot, or 1 m/s; Direction: 10°
 Dial linearity: ± 2%
 Input voltage: 115 Vac, 50/60 Hz (230 Vac optional)
 Size: 14" W x 7.75" H x 6.75" D
 Weight/Shipping: 7 lbs/14 lbs (3.2 kg/6.4 kg)

Sensor

See Model 200-2206 NovaVane

Ordering Information

- 200-2218 Analog Indicating Wind System, consists of 200 2206 NovaVane and 200-22151 Indicator Console (115 Vac input), specify wind speed range 0-120 mph, 0-120 knots, or 0-45 m/s
- 200-22151 Wind Indicator Console, specify units and range
- 200-22152 Master Wind Indicator Console for use when a second (slave) display is needed, specify units and range
- 200-22155 Slave Wind Indicator Console, specify units and range
- 200-221-230V 230 Vac Input Option for above consoles
- 200-2206 NovaVane sensor alone, ac generator and synchro transducers
- 200-2206SA Synchro to Analog Output Assy, consult factory
- 330-0820 Signal Cable, per foot



200-2206 NovaVane Wind Speed & Direction Sensor

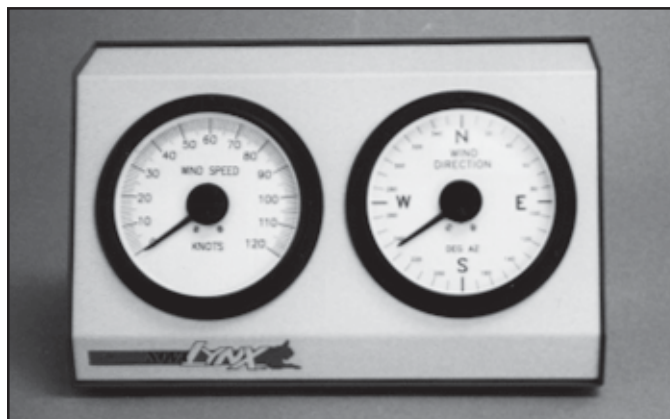

200-22151 Wind Indicator Console

200-05103 Wind Monitor

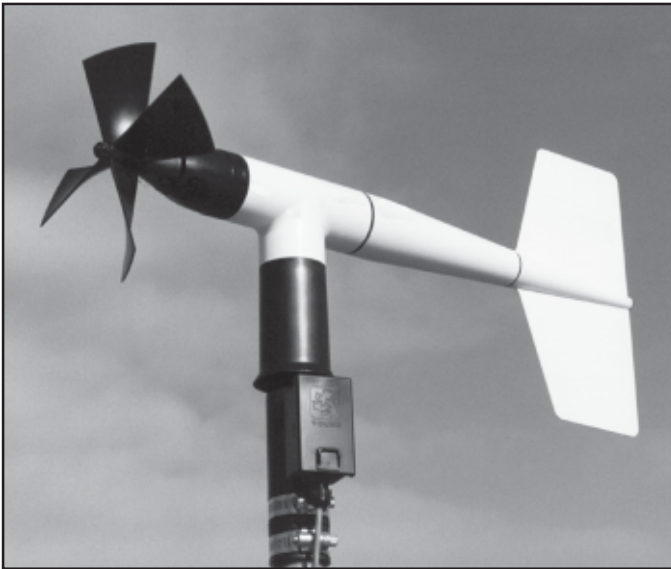

The **Model 200-05103 Wind Monitor** is a high performance, rugged wind sensor. Its simplicity and corrosion-resistant construction make it ideal for a wide range of wind measuring applications. The instrument is made of UV stabilized plastic with stainless steel and anodized aluminum fittings. Precision grade, stainless steel ball bearings are used. Transient protection and cable terminations are in a convenient junction box. The instrument mounts on standard 1" pipe.

The wind speed sensor is a four blade helicoid propeller. Propeller rotation produces an AC sine wave voltage signal with frequency directly proportional to wind speed. Slip rings and brushes are eliminated for increased reliability. The wind direction sensor is a rugged yet lightweight vane with a sufficiently low aspect ratio to assure good fidelity in fluctuating wind conditions. Vane angle is sensed by a precision potentiometer housed in a sealed chamber. With a known excitation voltage applied to the potentiometer, the output voltage is directly proportional to vane angle. A mounting orientation ring assures correct realignment of the wind direction reference when the unit is removed for maintenance.

For offshore and marine use, Model 200-05106 Wind Monitor-MA features special waterproof bearing lubricant and a sealed, heavy duty cable pigtail in place of the standard junction box. Separate signal conditioning for voltage or current outputs is available.

The Wind Monitor is available with two additional output signal options. Model 200-05103V offers calibrated 0-1 Vdc outputs (0-5 Vdc optional), convenient for use with many data loggers. Model 200-05103L provides a calibrated 4-20 mA current

signal for each channel, useful in high noise areas or for long cables (up to several kilometers). Signal conditioning electronics are integrated into the sensor junction box.

Specifications

Range

Wind speed: 0-60 m/s (134 mph)
Gust survival: 100 m/s (220 mph)
Azimuth: 360° mechanical, 355° electrical (5° open)

Accuracy

Wind speed: ± 0.3 m/s (0.6 mph)
Wind direction: $\pm 3^\circ$

Threshold*

Propeller: 1.0 m/s (2.2 mph) 05103, 1.1 m/s (2.4 mph) 05106
Vane: 1.1 m/s (2.4 mph) 05103, 1.3 m/s (2.9 mph) 05106

Dynamic Response*

Propeller distance constant (63% recovery) 2.7 m (8.9 ft)
Vane delay distance (50% recovery) 1.3 m (4.3 ft)

Damping ratio: 0.3

Damped natural wavelength: 7.4 m (24.3 ft)

Undamped natural wavelength: 7.2 m (23.6 ft)

Signal Output

Wind speed: magnetically induced AC voltage, 3 pulses per revolution. 1800 rpm (90 Hz) = 8.8 m/s (19.7 mph)
Azimuth: analog DC voltage from conductive plastic potentiometer- resistance 10K ohms, linearity 0.25%, life expectancy- 50 million revolutions

Power Requirement

Potentiometer excitation: 15 Vdc maximum

Dimensions

Overall height: 37 cm (14.6")
Overall length: 55 cm (21.7")
Propeller: 18 cm (7") diameter
Mounting: 34 mm (1.34") diameter (standard 1" pipe)

Weight

Sensor weight: 1.0 kg (2.2 lbs)
Shipping weight: 2.3 kg (5 lbs)

*Nominal values, determined in accordance with ASTM standard procedures.

200-05103V (0-1 Vdc Outputs)

Power Requirement: 8-24 Vdc (5 mA @ 12 Vdc)
Operating Temperature: -50° to 50° C
Output Signals: 0-1.00 Vdc full scale, 0-5.00 Vdc optional

200-05631 (4-20 mA Outputs)

Power Requirement: 8-30 Vdc (40 mA max.)
Operating Temperature: -50° to 50° C
Output Signals: 4-20 mA full scale

Ordering Information

200-05103	Wind Monitor, less cable
200-05103L*	Wind Monitor, 4-20mA output
200-05103V*	Wind Monitor, specify 0-1 Vdc or 0-5 Vdc
200-05103-45	Alpine Wind Monitor
200-05106	Wind Monitor-MA (Marine Model), 10' cable
200-05603B*	Wind Sensor Interface, specify 0-1 Vdc or 0-5 Vdc
200-05631B*	Wind Line Driver, 4-20 mA current loop
330-0524	Signal Cable, per foot

*Specify wind speed scaling:

0-50 m/s	Add suffix "M"
0-100 mph	Add suffix "P"
0-100 knots	Add suffix "N"
0-200 km/hr	Add suffix "K"

200-05305 Wind Monitor - Air Quality

The **Model 200-05305 Wind Monitor-AQ** is a high resolution wind sensor designed specifically for air quality applications. It combines simple, corrosion-resistant construction with low threshold, fast response and excellent fidelity. The Wind Monitor-AQ meets the requirements of the following regulatory agencies: • U.S. Environmental Protection Agency-Ambient Monitoring Guidelines for Prevention of Significant Deterioration (PSD). • U.S. Nuclear Regulatory Agency-NRC Regulatory Guide 1.23 Meteorological Programs in Support of Nuclear Power Plants. • American Nuclear Society-Standard for Determining Meteorological Information at Power Plants.

Wind speed is sensed by a lightweight, carbon fiber thermoplastic (CFT), helicoid propeller. Propeller rotation produces an AC sine wave voltage signal with frequency directly proportional to wind speed. Slip rings and brushes are not used. The instrument body is UV stabilized plastic with stainless steel and anodized aluminum fittings. Precision grade, stainless steel ball bearings are used throughout. Transient protection and cable terminations are located in a convenient junction box. The instrument mounts on standard 1" pipe.

The wind direction sensor is a lightweight vane with performance characteristics that assure excellent fidelity in fluctuating wind conditions. Vane position is sensed by a precision potentiometer. Output is a DC voltage directly proportional to vane angle.

The Wind Monitor-AQ is available with two additional output signal options. Model 200-05305V offers calibrated 0-1 Vdc outputs (0-5 Vdc optional), convenient for use with many data loggers. Model 200-05305L provides a

calibrated 4-20 mA current signal for each channel, useful in high noise areas or for long cables (up to several kilometers). Signal conditioning electronics are integrated into the sensor junction box.

Specifications**Range**

Wind speed: 0-50 m/s (112 mph)
Azimuth: 360° mechanical, 355° electrical (5° open)

Accuracy

Wind speed: ± 0.2 m/s (0.4 mph)
Wind direction: $\pm 3^\circ$

Threshold*

Propeller: 0.4 m/s (0.9 mph)
Vane: 0.5 m/s (1.0 mph) at 10° displacement

Dynamic Response*

Propeller distance constant (63% recovery): 2.1 m (6.9 ft)
Vane delay distance (50% recovery): 1.2 m (3.9 ft)
Damping ratio: 0.45
Damped natural wavelength: 4.9 m (16.1 ft)
Undamped natural wavelength: 4.4 m (14.4 ft)

Signal Output

Wind speed: magnetically induced AC voltage, 3 pulses per revolution.
1800 rpm (90 Hz) = 9.2 m/s (20.6 mph)
Azimuth: analog DC voltage from conductive plastic potentiometer-resistance 10K ohms, linearity 0.25%, life expectancy- 50 million revolutions

Power Requirement

Potentiometer excitation: 15 Vdc maximum

Dimensions

Overall height: 38 cm (15.0 in)
Overall length: 65 cm (25.6 in)
Propeller: 20 cm (7.9") diameter
Mounting: 34 mm (1.34") diameter (standard 1" pipe)

Weight

Sensor weight: 0.7kg (1.5 lbs)
Shipping weight: 2.3 kg (5 lbs)

**Nominal values, determined in accordance with ASTM standard procedures.
Shielded bearings lubricated with type LO-1 light general purpose instrument oil.*

200-05305V (0-1 Vdc outputs)

Power Requirement: 8-24 Vdc (5 mA @ 12 Vdc)
Operating Temperature: -50° to 50° C
Output Signals: 0-1.00 Vdc full scale, 0-5.00 Vdc optional

200-05305L (4-20 mA outputs)

Power Requirement: 8-30 Vdc (40 mA max.)
Operating Temperature: -50° to 50° C
Output Signals: 4-20 mA full scale

Ordering Information

200-05305	Wind Monitor-AQ, less cable
200-05305L*	Wind Monitor, 4-20 mA output
200-05305V*	Wind Monitor, specify 0-1 Vdc or 0-5 Vdc
200-05603B*	Wind Sensor Interface, specify 0-1 Vdc or 0-5 Vdc
200-05631B*	Wind Line Driver, 4-20 mA current loop
330-0524	Signal Cable, per foot

*Specify wind speed scaling:

0-50 m/s	Add suffix "M"
0-100 mph	Add suffix "P"
0-100 knots	Add suffix "N"
0-200 km/hr	Add suffix "K"

200-27005 Gill UVW Anemometer

The **Model 200-27005 Gill UVW Anemometer** measures the three orthogonal vectors of the wind, along wind component "U", across wind component "V", and vertical wind component "W". The three propeller anemometer sensors are mounted at right angles on a common mast. Each sensor measures the wind component parallel with its axis of rotation. Propeller response as a function of wind angle approximates the cosine law, allowing true wind velocity and direction to be calculated.

The UVW Anemometer is designed for maximum sensitivity at lower wind speeds. Optional carbon fiber thermoplastic (CFT) propellers are available for applications requiring greater range and durability. Rain and dust are excluded from the precision bearings by a continuous duty air blower that keeps the instrument under a slight positive pressure.

The propeller anemometer is a precision air speed measuring instrument. The four blade helicoid propeller drives a miniature tach-generator. Output voltage is

directly proportional to the axial component of the wind speed. Signal polarity indicates direction of propeller rotation. The propeller anemometer is also available with single or dual direction photochopper transducer. The propeller anemometer is especially suited for measuring the vertical wind component. Since normal wind direction seldom exceeds $\pm 30^\circ$ from horizontal, propeller response can be calibrated to follow the cosine law within 3% over this range.

Specifications

08274 Expanded Polystyrene Propeller (EPS)

Diameter: 22 cm
Pitch: 29.4 cm wind passage per revolution
Range: 0-25 m/s (55 mph)
Threshold:* 0.3 m/s (0.6 mph)
Distance constant:* 1.0 m (3.2 ft)

08254 Carbon Fiber Thermoplastic Propeller (CFT)

Diameter: 20 cm
Pitch: 30.0 cm wind passage per revolution
Range: 0-35 m/s (80 mph)
Threshold:* 0.4 m/s (0.8 mph)
Distance constant:* 2.1 m (6.9 ft)

Signal Output

Standard tach-generator transducer: Analog DC voltage proportional to wind component. Polarity indicates rotation direction. 1800 RPM (500 mV) = 8.8 m/s (19.7 mph).
Optional photochopper transducer: Voltage pulse with frequency proportional to wind component. 10 pulses per revolution. 1800 RPM (300 Hz) = 8.8 m/s (19.7 mph)

Power Requirement

24 Vac/12 W for blower motor in UVW Anemometer (separate 115/230V transformer supplied). Propeller Anemometer with tach-generator is self-powered. Optional photochopper transducer requires 5-15 Vdc at 11 mA.

Dimensions

UVW Anemometer: overall height 107 cm (42"), each sensor projects 41 cm (16"), base diameter 16 cm (6.2"), mounting 34 mm (1.34") diameter (standard 1" pipe).
Propeller Anemometer: Overall length with mounting 43 cm (17"), housing diameter 2.5 cm (1"), mounts on standard 3/4" pipe.

Weight

UVW Anemometer: 3.6 kg (7.9 lbs), shipping weight 8.2 kg (18 lbs)
Propeller Anemometer: 0.5 kg (1.2 lbs)

*Nominal values determined in accordance with ASTM standard procedures.

Ordering Information

200-27005	UVW Anemometer with 200-08274 EPS Propellers, less cable
add suffix "T"	Optional 200-08254 CFT Propellers
add suffix "J"	Optional 12 Vdc Blower
200-27106	Propeller Anemometer with 08274 EPS Propeller, standard tach-generator transducer, less cable
add suffix "D"	Optional single-direction photochopper
add suffix "F"	Optional two-direction photochopper, specify 3, 6, or 15 pulses per revolution
add suffix "T"	Optional 200-08254 CFT Propeller
200-08274	EPS Propeller, 22 cm diameter
200-08254	CFT Propeller, 20 cm diameter
330-0820	Signal Cable, per foot



200-06201 Wind Tracker Display

The **Model 200-06201 Wind Tracker** wind speed and wind direction indicator offers big performance in a compact display. Wind speed is displayed in your choice of units, knots, mph, km/h, m/s. Maximum wind speed is saved on the display until reset by the operator. Wind direction information is clearly displayed on a circular compass pattern of LEDs. Multicolored segments give a quick visual indication of current direction and direction variability. Real-time or averaged data can be displayed. The **200-06206 Marine Wind Tracker** indicates wind angle relative to vessel heading. Front panel brightness control allows adjustment for best viewing in any light.

A variety of wind sensors are supported. Standard outputs are 0-5 Vdc and RS485 for additional displays. Alarms for both wind speed and wind direction are provided. The Wind Tracker is very compact. Face size is 144 mm x 144 mm to fit standard DIN panel configurations. Depth is 36 mm for easy mounting on vertical bulkheads or wall surfaces. 12-30 Vdc power enables the Wind Tracker to be powered by external batteries or AC wall adapter (included).

Specifications

Wind Speed Range

0-100 mph, 0-50 m/s, 0-200 km/h, 0-100 knots

Wind Direction Range

200-06201: 0-360° (36 points)

200-06206: 0-180° (port and starboard)

Display Resolution

Wind Speed & Maximum: 1 unit (0.1 M/S only)

Wind Direction: 10° (36 points circular), 1° (digital display mode)

Compatible Sensors

Wind Monitor, Wind Sentry, 200-101908 Current Loop Wind Sensor, 200-7000-3 WindSonic, 200-WS-22 Current Loop Wind Sensor, 200-2201 NovaVane. Other sensors can be used with this display if the output can be set up for the correct 4-20 mA signals

Other Inputs/Outputs

RS485 for additional slave displays

NMEA compatibility on 200-06206 only

Voltage Outputs

0-5 Vdc Full Scale for WS & WD

Alarm Relays

Normally Open contacts for WS & WD, with adjustable delays

Contact Rating

5A resistive, 2A inductive @ 24 Vac/30 Vdc

Remote Displays

Up to 16 remote displays can be connected to one sensor

Power Requirement

12-30 Vdc, 4.5 W

Dimensions

144 mm (5.65") x 144 mm (5.65") x 36 mm (1.4")

Panel Cutout: 138 mm (5.43") x 138 mm (5.43")

Weight

Display: 1 lb (0.45 kg)

Shipping: 3 lb (1.4 kg)

Ordering Information

200-06201-75	Wind Tracker, 120V/60Hz adapter
add suffix "C"	Optional 0-540° Wind Direction Range
add suffix "H"	Optional 230V/50-60Hz Adapter
200-06206-75	Marine Wind Tracker, 120V/50Hz adapter
add suffix "H"	Optional 230V/50-60Hz Adapter
200-06260	Protective Enclosure
200-06280	Rack Mounting Panel, 19" rack



200-06201 Wind Tracker



200-06206 Marine Wind Tracker with optional 200-06260 Protective Enclosure

200-03002 Wind Sentry

The **Model 200-03002 Wind Sentry Anemometer and Vane** are professional quality wind sensors which are suitable for a wide range of wind measurement applications. These moderately priced sensors are principally of thermoplastic construction providing excellent corrosion resistance, low sensor weight, and minimal parts count. In addition to being available as a set complete with crossarm, the sensors are also available separately with mounting brackets.

The anemometer has three hemispherical molded plastic cups. Cup wheel rotation produces an AC sine wave voltage signal with frequency directly proportional to wind speed. This AC voltage signal is induced in a coil by a two pole circular magnet mounted on the cup wheel shaft. One complete sine wave cycle is produced for each cup wheel revolution.

Wind vane position is transmitted by a 10k ohm precision conductive plastic potentiometer which requires a regulated excitation voltage. With a constant voltage applied to the potentiometer, the output signal is an analog voltage directly proportional to azimuth angle. The plastic vane is molded directly on the anodized aluminum vane shaft.

Strain reliefs with seals are provided for cable entry to the sensors and termination junction box.



200-03002 Wind Sentry

Specifications

Range

Wind speed: 0-50 m/s (112 mph)
Gust survival: 60 m/s (134 mph)
Azimuth: 360° mechanical, 355° electrical (5° open)

Accuracy

Wind speed: ± 1.1 mph
Wind direction: ± 5°

Threshold*

Cup Anemometer: 1.1 m/s (2.5 mph)
Vane: 1.3 m/s (2.9 mph) at 10° displacement
1.9 m/s (4.2 mph) at 5° displacement

Dynamic Response

Cup wheel distance constant: 2.3 m (7.5 ft)
Vane delay distance: 0.5 m (1.6 ft)
Damping ratio: 0.20

Signal Output

Wind speed: Magnetically induced AC sine wave voltage, 1 pulse per revolution, 1800 rpm (30 Hz) = 22.8 m/s (51.0 mph)
Azimuth: Analog DC voltage from conductive plastic potentiometer - resistance 10K ohms, linearity 0.5%, life expectancy 20 million revolutions.

Power Required

Potentiometer excitation: Regulated voltage recommended, 5-15 Vdc
Sensor interface: 5-15 Vdc unregulated
Line driver: 12-30 Vdc unregulated (depending upon line and load resistance)

Dimensions

Overall height: 32 cm (12.6")
Crossarm length: 28 cm (11") between instrument centers
Vane length: 22 cm (8.7")
Cup wheel: 12 cm (4.7") dia
Mounting: 34 mm (1.34") dia (standard 1" pipe)

Weight

Sensors: 0.7 kg (1.5 lbs)
Shipping: 1.3 kg (3 lbs)

*Nominal values determined in accordance with ASTM standard procedures.

Ordering Information

200-03002	Wind Sentry Anemometer and Vane with Crossarm, less cable
200-03002L	Wind Sentry with 4-20 mA Output
200-03101	Wind Sentry Anemometer with Mounting Bracket, less cable
200-03301	Wind Sentry Vane with Mounting Bracket, less cable
200-03603*	Wind Sensor Interface (specify 0-1 Vdc or 0-5 Vdc)
200-03631*	Wind Line Driver (4-20 mA current loop)
330-0524	Sensor Cable, per foot

*Specify wind speed scaling
0-50 m/s Add suffix "M"
0-100 knots Add suffix "N"
0-200 km/hr Add suffix "K"

200-81000 Ultrasonic Anemometer



200-81000 Ultrasonic Anemometer

The **Model 200-8100 Ultrasonic Anemometer** is a three-dimensional no-moving-parts wind sensor. Two-dimensional anemometers meet the need for economy, but they ignore the important vertical wind component. The 200-81000 measure three dimensional wind velocity based on the transit time of ultrasonic acoustic signals. From speed of sound, sonic temperature is derived. Speed of sound and sonic temperature are corrected for crosswind effects.

Measurement data are available as voltage output signals or serial output using RS232 or RS485 connections. Both voltage and serial output may be configured for various output formats. Operating parameters may be edited using ordinary terminal software on a PC. Simple menus make it easy. All parameters are stored in nonvolatile memory.

The sensor features robust construction with three opposing pairs of ultrasonic transducers supported by stainless steel members. This arrangement provides rigidity to the anemometer while offering a measure of protection to the transducers. The transducers are

arranged so that measurement are made through a common volume, thereby improving the validity of the measurement. A fast 160 Hz sampling rate ensures superior measurement resolution.

Superior environmental resistance is achieved by using UV stabilized thermoplastic, stainless steel, and anodized aluminum components. Electrical connections are made via an easily accessible junction box. The unit mounts on standard 1" pipe.

Specifications

Operating Temperature

-50 to +50 °C

Range

Wind speed: 0 to 40 m/s (0 to 90 mph)

Resolution: 0.01 m/s

Threshold: 0.01 m/s

Accuracy: $\pm 1\%$ rms ± 0.05 m/s (0 to 30 m/s) $\pm 3\%$ rms (30 to 40 m/s)

Wind direction: 0 to 360 degrees

Elevation range: ± 60 degrees

Resolution: 0.1 degree

Accuracy: ± 2 degrees (1 to 30 m/s) ± 5 degrees (30 to 40 m/s)

Speed of sound: 300 to 360 m/s

Resolution: 0.01 m/s

Accuracy: $\pm 0.1\%$ rms ± 0.05 m/s (0 to 30 m/s)

Sonic temperature: -50 to +50 °C

Resolution: 0.01 °C

Accuracy: ± 2 °C (0 to 30 m/s)

Serial Output

RS232 or RS485

1200 to 38400 baud

4 to 32 Hz (user-selected)

User programmable ASCII output configuration (select from U, V, W, Speed of sound, Sonic temperature, 2D speed, 3D speed, Azimuth, Elevation)

Preset outputs:

NMEA- Marine Standard

RMYT- Wind Tracker

Units: m/s, cm/s, MPH, Knots, Km/hr

Analog Voltage Outputs

4 voltage outputs, 0 to 5000 mV (select from U, V, W, Sonic temperature or Speed, Azimuth, Elevation, Sonic temperature)

Power Requirement

12 to 30 Vdc , 4 watts

Dimensions

56 cm high x 17 cm radius (3 support arms)

Weight/Shipping: 1.7 kg (3.8 lb)/4.5 kg (10 lb)

Ordering Information

200-81000	Ultrasonic Anemometer
330-0524	Cable, per foot

200-85000 Ultrasonic Anemometer

The **Model 200-85000 Ultrasonic Anemometer** is a 2-axis, no-moving-parts wind sensor. It is ideal for general meteorological applications requiring accurate, reliable wind measurement.

The sensor features durable, corrosion-resistant construction with opposing pairs of ultrasonic transducers secured in a streamlined molded frame. The 85000 is fully wind-tunnel tested and calibrated to provide accurate wind measurement over a wide operating range.

The standard sensor includes many useful output options. Analog voltage outputs are provided for wind speed and wind direction. A variety of serial output formats are also available on the standard sensor. These include ASCII text, RMYT (compatible with Wind Tracker display), and NMEA formats. Operating parameters may be edited using ordinary terminal software on a PC. Simple menus make it easy. All parameters are stored in nonvolatile memory.

Superior environmental resistance is achieved by using UV stabilized thermoplastic, stainless steel, and anodized aluminum components. The sensor installs on readily available 1" IPS pipe (1.34" o.d.). Wiring connections are made in a convenient weatherproof junction box with screw terminals; special mounting adapters, connectors, and cables are not required.

Specifications

Wind Speed: 0 to 70 m/s (0 to 156 mph)
Resolution: 0.1 m/s
Accuracy: (30 m/s) \pm 2% or 0.1 m/s, (70 m/s) \pm 3%

Wind Direction: 0 to 360 degrees
Resolution: 1 degree
Accuracy: \pm 2 degrees

Serial Output: RS232 or RS485

Formats: ASCII Text, RMYT, NMEA

Units: m/s, mph, knots, km/hr

Analog Voltage Outputs:

Wind Speed: 0 to 5 V
Wind Direction: 0 to 5 V

Power Requirement: 9 to 16 Vdc, 30 mA typical

Operating Temperature: -50 to +50 °C



200-85000 Ultrasonic Anemometer

Dimensions:

34 cm high x 17 cm wide
Weight: 0.7 kg (1.5 lb)
Shipping Weight: 1.6 kg (3.5 lb)

Ordering Information

200-85000	Ultrasonic Anemometer
330-0524	Cable, per foot

200-7000 WindSonic Ultrasonic Anemometer

A lightweight unit, the **200-7000 WindSonic Ultrasonic Anemometer** is of a robust, high strength construction. Without the need for expensive on-site calibration or maintenance, and with a corrosion free exterior, WindSonic is a true fit and forget unit.

The flexible design enables you easily to configure WindSonic to deliver the information you require. By using the software provided it is possible to select the output rate and choose the units of measurement that suit your application. Ensuring accuracy and reliability, WindSonic automatically transmits an anemometer status code with each output to indicate its operating status. Available in three options, providing a number of different digital and analog outputs, WindSonic is supplied with NMEA and RS232 digital output as standard.

Maintenance free, quick and easy to install, WindSonic is designed to be mounted using a standard pole fitting and comes complete with all screw fittings, a mating marine grade connector, and comprehensive user manual.

Providing accurate results in all weather conditions, WindSonic exhibits a number of distinct advantages:

- Consistent performance throughout life (no accuracy degradation due to wear of moving parts)
- Corrosion free, UV resistant material
- Low start speed (0.01 m/s, 0.09 knots)
- Maintenance free
- No calibration required
- Robust construction
- Software configurable
- Status code output
- True 0-359° operation (no dead band on direction output)
- Wind speed and direction from a single unit

Ordering Information

200-7000-1	WindSonic Ultrasonic Anemometer RS232 output
200-7000-2	WindSonic Ultrasonic Anemometer RS232/422/485 output
200-7000-3	WindSonic Ultrasonic Anemometer RS232/422/485 and 0-5V or 4-20 mA output
200-7000-4	WindSonic Ultrasonic Anemometer SDI-12 output
200-7000-00	WindSonic Connector Kit, not assembled
200-7000-01	9-Pin Serial Connector Kit, not assembled
200-7000-02	WindSonic Cable Assembly Fee
200-7000-03	WindSonic Mounting Stub
200-7000-04	WindSonic Boom Mounting Assy
330-04TP24	Signal Cable, per foot



200-7000 WindSonic Ultrasonic Anemometer

Specifications

Outputs

Output 1, 2, or 4 outputs per second
Parameters Wind Speed and Direction or U and V (vectors)
Units of measure m/s, knots, mph, kph, ft/min

Wind Speed

Range 0-134 mph (0-60 m/s)

Accuracy $\pm 2\%$

Resolution 0.02 mph (0.01 m/s)

Wind Direction

Range 0 to 359° – no dead band

Accuracy $\pm 3^\circ$

Resolution 1°

Anemometer Status

Message supplied as part of standard output

Power Requirement

Anemometer 9-30 Vdc @ 14.5 mA typical for option 1

Outputs

Option 1: RS232 (9600 baud)

Option 2: RS232 + RS422 + RS485 (9600 baud) + NMEA*

Option 3: RS232 + RS422 + RS485 + NMEA* + 0-5V or 4-20 mA

Option 4: SDI-12

*NMEA 0183 Version 3

Maximum Recommended Cable Length

RS232: 20' (6.5 m)

RS422/485: 3200' (1 km)

Analog voltage: 20' (6.5 m)

Analog current: resistance dependent, max 250 ohms

Environmental

Moisture Protection IP65

Operating Temperature -31° to +158° F (-35° to +70° C)

Storage Temperature -40° to +194° F (-40° to +90° C)

Operating Humidity < 5% to 100%

EMC

EN 61000-6-2: 2001

EN 61000-6-3: 2001

MTBF: 15 years

Materials: External Construction LURAN S KR 2861/1C ASA/PC

Dimensions

Size 5.6" x 6.3" (142 x 160 mm)

Weight 1 lb (0.45 kg)

Optional Factory Calibration: Traceable to national standards

Mounting: Pipe Mounting 1.75" (44.45 mm) diameter

200-1390 WindObserver II Ultrasonic Anemometer

The **WindObserver II** provides the best solution on the market for reliable, accurate, and cost-effective wind speed and directional measurement. The elimination of moving parts together with a rugged stainless steel construction means that WindObserver II is virtually maintenance-free and requires no calibration on site. The heated head keeps the unit free from ice and snow, providing continuous use even in the most extreme weather conditions.

A new flexible design ensures that the WindObserver II can be configured by the user to their exact requirements, which may include analogue outputs, 10 Hz output, heating, or sonic temperature.

The Windows™-based WindCom communications package allows the user to operate the anemometer in various modes, permitting the measurement of U & V vectors or wind speed and direction. Communication is via an RS422 bidirectional link, which allows several units to be networked together and data to be logged on demand. The WindObserver II has been rigorously tested to internationally recognised standards and meets the stringent performance criteria specified by airport, marine, oil, production, meteorological, and utility organizations around the world.

Ordering Information

200-1390-PK-006 WindObserver II, RS422, 2m cable
 200-1390-PK-006/10M Same as 200-1390-PK-006 except 10m cable

200-1390-PK-007 WindObserver II, heated, RS422, 2m cable
 200-1390-PK-007/10M Same as 200-1390-PK-007 except 10m cable

200-1390-PK-026 WindObserver II, RS422 & Analog, 2m cable
 200-1390-PK-026/10M Same as 200-1390-PK-026 except 10m cable

200-1390-PK-027 WindObserver II, heated, RS422 & Analog, 2m cable
 200-1390-PK-027/10M Same as 200-1390-PK-027 except 10m cable

200-1390-MB Mouting Bracket



Specifications

DIMENSIONS

Size: 405mm x 210mm
 Weight: 1.5kg

MEASUREMENT

Output: 1Hz, 4Hz, 10Hz
 Parameters: UV, Polar, NMEA, Tunnel
 Units: M/S, Knots, MPH, KPH Ft/min
 Averaging: Flexible 1-3600 seconds

WIND SPEED

Range: 0-65 m/s (0-145 mph)
 Starting Threshold: 0.01 m/s
 Accuracy: 2%
 Resolution: 0.01 m/s
 Offset: ± 0.01 m/s

DIRECTION

Range: 0-359°
 Dead Band Direction: None
 Accuracy: $\pm 2^\circ$
 Resolution: 1°

SONIC TEMPERATURE

Range: -40deg;C to +70°C (refer to user manual)

DIGITAL OUTPUT

Communication: RS422, full duplex

Baud Rates: 1200 2400 4800 9600 19200 38400
 Formats: 8 data, odd, even or no parity
 Anemometer Status: Supplied as part of standard message

ANALOGUE OUTPUT - OPTIONAL

Quantity: 3 (speed, direction, status or sonic temp)
 Scale: Multiples of ± 10 m/s up to 70 m/s
 Type $\pm 2.5V$, 0-5V or 4-20mA
 V Output Resistance: 60 Ohms
 4-20mA Loading: 10-300 Ohms

MATERIALS

External Construction: Stainless Steel 316

ENVIRONMENTAL

Moisture Protection: IP66 (NEMA4X)
 Operating Temperature: -55°C to +70°C
 Humidity: 5% to 100% RH
 Precipitation: 300mm/hr
 EMC: EN 61000-6-2 : 2001
 EN 61000-6-3 : 2001
 Icing: MILSTD810E Method 521.1 Procedure 1

MISC

Standards: Traceable to NAMAS standards
 Site Calibration: None Required
 Integrity Check Unit (Zero Wind) supplied as optional extra

POWER REQUIREMENT

Anemometer Only: 9-30 Vdc (40mA @ 12 Vdc)
 Heating Optional: 3A @ 24V ac or dc

200-101908 Current Loop Wind Sensors

- *Low Threshold*
- *Lightweight*
- *Low Power CMOS Design*
- *4-20 mA Outputs*
- *Optional External Heaters*

The **Model 200-101908 Current Loop Wind Sensors** combine accuracy and reliability with low cost. Sensors with current loop outputs are ideal for applications requiring more than a few hundred feet of separation between the sensor and the signal conditioning, data acquisition, or display systems. These same sensors are also effective in high electrical noise environments. Additionally, the amount of wiring is reduced when current loops are used which can help to reduce both the total cost and time of installation of a turn-key system.

The 200-101908 Current Loop Wind Sensors meet the EPA's Prevention of Significant Deterioration (PSD) requirements. They are also well suited for general wind monitoring applications. Wind speed is sensed by a three-cup anemometer and is converted to an electrical signal by a 20-slot photochopper which uses a solid-state light source for maximum reliability. Wind direction is sensed by a counterbalanced wind vane coupled to a precision, low torque potentiometer. Both the wind speed and wind direction sensors use stainless steel precision ball bearings for maximum life and low threshold. Traceability to NIST is available as an option for each anemometer cup assembly by comparison testing against an NIST transfer standard at the factory wind tunnel.

The wind sensors and their crossarm are an integral unit. The prewired crossarm mounts on a 3/4" IPS vertical pipe stub (1.05" o.d.). Orientation of the crossarm is along an east-west plane. A 24 Vdc/50 mA source is required to operate the wind set over a four conductor cable which can be up to a mile in length. The 24 Vdc/50 mA source can be supplied by the Model 200-101949 Wind Speed/Wind Direction Current Loop Display or by any customer supplied voltage source which meets the 24 Vdc/50 mA requirements.

Optional external heaters are available for both sensors. These heaters consume approximately 10 watts of power per sensor and are thermostatically controlled. The optional external heaters require customer supplied AC power.

Specifications

Wind Speed

Accuracy: 0.25 mph or $\pm 1.5\%$ (± 0.11 m/s)
 Threshold: <1 mph (<0.45 m/s)
 Distance constant: 15.0' (4.6 m) of air max,
 8.0' (2.4 m) of air max (optional)
 Operating range: 0-125 mph (0-55 m/s)
 Signal output: 4-20 mA proportional to 0-100 mph
 Power requirements: 24 Vdc at 20 mA maximum
 Heater power: 115 Vac, 60 Hz, 20 watts; 220 Vac, 50 Hz, 20 watts
 Weight: less than 2 lbs (0.9 kg)
 Turning radius: 3.75" (9.5 cm)
 Operating temperature: -40° to 140°F (-40° to 60°C)

Wind Direction

Accuracy: $\pm 3^\circ$
 Threshold: <1 mph (<0.45 m/s)
 Distance constant: 15.0' (4.6 m) of air max,
 8.0' (2.4 m) of air max (optional)
 Damping ratio: 0.4-0.6 at 10° initial angle of attack
 Operating range: 0-360° mechanical
 Signal output: 4-20 mA proportional to 0-540°
 Power requirements: 24 Vdc at 20 mA maximum
 Heater power: 115 Vac 60 Hz 20 watts; 220 Vac 50 Hz 20 watts
 Weight: less than 2 lbs (0.9 kg)
 Turning radius: 17.5" (41.9 cm)
 Operating temperature: -40° to 140°F (-40° to 60°C)

Ordering Information

200-101908-3	Current Loop Wind Sensors 0-360°, less cable & conn
200-101908-5	Current Loop Wind Sensors 0-540°, less cable & conn
200-101234-0	External Heater, 115 Vac
200-101234-1	External Heater, 220 Vac
200-101949	Digital Current Loop Display (WS/WD)
200-101982	Connector
330-0420	SensorCable, per foot
200-1012/xxx	Heater Cable with Connector, specify cable length



200-102083 Wind Mark III Wind Sensors

- Low Threshold
- Lightweight
- Low Power CMOS Design
- Optional External Heaters

The **Wind Mark III Wind Sensors** combine accuracy and reliability with low cost. The sensors meet EPA Prevention of Significant Deterioration (PSD) requirements. They are also well suited for general wind monitoring applications.

Wind speed is sensed by a three-cup anemometer and is converted to an electrical signal by a 20-slot photochopper, which uses a solid-state light source for maximum reliability. Wind direction is sensed by a counterbalanced wind vane coupled to a precision, low-torque potentiometer. Both the wind speed and wind direction sensors use stainless steel precision ball bearings for maximum life and low threshold. Traceability to NIST is available as an option for each anemometer cup assembly by comparison testing against an NIST transfer standard in the factory wind tunnel.

The sensors and their crossarm are an integral unit. The prewired crossarm mounts on a 3/4 inch IPS vertical pipe stub (1.05" o.d.) Orientation of the crossarm is along an East-West plane.



Specifications

Wind Speed

Accuracy: 0.25 mph or $\pm 1.5\%$ (± 0.11 m/s)
 Threshold: < 1 mph (<0.45 m/s)
 Distance constant: 15.0' (4.6 m) of air max,
 8.0' (2.4 m) of air max (optional)
 Operating range: 0-125 mph (0-55 m/s)
 Signal output: Nominal 2.0 Vpp into 4.7 Kohm, frequency proportional to wind speed, amplitude dependent on supply voltage
 Power requirements: 5-7 Vdc @ 1 mA nominal
 Heater power: 115 Vac, 60 Hz, 20 watts; 220 Vac, 50 Hz, 20 watts
 Weight: less than 2 lbs (0.9 kg)
 Turning radius: 3.75" (9.5 cm)
 Operating temperature: -40° to 140°F (-40° to 60°C)

Wind Direction

Accuracy: $\pm 3^\circ$
 Threshold: < 1 mph (<0.45 m/s)
 Distance constant: 15.0' (4.6 m) of air max,
 8.0' (2.4 m) of air max (optional)
 Damping ratio: 0.4-0.6 at 10° initial angle of attack
 Operating range: 0-360° mechanical
 Signal output: Variable DC voltage, magnitude proportional to wind direction
 Power requirements: Max 5 mA through 2 Kohms
 Heater power: 115 Vac, 60 Hz, 20 watts; 220 Vac, 50 Hz, 20 watts
 Weight: less than 2 lbs (0.9 kg)
 Turning radius: 17.5" (41.9 cm)
 Operating temperature: -40° to 140°F (-40° to 60°C)

Ordering Information

200-102083	Wind Mark III Wind Sensors with Crossarm, less cable and connector
200-101234-0	External Heater, 115 Vac
200-101234-1	External Heater, 220 Vac
200-102138	Replacement Cup Assy, black Lexan
200-101944	Replacement Vane Assy, fast response magnesium
200-100609-0	Connector
330-0624	Sensor Cable, per foot
200-1012/xxx	Heater Cable with Connector, specify cable length
200-101278	Wind System consisting of: 200-WM-III Wind Sensor Set, 50' of wind cable with connector, electronics package in NEMA enclosure with analog outputs 0-5V or 0-1V, 0 to 50/100 mph and 0 to 540°

Signal conditioners for the WM-III sensors are available in modular form with a variety of full scale ranges, engineering units, outputs, and several other options. Consult factory for information.

200-2020 Micro Response Wind Sensors

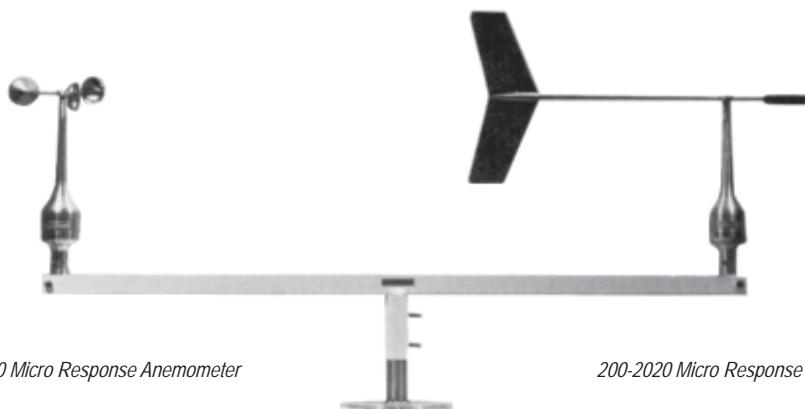

200-2030 Micro Response Anemometer

200-2020 Micro Response Vane

The Micro Response Wind Sensors have been carefully designed to provide accuracy, sensitivity, dependability, and ease of use. They are sensitive enough to catch the slightest breeze, yet rugged enough to withstand gale force winds. Fixed keying of the sensor bodies makes orientation necessary one time only. The crossarm can be installed quickly and accurately on a tower or mast. Micro Response Wind Sensors are selected when the requirement is for high response, low maintenance sensors.

The **Model 200-2020 Micro Response Wind Vane** is a highly reliable, low threshold wind direction sensor. It responds to winds as low as 0.5 mph. The machined aluminum body is aerodynamically shaped to combat sensor-induced turbulence. A labyrinth beneath the vane assembly prevents water and dust particles from reaching the sealed bearings at the top of the shaft. The reinforced, lightweight foam tail has a butyrate skin and a stainless steel counterweight.

As the vane turns, it rotates a stainless steel shaft held in place with instrument-grade bearings. A waterproof, wirewound potentiometer with zero gap is coupled to the base of the shaft. This potentiometer has excellent linearity. Very low torque (0.15 inch ounces) is required to move the wiper. The use of a single wiper doubles the life expectancy of the potentiometer compared to dual-wiper potentiometers. Electronic switching in the signal conditioning module provides a range of 0-540°.

The **Model 200-2023 Crossarm** is recommended for mounting the vane in conjunction with the micro response anemometer. A mast adapter is available for mounting either sensor alone on a 1" (25 mm) o.d. mast.

Once installed and oriented, the sensors can be removed from the crossarm or mast adapter for maintenance and reinstalled without reorientation. A keyed connector allows replacement in the original position only.

Specifications

Micro Response Vane

Sensor: Counterbalanced tail
 Transducer: 5K-ohm potentiometer, single wiper
 Excitation: 1 mA, +5 Vdc
 Range: 0-360° or 0-540°
 Accuracy: $\pm 2^\circ$, 5° deadband at North
 Resolution: $< 1^\circ$
 Potentiometer linearity: 0.5%
 Threshold: 0.5 mph (0.22 m/s)
 Damping ratio: 0.4
 Delay distance: 3.5' (1.1 m)
 Operating temperature: -40° to +60°C
 Materials: Aluminum body with foam tail
 Size: Body: 12" H x 2.75" dia (305 mm x 70 mm)
 Turning radius: 18" (457 mm)
 Mounting: Direct to 200-2023 crossarm or with adapter to 1" (25 mm) o.d. mast
 Weight/shipping: 2.5 lbs/7 lbs (1.1 kg/3.2 kg)

Crossarm

Size: 48" W x 6" H x 1" square (1219 mm x 152 mm x 25 mm)
 Mounting: 1" (25 mm) o.d. mast
 Weight/shipping: 3.5 lbs/5 lbs (1.6 kg/2.3 kg)

Heater

Heating capability: To approx 20°C above ambient temperature at 0 mph wind
 Control: Optional Model 200-10681 thermostat
 Input voltage:
 200-20201: 115 Vac, 50/60 Hz
 200-20201-A: 230 Vac, 50/60 Hz
 Power: 20 W standard
 Size: 2.64" dia x 1.5" H (67 mm x 38 mm)
 Weight/shipping: 1 lb/2 lbs (0.4 kg/0.9 kg)

200-2030 Micro Response Wind Sensors

The **Model 200-2030 Micro Response Anemometer** is a highly responsive and rugged 3-cup anemometer designed to measure very low wind speeds (0.5 mph threshold). It is constructed entirely of stainless steel and anodized aluminum to resist corrosive environments. Like its wind vane counterpart, the micro response anemometer has an aerodynamically shaped body and utilizes a labyrinth to prevent dust and water from reaching the bearings.



200-2030 Anemometer

Rotation of the main shaft by the cup assembly moves a slotted disc through a photon beam, which is generated by a long-life infrared LED. The interruption of the beam causes a pulse output with a frequency proportional to wind speed. A quick release waterproof connector is standard. The photon-coupled chopper is mounted on the connector and can be removed from the body simply by removing the connector.

One other type of micro response anemometer is available, similar to 200-2030 except in terms of output. The 200-2031 utilizes a dc generator to produce a dc voltage proportional to wind speed. The main shaft couples the cup assembly directly to the generator. Output is approximately 5.5 mV/mph.

The **Model 200-20201 Heaters** are available for use in cold climates to minimize freezing of the vane and anemometer shafts. The heater assembly mounts between the top and bottom sections of the sensor body. It consists of a solid block of aluminum with a machined cavity containing a 20-watt heater. The block acts as a heat sink. The heater raises the block's temperature 20°C above the ambient temperature. Environmental connectors are supplied with the heater. An optional thermostat is available. One thermostat will control any number of heaters.

Specifications

Micro Response Anemometer

Sensor: 3-cup assembly, black lexan, 2" diameter cups

Transducer:

200-2030 light chopper

200-2031 dc generator

Excitation: 200-2030 25 mA, +12 Vdc

Light source: 200-2030 LED

Output:

200-2030: 30 pulses/revolution, 900 Hz at 89 mph

200-2031: approx 5.5 mV/mph

Range: 0-100 mph (0-45 m/s)

Accuracy: \pm 0.15 mph or 1%

Threshold:

200-2030: 0.5 mph (0.22 m/s)

200-2031: 1 mph (0.45 m/s)

Distance constant: 5' (1.5 m)

Operating temperature: -40° to +60°C

Materials: Stainless steel and anodized aluminum

Size: Body: 12" H x 2.75" dia (305 mm x 70 mm)

Turning radius: 3.8" (97 mm)

Mounting: Direct to 200-2023 crossarm or with adapter

to 1" (25 mm) o.d. mast

Weight/shipping: 2.5 lbs/7 lbs (1.1 kg/3.2 kg)

Ordering Information

200-2020	Micro Response Wind Vane
200-2030	Micro Response Anemometer, light chopper
200-2031	Micro Response Anemometer, dc generator
200-2023	Crossarm for mounting two micro response wind sensors to 1" (25 mm) o.d. mast
200-20231	Mast Adapter to mount one micro response wind sensor to 1" (25 mm) o.d. mast
200-20201	Sensor Heater Assembly, 115 Vac
200-20201-A	Sensor Heater Assembly, 230 Vac
200-10681	Thermostat Control for sensor heater; one thermostat required for any number of heaters; requires junction box
200-M488035	Spare Parts Kit for 200-2020, including tail assembly, potentiometer, 2 bearings, and 4 set screws
200-M488036	Spare Parts Kit for 200-2030, including cup assembly, light chopper assembly, 2 bearings, 2 E-rings, and 3 set screws
200-M488037	Spare Parts Kit for 200-2031, including cup assembly, dc generator, 2 bearings, 2 E-rings, and 2 set screws
330-0220	Cable for 200-2031, per foot
330-0320	Cable for 200-2020, per foot
330-0524	Cable for 200-2030, per foot

200-WS-21-A Dual Set Point Wind Alarm



200-WS-21 Dual Set Point Wind Alarm

The **200-WS-21-A Dual Set Point Wind Alarm** is a microprocessor-based wind alarm system. It sounds an alarm and controls the operation of two electrical relays whenever wind speed reaches either of two independently user selected limits. It has 0 to 100 mph wind speed measurement and alarm range. A liquid crystal display provides a readout of the measured wind speed, maximum wind speed, and it is also used to display the menus for the user to select the alarm parameters.

Each of the two set point alarms control a self-contained Form "C" electrical relay. These relays may be used to control small electrical devices or to control external power relays for high current or inductive loads. An audible alarm, which may be user silenced, is also included within the WS-21-A. To eliminate erratic or premature operation of controlled devices, the WS-21-A includes provision for setting a delay or confirmation interval prior to initiation of an alarm and also a delay time prior to negating an alarm.

All set points and the maximum wind speed value are stored in non-volatile memory so that these values are not lost if there is a power failure. The circuits are designed to have high electrical noise immunity to transient spikes generated by loads being switched with the alarm relays. The unit restarts in the running mode after a power failure.

The 200-WS-01B Anemometer is a compact three-cup unit which conveniently mounts on a 1.062" o.d. pipe (3/4" I.P.S. pipe). The contactor-type speed transducer permits use of an interconnecting cable of almost unlimited length.



Wind Alarm Display

Specifications

Wind speed transducer: Sealed magnetic switch
 Measurement range: 0-100 mph
 Survivability range: 125 mph
 Average speed resolution: 0.1 mph
 Starting threshold speed: 1 mph
 Integration interval: 2 seconds
 Measurement accuracy: 1 mph or $\pm 3\%$ which ever is larger
 Alarm ON and/or OFF delay: 0-99 seconds
 Timing accuracy: $\pm 2\%$
 Controls:
 Protected push buttons that select:
 Run or set values
 Select menu items
 Increment/decrement alarm settings
 Reset stored maximum speed value
 Rocker switches that select:
 English or Metric units
 Audio alarm on or off
 Wind or Temperature mode
 Indicators:
 LEDs for alarm point 1 & 2
 2 line x 16 character LCD
 Display character size: 3 x 8 mm
 Operating temperature: Control module only -20° to +70°C
 Input power: 12V ac or dc
 Current: 50 mA maximum
 Alarm: Contacts rated 3A @ 24 Vdc / 115Vac
 Form "C" (SPDT) configuration
 Anemometer cable length: 40' standard, 2-conductor 24 AWG
 Weight/shipping 11lb/2lbs

Ordering Information

200-WS-21-A	Dual Set Point Wind Alarm
200-WS-21P	Power Pack, 110-240Vac
200-WS-01B	Replacement Anemometer
330-0224	Additional Cable, per foot

200-WS-23 Current Loop Wind Sensor



Current Loop Wind Sensor Printed Circuit Board in NEMA Enclosure



200-WS-02 Wind Speed & Direction Sensor

The **WeatherPort Model 200-WS-23 Wind Sensor** monitors wind speed and direction. The electronics converts the raw signals from the wind sensors to proportional 4 to 20 mA current loop values for use by process control or monitoring systems. It acts like a variable resistance that draws 4-20 mA when powered with 8 to 30 Vdc. No external power is required because the encoding electronics for wind speed and for wind direction are isolated and powered from their respective 2-wire current loops.

Two versions are offered. The 200-WS-23 measures both wind speed and direction, while the 200-WS-23S measures wind speed only. Both systems consist of two subassemblies, a wind sensor and a signal conditioning electronics package in a NEMA housing. Although it has only one PC board, it contains two completely independent circuits, one for wind speed and one for wind direction.

The wind sensor includes a three cup anemometer and wind vane. The sensor is ruggedly constructed of UV resistant ABS plastic and anodized aluminum parts, and includes 40' of cable. Additional cable lengths can be supplied. The electronics package is supplied in a gasketed wall mount NEMA enclosure.

Specifications

Wind Speed

Speed threshold: 0.8 mph
 Transducer type: Reed switch
 Speed constant: 1.25 mph = 1 pps
 Measurement range: 0-100 mph (standard)
 Optional: 0-50 m/s, 0-100 knots, 0-200 km/hr
 Accuracy: 1 mph or $\pm 3\%$

Wind Direction

Azimuth accuracy: $\pm 3^\circ$
 Bearings: Bushing
 Potentiometer gap: 5°
 Threshold: 1.2 mph
 Measurement range: 0-360°

Current Loop

Accuracy: $\pm 1\%$ full scale
 Output span: 4 to 20 mA, proportioned to 0-100 mph
 Output span: 4 to 20 mA, proportioned to 0-360°
 Supply voltage range: 8 to 30 Vdc
 2-wire loop interface: Screw terminal block
 Interface power: Derived from current loop
 Circuit time constant: 1 sec
 Temperature range: -58° to 140° F (-50° to 60° C)

Dimensions

Wind speed and direction: 12" H x 10" W
 Wind speed only: 4.5" H x 8.5" W
 Electronics enclosure size: 4.7" H x 4.7" W x 2.25" D
 Sensor cable length: 40'
 Weight/Shipping: 4 lbs/6 lbs

Ordering Information

200-WS-23	Current Loop Wind Speed & Direction Sensor
200-WS-23S	Current Loop Wind Speed Sensor
200-WS-01B	Replacement Wind Speed Sensor
200-WS-02F	Replacement Wind Speed & Direction Sensor
330-0524	Additional Sensor Cable, per foot
395-A-003	Optional Mast Mounting Hardware, for electronics encl

200-455 Totalizing Anemometer with 10-Min Timer



Model 200-455 Totalizing Anemometer with Optional Carrying Case and Optional Battery

The Model 200-455 Totalizing Anemometer with Continuous Counting and 10-Minute Totalizer provides a record of the total horizontal wind movement past a fixed point, measured to the nearest 0.1 mile. The unit may be run in either continuous or 10-minute mode. The 10-minute mode automatically logs the wind run distance for a period of ten minutes and then shuts down. The results of a logging event are displayed to the nearest tenth of a mile on the liquid crystal display until the operator resets the counter to zero. The system includes an anemometer with 40' cable and a control module which digitally displays the total wind run distance. The system is powered by an external 12 volt battery, such as the 200-455B4 or 200-455B7 (not included).

Specifications

Anemometer

Type: 3-cup anemometer, 4.25" turning radius, injection molded, glass filled nylon cups
 Accuracy: 1 mph
 Threshold: 1 mph
 Cup constant: 80.5 cup revolutions = 0.1 wind run miles
 Speed constant: 1 Hz = 1.49 mph
 Electrical output: Switch closure, 3 closures per revolution
 Cable: 2-conductor 24 AWG shielded PVC jacket, 40' standard
 Mount: 1-1/16" o.d. pipe (standard 3/4" I.P.S. pipe), set screw adjustment
 Weight: 1 lb

Control Module

Display: 7 digit LCD, with 0.2" character height; internal 3V lithium battery provides 10 year display life
 Controls: Function select switch, 10-minute cycle start switch, and red LED indicator showing that 10-minute cycle is in progress
 Calibration: 0.1 mile
 Control module power supply: +12 Vdc (+9 to +24 Vdc range), not included
 Current Drain: 5 mA dc continuous, 8 mA dc 10-minute mode
 Cable: 2-conductor for connection to external 12 Vdc, 6' standard
 Size: 5.25" wide x 2.375" high x 5.25" deep
 Weight: 2 lbs

Ordering Information

200-455	Totalizing Anemometer, includes sensor with 40' cable and control module
200-455CC	Carrying Case
200-455B4	Battery Assembly, 12 Vdc 4 AH
200-455B7	Battery Assembly, 12 Vdc 7 AH
310-140	AC Battery Charger
330-0224	Add'l Signal Cable, per foot

200-WS-25 Wind Logger with Real-Time Display

The **200-WS-25 Wind Logger with Real-Time Display** is designed to provide an affordable and easy-to-use solution to monitor wind speed and direction data. It records wind speed, gust, wind direction, time and date, and battery voltage.

The wind logger records directly to a Secure Digital (SD™) card up to 2GB. No special computer interface cables are required. A new file is created and saved to the card for each day the logger is in use. Data is stored in a text file in Comma Separated Value (CSV) format and can easily be viewed and analyzed using standard spreadsheet software.

Using the recorded data is simple. The SD™ card is inserted into a card reader attached to the USB port on your computer (Windows, Macintosh, or Linux) and will then show up as a drive. To view and graph the data, click on the spreadsheet corresponding to the day of interest. Microsoft Excel, OpenOffice.org, or practically any spreadsheet program can be used to view, graph, and analyze your wind data.

Example of a wind logger data record:

```

2007-09-07 14:47:30.334.6 1.157 0.0 0.0 0.0 0.0 0.0 159.0 295.957 1.1 023,1023,1023,1023,11 6.52
2007-09-07 14:48:30.334.4 1.040 0.0 0.0 0.0 0.0 177.0 205.484 1.3 023,1023,1023,1023,11 5.48
2007-09-07 14:49:30.548.0 2.550 0.0 0.0 0.0 0.0 180.0 295.037 0.1 023,1023,1023,1023,11 5.56
2007-09-07 14:50:30.856.88 0.0 0.0 0.0 0.0 0.0 180.0 285.056 0.1 023,1023,1023,1023,11 5.56

```

Date and time	Speed MPH	Gust MPH	Speed m/s	Pulse Count since the last record	Wind Direction *	Battery Voltage	checksum
---------------	--------------	-------------	--------------	--------------------------------------	------------------	--------------------	----------



200-WS-25 Wind Logger with Real-Time Display shown with optional tripod, sensor mast, and mast mounting hardware

Features

Easy set-up with the three front panel buttons, no computer required.

Adjustable logging interval: 10 to 50,000 seconds (e.g., a 60 sec interval will log 88 days on a 128MB SD™ card)

LCD Display: Screen displays current information and is used for configuring the data logger.

Simple menu-driven interface makes setup easy. A bright backlight makes the logger easy to use at night.

Clock: An accurate real-time clock is used to time-stamp each measurement, accurate to within 10 minutes per year.

Logging: The data logger supports Secure Digital™ or Multi Media Card™ 128 megabytes up to 2 gigabytes.

Communications: An available RS232 serial port is a feature of every wind logger.

Ordering Information

200-WS-25 Wind Logger with Real-Time Display includes 200-WS-02F Wind Sensor with 40' cable, Wind Data Logger in NEMA-4X Enclosure, 12V 7AH Battery, AC Battery Charger, SD™ Memory Card, and USB SD™ Card Reader

Options

200-WS-25T Optional Temperature Sensor, 25' cable
 200-WS-25TS Optional Solar Radiation Shield for Temp Sensor
 200-WS-01B Replacement Wind Speed Sensor, 40' cable
 190-510 5' Tripod
 190-312 5' Sensor Mast
 395-A Mast Mounting Hardware
 200-WS-25SP 5W Solar Panel Battery Charger

200-2520 Wind Meter

- Simple Operation
- Convenient Size
- ± 0.5 mph

The **Model 200-2520 Wind Meter** is an easy-to-use wind speed meter. The user simply holds the meter at eye level while facing the wind, and wind speed is indicated by the position of a white pith ball in the tube. Two scales are provided: low (2 to 10 mph) and high (4 to 66 mph). Covering a hole at the top of the meter allows reading on the higher scale. Accuracy is ± 0.5 mph on the low scale and ± 2 mph on the high scale.

Specifications

Low range: 2 to 10 mph
 High range: 4 to 66 mph
 Accuracy: ± 0.5 mph (low range) to ± 2 mph (high range)
 Size: 6.75" H x 1.75" W x 0.6" D (171 mm x 44 mm x 15 mm)
 Weight/shipping: 0.2 lb/1 lb (0.1 kg/0.4 kg)

Ordering Information

200-2520 Wind Meter



200-2530 Wind Speed Indicator

- Direct Reading Dual Scale
- 100% Pneumatic
- Constructed of Rugged Plastic

The **Model 200-2530 Wind Speed Indicator** includes a rugged sensor for measurement of wind speed and an attractive indicator for mounting either indoors or outdoors. The sensor is a pitot tube with a vane which directs it into the wind. Pressure is transmitted through plastic tubing to a red oil-base fluid in the indicator tube. The level of the fluid indicates wind speed both in miles per hour and on the Beaufort scale. Wind direction can be observed from the vane position. All mounting hardware for both the sensor and the indicator is included.

Specifications

Sensor: Pitot tube
 Range: 0 to 80 mph, 1 to 12 Beaufort scale
 Dimensions:
 Sensor: 11" H x 4.75" turning radius (279 mm x 121 mm)
 Indicator: 6" H x 7.5" W x 1.75" D (152 mm x 191 mm x 44 mm)
 Weight/Shipping: 4 lbs/8 lbs (1.8 kg/3.6 kg)

Ordering Information

200-2530 Wind Speed Indicator, includes sensor, indicator, 50' of connecting tubing, and mounting hardware



200-960 Handheld Anemometer

The **Model 200-960 Handheld Anemometer** utilizes a three-cup design to eliminate the cumbersome need to orient the device as measurements are obtained irrespective of wind direction, a major benefit in practical use that provides accurate readings at any time. The large LCD display shows the current wind speed, max wind speed, average wind speed, and bar graph of current Beaufort values. By a simple push of a button you can select one of the following units: kilometers/hour, knots, meters/second, or miles/hour. An integrated tripod thread allows stationary use of the Windtronic 2. A combination of precision mechanics and quartz-controlled electronics guarantees the highest level of accuracy over the entire temperature range. A standard lithium battery will supply your wind meter with power for approximately 10 years. After that time, you can simply replace the battery yourself.

Specifications

Sensor head: Cup-Type, jewel bearing
provides readings irrespective of wind direction

LCD-Display:

- Current wind speed
- Average wind speed*
- Maximum wind speed*
- Beaufort bar graph
- (* max 8 days data storage)

Wind Speed Units: (Selectable)

- KM/H (kilometers/hour)
- KTS (Knots)
- M/S (meter/second)
- MPH (miles/hour)

Measuring Range:

- 2.5-150 KM/H
- 1.3-81 Knots
- 0.7-42 M/S
- 1.5-93 MPH

Resolution: 0.1 (0-19.9), 1 (20-150)

Accuracy: typ $\pm 4\%$, ± 1 digit

Housing:

- Tripod thread in bottom of housing
- Plastic, densely bonded
- Water-resistant and floats
- Nylon protective bag

Battery: Button cell CR2032, replaceable

Battery life: up to 10 years

Dimensions: approx 127 x 55 x 28 (39) mm

Weight: approx 95 grams

Ordering Information

200-960-1 Windtronic 2 Handheld Anemometer with Case



200-960 Windtronic 2

Kestrel 1000 Pocket Wind Meter La Crosse EA-3010U Anemometer



The Kestrel® 1000 measures

- Current Wind Speed
- Maximum Wind Gust
- Average Wind Speed

Quality by Design

- All instruments and accessories are completely assembled in the USA
- Patented user-replaceable impeller
- Low friction sapphire jewel bearing

Features

- Protective cover with sure-grip overmolding
- Data hold function
- Large easy-to-read display
- Waterproof and floats
- Lanyard and battery included
- Two-year warranty

Ordering Information

200-0810 Kestrel 1000 Pocket Wind Meter
200-0801 Replacement Impeller



La Crosse EA-3010U Features

- Wind Speed (mph, km/h, m/s, knots)
- Displays MAX & Average
- Wind Speed Since Power On
- Beaufort Scale Bar Graph (0-12)
- Wind Chill (°F or °C)
- Temperature (°F or °C)
- Backlight with Auto Off
- Battery Saving Auto Off
- Neck Band Included for Easy Carrying

Specifications

- Maximum measured speed : 67 mph
- Minimum measured speed : 0.44 mph
- Resolution-wind speed : 0.1 for all units
- Temperature measuring range : -21.8 to 138.2 °F (-29.9 to 59 °C)
- Resolution-temperature : 0.2°F (0.1°C)
- Power requirements : 1 CR2032 button cell

Ordering Information

200-3010 La Crosse Handheld Anemometer

Calibration Accessories

The **Model 200-18802 Anemometer Drive** provides a convenient and accurate way to rotate clockwise or counter-clockwise at any rate between 200 and 15,000 RPM in 100 RPM increments. The LCD display is referenced to an accurate and stable quartz timebase. For completely portable operation, the unit can be operated on internal batteries. For extended operation, an AC wall adapter is included.

The **Model 200-18811 Anemometer Drive** is identical to the 200-18802 except the drive motor incorporates a gear reducer for operation in the range of 20 to 990 RPM in 10 RPM increments. The lower range is recommended for cup anemometer calibration.

Specifications

200-18802

Range: 200-15,000 RPM in 100 RPM increments
 Rotation: Clockwise or counter-clockwise
 Display resolution: 1 RPM
 Quartz timebase reference: 0.1 RPM
 Power requirements: 2 x 9V (alkaline or lithium) batteries, 115Vac wall adapter included (230Vac add suffix H)

200-18811

Range: 20-990 RPM in 10 RPM increments
 Display resolution: 0.1 RPM

Ordering Information

200-18802	Anemometer Drive, 200-15000 RPM
200-18811	Anemometer Drive, 20-990 RPM
add suffix H	230V/50-60Hz input power



200-18802 Anemometer Drive

The **Model 200-18112 Vane Angle Bench Stand** is used for benchtop wind direction calibration of the Wind Monitor family of sensors. The mounting post engages the direction orientation notch on the Wind Monitor. An easy to read pointer indicates 0-360° with 0.5° resolution.

The **Model 200-18212 Vane Angle Fixture Tower Mount**, similar to the 200-18112, the tower mount feature allows use on the tower as well as the bench top. The fixture is temporarily placed on the tower between the Wind Monitor and its tower mounting. Index keys and notches are engaged to preserve direction reference.

Specifications

Range: 0-360°
 Resolution: 0.5°

Ordering Information

200-18112	Vane Angle Bench Stand
200-18212	Vane Angle Fixture - Tower Mount



200-18112 Vane Angle Bench Stand

Calibration Accessories

The **Model 200-18310 Propeller Torque Disc** checks anemometer bearing torque with 0.1 gm/cm resolution. The disc temporarily replaces the propeller for torque measurement or simple yet accurate pass/fail checks. Charts included with the unit relate torque to propeller threshold with limits for acceptable bearing performance. The **Model 200-18312 Cup-Wheel Torque Disc** checks cup anemometer bearing torque.

The **Model 200-18301 Vane Alignment Rod** helps align the vane of a wind sensor to a known direction reference during installation. The base of the device has an index key that engages the direction orientation notch in the sensor allowing the sensor to be removed without losing wind direction reference.

The **Model 200-18331 Vane Torque Gauge** checks vane bearing torque of Wind Monitor family of sensors. Slip the fixture over the main housing and make simple yet accurate vane torque measurements. Charts relating vane torque to vane threshold provide limits for acceptable bearing performance.

Specifications

200-18310

Range: 0-5.4 gm/cm
Resolution: 0.1 gm/cm

200-18331

Range: 0-50 gm/cm
Resolution: 5 gm/cm

Ordering Information

200-18301	Vane Alignment Rod
200-18310	Propeller Torque Disc
200-18312	Cup-Wheel Torque Disc
200-18331	Vane Torque Gauge



200-18310 Propeller Torque Disc



200-2916 Compass

The **Model 200-2916 Compass** is a rugged, liquid-filled sighting compass. It is housed in a sturdy plastic case and has a jewelled pivot for smooth operation and luminous letters for easy reading. A sighting slot, wire hairline, and lens are built-in for precise orientation.

The 200-2916 is used to align various wind direction sensors to true North. Orientation of the wind sensor is done after the weather station is set up. True North is usually found by reading a magnetic compass and applying the correction for magnetic declination, where magnetic declination is the number of degrees between True North and Magnetic North.

Specifications

Size: 2" diameter x 1" thick
Weight/shipping: 3 oz/1 lb

Ordering Information

200-2916 Compass

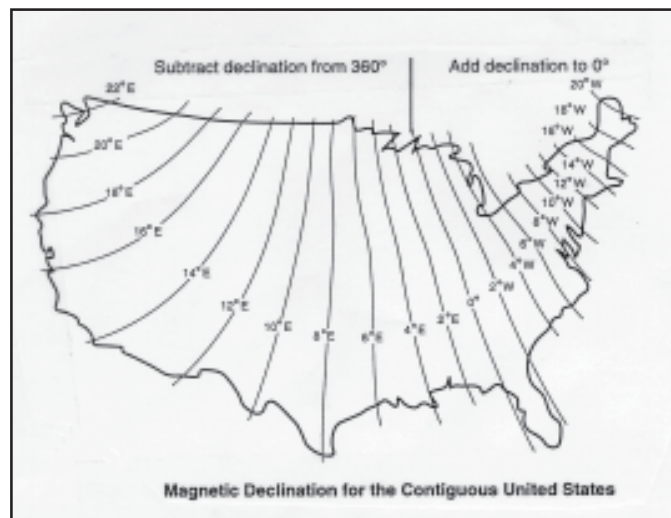

For converting magnetic bearings to true bearings

Wind Direction Calibrators

The **200-1249-A Wind Direction Calibrator** is a mechanical device used to calibrate systems which include Micro Response or Low Threshold Wind Vanes (Model 200-2020 or 200-2005). It mounts directly on the vane and has three possible uses. First, it can be used to position the vane at four points, exactly 90° apart, to check the readings of output devices. Second, it can be used in sigma system calibration to give a direction change of exactly 90°. And third, it can be used to hold the vane tail in place during orientation to north. A similar mechanical device, Model 200-1247, is available to assist in wind direction calibration of the Skyvane wind sensor.

Ordering Information

200-1247	Wind Direction Calibrator, for use with Skyvane
200-1249-A	Wind Direction Calibrator, for use with 200-2005 or 200-2020 Vane

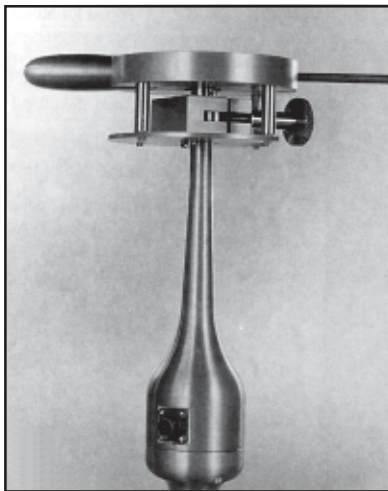

200-1249-A Wind Direction Calibrator

Wind Speed Calibrators

Two types of **Wind Speed Calibrators** are available in the Model 200-1230 Series. The first type, including Models 200-1234-A, 200-1235-A, and 200-1236-A, is designed for tower calibration of Micro Response and Low Threshold Anemometers. The calibrator mounts directly on the anemometer shaft and rotates the shaft at a known rate using a constant speed motor. The unit requires 115 Vac for operation. The Model 200-12341 Power Cable can be used to connect the calibrator to the power supply of a 380-8190 Solar Radiation Shield.

The second type of wind speed calibrator is more suited to laboratory or bench calibration applications. This type, including Models 200-1230, 200-1231, and 200-1233, is attached to the anemometer shaft by neoprene tubing. The calibrator must be supported near the anemometer. The constant speed synchronous motor driving these units requires 115 Vac 60 Hz. On special order, 230 Vac 50 Hz models can be supplied; however, the rotation rate will be lower due to the lower input frequency.

Ordering Information

200-1230	Handheld Wind Speed Calibrator, 300 rpm (250 rpm at 50 Hz)
200-1231	Handheld Wind Speed Calibrator, same as 200-1230 except 1800 rpm (1500 rpm at 50 Hz)
200-1233	Handheld Wind Speed Calibrator, same as 200-1230 except 600 rpm (500 rpm at 50 Hz)

Please consult NovaLynx for price and availability of the 200-1234-A, 200-1235-A, and 200-1236-A calibrators.



200-1233 Hand-Held Wind Speed Calibrator

200-2620 Wind Sock

The **Model 200-2620 Wind Sock** is a cloth cone open at both ends and used to indicate wind direction. It can also be used to estimate wind speed by its angle. The most common application of wind socks is wind indication at small airports.

Our wind socks are manufactured in the USA of international orange nylon for high visibility, and are urethane coated for superior fade resistance and color retention. The hems and seams are double-stitched for strength. The standard wind sock is 8 feet long, with a throat diameter of 18 inches.

The sock laces onto either the **200-26201 Ball Bearing Frame** or the **200-26202 Hoop and Bail Frame**, which supports the throat. The 200-26201 frame includes a short length of threaded pipe for attaching to a supporting pole using a 3/4" pipe coupler (coupler is not included). The 200-26202 includes a 3/4" pipe coupler.

Specifications

Size: 8' L x 18" throat dia x 8" tail dia (2.4 m x 457 mm x 203 mm)

Weight/shipping:

Wind sock: 1.5 lbs/2 lbs (0.7 kg/0.9 kg)

Ball bearing frame: 7 lbs/9 lbs (UPS 30 lbs oversize) (3 kg/4 kg)

Hoop and bail frame: 3 lbs/5 lbs (2 kg/3 kg)

Ordering Information

200-2620	Wind Sock
200-26201	Ball Bearing Frame
200-26202	Hoop and Bail Frame



*200-26201 Ball Bearing Frame
shown with 200-2620 Wind Sock*



200-26202 Hoop and Bail Frame

200-2510-A 260-2511-A Totalizing Anemometer

- 8-Digit Electronic Counter
- Pre-Drilled Mounting Base
- English or Metric Models

The **200-2510/11-A Totalizing Anemometer** is equipped with a counter to provide a simple, yet precise, method of determining average wind speed and total air passage. It has been redesigned to replace the old mechanical instruments that are no longer being produced. The new unit is self-contained and consists of an anemometer for wind measurement readings and a programmable 8-digit electronic LCD digital display that converts cup rotation to counter increment. Average wind speed can be calculated from the difference between successive counter readings divided by the time interval between readings. The easy-to-read display is housed in a NEMA-4X enclosure and is powered by an internal lithium battery with a 5+ year life. The unit can be calibrated to readout in miles or kilometers.

In an evaporation station, the anemometer is typically mounted on the platform supporting the evaporation pan. The unit is supplied with a pre-drilled mounting flange for this purpose.

Specifications

Sensor: 3-cup assembly, glass reinforced nylon, 1.125" diameter cups
 Transducer: Magnet reed switch, permanent magnet
 Output: Counter increment
 Counter type: 8-digit electronic, LCD in NEMA-4X enclosure
 Counter range: 0 to 9,999,999.9 mile or kilometer
 Resolution (counter and contact): 0.1 mile or 0.1 km
 Sensor range: 0 to 100 mph (0 to 45 m/s)
 Threshold: 0.8 mph (0.35 m/s)
 Cup constant: 960 revolutions/mile (428 revolutions/km)
 Materials: Thermoplastic, anodized aluminum, stainless steel
 Mounting: Pre-drilled flanged base
 Size: Body: 5.5" W x 5" D x 16" H (140 x 127 x 400 mm)
 Turning radius: 6"
 Weight/shipping: 5 lbs/9 lbs (2.3 kg/4 kg)

Ordering Information

200-2510-A	Totalizing Anemometer with Digital Display, miles
200-2511-A	Totalizing Anemometer with Digital Display, kilometers
200-WS-01C	Replacement Wind Speed Sensor



200-2510-A Totalizing Anemometer

Temperature & Humidity

225-5020-A Hygrothermograph	74
220-730 Dial Hygrometer	75
225-930 Dial ThermoHygrometer	75
210-4410 Standard Thermometer	76
210-4420 Min-Max Thermometer Set	76
225-520 Pocket Sling Psychrometer	77
225-570 Sling Psychrometer	77
225-564 Fan Psychrometer	78
225-566 Battery Psychrometer	78
225-5230 Assmann Psychrometer	79
225-569 Pocket Psychrometric Slide Rule	80
225-HMP60 Humidity/Temp	81
225-HMP155 Humidity/Temp	81
210-4470 & 210-4480 Temperature Sensors	82
210-201, 210-301, & 201-600 Temperature Sensors	83
210-TP1 Temperature Sensor	84
210-WE700 Temperature Sensor	85
225-THT-1 Temperature & Humidity Sensor	86
210-41342 Temp & 225-41382 T/RH	87
225-42603 Temp Tracker	87
210-5320 Series Dew Cell	88
Fuel Moisture Sticks & Scale	89
250-124 Soil Moisture Sensor	89
210-421-A General Purpose Temperature Alarm	90
210-EC Series Frost Alarms	91
225-HM34 Relative Humidity & Temperature Indicator	92
225-RH520A RH/Temp Digital Chart Recorder	93
225-445703 Big Digit Hygro-Thermometer	94
380-280 Radiation Shield	95
380-281 Radiation Shield	95
380-41003 Radiation Shield	96
380-43408 Radiation Shield	97
380-43502 Radiation Shield	97
380-600 Thermometer Shelter	98
380-601 Small Instrument Shelter	98
380-605 Large Instrument Shelter	99
220-HMK15 Humidity Calibrator	100
220-HMK41 Calibration Kit	100

225-5020-A Hygrothermograph

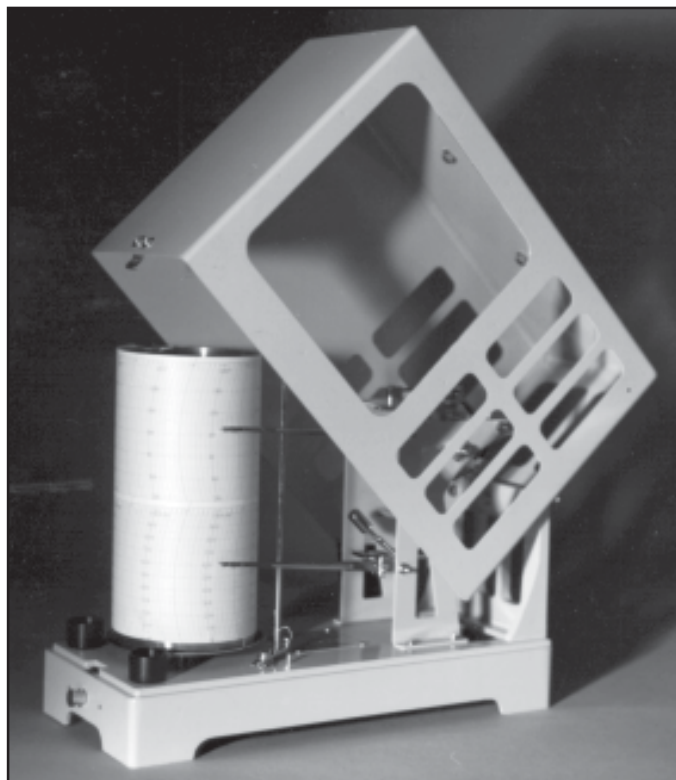

The **Model 225-5020-A Hygrothermograph** is a precision, self-contained instrument that measures and records ambient temperature and relative humidity simultaneously on a double scale chart. It is ideal for measurements in laboratories, computer rooms, libraries, museums, or agricultural areas.

The hygrothermograph employs an aged bimetal strip which distorts with changes in temperature. This distortion is magnified through a lever system which moves a pen arm over the upper half of a 7" high chart. The response is linear. Temperature is recorded over a 60°C or 110°F span. The span can be adjusted up or down to match the temperature range of the installation site. Corresponding charts are available. Normal calibration adjustments are made by turning a knurled knob which moves the pen up or down the scale through movements of the lever system.

A specially treated bundle of human hair is used to measure relative humidity over the full range of 0-100%. The hair expands and contracts with increasing or decreasing water vapor in the air. This movement is transmitted to the pen arm using a linkage system. Opposing quadrants in the linkage linearize the nonlinear response of the hair bundle.

The chart is installed on a self-contained, battery-operated clock. The drum rotation may be selected as 1 day (26 hours), 7 days (176 hours), or 31 days. Internal parts of the hygrothermograph are chrome plated brass. Pivots are polished instrument-grade stainless steel for fast response. The base of the case is cast aluminum. Large openings in the sides, end, and bottom permit free flow of ambient air to the sensors. A glass window in the hinged cover makes chart reading easy. Recording is accomplished using reliable, replaceable cartridge pens. When the hygrothermograph is used outdoors, it must be protected from direct solar radiation by installing it in an instrument shelter.

Specifications

Measurements: Temperature and Humidity

Temperature Sensor: Aged Bimetal Strip

Span: 60°C, 110°F (adjustable)

Accuracy: ±1%

Graduations: 1°C, 2°F

Humidity Sensor: Hair Bundle

Range: 0-100% RH

Accuracy: ±1% mid-scale, ±3% extremes

Graduations: 1%

Chart size: 7" H x 11" L (178 mm x 280 mm)

Clock type: 1.5 Vdc battery-operated (2 AA cells)

Drum rotation: 1 day (26 hrs), 7 days (176 hrs), or 31 days, switch selectable

Pen type: Cartridge

Size: 12.5" L x 11.5" H x 6" D (318 mm x 292 mm x 152 mm)

Weight/shipping: 10 lbs/16 lbs (4.5 kg/7.3 kg)

Ordering Information

225-5020-A	Hygrothermograph with battery-operated 1-7-31 day clock, two pens, and one pack of weekly or monthly charts (specify charts)
225-50211	Replacement Hair Bundle
390-8827-A	Replacement Clock
390-88101	Replacement Cartridge Pen, blue ink
390-88102	Replacement Cartridge Pen, red ink
225-5020-GL	Replacement Plexiglass Window (T950114)

Charts	Range	Drum Rotation	Charts/Box
225-50201	-20 to +40°C, 0-100%	7 days	55
225-50202	+10 to +120°F, 0-100%	7 days	55
225-50203	-30 to +80°F, 0-100%	7 days	55
225-50204	-20 to +40°C, 0-100%	1 day	400
225-50205	+10 to +120°F, 0-100%	1 day	400
225-50206	-30 to +80°F, 0-100%	1 day	400
225-50207	-20 to +40°C, 0-100%	31 days	25
225-50208	+10 to +120°F, 0-100%	31 days	25
225-50209	-30 to +80°F, 0-100%	31 days	25
225-50212	-10 to +50°C, 0-100%	7 days	55
225-50213	-5 to +55°C, 0-100%	31 days	25
225-50214	-10 to +50°C, 0-100%	1 day	400
390-M699120	-10 to +50°C, 0-100%	31 days	25

220-730 Dial Hygrometer

When great accuracy ($\pm 3\%$) is called for, specify the **Model 220-730 Precision Hygrometer**. It has a polished brass case (6" dia x 1-5/8" D) and a 4-3/4" white dial, graduated every 1%. The "Supratherm" synthetic sensor element is very responsive and durable. Three holes in the flange permit easy wall mounting (screws included).

Ordering Information

220-730 Dial Hygrometer

225-930 Dial ThermoHygrometer

The **Model 225-930 Precision ThermoHygrometer** provides accurate humidity and temperature readings. It's an ideal instrument for homes, museums, health clubs, storage facilities, etc. The upper scale shows humidity from 20% to 100%, as measured by the "Supratherm" element, which is accurate to $\pm 3\%$. The lower scale is temperature, from -4° to 122°F ($^{\circ}\text{C}$ also). The polished brass case is 6" dia x 1-5/8" D. The white dial is 4-3/4" dia. In the flange there are three holes for mounting (screws included) to a wall.

Ordering Information

225-930 Dial ThermoHygrometer

210-4410 Standard Thermometer

The **Model 210-4410 Standard Mercury Thermometer** is 10-1/2 inches long and is mounted on a stainless steel back. Two models are available: the Model 210-4410 with a range of -38° to +130°F and the Model 210-4411 with a range of -38° to +55°C. Accuracy is ± 0.15°F above freezing. A stainless steel support is available to mount the thermometer the proper distance from a wall.

Specifications

Range: 210-4410: -38° to +130°F
 210-4411: -38° to +55°C
 Accuracy: ± 0.15°F above 32°F
 Size: 12" L x 1" W (305 mm x 25 mm)
 Weight/shipping: 0.25 lb/1 lb (0.1 kg/0.5 kg)

Ordering Information

210-4410	Standard Thermometer, °F
210-4411	Standard Thermometer, °C
210-4412	Mounting Support

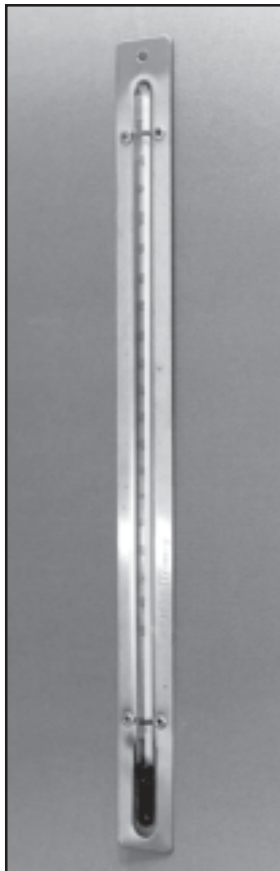

210-4410 Standard Thermometer

210-4420 Min-Max Thermometer Set

The **210-4420 Series Min-Max Thermometer Sets**, made to U.S. National Weather Service specifications, consist of a Townsend support (a weatherproof metal stand and base with two adjustable thermometer holders attached to rotatable metal posts), a maximum indicating thermometer and a minimum indicating thermometer, each secured to a stainless steel metal plate. The mercury filled maximum thermometer is 10-1/2" long with graduations and numerals etched in the glass. It has a constricted capillary just above the bulb which prevents the mercury from flowing back with lowering temperatures. It remains fixed at the warmest temperature to which it has been exposed. The minimum thermometer is also an etched stem type, 10-1/2" long, similar to the maximum thermometer. It has a long, thin, dark colored float, held in tension in the capillary, which moves down towards the bulb with lowering temperatures. When the air temperature warms, the alcohol rises past the float, which remains fixed at the minimum temperature.

Specifications

Range: 210-4420: Minimum -50° to +120°F, Maximum -38° to +130° F
 210-4421: Minimum -45° to +50°C, Maximum -38° to +55 °C
 Graduations: 1°F, 0.5°C
 Accuracy: ± 0.2°C above 0°C
 Size (thermometer): 10.5" L x 1" W (267 mm x 25 mm)
 Weight/shipping (set): 2 lbs/5 lbs (0.9 kg/2.3 kg)

Ordering Information

210-4420	Min-Max Thermometer Set, °F includes 210-4429 and 210-4425 Thermometers, 210-4422 Townsend Support
210-4421	Min-Max Thermometer Set, °C includes 210-4430 and 210-4426 Thermometers, 210-4422 Townsend Support
210-4422	Townsend Support
210-4425	Maximum Thermometer, -38° to +130°F
210-4426	Maximum Thermometer, -38° to +55°C
210-4429	Minimum Thermometer, -50° to +120°F
210-4430	Minimum Thermometer, -45° to +50°C

Other ranges available. Contact NovaLynx.

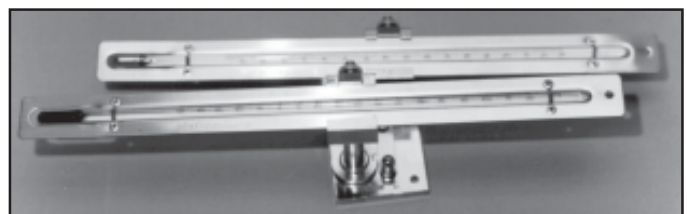

210-4420 Min-Max Thermometer Set

225-520 Pocket Sling Psychrometer

The **Model 225-520 Pocket Sling Psychrometer** is only 7.5" in overall length and comes with a convenient pocket-size carrying case. The two 5.5" red liquid filled thermometers are attached to an aluminum back with a handle for whirling. The handle folds down when not in use. Instrument range is either +20° to +110°F or -5° to +45°C. Humidity tables are provided. Replacement wicks are available.

Specifications

Range:

225-520: +20° to +110°F (1° graduations)

225-521: -5° to +45°C (1° graduations)

Size: 7.5" L x 1" W (190 mm x 25 mm)

Weight/shipping: 0.3 lb/1 lb (0.1 kg/0.5 kg)

Ordering Information

225-520-A	Pocket Sling Psychrometer °F; includes case
225-521-A	Pocket Sling Psychrometer °C; includes case
225-522-A	Replacement Thermometer for Model 225-520
225-523-A	Replacement Thermometer for Model 225-521
225-568-A	Replacement Wicks, 24" length

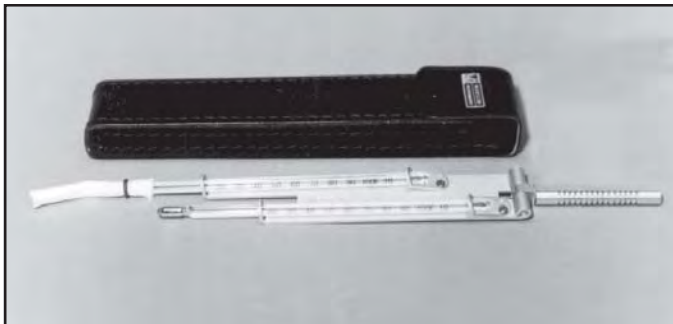

Model 225-520 Pocket Sling Psychrometer

225-570 Sling Psychrometer

The 225-570-A Sling Psychrometer is a standard sling psychrometer meeting U.S. National Weather Service recommendations. It consists of two 9.5" red liquid filled thermometers mounted on a stainless steel back. The wet bulb thermometer has a muslin wick covering the bulb. A wooden swivel handle with a chain for whirling is attached to the thermometer back. The 225-570 Sling Psychrometer has a range of -20° to +120°F; the range of the 225-571 is -30° to +50°C. Each sling psychrometer utilizes two matched thermometer tubes reading the same temperature to minimize error when measuring relative humidity. Humidity tables are provided with each instrument. Replacement wicks are available.

Specifications

Range:

225-570: -20° to +120°F (1° graduations)

225-571: -30° to +50°C (0.5° graduations)

Thermometer accuracy: ± 1.5°F

Size: 12" L x 1.5" W (305 mm x 38 mm)

Weight/shipping: 0.4 lb/1 lb (0.2 kg/0.5 kg)

Ordering Information

225-570-A	Sling Psychrometer °F
225-571-A	Sling Psychrometer °C
225-572-A	Replacement Thermometer °F
225-573-A	Replacement Thermometer °C
225-568	Replacement Wicks, 24" length

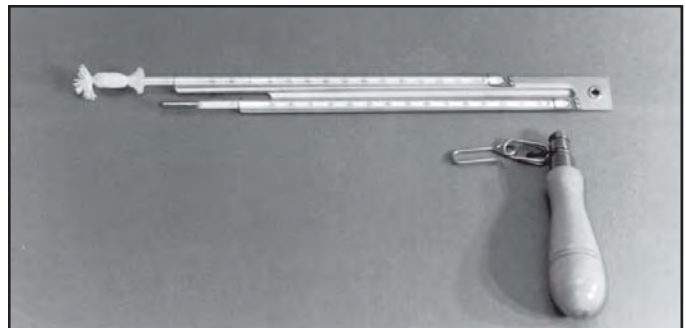

Model 225-570 Sling Psychrometer

225-564 Fan Psychrometer

The **Model 225-564 Fan Psychrometer** is used for determination of dew point and relative humidity. It consists of 9.5" dry and wet bulb thermometers mounted on a common back, a water bottle, fan, motor, and 6-volt battery. It is easier to read and provides more consistent results than a conventional sling psychrometer.



Model 225-564 Fan Psychrometer

The components are mounted on a wooden base. The bulb of the lower thermometer is covered with a close fitting tubular muslin wick. When the fan is turned on for a period of 2-3 minutes, water is evaporated from the wick-covered thermometer. The wet bulb and dry bulb temperatures are recorded and the humidity is determined using the chart provided or a psychrometric slide rule. Thermometer range is -20° to $+120^{\circ}\text{F}$ or -30° to $+50^{\circ}\text{C}$. The unit comes complete with humidity chart and instructions. Replacement wicks are available.

Specifications

Range:

225-564: -20° to $+120^{\circ}\text{F}$ (1° graduations)

225-565: -30° to $+50^{\circ}\text{C}$ (0.5° graduations)

Size: 7" W x 5.5" D x 14.5" H

Accuracy: $\pm 0.5^{\circ}\text{F}$ or $\pm 0.25^{\circ}\text{C}$

Weight/shipping: 4 lbs/5 lbs

Ordering Information

225-564-A	Fan Psychrometer, $^{\circ}\text{F}$
225-565-A	Fan Psychrometer, $^{\circ}\text{C}$
225-568	Replacement Wicks, 24" length
225-572-A	Replacement Thermometer, $^{\circ}\text{F}$
225-573-A	Replacement Thermometer, $^{\circ}\text{C}$
225-990	Replacement Motor
225-991	Replacement Battery

225-566 Battery Psychrometer

The **Model 225-566 Battery Operated Psychrometer** quickly and easily measures wet-bulb and dry-bulb temperatures. These can be converted into relative humidity or dew point temperature using a chart on the instrument face, a psychrometric slide rule (provided), or tables (also provided) for a more accurate determination.

The instrument is self contained and portable. It is small enough to be hand-held, but has an opening on the rear of the plastic case for wall-mounting if required. Three "D" cell batteries provide power for up to 1,000 observations.

The instrument is designed to meet federal specification GG-P-725B type III style B. It consists of a matched pair of 8" long thermometers, a permanent magnet fan motor, a two ounce plastic water bottle, and an illuminating lamp. The



Model 225-566 Battery Operated Psychrometer

small fan creates an air flow of 15 feet/second over the thermometer bulbs and the lamp illuminates the thermometers from behind. Two models are available: the 225-566F with a range of $+10^{\circ}$ to $+120^{\circ}\text{F}$ and the 225-566C with a range of -15° to $+45^{\circ}\text{C}$.

Specifications

Range: 225-566F: $+10^{\circ}$ to $+120^{\circ}\text{F}$ (1° graduations)

225-566C: -15° to 45°C (0.5° graduations)

Accuracy: $\pm 0.3^{\circ}\text{F}$ or $\pm 0.2^{\circ}\text{C}$

Size: 10" W x 4.5" D x 2" H (254 mm x 114 mm x 51 mm)

Weight/shipping: 1.25 lbs/3.5 lbs (0.6 kg/1.6 kg)

Ordering Information

225-566F-A	Battery Operated Psychrometer, $^{\circ}\text{F}$; includes carrying case, water bottle, psychrometric slide rule, RH tables, extra wicking, and spare light bulb
225-566C-A	Battery Operated Psychrometer, $^{\circ}\text{C}$
225-567F-A	Replacement Thermometer, $^{\circ}\text{F}$ (set of 2)
225-567C-A	Replacement Thermometer, $^{\circ}\text{C}$ (set of 2)

225-5230 Assmann Psychrometer

The **Model 225-5230 Assmann Psychrometer** utilizes two precision mercury thermometers with 3-point calibrations. A calibration certificate gives the correction required at each point. Corrected accuracy is better than $\pm 0.1^{\circ}\text{C}$. The double-tube thermometers are protected by a chrome-plated brass case. The thermometer bulbs are guarded by double-walled radiation shields thermally isolated from the main housing by a plastic bushing. Aspiration of the bulbs is accomplished by a spring-wound fan which will provide eight minutes of aspiration per winding.

Two models are available, the 225-5230 measures over a range of -30° to $+50^{\circ}\text{C}$ and the 225-5231 has a range of -20° to $+130^{\circ}\text{F}$. Each instrument is supplied with a wind shield, a mounting support, a syringe to moisten the wet-bulb wick, extra wicks, psychrometric tables, and a wooden carrying case.

Specifications

Range:

225-5230: -30° to $+50^{\circ}\text{C}$ (0.2° graduations)

225-5231: -20° to $+130^{\circ}\text{F}$ (0.5° graduations)

Accuracy: $\pm 0.1^{\circ}\text{C}$ with corrections provided

Size: 4" dia x 16" L (100 mm x 405 mm)

Weight/shipping: 3 lbs/10 lbs (1.4 kg/4.5 kg)

Ordering Information

225-5230	Assmann Psychrometer, $^{\circ}\text{C}$ includes accessories and carrying case
225-5231	Assmann Psychrometer, $^{\circ}\text{F}$ includes accessories and carrying case
225-52301	Spare Thermometer for 225-5230 with calibration certificate
225-52311	Spare Thermometer for 225-5231 with calibration certificate
225-568	Replacement Wick Material, 24" length

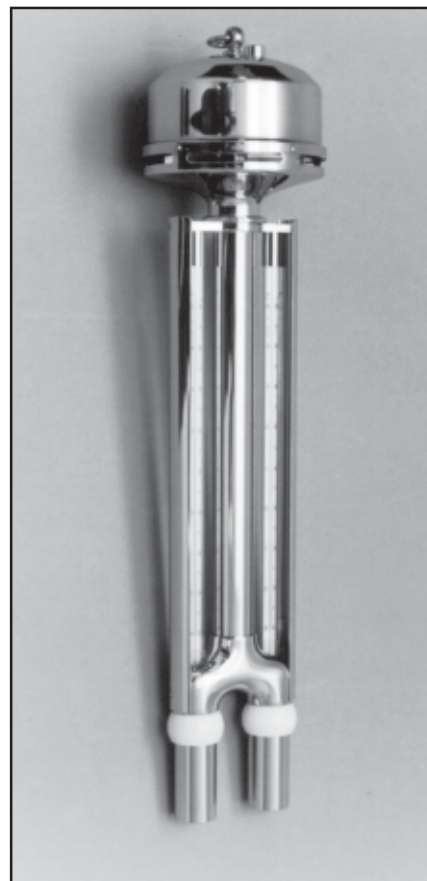

225-5230 Assmann Psychrometer

225-569 Pocket Psychrometric Slide Rule

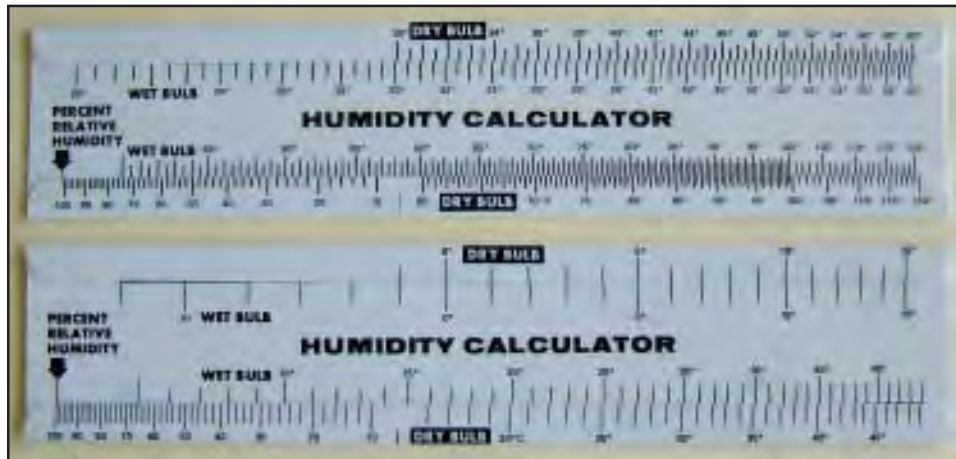

The **225-569 Pocket Psychrometric Slide Rule** quickly converts wet-bulb and dry-bulb temperatures to relative humidity. The user simply lines up the two temperatures and reads relative humidity directly. The RH scale ranges from 10% to 100% with graduations of 2%. Values to 1% RH may be estimated. Two models are available. The 225-569F Slide Rule has a temperature scale of 20° to 100°F, and the 225-569C has a scale of -5° to 50°C. Both are small, lightweight, and durable.

Specifications

Scale:
 225-569C: -6° to +49°C (1°)
 225-569F: +20° to +120°F (0.5°; 1° from 100-120°)
 Size: 7" L x 1.4" W (178 mm x 36 mm)
 Weight: 0.5 oz (14 g)

Ordering Information

225-569C	Pocket Psychrometric Slide Rule, °C
225-569F	Pocket Psychrometric Slide Rule, °F

225-HMP60 Humidity/Temp

The **225-HMP60A Relative Humidity & Temperature Sensor** features the laser trimmed INTERCAP® capacitive for accurate relative humidity measurements. The chip is user replaceable and requires no calibration. A membrane filter protects the sensor from dirt and dust. The 225-HMP60A also measures temperature. The sensor should be mounted in a solar radiation shield when placed outdoors.

Specifications

Humidity measurement range: 10 to 90% (for which accuracy is specified)
 Humidity accuracy: Better than $\pm 3\%$ @ +68°F (+20°C)
 Humidity operating range: 0-100% RH
 Stability: $\pm 2\%$ RH over 2 years
 Temperature measurement range: -40° to +140°F (-40° to +60°C)
 Temperature accuracy: 1.1°F ($\pm 0.6^\circ$) @ +68°F (+20°C)
 Input power: 7-28 Vdc
 Current consumption: 2 mA typical
 Output signal: 0 to 1 Vdc standard, 0 to 5 Vdc available
 Housing material: Chrome-coated aluminum (IP 65)
 Size: 0.47" Dia (12 mm) x 3" L (80 mm), threaded M12 x 1
 Cable length: 12" (313 mm) with molded connector
 Cable connector: Screw-on 4-pin M8 molded 1.5" L (37 mm)

Ordering Information

225-HMP60A	Relative Humidity & Temperature Sensor, with 4-pin connector
220-15778	Replacement Humidity Chip, INTERCAP®
220-17039	Replacement Membrane Filter
330-0524	Sensor Cable for 225-HMP60, 5C 24AWG



225-HMP155A & 225-HMP60A Relative Humidity & Temperature Sensors

225-HMP155 Humidity/Temp

The **220-HMP155D Humidity Sensor** provides reliable humidity measurement utilizing a new generation HUMICAP 180R sensor that has excellent stability and withstands well in harsh environments. The probe structure is solid and the sensor is protected with a sintered teflon filter. The 220-HMP155D is especially designed for use in meteorological applications and hydrological weather stations. It has a weatherproof IP66 housing and 11 feet of cable with an 8-pin MP12 connector. An electrical circuit in the sensor body converts the capacitance to a voltage output which is linearly proportional to the ambient relative humidity. Calibration adjustment potentiometers are provided.

The **225-500-B Relative Humidity & Temperature Sensor** has the addition of an integrated circuit transducer that provides a linear microamp current output proportional to temperature. The **225-501-B** utilizes a one-element thermistor and the **225-HMP155A** uses an active temperature circuit with a linear 0-1 Vdc output. Contact NovaLynx for other temperature sensor options.

Specifications

220-HMP155D Humidity Sensor
 Sensing element: Thin film capacitor, with membrane filter
 Measuring range: 0-100% RH
 Output: 0-1 Vdc with high and low calibration adjustments
 Accuracy: $\pm 1\%$ (0-90% RH) $\pm 2\%$ (90-100% RH) at 20
 Response time: 20 seconds with filter
 Operating temperature: -40° to +140°F (-40° to 60°C)
 Excitation voltage: 7-35 Vdc
 Power consumption: < 4 mA
 Size: 0.75" Dia x 9.45" L
 Weight/shipping: 10 oz/1 lb

225-HMP155A Relative Humidity & Temperature Sensor
 Humidity: Same as 220-HMP155D
 Temperature: Same as 225-HMP60A

225-500-B Relative Humidity & Temperature Sensor
 Humidity: Same as 220-HMP155D
 Temperature: Same as 210-201

225-501-B Relative Humidity & Temperature Sensor
 Humidity: Same as 220-HMP155D
 Temperature: Same as 110-WS-16T

Ordering Information

220-HMP155D	Relative Humidity Sensor, 11' cable
225-HMP155A	Relative Humidity & Temperature Sensor, 11' cable
225-500-B	Relative Humidity & Temperature Sensor, 11' cable
225-501-B	Relative Humidity & Temperature Sensor, 11' cable
220-180R	Replacement Humidity Sensing Element
220-219452SP	Replacement Teflon Filter
330-0524	Sensor Cable, 5 conductor 24AWG shielded

210-4470 & 210-4480 Temperature Sensors

NovaLynx offers a wide variety of temperature probes for air, water, and soil temperature measurements. Most of the probes will interface to various data loggers with some additional external conditioning resistors. Some of the probes require signal conditioning to produce a linear analog output, i.e. 0-5 Vdc or 4-20 mA. For correct air temperature measurements the probes should be placed in a solar radiation shield. NovaLynx offers a variety of solar radiation shields to choose from.

The **210-4480 Series Thermistor Probes** incorporate a 3-element thermistor composite and its measuring range is -50°C to +50°C when used in conjunction with the thermolinear network.

Specifications

Sensor element: 3-element composite thermistor
 Range: -50°C to +50°C
 Accuracy and interchangeability:
 ± 0.1°C when incorporated in a thermolinear network
 Time constant: 1.4 minute
 Size: 210-4480: 0.43" Dia x 5.25" L
 Signal conditioner: 195-208 Resistor Network for NovaLogger and other dataloggers requires a regulated low level DC source from the datalogger.

Ordering Information

210-4480-A	Air Temperature Probe, 3-element thermistor, includes 5' cable
210-4480-B	Air Temperature Probe, includes 20' cable
210-4480-C	Air Temperature Probe, includes 30' cable
210-4485	Water/Soil Temperature, includes 50' cable
195-208	Precision Resistor Network
330-0420	Cable, 4 conductor 20 AWG shielded

The **Model 210-4470 Platinum Resistance Temperature Probes** can input directly to a temperature recorder or to a signal conditioning module to provide an analog voltage output proportional to temperature. The 99.99% pure platinum wire has a resistance of 100 ohms at 0°C. The platinum element is encased in a 6" long stainless steel housing and the cable is sealed to prevent moisture intrusion. Other probe configurations (piercing models, thermowell adapters, etc.) are available on special order.

Specifications

Sensor element: 100 ohm platinum wire
 Range: -50°C to 100°C
 Absolute interchangeability and accuracy:
 210-4470: ± 0.3°C
 210-4470-A: ± 0.1°C
 Time constant: 15 seconds
 Probe size: 0.4" dia x 6" L
 Weight/shipping: 0.5 lb/1 lb
 Signal conditioner: 210-TX92A-1-L RTD Transmitter
 -40° to 140° F (-40° to +60° C), 4-20 mA

Ordering Information

210-4470	Platinum Resistance Temperature Probe, ± 0.3° C accuracy, includes 10' of 3 conductor cable
210-4470-A	Platinum Resistance Temperature Probe, ± 0.1° C accuracy, includes 3' of 4 conductor cable
210-TX92A-1-L	RTD Transmitter, -40/140F (-40/60C)
330-0324	Cable, 3 Conductor 24 AWG
330-0424	Cable, 4 Conductor 24 AWG

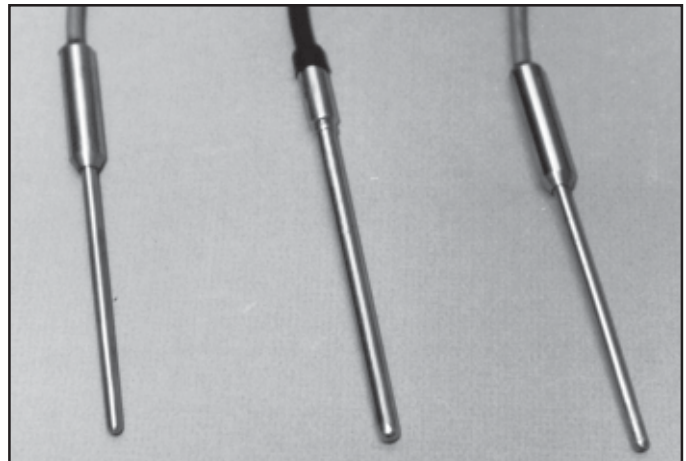

Model 210-4470 & 210-4480 Series Temperature Probes

210-201, 210-301, & 201-600 Temperature Sensors

The **Model 210-201 Air Temperature Sensor** and the **Model 210-600 Water/Soil Temperature Sensor** are two-terminal integrated circuit transducers that provides a linear output current proportional to the absolute temperature. Laser trimming of the chip's thin film resistors is used to calibrate the output. They are supplied with 25' cable but can be used with longer lengths because the high impedance current is insensitive to voltage drop over long lines. These probes will interface with most of the NovaLoggers with an external resistor. The 135-104 Series Translator Boards will convert the signal to an analog signal, i.e. 0-5V to 4-20 mA.

Specifications

Range: -40° to +140°F (-40° to +60°C)
 Output: 1µA/°K for supply voltages between +4 and +30 V
 (298.2 µA at 25°C)
 Accuracy: ± 0.4°C
 Linearity: 0.3°C
 Humidity: 0-100% RH
 Size: 2" L x 1/4" dia
 Weight: 1 lb/2 lb

Ordering Information

210-201	Air Temperature Sensor, includes 25' cable
210-600	Water/Soil Temperature Sensor, includes 25' cable
330-0324	Cable, 3 conductor 24 AWG shielded
330-0218DB	Cable for water & soil probes, 2 conductor 20 AWG direct burial

The **Model 210-301 Temperature Sensor** is a three-terminal integrated circuit sensor whose output voltage is linearly proportional to the Fahrenheit temperature. This sensor does not require any external calibration or trimming to provide typical accuracies of ± 0.5°F at room temperature and ± 1.5°F over a full 0-120°F temperature range. It operates from 5-30 Vdc and has a linear 10mV/°F output. With a common reference to input and output, it easily interfaces with most dataloggers and outputs a direct reading analog output, i.e. 0.8 Vdc = 80°F.

Specifications

Range: 0°F to 300°F
 Output: 0 to 1.2 Vdc, current drain 0.075 mA
 (with single DC power supply 5-30 Vdc)
 Accuracy: ± 0.5°F at 77°F, ± 1.5°F over full range
 Linearity: ± 0.5°F typical
 Humidity: 0-100% RH
 Size: 2" L x 1/4" dia
 Weight/shipping: 1 lb/2 lb

Ordering Information

210-301	Air Temperature Sensor, includes 25' cable
210-301W	Water or Soil Temp Sensor, includes 25' cable
330-0324	Cable, 3 conductor 24 AWG shielded



210-201 & 210-301 Temperature Sensor

210-TP1 Temperature Sensor

The **Model 210-TP1 Air Temperature Sensor** provide accurate temperature measurements in harsh environmental conditions as well as indoor locations. The probe is normally placed in a solar radiation shield or wooden shelter. Standard industrial outputs (0-5 Vdc or 4-20 mA) are available for digital displays, recorders, data loggers, and telemetry systems. The electronic signal conditioning unit is molded in line with the sensor.

Specifications

Sensor

Element: Precision integrated circuit
Accuracy: $\pm 0.8^{\circ}\text{F}$ ($\pm 0.4^{\circ}\text{C}$)
Maximum range: -40° to $+120^{\circ}\text{F}$

Sensor Cable

Outer sheath: Black polypropylene
Wire: 22 gauge, shielded
Sensor cap: Potted PVC
Temperature: -40° to $+60^{\circ}\text{C}$
Humidity: 100%

Signal Conditioning

Range: -40° to $+120^{\circ}\text{F}$ (-40° to $+48.9^{\circ}\text{C}$)
Output: 0-5 Vdc or 4-20 mA, 3-wire device
Power: 9-24 Vdc, $< 5\text{mA}$
Enclosure: Potted ABS thermoplastic (in line)
Size: 1" x 0.75" x 2"
Cable: 40' total, 25' sensor to enclosure, 15' enclosure to output cable
Weight/shipping: 3 lbs/5 lbs

Ordering Information

210-TP1	Temperature Sensor -40 to $+120^{\circ}\text{F}$, 0-5 Vdc output
210-TP1C	Temperature Sensor -40 to $+120^{\circ}\text{F}$, 4-20 mA output
210-CAB1	TP1 Sensor Cable (from sensor to enclosure)
210-CAB2	TP1 Signal Cable (from enclosure to output cable)

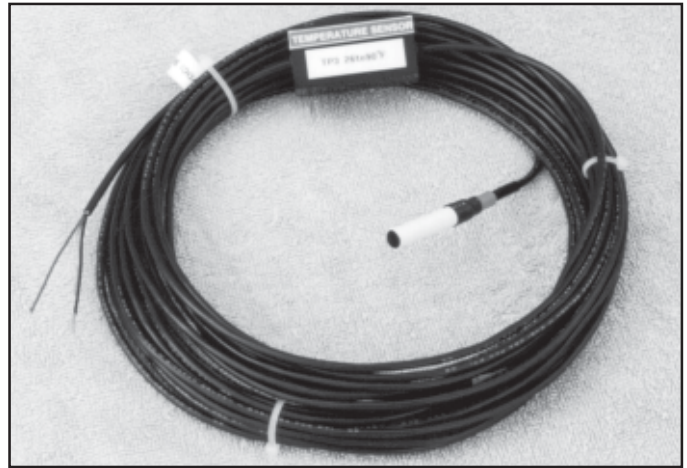

210-TP1 Temperature Sensor

210-WE700 Temperature Sensor

The **Model 210-WE700 Temperature Sensor** is a two-wire loop-powered device. The sensor is totally potted and sealed. It can be used for air temperature or water temperature applications. For air temperature, the probe is normally installed in a solar radiation shield or wooden instrument shelter.

Specifications

Type: Precision RTD
Output: 4-20 mA
Range: -58° to +122°F (-50° to +50°C)
Accuracy: $\pm 0.2^\circ\text{F}$ ($\pm 0.1^\circ\text{C}$)
Operating voltage: 10-36 Vdc
Current draw: Same as sensor output
Warm-up time: 5 seconds minimum
Operating temperature: -50° to +100°C
Sensor size: 3/4" diameter x 4-1/2"
Sensor cap: Potted stainless steel
Cable: 2 conductor, 25' standard
Weight/shipping: 1/2 lb/2 lbs

Ordering Information

210-WE700	Temperature Sensor
201-WE700C	Additional Cable, per foot



210-WE700 Temperature Sensor

225-THT-1 Temperature & Humidity Sensor



The **225-THT-1 Temperature & Humidity Sensor** is configured for measuring relative humidity and temperature in environmental control systems, where condensation or dust will commonly be encountered. A fully gasketed watertight enclosure, locking strain relief connections, and a brass sintered filter protect the electronics and sensors from environmental or mechanical damage.

An electronic circuit in the enclosure converts the capacitance to a voltage output which is linearly proportional to the ambient relative humidity. Temperature is sensed by a 100 ohm platinum resistance element and converted to a linear analog output. The sensor should be mounted in a solar radiation shield when placed outdoors. The remote probe comes with four feet of cable and a mounting clamp.

The sensor can be powered by 10-30Vdc, 120Vac 50/60Hz, or 220Vac 50/60Hz. It features three outputs for relative humidity and three outputs for temperature, 0-1V, 0-5V, and 4-20mA. All six outputs are available on a terminal strip inside the enclosure and can be used at the same time.

Ordering Information

225-THT-1	Temperature and Humidity Sensor
225-THT-BC	Battery Cable, per foot
225-THT-PC6	AC Power Cable (115V plug), 6'
225-THT-PC25	AC Power Cable (115V plug), 25'
330-0524	Signal Cable, per foot
380-281-THT	Solar Radiation Shield with mast mounting hardware

Specifications

Sensors:
Relative humidity: Capacitive (thin film)
Temperature: PT100 RTD

Range:
Relative Humidity: 5.0% to 95% RH
Temperature: -5° to 175°F (-20° to 80°C)

Accuracy: ±2% RH, ±0.5°C

Response time (without filter):
Relative humidity: 90% of measured value in 15 seconds
Temperature: approximately 60 seconds

Output:
0 to 1 Vdc for 0-100% RH
0 to 5 Vdc for 0-100% RH
4 to 20 mA for 0-100% RH
0 to 1 Vdc for -20° to 80°C
0 to 5 Vdc for -20° to 80°C
4 to 20 mA for -20° to 80°C

Operating range: -4° to 180°F (-20° to 80°C)

Power supply required:
120 Vac, 50/60 Hz or
220 Vac, 50/60 Hz or
10 to 30 Vdc

Housing: ABS plastic, watertight, with strain reliefs
Filter: sintered brass

Dimensions:
Housing: 4.8" x 4.8" x 2.2"
Probe: 6.25" x 1" diameter, includes 4' cable

Weight/Shipping: 18 oz/2 lbs

210-41342 Temp & 225-41382 T/RH

225-42603 Temp Tracker

The **Model 210-41342 Temperature Probe** is a 1000 Ohm Platinum RTD encased in a stainless steel protective sheath. The sensing element is securely mounted in a convenient junction box. For special applications, the temperature probe is available with various output options. The 4-20 mA current output is useful in high noise, industrial settings or for long cable lengths. The 0-1 Vdc option provides a calibrated voltage output signal. Low power circuitry makes it ideal for field studies and remote data-logging applications.

The **225-41382 Relative Humidity & Temperature Probe** combines a high accuracy humidity sensor and a 1000 Ohm Platinum RTD. Available with 0-1 Vdc or 4-20 mA outputs, sensors are mounted in a common junction box.

The **225-46203 Temp Tracker** is a versatile temperature, dew point, and relative humidity indicator. Measured values are displayed on the front panel in large illuminated digits: temperature is shown on the left, relative humidity on the right. Maximum and minimum values are saved and can be viewed at any time. Use with the 225-41382LC Humidity & Temperature Probe.

Ordering Information

210-41342LC	Temperature Probe, °C, 4-20 mA output
210-41342LF	Temperature Probe, °F, 4-20 mA output
210-41342VC	Temperature Probe, °C, 0-1 Vdc output
210-41342VF	Temperature Probe, °F, 0-1 Vdc output
225-41382LC2	Humidity & Temperature Probe, °C, 4-20 mA output
225-41382LF2	Humidity & Temperature Probe, °F, 4-20 mA output
225-41382VC	Humidity & Temperature Probe, °C, 0-1 Vdc output
225-41382VF	Humidity & Temperature Probe, °F, 0-1 Vdc output
225-46203	Temp Tracker, 110V
225-46203H	Temp Tracker, 230V
380-41003P	Multi-Plate Solar Radiation Shield



Temp Tracker

Specifications

Temperature (41342, 41382)
 Calibrated Measuring Range:
 -50 to 50 °C (suffix C)
 -50 to 150 °F (suffix F)
 Response Time: 10 seconds (without filter)
 Accuracy at 23 °C: ± 0.3 °C
 Sensor Type: Platinum RTD
 Output Signal: V Option: 0-1 Vdc
 L Option: 4-20 mA

Relative Humidity (41382)
 Measuring Range: 0-100% RH
 Accuracy at 20-25 °C: ± 1% RH
 Stability: Better than ± 1% RH per year
 Response Time: 10 seconds (without filter)
 Sensor Type: Rotronic Hygromer™
 Output Signal: V option: 0-1 Vdc
 L option: 4-20 mA

Power Required	41342	41382
V Option: 10-28 Vdc	5 mA	8 mA
L Option: 10-28 Vdc	20 mA	40 mA

Temp Tracker (46203)

Range:
 Temperature: -50.0 to 150.0 °F, -50.0 to 50.0 °C
 Relative Humidity: 0-100%
 Display resolution:
 Temperature: 0.1 °F, 0.1 °C
 Relative Humidity: 1%
 Dewpoint: 1 °F, 1 °C
 Voltage outputs: 0-5 Vdc Full Scale for T & RH
 Alarm relays: Normally open contacts for T & RH
 Contact rating 5A resistive, 2A inductive @ 250 Vac, 30 Vdc
 Remote displays: 16 maximum
 Power requirement: 12 to 30 Vdc, 4.5 W
 Dimensions: 5.43" x 5.65" x 1.4" (144 mm x 144 mm x 138 mm)



Relative Humidity & Temperature Probes

210-5320 Series Dew Cell



210-5320 Dew Cell

The **Model 210-5320 Dew Cells** are improved versions of the traditional lithium chloride (LiCl) sensor. The sensors include a bifilar heater composed of a pair of gold wire electrodes. These are wound over a fiberglass wick treated with LiCl. The LiCl is highly hygroscopic. As it absorbs water from the atmosphere, its conductance increases. This causes additional current to run through the heater, heating the sensor, or dew cell, to the equilibrium temperature at which the LiCl again becomes nonconductive. Equilibrium temperature is measured by a temperature sensor located in the hollow cavity under the heater and is translated to dew point temperature based on a linear relationship.

Two types of dew cells are available, differing only in their temperature sensors. The 210-5320 utilizes a 3-element thermistor, while the 210-5321 features a 100 ohm platinum resistance probe. Both models include a perforated protective shield, temperature sensor leads, and heater leads. The heater requires 24 Vac for excitation, making AC power and a transformer necessary for dew cell operation.

To protect the dew cell from sunlight and the elements when it is used outdoors, it must be installed in a radiation shield or an instrument shelter. The 380-43408DPT Motor-Aspirated Radiation Shield includes a transformer and a mounting adapter for the 210-5320. It will also hold a temperature probe. The 210-53212 Dew Cell Power Supply is designed for use with a dew cell installed in an instrument shelter. The 210-53212 consists of a transformer, a ballast resistor, and a terminal strip, all in a weatherproof enclosure.

Specifications

Dew Cell

Measuring range: -40° to +40°C

Temperature sensor:

210-5320: Thermistor composite (same as 4480-A)

210-5321: 100 ohm platinum resistance

Accuracy*: ± 1.3°C

*After the appropriate correction, based on relative humidity, is added.

Time constant: 2.0 minutes (typical operation inside 8152-A Shield)

Heater winding: Gold wire

Salt: 8% LiCl solution

Operating temperature: -40° to +55°C

Operating humidity: 17-100% RH at -12°C, 12-100% RH at 30°C

Storage conditions: -40° to +85°C, 0-70% RH

Input voltage: 24 Vac

Power consumption: 2.4 VA

Size: 0.375" dia x 3.75" L (10 mm x 95 mm)

Weight/shipping: 0.5 lb/1 lb (0.22 kg/0.45 kg)

Ordering Information

210-5320	Dew Cell, 3 element thermistor
210-5321	Dew Cell, 100 ohm platinum resistance
210-53212	Stand-Alone Power Supply, 115 Vac
210-53212-A	Stand-Alone Power Supply, 230 Vac
380-43408DPT	Motor-Aspirated Solar Radiation Shield (holds one dew point sensor and one temperature sensor)
330-0320	Cable to connect dew cell transformer to AC power; 3-conductor, 20 AWG, shielded
330-0420	Cable to connect dew cell to signal conditioning module; 4-conductor, 20 AWG, shielded
M482020	Lithium Chloride Solution, for re-treating the sensor

Fuel Moisture Sticks & Scale

The **Model 225-7918 Fuel Moisture Sticks** are used to estimate moisture content of small forest fuels for prescribed burning operations and to determine forest fire danger ratings. The sticks are placed over a duff bed of coniferous needles or hardwood leaves in the area where moisture is to be measured. The exposed sticks are then weighed on the **225-7917 Fuel Moisture Scale** and the weight in excess of the oven-dry weight represents fuel moisture. Sticks should be replaced every 90 days.

Specifications

Materials: 4 ponderosa pine sapwood dowels spaced 1/4" apart on 2 hardwood connecting dowels and secured with wire brads or staples, and a brass screw hook. Dowels are oven-dried to uniform moisture content of 15% or less.

Overall dimensions: 2-3/4" wide x 18-1/2" long

Oven-dry weight: 100 grams

Ordering Information

225-7917	Fuel Moisture Scale
225-7918	10-Hour Fuel Moisture Stick
225-7919	Support Brackets, set of 2

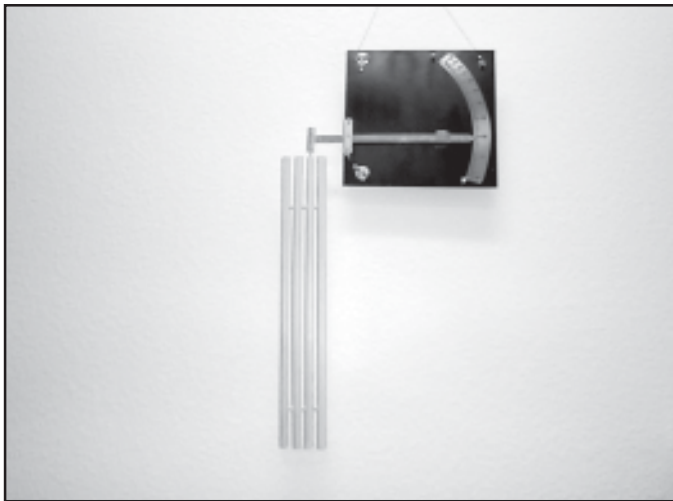

225-7917 Fuel Moisture Scale with 225-7918 Fuel Moisture Stick

250-124 Soil Moisture Sensor

The **Model 250-124 Soil Moisture Sensor** monitors soil moisture reliably in all types of soils at all moisture levels. Soil moisture in fields, turf, landscapes, and greenhouses may be monitored equally well. The sensor output signal may be used to directly control irrigation. The sensor reads the percent of available moisture by volume, independent of soil texture.

Water is the primary factor in determining the dielectric constant of soil. The soil moisture sensor measures the dielectric constant which is directly related to water content in reasonable growing conditions. The probe consists of a small electronic module, encapsulated for environmental protection, attached to one end of the cylindrical probe. A 10' cable is provided to supply power and read out the soil moisture signal. Exposed material is epoxy.

Specifications

Power requirements: 12 Vdc \pm 20% @ 40mA

Output: 4-20mA, 0-1mA, or 0-5Vdc = 0-100% soil moisture (Linear)

Overall size: 3/4" diameter x 27" long

Shipping weight: 3 lbs

Turn-on time: 1 second from power up

Operating temperature range: 0-70°C

Ordering Information

250-124C-1	Soil Moisture Sensor, 0-1 mA output
250-124C-4	Soil Moisture Sensor, 4-20 mA output
250-124V	Soil Moisture Sensor, 0-5 V output
250-12CAB	Additional Cable, per foot



250-124 Soil Moisture Sensor

210-421-A General Purpose Temperature Alarm

The **Model 210-421-A Temperature Alarm** is a microprocessor-based dual-setpoint temperature alarm suitable for environmental and industrial applications. It can also be configured as a frost alarm. It sounds an alarm and controls the operation of two electrical circuits whenever the temperature reaches either of two independently set limits. The temperature range is -40° to 160° F (-40° to 71° C) and the alarm range is the same. The alarms can be selected to operate either greater than or less than the selected temperature output. A liquid crystal display provides readout of the measured temperatures and is also used to display maximum and minimum temperatures as well as the values of the various alarm parameters using a series of setup menus.

Self-contained relays for each alarm point can be used to actuate external devices such as small pumps or sirens. These internal relays may be used to control external power relays if high current loads are to be switched. An audible alarm, which may be silenced if desired, is also included within the 210-421-A. To eliminate erratic or premature operation of controlled devices, the 210-421-A includes provision for setting a delay or conformation interval prior to the initiation of an alarm and also a delay time prior to negating an alarm.

All setpoints and maximum and minimum temperature values are stored in non-volatile memory so that these values are not lost if there is a power failure. The circuits are designed to have high electrical noise immunity to transient spikes generated by loads being switched with the alarm relays. The unit restarts in the running mode after a power failure.

The temperature sensing probe is based on a precision thermistor and is designed to measure over a wide range of temperatures. The Model 380-280 Solar Radiation Shield is recommended for use with the air temperature probe in outdoor applications.



210-421-A General Purpose Temperature Alarm

Specifications

Temperature sensor: Precision thermistor
 Measurement range: -40° to +160° F (-40° to +71° C)
 Alarm range: -40° to +160° F (-40° to +71° C)
 Resolution: 0.1°
 Accuracy: ± 0.5° F (± 0.2° C)
 Alarm ON and OFF delay range: 0-99 seconds
 Controls: Protected push buttons that select
 Run or set variables
 Select menu item
 Increment alarm setting
 Decrement alarm setting
 Clear stored max and min values
 Indicators: LEDs for alarm point 1 and 2
 2 line x 16 character LCD
 Display character size 3x8 mm
 Operating temperature: Control module only -20° to +50° C
 Input power: 12 Vac or dc
 Current: 50 mA maximum
 Alarm: Contacts rated 3A @ 24 Vdc/115 Vac
 Form "C" (SPDT) configuration
 Temperature cable length: 40' 2-conductor
 Weight/Shipping: 1 lb/2 lbs

Ordering Information

210-421-A	Temperature Alarm
210-421W-A	Temperature Alarm, with waterproof probe
210-421P	Plug-In Power Pack, 12V/500mA
330-0224	Add'l Cable for 210-421-A, per foot (max 100')
330-0218DB	Add'l Cable for 210-421W-A, per foot (max 100')
380-280	Solar Radiation Shield

210-EC Series Frost Alarms



- American made
- Easy to use - Simple, proven design
- Lighted scale
- Alarm buzzer and light

These low cost instruments monitor temperature and sound an alarm when temperature falls to the setpoint. **Models 210-EC1 and 210-EC2** both have a temperature meter with a monitor scale range of 10° to 110° F. The 210-EC1 has an alarm setpoint range of 25° to 35° F. The 210-EC2 (shown) has an alarm setpoint range of 30° to 40° F.

The **Model 210-EC1C** has a temperature meter with a monitor scale range of -10° to +40° C and an alarm setpoint range of -4° to +2° C.

All three models include a sensor probe with 1' cable, which may be wired up to a mile from the frost alarm using ordinary 20 AWG or larger copper cable or telephone type wire.

The frost alarms come with a plug-in transformer that operates from 110 Vac/60 Hz. A separate 12 Vdc power input is also provided so the unit may be connected to a 12 volt backup battery to allow the system to remain operational in the event of power failure.

Specifications

Accuracy: ± 2%
 Alarm setpoint range:
 EC1 25° to 35° F
 EC2 30° to 40° F
 EC1C -4° to +2° C
 Alarm buzzer: 75 dB at 2 feet
 Size: 6-1/4" x 3-3/4" x 2" deep
 Weight: 1 lb 10 oz

Ordering Information

210-EC1	Frost Alarm 25/35F
210-EC2	Frost Alarm 30/40F
210-EC1C	Frost Alarm -4/+2C
210-277-5	Replacement Temperature Sensor

225-HM34 Relative Humidity & Temperature Indicator

- Lightweight, pocket-size
- Extendable probe
- Automatic power off
- Measures humidity and temperature
- Fast response with $\pm 2\%$ accuracy

The **Model 225-HM34 Relative Humidity and Temperature Indicator** provides a fast and convenient way to spot-check relative humidity and temperature. The instrument includes a “hold” button which allows the user to retain a relative humidity or temperature measurement until it has been noted or recorded. If no measurements are made for 3 minutes, the unit automatically switches itself off. This automatic power-off function prevents accidental discharge of the battery.

The 225-HM34 incorporates the HUMICAP® Sensor, which is accurate, durable, and insensitive to dust and most chemical contaminants. Both the humidity and temperature sensors are housed in an extendable probe that is retracted back into the rugged plastic casing for storage, creating a compact and easy to carry device. Each unit includes a 9-volt battery, attached probe, protective membrane filter, and carrying case.

Specifications

Relative Humidity

Sensor type: HUMICAP®H thin film capacitive sensor
 Range: 0-100% RH
 Accuracy: $\pm 2\%$ (0-90% RH), $\pm 3\%$ (90-100% RH)
 Resolution: 0.1% RH
 Temperature dependence: $\pm 0.02\%$ RH/°F ($\pm 0.04\%$ RH/°C)
 Response time (90%): 10 sec with membrane filter, 5 sec with plastic grid

Temperature

Sensor: Pt 100 IEC 751 1/3 Class B
 Range: -4° to $+140^{\circ}$ F (-20° to $+60^{\circ}$ C)
 Accuracy: $\pm 0.5^{\circ}$ F ($\pm 0.3^{\circ}$ C)
 Resolution: 0.1°F (0.1°C)
 Temperature dependence: $\pm 0.02^{\circ}$ F/°F ($\pm 0.02^{\circ}$ C/°C)

General

Display: 3 1/2 digit LCD
 Power supply: 9 V battery
 Battery life: 50 h
 Hold function: Push-button hold of displayed value
 Power off: Automatic, after 3 minutes, unless “hold” is activated
 Size: 6.3" x 2.2" x 1.1" (160 mm x 57 mm x 27 mm)
 Weight/shipping: .5 lbs/2 lbs



225-HM34 Pocket-Sized Humidity & Temperature Indicator

Ordering Information

225-HM34-C	Handheld Humidity and Temperature Indicator, °C
225-HM34-F	Handheld Humidity and Temperature Indicator, °F

225-RH520A RH/Temp Digital Chart Recorder

The **225-RH520A RH/Temp Digital Chart Recorder** offers simultaneous numerical and graphical display of humidity and temperature readings, plus time and date. It measures humidity (10 to 95% RH) and temperature (-20.0°F to 140.0°F) and calculates dew point. Utilizes a large dual graphical LCD display with adjustable vertical and horizontal TAC resolution. Internal memory records up to 49,000 data points and can be transferred to a PC via RS-232 serial port for further data analysis. LCD indicates percentage of memory remaining. Replaceable probe does not require recalibration. Probe extends up to 1 meter for measurements in closed environments. Audible and visual alarm has Hi/Low setpoints. Output socket is used with optional external alarm module. Desk or wall mount. Complete with built-in stand, detachable probe with 3ft (1m) cable, RS232 cable, 110 Vac adaptor and 3 AA batteries.

Specifications

Relative humidity range: 10 to 95.0% RH
 Temperature range: -20.0 to 140.0 °F (-28 to 60 °C)
 Accuracy: ± 3% RH; ± 1.8 °F (± 1°C)
 Dimensions: 5" x 7.7" x 0.9" (129 x 195 x 22 mm)
 Weight: 12.6 oz (357 g)

Ordering Information

225-RH520A	RH/Temp Digital Chart Recorder includes 110Vac adapter
225-RH520A-220	RH/Temp Digital Chart Recorder includes 220Vac adapter
225-RH520A-NIST	RH/Temp Digital Chart Recorder with NIST Certificate
225-RH522	Replacement Humidity-Temperature Probe
225-SL123	AC Alarm Relay Module 9' cable (3m)
225-SL124	DC Alarm Relay Module 9' cable (3m)

225-445703 Big Digit Hygro-Thermometer

The **225-445703 Big Digit Hygro-Thermometer** displays simultaneous measurements of temperature and relative humidity with 1" digits on super large LCD display. Features minimum and maximum memory with reset for both temperature and humidity readings, Fahrenheit/Celsius switchable temperature units, and low battery indicator. Comes complete with built-in tilt stand, wall mounting bracket, and 1.5V AAA battery. Suitable applications include factories, greenhouses, museums, libraries, and offices to monitor temperature and humidity conditions and record extremes during the day. CE approved.



Specifications

Measuring range:

Temperature: 14 to 140°F (-10 to 60°C)

Humidity: 10% to 99%

Accuracy:

Temperature: 1.8°F within 32 to 122°F (1°C within 0 to 50°C)

Humidity: 5% RH within 25-85% RH and 32 to 122°F (-10 to 60°C)

Dimensions: 4.3x3.9x0.78" (110x100x20mm)

Ordering Information

225-445703 Big Digit Hygro-Thermometer

380-280 Radiation Shield

The **Model 380-280 Solar Radiation Shield** is a low cost solution for protecting temperature and relative humidity probes. It consists of four molded plastic plates and a powder coated aluminum mounting arm. The wedge-shaped plates provide maximum airflow around the probe while at the same time minimizing direct exposure of the probe tip to sunlight. The shield is shaped to allow natural air convection around the probe so that the air being measured inside the shield is a good representation of the outside air. The shield also provides protection from rain and snow. The 380-280 can be used with sensors from 0.25" diameter up to 0.75" diameter. The lower protective shroud provides added protection for sensors up to 8" in length.

Specifications

Capacity: 1 probe (temperature, humidity, or temperature/humidity)
 Radiation error: 2°F (1°C) @ WS > 3 mph
 Material: UV stabilized ABS plates, PVC top cap, white powdercoated aluminum mounting bracket
 Mounting: 1.25" o.d. U-bolt
 Size: 4" Dia x 10" H (102 mm x 254 mm)
 mounting arm 6" L (152 mm)
 Weight/shipping: 1 lb/2 lbs

Ordering Information

380-280 Self-Aspirated Solar Radiation Shield

380-281 Radiation Shield

The **Model 380-281 Solar Radiation Shield** is designed with a highly reflective white surface to reflect the sun's direct radiation. It is constructed of powder coated aluminum and consists of a flat deflection plate, three wedge-shaped plates, and a mounting arm. The wedge-shaped plates provide maximum airflow around the probe while at the same time minimizing direct exposure of the probe tip to sunlight. The use of multiple plates with openings in the top of each promotes a rising flow of air through the shield. The shield provides protection from scattered as well as direct radiation. The 380-281 is often used at weather stations where no ac power is available to run a motor aspirated shield.

The **Model 380-283 Fan Aspirated Solar Radiation Shield** includes a solar powered fan mounted on top of the shield.

Specifications

Capacity: 1 probe (temperature, humidity, or temperature/humidity)
 Radiation error: 2°F (1°C) @ WS > 3 mph
 Material: Aluminum
 Finish: Gloss white powder coat
 Mounting: 1.25" o.d. U-bolt
 Size: 6" Dia x 12.5" H (152 mm x 318 mm)
 mounting arm 6" L (152 mm)
 Weight/shipping: 2.5 lbs/4 lbs (1.1 kg/1.8 kg)

Ordering Information

380-281 Self-Aspirated Solar Radiation Shield
 380-283 Fan-Aspirated Solar Radiation Shield, solar powered



380-280 Solar Radiation Shield



380-281 Solar Radiation Shield

380-41003 Radiation Shield



The **Model 380-41003 Multi-Plate Radiation Shield** protects temperature and relative humidity sensors from error-producing solar radiation and precipitation. Compact size and light weight make this shield useful for many applications. The multiple discs have a unique profile that blocks direct and radiated solar radiation, yet permits easy passage of air. The disc material is specially formulated for high reflectivity, low thermal conductivity, and maximum weatherability. The rugged U-bolt mounting clamp attaches easily to any vertical pipe up to 2" diameter.

Specifications

Sensor types: Accommodates temperature and humidity sensors up to 26 mm (1") diameter

Radiation error: @ 1080 W/m² intensity, dependent on wind speed

0.4°C (0.7°F) RMS @ 3 m/s (6.7 mph)

0.7°C (1.3°F) RMS @ 2 m/s (4.5 mph)

1.5°C (2.7°F) RMS @ 1 m/s (2.2 mph)

Construction:

UV stabilized white thermoplastic plates

Aluminum mounting bracket, white

Stainless steel U-bolt clamp

Dimensions: 12 cm (4.7") diameter x 27 cm (10.6") high

Mounting fits vertical pipe 25-50 mm (1-2") diameter

Weight/shipping: 0.7 kg (1.5 lb)/1.4 kg (3 lb)

Ordering Information

380-41003	Solar Radiation Shield, includes universal adapter for sensors up to 12.5 mm diameter
380-41003P	Solar Radiation Shield, includes custom sensor adapter, specify diameter from 12.5 to 26 mm
380-41003P-24	Solar Radiation Shield, includes 24mm adapter for RM Young probes
380-41390	Junction Box, specify sensor diameter (6 mm max)

380-43408 Radiation Shield

380-43502 Radiation Shield

The **Model 380-43408 Motor Aspirated Radiation Shield** provides maximum sensor protection from incoming short wave solar radiation and outgoing long wave radiation. The shield employs concentric downward facing intake tubes and a small canopy shade to isolate the sensor from direct and indirect radiation. A continuous duty blower draws ambient air through the intake tubes and across the sensor minimizing heat transfer to the sensor. Compact shield components reduce radiation absorption and improve aspiration efficiency. Specially selected plastic materials provide high reflectivity, low conductivity, and maximum weatherability. The versatile DC blower is designed for continuous duty of 80,000 hours at 25° C. Brushless electronic commutation is achieved using dependable solid state circuitry.



Specifications

Sensor types: Accommodates temperature and humidity sensors up to .75" (19 mm) diameter
 Radiation error: @ 1000 W/m² intensity
 Ambient temperature: 0.4°F (0.2°C) RMS
 Delta T: 0.1°F (0.05°C) RMS with like shields equally exposed
 Aspiration rate: 11 to 25 fps (3.4 to 7.6 m/s) depending on sensor size
 Power requirement: 12 Vdc @ 500 mA for blower, AC adapter included
 Construction:
 UV stabilized thermoplastic shield, white
 Aluminum cross tube & mounting brackets, white painted
 Stainless steel u-bolt clamp
 Dimensions:
 Length: 43-75" (110-190 cm) adjustable
 Shield: 1.3" (34 mm) dia x 4" (10 cm) length
 Blower housing: 5.9" (15 cm) dia x 3.5" (9 cm) length
 Mounting: Adjustable V-blocks and u-bolts fit vertical, horizontal, or diagonal tower members 1-2" (25-50 mm) dia
 Weight/shipping: 5.3 lbs/13 lbs (2.4 kg/5.9 kg)

Ordering Information

380-43408	Motor Aspirated Shield, 110V/60Hz AC adapter
380-43408H	Motor Aspirated Shield, 230V/50-60Hz AC adapter
380-43482	Probe Top Cover
380-41390	Accessory Junction Box, specify sensor diameter (10 mm max)

The **Model 380-43502 Aspirated Radiation Shield** provides maximum sensor protection from incoming short wave solar radiation and outgoing long wave radiation. The shield employs a triple walled intake tube and multiple canopy shades to isolate the sensor from precipitation and solar radiation. A continuous duty blower draws ambient air through the intake tubes and across the sensor, minimizing radiation errors. Compact shield components reduce radiation absorption and improve aspiration efficiency. Specially selected plastic materials provide high reflectivity, low conductivity, and maximum weatherability. The versatile DC blower is designed for continuous duty of more than 80,000 hours (9 years) at 77°F (25°C). Brushless electronic commutation is achieved using dependable solid state circuitry.

Specifications

Sensor types: Accommodates temperature and humidity sensors up to .94" (24mm) in diameter
 Radiation error: @ 1000 W/m² intensity
 Ambient temperature: 0.4°F (0.2°C) RMS
 Delta T: 0.1°F (0.05°C) RMS with like shields equally exposed
 Aspiration rate: 16 to 35 fps (5 to 11 m/s) depending on sensor size
 Power requirement: 12-14 Vdc @ 500 mA for blower, AC adapter included
 Construction:
 UV stabilized white thermoplastic shield and blower housing
 Aluminum mounting bracket, white coated
 Stainless steel u-bolt clamp
 Dimensions:
 Overall: 13" high x 8" dia (33 cm x 20 cm)
 Shield: 2.8" dia x 4.7" length (70 mm x 12 cm)
 Blower housing: 6.7" dia x 4.3" (17 cm x 11 cm)
 Mounting: V-block and u-bolt fits vertical post or tower members 1-2" (25-50 mm) diameter
 Weight/Shipping: 2.5 lb/6 lb (1.1 kg/2.7 kg)

Ordering Information

380-43502 Aspirated Radiation Shield

380-600 Thermometer Shelter

Instrument shelters protect temperature and relative humidity sensors and other instruments against errors and damage due to solar radiation, wind, and precipitation.

The **Model 380-600 Thermometer Shelter** will house a thermometer or temperature dial. It is constructed of wood with louvered front and sides. The bottom panel has holes to increase natural ventilation. The shelter is painted white and includes a lock and key. Mounting holes are provided to install the 380-600 on a wall or post. Ideal installation is on a wall with a northern exposure to prevent excessive heating by the sun. If installed on a post, protection from direct sunlight must be provided. Shipped assembled.

Specifications

Material: Wood, white latex painted finish
Size: 23.5" H x 10" W x 7.5" D outside, 18" x 8" x 5.75" inside
Weight/shipping: 9 lbs/12 lbs

Ordering Information

380-600 Thermometer Shelter



380-600 Thermometer Shelter

380-601 Small Instrument Shelter

The **Model 380-601 Small Instrument Shelter** conforms to U.S. Weather Bureau Specification No. 450.0164 and is made to hold thermographs, hygrothermographs, and other recording instruments. Sides are horizontally slatted for free airflow while providing protection from sun, wind, and rain. The double roof provides additional protection against direct solar radiation. Mounts on a post (not supplied). The shelter is shipped completely assembled.

Specifications

Material: Wood, white latex painted finish
Size: 19.5" H x 19" W x 11.25" D outside, 15" x 15" x 7.25" inside
Weight/shipping: 22 lbs/26 lbs

Ordering Information

380-601 Small Instrument Shelter



380-601 Small Instrument Shelter

380-605 Large Instrument Shelter

The **Model 380-605 Large Instrument Shelter** is built to National Weather Service standards. It is sometimes called a Cotton Region Shelter. The enclosure is large enough to house several recording instruments, such as hygrothermographs. Thermometers and sensor probes can be mounted on a board which spans the inside of the box. The shelter is constructed of clear pine and painted with three coats of white latex paint. It has louvers on all four sides and vents in the bottom to provide natural ventilation while excluding solar radiation and precipitation, allowing ambient conditions to exist inside. A double roof provides added protection against direct solar radiation. A lock and key are included for security. Optional wood or metal legs are available. For best results, shelter should be installed over short grass. Legs should be anchored to prevent overturning of the shelter in high winds. Shipped partially assembled, the shelter can be assembled easily in approximately 30 minutes.

Specifications

380-605 Large Instrument Shelter

Material: Clear pine, white latex painted finish

Thermometer mount: Interior cross-board

Size: 31.5" H x 30.25" W x 20.75" D outside, 26"x 27.25" x 18" inside

Wood legs: 48"

Metal legs: 60"

Weight/shipping: 65 lbs/73 lbs

Wood legs: 20 lbs/25 lbs

Metal legs: 15 lbs/18 lbs

Ordering Information

380-605	Large Instrument Shelter
380-608	Wood Leg Kit
380-609	Metal Leg Kit

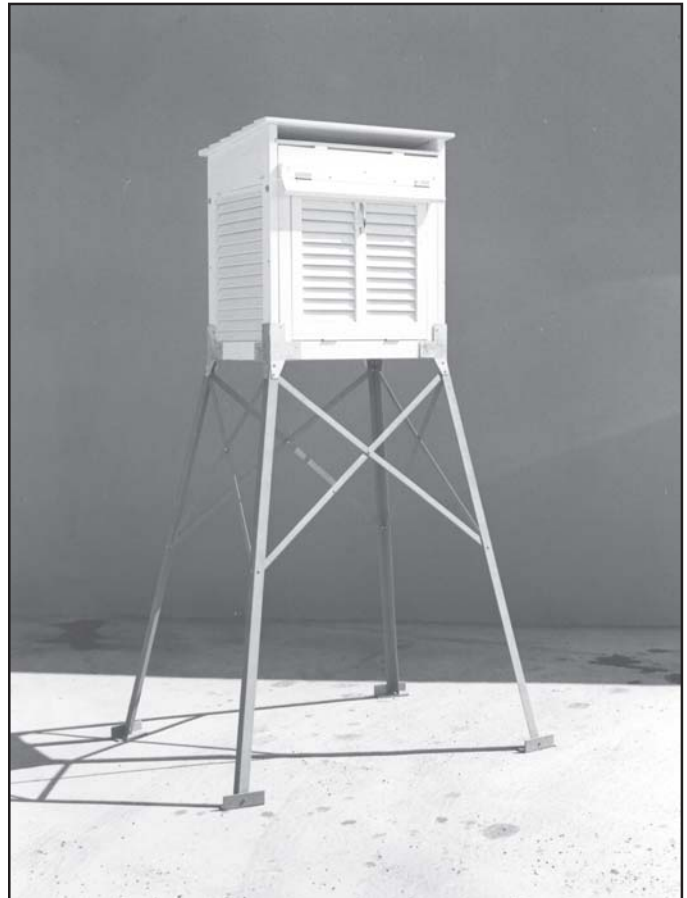

380-605 Large Instrument Shelter with 380-609 Metal Leg Kit

220-HMK15 Humidity Calibrator

The **220-HMK15 Humidity Calibrator** makes calibration and spot checking of humidity probes and transmitters easy and reliable. The operating principle is based on the fact that a saturated salt solution generates a certain relative humidity in the air above it. The reading of the humidity probe can then be adjusted accordingly. This is a generally accepted and reliable method for calibrating humidity instruments. The structure of the HMK15 is designed to ensure fast and stable temperature equilibration. No external power is required. In addition to laboratory use, it is also suitable for on-site checks. Special transit covers make the HMK15 simple to transport. The HMK15 includes a thermometer for measuring the temperature during calibration. It can also be used for checking the temperature measurement accuracy of the transmitter. The accuracy of the thermometer is $\pm 0.54^{\circ}\text{F}$ ($\pm 0.3^{\circ}\text{C}$).

Specifications

The standard HMK15 consists of the following parts:

- Two salt chambers, chamber covers, and transit covers
- Base plate
- Calibrated thermometer
- Measurement cup and mixing spoon

Each salt chamber has holes with a diameter of 12, 13.5, and 18.5 mm. There are two holes with a diameter of 13.5 mm.

Ordering Information

220-HMK15	Humidity Calibrator
220-19766HM	Extra Salt Chamber
220-HM27032	Carrying Bag
220-5135	Lithium Chloride (11%) 100 grams
220-5136	Potassium Sulfate (97%) 100 grams
220-5137	Sodium Chloride (75%) 100 grams



220-HMK15 Humidity Calibrator

220-HMK41 Calibration Kit

The **220-HMK41 Calibration Kit** includes HMI41, HMP46, NIST traceable certificate of calibration, and carrying case. The HMI41 hand held indicator has an easy-to-read LCD display. Temperature readout is available in either degrees Centigrade or Fahrenheit. In addition to displaying humidity and temperature readings, the HMI41 can calculate dewpoint and wet bulb temperature, absolute humidity and mixing ratio. Calculated variables are available in metric and non-metric. The HMP46 humidity and temperature probe is solid and rugged; its stainless steel probe head is made to withstand rough handling in mechanically demanding applications. These features, plus fast response time, high measurement accuracy and excellent stability, as well as the wide temperature range of the probe, make the HMI41/HMK46 combination an ideal choice for the most demanding applications.

Specifications

Humidity

Range: 0-100%

Accuracy: $\pm 2\%$ 0-90% RH, $\pm 3\%$ 90-100% RH

Temperature

Range: $-40/+212^{\circ}\text{F}$ ($-40/+100^{\circ}\text{C}$)

General

Typical ranges of calculated variables:

Dewpoint temp: $-40/+122^{\circ}\text{F}$ ($-40/+100^{\circ}\text{C}$)

Absolute humidity: 0/262 gr/ft³ (0/600 g/m³)

Wet bulb temperature: $32/212^{\circ}\text{F}$ (0-100°C)

Mixing ratio: 0/4200 gr/lb d.a. (0/600 g/kg d.a.)

Cable length: 1500 mm, extended spiral cable

Operating temperature range: $-4/+140^{\circ}\text{F}$ ($-20/+60^{\circ}\text{C}$)

Electronics housing: ABS plastic, NEMA-4 (IP 65)

Probe head: stainless steel

Sensor protection: sintered filter

Weight: 450 g

Ordering Information

220-HMK41	Humidity Calibration Kit
220-19446	Serial Communication Cable



220-HMK41 Calibration Kit

Barometric Pressure

230-P111 Dial Barometer	102
230-600 Series Barometric Pressure Sensors	103
230-PTB110 Series Analog Barometers	104
230-278 Barometric Pressure Transducer	105
230-276 Barometric Pressure Sensor	106
110-WS-16BP Barometric Pressure Sensor	107
230-WE100 Barometric Pressure Sensor	108
230-M202 Handheld Barometer-Altimeter	109
230-044 Handheld Barometer-Altimeter-Compass	110

230-P111 Dial Barometer

The Model 230-P111 Dial Barometer is rated at ± 0.05 inches (about ± 1.5 millibars) in mid-range. The 6" lacquered brass case houses a precision rack-and-pinion temperature-compensated movement, and the main pointer has a knife edge to minimize parallax error when taking readings. Not recommended for use above 3,500 feet.

Specifications

Sensor: aneroid bellows
Indicating range: 27.50-31.50 inches, 931-1067 millibars
Graduations: 0.05 inches, 1 millibar

Ordering Information

230-P111 Dial Barometer



230-P111 Dial Barometer

230-600 Series Barometric Pressure Sensors

The **230-600 Series Barometric Pressure Sensors** offer unparalleled performance and flexibility for atmospheric pressure measurement. The barometer is available in two configurations to satisfy a variety of applications; Model 230-600C provides a 4-20 mA current output, Model 230-600V provides 0-5 Vdc output. Both models offer serial output in addition to the analog signal.

When ordered with a NovaLynx data logger, the barometer can be mounted inside the data logger enclosure. For other applications, the 230-601 series consists of the same 230-600 sensor mounted inside a weathertight polycarbonate enclosure and includes 25' of output signal cable. Cable connections are inside. Mounting hardware is available for easy attachment to towers and masts.

Specifications

Operating range:

500-1100 mb (14.7-32.5 inHg) Standard Factory Default
 Other pressure ranges within the 500 to 1100 mb span may be selected via software commands but the full scale output signal range will always be the same, 0-5000mV. For example, 750 to 850 mb = 0-5 Vdc.

Output signal:

4-20 mA (230-600C)
 0-5 Vdc (230-600V)
 Serial RS232 (all models)

Operating temperature:

-50° to +60°C

Accuracy:

± 0.3 mb (.01 inHg) @ 20°C
 ± 0.5 mb (.015 inHg) over temperature range

Power requirement:

7 to 30 Vdc at 25 mA (230-600C)
 7 to 30 Vdc at 3 mA (230-600V)

Dimensions:

Sensor with backplate 3.5" L x 2.4" W x 0.8" D (90 x 60 x 20 mm)
 Enclosure 4.7" x 4.7" x 2.25"

Weight/Shipping:

Sensor only .2 lb/1 lb
 Sensor in enclosure 1.2 lbs/2 lbs

Other:

Sea-level offset

Ordering Information

230-600C	Barometric Pressure Sensor, 4-20mA output
230-600V	Barometric Pressure Sensor, 0-5V output
230-601C	Barometric Pressure Sensor, in polycarb enclosure, includes 25' cable, 4-20mA output
230-601V	Barometric Pressure Sensor, in polycarb enclosure, includes 25' cable, 0-5V output
330-0524	Additional Cable, per foot
395-A-003	Mast Mounting Hardware



230-600 Barometric Pressure Sensor



230-601 Barometric Pressure Sensor in Weatherproof Enclosure

230-PTB110 Series Analog Barometers



The **230-PTB110 Barometer** is designed both for accurate barometric pressure measurements at a room temperature and for general environmental pressure monitoring over a wide temperature range.

The PTB110 barometer uses the Vaisala BAROCAP® Sensor, a silicon capacitive absolute pressure sensor developed for barometric pressure measurement applications. The sensor combines the outstanding elasticity characteristics and mechanical stability of single-crystal silicon with the proven capacitive detection principle.

The excellent long-term stability of the barometer minimizes or even removes the need for field adjustment in many applications.

The PTB110 is suitable for a variety of applications, such as environmental pressure monitoring, data buoys, laser interferometers, and in agriculture and hydrology. The compact PTB110 is especially ideal for data logger applications as it has low power consumption. Also an external on/off control is available. This is practical when the supply of electricity is limited.

Specifications

Operating range:

230-PTB1104: 600-1060 mb

230-PTB1105: 800-1060 mb

Temperature range: -40/+140 °F (-40/+60 °C)

Humidity range: Non-condensing

Linearity* ± 0.25 mb

Hysteresis* ± 0.03 mb

Repeatability* ± 0.03 mb

Calibration uncertainty** ± 0.15 mb

Accuracy at +20 °C*** ± 0.3 mb

* Defined as ± 2 standard deviation limits of end-point non-linearity, hysteresis error or repeatability error.

** Defined as ± 2 standard deviation limits of inaccuracy of the working standard including traceability to NIST.

*** Defined as the root sum of the squares (RSS) of end-point non-linearity, hysteresis error, repeatability error and calibration uncertainty at room temperature.

Total accuracy at

+59/+77 °F (+15/+25 °C): ± 0.3 mb

+32/+104 °F (0/+40 °C): ± 0.6 mb

-4/+113 °F (-20/+45 °C): ± 1.0 mb

-40/+140 °F (-40/+60 °C): ± 1.5 mb

Long-term stability: ± 0.1 mb/year

Supply voltage 10-30 Vdc

Current consumption: less than 4 mA

Output voltage: 0-2.5 Vdc or 0-5 Vdc

Resolution: 0.1 mb

Load resistance: Minimum 10 kohm

Load capacitance: Maximum 47 nF

Settling time: 1 s to reach full accuracy after power-up

Response time: 500 ms to reach full accuracy after a pressure step

Pressure connector: M5 (10-32) internal thread

Pressure fitting: Barbed fitting for 1/8"

Minimum pressure limit: 0 mb abs

Maximum pressure limit 2000 mb abs

Electrical connector: Removable connector for 5 wires (AWG 28-16)

Terminals

Pin 1: external triggering

Pin 2: signal ground

Pin 3: supply ground

Pin 4: supply voltage

Pin 5: signal output

Housing material (plastic cover): ABS/PC blend

Housing classification: IP32

Metal mounting plate: Aluminum

Dimensions: 3.54" x 2.69" x 1.11" (90 mm x 68.4 mm x 28.1 mm)

Weight/Shipping: 3 oz (90 g)/1 lb (.5 kg)

Electromagnetic compatibility:

Complies with EMC standard EN 61326-1, Generic Environment

Ordering Information

230-PTB1104 Analog Barometric Pressure Transmitter
600-1060 mb

230-PTB1105 Analog Barometric Pressure Transmitter
800-1060 mb

230-278 Barometric Pressure Transducer

230-278 Barometric Pressure Transducer

The **Model 230-278 Barometric Pressure Transducer** is designed for use in environmental applications that require excellent accuracy, fast dynamic response, and long-term stability and reliability. To withstand the environmental extremes typically found in Automated Weather Station (AWS) and environmental monitoring applications, the 230-278 housing is constructed of stainless steel and polyester. A removable 5-pin terminal strip module is provided for easy connection to data logger and signal connections, and a 1/8" barbed fitting is used for pressure connection. The transducer's footprint (3.6" x 2.4" x 1.0") makes it ideal for use as a new or drop-in replacement to existing configurations.

The 230-278 is operable in temperatures from -40°F to +140°F (-40°C to +60°C). This unit consumes low levels of power (3mA nominal) while in operation. Its sleep mode feature reduces power consumption to 1 μ A, and provides instant startup for applications where pressure readings must be taken quickly.

Principles of Operation The 230-278 utilizes the Setraceram™ capacitive sensor and proprietary custom IC analog circuit. This fundamentally simple design and thermally stable glass fused ceramic sensing capsule is coupled with a sophisticated capacitance charge-balance IC circuit where accurate signal conditioning and environmental compensation is performed. The Setraceram™ sensor provides excellent thermal expansion coefficient and low mechanical hysteresis, which contributes to the long-term stability of the instrument.

Specifications**Performance Data**

Pressure Range	500	600	800
Temperature Accuracy (mb)			
68°F (20C)	±0.6	±0.5	±0.3
32-104°F (0/40C)	±1.2	±1.0	±0.6
4-122°F (-20/50C)	±2.0	±1.5	±1
40-140°F (-40/60C)	±2.5	±2.0	±1.5
Non-Linearity	±0.5	±0.4	±0.25
Hysteresis	±0.06	±0.05	±0.03
Non-Repeatability	±0.04	±0.03	±0.02
Resolution	0.01 mb		
Long term stability:	0.1 mb/yr		
Warm-up:	< 1 sec from shutdown mode (Warm-up shift < 0.1 mb maximum)		
Response time:	< 100 mSec		
Proof pressure:	1500 mb		
Burst pressure:	2000 mb		

Environmental Data

Operating temperature: -40°F to +140°F (-40°C to +60°C)
Storage temperature: -76°F to +248°F (-60°C to +120°C)

Physical Description

Case: Stainless steel and polyester
Pressure fitting: 1/8" (i.d.) barbed fitting
Electrical connection: 5-pin terminal block
Dimensions: 3.6" x 2.4" x 1.0"
Weight: 4.8 oz (135g) approx

Electrical Data

Electrical circuit: 3 or 4 wire
Excitation:** 9.5 to 28 Vdc
Output:*** 0 to 2.5 Vdc
0 to 5 Vdc
Output impedance: < 10 ohms
Output noise: < 50 microvolts
Current consumption: 3 mA nominal (operating mode)
1 μ A (sleep mode)

** Internal regulation minimizes effect of excitation variation, with < 0.02 mb output change over 9.5 Vdc to 28 Vdc range

*** Zero output saturates at about 20 mV

Ordering Information

230-278-5	Barometric Pressure Transducer, 0-5 Vdc 500 to 1100 mb
230-278-6	Barometric Pressure Transducer, 0-5 Vdc 600 to 1100 mb
230-278-8	Barometric Pressure Transducer, 0-5 Vdc 800 to 1100 mb

230-276 Barometric Pressure Sensor

The **Model 230-276 Barometric Pressure Sensor** is an extremely accurate and stable transducer based on the Setraceram sensing element. This glass fused ceramic capacitive sensing capsule is the heart of this environmental pressure transducer because of its inherent thermal stability, low hysteresis and fundamentally simple design. The custom Application Specific Integrated Circuit (ASIC) works hand-in-hand with the Setraceram sensor to achieve long term stability and high accuracy. This circuit also allows the 230-276 to operate with as little as 5.0 Vdc excitation (optional) for remote battery or solar powered applications. The standard unit has a convenient mounting bracket and simple 1/8" tube fitting for quick installation.

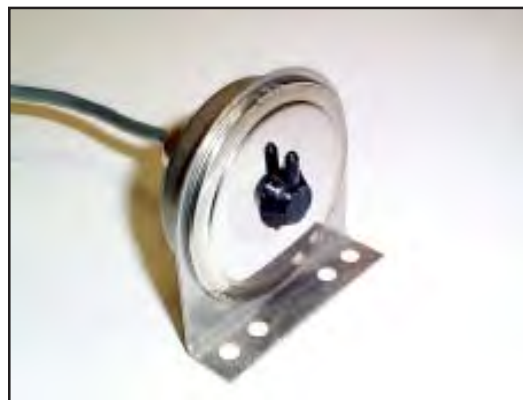

Model 230-276 Barometric Pressure Transducer

Specifications

Range: 600 to 1100 mb, maximum pressure 20 psia
800 to 1100 mb, maximum pressure 20 psia
Accuracy: < $\pm 0.25\%$ FS RSS of non-linearity, hysteresis, and non-repeatability
Resolution: Infinite, limited only by output noise level (0.005%FS)
Thermal effects: < 1%, zero; < 1% span, 30° to 130°F (0° to 55°C)
Long Term Stability: < $\pm 0.25\%$ FS over 6 months at 70°F
Time Constant: < 10 milliseconds to reach 90% final output with step function pressure input
Operating temperature: 0 to 175°F (-20 to 80°C)
Vibration: 2 g from 5 Hz to 500 Hz
Acceleration: 10 g maximum
Shock: 50 g operating, 1/2 sine 10 ms
Pressure fitting: 1/8" tube fitting
Electrical connection: 2 foot multiconductor cable
Excitation power: 12 Vdc standard @ 25 mA
Output: 0.1 to 5.1 Vdc
Output impedance: 5 ohms
Output noise: < 200 microvolts RMS (0 Hz to 100 Hz)
Size: 2.08" W x 0.87" D x 2.08" H
Weight/shipping: 0.5 lbs/1.5 lbs

Ordering Information

230-276-8	Barometric Pressure Sensor, 800-1100 mb range
230-276-6	Barometric Pressure Sensor, 600-1100 mb range
330-0524	Cable, 5-conductor, 24 AWG

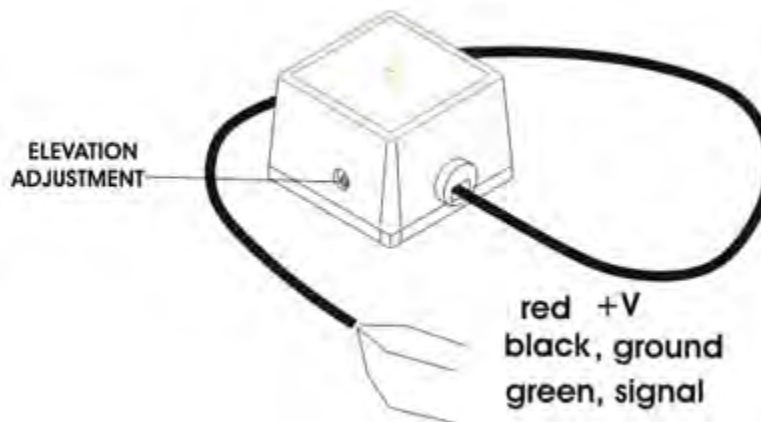
110-WS-16BP Barometric Pressure Sensor

The **110-WS-16BP Barometric Pressure Sensor** uses a piezoresistive sensing element which responds to changes in barometric pressure with a corresponding change in resistance. This resistance is converted to a voltage from which a microprocessor (or another data processor) calculates the barometric pressure at the elevation where the barometer is located.

Because barometric pressure varies with elevation, the BP sensor must be adjusted to read correctly for the elevation at which it is installed. This is done using the offset adjustment screw located on the side of the sensor.

The sensor is designed to be mounted indoors. This arrangement assumes that the barometric pressure indoors and outdoors is equal. An 18" length of cable is provided.

Specifications

Range: 28.25 to 30.75 in Hg (956.6 to 1041.3 mb)
Measurement span: 2.50 in Hg (85 mb)
Resolution: ± 0.01 in Hg or ± 0.3 mb
Altitude offset: 0 to +10,000 feet, screwdriver adjustable
Absolute Accuracy: 0.05 in Hg
Input power: 10 to 18 Vdc
Output voltage: 0 to 5 Vdc = 2.5 in Hg (85 mb) span

Ordering Information

110-WS-16BP Barometric Pressure Sensor

230-WE100 Barometric Pressure Sensor

The highly accurate **Model 230-WE100 Barometric Pressure Sensor** covers a pressure range from 800 to 1100 mb. The barometric pressure transmitter is fully temperature compensated within an operating range of -40° to 65° C. The barometric pressure sensors are supplied with 25' of marine grade cable, with lengths up to 500' available upon request. The barometric pressure transmitter's output is 4-20 mA with a two-wire configuration.

Specifications

Output: 4-20 mA
Range: 800-1100 mb
Accuracy: $\pm 1\%$ of full scale
Linearity/Hysteresis: $\pm 0.1\%$
Operating voltage: 10-36 Vdc
Current draw: Same as sensor output
Warm up time: 3 seconds minimum
Operating temperature: -40° to +55°C
Sensor size: 3" x 2" x 1"
Weight: 0.13 lb

Ordering Information

230-WE100 Barometric Pressure Sensor
230-WE100C Additional Cable, per foot



230-WE100 Barometric Pressure Sensor

230-M202 Handheld Barometer-Altitude



- Easy to use
- Rugged and sensitive
- Highly accurate
- Ideal portable pressure reference for weather station site certification and production process monitoring
- Displays station or sea level pressure
- Altitude in feet or meters
- NIST certificate included
- CE compliant

The **230-M202 Handheld Digital Barometer-Altitude** combines accurate pressure sensing with the power of microprocessor-based computations to provide instantaneous pressure and altitude readings. A combination of small size, digital display, versatility, and high accuracy make it ideal for field measurements or as a portable pressure reference.

Keypad controls provide access to the operating functions. Pressure or altitude may be displayed in a variety of units. The LCD display shows the data output and operating mode. Data logging mode stores up to 240 readings for future recall. The unit is powered by four AA alkaline batteries (included) which provide approximately 100 hours of continuous use.

The 230-M202 includes features for minimum and maximum (Min/Max) value capture, tare readings, and user selectable engineering units. A selectable altitude function allows users to enter site altitude above sea level in order to display local barometric pressure or barometric pressure corrected to sea level. User referenced altitude (referenced to map or trig markers) or altitude based on US Standard Atmosphere of 1962 can be selected for display. Using the altitude function with the Min/Max and Tare features makes the 230-M202 very useful for accurately measuring changes in altitude.

This instrument measures atmospheric pressure very accurately, to within 0.015" Hg. The 316 stainless steel pressure sensor has extremely low sensitivity to shock, vibration, acceleration, and changes in orientation or temperature, yet features high sensitivity to pressure variations. The device is temperature compensated over its operating temperature range. Each unit comes with a certificate of calibration traceable to NIST.

Specifications

Units	Full Scale	Accuracy	Resolution
Pressure			
mm Hg	1000	± .15	.1
in Hg	39.37	± .01	.001
mb	1333	± .2	.1
kPa	133	± .02	.01
psi	19.33	± .01	.001
Altitude			
feet	36,000	± 9	1.0
meters	10,973	± 3	1.0

Approvals: CE compliant
 Display: 5 significant digit LCD (0.25" high)
 2 line x 16 alphanumeric characters
 NIST traceability: NIST certificate supplied
 Power: 4 AA alkaline batteries (included) with user enabled automatic shut-off
 Temperature:
 Storage: -40° to +140° F (-40° to +60° C)
 Operating: 23° to +122° F (-5° to +50° C)
 Process connections: 1.8" female NPT, 316SS
 Enclosure: 14 ounce (6.5" x 3.6" x 2.25") ABS plastic case
 Media compatibility: Isolated AI sensor for fluids compatible with 316SS
 Pressure limits: 77 PSIA (4,000 mm Hg Abs)
 Tare: Nulls applied pressure to allow measurement of vacuum, gauge pressure, or change in pressure or altitude from a reference point
 Min/Max capture: Capture speed is equal to the selected damping rate
 Damping rates: User selectable from 0.1 to 25 seconds
 Backlight: Green, changes to Red for over pressure
 Engineering unit selection: mm Hg, PSI, in Hg, mbar, bar, kPa, Torr
 Altitude: Displayed in feet or meters. Can be set by user based on map or trig marker information or standard altitude uses U.S. Standard Atmosphere of 1962 data
 Contrast Adjustment: Adjusts display for best viewing
 Accuracy: (Full Scale = 38.674 PSIA or 2,000 mm Hg Abs)
 ± 0.015% F.S. from 0-1,000 mm HgA
 ± 0.025% F.S. 0-1,000 - 2,000 mm HgA
 Field recalibration: Supported through firmware feature
 Weight/shipping: 1.6 lb/3 lbs

Ordering Information

230-M202 Handheld Digital Barometer-Altitude includes NIST certificate and protective boot

230-044 Handheld Barometer-Altimeter-Compass

- Altitude profile for graphical information about altitude changes
- Storage of maximum, minimum, and total readings
- Accumulated ascents
- Weather forecast with symbols
- Barometer 300-1100 mb (hPa)
- Real and relative air pressure
- Temperature in Celsius and Fahrenheit
- Electronic compass with rotating bezel ring
- Clock with date and stop watch
- Easy-to-read high-contrast backlit liquid crystal display



The **230-044 Digital Barometer Altimeter and Compass** uses a high-precision, extremely responsive air pressure transducer to display absolute pressure, altitude, and corrected barometric pressure on an easy-to-read high-contrast liquid crystal display. An electronic thermometer and weather forecast symbols are also incorporated into the design, making the 230-044 a very versatile pocket weather instrument. Easy to use, it features more than twenty functions from just five keys, and can be operated with one hand. For determining pressure-change trends or logging altitude excursion, there is an LCD barograph display. Minimum, maximum, and cumulative values can be obtained easily. Lightweight and compact, the 230-044 includes a lanyard for field portability.

Specifications

Altitude measuring range: -700 m to +9,000 m (-2,300' to +29,500')
Altitude resolution: 1 meter or 1 foot
Accuracy: within ± 5 m (16') 0-4000 m, ± 8 m (26') 4000-6000 m
Pressure measuring range: 300-1,100 mb (hPa) only
Pressure resolution: 1 mb (hPa), Absolute & Sea Level
Temperature measuring range: 10°C to +70°C (-4°F to +158°F)
Temperature resolution: 0.1°F, 0.1°C
Compass: 0-360° with 1° resolution and 16 cardinal indicators
Clock: Date and time, 2 alarms, chronograph with 1/100 second resolution
Weather forecast display: 3 symbols
Dimensions: 73 mm L x 60 mm W (2.9" x 2/4")
Batteries: 2 x 3V CR2032 lithium batteries, included
Weight/shipping: < 1 lb/2 lbs

Ordering Information

230-044 Digital Barometer Altimeter and Compass

Solar Radiation

240-8101 Star Pyranometer	112
240-152 Shadow Band	113
240-200SZ Silicon Pyranometer	114
240-120 SP-Lite Silicon Pyranometer	115
240-140 & 240-150 Silicon Cell Pyranometer	116
240-6450 Solar Radiation Sensor	117
240-CMP3 Pyranometer	118
240-8104 Albedometer	119
240-8111 Pyrriometer	120
240-8110 Net Radiometer	121
240-100 Net Radiometer	122
240-110 NR-Lite Net Radiometer	123
240-CUV4 Broadband UV Radiometer	124
240-1070 Sunshine Recorder	125
240-CSD3 Sunshine Duration Sensor	126

240-8101 Star Pyranometer

The **Model 240-8101 Star Pyranometer** (ISO First Class) is a basic instrument for measuring direct and diffuse solar radiation (global radiation). The sensing element is composed of 12 wedge-shaped, thin copper sectors arranged radially, 6 white alternating with 6 black. Six chromel-constantan thermocouples are embedded in each sector to produce a 72 junction thermopile. Output from the thermopile is approximately $15\mu\text{V}/\text{W}/\text{m}^2$. The white sectors of the sensing element are painted with a Kodak paint that yields an almost perfect reflective surface. The black sectors are painted a highly absorbent flat black. When the sensor is exposed to solar radiation, a temperature difference is created between the black and white sectors. This temperature difference is proportional to the radiation intensity and is not affected by ambient temperature.

The windshield protecting the sensor is a 2.75" diameter, polished crystal glass dome which admits electromagnetic radiation between 0.3 and 3 microns. The highly reflective outer surface, along with the mass of the case, keeps the case interior at ambient temperature. Instrument leveling is accomplished by means of a bull's-eye level and three leveling feet.

When used in conjunction with an optional shadow band, the star pyranometer will measure diffuse solar radiation. Direct radiation can be measured using two star pyranometers: one, with a shadow band, to measure diffuse radiation and a second, without the shadow band, to measure both direct and diffuse. The difference between the two measurements is direct radiation.



240-8101 Star Pyranometer
with 240-8106 Protective Housing

The **Model 240-8106 Protective Housing** uses a ventilator to blow air from the bottom to the top of the star pyranometer, keeping the glass dome free of condensation, dew, and rain. In addition, there is an electric heater that turns on at approximately $+10^{\circ}\text{C}$ ($+50^{\circ}\text{F}$) which assists



240-8101 Star Pyranometer

in keeping the glass dome clear when it snows. This unit will help keep maintenance to a low level. The glass dome must be kept clean at all times to provide accurate readings. The unit requires 24 Vac at 80 Va for proper operation.

Specifications

Sensing element: 12 black & white copper segments with 6 thermocouples each
Spectral sensitivity: 0.3 to 3 μm
Azimuth response: < 3% of the value
Cosine response: < 3% of the value, zenith angle 0-80°
Response time: < 25 sec(95%), < 45 sec (99%)
Measuring range: 0-1500 W/m^2
Resolution: <1 W/m^2
Stability: < 1% per year (temporary operation)
Temperature effect: < 1% of the value between -20°C to $+40^{\circ}\text{C}$
Linearity: < 0.5% in the range 0.5-1330 W/m^2
Impedance: About 35 ohm
Output: About $15\mu\text{V}/\text{W}/\text{m}^2$ or 4-20 mA = 0-1500 W/m^2
Ambient temperature: -40°C to $+60^{\circ}\text{C}$ / -40°F to $+140^{\circ}\text{F}$
Size: 5.4" Dia x 3.6" H
Weight/shipping: 1.9 lbs/4 lbs

Ordering Information

240-8101	Star Pyranometer (mV output), with 3 meters cable
240-8102	Star Pyranometer (4-20mA output), with 3 m cable
240-153-8101	Tower Mount, 1' boom with tower mounting hardware
240-153-8106	Tower Munt, 22" boom with tower mounting hardware
240-8101-A5	Amplifier PCB 0-5V Output
240-8101-C	Additional Cable, per meter
240-8101-D	Glass Dome
240-8101-OR	O-Rings, set of 3
240-8101-SG	Silica Gel, 100 grams
240-8101-SGC	Silica Gel Container, filled
240-8106	Protective Housing, 24 Vac
240-8106PS110	Power Adapter for 240-8196, 110 Vac to 24 Vac
240-8106PS220	Power Adapter for 240-8106, 220 Vac to 24 Vac

240-152 Shadow Band

The **Model 240-152 Shadow Band** is used with a pyranometer for measurement of diffuse sky radiation. The shadow band prevents direct solar radiation from reaching the pyranometer. If used in conjunction with a second pyranometer without a shadow band, direct radiation can be calculated by finding the difference between the two pyranometer measurements.

The shadow band is ruggedly constructed of black anodized aluminum, weighs approximately 24 pounds, and uses a 3" band of approximately 25" diameter to shade the pyranometer. A platform at the center supports the pyranometer in a level position. The declination setting must be adjusted regularly. Engraved markings for latitude and solar declination make the device easy to set up.

Specifications

Accuracy: Correctable to 2%
Latitude adjustment: Ring rotates 0-60°
Declination adjustment: Slide $\pm 25^\circ$
Band width: 3" (76 mm)
Ring diameter: 25" (635 mm)
Mount: Platform
Leveling: 3 adjustment thumbscrews
Size: 26" W x 29" H x 23" D
Weight/shipping: 24 lbs/86 lbs (dim wt)

Ordering Information

240-152 Shadow Band



240-152 Shadow Band, shown with 240-8101 Star Pyranometer

240-200SZ Silicon Pyranometer

The **Model 240-200SZ Silicon Pyranometer** is designed for field measurement of global solar radiation in agricultural, meteorological, and solar energy studies. In clear unobstructed daylight conditions, the 240-200SZ compares favorably with first class thermopile type pyranometers, but at a fraction of the cost. It features a silicon photovoltaic detector mounted in a fully cosine-corrected miniature head. Current output, which is directly proportional to solar radiation, is calibrated under natural daylight conditions in units of watts per square meter (W/m^2). Under most conditions of natural daylight, the error is less than 5%. Because the spectral response of the 240-200SZ does not include the entire solar spectrum, it must be used only in the natural daylight conditions for which it was calibrated. It should not be used under vegetation, artificial lights, in a greenhouse, or to measure reflected solar radiation.



Specifications

Sensor: High stability silicon voltaic detector (blue enchance)
 Accuracy: $\pm 5\%$ typical under natural daylight conditions
 Sensitivity: 100 μA per 1000 W/m^2 typical
 Linearity: Max deviation of 1% up to 3000 W/m^2
 Stability: $< \pm 2\%$ change over a one year period
 Response time: 10 μs
 Temperature dependence: 0.15% per $^{\circ}C$ max
 Cosine correction: Cosine corrected up to 80° angle of incidence
 Azimuth: $< \pm 1\%$ error over 360° at 45° elevation
 Tilt: no error induced from orientation
 Operating temperature: $-40^{\circ}C$ to $+65^{\circ}C$ ($-40^{\circ}F$ to $+149^{\circ}F$)
 Sensor housing: Weatherproof anodized aluminum case with acrylic diffuser and stainless steel hardware
 Size: 3" Dia x 1.4" H
 Weight/shipping: 1 lb/2 lbs

Ordering Information

240-200SZ	Silicon Pyranometer with mounting and leveling fixture, 10' cable
240-200SZ/50	Silicon Pyranometer with mounting and leveling fixture, 50' cable
240-200SZ/100	Silicon Pyranometer with mounting and leveling fixture, 100' cable
240-153	Tower Mount, 1' boom with tower mounting hardware
240-LI200SZ-A4	Amplifier PCB, 4-20 mA loop
240-LI200SZ-A5	Amplifier PCB, 0-5 V

240-120 SP-Lite2 Silicon Pyranometer

The **240-120 SP-Lite2 Silicon Pyranometer** is designed for routine global solar radiation measurements on a plane surface. It is suitable for all weather operation. The sensor measures the solar energy received from the entire hemisphere. It is ideal for measuring available energy. Applications include photo voltaic/solar energy monitoring, agricultural evapotranspiration estimation, air pollution dispersion calculations using the Delta-T method, and educational uses. The SP-Lite2 employs a photo-diode detector that generates a voltage output signal proportional to the total amount of incoming solar radiation. Sensitivity is proportional to the cosine of the solar angle of incidence, allowing for accurate and consistent measurement. The good cosine response performance is due to the unique conical shaped self-cleaning diffuser design. The SP-Lite2 is suitable for use with a digital voltmeter or data logger. Irradiance in W/m^2 units can be derived by dividing sensor output signal voltage by the factory supplied calibration coefficient.

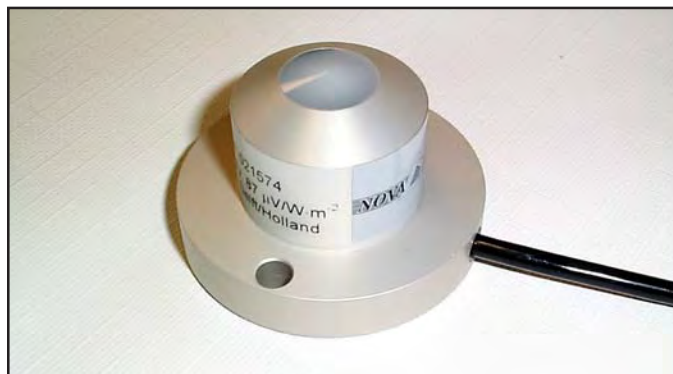

Specifications

Sensitivity: Approx 80 mV/1000 W/m^2

Spectral response: Equals silicon

Temperature range: -30 to +70 °C

Response time: Less than 1 sec

Range: +2000 W/m^2

Temperature dependence: $\pm 0.15\%/^{\circ}C$

Cosine error up to 80 degrees: < 10%

Spectral range: 0.4-1.1 micron

The SP-Lite2 Silicon Pyranometer compares favorably to ISO 9060 specified First Class Thermopile Pyranometers under clear and unobstructed natural daylight conditions and fully complies with CE directives.

Ordering Information

240-120	SP-Lite2 Silicon Pyranometer includes 3 meters cable
240-153	Tower Mount, 1' boom with tower mounting hardware
240-120-A	Amplifier PCB, specify output
330-0220S	Cable, 2-conductor, 20 AWG shielded

240-140 & 240-150 Silicon Cell Pyranometer

The **Model 240-140 Silicon Cell Pyranometer** measures global solar radiation. When used with the 240-152 Shadow Band, it will measure diffuse radiation. This pyranometer is low cost, lightweight, and easy to install. The 240-150 includes a mounting and leveling plate. The sensor is a silicon photovoltaic cell that absorbs radiation from 0.35 to 1.15 microns. The silicon cell converts this light energy into electrical energy and the output voltage (approximately 80 mV/1000 W/m²) is essentially linear with light intensity. Because the instrument is light sensitive, not heat sensitive, full scale response time is less than one millisecond. If the output is integrated over a daily period, the accuracy of the value is within $\pm 3\%$. Accuracy of instantaneous values is $\pm 5\%$.



240-150 Silicon Cell Pyranometer with Mounting and Leveling Plate

Specifications

Sensor: Silicon photovoltaic cell
 Spectral response: 0.35 to 1.15 microns
 Sensitivity: Approx 80 mV/1000 W/m²
 Full scale response time: < 1 millisecond
 Impedance: 1 ohm
 Accuracy: $\pm 5\%$
 Temperature compensation: +4° to +60°C
 Windshield: Pyrex glass dome
 Leveling: Circular level and 3 threaded feet
 Size: 5" Dia x 2" H
 Weight/shipping: 1 lb/2 lbs

Ordering Information

240-140	Silicon Cell Pyranometer, 10' cable
240-140/20	Silicon Cell Pyranometer, 20' cable
240-140LM	Leveling/Mounting Plate Kit
240-150	Silicon Cell Pyranometer, with leveling/mounting plate, 10' cable
240-153	Tower Mount, 1' boom with tower mounting hardware
135-100-SR	Amplifier PCB for 240-140/150, 100mV to 5V
330-0220S	Cable, 2-conductor, 20 AWG shielded

240-6450 Solar Radiation Sensor



Solar Radiation Sensor



Shown in 110-WS-16SRD Configuration (includes mounting arm and 40' cable)

The **240-6450 Solar Radiation Sensor**, or solar pyranometer, measures global radiation, the sum at the point of measurement of both the direct and diffuse components of solar irradiance. The sensor's transducer, which converts incident radiation to electrical current, is a silicon photodiode with wide spectral response.

The outer shell shields the sensor body from thermal radiation and provides an airflow path for convection cooling of the body, minimizing heating of the sensor interior. It includes a cutoff ring for cosine response, a level indicator, and fins to aid in aligning the sensor with the sun's rays. The space between the shield and the body also provides a runoff path for water, greatly reducing the possibility of rain or irrigation water entrapment. The diffuser is welded to the body for a weathertight seal; it provides an excellent cosine response. The transducer is an hermetically-sealed silicon photodiode; the included amplifier converts the transducer current into 0 to +2.5 Vdc output corresponding to 0 to 1500 W/m². Spring-loaded mounting screws, in conjunction with the level indicator, enable rapid and accurate leveling of the sensor. Each sensor is calibrated against a secondary standard which is calibrated periodically against an Eppley Precision Spectral Pyranometer in natural daylight.

The sensor is a 3-wire device and requires a low current, less than 2mA dc power to operate the internal amplifier

Specifications

General

Operating temperature: -40° to +150° F (-40° to +65° C)

Storage temperature: -50° to +158° F (-45° to +70° C)

Transducer: Silicon photodiode

Spectral response (10% points): 400 to 1100 nanometers

Cosine response

Percent of reading: ±3% (0° to ±70° incident angle);
±10% (±70° to ±85° incident angle)

Percent of full scale: ±2% (0° to ±90°)

Cable: 3-conductor, 24 AWG, 15'

I/O Specifications

White wire: Output (0 to +3Vdc); 1.67 mV per W/m²

Black wire: Ground

Red wire: +3 to +7Vdc ±10%; 1mA (typical)

Temperature Coefficient: +0.067% per °F (+ 0.12% per °C)

Reference temperature: 77°F (25°C)

Correction per degree above reference temp:

-0.067% of reading per °F (-0.12% per °C)

Correction per degree below reference temp:

+0.067% of reading per °F (+0.12% per °C)

Housing material: UV-resistant PVC plastic

Dimensions (length x width x height): 2.00" x 2.75" x 2.25" (51x70x57 mm)

Weight: 1.5 lbs (680 g)

Sensor Output

Resolution and units: 1 W/m²

Range: 0 to 1800 W/m²

Accuracy: ±5% of full scale (Reference: Eppley PSP at 1000 W/m²)

plus 45 W/m² per 100' (30 m) of additional cable

Drift: Up to ±2% per year

Ordering Information

240-6450	Solar Radiation Sensor, includes 15' cable
240-153-6450	Tower Mounting Bracket
330-0324	Additional Cable, per foot

240-CMP3 Pyranometer

The **240-CMP3 Pyranometer** is an instrument for measuring the solar irradiance. The thermopile sensor construction measures the solar energy that is received from the total solar spectrum and the whole hemisphere (180 degrees field of view). The output is expressed in Watts per meter square. The CMP3 pyranometer is designed for continuous indoor and outdoor use.

The CMP3 Pyranometer (ISO Second Class) is intended for shortwave global solar radiation measurements in the spectral range from 310 to 2800 nm. The thermopile detector measures irradiance up to 2000 W/m² with response time < 18 seconds and typical sensitivity 10 μV/W/m² that varies < 5% from -10 to +40 °C. Operating temperature range is -40 to +80 °C and the stability is better than 1% per year.

The CMP3 Pyranometer features a snap-on white sun shield, integrated leveling, and a weatherproof connector which is supplied pre-wired with 10 m of signal cable for simple installation. An optional mounting rod and longer cable lengths are available. Two CMP3s can easily be mounted back-to-back to make a low cost albedometer.

Specifications

Spectral range (50% points): 310 to 2800 nm
Sensitivity (μV/W/m²): 5 to 15
Response time (95 %): < 18 s
Non-linearity (0-1000 W/m²): 2.5%
Non-stability (change/year): < 1%
Max irradiance: 2000 W/m²
Field of view (degrees): 180
Housing material: Anodized aluminum body
Dimensions: 79 x 67 mm
Weight: 300g and 600g with cable

Ordering Information

240-CMP3 Pyranometer, includes 10 meters cable
240-CMP3-MR Mounting Rod, 300 mm long x 12 mm dia



240-CMP3 Pyranometer



Two 240-CMP3 Pyranometers in albedometer configuration. Shown with optional 240-CMP3-MR Mounting Rod.

240-8104 Albedometer



Model 240-8104 Albedometer

The **Model 240-8104 Albedometer** is essentially a combination of two star pyranometers, one facing upward and one facing downward. The upward facing pyranometer measures global radiation (diffuse and direct solar radiation), while the downward facing pyranometer measures reflected solar radiation. Separate outputs are provided for each pyranometer, which can be recorded together on a strip chart recorder. Albedo, the fraction of incident radiation reflected by a surface, can be calculated from the output data (albedo = reflected radiation \div global radiation). Short-wave net radiation can also be calculated.

Like the 240-8101 Star Pyranometer, the 240-8104 Albedometer has a spectral response of 0.3 to 3 microns. Thus, no long-wave terrestrial radiation is measured. This is the major difference between the albedometer and the 240-8111 Pyrradiometer, which measures short and long-wave radiation and is similar in appearance to the 240-8104.

Each star pyranometer is protected by a crystal glass dome. Desiccant tubes are attached to the housing to absorb internal moisture. An 8" long mounting handle is provided. Circular levels are included on each face to aid in installation. Each sensor is supplied with a calibration certificate.

- WMO & ISO 9060 First Class
- Two separate outputs
- Global and reflected solar radiation
- Independent from ambient temperature

Specifications

Sensing element: 12 black & white copper segments with 6 thermocouples each
 Sensitivity: 0.3 to 3 μ m
 Azimuth response: < 3% of the value
 Cosine response: < 3% 0.95% of the value, 0° to 80° zenith angle \pm 3% from 60° to 80° zenith angle
 Response time: < 25 seconds
 Measuring range: 0-1500 W/m²
 Resolution: < 1 W/m²
 Stability: < 1% per year (temporary operation)
 Temperature effect: < 1% of the value between -20 °C to 40°C
 Linearity: < 0.5% in the range 0.5-1330 W/m²
 Impedance: Approx 35 ohms
 Ambient temperature: -40°C to +60°C
 Windshield: Polished glass dome, 2.75" dia x 0.08" thick (70 x 2 mm)
 Leveling: Bull's-eye level on each face
 Size: 14.6" L x 4.5" W x 4.2" H (371 x 114 x 107 mm)
 Weight/shipping: 3.5 lbs/10 lbs (1.6 kg/4.5 kg)
 Cable: 2 polar shielded, 3 m length

Ordering Information

240-8104	Albedometer; including 2 desiccant tubes, silica gel, and 3 meters of cable
240-8104-D	Glass Dome, 2 required
240-8104-OR	O-Rings, set of 6
240-8104-SG	Silica Gel, 100 grams
240-8104-SGC	Silica Gel Container, filled
330-0524	Additional Cable, per foot

240-8111 Pyrradiometer

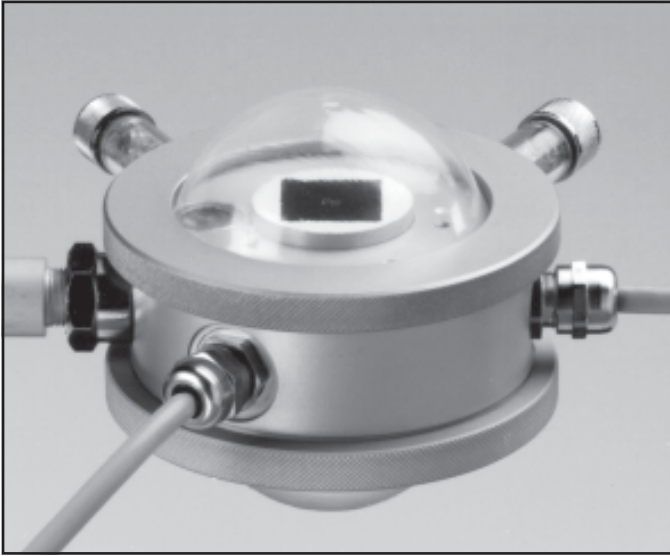

Model 240-8111 Pyrradiometer

The **Model 240-8111 Pyrradiometer** is a total hemispherical radiometer, used for exact determination of net radiation in short-wave and long-wave radiation range (0.3 to $>30 \mu\text{m}$) with two separately working receivers and with a built-in Pt-100 resistance thermometer to determine reference temperature. Two black, radiation absorbing plates act as sensors, one facing upward and one facing downward. Each transfers the energy absorbed to a separate 90-junction copper-constantan thermopile. Both of the two outputs are approximately $15 \mu\text{V/W/m}^2$, one representing downward total radiation and the other representing upward total radiation. The difference between these two provides net radiation.

Lupolene domes shield the thermopiles from wind and moisture. Lupolene is essentially transparent to radiation from 0.3 to 60 microns. Two desiccant tubes are supplied to remove water vapor from inside the instrument housing. For long-term applications, fittings permit attachment of a nitrogen source for continuous purging. Levels are embedded in both the top and bottom faces of the pyrradiometer, and a 10" mounting arm is included.

- *WMO First Class*
- *Long-wave and short-wave measurements*
- *Independent from ambient temperature*
- *Separate outputs for upward and downward radiation*

Specifications

Internal temperature sensor: 100-ohm platinum resistance sensor
 Spectral Sensitivity: 0.3 to $>30 \mu\text{m}$
 Azimuth response: $< 5\%$ of the value
 Cosine response: $< 5\%$ of the value, zenith angle 0° to 80°
 Response time: $< 25 \text{ sec}$ (95%), $< 45 \text{ sec}$ (99%)
 Measuring range: 0-1500 W/m^2
 Resolution: $< 1 \text{ W/m}^2$
 Stability: $< 3\%$ per year (temporary operation)
 Temperature effect: $< 2\%$ of the value between -20°C to $+40^\circ\text{C}$
 Linearity: $< 2\%$ in the range 0.5-1330 W/m^2
 Impedance: About 190 ohm/receiver plate
 Output: About $15 \mu\text{V/W/m}^2$
 Ambient temperature: -40°C to $+60^\circ\text{C}$
 Windshield: Lupolene dome, 2.4" (62 mm) diameter
 Leveling: Bull's-eye levels on each face
 Size: 14" L x 4" W x 3.5" H (355 x 100 x 90 mm)
 Weight/shipping: 4 lbs/7 lbs (1.8 kg/3.2 kg)
 Cable: 4 polar shielded, 5 m length

Ordering Information

240-8111	Pyrradiometer, including 2 desiccant tubes, silica gel, platinum resistance temperature sensor, and 5 meters of cable
240-8111-D	Lupolene Dome, 2 required
240-8111-OR	O-Rings, set of 4
240-8111-PT	Pt-100 Platinum Element
240-8111-SG	Silica Gel, 100 grams
240-8111-SGC	Silica Gel Container, filled
330-0420	Additional Cable, per foot

240-8110 Net Radiometer



240-8110 Net Radiometer

The **Model 240-8110 Net Radiometer** is an instrument for direct and instantaneous determination of net radiation (difference between incident and reflected radiation) in short and long wavelength range.

The receiver plate facing up measures short-wave global radiation and long-wave radiation of the atmosphere according to its temperature. The receiver plate facing down measures reflected short-wave radiation and long-wave radiation according to the temperature emitted by the surface beneath the sensor. Both of the receiver plates are electrically cross-connected, thus, a direct determination of net radiation is possible.

A positive sign of the value measured means radiation flux directed to the reference surface, a negative sign radiation flux off the reference surface. Hence follows that the reference surface is gaining radiant energy when positive values are measured. At negative signs the surface loses energy by long-wave radiation.

The instrument consists of the sensor with a desiccant (silica gel) container and a 400 mm (16") long support arm. The sensing element of the instrument consists of 16 Cu-CuNi thermocouple covered by two circular blackened copper plates (receiver plates) which are protected by two lupolene domes. Watertight sealing is achieved by two fixing rings and o-rings. Two bull's-eye levels permit horizontal adjustment. The silica gel container is incorporated in the front of the case.

- *WMO First Class*
- *Independent from ambient temperature*
- *Direct and instantaneous determination of net radiation*

Specifications

Spectral sensitivity: 0.3 to >30 μm
 Azimuth response: 0.5% of the value
 Cosine response: < 5% of the value, zenith angle 0° to 80°
 Response time: < 25 sec (95%), < 45 sec (99%)
 Measuring range: 0-1500 W/m^2 (positive & negative)
 Resolution: < 1 W/m^2
 Stability: < 3% per year (temporary operation)
 Temperature effect: < 2% of the value between -20°C to +40°C
 Linearity: < 2% in the range 0.5-1330 W/m^2
 Impedance: About 5 ohm
 Output: About 15 $\mu\text{V}/\text{W}/\text{m}^2$ (positive & negative)
 Ambient temperature: -40°C to +60°C (-40°F to +140°F)
 Size: 21" L x 2" W x 1.5" H
 Weight/shipping: 1 lb/4 lbs

Ordering Information

240-8110	Net Radiometer, includes desiccant tube, silica gel, and 3 meters cable
240-8110-C	Additional Cable, per meter
240-8110-D	Lupolene Dome, 2 required
240-8110-OR	O Rings, set of 3
240-8110-SG	Silica Gel, 100 grams
240-8110-SGC	Silica Gel Container, filled

240-100 Net Radiometer

The **Model 240-100 Net Radiometer** contains a high output 60 junction thermopile with a nominal resistance of 4 ohms and linear calibration. The thermopile is mounted in a glass reinforced plastic frame with a built-in level. A ball joint is supplied on the stem to facilitate leveling. Thermopile surfaces (or sensor surfaces) and surrounding surfaces are flat black and the frame is black to reduce internal reflections.

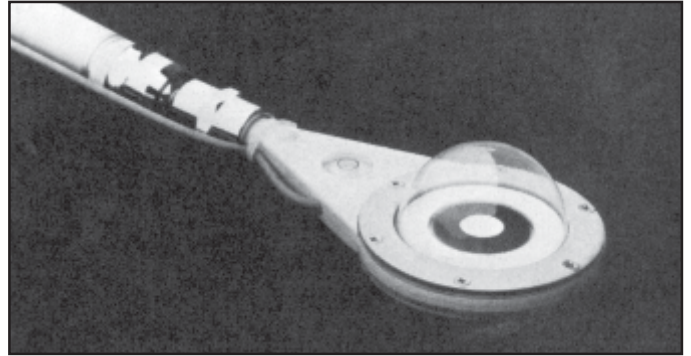

Sensor surfaces are protected from excessive convective cooling by a hemispherical polyethylene windshield. Polyethylene is used for the windshield material because it is transparent to both long and shortwave energy. The windshield is heavy duty and is self supporting so no pressurization is required. A desiccant supply is contained in the support arm to keep air spaces inside the windshield dry. The instrument and its support arm also contain purge ports. A mounting bracket is supplied for mounting to horizontal or vertical pipes.

Specifications

Spectral response: 0.25 to 60 μm
Nominal calibration factors: For positive values 9.3 $\text{W}/\text{m}^2/\text{mV}^1$
For negative values 11.6 $\text{W}/\text{m}^2/\text{mV}^1$
Nominal resistance: 4 ohms
Time constant: Approx 30 sec
Wind affect: Positive up to 5.9% reduction @ 7m/s
Negative up to 1% reduction @ 7 m/s
Power required: None
Windshield: Polyethylene dome, 0.25mm thick
Support arm: 0.02m D x 0.75m L
Size: 57mm H x 72mm W x 177mm L
Standard cable: Shielded 2-conductor, 7m long
Weight/Shipping: 2 lbs/5 lbs

Ordering Information

240-100	Fritschen Type Net Radiometer, includes 25' cable
240-M488084	Spare Parts Kit, including 2 domes, 2 o-rings, and silica gel desiccant
330-0220S	Additional Cable, per foot

240-110 NR-Lite2 Net Radiometer

The **240-110 NR-Lite2 Net Radiometer** is designed for routine measurement of net radiation which is the balance between incoming and outgoing radiation under outdoor conditions. The detector is based on a Teflon coated, weather resistant black conical absorber. In contrast to other sensor designs, NR-Lite2 requires no fragile plastic domes. This results in a virtually maintenance free design. The NR-Lite2 is suitable for:

- Agricultural Meteorology: Evapotranspiration calculations and crop damage prevention
- Building physics: Study of thermal stress and heat balance
- Road Safety: Highway condition monitoring

The NR-Lite2 is easy to use. It is based on a thermopile sensor. The voltage is proportional to the net radiation. It can be directly connected to voltmeter or data logger with a mV input. The NR-Lite2 is suitable for conditions outdoor use and fully complies with CE regulations.

Specifications

Spectral response: 0-100 microns
Detector protection: Teflon coated (no domes)
Sensitivity (upper detector): 10 $\mu\text{V}/\text{W}/\text{m}^2$ (nominal)
Recommended output range
For atmospheric application: -25 to +25 mV
Sensor asymmetry: $\pm 20\%$
Range: -2000 to +2000 W/m^2
Response time (1/e): 20 sec (nominal)
Temperature range: -30 °C to +70 °C
Directional error (0-60 degrees at 1000 W/m^2): < 30 W/m^2
Support arm: 16 x 400 mm
Sensor enclosure: 80 mm dia

Ordering Information

240-110	NR-Lite2 Net Radiometer, includes 15m cable
240-110-A	Amplifier PCB, specify output
220-0220S	Additional Cable, per foot



240-CUV4 Broadband UV Radiometer

The **240-CUV4 Broadband UV Radiometer** is a general-purpose instrument for applications in meteorology, for material testing, for monitoring of lamps, and for use in ageing tests in solar simulators.

High quality dome and diffuser give optimised directional response, an optical filter provides sensitivity to combined UV-A and UV-B as shown in the graph below. The photodiode generates a voltage output linearly proportional to the UV intensity.

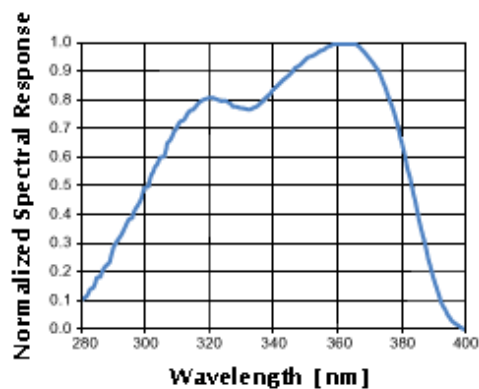

A waterproof plug and socket cable connection facilitates easy installation. The snap-on sun shield covers the connector and allows viewing of the integrated bubble level. The screw-in drying cartridge can be removed by simply using a coin, for replacement of the desiccant that is supplied in convenient refill packets.

CUV 4 is not suitable for the measurement of specific parts of the UV spectrum such as UV-A, UV-B, UV-E / UV-Index. For measurement of these parameters please contact NovaLynx for recommendations.



Specifications

Spectral range: 305 to 385 nm
 Sensitivity: 1 mV / W / m²
 Temperature dependence of sensitivity: +0.1%/°C
 Response time (95%): < 1%
 Non-linearity: < 1%
 Maximum irradiance: 100 W/m²
 Operating temperature: -40 to +80 °C
 Directional error: < 10%

Ordering Information

240-CUV4 Broadband UV Radiometer, 32' cable
 240-CUV4-C Additional Cable, per meter

240-1070 Sunshine Recorder

The **Model 240-1070 Campbell-Stokes Sunshine Recorder** employs a glass sphere to focus the sun's rays to an intense spot, which will char a mark on a curved card mounted concentrically with the sphere. As the earth rotates, the position of the spot moves across the card. When the sun is obscured, the trace is interrupted. At the end of the day the total length of the trace, less gaps, is proportional to the duration of sunshine.

The record cards are made from a special board which produces a clearly visible trace even in weak sunlight. The cards are treated to char rather than burn to ensure clarity of the trace. Different cards are used for different seasons. Each card is marked with hourly intervals. An optional transparent plastic template marked with scales enables the length of the curved trace to be accurately measured.

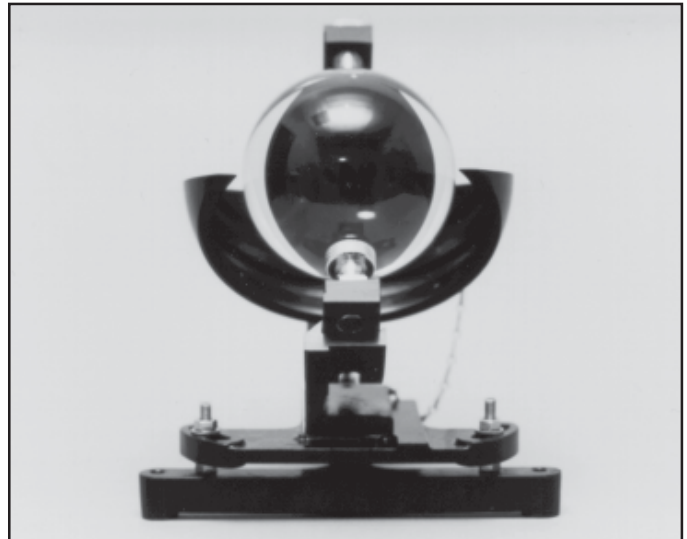

Specifications

Latitude adjustments: 0-65° N or S
 Sphere: 102 mm ± 1.3 mm
 Focal length-sodium D light: 74.9 mm ± 0.25 mm
 Dimensions: 240 mm x 187 mm x 165 mm
 Weight/Shipping: 10 lbs/14 lbs

Ordering Information

240-1070	Campbell-Stokes Pattern Sunshine Recorder, 45-65° N/S, includes 1 package of record cards
240-1071	Campbell-Stokes Pattern Sunshine Recorder, 0-45° N/S, includes 1 package of record cards
240-1072	Sunshine Record Cards (1 year supply) 200 summer, 200 winter, 100 spring/autumn
240-1073	Transparent Measuring Template
240-1074	Replacement Glass Sphere

240-CSD3 Sunshine Duration Sensor



- Waterproof plug-and-socket cable connection for easy installation and servicing
- Humidity indicator to show when a change of drying cartridge is necessary
- Larger capacity drying cartridge that is easier to change at reduced intervals
- Glass tube, instead of plastic, for improved resistance to scratching by storm-blown sand and ice
- Operating temperature range -40° to $+70^{\circ}$ Celsius

The **Model 240-CSD3 Sunshine Duration Sensor** provides the number of sunshine hours per day. The 240-CSD3 has no moving parts and uses three photo-diodes with specially designed diffusers to make an analog calculation of when it is sunny (direct solar irradiance greater than 120 W/m^2). An output is switched high or low to indicate “sunny” or “not sunny” conditions. The calculated direct irradiance value is also available.

The 240-CSD3 operates from 12 Vdc power and has built-in heaters to dissipate rain, snow, and frost. These are normally switched externally but an optional internal thermostat control is available.

Sunshine duration sensors are widely used in weather networks to provide the number of sunshine hours per day for tourist information. In agriculture the 240-CSD3 monitors the amount of sunshine received by crops.

Specifications

Spectral range: 400 to 1100 nm
 Operating temperature: -40°C to 70°C
 Sunshine Yes signal: $1 \pm 0.1 \text{ V}$ if direct irradiance signal $> 120 \text{ W/m}^2$
 Sunshine No signal: $0 \pm 0.1 \text{ V}$ if direct irradiance signal $< 120 \text{ W/m}^2$
 Accuracy of sunshine hours: $> 90\%$ in monthly total
 Analog output signal: 1 mV per W/m^2 of direct irradiance
 Accuracy of direct signal: $> 90\%$ for clear sky
 Non-stability: $< 2\%$ change per year
 Temperature dependence: $< 0.1\%/K$
 Response time: $< 1 \text{ ms}$
 Power requirement: 12 Vdc

Ordering Information

240-CSD3	Sunshine Duration Sensor includes 15 meters cable
240-CSD3-T	Sunshine Duration Sensor, with internal thermostat includes 15 meters cable

Precipitation

260-2500 Tipping Bucket Rain Gauges	128
260-2501-A Tipping Bucket Rain Gauge	129
260-2505 Tipping Bucket Rain Gauge	130
260-52202 Tipping Bucket Rain Gauge	131
260-7852 Rain Collector	132
260-2530 Fence Post Rain Gauge	133
260-2531 Plastic Rain Gauge	133
260-2510 NWS Type Rain Gauge	134
260-2520 Forestry Rain Gauge	135
260-700 Ultrasonic Snow Depth Sensor	136
260-2590 Precipitation Detector	137
260-2591 Leaf Wetness Sensor	137
260-2101 Rain Logger	138
260-2103 Rain Logger	139
260-952 Rain Gauge Wind Screen	140
260-950 Mounting Plate	140
260-2595 Rain Gauge Calibrator	141
260-2696 Digital Event Counter	142
260-2597 Pocket Counter	142

260-2500 Tipping Bucket Rain Gauges

The **Model 260-2500 Tipping Bucket Rain Gauge** is a dependable instrument used for measuring precipitation. Rainfall entering the 8" or 12" funnel collector is directed to the tipping bucket assembly. When an incremental amount of precipitation has been collected, the bucket assembly tips and activates a magnetic reed switch. The sample is discharged through the base of the gauge. A momentary electrical contact closure is provided for each increment of rainfall. This contact closure is used to operate the Model 260-6113-A Event Recorder or other data acquisition systems. A level is provided on the base for correct positioning of the unit. The unit is manufactured of anodized aluminum and powder coated aluminum. The funnel has a screen to prevent debris from entering the gauge. It is shipped complete with mounting brackets and 25' of cable.

The **Model 260-2500E Electric Rain/Snow Gauge** is used where 115V power is available and precipitation is often in the form of snow. A heating kit has been added to the basic Model 260-2500 Rain Gauge to provide the capability for measuring snowfall. The 260-2500E has a 400 watt heater unit installed on the base of the rain gauge. The outer tube is insulated and a freeze point thermostat controls the temperature at the funnel. Snow falling into the funnel is melted and the resulting water drains into the tipping bucket assembly. It includes 25' of power cable and 25' of signal cable.



260-2500 Tipping Bucket Rain Gauge

Specifications

Capacity: Unlimited

Orifice:

Model 260-2500: 8" (20 cm)

Model 260-2500-12: 12" (30 cm)

Calibration: 0.01", 0.25 mm, 0.5 mm, 1 mm

Accuracy: $\pm 1\%$ at 2"/hr

Output: 0.1 second switch closure

Contact rating: 3 watts, 0.25 amps, 24 Vdc

Size:

Model 260-2500: 8" x 17"

Model 260-2500-12: 12" x 20"

Weight/Shipping:

Model 260-2500: 7 lb/12 lb

Model 260-2500-12: 14 lb/18 lb

Note: 1 mm calibration is not available for 260-2500-12 series.

Ordering Information

260-2500	8" Rain Gauge, 0.01"/tip
260-2500M	8" Rain Gauge, 1 mm/tip
260-2500M.25	8" Rain Gauge, 0.25 mm/tip
260-2500M.5	8" Rain Gauge, 0.5 mm/tip
260-2500E	8" Electric Rain Gauge, 0.01"/tip, 115 Vac
260-2500ME	8" Electric Rain Gauge, 1 mm/tip, 115 Vac
260-2500ME.25	8" Electric Rain Gauge, 0.25 mm/tip, 115 Vac
260-2500ME.5	8" Electric Rain Gauge, 0.5 mm/tip, 115 Vac
260-2500-12	12" Rain Gauge, 0.01"/tip
260-2500M-12.25	12" Rain Gauge, 0.25 mm/tip
260-2500E-12	12" Electric Rain Gauge, 0.01"/tip, 115 Vac
260-2500ME-12.25	12" Electric Rain Gauge, 0.25 mm/tip, 115 Vac
260-2500H	Heater Kit for 8" 260-2500, 115 Vac
260-2500H-12	Heater Kit for 12" 260-2500-12, 115 Vac
260-2500HC/25	Additional Heater Cable, 25' add'l (50' total)
260-2500HC/75	Additional Heater Cable, 75' add'l (100' total)
330-0220	Additional Signal Cable, per foot
260-2595	Rain Gauge Calibrator
260-2596	Digital Event Counter
260-950	Rain Gauge Mounting Plate
260-952	Rain Gauge Wind Screen

260-2501-A Tipping Bucket Rain Gauge

The **Model 260-2501-A Tipping Bucket Rain Gauge** was designed for the National Weather Service to provide a reliable, low-cost tipping bucket rain sensor. It has been updated and improved with the addition of an inner funnel to even the flow of rainfall into the gauge, providing better accuracy at higher rainfall rates. Its simplicity of design assures trouble-free operation, yet provides accurate rainfall measurements. The tipping bucket mechanism activates a sealed reed switch that produces a contact closure for each 0.01" or 1 mm of rainfall (other calibrations available). The gauge has an 8" orifice and is manufactured of powder coated and anodized aluminum. The funnel screen prevents debris from entering the gauge. Shipped complete with mounting legs and 25' of signal cable.

Specifications

Sensor type: Tipping bucket
 Output: 0.1 second switch closure
 Switch: Sealed reed switch
 Sensitivity: 1 tip per 0.01", 1 tip per 1 mm (other calibrations available)
 Accuracy: $\pm 2\%$ up to 2"/hr
 Contact rating: 3 watts, 0.25 amps, 24 Vdc
 Size: 8" dia x 14½" high
 Mounting: 3 legs, ¼" diameter bolt holes on 9½" diameter bolt circle
 Weight/shipping: 3.5 lbs/5 lbs

Ordering Information

260-2501-A	8" Tipping Bucket Rain Gauge, 0.01"/tip, incl 25' cable
260-2501M-A	8" Tipping Bucket Rain Gauge, 1 mm/tip, incl 25' cable
260-2501M-A.2	8" Tipping Bucket Rain Gauge, 0.2 mm/tip, incl 25' cable
260-2501M-A.25	8" Tipping Bucket Rain Gauge, 0.25 mm/tip, incl 25' cable
260-2501M-A.5	8" Tipping Bucket Rain Gauge, 0.5 mm/tip, incl 25' cable
330-0220	Additional Signal Cable, per foot
260-2595	Rain Gauge Calibrator
260-2597	Pocket Size Digital Event Counter
260-2501MB	Rain Gauge Side Mounting Bracket
260-950	Rain Gauge Mounting Plate
260-952	Rain Gauge Wind Screen, 24" legs
260-955	Wind Screen Mounting Kit



260-2501-A Rain Gauge with 260-950 Mounting Plate



260-2501-A Rain Gauge with 260-2501MB Side Mounting Bracket

260-2505 Tipping Bucket Rain Gauge - Discontinued

The **Model 260-2505 Tipping Bucket Rain Gauge** utilizes the highest quality materials and unique funnel design for accurate rainfall measurement. Rain is collected by an 8" diameter brass orifice with a precision machined edge. Collected water passes through screens that filter debris, and it then funnels into a small catchment basin. The basin is constructed so that the force of the falling water is dissipated at the basin. Water that reaches the tipping buckets has a constant head taken from a point above the bottom of the basin. With this feature, the accuracy of the gauge at the calibration rate (0.5" per hour) is extended to rainfall rates as high as 2" per hour. Buckets tip as they fill which activates a sealed reed switch. This produces pulses which can be directed to event recorders, dataloggers, or other data acquisition devices. Case exterior is stainless steel. All moving parts are chrome plated. A built-in level and predrilled feet aid proper installation of the gauge. Screens prevent insect intrusion at all openings.

Specifications

Orifice: 20 cm (7.874")
Accuracy: 0.5% up to 2.0"/hr
Calibration: 0.01" or 0.25 mm
Capacity: Unlimited
Output: 0.1 second switch closure
Switch: Form A reed
Cable: 2-conductor, 20AWG, 33' (10 m) standard
Size: 8" dia x 18" (203 mm x 457 mm)
Weight/shipping: 8 lbs/15 lbs (3.6 kg/6.8 kg)

Ordering Information

260-2505	Tipping Bucket Rain Gauge, 0.01"/tip
260-2505M	Tipping Bucket Rain Gauge, 0.25mm/tip
330-0220	Additional Signal Cable, per foot



260-52202 Tipping Bucket Rain Gauge

The **260-52202 Tipping Bucket Rain Gauge** meets the specifications of the World Meteorological Organization (WMO). The design uses a proven tipping bucket mechanism for simple and effective rainfall measurement. The bucket geometry and material are specially selected for maximum water release, thereby reducing contamination and errors. Catchment area of 200 cm² and measurement resolution of 0.1 mm meet the recommendations of the WMO. Extensive use of molded thermoplastic components ensures maximum performance and value. Leveling screws and bullseye level are built-in for easy and precise adjustment in the field. Measured precipitation is discharged through a collection tube for verification of total rainfall. Model 260-52202 is heated for operation in cold temperatures. Power adapter is included. An unheated version, Model 260-52203, is available for use in moderate climates.

Specifications

Size: 18 cm dia x 30 cm high (39 cm high with mounting base)

Catchment Area: 200 cm²

Resolution: 0.1 mm per tip

Accuracy: 2% up to 25 mm/hr, 3% up to 50 mm/hr

Output: Magnetic reed switch (N.O.), rating 24 Vac/dc 500 mA

Operating Temperature: -20°C to +50°C (heated)

Power: 24 Vac @ 18 Watts for heater only

Mounting: Clamp for 1" (1.34" dia) iron pipe or 3 bolts on 160 mm dia circle

Other: Leveling adjustment, thermostatic control for heater, intake screen



Ordering Information

260-52202	Tipping Bucket Rain Gauge, heated, 110 Vac
260-52202H	Tipping Bucket Rain Gauge, heated, 220 Vac
260-52203	Tipping Bucket Rain Gauge, unheated
260-52250	Bird Wire Assembly

260-7852 Rain Collector

The **Model 260-7852 Rain Collector** is a tipping bucket rain gauge designed to meet the guidelines of the World Meteorological Organization. Rain enters the collector cone, passes through a debris-filtering screen, and collects in one chamber of the tipping bucket. The bucket tips when it has collected an amount of water equal to the increment in which the collector measures (0.01" or 0.2mm). As the bucket tips, it causes a switch closure and brings the second tipping bucket chamber into position. The rain water drains out through the screened drains in the base of the collector.

The body and base of the collector are constructed of tough, UV resistant plastic. The tipping bucket pivots on bearings that minimize friction and wear. Stainless steel adjustment screws under each chamber of the tipping bucket allow you to fine-tune the calibration. Mounting holes are predrilled in the base and a built-in leveling trough aids in installation.

Specifications

Sensor type: Tipping bucket with magnetic reed switch
Accuracy: $\pm 4\%$
Output: Contact closure
Attached cable length: 40' (12 m)
Cable type: 4-conductor, 26 AWG
Recommended maximum cable length: 900' (270 m)
Housing Material: UV-stabilized ABS plastic
Dimensions:
Rain collector: 8.75" diameter x 9.5" high (16.5 x 24 cm)
Collection area: 31 in² (200 cm²)
Weight: 2 lbs 3 oz (1 kg)

Ordering Information

260-7852 Rain Collector, 0.01"/tip
260-7852M Rain Collector, 0.2mm/tip
260-153-7852 Tower Mounting Arm, 1'



260-2530 Fence Post Rain Gauge

The wedge-shaped **Model 260-2530 Fence Post Rain Gauge** can measure up to 6" (150 mm) of rainfall. English and metric graduations are permanently molded in durable, weather-resistant plastic. The minimum graduation is 0.01" (or 0.1 mm). Screws are provided to mount the gauge.

Specifications

Capacity: 6" (150 mm)
 Resolution: 0.01" (0.1 mm)
 Size: 2.5" W x 2.25" D x 13.5" L (64 mm x 57 mm x 343 mm)
 Weight/shipping: 0.5 lbs/2 lbs (0.2 kg/0.9 kg)

Ordering Information

260-2530 Fence Post Rain Gauge



200-2530 Fence Post Rain Gauge

260-2531 Plastic Rain Gauge

The **Model 260-2531 Plastic Rain Gauge** measures up to 11" (280 mm) of precipitation and is made of clear, tough butyrate. The internal measuring tube, with a capacity of 1" (25 mm), is graduated to 0.01" or 0.2 mm. Precipitation greater than 1" overflows into the outer cylinder and is measured by pouring into the measuring tube. The receiving funnel and measuring tube are removed for collection of snow. A sturdy, rust-proof mounting bracket is included with the gauge.

Specifications

Capacity: 11" (280 mm)
 Resolution: 0.01" (0.2 mm)
 Size: 4" dia x 14" H (102 mm x 356 mm)
 Weight/shipping: 2 lbs/4 lbs (0.9 kg/1.8 kg)

Ordering Information

260-2531	Plastic Rain Gauge, english graduations
260-2531M	Plastic Rain Gauge, metric graduations
260-2531BP	Replacement Backplate (Mounting Bracket)
260-2531F	Replacement Funnel
260-2531MT	Replacement Measuring Tube, english
260-2531MMT	Replacement Measuring Tube, metric
260-2531OT	Replacement Outer Tube

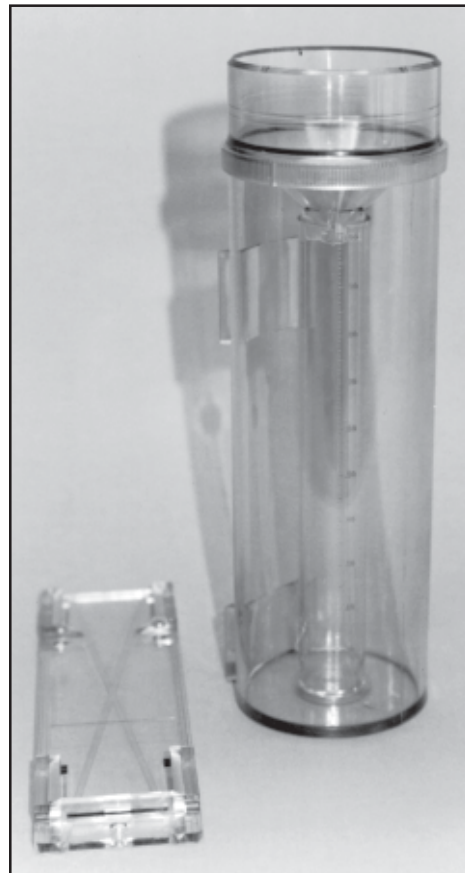

260-2531 Plastic Rain Gauge

260-2510 NWS Type Rain Gauge

The **Model 260-2510 National Weather Service Type Rain and Snow Gauge** is an all aluminum rain gauge with a total capacity of 20" of rainfall.

The upper portion of the funnel is cylindrical in shape and is turned to a sharp edge. Rainwater falling into the funnel is delivered into the receiver. The ratio is 10 to 1, so that 1" of rainfall delivers 10" of water to the receiver. The capacity of the receiver is 2" of rainfall. Any excess overflows into the outer chamber so it can be measured after the quantity in the receiver has been recorded and removed. The gauge can be read to 0.01".

When used as a snow gauge, the receiver and funnel are removed. Snowfall is collected in the overflow can and melted for measurement with the receiver and dipstick.

A black plexiglass measuring stick with both english and metric markings is included. An optional tripod support is available.

Specifications

Orifice: 8" (200 mm)
Capacity: 20" (500 mm)
Resolution: 0.01" (0.25 mm)
Material: Aluminum
Finish: White powder coat, anodized funnel
Size: 8" dia x 27" H (210 mm x 686 mm)
Weight/shipping (gauge only): 7 lbs/8 lbs (3.2 kg/3.6 kg)
Weight/shipping (tripod support): 8 lbs/10 lbs (3.6 kg/4.5 kg)

Ordering Information

260-2510	Rain and Snow Gauge includes measuring stick with english and metric units
260-2510S	Tripod Support
260-2510MS	Measuring Stick (24" length) english and metric



260-2520 Forestry Rain Gauge

The **Model 260-2520 Forestry Rain Gauge** includes a removable funnel, a calibrated measuring tube, a black plexiglass measuring stick graduated to 0.01" and 0.2 mm, and an overflow can. An optional support bracket is available.

The measuring tube holds exactly 0.5". Any excess overflows into the outer chamber so it can be measured after the quantity in the measuring tube has been recorded and removed. Total gauge capacity is 7".

When used as a snow gauge, the funnel and measuring tube are removed. Snowfall is collected in the overflow can and melted for measurement with the measuring tube and dipstick.

Specifications

Orifice: 8" (200 mm)

Capacity: 7" (178 mm)

Resolution: 0.01" (0.2 mm)

Material:

Gauge: White powdercoated aluminum

Funnel: Black anodized aluminum

Support bracket: Black powdercoated steel

Size: 8.25" Dia x 11" H (209 mm x 279 mm)

Weight/shipping (gauge): 3 lbs/5 lbs (1.4 kg/2.3 kg)

Weight/shipping (support bracket): 2 lbs/3 lbs (0.9 kg/1.4 kg)

Ordering Information

260-2520	Forestry Rain Gauge includes measuring stick with english and metric units
260-2520S	Support Bracket
260-2520MS	Measuring Stick (6" length) english and metric



260-700 Ultrasonic Snow Depth Sensor

The **Model 260-700 Ultrasonic Snow Depth Sensor** is an inexpensive solution for remotely measuring snow depth or water levels. The sensor works by measuring the time required for an ultrasonic pulse to travel to and from a target surface. An integrated temperature probe with solar radiation shield provides an air temperature measurement for properly compensating the distance measured. An embedded microcontroller calculates a temperature compensated distance and performs an error checking routine.

Both distance and air temperature are output as an analog signal between 0 to 2.5 Volts or 0 to 5 Volts. Measurements can also be output digitally as serial ASCII. Specify analog or digital output at time of order.

Due to the simplified interface, the depth sensor can interface with any datalogger or control system that can delay at least 3 seconds after powering up before measuring the output.

Specifications

Power: +12 to 24 Vdc, 50 mA (maximum sample time 2.4 seconds)
 Analog output: 0 to 2.5 or 0 to 5 Vdc
 Digital output: 1200 baud serial ASCII
 Range: .5 to 10 meters (1.6 to 32.8 feet)
 Beam width: 22 degrees
 Accuracy: ±1 cm or .4% distance to target
 Resolution: 3 mm (0.12 inches)
 Temperature range: -40° to +70°C (-40° to 158°F)
 Mounting: 1/2" galvanized threaded pipe
 Size: 8 x 8 x 13 cm (3 x 3 x 5 inches)
 Weight: .6 kg (1.3 lbs)
 Cable length: 7.6 meters (25 feet)
 Maximum cable length: 304 meters (1000 feet) for analog output,
 76 meters (250 feet) for digital output

Temperature Sensor Specifications

Accuracy: 1°C, -40° to +85°C
 Resolution: .5°C

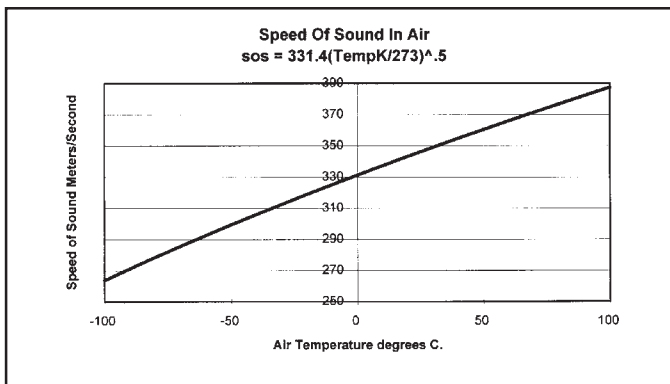

260-700 Ultrasonic Snow Depth Sensor

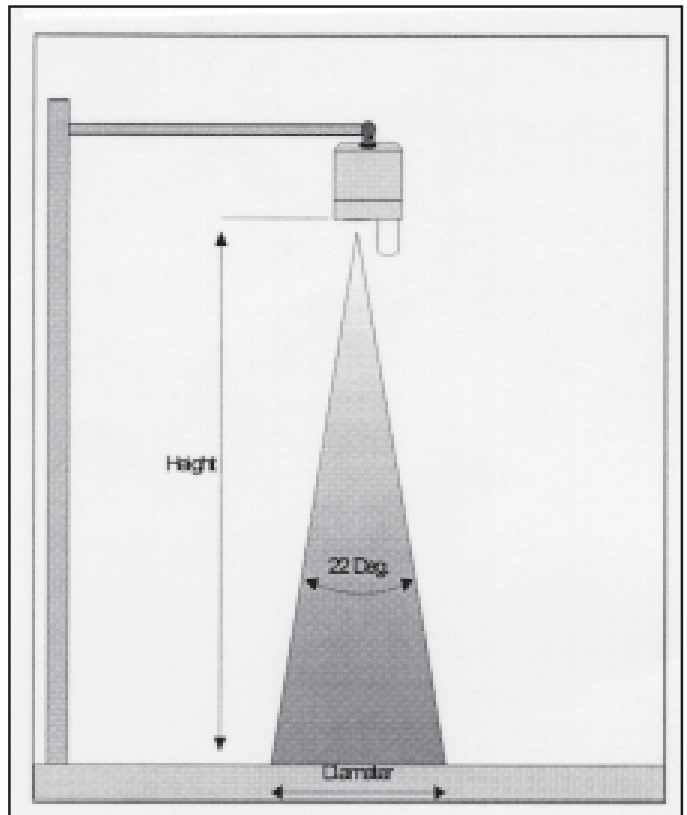

Depth Sensor Beam Width Example

Ordering Information

- 260-700 Ultrasonic Snow Depth Sensor
Specify 0-2.5 or 0-5 Vdc output
Includes 25' cable
- 260-700-D Ultrasonic Snow Depth Sensor, digital output
- 260-700-C Additional Signal Cable, per foot

260-2590 Precipitation Detector**260-2591 Leaf Wetness Sensor**

The **Model 260-2590 Precipitation Detector** is used to detect the onset of rainfall. A gold plated grid sensor activates the circuit when water is deposited onto the grid. The presence of water activates an internal relay that may be used to operate larger capacity external relays, alarms, doors, or may be used as an input to a data acquisition system.

An internal heater constantly dries the grid to prevent relay activation during times of dew, fog, or light moisture that is not actual precipitation. During periods of normal precipitation the heater is unable to dry the grid and the relay is activated. The heater power may be disconnected allowing the detector to be operated as a leaf wetness sensor.

The solid state electronics are mounted in a sealed weatherproof enclosure. The precipitation detector may be tilted to allow water to drain off. A mounting bracket is provided with the sensor to allow mounting onto a 1" pipe by a U-bolt. The wind screen may be used to prevent premature drying of the grid during precipitation events accompanied by high winds.

The unit requires +12 Vdc power for operation. A 115 Vac power adapter is provided with each unit. Power adapters for voltages other than 115 Vac are available upon request.

Specifications

Sensor: Gold plated grid 4" dia
 Output: Relay (0.5 amps)
 Heater: Resistive element
 Power: 12 Vdc (235 mA max.) 115 Vac 60 Hz adapter supplied,
 optional 220 Vac 50/60 Hz adapter available
 Size: Overall 4" dia x 2" high
 Weight/shipping: 4 lbs/5 lbs (1.8 Kg/2.3 Kg)

Ordering Information

260-2590	Precipitation Detector, 115 Vac, 25' cable
260-2591	Leaf Wetness Sensor, 115 Vac, 25' cable
260-2592	Leaf Wetness Sensor with heater control, 115 Vac, 25' cable
330-0524	Additional Cable, per foot



260-2590 Precipitation Detector

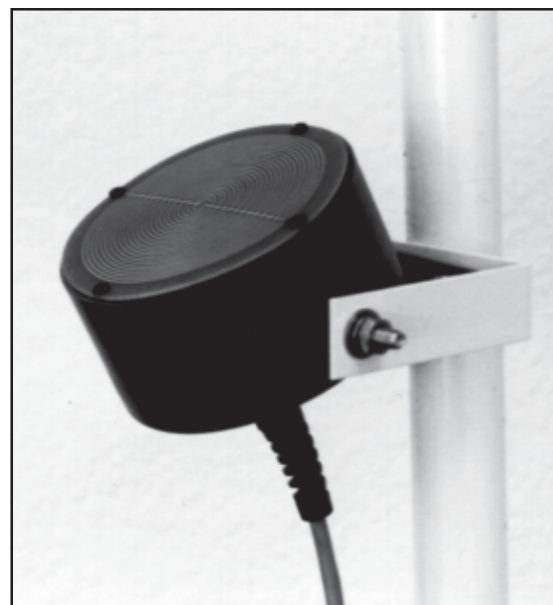

260-2590 Precipitation Dectector shown without wind screen

260-2101 Rain Logger

The **Model 260-2101 Rain Logger** is an inexpensive event data logger that connects to standard tipping bucket rain gauges to provide detailed rainfall history. The data can be useful in a wide range of fields such as agriculture, forestry, hydrology, and climatology.



This compact unit in a weatherproof case records the date and time of each bucket tip, along with the accumulated totals. Manual recording of rain gauge data is eliminated by this convenient unit, saving time and ensuring that critical readings are not missed. The data is stored in nonvolatile EEPROM memory that retains collected data even if the battery fails.

The 8000 tip/event capacity can record up to 80" of rainfall between readouts at 0.01" per tip. A red light blinks every two seconds when the unit is logging. Each tip/event is logged with resolution down to 0.5 second. A lithium battery provides approximately one year of continuous use and is easily replaced by the user. The unit can be mounted inside or outside the rain gauge housing (avoid direct sunlight).

For start up and readout, the 260-2101 connects easily to your PC using the **Model 260-2101SK PC Starter Kit**. The starter kit includes the software program, a serial interface cable, and a manual for software operation. The cable connects to an available 9-pin serial port on your PC. A portable data transfer unit is also available to download data from up to 60 rain loggers.

Programmable features include:

- **Delayed start** - The starting date and time can be programmed to begin recording up to three months after the logger is initialized.
- **Wrap around when full** - The logger can be programmed to stop recording when the memory is full, or to wrap around and overwrite the oldest data.
- **Debounce/lockout** - The logger has a lockout feature that enables it to ignore events for a programmable period of time after an event is recorded. For use with

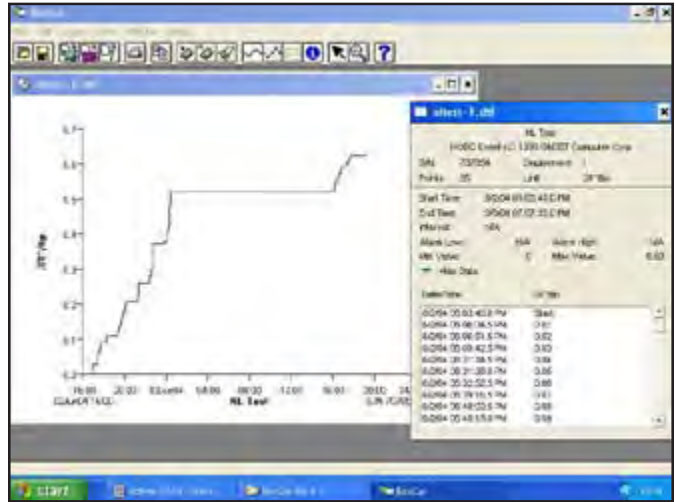

tipping bucket rain gauges, we recommend setting the lockout to one second to eliminate switch bounce.

The software lets you readout recorded data, view it in tabular and graphical formats, or export it for use with other programs such as Microsoft Excel and Lotus 1-2-3 spreadsheets. The data includes date and time stamp, plus the logger's start and stop times. The software also synchronizes logger and data transfer unit clocks to computer clock and checks battery status.

Specifications

- Event type:** Relay contact opening (rain gauge tip)
- Event resolution:** 0.5 seconds
- Minimum event duration:** 20 microseconds
- Operating temperature:** -20° to +70°C (-4° to +158°F)
- Timekeeping accuracy:** ±1 minute per week at 20°C
- Capacity:** 8000 events
- Battery:** CR-2032 lithium
- Case:** NEMA-type weatherproof enclosure
- Size:** 4.3" x 3.5" x 1.8" (108 x 89 x 44 mm)
- Weight/shipping:** 3.3 oz/1 lb

Ordering Information

- | | |
|-------------|--|
| 260-2101 | Rain Logger, 8000 event capacity |
| 260-2101SK3 | PC Starter Kit, includes ver 3.x software and serial interface cable |
| 260-2101SK4 | PC Starter Kit, includes ver 4.x software and serial interface cable |
| 260-2101TU | Data Transfer Unit, Discontinued |

Minimum system requirements: Pentium processor or better running Windows 95/98/NT/2000/XP. Must have one available serial port.

260-2103 Rain Logger



The **260-2103 Rain Logger** is an event data logger that connects to standard tipping bucket rain gauges to provide detailed rainfall history. The data can be useful in a wide range of fields such as agriculture, forestry, hydrology, and climatology.

This compact unit comes in a weatherproof case. It records the date and time of each bucket tip, along with the accumulated hourly, daily, weekly, or monthly totals. Data is stored in nonvolatile EEPROM memory that retains collected data even if the battery fails. The LCD display shows the total accumulated rainfall. Direct USB connectivity provides fast data download.

The 260-2103 runs for up to 1 year on a user-replaceable battery.

The 84,650 tip/event capacity can record up to 846" of rainfall between readouts at 0.01" per tip. The real time display will update with each tip of the bucket. For start up and readout, the 260-2103 connects easily to your PC using the 195-BHW-KIT Software Starter Kit. The 195-BHW Software Pro is required only for use with the 195-U-DT-1 U-Shuttle Data Transporter. The starter kit includes the software CD and a 6' USB interface cable. The cable connects to an available USB port on your PC.

If you order the 260-2103RGI Rain Gauge Installation, the rain gauge cable will be removed and the logger will be installed inside the gauge. The gauge and logger must be purchased together.

LCD display; total count, battery and memory status
User selectable scaling; inches or millimeters
Flexible start and stop options
Debounce/lockout
Offload logged data or check status while logging
Print graphs
Print preview

Specifications

Event type: Relay contact closure (rain gauge tip)
 Event resolution: 0.5 seconds
 Minimum event duration: 20 microseconds
 Operating temperature: -4° to +158° F (-20° to +70° C)
 Timekeeping accuracy: ±1 minute per month at 20° C
 Capacity: 84,650 events (128KB)
 Download time: 15 seconds
 Battery: CR-2032 lithium
 LCD display: LCD is visible from 31° to 122°F (0° to 50°C); the LCD may react slowly or go blank in temperatures outside this range.
 Waterproof case: Clear ABS, 2.7" x 4.3" x 1.3"

Computer System Requirements

PC: Windows 7 or 8 (Pro, Ultimate and Home Premium), Windows XP Pro, Windows XP Home
 Mac: OS X Versions 10.5.x, 10.6.x and 10.7.x.
 Java Runtime Environment (JRE) 1.6 (32-bit or 64-bit on Windows). Please note that version 1.6, also known as Java 6, is officially supported on OS X only on Intel Core 2 Duo processors or newer.
 One of the following Internet browsers (version number listed is the highest major version we tested): Safari 5 or greater, Firefox 7 or greater, Microsoft Internet Explorer 9.0.
 Minimum screen resolution of 1024x768
 256+ colors

Ordering Information

260-2103	Rain Logger with Display
195-BHW-KIT	HOBOWare Software CD and 6' USB interface cable
195-BHW	Software Pro for PC or Mac (includes software CD and 6' USB interface cable)
195-U-DT-1	U-Shuttle Data Transporter
260-2103RGI	Rain Gauge Installation (Only available with purchase of both rain gauge and logger. We install this logger in the 260-2500 and 260-2501-A rain gauges only.)

260-952 Rain Gauge Wind Screen

260-950 Mounting Plate

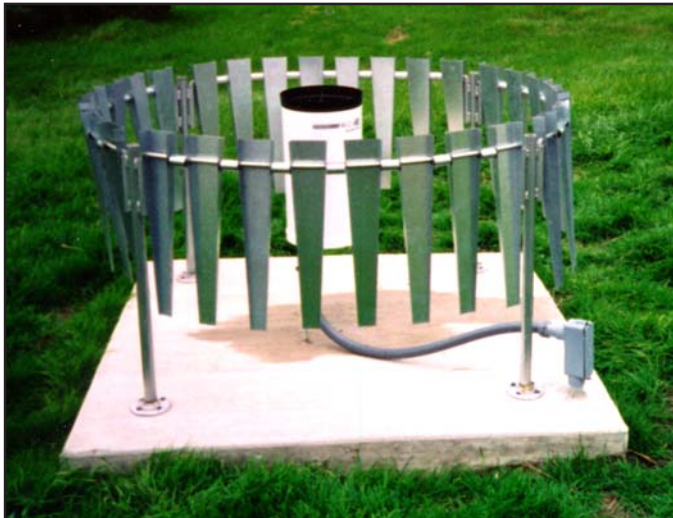

260-952 Precipitation Gauge Wind Screen

The **Model 260-952 Rain Gauge Wind Screen** minimizes the formation of strong updrafts that can distort the trajectories of precipitation particles falling toward a gauge. The screen also generates turbulent air motions over the gauge orifice to break up streamlines and thus improve the catch. Use of a wind screen is recommended with all precipitation gauges located in windy areas. The screen consists of 32 free-swinging metal leaves, evenly spaced around a 48" diameter. Each leaf is fabricated from 20-gauge galvanized sheet metal, 16" long, 3" wide at the top and 2" wide at the bottom. One of the quadrants swings out to permit easy access to the gauge. Two lengths of legs (2' and 3') are available due to variations in gauge height. A mounting kit is available for mounting to a wooden platform.

Specifications

Material:

Posts and rods: Zinc-plated steel
 Leaves: 20-gauge galvanized sheet metal
 Spacers: EMT conduit

Size:

260-952: 48" Dia x 24" H (1219 x 610 mm)
 260-953: 48" dia x 36" H (1219 mm x 919 mm)

Weight/shipping:

260-952: 44 lbs/47 lbs
 260-953: 50 lbs/53 lbs

Ordering Information

260-952	Rain Gauge Wind Screen, 24" legs
260-953	Rain Gauge Wind Screen, 36" legs
260-954	Leg Extender Kit, converts 260-952 to 260-953
260-955	Wind Screen Mounting Kit, flange adapters and #12 x 1-1/4" wood screws



260-2501 Rain Gauge with 260-950 Mounting Plate

The **Model 260-950 Rain Gauge Mounting Plate** is an easy and convenient way to mount your rain gauge. The mounting plate is sized to fit the 260-2500 and 260-2501 rain gauges. Welded to the bottom of the plate is a hub that will accept a standard 1" (1.34" o.d.). pipe. Hardware is supplied for mounting the rain gauge to the plate. The plate should be leveled prior to installing the gauge.

Specifications

Material: Aluminum
 Size: 10.75" Dia
 Weight/shipping: 2 lbs/3 lbs

Ordering Information

260-950	Rain Gauge Mounting Plate
---------	---------------------------

260-2595 Rain Gauge Calibrator

The **Model 260-2595 Rain Gauge Calibrator** is designed to simplify the field verification and calibration procedures for tipping bucket rain gauges. Included are a 946 ml calibrated plastic bottle, a precision machined water dispenser with four interchangeable orifices (these provide constant flow rates necessary for dynamic testing), and a 10 ml syringe useful in static tests. Calibration charts for all NovaLynx tipping bucket rain gauges are provided. Charts for other rain gauges are available.

Static calibration, adjusting each bucket to tip for a measured volume of water, is recommended for initial calibration adjustments. The 10 ml syringe allows very accurate water volume measurements.

Dynamic calibration, adjusting both buckets to achieve the correct output count for a measured volume of water at a constant flow rate, is recommended for minor adjustments and verification. The four orifices provide a wide range of rainfall rates. To obtain the error band of a gauge, test the dynamic operation both above and below the calibrated rate.

Field verification is standardized by providing a controlled water volume at a constant flow rate. To verify that gauge operation is within the specified accuracy, compare the output count of tips to the calibration chart.



Specifications

Calibrated bottle: Plastic with embossed lettering, fill ring molded into bottle at 946 ml point
 Orifice sizes: 1/32", 1/16", 3/32", and 1/8" dia

Ordering Information

260-2595 Rain Gauge Calibrator

Spare Parts

16000200	Plastic Bottle 32 oz
16000201	Orifice 1/32"
16000202	Orifice 1/16"
16000203	Orifice 3/32"
16000204	Orifice 1/8"
16000205	Syringe, 10cc x 1/5cc

260-2696 Digital Event Counter

260-2597 Pocket Counter



260-2596 Digital Event Counter

The **Model 260-2596 Digital Event Counter** is useful for counting tips at sites where monitoring equipment has no local display capability. The counter has a reset button on the display face and the liquid crystal display is visible even in bright sunlight.

The 260-2596 is a general purpose, miniature digital event counter that operates from switch contact or NPN open collector inputs. This unit provides years of silent operation without mechanical wear and is self-powered with a 2-wire connection that eliminates power wiring.

Specifications

Display: 6-digit LCD, 0.2" high
 Power: 3 volts
 Battery: Lithium
 Count input: Switch contact or solid-state transistor switch.
 Count speed: 100 counts/sec.
 Operating temperature: -30°C to +75°C
 Weight: 3 oz. without batteries

Ordering Information

260-2596 Digital Event Counter

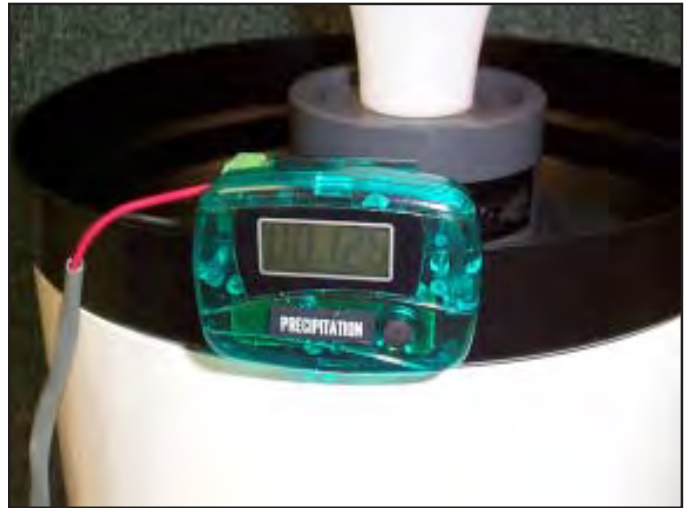

260-2597 Pocket Size Event Counter

The **Model 260-2597 Pocket-Size Digital Event Counter** is a low cost solution for counting tips when calibrating a tipping bucket rain gauge. This compact counter has a reset button on the display face and mounting clip on the back. The liquid crystal display is visible even in bright sunlight. The unit is self-powered with a 2-wire connection.

- Battery-powered
- LCD display is visible even in bright sunlight
- Clips to edge of rain gauge funnel
- Reset button on front of unit

Specifications

Display: 5-digit LCD 0.3" high
 Size: 2" wide x 1.5" high x 1" deep
 Battery: AG12 button cell
 Count input: Switch contact
 Built-in debounce: 2 counts/second max

Ordering Information

260-2597 Pocket-Size Digital Event Counter

Evaporation

Group 255 Evaporation Stations	144
Group 255 Evaporation Stations	145
255-212 Min-Max Thermometer	146
255-200 Evaporation Pan	146
255-100 Analog Output Evaporation Gauge	147
255-110 Evaporation Gauge Tester	147
255-620-A Automatic Refill System	148
255-704-A Evaporation Logger	149
255-250 Evaporation Pan Platform	150

Group 255 Evaporation Stations

The **Group 255 Evaporation Stations** are complete systems used to measure the amount of water lost each day to evaporation. There are two commonly used procedures for making these measurements. In both, a U.S. National Weather Service Class A Evaporation Pan, 10 inches deep and 47.5 inches in diameter, holds the water and is normally installed on a wooden platform set on the ground in a grassy location.

One alternative for measuring the daily evaporation loss is to use a graduated hook gauge set on a stillwell to determine the water level in the pan. The hook gauge is adjusted until the point just breaks the water surface, and a reading is taken from the attached scale. The second alternative uses a stillwell with a fixed point. Each time a measurement is taken, the pan is refilled to the level of the point using a calibrated graduate. The graduate has a surface area of 1/100 that of the pan, so that the amount of water added is the equivalent evaporation. The choice between these alternatives is generally made on a practical basis, such as the availability of daily replacement water.

The U.S. National Weather Service standard evaporation and climatological station requires daily observations to collect the data; thus, it is not suitable for remote, unattended locations. The recommended layout of the plot and instruments for a station in the northern hemisphere is shown in the diagram. The 16' x 20' plot is the minimum for the equipment shown. Accessories such as a rain gauge wind screen would require enlargement of the plot to 20' x 20'. This station should be installed on a sod surface where obstructions are no closer than 4 times their height. Shadows should not fall on the evaporation pan except for brief periods at sunrise and sundown. NovaLynx can provide the instruments to satisfy U.S. National Weather Service requirements.



255-214 Hook Gauge



255-205 Stillwell

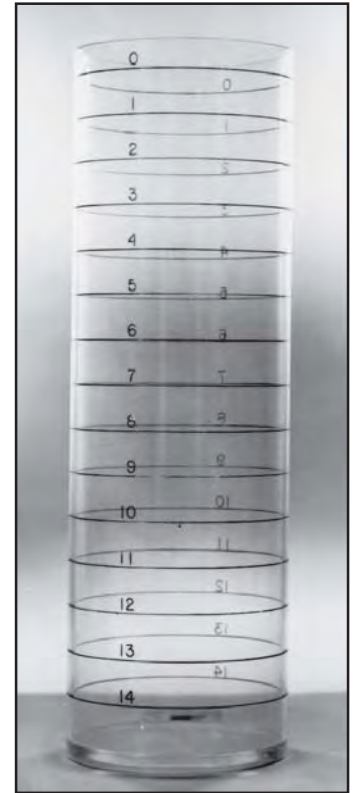

255-211E Replacement Graduate

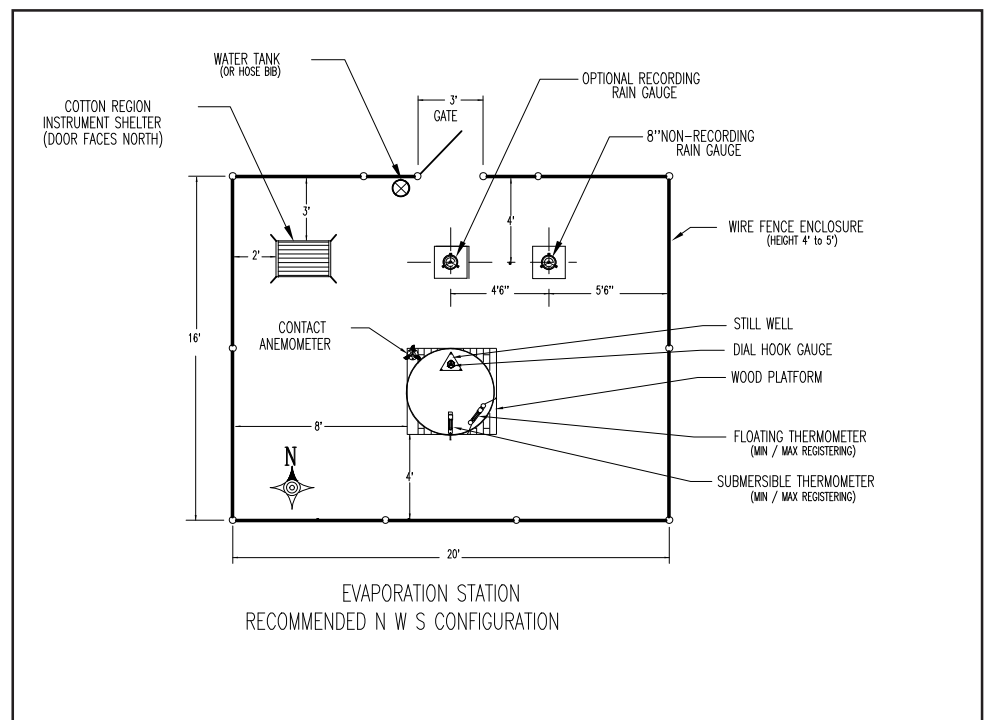

Group 255 Evaporation Stations

The amount of evaporation is a function of temperature, humidity, wind, and other ambient conditions. In order to relate the evaporation to current or expected conditions, the maximum and minimum temperatures of the water and the amount of air passage are normally recorded along with evaporation. Instruments for measuring air temperature, humidity, rainfall, and other parameters are described in their respective catalog sections.

Specifications

Evaporation Pan

Material: Low carbon stainless steel
Construction: Heliarc welded, with 1/2" drain plug
Size: 10" H x 47.5" I.D. (254 mm x 1206 mm)
Weight/shipping: 50 lbs/68 lbs (23 kg/31 kg) (Box 50" x 49" x 11")

Hook Gauge

Span: 3" or 7 cm
Graduations, stem: Major divisions 1" or 1 cm
Minor divisions 0.1" or 0.1 cm (1 mm)
Graduations, dial: Major divisions 0.01" or 0.1 mm
Minor divisions 0.002" or .02 mm
Size: 7" L x 5.25" Dia (178 mm x 133 mm)
Weight/shipping: 1 lb/3 lbs (0.5 kg/1.4 kg)

Stillwell

Material: Stainless steel
Size: 4" Dia x 9" H (102 mm x 229 mm)
Weight/shipping: 6.5 lbs/10 lbs (2.9 kg/4.5 kg)

Stillwell with Fixed Point

Height of point: 7.5" (191 mm)
Material: Stainless steel
Size: 4" Dia x 9" H (102 mm x 229 mm)
Weight/shipping: 6.6 lbs/10 lbs (3.0 kg/4.5 kg)

Replacement Graduate

Graduations: 0.01" or 0.2 mm
Material: Polycarbonate
Size: 4.75" I.D. x 16" H (121 mm x 406 mm)
Weight/shipping: 1.5 lbs/3 lbs (0.7 kg/1.4 kg)

Floating/Submersible Thermometer

Type: Digital minimum-maximum
Typical range: -18° to +65° C or 0° to +150° F
Mounting: Polypropylene floats with sun shield
Size: 11-1/4" long without floats, 13-1/2" with floats
Weight/shipping: 1 lb/3 lbs (0.5 kg/1.4 kg)

Totalizing Anemometer

Sensor: 3-cup assembly, glass reinforced nylon, 1.125" dia cups
Counter type: 8-digit electronic, LCD in NEMA-4X enclosure
Resolution (counter and contact): 0.1 mile or 0.1 km
Materials: Thermoplastic, anodized aluminum, stainless steel
Mounting: Pre-drilled flanged base
Size: 5.5" W x 5" D x 16" H (140 x 127 x 400 mm)
Weight/shipping: 5 lbs/9 lbs (2.3 kg/4 kg)

Wooden Platform

Material: Pressure treated 2x6 & 2x4 lumber
Size: Assembled 4' x 4', Disassembled 10" x 10" x 4'
Weight/shipping: 55 lbs/60 lbs

Ordering Information

Hook Gauge Evaporation Station, English (Class A Station)

255-200	Evaporation Pan
255-205	Stillwell
255-212	Floating/Submersible Min-Max Thermometer °F
255-214	Hook Gauge, English units
200-2510-A	Totalizing Anemometer, miles

Hook Gauge Evaporation Station, Metric

255-200	Evaporation Pan
255-205	Stillwell
255-212	Floating/Submersible Min-Max Thermometer °C
255-215	Hook Gauge, metric
200-2511-A	Totalizing Anemometer, kilometers

Fixed Point Evaporation Station, English

255-200	Evaporation Pan
255-210	Stillwell with Fixed Point
255-211E	Replacement Graduate, English
255-212	Floating/Submersible Min-Max Thermometer °F
200-2510-A	Totalizing Anemometer, miles

Fixed Point Evaporation Station, Metric

255-200	Evaporation Pan
255-210	Stillwell with Fixed Point
255-211M	Replacement Graduate, Metric
255-212	Floating/Submersible Min-Max Thermometer °C
200-2511-A	Totalizing Anemometer, kilometers



255-212 Min-Max Thermometer

The **255-212 Min-Max Thermometer** can be configured as either a floating or submersible thermometer for measuring the minimum and maximum temperatures of water, such as in an evaporation pan. It features a digital thermometer mounted on a non-magnetic base. The built-in solar radiation shield protects the thermometer against direct sunlight.

In a float-mounted installation, two floats are installed on the thermometer base to float the thermometer approximately 1/4" below the water surface. The thermometer is then attached to an anchor using flexible lines at least 10" long, but short enough to keep the unit approximately one foot from the edge of the pan and the gauge.

In a submerged installation, the thermometer base rests on the bottom of the pan. A non-magnetic handle is fastened to the base and hooked over the edge of the pan. The thermometer should be located on the inside-bottom of the south side of the pan (in the northern hemisphere) to ensure that the thermometer is shaded as much as possible from the direct rays of the sun.

Specifications

Thermometer type: Digital minimum-maximum
 Typical range: 0 to 150° F or -18 to 65° C
 Resolution: 0.1° from -19.9° to 199.9°, otherwise 1°
 Accuracy: ± 0.5° C or ± 1° C
 Dimensions:
 Stainless steel probe diameter 0.14", length 5"
 Case diameter 1-3/4", depth 1/2"
 Weight: 1-1/2 oz

General

Dimensions: 11-1/4" long without floats, 13-1/2" with floats
 Weight/shipping: 1 lb/3 lbs

Ordering Information

255-212D	Floating/Submersible Min-Max Thermometer, digital
210-4039	Replacement Thermometer

255-200 Evaporation Pan

The **255-200 Evaporation Pan** is a standard, National Weather Service Class A type for evaporation measurement. It is normally installed on a wooden platform set on the ground in a grassy location. The pan is filled with water and exposed to represent an open body of water. The pan is normally filled to within 2.5 inches of the top of the pan. The evaporation rate can be measured by manual readings or with an analog output evaporation gauge.

Specifications

Material: Low carbon stainless steel
 Construction: Heliarc welded, 1/2" drain plug
 Size: 10" H x 47.5" Dia (254 mm x 1206 mm)
 Weight/shipping: 50 lbs/68 lbs (23 kg/31 kg)
 Shipping carton dimensions: 50" x 49" x 11"

Ordering Information

255-200	Class A Stainless Steel Evaporation Pan
---------	---

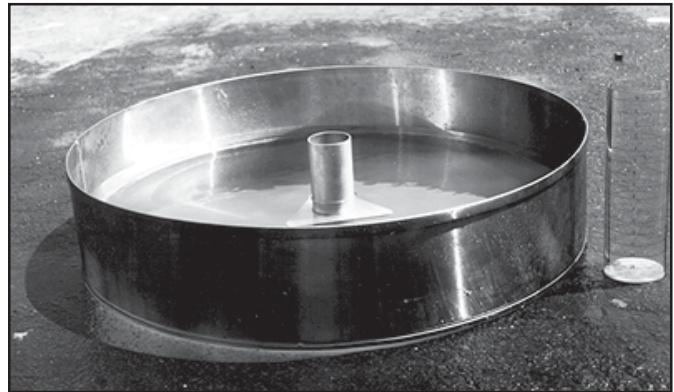

255-200 Evaporation Pan (shown with stillwell and replacement graduate)

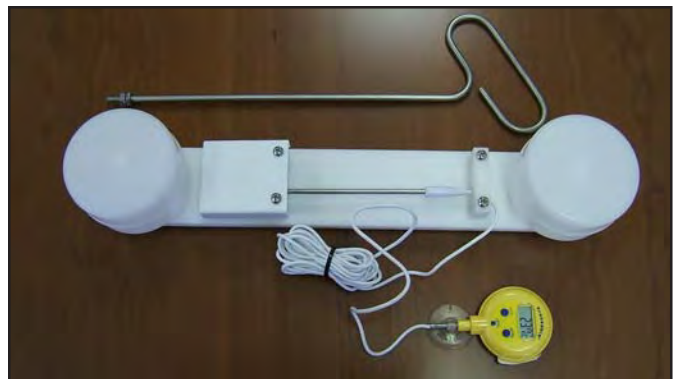

255-212D Floating/Submersible Min-Max Thermometer

255-100 Analog Output Evaporation Gauge

The **255-100 Analog Output Evaporation Gauge** is used to determine the evaporation rate by measuring the changing water level in an evaporation pan. A standard National Weather Service Class A Evaporation Pan is recommended. The instrument consists of a float, pulley, and counterweight attached to a precision 1000-ohm potentiometer mounted in a weatherproof housing. The triangular base plate is equipped with three leveling screws. The potentiometer produces a resistance output proportional to the position of the float which can be monitored on site using a data logger or remotely by telemetry equipment. The gauge can be placed directly in the pan, or connected to the pan by using the 255-100P/F stainless steel pipe and fittings.

Specifications

Potentiometer:

Accuracy: 0.25%
 Rotation: Continuous
 Resistance: 1000 ohms
 Operating temperatures: -40° C to 60° C
 Linearity: 0.25%
 Range: 0-10"

System accuracy: Gauge with pan & pipes \pm 0.25% over 10" range

Float: 4" diameter

Height: 27-1/2"

Diameter: 8"

Base: 16" triangle with leveling screws

Water input port: 1/2" NP coupling, female

Cable: 3 conductor, 50' included

Weight/Shipping: 7-1/2 lbs/15 lbs (Box 29" x 17" x 16")



255-100 Analog Output Evaporation Gauge

Ordering Information

255-100	Analog Output Evaporation Gauge, 50' cable
255-100C-4	Signal Conditioning PCB, 4-20mA Output
255-100C-4	Signal Conditioning PCB, 4-20mA Output, NEMA encl
255-100P/F	Stainless Steel Connecting Pipe and Fittings for attaching gauge to pan, 60"
255-100P/F-S	Stainless Steel Connecting Pipe and Fittings, 6"
255-100POT	Replacement Potentiometer

255-110-B Evaporation Gauge Tester

The **255-110-B Evaporation Gauge Tester** works with the 255-100 Evaporation Gauge to provide a direct reading in inches or millimeters, corresponding to the output from the evaporation gauge. The tester is used to set-up the evaporation gauge during initial installation and can be used to provide a direct reading of daily evaporation loss.



255-110-B Evaporation Gauge Tester

Specifications

Range: 0 to 239.8 millimeters or 0 to 9.44 inches
 Resolution: 0.01 mm or 0.001 inches
 Operating temperature range: 0 to 50 °C (32 to 122 °F)
 Accuracy: \pm 0.1% of reading
 DVM Display: 5-digit LCD
 Waterproof case: Clear ABS, 2.7" x 4.3" x 1.3"
 Battery: 2 AAA 1.5V alkaline batteries
 Weight/shipping: 8 oz/1 lb

Ordering Information

255-110-B	Evaporation Gauge Tester, inches
255-110M-B	Evaporation Gauge Tester, metric
255-110MS	3-Pin MS Connector Option (for use with old-style evaporation gauge)

255-620-A Automatic Refill System

The **255-620-A Automatic Refill System** provides a simple method to automatically refill an evaporation pan at specified times. It consists of a digital electronic water timer and an automatic float valve. The water timer switches on at a user-specified time, allowing water from an external water source to flow into the pan. Works with low (gravity flow) or high (city) water pressure. The float valve will stop the water flow at approximately 8-1/2" to 9-1/2" depending upon the water pressure. The timer then shuts off until the next programmed time.

Specifications

Power: One 9V alkaline battery
Operating temperature: 3 to 50 °C (37.4 to 122 °F)
Operating humidity: 0-100% RH
Housing: Aluminum and plastic, waterproof
Water connection: Standard garden hose fitting
Size: 8" x 6" x 4" approx
Weight/Shipping: 4 lbs/7 lbs

Ordering Information

255-620-A Automatic Refill System



255-620-A Automatic Refill System

255-704-B Evaporation Logger

- Set up to record the evaporation pan level in inches or millimeters.
- The logger is an 16-bit device and can provide a 0.002" resolution.
- The software provides easy logger setup.
- Stored data is collected by direct USB 2.0 interface cable to a laptop or personal computer.
- Graphing: View multiple parameters on one graph, Zoom and axis-control tools.
- Logger Status: Verify logger operation and current readings.
- Export Data to Other Programs: Microsoft® Excel or other ASCII-compatible programs.
- Requires two AAA 1.5V alkaline batteries with 1 year battery life.

The **255-704-B Evaporation Logger** is a voltage data logger that connects to the 255-100 Analog Output Evaporation Gauge to provide a recorded history of the evaporation pan level. Optional air and water temperature sensors can be connected to the logger to record temperature readings along with pan level. The data can be useful in a wide range of fields such as agriculture, water and waste management, and climatology.

The logger is mounted in a waterproof enclosure that is attached to the outside of the evaporation gauge. The clear cover allows viewing of the current evaporation pan level. Easy to use and reliable, with proper care the 255-704-B will provide years of accurate and reliable measurements.

Specifications

Inputs: 4 channel logging 0-2.50 Vdc inputs (16-bit)
 Channel 1 is setup for the evaporation pan level
 Channels 2, 3, and 4 can be used as temperature inputs
 Measurement capacity: 1.9 million measurements
 Download in 90 seconds for full memory via direct USB interface
 Programmable sample rate 1 sec to 18 hours
 Programmable start time or push-button start
 Operating temperature: -20° to +70°C (-4° to +158°F)
 Timekeeping accuracy: ± 1 minute per week at 20°C
 Battery: 2 AAA batteries, 1-year battery life
 Outer enclosure size: 5" x 5" x 3"
 Weight: 1.2 lbs
 Mounting: 8" diameter hose clamp attached to evaporation gauge
 Computer system requirements:
 PC: Windows 10, 8, 7, XP
 Mac: OSX Ver 10.11.x, 10.10.x, 10.9.x
 Java Runtime Environment (JRE): 1.7.0_17 and above
 (32-bit or 64-bit on Windows)
 Software required: 195-BHW-KIT includes Software and 6' USB Cable

Ordering Information

255-704-B	Evaporation Logger, with NEMA Enclosure
195-BHW-KIT	Software on CD-ROM and USB Interface Cable
210-TMC/20	Water or Air Temperature Sensor, 20' cable
380-280	Solar Shield for Air Temperature Sensor



255-704-B Evaporation Logger, shown with 255-100 Evaporation Gauge (not included)

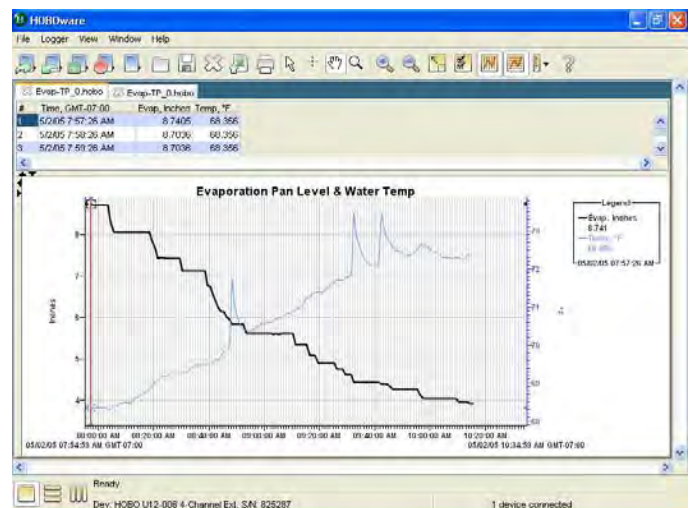

255-250 Evaporation Pan Platform

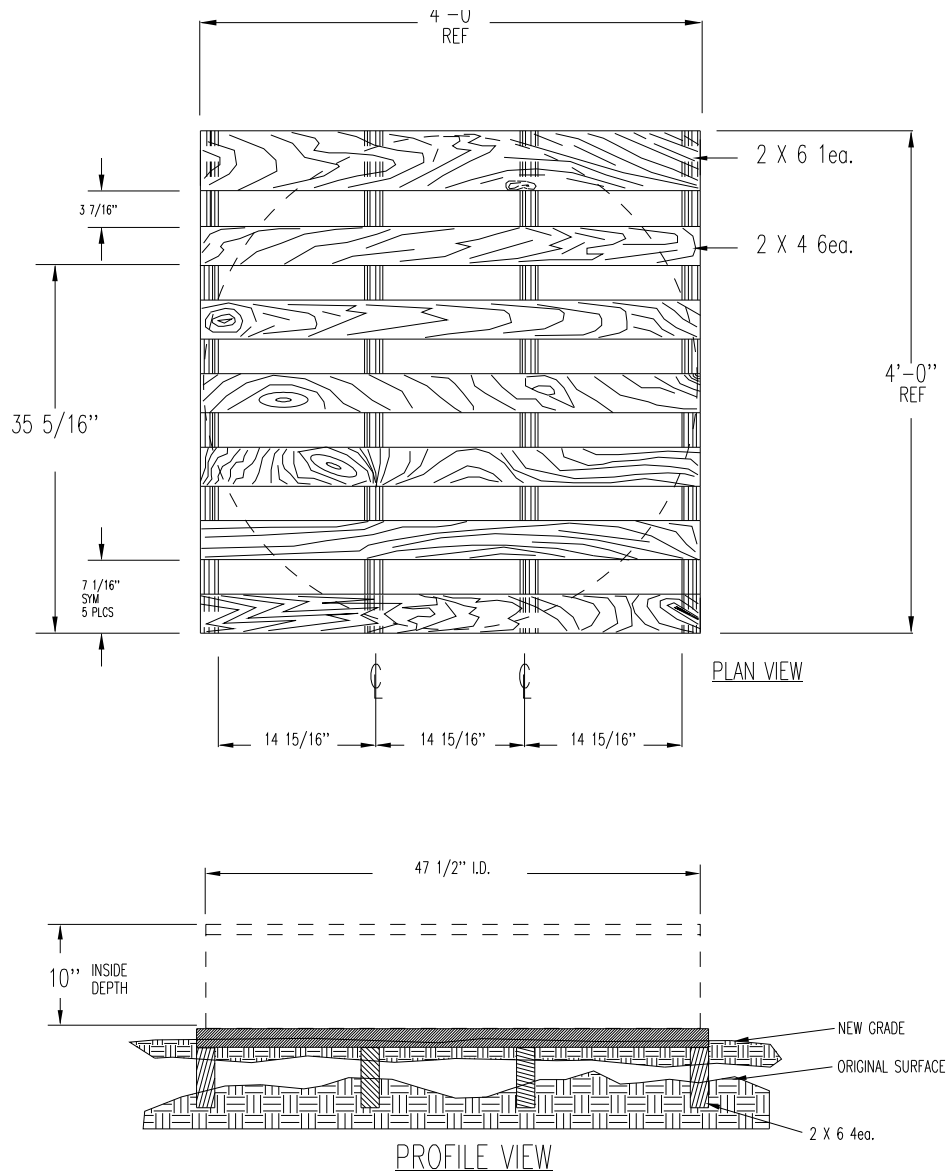

Water Level & Flow

280-FP Flow Probes	152
280-330 Submersible Pressure Transducer	153
280-IRU-9400 Ultrasonic Sensor	154

280-FP Flow Probes



The **Flow Probe** is a highly accurate water velocity instrument for measuring flows in open channels and partially-filled pipes. It consists of a protected water turbo-prop positive displacement sensor coupled

with an expandable probe handle ending in a digital readout display. The water flow meter incorporates true velocity averaging for the most accurate flow measurements. The flow probe is ideal for storm water runoff studies, sewer flow measurements, measuring flows in rivers and streams, and monitoring water velocity in ditches and canals.

The flow probe incorporates the unique **Turbo-Prop Propeller Sensor**, which uses the most accurate positive displacement technique available for velocity sensing. The turbo-prop is designed to shed debris and is protected inside a 2" diameter housing. The probe housing may be placed directly on the bottom of a pipe or streambed for measuring low flows down to 2" in depth. The flow meter propeller rotates freely on its bearing shaft with no mechanical interconnections for minimal friction. Magnetic material in the propeller tip passes a pickup point in the water velocity meter handle producing electrical impulses that are carried to the readout display by an internal cable. The turbo-prop is easily removed for cleaning or replacement.

The **Water Velocity Computer** receives an electrical signal from the propeller, amplifies the signal, and converts the reading to feet per second (or meters per second, depending on programming). The large LCD screen displays average, minimum, and maximum water velocity readings. Up to 30 sets of minimum, maximum, and average data readings can be stored in the water velocity computer. These data points can be reviewed on the computer screen for later analysis. The water velocity computer has a water-resistant housing and incorporates a unique four-button operation for changing functions and resetting the display. The water velocity computer is powered by a non-replaceable battery that will last approximately five years with normal use. Low battery warnings will also display as appropriate.

The **Flow Probe Handle** can telescope from 3.7 feet to 6 feet in length (FP111), 5.5 feet to 15 feet (FP211), or 2.5 feet to 5.5 feet (FP311). The handle is constructed of anodized aluminum for light weight and long life. The 15 foot length of the FP211 allows for measuring sewer flows

from street level and measuring stream flows from low bridges, while the 2.5 foot collapsed length of the FP311 is ideal for carrying into remote flow monitoring areas. A 3-foot (1.7-foot for the FP311) mylar coated staff gauge (graduated in hundredths of a foot and centimeters) is attached to the lower section of the probe for instant water depth measurements and accurate propeller positioning.

The flow probe can be used to measure the **True Average Water Velocity** of a channel's flow. As long as the turbo-prop sensor is in the water flow, the computer will average the water velocity. One reading is taken per second and a continuous average water velocity is displayed. To obtain the true average velocity, the flow probe should be slowly moved throughout the cross sectional area being measured. Once the reading becomes steady, the true average water velocity of the cross sectional area is obtained. This allows for highly accurate flow measurements, which average the differences in velocities that occur throughout a flow's cross-section and with water surges over time. The average water velocity can be saved by pressing the SAVE button and reviewed later.

Specifications

Range: 0.3-19.9 FPS (0.1-6.1 MPS)

Accuracy: 0.1 FPS

Averaging: True digital running average. Updated once per second.

Display: LCD, Glare and UV Protected

Control: 4 button

Datalogger: 30 sets, MIN, MAX, and AVG

Features: Timer, Low battery warning

Sensor Type: Protected turbo-prop propeller with magnetic pickup

Weight/Shipping:

FP111: 2 lbs (0.9 kg)/13 lbs (5.9 kg)

FP211: 3 lbs (1.4 kg)/23 lbs (10.4 kg)

FP311: 2.8 lbs (1.3 kg)/19 lbs (8.6 kg)

Expandable Length:

FP111: 3.7 to 6 ft (1.1 to 1.8 m)

FP211: 5.5 to 15 ft (1.7 to 4.6 m)

FP311: 2.5 to 5.5 ft (0.76 to 1.7 m)

Materials:

Probe: PVC and anodized aluminum with stainless steel water bearing

Computer: ABS/Polycarbonate housing with polyester overlay

Power: Internal lithium battery, Approx 5 year life, non-replaceable

Operating temperature: -4° to 158° F (-20° to 70° C)

Storage temperature: -22° to 176° F (-30° to 80° C)

Carrying case: The flow probe is shipped in a padded carrying case.

Approvals: CE

Ordering Information

280-FP111	Flow Probe (3.7' to 6' handle)
280-FP111-S	Flow Probe (3.7' to 6' handle with swivel)
280-FP211	Flow Probe (5.5' to 15' handle)
280-FP211-S	Flow Probe (5.5' to 15' handle with swivel)
280-FP311	Flow Probe (2.5' to 5.5' handle)

280-330 Submersible Pressure Transducer

The **Model 280-330 Pressure Transducer (PT)** combines a submersible probe, designed specifically for depth and level measurements, with the convenience of an external signal conditioning circuit mounted in a desiccant box.

The probe's pressure sensing element is isolated from the water by a titanium diaphragm and the electronics are housed in a titanium body. The PT cable, which is molded to the body, is a thick wall polyurethane jacketed cable with an integral vent tube and Kevlar strain relief cord.

An accurate water level measurement requires a dry ambient air pressure reference that the desiccant box provides. The PT is supplied with a can of indicating desiccant that changes from blue to pink when the desiccant bag should be replaced. Both the can and bag are rechargeable.



280-330 Submersible Pressure Transducer

Specifications

Probe

Pressure range: 0 to 5 through 0 to 250 psig
Over pressure: 4x
Combined non-linearity, hysteresis, and repeatability: $\pm 0.1\%$ F.S. BSL
Long term drift: Typically $\pm 0.1\%$ F.S. temperature range
Operation: -20° to 60°C
Compensated: -2° to 30°C
Temperature effects: $\pm 0.3\%$ total error band
PT cable length: 40' standard, 500' max
(consult factory for longer lengths)
Dimensions: 0.69" Diameter x 3.8" Long

Signal Conditioning and Desiccant Box

Range: 25.5' standard
Output: 0 to 5 Vdc
Power: 10 to 15 Vdc, 20 mA
Signal cable: 25', 5 conductor shielded
Dimensions: 6" x 4" x 4"
Weight: 3 lbs

Ordering Information

280-330 Pressure Transducer, specify range in feet
280-330C Add'l Vented Cable, per foot

280-IRU-9400 Ultrasonic Sensor



- Range from 0.5 to 35 ft (150 mm to 10.67 m)
- Self-contained sensor
- Works for water and snow level
- Easy to install
- Internal temperature compensation
- Virtually maintenance free
- Programmed via computer interface using the RST-3001 (USB) or the RST-2001A (RS232) module or RS232 and Windows™ compatible software

Outputs

- 4-20 mA
- 0-2.5 V or 0-5 V (selectable via software)

The **280-IRU-9400 Ultrasonic Sensor** uses ultrasonic technology to provide a non-contact method of detecting level of water or snow. The ultrasonic sensor transmits pulsed waves of high frequency sound. If the sound wave meets a reflective object, such as liquid, it bounces back toward the sensor. The sensor records the time required for the sound wave to travel to the target and return. Using the speed of sound, which is a well-known variable, the sensor calculates the distance to the object.

Until recently, the many factors that influence the speed of sound created inaccurate readings. Now with low cost microprocessor technology, many of these variables can be factored into the equation and eliminated. Temperature change is one such variable. The 280-IRU-9400 sensors use internal temperature compensation to offset the effects of these changes. The 280-IRU-9400 can also compensate for other variables, such as wave action, agitators, and humidity. Sensor adjustments are made via a computer USB interface using an RST module* and Windows™ compatible software.

*The RST module is sold separately. The software is included with RST unit.

Specifications

Operating Range: 0.5 to 35 feet (0.15 to 10.67 meters)
Available Outputs: 4-20 mA, 0-2.5 V / 0-5 V (selectable via software)
Operating Voltage: 12-28 Vdc
Programming Voltage: 15-28 Vdc
Total Current Draw: 75 mA @ 24 Vdc
Maximum Power Rating: 2.5 W
Housing: Polycarbonate/PET blend
Mounting: 2 inch NPT or 3/4 inch NPT
Transducer Type: Electrostatic
Ratings: NEMA 12
Approvals: CSA General Purpose (pending)
Response Time: Programmable (20 ms minimum)
Sample Rate: Programmable (1-22 Hz)
Resolution: 0.1 inch (2.5 mm)
Accuracy: ± 0.25% of detected range (with no temperature gradient)
Adjustments: USB interface using RST-3001, or RS232 interface using RST-2001A
Operating Temperature: -40° to +140° F (-40° to 60° C)
Beam Pattern: 9° off axis (at full signal strength and sensitivity settings)
Electrical Connection: Pigtail
Frequency: 50 kHz

Ordering Information

280-IRU-9423-C6	Ultrasonic Sensor, 4-20 mA Includes 6' cable, specify if addl cable is required Note: this is a 4-wire device (not loop powered)
280-IRU-9429-C6	Ultrasonic Sensor, 0-2.5 V / 0-5 V Includes 6' cable, specify if addl cable is required
280-RST-2001A	RST Module, RS232
280-RST-3001	RST Module, USB

Water Quality

270-WQ Water Quality Sensors	156
270-WQ Water Quality Sensors	157

270-WQ Water Quality Sensors

The **270-WQ101 Submersible Temperature Sensor** is a rugged reliable water temperature measuring device. The temperature transmitter probe is molded to 25' of marine grade cable, with lengths up to 500' available. The temperature sensor has a two wire configuration for minimum current draw. The temperature transmitter's electronics are completely encapsulated in marine grade epoxy within a stainless steel housing.



Output: 4-20 mA
 Range: -58 to 122°F (-50 to 50°C)
 Accuracy: ± 0.2°F or ± 0.1°C
 Maximum pressure: 200 psi
 Operating voltage: 10-36 Vdc
 Current draw: Same as sensor output
 Warm-up time: 5 seconds minimum
 Operating temperature: -58 to 122°F (-50 to 50°C)
 Size of probe: 3/4" diameter x 4-1/2" long (1.9 cm x 11.4 cm)
 Weight: 8 ounces (227 g)

Ordering Information

270-WQ101 Temperature Sensor, includes 25' cable
 270-WQEXC Extra Cable, over included cable length, up to 500'

The **270-WQ-COND Conductivity Sensors** are suitable for measuring conductivity in a wide variety of applications including laboratories, streams, rivers, and groundwater. The conductivity sensor's small size and rugged housing make it useful for hand held measurements or permanent installation.

Conductivity Range: 0 to 200 µS/cm, 200 to 2000 µS/cm, 2 to 20 mS/cm, 20 to 200 mS/cm, 200 to 2000 mS/cm
 Conductivity Resolution: 0.1 µS/cm, 1 µS/cm, 0.01 mS/cm, 0.1 mS/cm, 1 mS/cm
 Conductivity Accuracy: +0.5% of reading
 Temperature Range: 23 to 158°F (-5 to 70°C)
 Temperature Resolution: 0.02°F (0.01°C)
 Temperature Accuracy: +0.4°F (0.2°C)
 Temperature Compensation: automatic (2%/°C normalized to 25°C)
 Temperature Response: 99% in <20 seconds
 Output: Dual 4-20 mA (Conductivity and Temperature)
 Maximum Pressure: 35 psi (82 ft (25m))
 Immersion Depth: 1.4 inches (36 mm)
 Operating Voltage: 10-36 Vdc
 Current Draw: 20 mA plus sum of both sensor outputs
 Warm Up Time: 12 seconds minimum
 Operating Temperature: 23 to +158°F (-5 to +70°C)
 Storage Temperature: -4 to +212°F (-20 to +100°C)
 Dimensions: 0.86" diameter x 8" long (2.2 cm x 202 mm)
 Weight: 8 oz (227 g) plus cable

Ordering Information

270-WQ-COND Conductivity Sensor, includes 25' cable
 Specify conductivity sensor range when ordering
 270-WQEXC Extra Cable, over included cable length, up to 500'

The **270-WQ201 pH Sensor** is a rugged reliable water pH measuring device. The pH transmitter is mounted on 25' of marine grade cable, with lengths up to 500' available on request. The pH sensor output is 4-20 mA with a three wire configuration. The pH transmitter's electronics are completely encapsulated in marine grade epoxy within a stainless steel housing. The pH transmitter also uses a removable shield and replaceable pH sensor element for easy maintenance.



Output: 4-20 mA
 Range: 0-14 pH
 Accuracy: 2% of full scale
 Maximum pressure: 40 psi
 Operating voltage: 10-30 Vdc
 Current draw: 5.5 mA plus sensor output
 Warm-up time: 3 seconds minimum
 Operating temperature: 23 to +131°F (-5 to +55°C)
 Size of probe: 1-1/4" diameter x 10" long (3.2 cm x 25.4 cm)
 Weight: 1 lb (454 g)

Ordering Information

270-WQ201 pH Sensor, includes 25' cable
 270-WQEXC Extra Cable, over included cable length, up to 500'

The **270-WQ401 Dissolved Oxygen Sensor** is a rugged reliable water oxygen level measuring device. The dissolved oxygen sensors are attached to 25' of marine grade cable, with lengths up to 500' available upon request. The dissolved oxygen sensor output is 4-20 mA with a three wire configuration. The dissolved oxygen sensor's electronics are completely encapsulated in marine grade epoxy within a stainless steel housing. The dissolved oxygen sensor uses a removable shield and dissolved oxygen element for easy maintenance.



Output: 4-20 mA
 Range: 0-100% saturation, 0-8 ppm, temperature compensated to 25°C
 Accuracy: ± 0.5% of full scale
 Maximum pressure: 40 psi
 Operating voltage: 10-36 Vdc
 Current draw: 15.5 mA plus sensor output
 Warm-up time: 10 seconds minimum
 Operating temperature: -40 to +131°F (-40 to +55°C)
 Size of probe: 1-1/4" diameter x 11" long (3.2 cm x 27.9 cm)
 Weight: 1 lb
 Membrane: 0.001 FEP Teflon (standard)
 Combined error: 2% FS

Ordering Information

270-WQ401 Dissolved Oxygen Sensor, includes 25' cable
 270-WQEXC Extra Cable, over included cable length, up to 500'

270-WQ Water Quality Sensors

The **Model 270-WQ730 Turbidity Sensor** is a highly accurate submersible instrument for environmental or process monitoring. Applications include water quality testing and management, river monitoring, stream measurement, reservoir water quality testing, groundwater testing, water and wastewater treatment, and effluent and industrial control. In accordance with USEPA Method 180.1 for turbidity measurement, the turbidity sensor is a 90 degree scatter nephelometer. The sensor directs a focused beam into the monitored water. The light beam reflects off particles in the water and the resultant light intensity is measured by a photodetector positioned at 90 degrees to the light beam. The detected light intensity is directly proportional to the turbidity of the water. The turbidity sensor utilizes a second light detector to correct for light intensity variations, color changes, and minor lens fouling.

The **Model 270-WQ770-B Turbidity Meter** combines the turbidity sensor described above with a handheld meter that has a 6-digit LED screen, 4-button control panel, and an internal 9V battery. The handheld portable water meter can be used for environmental or process sites that do not require permanent monitoring. The meter will display readings directly in either nephelometric turbidity units (NTU) or parts per million (PPM). The meter also includes an automatic shutoff feature to conserve battery power.



Range:

Sensor 0-50 NTU and 0-1000 NTU

Meter 0-50 NTU or 0-1000 NTU selectable

Accuracy: $\pm 1\%$ of full scale

Meter Resolution: 12 bit

Output: 4-20mA (sensor, both ranges), LED screen (meter)

Method: Nephelometer with correction

Operating voltage: 10-36 Vdc @ 40 MS (sensor)

Internal 9Vdc battery (meter)

Current draw: 30 mA plus sensor output (sensor)

Warm-up time: 5 seconds minimum (sensor)

Operating temperature:

Sensor 14 to 122°F (-10 to +50°C)

Meter 32 to 122°F (0 to +50°C)

Materials: 306 stainless steel, delrin, polyurethane jacketed cable

Maximum pressure: 30 psi

Light source: Infrared LED, (880nm)

Cable length: Sensor=25' standard (optional to 500')

Size: Sensor= 1-1/2" dia x 8.5" long (3.8 cm x 21.6 cm)

Weight: 1 lb (454 g) (sensor); 2 lbs (907 g) (meter+sensor)

Ordering Information

270-WQ730	Turbidity Sensor, includes 25' cable
270-WQ770-B	Turbidity Meter, includes 10' cable
	Please specify 50 or 1,000 NTU setup at time of order.
270-WQEXC	Extra Cable, over included cable length, up to 500'

Note: The 270-WQ sensors are designed for fresh water use only.

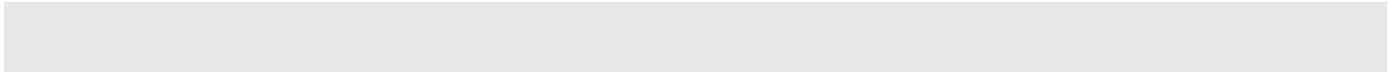

Towers & Lightning Protection

Tripod Towers	160
Aluminum Towers	160
Mounting Hardware & Accessories	161
Tower Lightning Protection.....	162
Sensor Line Lightning Protection	162

Tripod Towers

The tripod towers provided by NovaLynx are constructed of steel tubing for durability and strength. Five foot and ten foot heights are available. Horizontal bracing is a feature of the tripod towers. The tower's foot brackets can be bolted onto concrete foundations or onto wooden platforms for either permanent or temporary installation. Sensors may be clamped directly onto the tower legs or elevated above the tower using insertable masts. For stability, both tripod towers require that the mast be inserted into the two collar clamps. Guy kits are recommended for areas with high winds and for masts that extend above the tower by ten feet. Locations exposed to lightning require a grounding kit.

Ordering Information

190-505	3' Tripod
190-510	5' Tripod
190-520	10' Tripod

Aluminum Towers

NovaLynx provides free-standing towers with legs constructed of tubular aluminum in a triangle pattern. The equilateral triangle formed by the welded aluminum rod cross bracing produces the same superior strength as in steel towers, but with lighter weight for the same height. A nine foot long section with a tapered end is used as the top section of the stacked tower. This same tapered section may be used by itself to form a nine foot tower. Base plates are available for easy installation into concrete or onto roofs. Guy wires are normally required for roof mount tower. Heavy-duty versions of the aluminum towers are available for use in high winds. Other tower configurations are available. Contact NovaLynx for details.

Ordering Information

190-610	10' Aluminum Tower, tapered top, w/o base
190-611	30' Aluminum Stacked Tower, std duty, w/o base
190-612	30' Aluminum Stacked Tower, heavy duty, w/o base
190-618	Ground Mount, standard duty, base section 4' x 14" each side
190-619	Roof Mount, standard duty, base plate 14" each side
190-618-HD	Ground Mount, heavy duty, base section 4' poles, 3 each
190-619-HD	Roof Mount, heavy duty, base plate 18" each side



Weather Station with 5' Tripod



Weather Station with 10' Tower



Weather Station with 30' Tower

Mounting Hardware & Accessories

NovaLynx provides a variety of mounting hardware for sensor installations onto towers. Mounting hardware such as vertical masts and horizontal booms are furnished as optional equipment and are not included as part of tower model numbers. Special accessories for stacked towers such as safety climbs, work platforms, lights, and anti-climb devices are available when specified at the time of tower order. Grounding kits and guy kits are also sold as optional equipment for towers. Mounting stubs of various diameters are available to support the various types of sensors. NovaLynx can help you select the proper hardware to match the sensors being mounted on the tower.

Ordering Information

190-205	Tripod Guy Kit for 5' Tripod, without earth anchors
190-210	Tripod Guy Kit for 10' Tripod, without earth anchors
190-211	Earth Anchors for Tripod Guy Kit, 15" auger style, set of 3
190-212	Roof Anchors for Tripod Guy Kit, 5/8" x 14" eye-bolt and plates, set of 3
190-213	Heavy Duty Earth Anchor (one), 6" diameter x 48" long
190-221	Tower Guy Kit, for towers up to 30', ground mount
190-222	Tower Guy Kit, for towers up to 30', roof mount
190-302	Aluminum Sensor Mast, 3' swaged-type, 1.25" one end, 1.062" opposite end
190-310	Aluminum Sensor Mast, 5' x 1.34" o.d. threaded one end
190-311	Aluminum Sensor Mast, 5' x 1.66" o.d. threaded one end
190-312	Aluminum Sensor Mast, 5' swaged-type, 1.25" one end, 1.062" opposite end
190-320	Aluminum Sensor Mast, 10' x 1.34" o.d. threaded one end
190-321	Aluminum Sensor Mast, 10' x 1.66 o.d. threaded one end
190-322	Aluminum Sensor Mast, 10' swaged-type, 1.25" one end, 1.062" opposite end
190-330	Galvanized Sensor Mast, 5' x 1.34" o.d. threaded one end
190-331	Galvanized Sensor Mast, 5' x 1.66" o.d. threaded one end
190-340	Galvanized Sensor Mast, 10' x 1.34" o.d. threaded one end
190-341	Galvanized Sensor Mast, 10' x 1.66 o.d. threaded one end
190-350	Mast Adapter, reduces 1.34" o.d. mast to 0.84" o.d.
190-351	Mast Adapter, reduces 1.34" o.d. mast to 1.05" o.d.
190-410	6' Fixed Horizontal Boom, 2" square, galvanized
190-411	6' Retractable Horizontal Boom, 2" square
190-412	6' Fixed Horizontal Boom, 1-1/2" sq, galvanized
190-413	6' Fixed Horizontal Boom, 1-1/2" sq, galvanized, with mounting hardware for 240-150 Solar Rad Sensor
190-414	6' Fixed Horizontal Boom, 1-1/2" sq, galvanized, with mounting hardware for precip gauge
190-420	Mounting Stub, 0.084" o.d. x 6" stub
190-421	Mounting Stub, 1.05" o.d. x 6" stub
190-422	Mounting Stub, 1.34" o.d. x 6" stub
190-423	Mounting Stub, 1.66" o.d. x 6" stub

Tower Lightning Protection



Electrical surges due to lightning are common sources of sensor and data acquisition equipment failure. The lightning protection packages described below improve the likelihood of continued functioning of equipment exposed to frequent lightning storms, and these packages are highly recommended for systems in such locations. Protection against a direct lightning strike, of course, cannot be guaranteed.

Tower grounding kits use ground rods and copper cable or copper strips to conduct any electrical charges due to lightning directly to the ground. In the 190-121, a straight ground rod is mounted to the tower leg at the top of the tower. The 190-122 provides an angled rod, for use when wind sensors will be mounted on top of the tower. The 190-120 does not use a top-mounted ground rod, but uses 25 foot by 1-1/2" copper strips, clamps, and ground rods attached to each tower leg. The 190-110 is a low cost grounding kit designed for use with a tripod. Mounting hardware is included with each package. Ground cable must be ordered separately, except for the 190-110.

AC power lines to the junction box and to instruments on the tower are protected by the 350-1077 and 350-1077-A Secondary AC Power Surge Arrestors. When a surge occurs, these devices divert it to earth ground and immediately self-restore. The 350-1077 and 350-1077-A must be mounted in a junction box.

Sensor Line Lightning Protection

Sensor line surge arrestor packages protect the sensor signal lines and dedicated or switched telephone lines. Each package utilizes a two-stage transient suppressor. When a surge occurs, a zener diode clamps the voltage (24 Vdc) at a safe level and series resistors absorb the remainder of the voltage. A gas discharge tube is activated if the voltage is greater than 150 Vac. These components absorb the bulk of the transient and discharge it to earth ground. After the transient passes, the entire circuit recovers automatically. The 350-B380-24V protects four lines and the 350-B480-24V protects eight lines. Screw terminals are provided for input and output connections. These line arrestors are normally mounted in a junction box.

NovaLynx offers customized packaged units consisting of a junction box, surge board, ac protection, fused 115 Vac input/output circuits, ground rod, and ground cable. Consult the factory for a quotation.

Ordering Information

190-110	Tripod Grounding Kit; 1 ground rod, clamps, 5' wire #4AWG
190-120	Tower Grounding Kit; 1-1/2" copper strips, clamps, and ground rods attached to each tower leg
190-121	Tower Grounding Kit; includes 2 straight ground rods and mounting hardware. Requires 330-T605004 Ground Cable.
190-122	Tower Grounding Kit; includes 1 angled ground rod, 1 straight ground rod, and mounting hardware. Requires 330-T605004 Ground Cable.
330-T605000	Ground Cable, #4 copper, PVC jacket
330-T605004	Ground Cable, 2/0 bare copper, for use with tower lightning protection kits. Length should equal the height of the tower plus the distance to the ground rod.
330-T713018	Ground Rod, copper plated, 8 feet
350-1077	Secondary (Junction Box) AC Power Surge Arrestor, 115/230 Vac
350-1077-A	Secondary (Junction Box) AC Power Surge Arrestor, 220-277 Vac
350-B380-24V	Sensor Line Surge Protector, 4 lines
350-B480-24V	Sensor Line Surge Protector, 8 lines



350-B480-24V Sensor Line Surge Protector

Power Supplies

310-120 Series Rechargeable Batteries	164
Group 310 AC Power Supplies	165
Group 320 Solar Panel Battery Chargers	166

310-120 Series Rechargeable Batteries

The **310-120 Series Rechargeable Batteries** are non-spillable lead acid batteries. The unique construction and sealing techniques guarantee leakproof operation in any position with no adverse effect to capacity or service life. An electrolyte suspension system consisting of a high porosity, glass fiber material in conjunction with plates, totally absorbs and contains the electrolyte.

The 310-120 Series batteries have an expected life span of 3 to 5 years in float service applications. More than 1000 discharge/recharge cycles can be realized, dependent on the average depth of discharge. They have been designed to withstand occasional over discharge. While it is not recommended, 310-120 Series batteries can recover their full capacity under normal charging conditions, even when they have been subjected to extreme over discharge.

In normal float service, the gases generated inside the battery are continually recombined, and return to the water content of the electrolyte. Therefore, electrical capacity is not lost due to "drying up" of the electrolyte. Actually, through the gradual and very slow corrosion of the electrodes, the battery will eventually lose capacity and come to the end of service life. It should be noted that the corrosive process will be accelerated by high ambient operating temperatures and/or high charging voltage.

The 310-120 Series batteries can be operated in parallel for applications requiring more power. For custom power requirements, factory engineers can design a charging system that may include large capacity storage batteries.

Specifications

Nominal voltage: 12V

Nominal capacity:

310-120:

20 hr rate of 0.20A to 10.5V 4.0Ah

10 hr rate of 0.37A to 10.5V 3.7Ah

5 hr rate of 0.68A to 10.2V 3.4Ah

1 hr rate of 2.40A to 9.60V 2.4Ah

310-121:

20 hr rate of 0.6A to 10.50V 12.0Ah

10 hr rate of 1.1A to 10.50V 11.0Ah

5 hr rate of 2.1A to 10.20V 10.5Ah

1 hr rate of 7.2A to 9.60V 7.2Ah

310-122:

20 hr rate of 0.35A to 10.50V 7.0Ah

10 hr rate of 0.65A to 10.50V 6.5Ah

15 hr rate of 1.19A to 10.20V 5.95Ah

1 hr rate of 4.20A to 9.60V 4.2Ah

Weight (approx):

310-120: 3.74 lbs (1.7 kgs)

310-121: 8.82 lbs (4 kgs)

310-122: 6.17 lbs (2.64 kgs.)

Operating temperature range:

Charge: 5° to 122° F (-15° to 50° C)

Discharge: -4° to 140° F (-20° to 60° C)

Charge retention (shelf life) at 68° F (20° C):

1 month 97%, 3 months 91%, 6 months 85%

Life expectancy:

Standby use: 3 to 5 years

Cycle use (approx):

100% depth of discharge 250 cycles

50% depth of discharge 550 cycles

30% depth of discharge 1200 cycles

Sealed construction:

Can be operated in any position without leakage.

Housing material: ABS Resin

Ordering Information

310-120	Rechargeable Battery, 12 Volt 4 Amp Hour
310-122	Rechargeable Battery, 12 Volt 7 Amp Hour
310-121	Rechargeable Battery, 12 Volt 12 Amp Hour
310-126	Rechargeable Battery, 12 Volt 33 Amp Hour

Group 310 AC Power Supplies

NovaLynx offers a selection of AC power supplies including single, dual, and triple output models providing various levels of DC voltages required to power the NovaLynx signal conditioning boards, data loggers, and sensors. The wall mount models are chassis-mountable and will fit into the NovaLynx enclosures. The 310-144 can also be used as a float charger to trickle charge the 310-120 series batteries.

Specifications

310-144 Power Supply/AC Adapter/Float Charger

Used where 12 Vdc at less than 300mA is required

Input: 100-240 Vac

Output: 13.8 Vdc @ 300 mA (regulated)

Size: 2-1/8" x 2" x 1-7/8" (potted, plastic)

310-170 Power Supply Chassis

Used to power up to two 300 series LED meters

Input: 115 Vac or 220 Vac

Output: 5 Vdc @ 500 mA

Size: 2" x 2" x 4" (open frame, metal)

310-300 Isolation Transformer

Used where a 220 Vac source is stepped down to 115 Vac

Input: 220 Vac 50/60 Hz

Output: 115 Vac, 50 VA

Size: 3" x 2-1/2" x 2-1/2" (metal transformer, open)

Ordering Information

310-144	Power Supply/AC Adapter/Float Charger, 100-240 Vac, 13.8 Vdc
310-170	Power Supply Chassis, 115 Vac or 220 Vac, 5 Vdc
310-300	Isolation Transformer, 220 Vac 50/60 Hz, 115 Vac

Group 320 Solar Panel Battery Chargers

Meteorological instruments and systems are often located in remote areas to gather localized weather data. These remote areas may not have commercial grade power or the local power lines may not be accessible for use at the instrument site. To overcome this lack of power, most meteorological instruments and systems have been designed to operate from +12 volt batteries. Because batteries have a limited capacity, they need to be replaced with fully charged batteries on a regular schedule or battery charging must be provided at the remote site.

The **320 Series Solar Panels** use the sun's energy to recharge batteries. These panels feature regulator circuits designed to allow effective charging of the 310 series batteries. A charging regulator used with the solar panel prevents the batteries from being over-charged and from being charged at current levels that could damage the batteries. The regulator also prevents the battery power from being discharged back through the solar panel at night. The Model 320-600 Solar Panel, when used with a 7 AH battery, will typically provide continuous operation for a 60 to 80 mA load. For custom power requirements factory engineers can design a charging system which may include large capacity storage batteries.

All of the standard panels include 20' of cable, regulator, and mounting brackets. The mounting brackets are designed to mount on a 1.05" o.d. vertical pipe or pole and have provision to adjust the elevation angle.

Specifications

320-600 Solar Panel

Maximum output: 0.6 Amps (10 Watts)
 Regulated voltage output: 14.3 V
 Size: 14.1" x 13"
 Weight/shipping: 6 lbs/8 lbs

320-900 Solar Panel

Maximum output: 1.4 Amps (20 Watts)
 Regulated voltage output: 14.3 V
 Size: 23" x 14"
 Weight/shipping: 8 lbs/10 lbs

Note: Ratings at conditions of 1000 Wm² at 25°C

Ordering Information

320-600	Solar Panel, 600 mA, 12 Vdc
320-900	Solar Panel, 1.4 Amp, 12 Vdc
330-0220	Additional cable, 2 conductor, 20 AWG



320-600 Solar Panel

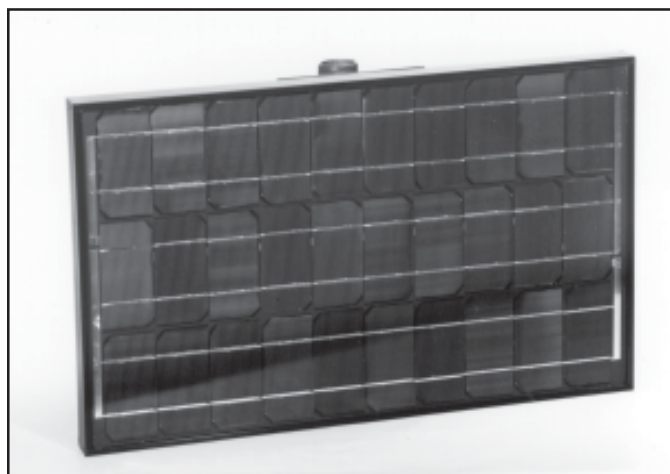

320-900 Solar Panel

Pens, Ink, Clocks, & Charts

Pens and Ink	168
Replacement Clocks	169
Chart Paper	170
Chart Paper	171
Chart Paper Examples	172

Pens and Ink

PENS

For Graphic Instruments

Model	Type	For
8810 (M666013)	V-point	All except Sigma and Skyline Series
50257	Cartridge, red	Sigma and Skyline Series
50258	Cartridge, violet	Sigma and Skyline Series
50259	Cartridge, blue	Sigma and Skyline Series
88101 (M666110)	Cartridge, blue	All except Sigma and Skyline Series
88102 (M666111)	Cartridge, red	All except Sigma and Skyline Series

For Strip Chart Recorders

Model	Type	For
87603 (M673051)	Electronic	8750, 8760, 8761
87611	Cartridge, red	8760-A, 8761-A
87612	Cartridge, green	8760-A
87613	Electronic	8760-A, 8761-A
87614	Electronic	8760-A
8811	Capillary	8700 Series
8816	Cartridge, red, long	4742, 8740
88161	Cartridge, blue, long	4742, 8740
8817	Cartridge, blue, short	4741, 4742, 8740, 8741
88171	Cartridge, red, short	4741, 4742, 8740, 8741
8818 (M674120)	Capillary (point only)	4730 Series, 8710 Series, 8730 Series
88103	Cartridge, red	8720, 8721, 8722, 8723
88104	Cartridge, green	8720, 8722, 8723
88105	Cartridge, blue	8722, 8723
88106	Cartridge, brown	8723
88108	Cartridge, red	4771, 8771
88112	Cartridge dotting wheel	4776, 8776
88116	Cartridge dotting wheel	8746
M671118	Cartridge dotting wheel	8736-A (6-point)
M671119	Cartridge dotting wheel	8736-B (12-point), 8736-C (24-point)

PEN & INK KITS

Model	For	Includes
87502	8751	5 cartridge pens, 1 syringe, 10 cc red ink
87505	8751	5 cartridge pens, 1 syringe, 10 cc green ink
87601 (M673050)	8750, 8760, 8761	5 cartridge pens, 1 syringe, 10 cc red ink
87602 (M673049)	8750, 8760, 8761	5 cartridge pens, 1 syringe, 10 cc green ink

INK

For Graphic Instruments

These small bottles fit inside the instrument case and are designed to fill V-point pens. The bottles can be refilled using the bulk ink below.

Model	Type	Color	Amount
8820 (M666124)	Medium dry	Blue	15 ml
8821 (M666123)	Medium dry	Red	15 ml

For Strip Chart Recorders

These small bottles are designed to fit inside the recorder case for convenient pen maintenance. Each recorder type utilizes a different bottle shape, as shown. These bottles can be refilled using the bulk ink below.

Model	Color	Amount
4730 Series and 8730 Series Recorders:		
8849	Black	3 bottles, 20 cc each
8850	Red	3 bottles, 20 cc each
8851	Blue	3 bottles, 20 cc each
8852	Green	3 bottles, 20 cc each
8711 Recorder and 1-Pen ET Recorders:		
8855 (M666128)	Red	1 bottle, 40 cc
8860 (M666127)	Black	1 bottle, 40 cc
8710 Recorder and 2-Pen ET Recorders:		
8856 (M666025)	Red	3 bottles, 20 cc each
8857 (M666035)	Black	3 bottles, 20 cc each
8858 (M666120)	Blue	3 bottles, 20 cc each
Dotting Recorders:		
8853 (M666027)	6 different	6 bottles, 20 cc each
8854 (M666028)	12 different	12 bottles, 20 cc each

Bulk Refill Ink

Model	Type	Color	Amount
88221 (M666107)	Fast dry	Red	1 pint
88222 (M666108)	Fast dry	Blue	1 pint
88223	Fast dry	Green	1 pint
88224	Fast dry	Black	1 pint
88231 (M666105)	Medium dry	Red	1 pint
88232 (M666106)	Medium dry	Blue	1 pint
88233	Medium dry	Green	1 pint
88234	Medium dry	Black	1 pint

Replacement Clocks

CLOCKS

The graphic recording instruments in this catalog feature a new model clock. The rotation period of these clocks can be set at 1 day, 7 days, or 31 days. The desired period is selected by means of a switch on the top of the clock. The switch changes the pulse rate of an electronic circuit inside. These clocks are all battery-operated, requiring two AA batteries.

Clock Model No.	Type	Drum Rotation	Drum Diameter	Drum Height	For Instrument Model No.
8825-A	Battery-operated	26/176 hours/31 days	4.32"	6.32"	4010, 4010-A, 4011, 4012, 4012-A, 4013, 4014, 4014-A, T601
8826-A	Battery-operated	26/176 hours/31 days	4.0"	5.06"	6113, 6113-A, 6114, 6115, P521, 6710, 6711, 6712, 6713, 6714
8827-A	Battery-operated	26/176 hours/31 days	3.66"	7.25"	4130, 4131, 5005, 5005-A, 5006, 5007, 5020, 5020-A, 5021, 5022, 5023, 5024, 5025, H302, 6505, 6845-A, 6845-B, 6848, 6848-A, 7010, 7010-A, 7011, 7012, 7013, 7014
8828-A	Battery-operated	26/176 hours/31 days	3.66"	3.75"	3008, 3009, 3010, 3010-A, 3011, 4110, 4110-A, 4111, 4112, 4112-A, 4113, 4114, 4115, T610, 5030, 5030-A, 5031, 5032, 5033, 5035, H324, 6810, 6810-A, 6811, 6812, 6813, 7020, 7020-A, 7021, 7022, 7023, 7025, 7026, B231
8829-A	Battery-operated	26/176 hours/31 days	3.66"	10.44"	4030, 4030-A, 4031, 4032, 4032-A, 4033, 4034, 4035, 4036, 4037, 5010, 5010-A, 5011, 5012, 5013, 5014
8830-A	Battery-operated	26/176 hours/31 days	3.66"	5.06"	6507, 6508, 6509, 6510, 6510-A, 6511, 6512, 6513, 6513-A, 6514, 6760, 6761
8840-A	Battery-operated	26/176 hours/31 days	3.66"	7.032"	4020, 4020-A, 4021, 4022, 4022-A, 4023, 4024, 4025

Limited numbers of the older clocks are still available. These clocks feature rotation periods of either [1 day/7 days] or [31 days]. Selection of the daily or weekly period is accomplished by a change gear. Spring-wound or battery-operated mechanisms may be available. Replacement clocks are available for discontinued as well as active graphic recording instruments. Consult NovaLynx for more information.

Chart Paper

For Graphic Instruments

Model	Instrument Description	Chart Part No.	WeatherMeasure Model No.	Chart Range	Recording Period
3008	Pyranograph	M699170	C401-D	0 to 2.5 ly/min	24 hours
R401		M699171	C401-W	0 to 2.5 ly/min	168 hours
5005	Meteorograph	50051		-20 to 50°C, 0-100%, 940-1045 mb	176 hours
		50052		-10 to 120°C, 0-100%, 940-1045 mb	176 hours
		50053		-10 to 120°C, 0-100%, 27.9-31" Hg	176 hours
		50054		-20 to 50°C, 0-100%, 705-785 mm Hg	176 hours
		50055		-20 to 50°C, 0-100%, 940-1045 mb	26 hours
		50056		-10 to 120°F, 0-100%, 940-1045 mb	26 hours
		50057		-10 to 120°F, 0-100%, 27.9-31" Hg	26 hours
		50058		-20 to 50°C, 0-100%, 705-785 mm Hg	26 hours
		50059		-20 to 50°C, 0-100%, 940-1045 mb	31 days
		50060		-10 to 120°F, 0-100%, 940-1045 mb	31 days
		50061		-10 to 120°F, 0-100%, 27.9-31" Hg	31 days
		50062		-20 to 50°C, 0-100%, 705-785 mm Hg	31 days
5013	Meteorograph	M699083	C701-W-MB-HF	10 to 120°F, 0-100%, 945-1045 mb	168 hours
		M699087	C701-W-MB-HC	-10 to 50°C, 0-100%, 945-1045 mb	168 hours
		M699089	C701-W-HG-LF	-30 to 80°F, 0-100%, 27.9-31" Hg	168 hours
		M699091	C701-W-HG-HF	10-120°F, 0-100%, 27.9-31" Hg	168 hours
5023	Hygrothermograph	M699121	C311-D-C	-20 to 40°C, 0-100%	24 hours
		M699123	C311-D-HF	10 to 120°F, 0-100%	24 hours
		M699124	C311-W-HF	10 to 120°F, 0-100%	168 hours
		M699125	C311-D-WF	-30 to 80°F, 0-100%	24 hours
		M699126	C311-W-LF	-30 to 80°F, 0-100%	168 hours
		M699130	C311-W-CX	-15 to 45°C, 0-100%	168 hours
5025	Sigma Hygrothermograph	50251 (M699113)	C302-W-HC	0 to 55°C, 0-100%	176 hours
H302	Skyline Hygrothermograph	50252 (M699117)	C302-W-HF	20 to 120°F, 0-100%	176 hours
		50253 (M699115)	C302-W-LF	-40 to 60°F, 0-100%	176 hours
P521	Event Recorder	M699190	C501-D	0-50 events	24 hours
		M699191	C501-W	0-50 events	168 hours
		M699192	C501-M	0-50 events	31 days
7013	Microbarograph	M699061	C211-W-HG	27.9-31" Hg	168 hours
		M699063	C211-W-MB	945-1045 mb	168 hours
7022	Barographs	M699050	C201-W-MB	945-1045 mb	31 days
B201		M699051	C201-W-HG	27.9 to 31" Hg	168 hours

Chart Paper

For Strip Chart Recorders

Model	Instrument Description	Chart Number	Range
2350	Recording Wind System	23501	0-50/0-100 mph or m/s
		23502	0-360°
W224	Recording Wind System	Call NovaLynx	
W225	Recording Wind System	Call NovaLynx	
E- & F-Series	Recording wind System	87003	0-50/0-100, 0-540°
		87004	0-25/0-50, 0-540°
		87005	0-100/0-200, 0-540°
4740	Temperature Recorder	Call NovaLynx	
4770	Temperature Recorder	Call NovaLynx	
5410	Temp/RH Recorder	Call NovaLynx	
8342	Visibility Recorder	Call NovaLynx	
8700	2-Pen Galvanometric Recorder	Call NovaLynx	
8703	Recorder	Call NovaLynx	
8701	1-Pen Galvanometric Recorder	Call NovaLynx	
8702	Recorder	Call NovaLynx	
8710	2-Pen Wide-Bed Recorder	23301	0-50/0-100, 0-540°
EW-12V/12V	(Millivolt Input)	23302 (M699498)	0-100, 0-360°
		M699497	0-100, 0-540°
8711	1-Pen or Multipoint Wide-Bed Recorder	Call NovaLynx	
8716	Wide-Bed Recorder	Call NovaLynx	
EW-12V	(Millivolt or Thermocouple Input)	Call NovaLynx	
8720	2-Pen Wide-Bed Recorder	Call NovaLynx	
8721	1-Pen or Multipoint Wide-Bed Recorder	Call NovaLynx	
8726	Wide-Bed Recorder	Call NovaLynx	
8722	3-Pen Wide-Bed Recorder	Call NovaLynx	
8723	4-Pen Wide-Bed Recorder	Call NovaLynx	
8750	1-Pen or 2-Pen Field Recorder	Call NovaLynx	
8751	Recorder	Call NovaLynx	
8771	1-Pen or Multipoint Small Recorder	Call NovaLynx	
8776	Small Recorder	Call NovaLynx	
EW-2200	1-Pen or Multipoint Wide-Bed Recorder (Platinum Resistance Input)	Call NovaLynx	
ET-12V	1-pen or Multipoint Recorder (Millivolt or Thermocouple Input)	Call NovaLynx	
ET-2200	1-Pen or Multipoint Recorder (Platinum Resistance Input)	Call NovaLynx	

Note: The chart numbers in parentheses are no longer active. Use the alternate numbers for ordering.

For Strip Chart Graphic Instruments

Model	Instrument Description	Chart Number
5027	Strip Chart Hygrothermograph	Call NovaLynx
6120	Long-term Event Recorder	Call NovaLynx
6515	Water Level Recorder	Call NovaLynx
6516	Water Level Recorder	Call NovaLynx
6517	Water Level Recorder	Call NovaLynx
65225	Water Level Recorder	Call NovaLynx
6560	Water Level Recorder	Call NovaLynx
6575	Water Level Recorder	Call NovaLynx
6610	Water Current Recorder	Call NovaLynx
7030	Long-term Microbarograph	Call NovaLynx

Chart Paper Examples

Monthly

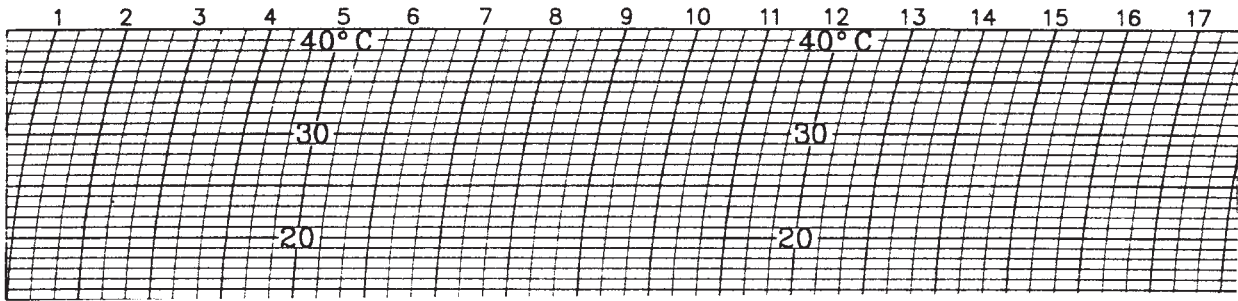

Weekly

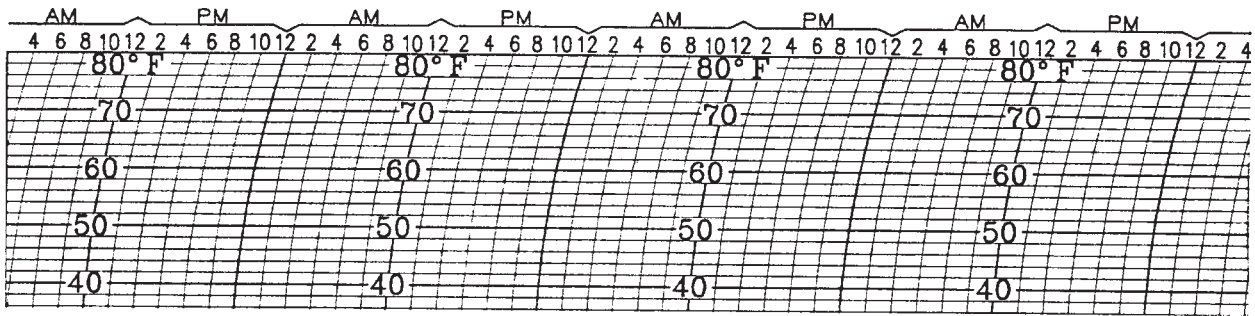

Daily

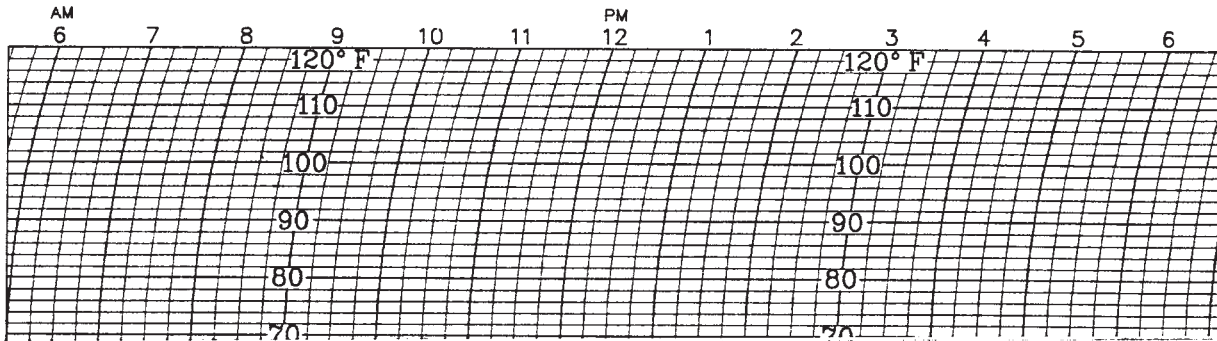

Reference

Conversion Factors	174
Wind Conversion Table	175
Temperature Conversion Table	176
Relative Humidity Table	177
Pressure Conversion Table	178
Glossary of Meteorological Terms	179

Conversion Factors

CONVERSION FACTORS

atmospheres \times 29.92 = inches of mercury at 0°C
 atmospheres \times 1013.25 = millibars
 atmospheres \times 760 = millimeters of mercury at 0°C
 atmospheres \times 14.7 = pounds/square inch

BTU/foot² min. \times 1.134 = joules/centimeter² min.
 BTU/foot² min. \times 0.271 = langley/min.
 BTU/foot² min. \times 189 = watts/meter²

cubic feet/sec. \times 0.02832 = cubic meters/sec.
 cubic feet/sec. \times 0.6463 = million gallons/day

feet/sec. \times 1.097 = kilometers/hour
 feet/sec. \times 0.592 = knots
 feet/sec. \times 0.305 = meters/sec.
 feet/sec. \times 0.682 = miles/hour

footcandles (lumens/square foot) \times 10.764 =
 lux (lumens/square meter)

inches of mercury \times 33.864 = millibars
 inches of mercury \times 25.4 = millimeters of mercury
 inches of mercury \times 3.3864 = kilopascals
 inches of mercury \times 0.4912 = pounds/square inch
 inches of mercury \times 0.03342 = standard atmospheres

joules/centimeter² min. \times 0.8821 = BTU/foot² min.
 joules/centimeter² min. \times 0.2389 = langley/min.
 joules/centimeter² min. \times 166.66 = watts/meter²

kilometers/hour \times 0.911 = feet/sec.
 kilometers/hour \times 0.540 = knots
 kilometers/hour \times 0.278 = meters/sec.
 kilometers/hour \times 0.621 = miles/hour

kilopascals \times 0.2953 = inches of mercury at 0°C
 kilopascals \times 10 = millibars
 kilopascals \times 7.50075 = millimeters of mercury at 0°C
 kilopascals \times 0.1450 = pounds/square inch

knots \times 1.689 = feet/sec.
 knots \times 1.853 = kilometers/hour
 knots \times 0.515 = meters/sec.
 knots \times 1.152 = miles/hour

langley/min. \times 697.32 = watts/meter²
 langley/min. \times 4.1855 = joules/centimeter² min.
 langley/min. \times 3.692 = BTU/foot² min.

lumens/square foot (footcandles) \times 10.764 =
 lumens/square meter (lux)
 lumens/square meter (lux) \times 0.0929 =
 lumens/square foot (footcandles)

meters/sec. \times 3.281 = feet/sec.
 meters/sec. \times 3.600 = kilometers/hour
 meters/sec. \times 1.943 = knots
 meters/sec. \times 2.237 = miles/hour

miles/hour \times 1.467 = feet/sec.
 miles/hour \times 1.609 = kilometers/hour
 miles/hour \times 0.868 = knots
 miles/hour \times 0.447 = meters/sec.

millibars \times 0.02953 = inches of mercury
 millibars \times 0.0010197 = kilograms/centimeter²
 millibars \times 0.100 = kilopascals
 millibars \times 0.7500616 = millimeters of mercury
 millibars \times 0.014504 = pounds/square inch
 millibars \times 0.0009869 = standard atmospheres

millimeters of mercury \times 0.03937 = inches of mercury
 millimeters of mercury \times 0.13332 = kilopascals
 millimeters of mercury \times 1.33322 = millibars
 millimeters of mercury \times 0.01934 = pounds/square inch
 millimeters of mercury \times 0.001316 = standard
 atmospheres

million gallons/day \times 1.54723 = cubic feet/second

watts/meter² \times 0.00529 = BTU/foot² min.
 watts/meter² \times 0.006 = joules/centimeter² min.
 watts/meter² \times 0.00143 = langley/min.

Wind Conversion Table

Miles per Hour	Knots	Meters per Second	Feet per Second	Kilometers per Hour	Feet per Minute	Miles per Hour	Knots	Meters per Second	Feet per Second	Kilometers per Hour	Feet per Minute
1	0.9	0.4	1.5	1.6	88	51	44.3	22.8	74.8	82.1	4488
2	1.7	0.9	2.9	3.2	176	52	45.2	23.2	76.3	83.7	4576
3	2.6	1.3	4.4	4.8	264	53	46.0	23.7	77.7	85.3	4664
4	3.5	1.8	5.9	6.4	352	54	46.9	24.1	79.2	86.9	4752
5	4.3	2.2	7.3	8.0	440	55	47.8	24.6	80.7	88.5	4840
6	5.2	2.7	8.8	9.7	528	56	48.6	25.0	82.1	90.1	4928
7	6.1	3.1	10.3	11.3	616	57	49.5	25.5	83.6	91.7	5016
8	6.9	3.6	11.7	12.9	704	58	50.4	25.9	85.1	93.3	5104
9	7.8	4.0	13.2	14.5	792	59	51.2	26.4	86.5	95.0	5192
10	8.7	4.5	14.7	16.1	880	60	52.1	26.8	88.0	96.6	5280
11	9.6	4.9	16.1	17.7	968	61	53.0	27.3	89.5	98.2	5368
12	10.4	5.4	17.6	19.3	1056	62	53.8	27.7	90.0	99.8	5456
13	11.3	5.8	19.1	20.9	1144	63	54.7	28.2	92.4	101.4	5544
14	12.2	6.3	20.5	22.5	1232	64	55.6	28.6	93.9	103.0	5632
15	13.0	6.7	22.0	24.1	1320	65	56.4	29.1	95.3	104.6	5720
16	13.9	7.2	23.5	25.7	1408	66	57.3	29.5	96.8	106.2	5808
17	14.8	7.6	24.9	27.4	1496	67	58.2	30.0	98.3	107.8	5896
18	15.6	8.0	26.4	29.0	1584	68	59.1	30.4	99.7	109.4	5984
19	16.5	8.5	27.9	30.6	1672	69	59.9	30.8	101.2	111.0	6072
20	17.4	8.9	29.3	32.2	1760	70	60.8	31.3	102.7	112.7	6160
21	18.2	9.4	30.8	33.8	1848	71	61.7	31.7	104.1	114.3	6248
22	19.1	9.8	32.3	35.4	1936	72	62.5	32.2	105.6	115.9	6336
23	20.0	10.3	33.7	37.0	2024	73	63.4	32.6	107.1	117.5	6424
24	20.8	10.7	35.2	38.6	2112	74	64.3	33.1	108.5	119.1	6512
25	21.7	11.2	36.7	40.2	2200	75	65.1	33.5	110.0	120.7	6600
26	22.6	11.6	38.1	41.8	2288	76	66.0	34.0	111.5	122.3	6688
27	23.4	12.1	39.6	43.5	2376	77	66.9	34.4	112.9	123.9	6776
28	24.3	12.5	41.1	45.1	2464	78	67.7	34.9	114.4	125.5	6864
29	25.2	13.0	42.5	46.7	2552	79	68.6	35.3	115.9	127.1	6952
30	26.1	13.4	44.0	48.3	2640	80	69.5	35.8	117.3	128.7	7040
31	26.9	13.9	45.5	49.9	2728	81	70.3	36.2	118.8	130.4	7128
32	27.8	14.3	46.9	51.5	2816	82	71.2	36.7	120.3	132.0	7216
33	28.7	14.8	48.4	53.1	2904	83	72.1	37.1	121.7	133.6	7304
34	29.5	15.2	49.9	54.7	2992	84	72.9	37.6	123.2	135.2	7392
35	30.4	15.6	51.3	56.3	3080	85	73.8	38.0	124.7	136.8	7480
36	31.3	16.1	52.8	57.9	3168	86	74.7	38.4	126.1	138.4	7568
37	32.1	16.5	54.3	59.5	3256	87	75.5	38.9	127.6	140.0	7656
38	33.0	17.0	55.7	61.2	3344	88	76.4	39.3	129.1	141.6	7744
39	33.9	17.4	57.2	62.8	3432	89	77.3	39.8	130.5	143.2	7832
40	34.7	17.9	58.7	64.4	3520	90	78.2	40.2	132.0	144.8	7920
41	35.6	18.3	60.1	66.0	3608	91	79.0	40.7	133.5	146.5	8008
42	36.5	18.8	61.6	67.6	3696	92	79.9	41.1	134.9	148.1	8096
43	37.3	19.2	63.1	69.2	3784	93	80.8	41.6	136.4	149.7	8184
44	38.2	19.7	64.5	70.8	3872	94	81.6	42.0	137.9	151.3	8272
45	39.1	20.1	66.0	72.4	3960	95	82.5	42.5	139.3	152.9	8360
46	39.9	20.6	67.5	74.0	4048	96	83.4	42.9	140.8	154.5	8448
47	40.8	21.0	68.9	75.6	4136	97	84.2	43.4	142.3	156.1	8536
48	41.7	21.5	70.4	77.2	4224	98	85.1	43.8	143.7	157.7	8624
49	42.6	21.9	71.9	78.9	4312	99	86.0	44.3	145.2	159.3	8712
50	43.4	22.4	73.3	80.5	4400	100	86.8	44.7	146.7	160.9	8800

taken from Smithsonian Meteorological Tables

Temperature Conversion Table

Conversion Formulas:

$$t_C = \frac{5}{9} (t_F - 32) \quad t_F = 1.8 t_C + 32$$

°Celsius	°Fahrenheit	°Celsius	°Fahrenheit	°Celsius	°Fahrenheit	°Celsius	°Fahrenheit
-50°	-58.0°	-10°	14.0°	26°	78.8°	66°	150.8°
-49	-56.2	-9	15.8	27	80.6	67	152.6
-48	-54.4	-8	17.6	28	82.4	68	154.4
-47	-52.6	-7	19.4	29	84.2	69	156.2
-46	-50.8	-6	21.2	30	86.0	70	158.0
-45	-49.0	-5	23.0	31	87.8	71	159.8
-44	-47.2	-4	24.8	32	89.6	72	161.6
-43	-45.4	-3	26.6	33	91.4	73	163.4
-42	-43.6	-2	28.4	34	93.2	74	165.2
-41	-41.8	-1	30.2	35	95.0	75	167.0
-40	-40.0	FREEZING POINT OF WATER		36	96.8	76	168.8
-39	-38.2	0	32.0	37	98.6	77	170.6
-38	-36.4	+1	33.8	38	100.4	78	172.4
-37	-34.6	2	35.6	39	102.2	79	174.2
-36	-32.8	3	37.4	40	104.0	80	176.0
-35	-31.0	4	39.2	41	105.8	81	177.8
-34	-29.2	5	41.0	42	107.6	82	179.6
-33	-27.4	6	42.8	43	109.4	83	181.4
-32	-25.6	7	44.6	44	111.2	84	183.2
-31	-23.8	8	46.4	45	113.0	85	185.0
-30	-22.0	9	48.2	46	114.8	86	186.8
-29	-20.2	10	50.0	47	116.6	87	188.6
-28	-18.4	11	51.8	48	118.4	88	190.4
-27	-16.6	12	53.6	49	120.2	89	192.2
-26	-14.8	13	55.4	50	122.0	90	194.0
-25	-13.0	14	57.2	51	123.8	91	195.8
-24	-11.2	15	59.0	52	125.6	92	197.6
-23	-9.4	16	60.8	53	127.4	93	199.4
-22	-7.6	17	62.6	54	129.2	94	201.2
-21	-5.8	18	64.4	55	131.0	95	203.0
-20	-4.0	19	66.2	56	132.8	96	204.8
-19	-2.2	20	68.0	57	134.6	97	206.6
-18	-0.4	21	69.8	58	136.4	98	208.4
-17	+1.4	22	71.6	59	138.2	99	210.2
-16	3.2	23	73.4	60	140.0	BOILING POINT OF WATER	
-15	5.0	24	75.2	61	141.8	100	212.0
-14	6.8	25	77.0	62	143.6		
-13	8.6			63	145.4		
-12	10.4			64	147.2		
-11	12.2			65	149.0		

Relative Humidity Table

RELATIVE HUMIDITY

DERIVED FROM WET-BULB AND DRY-BULB TEMPERATURES (°C)

t C°	t-t ¹														
	0.2	0.4	0.6	0.8	1.0	1.2	1.4	1.6	1.8	2.0	2.2	2.4	2.6	2.8	3.0
-10	93	87	80	74	67	61	54	48	41	35	28	22	16	9	3.0
-9	94	88	81	75	69	63	57	51	45	39	33	27	21	15	9
-8	94	88	83	77	71	65	60	54	48	43	37	32	26	20	15
-7	95	89	84	78	73	67	62	57	52	46	41	36	31	25	20
-6	95	90	85	79	74	69	64	59	54	49	45	40	35	30	25
-5	95	90	86	81	76	71	66	62	57	52	48	43	39	34	29
-4	95	91	86	82	77	73	68	64	59	55	51	46	42	38	33
-3	96	91	87	82	78	74	70	66	62	57	53	49	45	41	37
-1	96	92	88	84	81	77	73	69	66	62	58	54	51	47	43
0	96	93	89	85	81	78	74	71	67	64	60	57	53	50	46
1	97	93	90	86	83	80	76	73	70	66	63	59	56	53	49
2	97	93	90	87	84	81	78	74	71	68	65	62	59	55	52
3	97	94	91	88	84	82	78	76	72	70	67	64	61	58	55
4	97	94	91	88	85	82	79	77	74	71	68	65	62	60	57
5	97	94	91	88	86	83	80	77	75	72	69	67	64	61	58
6	97	94	92	89	86	84	81	78	76	73	70	68	65	63	60
7	97	95	92	89	87	84	82	79	77	74	72	69	67	64	62
8	97	95	92	90	87	85	82	80	77	75	73	70	68	65	63
9	98	95	93	90	88	85	83	81	78	76	74	71	69	67	64
10	98	95	93	90	88	86	83	81	79	77	74	72	70	68	66
11	98	95	93	91	89	86	84	82	80	78	75	73	71	69	67
12	98	96	93	91	89	87	85	82	80	78	76	74	72	70	68
13	98	96	93	91	89	87	85	83	81	79	77	75	73	71	69
14	98	96	94	92	90	88	86	84	82	79	78	76	74	72	70
15	98	96	94	92	90	88	86	84	82	80	78	76	74	73	71

t = dry-bulb temperature
t¹ = wet-bulb temperature
t - t¹ = wet-bulb depression

C°	% Relative Humidity														
	0.5	1.0	1.5	2.0	2.5	3.0	3.5	4.0	4.5	5.0	5.5	6.0	6.5	7.0	7.5
16	95	90	85	81	76	71	67	63	58	54	50	46	42	38	34
17	95	90	86	81	76	72	68	64	60	55	51	47	43	40	36
18	95	91	86	82	77	73	69	65	61	57	53	49	45	41	38
19	95	91	87	82	78	74	70	65	62	58	54	50	46	43	39
20	96	91	87	83	78	74	70	66	63	59	55	51	48	44	41
21	96	91	87	83	79	75	71	67	64	60	56	53	49	46	42
22	96	92	87	83	80	76	72	68	64	61	57	54	50	47	44
23	96	92	88	84	80	76	72	69	65	62	58	55	52	48	45
24	96	92	88	84	80	77	73	69	66	62	59	56	53	49	46
25	96	92	88	84	81	77	74	70	67	63	60	57	54	50	47
26	96	92	88	85	81	78	74	71	67	64	61	58	54	51	49
27	96	92	89	85	82	78	75	71	68	65	62	58	56	52	50
28	96	93	89	85	82	78	75	72	69	65	62	59	56	53	51
29	96	93	89	86	82	79	76	72	69	66	63	60	57	54	52
30	96	93	89	86	83	79	76	73	70	67	64	61	58	55	52
31	96	93	90	86	83	80	77	73	70	67	64	61	59	56	53
32	96	93	90	86	83	80	77	74	71	68	65	62	60	57	54
33	97	93	90	87	83	80	77	74	71	68	66	63	60	57	55
34	97	93	90	87	84	81	78	75	72	69	66	63	61	58	56
35	97	94	90	87	84	81	78	75	72	69	67	64	61	59	56
36	97	94	90	87	84	81	78	75	73	70	67	64	62	59	57
37	97	94	91	87	84	82	79	76	73	70	68	65	63	60	58
38	97	94	91	88	84	82	79	76	74	71	68	66	63	61	58
39	97	94	91	88	85	82	79	77	74	71	69	66	64	61	59
40	97	94	91	88	85	82	80	77	74	72	69	67	64	62	59

Condensed from Bulletin of the U.S. Weather Bureau No. 1071

Pressure Conversion Table

Millibars	In. Hg	mm Hg	Millibars	In. Hg	mm Hg	Millibars	In. Hg	mm Hg
900	26.577	675.06	950	28.053	712.56	1000	29.530	750.06
901	26.607	675.81	951	28.083	713.31	1001	29.560	750.81
902	26.636	676.56	952	28.113	714.06	1002	29.589	751.56
903	26.666	677.31	953	28.142	714.81	1003	29.619	752.31
904	26.695	678.06	954	28.172	715.56	1004	29.648	753.06
905	26.725	678.81	955	28.201	716.31	1005	29.678	753.81
906	26.754	679.56	956	28.231	717.06	1006	29.707	754.56
907	26.784	680.31	957	28.260	717.81	1007	29.737	755.31
908	26.813	681.06	958	28.290	718.56	1008	29.766	756.06
909	26.843	681.81	959	28.319	719.31	1009	29.796	756.81
910	26.872	682.56	960	28.349	720.06	1010	29.825	757.56
911	26.902	683.31	961	28.378	720.81	1011	29.855	758.31
912	26.931	684.06	962	28.408	721.56	1012	29.884	759.06
913	26.961	684.81	963	28.437	722.31	1013	29.914	759.81
914	26.990	685.56	964	28.467	723.06	1014	29.943	760.56
915	27.020	686.31	965	28.496	723.81	1015	29.973	761.31
916	27.049	687.06	966	28.526	724.56	1016	30.002	762.06
917	27.079	687.81	967	28.555	725.31	1017	30.032	762.81
918	27.109	688.56	968	28.585	726.06	1018	30.062	763.56
919	27.138	689.31	969	28.615	726.81	1019	30.091	764.31
920	27.168	690.06	970	28.644	727.56	1020	30.121	765.06
921	27.197	690.81	971	28.674	728.31	1021	30.150	765.81
922	27.227	691.56	972	28.703	729.06	1022	30.180	766.56
923	27.256	692.31	973	28.733	729.81	1023	30.209	767.31
924	27.286	693.06	974	28.762	730.56	1024	30.239	768.06
925	27.315	693.81	975	28.792	731.31	1025	30.268	768.81
926	27.345	694.56	976	28.821	732.06	1026	30.298	769.56
927	27.374	695.31	977	28.851	732.81	1027	30.327	770.31
928	27.404	696.06	978	28.880	733.56	1028	30.357	771.06
929	27.433	696.81	979	28.910	734.31	1029	30.386	771.81
930	27.463	697.56	980	28.939	735.06	1030	30.416	772.56
931	27.492	698.31	981	28.969	735.81	1031	30.445	773.31
932	27.522	699.06	982	28.998	736.56	1032	30.475	774.06
933	27.551	699.81	983	29.028	737.31	1033	30.504	774.81
934	27.581	700.56	984	29.058	738.06	1034	30.534	775.56
935	27.611	701.31	985	29.087	738.81	1035	30.564	776.31
936	27.640	702.06	986	29.117	739.56	1036	30.593	777.06
937	27.670	702.81	987	29.146	740.31	1037	30.623	777.81
938	27.699	703.56	988	29.176	741.06	1038	30.652	778.56
939	27.729	704.31	989	29.205	741.81	1039	30.682	779.31
940	27.758	705.06	990	29.235	742.56	1040	30.711	780.06
941	27.788	705.81	991	29.264	743.31	1041	30.741	780.81
942	27.817	706.56	992	29.294	744.06	1042	30.770	781.56
943	27.847	707.31	993	29.323	744.81	1043	30.800	782.31
944	27.876	708.06	994	29.353	745.56	1044	30.829	783.06
945	27.906	708.81	995	29.382	746.31	1045	30.859	783.81
946	27.935	709.56	996	29.412	747.06	1046	30.888	784.56
947	27.965	710.31	997	29.441	747.81	1047	30.918	785.31
948	27.994	711.06	998	29.471	748.56	1048	30.947	786.06
949	28.024	711.81	999	29.500	749.31	1049	30.977	786.81
						1050	31.006	787.56

Glossary of Meteorological Terms

A

Absolute humidity: In a system of moist air, the ratio of the mass of water vapor to the total volume of the system. Usually expressed as grams per cubic meter (g/m^3).

Absolute instrument: An instrument whose calibration can be determined by means of simple physical measurements on the instrument. Compare to secondary instrument.

Absolute temperature: Temperature based on an absolute scale.

Absolute temperature scale: A temperature scale based on absolute zero. See Kelvin temperature scale.

Absolute zero: A hypothetical temperature characterized by a complete absence of heat and defined as 0°K , -273.15°C , or -459.67°F .

Absorption: The process in which incident radiation is retained by a substance. A further process always results from absorption.

Absorption hygrometer: A type of hygrometer which measures the water vapor content of the atmosphere by means of the absorption of vapor by a hygroscopic chemical.

Accretion: Growth of a cloud or precipitation particle by the collision and union of a frozen particle with a super-cooled water drop.

Accuracy: The degree of conformity of an indicated value to an accepted standard value, or ideal value. See accuracy rating, measured accuracy.

Accuracy rating: A number of quantity defining a limit that errors will not exceed when a device is used under specified operating conditions. Accuracy rating can be expressed in a number of forms, i.e. in terms of the measured variable ($\pm 1^\circ\text{C}$), percent of span ($\pm 0.5\%$ of span), percent of upper range value ($\pm 0.5\%$ of upper range value F.S.), percent of scale length ($\pm 0.5\%$ of scale length), or percent of actual output reading ($\pm 1\%$ of actual output reading).

Acid rain: Precipitation that carries to earth sulfuric and nitric acid accumulated from air pollutants.

Acre-foot: The volume of water required to cover one acre to a depth of one foot; 43,560 cubic feet.

Actinograph: A recording actinometer.

Actinometer: An instrument which measures the intensity of radiation by determining the amount of chemical change or fluorescence produced by that radiation.

Actual pressure: The atmospheric pressure at the level of the barometer. May or may not be the same as station pressure.

Adfreezing: The process by which one object becomes adhered to another by the binding action of ice.

Adiabatic process: A thermodynamic change of state in a system in which there is no transfer of heat or mass across the boundaries of the system. In an adiabatic process, compression always results in warming, expansion in cooling. Compare to diabatic process.

Aeolian: Pertaining to the action or effect of the wind.

Derived from the name of the Greek god of the winds, Aeolus.

Aeolian anemometer: An anemometer utilizing the principle that the pitch of the aeolian tones generated by air moving past an obstacle is a function of the speed of the air. Largely a curiosity and has been put to no practical application in modern meteorology.

Aerial: Of or pertaining to the air, atmosphere, or aviation. Also, same as antenna.

Aerograph: In general, any self-recording instrument carried aloft by any means to obtain meteorological data.

Aerometeorograph: A self-recording instrument used on aircraft for the simultaneous recording of atmospheric pressure, temperature, and humidity.

AFOS: Automation of Field Operations and Services. A communication system developed in the 1970s by the National Weather Service which utilized minicomputers, video displays, and high-speed communications to replace teletype and facsimile machines. It was replaced by AWIPS in the 1990s.

Air current: Very generally, any moving stream of air. It has no particular technical connotation.

Air density: The mass density of a parcel of air expressed in units of mass per volume.

Airlight formula: See Koschmieder's law.

Air meter: A small anemometer with flat vanes which indicates the number of linear feet or meters of air which have passed the instrument during its exposure.

Albedo: The ratio of the amount of electromagnetic radiation reflected by a body to the amount incident upon it, commonly expressed as a percentage. The albedo is to be distinguished from the reflectivity, which refers to one specific wavelength.

Albedometer: An instrument used for the measurement of the reflecting power (the albedo) of a surface. A pyranometer adapted for the measurement of radiation reflected from the earth's surface is sometimes employed as an albedometer.

ALERT: Automated Local Evaluation in Real Time. Flood warning program, developed by the National Weather Service in the 1970s, that uses remote sensors in the field to transmit environmental data to a central computer in real time.

Allard's law: A basic equation in night visual range theory, relating the illuminance of a point source of light to distance and the transmissivity of the atmosphere.

ALOHA: Areal Locations of Hazardous Atmospheres. A computer model used to predict how a hazardous gas cloud might disperse in the atmosphere after an accidental chemical release. Part of the CAMEO system.

Alter shield: A type of rain gauge shield consisting of freely hanging, evenly spaced slats arranged circularly around the gauge. The advantage of this shield is that the slats do not easily accumulate snow, permitting its use on unattended gauges. See rain gauge shield.

Altimeter: An instrument which determines the altitude of an object with respect to a fixed level. There are two general types of altimeters: (a) the pressure altimeter, which gives an approximate measure of altitude from a pressure measurement and an assumed standard temperature distribution; and (b) the radio altimeter, which deduces altitude by electronic techniques.

Altimeter setting: The value of atmospheric pressure to which the scale of a pressure altimeter is set so as to indicate airport elevation. The altimeter setting is included as part of an aviation weather observation.

Anabatic wind: An upslope wind due to local surface heating. Opposite of katabatic wind.

Glossary of Meteorological Terms

Analog: Pertaining to measurements or devices in which the output varies continuously, i.e. voltage or rotation signals. Compare to digital.

Anemo-biograph: A recording pressure-tube anemometer in which the wind scale of the float manometer has been made linear by the use of springs, i.e. Dines anemometer.

Anemoclinograph: A recording anemoclinometer.

Anemoclinometer: General name for a type of instrument which measures the inclination of the wind to the horizontal plane. See bivane.

Anemograph: A recording anemometer.

Anemometer: A general term for instruments designed to measure the speed or force of the wind. Italian architect Leon Battista Alberti invented the first mechanical anemometer in 1450. Derived from the Greek word "anemos," meaning wind.

Aneroid: Literally "not wet", containing no liquid.

Aneroid barograph: An aneroid barometer arranged so that the deflection of the aneroid capsule actuates a pen which graphs a record on a rotating drum. Sometimes called aneroidograph.

Aneroid barometer: A barometer which measures atmospheric pressure using one or a series of aneroid capsules. Also called holosteric barometer.

Aneroid capsule: A thin metal disc partially evacuated of air used to measure atmospheric pressure by measuring its expansion and contraction.

Aneroidogram: The record of an aneroid barograph.

Angstrom compensation pyrhelimeter: An absolute instrument developed by Swedish physicist Knut Johan Angstrom (1857-1910) for the measurement of direct solar radiation. The radiation receiver station consists of two identical manganin strips whose temperatures are measured by attached thermocouples. One of the strips is shaded, while the other is exposed to sunlight. An electrical heating current is passed through the shaded strip so as to raise its temperature to that of the exposed strip. The electric power required to accomplish this is a measure of the solar radiation.

Angstrom pyrgeometer: An instrument developed by Swedish physicist Knut Johan Angstrom (1857-1910) for measuring the effective terrestrial radiation. It consists of four manganin strips, of which two are blackened and two are polished. The blackened strips are allowed to radiate to the atmosphere while the polished strips are shielded. The electrical power required to equalize the temperature of the four strips is taken as a measure of the solar radiation.

Antenna: A conductor or system of conductors for radiating and/or receiving radio energy. Also called aerial.

Antenna feed: See feed.

Antenna gain: See gain.

Antenna pattern: Same as radiation pattern.

Anticyclone: An area of high atmospheric pressure which has a closed circulation that is anticyclonic (clockwise in northern hemisphere and counterclockwise in southern hemisphere).

Antitriptic wind: In Jeffreys' classification, a wind for which the pressure force exactly balances the viscous force, in which the vertical transfers of momentum predominate.

Apparent freezing point: Same as freezing point.

Apparent temperature: The perceived temperature derived from either a combination of temperature and wind (wind chill) or temperature and humidity (heat index).

Approximate absolute temperature scale: A temperature scale with the ice point at 273° and boiling point of water at 373°. It is intended to approximate the Kelvin temperature scale with sufficient accuracy for many sciences, notably meteorology.

ARDC model atmosphere: See standard atmosphere.

ASCII: American Standard Code for Information Interchange. A standard code used to represent data using 8 bits (7 data bits and 1 parity bit) per character.

ASOS: Automated Surface Observing System. A network of instrumented weather stations deployed primarily by the National Weather Service to make weather observations without operator involvement.

Aspiration meteorograph: An instrument, for the recording of two or more meteorological parameters, in which the ventilation is provided by a suction fan.

Aspiration psychrometer: A psychrometer in which the ventilation is provided by a suction fan.

Aspiration thermograph: A thermograph in which ventilation is provided by a suction fan.

Aspirator: A device attached to a meteorological instrument to provide ventilation; usually a suction fan.

Assmann psychrometer: A special form of the aspiration psychrometer, developed by German meteorologist Dr. Richard Assmann, in which the thermometric elements are well shielded from radiation. Psychrometric measurements may be taken with the instrument in the presence of direct solar radiation.

Asynchronous: Lacking a relationship to a time base or clock. In asynchronous communications, individual data characters are sent at an arbitrary rate.

Atmidometer: Same as atmometer.

Atmometer: General name for an instrument which measures the evaporation rate of water into the atmosphere. See clay atmometer, evaporation pan, evapotranspirometer, Livingston sphere, Piché evaporimeter, radio atmometer.

Atmoradiograph: A device for measuring the frequency of occurrence of atmospheric whose intensity is greater than a predetermined level.

Atmosphere: The envelope of air surrounding the earth and bound to it more or less permanently by virtue of the earth's gravitational attraction. The system whose chemical properties, dynamic motions, and physical processes constitute the subject matter of meteorology. Also, a unit of pressure. See standard atmosphere.

Atmospheric pressure (barometric pressure): The pressure exerted by the atmosphere as a consequence of gravitational attraction exerted upon the "column" of air lying directly above the point in question.

Atmospheric radiation: Infrared radiation emitted by or being propagated through the atmosphere.

Attenuation: In physics, any process in which the flux density (or power, amplitude, intensity, illuminance, etc.) of a "parallel beam" of energy decreases with increasing distance from the source.

Attenuation is always due to the action of the transmitting medium itself, mainly by absorption and scattering. In meteorological optics, the attenuation of light is termed extinction.

Glossary of Meteorological Terms

Audio-modulated radiosonde: A radiosonde whose carrier wave is modulated by audio-frequency signals whose frequency is controlled by the sensing elements of the instrument.

Aviation weather forecast: A forecast of weather elements of particular interest to aviation; including ceiling, visibility, upper winds, icing, turbulence, precipitation types, and storms.

Aviation weather observation: An evaluation, according to set procedures, of those weather elements which are most important for aircraft operations. Always includes cloud height or vertical visibility, sky cover, visibility, obstructions to vision, certain atmospheric phenomena, and wind speed and direction. Complete observations include sea level pressure, temperature, dew point temperature, and altimeter setting. Compare to synoptic weather observation.

AWIPS: Advanced Weather Interactive Processing System. The computerized system that processes NEXRAD and ASOS data received at National Weather Service Forecast Offices.

AWOS: Automated Weather Observing System. A self-contained weather station designed to make aviation weather observations without operator involvement.

B

Backing: A change in wind direction in a counterclockwise sense; opposite of veering.

Backlash: The play or loose motion in an instrument due to the clearance existing between mechanically contacting parts.

Backplane: Area of a computer or other device where various logic and control elements are interconnected. Often a printed circuit board into which other circuit boards plug at right angles.

Balloon: See captive balloon, ceiling balloon, constant-level balloon, free balloon, hurricane beacon, kytoon, Moby Dick balloon, pilot balloon, radiosonde balloon, rockoon, skyhook balloon, transosonde.

Balloon ceiling: The ceiling classification which is applied when the ceiling height is determined by timing the ascent and disappearance of a ceiling balloon or pilot balloon.

Balloon cover: A cover which fits over a large inflated balloon to facilitate handling in high or gusty winds.

Balloon drag: A small balloon, loaded with ballast and inflated so that it will explode at a predetermined altitude, which is attached to a larger balloon.

Balloon shroud: Same as balloon cover.

Bandwidth: The number of cycles per second between the limits of a frequency band.

Bankfull stage: The stage, on a fixed river gauge, corresponding to the top of the lowest banks within the reach for which the gauge is used as an index. Compare to flood stage.

Bar: A unit of pressure equal to 10^6 dyne per cm^2 (10^6 barye), 1000 millibars, 29.53 inches of mercury.

Barogram: The record of a barograph.

Barograph: A continuous-recording barometer.

Barometer: An instrument for measuring the pressure of the atmosphere. The two principal types are aneroid and mercurial.

Barometric altimeter: Same as pressure altimeter.

Barometric column: Same as mercury column.

Barometric constant: Factor relating the pressure and the height of a column of mercury, for example, 1 mb = 0.750062 mm, 1 mm = 1.333224 mb.

Barometric correction table: Table or graph to facilitate compensation of the instrumental errors of a mercury barometer. The required compensation is generally very small and is normally included in the barometric reduction table. See compensation of instruments.

Barometric corrections: The corrections that must be applied to the reading of a mercury barometer in order that this observed value may be rendered accurate. There are four kinds. (1) The instrument correction is the mean difference between the readings of a given mercury barometer and those of a standard instrument. It is a composite correction, including the effects of capillarity, index misalignment, imperfect vacuum, and scale correction, which are the barometric errors. (2) The temperature correction is applied to account for the difference between the coefficient of expansion of mercury and that of the scale. (3) The gravity correction is necessary because the acceleration of gravity varies with both altitude and latitude. (4) The removal correction is applied when the barometer elevation differs from the adopted station elevation and/or climatological station elevation. See also capacity correction. U.S. Weather Bureau, 1941: *Barometers and the Measurement of Atmospheric Pressure*, Circular F, 7th ed., rev

Barometric errors: See barometric corrections.

Barometric hypsometry: The technique of estimating elevation by means of atmospheric pressure measurements.

Barometric pressure: Same as atmospheric pressure.

Baroswitch: A pressure-operated switching device used in a radiosonde. In operation, the expansion of an aneroid capsule causes an electrical contact to scan a radiosonde commutator composed of conductors separated by insulators.

Barothermograph: An instrument that automatically records pressure and temperature.

Basin: See river basin.

Basin accounting: See hydrologic accounting.

Basin lag: A computed characteristic of a particular river basin, expressed as the time difference between the time-center of mass of rainfall and the time-center of mass of resulting runoff.

Basin recharge: The difference between amounts of precipitation and runoff for a given storm. It is that portion of the precipitation that remains in the basin as soil moisture, surface storage, ground water, etc.

Baud: A unit of signaling speed representing the number of code elements sent per second; often, bits per second.

BCD: Binary Coded Decimal. A coding system in which each decimal digit from 0 to 9 is represented by a 4-digit binary number.

Beaufort wind scale: A system of estimating and reporting wind speed, originally based on the effect of various wind speeds on the amount of canvas that a full-rigged nineteenth century frigate could carry.

Bellani atmometer: An instrument which measures evaporation by measuring the loss of water from a burette reservoir through a ceramic disc.

Bellows: See aneroid capsule.

Glossary of Meteorological Terms

Bimetallic thermometer: A thermometer, the sensitive element of which consists of two metal strips which have different coefficients of expansion and are brazed together. The distortions of the system in response to temperature variations are used as a measure of temperature. It is a type of deformation thermometer.

Bimetal strip: See bimetallic thermometer.

Binary: A numbering system using a base number of 2 and having only two digits: 0 and 1. The fundamental system of representing information with electrical pulses.

Bit: Abbreviation for binary digit. The smallest unit of information, equal to one binary decision, i.e. 1/0, on/off, yes/no.

Bivane: A wind vane used to obtain the horizontal and vertical components of the wind.

Black body: A hypothetical, ideal body which absorbs completely all incident radiation, independent of wavelength and direction. No actual substance behaves as a true black body, although platinum black and other soots rather closely approximate this ideal. However, one does speak of a black body with respect to a particular wavelength interval. Compare to gray body, white body.

Black-bulb thermometer: A thermometer whose sensitive element has been made to resemble a black body by covering it with lamp black. The thermometer is placed in an evacuated transparent chamber which is maintained at a constant temperature. The instrument responds to insolation, modified by the transmission characteristics of its container.

Blizzard: A severe weather condition characterized by low temperatures and strong winds bearing a great amount of snow, either falling or picked up from the ground.

Boiling point: Temperature of equilibrium between the liquid and vapor phases of a substance at a given pressure.

Bologram: The record obtained from a bolometer.

Bolometer: Instrument for measuring the intensity of radiant energy. Its principle is based on the variation of electrical resistance, with the incoming radiation, of one or both the metallic strips which the instrument comprises.

Bottle thermometer: A thermoelectric thermometer used for measuring air temperature. The name is derived from the fact that the reference thermocouple is placed in an insulated bottle.

Bourdon tube: Closed, curved, flexible tube of elliptic cross section which is deformed, according to type, by variations of atmospheric pressure or temperature and so provides a measurement of the particular parameter.

Breeze: Wind with a speed between 4 and 27 knots (4 and 31 mph); Beaufort scale numbers 2 through 6.

Bridled-cup anemometer: A combination cup anemometer and pressure-plate anemometer, consisting of an array of cups about a vertical axis of rotation, the free rotation of which is restricted by a suitable spring arrangement.

British thermal unit: A unit of energy defined as the heat required to raise the temperature of one pound of water one degree Fahrenheit. It is equal to 252.1 calories or to 1055 joules.

Brontometer: A general term to designate apparatus designed to observe the details of weather during thunderstorms.

Bucket thermometer: A water-temperature thermometer provided with an insulated container around the bulb. It is lowered into the sea on a line until it has had time to reach the temperature of the surface water, then withdrawn and read.

The insulated water surrounding the bulb preserves the temperature reading and is available as a salinity sample.

Burst: A radar term for a single pulse of radio energy.

Bus: A set of electrical conductors, often on a backplane, that carry data and power signals among the various components of a computer.

Byte: The group of bits which a computer processes as a unit; often, 8 bits.

C

Calibration: The process whereby a position on the scale of an instrument is identified with the magnitude of the signal (or input force) actuating the instrument.

Calibration error: The inaccuracy that the manufacturer permits when the unit is calibrated in the factory.

Calm: Wind with a speed below 1 knot (1 mph); Beaufort scale number 0.

Calorie: A unit of heat originally defined as the amount of heat required to raise the temperature of water through one degree centigrade (the gram-calorie or small calorie), but this proved to be insufficiently precise. The 15° gram-calorie (cal₁₅) is the amount of heat required to raise the temperature of one gram of water from 14.5° to 15.5°C, and is equal to 4.1855 joules. The kilogram calorie or large calorie (Kcal, kg-cal, or Cal) is 1,000 times as large as a calorie.

Calorimeter: An instrument designed to measure quantities of heat. Sometimes used in meteorology to measure solar radiation.

Campbell-Stokes recorder: A sunshine recorder of the type in which the time scale is supplied by the motion of the sun. It consists essentially of a spherical lens which burns an image of the sun upon a specially prepared card.

CAMEO: Computer-Aided Management of Emergency Operations. A system of software applications used to plan for and respond to chemical emergencies. Developed by the U.S. Environmental Protection Agency (EPA) and the National Oceanic and Atmospheric Administration (NOAA).

Canadian hardness-gauge: A type of disk hardness-gauge, especially useful in relatively soft snow. See disk hardness gauge.

Candela: Unit of luminous intensity. One candela is one lumen per steradian. Formerly called the candle.

Candle: A unit of luminous intensity of a light source. See candela.

Candlepower: Luminous intensity expressed in candelas.

Capacity correction: The correction applied to a mercury barometer with a nonadjustable cistern in order to compensate for the change in level of the cistern as the atmospheric pressure changes. Thus, as the pressure falls, the height of the cistern increases, due to the exchange of mercury between the barometer tube and its cistern. This correction is not required if the scale is calibrated as in the Kew barometer. See also barometric corrections.

Capillary collector: An instrument for collecting liquid water from the atmosphere.

Glossary of Meteorological Terms

Captive balloon: A buoyant balloon kept from rising freely by means of a line secured to a point on the ground, as opposed to a free balloon. See kytoon.

Carbon-film hygrometer element: An electrical hygrometer element constructed of a plastic strip coated with a film of carbon black dispersed in a hygroscopic binder. Variations in atmospheric moisture content vary the volume of the binder and thus change the resistance of the carbon coating. This element is characterized by high sensitivity and rapid response.

Cardinal winds: Winds from the four cardinal points of the compass; that is, north, east, south, and west winds.

Carrier frequency: The frequency of a carrier wave.

Carrier wave: Transmitted energy which is modulated in order to carry information. Usually, it is in the form of a radio-frequency sine wave, modulated either in amplitude or in frequency.

Carry-over: The portion of the streamflow during any month or year derived from precipitation in previous months or years.

Catch: The amount of precipitation captured by a rain gauge.

Ceiling: The height ascribed to the lowest layer of clouds or obscuring phenomena when it is reported as broken, overcast, or obscuration and not classified as "thin" or "partial." The ceiling is termed unlimited when these conditions are not satisfied.

Ceiling balloon: A small balloon used to determine the height of the cloud base. The height can be computed from the ascent velocity of the balloon and the time required for its disappearance into the cloud.

Ceiling classification: A description or explanation of the manner in which the height of the ceiling is determined, i.e. aircraft ceiling, balloon ceiling, estimated ceiling, indefinite ceiling, measured ceiling, precipitation ceiling.

Ceiling light: A type of cloud height indicator which uses a searchlight to project vertically a narrow beam of light onto the cloud base. The height of the cloud is determined using a clinometer, located at a known distance from the ceiling light, to measure the angle included by the illuminated spot on the cloud, the observer, and the ceiling light.

Ceiling projector: Same as ceiling light.

Ceilometer: An automatic, recording cloud height indicator.

Celsius temperature scale: International thermometric scale on which the freezing point of water equals 0° and the boiling point equals 100° at standard atmospheric pressure (760 mm Hg). Named for Swedish astronomer Anders Celsius (1701-1744), who devised the system in 1742.

Centibar: The pressure unit of the meter-ton-second system of physical units, equal to 10 millibars or 10⁴ dynes per cm².

Centigrade temperature scale: The older name for the Celsius temperature scale. Officially abandoned by international agreement in 1948, but still in common use.

Centimeter-gram-second system: A system of physical units based on the use of the centimeter, gram, and the second as elementary quantities of length, mass, and time.

Channel storage: The water volume within a specified portion of a stream channel.

Character: Part of a computer word that has meaning in itself; often, a byte.

Chronograph: A clock-driven device for recording the time of occurrence of an event or the time interval between the occurrence of events.

Chronometric radiosonde: A radiosonde whose carrier wave is switched on and off in such a manner that the interval of time between the transmission of signals is a function of the magnitude of the meteorological elements being measured.

Chronothermometer: A thermometer consisting of a clock mechanism the speed of which is a function of temperature.

Cistern barometer: A mercury barometer in which the lower mercury surface is larger in area than the upper surface. The basic construction of a cistern barometer is as follows: A glass tube one meter in length, sealed at one end, is filled with mercury, and then inverted. The tube is mounted so that its mount penetrates the upper surface of a reservoir of mercury called the cistern of the barometer. See Fortin barometer, Kew barometer.

Class A pan: See evaporation pan.

Clay atmometer: An atmometer consisting of a porous porcelain or ceramic container connected to a calibrated reservoir filled with distilled water. Evaporation is determined by the depletion of water in the reservoir.

Clear-air turbulence: Turbulence encountered by aircraft when flying through air space devoid of clouds. Thermals and wind shear are the main causes.

Clinometer: An instrument for measuring angles of inclination. Used in conjunction with a ceiling light to measure cloud height at night.

Cloud: A hydrometeor consisting of a visible aggregate of minute water and/or ice particles in the atmosphere above the earth's surface. Cloud differs from fog only in that the latter is, by definition, in contact with the earth's surface.

Cloud base: For a given cloud or cloud layer, the lowest level in the atmosphere at which the air contains a perceptible quantity of cloud particles.

Cloud height: The height of the cloud base above the local terrain.

Cloudburst: Any sudden and heavy rain, almost always of the shower type.

CMOS: Complementary Metal-Oxide Semiconductor. A method of making silicon chips that results in low power consumption by the circuits.

Coalescence: Formation of a single water drop by the union of two or more colliding drops.

Cockeyed bob: A colloquial term in western Australia for a squall, associated with thunder, on the northwest coast in summer.

Code-sending radiosonde: A radiosonde which transmits the indication of the meteorological sensing elements in the form of a code consisting of combinations of dots and dashes.

Collector: A class of instruments employed to determine the electric potential at a point in the atmosphere, and ultimately the atmospheric electric field.

Color temperature: An estimate of the temperature of an incandescent body, determined by observing the wavelength at which it is emitting with peak intensity (its color) and using that wavelength in Wien's law.

Combined error: The total of all deviations of a transducer's output from a specified straight line in a constant environment.

Glossary of Meteorological Terms

Comb nephoscope: A direct-vision nephoscope which is constructed in the following manner: a comb consisting of a cross-piece containing equispaced vertical rods is attached to one end of a column eight to ten feet long and is supported on a mounting that is free to rotate about its vertical axis. In use, the comb is turned so that the cloud appears to move parallel to the tips of the vertical rods.

Commutator: See radiosonde commutator.

Condenser-discharge anemometer: A contact anemometer connected to an electrical circuit which is so arranged that the average wind speed is indicated.

Conductivity: A unit measure of electrical conduction. The facility with which a substance conducts electricity, as represented by the current density per unit electrical-potential gradient in the direction of flow. Electrical conductivity is the reciprocal of electrical resistivity and is expressed in units such as mhos (reciprocal ohms) per cm. It is an intrinsic property of a given type of material under given physical conditions (dependent mostly on temperature). Conductance, on the other hand, varies with the dimensions of the conducting system and is the reciprocal of the electrical resistance.

Compass points: The cardinal points of the compass, i.e. north, south, east, west.

Compensated pyrheliometer: Pyrheliometer based on the comparison of the heating of two identical metal strips, one exposed to radiation, the other to a joule effect.

Compensation of instruments: The use of electromechanical devices to reduce (compensate for) the sensitivities of meteorological sensors to other parameters (e.g., the effect of temperature on a pressure sensor).

Condensation: The process by which a vapor becomes a liquid. In meteorology it occurs when water vapor changes to dew, fog, or becomes a cloud.

Condensation nucleus: Small particle on which water vapor condenses.

Conformal coating: A protective coating applied to circuits.

Constant-level balloon: A balloon designed to float at a constant pressure level. This may be accomplished by a pressure valve which controls the release of ballast so as to maintain flight above a selected pressure level until the supply of ballast is exhausted. See Moby Dick balloon, skyhook balloon, transosonde.

Constant-pressure balloon: Same as constant-level balloon.

Contact anemometer: Anemometer which generates an electrical contact output with a frequency proportional to wind speed.

Contact-cup anemometer: Same as contact anemometer.

Cooling-power anemometer: The general term for anemometers operating on the principle that the heat transfer to air from an object at an elevated temperature is a function of the air speed. Examples are the hot-wire anemometer and the katathermometer.

Coordinated Universal Time (UTC): The international standard of time, kept by atomic clocks around the world. Formerly known as Greenwich Mean Time (GMT), local time at zero degrees longitude at the Greenwich Observatory, England. UTC uses a 24-hour clock.

Coriolis force: In meteorology, a deflecting force acting on a body in motion and resulting from the earth's rotation. It deflects air currents to the right in the northern hemisphere and to the left in the southern hemisphere, thus having an effect on wind direction.

Coronagraph: An instrument for photographing the corona and prominences of the sun at times other than at solar eclipse.

Cotton-region shelter: A medium-sized instrument shelter. It is a white louvered box with a flat double roof and is mounted four feet above the ground on a four-legged stand.

Counterradiation: The downward flux of atmospheric radiation passing through a given level surface, usually taken as the earth's surface. This result of infrared (long-wave) absorption and re-emission by the atmosphere is the principal factor in the greenhouse effect.

CPU: Central Processing Unit. The part of a computer which controls and directs all functions.

Creeping: Defect in the action of an aneroid barometer resulting in a sluggish adjustment of the index toward the correct reading when the barometer is subjected to a large and rapid change in pressure.

Crosswind: A wind blowing in a direction perpendicular to the course of a moving object.

CRT: Cathode Ray Tube. A display element, consisting of a vacuum tube and screen, used with computers.

Cryopedometer: Instrument for measuring the depth to which the soil is frozen.

Cup anemometer: Anemometer which measures wind speed by the speed of rotation of 3 or 4 hemispherical or conical cups, each fixed to the end of a horizontal arm projecting from a vertical axis. Invented by Thomas Romney Robinson (1792-1882), Irish astronomer and physicist, about 1845. See condenser-discharge anemometer, contact anemometer. Compare to bridled-cup anemometer.

Current meter: Any one of numerous devices for the measurement of either speed alone or of both direction and speed (set and drift) in flowing water.

Cyanometer: Generally, an instrument designed to measure or estimate the blueness of the sky. See Linke-scale.

Cyclone: An area of low atmospheric pressure which has a closed circulation that is cyclonic (counterclockwise in northern hemisphere and clockwise in southern hemisphere).

D

Damping ratio: A constant which describes the performance of a wind vane in response to a step change in wind direction. It is calculated from the relative amount of overshoot on two successive swings (half cycles) of a decaying oscillation. This specification is dimensionless and is generally between 0.3 and 0.7.

Data acquisition: The process by which events in the real world are translated into machine-readable signals.

Dead band: The range through which the input may be varied without initiating a response. Usually expressed as a percentage of full-scale range.

Glossary of Meteorological Terms

Decibar: A unit of pressure used principally in oceanography. One decibar (10^5 dynes/cm²) equals 0.1 bar. In the ocean, hydrostatic pressure in decibars very nearly equals the corresponding depth in meters.

Decibel: A measure of the relative power, or of the relative values of two flux densities, especially of sound intensities and radar power densities. The decibel is derived from the less frequently used unit, the bel, named in honor of Alexander Graham Bell.

Deformation thermometer: A thermometer using transducing elements which deform with temperature. Examples are the bimetallic thermometer and the Bourdon tube type of thermometer.

Deepening: A decrease in the central pressure of a pressure system. Usually applied to a low rather than to a high.

Degree day: A unit that represents one degree of deviation from a reference point in the mean daily outdoor temperature (usually 65°F) and that is used to measure heating and cooling requirements. Generally, a measure of the departure of the mean daily temperature from a given standard; one degree day for each degree (°C or °F) of departure above (or below) the standard during one day. Degree days are accumulated over a "season." As used by the U.S. Army Corps of Engineers, freezing degree days are computed above and below 32°F, positive if above and negative if below.

Degree hour: As used by the U.S. Army Corps of Engineers, the departure (in °F) of the hourly temperature from a standard 32°F, positive if above and negative if below. Degree hours may be accumulated over any period of time, depending upon the use to which they are applied.

Delay distance: The length of air flow past a wind vane required for the vane to respond to 50 percent of a step change in wind direction. Expressed in feet or meters and calculated from delay time times wind tunnel speed.

Delta temperature: The difference between temperature measurements taken at two significant levels above the ground. Temperatures at 10 and 40 meters are commonly used.

Depression: In meteorology, an area of low pressure; a low or trough.

Dew: Water condensed onto objects at or near the ground, due to the fact that their temperatures have fallen below the dew point temperature of the surrounding air, but not below freezing.

Dew cell: An instrument used to determine dew point.

Dew point (or dew-point temperature): The temperature to which a sample of air must be cooled, while the mixing ratio and barometric pressure remain constant, in order to attain saturation by water vapor. When this temperature is below 0°C, it is sometimes called the frost point.

Dew-point apparatus: Same as dew-point hygrometer.

Dew-point hygrometer: Hygrometer in which the dew (frost) point is determined by observing the temperature of an artificially cooled surface at the moment at which dew (frost) first appears on it.

Dew-point spread: The difference between the air temperature and the dew-point. Also called dew-point deficit, dew-point depression.

Diabatic process: Thermodynamic change of state of a system in which there is transfer of heat across the boundaries of the system. Compare to adiabatic process.

Diamond-Hinnman radiosonde: A variable audio-modulated radiosonde developed at the Bureau of Standards and used by the United States weather services.

Diffuse solar radiation (sky radiation): Downward scattered and reflected solar radiation, coming from the whole hemisphere with the exception of the solid angle of the sun's disc on a surface perpendicular to the axis of this cone.

Diffusion hygrometer: A hygrometer based upon the diffusion of water vapor through a porous membrane.

Digital: Pertaining to measurements or devices in which the output varies in discrete steps, i.e. on-off or pulse signals. Compare to analog.

Dines anemometer: A type of pressure-tube anemometer, named after the inventor.

Dines radiometer: An instrument for measuring radiant energy. It consists of an ether differential thermometer with blackened bulbs. One of the bulbs is exposed to the unknown radiation and the other to a black body source whose temperature can be varied. Equality of radiation is indicated by the balance of the differential thermometer.

Direct solar radiation: Radiation coming from the solid angle of the sun's disc, as opposed to diffuse sky radiation, effective terrestrial radiation, or radiation from any other source. Direct solar radiation is measured by pyrhemometers.

Discharge: Rate of flow of water past a point in a stream, expressed as volume per unit time, i.e. cubic feet per second.

Disdrometer: Apparatus designed to measure and record the size distribution of raindrops as they occur in the atmosphere.

Disk hardness gauge: An instrument for measuring snow hardness in terms of the resistance of snow to the pressure exerted by a disk attached to a spring-loaded rod, a gauge calibrated in pounds per square inch registers the amount of resistance. See Canadian hardness gauge.

Distance constant: The length of fluid flow (gas or liquid) past a sensor required for the sensor to respond to 63.2% of a step change in speed. Expressed in feet or meters. For anemometers, this value is calculated from time constant times wind tunnel speed.

Dobson spectrophotometer: A photoelectric spectrophotometer which is used in the determination of the ozone content of the atmosphere.

Doppler radar: Radar that can measure radial velocity, the instantaneous component of motion parallel to the radar beam (i.e., toward or away from the radar antenna). Named for J. Christian Doppler, an Austrian physicist, who in 1842 explained why the whistle of an approaching train had a higher pitch than the same whistle when the train was moving away.

Dosimeter: An instrument for measuring the ultraviolet in solar and sky radiation.

Double-theodolite observation: A technique for making winds aloft observations in which two theodolites located at either end of a baseline follow the ascent of a pilot balloon. Synchronous measurements of the elevation and azimuth angles of the balloon, taken at periodic intervals, permit computation of the wind vector as a function of height.

Glossary of Meteorological Terms

Downdraft: A relatively small-scale, downward moving current of air.

Downward total radiation: Solar and terrestrial radiation directed downwards (towards the earth's surface); incoming radiation.

Downwind: The direction toward which the wind is blowing; with the wind.

Drainage area: The size of the area comprising a watershed or river basin. Also called catchment area.

Drift: The variation over a period of time in device output when the input parameter is fixed. Temperature change is a common cause of drift.

Drizzle: Very small precipitation drops (diameters less than 0.5 mm) that appear to float with air currents while falling in an irregular path. Unlike fog droplets, drizzle falls to the ground.

Dropsonde: A radiosonde which is dropped by parachute from an aircraft for the purpose of obtaining soundings of the atmosphere below.

Drosometer: An instrument used to measure the amount of dew formed on a given surface.

Dry adiabatic lapse rate: The rate of decrease of temperature with height when unsaturated air is lifted adiabatically (without exchange of heat with its surroundings). The decrease is due to expansion as the air is lifted to a lower pressure.

Dry-bulb temperature: Technically, the temperature registered by the dry-bulb thermometer of a psychrometer. However, it is identical with the temperature of the air and may also be used in that sense.

Dry-bulb thermometer: Companion to the wet-bulb thermometer in a psychrometer. Used to measure ambient air temperature.

Dyne: The unit of force in the centimeter-gram-second system of physical units, i.e. one gm cm per sec², equal to 7.233 x 10⁻⁵ poundal.

E

EBCDIC: Extended Binary Coded Decimal Interchange Code. A standard code used to represent data using 8 bits per character.

Ebert ion-counter: An ion counter of the aspiration condenser type, used for the measurement of the concentration and mobility of small ions in the atmosphere.

Eddy velocity: Difference between the instantaneous wind velocity at a point and the mean wind velocity taken over a given time interval. Also called fluctuation velocity.

Effective snow melt: That part of snow melt that reaches stream channels as runoff.

Effective terrestrial radiation: The difference between the outgoing infrared terrestrial radiation of the earth's surface and the downcoming infrared counterradiation from the atmosphere.

Electrical hygrometer: A hygrometer which uses a transducing element whose electrical properties are a function of atmospheric water vapor content. The humidity strip and carbon-film hygrometer element are examples of such a transducer.

Electrical thermometer: A thermometer which uses a transducing element whose element properties are a function of its thermal state. Common meteorological examples of such thermometers are the resistance thermometer and the thermoelectric thermometer.

Electrolytic strip: Same as humidity strip.

Electrometer: An instrument for measuring differences of electric potential.

Electronic theodolite: See radar theodolite, radio direction-finder.

Electroscope: A general name for instruments which detect the presence of (but do not necessarily measure) small electrical charges by electrostatic means. Compare to electrometer.

Emanometer: An instrument for the measurement of the radon content of the atmosphere.

Eolian: Same as Aeolian.

Eppley pyrhelimeter: A pyrhelimeter of the thermoelectric type. Radiation is allowed to fall on two concentric silver rings, the outer covered with magnesium oxide and the inner covered with lamp black. A system of thermocouples (thermopile) is used to measure the temperature difference between the rings. Attachments are provided so that measurements of direct and diffuse solar radiation may be obtained.

EPROM: Erasable Programmable Read Only Memory. Programmable read-only memory which can be erased, usually by ultraviolet light, and re-programmed.

Error: The difference between the measured value and the true value. See instrument error, observational error, random error, standard error, systematic error. See also accuracy, accuracy rating, measured accuracy.

Error distribution: The probability distribution of random errors, typically a normal distribution with a zero mean.

Evaporation: The process by which a liquid is transformed to a vapor. The opposite of condensation.

Evaporation gauge: General name for an instrument which measures the evaporation rate of water into the atmosphere. Same as atmometer.

Evaporation hook gauge: See hook gauge.

Evaporation opportunity: The ratio of the actual amount of water evaporated into the atmosphere to the evaporative power. Also called relative evaporation.

Evaporation pan: A type of atmometer. It is a pan used in the measurement of the evaporation of water into the atmosphere. The NWS Class A pan is a cylindrical container 48 inches in diameter and 10 inches deep.

Evaporation rate: The volume of liquid water evaporated per unit area in unit time, usually measured as the depth of liquid water lost per unit time from the whole area.

Evaporative power (or capacity): A measure of the degree to which the weather or climate of a region is favorable to the process of evaporation. Usually considered to be the rate of evaporation, under existing atmospheric conditions, from a surface of water which is chemically pure and has the temperature of the lowest layer of the atmosphere.

Evaporimeter: Same as atmometer.

Evaporograph: Instrument which measures and records the amount of evaporation over time.

Glossary of Meteorological Terms

Evapotranspiration (ET): The combined processes by which water is transferred from the earth's surface to the atmosphere: evaporation of liquid or solid water plus transpiration from plants.

Evapotranspirometer: A type of lysimeter that measures the rate of evapotranspiration. It consists of a vegetation soil tank so designed that all water added to the tank and all water left after evapotranspiration can be measured.

Extinction: The attenuation of light.

F

FAA: Federal Aviation Administration.

Fahrenheit temperature scale: A temperature scale on which the freezing point of water equals 32° and the boiling point equals 212° at standard atmospheric pressure (760 mm Hg). Introduced in 1724 by German physicist Gabriel Daniel Fahrenheit (1686-1736).

Feed: The source of illumination for an antenna reflector. Also called antenna feed.

Fiducial point: A point (or line) on a scale used for reference or comparison purposes. In calibration of meteorological thermometers, for example, the fiducial points are 100°C (212°F) and 0°C (32°F), which correspond to the boiling point and ice point at standard pressure (760 mm Hg).

Fiducial temperature: That temperature at which, in a specified latitude, the reading of a particular barometer requires no temperature or latitude correction.

Field elevation: The officially designated elevation of an airport above mean sea level, taken as the highest point on any of the runways of the airport. Same as airport elevation.

Filling: An increase in the central pressure of a pressure system; opposite of a deepening. More commonly applied to a low rather than a high.

Fire-danger meter: A graphical aid used in fire weather forecasting to calculate the degree of forest-fire danger (or burning index). Commonly in the form of a circular slide rule, the fire-danger meter relates numerical indices of (a) the seasonal stage of foliage, (b) the cumulative effect of past precipitation or lack thereof, (c) the measured fuel moisture, and (d) the speed of the wind in the woods.

Fire weather: The state of the weather with respect to its effect upon the kindling and spreading of forest fires.

Firmware: Programs or instructions which are stored in read-only memory.

Firn: Old snow that has become granular and compacted as a result of melting and refreezing.

Fixed-beam ceilometer: See ceilometer.

Flight forecast: An aviation weather forecast for a specific flight.

Float barograph: A type of recording siphon barometer. The mechanically magnified motion of a float resting on the lower mercury surface is used to record atmospheric pressure on a rotating drum.

Floating pan: An evaporation pan in which the evaporation is measured from water in a pan floating in a larger body of water.

Float-type rain gauge: A class of rain gauge in which the level of the collected rain water is measured by the position of a float resting on the surface of the water.

Flood: Overflowing by water of the normal confines of a stream or other body of water, or accumulation of water by drainage over areas which are not normally submerged.

Flood stage: That stage, on a fixed river gauge, at which overflow of the natural banks of the stream begins to cause damage in any portion of the reach for which the gauge is used as an index.

Flyoff: The total amount of water transferred to the atmosphere by evapotranspiration.

Foehn: A warm, dry wind on the lee side of a mountain range, the warmth and dryness due to adiabatic compression upon descent.

Fog: A hydrometeor consisting of a visible aggregate of minute water droplets suspended in the atmosphere near the earth's surface. Fog differs from cloud only in that the base of fog is at the earth's surface while clouds are above the surface.

Fogbow: A faintly-colored circular arc similar to a rainbow but formed on fog layers containing drops whose diameters are 100 microns or less. Also called mistbow, white rainbow.

Föhn: See foehn.

Foot-candle: A unit of illuminance or illumination equal to one lumen per foot². This is the illuminance provided by a light source of one candle at a distance of one foot.

Foot-lambert: A unit of luminance (photometric brightness). The foot-lambert describes the luminance of a surface that emits or reflects one lumen per square foot; it is the luminance of a perfectly reflecting surface under an illumination of one foot-candle. One foot-lambert equals 0.3183 candles per square foot.

Foot-pound: A unit of energy equal to 1.356 joules.

Forel scale: A scale of yellows, greens, and blues for recording the color of sea water, as seen against the white background of a Secchi disk.

Fortin barometer: A type of cistern barometer in which the level of mercury in the cistern is adjusted to the zero point of the scale before each reading.

Free balloon: A buoyant balloon rising freely in the atmosphere, as opposed to a captive balloon.

Free lift: The actual lifting force of an inflated balloon, usually expressed in grams.

Freezing level: Lowest altitude in the atmosphere over a given location at which the air temperature is 0°C.

Freezing nucleus: Particle on which the freezing of water occurs.

Freezing point: Temperature at which a liquid solidifies under any given set of conditions. It may or may not be the same as the melting point or the more rigidly defined true freezing point or (for water) ice point.

Fresh breeze: Wind with a speed between 17 and 21 knots (19 and 24 mph); Beaufort scale number 5.

Fresh gale: Wind with a speed between 34 and 40 knots (39 and 46 mph); Beaufort scale number 8.

Frost: Ice crystal deposits formed by sublimation (conversion of water vapor directly to ice) when temperature and dew point are below freezing.

Frequency modulation: A type of modulation in which the frequency of a continuous radio carrier wave is varied in accordance with the properties of a second (modulating) wave.

Frost-point hygrometer: An instrument for measuring the frost point of the atmosphere.

Glossary of Meteorological Terms

FSK: Frequency Shift Keying. A form of frequency modulation of a data signal performed by a modem for transmission over dedicated wire or phone lines.

F.S. output: The transducer's output when the maximum sensed value is applied to the transducer's input. For example, the F.S. output of a 4-20 mA transmitter is 20 mA, whereas its span is only 16 mA.

Fuel-moisture: Determined by weighing a special type of wooden stick that has been exposed in the woods, its weight being proportional to its contained water. Sticks are rated 1-hour, 10-hour, 100-hour, or 1000-hour based on the time required to lose or gain 63% of the difference between the dead fuel itself and the surrounding atmosphere. Fuel moisture percentage is computed by dividing the weight of "water" in the fuel by the oven-dried weight of the fuel, then multiplying by 100.

Fujita tornado scale: Based upon damage patterns, classifies twisters into six categories of wind speed (F0 thru F5), ranging from 40 to 318 mph estimated wind speed, plus a hypothetical F6 with winds from 318 mph to Mach 1. Developed in 1971 by T. Theodore Fujita of the University of Chicago. Also known as the Fujita-Pearson Scale.

Full duplex: Operation mode of a communication circuit in which each end can simultaneously transmit and receive.

G

Gain: An increase or amplification. There are two general usages of the term in radar meteorology: (a) antenna gain (or gain factor) is the ratio of the power transmitted along the beam axis to that of an isotropic radiator transmitting the same total power; and (b) receiver gain (or video gain) is the amplification given a signal by the receiver.

Gain factor: See gain.

Gale: Wind with a speed between 28 and 55 knots (32 and 63 mph); Beaufort scale numbers 7 through 10.

Galilei: The unit of acceleration in the centimeter-gram-second system of units, equal to one cm per sec². Commonly used in gravimetry.

Gas thermometer: A thermometer which utilizes the thermal properties of gas. There are two forms of this instrument: (a) a type in which the gas is kept at constant volume, and pressure is the thermometric property; and (b) a type in which the gas is kept at constant pressure, and volume is the thermometric property. The gas thermometer is the most accurate of all thermometers and is used as the standard instrument for measurement of temperature.

Gauge relation: An empirical curve relating stream discharge or stage at a point on a stream to discharge or stage at one or more upstream points and, possibly, to other parameters. Also called stage relation.

Gentle breeze: Wind with a speed between 7 and 10 knots (8 and 12 mph); Beaufort scale number 3.

Geostrophic wind: That horizontal wind velocity at which the Coriolis acceleration exactly balances the horizontal pressure force. It is directed along contour lines or isobars.

Geostrophic wind level: The lowest level at which the wind becomes geostrophic in the theory of the Ekman spiral. Also called gradient wind level.

Geostrophic-wind scale: A graphical device used for the determination of the speed of the geostrophic wind from the isobar or contour-line spacing on a synoptic chart.

Gerdien aspirator: An instrument used for the determination of the electrical conductivity of the atmosphere.

Glass: In nautical terminology, a contraction for "weather glass" (a mercury barometer).

Glaze: A coating of ice, generally clear and smooth, formed by the freezing of supercooled water on a surface.

Glime: An ice coating with a consistency intermediate between glaze and rime.

Global radiation: The total of direct solar radiation and diffuse sky radiation received by a unit horizontal surface.

Global radiation is measured by pyranometers.

Goldbeater's-skin hygrometer: A hygrometer using goldbeater's skin as the sensitive element. Variations of the physical dimensions of the skin caused by its hygroscopic character indicate relative humidity. (Note: Goldbeater's skin is the prepared outside membrane of the large intestine of an ox. It is used in goldbeating to separate the leaves of the metal.)

Goniometer: An instrument used for measuring geometric angles. See radio direction-finder.

Gradient wind: Any horizontal wind velocity tangent to the contour line of a constant pressure surface (or to the isobar of a geopotential surface) at the point in question.

Gradient wind level: Same as geostrophic wind level.

Gram: A c.g.s. (centimeter-gram-second) unit of mass. Originally defined as the mass of 1 cubic centimeter of water at 4°C but now taken as the one-thousandth part of the standard kilogram, a mass preserved by the International Bureau of Weights and Measures.

Gram calorie: See calorie.

Gram-mole: See mole.

Gram-molecule: See mole.

Graphing board: Board that holds graph paper on which is plotted information obtained from a pilot-balloon observation.

Grass minimum: The minimum temperature shown by a minimum thermometer exposed in an open situation with its bulb at the level of the tops of the grass blades of short turf.

Grass temperature: The temperature registered by a thermometer with its bulb at the level of the tops of the grass blades in short turf.

Gravity wind: A wind (or component thereof) directed down the slope of an incline and caused by greater air density near the slope than at the same levels some distance horizontally from the slope. Also called drainage wind and sometimes called katabatic wind.

Gray body: A hypothetical body which absorbs some constant fraction, between zero and one, of all electromagnetic radiation incident upon it, which fraction is the absorptivity and is independent of wavelength. Compare to black body, white body.

Glossary of Meteorological Terms

Grid nephoscope: A direct-vision nephoscope constructed in the following manner: A grid-work of bars is mounted horizontally on the end of a vertical column and made free to rotate about the vertical axis. The observer rotates the grid and adjusts his or her position until some feature of the cloud appears to move along the major axis of the grid. The azimuth angle at which the grid is set is taken as the direction of cloud motion.

Ground-check chamber: A chamber used to check the sensing elements of radiosonde equipment.

Ground-Hog Day: February 2nd. In American folklore, a day that is popularly supposed to provide the key to the weather for the remainder of the winter. Specifically, if the ground-hog upon emerging from its hole casts a shadow, it will return underground, thereby foreboding more wintery weather. There is no convincing statistical evidence to support this belief.

Gust: A sudden brief increase in the speed of the wind, followed by a lull or slackening. Compare to peak gust.

Gustiness components: The ratios, to the mean wind speed, of the average magnitudes of the component fluctuations of the wind along three mutually perpendicular axes.

Gustiness factor: A measure of the intensity of gusts given by the ratio of the total range of wind speed between gusts and the intermediate periods of lighter wind to the mean wind speed, averaged over both gusts and lulls.

Gustsonde: An instrument, dropped from high altitude and carried by a stable parachute, used to measure the vertical component of turbulence aloft.

H

Hail: Precipitation composed of balls or irregular lumps of ice with diameters between 5 and 50 mm.

Hair hygrometer: A recording hair hygrometer.

Hair hygrometer: A hygrometer in which the sensitive element is a strand or strands of human hair, the length of which is a function of the relative humidity of the air.

Half duplex: Operation mode of a communication circuit in which each end can transmit and receive, but not simultaneously.

Hardware: Physical equipment used in data processing. Compare to firmware, software.

Haze: Fine dust or salt particles dispersed through a portion of the atmosphere; a type of lithometer. The particles are so small they cannot be felt or seen with the naked eye. Many haze formations are caused by the presence of an abundance of condensation nuclei which may grow in size, due to a variety of causes, and become mist, fog, or cloud.

Hazemeter: Name sometimes given to a transmissometer.

Head wind: A wind blowing in a direction opposite to the heading of a moving object, thus opposing the object's intended progress; the opposite of a tailwind.

Heliograph: An instrument which records the duration of sunshine and gives a quantitative measure of the amount of sunshine by the action of the sun's rays upon blueprint paper. A type of sunshine recorder.

Heliostat: A clock-driven instrument mounting which automatically and continuously points in the direction of the sun. It is used with a pyrheliometer when continuous direct solar radiation measurements are required.

Heliotropic wind: A subtle, diurnal component of the wind velocity leading to a diurnal shift of the wind or turning of the wind with the sun, produced by the east-to-west progression of daytime surface heating.

Helium (He): An inert gas. A colorless, monatomic element which is found to occur in dry air to the extent of only 0.000524 percent by volume. Helium is very light, having a molecular weight of only 4.003 and specific gravity referred to air of 0.138. Because helium is non-inflammable and has a lifting power 92 percent of that of hydrogen, it is widely used as the inflation gas for meteorological balloons.

Hexadecimal: A numbering system using a base number of 16 and including the ten decimal digits (0 to 9) along with six alpha digits (A to F). Thus, a digit is available to represent each of the possible values of a 4-bit binary digit.

High: An area of high barometric pressure, with its attendant system of winds; an anticyclone.

Hi-reference signal: The audio-frequency signal transmitted by the Diamond-Hinman radiosonde when the baroswitch pen passes each fifteenth contact of the commutator, up to a number determined by the design of the commutator, and each fifth contact thereafter. This signal is transmitted so that the pressure, temperature, and humidity may be more readily distinguished.

Histogram: A graphical representation of a frequency distribution. The range of the variable is divided into class intervals for which the frequency of occurrence is represented by a rectangular column. The height of the column is proportional to the frequency of observations within the interval.

Holosteric barometer: Same as aneroid barometer. Holosteric means wholly made of solids, while aneroid means devoid of liquid.

Hook gauge: An instrument used to measure changes in the level of the water in an evaporation pan. The gauge is normally placed in a stillwell and adjusted so that the point of the hook just breaks the water surface. The change in water level is read on the attached micrometer.

Hot film anemometer: Anemometer which measures wind speed by measuring the degree of cooling of a metal film heated by an electric current. A type of cooling-power anemometer.

Hot wire anemometer: Anemometer which measures wind speed by measuring the degree of cooling of a metal wire heated by an electric current. A type of cooling-power anemometer.

Hotplate precipitation gauge: An instrument which measures rainfall and snowfall by electronically maintaining the temperature of two back-to-back round plates at a constant temperature above ambient and measuring the difference of the power required to hold them at that temperature. Developed and patented by The National Center for Atmospheric Research of Boulder, Colorado, and the Desert Research Institute of Reno, Nevada.

Humidity: Water vapor content of the air. See absolute humidity, dew point, mixing ratio, relative humidity, specific humidity.

Humidity coefficient: A measure, proposed by Angstrom, of the precipitation effectiveness of a region.

Glossary of Meteorological Terms

Humidity element: The transducer of any hygrometer, i.e. that part of a hygrometer that quantitatively “senses” atmospheric water vapor.

Humidity strip: The humidity transducing element in a Diamond-Hinman radiosonde. Also called electrolytic strip.

Hurricane balloon: See hurricane beacon.

Hurricane beacon: An air-launched balloon designed to be released in the eye of a tropical cyclone, float within the eye at predetermined levels, and transmit radio signals for RDF positioning.

Hurricane-force wind: Wind with a speed above 64 knots (73 mph); Beaufort scale numbers 12 through 17.

Hurricane wind: In general, the severe wind of an intense tropical cyclone (hurricane or typhoon). The term has no further technical connotation, but, unfortunately, is easily confused with the strictly defined hurricane-force wind.

Hydrogen (H): A colorless and odorless gaseous element. The lightest and apparently the most abundant chemical element in the universe. However, it is found only in trace quantities in the observable portion of our atmosphere, only about 0.00005 percent by volume of dry air. Hydrogen has a molecular weight of 2.0160 and specific gravity referred to air of 0.0695. At one time hydrogen was the commonly used inflation gas for meteorological balloons, but because of its dangerous combustibility, it has been largely replaced by helium.

Hydrograph: A graphical representation of stage or discharge at a point on a stream as a function of time.

Hydrography: The study of waters (including oceans, lakes, and rivers) embracing either: (a) their physical characteristics, from the standpoint of the oceanographer or limnologist; or (b) the elements affecting safe navigation, from the point of view of the mariner. Compare to hydrology.

Hydrologic accounting: A systematic summary of the terms (inflow, outflow, and storage) of the storage equation as applied to the computation of soil-moisture changes, ground-water changes, etc. An evaluation of the hydrologic balance of an area. Also called basin accounting, water budget.

Hydrologic balance: Generally, the relative states of inflow, outflow, and storage of moisture over a given area of earth's surface.

Hydrologic cycle: The succession of stages through which water passes on the ground and in the atmosphere: evaporation from land or bodies of water, condensation to form clouds, precipitation, accumulation in the soil or in bodies of water, and re-evaporation.

Hydrologic year: Same as water year.

Hydrology: The scientific study of the waters of the earth, especially with relation to the effects of precipitation and evaporation upon the occurrence and character of water in streams, lakes, and on or below the land surface. In terms of the hydrologic cycle, the scope of hydrology may be defined as that portion of the cycle from precipitation to re-evaporation or return to the water of the seas. Applied hydrology utilizes scientific findings to predict rates and amounts of runoff (river-forecasting), estimate required spillway and reservoir capacities, study soil-water-plant relationships in agriculture, estimate available water supply, and for other applications necessary to the management of water resources. Compare to hydrography.

Hydrometeor: A general term for atmospheric water in any of its forms, i.e. clouds, fog, hail, ice crystals, rain.

Hydrometer: An instrument used for measuring the specific gravity of a liquid.

Hydrophotometer: An instrument for measuring the extinction coefficient in water.

Hydrosphere: The water portion of the earth as distinguished from the solid part, called the lithosphere, and from the gaseous outer envelope, called the atmosphere.

Hyetal: Of or pertaining to rain.

Hygristor: A modification of the dew cell used in radiosonde equipment.

Hygrodeik: A form of psychrometer with wet-bulb and dry-bulb thermometers mounted on opposite sides of a specially designed graph on opposite sides of a specially designed graph of the psychrometric tables. It is so arranged that the intersections of two curves determined by the wet-bulb and dry-bulb readings yield the relative humidity, dew-point, and absolute humidity.

Hydrogram: The record made by a hygrograph.

Hydrograph: A hygrometer which includes an arrangement for the time recording of atmospheric humidity.

Hygrometer: An instrument used to measure the water vapor content of the air.

Hygroscope: An instrument that shows changes in humidity.

Hygroscopic: Readily taking up and retaining moisture.

Hygrothermograph: An instrument resulting from the combination of a thermograph and a hygrograph and furnishing, on the same chart, simultaneous time recording of ambient temperature and humidity.

Hygrothermoscope: Apparatus using the combined simultaneous action of a bimetallic thermometer and a hair hygrometer to move a needle in front of a divided scale. Its construction permits dew point variations to be indicated approximately.

Hypsometer: An instrument used to determine atmospheric pressure or elevation by observing the boiling point of water or other liquids. The sensitivity of the hypsometer increases with decreasing pressure, making it more useful for high altitude work.

Hysteresis: The maximum difference in output for any given input (within the specified range) when the value is approached first with increasing, and then with decreasing, input signals. Caused by energy absorption in the elements of the measuring instrument. Usually expressed as a percentage of full-scale range.

Hythergraph: A type of climatic diagram whose coordinates are some form of temperature vs. a form of humidity or precipitation.

/

Ice crystals: A type of precipitation composed of unbranched crystals in the form of needles, columns, or plates. Usually has a very slight downward motion and may fall from a cloudless sky.

Ice point: The true freezing point of water. The temperature at which a mixture of air-saturated pure water and pure ice may exist in equilibrium at a pressure of one standard atmosphere.

Iceing-rate meter: An instrument for the measurement of the rate of ice accretion on an unheated body.

Glossary of Meteorological Terms

IFLOWS: Integrated Flood Observing and Warning System. A joint undertaking by the National Weather Service and the participating States to improve flood warning capabilities by giving local communities the ability to obtain real-time rain and stream level data.

IFR: Abbreviation for Instrument Flight Rules, but commonly used to refer to the weather and/or flight conditions to which these rules apply, i.e. low visibility.

Illuminance: The total luminous flux received on a unit area of a given real or imaginary surface, expressed in such units as the foot-candle, lux, or phot.

Illuminometer: Same as photometer.

Impactor: A general term for instruments which sample atmospheric suspensoids by impactation. Same as impactometer.

Inaccuracy: The difference between the input quantity applied to a measuring instrument and the output quantity indicated by the instrument. The inaccuracy of an instrument is equal to the sum of its instrument error and its uncertainty.

Inch of mercury: A common unit used in measurement of atmospheric pressure. Defined as that pressure exerted by a one-inch column of mercury at standard gravity and a temperature of 0°C.

Index: The indicating part of an instrument. For example, the hand of a watch or the meniscus of a mercury column.

Indicator: An instrument used to reveal but not necessarily measure the presence of an electrical quantity. It is used to display the output of a sensing element after suitable amplification and modification. Sometimes called display.

Inert gas: Any one of six gases, helium, neon, argon, krypton, xenon, and radon, all of whose shells of planetary electrons contain stable numbers of electrons such that the atoms are chemically inactive.

Infiltration: Movement of water through the soil surface into the soil, or the quantity of water entering the soil. Infiltration is equal to the total precipitation less the losses due to interception by vegetation, retention in depressions on the land surface, evaporation, and surface runoff.

Infiltration capacity: The maximum rate at which precipitation can pass through the surface into the soil, for a given soil in a given condition.

Infrared radiation: Electromagnetic radiation lying in the wavelength interval between 0.8 micron and 1 millimeter. At the lower limit of this interval, the infrared radiation spectrum is bounded by visible radiation, while on its upper limit it is bounded by microwave radiation.

Input (or input signal): The quantity to be measured (or modulated, or detected, or operated upon) which is received by an instrument. For a thermometer, temperature is the input quantity.

Insolation: In general, solar radiation received at the earth's surface. Contracted from incoming solar radiation.

Instrument: A term used to describe a sensor (or sensors), the associated transducer(s), and the data readout or recording device.

Instrument correction: The mean difference between the readings of a given instrument and those of a standard instrument.

Instrument error: The correctable part of the inaccuracy of an instrument.

Instrument exposure: The physical exposure of an instrument. The effect of the immediate environment upon the representativeness of the measurements obtained by meteorological instruments is considerable and not always correctable. The purpose of the instrument shelter is to provide as good an exposure as possible.

Instrument flight rules (IFR): A set of regulations set down by the U.S. Civil Aeronautics Board to govern the operational control of aircraft on instrument flight. The abbreviation of this term is seldom used to denote the rules themselves, but is in popular use to describe the weather and/or flight conditions to which these rules apply.

Instrument landing system (ILS): A navigational aid used to facilitate the landing of an aircraft at an airport in instrument weather, i.e. low visibility.

Instrument shelter: A box-like structure designed to protect certain meteorological instruments from exposure to direct sunlight, precipitation, and condensation, while at the same time providing adequate ventilation. Instrument shelters are painted white, have louvered sides, usually a double roof, and are mounted on a stand several feet above the ground with the door side facing poleward. See cotton-region shelter, Stevenson screen.

Instrument weather: In aviation terminology, route or terminal weather conditions of sufficiently low visibility to require the operation of aircraft under instrument flight rules.

Interceptometer: A rain gauge which is placed under trees or foliage to determine the rainfall in that location. By comparing this catch with that from a rain gauge set in the open, the amount of rainfall which has been intercepted by foliage can be determined.

Interface: The point (physical and/or electrical) where two distinct data processing elements meet.

International Geophysical Year: By international agreement, a period during which greatly increased observation of worldwide geophysical phenomena is undertaken through the cooperative effort of participating nations. July 1957 to December 1958 was the first such year. However, precedent was set by the International Polar Years of 1882 and 1932.

International index numbers: A system of designating meteorological observing stations by number, established and administered by the World Meteorological Organization. Under this scheme, specified areas of the world are divided into "blocks" each bearing a two-number designator. Stations within each block have an additional unique three-number designator, the numbers generally increasing from east to west and from south to north.

International Practical Temperature Scale of 1948

(IPTS-48): Specified by the 9th General Conference of Weights and Measures held in 1948. In the IPTS-48, the name "degree Centigrade" was replaced by "degree Celsius."

International Practical Temperature Scale of 1968 (IPTS-68): Set by the 1968 General Conference of Weights and Measures. In the IPTS-68, both thermodynamic and practical units were defined to be identical and equal to 1/273.16 of the thermodynamic temperature of the triple point of water. The unit itself was renamed "the kelvin" in place of "degree Kelvin" and designated "K" in place of "°K".

Glossary of Meteorological Terms

International Temperature Scale of 1927 (ITS-27): Adopted by the 7th General Conference of Weights and Measures in 1927.

International Temperature Scale of 1990 (ITS-90): An approximation to the thermodynamic temperature scale, it became the internationally recognized standard on January 1, 1990. On the ITS-90 scale, the atmospheric boiling temperature of water is approximately 373.124K (99.974°C).

International synoptic code: A synoptic code approved by the World Meteorological Organization in which the observable meteorological elements are encoded and transmitted in "words" of five numerical digits length. Often abbreviated synoptic code.

Isobar: A line of equal or constant pressure.

Isobaric: Of equal or constant pressure, with respect to either space or time.

Iso-elastic spring: A spring which is designed to achieve a fixed spring constant over a wide temperature range. Usually, this involves an alloy with high nickel content such as Ni-Span C. It is common for these springs to be stress relieved at elevated temperature after forming.

Isohel: A line drawn through geographical points having the same duration of sunshine (or other function of solar radiation) during a given interval of time.

Isohume: A line drawn through points of equal humidity on a given surface.

Isohyet: Line drawn through geographical points recording equal amounts of precipitation during a given time period or for a particular storm.

Isonep: A line drawn through all points on a map having the same amount of cloudiness.

Isophane: A line drawn through geographical points where a given seasonal biological event occurs on the same date.

Isopluvial: A line drawn through geographical points having the same pluvial index.

Isotherm: A line of equal or constant temperature.

Isothermal layer: Atmospheric layer throughout which there is no change of temperature with height, i.e. a zero lapse rate.

Isotropic radiation: Diffuse solar radiation which has the same intensity in all directions.

Ivory point: A small pointer extending downward from the top of the cistern of a Fortin barometer. The level of the mercury in the cistern is adjusted so that it just comes in contact with the end of the pointer, thus setting the zero of the barometric scale.

J

Jevons effect: The effect upon the measurement of rainfall caused by the presence of the rain gauge.

Jordan sunshine recorder: A sunshine recorder of the type in which the time scale is supplied by the motion of the sun. It consists of two opaque metal semi-cylinders mounted with their curved surfaces facing each other. Each of the semi-cylinders has a short narrow slit in its flat side. Sunlight entering the slits falls on light sensitive paper which lines the curved side of the semi-cylinder. One semi-cylinder covers morning hours, the other afternoon hours.

Joule: A unit of energy equal to 10^7 ergs or to 0.2389 calories.

K

Katabatic wind: Any wind blowing down an incline. If warm, it is a foehn. If cold, it may be a fall wind or a gravity wind.

Katathermometer: A type of cooling-power anemometer based upon the principle that the time constant of a thermometer is a function of its ventilation.

Kelvin temperature scale: An absolute temperature scale with the ice point of pure water defined as 273.16K. The size of the degree is the same as on the Celsius scale, and the zero point is absolute zero. Temperatures on this scale are called kelvins, not degrees kelvin, the unit kelvin is not capitalized, and the symbol (capital K) stands alone with no degree symbol. There are no negative temperatures in the Kelvin scale. In photometry, the Kelvin scale is used to express "color temperature," a simplified way to characterize the spectral properties of a light source.

Technically, color temperature refers to the temperature to which one would have to heat a theoretical "black body" source to produce light of the same visual color. The Kelvin temperature scale is named after the British mathematician and physicist William Thomson (Lord Kelvin), who proposed it in 1848.

Kew-pattern barometer: Mercurial barometer with a fixed scale and cistern and which therefore requires only one adjustment before each reading.

Kilogram calorie: See calorie.

Koschmieder's law: A basic equation in daytime visual range theory, relating the apparent luminance of a distant black object, the apparent luminance of the background sky above the horizon, and the extinction coefficient of the atmosphere.

Knot: The unit of speed in the nautical system; one nautical mile per hour. It is equal to 1.1508 statute miles per hour or 0.5144 meters per second.

Konimeter: An instrument for determining the dust content of a sample of air. Also spelled conimeter.

Koniscope: An instrument which indicates the presence of dust particles in the atmosphere. Also spelled coniscope.

Koschmieder's Law: A basic equation in daytime visual range theory, relating the apparent luminance of a distant black object, the apparent luminance of the background sky above the horizon, and the extinction coefficient of the air layer near the ground. Also called airlight formula.

Krypton: An inert gas. An element found in the atmosphere to the extent of only 0.000114 percent by volume. Its molecular weight is 83.7.

Kytoon: A captive balloon used to maintain meteorological equipment aloft at approximately a constant height. The kytoon is streamlined and combines the aerodynamic properties of a balloon and a kite.

L

Lambert: A unit of luminance (photometric brightness). One lambert is the luminance of a surface that emits or reflects one lumen per square centimeter. The lambert honors the German physicist Johann Lambert (1728-1777), who showed that the illuminance of a surface is inversely proportional to the square of the distance from the light source.

Glossary of Meteorological Terms

Laminar Smooth, non-turbulent. Often used to describe cloud formations which appear to be shaped by a smooth flow of air traveling in parallel layers or sheets.

Langley: A unit of energy per unit area commonly employed in radiation theory. Equal to one gram-calorie per square centimeter.

Lapse line: A curve showing the variation of temperature with height in the free air. See lapse rate.

Lapse rate: The decrease of an atmospheric variable with height, the variable being temperature, unless otherwise specified.

Large calorie: See calorie.

Laurence: A common type of terrestrial scintillation; shimmering over a hot surface (such as a roadway) on a quiet, cloudless, summer day.

Leeward: Facing away from the wind.

Lee wave: A wave disturbance in airflow due to some barrier in the flow, i.e. a hill or mountain.

LIDAR: Light Detecting And Ranging. A technique used to detect atmospheric constituents or related parameters such as atmospheric extinction coefficient. Light is produced in a modulated source and the resulting backscattered or reflected light is analyzed to quantify some property of the atmosphere.

Light: Visible radiation (about 0.4 to 0.7 microns in wavelength) considered in terms of its luminous efficiency, that is, evaluated in proportion to its ability to stimulate the sense of sight.

Light air: Wind with a speed between 1 and 3 knots (1 and 3 mph); Beaufort scale number 1.

Light breeze: Wind with a speed between 4 and 6 knots (4 and 7 mph); Beaufort scale number 2.

Linearity: The maximum deviation of any points from a straight line drawn as a "best fit" through the calibration points of an instrument with a linear response curve. Usually expressed as a percentage of full-scale range.

Linke-scale: A type of cyanometer, an instrument used to measure the blueness of the sky. The Linke-scale is simply a set of eight cards of different standardized shades of blue. They are evenly numbered 2 to 26. The odd numbers are used by the observer if he or she judges the sky color to lie between any of the given shades.

Liquid thermometer: Thermometer in which the difference in the rates of expansion with temperature of a liquid and its receptacle is used as a measure of the temperature. The liquid used may be ethyl alcohol, toluene, petroleum, or mercury.

Lithometeor: The general term for dry atmospheric suspensoids, including dust, haze, smoke, and sand. Compare to hydrometeor.

Lithosphere: The outer, solid portion of the earth; the crust of the earth.

Livingstone sphere: An clay atmometer consisting of a hollow ceramic sphere through which evaporation occurs. Evaporation is measured by the loss of water from the reservoir which feeds the sphere.

Lizard balloon: A balloon having a detachable tail which is released when the balloon has undergone a predetermined expansion. It thus serves to measure approximately the density of the atmosphere at the point of release.

Local visual distance: The meteorological visual range, which can be estimated from the average extinction coefficient using the Koschmieder equation.

Local winds: Winds which, over a small area, differ from those which would be appropriate to the general pressure distribution.

Long-wave radiation: Radiation with wavelengths greater than 4 microns. (In meteorology, same as infrared radiation.)

Lo-reference signal: The audio-frequency signal transmitted by the Diamond-Hinman radiosonde when the baroswitch pen passes each fifth contact of the commutator up to a number determined by the design of the commutator. It then signals every contact except the fifth, which is transmitted as a hi-reference signal.

Low: An area of low barometric pressure, with its attendant system of winds. Also called a depression or cyclone.

Low level wind shear: A local variation in the wind direction or speed. This condition can present danger to aircraft, especially at landing, when a sudden shift from headwind to tailwind can cause a rapid loss of airspeed and lift.

Lucimeter: Instrument for measuring the mean intensity of global solar radiation (direct and diffuse) near the earth's surface in a specified time interval.

Lull: A momentary decrease in the speed of the wind.

Lumen: A unit of luminous flux. The lumen is equal to the luminous flux radiated into a unit solid angle (steradian) from a small source having a luminous intensity of one candle. An ideal source possessing an intensity of one candle in every direction would radiate a total of 4 pi lumens. "Lumen" is a Latin word for light.

Luminance: A measure of the intrinsic luminous intensity emitted by a source in a given direction. Luminance is a measure only of light. The comparable term for electromagnetic radiation in general is radiance.

Luminescence: Any emission of light at temperatures below that required for incandescence.

Luminous flux: The flux of visible radiation, so weighted as to account for the manner in which the response of the human eye varies with the wavelength of radiation. The basic unit for luminous flux is the lumen.

Luminous intensity: The intensity (flux per unit solid angle) of visible radiation weighted to take into account the variable response of the human eye as a function of the wavelength of light. Usually expressed in candles.

Lux: A photometric unit of illuminance or illumination equal to one lumen per square meter.

Lysimeter: A type of evaporation gauge consisting of a tank or pan of soil placed in a field so that the soil, water, thermal, and vegetative properties in the tank duplicate as closely as possible the properties of the surrounding area.

M

Magnetic wind direction: The direction, with respect to magnetic north, from which the wind is blowing. Distinguish from true wind direction.

Magneto anemometer: A cup anemometer with its shaft mechanically coupled to a magneto.

Glossary of Meteorological Terms

Magnetograph: A recording magnetometer.

Magnetometer: General name for an instrument which measures the earth's magnetic field intensity.

Manometer: An instrument for measuring the pressure of gases and vapors. A mercury barometer is a type of manometer.

Marine barometer: A mercury barometer designed for use aboard ship. The instrument is of the fixed-cistern type (see Kew barometer). The mercury tube is constructed with a wide bore for its upper portion and with a capillary bore for its lower portion. This is done to increase the time constant of the instrument and thus prevent the motion of the ship from affecting the reading. The instrument is suspended in gimbals to reduce the effects of pitch and roll of the ship.

Marine rainbow: A rainbow seen in the spray of the ocean. It is optically the same phenomenon as the ordinary rainbow.

Marine thermometer: See sea-water thermometer, reversing thermometer.

Mariners 1-2-3 Rule: A method of avoiding winds associated with a tropical cyclone by taking into account the forecast track error of the National Weather Service over a 10 year period which is approximately 100 nm in 24 hours, 200 nm for 48 hours, and 300 nm in 72 hours. The forecast track error is added to the 34 knot wind radii to compute the danger area.

MARPLOT: Mapping Applications for Response, Planning, and Local Operational Tasks. Part of the CAMEO system.

MARS: Motor Aspirated Radiation Shield. See radiation shield.

Marvin sunshine recorder: A sunshine recorder of the type in which the time scale is supplied by a chronograph. It consists of two bulbs, one of which is blackened, which communicate through a glass tube of small diameter. The tube is partially filled with mercury and contains two electrical contacts. When the instrument is exposed to sunshine, the air in the blackened bulb is warmed more than that in the clear bulb. The warmed air expands and forces the mercury through the connecting tube to a point where the electrical contacts are shorted by the mercury. This completes the electrical circuit to the pen of the chronograph.

Maximum thermometer: Thermometer used for measuring the highest temperature attained during a given interval of time, for example, a day.

Maximum-wind level: The height at which the maximum wind speed occurs, determined in a winds-aloft observation.

Maxwell's law: The statement that the viscosity of air is independent of the density of air.

Mean radiant temperature: The temperature at which an object gives out as much radiation as it receives from its surroundings.

Mean temperature: The average temperature of the air as indicated by a properly exposed thermometer for a given time period, usually a day, a month, or a year.

Measured accuracy: The maximum positive and negative deviation observed in testing a device under specified conditions and by a specified procedure. It is usually measured as an inaccuracy and expressed as accuracy, typically in terms of the measured variable, percent of span, percent of upper range variable, percent of scale length, or percent of actual output reading. See accuracy, accuracy rating.

Melting level: The level at which ice crystals and snowflakes melt as they descend through the atmosphere.

Melting point: The temperature at which a solid substance undergoes fusion, i.e. melts, changes from solid to liquid form. All substances have their characteristic melting points. For very pure substances the temperature range over which the process of fusion occurs is very small. The melting point of a pure crystalline solid is a process of pressure. It increases with increasing pressure for most substances. However in the case of ice (and a few other substances) the melting point decreases with increasing pressure. Under a pressure of one standard atmosphere, the melting point of pure ice is the same as the ice point, that is 0°C or 32°F.

Meniscus: The upper surface of a column of liquid.

Mercurial barometer: Same as mercury barometer.

Mercury: A metallic element of atomic weight 200.61, unique (for metals) in that it remains liquid under all but very extreme temperatures.

Mercury barometer: Barometer in which pressure is determined by balancing air pressure against the weight of a column of mercury in an evacuated glass tube.

Mercury column: (Also called barometer column, barometric column.) The column of mercury employed in a mercury barometer, the height of which (inches of mercury) is used as a measure of atmospheric pressure.

Mercury-in-glass thermometer: A common type of liquid-in-glass thermometer, used, in meteorology, in psychrometers and as a maximum thermometer.

Mercury-in-steel thermometer: A liquid-in-metal thermometer in which mercury is enclosed in a steel envelope. The change in internal pressure caused by the temperature variation is measured by a Bourdon tube which is connected to the mercury by a capillary tube. This instrument is highly accurate and has extremely good pen control when arranged as a thermograph.

Mercury thermometer: A liquid-in-glass or liquid-in-metal thermometer using mercury as the liquid.

Mesonet: A regional network of observing stations (usually surface stations) designed to diagnose mesoscale weather features and their associated processes.

Mesoscale: Pertaining to atmospheric phenomena having horizontal scales ranging from a few to several hundred kilometers, including thunderstorms, squall lines, fronts, precipitation bands in tropical and extratropical cyclones, and topographically generated weather systems such as mountain waves and sea and land breezes.

Meteorogram: A record obtained from a meteorograph. A chart in which meteorological variables are plotted against time.

Meteorograph: An instrument which automatically records the measurement of two or more meteorological elements.

Meter-ton-second system: A system of physical units based upon the use of the meter, the metric ton (10⁶ grams), and the second as elementary quantities of length, mass, and time, respectively.

Michaelson actinograph: A pyrheliometer of the bimetallic type used to measure the intensity of direct solar radiation.

Microbarm: That portion of the record of a microbarograph between any two (or a specified small number) of successive crossings of the average pressure level (in the same direction). Analogous to microseism.

Glossary of Meteorological Terms

Microbarogram: The record or trace made by a microbarograph.

Microbarograph: An aneroid barograph designed to record atmospheric pressure variations of very small magnitude.

Micropluviometer: Rain gauge which registers precipitation that is too light to be registered by ordinary recording of the depth of water from precipitation. Same as ombrometer.

Microprocessor: A small, limited-capacity central processing unit contained entirely on one semiconductor chip.

Microseism: A feeble oscillatory disturbance of the earth's crust, detectable only by very sensitive seismographs. Certain types of microseisms seem to be closely correlated with pressure disturbances. See microbarm.

Millibar: A unit of pressure which directly expresses the force exerted by the atmosphere. Equal to 1000 dynes/cm² or 100 pascals.

Minimum thermometer: Thermometer used for measuring the lowest temperature attained during a given interval of time, for example, a day.

Mirror nephoscope: A nephoscope in which the motion of the cloud is observed by its reflection in a mirror.

Mist: A hydrometeor consisting of an aggregate of microscopic and more-or-less hygroscopic water droplets suspended in the atmosphere. It reduces visibility to a lesser extent than fog. The relative humidity of mist is often less than 95 percent.

Mistbow: Same as fogbow.

Mixing ratio: In a system of moist air, the dimensionless ratio of the mass of water vapor to the mass of dry air. For many purposes, the mixing ratio may be approximated by the specific humidity.

MMTS: Maximum-Minimum Temperature System. Electronic temperature measurement devices deployed by the US National Weather Service as a part of their cooperative network beginning in the mid-1980s.

Moby Dick balloon: A large plastic constant-level balloon for duration flying (in excess of 24 hours) at altitudes above 40,000 feet, used for the determination of wind fields and the measurement of upper atmospheric parameters.

Modem: A device that allows a terminal or computer at one location to communicate with a terminal or computer at a distant location via wire or phone lines.

Moderate breeze: Wind with a speed between 11 and 16 knots (13 and 18 mph); Beaufort scale number 4.

Moderate gale: Wind with a speed between 28 and 33 knots (32 and 38 mph); Beaufort scale number 7.

Modulation: The process of modifying some characteristic of a wave (the carrier) so that it varies in step with the instantaneous value of another wave (the modulating wave) in order to transmit a message. The modified characteristic may be frequency, phase, and/or amplitude.

Mole: A unit of mass numerically equal to the molecular weight of the substance. The gram-mole or gram-molecule is the mass in grams numerically equal to the molecular weight, i.e. a gram-mole of oxygen is 32 grams.

Moll thermopile: A thermopile used in some types of radiation instruments. See solarimeter.

Monsoon: A seasonal wind of persistent direction, characterized by a pronounced change in direction between seasons.

Mountain barometer: Any conventional barometer fitted with an extended scale so that atmospheric pressure measurements may be made at both high and low altitudes.

Mount Rose snow sampler: A particular pattern of snow sampler having an internal diameter of 1.485 inches so that each inch of water in the sample weighs one ounce.

Moveable scale barometer: A mercury barometer of the fixed cistern type in which a moveable scale terminating in an ivory point is used to compensate for the variations in the height of the mercury in the cistern.

MSL: Abbreviation for mean sea level.

MST radar: Abbreviation for mesosphere-stratosphere-troposphere radar. A type of wind profiler designed to measure winds and other atmospheric parameters up to altitudes of 100 km or more.

MTBF: Abbreviation for mean time between failures.

Multiple register: A chronograph used to make a time-record of certain measured meteorological elements. The most common type, the triple register, records wind direction and speed, duration of sunshine, and amount of rainfall (sensed respectively by a contact anemometer, Marvin sunshine recorder, and tipping bucket rain gauge). The register consists of a rotating, clock-driven drum on a helical axis, a separate pen for each element, and the actuating mechanism for the pens. Double registers are also used. Multiples registers of this type are becoming obsolete.

Multiplexer: A device that combines several separate communications signals into one and outputs them on a single line.

Muskingum method: A method of streamflow routing which assumes that storage is a linear function of the weighted flow in the reach and is adaptable to a simple mathematical solution.

N

Nansen bottle: A device used by oceanographers to obtain subsurface samples of sea water. The "bottle" is lowered by wire, its valves open at both ends. It is then closed in situ by allowing a weight (called a messenger) to slide down the wire and strike the reversing mechanism. This causes the bottle to turn upside down, closing the valves and reversing the reversing thermometers which are mounted on it in a special thermometer case. If, as is usually the case, a series of bottles are lowered, then the reversal of each bottle releases another messenger to actuate the bottle beneath it.

Nautical mile: The nautical mile is closely related to the geographical mile which is defined as the length of one minute of arc on the earth's equator. By international agreement, the nautical mile is now defined as 1852 meters.

Nasen cast: A series of Nansen-bottle water samples and associated temperature observations resulting from one release of a messenger.

Nephelometer: An instrument which measures the scattering function of particles suspended in a medium in order to determine the visual range through the medium. See visibility meter.

Nepheloscope: (1) An instrument for demonstrating the temperature changes which occur in air that is rapidly expanded or compressed. (2) A laboratory instrument for the production of clouds by the condensation process. (3) Same as nephoscope.

Glossary of Meteorological Terms

Nephometer: A general term for instruments designed to measure the amount of cloudiness.

Nephoscope: An instrument for determining the direction of cloud motion. There are two basic designs of nephoscope, the direct-vision nephoscope and the mirror nephoscope. Also called nepheloscope.

Net pyranometer: An instrument for measuring the difference of the solar radiation falling on both sides of a horizontal surface from the whole hemisphere.

Net pyrgeometer: An instrument for measuring the difference between incoming and outgoing terrestrial radiation.

Net radiation: The difference between downward and upward (total) radiation; net flux of all radiation.

Net radiometer: An instrument for the measurement of the net flux of downward and upward total (solar and terrestrial) radiation through a horizontal surface.

Net solar radiation: The difference between the solar radiation directed downward and upward; net flux of solar radiation.

Newtonian telescope: A reflecting type telescope with a 45° mirror, so that the primary image is observed through a hole in the side of the tube.

NEXRAD: Acronym for NEXt generation weather RADar. A network of advanced Doppler radars, known as the WSR-88D (Weather Surveillance Radar - 1988 Doppler), developed in the 1980s and implemented in the 1990s to replace the aging network of WSR-57 and WSR-74 radar systems.

Nine light indicator: A remote indicator for wind speed and direction used in conjunction with a contact anemometer and a wind vane. The indicator consists of a center light, connected to the contact anemometer, surrounded by eight equally spaced lights which are individually connected to a set of similarly spaced electrical contacts on the wind vane. Wind speed is determined by counting the number of flashes of the center light during an interval of time. Direction, indicated by the position of the illuminated outer bulbs, is given to 16 points of the compass.

Nipher shield: A conically shaped, copper rain gauge shield.

Nonlinear: Not a linear function of the relevant variables.

Non-recording rain gauge: A rain gauge which indicates but does not record the amount of precipitation captured.

Normal operating conditions: The range of operating conditions within which a device is designed to operate and for which operating influences are stated. See operating conditions, reference operating conditions.

Normal-plate anemometer: A type of pressure-plate anemometer in which the plate, restrained by a stiff spring, is held perpendicular to the wind. The wind-activated motion of the plate is measured electrically. The natural frequency of this system can be made high enough so that resonance magnification does not occur.

NRM wind scale: A wind scale adapted by the U.S. Forest Service for use in the forested areas of the northern Rocky Mountains (NRM). It is an adaptation of the Beaufort wind scale. The difference between these two scales lies in the specification of the visual effects of the wind. The force numbers and the corresponding wind speeds are the same in both.

NWS: National Weather Service. Administered by the U.S. Department of Commerce.

O

Obscuring phenomenon: An atmospheric phenomenon, other than clouds, which obscures a portion of the sky from the point of observation. Also called obscuration.

Observational error: The difference between the true value of some quantity and its observed value. Every observation is subject to certain errors. *Systematic errors* affect the whole of a series of observations in nearly the same way. For example, the scale of an instrument may be out of adjustment. These instrument errors can be detected and corrected by comparison with a standard. The personal equation of an observer may lead him or her to make small systematic errors in his or her readings, for example, if the scale is not at eye level. *Random errors*, which appear in any series of observations, are generally small and as likely to be positive as negative. Their magnitudes are usually distributed according to the error distribution. *Mistakes* are widely discrepant readings.

Ombrometer: A rain gauge capable of measuring very small amounts of precipitation. Also called micropluviometer, trace recorder.

Ombroscope: An instrument which indicates the presence of precipitation. The ombroscope consists of a heated, water-sensitive surface which indicates by mechanical or electrical techniques the occurrence of precipitation.

Operational weather limits: The limiting values of ceiling, visibility, and wind, or runway visual range, established as safety minima for aircraft landings and take-offs.

Operating conditions: Conditions to which a device is subjected, not including the variable measured by the device. See normal operating conditions, reference operating conditions.

Operating influence: The change in a performance characteristic caused by a change in a specified operating condition from reference operating condition, all other conditions being held within the limits of reference operating conditions.

Orographic precipitation: Precipitation caused by the ascent of moist air over an orographic barrier such as a mountain range.

OSHA: Occupational Safety and Health Administration. A regulatory office of the U.S. Department of Labor.

Owens dust recorder: An instrument for rapidly obtaining samples of airborne dust; a type of dust counter. Particles pass through a cylindrical chamber, are drawn at high velocity through a narrow slit, and then impinge upon a microscope cover glass located a short distance from the slit. Analysis for quantity and size of the particles is made using a microscope. The vacuum required to operate the instrument is developed by an attached hand pump.

P

PAR: Abbreviation for photosynthetically active radiation.

Parachute radiosonde: Same as dropsonde.

Parantheion: A refraction phenomenon similar to a parhelion, but occurring generally at a distance of 120° (occasionally 90° and 140°) from the sun, on the parhelic circle.

Paraselen: A weakly colored lunar halo identical in form and optical origin to the solar parhelion.

Glossary of Meteorological Terms

Paraselenic circle: A halo phenomenon consisting of a horizontal circle passing through the moon, corresponding to the parhelic circle through the sun. Produced by reflection of moonlight from ice crystals.

Parahelic circle: A halo consisting of a faint white circle passing through the sun and running parallel to the horizon for as much as 360° of azimuth. Produced by reflection of sunlight from ice crystals.

Parhelson: Either of two colored luminous spots that appear at points 22° (or somewhat more) on both sides of the sun and at the same elevation as the sun. Also called mock sun, sun dog.

Parallel data transmission (parallel output): A form of data transmission in which the bits of each character are all sent simultaneously, resulting in extremely fast communication but requiring a communication path for each bit. Compare to serial data transmission.

Parity: The addition of one or more redundant bits to information to verify its accuracy.

Pascal: Name given to the unit of pressure in the International System of Units (SI). Equal to 1 newton/meter² or 0.01 millibar.

Pascal's law: A hydrostatic principle that pressure supplied to an enclosed fluid is transmitted undiminished to every portion of the fluid and to the walls of the containing vessel.

Peak gust: In United States weather observing practice, the highest "instantaneous" wind speed recorded at a station during a specified period, usually the 24-hour observation day. Therefore, a peak gust need not be a true gust of wind.

P-E index: Abbreviation for precipitation effectiveness index.

Pendulum anemometer: A pressure-plate anemometer consisting of a plate which is free to swing about a horizontal axis in its own plane above its center of gravity. The angular deflection of the plate is a function of the wind speed. This instrument is not used for station measurements because of the false reading which results when the frequency of the wind gusts and the natural frequency of the swinging plate coincide. This was the earliest form of anemometer.

Penetrometer: A pointed device which indicates the amount of resistance encountered when it is forced into a material such as snow or soil. See ram penetrometer.

P-E quotient: Abbreviation for precipitation-evaporation quotient.

P-E ratio: Abbreviation for precipitation-evaporation ratio.

Percolation: The gravity flow of water within soil.

Permeability: Capacity of a soil or other surface to be penetrated by water sinking into the ground under the force of gravity. It thus expresses the rate of percolation.

Personal equation: A systematic observational error due to the characteristics of the observer. The uncertainty in a reading made by an observer may be ascertained by a statistical analysis of his or her readings.

Pers sunshine recorder: A sunshine recorder of the type in which the time scale is supplied by the motion of the sun. The instrument, which is pointed at the celestial pole, consists of a hemispherical mirror mounted externally on the optical axis of a camera. The lens of the camera forms an image of the sun which is reflected by the hemispherical mirror so that as the sun moves across the sky, the image traces an arc of a circle on the photographic paper.

Phenolic: A plastic molding component formed by the reaction of phenol and formaldehyde. It can be heavily reinforced or "filled" with glass fibers or other materials. Phenolics are known for their high impact strength, excellent wear characteristics, and dimensional stability over a wide temperature range.

Phot: A photometric unit of illuminance or illumination equal to one lumen per square centimeter.

Photoelectric cell: A transducer which converts electromagnetic radiation in the infrared, visible, and ultraviolet regions into electrical quantities such as voltage, current, or resistance. Also called photo cell.

Photoelectric photometer: See photometer.

Photoelectric transmittance-meter: An instrument for measuring the transmissivity of the atmosphere; a type of transmissometer. It consists of a constant-intensity collimated light source located at a suitable distance from a photoelectric cell. Variation in the turbidity of the atmosphere causes changes in the intensity of the light received by the photo cell, thereby varying its electrical output. Also called photoelectric transmissometer.

Photographic barograph: A mercury barometer arranged so that the position of the upper or lower meniscus may be measured photographically. In one design the image of the meniscus is formed on a rotating drum covered with sensitized paper so that a continuous record of pressure as a function of time is obtained.

Photometer: An instrument for measuring the intensity of light or the relative intensity of a pair of lights. Also called an illuminometer. If the instrument is designed to measure the intensity of light as a function of wavelength, it is called a spectrophotometer. Photometers may be divided into two classes: photoelectric photometers in which a photoelectric cell is used to compare electrically the intensity of an unknown light with that of a standard light; and visual photometers in which the human eye performs the function of a photo cell. A photometer used to measure the intensity of a distant light is referred to as a telephotometer or transmissometer.

Photopolarimeter: A polarimeter utilizing a Wollaston prism as a polarizer and a Nicol prism as an analyzer.

Phytometer: A device, similar to a potometer, for measuring transpiration, consisting of a vessel containing soil in which one or more plants are rooted and sealed so that water can escape only by transpiration from the plant.

Pibal: Contraction for pilot balloon observation.

Piche evaporimeter: An atmometer which uses a filter paper disc as the evaporating element. The amount of water evaporated through the paper is read at the graduated tube reservoir.

Pilot balloon: A small balloon whose ascent is followed by a theodolite in order to obtain data for the computation of winds aloft.

Pilot balloon observation: A method of winds aloft observation in which the elevation and azimuth angles of a theodolite are read while visually tracking a pilot balloon. Balloon height data is estimated from assumed balloon ascension rates.

Pitot-static tube: Same as pitot tube.

Glossary of Meteorological Terms

Pitot tube: An instrument for measuring the relative speed of a fluid. It consists of a concentric pipe arrangement in which the inner pipe is open at one end and the outer pipe is perforated and closed at both ends. Each pipe is connected to a manometer. The unit is operated with the open end pointing upstream, so that the inner pipe measures the total pressure and the outer pipe measures the static pressure. The difference between these pressures, the dynamic pressure, is proportional to the square of the fluid speed.

Pitot tube anemometer: A pressure tube anemometer, consisting of a pitot tube mounted on the windward end of a wind vane and a suitable manometer to measure the developed pressure and calibrated in units of wind.

Pluvial: Pertaining to rain, or more broadly, to precipitation.

Pluvial index: The amount of precipitation falling in one day, or other specified period, that is likely to be equalled or exceeded in any given place only once in a century. That is, a precipitation amount that has a return period of 100 years.

Pluviograph: Same as recording rain gauge.

Pluviometer: Same as rain gauge.

Pluvioscope: Apparatus from which the nature and time of precipitation may be determined.

Polarimeter: An instrument for determining the degree of polarization of light. See photopolarimeter.

Polariscope: An instrument for studying, or examining substances in, polarized light. See Savant polariscope.

Pole-star recorder: An instrument used to determine approximately the amount of cloudiness during the dark hours. It consists of a fixed long-focus camera positioned so that Polaris is permanently within its field of view. The apparent motion of the star appears as a circular arc on the photograph and is interrupted as clouds come between the star and the camera.

Potential evaporation: Same as evaporative power.

Potential evapotranspiration: The amount of moisture which, if available, would be removed from a given land area by evapotranspiration. Expressed in units of water depth.

Potential temperature: Temperature assumed by an unsaturated air parcel when brought adiabatically to a standard pressure (1,000 mb).

Potentiometer: An instrument for measuring differences in electric potential.

Potometer: A device, similar to a phytometer, for measuring transpiration. It consists of a small vessel containing water and sealed so that the only escape of moisture is by transpiration from a leaf, twig, or small plant with its cut end inserted in the water.

Precipitable water: Amount of water, expressed as a depth or as a mass, which would be obtained if all the water vapor in a specified column of the atmosphere were condensed and precipitated.

Precipitation: Any and all forms of water particles, liquid or solid, that fall from the atmosphere and reach the ground.

Precipitation-effectiveness index: For a given location, a measure of the long-range effectiveness of precipitation in promoting plant growth. Also called precipitation-evaporation index.

Precipitation-effectiveness ratio: Same as precipitation-evaporation ratio.

Precipitation-evaporation index: Same as precipitation-effectiveness index.

Precipitation-evaporation quotient: A measure of long-term precipitation effectiveness. The ratio of the normal annual rainfall to the normal annual evaporation.

Precipitation-evaporation ratio: For a given locality and month, an empirical expression devised for the purpose of classifying climates numerically on the basis of precipitation and evaporation.

Precipitation gauge: General term for any device that measures precipitation; principally a rain gauge or snow gauge.

Precipitation scavenging: Removal of pollutants from the air by either rain or snow.

Pressure altimeter: An aneroid barometer with a scale graduated in altitude instead of pressure units.

Pressure gradient: The rate of decrease of pressure per unit distance at a fixed time.

Pressure jump: A sudden, significant increase in station pressure.

Pressure-plate anemometer: An anemometer which measures wind speed in terms of the drag which the wind exerts on a solid body. See bridled-cup anemometer, normal-plate anemometer, pendulum anemometer.

Pressure port: A device used to create a static pressure inlet for a barometric pressure sensor by shielding the sensor from the effects of wind.

Pressure tendency (barometric tendency): The change in barometric pressure within a specified period of time (typically 3 hours for meteorological observations).

Pressure-tube anemometer: An anemometer which derives wind speed from measurements of dynamic wind pressures. Wind blowing into a tube develops a pressure greater than the static pressure, while wind blowing across a tube develops a pressure less than the static. This pressure differential, which is proportional to the square of the wind speed, is measured by a suitable manometer. See anemo-biograph, Dines anemometer, Pitot tube.

PROM: Programmable Read-Only Memory. Read-only memory which can be programmed by the user using a special hardware programmer.

Price meter: A current meter consisting of six conical cups, mounted around a vertical axis, which rotate and generate a signal with each rotation. Tail vanes and a heavy weight stabilize the instrument.

Primary rainbow: The most common of the principal rainbow phenomena, which appears as an arc of about 42° about the observers antisolar point. On occasion, inside the primary rainbow one or more supernumerary rainbows may be seen. The secondary rainbow lies outside the primary rainbow at an angular radius of about 50°.

Propeller anemometer: A rotation anemometer which has a horizontal axis upon which helicoidal shaped vanes are mounted. See windmill anemometer.

Protected thermometer: A reversing thermometer which is encased in a strong glass outer shell that protects it against hydrostatic pressure. Compare to unprotected thermometer.

Protocol: A set of rules or conventions used to standardize data transfer between devices.

PSK: Phase Shift Keying. A form of phase modulation of a data signal performed by a modem for transmission over dedicated wire or phone lines.

Glossary of Meteorological Terms

Psychrograph: A self-recording psychrometer.

Psychrometer: An instrument used to measure the water vapor content of the air. A type of hygrometer. It consists of a wet-bulb and a dry-bulb thermometer. See aspiration psychrometer, Assmann psychrometer, hygrodeik, sling psychrometer.

Psychrometric calculator: A device for computing certain psychrometric data, usually the dew point and the relative humidity, from known values of the dry-bulb and wet-bulb temperatures and the atmospheric pressure. One type is the circular slide-rule form and, like the psychrometric tables, it is derived from the psychrometric formula.

Psychrometric tables: Tables prepared from the psychrometric formula and used to obtain vapor pressure, relative humidity, and dew point from values of wet-bulb and dry-bulb temperatures.

p.t.u.: Abbreviation for the pressure, temperature, and humidity data obtained by a radiosonde observation.

Pulse-time-modulated radiosonde: A radiosonde which transmits the indications of the meteorological sensing elements in the form of pulses spaced in time. The meteorological data are evaluated from the intervals between the pulses. Also called time-interval radiosonde.

Pyranograph: An instrument for recording global solar radiation.

Pyranometer: An instrument which measures combined direct solar radiation and diffuse sky radiation. See pyrhelimeter, Robitzsch actinograph, solarimeter. See also albedometer.

Pyrgeometer: An instrument which measures the effective terrestrial radiation. See Angstrom pyrgeometer.

Pyrhelimeter: An instrument for measuring the intensity of direct solar radiation at normal incidence. See Angstrom compensation pyrhelimeter, Eppley pyrhelimeter, Michaelson actinograph, silver-disc pyrhelimeter, spectropyrhelimeter, water-flow pyrhelimeter.

Pyrradiometer: An instrument for the measurement of both solar and terrestrial radiation.

Q

QFE: Atmospheric pressure at field elevation.

QNH: Same as altimeter setting.

Quadrant electrometer: A very sensitive electrostatic electrometer for measuring small potential differences.

R

Rabal: A method of winds aloft observation essentially the same as a pilot balloon observation except the height data is derived from the radiosonde observation rather than from assumed ascension rates.

Radar: Acronym for RAdio Detection And Ranging. An electronic instrument used to detect distant objects and measure their range by how they scatter or reflect radio energy. Precipitation and clouds are detected by measuring the strength of the electromagnetic signal reflected back. See Doppler radar, NEXRAD.

Radarsonde: A system in which radar techniques are used to determine the range, elevation, and azimuth of a radar target carried aloft by a radiosonde, so that wind data may be obtained along with the other meteorological data.

Radar theodolite: A radar which is used to obtain the azimuth, elevation, and slant range of an airborne target.

Radar wind system: Apparatus in which radar techniques are used to determine the range, elevation, and azimuth of a balloon-borne target, to computer upper-air wind data. It is a type of rawin system.

Radiance: In radiometry, a measure of the intrinsic radiant intensity emitted by a radiator in a given direction.

Radiant energy: The energy of any type of electromagnetic radiation. Also called radiation.

Radiant-energy thermometer: An instrument which determines the black-body temperature of a substance by measuring its thermal radiation.

Radiation: Emission or transfer of energy in the form of electromagnetic waves or particles.

Radiation pattern: A diagram showing the intensity of the radiation field in all directions from a transmitting radio or radar antenna at a given distance from the antenna.

Radiation shield: A device used on certain types of instruments to prevent unwanted radiation from affecting the measurement of a quantity. Also called solar radiation shield.

Radiator: Any source of radiant energy, especially electromagnetic energy.

Radio atmometer: An instrument designed to measure the effect of sunlight on evaporation from plant foliage. It consists of a porous clay atmometer whose surface has been blackened so that it absorbs radiant energy.

Radio direction-finder: An instrument for determining the direction from which radio waves approach a receiver. It may consist of a manually operated direction indicator, or it may use a servo system to position the antenna automatically in the direction of the incident waves. This instrument may be used in place of a theodolite for observation of a radiosonde. Also called radio theodolite, radio goniometer.

Radio frequency (RF): The RF waves emanating from an antenna are generated by the movement of electrical charges in the antenna. Electromagnetic waves can be characterized by a wavelength and a frequency. The wavelength is the distance covered by one complete cycle of the electromagnetic wave, while the frequency is the number of electromagnetic waves passing a given point in one second. The frequency of an RF signal is usually expressed in terms of a unit called the "hertz" (abbreviated Hz). One Hz equals one cycle per second. One megahertz (MHz) equals one million cycles per second.

Radio theodolite: An instrument for determining the direction from which radio waves approach a receiver. It may consist of a manually operated direction indicator, or it may use a servo system to position the antenna automatically in the direction of the incident waves.

Glossary of Meteorological Terms

Radioactive snow gauge: A device which automatically records the water equivalent of snow on a given surface as a function of time. A small sample of a radioactive salt is placed in the ground in a shielded collimator which directs a beam of radioactive particles upwards. A Geiger-Müller counting system located above the snow level measures the amount of depletion of radiation caused by the presence of snow.

Radiometer: An instrument for measuring radiant energy. See actinometer, Dines radiometer, photometer, Tulipian radiometer.

Radiosonde: A balloon-borne instrument for the simultaneous measurement and transmission of meteorological data. It includes transducers for the measurement of pressure, temperature, and humidity; a modulator for the conversion of the output of the transducers to a quantity which controls a property of the radio frequency signal; a selector switch which determines the sequence in which the parameters are to be transmitted; and a transmitter which generates the radio-frequency carrier.

Radiosonde balloon: A balloon used to carry a radiosonde aloft, considerably larger than pilot balloons or ceiling balloons.

Radiosonde commutator: A component of a radiosonde consisting of a series of alternate electrically conducting and insulating strips. As these are scanned by a contact the radiosonde transmits temperature and humidity signals alternately. The contact may be a baroswitch as in the Diamond-Hinman radiosonde, or may be motor driven.

Radiosonde modulator: That part of an audio-modulated radiosonde consisting of the baroswitch, the sensing elements, the reference elements, and the relay.

Radiosonde observation: An evaluation of upper air temperature, pressure, and humidity from radio signals received from a balloon-borne radiosonde.

Radiosonde recorder: An instrument, located at the surface observing station, which is used to record the data presented by a radiosonde aloft.

Radiosonde transmitter: The component of the radiosonde which includes the modulating blocking oscillator and the radio-frequency carrier oscillator.

Radiosonde-radiowind system: Apparatus consisting of (a) standard radiosonde and radiosonde ground equipment to obtain upper-air data on pressure, temperature, and humidity, and (b) a self-tracking radio direction-finder to provide the elevation and azimuth angles of the radiosonde so that wind vectors may be obtained. It is a type of rawinsonde system.

Rain: Precipitation composed of liquid water drops more than 0.5 mm in diameter, falling in relatively straight, but not necessarily vertical, paths. Compare to drizzle.

Rain gauge: Instrument for measuring the depth of water from precipitation that is assumed to be distributed over a horizontal, impervious surface and not subject to evaporation.

Rain gauge shield: A device which surrounds a rain gauge and acts to maintain horizontal flow in the vicinity of the funnel so that the catch will not be influenced by eddies generated near the gauge. See Alter shield, Nipher shield, Wild fence.

Rain-intensity gauge: An instrument which measures the instantaneous rate at which rain is falling on a given surface. Also called a rate-of-rainfall gauge.

Rainbow: Any one of a family of circular arcs consisting of concentric colored bands, arranged from red on the inside to blue on the outside, which may be seen on a "sheet" of water drops (rain, fog, spray). The most common of the many possible is the primary rainbow. The second most common is the secondary rainbow, seen outside the primary bow and having the reverse spectral sequence. Tertiary and higher order bows are exceedingly rare due to their low luminosity. Supernumerary rainbows are seen fairly often just within the primary bow.

Raindrop spectrograph: An instrument which automatically determines the size distribution of raindrops.

RAM: Random Access Memory. The memory of a computer which can be read and written into at any location without passing through preceding locations.

Ram penetrometer: A cone-tipped metal rod designed to be driven downward into deposited snow or firn. The measured amount of force required to drive the rod a given distance is an indication of the physical properties of the snow or firn.

Random: Eluding precise prediction, completely irregular.

Random error: The inherent imprecision of a given process of measurement, the unpredictable component of repeated independent measurements of the same object under sensibly uniform conditions.

Range: The interval between the lower and upper measuring limits of an instrument, i.e. a thermometer with a range of -35 to 50°C. Compare to span.

Rankine temperature scale: An absolute temperature scale with the degree of the Fahrenheit scale and the zero point of the Kelvin scale. The freezing point of water equals 491.67°. The boiling point of water equals 671.67°. The temperature scale is named after the Scottish engineer and physicist William John Macquorn Rankine, who proposed it in 1859.

Raob: Contraction for radiosonde observation.

Rate-of-rainfall gauge: Same as rain-intensity gauge.

Rawin: A method of winds aloft observation accomplished by tracking a balloon-borne radar target or radiosonde with either radar or a radio theodolite.

Rawinsonde: A method of upper air observation consisting of an evaluation of the wind speed and direction, temperature, pressure, and humidity aloft by means of a balloon-borne radiosonde tracked by radar or a radio theodolite.

Rawin target: A special type of radar target, usually a corner reflector, tied beneath a free balloon and designed to be an efficient reflector of radio energy.

RAWS: Remote Automated Weather Station. A network of weather stations positioned throughout the U.S. that collect, store, and forward data hourly via satellite to a computer system located at the National Interagency Fire Center in Boise, Idaho.

RDF: Radio Direction Finder.

Reach: A definite portion of a stream channel, commonly taken between two gauging stations, but may be taken between any two specified points.

Real-time: The actual time during which physical events take place.

Glossary of Meteorological Terms

Reaumur temperature scale: A scale with the ice point at zero degrees and the boiling point of water at 80 degrees, with pressure of one atmosphere.

Receiver: (1) The initial component or the sensing element of a measuring system. For example, the receiver of a rain gauge is the funnel which captures the rain and the receiver of a thermoelectric thermometer is the measuring thermocouple.

(2) An instrument used to detect the presence of and to determine the information carried by electromagnetic radiation, i.e. a radio receiver.

Recording potentiometer: An instrument which automatically records the voltage applied to it, as a function of time.

Recording rain gauge: A rain gauge which automatically records the amount of precipitation collected, as a function of time.

Reduction: In general, the transformation of data from a "raw" form to some useable form. In meteorology, this often refers to the conversion of the observed value of an element to the value which it would theoretically have at some selected or standard level. The most common reduction in weather observing is that of station pressure to sea level pressure.

Reflected solar radiation (reflected global radiation): Upward-directed solar radiation, reflected by the earth's surface and the atmosphere.

Reflecting nephoscope: Same as mirror nephoscope.

Reflection rainbow: A rainbow formed by light rays which have been reflected from an extended water surface. Not to be confused with a reflected rainbow whose image may be seen in a still body of water. The center of a reflection rainbow is at the same elevation as the sun but in the opposite part of the sky.

Reflector: In general, any object that reflects incident energy. Usually it is a device designed for specific reflection characteristics.

Reflectometer: Downward-facing pyranometer used for measuring reflected solar radiation.

Reference operating conditions: The range of operating conditions of a device within which operating influences are negligible. The range is usually narrow. Reference operating conditions are the conditions under which reference performance is stated and the base from which the values of operating influences are determined. See normal operating conditions, operating conditions.

Register: The writing component of a recording instrument.

Relative evaporation: See evaporative opportunity.

Relative humidity: The ratio of the existing amount of water vapor in the air at a given temperature to the maximum amount that could exist at that temperature. Usually expressed in percent.

Repeatability: The closeness of agreement among a number of consecutive output values measuring the same input value under the same operating conditions, approaching from the same direction. Usually measured as nonrepeatability but expressed as repeatability, a percentage of span.

Reproducibility: The closeness of agreement among measurements of the same value of the same quantity where the individual measurements are made under different defined conditions, i.e. by different methods or with different measuring instruments.

Resistance thermometer: A type of electrical thermometer in which the thermal element is a substance whose electrical resistance varies with the temperature. Such thermometers can be made with very short time constants and are capable of highly accurate measurements.

Resolution: The smallest change in the environment that causes detectable change in the indication of an instrument. Compare to sensitivity.

Response: The value of the quantity measured, as indicated or otherwise provided by a measuring instrument.

Response time: The time required for an instrument to register a designated percentage (frequently 90%) of a step change in the variable being measured.

Retreater: A defective maximum thermometer of the liquid-in-glass type in which the mercury flows too freely through the constriction. Such a thermometer will indicate a maximum temperature that is too low.

Reversing thermometer: A mercury-in-glass thermometer which records the temperature upon being inverted and retains its reading until being returned to the first position.

RF: Abbreviation for radio frequency.

Ridge: An elongated area of relatively high pressure. Usually associated with and most clearly identified as an area of maximum anticyclonic curvature of the wind flow. The opposite of a trough.

Rime: An accumulation of granular ice tufts on the windward sides of exposed objects that is formed from supercooled fog or cloud and built out directly against the wind.

River basin: The total area drained by a river and its tributaries. Same as watershed.

River forecast: A forecast of the expected stage or discharge at a specified time, or of the total volume of flow within a specified interval of time, at one or more points along a stream.

River gauge: A device for measuring the river stage. Also called stream gauge.

River stage: See stage.

RMS: Root Mean Square. This notation is used frequently with error analysis. In that context, it is the square root of the arithmetic mean of the squares of the deviations of the individual calibration points from the theoretical or ideal response.

Robitzsch actinograph: A pyranometer developed by M. Robitzsch. Its design utilizes three bimetallic strips which are exposed horizontally at the center of a hemispherical glass bowl. The outer strips are white reflectors and the center strip is a blackened absorber. The bimetals are joined in such a manner that the pen of the instrument deflects in proportion to the difference in temperature between the black and white strips and is thus proportional to the intensity of the received radiation.

Rocketsonde (meteorological rocket): A rocket designed primarily for routine upper air observations in the lower 250,000 feet of the atmosphere, especially that portion inaccessible to balloons (above 100,000 feet).

Rockoon: A high-altitude sounding system consisting of a small solid-propellant research rocket carried aloft by a large plastic balloon. The rocket is fired near the maximum altitude of the balloon flight.

Glossary of Meteorological Terms

ROM: Read Only Memory. A memory that cannot be altered in normal use of a computer, Usually used to store information permanently, such as firmware programs.

ROMAN: Real-Time Observations Monitor and Analysis Network. A web-based weather observations monitor linking RAWS, airport observations, and other miscellaneous observations to a single user interface.

Rotating multicylinder: An instrument consisting of a series of graduated cylinders possessing selective collection efficiencies. It is used for the measurement of quantities relating to the size distribution of cloud droplets.

Rotation anemometer: A type of anemometer in which the rotation of an element serves to measure the wind. Rotation anemometers are divided into two classes; those in which the axis of rotation is horizontal, such as the windmill anemometer, and those in which the axis of rotation is vertical, such as the cup anemometer.

RS232: A standard interface between a computer input/output port and a peripheral device. Signal properties including time duration, voltage, and current, are specified by the Electronic Industries Association.

RS422: A protocol similar to RS232 which makes use of differential transmission to provide high speed data transmission over significantly longer distances.

RS485: A protocol similar to RS232 which permits data interchange on multidrop networks of up to 32 nodes using a single twisted pair cable. In order for this protocol to be used, each device on a network must have some level of intelligence in order establish orderly data transfer over a single path.

Runoff: The portion of the precipitation on the land which ultimately reaches the streams, especially the water from rain or melted snow that flows over the surface.

Runway visibility: The visibility along an identified runway, determined from a specified point on the runway with the observer facing in the same direction as a pilot using the runway. Compare to runway visible range.

Runway visual range (RVR): The maximum distance along the runway at which the runway lights are visible to a pilot at touchdown. Runway visual range may be determined by an observer located at the end of the runway, facing in the direction of landing, or by means of a transmissometer installed near the end of the runway.

S

Salinometer: Any device or instrument for measuring salinity, especially one based on electrical conductivity methods.

SAM: Station for Atmospheric Measurements. A portable meteorological station used to provide weather data to the ALOHA air model that predicts how a cloud of pollutant gas might disperse in the atmosphere after an accidental release. Also see CAMEO.

Saturation: The condition of the atmosphere when the amount of water vapor present is the maximum possible at the existing temperature.

Savart polariscope: A polariscope consisting of a specially constructed double plate polarizer and a tourmaline plate analyzer. Polarized light passing through the instrument is indicated by the presence of parallel colored fringes, while unpolarized light results in a uniform field.

SAWRS: Supplemental Aviation Weather Reporting Station. A facility where weather observations are taken, prepared, and transmitted by a local operator under federal government supervision.

SCADA: Supervisory Control and Data Acquisition. A type of industrial process control system used for gathering data in real time from remote locations in order to control equipment and conditions.

Scale: The array of indicating marks and figure in relation to which the position of an index is observed, i.e. a scale plate on a recorder.

Scatter: The process by which small particles suspended in a medium of a different refractive index diffuse a portion of the incident radiation in all directions. In scattering no energy transformation results, only a change in the spatial distribution of the radiation. Along with absorption, scattering is a major cause of the attenuation of radiation by the atmosphere.

Scattered radiation: Solar radiation scattered by particles in the atmosphere.

Scattering coefficient: A measure of the attenuation due to scattering of light as it traverses a medium containing scattering particles.

Scintillation: Generic term for rapid variations in apparent position, brightness, or color of a distant luminous object viewed through the atmosphere.

Scintillometer: A type of photoelectric photometer used to measure high-altitude winds on the assumption that stellar scintillation is caused by atmospheric inhomogeneities being carried along by wind near the tropopause level.

Scud: Ragged low clouds, usually stratus fractus. Most often applied when such clouds are moving rapidly beneath a layer of nimbostratus.

Sea level pressure: The atmospheric pressure at mean sea level either directly measured by stations at sea level or empirically determined from the station pressure and temperature by stations not at sea level. Used as a common reference for analyses of surface pressure patterns.

Sea rainbow: Same as marine rainbow.

Sea water thermometer: A thermometer designed for use in measuring the temperature of sea water. One form consists of a mercury-in-glass thermometer protected by a perforated metal case. Another form consists of a mercury-in-glass thermometer surrounded by a metal case which forms a well around the bulb of the thermometer. When the thermometer is raised from the water, a sample is retained in the well. See bucket thermometer, reversing thermometer.

Secchi disk: A white disk 12" or more in diameter which is lowered into the sea to estimate transparency of the water. The depths are noted at which it first disappears when lowered and reappears when raised.

Secondary instrument: An instrument whose calibration is determined by comparison with an absolute instrument.

Glossary of Meteorological Terms

Secondary rainbow: A rainbow of angular radius of about 50° often seen outside the primary rainbow of 42° radius. The secondary rainbow is formed by two internal reflections (rather than one as in the primary rainbow), plus two refractions. Its spectral color sequence is from red inside to violet outside. Because each reflection introduces light losses, the secondary bow is much less bright than the primary bow.

Seismograph: An instrument used to measure and record earthquake vibrations and other earth tremors.

Sensing element: The element directly responsive to the value of the measured variable.

Sensitivity: The ratio of the output of an instrument to the input value, i.e. a rain gauge with a sensitivity of 1 tip per 0.01".

Sensor: The part of a measuring instrument which responds directly to changes in the environment.

Serial data transmission (serial output): A form of data transmission in which the bits of each character are sent one at a time along a single communication path. Compare to parallel data transmission.

Short-wave radiation: Radiation with wavelengths less than 4 microns.

Shower: Precipitation from a cumuliform cloud. Characterized by the suddenness of beginning and ending, by the rapid change in intensity, and usually by a rapid change in the condition of the sky. The solid or liquid water particles are usually bigger than the corresponding elements in other types of precipitation.

Sigma Theta (wind direction): The standard deviation of wind direction. Provides an indication of the variability of the wind direction. Used in calculations of atmospheric stability.

SIGMET information: Meteorological information issued by a watch office concerning the occurrence or forecast of weather phenomena which may affect the safety of aircraft operations.

Signal conditioning: The processing of the form or mode of a signal so as to make it intelligible to, or compatible with, a given device.

Significant level: In a radiosonde observation, a level (other than a standard level) for which values of pressure, temperature, and humidity are reported because temperature and/or humidity data at that level is sufficiently important or unusual to warrant the attention of the forecaster.

Simplex: Operation mode of a communication circuit in which one end can only transmit and the other end can only receive.

Sine galvanometer: A magnetometer of the electromagnetic type which is used to measure the horizontal intensity of the earth's magnetic field.

Siphon barograph: A recording siphon barometer.

Siphon barometer: A mercury barometer in which the tube is U-shaped and the upper and lower mercury surfaces have the same diameter.

Six's thermometer: A thermometer, invented by James Six in 1782, which simultaneously indicates the maximum and minimum temperatures attained during a given interval of time. A U-tube min/max thermometer.

Sky cover: The amount of sky covered or concealed by clouds or obscuring phenomena. It is reported in tenths, so that 0.0 indicates a clear sky and 1.0 (or 10/10) indicates a completely covered sky. The following classifications are used in aviation weather observations: clear, scattered, broken, overcast, partial obscuration, obscuration.

Skyhook balloon: A large plastic constant-level balloon for duration flying at very high altitudes.

Slant range: The line-of-sight distance between two objects.

Sleet: Frozen or partly frozen rain.

Sling psychrometer: Psychrometer to which a small chain or rotary handle is attached so that the observer can rotate the instrument rapidly to properly ventilate the thermometer bulbs.

SNOTEL: SNOW TELEmetry. An automated network of snowpack data collection sites. The Natural Resources Conservation Service (NRCS), formerly the Soil Conservation Service (SCS), has operated the Federal-State-Private Cooperative Snow Survey Program in the western United States since 1935. A standard SNOTEL site consists of a snow pillow, a storage type precipitation gauge, an air temperature sensor, and a small shelter for housing electronics.

Snow: Precipitation composed of white or translucent ice crystals, chiefly in complex branched hexagonal forms.

Snow board: A flat, solid, white material, such as painted plywood, approximately two feet square, which is laid on the ground or snow surface to obtain more accurate measurements of snowfall and water content.

Snow bridging: An effect noted primarily in wet snow conditions when snow clings to the sides of a precipitation gauge and gradually accumulates until the gauge orifice is capped with accumulated snow. This effect can be minimized by using large collectors, and wind screens around gauges.

Snow core: A sample of either freshly fallen snow, or the combined old and new snow on the ground, obtained by pushing a cylinder down through the snow layer and extracting it.

Snow course: An established line or transect of measurements of snow water equivalent across a snow field in representative mountainous terrain, where appreciable snow accumulates, to monitor seasonal snowpack.

Snow cutter: A saw-toothed piece of metal which slips over the top of the overflow can of a standard rain gauge when it is used to cut snow samples for the determination of water content of snow on the ground. Not required except where ice or dense snow accumulation are persistent problems.

Snow flurry: Snow shower, particularly of a very light and brief nature.

Snow gauge: Apparatus designed to measure the amount of precipitation falling in the form of snow. The device determines the weight of the snow or the volume of water after the snow melts.

Snow grains: Precipitation of very small, white, opaque particles of ice, fairly flat or elongated, with diameters less than 1 mm. The solid equivalent of drizzle.

Snow pellets (soft hail): Precipitation of white, opaque, spherical or conical ice particles that are crisp and easily crushed and that have diameters of 2 to 5 mm.

Glossary of Meteorological Terms

Snow pillow: An instrument used to measure snow water equivalents. Snow pillows typically have flat stainless steel surface areas. The pillow below this flat surface is filled with antifreeze solution and the pressure in the pillow is related to the water-equivalent depth of the snow on the platform.

Snow sampler: Snow gauge composed of a metal cylinder, closed at one end, used to obtain a sample of snow from which the water is measured after melting.

Snow stake: Graduated fixed stake used in regions of abundant snowfall to facilitate the measurement of snow depth.

Snow stick: A portable rod used to measure snow depth.

Snow survey: Determination of the total amount of snow covering a watershed or a given region. Both depth and water content of the snow may be measured, and the results may be used to predict the amount of water that will be available after melting.

Snow tube: Same as snow sampler.

Software: The programs and instructions which direct a computer.

Soil evaporimeter: Instrument used to measure the amount of water evaporated from the soil surface during a given time interval.

Soil moisture: Moisture contained in the soil above the water table, including water vapor which is present in the soil pores. In some cases this term refers strictly to the humidity contained in the root zone of plants.

Soil thermometer (geothermometer): Thermometer for measuring the temperature in the soil at different depths.

Solar constant: Amount of solar radiation incident, per unit area and time, on a surface which is perpendicular to the radiation and is situated at the outer limit of the atmosphere, the earth being at its mean distance from the sun. It equals approximately 2.00 ly/min (1400 W/m²).

Solarimeter: Name sometimes used in place of pyranometer as a generic term.

Solar radiation: The total electromagnetic radiation emitted by the sun. About 99.9 percent of its energy output falls within the wavelength interval from 0.15 microns to 4.0 microns, with peak intensity near 0.47 microns. About one-half of the total energy in the solar beam falls in the visible spectrum from 0.4 to 0.7 microns, and most of the other half falls in the near infrared, a small additional portion falling in the ultraviolet.

Solar radiation shield: See radiation shield.

Solid-state device: An element that can control current without moving parts, heated filaments, or vacuum gaps.

Sonic anemometer: An anemometer which measures wind speed by means of the properties of wind-borne sound waves. It operates on the principle that the propagation velocity of a sound wave in a moving medium is equal to the velocity of sound with respect to the medium plus the velocity of the medium. The sonic anemometer is an absolute instrument and has the advantages of a very short time-constant and an absence of moving mechanical parts.

Sonic thermometer: A thermometer based upon the principle that the velocity of a sound wave is a function of the temperature of the medium through which it passes. Sonic thermometers possess very short time-constants and eliminate radiation error.

Sounding: Same as an upper air observation, but commonly used to refer to a single complete radiosonde observation.

Span: The algebraic difference between the upper and lower limits of the measuring range of an instrument, e.g. a thermometer with a range of -35 to 50°C has a span of 85°C.

Specific humidity: In a system of moist air, the dimensionless ratio of the mass of water vapor to the total mass of the system.

Spectral hygrometer: A hygrometer which determines the amount of precipitable moisture in a given region of the atmosphere by measuring attenuation of radiant energy caused by the absorption bands of water vapor.

Spectral solar radiation: Solar radiation of selected wavelengths.

Spectroheliograph: An instrument for taking photographs of an image of the sun in monochromatic light.

Spectrohelioscope: Similar to the spectroheliograph, but used for visual instead of photographic purposes.

Spectrophotometer: A photometer which measures the intensity of radiation as a function of the frequency (or wavelength) of the radiation.

Spectropyreheliometer: An instrument which measures the spectral distribution of the intensity of direct solar radiation.

Spirit thermometer: A liquid-in-glass thermometer which uses an organic substance such as alcohol as the thermometer liquid. This type of thermometer has a low freezing point and a high coefficient of expansion. It is less accurate, however, than a mercury thermometer.

Spliced tail: A type of wind vane having a split or V-shaped tail. The apex orients itself to the direction of the wind.

Squall: A strong wind characterized by a sudden onset, a duration on the order of minutes, and a rather sudden decrease in speed.

Staff gauge: A graduated scale placed in a position so that the stage of a stream may be read directly from it. Staff gauges may be placed on bridge piers or pilings, etc., or placed on specially constructed supports.

Stage: The elevation of the water surface in a stream as measured by a river gauge with reference to some arbitrarily selected zero datum.

Standard atmosphere: A standard unit of atmospheric pressure, defined as the pressure exerted by a 760 mm column of mercury at standard gravity (980.665 cm/sec²) at 0°C. 1 standard atmosphere is equal to 760 mm Hg, 29.9212 inches Hg, or 1013.250 mb. Also, a hypothetical vertical distribution of atmospheric temperature, pressure, and density which, by international agreement, is taken to be representative of the atmosphere.

Standard error: The standard deviation (positive square-root of the variation) of the errors associated with physical measurements of an unknown quantity, or statistical estimates of an unknown parameter or of a random variable.

Standard level (mandatory level): One of several constant-pressure levels in the atmosphere for which a complete evaluation of data derived from upper air observations is required.

Static pressure vent: A vent used with pressure sensors to reduce the effect of wind on the pressure inlet. It is normally mounted remotely and connected to the sensor using airtight tubing.

Station pressure: The atmospheric pressure computed using station elevation as the reference datum level. Station pressure is usually the base value from which sea level pressure and altimeter setting are determined.

Glossary of Meteorological Terms

Statute mile: A unit of distance equal to 5280 feet. It is sometimes referred to as a land mile.

Stevenson screen: A type of instrument shelter. It is a wooden box painted white with double louvered sides and mounted on a stand four feet above the ground. Designed by Thomas Stevenson, civil engineer (father of Robert Louis Stevenson).

Still well (or stilling well): A cylinder installed in a body of water or an evaporation pan to hold a sensor, such as a float to measure water level or a hook gage. The stillwell is constructed so that there is free movement of water in and out of it, and it therefore provides a representative sample of the water body. It functions to protect the sensor in some cases and to provide an undisturbed water surface in other cases.

Storm: Wind with a speed between 56 and 63 knots (64 and 72 mph); Beaufort scale number 11.

Stream gauge: Same as river gauge.

Strong breeze: Wind with a speed between 22 and 27 knots (25 and 31 mph); Beaufort scale number 6.

Strong gale: Wind with a speed between 41 and 47 knots (47 and 54 mph); Beaufort scale number 9.

Sun dog: Same as parhelion.

Sunshine recorder: An instrument designed to record the duration of sunshine at a given location without regard to intensity. See Campbell-Stokes recorder, Jordan sunshine recorder, Marvin sunshine recorder, Pers sunshine recorder.

Supercooled water: Liquid water at temperatures colder than freezing.

Supernumerary rainbows: A set of weakly colored rainbow arcs sometimes discernable inside a primary rainbow.

Super-pressure balloon: See constant-level balloon.

Switching power supply: A power supply which achieves its output regulation by means of one or more active power handling devices which are alternately placed in the "off" or "on" states. It is more efficient than linear supplies which vary the conduction of power devices to achieve output regulation.

Synchro: A motorlike device containing a rotor and a stator and capable of converting an angular position into an electrical signal, or an electrical signal into an angular position. When several synchros are correctly connected, all of the rotors will align themselves into the same angular position. This is useful, since one synchro whose angular motion is forced to change, can drive another synchro to indicate the angular change.

Synchronous: Having a specific relationship to a time base or clock. In synchronous communications, data characters are sent according to a timing signal which synchronizes the two communicating devices.

Synoptic: In general, pertaining to or affording an overall view. In meteorology, this term has become somewhat specialized in referring to the use of meteorological data obtained simultaneously over a wide area for the purpose of obtaining a comprehensive and nearly instantaneous picture of the state of the atmosphere. Thus, to a meteorologist, "synoptic" takes on the additional connotation of simultaneity.

Synoptic weather observation: A surface weather observation, made at periodic times, of sky cover, state of the sky, cloud height, atmospheric pressure reduced to sea level, temperature, dew point, wind speed and direction, amount of precipitation, hydrometeors and lithometeors, and special phenomena that prevail at the time of the observation or have been observed since the previous specified observation.

Compare to aviation weather observation.

Systematic error: That part of the inaccuracy of a measuring instrument, or statistical estimate of a parameter, that is due to a single cause or small number of causes having the same sign, and hence, in principle, is correctable; a bias or constant offset from the true value. In the absence of random errors, the true value is equal to the instrumental reading or statistical mean estimate minus the systematic error.

T

Tail wind: A wind blowing in the same direction as the heading of a moving object, thus assisting the object's intended progress. The opposite of a head wind.

Teardrop balloon: A sounding balloon which, when operationally inflated, resembles an inverted teardrop.

Telemeteorograph: Any meteorological instrument, such as a radiosonde, in which the recording apparatus is located at some distance from the measuring apparatus.

Telemeter: The measuring, transmitting, receiving, and indicating apparatus for obtaining the value of a quantity at a distance.

Telemetry: The transmission of data collected at a remote location over communications channels to a central station.

Telephotometer: A photometer that measures the received intensity of a distance light source.

Telethermoscope: A temperature telemeter.

Temperature: In thermodynamics, the integrating factor of the differential equation referred to as the first law of thermodynamics. In statistical mechanics, a measure of translational molecular kinetic energy (with three degrees of freedom). In general, the degree of hotness or coldness as measured on some definite temperature scale by means of any of various types of thermometers.

Temperature coefficient: (1) The ratio of the speeds of a chemical reaction at two temperatures differing by 10°C. (2) A factor relating the response characteristics of a device with changes in the ambient temperature.

Temperature correction: The correction applied to an instrument to account for the effect of temperature upon its response characteristics.

Temperature scale: See approximate absolute temperature scale, Celsius temperature scale, centigrade temperature scale, Fahrenheit temperature scale, international practical temperature scale, international temperature scale, Kelvin temperature scale, Rankine temperature scale, Reaumur temperature scale.

Tercentesimal thermometric scale: Sir Napier Shaw's name for the approximate absolute temperature scale.

Terminal: A generic term for any machine that enables a human being to communicate with a computer.

Glossary of Meteorological Terms

Terrestrial radiation: The total infrared radiation emitted from the earth's surface. To be carefully distinguished from atmospheric radiation, effective terrestrial radiation, and insolation.

Thaw: To free something from the binding action of ice by warming it to a temperature above the melting point of ice. Also, a warm spell when ice and snow melt.

Theodolite: An optical instrument which consists of a sighting telescope mounted so that it is free to rotate around horizontal and vertical axes, with graduated scales so that the angles of rotation may be measured. Used to observe the motion of a pilot balloon.

Thermal shift: The change in the measured transducer output caused by changes in ambient temperature. Usually expressed a percentage of full scale.

Thermistor: A semiconductor which exhibits rapid and extremely large changes in resistance for relatively small changes in temperature.

Thermocouple: A temperature-sensing element which converts thermal energy directly into electrical energy. In its basic form it consists of two dissimilar metallic conductors connected in a closed loop. Each junction forms a thermocouple. If one thermocouple is maintained at a temperature different from that of the other, an electrical current proportional to this temperature difference will flow in the circuit. The value varies with the materials used. Couples of copper and constantan, which generate approximately 40 microvolts per °C of couple temperature difference, are often used for meteorological purposes.

Thermodynamic temperature: A measure, in kelvins (K), proportional to the thermal energy of a given body at equilibrium. A temperature of 0K is called "absolute zero" and coincides with the minimum molecular activity (i.e. thermal energy) of matter. Thermodynamic temperature was formerly called "absolute temperature." In practice, the International Temperature Scale of 1990 (ITS-90) serves as the basis for high-accuracy temperature measurements in science and technology.

Thermoelectric thermometer: A type of electrical thermometer consisting of two thermocouples which are series-connected with a potentiometer and a constant-temperature bath. One couple, called the reference junction, is placed in a constant-temperature bath, while the other is used as the measuring junction.

Thermogram: The record of a thermograph.

Thermograph: A self-recording thermometer.

Thermo-integrator: An apparatus, used in studying soil temperatures, for measuring the total supply of heat during a given period.

Thermometer: An instrument for measuring temperature by utilizing the variation of the physical properties of substances according to their thermal states. Thermometers may be classified into types according to their construction; deformation thermometer, electrical thermometer, gas thermometer, liquid-in-glass thermometer, liquid-in-metal thermometer, sonic thermometer.

Thermometer screen: Same as instrument shelter.

Thermometer shelter: Same as instrument shelter.

Thermometer support: A device used to hold liquid-in-glass maximum and minimum thermometers in the proper recording position inside an instrument shelter, and to permit them to be read and reset. See Townsend support.

Thermopile: A transducer for converting thermal energy directly into electrical energy. It is composed of pairs of thermocouples which are connected either in series or in parallel. Thermopiles are used in thermoelectric radiation instruments when the output of a single pair of thermocouples is not large enough. See Moll thermopile, Eppley pyrhelimeter.

Thermoscreen: Same as instrument shelter.

Thermostat: A device used to switch electrical current at a selectable setpoint temperature.

Threshold (starting speed): The lowest value of a measured quality at which a sensor responds. Compare to tracking.

Tide gauge: A device for measuring the height of tide. It may be simply a graduated staff in a sheltered location where visual observations can be made, or it may consist of an elaborate recording instrument (sometimes called a marigraph) making a continuous graphic record of tide height against time. Such an instrument is usually actuated by a float in a pipe communicating with the sea through a small hole which filters out shorter waves.

Time constant: The time required for an instrument to register 63.2% of a step change in the variable being measured.

Tipping-bucket rain gauge: A rain gauge where the precipitation collected by the receiver empties into one side of a chamber which is partitioned transversely at its center and is balanced bistably upon a horizontal axis. When a predetermined amount of water has been collected, the chamber tips, spilling out the water and placing the other half of the chamber under the receiver. Each tip of the bucket generates a signal.

Torricelli's tube: An early and once universal name for the mercury barometer.

Torsion hygrometer: A hygrometer in which the rotation of the hygrometric element is a function of humidity.

Totalizing anemometer: An anemometer in which the sensor rotation is transmitted to a mechanical counter which directly integrates the air movement past the sensor. Used to determine total air passage (wind run). Average wind speed can be calculated from the difference between successive counter readings divided by the time interval between readings.

Total lift: The upward force produced by the gas in a balloon. It is equal to the free lift plus the weight of the balloon and the attached equipment.

Total radiation: The sum of solar and terrestrial radiation.

Townsend support: A fixed support for mounting maximum and minimum thermometers of the liquid-in-glass type. The support holds the thermometers at the correct operating attitude and also permits their rotation for resetting when desired.

Trace: A precipitation amount of less than 0.005 inches. Also, the record made by any self-registering instrument.

Trace recorder: Same as ombrometer.

Tracking: The lowest value of a measured quality at which a sensor meets its accuracy specification.

Transducer: A device which converts energy from one form into another, i.e. an ac generator transducer which converts the mechanical motion of anemometer cups into an electrical signal.

Transmissivity: A measure of luminous flux remaining in a light beam after it has passed through a specified distance of the atmosphere.

Glossary of Meteorological Terms

Transmissometer: An instrument which measures the transmissivity of the atmosphere between two points for the determination of visual range.

Transpiration: The process by which water in plants is transferred as water vapor to the atmosphere. Also, the amount of water so transferred.

Transponder ranging: An addition to a rawinsonde system which allows determination of the slant range to the radiosonde.

Triple-point temperature: The temperature at which all three phases of a substance can exist in equilibrium. This temperature occurs at only one pressure. The triple-point of water is 273.16°K and is the basis of the Kelvin scale.

Tropopause: The boundary between the troposphere and stratosphere, usually characterized by an abrupt change in lapse rate. Its height varies from 10 to 20 km. Regions above the tropopause have greater atmospheric stability than regions below.

True freezing point: The temperature at which the liquid and solid forms of a substance may exist in equilibrium at a given pressure (usually one standard atmosphere). The true freezing point of water is known as the ice point.

True wind direction: The direction, with respect to true north, from which the wind is blowing. Distinguish from magnetic wind direction. In all standard upper-air and surface weather observations, it is true wind direction that is reported.

Trough: An elongated area of relatively low atmospheric pressure. Usually associated with and most clearly identified as an area of maximum cyclonic curvature of the wind flow. The opposite of a ridge.

T-sonde: A radiosonde equipped to measure temperature only.

TTL: Transistor-Transistor Logic.

Tulipan radiometer: A calorimetric radiation instrument of historic interest used for the measurement of outgoing heat radiation from the earth during an interval of time. The time integration is performed by allowing the radiation to fall on an uninsulated vessel containing a volatile liquid. The amount of liquid distilled into a connected insulated vessel is a measure of the incident radiation.

U

Ultraviolet radiation: Electromagnetic radiation of shorter wavelength than visible radiation but longer than x-rays, between 0.02 and 0.4 micron (200 and 4000 angstrom).

Uncertainty: The standard deviation of a sufficiently large number of measurements of the same quantity by the same instrument or method. The non-correctable part of the inaccuracy of an instrument, it represents the limit of measurement precision. The uncertainty of an instrument is caused by the unpredictable effects upon its performance of such factors as friction, backlash, and electronic noise.

Unprotected thermometer: A reversing thermometer (for sea-water temperature) which is not protected against hydrostatic pressure. The mercury bulb is therefore squeezed, and the amount of mercury broken off on reversal is a function of both temperature and of hydrostatic pressure.

Updraft: A relatively small-scale, upward moving current of air.

Upper air: That portion of the atmosphere which is above the lower troposphere. Generally applied to levels above 850 mb.

Upper air observation: A measurement of atmospheric conditions aloft, above the effective range of a surface weather observation. Elements evaluated include temperature, humidity, pressure, wind speed, and wind direction.

Upward total radiation: Solar and terrestrial radiation directed upward (away from the earth's surface); outgoing radiation.

Upwind: In the direction from which the wind is blowing.

UTC: Coordinated Universal Time.

V

VDI: Video Display Terminal. An input and display device which includes a keyboard and a screen and allows a human to communicate with a computer.

Vane: See wind vane.

Variograph: A recording variometer.

Variometer: A instrument designed to study small fluctuations of some quantity. The microbarograph is an example of a recording pressure variometer.

Vectopluiometer: A rain gauge or array of rain gauges designed to measure the inclination and direction of falling rain.

Vector: Any quantity, such as force velocity, or acceleration, which has both magnitude and direction at each point in space, as opposed to scalar which has magnitude only. Such a quantity may be represented geometrically by an arrow of length proportional to its magnitude, pointing in the assigned direction.

Veering: A change in wind direction in a clockwise sense. The opposite of backing.

Venturi tube: A tube designed to measure the rate of flow of fluids. It consists of a tube having a constriction or throat at its midsection. The difference between the pressure measured at the inlet and at the throat is a function of the fluid velocity. Compare to Pitot tube.

Vernier scale: A small, moveable graduated scale adjacent and parallel to the main scale of an instrument. It provides a means for interpolating between the graduations of the main scale.

Vertical anemometer: General name for an instrument designed to measure the vertical component of the wind speed. See anemoclinometer.

Vertical-current recorder: General term for an instrument which records the vertical electric current in the atmosphere.

Vertical visibility: The distance that an observer can see vertically into a surface-based obscuring phenomenon such as fog, rain, or snow. The distance estimate must be based upon ceiling balloon ascensions or ceiling light projector measurements.

VFR: Abbreviation for visual flight rules, but commonly used to refer to the relatively favorable weather and/or flight conditions to which these rules apply.

Virga: Precipitation falling from a cloud, usually in wisps or streaks, but evaporating before it reaches the ground.

Virtual temperature: Temperature to which absolutely dry air would have to be brought in order for it to have the same density as moist air, considered at the same pressure.

Glossary of Meteorological Terms

Visibility: The greatest distance at which it is just possible to see and recognize with the unaided eye (1) in the daytime, a prominent dark object against the sky at the horizon, and (2) at night, a known, preferably unfocused, moderately intense light source.

Visibility meter: General term for an instrument used to make direct measurements of visual range or measurements of the physical characteristics of the atmosphere (or other medium) which determine the visual range.

Visibility sensor: General term for an instrument used to make direct measurements of visual range or measurements of the physical characteristics of the atmosphere which determine the visible range.

Visible radiation: Electromagnetic radiation lying within the wavelength interval to which the human eye is sensitive, the spectral interval from approximately 0.4 to 0.7 microns (4000 to 7000 angstroms). Bounded on the short-wavelength end by ultraviolet radiation and on the long-wavelength end by infrared radiation.

Visual range: The maximum distance, usually horizontally, at which a given object or light source is just visible under particular conditions of transmittance and background luminance.

VOLMET broadcast: Routine broadcast of meteorological information for aircraft in flight.

Vortex thermometer: A thermometer used in aircraft which automatically corrects for adiabatic and frictional temperature rises by imparting a rotary motion to the air passing the thermal sensing element.

Vorticity: A vector measure of local rotation in an airflow.

W

Wadi: A valley, gully, or streambed in northern Africa and southwestern Asia that remains dry except during the rainy season. A stream that flows through such a channel.

Wadi gauge: Same as river gauge or stream gauge.

Warning stage: The stage on a fixed river gauge at which it is necessary to begin issuing warnings or river forecasts if adequate precautionary measures are to be taken before flood stage is reached.

Water: Dihydrogen oxide, molecular formula H₂O.

Water balance: Balance of the water resources of a region, comparing precipitation and inflow with outflow, evaporation, and accumulation.

Water budget: See hydrologic accounting.

Water equivalent: The depth of water that would result from the melting of snow or ice, assuming measurement on a horizontal surface and no infiltration or evaporation.

Water-flow pyrhelometer: An absolute pyrhelometer, developed by C.G. Abbott, in which the radiation-sensing element is a blackened water-calorimeter.

Water-stage recorder: A device for obtaining a continuous record of stage at a point on a stream. The most common recorders consist of a float-actuated pen which traces a record on a clock driven chart.

Water table: The depth below which the ground is saturated with water. No water table exists if the ground water is confined by an overlying impermeable stratum, as in the case of artesian ground water.

Water year: Any twelve-month period, usually selected to begin and end during a relative dry season. Used a basis for processing streamflow and other hydrologic data. The period from October 1 to September 30 is widely used in the U.S.

Watershed: The total area drained by a river and its tributaries. Same as river basin.

Watt: A unit of power equal to one joule per second or 10⁷ ergs per second.

Wave pole: A device for measuring sea-surface waves. It consists of a weighted pole below which a disk is suspended at a depth sufficiently deep for the wave motion associated with deep-water waves to be negligible. The pole will then remain nearly as if anchored to the bottom, and wave height and period can be ascertained by observing or recording the length of the pole that extends above the surface.

Wave recorder: An instrument for recording ocean waves. Most recorders are designed for recording wind waves, that is waves of periods up to about 25 seconds, but some are designed to record waves of longer periods such as tsunamis or tides.

Wave staff: Same as wave pole.

Weather: The state of the atmosphere, mainly with respect to its effects upon life and human activities. As distinguished from climate, weather consists of the short-term (minutes to months) variations of the atmosphere.

Weather glass: An old nautical term for mercury barometer.

Weather stick: Made of fir or birch and attributed to northeast Native American tribes, the stick is said to rise indicating fair weather and to drop when inclement weather is approaching. The movement of the tip appears to track the relative humidity.

Weighing rain gauge: A precipitation gauge consisting of a receiver in the shape of a funnel which empties into a bucket mounted upon a weighing mechanism. The weight of the catch is recorded as inches of precipitation.

Weight barograph: A recording weight barometer.

Weight barometer: A mercury barometer which measures atmospheric pressure by weighing the mercury in the column or cistern.

Wet-bulb depression: Difference between the temperatures of the dry-bulb and the wet-bulb thermometers of a psychrometer.

Wet-bulb temperature: The lowest temperature that can be obtained on a wet-bulb thermometer in any given sample of air. Obtained by evaporation of water (or ice) from the muslin wick. Used in computing dew point and relative humidity.

Wet-bulb thermometer: A thermometer with a muslin-covered bulb which is moistened. Used to measure wet-bulb temperature.

Wet-bulb zero height (WBZ): The height above ground level (in feet) where the wet-bulb temperature goes below 0°F.

Glossary of Meteorological Terms

White body: A hypothetical “body” whose surface absorbs no electromagnetic radiation of any wavelength. An idealization exactly opposite to that of the black body. In nature, no true white bodies are known. Most white pigments exhibiting high reflectivity for visible radiation are fairly good absorbers in the infrared range, hence they are not white bodies in the sense of radiation theory. However, one does speak of a white body with respect to a particular wavelength interval. Compare to black body, gray body.

White rainbow: Same as fogbow.

Whole gale: Wind with a speed between 48 and 55 knots (55 and 63 mph); Beaufort scale number 10.

Wien’s law: One of the radiation laws which states that the wavelength of maximum radiation intensity for a black body is inversely proportional to the absolute temperature of the radiating black body.

Wild fence: A wooden enclosure about sixteen feet square and eight feet high with a precipitation gauge at its center. The function of the fence is to minimize eddies around the gauge and thus ensure a catch that is representative of the actual rainfall or snowfall.

Wilting point: Value of soil moisture, expressed as a percentage of the mass of dry soil, below which a plant living in the soil dies by wilting.

Wind: Air in motion relative to the surface of the earth.

Almost exclusively used to denote the horizontal component.

Wind cone: Same as wind sock.

Wind direction: The direction from which the wind is blowing, measured in points of the compass or in azimuth degrees.

Wind gust: See gust and peak gust.

Wind passage: The distance or length of flow of the air past a point during a given interval of time.

Wind profiler: A radar that is used to measure vertical profiles of the wind. Also called wind profiler radar, wind profiling radar.

Wind rose: A flower-like diagram indicating the relative frequencies of different wind directions for a given station and period of time.

Wind run: The distance or length of flow of the air past a point during a given interval of time.

Wind shear: A local variation of the wind vector or any of its components in a given direction.

Wind sleeve: Same as windsock.

Wind sock: A fabric cone attached to a metal ring and used to indicate wind direction, often at airfields.

Wind speed: Rate of wind movement in distance per unit time.

Wind vane: An instrument used to indicate wind direction.

Wind vector: A component of the wind (often using Cartesian coordinates, i.e. X and Y wind vectors). Also, an arrow representing wind velocity, drawn to point in the direction of the wind and with a length proportional to wind speed.

Wind velocity: A vector term which includes both wind speed and wind direction.

Wind wave: A wave resulting from the action of wind on a water surface.

Windmill anemometer: A rotation anemometer in which the axis of rotation is horizontal. The instrument has either flat vanes (as in the air meter) or helicoidal vanes (as in the propeller anemometer). The relation between wind speed and angular rotation is almost linear.

Winds aloft: The wind speed and direction at various levels in the atmosphere above the level reached by surface weather observations.

Winds-aloft observation: The measurement and computation of wind speeds and directions at various levels above the surface of the earth. Methods include pilot balloon observations, rawals, rawin or rawinsonde observations, radar tracking, or acoustic sounding.

Winds-aloft plotting board: A graphical aid used in the reduction of data from a winds aloft observation.

Windward: Situated on the side from which the wind blows.

Wiresonde: An atmospheric sounding instrument which is supported by a captive balloon and used to obtain temperature and humidity data from the ground level to a height of a few thousand feet. The data is telemetered to the ground through a wire cable.

Wire weight gauge: A river gauge in which a weight suspended on a wire is lowered to the water surface from a bridge or other overhead structure to measure the distance from a point of known elevation to the water surface.

Word: A fixed-length group of bits representing the largest data element handled as a unit by a computer. Word length is determined by the capacity of the CPU registers.

Wyoming shield: A type of rain gauge shield consisting of two snow fences, developed by the University of Wyoming Water Resources Research Institute. See rain gauge shield.

X-Y-Z

X-ray: Electromagnetic radiation of very short wavelength, lying within the wavelength interval of 0.1 to 1.5 angstroms (between gamma rays and ultraviolet radiation). X-rays penetrate various thicknesses of all solids, and they act on photographic plates in the same manner as light. Secondary x-rays are produced whenever s-rays are absorbed by a substance. In the case of absorption by a gas, this results in ionization.

Yagi-Uda antenna: Commonly known as Yagi antenna. A type of directional antenna used on some types of radar and radio equipment consisting of an array of elemental, single-wire dipole antennas and reflectors. Invented in 1926 by Shintaro Uda and Hidetsugu Yagi of Tohoku University, Japan.

Zephyr: Any soft, gentle breeze.

Zulu time: Same as Coordinated Universal Time (UTC).

Index

- 100-0802 Kestrel RH Calibration Kit 18
- 100-0804SER Kestrel PC Interface, serial 18
- 100-0804USB Kestrel PC Interface, USB 18
- 100-0805 Kestrel Carrying Case 18
- 100-0830 Kestrel 3000 18
- 100-0840GRY Kestrel 4000, dark gray 18
- 100-6152C Vantage Pro Weather Station 17
- 100-6450 Solar Radiation Sensor 17
- 100-6490 UV Sensor 17
- 100-6510SER WeatherLink for Vantage Pro2 17
- 100-6510USB WeatherLink for Vantage Pro2 17
- 100-6510X Extra User License Kit 17
- 100-6520 WeatherLink for Vantage Pro2 17
- 100-7716 Mounting Tripod 17
- 100-7717 Mounting Pole Kit 17
- 110-WS-16 Modular Weather Station 11
- 110-WS-16BP Barometric Pressure Sensor 11
- 110-WS-16CC Carrying Case 11
- 110-WS-16D Data Acquisition Module 11
- 110-WS-16EPA High Sensitivity Weather Station 11
- 110-WS-16HHD Hand Held PC 11
- 110-WS-16M Telephone Modem 11
- 110-WS-16M6 Memory Expansion to 640KB 11
- 110-WS-16MDC Telephone Modem, 12 Vdc 11, 21
- 110-WS-16N-A Data Acquisition Module in NEMA 11
- 110-WS-16N-A33 Data Acquisition Module in NEMA 11
- 110-WS-16N-B Data Acquisition Module in NEMA 11
- 110-WS-16P Power Supply 11
- 110-WS-16PBU Battery Backup for WS-16D 11
- 110-WS-16PE Power Supply, 220Vac 11
- 110-WS-16RC Rain Gauge 11
- 110-WS-16SML Display Software 11, 14
- 110-WS-16SMM Met Manager Software 11, 16
- 110-WS-16SMV Met Viewer Software 16
- 110-WS-16SR Solar Radiation Sensor 11
- 110-WS-16SRD Solar Radiation Sensor 11
- 110-WS-16STH HTML Option 15
- 110-WS-16STR Graphical Display Software 11, 15
- 110-WS-16STR-H HTML Option 11
- 110-WS-16T Air Temperature Sensor 11
- 110-WS-16TH Temperature & Humidity Sensor 11
- 110-WS-16THS Solar Radiation Shield 11
- 110-WS-16TM Tripod & Sensor Mast 11
- 110-WS-16TWS Water or Soil Temperature Sensor 11
- 110-WS-18-A Portable Weather Station ws/wd/t 13
- 110-WS-18-B Portable Weather Station ws/wd/t/rh 13
- 110-WS-18BP Barometric Pressure Sensor 13
- 110-WS-18H Relative Humidity Sensor 13
- 110-WS-18HHD Hand Held PC 13
- 110-WS-18M2 Memory Expansion to 256KB 13
- 110-WS-18M5 Memory Expansion to 512KB 13
- 110-WS-18RG Rain Gauge 0.02"/tip 13
- 110-WS-18SML Display Software 13
- 110-WS-18SMM Met Manager Software 13
- 110-WS-18SP Solar Panel, 10 watt 13
- 110-WS-18SR Solar Radiation Sensor 13
- 110-WS-18STR Graphical Display Software 13
- 110-WS-18STR-H HTML Option 13
- 110-WS-18TH Temp/Humidity Sensor 13
- 110-WS-18TWS Water/Soil Temperature Sensor 13
- 110-WS-18USB USB to DB9 Serial Adapter 13
- 1205-05/xxx Serial Cable 11
- 130-205 DC Voltage Input (RH, BP, SR) 26
- 130-205Q2 Loop-Powered Signal Conditioner (SR) 26
- 130-206 RTD Input (Temp, Dew Point) 26
- 130-207 Potentiometer Input (Wind Dir, Evap) 26
- 130-208 Frequency Input (Wind Speed) 26
- 130-209 AC Voltage Input (Power Line) 26
- 130-H902 DIN Rail Power Supply 26
- 130-H910 DIN Rail Power Supply 26
- 135-100 WS/WD Translator PCB 27
- 135-100-SR Amplifier PCB, 0-5V 115
- 135-100-SR Amplifier PCB for 240-140/150 116
- 135-102 Digital to Analog Conversion PCB 27
- 135-104 General Purpose Translator PCB 28
- 135-114 General Purpose Translator PCB 28
- 135-115 General Purpose Translator PCB 28
- 140-400 900 MHz Spread Spectrum Radio 23
- 140-400A11 Yagi Antenna 11dB 23
- 140-400A15 Yagi Antenna 15 dB 23
- 140-400A8 Yagi Antenna 8 dB 23
- 140-400C20 Dipole Antenna Ext Cable 20' 23
- 140-400C20Y Yagi Antenna Cable 20' 23
- 140-400C40 Dipole Antenna Ext Cable 40' 23
- 140-400C40Y Yagi Antenna Cable 40' 23
- 140-400C6Y Yagi Antenna Cable 6' 23
- 16000200 Plastic Bottle for Calibrator 141
- 16000201 Orifice 1/32" 141
- 16000202 Orifice 1/16" 141
- 16000203 Orifice 3/32" 141
- 16000204 Orifice 1/8" 141
- 16000205 Syringe 141
- 190-110 Tripod Grounding Kit 162
- 190-120 Tower Grounding Kit 162
- 190-121 Tower Grounding Kit 162
- 190-122 Tower Grounding Kit 162
- 190-205 Tripod Guy Kit for 5' Tripod 161
- 190-210 Tripod Guy Kit for 10' Tripod 161
- 190-211 Earth Anchors for Tripod Guy Kit 161
- 190-212 Roof Anchors for Tripod Guy Kit 161
- 190-213 Heavy Duty Earth Anchor (one) 161
- 190-221 Tower Guy Kit, ground mount 161
- 190-222 Tower Guy Kit, roof mount 161
- 190-302 Aluminum Sensor Mast, 3' swaged-type 161
- 190-310 Aluminum Sensor Mast, 5' x 1.34" o.d. 161
- 190-311 Aluminum Sensor Mast, 5' x 1.66" o.d. 161
- 190-312 Aluminum Sensor Mast, 5' swaged-type 161
- 190-320 Aluminum Sensor Mast, 10' x 1.34" o.d. 161
- 190-321 Aluminum Sensor Mast, 10' x 1.66 o.d. 161
- 190-322 Aluminum Sensor Mast, 10' swaged-type 161
- 190-330 Galvanized Sensor Mast, 5' x 1.34" o.d. 161
- 190-331 Galvanized Sensor Mast, 5' x 1.66" o.d. 161
- 190-340 Galvanized Sensor Mast, 10' x 1.34" o.d. 161
- 190-341 Galvanized Sensor Mast, 10' x 1.66 o.d. 161
- 190-350 Mast Adapter, reduces 1.34" to 0.84" o.d. 161
- 190-351 Mast Adapter, reduces 1.34" to 1.05" o.d. 161
- 190-410 6' Fixed Horizontal Boom, 2" square 161
- 190-411 6' Retractable Horizontal Boom, 2" square 161
- 190-412 6' Fixed Horizontal Boom, 1-1/2" square 161
- 190-413 6' Fixed Horizontal Boom, 1-1/2" square 161
- 190-414 6' Fixed Horizontal Boom, 1-1/2" square 161
- 190-420 Mounting Stub, 0.084" o.d. x 6" stub 161
- 190-421 Mounting Stub, 1.05" o.d. x 6" stub 161
- 190-422 Mounting Stub, 1.34" o.d. x 6" stub 161
- 190-423 Mounting Stub, 1.66" o.d. x 6" stub 161
- 190-505 3' Tripod 160
- 190-510 5' Tripod 160
- 190-520 10' Tripod 160

- 190-610 10' Aluminum Tower 160
 190-611 30' Aluminum Stacked Tower, std duty 160
 190-612 30' Aluminum Stacked Tower, heavy duty 160
 190-618 Ground Mount, standard duty 160
 190-618-HD Ground Mount, heavy duty 160
 190-619 Roof Mount, standard duty 160
 190-619-HD Roof Mount, heavy duty 160
 195-00811 Custom Programming for 195-26800 24
 195-208 Precision Resistor Network 82
 195-26800 Meteorological Translator 24
 195-26880 Rack Mounting Panel 24
 195-BHW Software 139
 195-BHW-LITE Software 139, 149
 195-CABLE USB Interface Cable 149
 195-U-DT-1 U-Shuttle Data Transporter 139
 195-WS-16A Audible Alarm Option 21
 195-WS-16AD21 Automatic Voice Dialer 22
 195-WS-16AD45 Automatic Voice Dialer 22
 195-WS-16D Data Logger Desktop Enclosure 21
 195-WS-16HHD Hand Held PC 21
 195-WS-16M Telephone Modem 21
 195-WS-16M6 Optional Memory Expansion to 640KB 21
 195-WS-16N Data Logger in NEMA-4X Enclosure 21
 195-WS-16P AC Power Supply, 115V 21
 195-WS-16PE AC Power Supply, 220V 21
 195-WS-16SML Display Software 21
 195-WS-16SMM Met Manager Software 21
 195-WS-16STR Graphical Display Software 21
 195-WS-16USB USB to Serial Adapter 21
 200-03002 Wind Sentry Anemometer and Vane 52
 200-03002L Wind Sentry with 4-20 mA Output 52
 200-03101 Wind Sentry Anemometer 52
 200-03301 Wind Sentry Vane 52
 200-03603 Wind Sensor Interface 52
 200-03631 Current Loop Converter 4-20 mA 46
 200-03631 Wind Line Driver 52
 200-05103 Wind Monitor 48
 200-05103-45 Alpine Wind Monitor 48
 200-05103L Wind Monitor, 4-20mA output 48
 200-05103V Wind Monitor, specify 0-1Vdc or 0-5Vdc 48
 200-05106 Wind Monitor-MA (Marine Model) 48
 200-05305 Wind Monitor-AQ 49
 200-05305L Wind Monitor, 4-20 mA output 49
 200-05305V Wind Monitor, specify 0-1Vdc or 0-5Vdc 49
 200-05603 Wind Sensor Interface, 0-1Vdc or 0-5Vdc 49
 200-05603B Wind Sensor Interface, 0-1Vdc or 0-5Vdc 48
 200-05631 Wind Line Driver, 4-20 mA 49
 200-05631B Wind Line Driver, 4-20 mA 48
 200-0581 Kestrel 1000, blue 67
 200-06201 Wind Tracker, 110V 51
 200-06201C Wind Tracker, 0-540° range 51
 200-06201H Wind Tracker, 230V 51
 200-06206 Marine Wind Tracker, 110V 51
 200-06206H Marine Wind Tracker, 230V 51
 200-06260 Protective Enclosure 51
 200-06280 Rack Mounting Panel, 19" rack 51
 200-0801 Kestrel Replacement Impeller 18, 67
 200-08254 CFT Propeller 50
 200-08274 EPS Propeller 50
 200-100609-0 Connector 58
 200-1012/xxx Heater Cable with Connector 57, 58
 200-101234-0 External Heater, 115 Vac 57, 58
 200-101234-1 External Heater, 220 Vac 57, 58
 200-101278 Wind System 58
 200-101908-3 Current Loop Wind Sensors 0-360° 57
 200-101908-5 Current Loop Wind Sensors 0-540° 57
 200-101944 Vane Assy, magnesium 58
 200-101949 Digital Current Loop Display 57
 200-101982 Connector 57
 200-102083 Wind Mark III Wind Sensors w/Crossarm 58
 200-102138 Cup Assy, black Lexan 58
 200-10681 Thermostat Control 60
 200-1230 Handheld Wind Speed Calibrator, 300 rpm 70
 200-1231 Handheld Wind Speed Calibrator, 1800 rpm 70
 200-1233 Handheld Wind Speed Calibrator, 600 rpm 70
 200-1247 Wind Direction Calibrator, Skyvane 70
 200-1249-A Wind Direction Calibrator, 2005 2020 70
 200-1390 WindObserver II 56
 200-18112 Vane Angle Bench Stand 68
 200-18212 Vane Angle Fixture, tower mount 68
 200-18301 Vane Alignment Rod 69
 200-18310 Propeller Torque Disc 69
 200-18312 Cup-Wheel Torque Disc 69
 200-18331 Vane Torque Gauge 69
 200-18802 Anemometer Drive, 200-15000 RPM 68
 200-18811 Anemometer Drive, 20-990 RPM 68
 200-2020 Micro Response Wind Vane 60
 200-20201 Sensor Heater Assembly, 115 Vac 60
 200-20201-A Sensor Heater Assembly, 230 Vac 60
 200-2023 Crossarm 60
 200-20231 Mast Adapter 60
 200-2030 Micro Response Anemometer, light chopper 60
 200-2031 Micro Response Anemometer, dc generator 60
 200-21101 Mast Adapter 46
 200-2201 NovaVane, AC generator and pot 46
 200-2206 NovaVane, AC generator and synchro 46, 47
 200-2206SA Synchro to Analog Output Assy 47
 200-221-230V 230 Vac Input Option 47
 200-22151 Wind Indicator Console 47
 200-22152 Master Wind Indicator Console 47
 200-22155 Slave Wind Indicator Console 47
 200-2218 Analog Indicating Wind System 47
 200-23301 Chart 0-50/0-100 0-540° 171
 200-23302 Chart 0-100 0-360° 171
 200-23501 Chart 0-50/0-100 mph or m/s 171
 200-23502 Chart 0-360° 171
 200-2510 Totalizing Anemometer, miles 72, 145
 200-2511 Totalizing Anemometer, kilometers 72, 145
 200-2520 Wind Meter 65
 200-2530 Wind Speed Indicator 65
 200-2620 Wind Sock 71
 200-26201 Ball Bearing Frame 71
 200-26202 Hoop and Bail Frame 71
 200-27005 UVW Anemometer 50
 200-27005J 12Vdc Blower for UVW Anemometer 50
 200-27005T With Optional CFT Propellers 50
 200-27106 Propeller Anemometer 50
 200-27106D With Optional Single-Direction Photocho 50
 200-27106F With Optional Two-Direction Photochoppe 50
 200-27106T With Optional CFT Propellers 50
 200-2916 Compass 69
 200-455 Totalizing Anemometer 63
 200-455B4 Battery Assembly, 12 Vdc 4 AH 63
 200-455B7 Battery Assembly, 12 Vdc 7 AH 63
 200-455CC Carrying Case 63
 200-600 Crossarm 44
 200-601 Wind Speed & Direction Sensors w/Crossarm 44
 200-605 High Sensitivity WS/WD Sensors w/Crossarm 45

- 200-7000-00 WindSonic Connector Kit 55
- 200-7000-01 9-Pin Serial Connector Kit 55
- 200-7000-02 WindSonic Cable Assembly Fee 55
- 200-7000-03 WindSonic Mounting Stub 55
- 200-7000-04 WindSonic Boom Mounting Assy 55
- 200-7000-1 WindSonic, RS232 55
- 200-7000-2 WindSonic, RS232/422/485 55
- 200-7000-3 WindSonic, RS232/422/485 & Analog 55
- 200-7000-4 WindSonic, SDI-12 55
- 200-81000 Ultrasonic Anemometer 53
- 200-85000 Ultrasonic Anemometer 54
- 200-960 Handheld Anemometer 66
- 200-M488035 Spare Parts Kit for 200-2020 60
- 200-M488036 Spare Parts Kit for 200-2030 60
- 200-M488037 Spare Parts Kit for 200-2031 60
- 200-WS-01 Wind Speed Sensor 44
- 200-WS-01C Replacement Sensor for 2510/11 72
- 200-WS-02 Wind Speed & Direction Sensors 11, 44
- 200-WS-02F Wind Sensor 64
- 200-WS-04 Wind Direction Sensor 44
- 200-WS-04H High Sensitivity Wind Direction Sensor 45
- 200-WS-05 High Sensitivity WS/WD Sensors 11, 45
- 200-WS-21-A Dual Set Point Wind Alarm 61
- 200-WS-21P Power Pack, 110-240Vac 61
- 200-WS-23 Current Loop Wind Sensor, WS/WD 62
- 200-WS-23S Current Loop Wind Sensor, speed only 62
- 200-WS-25 Wind Logger 64
- 210-201 Air Temperature Sensor 83
- 210-301 Air Temperature Sensor 83
- 210-301W Water or Soil Temp Sensor 83
- 210-41342LC Temperature Probe °C, 4-20 mA out 87
- 210-41342LF Temperature Probe °F, 4-20 mA out 87
- 210-41342VC Temperature Probe °C, 0-1 Vdc out 87
- 210-41342VF Temperature Probe °F, 0-1 Vdc out 87
- 210-421-A Temperature Alarm 90
- 210-421P Plug-In Power Pack, 12V/500mA 90
- 210-421W-A Water Temperature Alarm 90
- 210-4410 Standard Thermometer °F 76
- 210-4411 Standard Thermometer °C 76
- 210-4412 Mounting Support 76
- 210-4420 Min-Max Thermometer Set °F 76
- 210-4421 Min-Max Thermometer Set °C 76
- 210-4422 Townsend Support 76
- 210-4425 Maximum Thermometer -38/+130°F 76
- 210-4426 Maximum Thermometer -30/+55°C 76
- 210-4429 Minimum Thermometer -50/+120°F 76
- 210-4430 Minimum Thermometer -45/+50°C 76
- 210-44332 Replacement Magnet 146
- 210-4470 Platinum Resistance Temperature Probe 82
- 210-4470-A Platinum Resistance Temperature Probe 82
- 210-4480-A Air Temperature Probe, 5' cable 82
- 210-4480-B Air Temperature Probe, 20' cable 82
- 210-4480-C Air Temperature Probe, 30' cable 82
- 210-4485 Water/Soil Temperature 82
- 210-44921 Replacement Thermometer °F 146
- 210-44931 Replacement Thermometer °C 146
- 210-454039 Replacement Thermometer 146
- 210-5320 Dew Cell, 3 element thermistor 88
- 210-5321 Dew Cell, 100 ohm platinum resistance 88
- 210-53212 Stand-Alone Power Supply, 115 Vac 88
- 210-53212-A Stand-Alone Power Supply, 230 Vac 88
- 210-600 Water/Soil Temperature Sensor 83
- 210-CAB1 TP1 Sensor Cable, from sensor to encl 84
- 210-CAB2 TP1 Signal Cable, from encl to output 84
- 210-TMC/20 Water or Air Temperature Sensor 149
- 210-TP1 Temperature Sensor, 0-5Vdc 84
- 210-TP1C Temperature Sensor, 4-20mA 84
- 210-TX92A-1-L RTD Transmitter, for 210-4470 -4470- 82
- 210-WE700 Temperature Sensor 85
- 220-15778 Replacement Humidity Chip 81
- 220-17039 Replacement Membrane Filter 81
- 220-180R Replacement Humidity Sensing Element 81
- 220-19446 Serial Communication Cable 100
- 220-19766HM Extra Salt Chamber 100
- 220-219452SP Replacement Teflon Filter 81
- 220-5135 Lithium Chloride (11%) 100 grams 100
- 220-5136 Potassium Sulfate (97%) 100 grams 100
- 220-5137 Sodium Chloride (75%) 100 grams 100
- 220-730 Dial Hygrometer 75
- 220-HM27032 Carrying Bag 100
- 220-HMK15 Humidity Calibrator 100
- 220-HMK41 Humidity Calibration Kit 100
- 220-HMP155D Relative Humidity Sensor 81
- 225-41382LC2 RH/Temp Probe °C, 4-20mA out 87
- 225-41382LF2 RH/Temp Probe °F, 4-20mA out 87
- 225-41382VC RH/Temp Probe °C, 0-1Vdc out 87
- 225-41382VF RH/Temp Probe °F, 0-1Vdc out 87
- 225-445703 Big Digit Hygro-Thermometer 94
- 225-46203 Temp Tracker, 110V 87
- 225-46203H Temp Tracker, 230V 87
- 225-500-B Relative Humidity & Temperature Sensor 81
- 225-501-B Relative Humidity & Temperature Sensor 81
- 225-5020-A Hygrothermograph 74
- 225-5020-GL Plexiglass Window (T95011) 74
- 225-50201 Charts -20/+40°C 0-100% 7d 74
- 225-50202 Charts +10/+120°F 0-100% 7d 74
- 225-50203 Charts -30/+80°F 0-100% 7d 74
- 225-50204 Charts -20/+40°C 0-100% 1d 74
- 225-50205 Charts +10/+120°F 0-100% 1d 74
- 225-50206 Charts -30/+80°F 0-100% 1d 74
- 225-50207 Charts -20/+40°C 0-100% 31d 74
- 225-50208 Charts +10/+120°F 0-100% 31d 74
- 225-50209 Charts -30/+80°F 0-100% 31d 74
- 225-50211 Replacement Hair Bundle 74
- 225-50212 Charts -10/+50°C 0-100% 7d 74
- 225-50213 Charts -5/+55°C 0-100% 31d 74
- 225-50214 Charts -10/+50°C 0-100% 1d 74
- 225-520-A Pocket Sling Psychrometer F 77
- 225-521-A Pocket Sling Psychrometer C 77
- 225-522-A Replacement Thermometer F 77
- 225-523-A Replacement Thermometer C 77
- 225-5230 Assmann Psychrometer °C 79
- 225-52301 Spare Thermometer for 225-5230 79
- 225-5231 Assmann Psychrometer °F 79
- 225-52311 Spare Thermometer for 225-5231 79
- 225-564-A Fan Psychrometer °F 78
- 225-565-A Fan Psychrometer °C 78
- 225-566C Battery Operated Psychrometer °C 78
- 225-566F Battery Operated Psychrometer °F 78
- 225-567C Repl Thermometer °C 2/set 78
- 225-567F Repl Thermometer °F 2/set 78
- 225-568 Replacement Wicks, 24" length 77, 78, 79
- 225-569C Pocket Psychrometric Slide Rule °C 80
- 225-569F Pocket Psychrometric Slide Rule °F 80
- 225-570-A Sling Psychrometer F 77
- 225-571-A Sling Psychrometer C 77
- 225-572-A Replacement Thermometer °F 78
- 225-572-A Replacement Thermometer F 77

- 225-573-A Replacement Thermometer °C 78
 225-573-A Replacement Thermometer C 77
 225-7917 Fuel Moisture Scale 89
 225-7918 10-Hour Fuel Moisture Stick 89
 225-7919 Support Brackets, set of 2 89
 225-930 Dial Thermohygrometer 75
 225-990 Replacement Motor 78
 225-991 Replacement Battery 78
 225-HM34-C Handheld RH/Temp Indicator °C 92
 225-HM34-F Handheld RH/Temp Indicator °F 92
 225-HMP155A Relative Humidity & Temperature Sensor 81
 225-HMP60A Relative Humidity & Temperature Sensor 81
 225-RH520 RH/Temp Digital Chart Recorder 110V 93
 225-RH520-220 RH/Temp Digital Chart Recorder 220V 93
 225-RH520-NIST RH/Temp Digital Chart Recorder 93
 225-RH522 Humidity-Temperature Probe 93
 225-SL123 AC Alarm Relay Module 93
 225-SL124 DC Alarm Relay Module 93
 225-THT-1 Temperature and Humidity Sensor 86
 225-THT-BC Battery Cable, per foot 86
 225-THT-PC25 AC Power Cable, 25' 86
 225-THT-PC6 AC Power Cable, 6' 86
 230-044 Digital Barometer Altimeter Compass 110
 230-276-6 Barometric Pressure Sensor, 600-1100 mb 106
 230-276-8 Barometric Pressure Sensor, 800-1100 mb 106
 230-278 Barometric Pressure Transmitter 105
 230-600C BP Sensor PCB 4-20mA 103
 230-600V BP Sensor PCB 0-5V 103
 230-601C BP Sensor in Encl 4-20mA 103
 230-601V BP Sensor in Encl 0-5V 103
 230-M202 Handheld Digital Barometer-Altimeter 109
 230-P111 Dial Barometer 102
 230-WE100 Barometric Pressure Sensor 108
 240-100 Fritschen Type Net Radiometer 122
 240-1070 Campbell-Stokes Sunshine Recorder 45-65° 125
 240-1071 Campbell-Stokes Sunshine Recorder 0-45° 125
 240-1072 Sunshine Record Cards 125
 240-1073 Transparent Measuring Template 125
 240-1074 Replacement Glass Sphere 125
 240-110 NR-Lite Net Radiometer 123
 240-110-A Amplifier PCB, specify output 123
 240-120 SP-Lite Silicon Pyranometer 115
 240-140 Silicon Cell Pyranometer 116
 240-140LM Leveling/Mounting Plate Kit 116
 240-150 Silicon Cell Pyranometer, with mtg plate 116
 240-152 Shadow Band 113
 240-153 Tower Mount, 1' boom 112, 114, 115, 116
 240-200SZ Silicon Pyranometer, 10' cable 114
 240-200SZ/100 Silicon Pyranometer, 100' cable 114
 240-200SZ/50 Silicon Pyranometer, 50' cable 114
 240-6450 Solar Radiation Sensor 117
 240-8101 Star Pyranometer, mV output 112
 240-8101-C Additional Cable, per meter 112
 240-8101-D Glass Dome 112
 240-8101-OR O-Rings, set of 3 112
 240-8101-SG Silica Gel, 100 grams 112
 240-8101-SGC Silica Gel Container, filled 112
 240-8102 Star Pyranometer, 4-20mA output 112
 240-8104 Albedometer 119
 240-8104-D Glass Dome, 2 required 119
 240-8104-OR O-Rings, set of 6 119
 240-8104-SG Silica Gel, 100 grams 119
 240-8104-SGC Silica Gel Container, filled 119
 240-8106 Protective Housing, 24 Vac 112
 240-8106PS Power Adapter, 220 Vac to 24 Vac 112
 240-8110 Net Radiometer 121
 240-8110-C Additional Cable, per meter 121
 240-8110-D Lupolene Dome, 2 req 121
 240-8110-OR O-Rings, set of 3 121
 240-8110-SG Silica Gel, 100 grams 121
 240-8110-SGC Silica Gel Container, filled 121
 240-8111 Pyrradiometer 120
 240-8111-D Lupolene Dome, 2 req 120
 240-8111-OR O-Rings, set of 4 120
 240-8111-PT Pt-100 Platinum Element 120
 240-8111-SG Silica Gel, 100 grams 120
 240-8111-SGC Silica Gel Container, filled 120
 240-CMP3 Pyranometer 118
 240-CMP3-MR Mounting Rod 118
 240-CSD3 Sunshine Duration Sensor 126
 240-CUV3 Broadband UV Radiometer 124
 240-LI200SZ-A4 Amplifier PCB, 4-20 mA 114
 240-LI200SZ-A5 Amplifier PCB, 0-5 V 114
 240-M488084 Spare Parts Kit, 240-100 3032-A 122
 240-USEA Amplifier PCB 0-5V Output 112
 250-124C-1 Soil Moisture Sensor, 0-1 mA output 89
 250-124C-4 Soil Moisture Sensor, 4-20 mA output 89
 250-124V Soil Moisture Sensor, 0-5 V output 89
 250-12CAB Additional Cable, per foot 89
 255-100 Evaporation Gauge, 50' cable 147
 255-100P/F SS Connecting Pipe and Fittings 147
 255-100POT Replacement Potentiometer 147
 255-110 Evaporation Gauge Tester 147
 255-110MS 3-Pin MS Connector Option 147
 255-200 Evaporation Pan 145, 146
 255-205 Stillwell 145
 255-210 Stillwell with Fixed Point 145
 255-211E Replacement Graduate, English 145
 255-211M Replacement Graduate, Metric 145
 255-212C Fit/Sub Min-Max Thermometer °C Disc
 255-212C Fit/Sub Min-Max Thermometer, °C Disc
 255-212D Fit/Sub Min-Max Thermometer, digital 146
 255-212F Fit/Sub Min-Max Thermometer °F Disc
 255-212F Fit/Sub Min-Max Thermometer, °F Disc
 255-214 Hook Gauge, English units 145
 255-215 Hook Gauge, metric 145
 255-250 Evaporation Pan Platform 150
 255-620 Automatic Refill System 148
 255-704-B Evaporation Logger 149
 260-153-7852 Tower Mounting Arm, 1' 132
 260-2101 Rain Logger 138
 260-2101SK3 PC Starter Kit, ver 3.x 138
 260-2101SK4 PC Starter Kit, ver 4.x 138
 260-2101TU Data Transfer Unit 138
 260-2103 Rain Logger 139
 260-2500 8" Rain Gauge, 0.01"/tip 128
 260-2500-12 12" Rain Gauge, 0.01"/tip 128
 260-2500E 8" Electric Rain Gauge, 0.01"/tip 128
 260-2500E-12 12" Electric Rain Gauge, 0.01"/tip 128
 260-2500H Heater Kit for 8" 260-2500 128
 260-2500H-12 Heater Kit for 12" 260-2500-12 128
 260-2500HC/25 Additional Heater Cable, 25' 128
 260-2500HC/75 Additional Heater Cable, 75' 128
 260-2500M 8" Rain Gauge, 1 mm/tip 128
 260-2500M-12.25 12" Rain Gauge, 0.25 mm/tip 128
 260-2500M.25 8" Rain Gauge, 0.25 mm/tip 128
 260-2500M.5 8" Rain Gauge, 0.5 mm/tip 128
 260-2500ME 8" Electric Rain Gauge, 1 mm/tip 128

- 260-2500ME-12.25 12" Electric Rain Gauge, 0.25 mm/ 128
- 260-2500ME.25 8" Electric Rain Gauge, 0.25 mm/tip 128
- 260-2500ME.5 8" Electric Rain Gauge, 0.5 mm/tip 128
- 260-2501-A 8" Tipping Bucket Rain Gauge 0.01"/tip 129
- 260-2501M-A 8" Tipping Bucket Rain Gauge 1 mm/tip 129
- 260-2501M-A.25 8" Tipping Bucket Rain Gauge 0.25mm 129
- 260-2501M-A.5 8" Tipping Bucket Rain Gauge 0.5mm 129
- 260-2501MB Side Mounting Bracket 129
- 260-2505 Tipping Bucket Rain Gauge, 0.01"/tip 130
- 260-2505M Tipping Bucket Rain Gauge, 0.25mm/tip 130
- 260-2510 Rain and Snow Gauge 134
- 260-2510MS Measuring Stick (24") in/mm 134
- 260-2510S Tripod Support 134
- 260-2520 Forestry Rain Gauge, english 135
- 260-2520MS-E Measuring Stick (6") English 135
- 260-2520S Support Bracket 135
- 260-2530 Fence Post Rain Gauge 133
- 260-2531 Plastic Rain Gauge, english graduations 133
- 260-2531BP Replacement Backplate 133
- 260-2531F Replacement Funnel 133
- 260-2531M Plastic Rain Gauge, metric graduations 133
- 260-2531MMT Replacement Measuring Tube, metric 133
- 260-2531MT Replacement Measuring Tube, english 133
- 260-2531OT Replacement Outer Tube 133
- 260-2590 Precipitation Detector 137
- 260-2591 Leaf Wetness Sensor 137
- 260-2592 Leaf Wetness Sensor with Heater 137
- 260-2595 Rain Gauge Calibrator 141
- 260-2596 Digital Event Counter 142
- 260-2597 Pocket-Size Digital Event Counter 142
- 260-52202 Tipping Bucket Rain Gauge 110 Vac 131
- 260-52202H Tipping Bucket Rain Gauge 220 Vac 131
- 260-52203 Tipping Bucket Rain Gauge 131
- 260-52250 Bird Wire Assy 131
- 260-700 Ultrasonic Snow Depth Sensor 136
- 260-700-D Ultrasonic Snow Depth Sensor, digital 136
- 260-7852 Rain Collector 132
- 260-950 Rain Gauge Mounting Plate 140
- 260-952 Rain Gauge Wind Screen, 24" legs 140
- 260-953 Rain Gauge Wind Screen, 36" legs 140
- 260-954 Leg Extender Kit 140
- 260-955 Wind Screen Mounting Kit 140
- 270-WQ101 Temperature Sensor 156
- 270-WQ201 pH Sensor 156
- 270-WQ301 Conductivity Sensor 156
- 270-WQ401 Dissolved Oxygen Sensor 156
- 270-WQ720 Turbidity Sensor 157
- 270-WQ770 Turbidity Meter 157
- 280-330 Pressure Transducer, specify range in ft 153
- 280-330C Add'l Vented Cable, per ft 153
- 280-FP111 Flow Probe 152
- 280-FP211 Flow Probe 152
- 280-FP311 Flow Probe 152
- 280-IRU-9423-C6 Ultrasonic Sensor 154
- 280-IRU-9429 Ultrasonic Sensor 0-2.5 0-5V 154
- 280-RST-2001A RST Module, RS232 154
- 280-RST-3001 RST Module, USB 154
- 300-1172 Wind Speed Dial, 0-100 mph 32
- 300-11722 Wind Speed Dial, 0-120 mph 32
- 300-11725 Wind Speed Dial, 0-120 knots 32
- 300-1173 Wind Direction Dial, 0-360° 32
- 300-1174 Wind Direction Dial, 0-540° 32
- 300-11761 Temperature Dial, -40 to +120°F 32
- 300-11763 Temperature Dial, 0 to +120°F 32
- 300-1178 Relative Humidity Dial, 0-100% 32
- 300-1180 Barometric Pressure Dial, 945-1045 mb 32
- 300-11800 Barometric Pressure Dial, 27.5-31.5"Hg 32
- 300-400 Series Dual Analog Display Consoles 32
- 300-50XXX Large Digital Displays 32
- 300-550 LED Meter, specify range, 3-1/2 digit 32
- 300-650 LCD Meter, specify range, 3-1/2 digit 32
- 300-87003 Chart 0-50/0-100 0-540° 171
- 300-87004 Chart 0-25/0-50 0-540° 171
- 300-87005 Chart 0-100/0-200 0-540° 171
- 300-M699497 Chart 0-100 0-540 171
- 300-M699498 Use 390-23302 171
- 310-120 Rechargeable Battery 12V 4AH 164
- 310-121 Rechargeable Battery 12V 12AH 164
- 310-122 Rechargeable Battery 12V 7AH 164
- 310-126 Rechargeable Battery 12V 33AH 164
- 310-140 AC Power Supply/Adapter/Charger 115Vac 63, 165
- 310-170 Power Supply Chassis 115Vac or 220Vac 5Vdc 165
- 310-300 Isolation Transformer 220Vac-115Vac 165
- 320-600 Solar Panel 0.6A (10W) 21, 166
- 320-900 Solar Panel 1.4A (20W) 166
- 330-0220S Cable 2C 20AWG shielded 115, 116, 122
- 330-04TP24 Signal Cable 55
- 330-0820 Cable 8C 20AWG shielded 47
- 330-T605000 Ground Cable, #4 copper, PVC jacket 162
- 330-T605004 Ground Cable, 2/0 bare copper 162
- 330-T713018 Ground Rod, 8 feet 162
- 350-1077 AC Power Surge Arrestor 115/230 Vac 162
- 350-1077-AAC Power Surge Arrestor 220-277 Vac 162
- 350-290 Transient Protection, per input channel 27, 28
- 350-B380-24V Sensor Line Surge Protector, 4 lines 162
- 350-B480-24V Sensor Line Surge Protector, 8 lines 162
- 380-280 Self-Aspirated Solar Radiation Shield 95
- 380-281 Self-Aspirated Solar Radiation Shield 95
- 380-281-THT Solar Radiation Shield for 225-THT-1 86
- 380-283 Solar-Fan-Aspirated Solar Radiation Shield 95
- 380-41003 Solar Radiation Shield 96
- 380-41003P Solar Radiation Shield, custom adapter 96
- 380-41390 Junction Box 96, 97
- 380-43408 Motor Aspirated Shield 97
- 380-43408DPT Motor-Aspirated Solar Radiation Shield 88
- 380-43408H Motor Aspirated Shield, 230Vac/50-60Hz 97
- 380-43482 Probe Top Cover 97
- 380-43502 Motor Aspirated Shield 97
- 380-600 Thermometer Shelter 98
- 380-601 Small Instrument Shelter 98
- 380-605 Large Instrument Shelter 99
- 380-608 Wood Leg Kit 99
- 380-609 Metal Leg Kit 99
- 390-50051 Charts -20/50°C 0-100% 940-1045mb 176h 170
- 390-50052 Charts -10/120°C 0-100% 940-1045mb 176h 170
- 390-50053 Charts -10/120°C 0-100% 27.9-31"Hg 176h 170
- 390-50054 Charts -20/50°C 0-100% 705-785mmHg 176h 170
- 390-50055 Charts -20/50°C 0-100% 940-1045mb 26h 170
- 390-50056 Charts -10/120°F 0-100% 940-1045mb 26h 170
- 390-50057 Charts -10/120°F 0-100% 27.9-31"Hg 26h 170
- 390-50058 Charts -20/50°C 0-100% 705-785mmHg 26h 170
- 390-50059 Charts -20/50°C 0-100% 940-1045mb 31d 170
- 390-50060 Charts -10/120°F 0-100% 940-1045mb 31d 170
- 390-50061 Charts -10/120°F 0-100% 27.9-31"Hg 31d 170
- 390-50062 Charts -20/50°C 0-100% 705-785mmHg 31d 170
- 390-50251 Charts C302-W-HC 0/55°C 0-100% 176h 170
- 390-50252 Charts C302-W-HF 20/120°F 0-100% 176h 170
- 390-50253 Charts C302-W-LF -40/60°F 0-100% 176h 170

- 390-50257 Cartridge Pen, red 168
 390-50258 Cartridge Pen, violet 168
 390-50259 Cartridge Pen, blue 168
 390-87502 Pen & Ink Kit, red, for 8751 168
 390-87505 Pen & Ink Kit, green, for 8751 168
 390-87601 Pen & Ink Kit, red, for 8750 8760 8761 168
 390-87602 Pen & Ink Kit, green, for 8750 8760 8761 168
 390-87603 Electronic Pen, for 8750 8760 8761 168
 390-87611 Cartridge Pen, red, for 8760-A 8761-A 168
 390-87612 Cartridge Pen, green, for 8760-A 168
 390-87613 Electronic Pen, for 8760-A 8761-A 168
 390-87614 Electronic Pen, for 8760-A 168
 390-8810 V-point Pen 168
 390-88101 Cartridge Pen, blue 168
 390-88102 Cartridge Pen, red 168
 390-88103 Cartridge Pen, red, 8720 8721 8722 8723 168
 390-88104 Cartridge Pen, green, for 8720 8722 8723 168
 390-88105 Cartridge Pen, blue, for 8722 8723 168
 390-88106 Cartridge Pen, brown, for 8723 168
 390-88108 Cartridge Pen, red, for 4771 8771 168
 390-8811 Capillary Pen, for 8700 Series 168
 390-88112 Cartridge Dotting Wheel, for 4776 8776 168
 390-88116 Cartridge Dotting Wheel, for 8746 168
 390-8816 Cartridge, red, long, for 4742 8740 168
 390-88161 Cartridge, blue, long, for 4742 8740 168
 390-8817 Cartridge, blue, short, for 4741 4742 874 168
 390-88171 Cartridge Pen, red, short, for 4741 4742 168
 390-8818 Capillary Pen Point Only 168
 390-8820 Ink, medium dry, blue, 15 ml 168
 390-8821 Ink, medium dry, red, 15 ml 168
 390-88221 Ink, fast dry, red, 1 pint 168
 390-88222 Ink, fast dry, blue, 1 pint 168
 390-88223 Ink, fast dry, green, 1 pint 168
 390-88224 Ink, fast dry, black, 1 pint 168
 390-88231 Ink, medium dry, red, 1 pint 168
 390-88232 Ink, medium dry, blue, 1 pint 168
 390-88233 Ink, medium dry, green, 1 pint 168
 390-88234 Ink, medium dry, black, 1 pint 168
 390-8825-A Battery-operated Clock 26h/176h/31d 169
 390-8826-A Battery-operated Clock 26h/176h/31d 169
 390-8827-A Battery-operated Clock 26h/176h/31d 74, 169
 390-8828-A Battery-operated Clock 26h/176h/31d 169
 390-8829-A Battery-operated Clock 26h/176h/31d 169
 390-8830-A Battery-operated Clock 26h/176h/31d 169
 390-8840-A Battery-operated Clock 26h/176h/31d 169
 390-8849 Black Ink, 3 bottles, 20 cc each 168
 390-8850 Red Ink, 3 bottles, 20 cc each 168
 390-8851 Blue Ink, 3 bottles, 20 cc each 168
 390-8852 Green Ink, 3 bottles, 20 cc each 168
 390-8853 Ink, 6 different, 6 bottles, 20 cc each 168
 390-8854 Ink, 12 different, 12 bottles, 20 cc each 168
 390-8855 Red Ink, 1 bottle, 40 cc 168
 390-8856 Red Ink, 3 bottles, 20 cc each 168
 390-8857 Black Ink, 3 bottles, 20 cc each 168
 390-8858 Blue Ink, 3 bottles, 20 cc each 168
 390-8860 Black Ink, 1 bottle, 40 cc 168
 390-M666013 Use 390-8810 168
 390-M666025 Use 390-8856 168
 390-M666027 Use 390-8853 168
 390-M666028 Use 390-8854 168
 390-M666035 Use 390-8857 168
 390-M666105 Use 390-88231 168
 390-M666106 Use 390-88232 168
 390-M666107 Use 390-88221 168
 390-M666108 Use 390-88222 168
 390-M666110 Use 390-88101 168
 390-M666111 Use 390-88102 168
 390-M666120 Use 390-8858 168
 390-M666123 Use 390-8821 168
 390-M666124 Use 390-8820 168
 390-M666127 Use 390-8860 168
 390-M666128 Use 390-8855 168
 390-M671118 Cartridge Dotting Wheel, 6 point 168
 390-M671119 Cartridge Dotting Wheel, 12 point 168
 390-M673049 Use 390-87602 168
 390-M673050 Use 390-87601 168
 390-M673051 Use 390-87603 168
 390-M674120 Use 390-8818 168
 390-M699050 Charts C201-W-MB 945-1045mb 31d 170
 390-M699051 Charts C201-W-HG 170
 390-M699061 Charts C211-W-HG 170
 390-M699063 Charts C211-W-MB 170
 390-M699083 Charts C701-W-MB-HF 170
 390-M699087 Charts C701-W-MB-HC 170
 390-M699089 Charts C701-W-HG-LF 170
 390-M699091 Charts C701-W-HG-HF 170
 390-M699113 Use 390-50251 170
 390-M699115 Use 390-50253 170
 390-M699117 Use 390-50252 170
 390-M699120 Charts -10/+50°C 0-100% 31d 74
 390-M699121 Charts C311-D-C 170
 390-M699123 Charts C311-D-HF 170
 390-M699124 Charts C311-W-HF 170
 390-M699125 Charts C311-D-WF 170
 390-M699126 Charts C311-W-LF 170
 390-M699130 Charts C311-W-CX 170
 390-M699170 Chart C401-D 0-2.5ly/min 24h 170
 390-M699171 Charts C401-W 0-2.5ly/min 168h 170
 390-M699190 Charts C501-D 0-50 events 170
 390-M699191 Charts C501-W 0-50 events 170
 390-M699192 Charts C501-M 0-50 events 170
 395-0604 NEMA-4X Fiberglass Enclosure w/backplate 29
 395-0806 NEMA-4X Fiberglass Enclosure w/backplate 29
 395-1008 NEMA-4X Fiberglass Enclosure w/backplate 29
 395-110 Small Desktop Enclosure, 115 Vac 29
 395-120 Large Desktop Enclosure, 115 Vac 29
 395-1210 NEMA-4X Fiberglass Enclosure w/backplate 29
 395-123-# Rack Mount Enclosure, 5", 7", or 9" 29
 395-1412 NEMA-4X Fiberglass Enclosure w/backplate 29
 395-1614 NEMA-4X Fiberglass Enclosure w/backplate 29
 395-240 MS Type Quick Release Connector 29
 395-250 Termination Strip, 12 position 29
 395-301 Small NEMA Polycarbonate Enclosure 29
 395-302 Large NEMA Polycarbonate Enclosure 29
 395-304 Termination J-Box 46
 395-990 Desiccant (2 packs) 29
 395-A Tower or Mast Mounting Hardware 21, 29
 395-B Unistrut Tower or Mast Mounting Hardware 29
 395-C Power Supply/Battery Charger Assy 100-240Vac 21, 29
 395-E Sunshield, for mid-size boxes 21, 29
 395-F Sunshield, for large boxes 29
 395-G 4AH Battery Assy 29
 395-H 7AH Battery Assy 21, 29
 395-I 12AH Battery Assy 29
 400-15-187 Replacement Transformer for 400-2095 36
 400-15-45 Replacement Lamp for 400-2095 36
 400-2090 Sight Clinometer 36
 400-2095 Ceiling Light Projector 36

400-50-209P3 Replacement Silicone Sealing Ring 36
400-6000 Visibility Sensor 39
400-6000CK Calibration Kit 39
400-8210 Pilot Balloon, 10 gm, red 34
400-8230 Pilot Balloon, 30 gm, red 34
400-8231 Pilot Balloon, 30 gm, black 34
400-8232 Pilot Balloon, 30 gm, natural 34
400-8233 Pilot Balloon, 100 gm, red 34
400-8234 Pilot Balloon, 100 gm, black 34
400-8235 Pilot Balloon, 100 gm, natural 34
400-8236 Pilot Balloon, 200 gm, natural 34
400-8237 Sounding Balloon, 300 gm, natural 34
400-8239 Sounding Balloon, 500 gm, natural 34
400-8242 Sounding Balloon, 800 gm, natural 34
400-8260-A10 10G Balloon Filling System 34
400-8266 Helium Tank Regulator 34
400-8318 Pilot Balloon Light 34
400-CBME40 Cloud Ceilometer, 12,500 feet 40
400-CBME80 Cloud Ceilometer, 25,000 feet 40
400-CHI-BE Digital Display for CBME40/80 40
400-CHI-BL Blower Option for CBME40/80 40
400-CHI-DM FSK Modem for CBME40/80 40
400-CHI-S Support Stand for CBME40/80 40
400-CHI-SS Sun Shutter for CBME40/80 40
400-CHI-SW Display Software for CBME40/80 40
400-SVS1 Sentry Visibility Sensor 38
410-SKAC AC Adapter 120V/60Hz 42
410-SKAC-220 AC Adapter 220V 42
410-SKDC Cigarette Lighter Adapter 42
410-SKLC Carrying Case 42
410-SKMB Wall Mounting Bracket 42
410-SkyScan Hand-Held Lightning Detector 42

A

AC Power Surge Arrestor 162
Albedometer 119
Altimeter 109, 110
Aluminum Tower 160
Analog Display 32
Analog Indicating Wind System 47
Analog Look-up Table 30
Anemometer
 44, 45, 46, 48, 49, 50, 52, 53, 54, 55, 56, 57, 60, 61, 62, 63, 64, 72
Anemometer Drive 68
Antenna 23
Assmann Psychrometer 79
Automatic Voice Dialer 22

B

Balloon Filling System 34
Balloons 34
Barometer 102, 103, 105, 106, 108, 109, 110
Barometric Pressure Dial 32
Barometric Pressure Sensor
 11, 13, 103, 105, 106, 108, 110
Battery 164
Battery Backup for WS-16D 11
Battery Charger, AC 165
Battery Charger, Solar 166
Battery Operated Psychrometer 78
Bird Wire Assembly 131

C

Campbell-Stokes Pattern Sunshine Recorder 125
Ceiling Light Projector 36
Ceilometer 40
Class A Evaporation Pan 146
Class A Evaporation Station 145
Clinometer 36
Compass 69, 110
Conductivity Sensor 156
Conversion Factors 174
Cotton Region Shelter 99
Cup-Wheel Torque Disc 69
Current Loop Wind Sensor 57, 62

D

Data Acquisition Module 11
Data Logger 10, 21, 139
Data Transporter 139
Desiccant 29
Desktop Enclosure 29
Dew Cell 88
Dialer 22
Digital Barometer & Altimeter 110
Digital Barometer-Altitude 109
Digital Compass 110
Digital Event Counter 142
Digital to Analog Conversion PCB 27
Display 24
Display Software 11, 13, 14, 21
Dissolved Oxygen Sensor 156
Dual Set Point Wind Alarm 61

E

Enclosure 29
Evaporation Gauge 147
Evaporation Gauge Tester 147
Evaporation Logger 149
Evaporation Pan 145, 146
Evaporation Pan Automatic Refill System 148
Evaporation Pan Platform 150
Evaporation Station 145
Event Counter 142
Event Logger 139

F

Fan Aspirated Solar Radiation Shield, solar power 95
Fan Psychrometer 78
Fence Post Rain Gauge 133
Fixed Point 145
Floating/Submersible Min-Max Thermometer 145, 146
Flow Probe 152
Forestry Rain & Snow Gauge 135
Fritschen Type Net Radiometer 122
Fuel Moisture Scale 89
Fuel Moisture Stick 89

G

General Purpose Translator PCB 28
Glossary 179

Graphical Display Software 11, 13, 15, 21
 Ground Cable 162
 Ground Rod 162
 Grounding Kit 162

H

Hair Bundle 74
 Hand Held PC for local display 11, 13, 21
 Handheld Barometer & Altimeter 110
 Handheld Barometer-Altitude 109
 Handheld Humidity & Temperature Sensor 92
 Handheld Wind Speed Calibrator 70
 Heated Rain & Snow Gauge 128, 131
 Helium Tank Regulator 34
 High Sensitivity Modular Weather Station 11
 High Sensitivity Wind Sensor 11
 Hook Gauge 145
 HTML Option for WS-16STR 15
 HTML Option for WS-18STR 13
 Humidity & Temperature Digital Chart Recorder 93
 Humidity & Temperature Sensor 87, 92
 Humidity Calibration Kit 100
 Humidity Calibrator 100
 Humidity Sensor 11, 13, 81
 Hygro-Thermometer 94
 Hygrometer Dial 75
 Hygrothermograph 74
 HyperTerminal 10, 20

I

Instrument Shelter 98

L

LCD Display 32
 Leaf Wetness Sensor 137
 LED Display 32
 Lightning Detector 42
 Lightning Protection 162
 Lithium Chloride Solution 88
 Loop-Powered Signal Conditioner 26

M

Marine Wind Tracker Display 51
 Maximum Thermometer 76
 Measuring Stick 134, 135
 Met Manager Software 11, 13, 16, 21
 Met Viewer Software 16
 Meteorological Balloons 34
 Meteorological Display 24
 Meteorological Translator 24
 Micro Response Anemometer 60
 Micro Response Wind Vane 59
 Min-Max Thermometer 146
 Minimum Thermometer 76
 Modem, Spread Spectrum Radio 23
 Modular Weather Station 10, 11, 13
 Motor Aspirated Solar Radiation Shield 97
 Mounting Hardware for enclosures 29

N

NEMA Fiberglass Enclosure 29
 NEMA Polycarbonate Enclosure 29
 Net Radiometer 121, 122, 123
 NovaLogger 2000 21
 NovaVane Wind Speed & Direction Sensor 46, 47

P

Pens and Ink 168
 pH Sensor 156
 Pilot Balloon Light 34
 Pilot Balloons 34
 Pitot Tube 65
 Plastic Rain Gauge 133
 Platinum Temperature Sensor 82
 Pocket Psychrometric Slide Rule 80
 Pocket Sling Psychrometer 77
 Portable Weather Station 12
 Power Supply, AC 165
 Power Supply, for desktop enclosure 11
 Power Supply, Solar 166
 Precipitation Detector 137
 Pressure Conversion Table 178
 Pressure Transducer 153
 Procomm 10, 20
 Propeller Torque Disc 69
 Psychrometer 78, 79
 Psychrometric Slide Rule 80
 Pyranometer 112, 114, 116, 117, 118, 119
 Pyrriometer 120

R

Rack Mount Enclosure 29
 Radio 23
 Radiometer 121, 122, 123, 124
 Rain Gauge 11, 13, 128, 129, 130, 131, 132, 134, 135
 Rain Gauge Calibrator 141
 Rain Gauge Mounting Plate 140
 Rain Gauge Side Mounting Bracket 129
 Rain Gauge Wind Screen 140
 Rain Logger 138, 139
 Rechargeable Battery 164
 Relative Humidity & Temperature Sensor 81
 Relative Humidity Dial 32
 Relative Humidity Sensor 11, 13, 81
 Relative Humidity Table 177
 Replacement Graduate 145
 RH/Temp Digital Chart Recorder 93
 RST Module 154

S

Sensor Line Lightning Protection 162
 Sensor Line Surge Protector 162
 Sentry Visibility Sensor 38
 Shadow Band 113
 Sight Clinometer 36
 Signal Conditioners 26
 Silicon Pyranometer 114, 116
 SkyScan Lightning Detector 42
 Sling Psychrometer 77

Snow Depth Sensor 136
Snow Gauge 128, 131, 134, 135
Soil Moisture Sensor 89
Soil Temperature Sensor 11, 13, 83
Solar Panel Battery Charger 11, 13, 21, 166
Solar Radiation Sensor 11, 13, 17, 117
Solar Radiation Shield 11, 95, 96, 97
Sonic Anemometer 53, 54, 55, 56
Sounding Balloons 34
Spread Spectrum Radio 23
Standard Rain & Snow Gauge 134
Standard Thermometer 76
Star Pyranometer 112
Stillwell 145
Stillwell with Fixed Point 145
Sunshield for enclosures 29
Sunshine Duration Sensor 126
Sunshine Recorder 125
Surge Arrestor 162

T

Telephone Modem 11
Temp Tracker Display 87
Temperature & Humidity Sensor 11, 13, 86
Temperature Alarm 90
Temperature Dial 32
Temperature Digital Chart Recorder 93
Temperature Sensor 11, 81, 82, 83, 84, 85, 87, 156
Thermohygrometer Dial 75
Thermometer 76, 77, 78, 79
Thermometer Shelter 98
Tipping Bucket Rain Gauge 128, 129, 130, 131, 132
Totalizing Anemometer 63, 72, 145
Tower 160
Tower Grounding Kit 162
Tower Lightning Protection 162
Townsend Support 76
Translator 24
Transportable Weather Station 13
Tripod 160
Tripod Grounding Kit 162
Turbidity Meter 157
Turbidity Sensor 157

U

Ultrasonic Anemometer 53, 54, 55, 56
Ultrasonic Sensor 154
Ultrasonic Snow Depth Sensor 136
USB to DB9 Serial Adapter 13
UV Radiometer 124
UV Sensor 17
UVW Anemometer 50

V

Vane 44, 45, 52, 57, 59
Vane Alignment Rod 69
Vane Angle Bench Stand 68
Vane Angle Fixture 68
Vane Torque Gauge 69
Vantage Pro2 Weather Station 17
Visibility Sensor 38, 39
Voice Dialer 22

W

Water Flow Sensor 152
Water or Soil Temperature Sensor 11, 13, 83
Water Temperature Alarm 90
Water Velocity Sensor 152
Weather Meter 18
Weather Station 10, 12, 17
Weather Tracker 18
WeatherLink for Vantage Pro2 17
WeatherPort General Purpose Wind Sensors 44
WeatherPort High Sensitivity Wind Sensors 45
Wind Alarm 61
Wind Conversion Table 175
Wind Direction Calibrator 70
Wind Direction Dial 32
Wind Indicator Console 47
Wind Logger with Real-Time Display 64
Wind Mark III Wind Sensors 58
Wind Meter 18, 65, 67
Wind Monitor 48
Wind Monitor-AQ 49
Wind Monitor-MA 48
Wind Screen 140
Wind Sentry Anemometer and Vane 52
Wind Sock 71
Wind Speed & Direction Sensors
11, 44, 45, 46, 47, 48, 49, 53, 54, 55, 58, 62
Wind Speed Alarm 61
Wind Speed Dial 32
Wind Speed Indicator 65
Wind Tracker Display 51
Wind Translator PCB 27
WindCom Communications Package 56
WindObserver II 56
Windows HyperTerminal 10, 20
WindSonic 55
Windtronic 2 Handheld Anemometer 66
WM-III Wind Sensors 58
WS-16 Modular Weather Station 10
WS-18 Portable Weather Station 12

Y

Yagi Antenna 23

Ordering Information

NovaLynx Corporation
PO Box 240
Grass Valley, CA 95945-0240

Phone: (530) 823-7185
Toll Free: (800) 321-3577 U.S. only
Fax: (530) 823-8997
E-mail: nova@novalynx.com
Website: www.novalynx.com

NovaLynx Federal ID: 68-0237829

Payment Terms: Domestic payment terms are net 30 days with approved credit. Visa, MasterCard, Discover, and American Express credit cards are accepted. Card is charged at the time of shipment. C.O.D. orders are accepted for domestic shipments only. Some orders may require prepayment or progress payments. Interest of 1.5% per month will be charged on past due accounts. Discounts may be withdrawn on past due accounts.

International Orders: Full payment is required in advance by wire transfer, credit card, or bank draft on a US bank. Confirmed irrevocable letter of credit may be accepted for some orders. Please contact NovaLynx for instructions prior to arranging any payment. Payment amount must include all applicable charges including freight, export processing fees, and banking charges. *Please instruct your bank that you will absorb all fees.* NovaLynx must receive the full amount due.

A processing fee will be added to each international order to defray some of the additional costs associated with international commerce. This fee may be waived for orders under \$500.00 paid by credit card or bank draft.

Minimum Order: No minimum purchase is required, however NovaLynx charges \$5.00 minimum shipping (\$15.00 minimum for C.O.D. orders).

Pricing: All prices are in U.S. Dollars. Prices do not include freight, installation, installation assistance, or any federal, state, or local taxes. Orders shipped to a California address or received by a customer at our factory may be subject to California sales tax. Applicable taxes will be added as a separate item on the purchaser's invoice unless a valid exemption, California resale certificate, or direct payment permit is provided to NovaLynx prior to shipment.

Any certification and/or inspection specifications which are in addition to the usual NovaLynx quality control procedures may be subject to an additional charge.

Prices and specifications are subject to change without notice.

Discounts: Discounts will be considered on a case-by-case basis. Qualification for discounts will be at the sole discretion of NovaLynx. Quantity discounts apply to number of units in a single purchase order. Blanket orders for a specific number of units over a specific term will be considered.

Shipping: Unless specific instructions accompany the order, we will use our judgement as to the best method of shipment. Most orders are shipped via United Parcel Service. Special arrangements can be made for other carriers. All shipments are F.O.B. Auburn, California. Title and risk of loss will pass to the purchaser upon delivery to the freight carrier. The purchaser is responsible for all transportation and insurance charges. Shipping containers are not returnable.

Returns: Unused products may be returned within 90 days from date of purchase only with prior authorization and must be resalable as new. A 15% restocking fee may be charged. Sensors and cables with customer specified lengths carry a minimum restocking fee of \$50.00 per probe. Products that may not be returned include: specially modified versions of our standard hardware and software; obsolete products; non-standard products obtained as a service to the customer. Please call NovaLynx to obtain a return authorization number and shipping instructions prior to returning any products to the factory. We recommend using a carrier that provides a tracking number and proof of delivery. The cost of sending a product to NovaLynx for repair or replacement is paid by the customer. NovaLynx will pay for the return shipment if the product is deemed to be defective under warranty. Include the return authorization number, a description of the problem, and complete contact information with your shipment. Products that arrive damaged in shipment, without a return authorization number, or without appropriate documentation may be returned to the sender unrepaired or may be scrapped if we are unable to arrange return shipping. The warranty will be voided for products damaged in shipment due to improper packaging.

Warranty: NovaLynx Corporation warrants that its products are free from defects in material and workmanship under normal use and service for a period of one year from the date of shipment from factory. NovaLynx's obligations under this warranty are limited to, at NovaLynx's option: (i) replacing; or (ii) repairing; any products determined to be defective. In no case shall NovaLynx's liability exceed product's original purchase price. This warranty does not apply to any equipment that has been repaired or altered, except by NovaLynx, or which has been subjected to misuse, negligence, or accident. It is expressly agreed that this warranty will be in lieu of all warranties of fitness and in lieu of the warranty of merchantability.