



AIRASSURE™ INDOOR AIR QUALITY MONITOR MODEL 8144

OPERATION AND MAINTENANCE MANUAL

P/N 6015658, REVISION D
SEPTEMBER 2021



START SEEING THE BENEFITS OF REGISTERING TODAY!

Thank you for your TSI instrument purchase. Occasionally, TSI releases information on software updates, product enhancements and new products. By registering your instrument, TSI will be able to send this important information to you.

<http://register.tsi.com>

As part of the registration process, you will be asked for your comments on TSI products and services. TSI's customer feedback program gives customers like you a way to tell us how we are doing.



UNDERSTANDING, ACCELERATED

TSI Incorporated - Visit our website **www.tsi.com** for more information.

USA **Tel:** +1 800 874 2811
UK **Tel:** +44 149 4 459200
France **Tel:** +33 1 41 19 21 99
Germany **Tel:** +49 241 523030

India **Tel:** +91 80 67877200
China **Tel:** +86 10 8219 7688
Singapore **Tel:** +65 6595 6388

Copyright©

TSI Incorporated / 2021 / All rights reserved.

Part Number

6015658 / Revision D / September 2021

Address

TSI Incorporated / 500 Cardigan Road / Shoreview, MN 55126 / USA

Fax No.

(651) 490-3824

LIMITATION OF WARRANTY AND LIABILITY (effective February 2020)

(For country-specific terms and conditions outside of the USA, please visit www.tsi.com.)

Seller warrants the goods, excluding software, sold hereunder, under normal use and service as described in the operator's manual, to be free from defects in workmanship and material for 120 days, or if less, the length of time specified in the operator's manual, from the date of shipment to the customer. This warranty period is inclusive of any statutory warranty. This limited warranty is subject to the following exclusions and exceptions:

- a. Hot-wire or hot-film sensors used with research anemometers, and certain other components when indicated in specifications, are warranted for 90 days from the date of shipment;
- b. Pumps are warranted for hours of operation as set forth in product or operator's manuals;
- c. Parts repaired or replaced as a result of repair services are warranted to be free from defects in workmanship and material, under normal use, for 90 days from the date of shipment;
- d. Seller does not provide any warranty on finished goods manufactured by others or on any fuses, batteries or other consumable materials. Only the original manufacturer's warranty applies;
- e. This warranty does not cover calibration requirements, and seller warrants only that the instrument or product is properly calibrated at the time of its manufacture. Instruments returned for calibration are not covered by this warranty;
- f. This warranty is **VOID** if the instrument is opened by anyone other than a factory authorized service center with the one exception where requirements set forth in the manual allow an operator to replace consumables or perform recommended cleaning;
- g. This warranty is **VOID** if the product has been misused, neglected, subjected to accidental or intentional damage, or is not properly installed, maintained, or cleaned according to the requirements of the manual. Unless specifically authorized in a separate writing by Seller, Seller makes no warranty with respect to, and shall have no liability in connection with, goods which are incorporated into other products or equipment, or which are modified by any person other than Seller.
- h. This warranty is **VOID** if the product is used in environments other than indoors.

The foregoing is **IN LIEU OF** all other warranties and is subject to the **LIMITATIONS** stated herein. **NO OTHER EXPRESS OR IMPLIED WARRANTY OF FITNESS FOR PARTICULAR PURPOSE OR MERCHANTABILITY IS MADE. WITH RESPECT TO SELLER'S BREACH OF THE IMPLIED WARRANTY AGAINST INFRINGEMENT, SAID WARRANTY IS LIMITED TO CLAIMS OF DIRECT INFRINGEMENT AND EXCLUDES CLAIMS OF CONTRIBUTORY OR INDUCED INFRINGEMENTS.**

BUYER'S EXCLUSIVE REMEDY SHALL BE THE RETURN OF THE PURCHASE PRICE DISCOUNTED FOR REASONABLE WEAR AND TEAR OR AT SELLER'S OPTION REPLACEMENT OF THE GOODS WITH NON-INFRINGEMENT GOODS.

TO THE EXTENT PERMITTED BY LAW, THE EXCLUSIVE REMEDY OF THE USER OR BUYER, AND THE LIMIT OF SELLER'S LIABILITY FOR ANY AND ALL LOSSES, INJURIES, OR DAMAGES CONCERNING THE GOODS (INCLUDING CLAIMS BASED ON CONTRACT, NEGLIGENCE, TORT, STRICT LIABILITY OR OTHERWISE) SHALL BE THE RETURN OF GOODS TO SELLER AND THE REFUND OF THE PURCHASE PRICE, OR, AT THE OPTION OF SELLER, THE REPAIR OR REPLACEMENT OF THE GOODS. IN THE CASE OF SOFTWARE, SELLER WILL REPAIR OR REPLACE DEFECTIVE SOFTWARE OR IF UNABLE TO DO SO, WILL REFUND THE PURCHASE PRICE OF THE SOFTWARE. **IN NO EVENT SHALL SELLER BE LIABLE FOR LOST PROFITS, BUSINESS INTERRUPTION, OR ANY SPECIAL, INDIRECT, CONSEQUENTIAL OR INCIDENTAL DAMAGES.** SELLER SHALL NOT BE RESPONSIBLE FOR INSTALLATION, DISMANTLING OR REINSTALLATION COSTS OR CHARGES. No Action, regardless of form, may be brought against Seller more than 12 months after a cause of action has accrued. The goods returned under warranty to Seller's factory shall be at Buyer's risk of loss, and will be returned, if at all, at Seller's risk of loss.

Buyer and all users are deemed to have accepted this LIMITATION OF WARRANTY AND LIABILITY, which contains the complete and exclusive limited warranty of Seller. This LIMITATION OF WARRANTY AND LIABILITY may not be amended, modified or its terms waived, except by writing signed by an Officer of Seller.

Buyer further agrees that purchase of TSI's AirAssure™ IAQ Monitors Buyer agrees to the Terms and Conditions of Use and the Privacy Policy located at www.tsi.com/tsilink.

Service Policy

Knowing that inoperative or defective instruments are as detrimental to TSI as they are to our customers, our service policy is designed to give prompt attention to any problems. If any malfunction is discovered, please contact your nearest sales office or representative, or call TSI's Customer Service department at (800) 680-1220 (USA) or (001 651) 490-2860 (International) or visit www.tsi.com.

Trademarks

TSI and TSI logo are registered trademarks of TSI Incorporated in the United States and may be protected under other country's trademark registrations. AirAssure and DustTrak are trademarks of TSI Incorporated. Wi-Fi is a registered trademark of the Wi-Fi Alliance. 3M and Command brand are registered trademarks of the 3M Company.

Cloud Software End User Licensing Agreement and Privacy Policy

Go to tsilink.com to view the **TERMS OF USE & PRIVACY POLICY** link.

Contents

Safety Information	v
Description of Caution/Warning Symbols	v
Caution	v
Warning	v
Caution and Warning Symbols	v
Laser Safety	vii
Labels	viii
Reusing and Recycling	viii
Chapter 1 Product Overview	1
Unpacking	2
AirAssure™ IAQ Monitor Replacement Parts	3
Chapter 2 Setting Up	5
Create an Account TSI Link™ Solutions for Cloud Features	6
Connecting the AirAssure™ IAQ Monitor to a Wi-Fi® Network	7
Installing the AirAssure™ Indoor Air Quality Monitor	14
Getting Help	18
Chapter 3 Operation	19
Overview	19
How to Register your AirAssure™ IAQ Monitor(s) and Account Onboarding	19
How to View Data from one or more AirAssure™ IAQ Monitors	22
How to Download Data from one or more AirAssure™ IAQ Monitors	23
How to Download Data from the microSD Card in the AirAssure™ IAQ Monitor	23
Interpreting the Data Downloaded from the microSD Card or from the Cloud	24
Chapter 4 Maintenance	25
Replacing the Multi-Sensor Cartridge and Membrane	27
Replacing the PM Sensor	29
Replacing the CO ₂ Sensor	29
Replacing the Formaldehyde Sensor	30
Chapter 5 Troubleshooting the AirAssure™ Indoor Air Quality Monitor	33
Appendix A Specifications*	35

(This page intentionally left blank)

Safety Information

Description of Caution/Warning Symbols

Appropriate caution/warning statements are used throughout the manual and on the instrument that require you to take cautionary measures when working with the instrument.

Caution



CAUTION

Failure to follow the procedures prescribed in this manual might result in irreparable equipment damage. Important information about the operation and maintenance of this instrument is included in this manual.

Warning





WARNING

Warning means that unsafe use of the instrument could result in serious injury to you or cause damage to the instrument. Follow the procedures prescribed.

Caution and Warning Symbols

The following symbols may accompany cautions and warnings to indicate the nature and consequences of hazards:

	Warns that the instrument contains a laser and that important information about its safe operation and maintenance is included in the manual.
	Warns that the instrument is susceptible to electrostatic discharge (ESD) and ESD protection should be followed to avoid damage.
	Indicates the connector is connected to earth ground and cabinet ground.



WARNING

- Use of components other than those specified by TSI® Incorporated (TSI®) may impair the safety features provided by the equipment.
- When mains power adapters are used, the equipment should be positioned so the mains plug will remain accessible for emergency disconnect.



CAUTION

- The AirAssure™ Indoor Air Quality monitor enclosure is designed for **INDOOR USE ONLY**. The monitor is **NOT** water or spray resistant.
- The power adapter provided with the AirAssure™ IAQ monitor is rated for indoor use only. **DO NOT** use any other power supply with the AirAssure™ IAQ monitor.



CAUTION

NEVER open the monitor when it is powered on or connected to the power adapter!

The monitor contains very sensitive sensors that are susceptible to electrostatic discharge (ESD) and ESD precautions should be followed to avoid damage.



NOTE

Installation videos can be found on our website www.tsi.com/tsilink.

NOTE

The safety of any system incorporating the AirAssure™ IAQ monitor is the responsibility of the installer of the system.

Laser Safety

- AirAssure™ Indoor Air Quality monitors are Class 1 laser-based instruments.
- During normal operation, you will not be exposed to laser radiation.
- You will not be exposed to the laser radiation when the AirAssure™ IAQ monitor is disassembled.
- The PM sensor has a laser inside it. **DO NOT** open the PM sensor inside AirAssure™ IAQ monitor when the AirAssure™ IAQ monitor is powered.

Take these precautions:

- **DO NOT** remove any parts from the AirAssure™ Indoor Air Quality monitor unless you are specifically told to do so in this manual.



WARNING

The use of controls, adjustments, or procedures other than those specified in this manual may result in exposure to hazardous optical radiation.







WARNING

If the AirAssure™ IAQ monitor is used in a manner not specified by the manufacturer, the protection provided by the equipment may be impaired.

When operated according to the manufacturer's instruction, this device is a Class 1 laser product as defined by U.S. Department of Health and Human Services standards under the Radiation Control for Health and Safety Act of 1968. A certification and identification label like the one shown below is affixed to each instrument.

Labels

Advisory labels and identification labels are attached to the instrument.

<p>1. Serial Number Label (back)</p>	 <p>AirAssure IAQ Model 8144 PN: 8144-6 SN: 814462021001 Wi-Fi 2.4 GHz MAC: A0-51-0B-6A-46-86 PWD: a9b3384f79b2 Contains FCC ID: 2AC7Z-ESP32WROVERE Contains IC ID: 21098-ESPWROVERE 5V ---1A (USB-C) 24VAC 50-60Hz 0.5A (Back) TSI Incorporated www.tsi.com Made in U.S.A.</p>
<p>2. Laser Radiation Label (internal, on the PM sensor)</p>	
<p>3.  Safety Details</p>	<p>FCC ID: 2AC7Z-ESPWROVERE Contains IC ID: 2AC7Z-ESPWROVERE</p>
<p>4. European symbol for non-disposable item. Item must be recycled.</p>	

Reusing and Recycling



As part of TSI[®] Incorporated’s effort to have a minimal negative impact on the communities in which its products are manufactured and used:

-  If instrument becomes obsolete, return to TSI[®] Incorporated for disassembly and recycling.

Chapter 1

Product Overview

TSI® Incorporated's AirAssure™ Indoor Air Quality Monitor is a real-time Particulate Matter (PM) and Gas monitor designed to provide accurate gas and mass concentrations as well as temperature, humidity, and barometric pressure measurements. The monitor is designed to be deployed in less than ten minutes and is intended for indoor air quality monitoring only.

Data from the sensor is available at www.tsi.com/tsilink. All you need is an internet connection and web browser. The AirAssure™ IAQ monitor connects to the internet using 2.4 GHz Wi-Fi® to upload data. Cloud data can be viewed in a web browser. There is no need to install an app on your smartphone. Logged data is also available on the internal microSD card accessible from the bottom of the device.

The AirAssure™ IAQ monitor comes with a PM sensor factory calibration, whose standards adhere to the same standards that are applied to other high-quality TSI® monitors like the DustTrak™ and AM520 models. The AirAssure™ IAQ monitors also come with self-diagnostics to enable you to run the monitor with greater than 95% run-time.









Figure 1: Front View of AirAssure™ IAQ Monitor

® Wi-Fi is a registered trademark of Wi-Fi Alliance.



Unpacking



Compare all the components you received with those listed in the table below.

Item	Qty	Description
	1	AirAssure™ Indoor Air Quality Monitor
	1	USB Power Supply
	1	Country Specific Plug Adapter Kit
	1	2m USB-A to USB-C Cable
	1	24 VAC Terminal Connector
	1	32 GB microSD card (installed)
	1	Mounting Kit: (2 screw and plug sets, 8 tape strips, 1 level)

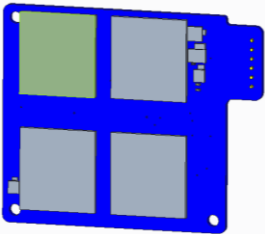
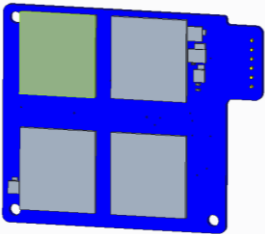
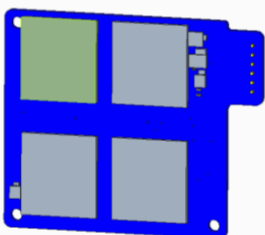
AirAssure™ IAQ Monitor Replacement Parts

Listed below are replacement items for the AirAssure™ Indoor Air Quality Monitor. Contact [TSI®](#) for purchase information.

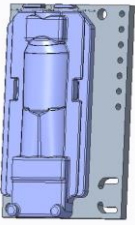
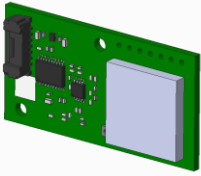
Item	Part Number	Description
	814408	Replacement 2-Gas Variant Sensor Cartridge: tVOC, Temperature, Relative Humidity, and Barometric Pressure
	814401	Replacement 4-Gas Variant Sensor Cartridge: CO, tVOC, Temperature, Relative Humidity, and Barometric Pressure
	814402	Replacement 6-Gas Variant Sensor Cartridge: CO, O ₃ , tVOC, NO ₂ , and SO ₂ , Temperature, Relative Humidity, and Barometric Pressure
	814403	Replacement TSI® Calibrated PM Sensor

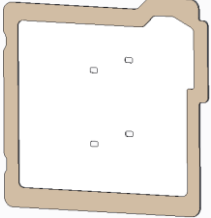
Item	Part Number	Description
	814404	Replacement CO ₂ Sensor
	814405	Replacement Formaldehyde Sensor
	814406	Replacement Power Supply Kit
	814407	Replacement Membrane Filters (pack of 3)

Chapter 2

Setting Up

The AirAssure™ Indoor Air Quality Monitor is delivered fully assembled and ready to be mounted on an interior wall. Start by unpacking the device and its contents from the shipping package. The monitor is intended to be connected to local 2.4 GHz Wi-Fi® to access all cloud features, but it can be used without Wi-Fi® if needed as all data is recorded to a pre-installed microSD memory card accessible from the bottom of the case next to the USB-C port.

A quick start guide is shipped with each instrument. It provides the necessary steps to configure the Wi-Fi® settings for connecting the device to a local Wi-Fi® network and will also guide you through installation. A digital copy of the Quick Start Guide can also be found at www.tsi.com/tsilink.

NOTE

As long as a suitable microSD card is installed, the AirAssure™ IAQ monitor will store data on the card whether or not the unit is connected to Wi-Fi®. TSI® is not liable for corrupt data on the memory card.

NOTE

If Wi-Fi® is connected and then lost, the AirAssure™ IAQ monitor cannot read data from the microSD card and upload the data to the cloud when Wi-Fi® is available. However, as long as power is uninterrupted, an internal data buffer will store approximately 7 days of data (logged at 15 min. intervals), which will then be uploaded to the cloud once internet has been restored. Data older than that will be available only on the microSD card. Currently, customers cannot manually upload microSD card data to the TSI® Cloud. You will be notified on the cloud data if the AirAssure™ IAQ monitor has trouble writing to the microSD card.

NOTE

The monitor does not have the capability to connect to public Wi-Fi® networks that require a second step of browser authentication, such as a free public hotel or airport network. A different network will need to be chosen.

NOTE

Some corporate networks require the device MAC address for security. This can be found on the serial number label of the monitor.



CAUTION

NEVER open the monitor when it is powered on or connected to the power adapter!

The monitor contains very sensitive sensors that are susceptible to electrostatic discharge (ESD) and ESD precautions should be followed to avoid damage.



If using the microSD card only, you can skip the steps below for connecting to Wi-Fi® and the cloud.

Create an Account TSI Link™ Solutions for Cloud Features

1. Open the browser on your phone/computer to <http://www.tsi.com/tsilink> and click on the **SIGN IN / SIGN UP** button.

For detailed steps, please see [Chapter 3](#).

2. After creating an account or using an existing account, click on the plus icon in the lower right. Hovering over it will show “Activate New Device”.

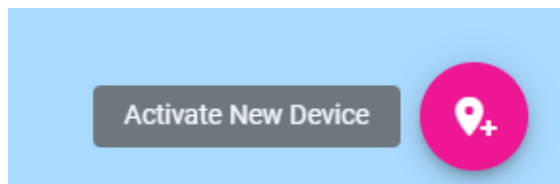

3. Enter the serial number from the back of your device.

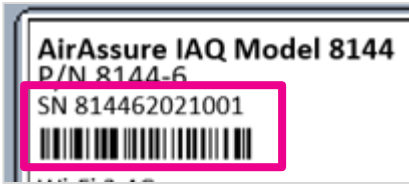

4. Enter other information.

A screenshot of a mobile application interface titled "Activate Device" with a location pin icon. The screen prompts the user to provide information for activation. Under the heading "Device Details", there are two input fields. The first field is labeled "Device/Location Name" with a red asterisk and contains the text "NHS Middle School". The second field is labeled "Device Serial Number" with a red asterisk and contains the text "814462021001", which is highlighted with a red rectangular box. Below the second field, there is a note: "Printed on the bottom of the device. No spaces." The screen also shows character counts: "17 / 25" for the first field and "11 / 11" for the second field.

Connecting the AirAssure™ IAQ Monitor to a Wi-Fi® Network

For best results, set up the device before mounting it in a permanent location. However, ensure you have good Wi-Fi® strength in the final location. If access to Wi-Fi® is not available, data will always be stored on the included microSD memory card.

The AirAssure™ Indoor Air Quality Monitor can be powered by a USB wall plug power supply and USB-C cable or by 24 Volts AC via a connector on the back of the device. A screw terminal connector is provided to wire the 24 Volts AC to the back of the AirAssure™ IAQ unit. If using 24 VAC, it is best to set up the Wi-Fi® with the wall plug before mounting and connecting to 24 VAC to verify everything is set up properly.

It can be mounted using screws or using double-sided tape (included).

1. Remove the power supply, plug adapter kit, and USB-C cable from its packaging. Select your region's plug connector and mate it to the power supply by "snapping" the plug connector into the adapter.



2. Connect the other end of the USB cable to the USB-C port on the bottom of the monitor.

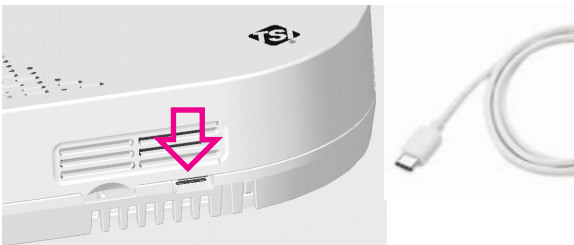

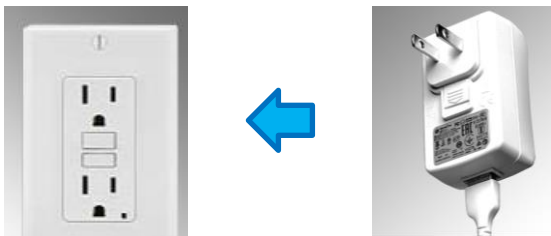

3. Connect the USB-A cable end into the power supply and then plug-in the power adapter to a nearby power outlet.

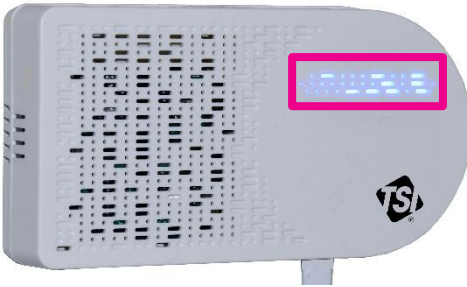

- The monitor should turn on as indicated by the light bar on the front. To connect the monitor to the internet, you first have to connect to the monitor's hot spot.



- Pulse yellow indicates that the monitor is in set up mode as a Wi-Fi® hotspot. It will remain in this mode for 60 seconds. If you need more time, simply unplug and plug the monitor back in again.

 LED	 Wi-Fi®	 Cloud
Pulse Yellow	Set up Mode	
Pulse White	Connecting	
Pulse Blue	Connected	Connecting
Solid Blue	Connected	Connected
Solid White	No connection	No connection

- Locate the label on the back of the monitor.



7. With your phone camera, scan the QR code at the top of the label to connect to the monitor's Wi-Fi® hotspot. You should be prompted to connect to a new Wi-Fi® network called "AirAssure IAQ 8144XXX..."

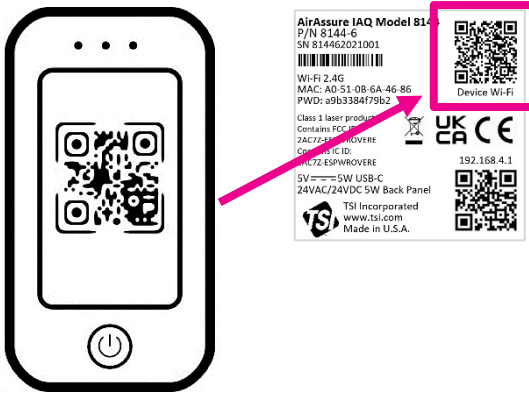

8. If you are not connected automatically, you can still connect manually by searching for Wi-Fi® networks and connecting to the one listed as "AirAssure IAQ 8144XXX..."

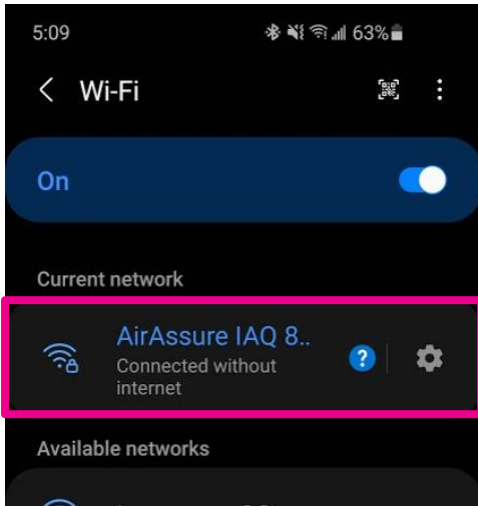

9. Once connected to the AirAssure™ IAQ monitor Wi-Fi® network, use your phone camera again to connect to the setup web page or open your phone browser and enter a URL of **192.168.4.1**.

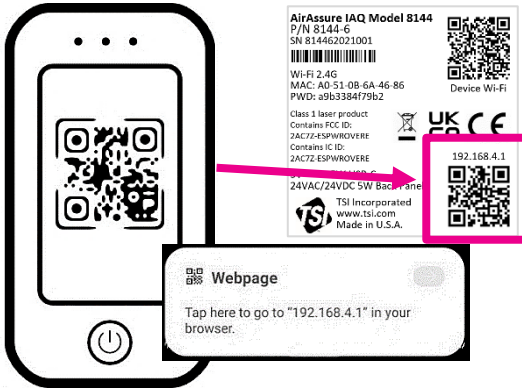

10. You should see a web page like the one below. Select your home or office Wi-Fi® network from the list.

**TSI AirAssure™
IAQ Monitor Setup**

**SN: 81442110016 MAC:
C4:DD:57:A8:FE:A8**

**Connect AirAssure™ IAQ Monitor
to a Nearby Wi-Fi Network**

Choose Wi-Fi Network Name (SSID)
(refresh webpage to reload Wi-Fi Networks list)

(Select Wifi Network) ▼

11. Enter the local Wi-Fi® password and click **Save**.

Connect AirAssure™ IAQ Monitor to a Nearby Wi-Fi Network

Choose Wi-Fi Network Name (SSID)
(refresh webpage to reload Wi-Fi Networks list)

Inverness_Guest1

Wi-Fi Network Password
(leave blank if no password)

.....

Note: Use the password for your local Wi-Fi network. Do not use the Network Security Key from the device label.



Show Password

SAVE

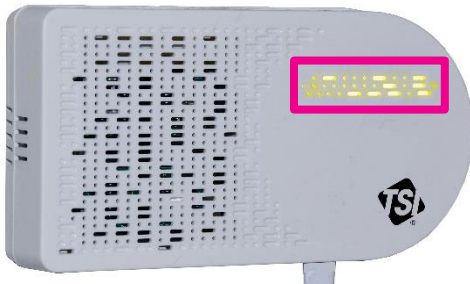
12. The monitor should automatically power cycle and start again with a pulsing yellow LED light bar.



13. The process of connecting to your local internet will be reflected in the color sequence shown below. This may take several minutes.



 LED	 Wi-Fi®	 Cloud
Pulse Yellow	Set up Mode	
Pulse White	Connecting	
Pulse Blue	Connected	Connecting
Solid Blue	Connected	Connected
Solid White	No connection	No connection

14. If all connections are made, the LED will be solid blue. 

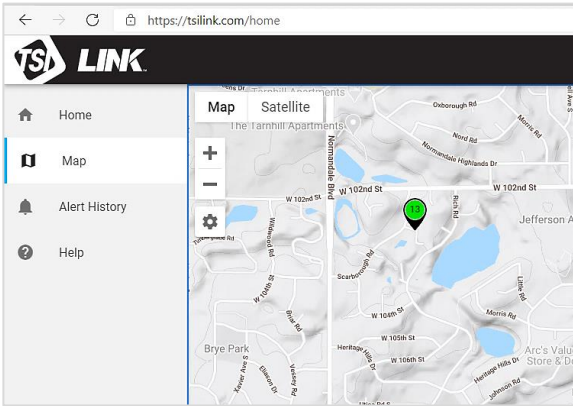
15. You can then connect to your device through TSI Link™ Solutions at www.tsi.com/tsilink.



16. If the LED light bar stops at solid white, review the steps above and repeat as needed or see the [“Getting Help”](#) section below.

 LED	 Wi-Fi®	 Cloud
Pulse Yellow	Set up Mode	
Pulse White	Connecting	
Pulse Blue	Connected	Connecting
Solid Blue	Connected	Connected
Solid White	No connection	No connection

3. If using screws, position the template from the quick start guide and use the included level to mark the screw locations on the wall for mounting. If using a wall plug, install the screws and mount the monitor.

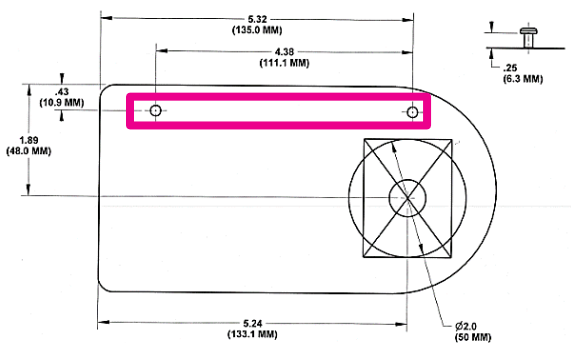

4. If using 24 VAC power, mark the cut-out guide area for the wiring feed through (large circle or rectangle).

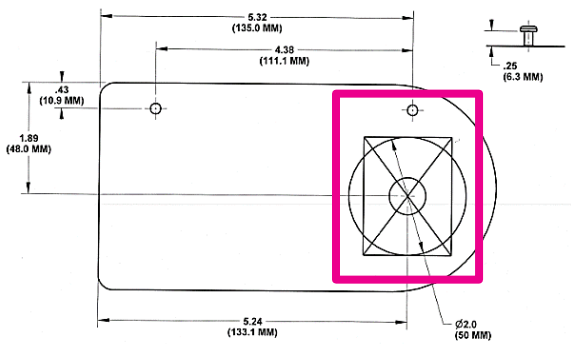

5. Cut the hole and connect the wiring (22-16 AWG, 0.5-1.5 mm²) to the 24 VAC plug.

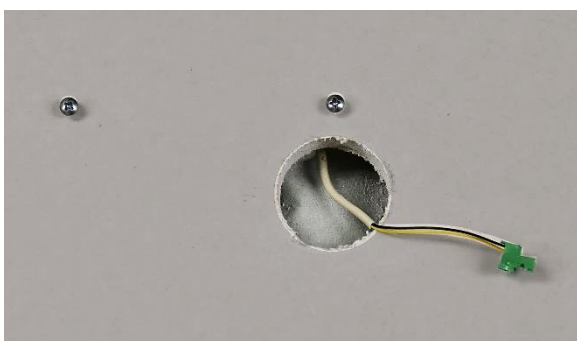

- Before applying power to the connection, insert the 24 VAC plug into back of monitor and mount it on the wall.



- If the screws need to be more secure, press gently on the two pads on top of the front cover and push down and away from the wall.



NOTE

NEVER open the monitor when it is powered on or connected to the power adapter!

The monitor contains very sensitive sensors that are susceptible to electro-static discharge (ESD) and ESD precautions should be followed to avoid damage.





- Tighten the screws as needed and close the cover again.



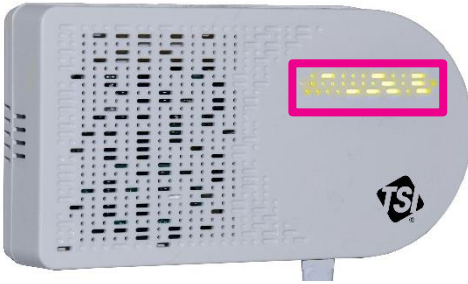

9. When power is now applied, the light bar on the monitor will illuminate and pulse yellow.



10. The process of connecting to your local internet will be reflected in the color sequence shown below. This may take several minutes. The LED light bar should be solid blue.

 LED	 Wi-Fi®	 Cloud
Pulse Yellow	Set up Mode	
Pulse White	Connecting	
Pulse Blue	Connected	Connecting
Solid Blue	Connected	Connected
Solid White	No connection	No connection

11. If the LED light bar stops at solid white, then review the steps above and repeat as needed or see the [troubleshooting section](#) in Chapter 5 or the “[Getting Help](#)” section below.

 LED	 Wi-Fi®	 Cloud
Pulse Yellow	Set up Mode	
Pulse White	Connecting	
Pulse Blue	Connected	Connecting
Solid Blue	Connected	Connected
Solid White	No connection	No connection

Getting Help

There is a wealth of support material available online. Please check the Help Center at: www.tsi.com/tsilink.

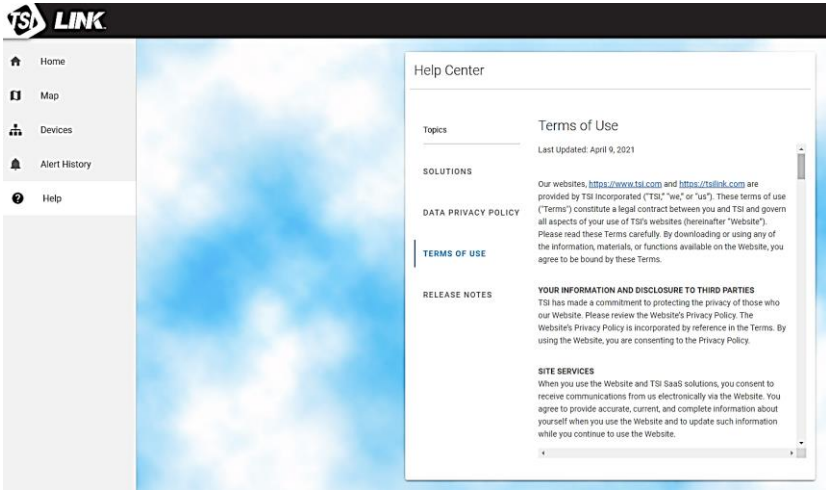

Chapter 3

Operation

Overview

The AirAssure™ Indoor Air Quality (IAQ) Monitor's primary use is for indoor applications. It is designed to operate 24/7 when powered by a power outlet or 24 Volts AC low-voltage building power. Once you have setup your monitor(s) and connected them to a local wireless (Wi-Fi®) network, you can log into the TSI® Cloud platform, www.tsi.com/tsilink, to view the air quality in real time. It will give you insights into how the air quality varies over time inside of your indoor space. Monitoring your indoor air allows you to start seeing trends, which can lead to making more informed decisions, benefiting you and potentially the entire building/community.

How to Register your AirAssure™ IAQ Monitor(s) and Account Onboarding

1. After the unit is powered on, check to make sure the light bar is a steady blue color after 2 minutes. If not, go to the [troubleshooting](#) chapter to fix connectivity issues.
2. From any location, open your web browser and enter the AirAssure™ IAQ monitor landing page (www.tsi.com/tsilink).
3. On the landing page click on **SIGN IN / SIGN UP** button.
4. Click on **SIGN IN / SIGN UP** and choose **SIGN UP**. Then enter the information required and click **SIGN UP**.

The screenshot shows the TSI Sign Up form. At the top is the TSI logo with the tagline "UNDERSTANDING. ACCELERATED." Below the logo are two tabs: "Sign In" and "Sign Up", with "Sign Up" being the active tab. The form contains several input fields: an email field with "yours@example.com", a password field with "your password" and an eye icon, a first name field with the placeholder "Enter your first name", a last name field with the placeholder "Enter your last name", and a country dropdown menu currently set to "United States". Below the fields is a checkbox for "I agree to the Terms of Service and Privacy Policy." At the bottom is a large grey button labeled "SIGN UP >".

5. You will receive an e-mail from TSI Link™ Solutions to verify your e-mail address. Once you receive this e-mail click on the **Verify Link**.
6. Go back to the web browser and click **DONE** on the AirAssure™ IAQ monitor screen.

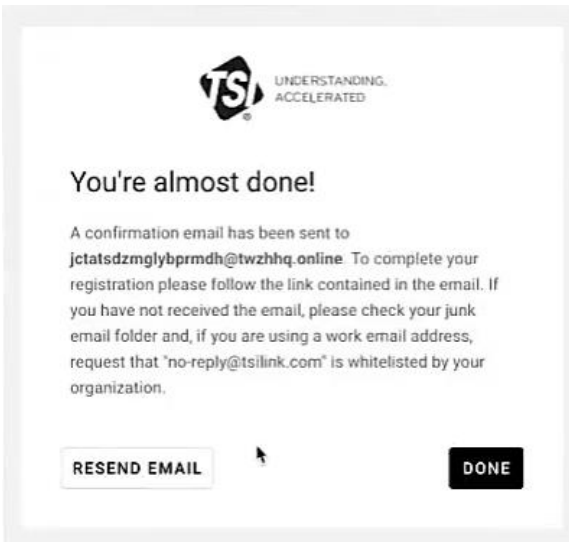

7. Wait for the 10-second count down then log in with your new online AirAssure™ IAQ monitor login credential.
8. Register your device by entering in the required information and click **DONE**. If you do not see the Device Registration screen, click the “Plus” icon  on the bottom right of the map.
 - Note that you can enter Latitude and Longitude using the browser location or the tool by going to <https://www.latlong.net/>

 **Activate Device**

Please provide the following information to activate your device and see it on the TSI Link map.

<p>Device Details</p> <p>Device Type * AirAssure ▼</p> <hr/> <p>Device/Location Name * 0 / 25</p> <hr/> <p>Device Serial Number * 0 / 11</p> <p><small>Printed on the bottom of the device. No spaces.</small></p> <hr/> <p><input type="checkbox"/> Make Data Viewable</p> <p><small>Your device data will be shown on the map for other TSI Link customers. This only includes device location and measurements, and other customers cannot export any data.</small></p> <p><input checked="" type="checkbox"/> Indoor Sensor </p> <p><small>The AirAssure device is designed for indoor use only.</small></p> <p><small>* = required</small></p>	<p>Device Location</p> <p>USE BROWSER LOCATION</p> <p><small>Set device latitude/longitude using web browser location.</small></p> <hr/> <p>Latitude * _____</p> <hr/> <p>Longitude * _____</p> <hr/> <p><small>Convert an address to coordinates at https://www.latlong.net/</small></p>
--	---

CLOSE **DONE** >

9. Adjust the device pin location if needed and/or click **DONE**.

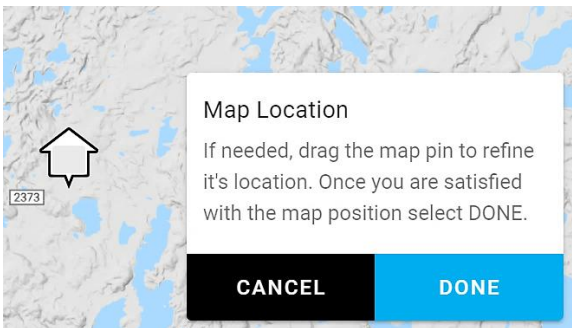

- When the device is connected and running, verify your device pin is displaying current measurements to confirm you successfully signed up for an online account and registered your device.

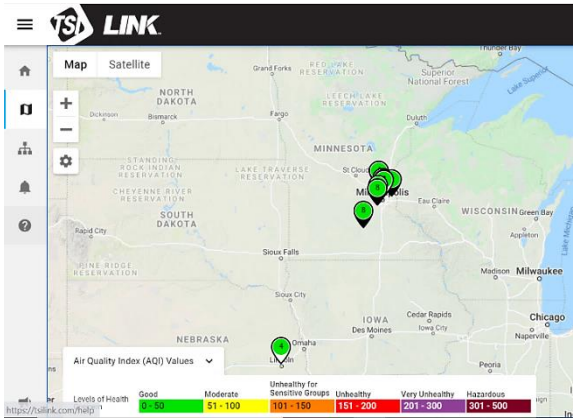

How to View Data from one or more AirAssure™ IAQ Monitors

- Go to www.tsi.com/tsilink and log in.
- Click on the map and zoom in to the area where your AirAssure™ IAQ device pin is located.
- Click on the device pin to view the current values.
- Or click on the devices tab to view high-level readings of multiple devices side by side.

The screenshot shows the TSI LINK web application interface. At the top, there is a navigation bar with the TSI LINK logo and a hamburger menu icon. Below the logo, there are icons for Home, Map, Devices, Alert History, and Help. The main area is the 'Manage Devices' page, which includes a search bar and a table of registered devices.

Name	Device	Access ↑	Condition
South Owasso	BlueSky	Owned	▼
Bloomington outdoor	BlueSky	Owned	▼
South Owasso Indoor	BlueSky	Owned	▼

- Please note to view data on the cloud right after you installed the AirAssure™ IAQ monitor, powered it **ON** and connected it to the TSI Link™ Solutions, please wait at least 15 minutes before you see a data point in the cloud.

How to Download Data from one or more AirAssure™ IAQ Monitors

1. Go to www.tsi.com/tsilink and log in.
2. Click on the map and zoom in to the area where your AirAssure™ IAQ device pin is located.
3. Click on the device pin.
4. Click on the history button.
5. Click on the three dots in the top left corner and select **Export CSV**.

How to Download Data from the microSD Card in the AirAssure™ IAQ Monitor

1. To avoid the remote possibility of corrupting data on the card, disconnect the power to the unit by disconnecting the USB cable from the power adapter.
2. The microSD card slot is located next to the USB connector. Remove the card by pressing in with a fingernail or tool until the card is ejected.

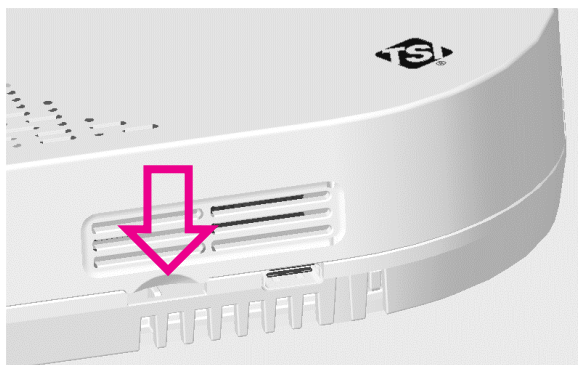

3. Insert the card into a computer (you may need a commonly-available adapter) and download the data. You have the options to erase and reinstall the card, insert a new card, or choose to not install a microSD card. If the AirAssure™ IAQ monitor has any issues writing to the card, an error flag will be activated on the cloud that action needs to be taken.
4. The 32 GB card provided will store approximately a maximum of 300 million data entries or the equivalent of hundreds of years of data.

Interpreting the Data Downloaded from the microSD Card or from the Cloud

Data downloaded from the AirAssure™ Indoor Air Quality Monitor from the microSD card or cloud is stored as an ASCII format file with the serial number and date as the filename and .csv as the extension (e.g. 81442110016-2020111.csv). This format is easily imported into spreadsheet and database programs.

	A	B	C	D
1	# TSI AirAssure IAQ			
2	#			
3	# Model: 8144 Serial: 81442116012			
4	# Firmware: v0.8.0-dc			
5	#			
6	# Temperature/Humidity sensor			
7	# Model: Serial: 46			

The top line of the output in the file has header information such as model, serial number, firmware version, etc. Farther down there are descriptions of the data in each column along with the data. The actual output of the file will depend on the number and configurations of sensors installed in your particular device.

	A	B	C	D	E
58	Timestamp	System St	Temperat	Humidity	Temperat Ba
59	UTC		C	%	int
60	4/29/2021 21:16	1	24.2	27	0
61	4/29/2021 21:31	0	24	27	0

Most of them are self-explanatory but a few such as sensor status bits require further explanation that can be found in Frequently Asked Questions (FAQs) at www.tsi.com/tsilink.

Chapter 4



Maintenance

Replacement sensors can be ordered from TSI® Incorporated. Although sensor life times vary depending on the conditions they are exposed to, conservative recommended replacement intervals are listed below for each sensor:

NOTE

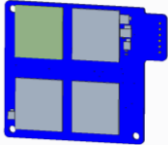
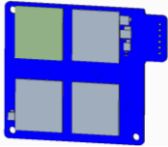
Recommend replacement intervals are derived from the expected indoor conditions: Temperature (65 to 75°F/18 to 24°C) and Relative Humidity (30 to 50%).

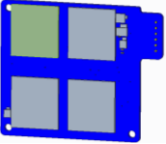
Item	Part Number	Description	Recommended Replacement Interval
	814408	2-Gas Variant Sensor Cartridge: tVOC, Temperature, Relative Humidity, and Barometric Pressure	1 year
	814401	4-Gas Variant Sensor Cartridge: CO, tVOC, Temperature, Relative Humidity, and Barometric Pressure	1 year

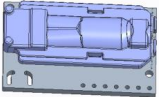
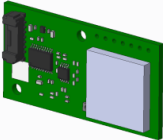
Item	Part Number	Description	Recommended Replacement Interval
	814402	6-Gas Variant Sensor Cartridge: CO, O ₃ , tVOC, NO ₂ , and SO ₂ , Temperature, Relative Humidity, and Barometric Pressure	1 year
	814407	Membrane Filters (Pack of 3)	Replace when replacing the gas sensors above
	814403	TSI® Calibrated PM Replacement Sensor	3 years
	814404	CO ₂ Replacement Sensor	3 years
	814405	Formaldehyde Replacement Sensor	1 year

- Any maintenance should be performed only after powering the unit down by disconnecting the USB cable from the power adapter or removing the unit from the wall and disconnecting the 24 VAC power connector from the back panel.



CAUTION

NEVER open the monitor when it is powered on or connected to the power adapter!

The monitor contains very sensitive sensors that are susceptible to electrostatic discharge (ESD) and ESD



precautions should be followed to avoid damage.

2. There are two indents at the top of the unit indicating where to press down and out to separate the cover from the base. The cover will pivot from the bottom allowing the cover to be removed.

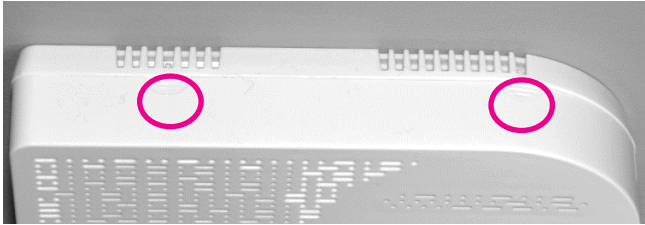

3. You can identify the sensors based on the table above and picture below. Detailed directions follow for each sensor.



Replacing the Multi-Sensor Cartridge and Membrane

1. Release the lever at the bottom-left of the board and lift the bottom of the PC board slightly away from the back panel.
2. Pull straight out from the back panel at the top and bottom of the connector on the right until the board is free.
3. Replace the old board with the new board.
4. Remove the old membrane filter on the cover of the monitor and replace it with a new membrane. This will extend the life of the sensors by protecting them from dust and debris.

5. Replace the cover, power up the monitor and connect it to the cloud to register the new sensors and their calibration values.

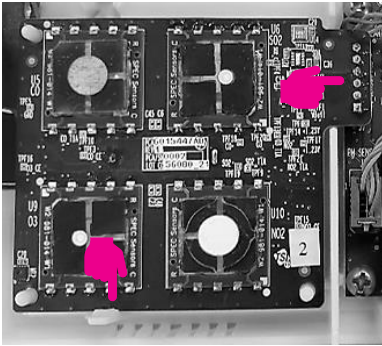

Replacing the PM Sensor

1. Unplug the connector on the left by pressing the locking clips in from the top and bottom and pulling the connector straight out.
2. Pull the sensor module from the top and pivot it away from the PC board.
3. Lift the PM sensor module up and away from the case.
4. Reverse the steps for the new sensor.
5. Replace the cover, power up the monitor and connect it to the cloud to register the new sensor and its calibration values.

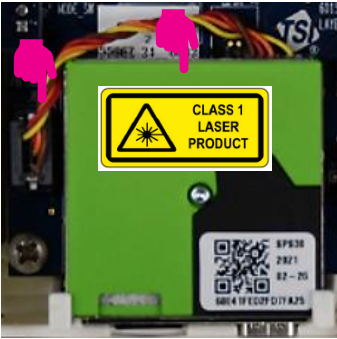

Replacing the CO₂ Sensor

1. Unplug the connector on the left by pressing the locking clips in from the top and bottom and pulling the connector straight out.
2. Pull the sensor module from the top and straight away from the case.
3. Reverse the steps for the new sensor.
4. Replace the cover, power up the monitor and connect it to the cloud to register the new sensor and its calibration values.



Replacing the Formaldehyde Sensor

1. The formaldehyde sensor is located on the left side of the monitor on a separate PC-board.

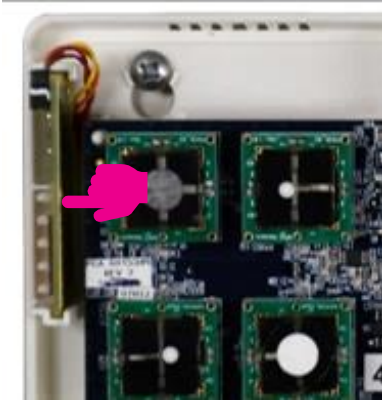

2. Depress the back of the cable connector (pushing into the page in the picture below).

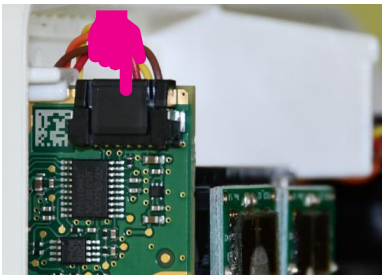

3. Pull the connector from the top and up.

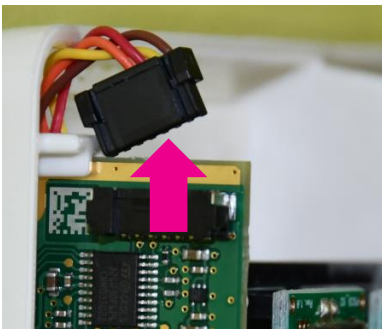

4. Pull the sensor module PC-board from the top and straight away from the wall. You may have to wiggle it up and down to release.

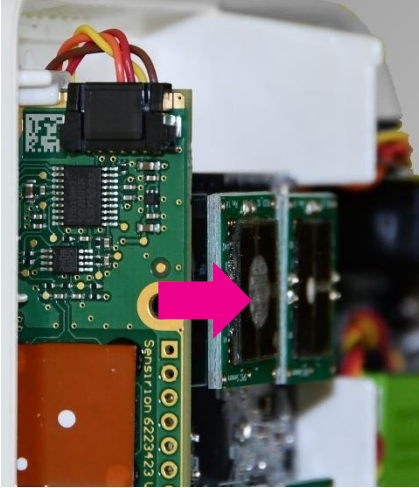



5. Reverse the steps for the new sensor.
6. Replace the cover, power up the monitor and connect it to the cloud to register the new sensor and its calibration values.

Chapter 5

Troubleshooting the AirAssure™ Indoor Air Quality Monitor

Detailed troubleshooting and frequently asked questions can be found at www.tsi.com/tsilink.

The table below lists some symptoms, possible causes, and recommended solutions for common problems encountered with the AirAssure™ Indoor Air Quality Monitor.

Possible Cause	Corrective Action		
The AirAssure™ IAQ monitor does not turn on			
Bad Power Connection	Check all power connections from the outside of the Enclosure to the Monitor. If you are powering with 24 VAC, confirm that the proper voltage is present or try powering with the USB power supply. If using the USB power supply, try a different power supply and/or cable.		
The AirAssure™ IAQ monitor has no data on the TSI® Cloud			
Check the LED status bar	If the device is not connecting (solid blue after 2 minutes), check your local 2.4 GHz Wi-Fi® connection strength with another device like a phone. If there is a good signal, follow the directions in the Setting Up section to check the connection.		
	 LED	 Wi-Fi	 Cloud
	Pulse Yellow	Set up Mode	
	Pulse White	Connecting	
	Pulse Blue	Connected	Connecting
	Solid Blue	Connected	Connected
	Solid White	No connection	No connection

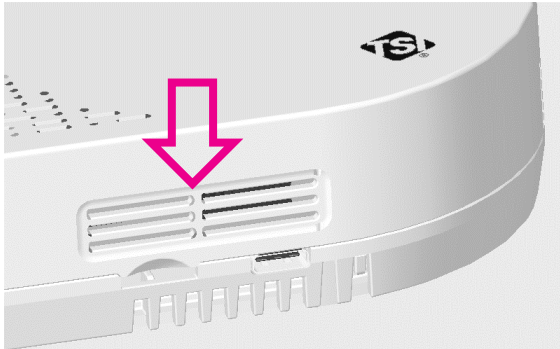
Possible Cause	Corrective Action
<p>Cannot connect to Wi-Fi® or the internet.</p>	<p>Note that AirAssure™ IAQ monitor can only connect to 2.4 GHz Wi-Fi® signals. Most Wi-Fi® routers provide several frequency channels. Please make sure you are connecting to the 2.4 GHz channel.</p> <p>The monitor does not have the capability to connect to public networks that require a second step of browser authentication, such as a free public hotel or airport network. A different network will need to be chosen.</p> <p>Some corporate networks require the device MAC address for security. This can be found on the serial number label of each monitor.</p>
<p>PM readings are unusually low</p>	
<p>Plugged with dust or debris</p>	<p>Check the inlet and outlet ports next to the USB connection. If they are plugged, gently blow out debris with clean compressed air.</p> 
<p>Replace sensor</p>	<p>Sensor may be past its recommended replacement cycle.</p>
<p>PM or gas readings are not correct</p>	
<p>Custom calibration factor is incorrect</p>	<p>Check the custom calibration factor on TSI® Link. Is the value correct? Was it changed by mistake?</p>
<p>No custom calibration factor</p>	<p>Values can be corrected by using a custom calibration factor. The custom calibration factor can be changed in the cloud.</p>
<p>Replace sensor</p>	<p>Sensor may be past its recommended replacement cycle (see maintenance section for recommended replacement cycle times).</p>

Appendix A

Specifications*

Overall	
Operating Temp Range.....	0 to 40°C (32 to 104°F)
Operating Humidity Range.....	15 to 95% non-condensing
Storage Temperature	5 to 30°C (41 to 86°F)
Case Dimensions	171 mm x 89 mm x 33 mm 6.75 in. x 3.5 in. x 1.3 in.
Weight	0.23 kg (0.5 lbs.)

PM Sensor (PM 2.5)	
Concentration Range	0 to 1000 µg/m ³
Measurement Resolution	1 µg/m ³
Counting Efficiency	50% at 0.3 µm and 98% at 0.5 µm
Accuracy	±10 % @ 100 to 1000 µg/m ³ when compared to a DustTrak™ DRX monitor
Zero Stability	±1 µg/m ³

Gas Sensors (if installed)	
CO ₂ Range	0 to 10,000 ppm
CO ₂ Resolution.....	1 ppm
Formaldehyde Range.....	0 to 1 ppm
Formaldehyde Resolution	1 ppb
tVOC Range.....	0 to 0.016 mg/m ³
tVOC Resolution	1 ppb (EtOH) & 0.001 mg/m ³ (tVOC)
CO Range	0 to 800 ppm
CO Resolution.....	0.1 ppm
SO ₂ Range	0 to 20 ppm
SO ₂ Resolution.....	1 ppb
Ozone Range	0 to 5 ppm
Ozone Resolution.....	1 ppb

Gas Sensors (if installed)	
NO ₂ Range	0 to 5 ppm
NO ₂ Resolution	1 ppb

Temperature Sensor	
Range	-40 to 125°C (-40 to 257°F)
Accuracy	±0.5°C (±32.9°F)

Humidity Sensor	
Range	0 to 100% RH
Accuracy	±3% RH

Barometric Pressure Sensor	
Range	8 to 35 inHg (270 to 1185 hPa)
Accuracy	± 0.12 inHg (± 4 hPa)

AC and DC Power Requirements	
24 VAC Back Panel	24 VAC, 50/60 Hz
USB-C.....	AC/DC Adapter Input: 100 to 240 VAC, 50 to 60 Hz AC/DC Adapter Output: 5 VDC
Power Consumption	< 5 W

Environmental/Installation Requirements	
Maximum Altitude	2000 meters (6,560 feet)
Pollution Degree	2
Installation/Overvoltage Category	II

**Specifications are subject to change without notice.*



UNDERSTANDING, ACCELERATED

TSI Incorporated – Visit our website www.tsi.com for more information.

USA Tel: +1 800 680 1220

UK Tel: +44 149 4 459200

France Tel: +33 1 41 19 21 99

Germany Tel: +49 241 523030

India Tel: +91 80 67877200

China Tel: +86 10 8219 7688

Singapore Tel: +65 6595 6388

P/N 6015658 Rev. D (US)

©2021 TSI Incorporated

Printed in U.S.A.

