

audioquest®

**US RETAIL
PRICE BOOK**

FALL 2020

TABLE OF CONTENTS

4 USB Digital-Audio Converters

DragonFlys
JitterBug
USB Extenders and Adaptors

6 AC Power

PowerQuest Power Conditioners
Niagara Power Conditioners
AC Power Cables
 NRG Series
 Wind Series
 Storm Series
Accessories

13 Speaker Cables

Q2 and Type Series
Rocket Series
Folk Heroes
 Robin Hood
 William Tell
Mythical Creatures
 ThunderBird
 FireBird
 Dragon
Accessories

24 Analog-Audio Interconnect Cables

Bridges & Falls
Rivers & Elements
Accessories

28 Subwoofer Cables

29 Tonearm Cables

30 LYRA Reference Phono Cartridges

31 Vinyl and Headphone Accessories

32 HDMI

HDMI Cables
Accessories

37 Digital-Audio Interconnect Cables

USB Cables
Optical Cables and Accessories
Digital Coax Cables and Accessories
AES/EBU Cables
Ethernet Cables (RJ/E)

44 Accessories

48 Tools

49 Instant Tool-less Connectors (ITC)

50 Bulk Cables

In-Wall Rated
Not-Rated Speaker Cables
SureGrip® Speaker Connectors
Spade, Pin, and Banana Connectors
In-Wall Rated Analog-Audio Bulk Cables
CAT6 and CAT7 Ethernet Bulk Cables

56 Installer Packs

58 POP and Promotional Items

61 Index

Shipping

Our preferred shipper is FedEx.

Free Shipping:

AudioQuest pays shipping on orders of 250.00 or more (except Alaska, Hawaii, and Puerto Rico). For dealer locations where Ground shipping takes 4 days or more, orders ship via 3-day service (except spools).

Expedited Shipping:

If dealer chooses to expedite an order of 250.00 or more, dealer only pays difference between default shipping method and desired shipping method; for orders under 250.00, dealer pays all shipping charges.

Urgent Orders:

Please mark Purchase Order accordingly and specify the desired delivery date, not the ship date.

Spools:

The default shipping method is Ground, regardless of value of order or dealer's location. Expedited shipping is available at dealer's expense.

Drop Ship:

Processed as a separate order and incurs a 5.00 service charge. Drop Ship is not available outside the US.

Alaska, Hawaii, and Puerto Rico:

AudioQuest pays shipping on orders of 500.00 or more that do not include bulk spools; AudioQuest pays shipping on orders of 1,000.00 or more that include bulk spools.

Terms and Conditions

- Terms: 2% 20 net 30 days.
- Credit cards can only be used for payment on accounts that are prepaid. Credits card cannot be used for payment on accounts with open terms.
- Each order stands alone. No additions allowed. Please order carefully.
- Prices are subject to change without notice.
- All prices are in US dollars.
- As used throughout this price book, "Retail" carries the same meaning as Manufacturer's Suggested Retail Price (M.S.R.P).

Returns

- All returns are subject to approval by AudioQuest.
- All returns may be subject to a 20% re-stocking charge.
- Built-to-order products may not be returned.
- All sales are final for custom speaker cables produced at 5 feet or less.
- A Return Merchandise Authorization (RMA) number must be issued by AudioQuest before any product may be returned.
- The RMA number must appear on the outside of the shipping carton, near or on the address label.

Contact Information

AudioQuest Headquarters
2621 White Road, Irvine, CA 92614
www.audioquest.com
Ph: 949.790.6000 | Fax: 949.585.0444 | Toll Free: 800.747.2770

Email orders and related correspondence: orders@audioquest.com
Email Return Merchandise Authorization (RMA): rma@audioquest.com
General email and all other correspondence: info@audioquest.com

AudioQuest: Doing No Harm Since 1980



William (Bill) Low
Founder / CEO

For 40 years now, AudioQuest, headquartered in Irvine, California, has been a leading developer, manufacturer, and distributor of high-performance audio/video products and custom-install solutions. Although best known for our comprehensive range of analog, digital, and AC power cables, our portfolio has expanded to a diverse assortment of products, including the multi-award-winning DragonFly DACs, LYRA phono cartridges, and Niagara and PowerQuest power products.

Our ultimate goal is the same today as it was 40 years ago: Do No Harm! By this we mean that all cables and components, to the extent that is technologically feasible, should get out of the music's way by inducing the least amount of noise and distortion.

The Evolution Continues: The Four Elements Today

While minimizing noise and damage to the audio signal remains the North-Star constant, the ways in which AudioQuest engages these challenges always evolves. While there are still Four Elements that describe our foundational materials and design philosophies, a growing number of technologies cross and even go beyond our original Four Elements. Many have become crucial enough to demand visibility. Noise-Dissipation is an umbrella Element under which many of these meaningful techniques and technologies will reside. While Geometry is no longer identified as one of The Four Elements, it remains inextricably tied to all other Elements of cable design and manufacture.

Solid Conductors: Strand interaction remains the biggest potential source of distortion in cables. Solid Conductors are the aspirational ideal and most complete solution to this problem. However, thoughtfully arranged multi-conductor geometries such as concentric windings are used to create our Semi-Solid Conductor technologies. These avoid many strand-distortion mechanisms and are in their own right ideal in a growing number of applications.

Directionality: All drawn metal conductors have a non-symmetrical, fish-scale-like grain structure. Because the highest Radio Frequencies (RF) are subject to skin effect, traveling on this deformed outer-surface layer of the conductor, there is a resulting increase in RF impedance in one direction versus the other. Since induced RF noise is parasitic (and doesn't travel with the primary signal current), it takes the path of least resistance. At AudioQuest, we test every conductor so it is used in the direction that drains the induced noise away from where it will cause the most harm, optimizing the cable and the system's performance.

Noise-Dissipation: Unwanted Radio-Frequency (RF) noise is and has always been picked up and induced into cable. This contamination ultimately masks and distorts critical portions of the audio/video signal. As this distortion-causing (parasitic) RF signal is more present today than at any previous time in history, we must depend on a wider arsenal of Noise-Dissipation technologies:

- ZERO Tech (No Characteristic Impedance) applies Ultra-Linear Noise-Dissipation across the widest range of frequencies possible. It also enables uncompressed transient current transfer for AC power and loudspeaker/power amplifier applications.
- GND Tech (Ground-Noise Dissipation) cancels induced RF noise via its unique phase-cancelling array.
- Tried-and-true DBS (Dielectric-Bias System) has evolved to include RF-Noise Traps that further reduce dielectric distortion and induced noise.

Metal Quality: Higher-purity conductor metals with smoother surfaces and internal crystal structures greatly reduce noise and distortion. Carefully finessed mixes of metals and conductor sizes can be effectively used to define a cable's Sonic Signature—a cost-effective technique for high-value, high-performance models.



Solid Conductors

Directionality

Noise-Dissipation

Metal Quality

DragonFly

Naturally Beautiful Sound at Your Fingertips—Whenever and Wherever You Want It

With today's smartphones, tablets, and computers, music and videos are far more accessible than ever before.

Unfortunately, the digital-to-analog converters (DACs) inside these devices are highly compromised, even when the sample-rate numbers (24/192, etc.) look impressive. These built-in DACs may make audible sound, but they don't make beautiful music.

A DragonFly bypasses the compromised audio circuitry within these devices to deliver naturally beautiful sound to earbuds, headphones, desktop speakers, or complete audio systems.

Whether using a free streaming service, premium High-Resolution or MQA-encoded streaming (such as Tidal Masters), or playing MP3 files or videos, all DragonFlies make these experiences much more compelling and immersive.

DragonFly Black delivers great performance and value. Red ups the game with more power, more grip, and deeper sonic immersion. Now, DragonFly Cobalt, with its more advanced processor, microcontroller, and RF noise filtering, provides even greater clarity, dynamics, and finesse than previously possible.



DragonFly DAC + Preamp + Headphone Amp

- Plays all music files: MP3 to High-Res and MQA
- Compatible with Apple® and Windows® PCs
- Compatible with iOS devices (requires Apple Lightning to USB 3 Camera Adaptor)
- Compatible with Android devices (requires DragonTail or other USB Adaptor for Android Devices)
- Bit-perfect variable output drives headphones, powered speakers, or power amp
- Fixed output feeds preamp or receiver



	DragonFly Black	DragonFly Red	DragonFly Cobalt
Output	1.2 volts	2.1 volts	
DAC Chip	ESS ES9010 with minimum-phase fast roll-off filter	ESS ES9016 with minimum-phase fast roll-off filter	ESS ES9038Q2M DAC chip with minimum-phase slow roll-off filter for more natural sound
Volume Control	Analog Volume Control	64-Bit Bit-Perfect Digital Volume Control	
Desktop Compatibility	Windows 7 and later; Apple 10.6.8 and later; Linux (no tech support provided)		
Mobile Compatibility	Apple iOS 5 and later; Android 5.0 and later		
Included Adaptor			DragonTail A to C Adaptor
Accessories	Protective Endcap, Leatherette Pouch		
Dimensions	62mm (l) x 19mm (w) x 12mm (h)	62mm (l) x 19mm (w) x 12mm (h)	57mm (l) x 19mm (w) x 12mm (h)
	Retail: 99.95	Retail: 199.95	Retail: 299.95

JitterBug USB Data and Power Noise Filter



- Dual Discrete Noise-Dissipation Circuits
- Reduces the noise and ringing that plague both the data and power lines of USB ports
- Measurably reduces jitter and packet errors
- Improves dynamic contrast, warmth, and resolution
- Use JitterBug in series with almost any USB DAC, including DragonFlies Black and Red, or in parallel with DragonFly Cobalt

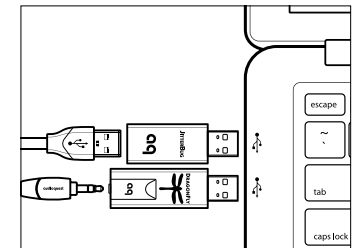

Retail: 69.95

USB Extenders and Adaptors

DragonTail USB Extenders feature 5% Silver Solid Conductors and are Direction-Controlled for reduced RF noise.



DragonTail USB A 2.0 Extender

Female USB A to Male A

Retail: 29.95



DragonTail USB A to Micro Adaptor

Female USB A to Male Micro

Retail: 29.95



DragonTail A to C Adaptor

(included with DragonFly Cobalt)

Retail: 29.95

AC Power Conditioners

Niagara and PowerQuest: Low-Z Power | Noise-Dissipation Systems

Redefining the science of AC power conditioning

What is a power conditioner and why is it necessary?

For some, a power conditioner is merely a device that provides enough outlets for the entire audio/video system while also protecting the connected devices from electrical storms and wiring faults. Yet, for the discriminating listener, many power conditioners can make an audio/video system perform far worse.

Yes, a home or building may have dimming lights or an occasional brown-out, and the utilities' AC sine wave is always far from perfect. However, where incoming power is concerned, there are two reasons an audio/video system does not perform up to its full potential: 1) The current transients that supply the power amplifier are compressed, and 2) The ever-increasing levels of radio-frequency noise are masking (covering up) the system's low-level signal content.

When compared to or measured against either Niagara or PowerQuest, a simple power bar or a dedicated AC wall outlet can lose up to a third of the low-level audio information that contain much of a recording's harmonics, imaging, high frequencies, and bottom-end grip—and once that information is gone, it's gone forever.

AudioQuest's Niagara and PowerQuest technologies are unique amongst all power products—whether they're isolation transformers, AC regenerators, battery back-up, re-clocking devices, or other types. Niagara and PowerQuest filters and Ground-Noise Dissipation work evenly, or linearly, across a far wider range of induced noise frequencies. Additionally, Niagaras 3000, 5000, and 7000 feature Transient Power Correction, which supplies a current reservoir to greatly bolster the performance of any power amplifier.



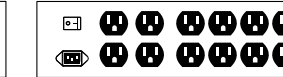
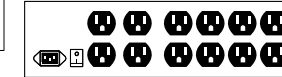

	PowerQuest 2	PowerQuest 3	Niagara 1200	Niagara 3000	Niagara 5000	Niagara 7000
Linear Noise-Dissipation Technology	More than 18 octaves of differential filtering	More than 18 octaves of differential filtering; 14 octaves common-mode filtering	Level-X More than 19 octaves of differential filtering	Level-X More than 21 octaves differential-mode filtering	Level-X More than 23 octaves differential-mode filtering; 16 octaves common-mode filtering	Level-X More than 23 octaves differential-mode filtering; 20 octaves common-mode filtering
Patented Ground-Noise Dissipation	1 outlet	2 outlets	2 banks (all outlets)	3 banks (all outlets)	6 banks (all outlets)	6 banks (all outlets)
Non-Sacrificial Surge Protection	Withstands multiple AC surges and spikes up to 6000V/3000A without sustaining damage		Sonically Non-Invasive; Withstands multiple AC surges and spikes up to 6000V/3000A without sustaining damage			
Transient Power Correction	N/A	N/A	N/A	55 amps peak; Provides a current reservoir for any power amplifier (up to 25mS)	90 amps peak; Provides a current reservoir for any power amplifier (up to 25mS)	90 amps peak; Provides a current reservoir for any power amplifier (up to 25mS)
Patented DBS Symmetrical Power Isolation Transformer	N/A	N/A	N/A	N/A	N/A	2 (source component outlet banks)
Maximum RMS Current	15 Amps (RMS) @ 120V	15 Amps (RMS) @ 120V	15 Amps (RMS) @ 120V	15 Amps (RMS) @ 120V	20 Amps (RMS) @ 120V	20 Amps (RMS) @ 120V
Outlets	6 total: (1) 4K/8K Video, (4) Source, (1) High-Current	8 total: (2) 4K/8K Video, (4) Source, (2) High-Current	7 total: (5) Source (including video), (2) High-Current	7 total: (5) Source (including video), (2) High-Current	12 total: (8) Source (including video), (4) High-Current	12 total: (8) Source, (4) High-Current
USB-A Charging Ports	2 high-speed ports (3.4 amp capacity)	4 high-speed ports (4.8 amp capacity)	N/A	N/A	N/A	N/A
Power Cable	Direction-Controlled Semi-Solid Concentric		Power cable not included			
Signal Line Protection	Cable/Satellite	Cable/Satellite, Phone, Network	N/A	N/A	N/A	N/A
Dimensions	15.47" L x 3.15" W x 6.02" H (Includes wall-mounting holes and detachable base)	15.47" L x 3.15" W x 7.40" H (Includes wall-mounting holes and detachable base)	19.4" W x 3.2 H" x 7.5" D	17.5" W x 3.45" H x 15.2" D (2-RU rack mount kit included)	17.5" W x 5.24" H x 17.2" D (3-RU rack mount kit on request)	17.5" W x 5.24" H x 17.2" D (3-RU rack mount kit on request)
Weight	4.85 lbs.	5.51 lbs.	18 lbs.	25 lbs.	38 lbs.	86 lbs.
	Retail: 199.95	Retail: 299.95	Retail: 999.95	Retail: 2,999.95	Retail: 4,999.95	Retail: 9,499.95

AC Power Cables

Low-Z | Noise-Dissipation NRG, Wind, and Storm Series

The power cords that are supplied with most audio/video components have many admirable features. They're durable, flexible, small, and they will unfailingly supply the required AC voltage from the utilities' service tap for many years to come. They're also inexpensive.

Unfortunately, these "commodity" power cords were never up to the task of supplying sensitive components with the quality power they need. By this, we mean power that is unrestricted when delivering current transients to a power amplifier. The power cord must not add noise to the audio/video signal via RF (radio-frequency) noise that is induced into, or picked up by, the AV component. The ground lead is the worst offender in this regard, as it has no component power supply to help lessen the damage from the induced RF noise. Typically, the ground noise drains directly towards the component's signal path.

Even with an advanced AC power system like Niagara or PowerQuest, the AC cord is a branch of noise-dissipation system. Like plumbing, the RF noise must be drained away from the circuits upon which it could do harm. Many ask, if my wall wiring is so many yards in length, how can a 6-foot cord possibly matter? It matters for the same reason four square inches of mud and debris can back up a plumbing system or a rain gutter. The drainage or distribution of water currents and noise currents work in the exact same manner. They are one system.

With AudioQuest power cords and our unique technologies such as ZERO Tech (No Characteristic Impedance) and our patented GND (Ground-Noise Dissipation), you will experience greater dynamics, bass grip, extended high frequencies, and the blackest background you've ever heard.

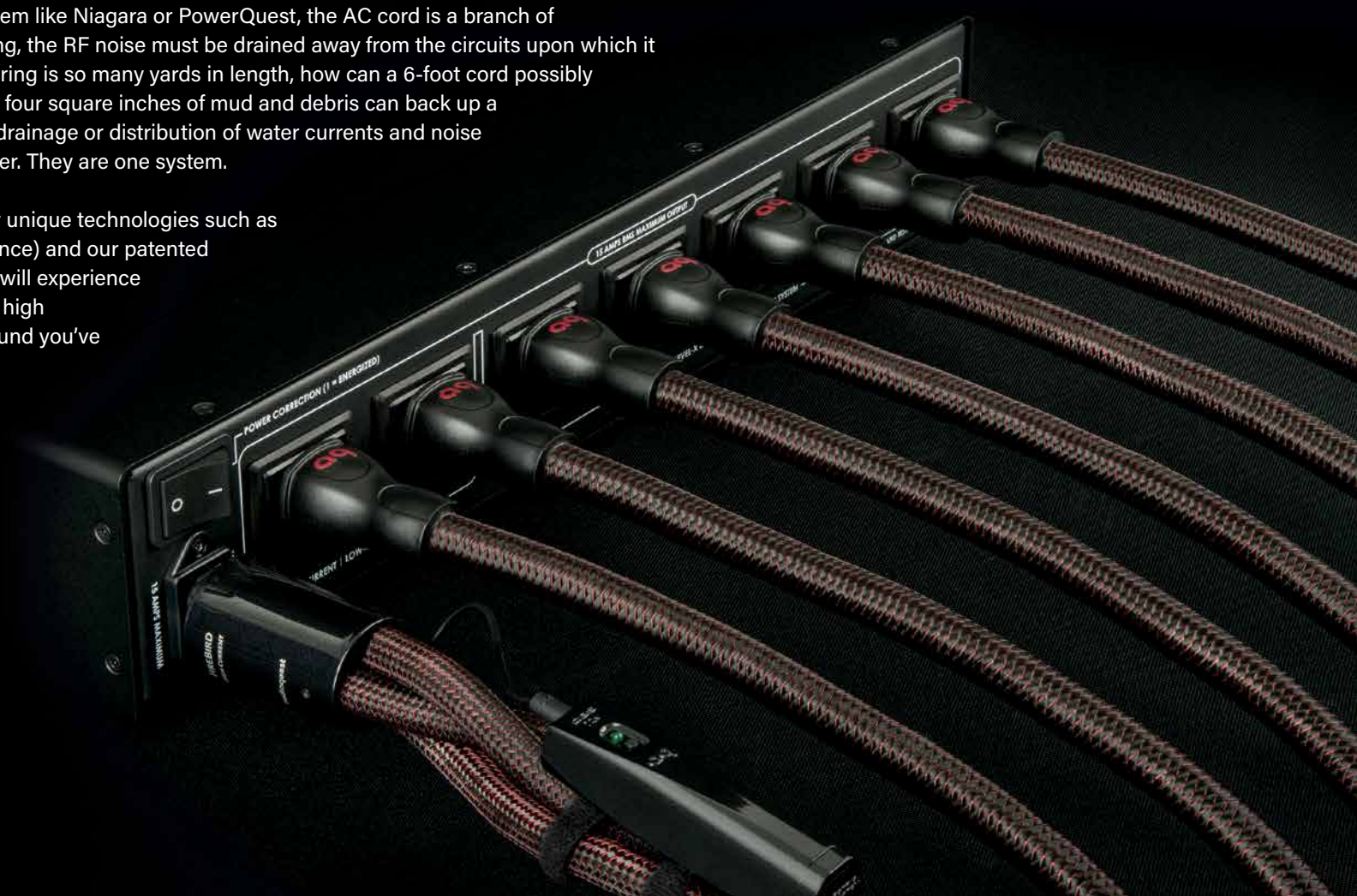

AC Power Cables: NRG Series

NRG-Y and NRG-Z Series cables with the C7 connector feature a three-pronged male plug. Though there is no third ground lead, there are Radio-Frequency shield drain leads that must connect to Earth Ground. This construction is also required for our proprietary ZERO Technology.

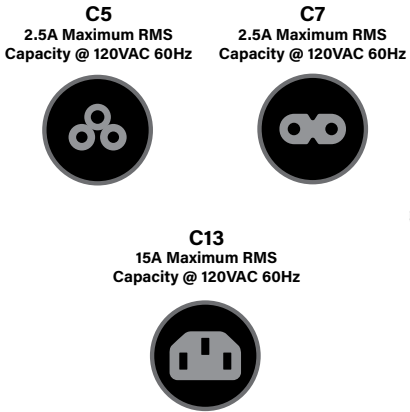

Model		NRG-X2	NRG-Y2	NRG-Z2	NRG-X3	NRG-Y3	NRG-Z3
Metal		Semi-Solid Concentric Long-Grain Copper (LGC)		Semi-Solid Concentric Perfect-Surface Copper+ (PSC+)	Semi-Solid Concentric Long-Grain Copper (LGC)		Semi-Solid Concentric Perfect-Surface Copper (PSC)
Gauge		17 AWG			16 AWG (12 Amp @ 120V)		14 AWG (15 Amp @ 120V)
Technology		ZERO Tech (No Characteristic Impedance)			ZERO Tech (No Characteristic Impedance)		ZERO Tech (No Characteristic Impedance); Patented GND (Ground-Noise Dissipation)
Jacket		Black PVC with Red Stripes	Dark Gray/Black Braid	Dark Red/Black Braid	Black PVC with Red Stripes	Dark Gray/Black Braid	Dark Red/Black Braid
Terminations		Cold-Welded Connectors					
Meters	Feet	Retail	Retail	Retail	Retail	Retail	Retail
1m	3' 3"	64.95	104.95	189.95	79.95	129.95	199.95
2m	6' 6"	79.95	129.95	239.95	99.95	159.95	279.95
3m	9' 10"	94.95	154.95	289.95	119.95	189.95	359.95
4.5m	14' 9"	117.95	192.95	364.95	149.95	234.95	479.95
6m	19' 8"	139.95	229.95	439.95	179.95	279.95	599.95



C17
For components that use the ungrounded C17 connector, please use C13. The grounded male plug is necessary to make use of our Noise-Dissipation System.

NRG AC cables are also sold in Installer Packs. See page 56.

AC Power Cables: Wind Series

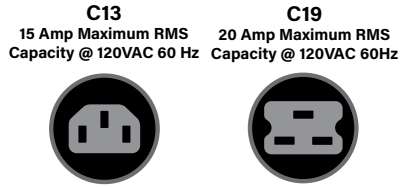

Never assume which of these is required for a component or power conditioner. Some manufacturers prefer the performance of one IEC inlet type over another—even when their circuit's current draw is minimal.



Wind Series Plugs

Mistral Plugs for Wind Series XTRM

XTRM cables have upgraded plugs equivalent in quality to the Storm Series plugs.

Model		Monsoon	Monsoon XTRM	Blizzard ● 72v DBS	Blizzard XTRM ● 72v DBS	Silver Cloud ● 72v DBS	Silver Cloud XTRM ● 72v DBS
Plug Type		Gold-Plated Molded	Hanging Silver Over Red Copper	Gold-Plated Molded	Hanging Silver Over Red Copper	Gold-Plated Molded	Hanging Silver Over Red Copper
Metal		Semi-Solid True-Concentric Perfect-Surface Copper+ (PSC+) and Long-Grain Copper (LGC)		Semi-Solid True-Concentric Perfect-Surface Copper+ (PSC+)		Semi-Solid True-Concentric Perfect-Surface Silver (PSS) and Perfect-Surface Copper+ (PSC+)	
Gauge		12 AWG (20 Amps RMS @ 60 Hz)					
Technology		ZERO Tech (No Characteristic Impedance) for Uncompressed Current Transfer; GND (Ground-Noise Dissipation)					
Jacket		Dark Blue/Black Braid 		Silver/Black Braid 		Black/Black Braid 	
Terminations		Direct-Gold and Silver Plated; Cold-Welded Connectors					
Meters	Feet	Retail	Retail	Retail	Retail	Retail	Retail
1m	3' 3"	329.95	669.95	574.95	824.95	1,749.95	2,049.95
2m	6' 6"	449.95	789.95	749.95	999.95	2,999.95	3,299.95
3m	9' 10"	569.95	909.95	924.95	1,174.95	4,249.95	4,549.95
4.5m	14' 9"	749.95	1,089.95	1,187.95	1,437.95	-	6,424.95
6m	19' 8"	929.95	1,269.95	1,449.95	1,699.95	-	8,299.95
Other prepared lengths use formula:		-	120.00/m + 549.95	-	175.00/m + 649.95	-	1,250.00/m + 799.95

Mistral AC Power Bulk Cable

Metal: Semi-Solid True-Concentric Perfect-Surface Copper+ (PSC+) and Long-Grain Copper (LGC)

Gauge: 12 AWG

Technology: GND (Ground-Noise Dissipation)

Jacket: Dark Gray/Light Gray PVC

Terminations: Mistral AC Power Plugs

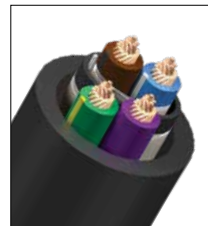

Per Meter

Retail: 100.00

Mistral AC Power Plugs

Sold separately.



Mistral Wall Plug
Retail: 129.95



Mistral IEC C-13 Plug
Retail: 129.95



Mistral IEC C-19 Plug
Retail: 129.95





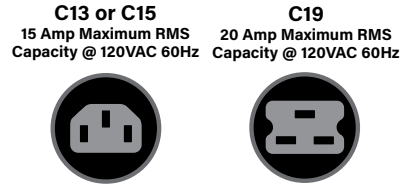





AC Power Cables: Storm Series

Never assume which of these is required for a component or power conditioner. Some manufacturers prefer the performance of one IEC inlet type over another—even when their circuit's current draw is minimal.







Plugs for Storm Series

Variable Current (High-Current) AC Power Cables - Optimized for use with AC power conditioners/regenerators, power amplifiers, and any components that contain a built-in power amplifier, including AV receivers, powered speakers, and powered subwoofers.

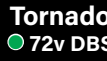
Model		 Thunder ● 72v DBS	 Tornado ● 72v DBS	 Hurricane ● 72v DBS	 FireBird ● 72v DBS	 Dragon ● 72v DBS
Metal		Solid Long-Grain Copper (LGC) and Perfect-Surface Copper (PSC)	Solid Perfect-Surface Copper (PSC) and Solid Perfect-Surface Copper+ (PSC+)	Solid Perfect-Surface Copper+ (PSC+)	Solid Perfect-Surface Silver (PSS) and Perfect-Surface Copper+ (PSC+)	Primarily Solid Perfect-Surface Silver (PSS)
Technology ZERO Tech (No Characteristic Impedance) for Uncompressed Current Transfer; GND (Ground-Noise Dissipation)						
Jacket		Brown/Black Braid 	Silver/Black Braid 	Dark Blue/Black Braid 	Dark Red/Black Braid 	Black/Black Braid 
Termination and Gauge Hanging-Silver over Red and Beryllium Copper - 11 AWG Line and Neutral / 12 AWG Ground (20 Amps RMS @ 120V)						
Meters	Feet	Retail	Retail	Retail	Retail	Retail
1m	3' 3"	849.95	1,199.95	1,749.95	3,400.00	5,400.00
2m	6' 6"	999.95	1,499.95	2,499.95	5,800.00	9,800.00
3m	9' 10"	1,149.95	1,799.95	3,249.95	8,200.00	14,200.00
Other prepared lengths use formula:		150.00/m + 699.95	300.00/m + 899.95	750.00/m + 999.95	2,400.00/m + 1,000.00	4,400.00/m + 1,000.00

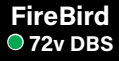
Constant-Current (Source) AC Power Cables - Optimized for use with audio/video source components, which have a constant or "fixed" current draw.

Model		-	 Tornado ● 72v DBS	 Hurricane ● 72v DBS	 FireBird ● 72v DBS	 Dragon ● 72v DBS
Termination and Gauge Hanging-Silver over Red and Beryllium Copper - 16 AWG Line, Neutral and Ground (12 Amps RMS @ 60 Hz)						
Meters	Feet	-	Retail	Retail	Retail	Retail
1m	3' 3"	-	949.95	1,399.95	2,900.00	4,400.00
2m	6' 6"	-	1,099.95	1,899.95	4,800.00	7,800.00
3m	9' 10"	-	1,249.95	2,399.95	6,700.00	11,200.00
Other prepared lengths use formula:		-	150.00/m + 799.95	500.00/m + 899.95	1,900.00/m + 1,000.00	3,400.00/m + 1,000.00

AC Power Accessories

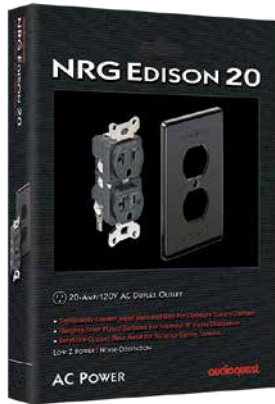
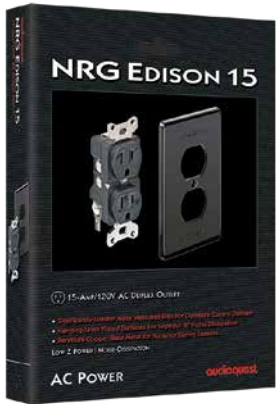

NRG Edison Duplex Wall Outlet

- Low-Z Power Noise-Dissipation
- Polished High-Tension Surfaces with Hanging-Silver Plating
- Significantly Greater Metal Mass For Optimum Current Delivery
- Beryllium-Copper Base Metal
- Includes Duplex Outlet, Wall Plate and Hardware

NRG Edison (15 Amp)

Retail: 179.95

NRG Edison (20 Amp)

Retail: 179.95



C7 90° Adaptor Kit

- Provides 90° bends for C7 power connections
- Also connects for double bends
- Non-polarized for maximum flexibility
- Retail package contains 1 x "E" adaptor and 1 x "U" adaptor

Set of 2

Retail: 35.90

AC Power C7 90° Adaptors are also sold in Installer Packs. See page 56.

Female to Male IEC C-13 Adaptors

Premium Single-Piece Metal Conductors from Input to All Outputs Preserve Advantages of Superior AudioQuest NRG Series AC Cables.



IEC90°/1

Adaptor Bends in Direction of 1 Center

Retail: 19.95



IEC90°/2

Adaptor Bends in Direction of 2 Outer Pins

Retail: 19.95



IEC>3US Power Strip

Retail: 39.95

Fog Lifters

Place Fog Lifters beneath audio and AC power cables to significantly reduce RF noise coupling, whether with the floor, or due to misdirected efforts to isolate cable with stands or clamps that themselves have too much contact mass and are sources of RF noise.

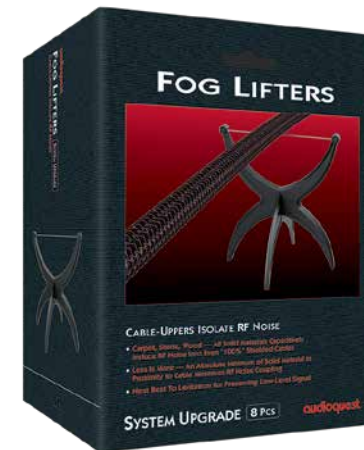

Set of 8

Retail: 149.95

Speaker Cables

Meticulously Designed to Minimize Noise and Distortion

Do No Harm: The Four Elements Today

AudioQuest's Four Elements are always applied in the most thoughtful, effective ways to offer the best performance for the money—at all price points. While our implementation of these techniques has evolved over the years, our guiding principle remains the same: *Do No Harm*.

Solid Conductors

Strand interaction remains the biggest potential source of distortion in cables. Solid Conductors are the aspirational ideal and most complete solution to this problem. However, thoughtfully arranged multi-conductor geometries such as concentric windings are used to create our Semi-Solid Conductor technologies. These avoid many strand-distortion mechanisms and are in their own right ideal in a growing number of applications.

High-Purity Metal

Higher-purity conductor metals with smoother surfaces and internal crystal structures greatly reduce noise and distortion. Carefully finessed mixes of metals and conductor sizes can be effectively used to define a cable's *Sonic Signature*—a cost-effective technique for high-value, high-performance models.

Noise-Dissipation

Unwanted Radio-Frequency (RF) noise is and has always been picked up and induced into cable. This contamination ultimately masks and distorts critical portions of the audio/video signal. As this distortion-causing (parasitic) RF signal is more present today than at any previous time in history, we must depend on a wider arsenal of Noise-Dissipation technologies:

- Directionally Controlled conductors minimize high-frequency noise by "directing" or draining it away from the most vulnerable circuits.
- ZERO Technology (No Characteristic Impedance) applies Ultra-Linear Noise-Dissipation across the widest range of frequencies possible. It also enables uncompressed transient current transfer for AC power and loudspeaker/power amplifier applications.
- Ground-Noise Dissipation (GND) cancels induced RF noise via its unique phase-cancelling array.
- Tried-and-true DBS has evolved to include RF-Noise Traps that further reduce dielectric distortion and induced noise.

Dielectric

Insulation is necessary between conductors to minimize signal interaction and electrical shorts. The ideal is virtually no dielectric interaction (such as is achieved with our ZERO Technology). However, by optimizing the dielectric material between signal conductors, this distortion is greatly minimized.



Speaker Cable Applications

Full-Range (FR) Non-BiWire, All Models

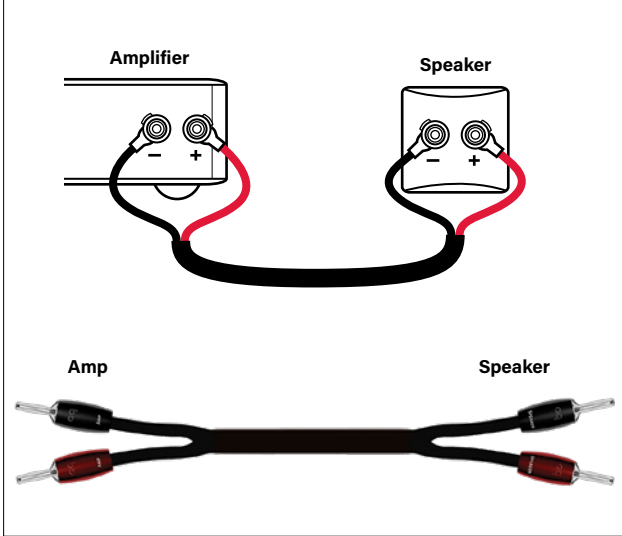

Single-BiWire (SBW) Rocket Models Only

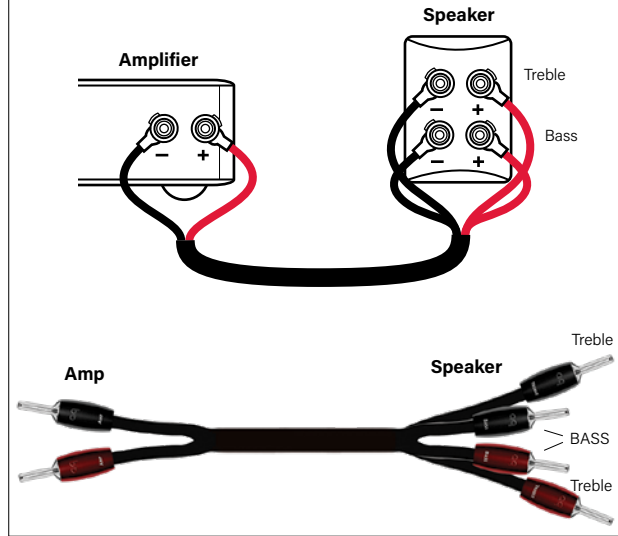

BiWire COMBO Folk Heroes and Mythical Creatures ZERO and BASS Combination

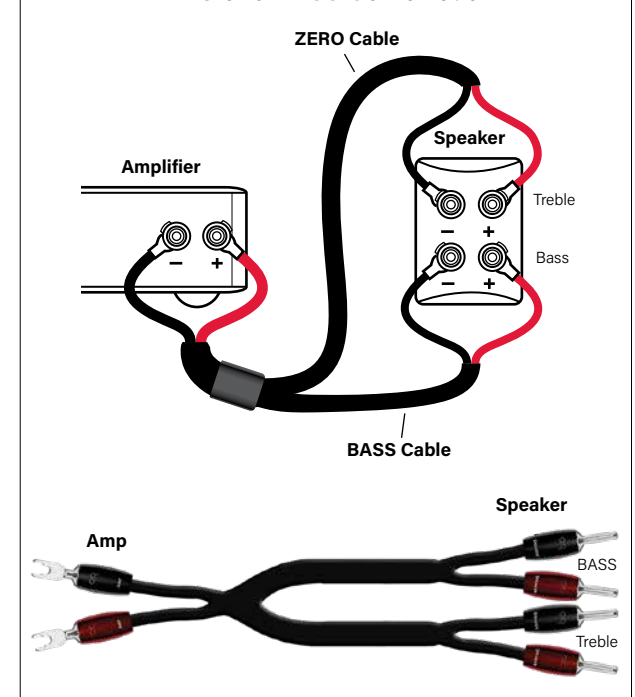

Single-BiAmp (SBA) Rocket Models Only

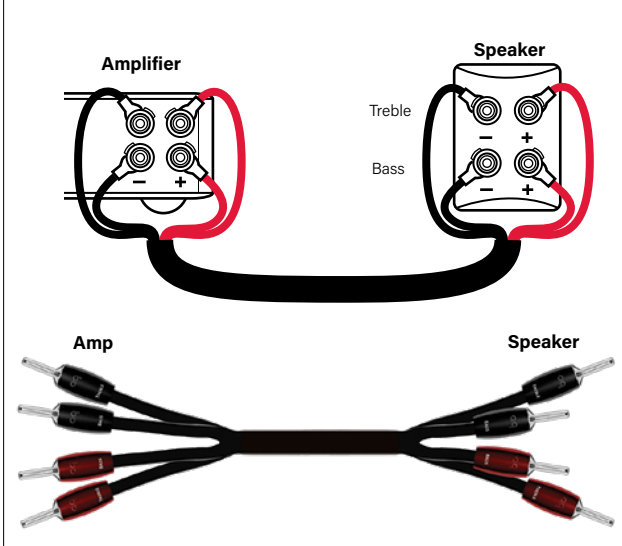

Termination Upcharge:

SureGrip 300 Multi-Spade or Banana
Retail: 89.00

500 Series Multi-Spade or Banana
Retail: 159.00

1000 Series Multi-Spade or Banana
Retail: 239.00

REL Acoustics™ Stereo High-Level Subwoofer Cable



This represents one of several connection possibilities with REL Subwoofers.
Please contact your AudioQuest service representative for assistance.

Mythical Creature & Folk Hero Termination Options: Bananas or Spades?

Amplifier-End Connector:

Choice of 1000 Series Multi-Spade, Banana, U-Spade, or V-Spade (Silver only)



Insulated (compliant) binding posts may not allow for 2 sets of connectors.

Often, the choice between terminating speaker cables with spade lugs or banana plugs will come down to personal preference. However, today's EU-compliant isolated binding posts are being used on more power amplifiers than ever before. This sometimes makes it difficult, if not impossible, to use a banana connector. Further, given the girth and weight of our Mythical Creature Series speaker cables, a spade may be better capable of fully supporting the cable. This is particularly a concern with binding posts that do not allow a banana connector to fully seat into the post.

Further, the EU-compliant posts will neither accept our V-Spade nor allow our Multi-Spade to be fully seated. For these applications (or when you're not certain), **we highly recommend the U-Spade**, as it can accommodate any binding post. The V-Spade is a specialty spade connector that works well with large wingnut binding posts (such as the Mundorf), as it allows extra clearance.

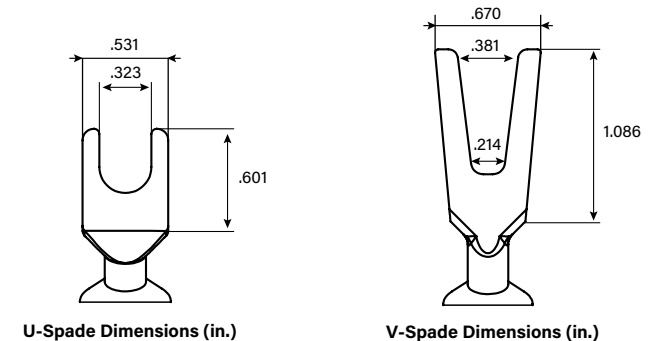
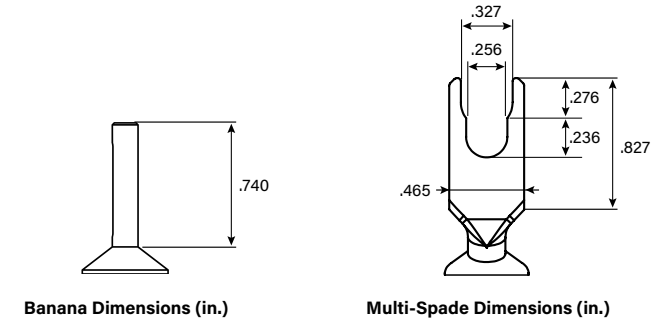

Speaker-End Connector:

Choice of 1000-Series Spade or Banana (Silver only)

Here we typically recommend the **U-Spade** or banana connector. However, even though there is less weight and pressure on this side of the cable (particularly for Bi-Wire sets), it is nevertheless important to note the binding post's design. If a banana connector cannot seat all the way into the binding post, we recommend one of our spade connectors.

How to Order Prepared Speaker Cables

First please specify type of connector (banana or appropriate spade), then the finish of connector (silver*).

(*or gold where applicable)

Pair prices shown. Also available in singles (i.e. for center channel, subwoofer, or mono) at half pair price.

When ordering any factory-terminated speaker cable, please include the required elements shown in the examples below:

Qty.	Pair or Single	Length	Model	FR/BWC/SBW	Amplifier Termination	Speaker Termination	Silver or Gold
1	Pair	10 ft.	Rocket 88	FR	Spade	Banana	Silver
1	Single	6 ft.	William Tell	COMBO	U-Spade	Banana	N/A
1	Single	10 ft.	Rocket 44	SBW	Spade	Banana	Gold

Speaker Cables: Q2 and Type Series (5, 9, Type9+DBS)

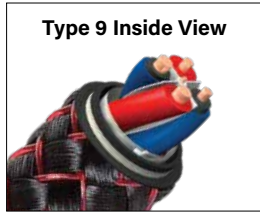
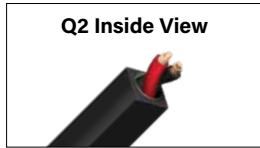

Model	Q2	Type 5	Type 9	Type 9+DBS ● 72v DBS
Metal	Concentric Long-Grain Copper (LGC)	Solid PSC+ Sonic-Signature Conductors and Long-Grain Copper (LGC)	Solid Perfect-Surface Copper+ (PSC+)	
Gauge	15 AWG	15 AWG	15 AWG	15 AWG
Geometry	Low-Inductance Twisted-Pair		Star-Quad	
Noise-Dissipation	No	Carbon-Based Noise-Dissipation	Multi-Layer Carbon-Based Noise-Dissipation	
Jacket	Prepared: Black PVC Bulk: White or Black PVC	Brown/Black Braid	Red/Black Braid	
Plugs	Prepared: SureGrip 100 (Silver) Banana Bulk: SureGrip 100 (Silver or Gold) Banana	SureGrip 300 (Silver or Gold) Choice of Multi-Spade or Banana	500 Series (Silver or Gold) Choice of Multi-Spade or Banana	1000 Series (Silver) Choice of Multi-Spade or Banana
Prepared Lengths in Feet	Retail	Retail	Retail	Retail
6' Pair	-	339.95	579.95	879.95
8' Pair	-	369.95	639.95	939.95
10' Pair	229.95	399.95	699.95	999.95
12' Pair	-	429.95	759.95	1,059.95
15' Pair	-	474.95	849.95	1,149.95
Other prepared lengths use formula:	-	15.00/ft + 249.95	30.00/ft + 399.95	30.00/ft + 699.95
Bulk Cables in Feet	Retail	Retail	Retail	Retail
164' Bulk	-	-	15.00/ft	-
328' Bulk	1,148.00/box	7.50/ft	-	-

Note: For bulk cables, retail price is listed per foot. Q2 bulk length is sold in a retail box.

Speaker Cables: Rocket Series

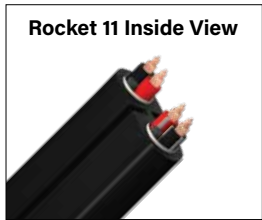

Model	Rocket 11	Rocket 22	Rocket 33	Rocket 44	Rocket 88 ● 72v DBS
Metal	Semi-Solid True-Concentric Long-Grain Copper (LGC)	Semi-Solid True-Concentric PSC and LGC	Solid PSC and LGC	Solid PSC+ and PSC	Solid PSC+
Gauge	14 AWG	12 AWG	14 AWG	13 AWG	
Geometry	Double Spiral-Pair		Double Star-Quad		
Dielectric	PVC		Foamed-Polyethylene (For All Positive Conductors)		
Noise-Dissipation	No		Carbon-Based Noise-Dissipation		
Jacket	Black with Gray Stripes CL3 PVC	Black with Blue Stripes CL3 PVC	Red/Black Braid or PVC	Silver/Black Braid or PVC	Green/Black Braid or PVC
Application Options	Full-Range and Single-BiWire			Full-Range, Single-BiWire, REL	
Plugs	SureGrip 300 (Silver or Gold) Choice of Multi-Spade or Banana		SureGrip 300 (Silver or Gold) Choice of Multi-Spade or Banana	500 Series (Silver or Gold) Choice of Multi-Spade or Banana	
Prepared Lengths in Feet	Retail	Retail	Retail	Retail	Retail
8' Pair	283.95	359.95	399.95	629.95	1,199.95
10' Pair	299.95	399.95	445.95	729.95	1,339.95
12' Pair	-	-	499.95	829.95	1,479.95
15' Pair	339.95	499.95	574.95	979.95	1,689.95
Other prepared lengths use formula:	8.00/ft + 219.95	20.00/ft + 199.95	25.00/ft + 199.95	50.00/ft + 229.95	70.00/ft + 639.95
Bulk Cables in Feet	Retail	Retail	Retail	Retail	Retail
30' Bulk	109.95/box	-	-	-	-
164' Bulk	4.00/ft	10.00/ft	12.50/ft	25.00/ft	35.00/ft
328' Bulk	4.00/ft	10.00/ft	12.50/ft	-	-

Note: For bulk cables, retail price is listed per foot. Rocket 11 30' sold in retail package.

Speaker Cables: Robin Hood (Folk Heroes)



Model	Robin Hood ZERO ● 72v DBS	Robin Hood BASS ● 72v DBS	Robin Hood BiWire COMBO (ZERO + BASS) ● 72v DBS	Robin Hood SILVER ● 72v DBS	Robin Hood SILVER BiWire COMBO (SILVER + BASS) ● 72v DBS
Metal	Solid Perfect-Surface Copper+ (PSC+)		Refer to Specs for ZERO and BASS	Solid PSS Sonic-Signature Conductors and PSC+	Refer to Specs for SILVER and BASS
Gauge	15 AWG			15 AWG	
Geometry	ZERO Tech (No Characteristic Impedance)			ZERO Tech (No Characteristic Impedance)	
Noise-Dissipation	Multi-Layer Carbon-Based Noise-Dissipation	GND (Ground-Noise Dissipation)		Multi-Layer Carbon-Based Noise-Dissipation	
Jacket	Dark Green/Black Braid	Black Braid		Light Gray/Black Braid	
Application Options	Full-Range or BiWire COMBO (when combined with BASS cable)	BiWire COMBO (when combined with ZERO cable)	Full-Range or BiWire COMBO (when combined with BASS cable)		
Plug Options (1000 Series, Silver)	AMP-Side: Choice of U-Spade (recommended default), Banana, Multi-Spade, or V-Spade / SPEAKER-Side: Choice of U-Spade (recommended default), Banana, or Multi-Spade				
Prepared Lengths in Feet	Retail	Retail	Retail	Retail	Retail
8' Pair	1,790.00	1,790.00	3,580.00	4,990.00	6,780.00
10' Pair	1,990.00	1,990.00	3,980.00	5,990.00	7,980.00
12' Pair	2,190.00	2,190.00	4,380.00	6,990.00	9,180.00
15' Pair	2,490.00	2,490.00	4,980.00	8,490.00	10,980.00
Other prepared lengths use formula:	100.00/ft + 990.00	100.00/ft + 990.00	200.00/ft + 1,980.00	500.00/ft + 990.00	600.00/ft + 1,980.00

Speaker Cables: William Tell (Folk Heroes)



Model	William Tell ZERO ● 72v DBS	William Tell BASS ● 72v DBS	William Tell BiWire COMBO (ZERO + BASS) ● 72v DBS	William Tell SILVER ● 72v DBS	William Tell SILVER BiWire COMBO (SILVER + BASS) ● 72v DBS
Metal	Solid Perfect-Surface Copper+ (PSC+)	Solid PSC+ Sonic-Signature Conductors and LGC	Refer to Specs for ZERO and BASS	Solid PSS Sonic-Signature Conductors and PSC+	Refer to Specs for SILVER and BASS
Gauge	13 AWG			13 AWG	
Geometry	ZERO Tech (No Characteristic Impedance)			ZERO Tech (No Characteristic Impedance)	
Noise-Dissipation	Multi-Layer Carbon-Based Noise-Dissipation	GND (Ground-Noise Dissipation)		Multi-Layer Carbon-Based Noise-Dissipation	
Jacket	Dark Red/Black Braid	Black Braid		Silver/Black Braid	
Application Options	Full-Range or BiWire COMBO (when combined with BASS cable)	BiWire COMBO (when combined with ZERO cable)		Full-Range or BiWire COMBO (when combined with BASS cable)	
Plug Options (1000 Series, Silver)	AMP-Side: Choice of U-Spade (recommended default), Banana, Multi-Spade, or V-Spade / SPEAKER-Side: Choice of U-Spade (recommended default), Banana, or Multi-Spade				
Prepared Lengths in Feet	Retail	Retail	Retail	Retail	Retail
8' Pair	2,990.00	2,000.00	4,990.00	6,990.00	8,990.00
10' Pair	3,390.00	2,200.00	5,590.00	8,390.00	10,590.00
12' Pair	3,790.00	2,400.00	6,190.00	9,790.00	12,190.00
15' Pair	4,390.00	2,700.00	7,090.00	11,890.00	14,590.00
Other prepared lengths use formula:	200.00/ft + 1,390.00	100.00/ft + 1,200.00	300.00/ft + 2,590.00	700.00/ft + 1,390.00	800.00/ft + 2,590.00

Speaker Cables: ThunderBird (Mythical Creatures)



Model	ThunderBird ZERO ● 72v DBS	ThunderBird BASS ● 72v DBS	ThunderBird BiWire COMBO (ZERO + BASS) ● 72v DBS
Metal	Solid Perfect-Surface Copper+ (PSC+)	Solid PSC+ Sonic-Signature Conductors and LGC	Refer to Specs for ZERO and BASS
Gauge	10 AWG		
Geometry	ZERO Tech (No Characteristic Impedance)		
Noise-Dissipation	Multi-Layer Carbon-Based Noise-Dissipation	GND (Ground-Noise Dissipation)	
Jacket	Blue/Black Braid		
Application Options	Full-Range or BiWire COMBO (when combined with BASS cable)	BiWire COMBO (when combined with ZERO cable)	
Plug Options (1000 Series, Silver)	AMP-Side: Choice of U-Spade (recommended default), Banana, Multi-Spade, or V-Spade / SPEAKER-Side: Choice of U-Spade (recommended default), Banana, or Multi-Spade		
Prepared Lengths in Feet	Retail	Retail	Retail
8' Pair	4,940.00	3,660.00	8,600.00
10' Pair	5,700.00	4,100.00	9,800.00
12' Pair	6,460.00	4,540.00	11,000.00
15' Pair	7,600.00	5,200.00	12,800.00
Other prepared lengths use formula:	380.00/ft + 1,900.00	220.00/ft + 1,900.00	600.00/ft + 3,800.00

Speaker Cables: FireBird (Mythical Creatures)



Model	FireBird ZERO ● 72v DBS	FireBird BASS ● 72v DBS	FireBird BiWire COMBO (ZERO + BASS) ● 72v DBS
Metal	Solid Perfect-Surface Silver (PSS) Sonic-Signature Conductors and Perfect-Surface Copper+ (PSC+)		Refer to Specs for ZERO and BASS
Gauge	10 AWG		
Geometry	ZERO Tech (No Characteristic Impedance)		
Noise-Dissipation	Multi-Layer Carbon-Based Noise-Dissipation	GND (Ground-Noise Dissipation)	
Jacket	Dark Red/Black Braid		
Application Options	Full-Range or BiWire COMBO (when combined with BASS cable)	BiWire COMBO (when combined with ZERO cable)	
Plug Options (1000 Series, Silver)	AMP-Side: Choice of U-Spade (recommended default), Banana, Multi-Spade, or V-Spade / SPEAKER-Side: Choice of U-Spade (recommended default), Banana, or Multi-Spade		
Prepared Lengths in Feet	Retail	Retail	Retail
8' Pair	15,500.00	12,300.00	27,800.00
10' Pair	18,900.00	14,900.00	33,800.00
12' Pair	22,300.00	17,500.00	39,800.00
15' Pair	27,400.00	21,400.00	48,800.00
Other prepared lengths use formula:	1,700.00/ft + 1,900.00	1,300.00/ft + 1,900.00	3,000.00/ft + 3,800.00

Speaker Cables: Dragon (Mythical Creatures)



Model	Dragon ZERO ● 72v DBS	Dragon BASS ● 72v DBS	Dragon BiWire COMBO (ZERO + BASS) ● 72v DBS
Metal	Solid Perfect-Surface Silver (PSS) Sonic-Signature Conductors and Perfect-Surface Copper+ (PSC+)		Refer to Specs for ZERO and BASS
Gauge	10 AWG		
Geometry	ZERO Tech (No Characteristic Impedance)		
Noise-Dissipation	Multi-Layer Carbon-Based Noise-Dissipation	GND (Ground-Noise Dissipation)	
Jacket	Black Braid		
Application Options	Full-Range or BiWire COMBO (when combined with BASS cable)	BiWire COMBO (when combined with ZERO cable)	
Plug Options (1000 Series, Silver)	AMP-Side: Choice of U-Spade (recommended default), Banana, Multi-Spade, or V-Spade / SPEAKER-Side: Choice of U-Spade (recommended default), Banana, or Multi-Spade		
Prepared Lengths in Feet	Retail	Retail	Retail
8' Pair	27,500.00	21,100.00	48,600.00
10' Pair	33,900.00	25,900.00	59,800.00
12' Pair	40,300.00	30,700.00	71,000.00
15' Pair	49,900.00	37,900.00	87,800.00
Other prepared lengths use formula:	3,200.00/ft + 1,900.00	2,400.00/ft + 1,900.00	5,600.00/ft + 3,800.00

Speaker Cable Accessories

PSC BiWire Jumpers

Solid PSC Copper Jumpers replace stamped jumpers supplied with BiWirable speakers.

Set of (4) 4-inch Jumpers.



BiWire Jumpers-G (Direct-Gold Plated)
Retail: 29.95



BiWire Jumpers-S (Direct-Silver Plated)
Retail: 29.95

BiWire Jumpers

Easy and affordable upgrades over the common gold-plated, stamped-brass jumpers included with most biwireable loudspeakers. AudioQuest BiWire Jumpers use Direction-Controlled Solid Perfect-Surface Copper+ (PSC+, Saturn) or Perfect-Surface Silver (PSS, Jupiter) conductors.

Choice of Hanging-Silver or Hanging-Gold 500 Series Banana or Multi-Spade connectors. Please specify silver or gold when ordering. Length of jumpers is 8 inches including connectors.



Saturn (PSC+)
Set of 4
Retail: 229.95



Jupiter (PSS)
Set of 4
Retail: 549.95

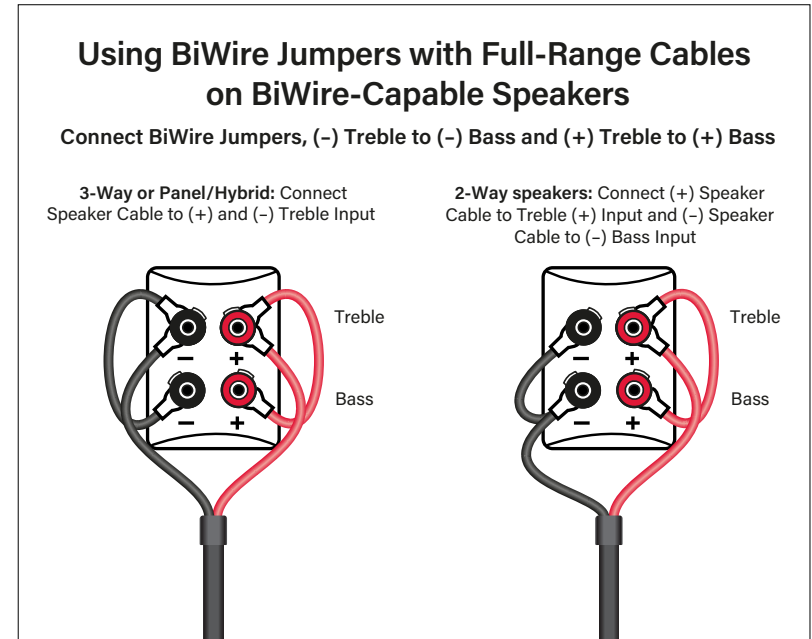

Fog Lifters

Place Fog Lifters beneath audio and AC power cables to significantly reduce RF noise coupling, whether with the floor, or due to misdirected efforts to isolate cable with stands or clamps that themselves have too much contact mass and are sources of RF noise.

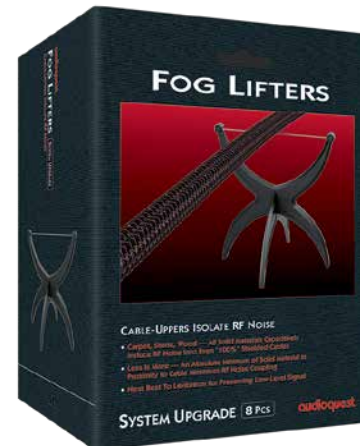

Set of 8
Retail: 149.95

Analog-Audio Interconnect Cables

The Higher You Climb, The Less You Hear?

Climbing the ladder of AudioQuest Analog Interconnect Cables leads to better and better performance. This makes immediate sense, but perhaps less intuitive is the fact that moving up the line means you hear less of the cable. The reason is simple: As more of the delicate audio signal is protected from damage along the way, the listener experiences more of the truth and emotional impact of the music. Greater faithfulness to the audio signal is made possible by the use of superior materials and the careful implementation of increasingly sophisticated design and construction techniques.

Music is wonderfully complex, and our ears are very sensitive to its nuances. The remarkably affordable Bridges & Falls Series is an amazing place to start the journey. Yet, every step up the ladder to the Elements Series delivers even more clarity, smoother and more natural sound, greater dynamic slam, and more nuanced expression from the music.

As you climb with your customers, you'll hear progressions in metal, from Solid Long-Grain Copper to Perfect-Surface Copper, Copper+, and Silver; in Geometry, from Double- to Triple-Balanced; in insulation, from Foamed-PE to FEP Air-Tubes; and in Noise-Dissipation techniques, from Metal- to Carbon-Based Multi-Layer Noise-Dissipation and our patented Dielectric-Bias System.

Throughout the line, the AQ performance-driven value system is always 100% evident. Climb until the incremental cost of the higher model is no longer the least expensive way to make the most improvement—but don't be surprised if your customers find themselves at the top of the line before reaching that point!



Angel



Wind



Victoria



Water



Sydney



Yukon



Big Sur



Mackenzie



Golden Gate



Red River



Evergreen



Chicago



Analog-Audio Interconnect Cables: Bridges & Falls

	Tower		Evergreen		Golden Gate		Big Sur		Sydney		Victoria ● 72v DBS		Yosemite ● 72v DBS		Angel ● 72v DBS	
3.5mm Male Mini																
2-Male RCA																
3.5mm Female Mini																
5 Pin DIN																
Model	Tower	Evergreen	Golden Gate	Big Sur	Sydney	Victoria ● 72v DBS	Yosemite ● 72v DBS	Angel ● 72v DBS								
Metal	Solid Long-Grain Copper (LGC)		Solid Perfect-Surface Copper (PSC)		Solid Perfect-Surface Copper+ (PSC+)		Solid Perfect-Surface Silver (PSS)									
Geometry	Asymmetrical Double-Balanced (Lower Impedance on Ground, Same Quality + and - Conductors)															
Dielectric	Foamed-Polyethylene						Polyethylene Air-Tubes				FEP Air-Tubes					
Noise-Dissipation	Metal-Layer Noise-Dissipation						Carbon-Based Noise-Dissipation									
Jacket	Black with White Stripes PVC	Green/Black Braid	Red/Black Braid	Brown/Black Braid	Dark Gray/Black Braid	Blue/Black Braid	Green/Black Braid	Silver/Black Braid								
Termination	Cold-Welded, Gold-Plated			Cold-Welded, Gold-Plated Pure Purple Copper	Cold-Welded, Direct-Silver Plated Pure Purple Copper	Cold-Welded, Direct-Silver Plated Pure Red Copper										
Application																
3.5mm Male Mini - 2-Male RCA				Yes												
2-Male RCA - 2-Male RCA				Yes												
3.5mm Male Mini - 3.5mm Male Mini				Yes												
3.5mm Male Mini - 3.5mm Female Mini		3m and 5m Only	No	2m and 5m Only	No	No	2m and 5m Only	Yes								
3.5mm Male Mini - 5 Pin DIN		No						Yes								
5 Pin DIN - 5 Pin DIN		No						Yes								
5 Pin DIN - 2-Male RCA		No						Yes								
Meters	Feet	Retail	Retail	Retail	Retail	Retail	Retail	Retail	Retail	Retail	Retail	Retail	Retail	Retail	Retail	Retail
0.6m	1' 11"	27.95	45.95	74.95	117.95	169.95	299.95	571.95	999.95							
1m	3' 3"	29.95	49.95	79.95	129.95	199.95	349.95	659.95	1,199.95							
1.5m	4' 11"	32.95	54.95	87.95	144.95	234.95	399.95	769.95	1,449.95							
2m	6' 6"	35.95	59.95	94.95	159.95	269.95	449.95	879.95	1,699.95							
3m	9' 10"	41.95	69.95	109.95	189.95	339.95	549.95	1,099.95	2,199.95							
5m	16' 4"	53.95	89.95	139.95	249.95	479.95	749.95	1,539.95	3,199.95							
8m	26' 2"	71.95	119.95	184.95	339.95	689.95	1,049.95	2,199.95	4,699.95							
12m	39' 4"	95.95	159.95	244.95	459.95	969.95	1,449.95	3,079.95	6,699.95							
16m	52' 5"	119.95	199.95	304.95	579.95	1,249.95	1,849.95	3,959.95	8,699.95							
20m	65' 7"	143.95	239.95	364.95	699.95	1,529.95	2,249.95	4,839.95	10,699.95							
Other prepared lengths use formula:		-	-	-	-	-	100/m + 249.95	220/m + 439.95	500/m + 699.95							

Tower and Golden Gate are also sold in Installer Packs. See page 56.

Note: Victoria is out of stock until further notice.

Analog-Audio Interconnect Cables: Rivers & Elements



Model	Chicago	Red River	Mackenzie	Yukon	Water ● 72v DBS	Earth ● 72v DBS	Wind ● 72v DBS	Fire ● 72v DBS	
Metal	Solid Long-Grain Copper (LGC)	Solid Perfect-Surface Copper (PSC)	Solid Perfect-Surface Copper+ (PSC+)			Solid Perfect-Surface Silver (PSS)			
Geometry	Double-Balanced	Triple-Balanced (Separate Ground-Reference Conductor)							
Dielectric	Hard-Cell Foam			Polyethylene Air-Tubes		FEP Air-Tubes			
Noise-Dissipation	Metal-Layer Noise-Dissipation		Carbon-Based Noise-Dissipation		Carbon-Based Multi-Layer Noise-Dissipation				
Jacket	Green/Black Braid or CL3/FT4 PVC	Red/Black Braid or CL3/FT4 PVC	Brown/Black Braid or CL3/FT4 PVC	Black/Dark Gray Braid	Blue/Black Braid	Green/Black Braid	Silver/Black Braid	Red/Black Braid	
Termination	Cold-Welded, Gold-Plated		Cold-Welded, Hanging-Silver directly over pure Purple Copper		Cold-Welded, Hanging-Silver Plating directly over High-Purity Red Copper Plugs				
Application									
Male RCA - Male RCA	Yes				Yes				
Female XLR - Male XLR	No				Yes				
Meters	Feet	Retail	Retail	Retail	Retail	Retail	Retail	Retail	Retail
0.5m	1' 7"	94.95	169.95	254.95	394.95	599.95	999.95	1,699.95	2,499.95
0.75m	2' 5"	97.95	174.95	267.95	422.95	649.95	1,099.95	1,999.95	2,999.95
1m	3' 3"	99.95	179.95	279.95	449.95	699.95	1,199.95	2,299.95	3,499.95
1.5m	4' 11"	104.95	189.95	304.95	504.95	799.95	1,399.95	2,899.95	4,499.95
2m	6' 6"	109.95	199.95	329.95	559.95	899.95	1,599.95	3,499.95	5,499.95
3m	9' 10"	119.95	219.95	379.95	669.95	1,099.95	1,999.95	4,699.95	7,499.95
4.5m	14' 9"	134.95	249.95	454.95	834.95	1,399.95	2,599.95	6,499.95	10,499.95
5m	16' 4"	139.95	259.95	479.95	889.95	1,499.95	2,799.95	7,099.95	11,499.95
6m	19' 8"	149.95	279.95	529.95	999.95	1,699.95	3,199.95	8,299.95	13,499.95
Other prepared lengths use formula:		10/m + 89.95	20/m + 159.95	50/m + 229.95	110/m + 339.95	200/m + 499.95	400/m + 799.95	1,200/m + 1,099.95	2,000/m + 1,499.95
Bulk Cables		Retail	Retail	Retail	Retail	Retail	Retail	Retail	Retail
50m Bulk	164'	-	-	25.00/ft	-	-	-	-	-
100m Bulk	328'	5.00/ft	10.00/ft	-	-	-	-	-	-

Note: For bulk cables, retail price is listed per foot.

Analog-Audio Interconnect Accessories

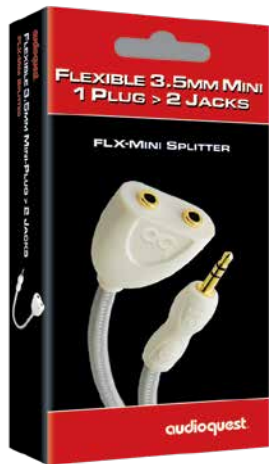

FLX-Mini Splitter

3.5mm Mini Male Stereo >
(2) 3.5mm Female Stereo

Metal: Solid Perfect-Surface
Copper+ (PSC+)

Length: 15cm (6 in.)

Retail: 19.95



FLX-Mini/RCA Adaptor

3.5mm Mini Male Stereo \leftrightarrow
2 Female RCA (L & R)

Metal: Solid Perfect-Surface
Copper+ (PSC+)

Length: 15cm (6 in.)

Retail: 19.95

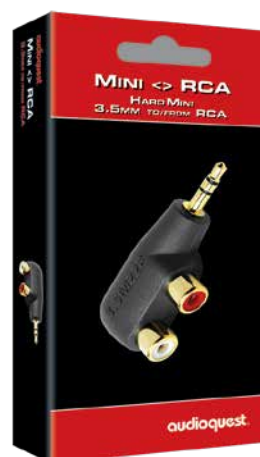

Hard Mini/RCA Adaptor

Hard Mini 3.5mm Male \leftrightarrow
2 Female RCA (L & R)
(Not for Bridges & Falls)

Retail: 19.95

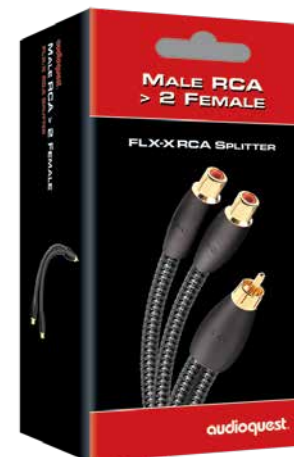

FLX-X RCA Splitter

RCA Male >
2 Female RCA (L & R)

Metal: Solid Long-Grain Copper
(LGC)

Length: 15cm (6 in.)

Retail: 19.95



FLX-X RCA Splitter

RCA Female >
2 Male (L & R)

Metal: Solid Long-Grain
Copper (LGC)

Length: 15cm (6 in.)

Retail: 19.95

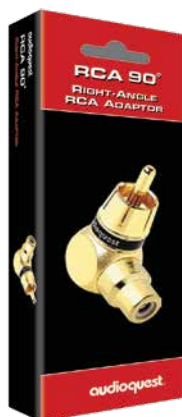

M21F-90 Adaptor

Female RCA to Right Angle
Male RCA

Retail: 12.95



Hard RCA Splitter

Male RCA > 2 Female RCA

Retail: 15.95



RCA - RCA Coupler

Female RCA \leftrightarrow Female RCA

Retail: 9.95



PreAmp Jumpers

Solid Perfect-Surface Copper+ (PSC+) conductors
in Polyethylene Air-Tubes. Replaces factory fitted
"U" jumpers on integrated amps and receivers.

Retail: 39.95

Subwoofer Cables



Model	Black Lab	Greyhound	Irish Red	Boxer	Husky 72v DBS	Wolf 72v DBS	
Metal	Long-Grain Copper (LGC)	0.5% Silver		1.25% Silver	5% Silver	10% Silver	
Conductor	Solid Conductors						
Geometry	Symmetrical Coax			Double-Balanced	Triple-Balanced		
Dielectric	Foamed-Polyethylene			Polyethylene Air-Tubes		FEP Air-Tubes	
Noise-Dissipation	Metal-Layer Noise-Dissipation			Carbon-Based Noise-Dissipation	Carbon-Based Multi-Layer Noise-Dissipation		
Jacket	Black with White Stripes CL3/FT4 Rated PVC	Light Gray-Striped White CL3/FT4 Rated PVC	Up to 5m: Red/Black Braid 8m and Longer CL3/FT4 Rated: Black PVC with Red Stripes	Up to 5m: Brown/Black Braid 8m and Longer CL3/FT4 Rated: Black PVC with Brown Stripes	Blue/Black Braid or CL3/FT4 Rated Black PVC with Blue Stripes (Any Length)	Silver/Black Braid or CL3/FT4 Rated Black PVC with Silver Stripes (Any Length)	
Termination	Cold-Welded, Gold-Plated			Cold-Welded, Hanging-Silver directly over pure Red Copper			
Application - Attached Chassis-Ground Connector							
RCA - RCA	Yes						
RCA/XLR Mixed	No			Yes			
XLR - XLR	No			Yes			
Meters	Feet	Retail	Retail	Retail	Retail	Retail	
2m	6' 6"	42.95	59.95	88.95	177.95	879.95	
3m	9' 10"	49.95	69.95	99.95	199.95	999.95	
5m	16' 4"	64.95	85.95	124.95	243.95	1,239.95	
8m	26' 2"	89.95	109.95	164.95	309.95	1,599.95	
12m	39' 4"	119.95	139.95	214.95	397.95	2,079.95	
16m	52' 5"	149.95	169.95	264.95	485.95	2,559.95	
20m	65' 7"	179.95	199.95	314.95	573.95	3,039.95	
Other prepared lengths use formula:		-	-	-	-	60.00/m + 219.95	120.00/m + 639.95

Note: Greyhound is optimized for custom-installation projects that require its thin, discreet design. It does not include a chassis-ground connector.

Tonearm Cables

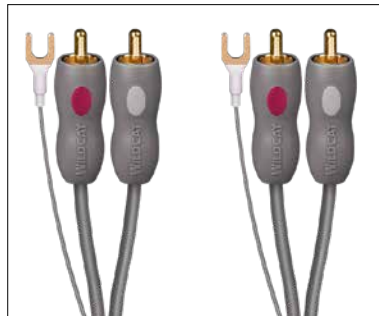

Model		WildCat	Cougar ● 72v DBS	LeoPard ● 72v DBS	WEL Signature ● 72v DBS
Metal		Solid Perfect-Surface Copper (PSC)	Solid Perfect-Surface Copper+ (PSC+)	Solid Perfect-Surface Silver (PSS)	
Dielectric		Foamed-Polyethylene		FEP Air-Tubes	
Noise-Dissipation		Metal-Layer Noise-Dissipation		Carbon-Based Multi-Layer Noise-Dissipation	
Capacitance		Less than 65pF/1.5m		Less than 56pF/1.2m	
Jacket		White/Gray Braid	Black Braid	Gray PVC	Gray/Black Stripes PVC
Application - Attached Chassis-Ground Connector					
RCA - RCA		Yes	Yes	Yes	
Straight 5-pin JIS Plug - RCA		Yes	Yes	Yes	
Right Angle 5-pin JIS Plug - RCA		No	No	Yes	
XLR - XLR		No	No	Yes	
JIS or RCA - XLR		No	No	Call	
Meters	Feet	Retail	Retail	Retail	Retail
1.2m	3' 11"	-	-	899.95	4,125.00
1.5m	4' 11"	119.95	399.95	-	-
2.0m	6' 6"	-	-	1,199.95	4,917.00



Reference Phono Cartridges



Stylus Performance Treatment
Retail: 60.00/each



Delos
Retail: 1,995.00



Kleos
Retail: 3,695.00



Kleos SL
Retail: 3,995.00



Kleos Mono
Retail: 3,995.00



Etna λ Lambda
Retail: 8,995.00



Etna SL λ Lambda
Retail: 9,995.00



Etna λ Lambda Mono
Retail: 9,995.00



Atlas λ Lambda
Retail: 11,995.00



Atlas SL λ Lambda
Retail: 12,995.00



Atlas λ Lambda Mono
Retail: 12,995.00

Vinyl and Headphone Accessories

GroundGoody Tonearm & Ground Wires

AudioQuest GroundGoody's use Direction-Controlled Perfect-Surface Conductors and Direct-Silver Plated (#10 stud) spades to help prevent hum and efficiently drain radio-frequency noise. Partner GroundGoody with any AudioQuest RCA cable to create a low-distortion and low-noise tonearm cable.



GroundGoody Saturn

Perfect-Surface Copper+ (PSC+) Conductors

	Feet	Retail
0.6m	1' 11"	27.95
1m	3' 3"	29.95
1.5m	4' 11"	31.95
2m	6' 6"	33.95
3m	9' 10"	37.95



GroundGoody Jupiter

Perfect-Surface Silver (PSS) Conductors

Meters	Feet	Retail
0.6m	1' 11"	129.95
1m	3' 3"	199.95
1.5m	4' 11"	279.95
2m	6' 6"	359.95
3m	9' 10"	519.95

Anti-Static Record Brush

Highly Conductive Carbon Fibers

Single

Retail: 16.95



Super-Conductive Anti-Static Record Brush

1,248,000 Highly Conductive Carbon Fibers with No-Resistance Path to Finger-Grip

Single

Retail: 29.95



HL-5 Headshell Leads

Silk-wrapped Linear-Crystal Copper Litz Conductors

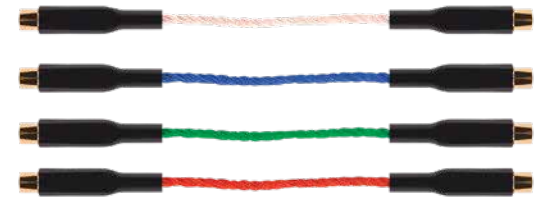

Set of 4

Retail: 59.95

NightBird Model One

- Fits NightHawk and NightOwl Headphones
- Perfect-Surface Copper+ (PSC+)
- Noise-Dissipation
- Robust: Tested to 28,000 bends



Meters	Feet	Retail
2m	6' 6"	99.95
3m	9' 10"	129.95
4m	13' 1"	159.95
5m	16' 4"	189.95

Headphone Plug Adaptor

- Stereo 3.5mm Female > Stereo 1/4" Male
- Silver Plating Directly Over Extreme-Purity Brass
- Superior Materials and Firm Contact Pressure Ensure Ideal Signal Transfer



Retail: 29.95

Perch Headphone Stand

- Easily and safely accommodates all headphones
- High-quality materials
- Heavy base provides stability



Retail: 89.95

HDMI Cables

Does AudioQuest offer the right HDMI cables for 4K TVs, 8K TVs, and beyond?

Yes! All of AudioQuest's new 48Gbps HDMI cables can transfer up to professional 10K Ultra-HD video. The impressive 48Gbps data rate is made possible by four balanced audio/video pairs capable of 12Gbps each. And, of course, the latest technology is backwards compatible with 4K displays.

Video Up to 10K

AudioQuest 48Gbps HDMI cables are completely backwards compatible with existing devices and have the bandwidth required for video with resolutions up to 10K and resolutions/refresh rates up to 8K/60 and 4K/120.

HDR (High Dynamic Range)

All AudioQuest HDMI cables support HDR (High Dynamic Range) and Dynamic HDR. HDR content expands the contrast of the image for blacker blacks and brighter whites/highlights as well as greater color saturation and brightness. In addition, 4K Ultra-HD content allows for a wider color range.

This combination of technologies results in more realistic HDR images with greater perceived depth. Dynamic HDR (HDR10+ and Dolby Vision, for example) enables frame-by-frame HDR optimization rather than HDR settings that are fixed for the entire program. The most prominent current HDR formats are HDR10, HDR10+, and Dolby Vision.

AudioQuest 18Gbps and 48Gbps HDMI cables are compatible with all varieties of HDR, which can be found on Ultra-HD Blu-ray, and all major streaming services, including Netflix, Amazon Prime, Disney+, Apple TV+, and others.

ARC (Audio Return Channel) and eARC (enhanced Audio Return Channel)

HDMI's Audio Return Channel (ARC) sends audio from a TV to a soundbar or AV receiver for greater simplicity and flexibility in system setup. Hardware's previous ARC capabilities max out at lossy (compressed) 5.1-channel surround sound.

Today's HDMI 2.1 hardware supports enhanced Audio Return Channel (eARC), which increases the digital bandwidth dramatically to support uncompressed and lossless high-resolution multichannel audio, including Dolby TrueHD and Atmos, and DTS-HD Master Audio and DTS: X.

8K-10K



48G_{bps}

Not only do all current generations of AudioQuest HDMI cables have the conductors and bandwidth required for eARC's enhanced sonic capabilities, but, in order to ensure superior audio performance, the ARC-channel conductor-pair is internally controlled for direction, running in the opposite direction from the 4 pairs that carry information to the TV.

Finally, AudioQuest's eARC-Priority models include 4 Silver-Plated Forest 48-level audio/video data pairs—but with a far superior single data pair for the TV's audio output. By upgrading the ARC data path only, audiophile quality is made possible at a fraction of the cost of upgrading all 5 data pairs.



New Packaging

AudioQuest has turbo-charged all of its HDMI packaging with easy-to-read icons and explanations of the design and material elements that define each cable and its place in the line. Comparing, contrasting and selecting the right cable is easier than ever before.



1.25% SILVER

Solid Conductors

Solid Long-Grain Copper, Silver-Plated Copper, or Perfect-Surface Silver maximize Noise-Dissipation and overall performance.

LEVEL 2 Metal Layer + Direction

Noise Dissipation

Six Levels of Noise-Dissipation (ND) combat distortion caused by RF Noise contaminating digital and analog circuitry.

eARC

1.25% Silver Level-2 ND

Because sound is where all the emotion and drama comes from, AQ's eARC channel gets 100% the same love as the four AV channels.

Limited

Lifetime Warranty

We've got your back. Performance backed by reliability.

48Gbps

4 x 12 = 48

The 48Gbps necessary for all of HDMI's new and future features is made possible by upgrading the 4 AV channels from 6 to 12Gbps.

HDMI A/V Cables: 18Gbps, 48Gbps, and eARC-Priority: BlueBerry to Vodka eARC (5 more models on next page)

- All models use Solid Signal and Ground-Reference Conductors.
- All 19 conductors (A/V, eARC, Ground-Reference Drains, Control, Power) are Direction-Controlled.
- AudioQuest "48" HDMI cables up through 5m have the bandwidth required for video with resolutions up to 10K, resolutions/refresh rates up to 8K/60 and 4K/120.
- All generations of HDMI cable are fully compatible with all previous hardware — It's the new HDMI hardware capabilities that require the latest cables.



Model		BlueBerry	Pearl 48	Forest 48	Cinnamon 48	Carbon 48	Cherry Cola	Vodka 48	Vodka eARC
18 Gbps or 48 Gbps		18Gbps 4K-8K	48Gbps 8K-10K	48Gbps 8K-10K	48Gbps 8K-10K	48Gbps 8K-10K	18Gbps 4K-8K	48Gbps 8K-10K	48Gbps 8K-10K
A/V Conductor		Solid Long-Grain Copper (LGC)		0.5% Silver	1.25% Silver	5% Silver	Fused Silica (Quartz)	10% Silver	0.5% Silver
eARC Conductor		Solid Long-Grain Copper (LGC)		0.5% Silver	1.25% Silver	5% Silver	0.5% Silver	10% Silver	10% Silver
Ground Reference		Tinned Copper			0.5% Silver	1.25% Silver	Tinned Copper	5% Silver	5% Silver eARC
Noise-Dissipation		All 19 Conductors Direction-Controlled			Metal-Layer + Direction	Carbon + Metal + Direction	Carbon + Galvanic Isolation	Carbon + Metal + Direction	
Jacket 0.75-2.25m		CMG (CL3/FT4)			Red Braid	Carbon Braid	N/A	Blue Braid	Blue Braid
Jacket 3.0m +		CMG (CL3/FT4)	CMG (CL3/FT4)	CMG (CL3/FT4)	CMG (CL3/FT4)	CMG (CL3/FT4)	CMG (CL3/FT4)	CMG (CL3/FT4)	CMG (CL3/FT4)
Meters	Feet	Retail	Retail	Retail	Retail	Retail	Retail	Retail	Retail
0.75m	2' 6"	29.95	39.95	69.95	119.95	199.95	-	399.95	159.95
1.5m	5' 0"	35.95	49.95	89.95	159.95	259.95	-	499.95	199.95
2.25m	7' 6"	42.95	59.95	109.95	189.95	319.95	-	599.95	239.95
3m	10' 0"	49.95	69.95	129.95	229.95	379.95	-	699.95	279.95
5m	16' 5"	99.95	169.95	259.95	399.95	-	699.95	-	-
All Models are 18Gbps 4K-8K for Lengths 8m and Longer									
8m	26' 2"	-	164.95	259.95	-	-	-	-	-
10m	33' 0"	-	239.95	349.95	-	-	799.95	-	-
12.5m	41' 0"	-	299.95	449.95	-	-	-	-	-
15m	50' 0"	-	399.95	-	-	-	899.95	-	-
20m	66' 0"	-	-	-	-	-	999.95	-	-
25m	82' 0"	-	-	-	-	-	1,099.95	-	-
30m	100' 0"	-	-	-	-	-	1,199.95	-	-

HDMI A/V Cables: 18Gbps, 48Gbps, and eARC-Priority: Carbon 48 to Dragon eARC (4 more models on previous page)

- All models use Solid Signal and Ground-Reference Conductors.
- All 19 conductors (A/V, eARC, Ground-Reference Drains, Control, Power) are Direction-Controlled.
- AudioQuest "48" HDMI cables up through 5m have the bandwidth required for video with resolutions up to 10K, resolutions/refresh rates up to 8K/60 and 4K/120.
- All generations of HDMI cable are fully compatible with all previous hardware — It's the new HDMI hardware capabilities that require the latest cables.



Model		Carbon 48	Cherry Cola	Vodka 48	Vodka eARC	ThunderBird 48	ThunderBird eARC	FireBird 48 ● 72v DBS	Dragon 48 ● 72v DBS	Dragon eARC ● 72v DBS
18 Gbps or 48 Gbps		48Gbps 8K-10K	18Gbps 4K-8K	48Gbps 8K-10K	48Gbps 8K-10K	48Gbps 8K-10K	48Gbps 8K-10K	48Gbps 8K-10K	48Gbps 8K-10K	48Gbps 8K-10K
A/V Conductor		5% Silver	Fused Silica (Quartz)	10% Silver	0.5% Silver	10% Silver	0.5% Silver	100% PSS Silver	100% PSS Silver	0.5% Silver
eARC Conductor		5% Silver	0.5% Silver	10% Silver	10% Silver	10% Silver	10% Silver	100% PSS Silver	100% PSS Silver	100% PSS Silver
Ground Reference		1.25% Silver	Tinned Copper	5% Silver	5% Silver eARC	10% Silver	10% Silver eARC	10% Silver	100% PSS Silver	100% PSS Silver eARC
Noise-Dissipation		Carbon + Metal + Direction	Carbon + Galvanic Isolation	Carbon + Metal + Direction		Graphene + Global Carbon + Direction		72v DBS, Graphene + Global Carbon + Direction		
Jacket 0.75-2.25m		Carbon Braid	N/A	Blue Braid	Blue Braid	Blue Braid	Dark Blue Braid	Red Braid	Black Braid	Black Braid
Jacket 3.0m +		CMG (CL3/FT4)	CMG (CL3/FT4)	CMG (CL3/FT4)	CMG (CL3/FT4)	CMG (CL3/FT4)	CMG (CL3/FT4)	CMG (CL3/FT4)	CMG (CL3/FT4)	CMG (CL3/FT4)
Meters	Feet	Retail	Retail	Retail	Retail	Retail	Retail	Retail	Retail	Retail
0.75m	2' 6"	199.95	-	399.95	159.95	699.95	349.95	1,299.95	2,199.95	899.95
1.5m	5' 0"	259.95	-	499.95	199.95	849.95	419.95	1,699.95	2,799.95	1,199.95
2.25m	7' 6"	319.95	-	599.95	239.95	999.95	489.95	2,099.95	3,399.95	1,499.95
3m	10' 0"	379.95	-	699.95	279.95	1,149.95	559.95	2,499.95	3,999.95	1,799.95
5m	16' 5"	-	699.95	-	-	-	-	-	-	-
All Models are 18Gbps 4K-8K for Lengths 8m and Longer										
10m	33' 0"	-	799.95	-	-	-	-	-	-	-
15m	50' 0"	-	899.95	-	-	-	-	-	-	-
20m	66' 0"	-	999.95	-	-	-	-	-	-	-
25m	82' 0"	-	1,099.95	-	-	-	-	-	-	-
30m	100' 0"	-	1,199.95	-	-	-	-	-	-	-

HDMI Accessories

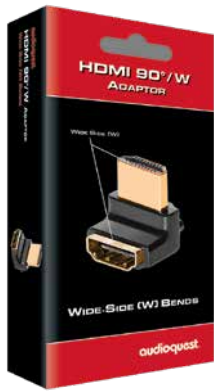

HDMI 90°/W Adaptor
Wide Side [W]
Right Angle Bend

Retail: 19.95

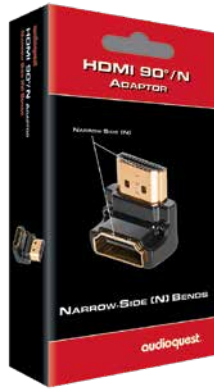

HDMI 90°/N Adaptor
Narrow Side [N]
Right Angle Bend

Retail: 19.95



HDMI 90° NU/R Flat Adaptor
Narrow Up [NU]
Bends Right

Retail: 19.95

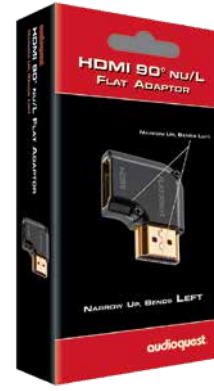

HDMI 90° NU/L Flat Adaptor
Narrow Up [NU]
Bends Left

Retail: 19.95



HDMI A ↔ C Adaptor
Standard [Type A] to
Mini [Type C]

Retail: 19.95



HDMI A ↔ D Adaptor
Standard [Type A] to
Micro [Type D]

Retail: 19.95



HDMI A → C/D Adaptor
Standard [Type A] to Mini [C]
and Micro [D]

Retail: 19.95



HDMI A ↔ A Coupler
Female HDMI to Female
HDMI

Retail: 19.95



**Mini Display Port to
HDMI 4K Adaptor**

Retail: 36.95



**HDMI-IN > DVI-OUT
Adaptor**
F-HDMI to M-DVI

Retail: 34.95



**DVI-IN > HDMI-OUT
Adaptor**
F-DVI to M-HDMI

Retail: 34.95

Certain HDMI Adaptors are also sold in Installer Packs. See page 57.

Digital-Audio Interconnect Cables

Perfect Sound Forever?

That bold statement introduced CD players to the world back in 1983. Those claiming perfection believed ones and zeros to be so beyond reproach that traditional concerns about the integrity of the playback system had become irrelevant overnight. But the CD wasn't close to perfect. Those who listened quickly figured out that the equipment and cables in the audio system mattered every bit as much as they had in the analog era.

However, to this day, stating the truth in public that digital-audio cables can make minor to even staggering differences in an audio system's performance is like yelling, "food fight" in a crowded cafeteria—you'd better get ready to duck because there will be incoming.

Yet, the same kind of music lovers and listeners who heard the CD for what it is also know that soul-satisfying digital-audio playback requires the best digital-audio cables. And the best cables reduce the most noise and distortion.

Today, there are more ways to consume digital audio than ever. Many gave up silver discs for the convenience of inferior-sounding compressed downloads, and now we've seemingly got the best of both convenience and performance: We are able to stream high-res files to our phones and mobile devices and into our homes.

AudioQuest's digital-audio cables employ all of our proven techniques for minimizing noise and distortion: better metals, better geometry, better dielectric, Dielectric-Bias System (DBS), Noise-Dissipation, Direction-Controlled Conductors, and other ingredients needed for optimizing each specific application.

The digital future is brighter and more beautiful sounding than ever...*if* your digital-audio cables are capable of treating fragile audio data as it deserves to be treated—that is, with the love and respect reserved for music.





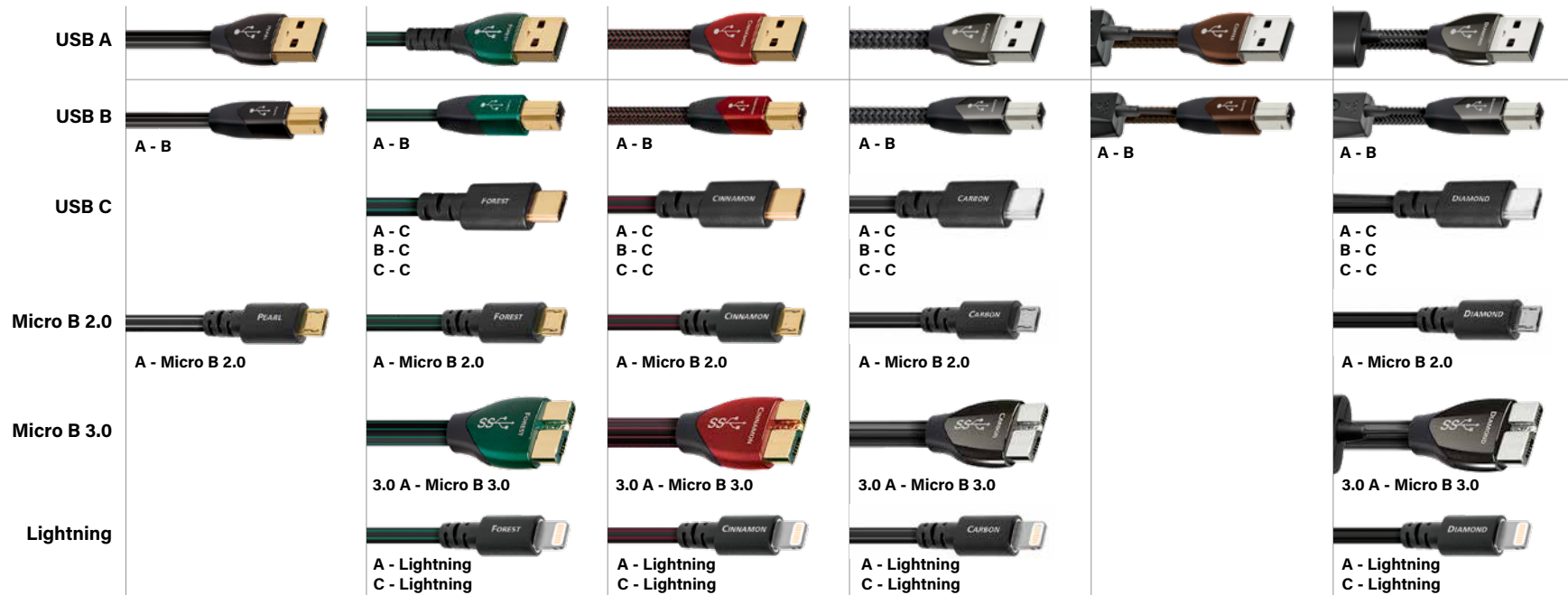











Digital-Audio Interconnects: USB Cables



Model		Pearl	Forest	Cinnamon	Carbon	Coffee 72v DBS	Diamond 72v DBS
Metal (USB A-B)		Solid Long-Grain Copper (LGC)	0.5% Silver, Solid	1.25% Silver, Solid	5% Silver, Solid	10% Silver, Solid	100% Perfect-Surface Silver (PSS), Solid
Metal (All Other Versions)		Long-Grain Copper (LGC) Semi-Solid Concentric	0.5% Silver Semi-Solid Concentric	1.25% Silver Semi-Solid Concentric	5% Silver Semi-Solid Concentric	N/A	100% Perfect-Surface Silver (PSS), Solid
Dielectric		Hard-Cell Foam					
Noise-Dissipation		Metal-Layer Noise-Dissipation			Carbon-Based Noise-Dissipation for USB A - B and USB 3.0 A - 3.0 Micro		
Jacket		Black PVC with White Stripes	Black PVC with Green Stripes	USB A-B: Red/Black Braid All others: Black PVC with Red Stripes	Gray/Black Braid	Brown/Black Braid	USB A-B: Silver/Black Braid All others: Black PVC with Silver Stripes
Available Configurations		USB A - B USB A - Micro B	USB A - B USB A - C USB A - Micro B 2.0 USB A - Lightning USB 3.0 A - Micro B 3.0 USB B - C USB C - C USB C - Lightning	USB A - B USB A - C USB A - Micro B 2.0 USB A - Lightning USB 3.0 A - Micro B 3.0 USB B - C USB C - C USB C - Lightning	USB A - B USB A - C USB A - Micro B 2.0 USB A - Lightning USB 3.0 A - Micro B 3.0 USB B - C USB C - C USB C - Lightning	USB A - B	USB A - B USB A - C USB A - Micro B 2.0 USB A - Lightning USB 3.0 A - Micro B 3.0 USB B - C USB C - C USB C - Lightning
Meters	Feet	Retail	Retail	Retail	Retail	Retail	Retail
0.75m	2' 5"	39.95	64.95	89.95	169.95	369.95	649.95
1.5m	4' 11"	49.95	79.95	109.95	219.95	449.95	799.95
3m	9' 10"	69.95	109.95	149.95	319.95	599.95	1,099.95
5m	16' 4"	99.95	-	199.95	449.95	799.95	1,499.95

USB Connector Applications

<p>USB A</p>   <p>For all devices that use the original USB connection.</p>	<p>USB B</p>   <p>Typically for use with computer peripherals, such as hard drives and network devices, as well as digital-audio components, including DACs and streamers.</p>	<p>USB C</p>   <p>Typically for use with newer devices, including desktops, laptops, smartphones, tablets, game consoles, hard drives, and more.</p>	<p>Micro B 2.0</p>   <p>Typically for use with compact and mobile devices, including Android smartphones and computer peripherals.</p>	<p>USB 3.0 A</p>   <p>SuperSpeed USB for transferring data at up to 5Gbps.</p>	<p>Micro B 3.0</p>   <p>SuperSpeed USB for transferring data at up to 5Gbps, typically for use with smartphones, tablets, and computer peripherals.</p>	<p>Lightning</p>   <p>For use with Apple devices, including iPhones and iPads.</p>
--	---	---	---	---	--	---

USB Accessories



USB A → C Adaptor

Retail: 21.95



USB B ↔ Micro B 2.0 Adaptor

Retail: 16.95



USB Mini B ↔ Micro B 2.0 Adaptor

Retail: 16.95



JitterBug

USB Data & Power Noise Filter

Retail: 69.95



Digital-Audio Interconnects: Optical Cables

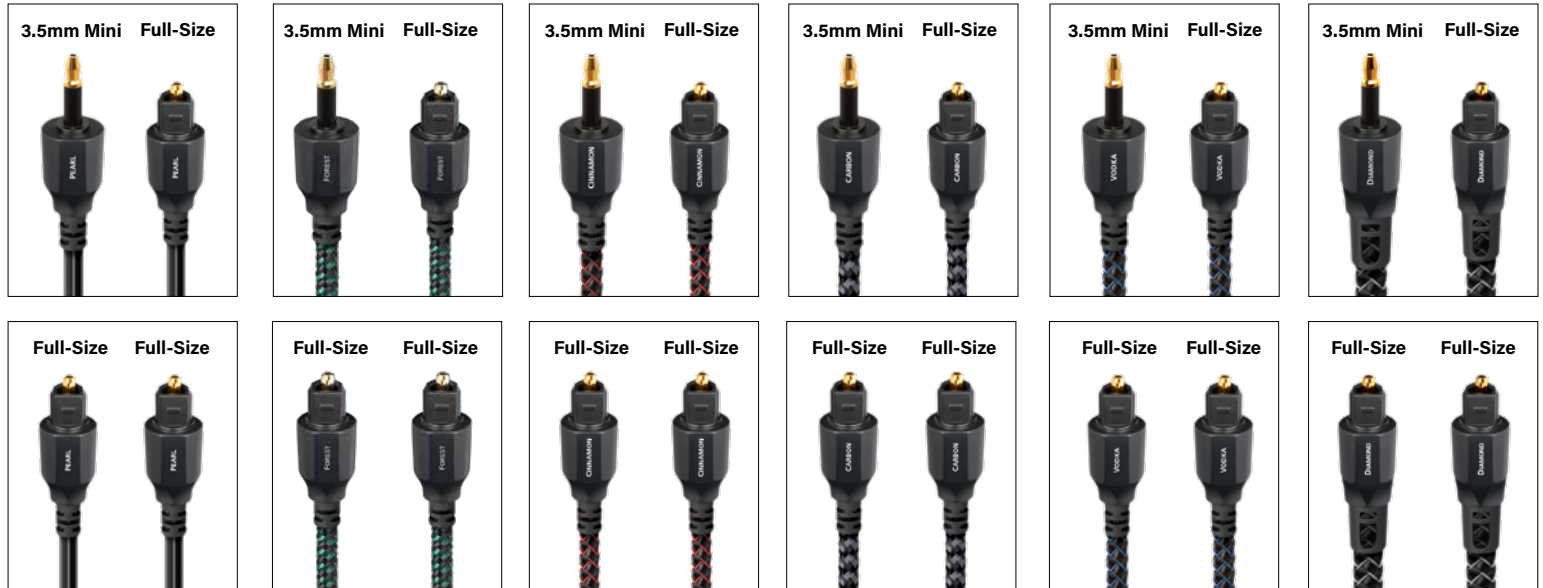

Model		Pearl	Forest	Cinnamon	Carbon	Vodka	Diamond
Conductors		Low-Dispersion Fiber		Lower-Dispersion Higher-Purity Fiber	19 Narrow-Aperture Synthetic Fibers	217 Narrow-Aperture Synthetic Fibers	300 Narrow-Aperture Quartz (Fused-Silica) Fibers
Jacket		Black with Gray Stripes In-Wall Rated PVC	0.75m and 1.5m: Green/Black Braid 3.0m and Longer: In-Wall Rated PVC	0.75m and 1.5m: Red/Black Braid 3.0m and Longer: In-Wall Rated PVC	Gray/Black Braid	Blue/Black Braid	Silver/Black Braid
Meters	Feet	Retail	Retail	Retail	Retail	Retail	Retail
0.75m	2' 5"	29.95	49.95	79.95	129.95	219.95	499.95
1.5m	4' 11"	35.95	59.95	99.95	159.95	299.95	-
3m	9' 10"	49.95	89.95	139.95	219.95	459.95	-
5m	16' 4"	69.95	129.95	199.95	299.95	689.95	-
8m	26' 2"	99.95	179.95	289.95	-	-	-
12m	39' 4"	139.95	259.95	409.95	-	-	-
16m	52' 5"	179.95	339.95	529.95	-	-	-

Optical Pearl, Forest, and Cinnamon are also sold in Installer Packs. See page 56.

Optical Accessory



Optical Mini Adaptor

Retail: 16.95

Digital-Audio Interconnects: Digital Coax Cables



Model		Forest	Cinnamon	Carbon	Coffee ● 72v DBS	Diamond ● 72v DBS	Wild ● 72v DBS	WEL Signature ● 72v DBS
Metal		0.5% Silver	1.25% Silver	5% Silver	10% Silver	100% Perfect-Surface Silver (PSS)		
Conductor		Solid Conductors						
Gauge		24 AWG			21 AWG			
Dielectric		Hard-Cell Foam						
Noise-Dissipation		Metal-Layer Noise-Dissipation		Carbon-Based Multi-Layer Noise-Dissipation			Carbon-Based Multi-Layer Noise-Dissipation, 2 x EMI Absorption	Carbon-Based Multi-Layer Noise-Dissipation, 3 x EMI Absorption
Jacket		Black PVC with Green Stripes	Red/Black Braid	Black/Dark Gray Braid	Brown/Black Braid	Silver/Black Braid	Navy Blue Braid	Black Braid
Terminations		Cold-Welded, Gold-Plated		Cold-Welded, Hanging-Silver Directly Over Pure Purple Copper	Cold-Welded, Hanging-Silver Directly Over Pure Red Copper		Cold-Welded, Hanging-Silver Directly Over Machined Pure Red Copper	
Shield		Foil + Tinned Braid	Foil + Silver-Plated Braid		Silver-Plated Braid		Copper Foil + 100% PSS-Silver Spiral	
Meters	Feet	Retail	Retail	Retail	Retail	Retail	Retail	Retail
0.75m	2' 5"	34.95	79.95	217.95	549.95	1,074.95	2,255.00	3,740.00
1.0m	3' 4"	-	-	219.95	599.95	1,199.95	2,475.00	4,125.00
1.5m	4' 11"	39.95	99.95	269.95	699.95	1,449.95	2,915.00	4,895.00
2.0m	6' 7"	-	-	319.95	-	1,699.95	3,355.00	5,665.00
3m	9' 10"	49.95	139.95	369.95	999.95	2,199.95	4,235.00	7,205.00
5m	16' 4"	69.95	199.95	469.95	1,399.95	3,199.95	5,995.00	10,285.00
Other prepared lengths use formula:		-	-	100.00/m + 119.95	140.00/m + 359.95	500.00/m + 699.95	880.00/m + 1,595.00	1,540.00/m + 2,585.00

Digital Coax Forest is also sold in Installer Packs. See page 57.

Digital Coax Accessory



RCA > BNC

Female RCA to Male BNC Adaptor

Retail: 9.95

Digital-Audio Interconnects: AES/EBU Cables



Model		Carbon	Diamond ● 72v DBS	Wild ● 72v DBS	WEL Signature ● 72v DBS
Metal		5% Silver	100% Perfect-Surface Silver (PSS)		
Conductor		Solid Conductors			
Gauge		24 AWG	21 AWG		
Dielectric		Hard-Cell Foam			
Noise-Dissipation		Carbon-Based Multi-Layer Noise-Dissipation	Carbon-Based Multi-Layer Noise-Dissipation, 2 x EMI Absorption		Carbon-Based Multi-Layer Noise-Dissipation, 3 x EMI Absorption
Jacket		Dark Gray/Black Braid	Silver/Black Braid	Navy Blue Braid	Black Braid
Termination		Cold-Welded, Hanging-Silver Directly Over Pure Purple Copper	Cold-Welded, Hanging-Silver Directly Over Pure Red Copper	Cold-Welded, Hanging-Silver Directly Over Machined Pure Red Copper	
Shield		Foil + Tinned Braid		Foil + Silver-Plated Spiral	
Meters	Feet	Retail	Retail	Retail	Retail
0.75m	2' 5"	217.95	1,074.95	2,255.00	3,740.00
1.0m	3' 4"	219.95	1,199.95	2,475.00	4,125.00
1.5m	4' 11"	269.95	1,449.95	2,915.00	4,895.00
2.0m	6' 7"	319.95	1,699.95	3,355.00	5,665.00
3.0m	9' 10"	369.95	2,199.95	4,235.00	7,205.00
5.0m	16' 4"	469.95	3,199.95	5,995.00	10,285.00
Other prepared lengths use formula:		100.00/m + 119.95	500.00/m + 699.95	880.00/m + 1,595.00	1,540.00/m + 2,585.00

Digital-Audio Interconnects: Ethernet Cables (RJ/E)



Model		Pearl	Forest	Cinnamon	Vodka	Diamond 72v DBS
Metal		Long-Grain Copper (LGC)	0.5% Silver	1.25% Silver	10% Silver	100% Perfect-Surface Silver (PSS)
Conductor		Solid Conductors				
Dielectric		Geometry Stabilizing Solid High-Density Polyethylene				
Noise-Dissipation		Direction-Controlled Conductors			Carbon-Based Noise-Dissipation	
Jacket		CMG (CL3 & FT4) Rated Black PVC with Gray Stripes	CMG (CL3 & FT4) Rated Black PVC with Green Stripes	Up to 3.0m: Red/Black Braid 5.0m and Longer: CMG (CL3 & FT4) Rated Black PVC with Red Stripes	Up to 3.0m: Blue/Black Braid 5.0m and Longer: CMG (CL3 & FT4) Rated Black PVC with Blue Stripes	Silver/Black Braid
Termination		Gold-Plated Nickel Connectors with 100% Shield Coverage			Precision-Made Low-Loss Ultra-Wide Bandwidth Telegärtner Connectors with 100% Shield Coverage and Strain Relief	
Meters	Feet	Retail	Retail	Retail	Retail	Retail
0.75m	2' 5"	39.95	59.95	99.95	449.95	999.95
1.5m	4' 11"	49.95	79.95	119.95	599.95	1,599.95
3m	9' 10"	69.95	109.95	159.95	849.95	2,899.95
5m	16' 4"	99.95	149.95	209.95	1,199.95	4,699.95
8m	26' 2"	139.95	209.95	289.95	1,699.95	7,399.95
12m	39' 4"	199.95	289.95	389.95	2,349.95	10,999.95

Ethernet (RJ/E) Pearl, Forest and Cinnamon are also sold in Installer Packs. See page 57.

Accessories



Enhanced Performance (72v) Dielectric-Bias Pack - BLACK Model
with built-in radio-frequency noise-trap

Each
Retail: 89.95



Maximum Performance (72v) Dielectric-Bias Pack - CARBON Model
with Level-1 pre-formed radio-frequency noise-trap

Each
Retail: 139.95



SorboGel Q-Feet System
Set of 4 energy-absorbing feet each with a "tray" which improves performance and protects furniture. Each foot supports up to 4 kg. (8 lbs.).

Retail: 129.95



CleanScreen Kit
5 oz. (150 ml.) Bottle + 0.3 oz. (10 ml.)
Spray + Retractable Brush

Retail: 22.95



CleanScreen Pack
6 oz. (200 ml.) Bottle + Microfiber
Cleaning Cloth

Retail: 17.95



Sorbothane Self-Stick Sheet
6" x 6" x 0.10" sheet can be cut to size to damp anything, especially effective on top surface of speaker stands.

Retail: 49.95

Accessories



RCA \leftrightarrow BNC Adaptor
Female RCA to/from Male BNC

Retail: 9.95



F > RCA Male Adaptor
Female RCA to Male RCA

Retail: 12.95



F > BNC Male Adaptor
75Ω

Retail: 12.95



F > 2F Splitter
3GHz 75Ω

Retail: 21.95



F > 4F Splitter
3GHz 75Ω

Retail: 25.95



F \leftrightarrow F
75Ω Coupler

Retail: 8.95

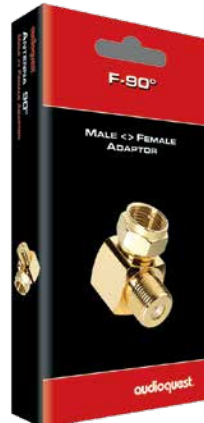

F-90$^\circ$
Male \leftrightarrow Female Adaptor

Retail: 12.95

Accessories

RCA-300

Fits cables up to 7.0mm O.D.
Gold-Plated. Requires soldering.



#300 Male
Set of 4
Retail: 24.95

#300 Female
Set of 4
Retail: 24.95

RCA-800

Fits cables up to 9.0mm O.D.
Direct-Silver Plated. Requires soldering.



#800 Male
Set of 4
Retail: 69.95

XLR Connectors

Fits cables up to 9.0mm O.D.
Direct-Silver Plated. Requires soldering.



#81 Male
Pair
Retail: 59.95

#80 Female
Pair
Retail: 59.95

Right-Angle F and RCA Plugs

Fits cables up to 7.5mm O.D.
Gold-Plated. Requires soldering.



F-90°
Pair
Retail: 24.95

RCA-90°
Pair
Retail: 24.95

Accessories



RJ45 Noise-Stopper Caps

AQ Noise-Stopper Caps fit over unused RJ45 inputs or outputs, preventing RFI and EMI noise from entering the active circuit. Noise-Stopper Caps also protect against dust and corrosion.

Set of 4
Retail: 29.95



USB-A Noise-Stopper Caps

AQ Noise-Stopper Caps fit over unused USB inputs or outputs, preventing RFI and EMI noise from entering the active circuit. Noise-Stopper Caps also protect against dust and corrosion.

Set of 4
Retail: 29.95



HDMI Noise-Stopper Caps

AQ Noise-Stopper Caps fit over unused HDMI inputs or outputs, preventing RFI and EMI noise from entering the active circuit. Noise-Stopper Caps also protect against dust and corrosion.

Set of 4
Retail: 29.95

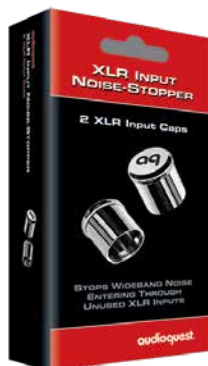

XLR Input (Female) Noise-Stopper Caps

Blocks a significant path for incoming high-frequency energy to interfere with circuit performance.

Pair
Retail: 39.95

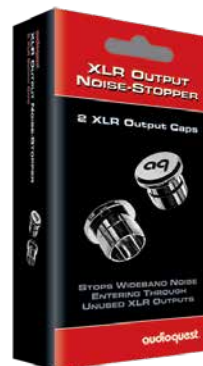

XLR Output (Male) Noise-Stopper Caps

Blocks a significant path for incoming high-frequency energy to interfere with circuit performance.

Pair
Retail: 39.95

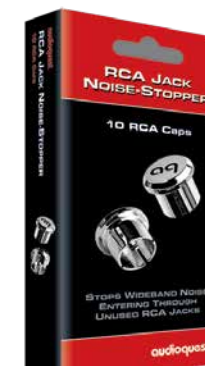

RCA Noise-Stopper Caps

Blocks a significant path for incoming high-frequency energy to interfere with circuit performance.

Set of 10
Retail: 49.95

Tools

All the Tools necessary to Cut, Strip, Prepare, and Terminate any AudioQuest Cable

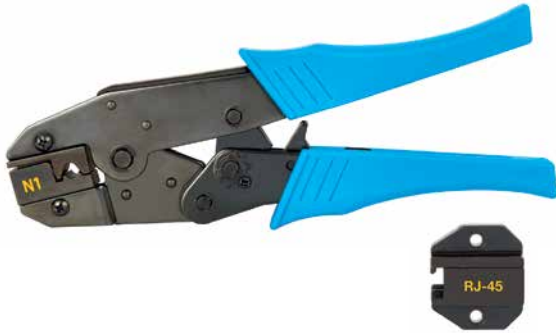

Cat6/6a/7 Crimper Tool and Die

Includes Cat6 and Cat 7 Die

Retail: N/A

Cat6 Die

Also sold separately

Retail: N/A



Rivers Interconnect Crimper Tool

Use with either AudioQuest Chicago RCA, Red River and Mackenzie RCA or XLR plugs.

Retail: N/A



AQ Ratchet Crimper Tool

For up to 8 AWG Conductors

Retail: N/A



Klein Crimper Tool

For connectors up to 10 AWG

Retail: N/A



Klein Cable Cutter

Retail: N/A



Wire Stripper/Cutter/Plier Combo Tool

Retail: N/A



Binding-Post Wrench

Real tool-quality double-ended nut driver with metal inserts.

Fits 7/16" and 1/2" binding posts.

Retail: 17.95



Ideal Articulated Stripper

For 8-22 AWG Conductors

Retail: N/A



Paladin Jacket Stripper

Cleanly and easily removes the jacket on all AudioQuest Interconnect and Speaker Cables

Retail: N/A



AQ Silver Solder

Easy to use. Clearly sounds better.

1lb. Solder

Retail: 184.00

1/4 lb. Solder

Retail: 48.00

Instant Tool-less Connectors (ITC) for Analog-Audio, Mini-Coax, and RG6 Cables on Spools

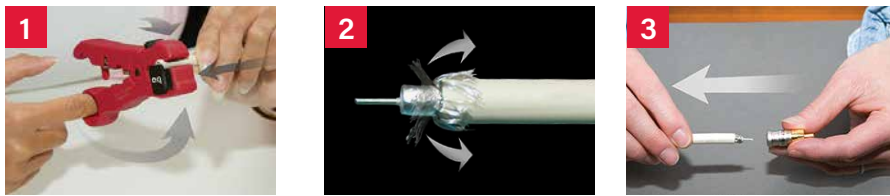

ITC One-Step Stripper for 18 and 24 AWG
 For HD6, ITA, and ITV Cables
Retail: N/A

18 AWG Connectors and Cables for Video, RF, Digital, Subwoofer



ITC-18G/RCA
 Each
Retail: 2.92



ITC-18G/F
 Each
Retail: 1.76



ITC-18G/BNC
 Each
Retail: 3.80

		HD6 Pearl	HD6 Forest	HD6 Carbon
Metal		Solid Conductive-Coated Copper	Solid 0.5% Silver	Solid 5% Silver
Shield		3-Layer Shield: Foil + 90% Braid + Foil		4-Layer Shield: Carbon-Loaded PE + Foil + 90% Braid + Foil
CL3 Jacket Color Choices		Dark Gray or White Stripes	Gray, Green or White Stripes	Black, Gray, or White Stripes
Meters	Feet	Retail		Retail
76m	250'	-		3.30/ft
152m	500'	0.66/ft		-

24 AWG Connectors and Cables for Analog-Audio and Video



ITC-24G/RCA
 Each
Retail: 2.92



ITC-24G/F
 Each
Retail: 2.92



ITC-24G/BNC
 Each
Retail: 3.80

		Audio	ITA-1/1	ITA-3/3	ITA-5/5
Center Conductor Metal			Solid Long-Grain Copper (LGC)	Solid Perfect-Surface Copper (PSC)	Solid Perfect-Surface Copper+ (PSC+)
Neg. Conductor/Shield			LGC HyperLitz	PSC HyperLitz	PSC+ HyperLitz
CL3 Jacket			Blue (Pair)	Green (Pair)	Dark Gray (Pair)
Meters	Feet	Retail		Retail	Retail
15.2m	50'	3.00/ft		-	-
76m	250'	3.00/ft		5.00/ft	8.00/ft
152m	500'	3.00/ft		-	-

Color Bands for 18 and 24 AWG ITC Connectors

Silicon rubber bands fit all ITC connectors—even after they're attached to the cable—for easy cable identification. Available in bags of 20. One color per bag – no mixed colors. Available in 10 colors.

Bag of 20
Retail: 3.75



		Video	ITV-G
Center Conductor Metal			Solid 1.25% Silver
Neg. Conductor/Shield			Foil + Tinned Braid
CL3 Jacket			Gray
Meters	Feet	Retail	
152m	500'	0.84/ft	

CL3/FT4 In-Wall Rated Bulk Speaker Cables

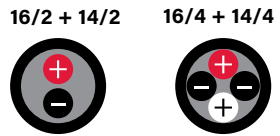

Model		SLiP-DB 16/2	SLiP-DB 16/4	SLiP-DB 14/2	SLiP-DB 14/4	SLiP XTRM 14/2	SLiP XTRM 14/4
Metal		Semi-Solid Concentric Long-Grain Copper (LGC)				Semi-Solid True Concentric Perfect-Surface Copper (PSC) and Long-Grain Copper (LGC)	
Gauge		16 AWG	16 AWG	14 AWG			
Jacket		White PVC with Silver Stripes or Gray PVC with Red Stripes				Dark Gray PVC with Blue Stripes	
Meters	Feet	Retail	Retail	Retail	Retail	Retail	Retail
30m	100'	1.30/ft	2.05/ft	1.55/ft	2.80/ft	-	-
50m	164'	-	-	-	-	6.00/ft	12.00/ft
76m	250'	1.30/ft	2.05/ft	1.55/ft	2.80/ft	-	-
100m	328'	-	-	-	-	6.00/ft	12.00/ft
152m	500'	1.30/ft	2.05/ft	1.55/ft	2.80/ft	-	-



Model		Rocket 11	Rocket 22	Rocket 33	Rocket 44	Rocket 88
Metal		Semi-Solid True-Concentric Long-Grain Copper (LGC)	Semi-Solid True-Concentric PSC and LGC	Solid PSC and LGC	Solid PSC+ and PSC	Solid Perfect-Surface Copper+ (PSC+)
Gauge		13 AWG	12 AWG	14 AWG	13 AWG	
Geometry		Double-Spiral		Double Star-Quad		
Dielectric		PVC		Foamed-Polyethylene (For All Positive Conductors)		
Noise-Dissipation		No		Carbon-Based Noise-Dissipation		
Jacket		Black or White PVC	Black or White PVC	Black PVC with Red Stripes	Black PVC with Gloss Black Matte Stripes	Black PVC with Green Stripes
Single BiWire Capable		Yes				
Meters	Feet	Retail	Retail	Retail	Retail	Retail
50m	164'	4.00/ft	10.00/ft	12.50/ft	25.00/ft	35.00/ft
100m	328'	4.00/ft	10.00/ft	12.50/ft	-	-

Note: For bulk cables, retail price is listed per foot.

Not-Rated Bulk Speaker Cables

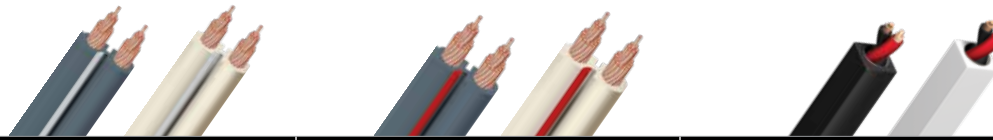

Model		G2	X2	Q2
Metal		Semi-Solid Concentric Long-Grain Copper (LGC)		
Gauge		16 AWG	14 AWG	15 AWG
Jacket		Dark Gray PVC or Off-White PVC	Dark Gray PVC or Off-White PVC	Black PVC or White PVC
Meters	Feet	Retail	Retail	Retail
9.1m	30'	54.95	79.95	-
15.2m	50'	89.95	129.95	-
30m	100'	169.95	249.95	-
100m	328'	574.00	820.00	1,148.00

Note: G2, X2, and Q2 bulk lengths are sold in a retail box.



Model		Rocket 33	Rocket 44	Rocket 88
Metal		Solid Perfect-Surface Copper (PSC) and Long-Grain Copper (LGC)	Solid Perfect-Surface Copper+ (PSC+) and Perfect-Surface Copper (PSC)	Solid Perfect-Surface Copper+ (PSC+)
Gauge		14 AWG	13 AWG	
Geometry		Double Star-Quad		
Dielectric		Foamed-Polyethylene (For All Positive Conductors)		
Noise-Dissipation		Carbon-Based Noise-Dissipation		
Jacket		Red/Black Braid	Silver/Black Braid	Green/Black Braid
Single BiWire Capable		Yes		
Meters	Feet	Retail	Retail	Retail
50m	164'	12.50/ft	25.00/ft	35.00/ft
100m	328'	12.50/ft	-	-

Note: For bulk cables, retail price is listed per foot.

SureGrip® Speaker Connectors

Fits up to 9 AWG Speaker Cables



SureGrip® 100 Banana
Direct-Silver or Gold over Beryllium-Copper

Set of 8
Retail: 49.95

Set of 12
Retail: 74.95

Bag of 80
Retail: 499.50

Bag of 120
Retail: 749.50

SureGrip® 100 Multi-Spade
Direct-Silver or Gold Plating over Purple Copper

Set of 8
Retail: 49.95

Set of 12
Retail: 74.95

Bag of 80
Retail: 499.50

Bag of 120
Retail: 749.50

Allen Tool Included



SureGrip® 300 Banana
Direct-Silver or Gold over Beryllium-Copper

Set of 4
Retail: 49.95

Tray of 40
Retail: 450.00

SureGrip® 300 Multi-Spade
Direct-Silver or Gold Plating over Purple Copper

Set of 4
Retail: 49.95

Tray of 40
Retail: 450.00

Allen Tool Included



Black Labels Included



500 Series Banana or Multi-Spade
Hanging-Silver directly over pure Purple Copper or Hanging-Gold directly over pure Purple Copper. Silver or Gold.

507 - Sized for 7 AWG (same as original 500 connector)
509 - Sized for 9 AWG

Set of 4
Retail: 119.95

Set of 6
Retail: 179.95

Combination Allen and Phillips Tool Included



1000 Series Banana or Multi-Spade
Hanging-Silver directly over pure Red Copper.

1003 - Sized for 3 AWG
1005 - Sized for 5 AWG
1007 - Sized for 7 AWG (same as original 1000 connector)
1009 - Sized for 9 AWG









Set of 4
Retail: 199.95

Set of 6
Retail: 299.95

Combination Allen and Phillips Tool Included

Spade, Pin, and Banana Connectors

Supplied with Red and Black "Boots" (except 1002)

 <p>1410/S 1410/G Direct-Silver Plated and Direct-Gold Plated Up to 14 AWG 3/16" Binding Post</p> <p>Set of 4 Retail: 12.50</p>	 <p>1010/S 1010/G Direct-Silver Plated and Direct-Gold Plated Up to 10 AWG 3/16" Binding Post</p> <p>Set of 4 Retail: 12.50</p>	 <p>1414/S 1414/G Direct-Silver Plated and Direct-Gold Plated Up to 14 AWG 1/4" Binding Post</p> <p>Set of 4 Retail: 12.50</p>
 <p>1014/S 1014/G Direct-Silver Plated and Direct-Gold Plated Up to 14 AWG 1/4" Binding Post</p> <p>Set of 4 Retail: 12.50</p>	 <p>1056/S 1056/G Direct-Silver Plated and Direct-Gold Plated Up to 10 AWG 5/16" Binding Post</p> <p>Set of 4 Retail: 12.50</p>	 <p>P10M/S P10M/G Hanging-Silver and Hanging Gold Up to 10 AWG 1/4" and 5/16" Binding Post</p> <p>Set of 4 Retail: 15.00</p>
 <p>BP10/S BP10/G Direct-Silver Plated and Direct-Gold Plated Up to 10 AWG Bendable Pin Fits Almost Everything</p> <p>Set of 4 Retail: 12.50</p>	 <p>Crimp-BFA/S Crimp-BFA/G Direct-Silver Plated and Direct-Gold Plated Up to 9 AWG Standard Banana Jack</p> <p>Set of 4 Retail: 20.00</p>	 <p>1002/S 1002/G Direct-Silver Plated and Direct-Gold Plated Up to 9 AWG Standard Banana Jack</p> <p>Set of 4 Retail: 30.00</p>

Termination "Pants" for Speaker Cables



	Full-Range	Single BiWire
Model	Retail	Retail
Rocket 11 Pants set/4	12.95	12.95
Rocket 22 Pants set/4	12.95	12.95
Rocket 33 Pants set/4	12.95	12.95
Rocket 44 Pants set/4	12.95	12.95
Rocket 88 Pants set/4	12.95	12.95

CL3/FT4 In-Wall Rated Analog-Audio Bulk Cables



Model		Chicago	Red River	Mackenzie
Metal		Solid Long-Grain Copper (LGC)	Solid Perfect-Surface Copper (PSC)	Solid Perfect-Surface Copper+ (PSC+)
Geometry		Double-Balanced	Triple-Balanced (Separate Ground-Reference Conductor)	
Dielectric		Hard-Cell Foam		
Noise-Dissipation		Metal-Layer Noise-Dissipation		Carbon-Based Multi-Layer Noise-Dissipation
Jacket		Green/Black Braid or Black PVC with Green Stripes	Red/Black Braid or Black PVC with Red Stripes	Brown/Black Braid or Black PVC with Brown Stripes
Meters	Feet	Retail		Retail
50m	164'	-		25.00/m
100m	328'	5.00/m	10.00/m	-

Note: For bulk cables, retail price is listed per meter.

Field Termination Connectors

To download Chicago, Red River, and Mackenzie cable termination manuals, go to <https://www.audioquest.com/custom-install/manuals>



Rivers Interconnect Crimper Tool

Use with either AudioQuest Chicago RCA, Red River and Mackenzie RCA or XLR plugs.

Retail: N/A



Chicago RCA

Cold-Welded, Gold-Plated

Set of 4
Retail: 69.95



Red River RCA

Cold-Welded, Gold-Plated

Set of 4
Retail: 69.95



Red River XLR

Cold-Welded, Gold-Plated

Set of 4
Retail: 129.95



Mackenzie RCA

Cold-Welded, Hanging-Silver directly over pure Purple Copper

Set of 4
Retail: 99.95



Mackenzie XLR

Cold-Welded, Hanging-Silver directly over pure Purple Copper

Set of 4
Retail: 149.95

CAT6 and CAT7 Ethernet Bulk Cables

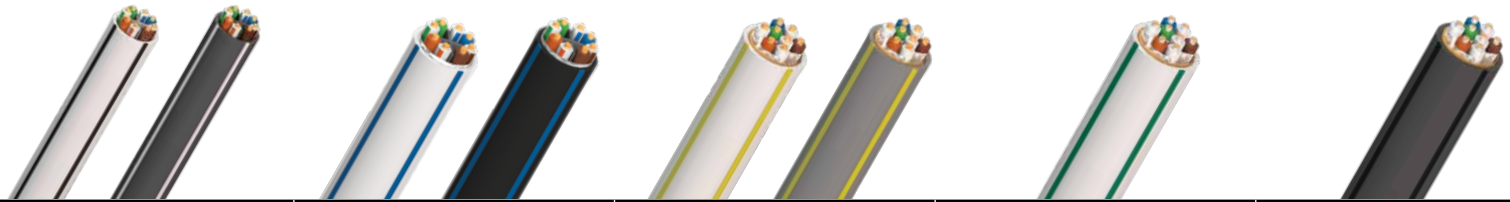

		CAT 600 DCP	CAT 600 FMJ	CAT 700 Pearl	CAT 700 Forest	CAT 700 Carbon
Metal		Solid Long-Grain Copper (LGC)			Solid 0.5% Silver	
Shield		N/A	Overall Shield	Overall Shield and Individual Pairs		
Gauge		23 AWG				
Dielectric		Solid High-Density Polyethylene			Hard-Cell Foam	
Jacket		CMG (CL3/FT4) Rated White PVC with Black Stripes or Dark Gray PVC with White Stripes	CMG (CL3/FT4) Rated White or Black PVC with Blue Stripes	CMG (CL3/FT4) Rated White or Medium Gray PVC with Yellow PVC	CMG (CL3/FT4) Rated White PVC with Green Stripes	CMG (CL3/FT4) Rated Dark Gray PVC with Black Stripes
Meters	Feet	Retail	Retail	Retail	Retail	Retail
152m	500'	-	1.25/ft	2.25/ft	3.95/ft	16.00/ft
304m	1000'	0.95/ft	-	-	-	-

Note: For bulk cables, retail price is listed per foot.

CAT6/7 Connectors

To download CAT600 and CAT700 cable termination manuals, go to <https://www.audioquest.com/custom-install/manuals>



Load Bar Connector Boot

CAT600 DCP Connectors

Fits all standard Cat6 cables

Each
Retail: 1.60



Load Bar Connector Boot

CAT600 FMJ Connectors

Fits all standard shielded Cat6 cables

Each
Retail: 3.15



Load Bar Connector Boot

CAT700 Connectors

Fits all standard Cat6a/Cat7 cables

Each
Retail: 3.25



CAT700 Telegärtner Male Connector

Fits all standard Cat6a/Cat7 cables



Each
Retail: 25.00

Installer Packs

Cables and Accessories in Installer-Friendly bags instead of hanging boxes.

Installer Packs provide exactly what you need to get the job done. Each Pack includes a number of high-value, high-performance AudioQuest pieces and comes with convenient integrated labels that you can peel off and place on your invoice. No retail packaging, no garbage in your truck, no excess waste or cost.

AC Power Cables
Packs of 5

Meters	Feet	NRG-X2 Retail Each	NRG-X3 Retail Each
0.3m	1'	54.95	65.95
0.6m	2'	58.95	71.95
0.9m	3'	63.95	77.95

AC Power Cables
Single Packs



Meters	Feet	NRG-Y2 Retail	NRG-Y3 Retail	NRG-Z2 Retail	NRG-Z3 Retail
0.3m	1'	87.95	108.95	154.95	163.95
0.6m	2'	94.95	117.95	169.95	187.95
1m	3' 3"	104.95	129.95	189.95	199.95

AC Power C7 90° Adaptors
Packs of 10



E = Equal radius Retail Each	U = Unequal radius Retail Each
17.95	17.95

Analog-Audio Interconnect Cables
Packs of 5

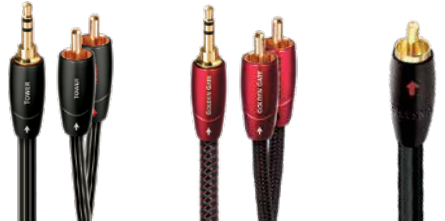

Meters	Feet	Tower Retail Each	Golden Gate Retail Each	Alpha-Snake Retail Each
0.6m	1' 11"	27.95	74.95	18.95
1m	3' 3"	29.95	79.95	21.95
2m	6' 6"	35.95	94.95	27.95
3m	9' 10"	41.95	109.95	32.95

Analog-Audio FLX-X RCA Splitters
Packs of 5



M22F Retail Each	F22M Retail Each
16.95	16.95

Optical Cables
Packs of 5



Meters	Feet	Pearl Retail Each	Forest Retail Each	Cinnamon Retail Each
0.75m	2' 5"	29.95	49.95	79.95
1.5m	4' 11"	35.95	59.95	99.95
3m	9' 10"	49.95	89.95	139.95

Available in Full-to-Full configurations only.

HDMI Cables

Packs of 5



		BlueBerry	Pearl 48	Forest 48
Meters	Feet	Retail Each	Retail Each	Retail Each
0.5m	1' 7"	27.95	36.95	63.95
0.75m	2' 6"	29.95	39.95	69.95
1.5m	5' 0"	35.95	49.95	89.95
2.25m	7' 6"	42.95	59.95	109.95
3m	10' 0"	49.95	69.95	129.95
5m	16' 5"	99.95	169.95	259.95

BlueBerry meets the 18G bandwidth required for video up to 8K/30;
 Pearl 48 and Forest 48 extend this capability up to 8K/60 and 4K/120.

HDMI Adaptors

Packs of 5

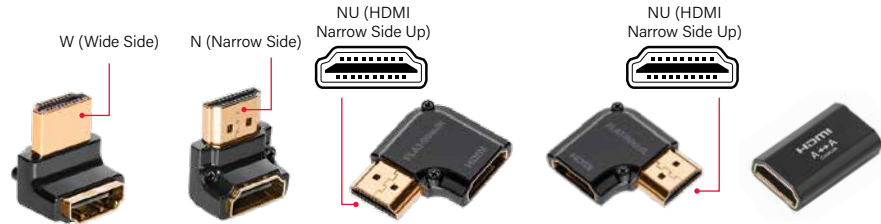

HDMI 90°/W	HDMI 90°/N	HDMI 90° NU/R	HDMI 90° NU/L	HDMI Coupler
Retail Each	Retail Each	Retail Each	Retail Each	Retail Each
19.95	19.95	19.95	19.95	19.95

Ethernet Cables (RJ/E)

Packs of 5



		Pearl	Forest	Cinnamon
Meters	Feet	Retail Each	Retail Each	Retail Each
0.2m	0' 8"	N/A	N/A	N/A
0.5m	1' 7"	N/A	N/A	N/A
0.75m	2' 5"	39.95	59.95	99.95
1.5m	4' 11"	49.95	79.95	119.95
3m	9' 10"	69.95	109.95	159.95
5m	16' 4"	99.95	149.95	209.95

Digital Coax Cables

Packs of 5



		Forest
Meters	Feet	Retail Each
0.75m	2' 5"	34.95
1.5m	4' 11"	39.95
3m	9' 10"	49.95
5m	16' 4"	69.95

AudioQuest Branded Point of Purchase (POP) Materials



Slat Wall Sign

Retail: N/A



Acrylic Wall Sign - Red

Retail: N/A



Acrylic Wall Sign - Black

Retail: N/A



Tent Card

Retail: N/A



Window Sticker

Retail: N/A



Individual Spool Holder

Rugged metal Spool holder will hold almost all AQ Spools. Supplied with slat wall brackets.

Retail: N/A



In-Store Display Rack

Spool holder sold separately.
Dimensions: 76"(h) x 35"(w) x 13"(d)

Retail: N/A



Standalone Display Rack

Retail: N/A

AudioQuest Branded Promotional Items



Polo Shirt

Our versatile polo shirt looks great with anything. Classic black with a discreet silver AudioQuest logo, it features moisture-wicking technology and dries quickly. Look cool, stay cool. Men's sizes: S-2XL; Women's sizes: S-XL.

Retail: 60.00



T-Shirt

Our classic crewneck t-shirt is made from 100% lightweight, preshrunk cotton for a perfect fit that's as attractive as it is comfortable. Our t-shirt features a tasteful red AudioQuest logo against a solid black background. Made by Port and Company. Sizes: S-3XL

Retail: 20.00



Hooded Jacket

Our ultra-comfortable jacket features a three-panel hood with drawcords and toggles for a warm, snug fit. The zippered front, open hand pockets, and zippered sleeve pocket add convenience and style. The colorblocked gray-and-black design highlights a subtle AudioQuest logo in silver. Sizes: S-3XL

Retail: 75.00



Chino Washed Cotton Baseball Cap

Our baseball cap has a durable 8-stitch bill for a long-lasting, contoured shape. The Velcro fastener provides easy adjustments for a perfect fit. Available in black with red AudioQuest logo and trim, this cap looks and feels great. One size fits all.

Retail: 19.95



Beanie

Red, gray, and black, with our classic red AudioQuest logo, our stylish beanie is made from super-stretch, fine-gauge acrylic, for a warm, snug fit over your head and ears. The perfect accessory for those cooler days. One size fits all.

Retail: 19.95



Pen

Take note: With its discreet AQ logo, piano-black lacquered tube, and chrome accents, this ballpoint pen has the looks to match the quality of your prose. Keep it in your AudioQuest backpack and take it with you wherever you go.

Retail: 24.95



Tumbler

With its double-wall vacuum construction and copper insulation, this 14oz tumbler keeps drinks hot for 8 hours or cold for a full 24. The external design provides a comfortable gripping surface and prevents condensation from forming on the outside of the tumbler. Perfect for use while on the go, the push-on lid with thumb slider affords mess-free sipping.

Retail: 25.00



Water Bottle

Made by Specialized, this 26-ounce leak-proof water bottle has a self-sealing valve and features easy-to-squeeze BPA-free, recyclable plastic. Our distinct Wolves artwork is printed with a non-solvent based, CPSC-approved ink. Just aim and squeeze for clean, pure refreshment.

Retail: 12.95

AudioQuest Branded Promotional Items



License Plate

It's all about the journey. Take your love for AudioQuest on the road with this license-plate frame. The clean, simple design features our red AudioQuest logo and "Experience the Difference" mantra set against a black background—perfect for any ride. Vroom!

Retail: 6.00



Backpack

Available in black with our black AudioQuest and Four Elements logos. Accommodates laptops with 13" screens and tablets. Made of nylon.

Retail: 19.95



Padded Backpack

Do no harm with our padded backpack. It features a discreet front-panel zipper, multiple internal pockets, and mesh side pockets for drinks and other items. A padded laptop insert safely accommodates screens up to 15". Mesh backing and straps are durable and comfortable, making the backpack as easy to carry as it is to wear.

Retail: 29.95



Tote Bag

This super-durable tote bag is made of water-repellent polyester and has a long strap that fits easily over a shoulder. Measuring 38cm x 36.5cm (15in x 14.4in), its slim pocket is perfect for carrying AudioQuest merchandise—pens, tumblers, price books—and even an LP or two! The simple black-on-black design features a subtly stylish AQ logo.

Retail: 20.00

Index

A

AC Power Cables

Blizzard	10
Blizzard XTRM	10
Dragon (High-Current)	11
Dragon (Source)	11
FireBird (High-Current)	11
FireBird (Source)	11
Hurricane (High-Current)	11
Hurricane (Source)	11
Mistral AC Power Bulk Cable	10
Mistral IEC C-13 Plug	10
Mistral IEC C-19 Plug	10
Mistral Wall Plug	10
Monsoon	10
Monsoon XTRM	10
NRG-X2	9
See also Installer Packs, pg. 54	
NRG-X3	9
See also Installer Packs, pg. 54	
NRG-Y2	9
See also Installer Packs, pg. 54	
NRG-Y3	9
See also Installer Packs, pg. 54	
NRG-Z2	9
See also Installer Packs, pg. 54	
NRG-Z3	9
See also Installer Packs, pg. 54	
Silver Cloud	10
Silver Cloud XTRM	10
Thunder (High-Current)	11
Tornado (High-Current)	11
Tornado (Source)	11

AC Power Conditioners

Niagara 1200	7
Niagara 3000	7
Niagara 5000	7
Niagara 7000	7
PowerQuest 2	7
PowerQuest 3	7

Acrylic Wall Sign - Black, Red

Adaptors

C7 90° Adaptor Kit	12
See also Installer Packs, pg. 54	
DragonTail A to C Adaptor	5
DragonTail USB A 2.0 Extender	5
DragonTail USB A to Micro Adaptor	5
DVI-IN to HDMI-OUT Adaptor	34

F-90° Adaptor	43
FLX-Mini/RCA Adaptor	27
F to BNC Male Adaptor	43
F to RCA Male Adaptor	43
Hard Mini/RCA Adaptor	27
HDMI 90° /W Adaptor	34
See also Installer Packs, pg. 55	
HDMI 90°/N Adaptor	34
See also Installer Packs, pg. 55	
HDMI 90° NU/L Flat Adaptor	34
See also Installer Packs, pg. 55	
HDMI 90° NU/R Flat Adaptor	34
See also Installer Packs, pg. 55	
HDMI A - A Coupler	34
HDMI A - C Adaptor	34
HDMI A - D Adaptor	34
HDMI A to C/D Adaptor	34
HDMI-IN to DVI-OUT Adaptor	34
IEC>3US Power Strip	12
IEC90/1	12
IEC90/2	12
M21F-90 Adaptor	27
Mini Display Port to HDMI 4K Adaptor	34
Optical Mini Adaptor	38
RCA - BNC Adaptor	43
RCA to BNC	39
USB A to C Adaptor	37
USB B - Micro B 2.0 Adaptor	37
USB Mini B - Micro B 2.0 Adaptor	37

AES/EBU Cables

Carbon	40
Diamond	40
WEL Signature	40
Wild	40

Analog-Audio Interconnect Cables

Alpha-Snake	
See Installer Packs, pg. 54	
Angel	25
Big Sur	25
Chicago	26
See also Bulk Cables, pg. 52	
Earth	26
Evergreen	25
Fire	26
Golden Gate	25
See also Installer Packs, pg. 54	
Mackenzie	26
See also Bulk Cables, pg. 52	
Red River	26
See also Bulk Cables, pg. 52	

Sydney	25
Tower	25
See also Installer Packs, pg. 54	
Victoria	25
Water	26
Wind	26
Yosemite	25
Yukon	26

B

Backpack	58
Backpack, Padded	58
Baseball Cap	57
Beanie	57
BiWire Jumpers	
BiWire Jumpers-G	23
BiWire Jumpers-S	23
Jupiter (PSS)	23
Saturn (PSC+)	23

Bulk Cables

CAT600 DCP	53
CAT600 FMJ	53
CAT700 Carbon	53
CAT700 Forest	53
CAT700 Pearl	53
Chicago	52
G2	49
HD6 Carbon	47
HD6 Forest	47
HD6 Pearl	47
ITA-1/1	47
ITA-3/3	47
ITA-5/5	47
ITV-G	47
Mackenzie	52
Q2	49
Red River	52
Rocket 11	48
Rocket 22	48
Rocket 33	48, 49
Rocket 44	48, 49
Rocket 88	48, 49
SLiP-DB 14/2	48
SLiP-DB 14/4	48
SLiP-DB 16/2	48
SLiP-DB 16/4	48
SLiP XTRM 14/2	48
SLiP XTRM 14/4	48
X2	49

C

CleanScreen Kit	42
CleanScreen Pack	42
Connectors	

507 Series Banana	50
507 Series Multi-Spade	50
1000 Series Banana	50
1000 Series Multi-Spade	50
Banana Connectors	51
CAT600 DCP Connectors	53
CAT600 FMJ Connectors	53
CAT700 Connectors	53
CAT700 Telegärtner Male Connector	53
Chicago RCA	52
Color Bands for 18 and 24 AWG ITC Connectors	47
F-90°	44
ITC-18G/BNC	47
ITC-18G/F	47
ITC-18G/RCA	47
ITC-24G/BNC	47
ITC-24G/F	47
ITC-24G/RCA	47
Mackenzie RCA	52
Mackenzie XLR	52
Pin Connectors	51
RCA-90°	44
RCA-300	44
RCA-800	44
Red River RCA	52
Red River XLR	52
Spade Connectors	51
SureGrip 100 Banana	50
SureGrip 100 Multi-Spade	50
SureGrip 300 Banana	50
SureGrip 300 Multi-Spade	50
XLR Connectors	44

Couplers

F - F Coupler	43
HDMI A - A Coupler	
See also Installer Packs, pg. 55	
RCA - RCA Coupler	27

D

Dielectric-Bias Pack - 72v DBS Black, Enhanced Performance	42
Dielectric-Bias Pack - 72v DBS Carbon, Maximum Performance	42

Index

Digital Coax Cables

Carbon	39
Cinnamon	39
Coffee	39
Diamond	39
Forest	39
See also Installer Packs, pg. 55	
WEL Signature	39
Wild	39

Display Rack, In-Store

Display Rack, Standalone

DragonFly Black

DragonFly Cobalt

DragonFly Red

E

Ethernet Cables (RJ/E)

Cinnamon	41
See also Installer Packs, pg. 55	
Diamond	41
Forest	41
See also Installer Packs, pg. 55	
Pearl	41
See also Installer Packs, pg. 55	
Vodka	41

F

Fog Lifters

G

GroundGoody Jupiter

GroundGoody Saturn

H

HDMI Cables

BlueBerry	34
See also Installer Packs, pg. 57	
Carbon 48	34, 35
Cherry Cola	34, 35
Cinnamon 48	34
Dragon 48	35
Dragon eARC	35
FireBird 48	35
Forest 48	34
See also Installer Packs, pg. 57	
Pearl 48	34
See also Installer Packs, pg. 57	

ThunderBird 48	35
ThunderBird eARC	35
Vodka 48	34, 35
Vodka eARC	34, 35

Headphone Plug Adaptor

HL-5 Headshell Leads

Hooded Jacket

J

JitterBug

See also USB Accessories, pg. 37

L

License Plate

LYRA

Atlas SL λ Lambda	30
Atlas λ Lambda	30
Atlas λ Lambda Mono	30
Delos	30
Etna SL λ Lambda	30
Etna λ Lambda	30
Etna λ Lambda Mono	30
Kleos	30
Kleos Mono	30
Kleos SL	30
Stylus Performance Treatment	30

N

NightBird Model One

Noise-Stopper Caps

HDMI Noise-Stopper Caps	45
RCA Noise-Stopper Caps	45
RJ45 Noise-Stopper Caps	45
USB-A Noise-Stopper Caps	45
XLR Input (Female) Noise-Stopper Caps	45
XLR Output (Male) Noise-Stopper Caps	45

O

Optical Cables

Carbon	38
Cinnamon	38
Diamond	38
Forest	38
Pearl	38
Vodka	38

P

Pen

Perch Headphone Stand

Point of Purchase (POP) Materials

Polo Shirt

PreAmp Jumpers

Promotional Items, AQ Branded

R

Record Brush, Anti-Static

Record Brush, Super-Conductive

Anti-Static

RJ/E Ethernet Cables

S

Silver Solder

Slat Wall Sign

SorboGel Q-Feet System

Sorbothane Self-Stick Sheet

Speaker Cables

Dragon BASS	22
Dragon BiWire COMBO	22
Dragon ZERO	22
FireBird BASS	21
FireBird BiWire COMBO	21
FireBird ZERO	21
Q2	16
See also Bulk Cables, pg. 49	
Robin Hood BASS	18
Robin Hood BiWire COMBO	18
Robin Hood SILVER	18
Robin Hood SILVER BiWire COMBO	18
Robin Hood ZERO	18
Rocket 11	17
See also Bulk Cables, pg.48	
Rocket 22	17
See also Bulk Cables, pg.48	
Rocket 33	17
See also Bulk Cables, pg.48	
Rocket 44	17
See also Bulk Cables, pg.48	
Rocket 88	17
See also Bulk Cables, pg.48	
ThunderBird BASS	20
ThunderBird BiWire COMBO	20
ThunderBird ZERO	20
Type 5	16
Type 9	16
Type 9+DBS	16
William Tell BASS	19

William Tell BiWire COMBO

William Tell SILVER

William Tell SILVER BiWire COMBO

William Tell ZERO

Splitters

FLX-Mini Splitter

FLX-X RCA Splitter

See also Installer Packs, pg. 54

F to 2F Splitter

F to 4F Splitter

Hard RCA Splitter

Spool Holder

Subwoofer Cables

Black Lab

Boxer

Greyhound

Husky

Irish Red

Wolf

T

Tent Card

Termination "Pants" for Speaker

Cables

Tonearm Cables

Cougar

LeoPard

WEL Signature

WildCat

Tools

AQ Ratchet Crimper Tool

Binding-Post Wrench

Cat6/6a/7 Crimper Tool and Die

Cat6 Die

Ideal Articulated Stripper

ITC One-Step Stripper for 18 and

24 AWG

Klein Cable Cutter

Klein Crimper Tool

Paladin Jacket Stripper

Rivers Interconnect Crimper

Tool

Wire Stripper/Cutter/Plier

Combo Tool

Tote Bag

T-Shirt

Tumbler

Index

U

USB Cables

<i>Carbon</i>	36
<i>Cinnamon</i>	36
<i>Coffee</i>	36
<i>Diamond</i>	36
<i>Forest</i>	36
<i>Pearl</i>	36

W

Wall Outlets

<i>NRG Edison (15 Amp)</i>	12
<i>NRG Edison (20 Amp)</i>	12

Water Bottle	57
---------------------------	----

Window Sticker	56
-----------------------------	----

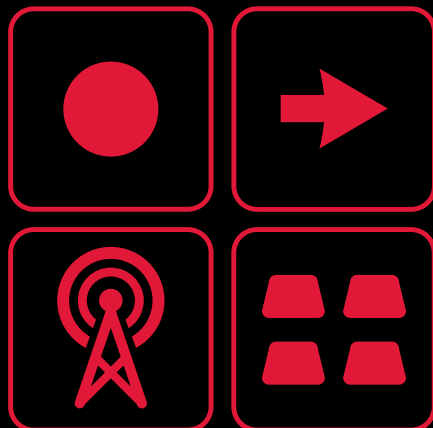

audioquest®

California, USA ▪ The Netherlands
Tel +1 949.790.6000 ▪ www.audioquest.com