



User Guide



HP ENVY Pro 6400 All-in-One series

HP company notices

THE INFORMATION CONTAINED HEREIN IS SUBJECT TO CHANGE WITHOUT NOTICE.

ALL RIGHTS RESERVED. REPRODUCTION, ADAPTATION, OR TRANSLATION OF THIS MATERIAL IS PROHIBITED WITHOUT PRIOR WRITTEN PERMISSION OF HP, EXCEPT AS ALLOWED UNDER THE COPYRIGHT LAWS. THE ONLY WARRANTIES FOR HP PRODUCTS AND SERVICES ARE SET FORTH IN THE EXPRESS WARRANTY STATEMENTS ACCOMPANYING SUCH PRODUCTS AND SERVICES. NOTHING HEREIN SHOULD BE CONSTRUED AS CONSTITUTING AN ADDITIONAL WARRANTY. HP SHALL NOT BE LIABLE FOR TECHNICAL OR EDITORIAL ERRORS OR OMISSIONS CONTAINED HEREIN.

© Copyright 2020 HP Development Company, L.P.

Microsoft and Windows are either registered trademarks or trademarks of Microsoft Corporation in the United States and/or other countries.

Mac, OS X, macOS, and AirPrint are trademarks of Apple Inc., registered in the U.S. and other countries.

ENERGY STAR and the ENERGY STAR mark are registered trademarks owned by the U.S. Environmental Protection Agency.

Android and Chromebook are trademarks of Google LLC.

Amazon and Kindle are trademarks of Amazon.com, Inc. or its affiliates.

iOS is a trademark or registered trademark of Cisco in the U.S. and other countries and is used under license.

Safety information



Always follow basic safety precautions when using this product to reduce risk of injury from fire or electric shock.

- Read and understand all instructions in the documentation that comes with the printer.
- Observe all warnings and instructions marked on the product.
- Unplug this product from wall outlets before cleaning.
- Do not install or use this product near water, or when you are wet.
- Install the product securely on a stable surface.
- Install the product in a protected location where no one can step on or trip over the line cord, and the line cord cannot be damaged.
- If the product does not operate normally, see [Solve a problem on page 81](#).
- There are no user-serviceable parts inside. Refer servicing to qualified service personnel.

Table of contents

1 Printer parts	1
Printer overview	2
Buttons	4
Print reports from control panel	7
Edge lighting and status lights	8
Quiet Mode	13
Auto-Off	14
Sleep mode	15
Adjust printer lights or volume	16
2 Load media and paper basics	17
Load media	18
Load original	21
Change the default paper size detected by the printer	23
Paper basics	24
3 Connect your printer	25
Connect using the HP Smart app	26
Connect to a wireless network with a router	27
Connect wirelessly without a router	30
Change the connection type	34
Wireless settings	35
Advanced printer management tools (for wireless printers)	36
Tips for setting up and using a wireless printer	37
4 Printer management tools	38
Use the HP Smart app to print, copy, scan, and troubleshoot	39
Open the HP printer software (Windows)	40
Toolbox (Windows)	41
Embedded web server	42
Update the printer	44

5 Print	45
Print using the HP Smart app	46
Print from mobile devices	47
Print with Print Anywhere	48
Print using a computer	49
Tips for print success	54
6 Manage cartridges	56
Information on cartridges and the printhead	57
Check the estimated ink levels	58
Order ink supplies	59
HP Instant Ink	60
Replace the cartridges	61
Use single cartridge mode	63
Cartridge warranty information	64
Tips for working with cartridges	65
7 Copy, Scan, and Mobile Fax	66
Copy and scan using HP Smart	67
Copy from the printer	69
Scan	70
Tips for copy and scan success	74
Mobile Fax	75
8 Web Services	76
What are Web Services?	77
Set up Web Services	78
Print with HP ePrint	48
Remove Web Services	80
9 Solve a problem	81
Get help from the HP Smart app	82
Get help in this guide	83
Understand printer reports	104
Solve problems using Web Services	106
Maintain the printer	107
Restore original factory defaults and settings	110
HP support	111

10 HP EcoSolutions (HP and the Environment)	113
Energy Save Mode	114
Appendix A Technical information	115
HP Company notices	116
Specifications	117
Regulatory notices	119
Environmental product stewardship program	125
Index	134

1 Printer parts

This section contains the following topics:

- [Printer overview](#)
- [Buttons](#)
- [Print reports from control panel](#)
- [Edge lighting and status lights](#)
- [Quiet Mode](#)
- [Auto-Off](#)
- [Sleep mode](#)
- [Adjust printer lights or volume](#)

Printer overview

- [Top and front view](#)
- [Back view](#)

Top and front view

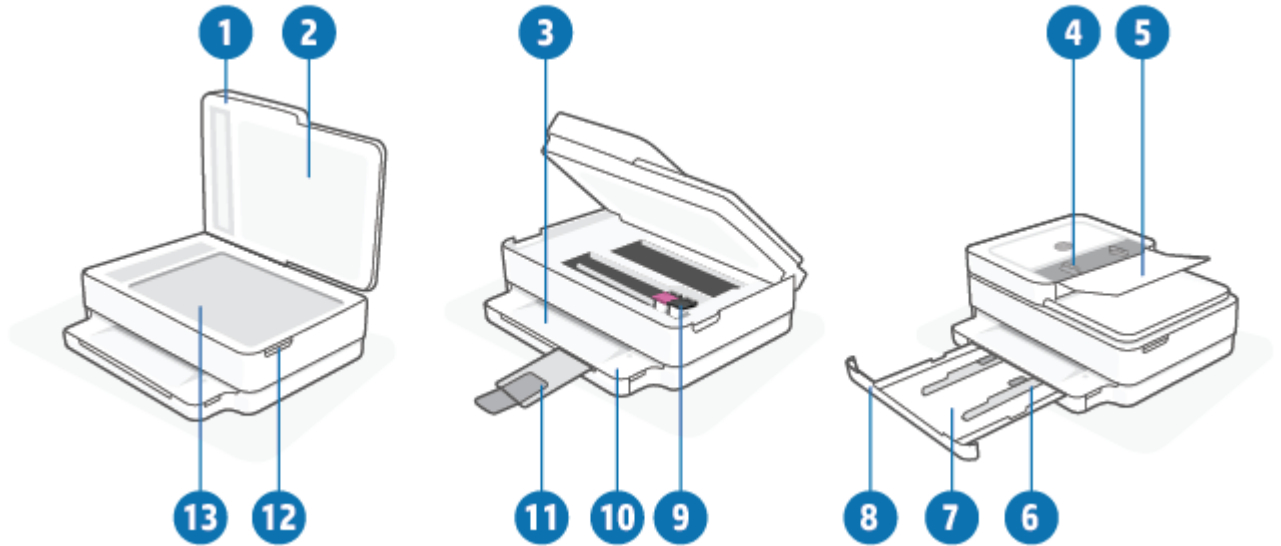

Feature	Description
1	Scanner lid
2	Lid-backing
3	Output tray
4	Document feeder paper-width guides
5	Document feeder input tray
6	Paper-width guides
7	Paper tray
8	Paper tray door
9	Ink cartridges
10	Control panel
11	Output tray extender (also referred to as the tray extender)
12	Cartridge access door
13	Scanner glass

Back view

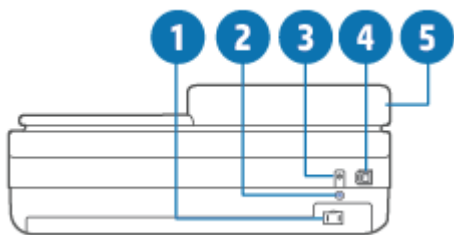







1	Power connection
2	Wi-Fi button
3	Power button
4	USB port
5	Document feeder input tray

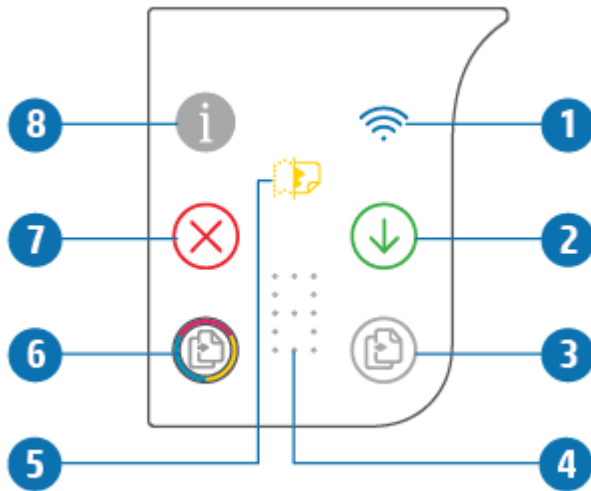

Buttons

- [Control panel buttons](#)
- [Buttons on the back of the printer](#)
- [Button combinations](#)





Control panel buttons











Feature	Description
1	 (Wireless light): Lights blue. Indicates the status of the printer wireless connection. Lights up solid when connected, blinks when not connected.
2	 (Resume button): When it lights up, press to resume a job after a disruption (for example, after loading paper or clearing a paper jam). For more information, see Printer warning or error status on page 100 .
3	 (Start Copy Black): Lights white. Starts a black-and-white copy job. To increase the number of copies, press the button multiple times.
4	 (Number counter indicator): Used to show copy count and error codes (lights white). For more information, see Printer warning or error status on page 100 .
5	 (Document feeder error indicator): Warning icon to indicate a document feeder error, like a paper jam or mis-pick.
6	 (Start Copy Color): Lights colored, slowly changing color. Starts a color copy job. To increase the number of copies, press the button multiple times.



Feature	Description
7	 (Cancel button): When it lights up, press to stop the current operation.
8	 (Information button): Prints out a printer information page on the current status. <ul style="list-style-type: none"> If it is blinking white, press to confirm a connection attempt from other devices. If it is amber (possibly blinking), it indicates an HP Instant Ink warning or error. Press the button to print an information page, check the HP Instant Ink section for diagnostic results, and then follow the instructions on the page. <p>NOTE: HP Instant Ink service might not be available in all countries. To check availability, visit hpinstantink.com.</p>

Buttons on the back of the printer

 (Power connection)	Use only the power cord supplied by HP.
 (Power button)	Press to turn the printer on or off.
 (USB port)	Use a USB cable to connect the printer to other devices.
 (Wi-Fi button)	<ul style="list-style-type: none"> Press to turn on or off the printer wireless capabilities of connecting to a wireless network with a router or an access point. Press and hold for at least three seconds to restore the network settings to default settings. This will also put the printer back into the Auto Wireless Connect (AWC) setup mode. The printer must be in the AWC setup mode to connect to the HP Smart app and your network. For more information, see Connect using the HP Smart app on page 26.

Button combinations









Function	Button combination	Instruction
Wi-Fi Auto Wireless Connect (AWC) network reset		Press and hold the Wi-Fi button for at least three seconds to restore the network settings to default settings. This will also put the printer back into the Auto Wireless Connect (AWC) setup mode.
Enter Wi-Fi Protected Setup (WPS) Push Button mode	 + 	Press and hold the Wi-Fi button and Power button on the back of the printer for three seconds.
Enter Wi-Fi Protected Setup (WPS) PIN mode and print a page with PIN code	 + 	Press and hold the Information button for at least three seconds to light all the buttons, then press the Information and Resume buttons at the same time for five seconds.
Turn Wi-Fi Direct on or off	 +  + 	Press and hold the Information button for at least three seconds to light all the buttons, then press the Information, Cancel and Resume buttons at the same time.

Function	Button combination	Instruction
Complete product reset		<p>A complete product reset will clear all your personal data, settings, and network information from the printer.</p> <p>With the cartridge access door open, press and hold the Power button for at least five seconds.</p>
Restore factory defaults		<p>Restoring the printer to factory defaults will remove all settings and functions previously set up on the printer.</p> <p>With the cartridge access door open, press and hold the Wi-Fi and Power buttons for at least three seconds.</p>

Print reports from control panel



NOTE: Before printing reports, press and hold  (the Information button) for at least three seconds to light up all the buttons on the control panel, and then follow the instructions in the table.

Printer report	How to print	Description
Printer Information Page	Press  . For this report, do not hold the Information button for three seconds first.	Printer Information Page provides the summary information about various aspects of the printer and their current status. The general status of Network, Wi-Fi Direct, Mobile Printing, and HP Instant Ink is mainly included in this report.
Printer Status Report	Press  and  at the same time.	Printer Status Report provides the current printer information, cartridge status, or recent events. It can also help troubleshoot printer problems.
Wireless Network Test Report and Network Configuration Page	Press  and  at the same time.	Wireless Network Test Report shows the diagnostics results for the status of the wireless network, wireless signal strength, detected networks, and more. Network Configuration Page shows the network status, hostname, network name, and more.
Wireless Quick Start Guide	Press  .	Wireless Quick Start Guide provides the step-by-step instructions to help you set up the wireless connection.
Wi-Fi Direct Guide	Press  and  at the same time.	Wi-Fi Direct Guide provides the instructions to help you set up and use Wi-Fi Direct.
Web Services Reports	Press  .	Depending on Web Services status, Web Services Reports provide different instructions to help you turn on Web Services, set up Web Services, or fix connection issues, and more.
Print Quality Report		To print the Print Quality Diagnostic Report: <ul style="list-style-type: none"> • Embedded web server (EWS): Click the Tools tab, click Print Quality Toolbox under Utilities, and then click the Print Quality Report button. • HP Smart app (Win10): In the Printer settings, click Printer Reports, click Print Quality Diagnostics, and then click Print.

Edge lighting and status lights

- [Status lights overview](#)
- [Edge lighting](#)

Status lights overview

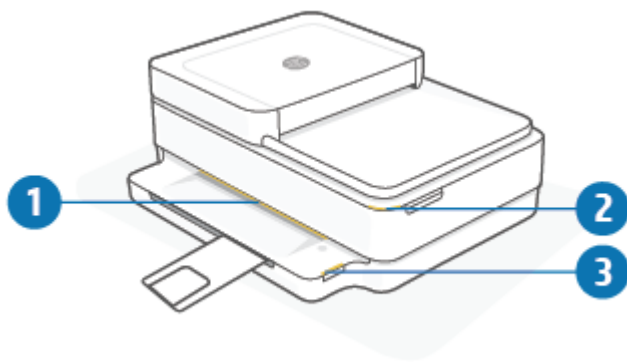

Feature	Description
1	Edge lighting: Can glow blue, white, green, amber, or purple to show various printer statuses. For more information, see the following section.
2	Cartridge access door light: The cartridge access door light is a curved strip of lighting in the top right corner. When lit, it indicates an ink error. Ink cartridge lights: The black and color ink cartridges have a light for each that blinks to indicate an error. Open the door to investigate the issue. For more information, see Printer warning or error status on page 100 .
3	Paper tray light: The paper tray light blinks to the right of the control panel, on the side, above the edge of the paper tray. When lit, it indicates media errors or warnings such as media size mismatch, paper width mismatch, or paper length mismatch. For more information, see Printer warning or error status on page 100 .

Edge lighting

The printer Edge lighting consists of a large light bar across the front of the printer. These lights communicate printer states with color and movement.

Table 1-1 Edge lighting - purple

Light behavior	Description
The light bar glows purple from the middle outward, repeating.	The printer is in Wi-Fi setup mode, waiting for the HP Smart app or HP printer software to connect. This lighting pattern means your printer is beaconing and ready to be found for setup. Complete setup using the HP Smart app or HP printer software. The printer will stay in Wi-Fi setup mode for two hours. To reset Wi-Fi setup mode, press the Wi-Fi button on the back of the printer.

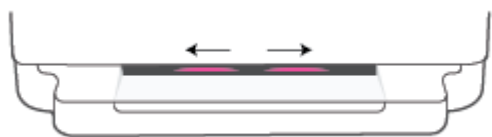

Table 1-1 Edge lighting - purple (continued)



Light behavior	Description
The light bar glows purple in the center.	Printer is connecting to the HP Smart app and this state persists until network credentials are passed to the printer. After three minutes with no activity, the printer will return to the waiting state.
	
The outside edges of the light bar pulse purple, repeating.	The printer is connected to a wireless network and WPS Push Button mode is in progress.
	
Amber flashes in the center with two persistent purple light bars at the outside edges.	An error occurred during WPS Push Button mode.
	

Table 1-2 Edge lighting - amber

Light behavior	Description
Amber glows across the large light bar.	There is a warning or printer blocking error. For more information on amber Edge lighting, causes, and solutions, see Printer warning or error status on page 100 . When the printer exits the error state, the amber light will transition to green in the center.
	
The light bar glows amber towards the edges, and then transitions to green.	The printer is restored to factory defaults and will automatically restart after it is done.
	

Table 1-2 Edge lighting - amber (continued)

Light behavior	Description
<p>The light bar fast blinks amber.</p> 	<p>There is a serious printer error. All LEDs on the printer fast blink. Turn the printer off and then on again to resolve the issue.</p>
<p>Three quick amber flashes in the center of the light bar.</p> 	<p>Currently disabled button is pressed.</p>

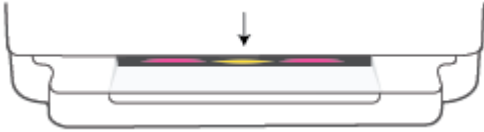
Table 1-3 Edge lighting - blue



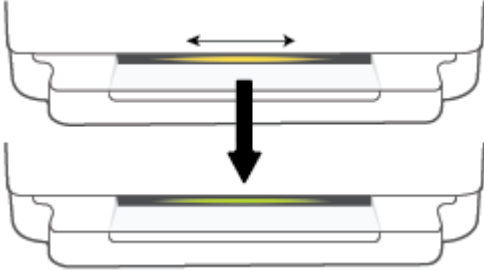



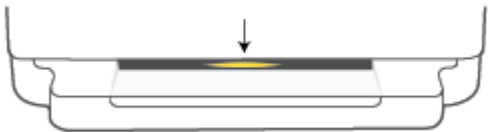

Light behavior	Description
<p>The light bar pulses blue towards the center, ends with one small light bar glowing blue.</p> 	<p>Wi-Fi Direct is on by default for your printer. It can also be turned on again by pressing buttons from the control panel.</p> <p>TIP: To turn on Wi-Fi Direct from the printer control panel, press and hold  until all the buttons light up, and then press , , and  at the same time.</p>
<p>The light bar pulses blue towards the center, ends with a small light bar glowing amber in the center.</p> 	<p>Wi-Fi Direct is turned off by pressing buttons from the control panel.</p> <p>TIP: To turn off Wi-Fi Direct from the printer control panel, press and hold  until all the buttons light up, and then press , , and  at the same time.</p>
<p>The light bar glows blue and moves towards the edges, pulses amber in the center.</p> 	<p>The printer has either lost Wi-Fi connection, or there is a connection error during setup.</p>

Table 1-3 Edge lighting - blue (continued)

Light behavior	Description
<p>The light bar blinks blue and amber quickly three times in the center.</p>	<p>The number of Wi-Fi Direct connections has reached the maximum of five devices. To use Wi-Fi Direct from other devices, you must disconnect currently connected devices.</p>
	
<p>The light bar pulses blue from the center, ends with light bar glowing green, repeating.</p>	<p>The printer is identifying itself, when triggered by an iOS device through Printer Settings.</p>
	

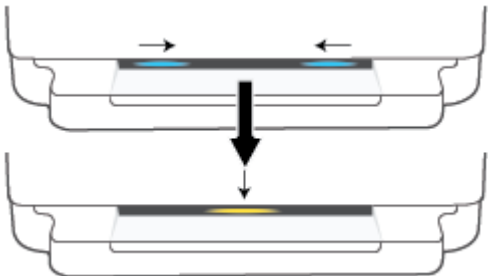
Table 1-4 Edge lighting - white

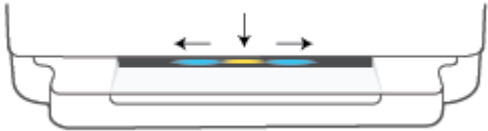

Light behavior	Description
<p>The light bar glows blue-white in the center.</p>	<p>The printer is idle and connected to a wireless network. The computer or HP Smart app is directly connected to the printer using Wi-Fi Direct.</p>
	
<p>The light bar glows white in the center.</p>	<p>The printer is idle and not connected to a wireless network.</p>
	<p>For how to connect the printer to your wireless network, see Connect using the HP Smart app on page 26.</p> <p>For how to connect your device to the printer directly using Wi-Fi Direct, see Connect wirelessly without a router on page 30.</p>

Table 1-4 Edge lighting - white (continued)

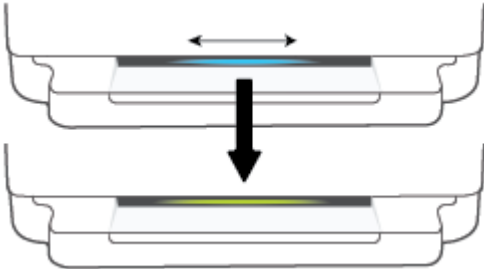
Light behavior	Description
<p>The light bar pulses white and moves outwards. Bar stays lit during printing.</p> 	<p>The printer is processing and printing a print job.</p>
<p>The light bar pulses white in the center, repeating.</p> 	<p>The printer is processing a scan job.</p>

Table 1-5 Edge lighting - green

Light behavior	Description
<p>Green glows across the light bar, then transitions into other relevant lighting pattern (setup, idle, so on). Green glow appears and fades out when powering off.</p> 	<p>The printer is powering on or off. Do not unplug the power cord until the printer is turned on or off.</p>
<p>Green pulses in the center of the light bar.</p> 	<p>The printer is updating firmware or is in update mode. One of the following might occur:</p> <ul style="list-style-type: none">• The printer is downloading an update.• An update is in progress.• There is an update error. The printer will restart and try to update later. <p>NOTE: The printer must be on during the process of updating. Do not unplug the power cord before the update is complete.</p>

Quiet Mode

Quiet Mode slows down printing to reduce overall noise without affecting print quality. Quiet Mode only works for printing with **Better** print quality on plain paper. To reduce printing noise, turn on Quiet Mode. To print at normal speed, turn Quiet Mode off. Quiet Mode is off by default.

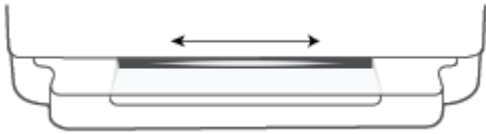
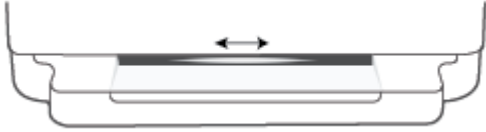
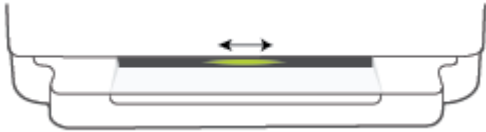
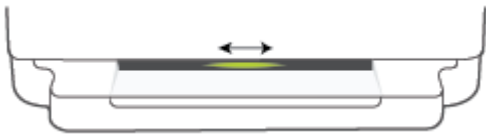

NOTE: In Quiet Mode, if you print on plain paper with the **Draft** or **Best** print quality, or if you print photos or envelopes, the printer works in the same way as when Quiet Mode is off.

To turn Quiet Mode on or off from an Android or iOS device

1. Open HP Smart. For more information, see [Use the HP Smart app to print, copy, scan, and troubleshoot on page 39](#).
2. Tap the printer image on the **Home** screen.
3. Tap **Quiet Mode**, and then change the setting.

To turn Quiet Mode on or off from the embedded web server (EWS)

1. Open the EWS. For more information, see [Open the embedded web server on page 36](#).
2. Click the **Settings** tab.
3. In the **Preferences** section, select **Quiet Mode**, and then select **On** or **Off**.
4. Click **Apply**.

Auto-Off

This feature turns the printer off after 2 hours of inactivity to help reduce energy use. **Auto-Off turns the printer off completely, so you must use the Power button to turn the printer back on.** If your printer supports this energy-saving feature, Auto-Off is automatically enabled or disabled depending on printer capabilities and connection options. Even when Auto-Off is disabled, the printer enters [Energy Save Mode on page 114](#) after 5 minutes of inactivity to help reduce energy use.

- Auto-Off is always enabled if the printer does not have network or fax capability.
- Auto-Off is disabled when a printer's wireless or Wi-Fi Direct capability is turned on or when a printer with fax, USB, or Ethernet network capability establishes a fax, USB, or Ethernet network connection.

Sleep mode

Power usage is reduced while in Sleep mode. After initial setup of printer, the printer will enter Sleep mode after five minutes of inactivity. Use the HP Smart app to change the period of inactivity before the printer sleeps by selecting **Advanced Settings**. You can also change this setting using the printer's embedded web server by completing the following steps.

To change the time to Sleep mode

1. Open the embedded web server (EWS). For more information, see [Open the embedded web server on page 36](#).
2. Click the **Settings** tab.
3. In the **Power Management** section, click **Energy Save Mode**, and select the desired option.



NOTE: If prompted for a password, enter the PIN from the label on your printer. It might be near the cartridge access area inside the printer or on the back, side, or bottom of the printer.

4. Click **Apply**.

Adjust printer lights or volume

You can adjust the brightness of the printer lights or the volume of the sound effects according to your environment and needs.

To adjust printer lights or volume from an Android or iOS device

1. Open HP Smart. For more information, see [Use the HP Smart app to print, copy, scan, and troubleshoot on page 39](#).
2. Tap the printer image on the **Home** screen.
3. Find and change the settings from **Preferences**.

2 Load media and paper basics

- [Load media](#)
- [Load original](#)
- [Change the default paper size detected by the printer](#)
- [Paper basics](#)

Load media

To load paper

1. Open the paper tray.

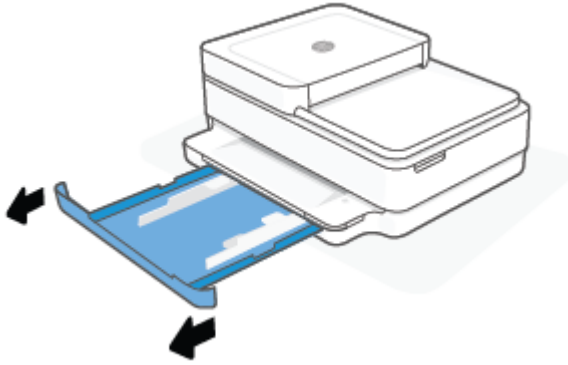

2. Slide the paper-width guides to the edges of the paper tray.

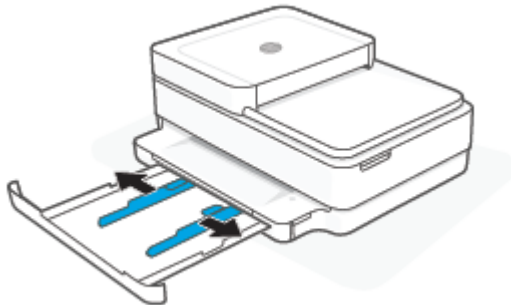

3. Insert a stack of full-size or photo paper into the middle of the paper tray with the short edge oriented towards the printer. For photo paper, make sure the side to be printed on is facing down. Then slide the stack of paper in until it stops.

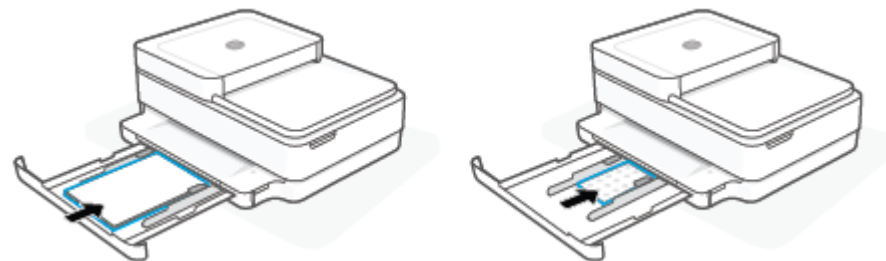

4. Slide the paper-width guides to the left and right edges of the full-size or photo paper until they stop at both edges.

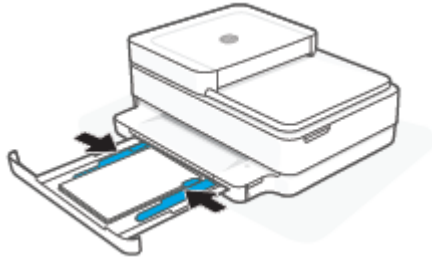

5. Close the paper tray.

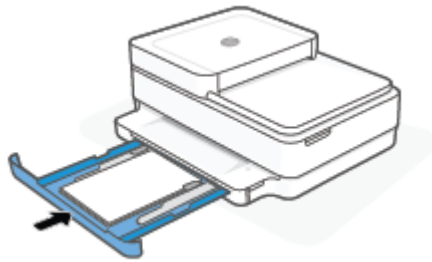

To load envelopes

1. Open the paper tray.

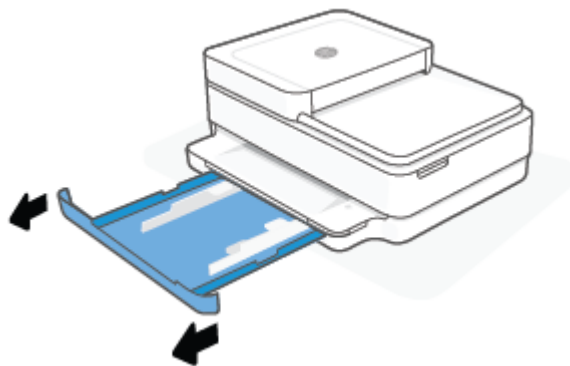

2. Slide the paper-width guides to the edges of the paper tray.

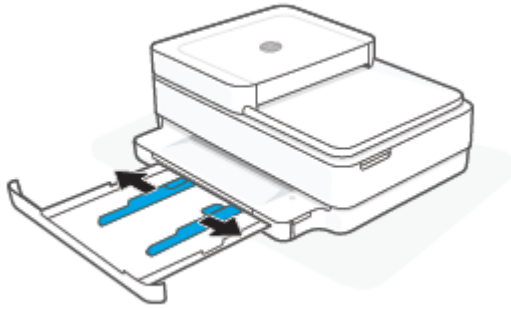

3. Insert one or more envelopes into the middle of the paper tray and slide the stack of envelopes in until it stops. The side to be printed on should face down in the printer.

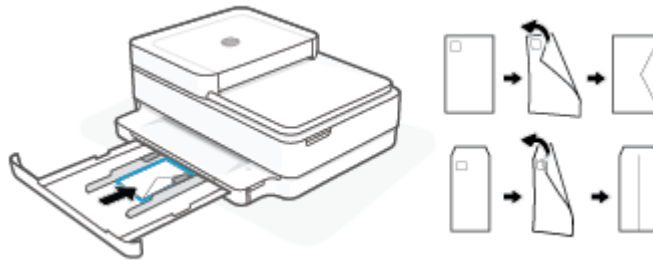

4. Slide the paper-width guides to the left and right edges of the stack of envelopes until they stop at both edges.

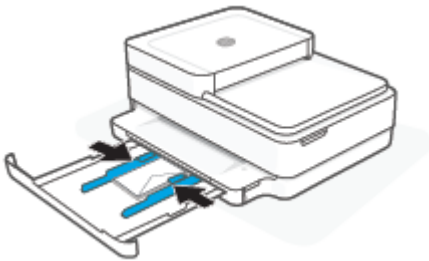

5. Close the paper tray.

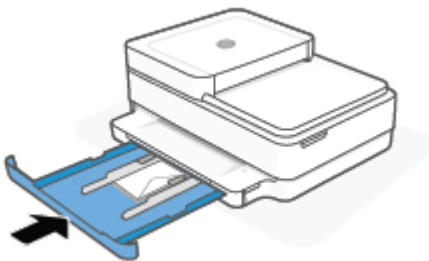

Load original

To load original on the scanner glass

1. Lift the scanner lid.



2. Load the original, print-side down, on the scanner glass, aligned with the top-left corner.

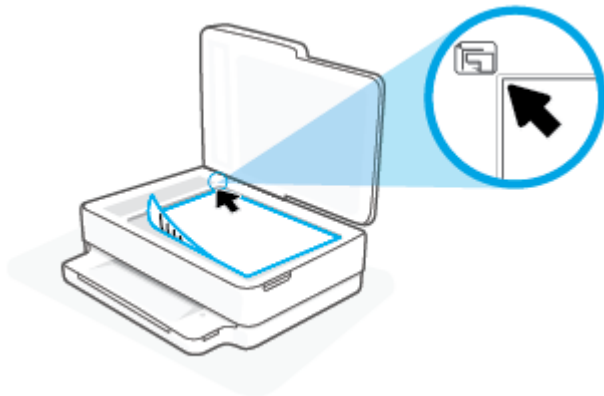

3. Close the scanner lid.

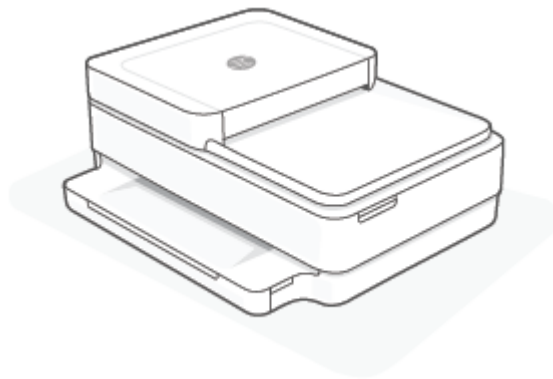

To load an original in the document feeder

1. Open the document feeder input tray.

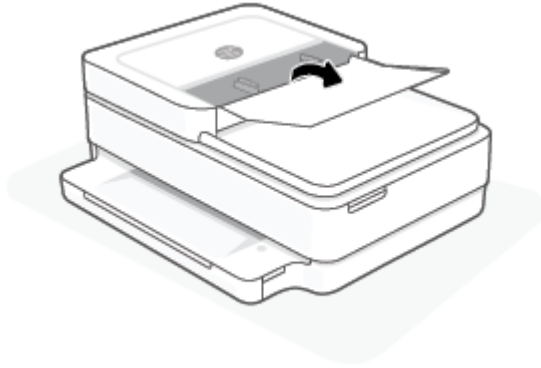

2. Slide paper-width guides outwards.
3. Load original print-side up in the document feeder.

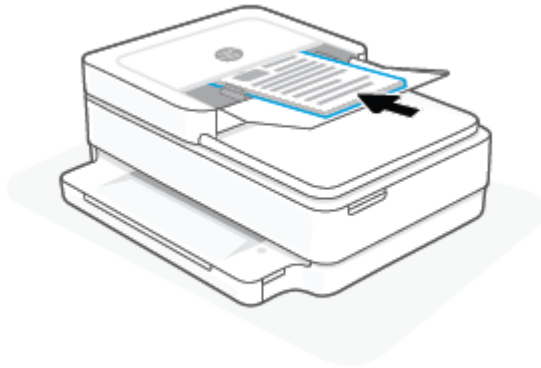

4. Slide paper-width guides inward until they stop at the edge of paper.

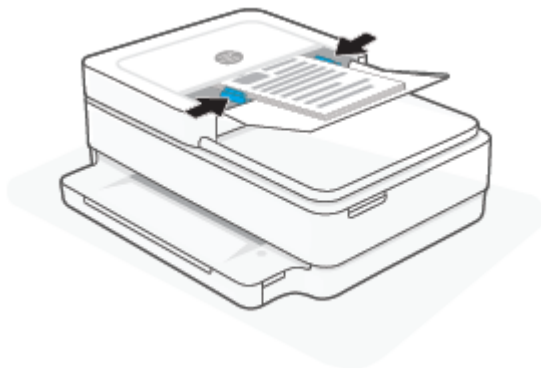

Change the default paper size detected by the printer

The printer can automatically detect whether the paper tray has paper loaded and detect whether the loaded paper is large, small, or medium width. You can change the default large, medium, or small paper size detected by the printer.

To change the default paper size detected by the printer from an Android or iOS device

1. Open the HP Smart app.
2. Tap the printer image on the **Home** screen.
3. Find and change the settings from **Preferences**.

To change the default paper size detected by the printer from the embedded web server (EWS)

1. Open the embedded web server (EWS). For more information, see [Open the embedded web server on page 36](#).
2. Click the **Settings** tab.
3. In the **Preferences** section, click **Tray and Paper Management**, and then select the desired option.
4. Click **Apply**.

Paper basics

The printer is designed to work well with most types of office paper. It is best to test a variety of print paper types before buying large quantities. Use HP paper for optimum print quality. Visit the HP website at www.hp.com for more information about HP paper.



HP recommends plain papers with the ColorLok logo for printing everyday documents. All papers with the ColorLok logo are independently tested to meet high standards of reliability and print quality, and produce documents with crisp, vivid color, bolder blacks, and that dry faster than ordinary plain papers. Look for papers with the ColorLok logo in a variety of weights and sizes from major paper manufacturers.

3 Connect your printer

- [Connect using the HP Smart app](#)
- [Connect to a wireless network with a router](#)
- [Connect wirelessly without a router](#)
- [Change the connection type](#)
- [Wireless settings](#)
- [Advanced printer management tools \(for wireless printers\)](#)
- [Tips for setting up and using a wireless printer](#)

Connect using the HP Smart app

To set up using the HP Smart app

You can use the HP Smart app to set up the printer on your wireless network. The HP Smart app is supported on iOS, Android, Windows, and macOS devices. For information about this app, see [Use the HP Smart app to print, copy, scan, and troubleshoot on page 39](#).

1. Make sure your computer or mobile device is connected to your wireless network and you know the Wi-Fi password of your wireless network.
2. If you are using an iOS or Android mobile device, make sure that Bluetooth is turned on. (HP Smart uses Bluetooth to make the setup process faster and easier on iOS and Android mobile devices.)



NOTE: HP Smart uses Bluetooth for printer setup only. Printing using Bluetooth is not supported.

3. Make sure the printer is in the Auto Wireless Connect (AWC) setup mode.

When the printer is in the AWC setup mode, the Edge lighting will glow purple, pulsing from the middle outward, repeating.

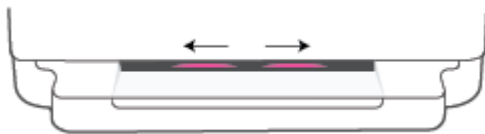



If this is the first time you set up the printer, the printer is ready for setup and in AWC mode immediately after it is powered on. The printer will keep searching for the HP Smart app to connect within two hours, and then stops searching.

If it has been longer than two hours, press and hold the  **Wireless** button on the back of the printer for at least three seconds to put the printer back in AWC setup mode.

4. Open the HP Smart app, and then do one of the following:
 - **iOS/Android:** On the home screen, tap the Plus icon (+) and then select the printer. If the printer is not in the list, tap **Add Printer**. Follow the onscreen instructions to add the printer to your network.
 - **Windows and macOS:** On the home screen, tap the Plus icon and select the printer. If the printer is not found, click or tap **Set up a new printer**. Follow the onscreen instructions to add the printer to your network.

Connect to a wireless network with a router



TIP: To print the Wireless Quick Start Guide, press and hold  until all the buttons on the control panel light up, and then press  again.

- [Connect your printer to a wireless network using Wi-Fi Protected Setup \(WPS\)](#)
- [Connect your printer to a wireless network using HP printer software](#)

Connect your printer to a wireless network using Wi-Fi Protected Setup (WPS)

Before you can connect your printer to a wireless network using WPS, make sure you have the following:

- A wireless 802.11b/g/n network that includes a WPS-enabled wireless router or access point.





NOTE: The printer only supports connections using 2.4 GHz or 5 GHz.

- A computer connected to the wireless network that you intend to connect the printer to. Be sure you have installed the HP printer software on the computer.

If you have a WPS router with a WPS push button, follow the **Push Button method**. If you are not certain your router has a push button, follow the **PIN method**.

To use the Push Button Configuration (PBC) method

1. Press and hold  and  on the back of printer for at least three seconds to start WPS Push Button method.

The Edge lighting shows the outside edges of the light bar pulsing purple, repeating.



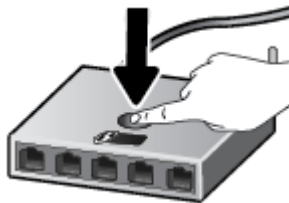

2. Press the WPS button on your router.



NOTE: The product begins a timer for approximately two minutes while a wireless connection is established.

If the printer connects successfully, the Edge lighting glows purple at the outside edges of the light bar. Flashing amber lighting in the middle of the light bar indicates an error.

To use the PIN method

1. Press and hold  until all the buttons on the control panel light up, and then press and hold  and  for at least five seconds to start WPS PIN method and print a page with a PIN code.

The Edge lighting shows the light bar glowing purple near the edges.



2. Open the configuration utility or software for the wireless router or wireless access point, and then enter the WPS PIN.

 **NOTE:** For more information about using the configuration utility, see the documentation provided with the router or wireless access point.

Wait for about two minutes. If the printer connects successfully, the light bar glows white in the center.

Connect your printer to a wireless network using HP printer software

To connect the printer to an integrated wireless WLAN 802.11 network, you will need the following:

- A wireless 802.11b/g/n network that includes a wireless router or access point.

 **NOTE:** The printer only supports connections using 2.4 GHz or 5 GHz.

- A computer connected to the wireless network that you intend to connect the printer to.
- Network name (SSID).
- WEP key or WPA Passphrase (if needed).

To connect your printer using HP printer software (Windows and macOS)

1. Depending on whether you have installed the HP printer software or not, do one of the following:

If you have not installed the HP printer software on your computer

- a. Visit 123.hp.com to download and install the printer software.
- b. Follow the onscreen instructions.

If you have the HP printer software installed on your computer

- a. Open the printer software. For more information, see [Open the HP printer software \(Windows\) on page 40](#).
- b. In the printer software, click **Tools**.

- c. Click **Device Setup & Software**.
 - d. Click **Connect a new device**, and then follow the onscreen instructions.
- 2. After the printer connects successfully, the large light bar of the Edge lighting glows light blue in the center.

Connect wirelessly without a router

With Wi-Fi Direct, you can print wirelessly from a computer, smart phone, tablet, or other wireless-capable device—without connecting to an existing wireless network.

Guidelines for using Wi-Fi Direct

- Make sure your computer or mobile device has the necessary software.
 - If you are using a computer, make sure you have installed the HP printer software.
If you have not installed the HP printer software on the computer, connect to Wi-Fi Direct first and then install the printer software. Select **Wireless** when prompted by the printer software for a connection type.
 - If you are using a mobile device, make sure you have installed a compatible printing app. For more information, visit the HP Mobile Printing website at www.hp.com/go/mobileprinting. If a local version of this website is not available in your country/region or language, you might be directed to the HP Mobile Printing website in another country/region or language.
- Make sure Wi-Fi Direct for your printer is turned on.
- Up to five computers and mobile devices can use the same Wi-Fi Direct connection.
- Wi-Fi Direct can be used regardless of whether the printer is connected to a network using a wireless connection or not.
- Wi-Fi Direct cannot be used to connect a computer, mobile device, or printer to the Internet.

To turn Wi-Fi Direct on or off from the control panel

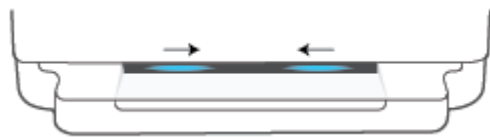

- ▲ On the printer control panel, press and hold  until all the buttons light up, and then press , , and  at the same time.

- When Wi-Fi Direct is turned on, blue light travels from the edges to the center of the light bar.

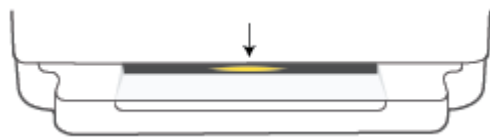

- When Wi-Fi Direct is turned off, blue light travels from the edges to the center of the light bar, ending with an amber glow.



 **NOTE:** If the printer is in the AWC setup mode, you will not be able to turn Wi-Fi Direct on or off from the control panel. You can either wait until the AWC setup has been completed or press  **Wireless** button on the back of the printer to exit the AWC setup mode.

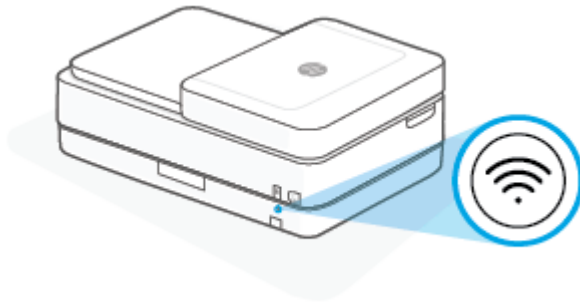

 **TIP:** The Wi-Fi Direct guide provides instructions about how to use Wi-Fi Direct. To print the guide, press and hold  until all the buttons light up, and then press  and  together. The guide may not be available in all languages.

To turn Wi-Fi Direct on or off from an Android or iOS device

1. Open HP Smart. For more information, see [Use the HP Smart app to print, copy, scan, and troubleshoot on page 39](#).
2. Tap the printer icon, and then **ind** and tap **Advanced Settings**.
3. Follow the on-screen instructions to connect to the printer Embedded Web Server.
4. In the Embedded Web Server, tap **Network > Wi-Fi Direct > Status > Edit Settings**.
5. Select the option to turn Wi-Fi Direct on or off, and then tap **Apply**.

 **TIP:** You can change the Wi-Fi Direct connection security setting for the printer here.

Wi-Fi Direct connection security setting

- If the Wi-Fi Direct connection security for the printer is set to **Manual** (the default setting), you need to do one of the following to connect to the printer on your mobile device or computer.
 - If  (the Information button) is blinking white, press it within 30 seconds.
 - If the printer prints out a page with a PIN code, follow the instruction on the page.

 **TIP:**

- You can also turn on Wi-Fi Direct or change the Wi-Fi Direct connection security setting from the EWS. For more information about using the EWS, see [Open the embedded web server on page 36](#).
 - To find the Wi-Fi Direct name and password, press  (the Information button) to print a printer information page.
 - Edge lighting shows Wi-Fi Direct status. For more information, see [Edge lighting on page 8](#).
-

To print from a wireless-capable mobile device that supports Wi-Fi Direct

Make sure you have installed the latest version of HP Print Service Plugin on your mobile device (if using an Android device). You can download this plugin from the Google Play application store.

1. Make sure you have turned on Wi-Fi Direct on the printer.
2. Turn on Wi-Fi Direct on your mobile device. For more information, see the documentation provided with the mobile device.
3. From your mobile device, select a document from a print enabled application, and then select the option to print the document.

The list of available printers appears.

4. From the list of available printers, choose the Wi-Fi Direct name shown such as DIRECT-**-HP ENVY Pro 6400 series (where ** are the unique characters to identify your printer).

Enter the Wi-Fi Direct password when prompted.

5. Print your document.

To print from a wireless-capable mobile device that does not support Wi-Fi Direct

Make sure you have installed a compatible printing app on your mobile device. For more information, visit the HP Mobile Printing website at www.hp.com/go/mobileprinting. If a local version of this website is not available in your country/region or language, you might be directed to the HP Mobile Printing website in another country/region or language.

1. Make sure you have turned on Wi-Fi Direct on the printer.
2. Turn on the Wi-Fi connection on your mobile device. For more information, see the documentation provided with the mobile device.



NOTE: If your mobile device does not support Wi-Fi, you are not able to use Wi-Fi Direct.

3. From the mobile device, connect to a new network. Use the process you normally use to connect to a new wireless network or hotspot. Choose the Wi-Fi Direct name from the list of wireless networks shown such as DIRECT-**-HP ENVY Pro 6400 series (where ** are the unique characters to identify your printer).

Enter the Wi-Fi Direct password when prompted.

4. Print your document.

To print from a wireless-capable computer (Windows)

1. Make sure you have turned on Wi-Fi Direct on the printer.
2. Turn on the computer's Wi-Fi connection. For more information, see the documentation provided with the computer.



NOTE: If your computer does not support Wi-Fi, you are not able to use Wi-Fi Direct.

3. From the computer, connect to a new network. Use the process you normally use to connect to a new wireless network or hotspot. Choose the Wi-Fi Direct name from the list of wireless networks shown such as DIRECT-**-HP ENVY Pro 6400 series (where ** are the unique characters to identify your printer).

Enter the Wi-Fi Direct password when prompted.

4. Print your document.

Change the connection type

If you first set up your printer and installed the software with a USB cable, directly connecting the printer to your computer, you can easily change to a wireless network connection. You will need a wireless 802.11a/b/g/n network that includes a wireless router or access point.



NOTE: The printer supports connections using 2.4GHz or 5GHz .

Before changing from a USB connection to a wireless network, make sure that:

- The printer is connected to your computer with the USB cable until you are prompted to disconnect the cable.
- The computer is connected to the wireless network that you intend to install the printer on.

You can also change from a wireless connection to a USB connection.

To change from a USB connection to a wireless network (Windows)

1. Open the HP printer software. For more information, see [Open the HP printer software \(Windows\) on page 40](#).
2. In the printer software, click **Tools**.
3. Click **Device Setup & Software**.
4. Select **Connect a new device**. Follow the onscreen instructions.

To change from a USB connect to a wireless network using the HP Smart app (Windows 10/macOS)

1. Open the HP Smart app. For information about how to open the app on a Windows 10 computer, see [Use the HP Smart app to print, copy, scan, and troubleshoot on page 39](#).
2. Make sure your printer is selected.



TIP: If you want to select a different printer, click the (+) on the toolbar at the left side of the screen, and then select a different printer from the list of all available printers.

3. Click **Learn More** when you see “Make printing easier by connecting your printer wirelessly” on top of the home page of the app.

To change from a wireless connection to a USB connection (Windows/macOS)

- ▲ Connect the printer and the computer with a USB cable. The USB port is at the back of the printer.

Wireless settings

You can set up and manage your printer wireless connection. This includes printing information about network settings, turning the wireless function on or off, and restoring wireless settings.

To turn on or off the wireless capability of the printer

Press  **Wireless** button on the back of the printer to turn on or off the printer wireless capabilities.

- If the printer has an active connection to a wireless network, the large bar of the Edge lighting glows light blue in the center.
- If wireless is turned off, the large light bar of the Edge lighting glows white in the center.
- For more information about the wireless status, see [Edge lighting on page 8](#).

To restore network settings to default settings

- Press and hold  **Wireless** button on the back of the printer for at least three seconds. Then the printer enters the Auto Wireless Connect (AWC) setup mode. It keeps searching and waiting for the HP Smart app to connect within about two hours, and then stops searching.

To change wireless settings (Windows)

This method is available if you have already installed the printer software.

1. Open the HP printer software. For more information, see [Open the HP printer software \(Windows\) on page 40](#).
2. In the printer software, click **Tools**.
3. Click **Device Setup & Software**.
4. Select **Reconfigure Wireless Settings**. Follow the onscreen instructions.

Advanced printer management tools (for wireless printers)

When the printer is connected to a network, you can use the embedded web server (EWS) to view status information, change settings, and manage the printer from your computer.

 **NOTE:** You can open and use the EWS without being connected to the Internet. However, some features are not available.



 **NOTE:** To view or change some settings, you might need a password.

- [Open the embedded web server](#)

Open the embedded web server

You can use one of the following ways to open the embedded web server.

To open the embedded web server through a network

1. From the printer control panel, press and hold  (the Information button) until all the buttons light up, and then press  and  at the same time to print the wireless network test report and network configuration page.
2. Find out the IP address or hostname of the printer from the network configuration page.
3. In a supported web browser on your computer, type the IP address or hostname assigned to the printer.

For example, if the IP address is 192.168.0.12, type the following address into a web browser:
`https://192.168.0.12.`

To open the embedded web server from HP Smart (Windows and macOS)

To open the embedded web server from HP Smart:

1. Click on the printer image.
2. Click **Advanced Settings**.

To open the embedded web server through Wi-Fi Direct

1. Make sure Wi-Fi Direct is turned on. For more information, see [Connect wirelessly without a router on page 30](#).
2. From your wireless computer, turn wireless on, then search for and connect to the Wi-Fi Direct name, for example: DIRECT-**-HP ENVY Pro 6400 series. Enter the Wi-Fi Direct password when prompted.
3. In a supported web browser on your computer, type the following address: `https://192.168.223.1.`

For information about cookies, see [Embedded web server on page 42](#).

Tips for setting up and using a wireless printer

Use the following tips to set up and use a wireless printer:

- When setting up the wireless networked printer using a computer, make sure:
 - Your wireless router or access point is powered on.
 - Your computer is connected to a wireless network (not using an Ethernet cable).
 - The printer is in the AWC setup mode.

The printer searches for wireless routers, then lists the detected network names on the computer.

- If your computer or mobile device is connected to a Virtual Private Network (VPN), you need to disconnect from the VPN before you can access any other device on your network, including the printer.
- Learn more about configuring your network and the printer for wireless printing. [Click here to go online for more information.](#)
- Learn how to find your network security settings. [Click here to go online for more information.](#)
- Learn about the HP Print and Scan Doctor. [Click here to go online for more information.](#)



NOTE: This utility is only available for Windows operating system.

- Use the [HP online firewall troubleshooter](#) to determine if a firewall or antivirus program is preventing your computer from connecting to the printer and find resolutions.

4 Printer management tools

- [Use the HP Smart app to print, copy, scan, and troubleshoot](#)
- [Open the HP printer software \(Windows\)](#)
- [Toolbox \(Windows\)](#)
- [Embedded web server](#)
- [Update the printer](#)

Use the HP Smart app to print, copy, scan, and troubleshoot

HP Smart helps you to set up, copy, scan, print, share, and manage your HP printer. You can share documents and images through email, text messages, and popular cloud and social media services (such as iCloud, Google Drive, Dropbox, and Facebook). You can also set up new HP printers, as well as monitor and order supplies.



NOTE: The HP Smart app might not be available in all languages. Some features might not be available with all printer models.

To install the HP Smart app

- ▲ The HP Smart app is supported on iOS, Android, Windows 10, and macOS devices. To install the app on your device, go to 123.hp.com and follow the onscreen instructions to access your device's app store.

To open the HP Smart app on a Windows 10 computer

- ▲ After installing the HP Smart app, from the device desktop, click **Start**, and then select **HP Smart** from the app list.

Connect to your printer

- ▲ Make sure that your device is connected to the same network as the printer. Then HP Smart will automatically detect the printer.

Get more information about the HP Smart app

For basic instructions on how to print, copy, scan, and troubleshoot using HP Smart, see [Print using the HP Smart app on page 46](#), [Copy, Scan, and Mobile Fax on page 66](#) and [Get help from the HP Smart app on page 82](#).

For more information about using HP Smart for printing, copying, scanning, accessing printer features, and troubleshooting issues, go to:

- **iOS/Android:** www.hp.com/go/hpsmart-help
- **Windows 10:** www.hp.com/go/hpsmartwin-help
- **macOS:** www.hp.com/go/hpsmartmac-help

Open the HP printer software (Windows)

After installing the HP printer software, double-click the printer icon on the desktop or do one of the following to open the printer software:

- **Windows 10:** From the computer desktop, click **Start**, select **HP** from the app list, and then select the icon with the printer name.
- **Windows 7:** From the computer desktop, click **Start**, select **All Programs**, click **HP**, click the folder for the printer, and then select the icon with the printer name.



NOTE: If you have not installed the HP printer software, visit [123.hp.com](https://www.hp.com) to download and install the necessary software.

Toolbox (Windows)

The Toolbox provides maintenance information about the printer.



NOTE: The Toolbox can be installed along with the HP printer software if the computer meets the system requirements. For information about system requirements, see [Specifications on page 117](#).

To open the Toolbox

1. Open the HP printer software. For more information, see [Open the HP printer software \(Windows\) on page 40](#).
2. Click **Print & Scan**.
3. Click **Maintain Your Printer**.

Embedded web server

When the printer is connected to a network, you can use the printer's embedded web server (EWS) to view status information, change settings, and manage it from your computer.

 **NOTE:** For your security, some settings in the EWS are password-protected. If prompted for a password, enter the PIN from the label on your printer. It might be near the cartridge access area inside the printer or on the back, side, or bottom of the printer.

 **NOTE:** You can open and use the embedded web server without being connected to the Internet. However, some features are not available.

- [About cookies](#)
- [Embedded web server cannot be opened](#)

About cookies

The embedded Web server (EWS) places very small text files (cookies) on your hard drive when you are browsing. These files let the EWS recognize your computer the next time you visit. For example, if you have configured the EWS language, a cookie helps remember which language you have selected so that the next time you access the EWS, the pages are displayed in that language. Some cookies (such as the cookie that stores customer-specific preferences) are stored on the computer until you clear them manually.

You can configure your browser to accept all cookies, or you can configure it to alert you every time a cookie is offered, which allows you to decide which cookies to accept or refuse. You can also use your browser to remove unwanted cookies.

Depending on your printer, if you disable cookies, you also disable one or more of the following features:

- Using some setup wizards
- Remembering the EWS browser language setting
- Personalizing the EWS Home page

For information about how to change your privacy and cookie settings and how to view or delete cookies, see the documentation available with your Web browser.

Embedded web server cannot be opened

Check your network setup

- Make sure you are not using a phone cord or a crossover cable to connect the printer to the network.
- Make sure the network cable is securely connected to the printer.
- Make sure the network hub, switch, or router is turned on and working correctly.

Check the computer

- Make sure the computer that you are using is connected to the same network as the printer.



Check your web browser

- Make sure the web browser meets the minimum system requirements. For information about system requirements, see [Specifications on page 117](#).
- If your web browser uses any proxy settings to connect to the Internet, try turning off these settings. For more information, see the documentation available with your web browser.
- Make sure JavaScript and cookies are enabled in your web browser. For more information, see the documentation available with your web browser.

Check the printer IP address

- Make sure the printer IP address is correct.

To verify the printer IP address:

- Press and hold  (the Information button) for three seconds until all the control panel buttons are lit.
- Press  (the Information button) and  (the Resume button) at the same time to print the Network Configuration Report.
- Make sure the printer IP address is valid. The printer IP address should have the similar format as the router IP address. For example, the router IP address might be 192.168.0.1 or 10.0.0.1 and the printer IP address is 192.168.0.5 or 10.0.0.5.

If the printer IP address is similar to 169.254.XXX.XXX or 0.0.0.0, it is not connected to the network.

 **TIP:** If you are using a computer running Windows, you can visit the HP online support website at www.support.hp.com. This website provides information and utilities that can help you correct many common printer problems.

Update the printer

By default, if the printer is connected to a network and Web Services has been enabled, the printer automatically checks for updates.

To enable the printer to automatically check for updates

1. When HP Web Services are enabled during printer setup, the printer will automatically be enrolled to check for updates.
2. To turn auto-updates off, turn off Web Services first.

To update the printer using the embedded web server

1. Open the EWS.
For more information, see [Open the embedded web server on page 36](#).
2. Click the **Tools** tab.
3. In the **Printer Updates** section, click **Firmware Updates**, and then follow the onscreen instructions.

 **NOTE:** If prompted for a password, enter the PIN from the label on your printer. It might be near the cartridge access area inside the printer or on the back, side, or bottom of the printer.

 **NOTE:** If prompted for proxy settings and if your network uses proxy settings, follow the onscreen instructions to set up a proxy server. If you do not have the details, contact your network administrator or the person who set up the network.

 **NOTE:** If a printer update is available, the printer downloads and installs the update, and then restarts.

5 Print

Most print settings are automatically handled by the software application. Change the settings manually only when you want to change print quality, print on specific types of paper, or use special features.

This section contains the following topics:

- [Print using the HP Smart app](#)
- [Print from mobile devices](#)
- [Print with Print Anywhere](#)
- [Print using a computer](#)
- [Tips for print success](#)

Print using the HP Smart app

This section provides basic instructions for using the HP Smart app to print from your Android, iOS, Windows 10 or macOS device. For more information about using the HP Smart app, go to:

- **iOS/Android:** www.hp.com/go/hpsmart-help
- **Windows 10:** www.hp.com/go/hpsmartwin-help
- **macOS:** www.hp.com/go/hpsmartmac-help

To print from an Android or iOS device

1. Make sure you have loaded paper in the paper tray. For more information, see [Load media on page 18](#).
2. Open the HP Smart app.
3. Tap the Plus icon if you need to change to a different printer, or add a new printer.
4. Tap a printing option (for example, **Print Photos** or **Print Facebook Photos**, etc.). You can print photos and documents from your device, cloud storage, or social media sites.
5. Select the photo or document you want to print.
6. Select the appropriate options. To view more settings, click or tap **More settings**. For more information about printing settings, see [Printer settings tips on page 54](#).
7. Tap **Print**.

To print from a Windows 10 device

1. Make sure you have loaded paper in the paper tray. For more information, see [Load media on page 18](#).
2. Open HP Smart. For more information, see [Use the HP Smart app to print, copy, scan, and troubleshoot on page 39](#).
3. On the HP Smart Home screen, make sure your printer is selected.

 **TIP:** If you want to select a different printer, click the (+) on the toolbar at the left side of the screen, and then select a different printer from the list of all available printers.

4. Select **Print Photos**, locate a photo you want to print, and then click or tap **Select Photos to Print**.
Select **Print Documents**, locate a PDF document you want to print, and then click or tap **Print**.
5. Select the appropriate options. To view more settings, click or tap **More settings**. For more information about printing settings, see [Printer settings tips on page 54](#).
6. Click or tap **Print** to begin printing.

Print from mobile devices

You can print documents and photos directly from your mobile devices, including iOS, Android, Windows Mobile, Chromebook and Amazon Kindle Fire.

 **NOTE:** You can also use the HP Smart app to print from mobile devices. For more information, see [Print using the HP Smart app on page 46](#).

To print from mobile devices

1. Make sure your printer is connected to the same network as your mobile device.

 **TIP:** If you want to print without connecting to a router, use Wi-Fi Direct to print from a mobile device. For more information, see [Connect wirelessly without a router on page 30](#).

2. Enable printing on your mobile device:

- **iOS:** Use the **Print** option from the **Share** menu or .

 **NOTE:** Devices running iOS 4.2 or later have AirPrint preinstalled.

- **Android:** Download the HP Print Service Plugin (supported by most Android devices) from the Google Play Store and enable it on your device.
- **Windows Mobile:** Tap **Print** from the **Device** menu.

 **NOTE:** If your printer is not listed, you might need to do a one-time setup of the printer using the **Add Printer** wizard.

- **Chromebook:** Download and install the **HP Print for Chrome** app from the Chrome Web Store to enable Wi-Fi printing.
- **Amazon Kindle Fire HD9 and HDX:** The first time you select **Print** on your device, the HP Print Service Plugin is automatically downloaded to enable mobile printing.

 **NOTE:** For detailed information about enabling printing from your mobile devices, visit the HP Mobile Printing website (www.hp.com/go/mobileprinting). If a local version of this website is not available in your country/region or language, you might be directed to the HP Mobile Printing website in another country/region or language.

3. Make sure the loaded paper matches the paper settings of the printer (see [Load media on page 18](#) for more information). Accurately setting the paper size for the paper that is loaded enables your mobile device to know what paper size it is printing.

Print with Print Anywhere

Print Anywhere is a free service from HP that allows you to use the HP Smart app with your HP Account to print remotely using cellular data or a remote Wi-Fi connection.

With Print Anywhere, you can print to your HP web-connected printer anytime, from any location. [Click here to go online for more information.](#)

Before you can use Print Anywhere, make sure the printer is connected to an active network providing Internet access.

To print a document using HP ePrint

1. If you created an HP Account during printer setup (might not be available in all countries/regions), **HP ePrint** was automatically enabled.

If you did not create an HP Account during setup, follow the steps below for your operating system to enable **HP ePrint**.

iOS/Android

- a. From the HP Smart app home screen, tap your printer.
- b. Tap **Print Anywhere**.
- c. Sign in or create an HP Account when prompted.
- d. Tap **Enable**.

Windows 10/macOS

- a. From the HP Smart app home screen, click **Printer Settings**.
 - b. On the **Print Anywhere** tab, click **Sign In**.
 - c. Sign in or create an HP Account when prompted.
 - d. Click **Enable**.
2. Open HP Smart, and then print your document. For more information, see [Print using the HP Smart app on page 46](#).



NOTE: If you want to use **HP ePrint** capabilities from multiple devices, you need to sign in with your HP Account on each of the additional devices. After signing in, the new device will be ready to print with **HP ePrint**.

Print using a computer

- [Print documents](#)
- [Print photos](#)
- [Print envelopes](#)
- [Print on both sides \(duplexing\)](#)
- [Print using the maximum dpi](#)
- [Print using a Mac desktop or laptop](#)

Print documents

Before printing documents, make sure you have paper loaded in the paper tray and the output tray is open. For more information about loading paper, see [Load media on page 18](#).

To print a document (Windows)

1. From your software, select **Print**.
2. Make sure your printer is selected.
3. Click the button that opens the **Properties** dialog box.

Depending on your software application, this button might be called **Properties**, **Options**, **Printer Setup**, **Printer Properties**, **Printer**, or **Preferences**.

4. Select the appropriate options.
 - On the **Layout** tab, select **Portrait** or **Landscape** orientation.
 - On the **Paper/Quality** tab, select the appropriate paper type from the **Media** drop-down list in the **Tray Selection** area, select the appropriate print quality in the **Quality Settings** area, and then select the appropriate color in the **Color** area.
 - Click **Advanced** to select the appropriate paper size from the **Paper Size** drop-down list.



NOTE: If you change the paper size, make sure that you have loaded the correct paper in the paper tray.

For more printing tips, see [Printer settings tips on page 54](#).

5. Click **OK** to close the **Properties** dialog box.
6. Click **Print** or **OK** to begin printing.

To print on both sides of the page (Windows)

1. From your software, select **Print**.
2. Make sure your printer is selected.
3. Click the button that opens the **Properties** dialog box.

Depending on your software application, this button might be called **Properties**, **Options**, **Printer Setup**, **Printer Properties**, **Printer**, or **Preferences**.

4. Select the appropriate options.
 - On the **Layout** tab, select **Portrait** or **Landscape** orientation, and then select an appropriate flipping paper option from the **Print on Both Sides Manually** drop-down list.
 - On the **Paper/Quality** tab, select the appropriate paper type from the **Media** drop-down list in the **Tray Selection** area, select the appropriate print quality in the **Quality Settings** area, and then select the appropriate color in the **Color** area.
 - Click **Advanced** to select the appropriate paper size from the **Paper Size** drop-down list.

 **NOTE:** If you change the paper size, make sure that you have loaded the correct paper in the paper tray.

For more printing tips, see [Printer settings tips on page 54](#).

5. After all of the odd numbered pages have printed, remove the document from the output tray.
Flip the document by the long edge or short edge according to the option you set at the previous step.
Reload the document. Make sure the blank side of the document is facing out from the printer.
6. Press  (the Resume button) to print the other side of the document.

Print photos

Before printing photos, make sure you have photo paper loaded in the paper tray and the output tray is open. For more information about loading paper, see [Load media on page 18](#).

To print a photo on photo paper (Windows)

1. From your software, select **Print**.
2. Make sure your printer is selected.
3. Click the button that opens the **Properties** dialog box.
Depending on your software application, this button might be called **Properties**, **Options**, **Printer Setup**, **Printer Properties**, **Printer**, or **Preferences**.
4. Select the appropriate options.
 - On the **Layout** tab, select **Portrait** or **Landscape** orientation.
 - On the **Paper/Quality** tab, select the appropriate paper type from the **Media** drop-down list in the **Tray Selection** area, select the appropriate print quality in the **Quality Settings** area, and then select the appropriate color in the **Color** area.
 - Click **Advanced** to select the appropriate photo size from the **Paper Size** drop-down list.

 **NOTE:** If you change the paper size, make sure that you have loaded the correct paper in the paper tray.

For more printing tips, see [Printer settings tips on page 54](#).

5. Click **OK** to return to the **Properties** dialog box.
6. Click **OK**, and then click **Print** or **OK** in the **Print** dialog box.

 **NOTE:** After the printing is finished, remove unused photo paper from the paper tray. Store the photo paper so it does not start to curl, which could reduce the quality of your printout.

Print envelopes

Before printing envelopes, make sure you have envelopes loaded in the paper tray and the output tray is open. You can load one or more envelopes into the paper tray. Do not use shiny or embossed envelopes or envelopes that have clasps or windows. For more information about loading envelopes, see [Load media on page 18](#).

 **NOTE:** For specific details on how to format text for printing on envelopes, consult the help files in your word application.

To print an envelope (Windows)

1. From your software, select **Print**.
2. Make sure your printer is selected.
3. Click the button that opens the **Properties** dialog box.

Depending on your software application, this button might be called **Properties**, **Options**, **Printer Setup**, **Printer Properties**, **Printer**, or **Preferences**.

4. Select the appropriate options.
 - On the **Layout** tab, select **Portrait** or **Landscape** orientation.
 - On the **Paper/Quality** tab, select the appropriate paper type from the **Media** drop-down list in the **Tray Selection** area, select the appropriate print quality in the **Quality Settings** area, and then select the appropriate color in the **Color** area.
 - Click **Advanced** to select the appropriate envelope size from the **Paper Size** drop-down list.

For more printing tips, see [Printer settings tips on page 54](#).

5. Click **OK**, and then click **Print** or **OK** in the **Print** dialog box.

Print on both sides (duplexing)

To print on both sides of the paper (Windows)

1. Load paper in the paper tray. For more information, see [Load media on page 18](#).
2. From your software, select **Print**.
3. Make sure your printer is selected.
4. Click the button that opens the **Properties** dialog box.

Depending on your software application, this button might be called **Properties**, **Options**, **Printer Setup**, **Printer Properties**, **Printer**, or **Preferences**.

 **NOTE:** To set print settings for all print jobs, make the changes in the HP printer software provided with the printer. For more information on the HP printer software, see [Printer management tools on page 38](#).

5. On the **Printing Shortcuts** or **Printing Shortcut** tab, select a shortcut which supports the **Print On Both Sides** setting. Select an option from the **Print On Both Sides** drop-down list.

To change other print settings, click the other tabs.

For more printing tips, see [Printer settings tips on page 54](#).



NOTE: If you change the paper size, be sure to load the correct paper in the paper tray and set the paper size on the printer control panel.

6. Click **OK** to close the **Properties** dialog box.
7. Click **Print** or **OK** to begin printing.

Print using the maximum dpi

Use maximum dots per inch (dpi) to print high-quality, sharp images on photo paper. Printing in maximum dpi takes longer than printing with other settings and requires a large amount of disk space. For a list of supported print resolutions, visit the product support website at www.support.hp.com.

To print in maximum dpi mode (Windows)

1. From your software, select **Print**.
2. Make sure your printer is selected.
3. Click the button that opens the **Properties** dialog box.

Depending on your software application, this button might be called **Properties**, **Options**, **Printer Setup**, **Printer Properties**, **Printer**, or **Preferences**.

4. Select the appropriate options.
 - Click **Paper/Quality** tab. From the **Media** drop-down list, select the appropriate paper type.
 - Click the **Advanced** button. Select the appropriate paper size from the **Paper Size** drop-down list. Select **Max DPI Enabled** from the **Print Quality** drop-down list. Then click **OK** to close the **Advanced Options** dialog box.



NOTE: Not all paper types support maximum dpi. You will see an alert icon beside the option if the selected paper type in the **Media** drop-down list does not support it.

For more printing tips, see [Printer settings tips on page 54](#).

5. Confirm the paper orientation on the **Layout** tab, and then click **OK** to print.

Print using a Mac desktop or laptop

Instructions for HP AirPrint-compatible printers and Mac computers with macOS and OS X 10.7 (Lion) and later.

Printer connected to network

If your printer is already set up and connected to your wireless network, you can enable printing from a Mac desktop or laptop using the **System Preferences** menu.

1. Open **System Preferences** and select **Printers and Scanners**.
2. Click **Add +** to set up the printer on your Mac. Choose your printer from the displayed list of network printers, then click **Add**. This will install the available print, scan, or fax drivers for your printer.

These instructions let you print from your Mac. Continue to use the HP Smart app to monitor ink levels and printer alerts.

Printer not connected to network

- ▲ If you have not set up or connected your printer to your network, go to 123.hp.com to install the necessary software. When you complete printer setup, use the HP Utility from the **Applications** folder to monitor ink levels and printer alerts.

Tips for print success

- [Ink tips](#)
- [Paper loading tips](#)
- [Printer settings tips](#)

To print successfully, the HP cartridges should be functioning properly with sufficient ink, the paper should be loaded correctly, and the printer should have the appropriate settings.

Ink tips

- Use original HP cartridges.
- Install both the black and tri-color cartridges correctly.
For more information, see [Replace the cartridges on page 61](#).
- Check the estimated ink levels in the cartridges to make sure there is sufficient ink.
For more information, see [Check the estimated ink levels on page 58](#).
- If the print quality is not acceptable, see [Fix print quality issues on page 96](#) for more information.



NOTE: Original HP cartridges are designed and tested with HP printers and papers to help you easily produce great results, time after time.

HP cannot guarantee the quality or reliability of non-HP supplies. Product service or repairs required as a result of using a non-HP supply will not be covered under warranty.

If you see a 'Non-HP Cartridge' message displayed from the printer software and you believe you purchased original HP cartridges, go to: www.hp.com/go/anticounterfeit.

Paper loading tips

- Load a stack of paper (not just one page). All of the paper in the stack should be in the same size and type to avoid a paper jam.
- Load the paper with the side to be printed on facing up.
- Make sure that paper loaded in the paper tray lays flat, and the edges are not bent or torn.
- Adjust the paper-width guides in the paper tray to fit snugly against all paper. Make sure the paper-width guides do not bend the paper in the paper tray.

For more information, see [Load media on page 18](#).

Printer settings tips

Printer settings tips (Windows)

- To change default print settings, open the HP printer software, click **Print & Scan**, and then click **Set Preferences**. For information how to open the printer software, see [Open the HP printer software \(Windows\) on page 40](#).
- To understand paper and paper tray settings:

- **Paper Size:** Select the paper size you loaded in the paper tray.
- **Paper Type:** Select the paper type you are using.
- To understand color or black and white settings:
 - **Color:** Uses ink from all cartridges for full color prints.
 - **Black & White** or **Black Ink Only:** Uses the black ink only for normal or lower quality black and white prints.
 - **High Quality Grayscale:** Uses ink from both the color and black cartridges to produce a wider range of black and grey tones for high quality black and white prints.
- To understand print quality settings:

The print quality is measured in print resolution dots per inch (dpi). Higher dpi produces clearer and more detailed prints, but slows print speed and might use more ink.

 - **Draft:** Lowest dpi typically used when ink levels are low or when high quality prints are not needed.
 - **Normal:** Suitable for most print jobs.
 - **Best:** Better dpi than **Better**.
 - **Max DPI Enabled:** Highest dpi setting available for print quality.
- To understand page and layout settings:
 - **Orientation:** Select **Portrait** for vertical prints or **Landscape** for horizontal prints.
 - **Print on Both Sides:** Manually flip the pages after one side of the paper prints out so that you can print on both sides of the paper.
 - **Flip on Long Edge:** Select it if you want to flip pages by the long edge of the paper when printing on both sides of the paper.
 - **Flip on Short Edge:** Select it if you want to flip pages by the short edge of the paper when printing on both sides of the paper.
 - **Pages per Sheet:** Helps you specify the order of the pages if you print the document with more than two pages per sheet.

6 Manage cartridges

- [Information on cartridges and the printhead](#)
- [Check the estimated ink levels](#)
- [Order ink supplies](#)
- [HP Instant Ink](#)
- [Replace the cartridges](#)
- [Use single cartridge mode](#)
- [Cartridge warranty information](#)
- [Tips for working with cartridges](#)

Information on cartridges and the printhead

The following tips help maintain HP cartridges and ensure consistent print quality.

- The instructions in this guide are for replacing cartridges, and are not intended for first time installation.
- Keep all cartridges in the original sealed packages until they are needed.
- Be sure to turn off the printer properly.
- Store cartridges at room temperature (15-35° C or 59-95° F).
- Do not clean the printhead unnecessarily. This wastes ink and shortens the life of the cartridges.
- Handle cartridges carefully. Dropping, jarring, or rough handling during installation can cause temporary printing problems.
- If you are transporting the printer, do the following to prevent ink leaking from the printer or other damage from occurring to the printer:
 - Make sure you turn off the printer by pressing  (the Power button). Wait until all sounds of internal motion stop before unplugging the printer.
 - Make sure you leave the cartridges installed.
 - The printer must be transported sitting flat; it should not be placed on its side, back, front, or top.

Check the estimated ink levels

You can check the estimated ink levels from the printer software, printer control panel or HP Smart.

To check the ink levels from the printer software (Windows)

1. Open the HP printer software.
2. In the printer software, click **Estimated Levels**.

To check the ink levels from HP Smart

- ▲ Open HP Smart on your mobile device. The estimated ink levels for your printer appear at the top of the screen, beside the picture of the printer.

 **NOTE:** Ink level warnings and indicators provide estimates for planning purposes only. When an indicator shows low-ink levels, consider having a replacement ink cartridge available to avoid possible printing delays. You do not need to replace ink cartridges until print quality becomes unacceptable.

 **NOTE:** If you have installed a refilled or remanufactured cartridge, or a cartridge that has been used in another printer, the ink level indicator might be inaccurate or unavailable.

 **NOTE:** Ink from the cartridges is used in the printing process in a number of different ways, including in the initialization process, which prepares the printer and cartridges for printing, and in printhead servicing, which keeps print nozzles clear and ink flowing smoothly. In addition, some residual ink is left in the cartridge after it is used. For more information, see www.hp.com/go/inkusage.

Order ink supplies

Before ordering cartridges, locate the correct cartridge number.

To locate the cartridge number on the printer

- The cartridge number is located inside the cartridge access door.

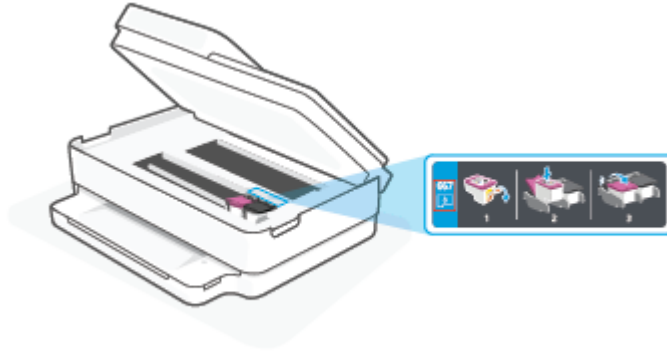

To locate the cartridge number from the HP Smart app

- Open HP Smart. Click or tap the printer image, and then click or tap **Supported Supplies**.

To order original HP supplies for the printer, go to www.hp.com/buy/supplies. If prompted, choose your country/region, and then follow the prompts to find the right cartridges for your printer.

 **NOTE:** Ordering cartridges online is not supported in all countries/regions. If it is not available in your country/region, you may still view supplies information and print a list for reference when shopping at a local HP reseller.

HP Instant Ink

Your printer is eligible for the HP Instant Ink replacement service, which can reduce your printing costs and save you time. After you enroll in the service, your printer automatically keeps track of your ink levels and orders more ink for you when the ink is running low. HP ships the new cartridges straight to your door before your ink runs out, so you'll always have ink on hand when you need it. Additionally, the cartridges that you receive contain more ink than HP XL cartridges, so you'll need to replace cartridges less frequently. To learn more about how HP Instant Ink can save you time and money, go to hpinstantink.com.



NOTE: HP Instant Ink service might not be available in all countries. To check availability, visit hpinstantink.com.

Replace the cartridges

 **NOTE:** For information on recycling used ink supplies, see [HP inkjet supplies recycling program](#) on page 127.

 **NOTE:** At this time, some portions of the HP website are available in English only.

 **NOTE:** Not all cartridges are available in all countries/regions.

To replace the cartridges

1. Check that power is on.
2. Remove the old cartridge.
 - a. Open the cartridge access door.

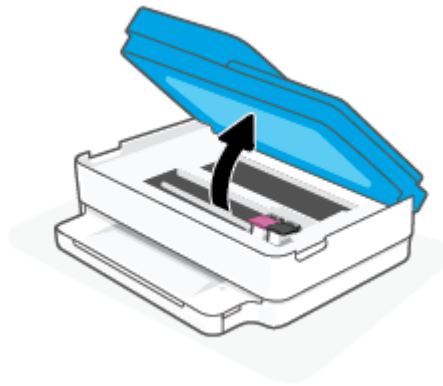

- b. Open the latch on the cartridge slot. And then remove the cartridge from the slot.



3. Insert a new cartridge.
 - a. Remove the cartridge from packaging.

- b. Remove plastic tape using the pull tab.

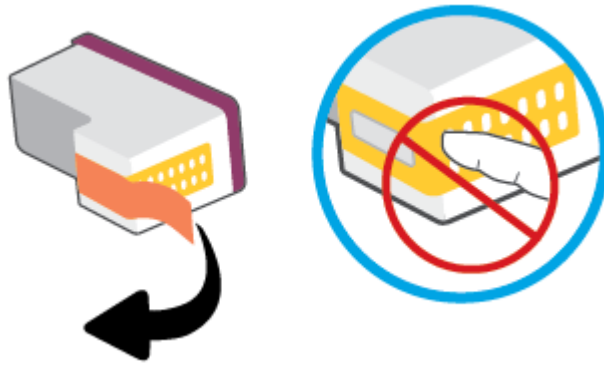

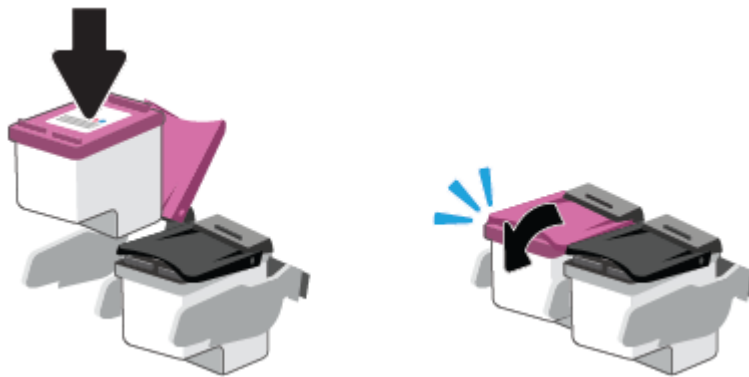

 **NOTE:** Do not touch the electrical contacts on the cartridge.

- c. Slide the new cartridge in the slot and close the latch until it clicks.

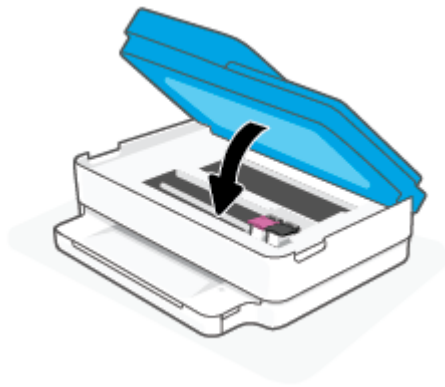

4. Close the cartridge access door.



 **NOTE:** The HP printer software prompts you to align the ink cartridges when you print a document after installing a new ink cartridge.

Use single cartridge mode

Use the single cartridge mode to operate the printer with only one cartridge. The single cartridge mode is initiated when one of the following occurs.

- There is only one cartridge installed in the carriage.
- A cartridge is removed from the carriage if there are two cartridges installed previously.



NOTE: If the printer enters the single cartridge mode when two cartridges are installed in the printer, verify that the protective piece of plastic tape has been removed from each cartridge. When the plastic tape covers the cartridge contacts, the printer cannot detect that the cartridge is installed. If there is no plastic tape on the cartridges, try cleaning the cartridge contacts. For information about cleaning cartridge contacts, see [Ink cartridge issues on page 91](#).

To exit the single cartridge mode

- Install both the black and tri-color cartridges in the printer.

Cartridge warranty information

The HP cartridge warranty is applicable when the cartridge is used in its designated HP printing device. This warranty does not cover HP cartridges that have been refilled, remanufactured, refurbished, misused, or tampered with.

During the warranty period, the cartridge is covered as long as the HP ink is not depleted and the end of warranty date has not been reached. The end of warranty date, in YYYY/MM/DD format, may be found on the cartridge as indicated:

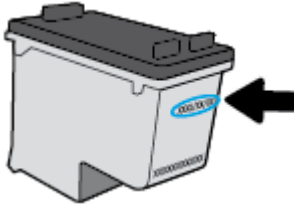

For a copy of the HP Limited Warranty Statement, visit www.hp.com/go/orderdocuments.

Tips for working with cartridges

Use the following tips to work with cartridges:

- To protect the cartridges from drying out, always turn the printer off using the Power button.
- Do not open or untape cartridges until you are ready to install them. Leaving tape on the cartridges reduces ink evaporation.
- Insert the cartridges into the correct slots. Match the color of each cartridge to the color of the cartridge latch. Make sure the cartridges snap into place.
- Align the printer for best print quality. See [Printing issues on page 93](#) for more information.
- When the **Estimated Cartridge Levels** screen in the HP Smart app or the **Estimated Levels** screen in the printer software shows one or both cartridges in a low state, consider getting replacement cartridges to avoid possible printing delays. You do not need to replace the cartridges until print quality becomes unacceptable. See [Replace the cartridges on page 61](#) for more information.
- If you remove a cartridge from the printer for any reason, try to replace it again as soon as possible. If a cartridge is left unprotected outside the printer, its nozzles might dry out and clog up.
- Cartridges can be left in the printer for extended periods of time. However, to assure optimal cartridge health, be sure to turn off the printer properly when the printer is not in use.
- Press  (the Power button) to turn off the printer. Wait until the power light turns off before unplugging the power cord or turning off a power strip.

 **CAUTION:** If you incorrectly turn the printer off, the print carriage might not return to the correct position, causing problems with the cartridges and print quality issues.

7 Copy, Scan, and Mobile Fax

- [Copy and scan using HP Smart](#)
- [Copy from the printer](#)
- [Scan](#)
- [Tips for copy and scan success](#)
- [Mobile Fax](#)

Copy and scan using HP Smart

You can use the HP Smart app to copy and scan documents or photos using your device camera. HP Smart includes editing tools that allow you to adjust the scanned image before saving, sharing, or printing. You can print, save your scans locally or in cloud storage, and share them via email, SMS, Facebook, Instagram, etc. To copy and scan with HP Smart, follow the instructions provided in the appropriate section below, depending on the type of device you are using.

This section provides basic instructions for using the HP Smart app to copy or scan from your Android, iOS, Windows 10 or macOS device. For more information about using the HP Smart app, go to:

- **iOS/Android:** www.hp.com/go/hpsmart-help
- **Windows 10:** www.hp.com/go/hpsmartwin-help
- **macOS:** www.hp.com/go/hpsmartmac-help
- [Copy and scan from an Android or iOS device](#)
- [Scan from a Windows 10 device](#)

Copy and scan from an Android or iOS device

To copy from an Android or iOS device

1. Open the HP Smart app.
2. Tap the Plus icon if you need to change to a different printer, or add a new printer.
3. Tap **Copy**. The built-in camera will open.
4. Put a document or photo in front of the camera, select a size option to help identifying the size of the original, and then tap the round button at the bottom of the screen to take a picture.

 **TIP:** For the best result, adjust the camera position to place the original within the provided frame on the preview screen.

5. Set the number of copies or make other adjustments if necessary:
 - Tap the Add Pages icon to add more documents or photos.
 - Tap the Delete icon to remove documents or photos.
 - Tap **Resize** to adjust how to fill the original to the paper.
6. Tap **Start Black** or **Start Color** to make a copy.

To scan from an Android or iOS device

1. Open the HP Smart app.
2. Tap the Plus icon if you need to change to a different printer, or add a new printer.
3. Select **Camera Scan**. The built-in camera will open. Scan your photo or document using the camera.
4. When you have finished adjusting the scanned document or photo, save, share, or print it.

Scan from a Windows 10 device

To scan a document or photo using the device camera

If your device has a camera, you can use the HP Smart app to scan a printed document or photo with the device camera. You can then use HP Smart to edit, save, print or share the image.

1. Open HP Smart. For more information, see [Use the HP Smart app to print, copy, scan, and troubleshoot on page 39](#).
2. Select **Scan**, and then select **Camera**.
3. Put a document or photo in front of the camera, and then click or tap the round button at the bottom of the screen to take an image.
4. Adjust boundaries if needed. Click or tap the Apply icon.
5. Make other adjustments if necessary:
 - Click or tap **Add Pages** to add more documents or photos.
 - Click or tap **Edit** to rotate or crop the document or image, or adjust its contrast, brightness, saturation, or angle.
6. Select the file type you want, and then click or tap the Save icon to save it or click or tap the Share icon to share it with others.

To edit a previously scanned document or photo

HP Smart provides editing tools, such as crop or rotate, so that you can use to adjust a previously scanned document or photo on your device.

1. Open HP Smart. For more information, see [Use the HP Smart app to print, copy, scan, and troubleshoot on page 39](#).
2. Select **Scan**, and then select **Import**.
3. Select the document or photo that you want to adjust, and then click or tap **Open**.
4. Adjust boundaries if needed. Click or tap the Apply icon.
5. Make other adjustments if necessary:
 - Click or tap **Add Pages** to add more documents or photos.
 - Click or tap **Edit** to rotate or crop the document or image, or adjust its contrast, brightness, saturation, or angle.
6. Select the file type you want, and then click or tap **Save** or **Share** to save the file or share it with others.

Copy from the printer

The **Copy** button on the printer display allows you to easily select number of copies and color or black and white for copying on plain paper.



From the scanner glass

1. Load paper in the paper tray.

For information about how to load paper, see [Load media on page 18](#).

2. Load the original, print-side down, on the scanner glass, aligned with the top-left corner.

For more information, see [Load original on page 21](#).

3. Press either the **Start Copy Black** button () or the **Start Copy Color** button () to make a copy.

Copying will start two seconds after the last button press.

 **TIP:** You can increase the number of copies by pressing the button multiple times.



From the automatic-document feeder

1. Load paper in the paper tray.

For information about how to load paper, see [Load media on page 18](#).

2. Load the original print side up into the document feeder.

For more information, see [Load original on page 21](#).

3. Press either the **Start Copy Black** button () or the **Start Copy Color** button () to make a copy.

Copying will start two seconds after the last button press.

 **TIP:** You can increase the number of copies by pressing the button multiple times.

Scan

You can scan documents, photos, and other paper types, and send them to a variety of destinations, such as a computer or an email recipient.

When scanning a borderless original, use the scanner glass and not the document feeder.



NOTE: Some scan functions are only available after you have installed the HP printer software.

- [Scan using HP printer software](#)
- [Scan using Webscan](#)

Scan using HP printer software

- [Scan to a computer](#)
- [Scan to email](#)
- [Create a new scan shortcut \(Windows\)](#)
- [Change scan settings \(Windows\)](#)

Scan to a computer

Before scanning to a computer, make sure you have already installed the HP recommended printer software. The printer and computer must be connected and turned on.

In addition, on Windows computers, the printer software must be running prior to scanning.

To enable the scan to a computer feature (Windows)

If the printer is connected to the computer with a USB connection, the feature for scanning to computer is enabled by default and cannot be disabled.

If you are using a network connection, follow these instructions if the feature has been disabled, and you wish to enable it again.

1. Open the HP printer software. For more information, see [Open the HP printer software \(Windows\) on page 40](#).
2. Go to the **Scan** section.
3. Select **Manage Scan to Computer**.
4. Click **Enable**.

To scan an original from HP printer software (Windows)

1. Load the original print-side up in the document feeder, or load the original, print-side down, aligned with the top-left corner of the scanner glass.
2. Open the HP printer software. For more information, see [Open the HP printer software \(Windows\) on page 40](#).

3. In the printer software, under **Print & Scan**, click **Scan**, and then click **Scan a Document or Photo**.
4. Under **Scan Shortcuts**, select the type of scan you want, and then click **Scan**.

 **NOTE:** The initial screen allows you to review and modify basic settings. Click the **More** link at the top right corner of the Scan dialog to review and modify detailed settings.

For more information, see [Change scan settings \(Windows\) on page 72](#).

Scan to email

To scan a document or photo to email from HP printer software (Windows)

1. Load the original print-side up in the document feeder, or load the original, print-side down, aligned with the top-left corner of the scanner glass.
2. Open the HP printer software. For more information, see [Open the HP printer software \(Windows\) on page 40](#).
3. In the printer software, under **Print & Scan**, click **Scan**, and then click **Scan a Document or Photo**.
4. Under **Scan Shortcuts**, select **Email as PDF** or **Email as JPEG**, and then click **Scan**.

 **NOTE:** The initial screen allows you to review and modify basic settings. Click the **More** link at the top right corner of the Scan dialog to review and modify detailed settings.

For more information, see [Change scan settings \(Windows\) on page 72](#).

If **Show Viewer After Scan** is selected, you can make adjustments to the scanned image in the preview screen.

Create a new scan shortcut (Windows)

You can create your own scan shortcut to make scanning easier. For example, you might want to regularly scan and save photos in PNG format, rather than JPEG.

1. Load the original print-side up in the document feeder, or load the original, print-side down, aligned with the top-left corner of the scanner glass.
2. Open the HP printer software. For more information, see [Open the HP printer software \(Windows\) on page 40](#).
3. In the printer software, under **Print & Scan**, click **Scan**, and then click **Scan a Document or Photo**.
4. Click **Create New Scan Shortcut**.
5. Enter a descriptive name, choose an existing shortcut on which to base your new shortcut, and then click **Create**.

For example, if you are creating a new shortcut for photos, choose either **Save as JPEG** or **Email as JPEG**. This makes available the options for working with graphics when scanning.

6. Change the settings for your new shortcut to meet your needs, and then click the save icon to the right of the shortcut.



NOTE: The initial screen allows you to review and modify basic settings. Click the **More** link at the top right corner of the Scan dialog to review and modify detailed settings.

For more information, see [Change scan settings \(Windows\) on page 72](#).

Change scan settings (Windows)

You can modify any of the scan settings either for a singular use or save the changes to use permanently. These settings include options such as page size and orientation, scan resolution, contrast, and the folder location for saved scans.

1. Load the original print-side up in the document feeder, or load the original, print-side down, aligned with the top-left corner of the scanner glass.
2. Open the HP printer software. For more information, see [Open the HP printer software \(Windows\) on page 40](#).
3. In the printer software, under **Print & Scan**, click **Scan**, and then click **Scan a Document or Photo**.
4. Click the **More** link in the top right corner of the HP Scan dialog.

The detailed settings pane appears on the right. The left column summarizes the current settings for each section. The right column allows you to change the settings in the highlighted section.

5. Click each section at the left of the detailed settings pane to review the settings in that section.

You can review and change most settings using drop-down menus.

Some settings allow greater flexibility by displaying a new pane. These are indicated by a + (plus sign) at the right of the setting. You must either accept or cancel any changes on this pane to return to the detailed settings pane.

6. When you have finished changing settings, do one of the following.
 - Click **Scan**. You are prompted to save or reject the changes to the shortcut after the scan is finished.
 - Click the save icon to the right of the shortcut. It saves the changes into the shortcut so that you can reuse them. Otherwise, the changes only affect the current scan. Then click **Scan**.



Learn more about using the HP Scan software. [Click here to go online for more information](#). At this time, this website might not be available in all languages.

- Customize scan settings, such as image file type, scan resolution, and contrast levels.
- Scan to network folders and cloud drives.
- Preview and adjust images before scanning.

Scan using Webscan

Webscan is a feature of the embedded web server that lets you scan photos and documents from your printer to your computer using a web browser.

This feature is available even if you did not install the printer software on your computer.

For more information, see [Open the embedded web server on page 36](#).



NOTE: By default, Webscan is off. You can enable this feature from the EWS.

If you are unable to open Webscan in the EWS, your network administrator might have turned it off. For more information, contact your network administrator or the person who set up your network.

To enable Webscan

1. Open the embedded web server. For more information, see [Open the embedded web server on page 36](#).
2. Click the **Settings** tab.
3. In the **Security** section, click **Administrator Settings**.
4. Select **Webscan from EWS** to enable Webscan.
5. Click **Apply**.

To scan using Webscan

Scanning using Webscan offers basic scan options. For additional scan options or functionality, scan from the HP printer software.

1. Load the original, print-side down, on the scanner glass, aligned with the top-left corner.
2. Open the embedded web server. For more information, see [Open the embedded web server on page 36](#).
3. Click the **Scan** tab.
4. Click **Webscan** in the left pane, change any settings, and then click **Start Scan**.

Tips for copy and scan success

Use the following tips to copy and scan successfully:

- Keep the glass and the back of the lid clean. The scanner interprets anything it detects on the glass as part of the image.
- Load the original print side up into the document feeder, or load the original print side down aligned with the top-left corner of the scanner glass.
- To make a large copy of a small original, scan the original into the computer, resize the image in the scanning software, and then print a copy of the enlarged image.
- If you want to adjust scan size, output type, scan resolution, or file type, and so on, start scan from the printer software.
- To avoid incorrect or missing scanned text, make sure the brightness is set appropriately in the software.
- If you want to scan a document with several pages into one file instead of multiple files, start the scan with the printer software or app.

Mobile Fax

Use the HP Smart app to quickly scan and fax multiple pages at once from your mobile device or computer. The HP Smart app will securely send your fax.

For more information about Mobile Fax, visit the [HP Smart website](#).

Use Mobile Fax in the HP Smart app

1. Make sure your mobile device or computer are connected to a network. Launch the HP Smart app and sign into or create your HP Account.
2. Select the Mobile Fax tile.

If you do not see the **Mobile Fax** tile, enable it as follows:

- On a mobile device: Tap **Personalize Tiles**, tap the **Mobile Fax** toggle to enable the tile, and then go back to the Home screen.
- On a Windows 10/Mac device: Click the **Settings**, select **Personalize Tiles**, and click the **Mobile Fax** toggle to enable the tile. Then, go back to the Home screen.



NOTE: Mobile Fax is available in specific countries/regions. If you do not see a Mobile Fax option in the Personalize Menu, Mobile Fax might not be available in your country/region.

3. Fill out the necessary mobile fax information.
4. To add a cover page, tap the **Add a cover page** toggle, and then type a subject and message
5. Scan the item you want to fax using your printer or mobile device camera, or attach a supported file type. Send the fax when ready.

Your fax will be securely delivered and you can track the status in the HP Smart app.

8 Web Services

This section contains the following topics:

- [What are Web Services?](#)
- [Set up Web Services](#)
- [Print with HP ePrint](#)
- [Remove Web Services](#)

What are Web Services?

The printer offers innovative, web-enabled solutions that can help you quickly access the Internet, obtain documents, and print them faster and with less hassle—and all without using a computer.



NOTE: To use these web features, the printer must be connected to the Internet. You cannot use these web features if the printer is connected using a USB cable.

HP ePrint

- **HP ePrint** is a free service from HP that allows you to print to your HP ePrint-enabled printer anytime, from any location. It's as simple as sending an email to the email address assigned to your printer when you enable Web Services on the printer. No special drivers or software are needed. If you can send an email, you can print from anywhere, using **HP ePrint**.



NOTE: Use your [HP Account](#) (might not be available in all countries/regions), to sign in and configure the HP ePrint settings.

Once you have signed up for an account on www.hpSMART.com, you can sign in to view your **HP ePrint** job status, manage your **HP ePrint** printer queue, control who can use your printer's **HP ePrint** email address to print, and get help for **HP ePrint**.

Set up Web Services

Before you set up Web Services, make sure your printer is connected to the Internet.

To set up Web Services, use one of the following methods.

To set up Web Services using the printer control panel

1. Print the Web Services Report by holding the Information button for three seconds until all buttons are lit. Press the Resume button.
2. The page will contain instructions on setting up HP Web Services.

To set up Web Services using the embedded web server

1. Open the EWS. For more information, see [Open the embedded web server on page 36](#).
2. Click the **Web Services** tab.
3. In the **Web Services Settings** section, click **Setup**, click **Continue**, and follow the onscreen instructions to accept the terms of use.
4. If prompted, choose to allow the printer to check for and install printer updates.



NOTE: When updates are available, they are automatically downloaded and installed, and then the printer restarts.



NOTE: If prompted for proxy settings and if your network uses proxy settings, follow the onscreen instructions to set up a proxy server. If you do not have the proxy details, contact your network administrator or the person who set up the network.

5. When the printer is connected to the server, the printer prints an information page. Follow the instructions on the information page to finish the setup.

To set up Web Services using the HP printer software (Windows)

1. Open the HP printer software. For more information, see [Open the HP printer software \(Windows\) on page 40](#).
2. In the window that appears, double-click **Print & Scan** and then select **Connect Printer to the Web** under **Print**. The printer's home page (embedded web server) opens.
3. On the **Web Services** tab, click **Continue**, and follow the onscreen instructions to accept the terms of use.
4. If prompted, choose to allow the printer to check for and install printer updates.



NOTE: When updates are available, they are automatically downloaded and installed, and then the printer restarts.



NOTE: If prompted for proxy settings and if your network uses proxy settings, follow the onscreen instructions to set up a proxy server. If you do not have the details, contact your network administrator or the person who set up the network.

5. When the printer is connected to the server, the printer prints an information page. Follow the instructions on the information page to finish the setup.

Print with HP ePrint

HP ePrint allows you to print to your HP ePrint-enabled printer anytime, from any location.



Before you can use HP ePrint, make sure the printer is connected to an active network providing Internet access.

To print a document using HP ePrint

1. Make sure you have set up Web Services.

For more information, see [Set up Web Services on page 78](#).

2. To obtain the email address for your printer:

- a. Press and hold  (the Information button) for three seconds until all the control panel buttons are lit.
- b. Press  (the Resume button) to print a Web Services information page, and then find the email address for your printer from the page.

3. Email your document to the printer.

- a. On your computer or mobile device, open your email application.



NOTE: For information about using the email application on your computer or mobile device, see the documentation provided with the application.

- b. Create a new email and attach the document to print.
- c. Send the email to the printer email address.

The printer prints the attached document.



NOTE:

- Enter only the HP ePrint email address in the "To" field. Do not enter any additional email addresses in the other fields. The HP ePrint server does not accept email print jobs if there are multiple addresses in the "To" field or any address in the "Cc" field."
- The email will be printed once it is received. As with any email, there is no guarantee when or whether it will be received. You can check the print status on [HP Smart website](#) (might not be available in all countries/regions).
- Documents printed with HP ePrint may appear different from the original. Style, formatting, and text flow may differ from the original document. For documents that need to be printed with a higher quality (such as legal documents), we recommend that you print from the software application on your computer, where you will have more control over what your printout looks like.

Remove Web Services

Use the following instructions to remove Web Services.

To remove Web Services using the embedded web server

1. Open the EWS. For more information, see [Open the embedded web server on page 36](#).
2. Click the **Web Services** tab, and then click **Remove Web Services** in the **Web Services Settings** section.
3. Click **Remove Web Services**.
4. Click **Yes** to remove Web Services from your printer.

9 Solve a problem

This section contains the following topics:

- [Get help from the HP Smart app](#)
- [Get help in this guide](#)
- [Understand printer reports](#)
- [Solve problems using Web Services](#)
- [Maintain the printer](#)
- [Restore original factory defaults and settings](#)
- [HP support](#)

Get help from the HP Smart app

The HP Smart app provides alerts for printer issues (jams and other problems), links to help content, and options to contact support for additional assistance.

Get help in this guide

This section contains the following topics:

- [Jams and paper-feed issues](#)
- [Ink cartridge issues](#)
- [Printing issues](#)
- [Network and connection issues](#)
- [Printer hardware issues](#)
- [Printer warning or error status](#)

Jams and paper-feed issues

- [Clear a paper jam](#)
- [Learn how to avoid paper jams](#)
- [Solve paper-feed problems](#)

Clear a paper jam

 **NOTE:** Paper jams can occur in several areas. Clear paper jam from the paper tray first. It helps to clear the paper path and make clearing jams from other areas easier. Then continue to the next area until all paper jams are located and cleared.

To clear a paper jam from the paper tray

1. Remove all the paper from the paper tray, including both loose and jammed paper.
2. Use a flashlight to check for any jammed paper or foreign objects in the paper path and remove them.

To avoid tearing any whole sheets of paper, gently pull the paper with both hands.

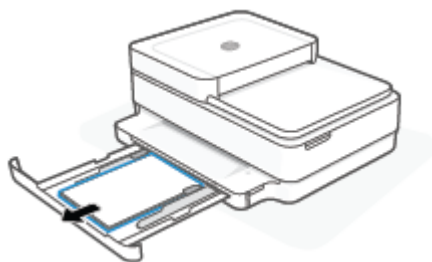

3. Press  (the Cancel button). The printer tries to clear the jam automatically.

To clear a paper jam from the output tray

1. Remove all the paper from the output tray, including both loose and jammed paper.

2. Use a flashlight to check for any jammed paper or foreign objects in the paper path and remove them.
To avoid tearing any whole sheets of paper, gently pull the paper with both hands.

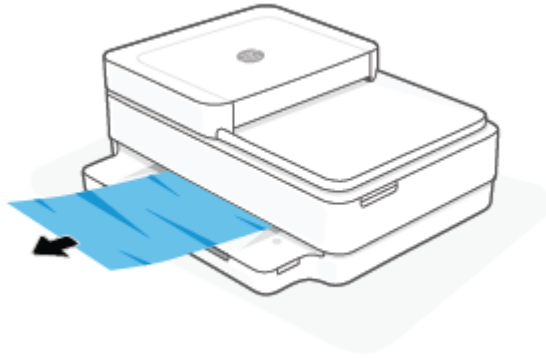

To clear a paper jam from the cartridge access area

1. Press  (the Cancel button) to try to clear the jam automatically. If this does not work, complete the following steps to clear the jam manually.
2. Open the cartridge access door.

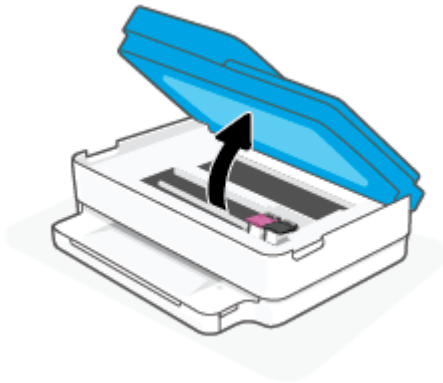

3. Wait until the carriage stops moving.
4. Press  to turn off the printer. Then disconnect the power cord from the rear of the printer.

 **CAUTION:** To avoid the risk of electrical shock, you must unplug the power cord to move the carriage by hand.

5. Use a flashlight to check for any jammed paper or foreign objects in the cartridge access area and remove them.

To avoid tearing any whole sheets of paper, gently pull the paper with both hands.

6. Remove the paper path cover.

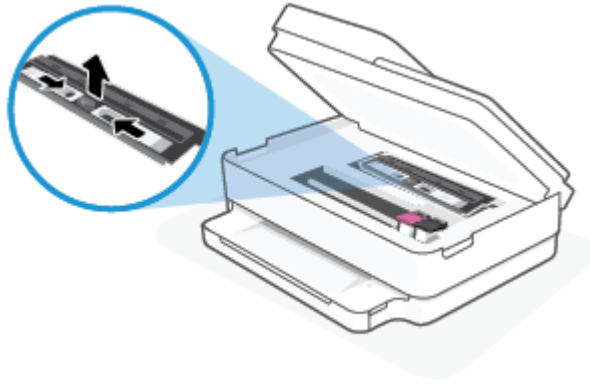

7. If the carriage is in the center of the printer, slide it to the right, and then remove any paper or objects blocking the carriage path.

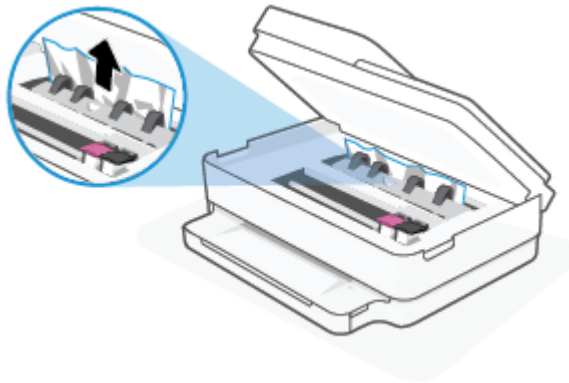

8. Close the cartridge access door.

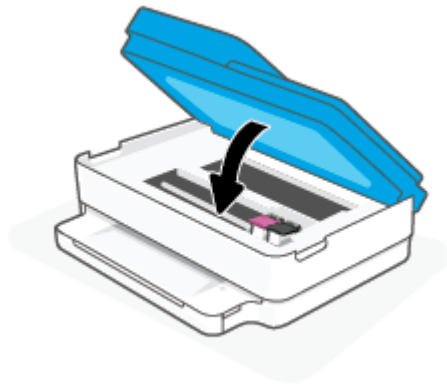

9. Reconnect the power cord to the rear of the printer to turn it on.

To clear an internal paper jam

CAUTION: Avoid pulling jammed paper from the front of the printer. Instead follow the steps below to clear the jam. Pulling out jammed paper from the front of the printer might cause the paper to tear and leave torn pieces inside the printer; this could result in more jams later.

1. Check the paper path inside the printer.

- a. Open the cartridge access door.

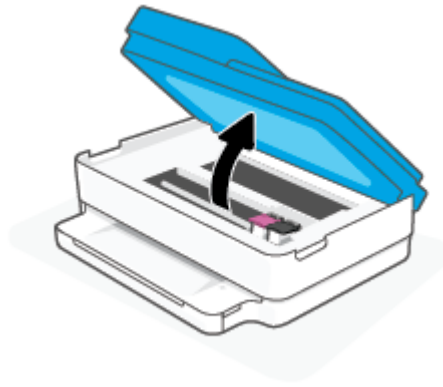

- b. Remove the paper path cover.

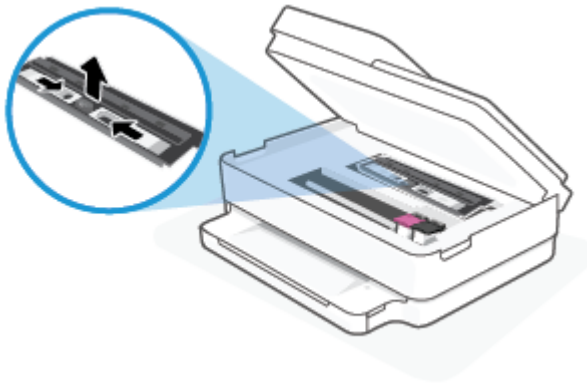

- c. Lift the duplexer cover up and remove jammed paper.

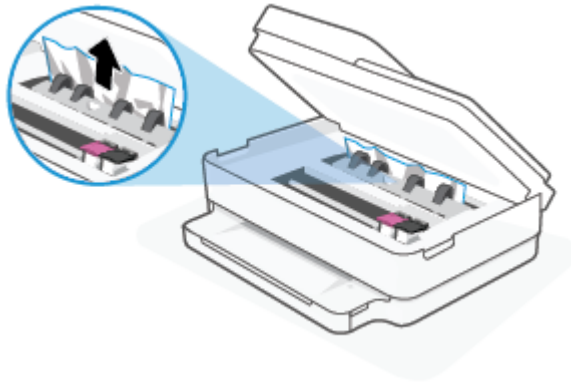

- d. Reinsert the paper path cover. Make sure it snaps into place.

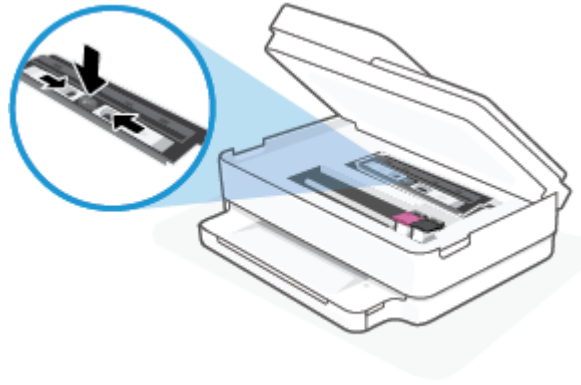

- e. Close the cartridge access door.

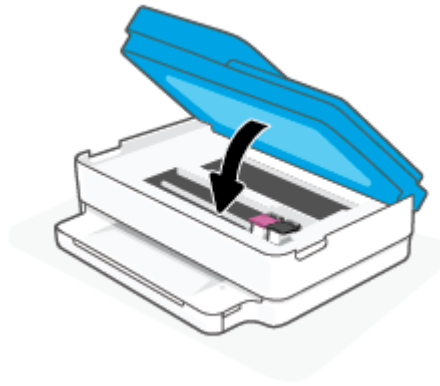

- f. Touch  on the control panel to continue the current job.

2. If the problem is not resolved, check the print carriage area inside the printer.

 **CAUTION:** During the process, avoid touching the cable attached to the print carriage.

- a. Open the cartridge access door.

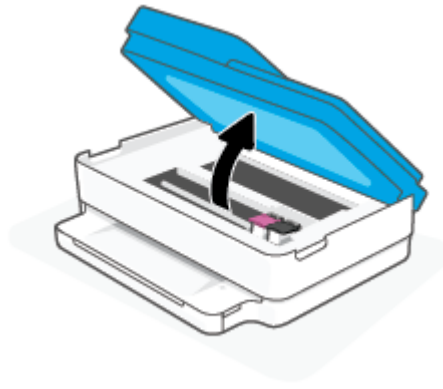



- b. If there is any jammed paper, move the print carriage to the far right of the printer, grasp the jammed paper with both hands, and then pull it towards you.

⚠ CAUTION: If the paper tears when you are removing it from the rollers, check the rollers and wheels for torn pieces of paper that might be remaining inside the printer.

If you do not remove all the pieces of paper from the printer, more paper jams are likely to occur.

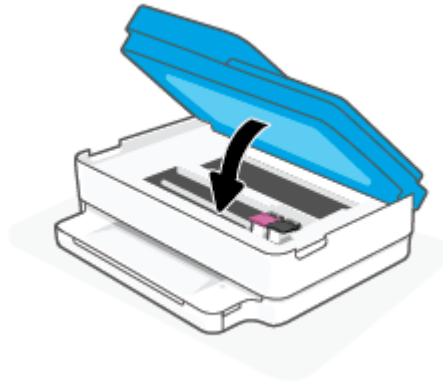
- c. Move the carriage to the far left of the printer, and do the same as in the previous step to remove any torn pieces of paper.
- d. Close the cartridge access door.



- e. Touch  on the control panel to continue the current job.
- 3. If the problem is still not resolved, check the tray area.
 - a. Pull out the paper tray to extend it.

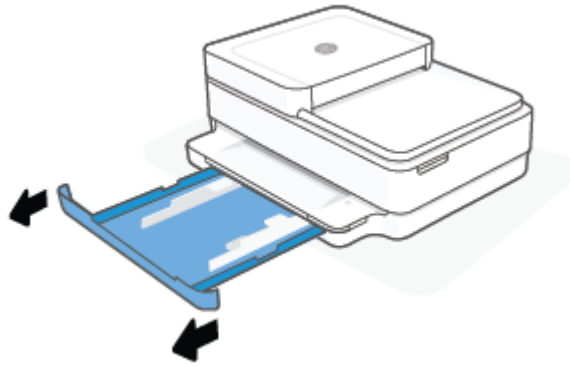

- b. Carefully turn the printer on its side to expose the bottom of the printer.
- c. Check the gap in the printer where the paper tray was. If there is any jammed paper, reach into the gap, grasp the paper with both hands and pull it towards you.

⚠ CAUTION: If the paper tears when you are removing it from the rollers, check the rollers and wheels for torn pieces of paper that might be remaining inside the printer.

If you do not remove all of the pieces of paper from the printer, more paper jams are likely to occur.

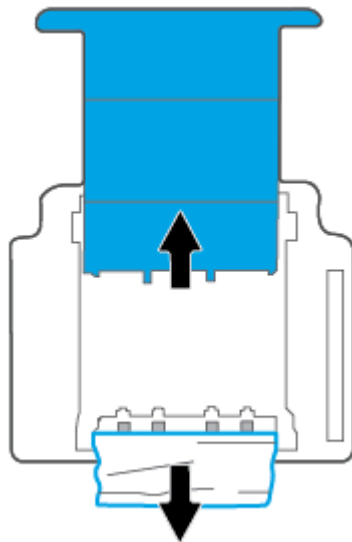

- d. Carefully turn the printer up again.
- e. Push the paper tray back in.
- f. Touch  on the control panel to continue the current job.

To clear a paper jam in the document feeder

- a. Lift the cover of the document feeder.

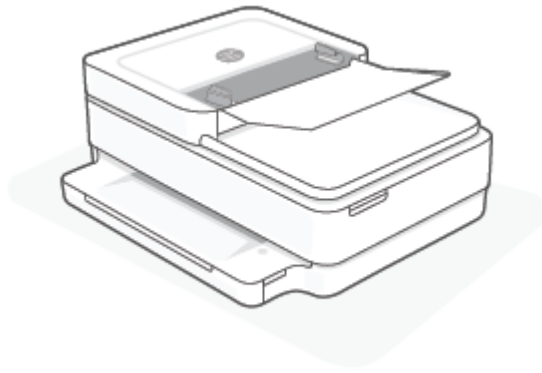

- b. Gently pull the jammed paper out of the rollers.

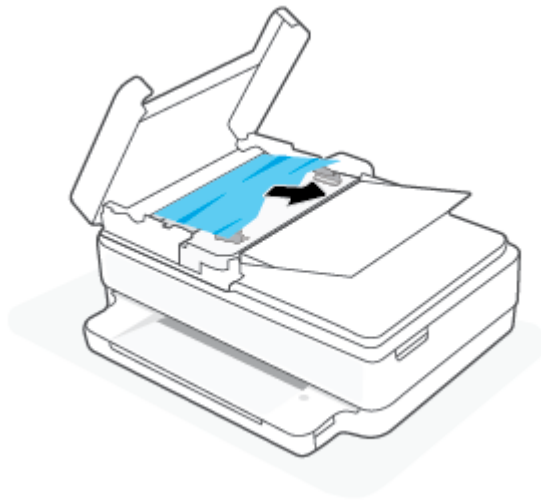

⚠ CAUTION: If the paper tears when you are removing it from the rollers, check the rollers and wheels for torn pieces of paper that might remain inside the printer.

If you do not remove all the pieces of paper from the printer, more paper jams are likely to occur.

- c. Close the document feeder input tray, pressing down firmly until it snaps into place.

Learn how to avoid paper jams

To help avoid paper jams, follow these guidelines.

- Remove printed papers from the output tray frequently.
- Make sure that you are printing with paper that is not wrinkled, folded, or damaged.
- Prevent curled or wrinkled paper by storing all unused paper flat in a resealable bag.
- Do not use paper that is too thick or too thin for the printer.
- Make sure that the trays are loaded correctly and are not too full. For more information, see [Load media on page 18](#).
- Ensure that paper loaded in the paper tray lays flat and the edges are not bent or torn.

- Do not combine different paper types and paper sizes in the paper tray; the entire stack of paper in the paper tray must be the same size and type.
- Adjust the paper-width guides in the paper tray to fit snugly against all paper. Make sure the paper-width guides do not bend the paper in the paper tray.
- Do not force paper too far inside the paper tray.
- If you are printing on both sides of a page, do not print highly saturated images on light weight paper.
- If the printer is about to run out of paper, allow the printer to run out of paper first, and then add paper. Do not load paper when the printer is printing.

Solve paper-feed problems

What kind of problem are you having?

- **Paper is not picked up from the paper tray**
 - Make sure paper is loaded in the paper tray. For more information, see [Load media on page 18](#).
 - Adjust the paper-width guides in the paper tray to fit snugly against all paper. Make sure the paper-width guides do not bend the paper in the paper tray.
 - Make sure paper in the paper tray is not curled. Uncurl paper by bending it in the opposite direction of the curl.
- **Pages are skewing**
 - Make sure the paper is loaded in the middle of the paper tray and the paper-width guides are fit against the left and right sides of the paper.
 - Load paper into the printer only when it is not printing.
- **Multiple pages are being picked up**
 - Adjust the paper-width guides in the paper tray to fit snugly against all paper. Make sure the paper-width guides do not bend the paper in the paper tray.
 - Make sure the paper tray is not overloaded with paper.
 - Make sure the pieces of the loaded paper are not sticking together.
 - Use HP paper for optimum performance and efficiency.

Ink cartridge issues

- [Identify whether a cartridge has a problem](#)
- [Fix cartridge problems](#)

Identify whether a cartridge has a problem

If a cartridge has a problem, you might get a cartridge problem message from the printer software or the HP Smart app, or the Cartridge access door lights up.

To identify whether a specific cartridge has a problem, open the cartridge access door, and then check the ink cartridge light. If it lights up or is blinking, the corresponded cartridge has an issue. For more information on cause and solution, see [Printer warning or error status on page 100](#).

Fix cartridge problems

If an error occurs after a cartridge is installed, or if a message indicates a cartridge problem, try removing the cartridges, verifying the protective piece of plastic tape has been removed from each cartridge, and then reinserting the cartridges. If this does not work, clean the cartridge contacts. If the problem is still not resolved, replace the cartridges. For information about replacing cartridges, see [Replace the cartridges on page 61](#).

To clean cartridge contacts

⚠ CAUTION: The cleaning procedure should take only a few minutes. Make sure that the cartridges are reinstalled in the printer as soon as possible. It is not recommended to leave the cartridges outside the printer longer than 30 minutes. If cartridges are left unprotected outside the printer, their nozzles might dry out and clog up.

1. Check that power is on.
2. Open the cartridge access door.

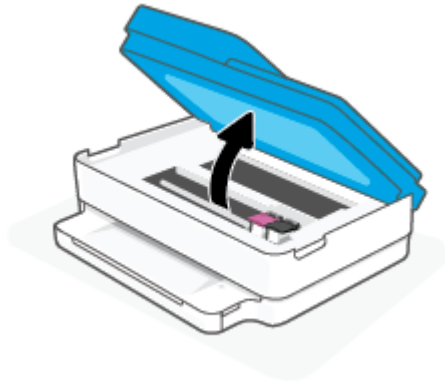

3. Wait until the carriage stops moving.
4. Remove the cartridge indicated in the error message.



5. Clean the cartridge contacts and printer contacts.
 - a. Hold the cartridge by its sides with the bottom pointing up and locate the electrical contacts on the cartridge.

The electrical contacts are the small gold-colored dots on the cartridge.

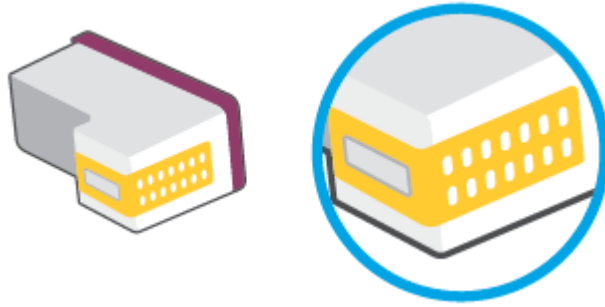

- b. Wipe only the contacts with a dry swab or lint-free cloth.

CAUTION: Be careful to wipe only the contacts, and do not smear any of the ink or other debris elsewhere on the cartridge.

- c. On the inside of the printer, locate the contacts for the cartridge.

The printer contacts are the set of gold-colored bumps positioned to meet the contacts on the cartridge.

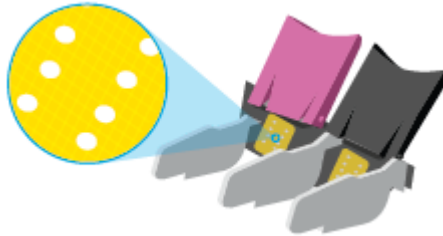

- d. Use a dry swab or lint-free cloth to wipe the contacts.
6. Reinstall the cartridge.
7. Close the Cartridge access door.
8. Check if the error message has gone away. If you still receive the error message, turn the printer off, and then on.

NOTE: If one cartridge is causing problems, you can remove it and use the single cartridge mode to operate the printer with only one cartridge.

Printing issues

What do you want to do?

- [Fix problems with page not printing \(unable to print\)](#)
- [Fix print quality issues](#)

Fix problems with page not printing (unable to print)

To resolve print issues (Windows)

Make sure that the printer is turned on and that there is paper in the paper tray. If you are still unable to print, try the following in order:

1. Check for error messages from the printer software and resolve them by following the onscreen instructions.
2. If your computer is connected to the printer with a wireless connection, confirm that the connection is working.
3. Verify that the printer is not paused or offline.

To verify that the printer is not paused or offline

- a. Depending upon your operating system, do one of the following:
 - **Windows 10:** From the Windows **Start** menu, select **Windows System** from the app list, select **Control Panel**, and then click **View devices and printers** under **Hardware and Sound**.
 - **Windows 8.1 and Windows 8:** Point to or tap the upper-right corner of the screen to open the Charms bar, click the **Settings** icon, click or tap **Control Panel**, and then click or tap **View devices and printers**.
 - **Windows 7:** From the Windows **Start** menu, click **Devices and Printers**.
 - b. Either double-click the icon for your printer or right-click the icon for your printer and select **See what's printing** to open the print queue.
 - c. On the **Printer** menu, make sure there are no check marks next to **Pause Printing** or **Use Printer Offline**.
 - d. If you made any changes, try to print again.
4. Verify that the printer is set as the default printer.

To verify that the printer is set as the default printer

- a. Depending upon your operating system, do one of the following:
 - **Windows 10:** From the Windows **Start** menu, select **Windows System** from the app list, select **Control Panel**, and then click **View devices and printers** under **Hardware and Sound**.
 - **Windows 8.1 and Windows 8:** Point to or tap the upper-right corner of the screen to open the Charms bar, click the **Settings** icon, click or tap **Control Panel**, and then click or tap **View devices and printers**.
 - **Windows 7:** From the Windows **Start** menu, click **Devices and Printers**.
- b. Make sure the correct printer is set as the default printer.
The default printer has a check mark in a black or green circle next to it.
- c. If the wrong printer is set as the default printer, right-click the correct printer and select **Set as Default Printer**.
- d. Try using your printer again.

5. Restart the print spooler.

To restart the print spooler

- a. Depending upon your operating system, do one of the following:

Windows 10

- i. From the Windows **Start** menu, select **Windows Administrative Tools** from the app list, and then select **Services**.
- ii. Right-click the **Print Spooler**, and then click **Properties**.
- iii. On the **General** tab, next to **Startup type**, make sure that **Automatic** is selected.
- iv. If the service is not already running, under **Service status**, click **Start**, and then click **OK**.

Windows 8.1 and Windows 8

- i. Point to or tap the upper-right corner of the screen to open the Charms bar, and then click the **Settings** icon.
- ii. Click or tap **Control Panel**, and then click or tap **System and Security**.
- iii. Click or tap **Administrative Tools**, and then double-click or double-tap **Services**.
- iv. Right-click or touch and hold **Print Spooler**, and then click **Properties**.
- v. On the **General** tab, next to **Startup type**, make sure that **Automatic** is selected.
- vi. If the service is not already running, under **Service status**, click or tap **Start**, and then click or tap **OK**.

Windows 7

- i. From the Windows **Start** menu, click **Control Panel**, **System and Security**, and then **Administrative Tools**.
 - ii. Double-click **Services**.
 - iii. Right-click the **Print Spooler**, and then click **Properties**.
 - iv. On the **General** tab, next to **Startup type**, make sure that **Automatic** is selected.
 - v. If the service is not already running, under **Service status**, click **Start**, and then click **OK**.
- b. Make sure the correct printer is set as the default printer.
The default printer has a check mark in a black or green circle next to it.
 - c. If the wrong printer is set as the default printer, right-click the correct printer and select **Set as Default Printer**.
 - d. Try using your printer again.

6. Restart the computer.

7. Clear the print queue.

To clear the print queue

- a. Depending upon your operating system, do one of the following:
 - **Windows 10:** From the Windows **Start** menu, select **Windows System** from the app list, select **Control Panel**, and then click **View devices and printers** under **Hardware and Sound**.
 - **Windows 8.1 and Windows 8:** Point to or tap the upper-right corner of the screen to open the Charms bar, click the **Settings** icon, click or tap **Control Panel**, and then click or tap **View devices and printers**.
 - **Windows 7:** From the Windows **Start** menu, click **Devices and Printers**.
- b. Double-click the icon for your printer to open the print queue.
- c. On the **Printer** menu, click **Cancel all documents** or **Purge Print Document**, and then click **Yes** to confirm.
- d. If there are still documents in the queue, restart the computer and try printing again after the computer has restarted.
- e. Check the print queue again to make sure it is clear, and then try to print again.

Fix print quality issues



NOTE: To protect the cartridges from drying out, always turn the printer off using the Power button.

To improve print quality (Windows)

1. Make sure you are using original HP cartridges.
2. Check the paper type.

For best print quality, use high quality HP paper, or papers that adhere to the ColorLok® standard. For more information, see [Paper basics on page 24](#).

Always make sure the paper you are printing on is flat. For best results when printing images, use HP Advanced Photo Paper.

Store specialty paper in its original packaging inside a resealable plastic bag on a flat surface in a cool, dry place. When you are ready to print, remove only the paper you plan to use immediately. When you have finished printing, return any unused photo paper to the plastic bag. This prevents the photo paper from curling.

3. Check the printer software to make sure you have selected the appropriate paper type from the **Media** drop-down list and print quality from the **Quality Settings** drop-down list.

In the printer software, click **Print & Scan**, and then click **Set Preferences** to access the print properties.

4. Check the estimated ink levels to determine if the cartridges are low on ink.

For more information, see [Check the estimated ink levels on page 58](#). If the cartridges are low on ink consider replacing them.

5. Align the cartridges.

To align the cartridges

- a. Load letter or A4 unused plain white paper into the paper tray.
- b. Open the printer software. For more information, see [Open the HP printer software \(Windows\) on page 40](#).
- c. In the printer software, click **Print & Scan** and then click **Maintain Your Printer** to access the printer toolbox.

The printer toolbox appears.

- d. Click **Align Cartridges** on the **Device Services** tab.

The printer prints an alignment page.

- e. Follow the onscreen instructions to align the cartridges. Recycle or discard the cartridge alignment sheet later.

6. Print a diagnostics page if the cartridges are not low on ink.

To print a diagnostics page

- a. Load letter or A4 unused plain white paper into the paper tray.
- b. Open the printer software. For more information, see [Open the HP printer software \(Windows\) on page 40](#).
- c. In the printer software, click **Print & Scan** and then click **Maintain Your Printer** to access the printer toolbox.
- d. Click **Print Diagnostic Information** on the **Device Reports** tab to print a diagnostics page.
- e. Examine the color blocks on the diagnostics page.

If any of the color blocks show white lines, are faded, or are missing completely, continue to the next step.

Figure 9-1 Color blocks without defects

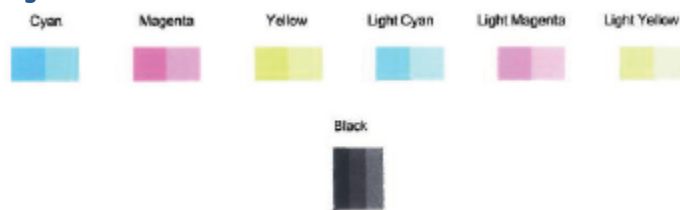

Figure 9-2 Example of color blocks with defects



7. Clean the cartridges.

To clean the cartridges

- a. Load letter or A4 unused plain white paper into the paper tray.
- b. Open the printer software. For more information, see [Open the HP printer software \(Windows\) on page 40](#).
- c. In the printer software, click **Print & Scan** and then click **Maintain Your Printer** to access the printer toolbox.
- d. Click **Clean Cartridges** on the **Device Services** tab. Follow the onscreen instructions.



Network and connection issues

What do you want to do?

- [Fix wireless connection](#)
- [Fix Wi-Fi Direct connection](#)

Fix wireless connection

Choose one of the following troubleshooting options.





- Verify that the printer and the wireless router are turned on and have power. Also make sure that the wireless radio in the printer is turned on.
- Check that the Wireless indicator  on the control panel is on.
- From the printer control panel, press the Resume  and  (the Information button) at the same time to print the wireless network test report and network configuration page.

Check the top of the wireless network test report to see if something failed during the test. You can also see your Wi-Fi signal strength.

- See the **DIAGNOSTICS RESULTS** section for all tests that were performed, to determine whether or not your printer passed. If there are issues, perform the recommended steps listed in the report, and then try using your printer again.
- From the **CURRENT CONFIGURATION** section, find out the Network Name (SSID) to which your printer is currently connected. Make sure that the printer is connected to the same network as your computer or mobile devices.
- **Check your Wi-Fi signal strength.** If the signal is weak, verify that the printer is within the range of the wireless network. For most networks, the printer must be within 30 m (100 ft) of the wireless access point (wireless router).
- Restore network settings and then reconnect the printer. See [Connect using the HP Smart app on page 26](#).
- From HP Smart help center, find printer connection help, and then follow onscreen instructions.
- If you are printing from a Windows computer, try using the [HP Print and Scan Doctor](#) utility to diagnose and fix the issue automatically.

- To determine if a firewall or antivirus program is preventing your computer from connecting to the printer and find resolutions, use the [HP online firewall troubleshooter](#).
- For more information about troubleshooting wireless network connection issues, visit www.hp.com/go/wirelessprinting

Fix Wi-Fi Direct connection

1. Make sure that Wi-Fi Direct is on. If it is off, press and hold  (the Information button) for at least three seconds to turn on all the button lights, and then press and hold , , and  together.
2. From your wireless computer or mobile device, search for and connect to the Wi-Fi Direct name of your printer.

If you are using a mobile device that does not support Wi-Fi Direct, make sure you have installed a compatible printing app. For more information, visit the HP Mobile Printing website at www.hp.com/go/mobileprinting. If a local version of this website is not available in your country/region or language, you might be directed to the HP Mobile Printing website in another country/region or language.



NOTE: If your mobile device does not support Wi-Fi, you are not able to use Wi-Fi Direct.

3. If the Wi-Fi Direct connection security for the printer is set to **Manual**, do one of the following to connect to the printer.
 - Make sure to enter the correct Wi-Fi Direct password or PIN code when prompted.
 - If  (the Information button) is blinking white on the printer control panel, make sure to press it within 30 seconds to confirm the connection.
4. Make sure that the number of Wi-Fi Direct connections has not reached the maximum of five devices.
5. For more assistance with resolving Wi-Fi Direct problems or configuring Wi-Fi Direct, visit www.hp.com/go/wpc-wirelessdirect.

Printer hardware issues



TIP: Run the [HP Print and Scan Doctor](#) to diagnose and automatically fix printing, scanning, and copying issues. The application is only available in some languages.

The printer shuts down unexpectedly

- Check the power and power connections.
- Make sure the printer's power cord is connected firmly to a functioning power outlet.

The cartridge access door is open

- Close the cartridge access door to begin printing.

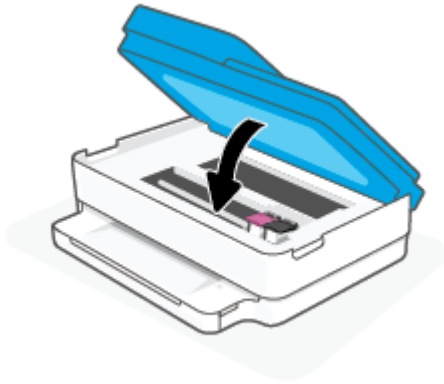

Cartridges alignment fails

- If the alignment process fails, make sure you have loaded unused, plain white paper into the paper tray. If you have colored paper loaded in the paper tray when you align the ink cartridges, the alignment fails.
- If the alignment process fails repeatedly, you may need to clean the printhead, or you might have a defective sensor.
- If cleaning the printhead does not solve the problem, contact HP support. Go to www.support.hp.com. This website provides information and utilities that can help you correct many common printer problems. If prompted, select your country/region, and then click **All HP Contacts** for information on calling for technical support.

Resolve printer failure

- ▲ Turn the printer off, then on. If that does not resolve the problem, contact HP.

For more information about contacting HP support, see [HP support on page 111](#).

Printer warning or error status



 **NOTE:** The HP Smart app provides detailed information for printer warnings and errors. Open the app and check the printer status, and then follow the onscreen instructions to fix the issue. Then check the following for additional assistance if needed.



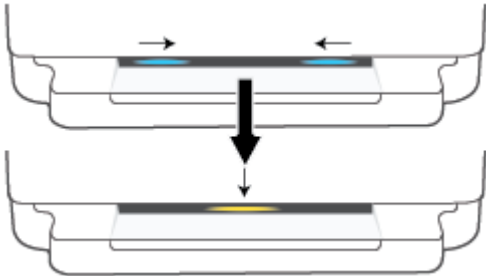
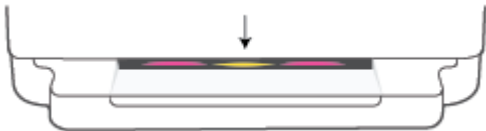



- [Wireless connection errors](#)
- [Paper error status](#)
- [Ink error status](#)
- [Error Codes on control panel](#)

Wireless connection errors



Light behavior	Cause and Solution
<p>The large light bar pulses blue from the middle to the edges, repeating. Between each cycle, there is an amber flash on the large light bar.</p> 	<p>There is an Auto Wireless Connect (AWC) error.</p> <ul style="list-style-type: none"> • If it occurs during the AWC setup mode, for the more instructions, see Connect using the HP Smart app on page 26. • If it occurs after the connection has been completed successfully, for troubleshooting the issue, see Network and connection issues on page 98.
<p>The large light bar glows purple at the outside edges and flashes amber in the center.</p> 	<p>There is a wireless connection error during the Wi-Fi Protected Setup (WPS) mode.</p> <ul style="list-style-type: none"> • For more information on how to connect the printer, see Connect your printer to a wireless network using Wi-Fi Protected Setup (WPS) on page 27. • For more information on how to troubleshoot the issue, see Network and connection issues on page 98.



Paper error status

Light behavior				Cause and Solution
Edge lighting	Paper tray light			Cause and Solution
Amber across the large light bar	Blinking	On	Off	<p>The printer receives a printing job, starts feeding paper, and detects that the paper width for the printing job is bigger than the width of the loaded paper.</p> <p>Press  (the Cancel button) to cancel the printing job and eject paper.</p> <p>To avoid the paper size mismatch problem, do one of the following before printing.</p> <ul style="list-style-type: none"> • Change the paper size setting for the printing job to match the paper loaded. • Remove all paper from the paper tray, and then load paper that matches the paper size setting for the printing job. <p>TIP: You can change the default paper size automatically detected by the printer. For more information, see Change the default paper size detected by the printer on page 23.</p>
Amber across the large light bar	Blinking	On	On	<p>One of the following might have occurred.</p> <ul style="list-style-type: none"> • The printer receives a multipage printing job, detects that the paper length for the printing job does not match the length of the loaded paper, and then prints out the first page of the job with errors.

Light behavior					Cause and Solution
Edge lighting	Paper tray light				
					<p>To cancel the printing job, press  (the Cancel button).</p> <p>To continue printing the remaining pages, press  (the Resume button). The remaining pages will have the same errors as the first page.</p> <p>To change the default paper size automatically detected by the printer, see Change the default paper size detected by the printer on page 23.</p> <ul style="list-style-type: none"> The printer receives a printing job, and detects that there is no paper in the paper tray. <p>To cancel the printing job, press  (the Cancel button).</p> <p>To continue printing, load paper, and then press  (the Resume button).</p> <p>For information about how to load paper, see Load media on page 18.</p>

Ink error status

Light behavior					Cause and Solution
Edge lighting	Cartridge access door	Ink cartridge light			
Amber across the large light bar	Blinking	On for the cartridge with issue			<p>One of the following might have occurred.</p> <ul style="list-style-type: none"> A counterfeit or previously used cartridge is installed. The corresponding cartridge is very low on ink. <p>Try the following solutions to solve the problem.</p> <ul style="list-style-type: none"> If the corresponding cartridge is newly installed, it might be counterfeit or previously used. Refer to the message in the HP printer software or the HP Smart app for more information. If the corresponding cartridge is not newly installed, it is very low on ink. Press  (the Resume button) to continue printing, and replace the cartridge when the print quality is no longer acceptable. For information about how to replace cartridges, see Replace the cartridges on page 61.
Amber across the large light bar	Blinking	Blinking for the cartridge with issue	On	Off	<p>One of the following might have occurred.</p> <ul style="list-style-type: none"> The corresponding cartridge is missing. <p>If one of the cartridges is missing, the printer enters single cartridge mode. To exit the single cartridge mode, insert the</p>

Light behavior					Cause and Solution
Edge lighting	Cartridge access door	Ink cartridge light			
					<p>corresponding cartridge. For more information about the single cartridge mode, see Use single cartridge mode on page 63.</p> <ul style="list-style-type: none"> The corresponding cartridge is installed improperly, or still has plastic tape on it. <p>Remove the corresponding cartridge, make sure there is no plastic tape on it, and then reinsert the cartridge securely. For more information, see Replace the cartridges on page 61.</p>
Amber across the large light bar	On	Off	Off	Off	The Cartridge access door is open. It must be closed to begin printing.
Amber across the large light bar	Fast blinking	Fast blinking, alternating on both cartridges	On	Off	<p>The carriage inside the printer has stalled.</p> <p>Press  (the Cancel button) to cancel the printing job. Open the Cartridge access door and make sure the carriage is not obstructed. Move the carriage to the right and close the Cartridge access door. If the problem is still not resolved, see Jams and paper-feed issues on page 83 for more information.</p>

Error Codes on control panel

Summary of supported error codes:

Error Codes	Description
E0	Unusable cartridge
E1	Paper size mismatch error
E2	Sensor/Paper length mismatch error
E3	Ink carriage stall
E4	Paper jam
E5	Scanner failure
E6	General printer error
E9	Update error

Understand printer reports

You can print the following reports to help troubleshoot problems with the printer.

- [Printer status report](#)
- [Network configuration page](#)
- [Print quality report](#)
- [Wireless test report](#)
- [Web access test report](#)

For more information on how to print these reports, see [Print reports from control panel on page 7](#).

Printer status report

Use the printer status report to view current printer information and cartridge status. Also use the printer status report to help you troubleshoot problems with the printer.

The printer status report also contains a log of recent events.

If you need to call HP, it is often useful to print the printer status report before calling.

Network configuration page

If the printer is connected to a network, you can print a network configuration page to view the network settings for the printer and a list of networks detected by your printer. The last page of the report includes a list of all detectable wireless networks in the area, along with signal strength and the channels being used. This might help you select a channel for your network which is not heavily used by other networks (which will improve network performance).



NOTE: In order to get the list of detected wireless networks in the area, the wireless radio on the printer should be turned on. If it is off the list is not displayed.

You can use the network configuration page to help troubleshoot network connectivity problems. If you need to call HP, it is often useful to print this page before calling.

Print quality report

Print quality problem can be due to many causes - incorrect software setting, a poor image source file, or the printing system itself. If you are unhappy with the quality of your prints, a Print Quality Report page can help you determine if the printing system is working correctly.

Wireless test report

When you print the Wireless Test Report, a number of tests are run to check various conditions of the printer wireless connection. The report shows the results of the tests. If an issue is discovered, message along with how to fix it is provided at the top of the report. Some key wireless configuration details are provided at the bottom section of the report.

Web access test report

Print the web access report to help identify internet connectivity issues which can affect Web Services.

Solve problems using Web Services

If you are having problems using Web Services, such as **HP ePrint**, check the following:

- Make sure the printer is connected to the Internet using an wireless connection.



NOTE: You cannot use these web features if the printer is connected using a USB cable.

- Make sure the latest product updates have been installed on the printer.
- Make sure Web Services is enabled on the printer. For more information, see [Set up Web Services on page 78](#).
- Make sure the network hub, switch, or router is turned on and working correctly.
- If you are connecting the printer using a wireless connection, make sure the wireless network is functioning properly. For more information, see [Network and connection issues on page 98](#).
- If you are using **HP ePrint**, check the following:
 - Make sure the printer's email address is correct.
 - Make sure that the printer's email address is the only address listed in the "To" line of the email message. If other email addresses are listed in the "To" line, the attachments you are sending might not print.
 - Make sure you are sending documents that meet the **HP ePrint** requirements. For more information, visit the [HP Smart website](#). This site might not be available in all countries/regions.
- If your network uses proxy settings when connecting to the Internet, make sure the proxy settings you are entering are valid:
 - Check the settings being used by the web browser you are using (such as Internet Explorer, Firefox, or Safari).
 - Check with the IT administrator or person who set up your firewall.

If the proxy settings used by your firewall have changed, you must update these settings in either the printer control panel or the embedded web server. If these settings are not updated, you will not be able to use Web Services.

For more information, see [Set up Web Services on page 78](#).



TIP: For additional help on setting up and using Web Services, visit the [HP Smart website](#). (might not be available in all countries/regions).

Maintain the printer

Clean the scanner glass

Dust or dirt on the scanner glass, scanner lid backing, or scanner frame can slow down performance, degrade the quality of scans, and affect the accuracy of special features such as fitting copies to a certain page size.

To clean the scanner glass

⚠ WARNING! Before cleaning the printer, turn the printer off by pressing  (the Power button) and unplugging the power cord from the electrical socket.

1. Lift the scanner lid.



2. Clean the scanner glass and lid backing by using a soft, lint-free cloth that has been sprayed with a mild glass cleaner.



⚠ CAUTION: Use only glass cleaner to clean the scanner glass. Avoid cleaners that contain abrasives, acetone, benzene, and carbon tetrachloride, all of which can damage the scanner glass. Avoid isopropyl alcohol because it can leave streaks on the scanner glass.

CAUTION: Do not spray the glass cleaner directly on the scanner glass. If too much glass cleaner is applied, the cleaner could leak under the scanner glass and damage the scanner.

3. Close the scanner lid, and turn on the printer.

Clean the exterior

 **WARNING!** Before cleaning the printer, turn the printer off by pressing  (the Power button) and unplug the power cord from the electrical socket.

Use a soft, damp, lint-free cloth to wipe dust, smudges, and stains off of the case. Keep fluids away from the interior of the printer, as well as from the printer control panel.

Clean the document feeder

If the document feeder picks up multiple pages or if it does not pick up plain paper, you can clean the rollers and separator pad.

To clean the rollers or separator pad

 **WARNING!** Before cleaning the printer, turn the printer off by pressing  (the Power button) and unplug the power cord from the electrical socket.

1. Remove all originals from the document feeder tray.

2. Lift the document feeder input tray.

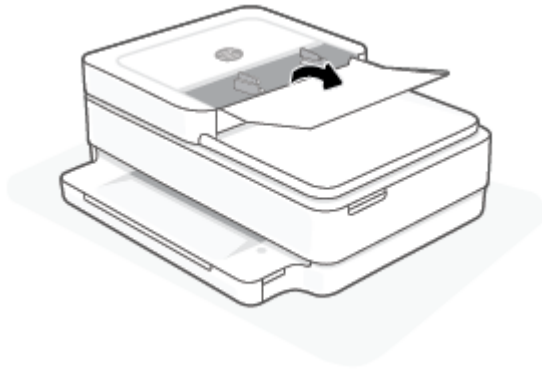

This provides easy access to the rollers (1) and separator pad (2).

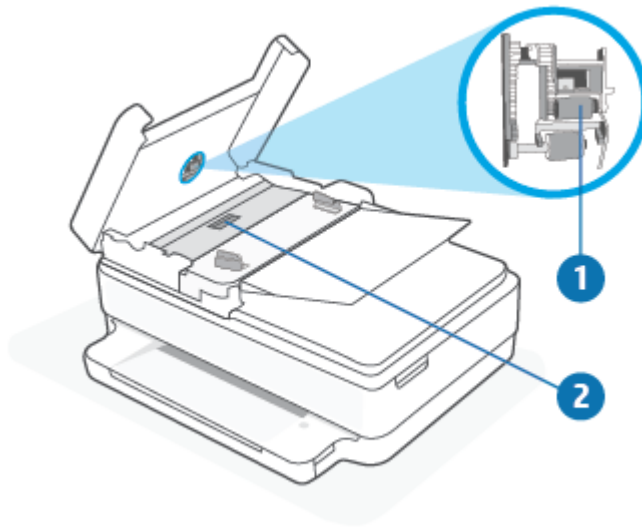

1	Rollers
2	Separator pad

3. Lightly dampen a clean lint-free cloth with distilled water, then squeeze any excess liquid from the cloth.
4. Use the damp cloth to wipe any residue off the rollers or separator pad.



 **NOTE:** If the residue does not come off using distilled water, try using isopropyl (rubbing) alcohol.

5. Close the cover of the document feeder.

Restore original factory defaults and settings

If you disable some functions or change some settings and want to change them back, you can restore the printer to the original factory settings or network settings.

To restore the printer to the original factory defaults

1. Lift the cartridge access door to expose the cartridge area.
2. While the cartridge access door is open, press and hold  (the Power button) and  **Wireless** button on the back of the printer for three seconds.

To restore the printer to the original network settings

- On the back of the printer, press and hold the  **Wireless** button for at least three seconds.

 **NOTE:** When you reset the printer network settings, previously configured wireless settings (such as the link speed or IP address) are removed. The IP address is set back to the Automatic mode.

 **TIP:** You can visit the HP online support website at www.support.hp.com for information and utilities that can help you correct many common printer problems.

(Windows) Run the [HP Print and Scan Doctor](#) to diagnose and automatically fix printing, scanning, and copying issues. The application is only available in some languages.

HP support

For the latest product updates and support information, visit the product support website at www.support.hp.com. HP online support provides a variety of options for help with your printer:



Get troubleshooting assistance: Find information for resolving paper jams, network connection issues, print quality issues, printer errors, and more.



Get software and drivers: Download software, drivers, and firmware you need for the printer.



Ask the community: Join the community forums to find solutions, ask questions, and share tips.



HP Diagnostics Solutions: Use HP online tools to detect your printer and find recommended solutions. For Windows operating systems, you can automatically diagnose and resolve printer issues with [HP Print and Scan Doctor](#).



NOTE: You can also find help online by visiting the [Printer Essentials](#) webpage. Here you can find links to install the HP Smart app, purchase replacement ink for your printer (including HP Instant Ink, if applicable), and get help with common printer tasks.

Contact HP

If you need help from an HP technical support representative to solve a problem, visit the www.support.hp.com. The following contact options are available at no cost for in-warranty customers (HP agent-assisted support for out-of-warranty customers may require a fee):



Chat with an HP support agent or the HP Virtual Agent online.



Call an HP support agent.

When contacting HP support, be prepared to provide the following information:

- Product name (Located on the printer)
- Product number and serial number (located inside the cartridge access door)



Register printer

By taking just a few minutes to register, you can enjoy quicker service, more efficient support, and product support alerts. If you did not register your printer while installing the software, you can register now at <https://www.register.hp.com>.

Additional warranty options

Extended service plans are available for the printer at additional costs. Go to www.support.hp.com, select your country/region and language, then explore the extended warranty options available for your printer.

10 HP EcoSolutions (HP and the Environment)

HP is committed to helping you optimize your environmental footprint and empowering you to print responsibly—at home or in the office.

For more detailed information about environmental guidelines that HP follows during the manufacturing process, see [Environmental product stewardship program on page 125](#). For more information about HP's environmental initiatives, visit www.hp.com/ecosolutions.

Energy Save Mode

Power usage is reduced while in Energy Save Mode.

After initial setup of printer, the printer will enter Energy Save Mode after 5 minutes of inactivity.

To change the time to Energy Save Mode from the embedded web server (EWS)

1. Open the embedded web server (EWS). For more information, see [Open the embedded web server on page 36](#).
2. Click the **Settings** tab.
3. In the **Power Management** section, click **Energy Save Mode**, and select the desired option.
4. Click **Apply**.

A Technical information

The technical specifications and international regulatory information for the HP ENVY Pro All-in-One 6400 series are provided in this section.

For additional specifications, see the printed documentation that came with the HP ENVY Pro All-in-One 6400 series.

This section contains the following topics:

- [HP Company notices](#)
- [Specifications](#)
- [Regulatory notices](#)
- [Environmental product stewardship program](#)

HP Company notices

The information contained herein is subject to change without notice.

All rights reserved. Reproduction, adaptation, or translation of this material is prohibited without prior written permission of HP, except as allowed under the copyright laws. The only warranties for HP products and services are set forth in the express warranty statements accompanying such products and services. Nothing herein should be construed as constituting an additional warranty. HP shall not be liable for technical or editorial errors or omissions contained herein.

© Copyright 2020 HP Development Company, L.P.

Microsoft and Windows are either registered trademarks or trademarks of Microsoft Corporation in the United States and/or other countries.

Bluetooth is a trademark owned by its proprietor and used by HP Inc. under license.

Specifications

The information here is subject to change without notice. For more product specifications, see the Product Data Sheet at www.support.hp.com.

System requirements

- For information about software and system requirements or future operating system releases and support, visit the HP online support website at www.support.hp.com.

Environmental specifications

- Recommended operating temperature range: 15°C to 30°C (59°F to 86°F)
- Allowable operating temperature range: 5°C to 40°C (41°F to 104°F)
- Humidity: 25% to 75% RH non-condensing (recommended);
- Nonoperating (Storage) temperature range: -40°C to 60°C (-40°F to 140°F)
- In the presence of high electromagnetic fields, it is possible the output from the printer may be slightly distorted

paper tray capacity

- Plain paper sheets: Up to 80
- Envelopes: Up to 10
- Index cards: Up to 40
- Photo paper sheets: Up to 30

Output tray capacity

- Plain paper sheets: Up to 25
- Envelopes: Up to 5
- Photo paper sheets: Up to 10

Document feeder input tray capacity

- Plain paper sheets: Up to 35

Paper size

- For a complete list of supported media sizes, see the printer software.

Paper weights

- Plain Paper: 60 to 90 g/m² (16 to 32 lb bond)
- Envelopes: 75 to 90 g/m² (20 to 55 lb bond envelope)
- Cards: Up to 200 g/m² (110 lb index maximum)
- Photo Paper: Up to 300 g/m² (145 lb bond)

Print specifications

- Print speeds vary according to the complexity of the document
- Method: drop-on-demand thermal inkjet
- Language: PCL3 GUI

Print resolution

- For a list of supported print resolutions, visit the product support website at www.support.hp.com.

Scan specifications

- • Optical Resolution: up to 1200 dpi
- • Hardware Resolution: up to 1200 x 1200 dpi
- • Enhanced Resolution: up to 1200 x 1200 dpi
- • Bitdepth: 24-bit color, 8-bit grayscale (256 levels of gray)
- • Maximum scan size from glass: 215.9 x 297 mm (8.5 x 11.7 inches)
- • Maximum scan size (Document feeder): 215.9 x 297 mm (8.5 x 11.7 inches)
- • Supported File Types: RAW, JPEG, PDF
- • Twain Version: 1.9

Copy specifications

- • Copy Resolution (black and color): up to 300 x 300 dpi
- • Digital image processing
- • Maximum number of copies varies by model.
- • Copy speeds vary according to the complexity of the document and model.

Cartridge yield

- Visit www.hp.com/go/learnaboutsupplies for more information on estimated cartridge yields.

Acoustic information

- If you have Internet access, you can access acoustic information from the [HP website](#).

Regulatory notices

The HP ENVY Pro All-in-One 6400 series meets product requirements from regulatory agencies in your country/region.

This section contains the following topics:

- [Regulatory model number](#)
- [FCC statement](#)
- [Notice to users in Korea](#)
- [VCCI \(Class B\) compliance statement for users in Japan](#)
- [Notice to users in Japan about the power cord](#)
- [Noise emission statement for Germany](#)
- [European Union Regulatory Notice](#)
- [Visual display workplaces statement for Germany](#)
- [Declaration of conformity](#)
- [Regulatory wireless statements](#)

Regulatory model number

For regulatory identification purposes, your product is assigned with a Regulatory Model Number. The Regulatory Model Number for your product is SNPRC-1807-02 and this number should not be confused with the marketing names or product numbers.

FCC statement

The United States Federal Communications Commission (in 47 CFR 15.105) has specified that the following notice be brought to the attention of users of this product.

This equipment has been tested and found to comply with the limits for a Class B digital device, pursuant to Part 15 of the FCC Rules. These limits are designed to provide reasonable protection against harmful interference in a residential installation. This equipment generates, uses and can radiate radio frequency energy and, if not installed and used in accordance with the instructions, may cause harmful interference to radio communications. However, there is no guarantee that interference will not occur in a particular installation. If this equipment does cause harmful interference to radio or television reception, which can be determined by turning the equipment off and on, the user is encouraged to try to correct the interference by one or more of the following measures:

- Reorient or relocate the receiving antenna.
- Increase the separation between the equipment and the receiver.
- Connect the equipment into an outlet on a circuit different from that to which the receiver is connected.
- Consult the dealer or an experienced radio/TV technician for help.

For further information, contact: Manager of Corporate Product Regulations, HP Inc. 1501 Page Mill Road, Palo Alto, CA 94304, U.S.A.

Modifications (part 15.21)

The FCC requires the user to be notified that any changes or modifications made to this device that are not expressly approved by HP may void the user's authority to operate the equipment.

This device complies with Part 15 of the FCC Rules. Operation is subject to the following two conditions: (1) this device may not cause harmful interference, and (2) this device must accept any interference received, including interference that may cause undesired operation.

Notice to users in Korea

B급 기기

(가정용 방송통신기자재)

이 기기는 가정용(B급) 전자파적합기기로서 주로 가정에서 사용하는 것을 목적으로 하며, 모든 지역에서 사용할 수 있습니다.

VCCI (Class B) compliance statement for users in Japan

この装置は、クラス B 機器です。この装置は、住宅環境で使用することを目的としていますが、この装置がラジオやテレビジョン受信機に近接して使用されると、受信障害を引き起こすことがあります。取扱説明書に従って正しい取り扱いをして下さい。

VCCI-B

Notice to users in Japan about the power cord

製品には、同梱された電源コードをお使い下さい。

同梱された電源コードは、他の製品では使用出来ません。

Noise emission statement for Germany

Geräuschemission

LpA < 70 dB am Arbeitsplatz im Normalbetrieb nach DIN 45635 T. 19

European Union Regulatory Notice



Products bearing the CE marking comply to applicable EU Directives and related European Harmonised Standards. The full Declaration of Conformity can be found at the following website:

www.hp.eu/certificates (Search with the product model name or its Regulatory Model Number (RMN), which may be found on the regulatory label.)

The point of contact for regulatory matters is HP Deutschland GmbH, HQ-TRE, 71025, Boeblingen, Germany.

Products with wireless functionality

EMF

- This product meets international guidelines (ICNIRP) for exposure to radio frequency radiation.

If it incorporates a radio transmitting and receiving device that in normal use, a separation distance of 20 cm ensures that radio frequency exposure levels comply with EU requirements.

Wireless functionality in Europe

- For products with 802.11 b/g/n or Bluetooth radio:
 - This product operates on radio frequency between 2400 MHz and 2483.5 MHz, with a transmit power of 20 dBm (100 mW) or less.
- For products with 802.11 a/b/g/n radio:
 - This product operates on radio frequencies between 2400 MHz and 2483.5 MHz, and between 5170 MHz and 5710 MHz, with a transmit power of 20 dBm (100 mW) or less.



AT	BE	BG	CH	CY
CZ	DE	DK	EE	EL
ES	FI	FR	HR	HU
IE	IS	IT	LI	LT
LU	LV	MT	NL	NO
PL	PT	RO	RS	SE
SI	SK	TR	UK	

CAUTION: IEEE 802.11x wireless LAN with 5.15-5.35 GHz frequency band is restricted for **indoor use only** for all countries reflected in the matrix. Using this WLAN application outdoor might lead to interference issues with existing radio services.

Visual display workplaces statement for Germany

GS-Erklärung (Deutschland)

Das Gerät ist nicht für die Benutzung im unmittelbaren Gesichtsfeld am Bildschirmarbeitsplatz vorgesehen. Um störende Reflexionen am Bildschirmarbeitsplatz zu vermeiden, darf dieses Produkt nicht im unmittelbaren Gesichtsfeld platziert werden.

Declaration of conformity

Declaration of conformity can be found at www.hp.eu/certificates.

Regulatory wireless statements

This section contains the following regulatory information pertaining to wireless products:

- [Exposure to radio frequency radiation](#)
- [Notice to users in Canada \(5 GHz\)](#)
- [Notice to users in Taiwan \(5 GHz\)](#)
- [Notice to users in Serbia \(5 GHz\)](#)
- [Notice to users in Mexico](#)
- [Notice to users in Brazil](#)

- [Notice to users in Canada](#)
- [Notice to users in Taiwan](#)
- [Notice to users in Japan](#)
- [Notice to users in Thailand \(5 GHz\)](#)

Exposure to radio frequency radiation

⚠ CAUTION: The radiated output power of this device is far below the FCC radio frequency exposure limits. Nevertheless, the device shall be used in such a manner that the potential for human contact during normal operation is minimized. This product and any attached external antenna, if supported, shall be placed in such a manner to minimize the potential for human contact during normal operation. In order to avoid the possibility of exceeding the FCC radio frequency exposure limits, human proximity to the antenna shall not be less than 20 cm (8 inches) during normal operation.

Notice to users in Canada (5 GHz)

⚠ CAUTION: When using IEEE 802.11a wireless LAN, this product is restricted to indoor use, due to its operation in the 5.15- to 5.25-GHz frequency range. The Industry Canada requires this product to be used indoors for the frequency range of 5.15 GHz to 5.25 GHz to reduce the potential for harmful interference to co-channel mobile satellite systems. High-power radar is allocated as the primary user of the 5.25- to 5.35-GHz and 5.65- to 5.85-GHz bands. These radar stations can cause interference with and/or damage to this device.

⚠ ATTENTION: Lors de l'utilisation du réseau local sans fil IEEE 802.11a, ce produit se limite à une utilisation en intérieur à cause de son fonctionnement sur la plage de fréquences de 5,15 à 5,25 GHz. Industrie Canada stipule que ce produit doit être utilisé en intérieur dans la plage de fréquences de 5,15 à 5,25 GHz afin de réduire le risque d'interférences éventuellement dangereuses avec les systèmes mobiles par satellite via un canal adjacent. Le radar à haute puissance est alloué pour une utilisation principale dans une plage de fréquences de 5,25 à 5,35 GHz et de 5,65 à 5,85 GHz. Ces stations radar peuvent provoquer des interférences avec cet appareil et l'endommager.

Notice to users in Taiwan (5 GHz)

在 5.25-5.35 赫茲頻帶內操作之無線資訊傳輸設備，限於室內使用。

Notice to users in Serbia (5 GHz)

Upotreba ovog uređaja je ograničena na zatvorene prostore u slučajevima korišćenja na frekvencijama od 5150-5350 MHz.

Notice to users in Mexico

La operación de este equipo está sujeta a las siguientes dos condiciones: (1) es posible que este equipo o dispositivo no cause interferencia perjudicial y (2) este equipo o dispositivo debe aceptar cualquier interferencia, incluyendo la que pueda causar su operación no deseada.

Para saber el modelo de la tarjeta inalámbrica utilizada, revise la etiqueta regulatoria de la impresora.

Notice to users in Brazil

Este equipamento opera em caráter secundário, isto é, não tem direito à proteção contra interferência prejudicial, mesmo de estações do mesmo tipo, e não pode causar interferência em sistemas operando em caráter primário.

Notice to users in Canada

Under Industry Canada regulations, this radio transmitter may only operate using an antenna of a type and maximum (or lesser) gain approved for the transmitter by Industry Canada. To reduce potential radio interference to other users, the antenna type and its gain should be so chosen that the equivalent isotropically radiated power (e.i.r.p.) is not more than that necessary for successful communication.

This device complies with Industry Canada licence-exempt RSS standard(s). Operation is subject to the following two conditions: (1) this device may not cause interference, and (2) this device must accept any interference, including interference that may cause undesired operation of the device.

WARNING! Exposure to Radio Frequency Radiation. The radiated output power of this device is below the Industry Canada radio frequency exposure limits. Nevertheless, the device should be used in such a manner that the potential for human contact is minimized during normal operation.

To avoid the possibility of exceeding the Industry Canada radio frequency exposure limits, human proximity to the antennas should not be less than 20 cm (8 inches).

Conformément au Règlement d'Industrie Canada, cet émetteur radioélectrique ne peut fonctionner qu'avec une antenne d'un type et d'un gain maximum (ou moindre) approuvé par Industrie Canada. Afin de réduire le brouillage radioélectrique potentiel pour d'autres utilisateurs, le type d'antenne et son gain doivent être choisis de manière à ce que la puissance isotrope rayonnée équivalente (p.i.r.e.) ne dépasse pas celle nécessaire à une communication réussie.

Cet appareil est conforme aux normes RSS exemptes de licence d'Industrie Canada. Son fonctionnement dépend des deux conditions suivantes : (1) cet appareil ne doit pas provoquer d'interférences nuisibles et (2) doit accepter toutes les interférences reçues, y compris des interférences pouvant provoquer un fonctionnement non souhaité de l'appareil.

AVERTISSEMENT relatif à l'exposition aux radiofréquences. La puissance de rayonnement de cet appareil se trouve sous les limites d'exposition de radiofréquences d'Industrie Canada. Néanmoins, cet appareil doit être utilisé de telle sorte qu'il doive être mis en contact le moins possible avec le corps humain.

Afin d'éviter le dépassement éventuel des limites d'exposition aux radiofréquences d'Industrie Canada, il est recommandé de maintenir une distance de plus de 20 cm entre les antennes et l'utilisateur.

Notice to users in Taiwan

低功率電波輻射性電機管理辦法

第十二條

經型式認證合格之低功率射頻電機，非經許可，公司、商號或使用者均不得擅自變更頻率、加大功率或變更設計之特性及功能。

第十四條

低功率射頻電機之使用不得影響飛航安全及干擾合法通信；經發現有干擾現象時，應立即停用，並改善至無干擾時方得繼續使用。

前項合法通信，指依電信法規定作業之無線電通信。低功率射頻電機須忍受合法通信或工業、科學及醫藥用電波輻射性電機設備之干擾。

Notice to users in Japan

この機器は技術基準適合証明又は工事設計認証を受けた無線設備を搭載しています。

Notice to users in Thailand (5 GHz)

เครื่องวิทยุคมนาคมนี้มีระดับการแผ่คลื่นแม่เหล็กไฟฟ้าสอดคล้องตามมาตรฐานความปลอดภัยต่อสุขภาพของมนุษย์จากการใช้เครื่องวิทยุคมนาคมที่คณะกรรมการกิจการโทรคมนาคมแห่งชาติประกาศกำหนด

This radio communication equipment has the electromagnetic field strength in compliance with the Safety Standard for the Use of Radio Communication Equipment on Human Health announced by the National Telecommunications Commission.

Environmental product stewardship program

HP is committed to providing quality products in an environmentally sound manner. Design for recycling has been incorporated into this product. The number of materials has been kept to a minimum while ensuring proper functionality and reliability. Dissimilar materials have been designed to separate easily. Fasteners and other connections are easy to locate, access, and remove using common tools. High priority parts have been designed to access quickly for efficient disassembly and repair. For more information, visit HP's Commitment to the Environment website at:

www.hp.com/sustainableimpact

- [HP tips for reducing environmental impact](#)
- [Eco-Tips](#)
- [European Union Commission Regulation 1275/2008](#)
- [Paper](#)
- [Plastics](#)
- [Safety data sheets](#)
- [Recycling program](#)
- [HP inkjet supplies recycling program](#)
- [Power consumption](#)
- [Disposal of waste equipment by users](#)
- [Chemical substances](#)
- [Declaration of the Presence Condition of the Restricted Substances Marking \(Taiwan\)](#)
- [The Table of Hazardous Substances/Elements and their Content \(China\)](#)
- [Restriction of hazardous substance \(Ukraine\)](#)
- [Restriction of hazardous substance \(India\)](#)
- [Restriction on hazardous substances statement \(Turkey\)](#)
- [EPEAT](#)
- [SEPA Ecolabel User Information \(China\)](#)
- [China Energy Label for Printer, Fax and Copier](#)
- [Battery disposal in Taiwan](#)
- [European Union Battery Directive](#)
- [Battery notice for Brazil](#)
- [California Perchlorate Material Notice](#)
- [Waste disposal for Brazil](#)

HP tips for reducing environmental impact

- Choose from a wide variety of HP papers with FSC® or PEFC™ certification, which indicates that the paper pulp came from a reputable and well-managed source.¹
- Conserve resources-look for paper made with recycled content.
- Recycle your Original HP cartridges-it's easy and free with the HP Planet Partners program, available in 47 countries and territories worldwide.²
- Save paper by printing on both sides of the page.
- Conserve energy by choosing ENERGY STAR® certified HP products.
- Lower your carbon footprint-all HP printers include power management settings that help you control energy use.
- Discover more ways HP and our customers are reducing environmental impact at www.hp.com/ecosolutions.

¹ HP papers certified under FSC®C017543 or PEFC™TMPEFC/29-13-198.

² Program availability varies. Original HP cartridge return and recycling is currently available in more than 50 countries, territories, and regions in Asia, Europe, and North and South America through the HP Planet Partners program. For more information, visit: www.hp.com/recycle.

Eco-Tips

HP is committed to helping customers reduce their environmental footprint. Please visit the HP Eco Solutions website for more information on HP's environmental initiatives.

www.hp.com/sustainableimpact

European Union Commission Regulation 1275/2008

For product power data, including the power consumption of the product in networked standby if all wired network ports are connected and all wireless network ports are activated, please refer to section P15 'Additional Information' of the product IT ECO Declaration at www.hp.com/hpinfo/globalcitizenship/environment/productdata/itecodesktop-pc.html.

Paper

This product is suited for the use of recycled paper according to DIN 19309 and EN 12281:2002.

Plastics

Plastic parts over 25 grams are marked according to international standards that enhance the ability to identify plastics for recycling purposes at the end of product life.

Safety data sheets

Safety Data Sheets, product safety and environmental information are available at www.hp.com/go/ecodata or on request.

Recycling program

HP offers an increasing number of product return and recycling programs in many countries/regions, and partners with some of the largest electronic recycling centers throughout the world. HP conserves resources by reselling some of its most popular products. For more information regarding recycling of HP products, please visit:

www.hp.com/recycle

HP inkjet supplies recycling program

HP is committed to protecting the environment. The HP Inkjet Supplies Recycling Program is available in many countries/regions, and lets you recycle used print cartridges and ink cartridges free of charge. For more information, go to the following website:

www.hp.com/recycle

Power consumption

HP printing and imaging equipment marked with the ENERGY STAR® logo is certified by the U.S. Environmental Protection Agency. The following mark will appear on ENERGY STAR certified imaging products:



Additional ENERGY STAR certified imaging product model information is listed at: www.hp.com/go/energystar

Disposal of waste equipment by users



This symbol means do not dispose of your product with your other household waste. Instead, you should protect human health and the environment by handing over your waste equipment to a designated collection point for the recycling of waste electrical and electronic equipment. For more information, please contact your household waste disposal service, or go to <http://www.hp.com/recycle>.

Chemical substances

HP is committed to providing our customers with information about the chemical substances in our products as needed to comply with legal requirements such as REACH (*Regulation EC No 1907/2006 of the European Parliament and the Council*). A chemical information report for this product can be found at: www.hp.com/go/reach.

Declaration of the Presence Condition of the Restricted Substances Marking (Taiwan)

台灣 限用物質含有情況標示聲明書

Taiwan Declaration of the Presence Condition of the Restricted Substances Marking

單元 Unit	限用物質及其化學符號 Restricted substances and their chemical symbols					
	鉛 (Pb)	汞 (Hg)	鎘 (Cd)	六價鉻 (Cr ⁺⁶)	多溴聯苯 (PBB)	多溴二苯醚 (PBDE)
	列印引擎 Print engine	—	○	○	○	○
外殼和 紙匣 External casing and trays	○	○	○	○	○	○
電源供應器 Power supply	—	○	○	○	○	○
電線 Cables	○	○	○	○	○	○
印刷電路板 Printed circuit board	—	○	○	○	○	○
控制面板 Control panel	—	○	○	○	○	○
墨水匣 Cartridge	○	○	○	○	○	○
掃描器組件 Scanner assembly	—	○	○	○	○	○

備考 1. “超出 0.1 wt %” 及 “超出 0.01 wt %” 係指限用物質之百分比含量超出百分比含量基準值。

Note 1: “Exceeding 0.1 wt %” and “exceeding 0.01 wt %” indicate that the percentage content of the restricted substance exceeds the reference percentage value of presence condition.

備考 2. “○” 係指該項限用物質之百分比含量未超出百分比含量基準值。

Note 2: “○” indicates that the percentage content of the restricted substance does not exceed the percentage of reference value of presence.

備考 3. “—” 係指該項限用物質為排除項目。

Note 3: “—” indicates that the restricted substance corresponds to the exemption.

若要存取產品的最新使用指南或手冊，請前往 www.support.hp.com。選取搜尋您的產品，然後依照畫面上的指示繼續執行。

To access the latest user guides or manuals for your product, go to www.support.hp.com. Select **Find your product**, and then follow the onscreen instructions.

The Table of Hazardous Substances/Elements and their Content (China)

产品中有害物质或元素的名称及含量

根据中国《电器电子产品有害物质限制使用管理办法》



部件名称	有害物质					
	铅 (Pb)	汞 (Hg)	镉 (Cd)	六价铬 (Cr(VI))	多溴联苯 (PBB)	多溴二苯醚 (PBDE)
外壳和托盘	○	○	○	○	○	○
电线	○	○	○	○	○	○
印刷电路板	X	○	○	○	○	○
打印系统	X	○	○	○	○	○
显示器	X	○	○	○	○	○
喷墨打印机墨盒	○	○	○	○	○	○
驱动光盘	X	○	○	○	○	○
扫描仪	X	○	○	○	○	○
网络配件	X	○	○	○	○	○
电池板	X	○	○	○	○	○
自动双面打印系统	○	○	○	○	○	○
外部电源	X	○	○	○	○	○

本表格依据 SJ/T 11364 的规定编制。

○：表示该有害物质在该部件所有均质材料中的含量均在 GB/T 26572 规定的限量要求以下。

X：表示该有害物质至少在该部件的某一均质材料中的含量超出 GB/T 26572 规定的限量要求。

此表中所有名称中含“X”的部件均符合中国 RoHS 达标管理目录限用物质应用例外清单的豁免。

此表中所有名称中含“X”的部件均符合欧盟 RoHS 立法。

注：环保使用期限的参考标识取决于产品正常工作的温度和湿度等条件。

Restriction of hazardous substance (Ukraine)

Технічний регламент щодо обмеження використання небезпечних речовин (Україна)

Обладнання відповідає вимогам Технічного регламенту щодо обмеження використання деяких небезпечних речовин в електричному та електронному обладнанні, затвердженого постановою Кабінету Міністрів України від 3 грудня 2008 № 1057

Restriction of hazardous substance (India)

This product, as well as its related consumables and spares, complies with the reduction in hazardous substances provisions of the "India E-waste (Management and Handling) Rule 2016." It does not contain lead, mercury, hexavalent chromium, polybrominated biphenyls or polybrominated diphenyl ethers in concentrations exceeding 0.1 weight % and 0.01 weight % for cadmium, except for where allowed pursuant to the exemptions set in Schedule 2 of the Rule.

Restriction on hazardous substances statement (Turkey)

Türkiye Cumhuriyeti: AEEE Yönetmeliğine Uygundur

EPEAT

Most HP products are designed to meet EPEAT. EPEAT is a comprehensive environmental rating that helps identify greener electronics equipment. For more information on EPEAT go to www.epeat.net. For information on HP's EPEAT registered products go to www.hp.com/hpinfo/globalcitizenship/environment/pdf/epeat_printers.pdf.

SEPA Ecolabel User Information (China)

中国环境标识认证产品用户说明

噪声大于 63.0 dB(A) 的办公设备不宜放置于办公室内，请在独立的隔离区域使用。

如需长时间使用本产品或打印大量文件，请确保在通风良好的房间内使用。

如您需要确认本产品处于零能耗状态，请按下电源关闭按钮，并将插头从电源插座断开。

您可以使用再生纸，以减少资源耗费。

China Energy Label for Printer, Fax and Copier

复印机、打印机和传真机能源效率标识实施规则

依据“复印机、打印机和传真机能源效率标识实施规则”，该打印机具有中国能效标识。标识上显示的能效等级和操作模式值根据“复印机、打印机和传真机能效限定值及能效等级”标准（“GB 21521”）来确定和计算。

1. 能效等级

产品能效等级分 3 级，其中 1 级能效最高。能效限定值根据产品类型和打印速度由标准确定。能效等级则根据基本功耗水平以及网络接口和内存等附加组件和功能的功率因子之和来计算。

2. 能效信息

喷墨打印机

— 操作模式功率

睡眠状态的能耗按照 GB 21521 的标准来衡量和计算。该数据以瓦特 (W) 表示。

— 待机功率

待机状态是产品连接到电网电源上功率最低的状态。该状态可以延续无限长时间，且使用者无法改变此状态下产品的功率。对于“成像设备”产品，“待机”状态通常相当于“关闭”状态，但也可能相当于“准备”状态或者“睡眠”状态。该数据以瓦特 (W) 表示。

- 睡眠状态预设延迟时间

出厂前由制造商设置的时间决定了该产品在完成主功能后进入低耗模式（例如睡眠、自动关机）的时间。该数据以分钟表示。

- 附加功能功率因子之和

网络接口和内存等附加功能的功率因子之和。该数据以瓦特 (W) 表示。

标识上显示的能耗数据是根据典型配置测量得出的数据，此类配置包含登记备案的打印机依据复印机、打印机和传真机能源效率标识实施规则所选的所有配置。因此，该特定产品型号的实际能耗可能与标识上显示的数据有所不同。

要了解规范的更多详情，请参考最新版的 GB 21521 标准。

Battery disposal in Taiwan

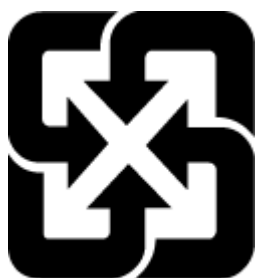

廢電池請回收

European Union Battery Directive



This product contains a battery that is used to maintain data integrity of real time clock or product settings and is designed to last the life of the product. Any attempt to service or replace this battery should be performed by a qualified service technician.

Battery notice for Brazil

A bateria deste equipamento nao foi projetada para ser removida pelo cliente.

California Perchlorate Material Notice

Perchlorate material - special handling may apply. See: www.dtsc.ca.gov/hazardouswaste/perchlorate

This product's real-time clock battery or coin cell battery may contain perchlorate and may require special handling when recycled or disposed of in California.

Waste disposal for Brazil



Não descarte o produto eletrônico em lixo comum

Este produto eletrônico e seus componentes não devem ser descartados no lixo comum, pois embora estejam em conformidade com padrões mundiais de restrição a substâncias nocivas, podem conter, ainda que em quantidades mínimas, substâncias impactantes ao meio ambiente. Ao final da vida útil deste produto, o usuário deverá entregá-lo à HP. A não observância dessa orientação sujeitará o infrator às sanções previstas em lei.

Após o uso, as pilhas e/ou baterias dos produtos HP deverão ser entregues ao estabelecimento comercial ou rede de assistência técnica autorizada pela HP.

Para maiores informações, inclusive sobre os pontos de recebimento, acesse:

www.hp.com.br/reciclar

Index

- B**
 - both sides, print on 51
 - buttons, control panel 4
- C**
 - Cartridge access door
 - locating 2
 - cartridge latch, cartridge
 - locating 2
 - cartridges
 - check ink levels 58
 - tips 57
 - clean
 - document feeder 108
 - exterior 108
 - scanner glass 107
 - connectors, locating 3
 - control panel
 - buttons 4
 - features 4
 - copy
 - specifications 118
 - customer support
 - warranty 112
- D**
 - diagnostic page 104
 - document feeder
 - clean 108
 - feeding problems, troubleshoot 108
 - double-sided printing 51
- E**
 - embedded web server
 - about 42
 - opening 36
 - troubleshoot, cannot be opened 42
 - Webscan 72
 - environment
 - Environmental product
 - stewardship program 125
 - environmental specifications 117
 - EWS. *See* embedded web server
- G**
 - glass, scanner
 - clean 107
- I**
 - ink levels, check 58
 - IP address
 - checking for printer 43
- J**
 - jams
 - clear 83
- M**
 - maintenance
 - check ink levels 58
 - clean 108
 - diagnostic page 104
 - media
 - duplexing 51
 - multi-feeds, troubleshoot 91
- N**
 - network connection
 - wireless connection 27
 - networks
 - connector illustration 3
 - view and print settings 7
 - wireless settings 104
- O**
 - operating systems supported 117
- P**
 - paper
 - clear jams 83
 - skewed pages 91
 - troubleshoot feeding 91
 - paper tray
 - locating 2
 - paper-feed problems, troubleshoot 91
 - power
 - troubleshoot 99
 - power input, locating 3
 - print
 - diagnostic page 104
 - double-sided 51
 - specifications 118
 - troubleshoot 99
 - print quality report 104
 - printer control panel
 - locating 2
 - printer software (Windows)
 - about 41
 - opening 40, 41
 - printer status report
 - information on 104
- R**
 - rear access
 - illustration 3
 - recycle
 - ink cartridges 127
 - regulatory notices 119
 - regulatory model identification number 119
 - wireless statements 121

- reports
 - diagnostic 104
 - web access 105
 - wireless test 104

S

- scan
 - from Webscan 72
 - scan specifications 118
- scanner glass
 - clean 107
- skew, troubleshoot
 - print 91
- software
 - scan 70
 - Webscan 72
- specifications
 - system requirements 117
- status
 - network configuration page 104
- system requirements 117

T

- technical information
 - copy specifications 118
 - environmental specifications 117
 - print specifications 118
 - scan specifications 118
- trays
 - clear paper jams 83
 - locating 2
 - paper-width guides 2
 - troubleshoot feeding 91
- troubleshoot
 - embedded web server 42
 - HP Smart 82
 - multiple pages are picked 91
 - network configuration page 104
 - paper not picked up from tray 91
 - paper-feed problems 91
 - power 99
 - print 99
 - printer status report 104
 - skewed pages 91
- two-sided printing 51

V

- view
 - network settings 7

W

- warranty 112
- web access test report 105
- Webscan 72
- Windows
 - system requirements 117
- wireless test report 104