

MP System Hardware Guide



The MP Hardware Guide describes how to connect and set up various signal conditioning and amplifier modules for use with an MP160, MP150, MP36 or MP45 System, and details applications and uses for the MP System.

To use this guide, navigate to specific pages using the page thumbnail images and bookmark links (left) or type an entry of interest into the 'Find' box.

- All specifications are subject to change without notice.

Check BIOPAC.COM > Support > Manuals for updates

Watch Tutorials at: www.biopac.com/videos for instructional overviews

BIOPAC Systems, Inc.
42 Aero Camino, Goleta, CA 93117
Tel (805) 685-0066 | Fax (805) 685-0067
www.biopac.com

IMPORTANT SAFETY NOTICE

BIOPAC Systems, Inc. instrumentation is designed for educational and research-oriented life science investigations. BIOPAC Systems, Inc. does not condone the use of its instruments for clinical medical applications. Instruments, components, and accessories provided by BIOPAC Systems, Inc. are not intended for the diagnosis, mitigation, treatment, cure, or prevention of disease.

The MP data acquisition unit is an electrically isolated data acquisition system, designed for biophysical measurements.

Exercise extreme caution when applying electrodes and taking bioelectric measurements while using the hardware with other external equipment that also uses electrodes or transducers that may make electrical contact with the Subject. Always assume that currents can flow between any electrodes or electrical contact points.

Extreme caution is also required when performing general stimulation (electrical or otherwise) on a subject. Stimulation currents should not be allowed to pass through the heart. Keep stimulation electrodes far from the heart and located close together on the same side of the subject's body.

It is very important (in case of equipment failure) that significant currents are not allowed to pass through the heart. If electrocautery or defibrillation equipment is used, it is recommended that all BIOPAC Systems, Inc. instrumentation be disconnected from the Subject.

CLEANING & DISINFECTING BIOPAC COMPONENTS

The following disinfectants are recommended for LIQUID “COLD” sterilization of BIOPAC transducers:

- **Cidex**[®] / **Cidex**[®] **OPA** Disinfectant Solution, Johnson & Johnson
- **Perform**[®] Powder Disinfectant Concentrate, Schülke & Mayr
- **Terralin**[®], Liquid Disinfectant Concentrate, Schülke & Mayr

▶ Always follow the manufacturer’s directions.

Recommended gas based method:

- Low temperature, **Ethylene Oxide (EtO)** gas sterilization

AFT Series

- All AFT components, with the exception of filters, will hold up to liquid and gas sterilization as specified in this document.

AFT25 Facemask

- See detailed guide shipped with the product; also available at www.biopac.com.

EL250 Series Electrodes

- Store electrodes in clean, dry area.
- After use, clean electrode with cold to tepid water
- DO NOT use hot water.
- Cotton swabs are suggested.
- Let the electrode dry completely before storing it.
- DO NOT allow the electrodes to come in contact with each other during storage.
- Electrodes may form a brown coating if they have not been used regularly. To remove the coating, gently polish the surface of the electrode element with non-metallic material or wipe it with mild ammonium hydroxide. Rinse with water and store the electrode in a clean, dry container.

GASSYS2

- See detailed guide shipped with the product; also available at www.biopac.com.

Probes

- Immersion temperature probes can be cleaned using standard liquid disinfectant methods, with direct immersion for the recommended period.
- Non-immersion probes can be wiped down with liquid disinfectant, alcohol, or sterilized using Ethylene oxide (EtO).

RX137 Series Airflow Heads

- Thorough cleaning retains precise measurements. Disinfecting is only useful on a previously cleaned apparatus. Using a gas for disinfecting does not provide cleaning. An appropriate disinfectant solution can clean and disinfect simultaneously.
 1. Immerse the apparatus in the liquid. It can be completely immersed since the electrical part is waterproof; a 30- to 60-minute bath is usually sufficient to detach or dissolve the dirt.
 2. Rinse under a strong tap.
 3. Rinse with distilled or demineralized water.
 4. Use air or another compressed gas to dry the apparatus. Blow through the screen and in each pressure tube; a pressure of 5 to 6 bars is acceptable.
 5. Finish drying with atmospheric air or with a warm blow dryer (hair dryer).

WARNING!

- | | |
|---------------------------------------|---|
| Do not use organic solvents | Dilute the disinfectant (as for hand washing) |
| Do not heat the apparatus above 50° C | Never touch the screen with a tool |
- Examples of liquids that may be used: Cidex[®] / Cidex OPA[®], Glutaral, Glutaraldéhyde
 - Example of gas that may be used: Ethylene oxide (EtO) gas sterilization

TSD130 Series Goniometers & Torsiometers

- Important: Disconnect sensors from instrumentation before cleaning or disinfecting.
- Cleaning: Wipe the sensors with a damp cloth, or a cloth moistened with soapy water. Do not use solvents, strong alkaline or acidic materials to clean the sensors.
- Disinfection: Wipe the sensors with a cloth moistened with disinfectant.

See detailed cleaning procedures for LDF and TSD140 series in LDF section.

BIOPAC Data Acquisition Units, Amplifiers or Accessory Modules

Clean BIOPAC module surfaces using any the following methods:

- Wipe lightly with a dry, lint-free cloth.
- Wipe lightly with a soft cloth dampened with a commercial, non-abrasive cleaner.
- Use a low-pressure air line to blow dust free, or carefully clean with a suitable vacuum cleaner.

To disinfect the module, wipe the surface with a soft cloth dampened with a solution of 70% alcohol in water.

WARNING! Do not spray, pour or spill any liquid on the module, including its connectors, switches or openings.

MP SYSTEM APPLICATIONS

Features

With proper hardware selection and setup, the MP System with *AcqKnowledge* software can be used for a wide array of application features. See the *AcqKnowledge* Software Guide or BIOPAC.COM for descriptions of the following features. For additional support, or for help with an unlisted application, please contact the BIOPAC Technical Support Division — an Applications Specialist will be glad to help.

Active Electrodes	Extra-cellular Spike Recording	Migrating Myoelectric Complex
Allergies	Facial EMG	Motor Unit Action Potential
Amplitude Histogram	FFT & Histograms	Movement Analysis
Anaerobic Threshold	FFT for Frequency Analysis	MRI Applications
Animal studies	Field Potential Measurements	Multi-Channel Sleep Recording
Auditory Evoked Response (AER)	Fine Wire EMG	Nerve Conduction Studies
Automate Acquisition Protocols	Forced Expiratory Flow & Volume	Neurology Research
Automated Data Analysis	Gait Analysis	Noninvasive Cardiac Output
Automatic Data Reduction	Gastric Myoelectric Activity	Noninvasive Electrode Measurements
Autonomic Nervous System Studies	Gastric Slow Wave Propagation	Nystagmus Investigation
Biomechanics Measurements	Gastrointestinal Motility Analysis	Oculomotor Research
Blood Flow / Blood Pressure /Blood Volume	Hardware Flexibility	Off-line ECG Averaging
Body Composition Analysis	Heart Rate Variability	On-line Analysis
Breath-By-Breath Respiratory Gas Analysis	Heart Sounds	On-line ECG Analysis
Cardiac Output	Histogram Analysis	Orthostatic Testing
Cardiology Research	Imaging Equipment, Interfacing	Peripheral Blood Flow
Cell Transport	Indirect Blood Pressure Recordings	Peristaltic (Slow Wave) Propagation
Cerebral Blood Flow	Integrated (RMS) EMG	Planted Tissue
Chaos Plots	Interface with Existing Equipment	Pressure Volume Loops
Common Interface Connections	Interface with Third-party transducer	Psychophysiology
Connect to MP Systems	Invasive Electrode Measurements	Pulsatile Tissue Studies
Control Pumps and Valves	Ion-selective Micro-electrode Interfacing	Pulse Rate Measurement
Cross- and Auto-correlation	Iontophoresis	Pulse Transit Time
Current Clamping	Irritants & Inflammation	Range of Motion
Defibrillation & Electrocautery	Isolated Inputs & Outputs	Real-time EEG Filtering
Dividing EEG into Specific Epochs	Isolated Lung Studies	Real-time EEG Filtering
ECG Analysis	Isometric Contraction	Recurrent Patterns
ECG Recordings, 12-Lead	Isotonic Contraction	Regional Blood Flow
ECG Recordings, 6-Lead	Jewett Sequence	Relative BP Measurement
EEG Spectral Analysis	Langendorff Heart Preparations	Remote Monitoring
Einthoven's Triangle	Laser Doppler Flowmetry	Respiration Monitoring
EMG and Force	Left Cardiac Work	Respiratory Exchange Ratio
EMG Power Spectrum Analysis	Long-term Monitoring	Rheumatology
End-tidal CO2	Lung Volume Measurement	Saccadic Eye Movements
Episode Counting	LVP	Sexual Arousal Studies
Ergonomics Evaluation	Median & Mean Frequency Analysis	Signal Averaging
Event-related Potentials	Micro-electrode signal amplification	Simultaneous Monitoring
Evoked Response		Single Channel Analysis
Exercise Physiology		Single-fiber EMG
External equipment, controlling		Software-controlled Stimulator
		Somatosensory Evoked Response
		Spectral Analysis
		Spike Counting
		SpO2 Analysis

Stand Alone Amplifiers
Standard Operating
Procedures
Startle Eye Blink Tests
Startle Response
Stimulator, software-
controlled
Systemic Vascular
Resistance
Template Analysis

Tissue Bath Monitoring
Tissue Conductance
Measurement
Tissue Magnitude & Phase
Modeling
Tissue Resistance &
Reactance
Ussing Chamber
Measurements
Ventricular Late Potentials

Vestibular Function
Video Capture, Synchronous
Visual Attention
Visual Evoked Response
VO2 Consumption
Volume/Flow Loop
Relationships
Working Heart Preparations

APPLICATION NOTES

BIOPAC has prepared a wide variety of application notes as a useful source of information concerning certain operations and procedures. The notes are static pages that provide detailed technical information about either a product or application. A partial list of Application Notes follows.

View or print application notes directly from the “Support” section of the BIOPAC web site

www.biopac.com.

Recording Hardware

- 004 - MP150 Firmware Compatibility
- 218 - Hardware API
- 223 - Physiological Measurement in MRI Systems
- 230 - Connections for Physiological Signals in an MRI
- 234 - Virtual Reality / Immersive Environment
- 235 - Zygomaticus Measures with Pressure Pad vs.

EMG in MRI or fMRI

239 - Send to AcqKnowledge from Vizard via parallel port

- 240 - Measurement Computing card setup
- 241 - Recording EMG data in an fMRI
- 242 - Recording ECG Data in an fMRI
- 243 - Gated Analysis for Data Recorded in an MRI

Amplifiers

- 102 - Biopotential Amplifier Testing With CBLCAL
- 103 - Remote Monitoring System - TEL100
- 109 - 3-, 6-, and 12-Lead ECG
- 110 - Amplifier Baseline Offset Adjustment
- 126 - Wireless Remote Monitoring - TEL100C-RF
- 136 - Battery Pack Instructions - BAT100
- 149 - O2100C Module Setup for the MP System
- 151 - CO2100C Module Setup for the MP System
- 154 - High Level Transducer Connections - HLT100C
- 160 - Gas Analysis Module Response Time
- 162 - Stimulation Features of MP150/100 Systems
- 170 - Laser Doppler Flow Module - LDF100C
- 175 - Stimulus Isolator Guidelines - STMISOC
- 184 - Interfacing Millar Mikro-Tip Catheters with

MP150/100

- 185 - iMac and G3 Compatibility Issues
- 187 - Electrodermal Response Guidelines - GSR100C
- 190 - Micro-Electrode Amplifier Guidelines - MCE100C
- 195 - MP System Data Sampling Reference
- 196 - Cardiac Output Measurement - EBI100C
- 206 - Continuous 12-Lead ECG
- 207, 208, 209 - UDP Install
- 224 - Noninvasive Blood Pressure NIBP100A Calibration
- 231 - Noninvasive Blood Pressure NIBP100B-R

Calibration Transducers

- 101 - Transducer Calibration and Signal Re-Scaling
- 114/b - Pneumotach Transducer - TSD107A /TSD107B*
- 127 - Precision Force Transducers
- 130 - Noninvasive Blood Pressure Measurement -

TSD120

- 132 - Variable Force Transducer- TSD105A
- 135 - Pneumotach Transducer - TSD117

140 - Goniometers: Angular Measurements - TSD130 series

141 - Tri-axial Accelerometer Calib - TSD109 series/SS26/27

- 144 - Hand Dynamometer Calibration - TSD121C
- 145 - Respiratory Effort Transducer - TSD101B
- 153 - Physiological Sounds Microphone - TSD108
- 159 - Hand Switch and Foot Switch - TSD116 Series
- 186 - Variable Assessment Transducer - TSD115

Software

- 105 - Auditory Brainstem Response (ABR) Testing
- 105b - ABR Testing for Jewett Sequence
- 108 - Data Reduction of Large Files
- 111 - Nerve Conduction Velocity
- 113 - Troubleshooting AcqKnowledge for Windows
- 115 - Hemodynamic Measurements
- 117 - Pulse Transit Time and Velocity Calculation
- 118 - EMG Frequency Signal Analysis
- 120 - X/Y Loop Area Analysis
- 121 - Waveform Data Reduction
- 122 - Power Spectrum Analysis
- 129 - Heart Rate Variability
- 131 - Averaging Mode in the MP System
- 148 - Automated ECG Analysis
- 150 - O2100C Module for Oxygen Consumption
- 152 - CO2100C Module for End-Tidal CO2
- 155 - AcqKnowledge File Formats for Mac OS
- 156 - AcqKnowledge File Formats for Windows OS
- 158 - Analyzing Inspired & Expired Lung Volume
- 161 - Automated Tissue Bath Analysis
- 168 - Analyzing Intraventricular Pressure Wave Data (LVP Analysis)
- 169 - Speech Motor Control
- 177 - ECG Analysis Using the Offline Averaging Mode
- 182 - Analysis of Blood Flow Data
- 183 - VO2 and RER Measurement
- 191 - Digital I/O Channels
- 198 - Prepulse Inhibition of Startle
- 199 - Impedance Cardiography and Pre-ejection Period
- 200 - Creating Arbitrary Waveforms for Stimulators
- 201 - SuperLab with AcqKnowledge
- 211 - EEG Analysis with AcqKnowledge
- 214 - EMG Startle Scoring for Prepulse Inhibition
- 216 - Electrodermal Activity (GSR) Scoring Methods
- 221 - Simplified VO2 Measurement (without CO2 Values)
- 222 - Pseudorandom Stimuli after Stim Presentation
- 226 - BIOPAC Software on Mac-Intel Core Duo Cmpt.
- 232 - EMG: Normalize to Max Voluntary Contraction
- 233 - Heart Rate Variability - Preparing Data
- 238 - Controlling the SDS100 Scent Delivery System

ACQKNOWLEDGE QUICK STARTS

“Quick Start” template files were installed to the Sample folder of the BIOPAC Program folder. Use a Quick Start template to establish the hardware and software settings required for a particular application or as a good starting point for customized applications.

Q##	Application(s)	Feature
1	EEG Sleep Studies	Real-time EEG Filtering Real-time EEG Filtering
2	EEG	Evoked Responses
3	EEG Evoked Response	Event-related Potentials Event-related Potentials
4	Evoked Response	Nerve Conduction Studies
5	Evoked Response	Auditory Evoked response & Jewett Sequence
6	Evoked Response	Visual Evoked Response
7	Evoked Response	Somatosensory Evoked Response
9	Evoked Response	Extra-cellular Spike Recording
10	Psychophysiology	Autonomic Nervous System Studies
12	Psychophysiology	Sexual Arousal Studies
13	EBI Cardiovasc. Hemodynamics Exercise Physiology	Cardiac Output Noninvasive Cardiac Output Measurement Noninvasive Cardiac Output
15	EOG	Nystagmus Investigation
16	EOG	Saccadic Eye Movements
17	Plethysmography	Indirect Blood Pressure Recordings
19	Sleep Studies	Multiple-channel Sleep Recording
20	Sleep Studies ECG ECG Analysis	Cardiovasc. Hemodynamics On-line ECG Analysis On-line ECG Analysis
21	Sleep Studies	SpO ₂ Analysis
22	ECG	Einthoven’s Triangle & 6-lead ECG
23	ECG	12-lead ECG Recordings
24	ECG	Heart Sounds
25	Cardiovasc. Hemodynamics	On-line Analysis
26	Cardiovasc. Hemodynamics	Blood Pressure
27	Cardiovasc. Hemodynamics	Blood Flow
28	Cardiovasc. Hemodynamics	LVP
31	NIBP	Psychophysiology
32	<i>In vitro</i> Pharmacology	Tissue Bath Monitoring
33	<i>In vitro</i> Pharmacology	Pulsatile Tissue Studies
34	<i>In vitro</i> Pharmacology	Langendorff & Working Heart Preparations
35	<i>In vitro</i> Pharmacology Isolated Lung Studies	Pulmonary Function Animal Studies
38	Pulmonary Function	Lung Volume Measurement
39	Exercise Physiology	Respiratory Exchange Ratio
40	EMG	Integrated (RMS) EMG
41	EMG	EMG and Force
42	Biomechanics	Gait Analysis
43	Remote Monitoring	Biomechanics Measurements
44	Biomechanics	Range of Motion
45	Vibromyography	Muscle Activity

EXTERNAL TRIGGER INPUTS – MP160/150/36R

MP system external trigger inputs are TTL compatible—this means that one needs to send the external trigger input 0 volts for a TTL low and 5 volts for a TTL high.

The external trigger inputs are equipped with internal pull-up resistors—this means that they automatically sit at TTL high, if left unattached.

- This is a common and helpful implementation, because all one requires to implement an external trigger is to pull the external trigger input low.
- This implementation is typically performed with an external switch placed between the external trigger input and ground.
 - When the switch is closed the external trigger input is pulled to TTL low.
 - When the switch is opened the external trigger input is pulled back (by the internal pull-up resistor) to TTL high.

To sync several MP systems together, so that one external trigger can start all the MP systems simultaneously:

1. Connect all the MP systems grounds together.
2. Connect all the MP systems external trigger inputs together.
3. Place a switch between any MP system external trigger input and ground.

When the switch is pressed, all the MP systems that are connected together will be triggered simultaneously.

MP160 SYSTEMS

AVAILABLE MP160 STARTER SYSTEMS

MP160 Licensed Systems – See corresponding license page for more information:

System	Windows Part #	Mac Part #
MP160	MP160WSW	MP160WS
MP160 System plus Actigraphy	MP160WSW-ACT	MP160WS-ACT
MP160 System plus Baroreflex	MP160WSW-BRS	MP160WS-BRS
MP160 plus Developer Bundle	MP160WSW-ENT	N/A
MP160 plus FaceReader Integration License	MP160WSW-FR	N/A
MP160 plus Network Data Transfer	MP160WSW-NDT	MP160WS-NDT
MP160 plus Pressure Volume Loop Analysis	MP160WSW-PVL	MP160WS-PVL
MP160 plus Scripting	MP160WSW-BAS	MP160WS-BAS
MP160 plus Vibromyography: 2-channel	VMG102WSW	VMG102WS
MP160 plus Vibromyography: 4-channel	VMG104WSW	VMG104WS
System Upgrade – MP150 to MP160	MP160U-W	MP160U-M

MP160 data acquisition and analysis systems with *AcqKnowledge 5* software provide a flexible tool for life science research. All systems are compliant with any Ethernet (UDP) ready 64-bit computer running Windows or Mac (*AcqKnowledge 5* or higher required). Record multiple data channels with variable sample rates to maximize storage efficiency at speeds up to 400 kHz (aggregate). Directly connect the computer to a single MP160 unit via the provided ETHUSB Ethernet adapter, or access multiple MP160s by connecting a switch box to the adapter*.

Basic MP160 System includes:

- Data acquisition unit: MP160
- Transducer module: AMI100D (2019), HLT100C (2016-2018)
- AcqKnowledge*® software license and installer USB keys
- Software Guide (PDF)
- Ethernet Connection
 - ETHUSB Ethernet adapter and Ethernet Cable: CBLETH1
- Power Supply: AC150A



See also: [MP160 Specifications](#)

Recommended MP160 configuration

For the best possible performance connect the MP System directly to the ETHUSB Ethernet USB adapter using the included CBLETH1 Ethernet cable. This allows uninterrupted use of the existing Ethernet card for Internet and local area network (LAN) access while using the MP System. **Although it is possible to run multiple MP160 units over a LAN, this solution is not recommended by BIOPAC.** BIOPAC recommends using the ETHUSB adapter and connecting directly between computer and the MP160, or to a switch box and the MP160. (If a computer does not require simultaneous connection to the network, a standard Ethernet cable can be used to connect the MP System to a computer.)

➡ Click to view the [MP160 System Diagram with BIOPAC Amplifier](#).

MP160 SYSTEM SPECIFICATIONS

Analog Inputs

Number of Channels:	16
Absolute Maximum Input:	±15 V
Operational Input Voltage:	±10 V
A/D Resolution:	16 Bits
Accuracy (% of FSR):	±0.003
Input impedance:	1.0 MΩ

Application Programming Interfaces options:

- Hardware Interface BHAPI
- Software Interface ACKAPI

Analog Outputs

Number of Channels:	2
Max output with acquisition:	2 channels
Output Voltage Range:	±10 V
D/A Resolution:	16 bits
Accuracy (% of FSR):	±0.003
Output Drive Current:	±5 mA (max)
Output Impedance:	100 Ω

Digital I/O*

Number of Channels:	16
Voltage Levels:	TTL, CMOS
External Trigger Input:	TTL, CMOS compatible - See also: External Trigger Inputs

*Digital signals accessed with optically isolated [STP100C/STP100C-C](#) and [STP-IO](#)—separate purchase

Time Base

Min Sample Rate:	2 samples/hour
Trigger Options:	Internal, External or Signal Level

Power

Amplifier Module Isolation:	Provided by the MP unit, isolated clean power
CE Marking:	EC Low Voltage and EMC Directives
Leakage current:	<8 μA (Normal), <400 μA (Single Fault)
Fuse:	2 A (fast blow)

Device specs	MP160
Max Sample Rate MP Internal Memory:	200 K samples/sec (400 K aggregate)
PC Memory/Disk:	200 K samples/sec (400 K aggregate)
Internal Buffer:	6 M samples
Waveform Output Buffer:	500 K samples
Serial Interface Type/Rate:	Ethernet: UDP (10M bits/sec)
Transmission Type:	Ethernet
Maximum cable length:	100 meters (Ethernet cable)
Power Requirements:	12 VDC @ 2 amp (uses AC150A)
Dimensions:	10 cm x 11 cm x 19 cm

Device specs	MP160
Weight:	1.154 kg
Operating Temperature Range:	0-70° C
Storage Temperature Range:	-10-70° C
Operating / Storage Humidity Range:	0-95% (non-condensing)
Operating / Storage Pressure Range:	0-300 kPA
Software Compatibility:	AcqKnowledge 5 and higher only (MP160 is not compatible with earlier AcqKnowledge versions)
OS Compatibility 64-bit architecture—requires a 64-bit operating system	
Ethernet Interface Windows	Microsoft® Windows® 10 64-bit, Windows 8.x 64-bit, and 7 64-bit supported (32-bit OS, including Windows XP, are not supported)
Mac	OS X 10.14, 10.13, 10.12, 10.11, 10.10, and 10.9 supported (these are all automatically 64-bit operating systems)
USB Interface	
Windows	Not supported
Mac	Not supported

ISOLATION

Designed to satisfy the following Medical Safety Test Standards affiliated with IEC 60601-1:

Creepage and Air Clearance

Dielectric Strength

Patient Leakage Current

Contact BIOPAC for additional details.

SIGNAL CONDITIONING MODULE COMPATIBILITY

O ₂ 100C/ CO ₂ 100C	EGG100C/EGG100D	EDA100C/EDA100D	AMI100D
DA100C	EMG100C/EMG100D	PPG100C/PPG100D	LDF100C
EBI100C	fEMG100D	RSP100C/RSP100D	MCE100C
ECG100C/ECG100D	EOG100C/EMG100D	SKT100C/SKT100D	STM100C
EEG100C/EEG100D	ERS100C/ERS100D	HLT100C	OXY100E
			TEL100C

MP160 also interfaces with [BioNomadix Series Wireless Modules](#).



CLEANING PROCEDURES

Be sure to unplug the power supply from the MP160 before cleaning. To clean the MP160, use a damp, soft cloth. Abrasive cleaners are not recommended as they might damage the housing. Do not immerse the MP160 or any of its components, as this can damage the system. Let the unit air-dry until it is safe to reconnect the power supply.

AC150A POWER SUPPLIES

The 12-volt in-line switching transformer connects the MP unit to the AC mains wall outlet. One transformer is included with each MP System; replacements can be ordered separately. These transformers are specified to satisfy IEC 60601-1 requirements and will accommodate 120-240 VAC (50/60 Hz) mains input.

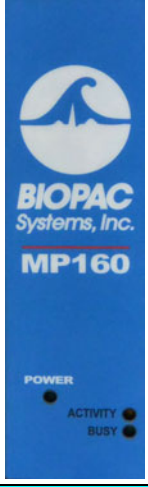
MP160 SYMBOLOGY

Front panel	See “Light Status” section for functionality details.	
	POWER	<p>Green light Indicates MP160 Power status.</p>
	ACTIVITY	<p>Amber light Indicates data traffic to or from MP160— <i>similar to Hard Disk activity light on any personal computer.</i></p>
	BUSY	<p>Green light Indicates MP160 data acquisition.</p>
Back panel		
	<p>Power ON Push in to power up the MP160</p> <p>OFF Pop out to cut the flow of power to the MP160</p>	<p>IMPORTANT! The MP160 does not have a “Hardware Reset” switch like a personal computer does. To reset the MP160 for any reason, turn the MP160 off, wait a few seconds, and then turn it back on.</p>
	<p>Fuse 2A 2 Amp fast-blow fuse holder; the maximum capacity of the fuse is 2 Amps.</p> <ul style="list-style-type: none"> To remove the fuse, use a screwdriver to remove the fuse cover, which is located below the word Fuse. 	
	<p>DC Input Use the DC Input to connect a battery, AC/DC converter or other power supply to the MP160.</p> <ul style="list-style-type: none"> The MP160 requires 12 VDC @ 1 Amp (minimum), 2 Amp (nominal) The receptacle can accept a “+” (positive) input in the center of the connector and a “-” (negative) input on the connector housing. 	
	<p>Ethernet The MP160 connects to the computer via the Ethernet port, located just to the right of the word Ethernet.</p> <ul style="list-style-type: none"> Uses a standard RJ-Ethernet connector (10 base T). 	
Side panel		
<p>Module connections</p>	<p>The two connector inputs are designed to connect directly to the AMI100D/HLT100C.</p> <ul style="list-style-type: none"> Analog signals are transmitted through the 37-pin connector (upper right side) Digital signals are transmitted through the 25-pin connector (lower-right side) and accessed with optically isolated STP100C/STP100C-C and STP-IO (not included) 	

ACTIVITY BUSY	MODE	LIGHT STATUS DESCRIPTION
A Bright B Bright	Self-Test	ACTIVITY and BUSY be bright for the duration of the self-test and setup process. This may take 3 – 10 seconds, depending on MP160 internal memory.
	Work	During data acquisition, ACTIVITY reflects command/data traffic (for acquisition speeds of 1000 Hz or more, ACTIVITY will be permanently bright or blink at a high frequency) and BUSY will be bright. It is normal for both lights to be on—this does not indicate a problem unless an Error Message is generated on the computer screen.
	Error	ERROR: In rare cases, a serious problem may prevent a self-test and the lights may be erratic: both on, both off, or any other static combination.
A Bright B Blink	Error	The MP160 enters the Error Mode if a fatal error occurs during the Self-test Mode. In the Error Mode, ACTIVITY is bright and BUSY is blinking at a frequency of 5 Hz.
A Blink B Bright	Error	If the self-test fails or setup fails, the Error mode is initiated and ACTIVITY will blink at about 5 Hz rate and BUSY will remain bright.
A Blink B off	Idle-1	ACTIVITY <u>blinks twice</u> with approximately 1.5-2 second interval and BUSY is OFF. Double blink means: <ul style="list-style-type: none"> - MP160 may be disconnected from LAN or, - MP160 is connected to LAN but did not receive IP address from network's DHCP server and default 169.254.xxx.xxx address is self-assigned to MP160. This is the standard state for MP160 connected to NIC through Ethernet network cable. It means the MP160 is in working condition and ready for acquisition. <i>AcqKnowledge</i> may communicate with the MP160 through a serial cable or through a network by using 169.254.xxx.xxx address and/or Ethernet cable.
	Idle-2	ACTIVITY <u>blinks once</u> with approximately 1.5-2 second interval and BUSY is OFF. Single blink means: <ul style="list-style-type: none"> - MP160 is connected to LAN and received IP address from network's DHCP server. It means the MP160 is in working condition and ready for acquisition.
A off B off	Self-Test	ACTIVITY and BUSY will go dark for less than 1 second at the end of the self-test before proceeding to the Idle mode.
	Wait	Under some conditions, such as when a dialog box is open, <i>AcqKnowledge</i> cannot send commands to the MP160. When command flow from the workstation stops, the MP160 acts as if there is an open dialog and enters the Wait Mode to wait for a command from the workstation it is "locked" to—commands from any other workstation will be ignored. When it receives a command, the MP160 return to the Work mode. After five minutes with no command communication, the MP160 will revert to the Idle mode.
	Error	ERROR: In rare cases, a serious problem may prevent a self-test and the lights may be erratic: both on, both off, or a static combination.

MP160 STATUS LIGHT PATHS

Startup (Power ON) > Self-test

When the MP160 is turned ON, ACTIVITY and BUSY will shine for the duration of the self-test and setup process. This may take 3 – 10 seconds, depending on MP160 internal memory.

Idle

MP160 is waiting for any command/request from *AcqKnowledge* or any workstation or any interface. [See Note 1]

Error

The MP160 enters the Error Mode if a fatal error occurs during the Self-test Mode.

Work

MP160 receives/sends commands/data to/from *AcqKnowledge*. [See Note 2]

Wait

MP160 cannot receive command due to software condition (i.e., dialog box open). [See Note 3]

NOTES

- IDLE**—Both light patterns are normal and indicate that the MP160 is waiting for a command—neither indicates a problem with the MP160. The MP160 can switch between Idle-1 and Idle-2. Idle-1 or Idle-2 pattern indicates which IP address the MP160 is using:
 - Idle-1: self-assigned address in 169.254.xxx.xxx network
 - Idle-2: address from DHCP server).
- WORK** — When the MP160 receives any command from any workstation, it locks on to that workstation and communicates with it exclusively. The MP160 “remembers” the active workstation and will ignore commands from any other workstation. The MP160 usually remains in the Working Mode until the *AcqKnowledge* software program is closed.
- WAIT** — Under some conditions, such as when a dialog box is open, *AcqKnowledge* cannot send commands to the MP160. When command flow from the workstation stops, the MP160 acts as if there is an open dialog and enters the Wait Mode to wait for a command from the workstation it is “locked” to—commands from any other work station will be ignored. When it receives a command, the MP160 enters the Work mode; if the MP160 does not receive a command within five minutes, it reverts to Idle.

MP160A-CE DATA ACQUISITION UNIT BLOCK DIAGRAM

The MP160 has an internal microprocessor to control the data acquisition and communication with the computer. There are 16 analog input channels, two analog output channels, 16 digital channels that can be used for either input or output, and an external trigger input. The digital lines can be programmed as either inputs or outputs and function in 8 channel blocks. Block 1 (I/O lines 0 through 7) can be programmed as either all inputs or all outputs, independently of block 2 (I/O lines 8 through 15).

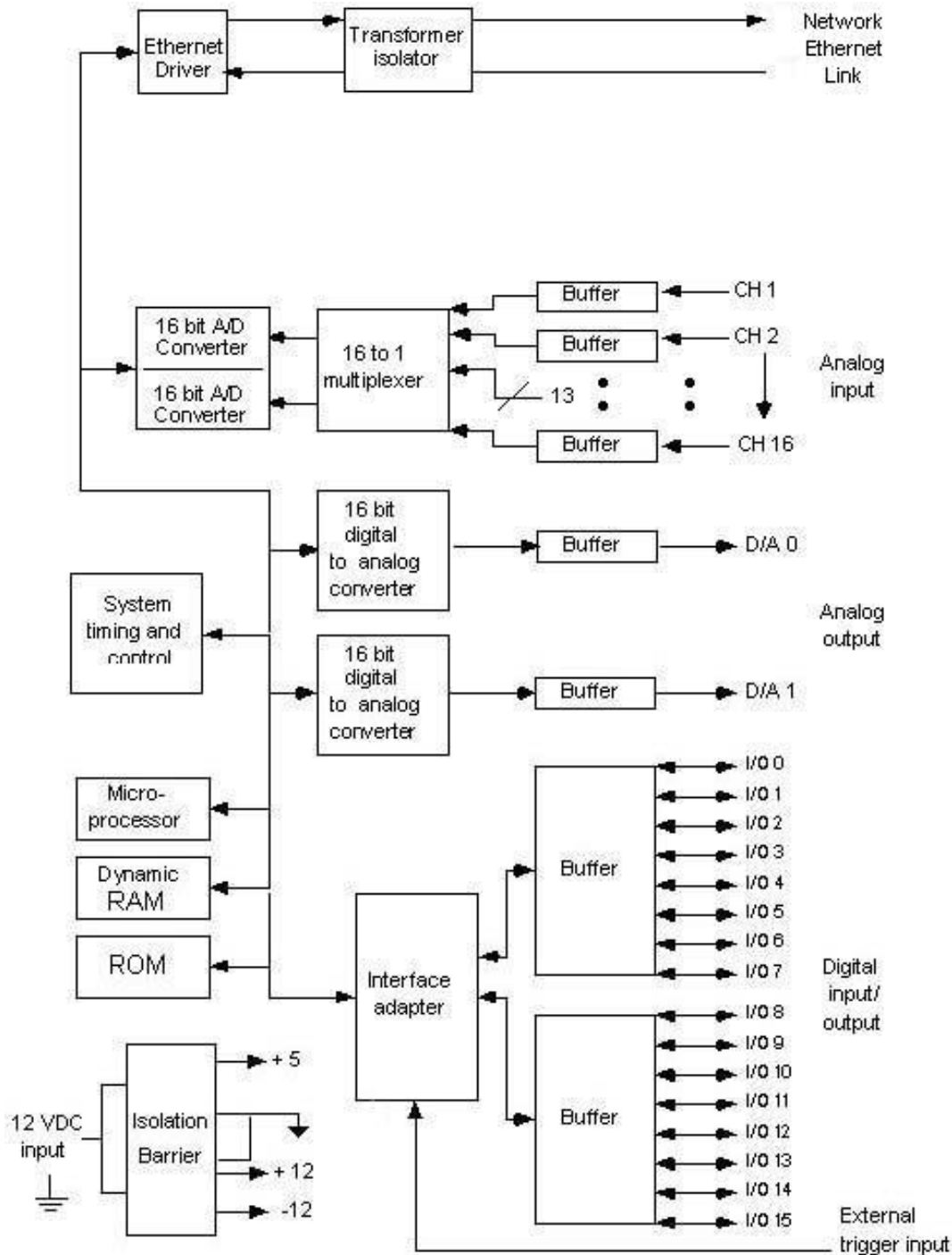

MP160A-CE block diagram

See also: MP160 Specifications

MP SYSTEM PIN-OUTS FOR MP160

Digital DSUB 25 (male) Pin-outs

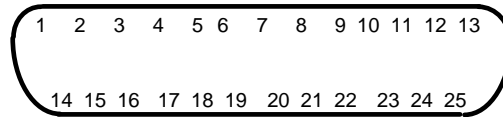

DIGITAL

Pin	Description	Pin	Description
1	I/O 0	14	I/O 4
2	I/O 1	15	I/O 5
3	I/O 2	16	I/O 6
4	I/O 3	17	I/O 7
5	GND D	18	GND A
6	GND D	19	Out 1
7	EXT T	20	Out 0
8	+5 VD	21	GND A
9	+5 VD	22	I/O 12
10	I/O 8	23	I/O 13
11	I/O 9	24	I/O 14
12	I/O 10	25	I/O 15
13	I/O 11		

Analog DSUB 37 (male) Pin-outs

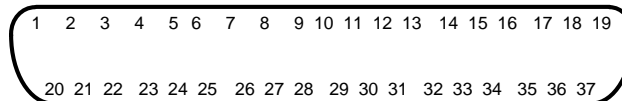

ANALOG

Pin	Description	Pin	Description
1	GND A	20	CH 1
2	GND A	21	CH 2
3	GND A	22	CH 3
4	GND A	23	CH 4
5	GND A	24	CH 5
6	GND A	25	CH 6
7	GND A	26	CH 7
8	GND A	27	CH 8
9	+12 V	28	+12 V
10	GND A	29	- 12 V
11	-12 V	30	CH 9
12	GND A	31	CH 10
13	GND A	32	CH 11
14	GND A	33	CH 12
15	GND A	34	CH 13
16	GND A	35	CH 14
17	GND A	36	CH 15
18	GND A	37	CH 16
19	GND A		

ETHERNET CONNECTOR PIN-OUTS (FOR MODEL MP160 ONLY)

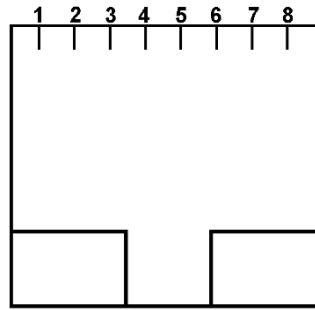

Front View

Pin	Description
1	TXD+
2	TXD-
3	RXD+
4	No Connection
5	No Connection
6	RXD-
7	No Connection
8	No Connection

ETHUSB USB 2.0 ETHERNET ADAPTER



ETHUSB is included in MP160/150 Systems, upgrades to MP160/150, and VR Systems.

Use to connect to a 10/100 Mbps network through a USB port—no need to open up your computer case to add an internal Ethernet card. The adapter's compliance with USB 2.0 (480 Mbps) ensures true 10/100 Mbps network speed without any compromise. Adapter is compact and USB bus-powered; no external power adapter required.

Key Features

- Instantly connect to a 10/100 Mbps network through a USB port—no need to open up your computer case to add an internal Ethernet card
- Compliant with USB 2.0 and USB 1.1 specifications
- Compliant with IEEE 802.3 (10Base-T) and 802.3u (100Base-TX) standards
- Powered by USB port—no external power adapter required
- Supports both full-duplex and half-duplex operations
- Supports suspend mode and remote wakeup via link-up and magic packet
- Equipped with diagnostic LEDs

System Requirements

- IBM compatible Pentium-233 MHz or faster PC or Mac
- 64 MB RAM or more
- One available USB port
- Windows 10, 8, 7, Mac OS X 10.x

Package Includes

- USB 2.0 to 10/100 Ethernet Adapter
- CD (Driver & User Manual)
- Quick Install Guide

Specifications

Cable Type: USB
Dimensions: 6.60 cm x 2.27 cm x 1.52 cm [2.60" x 0.90" x 0.60"]
Weight: 0.03 kg [0.06 lbs.]

Connector A: USB A (male)



Connector B: RJ45 (female)



Certifications: 802.3; 802.3u; USB 1.1; USB 2.0

ETHERNET ACCESSORIES

CBLETH1/2 – Ethernet Cables

CBLETH1 is a 2-meter Ethernet patch cable.

- MP160 Systems include one CBLETH1
- Use the CBLETH1 to connect the MP160 to an Ethernet interface (such as the ETHUSB interface shipped with your MP System).
- Use one CBLETH1 to connect the MP160 to an Ethernet Switch and one CBLETH1 to connect the Switch to a local area network (LAN).



CBLETH2 is a 2-meter Ethernet crossover cable.

- MP150 Systems include one CBLETH2.
- Use the CBLETH2 to connect the MP150 to an Ethernet interface (such as the ETHUSB interface shipped with your MP System).



MP36R SYSTEMS









MP36R Licensed Systems – See corresponding license page for more information:

System	Windows Part #	Mac Part #
MP36R	MP36RWSW	MP36RWS
MP36R with Basic Scripting	MP36RWSW-BAS	MP36RWS-BAS
MP36R plus Network Data Transfer	MP36RWSW-NDT	MP36RWS-NDT
MP36R Enterprise System	MP36RWSW-ENT	N/A
MP36R with 2-channel Vibromyography	VMG36R2WSW	VMG36R2WS
MP36R with 4-channel Vibromyography	VMG36R4WSW	VMG36R4WS

The MP36R data acquisition unit has an internal microprocessor to control data acquisition and communication with the computer. The MP36R unit takes incoming signals and converts them into digital signals that can be processed with the computer. There are four analog input channels, one of which can be used as a trigger input. To record signals, connect the MP36R unit to the computer and connect electrodes, transducers, and I/O devices to the MP36R unit.

MP36R Symbology

Symbol	Description	Explanation
	Type BF Equipment	Classification
	Attention	Consult accompanying documents
	On (partial)	Turns MP36/35 on assuming AC300A power adapter is powered by the mains
	Off (partial)	Turns MP36/35 off if but AC300A power adapter remains powered by the mains
	Direct current	Direct current output
	USB	USB port

COMPLIANCE

SAFETY

The MP36R satisfies the Medical Safety Test Standard s affiliated with IEC 60601- 1 and i s designated as Class I Type BF medical equipment

EMC

The MP36R satisfies the Medical Electromagnetic Compatibility (EMC) Test Standards affiliated with IEC 60601- 1-2.

Types of Input Devices

There are three types of devices that connect to the MP36R: electrodes, transducers, and I/O devices.

- Electrodes are relatively simple instruments that attach to the surface of the skin and pick up electrical signals in the body.
- Transducers, on the other hand, convert a physical signal into a proportional electrical signal.
- Input/Output devices (I/O for short) are specialized devices like pushbutton switches and headphones.

Simple Sensor Connectors

Regardless of the type of device connected, every sensor or I/O device connects to the MP36R using a “Simple Sensor” connector. Simple Sensor connectors are designed to plug only one way into the MP36R—it’s not possible to plug items in upside down or into the wrong socket.

- Electrodes, transducers, and the pushbutton switch all connect to the channel input ports on the front panel of the MP36R.
- Headphones and the stimulator connect to the “Analog out” port on the back panel of the MP36R. (There is also a 3.5 mm headphone jack for headphones with a mini-connector.)
- Digital devices connect to the “I/O Port” on the back panel.
- Trigger devices connect to the “Trigger” port on the back panel.

MP36R Front Panel



The front panel of the MP36R has an electrode check port, four analog input ports, and two status indicators.

Electrode Check

-  The Electrode Check port is a diagnostic tool used with *AcqKnowledge* 4.1 software to determine if the electrodes are properly attached to the subject.

Input Ports: CH 1, CH 2, CH 3, and CH 4

-  The four 9-pin female analog input ports on the MP36R acquisition unit are referred to as Channels.

Status Indicators

- **Busy**—indicator is activated when the MP36R is acquiring data and also during the first few seconds after the MP3X is powered on to indicate that a self-test is in progress. (When the MP3X passes the power-on test, the Busy light will turn off.)
- **Power**—status indicator is illuminated when the MP36R is turned on.

MP36R Back Panel



The back panel of the MP36R has an analog output port, a USB port, an I/O Port, a Trigger Port, a DC input, a fuse holder, and a power switch, and the unit’s serial number.

Analog Out Port – Low Voltage Stimulator

There is one 9-pin male “D” analog output port on the back of the MP36R that allows signals to be amplified and sent out to devices such as headphones. On the MP36, Analog Out is built-in low voltage stimulator.

USB Connection



The MP36R connects to the computer via a USB Port, located just below the word USB.

- Uses a standard USB connector.
- Should only be used to connect the MP36R to a PC or Macintosh.

Headphone Output

- Accepts a standard (1/8" or 3.5 mm) stereo headphone jack.

I/O Port

- Accepts a DB 25 Female connector.
- Input/Output port used to connect digital devices to the MP36R.

Trigger Input

- Accepts a male BNC connector.
- Input port used to send trigger signals from another device to the MP36R.
- See [External Trigger Inputs](#).

DC Input



Use the DC Input to connect a battery, AC/DC converter or other power supply to the MP36R.

-  The power supply requirements for the MP36R are 12 VDC @ 1 Amp. Only use the AC300A power adapter with the MP36R. The AC300A is a 12 VDC @ 1.25 Amp power supply adapter that can connect to any mains rated as 100-250 VAC @ 50/60Hz, 40VA.
- The receptacle is configured to accept a "+" (positive) input in the center of the connector and a "-" (negative) input on the connector housing.

Fuse Holder

The fuse holder contains a fast-blow fuse that helps protect the MP3X from shorts on its power, analog, and digital I/O lines. The MP36R uses a 1.0 amp fast-blow fuse.

- To remove the fuse, use a screwdriver to remove the fuse cover located below the word Fuse.

Power Switch



ON position — powers up the MP Unit



OFF position — cuts the flow of power

Fixed Hardware Low Pass Filters

To provide for anti-aliasing for the digital IIR filters and to reduce high frequency noise, the MP36R employs a low pass filter. These filtering options are incorporated into each MP unit channel: The low pass filter is set at approximately 20 KHz.

Fixed Hardware High Pass Filters

To accommodate the DC offsets associated with a range of biopotential and transducer signals, the MP36R employs a switchable bank of single pole high pass filters. These filtering options are incorporated into each MP unit channel: The high pass filter options are DC (HP filter off), 0.05 Hz, 0.5 Hz and 5 Hz.

MP36R Cleaning Procedures

Before cleaning, be sure to unplug the power supply from the MP36R. To clean the MP36R, use a damp, soft cloth. Abrasive cleaners are not recommended as they might damage the housing. Do not immerse the MP36R or any of its components in water (or any other fluid) or expose to extreme temperatures as this can damage the unit.

MP36R Specifications

Electrode Check Resistance Range:	0-1 MΩ (Vin+ and Vin- to GND)
Analog inputs:	4 isolated channels (front panel CH 1–CH 4)
Sample rate:	Max Min
	4 CH @ 100K s/second 1 sample/second
Trigger Input:	Analog CH1-CH4 or Digital D1-D8
Threshold:	Adjustable threshold level with Positive or Negative Trigger
A/D resolution:	24-bit (before digital filtering)
Signal to noise ratio:	> 89 dB min Tested at lowest Gain at 1,000 s/s with grounded front end
Voltage resolution:	Gain dependent: 2.38 microvolts /bit (Gain 5) to 0.024 nanovolts /bit (Gain 50,000)
Storage buffer:	512 K
Input voltage range:	Gain dependent: 400 microvolts to 4.0 Volts p-p
Input noise voltage:	9 nV rms /sqrt(Hz) and 0.1 uV rms noise (0.1 Hz to 35 Hz) - nominal
Input noise current:	100 fA rms /sqrt(Hz) and 10 pA p-p noise (0.1 Hz to 10 Hz) - nominal
Input protection:	± 1 mA/V current limited
Maximum input voltage:	4 V p-p (between Vin+ and Vin-)
Differential input impedance:	2 MΩ (between Vin+ and Vin-)
Software Filters:	Three programmable digital (IIR) filters; automatic or user-adjustable
Hardware Filters:	Fixed hardware low pass – 20 KHz Fixed hardware high pass – switchable DC, 0.05 Hz, 0.5 Hz, 5 Hz
Common mode input impedance:	(between Vin+/Vin- and GND)
DC	11 MΩ
AC (50/60 Hz)	1,000 MΩ
CMRR:	110 dB minimum at 50/60 Hz
Gain ranges:	5 – 50,000 (automatic preset or user adjustable)
Baseline adjustment:	<i>Gain</i> (automatic or user adjustable) 5, 10, 20, 50: ±100 mV 100, 200, 500: ±10 mV 1,000 to 50,000: ±4 mV
Electrode offset potential tolerance:	<i>Gain</i> 5, 10, 20, 50: ±2 V 100, 200, 500: ±200 mV 1,000 to 50,000: ±80 mV
Analog Output	
Number of channels:	1
D/A resolution:	16 bits
Accuracy:	±0.01% of FSR
Headphones	
Output impedance:	50 Ω
Output voltage:	-10 V to +10 V
Output drive current:	5 mA max
Serial interface:	USB, Type 2.0 high speed
Headphone:	Drives 16-32 Ω standard stereo headphones
I/O port:	8 TTL compatible inputs and 8 TTL compatible outputs
Trigger:	TTL compatible input and synchronization port – see External Trigger Inputs.
DC input:	Power input; requires 12 VDC @ 1 Amp. Use the AC300A 12 VDC @ 1.25 Amp power supply adapter to connect to any mains rated as 100-250 VAC @ 50/60Hz, 40VA.
Fuse:	1.0 amp fast-blow fuse
Dimensions & Weight:	7 cm x 29 cm x 25 cm, 1.4 Kg
Operating Temperature Range:	0 – 70 deg C
Storage Temperature Range:	-10 – 70 deg C
Operating / Storage Humidity Range:	0 – 95% (non-condensing)
Operating / Storage Pressure Range:	0 – 300 kPA

Mains Power Disconnection

To completely disconnect the MP36R unit and the AC300A power adapter from all poles of the supply mains, extract the power cord plug from the mains outlet.

Please note that the power switch on the back of the MP36R unit turns power ON and OFF to the MP36R unit only.

Extract the plug by grasping the plastic shell of the plug and pull firmly away from the mains outlet in a direction perpendicular to the face of the mains outlet. Take care not to touch the metal blades associated with the plug. This procedure will fully power down (de-energize) the MP36R unit and AC300A power adapter.

MP36R Unit Pin-outs

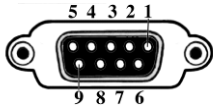
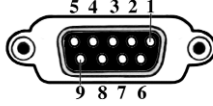
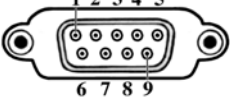
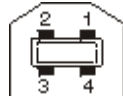
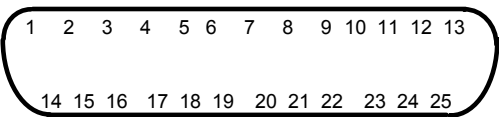
Electrode Check 	9-PIN FEMALE DSUB	2 Vin+	Electrode connection	
		3 GND		
		4 Vin-	Electrode connection	
CH Input 	9 PIN FEMALE DSUB (1 of 4)	1 Shield	drive	6 +5 V (100 mA max aggregate)
		2 Vin+		7 ID resistor lead 1; I ² C SCL
		3 GND		8 ID resistor lead 2; I ² C SDA
		4 Vin -		9 -5 V (100 mA max aggregate)
		5 Shield	drive	
Analog Output 	9 PIN MALE DSUB	1 Buffered analog or pulse output A.C. coupled (1,000 uF) Analog range: +/- 2.048 V Pulse range: 0 to 2.048 V	4 +5 V (100mA max.)	
		2 Low voltage stimulator Buffered, D.C. coupled Z out = 50 Ω Range: -10 V to +10 V	5 Buffered pulse output Z out = 1 kΩ Range: 0 to 5 V	
		3 GND	6 +12 V (100 mA max)	
			7 I ² C SCL – Do not connect	
Connector 	USB 1	+5	8 I ² C SDA	
		2 -Data	9 Monitor – Do not connect	
		3 Data +		
		4 GND		
I/O Port 	DSUB 25 (male)	1 Digital Output 1 0-5 V 8 ma	15 Digital Output 6	
		2 Digital Output 2 0-5 V 8 ma	16 Digital Output 7	
		3 Digital Output 3 0-5 V 8 ma	17 Digital Output 8	
		4 Digital Output 4 0-5 V 8 ma	18 Analog Input, Right 1 VRMS, centered at 0 V	
		5 GND Unisolated	19 Analog Input, Left 1 VRMS, centered at 0 V	
		6 GND Unisolated	20 RS-232-TX 0-5 V	
		7 RS-232-RX	21 I ² C-SCL 3.3 V	
		8 +5 V Unisolated/fused	22 Digital Input 5	
		9 I ² C-SDA 3.3 V	23 Digital Input 6	
		10 Digital Input 1† 0-5 V	24 Digital Input 7	
		11 Digital Input 2† 0-5 V	25 Digital Input 8	
		12 Digital Input 3† 0-5 V		
		13 Digital Input 4† 0-5 V		
		14 Digital Output 5		

† Digital Input are 0-5 V with 100 K ohm pullups to 5 V on board

MP36R TRANSDUCERS

Transducers listed below are for use with the MP36R four-channel data acquisition unit.

SS1LA Shielded Electrode Adapter	SS25LB Hand Dynamometer
SS2L Electrode Lead Set	SS26LB Tri Axial Accelerometer (± 5 g)
SS3LA EDA (Electrodermal Activity)	SS27L Tri Axial Accelerometer (± 50 g)
SS4LA Pulse Plethysmograph	SS28LA Heel-toe Strike
SS5LB Respiratory Effort	SS29L Multi-lead ECG Cable
SS6L Fast Response Temperature	SS30L Electronic Stethoscope
SS7L Waterproof Probe Temperature	SS36L Reflex Hammer
SS8L Liquid Immersion Probe Temperature	SS39L Breadboard
SS18L Digit Surface Temperature	SS40L-42L Differential Pressure
SS9LA Unisolated BNC Input Adapter	SS43L Variable Assessment (Psych)
SS70LA Isolated BNC Input Adapter	SS46L-52L Airflow Pneumotach Series
SS10L Pushbutton Hand Switch	SS53L-55L Digital Switch Series
SS11LA Airflow	SS56L Hand Clench Force Bulb
SS12LA Variable Range Force	SS57L EDA Lead for Disposable Setups
SS13L Pressure	SS60L Signal Cable for SS39L Breadboard
SS14L Displacement	SS61L Finger Twitch
SS17L Physiological Sounds Microphone	SS62L Speech Frequency Microphone
SS19L or SS19LA/LB Blood Pressure Cuff	SS63L-66L Force Series
SS20L-21L Twin Axis Goniometer	SS67L Pressure Pad/Respiration
SS22L-23L Single Axis Torsiometer	SS68L PH Probe
SS24L Single Axis Finger Goniometer	SS69L Dissolved Oxygen Probe
SS25LA Hand Dynamometer	

SS1LA SHIELDED ELECTRODE ADAPTER

The fully-shielded electrode interface cable permits high resolution recording of biopotential signals. The 3-meter adapter cable accepts standard 1.5 mm female Touchproof connectors. Use this lead adapter with:

- LEAD120 and EL120 Contact Post Electrodes
- LEAD110 Series and
 - EL160 Series Reusable Gold Cup Electrodes
 - EL250 Series Reusable Ag-AgCl Electrodes
 - EL350 Series Bar Electrodes
 - EL450 Series Needle Electrodes
- LEAD140 Series Clip Leads

To use disposable electrodes, connect 2 x LEAD110S-R/W shielded electrode leads to the VIN+ and VIN- inputs, and 1 x LEAD110 unshielded lead to the ground input. The LEAD110 series electrode leads will interface with any BIOPAC disposable electrode.

SS1LA SPECIFICATIONS

Cable length	3-meter
Termination	standard 1.5 mm female Touchproof connectors

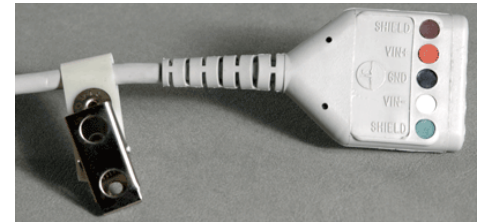

Note: The SS1L is a 3-meter electrode adapter for older style 2 mm pin connections. To convert 2 mm pin connections to Touchproof 1.5 mm connections, use CBL201.

SS2L ELECTRODE LEAD SET

- “SS2L” is used to reference SS2L, SS2LA, or SS2LB lead sets;
- SS2LB is recognized by current release BSL Lessons. This fully shielded cable assembly permits high-resolution recording of biopotentials. Each lead set has three pinch leads designed to snap directly onto standard disposable electrodes (such as the EL500 series electrodes). Each pinch lead is 1 meter long and terminates in a yoke connected to a 2-meter cable.



This is the general-purpose electrode cable used for almost all applications requiring the use of electrodes. These cables are used to connect the disposable electrodes that are placed on the surface of the skin to the MP3X/4X unit. Depending on where electrodes are placed, they can measure muscle contraction, heartbeats, or even brainwaves.

One end of the SS2L cable has a Smart Sensor connector on it that connects to the MP3X/4X and the other end splits into three smaller cables. Each end of the smaller cables is fitted with a pinch connector that clamps onto electrodes.

SS2L and SS2LA are discontinued products. SS2LB is the current product offering.

SS2L SPECIFICATIONS

Cable Length:	2 meters
Connector Type:	9 Pin DIN

SS3LA ELECTRODERMAL ACTIVITY (EDA) TRANSDUCER WITH REUSABLE ELECTRODES



The SS3LA transducer connects to a single MP3X/45 input channel to record electrodermal activity (changes in skin conductance) or, with modified setup, skin resistance*. The SS3LA operates by applying a fixed voltage (0.5 Volts DC) across the two electrodes and then detects the minute current flowing between the electrodes. Because the voltage (V) is fixed, from Ohms Law, the conductance (G) will be proportional to the current (I): $G = I/V = I/0.5 \text{ V}$. Circuitry in the SS3LA then converts the detected current to a voltage so it can be measured by the MP device. The software performs the necessary scaling and units conversion. Two reusable Ag-AgCl electrodes are mounted in individual, ergonomically designed, polyurethane housings for improved contact, attachable to the fingers by a Velcro strap. The electrodes have a 6 mm contact area with a 1.6 mm cavity to accommodate isotonic electrode gel (GEL101 or equivalent). The non-polarizable electrodes are shielded to minimize noise interference and improve recordings.

- See the SS57L EDA Lead for a disposable electrode option

USAGE RECOMMENDATIONS

Presets - BSL *PRO* (and AcqKnowledge software for MP36R) includes the following EDA presets:

- Electrodermal Activity (EDA), 0-35 Hz; **requires calibration**—see details below
- Electrodermal Activity (EDA) Change; no calibration required (BSL *PRO* 4.0.3 and earlier only)

To navigate to the presets in the software, choose **MP > Set Up Data Acquisition** (BSL 4.1) or **Set Up Channels** (BSL 4.0.3 or earlier) > **Channels** > and select the desired EDA preset from the **Preset** pop-up menu.

Single-point Calibration for (EDA) 0-35 Hz Preset

The following single-point calibration will yield very good results and is easy to perform:

1. Disconnect the electrodes.
2. Click “Setup” > “Scaling” button in the software’s EDA preset dialog.
3. Click the **Cal 2** button.
4. Add the new **Cal 2** value to the default **Cal 1** value (example below left, $1000 + 31.3725 = 1031.3725$). If the new **Cal 2** value is negative, then subtract that value from **Cal 1**.

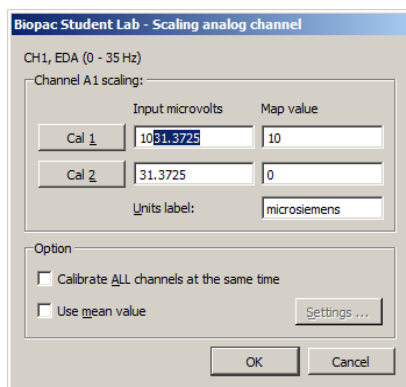

BSL 4.x and AcqKnowledge 4.x EDA Scaling Dialog

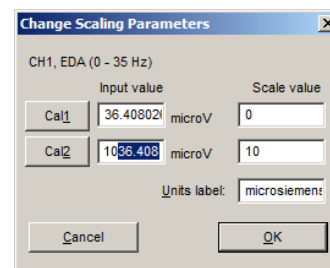

Note that **Cal 1** and **Cal 2** values are reversed in software versions BSL 3.7.x and earlier.

BSL 3.7.x EDA Scaling Dialog

Two-point Calibration for (EDA) 0-35 Hz Preset

Two-point calibration offers the advantage of greater accuracy, but is a more complex procedure. To perform:

1. Prepare two 1% calibration resistors: 100 kilohm (10 microsiemens) and 1 megaohm (1 microsiemen). Insulate the resistor using clear tape such that when held, the fingers will not directly contact the resistor leads.
2. Place the 1 megaohm resistor such that one resistor lead contacts one electrode pad and the other resistor lead contacts the opposite electrode pad.
3. Click “Setup” > “Scaling” button in the software’s EDA preset setup dialog.

4. In the Scaling dialog box, set the **Cal 1 Scale value** to “1” and click **Cal 1**.
5. Repeat Step 2 using the 100 kilohm resistor.
6. In the Scaling dialog box, set the **Cal 2 Scale value** to “10” and click **Cal 2**.

If the file is now saved as a template (*.gtl), the calibration values will be maintained as long as the transducer is matched to the software each time it is used.

Verify - check the accuracy of the SS3LA:

1. Click **Start** to begin a recording.
2. Place an insulated 100 kilohm resistor (10 microsiemens) across the electrode pads (resistor must be insulated from fingers).
3. Click **Stop**.
4. Check the EDA value when the resistor was placed across the electrodes using measurements.
 - The software should produce a reading of 10 microsiemens (μsiemens).

Setup - There must be good electrical connections between the skin and the electrodes for EDA to work properly.

Gel - When using GEL101 isotonic gel it is important that the gel has a chance to be absorbed and make good contact before recording begins. Accordingly:

1. Apply GEL101 to the skin at the point of electrode contact and rub it in.
2. Fill the SS3LA electrode cavity with GEL101.
3. Attach the SS3LA electrode to the subject.
4. Wait 5 minutes (minimum) before starting to record data.

***Measuring skin resistance** - Use an Expression calculation channel to take reciprocal of conductance, and then apply proper scaling.

Tip



To detect a good signal, subjects should have a little sweat on their hands (not a lot, but enough so that their hands are not completely smooth or cold). If subjects wash their hands just prior to the recording or if they have been sitting in a cold room, then they must do something to activate the sweat glands before beginning calibration or recording. If subjects begin with colder hands, the scale will be diminished and the signal will be easily saturated once they “warm up” during the lesson.

CLEANING THE SS3LA TRANSDUCER

- The GEL should be immediately cleaned off the electrodes after each use. Dried gel will act as insulator preventing electrical contact with the skin, and the Ag-AgCl electrode disk could degrade quickly with time because of the porous electrode surface.
- To clean the electrodes, wet a cotton swab or toothbrush with water and remove the electrode gel. Always dry the electrodes after cleaning.
- If needed, use Hydrogen Peroxide solution (2-3%) to brighten electrode surface (optional) or to sterilize the electrode. Do not place the electrode in solution, but rather use a cotton swab or toothbrush. Dry the electrodes after cleaning.
- If a dark residue remains after the above cleaning methods are used, then a cleaner with pumice (such as Ajax) can be used on the wetted cotton swab or toothbrush.

SS3LA SPECIFICATIONS

Electrode Type:	Ag/AgCl, shielded	Weight:	4.5 grams
Excitation:	0.5 V DC	Cable Length:	2 meters
Range:	0.1-100 μsiemens (normal human range is 1-20 μsiemens)	Connector Type:	9 Pin DIN
Surface Area:	6 mm contact area	Sterilizable:	Yes (contact BIOPAC)
Gel Cavity Area:	1.66 mm		
Dimensions:	16 mm (long) × 17 mm (wide) × 8 mm (high)		

SS5LB RESPIRATORY EFFORT TRANSDUCER



The SS5LB transducer is used to record respiration via chest or abdomen expansion and contraction. This transducer is useful for determining how deeply someone is breathing and for calculating the person's breathing rate or respiration rate. The transducer is a strain assembly that measures the change in thoracic or abdominal circumference. The strap presents minimal resistance to movement and is extremely unobtrusive.

Due to its novel construction, the SS5LB can measure extremely slow respiration patterns with no loss in signal amplitude while maintaining excellent linearity and minimal hysteresis. The respiratory effort transducer has a 2-meter flexible lightweight cable. The center plastic housing protects the delicate sensor within.

The transducer is attached by a fully adjustable nylon strap, which allows the transducer to fit almost any circumference.

To attach the nylon belt to the transducer, thread the strap through the corresponding slots on the sensor assembly. Place the transducer around the body at the level of maximum respiratory expansion (generally about 5cm below the armpits). At maximum expiration, adjust the strap so there is slight tension to hold the strap around the chest.

SS5LB SPECIFICATIONS

Response:	True DC
Circumference Range:	9 cm – 130 cm (Can be increased with a longer nylon strap)
Interface:	MP36/35/30/45
Dimensions:	95 mm (long) × 47mm (wide) × 15mm (thick)
Weight:	9 grams
Sterilizable:	Yes (contact BIOPAC for details)
Cable Length:	2 meters (flexible, lightweight)
Connector Type:	9 Pin DIN

TEMPERATURE TRANSDUCERS

SS6L: Fast Response

SS7L: Waterproof Probe

SS8L: Liquid Immersion Probe

SS18L Digit Surface

SS6L TEMPERATURE TRANSDUCER

The SS6L is a small fast-response thermistor used to measure small variations in temperature, either on the skin surface or in exhaled airflow. The recorded temperature changes during breathing can be used to indicate respiration rate. Attach the SS6L to the skin surface with Surgical Tape (TAPE1).

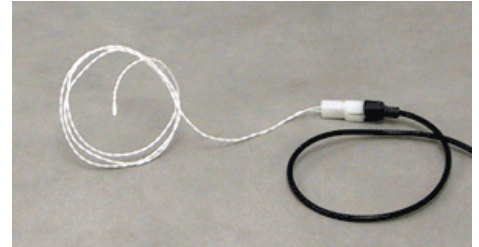

RX202A Sensor (white) shown at right with transducer connector (black); ships as sensor only.

This is a replacement sensor for

- TSD202A for MP research systems
- SS6L for BSL education systems
- SS6 for telemetry/wireless systems

The sensor snaps onto the "SS" transducer connector for connection to a BIOPAC data acquisition system.

SS6L SPECIFICATIONS

Response time (in stirred oil bath):	0.6 sec
Nominal resistance:	2252 Ω @ 25° C
Maximum operating temperature:	100° C
Accuracy and Interchangeability:	$\pm 0.1^\circ$ C
Connector Type:	9 Pin DIN
Compatibility:	YSI® series 400 temperature probes
Cable Length:	2 meters (flexible, lightweight)
Sterilizable:	No
Dimensions:	5 m x 1.7 m

SS7L WATERPROOF PROBE

Use this vinyl probe for core (oral/rectal) temperature recordings.



SS7L SPECIFICATIONS

Response time (in stirred oil bath):	1.1 sec
Max operating temp:	60° C
Accuracy & Interchangeability:	$\pm 0.2^\circ$ C
Compatibility:	YSI(r) series 400
Dimensions:	9.8 mm x 3.3 mm
Cable:	3 meters

SS8L LIQUID IMMERSION PROBE

Use this stainless steel probe for dry or wet bath temperature measurements.



SS8L SPECIFICATIONS

Response time (in stirred oil bath):	3.6 sec
Max operating temp:	60° C
Accuracy & Interchangeability:	±0.2° C
Compatibility:	YSI(r) series 400
Dimensions:	4 mm x 115 mm
Cable:	3 meters

SS18LA DIGIT SURFACE TEMPERATURE TRANSDUCER

The SS18LA is designed to record skin temperature of the fingers or toes. The probe contains a surface temperature sensing element encased in a polyurethane housing that conforms to curved skin surfaces and includes a Velcro strap for easy attachment.

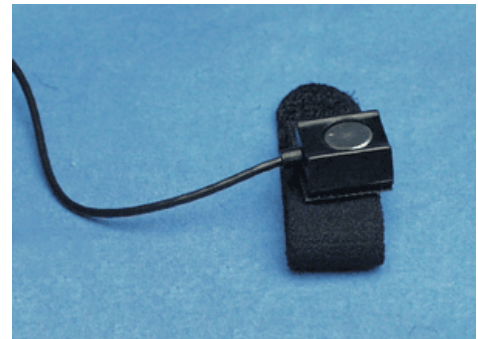

SS18L SPECIFICATIONS

Response time (in stirred oil bath):	1.1 sec
Size	
with housing:	16 mm (long) x 17 mm (wide) x 8 mm (high)
sensor only:	10 mm sensing diameter, 1.4 mm sensor thickness
Interface:	MP3X
Nominal Resistance:	2252 ohms at 25° C (sensor only)
Maximum operating temperature:	60° C (when used with MP3X)
Accuracy and Interchangeability:	0.2° C (after calibration)
Cable Length:	3 meters
Compatibility:	YSI series 400 temperature probes (sensor only)
Sterilizable:	No

INPUT ADAPTERS

SS9LA Unisolated BNC Input Adapter

SS70LA Isolated BNC Input Adapter

SS71L Isolated BNC Input Adapter – MP30

See also: OUT2 BNC Output Adapter

SS9LA Unisolated BNC Input Adapter

This unisolated input adapter is for MP36, MP36R, MP35, and MP45 Systems only. Use to send signals from other devices (other chart recorders, amplifiers and signal generators) to be recorded by a Biopac Student Lab System or a Research System with *AcqKnowledge*.

SS9LA has a built-in divide by 10 attenuation which provides a ± 20 V input range on MP36, MP36R and MP45, a ± 10 V input range on MP35. The 2-meter cable terminates in a male BNC for easy connections.



SS9LA Specifications

Cable length:	2 meter
Connector type:	BNC
Signal range:	± 20 V (MP36/MP36R/MP45) ± 10 V (MP35)

WARNING! Never connect the SS9LA BNC Input Adapter to an MP3X unit if electrodes from other channels are connected to human subjects – this may void the electrical isolation (one un-isolated channel input voids the isolation of all channel inputs).

This cable replaces the SS9L, effective January 2014.

SS70LA Isolated BNC Input Adapter for MP36/MP35



This BNC adapter is required when connecting un-isolated third party devices (i.e. amplifiers, chart recorders or signal generators), while electrodes, attached to human Subjects are connected to other input channels.

Connector Type:	BNC
Signal range:	± 10 V (MP36/MP36R/MP35/MP45)

This adapter replaces the SS70L, effective June 2017.

SS71L Isolated BNC Input Adapter for MP30



This BNC adapter is required when connecting un-isolated third party devices (i.e. amplifiers, chart recorders or signal generators), while electrodes, attached to human Subjects are connected to other input channels.

Connector Type:	BNC
Signal range:	± 10 V

WARNING! Since all MP inputs share a common isolated ground, connecting an un-isolated device to any channel voids the isolation for all channels and exposes the Subject to possible shock hazards.

SS10L PUSHBUTTON HAND SWITCH

The SS10L pushbutton hand switch is used for remote event marking or for psychophysiological response tests. This easy to hold pushbutton switch is very rugged and reliable, and makes it simple to mark events during recording. When data from the button is displayed on the screen, it normally reads 0 Volts, and when the button is pressed it reads +5 mV.



SS10L SPECIFICATIONS

Cable Length:	2 meters
Connector Type:	9 Pin SS to MP36/35 front panel input

See also: Force Transducer Tension Adjuster (HDW100A)

SS12LA VARIABLE RANGE FORCE TRANSDUCER

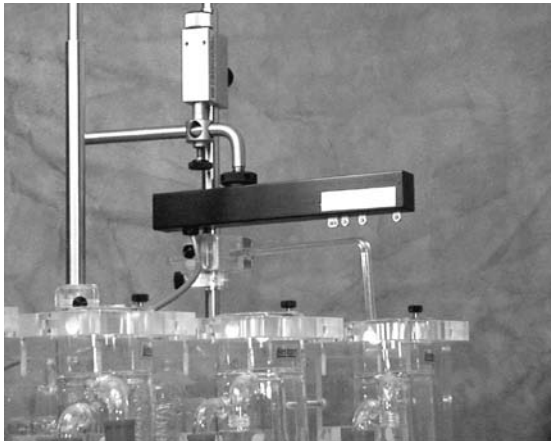

SS12LA Sample Setup



SS12LA Variable Range Force Transducer

Force transducers are devices capable of transforming a force into a proportional electrical signal. The SS12LA variable range force transducer element is a cantilever beam load cell incorporating a thin-film strain gauge. Because the strain elements have been photolithographically etched directly on the strain beam, these transducers are rugged while maintaining low non-linearity and hysteresis. Drift with time and temperature is also minimized, because the strain elements track extremely well, due to the deposition method and the elements' close physical proximity. The SS12LA also incorporates impact and drop shock protection to insure against rough laboratory handling.

Forces are transmitted back to the beam via a lever arm to insure accurate force measurements. Changing the attachment point changes the full scale range of the force transducer from 50 g to 1000 g. The beam and lever arm are mounted in a sealed aluminum enclosure that includes a 3/8" diameter mounting rod for holding the transducer in a large variety of orientations. The SS12LA comes equipped with a 2-meter cable and plugs directly into the MP3X module.

The SS12LA mounting rod can be screwed into the transducer body in three different locations, two on the top and one on the end surfaces of the transducer. The mounting rod can be placed in any angle relative to the transducer orientation. The SS12LA can be used in any axis and can be easily mounted in any standard measurement fixture, including pharmacological setups, muscle tissue baths and organ chambers.

The SS12LA has 5 different attachment points that determine the effective range of the force transducer. These ranges are 50 g, 100 g, 200 g, 500 g and 1,000 g. The point closest to the end is the 50 g attachment point, while the point closest to the middle is the 1,000 g attachment point.

Two **S-hooks** are provided with the SS12LA; one has a .032" diameter wire and the other has a .051" diameter wire. The smaller hook is to be used for the 50 g, 100 g and 200 g ranges. The larger hook is intended for the 500 g and 1000 g ranges. The larger hook is intentionally a tight fit to generate a downward pull vector. To further increase proper readings, keep the unit level and align anything that hangs off the hook straight beneath it rather than at a sideways angle.



SS12LA S-hooks

SS12LA SPECIFICATIONS*

Lever Arm Position (hook ring)	Full Scale Range (FSR)	10Hz Noise	1Hz Noise
50 grams	50 grams	2.5 mg	1 mg
100 grams	100 grams	5 mg	2 mg
200 grams	200 grams	10 mg	4 mg
500 grams	500 grams	25 mg	10 mg
1000 grams	1000 grams	50 mg	20 mg
Sensitivity	1 mV/V (for 5 V excitation, output is 5 mV at full scale)		
Temperature Range	-10° C to 70° C		
Thermal Zero Shift*	<±0.03% FSR/° C		
Thermal Range Shift*	<0.03% Reading/° C		
Excitation Voltage	5 VDC		
Nonlinearity*	<±0.025% FSR*		
Hysteresis*	<±0.05% FSR*		
Non-repeatability*	<±0.05% FSR*		
30-Minute Creep*	<±0.05% FSR*		
Dimensions	19 mm (wide) × 25 mm (thick) × 190 mm (long)		
Weight (with mounting rod)	300 g		
Cable length	3 meters		
Materials	Aluminum: hook rings Anodized aluminum: housing Stainless Steel: attachment arm		

* These parameters assume the transducer is set for a 50 g range. For all other range settings, force measurements from 10% to 90% full scale are linear to ±1.0%.

CALIBRATION

The SS12LA is easily calibrated using weights of known mass. Ideally, calibration should be performed with weights that encompass the range of the forces expected during measurement and should cover at least 20% of the full scale range of the transducer. When calibrating for maximum range on the force transducer, use weights that correspond to 10% and 90% of the full scale range for best overall performance.

FORCE TRANSDUCER CALIBRATION

Calibrating a force transducer is a two step process. The first step involves finding the optimal Gain setting for the transducer and the second step is the actual calibration.

- 1) To find the optimal Gain setting:
 - a) Start with the software Preset for the force range desired.
 - To set the Presets: MP3X menu > Setup Channels > Analog Presets > “Force (range)”
 - b) Load the transducer with the maximum expected weight.
 - c) Collect data for a few seconds at these settings.
 - d) Inspect the sample data; look for data that is “railed” or “clipped.” This occurs when the input signal (times the gain setting) is too large relative to the maximum input range. An example of clipped data follows.

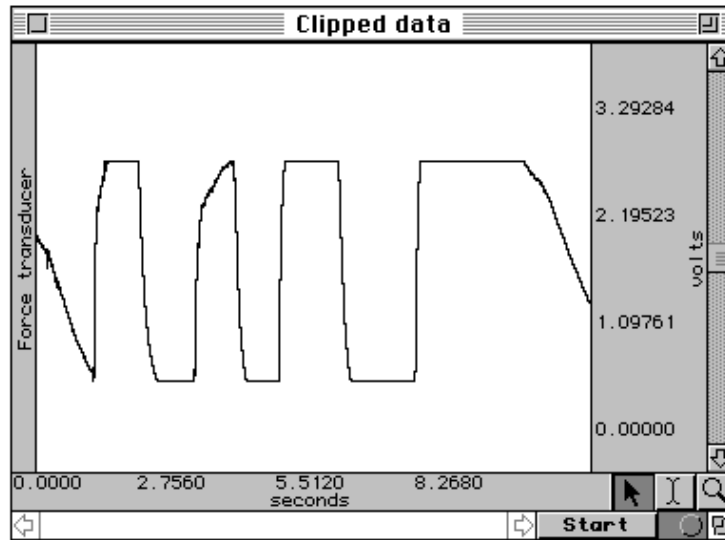

Gain set too high — Clipped Force data

e) If the signal is clipped, decrease the Gain setting by one step (e.g., from x5000 to x2500) and collect new data at the lower gain setting.

- To access the Gain setting: **MP3X** menu > **Setup Channels** > **Force** preset channel > **View/Change Parameters** icon > **Gain** pull-down menu

f) Repeat this procedure until the signal no longer appears “clipped.”

Once an optimal gain setting for the transducer has been established, this same gain setting can be used for other similar transducers and similar measurements.

2) The next step is to actually calibrate the transducer, which means mapping the input signal to more meaningful units (such as grams). To do this:

a) Access the Channel scaling dialog box (MP3X menu > Setup Channels > Force preset channel > View/Change Parameters icon > Scaling button).

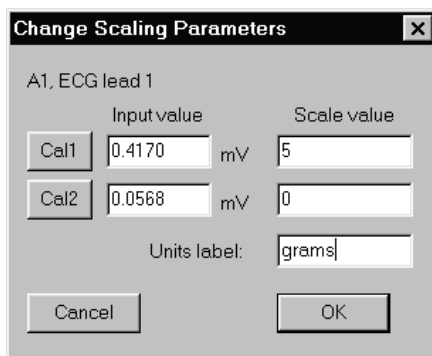

Note:
 In this sample dialog, a weight of 5 grams was placed on the transducer and the Cal 1 button was pressed. The transducer weight was then removed and Cal 2 was pressed.

b) Place the maximum expected weight or force on the transducer.

c) Click on the **Cal 1** button in the Channel scaling window.

- A voltage value will be automatically entered in the corresponding **Input value** box.

d) Remove all weight or force from the transducer.

e) Click on the **Cal 2** button in the same scaling window.

- A voltage value will be automatically entered in the corresponding **Input value** box.

The transducer will be calibrated to the set values the next time an acquisition is started.

SS13L PRESSURE TRANSDUCER

The SS13L pressure transducer is used to measure direct arterial or venous blood pressure in animals or to record pressure changes within a closed system such as an organ or tissue bath system. Connect to the tubing via the standard rotating Luer-lok fittings. This assembly consists of a disposable transducer with a 30 cm cable that attaches to a reusable 3-meter cable that is designed to interface with the MP3X. The transducer is supplied non-sterile but can be cold sterilized.

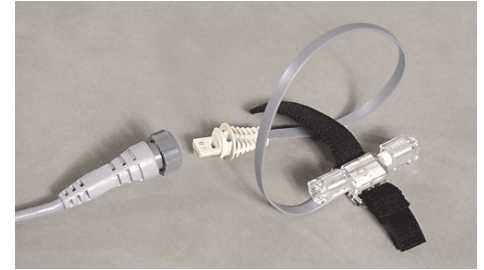

Note: The SS13L Pressure transducer is not intended for use with humans.

Typical software settings for the blood pressure transducer are described in the table below:

Filter 1	Filter 2	Filter 3	Hardware filter	Gain	Coupling
Low pass 66.5 Hz Q = 0.5	Low pass 38.5 Hz Q = 1.0	Band Stop 60 Hz Q = 1.0	1 KHz	1000 (preset)	DC

These settings are automatically applied when the **Pressure** preset is selected, but settings can be adjusted if necessary.

PRESSURE TRANSDUCER CALIBRATION

Calibrating a blood pressure transducer is a two step process. The first step involves finding the optimal gain setting for the transducer and the second step is the actual calibration.

- 1) To find the optimal gain setting:
 - a) Start with the software Presets (in this case, a gain of 1000)
 - To set the Presets: **MP3X menu > Set Up Data Acquisition > Channels > Analog Presets > select “Blood Pressure (Arterial)”**
 - b) Bring the transducer to the approximate maximum and minimum expected pressures.
 - c) Collect data for a few seconds at these settings.
 - d) Inspect the sample data; look for data that is “railed” or “clipped.” This occurs when the input signal (times the gain setting) is too large relative to the maximum input range. An example of clipped data is shown at right.
 - e) If the signal is clipped, decrease the gain setting by one step (e.g., from x5000 to x2000) and collect new data at the lower gain setting.
 - To access the Gain setting: **MP3X menu > SetUp Data Acquisition > Channels > Blood Pressure (Arterial) preset channel > Setup button > Gain pull-down menu**
 - f) Repeat this procedure until the signal no longer appears “clipped.”

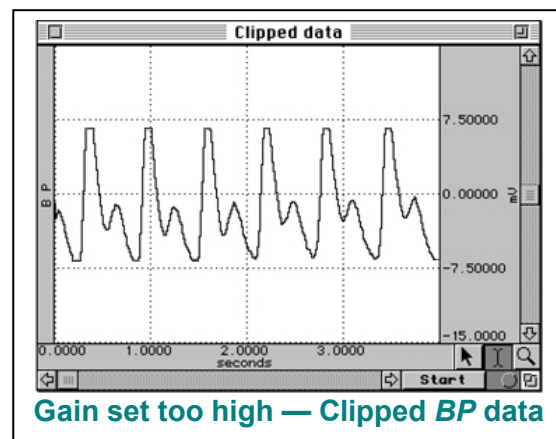

Once an optimal gain setting for the transducer has been established, this same gain setting can be used for other similar transducers and similar measurements.

- 2) The next step is to actually calibrate the transducer, which means mapping the input signal to more meaningful units (such as mmHg). To do this:
 - a) Access the Channel scaling dialog box (**MP3X menu > Set Up Data Acquisition > Channels > Blood Pressure (Arterial) Preset channel > Setup button > Scaling button**).

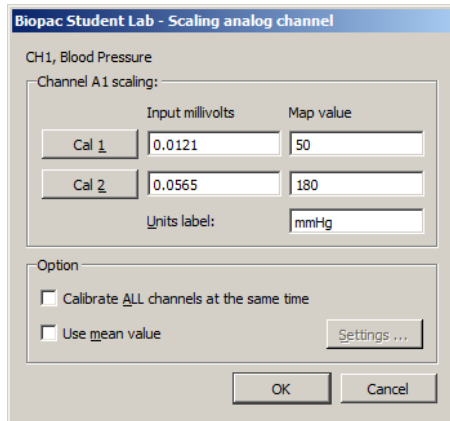

Note:

In this sample dialog, the transducer was brought to a pressure of 50 mmHg and the Cal 1 button was pressed.

The transducer was then brought to a pressure of 180 mmHg, and Cal 2 was pressed.

- b) Bring the transducer to the lowest expected pressure.
- c) Click on the **Cal 1** button in the Channel scaling window.
 - A voltage value will be automatically entered in the corresponding **Input value** box.
- d) Bring the transducer to the highest expected pressure.
- e) Click on the **Cal 2** button in the same scaling window.
 - A voltage value will be automatically entered in the corresponding **Input value** box.

The software will now interpolate between these two calibration points to give accurate measurements in mmHg.

SS13L PRESSURE TRANSDUCER SPECIFICATIONS

Operational pressure:	-50 mmHg to +300 mmHg
Overpressure:	-500 mmHg to + 4000 mmHg
Sensitivity:	25 μ V/mmHg (at 5 VDC excitation)
Accuracy:	\pm 1.5% of reading or \pm 1.0 mmHg (whichever is greater)
Operating temperature:	10° C to 40° C
Storage temperature:	-30° C to +60° C
Volume displacement:	0.04 mm per 100 mmHg
Leakage current:	10 μ A RMS @ 115 VAC 50 Hz
Dynamic response:	100 Hz
Unbalance:	50 mmHg max
Connection Ports:	male Luer and female Luer (sensors shipped prior to summer 2010 were male Luer on both sides)
Eight-hour drift:	1 mmHg after 5-minute warm-up
Isolation:	\leq 5 μ A leakage at 120 VAC/60 Hz
Defibrillation:	Withstands 5 charges of 400 joules in 5 minutes across a load
Combined effects of sensitivity, linearity and hysteresis:	1 mmHg (nominal)
Transducer cable:	30 cm
Interface cable:	3 meters
Transducer dimensions:	67 mm long X 25 mm wide
Weight:	11.5 grams

RX104A REPLACEMENT ELEMENT

RX104A is the replacement pressure-sensing element for blood pressure transducer SS13L. It does not include the Smart Sensor connector and cable.



See also: Tension Adjuster (HDW100A)

SS14L DISPLACEMENT TRANSDUCER

For use in recording very slight movements in a range of physiological preparations, the SS14L incorporates a semi-isotonic strain gauge and a stainless steel lever that can be mounted in any position.



SS14L SPECIFICATIONS

Sensitivity Range:	1 mm to 100 mm
Strain Gauge:	500 ohm silicon
Lever Length:	27 cm
Support Rod Length:	15 cm
Cable Length:	3 meters
Interface:	MP3X

SS25LA HAND DYNAMOMETER

Use the hand dynamometer to measure grip force—use in isolation or combine with EMG recordings for in-depth studies of muscular activity. The lightweight, ergonomically designed transducer provides direct readings in kilograms or pounds. The simple calibration procedure makes this device easy to use for precise force measurements, and the isometric design improves experiment repeatability and accuracy. The SS25LA is a basic unit, designed for student lessons; it can also be used in the MRI, with proper module setup, since it employs plastics in the spring constant. The highest performance dynamometer is TSD121C, which employs a four terminal, laser-trimmed, Wheatstone bridge built onto metal elements.

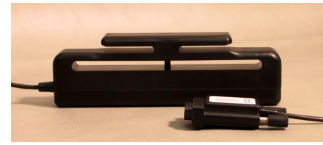

Hardware Setup

Connect the SS25LA Simple Sensor to a CH input on the front panel of an MP3X/45 unit.

Proper grip: Place the palm across the shorter bar and wrap fingers to center the force.

Scaling — Software Setup

- 1) Select **Set Up Channels** under the MP menu and enable one analog channel.
- 2) Select the desired **Clench Force** Preset (kg or lbs, the example to the right is shown in units of kg.)
- 3) Click the **Setup** button.
- 4) Click the **Scaling** button to activate a dialog box similar to the one shown at right.
- 5) In the **Map value** column, note the default scaling of “0” for **Cal2** and “100” for **Cal1**. These represent 0 and 100 kilograms, respectively.
- 6) Place the SS25LA on a flat surface.
- 7) Click the **Cal2** button to obtain an initial calibration reading. A value similar to the above example “0.7556” will appear.
- 8) To obtain the **Cal1** input value, add the **Cal2** input value to the default **Cal1** 3.5 mV per 100 kg value. (In this example, this value would be 0.7556 mV + 3.5 mV = 4.2556 mV.)

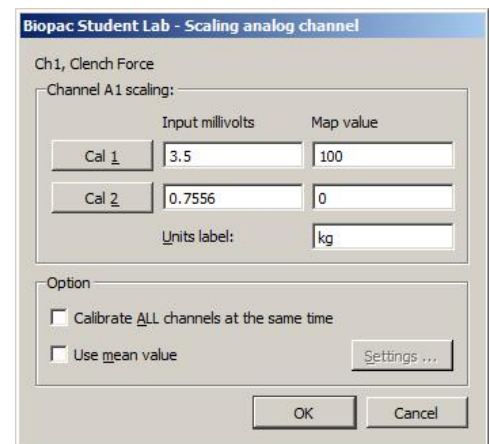

Note: The above instructions are for BSL 4 and higher. In BSL 3.7.7 and earlier, placement of the CAL1 and CAL2 scale values are reversed.

Optional Calibration Confirmation

- a) Click “Start” to begin data acquisition.
- b) Place the SS25LA on a flat surface and then place a known weight on the uppermost portion of the grip.
- c) Review the data to confirm that the known weight is reflected accurately in the data (sample at right).
- d) Adjust the Scaling parameters and repeat steps a-c as necessary.

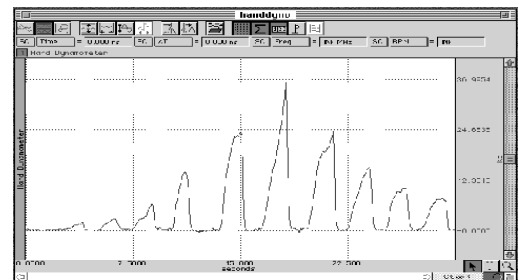

SS25LA Specifications

- Clench Force Range: 0-50 kgf
- Nominal Output: 13.2 μ V/kgf
- Linearity: 8%
- Sensitivity: 0.75 kg
- Weight: 323 grams
- Cable Length: 3 meters
- Dimensions: 17.78 cm (long) x 5.59 cm (wide) x 2.59 cm (thick)

NOTE: See Hardware Guide Appendix for SS25LA hysteresis specification and response diagram.

SS25LB HAND DYNAMOMETER

Use the hand dynamometer to measure grip force—use in isolation or combine with EMG recordings for in-depth studies of muscular activity. The lightweight, ergonomically designed transducer provides direct readings in kilograms or pounds. The simple calibration procedure makes this device easy to use for precise force measurements, and the isometric design improves experiment repeatability and accuracy. The SS25LB is a basic unit, designed for student lessons; it can also be used in the MRI, with proper module setup, since it employs plastics in the spring constant.

The highest performance dynamometer is TSD121C, which employs a four terminal, laser-trimmed, wheatstone bridge built onto metal elements.



Hardware Setup

Connect the SS25LB Simple Sensor to a CH input on the front panel of an MP36/36R/35/45 unit.

Proper grip: Place the palm across the shorter bar and wrap fingers to center the force.

Scaling—Software Setup for the MP36/MP36R/MP35/MP45

Note: When using with Biopac Student Lab, the SS25LB is compatible with versions 4.1 and higher only.

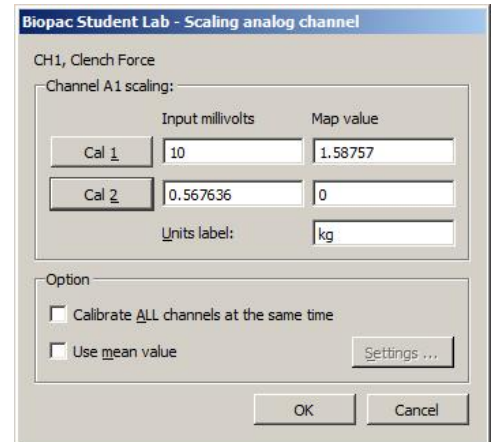

- 1) Select **Set Up Data Acquisition > Channels** under the MP menu and enable one analog channel.
- 2) Select the desired **Clench Force (SS25LB)** Preset in units of kg, lbs, or N. (Example above is units of kg.)
- 3) Click the **Setup** button.
- 4) Click the **Scaling** button to activate a dialog box similar to the one shown at right.
- 5) In the **Map value** column, note the default scaling of “0” for **Cal 2** and “1.58757” for **Cal 1**. These represent 0 and 1.58757 kilograms, respectively. **The MAP values must not be altered.**
- 6) Place the SS25LB on a flat surface.
- 7) Click the **Cal 2** button to obtain an initial calibration reading. A value similar to the above example will appear.
- 8) To obtain the **Cal 1** input value, add the **Cal 2** input value to the default **Cal 1** 10 mV per 1.58757 kg value. (In the above example, this value would be 0.567636 mV + 10 mV = 10.567636 mV.)

Optional Calibration Confirmation

- a) Make sure the SS25LB is connected to the same channel as enabled in Step 1 above.
- b) Click “**Start**” to begin data acquisition.
- c) Place the SS25LB on a flat surface and then place a known weight on the uppermost portion of the grip.
- d) Review the data to confirm that the known weight is reflected accurately in the data (sample above).
- e) Adjust the Scaling parameters and repeat steps a-c as necessary.

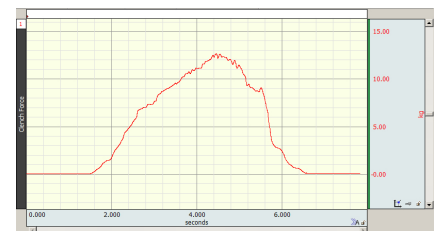

SS25LB Specifications

Clench Force Range:	0-50 kgf	Weight:	323 grams
Nominal Output:	6.299 mV/kgf	Cable Length:	3 meters
Linearity:	6%	Dimensions:	17.78 cm (long) x 5.59 cm (wide) x 2.59 cm (thick)
Sensitivity:	20 gf		

NOTE: See Hardware Guide Appendix for SS25LB hysteresis specification and response diagram.

SS29L MULTI-LEAD ECG CABLE

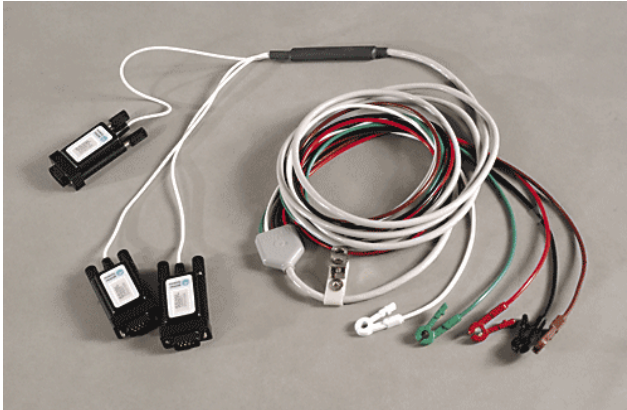

The SS29L Multi-Lead ECG Cable permits high-resolution ECG recordings. This multi-lead set can simultaneously record Leads I, II, III, aVR, aVL, aVF, plus one precordial chest lead V(1-6). A 12-Lead ECG recording can be obtained by alternating the chest lead electrode from position V1 through V6. The cable terminates in three Smart Sensors that connect to the MP3X.

SS29L SPECIFICATIONS

Input Cable Length:	2 meters
Electrode Lead Length:	1 meter
Internal connection:	Built-in Wilson terminal
Electrode interface:	Connects to standard snap-connector disposable electrodes (EL503)

SS30L ELECTRONIC STETHOSCOPE TRANSDUCER

The **SS30L** stethoscope was developed to teach the standard procedure for listening to heart sounds and Korotkoff sounds with a “normal” stethoscope, and record simultaneous sound data. A microphone in the **SS30L** records sound as it is heard and the BSL software displays the sound wave during and after recording (a variety of acoustical signals can be recorded). If ECG is also recorded, the timing of the heart sounds with the ECG can be correlated. The **SS30L** can be used with the **SS19L** Blood Pressure Cuff to record Korotkoff sounds for easy determination of systolic and diastolic blood pressure. With this combination, it is easy to obtain very accurate and repeatable results — usually within 10% of those determined by direct measurement.

- No calibration required, just select a **Stethoscope Preset** (Heart or Korotkoff Sounds)

See also: Biopac Student Lab Lesson 16 Blood Pressure and Lesson 17 Heart Sounds.

SS30L SPECIFICATIONS

Microphone Bandwidth:	20-100 Hz (does not impact acoustical bandwidth, used for data viewing)
Stethoscope Length:	
From Y to acoustic sensor point:	57 cm
From Y to ears:	21 cm
Microphone Cable length:	3 meters

SS31LA NONINVASIVE IMPEDANCE CARDIOGRAPHY MODULE

The SS31LA records the thoracic impedance parameters associated with Cardiac Output measurements. The SS31LA incorporates a precision high-frequency current source, which injects a very small ($400\mu\text{A}$ rms) current through the measurement tissue volume defined by the placement of a set of current source electrodes. A separate set of monitoring electrodes then measures the voltage developed across the tissue volume. Because the current is constant, the voltage measured is proportional to the characteristics of the biological impedance of the tissue volume. The SS31LA outputs impedance (Z) and derivative of impedance (dZ) in real time.



- Use with a 8-spot electrode lead configuration
- Use the SS31LA to measure changes in Cardiac Output under a variety of conditions: laying down, sitting up, standing up, and post-exercise.
- Use on stationary subjects; the SS31LA is sensitive to motion artifact.
- See BSL *PRO* Lesson **H21 Impedance Cardiology** for sample SS31LA setup and data.

Specifications

Outputs:

Impedance (Z)	(50 mV = 100 Ω)
Derivative Impedance (dZ)	(5 mV = 2 Ω /sec)
Operational Frequency:	100 KHz sine wave
Current Level:	400 μA (rms)

Bandwidth: (can limit in BSL *PRO* software)

Z :	DC – 100 Hz
dZ :	DC – 100 Hz

Dimensions: 14 cm (long) x 9.1 cm (wide) x 2.9 cm (high)

Weight: 400 grams

Electrode clip connects to standard snap electrode – use with an 8-spot electrode lead configuration

Note: SS31LA replaces the SS31L, which had lead connectors designed for strip electrodes, such as EL506, which were discontinued due to manufacturing limitations.

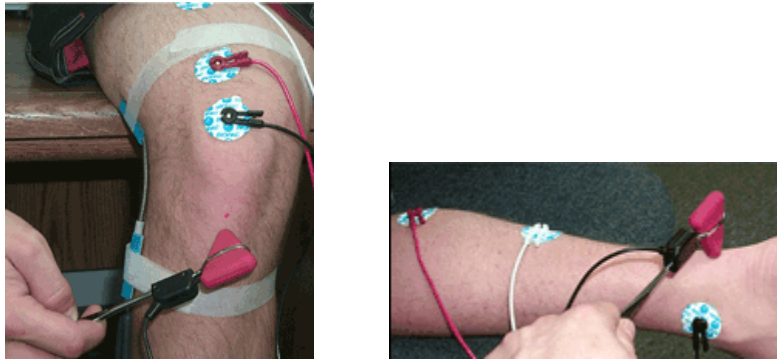
SS36L REFLEX HAMMER

This is a classic reflex hammer with a transducer attached to perform reflex measurements. It uses a Taylor Hammer—the most common type of reflex hammer used by doctors and nurses—and incorporates electronics to record the time and the relative strength of the impact. Being able to measure the strength of impact allows students to take threshold measurements; that is, they can measure how much of an impact is needed to elicit a response. The hammer only sends a response when contact is made with the subject. See Lessons L20, H16, H28.

SS39LA BREADBOARD

The Bioengineering Breadboard Lab consists of circuitry hardware and eight projects (with schematics and design notes) that demonstrate a very important subset of circuit design for recording and processing physiological signals. Students will use the MP36/35/45 and BSL *PRO* software to evaluate their designs. See Lessons H25, H26.

Project Book includes schematics for:

- Lab 1: Square Wave Oscillator
- Lab 2: Instrumentation Amplifier
- Lab 3: High Pass Active Filter
- Lab 4: Active Gain Block and Low Pass Filter
- Lab 5: Notch Filter for 50/60 Hz Rejection
- Lab 6: QRS Detection: Band Pass Filter
- Lab 7: QRS Detection: Absolute Value Circuit
- Lab 8: QRS Detection: Low Pass Filter and Overall System Test

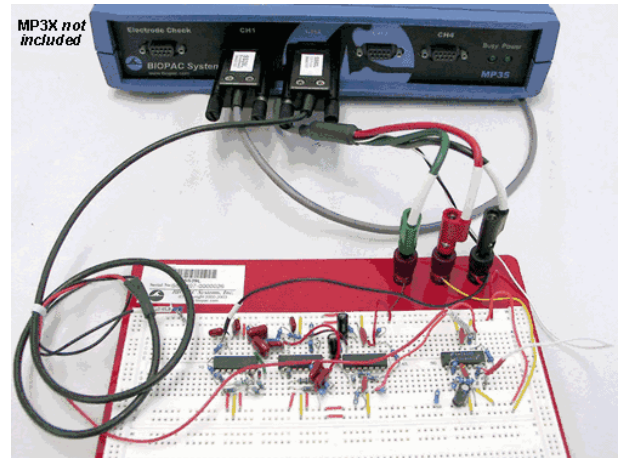

Circuitry Hardware

- Breadboard
- Signal/Power Cable:
 - 3 x Power Plugs: Green -5 V, Black GND, Red +5 V
 - 2 x Signal Wires: White-Signal, Black-GND
 - Built-in automatically resettable fuse
- Signal Cable: 2 x Signal Wires: Red-Signal, Black-GND
- Electrode Lead Interface: enables use of SS2L Lead Assembly
- Accessory Kit: capacitors, diodes, resistors, jumper wires, and other circuit-building components

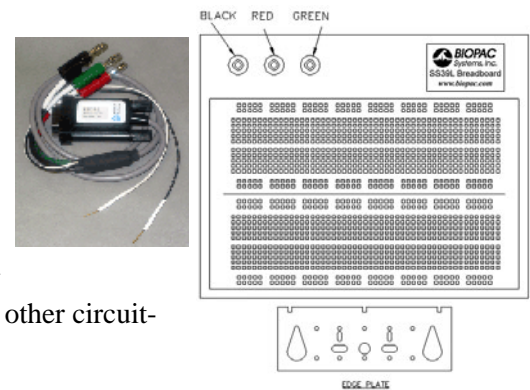

ACCESSORY OPTIONS

BSL-BMEACC BREADBOARD ACCESSORY KIT

Use to add work stations for the SS39LA Breadboard. Students can build a lab and rotate the power and signal cables from the SS39LA to connect to the Biopac Student Lab software and test the design.

Includes: breadboard, capacitors, diode, ic, ic quad OP-AMP, jumper wire kit, and resistors.



SS60LA SIGNAL CABLE FOR SS39LA BREADBOARD



Use this signal cable to add signal inputs to the SS39LA Signal Processing Breadboard, which ships with one combination power/signal cable.

BSL-TCI22 ELECTRODE LEAD INTERFACE



The electrode interface connects the SS2L Shielded Lead Assembly to the SS39LA Breadboard for circuit configurations that require electrodes. One BSL-TCI22 is shipped with the SS39LA; SS2L not included.

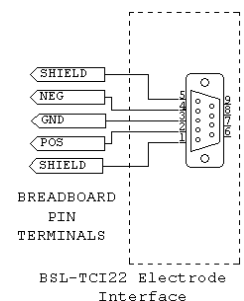

NOTE: Older-versions SS39L and SS60L were discontinued in August of 2017.

SS40L – 42L DIFFERENTIAL PRESSURE TRANSDUCER

SS40L	±2.5 cm H ₂ O
SS41L	±12.5 cm H ₂ O
SS42L	±25 cm H ₂ O



The SS40L-SS42L series differential pressure transducers are designed for low range pressure monitoring. The transducers plug directly into the MP3X general-purpose differential amplifier. The differential pressure ports are located on the front of the transducers and are easily connected to breathing circuits, pneumotachs or plethysmograph boxes. These transducers are very useful for interfacing a variety of small animal pneumotachs or plethysmographs to the MP System. The transducers are extremely sensitive and come in three ranges to suit a number of different applications. RX137 flow heads connect to the SS41L differential pressure transducer via standard 4 mm ID tubing. Included with each SS46L-SS52L.

SS40L – 42L Specifications

Voltage output (normalized to 1 volt excitation)

SS40L:	330 μ V/cm H ₂ O
SS41L:	130 μ V/cm H ₂ O
SS42L:	65 μ V/cm H ₂ O
Warm-up Drift:	±50 μ V
Stability:	±100 μ V
Dynamic Response:	100 Hz
Connection Ports/ID tubing Accepted:	3 mm to 4.5 mm
Dimensions: (high) x (wide) x (deep):	8.3 cm x 3.8 cm x 3.2 cm
Weight:	76 grams
Operating Temperature (compensated):	0 to +50 °C

SS43L VARIABLE ASSESSMENT (PSYCH) TRANSDUCER

Use this handheld, slide control transducer to record subjective responses to a variety of different stimuli. Use multiple transducers to allow several people to simultaneously answer the same question or otherwise respond to stimuli. Easily customize the response scale by inserting the parameters into the scale sleeve on the front of the unit.

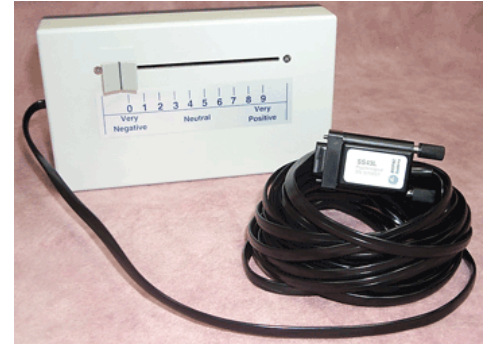

SS43L Specifications

Scale Output Range:	0-5 V
Scale Resolution:	Infinitely adjustable
Slide Control Length:	10 cm
Dimensions:	4 cm (high) x 11 cm (deep) x 19 cm (wide)
Weight:	230 grams
Cable Length:	7.6 meters

SS53L – SS55L DIGITAL SWITCH SERIES

Use for remote even marking or to externally trigger data acquisition for psychophysiological response tests. Monitor switch data as a digital input channel. Connects to the digital input on the MP36/35 only.

SS53L Hand switch

See Lessons H11, H16, H24, H27, H30.

SS54L Foot switch

See Lessons H11, H16, H24, H27, H30.

Switch Type: Pushbutton: ON - OFF
Dimensions: 69 mm (wide), 90 mm (long), 26 mm (high)
Cable Length: 1.8 meters
Connector Type: DSUB 25f

SS55L Eight-channel Marker Box

See Lessons H11, H16, H24, H27, H30.

Independently mark events, or provide responses, on up to eight channels simultaneously. Assign separate digital channels as event markers for individual analog input channels. Easily customize the response scale by inserting the parameters into the scale sleeve on the front of the unit.

Switch Type: Pushbutton: ON - OFF
Dimensions: 19 cm (wide), 11 cm (deep), 4 cm (high)
Cable Length: 3 meters
Connector Type: DSUB 25f

SS56L HAND CLENCH FORCE BULB

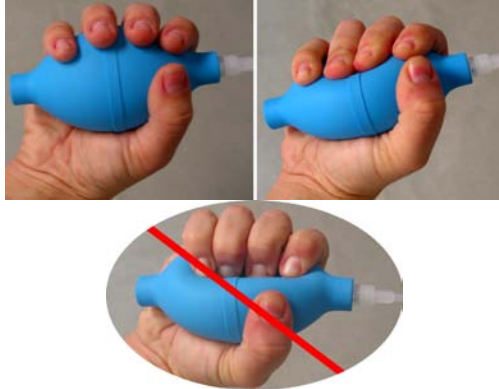

SS56L measures proportionality of bulb pressure to clench force in “kgf/m²” units (a pressure unit). This measure is accurate for the relative measures recorded in BSL Lesson 2 Electromyography (EMG) II. SS56L is recognized by current release BSL Lessons.

Specifications

Pressure Range:	BSL: 0 to 10,546 Kg-f/cm ² AcqKnowledge: 0 to 1.0546 Kg-f/cm ²	0 to 15 psi
Accuracy:	±3%	
Output:	BSL: 0.58 mV/100 Kg-f/cm ² AcqKnowledge: 0.58 mV/0.01 Kg-f/cm ²	4.1 mV/psi
Bulb Diameter:	5.8 cm	
Bulb Length:	11.1 cm	
Tubing Length:	3 meters	
Weight:	108 g	

Optional BSL *PRO* Presets:

- Clench Force - kpa (SS56L) - input value 20.48 mV scales to 34.47 kpa
- Clench Force - psi (SS56L) - input value 61.44 mV scales to 15 psi

SS57LA/SS57L LEAD SET FOR ELECTRODERMAL ACTIVITY (EDA) FOR USE WITH DISPOSABLE ELECTRODES

The EDA Lead connects to a single input channel to record electrodermal activity (changes in skin conductance) or, with modified setup, skin resistance from two EL507 disposable EDA (isotonic gel) electrodes.

Two pinch leads snap to the EL507 EDA electrodes and terminate in a two-conductor shielded cable with DSub9 connector.

SS57LA EDA Lead delivers accuracy over its specified range to within 5% with no calibration required.

Biopac Student Lab Systems: requires BSL 4.1 with MP36/35/45.

Research Systems:

- MP36R – connect directly to a CH input
- MP160/150 – add the DA100C amplifier (set Gain: 1000 and Bandwidth: DC to 10 Hz) and the TC1114 interface

For BSL 4.1 and AcqKnowledge 4.4.1 and higher, the SS57LA is the recommended option.

The SS57L is suitable for BSL 3 or MP30.

For a reusable electrode option, see the [SS3LA EDA Finger Transducer](#).

Specifications

Electrode Type:	Requires two Ag/AgCl disposable electrodes (EL507)
Excitation:	0.5 V DC
Range:	0.1-100 μ siemens (normal human range is 1-20 μ siemens)
Connector Type:	9 Pin DIN
Pinch Leads:	Red (+), Black (GND)
Weight:	4.5 grams
Cable Length:	2 meters
Accuracy:	Within 5% without calibration (SS57LA only)

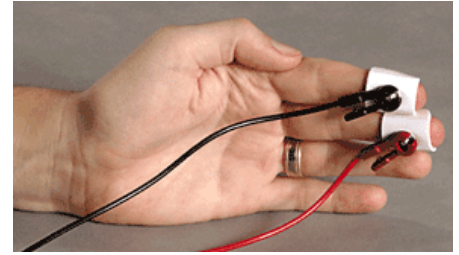

Usage Recommendations (SS57L)

Presets - BSL *PRO* (and AcqKnowledge software for MP36R) includes the following EDA presets:

- Electrodermal Activity (EDA), 0-35 Hz; **requires calibration**—see details below
- Electrodermal Activity (EDA) Change; no calibration required (BSL *PRO* 4.0.3 and earlier only)

To navigate to the presets in the software, choose **MP > Set Up Data Acquisition** (BSL 4.1) or **Set Up Channels** (BSL 4.0.3 or earlier) > **Channels** > and select the desired EDA preset from the **Preset** pop-up menu.

Single-point Calibration for (EDA) 0-35 Hz Preset

1. Disconnect the electrodes.
2. Click “Setup” > “Scaling” button in the software’s EDA preset dialog.
3. Click the **Cal 2** button.
4. Add the new **Cal 2** value to the default **Cal 1** value (example below left, $1000 + 31.3725 = 1031.3725$) If the new **Cal 2** value is negative, then subtract that value from **Cal 1**.

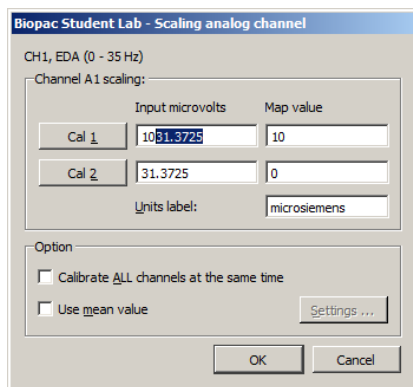

BSL 4.x and AcqKnowledge 4.x EDA Scaling Dialog

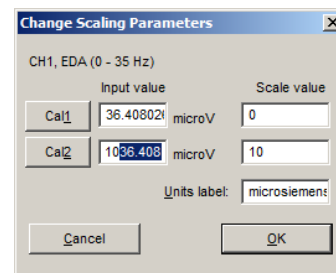

*Note that **Cal 1** and **Cal 2** values are reversed in software versions BSL 3.7.x and earlier.*

BSL 3.7.x EDA Scaling Dialog

Setup - There must be good electrical connections between the skin and the electrodes for EDA to work properly.

Gel – It is recommended that an isotonic gel (GEL101 or equivalent) be added to the disposable electrodes to assure optimal skin contact.

1. Apply a small dot of GEL to each electrode being careful not to get any on the adhesive portion.
2. Attach the electrodes to the subject.
3. Wait 5 minutes (minimum) before starting to record data to allow the gel to penetrate the skin.

Tip

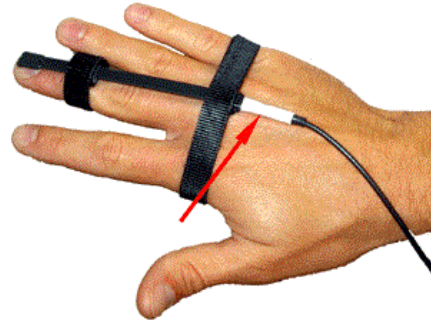

To detect a good signal, subjects should have a little sweat on their hands (not a lot, but enough so that their hands are not completely smooth or cold). If subjects wash their hands just prior to the recording or if they have been sitting in a cold room, then they must do something to activate the sweat glands before beginning calibration or recording. If subjects begin with colder hands, the scale will be diminished and the signal will be easily saturated once they “warm up” during the lesson.

SS61L FINGER TWITCH TRANSDUCER

Palmar attachment recommended: "UP" label facing out

"UP" label toward skin for posterior (dorsal) attachment

Use this transducer to record finger twitch responses from human subjects receiving electrical stimulation (using the HSTM01). The transducer conforms to the shape of the finger and attaches via a Velcro® strap and tape.

SPECIFICATIONS

Transducer Dimensions:	14.6 cm (long), 0.50 cm (wide)
Weight:	6 grams
Maximum Bend:	180° (can be fully curled)

SS62L SPEECH FREQUENCY MICROPHONE

Frequency Range:	60-12,000 Hz
Impedance:	600 Ohms
Type:	Cardioid
Cable:	6 meters
On/Off Switch:	none

Use this precision microphone for speech frequency analysis and other acoustic studies. For use with the MP36/35 only, requires continuous high-speed sample rate.

SS63L – SS83L FORCE TRANSDUCER SERIES

- SS83L** Force Transducer – 20 g
- SS63L** Force Transducer – 50 g
- SS64L** Force Transducer – 100 g
- SS65L** Force Transducer – 200 g
- SS66L** Force Transducer – 500 g

Force transducers are devices capable of transforming a force into a proportional electrical signal. The SS63L-SS83L series force transducer elements are cantilever beam load cells incorporating thin-film strain gauges. Because the strain elements have been photolithographically etched directly on the strain beam, these transducers are rugged while maintaining low non-linearity and hysteresis. Drift with time and temperature is also minimized, because the strain elements track extremely well, due to the deposition method and the elements close physical proximity. Forces are transmitted back to the beam via a self-centering pull-pin to insure accurate force measurements. The cantilever beam is mounted in a sealed aluminum enclosure that includes a 3/8" diameter mounting rod for holding the transducer in a large variety of orientations.

SS63L – SS83L Specifications

Noise: with 10 Hz LP filter:	2.5 mg
with 1 Hz LP Filter:	1.0 mg
Temperature:	-10° C to 70° C
Mounting rod:	9.5 mm (diameter), variable orientation
Weight:	250 g
Dimensions (L x W x Thick):	100 mm x 19 mm x 25 mm
Cable Length:	3 meters
Interface:	Dsub9 connector to MP3x/4x hardware

SS67L PRESSURE PAD/RESPIRATION TRANSDUCER

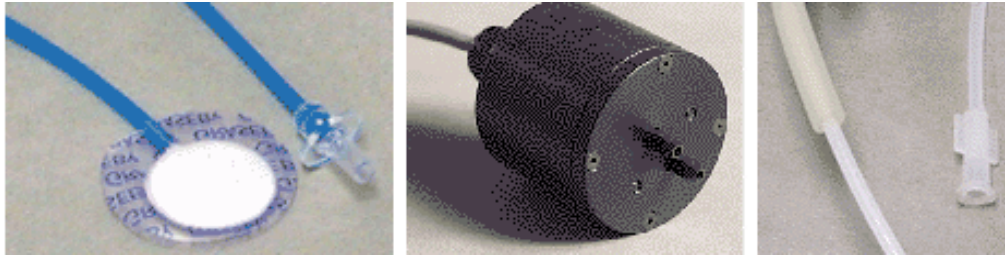

The SS67L consists of an RX110 pressure pad (left,) SS41L differential pressure transducer (center,) and tubing (right).

The multipurpose pressure pad/respiration transducer can be used to:

1. Noninvasively measure respiration—from a small mouse to a human.
2. Measure small pressing forces (like pinching fingers together) for Parkinson's evaluations.
3. Measure human smiling (with the sensor on the cheekbone).
4. Measure pulse when placed close to the heart.
5. Measure spacing and pressure between teeth coming together.

RX110 PRESSURE PAD

The RX110 is a self-inflating pressure pad connected to tubing terminating in a Luer male connector. The RX110 pressure pad is included with the SS67L Pressure Pad/Respiration Transducer. The RX110 sensor can be used many times, but may eventually need to be replaced because it is a sensitive pressure pad and may become damaged with rough use. Use TAPE1 or other single-sided adhesive to affix to the subject.

RX110 SPECIFICATIONS

Sensor Pad Diameter:	20 mm
Sensor Pad Thickness:	3.18 mm
Sensor Tubing Diameter:	2.2 mm
Sensor Tubing Length:	1 m → use BIOPAC tubing M106 for extra length
Sensor Tubing ID:	1.6 mm
Tubing Termination:	Luer male

SS68L PH PROBE TRANSDUCER

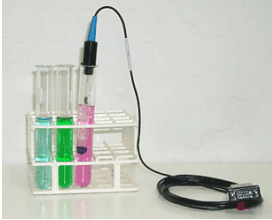

The SS68L probe transducer can measure pH within the range of 0-14.

The electrode provides approximately a single digit pH value change for every 5 mV change in the electrode reading, either positive or negative depending on whether the pH is above 7 or below it.

- A neutral buffer solution of pH 7 will read about 0 mV.
- A solution with a pH of 10 will read about -15 mV.
- A solution with a pH of 3 will read about 20 mV.

The SS68L pH Transducer includes a double-junction pH Probe and an interface to the Biopac Student Lab MP unit.

- Order probe only as RXPROBE01
- To use the BSL with an existing (BNC terminated) pH probe, order the interface only as BSL-TCI21.

SS68L SPECIFICATIONS

Type:	Double junction
Refillable:	Yes
Body:	Glass
Length:	3.25 m
Weight:	3.5 ounces
Diameter:	1.2 cm

SS69L DISSOLVED OXYGEN PROBE TRANSDUCER



Order probe only as **RXPROBE02**

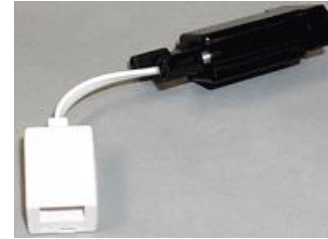

Order interface only as **BSL-TCI16**

SS69L Components

The SS69L transducer measures dissolved oxygen. The SS69L includes a dissolved oxygen probe and an interface to the MP36/MP35 Data Acquisition Unit.

The dissolved oxygen probe can be used to measure the concentration of dissolved oxygen in water samples tested in the field or in the laboratory. Use this sensor to perform a wide variety of tests or experiments to determine changes in dissolved oxygen levels, one of the primary indicators of the quality of an aquatic environment:

- Monitor dissolved oxygen in an aquarium containing different combinations of plant and animal species.
- Measure changes in dissolved oxygen concentration resulting from photosynthesis and respiration in aquatic plants.
- Use this sensor for an accurate on-site test of dissolved oxygen concentration in a stream or lake survey, in order to evaluate the capability of the water to support different types of plant and animal life.
- Measure Biological Oxygen Demand (B.O.D.) in water samples containing organic matter that consumes oxygen as it decays.
- Determine the relationship between dissolved oxygen concentration and temperature of a water sample.

See also: BSL *PRO* Lesson #A07 Fish Respiration and Q10.

Components	Dissolved O ₂ probe	Sodium Sulfite calibration standard (2.0 M Na ₂ SO ₃)
	Replacement membrane cap	Dissolved O ₂ electrode filling solution
	Calibration bottle & pipette	Polishing strips

Interface Use with BIOPAC BSL-TCI16 Transducer Connector to record with a BIOPAC MP36/35 Data Acquisition Unit.

Usage There are four steps to using the Dissolved O₂ probe:

1. Setup
2. Warm-up
3. Calibration — *optional*
4. Recording

1. Setup

- a. Remove and discard the blue protective cap from the tip of the probe.
- b. Unscrew the membrane cap from the tip of the probe.
- c. Use a pipette to fill the membrane cap with 1 mL of the Electrode Filling Solution.
- d. Carefully thread the membrane cap back onto the electrode.
- e. Place the probe into a beaker filled with about 100 mL of distilled water.

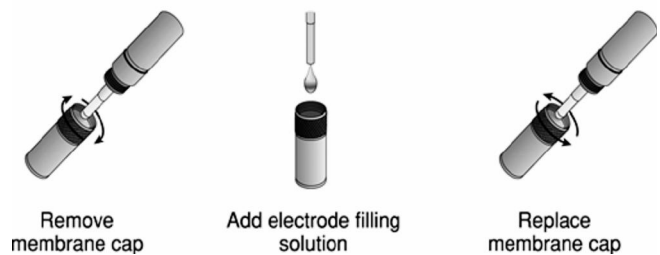

2. Warm-up

- a. Insert the BT connector on the RXPROBE02 into the BSL-TCI16 transducer connector.
- b. Connect the BSL-TCI16 transducer connector to the MP data acquisition unit.
- c. Turn the MP unit ON and wait 10 minutes for the probe to warm up.
 - The probe must stay connected to the interface at all times to keep it warmed up. If the probe is disconnected for more than a few minutes, the warm-up routine will need to be repeated.

Calibration — *optional*

- Calibration is optional. To measure relative change, probe calibration is not essential. To improve accuracy for discrete measurements, probe calibration is recommended.

Calibration in BSL 4.x or AcqKnowledge 4.x software for MP36R:

- a. First Calibration Point (Zero-Oxygen)
 - i) Launch the BIOPAC software and open the scaling dialog for the probe channel. (MP36/35 menu > Set Up Data Acquisition > Channels > Setup > Scaling Button.)
 - ii) Remove the probe from the water and place the tip of the probe into the Sodium Sulfite calibration solution as shown.

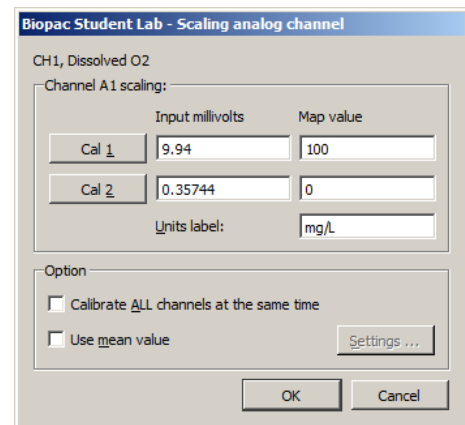
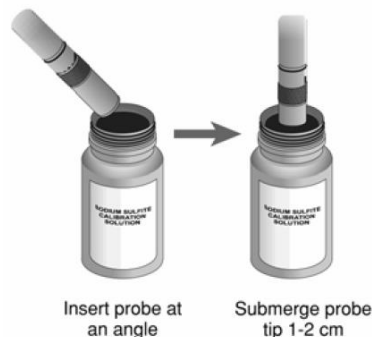

IMPORTANT: No air bubbles can be trapped below the tip of the probe or the calibration will be distorted. If the voltage does not rapidly decrease, tap the side of the bottle with the probe to dislodge any bubbles.

- iii) Wait until the voltage stabilizes (~2 minutes), and press the CAL 2 button. The Map value result should be in the 0.2 - 0.5 mV range.
- b. Second Calibration Point (Saturated Dissolved O₂)
 - i) Rinse the probe with distilled water and gently blot dry.
 - ii) Unscrew the lid of the calibration bottle and slide the grommet approximately 12 mm (1/2") onto the probe body.

- iii) Add water to the bottle to the depth of about 6 mm (1/4") and screw the bottle into the cap as shown. **IMPORTANT:** Do not touch the membrane or get it wet during this step.
- iv) Keep the probe in the position for about one minute and then press the CAL 1 button. The Map value result should be above 2 mV.
- v) Enter a Saturated Dissolved O₂ value (in mg/L) from Table 1, based on the current barometric pressure and air pressure values. If necessary, use Table 2 to estimate the air pressure at the current altitude. The example scaling on the previous page (9.94) is based upon an ambient temperature of 16° C and a barometric pressure of 760 mm. (To calibrate and monitor using Percent Saturation, use the conversion formula on the following page.)

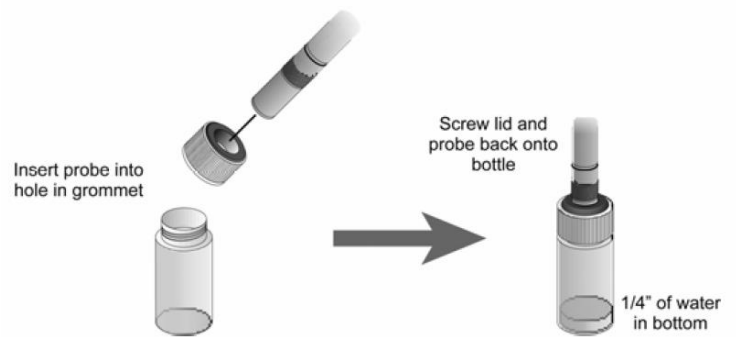

Calibration in BSL 3.7.x software:

(CAL 1 and CAL 2 values are reversed from BSL 4, uses "Scale value" instead of "Map value")

a. First Calibration Point (Zero-Oxygen)

- i) Launch the BIOPAC software and generate the scaling dialog for the probe channel. (MP menu > Set Up Channels > View/Change Parameters > Scaling Button.)
- ii) Enter 0 for CAL 1 Scale value.
- iii) Remove the probe from the water and place the tip of the probe into the Sodium Sulfite calibration solution.

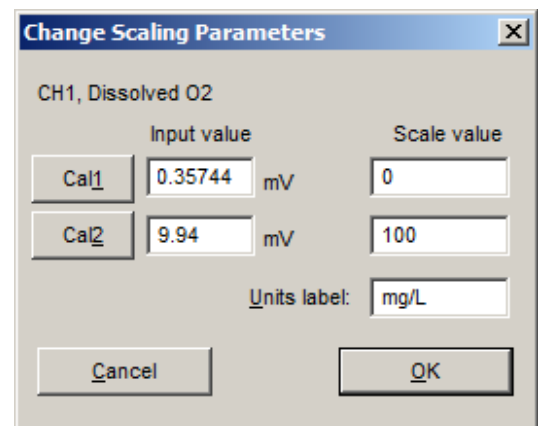

IMPORTANT: No air bubbles can be trapped below the tip of the probe or the calibration will be distorted. If the voltage does not rapidly decrease, tap the side of the bottle with the probe to dislodge any bubbles.

- iv) Wait until the voltage stabilizes (~2 minutes), press the CAL 1 button. The Input value result should be in the 0.2 - 0.5 mV range.

b. Second Calibration Point (Saturated Dissolved O₂)

- i) Rinse the probe with distilled water and gently blot dry.
- ii) Unscrew the lid of the calibration bottle and slide the grommet approx. 12 mm (1/2") onto the probe body.
- iii) Add water to the bottle to the depth of about 6 mm (1/4") and screw the bottle into the cap. **IMPORTANT:** Do not touch the membrane or get it wet during this step.
- iv) Keep the probe in the position for about one minute and then press the CAL 2 button. The Input value result should be above 2 mV.
- v) Enter a Saturated Dissolved O₂ value (in units of mg/L) from Table 1 as the CAL 2 scale value, based on the current barometric pressure and air pressure values. If necessary, use Table 2 to estimate the air pressure at the current altitude. The example scaling above right (9.94) is based upon an ambient temperature of 16° C and a barometric pressure of 760 mm. (To calibrate and monitor using Percent Saturation, use the conversion formula on the following page.)

Calibration and Monitoring Using Units of Percent Saturation

Instead of calibrating using units of mg/L (equal to parts per million or ppm), you may also choose to calibrate dissolved oxygen using units of % saturation. When doing a calibration for units of % saturation, the calibration point done in the sodium sulfite solution (zero oxygen) is assigned a value of 0%, and that for water-saturated air (or air-saturated water) is given a value of 100%. It must be noted, however, that 100% represents an oxygen-saturated solution only at that particular temperature, pressure, and salinity level. If you intend to compare your measured dissolved oxygen values with data collected under a different set of conditions, a preferable method would be to use units of mg/L.

To convert the %O₂ to mg/L, use the following formulae:

$$\% \text{ Saturation} = (\text{actual DO}_2 \text{ result} / \text{Saturated DO}_2 \text{ value from Table 1}) \times 100$$

For example, if the probe result is 6.1 mg/L at a temperature of 20° C and a pressure of 740 mmHg, the corresponding Table 1 value is 8.93 mg/L, so % Saturation = (6.1 / 8.93) x 100 = 68%

BSL 4.x: Set CAL 2 Map value to 0% and CAL 1 Map value to 100% and then press the CAL 1 button to map the probe voltage, proportional to dissolved O₂ to 100%.

BSL 3.7.x: Set CAL 1 Scale value to 0% and CAL 2 Scale value to 100% and then press the CAL 2 button to map the probe voltage, proportional to dissolved O₂ to 100%. (Set units label to mg/L)

Table 1

Dissolved O₂ (mg/L) in air-saturated distilled water (at various temp. & pressure)

	770 mm	760 mm	750 mm	740 mm	730 mm	720 mm	710 mm	700 mm	690 mm	680 mm	670 mm	660 mm	650 mm
0°C	14.76	14.59	14.38	14.19	13.00	13.80	13.61	13.42	13.23	13.04	12.84	12.65	12.46
1°C	14.38	14.19	14.00	13.82	13.63	13.44	13.26	13.07	12.88	12.70	12.51	12.32	12.14
2°C	14.01	13.82	13.64	13.46	13.28	13.10	12.92	12.73	12.55	12.37	12.19	12.01	11.82
3°C	13.65	13.47	13.29	13.12	12.94	12.76	12.59	12.41	12.23	12.05	11.88	11.70	11.52
4°C	13.31	13.13	12.96	12.79	12.61	12.44	12.27	12.10	11.92	11.75	11.58	11.40	11.23
5°C	12.97	12.81	12.64	12.47	12.30	12.13	11.96	11.80	11.63	11.46	11.29	11.12	10.95
6°C	12.66	12.49	12.33	12.16	12.00	11.83	11.67	11.51	11.34	11.18	11.01	10.85	10.68
7°C	12.35	12.19	12.03	11.87	11.71	11.55	11.39	11.23	11.07	10.91	10.75	10.59	10.42
8°C	12.05	11.90	11.74	11.58	11.43	11.27	11.11	10.96	10.80	10.65	10.49	10.33	10.18
9°C	11.77	11.62	11.46	11.31	11.16	11.01	10.85	10.70	10.55	10.39	10.24	10.09	9.94
10°C	11.50	11.35	11.20	11.05	10.90	10.75	10.60	10.45	10.30	10.15	10.00	9.86	9.71
11°C	11.24	11.09	10.94	10.80	10.65	10.51	10.36	10.21	10.07	9.92	9.78	9.63	9.48
12°C	10.98	10.84	10.70	10.56	10.41	10.27	10.13	9.99	9.84	9.70	9.56	9.41	9.27
13°C	10.74	10.60	10.46	10.32	10.18	10.04	9.90	9.77	9.63	9.49	9.35	9.21	9.07
14°C	10.51	10.37	10.24	10.10	9.96	9.83	9.69	9.55	9.42	9.28	9.14	9.01	8.87
15°C	10.29	10.15	10.02	9.88	9.75	9.62	9.48	9.35	9.22	9.08	8.95	8.82	8.68
16°C	10.07	9.94	9.81	9.68	9.55	9.42	9.29	9.15	9.02	8.89	8.76	8.63	8.50
17°C	9.86	9.74	9.61	9.48	9.35	9.22	9.10	8.97	8.84	8.71	8.58	8.45	8.33
18°C	9.67	9.54	9.41	9.29	9.16	9.04	8.91	8.79	8.66	8.54	8.41	8.28	8.16
19°C	9.47	9.35	9.23	9.11	8.98	8.86	8.74	8.61	8.49	8.37	8.24	8.12	8.00
20°C	9.29	9.17	9.05	8.93	8.81	8.69	8.57	8.45	8.33	8.20	8.08	7.96	7.84
21°C	9.11	9.00	8.88	8.76	8.64	8.52	8.40	8.28	8.17	8.05	7.93	7.81	7.69
22°C	8.94	8.83	8.71	8.59	8.48	8.36	8.25	8.13	8.01	7.90	7.78	7.67	7.55
23°C	8.78	8.66	8.55	8.44	8.32	8.21	8.09	7.98	7.87	7.75	7.64	7.52	7.41
24°C	8.62	8.51	8.40	8.28	8.17	8.06	7.95	7.84	7.72	7.61	7.50	7.39	7.28
25°C	8.47	8.36	8.25	8.14	8.03	7.92	7.81	7.70	7.59	7.48	7.37	7.26	7.15
26°C	8.32	8.21	8.10	7.99	7.78	7.78	7.67	7.56	7.45	7.35	7.24	7.13	7.02
27°C	8.17	8.07	7.96	7.86	7.75	7.64	7.54	7.43	7.33	7.22	7.11	7.01	6.90
28°C	8.04	7.93	7.83	7.72	7.62	7.51	7.41	7.30	7.20	7.10	6.99	6.89	6.78
29°C	7.90	7.80	7.69	7.59	7.49	7.39	7.28	7.18	7.08	6.98	6.87	6.77	6.67
30°C	7.77	7.67	7.57	7.47	7.36	7.26	7.16	7.06	6.96	6.86	6.76	6.66	6.56
31°C	7.64	7.54	7.44	7.34	7.24	7.14	7.04	6.94	6.85	6.75	6.65	6.55	6.45
32°C	7.51	7.42	7.32	7.22	7.12	7.03	6.93	6.83	6.73	6.63	6.54	6.44	6.34
33°C	7.39	7.29	7.20	7.10	7.01	6.91	6.81	6.72	6.62	6.53	6.43	6.33	6.24
34°C	7.27	7.17	7.08	6.98	6.89	6.80	6.70	6.61	6.51	6.42	6.32	6.23	6.13
35°C	7.15	7.05	6.96	6.87	6.78	6.68	6.59	6.50	6.40	6.31	6.22	6.13	6.03

TABLE 2

Elevation barometric pressure (based on barometric air pressure of 760 mmHg at sea level)

Elev. (feet)	Pressure (mmHg)	Elev. (feet)	Pressure (mmHg)	Elev. (feet)	Pressure (mmHg)	Elev. (feet)	Pressure (mmHg)
0	760	1500	720	3000	683	4500	647
250	753	1750	714	3250	677	4750	641
500	746	2000	708	3500	671	5000	635
750	739	2250	702	3750	665	5250	629
1000	733	2500	695	4000	659	5500	624
1250	727	2750	689	4250	653	5750	618

Recording

- Place the tip of the probe into the sample to be measured. Submerge the tip about 4–6 cm (2”).
- Gently stir the probe in the sample. **IMPORTANT:** Keep stirring the probe in the sample—water must always be flowing past the probe tip for accurate measurements. As the probe measures the concentration of dissolved oxygen, it removes oxygen from the water at the junction of the probe membrane. If the probe is left still in calm water, reported dissolved O₂ measurements will appear to be dropping.
- For this O₂ measurement to be valid, the sample must be at the same pressure and temperature as calibration solution.

How the Dissolved Oxygen Probe Works

The Dissolved Oxygen Probe is a Clark-type polarographic electrode that senses the oxygen concentration in water and aqueous solutions. A platinum cathode and a silver/silver chloride reference anode in KCl electrolyte are separated from the sample by a gas-permeable plastic membrane.

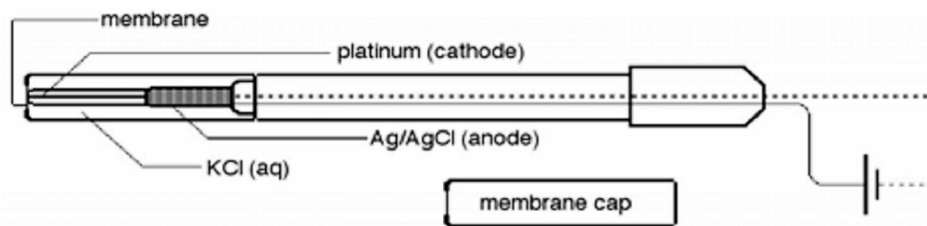

A fixed voltage is applied to the platinum electrode. As oxygen diffuses through the membrane to the cathode, it is reduced:

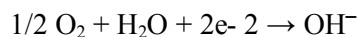

The oxidation taking place at the reference electrode (anode) is:

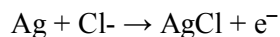

Accordingly, a current will flow that is proportional to the rate of diffusion of oxygen, and in turn to the concentration of dissolved oxygen in the sample. This current is converted to a proportional voltage, which is amplified and read by the MP hardware and BIOPAC software.

Storage

- < **24 hours:** Store the probe with the membrane end submerged in about 3 cm (1”) cm of distilled water
- > **24 hours:** Remove the membrane cap, rinse the inside and outside of the cap with distilled water, and then shake the membrane cap dry. Rinse the exposed anode and cathode inner elements, and then blot dry with a lab wipe. Reinstall the membrane cap loosely onto the electrode body for storage—do not tighten.

Polishing

The anode or cathode inner elements become discolored or appear corroded, use the polishing strips provided (once a year is generally sufficient). Contact BIOPAC for polishing details if necessary.

Maintaining and Replenishing the Sodium Sulfite Calibration Solution

The 2.0 M sodium sulfite (Na_2SO_3) solution can be prepared from solid sodium sulfite crystals: Add 25.0 g of solid anhydrous sodium sulfite crystals (Na_2SO_3) to enough distilled water to yield a final volume of 100 mL of solution. The sodium sulfite crystals do not need to be reagent grade; laboratory grade will work fine. Many high school chemistry teachers will have this compound in stock. Prepare the solution 24 hours in advance of doing the calibration to ensure that all oxygen has been depleted. If solid sodium sulfite is not available, substitute either 2.0 M sodium hydrogen sulfite solution, (sodium bisulfite, 20.8 g of NaHSO_3 per 100 mL of solution) or 2.0 M potassium nitrite (17.0 g of KNO_2 per 100 mL of solution).

SS72L MICROELECTRODE AMPLIFIER



The SS72L very high impedance (Z_{in}), single-ended input amplifier is fully shielded and operates with glass or wire electrodes. It is suitable for intracellular or extracellular measurements. The frequency response of the SS72L ranges from DC to 3000 Hz.

The SS72L input directly supports a variety of plug-in adapters to connect to a wide range of glass or wire electrodes, and includes an adapter to connect to glass microelectrodes with 2 mm female socket connection (i.e., A-M Systems 67604x series). The adapter firmly holds the glass microelectrode, so positioning can be handled via the support rod. The Ground input is on the bottom; one alligator clip lead (LEAD140) is included as an option for GND.

The SS72L Micro Electrode Amplifier can connect to any MPXX platform:

- MP36/MP36R/MP35/MP45: Connect directly to any input channel.
- MP160/150 System: Connect via DA100C and TCI114.

Specifications

Gain:	2
Input:	Single-ended, JFET type
Input Connector:	Touchproof male socket (1.5 mm pin diameter)
Input Ground Connector:	Touchproof male socket (1.5 mm pin diameter)
Adapter:	4.8 cm long, 4.5 mm diameter, Touchproof female (1.5 mm socket) to 2 mm male pin
Offset voltage:	0.05 mV nominal
Input bias current:	0.25 pA nominal
Input voltage range:	± 1 V with MP36/MP36R/MP35/MP45; ± 100 mV with MP160/150 via DA100C + TCI114 <i>For wider input voltage range using MP160/150 System and SS72L, contact BIOPAC</i>
Noise voltage:	2.5 μ V p-p (0.1-10 Hz)
Noise voltage density:	16 nV/sqrt (Hz)
Noise Current Density:	0.5 fA/sqrt (Hz)
Output:	Single-ended or differential
Output Connector:	Connects directly to MP36/MP36R/MP35/MP45; requires DA100C + TCI114 to MP160/150
Bandwidth	DC-3000 Hz, single poll roll-off
Shielded:	Yes, connects to MPXX ground pin
Input Impedance:	1 Gohm nominal
Power:	± 5 V (from MPXX platform)
Cable Length:	3 m (10')
Dimensions:	Support Rod: 10 cm long, 0.635 cm diameter Amplifier casing (shielded): 6.91 cm long, 3.175 cm diameter

SS72L Example Setups

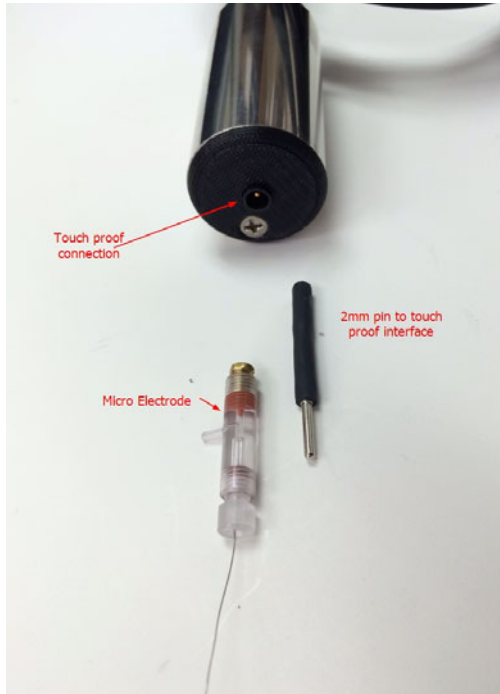

Figure 1



Figure 2



Figure 3

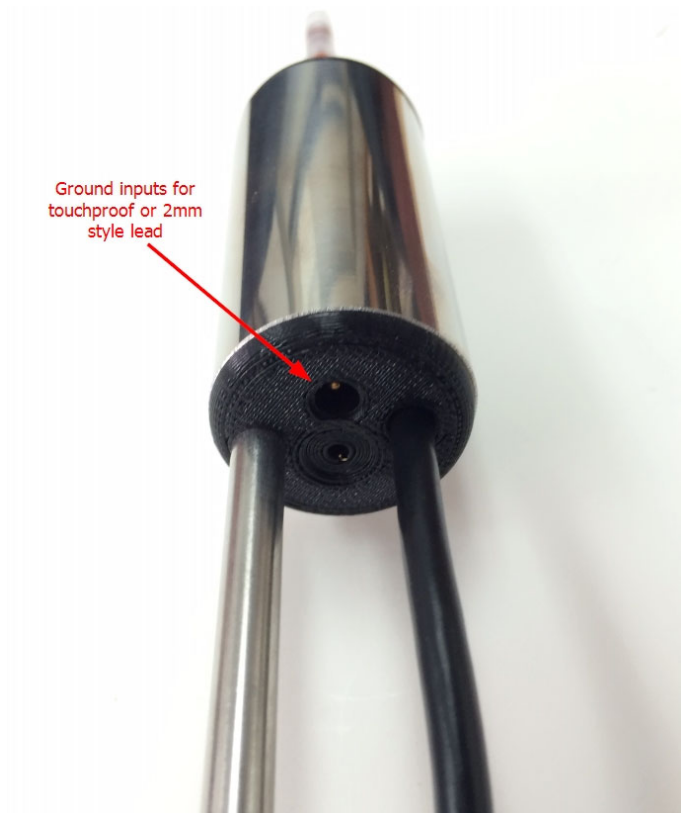

Figure 4

SS73L HALL EFFECT SWITCH TRANSDUCER ASSEMBLY



The SS73L Hall Effect Switch Transducer is used for detecting pedal or flywheel rotations on a cycle ergometer. Types of tests performed with this transducer include the Wingate Anaerobic Test (WAnT) covered in BIOPAC *PRO* lesson H05. This transducer detects the presence of a Neodymium Disc magnet (13 mm dia, 4.8 mm thick, 2.3 kg max pull) up to a distance of 18 mm.

The SS73L Hall Effect Switch Transducer is compatible with MP36, MP35, or MP45 hardware (Biopac Student Lab 4.0.1 or higher software,) or MP36R hardware (AcqKnowledge 4.4 or higher software).

The SS73L assembly includes an adhesive magnet, four adhesive wire tie mounts and four wire ties as shown in the above figure. The Switch Transducer has double-sided tape on the back side for mounting.



Caution: The neodymium disc magnet produces a strong magnetic field. Do not place near sensitive electronics (i.e. computers with hard drives). The magnet is shipped in protective foam with a prominent warning label.

SS73L SPECIFICATIONS

Parameter	Specification
Interfaces to:	MP36, MP36R, MP35, MP45
Input connector:	DB9 Male
Cable Length:	3 meters
Output Voltage range:	0 to 1 Volt
Signal Output Voltage Logic:	Magnet detected: 0 – 5 millivolt Magnet not detected: 1 Volt
Supply Voltage (From MP):	+5 Volts
Supply Current:	20 mA
Attenuation:	5 dB
Frequency Response:	0 – 1.6 KHz (+- 20%)
Noise Voltage (0 – 1,000 Hz):	0.02 mV RMS
Weight:	125 grams
Size of Hall Effect Switch housing (L x W x H):	26 mm x 11 mm x 3 mm
Magnet:	Neodymium Disc. Nickel plated, 13 mm diameter, 4.8 mm thick, 2.3 kg max pull
Maximum Sensing distance using the above magnet:	18 mm

NOTE: The magnet must be oriented such that the South Pole faces the Hall Effect switch.
The SS73L is not compatible with MP30 hardware.

SS73L HALL EFFECT SWITCH TRANSDUCER SETUP

The following describes the setup and use of the BIOPAC Hall Effect Switch transducer assembly (SS73L) with BSL *PRO* or *AcqKnowledge* software to count and record pedal revolutions of a cycle ergometer.

EQUIPMENT:

- BIOPAC Student Lab System:
 - MP36, MP36R, MP35 or MP45 hardware
 - Software: BSL 4.0.1 or higher or *AcqKnowledge* 4.4 or higher (*AcqKnowledge* is compatible with MP36R hardware only)
- BIOPAC Hall Effect Switch Transducer (SS73L) assembly*
- Plate loaded or pendulum balance cycle ergometer

Note*: The SS73L Hall Effect Switch Transducer assembly, includes a stick-on magnet, four stick-on wire tie mounts and four wire ties as shown in Figure 1. The switch has double-sided tape on the back side for mounting.

Caution: The neodymium disc magnet produces a strong magnet field. Do not place it near sensitive electronics (i.e., computer hard drives). It is shipped in protective foam.



Figure 1

HARDWARE SETUP

There are many types of cycle ergometers. Some have an exposed flywheel (Figure 2) and others conceal the flywheel with a plastic cover.

1. Locate the optimal position for attaching the Hall effect switch and the magnet on the ergometer. Placing the magnet on the flywheel is preferred because the flywheel rotates multiple times per pedal revolution and gives better pedal cadence (RPM) resolution. Find locations that meet these requirements.

If the Flywheel is exposed:

- The Hall effect switch can be securely mounted to the frame.
- The magnet can be placed on the flywheel such that it will pass by the center of the Hall effect switch (Figure 3).
- The gap between the Hall effect switch and the magnet is no more than 18 millimeters.



Figure 2

If the flywheel is concealed, or if there is no way to mount magnet on the flywheel:

- The magnet is placed on the inner side of the crank arm, held in place by the tape as well as magnet’s attraction to the iron in pedal’s shaft (Figure 4).
- The Hall Effect Switch can be securely mounted to the frame or chain cover such that the magnet will pass by the center of the switch (Figure 5).
- The gap between the Hall Effect Switch and the magnet is no more than 18 millimeters.

Some improvising may be necessary to meet the requirements (i.e. using spacers, etc.). The Hall Effect Switch can be held in place using the included double-sided tape, screws, or wire ties. Figure 3 shows an example of flywheel placement. Since the ergometer frame is round, a spacer/support piece was constructed out of plastic to firmly hold the switch, to align the switch and the magnet, and to keep the distance between them less than 18 mm.

Before attaching:

- Clean the mounting locations with isopropyl alcohol.
 - It is important that the south pole of the magnet be facing towards the Hall Effect switch. If the magnet’s polarity is reversed, the switch will not function. The south pole will be the side *opposite* the double-backed tape. If no tape is available, it is recommended to not attach the magnet until Step 8, where it can be moved back and forth near the Hall Effect switch to verify that it is detected. If the magnet is not oriented correctly, it can be difficult to remove due to the magnet’s strong pull-strength.
2. Peel off the protective layer of the double-backed tape and press the Hall effect switch and the magnet into position.

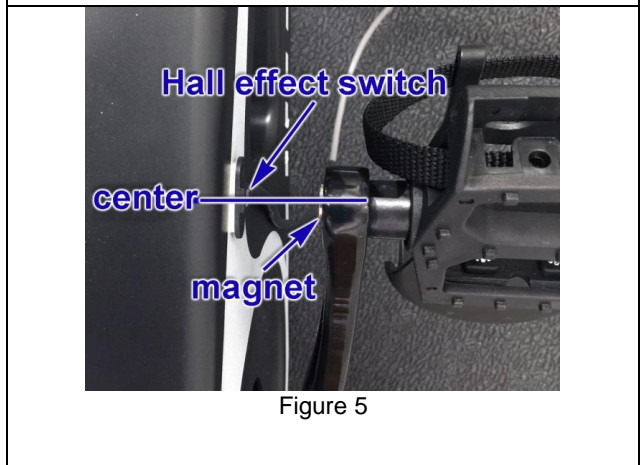
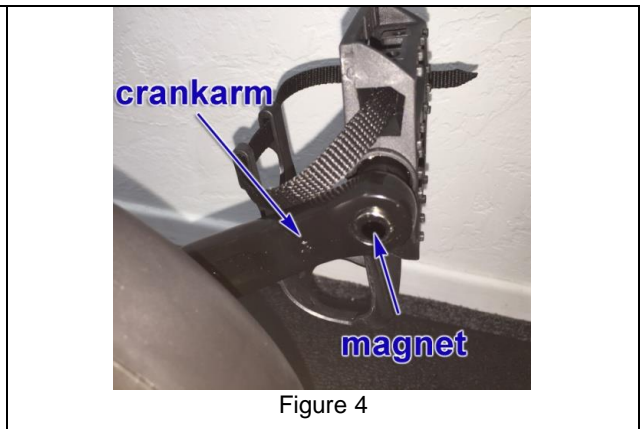
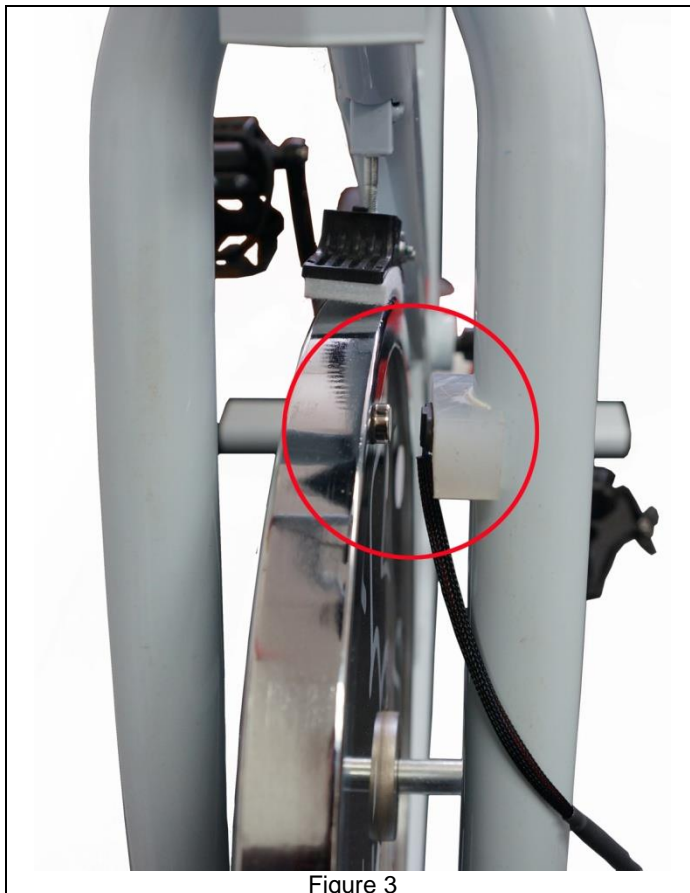

3. To protect the cable from moving parts, attach stick-on wire tie mounting plates in strategic locations and secure the cable using wire ties.
4. Determine the flywheel to pedal rotation ratio which is the precise number of rotations the flywheel makes for each rotation of the pedal (may not be an even integer): **Flywheel to pedal rotation ratio:** _____

It is assumed that the MP36/35/45 is connected to the host computer and that BSL *PRO* software has been installed. If using an MP36 or MP35, it should be connected to its power supply but turned OFF. If using an MP45, which obtains its power from the USB port, the unit will remain powered ON.

5. Plug the BIOPAC Hall Effect switch (SS73L) into an MP Input Channel (CH 1 used in examples).
6. Turn on the MP36/36R/35. Turning ON the hardware after the connections are made minimizes the chance of instrumentation errors caused by Electrostatic Discharge (ESD) during plug-in.

SOFTWARE SETUP

Launch the BSL 4 or *AcqKnowledge* 5 software and choose “**Create/Record a new experiment.**” Make sure “**Create empty graph**” is selected and click **OK**. The new empty graph will open to the following settings (CH1 enabled, “Acquire,” “Plot” and “Value” checked as shown below.)

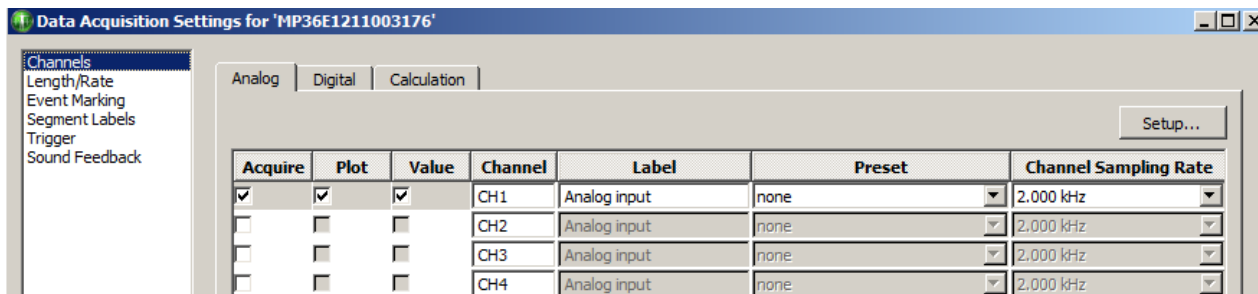

If using BSL 4.1.3 or higher or AcqKnowledge 5.0.3 and higher (SS73L presets established):

- a. Select “**Switch, Hall Effect (SS73L)**” from the CH1 “**Preset**” menu list.
- b. Click the “**Calculation**” tab, select “Acquire,” “Plot,” and “Value” for C1 and then select the Preset: “**Pedal Cadence (from SS73L)**.”
- c. Click the “**Setup**” button to open the Metachannels.
- d. Select the “**C1.0**” row and then click “**Setup Subchannel.**”
- e. Make sure that the Source channel is set to “**Primary Source Channel: Ch 1, Hall Effect Switch**” as shown in Figure 6.

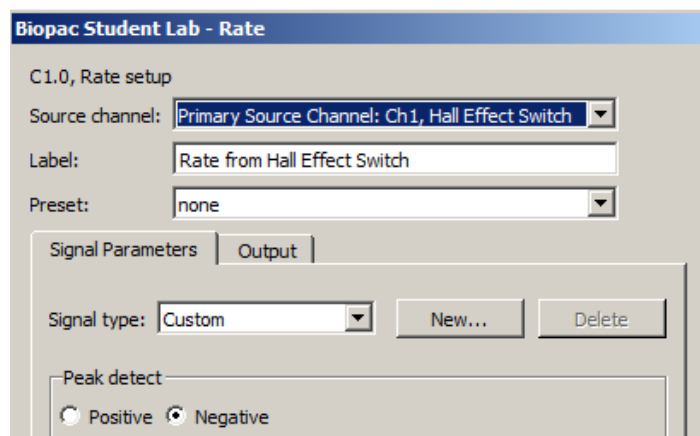

Figure 6

- f. Click **OK** to close the two Metachannel Setup dialogs.
- g. Select “**Length/Rate**” from the left column in Data Acquisition Settings. Verify that “Sample rate” is set to at least 2000 samples/second and adjust other parameters if necessary.
- h. Close out of the Data Acquisition Settings dialog and continue to **Step 7** on following page.

If using BSL 4.1.2 or prior OR AcqKnowledge 5.0.2 or prior (SS73L presets NOT established):

Contact [BIOPAC](http://www.biopac.com) to obtain a pre-configured graph template for these software versions.

7. Continue to **Step 8** if magnet is located on crank arm. If the magnet is placed on the flywheel, the following changes must be made prior to recording:
 - a. Enter this number into the Pedal Cadence calculation channel as follows:
 - i. Select “MP menu > Set Up Data Acquisition > Channels.”
 - ii. Click the “Calculation” tab, select “C1” and click “Setup.”
 - iii. Select Subchannel C1.1 (Cadence Divisor) and click “Setup Subchannel.”
 - iv. Replace the default divisor, “1,” with the “Flywheel to pedal rotation ratio” obtained in Step 4 on page 3. Be careful to not alter any other text in the expression.

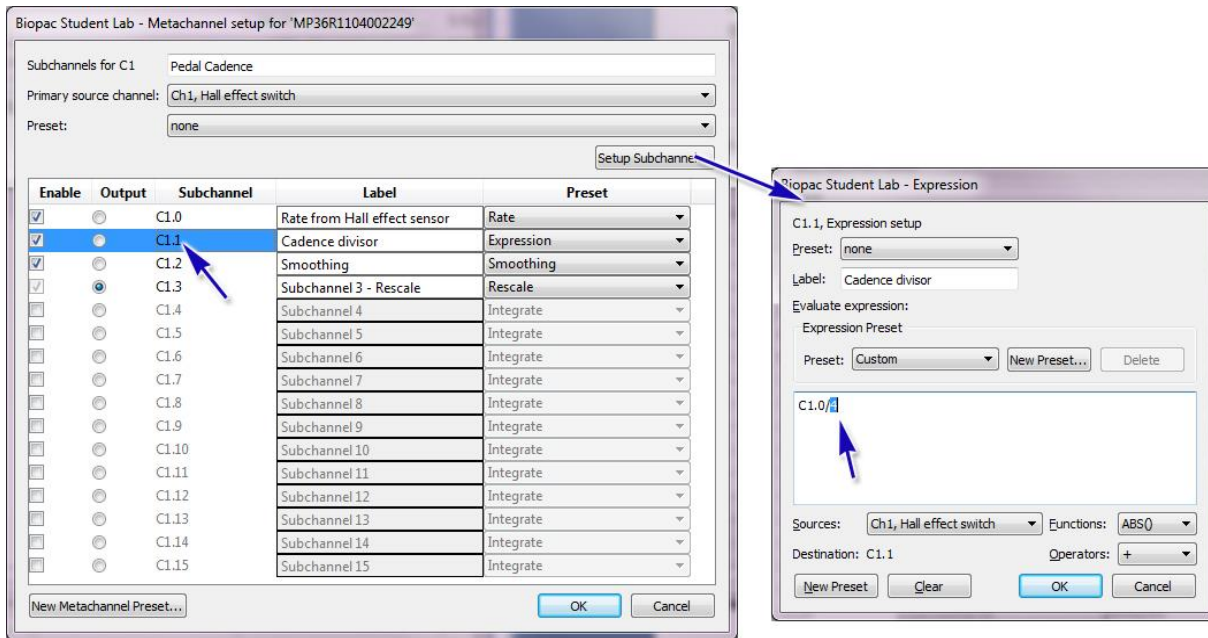

- v. Click “OK” in the Metachannel and Calculation channel dialogs and close the “Input Channels Setup” dialog.

8. Test the setup by clicking **Start** to begin a recording and then rotate the pedals a few rotations, and then click **Stop**. The data should look similar to that in Figure 7. CH1 baseline level should reside at 1000 mV and negative going pulses should indicate when the magnet passed by the Hall effect switch. The pedal cadence should show changes in RPM corresponding to interval between switch pulses.

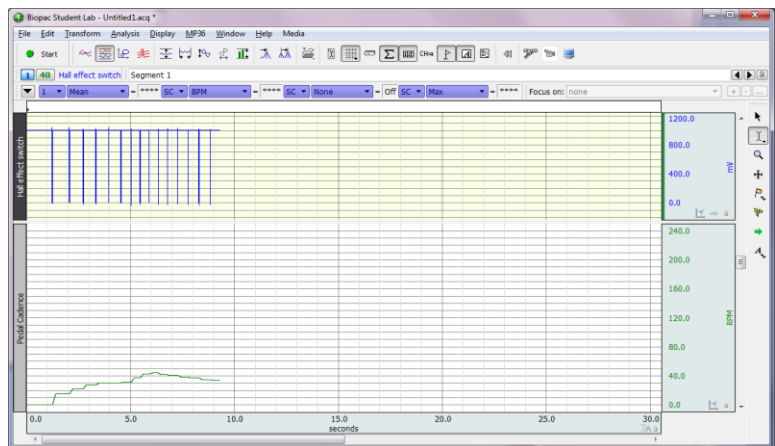



Figure 7

If no pulses are seen on CH1:

- The distance between the magnet and the Hall Effect switch is too great.
- The magnet does not pass over the center of the Hall Effect switch.
- The magnet polarity is incorrect and the magnet must be flipped.

Click the Rewind button  to erase the setup data.

IMPORTANT: Save the template with the new settings so these steps do not need to be repeated. Select File > Save As and choose “Save as type: Graph Template (*.gtl).” Use a different filename so as to not overwrite the original. Organize the files so the new template will be used in the future.

BSL STIMULATORS

Modular Stimulators (0-100 V):
 BSLSTMB for MP36/36R/35
 BSLSTMA for MP30/35/36/36R

Low Voltage Stimulator/Adapter:
 OUT3 Output Adapter for built-in Stimulator (MP36 only)
 SS58L Low Voltage Stimulator (MP35 only)

See also: HSTM01, ELSTM1, ELSTM2, EL300S and EL400 electrodes.



Lab set up note

Placing the BSLSTMA/B unit too close to MP3X hardware can result in data distortion of the BSLSTMA/B pulse width signal; the distortion is more apparent at higher sampling rates.

- NEVER set the BSLSTMA/B atop an MP3X
- Position the BSLSTMA/B away from the MP3X to reduce the signal distortion

Note The older “BSLSTM” uses dial reading and a flip range switch. The same guidelines and cautions described here apply, except when noted.

The BSLSTM Stimulator works in conjunction with the Biopac Student Lab System to allow precise stimulus pulse outputting. Use the BSLSTM and the BSL PRO to perform a wide array of measurements, such as:

- Twitch sub-threshold & threshold
- Maximum twitch responses
- Single twitch, summation
- Muscle tension/length vs. force
- Tetanic contraction
- Nerve conduction
- Fatigue
- Velocity

STIMULATOR PULSE DEFINITIONS

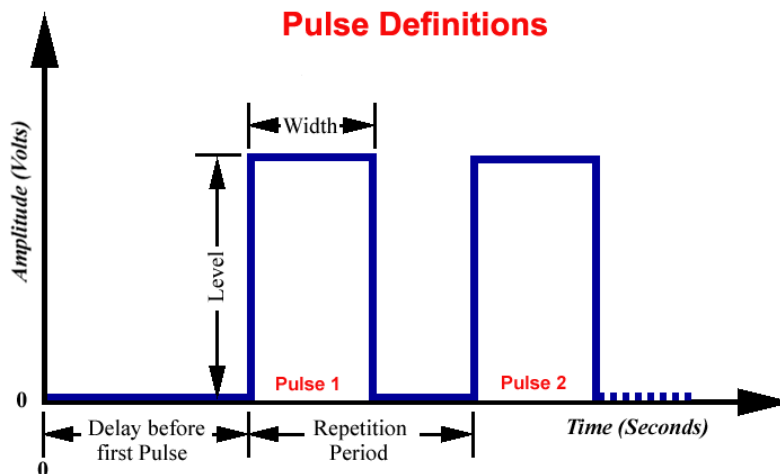

- Pulse width** The time that the pulse is in the non-zero or active state.
- Delay before first pulse** The initial delay from the start of acquisition to the start of the first pulse.
- Repetition period** The time between pulses, as measured from the start of one pulse to the start of the next pulse. This is the inverse of the Pulse rate.
- Pulse rate** The number of pulses that occur in a one-second interval, expressed in Hz. The **Pulse rate** relates to the **Pulse period** as follows:

Also called —
Pulse frequency
Repetition rate
Events per second

$$\text{Pulse rate (Hz)} = 1000 / \text{Repetition period (milliseconds)}$$

- Pulse Repetition** Use when referring to either Pulse rate or Pulse period.
- Pulse level** The amplitude of the pulse, expressed in Volts.
The output of the BSLSTM is 0 Volts when the pulse is not active.
- Number of pulses** The number of successive pulses that will be sent out at the selected Pulse Width, Pulse Rate, or Pulse Period, and Pulse Level.

FRONT PANEL TERMINOLOGY

BSLSTMA/B — Digital Display & Keyed Switch



BSLSTM — Dial Reading & Flip Switch

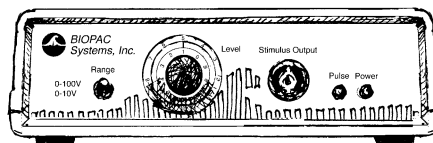

Range control Establishes the stimulus pulse output level range in Volts (0-10 Volts or 0-100 Volts).
BSLSTMA/B key control: Turn right to select a range of 0-10 Volts.

- Turn left to select a range of 0-100 Volts.
- Remove the key for added safety and control.

BSLSTM switch control: Flip down to select a range of 0-10 Volts.
Flip up to select a range of 0-100 Volts.

- If the **Range** is changed before recording begins, the **Preset** must also be changed (under the “Setup channels” option of the **MP3X** menu) in order to maintain direct Level recordings.
- If the **Range** is changed during recording, the user should manually enter a software marker to note the change (by holding down F9 on a PC or Esc key on a Mac). The pulse Level could then be determined by (mentally) moving the decimal place to the right or left, depending on how the **Range** was changed.

Reference BSLSTMA/B only: Refers to the pulse width of the signal on the Reference Output (on the back panel).

- **Actual** reflects the actual output width.
- **Fixed (15 ms)** establishes a pulse width of 15 ms, regardless of the actual pulse width.

The Reference control only affects the pulse width; in either case, the pulse level reflects the actual output level.

Level **Level** is used in conjunction with **Range** to set the stimulus pulse output level.
BSLSTMA/B digital display: Turn the Level control (right to increase, left to decrease) to establish the desired Level, as indicated on the digital display.

BSLSTM knob dial: The **Level** knob has a “Major scale” and a “Minor scale” which indicate the voltage level as shown below:

Range switch	Major scale	Minor scale
0-10 V	Volts	Volt / 10
0-100 V	Volts x 10	Volts

Turning the **Level** knob clockwise increases the voltage level, and turning it counterclockwise decreases the voltage. In the following close-up of the **Level** knob, the level reads 5.1 Volts (Range 0-10 V) or 51 Volts (Range 0-100 V).

As shown in the following diagram, the indicator mark is between the two dials.

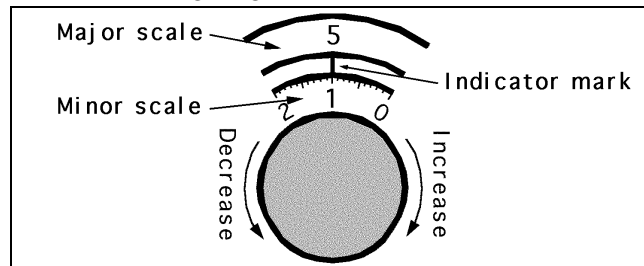

Close-up of “Level” adjustment knob

- Stimulus output** Stimulus pulse output for connection to external electrodes or other devices. This is a standard BNC style connector.
- Pulse indicator** LED flashes when the stimulus pulse is active: BSLSTMA/B = red. BSLSTM = green.
- Power indicator** Activated when the DC adapter is plugged in and the power switch on the back panel is turned ON.
 BSLSTMA/B: The LCD display is activated.
 BSLSTM: LED indicator lights green

BACK PANEL TERMINOLOGY

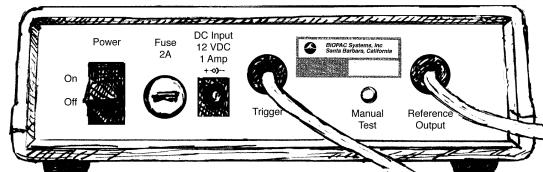

- Power switch** Rocker switch for turning the BSLSTM power ON and OFF.
- Fuse holder** If the fuse blows and must be replaced, use a screwdriver to open (counterclockwise) and close (clockwise) the fuse cap.
- DC Input** Socket for BIOPAC DC adapter.
- Trigger cable** Connects to the Analog Out connector on the back of the MP3X acquisition unit. The MP3X sends the Pulse width and Pulse rate information via this cable.
- Manual Test button** Used to diagnose problems with the BSLSTM stimulator unit.

When the **Trigger** and **Reference Output** cables are **disconnected** from the MP3X, the **Manual Test** button can be used to initiate a stimulus with a fixed pulse width of 2.5 milliseconds.
- Reference Output Cable** The stimulus marker output is labeled **Reference Output** on the back panel of the BSLSTM. This output cable connects to any of the four channel inputs (CH1, CH 2, CH 3, or CH 4) on the front of the MP3X acquisition unit. The output cable carries the stimulator marker pulse to the MP3X. The marker pulse has a fixed pulse width 15 ms and is generated each time the stimulator generates a pulse.
 - BSLSTMA/B: Use the front panel Reference switch to select Actual or Fixed.
 - BSLSTM has a fixed pulse width of 15 ms, selected so that the MP30 can capture the pulse with a sample rate as low as 100 samples per second.

If the BSL *PRO* software has been setup correctly, the amplitude of this marker will reflect the **Level** knob setting on the BSLSTM. See the **Range switch** section for information on how this reading can be affected.

Calibration

The “Reference Output” signal from the BSLSTM must be calibrated to ensure accurate results.

1. Choose the correct  **Preset** (via MP3X menu > Set Up Data Acquisition > Channels).

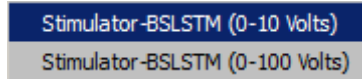

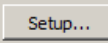
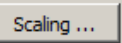
- For example, if using the BSLSTMA/B, (this Preset found in older BSL 3.7.x software only) don’t choose a “BSLSTM...” Preset.
 - Also, make sure the Preset matches the Voltage Range that will be used (0-10 V, or 0-100 V).
2. With stimulator connected and ON, turn the **Level** control counter-clockwise until the display reads 0 (or as close to 0 as possible).
 3. Get into the **Scaling** window for the Reference Output channel (via MP3X menu > Set Up Data Acquisition > Channels >  > ).
 4. Press the **Cal 2** button to obtain the signal representing 0 V out of the stimulator.

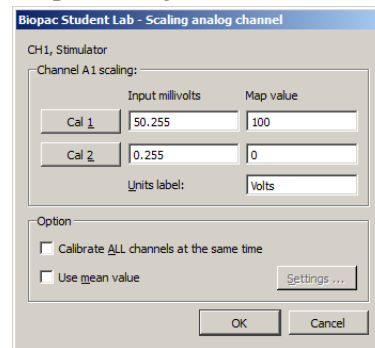
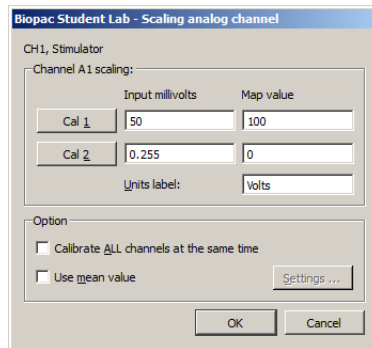

5. **Add** the Input value found in Cal 2 to the Input Value displayed for Cal 1.
 - For example, if “Cal 2” is pressed and provides an Input Value of .255 V, add the number .255 V to the existing 50 V and manually enter the total value of 50.255 V for Cal 1 Input Value.
 - *Note:* Even if the Cal 2 Input Value is negative, it must still be “added” to the number for Cal 1 (which essentially subtracts it) to arrive at the proper value.
6. Click **OK** to close out of the Scaling window and then close out of the Setup Channel window. The system is now ready to record.
7. *Optional:* Save the setup as a Graph Template to save these new scale settings. As long as neither the MP3X nor stimulator changes, the calibration should not need to be repeated.

NOTE: In earlier versions of BSL software (3.7.x) the Cal 1 and Cal 2 fields are **reversed** in the Scaling dialog. To calibrate using this older software, reverse the above instructions for Cal 1 and Cal 2.

CONNECTING THE BSLSTM TO THE MP3X

- 1) Turn the **MP3X** unit **OFF**.
- 2) Confirm that **Power** switch on the back of the **BSLSTM** is in the **OFF** position.
- 3) Set the **Range** on the front of the **BSLSTM** to **0-10 V**.
- 4) Set the **Level** to 1 Volt.
 - BSLSTM: 1 Volt is set when the Major Scale (top number) is 1 and the Minor Scale (lower number) is 0.
- 5) Plug the **Trigger** cable (female DB9 connector) from the back of the **BSLSTM** into the **Analog Out** port (DB9 Male connector) on the back of the **MP3X**.

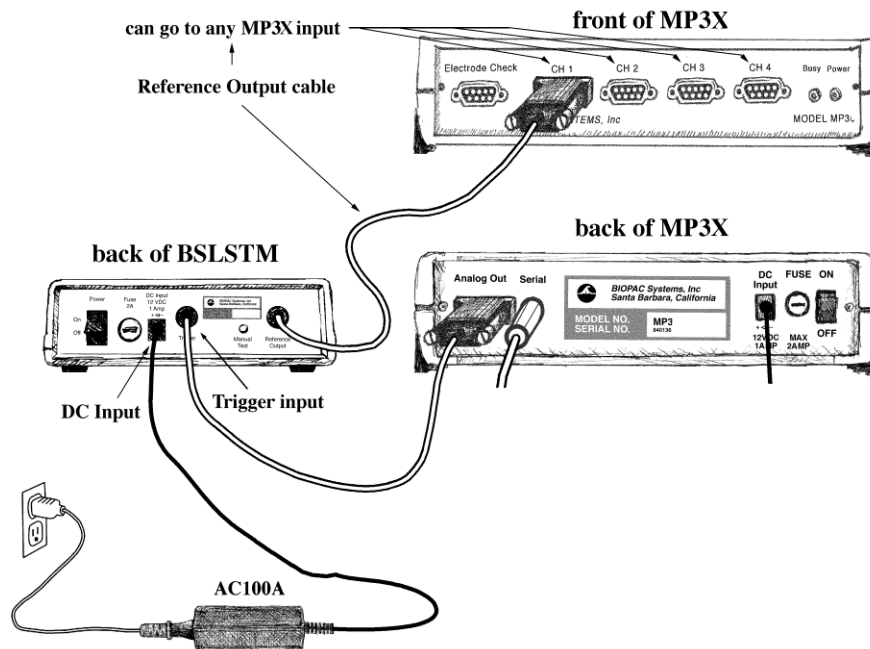

- 6) Plug the **Reference Output** cable (Male DB9 connector) from the back of the **BSLSTM** into an open channel input port (DB9 female connectors: CH 1, CH 2, CH 3, or CH 4) on the front of the **MP3X**.
- 7) Plug the 12 Volt **DC adapter** into the wall.
- 8) Mate the **DC output** connector on the end of the adapter cable to the **DC Input** socket on the back of the **BSLSTM**.
 - Make sure the connector is pressed in completely.
- 9) Plug the stimulator electrode assembly into the BNC connector on the front of the stimulator, labeled Output on the BSLSTMA/B and Stimulus Output on the BSLSTM.
- 10) Place the BSLSTMA/B unit away from the MP3X. Placing the BSLSTMA/B too close to MP3X hardware can result in data distortion of the BSLSTMA/B pulse width signal; the distortion is more apparent at higher sampling rates.
 - NEVER set the BSLSTMA/B atop an MP3X.
 - Position the BSLSTMA/B away from the MP3X to reduce the signal distortion.

BSLSTMA/B SPECIFICATIONS (This new unit has digital display and a keyed range switch)

Pulse width

Controlled by:	Computer, with lockable width limit
Range:	0.49 – 100 milliseconds
Resolution:	2 microseconds
Accuracy:	5% (Can be improved to better than 2% using the “Correction factor” in the “Stimulator Preferences” window.)
Correction factor	Range: 0 - 150 microseconds Average value: 60 microseconds

Pulse Repetition

Controlled by:	Computer-based software (BSL or AcqKnowledge)		
Pattern:	Selectable (1-254 pulses) or continuous		
Ranges—No Load:	5 seconds - .499 milliseconds Period (.2 - 3,333 Hz Rate)		
Ranges—Load:	2 K Ohm load		
	0 - 10 Volt Range: 5 seconds to the following minimum repetition period:		
	100 ms P.W.	300 ms	
	10 ms P.W.	30 ms	
	1 ms P.W.	3 ms	
	0 - 100 Volt Range: 5 seconds to the following minimum repetition period:		
	100 ms P.W.	100 Volts:	1 second
		50 Volts:	300 ms
	10 ms P.W.	100 Volts:	400 ms
		50 Volts:	30 ms
	1 ms P.W.	100 Volts:	4 ms
		50 Volts:	3 ms
Limits:	User adjustable lower and upper rate limits		
Resolution:	2 microseconds		
Accuracy:	Better than 2%		

Initial Pulse Delay

Time range:	Off or .5 - 100 milliseconds (software controlled)
Resolution:	2 microseconds

Pulse level

Control:	Manual (10 turn potentiometer)
Range (selectable with <i>Key Switch</i>):	<i>Range 1:</i> .025 - 10 Volts <i>Range 2:</i> .12 - 100 Volts Infinite (potentiometer adjustable) range
Current Output:	1 ms pulse: 500 ma 100 µs pulse: 1000 ma
Accuracy:	5% accuracy to digital readout

Reference Output

Pulse width:	Correlates to actual pulse output (Requires Calibration) Fixed (15 millisecond) or Direct (follows actual pulse output)
Amplitude:	0 - 50 mV correlates to 0 – 10 V actual output or 0 – 100 V actual output.

Manual Test Pulse

Pulse Width:	(Button on back panel) <i>Note:</i> Will only function when “Trigger” cable is <u>not</u> connected to the MP3X. 1 millisecond
--------------	--

Stimulator isolation

Volts:	2,000 Volts DC (HI POT test)
Capacitance coupling:	60 pF

Power requirements

Fuse	12 Volts DC adapter (included), 1 Amp
------	---------------------------------------

Fuse Dimensions:

Fuse Dimensions:	1.25” length × .25” diameter
------------------	------------------------------

Module Weight

Module Weight	610 grams
---------------	-----------

Module Dimensions

Module Dimensions	16 cm x 16 cm x 5 cm
-------------------	----------------------

BSLSTM SPECIFICATIONS

(This older unit uses dial reading and a flip range switch)

Pulse width

Controlled by: Computer, with lockable width limit
 Range: 50 microseconds – 100 milliseconds
 Resolution: 2 microseconds
 Accuracy: 5% (Can be improved to better than 2% using the “Correction factor” in the “Stimulator Preferences’ window.)
 Correction factor Range: 0 - 150 microseconds
 Average value: 110 microseconds

Pulse Repetition

Controlled by: Computer-based software
 Pattern: Selectable (1-254 pulses) or continuous
 Range—No Load: 5 seconds - .3 milliseconds Period (.2 - 3,333 Hz Rate)
 Range—Load: 2 K Ohm load
 0 - 10 Volt Range: 5 seconds to the following minimum repetition period:

100 ms P.W.	150 ms
10 ms P.W.	10.1 ms
1 ms P.W.	1.1 ms

 0 - 100 Volt Range: 5 seconds to the following minimum repetition period:

100 ms P.W.	100 Volts:	beyond functional limits
	50 Volts:	250 ms
10 ms P.W.	100 Volts:	200 ms
	50 Volts:	150 ms
1 ms P.W.	100 Volts:	20 ms
	50 Volts:	2.5 ms

 Limits: User adjustable lower and upper rate limits
 Resolution: 2 microseconds
 Accuracy: Better than 2%

Initial Pulse Delay

Time range: None or .5 - 100 milliseconds
 Resolution: 2 microseconds

Pulse level

Controlled by: Manually (10 turn potentiometer)
 Range (switchable): *Range 1:* .025 - 10 Volts
Range 2: .15 - 100 Volts
 Infinite (potentiometer adjustable) range
 Accuracy: 5% accuracy to dial indicator

Reference Output

Correlates to actual pulse output (Requires Calibration)
 Pulse width: 15 millisecond fixed pulse width
 Amplitude: 0 - 10 mV correlates to 0 – 10 V actual output or 0 – 100 V actual output

Manual Test Pulse

(Button on back panel)
Note: Will only function when “Trigger” cable is not connected to the MP3X.
 Pulse Width: 2.5 - 3 milliseconds

Stimulator isolation

Volts: 2,000 Volts DC (HI POT test)
 Capacitance: 60 pF

Capacitance coupling:

Power requirements

Fuse

12 Volts DC adapter (included), 1 Amp

Module Weight

Module Dimensions

250 V, 2 A, fast blow
 Dimensions: 1.25” length × .25” diameter
 610 grams
 16 cm x 16 cm x 5 cm

LOW VOLTAGE STIMULATOR

OUT3

The **MP36** includes a built-in low voltage stimulator—just use the Analog Out port.

- For connection to BIOPAC electrodes, add the **OUT3 BNC Adapter**.



SS58L

The **MP35** uses the **SS58L Low Voltage Stimulator** to the Analog Out port.



Connect any electrode or lead with a BNC connector (such as needle electrodes or clip leads) for direct stimulation of animal or tissue preps. Control the stimulus with the Output Control option of the BSL *PRO* software. Output can be monitored directly on the computer without any external cable.

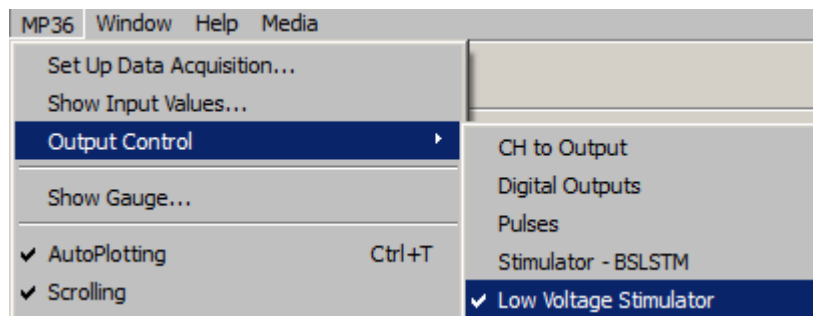

- Interface options: Nerve chambers — use BSLCBL3A or BSLCBL4B
- Stimulation electrodes — use ELSTM2
- Clip leads — use BSLCBL7, BSLCBL11, or BSLCBL12
- Pulse level: -10 V to + 10 V, software adjustable in 5 mV increments
- Pulse width: 0.05-100 milliseconds
- Pulse repetition: 5 seconds-0.1 millisecond (0.2-10,000 Hz)
- Power: No additional power required

STIMULATOR ELECTRODE GUIDELINES

— PLEASE READ —

It is very important to follow the electrode placement guidelines when connecting stimulator electrodes from the BSLSTM to a subject.

The BSLSTM can output lethal levels of energy!

- ❖ Always set the **Level** to “0” Volts prior to connecting the stimulator electrodes to the subject.
- ❖ Increase the **Level** adjustment slowly until a response is noted.
- ❖ Never increase the **Level** more than necessary to obtain the desired response.
- ❖ The **BSLSTM** should only be used under direct supervision of an Instructor.
- ❖ Never place any stimulator leads in the mouth or any other body orifice.
- ❖ To prevent a “Ground loop,” the **Ground** of the stimulator electrode and the **Ground** of the measuring electrode(s) must always be connected to the same location.
- ❖ Use the **HSTM01 Human Stimulation Electrode** for human stimulation.
- ❖ To prevent a current path that goes across or through the heart, the stimulator electrodes and the measuring electrodes should always be in close proximity.

For example, if making measurements on an arm, the stimulator electrodes and measuring electrodes — including the ground electrodes — must be on the same arm. Any other electrodes or transducers that make electrical contact with the body should not be connected while the stimulator is connected.

BSLCBL CABLE SERIES

- BSLCBL1A: Stimulator to Nerve Chamber – Standard Banana Plug
- BSLCBL2A: Stimulator to Nerve Chamber – 2 mm Pin (Mini-Banana) Plugs
- BSLCBL3A: Nerve Chamber to BSL – Standard Banana Plugs
- BSLCBL4B: Nerve Chamber to BSL – 2 mm Pin (Mini-Banana) Plugs
- BSLCBL5: 3.5 mm Phone Plug
- BSLCBL6: Stimulator to Output – 3.5 mm Mono Male Phone Plug
- BSLCBL7: Stimulator to Electrode – BNC to 2x Alligator Clip
- BSLCBL11: Stimulator to Electrode – BNC to 2x Electronic Test Clip (spring-loaded)
- BSLCBL12: Stimulator to Electrode – BNC to 2x Toothless Alligator Clip
- BSLCBL8/9: High Impedance – 1.5 mm Touchproof
- BSLCBL14A: MP36/35 Input Adapter for Research Amplifiers

Interface Cables

Stimulator to Nerve Chamber

Interface the BSL Stimulator with nerve conduction chambers. A BNC connector interfaces with the stimulator and two plugs attach to the nerve chamber.

Gold-plated

Stackable ground

Length: 1.2 meters

Pin Plugs: 2 mm (OD)

Standard Banana Plugs: 4 mm (OD)

BSLCBL1A
Banana Plugs



BSLCBL2A
2mm Pin Plugs

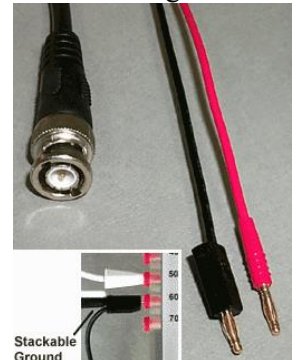

Nerve Chamber to Biopac Student Lab

Interface nerve conduction chambers with the Biopac Student Lab System; use to record the signals coming from the nerve. A BSL DSUB 9 connector interfaces with the Biopac Student Lab MP3X unit and two plugs attach to the nerve chamber.

Length: 1.2 meters

BSLCBL3A
Banana Plugs



BSLCBL4B
2mm Pin Plugs



BSLCBL3A/4B Specs

Gain: 1/10 (divide by 10)

Input Impedance (single-ended and common-mode):
 5×10^{11} Ohms (500 GigaOhms)

Common-Mode Rejection: 90 dB Typical

Input Bias Current: 3 pA Typical, 100 pA

Maximum Voltage Noise: 1.3 μ V p-p (0.1-10 Hz)

Voltage Noise Density: 36 nV /SQRT(Hz)

Current Noise Density: 0.01 pA /SQRT(Hz)

(Entire BSLCBL3A Cable)



(Entire BSLCBL4B Cable)



3.5 mm Phone Plug Adapter

Use BSLCBL5, 1.7 meters (included with TSD122). The cable has a built-in attenuation of 1/200, which translates 10 V to 50 mV.

Stimulator to Output

Use BSLCBL6 to interface the BSL Stimulator with 3.5 mm Mono Phone Jack outputs, like the OUT100 Headphones or the OUT101 Tubephone set for auditory stimulation. Required for Auditory Evoked Response experiments. Use with OUT3 for MP36 built-in low voltage stim.

Length: 1.3 meters

BSLCBL5

3.5 mm Phone Plug



BSLCBL6

3.5 mm Mono Phone Jack



Stimulator to Electrode

**BSLCBL7,
 BSLCBL11, and
 BSLCBL12**



BSLCBL7 - BNC to 2x Alligator Clip
 BSLCBL11 - BNC to 2x Electronic Test Clip (spring-loaded)
 BSLCBL12 - BNC to 2x Toothless Alligator Clip

Use these special electrode lead clips to interface stimulating electrodes, or to connect directly with animal preparations. Each 1-meter cable has two clips And terminates with one BNC connector to interface with BSLSTM, SS58L Stimulator, or OUT3 for MP36 low volt stimulator and silver or platinum wire electrodes.

Alligator Clip

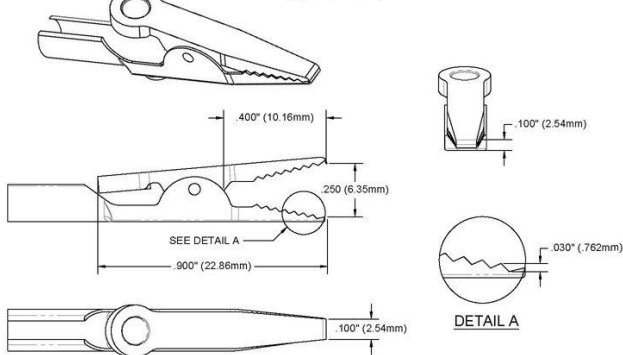

Retractable Clip

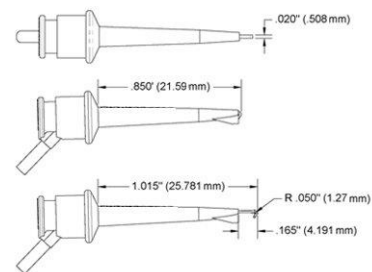

Toothless Clip

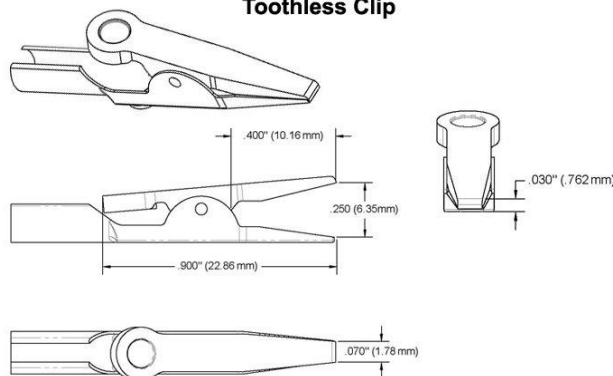

High-impedance cables

BSLCBL8 and BSLCBL9



These fully-shielded, high-impedance electrode interface cables permit high resolution recording of biopotential signals using reusable electrodes. The adapter terminates with standard 1.5 mm Touchproof electrode connectors to interface reusable electrodes (EL250, EL350, and EL450 series).

IMPORTANT: A ground connection, to the measurement point, is required when using BSLCBL8 or BSLCBL9. This connection is mandatory to allow the internal cable amplifiers to receive the required bias current. The ground connection is made from the center pin of the electrode lead attachment junction at the end of the cable to the preparation/animal/nerve under study.

Typically, a LEAD140 series lead, EL450 series needle electrode or LEAD110 series clip lead is used to establish this ground connection.

BSLCBL8/9 Specifications

- Input Range: BSLCBL8: MP36/36R: ± 2 V, MP35: ± 1 V, MP30: ± 70 mV, MP45: ± 2 V
 BSLCBL9: MP36/36R: ± 3.8 V, MP35: ± 3.8 V, MP30: ± 700 mV, MP45: ± 3.8 V
- Input Impedance: 500 GigaOhm (Single-ended & Common-Mode)
- Input Bias Current: 3 pA Typical, 100 pA Maximum
- Maximum Voltage Noise: 1.3 μ V p-p (0.1-10 Hz)
- Voltage Noise Density: 36 nV /SQRT(Hz)
- Current Noise Density: 0.01 pA /SQRT(Hz)
- Cable length: 2 meters
- Interface: MP3X (DSUB 9)
- Gain: BSLCBL8 (Gain = 1), BSLCBL9 (Gain = 1/10)

MP36/35 Input Adapter for Research Amplifiers BSLCBL14A



3.5 mm male phone plug adapter with built-in attenuation. Provides a divide by 10 attenuation to scale the ± 10 V signal range of BIOPAC's 100 series modules to the ± 2 V (MP36) or ± 1 V (MP35) device input ranges.

Interface with MP3X, MP45 or BIOPAC 100 series amplifiers through a connection to either the UIM100 or the IPS100C Isolated Power Supply. (Not compatible with MP30.)

See also: **TCI series** of available interfaces

SS-KIT-IN TRANSDUCER CONNECTOR INTERFACE KIT – INPUT



This kit is for users who wish to adapt their own transducers to the Biopac Student Lab *PRO* System or *AcqKnowledge* System with MP36R. The kit comes with a Smart Sensor connector, cable and components to properly interface with the transducers. The kit will allow quarter, half or full bridge transducers (pressure, force, strain, acceleration, sound, etc.) to be connected to the system.

SS-KIT-IN COMMENTS AND SUGGESTIONS

1) **Be careful of consumption.**

The bridge circuit should be designed so no more than 5mA are used to power the bridge. If the bridge takes more than 5mA, try reducing the voltage across the bridge by using series resistors or other kinds of regulators.

2) **Be careful of signal amplitude.**

Resistors RB, RC, and RF are used to reduce the output of the transducer to provide a signal no greater than ± 2 V (MP36/45), $\pm V$ (MP35) or ± 50 mV (MP30) between pins 2 and 4 on the 9 pin D-Sub (DB) Male connector. If the voltage is exceeded (of either polarity), the input amplifier stages will saturate.

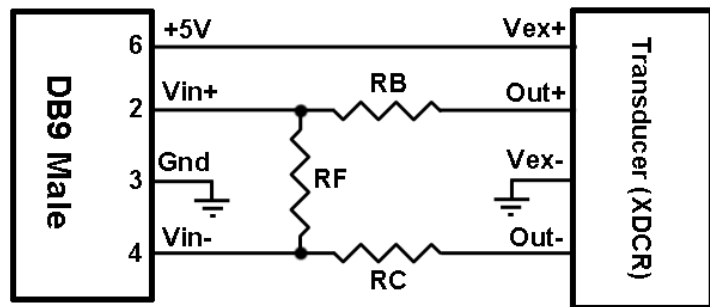

Schematic

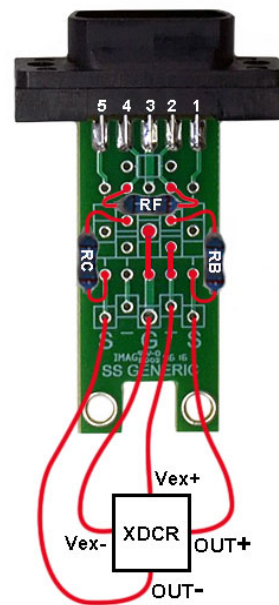

Printed circuit board layout

PIN	Description
1	Shield
2	Vin+
3	Ground
4	Vin-
5	Shield
6	+5 volts (ref)
7	No Connection
8	No Connection
9	-5 volts (ref)

9 Pin D Male connector pin-outs

SS-KIT-OUT Transducer Connector Interface Kit - Output

SS-KIT-OUT GUIDE

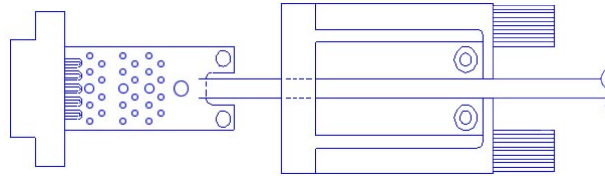

The SS-KIT-OUT allows custom cables to be made that connect to pins on the Analog Out port. Typical uses are:

1. Synchronizing 3rd party equipment to the MP3X's start of acquisition.
2. Listening to pulses ("clicks") or tones with headphones which can be used for reaction time studies.
3. Controlling audio or visual stimulus device (Audio tone, LED or Strobe flash, etc.).
4. Listening to input signals such as EMG via headphones or an audio amp./speaker.

Typical Analog Out connections include:

Analog Out Function	MP36/MP36R/MP35 and MP30
Listening to pulses ("Clicks") via headphones or audio amp./speakers	Headphone "+": pin 1 Headphones "-": pin 3
Headphones for listening to analog signals (EMG, etc)	Headphone "+": pin 1 Headphones "-": pin 3
Driving output LED's <ul style="list-style-type: none"> • To limit LED current, put resistor in series with pin 2. 	"+": pin 2 "-": pin 3
Synchronizing to 3 rd party equipment	Out "+": pin 5 Out "-": pin 3

The "Analog Out" port on the back panel of the MP36/MP36R/MP35 or MP30 (MP3X) can output pulses (digital) or analog voltage levels, or it can pipe out analog signals from one of the input channels. The port is controlled through one of the Output Control Panels in the Biopac Student Lab (BSL) *PRO* or *AcqKnowledge* software, which is described in the BSL *PRO* and *AcqKnowledge* manuals.

The following diagrams and table show the pin-outs of the "Analog Out" port on the back of the MP3X and the Printed Circuit Board (PCB) layout of the SS-KIT-OUT. Each pin is accessible on the PCB and can be located by the label shown in the table.

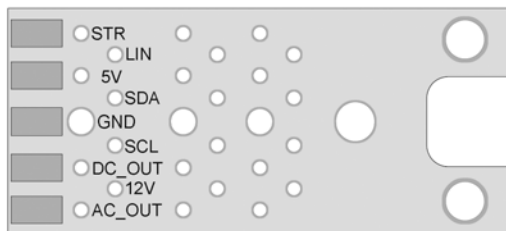

SS-KIT-OUT PCB

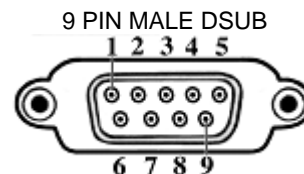

Back Panel—MP36/MP36R/MP35 or MP30

ANALOG OUT PORT

SS-KIT-OUT SPECIFICATIONS

PIN	LABEL on PCB	PIN FUNCTION		
		MP36/MP36	R/MP35	MP30
1	AC_OUT	Buffered analog or pulse output A.C. coupled (1,000 uF) Analog range: +/- 2.048 V Pulse range: 0 to 2.048V		Buffered analog or pulse output A.C. coupled (2,200 uF) Analog range: +/- 2.5 V Pulse range: 0 to 2.5V
2	DC_OUT	Buffered analog or pulse output D.C. coupled Z out = 50 Ω Range: 0 to 4.096 V		Buffered analog or pulse output D.C. coupled Z out = 50 Ω Range: 0 to 5 V
3	GND	Ground		Ground
4	5V	+5 V (100mA max.)		+7.5 V (100 mA max.)
5	STR	Buffered pulse output Z out = 1 kΩ Range: 0 to 5 V		Un-buffered analog or pulse output (D.C. coupled) Z out = 1 kΩ Range: 0 to 5 V
6	12V	+12 V (100 mA max)		Not used
7	SCL	I ² C SCL	Do not connect!	Not used
8	SDA	I ² C SDA	Do not connect!	Not used
9	LIN	Monitor	Do not connect!	Not Used

Notes Pins 1 and 2 For the MP36/MP36R/MP35, pins 1 and 2 can output analog or pulses when using MP3X firmware revision 1.26.037.030 or greater. When run under previous firmware, pins 1 and 2 can only be used for analog output. To identify the firmware revision, launch the BSL *PRO* or *AcqKnowledge* software and check the Help > About dialog. See the Support section at www.biopac.com for upgrade information.

Pins 3, 4 and 6 The Power supply pins (3, 4 and 6) can be used for external circuits as long as the load current does not exceed 100 mA.

ASSEMBLY NOTES

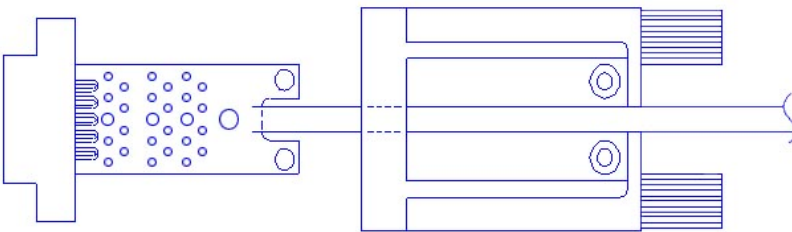

The PCB assembly fits into the thumb screw housing as shown. Two screws attach the PCB to the housing and hold the strain relief in place. The strain relief is used to prevent the cable and attached wires from pulling off the SS-KIT-OUT PCB. It is a good idea to place the strain relief over the cable prior to soldering the wires to the

PCB so that it only has to be slid on a small distance. If the strain relief fits too tightly around the cable, use water to wet the cable, allowing the strain relief to slide. Place the strain relief such that the case cover pinches and holds the cable. The stick on panel is used to cover the screws and protect the label.

STMHUM HUMAN-SAFE STIMULATOR – DB9

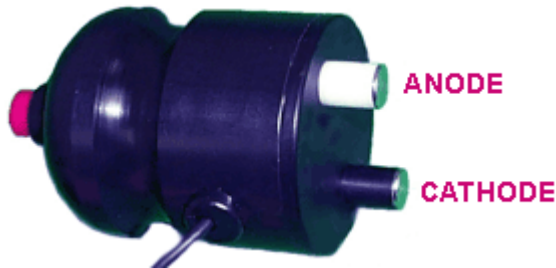

Human stimulation with a superior degree of safety and comfort

The STMHUM is a direct, human-safe stimulator that provides pulse output in the range of 0-100 V. The maximum width pulse that can be generated is limited to 1 msec by hardware, ensuring the STMHUM meets all stimulator safety standards.

The ergonomic design allows the user to focus on the electrode placement instead of worrying about holding the electrode.

- Subjects depress the red safety switch to allow the software-controlled stimulus presentation through
- To stop the stimulus, Subjects simply remove their thumb from the switch and the electrode shuts off.

Cable terminates in a DB9 connector to interface the “Analog out” port on MP36 and MP36R units; not compatible with MP35 or MP30 units. Requires software versions BSL 4.1.1 or AcqKnowledge 4.4.1 or higher.

The STMHUM eliminates the need for an external stimulator—use as a cost-effective alternative for the HSTM01+BSLSTMB/A hardware combination.

BIOPAC software provides an output control panel that allows for the voltage to be specified directly along with pulse frequencies. Set parameters using MP Menu > Output Control > Human Stimulator – STMHUM:

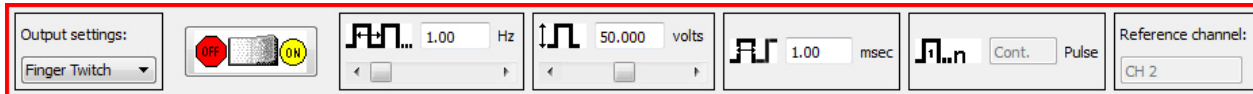

IMPORTANT! Refer to the Stimulation Safety Notes beginning on the next page.

STMHUM SPECIFICATIONS

Stimulus Type:	Voltage
Stimulus Pulse Width:	50 µsec to 1 msec
Step Up Voltage Ratio:	1:10
Maximum output voltage:	100 V
Safety Switch:	Yes (pushbutton)
Isolation Capacitance:	100 pF
Isolation Voltage:	1500 V
Power output:	Watt (instantaneous max.) = (100 V x 100 V)/500 Ohms = 20 Watts Joules (Watts x Seconds) = 20 Watts x 0.001 seconds = 0.020 Joules = 20 mJ
Stimulating Electrodes:	<i>Material:</i> Stainless steel; <i>Diameter:</i> 8 mm; <i>Spacing:</i> 2.54 cm
Dimensions:	<i>Height</i> (electrode bottom to button top): 7.7 cm; <i>Diameter:</i> 4.5 cm; <i>Weight:</i> 170 G
Cable:	<i>Length:</i> 3 m (10'); <i>Connector:</i> DB9 male
Interface:	MP36 or MP36R Analog Out port (DB9 female)

IMPORTANT SAFETY NOTES!

When using the STMHUM, it is possible to generate voltages as high as 100 V p-p. These voltages are potentially dangerous, especially if the stimulator’s high voltage outputs are connected across the subject’s heart. Across the heart means that the heart is potentially in the electrical path from lead to lead. This situation occurs when the stimulation electrodes are placed on opposite sides of the subject’s body.

NEVER PLACE STIMULATION ELECTRODES ON OPPOSITE SIDES OF THE SUBJECT’S BODY!

Always use the stimulator with the leads placed in relatively close proximity to each other and relatively far from the heart, and with the leads placed only on the **SAME** side of the body. The figure to the right illustrates correct connection techniques when using the STMHUM.

Example of correct stimulation electrode placement:

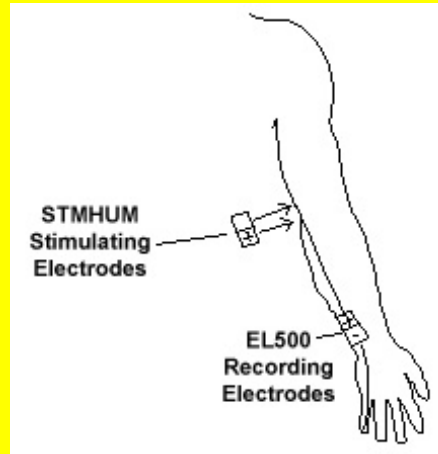

STIMULATION SAFETY

The harmonized, international regulatory standard relating to the safety of nerve and muscle stimulators is **IEC 60601-2-10:2015**. Certain stimulation equipment is excluded from this standard, such as stimulators intended for cardiac defibrillation; however, for the purposes of defining relevant safety metrics for the STMHUM stimulation unit, this standard is quite relevant.

STMHUM stimulation units are designed in such a manner that the power available to stimulate the subject is limited. This limitation of power is achieved through the use of stimulus isolation transformers which have physical constraints (due to their size and construction) which absolutely—in accordance to known physical laws—constrain the maximum transferable power to be no more than a specific level.

The IEC 60601-2-10:2015 standard clearly specifies the **limitation of output power** for a variety of wave types.

- * For stimulus pulse outputs, the maximum energy per pulse shall not exceed 300mJ, when applied to a load resistance of 500 ohms,
- * For stimulus pulse outputs, the maximum output voltage shall not exceed a peak value of 500 V, when measured under open circuit conditions.

STMHUM units employ stimulus isolation transformers that limit the output pulse width to 1 ms maximum, under 500 ohm load conditions. In addition, the highest available output voltage is 100 V pk-pk under open circuit conditions.

For the pulse energy calculation for STMHUM:

$$\begin{aligned} \text{Joules} &= \text{Watts} \times \text{Seconds} \\ \text{Watt (instantaneous max.)} &= (100 \text{ V} \times 100 \text{ V}) / 500 \text{ Ohms} = 20 \text{ Watts} \\ \text{Joules (Watts} \times \text{Seconds)} &= 20 \text{ Watts} \times 0.001 \text{ seconds} = 0.020 \text{ Joules} = 20 \text{ mJ} \end{aligned}$$

Accordingly, the highest possible energy output using the STMHUM is **20 mJ**, considerably **less than the 300 mJ maximum** as specified by IEC 60601-2-10:2015.

CAUTIONS FOR USE!

Even the safest stimulation units, if used incorrectly, can cause serious harm. The following points illustrate fundamental rules for using stimulus isolation units to stimulate subjects.

1) **NEVER APPLY THE STIMULUS SIGNAL IN SUCH A MANNER AS TO CAUSE CURRENT TO FLOW THROUGH THE HEART.**

Primarily considered, this rule implies that stimulation leads should never be split apart so as to be able to touch opposing sides of the body surrounding the heart.

For example: NEVER CONNECT THE STIMULUS ISOLATION UNIT SO THAT ONE LEAD TOUCHES THE LEFT ARM AND THE OTHER LEAD TOUCHES THE RIGHT ARM.

Both stimulus leads [(+) and (-)], should be applied to the SAME side (left or right) of the subject's body. Furthermore, always stimulate AWAY from the heart. Stimulation probes (such as BIOPAC's EL350 or the EL351), which constrain the distance from the positive stimulation output to the negative stimulation output, should always be used for skin surface stimulation of nerve or muscle.

The EL350 or the EL351 stimulation probes fix the distance between stimulation outputs to 35 mm. It is not recommended that this distance be increased for skin surface stimulation of nerve or muscle. An increase in this distance simply allows stimulation currents to circulate over a larger area, which is usually not necessary for nerve or muscle stimulation scenarios.

2) **Always start the stimulation process with the stimulator control set the LOWEST possible level.** The “Pulses” output control panel in the BIOPAC software is used to control the STMHUM. Set to the 0% level, prior to the onset of the stimulation protocol. During the protocol, increase the stimulus intensity by increasing the Level in small increments Stop increasing the intensity at the first sign of subject discomfort.

IMPORTANT NOTES!

- A) It takes as little as **15 micro-amps** directed across the heart to instigate ventricular fibrillation. This situation can be readily achieved by using sub-surface stimulation needle electrodes that insert directly into the heart. It is considerably more difficult to achieve ventricular fibrillation on the same heart using surface electrodes, but it is possible to do so, evidenced by the performance of cardiac defibrillation units used in hospitals or by paramedics.
- B) **Qualified experienced professionals** should supervise any protocols where electrical stimulation is applied to human subjects. Electrical stimulation protocols are not simple. Please contact BIOPAC Systems for any questions regarding the use of BIOPAC's stimulation units or accessories.

AMI100D AMPLIFIER INPUT MODULE

The AMI100D Amplifier Input Module is used for connecting Smart Amplifiers and other high level transducers to the MP160 system and provides 16 input and 2 output channels. It is the replacement for the HLT100C High Level Transducer module and functions in much the same fashion. The AMI100D includes additional smart functionality to communicate with Smart Amplifiers. To enable full communications with Smart Amplifiers, the AMI100D must be used with an MP160 unit running firmware version 2.1.0 or higher, and digital channel 15 must be allowed to float or must be held high (1) while *AcqKnowledge* is launched, (2) when Smart Amplifiers are configured, and (3) when data acquisition commences.

Signals from external equipment connected to the AMI100D must use an INISOA Signal Isolation Adapter for proper isolation for subjects connected to Smart Amplifiers.

Earlier-model 100C Series modules connect to the right side of the AMI100D. BioNomadix receivers, STP100C, and STM100C connect to the left side of the AMI100D. When using BioNomadix or 100C Series modules in conjunction with Smart Amplifiers, these modules must be set to channels not in use by Smart Amplifiers. Each Smart Amplifier occupies a single analog channel, and two signals may not share the same channel.

High level output transducers and adapters connect to the AMI100D via standard 6 pin RJ11 type connectors.

In addition to Smart Amplifiers, the following transducers and adapters also connect to the AMI100D module:

TSD109C/F Tri-axial Accelerometers	INISOA Input Signal Isolator
TSD111A Heel/Toe Strike Transducer	OUTISOA Output Signal Isolator
TSD115 Variable Assessment Transducer	DTU100 Digital Trigger Unit (MRI Synchronization)
TSD116 A/B/C Switches and Markers	NIBP-MRI Noninvasive Blood Pressure for MRI
TSD150 A/B: Active Electrodes	

Alternatively, the AMI100D module can be used to connect mains powered external equipment to the MP System when the system also connects to electrodes attached to humans.

IMPORTANT USAGE NOTE

To provide the maximum in subject safety and isolation, use electrically isolated signal adapters to connect mains powered external equipment (i.e., chart recorders, oscilloscopes, etc.) to the MP System. Use the INISOA adapter to connect to MP analog system inputs and the OUTISOA adapter to connect to analog system outputs.

- **See also:** setup notes for external devices and channel contention issues.



Connect the AMI100D to the right side of the MP160 and connect additional modules to the right side of the AMI100D (such as DA100C or other 100C Series amplifiers).



Left: MP160 Unit – **Right:** AMI100D Module

Smart Amplifiers, high level output transducers (e.g., TSD109C3 Tri-Axial Accelerometer) connect via the 16 analog RJ11 jacks on the AMI100D front panel. Up to 16 analog channels can be used at the same time, as long as no other analog channels are in use by other BIOPAC modules.

SPECIFICATIONS

Smart Amplifier/Transducer Inputs: 16 channels (front panel) – RJ11 jacks
System D/A Outputs: 2 channels (front panel) – RJ11 jacks
Isolated Power Access: ± 12 V, +5 V @ 100 ma (via all RJ11 jacks)
Weight: 540 grams
Dimensions: 7 cm (wide) x 11 cm (deep) x 19 cm (high)

PIN OUTS

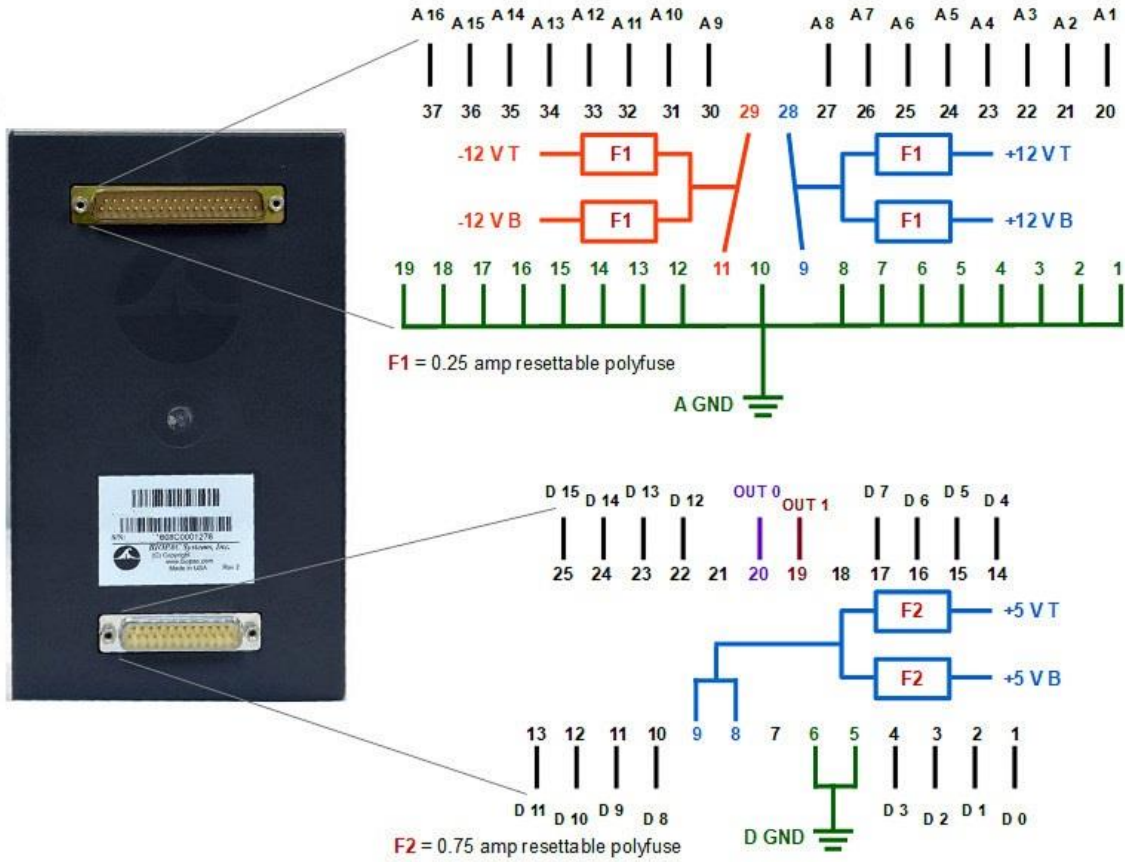

DSUB37 and DSUB25 Connectors

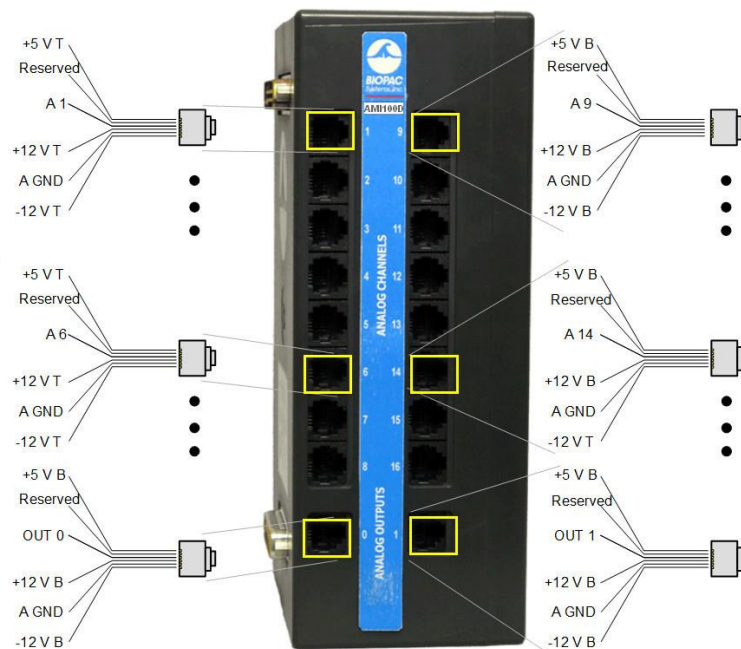

6-Position Modular Jacks

INTERFACE MODULE CONNECTION

When connecting the analog output sourcing from external devices to the MP150 or MP100, channel contention must be considered. To connect external device outputs to the MP150 or MP100:

- **Non-human subjects or only collecting data from external devices**—If the MP System is only collecting signals from non-human subjects (via MP system amplifier modules) or if the MP System is only collecting data from external devices:
 - Connect external device output signal to an unused **UIM100C** input channel (1-16)
- **Human subjects**—If the MP System is collecting signals from human subjects (via MP system amplifier modules), it's important to isolate the external device output signal from the MP System input.
 - Connect external device output signal to an unused **HLT100C-MP150** input channel (1-16) via **INISO**.



HLT100C-MP150 UIM100C

Channel contention issues

1. If an analog channel is used on the UIM100C or HLT100C-MP150, make certain that two external devices do not use the same analog channel.
2. If amplifier modules are connected to the MP System then those amplifier modules must be set to a channel which is not used by external devices plugged into the UIM100C or HLT100C-MP150.

For example:

Two external device outputs are connected to the MP150 system. Device one is a Noninvasive Blood Pressure (NIBP) monitor and device two is an Electronic Scale. In addition, an ECG100C module is attached to the MP150 System and is being used to measure the electrocardiogram. All devices are connected to a human subject.

In this case, to fully isolate the human subject:

- Both the NIBP monitor and the Electronic scale outputs should be connected to the MP150 inputs via the HLT100C-MP150, using one INISO for each input channel.
- The ECG100C should be snapped directly to the MP150 System and connected directly to the subject with the appropriate leads and electrodes.
- Assuming the NIBP is connected via INISO to HLT100C-MP150 channel 1 and the Electronic Scale is connected via INISO to HLT100C-MP150 channel 2, then the ECG100C amplifier must be set to a channel between 3-16.
 - The ECG100C can't use Channels 1 and 2 because both of these channels are being used by other devices.

If additional instruction or a special cable is required to connect the MP System to the device, please contact a BIOPAC Systems, Inc. applications engineer at support@biopac.com.

UIM100C UNIVERSAL INTERFACE MODULE

The UIM100C Universal Interface Module is the interface between the MP150* and external devices. Typically, the UIM100C is used to input pre-amplified signals (usually greater than +/- 0.1 volt peak-peak) and/or digital signals to the MP150 acquisition unit. Other signals (e.g., those from electrodes or transducers) connect to various signal-conditioning modules.

***The UIM100C is for MP150 hardware only.** For interfacing newer MP160 hardware, use the **MP160-specific** HLT100C High Level Transducer Module (Rev 2).

The Universal Interface Module (UIM100C) is designed to serve as a general-purpose interface to most types of laboratory equipment. The UIM100C consists of sixteen 3.5 mm mini-phone jack connectors for analog inputs, two 3.5 mm mini-phone jack connectors for analog outputs, and screw terminals for the 16 digital lines, external trigger, and supply voltages.

The UIM100C is typically used alone to connect polygraph and chart recorder analog outputs to the MP System. BIOPAC Systems, Inc. offers a series of cables that permit the UIM100C to connect directly to a number of standard analog signal connectors. Most chart recorders or polygraphs have analog signal outputs, which can be connected directly to the UIM100C.

The UIM100C allows access to 16 analog inputs and 2 analog outputs on one side, and 16 digital input/output lines, an external trigger, and supply voltages on the other side. The UIM100C is designed to be compatible with a variety of different input devices, including the BIOPAC series of signal conditioning amplifiers (such as the ECG100C).

Connecting the UIM100C to the MP System

- MP150: Snap the UIM100C onto the right side of the MP unit.

When using the Universal Interface Module (UIM100C) with other 100C-Series modules, the UIM100C is usually the first module cascaded in the chain. If using the STM100C, OXY100C or HLT100C-MP150, the module must be plugged in on the **left** of the UIM100C. Up to seventeen modules (including the UIM100C) can be snapped together, as illustrated in the following diagrams:



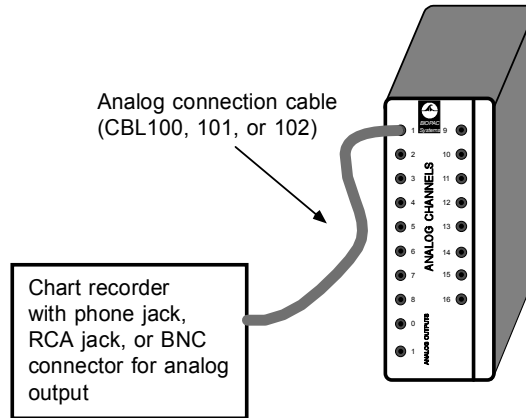

Typical UIM100C to polygraph interface

When using the UIM100C, be careful not to short the “analog output” terminals together, and not to short across any of the connectors on the “Digital” (back) side of the module.

IMPORTANT USAGE NOTE

Mains powered external laboratory equipment should be connected to an MP System through signal isolators when the system also connects to electrodes attached to humans.

To couple external equipment to an MP System, use:

- ❖ For **analog** signals — **INISO** or **OUTISO** isolator (with **HLT100C-MP150**)
- ❖ For **digital** signals — **STP100C** (with **UIM100C**)

Contact BIOPAC for details.

ANALOG CONNECTIONS

See also: Setup notes for external devices and channel contention issues.

As noted, the UIM100C requires cables equipped with standard 3.5mm mini-phone plugs to connect to analog signal sources. This type of connector is commonly available with many different mating ends. BIOPAC Systems, Inc. carries several different types, including BNC and phone plugs. Since the MP160/150 analog inputs are single-ended, the tip of the mini-phone plug is the input and the base (shield) of the mini-phone plug is the ground (or common).

NOTE: Make sure the cable that is routed into the UIM100C is a **mono** 3.5 mm phone plug.

To connect to existing equipment (such as polygraphs or chart recorders), run a cable from the analog output terminal of the external device to the UIM100C. Since there are so many different devices that can connect to the MP160/150 it’s impossible to cover them all.



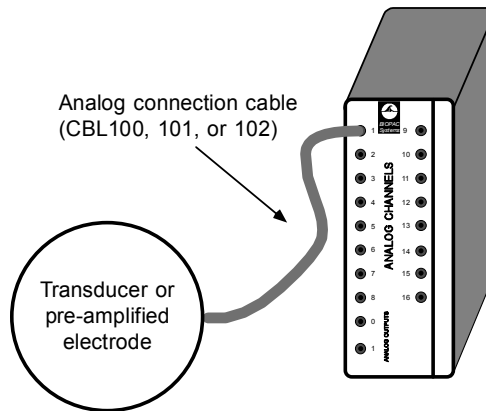

UIM100C connected to external analog signal source

DIGITAL CONNECTIONS

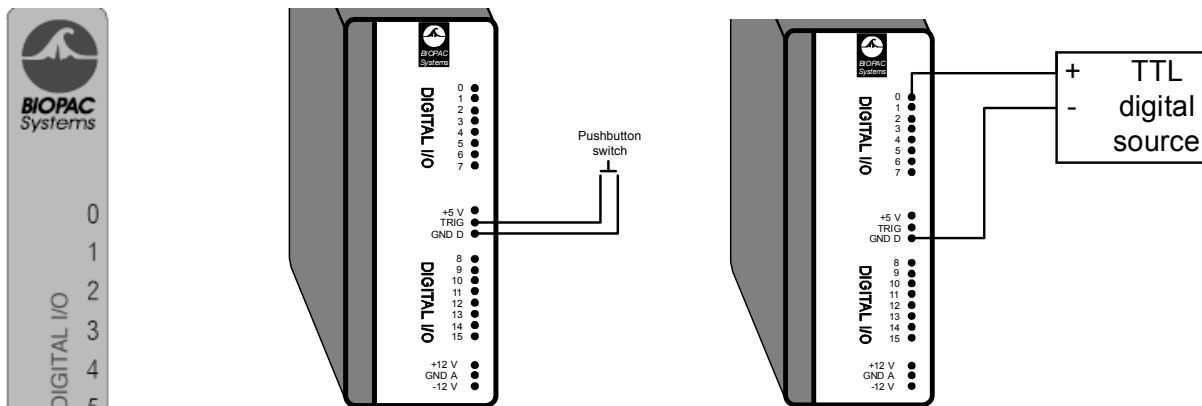

Trigger connected to UIM100C

MP unit to digital source connection

A digital signal has only two voltage levels: 0 Volts = binary 0 and +5 volts = binary 1.

A **positive edge** is a 0 to 1 transition and a **negative edge** is a 1 to 0 transition.

The MP150 digital I/O lines have internal pull-up resistors so that unconnected inputs read “1.” This means that external passive switches can be used to introduce digital (ON/OFF) data into the UIM100C by connecting the switch terminal between the digital I/O (0-15) and Ground (GND). In this configuration, the input will be read as “0.0” when the switch is closed and as “+5 V” when the switch is open.

The 16 digital input/output lines on the UIM100C have screw terminals that can accept pin plugs or bare wires, as shown above. Be careful not to short the +5, +12 V and -12 V terminals together or to the GND A or GND D output terminal, or the MP150 may become damaged.

The 16 digital lines are divided into two blocks, I/O 0 through 7 and I/O 8 through 15. Each block can be programmed as either inputs or outputs. Do not connect a digital input source to a block that is programmed as an output.

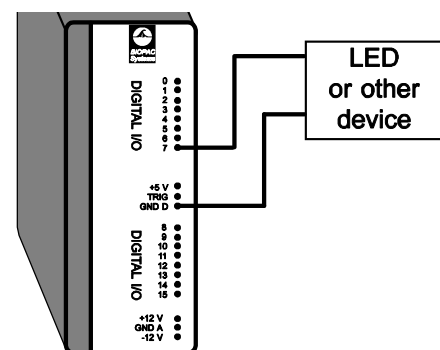

Output devices (such as leads or an LED) can be connected to the digital side of the UIM100C. Outputs can be connected so that they are “ON” either when a signal output from the UIM100C reads 0 Volts or when a +5 V signal is being output.

- When connecting to an LED, be sure to use a current-limiting resistor (typically 330 Ω) in series with the LED.

To connect an LED so that it defaults to “OFF” (i.e., the digital I/O reads 0), attach one lead of the output device to the GND D terminal on the UIM100C and connect the other lead to one of the digital I/O lines (I/O 7, for example). When configured this way, the device will be “OFF” when I/O 7 reads 0, and “ON” when I/O 7 reads a digital “1” (+5 Volts).

Alternatively, connect one of the device leads to the +5 V terminal on the UIM100C and leave the other lead connected to the digital line (e.g., I/O 7). With this setup, the device will be “ON” when the I/O line (in this case digital I/O 7) reads 0, and “OFF” when the I/O reads a digital “1” (+5 Volts).

UIM100C SPECIFICATIONS

Analog I/O:	16 channels (front panel) – 3.5 mm phone jacks
D/A Outputs:	2 channels (front panel) – 3.5 mm phone jacks
Digital I/O:	16 channels (back panel) – screw terminals
External Trigger:	1 channel (back panel) – screw terminal
Isolated Power:	± 12 V, +5 V @ 100 ma (back panel) – screw terminals
Weight:	520 g
Dimensions:	7 cm (wide) x 11 cm (deep) x 19 cm (high)

HLT100C-MP150 HIGH LEVEL TRANSDUCER INTERFACE MODULE

The HLT100C-MP150 module is used to interface all high level output transducers to the MP150 System or IPS100C Isolated Power Supply.

! Newer HLT100C “Rev 2” units, shipped with MP160 Systems and indicated “Rev 2” on the part number/barcode label, cannot physically be used with MP150+UIM combination or an IPS100C.

The HLT100C-MP150 module provides 16 input and 2 output channels. The HLT100C-MP150 is similar in function to the UIM100C Universal Interface Module, but it also provides power to the transducer when making a connection.

High level output transducers and adapters connect to the HLT100C-MP150 via standard 6 pin RJ11 type connectors. Transducers and adapters that presently require the HLT100C-MP150 module are:

TSD109	C/F: Tri-axial Accelerometers
TSD111A	Heel/Toe Strike Transducer
TSD115	Variable Assessment Transducer
TSD116	A/B/C: Switches and Markers
TSD150	A/B: Active Electrodes
INISO	Input Signal Isolator
OUTISO	Output Signal Isolator
DTU100	Digital Trigger Unit (MRI Synchronization)
NIBP-MRI	Noninvasive Blood Pressure for MR

Alternatively, the HLT100C-MP150 module can be used to connect mains powered external equipment to the MP System when the system also connects to electrodes attached to humans.

IMPORTANT USAGE NOTE

To provide the maximum in subject safety and isolation, use electrically isolated signal adapters to connect mains powered external equipment (i.e., chart recorders, oscilloscopes, etc.) to the MP System. Use the INISO adapter to connect to MP analog system inputs and the OUTISO adapter to connect to analog system outputs.

HARDWARE SETUP

- **See also:** setup notes for external devices and channel contention issues.

Connect the Digital and Analog cables from the MP150 directly to the HLT100C-MP150, then connect the UIM100C to the HLT100C-MP150. The HLT100C-MP150 module must be connected on the left side of the UIM100C module. This allows the use of other amplifier modules with the UIM100C while the HLT100C-MP150 is connected.

High level output transducers (e.g., TSD109 Tri-Axial Accelerometer) or active electrodes (e.g., TSD150A Active Electrode) connect via the 16 analog RJ11 jacks on the front of the HLT100C-MP150. Up to 16 analog channels can be used at the same time, as long as there are no other analog channels in use by the UIM100C module or by other BIOPAC modules.

Note If active electrodes are used, it may be necessary to attach a single ground lead to the UIM100C via the GND A terminal on the back of the module.

IMPORTANT

If contention exists, the channel data will be corrupted. For example, if four channels [Ch.1-4] were in use by the UIM100C, then only 12 channels [Ch. 5-16] could be used by the HLT100C-MP150.

HLT100C-MP150 SPECIFICATIONS

- Transducer Inputs: 16 channels (front panel) – RJ11 jacks
- System D/A Outputs: 2 channels (front panel) – RJ11 jacks
- Isolated Power Access: $\pm 12\text{ V}$, $+5\text{ V @ }100\text{ ma}$ (via all RJ11 jacks)
- Weight: 540 grams
- Dimensions: 7 cm (wide) x 11 cm (deep) x 19 cm (high)
- Pin-outs:

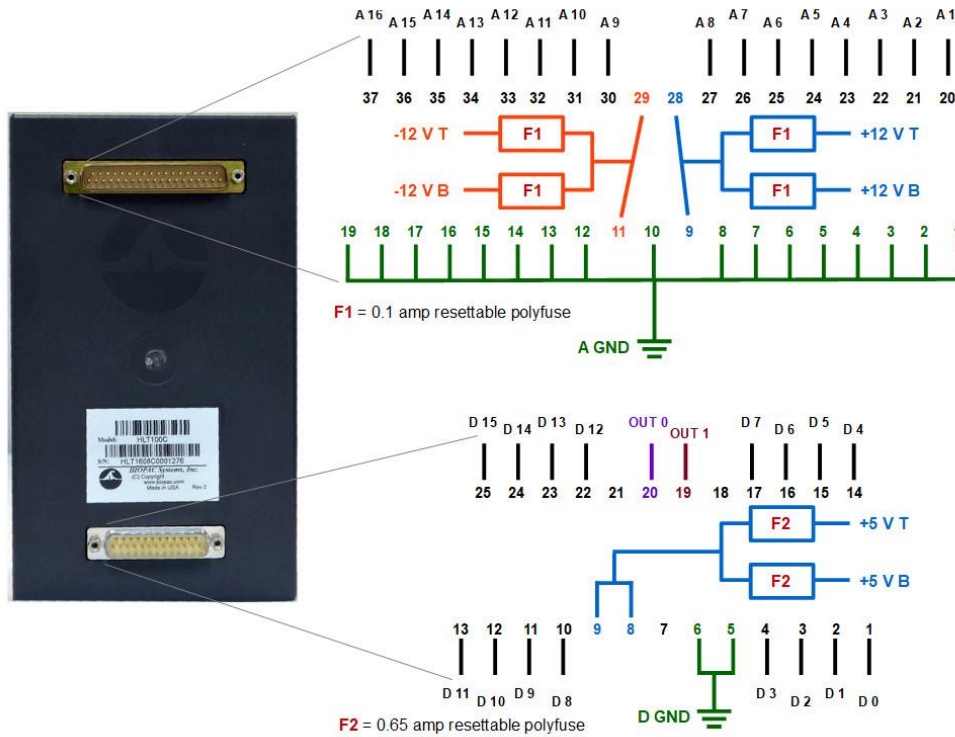

DSUB37 and DSUB25 Connectors

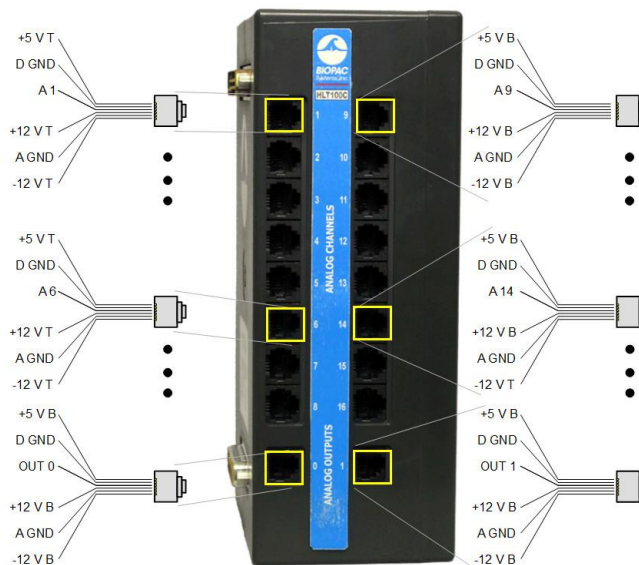

6-Position Modular Jacks

HLT100C HIGH LEVEL TRANSDUCER INTERFACE MODULE (REV 2 FOR MP160)

The HLT100C module is used to interface all high level output transducers to the MP System. The HLT100C module provides 16 input and 2 output channels. The HLT100C is similar in function to the UIM100C Universal Interface Module, but it also provides power to the transducer when making a connection. The HLT100C is also the standard interface module provided with the MP160 System.

! Newer HLT100C “Rev 2” units, shipped with MP160 Systems and indicated “Rev 2” on the part number /barcode label, cannot physically be used with MP150+UIM combination or an IPS100C. For MP150 with UIM100C, use the HLT100C-MP150.

High level output transducers and adapters connect to the HLT100C via standard 6 pin RJ11 type connectors. Transducers and adapters that presently require the HLT100C module are:

TSD109 C/F: Tri-axial Accelerometers	TSD150 A/B: Active Electrodes
TSD111A Heel/Toe Strike Transducer	INISOA Input Signal Isolator
TSD115 Variable Assessment Transducer	OUTISOA Output Signal Isolator
TSD116 A/B/C: Switches and Markers	DTU100 Digital Trigger Unit (MRI Synchronization)
	NIBP-MRI Noninvasive Blood Pressure for MR

Alternatively, the HLT100C module can be used to connect mains powered external equipment to the MP System when the system also connects to electrodes attached to humans.

IMPORTANT USAGE NOTE

To provide the maximum in subject safety and isolation, use electrically isolated signal adapters to connect mains powered external equipment (i.e., chart recorders, oscilloscopes, etc.) to the MP System. Use the INISOA adapter to connect to MP analog system inputs and the OUTISOA adapter to connect to analog system outputs.

HARDWARE SETUP

- **See also:** setup notes for external devices and channel contention issues.

Connect the HLT100C to the right side of the MP160 and connect amplifier modules to the right side of the HLT100C as shown below:



High level output transducers (e.g., TSD109 Tri-Axial Accelerometer) or active electrodes (e.g., TSD150A Active Electrode) connect via the 16 analog RJ11 jacks on the front of the HLT100C. Up to 16 analog channels can be used at the same time, as long as there are no other analog channels in use by the UIM100C module or by other BIOPAC modules.

NOTE: If active electrodes are used, it may be necessary to attach a single ground lead to the UIM100C via the GND A terminal on the back of the module.

IMPORTANT!

If contention exists, the channel data will be corrupted. For example, if four channels [Ch.1-4] were in use by the UIM100C, then only 12 channels [Ch. 5-16] could be used by the HLT100C.

HLT100C SPECIFICATIONS

Transducer Inputs:	16 channels (front panel) – RJ11 jacks
System D/A Outputs:	2 channels (front panel) – RJ11 jacks
Isolated Power Access:	±12 V, +5 V @ 100 ma (via all RJ11 jacks)
Weight:	540 grams
Dimensions:	7 cm (wide) x 11 cm (deep) x 19 cm (high)

PIN OUTS

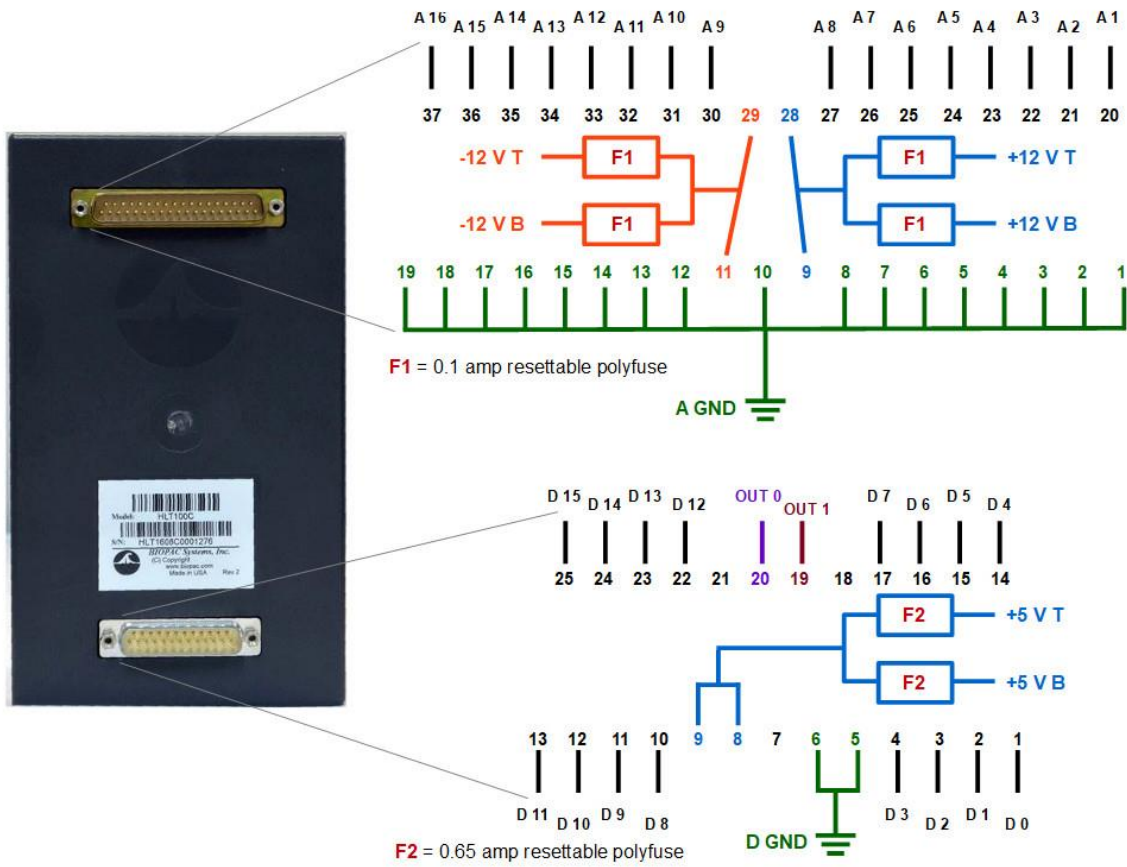

DSUB37 and DSUB25 Connectors

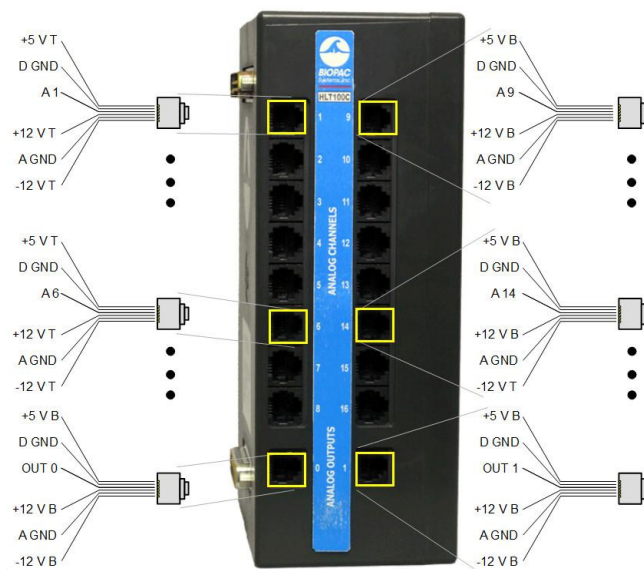

6-Position Modular Jacks

SIGNAL ISOLATORS

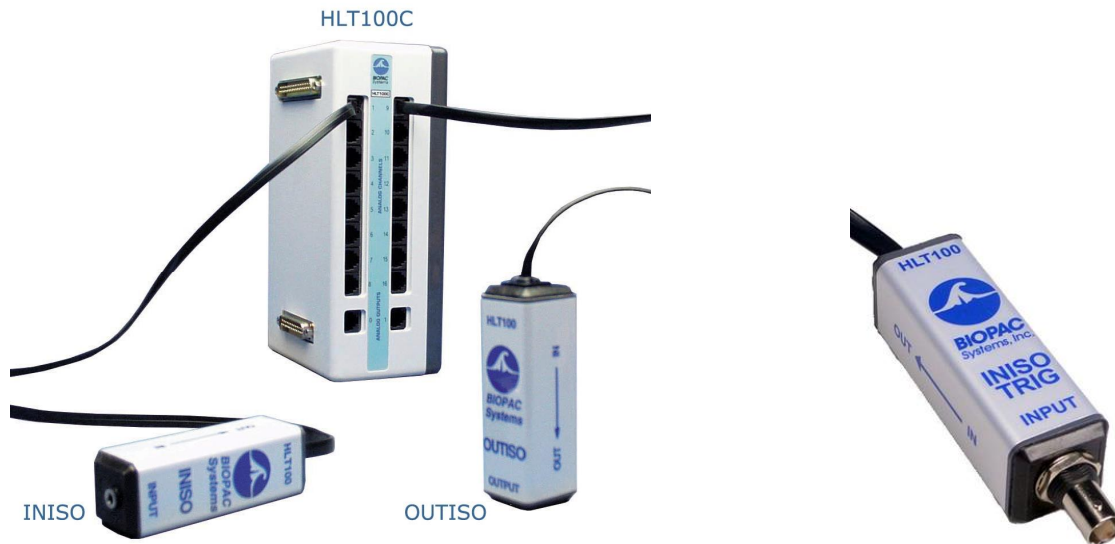

Analog signal isolators INISOA and OUTISOA (shown with HLT100C) Trigger Isolation Adapter INISO-TRIGA

SIGNAL ISOLATION

Analog signal isolators are used to connect mains powered external laboratory equipment to the MP System when it also connects to electrodes attached to humans. Each signal isolator comes with an RJ11 cable for connection to the AMI100D or HLT100C High Level Transducer modules.

- For digital (TTL compatible) isolation to the MP digital I/O ports, use the STP100C optical interface.
- If the MP System does not electrically connect to human subjects, signal connections to external equipment can be made through the AMI100D/HLT100C module and the respective analog or digital connection cable.

INISOA Use to connect external equipment outputs to MP analog input channels. The INISO plugs directly into any of the 16 input channels on the AMI100D/HLT100C module and incorporates a 3.5 mm phone jack for signal input connections. Select the appropriate analog connection cable to connect to the external equipment's output.

OUTISOA Use to connect MP analog signal outputs (amplifier and D/A) to external equipment inputs. The OUTISOA plugs directly into any of the 16 signal output channels, plus the two D/A outputs, on the AMI100D/HLT100C module and incorporates a 3.5 mm phone jack for signal output connections. The OUTISOA is very useful when the biopotential amplifier output signal requires routing to external equipment while being sampled by the MP System. Select the appropriate analog connection cable to connect to the external equipment's input.

INISOA AND OUTISOA SPECIFICATIONS

Isolator Type:	Analog	Isolation Voltage:	1500 VDC
Bandwidth:	DC to 50 kHz	Isolation Capacitance:	30 pF
Input/Output Range:	±10 V	Connector:	3.5 mm mono phone jack
Input Resistance:	200K Ω	Weight:	50 g
Output Resistance:	120 Ω	Dimensions:	2.6 cm (high) x 2.6 cm (wide) x 7.6 cm (long)
Output Current:	±5 mA	Included Cable:	2.1 m (straight through, M/M, 6 pin, RJ11)
Offset Voltage:	±20 mV (nominal)	Interface:	AMI100D or HLT100C
Temperature Drift:	200 μV/°C (nominal)		
Noise:	2.5 mV (rms)		

See also: Setup notes for external devices and channel contention issues.

TTL TRIGGER ISOLATION

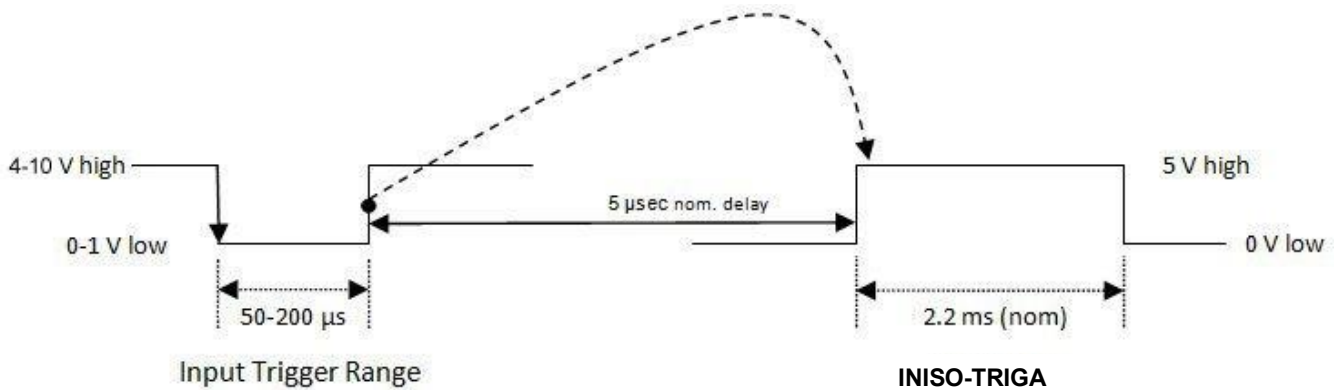

The TTL Trigger Isolation Adapter is ideal for recording trigger signals produced by MRI scanners (triggers on rising edge). Short duration TTL pulses have their pulse width elongated by the adapter, and this pulse width elongation allows short trigger pulses to be recorded using lower sampling rates.

This isolation adapter connects a TTL level source to the AMI100D/HLT100C module in the Control room (do not place INISO-TRIGA in Chamber room).

INISO-TRIGA SPECIFICATIONS

- Input trigger: pulse profile: Negative going pulse
 pulse width: 50-200 µsec
 triggering: Rising edge of input pulse
- Output pulse: profile: Positive pulse
 pulse width: 2.2 msec (nominal)
 pulse voltage range: 0-5 V (TTL)
- Propagation delay: ~ 5 µsec from rising edge of input trigger to rising edge of output signal
- Input Voltage: High 4-10 V; Low 0-1 V
- Input Current: High 5-15 ma; Low 0-0.25 ma
- Isolation: 1500 VDC
- Connectors: BNC female (Input) and Phone plug (Output)
- Cable: 2 m; phone plug connectors
- Interface: AMI100D or HLT100C module (plugs directly into any of the 16 input channels)

NOTE: INISO, OUTISO, and INISO-TRIG were discontinued in February of 2019. Current offerings are INISOA, OUTISOA, and INISO-TRIGA to support AMI100D compatibility in addition to HLT100C.

MOBITA WEARABLE, WIRELESS PHYSIOLOGICAL MONITORING & LOGGING

- **32 channels of data in the palm of your hand**
- **Mobile physiologic measurement with Mobita & AcqKnowledge**

MOBITA-W SERIES

Mobile 32-Channel Biopotential systems



MOBITA-W-32EEG System includes ConfiCap MB-32EEG-CAP-A

MOBITA-W-20EEG System includes ConfiCap MB-20EEG-CAP-B

MOBITA-W-12+20 System includes ConfiCap MB-12+20-CAP

MB-CAP SERIES

Mobita ConfiCap only



MB-32EEG-CAP-A

MB-20EEG-CAP-B

MB-12+20-CAP

Mobita Overview

Mobita® is a new wearable physiological signal amplifier system that can record up to 32 channels of high-fidelity wireless biopotential data, including ECG, EEG, EGG, EMG, and EOG data. The device includes a trigger channel that can be used to synchronize the system with other devices or data streams. When the onboard accelerometer is used with AcqKnowledge's Actigraphy feature, it is possible to evaluate a subject's activity levels.

Record in the lab or out, from simple to tough and demanding measurement situations. The system can either telemeter data back to a computer running AcqKnowledge for real-time display and analysis of the signals, or record it locally for later download. Easily switch between live or logging modes to suit your research protocol. Compact design, powerful specs, and impressive flexibility combine to create the ultimate solution for mobile physiologic measurement!

Key System Features

- 32 channels of wireless biopotential data
- Fully-integrated in AcqKnowledge® software
- Built-in 3D accelerometer for position information
- Trigger channel supports TTL inputs from 3rd - party hardware
- Built-in WiFi telemetry (range typical > 10 m indoors)
- No cable movement artifacts
- No filtering (including Notch filter) for true unadulterated signal quality
- True DC recording
- 24 bit data resolution
- Flash disk recording (up to 16 GB) for data back-up and holter applications
- Rechargeable Li-Po battery
- Rugged construction: sturdy, dustproof enclosure

Featured Applications

- Psychophysiology
- Neuroscience
- Exercise Physiology & Sports
- Gait & Movement Analysis
- Brain Computer Interface
- Sleep Studies
- Neuromarketing
- Home-based Ambulatory Testing

Flexibility

With AcqKnowledge and Mobita®, the system is quickly configured to do the work of multiple systems without the added cost of multiple amplifiers.

Quickly change the electrode configuration or signal type by swapping out the ConfiCap. Simply disconnect one header and snap on a new configuration for a completely different application. Record a 12-lead ECG while recording EEG and EMG data all with the same device.

Analyze with AcqKnowledge

- Powerful automated analysis routines for ECG, HRV, EEG, EMG, EGG, and many more!
- Intuitive user interface with fully customizable display

- Video Tutorials on key features and analysis routines
- Guided channel and acquisition setup with presets and quickstarts

MOBITA-W System Options



MOBITA-W-32EEG System
32-Channel EEG



MOBITA-W-20 EEG System
10/20 EEG + 13 open leads



MOBITA-W-10+12 System
32-Channel Biopotentials

Complete systems include one Mobita hardware unit, one ConfiCap configuration with accessories, and AcqKnowledge software. Each flexible Mobita system records up to 32 channels of data at up to 2K s/s. Stream data live into AcqKnowledge or log data for later upload. Swap ConfiCaps to change experiment protocols.

- **MOBITA-W-32EEG System** This system includes one Mobita hardware unit and one ConfiCap MB-32EEG-CAP-A with medium 32-channel headcap (H2O-CAP-M; other cap sizes available) and water electrodes. Water electrodes eliminate the need for gel. Individually shielded inputs.
- **MOBITA-W-20EEG System** This system includes one Mobita hardware unit and one ConfiCap MB-20EEG-CAP-B configured for 10/20 EEG; and EEG Cap (medium CAP100C; other sizes available). Leaves 13 open TouchProof inputs for user’s choice of biopotential data. Unshielded inputs.
- **MOBITA-W-12+20 System** This system includes one Mobita hardware unit and one ConfiCap MB-12+20-CAP to record up to 32 channels of biopotential data. Unshielded inputs.

Specifications

Sampling

Resolution: 24.414 nV/bit, referred to input
 Sampling rate: 2000, 1000, 500, 250 Hz
 Channel bandwidth: DC up to 0.2 x sample freq

Input:

Input signal difference: 409.6 mV pp
 Input common mode range: -2.0 V – +2.0 V
 Gain factor: 10
 Noise: < 0.4 μV RMS @ 0.1 – 10 Hz
 Input Impedance: >10 GΩ
 CMRR: > 100 dB typical
 # of channels: Up to 32 analog
 Power supply: Battery Li-Polymer with protection circuit

Accelerometer

Range: ± 16 g
 Resolution: 13 bit

Sensitivity: 3.9 mg/bit

Battery life:

WiFi mode: 8-10 hours (environment dependent)
 Logger Mode: 17-19 hours
 Hybrid Mode: WiFi and Logger: 8-10 hrs (environment dependent)

Note: The number of channels enabled does NOT significantly influence battery life.

Filtering

Filter: No filtering within channel bandwidth
 Type: Unipolar, bipolar (user configurable from unipolar inputs)
 Trigger: Either trigger (TTL) or generic (e.g., RS232 compatible) digital inputs possible through custom designed ConfiCap

Dimensions: 150 x 70 x 25 mm (with ConfiCap)

Computer Requirements

Computer should be running Windows 7 64-bit or Windows 8 64-bit with a Core i5 or a Core i7 processor.

Notes ! No support provided for operating systems older than Windows 7.

Slower computers may be able to use WiFi mode with the Mobita, but it may not be possible to transfer or import the logged data.

ConfiCap™ Options

ConfiCaps allow you to quickly change the configurations of the inputs for specific applications (i.e., 32-ch EEG, EMG, or combinations of ECG/EMG/EEG, etc.), customize your own design, or create protocol driven configurations when recording with a MOBITA-W System. Each channel is unipolar (single-ended) and AcqKnowledge is easily configured to create unique montages.

- **MB-32EEG-CAP-A 32-Channel EEG ConfiCap**

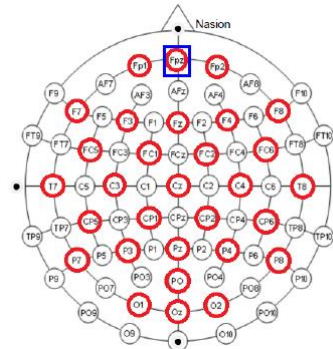

The MB-32EEG-CAP-A is a complete assembly for the Mobita wearable biopotential system that interfaces with a 32-channel electrode cap. This particular EEG cap uses water electrodes, which eliminates the need for gel. The assembly also includes a trigger connector for synchronization with other devices. The electrodes terminate in a Mobita confi-cap connector. Snap the assembly to the Mobita unit and attach the cap to a subject to record 32 channels of data for either in laboratory telemetry or remote data logging applications.

TIP: Use a permanent marker on the white top of each input to indicate its montage position to help expedite setup.

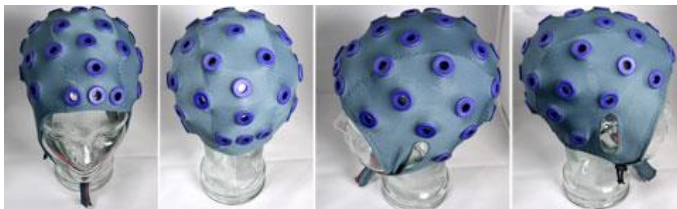

H2O-CAP Series Headcaps for Mobita Water Electrodes

- H2O-CAP-SMALL** 50-54 cm
- H2O-CAP-MEDIUM** 54-58 cm
- H2O-CAP-LARGE** 58-62 cm

Headcaps include 32 grommets for Mobita water-based electrodes. Each MB-32EEG-CAP-A assembly includes one user-specified H2O-CAP size); individual headcaps can be used to add to or replace the included cap.

- **RX-H2O-ELECT Replacement Water Electrode Pack**

Replacement pack of 100 water electrode strips for the Mobita EEG system. These small strips of absorbent material must be rolled up and inserted into the electrode cavity and placed on the EEG cap prior to recording. The Mobita wearable physiological signal amplifier system records 32 channels of high-fidelity wireless EEG data and includes 100 water electrode inserts. This pack of 100 strips can be used for additional subjects.

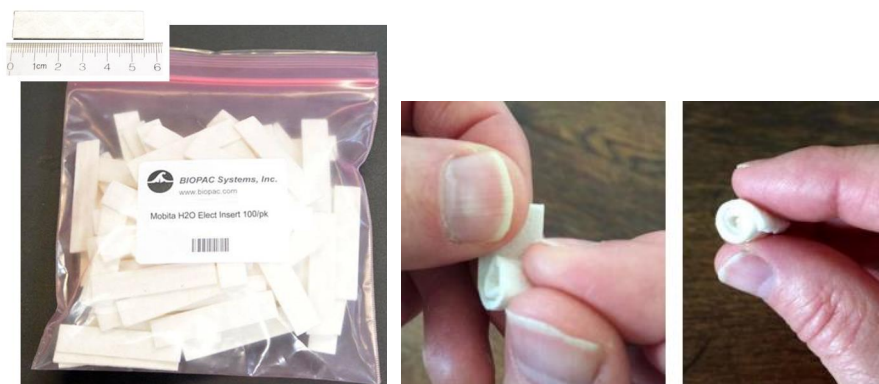

- **MB-20EEG-CAP-B EEG 10/20 + 13 TP Adapters**



The MB-20EEG-CAP-B is a complete assembly for the Mobita wearable biopotential system that interfaces with a 10/20 electrode cap and 1.5 mm Touchproof sockets for adding additional signals.

This combination interface allows for a full 10/20 EEG, plus optional biopotential signals for EOG, EMG, and ECG. Snap the assembly to the Mobita unit and attach the cap to a subject to record 32 channels of data for either in laboratory telemetry or remote data logging applications.

- **MB-12+20-CAP 12 Surface Electrodes + 20 TP Adapters**



The MB-12+20-CAP is a complete assembly for the Mobita wearable biopotential system that interfaces with 12 snap fit electrode leads and 20 Touchproof (1.5 mm) sockets. Record 32 channels of biopotential data using a variety of electrode configurations including both disposable and reusable options. Connect to the Mobita and the subject and record up to 32 channels of data for either in laboratory telemetry or remote data logging applications.

Breakout boxes are available. Contact [BIOPAC](http://www.biopac.com) for more information.

GPSTRACK GPS LOCATION SYNCHRONIZATION

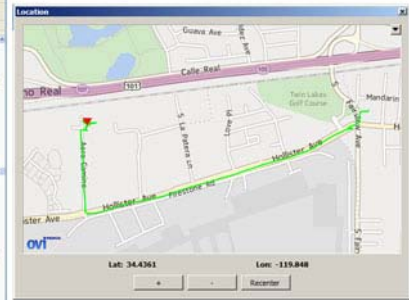
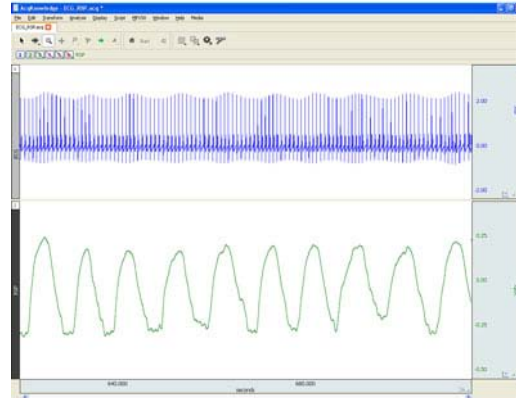

Use this GPS tracking device with *AcqKnowledge* to import and synchronize a subject's physical location with experiment data.

- Record GPS data for a moving subject in a wide area
- Operating time ~20 hours ... rechargeable batteries & USB included
- GPS Location for correlating physical location with physiological data
- Use *AcqKnowledge* to import and synchronize a subject's physical location with physiological data from the Mobita and BioHarness loggers
- Compatible with the Location Palette in *AcqKnowledge* 4.4

Specifications

GPS

Chipset:	SiRF Star III high performance low power GPS receiver
IC Frequency:	L1 1,575.42 MHz
Channels:	20 parallel tracking channels
GPS Tracking Sensitivity:	- 158 dBm
Protocol:	NMEA 0183 GGA, GSA, GSV, RMC WAAS/EGNOS Support

Operating Time

~20 hours continuous operation (3 AAA 900 mAh rechargeable battery @ 25°C)

LED Indicators

Power On/Off:	Amber
GPS Fix:	Green
Memory Full:	Red

Data Log

Maximum log points:	1,040,000 (RMC), approximate 2,800 logging hours
Logging mode:	6 logging mode, can be set in device setting mode

General

Storage Capacity:	128 Mbytes (1 Gbit NAND flash memory)
Interface:	USB 2.0 full speed
Battery:	3 AAA standard size rechargeable batteries
Operating Temperature:	- 20 ~ 50° C
Storage Temperature:	- 30 ~ 80° C
Humidity:	95 % non-condensing
Dimension:	90 mm x 45 mm x 23 mm
Weight:	~ 50 g (not including battery)

GPSTRACK-A GPS TRACKER FOR ACQKNOWLEDGE

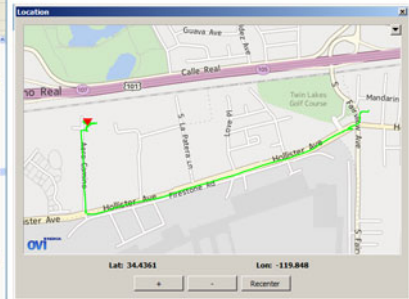
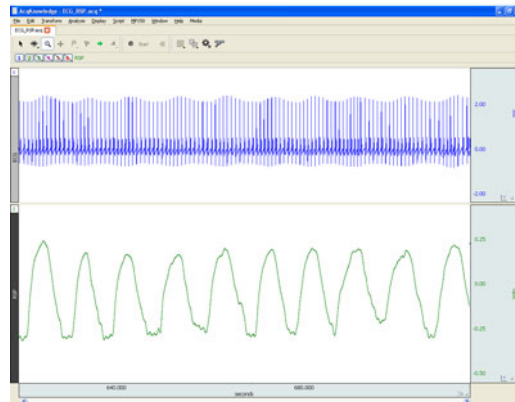

Use this portable GPS tracking device with *AcqKnowledge* to import and synchronize a subject's physical location with experiment data. Includes a USB micro SD card reader for easy interface with *AcqKnowledge*.

- Record GPS data for a moving subject in a wide area
- GPS Location for correlating physical location with physiological data
- Operating time ~24 hours ... built-in high-capacity Li-polymer battery
- Includes USB microSD reader, car charger, USB cable, carrying strap, protective case, documentation
- Use *AcqKnowledge* to import and synchronize a subject's physical location with physiological data from the BioNomadix Logger, Mobita, or BioHarness
- Compatible with the Location Palette in *AcqKnowledge* 4.4

Specifications

Product Specification:

Dimension: 43(L)x74(W)x9.9(H)mm
Weight: 55g
Volume: 32cc
Chipset: MTKII Super single chip
Channels: 66-channel all-in-view tracking
Frequency: 1575.42Mhz(L1, C/A code), built-in WAAS / EGNOS / MSAS Demodulator
Sensitivity: better than -165dBm
Fix Capability: 2D fix of 3 satellites, 3D of 4 satellites
Antenna Type: Built-in active antenna



Protocol:

NMEA Protocol Output: Ver 3.01
Baud Rate: 38,400 bps
Datum: WGS84
Update Frequency: 1 Hz (Default)
Data Bit: 8 Parity: N Stop bit: 1
Output Format: \$GGA, \$GSA, \$RMC, \$GSV

Logging Data:

Original Format: CSV file
Export Format: KMZ, GPX, NMEA, LOG
Standard Mode: Date, time, Latitude, Longitude, Altitude, Speed, Heading, and Voice.
Professional Mode: Date, Time, Latitude, Longitude, Altitude, Speed, Heading, Fix Mode, PDOP, HDOP, VDOP and Voice.

Voice Record Data:

Format: WAV
Rate: 48 kbps
Length Limit: no limited

Storage Card:

Type: MicroSD / T-Flash
Capacity: 64M, 128M, 256M, 512M, 1G, 2G, 4G
(Voice recording requires capacity above 512M)
Format: FAT (FAT16) files system

packing list:

- Multifunction GPS Data Logger Main Unit
- AC Adaptor* (Input: 110-250V)
- Car Charger (Input: 12V)
- Charging Cable (Support Auto ON/OFF Function 2 meters)
- Protective Case
- Carrying Strap
- USB MicroSD Reader*
- User Manual*
- Software CD*
- Warranty Card

* Optional Accessories, differences according to the different sales regions or version.



■ Time to First Fix:

Acquisition time (Averaged*1):
Reacquisition: <1 second
Hot Start: 1 second
Warm Start: 32 seconds
Cold Start: 35 seconds

■ Accuracy:

Non DGPS (Differential GPS):
3.0m/CEP(50%) 5.0m/CEP(95%)
With DGPS corrected (EGNOS / WAAS):
1.5m/CEP(30-50%) 2.5m/CEP(95%)
(with EPS2 technology)

■ Dynamic Condition:

Altitude Limit: 18,000 meters (60,000 feet) max
Velocity Limit: 515 meters/sec (1,000 knots) max
Acceleration Limit: 4G max
Jerk Limit: 20 m/sec
Minimal Data Resolution: 0.000001 degree
(Latitude, Longitude); 0.1km/h (Velocity); 0.1 Degree
(Direction); 0.1m (Altitude)
Data Format (Latitude, Longitude): dd.ddddd
(degree)

■ USB MicroSD Reader (optional):

Type: MicroSD / T-Flash, support SDHC
USB Type: USB 2.0

■ Power Supplies:

- Main Unit: Built-in rechargeable Lithium polymer battery with capacity (1000mAh)
The duration of V-900's built-in battery is dependent on your selected operating mode. The battery duration at different operating modes is as follows*2:

Navigation & Track Log Mode: 14 - 16 hours
Navigation Mode: 15 - 17 hours
Track Log Mode: 22 - 24 hours
Spy Mode: 15 - 30 days

- AC Adapter (optional):

Model: V-30AC
Input: AC100-240V, 50-60HZ, 11VA
Output: DC 5.0V, 600mA

- Car Charger:

Model: V-10DC
Input: DC 12V
Output: DC 5.0V, 1000mA

■ Operation:

Operation Temperature: -10°C to + 50°C
Store Temperature: -20°C to + 60°C
Operation Humidity: 5% to 95% (No condensing)

*1 The test environment shall be a place in open sky.

*2 Duration time is subject to the environment of use, operating mode, positioning status, and data format.

We reserve the right to make changes and improvements to any of the products described in this document without prior notice.

BIONOMADIX SERIES

The BioNomadix system is a wireless, multi-channel physiological recording platform. Its untethered design allows for nearly unlimited freedom of movement and unsurpassed comfort, enabling subjects to easily relax into their protocol. There are twelve different BioNomadix modules sets, each consisting of a matched transmitter and receiver specifically optimized for desired physiological signals. Multiple BioNomadix module sets (typically eight maximum) can be used to create a customized BioNomadix system.



Each BioNomadix module set is capable of recording of two independent channels, with the exception of the Accelerometer module, which records three channels.

BIONOMADIX TRANSMITTER AND RECEIVER SETS

BN-ACCL3	BioNomadix Accelerometer	BN-DYNEMG	BioNomadix Dynamometry and EMG
BN-ECG2	BioNomadix 2-Channel ECG	BN-EOG2	BioNomadix 2-Channel EOG
BN-EEG2	BioNomadix 2-Channel EEG	BN-NICO	BioNomadix Cardiac Output
BN-EGG2	BioNomadix 2-Channel EGG	BN-RSP2	BioNomadix 2-Channel Respiration
BN-EMG2	BioNomadix 2-Channel EMG	BN-RSPEC	BioNomadix RSP and ECG
BN-PPGED	BioNomadix PPG and EDA	BN-SKT2	BioNomadix 2-Channel Skin Temp
BN-GONIO	BioNomadix 2-Channel Goniometry	BN-STRIKE	BioNomadix 2-Channel Heel/Toe Strike

BioNomadix [BN-GYRO-75](#) and [BN-GYRO-300](#) Angular Rate Sensors are [discontinued items](#).

BIONOMADIX TRANSMITTER ONLY

BN-ACCL3-T	Accelerometer	BN-DYNEMG-T	Dynamometry and EMG
BN-ECG2-T	2-Channel ECG	BN-EOG2-T	2-Channel EOG
BN-EEG2-T	2-Channel EEG	BN-NICO-T	Cardiac Output
BN-EGG2-T	2-Channel EGG	BN-RSP2-T	2-Channel Respiration
BN-EMG2-T	2-Channel EMG	BN-RSPEC-T	RSP and ECG
BN-PPGED-T	PPG and EDA	BN-SKT2-T	2-Channel Skin Temp
BN-GONIO-T	Goniometry	BN-STRIKE-T	2-Channel Heel/Toe Strike

🔗 Click to view a [BioNomadix System Diagram](#).

BIONOMADIX LOGGER (BN-LOGGER) *Get the real-world data your application demands!*

BioNomadix Loggers wirelessly record physiological data as subjects freely and naturally live their lives—record from up to three dual-channel wearable BioNomadix Transmitters* plus a built-in accelerometer. Sync the BioNomadix Logger with GPS for a correlation between physiological and location data.

Use as a stand-alone system with *AcqKnowledge* or combine with BioNomadix Receivers and a computer running *AcqKnowledge*:



- Sync Transmitters to the Logger mode for remote data logging.
- Combine Transmitters with BioNomadix wireless Receivers to operate in the lab for real-time telemetry.

The compact Logger device provides a color display for visual feedback, speaker for auditory feedback, vibration for haptic feedback, voice journal for participant comments, event markers, and alarms. Includes micro-USB to USB cable for charging/data transfer, AC Charger and belt case.

* Existing BioNomadix devices require a firmware upgrade to be compatible with Loggers—see BN-TX-UPG online for details.

NOTE: BioNomadix Logger requires *AcqKnowledge* software version 4.4.1 or higher.

BioNomadix Logger Specifications

Weight: 121.2 grams	Transmitter: Ultra-low power 2.4 GHz bi-directional digital RF transmitter
Dimensions: 9.42 cm x 5.76 cm x 2.3 cm	Rate: 2 kHz, maximum
Screen: Color, 6 cm diagonal	RF reception range: 1 meter (line of sight, approx.)
Memory: 32 GB	Charger: Integrated USB charger with AC wall adapter BN-LOG-CHRG
Battery: 1800 mAh Lithium-ion	Compliance: FC, CE, IC, VCCI -FCC Part 15 B FCC ID: ZWIBNXT1, IC: 9901A-BNXT1
Operating time: 24 hours (recording)	Built-in Accelerometer: X, Y, Z – axes; rate 100-400 Hz; Range: ±2-16 G
Time to full charge: ~12 hours	

➔ Click to view a [BioNomadix Logger System Diagram](#).

BIONOMADIX ELECTRODE LEAD SET (use with wireless and Smart Amplifiers)

BN-EL15-LEAD2	Electrode Lead 2 x 15 cm to BioNomadix or 100D Smart Amps
BN-EL15-LEAD3	Electrode Lead 3 x 15 cm to BioNomadix or 100D Smart Amps
BN-EL30-LEAD2	Electrode Lead 2 x 30 cm to BioNomadix or 100D Smart Amps
BN-EL30-LEAD3	Electrode Lead 3 x 30 cm to BioNomadix or 100D Smart Amps
BN-EL45-LEAD2	Electrode Lead 2 x 45 cm to BioNomadix or 100D Smart Amps
BN-EL45-LEAD3	Electrode Lead 3 x 45 cm to BioNomadix or 100D Smart Amps
BN-EL50-LEAD2	Electrode Lead 2 x 50 cm to BioNomadix BN-NICO
BN-EL50-LEAD4	Electrode Lead 4 x 50 cm to BioNomadix BN-NICO
BN-EDA-LEAD2	EDA Electrode Lead 2 x 15 cm to BioNomadix BN-PPGED or Smart Amplifier EDA100D
BN-EDA25-LEAD2	EDA Electrode Lead 2 x 25 cm to BioNomadix BN-PPGED or Smart Amplifier EDA100D
BN-ADAPT-2	Adapter 2 x 10 cm for connecting 1.5 mm Touchproof leads to BN Transmitter
BN-ADAPT-3	Adapter 3 x 10 cm for connecting 1.5 mm Touchproof leads to BN Transmitter

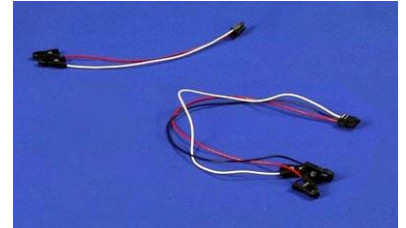

BIONOMADIX TRANSDUCERS (use with wireless and Smart Amplifiers)

BN-PULSE-XDCR	Pulse Transducer for BioNomadix BN-PPGED or Smart Amplifier PPG100D
BN-PULSEEAR-XDR	Pulse Earclip Transducer for BioNomadix BN-PPGED or Smart Amplifier PPG100D
BN-RESP-XDCR	Respiration Transducer for BioNomadix BN-RSP2, BN-RSPEC, or Smart Amplifier RSP100D
BN-TEMP-A-XDCR	Skin Temp Skin Transducer for BioNomadix BN-SKT2 or Smart Amplifier SKT100D
BN-TEMP-B-XDCR	Fast-Response Temp Transducer for BioNomadix BN-SKT2 or Smart Amplifier SKT100D
BN-STRIKE-XDCR	Heel-Toe Strike Transducer for BioNomadix BN-STRIKE
BN-GON-110-XDCR	Twin-axis Goniometer Transducer for BioNomadix BN-GONIO
BN-GON-150-XDCR	Twin-axis Goniometer Transducer for BioNomadix BN-GONIO
BN-TOR-110-XDCR	Single-axis Torsiometer Transducer for BioNomadix BN-GONIO
BN-TOR-150-XDCR	Single-axis Torsiometer Transducer for BioNomadix BN-GONIO
BN-GON-F-XDCR	Single-axis Goniometer Transducer for BioNomadix BN-GONIO

BIONOMADIX ACCESSORIES

Straps

RXSTRAPBN-20	BioNomadix Strap 20 cm x 25.4 mm
RXSTRAPBN-33	BioNomadix Strap 33 cm x 25.4 mm
RXSTRAPBN-76	BioNomadix Strap 76 cm x 25.4 mm
RXSTRAPBN-137	BioNomadix Strap 137 cm x 25.4 mm

EEG Caps (for BN-EEG2)

BN-EEGCAP-SYS	BioNomadix 10/20 EEG Cap System
BN-CAP-SMALL	BioNomadix EEG Cap – Small (50-54 cm)
BN-CAP-MEDIUM	BioNomadix EEG Cap – Medium (54-58 cm)
BN-CAP-LARGE	BioNomadix EEG Cap – Large (58-62 cm)

Chargers

BN-BAT-CHRG for Transmitters, – *full charge lasts 72-90 hours, full charge in approximately 1 hr.*
 BN-LOG-CHRG for Loggers – *full charge lasts 24 of operation with 30 days stand-by, full charge in approximately 12 hours. Both chargers provide a lifespan of 500 charge/discharge cycles—or 35,000 hours!*

BIONOMADIX SHIRT (BN-SHIRT)



Use this stretch mesh shirt to comfortably hold multiple devices in place when subjects will have several BioNomadix transmitters attached to their body—wear as is or under clothing. Pockets hold the transmitter and have reinforced access slots to pass leads through for connection, plus zippers add easy access to attachment sites. Select size so the shirt is worn tight to hold the BioNomadix transmitter and sensors in place.

The BioNomadix shirt provides a greater degree of comfort and mounting flexibility for multi-sensor studies.

The shirt allows the subject to wear the devices in natural and well balanced positions for long-term physiological studies exercise regimes. This natural, unhindered environment significantly improves the quality of the data, and makes it much easier for subjects to respond naturally. Available sizes, extra small, small, medium, large, and extra large (see sizing dimensions below).

- **22 pockets:** 2 neck front, 2 neck back, 4 chest center, 4 back center, 2 hip front, 2 hip back, 3 left arm , 3 right arm
- **4 zippers:** right front from arm to hip, left back from shoulder to hip, right and left under arm from neck front to neck back
- **4 strap bands:** 4 rows of strap bands (2 loops front, 2 loops back) for RSP transducer strap

BIONOMADIX SHIRT SIZING

	BN-SHIRT-XS	BN-SHIRT-S	BN-SHIRT-M	BN-SHIRT-L	BN-SHIRT-XL
Front: Chest	38.7 cm (15.25")	40.6 cm (16")	42.5 cm (16.75")	47.6 cm (18.75)	52.7 cm (20.75")
Front: Waist	29.2 cm (11.5")	31.8 cm (12.5")	34.3 cm (13.5")	39.4 cm (15.5")	43.8 cm (17.25")
Front: Hip	28.6 cm (11.25")	30.5 cm (12")	33 cm (13")	38.1 cm (15")	43.8 cm (17.25")
Back: Chest	44.5 cm (17.5")	47.6 cm (18.75")	48.9 cm (19.25")	53.3 cm (21")	60.3 cm (23.75")
Back: Waist	36.5 cm (14.375")	39.4 cm (15.5")	45.7 cm (18")	45.7 cm (18")	51.4 cm (20.25")
Back: Hip	36.2 cm (14.25")	39.4 cm (15.5")	45.7 cm (18")	45.7 cm (18")	51.4 cm (20.25")
Back: Length	61 cm (24")	62.2 cm (24.5")	64.8 cm (25.5")	67.9 cm (26.75")	71.1 cm (28")

BIONOMADIX BIOSHIRT (BN-BIOSHIRT)



Smart shirt simultaneously acquires ECG and Respiration data while subjects roam freely

The lightweight, comfortable BioNomadix BioShirt contains a respiration sensor and fabric electrodes to wirelessly record both respiration and ECG while ambulatory subjects move freely and perform tasks in short or long-term studies, in the lab, or in the real world. The shirt connects to a wireless BioNomadix [BN-RSPEC Respiration & ECG Transmitter](#) placed in a small pocket on the front of the BioShirt—no electrodes, gels, or wires to fuss over. Transmit data to either a stand-alone BioNomadix [Smart Center, Logger](#) or an [MP160/150 System](#) with matched BioNomadix Receiver module.

[BioNomadix wireless recording](#) and [AcqKnowledge software](#) provide a powerful, complete solution that supports advanced analysis for [applications](#) and [measurements](#) for a variety of physiological parameters, including: Heart rate, respiration rate, Heart rate variability (HRV), Respiratory Sinus Arrhythmia (RSA), etc.

Combine with the [Logger](#), [GPS tracker](#), and other wireless sensing devices for comprehensive analysis of your subject’s experience. The Logger’s accelerometer can provide activity information, the GPS will provide a history of a subject’s movements.

Sized separately for men and women, for a snug fit below the bust to maintain sensor contact.

BIOSHIRT SPECIFICATIONS

Attachment Features:	Single-pocket Smart Shirt holds BN-RSPEC Transmitter (Respiration and ECG), woven-in fabric electrodes	
Materials:	76% Nylon/Polymid, 23% Elastane, 1% Polyester	
Sizes: (M = Male, F = Female)	BN-BIOSHIRT-MS 76-82 cm (29.9-32.2")	BN-BIOSHIRT-FXS 65-69 cm (25.5-27.1")
	BN-BIOSHIRT-MM 83-89 cm (32.6-35.0")	BN-BIOSHIRT-FS 69-73 cm (27.1-28.7")
	BN-BIOSHIRT-ML 90-96 cm (35.4-37.8")	BN-BIOSHIRT-FM 73-77 cm (28.7-30.3")
	BN-BIOSHIRT-MXL 97-103 cm (38.2-40.5")	BN-BIOSHIRT-FL 77-81 cm (30.3-31.9")
	BN-BIOSHIRT-MXXL 104-110 cm (40.9-43.3")	BN-BIOSHIRT-FXL 81-85 cm (31.9-33.5")
	BN-BIOSHIRTM3XL 111-117 cm (43.7-46.0")	BN-BIOSHIRT2XL 85-89 cm (33.5-35.0")
	BN-BIOSHIRT4XL 118-124 cm (46.4-48.8")	BN-BIOSHIRT3XL 89-93 cm (35.0-36.6")
		BN-BIOSHIRT4XL 93-97 cm (36.6-38.1")
Care Instructions:	Wash separately, line dry, no fabric softener	

SETUP OVERVIEW

1. Setup the BioNomadix transmitter with subject.
2. Setup the BioNomadix receiver.
3. Setup the software.



HARDWARE SETUP

Transmitter and Receiver units are shipped as a matched pair and must always be used as a pair (see serial number and ID sync options). Up to 16 channels per BioNomadix system can be monitored simultaneously, returning data quality equal to standard BIOPAC MP modules. Normal operating range between transmitter and receiver is 10 meters line of sight in standard laboratory environments. For additional guidelines, see BioNomadix Operational Range and Characteristics on page 12.

BIONOMADIX TRANSMITTER

Setup

1. Connect the electrode lead set or transducer to the BioNomadix Transmitter module inputs. Squeeze lock connector and push until it clicks into place. CH A and CH B require an appropriate lead set or transducer based on signal type.
2. Attach electrodes and electrode leads or transducer to the Subject Position.
3. Secure the Transmitter module on Subject, (i.e. with a strap, or inside a BioNomadix shirt pocket).
 - For optimum results, the BioNomadix Custom Sport Shirt or BioShirt is recommended. This specially-designed shirt is made of a lightweight material with numerous “pockets” for housing multiple transmitters. The BioNomadix Shirt incorporates zippered openings for positioning electrode leads properly. The BioNomadix BioShirt has one pocket for use with a BN-RSPEC (Respiration and ECG) Transmitter and “smart” electrodes woven into the fabric.
4. Set the power switch on the BioNomadix Transmitter to ON. The Status light will flash sequences based upon connectivity and battery life.
5. Double blinks occurring every two seconds indicate successful pairing and normal operation between transmitter and receiver.

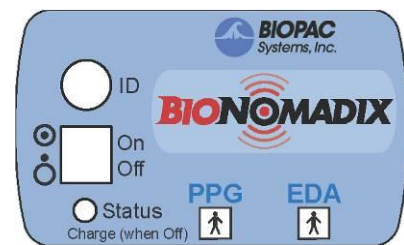

CONTROLS

ID: Press to illuminate Status light of matching Receiver unit.

On/Off: Power switch for the transmitter. The transmitter power must be turned OFF for charging.

Status: Solid amber when battery power is low. Approximately one hour of operation remains after light turns amber, full-charge with BN-BAT-CHRG battery charger typically requires one hour.

Channels: Connect the electrode leads to the matched BioNomadix Transmitter module inputs. (Squeeze lock connector and push until it clicks into place).

BIONOMADIX RECEIVER

BEFORE BEGINNING:

- Decide whether one or both available channels will be used. (If using only one channel, set “**A**” to ON and “**B**” to OFF.)
- Decide which channel bank will be used and select “**X**” or “**Y**.”
- Set channel slider to correct position.
- Attach Receiver unit to the right side of the MP160/150 unit, or the left side of the IPS100C. The Status light will turn green when communicating with transmitter. As with standard BIOPAC hardware, additional modules can be attached to the receiver.
- Set desired channel options on the Receiver module.

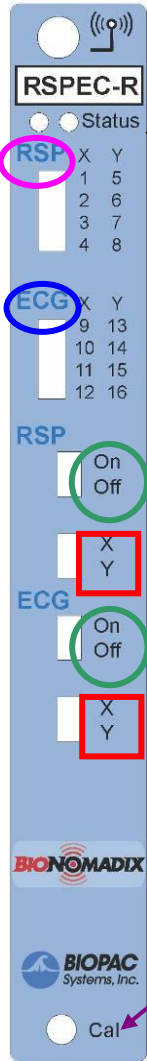

The **RSPEC** Receiver unit is depicted, but controls operate similarly for all units.

 Wireless antenna input

Receiver LED: Steady green when paired with transmitter. Blinks amber once per second when communication is interrupted.

Input Signals: **A** = ● **B** = ●

“**A**” Assigns the input signals for channels 1-8.

“**B**” Assigns the input signals for channels 9-16.

On/Off ●

Enables or disables module channels: “**A**” channels 1-8 “**B**” channels 9-16.

X/Y channel banks ■

Selects between “X” channel bank or “Y” channel bank.

“**A**” X bank is 1-4, Y bank is 5-8.

“**B**” X bank is 9-12, Y bank 13-16.

NOTE: “**A**” or “**B**” banks that are turned off will free up those associated Analog channels for use by other signal types.

Cal: Recessed Calibration button. **NOTE:** Calibration is not required, most users can use factory presets. Calibration is an advanced procedure.

TRANSMITTER BATTERY LIFE

Transmitter battery life is described below as a change of color in the sequence of LED flashes.

LED Color Pattern				Charge %
green	green	green	green	75% - 100%
yellow	green	green	green	50% - 75%
yellow	yellow	green	green	25% - 50%
yellow	yellow	yellow	green	5% - 25%
yellow	yellow	yellow	yellow	< 5%

IMPORTANT: *If the transmitter is to be stored for prolonged periods, it is strongly recommended that the battery be fully charged and the transmitter turned off prior to storage. Failure to do so may result in permanent damage to the battery.*

SOFTWARE SETUP

Recording data with AcqKnowledge software

After completing setup, click Start in the AcqKnowledge software to begin recording data.

If the paired signal is interrupted due to electrical interference or a subject wandering out of range, the most recently-acquired data point will be retained, with normal acquisition continuing once communication is reestablished. See also: [BioNomadix Operational Range and Transmission Characteristics](#).

FULL BIONOMADIX MODULE SPECS

Table 1: BioNomadix Dual Biopotential Pairs – See Table 2 for Dual Transducer, Table 3 for Combo Pairs, and Table 4 for Accelerometer

BioNomadix Pair	BN-ECG2	BN-EEG2	BN-EGG2	BN-EMG2	BN-EOG2
Signal type:	Dual Channel ECG	Dual Channel EEG	Dual Channel EGG	Dual Channel EMG**	Dual Channel EOG
Bandlimits Max: Factory preset: Filter options:	0.05 Hz to 150 Hz 1 Hz to 35 Hz 0.05 or 1 Hz HP, 35 or 150 Hz LP	0.1 Hz to 100 Hz 0.5 Hz to 35 Hz 0.1 or 0.5 Hz HP, 35 or 100 Hz LP	0.005 Hz to 1.0 Hz 0.005 Hz to 1.0 Hz 0.005 Hz HP, 1 Hz LP	5 Hz to 500 Hz 10 Hz to 500 Hz 5 or 10 Hz HP, 250 or 500 Hz LP	0.005 Hz to 100 Hz 0.005 Hz to 35 Hz 0.005 or 1 Hz HP, 35 or 100 Hz LP
Alternative signal:	Heart Rate Mode	Delta, Theta, Alpha, Beta		Envelope Detection Mode	Derivative Mode
Notch filter:	50/60 Hz user-controlled switch; typically not required—factory preset OFF. See Appendix for more hardware-specific output options.				
Noise Voltage (shorted inputs):	0.9 µV rms (bandwidth of 0.05 Hz to 150 Hz)	0.2 µV rms (bandwidth of 0.10 Hz to 100 Hz)	0.5 µV rms (bandwidth of 0.005 Hz to 1 Hz)	1.5 µV rms (bandwidth of 1.0 Hz to 500 Hz)	0.9 µV rms (bandwidth of 0.005 Hz to 100 Hz)
Input Voltage Range:	up to 10 mV P-P	up to 2 mV P-P	up to 10 mV P-P	up to 10 mV P-P	up to 10 mV P-P
Output Voltage Range:	±10 V (receiver output)				
CMRR	110 dB typical at 50/60Hz; 90dB minimum for ECG, EEG, EMG, and EOG, 100 db minimum for EGG				
CMII	1000 MΩ (50/60 Hz)				
Differential Input Impedance:	2 MΩ				
Fixed Gain:	2,000	10,000	2,000	2,000	2,000
Operating Time:	72-90 hours				
Included strap:	137 cm - BN-STRAP137	76 cm - BN-STRAP76	137 cm - BN-STRAP137	33 cm - BN-STRAP33	76 cm – BN-STRAP76
Size Weight:	Transmitter (approx.): 6 cm x 4 cm x 2 cm; 54 grams; Receiver (approx.): 4 cm x 11 cm x 19 cm; 380 grams				
Input:	See BioNomadix electrode lead cable options (BN-ELxx-LEADx). Each biopotential transmitter requires at least one GND. To eliminate redundant biopotential GND, use a 3-lead electrode lead cable for one input (CH A or B) and a 2-lead electrode lead cable for the other input (CH A or B) on each BioNomadix transmitter. Use BN-ADAPT-TP2/3 for Touchproof connections, including BN-EEGCAP-SYS.				

****NOTE for BN-EMG2:** Due to digital data buffering and wireless transmission factors (large fixed component (15.6 ms) and small variable component (±0.5 ms rms), the BN-EMG2 module is not recommended for applications such as Nerve Conduction Velocity or any physiological signal where equivalently small timing differences are being measured. For these types of studies, BIOPAC recommends the wired [EMG100C](#) amplifier.

Table 2: BioNomadix Dual Transducer – See Table 1 for Biopotentials, Table 3 for Combo Pairs, and Table 4 for Accelerometers

BioNomadix	BN-SKT2	BN-RSP2	BN-GONIO	BN-STRIKE
Signal type:	Dual Channel SKT <i>temp</i>	Dual Channel RSP <i>resp</i>	Dual Channel Goniometry	Dual Channel Strike Data
Bandlimits/Max:	DC to 10 Hz	DC to 10 Hz	DC to 100 Hz	DC to 100 Hz
Factory preset:	DC to 1 Hz	DC to 1 Hz	DC to 10 Hz	DC to 10 Hz
Filter Options:	DC, 0.5 Hz HP, 1 or 10 Hz LP	DC, 0.5 Hz HP, 1 or 10 Hz LP	DC, 3 Hz, 10 Hz, or 100 Hz LP	DC, 3 Hz, 10 Hz, or 100 Hz LP
Notch filter:	50/60 Hz user-controlled switch; typically not required—factory preset OFF. See Appendix for additional hardware-specific output options.			50/60 Hz user-controlled switch – factory preset OFF
Resolution:	0.01° C (rms)	FSR/4096; (4.88 mV)	0.01° rotation (rms)	N/A
Signal range:	13 to 51° C	± 10 V (at output)	± 180°	± 10 V (at output)
Output Voltage range:	± 10 V (receiver output)			
Operating time:	72-90 hours			
Included strap:	137 cm - BN-STRAP-137	137 cm - BN-STRAP-137	76 cm - BN-STRAP-76 & BN-STRAP-33	33 cm - BN-STRAP-33
Input:	BN-TEMP-A/B-XDCR	BN-RESP-XDCR	BN-GON-110-XDCR BN-GON-150-XDCR BN-GON-F-XDCR BN-TOR-100-XDCR BN-TOR-150-XDCR	BN-STRIKE-XDCR

BN-ADAPT-GONIO

This adapter connects goniometers and torsionometers to a wireless BN-GONIO Transmitter, use one adapter per channel.

BioNomadix goniometers and torsionometers include the required BN-ADAPT-GONIO adapter(s):

- Two adapters included with BN-GON-110-XDCR and BN-GON-150-XDCR goniometers
- One adapter included with BN-GON-F-XDCR finger goniometer and BN-TOR-110-XDCR and BN-TOR-150-XDCR torsionometer

Adapters can also be used with existing BIOPAC or 3rd-party goniometers and torsionometers to make them compatible with the BioNomadix wireless transmitter. These adapters are required if not using BioNomadix Transducers.

Table 3: BioNomadix Combo Pairs – See Table 1 for Biopotentials, Table 2 for Dual Transducer and Table 4 for Accelerometer

BioNomadix	BN-RSPEC	BN-PPGED	BN-NICO	BN-DYNEMG
Signal type:	RSP plus ECG	PPG plus EDA	Z and dZ/dt	Dynamometry plus EMG
Excitation:	--	--	Type: Alternating current sine wave Current: 1 mA rms Frequency: 50 kHz	--
BandlimitsMax: Factory preset: Filter Options:	Respiration (CH A): see BN-RSP2 spec ECG (CH B) : see BN-ECG2 spec	Both: DC to 10 Hz: PPG: 0.5 Hz to 3 Hz EDA: DC to 3 Hz Both: DC, 0.5 Hz HP, 3 or 10 Hz LP EDA: 1 Hz LP	Both: DC to 50 Hz* Both: DC to 50 Hz* DC, 1, 3, 5, 50 Hz* LP *Units shipped before 11/2016 are bandlimited to 10 Hz.	Dyn: DC 100 Hz Dyn: DC to 10 Hz Dyn: DC, 3 Hz, 10 Hz, or 100 Hz LP EMG: see BN-EMG2 specs
Notch filter:	50/60 Hz user-controlled switch; typically not required—factory preset OFF. See Appendix for additional hardware-specific output options.			
Resolution:	see BN-RSP2 and BN-ECG2 specs	PPG: FSR/4096; (4.88 mV) EDA: 0.012 μS (min step)	Z: nominally ~0.05 Ω (rms) at 10 Hz BW dZ/dt: ~0.0075 Ω/sec (rms) at 10 Hz BW	Dyn: 35 micro kg-f/cm2 (0.0005 psi) (rms) EMG: see BN-EMG specs
Signal range:	see BN-RSP2 and BN-ECG2 specs	PPG: ±10 V (at output) EDA: 0 to 50 μS; <i>excitation</i> : 0.5 V constant V	Z: 5 to 100 Ω (mag) dZ/dt: ±10 Ω/sec	Dyn: 0 – 1.055 kg-f/cm2 EMG: up to 10 mV P-P
Output Voltage range:	± 10 V (receiver output)			
Operating time:	72-90 hours	24 hours	24 hours	75 hours
Included strap:	137 cm - BN-STRAP137	33 cm - BN-STRAP33	137 cm - BN-STRAP137	33 cm - BN-STRAP-33
Input:	CH A: BN-RESP-XDCR CH B: BN-ELxx-LEAD3	CH A: BN-PULSE-XDCR or BN-PULSEEAR-XDR CH B: BN-EDA-LEAD2 or BN-EDA25-LEAD2	2 x BN-EL50-LEAD4 (or 2 x BN-EL50-LEAD2)	CH A: BN-CLENCH-XDCR CH B: BN-ELxx-LEAD3

Table 4: BioNomadix Accelerometer– See Table 1 for Biopotentials, Table 2 for Dual Transducer, and Table 3 for Combo Pairs

BioNomadix	BN-ACCL3
Signal type:	G (X, Y, Z)
Bandlimits <i>Max:</i> <i>Factory preset:</i> <i>Filter Options:</i>	±2, ±4, ±8 or ±16 G ± 16 G at 400 Hz LP DC to 3.13 Hz LP up to 400 Hz LP (in power of 2 steps)
Alternative signal:	Tap Event Mark Mode (<i>replaces</i> G)
Resolution:	X: 5 mg rms, Y: 6 mg rms, Z: 9 mg (rms) (±2 G scale at 400 Hz LP)
Signal range:	<i>Selectable:</i> ±2, ±4, ±8 or ±16 G
Output Voltage range:	±10 V (receiver output)
Operating time:	72-90 hours
Included strap:	33 cm - BN-STRAP33
Input:	Attach BioNomadix transmitter to subject – no additional hardware input required; sensor is internal to transmitter.

Table 5: Common Specs

Operational Range:	10 meters (line-of-sight) typical in standard laboratory setups. See also: <i>Operational Range and Characteristics</i> .
Delay:	Large fixed component (15.6 ms) and small variable component (±0.5 ms rms)
Operating Temp Humidity:	Temperature: 5-45° C Humidity: 95% non-condensing
Size Weight:	Transmitter: (approx.): 6 cm x 4 cm x 2 cm: 54 grams Receiver: (approx.): 4 cm x 11 cm x 19 cm: 380 grams
Transmitter:	Type: Ultra-low power, 2.4 GHz bi-directional digital RF transmitter Rate: 2,000 Hz (between transmitter and receiver)
Receiver Power:	Use with an MP Research System or with isolated power supply IPS100C for 3rd-party data acquisition system.
Battery Charger:	BioNomadix transmitters use an L-ion battery: full charge takes approx. 1 hour to provide maximum operating time. A battery charger is included with each module pair. See BN-CHRG for charge time and recharge cycle details.
Compliance:	FCC, CE, IC,  - FCC Part 15 B - FCC ID: receiver: ZWIBNXR1, transmitter ZWIBNXT1 IC: receiver: 9901A-BNXR1, transmitter: 9901A-BNXT1

BIONOMADIX ELECTRODE LEADS

All BioNomadix electrode leads use lightweight, insulated tinsel wire 1.25 mm OD with female mini-pinch clips and squeeze lock connectors

2-LEAD BIONOMADIX ELECTRODES LEADS (also for biopotential Smart Amplifiers)

- Lead wires: 2 (red and white)
- Electrode clips: 2
- Length: BN-EL15-LEAD2: 15 cm, BN-EL30-LEAD2; 30 cm, BN-EL45-LEAD2; 45 cm
- Interface: Secondary channel lead for the following BioNomadix Transmitters: BN-ECG2, BN-EEG2, BN-EGG2, BN-EMG2, BN-EOG2, (*first channel lead should be a BN-ELxx-LEAD3 three lead set to establish ground*). *Do not use for EDA or NICO!*

2-LEAD FOR NICO – BN-EL50-LEAD2

- Lead wires: 2 (insulated leads black)
- Electrode clips: 2 (alligator clips with teeth)
- Length: 50 cm
- Interface: NICO CH A or CH B

To eliminate redundant ground leads for biopotentials, use 3-lead for primary input and 2-lead for secondary input for each BioNomadix unit.

3-LEAD BIONOMADIX ELECTRODES LEADS (also for biopotential Smart Amplifiers)

- Lead wires: 3 (red, white and black)
- Electrode clips: 3
- Length: BN-EL15-LEAD3; 15 cm, BN-EL30-LEAD3; 30 cm, BN-EL45-LEAD3; 45 cm
- Interface: Primary and secondary channel lead for the following BioNomadix Transmitters: BN-ECG2, BN-EEG2, BN-EGG2, BN-EMG2, BN-EOG2. *Do not use for EDA or NICO!*

4-LEAD BIONOMADIX ELECTRODE LEADS

- Leads: 4 (red x 2 and white x 2)
- Electrode clips: 4
- Length: BN-EL50-LEAD4; 50 cm
- Interface: designed for BN-NICO: CH A or CH B (can be used with other BioNomadix biopotential transmitters)
- Connection: See diagram (right) for BN-EL50-LEAD4 leads and EL500 paired spot electrodes.

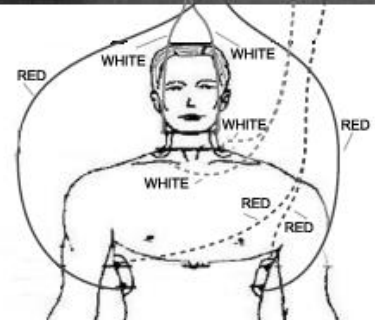

EDA BIONOMADIX ELECTRODE LEADS (also for Smart Amplifier EDA100C)

- Leads: 2 (red and black)
- Electrode clips: 2
- Length: BN-EDA-LEAD2; 15 cm, BN-EDA25-LEAD2; 25 cm
- Interface: Only use in CH B EDA on wireless BioNomadix Transmitter BN-PPGED

BIONOMADIX TO TOUCHPROOF ADAPTERS

- Leads: 2 (red and white, BN-ADAPT-2) **or** 3 (red, white and black, BN-ADAPT-3)
- Electrode clips: 2 (BN-ADAPT-2) **or** 3 (BN-ADAPT-3)
- Length: 10 cm
- Interface: Use these adapters to connect 1.5 mm Touchproof electrodes to a BioNomadix transmitter.

BIONOMADIX OPERATIONAL RANGE AND TRANSMISSION CHARACTERISTICS

The BioNomadix system is a very low power transmission system designed for physiological measurements in a laboratory setting. In this explanation, a BioNomadix transmitter is referred to as series BN-Tx and a BioNomadix receiver as series BN-Rx.

Primary design objectives for the BioNomadix system:

- 1) BN-Tx and BN-Rx units to emulate operation, as if “attached by cable”
- 2) Transmission effects not to disturb physiological source
- 3) Classification subject to class B digital device pursuant to FCC part 15
- 4) Long BN-Tx operational time, after recharge
- 5) Quick recharge time, under one hour
- 6) Bn-Tx units to be as lightweight, rugged and small as possible
- 7) Minimal user setup required, simply power up and start collecting data

BioNomadix Operational Range and Characteristics

A primary objective of the BioNomadix System is that it cannot behave in a fashion that would permit any arbitrary time delay between transmitter and receiver. This objective is critical for the BioNomadix System because it insures robust time synchronization between any BN-Tx units and external hardware. Because of the requirement to “behave as though a cable connects BN-Tx and BN-Rx”, the BioNomadix System required a special and optimized protocol to insure the best possible attempts to send data, within a limited (10 sample) time frame. If data could not be sent within this time frame, then data would be replaced with the last data value sent for a short time period (for up to about one second) thereafter until finally, assuming a reconnect was not possible, the transmitted data (not received) will be identified as null (zero) values.

The BioNomadix System operational transmission range is 10 meters line-of-sight, typical, in standard laboratory environments. Operational range can vary depending on factors such as presence of electromagnetic interference, multi-path, or radio frequency signal blocking. In the event of a communications failure, BioNomadix Tx and Rx modules will attempt to re-establish communications until such communications can be re-established.

BioNomadix Tx are purposely kept at very low power so as not to disrupt the sensitive biophysical parameter measured, to enhance battery life, and to satisfy the relevant FCC regulations. If a BN-Tx and BN-Rx pair is used outside of the laboratory (without the benefit of multi-path) and if the BN-Tx is line-of-sight blocked from the BN-Rx, then communication dropouts are increasingly likely. A functional solution is to keep the BN-Tx and BN-Rx in constant line-of-site view.

BioNomadix signal performance is best with “line-of-sight” connection from transmitter unit to receiver unit. Signal dropouts happen when a conductive surface (metal or human body) is placed between the transmitter and receiver unit. If this happens, and there are no other radio frequency reflective surfaces in the room, then the radio waves can’t get from transmitter unit to receiver. This phenomenon is referred to as “body-blocking.” The solution is to place the transmitter and receiver units closer together and to eliminate potential for body-blocking.

Case studies

Case 1: Multiple people wearing BioNomadix Tx units are walking around in a room and the BN-Rx units are placed in a nearby room. Periodically, when body blocking occurs, short signal dropouts are noted.

Solution 1: Place the BN-Rx units, with MP160/150, directly above the subjects in the room. This will greatly minimize the potential for body-blocking, from Tx unit to Rx unit, as subjects move around.

Case 2: Multiple people wearing BioNomadix Tx units are sitting in a room with a central table. The BioNomadix Rx units are placed in a nearby room. Periodically, when body blocking occurs, short signal dropouts are noted.

Solution 2: Mount the receiver (BN-Rx) units, with MP160/150, underneath the center of the table, around which the subjects are sitting. Mount a platform to the underside of the table and rest the receiver with MP160/150 on it. This situation places the receivers just one or two meters away from the transmitters attached to the subjects.

BioNomadix Transducers

Pulse BioNomadix Transducer BN-PULSE-XDCR

Emitter/Detector Wavelength: 860 nm ± 60 nm
Optical LP Filter Cutoff: 800 nm
The operational range of the emitter and detector falls within the wavelength range of 800 nm to 920 nm. The filter is placed over the receiver; the filter of 800 nm is an optical lowpass, so wavelengths longer than 800 nm will pass thru.
Nominal Output: 20 mV (peak-peak)
Power: 10 mA drive current
Sterilizable: Yes (contact BIOPAC for details)
Dimensions (L x W x H): 16 mm x 17 mm x 8 mm
Transducer Weight: 4.5 grams Cable: 45 cm
Interface: Use in CH A PPG on the BioNomadix BN-PPGED or with Smart Amplifier PPG100D

Pulse Earclip Transducer BN-PULSEEAR-XDR

Emitter/Detector Wavelength: 890 nm (nominal maximum)
Optical Low Pass Filter Cutoff: ambient visible light filter
The transducer operates with the BioNomadix Pulse Transmitter (BN-PPGED) and consists of a matched infrared emitter and photo-diode, which transmits changes in infrared reflectance resulting from varying blood flow.
Wavelength: 800-1,000 nm (70% spectral response)
Nominal Output: 20 mV (peak-peak)
Power: 10 mA drive current
Sterilizable: Yes (contact BIOPAC for details)
Dimensions (L x W x H): 16 mm x 17 mm x 8 mm
Transducer Weight: 4.5 grams Cable length: 80 cm
Interface: Use in CH A PPG on the BioNomadix BN-PPGED or with Smart Amplifier PPG100D

Respiration Transducer BN-RESP-XDCR

Response: True DC
Circumference Range: 15 cm x 150 cm (increase with a longer strap)
Dimensions: 66 mm (long) x 40 mm (wide) x 15mm (thick)
Weight: 18 grams
Sterilizable: YES: use standard gas sterilization techniques [i.e., Ethylene Oxide (EtO)]
Variable Resistance Output: 5 - 125 KOhm
Cable: 30 cm
Interface: BN-RSP2 CH A RSP or CHB RSP, BN-RSPEC CHA RSP, or Smart Amplifier RSP100D

Clench Force Transducer

Pressure Range:	0 to 1.0546 Kg-f/cm ² (0 to 15 psi)
Error Band:	± 2% full scale
Accuracy:	±25% full scale – best fit straight line
Output:	25 mV/0.01 Kg-f/cm ² (0.176 V/psi)
Bulb Diameter:	5.8 cm
Bulb Length:	11.1 cm
Weight:	108 grams
Cable Length:	45 cm
Interface:	Use with the BN-DYNEMG Dynamometer and EMG module

BN-CLENCH-XDCR**Heel-Toe Strike Transducer**

Nominal Output Range:	-1 to +1 Volt
Nominal Contact Force:	200 g to indicate heel-toe strike
Attachment:	TAPE 1, TAPE 2, vinyl electrical or duct tape
FSR Dimensions:	18.3 mm (dia) x 0.36 mm (thick) and 30 cm pigtail lead
FSR Active Area:	12.7 mm diameter
Interface:	BN-STRIKE transmitter (STRK A, STRK B)

BN-STRIKE-XDCR**Skin Temperature Transducer**

Nominal Resistance:	2252 ohm at 25° C
Maximum operating temperature:	60° C
Accuracy and Interchangeability:	0.2° C
Response Time:	1.1 sec (attached to skin)
Compatibility:	YSI series 400 temperature probes
Sterilizable:	NO (Not designed for immersion)
Cable:	30 cm
Dimensions:	9.8 mm (diameter) x 3.3 mm (high)
Interface:	BN-SKT2 only: CH A SKT and/or CH B SKT, or Smart Amplifier SKT100D

BN-TEMP-A-XDCR**Skin Temperature Transducer**

Nominal resistance:	2252 ohm @ 25° C
Maximum operating temperature:	60° C (when used with BN-SKT2)
Accuracy and Interchangeability:	0.2° C
Response Time:	0.6 sec (in air)
Compatibility:	YSI series 400 temperature probes
Sterilizable:	NO (Not designed for immersion)
Cable:	30 cm
Dimensions:	1.7 mm (diameter) x 5 mm (long)
Interface:	BN-SKT2 only: CH A SKT and/or CH B SKT, or Smart Amplifier SKT100D

BN-TEMP-B-XDCR (Fast Response)

Goniometer & Torsiometer Transducers BN-GON-XDCR, BN-TOR-XDCR, BN-GON-F-XDCR

Use with BN-GONIO Goniometry Module.

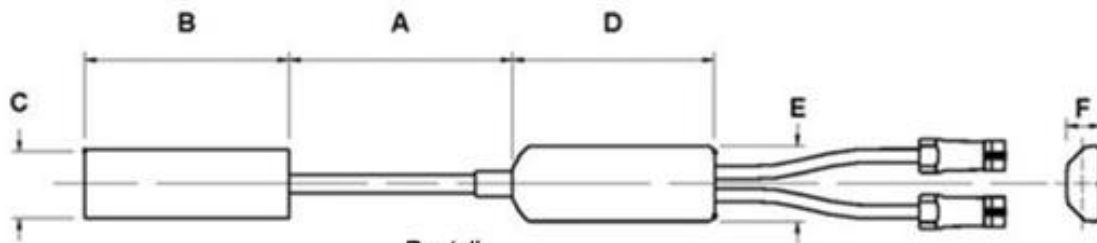

	Part #				
	BN-GON-110-XDCR	BN-GON-150-XDCR	BN-TOR-110-XDCR	BN-TOR-150-XDCR	BN-GON-F-XDCR
BioNomadix via BN-GONIO					
Number of channels	2	2	1	1	1
Measuring range	±150	±150	±150	±150	±150
Dimensions mm					
A. Maximum	110	150	110	170	35
A. Minimum	70	100	70	115	30
B.	60	70	60	70	18
C.	18	18	18	18	8
D.	54	54	54	54	15
E.	20	20	20	20	8
F.	9	9	9	9	5
Bend radius (mm) – min.	18	18	18	18	3
Weight (g)	23	25	22	23	8
Crosstalk¹	±5%	±5%	N/A	N/A	N/A
Nominal Output	5 µV/degree normalized to 1 V excitation				
Temperature Zero Drift	0.15 degrees angle / °C				
Cable length	6 m				
Endblock height	Cable end 9.4 mm, distal end 8.2 mm				
Transducer type	Strain gauge				
Life²	600,000 cycles minimum				
Accuracy	±2° measured over 90° from neutral position				
Repeatability	Better than ±1°				
Analog resolution	Infinite				
Operating temp range	+0° to +40° C				
Storage temp range	-20° C to +50° C				
Operating/Storage humidity range	30% to 75%				
Atmospheric pressure range					
Operation	700hPa to 1060hPa				
Storage	500hPa to 1060hPa				

¹ Specification of crosstalk for all Biometrics twin axis SG series goniometers is measured over ± 60°. i.e. if a joint is moved through 60° from the neutral position in one plane without movement in the orthogonal plane, then the sensor output in the orthogonal plane may change by a maximum ±3°.

² Life test results have been collected by cycling the sensors through movements that would happen during everyday use. For example, placing a sensor on an adult elbow and moving from the neutral position to maximum flexion and back to the neutral position, the unit will function for a minimum of 600,000 cycles.

BIONOMADIX ACCESSORIES SPECS

BioNomadix Shirt

Attachment Features: 22 pockets: 2 neck front, 2 neck back, 4 chest center, 4 back center, 2 hip front, 2 hip back, 3 left arm, 3 right arm
 4 zippers: right front from arm to hip, left back from shoulder to hip, right and left under arm from neck front to neck back
 4 strap bands: 4 rows of strap bands (2 loops front, 2 loops back) for RSP transducer strap

Materials: Black 6 oz. eyelet mesh 88% Polyester / 12% Spandex; metal zippers

Sizes: BN-SHIRT-XS extra small BN-SHIRT-L large
 BN-SHIRT-S small BN-SHIRT-XL extra large
 BN-SHIRT-M medium

Care instructions: Machine Wash, Warm / Line Dry

BioNomadix Strap

Dimensions: Length 20 cm, 33 cm, 76 cm, 137 cm (all widths 2.5 cm)
 Material: stretch Velcro® - hook/loop type
 Use with: BioNomadix Transmitters
 Length: RXSTRAP-BN-20; 20 cm RX-STRAP-BN-33; 33 cm
 RXSTRAP-BN-76; 76 cm RXSTRAP-BN-137; 137 cm

BioNomadix 10/20 EEG Cap System

Attachment: Ribbon cable (25 cm) from cap to 19 Touchproof (1.5 mm) sockets
 Material: Lycra
 Use with: BN-EEG2
 Lead adapters: BN-ADAPT-TP2 or BN-ADAPT-TP3 depending on sites to be recorded
 Sizes: BN-CAP-SMALL (50-54 cm,) BN-CAP-MEDIUM (54-58 cm,) BN-CAP-LARGE (58-62 cm)
 Components: 1 x medium cap with 19-pin ribbon cable
 1 x mating cable with 1.5 mm Touchproof connectors
 2 x earclip reference electrodes
 1 x blunt-tipped syringe
 1 x EEG recording gel
 1 x chest harness (holds cap in place)
 1 x liquid soap (to wash cap after use)

WHITE TIP	WIRE COLOR	RED TIP
Fp1	Brown	Fp2
F3	Red	F4
C3	Orange	C4
P3	Yellow	P4
01	Green	02
F7	Blue	F8
T3	Violet	T4
T5	Gray	T6
Gnd	White	Cz
Fz	Black	Pz

BioNomadix Battery Charger: BN-BAT-CHRG

To charge, the BioNomadix Transmitter must be in the OFF position and have no electrode leads or transducers attached.

Connector:	DC polarized squeeze-clip plug to mate with all BioNomadix Transmitters
Number of cells:	1 L-ion
Charger current	1000 mA (660 mA for IB-16800)
Current tolerance:	+10%
Voltage limit:	Preset
Voltage limit tolerance:	+0.2%
Operating temperature:	0° C to 40° C
Input voltage:	90 VAC to 240 VAC
Frequency	50 Hz to 60 Hz
Wall plug:	ships with US blades; adapters available for Euro, China or Australia
Output cable length:	1.7 meter (~6 feet)
Connector	DC polarized squeeze-clip plug to mate with all BioNomadix Transmitters
Weight:	142 grams (5 oz.)
Dimensions:	75 mm x 51 mm x 40 mm
Lithium Ion Chemistry	
Termination algorithm:	CCCV
Termination indicated	Current falls to limit value/5
Top-off charge:	1 hour or current falls to limit value/10
Restart threshold:	7/8 of termination voltage or every 2 hours
Maintenance charge:	N/A
Charge voltage limit:	Preset to 4.20 V (one L-ion cell)
Override timer:	None

IMPORTANT: *If the transmitter is to be stored for prolonged periods, it is strongly recommended that the battery be fully charged and the transmitter turned off prior to storage. Failure to do so may result in permanent damage to the battery. To avoid shortening battery life, it is also recommended that transmitter be disconnected from the charger prior to storing for long periods. For extremely long-term disuse, transmitter should be charged once a month, then disconnected between charge cycles.*

BIONOMADIX COMPLIANCE STATEMENT

This device complies with part 15 of the FCC Rules. Operation is subject to the following two conditions: (1) This device may not cause harmful interference, and (2) this device must accept any interference received, including interference that may cause undesired operation.

INDUSTRY CANADA INFORMATION

Under Industry Canada regulations, this radio transmitter may only operate using an antenna of a type and maximum (or lesser) gain approved for the transmitter by Industry Canada. To reduce potential radio interference to other users, the antenna type and its gain should be so chosen that the equivalent isotropically radiated power (e.i.r.p.) is not more than that necessary for successful communication.

This radio transmitter (IC: 9901A-BNXR1) has been approved by Industry Canada to operate with the antenna types listed below with the maximum permissible gain and required antenna impedance for each antenna type indicated. Antenna types not included in this list, having a gain greater than the maximum gain indicated for that type, are strictly prohibited for use with this device.

WLAN antenna, maximum gain 1.5 dBi, 50 ohm

This device complies with Industry Canada licence-exempt RSS standard(s). Operation is subject to the following two conditions: (1) this device may not cause interference, and (2) this device must accept any interference, including interference that may cause undesired operation of the device.

Conformément à la réglementation d'Industrie Canada, le présent émetteur radio peut fonctionner avec une antenne d'un type et d'un gain maximal (ou inférieur) approuvé pour l'émetteur par Industrie Canada. Dans le but de réduire les risques de brouillage radioélectrique à l'intention des autres utilisateurs, il faut choisir le type d'antenne et son gain de sorte que la puissance isotrope rayonnée équivalente (p.i.r.e.) ne dépasse pas l'intensité nécessaire à l'établissement d'une communication satisfaisante.

Le présent émetteur radio (IC: 9901A-BNXR1) de modèle s'il fait partie du matériel de catégorie I) a été approuvé par Industrie Canada pour fonctionner avec les types d'antenne énumérés ci-dessous et ayant un gain admissible maximal et l'impédance requise pour chaque type d'antenne. Les types d'antenne non inclus dans cette liste, ou dont le gain est supérieur au gain maximal indiqué, sont strictement interdits pour l'exploitation de l'émetteur. réseau local sans fil antenne, le gain max 1.5 dBi, 50 ohm

Le présent appareil est conforme aux CNR d'Industrie Canada applicables aux appareils radio exempts de licence. L'exploitation est autorisée aux deux conditions suivantes : (1) l'appareil ne doit pas produire de brouillage, et (2) l'utilisateur de l'appareil doit accepter tout brouillage radioélectrique subi, même si le brouillage est susceptible d'en compromettre le fonctionnement.

CLASS A ITE

この装置は、クラスA情報技術装置です。この装置を家庭環境で使用すると電波妨害を引き起こすことがあります。この場合には使用者が適切な対策を講ずるよう要求されることがあります。VCCI-A

BIONOMADIX—OPTIONAL CALIBRATION

Isolated Power Supply

To use BioNomadix with the Isolated Power Supply (IPS100C), use CBL102 cable to connect the IPS100C to the Receiver output channel. This is accessible via the front panel of the IPS100C.

Signal Validation

BioNomadix units are factory calibrated, but if user-calibration is desired for measurement verification, the following steps may be used. Please see the appropriate section for BioNomadix calibration guidelines.

- BN-ECG, BN-EEG, BN-EGG, BN-EMG, BN-EOG
- BN-EDA
- BN-NICO
- BN-PPG and BN-RSP
- BN-SKT
- BN-GON and BN-TOR
- BN-STRIKE
- BN-DYNEMG
- BN-ACCL

BN-ECG, BN-EEG, BN-EGG, BN-EMG, BN-EOG BIOPOTENTIAL CALIBRATION

Three alligator clips will be required to calibrate a Biopotential Transmitter/Receiver set.

- 1) Attach alligator clip to LEAD side of electrode pinch clip (see figure on right).
- 2) Connect black and white pinch clips together (this combination is attached to signal generator ground).
- 3) Connect red pinch clip to signal generator output for the Transmitter/Receiver set.

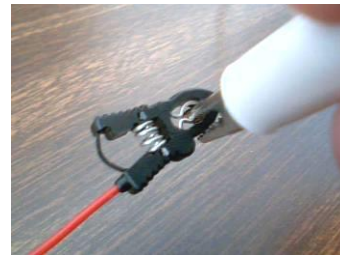

- ECG, EGG, EMG, EOG

The signal generator should be set to 1 mV peak to peak sine wave in the appropriate signal frequency range for the Transmitter/Receiver set. The total gain of the Transmitter/Receiver set is 2,000. The measured output voltage from the Receiver should be 1 mV p-p * 2000 or 2 V p-p. The maximum input signal is 10 mV p-p.

- EEG

The signal generator should be set to 1 mV peak to peak in the appropriate signal frequency range for the Transmitter/Receiver set. The total gain of the Transmitter/Receiver set is 10,000. The measured output voltage from the Receiver should be 1 mV p-p * 10,000 or 10 V p-p. The maximum input signal is 2 mV p-p.

BN-EDA ELECTRODERMAL CALIBRATION

Transmitter/Receiver set can be calibrated by applying a known resistance (conductance) to the EDA electrode pinch connectors via alligator clips. Suggested values of conductance would be 0 μ Siemens (infinite ohms – no connection) and 10 μ Siemens (100 K ohms). The EDA Transmitter/Receiver set outputs +10 V for a 50 μ S measured conductance. The EDA Transmitter/Receiver set will output approximately +2 V for a 10 μ S measured conductance.

BN-NICO CALIBRATION

Mapping for Z : 0.8 V to 10 ohms 9 V to 100 ohms

The calibration values for Z are approximate. For a more exact calibration for Z, introduce a 10 ohm resistor between the paired leads (Iout, Vin+) and (Vin-, Iin) to simulate a 10 ohm impedance magnitude. Use a 100 ohm resistor to simulate a 100 ohm impedance magnitude. See figure at right for details:

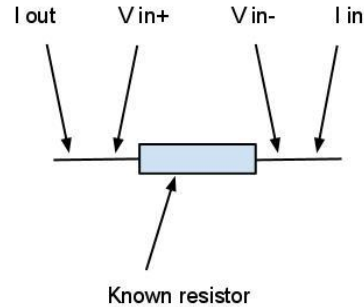

For the most accurate calibrations, use known impedances (resistances) that bracket the expected high and low values being recorded. For conventional noninvasive cardiac output measurements, optimal low impedance is 15 ohms and optimal high impedance is 40 ohms.

Mapping for dZ/dt: 0 V to 0 ohms/sec 10 V to 10 ohms/sec

The calibration values for dZ/dt can be accomplished by introducing a known and varying resistance that can be precisely set to a specific rate of change. For calibration related to cardiac output measurements, a varying resistance of ± 1 ohms/seconds to ± 5 ohms/second is ideal. A photonically-isolated voltage controlled resistance can be used for this calibration. A cadmium sulfide cell in parallel with a resistance of 25 ohms can be employed in conjunction with a signal generator driven LED to provide a varying light intensity to modulate the resistance of the cadmium sulfide cell.

BN-PPG AND BN-RSP PULSE AND RESPIRATION CALIBRATION

User-calibration not recommended, as the measurements performed are essentially dimensionless. However, it's possible to calibrate the PPG Transmitter/Receiver set by introducing a variable gray-scale density pattern to the PPG probe in a dark environment. The RSP Transmitter/Receiver set can be calibrated by applying differing amounts of force to the RSP transducer/belt combination to stretch the belt over different distances.

BN-SKT SKIN TEMPERATURE CALIBRATION

Insert probe into temperature well set to the appropriate temperature. As an alternative, replace the thermistor with known temperature(s) that reflects the specific temperature(s) simulated. The temperature probe specifications are equivalent to YSI@ 400 series probes. The temperature range for the SKT Transmitter/Receiver set is 13 to 51 degrees C. Using the specified temperature probe: 13 degrees provides a -10 V output and 51 degrees provides a +10 V output.

BN-GON, BN-TOR GONIOMETER CALIBRATION

This is general calibration information for all BIOPAC Goniometers and Torsiometers:

When using all goniometers and torsiometers, the minimum value of bend radius must be observed at all times, particularly when attaching and removing the sensors from the subject. Failure to do this will result in reduced unit life or failure.

The sensors have been designed to be as light as possible and the operating force to be a minimum. This permits free movement of the joint without influence by the sensors. The sensors measure the angle subtended between the endblocks. Use the software calibration features (under Setup Channels) to calibrate any of the BIOPAC series goniometers.

Each goniometer requires a DA100C amplifier, BN-GONIO, or MP3X/45 analog input per rotational axis. Accordingly, the twin axis goniometers will need two DA100C amplifiers, one BN-GONIO or two MP3X/45 analog channels to simultaneously measure both rotational axes.

Excitation voltages are factory preset for the various data acquisition platforms, however excitation voltages are user-adjustable on the DA100C. Recommended excitation is +5VDC.

1. Place goniometer with care to verify that limb/joint/torso attachment will not result in over stretch at the limits of limb/joint/torso movement
2. Put body in the first position, which brackets one end of range of movement. Press CAL 1.
3. Put body in the second position, which brackets The other end of range of movement. Press CAL 2.

BN-STRIKE HEEL-TOE STRIKE CALIBRATION

BN-Strike requires no calibration.

BN-DYNEMG CALIBRATION

The BN-DYNEMG needs consideration for calibration on pressure bulb.

The pressure bulb transducer measures applied hand grip strength, via pressure changes manifesting in the bulb, during squeezing. The units of pressure are force per unit area. The pressure bulb transducer configuration determines the factory preset scaling, typically in units of kg/m*m or kg/cm*cm. If another or different calibration required, the following method can be used.

To calibrate:

1. Place bulb on flat, stable, drawing surface
2. Press CAL 1 - enter 0 kg/unit area
3. Place known weight on bulb (X- kg)
4. Use pencil to outline flattened portion of bulb on table, use ruler to measure the flattened area outline from side to side, and record this value as area "A"
5. Press CAL 2 - enter X/A kg/unit area

BN-ACCL ACCELEROMETER CALIBRATION

Orient Transmitter unit in the X, Y, and Z directions with respect to Earth’s gravity. This action will introduce 1 G in positive axis direction and -1 G in the negative axis direction. The accelerometer Transmitter/Receiver set has user-selectable ranges: ± 2 , ± 4 , ± 8 or ± 16 G. The maximum value of each range selection provides a +10 V output and the minimum value of each range selection provides a -10 V output. When using the ± 2 G range, a + 1 G input will provide a +5 V output and a -1 G input will provide a -5 V output, when properly scaled.

The BN-ACCL has a factory default of ± 16 G. Use the DIP switches on the side of the BN-ACCL Receiver Module to set the Transmitter to the desired range. If the range needs to be set to something other than ± 16 G, perform the following steps prior to calibration using Earth’s gravity, as described in the previous paragraph.

1. In *AcqKnowledge*, select “**Set Up Data Acquisition > Channels.**”
2. Select “**View by Modules...**” and add new module “**ACCL3-R,**” assuming not yet added.
3. Select the desired X, Y and Z channels and click **OK** (see right).
4. Then select “**View by Channels...**”. Click the “**Setup**” button.
5. Click “**Yes**” to the channel scaling modification prompt.

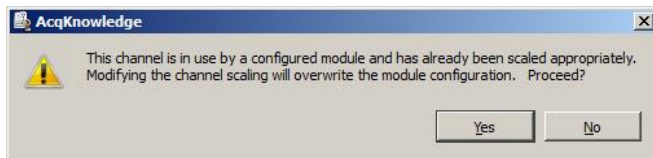

6. Set desired Scaling as shown in the following table and click **OK**:

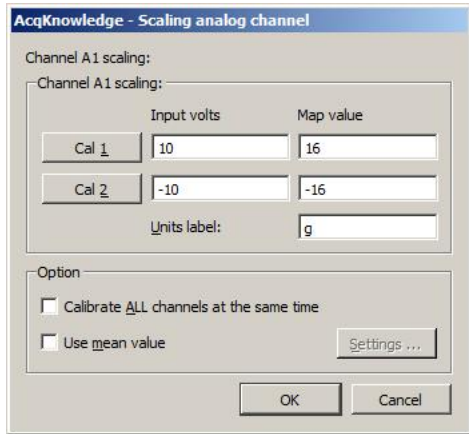
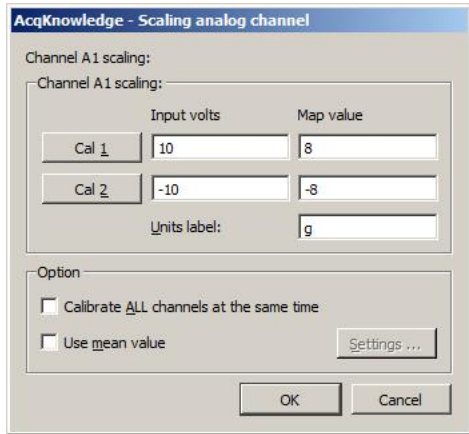
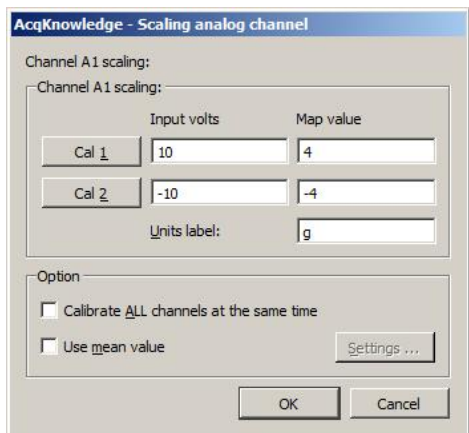
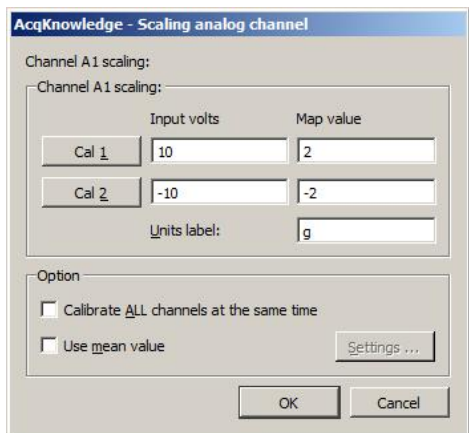
±16 G Range	±8 G Range
	
±4 G Range	±2 G Range
	



FILTER OPTION SWITCH GUIDE

Switches are on the side of the BioNomadix receiver when pulled apart from other modules. Adjust switch position with a small tipped screwdriver.



Switch positions: “UP” = ON, DOWN” = OFF

NOTE: If the switch settings are modified, preset MP160/150 module setup cannot be used and channels must be configured manually.

Mains Notch Filter

- All modules except ACCL3 and NICO

Notch Filter	SW1	SW2
60 Hz	UP	DOWN
50 Hz	UP	UP
OFF	DOWN*	DOWN or UP

*indicates Factory Preset

BioNomadix Receiver Switches

- SW3 is ignored if Alternative Signal is enabled (UP)

ECG2-R BioNomadix Receiver	
Filter Option	Switch Number
High Pass	SW3
0.05 Hz HP	DOWN
1 Hz HP	UP*
Low Pass	SW4
35 Hz LP	UP*
150 Hz LP	DOWN

* indicates Factory Preset

EMG2-R BioNomadix Receiver	
Filter Option	Switch Number
High Pass	SW3
5 Hz HP	DOWN
10 Hz HP	UP*
Low Pass	SW4
250 Hz LP	UP
500 Hz LP	DOWN*

EEG2-R BioNomadix Receiver	
Filter Option	Switch Number
High Pass	SW3
0.1 Hz HP	DOWN
0.5 Hz HP	UP*
Low Pass	SW4
35 Hz LP	UP*
100 Hz LP	DOWN

EOG2-R BioNomadix Receiver	
Filter Option	Switch Number
High Pass	SW3
0.005 HP	DOWN*
1 Hz HP	UP
Low Pass	SW4
35 Hz LP	UP*
100 Hz LP	DOWN

EGG2-R BioNomadix Receiver	
Filter Option	Switch Number
Low Pass	SW3
1 Hz HP	UP*
Disabled	DOWN

SKT2-R BioNomadix Receiver		
Filter Option	CH A	CH B
Low Pass	SW3	SW5
10 Hz LP	DOWN	DOWN
1 Hz LP	UP**	UP*

RSP2-R BioNomadix Receiver			* indicates Factory Preset	PPGED-R BioNomadix Receiver		
Filter Option	CH A	CH B		Filter Option	PPG CH A	EDA CH B
Low Pass	SW3	SW5		Low Pass	SW3	SW5
10 Hz LP	DOWN	DOWN		3 Hz LP	UP*	UP*
1 Hz LP	UP*	UP*		10 Hz LP	DOWN	DOWN
High Pass	SW4	SW6		High Pass	SW4	SW6
0.5 Hz HP	UP	UP		0.5 Hz HP	UP*	UP
DC	DOWN*	DOWN*	DC	DOWN	DOWN*	

RSPEC-R BioNomadix Receiver				
Filter Option	RESP CH A		ECG CH B	
Low Pass	SW6		SW4	
	1 Hz LP	UP*	35 Hz LP	UP*
	10 Hz LP	DOWN	150 Hz LP	DOWN
High Pass	SW7		SW3	
	0.5 Hz HP	UP	1 Hz HP	UP*
	DC	DOWN*	0.05 Hz HP	DOWN

NICO-R BioNomadix Receiver		
Filter Option	Switch Number	
Low Pass	SW1 (Z CH)	SW2 (dZ CH)
5 Hz LP	UP	UP
Low Pass	SW3 (Z CH)	SW4 (dZ CH)
3 Hz LP	UP	UP
Low Pass	SW5 (ZCH)	SW6 (dZ CH)
1 Hz LP	UP	UP
DC to 50* Hz	DOWN for all switches*	

*Bandlimited to 10 Hz in BN-NICO units shipped before 11/2016

DYNEMG BioNomadix Receiver				
Filter Option	DYN CH A		EMG CH B	
Low Pass	SW6		SW4	
	3 Hz LP	UP	250 Hz LP	UP
	100 Hz LP	DOWN*	500 Hz LP	DOWN*
	SW7		SW5	
	10 Hz LP	UP*	Envelope detection mode EMG CH B	UP
	100 Hz LP	DOWN	EMG signal output	DOWN*
High Pass	HP N/A for DYN		SW3	
	--	--	10 Hz HP	UP*
	--	--	1.0 Hz HP	DOWN

G-Mode	ACCL3-R BioNomadix Receiver				
	Filter Option		Switch Number		
	Nyquist	Rate	SW1	SW2	SW3
	3.13 Hz	6.25 Hz	UP	UP	UP
	6.25 Hz	12.5 Hz	DOWN	UP	UP
	12.5 Hz	25 Hz	UP	DOWN	UP
	25 Hz	50 Hz	DOWN	DOWN	UP
	50 Hz	100 Hz	UP	UP	DOWN
	100 Hz	200 Hz	DOWN	UP	DOWN
	200 Hz	400 Hz	UP	DOWN	DOWN
400 Hz	800 Hz	DOWN*	DOWN*	DOWN*	
Range		SW4		SW5	
2 G		UP		UP	
4 G		DOWN		UP	
8 G		UP		DOWN	
16 G		DOWN*		DOWN*	



ALTERNATIVE SIGNAL SWITCH GUIDE

Warning: Alternative signal *replaces* the raw signal. To display raw and processed signal alternative(s), use *AcqKnowledge* calculation channels.

ECG2-R and RSPEC-R BioNomadix Receivers		EOG2-R BioNomadix Receiver	
Signal Output	SW5	Signal Output	SW5
ECG – Factory Preset	DOWN	EOG – Factory Preset	DOWN
Heart Rate – Alternative Signal	UP	Derivative – Alternative Signal	UP

EEG2-R BioNomadix Receiver				
Signal Output	SW5	SW6	SW7	SW8
EEG – Factory Preset	DOWN	DOWN	DOWN	DOWN
Delta – Alternative Signal	UP	DOWN	DOWN	DOWN
Theta – Alternative Signal	--	UP	DOWN	DOWN
Alpha – Alternative Signal	--	--	UP	DOWN
Beta – Alternative Signal	--	--	--	UP

EMG2-R BioNomadix Receiver	
Signal Output	SW5
EMG – Factory Preset	DOWN
Integrated RMS Alternative Signal (Envelope Detection Mode)	UP

ACCL3-R BioNomadix Receiver		ACCL3-R switch settings for Alternative Signal TAP				
G – Factory Preset	DOWN	Tap-Mode	Filter Option	Switch Number		
Tap (Event Mark) – Alternative Signal	UP		Rate (G-Mode) or Duration (Tap Mode)	SW1	SW2	SW3
Signal Output	SW6		5000 μ S	UP	UP	UP
G-Mode	DOWN		4375 μ S	DOWN	UP	UP
Tap Mode	UP		3750 μ S	UP	DOWN	UP
			3125 μ S	DOWN	DOWN	UP
			2500 μ S	UP	UP	DOWN
			1875 μ S	DOWN	UP	DOWN
			1875 μ S	UP	DOWN	DOWN
			625 μ S	DOWN	DOWN	DOWN
			Range (G-Mode) or Threshold (Tap Mode)	SW4		SW5
			2 G	UP		UP
			4 G	DOWN		UP
			6 G	UP		DOWN
		8 G	DOWN		DOWN	

GONIO-R BioNomadix Receiver				
Filter Option	CH A		CH B	
Low Pass	SW3		SW5	
	3 Hz LP	UP	3 Hz LP	UP
	100 Hz LP	DOWN*	100 Hz LP	DOWN*
	SW4		SW6	
	10 Hz LP	UP*	10 Hz LP	UP*
	100 Hz LP	DOWN	100 Hz LP	DOWN

STRIKE-R BioNomadix Receiver				
Filter Option	CH A		CH B	
Low Pass	SW3		SW5	
	3 Hz LP	UP	3 Hz LP	UP
	100 Hz LP	DOWN*	100 Hz LP	DOWN*
	SW4		SW6	
	10 Hz LP	UP*	10 Hz LP	UP*
	100 Hz LP	DOWN	100 Hz LP	DOWN

BIONOMADIX SMART CENTER (BN-SMART-ESS, BN-SMART-ENH)

Start Collecting High-Fidelity Wireless Data in Minutes

Smart Center Essentials



Smart Center Enhanced

Adds BioNomadix Logger + Basic Scripting

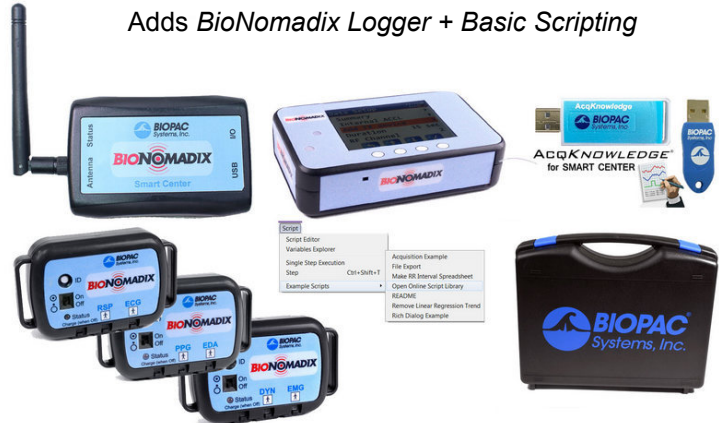

BioNomadix Smart Center is an easy-to-use, small-form data acquisition unit and wireless receiver that records physiological data in most major application areas using BioNomadix Transmitters. The Smart Center offers a compact and sophisticated physiology platform that sets up in minutes. Simply plug the Smart Center into the computer, set up the transmitters and subject, then start recording high quality data with AcqKnowledge for Smart Center.

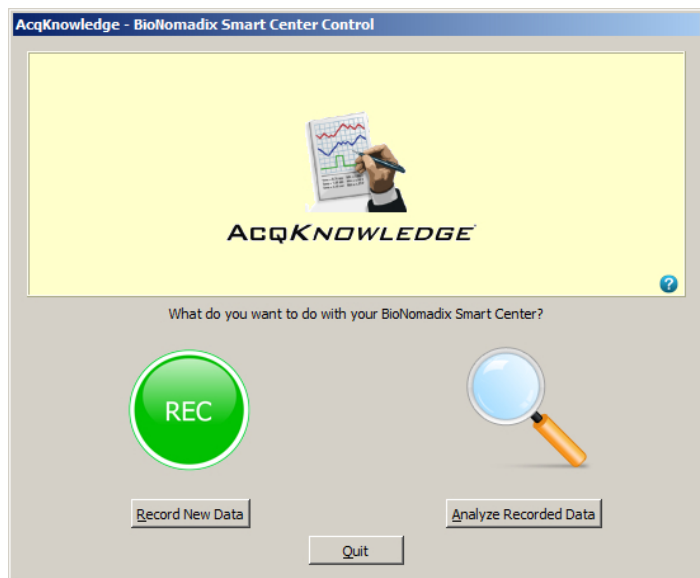

Transmitters are automatically detected and paired using the AcqKnowledge for Smart Center setup wizard and guided prompts.

Smart Center is available in Essentials or Enhanced packages, with additional licensed functionalities available for either system. Adhesive Velcro® disks are included for mounting unit on various surfaces.

Smart Center supports all BioNomadix Transmitter types for collecting a full range of body signals. When connected, Smart Center appears in the AcqKnowledge software as a stand-alone hardware menu item. Use the full range of AcqKnowledge software's powerful automation, measurement, and reporting tools, cited in thousands of publications.

Smart Center does not require a battery and is entirely USB-powered. (Wireless BioNomadix transmitters are battery-powered and include an AC wall charger. Transmitters last up to 72 hours on a charge.)

The included Smart Center case holds the Smart Center, up to four transmitters, two transmitter chargers, Logger, Logger Charger, USB cable, antennas, with room to spare for accessories—electrodes, leads, gels, straps, etc. (accessories purchased separately). The durable case makes moving the complete system easy and protects hardware during transport or storage.

Add the BN-SMART-IOCBL cable to access 8 digital input lines and record synchronization signals from SuperLab or E-Prime stimulus/response studies.

High Level Features

- Small form factor
- Direct connection to computer
- 9 Channels of wireless data
- Simple to use and easy to connect
- Signal-specific analysis options
- 10 meter range
- Up to 2 kHz data acquisition speed
- Digital input

BioNomadix Transmitters for Smart Center support the following signals—EEG, ECG, EMG, EOG, EGG, EDA, RSP, SKT, PPG, Cardiac Output, Accelerometry, Goniometry, Dynamometry, Heel-Toe Strike.

See specifications for specific BioNomadix Transmitter types and part numbers.

BioNomadix Smart Center Essentials (BN-SMART-ESS)

- Smart Center unit
- 2-3 transmitters, select quantity and signals when ordering
- Micro-USB-to-USB cable
- *AcqKnowledge 5* for Smart Center
- USB Software Installation and License keys
- Durable form-fitted carrying case

BioNomadix Smart Center Enhanced (BN-SMART-ENH) adds:

- 3 transmitters included (select signals when ordering)
- BioNomadix Logger—wireless, wearable data logger ([BN-LOGGER](#))
- BIOPAC Basic Scripting

Smart Center Compatible Licensed Feature Options

Add additional *AcqKnowledge* software Licensed features to an existing Smart Center package:

- [BIOPAC Basic Scripting license](#)—Customize the display and simplify the user interface. With scripting, it's possible to consolidate many tasks into one automated routine that eliminates the potential for error. Guarantee reproducibility every time with a Basic Script, no matter who is controlling the experiment. (Add to Essentials, included in Enhanced.)
- [Actigraphy](#)—Record long-term accelerometer data and analyze sleep and activity patterns of mobile subjects.
- [FaceReader Integration](#)—Synchronize with existing FaceReader emotion reading software for analyzing facial movements and classifying subject's response.
- [Network Data Transfer](#)—Real-time data transfer system that allows access to data being acquired into a graph by *AcqKnowledge* for use in an external application.
- [Remote Monitoring](#)—Provides a simple browser interface from which acquisitions can be started or stopped and remote data can be viewed during and post-acquisition.

Specifications

Unit Dimensions:	92 mm (L) x 60 mm (W) x 27 mm (D)
Maximum Sample Rate:	2 kHz per channel
Bit Rate:	12 bits per sample
Frequency:	2.4 GHz
Ports:	USB (1), I/O (1)
Antenna:	Yes, removable
Power Source:	Computer USB (cable included)
Range:	10 meters line-of-sight
Transmission:	Wireless, with Dual or Tri-Signal BioNomadix Transmitters
Maximum Transmitters Supported:	3
Maximum Data Channels:	9, plus derived signals selectable in software
Software:	AcqKnowledge 5 for Smart Center
Supported OS:	Windows 10/8.x/7, Mac OS X 10.10-10.12
FCC ID:	ZWIBNXR1
IC:	9901A-BN XR1
VCCI:	211-128161
Carrying Case Dimensions:	34 cm (L) x 28.47 cm (W) x 8.24 cm (D)

Supported Signals & BioNomadix Transmitters*

Electrocardiogram	BioNomadix BN-ECG2-T
Electromyogram	BioNomadix BN-EMG2-T
Electroencephalogram	BioNomadix BN-EEG2-T
Electrogastrogram	BioNomadix BN-EGG2-T
Electrooculogram	BioNomadix BN-EOG2-T
Respiration	BioNomadix BN-RSP2-T
Skin Temperature	BioNomadix BN-SKT2-T
Photo Plethysmogram & Electrodermal Activity	BioNomadix BN-PPGED-T
Respiration & Electrocardiogram	BioNomadix BN-RSPEC-T
Cardiac Output (dZ-Dt)	BioNomadix BN-NICO-T
Dynamometry & Electromyography	BioNomadix BN-DYNEMG-T
Goniometry	BioNomadix BN-GONIO-T
Heel-Toe Strike	BioNomadix BN-STRIKE-T
Accelerometry	BioNomadix BN-ACCL3-T

*For full transmitter specs and necessary leads/electrodes, see [BioNomadix HARDWARE GUIDE](#)

I/O TTL INTERFACE FOR SMART CENTER (BN-SMART-IOCBL)

Access 8 Digital TTL inputs on the Smart Center



This 1 meter cable connects to the small I/O port on the Smart Center and terminates in a male DSub25 connector. Use to connect to E-Prime, SuperLab, or other visual presentation systems.

Pin assignments match E-Prime style pin assignments:

- the first TTL digital input channel is pin 2 of the DSub
- the final TTL digital input is pin 9 of the Dsub

Note: The Smart Center does not presently support digital output, however this functionality may be added in a future firmware and software revision—contact BIOPAC to indicate your interest in Smart Center digital output lines.

TRI-AXIAL ACCELEROMETERS

SS26LB, TSD109C3 and TSD109C2-MRI (± 5 g)
SS34L and TSD109J1 (± 200 g)
BN-ACCL3

Tri-Axial Accelerometers connect directly to BIOPAC hardware and require no additional amplification. They provide three outputs, each simultaneously measuring acceleration in the X, Y, and Z directions. They are the same size and can be used on any part of the body or on external equipment.

- ± 5 g accelerometers are optimal for measuring accelerations when performing slow movements, such as walking.
- ± 200 g accelerometers are optimal for measuring quick movements, such as swinging a tennis racket or high impact events commonly encountered in exercise physiology experiments.

The transducers can be used on any part of the body or attached to external equipment. The pliable and unobtrusive design conforms readily to body contours and includes a Velcro[®] strap for easy attachment.

For the TSD109C2-MRI: Strap the accelerometer on finger, wrist, toe, or foot. To minimize artifact associated with cable tugging, during movement activities, tape the sensor securely in place using TAPE1. The sensor cabling can be secured to the subject via a thermally insulating sleeve, such as nylon wire loom. The loom will permit the cable to travel freely during subject motion.

The frequency response extends from DC to 500 Hz. The accelerometers are extremely accurate and can easily be calibrated by simply changing their orientation in three-dimensional space, so that gravity ($G=1$) acts only upon the desired axis. Trace metallic parts do not make contact to the subject; must be used with 3-axis MECMRI-9 cables provided.

MRI Use (TSD109C2-MRI): **MR Conditional to 7T**

Note: Use with provided MECMRI-9 cable and MRIRFIF filter. Conductive parts of transducer are electrically and thermally isolated from subject.

Equipment

- The SS26LB/SS34L accelerometers connect to the MP36/35 Data Acquisition Unit.
- The TSD109 series accelerometers connect to the AMI100D or HLT100C High Level Transducer module.
- The TSD109C2-MRI is intended for MRI use and ships with a longer (10 m) cable, plus an MECMRI-HLT/AMI (2 m) interface cable and filter set (MRIFIF).



*Tri-axial accelerometer
uses 3 channel inputs*

Accelerometer Specifications (SSL/TSD)

	SS26LB / TSD109C3 / TSD109C2-MRI	SS34L / TSD109J1
Range (Output):	±5 G	±200 G
Noise:	0.5 mG/SQRT[Hz] (rms)	4.3 mG/SQRT[Hz] (rms)
Bandwidth:	DC-500 Hz (-3 dB)	DC-1000 Hz (-3 dB)
Nonlinearity:	±0.2% of FSR	±0.5%
Cross-axis Sensitivity:	±1% of FSR	±1.4%
Package Alignment Error:	±1°	N/A
Interaxis Alignment Error:	±0.1°	N/A
Power:	+5 V @ 25 mA	+5 V @ 10 mA
Noise:	0.25 mG/sqrt(Hz) rms	0.25 mG/sqrt(Hz) rms
Supply Current:	0.5 mA	0.5 mA
Supply Voltage:	+5 V (nominal)	+5 V (nominal)
Supply Voltage Range:	4 V . 6 V	4 V . 6 V
Interface:	MP36/35 Data Acquisition Unit (SS26LB, SS34L) MP160/150/AMI100D/HLT100C Module (TSD109J1, TSD109C3, TSD109C2-MRI)	
Package:	Compliant silicone housing	
Dimensions:	16 mm (L) x 17 mm (W) x 8 mm (H)	
Weight:	4.5 grams	
Sterilizable:	Yes (contact BIOPAC for details)	
Cable length:	3 meters (10 meters for TSD109C2-MRI)	
Operational Temp:	0-50° C	
Operational Humidity:	0-95% non-condensing	

NOTE: The SS26LA (±5 G) was discontinued in September of 2013 and the SS27L and TSD109F (±50 G) were discontinued in May of 2015.

The TSD109C2 and TSD109J were discontinued in February of 2019. Current offerings are TSD109C3 and TSD109J1 to support AMI100D and HLT100C interface module compatibility.

Gain Constant and Offset Specifications (SSL/TSD)

Type	Gain Constant	Offset @ 0 G (Typical)
SS26LB	125 mV/g	1 V
SS34L	1.6 mV/g	340 mV
TSD109C3 / TSD109C2-MRI	200 mV/g	1.5 V
TSD109J1	7 mV/g	1.45 V

Hardware Setup

The accelerometers have three output connectors, one each for the X, Y, and Z axes. Each output connector must be connected to an **MP3X** input channel (SS26LB/SS34L,) or to the appropriate AMI100D/HLT100C input channel (TSD109 series). For example, connect the X-axis to Channel 1, Y-axis to Channel 2, and Z-axis to Channel 3.

IMPORTANT

Make sure the selected channel is **not** already assigned to any other BIOPAC module; up to 5 Accelerometers can be used with a single MP System. **If contention exists, the channel data will be corrupted.**

See also: Setup notes for external devices and channel contention issues.

Software Setup

SS26LB/SS34L:

- Select **MP3X > Set Up Data Acquisition > Channels > Setup** and enable three analog channels, one for each axis.
- For each channel, select the appropriate **Accelerometer Preset** (5 g or 200 g) from the **Preset** list.
- Click on **Setup** and then click on **Scaling**:
- In the **Map value** fields, enter the scaling factors required, -1 for Cal 1 and 1 for Cal 2.
- Enter **g's** for the **Units label**, as shown. (This unit should appear by default in Accelerometer presets.)
- Take the accelerometer and rest it in the upright position on the tabletop.
- Calibrate the device by rotating it through 180° and taking a calibration reading at each point.
- To calibrate the Y-axis, start with the transducer sitting on the table, face up, and click Cal 1. Rotate the transducer 180°, so that it is now sitting upside down, and click the Cal 2 button. This procedure must be followed for each axis. A label on the front of the transducer displays the X- and Y-axes. The Z-axis rotates from the end with the label and the end with the cable.

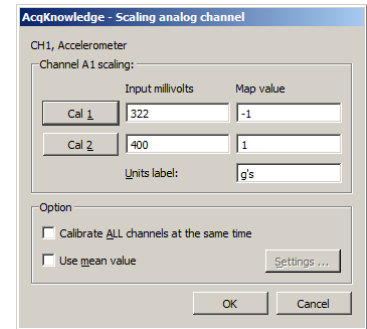

TSD109 Series:

- Select **MP160/150 > Set Up Data Acquisition > Channels > Add New Module**.
- Choose **AMI100D** or **HLT100C-A1** from the module type list and click **Add**.
- Choose **TSD109C (5 g)** or **TSD109J (200 g)** from the transducer list and click **OK**.
- Follow the onscreen calibration dialogs.
- Repeat steps a-d for channels A2 (Y-Axis) and A3 (Z-axis).

Testing Calibration

To see if the calibration is correct:

- Start acquiring data (for the test procedure, a sample rate of 50 samples per second should be used).
- Rotate the accelerometer 180° through each axis.
- Set the vertical scale to 1 and the midpoint to 0 for all channels.
- Repeat the calibration procedure (by rotating the transducer 180°) through each axis.
- Visually confirm the correct calibration.

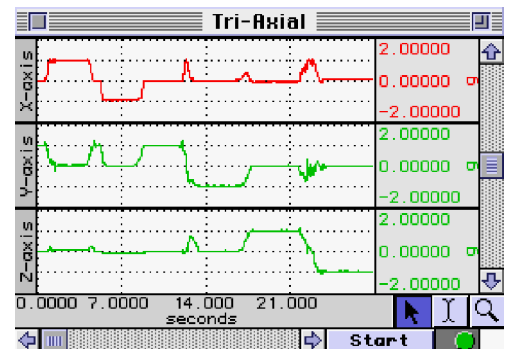

The screen shot above shows a tri-axial accelerometer being rotated through each axis. Channel 1 (X-axis) shows the signal moving from 1 g to -1 g as the transducer is rotated. Likewise, Channel 2 (Y-axis) shows the same phenomenon as previously described. Finally, Channel 3 (Z-axis) has also been tested and the calibration confirmed.

BIONOMADIX WIRELESS ACCELEROMETER

The BioNomadix wireless Tri-axial Accelerometer (BN-ACCL3) is a broad spectrum acceleration measurement system. The transmitter can be attached to any part of the subject's body to measure three-axis acceleration associated with movement in that particular location.

The system comes factory preset to support an operational range of ± 16 G, with a maximum system bandwidth of 400 Hz. Ranges can be set to as low as ± 2 G with bandwidths as low as 3 Hz.

The system can also be configured to act as a "tap detector," detect either single or double taps. In this mode, the system can act as an event recorder for self-report. When "double-tapped," for example, the system will output a pulse to precisely mark the time location of the observed event.

In Acceleration measurement mode, the BN-ACCL3 will output X, Y and Z acceleration values on three associated channels. The system is very well suited for mobile applications. The system can measure the acceleration of gravity (static) for tilt-sensing and can also measure very fast-changing, dynamic acceleration resulting from rapid movement or impact.



BN-ACCL3 Specifications

BioNomadix	BN-ACCL3
Signal type:	G (X, Y, Z)
Bandlimits Max: Factory preset: Filter Options:	$\pm 2, \pm 4, \pm 8$ or ± 16 G ± 16 G at 400 Hz LP DC to 3.13 Hz LP up to 400 Hz LP (in power of 2 steps)
Alternative signal:	Tap Event Mark Mode (<i>replaces</i> G)
Resolution:	X: 5 mg (rms), Y: 6 mg (rms), Z: 9 mg (rms) (± 2 G scale at 400 Hz LP)
Signal range:	Selectable: $\pm 2, \pm 4, \pm 8$ or ± 16 G
Output Voltage range:	± 10 V (receiver output)
Transmitter type & rate	Type: Ultra-low power, 2.4 GHz bi-directional digital RF transmitter Rate: 2,000 Hz (between transmitter and receiver)
Delay:	Large fixed component (12.5 ms) and small variable component (± 0.5 ms)
Operational range:	10 meters (line-of-sight) typical in standard laboratory setups. See also: <i>Operational Range and Characteristics</i> .
Operational temp:	5-45° C
Operational humidity:	0-95% non-condensing
Transmitter Battery: Charger:	BioNomadix transmitters use an L-ion battery: full charge takes approx. 1 hour to provide maximum operating time. A battery charger is included with each module pair. See BN-CHARGER for charge time and recharge cycle details.
Operating time:	72-90 hours
Receiver Power:	Use with an MP Research System or with isolated power supply IPS100C/D for 3rd-party data acquisition system.
Included strap:	33 cm - BN-STRAP33
Size & Weight:	Transmitter (approx.): 6 cm x 4 cm x 2 cm; 54 grams; Receiver (approx.): 4 cm x 11 cm x 19 cm; 380 grams
Input:	Attach BioNomadix transmitter to subject . no additional hardware input required; sensor is internal to transmitter.

See also: Tri-Axial Accelerometer Application Notes 141, 266 and 273 [here](#).

TSD108 AND SS17L PHYSIOLOGICAL SOUNDS TRANSDUCER (CONTACT MICROPHONE)



The physiological sounds transducer connects to the DA100C amplifier (TSD108) or the MP3x/4x hardware (SS17L). The transducer can be used with the Noninvasive Blood Pressure Cuff or as a stand-alone device. If used with the cuff, Korotkoff sounds can be recorded for easy determination of systolic and diastolic blood pressure. When used on its own, it can record a variety of acoustical signals, including heart sounds and sounds associated with rubbing or grinding (e.g., Bruxism). The acoustical transducer element is a Piezo-electric ceramic disk that is bonded to the interior of a circular metallic housing.

- **TSD108:** Korotkoff signal is recorded by a DA100C amplifier set to AC, 5000 Hz LP and a gain of 50 to 200.
- **SS17L:** To record the Korotkoff signal, select SS17L preset from MP3x/MP4x > Set Up Channels menu.

The signal for the physiological sounds transducer is usually further conditioned by the software. In a calculation channel, the signal can be bandpass filtered from 50 to 200 Hz. The sampling rate for the entire recording needs to be about 500 Hz, assuming the physiological sounds transducer is used.

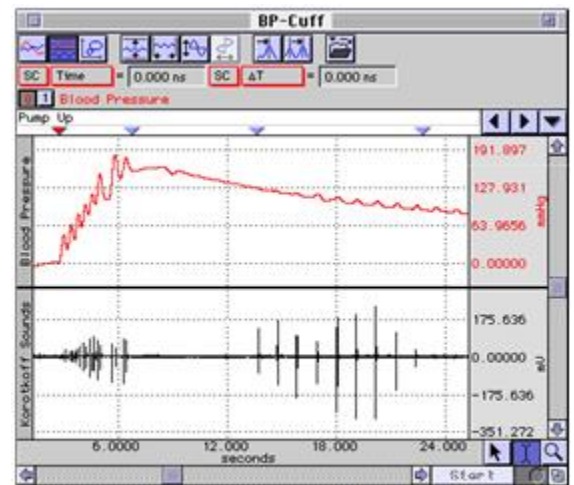

Cuff Blood Pressure Versus Korotkoff Sounds

TSD108/SS17L SPECIFICATIONS

Frequency Response:	35 Hz to 3500 Hz
Housing:	Stainless Steel
Sterilizable:	Yes (contact BIOPAC for details)
Noise:	5 μ V rms – (500 Hz - 3500 Hz)
Output:	2 V (p-p) maximum
Weight:	9 g
Dimensions:	29 mm diameter, 6 mm thick
Cable Length:	3 m
Interface:	DA100C (TSD108), MP3x (SS17L)
Calibration:	None required
TEL100C Compatibility:	SS17

HEEL-TOE STRIKE TRANSDUCERS

SS28LA

TSD111A

SS28A

BN-STRIKE-XDCR

Use this transducer to record heel and toe strike activity as the subject walks. The heel/toe strike data is recorded on two analog channels; One channel records heel strike and the other, toe strike. Strikes are indicated by positive deflections on the graph. Two force sensitive resistors (FSR) attach to the sole of a shoe; use two transducers to record from both feet.



HEEL-TOE STRIKE SPECIFICATIONS

Nominal Output Range: (after amplification)	0 to +10 V
Nominal Contact Force:	200 g to indicate heel/toe strike
Attachment:	TAPE1, TAPE2, Vinyl Electrical or Duct Tape
FSR Dimensions:	18.3 mm (dia) x 0.36 mm (thick) and 30 cm pigtail lead
FSR Active Area:	12.7 mm (dia)
Cable Length:	7.6 meters
Cable Length – BN-STRIKE-XDCR:	30 cm
Interface: SS28LA	MP36/35 System
TSD111A	AMI100D/HLT100C/MP160/150 System
SS28A	TEL100C/MP160/150 System
BN-STRIKE-XDCR	BN-STRIKE/MP160/150 System

HEEL-TOE STRIKE CALIBRATION

BN-STRIKE, TSD111A, SS28LA or SS28A do not require calibration.

Registered impulses on each channel simply reflect the timing marks associated with heel/toe strike contact during gait. The amplitude of each impulse is indicative of force measured at the time of strike. Although this amplitude value does not have an exact linear relationship to force, it is monotonically related. As force increases, amplitude increases. If precise force measurements are required, then weights could be sequentially applied to each sensor to perform a rough calibration within a narrow operational range. Furthermore, an expression channel could be used in *AcqKnowledge* (TSD111A) or *BSL PRO* (SS28LA) software to linearize a heel/toe strike sensor over a wide operational range.

RX111 REPLACEMENT HEEL-TOE STRIKE SENSOR

Replacement strike sensor for Heel/Toe Strike transducers.



Note: Heel/Toe Strike Transducers without the "A" suffix in the part number (SS28L/TSD111) do not have a replaceable sensor. Check the part number or check the cable for a removable sensor connector before ordering this replacement.

TSD115 TSD115A VARIABLE ASSESSMENT TRANSDUCERS

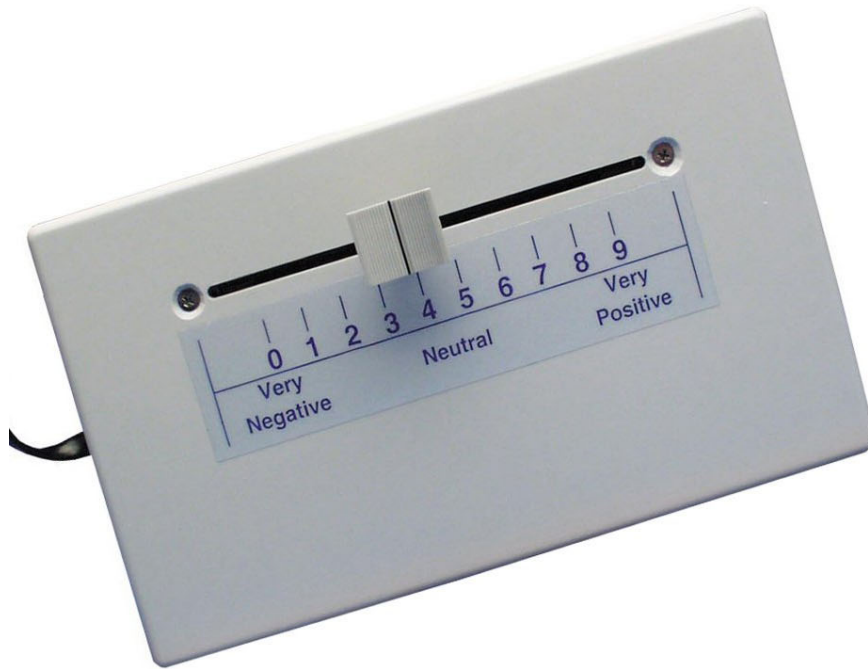

The TSD115 incorporates a slide control with graduated scale that allows the user to gauge their subjective response to a variety of different stimuli. Multiple TSD115 transducers can be used simultaneously allowing several people to answer the same question or otherwise respond to stimuli. The transducer is lightweight and fits easily into the subject's hand or lap. The TSD115 comes equipped with a 7.6-meter cable and is designed for direct connection to the AMI100D/HLT100C module.

This graph shows a measurement that identifies the responses (on a scale from 0 to 9) of the four clients to a particular question. In this case, at 23.08 seconds into the recording, the responses to question four were:

Client 1: 3.225	Client 3: 7.590
Client 2: 8.036	Client 4: 8.989

The TSD115A Variable Assessment Dial transducer is an assessment dial that allows subjects to report subjective assessments by turning a knob between values from 1 to 10. This may be used to correlate subjective reporting with physiological measures. This lightweight transducer connects directly to an AMI100D/HLT100C via a 7.6 m long cable and fits easily into a subject's hand or lap. The knob is affixed with a small screw and may be removed by users who want to cover the dial with their own ratings label. Two adhesive Velcro® discs are included with the transducer to allow the unit to be affixed to a desk or wall instead of allowing for handheld operation.

TSD115-MRI VARIABLE ASSESSMENT TRANSDUCER FOR MRI

The TSD115-MRI comes equipped with an 8-meter cable and is designed for connection to the AMI100D/HLT100C via the MECMRI-HLT cable-filter set. Trace conductive parts (metallic parts) of transducer do not make contact to the subject.

MRI Use: MR Conditional to 3T

Note: Conductive parts of transducer are electrically and thermally isolated from subject.

TSD115-MRI Components:

- Polyvinyl chloride (PVC) Plastic
- Acrylonitrile Butadiene Styrene (ABS) Thermo-molded, Plastic
- Polymer thick film device (rigid substrate, printed semi-conductor)
- Copper clad fiberglass lamination (PCB material)
- Stainless steel screws/nuts
- Tinned copper wire
- Silicone elastomer

TSD115/115A Calibration

1. Generate the **Scaling** dialog for the first selected channel.
2. Slide the horizontal indicator all the way to the right side of the TSD115. (This reports the highest output for the TSD115, a value close to +5.0 volts.)
3. Click the **Cal1** button to assign this value to “9.” (This directs the system to collect the exact value output by the TSD115 when it’s set to any specific indicator position.)
4. Slide the horizontal indicator all the way to the left on the TSD115. (This reports the lowest output for the TSD115, a value close to 0.0 volts.)
5. Click the **Cal2** button to assign this value to “0.”
6. Select the next channel and repeat this procedure for the remaining channels.

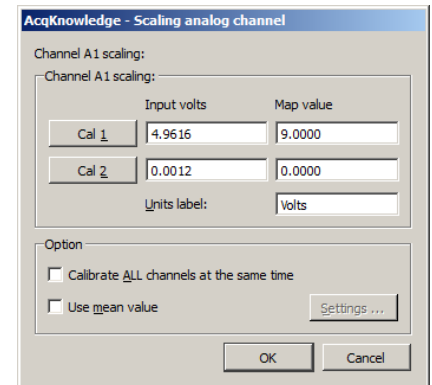

Specifications

	TSD115/115A	TSD115-MRI
Cable Length:	7.6 m	8 m
Interface:	AMI100D/HLT100C	MECMRI-HLT to AMI100D/HLT100C
Scale Output Range:	0-5 V DC	
Scale Resolution:	Infinitely adjustable	
Slide/Dial Control Length:	10 cm	
Dimensions		
TSD115:	4 cm (high) x 11 cm (deep) x 19 cm (wide)	
TSD115A:	10 cm (L) x 5.1 cm (W) x 2.1 cm (height)	
Weight:		
TSD115:	230 g	
TSD115A:		

See also: Application Note #AH186 – Psychological Assessment (TSD115)

TSD116 SERIES SWITCHES AND MARKERS



The TSD116 series is used for externally triggering data acquisition, remote event marking, or psychophysiological response tests. The switches can be monitored as input channels.

- **TSD116A** — single channel hand switch that connects to an AMI100D/HLT100C or UIM100C.
- **TSD116B** — single channel foot switch that connects to an AMI100D/HLT100C or UIM100C.
- **TSD116C** — compact eight-channel digital marker box that connects to a UIM100C only, The TSD116C allows users to independently mark events, or provide responses, on up to eight channels simultaneously. Because digital channels can be interleaved with analog channels when using *AcqKnowledge*, it's easy to assign separate digital channels as event markers for individual analog input channels.
- **TSD116D** — eight-channel marker box that connects to the 25-pin connector on the back of the STP100C only. Ships with a Y-splitter cable to allow the parallel port to be connected to a stimulation presentation system. TSD116D terminates in a 25-pin DSub pass-through connector with the ground line (pin 18) of the box and each of the switches wired to the appropriate digital input pin of the DSub connector (pin 2 through 9).

TSD116 SERIES SPECIFICATIONS

Switch Type:	Pushbutton: (ON) – OFF
Dimensions	
TSD116A:	19 mm (dia) x 63 mm (long)
TSD116B:	69 mm (wide) x 90 mm (long) x 26 mm (high)
TSD116C:	19 cm (wide) x 11 cm (deep) x 4 cm (high)
TSD116D:	19 cm (wide) x 11 cm (deep) x 4 cm (high)
Cable Length	
TSD116A:	1.8 meters
TSD116B:	1.8 meters
TSD116C:	3 meters
TSD116D:	3 meters
Connector Type	
TSD116A:	2 mm pin plugs (includes CBL124 adapter for connection to AMI100D/HLT100C)
TSD116B:	2 mm pin plugs (includes CBL124 adapter for connection to AMI100D/HLT100C)
TSD116C:	Stripped and tinned wires
TSD116D:	25-pin DSub
Interface:	
TSD116A:	AMI100D, HLT100C, or UIM100C
TSD116B:	AMI100D, HLT100C, or UIM100C
TSD116C:	UIM100C
TSD116D:	STP100C
TEL100C Compatibility:	SS10 Hand switch

TSD150 SERIES ACTIVE ELECTRODE



TSD150A — 35 mm spacing **TSD150B** — 20 mm spacing

TSD150 Active Electrodes are available in three configurations; the difference is the spacing between the stainless steel pads of the surface electrode. The surface electrode pads of the TSD150A and TSD150B have a diameter of 11.4 mm.

Note: GROUND MUST BE USED — Unlike most active electrodes, TSD150 series active electrodes have only two stainless steel disks attached to an electrode case. The third disk, commonly centered between the two, is not necessary. In place of this third disk, a separate ground electrode is used. The LEAD110A is typically used as the ground electrode, connected to a CBL201 conversion cable, and in turn connected to the GND A terminal at the rear of the UIM100C. (For MP160 with AMI100D/HLT100C, the LEAD110A is connected to a CBL229 conversion cable, which is then connected to an unoccupied input or output on the AMI100D/HLT100C). If one or more active electrodes are used on a single subject, only one Ground lead (LEAD110A) is required to act as Ground reference for all the active electrodes.

TSD150A/B ACTIVE ELECTRODES –35 MM, 20 MM

TSD150A and TSD150B may be used as a surface electrode or as a fine wire electrode. Conversion of the surface to fine wire electrode is easily accomplished by replacing the stainless steel pads with screw-springs that connect to the internal amplifier.

CONVERSION FROM SURFACE ELECTRODE TO FINE WIRE ELECTRODE SYSTEM

To convert the active electrode from a surface electrode to a fine wire electrode system, the stainless steel pads of the surface electrode must be unscrewed from the active electrode case. To accomplish this task:

- 1) Grasp the stainless steel pads and rotate them counterclockwise until they are disconnected from the case.
- 2) Screw the screw-spring combinations (fine wire electrode attachment) into the holes left by the removal of the stainless steel pads.
- 3) Attach the active electrode case (using tape or an elastic strap) to the limb of the subject, near the insertion site of the fine wire electrodes.
- 4) Gently bend the springs and place one fine wire electrode in the gap formed by bending the spring. Allow the spring to return to its upright position.
- 5) Repeat this procedure for the other fine wire electrode.

Note: If the wire-spring contact does not provide a good EMG signal, it may be necessary to rub the fine wire electrode with an emery cloth to remove the insulation prior to placing the wire in the spring.

To convert the system back to a surface electrode system, simply unscrew the screw-spring combinations, place them in a secure place and re-screw the stainless steel electrode pads into the electrode case.

TSD150 OPERATION

- 1) Attach the active electrode to the subject, with pads to the skin surface; use surgical tape (TAPE1) or an elastic strap. The active electrode requires good skin surface contact, so to obtain the best readings; select an area where skin surface is free of hair and/or lesions and abrade the skin slightly with the ELPAD.
- 2) Plug the active electrode into the desired channel (1-16) of the AMI100D/HLT100C module via a CBL229 conversion cable.

IMPORTANT! Make sure that the chosen channel is **not** already assigned to any other BIOPAC module; up to 16 active electrodes can be used with a single MP System. **If contention exists, the channel data will be corrupted.**

- 3) After connecting the active electrode into the AMI100D/HLT100C module attaching the active electrode to the subject, a Ground electrode will still need to be attached to the subject if no other ground is provided via another biopotential amplifier. The Ground electrode will act as reference for 1 to 16 active electrodes. The LEAD110A, 3-meter, unshielded electrode lead is recommended for this purpose. The LEAD110A will connect directly to any standard snap surface electrode (like the EL503). The surface electrode can be placed at any point on the subject, and performance is optimal when the electrode makes good contact with the skin surface.
 - **For MP160 with AMI100D or HLT100C:** The free end of the LEAD110A is connected to a CBL229 conversion cable and plugged into an unused input or output of the AMI100D/HLT100C.
 - **For MP150 with UIM100C:** The free end of the LEAD110A is connected to a CBL201 conversion cable, which is in turn inserted directly to the GND A terminal on the back of the UIM100C. To insert the LEAD110A/CBL201 into the GND A terminal, use a small screwdriver to back out the terminal locking screw, insert the CBL201 2 mm pin plug into the terminal opening and then tighten down the locking screw.
- 4) At this point, the active electrode is ready for data collection. Set up the active electrode **Scaling** in *AcqKnowledge*, by setting the MAP values to a factor of the default value divided by 330. See the *AcqKnowledge* Software Guide for more information on channel scaling. The recommended sampling rate for the MP System is 2000 Hz on each active electrode channel.

TSD150A/B CALIBRATION

The TSD150 series does not require calibration.

TSD150A/B ACTIVE ELECTRODE SPECIFICATIONS

Recommended Sample Rate:	<i>Best:</i> 2000 Hz, <i>Minimum:</i> 1000 Hz
Gain:	330 (nominal)
Input Impedance:	100 M Ω
CMRR:	95 dB (Nominal)
3 dB Bandwidth:	12 Hz – 500 Hz
Noise Voltage:	2 μ v rms (bandwidth of 12-500 Hz)
Cable:	3 meters, lightweight, shielded
Electrode Spacing	
TSD150A:	Wide — 35 mm
TSD150B:	Narrow — 20 mm
Stainless steel disk diameter:	11.4 mm
Fine Wire Attachment:	Screw springs
Ground Lead:	Requires LEAD110A for proper operation (one per subject)
Dimensions:	17.4 mm wide x 51 mm long x 6.4 mm thick
Weight:	9.5 grams
Interface:	AMI100D, HLT100C, or UIM100C

See also: LEAD110A, TAPE1 / TAPE2

IPS100D ISOLATED POWER SUPPLY MODULE



The IPS100D is used to operate 100C and 100D Series amplifier modules **independently** of an MP data acquisition unit. The IPS100D module couples the 100-series amplifier outputs directly to any **other** data acquisition system, oscilloscope or chart recorder. 100D Series Smart Amps connect directly to the RJ12 analog channel outputs on the IPS100D's front panel to receive the necessary isolated power, while older-style 100C Series Amplifier modules snap onto the side. The IPS100D allows users to operate up to 16 100C or 100D amplifiers on a stand-alone basis. The IPS100D is generally used with animal or tissue preparations. When collecting data from electrodes attached to humans, use the OUTISOA adapter to couple signals to external equipment.

100D Series Smart Amps may be connected to the IPS100D. In order to send isolated signals to external equipment, the CBL237 + OUTISOA combination should be used. The MEC104D is the appropriate extension cable for the Smart Amp series.

Includes In-line Transformer (AC300A) and USA or EURO power cord.

IMPORTANT USAGE NOTE

Do not use the IPS100D with a BIOPAC MP based system.

100C Series Amplifiers: For a fully isolated recording system using the IPS100D, couple signal inputs through an OUTISOA adapter. Contact BIOPAC for details.

THIRD-PARTY SOFTWARE CONSIDERATIONS:

When using third-party data acquisition software, additional signal processing will be required in order to obtain the proper biopotential physical units.

- Signal inversion voltage mapping must be applied in the software scaling (see page 2).
- Filters in Smart Amps are fixed, any additional filtering must be applied in the software.

IPS100D SPECIFICATIONS

Amplifier Output Access: 16 channels (front panel) – RJ12 jacks
 Isolated Power Access: ± 12 V, +5 V @ 100 ma (back panel) – screw terminals
 Weight: 0.907 kg (unit only)
 Dimensions: 7 cm (wide) x 11 cm (deep) x 19 cm (high)
 Power Source: 12 VDC @ 1 amp (uses AC300A transformer)

AMP VOLTAGE MAPPING:

Amp Type	Default Voltage Mapping
ECG100D, EOG100D, fEMG100D, EGG100D	0 V → 0 mV 10 V → -5 mV
EMG100D	0 V → 0 mV 10 V → -20 mV
ERS100D, EEG100D	0 V → 0 μ V 10 V → -500 μ V
RSP100D, PPG100D	0 V → 0 V 1 V → 1 V
EDA100D	cal_1 V → 0.1 μ S cal_2 V → 20 μ S
SKT100D	0 V → 32 deg C 10 V → 52 deg C
NICO100D (Z):	cal_1 V → 20 ohm cal_2 → 40 ohm
NICO100D (dZ):	cal_1 → 0 ohm/sec cal_2 → 4 ohm/sec

IPS100C ISOLATED POWER SUPPLY MODULE



The IPS100C is used to operate 100-series amplifier modules **independent** of an MP data acquisition unit. The IPS100C module couples the 100-series amplifier outputs directly to any **other** data acquisition system, oscilloscope or chart recorder. Amplifier modules snap onto the side of the IPS100C to receive the necessary isolated power and to direct the modules' output to the front panel of the IPS100C. The IPS100C allows users to operate up to 16 amplifiers on a stand-alone basis. The analog channel outputs are provided via 3.5 mm phone jacks on the front panel. The IPS100C is generally used with animal or tissue preparations. When collecting data from electrodes attached to humans, use the AMI100D/HLT100C module with OUTISOA and INISOA adapters to couple signals to external equipment.

Includes In-line Transformer (AC300A) and USA or EURO power cord.

IMPORTANT USAGE NOTE

Do not use the IPS100C with an MP based system. For a fully isolated recording system using the IPS100C, couple signal inputs and outputs through the AMI100D/HLT100C module and OUTISOA and INISOA adapters, respectively. Contact BIOPAC for details.

IPS100C SPECIFICATIONS

Amplifier Output Access:	16 channels (front panel) – 3.5 mm phone jacks
Isolated Power Access:	± 12 V, +5 V @ 100 ma (back panel) – screw terminals
Weight:	662 grams (unit only)
Dimensions:	7 cm (wide) x 11 cm (deep) x 19 cm (high)
Power Source:	12 VDC @ 1 amp (uses AC300A transformer)

! Newer HLT100C “Rev 2” units, shipped with MP160 Systems and indicated “Rev 2” on the part number/barcode label, cannot physically be used with MP150+UIM combination or an IPS100C.

The HLT100C-MP150 module provides 16 input and 2 output channels. The HLT100C-MP150 is similar in function to the UIM100C Universal Interface Module, but it also provides power to the transducer when making a connection.

DA100C – DIFFERENTIAL AMPLIFIER MODULE



Typical Connection Schematic of Wheatstone Bridge Transducer to DA100C Amplifier

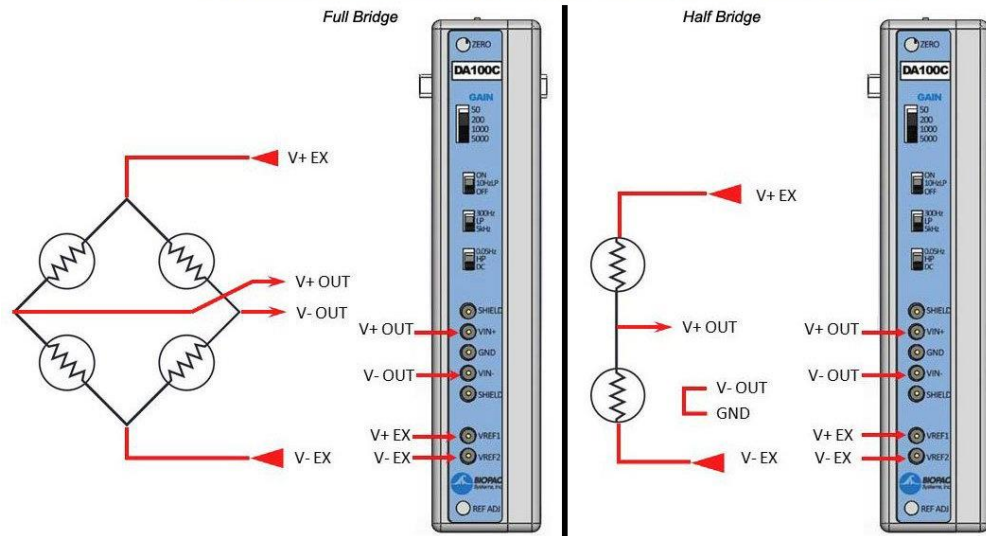

The differential amplifier module (DA100C) is a general purpose, single channel, differential amplifier. The DA100C is designed for use in the following measurement applications:

- Blood pressure (hemodynamics)
- Displacement (linear or angular)
- Muscle strain or force (pharmacology)
- Physiological sounds
- Temperature
- Humidity

The DA100C has one differential input linear amplifier with adjustable offset and gain. The DA100C is used to amplify low-level signals from a variety of sources. The DA100C has built-in excitation capability, so it can work directly with many different types of transducers, such as:

- Pressure transducers
- Strain gauges
- Accelerometers
- Microphones
- Electrogoniometers
- Piezo sensors
- Wheatstone bridges
- Photocells
- Thermistors

Compatible BIOPAC Transducers are:

TRANSDUCER	TYPE	TRANSDUCER	TYPE
TSD104A	Precision Pressure	TSD121C	Hand Dynamometer
TSD105A	Variable Range Force	TSD125 Series	Fixed Range Force
TSD107B	High Flow Pneumotach	TSD127	Low Flow Pneumotach
TSD108	Physiological Microphone	TSD130 Series	Goniometers & Torsiometers
TSD117	Medium Flow Pneumotach	TSD137 Series	Very Low Flow Pneumotach
TSD120	Noninvasive BP cuff	TSD160 Series	Differential Pressure

If the input signal is applied differentially between the VIN+ and VIN- inputs, the Input Signal Range can be centered on any voltage from -10 V to +10 V with respect to GND. If the signal is applied to a single input (with the other input grounded), then that signal can range over the selected Input Signal (pk- pk) with respect to GND.

The DA100C can be used to directly connect existing transducers. The DA100C can be outfitted with connector assemblies for easy interfacing to a variety of “off the shelf” pressure transducers, force gauges, and strain gauges.

TRANSDUCER CONNECTOR INTERFACES

These transducer connector interfaces (TCIs) have pin plugs on one side and the transducer mating connector on the other. The following TCIs are available. Or the TCI Kit can be used to make a custom adapter.

- TCI100** Grass/Astromed transducers – 6 pin
- TCI101** Beckman transducers – 5 pin
- TCI102** World Precision Instrument transducers – 8 pin
- TCI103** Lafayette Instrument transducers – 9 pin
- TCI104** Honeywell transducers – 6 pin
- TCI105** Modular phone jack connector – 4 pin
- TCI106** Beckman transducers – 12 pin
- TCI107** Nihon Koden transducers – 5 pin
- TCI108** Narco transducers – 7 pin
- TCI109** Fukuda transducers – 8 pin
- TCI110** **Gould transducers – 12 pin: Discontinued → use Fogg Cable and an available BIOPAC TCI**
- TCI111A** Liquid metal transducers – 1.5 mm Touchproof male plugs (two)
- TCI112** Hokanson transducers – 4 pin
- TCI113** Hugo Sachs/Harvard Apparatus — 6 pin
- TCI114** “SS” Series Transducers



Important Notes when using TCI114

- Set REF ADJ pot. On the DA100C: VREF1 to +5V, VREF2 to -5V
- The following SS Series Transducers require multiple channel inputs and therefore require a corresponding number of TCI114 with a DA100C each:
 - SS20L and SS21L Twin-axis Goniometers (2 channels)
 - SS26L and SS27L Tri-Axial Accelerometers (3 channels)
- The TCI114 interface is designed for SS Series Transducers only
 - SS1L, SS1LA, SS2L, or SS29L Electrode Leads and Adapters – not recommended: signal may be obtained but quality may be impaired.
 - SS53L, SS54L, and SS55L Digital Switches – not supported: digital interface required; use [TSD116 Series](#) Switches & Markers.
 - SS58L Low-Voltage Stimulator – not supported.
 - OUT1 Headphones – not supported.

TCI115 Interface XLR Microphone

The TCI115 will operate with a balanced (differential output) or unbalanced (single-ended output) XLR microphone. Interface all standard XLR microphones to the BIOPAC DA100C for use with a Research System. Accommodates a six meter XLR microphone cable. Input signal level maximum is 400 mv (p-p).

Microphones must be dynamic or have battery-powered condenser (the MP system does not provide 48 V phantom powering).

TCIPPG1 Geer to PPG100C only — 7 pin

DA100C VOLTAGE REFERENCES

The DA100C has two adjustable voltage sources (VREF1 and VREF2) for activating passive sensors like pressure transducers, strain gauges, thermistors and photocells. The references can be set anywhere from -5.0 V to +5.0 V. GND is at 0 V. VREF1 and VREF2 track each other with opposite polarity, thus a maximum differential of 10 V is obtainable for driving external transducers. For example, if VREF1 is set to +1.0 V (with respect to GND), then VREF2 will automatically be set to -1.0 V.

The references can be adjusted using the REF ADJ potentiometer near the bottom of the module. The voltage references can handle up to 20 mA sourcing or sinking to each other or GND. Pay close attention to the sensor drive requirements so as to minimize overall current consumption.

FREQUENCY RESPONSE CHARACTERISTICS

Use the **10 Hz LP** lowpass filter for connecting the DA100C to most pressure, force, and strain transducers (i.e., TSD104A, TSD105A, TSD120, TSD121C, TSD125 Series, and TSD130 Series).

Use the **300 Hz LP** lowpass filter for connecting the DA100C to devices with higher frequency output signals (i.e., TSD107B, TSD108, TSD117).

Use the **5,000 Hz LP** lowpass filter for connecting the DA100C to devices with the highest frequency signals, such as microphones and clamp signals (patch, voltage or current).

See also: the sample frequency response plots. 10 Hz LP, 300 Hz LP, 5000 Hz LP

DA100C CALIBRATION

- A. Reference calibration
- B. Amplifier gain calibration
- C. Transducer calibration if applying physical variable
- D. Transducer calibration if not applying physical variable

A. Reference Calibration

The **REFCAL** is used to check the reference voltage of the **DA100C**. The ref voltage is used to provide excitation to passive transducers.

B. Amplifier Gain Calibration

Use the CBLCAL.

C. Transducer Calibration if applying physical variable

1. Plug transducer it into the DA100C.
2. Set the gain switch on the DA100C to the desired level.
3. Apply the physical variable to the transducer on the low end of the expected range.
4. Press on Cal 1 in the scaling window in *AcqKnowledge*.
5. Apply the physical variable to the transducer on the high end of the expected range.
6. Press on Cal 2 in the scaling window in *AcqKnowledge*.
7. Review the Input Voltage differential (provided in the scaling window as a consequence of pressing CAL1 and CAL2) and adjust if necessary.
 - If the Input Voltage differential signal is less than +/- 50 mV it may be appropriate to increase the gain setting on the DA100C.
 - If either Input Voltage differential signal is higher than 9.9 V or less than -9.9 V, then reduce the gain setting on the DA100C.

NOTE: If the Gain switch setting on the DA100C is adjusted, steps 3-7 will need to be repeated.

The **physical variable** for calibration varies based on the transducer type. See the appropriate transducer specification for details:

<i>TRANSDUCER</i>	<i>TYPE</i>	<i>TRANSDUCER</i>	<i>TYPE</i>
TSD104A	Precision Pressure	TSD121C	Hand Dynamometer
TSD105A	Variable Range Force	TSD125 Series	Fixed Range Force
TSD107B	High Flow Pneumotach	TSD127	Low Flow Pneumotach
TSD108	Physiological Microphone	TSD130 Series	Goniometers & Torsiometers
TSD117	Medium Flow Pneumotach	TSD137 Series	Very Low Flow Pneumotach
TSD120	Noninvasive BP cuff	TSD160 Series	Differential Pressure

D. Transducer Calibration if not applying physical variable

Use this procedure to calibrate the transducer if the required physical variable changes can't easily be generated.

1. Calculate the de-normalized voltage calibration factor, V_Y .
 - a) Note the factory calibration constant “K” (generally listed as “Output” in the transducer specifications), expressed in the form of voltage/physical variable per volt excitation ((V/P)/V),
 - b) Multiply K ((V/P)/V) by the reference voltage (RV) of the DA100C (2 V factory preset).
 - c) Multiply the result $[K((V/P)/V) * RV] = V_Y$ by the Gain switch setting value on the DA100C.
2. Plug the transducer into the DA100C.
3. Place the transducer in the ambient or zero state.
4. Press CAL1 ...this will generate a value V_{zero} in the Input Voltage box
5. Enter the ambient or zero physical value in the Cal 1 Map/Scale window
6. Enter CAL2 Input Voltage as $V_{zero} + V_Y$
7. Enter the ambient + delta physical value in the Cal 2 Map/Scale window

DA100C SPECIFICATIONS

Gain:	50, 200, 1000, 5000										
Output Range:	±10 V (analog)										
Frequency Response	Maximum bandwidth (DC-5,000 Hz)										
Low Pass Filter:	10 Hz, 300 Hz, 5000 Hz										
High Pass Filter:	DC, 0.05 Hz										
Input Voltage (max):	±200 mV (protected)										
Noise Voltage:	0.11 µV rms – (0.05-10 Hz)										
Temperature Drift:	0.3 µV/°C										
Z (Differential input):	2 MΩ										
CMRR:	90 dB min										
CMIV—referenced to											
Amplifier ground:	±10 V										
Mains ground:	±1500 VDC										
Voltage Reference:	variable: up to ±5 V excitation (10 V delta) maximum @ 20 MA (max) (preset to 2 volts excitation)										
Signal Source:	Variety of transducers										
Input Voltage Range	<table border="0"> <thead> <tr> <th><u>Gain</u></th> <th><u>V_{in} (mV)</u></th> </tr> </thead> <tbody> <tr> <td>50</td> <td>±200</td> </tr> <tr> <td>200</td> <td>±50</td> </tr> <tr> <td>1000</td> <td>±10</td> </tr> <tr> <td>5000</td> <td>±2</td> </tr> </tbody> </table>	<u>Gain</u>	<u>V_{in} (mV)</u>	50	±200	200	±50	1000	±10	5000	±2
<u>Gain</u>	<u>V_{in} (mV)</u>										
50	±200										
200	±50										
1000	±10										
5000	±2										
Maximum Over-Voltage for Differential Input:	±25 V										
Weight:	350 grams										
Dimensions:	4 cm (wide) x 11 cm (deep) x 19 cm (high)										
Input Connectors:	Seven 2 mm female sockets: (Vin+, Ground, Vin-, 2 of shield, 2 of signal excitation)										

PRESSURE PAD/RESPIRATION TRANSDUCER & SENSOR

The multipurpose Pressure Pad/Respiration (pneumogram) transducer can be used to measure:

- Pulse when placed close to the heart or on a major pulse point
- Noninvasive respiration—from a small mouse to a human for standard setups, from animal only for MRI.*
- Small pressing forces (like pinching fingers together) for Parkinson’s evaluations.
- Human facial expressions (i.e., smiling/frowning with the sensor on the cheekbone).
- Spacing and pressure between teeth coming together.
- Startle blink response

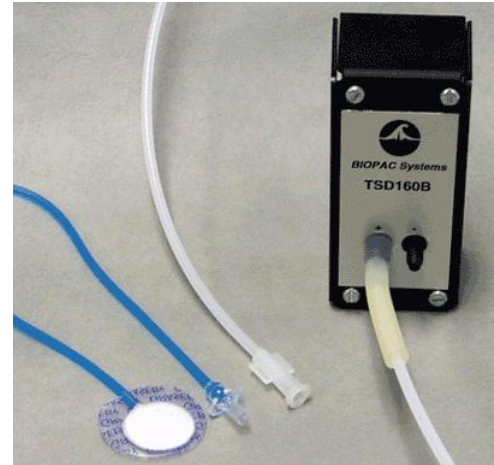

The transducer assembly includes a self-inflating pressure sensing pad connected to tubing terminated in a Luer male connector to interface additional tubing included for connection to the transducer. The pressure pad can be used many times, but may eventually need to be replaced if the sensor is damaged with rough or prolonged use.

TSD110 ±12.5 cm H₂O differential pressure transducer (TSD160B) plus pressure sensing pad (RX110) and tubing (AFT30 1.8 m). Requires DA100C to interface to MP160/150 Research System.

RX110 This replacement item is the sensor pad only, without additional tubing or transducer. One RX110 sensor is included with each TSD110 Respiration Pad Transducer.
 Pad: 20 mm Dia x 3.18 mm thick Sensor Tubing: 1.6 mm ID, 2.2 mm Dia, 1 m, Luer male

TSD110-MRI ±12.5 cm H₂O differential pressure transducer (TSD160B) plus pressure sensing pad (RX110-MRI) and additional tubing (AFT30-XL x 2 = 11 m). Requires DA100C to interface to MP160/150 Research System.

Place the differential pressure transducer in the MRI Control Room. To control for ambient pressure changes that may occur between the MRI Control Room and the MRI Chamber Room (such as if the control room door is opened), run the second AFT30-XL from the TSD160B through the wave guide into the MRI Chamber Room. The AFT30-XL tubing will add < 50 msec to the sensing of the waveform peak.

* TSD110-MRI is not recommended for human respiration; see TSD221-MRI instead.

MRI Use: MR Safe

TSD110-MRI Transducer Components – MRI Chamber room only: Tubing: Polyethylene (polymerized urethane), RX110-MRI Sensor: Plastic with Polyethylene foam

RX110-MRI This item is the sensor pad only, without additional tubing or transducer. One RX110-MRI sensor is included with the TSD110-MRI Respiration Pad Transducer. The RX110-MRI pressure pad does not contain any metallic parts and can be used inside the MRI bore.

Pad: 20 mm Dia x 3.18 mm thick Sensor Tubing: 1.6 mm ID, 2.2 mm Dia, 1 m, Luer male

MRI Use: MR Safe

RX110-MRI Components: Plastic with Polyethylene foam

CABLE CALIBRATORS FOR BIOPOTENTIAL AMPLIFIERS



CBLCALC Calibration Cable for 100C-series Biopotential Amplifiers.

CBLCAL Calibration Cable for 100B-series Biopotential Amplifiers. Use the CBLCAL to verify the signal calibration of the DA100C.

REFCAL Used to check the reference voltage of the DA100C.

Use CBLCAL/C to verify the calibration of the any of the Biopotential amplifiers. The cable (1.8m) connects between the amplifier input and the UIM100C or AMI100D/HLT100C D/A output 0 or 1. To verify the amplifier's frequency response and gain settings, create a stimulus signal using *AcqKnowledge* and monitor the output of the amplifier connected to the Calibration Cable. The Calibration Cable incorporates a precision 1/1000 signal attenuator.

Amplifier specification tests are performed at the factory before shipping, but a Calibration Cable can ensure users peace of mind by permitting precise frequency response and gain calibrations for exact measurements.

CBLCAL/C CALIBRATION

Hardware Setup

1. Connect the MP160 to the AMI100D/HTL100C (or MP150 to UIM100C) and biopotential amplifiers as normal.
2. Connect the CBLCAL/C between the selected amplifier and the UIM100C, inserting the single 3.5mm plug into the UIM100C Analog Output "0" port.
 - **To connect CBLCAL/C to the AMI100D or HLT100C**, a BIOPAC CBL122 adapter cable is required. This adapter cable consists of a 3.5 mm jack and an RJ11 plug. Connect the CBLCAL/C to the 3.5 mm jack, and plug the RJ11 end into the AMI100D/HLT100C Analog Output "0" port.
3. Connect the end containing several 2 mm pins into the corresponding holes on the face of the biopotential amplifier.
4. Select a Gain setting of 1,000 for DA, ECG, EGG, EMG, and EOG, or 5,000 for EEG and ERS.
5. Turn all filters to the desired position.
6. Select an appropriate channel on the top of the amplifier being tested (usually channel one, as this is the default setup in the software).

Software Setup

1. Under **Channel Setup**, insure that the default is set to analog channel one (A1).
2. Under **Acquisition Setup**
 - a) Choose a sampling rate of 2000 Hz (or higher).
 - b) Choose an acquisition period of at least 5 seconds.
 - c) Choose Record Last mode.
3. Under **Stimulator Setup** (see figure below)

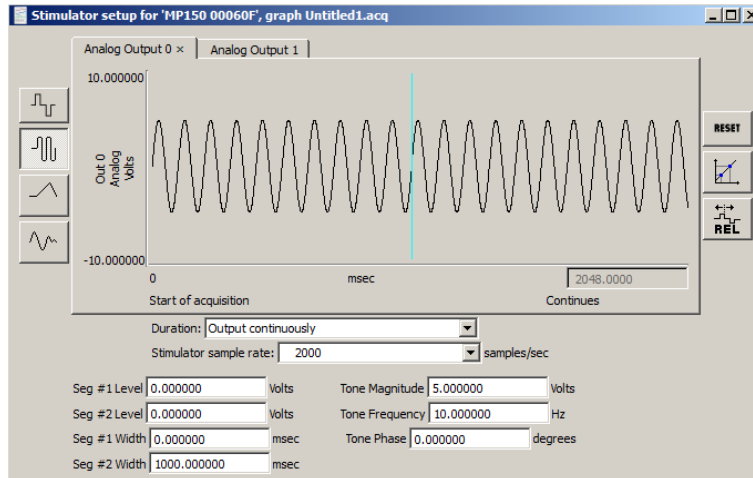

- a) Select the sine wave for the shape of the output signal.
- b) Set the “Seg. #1 Width” to zero. This means that the signal will be transmitted continuously starting at time-point zero.
- c) Set “Seg. #2 Width” to 1,000 msec (one second). This is the length of the output signal.
- d) Select “Analog Output: 0.”
- e) Select “Output continuously.”
- f) The most important settings are the signal magnitude and frequency. Set the magnitude to 5 Volts (i.e., 10 V p-p) if the module gain setting is 1,000. If the lowest module gain setting available is 5,000, choose 1 Volt.
- g) Set the frequency to 10 Hz to check the gain calibration (on a sinusoidal signal, this setting is appropriate for all biopotential amplifiers).

CALIBRATION PROCEDURE

AcqKnowledge is now set-up to check for the proper calibration of biopotential amplifiers.

1. Start the acquisition. Theoretically, since **record last** mode is enabled signal output is continuous, AcqKnowledge could acquire data forever.
2. Stop the acquisition when the waveform has stabilized.
3. Use the “I-beam” cursor to select the latter part of the record.
4. Perform all the calibration measurements on the latter part of the collected record.
 - a) Scale the waveform into some semblance of the one in the following figure.
 - b) Select the Pk-Pk (peak to peak) measurement to determine amplitude. The measured voltage depends on the voltage input and the gain setting on the amplifier. Use the following formula to determine this number.

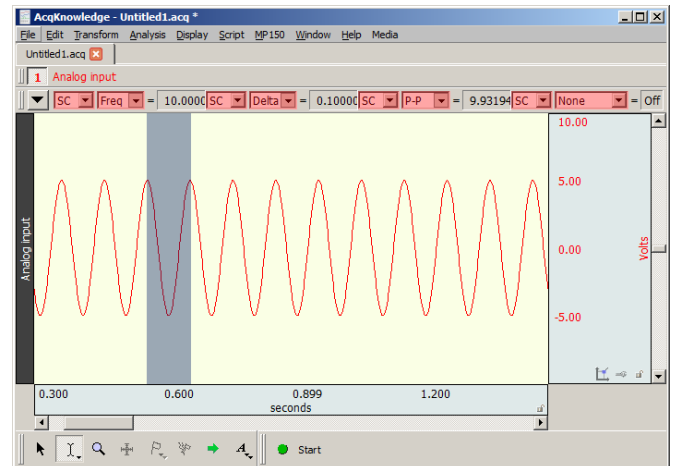

$$\text{Measured Voltage} = (\text{Stimulator Input Voltage}) * (1/1,000) * (\text{Biopotential Amplifier Gain Setting})$$

- If the amplifier gain setting is 1,000, it will cancel the CBLCAL/C attenuation (1/1,000). Therefore, the measured voltage will equal the stimulator input voltage. In this example, assuming a gain setting of 1,000 and a stimulator input of 10 V (pk-pk), the expected signal will be very close to 10 V (p-p).
- It is important to measure the amplitude of the acquired waveform correctly. Highlight several peaks with the “I-beam” cursor.
 - Click the “peak detection” icon at the top of the graph window twice. This will precisely highlight one of the many peak-to-peak amplitudes.
 - Open one of the pop-up measurement windows and select “p-p” to measure the amplitude of the waveform. This result indicates the vertical distance of the waveform between the two selected peaks (see figure above).
 - To verify the consistency of the difference in peak-to-peak values, click the “peak detection” icon again. This will move the cursor to the next available peak below.
 - Repeat this several times to verify the subsequent peak heights. If the measured peak-to-peak height is 10.04 Volts, the acquired signal can be ascertained as ± 5.02 Volts. If the stimulator outputs a 5 Volt magnitude signal, then measuring 5.02 Volts (0-pk) is considered accurate for any biopotential amplifier (the analog output stimulator is accurate to within $\pm .5\%$). To best determine the accuracy of the amplifier, consider an average of measurements.

REFCAL REFERENCE CALIBRATOR FOR THE DA100C



The **REFCAL** is used to check the reference voltage of the **DA100C**. It connects to the DA100C and displays the reference voltage as an analog input signal. This makes it very easy to adjust the reference voltage of the DA100C to suit the transducer.

The **REFCAL** connects the **VREF1** and **VREF2** voltage reference outputs directly to the DA100C inputs via a precision attenuator of value (1/50). When using the **REFCAL** to set the DA100C references, the DA100C should be set to DC with a gain of 50.

The voltage output on the selected channel of the DA100C will be the voltage difference between **VREF1** and **VRREF2**:

$$V_{OUT} = V_{REF1} - V_{REF2}$$

TSD104A BLOOD PRESSURE TRANSDUCER

The TSD104A measures direct arterial or venous blood pressure in animals or records pressure changes within an in-vitro circuit (e.g. Langendorff heart preparation). The TSD104A connects to tubing via standard Luer Lok fittings. The transducer is small and lightweight and the slotted base, with integral Velcro strap, permits easy mounting. The TSD104A interfaces with the DA100C general-purpose transducer amplifier. The transducer is supplied non-sterile but can be sterilized using ethylene oxide (ETO) gas. TSD104A includes the transducer with sensor element; replacement sensors (RX104A) can be purchased without the cable, making this a very economical solution for pressure sensing applications.



TSD104A TSD104A-MRI

TSD104A-MRI BLOOD PRESSURE TRANSDUCER FOR MRI

Use this blood pressure transducer for general arterial pressure studies in the MRI.

The TSD104A-MRI terminates in a DSUB9 connector and requires the [MECMRI-DA](#) cable/filter interface to DA100C.

MRI Usage: MR Conditional to 7T

Condition: Conductive parts are electrically and thermally isolated from subject. For animal use only when using direct to catheter blood pressure measurement.

RX104A REPLACEMENT ELEMENT

The RX104A is a replacement element for the TSD104A or SS13L blood pressure transducer; it does not include the TCI connector and cable.

RX104A-MRI REPLACEMENT ELEMENT

RX104A-MRI is the replacement pressure-sensing element for blood pressure transducer TSD104A-MRI; it does not include the connector and cable.

MRI Usage: MR Conditional to 7T

Condition: Animal use only



TSD104A/TSD104A-MRI Specifications

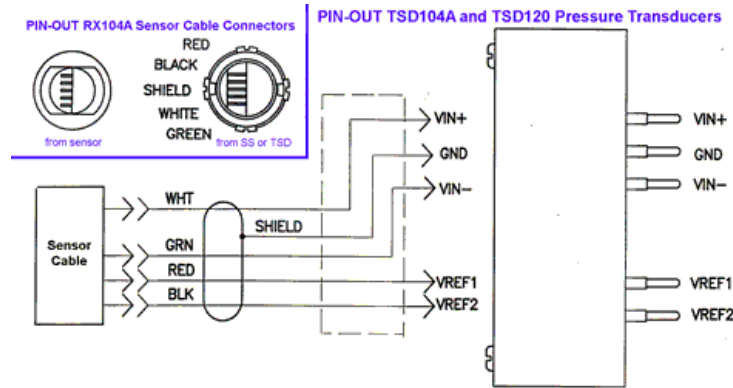

Operational pressure:	-50 mmHg to +300 mmHg
Overpressure:	-400 mmHg to +4,000 mmHg
Dynamic Response:	100 Hz
Unbalance:	50 mmHg max
Connection Ports:	Male Luer and female Luer (sensors shipped prior to summer 2010 were male Luer on both sides)
Eight-hour Drift:	1mmHg after 5 minute warm-up
Isolation:	≤ 5 μA leakage at 120 VAC/60 Hz
Defibrillation:	Withstands 5 discharges of 400 joules in 5 minutes across a load
Operating temperature:	+15° C to +40° C
Storage Temperature:	-30° C to +60° C
Temperature Coefficient:	± 0.4 mmHg / deg C
Combined effects of sensitivity, linearity, and hysteresis:	1 mmHg (nominal)
Output:	5 μV/mmHg (normalized to 2 V excitation)
Weight:	11.5 grams
Transducer Dimensions:	67mm long x 25mm wide
Cable length:	TSD104A 3 meters TSD104A-MRI 8 meters RX104A No cable
Interface:	TSD104A DA100C TSD104A-MRI MECMRI-DA to DA100C

TSD104A Calibration

See DA100C Calibration options.

TSD105A ADJUSTABLE FORCE TRANSDUCER

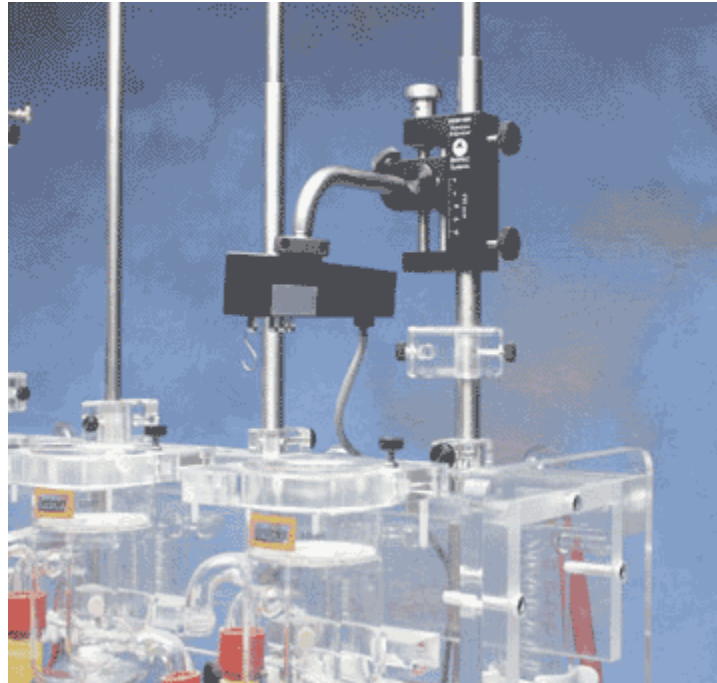

TSD105A shown with HDW100A

Force transducers are devices capable of transforming a force into a proportional electrical signal. The TSD105A force transducer element is a cantilever beam load cell incorporating a thin-film strain gauge. Because the strain elements have been photolithographically etched directly on the strain beam, these transducers are rugged while maintaining low non-linearity and hysteresis. Drift with time and temperature is also minimized, because the strain elements track extremely well, due to the deposition method and the elements' close physical proximity. The TSD105A also incorporates impact and drop shock protection to insure against rough laboratory handling.

Forces are transmitted back to the beam via a lever arm to insure accurate force measurements. Changing the attachment point changes the full scale range of the force transducer from 50 g to 1000 g. The beam and lever arm are mounted in a sealed aluminum enclosure that includes a 3/8" diameter mounting rod for holding the transducer in a large variety of orientations. The TSD105A comes equipped with a 2-meter cable and plugs directly into the DA100C amplifier.

The TSD105A mounting rod can be screwed into the transducer body in three different locations, two on the top and one on the end surfaces of the transducer. The mounting rod can be placed in any angle relative to the transducer orientation. The TSD105A can be used in any axis and can be easily mounted in any standard measurement fixture, including pharmacological setups, muscle tissue baths and organ chambers.

The TSD105A has 5 different attachment points that determine the effective range of the force transducer. These ranges are 50 g, 100 g, 200 g, 500 g and 1,000 g. The point closest to the end is the 50 g attachment point, while the point closest to the middle is the 1,000 g attachment point.

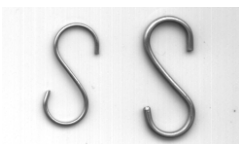

Two hooks are provided with the TSD105A. One with a .051" diameter wire and the other with a .032" diameter wire. The larger hook is intended for the 500 g and 1000 g ranges and the smaller hook is to be used for the 50 g, 100 g and 200 g ranges.

TSD105A CALIBRATION

The TSD105A is easily calibrated using weights of known mass. Ideally, calibration should be performed with weights that encompass the range of the forces expected during measurement and should cover at least 20% of the full scale range of the transducer. When calibrating for maximum range on the force transducer, use weights that correspond to 10% and 90% of the full scale range for best overall performance.

See also: DA100C Calibration options.

TSD105A SPECIFICATIONS

Rated Output:	1 mV/V (normalized to 1 V excitation)
Ranges:	50, 100, 200, 500, 1000 grams
Noise (rms):	(Range/50) mg @ 10 volts excitation, 1 Hz bandwidth
Nonlinearity: $\pm 0.025\%$	FSR
Hysteresis: $\pm 0.05\%$	FSR
Nonrepeatability: $\pm 0.05\%$	FSR
30 minute creep:	$\pm 0.05\%$ FSR
Temperature Range:	-10° C to 70° C
Thermal Zero Shift:	$\pm 0.03\%$ FSR/° C
Thermal Range Shift:	0.03% Reading/° C
Maximum Excitation:	10 VDC
Mounting Rod:	9.5 mm (dia) – variable orientation
Weight:	300 g (with mounting rod)
Length:	19 mm (wide), 25 mm (thick), 190 mm (long)
Cable Length:	3 meters
Interface:	DA100C

TSD107B HIGH-FLOW PNEUMOTACH TRANSDUCER



The TSD107B is a highly linear, wide range, airflow transducer. Using the TSD107B and a DA100C amplifier with the MP System, a variety of tests relating to airflow and lung volume can be performed. With the equipment listed below and the proper software parameters, precise lung volume measurements can be obtained.

EQUIPMENT

- MP System for data acquisition
- DA100C general purpose amplifier
- TSD107B pneumotach transducer

HARDWARE SETUP

1. Select DA100C module for Channel 1.
2. Set Gain at 1000.
3. Set the high frequency response to 10 Hz (300 Hz in some cases).
4. Set the low frequency response to DC.
5. Set VREF1 to +1.0 Volts (default) with a Volt/ohm meter or with BIOPAC REFCAL (VREF2 will track VREF1 with opposite polarity).
6. Plug the TCI connector into DA100C.
7. Insert the airflow tube between the bacterial filter and the airflow transducer.
8. Place the mouthpiece on the free end of the bacterial filter.

SOFTWARE SETUP

1. Under **Setup Channels** select channel 1 and click on the scaling button.
2. Complete the scaling dialog box as shown here:

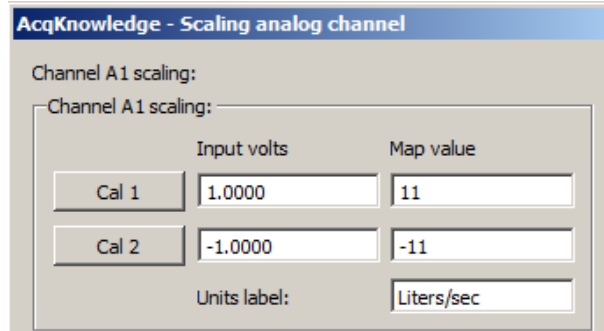

3. Under **Setup Acquisition** set
 - a) Storage: Disk
 - b) Sample rate: 50 samples per second
 - c) Acquisition length: 30 seconds.

RECORDING PROCEDURE

1. Start breathing normally through the mouthpiece.
2. After several normal breaths, inspire as deeply as possible (just once) and then return to normal breathing for several seconds
3. Expire as completely as possible.
4. Return to normal breathing for the remainder of the recording.

The recorded wave should look something like the top wave in the following graph. Normal Tidal Volume can vary quite a bit, even over a 30-second period. Note that in Wave 4 – adj volume, the starting tidal volume is almost a liter, then, as the test progresses, the tidal volume drops to about 0.5 liters. This level of variation is somewhat expected, since respiratory effort has a strong voluntary component.

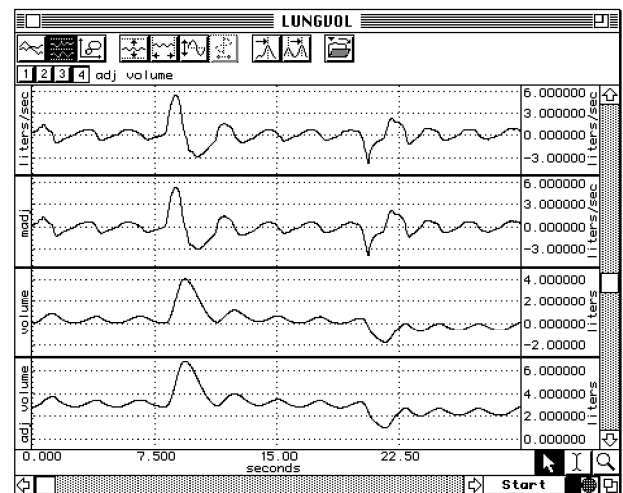

ANALYSIS — ACQKNOWLEDGE

1. Duplicate the recorded data.
2. Subtract the mean value of the entire record from the duplicated data to create the Mean Adjusted Flow (madj). This procedure will simply remove any DC bias from the airflow signal.
3. Duplicate madj.
4. Integrate the duplicated madj channel. This process results in the third wave, which is the volume (in liters), which correlates to the airflow.
5. To correct for the proper residual volume in the lungs (estimated at about 1 liter), add a constant to the third wave to create a new adjusted volume (adj volume). The minimum point on this curve should be the estimated residual lung volume (1 liter).

TSD107B CALIBRATION

The TSD107B is factory calibrated to nominally satisfy the scaling factor:

$$1 \text{ mVolt output} = 11.1 \text{ liters/sec flow rate}$$

When connected to the DA100C with Gain =1,000, the calibration factor is:

$$1 \text{ Volt} = 11.1 \text{ liters/sec}$$

This graph illustrates how a calibration check is performed.

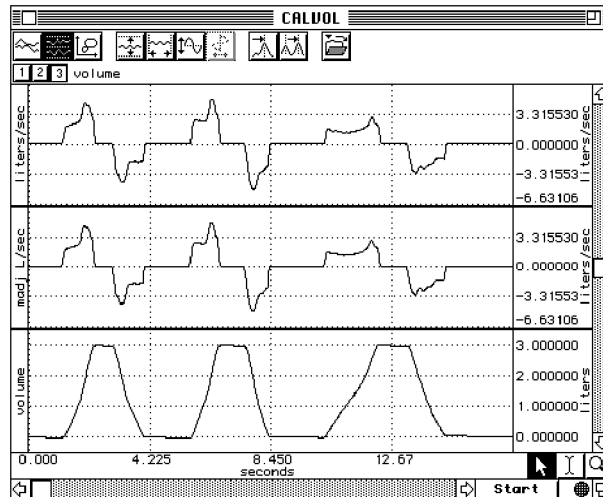

1. Insert a three-liter calibration syringe into the free end of the airflow tube.
2. Push three liters of air through the airflow transducer, first one direction, then the other.
3. Subtract the mean value of the first wave from the second wave, to correct for DC bias.
4. Integrate the second wave; the result will be placed in the third channel (volume).

As air is forced back and forth through the transducer, the expected volume would be from 0 to 3 liters. As air goes one way the volume climbs to 3 liters, and as that same air is then pulled the other direction through the transducer, the volume signal should head back to 0. As shown in the sample graph, the volume measurement is independent of the rate of flow, as would be expected for a linear airflow measurement transducer.

See also: DA100C Calibration options.

TSD107B SPECIFICATIONS

Pneumotach type:	Hans Rudolf® #4813 with integral differential pressure transducer
Voltage excitation:	+/- 5 volts (10 volts pk-pk) maximum
Nominal Output:	45 μ V/[liters/sec] (normalized to 1 V excitation)
Calibration factor:	90 micro-volts/(liters/second) – normalized to 2 VDC excitation
Calibrated flow range:	\pm 800 Liters/min
Dead space volume:	87.8 ml
Back pressure:	2.8 cm H ₂ O/400 liters/min
Flow bore (Ports):	35 mm OD
Weight:	690 grams
Dimensions:	4 cm (deep) x 11 cm (high) x 19 cm (wide)
Cable:	3 meters
Interface:	DA100C

MEDIUM-FLOW PNEUMOTACH TRANSDUCER

- SS11LB and SS11LA for MP3X and MP45 System
- TSD117A & TSD117A-MRI for MP160/150 System
- RX117A-MRI Replacement Airflow Head
- **See also:** **AFT series** of accessories for airflow and gas analysis

The SS11LB handheld airflow transducer is intended for human use and can be used to perform a variety of tests relating to airflow and lung volume. The transducer is factory-calibrated to measure airflows ranging from -10 to +10 liters/second within +/-5%. The transducer has a removable head (RX117A-MRI) for sterilization and replacement.



The SS11LB transducer incorporates the following improvements over the earlier-model SS11LA:

- No calibration syringe is required.
- Airflow measurement is much less susceptible to changes in transducer orientation.
- New tiered airflow head design allows for direct connection to multiple standard pulmonary ID/OD hoses and components without the need for couplers.
- Flow correction that was previously only included in lessons (via syringe) is now in Lessons and BSL *PRO* analog preset.

Use standard disposable mouthpieces with disposable bacterial filters, or use an autoclavable mouthpiece, depending on budget and/or lab preference. Direct connection to AFT36 35 mm Filtered mouthpiece. The SS11LB can also be used with the AFT22 Non-Rebreathing T-valve for low dead space requirements, and to monitor expiration and inspiration signals separately.

NOTE: SS11LB is compatible with BSL 4.1.1 and above or *AcqKnowledge* 4.4.2 and above. For earlier BSL and *AcqKnowledge* software versions, use SS11LA. (See page 2.)

FLOWCAL Optional SS11LB Calibration/Validation Kit



To perform an optional SS11LB user calibration, use the FLOWCAL Kit.

This kit consists of a calibrated 3-Liter calibration syringe (AFT27) plus coupler (AFT11D) that connects the syringe to the SS11LB. Download the free graph template file and FLOWCAL procedure from the [BIOPAC FLOWCAL](#) page.

Users wishing to perform an accurate validation should also have equipment that can measure humidity, temperature, and pressure of the lab environment.

The SS11LB is factory-calibrated for use when directly connected to a mouthpiece. If the flow transducer is connected to a hose, facemask, or other tubing it should be recalibrated with those attachments by using the syringe and this kit.

SS11LA Medium Flow Pneumotach Transducer

Older model SS11LA with RX117 is available for systems running BSL 4.1.0 and below or AcqKnowledge 4.4.1 and below (software upgrade recommended), and is the shipping airflow transducer model for Chinese, Italian, and Russian BSL 3.7 Systems. Use AFT1 Filter + AFT2 mouthpiece with SS11LA flow head RX117. See page 5 for SS11LA connection and calibration instructions.

TSD117A Medium Flow Pneumotach Transducer

The TSD117A is intended for human use and can be used to perform a variety of tests relating to air flow, lung volume and expired gas analysis. The new tiered flow head allows for direct connection to multiple standard pulmonary ID/OD hoses and components without the need for couplers. The flow head is removable, for easy cleaning and sterilization or replacement (RX117A-MRI). The TSD117A interfaces with the DA100C general-purpose transducer amplifier.

Replaces older model TSD117/RX117.

TSD117A-MRI Medium Flow Pneumotach Transducer

The TSD117A-MRI is designed for use in the MRI environment and interfaces with the MECMRI-DA to the DA100C general-purpose transducer amplifier. Includes RX117A-MRI removable flow head.

Replaces older model TSD117-MRI/RX117-MRI.

The TSD117A-MRI terminates in a DSUB9 and requires MECMRI-DA for proper operation.

MRI Use: MR Conditional to 3T

Note: Conductive parts of transducer are electrically and thermally isolated from subject. The TSD117-MRI is used outside the bore in the MRI Chamber Room and AFT7-L tubing is connected to reach the subject using AFT35-MRI non-rebreathing T-valve.

Components: Polyvinyl Chloride (PVC) Plastic, Polycarbonate Clear Plastic, Acrylonitrile Butadiene Styrene (ABS) Thermo-molded, Plastic, Polymer thick film device (rigid substrate, printed semi-conductor), Copper clad fiberglass lamination (PCB material), Stainless steel screen (type 316L), Stainless steel machine screws/nuts, tinned copper wire, Silicone elastomer, PVDF (Kynar®) heat shrink tubing

Please note the following for all airflow transducers:

- The bacterial filter and mouthpiece are disposable and are “one per person” items. Use a new disposable filter and mouthpiece each time a different person is to be breathing through the airflow transducer.
- For more effective calibration, use a bacterial filter between the calibration syringe and the airflow transducer.

Normal Measurement Connections

- SS11LA/SS11LB plugs directly into the MP3X or MP45 unit
- TSD117A plugs directly into the DA100C amplifier module
- TSD117A-MRI plugs into MECMRI-DA cable to DA100C amplifier module

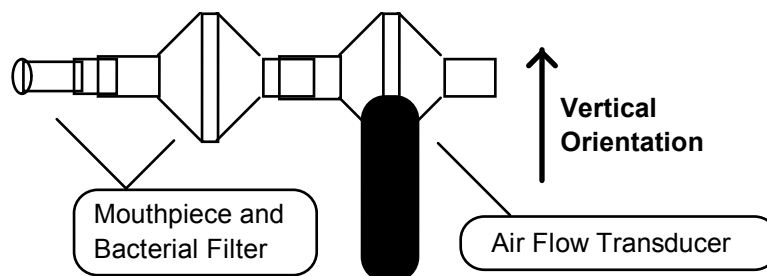

For the most accurate lung volume recording, be sure to use a noseclip to prevent airflow through the nose. Also, be sure not to remove the airflow transducer assembly from the mouth during the recording. All air leaving or entering the lungs must pass through the airflow transducer during the lung volume measurement.

Use the following measurement procedure for determining lung volume:

1. Breathe normally for 3 cycles (start on inspire)
2. Inspire as deeply as possible
3. Return to normal breathing for 3 cycles
4. Expire as deeply as possible
5. Return to normal breathing (end on expire)

Data Processing

When integrating the collected data to determine lung volume, it's important to integrate from the starting point of the first inspire, to the end point of the last expire. Before integration, the mean of the selected (airflow) data must be determined and then subtracted from the record. This process insures that the integral will have the same starting and ending point.

Calibration For Medium-Flow Pneumotachs

1. Syringe Calibration

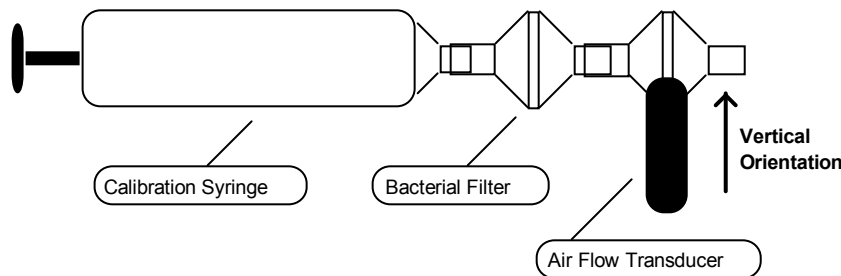

After the calibration process, please remove the calibration syringe and attach a new bacterial filter and mouthpiece to the airflow transducer.

It's very important that each individual use his/her own mouthpiece and bacterial filter.

Place the narrow end of the bacterial filter and mouthpiece assembly into either side of the airflow transducer. Airflow data can now be recorded. For best results, hold the airflow transducer vertically.

2. Mathematical Calibration (TSD117A and TSD117-MRI)

The transducer can be roughly calibrated without using the calibration syringe. Using the transducer's nominal output of 60 μV per liter/sec (normalized to 1 volt excitation), the following calibration factors can be entered in the software Scaling window.

Scaling Factors for Rough Calibration of the airflow transducer

The following equation illustrates why 0.12 volts maps to 1.00 liter/sec:

$$\text{Calibration Constant} \cdot \text{Amp Gain} \cdot \text{Amp Excitation} = \text{Scale Factor}$$

Thus

$$60 \mu\text{V}/[\text{liter}/\text{sec}] \cdot 1000 \cdot 2 \text{ Volts} = 0.12 \text{ V} / [\text{liter}/\text{sec}]$$

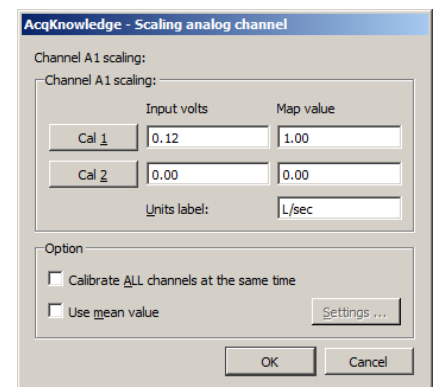

Data can now be collected directly. Prior to analyzing the data, remember that there will always be some offset recorded in the case of zero flow.

Note: With the TSD117A and MP160/150 system, it's possible to largely trim this offset out, using the ZERO potentiometer on the DA100C amplifier, but some residual will always remain.

To remove residual offset after the flow data has been collected, select a portion of the baseline (zero flow reading) and calculate the mean value using the popup measurements. Subtract this mean value from the raw data to obtain a mean corrected flow signal.

Now, the integral of the mean can be calculated as shown in this graph →

In this case, a 600 ml-calibration syringe was used to check the rough calibration of the airflow transducer. The rough calibration indicates a syringe volume of about 550 ml, so this method may only be expected to be accurate within ±10% of the real reading.

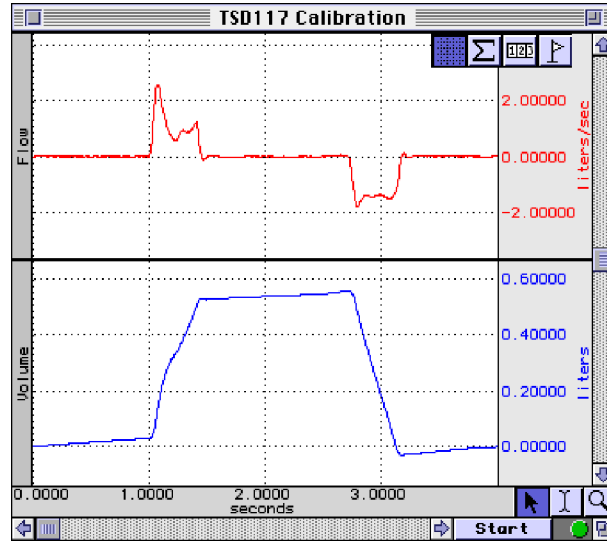

Flow Measurement and Volume Calculation

To achieve a more exact calibration, start with the above scaling factors and then boost or drop them slightly as indicated by the rough calibration. In this case, if the map value correlating to 0.12 volts were boosted about 10% to 1.10 (from 1.0 liters/sec), the resulting calibration would be fairly accurate.

See also: DA100C Calibration options.

>>> All Instructions also apply to the older airflow transducer — model SS11L with non-removable head <<<

SS11LA To MP3X Connection

1. Make sure the BIOPAC MP3X unit is turned OFF.
Note: Turn the MP3X power off even if the software is running.
2. The airflow transducer (SS11LA) can be plugged into any input channel on the MP3X.
3. After the transducer is plugged in securely, turn the MP3X power ON.
4. Launch the BSL or AcqKnowledge software.

IMPORTANT: After launching the software, allow at least 5 minutes for the SS11LA/LB Airflow Transducer to properly warm up.

Note: SS11LA to MP connection instructions also apply to 2-channel MP45 hardware.



SS11LA to MP3X connection

Rough Calibration (MP3X)

1. Choose the MP3X menu and select **Set Up Data Acquisition > Channels**.
2. Select the **Analog** channel that the SS11LA transducer is plugged into and activate it by checking the **Acquire**, **Plot** and **Values** boxes.
3. Click the **Preset** pop-up menu  and select **Airflow (SS11LA)** from the Preset list.
4. Click the **Setup** button in upper right of Channels screen.
5. Click the **Scaling** button at bottom of Setup screen. Note the default **Cal1 Input value** is 3000 microvolts, and the **Cal1 Map value** is 10, as shown in upper right example.
6. Click **Cal2**: Note the adjusted **Input value**. (Leave the **Map value** at 0.)
7. Add the adjusted **Cal2 Input value** to the **Cal1 Input value**, as shown in lower right example.
8. Click **OK**.

The SS11LA can be roughly calibrated without using the AFT6 calibration syringe by choosing the SS11LA preset and re-scaling to account for amplifier excitation. Use the “Rough Calibration” steps shown on the left to apply this calibration method.

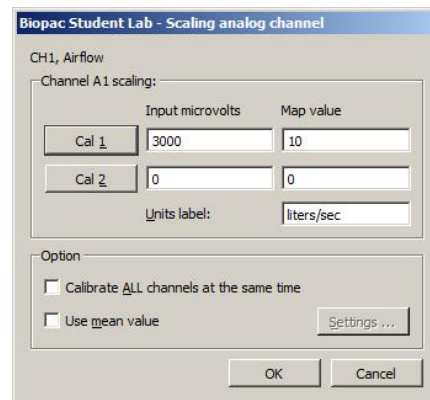

SS11LA Default Scaling

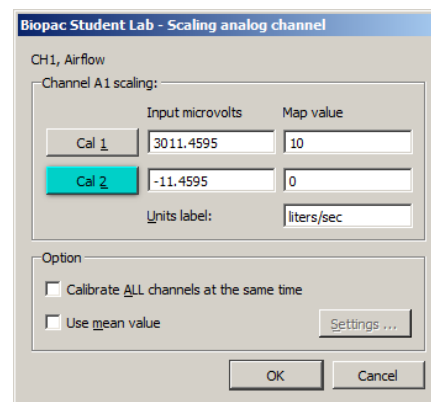

SS11LA Adjusted Scaling

Using the Calibration Syringe

1. Place a filter onto the end of the calibration syringe.
2. **Insert** the Calibration Syringe/Filter Assembly into the airflow transducer.

IMPORTANT!
 Always insert on the side labeled “Inlet.”

Never hold onto the airflow transducer handle when using the Calibration Syringe or the syringe tip may break.

3. **Pump** the plunger several times before the recording. **Always** pull and push the plunger all the way until it stops when using the syringe. This assures that the full volume of air (0.6 liter) flows in and out of the airflow transducer.

The filter is necessary for calibration because it forces the air to move smoothly through the transducer. This assembly can be left connected for future use. The filter only needs to be replaced if the paper inside the filter tears.

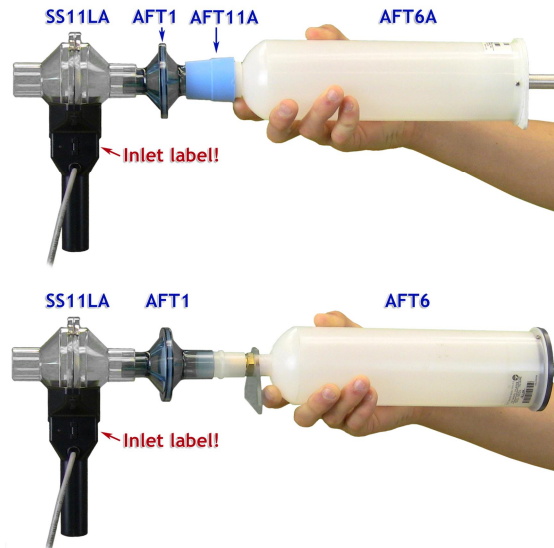

Calibration Syringe into airflow transducer

Insert syringe assembly so that the transducer cable exits on the left, as shown above.

- **If** using an older **SS11L** transducer with non-removable head, insert syringe assembly into the larger diameter port.

IMPORTANT: If the lab sterilizes the airflow heads after each use, make sure a clean head is installed now.

The Airflow Transducer is sensitive to gravity so it needs to be held upright throughout the calibration and recording.



Proper handling of the Calibration Syringe Assembly

Recording with the Airflow Transducer

- 1) **Attach** the appropriate filter and mouthpiece on the side labeled **Inlet**.

WARNING

The bacterial filter and mouthpiece are disposable and are “**one per person**” items. Please use a new disposable filter and mouthpiece each time a different person is to be breathing through the airflow transducer.

- 2) Breathe through the airflow transducer, following the proper procedure defined to the right.

If using SS11LA transducer and not sterilizing the head after each use, insert a filter and mouthpiece into the airflow transducer on the side labeled “Inlet.”

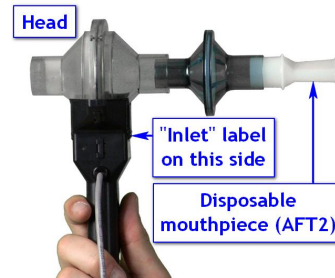

SS11LA with unsterilized head

If using SS11LA transducer and sterilizing the head after each use, insert a disposable mouthpiece (BIOPAC AFT2) or a sterilizable mouthpiece (BIOPAC AFT8) into the airflow transducer on the side labeled “Inlet.”



SS11LA with sterilized head

Hints for obtaining optimal data:

- a) Keep the Airflow Transducer upright at all times.

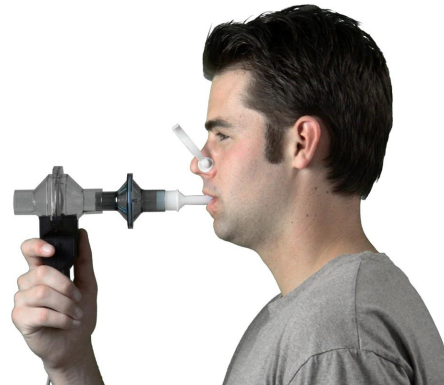

- b) Always insert on and breathe through the side of the SS11LA airflow transducer labeled “Inlet.”
- c) Always use a nose clip when breathing through the airflow transducer and secure a tight seal with the mouth so that air can only escape through the airflow transducer.
- d) Always begin breathing normally through the airflow transducer prior to the beginning of the recording and continue past the end of the recording.

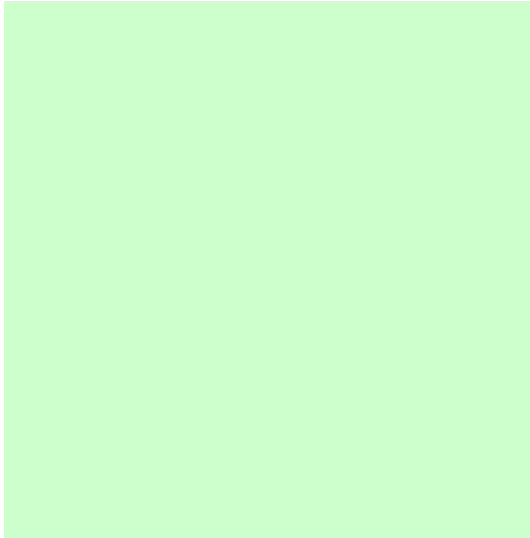

- e) If starting the recording on an inhale, try to end on an exhale, and vice-versa. This is not absolutely critical, but will increase the accuracy of Airflow to Volume calculations.
- f) The Subject must try to expand the thoracic cavity to its largest volume during maximal inspiratory efforts. (The Subject should wear loose clothing so clothing does not inhibit chest expansion.)
- g) During recording of FEV, the Subject should attempt to exhale as quickly as possible into the mouthpiece.
- h) During recording of MVV, the Subject should attempt to exhale and inhale as quickly and deeply as possible. Breathing rates should be faster than 60 breaths/minute or greater than 1 breath/second for the best results. The breathing needs to be maintained for 12-15 seconds.

RX117A-MRI Replacement Airflow Head



The RX117A-MRI is a sterilizable airflow head for the TSD117A, TSD117A-MRI, and SS11LA pneumotach transducers. The material used in the flow head is polycarbonate and the screen is Stainless Steel. To reduce the cost of disposable items, use the RX117A-MRI with the AFT8 sterilizable mouthpiece. (22 mm ID/30 mm OD). Multiple RX117A-MRI heads help eliminate equipment downtime during cleaning procedures.

Recommended sterilization: cold sterilization (i.e., Cidex® OPA) or autoclave. If autoclaved, RX117A-MRI Airflow Heads should be cleaned at the lowest autoclave temperature setting. The life cycle will be about 10-20 cycles, depending upon temperature used.

MRI Use: MR Conditional to 3T

Condition: The RX117-MRI head is used with the TSD117A-MRI transducer outside the bore of the MRI Chamber Room and AFT7-L tubing is connected to the subject.

Handheld Pneumotach and Flow Head Specifications

TRANSDUCER:	TSD117A	TSD117A-MRI	SS11LB/SS11LA
Interface:	DA100C	MECMRI-DA to DA100C	MP36/35/45
Cable Length:	3 m shielded	8 m, shielded	3 m, shielded
Flow Rate:	±10 liters/sec (highest linearity (±5 liters/sec)		
Nominal Output:	60 µV/[liters/sec] (normalized to 1 V excitation)		
¼" 25 TPI mounting nut:	Standard camera mount		
Handle Dimensions:	127 mm (length) x 23 mm (thick) x 35 mm (wide)		
Handle Construction:	Black ABS		
RX117A-MRI SPECS:			
Flow Head Construction:	Clear Acrylic		
Flow Bore (Ports):	Inner Diameter: 22 mm, Tiered Outer Diameter: 29 mm, 31 mm, 35 mm		
Flow Head Dimensions:	82.5 mm (diameter) x 101.5 mm (length)		
Flow Head Weight:	80 g		
Handle Weight:	85 g		
Dead Space:	93 ml		

TSD127 PNEUMOTACH AIRFLOW TRANSDUCER

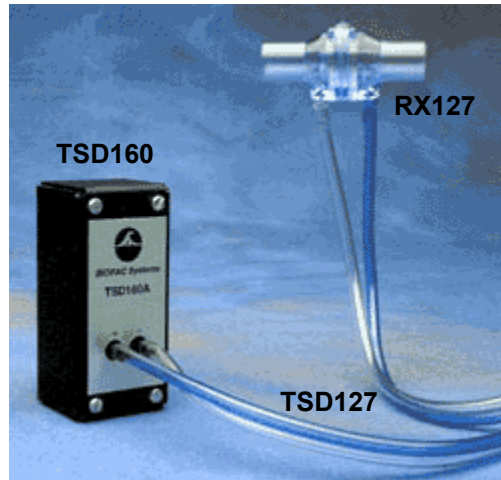

The TSD127 can perform a variety of pulmonary measurements relating to airflow, lung volume and expired gas analysis. The TSD127 is intended for animal and human use and consists of a pneumotach airflow head (RX127) coupled to a precision, highly sensitive, differential pressure transducer (TSD160A). The TSD127 will connect directly to a breathing circuit or plethysmogram chamber. The detachable flow head (RX127) makes cleaning and sterilization easy.

- For airflow and lung volume measurements, connect a short airflow cannula to the TSD127.
- For measurements of expired gases, use the TSD127 with the AFT22 non-rebreathing valve.
- All connections can be performed with AFT11 series couplers.

TSD127 CALIBRATION

Follow the procedure for TSD117 but move the calibration syringe plunger at a reduced velocity due to the higher sensitivity to flow of the TSD127.

See also: DA100C Calibration options.

TSD127 SPECIFICATIONS

Range:	± 90 liters/min (±1.5 liters/sec)	Dimensions:	5.7 cm (long) – airflow head
Nominal Output:	500 μ V/[liters/sec] (normalized to 1 V excitation)	Ports:	15 mm OD / 11 mm ID
Dead Space:	11 cc	Tubing Length:	1.8 meters (to DA100C)
Weight:	11 grams – airflow head	Interface:	DA100

RX127 REPLACEMENT AIRFLOW HEAD

The RX127 is a low airflow head for the TSD127 pneumotach transducer. Multiple RX127 heads help eliminate equipment downtime during cleaning procedures. (11 mm ID/15 mm OD)

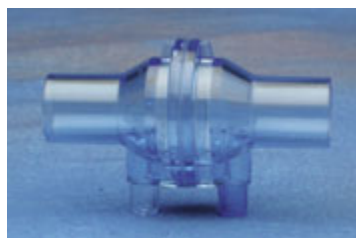

PNEUMOTACH AIRFLOW TRANSDUCERS

- TSD137 SERIES FOR MP160/MP150 SYSTEM
- SS46L-SS52L SERIES FOR MP3X AND MP45 SYSTEM
- RX137 SERIES REPLACEMENT FLOW HEADS



The TSD137/SS46L-SS52L series pneumotachs can be used to perform a variety of small animal and human pulmonary measurements relating to airflow, lung volume and expired gas analysis. These pneumotach transducers consist of a low flow, pneumotach airflow head (RX137B through RX137H and SS46L through SS52L) coupled to a precision, highly sensitive, differential pressure transducer (TSD160A or SS40L) via RX137 tubing. The pneumotachs will connect directly to a

breathing circuit or plethysmogram chamber. For airflow and lung volume measurements, connect a short airflow cannula to the RX137 series flow head. All pneumotachs are equipped with an internal heating element and AC137A 6-volt power supply.

MRI Use (TSD137): MR Conditional

Condition: Tested to 3T: Contains ferrous material – must be clamped down in the safe MRI operating area.

Components: Brass, stainless steel, copper

See also: DA100C Calibration options.

RX137 Series Replacement Airflow Heads (SHOWN ABOVE)

For TSD137 & SS46L-SS52L Series Pneumotachs

The RX137 series are airflow heads for the TSD137 and SS46L-52L series pneumotach transducers. The RX137 heads can be mixed and matched with any of the TSD137 and SS46L-SS52L series pneumotachs. Switching one head for another when using a single pneumotach can accommodate a wide range in flows. RX137 heads connect to the TSD160A or SS40L differential pressure transducer via standard 3 mm or 4 mm ID tubing. Multiple RX137 heads help eliminate equipment downtime during cleaning procedures.

Pneumotach Airflow Transducer Calibration

Connect tubing between the calibration syringe and the transducer, then follow the procedure for TSD117/SS11LA but move the calibration syringe plunger at a reduced velocity due to the very high sensitivity to flow of the TSD137/SS46L-SS52L series. Each of the TSD137/SS46L-SS52L series is factory calibrated to a known flow level, as indicated on the transducer.

Flow Head Cleaning & Disinfection

IMPORTANT:

- RX137 series airflow heads are manufactured with a very thin layer of synthetic resin, so they should **never** be cleaned with an organic solvent. We recommend cleaners such as Hydro-Merfen at the concentration used for medical material, or Gluterox.
- Before using the airflow head, be sure it is dry.
- Never heat the airflow head higher than 50 C.
 1. Submerge the airflow head in a disinfectant solution for approximately one hour.
 2. Rinse the airflow head with distilled or de-mineralized water.
 3. Use compressed air or another compressed gas [pressure up to 5 kg / cm² (5 bar)] to drive any remaining water out of the airflow head.
 4. Allow the airflow head to dry completely in ambient air (or continue using compressed air if time requires it).

TSD/RX137 & SS46L-SS52L Series Specifications

Part# <i>DA100C TSD160/SS40L MP36/35/30/45</i>	TSD137B RX137B1 SS46L	TSD137C RX137C1 SS47L	TSD137D RX137D1 SS48L	TSD137E RX137E1 SS49L	TSD137F RX137F1 SS50L	TSD137G RX137G1 SS51L	TSD137H RX137H1 SS52L
Range (ml/sec):	±50	±83	±167	±583	±1667	±2667	±13333
Dead Space (cc):	0.8	0.9	2.0	4.0	18.15	13.87	80.0
Nominal Output (µV [ml/sec]):	15.40	5.78	2.10	0.924	1.155	0.4815	0.1925
Flow Ports ID/OD (mm):	2.4 - 3.9	3.76 - 5.2	6.4 - 7.9	9.5 - 15.0	19.0 - 22.0	Port 1: 15.0 - 22.0 Port 2: 13.2 - 15.0	28.6 - 35.0
RX Head Length (mm):	75	75	75	60	60	60	60
RX Head Weight (grams):	90	90	100	60	100	150	250
Approx. Size:	Mouse	Rat/Guinea Pig	Cat/Rabbit	Small Dog	Medium Dog	Large Dog	Adult Human
Approx. Weight:	50 g	350 g	750 g	5.5 kg	15 kg	25 kg	--
Nominal Output:	TSD137B, C, H = normalized to 1 V excitation TSD137D, E, F, G & SS46L-52L = normalized to 5 V excitation						
Tubing Length:	1.8 m (to TSD160A/SS40L)						

PNEUMOTACH 200 SERIES AIRFLOW TRANSDUCERS

These flow transducers are designed for humans and animals ranging in size from mice to medium-sized dogs. They include a detachable flow head (RX237B through H) and a differential pressure transducer (TSD160A or SS40L).



Available Flow Rates

17 ml/sec	Mouse/Rat
167 ml/sec	Cat/Rabbit
1.67 L/sec	Medium Dog
16.7 L/sec	Human

- Lightweight and robust
- Economical, sensitive and robust
- Linear and direction sensitive
- Easily cleaned, disinfected or sterilized
- Twin, non kink silicone tubing

For cleaning instructions, see the [Cleaning Guidelines](#).

MRI Usage: MR Conditional

Condition: Animal use only. Contains ferrous material – must be clamped down in the safe MRI operating area.

Components: Brass, stainless steel, copper

RX237 SERIES REPLACEMENT AIRFLOW HEADS

For TSD237 and SSLA Series Pneumotachs

Detachable flow heads in are machined from acetal to give good stability with low weight and have found application in pediatrics and in the respiration measurement of animals such as dogs, cats, rats and mice.

TSD/SSLA/RX237 Series Specifications

BIOPAC Part #		Flowhead Type	Dead Space (ml)	Linear Range L/min	Approx. Flow for 10 mm H ₂ O	Tube (OD mm)	Length (mm)	Weight (gm)
Transducer	Flowhead							
TSD237B/SS46LA	RX237B	F1L	0.6	± 1	1.2 L/min	5	40	14
TSD237D/SS48LA	RX237D	F10L	2	± 10	12 L/min	8	54	22
TSD237F/SS50LA	RX237F	F100L	9	± 100	90 L/min	16	54	38
TSD237H	RX237H	F1000L	320	± 1000	485 L/min	29.5	198	260

Note: One of the problems historically encountered with pneumotachographs is condensation from expired air. This can be prevented by fitting a non-return valve and measuring only inspiration or alternatively by heating the flowhead, but viscosity errors may arise (from which in the first few breaths especially) preheat the inspired air most uncomfortably. In this range of flow heads, **the problem is approached from a fresh angle**. By mounting fine stainless steel gauze in plastic rings, thermal inertia is greatly reduced. The gauze therefore rapidly equilibrates in temperature with passing air and condensation is minimal.

BLOOD PRESSURE CUFF AND TRANSDUCER

- TSD120 for MP160/MP150 System
- RX120 Series Cuff for TSD120
- SS19L/LA/LB for MP3x & MP45 System



TSD120



RX120A and RX120F cuff options

BLOOD PRESSURE MEASUREMENT

The most common form of indirect blood pressure measurement employs a pressure cuff, pump and pressure transducer. This complete assembly is commonly referred to as a *sphygmomanometer*.

Typically, the cuff is wrapped around the upper arm and is inflated to a pressure exceeding that of the brachial artery. This amount of pressure collapses the artery and stops the flow of blood to the arm. The pressure of the cuff is slowly reduced as the pressure transducer monitors the pressure in the cuff. As the pressure drops, it will eventually match the systolic (peak) arterial pressure. At this point, the blood is able to “squirt” through the brachial artery. This squirting results in turbulence that creates the Korotkoff sounds. The cuff pressure continues to drop, and the pressure eventually matches the diastolic pressure of the artery. At that point, the Korotkoff sounds stop completely, because the blood is now flowing unrestricted through the artery.

SETUP

The graph at right illustrates a typical recording using the TSD120/SS19L.

- **TSD120:** Pressure signal is recorded via a DA100C amplifier set to DC, 10Hz LP and a gain of 200.
- **SS19L/LA/LB:** To record the pressure signal, Select SS19L/LA/LB preset from the MP3x/MP4x > Set Up Channels menu.

RECORDING

As the cuff is wrapped around the upper arm of the subject, be sure to place the physiological sounds transducer **underneath** the blood pressure cuff, **directly over the brachial artery**. Transducer placement is very important to get the best possible recordings of Korotkoff sounds. Finish wrapping the cuff around the upper arm and secure it with the Velcro® seal. Now, start inflating the cuff with the pump bulb.

The pressure trace shows the hand pump driving the cuff pressure up to about 150 mmHg. Then the cuff pressure is slowly released by adjusting the pump bulb deflation orifice. Notice that the Korotkoff sounds begin appearing when the cuff pressure drops to about 125 mmHg (bottom trace). As the pressure continues to drop, the Korotkoff sounds eventually disappear, at about 85 mmHg. The **systolic pressure** would be identified at 125 mmHg and the **diastolic pressure** would be 85 mmHg.

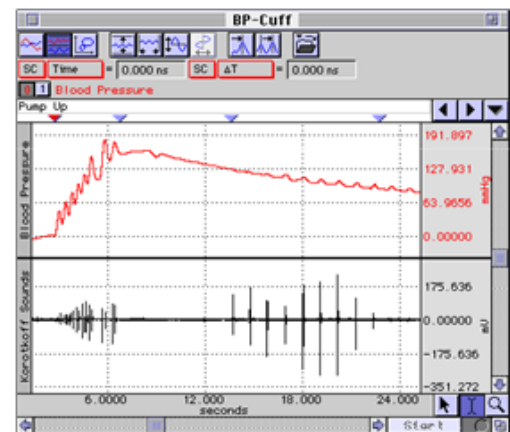

Cuff Blood Pressure Versus Korotkoff Sounds

CALIBRATION

A) TSD120

The TSD120's built-in pressure transducer will require an initial calibration prior to use. To calibrate the transducer, wrap the cuff into a roll and begin to inflate the cuff slowly with the pump bulb. The pressure change will be noticeable on the mechanical indicator. Set the cuff pressure to one lower pressure (typically 20 mmHg) and then one higher pressure (typically 100 mmHg). In this manner the pressure transducer can be calibrated using the standard procedure in the SCALING dialog (in *AcqKnowledge*). To use the cuff at a future date, simply save the calibration settings in a stored file.

See also: DA100C Calibration options.

B) SS19L

The built-in pressure transducer of the SS19L/LA/LB requires an initial calibration prior to use. To calibrate the transducer, wrap the cuff into a roll and begin to inflate the cuff slowly with the pump bulb. Notice the pressure change on the mechanical indicator. Set the cuff pressure to one lower pressure (typically 20 mmHg) and then one higher pressure (typically 100 mmHg). In this manner the pressure transducer can be calibrated using the standard procedure in the Scaling dialog box of the BSL *PRO* software. To use the cuff at a future date, simply save the calibration settings as a New Channel Preset or in a graph template or data file.

C) SS19LA/LB

SS19LA/LB uses an on-screen gauge display only and does not include a physical gauge. Gauge color can be set under Lesson Preferences.

NOTE: The SS19LB is only compatible with BSL 4.1 and higher.

BSL 3.7.7

1. With **cuff deflated**, connect the SS19LA to the desired MP unit input channel.
2. Set the input channel preset to Blood Pressure Cuff SS19LA (MP > Set Up Channels > SS19LA preset)
3. Click on "View/Change Parameters" > "Scaling".
4. Click the CAL 1 button
5. Add the CAL 1 input value to the CAL 2 input value.
6. Click OK and close dialogs.

BSL 4

1. Repeat steps 1 and 2 from above.
2. Click "Setup" > "Scaling".
3. Click the CAL 2 button
4. Add the CAL 2 input value to the CAL 1 input value and click OK.

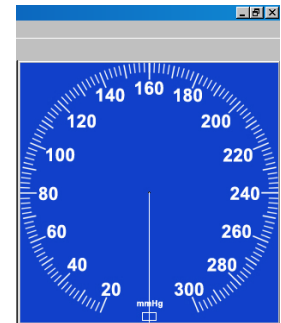

NOTE: The SS19LA/LB is **not** compatible with MP45 Systems (USB chip conflict). Use SS19L with MP45 Systems.

Example in BSL 4 – initial scaling dialog (SS19LA):

Clicking **CAL 2** results in an Input value of 0.071 mV.

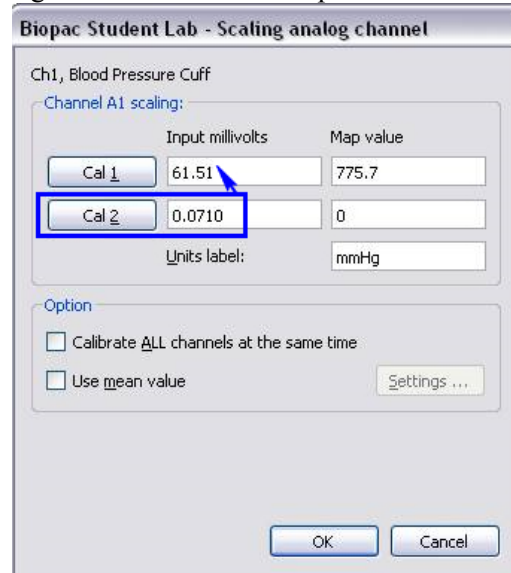
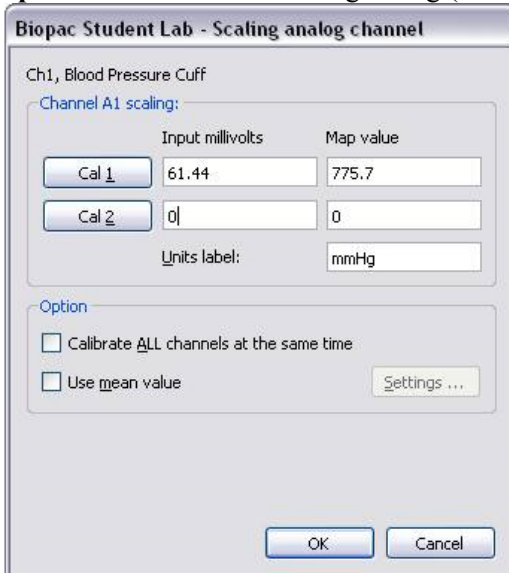

Adding 0.071 to the initial value of 61.44 results in an adjusted **CAL 1** value of 61.51 mV. (Your result may vary slightly from the example).

NOTE: For the SS19LB, the default initial scaling values are: **CAL1 = 40.96, Map value = 258.57**

IMPORTANT: CAL 1 and CAL 2 values are reversed between BSL 3.7.7 and BSL 4.

BLOOD PRESSURE CUFF SPECIFICATIONS

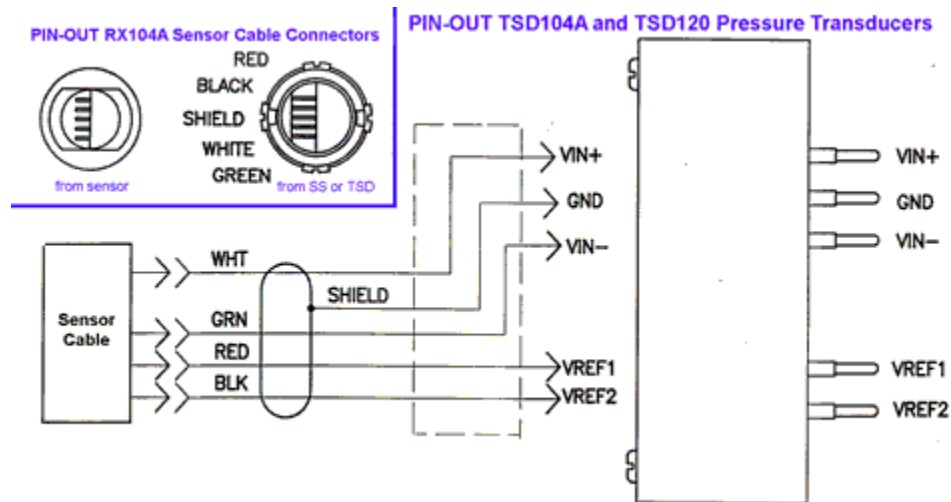

Pressure range:	20 mmHg to 300 mmHg
Manometer accuracy:	±3 mmHg
Output:	5 µV/mmHg (normalized to 1 V excitation)
Cuff circumference range:	25.4 cm to 40.6 cm (as shipped with RX120 d; cuff is switchable)
Cuff Dimensions:	14.5 cm (wide) x 54 cm (long)
Weight:	350 grams
Cable Length:	3 meters, shielded
Interface:	
TSD12 0	DA100C
SS19L/LA/LB	MP3x/4x

RX120 SERIES BLOOD PRESSURE CUFFS

The RX120 series are optional blood pressure cuffs, of varying sizes, which can be quickly and easily swapped in and out of the noninvasive blood pressure cuff transducer. Use a single transducer and substitute one cuff for another to accommodate a wide range in limb circumferences.

RX120 SPECIFICATIONS

Cuff	Circumference Range (cm)	Width (cm)	Length (cm)	
RX120A	9.5-13.5	5.2	18.5	
RX120B	13.0-1	9.0	7.5	26.1
RX120C	18.4-2	6.7	10.5	34.2
RX120D	25.4-4	0.6	14.5	54.0
RX120E	34.3-5	0.8	17.6	63.3
RX120F	40.6-6	6.0	21.0	82.5

TSD121C HAND DYNAMOMETER



The TSD121C is an isometric dynamometer that measures gripping (compression) or pulling (tension) forces associated with a wide variety of muscle groups. The isometric design improves experiment repeatability and accuracy. Forces are easily recorded in pounds, grams, kilograms force or in Newtons.

The TSD121C can be used for both compression (gripping) and tension (pulling) muscle strength studies under isometric constraint.

- For compression measurements, simply squeeze the handle of the transducer. This simple operation makes for very simple and quick hand strength measurements.
- For tension measurements, the attached sturdy metal eye loops can be threaded using rope or chain. In this configuration, arm curling, leg lifting and digit activation forces can be measured. For these measurements, one loop is clamped securely and the other loop is attached, via cabling, to the appropriate body location under test.

The TSD121C has a 3-meter cable terminated in a connector that interfaces with the DA100C general-purpose transducer amplifier. The ergonomic soft handle design and simple calibration procedure make this device very easy to use.

For in-depth studies of muscular activity, combine TSD121C force recordings with EMG recordings; see the EMG100C amplifier for more information.

TSD121C CALIBRATION

With the proper equipment and correct scaling techniques described below, precise force measurements can be obtained.

EQUIPMENT

- TSD121C Hand Dynamometer
- MP System and DA100C General Purpose Transducer Amplifier
- SS25 Simple Sensor Hand Dynamometer
- MP System and TEL100C Remote Monitoring Module Set

HARDWARE SETUP

Connect the TSD121C to the DA100C, or the SS25 to the TEL100C. When using this type of transducer, proper hand placement is at the uppermost portion of the foam grip, directly below the dynagrip connections.

SOFTWARE SETUP

1. Select **MP160/150 > Set Up Data Acquisition > Channels** and enable one analog channel; make sure this channel matches the Analog Output Channel physically selected on the DA100C amplifier.)
2. Select **Setup > Scaling**. A dialog similar to the example shown at right will be generated.
3. In the **Map value** fields, enter the values 0 and 1 respectively. These represent 0 and 1 kilograms.
4. Enter “kgf” for the **Units label**, as shown.
5. Place the TSD121C on a flat surface and click the **Cal 1** button.
6. Note the value appearing in the **Cal 1** Input field.

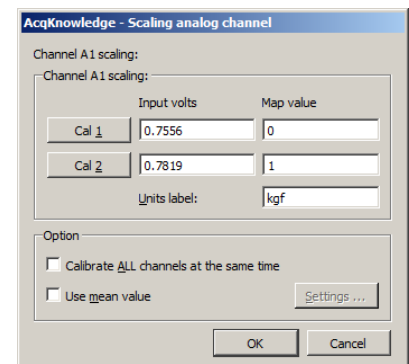

7. Add 13.15 μV per volt of excitation (V_{ex}) to this value and enter the result in the **CAL 2** Input field.

The DA100C amplifier is factory set to a default 2 V (± 1 V) of excitation. If the amplifier has been set to a different level of excitation, use the following equation wherein: V = volts of excitation per 1 kgf and G = gain setting on the DA100C or TEL100C module:

$$(13.15 \mu\text{V} * G * V_{\text{ex}}) + \text{Cal 1} = \text{Cal 2}$$

To more precisely tune the **Cal 2** value for tension measurements, proceed to alternate Steps 6a and 7a:

6a. Hang a known weight from the eyelets of the TSD121C and enter that weight value in the **CAL 2 MAP** value field.

7a. Click the **CAL 2** button.

If using the TSD121C dynamometer to record hand clench compression measurements, modify the **CAL 2** value to reflect ~80% of the **CAL 2** value resulting from the eyelet (tension) method of calibration. This 80% derating suggestion accounts for the shifting of the collective applied force vector - resulting from hand clench - closer to the pivot axis of the TSD121C (near bottom).

Another way to correct for handle derating is to create a calculation channel using the expression $A1 * 1.466$, where A1 is the analog channel receiving the signal from the TSD121C. This correction assumes that the user is gripping the unit right under the eyelets.

In *AcqKnowledge* 4.1 and higher, simply use **Set Up Data Acquisition > Channels > Add New Module**. Choose DA100C as the module type. Choose the correct physical channel switch position and select the TSD121C from the transducer list. Then follow the calibration prompts.

TESTING CALIBRATION

To see if the calibration is correct for the MP System:

1. Start acquiring data.
2. Place the hand dynamometer on a flat surface.
3. Place a known weight on the uppermost portion of the grip.
4. Check the data — the weight should be reflected accurately in the data acquired.

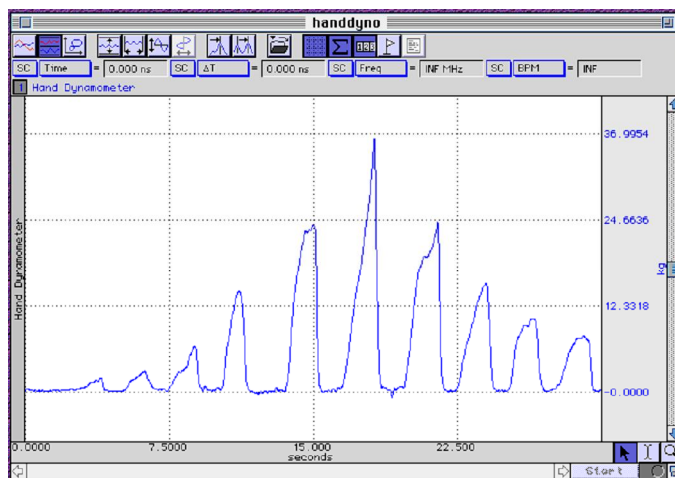

Sample Data

See also: DA100C Calibration options.

TSD121C SPECIFICATIONS

Isometric Range:	0-100 kgf
Nominal Output:	13.2 μ V/kgf (normalized to 1 V excitation)
Linearity:	< \pm 0.03% of rated output
Nonrepeatability:	< \pm 0.02% of rated output
Creep after 30 minutes:	< 0.05% of rated output
Hysteresis:	< \pm 0.02% of rated output (compression only or tension only)
Sensitivity:	2.2 grams rms (5 V excitation, DC-10 Hz)
Weight:	315 g
Dimensions:	185 mm (long) x 42 mm (wide) x 30 mm (thick)
Cable Length:	3 m
Interface:	DA100C
TEL100C compatibility:	SS25

TSD121C COMPRESSIVE FORCE RESPONSE

The following chart depicts the compressive force curve of the TSD121C; (how the dynamometer behaves at different forces). Force was applied to the handle at a position 3.8 cm (1.5”) from the eyelets, using the TSD121C Handle Preset.

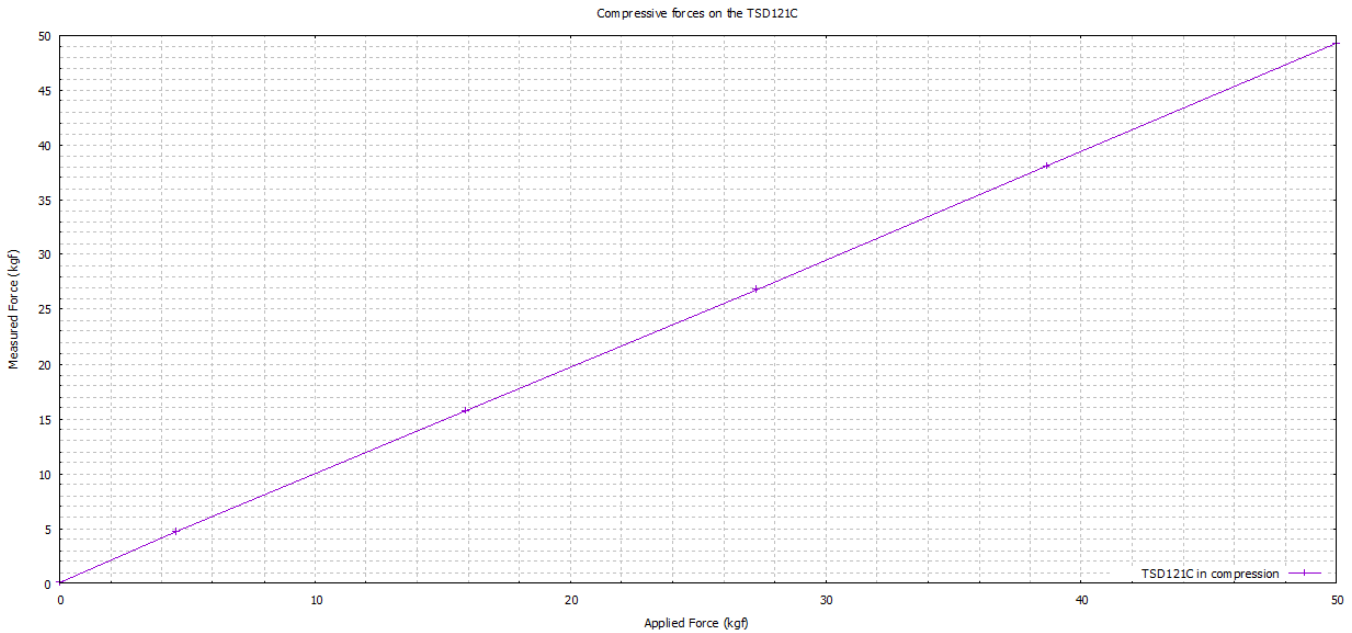

TSD121C Compressive Force Profile

Force Applied	TSD121C Compression
0	0.049
4.545	4.734
15.909	15.764
27.272	26.821
38.636	38.105
50	49.314

Tabular Data for TSD121C Compressive Force Profile

TSD125 SERIES PRECISION FORCE TRANSDUCERS

TSD125B (20 g)

TSD125C (50 g)

TSD125D (100 g)

TSD125E (200 g)

TSD125F (500 g)

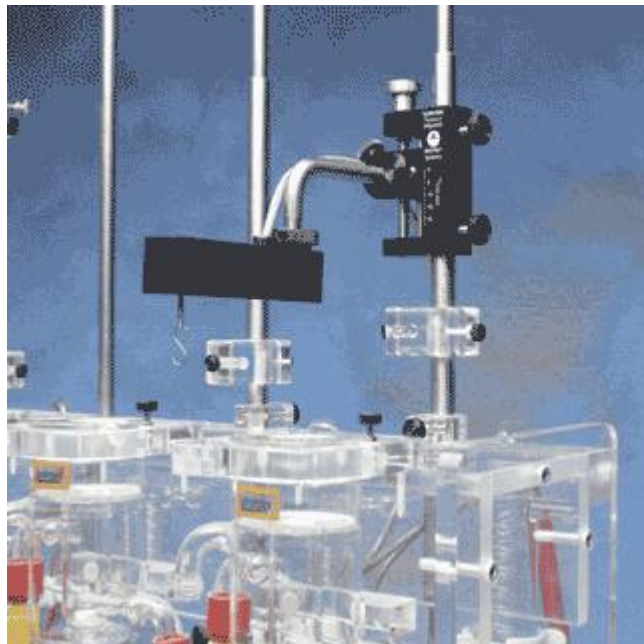

TSD125 shown with HDW100A

Force transducers are devices capable of transforming a force into a proportional electrical signal. The TSD125 series force transducer elements are cantilever beam load cells incorporating thin-film strain gauges. Because the strain elements have been photolithographically etched directly on the strain beam, these transducers are rugged while maintaining low non-linearity and hysteresis. Drift with time and temperature is also minimized, because the strain elements track extremely well, due to the deposition method and the elements close physical proximity. Forces are transmitted back to the beam via a self-centering pull-pin to insure accurate force measurements. The cantilever beam is mounted in a sealed aluminum enclosure that includes a 3/8" diameter mounting rod for holding the transducer in a large variety of orientations.

TSD125 SERIES CALIBRATION

The following graphs illustrate actual data taken with the TSD125C (50 gram force transducer) and TSD125F (500 gram force transducer). The force transducers were connected directly to a DA100C amplifier with the excitation set to ± 5 Volts. The DA100C gain was set to 1,000. The RMS noise output was determined by calculating the standard deviation of the amplified and calibrated signal over a period of time.

The RMS noise of each force transducer was determined in three different settings.

- 1) Channel 1 RMS Noise at DA100C output
- 2) Channel 41 RMS Noise after 10 Hz Low Pass IIR real time filtering
- 3) Channel 40 RMS Noise after 1Hz Low Pass IIR real time filtering

RMS NOISE PERFORMANCE OF TSD125F FOR DIFFERENT BANDWIDTHS

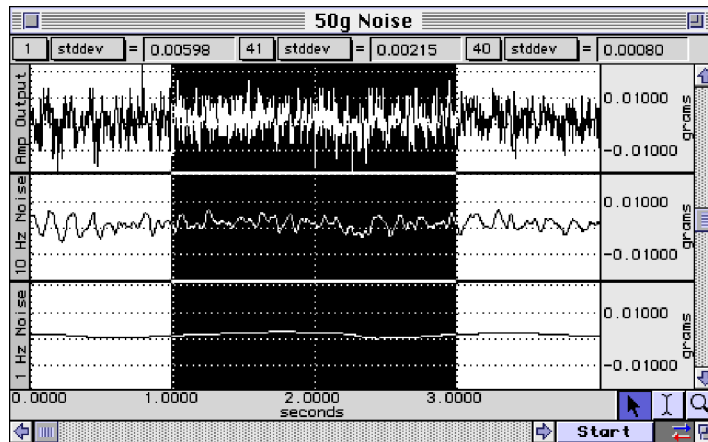

RMS NOISE PERFORMANCE OF TSD125C FOR DIFFERENT BANDWIDTHS

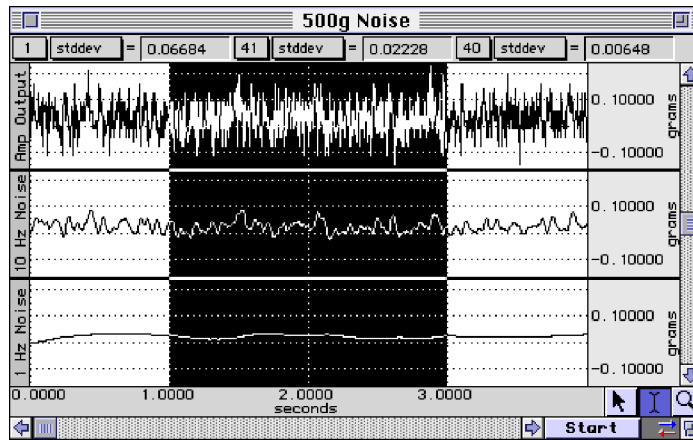

See also: DA100C Calibration options.

TSD125 SERIES SPECIFICATIONS

Device	Full Scale Range RMS Noise [10 volts Excitation]		
	(FSR)	10 Hz	1 Hz
TSD125B:	20 gram	1.0 mg RMS	.04 mg RMS
TSD125C:	50 gram	2.5 mg RMS	1 mg RMS
TSD125D:	100 gram	5 mg RMS	2 mg RMS
TSD125E:	200 gram	10 mg RMS	4 mg RMS
TSD125F:	500 gram	25 mg RMS	10 mg RMS
Nonlinearity:	<±0.025% FSR		
Hysteresis:	<±0.05% FSR		
Nonrepeatability:	<±0.05% FSR		
30-Minute Creep:	<±0.05% FSR		
Temperature Range:	-10°C to 70°C		
Thermal Zero Shift:	<±0.03% FSR/°C		
Thermal Range Shift:	<0.03% Reading/°C		
Maximum Excitation:	10 VDC		
Full Scale Output:	1 mV/V (normalized to 1 V excitation)		
Weight:	250 grams		
Dimensions:	100 mm (long) x 19 mm (wide) x 25 mm (high)		
Mounting Rod:	9.5 mm (dia) – variable orientation		
Cable Length:	3 meters		
Interface:	DA100C		

TENSION ADJUSTERS

HDW100A TENSION ADJUSTER

HDW200A 3RD-PARTY TENSION ADJUSTER ADAPTER

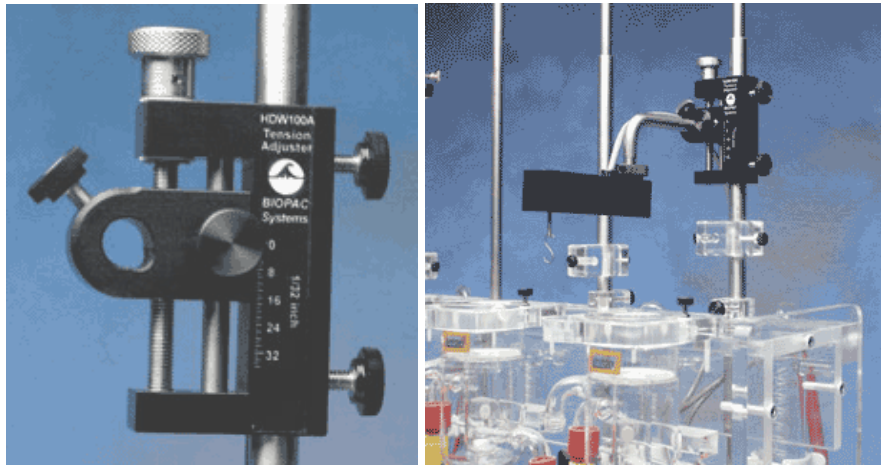

HDW100A and TSD125/SS12LA

The HDW100A tension adjuster operates with the TSD105A, TSD125, SS12LA force transducers and SS14L displacement transducer. The rugged design and stability of the mounting allow for fine position control. The position adjuster is located on the top for easy access and smooth operation. Vertical scales are provided for both metric and standard units. The HDW100A slides directly onto vertical rod laboratory stands and force transducers are clamped into the unit horizontally.

HDW100A SPECIFICATIONS

Travel Range:	25 mm
Resolution:	0.0025 mm per degree rotation
Stand Clamp:	13.25 mm ID
Transducer Clamp:	11 mm ID
Weight:	140 grams
Dimensions:	93 mm (high) x 19 mm (thick) x 74 mm (deep)

HDW200 ADAPTER FOR 3RD-PARTY TENSION ADJUSTERS

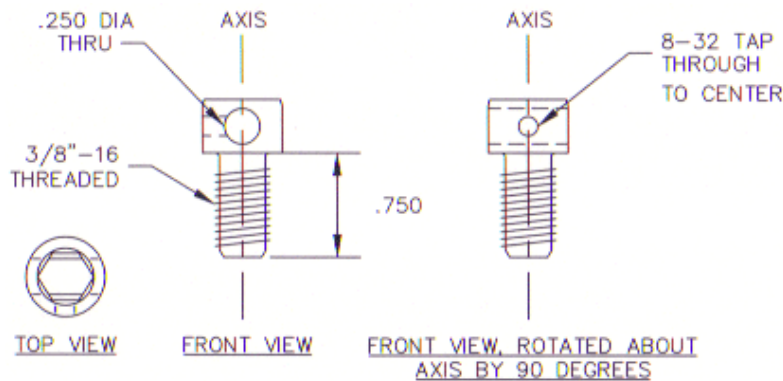

This adapter allows 3rd-party tension adjusters to interface with BIOPAC Force Transducers.

- Fits any tension adjuster with an arm diameter of 6.35 mm (1/4") or less, such as “riser” style tension adjusters from Lafayette and Wards.

Goniometers & Torsiometers

- TSD130 Series
- SS20L-SS24L
- SS20-SS24
- BN-GON-XDCR Series
- BN-TOR-XDCR Series
- BN-GON-F-XDCR

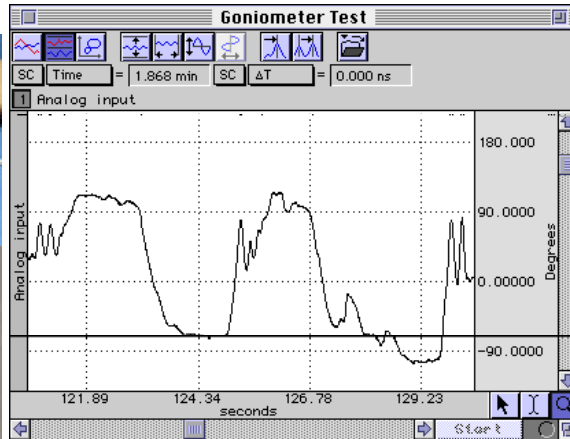
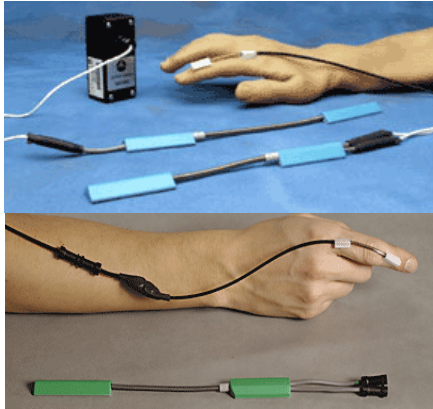

In the example above, the TSD130A was connected directly to a DA100C amplifier, the DA100C gain was set to 1,000, and AcqKnowledge was used to calibrate the signal to provide angular measurements from approximately +90° to -90°.

Transducer	MP1XX (DA100C)	MP3X/MP45	TEL100C	BN-GONIO
Twin-axis Goniometer 110	TSD130A	SS20L	SS20	BN-GON-110-XDCR
Twin-axis Goniometer 150	TSD130B	SS21L	SS21	BN-GON-150-XDCR
Torsiometer 110	TSD130C	SS22L	SS22	BN-TOR-110-XDCR
Torsiometer 150	TSD130D	SS23L	SS23	BN-TOR-150-XDCR
Single-axis Goniometer 35	TSD130E	SS24L	SS24	BN-GON-F-XDCR

BIOPAC Goniometers and Torsiometers are designed for the measurement of limb angular movement. Goniometers transform angular position into a proportional electrical signal. Goniometers incorporate gauge elements that measure bending strain along or around a particular axis.

BIOPAC goniometers are unobtrusive and lightweight, and can be attached to the body surface using double-sided surgical tape (and can be further secured with single sided tape). The goniometers have a telescopic endblock that compensates for changes in distance between the two mounting points as the limb moves. The gauge mechanism allows for accurate measurement of polycentric joints. All sensors connect directly to the BIOPAC Acquisition Unit as part of an MP or BSL System. Activity data can be displayed and recorded, leaving the subject to move freely in the normal environment.

The bending strain is proportional to the sum total angular shift along the axis. Because the bending force is extremely small, the output signal is uniquely a proportional function of the angular shift.

Twin-axis Goniometers Dual output devices that can measure angular rotation about two orthogonal planes simultaneously. Goniometers provide outputs to simultaneously measure around two orthogonally rotational axes (e.g. wrist flexion/extension and radial/ulnar deviations).

- wrist or ankle use **TSD130A/SS20L/SS20/BN-GON-110-XDCR**
- elbow, knee or shoulder use **TSD130B/SS21L/SS21/BN-GON-150-XDCR**

Torsiometers Measure angular twisting (as on the torso, spine or neck) as opposed to bending. Torsiometers measure rotation about a single axis (e.g. forearm pronation/supination).

- neck use **TSD130C/SS22L/SS22/BN-TOR-110-XDCR**
- along the torso or spine use **TSD130D/SS23L/SS23/BN-TOR-150-XDCR**

Single-axis Goniometer Measures the angle in one plane only; designed to measure digit joint movement.

- fingers, thumb or toes use **TSD130E/SS24L/SS24/BN-GON-F-XDCR**

ATTACHMENT TO THE SUBJECT

Various combinations of display and recording instrumentation have been carefully developed fulfilling the requirements of specific research applications. Due to the wide range of applications, one method of attachment cannot be recommended. Experience has proven that standard medical adhesive tape is an excellent adhesion method in the majority of cases. Single-sided and double-sided medical tape (such as BIOPAC TAPE1 or TAPE2) should be used for the best results.

1. Attach pieces of double-sided tape to the underside of the goniometer endblocks.
2. Stick the tape to the subject and allow for the telescoping of the goniometer. The goniometer should be fully extended when the joint is fully flexed.
3. Press the two endblocks firmly onto the subject and ensure that the goniometer is lying over the top of the joint. When the joint is extended, the goniometer may present an “oxbow.”
4. For additional security, pass a single wrap of single-sided medical tape around each endblock.
5. Secure the cable and connector leaving the goniometer with tape to ensure that they do not pull and detach the goniometer.

For accurate results from long recordings

Employ double-sided adhesive between the endblocks and skin, and place single-sided adhesive tape over the top of the endblocks. **No tape should come into contact with the spring.** The connection lead should also be taped down near the goniometer.

For applications where quick or rapid movements are involved

Fit a “sock” bandage over the whole sensor and interconnect lead. This does not apply to the finger goniometer (TSD130E/SS24L/SS24/BN-GON-F-XDCR), which has a different working mechanism.

When the goniometer is mounted across the joint, the center of rotation of the sensor measuring element may not coincide with the center of rotation of the joint (for example, when measuring flexion /extension of the wrist). As the joint moves through a determined angle, the relative linear distance between the two mounting positions will change.

To compensate for this, all sensors are fitted with a telescopic endblock that permits changes in linear displacement between the two endblocks along axis ZZ without the measuring element becoming over-stretched or buckled.

In the free or unstretched position, the distance between the two endblocks is L1.

If a light force is applied, pushing the endblocks away from each other, this length will increase to a maximum of L2.

When the light force is removed, the distance between the two endblocks will automatically return to L1.

This creates several advantages: accuracy is improved; sensors can be worn comfortably and undetected under normal clothing; the tendency for the position of the sensors to move relative to the underlying skeletal structure is reduced.

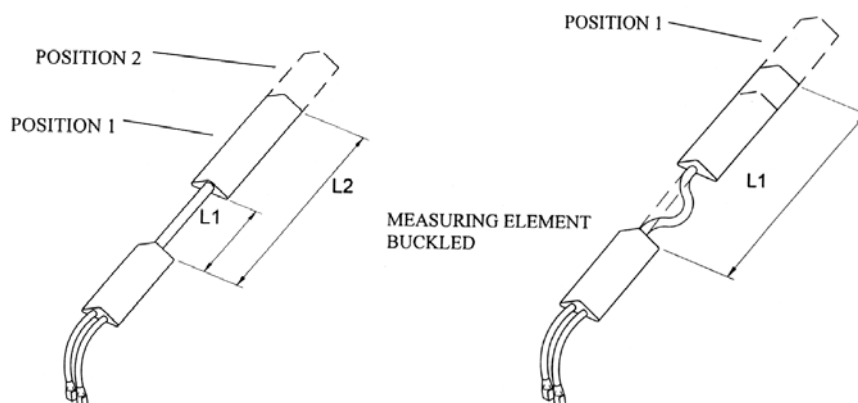

If a light force is now applied, pushing the two endblocks linearly towards each other, the only way the distance L1 can decrease in length is if the measuring element buckles.

- Buckling is detrimental to the accuracy of the goniometer and torsionmeter sensors, so attachment instructions are provided for the most commonly measured joints (on page 8), to ensure that it does not occur in practice.

There is no universal rule governing which size of sensor is most suitable for a particular joint; this depends on the size of the subject.

In general, the sensor must be capable of reaching across the joint so that the two endblocks can be mounted where the least movement occurs between the skin and the underlying skeletal structure. In certain circumstances, more than one size of sensor will be appropriate.

WARNINGS

1. Take care to handle the goniometer and torsionmeter sensors as instructed. Mishandling may result in inaccurate data, reduced equipment life, or even failure.
2. Observe the minimum bend radius value for each goniometer and torsionmeter at all times, particularly when attaching and removing the sensors from the subject. Failure to do this will result in reduced equipment life or failure.
3. Never remove the goniometer from the subject by pulling on the measurement element and/or protective spring. Remove the endblocks individually and carefully, making sure not to exceed the minimum permissible bend radius, particularly where the measuring element enters the endblocks.
4. Take care when mounting goniometers to ensure that the measurement element always forms a “simple” bend shape. Accuracy will be reduced if an “oxbow” shape occurs in the element.
5. Do not bend the finger goniometer more than $\pm 20^\circ$ in the Y-Y Plane or reduced equipment life and/or failure may result.
6. Do not exceed rotations of $\pm 90^\circ$ about ZZ. Exceeding the torsionmeter range may result in a reduction of the life of the unit or failure.
7. Disconnect the transducers from the BIOPAC Acquisition Unit before cleaning or disinfecting goniometers and torsionmeters.

MAINTENANCE & SERVICE

No periodic maintenance is required to ensure the correct functioning of the sensors.

The sensors contain no user serviceable components.

If the sensor fails, it should be returned to BIOPAC Systems, Inc.

- **Please request a Return Merchandise Authorization (RMA) number** before returning the sensor and include a description of what has been observed and what instrumentation was in use at the time of sensor failure in the return package.

Calibration

When using all goniometers and torsionmeters, the minimum value of bend radius must be observed at all times, particularly when attaching and removing the sensors from the subject. Failure to do this will result in reduced unit life or failure.

The sensors have been designed to be as light as possible and the operating force to be a minimum. This permits free movement of the joint without influence by the sensors. The sensors measure the angle subtended between the endblocks. Use the software calibration features (under Setup Channels) to calibrate any of the BIOPAC series goniometers.

Each goniometer requires a DA100C amplifier, BN-GONIO or MP3X/45 analog input per rotational axis. Accordingly, the twin axis goniometers will need two DA100C amplifiers, one BN-GONIO or two MP3X/45 analog channels to simultaneously measure both rotational axes. The recommended excitation voltage is +5 VDC.

1. Place goniometer with care to verify that limb/joint/torso attachment will not result in over stretch at the limits of limb/joint/torso movement.
2. Put body in the first position, which brackets one end of range of movement. Press CAL 1.
3. Put body in the second position, which brackets the other end of range of movement. Press CAL 2.

Specifications

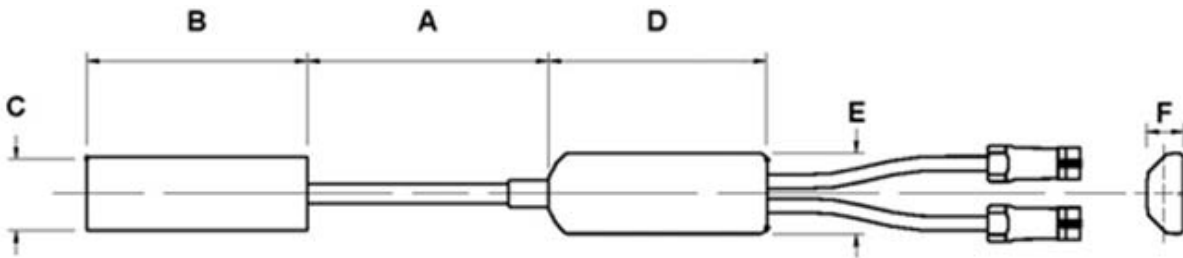

Part

Part #	TSD130A	TSD130B	TSD130C	TSD130D	TSD130E
MP1XX via DA100C	SS20	SS21	SS22	SS23	SS24
Telemetry TEL100C	SS20L	SS21L	SS22L	SS23L	SS24L
MP36/36R/35/30/45	BN-GON-110-XDCR	BN-GON-150-XDCR	BN-TOR-110-XDCR	BN-TOR-150-XDCR	BN-GON-F-XDCR
BioNomadix via BN-GONIO					
Number of channels	2	2	1	1	1
Measuring range (degrees)	±150	±150	±150	±150	±150
Dimensions mm					
A. Maximum	110	150	110	170	35
A. Minimum	70	100	70	115	30
B.	60	70	60	70	18
C.	18	18	18	18	8
D.	54	54	54	54	15
E.	20	20	20	20	8
F.	9	9	9	9	5
Bend radius (mm) – min.	18	18	18	18	3
Weight (g)	23	25	22	23	8
Crosstalk¹	±5%	±5%	N/A	N/A	N/A
Nominal Output	5 µV/degree normalized to 1 V excitation				
Temperature Zero Drift	0.15 degrees angle / °C				
Cable length	6 meters for TSD130 Series/SS20L-24L, 1.8 meters for SS20-24, 10 cm for BN-GON/BN-TOR				
Endblock height	Cable end 9.4 mm, distal end 8.2 mm				
Transducer type	Strain gauge				
Life²	600,000 cycles minimum				
Accuracy	±2° measured over 90° from neutral position				
Repeatability	Better than ±1°				
Analog resolution	Infinite				
Operating temp range	+0° to +40° C				
Storage temp range	-20° C to +50° C				
Operating/Storage humidity range	30% to 75%				
Atmospheric pressure range					
Operation	700 hPa to 1060 hPa				
Storage	500 hPa to 1060 hPa				

¹ Specification of crosstalk for all Biometrics twin-axis SG series of goniometers is measured over ±60°. i.e., if a joint is moved through 60° from the neutral position in one plane without movement in the orthogonal plane, then the sensor output in the orthogonal plane may change by a maximum ±3°.

² Life test results have been collected by cycling the sensors through movements that would happen during everyday use. For example, placing a sensor on an adult elbow and moving from the neutral position to maximum flexion and back to the neutral position, the unit will function for a minimum of 600,000 cycles.

OVERVIEW OF THE BIOPAC GONIOMETER SERIES

As with all measuring equipment, to correctly interpret the data, understanding the working principles (i.e., what the sensor measures) before use is helpful. BIOPAC Systems, Inc. manufactures three types of sensors:

1.

The single axis finger goniometer permits the measurement of angles in one plane.

Angles are measured when rotating one endblock relative to the other about axis X-X.

The goniometer is not designed to measure rotations about Y-Y. Any attempt to bend the unit in this way more than ± 20 from the neutral position will result in a reduction of the life of the unit or failure.

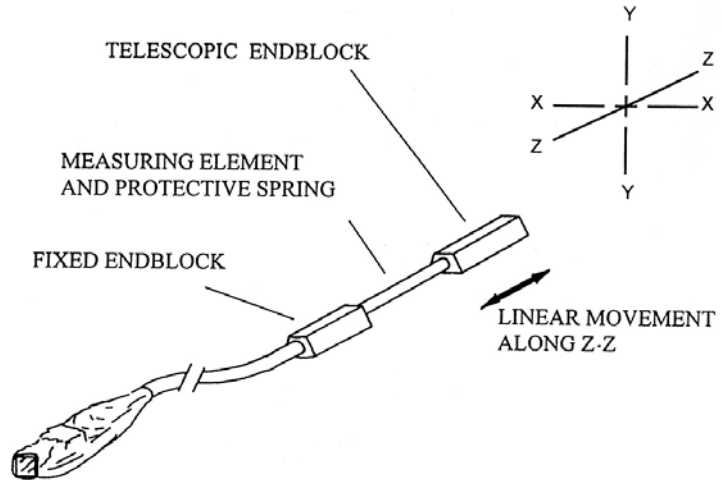

The goniometer does not measure rotations about axis Z-Z, though this movement is permitted without reduced life or damage occurring. This goniometer is designed primarily for the measurement of finger and toe flexion/extension.

2.

The twin axis goniometers permit the simultaneous measurement of angles in two planes, e.g. wrist flexion / extension and radial / ulnar deviation. Rotation of one endblock relative to the other about axis X-X is measured using the gray plug. Similarly, rotation of one endblock relative to the other about axis Y-Y is measured using the blue marked plug.

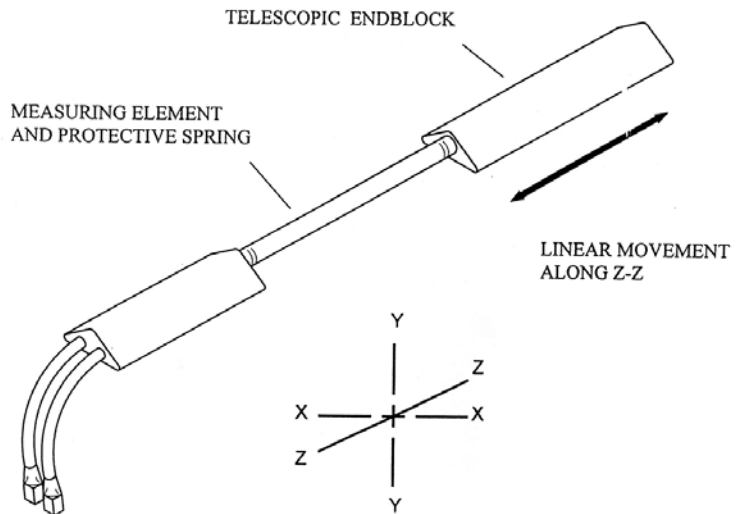

Assuming the goniometer is mounted correctly (as outlined here), the outputs of the two channels are independent of linear displacements along axis Z-Z.

It should be noted that rotation of one endblock relative to the other around axis Z-Z cannot be measured. These goniometers function in the same way, and differ only in size.

3.

The single axis torsionometers permit the measurement of rotation in one plane, e.g. forearm pronation/supination.

Axial rotation of one endblock relative to the other along axis Z-Z is measured from the gray plug.

If the torsionometer is bent in planes X-X or Y-Y, the output remains constant.

All torsionometers function in the same way, and difference only in size.

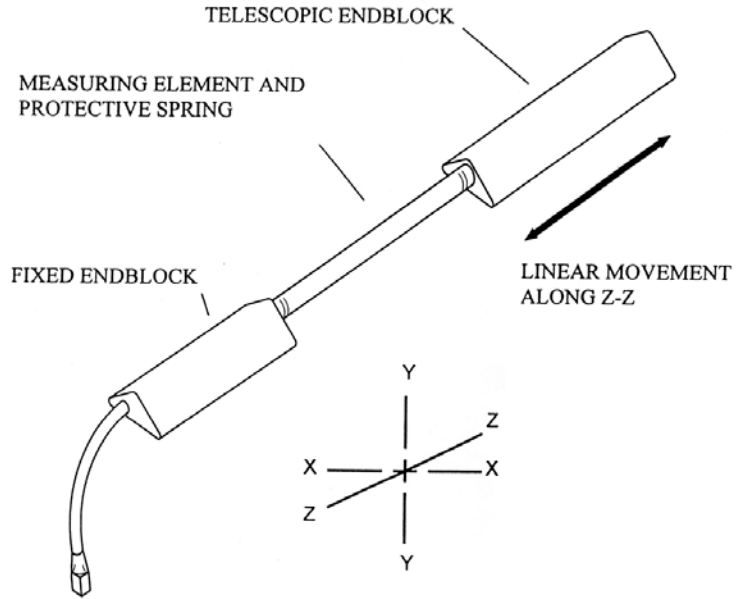

WARNING!

Torsionometers measure rotations about ZZ in the range $\pm 90^\circ$. Exceeding the range may result in a reduction of the life of the unit or failure.

The working mechanism is the same for all three types of sensors. There is a composite wire between the two endblocks that has a series of strain inside the protective spring gauges mounted around the circumference. As the angle between the two ends changes, the change in strain along the length of the wire is measured and this is equated to an angle. The design is such that only angular displacements are measured.

If the two ends move linearly relative to each other, within the limits of telescopic endblock, without changing the relative angles between them, then the outputs remain constant.

The amount of strain induced in the gauges is inversely proportional to the bend radius that the beam is bent around. If the stated minimum permissible bend radius is exceeded then unit life will be reduced or, in severe cases, failure may result.

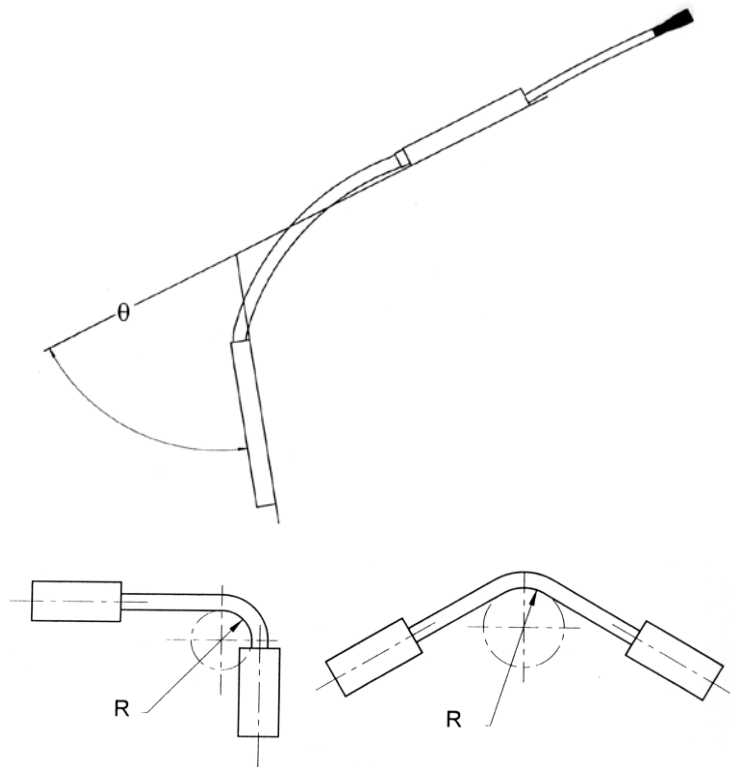

SIGN CONVENTIONS

The sign convention for certain joints will differ, depending which side of the body the sensor is attached to. The following figures show sign conventions for the most common joints.

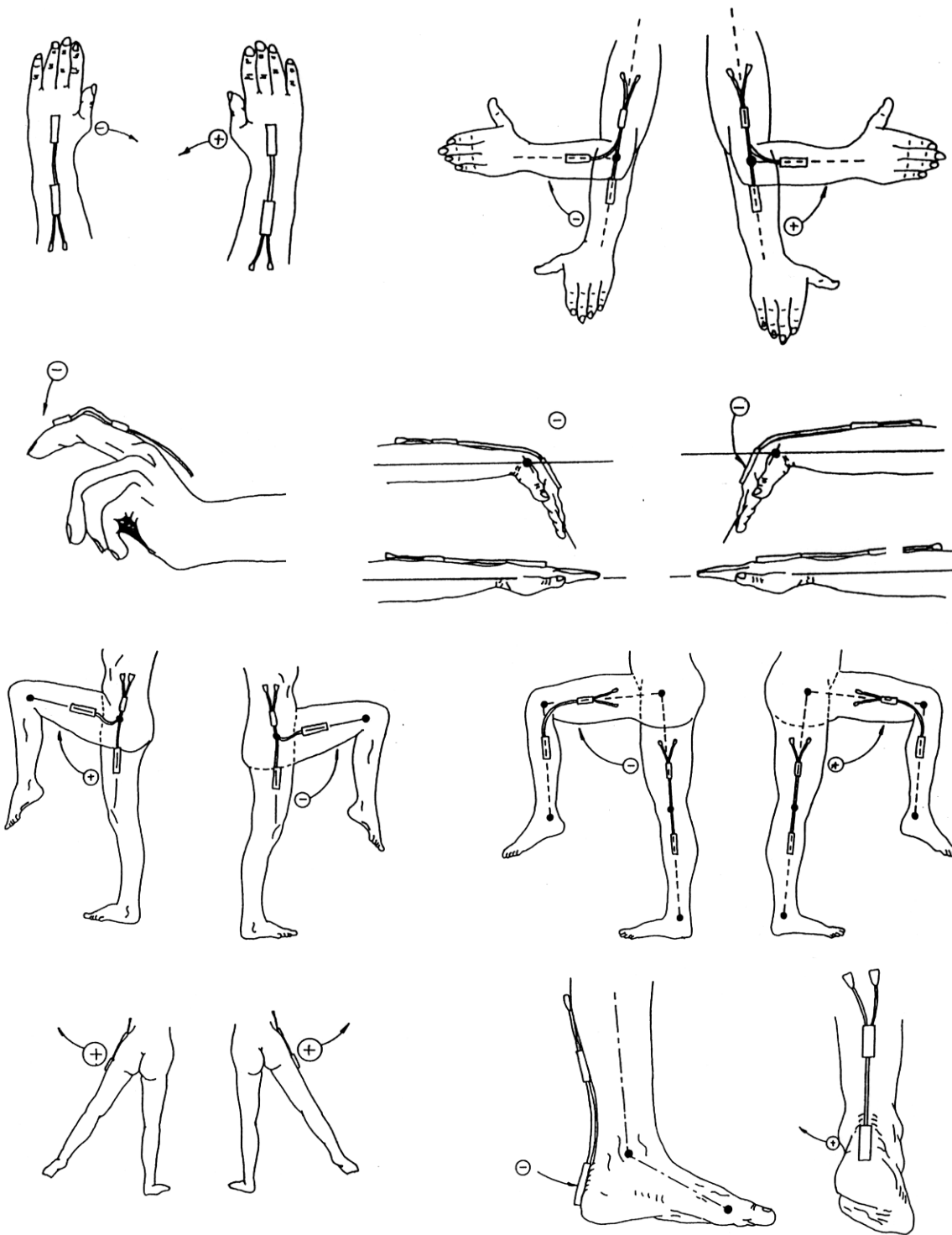

WRIST – Goniometer TSD130A/SS20L/SS20/BN-GON-110-XDCR

Attach the telescopic endblock to the back of the hand, with the center axis of the hand and endblock coincident (top of figure — viewed in the frontal plane). While fully flexing the wrist (middle and bottom of figure), extend the goniometer to Position 2 (as shown on page 2) and attach the fixed endblock to the forearm so that when viewed from the dorsal plane, the axes of the forearm and endblock are coincident. The wrist may now be flexed or extended, abducted or adducted, with the goniometer freely sliding between Positions 1 and 2. Measurement of flexion/extension is obtained from the gray plug, and abduction/adduction is obtained from the blue plug.

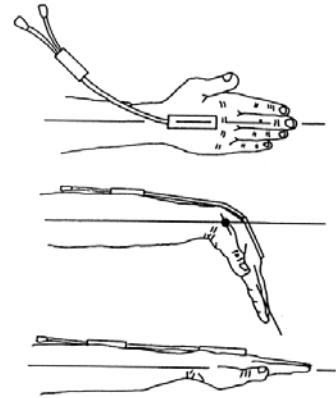

ARTICULAR COMPLEX OF THE FOOT – Goniometer TSD130A/SS20L/SS20/BN-GON-110-XDCR

Attach the telescopic endblock to the back of the heel. Extend the ankle to the maximum extension anticipated during measurement, and attach the fixed endblock to the posterior of the leg, with the goniometer in Position 1 (maximum length, as shown on page 2) so that the axes of the leg and endblock are coincident. Flexion/extension of the ankle may now be monitored using the gray plug and pronation/supination using the blue marked plug.

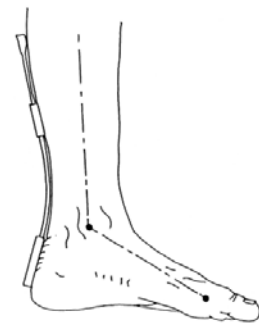

ELBOW – Goniometer TSD130B/SS21L/SS21/BN-GON-150-XDCR

Attach the telescopic endblock to the forearm with the center axis of the endblock coincident with the center axis of the forearm. With the elbow fully extended, move the goniometer to Position 2 (maximum length, as shown on page 2) and attach the fixed endblocks to the upper arm, with the center of the endblock and the center axis of the upper arm coincident. Now the elbow may be fully extended with the telescopic endblock freely sliding between Positions 1 and 2. Measurement of flexion/extension is obtained from the blue marked plug, and the gray plug is redundant. Note that the telescopic endblock is mounted on the half of the forearm nearest to the elbow joint. Movements of pronation and supination may be made and will affect the measurement of flexion/extension by a small amount.

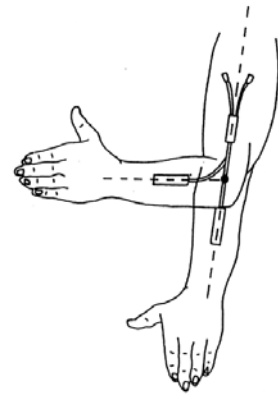

HIP – Goniometer TSD130B/SS21L/SS21/BN-GON-150-XDCR

Attach the fixed endblock to the side of the trunk in the pelvic region. With the limb in the position of reference, extend the goniometer to Position 2 (maximum length, as shown on page 2) and attach the telescopic endblock to the thigh, so that axes of the thigh and endblock coincide (when viewed in the sagittal plane, as shown). The thigh may now be flexed or extended, abducted or adducted, with the goniometer sliding freely between Positions 1 and 2. Measurements of flexion/extension are obtained from the blue marked, and abduction/adduction from the gray plug.

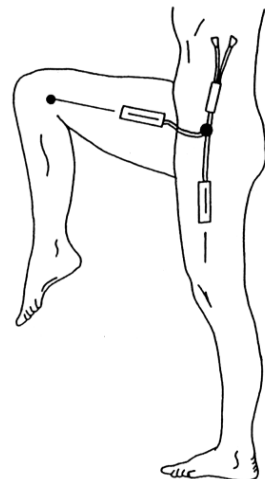

KNEE – Goniometer TSD130B/SS21L/SS21/BN-GON-150-XDCR

Mount the telescopic endblock laterally on the leg so the axes of the leg and endblock coincide, when viewed in the sagittal plane. With the leg fully extended in the position of reference, extend the goniometer to Position 2 (maximum length, as shown on page 2) and attach the fixed endblock to the thigh so the axes of the thigh and endblock coincide.

The knee may now be flexed or extended with the goniometer freely sliding between Positions 1 and 2. Measurements of flexion/extension may be monitored using the blue marked plug and varus/valgus may be monitored using the gray plug.

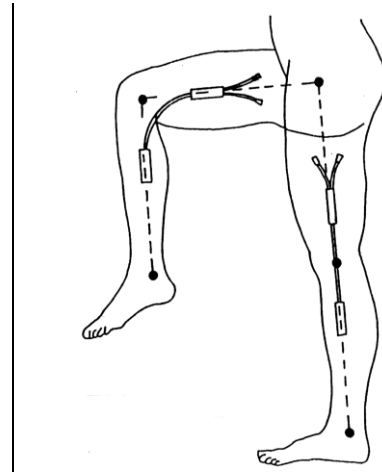

FOREARM PRONATION /SUPINATION – Torsiometer TSD130C/SS22L/SS22/BN-TOR-110-XDCR or TSD130D/SS23L/SS23/BN-TOR-150-XDCR

Attach the two endblocks of the torsiometer to the forearm, with the slider mechanism approximately midway between the two extremes.

Measurements of pronation/supination may now be made from the gray plug. Movements of wrist flexion/extension or radial/ulnar deviation will not affect the output.

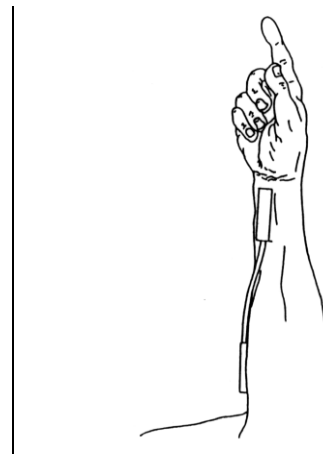

FINGERS AND TOES –Goniometer TSD130E/SS24L/SS24/BN-GON-F-XDCR

The single axis goniometer is intended for use on fingers and toes. Angles are measured by rotating one endblock relative to the other about axis X-X (as shown on page 2).



The goniometer is not designed to measure rotations about Y-Y. **Any attempt to bend the unit in this way more than +/-20° from the neutral position will result in reduced unit life or failure.** The goniometer does not measure rotations about the axis Z-Z.

The unit is designed to fit over the joint to be measured and has extremely high flexibility to ensure the instrument does not interfere with normal joint movement. One endblock is attached either side of the joint.

Unlike other BIOPAC Goniometers and Torisometers, and “Z” series sensors, an “oxbow” shape is permitted in the measuring element. This is not detrimental to the results and does not reduce life of sensor. Care should be taken, however, **that the minimum bend radius is not exceeded.**

TSD160 SERIES – HIGH SENSITIVITY DIFFERENTIAL PRESSURE TRANSDUCERS



The TSD160 series differential pressure transducers are designed for low range pressure monitoring. The transducers plug directly into the DA100C general-purpose differential amplifier. The differential pressure ports are located on the front of the transducers and are easily connected to breathing circuits, pneumotachs or plethysmograph boxes. These transducers are very useful for interfacing a variety of small animal pneumotachs or plethysmographs to the MP System. The transducers are extremely sensitive and come in three ranges to suit a number of different applications. RX137 heads connect to the TSD160A differential pressure transducer via standard 3 mm or 4 mm ID tubing.

TSD160 SERIES SPECIFICATIONS

Part	TSD160A	TSD160B	TSD160C	TSD160D	TSD160E	TSD160F
Operational Pressure:	±2.5 cm H ₂ O	±12.5 cm H ₂ O	±25 cm H ₂ O	±75 cm H ₂ O	±350 cm H ₂ O	±1,000 cm H ₂ O
Overpressure (max):	±250 cm H ₂ O	±380 cm H ₂ O	±380 cm H ₂ O	±700 cm H ₂ O	±700 cm H ₂ O	±4,200 cm H ₂ O
Voltage Output (normalized to 1 v excitation)	327.5 µV/cm H ₂ O	131 µV/cm H ₂ O	65.5 µV/cm H ₂ O	21.9 µV/cm H ₂ O	14.22 µV/cm H ₂ O	7.11 µV/cm H ₂ O

- Warm-up Drift: ±50µV
- Stability: ±100µV
- Operating Temperature: 0°C to +50°C (compensated)
- Storage Temperature: -40°C to +125°C
- Combined Linearity and Hysteresis Error: ±0.05%
- Dynamic Response: 100 Hz
- Connection Ports: Accepts 3 mm to 4.5 mm ID tubing
- Dimensions: 8.3 cm (high) x 3.8 cm (wide) x 3.2 cm (deep)
- Weight: 76 g
- Interface: DA100C

TSD160 SERIES CALIBRATION

See also: DA100C Calibration options.

VIBROMYOGRAPHY SYSTEMS & TRANSDUCERS

Complete VMG System (WSW Windows, WS Mac)

Everything required to record and analyze VMG Data

VMG System with MP160/150 System with MP36R System

2-channel **VMG102WSW** or **WS** **VMG36R2WSW** or **WS**

4-channel **VMG104WSW** or **WS** **VMG36R4WSW** or **WS**

VMG Transducer only

Stand-alone VMG transducers to extend existing systems

Large muscle **TSD250A**

VMG Transducer & License Pack (-W Win, -M Mac)

Add VMG to an existing MP Research System

For MP160/150 **VMG150PACK-W** or **-M**

For MP36R **VMG36RPACK-W** or **-M**

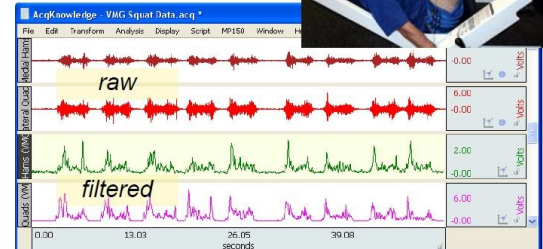

BIOPAC Vibromyography (VMG) solutions allow researchers to study muscle performance and strength balance using precision microelectromechanical (MEMS) accelerometers, about the size of a quarter, and advanced signal analysis algorithms to monitor muscle vibration. The transducer and software algorithm are optimized for assessing voluntary muscle effort (Type IIb muscle fiber activity).

Transducers are secured over the muscle belly and record the small vibrations that occur when the muscle is activated. The transducer includes band-pass filtering to eliminate most motion artifacts including physiologic tremor. *AcqKnowledge* software automated VMG Analysis uses wavelet packet analysis to simplify the analysis process and extract the vibrational components that correlate with the effort generated by the muscle being studied.

VMG Benefits

- Ability to perform muscle balance assessments
- Improved reproducibility between muscles and individuals
- Convenient setup
- Reduced setup time
- Improved subject comfort
- No electrodes
- No skin preparation

VMG provides extremely reproducible results. The single sensor solution and the lack of skin preparation improve the reliability and reproducibility of muscle effort recordings between muscles and across subjects. One major benefit of being able to compare results between muscles and between subjects is the ability to perform muscle balance assessments.

→ See videos, Application Notes, and Publications at www.biopac.com/vibromyography-vmg-muscle-activity.

TSD250A Vibromyography Transducer



The TSD250A is a sensitive accelerometer (32.64 mm diameter) that uses advanced signal analysis algorithms to monitor small muscle vibrations that occur when a muscle is activated. This transducer is optimized for assessing voluntary muscle effort and includes band-pass filtering for eliminating most motion artifacts including physiologic tremor.

- **TSD250A** is used for for measuring absolute muscle force from substantial muscle groups, such as leg muscles.

This transducer operates in differential mode in order to achieve superior noise reduction, delivering two channels of vibration data along a three meter cable to a converter unit which both converts the signal to single-ended mode and adapts the VMG signal appropriately for use with the BIOPAC Research platform.

TSD250A is compatible with both the MP160/150 and MP36R systems and includes dual output connectors to connect via an adjusted DA100C (5 V excitation voltage) amplifier-to-TCI114 interface for MP160/150 Systems, or directly to an MP36R System.

NOTE: The TSD250A sensor is a replacement for the discontinued TSD250. When comparing multiple subjects identical transducers should be used. Results recorded with a TSD250A may not be directly comparable to TSD250 or TSD251 data. (The TSD251 facial muscle transducer has also been discontinued.)

Up to 16 VMG transducers can be attached per MP160/150 System and up to four VMG transducers can be connected per MP36R System.

Optimal results are achieved by holding the transducer against the skin with an elastic or athletic wrap using moderate pressure. Either surface of the transducer can be placed against the skin surface; the convex surface may facilitate use on a concave surface. Transducer can be secured with a variety of attachment methods (not included), such as double-sided adhesive, Ace® bandages and Nylatex® wraps (6 cm - 10 cm width suggested).

Do not use excessive pressure in securing the transducers—snug enough not to move is adequate.

VMG Specifications

Complete System Components

Data Acquisition System	Choose MP160 System and DA100C-to-TCI114 Interface or MP36R System (no transducer interface required, direct connection)
VMG Transducers	Choose TSD250A - two for 2-channel, four for 4-channel
VMG License	AcqKnowledge VMG License Key

VMG Transducer Specifications

Sensor	TSD250A
Type:	Accelerometer
Dimensions: (W x H)	32.64 mm (octagonal) x 9.14 mm (sidewall) to 12.57 mm (dome)
Weight:	10 grams
Operational Frequency Range:	20-200 Hz
Output:	MP160/150: ±10 V MP36R: ±0.2 V
Gain Constant:	MP160/150: 50 V/g MP36R: 1 V/g
Voltage Noise Floor:	MP160/150: 16 mV (rms) MP36R: 0.32 mV (rms)
Sensitivity:	0.32 mg (rms)
Temperature Range:	0 - 50° C
Maximum Shock:	2000 g
Termination:	TCI114 to DA100C and DSUB9 M 9-pin to MP36R
Interface:	MP160/150: via DA100C, MP36R: direct connection to CH analog input
Minimum sampling rate:	Sample acquisition rate must be set to 2000 Hz for proper operation of the VMG algorithm.

VMG License

AcqKnowledge VMG License Key	VMG functionality is available in AcqKnowledge 4.1.1 or above via License Key Activation. The VMG License must be authorized to access VMG functionality. The VMG License: <ul style="list-style-type: none"> ▪ adds “Vibromyography” Calculation channel Preset with required scaling and calibration ▪ adds “Vibromyography Filter” option under the Analysis menu ▪ includes graph template QuickStart Q45 Vibromyography (.gtf)
------------------------------	--

Transducer & License Pack Components

VMG Transducer (1)	TSD250A
AcqKnowledge VMG License Key	VMG License Authorization; requires AcqKnowledge 4.1.1 or above

TCI SERIES TRANSDUCER CONNECTOR INTERFACES

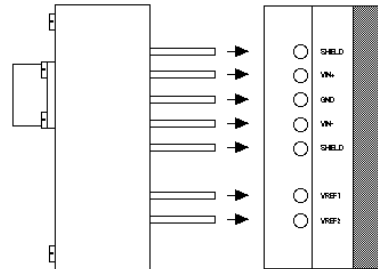

TCI interface options

TCI to DA100C Connection

TCI Series transducer connector interfaces (TCIs) adapt a variety of transducer types to the DA100C module (TCIPPG Series connect directly to the PPG100C amplifier). Probes and transducers normally used with Grass, Beckman, World Precision Instruments and Lafayette Instrument's equipment can be used directly with the DA100C when used with the appropriate transducer connector interface. The front of the TCI contains the appropriate connector while the rear has seven 2 mm pin jacks which plug directly into the DA100C.

TCIs are available for the transducer brands listed below. If no existing connector matches the required equipment, BIOPAC will build a special TCI for users, or users can use the TCIKITC to build their own. Please call or write BIOPAC with specific needs.

- TCI100** Grass/Astromed transducers – 6 pin
- TCI101** Beckman transducers – 5 pin
- TCI102** World Precision Instrument transducers – 8 pin
- TCI103** Lafayette Instrument transducers – 9 pin
- TCI104** Honeywell transducers – 6 pin
- TCI105** Modular phone jack connector – 4 pin (*also used to interface NIBP100A and NIBP100D*)
- TCI106** Beckman transducers – 12 pin
- TCI107** Nihon Koden transducers – 5 pin
- TCI108** Narco transducers – 7 pin
- TCI109** Fukuda transducers – 8 pin
- TCI110** Gould transducers – 12 pin: *Discontinued → use Fogg Cable and an available BIOPAC TCI*
- TCI111A** Liquid metal transducers – 1.5 mm Touchproof male plugs (two)
- TCI112** Hokanson transducers – 4 pin
- TCI113** Hugo-Sachs/Harvard Apparatus – 6 pin
- TCI114** BIOPAC SS Series Transducers – 9 pin
- TCI115** Interface XLR Microphone

- TCIPPG1** PPG100C amplifier to Geer Photo-electric (IR) plethysmogram transducer – 7 pin
- TCIPPG2** PPG100C amplifier to TSD204 VPG vaginal plethysmogram transducer
- TCIPPG3** PPG100C amplifier to Nonin DSUB9 – 9 pin

- TCIKIT/C** Build a customized adapter

TCI100 GRASS TRANSDUCER INTERFACE

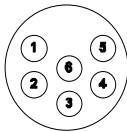
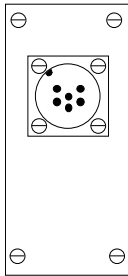

<i>Pin</i>	<i>Signal</i>
1	VREF2 (Set to -1 V)
2	VIN-
3	VIN+
4	VREF1 (Set to +1 V)
6	GND
Connector	ITT Cannon WK-F-32S
Typical VREF	±1 V

TCI101 BECKMAN TRANSDUCER INTERFACE

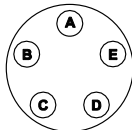
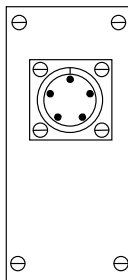

<i>Pin</i>	<i>Signal</i>
A	VIN-
B	VIN+
C	VREF1 (Set to +1 V)
D	VREF2 (Set to -1 V)
E	GND
Connector	ITT Cannon CA-3102-E-14S-5S
Typical VREF	±1 V

TCI102 WPI TRANSDUCER INTERFACE

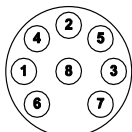
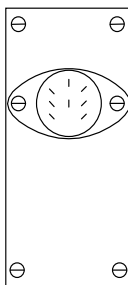

<i>Pin</i>	<i>Signal</i>
1	VREF1 (Set to +5 V)
2	VIN+
3	VIN-
4	VREF2 (Set to -5 V)
Connector	CUI Stack SDS-80J
Typical VREF	±5 V

TCI103 LAFAYETTE TRANSDUCER INTERFACE

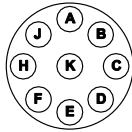
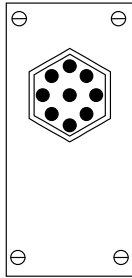

<i>Pin</i>	<i>Signal</i>
C	VREF2 (Set to -5 V)
E	GROUND
H	VIN+
K	VREF1 (Set to +5 V)
Connector	Amphenol 12F-013
Typical VREF	± 5 V

TCI104 HONEYWELL TRANSDUCER INTERFACE

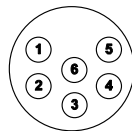
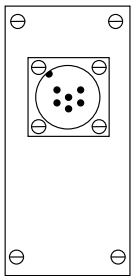

<i>Pin</i>	<i>Signal</i>
1	VREF2 (Set to -1 V)
2	VIN-
3	VIN+
4	VREF1 (Set to +1 V)
5	GND
Connector	ITT Cannon WK-F-32S
Typical VREF	±1 V

TCI105 PHONE PLUG (RJ-11) TRANSDUCER INTERFACE

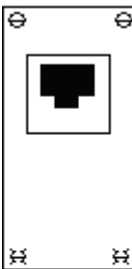

<i>Pin</i>	<i>Signal</i>
1	VREF1 (Set to +3 V)
2	VIN +
3	VIN -
4	VREF2 (Set to -3 V)
Connector	RJ-11 Phone plug
Typical VREF	±2 V DC

TCI106 BECKMAN (12-PIN) TRANSDUCER INTERFACE

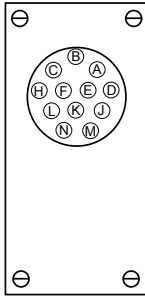

<i>Pin</i>	<i>Signal</i>
A	VIN +
B	VIN -
C	VREF2 (-1 V)
D	VREF1 (+1 V)
E	Ground
Connector	Amphenol 165-12
Typical VREF	±1 V

TCI107 NIHON KOHDEN TRANSDUCER INTERFACE

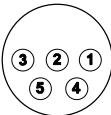
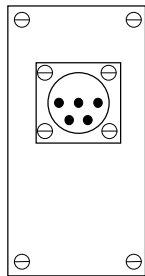

<i>Pin</i>	<i>Signal</i>
2	VIN+
3	VREF1 (+1 V)
4	VREF2 (-1 V)
5	VIN -
Connector	JAE SRC-02A13-5S
Typical VREF	±1 V

TCI108 NARCO (7-PIN) TRANSDUCER INTERFACE

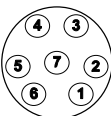
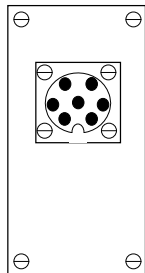

<i>Pin</i>	<i>Signal</i>
1	VIN+
2	VIN -
4	GND
5	(connect 1,600-ohm resistor between pins 5 and 7)
6	VREF1 (+1 V)
7	VREF2 (-1 V)
Connector	Amphenol 703-91T-3478-009
Typical VREF	±1 V

TCI109 FUKUDA TRANSDUCER INTERFACE

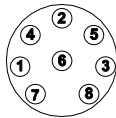
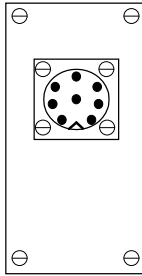

Pin	Signal
1	VIN+
3	VIN-
6	VREF2 (-1 V)
7	VREF1 (+1 V)
Connector	Hirshmann MAS 8100
Typical VREF	±1 V

TCI110 GOULD TRANSDUCER INTERFACE

Discontinued – [see options online](#)

TCI111A LIQUID METAL TRANSDUCER INTERFACE

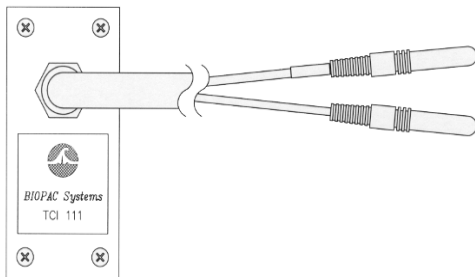

Connector: Signal

A (top)	XDCR
B (bottom)	XDCR
Connector Type:	1.5 mm Touchproof male plugs (accepts 1.5 mm Touchproof female socket XDCRs)

The TCI111A comes with an attached 3 meter cable that terminates in two Touchproof 1.5 mm male plugs for connecting to two 1.5 mm Touchproof 1.5 mm female sockets for Mercury (old style) or Indium Gallium liquid metal strain gauges.

TCI112 HOKANSON TRANSDUCER INTERFACE

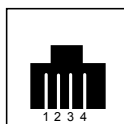
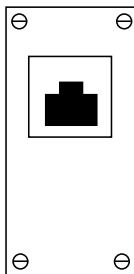

four pin jack

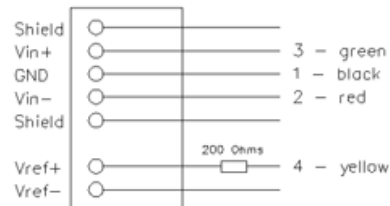

Pin Signal

1	Iex +
2	VIN +
3	VIN -
4	Iex -
Connector	RJ-11 Phone plug
Typical Iex:	5 mA

TCI113 HUGO SACHS/HARVARD APPARATUS INTERFACE



Six-pin female:

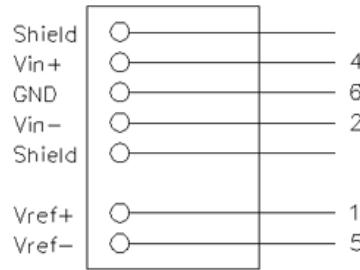

TCI114 BIOPAC SS SERIES INTERFACE

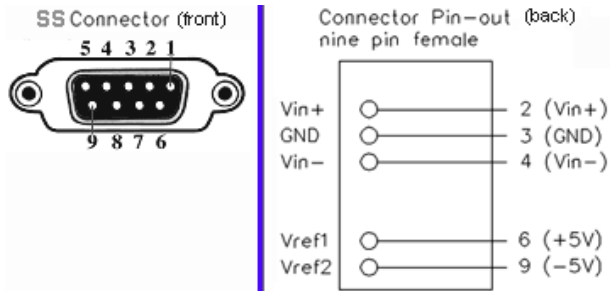

TCI115 INTERFACE XLR MICROPHONE

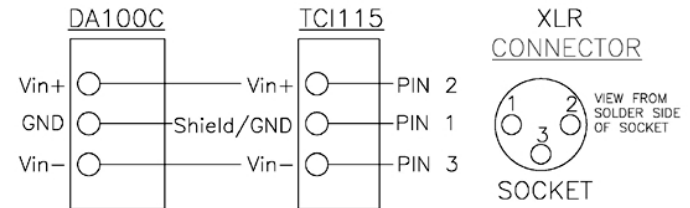

TCIPPG1 PPG—GEER TRANSDUCER INTERFACE

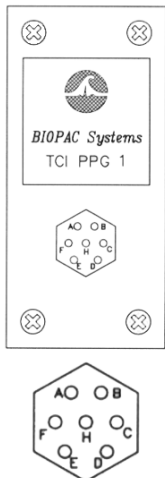

<i>Pin</i>	<i>Signal</i>
A	not used
B	not used
C	not used
D	Ground
E	VIN +
F	+5 Vex
G	not used
Connector	Amphenol 7-pin

TCIPPG2—VPG

Interface for TSD204—see [VPG Hardware](#) for specs

TCIPPG3—NONIN 9-PIN INTERFACE

Interface: All Nonin 9-pin DSUB sensors
 Connector: 9 pin DSUB female
 Operational LED Current: 20 mA
 Bandwidth: 0.05 Hz to 160 Hz
 (PPG100C performs upper band-limiting)

TCIKIT AND TCIKITC CUSTOM INTERFACE KITS

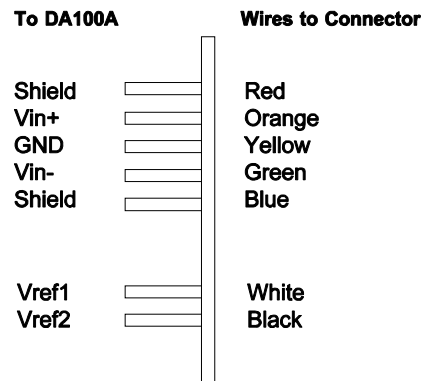
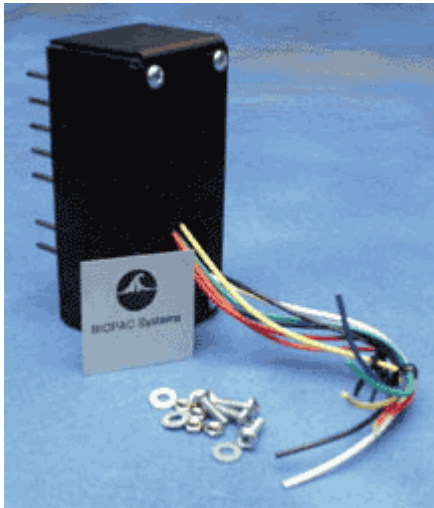

Build custom transducer connector interfaces for DA100C amplifier modules.

- **TCIKIT** do-it-yourself kit includes housing, PC board with 7 attached PIN plugs (2 mm) and instructions. The kit comes partially assembled. Mount a connector to the housing and solder wires to the pins.
- **TCIKITC** is used to connect non-BIOPAC electrodes and transducers directly to BIOPAC biopotential or transducer amplifier modules.

The TCI case has two connector holes on the front, 0.44” and 0.75” in diameter. These sizes should accommodate most connectors. The aluminum label is intended to cover up the unused hole. Color-coded wires have been soldered to each of the seven DA100C input pins. They are connected as shown above.

ADAPTING THE TCI

The following instructions are for adapting the TCI for any particular connection. A “Bulkhead Mount” connector is the best type of connector to use.

1. Remove four screws from back of TCI so that the TCI PC board and case are separate.
2. Remove four connector-mounting screws from TCI case and set aside.
3. Check to see that the connector fits the TCI case. If not, the smaller (0.44”) hole can be enlarged using a hole enlarging drill bit.
4. Clip off unused wires from the TCI PC board. Be very careful not to clip the ones that will be used.
5. Note that most connectors must be mounted from the outside of the case. This means that the wires should first be routed through the appropriate hole, and then soldered to the connector.
6. Solder the appropriate wires to the connector.

CAUTION! When soldering wires or components on the TCI PC board, be very careful not to desolder the pre-aligned pin plugs—albeit might not be possible to get them straight if they are inadvertently desoldered.

7. Bolt the connector to the case using the supplied 4-40 screws and nuts.
8. Bolt the TCI PC board to the TCI case.
9. Cover unused hole with supplied label.

SMART AMPLIFIER 100D SERIES

Biopotential Smart Amplifiers: ECG100D, EEG100D, EGG100D, EMG100D, fEMG100D (facial EMG), EOG100D, ERS100D

Transducer Smart Amplifiers: EDA100D, NICO100D, PPG100D, RSP100D, SKT100D



Smart Amplifier 100D Series are compact amplifier modules designed specifically for recording high-quality biopotential and transducer signals. Smart Amplifiers are small, light, and offer unparalleled ease-of-use. Quick, automated setup and calibration is performed in *AcqKnowledge* software with the MP160 System. All amplifiers feature a 3-meter RJ11 cable that connects to the new AMI100D Amplifier Input Module. Plug in the amp, attach electrodes/transducers to subject, and follow the automated setup wizard in *AcqKnowledge* software to begin recording high quality data in minutes.

FEATURES:

- High quality, low noise signals equivalent to or exceeding data quality of 100C-Series amplifiers
- Small, light form factor, comfortable for the subject
- Connect directly to the AMI100D interface
- Co-exist with other connected C-Series modules
- Quick, automated setup in *AcqKnowledge* software
- *AcqKnowledge* provides signal type information for connected Smart Amps and software options for signal-appropriate derived signals (e.g. heart rate)
- *AcqKnowledge* software detects when amplifiers are not connected properly
- Use BN-Series electrode leads and transducers
- Compatible with *AcqKnowledge* software version 5.0.4 or higher

Smart Amplifiers connect to an MP160 Research System* via an Amplifier Interface Module (AMI100D). For output, add CBL237 with INISOA or similar. *AcqKnowledge* Smart Amp setup includes guides and prompts to prevent errors. Plus, channels are automatically set to be plotted and include an input values display, with the initial visual range set to the min/max input range for the Smart Amplifier signal type, in appropriate units. *AcqKnowledge* 5.0.4 and above support Smart Amp functionality.

*Smart Amps are not compatible with MP150, MP100, HLT100C, or MP36R devices.

IMPORTANT: For AMI100D and Smart Amplifier recognition, Digital Channel 15 must be undriven or held high until the system begins acquiring data.

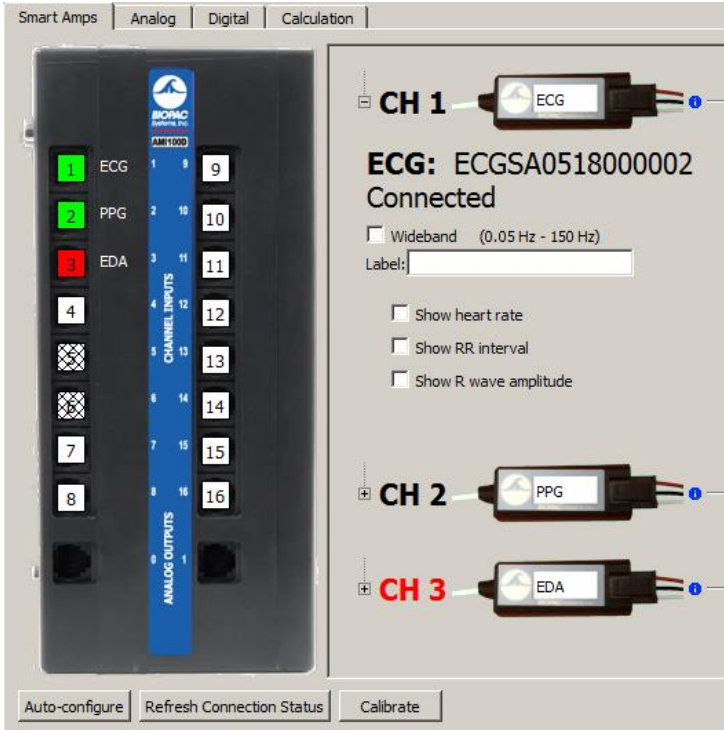

AcqKnowledge software auto-detects signal type and offers derived measures for connected amps

Green: Configured & detected

Red: Configured but not found

White: Unused/available

Dashed: In use/not available

For quick access to Smart Amp options, click the CH# box.

Smart Amplifier Carrying Case (included)



Smart Amplifier Straps (order separately)

Dimensions: Length 20 cm, 33 cm, 76 cm, 137 cm (all widths 2.5 cm)

Material: Stretch Velcro® - hook/loop type

Use with: Smart Amplifiers

Length: BN-STRAP-20-D; 20 cm (wrist)
 BN-STRAP-33-D; 33 cm (larger wrist/ankles)
 BN-STRAP-76-D; 76 cm (neck/leg)
 BN-STRAP-137-D; 137 cm (chest)



SMART AMPLIFIER SPECIFICATIONS (BIOPOTENTIAL)

Amp	Gain (fixed)	Normal Bandwidth*	Maximum Bandwidth	Derived Signal(s) default frequencies & settings (default settings are adjustable in software)	Interface (not included)
ECG100D	x2000	HP: 1 Hz LP: 35 Hz	0.05 Hz – 150 Hz	<p>Show heart rate in beats per minute in a separate channel using rate detector calculation.</p> <p>Show RR interval (inter beat interval) in a separate channel using rate detector calculation, unit = sec.</p> <p>Show R wave amplitude in a separate channel using peak maximum output calculation, unit = mV</p> <p>Defaults: Positive detection, 25 ms baseline removal, 5% auto threshold detection, detection window 40-180 BPM</p>	<p>Electrode lead Electrodes</p> <p>Always connect a single ground lead when connecting biopotential amplifiers!</p> <p>BN-EL*-LEAD3</p> <p>if ground electrode is required</p> <p>or</p> <p>BN-EL*-LEAD2</p> <p>if subject is connected to another Smart Amplifier with ground lead</p> <p>*select 15, 30, or 45 cm</p>
EEG100D	x20000	HP: 0.5 Hz LP: 35 Hz	0.5 Hz – 150 Hz	<p>EEG Bands</p> <p>Alpha: 8 Hz – 13 Hz Theta: 4 Hz – 8 Hz</p> <p>Beta: 13 Hz – 30 Hz Gamma: 30 Hz – 90 Hz</p> <p>Delta: 0.5 Hz – 4 Hz all bands</p> <p>Defaults: All bands IIR bandpass low+highpass filters, Q=0.707</p>	
EGG100D	x2000	HP: 0.005 Hz LP: 1 Hz	0.005 Hz – 1 Hz	—	
EMG100D	X500	HP: 10 Hz LP: 500 Hz	5 Hz – 500 Hz	<p>Show Integrated EMG using an integrate calculation channel. Default: Average over samples mode with 1000 sample window, rectification enabled</p>	
fEMG100D	x2000	HP: 10 Hz LP: 500 Hz	5 Hz – 500 Hz	<p>Show root mean square (RMS) using an integrate calculation channel. Default: Average over samples mode with 1000 sample window, RMS with baseline removal</p> <p>Use line frequency filter (narrowband only) The narrowband filter for the EMG and fEMG smart amplifiers includes a line frequency comb band stop filter. Although this helps remove common mode noise, this filter does affect frequencies that lie within the physiological frequency range of EMG signals. When examining the recorded narrowband data using an FFT, this can appear odd.</p> <p>Use this option to toggle on/off the line frequency comb filter for EMG and fEMG amps.</p>	
EOG100D	x2000	HP: 0.05 Hz LP: 35 Hz	0.05 Hz – 150 Hz	<p>Show derivative of the EOG using an IIR bandpass filter (30 Hz, Q = 0.8).</p>	
ERS100D	x20000	HP: 20 Hz LP: 3000 Hz	1 Hz – 10,000 Hz	—	

*All normal bandwidth filters are IIR with a Q = 0.707 (not software adjustable). For the line frequency setting, Smart Amplifiers also include a comb bandstop IIR filter with a Q = 5.

SMART AMPLIFIER SPECIFICATIONS (TRANSDUCER)

Amp	Normal Bandwidth*	Maximum Bandwidth	Derived Signal(s) default frequencies & settings (default settings are adjustable in software)	Interface (not included)
EDA100D	HP: None/DC LP: 3 Hz	DC – 10 Hz	Show phasic EDA of short-term phasic EDA using IIR filter calculation channel. Defaults: IIR high pass, 0.5 Hz cutoff, Q=0.707	BN-EDA-LEAD2 , 15 cm or BN-EDA-LEAD25 , 25 cm
NICO100D	: HP: None/DC LP: 1 Hz d /dt: HP: None/DC LP: 50 Hz	DC – 100 Hz	—	LEAD131 for 4 -spot electrode configuration, or LEAD132 for 8-spot electrode configuration
PPG100D	HP: 0.5 Hz LP: 3 Hz	DC – 25 Hz	Show pulse rate: heart rate derived from PPG in a separate calculation channel using rate detector calculation. Defaults: Positive detection, 25 ms baseline removal, 5% auto threshold detection, detection window 40-180 BPM	BN-PULSE-XDCR or BN-PULSEEAR-XDCR (finger or ear clip)
RSP100D	HP: 0.05 Hz LP: 1 Hz	DC – 10 Hz	Show respiration rate (normal breathing) Show respiration rate, elevated (20) Defaults: Positive detection, 25 ms baseline removal, 5% auto threshold detection, detection window 6-20 BPM (normal), 6-50 BPM (elevated)	BN-RESP-XDCR respiration transducer with elastic chest band
SKT100D	HP: None/DC LP: 1 Hz	DC – 10 Hz	—	BN-TEMP-A-XDCR skin temp trans or BN-TEMP-B-XDCR fast response trans

*All normal bandwidth filters are IIR with a Q = 0.707 (not software adjustable). For the line frequency setting, Smart Amplifiers also include a comb bandstop IIR filter with a Q = 5.

SMART AMPLIFIER COMMON SPECIFICATIONS

Dimensions	1.8 cm x 4.6 cm x 1.1 cm
Cable	3 m RJ11
Weight	48 g (amp only ~ 9 g)
Accessories	<p>Included:</p> <ul style="list-style-type: none"> 1 x clip for attaching Smart Amplifier to subject 10 x silicone cable ID tags for easy identification (attaches to both ends of cable) 1 x zippered carrying case (16 x 10 x 3.5 cm) 1 x silicone cable wrap for optionally shortening overall cable length 1 x cable management for routing cable around the subject Electrode leads, electrodes <p>Optional Straps:</p> <ul style="list-style-type: none"> 20, 33, 76, 137 cm—order BN-STRAP-#-D (see page 2)

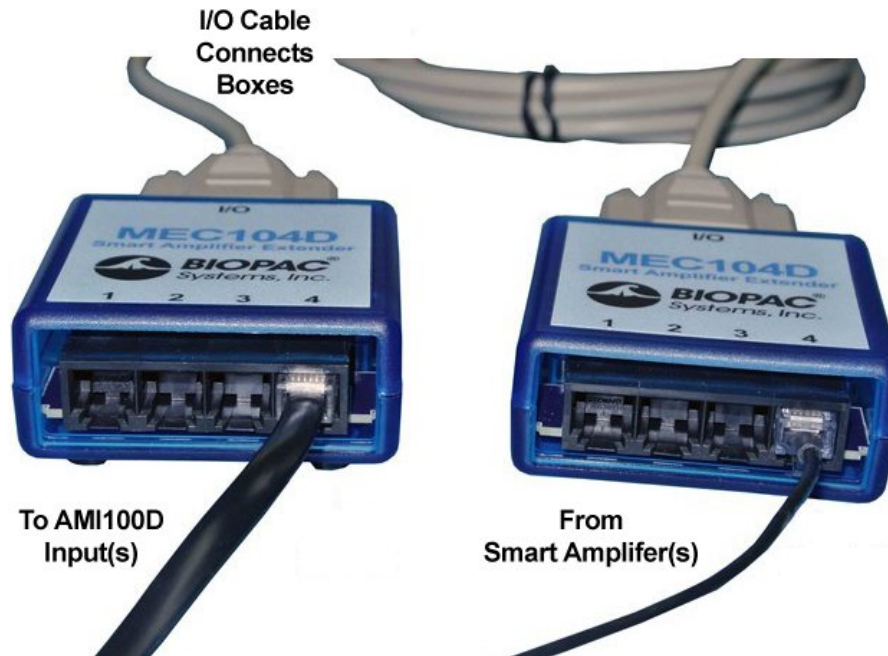
MEC104D SMART AMPLIFIER EXTENDER CABLE

The MEC104D Smart Amplifier Extender provides a three-meter extension cable for up to four Smart Amplifiers. It consists of two extension boxes, one 3-meter I/O cable connecting the two extension boxes, and four RJ12 connection cables. One extension box connects up to four RJ12 cables to input channels of the AMI100D; up to four Smart Amplifiers plug into the other extender box. Multiple MEC104D extenders may be used simultaneously with an AMI100D.

While designed specifically for the Smart Amplifiers, the MEC104D may also be used with other high-level transducers, such as accelerometers.

Important! The MEC104D does not include any built-in isolation; if external equipment is connected to the MEC104D, an INISOA should be used for each external connection.

BIOPAC AMPLIFIER OVERVIEW



BIOPAC Amplifier Modules

The 100C series biopotential/transducer amplifier modules are single channel, differential input, linear amplifiers with adjustable offset and gain. These modules are used to amplify smaller voltage signals coming from raw electrodes and transducers (typically less than ± 0.01 volt). In addition to amplifying signals, most of the 100C series modules include selectable signal conditioning ability so that data may be filtered or transformed as it is being collected.

- **Biopotential modules:** ECG100C, EEG100C, EGG100C, EMG100C, EOG100C, ERS100C
- **Transducer modules:** EDA100C; PPG100C; RSP100C; SKT100C
- **MRI Smart modules**—advanced signal processing circuitry removes spurious MRI artifact from the source physiological data: ECG100C-MRI; EDA100C-MRI; EEG100C-MRI; EMG100C-MRI; PPG100C-MRI.

Modules can be cascaded by snapping the modules together. Up to sixteen 100C series modules can be connected to the MP System at any one time.

- Click to view a [Biopotential Module System Diagram with MP160/150](#)
- Click to view a [Transducer Module System Diagram with MP160/150](#)
- Click to view an [MRI Smart Module System Diagram with MP160/150](#)

IMPORTANT

When cascading modules, it is important to remember that **no two amplifiers may be set to the same channel**. If two connected amplifier modules are left on the same channel, then contention will result and both amplifier outputs will give erroneous readings.

AMPLIFIER GLOSSARY

- Amplifier offset** Set by the zero adjust control trim potentiometer near the top of the module. The offset control can be used to adjust the zero point or “baseline” of a signal.
- Gain Switch** The four-position slide Gain switch controls sensitivity. Lower gain settings will amplify the signal to a lesser extent than higher gain settings. If the signal plotted on the screen appears to be very small for a given channel, increase the Gain for that particular channel. Conversely, if the signal seems to be “cropped” at +10 Volts or –10 Volts, decrease the Gain.
- Connections** Transducers and electrodes connect to the amplifiers using 1.5 mm female Touchproof connectors.

- Electrodes** The biopotential amplifier modules use a three-electrode arrangement (VIN+, GND, VIN-). Although certain applications may require different arrangements of electrodes and/or transducers, some generalizations about electrode and transducer connections can be made. Electrodes measure the electrical activity at the surface of the skin, and since electricity flows from - to +, measuring the flow of a signal requires that there be (at least) one “-” electrode and (at least) one “+” electrode. An additional electrode, a “ground” (or earth) electrode is used to control for the general level of electrical activity in the body.
- Leads** Typically, electrode leads are used to connect individual electrodes to the xxx100C amplifier. Most electrode leads are shielded, which means they introduce less noise than an unshielded lead. A shielded electrode lead has an extra jack on one end that plugs into the SHIELD input on the amplifier modules. A standard electrode lead configuration consists of two LEAD110S electrode leads (one connected to the VIN + input and one to the VIN - input on the amplifier) and a single LEAD110 (connected to the GND input on a biopotential amplifier).
- Transducers** Transducers, on the other hand, are not designed to measure electrical activity directly and usually involve simpler connections. The transducers discussed in this manual translate physical changes (in temperature, for instance) into electrical signals. Connections for individual transducers are discussed in each section.
- Channel** The active channel is selected using the channel select switch on the top of the module. The channel select switch can direct the amplifier output to one of sixteen possible MP System input channels. *Remember to make sure that each amplifier module is set to a unique channel.*
- Zero Adjust** On input signals, a limited range in baseline level (DC offset) can be “zeroed out” using the zero adjust potentiometer. Typically, the zero adjust will not have to be used (as it is preset at the factory). However, some of the 100C series modules can measure DC signals and, in certain circumstances, signal “zeroing” may be required.
- Setup** All 100C Series biopotential or transducer amplifiers incorporate specific gain, coupling and filtering options that are appropriate for the biopotential type or transducer signal that requires measurement. Generally, when an electrode or transducer is inserted into the corresponding 100C series module, the amplifier will immediately produce a useful output, with no user adjustments necessary.
- Certain functionality is added to each module to optimize its performance with its intended signal measurement. For example, all 100C series biopotential amplifiers incorporate a selectable interference filter. When the interference filter is on, 50/60 Hz interfering signals are suppressed.
- Filters** All 100C series amplifiers are constructed with filters that have a high degree of phase linearity. This means the 100C series modules will filter signals with as little distortion as possible. These modules also incorporate protection circuitry to limit input current in the event of input signal overload. Notch and bandstop filters have the potential to cause distortion, especially in the form of “ringing” in the data stream; biopotential hardware notch filters are implemented in conjunction with LP or HP functions to minimize distortion.
- Line Freq** Line Frequency is set using the recessed switch boxes on the left panel of the amplifier module (50 Hz = all switches down, 60 Hz = all switches up). It is important to select the correct line frequency for your geographical region. Typically, U.S. line frequency is 60 Hz; Europe and China 50 Hz. Contact BIOPAC for additional line frequency information. All MP biopotential amplifier modules which contain a 50/60 Hz notch filter only engage the filter when the pass filter is also ON:
- ECG100C, EEG100C, EOG100C amplifiers: the 50/60 Hz notch is only engaged when the 35 Hz LPN low pass notch filter switch is set to ON.
 - EMG100C, ERS100C amplifiers: the 50/60 Hz notch is only engaged when the 100 Hz HPN high pass notch filter switch is set to ON.

See individual module sections for details.

ECG100C – ELECTROCARDIOGRAM AMPLIFIER MODULE

The electrocardiogram amplifier module (ECG100C) is a single channel, high gain, differential input, biopotential amplifier designed specifically for monitoring the heart’s electrical activity, and for use in the following applications:

- | | |
|---|---|
| Conventional electrocardiogram (12-lead ECG) | Chaos investigations (heart rate variability) |
| Einthoven’s triangle potential measurement (3-lead ECG) | Heart arrhythmia analysis |
| Transverse-plane ECG measurement (V1 through V6) | Exercise physiology studies |
| Vectorcardiogram measurement | |

The ECG100C will connect directly to any of BIOPAC Systems, Inc.’s series of Ag-AgCl lead electrodes. The best choice for electrodes depends on the application, but typically the EL500 series (i.e., EL501, EL502, EL503) of adhesive/disposable snap electrodes are used in conjunction with the LEAD110/LEAD110S pinch lead. If reusable electrodes are required, the EL258 is typically used; when using EL258 electrodes, adhesive disks (ADD208) and electrode gel (GEL100) are also needed. Use two shielded electrodes (EL258S) for the signal inputs and one unshielded electrode (EL258S) for the ground.

The ECG100C has built in drive capability for use with shielded electrode leads. If high bandwidth (resolution) ECG measurements are required, then shielded electrode leads are recommended. When the interference filter is switched on, shielded leads are typically not necessary. The ECG100C is designed to pass the ECG signal (P, Q, R, S, T waves) with minimal distortion.

R-WAVE DETECTOR FUNCTION

The ECG100C has an additional R-wave detector function. When enabled, the output signal will produce a smoothed positive peak every time the R-wave is detected.

This graph illustrates ECG data recorded with the ECG100C. The top waveform is a raw ECG wave, and the bottom waveform is the same signal processed using the R-wave detector in the ECG100C module.

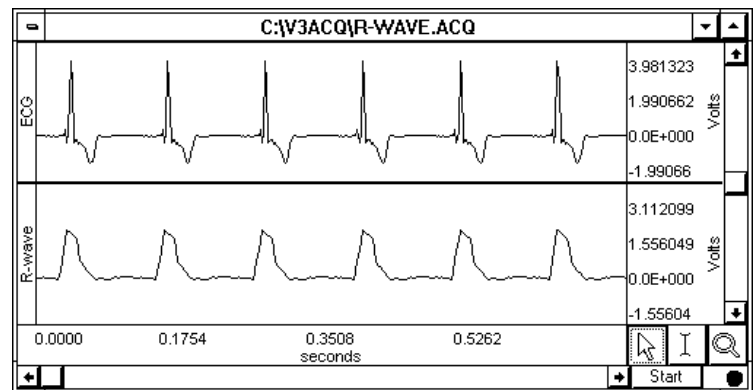

This function is extremely useful for rate calculations when a well-defined peak is desired.

Enabling the R-wave detector is useful for calculating BPM and IBI, as it tends to remove any components of the waveform that might be mistaken for peaks.

The R-wave detector circuitry consists of:

- 17 Hz band pass filter with Q = 5
- Full wave rectifier
- 10.0 Hz, three pole, low pass filter with Q = 0.707

These settings are optimized for ECG data sampled at 250 Hz or faster. For data sampled at less than 250 Hz, the low pass filter might be set to 5 Hz.

RECORDING A 12-LEAD ECG

- For full, simultaneous, 12-lead ECG recording, eight ECG100C amplifiers are required, along with a WT100C Wilson Terminal. Two of the ECG100C are used to simultaneously record Leads I, II, III, aVR, aVL and aVF, while the remaining six ECG100C are used to generate the six precordial leads.
- To perform a standard 12-lead ECG recording using only three ECG100C amplifiers, use the TSD155C. The TSD155C multi-lead ECG cable is 3 meters long and incorporates a built-in Wilson Terminal for simultaneous recording of Leads I, II, III, aVR, aVL, aVF and one (movable) precordial lead [V1, V2, V3, V4, V5 or V6].

CONNECTIONS

This figure shows the electrode connections to the ECG100C for the measurement of **Lead I**. Signals from this electrode montage can be used to calculate BPM (or IBI) and general-purpose ECG applications.

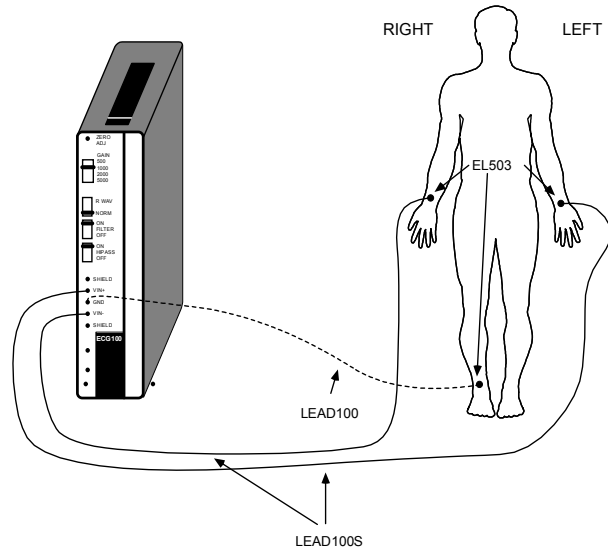

This figure shows the electrode connections to two ECG100C modules for recording a standard **two lead ECG** (Lead I and Lead III). Although only two channels are directly acquired, Lead II can be computed (either on-line or after the fact) by summing Lead I and Lead III. For this setup, the GND input on Lead I is internally connected to the GND input on Lead III, and the VIN+ on Lead I is connected to the VIN- on Lead III via a JUMP100C jumper lead.

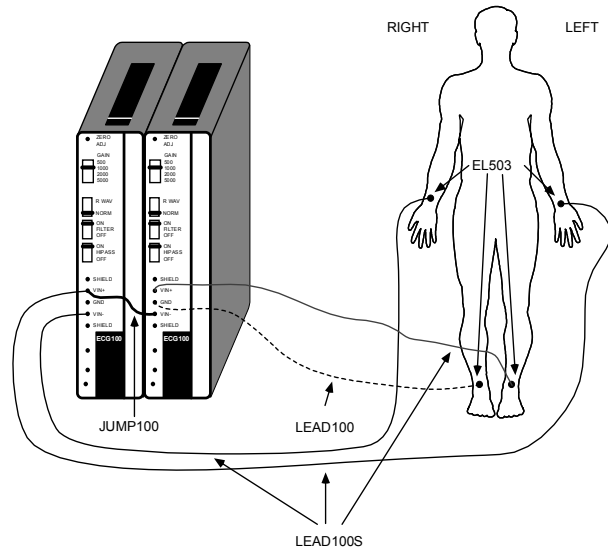

FREQUENCY RESPONSE CHARACTERISTICS

The ECG100C includes a high pass filter that is used to stabilize the ECG baseline. When the **HP** switch is set to 1.0 Hz, P and T wave amplitudes will be reduced somewhat, but the QRS wave will be virtually unchanged. The HP switch is usually ON when using the ECG100C for rate measurements only or when monitoring the ECG of an active subject.

The 0.05 Hz and 1.0 Hz lower frequency response high pass filter settings are single pole roll-off filters.

Modules can be set for 50 Hz or 60 Hz notch options to match the wall-power line frequency of the destination country. The proper setting reduces noise from interfering signals when the notch filter is engaged. Generally, wall-power line frequency is 60 Hz in the United States and 50 Hz in most of Europe and China; if necessary contact BIOPAC to determine the correct line frequency. To reset the line frequency setting, adjust the bank of switches on the left panel of the amplifier module.

Line Frequency switch bank is on the left panel of biopotential and transducer amplifiers

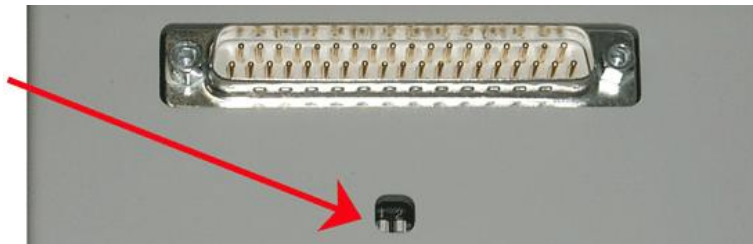

50 Hz

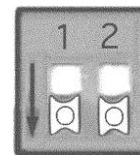

Both switches
DOWN

60 Hz

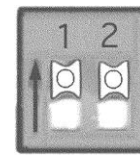

Both switches
UP

See also: Sample frequency response plots: 35 Hz LPN option (with 50 Hz notch enabled), 150 Hz LP option, and 35 Hz LPN option (with 60 Hz notch enabled)

ECG100C CALIBRATION

The ECG100C is factory set and does not require calibration. To confirm the accuracy of the device, use the CBLCALC.

ECG100C SPECIFICATIONS

- Gain: 500, 1000, 2000, 5000
- Output Selection: Normal, R-wave indicator
- Output Range: ± 10 V (analog)
- Frequency Response Maximum Bandwidth: (.05 Hz – 150 Hz)
 - Low Pass Filter: 35 Hz, 150 Hz
 - High Pass Filter: 0.05 Hz, 1.0 Hz
- Notch Filter: 50 dB rejection @ 50 Hz or 60 Hz
- Noise Voltage: 0.1 μ V rms – (0.05-35 Hz)
- Signal Source: Electrodes (three electrode leads required)
- Z (input) Differential: 2 M Ω
Common mode: 1000 M Ω
- CMRR: 110 dB min (50/60 Hz); **see also:** Shield Drive Operation
- CMIV–referenced to Amplifier ground: ± 10 V
Mains ground: ± 1500 VDC
- Input Voltage Range:

Gain	V _{in} (mV)
500	± 20
1000	± 10
2000	± 5
5000	± 2
- Maximum Over-Voltage for Differential Input: ± 25 V
- Weight: 350 grams
- Dimensions: 4 cm (wide) x 11 cm (deep) x 19 cm (high)
- Input Connectors: Five 1.5 mm male Touchproof sockets (Vin+, Ground, Vin-, 2 of shield)

See also: JUMP100C and MEC series

TSD155C MULTI-LEAD ECG CABLE

To record 12-lead ECG with a movable chest lead, use the TSD155C. The TSD155C multi-lead ECG cable is 3 meters long and incorporates a built-in Wilson Terminal for simultaneous recording of Leads I, II, III, aVR, aVL, aVF and one (movable) precordial lead [V1, V2, V3, V4, V5 or V6].

The TSD155C is used for performing a standard 12-lead ECG recording using only 3 ECG100C amplifiers.

See also: TEL100 Compatibility: SS29



WT100C WILSON TERMINAL FOR THE ECG100C

The WT100C is used to create a virtual reference electrode when measuring the transverse plane (i.e., precordial) ECG components [V1, V2, V3, V4, V5, and V6]. The virtual reference is created by the summation of the Right Arm (RA), Left Arm (LA) and Left Leg (LL) electrode leads. To measure all six transverse plane components, six ECG100C amplifiers are required. Use five of the JUMP100C jumper connectors to tie together the reference (Vin-) inputs of these amplifiers. This common reference connects to the virtual reference created by the WT100C.



EEG100C – ELECTROENCEPHALOGRAPH AMPLIFIER MODULE

The electroencephalogram amplifier module (EEG100C) is a single-channel, high-gain, differential input, biopotential amplifier designed specifically for monitoring the neuronal activity of the brain. The EEG100C is designed for use in the following applications:

- | | |
|--|-------------------|
| Conventional EEG (16 channel, unipolar or bipolar) | Sleep studies |
| Epilepsy investigations | Evoked responses |
| Tumor pathology studies | Cognition studies |

The EEG100C will connect directly to any of BIOPAC Systems, Inc.’s series of Ag-AgCl lead electrodes. Typically, EL503 electrodes are recommended for evoked response measurements. Use two shielded electrodes (LEAD110S) for the signal inputs and one unshielded electrode (LEAD110) for ground. If hair is present, disposable electrodes don’t work very well for scalp attachment—add electrode gel (GEL100) and tape the electrode lightly in place or use a conductive adhesive paste (like Ten20[®] or Collodion HV[®]).

The EEG100C has built-in drive capability for use with shielded electrode leads. If high bandwidth (resolution) EEG measurements are required, then shielded electrode leads are recommended. When the interference filter is switched on, shielded leads are typically not necessary.

This module is designed to pass the EEG signal ranges (Delta, Theta, Alpha, Beta, and Gamma) with minimal distortion. In addition, the EEG100C has a built-in Alpha wave detector. When enabled, the output signal will produce a smoothed wave with peaks that indicate points of maximum Alpha activity. The Alpha wave detector consists of a highly selective, six pole, 8-13 Hz bandpass filter, followed by a full wave rectifier, followed by a 6Hz, three pole, low pass filter. The EEG100C is capable of measuring Slow Cortical Potentials, down to 0.005 Hz in frequency (32 second time constant).

BIPOLAR EEG ELECTRODE PLACEMENT

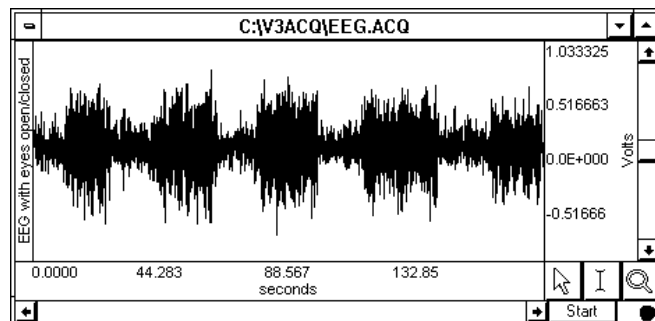
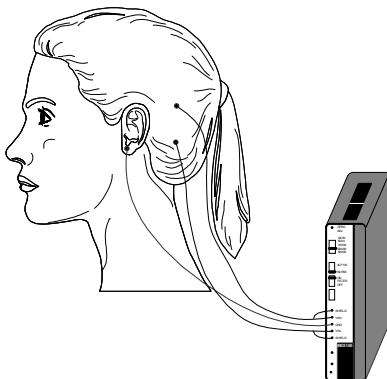

EEG waveform with eyes closed then opened

Bipolar connection to the occipital lobe

The illustration above shows a bipolar connection to the occipital lobe; to make a unipolar connection, relocate the VIN- electrode to the earlobe (where GND is attached). The graph indicates the change in the occipital EEG when eyes are closed and opened. The data is shown compressed, but can easily be expanded to show waveform differences in greater detail.

FREQUENCY RESPONSE CHARACTERISTICS

The 0.005 Hz high pass and 0.5 Hz high pass lower frequency response settings are single pole, roll-off filters.

Modules can be set for 50 Hz or 60 Hz notch options to match the wall-power line frequency of the destination country. The proper setting reduces noise from interfering signals when the notch filter is engaged. Generally, wall-power line frequency is 60 Hz in the United States and 50 Hz in most of Europe and China; if necessary contact BIOPAC to determine the appropriate line frequency. To reset the line frequency setting, adjust the bank of switches on the left panel of the amplifier module (as shown on the next page).

The 50/60 Hz notch is only engaged when the 35 Hz LPN filter switch on the EEG100C amplifier is set to ON.

FREQUENCY RESPONSE, CONT'D

See also: Frequency response Plots

35 Hz LPN (with 50 Hz notch enabled)

35 Hz LPN (with 60 Hz notch)

100 Hz LP option

Line Frequency switch bank is on the left panel of biopotential and transducer amplifiers

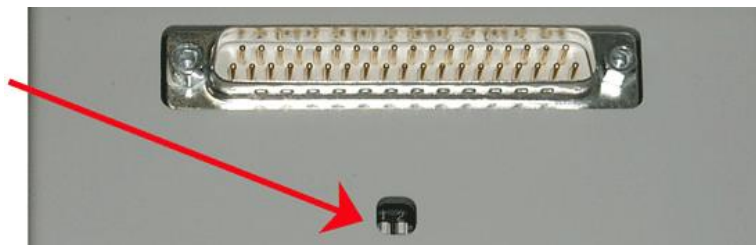

50 Hz

60 Hz

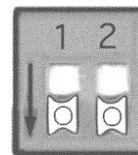

Both switches
DOWN

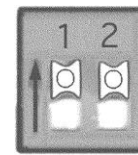

Both switches
UP

EEG100C CALIBRATION

The EEG100C is factory set and does not require calibration. To confirm the accuracy of the device, use the CBLCALC.

Hardware settings are based on line frequency, which varies by country. To confirm that line frequency is set correctly for the country, check the switches on the left panel of the amplifier.

EEG100C SPECIFICATIONS

Gain:	5000, 10000, 20000, 50000			
Output Selection:	Normal, Alpha Wave indicator			
Output Range:	±10 V (analog)			
Frequency Response	Maximum bandwidth (0.005 Hz – 100 Hz)			
Low Pass Filter:	35 Hz, 100 Hz			
High Pass Filter:	0.005 Hz, 0.5 Hz			
Notch Filter:	50 dB rejection @ 50 Hz or 60 Hz			
Noise Voltage:	0.1 µV rms – (0.005–35 Hz)			
Signal Source:	Electrodes (three electrode leads required)			
Z (input)	Differential: 2 MΩ		Common mode: 1000 MΩ	
CMRR:	110 dB min (50/60 Hz); see also: Shield Drive Operation			
CMIV—referenced to	Amplifier ground: ±10 V		Mains ground: ±1500 VDC	
Input Voltage Range:	<u>Gain</u>	<u>V_{in} (mV)</u>	<u>Gain</u>	<u>V_{in} (mV)</u>
	5000	±2	20000	±0.5
	10000	±1	50000	±0.2
Maximum Over-Voltage for Differential Input:	±25 V			
Weight:	350 grams			
Dimensions:	4 cm (wide) x 11 cm (deep) x 19 cm (high)			
Input Connectors:	Five 1.5 mm male Touchproof sockets (Vin+, Ground, Vin-, 2 of shield)			

See also: JUMP100C and MEC series

EEG ELECTRODE CAP SYSTEMS AND CAPS

Systems

BN-EEGCAP-SYS BioNomadix Wireless EEG Cap System
 CAP100C Electrode Cap System (Touchproof)

Cap Only

BN-CAP-SMALL CAP-INFANT
 BN-CAP-MEDIUM CAP-SMALL
 BN-CAP-LARGE CAP-MEDIUM
 CAP-LARGE



Electrode Cap System
(CAP100C shown)

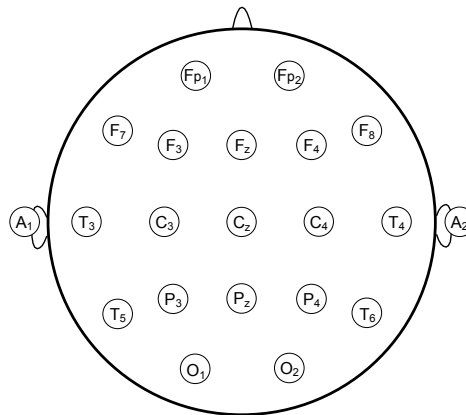

International 10-20 electrode montage



Cap only
(CAP-MEDIUM shown)

EEG CAP SYSTEMS

EEG Cap Systems include a medium EEG cap with accessories, plus mating cable to interface an EEG amplifier or MP36R/36R unit. The medium electrode cap fits most subjects over age five; infant, small, and large caps are also available; Systems ship with one medium cap (no substitutions).

The fabric cap has recessed tin electrodes attached to the Lycra-type fabric. The electrodes are pre-positioned in the International 10-20 montage (shown above). Since leads are available for all electrodes, unipolar or bipolar montage recordings can be obtained. The electrode cap comes with two ground electrodes, and can also be used for evoked potential investigations (such as ABR). When the electrode cap is in place, EEG recording gel is injected into each electrode (via a central gel access hole) with a blunt-tipped syringe.

Leads from the electrode cap terminate in 1.5 mm female Touchproof sockets, which connect to inputs on

- EEG100C electroencephalogram amplifier
 - To connect to older model EEG100A or EEG100B, add connection cable CBL201.
- BN-EEG2 BioNomadix Wireless EEG transmitter/receiver set
 - See BioNomadix® [HARDWARE GUIDE](#) for more information on BioNomadix® hardware.
- MP3X data acquisition unit via shielded electrode interface cable SS1LA

EEG CAP ONLY

Lycra-type fabric cap with recessed tin electrodes pre-positioned in the International 10-20 montage (shown above). Additional or replacement caps are available in a variety of sizes. Caps include a ribbon cable for connection to a cap system.

CAP SYSTEM SPECIFICATIONS

- Components:** 1 x medium cap with 19-pin ribbon cable (see CAP-SIZE Specs)
 1 x mating cable with 1.5 mm Touchproof connectors
 2 x earclip reference electrodes
 1 x blunt-tipped syringe
 1 x EEG recording gel
 1 x chest harness (holds cap in place)
 1 x liquid soap (to wash cap after use)
- Interface:** EEG100C (add CBL201 adapter for older EEG100A or EEG100B)
 BN-EEG2
 MP36/36R system via SS1LA adapter

CAP SIZE SPECIFICATIONS

- Sizes:**

	CAP-INFANT	45-50 cm
BN-CAP-SMALL	CAP-SMALL	50-54 cm
BN-CAP-MEDIUM	CAP-MEDIUM	54-58 cm
BN-CAP-LARGE	CAP-LARGE	58-62 cm

Material: Lycra

Cable: Ribbon cable from cap to 19 Touchproof 1.5 mm sockets
 Length: BN-CAP-SIZE 25 cm or CAP-SIZE 100 cm

100 cm	WIRE COLOR	RED TIP
WHITE TIP		
Fp1	Brown	Fp2
F3	Red	F4
C3	Orange	C4
P3	Yellow	P4
01	Green	02
F7	Blue	F8
T3	Violet	T4
T5	Gray	T6
Gnd	White	Cz
Fz	Black	Pz

Interface: Cap System BN-EEGCAP-SYS or CAP100C

EGG100C – ELECTROGASTROGRAM AMPLIFIER MODULE

ZERO

EGG100C

GAIN

500
1000
2000
5000

0.1Hz
LP

1.0Hz

0.05Hz
HP
DC

0.005Hz
HP
DC

SHIELD

VIN+

GND

VIN-

SHIELD



The EGG100C amplifies the electrical signal resulting from stomach and intestinal smooth muscle activity. The amplifier monitors the DC potential on the skin surrounding, or surface of, the intestine and stomach, which is indicative of the degree of slow wave contraction. The amplifier permits DC coupling to electrodes for signal amplification and presentation without discernible decay. The EGG100C also has built-in drive capability for use with shielded electrode leads.

The gastric slow wave (ECA) originates in the proximal stomach and propagates distally towards the pylorus. For recording, place multiple surface electrodes on the abdomen along the gastric axis and connect them to respective EGG100C amplifiers that have a common reference electrode placed near the xiphoid process. For consistent electrode-to-electrode spacing, use the EL500 dual electrodes with LEAD110 leads. For extremely tight electrode-to-electrode spacing, use the EL254 or EL258 reusable Ag-AgCl lead electrodes. The signals amplified at each electrode will be displayed on consecutive channels in *AcqKnowledge*.

FREQUENCY RESPONSE CHARACTERISTICS

The 0.005 Hz high pass lower frequency response setting is a single pole, roll-off filter.

See also: Frequency Response Plots: 0.05 Hz HP, 0.1 Hz LP, 1 Hz LP.

EGG100C CALIBRATION

The EGG100C is factory set and does not require calibration. To confirm the accuracy of the device, use the CBLCALC.

EGG100C SPECIFICATIONS

Gain & Input Voltage:	<u>Gain</u>	<u>V_{in} (mV)</u>
	500	±20
	1000	±10
	2000	±5
	5000	±2

Maximum Over-voltage for Differential Input: ±25 V

Output Range: ±10 V (analog)

Frequency Response Maximum bandwidth (DC – 1 Hz)

Low Pass Filter: 0.1Hz, 1Hz

High Pass Filter: DC, 0.005 Hz, 0.05 Hz

Noise Voltage: 0.1µV rms – (0.005-1.0 Hz)

Signal Source: Electrodes (three electrode leads required)

Z (input)

Differential: 2 MΩ

Common mode: 1000 MΩ

CMRR: 110 dB min (50/60 Hz); **see also:** Shield Drive Operation

CMIV—referenced to

Amplifier ground: ±10 V

Mains ground: ±1500 VDC

Weight: 350 grams

Dimensions: 4 cm (wide) x 11 cm (deep) x 19 cm (high)

Input Connectors: Five 1.5 mm male Touchproof sockets (Vin+, Ground, Vin-, 2 of shield)

EMG100C – ELECTROMYOGRAM AMPLIFIER MODULE

The electromyogram amplifier module (EMG100C) is a single-channel, high-gain, differential input, biopotential amplifier designed specifically for monitoring muscle and nerve response activity.

The EMG100C is designed for use in the following applications:

- Conventional bipolar EMG measurement
- Biomechanics
- Nerve conduction measurement
- Muscular reflex studies
- Motor unit potential measurement

The EMG100C will connect directly to any of BIOPAC’s Ag-AgCl lead electrodes. The best choice for electrodes depends on the application, but typically, the EL503 adhesive/disposable snap electrodes are used in conjunction with the LEAD110S pinch lead. If reusable electrodes are required, the EL508S is typically used; when using EL508S electrodes, adhesive disks (ADD208) and electrode gel (GEL100) are also required. Use two shielded electrodes (LEAD110S/EL503 or EL508S) for the signal inputs and one unshielded electrode (LEAD110/EL503 or EL508) for ground.

The EMG100C has built-in drive capability for use with shielded electrode leads. Shielded leads are typically required, as the EMG100C has a frequency response that extends through the 50/60 Hz interference bands. The EMG100C is designed to pass EMG signals and signals associated with nerve responses.

The EMG100C incorporates a variety of filtering options to optimize the amplifier performance when recording from either surface or needle electrodes, and when recording from either muscle or nerves. For instance, when recording EMG (muscle) from surface electrodes, the 10 Hz to 500 Hz bandwidth setting could be used, but when recording nerve propagation times, the 100 Hz to 5,000 Hz bandwidth setting could be used.

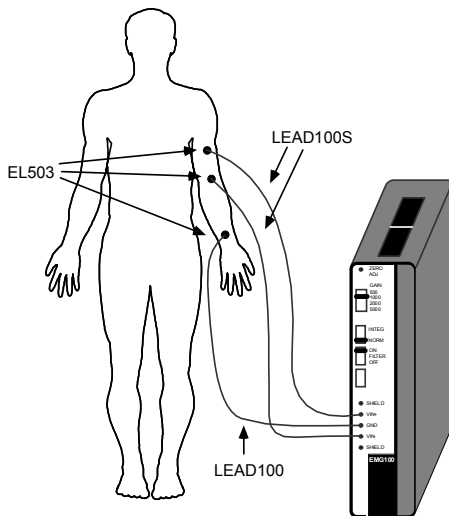

Electrode connections to the EMG100C to measure EMG activity from the arm biceps.

This graph shows raw EMG and integrated EMG.

To integrate EMG in real-time, set up a calculation channel in *AcqKnowledge* using the Integrate function with Rectify checked ON. In this case, this waveform would be augmented by a smoothed curve following the positive envelope of the EMG signal.

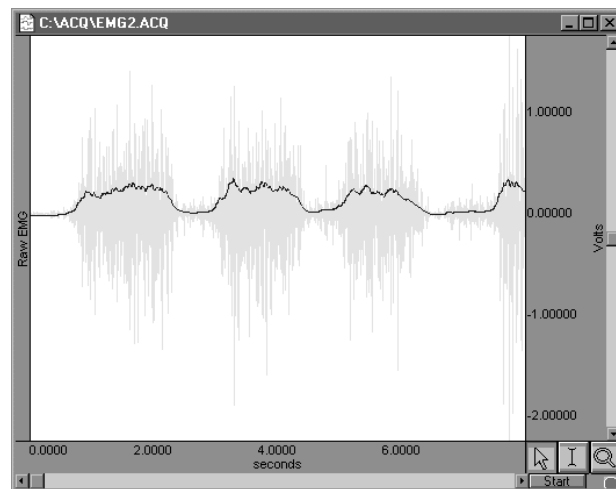

This graph shows a typical raw EMG recording. Waveform peaks indicate points of peak muscle activity.

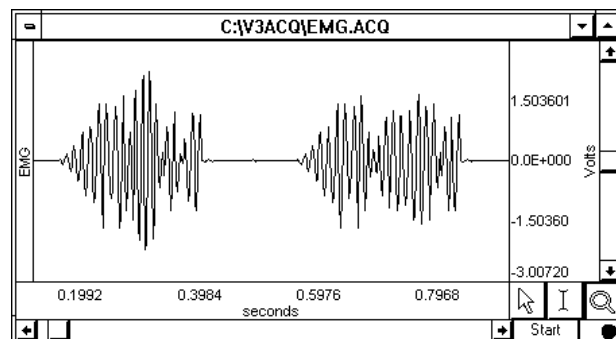

FREQUENCY RESPONSE CHARACTERISTICS

The 1 Hz high pass and 10 Hz high pass lower frequency response settings are single pole roll-off filters.

Modules can be set for 50 Hz or 60 Hz notch options to match the wall-power line frequency of the destination country. The proper setting reduces noise from interfering signals when the notch filter is engaged. Generally, wall-power line frequency is 60 Hz in the United States and 50 Hz in most of Europe and China; if necessary, contact BIOPAC to determine the appropriate line frequency. To reset the line frequency setting, adjust the bank of switches on the left panel of the amplifier module.

The 50/60 Hz notch is only engaged when the 100 Hz HPN filter switch on the EMG100C amplifier is set to ON.

Line Frequency switch bank is on the left panel of biopotential and transducer amplifiers

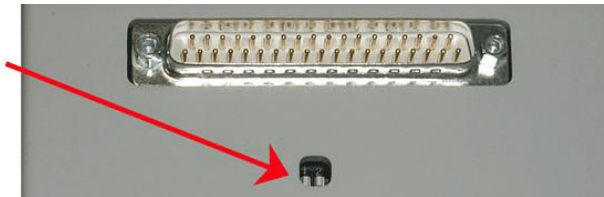

50 Hz

60 Hz

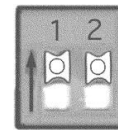
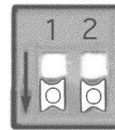

Both switches
DOWN

Both switches
UP

See also: Sample frequency response plots

100 Hz HPN option (with 50 Hz notch enabled)

100 Hz HPN option (with 60 Hz notch enabled)

500 Hz LP option

5000 Hz LP

EMG100C CALIBRATION

The EMG100C is factory set and does not require calibration. To confirm the accuracy of the device, use the CBLCAL.

EMG100C SPECIFICATIONS

Gain:	500, 1000, 2000, 5000
Output Range:	±10 V (analog)
Frequency Response	Maximum bandwidth (1.0 Hz – 5,000 Hz)
Low Pass Filter:	500 Hz, 5000 Hz
High Pass Filter:	1.0 Hz, 10 Hz, 100 Hz
Notch Filter:	50 dB rejection @ 50 Hz or 60 Hz
Noise Voltage:	0.2µV rms – (10-500 Hz)
Signal Source:	Electrodes (three electrode leads required)
Z (input)	
Differential:	2 MΩ
Common mode:	1000 MΩ
CMRR:	110 dB min (50/60 Hz)
CMIV-referenced to	
Amplifier ground:	±10 V
Mains ground:	± 1500 VDC
Input Voltage Range	<u>Gain</u> <u>V_{in} (mV)</u>
	500 ±20 1000 ±10
	2000 ±5 5000 ±2
Maximum Over-Voltage for Differential Input:	±25 V
Weight:	350 grams
Dimensions:	4 cm (wide) x 11 cm (deep) x 19 cm (high)
Input Connectors:	Five 1.5 mm male Touchproof sockets (Vin+, Ground, Vin-, 2 of shield)

See also: JUMP100C, MEC series

EOG100C – ELECTROOCULOGRAM AMPLIFIER MODULE

The electrooculogram amplifier module (EOG100C) is a single-channel, high-gain, differential input, biopotential amplifier designed for tracking eye movement. The EOG100C is designed for use in the following applications:

- | | | |
|-------------------------|-----------------------|-----------------------------|
| Sleep studies | Nystagmus testing | Vertigo investigations |
| Eye motion and tracking | REM activity analysis | Vestibular function studies |

The EOG100C senses the corneal-retinal potential inherent in the eyeball. As the eyes move in the horizontal and vertical planes, these potentials are superimposed to generate a DC voltage variation in the region immediately surrounding the eye sockets.

The EOG100C will connect directly to any of BIOPAC’s Ag-AgCl series lead electrodes. For most EOG applications, EL503 electrodes are used. Use two shielded electrode leads (LEAD110S) for the signal inputs and one unshielded electrode lead (LEAD110) for ground.

The EOG100C has built-in drive capability for use with shielded electrode leads. If high bandwidth (resolution) EOG measurements are required, then shielded electrode leads are recommended. When the interference filter is switched on, shielded leads are typically not necessary. The EOG100C is designed to pass the EOG signal to accommodate a large velocity range with minimal distortion.

This module includes an HP selection switch, which permits either absolute (DC) or relative (AC: 0.05 Hz HP) eye motion measurements. When performing absolute eye motion measurement, the eye position signal will still decay, but the time constant will be significantly longer than when performing relative eye motion measurement.

The EOG100C also has an EOG derivative function. When enabled, the output signal will produce a wave that will be directly proportional to the velocity of eye movement. Eye velocity measurement is useful for performing Nystagmus testing. The derivative function is obtained through the use of a specially designed bandpass filter (center frequency of 30 Hz, Q=0.8).

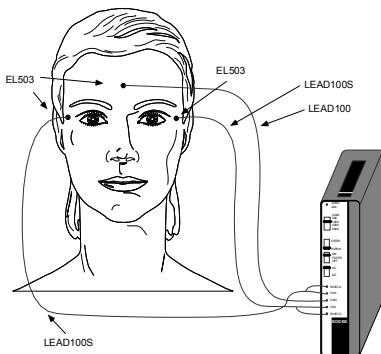

Setup to record horizontal eye movement

To increase accuracy, use electrodes above and below each eye and parallel them with JUMP100C Jumper leads when connecting to the vertical track EOG100C module.

This graph shows a horizontal eye movement recording. The positive peaks indicate eyes looking left. The negative peaks indicate eyes looking right. The derivative of this waveform would indicate the speed of eye motion during this time.

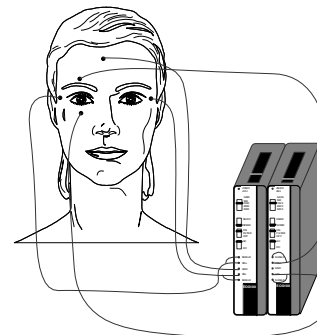

Setup for two EOG100C modules to record vertical and horizontal eye movement

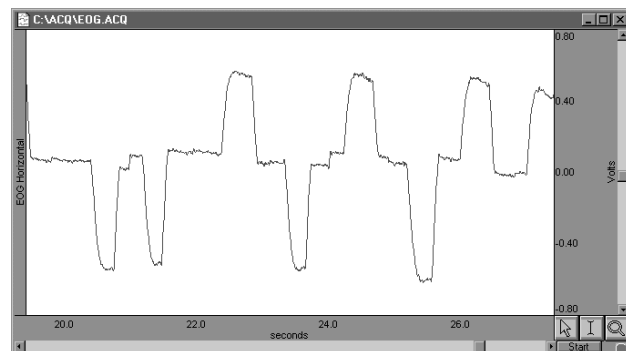

Typical EOG signal

FREQUENCY RESPONSE CHARACTERISTICS

The 0.05 Hz high pass lower frequency response setting is a single pole roll-off filter.

Modules can be set for 50 Hz or 60 Hz notch options to match the wall-power line frequency of the destination country. The proper setting reduces noise from interfering signals when the notch filter is engaged. Generally, wall-power line frequency is 60 Hz in the United States and 50 Hz in most of Europe and China; if necessary, contact BIOPAC to determine the appropriate line frequency. To reset the line frequency setting, adjust the bank of switches on the left panel of the amplifier module.

The 50/60 Hz notch is only engaged when the 35 Hz LPN filter switch on the EOG100C amplifier is set to ON.

Line Frequency switch bank is on the left panel of biopotential and transducer amplifiers

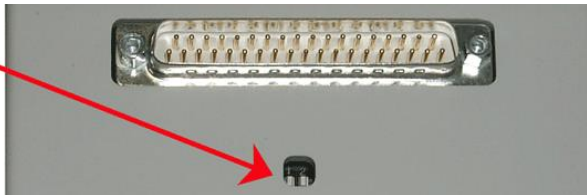

50 Hz

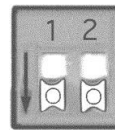

Both switches
DOWN

60 Hz

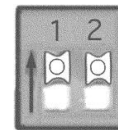

Both switches
UP

See also: Sample frequency response plots.

- 35 Hz LPN (with 50 Hz notch) 100 Hz LP
- 35 Hz LPN (with 60 Hz notch)

EOG100C CALIBRATION

The EOG100C is factory set and does not require calibration. To confirm the accuracy of the device, use the CBLCALC.

EOG100C SPECIFICATIONS

Gain:	500, 1000, 2000, 5000			
Output Selection:	Normal, Derivative output			
Output Range:	±10 V (analog)			
Frequency Response	Maximum bandwidth (DC – 100 Hz)			
Low Pass Filter:	35 Hz, 100 Hz			
High Pass Filter:	DC, 0.05 Hz			
Notch Filter:	50 dB rejection @ 50/60 Hz			
Noise Voltage:	0.1µV rms – (0.05-35 Hz)			
Signal Source:	Electrodes (three electrode leads required)			
Z (input)				
Differential:	2 MΩ			
Common mode:	1000 MΩ			
CMRR:	110 dB min (50/60 Hz); see also: Shield Drive Operation			
CMIV-referenced to				
Amplifier ground:	±10 V			
Mains ground:	±1500 VDC			
Input Voltage Range	<u>Gain</u>	<u>V_{in} (mV)</u>		
	500	±20	1000	±10
	2000	±5	5000	±2
Maximum Over-Voltage for Differential Input:	±25 V			
Weight:	350 grams			
Dimensions (WxDxH):	4 cm x 11 cm x 19 cm			
Input Connectors:	Five 1.5 mm male Touchproof sockets (Vin+, Ground, Vin-, 2 of shield)			

See also: JUMP100C and MEC series

ERS100C – EVOKED RESPONSE AMPLIFIER MODULE

The evoked response amplifier module (ERS100C) is a single channel, high gain, extremely low noise, differential input, biopotential amplifier designed to accurately amplify the very small potentials (< 200 nV) associated with evoked response measurement. The ERS100C is designed for use in the following applications:

- | | |
|---|--------------------------------|
| Auditory brainstem response (ABR) testing | Visual evoked response testing |
| Nerve conduction velocity and latency recording | Somatosensory response testing |

The ERS100C will connect directly to any of BIOPAC Systems, Inc.’s Ag-AgCl series of lead electrodes. Typically, the EL503 electrodes are recommended for evoked response measurements. Use two shielded electrodes (LEAD110S) for the signal inputs and one unshielded electrode (LEAD110) for the ground. If hair is present, disposable electrodes don’t work very well for scalp attachment—use electrode gel (GEL100) and tape the electrode lightly in place or use a conductive adhesive paste (like Ten20[®] or Collodion HV[®]).

The ERS100C has built-in drive capability for use with shielded electrode leads. Shielded leads are typically required, as the ERS100C has a frequency response that extends through the 50/60 Hz interference bands. Furthermore, the ERS100C is used to amplify extremely low level signals that can be easily corrupted by interfering signals.

The ERS100C incorporates selectable gain and bandwidth options to perform a variety of evoked response testing. The ERS100C is typically used with two shielded electrodes for signal input and one unshielded electrode for ground. In nearly all cases of stimulus response testing, the ERS100C will be used in conjunction with the STM100C and the MP System.

- The STM100C is a general-purpose stimulator that can be used to present auditory, visual or mechanical stimulus signals.

For most types of evoked response testing, the MP System will be operating in averaging mode. Typically, the stimulus output (usually a pulse) will be output through one of the analog channels (Out 0 or Out 1) or I/O 15 just prior to the data collection pass. Stimuli output on analog channels typically consists of pulses or tones, and stimulus output waveforms can easily be created and modified using the stimulator setup window, described in the *AcqKnowledge* Software Guide.

Auditory evoked potentials The ERS100C can record auditory evoked potentials, like the ABR. Use the STM100C to present an auditory pulse or “click” to the auditory stimulator, such as the ER-3A Tubephone. Present the acoustical signal to the active ear using a calibrated auditory earphone like the OUT101 Tubephone.

To record the ABR:

- 1) Place the active (VIN-) electrode at the earlobe or mastoid.
- 2) Place the reference (VIN+) electrode at the vertex.
- 3) Place the ground electrode at the forehead.

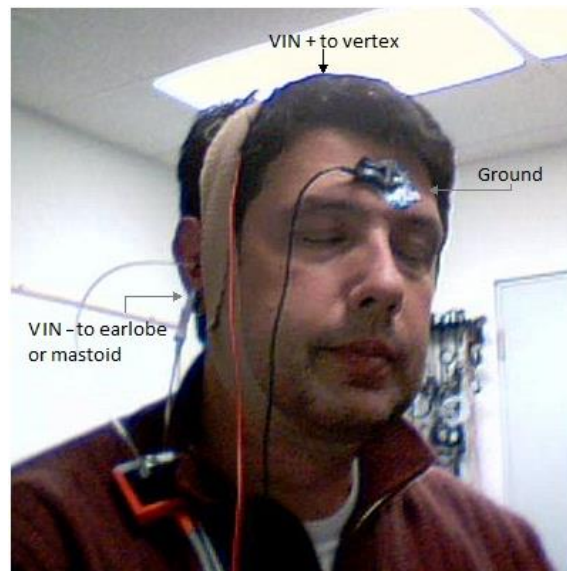

The MP System collected the data in the “Averaging” mode.

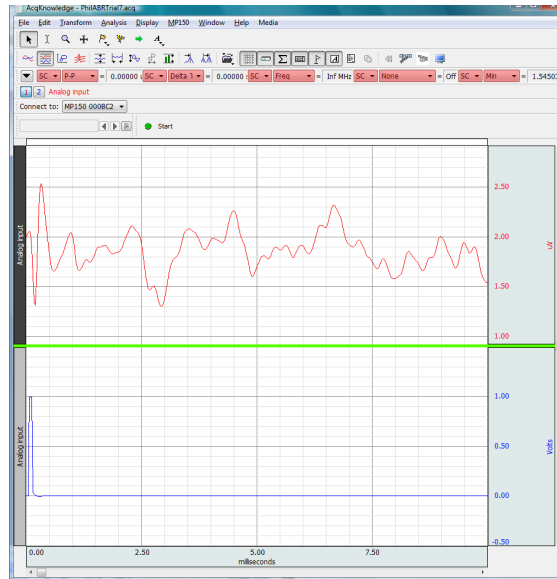

Somatosensory response

2000 trial ABR test performed using the ERS100C with the STM100C and OUT101 (TubePhone)

Somatosensory tests are used to characterize the perception of touch. Active electrodes are usually placed on an earlobe, and passive electrodes are placed on the contralateral earlobe. The ground electrode is placed on the forehead. In somatosensory response tests, the stimulation source is usually an electrical pulse or mechanical impulse applied at some point along the leg or arm.

General nerve conduction velocity

The ERS100C can also be used for general nerve conduction velocity tests, and will perform exceptionally well since the ultra low noise characteristics of the ERS100C are not required to obtain the best results and these tests don't require the extensive averaging required for auditory or visual evoked response measurements.

FREQUENCY RESPONSE CHARACTERISTICS

The 1 Hz high pass or 20 Hz high pass lower frequency response settings are single pole roll-off filters.

Modules can be set for 50 Hz or 60 Hz notch options to match the wall-power line frequency of the destination country. The proper setting reduces noise from interfering signals when the notch filter is engaged. Generally, wall-power line frequency is 60 Hz in the United States and 50 Hz in most of Europe and China; if necessary, contact BIOPAC to determine the appropriate line frequency. To reset the line frequency setting, adjust the bank of switches on the left panel of the amplifier module.

The 50/60 Hz notch is only engaged when the 100 Hz HPN filter switch on the ERS100C amplifier is set to ON.

Line Frequency switch bank is on the left panel of biopotential and transducer amplifiers

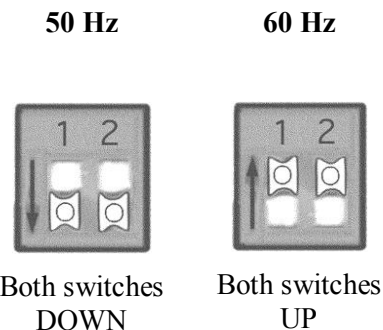
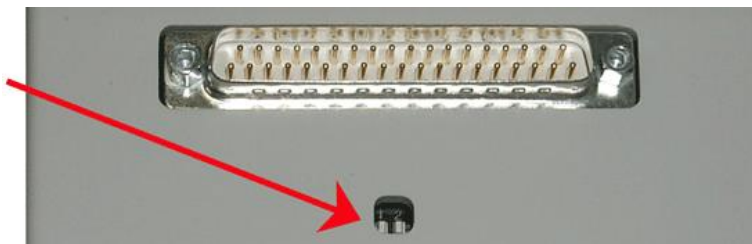

See also: Sample frequency response plots

- 100 Hz HPN (with 50 Hz notch)
- 100 Hz HPN (with 60 Hz notch)
- 3,000 Hz LP
- 10 kHz LP

ERS100C CALIBRATION

The ERS100C is factory set and does not require calibration. To confirm the accuracy of the device, use the CBLCALC.

ERS100C SPECIFICATIONS

Gain:	5000, 10000, 20000, 50000										
Output Range:	±10 V (analog)										
Frequency Response	Maximum bandwidth (1.0 Hz – 10 kHz)										
Low Pass Filter:	3 kHz, 10 kHz										
High Pass Filter:	1.0 Hz, 20 Hz, 100 Hz										
Notch Filter:	50 dB rejection @ 50 Hz or 60 Hz										
Noise Voltage:	0.5µV rms – (100-3000 Hz)										
Signal Source:	Electrodes (three electrode leads required)										
Z (input)											
Differential:	2 MΩ										
Common mode:	1000 MΩ										
CMRR:	110 dB min (50/60 Hz); see also: Shield Drive Operation										
CMIV–referenced to											
Amplifier ground:	±10 V										
Mains ground	±1500 VDC										
Input Voltage Range	<table><thead><tr><th>Gain</th><th>V_{in} (mV)</th></tr></thead><tbody><tr><td>5000</td><td>±2</td></tr><tr><td>10000</td><td>±1</td></tr><tr><td>20000</td><td>±0.5</td></tr><tr><td>50000</td><td>±0.2</td></tr></tbody></table>	Gain	V _{in} (mV)	5000	±2	10000	±1	20000	±0.5	50000	±0.2
Gain	V _{in} (mV)										
5000	±2										
10000	±1										
20000	±0.5										
50000	±0.2										
Maximum Over-Voltage for Differential Input:	±25 V										
Weight:	350 grams										
Dimensions:	4 cm (wide) x 11 cm (deep) x 19 cm (high)										
Input Connectors:	Five 1.5 mm male Touchproof sockets (Vin+, Ground, Vin-, 2 of shield)										

JUMP100/C – JUMPER CONNECTORS FOR BIOPOTENTIAL AMPLIFIERS



JUMP100 — for all connections between all 100B-series Biopotential amplifiers

JUMP100C — for all connections between all 100C-series Biopotential amplifiers

These jumper connectors (10 cm long) are used to create a common reference between biopotential amplifier modules. Link one reference electrode to multiple amplifier inputs using one jumper connector per amplifier. Jumper connectors are required when connecting the same reference electrode lead to two or more amplifiers, as in multi-lead ECG or unipolar EEG measurements.

JUMP100C-MRI – Y CABLE FOR MRI



This “Y” cable is functionally identical to the JUMP100C, but designed for use in the MRI environment when referencing two or more amplifier inputs to a single electrode input. Primarily used for recording biopotential measurements for EEG, ECG or EMG in the MRI. Two 1.5 mm Touchproof female inputs to one 1.5 mm Touchproof male input, cable length 10 cm.

MRI Use: MR Conditional to 9T

Components: Carbon composition, tin plated and gold plated brass connectors

- For two or more electrodes to one biopotential amplifier unit, use [CBL204-MRI](#); two 1.5 mm Touchproof male to one 1.5 mm Touchproof female—MRI equivalent of [CBL204](#).

TRANSDUCER MODULE EDA100C

NOTE TO GSR100C USERS:

- The term “Galvanic Skin Response” (GSR) has been superseded by “Electrodermal Activity” (EDA).
- GSR units ($\mu\text{mho/V}$) have been superseded by modern EDA units of $\mu\text{S/V}$ (microsiemens).
- There is no hardware or operational differences between the older GSR100C and the newer EDA100C amplifiers referred to in this document.

The EDA100C electrodermal activity amplifier module is a single-channel, high-gain, differential amplifier designed to measure skin conductance via the constant voltage technique. The EDA100C is designed for use in the following applications:

- General eccrine activity measurement Vestibular function analysis
- Vertigo and motion sickness studies Psychophysiological investigations

The EDA100C includes a selection switch for lower frequency response.

- DC—For **absolute** measures (e.g. skin conductance level)
- 0.05 Hz—For **relative** measures (e.g. skin conductance response)



IMPORTANT

GROUNDING: When using the EDA100C amplifier with other biopotential amplifiers attached to the same subject, it’s not necessary to attach the ground lead from the biopotential amplifier(s) to the subject. The subject is already appropriately referenced (grounded) to the system via the attachment to the EDA100C. If a biopotential ground is attached to the subject, then currents sourced from the EDA100C will be split to the biopotential amplifier ground lead, potentially resulting in measurement errors.

IMPORTANT

The EDA100C is typically used with TSD203 Ag-AgCl finger electrodes.

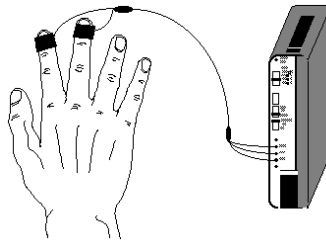

Skin conductance measurement using EDA100C and TSD203

The following graph shows the relationship between respiration rate and the electrodermal activity response (galvanic skin response). The left half of the graph marks the onset and completion of fast breathing (panting), and the subject begins to breathe normally at the time index corresponding to 12 seconds.

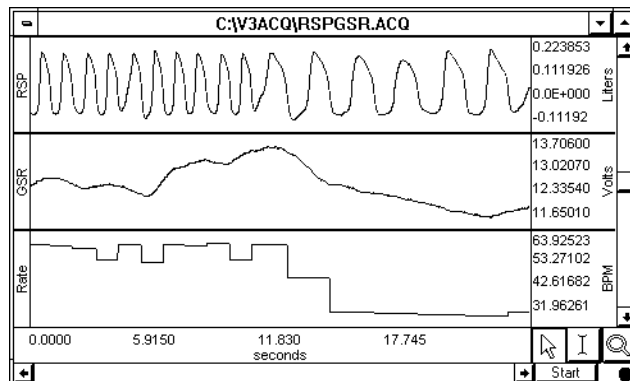

Electrodermal activity response, respiration and respiration rate waveforms

FREQUENCY RESPONSE CHARACTERISTICS

The 0.05 Hz high pass lower frequency response setting is a single pole roll-off filter.

See also: Sample frequency response plots.

1 Hz LP

10 Hz LP

EDA100C CALIBRATION

Note that the EDA100C has scale setting in units of “ μS per volt.” This is identical to the respective scale setting of μmho or micromho per volt. Namely, $1 \mu\text{S} = 1 \mu\text{mho}$.

SETUP INSTRUCTIONS

Lower frequency response at DC:

In the scaling window, set the input voltages so they map to the DC conductance ranges indicated by the sensitivity setting. For example, if the EDA100C is set to a Gain of $5 \mu\text{S}/\text{V}$, then 0 V will map to 0 μS or infinite resistance, and 1 V will map to 5 μS or 200 kohm.

Lower frequency response at 0.05 Hz:

In the scaling window, set the input voltages so they map to the “0.05 Hz” conductance ranges indicated by the sensitivity setting. For example if the EDA100C is set to a Gain of $5 \mu\text{S}/\text{V}$, then 0 V will map to X μS s and 1 V will map to (X+5) μS . Where “X” is the mean conductance being recorded.

To verify the Gain setting of the EDA100C:

1. Calibrate *AcqKnowledge* as detailed above for lower frequency response at DC.
2. Place the lower frequency response to DC.
3. Set the Gain switch on the EDA100C to $5 \mu\text{S}/\text{V}$.
4. Perform measurement with electrodes disconnected.
 - *AcqKnowledge* should produce a reading of 0 μS .
5. Insulate a 100 kohm resistor and place it from electrode pad to electrode pad (resistor must be insulated from fingers).
6. Perform measurement with electrode-resistor setup.
 - *AcqKnowledge* should produce a reading of 10 μS .

EDA100C SPECIFICATIONS

Unit Note—BIOPAC software calculates SCL/SCR in microsiemens. The traditional unit of conductance, Micromho (μmho) is interchangeable with the more current microsiemen (μS). To use Ohm, the traditional measure of resistance, convert as $1 \mu\text{S}$ equals 1,000,000 ohms.

Gain: 20, 10, 5, 2 micro-siemens/volt (i.e., micro-umhos/volt)

<i>Input conductance range</i>			
DC	0.05 Hz	<i>Minimum Resistance</i>	<i>Sensitivity</i>
0 to 200 $\mu\text{S/V}$	$\pm 200 \mu\text{S/V}$	5,000 Ω	20 $\mu\text{S/V}$
0 to 100 $\mu\text{S/V}$	$\pm 100 \mu\text{S/V}$	10,000 Ω	10 $\mu\text{S/V}$
0 to 50 $\mu\text{S/V}$	$\pm 50 \mu\text{S/V}$	20,000 Ω	5 $\mu\text{S/V}$
0 to 20 $\mu\text{S/V}$	$\pm 20 \mu\text{S/V}$	50,000 Ω	2 $\mu\text{S/V}$

Note: Normal human range is 1-50 μS

Output Range: 0-10 V nominal, ± 10 V full (analog)

Frequency Response

Low Pass Filter: 1 Hz, 10 Hz

High Pass Filter: DC, 0.05 Hz, 0.5 Hz

Sensitivity: 0.7 nano-mhos – with MP System

Excitation: $V_{\text{ex}} = 0.5$ VDC (Constant Voltage)

Signal Source: TSD203

Weight: 350 grams

Dimensions: 4 cm (wide) x 11 cm (deep) x 19 cm (high)

Input Connectors: Three 1.5 mm male Touchproof sockets (VIN+, Ground, VIN-)

PPG100C – PHOTOPLETHYSMOGRAM AMPLIFIER MODULE

The photoplethysmogram amplifier module (PPG100C) is a single channel amplifier designed for indirect measurement of blood pressure or density. The PPG100C is designed for use in the following applications:

- General pulse rate determination
- Blood pressure analysis
- Exercise physiology studies
- Psychophysiological investigations

The PPG100C couples to a photoplethysmogram (PPG) transducer (TSD200 or TSD200C) to record the Blood Volume Pulse (BVP) waveform via optical (photoplethysmogram) methods. The peak measurement recorded by the PPG100C indicates the point of maximal blood density in the respective location. Indications of blood pressure can be inferred by comparing the point of R-wave onset in the ECG to the point of maximum blood density recorded by the PPG100C.

The PPG100C includes lower frequency response selection switches, which permits either absolute (DC) or relative (via 0.05 or 0.5 Hz high pass filters) blood density measurements.

The PPG100C also has the capability to interface to a wide range of commercially available optical probes. Specifically, optical transducers for SpO₂ can easily be used with the PPG100C, via the TCIPPG3 snap on interface. The TCIPPG3 interface adapter plugs into the front of the PPG100C and allows it to work with SpO₂-type probes that terminate in a 9-pin D female connector (such as those from Nonin®). The visible light transmitter and receiver of the probe is employed to establish a very high quality, high S/N ratio, transmissive, photo-plethysmogram signal, suitable for evaluating PPG signal characteristics. Note that this configuration does not provide SpO₂ output, but rather a highly-detailed PPG waveform versus time. Probes are available for fingers, toes, earclip and universal attachment. BIOPAC probes compatible with the TCIPPG3 / PPG100C combination include the TSD124A, TSD124B and TSD124C. The TCIPPG3 also supports use of the OXY100E-200 extension cable.

FREQUENCY RESPONSE CHARACTERISTICS

The 0.05 Hz high pass and 0.5 Hz high pass lower frequency response settings are single pole roll-off filters.

See also: Sample frequency response plots. 10 Hz LP

PPG100C CALIBRATION

None required.

PPG100C SPECIFICATIONS

Gain:	10, 20, 50, 100
Output Range:	±10 V (analog)
Low Pass Filter:	3 Hz, 10 Hz
High Pass Filter:	DC, 0.05 Hz, 0.5 Hz
Noise Voltage:	0.5 µV rms – amplifier contribution
Excitation:	6 V
Signal Source:	TSD200 Photoplethysmogram Transducer
Weight:	350 grams
Dimensions:	4 cm (wide) x 11 cm (deep) x 19 cm (high)
Upper Frequency Response:	10 Hz
Lower Frequency Response:	DC or 0.05 Hz or 0.5 Hz
Noise Voltage:	0.5 µV (rms) – amplifier contribution

Gain Settings:

Input Signal Range (pk-pk):	Gain:
2000 mV	x 10
1000 mV	x 20
400 mV	x 50
200 mV	x 100

Input Connectors: Three 1.5 mm male Touchproof sockets (Vsup, Ground, Input)

This illustration shows the proper connections to use the TSD200 with the PPG100C. The TSD200 can be placed on other body locations by employing ADD208 adhesive disks to hold the TSD200 in place. The TSD200 connects to the PPG100C as follows:

<u>TSD200 Lead</u>	<u>PPG100C</u>
Red connector	VIN+/+VSUP
Black connector	GND
White* connector	VIN-/INPUT

*may be blue shrink wrap instead of white connector

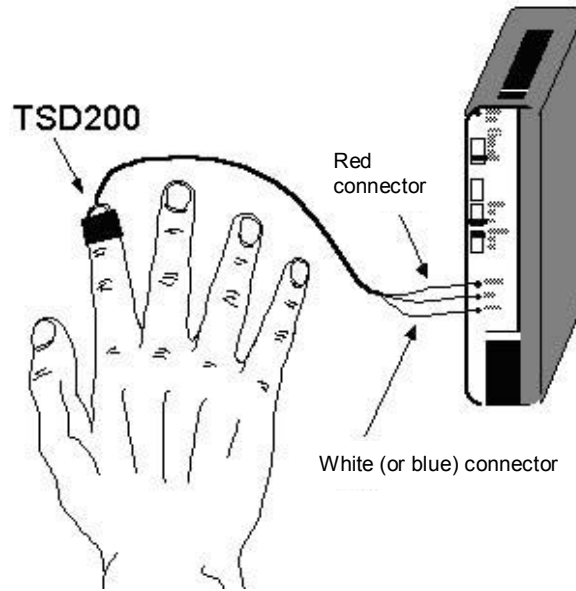

Finger pulse measurement using the PPG100C and TSD200

This graph illustrates photoplethysmogram data indicating blood density with respect to the acquired ECG. The distance between peaks on the two channels can provide indications of blood pressure, vascular resistance and compliance.

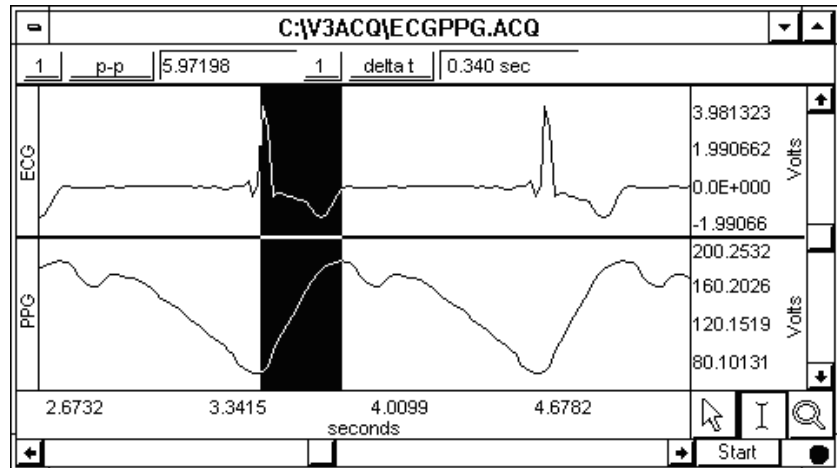

Photoplethysmogram data and ECG waveforms

PULSE PHOTOPLETHYSMOGRAM TRANSDUCERS

- TSD200 for MP160/MP150 System
- SS4LA for MP3X and MP45 System

The TSD200/SS4LA consist of a matched infrared emitter and photo diode, which transmits changes in blood density (caused by varying blood pressure) in specific body locations. When the TSD200 is attached to the skin, the infrared light is modulated by blood pulsing through the tissue below. The modulated, reflected light results in small changes in the resistance of the photo resistor, which yields a proportional change in voltage output.



The TSD200/SS4LA includes a shielded 2-meter cable and a stretchable Velcro® strap for easy attachment to the fingers, or it can be taped to other body parts. The TSD200/SS4LA can also be placed on other body locations by employing ADD208 adhesive disks to hold the transducer in place. Use the TSD200C ear clip transducer for easy attachment to the ear.

Place the transducer around the finger and adjust the Velcro® closure to provide only slight tension. Blood density readings can vary considerably depending on transducer location and tension changes.

The TSD200 connects to the PPG100C as follows (See also: PPG100C for a diagram):

<u>TSD200 Lead</u>	<u>PPG100C</u>
Red connector	VIN+/+VSUP (may also be black connector with red shrink wrap)
Black connector	GND
White connector	VIN-/INPUT (may also be black connector with blue shrink wrap)

The SS4LA plugs directly into the MP3x or MP45.

CALIBRATION

The TSD200/SS4LA does not require calibration.

TSD200C PULSE PHOTOPLETHYSMOGRAM WITH EARCLIP



The photodetector operates via incident photons, from an IR transmitter, impacting an IR detector. The incident photons result in a proportional passage of electrons in the detector. The IR detector operates like a photon-controlled current source. The transducer incorporates an appropriate clipping range, with linearity insured for arbitrarily low levels of reflected light. For the expected magnitude of incident infrared light, the photodetector operates in a linear fashion. Situations have not been encountered where the detector is operating non-linearly (near saturation).

The TSD200C transducer operates with the [PPG100C](#) amplifier to record the pulse pressure waveform. The TSD200C consists of a matched infrared emitter and photo diode, which transmits changes in infrared reflectance resulting from varying blood flow. The ergonomic housing design improves contact with the subject and helps reduce motion artifact. The TSD200C is primarily designed for ear attachment and comes with a shielded 2-meter cable and ear clip.

TSD200/200C/SS4LA SPECIFICATIONS

Emitter/Detector Wavelength: 860 nm \pm 60 nm
Optical Low Pass Filter Cutoff Wavelength: 800 nm

Note

The operational range of the emitter and detector fall within the wavelength range of 800 nm to 920 nm. The filter is placed over the receiver; the filter of 800 nm is an optical lowpass, so wavelengths longer than 800 nm will pass thru.

Emitter/Detector Spacing: 3.81 mm (.150 inch) – center to center

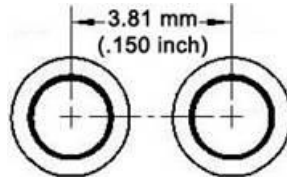

Nominal Output: 20 mV (peak-peak)
Power: 6 VDC Excitation @ 5 mA
Sterilizable: Yes (Contact BIOPAC for details)
Weight: 4.5 g
Dimensions (L x W x H): 16 mm x 17 mm x 8 mm
Attachment: Velcro strap
Cable: 3 m, shielded (TSD200, SS4LA), 2 m, shielded (TSD200C)
Interface: PPG100C
TEL100C Compatibility: SS4A

NOTE THE TSD200A EAR CLIP TRANSDUCER WAS DISCONTINUED IN AUGUST OF 2008.

TSD203 – ELECTRODERMAL RESPONSE TRANSDUCER

The TSD203 is a set of two Ag-AgCl electrodes, which incorporate molded housings designed for finger attachment. The TSD203 is used when measuring the electrodermal response. Each transducer includes a stretchable Velcro® strap for easy attachment.

Connectors:

Red heat shrink tubing = Vin+

White heat shrink tubing = Vin-

Black lead = GND

When the TSD203 is used to measure electrodermal response, the choice of electrolyte is extremely important. A higher impedance electrolyte using hyposaturated electrolyte concentrations of Cl⁻ (on the order of physiological levels) is necessary for effective monitoring of local eccrine activity.

Use GEL101 as an isotonic, hyposaturated, conductant with the TSD203 EDR transducer. Trace conductive parts (metal parts) do not make contact to the subject. TSD203 is not recommended for MRI use.

Storing and Cleaning

1. Store the transducer in a clean, dry area.
2. After use, clean the transducer with cold to tepid water.
 - a) DO NOT use hot water.
 - b) Cotton swabs are suggested.
 - c) Let the transducer dry completely before storing it.
3. DO NOT allow transducers to come in contact with each other during storage (adverse reaction could occur).
4. Transducers may form a brown coating if they have not been used regularly. To remove the coating, gently polish the surface of the transducer element with non-metallic material or wipe it with mild ammonium hydroxide. Rinse with water and store the transducer in a clean, dry container.

TSD203 SPECIFICATIONS

Electrode Type: Ag-AgCl (unpolarizable)

Attachment: integral Velcro strap

Contact area: 6 mm (dia)

Sterilizable: Yes, contact BIOPAC

Cable length: 3 m

Interface: EDA100C

Dimensions (LxWxH each): 16 mm x 17 mm x 8 mm

TEL100C compatibility: SS3A

TSD203 CALIBRATION

See the EDA100C transducer module.

RSP100C – RESPIRATION PNEUMOGRAM AMPLIFIER MODULE

The RSP100C respiration pneumogram amplifier module is a single channel, differential amplifier designed specifically for recording respiration effort. The RSP100C is designed for use in the following applications:

- Allergic responses analysis
- Exercise physiology studies
- Psychophysiological investigations
- Respiration rate determination
- Sleep studies

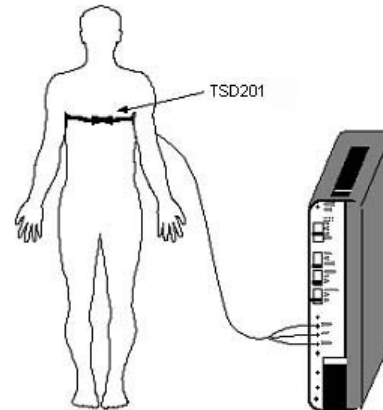

The RSP100C works with the TSD201 respiration transducer to measure abdominal or thoracic expansion and contraction.

The RSP100C includes a lower frequency response selection switch that permits either absolute (DC) or relative (via a 0.05 high pass filter) respiratory effort measurements.

The following illustration shows the placement and connections for recording thoracic respiration effort using the RSP100C and the TSD201 respiration transducer.

RSP100C AMPLIFIER MODULE SETTINGS

The RSP100C has three built-in filters and a number of different gain settings for the different uses of the transducer.

Type of Use	Gain Setting	Low Pass Filter	.5 Hz Filter	.05 Hz Filter
General	10	10 Hz	DC	DC
Exercise Physiology	10	1 Hz	.5 Hz	.05 Hz
Small Animal	20+	10 Hz	.5 Hz	.05 Hz

General

For most measurements with little or no subject movement. The most common setting is with all three filters at their bottom settings (10 Hz, DC, and DC) and the gain set at 10. This allows any signals slower than 10 Hz (cyclic rate) to pass, and is usually good for most measurements with little or no subject movement.

Exercise physiology

The transducer produces the best signal at the lowest gain and with all three filter settings at their top position (1 Hz, .5 Hz, and .05 Hz). This setting will allow only a signal between .5 Hz and 1 Hz to be transmitted, filtering out most of the signal interference due to extraneous chest and abdominal movement resulting from limb motion.

Smaller animals

For measurements with very small changes in thoracic circumference, increase the gain to magnify the signal. Increase the gain until a clear signal is obtained, but not so much that the signal is clipped.

PLACEMENT AND CONNECTIONS

This illustration shows the placement and connections to record thoracic and abdominal respiration effort using two RSP100C amplifier modules and two TSD201 respiration transducers.

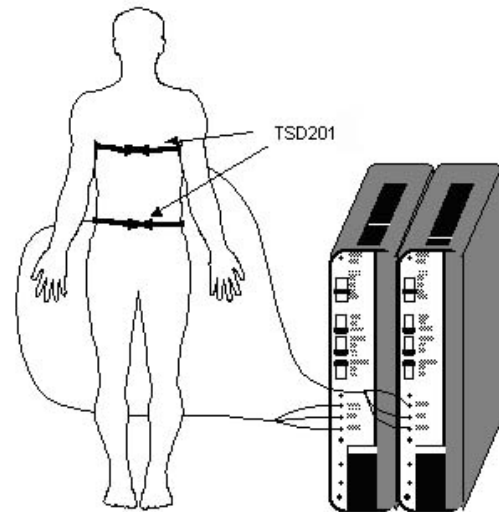

Connections for Thoracic and Abdominal Respiratory Effort Measurement

This graph shows the relationship between abdominal and thoracic expansion and contraction.

Calculate the peak-to-peak values for both abdominal and thoracic respiration effort were calculated with *AcqKnowledge*, and then the two peak-to-peak values were compared in the lowest channel. When abdominal breathing effort changes with respect to thoracic breathing effort, the lowest channel will quantify the extent of the change.

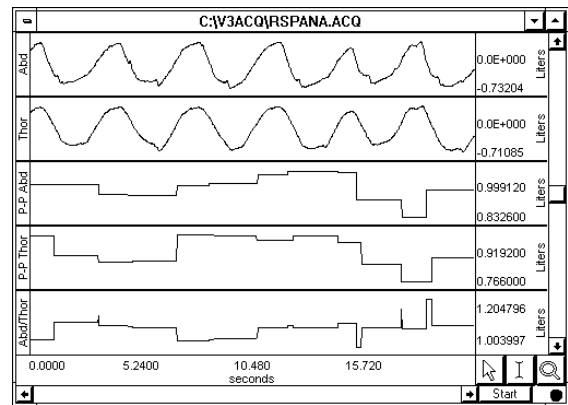

Thoracic vs. Abdominal respiration effort data

FREQUENCY RESPONSE CHARACTERISTICS

The 0.05 Hz high pass lower frequency response setting is a single pole roll-off filter. The 0.5 Hz high pass lower frequency response setting is a two pole roll-off filter.

See also: Sample frequency response plots: 1 Hz LP
 10 Hz LP

RSP100C CALIBRATION

None required.

RSP100C SPECIFICATIONS

Gain:	10, 20, 50, 100
Output Range:	±10 V (analog)
Frequency Response	
Low Pass Filter:	1 Hz, 10 Hz
High Pass Filter:	DC, 0.05 Hz, 0.5 Hz
Excitation Voltage	±0.5 V
Noise Voltage:	0.2 µV rms – amplifier contribution
Signal Source:	TSD201
Weight: 350	g
Dimensions:	4 cm (wide) x 11 cm (deep) x 19 cm (high)
Input Connectors:	Three 1.5 mm male Touchproof sockets (VIN+, Ground, VIN-)

TSD200-MRI PHOTOPLETHYSMOGRAM TRANSDUCER



The TSD200-MRI photoplethysmogram (PPG) transducer operates with the PPG100C-MRI to record the blood volume pulse waveform via optical (photoplethysmogram) methods. The TSD200-MRI consists of a matched infrared emitter and photo diode detector, which transmits changes in infrared reflectance resulting from varying blood flow. Blood is highly reflective of near infrared light wavelengths, due to the heme subunit of hemoglobin. When the PPG transducer is placed on the skin, in proximity to capillaries, the reflectance of the infrared light from the emitter to the detector will change in accordance to capillary blood volume. The PPG waveform peaks when capillary blood volume is maximized.

The transducer optics are designed to sense diffuse surfaces, including the skin surfaces of finger or toe. The transducer is sensitive to Blood Volume Pulse (BVP) via photo-plethysmographic methods.

The Diode and Phototransistor are mounted side by side on parallel axis in a black polyurethane housing. The Phototransistor is encased in a dark epoxy package which filters out visible ambient light. The transducer has a shielded 3-meter cable.

The ergonomic housing design improves contact with the subject and helps reduce motion artifact. Trace conductive (metal) parts of transducer do not make contact to the subject.

The TSD200-MRI only operates with the PPG100C-MRI amplifier.

MRI Use: MR Conditional to 7T

Note: Conductive parts of transducer are electrically and thermally isolated from subject.

Components: Polyvinyl chloride (PVC) Plastic, Polymer thick film device (rigid substrate, printed semiconductor), Copper clad fiberglass lamination (PCB material), Tinned copper wire, Silicone elastomer

CONNECTIONS

For MRI applications: Use the MECMRI-TRANS Cable/Filter to connect the TSD200-MRI to the PPG100C-MRI. See [BIOPAC Application Notes](#) regarding the proper installation of MECMRI cables for recording in an MRI environment.

For non-MRI applications: Connect the TSD200-MRI directly to the PPG100C-MRI.

TSD200-MRI Lead PPG100C-MRI

Red connector VIN++VSUP (May also be black connector with red shrink wrap)

Black connector GND

White connector VIN-/INPUT (May also be black connector with blue shrink wrap)

TSD200-MRI SPECIFICATIONSEmitter/Detector Wavelength: 860 nm \pm 60 nm

Optical Low Pass Filter Cutoff Wavelength: 800 nm

Note

The operational range of the emitter and detector fall within the wavelength range of 800 nm to 920 nm. The filter is placed over the receiver; the filter of 800 nm is an optical lowpass, so wavelengths longer than 800 nm will pass thru.

Emitter/Detector Spacing: 3.81 mm (.150 inch) - center to center

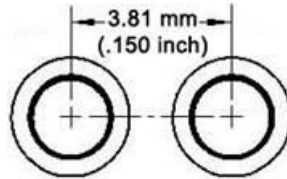

Nominal Output: 20 mV (peak-peak)

Power: 6 VDC Excitation @ 5 mA

Sterilizable: Yes (Contact BIOPAC for details)

Weight: 4.5 g

Dimensions (L x W x H): 16 mm x 17 mm x 8 mm

Cable: 3 m, shielded

Interface: PPG100C-MRI

TSD201 – RESPIRATION TRANSDUCER

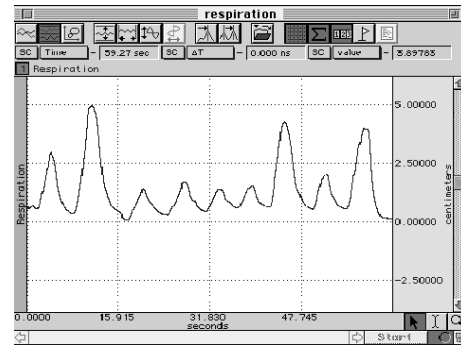
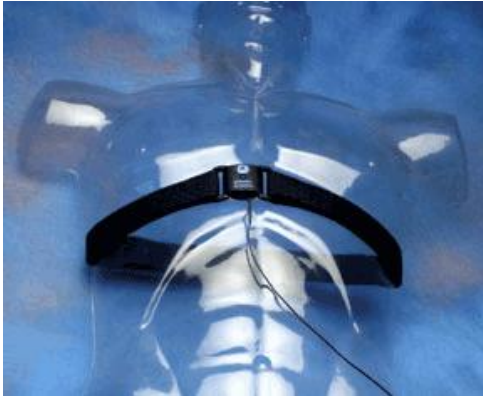

Sample Data for Subject at Rest

The TSD201 is a strain gauge transducer designed to measure respiratory-induced changes in thoracic or abdominal circumference, and can therefore be used to record respiratory effort. The TSD201 is essentially a resistive transducer and responds in a linear fashion to changes in elongation through its length, with resistance increasing as length increases.

The transducer is ideal for a variety of applications because it presents minimal resistance to movement and is extremely unobtrusive. Due to its unique construction, the TSD201 can measure extremely slow respiration patterns with no loss in signal amplitude while maintaining excellent linearity and minimal hysteresis.

The TSD201 plugs directly into the RSP100C amplifier module. It includes a fully adjustable nylon strap to accommodate a large range of circumferences (9 cm to 130 cm). To attach the nylon belt to the respiration transducer, thread the nylon strap through the corresponding slots so the strap clamps into place when tightened. Place the transducer around the body at the level of maximum respiratory expansion. This location will vary from the erect to supine positions (generally about 5 cm below the armpits).

Correct tension adjustment of the respiration transducer is important. For best sensitivity, the transducer must be just slightly tight at the point of minimum circumference (maximum expiration). To obtain proper tension, stretch the belt around the body and have the subject exhale. At maximum expiration, adjust the nylon strap so there is slight tension to hold the strap around the chest. For proper operation, there must always be at least a small amount of tension on the transducer.

The transducer has three 1.5 mm Touchproof connectors to connect to the amplifier. Insert the two colored lead transducer pin plugs into the two RSP100C inputs labeled XDCR. Either color lead can be connected to either XDCR input. Insert the single black transducer lead into the GND input of the RSP100C. The respiration transducer is ready for measurement. Trace conductive parts (metallic parts) do not make contact to the subject.

For MRI applications, see the TSD221-MRI Respiration Transducer.

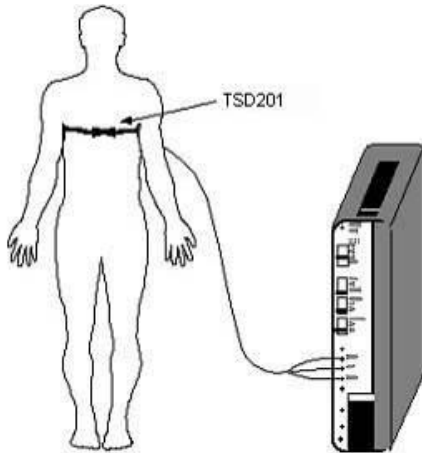
PLACEMENT AND CONNECTIONS

using one TSD201 respiration transducer

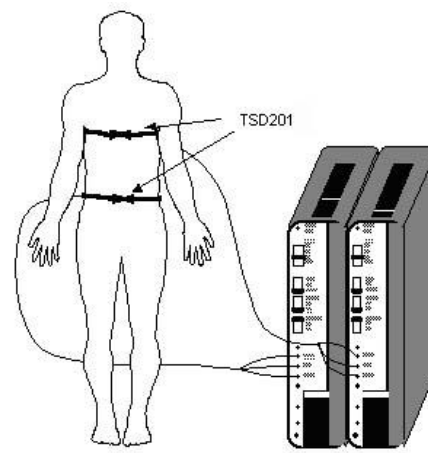

using two TSD201 respiration transducers

Placement and Connections for Thoracic and Abdominal Respiratory Effort Measurement

TSD201 CALIBRATION

The TSD201 does not require calibration.

TSD201 SPECIFICATIONS

True DC Response:	Yes
Variable Resistance Output:	5-125 K Ω (increases as length increases)
Circumference Range:	15 cm x 150 cm (can be increased with a longer strap)
Attachment:	Velcro® strap (adjustable length)
Sterilizable:	Yes (contact BIOPAC for details)
Sensor Weight:	18 g
Sensor Dimensions:	66 mm (long), 40 mm (wide), 15 mm (thick)
Cable Length:	3 meters
Interface:	RSP100C
TEL100C compatibility:	SS5B
Frequency Response:	DC-500 Hz
Operating Humidity Range:	0-95% non-condensing
Operating Temperature Range:	-20° C to +80° C

Sensitivity: Monotonic analog output. Sufficiently sensitive to detect heart motion in thoracic cavity, in addition to thoracic/abdominal expansion and contraction.

TSD221-MRI – RESPIRATION TRANSDUCER



This MR Safe fully pneumatic respiration transducer measures subject respiration (thoracic or abdominal) in the MRI. The extremely unobtrusive design presents minimal resistance to movement and can measure arbitrarily slow to very fast respiration patterns with no loss in signal amplitude, while maintaining excellent linearity and minimal hysteresis.

The TSD221-MRI incorporates a bellows-based design. As the subject breathes, a minimum and

maximum circumference for respiratory measurement is established, and the tension and relaxation of the bellows changes the associated bellows pressure. The bellows' behavior will be a tendency to come to physical equilibrium at the mean (average) circumference. This behavior results in effective high pass filtering of a very low value (~0.001 Hz).

The TSD221-MRI includes the respiration sensor in a mesh strap with self-adhering adjustable chest band (70 cm), a pressure transducer (± 2.5 cm H₂O TSD160A), and two cascadable segments of tubing for up to 14 m (AFT30-XL 10 m and AFT30-L 4 m). TSD221-MRI has no ferrous metals or conductive parts. The TSD221-MRI connects to the DA100C and an MP160/150 system (and does not require the MECMRI-DA or MECMRI-TRANS cable sets).

MRI Use: MR Safe

Components: Respiration sensor in compliant mesh sleeving, adjustable flexible chest band: TSD160A transducer, tubing for up to 14 meters (AFT30XL + AFT30L).

Placement and Connections

Place the transducer around the body at the level of maximum respiratory expansion, generally about 5 cm below the armpits but location will vary from the erect to supine positions. Correct tension adjustment of the respiration transducer is important. For best sensitivity, the transducer must be just slightly tight at the point of minimum circumference (maximum expiration). To obtain proper tension, stretch the belt around the body and have the subject exhale. At maximum expiration, adjust the nylon strap so there is slight tension to hold the strap around the chest.

To place TSD221-MRI on subject and connect to MP System:

1. Place sensing band around subject's chest and attach pneumatic tubing to the band as shown on right.
2. Connect TSD160A pressure transducer to the MP System's DA100C module.
3. Route tubing from the MRI table/bore through an available wave guide to TSD160A/DA100C.
4. Attach tubing to the TSD160A pressure transducer "+" port. (The "-" port is left open to atmosphere.)
5. Be careful to check all tubing junctions, as the transducer will fail to operate optimally if any leaks are present.

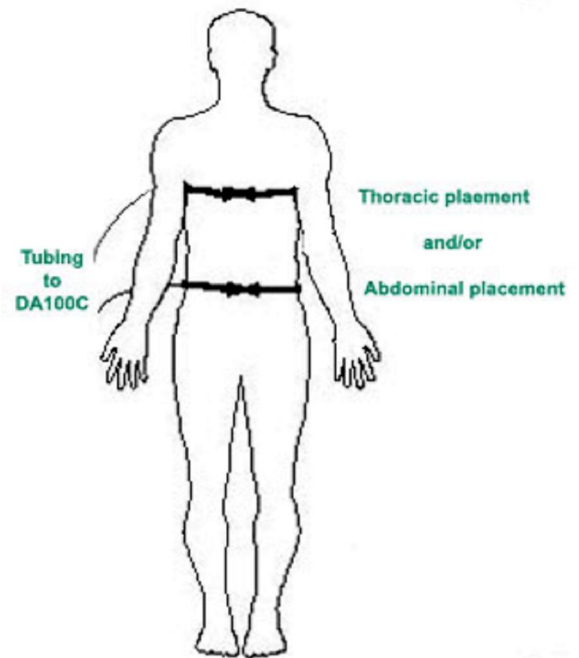

Software Setup in AcqKnowledge for TSD221-MRI

1. Launch *AcqKnowledge*, choose DA100C from the “What type of module should be added?” list and click “Add.”
2. Verify that the Channel Switch Position matches the physical channel switch position on the DA100C module and click “OK.” (If necessary, adjust channel position by dragging slider).
3. In the subsequent “DA100C Configuration” screen and on the DA100C module, use the following Gain and Filter settings:
 - a. Set Gain to 50 to start with and increase as necessary.
 - b. Set 10 Hz LP filter to “ON.”
 - c. Set HP filter to 0.05 Hz
4. Select “TSD221-MRI-Respiration Transducer, MRI” from the “Connected to:” drop-down list and click OK.
5. Close the Setup dialog.

TSD221-MRI Specifications

Sensor Construction:	MR Safe materials
True DC Response:	Yes
Pneumatic Design:	Attaches to TSD160A/DA100C
Sensitivity:	Linear Analog Output. Sufficiently sensitive to detect heart motion in thoracic cavity, in addition to thoracic/abdominal expansion and contraction.
Circumference Range:	50 cm x 120 cm (can be increased with a longer strap)
Attachment:	Velcro® strap (adjustable length)
Sterilizable:	Yes (contact BIOPAC for details)
Sensor Weight:	67 grams
Sensor Dimensions:	45 cm (long), 3.8 cm (wide), 1.1 cm (thick)
<i>Tubing:</i>	AFT30XL, 10 m, AFT30L, 4 m
<i>TSD160A</i>	Operational Pressure ± 2.5 cm H ₂ O Voltage Output: 327.5 μ V/cm H ₂ O (normalized to 1 V excitation) Click for detailed transducer specs
Interface:	DA100C
Frequency Response:	0.001 – 100 Hz*
Sensor Operating Humidity Range:	0-100% (can be used under water)
Operating Temperature Range:	0° C to 50° C (compensated)
Respiration Measurement Options:	TSD201 for MP160/150 System SS5LB for MP36 or MP36R System SS5B for TEL100C Telemetry System

***NOTE:** With any pressure based system, minute leaks are possible. Air leaks will contribute to a high pass filtering of respiration data. As long as leaks are minute, associated high pass filtering action will not materially affect the quality of the respiration data. To largely circumvent high pass filtering effects of leaks on respiration data, simply record data with the 0.05 Hz HP filter selected on the associated module.

SKT100C – SKIN TEMPERATURE AMPLIFIER MODULE

The SKT100C skin temperature amplifier module is a single channel, differential amplifier designed especially for skin and core temperature and respiration flow (rate) monitoring. The SKT100C is designed for use in the following applications:

- General temperature measurement
- Psychophysiological investigations
- Respiration rate determination
- Sleep studies

The SKT100C employs any of the BIOPAC TSD202 series thermistor transducers to measure temperature. The SKT100C includes a lower frequency response selection switch that permits either absolute (DC) or relative (via a 0.05 Hz or 0.5 Hz high pass filter) temperature measurements.

Connections and placement for **measuring respiration flow** using the SKT100C and the TSD202A fast-response surface temperature thermistor.

The SKT100C can also be used with the CBL203 and YSI Series 400 biomedical temperature probes. Connect CBL203 to SKT100C Vin+ and Vin- ports (either socket to either port); thermistors do not make electrical contact so GND is not required for safety.

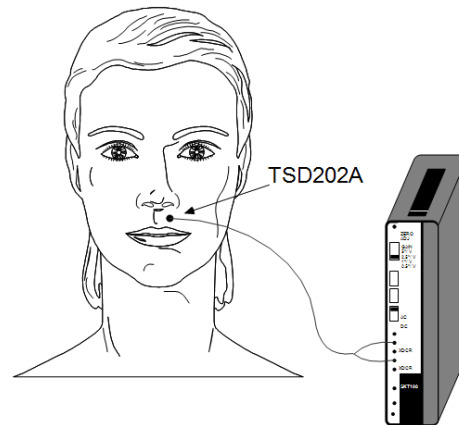

Respiration flow measurement using SKT100C and TSD202B

Connections and placement for **measuring index fingertip temperature** using the SKT100C and the TSD202D digit surface temperature probe. The probe is secured to the finger using the Velcro® strap on the transducer.

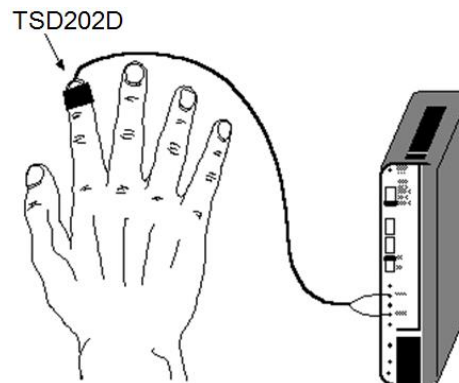

Index finger temperature measurement with TSD202D

This graph shows the relationship between fingertip skin temperature, skin conductance and heart rate. This configuration of physiological measurements can be useful for psychological testing and evaluation.

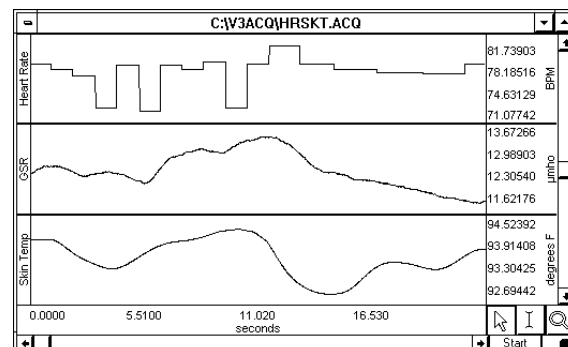

SKT versus EDA versus Heart Rate Waveforms

FREQUENCY RESPONSE CHARACTERISTICS

The 0.05 Hz high pass lower frequency response setting is a single pole roll-off filter.

See also: Sample frequency response plots: 1 Hz LP and 10 Hz LP

SKT100C CALIBRATION

Temperature Measurements

To measure **absolute** temperature, set the lower frequency response to DC.

To measure **relative** temperature changes, set the lower frequency response to 0.05 Hz or 0.5 Hz.

To set up *AcqKnowledge* to record temperature directly, perform the following:

- A. Lower frequency response at **DC**:
In the scaling window, set the input voltages so they map to the respective temperature ranges indicated by the sensitivity setting. In this case, 0 V will always map to 90° F.
- B. Lower frequency response at **0.05 Hz** or **0.5 Hz**:
In the scaling window, set the input voltages so they map to the respective temperature ranges indicated by the sensitivity setting. In this case, 0 V will map to the mean (average) temperature during the recording. Use this setting when temperature delta measurement is important, as when monitoring airflow (respiration rate).

Skin Temperature Measurements

To measure **absolute** skin temperature, place the lower frequency response to DC.

To measure **relative** skin temperature changes or **respiration** rate (**airflow**), place the lower frequency response to 0.05 Hz or 0.5 Hz.

To set up *AcqKnowledge* to record temperature directly, perform the following:

- A. Lower frequency response to **DC**:
In the scaling window, set the input voltages so they map to the “DC on” temperature ranges indicated by the sensitivity setting. In this case, 0 V will always map to 90° F.
- B. Lower frequency response to **0.05 Hz** or **0.5 Hz**:
In the scaling window, set the input voltages so they map to the respective temperature ranges indicated by the sensitivity setting. In this case, 0 V will map to the mean (average) temperature measured during the recording and 1 V will map to one-half the “delta range” values, which corresponds to the chosen Gain setting.

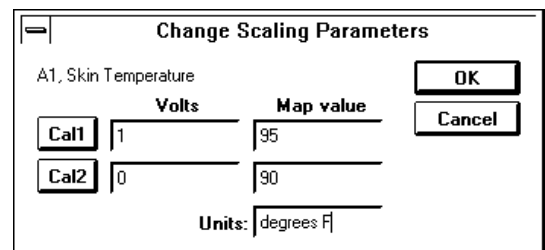

	Volts	Map value
Cal1	1	95
Cal2	0	90

Units: degrees F

Scaling setup window set to correspond to 5°/V setting on SKT100C

SKT100C SPECIFICATIONS

Gain: 5, 2, 1, 0.5 °F/V— can also calibrate in °C (see Input Signal Range below)
 Output Range: ±10 V (analog)
 Low Pass Filter: 1 Hz, 10 Hz
 High Pass Filter: DC, 0.05 Hz, 0.5 Hz
 Sensitivity: 180 micro °F (100 micro °C)— with MP System
 Signal Source: TSD202 Series Temperature Probe or CBL203 to YSI® Series 400 Biomedical Temperature Probes

Weight: 350 g

Dimensions: 4 cm (wide) x 11 cm (deep) x 19 cm (high)

Input Connectors: Three 1.5 mm male Touchproof sockets (VIN+, Ground, VIN-)

Input Signal Range:	Gain	Range (°F)	Range (°C)	Delta Range (°F)	Delta Range (°C)
	5	40-140	4.44-60	100	55.56
	2	70-110	21.11-43.33	50	27.78
	1	80-100	26.67-37.78	20	11.11
	0.5	85-95	29.44-35	10	5.56

TSD202 SERIES TEMPERATURE TRANSDUCERS



TSD202A The TSD202A employs a fast response thermistor, and is appropriate for use in locations where temperature changes rapidly, as with the temperature changes of inspired/expired breath. The TSD202A is useful for measuring skin temperature (in small areas) or airflow rate resulting from respiration, and is not designed for liquid immersion. For measuring skin (surface) temperature, simply tape the TSD202A to the location of interest. For measuring respiration rates, by monitoring airflow, place the TSD202A next to the mouth or nose so that inspired or exhaled air will intercept the tip of the TSD202A transducer.

RX202A Replacement Fast-response Temperature Sensor for TSD202A (MP Research systems), SS6L (BSL Education systems), or SS6 (wireless/telemetry systems) transducers. The sensor snaps onto the transducer connector for connection to a BIOPAC data acquisition system.

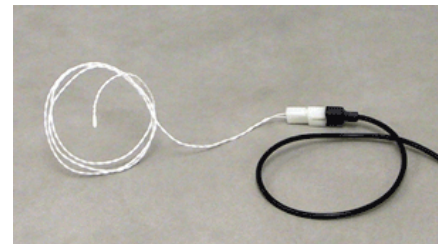

Note: RX202A Sensor (white) shown on right with transducer connector (black); *ships as sensor only.*

TSD202A-MRI The TSD202A-MRI fast response thermistor offers the same functionality as TSD202A but is specifically designed for MRI applications. Made with MR Conditional cables and connectors and does not have a patient clip attached to the cable.

RX202A-MRI Replacement temperature sensor for the TSD202A-MRI. The sensor snaps onto the transducer connector. *Ships as sensor only.*

MRI Use: **MR Conditional to 7T** (TSD202A-MRI and RX202A-MRI)

Condition: The TSD202A-MRI is a thermistor transducer that can be taped to the surface of a subject's skin. Apply the thermistor so that just the sensor portion is in contact with the skin. The insulated, conductive wire portion is typically routed away from the skin by sliding a piece of gauze or cloth between wire and the skin surface, prior to taping the transducer to the skin.

Components: Silicon semi-conductor, copper wire, Polyvinyl Chloride (PVC) plastic

TSD202B The TSD202B is a “Banjo” style surface probe useful for measuring surface temperature. The “Banjo” design allows efficient skin temperature measurements on a variety of body locations. The TSD202B is not designed for liquid immersion. For measuring skin (surface) temperature, simply tape the TSD202B to the location of interest.

IMPORTANT: The copper wire used in the TSD202B probe is **FRAGILE**. Do not bend or pull the cable when attaching/removing the probe. It's important not to torque the cable where it connects to the transducer element. COBAN wrap (rather than tape) is recommended for attaching the probe to the participant. This wrap is easy to remove and helps eliminate the risk of breakage.

- TSD202C** The TSD202C encases the internal thermistor in a stainless steel, waterproof housing, and is designed for liquid immersion and other temperature measurement applications where ruggedness is required and fast response is not critical.
- TSD202D** The TSD202D is a modified TSD202B, with a housing that conforms to curved skin surfaces and includes a stretchy Velcro® strap for easy attachment to the fingers or toes. The “Banjo” design allows efficient skin temperature measurements. The TSD202D is not designed for liquid immersion. For measuring skin (surface) temperature, simply tape the TSD202D to the location of interest. Insert the red lead and white lead transducer pin plugs into the two SKT100C inputs labeled XDCR. Either lead can be connected to either XDCR input.
- TSD202E** The TSD202E is a general-purpose waterproof thermistor. Trace conductive parts (metallic parts) do not make contact to the subject.
- TSD202F** The TSD202F is a small, flexible waterproof thermistor.

TSD202 SERIES SPECIFICATIONS

Response Time (in stirred oil bath)

TSD202A/TSD202A-MRI:	0.6 sec
TSD202B:	1.1 sec
TSD202C:	3.6 sec
TSD202D:	1.1 sec
TSD202E:	0.9 sec
TSD202F:	1.1 sec

Size with housing

TSD202A/TSD202A-MRI:	1.7 mm (diameter) x 5 mm (long)
TSD202B:	9.8 mm (diameter) x 3.3 mm (high)
TSD202C:	4 mm (diameter) x 115 mm (long)
TSD202D:	16 mm (long) x 17 mm (wide) x 8 mm (high)
(TSD202D – sensor only):	10 mm sensing diameter, 1.4 mm sensor thickness)
TSD202E:	9.8 mm (long) x 3.3 mm (diameter)
TSD202F:	9.8 mm (long) x 3.3 mm (diameter)

Sensor only: 10 mm sensing diameter, 1.4 mm sensor thickness

Interface: SKT100C

Nominal Resistance: 2252 Ω at 25° C

Maximum operating temperature: 60° C (when used with SKT100C)

Accuracy and Interchangability: 0.2° C

Cable length: 3 meters

Compatibility: YSI® series 400 temperature probes

Sterilizable: No

TEL100 Compatibility: SS6

ELECTRODES

In selecting the application site for any style of electrode, care should be taken that:

- 1) Electrode site is dry and free of excessive hair.
- 2) Electrode is not placed over scar tissue or on an area of established erythema or with a lesion of any kind.
- 3) Skin is properly prepared. (Prepare the skin at the electrode site. Use the ELPAD to lightly abrade the skin surface. Use a brisk dry rub to prepare the application site. Avoid excessive abrasion of the skin surface.)

EL120



The EL120 electrode has contact posts designed to improve contact through fur or hair. The 12 posts create a 10 mm contact area. The posts are 2mm deep to push through fur/hair to provide good contact with the skin surface.

Shipped in packs of 10.

Silver-silver chloride (Ag-AgCl) electrodes provide accurate and clear transmission of surface biopotentials and are useful for recording all surface biopotentials on animals and human EEG.

Notes:

- It is not necessary to use an EL120 for the ground; a generic electrode can be used for ground.
- Requires one LEAD120 per electrode.

ELECTRODES

In selecting the application site for any style of electrode, care should be taken that:

- 1) Electrode site is dry and free of excessive hair.
- 2) Electrode is not placed over scar tissue or on an area of established erythema or with a lesion of any kind.
- 3) Skin is properly prepared. (Prepare the skin at the electrode site. Use the ELPAD to lightly abrade the skin surface. Use a brisk dry rub to prepare the application site. Avoid excessive abrasion of the skin surface.)

EL160 Gold Cup



Reusable gold cup electrode with 10 mm cup diameter and 1.2 m cable. One electrode per package.

- EL160 with green cable
- EL160-R with red cable
- EL160-W with white cable

The leadwire terminates in a standard 1.5 mm Touchproof connector. Use with MEC Series Module Extension Cables for MP160/150 Systems or SS1LA 1.5 mm Touchproof Electrode Lead Adapter for MP3X Systems.

EL160-Ear – Ear Clip Electrodes



This pair of gold-plated ear clip electrodes has 1.5 m silicone-insulated leadwires ending in standard 1.5 mm Touchproof connectors.

Use with MEC Series Module Extension Cables for MP Research Systems or SS1LA 1.5 mm Touchproof Electrode Lead Adapter for BSL Systems.

Before use, check the electrode for damage and excessive wear. If in doubt, replace it.

Also available as individual standard gold cup electrodes: EL160 with green cable, EL160-R with red cable, and EL160-W with white cable.

Please do not use these electrodes unless you have been trained in the proper use and placement of these devices.

Cleaning Earclips and Surface Electrodes

After each use clean with warm water and a mild detergent. Use a soft cloth or Q-tip. Then disinfect with 70% alcohol or a water based disinfectant. Do not soak in water for prolonged periods, it causes deterioration of the electrode.

EL160-Ear Specifications

Electrodes: two
Material: Au Cup (gold plated discs)
Style: Ear Clip Electrodes
Leadwires: 1.5 meter silicone-insulated leadwires
Connector: leadwires terminate in standard 1.5 mm Touchproof connectors
Non-sterile
Reusable

ELECTRODES

In selecting the application site for any style of electrode, care should be taken that:

- 1) Electrode site is dry and free of excessive hair.
- 2) Electrode is not placed over scar tissue or on an area of established erythema or with a lesion of any kind.
- 3) Skin is properly prepared. (Prepare the skin at the electrode site. Use the ELPAD to lightly abrade the skin surface. Use a brisk dry rub to prepare the application site. Avoid excessive abrasion of the skin surface.)

EL250 Series Reusable Ag-AgCl Electrodes

EL250 Series reusable electrodes incorporate a variety of features which improve biopotential recordings.

- Non-polarizable
- Sintered to increase electrode/electrolyte contact area
- Does not require chloriding
- Reusable via resurfacing
- High stability recordings, to DC, when used with chloride salt gel electrolyte
- Electrolyte gel cavity reduces artifact due to electrolyte/electrode motion and minimizes electrolyte dissipation/drying over long term recordings

Surface biopotentials can be accurately and clearly transmitted with silver-silver chloride electrodes. EL250 Series reusable electrodes are permanently connected to 1-meter leads and terminate in standard 1.5 mm female Touchproof sockets for direct connection to the SS1L shielded electrode lead adapter (MP3x System), or the MEC110C (MP160/150 System). Use shielded electrode leads for minimal interference. The unshielded electrode leads work best as ground electrodes. Typically, one biopotential input requires two shielded electrodes for signal inputs and one unshielded electrode for ground.

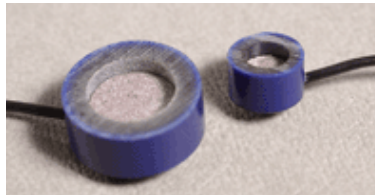

- EL254** Ag-AgCl Unshielded Electrode, 7.2 mm diameter housing, 4 mm contact area, includes 1 m lead terminated with a 1.5 mm female Touchproof socket for connection to the SS1L (MP3x System), or the MEC110C (MP160/150 System).
- EL254S** Ag-AgCl Shielded Electrode, 7.2 mm diameter housing, 4 mm contact area, includes 1 meter lead terminated with two 1.5 mm female Touchproof sockets for connection to the SS1L (MP3x System), or the MEC110C (MP160/150 System). The gray lead plug is for the electrode contact; the black lead pin plug is for the lead shield.
- EL258** Ag-AgCl Unshielded Electrode, 12.5 mm diameter housing, 8 mm contact area, includes 1 meter lead terminated with a 1.5 mm female Touchproof socket for connection to the SS1L (MP3x System), or the MEC110C (MP160/150 System).
- EL258S** Ag-AgCl Shielded Electrode, 12.5 mm diameter housing, 8 mm contact area, includes 1 meter lead terminated with two 1.5 mm female Touchproof sockets for connection to the SS1L (MP3x System), or the MEC110C (MP160/150 System). The gray lead plug is for the electrode contact; the black lead pin plug is for the lead shield.
- EL258H** Features a 2 mm gel injection hole, useful for EEG monitoring; use as both recording and reference electrodes. 12.5 mm diameter housing, 8 mm contact area, 1 m lead terminated with 1.5 mm female Touchproof socket for connection to the SS1L (MP3x System), or the MEC110C (MP160/150 System).

EL250 Series Radiotranslucent Ag-AgCl Recording Electrodes (Animals Only)

MRI Use: **MR Conditional** (tested to 9T)

Condition: For use with animals only, due to possible heating hazards associated with incomplete filling of gel reservoir with electrode gel.

EL254RT/258RT Components:

Electrode: Ag/AgCl Lead wire: Carbon
Enclosure: Epoxy Wire insulation: PVC

- EL254RT** Silver-silver chloride (Ag-AgCl) electrodes provide accurate and clear transmission of surface biopotentials. Reusable electrodes are permanently connected to robust and pliable leadwires. The leadwires terminate in standard 1.5 mm Touchproof connectors for interfacing to 100C series Biopotential modules or extension cables. 7.2 mm diameter housing, 4 mm contact area, includes 1.5 m lead terminated with a 1.5 mm female Touchproof socket for connection to the SS1L (MP3x System), or the MEC110C (MP160/150 System).
- EL258RT** As described above for EL254RT but with larger dimensions. 12.5 mm diameter housing, 8 mm contact area, includes 1.5 m lead terminated with 1.5 mm female Touchproof socket for connection to the SS1L (MP3x System), or the MEC110C (MP160/150 System).

✓ All EL250 Series electrodes require adhesive disks (ADD200 series) and recording gel (GEL1 or the preferred recording gel). See the **Electrode Accessories** section for further description.

Instructions for EL250 Series Electrodes

- 1) Store electrodes in clean, dry area.
- 2) After use, clean electrode with cold to tepid water
 - a) DO NOT use hot water.
 - b) Cotton swabs are suggested.
- 3) The electrodes should be completely dry before returning to storage.
- 4) DO NOT allow the electrodes to come in contact with each other during storage (adverse reaction could take place).
 - Electrodes may form a brown coating if they have not been used regularly. This should be removed by gently polishing the surface of the electrode element with non-metallic material. Wiping with mild ammonium hydroxide will also remove this coating. Rinse with water and store the electrode in a clean, dry container.
- 5) Remove an appropriate size electrode washer (ADD204, ADD208, or ADD212) from its waxed paper strip and carefully apply the washer to the electrode so the center hole of the washer is directly over the electrode cavity.
- 6) Fill the cavity with electrode gel (GEL100). No air bubbles should be present in the cavity.
- 7) Remove the white backing from the washer to expose the second adhesive side.
- 8) Place electrode on prepared skin area and smooth the washer into place.
- 9) Apply a few drops of electrode gel to fingertip and rub the exposed side of the adhesive washer (around the electrode) to rid its surface of adhesive quality.

EL350 SERIES BAR LEAD ELECTRODES



EL350

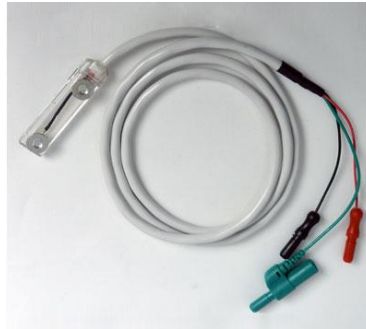

EL350S



EL351

Bar lead electrodes are recommended when applying a stimulus or recording a signal during nerve conduction, somatosensory or muscle twitch recordings with human subjects. All bar electrodes are nonferrous and consist of two tin electrodes placed 30 mm apart in a watertight acrylic bar; leads terminate in standard 1.5 mm Touchproof connectors. The bar configuration permits easy electrode placement without disturbing electrode-to-electrode spacing.

EL350 concave unshielded bar lead electrode for use with the STMISO

EL350S concave shielded bar lead electrode for biopotential recordings

EL351 convex bar lead electrode for stimulating

Use with MP160/150 System for recording or stimulation:

- Direct connection to any 100C-series Biopotential amplifier, STMISOLA stimulator, or STMISOC/D/E stimulus isolation adapters
- Interface via CBL201 1.5 mm Touchproof to 2 mm pin cable holder to 100A/100B-series amplifiers or STMISOA/B

Use with MP36 or MP36R

- Recording: interface via SS1LA
- Stimulation: interface via CBL207 1.5 mm Touchproof to BNC cable to STM200 or BSLSTMB Stimulators

When using bar electrodes for signal recording, a single ground lead (LEAD110 with EL503) is required.

In selecting the application site for any style of electrode, care should be taken that:

1. Electrode site is clean and free of excessive hair.
2. Electrode is not placed over scar tissue or on an area of established erythema or with a lesion of any kind.
3. Skin is properly prepared. (Prepare the skin at the electrode site. Use the ELPAD to lightly abrade the skin surface. Use a brisk dry rub to prepare the application site. Avoid excessive abrasion of the skin surface.)
4. Apply a small amount of isotonic or hypotonic gel to the skin at the electrode sites. BIOPAC GEL100 or GEL101 is recommended.



EL350 SERIES SPECIFICATIONS

Electrode spacing:	30 mm
Lead length:	61 cm
Connector type:	1.5 mm TouchProof

EL450 SERIES NEEDLE ELECTRODES

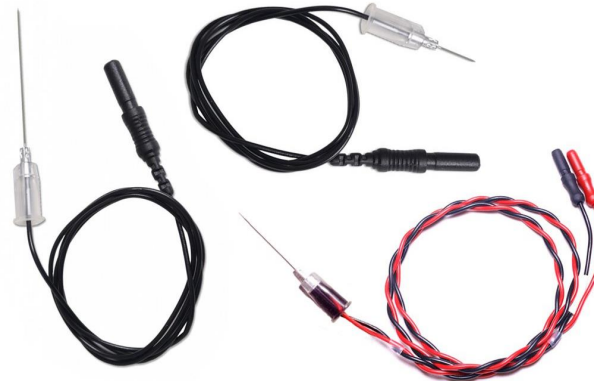

EL450 Series (L to R): EL450, EL452, EL451

Unipolar and Concentric Bipolar Needle Electrodes

Use these stainless steel needle electrodes for stimulation or recording in animal subjects and tissue preparations.

EL450 37 mm x 26g Teflon coated unipolar needle electrode with 61 cm lead

EL451 25 mm x 30g Teflon coated concentric bipolar electrode with 91 cm lead

- Disposable PTFE coated stainless steel needle electrodes have a super-flexible PVC insulated leadwire ending with a standard touch proof connector.
- Teflon coated needle electrodes are fully insulated, with a clear Teflon overcoat, except for the conductive needle tip. The coating prevents the needle from making contact with the subject except at the very tip of the needle, which is exposed.
- For applications that require better contact between the electrode and the subject to record a good signal, abrade the needle to remove the Teflon coating.

EL452 12 mm x 28g unipolar needle electrode with 61 cm lead

- Disposable uncoated (no Teflon) stainless steel ground reference needle electrodes have a super-flexible PVC insulated leadwire ending with a standard touch proof connector.

Needle electrodes are shipped non-sterile, so pre-sterilization is required.

Suggested Use

- When recording from a single site (e.g., studies of individual muscle fibers), use one EL451 electrode plus one EL452 ground electrode.
- For general-purpose recording (e.g., ECG), use a pair of EL450 or EL452 electrodes, plus one EL452 ground electrode.
- For stimulation, use a pair of EL450 or EL452 electrodes.

Interface Notes

Research System Users: CBL201 is required for connection to older model 100A/100B-series amplifiers or STMISOA/B.

Education System Users: Use SS1LA, BSLCBL8, or BSLCBL9 to interface the MP3X data acquisition unit.

EL500 SERIES – DISPOSABLE ELECTRODES



EL504



EL509



EL508

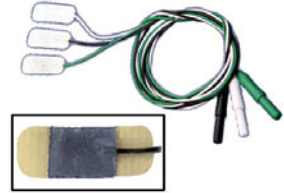

EL510

NOTE: EL506 strip electrodes were discontinued in December of 2018.



EL512

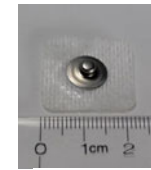

EL513

The EL500 Series disposable, Ag/AgCl snap electrodes provide the same signal transmission as BIOPAC's reusable electrodes, with added convenience and hygiene. Each peel-and-stick electrode is pre-gelled and designed for one time use only.

Use the EL500 series electrodes with a wide range of BIOPAC electrode leads and cables, such as SS1L, SS1LA, SS2L, SS2LA, SS2LB, LEAD108 series, Lead 110 series, Lead 110S series or any BIOPAC lead or electrode lead cable assembly indicated for use with snap electrodes.

Electrode Properties – Electrolyte Gel and Chloride Salt Concentration

For electrode gels (electrolytes), the higher the chloride salt content, the more conductive the electrode. Higher salt content, pre-gelled, surface electrodes are useful for making fast, high quality measurements of biopotentials, once the electrodes are applied to the skin surface. In addition, wet (liquid) gels further accelerate this process because the electrolyte migrates into the skin surface layers more easily and rapidly. High conductivity electrodes generally have reduced artifact, due to the low generated impedance between electrode and skin surface.

As the chloride salt content of the electrolyte drops, the less conductive the electrode. As the chloride content drops to 10% or less, then the electrode can be increasingly employed for long-term recording (greater than 2 hours), with reduced chance for skin irritation. In addition, hydrogels are gentler on the skin than wet (liquid) gels of the same salt concentration. Hydrogel based electrolytes will not migrate into the skin surface as easily or rapidly as with wet gels.

For Electrodermal activity measurements it's important to use an electrode with similar (isotonic) chloride salt content as per the skin surface, so as not to hypersaturate or hyposaturate the eccrine glands.

The impedance of the electrode/skin junction is highly dependent on the electrolyte type and the chloride salt concentration. For example, a hydrogel electrode with 4% chloride concentration will have about 10x higher impedance than a wet liquid gel electrode with 10% chloride concentration, after first application to the skin.

Electrode Properties – Backing Adhesive

The 500 series disposable electrodes come with a range of adhesive qualities. All electrodes are designed to adhere well to skin surfaces, but the adhesion characteristics can be grouped depending on the application.

The three adhesive groups are identified as follows:

Group 1: strong adhesive

Group 2: moderate adhesive, high tack

Group 3: moderate adhesive, low tack

Strong adhesive electrodes are best for biopotential measurements when the subject is moving. Moderate adhesive electrodes are optimal for long-term recordings. Lower tack electrodes can be repositioned and are best suited for delicate skin surfaces.

Usage Descriptions - 500 Series Disposable Ag/AgCl electrodes:

EL500: Dual high adhesion, high conductivity, low artifact, biopotential electrodes

EL501: High adhesion, high conductivity, low artifact, biopotential electrode

EL502: Long-term recording, high adhesion, low artifact, biopotential electrode

EL503: General purpose, economical, high conductivity, biopotential electrode

EL504: Long-term recording, moderate adhesion, high compliance, low artifact, gentle, biopotential electrode

EL507: Electrodermal activity measurement electrode*

EL508: MR Conditional electrode for general-purpose use – use only with LEAD108 series leads

EL509: MR Conditional electrode for electrodermal activity measurement – use only with LEAD108 series leads

EL510: MR Conditional electrode and lead set for general-purpose use

EL512: Small (2.54 cm) electrode, easy on the skin for infant applications

EL513: Disposable cloth electrode designed for recording EMG or ECG for sleep and facial applications

Skin Preparation

For highest electrode to skin conductivity, the skin should be lightly abraded with a gentle abrasive wipe, such as BIOPAC's ELPAD*. An alcohol wipe is not recommended, to improve conductivity, as this will only serve to dry out the skin surface. Lightly abrading the top layer of the epidermis will effectively remove dead skin cells and prepare the skin site to establish a high conductivity path, once the gelled electrode is applied.

After application, the electrode can be verified for robust galvanic connection to the skin via impedance checking. BIOPAC's EL-CHECK can be used to measure the impedance between any two applied surface electrodes. Because each electrode/electrolyte junction forms a half-cell, impedance measurements are more accurately measured at some frequency resident in the band of biopotentials. EL-CHECK operates by injecting a 3.5 uA rms constant current of 25 Hz through the electrodes undergoing impedance check. The complete series impedance loop, including both electrodes/skin junction and coupling body impedance, is reported. Ideally, the reading should be 10,000 ohms or less (approximately 5000 ohms per electrode). In practice, BIOPAC biopotential amplifiers are very tolerant of electrode/skin impedances, even higher than 50,000 ohms. However, the highest quality recordings will always be accompanied by electrode/skin impedance junctions of 10,000 ohms or less.

***IMPORTANT: Do not abrade the skin** when using EL507 electrodes for electrodermal activity. [Learn more about EDA Subject Prep.](#)

Electrode Chloride Salt Content and Adhesive Backing

Disposable Electrode Ag/AgCl	Chloride Salt %	Electrode Backing Adhesive
EL500	10% (wet gel)	Strong
EL501	10% (wet gel)	Strong
EL502 4%	(hydrogel)	Moderate, high tack
EL503	7% (wet gel)	Moderate, high tack
EL504	4% (hydrogel)	Moderate, low tack
EL507	0.5% (wet gel)	Strong
EL508	10% (wet gel)	Moderate, high tack
EL509	n/a: dry electrode – use any gel	Strong
EL510	4% (hydrogel)	Moderate, low tack
EL512	n/a: dry strip electrode – use GEL 100 or 101	Moderate, low tack
EL513	4% (hydrogel)	Moderate, low tack

Wet (liquid) electrolyte

The chloride salt content in WET gel electrodes from BIOPAC varies:

- 10% is used for short term applications such as resting ECG or stress test
- 7% is a more universal gel and can be used short term for most subjects, though some react long term
- 4% is a long-term, monitoring gel used for more than 24 hours
- 0.5% in electrodermal activity (EDA) electrodes

Hydrogel (solid) electrolyte

The chloride salt content in all hydrogel, solid electrolyte, electrodes from BIOPAC is 4%. This universal gel can be used short and long term, and is suitable for adult and infants.

Duration

BIOPAC does not recommend for applications running more than 24 hours.



Irritation Factors

Possible skin irritation can result from the gel or the adhesive on the tape backing of the electrode. To reduce the potential for skin irritation, choose an electrode which has lower electrolyte chloride content, reduced tape backing skin adhesion and electrolyte is hydrogel-based. Overall, the least impactful skin electrodes are the EL504, EL510, EL512 and EL513.

Note: About 2% of the population will react to any adhesives and gels put on a skin, regardless of composition or concentration. Internal body fluids are about 0.9% chloride salt. Skin sweat is typically 0.1% to 0.4% chloride salt.

Part	<i>Ag/AgCl Adhesive/Disposable Electrode Type</i>
EL500 Dual Electrodes	<p>Paired, pre-gelled, electrodes: The fixed spacing between the contacts of these dual electrodes are useful for general-purpose EMG measurements, electrical stimulation, bioimpedance and cardiac output studies. Hypo-allergenic, wet liquid gel electrolyte (10% chloride salt).</p> <p>These electrodes incorporate a gel cavity (16 mm diameter, 1.5 mm deep) situated between electrode and skin surfaces that helps reduce motion artifact.</p> <p>Dual Ag/AgCl electrode conductors: 11 mm diameter, 95 mm² conductive contact area, 41 mm spacing (center to center) mounted on 41 mm x 82 mm, moisture resistant, latex free, 1.5 mm thick foam tape with strong adhesive.</p>
EL501 Stress Test Electrodes	<p>Small stress test, pre-gelled, electrodes: Use for short-term recordings where the subject may be in motion or when electrodes should be closely placed, as for multi-channel ECG, EGG, EMG or EOG. Hypo-allergenic wet liquid gel electrolyte (10% chloride salt). These electrodes incorporate a gel cavity (16 mm diameter, 1.5 mm deep) situated between electrode and skin surfaces that helps reduce motion artifact.</p> <p>Single Ag/AgCl electrode conductor: 11 mm diameter, 95 mm² conductive contact area, mounted on 40 mm diameter, moisture resistant, latex free, 1.5 mm thick foam tape with strong adhesive.</p>
EL502 Long-term Recording Electrodes	<p>Small, pre-gelled, electrodes. Most appropriate for long-term (> 2 hours) biopotential measurements. Hypo-allergenic, hydrogel, solid, electrolyte (4% chloride salt) that adheres well to skin, but leaves no residue when removed.</p> <p>Single Ag/AgCl electrode conductor: 11 mm diameter, 95 mm² conductive contact area mounted on 41 mm diameter, moisture resistant, latex free, vinyl backing tape (0.12 mm thick) with moderately strong adhesive. The hydrogel base also lends these electrodes to electrical stimulation studies, such as for nerve conduction velocity or tDCS.</p>
EL503 General-purpose electrode	<p>Small, pre-gelled, electrodes: These economical electrodes are most suitable for general purpose, short-term recordings. The small diameter permits relatively closely-spaced biopotential recording. Hypo-allergenic wet liquid gel electrolyte (7% chloride salt).</p> <p>Single Ag/AgCl electrode conductor: 11 mm diameter, 95 mm² conductive contact area mounted on 35 mm diameter, moisture resistant, latex free, vinyl backing tape (0.12 mm thick) with moderately strong adhesive.</p>
EL504 High Flexibility Electrodes	<p>Small, pre-gelled, electrodes. Most appropriate for long-term (greater than 2 hours) biopotential measurements. Hypo-allergenic, hydrogel, solid, electrolyte (4% chloride salt) that adheres well to skin, but leaves no residue when removed.</p> <p>Single Ag/AgCl electrode conductor: 11 mm diameter, 95 mm² conductive contact area mounted on a cloth-based, 2.5 cm x 2.5 cm porous, latex free, backing fabric tape (0.2 mm thick). Particularly useful for applications on non-conforming surfaces, such as the face for EMG or fingers for nerve conduction studies.</p> <p>The electrodes are very comfortable and conform easily to a great variety of skin surfaces. These are optimal electrodes for facial EMG recording, due to gentle adhesion, high flexibility, cloth base and low potential for skin irritation. These electrodes are useful for general ECG, EMG and sleep studies. The hydrogel base also lends these electrodes to electrical stimulation studies, such as for nerve conduction velocity or tDCS. These latex-free, hypo-allergenic, electrodes adhere well to the skin, can be repositioned and are suitable for long term use with minimal irritation.</p>

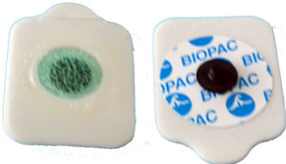
Part	<i>Ag/AgCl Adhesive/Disposable Electrode Type</i>
<p>EL507</p> <p>EDA Electrodes</p>	<p>Designed for electrodermal activity (EDA) measurements and are pre-gelled with isotonic gel. Isotonic gel is recommended for EDA measurements to establish physiological ionic equivalency to the skin surface. The electrodes conform and adhere well to a variety of skin surfaces. Typically, they are applied around fingers to create a firm bond. Also, these electrodes are very suitable for attachment to the palm of hand, wrist, toes or sole of foot. These electrodes incorporate a gel cavity (16 mm diameter, 1.5 mm deep) situated between electrode and skin surfaces that helps to stabilize measurements and reduce motion artifact.</p> <p>Wet Gel: 0.5% chloride salt (isotonic,) Electrode Contact Diameter: 11 mm, Electrode Contact Area: 95 mm², Size: 27 mm x 36 mm, Backing: 1.5 mm thick foam, latex free</p>
<p>EL508</p> <p>MRI General-Purpose Electrodes</p>	<p>These disposable, radio-translucent electrodes are pre-gelled. Use with LEAD108 series.</p> <p>MRI Use: MR Conditional</p> <p>Condition: Up to 7T, any scanning sequence. Up to 9T on animals. Use with LEAD108 series only.</p> <p>Electrode contact type: Ag/AgCl laminated on carbon composition plastic snap, Wet Gel: 10% chloride salt, Electrode Contact Diameter: 11 mm, Electrode Contact Area: 95 mm², Vinyl Tape Backing: 41 mm diameter, 0.12 mm thick, latex free</p> <p>EL508 Components: Substrate: Tape with medical grade adhesive, Label: Bi-Oriented Polypropylene (BOPP) or Vinyl, Stud: 40% Carbon-filled ABS plastic, Eyelet: 20% glass-filled ABS plastic coated with Ag/AgCl, Reticulated foam: Polyester-polyurethane, Gel: 10% chloride salt wet liquid gel electrolyte</p>

Part	<i>Ag/AgCl Adhesive/Disposable Electrode Type</i>
<p>EL509</p> <p>MRI EDA Electrodes</p>	<p>These disposable, radio-translucent, dry electrodes have a very long shelf-life and are ideal for electrodermal activity (EDA) measurements. They are content and dimensionally equivalent to the EL507 series electrodes, but with carbon composition snap and gel-free. Use with LEAD108 and isotonic electrode gel - GEL101 recommended for EDA.</p> <p>Isotonic gel is recommended for EDA measurements to establish physiological ionic equivalency to the skin surface. The electrodes conform and adhere well to a variety of skin surfaces. Typically, they are applied around fingers to create a firm bond. Also, these electrodes are very suitable for attachment to the palm of hand, wrist, toes or sole of foot. These electrodes incorporate a gel cavity (16 mm diameter, 1.5 mm deep) situated between electrode and skin surfaces that helps to stabilize measurements and reduce motion artifact.</p> <p>MRI Use: MR Conditional</p> <p>Condition: Up to 7T, any scanning sequence. Up to 9T on animals. Use with LEAD108 series only.</p> <p>Electrode contact type: Ag/AgCl laminated on carbon composition plastic snap, Electrode Contact Diameter: 11 mm, Electrode Contact Area: 95 mm², Size: 27 mm x 36 mm, Backing: 1.5 mm thick foam, latex free</p> <p>To add gel:</p> <ol style="list-style-type: none"> 1. Fill back cavity (adhesive side) with gel. 2. Add a drop of gel to the sponge pad. 3. Place the sponge pad into the cavity. 4. Press firmly to clear air pockets.  <p>EL509 Components: Substrate: Tape with medical grade adhesive, Label: Bi-Oriented Polypropylene (BOPP) or Vinyl, Stud: 40% Carbon-filled ABS plastic, Eyelet: 20% glass-filled ABS plastic coated with Ag/AgCl, Reticulated foam: Polyester-polyurethane, Gel: none; add BIOPAC GEL101 at time of application.</p>
<p>EL510</p> <p>MRI X-ray Electrodes</p>	<p>EL510 is a disposable, radio-translucent, set of three electrodes with hydrogel (4% chloride salt) electrolyte centers and hydrocolloid ends that terminate in 1.5 mm Touchproof leads. Each box includes 20 sets of 3 electrodes. Electrodes are 25 mm x 10 mm with a 10 mm x 10 mm, gelled, contact area. The thin, flexible, carbon composition leads are 58 cm long.</p> <p>MRI Use: MR Conditional</p> <p>Condition: Tested up to 3T, any scanning sequence, radiolucent head</p> <ul style="list-style-type: none"> • Pre-wired, carbon composition leads • Ag/AgCl contact type • Safely secures to limbs without a strap that could reduce circulation. • Gentle hydrogel centers and hydrocolloid ends adhesives • Long lasting and easy to use, even under high humidity • Radio-translucent materials allow for X-ray passage • Latex, phthalate/DEHP, BPA free 

Part	<i>Ag/AgCl Adhesive/Disposable Electrode Type</i>
<p>EL512</p> <p>Disposable Dry Infant Electrode</p>	<p>Small round dry electrode (2.54 cm; 1") that is easy on the skin for infant applications. Add gel before recording, such as GEL100 or GEL101. Foam backing with standard snap for lead connection; use with any pinch lead connector, such as LEAD110 series, LEAD108, or BN-LEAD series.</p> <p>Available in packs of 100 (order EL512) or 1000 (order EL512-10).</p>
<p>EL513</p> <p>Disposable Cloth Facial Electrode</p>	<p>Disposable cloth electrodes designed for recording EMG or ECG for sleep and facial applications.</p> <ul style="list-style-type: none"> • 10 mm contact area on 2 cm x 2 cm backing • Front has standard snap for lead connection (Use with LEAD110 or BN-LEAD series) • Back has conductive adhesive solid gel that tolerates repositioning for proper placement <p>The non-woven cloth base of the electrode is extremely conforming to contours of the face and very comfortable.</p> <p>Available packs of 60 (order EL513) or 600 (order EL513-10).</p>

ELECTRODES

In selecting the application site for any style of electrode, care should be taken that:

- 1) Electrode site is dry and free of excessive hair.
- 2) Electrode is not placed over scar tissue or on an area of established erythema or with a lesion of any kind.
- 3) Skin is properly prepared. (Prepare the skin at the electrode site. Use the ELPAD to lightly abrade the skin surface. Use a brisk dry rub to prepare the application site. Avoid excessive abrasion of the skin surface.)

EL650 SERIES REUSABLE SNAP ELECTRODES

EL650 Series reusable snap electrodes incorporate a variety of features which improve biopotential recordings.

- Non-polarizable
- Sintered to increase electrode/electrolyte contact area
- Does not require chloriding
- Reusable via resurfacing
- High stability recordings, to DC, when used with chloride salt gel electrolyte
- Electrolyte gel cavity reduces artifact due to electrolyte/electrode motion and minimizes electrolyte dissipation/drying over long term recordings



EL654 This is a reusable Ag-AgCl snap electrode with a 4 mm diameter.

EL658 This is a reusable Ag-AgCl snap electrode with a 8 mm diameter.

Use with ADD204 adhesive collars and interface with LEAD110S Series snap electrode leads or BioNomadix electrode lead sets.

EL654/658 SPECIFICATIONS

Sensor diameter: 4 mm Ag-AgCl (EL654,) 8 mm Ag-AgCl (EL658)

Housing diameter: 13 mm

Overall height: 6 mm (EL654,) 8 mm (EL658)

Gel cavity: 2 mm deep

Snap: 1 mm thick Ag-AgCl sintered sensor element mounted in an epoxy housing; all parts are firmly encapsulated with epoxy, resulting in a tough, durable waterproof assembly

How to Clean Reusable Electrodes

1. Do not leave GEL in the cavity after use. If GEL is left in cavity, the Ag-AgCl electrode disk could degrade quickly with time because the electrode surface is somewhat porous to promote good conductivity to the GEL.
2. To clean the reusable electrode, use a cotton swab or toothbrush with tap water.
3. Use any lab cleaner with pumice (such as Ajax) with cotton swab or toothbrush to remove any dark residue from electrode surface.
4. Use Hydrogen Peroxide solution (2-3%) to brighten electrode surface (optional) or to sterilize electrode. Do not place the electrode in solution, but simply clean the electrode surface using a cotton swab.
5. Dry electrode off completely before storage.

EL-CHECK – ELECTRODE IMPEDANCE CHECKER

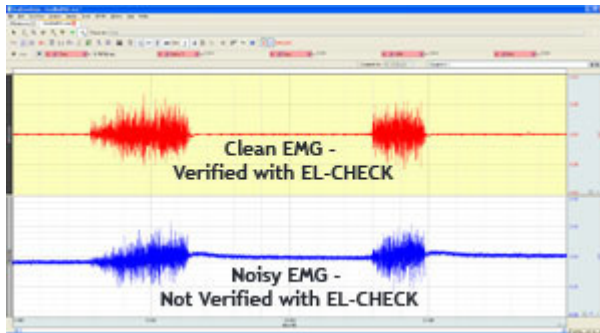

[BIOPAC EL-CHECK](#) video tutorial!

Use EL-CHECK to determine electrode/surface contact impedances. Measurements are selectable to a standard three-point contact (Vin+ to GND, Vin- to GND and Vin+ to Vin-). Electrode impedance range from < 5 kΩ to > 50 kΩ is indicated in seven levels. EL-CHECK accepts standard 1.5 mm Touchproof and BioNomadix connectors.

EL-CHECK will support over 50,000 10-second measurements with a single 9-volt battery.

The EL-CHECK is suitable for measuring electrode contact impedance for all surface biopotential measurements, including ECG, EEG, EGG, EMG, EOG, Bioimpedance and Impedance Cardiography. The EL-CHECK permits simultaneous connection of up to three electrode leads, for quick impedance checking between any two electrodes in the three connected leads (Active or Vin+) and (Reference or Vin-) and GND.

To test the impedance between any two electrode leads:

1. Insert the leads into the appropriate connectors on the front panel of the EL-CHECK.
2. Switch the selector knob to the corresponding position, and then press and hold the “Test” button.

Green, Yellow, Orange and/or Red LEDs will illuminate to indicate the measured electrode impedance. The EL-CHECK is only active when the “Test” button is pressed.

For best biopotential measurement results, the impedance between any two electrode leads should be less than 5 kΩ. To obtain electrode lead-to-lead impedances of less than 5 kΩ, it’s advisable to lightly abrade the skin with an abrasive pad, such as BIOPAC’s ELPAD, and then apply a well-gelled (not dry) surface electrode. Dried-out surface electrodes can sometimes be rejuvenated by applying a small amount of BIOPAC’s electrode gel to the contact pad of the electrode.

Specifications

Test Frequency:	25 Hz
Test Current:	3.5 μA rms (10 μA peak-peak: constant current)
Electrode Impedance Range Indicators:	< 5 kΩ, 5k-10 kΩ, 10 to 20 kΩ, 20k-30 kΩ, 30k-40 kΩ, 40-50 kΩ, > 50 kΩ
Lead Compatibility:	Standard female touchproof (1.5 mm) electrode leads, all BIOPAC electrodes and leads that terminate in female 1.5 mm touchproof sockets, all BN- EL and BN-Adapt series.
Testing Configurations Switch Selectable:	Active (Vin+) to Reference (Vin-), Active (Vin+) to Ground (GND), Reference (Vin-) to Ground (GND)
Power:	One 9 V Alkaline battery, ~50,000 impedance tests possible per battery
Dimensions:	14 cm long x 8 cm wide x 2.2 cm high
Weight:	132 grams

ELECTRODE ACCESSORIES GELS

Abrasive Pads

Before applying electrodes, abrade the skin lightly with an ELPAD to remove non-conductive skin cells and sensitize skin for optimal adhesion. Each ELPAD package contains 10 abrasive pads.



Adhesive

Use adhesive tape for attaching Active Electrodes and other devices. Use the preferred tape or BIOPAC's adhesive tape: **TAPE1** single-sided; **TAPE2** double-sided.

MRI Use: MR Safe

TAPE1 Components:

3M hypoallergenic surgical tape – Acrylic adhesive



Adhesive Disks

ADD200 series double-sided adhesive collars are used to hold reusable electrodes (EL254/8RT) firmly on the skin surface.

ADD204 19 mm outside diameter, use with EL254 and EL254S

ADD208 22 mm outside diameter, use with EL258 and EL258S

MRI Use: MR Safe

ADD204/208 Adhesive Disks Components:

Disks: 3M hypoallergenic medical tape – Acrylic polymer



Electrode Gels

GEL1 & GEL100 Non-irritating, hypo-allergenic gel used as a conductant with the EL250 series reusable electrodes. GEL1 = 50 g; GEL100 = 250 g. 5% NaCl (salt) content. 0.85 molar NaCl

MRI Use: MR Conditional

Condition: Max MR field strength 7T

MRI Notes When using with EL250 series electrodes, it's important to completely fill the EL250 series gel reservoir. Incomplete filling of reservoir may result in localized heating of gel at the electrode site.

GEL100 Components:

Water, Sodium Chloride, Propylene Glycol, Mineral Oil, Glyceryl Monostearate, Polyoxyethylene Stearate, Stearyl Alcohol, Calcium Chloride, Potassium Chloride, Methylparaben, Butylparaben, Propyl Paraben

GEL101 Non-irritating, isotonic gel is primarily used as a conductant for the TSD203 electrodermal response electrodes. Each tube contains 114 g (~4 ounces).

Consists of 0.5% Saline in a neutral base and is the appropriate GEL to use for GSR, EDA, EDR, SCR, and SCL. This electrode paste has an approximate molarity of 0.05M NaCl and is 0.5% Saline; the Saline concentration is adjusted to obtain a final paste molarity of 0.05M NaCl. This particular molarity is recommended by Fowles (1981). *Psychophysiology*, 18, 232-239

MRI Use: MR Conditional

Condition: Max MR field strength 7T

GEL101 Components:

Cetyl Alcohol #697313, Glycerol Monostearate, Lanolin, USP Anhydrous, Dimethicon Silicone TBF9-1000, Water, purified USP Sodium Chloride, Sodium Lauryl Sulfate, Sorbitol, 70 USP, Methylparaben, Propylparaben, Quaternium-15

- GEL102** Ten20 Conductive Gel 114 g (~4 ounces). Ten20 is a conductive and adhesive paste specifically formulated for use with reusable (non-disposable) electrodes. Ten20 contains the right balance of adhesiveness and conductivity, enabling electrodes to remain in place while allowing the transmittance of electrical signals. Ten20 is a uniquely washable and non-drying formula. Do not use too much paste—the size of the area of the paste becomes the effective size of the electrode; this can reduce interelectrode distances and potential differences measured. Wash skin promptly after use. 12.5% NaCl content, 2.15 molar NaCl
- GEL103** Tensive Adhesive Gel, 33 ml. Conductive adhesive gel. This safe, non-flammable, odorless gel is recommended for TENs or ECG to adhere non-adhesive electrodes to the skin.
- Eliminates tape and tape irritation
 - Conductive immediately, no need to wait
 - Non-flammable, no solvent odor
 - Best adhesive gel available
 - Hypoallergenic, bacteriostatic, non-irritating
 - Water soluble, easily removed with water
- GEL104** Electrode Gel - salt free - 250 g (8.5 oz). **SPECTRA 360®** electrode gel. The only salt-free and chloride-free electrically conductive gel, recommended for many biopotential measurements. Salt-free characteristics make it particularly suitable for electrical stimulation and long-term applications. However, it is not recommended for DC measures, such as EDA, ECG, EOG or slow potentials. Spectra 360 differs significantly from all other electrically conductive media...it works by wetting the skin, thereby reducing skin resistance.
- Salt-free, no sodium ion transfer
 - Non-irritating, hypoallergenic, bacteriostatic
 - Can be used with carbon compositing flexible electrodes
 - Can be used for ECG and TENS
 - Non-gritty STAY-WET® formula allows for prolonged use without re-application
- MRI Use:** **MR Conditional**
- Condition:** Max MR field strength 7T
- GEL104 Salt-Free Components:**
- Water, Propylene Glycol, Mineral Oil, Glyceryl Monostearate, Polyoxyethelene Stearate, Stearyl Alcohol, Methylparaben, Butylparaben, Propyl Paraben
- ELPREP** Skin Preparation Gel 114 grams (~4 oz). Designed for EEG, ECG, EMG, EOG, Cardiac Output and Bioimpedance measurements. This gel is abrasive and should be used with care not to overabrade the skin. It is not recommended for use with electrodes attached to conventional electrical stimulation equipment, such as voltage or current stimulators. Not to be used on subjects with a history of skin allergies to cosmetics and lotions. Topical use only. Prepare skin and apply small amount to appropriate electrode site by squeezing near tube opening. Gently rub gel into the skin surface. Apply small amount to disc electrode and press into the paste that has been applied to the scalp or other skin surface. Clean with warm water.

Coban Wrap

Self-adhesive Coban™ wrap can be used to hold electrodes, VMG transducers and fNIR sensors on a subject.



- 3 inch x 5 yard (fully stretched) (75 mm x 4.5 m)
- Latex free self-adherent wrap
- Nonsterile
- Tan

BSL-ACCPACK

The BSL Accessory Pack includes the consumable items to run 17 BSL Lessons. School bookstores can purchase the BSL Accessory Packs and sell them to students. Includes:

- 100 x EL503 Disposable Electrodes
- 10 x EL507 Disposable EDA (GSR) Electrodes (ten electrodes total)
- 1 x AFT1 Disposable Bacterial Filter
- 1 x AFT2 Disposable Mouthpiece
- 1 x AFT3 Noseclip
- 8 x ELPAD Abrasive Pads



BSL-ACCPACK-11B

The BSL Accessory Pack 11B includes the consumable items to run 17 BSL Lessons. This pack includes the AFT36 combination bacterial filter/mouthpiece optimized for the newer-model SS11LB airflow transducer. Includes:

- 100 x EL503 Disposable Electrodes
- 10 x EL507 Disposable EDA (GSR) Electrodes (ten electrodes total)
- 1 x AFT36 Disposable Bacterial Filter with Integrated Mouthpiece
- 1 x AFT3 Noseclip
- 8 x ELPAD Abrasive Pads

NOTE: BSL-ACCPACK-11B is not compatible with earlier-model SS11L or SS11LA airflow transducers or software versions earlier than BSL 4.1.1. If using earlier airflow transducers or software, order BSL-ACCPACK.

Alcohol Prep Pad Wipes (ALCPAD, ALCPAD-10)

These Disposable Wipe Prep Pads are sterile, 2-ply non-woven sponge pads saturated with Isopropyl Alcohol and sealed in individual airtight foil packets.

- Affordable
- Convenient Individual Packaging
- 2-Ply Enhances Strength for Cleaning & Disinfecting
- Airtight Poly-Lined Foil Pouches Minimized Dry Pads
- Active Ingredient: Isopropyl Alcohol
- Saturation Level: 70%
- Latex-Free
- Sterile



Quantity options: pack of 200 (order ALCPAD) or pack of 2000 (order ALCPAD-10)

ELECTRODE LEADS

LEAD108 SERIES — MR CONDITIONAL/RADIOTRANSLUCENT LEADS FOR EL508/EL509



Use the LEAD108 Series with EL508 MR Conditional, radiotranslucent electrodes and EL509 disposable radiotranslucent dry electrodes.

All LEAD108 Series terminate in 1.5 mm female Touchproof sockets.

MRI Lead Guidelines

For MRI use, shorter leads are better...specifically, keeping lead lengths much shorter than the wavelength of the Larmor frequency (42.6 MHz/T) is critical. For a 3T machine, this is the speed of light divided by (42.6*3*1E6) or 2.34 meters. As field strengths increase, then lead lengths should continue to shorten. To record ECG, or any other biopotential signal, in MRI, short leads such as LEAD108B (15 cm) and LEAD108C (30 cm) are recommended; do not use 2-meter or 1-meter leads for biopotential signals in MRI.

- *Recommended reading:* Thoralf Niendorf, Lukas Winter and Tobias Frauenrath (2012). [Electrocardiogram in an MRI Environment: Clinical Needs, Practical Considerations, Safety Implications, Technical Solutions and Future Directions](#), Advances in Electrocardiograms - Methods and Analysis, PhD. Richard Millis (Ed.), ISBN: 978-953-307-923-3, InTech, DOI: 10.5772/24340.

See [BIOPAC MRI Guidelines](#) for additional details.

- **MRI Usage:** **MR Conditional to 9T**
- **Condition:** Up to 9T, any scanning sequence, use with EL508 or EL509 MRI/RT electrodes only.
- **Lead108 Components:** Polyvinyl chloride (PVC) plastic, carbon fiber leadwire, tinned copper connectors (1.5 mm female Touchproof socket), electrode clip (carbon filled ABS plastic)

SPECIFICATIONS

- **Construction:** Carbon fiber leadwire and electrode snap
- **Leadwire Diameter:** 1.5 mm
- **Leadwire Resistance:** 156 Ohms/meter
- **Leadwire Length:** **LEAD108B** 15 cm, **LEAD108C** 30 cm

LEAD110 SERIES — ELECTRODE LEADS

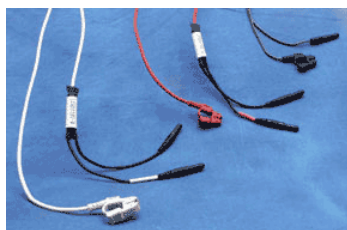

The LEAD110 Series, for use with disposable and other snap connector electrodes, are pinch leads for easy connection between the EL500-series snap electrodes and any BIOPAC biopotential amplifier or the GND terminal on the back of the UIM100C. Leads are 1.9 mm in diameter and terminate in standard 1.5 mm Touchproof connector and connect to BIOPAC modules or to a Modular Extension Cable (MEC series).

LEAD	TYPE	LENGTH	USAGE NOTE
LEAD110	Unshielded	1 m	Works best as a ground electrode
LEAD110A	Unshielded	3 m	Works best with ground or reference electrodes
LEAD110S-R	Shielded; red	1 m	Use with recording electrodes for minimal noise interference. White lead plug is for electrode contact; black lead pin plug is for lead shield.
LEAD110S-W	Shielded; white	1 m	Use with recording electrodes for minimal noise interference. White lead plug is for electrode contact; black lead pin plug is for lead shield.

See also: TSD155C Multi-lead ECG Cable
 WT100C Wilson Terminal (virtual reference)

LEAD115 LIGHTER LEAD SERIES



New series of unshielded 1-meter electrode leads with thin cable; suitable for facial EMG and other areas where lighter, shorter lead cables are required. Use for female Touchproof connectors to pinch clip connectors—connect electrodes to either a C-series amplifier or an MEC. The pinch connectors are light weight and the lead cable tinsel wire is 1.27 mm diameter.

LEAD115 (black), LEAD115-R (red), LEAD115-W (white)

LEAD120 LEAD FOR EL120



This 1-meter lead with 1.5 mm Touchproof connector works exclusively with the reusable EL120 electrode. Snap the electrode into place and then plug the lead in with the Touchproof connector. White—LEAD120-W Red—LEAD120-R

LEAD131, LEAD132

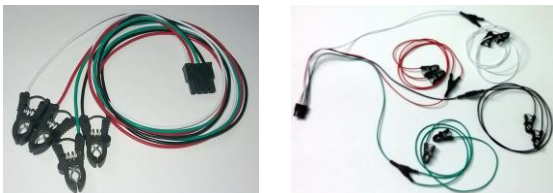

Use these electrode lead sets with D-series Smart Amplifiers EBI100D and NICO100D for impedance measurements.

LEAD131 has four (4) 50 cm clip leads, White I+, Red Vin+, Green VIN-, Black I-. Use for tetrapolar electrode configurations.

LEAD132 has eight (8) 64 cm clip leads (4 x 25 cm wires each split to 2 x 35 cm leads): Use for spot electrode configurations.

LEAD131 and LEAD132 electrode leads are only compatible with EBI100D and NICO100D amplifiers.

LEAD140 SERIES SPECIAL ELECTRODE LEAD CLIPS



LEAD140 Series Special Electrode Lead Clips have a 1 m black cable and a 1.5 mm Touchproof connector, and require the SS1LA interface. These lead clips that can be used for either recording or stimulation. They are useful for attaching BIOPAC amplifiers to a variety of unusual electrode types, ranging from bare wires, needles, unusual junctions, etc.

LEAD140 Alligator clip with teeth, length 40 mm: Use this fully-insulated, unshielded lead to connect fine wire electrodes, including irregular surfaces. There is ferrous metal in the clip.

LEAD141 Alligator clip with smooth (flat) clamp, length 40 mm: Use this fully-insulated, unshielded lead to connect to fine wire electrodes without damage, including arbitrarily small electrode wires. There is ferrous metal in the clip.

LEAD142 Retractable minigrabber clip lead with copper extension contacts, length 40 mm, extension length 3.5 mm: Use this unshielded lead to connect to fine wire electrodes up to 1 mm diameter. There is non-ferrous copper alloy in the clip.

MRI Usage: MR Conditional

Condition: Tested 3T-9T (LEAD142 only)

See the following page for diagrams of LEAD140 Series clamping width, length and height dimensions.

LEAD140 SERIES DIMENSIONAL DIAGRAMS

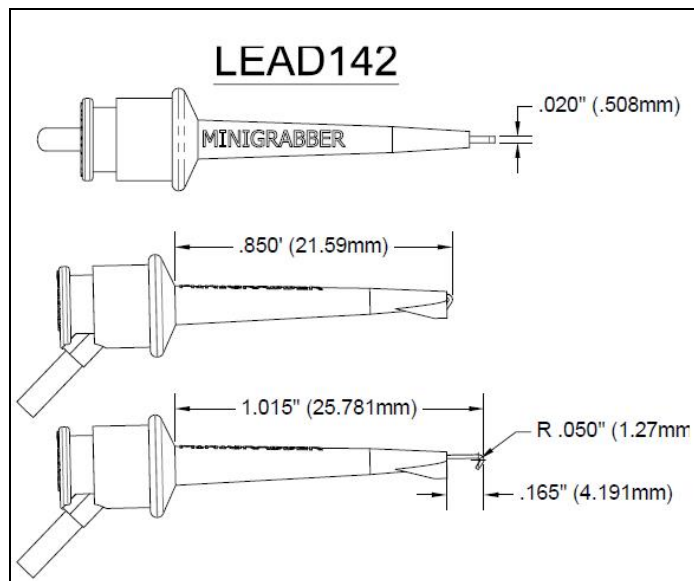
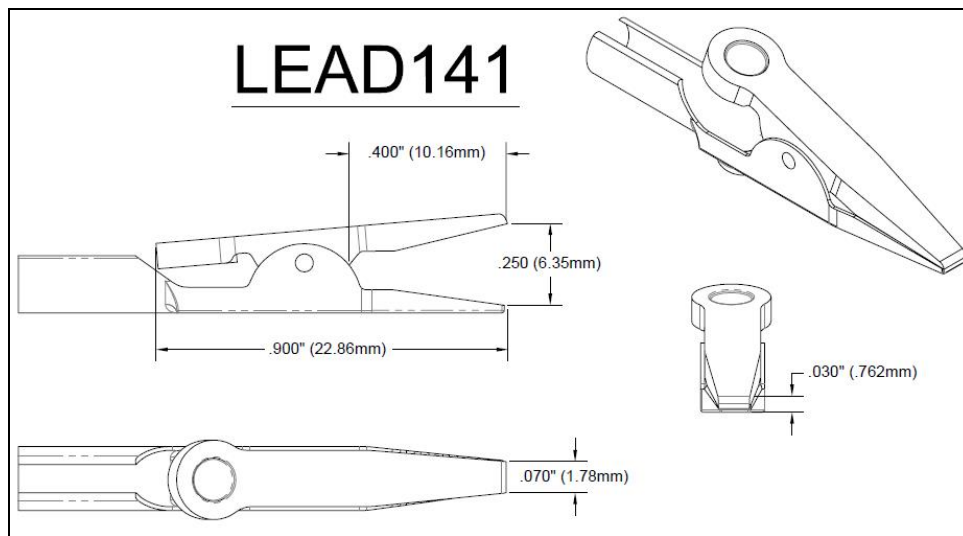
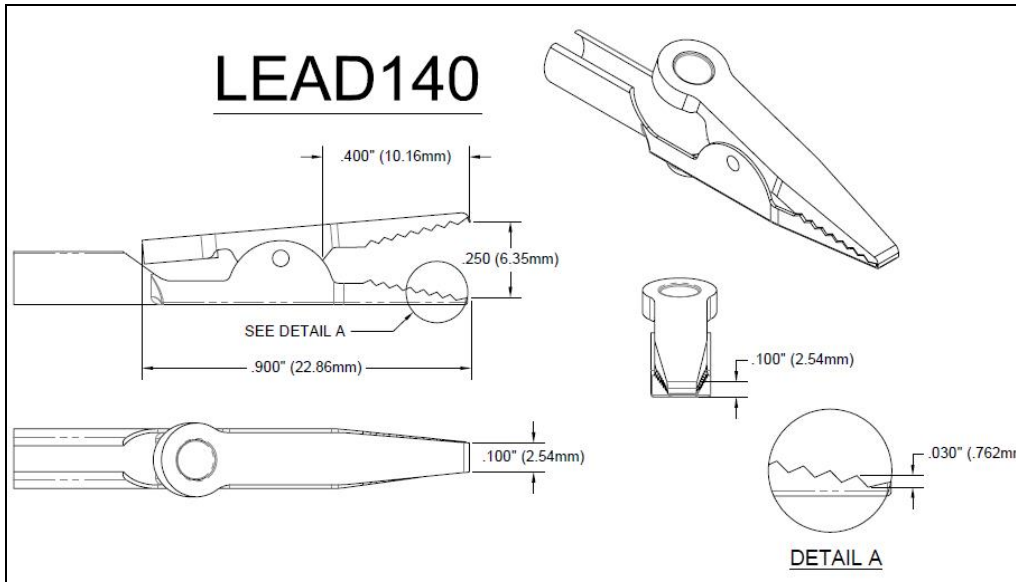

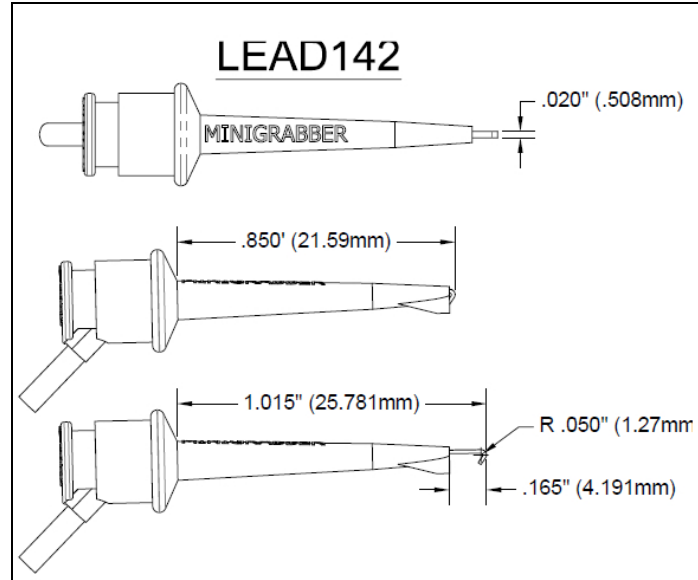

ELSTM1 UNSHIELDED STIMULATING BAR ELECTRODE AND CABLE KIT

The ELSTM1 is a stimulation electrode and BNC cable kit for MP160/150 Research Systems that will interface with either the STM200 or the STMISOLA. The kit is comprised of the BIOPAC [CBL207 cable](#) (BNC male to 2 x 1.5 mm Touchproof male connectors) and the [EL351](#) Unshielded Stimulation Bar Lead Electrode (2 x 1.5 mm Touchproof female connectors).

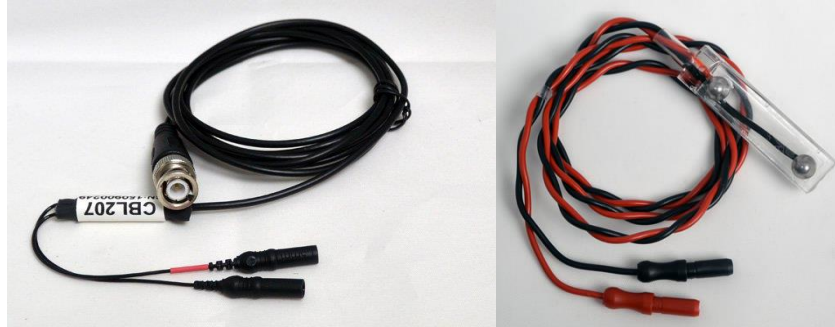

ELSTM1 SPECIFICATIONS

Bar length (EL351):	4 cm
Spacing between contacts:	3 cm
Electrode contact diameter:	1 cm
Lead length (EL351):	61 cm
Cable length (CBL207):	1 m

ELSTM2 UNSHIELDED NEEDLE ELECTRODES

Recommended for use when applying a stimulus to animal subjects and tissue preparations. The dual stainless steel needles are Teflon coated. The coating prevents the needle from contacting the subject except at the very tip of the needle, which is exposed. For applications that require better contact between the electrode and the subject to record a good signal, abrade the needle to remove the Teflon coating. Needle electrodes are shipped non-sterile, so pre-sterilization is required.



ELSTM2 SPECIFICATIONS

Needle Length:	2.5 cm
Needle Diameter:	0.3 mm
Cable length:	3.7 m
Connector type:	BNC
Interface:	BSLSTM Stimulator or SS58L for MP35 or OUT3 for MP36

MICROMANIPULATOR



This manual micromanipulator is a reliable, durable, and economical solution for high-precision experiments.

- Vernier scales allow readings to 0.1 mm
- X-axis fine control allows readings to 10 μm
- Includes tilting base
- Includes standard 12 mm clamp
- Includes 14 cm electrode holder
- All control knobs project to the rear, so units can be tightly grouped.

Control	Travel Range	Resolution
X-axis fine	10 mm	0.01 mm
X-axis	35 mm	0.1 mm
Y-axis	25 mm	0.1 mm
Z-axis	25 mm	0.1 mm
Weight:	1.4 kg (3 lbs.)	

Specify left- or right-handed unit when ordering.

MANIPULATOR-R Right-handed
MANIPULATOR-L Left-handed

NERVE CHAMBERS: NERVE1 AND NERVE2

These acrylic, desktop Nerve Chambers have 15 stainless steel pins for recording and stimulating a variety of different nerve preparations. Each stainless steel pin is spaced 5mm apart to provide a variety of recording and stimulating configurations. The sockets accept 2 mm pin plugs.

NERVE1 and NERVE2 Comparison

Feature	NERVE1	NERVE2
Deep Reservoir (35 mL)—contain Ringers or other solutions	X	X
Drain—facilitate extended viability of the preparation.	X	X
Agent Well — add compounds (ether, dry ice, etc.) 1.4 cm x 2 cm x 2 cm (h x w x l)	X	X
Lid—enclose the preparation. 50 mm thick	X	--
Valve & hose—flush and drain options	X	--

NERVE1 – WITH AGENT WELL AND LID

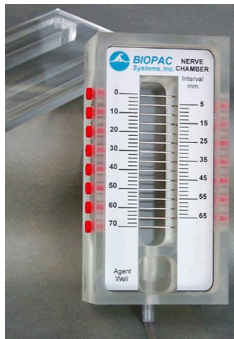

NERVE1 chamber includes:

- **Deep Reservoir** (35 mL) for containing Ringers or other solutions
- **Drain (with valve & hose)** to facilitate extended viability of the preparation
- **Agent Well** for adding compounds (such as ether or dry ice)
- **Lid** to enclose the preparation when the protocol requires it.

NERVE2 – STANDARD NERVE CHAMBER

NERVE2 chamber includes:

- **Deep Reservoir** (35 mL) for containing Ringers or other solutions.
- **Drain (with valve & hose)** to facilitate extended viability of your preparation.

NERVE CHAMBER SPECIFICATIONS (NERVE1/NERVE2)

Pins: 15, stainless steel

Spacing: 5 mm

Sockets: accepts 2 mm pin plugs

Reservoir: holds 35 mL (or use drain/valve)

Dimensions: 4.5 cm x 7 cm x 14 cm (H x W x L)

Agent well: (*NERVE1 only*) 1.4 cm x 2 cm x 2 cm (H x W x L)

Lid: (*NERVE1 only*) 50 mm thick

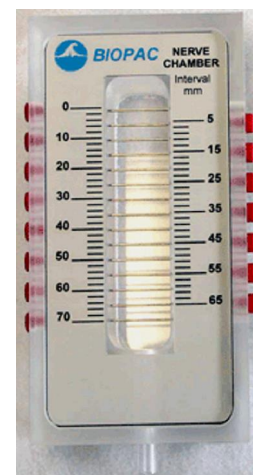

NERVE2

Related components:

- STM100C Stimulator Module
- STMISO Series Stimulator Modules
- MCE100C Micro-electrode Amplifier
- ERS100C Evoked Response Amplifier
- EMG100C Electromyogram Amplifier

NERVE CHAMBER CONNECTIONS

To connect the Nerve Chamber to MP-series Biopotential amplifiers (MCE100C, ERS100C, or EMG100C), use three JUMP100 connectors and three CBL200 adapter cables. Optionally, for additional lead length, use one MEC110C extension cable.

1. Plug the three JUMP100s into the desired points of the Nerve Chamber.
2. Connect the free ends of the JUMP100s to the mating ends of the CBL200s.
3. Then connect the free ends of the CBL200s to the Biopotential amplifier inputs. For additional lead length, plug the MEC110C into the Biopotential amplifier and plug the free ends of the CBL200s into the free end of the MEC110C.

To connect the Nerve Chamber to the STM100C Stimulator, use one CBL106 and one CBL102.

1. Plug the red and black leads (2 mm pins) of the CBL106 into the desired points of the Nerve Chamber.
2. Connect the free end (Female BNC) of the CBL106 to the mating end (Male BNC) of the CBL102.
3. Then insert the free end of the CBL102 (3.5 mm phone plug) into the 50 Ohm output of the STM100C.

Note: If the STM100C Stimulator is used with a Biopotential amplifier on the same nerve—which is nearly always the case—make sure that the black lead of the CBL106 (stimulation negative) is connected to the same pin as the ground lead going to the Biopotential amplifier. This is easy to do because the design of the JUMP100 allows stacking connections.

MRI, RADIOTRANSLUCENT, AND RADIO-OPAQUE COMPATIBILITY

Biopac Definitions

Radiotranslucent products as products that have no metal at all in the applied part. These are best suited for MRI applications.

MR Safe - an item that poses no known hazards in all MRI environments. Using the terminology, “MR Safe” items are non-conducting, non-metallic, and non-magnetic items such as a plastic Petri dish. An item may be determined to be MR Safe by providing a scientifically based rationale rather than test data.

MR Conditional - an item that has been demonstrated to pose no known hazards in a specified MR environment with specified conditions of use. “Field” conditions that define the MR environment include static magnetic field strength, spatial gradient magnetic field, dB/dt (time rate of change of the magnetic field), radio frequency (RF) fields, and specific absorption rate (SAR). Additional conditions, including specific configurations of the item (e.g., the routing of leads used for a neurostimulation system), may be required.

X-ray notes: MRI Safe or Conditional does not refer to the capability of an applied part to be used in an x-ray machine. **Radio-opaque** implies that the applied part is easily visible in an x-ray machine so it can be manipulated via the x-ray viewer. Radiotranslucent in this context implies that the applied part is only partially or not visible in the x-ray viewer.

Caution is required whenever employing electrode leads and electrodes in an MRI environment.

IMPORTANT! See [Safety Guidelines](#) for recording biopotential measurements in the MRI environment.

Under certain conditions, single fault and otherwise, low impedance conduction through the subject represents a potential hazard due to currents that may be induced in loops placed in the time-varying MRI field gradients and RF fields, and due to body movement in the static MRI field. Low impedance conduction can result in significant heating at the electrode/skin junction, because this point is often the part of the signal path with the highest impedance. Sufficient heating at the electrode/skin junction could result in burns.

For more information:

- Read the [Associated Application Notes](#) listed below.
- See the "Magnetic Resonance Imaging" section of a BIOPAC Hardware Guide (available at [Support > Manuals](#), or under the software Help menu, or on the software CD).
- Read [Methodological Issues in EEG-correlated Functional MRI Experiments](#) (Lemieux L, Allen PJ, Krakow K, Symms MR, Fish DR; International Journal of Bioelectromagnetism 1999; 1: 87-95).

Associated Application Notes:

[223 - Physiological Measurement in Magnetic Resonance Imaging Systems,](#)

[230 - Connections for Physiological Signals in an MRI](#)

MRI SMART MODULES

The MRI smart amplifiers incorporate advanced signal processing circuitry which removes spurious MRI artifact from the source physiological data. Signal processors can distinguish between physiological signal and MRI artifact as manifested by gradient switching during MRI sequences, such as Shim or EPI.

Because MRI-related transient artifact is removed at the source, the MRI version amplifier can be sampled at the same rate as during normal (non-MRI) physiological recording. There is no longer any requirement to over-sample the amplifier output to capture every nuance of MRI artifact to train secondary computer-based processing steps to remove such artifact.

In every aspect, data recording is easier, and the final results are cleaner when using the MRI version amplifiers to record physiological data in the fMRI or MRI.

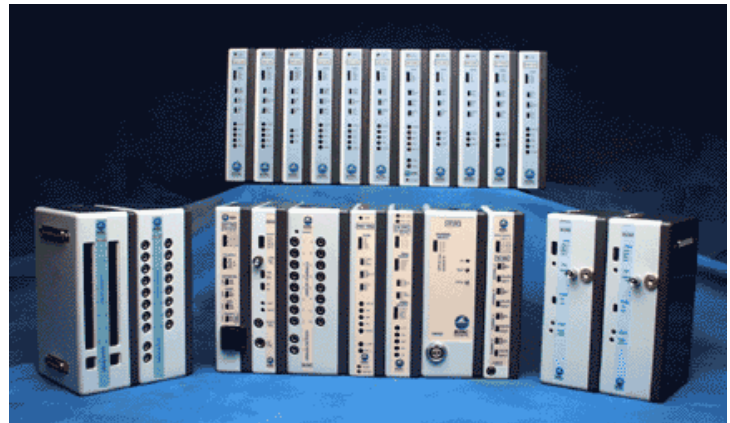

FEATURES

- Less sensitivity to electrode and transducer lead placement
- Improved gain selectability
- No missing spectra in physiological signal frequency band
- No requirement for acquisition oversampling
- No need for computer-based real-time or post-processing signal processing
- Clean data available as real-time analog output

Safety Guidelines for Recording Biopotential Measurements in the MRI Environment

1. Place **EL 508** or **EL509** MR Conditional and Radio Translucent electrodes on the subject as follows:
 - a. Prepare the subject's skin surface with ELPAD to create low contact source impedance at the electrode attachment site. Be careful to wipe away any excess electrode gel from the surface of the subject's skin.
 - b. Attach the electrodes as close to each other as possible (on the subject's skin) for the measurement.
 - c. Place electrodes in as straight of a line as possible which is perpendicular to the magnet's axis.
 - d. Place electrodes between 3-5 cm apart, if possible; the larger the area between the electrodes, the stronger the MRI gradient artifact.
2. Connect the electrode lead set to the electrodes according to these guidelines:
 - a. Make sure that the electrode leads do not loop in a "circle", "S" or "U" shape. Also, do not twist or braid the electrode leads. **Looped, braided or twisted leads pick up RF energy, resulting in current induction and increased localized heating.**
 - b. Run the leads out of the chamber bore in the simplest (straightest) manner possible.
 - c. Do not allow the electrode leads to touch the subject's bare skin. Electrode leads may heat up in the MRI.
 - Use a thermal insulator (such as a blanket or towel) between the electrode lead and the subject's skin.
 - It's also possible to use thermally-insulating foam jacket, similar to those used for insulating copper tubing, for placing the electrode leads to keep them away from the subject's skin.

See also [Safety Awareness Notes for Cables and Electrodes During MRI](#)

ECG100C-MRI

Gain:	500, 1000, 2000, 5000
Output selection:	Normal, R wave indicator
Frequency Response	Maximum Bandwidth (.05 Hz - 150 Hz) can be customized at BIOPAC
Low Pass Filter:	35 Hz, 150 Hz
High Pass Filter:	0.05 Hz, 1.0 Hz
Notch Interference Filter:	50 dB rejection @ 50 or 60 Hz
Noise Voltage (0.05-35 Hz):	0.1 μ V (rms)
Zin:	2M ohm (Differential), 1000M ohm (Common mode)
CMRR:	110 dB min (50/60 Hz)
Common Mode Input Voltage Range:	\pm 10 V (referenced to amplifier ground) \pm 1500 VDC (referenced to mains ground)
Output Range:	\pm 10 V (analog)
Input Voltage Range:	<u>Gain</u> <u>Vin (mV)</u> 500 \pm 20 1000 \pm 10 2000 \pm 5 5000 \pm 2
Maximum Over-Voltage for Differential Input:	\pm 25 V
Input Connectors:	Five 1.5 mm male Touchproof sockets (VIN+, Gnd, VIN-, 2 of shield)
Subject Interface:	EL508 MR Conditional and Radio Translucent electrodes and LEAD108 Series MR Conditional and Radio Translucent leads
Hardware Interface:	MECMRI-BIOP to MP160/150 System

EDA100C-MRI

Gain:	20, 10, 5, 2 μ siemens/volt (i.e. μ mhos/volt)
Low Pass Filter:	1 Hz, 10 Hz
High Pass Filter:	DC, 0.05 Hz, 0.5 Hz
Sensitivity:	0.7 nano-siemens (with MP System)
Constant Voltage Excitation:	Vex = 0.5 VDC
Output Range:	\pm 10 V full range (analog); 0-10 V nominal range
Input Signal Range:	<u>Gain</u> <u>Range (μmho)</u> 20 0-200 10 0-100 5 0-50 2 0-20
Input Connectors:	Three 1.5 male Touchproof sockets (VIN+, Gnd, VIN-)
Subject Interface:	EL509 MR Conditional and Radio Translucent electrodes and LEAD108 Series MR Conditional and Radio Translucent leads
Hardware Interface:	MECMRI-TRANS to MP160/150 System

Note: Normal human range is 1-50 μ mho.

Unit Note—BIOPAC software calculates SCL/SCR in μ mho, the traditional unit of conductance. Micromho (μ mho) is interchangeable with the alternative microsiemen (μ S). To use Ohm, the traditional measure of *resistance*, convert as 1 μ mho corresponds to 1,000,000 ohm.

EEG100C-MRI

Gain:	5000, 10000, 20000, 50000	
Output selection:	Normal, Alpha wave indicator	
Low Pass Filter:	35 Hz, 100 Hz	
High Pass Filter:	0.1 Hz, 1.0 Hz	
Notch Interference Filter:	50 dB rejection @ 50/60 Hz	
Noise Voltage (0.1-35 Hz):	0.1 μ V (rms)	
Zin:	2 Mohm (Differential) 1000 Mohm (Common mode)	
CMRR:	110 dB min (50/60 Hz)	
Common Mode Input Voltage Range:	\pm 10 V (referenced to amplifier ground) \pm 1500 VDC (referenced to mains ground)	
Output Range:	\pm 10 V (analog)	
Input Voltage Range:	<u>Gain</u>	<u>V_{in}</u>
	5000	\pm 2 mV
	10000	\pm 1 mV
	20000	\pm 0.5 mV
	50000	\pm 0.2 mV

Maximum Over-Voltage for Differential Input: \pm 25 V

Input Connectors: Five 1.5 mm male Touchproof sockets (VIN+, Gnd, VIN-, 2 of shield)

Subject Interface: EL508 MR Conditional and Radio Translucent electrodes and LEAD108 Series MR Conditional and Radio Translucent leads

Hardware Interface: MECMRI-BIOP to MP160/150 System

EMG100C-MRI

Gain:	500, 1000, 2000, 5000	
Low Pass Filter:	500 Hz, 5000 Hz	
High Pass Filter:	1.0 Hz, 10 Hz, 100 Hz	
Notch Interference Filter:	50 dB rejection @ 50/60 Hz	
Noise Voltage (10-500 Hz):	0.2 μ V (rms)	
Zin:	2 Mohm (Differential), 1000 Mohm (Common mode)	
CMRR:	110 dB min (50/60 Hz)	
Common Mode Input Voltage Range:	\pm 10 V (referenced to amplifier ground) \pm 1500 VDC (referenced to mains ground)	
Output Range	\pm 10 V (analog)	
Input Voltage Range	<u>Gain</u>	<u>V_{in} (mV)</u>
	500	\pm 20
	1000	\pm 10
	2000	\pm 5
	5000	\pm 2

Maximum Over-Voltage for Differential Input: \pm 25 V

Input Connectors: Five 1.5 mm male Touchproof sockets (VIN+, Gnd, VIN-, 2 of shield)

Subject Interface: EL508 MR Conditional and Radio Translucent electrodes and LEAD108 Series MR Conditional and Radio Translucent leads

Hardware Interface: MECMRI-BIOP to MP160/150 System

PPG100C-MRI

Gain:	10, 20, 50, 100
Low Pass Filter:	3 Hz, 10Hz
High Pass Filter:	DC, 0.05 Hz, 0.5 Hz
Noise Voltage:	0.5 μ V (RMS); amplifier contribution
Output Range:	\pm 10 V (analog)
Excitation:	6 V
Input Connectors:	Three 1.5 mm male Touchproof sockets (Vsup, Gnd, Input)
Subject Interface:	TSD200-MRI MR Conditional PPG Transducer, (red connector to VIN+/Vsup, black to Gnd, white or blue to VIN-/Input)*
Hardware Interface:	MECMRI-TRANS to MP160/150 System

*When used in the MRI scanner room, the TSD200-MRI connects to the MECMRI-1 cable. Connect red lead connector to Vin+/Vsup, black connector to Gnd, and white or blue connector to Vin-/INPUT.

NICO100C-MRI

Number of Channels:	2 – Magnitude (Z_o) and dZ/dt
Operational Frequencies:	50 kHz
Current Output:	4 mA (rms)—constant sinusoidal current
Outputs:	MAG of Impedance: 0-100 Ω dZ/dt of Impedance: 2 (Ω /sec)/V
Output Range:	\pm 10 V (analog)
Maximum Over-Voltage for Differential Input:	\pm 25 V
CMIV, referenced to:	Amplifier ground: \pm 10 V Mains ground: \pm 1500 VDC
Gain Range:	MAG: 10, 5, 2, 1 Ω /V dZ/dt : 2 (Ω /sec)/v constant (independent of MAG Gain)
LP Filter:	MAG: 10 Hz, 100 Hz dZ/dt : 100 Hz
HP Filter:	MAG: DC, 0.05 Hz dZ/dt : DC coupled
Sensitivity:	MAG: 0.0015 Ω rms @ 10 Hz bandwidth dZ/dt : 0.002 (Ω /s)/V rms @ 10 Hz bandwidth
Subject Interface:	EL508 MR Conditional and Radio Translucent electrodes (8,) LEAD 108B and/or LEAD108C MR Conditional and Radio Translucent electrode leads (8,) CBL204-MRI “Y” electrode lead adapters (4)
Hardware Interface:	MECMRI-NICO to MP160/150 System

NICO100C-MRI

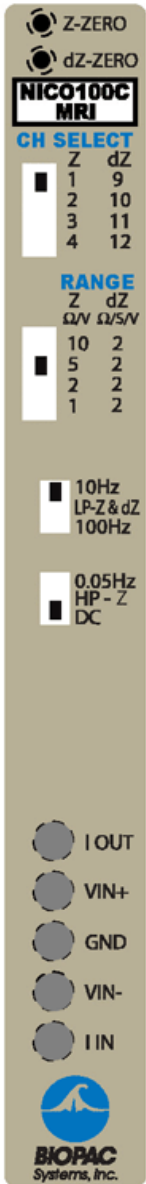

The NICO100C-MRI noninvasive cardiac output amplifier records the parameters associated with cardiac output measurements while subjects are undergoing fMRI or MRI scanning procedures. The NICO100C-MRI incorporates a precision high frequency current source, which injects a small (4 ma rms) measurement current through the thoracic volume defined by the placement of a set of current source electrodes. A separate set of monitoring electrodes then measures the voltage developed across the thorax volume. Because the current is constant, the voltage measured is proportional to the impedance characteristics of the thorax.

The NICO100C-MRI simultaneously measures impedance magnitude (Z_o ; labeled “Z” on the module) and derivative (dZ/dt ; labeled “DZ” on the module). Z_o and dZ/dt are recorded at a stimulation frequency of 50 kHz.

For operation, the NICO100C-MRI typically connects to the MECMRI-NICO Cable/Filter set. This set incorporates a shorter (2 meter), control room, cable (MECMRI-2) that connects the NICO100C-MRI to the patch-panel-attached MRIRFIF-3 Pi filter. The other side of this filter pokes through the patch panel to the chamber room where a longer (8 meter), chamber room, cable (MECMRI-1) connects between the patch panel filter and the subject electrode leads (four CBL204-MRI “Y” electrode lead adapters that connect to eight LEAD108B and/or LEAD108C carbon composition unshielded electrode leads terminating in 1.5 mm Touchproof sockets).

The NICO100C-MRI is typically used with EL508 disposable carbon composition (MRI conditional to 7T) electrodes but can function with other electrode types too.

For injecting current and averaging voltage at four paired-electrode sites (often required for cardiac output measurements), use four CBL204-MRI 1.5 mm Touchproof “Y” electrode lead adapters and eight LEAD108B and/or LEAD108C electrode leads with each NICO100C-MRI. One electrode lead is attached to each 508 electrode, with electrode lead pairs coupled together using the CBL204-MRI 1.5 mm Touchproof “Y” electrode lead adapter.

IMPORTANT: BIOPAC recommends that the shortest electrode leads possible are used for fMRI or MRI.

In this situation, due to the anatomical shape of the thorax, the best placement for all eight electrodes is along the frontal plane (wider dimension). When directed through the thorax, the measurement current seeks the shortest and most conducting pathway. Consequently, the measurement current flows through the thoracic aorta and vena cava superior and inferior.

Use the CH SELECT switch bank to assign NICO100C-MRI output (Z_o and dZ/dt) channels as follows:

Bank	Magnitude (o)	Derivative (d /dt)
1	Channel 1	Channel 9
2	Channel 2	Channel 10
3	Channel 3	Channel 11
4	Channel 4	Channel 12

If the particular NICO100C-MRI output is not used, the respective assigned channel cannot be used for another module’s output; users should simply not record on the unwanted but assigned channel.

MRI Cabling

When using NICO100C-MRI the MECMRI-NICO Cable/Filter Set is recommended. This cable set is identical to MECMRI-BIOP but incorporates a different five-line Pi filter set (MRIRFIF-3).

Grounding

When using the NICO100C-MRI amplifier with other biopotential amplifiers attached to the same subject, it’s not necessary to attach the ground lead from the biopotential amplifier(s) to the subject. The subject is already appropriately referenced to the subject via the attachment to the NICO100C-MRI. If a biopotential ground is attached to the subject, then currents sourced from the NICO100C-MRI will be split to the biopotential amplifier ground lead, potentially resulting in measurement errors.

Derivative Polarity – NICO100C vs. EBI100C

The NICO100C-MRI module incorporates an internal, hardware-based, derivative function, which outputs dZ/dt simultaneously with Z_o (impedance magnitude).

When used with *AcqKnowledge*, this internal derivative function outputs the inverted mathematically accurate dZ/dt signal so that it displays a positive-going peak, coincident with negative slopes indicated in Z_o , as per academic research convention. The dZ/dt polarity can be inverted to record as a negative-going pulse, if required, by simply inverting the scaling in the associated analog input channel DZ in *AcqKnowledge*.

The EBI100C does not include an internal, hardware-based, derivative function for the Z (impedance magnitude) channel. An *AcqKnowledge* calculation channel can be used to determine dZ/dt , if required.

Channel scaling can be employed to specify the dZ/dt polarity desired.

NICO100C-MRI Specifications

Number of Channels:	2 – Magnitude (Z_o) and dZ/dt
Operational Frequencies:	50 kHz
Current Output:	4 mA (rms)—constant sinusoidal current
Outputs:	MAG of Impedance: 0-100 Ω dZ/dt of Impedance: 2 (Ω/sec)/V
Output Range:	± 10 V (analog)
Maximum Over-Voltage for Differential Input:	± 25 V
CMIV, referenced to:	Amplifier ground: ± 10 V Mains ground: ± 1500 VDC
Signal Source:	Electrodes (requires 8 LEAD108B and/or LEAD108C electrode leads)
Gain Range:	MAG: 10, 5, 2, 1 Ω/V dZ/dt : 2 (Ω/sec)/v constant (independent of MAG Gain)
LP Filter:	MAG: 10 Hz, 100 Hz dZ/dt : 100 Hz
HP Filter:	MAG: DC, 0.05 Hz dZ/dt : DC coupled
Sensitivity:	MAG: 0.0025 (Ω) rms @ 10 Hz bandwidth dZ/dt : 0.005 (Ω/sec) rms @ 10 Hz bandwidth
Weight:	370 g
Dimensions:	4 cm (wide) x 11 cm (deep) x 19 cm (high)
Input Connectors:	Five 1.5 mm male Touchproof sockets (Output, V_{in+} , Ground, V_{in-} , Input)
Hardware Interface:	MECMRI-NICO to MP160/150 System

Possible NICO100C-MRI Lead Configurations

Setup Type	Amplifier	MEC	Lead	Adapter	Electrode
Simulated Equipotential <i>Absolute measures</i>	NICO100D <i>optimal</i>		LEAD132		4 x EL500
	NICO100D <i>optimal</i>	MEC104D	LEAD132		4 x EL500
	NICO100D		LEAD131		4 x EL503
	NICO100D	MEC104D	LEAD131		4 x EL503
	NICO100C	1 x MEC110C	8 x LEAD110	4 x CBL204	4 x EL500
	NICO100C		8 x LEAD110A	4 x CBL204	4 x EL500
	NICO100C-MRI <i>optimal</i>	1 x MECMRI-NICO	8 x LEAD108C	4 x CBL204-MRI	4 x EL508
	BN-NICO <i>optimal</i>		2 x BN-EL50-LEAD4		4 x EL500
Fully Equipotential <i>Absolute measures</i> Uses ICG strip conductor, circumferential, cardiographic electrode tape (ICG Tape)	NICO100C <i>optimal</i>	1 x MEC110C	4 x LEAD140		ICG Tape
	BN-NICO <i>optimal</i>		2 x BN-EL50-LEAD2		ICG Tape
Non-Equipotential <i>Relative measures</i> Suitable for establishing timing relationships between waves	NICO100D		LEAD131		2 x EL500
	NICO100D	MEC104D	LEAD131		2 x EL500
	NICO100C	1 x MEC110C	4 x LEAD110		2 x EL500
	NICO100C		4 x LEAD110A		2 x EL500
	NICO100C		1 x LEAD130		2 x EL500
	NICO100C-MRI	1 x MECMRI-NICO	4 x LEAD108C		4 x EL508
	BN-NICO		2 x BN-EL45-LEAD2		2 x EL500

TSD114-MRI RESPONSE/HAND FORCE TRANSDUCER FOR MRI



The TSD114-MRI consists of a pump bulb (RXPUMPBULB-MRI), pressure transducer (TSD104A equivalent, terminated in DSUB9), and tubing (AFT30-XL). Subjects can squeeze the bulb by hand or apply pressure via foot, thigh, etc. to indicate a response while in the MRI.

The output of the TSD114-MRI device is ultimately voltage. The device provides a output voltage which moves in a linear fashion with respect to applied pressure in the squeeze bulb. To obtain usable voltage output, the device requires amplification via BIOPAC's DA100C.

The device has high accuracy for pressure measurements, on the order of $\pm 1\%$. It's based on pneumatic principles of operation. It comes equipped with a 10 meter polyethylene tube; additional polyethylene tube extensions are available from BIOPAC.

To use the TSD114-MRI with a third-party A/D converter, use DA100C and IPS100C.

DA100C amplifies and conditions the mV level signal coming from TSD114-MRI

IPS100C will supply isolated power to DA100C

High level output voltage (anywhere in the range of ± 10 V, such as 0-5 V) can be obtained via the front panel of IPS100C, via 3.5 mm phono plug. This signal can be directed straight to the third-party A/D converter.

MRI Use: MR Safe

TSD114-MRI Components: Bulb: Polyvinyl Chloride, Tubing: Polyethylene (polymerized urethane), Connection barb: Nylon

TSD114-MRI Specifications

Pump Bulb: Rubber bulb with endcap for connection to the pressure transducer

Transducer: Equivalent to TSD104A

Maximum Diameter: 5.8 cm

Length: 11.1 cm

Sensitivity: 5 μ V per mmHg (for 2 V excitation)

- Used with the DA100C with factory CAL 2 V excitation, sensitivity is 10 μ V per mmHg
- Set for DA100C at $A_v = 1000$, sensitivity at MP160/150 is 10 mV per mmHg
- The MP160/150 can resolve to 300 μ V, so the system can resolve (.3 mV)/(10 mV/mmHg) or 0.03 mmHg
- To increase sensitivity, increase the excitation voltage up to 10 V (contact BIOPAC)

Tubing: See AFT30-XL

TSD121B-MRI HAND DYNAMOMETER FOR MRI



- Terminates in DSUB9 and **requires MECMRI-DA** for proper operation.

Use to measure clench force in the MRI. The lightweight, ergonomically designed transducer provides direct readings in kilograms-force or pounds-force. Use in isolation or combine with EMG recordings for in-depth studies of muscular activity. The isometric design improves experiment repeatability and accuracy. The TSD121B-MRI has an 8 meter cable terminated for connection to the MECMRI-DA. Trace conductive parts (metallic parts) of transducer do not make contact to the subject.

MRI Use: MR Conditional to 7T

Note: Conductive parts of transducer are electrically and thermally isolated from subject. The TSD121B-MRI has been employed repeatedly in 7T Siemens MAGNETOM, with SC72 gradient set, a maximum gradient amplitude of 70 mT/m, and a slew rate of 200 mT/m/ms. Tested sequences include EPI/DTI/MPRAGE. Studies include a 32-channel Nova Medical head coil. Proper operation was observed and no safety concerns were noted during these described circumstances.

Components: Transducer Body: Delrin®, Polyvinyl chloride (PVC) Plastic, Acrylonitrile Butadiene Styrene (ABS) Thermo-molded, Plastic, Polymer thick film device (rigid substrate, printed semi-conductor), Copper clad fiberglass lamination (PCB material), Stainless steel machine screws/nuts, Tinned copper wire, Silicone elastomer, PVDF (Kynar®) Heat Shrink Tubing

TSD121B-MRI SPECIFICATIONS

Isometric Range:	0-50 kgf
Nominal Output:	782 μ V/kgf (assumes DA100C VREF1 is set to +1 volt, the factory default)
Latency:	No material latency; any latency encountered will be a function of the DA100C filters used—the higher the lowpass selected, the smaller the delay
Weight:	323 g
Dimensions:	17.78 cm x 5.59 cm x 2.54 cm
Cable Length:	8 m
Interface:	MECMRI-DA to DA100C in control room

TSD121B-MRI CALIBRATION

Sample calibration values shown are for Gain 200 (per switch on the DA100C) and Range 20 kgf

1. Multiply Gain by Nominal Output: $200 * 782 \mu\text{V}/\text{kgf} = 0.1564 \text{ V}/\text{kgf}$.
2. Multiply the result by the Range: $0.1564 \text{ V} * 20 \text{ kgf} = 3.128 \text{ V}$ per 20 kgf range.
3. Plug the TSD121B-MRI into the cabling system/amplifier.
4. For **CAL1**: remove all weight from the TSD121B-MRI, press CAL1 to get the Input Value, and then enter 0 for Map (Scale) Value.
5. For **CAL2**: add 3.128 V (the result from step 2) to the CAL1 Input Value and enter it in the CAL2 Input Value, and then enter 20 kgf for the Map (Scale) Value.
6. Click **OK**.

In AcqKnowledge 4.1 and higher, you may alternatively use **Set Up Data Acquisition > Channels > Add New Module**. Choose DA100C as the module type. Choose the correct physical channel switch position and select the TSD121B-MRI from the transducer list. Then follow the calibration prompts.

TSD121B-MRI COMPRESSIVE FORCE PROFILE

The following chart depicts the compressive force curve of the TSD121B-MRI; (how the dynamometer behaves at different forces). Force was applied to the center of the handle.

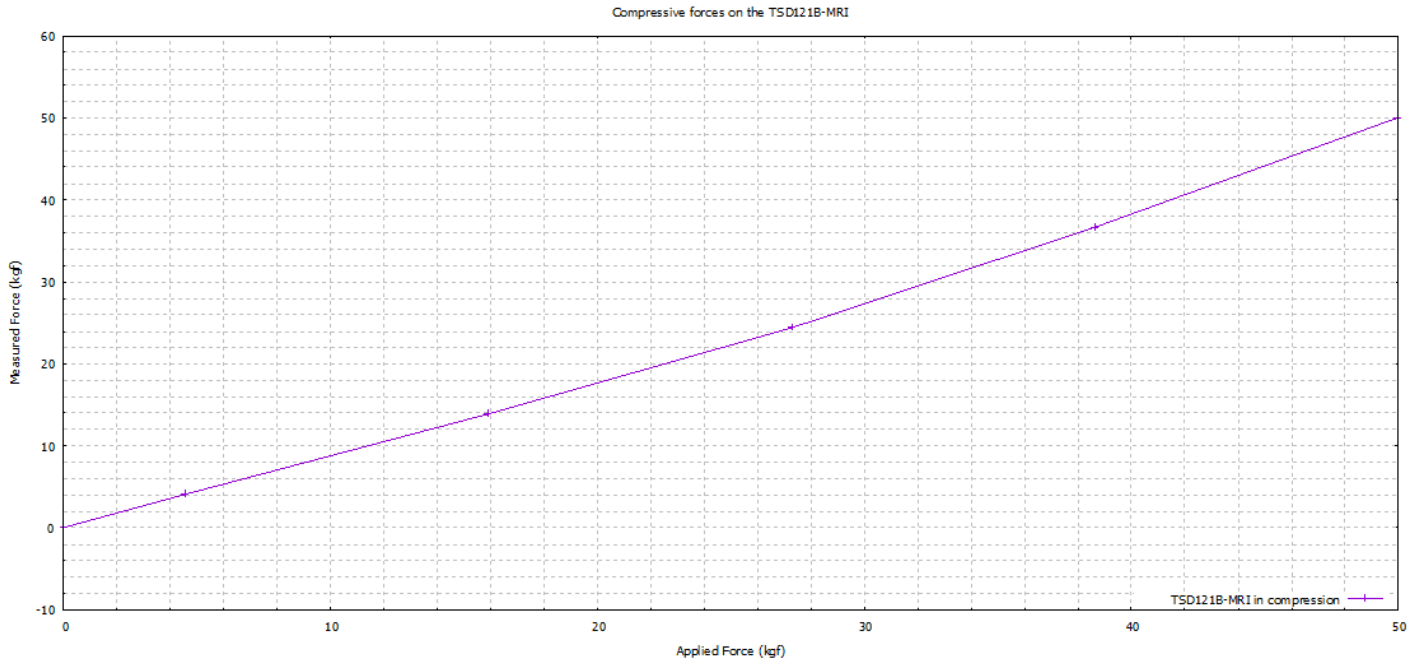

NOTE: See Hardware Guide Appendix for TSD121B-MRI hysteresis specification and response diagram.

TSD131-MRI FINGER TWITCH TRANSDUCER FOR MRI

The TSD131-MRI transducers record finger twitch responses from human subjects in the MRI. The transducer conforms to the shape of the finger and attaches via Velcro straps. Trace conductive parts (metallic parts) do not make contact to the subject.

Palmar attachment recommended, with “UP” label facing out:

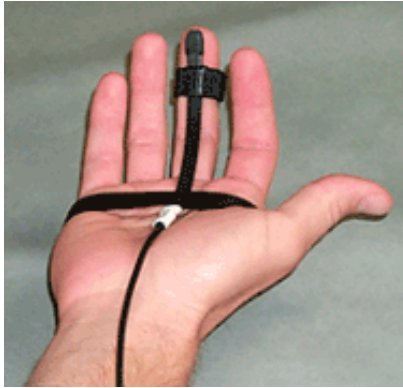

Palmar attachment recommended – “UP” label facing out

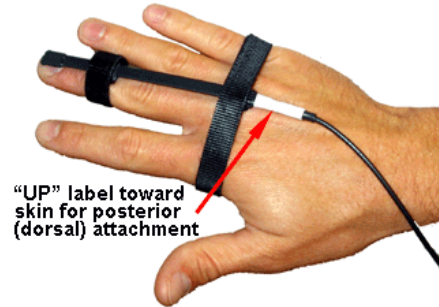

“UP” label toward skin for posterior (dorsal) attachment

If a protocol requires posterior (dorsal) attachment, “UP” label must be placed toward skin for optimum response.

MRI Use: MR Conditional to 3T

Note: Conductive parts of transducer are electrically and thermally isolated from subject.

Components: Polymer thick film device (flexible insulating substrate, printed conductor), Tinned copper wire, Silicone elastomer, PVDF (Kynar®) Heat Shrink Tubing

TSD131-MRI SPECIFICATIONS

Weight:	7 g
Dimensions (l x w):	14.6 cm x 0.50 cm
Cable Length:	8 m
Interface:	MECMRI-HLT to AMI100D or HLT100C

MRI CABLES

Use MECMRI Cables for [biopotential & transducer amplifiers](#) as specified when recording in MR environments.

MECMRI-1

This is a Biopotential or Transducer cable for use inside the MRI chamber room. It supports one to five subject or transducer electrical connections and is 8 meters long. The cable incorporates a plastic housed DSUB9 Male connector to panel mount with the chamber room exposed DSUB9 female connector of the MRIRFIF.



MRI Use: MR Conditional to 7T

Note: To collect physiological data, the MECMRI-1 cable DSUB-9 connector must be connected to the MRIRFIF filter on the patch panel. Electrode leads/electrodes employed should be carbon composition BIOPAC LEAD108/EL508 series. Transducers employed should be BIOPAC certified MR Conditional or MR Safe.

MECMRI-2

This is a Biopotential cable for use inside the MRI control room. It supports one to five subject electrical connections and is 2 meters long. The cable incorporates a plastic housed DSUB9 Male connector to panel mount with the control room exposed DSUB9 female connector of the MRIRFIF. This cable connects directly to any of the following biopotential amplifiers: ECG100C-MRI, EGG100C, EMG100C-MRI, EOG100C, EEG100C-MRI.



MECMRI-3

Transducer cable for use inside the MRI control room. It supports one to three-subject transducer connections and is 2 meters long. The cable incorporates a plastic housed DSUB9 Male connector to panel mount with the control room exposed DSUB9 female connector of the MRIRFIF. This cable connects directly to any of the following transducer amplifiers: PPG100C-MRI, RSP100C, SKT100C, EDA100C-MRI.

MECMRI-4 Note—One MECMRI-4 comes with the MECMRI-STIMISO setup kit.

This cable is used inside the MRI control room. It supports one channel of subject stimulator connection and is 2 meters long. The cable incorporates a plastic housed DSUB9 Male connector to panel mount with the control room exposed DSUB9 female connector of the MRIRFIF interference filter. This cable connects directly to any of the following stim isolation adapters: STMISOC, STMISOD, or STMISOE.

MECMRI-5 Note—One MECMRI-5 is included with the MECMRI-DA setup kit.

This 2-meter cable is used inside the MRI control room. It supports one channel of general-purpose transducer output and connects directly to the DA100C high-level transducer module and the MRIRFIF interference filter. Cable incorporates a plastic housed DSUB9 male connector to panel mount with the control room exposed DSUB9 female connector of the MRIRFIF interference filter.

MECMRI-8 Note—One MECMRI-8 is included with the MECMRI-AMI setup kit.

This cable is used inside the MRI control room. It supports one channel of high-level transducer output and is 2 meters long. The cable incorporates a plastic housed DSUB9 Male connector to panel mount with the control room exposed DSUB9 female connector of the MRIRFIF interference filter. This cable connects directly to the HLT100C or AMI100D high level transducer module.

MECMRI-9

The primary purpose of this cable is to permit use of three axis MRI accelerometers in the MRI.

This is an MRI compatible cable assembly : This cable connects between MRI-RFIF and HLT100C. This is three channel interface cable - 2 meters long. This part is a three channel version of MECMRI-8, which is a one channel cable between MRIRFIF and HLT100C or AMI100D. This cable will be used with the TSD109C2-MRI accelerometer.

NOTE: The MECMRI-6 and MECMRI-7 cables were discontinued in February of 2019. For current offerings, see MECMRI-8 (replaces 6) and MECMRI-9 (replaces 7), which support both HLT100C and AMI100D modules.

OXY-MRI

The OXY-MRI SpO2 amplifier is placed inside the MRI control room, the associated 9 meter fiber-optic sensor cable is passed through a waveguide (connecting control room to chamber room), and the finger sensor is attached to the subject in the MRI chamber room. No patch panel MRIRFIF connections are required because of the fiber-optic construction of the sensor cable.

MECMRI-OXY [Discontinued product](#)—Available by request for existing OXY100C users.

MRI Cable/Filter set for discontinued OXY100C Pulse Oximeter (see OXY100E or OXY-MRI).

MRIRFIF (COMBINATION FILTER)

MRIRFIF is a five-line Pi filter set, designed for interfacing between the MECMRI-1 chamber room cable and any of the MRI control room cables (MECMRI-2 to MECMRI-8).

See also: App Note 223 Physiological Measurements in Magnetic Resonance Imaging Systems Using BIOPAC Equipment.



1. **MRIRFIF:** -3 dB point = 100 kHz
2. **MRIRFIF-2:** -3 dB point = 1 MHz
3. **MRIRFIF-3:** -3 dB point = 500 kHz
4. **MRIRFIF + MRIRFIF-2** = -3 dB point = 70 kHz
 - attenuation is -60 db from 7 MHz to 1000 MHz
 - attenuation slope from 70 kHz to 7 Mhz is 30 dB per decade
5. **MRIRFIF-3 + MRIRFIF-2** = -3 dB point = 400 kHz
 - attenuation is -60 db from 7 MHz to 1000 MHz
 - attenuation slope from 400 kHz to 7 Mhz is 30 dB per decade

This Pi filter set has a dielectric withstand voltage of 1500 VDC and conforms to IEC 60601-1 requirements. The Pi filter set is designed to shunt RF energy from the MRI control or chamber room to EARTH GROUND without sacrificing CMRR performance for the recording of small valued biopotential or transducer signals.

MRIRFIF	DSUB 9 female				
Control Room side	1	2	3	4	5
Chamber Room side	5	4	3	2	1

The MRIRFIF’s symmetrical construction, with dual 9-pin female connectors, results in a pin swap for pins 1, 2, 3, 4, 5, regarding signal flow as illustrated above right:

Accordingly, if the MRIRFIF and associated cable assemblies (such as MECMRI-#) are used with any existing patch panel connectors, the existing connector must be a male/female 9-pin straight-through DSUB patch or filter connector. The male side of the existing connector must be on the Control room side to successfully connect the MRIRFIF to this connector.

Best performance is obtained by robustly attaching the GROUND of the MRIRFIF (metal enclosure) to EARTH GROUND at the junction panel. Mounting the MRIRFIF to the junction panel via the included L-bracket establishes an excellent ground to the panel. EARTH GROUND must be robust and held to the same potential as MAINS GROUND.

LEAKAGE CURRENTS

1. **MRIRFIF:** The IEC 60601-1 standard specifies a leakage current of 5 ma assuming double fault conditions. 265 VAC at 60 Hz will source 5ma into a reactance of 53 K. This reactance is equivalent to an effective subject capacitance to equipment ground of 0.05uF. The BIOPAC MP unit establishes a subject to ground capacitance of 0.005 uF. The Pi filter (MRIRFIF) incorporates a 0.002uF subject capacitance to ground (2 of 0.001 uF caps). Accordingly, even with 16 MECMRI cables (with 16 MRIRFIFs) this results in a capacitance of .037 uF, which is 74% of the IEC 60601-1 limit, assuming mains is 265 VAC at 60 Hz.

2. **MRIRFIF-2:** This filter has a dielectric withstand voltage of 1500 VDC and is compatible with IEC 60601-1 requirements. The filter is designed to shunt RF energy from the MRI or control room chambers to EARTH GROUND without sacrificing CMRR performance for the recording of small valued signals.

- MRIRFIF-2: -3 dB point = 1 MHz

The MRIRFIF-2 (nine-line Pi filter) is normally attached to the MRIRFIF to create a cascaded Pi filter for superior EMI rejection. The MRIRFIF-2 is also designed for interfacing between MRI chamber room specialty cable (such as with NICO100C-MRI) and the MRI control room cable.

If the specialty cable set is used with an existing patch panel connector, the MRIRFIF-2 should be plugged into the Control Room side of the patch panel connector, which must be a male/female 9-pin straight-through DSUB patch or filter connector. The male side of the existing connector must be on the Control room side to successfully connect to the MRIRFIF-2 and specialty cable.

Best performance is obtained by robustly attaching the GROUND of the MRIRFIF-2 (metal enclosure) to EARTH GROUND at the junction panel. Mounting the MRIRFIF-2 to the junction panel establishes an excellent ground to the panel. EARTH GROUND must be robust and held to the same potential as MAINS GROUND.

The IEC 60601-1 standard specifies a leakage current of 5 ma assuming double fault conditions. 265 VAC at 60 Hz will source 5 ma into a reactance of 53 K. This reactance is equivalent to an effective subject capacitance to equipment ground of 0.05 uF. The BIOPAC MP unit establishes a subject to ground capacitance of 0.005 uF, and the Pi filter (MRIRFIF-2) incorporates a 0.001 uF subject capacitance to ground. Accordingly, even with 16 MECMRI cables with 16 MRIRFIFs, this results in a capacitance of 0.021 uF, which is 42% of the IEC 60601-1 limit, assuming mains is 265 VAC at 60 Hz.

3. **MRIRFIF + MRIRFIF-2 & MRIRFIF-3 + MRIRFIF-2:** The IEC 60601-1 standard specifies a leakage current of 5 ma assuming double fault conditions. 265 VAC at 60 Hz will source 5 ma into a reactance of 53 K. This reactance is equivalent to an effective subject capacitance to equipment ground of 0.05 uF. The BIOPAC MP unit establishes a subject to ground capacitance of 0.005 uF. The Pi filter set (MRIRFIF + MRIRFIF-2) incorporates a 0.003 uF subject capacitance to ground. Accordingly, even with 15 MECMRI cables—with 15 MRIRFIFs—this results in a capacitance of .05 uF, which is 100% of the IEC 60601-1 limit, assuming mains is 265 VAC at 60 Hz.

MRIRFIF DIMENSIONS (ALL DIMENSIONS IN MM)

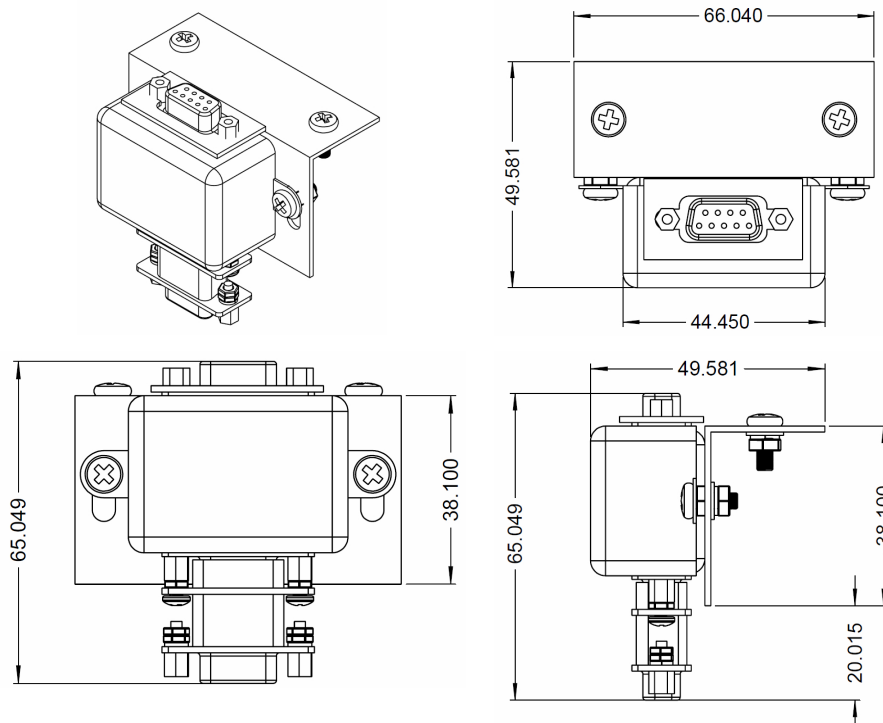

MRI CABLE SETS

MECMRI-xxxx cable systems for MRI applications. Cables must be attached to the MRI patch panel according to BIOPAC’s instructions; see web for diagrams. These cable sets include a five line Pi filter set, designed for interfacing between the MECMRI-1 chamber room cable and any of the MRI Control room cables (MECMRI-2 to MECMRI-6).

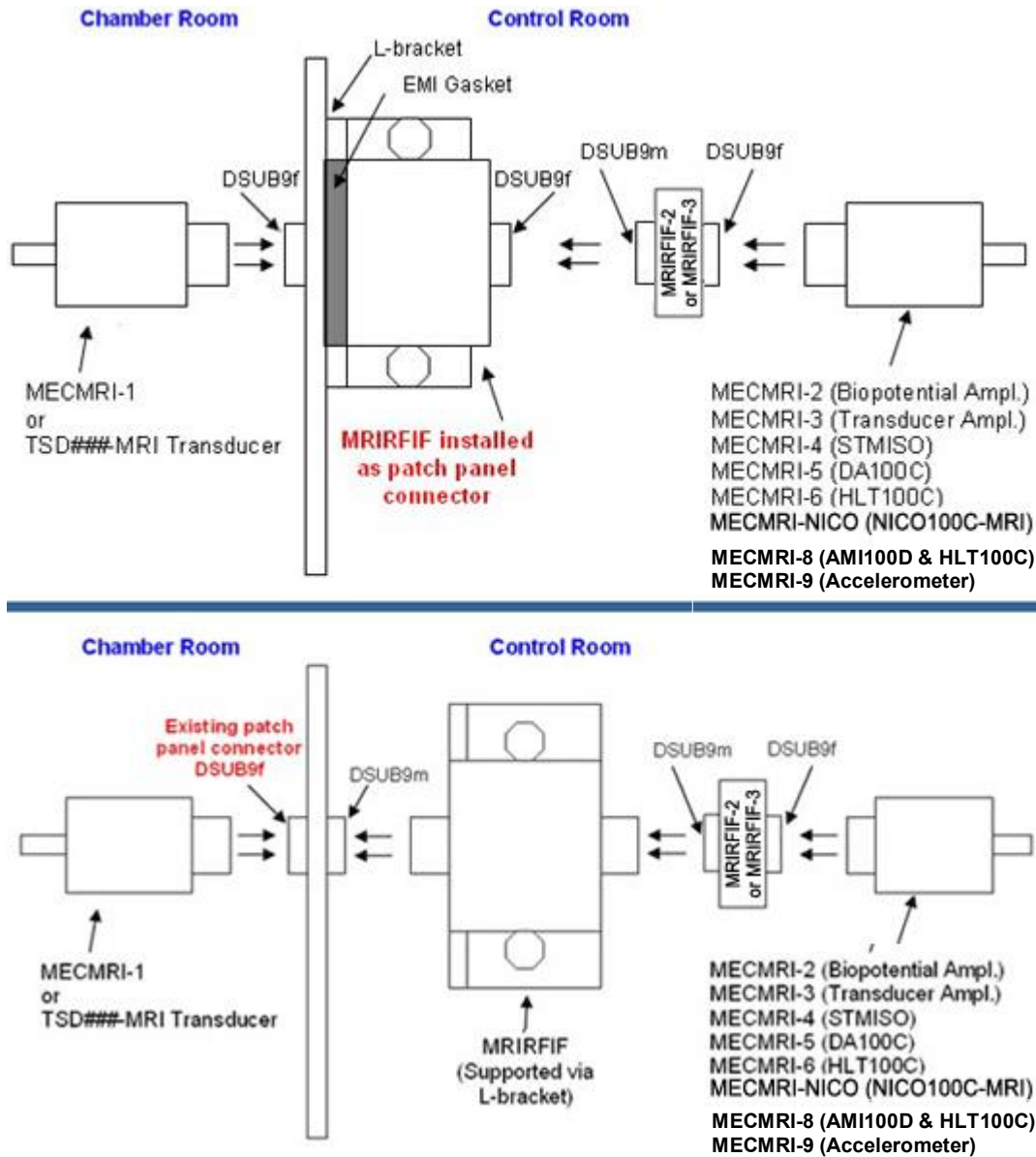

MRI Use: **MR Conditional to 7T**

Note: The MRIRFIF + MRIRFIF-2 Pi filter must be on the control room side of the patch panel. Conductive parts of cable are electrically and thermally isolated from subject.

MECMRI-xxx components—MRI chamber room cable only:

Tinned copper wire (99.99% pure copper), Polyvinyl chloride (PVC) plastic, Acrylonitrile Butadiene Styrene (ABS) Thermo-molded, Plastic, Solder (non-magnetically susceptible RoHs compliant), Copper clad fiberglass lamination (PCB material), Tinned copper connectors

MRI CABLE/FILTER SETS TABLE

The following table illustrates the components of each cable/filter set. See table for full descriptions of each included cable and filter.

CABLE/FILTER SETS	MRIRFIF	MRIRFIF-2	MRIRFIF-3	MECMRI-1	MECMRI-2	MECMRI-3	MECMRI-4	MECMRI-5	MECMRI-8	MECMRI-9
MECMRI-DA — For recordings with a transducer in the MRI chamber room and the DA100C in the MRI control room. Use to connect directly to the following transducers: Medium Flow Pneumotach (TSD117-MRI,) Hand clench dynamometer (TSD121B-MRI,) or arterial pressure TSD104A-MRI.	X							X		
MECMRI-AMI — For recordings in the MRI with the AMI100D or HLT100C. Use to connect directly to the following transducers: TSD115-MRI, TSD131-MRI, or TSD109C2-MRI accelerometer.	X								X	X
MECMRI-OXY — Use to connect to the OXY100C Pulse Oximeter and TSD123A/B Oximetry transducers for MRI applications. (Discontinued)		X								
MECMRI-STMISO — Use to connect directly to the following stim isolation adapters: STMISOC, STMISOD, or STMISOE.	X			X			X			
MECMRI-TRANS — For Transducer recordings in the MRI. Use to connect directly to the following transducer amplifiers: PPG100C-MRI, RSP100C*, SKT100C*, or EDA100C-MRI. Connection Sequence: Subject to transducer to MECMRI-1 to MRIRFIF to MECMRI-3 to transducer module. *These amplifiers can be used for MRI measurements.	X			X		X				
MECMRI-BIOP — Component set for Biopotential recordings in the MRI. Use to connect directly to any of the following biopotential amplifiers: ECG100C-MRI, EEG100C-MRI, EGG100C*, EMG-100C-MRI or EOG100C*. Connection Sequence: Subject to electrodes to leads to MECMRI-1 to MRIRFIF to MECMRI-2 to Biopotential Module. *BIOPAC can customize these amplifiers for use in MRI.	X			X	X					
MECMRI-NICO — Component (Cable/Filter) set for noninvasive cardiac output recordings in the fMRI and MRI. Use to connect directly to the NICO100C-MRI amplifier. Connection Sequence: Subject to electrodes to leads to MECMRI-NICO to NICO100C-MRI.		X	X	X	X					
PNEUMATIC LINES — No electrical MRI Cable/Filter required – use DA100C. TSD110-MRI, TSD114-MRI, TSD137 series, TSD221-MRI, TSD237 series (for animal.)										

DTU100 DIGITAL TRIGGER UNIT

Digital Trigger (MRI Trigger)

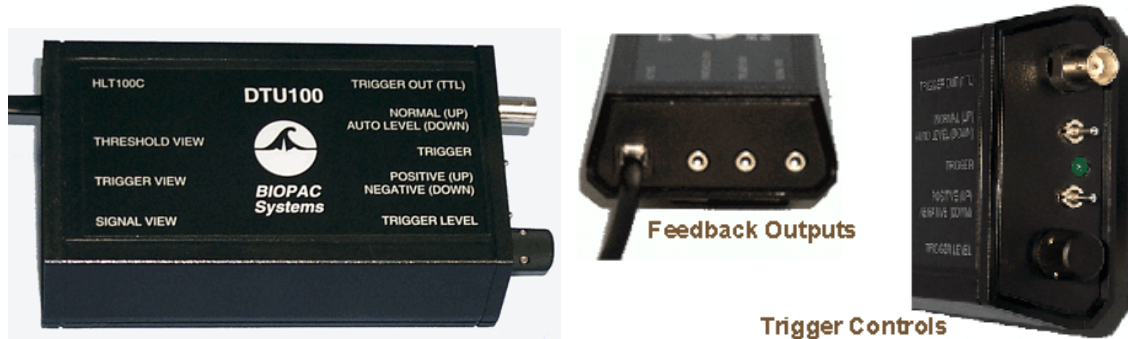

Use the DTU100 Digital Trigger Unit to trigger an MRI System with the occurrence of the R-wave present in human or animal (high frequency) ECG data. The DTU100 provides high-level (3000 V) isolation between the MP System and external equipment; the DTU100 is always used with the AMI100D or HLT100C module. This isolation is very important to maintain both subject safety and high quality signal recording. This external hardware module can accept data from any analog output associated with an MP System and convert that analog signal into a TTL compatible trigger suitable for synchronizing with external devices.

For the DTU100, “Analog output” means:

- 1) Analog output associated with any MP module (DA100C, ECG100C, etc) that is sending data to an MP System on Analog Input channels 1–16.
- 2) Analog output coming from the MP system via one of its D/A converters on Analog Output channel 0–1.

SYNCHRONIZATION

To synchronize an MRI System with the occurrence of the R-wave, record human or animal (high frequency) ECG data on an ECG100C amplifier and direct the output to an analog input channel on the MP160/150 Unit.

- a) Connect the DTU100 RJ11 cable to the AMI100D/HLT100C channel that is sourcing the ECG analog signal. For example, if acquiring ECG waveform on Channel 2, connect DTU100 RJ11 to channel 2 on the AMI100D/HLT100C.
- b) To monitor signals in *AcqKnowledge*, use CBL100 cables to CBL122 adapter to connect the Threshold, Trigger and/or Signal View to unused analog channel inputs on the AMI100D/HLT100C.
- c) Connect the Trigger Out (TTL) line to the MRI system requiring synchronization to the R-wave of the ECG.
- d) If the R-Wave is a clearly defined peak, run the DTU100 in Normal mode. If the R-wave is not always predominant, consider operating the DTU100 in Auto Level mode, or change the location of ECG leads on the subject to obtain a better-defined R-wave peak.
- e) Adjust the Trigger Level potentiometer to obtain a Trigger Signal. Change the Trigger Out polarity to Positive or Negative as required for the MRI equipment. Verify proper operation by noting the periodic lighting of the green Trigger LED. This LED should light briefly whenever the R-wave is detected.

DTU100 CONTROLS

AMI100D/HLT100C The DTU100 is always used with the AMI100D/HLT100C module. Use the RJ-11 straight through cable provided by BIOPAC to plug the DTU100 into the AMI100D/HLT100C.

Feedback Views The DTU100 incorporates three feedback outputs that can be monitored on the MP System to properly set the threshold (trigger) level and required Trigger Out polarity for any type of analog input. Connect a 3.5 mm mono phono cable (CBL100) to a CBL122 (mono-to-RJ11) adapter to connect the respective line to an unused MP system input channel.

Threshold View Shows the Threshold (Trigger) Level

Trigger View Shows the Trigger Output as sent to the external equipment.

Signal View Shows the analog input signal as sent to the DTU100.

Trigger Out Connect a TTL line with BNC female connector between the DTU100 and the trigger device.

Normal/Auto Level The DTU100 incorporates an optional Automatic Level control circuit. The Automatic Level control circuit will expand or compress the analog input signal to fit inside of a ± 5 V range.

- Normal — use if the analog input signal is clearly defined.
- Auto Level — use if the analog input signal has a widely varying baseline or significant change in amplitude from one desired trigger point to the next; or to try to improve signal definition.

Trigger The Trigger LED (green) lights up whenever the Trigger Out signal goes high.

Positive/Negative If analog data is above the threshold setting the DTU100 output can be set to either high (+5 V) or low (0.0 V). When analog data drops below the threshold value the output will be the opposite level.

Trigger Level Select a trigger level (or threshold) that will fire when analog data reaches that threshold.

See also: DTU200/300 Systems

ECG-GATE-CARDRESP-E/EL: COMPLETE DUAL CHANNEL GATING SYSTEMS

ECG-GATE-CARDRESP-E with DTU200

ECG-GATE-CARDRESP-EL with DTU300

This system provides the cardiac trigger via an electrocardiogram amplifier and includes an MP160/150 data acquisition & analysis system, dual channel cardiac respiratory gating system, and appropriate amplifiers, transducers, cables, electrodes, and leads.

The **MRI Smart Electrocardiogram Amplifier** ([ECG100C-MRI](#)) records electrical activity generated by the heart and will reliably record ECG from humans or animals. The amplifier output can be switched between normal ECG output and R-wave detection. The R-wave mode outputs a smoothed pulse with the occurrence of each R-wave. The exact timing of the R-wave is detected even under conditions of extreme signal artifact.

The **Respiration Transducer** ([TSD110-MRI](#)) requires no electrical connections inside the chamber and works on a number of body locations. The multipurpose assembly can be used to noninvasively measure pulse, respiration—from a small mouse to a human, small pressing forces (like pinching fingers together) for Parkinson's evaluations, human facial expressions (smiling, frowning, etc.), spacing and pressure between teeth coming together, or startle blink response.

The **dual channel gating system** ([DTU200](#) in -E or [DTU300](#) in -EL) works for small animal and human MRI applications. It sends cardiac trigger pulses to the MRI when a respiration signal is in the quiet phase. Additional filters and gain controls further refine the quality of the signal and ensure reliable triggering.

AcqKnowledge includes automation tools for artifact frequency removal, artifact projection removal, median filter artifact removal, and signal blanking.

System includes:

- MP160/150 Data Acquisition & Analysis System with *AcqKnowledge* software (for Windows or Mac)
- ECG100C-MRI Electrocardiogram Amplifier
- MECMRI-BIOP MRI Cable/Filter Set to Biopotential Amplifiers
- LEAD108B (x 3) Radiotranslucent Clip Lead—unshielded, 15 cm
- EL508 (100/pk) Disposable Radiotranslucent Electrodes (Human)
or
- EL510 (20/pk) Disposable Radiotranslucent Electrodes (Animal)
- TSD110-MRI Respiration Transducer
- DA100C General-purpose Transducer Amplifier
- Dual Channel Cardiac Respiratory Gating System
 - DTU200 with GATE-CARDRESp-E
 - DTU300 with GATE-CARDRESP-EL

DTU200/300 DUAL CHANNEL GATING SYSTEMS

DTU200 for small animal

DTU300 for human/large animal

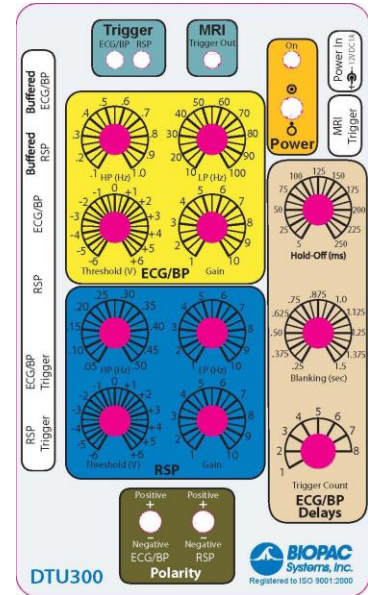
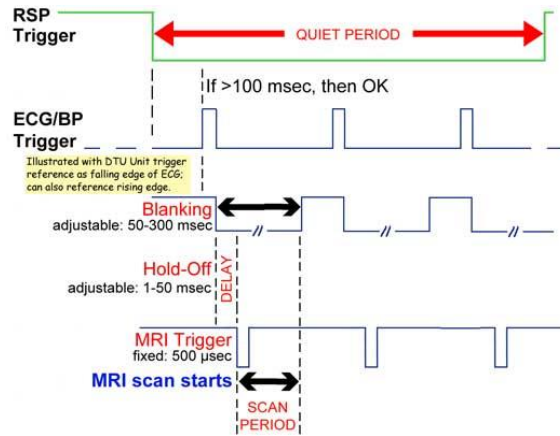
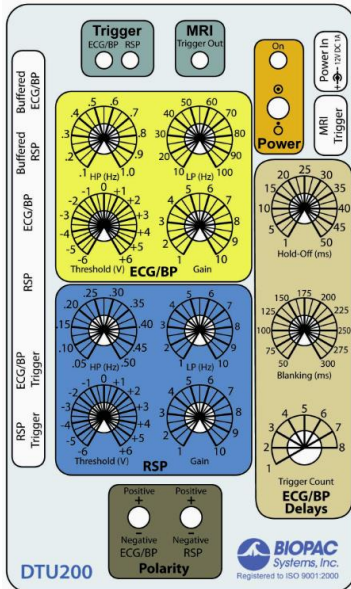

DTU200 and DTU300 dual channel gating systems for MRI applications send cardiac trigger pulses to the MRI when a respiration signal is in the quiet phase. Pre-processing filters and gain controls further refine the quality of the signal and ensure reliable triggering.

The system requires two analog input signals:

1. **Cardiac signal** – ECG, BP or Pulse from Electrocardiogram Amplifier (ECG100C/ECG100C-MRI), Micro Pressure Measurement System MPMS200 + TSD283), or Pulse Oximetry System (OXY300-MRI).
2. **Respiration signal** – small animal respiration pad (TSD110-MRI + DA100C General Purpose Transducer Amp) or human respiration transducer (TSD201 + RSP100C + MECMRI-TRANS).

Cardiac phase

- **Threshold:** The ECG or Blood pressure signal passes through a user selectable threshold that creates a square wave (0-5 volt) cardiac trigger signal.
 - **R-wave or BP signal crosses the threshold in both directions to initiate the MRI trigger signal pulse.**
- **Hold-Off:** A delay control allows precise timing of the trigger signal pulse relative to the rising or falling edge of the ECG R-wave (DTU200: 1-50 msec; DTU300 5-250 msec).
- **Blanking:** A blanking control, initiated on the falling edge of the first accepted ECG in the quiet period, provides a time discriminator (DTU200: 50-300 msec; DTU300: 250-1,500 msec) that prevents the DTU system from falsely triggering on an MRI-corrupted ECG signal.
- **Monitoring:** cardiac trigger channel is available for monitoring purposes using a BNC to 3.5mm cable (CBL102 and CBL122 adapter*, included). BIOPAC recommends monitoring this signal with the MP160/150 data acquisition and analysis system.

Respiration

- **Threshold:** The respiratory system also passes through a similar threshold to create a square wave when the signal crosses the threshold in both directions. The quiet period is user-selectable to be the interval between rising and falling edges or falling and rising edges of the RSP signal.
- **Monitoring:** This signal is available for monitoring purposes using a BNC to 3.5 mm cable (included) CBL102 and CBL122 adapter*. BIOPAC recommends monitoring this signal with the MP160/150 data acquisition and analysis system.

*MP150 users with UIM100C module should connect CBL102 directly to the UIM100C and do not need the CBL122 adapter. M160 users with AMI100D or HLT100C must connect CBL102 to the CBL122 and connect the RJ11 end of CBL122 to the AMI100D/HLT100C.

Signal Conditioning

- **Cardiac** Gain: 1-10 Low Pass Filter: 10-100 Hz High Pass Filter: 0.1-1 Hz
- **Respiration** Gain: 1-10 Low Pass Filter: 1-10 Hz High Pass Filter: 0.05-0.5 Hz

Output Controls

The MRI trigger channel only outputs a cardiac trigger when the respiration trigger channel goes into the quiet period, which occurs when the animal is between breaths and still. The system will output a precise number of cardiac triggers between each respiratory period by adjusting the trigger count control (1-8). Cardiac cycles are only considered if they occur >100 msec after the respiration trigger goes into the quiet period. If there isn't enough time to complete the required number of triggers, the unit will stop and wait for the next quiet period before starting a new count. For example, if the counter is set to output 5 triggers, but there is only enough time to send 4, the unit will ignore the fifth trigger and wait for the next quiet period before starting the count again.

Signal Monitoring

There are outputs for the cardiac and respiration conditioned signals (available at BNC ports: Buffered ECG/BP and Buffered RSP) and the respective triggers. The conditioned signals are in the ± 10 volt level range and trigger outputs are 0-5 volts. Seven BNC to 3.5 mm monitoring cables (CBL102) and CBL122 adapters* are included.

Compatibility

The unit will interface with either a BIOPAC MP160 or MP150 system. It will also work with third-party amplifiers and data acquisition systems that operate in the ± 10 volt range.

DTU200/300 Specifications

Inputs	ECG/BP RSP MRI Trigger	ECG /BP Trigger RSP Trigger Pulse width 500 μ sec, active low	Buffered ECG/BP Buffered RSP
Analog Signal Controls	ECG/BP	RSP	
	High-pass filter	0.1 – 1.0 Hz	0.05 – 0.5 Hz
	Low-pass filter	10 – 100 Hz	1 – 10 Hz
	Threshold	-6 to +6 V	-6 to +6 V
	Gain Range	1 – 10	1 – 10
Polarity	ECG/BP/RSP	+ (pos, up) or - (neg, down)	
ECG/BP Delays	Hold-Off	DTU200: 1 - 50 ms, DTU300: 5-250 ms	
	Blanking	DTU200: 50 -300 ms, DTU300: 250-1,500 ms	
	Trigger Count	1 – 8	
Status LED	Trigger	ECG/BP red	RSP red
	MRI Trigger Out	green	
	Power	yellow	
Power	Switch	ON (up), OFF (down)	
	Supply	12 V DC 1 A	

Blood Pressure Gating—Complete Systems

- Provide the cardiac trigger via a micro pressure measurement system

GATE-CARDRESP-E for small animal (DTU200) **GATE-CARDRESP-EL** for human or large animal (DTU300)

Includes:

- Dual Channel Cardiac Respiratory Gating System: DTU200 (-E) DTU300 (-EL)
- MP160/150 Data Acquisition & Analysis System with *AcqKnowledge* software (for Windows or Mac)
- TSD110-MRI Respiration Transducer (transducer, sensor, and tubing)
- DA100C General-purpose transducer amplifier
- Electrocardiography Amplifier ECG100C-MRI with leads and electrodes

OXY-MRI – SpO₂ MODULE WITH SENSOR FOR HUMAN MRI

MRI Use: MR Conditional

Condition: Must use MR finger sensor and max MR field strength 3T; module stays in control room.

OXY-MRI is a stand-alone system for adult human pulse oximetry (SpO₂) in the MRI; it can also be used with a BIOPAC MP160/150 Research System.

The system includes a SpO₂ amplifier and a fiber-optic oximetry sensor for the finger, plus a signal isolation adapter [INISOA](#) and interface cables to connect to an existing BIOPAC AMI100D or HLT100C (high level transducer interface module) for MP Research Systems. Additional finger sensors are available as [OXY-MRI-SENSOR](#).



The SpO₂ amplifier is used in the MRI control room, the 9 m fiber-optic sensor cable is passed through the wave guide, and the finger sensor is attached to the subject in the MRI chamber room. MRI-rated to 3.0 Tesla.

! OXY-MRI is not intended for animal use.

SYSTEM COMPONENTS

System includes: SpO₂ amplifier and pulse oximetry sensor for stand-alone use, plus INISOA signal isolator and dSUB9 cable to connect SpO₂ amp analog out to INISOA for use with a BIOPAC Research System.



Note: When simultaneously recording biopotential signals from a subject, or for safety in cases when the system is electrically connected to the subject (for recording or stimulation,) a BIOPAC AMI100D or HLT100C (not included) is required in order to connect the INISOA to the MP160/150 unit. If more than one OXY-MRI signal is to be recorded using the AMI100D or HLT100C, an additional [INISOA](#) can be obtained by contacting BIOPAC. (Only one INISOA is included in the OXY-MRI system.)

If not recording biopotential signals, the OXY-MRI cable can be connected directly to the UIM100C.

SPECIFICATIONS

Oxygen Saturation Display Range: 0–100% SpO₂

Pulse Rate Range: 18–321 BPM

Saturation Accuracy (Arms): 70–100% ± 2 digits

Note: ± 1 Arms represents approximately 68% of measurements

Pulse Rate Accuracy:

no motion 18–300 BPM ± 3 digits

low perfusion 40–240 BPM ± 3 digits

Displays:

Pulse Strength: LED, Bar graph, tri-color segments

Alarm Indicator: LED, bi-color

Alarm Silenced: LED, amber

Numeric Displays: 3-digit, 7-segment LEDs, green

Low Battery: LED, amber

Analog Outputs:

SpO₂ Output Range: 0-1 VDC (0–100% SpO₂), 1.27 VDC (out of track)

Pulse Rate Output Range: 0-1 VDC (0–300 BPM), 1.27 VDC (out of track)

Event Marker: 0 V (no event), 1 V (event occurred)

Accuracy: ± 2% (SpO₂), ± 5% (Pulse Rate)

Load Current: 2 mA maximum

Memory: 70 hours (assuming continuous operation)

Temperature

Operating: 0° C to +40° C (32° F to 104° F)

Storage/Transportation: -30° C to +50° C (-2° F to 122° F)

Humidity

Operating: 10–90% noncondensing

Storage/Transportation: 10–95% noncondensing

Altitude

Operating: up to 12,000 meters (40,000 feet)

Hyperbaric Pressure: up to 4 atmospheres

Mains Power Requirements: 100–240 VAC 50–60 Hz

Internal Power Requirements

Battery: 7.2 volt NiMH battery pack

Operating Life (fully charged battery): 16 hours minimum

Storage Life: 21 days minimum

Recharge Rate: 4 hours maximum

Dimensions: Approximately 219 mm (8.6") W x 92 mm (3.6") H x 142 mm (5.6") D

Weight: Approximately 900 grams (2 lbs) with battery

Warranty: SpO₂ amplifier: 3 years; pulse oximetry sensor: 90 days

Classification per IEC 60601-1/CSA601.1/UL60601-1:

Type of Protection: Internally powered (on battery power)

Degree of Protection: Type BF-Applied Part

Mode of Operation: Continuous

Enclosure Degree of Ingress Protection: IPX2

ACQKNOWLEDGE CALIBRATION (AMI100D or HLT100C)

1. Launch *AcqKnowledge*. The “Add new module” dialog should appear. If it does not, choose “MP160/150 > Set Up Data Acquisition > Channels.”
2. Choose “AMI100D-A1 or HLT100C-A1” from the module list and choose “Add.”

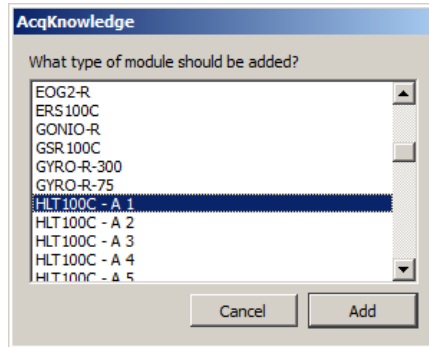

3. Select “OXY-MRI SPO2 Module Human-SPO2” from the “Transducer” list and click OK.

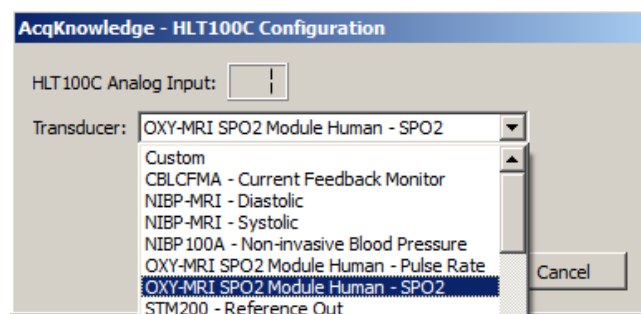

4. Follow the OXY-MRI SPO2 calibration and sensor prompts in order of appearance. (*AcqKnowledge* 4.4.2 and higher only.)

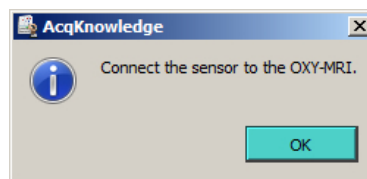
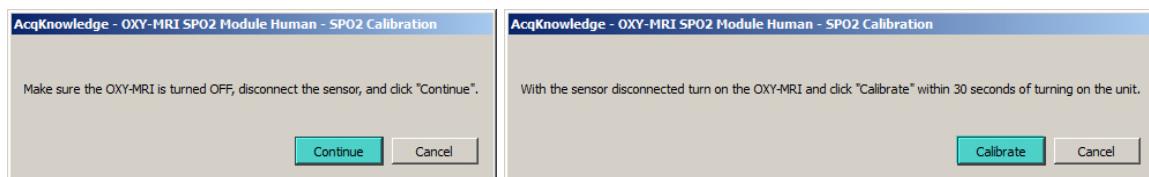

5. Choose “Add new module” and choose “AMI100D-A2 or HLT100C-A2” from the list and click “Add.”

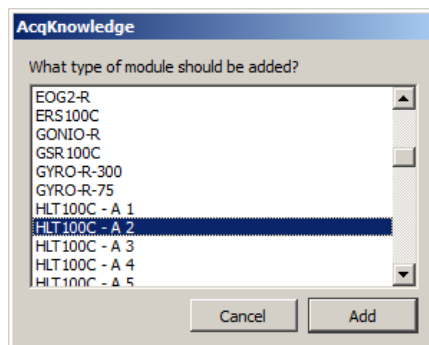

6. Select "OXY-MRI SPO2 Module Human-Pulse Rate" from the "Transducer" and click OK.

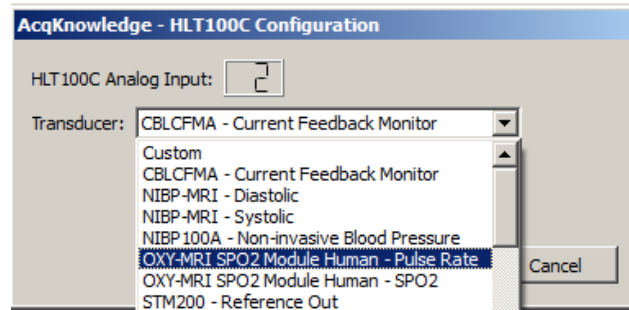

7. Follow the OXY-MRI Pulse Rate calibration and sensor prompts in order of appearance. (*AcqKnowledge* 4.4.2 and higher only.)

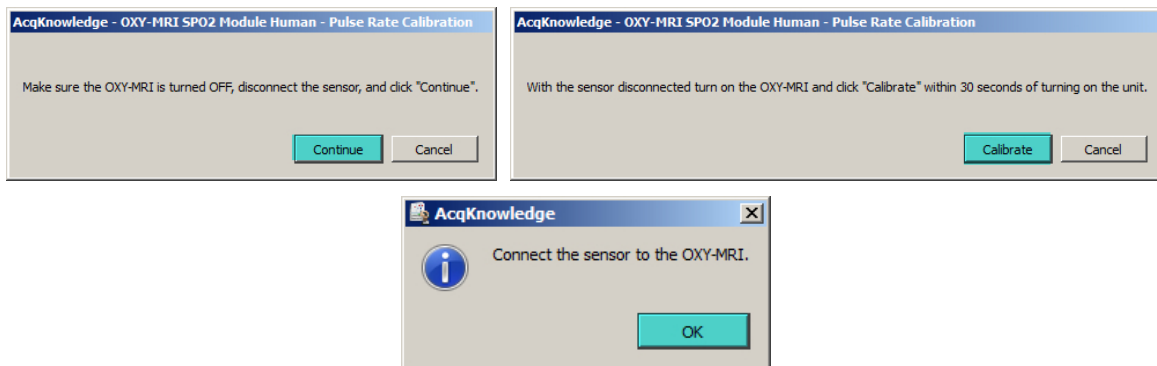

If the sensors are not properly connected, the following dialog will appear. Check the connections and click "Retry."

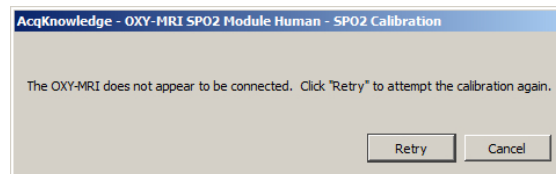

ACQKNOWLEDGE CALIBRATION (UIM100C)

1. Launch AcqKnowledge. The “Add new module” dialog should appear. If it does not, choose “MP160/150 > Set Up Data Acquisition > Channels.”
2. Choose “UIM100C-A1” from the module list and choose “Add.”

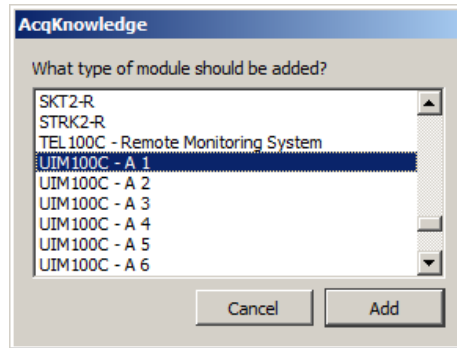

3. Choose “Custom” from the “Transducer” list and click OK to open the Scaling dialog.
4. Enter Cal 1, Cal 2, and Units Label as shown below and click OK.

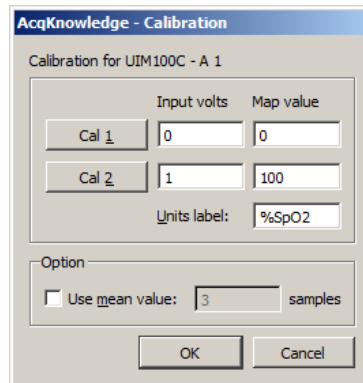

5. Choose “Add new module” and choose “UIM100C-A2” from the module list, and click “Add.”
6. Choose “Custom” from the “Transducer” list and click OK to open the Scaling dialog.
7. Enter Cal 1, Cal 2, and Units Label as shown below and click OK.

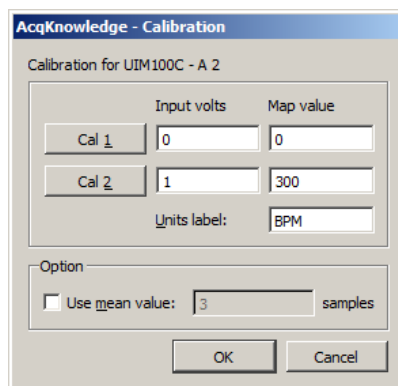

OXY300-MRI – SMALL ANIMAL NON-INVASIVE VITAL SIGNS MONITOR



MRI Usage: MR Conditional

Condition: Must use MR sensor clip and max MR field strength 9T; modules stay in control room.

OXY300-MRI is a complete system for collecting small animal SpO₂ measurements in an MRI environment.

- Works on conscious or anesthetized subjects
- Patented sensor supports heart rates in the range of 90-900 BPM
- Works with neonatal mice up to 500 gram rats
- MRI sensor works in closed, small and large bore MRI machines
 - regularly used in 9T magnets and has been successfully used in a 19T magnet
 - contact BIOPAC to discuss specific magnet strengths up to 19T
- Analog outputs interface cables included to interface with BIOPAC MP160/150 System via the AMI100D/HLT100C/UIM100C
- Immediate access to Vital Signs for pre-, intra- and post-operative measurements
- Arterial Oxygen Saturation
 - comprehensive health indicator
 - indicates lung efficiency, not just airflow
- Heart Rate
- Pulse Distention
 - indicates signal quality

SYSTEM COMPONENTS

Includes:

Small Animal Vital Signs Monitor - MouseOx[®] Plus Monitor

MRI sensor

Analog output data unit

Interface Cables (2 x CBL102, plus 2 x CBL123 if using MP160 with AMI100D or HLT100C)

OXY300-MRI REFERENCES

[OXY300-MRI User Manual](#)

[OXY300-MRI Publications](#)

SPECIFICATIONS

Oxygen Saturation ()

Measurement Range (pulse rate 90 to 900 bpm):	0 to 100% Arterial Blood Oxygen Saturation
Measurement Resolution (pulse rate 210 to 900 bpm):	1.5%, across entire range
Measurement Response Time:	SpO ₂ is reported to the user after each heartbeat

Heart Rate (bpm)

Measurement Range:	90 to 900 bpm																		
Measurement Resolution (pulse rate 210 to 900 bpm):	<table border="1"> <thead> <tr> <th>Rate (bpm)</th> <th>Resolution (bpm)</th> </tr> </thead> <tbody> <tr><td>210</td><td>2.4</td></tr> <tr><td>300</td><td>4.9</td></tr> <tr><td>400</td><td>8.7</td></tr> <tr><td>500</td><td>13.5</td></tr> <tr><td>600</td><td>19.4</td></tr> <tr><td>700</td><td>26.2</td></tr> <tr><td>800</td><td>34.0</td></tr> <tr><td>900</td><td>42.9</td></tr> </tbody> </table>	Rate (bpm)	Resolution (bpm)	210	2.4	300	4.9	400	8.7	500	13.5	600	19.4	700	26.2	800	34.0	900	42.9
Rate (bpm)	Resolution (bpm)																		
210	2.4																		
300	4.9																		
400	8.7																		
500	13.5																		
600	19.4																		
700	26.2																		
800	34.0																		
900	42.9																		
Measurement Response Time:	SpO ₂ is reported to the user after each heartbeat																		

Pulse Distention (µm)

Measurement Range (pulse rate 90 to 900 bpm):	0 to 800 µm
Measurement Resolution (pulse rate 210 to 900 bpm):	= 2.4% of measurement
Measurement Response Time:	Pulse distention is reported to the user after each heartbeat

Respiration

Respiration may be available as a derived signal but is not suitable for use with gating systems

Warning: No part of the OXY300-MRI MouseOx® Plus system other than the fiber optic cable and the sensor should go into an MRI machine.

Analog output interface:	2 x CBL102 (included) to UIM100C module for BIOPAC MP150 System 2 x CBL123 (included) to AMI100D/HLT100C module for BIOPAC MP160 System
Delay:	Fixed (0.7-1.4 seconds)
Small Animal Vital Signs Monitor:	MouseOx® Plus Control Box (Starr Life Sciences)
BNC Output Range:	±5 V

Screen refreshes every 0.72 seconds to update measurement values

12 VAC Power Supply (one of the following)

- US and Canada: Standard External Plug-in Power Supply
- International: Power Transformer and Power Cord to fit your wall receptacle

12-foot 2.0 USB Cable

CD with MouseOx® Plus Electronic User Manual

Universal Cable

Computer and Electrical Requirements for MouseOx Plus:

- Processor- PC with Pentium-class processor (Pentium 1 GHz or higher recommended)
- Computer Hardware
- VGA or higher resolution monitor (Super VGA recommended)
- 2.0 USB port

Operating System: Windows® XP, Vista, 7 or newer, compatible with Apple® computers when using a Windows® emulator

Memory: 1 GB RAM; 5 MB Hard-Drive Space for program (does not include data files)

Minimum Screen Resolution: 1024 by 768 pixels

The MouseOx® Plus has the following power requirements:

Operating Wall Voltage: 100-240 VAC @ 50-60 Hz - *you must use ONLY the provided power supply!*

Device Operating Voltage: 12 VAC

Max Operating Analog Current: 200 mA

Max Operating USB Current: 85 mA - MouseOx® Plus; 180 mA – STARR-Link™

(When using more than one of these devices, you must not operate the computer on batteries.)

OXY300-MRI SENSOR: SMALL-BORE MRI SENSOR INSTRUCTION SHEET

Small-Bore MRI Sensor Schematic

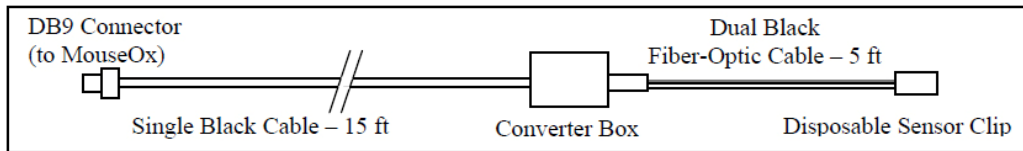

Usage Instructions:

1. Connect the DB9 Connector (9-pin connector) on the end of the thin black cable to the MouseOx® Control Box. Be sure that the MouseOx® software is not running when you do this.
2. Connect a disposable sensor clip to the fiber-optic cable. **You MUST USE a Mouse Thigh Clip for mice and a Rat Foot Clip for rats.** Place the protrusion on the end of the fiber-optic cable labeled “LED” into the hole on the clip half marked “LED,” then do the same for the side marked “PD.” Make sure that the fiber-optic cable is oriented so that it aligns over the handle as shown.

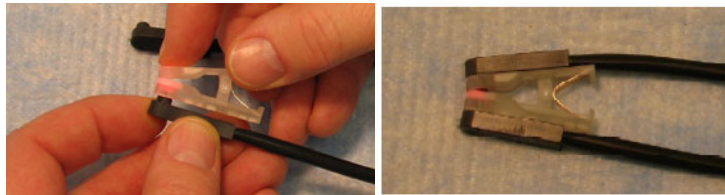

3. Connect the sensor clip to the animal:
 - a. **Mouse Thigh** – Place the clip on the thigh of a mouse as shown. For non-white fur, you **MUST** shave both locations of the sensor site. On white fur, shaving is not necessary, but will improve signal strength.
 - b. **Rat Foot** – Place the clip over the toes and locate it so that light shines through the **CENTER** of the foot. Support the clip/cable so that the animal’s foot is **NOT TWISTED** relative to its position before attaching the clip. The clip half marked “PD” should be on the bottom side of the foot.

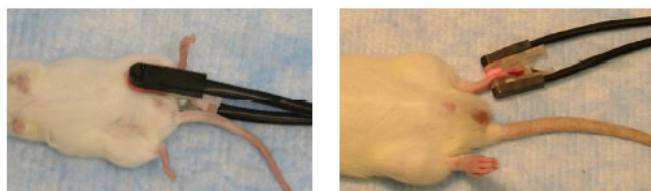

Mouse Thigh

Rat Foot

4. After locating the clip on the animal, distribute the dual black fiber-optic cable such that it proceeds straight from the animal and that it **DOES NOT** twist the animal’s foot. Try to lay the sensor clip so that both the LED and PD cables are lying on the table.
5. Run the MouseOx® software (Rev 6.0 or higher). To get to the Monitor Subject screen, choose “Anesthetized Measurements” then “Mouse Thigh” or “Rat Foot” depending on your application.

Other recommended guidelines:

- **Keep the body (rectal) temperature of the animal above 36° C.**
- Make sure that Pulse Distention exceeds 20 m when operating the system. If Pulse Distention is less than 20 m, try to relocate the sensor clip to improve it or **warm the animal.**
- If you are having trouble getting a good signal, try shaving the sensor location if applicable.
- **The non-ferrous spring will weaken with multiple uses. An unreasonably low oxygen saturation measurement (a healthy subject with a sat of 88% or less) is a clear sign of an over-used spring. To prevent this, and to promote infection control, replace the clip before each MRI session.**

CAUTION: Converter box contains trace amounts of ferrous material. Keep it away from the magnet bore.

O2100C AND CO2100C GAS CONCENTRATION MEASUREMENT MODULES

BIOPAC offers two fast-response analyzers for gas analysis. Each module measures partial pressure (of O₂ or CO₂, respectively) and thus module output is proportional to the pressure in the sample cell. Gas sampled must be free of liquids or any condensable vapors and should be filtered to 5 microns or better.

O2100C Records quickly varying oxygen concentration levels.

Ideal for monitoring time-averaged O₂ levels using mixing chambers or real-time O₂ levels for breath-by-breath measurements.

Employs an analysis technique based on the parametric oxygen measurement principle.

The O2100C is a paramagnetic-based oxygen measurement module designed to provide accurate measurement of the oxygen content in ambient air, expired breath and in breathing gas mixtures. The module provides a selectable range of analog outputs that map voltages to 0-100% oxygen concentration levels.

The module is a lightweight, and rugged unit that offers a number of advanced features, such as fast response and user-adjustable sampling flow rate.

The O2100C paramagnetic technology is non-depleting. This means there are no consumable parts and insures consistent performance over time. The selectivity of the paramagnetic measurement for oxygen means there is no interference from other respiratory gases. The O2100C small volume chamber allows a rapid gas exchange, giving the capability for fast response oxygen measurement.

The O2100C offers a stable and inherently linear measurement of oxygen. The excellent linearity of the O2100C makes it possible to calibrate the module by checking two optimally separated points in the desired measurement range.

CO2100C Records quickly varying carbon dioxide concentration levels.

Ideal for monitoring time-averaged CO₂ levels using mixing chambers or real-time CO₂ levels for breath-by-breath measurements.

Employs a single beam infrared, single wavelength, measurement technique.

The CO2100C is an infrared-based carbon dioxide measurement module designed to provide accurate measurement of the carbon dioxide content in ambient air, expired breath and in breathing gas mixtures. The module provides a selectable range of analog outputs that map voltages to 0-10% carbon dioxide concentration levels.

The module is a lightweight, and rugged unit that offers a number of advanced features, such as fast response and user-adjustable sampling flow rate.

The CO2100C is calibrated to measure carbon dioxide in the range 0 to 10%.

The CO2100C module measurement is based upon the single beam, single wavelength technique (SBSW), where wavelength selection is implemented via a carefully specified narrow-band optical filter. The speed of response is obtained by generating a fast infrared carrier signal, which is attenuated by the infrared absorption of carbon dioxide present, and a detection system that converts fast changes of this attenuation into an electrical output.

The CO2100C offers a stable and inherently linear measurement of carbon dioxide. The excellent linearity of the CO2100C makes it possible to calibrate the module by checking two optimally separated points in the desired measurement range.



Both modules are equipped with a variable speed pump to adjust the flow over a wide range of sampling conditions. Sampling line connections for input and output flow are readily accessible on the front panel of either module.

Each module can interface with the AFT15A and AFT15B mixing chambers (via the AFT20 or AFT31-MRI gas sampling interface kit), the AFT21 and AFT22 non-rebreathing T valves or the AFT25 mask with integral non-rebreathing T valve.

TECHNICAL USE NOTES

1. Snap the module together with the AMI100D, HLT100C, or UIM100C unit.
2. Select an unused channel on the channel selector switch on top of the module.
 - If two or more BIOPAC modules are set to the same channel, the outputs will conflict, resulting in erroneous readings.
3. Turn the MP160/MP150 unit on and start the *AcqKnowledge* software.
 - Please consult the “*AcqKnowledge* Software Guide” for information about *AcqKnowledge*.
4. Plug the adapter into the main power and insert the adapter plug into the back of the module.
 - The module is supplied with a 12 vdc @ 1 amp wall adapter—**do not use other wall adapters with a gas analysis module.**
 - The green POWER LED should light up. If it doesn’t, check the adapter main power and the connection to the O2100C module and then, if necessary, check the FUSE on the back of the O2100C/CO2100C module. [The FUSE ratings are: Instrumentation Type, Fast Blow @ 2 amps.]
 - The O2100C module has a warm-up time of approximately 1 minute. The CO2100C module has a warm-up time of approximately 15 minutes. Output readings during this warm-up period may be erratic.
5. Check for pump operation by turning the PUMP switch ON (after the green POWER LED comes on).
 - The module should emit a hum, indicating that the pump is working. Generally, the PUMP SPEED control will not have to be adjusted. However, it may be helpful to control sampling flow in the range of 50 to 200 ml/min depending upon measurement requirements.
 - The PUMP will start fast, then slow down and stabilize on a speed after a few seconds. This is a perfectly normal process, designed to overcome the pump’s initial mechanical hysteresis.
 - If the pump does not come on or comes on for a brief period and then shuts off, the PUMP SPEED control is set to a very low value (i.e., close to zero speed). To change the pump speed, keep the PUMP switch in the ON position and use a small straight blade screwdriver to turn the recessed potentiometer in the PUMP SPEED control. Turn trim POT clockwise to increase PUMP speed or counter-clockwise to decrease PUMP speed
6. Adjust the GAIN switch on the front of the module after proper startup.

Module	Gain	1V output	gas concentration	Voltage output range
O ₂	100 / V	100% O ₂		0 to 1 volt
O ₂	50 / V	50% O ₂		0 to 2 volts
O ₂	20 / V	20% O ₂		0 to 5 volts
O ₂	10 / V	10% O ₂		0 to 10 volts

CO₂	10 / V	10% CO₂	0 to 1 volt
CO₂	5 / V	5% CO₂	0 to 2 volts
CO₂	2 / V	2% CO₂	0 to 5 volts
CO₂	1 / V	1% CO₂	0 to 10 volts

O₂ example: If the **100% / V** setting is used, then 20.93% oxygen (atmospheric level) will be output as 0.2093 volts or 209.3 mV. Generally, GAIN can be left at the setting of 10% oxygen per volt (bottom position).

CO₂ example: If the **10% / V** setting is used, then 4% carbon dioxide (approximate concentration in expired breath) will be output as 0.40 V or 400 mV. Generally, GAIN can be left at the setting of 1% carbon dioxide per volt (bottom position).

GAS SAMPLING SETUP

1. Stabilize the measurement setup prior to sampling any gases. Pump speed, filters and sampling lines all affect the oxygen measurement of the module. Everything should be stable prior to attempting module calibration.
2. Attach a 5 micron filter (or better) on the sample input port prior to sampling any gases. The sample input port is a male Luer fitting on the front of the module. The module incorporates an internal particulate filter, however the addition of this external filter will extend the life of the internal filter and otherwise improve the long-term performance of the module. Always use a 5 micron hydrophobic sampling filter (or better) at the sampling input of the module. One is included with each module and each Gas Sampling Interface Kit (AFT20 or AFT31-MRI). The 5-micron hydrophobic filter will help to protect the module from airborne particulate matter and other contaminants.
3. If required, screw a 10/32 threaded Luer adapter into the sample output port bulkhead fitting and attach the venting line to the Luer adapter to vent undesirable gases away from the site of the module. The sample output port is adjacent to the sample input port (on the right, facing the front panel of the module) and is a bulkhead fitting with a 10/32 internal thread.

Important

Sample dry gases only. All excess water vapor above ambient levels should be removed from the sampling stream prior to being monitored by the module. To dry the sampling stream, use water vapor permeable tubing (i.e., NAFION®).

Before attaching the input sampling line tubing to the CO2100C:

1. Allow the CO2100C to warm up fully (15 minutes).
2. Blow out the input sampling line tubing with compressed (dry) air or calibration gas prior to attaching tubing to CO2100C input sampling port.

In case of humidity condensation in sampling line, it's recommended to disconnect the sampling line tubing from the CO2100C and blow out the tubing with compressed (dry) air or calibration gas prior to use of CO2100C.

The AFT20 or AFT31-MRI Gas Sampling Interface Kit includes all the items necessary (including NAFION® tubing) to efficiently connect the module to a variety of setups, including BIOPAC mixing chambers, facemasks and non-rebreathing T-valves.

CALIBRATION

Each gas concentration module comes factory-calibrated to $\pm 1\%$ concentration accuracy. Depending upon sampling line configuration and pump speed (flow rate,) the calibration may veer further from $\pm 1\%$ accuracy. Generally, **a gas calibration should be performed prior to all exacting measurements**. This may also be required when running at increased pump speeds and thus increased flow rate. Initial (Factory) oxygen accuracy calibration is usually inadequate for varying setup protocols. Proper calibration of the module should be performed after the specific measurement setup is in place.

The CO2100C and O2100C gas sampling modules are designed so that the gas sensors are held at ambient pressure, due to construction design which directs exhaust sampling direct to the ambient environment. In this regard, the modules are relatively insensitive to variations in sampling line pressure. However, it remains good practice to use setup configurations which will minimize any pressure variation in the sampling line.

Choose the calibration gases to bracket the expected measurements. For example:

- When performing End Tidal O₂ measurements, normal air can be used as the first calibration gas because the oxygen concentration is known as 20.93%. For the second gas, it might be best to use a calibration gas of 16% oxygen, 4% carbon dioxide and 80% nitrogen (such as BIOPAC's GASCAL). In this case, the measurements will be most accurate for the range of 16.00% to 20.93% oxygen.
- When performing End Tidal CO₂ measurements, normal air can be used as the first calibration gas because the carbon dioxide concentration is known as 0.04%. For the second gas, it might be best to use a calibration gas of 4% carbon dioxide, 16% oxygen and 80% nitrogen. In this case, the measurements will be most accurate for the range of 0.04% to 4% carbon dioxide.

Exact calibration is typically performed in *AcqKnowledge*, using the **Scaling** function under **Setup Channels**, once the measurement setup is in place.

1. Set up the measurement so that all gas sampling lines are in place between the module and the sampling chamber.
2. Adjust the PUMP SPEED control (if required) on the module.
3. Run the module and click on the CAL1 button when the first calibration gas is introduced into the sampling chamber.
4. Introduce a second calibration gas into the chamber and click on CAL2 when the second calibration gas is introduced into the sampling chamber.

Note Do not change the pump speed, the sampling filter or the sampling line length/configuration during or after a calibration. Changing any of these elements may reduce the accuracy of the calibration.

PUMP SPEED CONTROL

The pump speed is factory preset to result in a sampling flow rate of approximately 100 ml/min, when used with the AFT20 or AFT31-MRI Gas Sampling Interface Kit. The time delay between change of oxygen concentration at the sampling end of the Gas Sampling Interface Kit (AFT20 or AFT31-MRI) to measurement at the module is approximately 2.4 seconds. This is because the pump will move 100 ml/min and the internal volume of the Gas Sampling Interface Kit is about 4.0 ml.

$$\text{Volume in ml} = (\pi) \cdot (\text{radius in cm})^2 \cdot (\text{length in cm})$$

The Gas Sampling Interface Kit volume is calculated using:

PVC Sample Line:	72" long at 0.060" D	Volume = 3.336 ml
NAFION® Dryer:	12" long at 0.050" D	Volume = 0.386 ml
Misc. Tubing/Junctions:	6" long at 0.060" D	Volume = 0.278 ml

If the sample rate is 100 ml/min, then the pump will pull 4 ml in 2.4 seconds:

$$(60 \text{ sec/min}) \cdot (4 \text{ ml}) / (100 \text{ ml/min}) = 2.4 \text{ sec}$$

To check the flow rate, expire into the free end of the sampling line (30 cm Naflon tubing + 1.8 meters polyethylene tubing from AFT20 or AFT31-MRI Gas Sampling Kit) and simultaneously mark the recording (using the marker function in AcqKnowledge). The measured gas concentration level should show a change at approximately 2.5 seconds.

SPECIFICATIONS

O2100C Module measures the partial pressure of O₂.

CO2100C Module measures the partial pressure of CO₂.

Thus the module output is proportional to the pressure in the sample cell. Gas sampled must be free of any liquid or condensable vapors. Gas should be filtered to 5 microns or better.

	O2100C	CO2100C
Range:	0-100% O ₂	0-10% CO ₂
Repeatability:	±0.1% O ₂	0.03% CO ₂
Resolution:	±0.1% O ₂	0.1% CO ₂
Linearity:	±0.2% O ₂	0.1% CO ₂
Zero Stability:	±0.01% O ₂ /hr	0.1% CO ₂ /24 hours
Response Time: <i>Factory Preset:</i>	200 msec (T ₂₀ -T ₈₀) @ 200 ml/min 500 msec (T ₂₀ -T ₈₀) @ 100 ml/min 1000 msec (T ₂₀ -T ₈₀) @ 50 ml/min	150 msec (T ₂₀ -T ₈₀) @ 200 ml/min 250 msec (T ₂₀ -T ₈₀) @ 100 ml/min 350 msec (T ₂₀ -T ₈₀) @ 50 ml/min
Delay: (at 4 ml sampling line volume)	Flow (ml/min) = 240/Delay (sec) <i>Example: If Delay is 2 sec; Flow = 120 ml/min</i>	
Gain:	10, 20, 50, 100 (%O ₂ /Volt)	1, 2, 5, 10 (%CO ₂ /Volt)
Output Range:	0-10 volts	
Flow Range:	5-200 ml/min (50/150 ml/min recommended, increasing flow rate decreases response time)	
Temp Range:	5-50° C	10-45° C
Zero Drift:	±0.05% O ₂ /°C	±0.01% CO ₂ /°C
Span Drift:	±0.25% O ₂ /°C	±0.02% CO ₂ /°C
Warm Up Time:	About 1 minute	About 5 minutes
Humidity Range: (non-condensing)	0-95% non-condensing	0-90% non-condensing
Sampling Input Port:	Male Luer	
Sampling Output Port:	Bulkhead fitting, 10/32 internal thread	
Weight:	990 grams	740 grams
Dimensions:	7 cm (wide) x 11 cm (deep) x 19 cm (high)	
Power Source:	12 VDC @ 1 amp (uses AC100A transformer, included)	

- Gas sampled must be free of liquids or any condensable vapors.
- Gas sampled should be filtered to 5 microns or better.
- The O₂ module measures the partial pressure of O₂ and thus the module output is proportional to the partial pressure of O₂ in the sample cell.

For example, the partial pressure of 21% concentration of O₂ at sea level (760 torr) is:

$$760 \text{ torr} * 0.21 = 159.60 \text{ torr}$$

So at 700 torr and 21% O₂, the module output will be:

$$(700 \text{ torr} / 760 \text{ torr}) * 159.6 \text{ torr} = 147 \text{ torr}$$

Accordingly, when operating at an ambient pressure of 700 torr, the module scaling needs to be multiplied by a factor of (700/760) or 0.921 * (original scaling).

- The CO₂ module measures the partial pressure of CO₂ and thus the module output is proportional to the ambient pressure changes to the 3/2 power.

For example, the partial pressure of 4% concentration of CO₂ at sea level (760 torr) is:

$$760 \text{ torr} * 0.04 = 30.4 \text{ torr}$$

So at 700 torr and 4% CO₂, the module output will be:

$$(700 \text{ torr} / 760 \text{ torr}) ** 1.5 * 30.4 \text{ torr} = 26.87 \text{ torr}$$

Accordingly, when operating at an ambient pressure of 700 torr, the module scaling needs to be multiplied by a factor of (700/760) or ** 1.5 OR 0.884 (original scaling).

See also:

AFT Series Airflow & Gas Analysis Accessories
 Application Note # [AH149 — O2100C Module Setup](#)
 Application Note # [AH151 — CO2100C Module Setup](#)

GASSYS3 O₂ & CO₂ GAS ANALYSIS SYSTEM***Flexible Data Display & Reporting - VO₂, VCO₂, RER, RMR, EE, REE***

GASSYS3 Gas Analysis System—paired with the BIOPAC MP36 unit, SS11LB airflow transducer, and accessories—provides a lower-cost, compact, simpler, solution suitable for both education and research physiology applications. Obtain quality metabolic data, such as Volume of Oxygen Consumed ($\dot{V}O_2$), Volume of Carbon Dioxide eliminated ($\dot{V}CO_2$), Respiratory Exchange Ratio (RER), Energy Expenditure (EE, REE) and Resting Metabolic Rate (RMR) from Subjects at rest or during exercise.

GASSYS3 solves a myriad of challenges traditional methods of obtaining metabolic data often present, including high cost, extensive, complex and costly calibration requirements, and difficult operation.

- O₂ and CO₂ sensors
- 5-Liter Mixing Chamber
- Relative Humidity Sensors—ambient and chamber
- Temperature Sensors—ambient and chamber
- Barometric Sensor—ambient
- Fits Standard 35 mm Tubing
- Small and Compact Unit
- Automated Setup and Analysis
- Requires Less Frequent Gas Calibration

The BIOPAC GASSYS3 provides detailed insights on human subjects' responses in a variety of research applications, such as exercise physiology, sports science, biomedical engineering, psychophysiology, and many product development and consumer neuroscience applications.

- CO₂ sensor range extended from 5% to 10%, important for VO₂ Max measurements.
- Integrated heater lowers the relative humidity to prevent condensation from forming in and around the sensors.
- Integrated environmental sensors for both ambient and chamber air. These sensors are read in serially by the MP36 (under software control) and are used to adjust measurements based on changes in temperature, relative humidity, and barometric pressure.
- Small blower inside chamber, which helps mix the air, improves CO₂ sensor response time and helps prevent condensation inside the CO₂ sensor.
- Sealed Chamber prevents ambient air from corrupting the chamber air between expired air cycles.
- New design results in less air restriction.
- Auto-voltage calibration and memory circuitry added to the O₂ and CO₂ circuits to improve accuracy.

Measure Expired O₂ and CO₂ Concentrations

Required Equipment

- **GASSYS3** with included Power Supply (12V, 5A) with choice of cord (US, EU, China)
 - *optional*: [Calibration Kit GASKIT3](#)
- **MP36** with BSL 4.1.3 or above OR **MP36R** with *AcqKnowledge* 5.0.3 or above; not compatible with MP45.
- **Airflow Transducer** [SS11B](#)
- **T-Valve**
 - *option 1*: high flow T-valve (AFT21 35 mm OD) + Disposable filter with mouthpiece (AFT36) + Disposable Nose Clip (AFT 3).
 - *option 2*: Facemask with integrated T-valve (AFT25) + Syringe coupler, 35 mm to 25 mm (AFT11A).
 - *option 3*: low flow non-rebreathing T-valve (AFT22) + smooth bore tubing (AFT7-L) + flexible coupler (AFT11E).
- **Calibration syringe**—required to flush the chamber during setup if not performing gas calibration.
 - *option 1*: [AFT27](#) 3 L calibration syringe or equivalent 2, 3, 5- or 7-liter syringe.
 - *option 2*: soon to be released GASKIT3 calibration kit, which will include an AFT27.
- **Airflow & Gas Analysis Accessories**
 Choose [AFT Series](#) tubing, couplers, etc. accessories to suit your protocol.

Setup

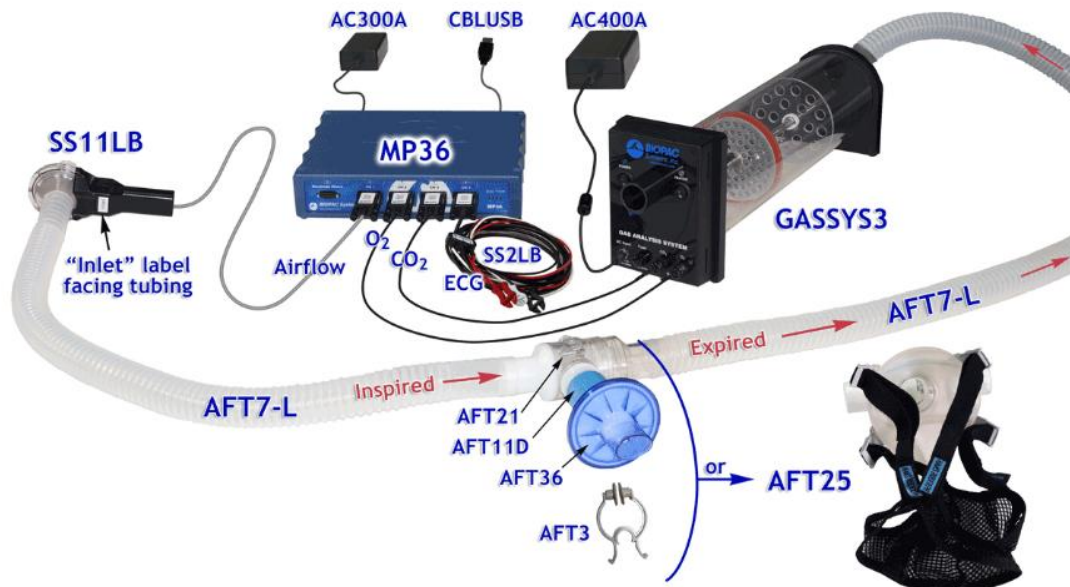

GASSYS3 Example Setup

Notes

- The non-rebreathing “T” valve directs only expired air to the GASSYS3. The mixing chamber inside the GASSYS3 averages respiratory outflows. This averaging effect causes the CO₂ and O₂ concentrations to vary in accordance with the mean values resident in multiple expired breaths.
 - For resting measurements, the airflow transducer can be placed on the output port of the GASSYS3.
 - For exercise measurements, the airflow transducer is placed on the inspired side of the T-valve to reduce the chance of condensation affecting airflow accuracy. The transducer should be held securely (i.e., stabilized on a tripod) to reduce vibration.

- When the subject inspires, air will be drawn into the GASSYS3 through the SS11LB air flow transducer, which is placed on the inspiration side to eliminate any effects associated with expired air humidity.
- When the subject expires, air will be directed to the GASSYS3 module, which is designed to work with saturated expired air.

Recording Procedure

See BSL *PRO* Lesson procedures:

- [H19 VO2 & RER](#)
- [H29 Basal Metabolic Rate](#)

Citations

These [Gas Analysis System Citations](#) used BIOPAC's previous Gas Analysis System GASSYS2—the new GASSYS3 can be used in place of the older GASSYS2 for these and other protocols.

Cleaning the BIOPAC GASSYS3



Note

Since the GASSYS3 processes only expired air, it is not necessary to clean using strong disinfectants such as Cidex OP. It is recommended to use 60-75% Isopropyl Alcohol in water.

- Never let isopropyl alcohol get on any of the sensors.

1) Unscrew (counterclockwise) the knob on the Inlet side (see below left figure).



- 2) Carefully pull the Inlet Plate away from the mixing chamber. It may be necessary to gently wiggle the plate side-to-side to remove it.
- 3) Gently pull the clear cylinder away from the Outlet/Sensor Plate. Be careful not to rotate the cylinder, as this can damage the cable.
- 4) Clean the clear cylinder, the support rod, and the heater plate with isopropyl alcohol and a soft cloth. Use swabs dipped in alcohol around the sensors and in the holes of the heater. It is important to avoid getting alcohol on the O₂, CO₂, and Temperature/Humidity sensors, as this can cause damage. For a margin of safety, note that the red areas in the below figure should not be cleaned.

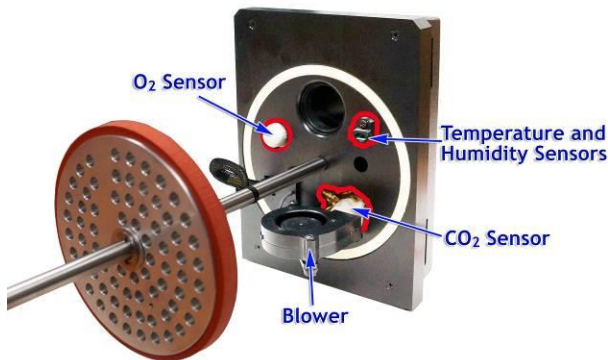

- 5) Reassemble the system in the reverse order. Please note the following:
 - a. The clear cylinder should fit snugly over the heater gasket. It may be necessary to slightly squeeze the cylinder, forcing it round, for it to begin to slide over the gasket. Push the cylinder slowly to prevent damaging the gasket. Do not allow the cylinder to rotate to avoid damaging the cable.
 - b. Both inlet and exhaust plates have a recessed circular area containing a gasket that must seal with the clear cylinder. It may be necessary to squeeze the cylinder, to make sure it seats into each recessed area correctly.
 - c. Once the clear cylinder is in place, insert the knob and begin slowly tightening (clockwise). As the knob is tightened, make sure that the cylinder does not come out of place on either end. Tighten the knob until snug.

GASCAL CALIBRATION GAS



COMPRESSED GAS, N.O.S.
(4% CO₂, 16% O₂,
BAL. N₂)

GASREG REGULATOR



Regulator with Yoke Inlet

GASCAL and GASCAL2

Composition: GASCAL: 4% Carbon Dioxide, 16% Oxygen, balance Nitrogen

GASCAL2: 8% Carbon Dioxide, 21% Oxygen, balance Nitrogen

Cylinder Type:

ED

Valve Connection:

CGA-973 works with GASREG regulator

Accuracy:

±0.03% absolute

Stability Guaranteed:

3 years

Cylinder Pressure:

2200 psig

Gas Volume:

560 liters

Cylinder Recycling:

Cylinder Recycling Program available. Contact support@biopac.com to receive instructions for returning a cylinder; delivery paid by sender and recycling covered by manufacturer.

GASREG

Use the non-corrosive, two stage regulator with flow control with the GASCAL Calibration Gas Cylinder.

This regulator is used to inject calibration gases into the GASSYS2/GASSYS3 or AFT15 chambers to create the secondary calibration points for a proper gas calibration of O₂ and CO₂ sensors.

- The initial case (for the primary calibration points) is the chamber flooded with ambient air (20.95% Oxygen, 0.04% Carbon Dioxide and balance Nitrogen).
- The secondary case (for the secondary calibration points) is using the GASCAL with GASREG to inject a calibrated gas mixture into the chamber.
- The chamber will be flooded with this mixture from GASCAL or GASCAL2.

GASCAL is a tank containing 4% carbon dioxide, 16% oxygen and balance (80%) nitrogen.

GASCAL2 is a tank containing 8% carbon dioxide, 21% oxygen and balance (71%) nitrogen.

Use 3.2 mm ID tubing to run from GASREG output to the chamber and seal the 3.2 mm ID tube to the input port of the chamber, during calibration.

Wait for the chamber to be flooded, typically about 1-2 minutes.

Put regulator at 10 psi and open up the flow valve.

After flooding, then largely close the flow valve, but keep some small flow during the calibration of secondary point, to maintain positive pressure in the chamber.

The chamber needs to be flooded prior to attempting to calibrate for secondary points.

After secondary calibration, shut down the tank by closing the main valve.

See also: [AFT16 Regulator Barb Interface Kit](#) for interfacing the GASCAL+GASREG combination to an AFT15 mixing chamber to calibrate the O₂100C or CO₂100C amplifier modules.

[AFT17 Regulator Barb Interface](#) to inject calibration gases into the RX-GAS3 Calibration Chamber to calibrate the GASSYS3 Gas Analysis System.

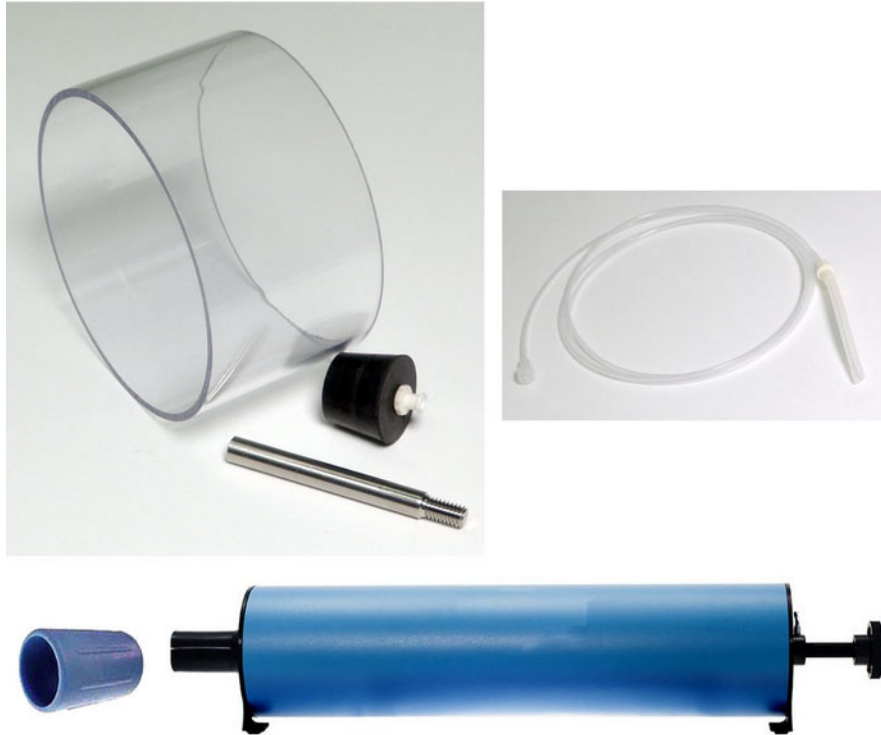
GASKIT3 CALIBRATION KIT FOR GASSYS3

This gas and airflow calibration kit works with the GASSYSTEM3 Gas Analysis System. It includes hardware interface items; it does not include gas cylinder(s) or regulator.

This calibration kit includes:

- Syringe and Coupler: AFT27 + AFT11D
- Calibration Chamber for GASSYS3: RX-GAS3
- Regulator Barb Interface/tubing to connect a regulator to the calibration chamber: AFT17

See also: GASCAL (4% CO₂, 16% O₂), GASCAL2 (8% CO₂, 21% O₂), GASREG regulator

RX-GAS3 CALIBRATION CHAMBER FOR GASSYS3

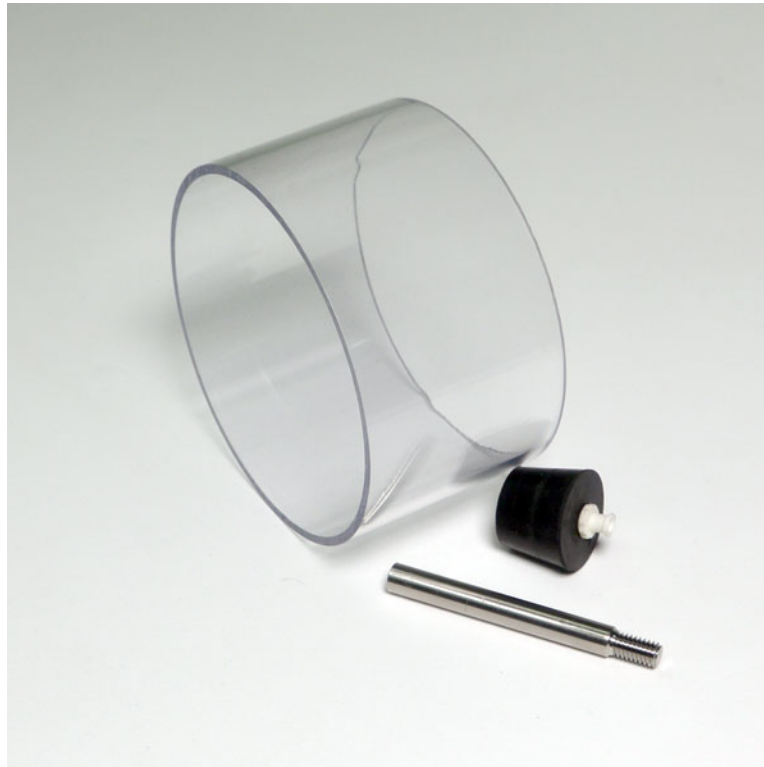

This is a short chamber that is used when performing calibration of the GASSYS3 Gas Analysis module. The large chamber and rod are replaced with a shorter chamber and rod. Using the included stopper on the inlet of the GASSYS3, calibration gases may then be injected into the calibration chamber using the AFT17 + GASREG + GASCAL/GASCAL2. After calibration, the larger chamber is used.

The stopper includes a standard female Luer lock connector to interface to other equipment as well.



RX-GAS3 connected to MP36

RX-GAS3-GASKET FOR GASSYS3

The RX-GAS3-GASKET is a set of endcap replacement gaskets for the GASSYS3 Gas Analysis Module. Over time the gaskets of the chamber for the GASSYS3 may deform and no longer make an airtight seal. This gasket set may be used to replace worn gaskets to maintain an airtight seal for the GASSYS3.

AFT SERIES AIRFLOW GAS ANALYSIS ACCESSORIES



See also: Student Accessory Packs
 BSL-ACCPACK and
 BSLACCPACK-11B

Includes the following airflow accessories:

Bacterial Filters	Mouthpieces	Calibration	Airflow Tubing	Facemasks & Accessories	Noseclip
AFT1 AFT4 AFT36	AFT2 ATF8 AFT9 RX-AFT35-MOUTH	AFT6A AFT16 AFT17 AFT27	AFT7 AFT7L AFT12	AFT10 AFT10S AFT25 RX-AFT25-SMALL RX-AFT25-MEDIUM RX-AFT25-LARGE RX-AFT25-CAP	AFT3
Gas Sampling Kits	AFT T-valves	Head Support	Gas Tubing	Mixing Chamber	Couplers
AFT20 AFT31-MRI	AFT21 AFT22 AFT23 AFT35-MRI	AFT24	AFT30	AFT15	AFT11A AFT11B AFT11C AFT11D AFT11E AFT11F AFT11H

DISPOSABLE BACTERIAL FILTERS

MRI Use: MR Safe

AFT1/4/36 Bacterial Filter Components: Polycarbonate Clear Plastic

AFT1 Disposable Bacterial Filter *Available in Packs of 10 or 250*

Designed to remove airborne bacteria. Pore Size: Virus Filtration Efficiency (VFE): 3.1 micron; Bacterial Filtration Efficiency (BFE): 2.8 micron. Use between any SS11L, SS11LA, SS11LB, or TSD117, or TSD117A and the AFT2. 22 mm ID/OD.

AFT4 Disposable Bacterial Filter

Designed to remove airborne bacteria; for use with the TSD107B, or other 35 mm breathing circuits, connects between the AFT7 and the AFT9. (35 mm ID/35 mm OD)

AFT36 Disposable Pulmonary Function Filter and Mouthpiece *Available in packs of 10 or 200*

This disposable bacteriological filter with integrated mouthpiece is recommended for use with the SS11LB or TSD117A airflow transducer, and attaches directly to the outside of the airflow head. Independent laboratory tests have verified 99.99% bacterial and viral filtration efficiency. This surpasses published ATS recommendations for flow resistance in pulmonary function instrumentation, which suggest resistance should be below 1.5 cm H₂O/L/sec at flow rates of 14 L/sec. Port: 35 mm OD. **NOTE:** The AFT36 is not compatible with earlier-style SS11L or SS11LA or TSD117 airflow transducers. (Use AFT1 + AFT2 instead.)

**MOUTHPIECES**

MRI Use: MR Safe

AFT Mouthpiece Components: Polyethylene EVA Copolymer, Thermoplastic Rubber, Polycarbonate Plastic

AFT2 Disposable Mouthpiece *Available in Packs of 10 or 250*

22 mm OD; connects to the older model SS11LA or TSD117 via the AFT1.

AFT8 Autoclavable Mouthpiece *Available in Packs of 1 or 10*

30 mm ID; interfaces with the SS11LA, SS11LB, or TSD117A and reduces the cost of disposable parts.

- RX117A-MRI Replacement Sterilizable Airflow Head: 22 mm ID/30 mm OD; autoclavable transducer head for the TSD117A; can be used with the AFT8 to reduce the cost of disposable items.

AFT9 Reusable Mouthpiece *Available in Packs of 1 or 10*

35 mm ID; designed to connect to the TSD107B or other 35 mm breathing circuits with the AFT7 via the AFT4. (Also connects to the AFT21 Non-rebreathing T Valve.)

NOSECLIP

MRI Use: MR Safe

AFT Noseclip Components: Thermoplastic Rubber, Polyvinyl Chloride (PVC) Plastic, Polyurethane Foam Plastic

AFT3 Disposable Noseclip *Available in Packs of 10 or 250*

Gently squeezes the nostrils shut while using the SS11LA or TSD117A Airflow Transducer.

CALIBRATION**AFT6A Calibration Syringe**

0.6 liter calibration syringe. **See also:** AFT27 3.0 liter Calibration Syringe

AFT27 Calibration Syringe (3.0 liter)

The AFT27 is a 3.0 Liter Calibration Syringe for the SS11LB, SS11LA or TSD117A Airflow Transducer. The AFT27 Calibration Syringe is certified to have a 3-liter volume that meets or exceeds an accuracy $\pm 0.5\%$ of the total displacement volume. The increased size and accuracy of this 3.0 liter calibration syringe provide a wider calibration range than the AFT6A for advanced studies. A coupler is included and can be reordered as AFT11D (SS11LB) if it is inadvertently discarded when an airflow accessory is removed. This adjustable aluminum calibration syringe is shipped with the volume locked to 3.0 L and BIOPAC templates and software settings are set for 3 L. The locking collar and graduated rod allow users to select other calibration volumes, from 0.5 Liters



to 3.0 Liters. The aluminum syringe has a universal connector and works with BIOPAC's AFT11D flexible coupler (35 mm OD, 35 mm OD).

NOTE The AFT27 3.0 Liter Calibration Syringe replaces the AFT26 2.0 Liter Calibration Syringe, which was discontinued in September of 2017.

AFT16 Regulator Barb Interface Kit

Use the Regulator Barb Interface Kit to interface the GASCAL+GASREG calibration gas combination to an AFT15 mixing chamber to calibrate the CO2100C carbon dioxide measurement and O2100C oxygen measurement amplifier modules.

Kit includes 2 meters of tubing that connect to the GASREG and mixing chamber along with two stoppers to seal the inlet and outlet ports of the mixing chamber.



AFT17 Regulator Barb Interface for GASSYS3

Use this Regulator Barb Interface with Luer lock to connect a regulator (such as GASREG) and GASCAL or GASCAL2 calibration gas to inject calibration gases into the RX-GAS3 Calibration Chamber to calibrate the GASSYS3 Gas Analysis System.

TUBING FOR AIRFLOW

MRI Use: MR Safe

AFT7/7L/12 Tubing Components: Polyethylene EVA Copolymer

AFT7 Smooth Bore Tubing

1 m length, 35 mm ID; connects to the TSD107B, AFT4, or other 35 mm breathing circuits.

See also: AFT part guide for additional applications. Sterilization: Cidex[®] / Cidex OPA[®] recommended

AFT7L Smooth Bore Tubing

3 m length, 35 mm ID; connects to the TSD107B, AFT4, or other 35 mm breathing circuits.

See also: AFT part guide for additional applications. Sterilization: Cidex[®] / Cidex OPA[®] recommended

AFT12 Tubing (22 mm)

Smooth bore tubing for use in 22 mm breathing circuits. (1.8 meter length, 22 mm ID)

FACEMASKS, FACEMASK ACCESSORIES

AFT10 Disposable Adult Facemask

These mouthpieces connect to 22 mm breathing circuits. Connects directly to the AFT1, AFT22 non-rebreathing T-valve, SS11LA/TSD117 airflow transducer (via AFT11B coupler) or SS11LB/TSD117A airflow transducer (via AFT11H coupler). Includes hook-ring to secure AFT10S adjustable head strap. (22 mm ID/25 mm OD)

MRI Use: MR Safe

AFT10 Facemask Components: Thermoplastic Elastomer, Polyvinyl Chloride (PVC) Plastic

AFT10S Adjustable Head Strap

This fully adjustable latex head strap holds the AFT10 disposable facemask securely to the subject's head. Use one or more straps to securely fasten the mask.

MRI Use: MR Safe

AFT10S Head Strap Components: Latex Rubber

AFT25 Facemask with Valve

This adult facemask with integral non-rebreathing T valve is a high performance, very low dead space, low airflow resistance mask and valve; suitable for high airflow applications (e.g. exercise physiology). The AFT25 incorporates two gas sampling ports (female Luer) for interfacing with the AFT20 Gas Sampling Kit. All ports are 35 mm OD, 28 mm ID



MRI Use: MR Safe

AFT25 Facemask Components: Mask: Thermoplastic Elastomer, Valve: Acetal Plastic, Acrylic Plastic, Aluminum (nickel plated silver,) Elastomer, Nylon, Thermoplastic Polyester, Polycarbonate Plastic, Silicone Rubber, Stainless Steel, Polysulfone Plastic

Headgear: Fabric with Velcro® straps

AFT25 Accessories—Masks and Cap

Airflow mask and cap accessories for the AFT25 adult facemask:

- **Masks** do not include T-valve. Available in small, medium, or large. To use, remove the valve and adapter from the original AFT25 mask and then attach them to the T-valve on the new mask via the valve adapter that is part of the AFT25 mask.

Mask Part Numbers: **RX-AFT25-SMALL, RX-AFT25-MEDIUM, RX-AFT25-LARGE**

MOUTH BREATHING MASK FACE PIECE DIMENSIONS

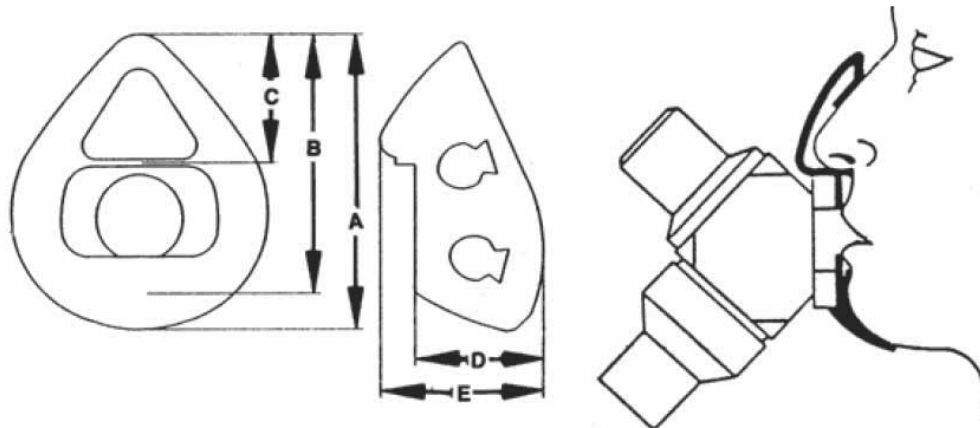

Part #	Size	A	B	C	D	E
		Inch (mm)	Inch (mm)	Inch (mm)	Inch (mm)	Inch (mm)
RX-AFT25-LARGE	Adult Large	5.3 (134.6)	4.8 (122.7)	2.4 (61.2)	2.0 (50.8)	3.0 (74.9)
RXAFT25-MEDIUM	Adult Medium	4.9 (125.2)	4.5 (113.0)	2.2 (54.6)	2.0 (50.8)	2.7 (67.3)
RX-AFT25-SMALL	Adult Small	4.6 (117.6)	4.2 (117.6)	1.9 (47.5)	2.0 (50.8)	2.6 (66.6)

GUIDELINES FOR MASK FIT: Adult Large Large Adult
 Adult Medium Large Adolescent to Medium Adult
 Adult Small 9 Years to Small Adult

- **Cap** does not include mask or T-valve. Cap includes cap, straps and clips for the AFT25 mask. Design ensures the mask has a secure fit to the subject's face and head, overcoming the problem of slipping during active or long-term setups, as with exercise physiology or sleep studies. Cap fits all three mask sizes.

Cap Part Number: **RX-AFT25-CAP**

Need a complete facemask with integral non-rebreathing T-valve? See our AFT25 high performance, very low dead space, low airflow resistance mask and valve; suitable for high airflow applications (e.g., exercise physiology).

MRI Use: MR Safe (see AFT25 Specifications on previous page for components)

COUPLERS

MRI Use: MR Safe

AFT11 Series Coupler Components: Thermoplastic Rubber, Polyvinyl Chloride (PVC) Plastic, Polycarbonate Clear Plastic, Acrylonitrile Butadiene Styrene (ABS) Thermo-molded, Plastic

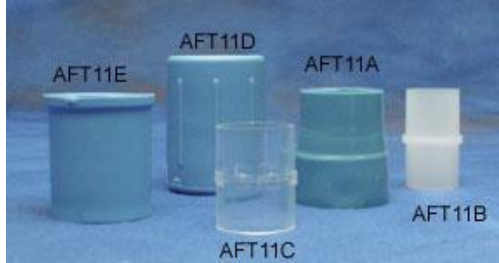

- AFT11A** Flexible
- AFT11C** Rigid
- AFT11E** Flexible
- AFT11H** Flexible
- AFT11B** Rigid
- AFT11D** Flexible
- AFT11F** Flexible

These couplers are very useful for connecting a variety of airflow port IDs and ODs to transducers, tubing and calibration syringes. Pick an AFT11 Series coupler that matches the port sizes to be interfaced.

AFT11 Series Coupler Guides

Coupler	Couples	Interface
AFT11A	25 mm OD/35 mm ID	AFT6A to AFT1
AFT11B	15 mm OD/22 mm ID	AFT10 to SS11LA
AFT11C	22mm OD/22 mm OD	AFT22 to AFT20
AFT11D	35 mm OD/35 mm ID	AFT27 to SS11LB
AFT11E	22 mm OD/35 mm ID	AFT7 to AFT22/25
AFT11F	35 mm OD/45 mm OD	SS52L to GASSYS3 or GASSYS2
AFT11H	35 mm OD/28.6 mm ID	AFT10 to SS11LB

Item 1	Item 2	Coupler	Item 1	Item 2	Coupler
15 mm OD	22 mm ID	AFT11B	25-30 mm OD	25-30 mm OD	AFT11A
20 mm OD	22 mm ID	AFT11B		28-35 mm ID	AFT11A
22 mm ID	15 mm OD	AFT11B	28-35 mm ID	25-30 mm OD	AFT11A
	20 mm OD	AFT11B		35 mm ID	AFT11A
22 mm OD	22 mm OD	AFT11C	34-37 mm ID	41-47 mm ID	AFT11F
	25 mm ID	AFT11C	35 mm ID	28-35 mm ID	AFT11A
22-25 mm OD	22 mm OD	AFT11E		38 mm ID	AFT11E
	25 mm ID	AFT11E	35-38 mm ID	22-25 mm OD	AFT11E
25 mm ID	22 mm OD	AFT11C	35-38 mm OD	35-38 mm OD	AFT11D
	25 mm ID	AFT11C	35 mm OD	28.6 mm OD	AFT11H

Note The AFT11I coupler for connecting the AFT26 2.0 Liter Calibration Syringe to the SS11LA airflow transducer was discontinued in September of 2019. To connect an existing AFT26 syringe to the SS11LA, use the following connections:

AFT26 + AFT11D + AFT11E + AFT11B + SS11LA

AFT15 MIXING CHAMBERS

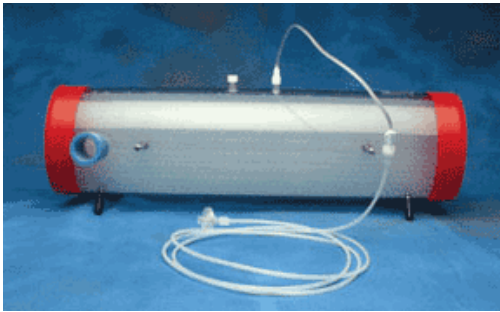

AFT15A/B mixing chambers incorporate dual baffles and flexible connection ports capable of interfacing with 35 mm or 22 mm breathing circuits.

Two female Luer connection ports are provided between the baffles for the simultaneous monitoring of O₂ and CO₂ concentrations.

AFT15A shown with AFT20 (not included)

AFT15A — 5 Liter

Use for demanding expired gas analysis measurements (e.g. VO₂ or RER measurements).

Dimensions: 13 cm (dia) x 47 cm (long) Coupling Ports: 35 mm OD, 25 mm ID

AFT15B — 8 Liter

Use for very high volume and rate expired gas analysis measurements (e.g. VO₂ or RER measurements).

Dimensions: 13 cm (dia) x 73 cm (long) Coupling Ports: 35 mm OD, 25 mm ID

MRI Use: MR Conditional to 3T

Condition: Mixing Chambers AFT15 (5 liter) and AFT15B (8 liter) can be placed in chamber room, where gas sampling lines to CO2100C and O2100C are directed through chamber to control room waveguide parts.

AFT15/15B Mixing Chamber Components: Aluminum; Stainless Steel; Nylon plastic; Vinyl; Polypropylene; Low-density polyethylene; Butyrate.

GAS SAMPLING INTERFACE KITS

AFT20

Use to interface the CO2100C and the O2100C modules with the TSD107B or TSD117A Airflow Transducer breathing circuits.

Includes: 1.8 meters of 1.5 mm inner diameter semi-flexible polyethylene tubing with M/F Luer connector; 30 cm Nafion[®] water vapor permeable tubing with M/F Luer connector; 5 micron filter with M/F Luer connector; M/F Luer to female Luer “Y” connector.



The AFT20 connects the CO2100C or O2100C directly to the sampling port of a mixing chamber. The AFT20 also permits sampling connections to the Non-rebreathing “T” Valves (AFT21 or AFT22).

MRI Use: MR Safe

AFT20 Gas Sampling Kit Components: Tubing: 1.8 m of 1.5 mm diameter polyethylene tubing with M/F Luer; Tubing: 30 cm Nafion[®] water vapor permeable tubing with M/F Luer connector; Y-connector: Acrylonitrile butadiene styrene (ABS) polycarbonate

AFT31-MRI



(L) AFT31-MRI components – (R) connected to AFT35-MRI mouthpiece

This 3.175 mm ID tubing is 10 meters long with male and female Luer locks for direct connection with the AFT35-MRI T-valve gas sampling port, CO2100C module, and/or O2100C module. To use both CO2100C and O2100C modules simultaneously, a “Y” connector gas sampling interface adapter is included, along with two Nafion® Drying Tubes and two 17 mm 45 micron Hydrophobic Filters to prevent moisture buildup.

Notes:

- The 3.175 mm polyethylene plastic tubing can be cleaned with isopropyl alcohol. Isopropyl alcohol is not recommended for sterilization.
- Hydrophobic filters and Nafion® Drying Tubes are used to keep gas samples clean and dry as they enter the sensing chambers of oxygen and carbon dioxide modules. Nafion® tubing should be replaced when tubing becomes discolored, and filters should be replaced monthly.
 - Replacement Drying Tubes and Hydrophobic Filters are available in packs of 10. When reordering, request RX-AFT20-NAFION and RX-AFT20-FILTER.
- Humidity effects of tubing, filters, and module setup are discussed in the [O2100C-CO2100C](#) spec sheet for Gas Concentration Measurement Modules.

MRI Use: MR Safe

AFT31-MRI Gas Sampling Kit Components: Polyethylene, Polyvinyl Chloride Plastic, Polycarbonate Clear Plastic, Nafion® water vapor permeable tubing, hydrophobic filter

ID/OD: 3.175 mm (1/8") / 6.35 mm (1/4")

Maximum Pressure: 358 psi @ 21° C

Operating Temperature Range: -73° to +79° C

“Y” connector: 1 x male to 2 x female

Length: 10 m

Type: Crack-Resistant Polyethylene Tubing

Material: Linear Low Density Polyethylene

Wall Thickness: 1.588 mm (1/16")

Bend Radius: 51 mm (2")

Durometer: 95A (Firm)

AFT T-VALVES

AFT21 Non-Rebreathing “T” Valve: Female, 35 mm

High performance, very low dead space, low airflow resistance valve, suitable for high airflow applications (e.g. exercise physiology). The non-rebreathing “T” valve incorporates a Female Luer connector gas sampling port for interfacing with the AFT20. All ports are 35 mm OD, 30 mm ID.

Includes: 35 mm OD coupler

Requires: AFT4, AFT7, and AFT9 for proper operation.



AFT22 (top left), **AFT21** (top right)
AFT20 (bottom)

AFT22 Non-Rebreathing “T” Valve: Male, 22 mm

Very low dead space valve, suitable for low to medium airflow applications. The non-rebreathing “T” valve incorporates a Male Luer connector gas sampling port for interfacing with the AFT20. Coupler ports are 22 mm OD fittings. Common port incorporates a 15 mm ID connection. Dead space 20 cc. Resistance: 0.29 cmH₂O at 5 liter per minute flow, 0.65 cmH₂O at 10 liter per minute. Single subject disposable item – **do not autoclave**. Includes: 22 mm OD coupler

Requires: AFT1 and AFT2 for proper operation.

Includes: 22 mm OD coupler *Requires:* AFT1 and AFT2 for proper operation.

MRI Use: MR Safe

AFT21/22 T-Valve Components: Acrylic Plastic, Elastosomer, Polycarbonate Clear Plastic

AFT23 Non-Rebreathing T-Valve, 35 mm

The AFT23 is a disposable paper mouthpiece featuring a one-way valve for pulmonary function measurements (expiratory only). It provides low air resistance, adds cross-contamination protection, and is strong and durable. It ships with eight extra valves. Mouthpiece OD: 35 mm. Fits AFT1 + AFT2 pulmonary function filter & mouthpiece set.

MRI Use: MR Safe

AFT23 T-Valve Components: Acrylic Plastic, Elastosomer, Paper

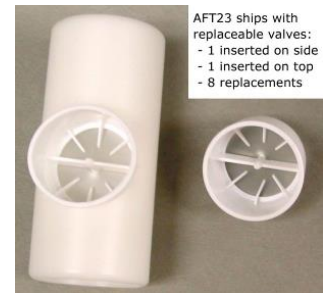

AFT35-MRI

The AFT35-MRI is a low-profile mouthpiece and non-rebreathing T-valve assembly specifically designed to fit inside an fMRI head coil.

NOTE: Although fit is fine with 32 channel head coils, a shortening (cut via snips) of the flexible snorkel mouthpiece may be required to encourage a better fit for 20 and 64 channel head coils.

Use the AFT35-MRI to perform the following airflow and lung volume tests:

- End Tidal CO₂
- VO₂ max
- Breath-by-breath Air Flow
- Breath-by-breath Volume
- Metabolic Studies



The assembly includes a female Luer lock connection for direct connection to AFT31-MRI gas sampling tubing for CO₂ and O₂ gas analysis. The Luer port has a removable male Luer sealing cap for when gas sampling is not used. The AFT35-MRI also interfaces with AFT7/7-L tubing, via the AFT11A coupler, for operation with the TSD117A-MRI ±300 L/min airflow transducer. Extra mouthpiece included.

For the AFT31-MRI, 3.175 mm ID tubing at 10 meters, the gas sensing delay will be approximately 47.1 seconds, assuming 100 ml/min total gas sampling flow rate. This delay includes 0.6 seconds additional, due to gas module internal sampling and 30 cm NAFION tubing.

Low clearance – only 25 mm between subject and coil

Dimensions: 25 mm breathing port height (excluding mouthpiece) x 35 mm outlet port diameter x 83 mm wide x 115 mm long

Deadspace: 88 ml

Sterilization: Cidex® / Cidex OPA® recommended

RX-AFT35-MOUTH

The RX-AFT35-MOUTH is a low profile liquid silicone mouthpiece replacement for the AFT35-MRI non-rebreathing T-valve assembly.

MRI Use: MR Safe



AFT35-MRI Sample Setups

Perform a variety of tests. Place transducer outside the bore in the MRI Chamber Room and run tubing to connect to the subject and breathing accessories; place amp in Control Room.

- **End Tidal CO₂:** CO2100C amp + AFT31-MRI tubing + AFT35-MRI airflow interface
- **Airflow & Lung Volume:** DA100C amp + MECMRI-DA cable/filter set + TSD117A-MRI transducer + AFT1 filter + AFT7L tubing + AFT11A coupler + AFT35-MRI
- **Airflow & Lung Volume with End Tidal CO₂:** DA100C + MECMRI-DA + TSD117A-MRI + AFT1 filter + AFT7L tubing + AFT11A + AFT35-MRI + AFT31-MRI + CO2100C
- **Metabolic:** DA100C + MECMRI-DA + TSD117A-MRI + AFT1 filter + 2 x AFT11A + 2 x AFT7L + AFT35-MRI + AFT31-MRI + AFT15A/B + CO2100C and/or O2100C

MRI Use: MR Safe

AFT35-MRI Components: Polyvinyl Chloride (PVC) plastic, Polyethylene EVA Copolymer, Thermoplastic Rubber, Polycarbonate Plastic, Acrylic Plastic, Elastomer, Paper, Latex Rubber, Polyurethane Foam Plastic, Acrylonitrile Butadiene Styrene (ABS) Thermo-molded

AFT24 Head Support



The AFT24 head support is used when breathing directly into the AFT21 non-rebreathing T valve for exercise physiology measurements. The AFT21 is secured directly in front of the subject and minimizes the strain associated with the weight of valves and tubing.

TUBING FOR GAS SAMPLING

AFT30 Series Tubing and M/F Luer Locks

Use this semi-flexible 1.5 mm tubing with male and female Luer locks to interface with the RX110 self-inflating pressure pad, TSD114 response/hand force pump bulb, or gas sampling ports on AFT15 mixing chambers, CO2100C module, or O2100C module. *See AFT31-MRI for gas sampling in the MRI.*

Assuming a gas sampling module (CO2100C/O2100C) flow rate of 100 ml/min, the following approximate delays will be introduced as a function of tubing length:

AFT30: 1.8 m length, 1.5 mm ID – 2.5 seconds*

AFT30-L: 4 m length, 1.5 mm ID – 4.8 seconds*

AFT30-XL: 10 m length, 1.5 mm ID – 11.1 seconds*

*These delays include 0.6 seconds additional – due to gas sampling module internal tubing and 30 cm NAFION tubing.

MRI Use: MR Safe

AFT30 Series Gas Sampling Kit Components: 1.5 mm diameter polyethylene tubing with M/F Luer



Part Summary for Typical Airflow / Gas Analysis Applications
 Pulmonary Function

Part #	High Flow <i>Exercising human</i>	Med. Flow <i>Resting human</i>	Low Flow <i>Child, Pig, Dog</i>	Very Low Flow <i>Small Animals</i>
AFT2 Mouthpiece		X		
AFT3 Noseclip	X	X		
AFT6A Calibration Syringe	X	X	X	
AFT7/7L Tubing	X (2)			
AFT9 Mouthpiece	X			
AFT21 T Valve	X			
AFT24 Head Support	X (optional)			
AFT36 Mouthpiece	X			
AC137 In-line Transformer				
DA100C Amplifier	X (2)	X	X	X
TSD107B Pneumotach (High)	X (2)			X
TSD117A Pneumotach (Med.)		X		
TSD127 Pneumotach (Low)			X	
TSD137 A-E Pneumotachs (Very Low)				X (by size)

Part Options: AFT25 = AFT21 + AFT9 + AFT3 + optional AFT24
 AFT2 + AFT3 = AFT0 + AFT11B

Exercise Physiology

Part #	Mixed Expiratory Gases		Breath-by-Breath		
	High Flow <i>Exercising human</i>	Med. Flow <i>Resting human</i>	High Flow <i>Exercising human</i>	Med. Flow <i>Resting human</i>	Low Flow <i>Dog</i>
AFT6A Calibration Syringe	X	X	X	X	X
AFT7 Tubing	X (2)		X		
AFT10 Facemask		X		X	
AFT10S Head Strap		X		X	
AFT11 Series Couplers		X (3)*		X	X (2)**
AFT12 Tubing		X (2)		X	
AFT15A Mixing Chamber	X	X			
AFT20 Interface Kit	X (2)	X (2)	X (2)	X	X (2)
AFT22 T Valve		X		X	X
AFT25 Facemask w/Valve	X		X		
DA100C Amplifier	X	X	X	X	X
CO2100C CO ₂ Module	X	X	X	X	X
O2100C O ₂ Module	X	X	X	X	X
TSD107B Pneumotach (High)	X		X		
TSD117A Pneumotach (Med.)		X		X	
TSD127 Pneumotach (Low)					X

Part Options: AFT25 = AFT21 + AFT9 + AFT3 + optional AFT24 * use 2 AFT11B and 1 AFT11C
 AFT10 + AFT10S = AFT2 + AFT3 + AFT11C ** use 1 AFT11B and 1 AFT11C

See also: AFT coupler guide for additional applications.

AFT Series Cleaning Disinfection

All AFT components, with the exception of filters, will hold up to liquid and gas sterilization as specified in this document.

The following disinfectants are recommended for LIQUID “COLD” sterilization of BIOPAC transducers:

- **Cidex**[®] / **Cidex**[®] **OPA** Disinfectant Solution, Johnson & Johnson
- **Perform**[®] Powder Disinfectant Concentrate, Schülke & Mayr
- **Terralin**[®], Liquid Disinfectant Concentrate, Schülke & Mayr

➡ Always follow the manufacturer’s directions.

Recommended gas-based method:

- Low temperature, **Ethylene Oxide (EtO)** gas sterilization

PULSE OXIMETRY

OXY100E Module (18-321 BPM)

OXY200 Module (for veterinary use only, 18-450 BPM)

TSD124 Series SPO2 Transducers for OXY100E or OXYSSH-SYS

TSD270 Series SPO2 Transducers for OXY200

These modules measure beat-by-beat, blood oxygen saturation (SpO₂) level in a noninvasive fashion. The OXY100E outputs four signals simultaneously:



- A:** SpO₂ value (Ch 1, 2, 3, or 4)
- B:** Pulse Plethysmogram (Ch 5, 6, 7, or 8)
- C:** Heart pulse rate (Ch 9, 10, 11, or 12)
- D:** Module Status (Ch 13, 14, 15, or 16)

These signals are directed to switchable blocks of different MP input channels. Up to four OXY modules can be used with a single MP System. The modules have built-in calibration for a simplified setup procedure. Each OXY module requires one of the TSD124 series SpO₂ transducers.

The modules operate in accordance to principles outlined by the Lambert-Beer law; this is an empirical relationship that relates the absorption of light to the properties of the material through which the light is traveling.

The OXY modules are noninvasive instruments that measure blood-oxygen percentage levels. The module probe incorporates light-emitting diodes (LEDs) which face photodiodes through a translucent part of the subject's body, usually a fingertip or an earlobe. One LED is red, with wavelength of 660 nm, and the other is infrared (approximately 910 nm). Light absorption at these wavelengths is different between oxyhemoglobin and its deoxygenated form. The oxyhemoglobin/deoxyhemoglobin ratio can be calculated via the ratio of the absorption of the

red and infrared light. In particular, the OXY modules output (as a proportional voltage) the percentage of arterial hemoglobin in the oxyhemoglobin state.

TSD124 Series SpO2 Transducers For OXY100E



TSD124 Series



TSD124A Finger

TSD124C Flex Wrap

The TSD124 series human oximetry transducers are reliable and simple to use on a wide range of subjects for both short-term and continuous noninvasive monitoring. The transducers incorporate Nonin’s PureLight® sensors and are backed by a six-month warranty. Use with the OXY100E oximetry amplifier or OXYSSH-SYS pulse oximetry system.

Available Types:

TSD124A Finger Clip Transducer

- Subject Range: > 30 kg (66 lbs)
- Preferred application: Index, middle or ring fingers
- Length: 1 m

TSD124B Ear Clip SpO2 Transducer

- Subject Range: > 40 kg (88 lbs)
- Length: 1 m

TSD124C Flex Wrap SpO2 Transducer (Ships with 25 RX124C adhesive wrap guides)

- Length: 1 m

RX124C Disposable FlexiWrap® adhesive guides for use with the reusable TSD124C Flex Sensor.

- Sized for adults (> 20 Kg or 44 lbs)
- Apply to index, middle or ring finger.
- Qty 25 per pack

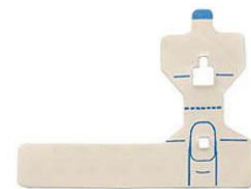

Also available: OXY100E-200 EXT Pulse Oximeter extension cable – 3m

TSD270 Series SpO2 Transducers For OXY200



The TSD270 series veterinary oximetry transducers are reliable and simple to use on a wide range of animals for both short-term and continuous noninvasive monitoring. The transducers incorporate Nonin’s PureLight® sensors and are backed by a six-month warranty. Use with the OXY200 Veterinary oximetry amplifier.

TSD270A Transflectance Transducer

The Transflectance Sensor, the smallest probe, is ideally suited for continuous monitoring from the paw, tail, or other vascularized part of the animal. It can be conveniently placed on the underside, base of the tail or other well-perfused surfaces. It is an excellent option during dental procedures.



TSD270A

TSD270B Small Animal Wrap Transducer

The flexible wrap sensor can be placed on a small, well-perfused appendage. This sensor is easily secured making it ideal for continuous monitoring during long surgical or other procedures. It is most often used on rodents or other very small animals.



TSD270B

Pulse Oximeter Calibration OXY100E/OXY200

Modules will operate with default values unless an exact calibration is performed using the recessed “Cal” button on the OXY module and AcqKnowledge scaling.

To access the “Scaling analog channel” dialog, click MP menu > Set Up Channels and then click “View by Channels,” click “Setup...” and click “Yes” when prompted.

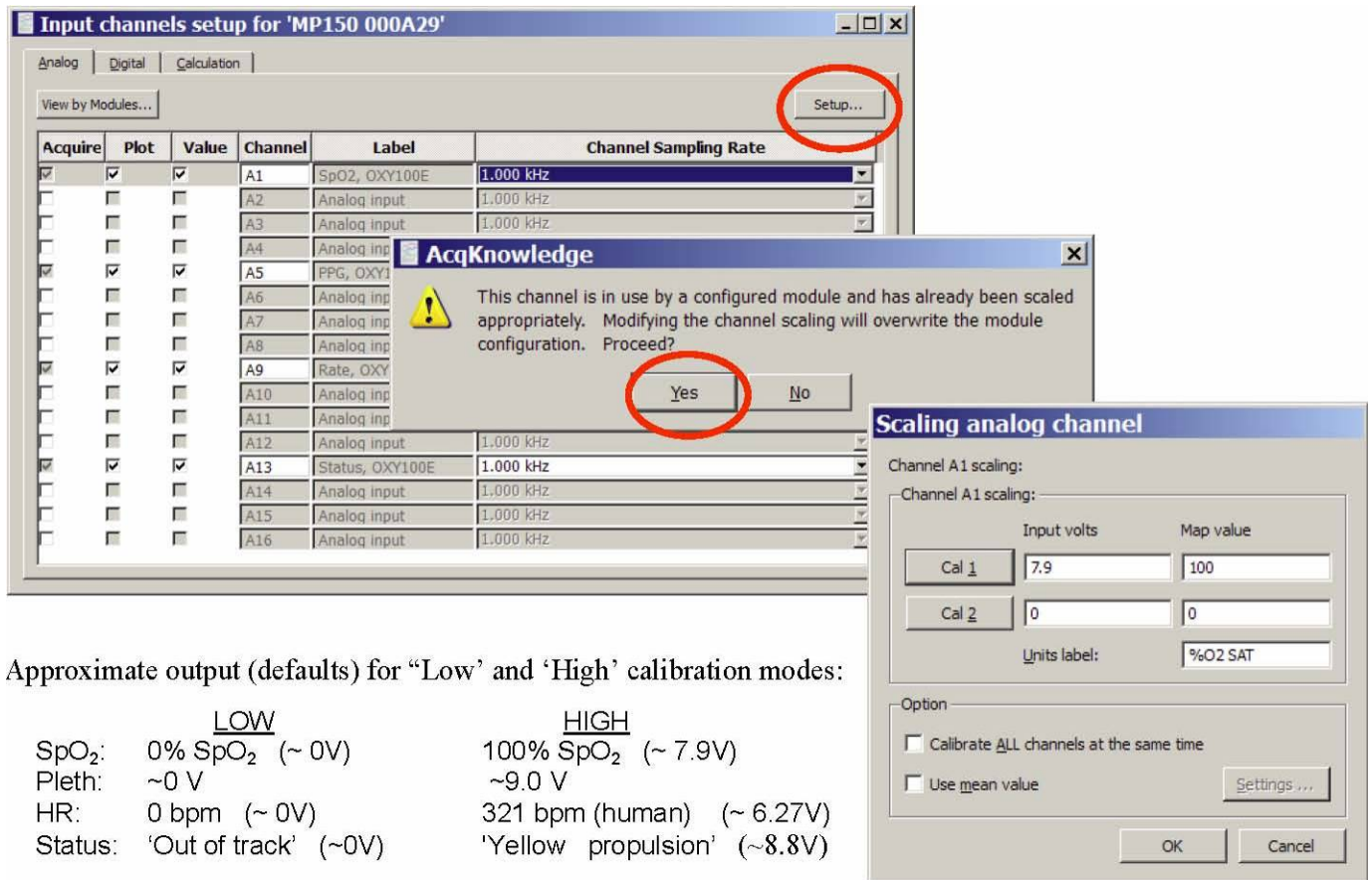

Input channels setup for 'MP150 000A29'

Acquire	Plot	Value	Channel	Label	Channel Sampling Rate
<input checked="" type="checkbox"/>	<input checked="" type="checkbox"/>	<input checked="" type="checkbox"/>	A1	SpO ₂ , OXY100E	1.000 kHz
<input type="checkbox"/>	<input type="checkbox"/>	<input type="checkbox"/>	A2	Analog input	1.000 kHz
<input type="checkbox"/>	<input type="checkbox"/>	<input type="checkbox"/>	A3	Analog input	1.000 kHz
<input type="checkbox"/>	<input type="checkbox"/>	<input type="checkbox"/>	A4	Analog inp	
<input checked="" type="checkbox"/>	<input checked="" type="checkbox"/>	<input checked="" type="checkbox"/>	A5	FPG, OXY1	
<input type="checkbox"/>	<input type="checkbox"/>	<input type="checkbox"/>	A6	Analog inp	
<input type="checkbox"/>	<input type="checkbox"/>	<input type="checkbox"/>	A7	Analog inp	
<input type="checkbox"/>	<input type="checkbox"/>	<input type="checkbox"/>	A8	Analog inp	
<input checked="" type="checkbox"/>	<input checked="" type="checkbox"/>	<input checked="" type="checkbox"/>	A9	Rate, OXY	
<input type="checkbox"/>	<input type="checkbox"/>	<input type="checkbox"/>	A10	Analog inp	
<input type="checkbox"/>	<input type="checkbox"/>	<input type="checkbox"/>	A11	Analog inp	
<input type="checkbox"/>	<input type="checkbox"/>	<input type="checkbox"/>	A12	Analog input	1.000 kHz
<input checked="" type="checkbox"/>	<input checked="" type="checkbox"/>	<input checked="" type="checkbox"/>	A13	Status, OXY100E	1.000 kHz
<input type="checkbox"/>	<input type="checkbox"/>	<input type="checkbox"/>	A14	Analog input	1.000 kHz
<input type="checkbox"/>	<input type="checkbox"/>	<input type="checkbox"/>	A15	Analog input	1.000 kHz
<input type="checkbox"/>	<input type="checkbox"/>	<input type="checkbox"/>	A16	Analog input	1.000 kHz

AcqKnowledge

This channel is in use by a configured module and has already been scaled appropriately. Modifying the channel scaling will overwrite the module configuration. Proceed?

Yes No

Scaling analog channel

Channel A1 scaling:

Input volts	Map value
Cal 1: 7.9	100
Cal 2: 0	0

Units label: %O₂ SAT

Option:

Calibrate ALL channels at the same time

Use mean value

Settings ...

OK Cancel

Approximate output (defaults) for “Low” and “High” calibration modes:

	<u>LOW</u>	<u>HIGH</u>
SpO ₂ :	0% SpO ₂ (~0V)	100% SpO ₂ (~7.9V)
Pleth:	~0 V	~9.0 V
HR:	0 bpm (~0V)	321 bpm (human) (~6.27V)
Status:	'Out of track' (~0V)	'Yellow propulsion' (~8.8V)

On the OXY module, use a paperclip or pen tip to press and hold the recessed “Cal” button. “Press and hold” the “Cal” button for ~1.5 seconds to switch between modes, as indicated by the Status LED states.

“Normal” Status LEDS = GREEN OFF and YELLOW OFF (YELLOW may occasionally flicker due to background processing)

“Calibration Low” Status LEDs = **CONSTANT GREEN ON** and YELLOW OFF

“Calibration High” Status LEDs = GREEN OFF and **CONSTANT YELLOW ON**

Release the “Cal” button as soon as the mode switches—continuously holding the button in the depressed state will *not* lead to another mode change. Modes cycle from normal to low, then to high, then back to normal.

- “Press and hold” the “Cal” button for ~1.5 seconds to switch to “Calibration Low” mode and then click the “Cal2” button in the software for any of the OXY module analog channels that are enabled.
- “Press and hold” the “Cal” button again for ~1.5 seconds to switch to “Calibration High” mode and then click the “Cal1” button in the software for any of the OXY module analog channels that are enabled.
- “Press and hold” the “Cal” button again for ~1.5 seconds to return to “Normal” mode.

It’s best to calibrate the OXY module once, then **Save As > Graph Template** to save the respective scale values.

OXY100E/200 Series Specifications

Outputs:	SpO ₂ , Pulse Rate, Pulse Waveform & Module Status
Pulse Rate Range:	OXY100E: 18-321 BPM, OXY200: 18-450 BPM
Pulse Rate Output Options*:	Standard (4 beat average, slew limited) Extended (8 beat average, slew limited)
Beat to Beat (un-averaged, non-slew limited, beat-to-beat value)	Fast (non-slew limited, 4 beat average) Standard (4 beat average, slew limited) Extended (8 beat average, slew limited)
SpO ₂ Range:	0-100%
SpO ₂ Accuracy:	70-100% ±2%
Measurement Wavelengths and Output Power:	Red: 660 nanometers @ 0.8 mW maximum average Infrared: 910 nanometers @ 12 mW maximum average
Operating Temperature Range:	0-50 degrees C
Operating Humidity Range:	10-90% (non-condensing)
Compatible Sensors:	BIOPAC TSD124 series
Principle of Operation:	Lambert-Beer law employing dual wavelengths

*for un-averaged, Beat-to-Beat Pulse Rate: use *AcqKnowledge* Rate detector on Pulse Waveform Output. All other settings are established by dip switches shown on page 5.

OXY100E and OXY200 Status Output Values

Event Weigh	t
Out of Track/No sensor	0/16*10 V (~ 0 V)
Artifact	1/16*10 V (~ 0.625 V)
Sensor Alarm	2 /16*10 V (~ 1.25 V)
Green Perfusion	16/16*10 V (~10 V)
Yellow Perfusion	14 /16*10 V (~8.75 V)
Red Perfusion	13 /16*10 V (~8.125 V)

OXY100E and OXY200 Switches

The dip switch bank on the back panel can be used to control output for the SpO₂ and HR channels. Use ‘Calibration’ for exact output levels. Output is ~10 V if the sensor is ‘out of track.’

Dip Switch			Channel	Output details
1	2	3	SpO₂	Range is 0 V (0%) to ~7.9 V (100%)
OFF	OFF	OFF	0-127 %	4-beat average values updated every pulse beat in standard ¹ mode <i>Factory setting</i>
OFF	ON	ON	0-127 %	4-beat average values updated every pulse beat in standard ¹ mode
ON	ON	ON	0-127 %	4-beat average values updated every pulse beat in standard ¹ mode
ON	OFF	OFF	0-127 %	4-beat average displayed values updated every 1.5 seconds in display ² mode
OFF	OFF	ON	0-127 %	8-beat average values updated every pulse beat in standard ¹ mode
ON	OFF	ON	0-127 %	8-beat average displayed values updated every 1.5 seconds in display ² mode
OFF	ON	OFF	0-127 %	Non-slew limited saturation with 4-beat averaging updated every pulse beat in standard ¹ mode
ON	ON	OFF	0-127 %	Non-slew limited, not averaged, beat to beat value updated every pulse beat in standard ¹ mode
4	5		HR	Range is 0 V (0 BPM) to ~6.27 V (321 BPM) for human OXY100E 0 V (0 BPM) to ~8.86 V (450 BPM) for veterinary OXY200
OFF	OFF		0-max ³ BPM	4-beat average values updated every pulse beat in standard ¹ mode <i>Factory setting</i>
ON	OFF		0-max BPM	4- beat average displayed values updated every 1.5 seconds in display ² mode
OFF	ON		0-max BPM	8-beat average values updated every pulse beat in standard ¹ mode
ON	ON		0-max BPM	8-beat average displayed values updated every 1.5 seconds in display ² mode

- ¹ **Standard** SpO₂ and Pulse rate updated on every pulse beat. SpO₂ and Heart Rate values are set to missing data values and out of track indicated.
- ² **Display** SpO₂ and Pulse rate updated every 1.5 seconds. Last in track values transmitted for ten seconds and out of track indicated; after ten seconds, values are set to missing data values.
- ³ **511 BPM** Output of 511 BPM (+10 V) indicates that sensor is not connected or signal is bad (out of track or sensor is not secured on the finger). The module never outputs BPM between range max (321 or 450) and 511.



OXY100C PULSE OXIMETER MODULE

Note: Effective August 2010, the OXY100E replaced the OXY100C

The OXY100C Pulse Oximeter Module is primarily used to measure beat-by-beat blood oxygen saturation (SpO₂) in a noninvasive fashion. The OXY100C probe incorporates light-emitting diodes (LEDs) which face photodiodes through a translucent part of the patient's body, usually a fingertip or an earlobe. One LED is red, with wavelength of 660 nm, and the other is infrared (approximately 910 nm). Light absorption at these wavelengths is different between oxyhemoglobin and its deoxygenated form. The oxyhemoglobin/deoxyhemoglobin ratio can be calculated via the ratio of the absorption of the red and infrared light. In particular, the OXY100C outputs (as a proportional voltage) the percentage of arterial hemoglobin in the oxyhemoglobin state. This ratio is expressed as the O₂ Saturation Level and will vary between 0% and 100%.

The OXY100C operates in accordance to the principles outlined by the Lambert-Beer law. This is an empirical relationship that relates the absorption of light to the properties of the material through which the light is traveling.

The Pulse Oximeter Module connects directly to the MP150 via the UIM100C. Up to four OXY100C modules can be used with a single MP System. The Pulse Oximeter Transducer (TSD123) connects to the OXY100C via a 3-meter extension cable (included with the OXY100C).

The OXY100C outputs four signals simultaneously. Output signals can be optionally directed to a number of different MP System input channels as determined with the BANK SELECT:

CH SIGNAL	Bank 1	Bank 2	Bank 3	Bank 4
A	O ₂ Saturation	Channel 1	Channel 2	Channel 3
B	Pulse Waveform	Channel 5	Channel 6	Channel 7
C	Pulse Rate	Channel 9	Channel 10	Channel 11
D	Module Status	Channel 13	Channel 14	Channel 15

There is an **ON/OFF** switch for each signal output channel on the OXY100C. Set the switch for each signal output channel to sample all, some or none of the signals. When any Signal Channel Enable switch is OFF (bottom position), the corresponding MP150 channel can be used by another input device.

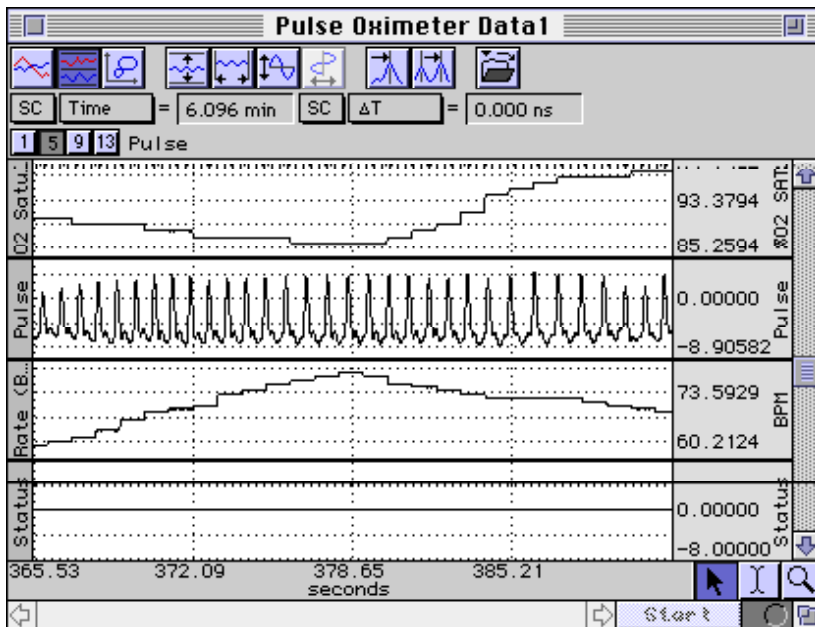

The OXY100C includes Calibration features that permit easy scaling of all these signals when using the OXY100C with the MP System.

The graph on the following page shows sample output.

O₂ Saturation
 (beat-by-beat, CH 1)

Pulse Waveform
 (beat-by-beat, CH 5)

Pulse Rate
 (continuous, CH 9)

Module Status
 (dynamic, CH13)

OXY100C CALIBRATION

Initial setup— OXY100C with an MP System:

1. Snap the OXY100C into the side of the UIM100C.
2. Connect the Analog cables directly from the MP150 to the OXY100C Analog mating connectors.
3. Connect the Digital cables directly from the MP150 to the OXY100C Digital mating connectors.
4. When the cable connections are secure, power up the MP150.
5. On the OXY100C module, place the four-position **Bank Select** switch to the first bank (top position). In this position, the OXY100C output signals will be directed as follows:

O ₂ Saturation	Channel 1	Pulse Rate	Channel 9
Pulse Waveform	Channel 5	Module Status	Channel 13

If using multiple OXY100C modules with a single MP System, be sure to place additional OXY100C modules on unique banks. Furthermore, please check that any OXY100C output does not reside on the same channel used by any other amplifier module.

6. On the OXY100C module, slide the four-position **Calibration** switch to the **OFF** position (bottom).
7. On the OXY100C module, set all the **Signal Channel Enables** to **ON** (top position).
8. Using the **Input Channels Setup** in *AcqKnowledge*, label the OXY100C signal outputs as follows:

<u>Channel</u>	<u>Label</u>
A5	Pulse
A9	Rate (BPM)
A13	Status (status reports a voltage, after calibration the stat

9. It's best to calibrate the OXY100C once, then **Save As > Graph Template** to save the respective scale values.

SCALE SETTING

1. **Determine the highest frequency component** of all the waveforms sampled. To properly sample the signals from the OXY100C, the sample rate of the MP150 (set from *AcqKnowledge*) will need to be double the rate of the highest frequency component resident in the input data.

If just the OXY100C is being used, the maximum sampling rate will normally be 50 Hz or less.

If the Pulse Waveform signal is not being sampled, the maximum sampling rate drops to double what the expected pulse rate maximum would be.

The fastest pulse rate detectable by the OXY100C is 250 BPM, so the safe sampling rate minimum would be: $2 \times [250 \text{ BPM}] / [60 \text{ sec/min}]$ or 8.33Hz

2. **Establish the Calibration Scaling for each channel**

O₂ Saturation (Channel 1) scaling

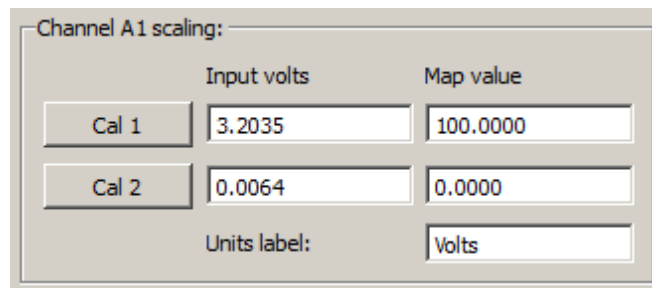

Channel A1 scaling:

	Input volts	Map value
Cal 1	3.2035	100.0000
Cal 2	0.0064	0.0000
Units label:	Volts	

- a) Slide the OXY100C Calibration switch to the CAL LO position.
- b) Click on the Cal2 button in the Channel A1 scaling dialog box.
- c) Slide the OXY100C Calibration switch to the CAL HI position.
- d) Click on the Cal1 button in the Channel A1 scaling dialog box.
- e) Enter the Map values: Cal1 = 100.00, Cal2 = 0.00
- f) Enter the Units label: %O2 SAT

Ideally, the nominal Cal1/Input volts value should be exactly 3.200. The nominal Cal2/Input volts value should be exactly 0.00. In practice, there will be very slight deviations from these expected values. The minimum O₂ Saturation level detectable by the OXY100C is 0.00%. The maximum O₂ Saturation level detectable is 100%. In the range from 80% to 100% the O₂ Saturation level is ±2% accurate. From 0% to 79%, the O₂ Saturation level is unspecified.

Pulse Waveform (Channel 5) scaling

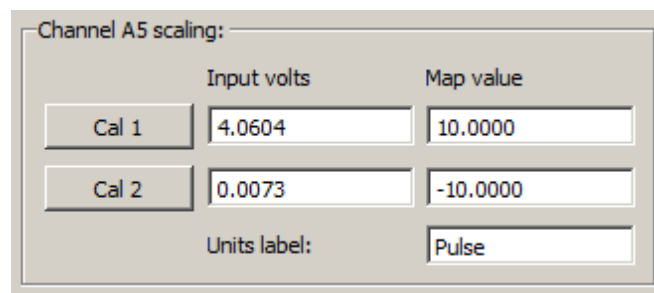

Channel A5 scaling:		
	Input volts	Map value
Cal 1	4.0604	10.0000
Cal 2	0.0073	-10.0000
Units label:	Pulse	

- a) Slide the OXY100C Calibration switch on the OXY100C module to the **OFF** position.
- b) Slide the OXY100C Calibration switch to the CAL LO position.
- c) Click on the Cal2 button in the Channel A5 scaling dialog box.
- d) Slide the OXY100C Calibration switch to the CAL HI position.
- e) Click on the Cal1 button in the Channel A5 scaling dialog box.
- f) Enter the Map values: Cal1 = 10.00, Cal2 = -10.00.
- g) Enter the Units label: Pulse

Ideally, the nominal **Cal1/Input** volts value should be exactly 4.064. The nominal **Cal2/Input volts** value should be exactly 0.00. In practice, there will be very slight deviations from these expected values. The Pulse Waveform output from the OXY100C is functionally equivalent to a standard plethysmographic waveform, such as obtained with the PPG100C and TSD200.

Pulse Rate (Channel 9) scaling

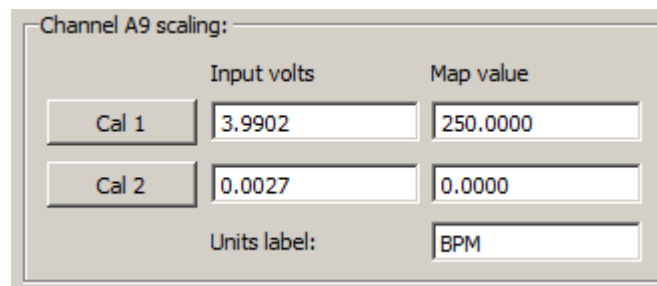

Channel A9 scaling:		
	Input volts	Map value
Cal 1	3.9902	250.0000
Cal 2	0.0027	0.0000
Units label:	BPM	

- a) Slide the OXY100C Calibration switch on the OXY100C module to the **OFF** position.
- b) Slide the OXY100C Calibration switch to the CAL LO position.
- c) Click on the Cal2 button in the Channel A9 scaling dialog box.
- d) Slide the OXY100C Calibration switch to the CAL HI position.
- e) Click on the Cal1 button in the Channel A9 scaling dialog box.

- f) Enter the Map values: Cal1 = 250.00, Cal2 = 0.00.
- g) Enter the Units label: BPM.

Ideally, the nominal **Cal1/Input volts** value should be exactly 4.00. The nominal **Cal2/Input volts** value should be exactly 0.00. In practice, there will be very slight deviations from these expected values.

The minimum BPM detectable by the OXY100C is 30. The maximum BPM detectable is 250. The BPM accuracy in the range of 30-250 BPM is $\pm 1\%$. The BPM settles to $\pm 1\%$ of the final reading less than 15 seconds after the sensor is properly applied.

Module Status (Channel 13) scaling

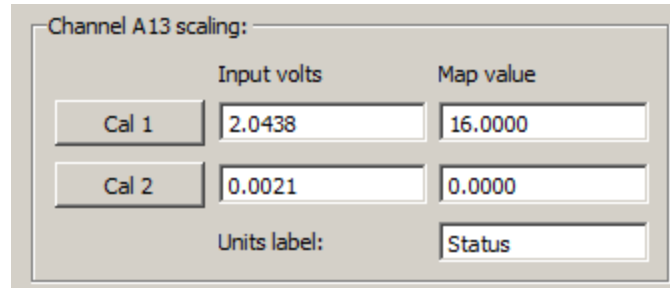

Channel A13 scaling:		
	Input volts	Map value
Cal 1	2.0438	16.0000
Cal 2	0.0021	0.0000
Units label:	Status	

- a) Slide the OXY100C Calibration switch on the OXY100C module to the **OFF** position.
- b) Slide the OXY100C Calibration switch to the CAL LO position.
- c) Click on the Cal2 button in the Channel A13 scaling dialog box.
- d) Slide the OXY100C Calibration switch to the CAL HI position.
- e) Click on the Cal1 button in the Channel A13 scaling dialog box.
- f) Enter the Map values: Cal1 = 16.00, Cal2 = 0.00.
- g) Enter the Units label: Status.

Ideally, the nominal **Cal1/Input volts** value should be exactly 2.048. The nominal **Cal2/Input volts** value should be exactly 0.00. In practice, there will be very slight deviations from these expected values.

MODULE STATUS LEVELS:

- | | |
|---|--|
| 0 – no status errors, all is well | 9 – probe error 2, sensor's IR led has failed |
| 1 – probe fell off subject, outputs at full scale | 10 – connect probe, probe not connected to OXY100C |
| 2 – unused | 11 – incorrect probe, incompatible probe connected |
| 3 – insufficient light, mean path is too low for valid readings | 12 – front end initializing |
| 4 – light interference, ambient noise detected on front end | 13 – unused |
| 5 – pulse out of range, pulse rate exceeds 250 BPM | 14 – unused |
| 6 – low signal strength, AC signal too low | 15 – unidentified probe, can't determine if probe is correct |
| 7 – monitor error 1, front end fatal error | 16 – probe failure, general |
| 8 – probe error 1, sensor's red led has failed | |

OXYSSH-SYS HUMAN OXIMETRY (SPO2) SYSTEM

This Human Pulse Oximetry System includes everything required to record SpO₂, Heart Rate, and Pulse with an MP36R Research System or MP36, MP35 or MP45* Education System.

Human SpO₂ System components:

- Oximeter for MP3X/45 (OXYSS)
- Pulse cable for OXYSS
- Rate cable for OXYSS
- SPO₂ Finger Transducer (TSD124A)

The system also accepts optional Ear Clip Transducer (TSD124B) and Flex Wrap Transducer (TSD124C).

To add Status output, add BSLCBL14 or BSLCBL14A.

Power is via the MP input so no external power supply is required.

The Oximeter module accepts currently offered Human SpO₂ Transducers (TSD124A/B/C) on the input and outputs SpO₂ via a 1.8 m (6') cable terminated in a DB9 Male connector for an MP device analog CH input.

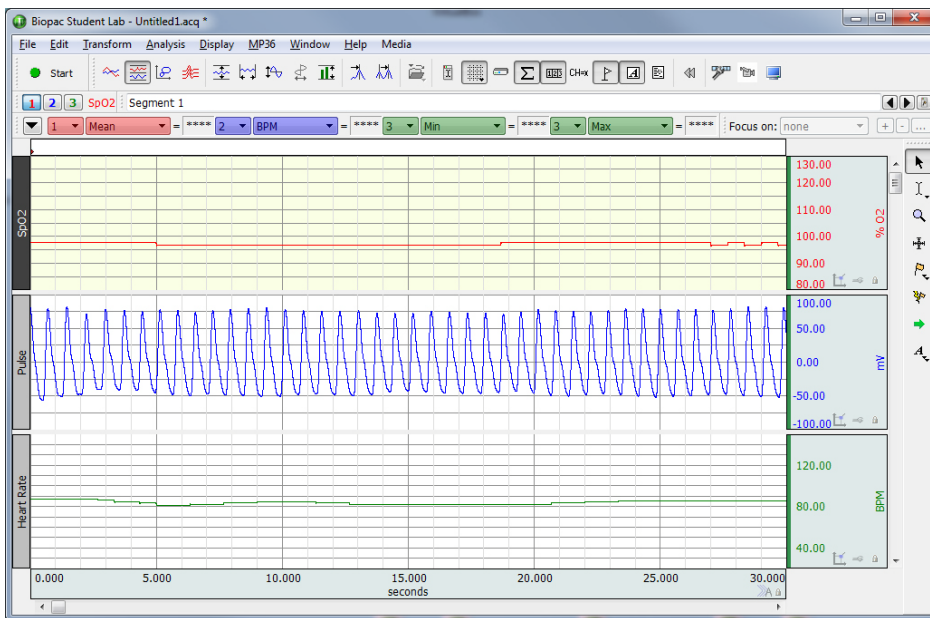

There are three auxiliary outputs (3.5 mm stereo jacks):

PULSE (uncalibrated) output cable is 3.5 mm male mono phone plug with 1.8 m (6') cable to DB9 Male; attenuates by 5 and employs 3.32 K Ohm resistor.

RATE output cable is 3.5 mm male mono phone plug with 1.8 m (6') cable to DB9 Male; attenuates by 5 and employs 7.62 K Ohm resistor.

STATUS output requires optional BSLCBL14 add-on, which is 3.5 mm male mono phone plug with 3 m (10') cable to DB9 Male; attenuates by 10, which translates 10 V to 1 V.

* When used with the MP45 two-channel system, only one of the three auxiliary outputs can be used in conjunction with the SpO₂ output.

OXYSSH-SYS Specifications

Outputs:	SpO ₂	Pulse	Rate	Status
Range	0 – 100 % O ₂	+ - 250 mV	18 – 321 BPM	0 – 200 mV
Averaging:	4-beat average*	No	4-beat average*	No
Accuracy:	+ - 2 digits for 70 – 100 %O ₂	N/A	+ - 3 digits, no motion, + - 5 digits with motion	+ - 5 mV
Update Rate (samples/sec)	3	75	3	75

Measurement Wavelengths and Output Power:

Red:	660 nanometers @ 0.8 mV maximum average
Infrared:	910 nanometers @ 1.2 mW maximum average
Finger transducer placement:	index, middle or ring fingers
Subject weight requirement**:	> 30 Kg (66 Lbs)
Operating Temperature Range:	0- 40 deg. C (32 – 104 deg. F)
Operating Humidity Range:	10 – 90% non-condensing
Weight:	366 grams (excluding BSLCBL14 cable)
Size of OXYSSH module:	9.5 cm x 6.5 cm x 3 cm
Length of MP interface cables:	1.8 m
Length of finger transducer cable:	1 m

Notes:

* SpO₂ and Rate outputs use 4-beat average values that are updated on every pulse beat.

**Subject weight requirement is based on the design of the Adult finger clip transducer that is included with the OXYSSH-SYS.

Status Indicators:

The OXYSSH outputs status information in two ways: (1) via LEDs on the OXYSSH module and (2) via output voltage levels on Status auxiliary output. A green blinking LED indicates the pulse oximeter is working properly and detecting SpO₂. An Orange blinking LED indicates an error condition (i.e., finger is not detected,) or the level of perfusion may be too low to measure SpO₂. If the status is indicating low perfusion, see [Appendix 2: Troubleshooting](#). The blink pattern of the LEDs (number of blinks in quick succession) provides more detailed information as shown in the following table:

OXYSSH Status condition	Green LED	Orange LED	Status Output
High Perfusion: working with amplitude of high signal quality	1 blink	Off	210 mV
Medium Perfusion: working with amplitude of moderate signal quality	2 blinks	Off	185 mV
Low Perfusion: working with amplitude of low signal quality	3 blinks	Off	170 mV
Sensor Alarm Error: finger transducer is providing an unusable signal	Off	1 blink	< 5mV
Out of Track Error: an absence of consecutive good pulse signals	Off	2 blinks	< 5 mV
Artifact Error: a detected pulse beat didn't match the current pulse interval	Off	2 blinks	13 mV
Sensor Disconnect Error – finger transducer is not connected to OXYSSH module or sensor is inoperable	Off	3 blinks	< 5 mV

Note: The stated output voltages are approximate and can vary by as much as +- 5mV when the OXYSSH is working (Green LED blinking) and +- 2 mV when there is an error condition.

OXYSSH Setup and Calibration

Setup:

1. Turn OFF MP unit. If using the MP45, it must be turned OFF by disconnecting the USB cable from the computer.
2. OXYSSH Connections:
 - a. Plug the TSD124A Finger clip transducer into the “Transducer” input on the OXYSSH.
 - b. Plug the 3.5 mm phone plug on the “Pulse”-BSLCBL15 cable into OXYSSH output labeled “Aux. - Pulse”.
 - c. Plug the 3.5 mm phone plug on the “Rate”-BSLCBL16 cable into the output labeled “Aux. - Rate”.
 - d. If monitoring “Status”, plug the 3.5 mm phone plug on the optional BSLCBL14 into the output labeled Aux. – Status.
3. MP connections: *
 - a. Plug in the “SpO2” cable into CH 1.
 - b. Plug the “Pulse”-BSLCBL15 cable into CH 2.
 - c. Plug the “Rate”-BSLCBL16 cable into CH 3.
 - d. Plug the BSLCBL14 (Status) cable into CH 4 (Optional).

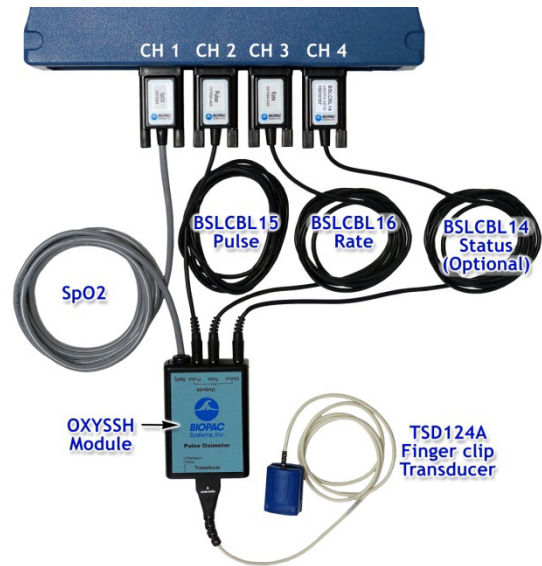

Figure 1

- Note*** The MP45 (not shown) is a two channel device, so only one of the auxiliary outputs can be used.
4. Turn ON the MP unit. If using the MP45, plug the USB cable into the computer.

Connecting TSD124A Finger Clip Transducer to Subject:

To obtain optimal pulse oximeter data, the finger clip transducer must be positioned at or near heart level and the **Subject** must be seated, relaxed and fingers should be warm. The finger transducer can be placed on the index, middle or ring finger. Make sure that the side of the clip displaying the finger graphic is properly oriented. The hand should be positioned so that there is no additional pressure placed on the transducer, and motion artifact should be minimized. Two recommended positions are:

- Hand resting in lap with palm facing up.
- Arm resting on arm rest with palm facing up.

Although it is possible to record pulse oximetry data during exercise, it is not recommended as it is difficult to control motion artifact. For resting vs. exercise comparisons, consider taking recordings only in the resting and post exercise state. After recording the “at rest” portion, click **Stop**. The **Subject** can then remove the finger clip transducer and begin exercising. Immediately after stopping exercise, the **Subject** must quickly return to a seated and relaxed position, reapply the finger transducer, and continue the recording.

Calibration:

If using BSL 4.1 or higher, or AcqKnowledge 4.4 or higher with MP36R, follow the steps below. If using software prior to BSL 4.0, it will be necessary to manually setup all channel parameters referencing Appendix 1 and then proceed starting at Step 4. (AcqKnowledge versions prior to 4.1 do not offer MP36R support.)

1. After launching the software, choose “**Create/Record a new experiment**” from the Startup dialog and click “**OK**” to display the “**Data Acquisition Settings**” dialog. Alternately, if the software is already running, select “**Set Up Data Acquisition**” from the MP menu.
2. From the **Channels > Preset** pop-up menu list, choose the correct preset for each of the four channels as shown below.

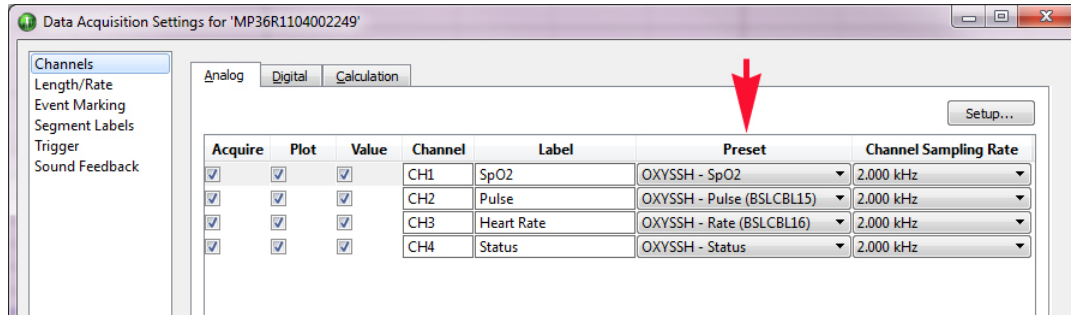

Figure 2

3. Exit the “**Data Acquisition Settings**” dialog using the “**Close**” button.
4. Click “**Start**” followed by “**Stop**” to record a small amount of data, which sets up the graph display.
5. Instruct the **Subject** to remove finger from the finger clip transducer.
6. Using the arrow selection tool, click the wrench button in the units (% O2) region of **CH 1** (SpO2) as shown in Figure 3 to display the Scaling dialog shown in Figure 4.
7. Click “**Cal 1**” to update the “**Input millivolts**” value and make sure the corresponding “**Map value**” is **127 % O2**.
8. Click “**OK**” to close the dialog.

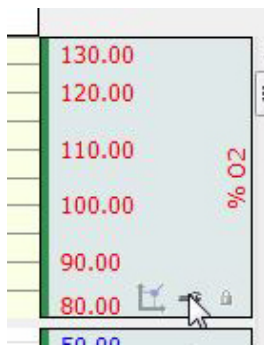

Figure 3

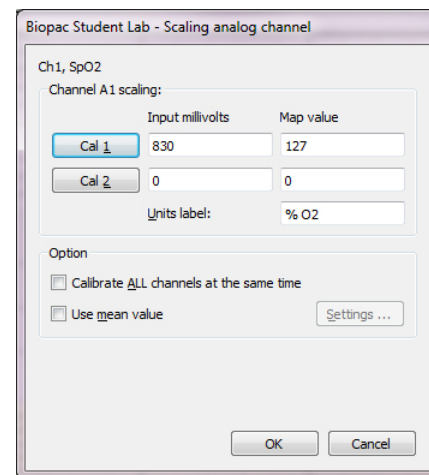

Figure 4

- It may be useful to enable **textual value display** in order to show the numerical values for SpO₂ during the recording. This option is not available in software prior to BSL 4.0. To enable, position the arrow cursor over the numerical values in the vertical scale region and click the mouse button. The dialog shown in Figure 5 will appear. Check the “**Show textual value display**” box and click “**OK**” to close the dialog.

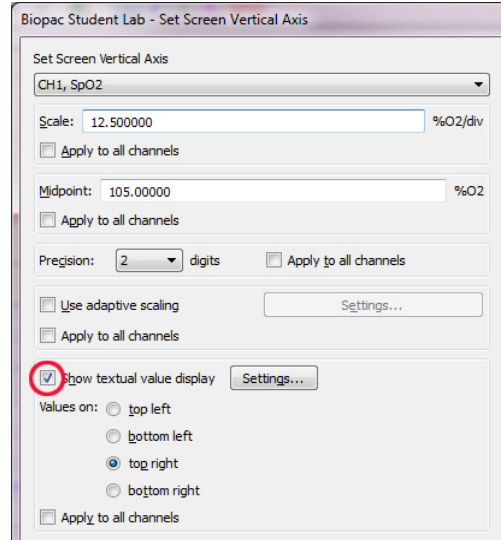

Figure 5

- Click the wrench button in the units (BPM) region of **CH 3** (Heart Rate) to display the Scaling dialog shown in Figure 6.
- Click “**Cal 1**” and make sure the corresponding “**Map value**” is **511** BPM.
- Click “**OK**” to close the dialog.
- Enable the “**Show textual value display**” option for CH 3.

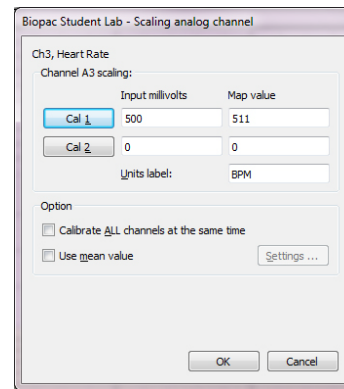

Figure 6

Recording

- Subject** attaches the finger clip transducer to index finger and gets into a seated and in a relaxed position.
- Click “**Start**” to begin the recording. The recording should resemble data shown in Figure 7.

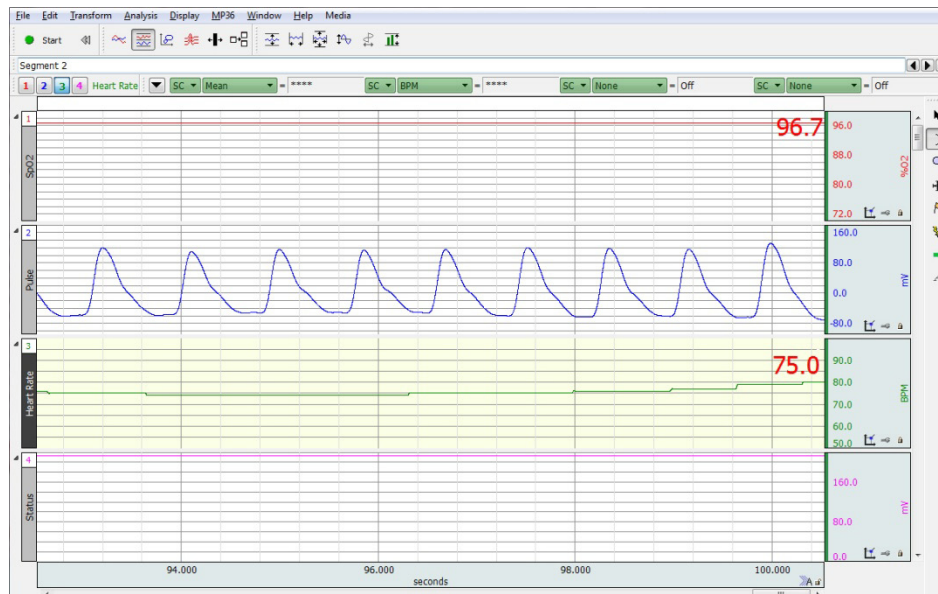
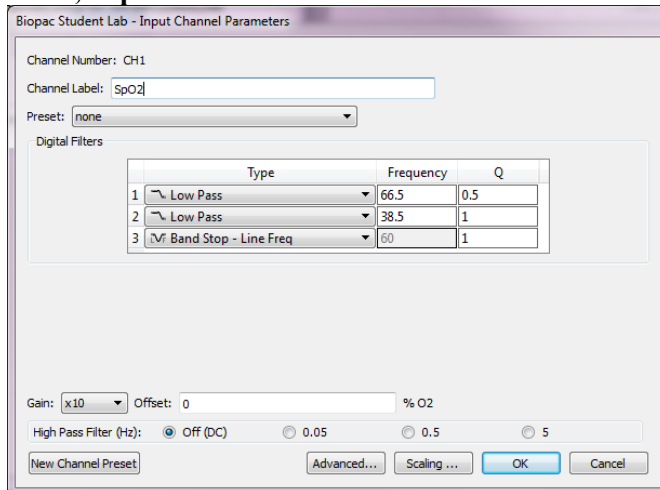

Figure 7

Appendix 1: Channel Settings

CH 1, “SpO2”:



Biopac Student Lab - Input Channel Parameters

Channel Number: CH1
Channel Label: SpO2
Preset: none

Digital Filters

	Type	Frequency	Q
1	Low Pass	66.5	0.5
2	Low Pass	38.5	1
3	Band Stop - Line Freq	60	1

Gain: x10 Offset: 0 % O2
High Pass Filter (Hz): Off (DC) 0.05 0.5 5

New Channel Preset Advanced... Scaling ... OK Cancel

Figure 8

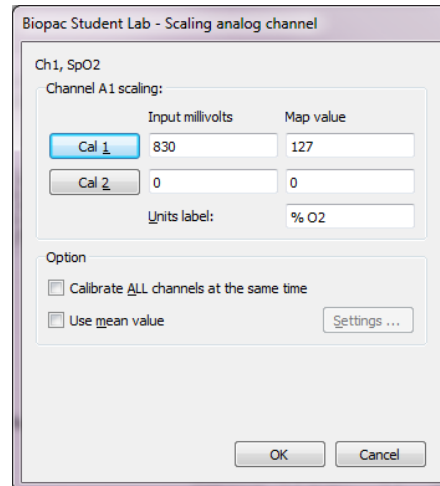

Biopac Student Lab - Scaling analog channel

Ch1, SpO2
Channel A1 scaling:

	Input millivolts	Map value
Cal 1	830	127
Cal 2	0	0

Units label: % O2

Option

Calibrate ALL channels at the same time
 Use mean value Settings ...

OK Cancel

Figure 9

CH 2, “Pulse”:

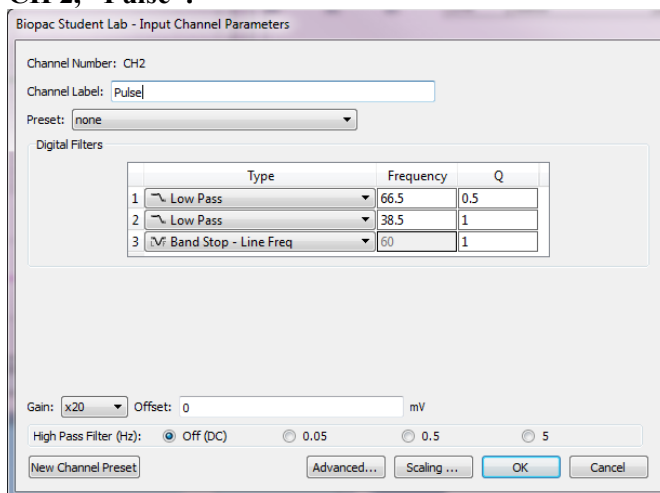

Biopac Student Lab - Input Channel Parameters

Channel Number: CH2
Channel Label: Pulse
Preset: none

Digital Filters

	Type	Frequency	Q
1	Low Pass	66.5	0.5
2	Low Pass	38.5	1
3	Band Stop - Line Freq	60	1

Gain: x20 Offset: 0 mV
High Pass Filter (Hz): Off (DC) 0.05 0.5 5

New Channel Preset Advanced... Scaling ... OK Cancel

Figure 10

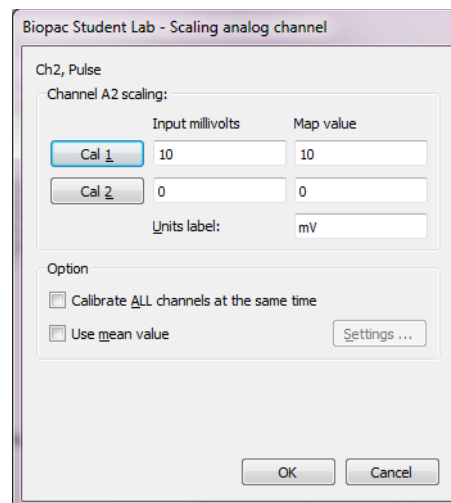

Biopac Student Lab - Scaling analog channel

Ch2, Pulse
Channel A2 scaling:

	Input millivolts	Map value
Cal 1	10	10
Cal 2	0	0

Units label: mV

Option

Calibrate ALL channels at the same time
 Use mean value Settings ...

OK Cancel

Figure 11

Ch 3, “Rate”:

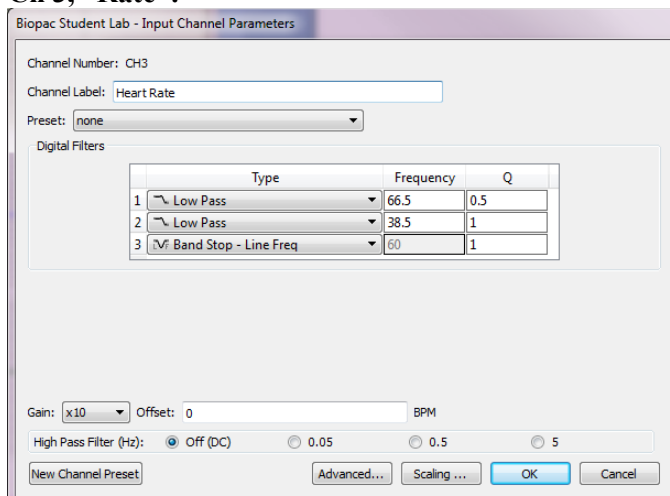

Biopac Student Lab - Input Channel Parameters

Channel Number: CH3
Channel Label: Heart Rate
Preset: none

Digital Filters

	Type	Frequency	Q
1	Low Pass	66.5	0.5
2	Low Pass	38.5	1
3	Band Stop - Line Freq	60	1

Gain: x10 Offset: 0 BPM
High Pass Filter (Hz): Off (DC) 0.05 0.5 5

New Channel Preset Advanced... Scaling ... OK Cancel

Figure 12

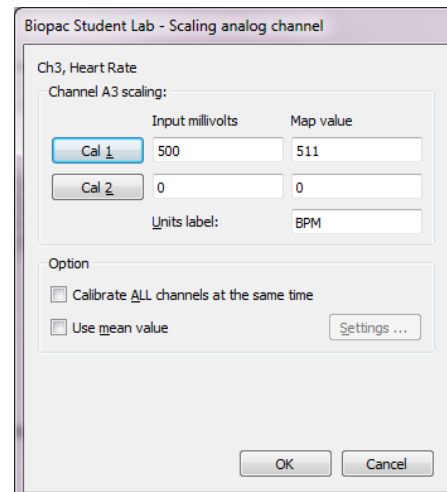

Biopac Student Lab - Scaling analog channel

Ch3, Heart Rate
Channel A3 scaling:

	Input millivolts	Map value
Cal 1	500	511
Cal 2	0	0

Units label: BPM

Option

Calibrate ALL channels at the same time
 Use mean value Settings ...

OK Cancel

Figure 13

Ch 4, “Status”:

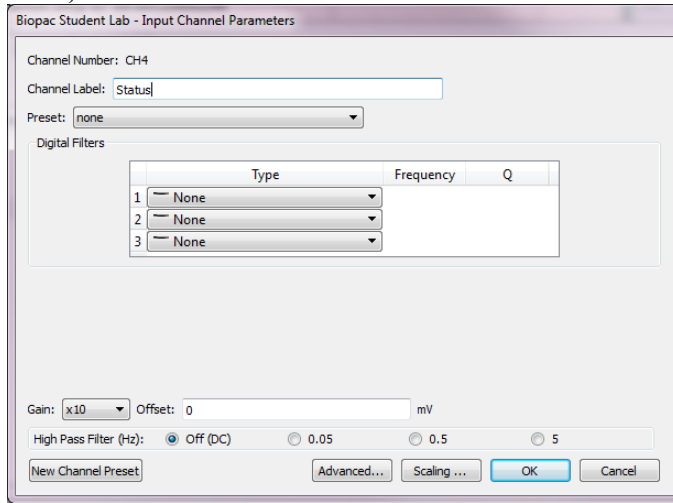

Figure 14

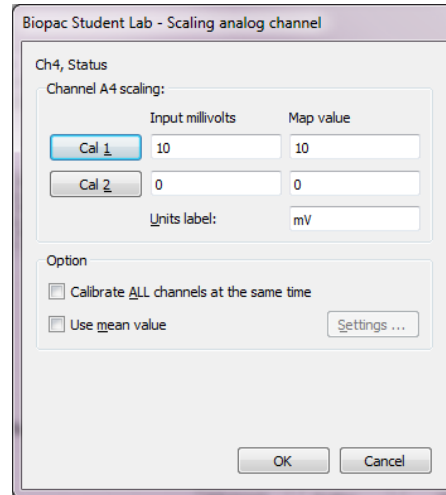

Figure 15

Appendix 2: Troubleshooting

If the status is indicating low perfusion:

- Reposition the finger transducer or place it on an alternate finger.
- Ensure that recording finger is warm. Lower body temperature will give poor readings.
- Make sure the finger transducer is not positioned above heart level.
- Reduce the amount of ambient light around the finger transducer.
- Remove any nail polish.

If the status is indicating an error condition:

- Make sure the finger transducer is plugged all the way into the OXYSSH module.
- Make sure the finger is placed all the way into the finger transducer.
- Turn the MP unit off and then back on.

TSD123 SERIES SPO₂ TRANSDUCERS FOR OXY100C



TSD123A



TSD123B

Note: TSD123 series is for existing OXY100C users only! New users should see SpO₂ Pulse Oximeter Amplifier - OXY100E and TSD124 series transducers.

TSD123A SPO₂ FINGER TRANSDUCER

The TSD123A Blood Oxygen Saturation Finger transducer connects to the OXY100C Pulse Oximeter module and is ideal for short term SpO₂ monitoring.

The transducer, with the OXY100C, provides continuous readings for SpO₂, pulse rate, Pulse Waveform, and Module Status. The transducer comes with a 1-meter cable, which plugs into the (3 m) extension cable included with the OXY100C.

TSD123B UNIVERSAL ADHESIVE SPO₂ TRANSDUCER

The Universal Adhesive TSD123B Blood Oxygen Saturation Transducer connects to the OXY100C Pulse Oximeter module, and comes with a 1-meter cable, which plugs into the (3 m) extension cable included with the OXY100C. Adhesive patches can be used to connect to the TSD123B to fingers, ears, and toes. The transducer fits into a special window cut into the adhesive patch, which allows the transducer to be located on almost any part of the body and is ideal for long-term monitoring.

The TSD123B, with the OXY100C, provides continuous readings for SpO₂, Pulse rate, Pulse Waveform, and Module Status.

TSD123A/B CALIBRATION

See also: the OXY100 transducer.

TSD123 SERIES SPECIFICATIONS

Optical Transmission:	Red (660 nm) and IR (940 nm)
Weight:	TSD123A: 23 grams, TSD123B: 6 grams
Dimensions:	TSD123A: 62 mm (long) x 23 mm (wide) x 26 mm (high) TSD123B: 12 mm (long) x 12 mm (wide) x 12 mm (high)
Sterilizable:	Yes (contact BIOPAC for details)
Cable Length:	1 meter
Interface:	OXY100C

EBI100C ELECTRICAL BIOIMPEDANCE AMPLIFIER



The EBI100C records the parameters associated with cardiac output measurements, thoracic impedance changes as a function of respiration or any kind of biological impedance monitoring.

The EBI100C incorporates a precision high frequency current source, which injects a very small (400 μ A) current through the measurement tissue volume defined by the placement of a set of current source electrodes. A separate set of monitoring electrodes then measures the voltage developed across the tissue volume. Because the current is constant, the voltage measured is proportional to the characteristics of the biological impedance of the tissue volume.

The EBI100C simultaneously measures impedance **magnitude** and **phase**. Impedance can be recorded at four different measurement frequencies, from 12.5 kHz to 100 kHz; cardiac output measurements are usually performed at a measurement frequency of 50 kHz.

For operation, the EBI100C connects to four unshielded electrode leads terminating in 1.5 mm female Touchproof sockets. The EBI100C is typically used with EL500 paired disposable electrodes, but can function with spot or ring electrodes, reusable electrodes, or needle electrodes.

The **CH SELECT** switch has four bank settings, which assign EBI100C output (i.e., Magnitude or Phase) channels as follows:

<u>Bank</u>	<u>Magnitude (MAG)</u>	<u>Phase (PHS)</u>
1	Channel 1	Channel 9
2	Channel 2	Channel 10
3	Channel 3	Channel 11
4	Channel 4	Channel 12

If the particular EBI100C output is not used, the respective assigned channel cannot be used for another module's output; users should simply not record on the unwanted but assigned channel.

Typical Configuration for Cardiac Output Measurements

For injecting current and averaging voltage at four paired-electrode sites (required for **cardiac output measurements**), use four CBL204 1.5 mm Touchproof "Y" electrode lead adapters and eight LEAD110 electrode leads with each EBI100C.

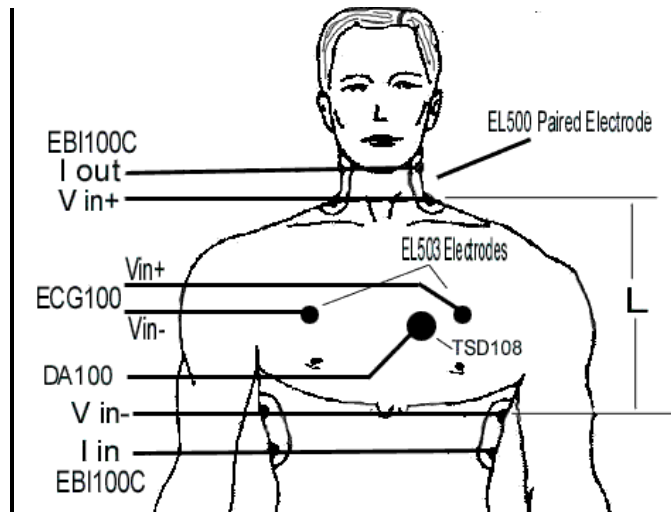

See also
Application Note #AH-196
Cardiac Output Measurement
www.biopac.com
and
Applications (Appendix)
in the "AcqKnowledge Software Guide"

When using EBI100C with MEC110C Module Extension Cable:

Connect the four CBL204 1.5 mm Touchproof “Y” lead adapters to the following color inputs on the MEC110C. I OUT = brown (Shield), VIN+ = red, VIN- = white, I IN = green (Shield). (The black GND port on the MEC110C is normally not used in this application.) The diagram below shows the eight LEAD110 electrode positions for impedance cardiography or cardiac output.

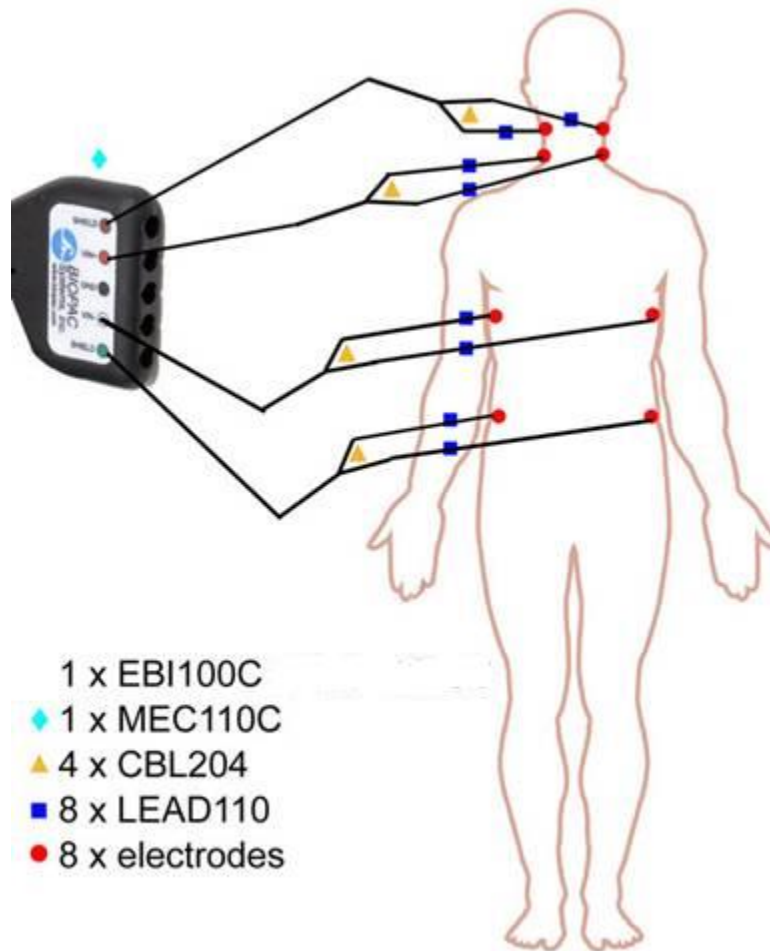

Grounding

When using the EBI100C amplifier with other biopotential amplifiers attached to the same subject, it's not necessary to attach the ground lead from the biopotential amplifier(s) to the subject. The subject is already appropriately referenced to the subject via the attachment to the EBI100C. If a biopotential ground is attached to the subject, then currents sourced from the EBI100C will be split to the biopotential amplifier ground lead, potentially resulting in measurement errors.

Derivative Polarity – EBI100C vs. NICO100C

The EBI100C does not include an internal, hardware-based, derivative function for the Z (impedance magnitude) channel. An *AcqKnowledge* calculation channel can be used to determine dZ/dt , if required. Channel scaling can be employed to specify the dZ/dt polarity desired.

The NICO100C module incorporates an internal, hardware-based, derivative function, which outputs dZ/dt simultaneously with Z (impedance magnitude). This internal derivative function also inverts the polarity of the dZ/dt signal so that it displays a positive-going peak, coincident with negative slopes indicated in Z, as per academic research convention.

Sample Data

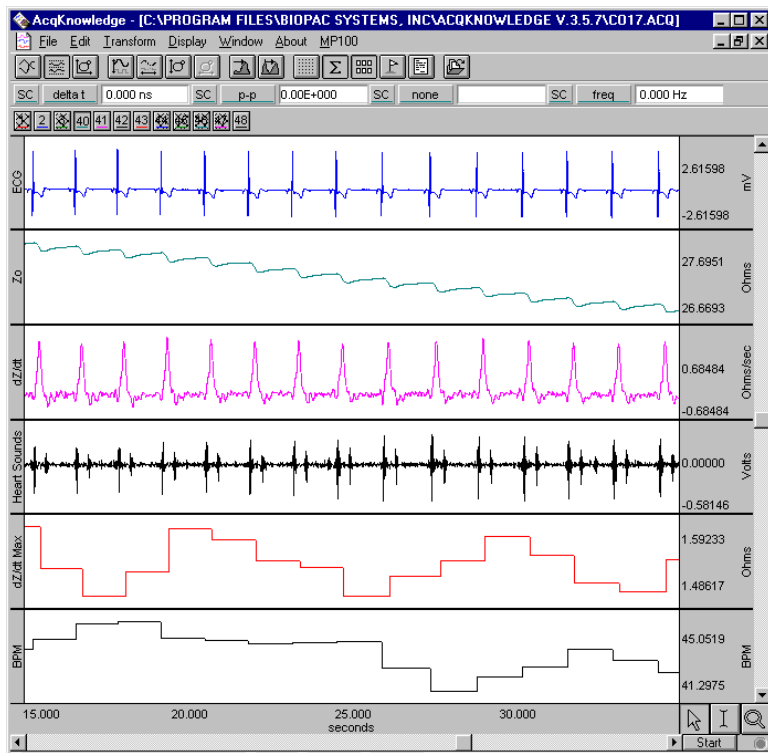

Note that dZ/dt maximum is determined on a cycle-by-cycle basis from the raw dZ/dt waveform.

Similarly, the heart rate in BPM is derived from the raw ECG waveform in Channel 1.

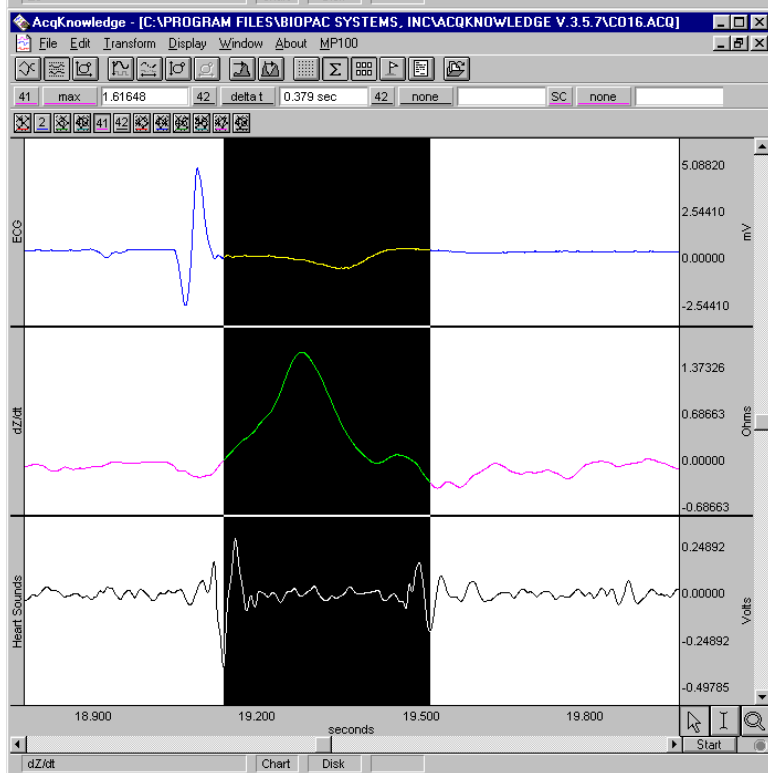

This graph illustrates the procedure for measuring Left Ventricular Ejection Time (T).

The AcqKnowledge cursor was swept to bridge from peak to peak in the filtered (40-60 Hz) Heart Sounds channel.

The Delta T (0.379 seconds) indicates the time from aortic valve opening to closing.

Applications

Cardiac Output

Cardiac Output can be determined noninvasively by employing electrical bioimpedance measurement techniques. Electrical bioimpedance is simply the characteristic impedance of a volume of tissue and fluid. In the case of Cardiac Output measures, the relevant tissue includes the heart and the immediate surrounding volume of the thorax, and the relevant fluid is blood. The electrical impedance of the thorax can be thought of as composed of two impedance types:

1. Z_0 (the base impedance) corresponds to non-time varying tissues, such as muscle, bone and fat.
2. dZ/dt is the magnitude of the largest impedance change during systole (Ω /sec).

BIOPAC Application Note #AH-196 Cardiac Output Measurements, implements the following equation, but other equations/modifications can be incorporated:

$$SV = r \cdot (L^2/Z_0^2) \cdot T \cdot dZ/dt$$

Where: SV = Stroke volume (ml)

r = Resistivity of blood (Ω cm)

L = Length between inner band electrodes (cm)

Water Content Measurement and Adiposity

This is an area of active research and so specific methods of performing total body water (TBW) measurements using BIA may change. The following formula is sometimes used:

$$TBW = A * (H^{**2}/R) + C$$

Where: A = a proportionality constant specific for a given subject population
H = subject's height
R = resistance obtained by single-frequency BIA (usually 50 kHz)
C = a constant

It may also be possible to obtain additional specificity in TBW measurements by performing BIA at multiple frequencies.

Frequency Response Plots

The 0.05 Hz lower frequency response setting is a single pole roll-off filter.

See also: Sample frequency response plots, 10 Hz LP, 100 Hz LP

EBI100C Calibration

The EBI100C can be calibrated using external loads. BIOPAC factory calibration is performed with 20, 200 and 900 Ohm loads. The EBI100C can measure from zero phase to 90 degree phase at the limits. Measurements of zero phase (using resistors) may not mean the output voltage of the phase signal is exactly zero. The user will need to scale the output voltage to 0 degrees phase when calibrating. Typically, a couple of tenths of volts are possible to obtain (at zero phase), depending on frequency of excitation.

For Cardiac Output Measurements

1. Set the EBI100C to a Frequency of 50 kHz and a Magnitude Gain range of 5 ohms/volt.
2. Introduce a 20 ohm resistor between the I Out / Vin+ combination terminal to the I In / Vin- combination terminal.
3. Press the Cal1 button...
4. Introduce a 40 ohm resistor between the I Out / Vin+ combination terminal to the I In / Vin- combination terminal.
5. Press the Cal2 button...

EBI100C SPECIFICATIONS

Number of Channels:	2 – Magnitude (MAG) and Phase (PHS)
Operational Frequencies:	12.5, 25, 50, 100 kHz
Current Output:	400µA (rms)—constant sinusoidal current
Outputs:	MAG of Impedance (0-1000 Ω)* PHS of Impedance (0-90°)*
Output Range:	±10 V (analog)
Maximum Over-Voltage for Differential Input:	±25 V
Operational Resistance:	The resistance range is 10 Ohms to 1,000 ohms; the minimum operational resistance is around 10 Ohms. A delta of 0.1 ohms is quite simple to measure with the correct EBI100C settings (assuming the data acquisition system used provides sufficient resolution.)
MAG Gain Range:	100, 20, 5, 1 Ω/volt
MAG LP Filter:	10 Hz, 100 Hz
MAG HP Filter:	DC, 0.05 Hz
MAG Sensitivity:	0.0015 Ω rms @ 10 Hz bandwidth
PHS Gain:	90°/10 volts
PHS LP Filter:	100 Hz
PHS HP Filter:	DC coupled
PHS Sensitivity:	0.0025 degrees @ 10 Hz bandwidth
CMIV – referenced to	
Amplifier ground:	±10 V
Mains ground:	±1500 VDC
Signal Source:	Electrodes (four electrode leads required)
Weight:	370 grams
Dimensions:	4 cm (wide) x 11 cm (deep) x 19 cm (high)
Input Connectors:	Five 1.5 mm male Touchproof sockets (Input, Vin+, Ground, Vin-, Output)

*The EBI100C and NICO100C amplifiers are specifically designed to measure complex impedances that have a magnitude between 10 Ω and 1000 Ω and phases between 0° and 90° degrees; they are not designed to measure any arbitrary impedance.

*Since these amplifiers require at least some small leakage path of DC current from I+ to I-, 89.9° degrees is the maximum measurement; they can't measure exactly to 90°.

Note—If a series capacitor is placed in the measurement circuit, then a large valued parallel resistor (10 K-100 K) should be placed across the capacitor to permit a small DC current to flow.

Possible EBI100C Lead Configurations

Setup Type	Amplifier	MEC	Lead	Adapter	Electrode
Simulated Equipotential <i>Absolute measures</i>	EBI100D <i>optimal</i>		LEAD132		4 x EL500
	EBI100D <i>optimal</i>	MEC104D	LEAD132		4 x EL500
	EBI100D		LEAD131		4 x EL503
	EBI100D	MEC104D	LEAD131		4 x EL503
	EBI100C <i>optimal</i>	1 x MEC110C	8 x LEAD110	4 x CBL204	4 x EL500
	EBI100C		8 x LEAD110A	4 x CBL204	4 x EL500
Fully Equipotential <i>Absolute measures</i> Uses ICG strip conductor, circumferential, cardiographic electrode tape (ICG Tape)	EBI100C <i>optimal</i>	1 x MEC110C	4 x LEAD140		ICG Tape
Non-Equipotential <i>Relative measures</i> Suitable for establishing timing relationships between waves	EBI100D		LEAD131		2 x EL500
	EBI100D	MEC104D	LEAD131		2 x EL500
	EBI100C	1 x MEC110C	4 x LEAD110		2 x EL500
	EBI100C		4 x LEAD110A		2 x EL500

NICO100C



The NICO100C noninvasive cardiac output amplifier records the parameters associated with cardiac output measurements. It incorporates a precision high frequency current source, which injects a very small (400 μ A) measurement current through the thoracic volume defined by the placement of a set of current source electrodes. A separate set of monitoring electrodes then measures the voltage developed across the thorax volume. Because the current is constant, the voltage measured is proportional to the impedance characteristics of the thorax.

The NICO100C simultaneously measures impedance magnitude (Z_o ; labeled “Z” on the module) and derivative (dZ/dt ; labeled “DZ” on the module). Z_o and dZ/dt can be recorded at four different measurement frequencies, from 12.5 kHz to 100 kHz; cardiac output measurements are usually performed at a measurement frequency of 50 kHz.

For operation, the NICO100C connects to four unshielded electrode leads terminating in 1.5 mm female Touchproof sockets.

The NICO100C is typically used with EL500 paired disposable electrodes but can function with spot or ring (tape) electrodes, reusable electrodes, or needle electrodes.

For injecting current and averaging voltage at four paired-electrode sites (often required for cardiac output measurements), use four CBL204 1.5 mm Touchproof “Y” electrode lead adapters and eight LEAD110 electrode leads with each NICO100C. In this situation, due to the anatomical shape of the thorax, the best placement for all eight electrodes is along the frontal plane (wider dimension). When directed through the thorax, the measurement current seeks the shortest and most conducting pathway. Consequently, the measurement current flows through the thoracic aorta and vena cava superior and inferior.

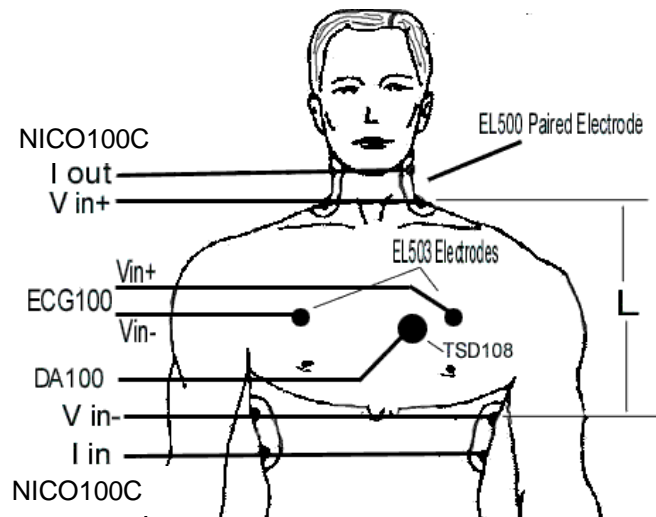

Use the CH SELECT switch bank to assign NICO100C output (Z_o and dZ/dt) channels as follows:

Bank	Magnitude (Z_o)	Derivative (dZ/dt)
1	Channel 1	Channel 9
2	Channel 2	Channel 10
3	Channel 3	Channel 11
4	Channel 4	Channel 12

If the particular NICO100C output is not used, the respective assigned channel cannot be used for another module’s output; users should simply not record on the unwanted but assigned channel.

WHEN USING NICO100C WITH MEC110C MODULE EXTENSION CABLE:

Connect the four CBL204 1.5 mm Touchproof “Y” lead adapters to the following color inputs on the MEC110C.

I OUT (Shield)	BROWN
VIN +	RED
VIN -	WHITE
I IN (Shield)	GREEN

The diagram below shows the eight LEAD110 electrode positions for impedance cardiography or cardiac output.

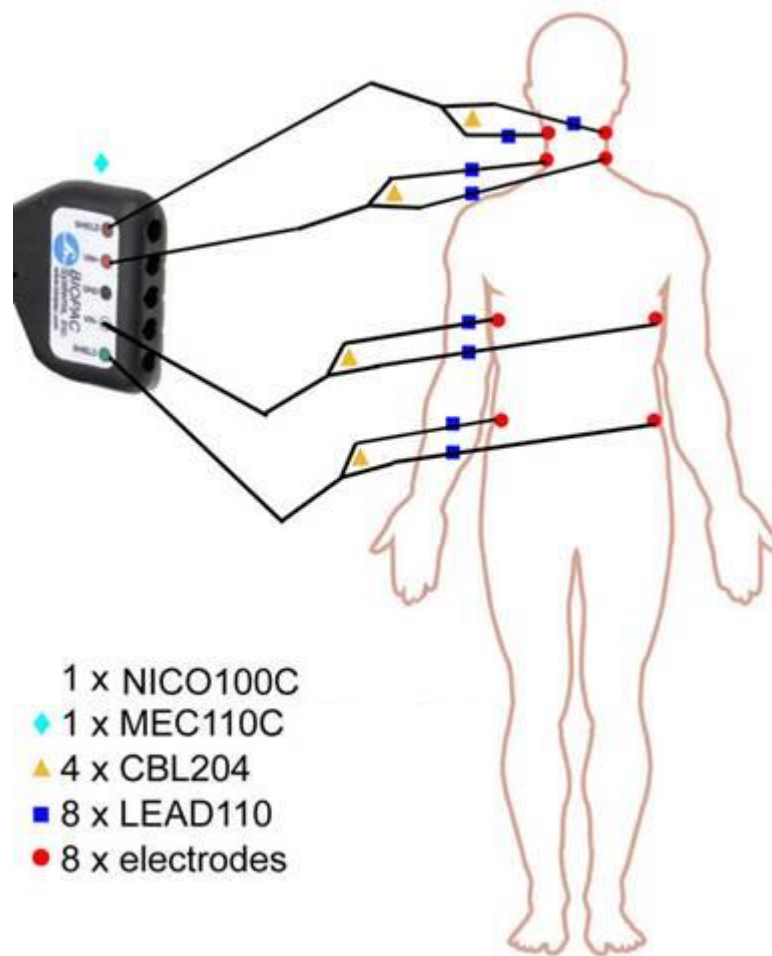

The black port (GND) on the MEC110C is typically ignored in this application. (See Grounding note below.)

GROUNDING

When using the NICO100C amplifier with other biopotential amplifiers attached to the same subject, it’s not necessary to attach the ground lead from the biopotential amplifier(s) to the subject. The subject is already appropriately referenced to the subject via the attachment to the NICO100C. If a biopotential ground is attached to the subject, then currents sourced from the NICO100C will be split to the biopotential amplifier ground lead, potentially resulting in measurement errors.

Derivative Polarity – NICO100C vs. EBI100C

The NICO100C module incorporates an internal, hardware-based, derivative function, which outputs dZ/dt simultaneously with Z (impedance magnitude). When used with AcqKnowledge, this internal derivative function also inverts the polarity of the dZ/dt signal so that it displays a positive-going peak, coincident with negative slopes indicated in Z, as per academic research convention.

The EBI100C does not include an internal, hardware-based, derivative function for the Z (impedance magnitude) channel. An AcqKnowledge calculation channel can be used to determine dZ/dt, if required. Channel scaling can be employed to specify the dZ/dt polarity desired.

NICO100C SPECIFICATIONS

Number of Channels:	2 – Magnitude (Zo) and dZ/dt	
Operational Frequencies:	12.5, 25, 50, 100 kHz	
Current Output:	400 µA (rms)—constant sinusoidal current	
Outputs:	MAG of Impedance: 0-100 Ω	dZ/dt of Impedance: 2 (Ω/sec)/v
Output Range:	±10 V (analog)	
CMIV, referenced to...	Amplifier ground: ±10 V	Mains ground: ±1500 VDC
Signal Source:	Electrodes (requires 4 electrode leads)	
Maximum Over-Voltage for Differential Input:	±25 V	
Gain Range:	MAG: 10, 5, 2, 1 Ω/V	dZ/dt: 2 (Ω/sec)/v constant (independent of MAG Gain)
LP Filter:	MAG: 10 Hz, 100 Hz	dZ/dt: 100 Hz
HP Filter:	MAG: DC, 0.05 Hz	dZ/dt: DC coupled
Sensitivity:	MAG: 0.0015 Ω rms @ 10 Hz bandwidth	dZ/dt: 0.002 (Ω/sec) rms @ 10 Hz bandwidth
Weight:	370 g	
Dimensions:	4 cm (wide) x 11 cm (deep) x 19 cm (high)	
Input Connectors:	Five 1.5 mm male Touchproof sockets (Output, Vin+, Ground, Vin-, Input)	

Possible NICO Lead Configurations

Setup Type	Amplifier	MEC	Lead	Adapter	Electrode
Simulated Equipotential <i>Absolute measures</i>	NICO100D <i>optimal</i>		LEAD132		4 x EL500
	NICO100D <i>optimal</i>	MEC104D	LEAD132		4 x EL500
	NICO100D		LEAD131		4 x EL503
	NICO100D	MEC104D	LEAD131		4 x EL503
	NICO100C	1 x MEC110C	8 x LEAD110	4 x CBL204	4 x EL500
	NICO100C		8 x LEAD110A	4 x CBL204	4 x EL500
	NICO100C-MRI <i>optimal</i>	1 x MECMRI-NICO	8 x LEAD108C	4 x CBL204-MRI	4 x EL508
BN-NICO <i>optimal</i>		2 x BN-EL50-LEAD4		4 x EL500	
Fully Equipotential <i>Absolute measures</i> Uses ICG strip conductor, circumferential, cardiographic electrode tape (ICG Tape)	NICO100C <i>optimal</i>	1 x MEC110C	4 x LEAD140		ICG Tape
	BN-NICO <i>optimal</i>		2 x BN-EL50-LEAD2		ICG Tape
Non-Equipotential <i>Relative measures</i> Suitable for establishing timing relationships between waves	NICO100D		LEAD131		2 x EL500
	NICO100D	MEC104D	LEAD131		2 x EL500
	NICO100C	1 x MEC110C	4 x LEAD110		2 x EL500
	NICO100C		4 x LEAD110A		2 x EL500
	NICO100C		1 x LEAD130		2 x EL500
	NICO100C-MRI	1 x MECMRI-NICO	4 x LEAD108C		4 x EL508
	BN-NICO		2 x BN-EL45-LEAD2		2 x EL500

ZCALC Z IMPEDANCE CALIBRATOR – EB100C/NICO100C

ZCALC is an impedance calibrator for the EBI100C or NICO100C impedance amplifier.

It includes ZCAL20 (20 ohm reference) and ZCAL50 (50 Ohm reference) impedance calibrators that plug into the front panel of the EBI100C or NICO100C via four Touchproof pins (I+, V+, V-, I-).

Procedure:

1. Plug ZCAL20 into the EBI100C or NICO100C.
2. Put EBI100C/NICO100C in desired mode and confirm that “Z” channel HP filter is set to “DC” position.
3. Record data on “Z” or impedance channel.
4. Press CAL1 in *AcqKnowledge* and then map the resulting voltage to “20 ohms.”
5. Remove ZCAL20 and replace with ZCAL50.
6. Press CAL2 in *AcqKnowledge* and then map the resulting voltage to “50 ohms.”

ZCALC is not compatible with the BioNomadix BN-NICO impedance amplifier.

SPECIFICATIONS

Dimensions: 1.5" x 1.9" x 1.25" (each case)

Connectors: Touchproof pins (I+, V+, V-, I-)

MCE100C MICRO-ELECTRODE AMPLIFIER

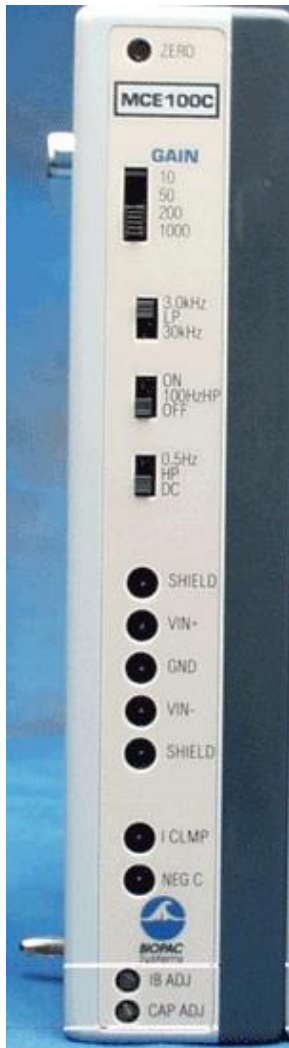

The MCE100C is an extremely high input impedance, low noise, differential amplifier that accurately amplifies signals derived from mini and micro-electrodes. Mini and micro electrodes are characterized by small surface contact areas that result in high electrode to tissue contact impedance. A number of selectable options make the amplifier module useful for general-purpose recording of cortical, muscle and nerve action/resting potentials.

The MCE100C is useful for measuring biopotentials (voltage signals) from the following types of electrodes:

- Catheter-based
- Fluid-filled glass
- Ion selective
- Needle (all types)
- Nerve chamber (NERVE1)

When performing voltage measurements using Ion Selective Microelectrodes, the adjacent shield output, associated with either the Vin+ or Vin- input, is the buffered output of the input signal (1x gain) at the Vin+ or Vin- port. These shield outputs can be used to measure reference electrode voltages (against a remote non-polarizable Ag/AgCl -indifferent- electrode) and the output of the MCE100C can be used to measure the differential voltages between a pair of ISM electrodes, one of them being the reference.

Generally considered, best performance is obtained when the mini or micro-electrode recording is performed in a shielded environment. The smaller the contact area of electrode, the higher the requirement for shielding. The MCE100C provides options for driven (voltage following) or grounded shields. Voltage following shields are useful for minimizing electrode lead input capacitance, to extend frequency response, when shielded cables are used. Grounded shields are useful for minimizing feedback noise and employed when distant shielding is utilized (Faraday

cage or spiral shielding).

For special recording cases, as included options, the MCE100C provides manual controls for input capacity compensation (0-100pF) and clamp (I-bias) current zeroing ($\pm 100\text{nA}$). In addition, the MCE100C incorporates an external voltage control to vary the clamp current proportionally to the control voltage (100 mV/nA), if required. For very accurate (less than ± 10 mV error) reference or differential voltage measurements, it's important to first calibrate out amplifier offset voltages by shorting the various inputs together to obtain a true 0 volt input for each measurement type.

An MP160/150A D/A output channel can drive this external voltage control to change clamp currents automatically during recording. The MCE100C also includes a clamp current monitor output so the clamp current can easily be recorded by another MP160/150 input channel.

For general-purpose recording, without input capacity compensation or a current clamp, use standard shielded or unshielded electrode leads terminating in 1.5 mm female Touchproof sockets.

Add simple input capacity compensation and current clamp control by connecting the respective signal ports to the [Vin+] input of the MCE100C using the JUMP100C jumper connectors.

For the best performance and shielding, use the MCEKITC to interface a micro-electrode lead cable to the MCE100C.

See also
Application Note #AH-190
 Using the MCE100C
 Micro-electrode Amplifier
www.biopac.com
 and
Applications (Appendix)
 in the "AcqKnowledge
 Software Guide"

Current Clamping can be enabled/disabled, by connecting/disconnecting the "I CLMP" port to either differential input of the MCE100C. Negative Capacity Compensation can be enabled/disabled, by connecting/disconnecting the "NEG C" port to either differential input of the MCE100C.

- See Application Note 190 for details: http://www.biopac.com/Manuals/app_pdf/app190.pdf

FREQUENCY RESPONSE PLOTS

The 0.5 Hz high pass lower frequency response setting is a single pole roll-off filter.

Modules can be set for 50 Hz or 60 Hz notch options to match the wall-power line frequency of the destination country. The proper setting reduces noise from interfering signals when the notch filter is engaged. Generally, wall-power line frequency is 60 Hz in the United States and 50 Hz in most of Europe; if necessary, contact BIOPAC to determine the correct line frequency, adjust the bank of switches on the left panel of the amplifier module.

- The 50/60 Hz notch on the MCE100C is only engaged when the 100 Hz HPN high pass notch filter switch is set to ON—see *Amplifier Filtering* for details.

Line Frequency switch bank is on the left panel of biopotential and transducer amplifiers

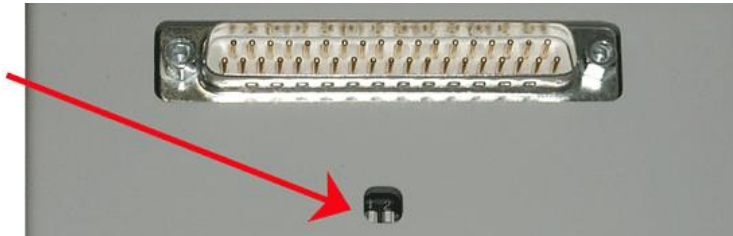

See also: Sample frequency response plots

50 Hz

60 Hz

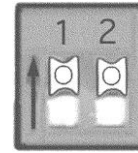
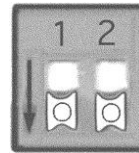

Both switches
DOWN

Both switches
UP

- 100 Hz HPN (with 50 Hz notch)
- 100 Hz HPN (with 60 Hz notch)
- 3 kHz LP
- 30 kHz LP

MCE100C CALIBRATION

No calibration required. Use the CBLCALC to verify accuracy.

MCE100C SPECIFICATIONS

Gain & Input Voltage:	<u>Gain</u>	<u>V_{in} (mV)</u>
	10	±1000
	50	±200
	200	±50
	1000	±10
Output Range:	±10 V (analog)	
Offset Voltage (DI):	Differential Input:	±5 mV maximum (V _{in+} to V _{in-})
Offset Voltage (SE):	Driven Shield to Input: ±15 mV typical (V _{in+} or V _{in-} to Adjacent Shield)	
Low Pass Filter:	3 kHz, 30 kHz	
High Pass Filter:	DC, 0.5 Hz, 100 Hz	
CMRR:	92 dB typical; see Shield Drive Operation	
CMIV – referenced to:	Isolated ground:	±10 V
	Mains ground:	±1500 VDC
Notch Filter:	50 dB rejection (50/60 Hz)	
Noise Voltage:	2.1 µV rms – (DC-3000 Hz)	
Noise Current:	0.1 fA/√Hz	
Input Bias Current:	±3 fA (typical), ±100 fA (maximum)	
Note: Current Clamping and Negative Capacity Compensation Disabled		
Z (input)		
Differential:	10 E15 Ω	
Common mode:	10 E15 Ω	
Capacit. Comp (Neg):	Input capacitance compensation (0-100 pF) – manual control	
I Clamp (I CLMP port):	Adjustable (±100 nA) - voltage control	
I Clamp Control:	Input 3.5 mm phone jack (100 mV/nA)	
I Clamp Monitor:	Output 3.5 mm phone jack (100 mV/nA)	
Signal Source:	Micro-electrodes	
Weight:	350 grams	
Dimensions:	4 cm (wide) x 11 cm (deep) x 19 cm (high)	
Input Connectors (front panel):	Seven 1.5 mm Touchproof sockets (V _{in+} , Gnd, V _{in-} , 2 of shield, I-clmp, neg C)	

MCEKITC CONNECTOR KIT FOR MCE100C MICRO-ELECTRODE AMPLIFIER

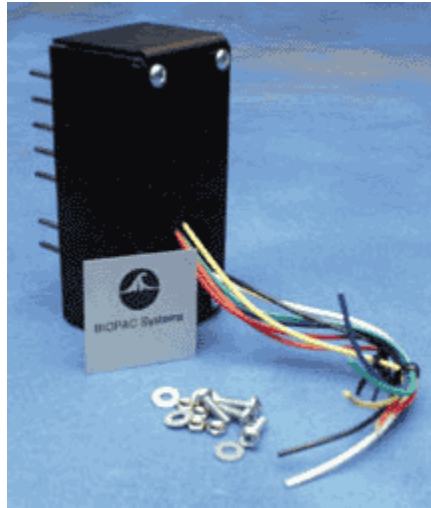

Build a customized adapter to a micro-electrode shielded cable. Cable shields can be tied to voltage follower drive or simply grounded. Input capacity compensation and clamp current options can be independently added to or removed from a cable configuration. The MCEKITC comes with seven attached Touchproof sockets (1.5 mm) and instructions.

The MCEKITC is a junction box assembly that plugs directly into the front panel of the MCE100C amplifier. The MCEKITC comes equipped with an assortment of wire and coaxial cable to customize the MCE100C for a variety of micro-electrode lead connectors. The MCEKITC construction allows the appropriate interface connector to be mounted to the housing and the respective socket pin wires to be soldered.

The MCEKITC is required when either of the last two MCE100C operational modes (5, 6) are used with micro-electrodes. The following table illustrates the configuration desired. The amplifier configuration is determined via the MCEKITC. The MCEKITC connects to the MCE100C and modifies the MCE100C appropriately. See the respective figure to determine the correct MCEKITC configuration for the application.

INPUT TYPE	SHIELD	CURRENT CLAMP	NEGATIVE CAPACITY	MCEKITC FIGURE
Differential	Grounded	No	No	A
Differential	Driven	No	No	B
Single-ended	Grounded	No	No	C
Single-ended	Grounded	No	Yes	D
Single-ended	Grounded	Yes	Yes	E
Single-ended	Driven	Yes	Yes	F

MCEKITC KIT LEGEND

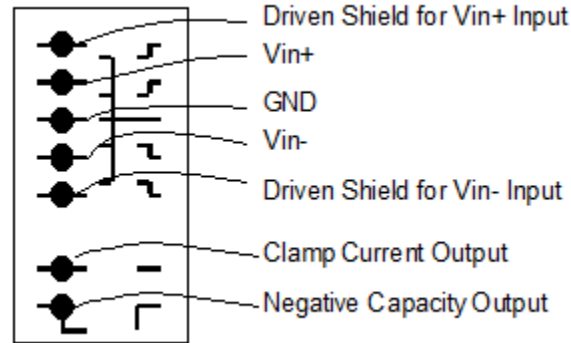

MCEKITC CONFIGURATIONS

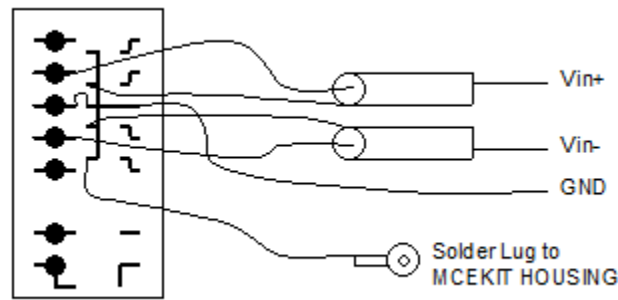

FIGURE A

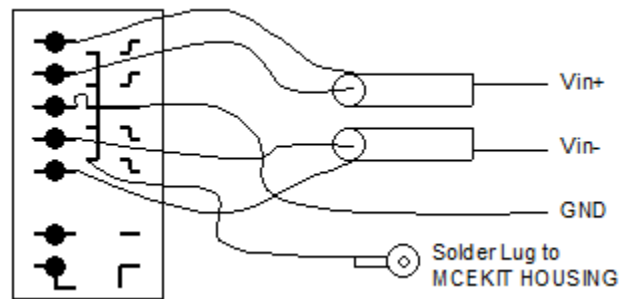

FIGURE B

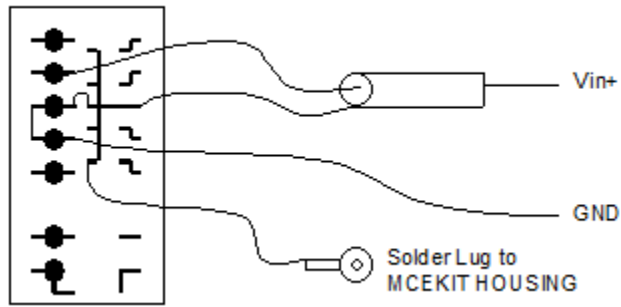

FIGURE C

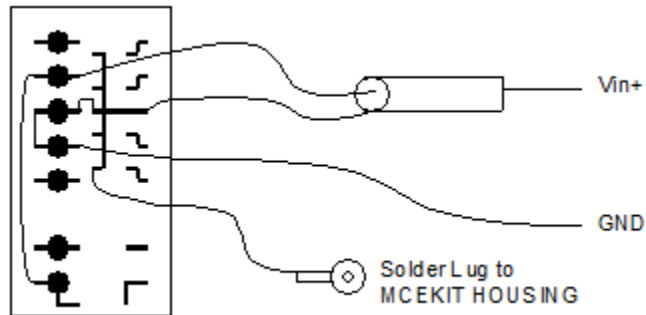

FIGURE D

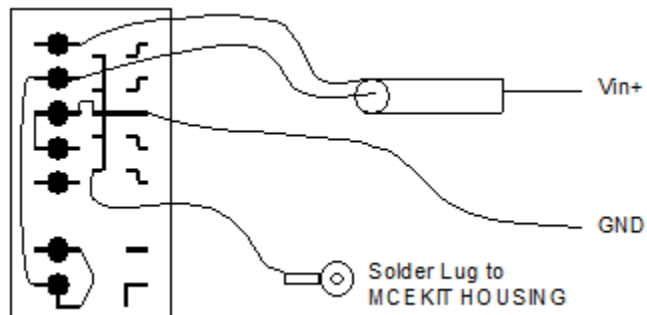

FIGURE E

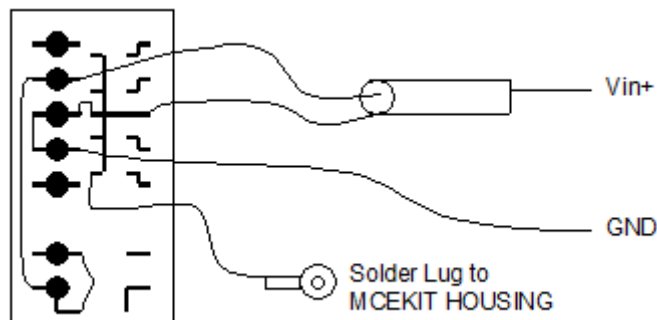

FIGURE F

LASER DOPPLER FLOWMETRY (LDF) - [click page number to jump to section](#)

LDF100C Laser Doppler Flowmetry Module: Controls, Indicators, Symbols. LDF Specs - [page 2](#)

TSD140 Series Laser Doppler Probes, Options, Handling, Applying, Quick Setup, Intro - [page 4](#)

LDFCAL Calibration Kit - [page 6](#)

LDF Calibration Procedure - [page 7](#)

Software Setup - [page 8](#)

Connecting Probes – [page 9](#)

LDF Safety & Warnings, Storage, Maintenance & Cleaning and Probe Specs - [page 12](#)

Troubleshooting - [page 14](#)

LDF – Basic Principles - [page 17](#)

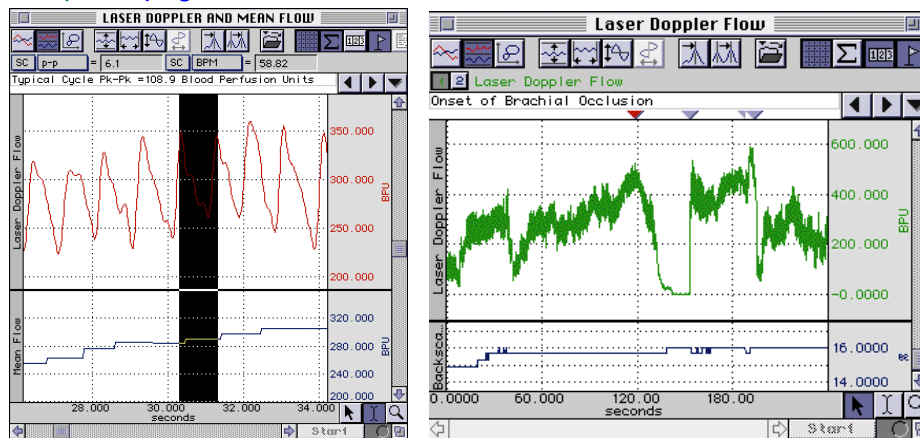

Sample blood perfusion data acquired with the LDF100C

Laser Doppler Flowmetry (or simply “LDF”) is an established and reliable method for the measurement of blood perfusion in microvascular research. Most LDF applications are concerned with monitoring the competence of regional (microvascular) blood supply following trauma, degenerative and pathological disease, surgical intervention and drug therapy.

LDF measurements are performed with the Laser Doppler Flowmetry module (LDF100C) and a wide range of fiber-optic based probes (TSD140 series) in order to access the tissue. Probes include small and lightweight probes for (non-invasive) skin and tissue surface measurements and needle type probes for direct (invasive) measurements within tissue, such as muscle and organ. Double-sided adhesive rings (ADD200 series) can be used to attach surface type probes to tissue; one size of ring fits both standard and miniature surface probes

LDF Calibration requires a calibration kit (LDFCAL), which includes a motility standard and positioning device to hold a probe in the solution during calibration. The motility standard comprises a carefully controlled solution of microspheres undergoing Brownian motion, which provides a standard calibration value of 1000 BPU \pm 5% at 21° C.

Unpacking LDF Components

IMPORTANT: It is essential that the **Warnings** and **Cautions** are fully understood before the LDF100C is used.

1. Inspect the packaging for damage before unpacking the component(s).
 - If the outer packaging or carton is wet or damaged in any way, immediately notify the shipping agent and file a claim. It is the receiver’s duty to notify the specific carrier’s local office. In the event of any damage, please save the shipping carton as evidence.
2. Unpack the component(s) and check the part(s) against the enclosed packing slip.
3. Remove the packaging and check for signs of obvious damage or defect either to the main body of the LDF100C module or the TSD140 series laser Doppler probes.
 - Contact BIOPAC Systems, Inc. for replacement of any damaged component.

LDF100C Laser Doppler Flowmetry Module

The LDF100C is a laser Doppler microvascular perfusion module that is capable of monitoring red blood cell (erythrocyte) perfusion in the microcirculation of a tissue. This module uses a Laser Doppler Flowmetry technique.

- Microvascular blood perfusion is indicated on the *AcqKnowledge* software display in relative units called Blood Perfusion Units (BPU).
- In common with all LDF devices, quantitative measurements of tissue blood perfusion in absolute units (e.g. ml/min/g of tissue) are not possible with the LDF100C.

The LDF100C laser Doppler microvascular perfusion module works by illuminating tissue with low power laser light using a probe (TSD140 series) containing optical fiber light guides. Laser light from one fiber is scattered within the tissue and some is scattered back to the probe. Another optical fiber collects the backscattered light from the tissue and returns it to the module. Most of the light is scattered by tissue that is not moving but a small percentage of the returned light is scattered by moving red blood cells. The light returned to the module undergoes signal processing to extract the signal related to the moving red blood cells.

The LDF100C is not a medical device. It is not designed for the diagnosis, mitigation or treatment of disease in humans.

Flow/flux/perfusion has the SAME meaning—this manual and the module uses the term “flow.”

Controls, Indicators and Symbols



Interface: Connect the LDF100 directly to the UIM100C as part of an MP system for data acquisition.

Channel Select Switch: Choose a channel setting that will not conflict with other modules to display Flow and Backscatter as follows:

Switch:	Flow	Backscatter
	CH 1	CH 5
	CH 2	CH 6
	CH 3	CH 7
	CH 4	CH 8

If the particular output (i.e., Flow or Backscatter) is not used, the respective assigned channel cannot be used for another module’s output. Do not record on the unwanted but assigned channel.

Cal Button: For calibrating new or existing probes (intentionally recessed).

Status LED:

- Red** laser is powered; i.e., probe is connected
- Green** software is running correctly, and no probe or defective probe is connected; or calibration status
- Amber** software is running correctly, and a recognized or unrecognized probe is connected

Analog Indicators:

	Warning	Backscatter (BS)	Perfusion (LDF)
--	----------------	-------------------------	------------------------

Calibrate probe	0 V	0 V
No probe	0 V	0 V
BS low	0 V	0 V
LDF over range	Data	5 V

Probe Connector: Combined fiber optic and electrical connector.

Use only TSD140 series probes.

Power plug: Mini-Din socket on the back panel; use to connect the AC101 DC power adapter that is included with each LDF100C module.

LDF100C Specifications

PERFORMANCE						
Measurements	Primary Measure: Microvascular blood flow (Relative RBC flow) Units: 0 – 5,000 BPU (blood perfusion units); 0 – 100% BS (backscatter)					
Range (linearity)	Up to 0.35% moving scatterers by volume					
Stability of reading	5%					
Probe identification	TSD140 Series Laser Doppler Probes use Smart Probe Technology. Calibration coefficients are automatically selected for previously calibrated probes					
Probe calibration	Flow: User set via LDFCAL motility standard of 1000 BPU \pm 5% @ 21° C Factory set using a motility standard (i.e., known concentration solution of latex spheres undergoing Brownian motion) Factory or user calibration using LDF CAL calibration solution.					
Zeroing	Automatic, controlled (unplug probe to check the zero level of the backscatter output)					
LASER						
Type	Temperature stabilized semi-conductor laser diode					
Mode of operation	Continuous					
Wavelength	830 \pm 10 nm					
Class	Class 1 (EN 60825-1 and 21 CFR 1040.10)					
Power at probe	< 0.5 mW from the probe					
ENVIRONMENTAL						
Operating temp	10° C – 35° C					
Storage temp	5° C – 50° C					
Operating humidity	0 – 70% (non-condensing)					
ELECTRICAL						
Power supply unit (PSU)	Ships with \pm 12, +5 VDC @ 2 amp (AC101A DC power adapter) PSU spec affects warm-up time and operating range. The LDF100C heats and cools the laser. At 3 A at +5 V, the laser is at the correct temperature after about 30 seconds.					
DATA OUTPUTS						
Analog	2 analog outputs					
Signals	Type	Units	Range	Resolution	Time Constant (filtering)	Output voltage
	Blood perfusion (BPU) LDF	0-5000 BPU	0 -5 V	< 2.5 BPU	200 ms	0 to +5 V Scaling: 1 BPU corresponds to 1 mV
	Backscatter (BS) tissue remittance	0-100%	0 -5 V	\leq 0.05%	200 ms	0 to +5 V Scaling: 1% corresponds to 50 mV
General	Technology: Oxford Optronix, Ltd. technology for LDF signal processing Weight: 790 g Dimensions: 19 cm x 7 cm x 11 cm (H x W x D)					

TSD140 Series Probes

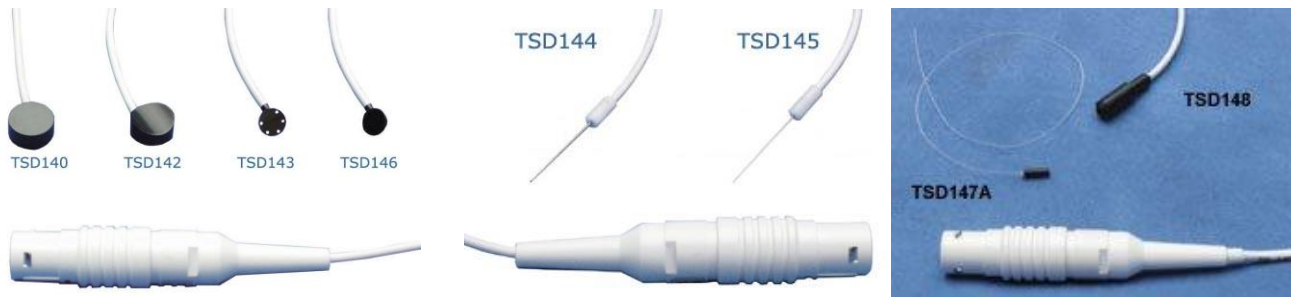

The TSD140 series offers a wide range of laser Doppler probes that interface with the LDF100C module. Probes are designed to allow the local monitoring of blood perfusion from almost any tissue type. All probes contain optical fibers, which are used to direct low power laser light to and from the tissue. Three types of probes (surface, needle, and disposable) and a driver are stocked for the LDF100C; other probes styles are available. Standard cable length for all probes is 3 m. Single fiber probes have an overall length of 30-100 cm and require the use of TSD148; they can be cut to any length with a sharp scalpel.

Probe cable lengths between 1 m and 8 m and needle and needle probes with shaft lengths of between 10 mm to 70 mm may be custom ordered. Contact *BIOPAC Systems, Inc.* for more information.

Probe Options

SURFACE Designed for skin and exposed tissue blood flow monitoring. Ideal for noninvasive measurements from skin or organ surfaces. The signal delivery fiber intersects the probe body at a right angle, making the probes easy to secure to the skin or tissue surface. Made from Tempalux.

- TSD140** Cutaneous blood flow anywhere on the skin surface.
- TSD142** Micro-vascular skin blood flow in the digits.
- TSD143** Small animal work, including post-operative monitoring, i.e., reconstructive surgery (suturable). Tissue attachment via double-sided adhesive rings or by suture. (See TSD146 for non-suturable mini probe.)
- TSD146** Small animal work and general tissue surface monitoring. (Tissue attachment via double-sided adhesive rings. (See TSD143 for suturable mini probe.)

NEEDLE Designed for invasive and endoscopic blood flow monitoring of tissue. Needle probes can be used both for noninvasive monitoring from the surface of tissues (by positioning the tip in contact/close proximity to the tissue) or for invasive placement and monitoring from regions within tissues. The signal delivery fiber terminates flush with the top of the needle, making the probes easy to insert into tissue. Made from medical grade stainless steel.

- TSD144** Microvascular blood flow measurements. Typically positioned using a micromanipulator clamp over soft tissues such as brain and muscle.
- TSD145** Micro-vessel or micro-vascular blood flow within skin, muscle, tumor and organ tissues. Fine probe diameters facilitate blood flow measurements from only a small number of capillaries.

DISPOSABLE Designed for safe, continuous, invasive microvascular blood flow monitoring. Composed of a polymethyl methacrylate core and a tough fluorinated polymer cladding. Incorporate a coupling bead to interface with the TSD148 single fiber driver for connection to the LDF100C module.

- TSD147A/AL** Blood flow measurements under the skin (use a standard 22G ID cannula to insert directly into tissue). TSD147A is 30 cm long, TSD147AL is 100 cm long.

MRI Use: MR Safe

TSD147A/AL Components – MRI chamber room; cable only:

Fiber Optic Cable: Polymethyl methacrylate core & tough fluorinated polymer cladding

DRIVER

TSD148 This is a precision-machined coupling system for interfacing the TSD147 series single fiber probes to the LDF100C. The TSD148 consists of a compact laser driver housed in a non-metallic Tempalux housing, terminated with a 2-meter cable for connection to the LDF100C module.

Handling TSD140 Series Probes



TSD140 series probes must be handled with care. Failure to do this may result in breakage of the internal optical fibers, scratching the polished probe ends or separation of the cable from the probe ends or connectors.



Do not use a worn or damaged probe.

The optical fibers used in the TSD140 series probes are glass and have a diameter of 125 μm . The fibers are flexible and can be bent; however, it is recommended that they are not subjected to bends with a radius less than 30 mm.

The connectors on TSD140 series probes must be kept clean and free from dust. Connectors should be inspected before each use. Dust can be removed from the connectors using a good quality 'air-duster.'

Check the integrity of TSD140 series probes by holding the probe end to a source of bright diffuse light (e.g. a lamp) and inspecting the connector end. Two bright spots of light of equal intensity should be visible from the pins within the connector.

Applying Probes to Tissue

Surface Surface probes may be attached to tissue using double-sided adhesive rings (such as ADD204 or ADD208). Alternatively, the miniature suturable probe can be sutured directly into position.

Needle Needle probes can be secured in a micromanipulator assembly or stand and placed above the tissue. Depending on the tissue, fine needle probes may be introduced directly into tissue after first ensuring an appropriate superficial incision has been made. Alternatively, a suitable introducer or catheter should be used. All needle style probes can optionally be secured in a micromanipulator assembly or stand.

- Bear in mind that all needle probes have a blunt end and may cause some degree of tissue trauma when inserted directly into tissue without using a suitable introducer.

Single fiber The insertable probe can be inserted into tissue using a standard 2G ID cannula. These probes can be cut to the desired length with a sharp scalpel. The single fiber probes require the TSD148 driver.

It is important to control the relative movements of the tissue (induced by breathing, etc.) with respect to the probe to reduce artifact in the perfusion signal. Allowing the supported probe to lightly come into contact with the surface of the tissue can reduce these artifacts. Under some conditions it may be best to hold the probe in position by hand.

It is essential to ensure that the pressure on the tissue is minimal, otherwise local occlusion of the microvasculature may result.

Avoid direct illumination of the measurement site from external lighting sources and direct sunlight. Excessive ambient lighting at the probe site can disturb the blood perfusion reading. If erroneous readings due to excessive ambient lighting levels are suspected, cover the attached probe and measurement area with a light piece of opaque material.

- Place the LDF100C module on a flat surface close to the point of measurement; note that the standard probe cable length is 3 m.
- The probe can be placed in or on tissue at any stage, either prior to or following connection to the LDF100C. Allow the module to warm up with a probe attached before taking any measurements.
- The probe can be exchanged for another at any stage without the need to first switch off the LDF100C.

- The probe does not need to be disconnected from the LDF100C prior to turning off the LDF100C.

Quick Set up and Use Guide

Place the LDF100C module on a flat surface close to the point of measurement.

Connect the AC101 to the LDF100C and plug the AC101 into a properly grounded AC Mains socket.

- When the module is powered (immediately after the double beep) the analog outputs both go to 0 V (half scale) for 3 sec and then to 0 V for a further 3 sec before outputting data.

Allow the instrument to warm up for 5 minutes before making any measurements.

Select a probe to make measurements with and connect it respecting the correct orientation. If no probe is connected to the LDF100C module, the Flow analog output will be held at 0 V and the Backscatter output at 0 volts. The status LED will be green when no probe is connected.

Introduction to Probe Calibration

The LDF100C system incorporates proprietary Smart Sensor technology that enables the module to recognize a previously calibrated probe and to automatically apply the necessary probe calibration coefficients. This alleviates the need to re-calibrate a probe every time a different probe is plugged in to the module. The module ‘recognizes’ a specific probe every time the probe is plugged in.

When probes are ordered at the same time as the LDF100C, BIOPAC will calibrate the LDF100C to the ordered probes with a “motility standard” before shipping the items. If a probe has previously been calibrated, there is generally no need to re-calibrate that probe. However, when probes are purchased separately, they will require calibrating before use using an LDF CAL calibration kit. When the calibration procedure ends, the calibration data is automatically stored in the module. The calibration data is automatically retrieved every time that particular probe is connected to the module.

LDFCAL Calibration Kit



Contents: Motility standard and positioning device

- The motility standard is a colloidal solution of suspended latex spheres. The size and concentration of spheres are carefully controlled so that calibration values are always reproducible. The LDFCAL provides a standard calibration value of 1000 BPU 5% @ 21° C.
- The size and relative density of the latex spheres is such that the artifact due to settling and aggregation is negligible during the calibration process.

Intended use: Use the calibration standard with the LDF100C blood flow monitor and probes when required. Probes require calibration if they are purchased separately from a monitor and for routine calibration purposes.

IMPORTANT! Please read the information contained in this section before using the calibration standard. Pay particular attention to the warnings and cautions. ⚠

Manufacturer: Oxford Optronix Ltd.

Probe Calibration Procedure—TSD140-TSD147

- To calibrate the single fiber driver adapter (TSD148), refer to the next section.

To perform a new probe calibration, a Calibration Kit (LDFCAL) is required, which contains a motility standard and a positioning device. The parameters are automatically stored and recalled when that particular probe is subsequently connected.



Every probe is supplied with a probe identification number (Probe ID) on the probe box label. The number is between 5 and 36 and must be unique for the probes used; using two probes with the same ID will result in invalid calibration data being used.

Calibration errors may occur if probes with the same probe identification number are used. Contact BIOPAC for advice if multiple probes have the same ID number.



The motility standard has a 3-month shelf life, so it's best to order only when required. The expiration date is indicated on the label. The solution must not be used beyond this date, as it will produce misleading values due to the aggregation of the latex spheres.



Do not use the motility standard in ambient temperatures below 15° C or above 25° C.



Store the motility standard within the temperature range 3 – 25° C. Do not freeze the solution.



Never attempt to re-fill the bottle with spilt solution. Errors may arise as a result of contamination.



Do not dilute the motility standard.



It is essential that the calibration procedure be performed on a stable and vibration-free surface. This is very important, any movement or vibration during the calibration procedure, however slight, is likely to result in erroneous calibration data.

1. Connect the probe to the front panel of the blood flow monitor.
2. Gently swirl the bottle to disperse the contents.
3. Open the bottle and allow the contents to settle for one minute before proceeding.
4. Carefully position the probe in the solution. This is best achieved by holding the probe cable within the jaws of the clamp and carefully lowering the active area of the probe into the center of the solution.

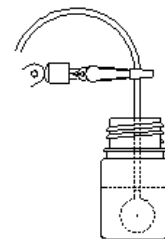

IMPORTANT! Keep the active surface of the probe as far as possible from the edge of the bottle. The probe should be supported in such a way that it does not swing or move while it is in the solution.

Read through all the instructions first before proceeding.

5. Press the CAL button on the front panel of the LDF100C once and then press the CAL button again within 10 seconds to confirm calibration. To end calibration at this point, wait 10 seconds and the calibration process will time out and stop. If proceeding, there will be one long beep.

IMPORTANT! Any vibration or movement during this period will invalidate the calibration procedure.

6. An audible double beep indicates a successful calibration.

- A series of audible beeps (long beep followed by a pause and then a number of rapid beeps) indicates a failed calibration. The number of rapid beeps equates to the error code—refer to Troubleshooting for more information on the error codes.

Driver Calibration Procedure— TSD148

- To calibrate a probe (TSD140-TSD147), refer to the preceding section.



1. **IMPORTANT!** Read the following information before attempting to calibrate the single fiber probe connecting adapter. Refer to calibration standard instructions for precautions to be taken.
2. Unscrew Part A.



3. Pull off Part B. (Note: This is a tight fit and may need to be twisted while it is pulled.)



4. Connect the single fiber adapter into the front panel of the blood flow monitor.
5. Gently swirl the bottle to disperse the contents before use. Open the bottle and allow the contents to settle for one minute before proceeding.
6. Carefully position Part C of the adapter in the solution. This is best achieved by holding the adapter cable within the jaws of the clamp and carefully lowering Part C into the center of the solution.

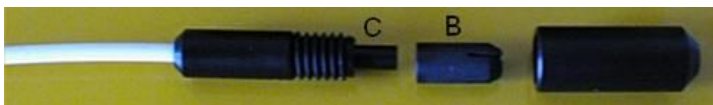

IMPORTANT! Keep the active surface of the probe as far as possible from the edge of the bottle. The adapter cable should be supported in such a way that it does not swing or move while in the solution. **Follow the calibration procedure detailed in the preceding section.**

7. Clean Part C to remove residual calibration solution by washing and wiping using water or 70% IMS or IPA. Allow Part C to dry before reassembling the adapter by pushing Part B onto Part C and then attaching Part A.

Software Setup (AcqKnowledge 4.1 and higher)

In AcqKnowledge versions 4.1 and higher, use Module Setup to select the LDF100C hardware and automatically set the scaling.

1. Launch AcqKnowledge, choose “LDF100C” from the “What type of module should be added?” dialog and click “Add.”

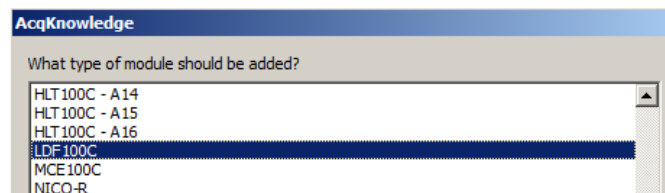

(If Module Setup does not appear automatically, go to the MP menu > Set Up Data Acquisition > Channels and click the “View by Modules” button. Then click “Add a New Module.”)

- Make sure the Channel Select setup dialog is set to “1-5” and click OK. (“Flow” will be assigned Channel A1 and “Backscatter” will be assigned Channel A5.)

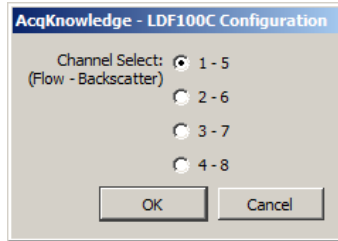

Software Setup (AcqKnowledge 4.0 and earlier)

AcqKnowledge must be set to scale the input values to the correct units for LDF measurements. Access the Scaling Parameters dialog under MP menu>Set Up Data Acquisition > Channels >Setup, and set the parameters for “Flow” (Channel A1) and “Backscatter” (Channel A5) as follows:

Flow (A1)

	Input	Scale	Units
Cal1	5	5000	BPU
Cal2	0	0	

Backscatter (A5)

	Input	Scale	Units
Cal1	5	100	%
Cal2	0	0	

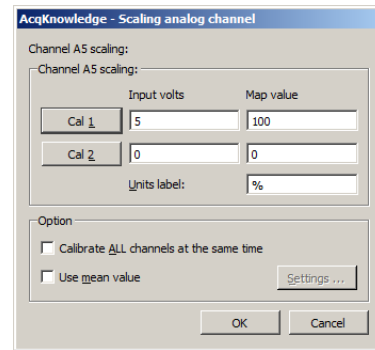
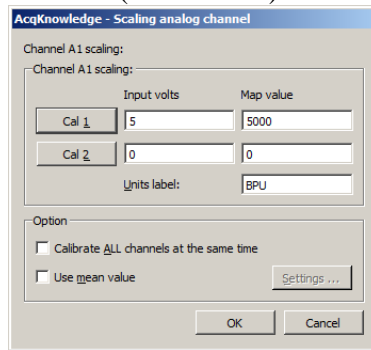

Connecting Probes to the LDF100C

Very carefully remove the probe from its protective case and check that the Probe Connector is clean and free from dust. The TSD140 series probes plug into the front of the LDF100C module, which contains the laser source, sensitive photo-detection and signal processing circuitry. All probes are standardized using a reference motility standard (LDFCAL) consisting of latex microspheres undergoing Brownian motion.

Connect the LDF100C module to a power source and then switch ON.

- The LED status indicator will be illuminated in Amber. (When the probe is not inserted, the indicator will illuminate Green only.)
- The start-up beeps are the same whether a probe is connected or not and whether a probe is calibrated.
- Analog indicators
 - no probe: BS = 0 V, LDF = 0 V
 - uncalibrated probe: BS = 0 V, LDF = 0 V

LDF PROBE

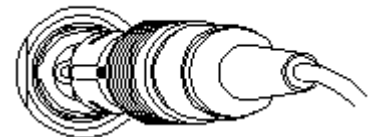

Select a TSD140 series probe.

Plug the TSD140 probe into the “PROBE” connector located on the front panel of the LDF100C, taking care to orient the connector plug with respect to the socket. Align the probe and push the connector firmly home into the socket until a click is heard.

- After a short delay, the module will enter Trend Mode, and the AcqKnowledge software display should show blood perfusion values as **XXXX BPU** (where XXXX is a number in the range 0-5000 units) and backscatter as **%** (a percentage).



Since the LDF100C is a light-based measurement system, random values may appear on the software display while probes are not attached to tissue. When the probe is in the air, the module will set the analog outputs to BS = 0 V, LDF = 0 V instead of outputting random values.

No warm-up period is required after connecting a probe if the module was already ON. If the module was not ON, allow 30 seconds minimum for warm up.

Disconnect

To disconnect the probe plug from the front panel socket, gently pull the connector by the ribbed part of the connector.



Attempting to remove the connector by any other part of the probe (for example, by pulling the cable sleeving) will cause irreparable damage to the probe.

TSD140 Series Probes Storage & Cleaning

When not in use, TSD140 series probes for the LDF100C should be stored in the probe box with the optical fiber coiled neatly. Following sterilization, probes should be stored unopened in the packaging in which they were sterilized.

Cleaning

Probes are cleaned prior to packing and shipment. It is recommended that the probe end on all new probes be wiped with a soft cloth, preferably one that does not shed fibers, dampened with a solution of 70% alcohol in water.

Probes should be cleaned immediately after use as it is easier to remove soiling and particulate matter before it dries onto surfaces.

Visually inspect the probe end, cable and connector.

- If there is no visible soiling, wipe the probe end and cable with a soft cloth dampened with a solution of 70% alcohol in water. Allow the alcohol to dry completely before using the probe.
- If there is visible soiling, clean the probe with warm water containing a mild detergent. To ensure that all soiling and particulate matter is removed, keep the probe beneath the surface of the cleaning solution and rub it carefully with a soft cloth or brush. Avoid immersing the probe connector in the cleaning solution. Rinse the probe end and cable in clean water. Wipe the probe end and cable with an absorbent cloth and leave the probe to dry completely.

Disinfection

To disinfect TSD140 series probes, immerse the probe end and cable (for the disinfectant manufacturer's recommended immersion times) in:

- 2% glutaraldehyde (Cidex[®] OPA)
- 70% alcohol in water

Sterilization

Some of the TSD140 series dedicated perfusion probes may be sterilized by moist heat (steam). They are capable of withstanding an autoclave cycle of 134° C for 3 minutes. With care a TSD140 series probe can be expected to survive between 10 – 20 sterilization cycles.



TSD140 series probes must be cleaned prior to sterilization.



It is the responsibility of the user to validate the sterility of TSD140 series probes after sterilization.

The TSD140 series probe should be packaged to maintain sterility after processing. The packaging material used should be appropriate for sterilization by steam, e.g. a tray within a pouch. The dimensions of the base of the tray should not be smaller than 15 cm x10 cm for a standard length probe.

1. Place the probe in the tray in a neat coil.
 - Starting at the connector end, tape the connector to the base of the tray using autoclave tape. Coil the probe onto the tray and lay the probe end in the center of the coil. Autoclave tape may be used to secure the cable to the tray. Do not use tape on the probe end. Do not rest the connector on the cable as it is heavy and may distort the cable.

2. Seal the tray into a pouch designed to withstand sterilization by steam.
3. Use only a validated autoclave to sterilize the TSD140 series probes.
 - Probes can be immersed in a non-corrosive sterilizing solution, such as 2% Glutaraldehyde (Cidex® OPA) or in a low-temperature, ethylene-oxide gas sterilization chamber. The maximum temperature to which **older** style probes can be exposed is 60° C.



Probe Identification

The LDF100C system incorporates proprietary Smart Sensor technology that enables the module to recognize a previously calibrated probe and to automatically apply the necessary probe calibration coefficients. This alleviates the need to re-calibrate a probe every time a different probe is plugged in to the module. The module ‘recognizes’ a specific probe every time the probe is plugged in.

New Probe

If a new (previously uncalibrated) probe is connected to the LDF100C module, then the module’s Flow and Backscatter outputs will be at 0 V. To take measurements, the probe must be calibrated (see following section on calibrating probes) or removed and replaced by a recognized probe. The status LED will be amber when a probe, recognized or unrecognized, is connected to the LDF100C.

Temperature Out of Range (Single beep every 16 seconds)

This warning will sound if the laser temperature is below the minimum or above the maximum for stable operation. It may occur during the warm-up period if the ambient temperature is low—this is normal and not a cause for concern. If this occurs during operation, the instrument should be moved to a cooler or warmer environment depending on the ambient temperature. With the temperature out of range, output signals will continue to be generated but may no longer be within the calibrated tolerance of the system and should be interpreted with caution. If the environmental temperature is below 25° C and this message occurs repeatedly soon after power-on, then a fault may have occurred; please contact BIOPAC Systems, Inc. for further advice.

TSD140 Series Probe Specifications

Part #	Style	Suturable	Body Dimensions	Angle of Laser Delivery Collection	Skin Tissue Monitoring
TSD140	Standard surface. Reusable, may be autoclaved.	no	8 mm (high) x 17 mm (dia)	Right angle to probe body	yes
TSD142	Digit surface. Reusable, may be autoclaved.	no	10 mm (high) x 17 mm (dia)	Right angle to probe body	yes
TSD143	Suturable Miniature surface. Reusable, may be autoclaved.	yes	5 mm (high) x 12 mm (dia)	Right angle to probe body	yes
TSD144	Needle. Reusable, may be autoclaved.	no	25 mm (long) x 1 mm (dia)	Straight	Invasive and endoscopic
TSD145	Fine needle. Reusable, may be autoclaved.	no	25 mm (long) x 0.5 mm (dia)	Straight	Invasive and endoscopic
TSD146	Miniature surface. Reusable, may be autoclaved.	no	5 mm (high) x 12 mm (dia)	Right angle to probe body	yes
TSD147A*	Disposable, insertable single fiber. Single-use recommended.	no	30 cm (long) x 0.5 mm (dia)	Straight	Insert via 22G ID cannula
TSD147AL*	Disposable, insertable single fiber. Single-use recommended.	no	100 cm (long) x 0.5 mm (dia)	Straight	Insert via 22G ID cannula

Part #	Style	Used with	Body Dimensions	Connection Type	Cable Length
TSD148	Single fiber Driver	TSD147A TSD147AL	28 mm (long) x 8 mm (dia)	In-line single fiber connector	3 meters

***Requires the TSD148 Single Fiber Driver for operation with the LDF100C.**

LDF Safety

This section contains important safety information related to the general use of the LDF100C laser Doppler perfusion module. Important safety information also appears throughout the LDF100C and TSD140 series sections as Warnings and Cautions.

! Warning A warning indicates the possibility of injury to the operator.



A caution indicates a condition that may lead to equipment damage and/or malfunction.

LDF100C incorporates semiconductor laser diode devices operating in continuous mode and emitting invisible laser radiation at a nominal operating wavelength of 830 nm. The maximum output power at the probe tip is less than 0.5 mW. Laser light emitted from the optical fiber is highly divergent. Although the characteristics of the laser radiation place the LDF100C device within the “Class 1” classification users should avoid directing the laser radiation onto the eye. Applying the probe to any tissue **OTHER THAN THE EYE** is harmless, even over prolonged time periods.

Warnings

! Warning **Never** apply an LDF100C probe directly to the eye. The laser beam may cause permanent damage to the retina.

! Warning **Do not** attempt to use the LDF100C if it is damaged or does not operate as described in this manual. There is a risk of electrical shock or other injury. The module must be returned to BIOPAC for repair.

Cautions for the Module



Do not attempt to operate the LDF100C in the vicinity of imaging or therapeutic equipment that emits ionizing radiation or produces a strong magnetic field as the performance of the module may be affected. Extra long probes are available that allow the LDF100C module to be operated at a safe distance from such equipment.



Do not attempt to autoclave, pressure sterilize, or expose to radiation, any part of the module.



Do not attempt repairs to the LDF100C module or TSD140 series probes. Only BIOPAC trained personnel should undertake repairs.



Do not use the LDF100C in the presence of strong or changing ambient lighting levels as this may result in erroneous measurements and artifacts.



Do not use probes, cables and other accessories unless supplied by BIOPAC, otherwise serious damage may result.



Do not mishandle the module; use extreme care at all times.



Do not use the module in the presence of flammable anesthetics, which represent an explosive hazard.

Cautions for the Probes



Do not drop, pull, stretch or apply mechanical shock to a TSD140 series probe. Permanent damage to the probe may result.



Do not apply tension to the probe cable. Permanent damage to the probe may result.



Do not soak or immerse the probe in any corrosive liquid solution. Permanent damage to the probe may result.



Do not mishandle. Handle the probes with great care to avoid breaking the optical fibers, scratching the polished ends or separating the probe ends or connectors from the fibers.

Maintenance

User Responsibility

Never use a defective product. Replace parts that are missing, broken, worn or damaged in any way immediately. This product (or its components) should be repaired only by BIOPAC Systems, Inc. trained engineers. Any exceptions to this recommendation must be made using written instructions supplied by BIOPAC Systems, Inc. If service is not provided by BIOPAC Systems, Inc. (or its appointed agents) then the user of this product will have the sole responsibility for any losses incurred as a result of unauthorized maintenance, improper repair, alterations or damage.

LDF100C

! Warning

Only BIOPAC technical staff should remove the cover of the LDF100C module. There are no user-serviceable parts inside. Inspect the module regularly for signs of wear and tear.

Checking TSD140 Series Probes

Inspect TSD140 series probes regularly to check the integrity of the internal optical fibers.

- A simple check is to hold the probe end to a source of bright diffuse light (e.g. a lamp) while visually inspecting the connector end. Two bright spots of light of equal intensity should be visible from the two large pins within the connector.

LDF100C Storage & Cleaning

When not in use, the LDF100C module should ideally be stored at room temperature, although it may be stored between 5° C to 50° C. When returning from extremes of temperature, it is important to allow the module to stabilize at room temperature before use.

To clean the surface of the module: wipe lightly with a dry, lint-free cloth. Or wipe lightly with a soft cloth dampened with a commercial, nonabrasive cleaner, or use a low-pressure air line to blow dust free, or carefully clean with a suitable vacuum cleaner.

To disinfect the module, wipe the surface with a soft cloth dampened with a solution of 70% alcohol in water.

! Warning Do not spray, pour or spill any liquid on the LDF100C module, its accessories, connectors, switches or openings.

Troubleshooting

! Warning Only BIOPAC technical staff should remove the cover of the LDF100C module. There are no user-serviceable parts inside.



Use of controls or adjustments or performance of procedures other than those specified herein may result in hazardous radiation exposure.

Contact support@biopac.com for problems using the LDF100C.

Beep & Led Guide

Beep	LED	Indication
Two beeps	Off	Initializing with no probe.
Two beeps	Red	Initializing with a probe connected.
—	Green	Instrument ready for use; no probe connected.
—	Amber	Instrument operating correctly with probe connected.
Single beep every 16 seconds	Amber or green	Laser temperature out of range (too hot or too cold).
Double beeps	Alternating amber/red, synchronized with beeps	Calibration button was pressed, awaiting confirmation. Note If the calibration button was pressed in error, wait 10 seconds for normal operation to resume. To confirm calibration, press the calibration button again during that 10-second period.
Long beep	Alternating amber/red	Calibration in progress.
Double beep	Amber	Calibration successful.
Long beep followed by a number of short beeps indicating the error.	Alternating red/amber, synchronized with error code beeps	Calibration failed. Error: 1, 2, 3, 4, 7 <i>Incorrect probe position or malfunctioning probe.</i> Reposition probe in motility standard and repeat calibration procedure. Error: 5, 6 <i>Vibration or movement of probe or cable.</i> Ensure LDFCAL motility standard is on a vibration-free surface and eliminate probe and cable movement; repeat calibration procedure.
Single beep	Amber	Calibration aborted (probe removed, or calibration button pressed).

Reducing Signal Artifact



Certain environmental conditions and probe application and positioning errors can affect laser Doppler blood perfusion readings.

Irrespective of the probe used, it is important to reduce the possibility of signal artifact, noise and signal dropout in the blood perfusion reading. The presence of motion artifact noise in the blood perfusion signal is often due to relative movements of the tissue (e.g. induced by breathing) with respect to the probe and/or probe cable movements. To minimize artifact, allow the probe to come into contact with the tissue such that the probe and tissue ‘move together’ and ensure that the cables do not move. It may be helpful to secure the probe cable to the table with adhesive tape at intervals.

It is also essential to ensure that undue probe pressure is not applied to the tissue, otherwise local occlusion of the microvasculature may result in a corresponding reduced blood perfusion reading.

Excessive ambient lighting at the probe measurement site can also disturb the blood perfusion reading. Avoid direct illumination of the measurement site from external lighting sources and direct sunlight. If erroneous readings due to excessive ambient lighting levels are suspected, cover the attached probe and measurement area with a light piece of opaque material.

In summary, avoid the following situations:

- Probe movement relative to the tissue.
- Movement of the probe cables.
- Strong ambient lighting sources such as surgical lights, fluorescent lights and direct sunlight.
- Changing ambient lighting.

Loss of signal due to excessive tissue occlusion could occur for the following reasons:

- Excessive probe pressure on the tissue.
- The formation of a hematoma (blood clot) within the tissue.

Electro-Magnetic Interference



With the proliferation of radio-frequency transmitting equipment and other sources of electrical noise in research environments (e.g. mobile phones, electrical appliances), high levels of such interference due to close proximity or strength of a source may result in disruption of performance of this device.

Erratic readings, cessation of operation or other incorrect functioning may indicate electro-magnetic interference to the module. If this occurs, survey the location of use to determine the source of the disruption and take actions to eliminate it:

- Turn equipment off in the vicinity of the module to isolate the equipment generating the electromagnetic interference.
- Relocate the other device(s).
- Increase the separation between the interfering equipment and the LDF100C module.

For further information and assistance contact BIOPAC.

Possible Errors & Suggestions

A. There is no response to the Power On button and the Power On LED indicator fails to light green.

The power adapter may not be properly connected to the LDF100C or to the Mains outlet, or it may not be functioning. Check all connections. If possible, try another adapter with the *same specification*; the adapter must have the same specification to maintain electrical safety.

B. There is no double beep upon power on and/or the initial beep does not occur.

If the power on indicator is not lit, the power supply may not be working. Notify institution service personnel to check and if necessary, replace with the same type and rating of adapter. If the power on indicator is lit, the module has failed the power on self-test. Do not use the module. Contact BIOPAC.

C. There is a continuous sound upon power on.

The module has failed the power-on self-test. Do not use the module. Contact BIOPAC.

D. The Temp. Out of Range beep sequence is emitted (an audible beep every 16 seconds).

This is normal during the warm-up period and not indicative of a fault.

Warning sounds if the laser temperature is above or below the range for stable operation. If this occurs, the instrument should be moved to warmer or cooler environment for proper operation. Output signals (analog voltage outputs and serial data) will be generated but should be interpreted with caution.

If the environmental ambient temperature is below 25° C and this error occurs repeatedly soon after power-on, then a fault may have occurred—contact BIOPAC for further advice.

E. The status LED remains green even though there is a probe connected.

This is likely a problem with the probe. If a spare probe is available, replace the probe connected to the module with the spare probe. It may be possible to determine which probe is faulty.

If the problem can't be resolved, contact BIOPAC.

F. The analog outputs are both 0 V.

This might occur a) when the probe is connected to the LDF100C; b) due to a low backscatter signal; and c) because probe calibration is required. Follow the instructions for probe calibration given in section 4.12.

G. Pressing the CAL button for probe calibration does not emit a double beep to indicate a probe calibration is under way.

The calibration process has failed to start. Try pressing the CAL button again. If there is still no response, contact BIOPAC.

H. The Error beep sequence (varying number of beeps) is emitted.

Probe calibration has failed. There are 7 series of error beeps used to indicate the reason for calibration failure. Beep sequences are explained below:

Error: 1, 2, 3, 4, 7 *Incorrect probe position or malfunctioning probe.*

Reposition probe in motility standard and repeat calibration procedure.

Error: 5, 6 *Vibration or movement of probe or cable.*

Ensure LDFCAL motility standard is on a vibration-free surface and eliminate probe and cable movement; repeat calibration procedure.

I. The BPU values are erratic.

The probe may have become detached, check and replace if required. Tissue movement may be excessive. The probe cable may be moving; re-route the cable and/or secure that cable at intervals using adhesive tape. There may be local electro-magnetic interference—see previous page.

J. The analog output signal is zero.

There may be a cable problem. Check that the cable attached to the analog output connector(s) is correctly configured. Notify institution service personnel and request that they check that i) the cable is correct and ii) the output signal(s) are available on the pins of the connector(s).

If the problem cannot be resolved, contact BIOPAC.

Obtaining Technical Assistance

For technical information and assistance or to order additional probes and accessories, please contact BIOPAC. When calling BIOPAC for technical support, it is helpful to have the serial number of the LDF100C module and/or TSD140 series probes and the version of *AcqKnowledge* software.

- The serial number of the LDF100C module can be found on the back panel.
- Probe serial numbers can be found on the cable label and Probe ID numbers are on the probe box.
- The *AcqKnowledge* software version appears under the **About** menu in the software.

Returning LDF Components

Contact BIOPAC for shipping instructions including a Returned Materials Authorization (RMA) number and a RMA Declaration (including decontamination of equipment) form.

Pack the module in its original shipping carton. If the original carton is not available, wrap the module securely using bubble wrap and pack it in a strong box surrounded by polystyrene chips and/or suitable foam inserts.

A probe should be returned in the probe storage box. If returning a probe on its own, wrap the probe storage box in bubble wrap and pack it in a strong box.

Use a recognized courier company for the return of the module and probes.

Warranty

BIOPAC warrants that this device is free from defects in both materials and workmanship.

THE ABOVE WARRANTIES ARE IN LIEU OF ALL WARRANTIES, EITHER EXPRESS OR IMPLIED, INCLUDING ANY WARRANTY OF MERCHANTABILITY OR FITNESS FOR A PARTICULAR PURPOSE.

The user shall determine suitability for use of this device for any procedure. BIOPAC shall not be liable for incidental or consequential loss or damages of any kind.

Principles of Laser Doppler Flowmetry**What does the LDF100C measure?**

The LDF100C is a laser Doppler blood flow (perfusion) module whose primary purpose is to measure real-time microvascular red blood cell (or erythrocyte) flow (perfusion) in tissue. Perfusion is sometimes also referred to as red blood cell flux. Laser Doppler signals from the tissue are recorded in BPU (Blood Perfusion Units) which is a relative units scale defined using a carefully controlled motility standard comprising a suspension of latex spheres undergoing Brownian motion.

The LDF100C laser Doppler flow module employs a technique called laser Doppler Flowmetry (LDF) and works by illuminating the tissue under observation with low power laser light from a probe containing optical fiber light guides. Laser light from one fiber is scattered within the tissue and some is scattered back to the probe. Another optical fiber collects the backscattered light from the tissue and returns it to the monitor. Most of the light is scattered by tissue that is not moving but a small percentage of the returned light is scattered by moving red blood cells. The light returned to the monitor undergoes signal processing to extract the signal related to the moving red blood cells. Microvascular blood flow (perfusion) is indicated in the *AcqKnowledge* software display in relative units called Blood Perfusion Units (BPU).

The LDF technique offers substantial advantages over other methods in the measurement of microvascular blood perfusion.

- Studies have shown that it is both highly sensitive and responsive to local blood perfusion and is also versatile and easy to use for continuous monitoring.
- The LDF100C is potentially noninvasive (since the TSD140 series probe is not actually required to touch the surface of the tissue) and in no way harms or disturbs the normal physiological state of the microcirculation.
- The small probe dimensions enable it to be employed in experimental environments not readily accessible using other techniques.

Measurements obtained by LDF are intrinsically of a relative nature. Although such measurements are proportional to flow, the factor of proportionality will be different for different tissues.

Blood Perfusion Signal and the BPU.

The primary function of the LDF100C is to produce a blood perfusion output signal that is proportional to the red blood cell flow (perfusion). This represents the transport of blood cells through microvasculature and is defined as:

$$\text{Microvascular Flow (Red Blood Cell Flux)} = \text{Number of blood cells moving in the tissue sampling volume} \times \text{Mean velocity of these cells}$$

Microvascular blood perfusion therefore, is the product of mean blood cell velocity and mean blood cell number concentration present in the small measuring volume of tissue under illumination from the probe. For the LDF100C, microvascular blood perfusion is indicated in the *AcqKnowledge* software display in relative units called Blood Perfusion Units (BPU). All LDF100C devices have been calibrated with a constant, known motility standard so that, for a given perfusion situation, all LDF100C probes will read the same value of blood perfusion expressed in blood perfusion units (BPU).

The standard Blood Perfusion output on the LDF100C has been optimally filtered with a time constant of 200 ms to give a clean and smooth looking signal while being able to respond to dynamic changes and pulsatile blood flow. This output is available as a continuous analog voltage for recording purposes via the MP system.

Backscatter Signal (BS)

The LDF100C also produces a signal, which is proportional to the total light remitted or backscattered from the tissue. This is called the Backscatter Signal (BS) and is available as an analog voltage output for recording purposes via the MP system. The backscatter is expressed as a percentage fraction of the laser light remitted from the tissue from the percentage of the maximum analog output possible for the backscatter signal. For example, in highly perfused tissues, the BS will be low due to increased photon absorption. Situations where the BS signal is close to zero may indicate that the probe has come into contact with whole blood. This could cause the BPU reading to saturate since the system is no longer monitoring microvascular perfusion.

What is the Meaning of Zero and Negative BPU?

The zero (0.00 V) reading of the LDF100C has been obtained by calibrating the system against a special static scattering material where no movements occur. In such cases the back-scattered light processed by the LDF100C contains no Doppler shifted frequency components and a true zero is obtained. In a true physical sense, 'noise' around zero can be both positive and negative, thus it is possible that a small negative reading (of up to -10 BPU) can be observed in conditions of zero perfusion.

A zero reading indicates zero motion both in the measuring volume under examination and artifactual motion arising from relative movements between the probe and the measuring volume. During *in vivo* measurements, rarely is an absolute zero obtained. Even during total occlusion of tissue blood perfusion, there is often some small, residual motion of blood cells trapped in the vessels, as well as some small muscle and tissue movement in the measuring volume. Even after surgical removal of tissue, localized cell movement and Brownian motion may still occur in the severed blood vessels.

What volume of tissue does the LDF100C measure?

LDF defines a flow (perfusion) parameter from information contained in the optical spectrum of light remitted from the tissue. The actual measurement sampling volume or depth can only be determined by identifying precisely which blood vessels and erythrocytes have interacted with the remitted light, which in turn, is principally dependant on two parameters; namely the optical scattering and optical absorption coefficients of the tissue under observation. Since both of these coefficients are entirely dependent on the site of observation and perfusion of the microvasculature at the time of measurement, it is impossible to determine the actual sampling volume/depth at any tissue site. Generally speaking, for well-perfused tissue such as muscle, the mean sampling depth has been estimated to be in the region 0.5-1.0 mm with a concomitant sampling volume in the region 0.3-0.5 mm³. For cutaneous measurements, the sampling depth is likely to be in the range 1.0 – 1.5 mm. These estimates have been obtained heuristically through many years of experience and are based on both *in vitro* observations and mathematical modeling of photon diffusion through “imaginary tissues” using Monte-Carlo techniques.

NIBP-A-MRI NONINVASIVE BLOOD PRESSURE SYSTEM



The NIBP-A-MRI CareTaker4 system measures relative central arterial pressure to provide continuous, noninvasive “Beat-by-Beat” Blood Pressure from at rest humans (≥ 15 kg) in the MRI; measures include Diastolic, Systolic, Mean Arterial Pressure. Heart rate (“HR”) is derived from the pulse pressure waveform using the scientific method of Pulse Decomposition Analysis (“PDA”).

Key Features

- Wireless transmission of blood pressure data from CareTaker blood pressure processing unit (via Bluetooth) to a PC—tablet included
- Beat-by-beat blood pressure data is used to generate systolic and diastolic values, which are available in real time from two D/A channels
- Measurements captured using a single disposable finger cuff inflated to low pressure—can be worn for extended periods with no discomfort or loss of circulation in the finger
- Designed for use with MRI recordings
- Easily export to AcqKnowledge Research Software for post-acquisition analysis
- Compact device with on-board display
- Automatic and manual calibration modes
- Integrated PDF report generation and alarms

System Components

- NIBP-A-MRI “CareTaker” Amplifier (FDA Approved and CE marked)
- Finger Cuff Transducers x 2
- Tubing 8 m
- Tablet computer
- Automatic Blood Pressure Calibration Unit
- Export Utility
- Bluetooth dongle
- Power Supply

MRI Use: MR Conditional

Condition: Unit remains in the control room and tubing passes through the waveguide to subject.

Calibration

The Caretaker device can be calibrated automatically using its self-calibration mode or manually with an included cuff. An export conversion utility is included to import calibrated pulse wave data to AcqKnowledge research software.

Compatibility

[MRI and fMRI setups](#)

NIBP-A-MRI Technical Specifications

Physical Specifications:	
Device Dimensions:	3.4 x 6.4 x 9.6 cm
Weight:	198 Grams
Operating Storage Conditions:	
Storage Temp:	-20 °C to +70 °C
Operating Temp:	0 °C to 40 °C
Operating Humidity:	0 to 95% non-condensing
Operating/Storage Pressure:	70 – 101 kPa
Operating/Storage Elevation:	0 – 3000 meters
Operating System Pressure:	-10 mmHg to +250 mmHg
Infection Control:	Wipe with Super Sani-Cloth or other disinfectant wipe
Liquid Ingress Rating:	IP52
Parameter Measurement Ranges:	
Heart Rate Range:	30 – 200 BPM
Heart Rate Resolution:	1 BPM
Heart Rate Accuracy:	±3 BPM
Heart Rate Averaging:	10 second moving average
Continuous Noninvasive Blood Pressure Method (“CNIBP”):	Pulse Decomposition Analysis (“PDA”)
CNIBP Systolic Range:	80 – 250 mmHg
CNIBP Diastolic Range:	50 – 150 mmHg
CNIBP MAP Range:	60 – 185 mmHg
CNIBP Accuracy:	±5 mmHg, Std. dev. < 8 mmHg
CNIBP Calibration:	Automatic (oscillometric sweep via finger cuff) or Manual (user input parameters)
CNIBP Recalibration Update Interval:	User configurable
CNIBP Measurement Update Interval:	User configurable and fixed intervals (0 seconds to 15 minutes)
Respiration Range:	6 – 32 breaths/minute
Respiration Accuracy:	±3 breaths/minute
Respiration Method:	Proprietary PDA, IBI, spectral analysis
User Interface Information:	
Integrated Liquid Crystal Display:	128 x 128 pixels
Clinical App Tablet Based Display:	8” diagonal LCD (Caretaker provided hardware)
Waveforms Displayed:	Continuous pulse rate, continuous pulse pressure, individual pulse shape
Audible Alarms:	None
Battery Charging Information:	
Battery Type & Certification:	2000 mAh lithium polymer UL certified
Operating Time:	8 – 24 hours, depending on use mode
Charging Time:	2 – 4 hours using provided wall charger
Charger Type & Certifications:	5 VDC barrel jack, UL, IEC
Charger Current & Voltage:	150 – 400 mAh @ 5 – 12 VDC
Communications:	
Bluetooth Frequency:	Bluetooth Low Energy (“BLE”), 2400 – 2483.5 MHz ISM band
Bluetooth Communications Range:	10 meters line of sight from host/display
Security Encryption:	AES 128-bit encrypted data stream

Disposable Finger Cuff Wrist Strap:	
Finger Cuff Dimensions:	3.8 mm x 14.2 mm
Finger Cuff Diameter Range:	12 – 30 mm
Wrist Cuff Dimensions:	346 mm x 38 mm
Cuff Materials:	Hypoallergenic polyurethane
Cuff Infection Control:	Single use only, dispose after each use

NIBP-A-MRI Clinical Specifications

Noninvasive Blood Pressure (NIBP) Standards Compliance Data (Self-Calibration):		
Compliance Standard:	ANSI/AAMI/ISO 81060-2: 2013 Noninvasive Sphygmomanometers – Part 2 Clinical Investigation of Automated Measurement Type	
Principle of Operation:	Oscillometry	
Systolic:	Range:	60 – 240 mmHg
	Accuracy:	Mean error ± 5 mmHg, Std. dev. < 8 mmHg
	Resolution:	1 mmHg
Diastolic:	Range:	40 – 160 mmHg
	Accuracy:	Mean error ± 5 mmHg, Std. dev. < 8 mmHg
	Resolution:	1 mmHg
Mean Arterial Pressure:	Range:	50 – 185 mmHg
	Accuracy:	Mean error ± 5 mmHg, Std. dev. < 8 mmHg
	Resolution:	1 mmHg
Validation Study:	Standard-Compliant simultaneous RRK readings by two clinicians 49 m / 77 f, Mean Age: 45.3 y, SD: 14.6 y. Mean Weight: 87.6 kg, SD: 24.3 kg	
	Systolic Specifics:	Diastolic Specifics:
Sample Size:	331 data points	
Mean:	-1.42 mmHg	2.24 mmHg
Standard Deviation:	6.68 mmHg	6.46 mmHg
Correlation:	0.90	0.88
Upper 95% Limits Of Agreement (+1.96 SD):	11.67	10.42
Lower 95% Limits Of Agreement (-1.96 SD):	14.51	14.90

Continuous Noninvasive Blood Pressure (cNIBP) Vital Sign Standards Compliance Data:			
Compliance Standard:	ANSI/AAMI/ISO 81060-2: 2013 Noninvasive Sphygmomanometers – Part 2 Clinical Investigation of Automated Measurement Type		
Principle of Operation:	Pulse decomposition analysis		
Systolic:	Range:	60 – 240 mmHg	
	Accuracy:	Mean error ± 5 mmHg, Std. dev. < 8 mmHg	
	Resolution:	1 mmHg	
Diastolic:	Range:	40 – 160 mmHg	
	Accuracy:	Mean error ± 5 mmHg, Std. dev. < 8 mmHg	
	Resolution:	1 mmHg	
Mean Arterial Pressure:	Range:	50 – 185 mmHg	
	Accuracy:	Mean error ± 5 mmHg, Std. dev. < 8 mmHg	
	Resolution:	1 mmHg	
BP Accuracy Validation Study:	ICU-based cohort with radial artery catheter 23 m / 11 f, Mean Age: 44.05 y, SD: 13.9 y. Mean Weight: 95.3 kg, SD: 27.4 kg		
Heart Rate:	Tracking Accuracy: Heart rate < 2 BPM, beat-by-beat inter-beat interval < 6 ms, range 30 – 200 BPM		
	Systolic Specifics:	MAP Specifics:	Diastolic Specifics:
Sample Size:	99,432 data points		
Mean:	-0.36 mmHg	1.50 mmHg	-0.52 mmHg
Standard Deviation:	7.66 mmHg	6.77 mmHg	6.98 mmHg
Correlation:	0.91	0.81	0.83
Upper 95% Limits Of Agreement (+1.96 SD):	14.65	11.77	13.16
Lower 95% Limits Of Agreement (-1.96 SD):	15.37	14.77	14.20

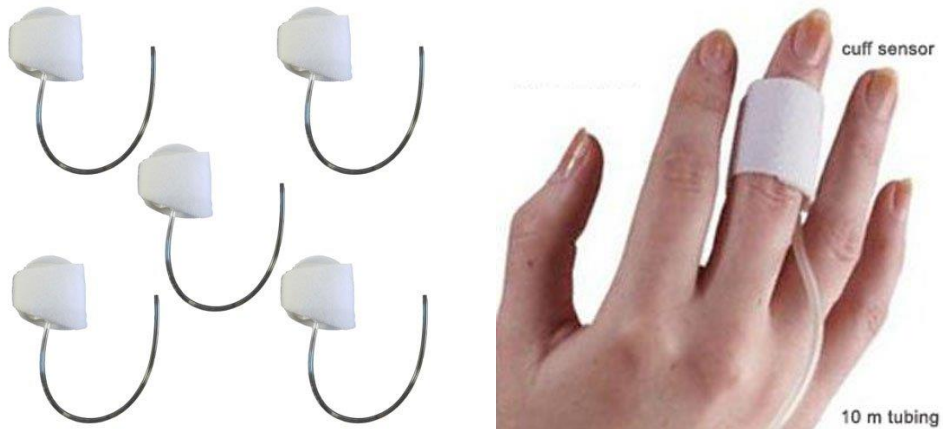
RXNIBP-A-MRI

This is a 5-pack of 10 m Finger Cuff Sensors for MRI Research with the NIBP-A-MRI System.

Sensor life: ~100 hours of intermittent MRI use

Finger Cuff Dimensions: 3.8 mm x 14.2 mm

Finger Cuff Diameter Range: 12 mm – 30 mm

Tubing: 10 m

Interface: NIBP-A-MRI

Cuff Materials: Hypoallergenic polyurethane

Cuff Infection Control: Single use only, dispose after each use

(Non-FDA Cleared)

HYPERBARIC/HYPOBARIC CHAMBER SETUP

1. Cuff controller and CNAP monitor must be in the same chamber with the same "pressure" environment as both are equipped with pressure sensor for surrounding pressure.
2. Pressure must be increased / decreased continuously rather than abruptly.
3. Hypobaric: take measures against overheating of the device as conventional cooling is limited (dim CNAP display low; do not restrict airflow through case).
4. No draught on cuff.
5. Hand on heart level in steady position.

SPECIFICATIONS

For complete specifications, see the **NIBP100D User Manual** online under the [product page](#) "Support" tab.

Components

- **Double-Cuff Finger Sensors** – one each size
 - **L** 24 - 28 mm dark red, **M** 18 - 24 mm Dark blue, **S** 10 - 18 mm Light blue
 - Finger cuff sensors are a consumable item and typically last ~12 months based on 3-4 hours/week.
- **Blood Pressure Cuffs** — one each size, latex-free
 - **Child** (12 – 19 cm), **Small Adult** (17 – 25 cm), **Adult** (23 – 33 cm), **Large Adult** (31 – 40 cm)
- **NIBP100D Monitor**
 - Dimensions 280 x 270 x 250 mm (11 x 10.6 x 9.8 in.)
 - Weight 7.5 Kg (16.6 lbs) including components and accessories necessary for operability of device
 - Battery Sealed lead gel, operating time = 2 hrs (fully charged battery, normal conditions)



Electrical properties

- Nominal voltage: 18 VDC \pm 10%
- Nominal current: 3 A
- Operability: No time-limit if powered by external mains adapter, at least 2 hrs if on battery-operation (fully charged battery)

NIBP100D continuous noninvasive arterial pressure

- Parameter classification
 - Sys, Dia, Mean [mmHg]
 - Pulse [bpm]
- Measuring range
 - Sys: 40 - 250 mmHg (5.3 – 33.3 kPa)
 - Dia: 30 - 210 mmHg (4 - 28 kPa)
 - Mean: 35 - 230 mmHg (4 – 30.6 kPa)
 - Heart rate indication range 20-200 bpm
 - Accuracy \pm 5 mmHg (0.6 kPa)
- Display resolution 1 mmHg (0.1 kPa)
- Inflation pressure
 - Typ.: 120 mmHg (16 kPa)
 - Min.: 30 mmHg (4 kPa)
 - Max.: 300 \pm 10 mmHg (41.3 kPa \pm 1.3 kPa)
- Excess pressure limit
 - 300 \pm 10 mmHg (40 kPa \pm 1.3 kPa)
 - Response time: < 3 sec.
 - Deflation time: < 15 sec
 - Protection against electric shock: Type BF

Output

- Sensor bridge voltage: 2 – 10 V (external monitor)
- Sensitivity: 5 $\mu\text{V/V/mmHg}$
- BP Wave Out: CNAP™ transducer cable 0.3 m; connector RJ11 6P4C (e.g. Abbott IBP catheter)
- Delay of analog out signal: 50 msec (fixed)

Interface

- To DA100C via TCI105 (sold separately)

External mains adapter

- Nominal voltage: 100 – 240 VAC
- Power frequency: ~50/60 Hz
- Power output: 18 V, 3.3 A
- Safety class: Class II with functional earth
- Earth leakage current: < 500 μA

Compliance and Approvals			
Safety class II (IEC 60601)	• IEC 60601-1	• IEC 60601-1-6	• EN 1060-4 (NBP)
Class II b (93/42/EEC)	• IEC 60601-1-2	• IEC 60601-1-8	• ISO 81060-2 (NBP)
Patent applied part type BF (defibrillation proof)	• IEC 80601-2-30		

Intellectual Property				
Patents	• US 6,669,648	• US 8,343,062	• JP 4.414.767	CE
	• EP 1 179 991	• EU 2 493 370	• JP 20075508872	
	• US 8,114,015	• US 8,814,800 B2	• CN 102647940	
	• EP 1 675 507	• EP 2 493 373	plus another 66 patents	

The NIBP100D CNAP™ Monitor 500 is CE and FDA approved.

Note: Electric and magnetic fields may interfere with the functional reliability of the device, so avoid using the NIBP100D CNAP™ Monitor 500 close to devices emitting powerful electromagnetic fields, e.g. x-ray equipment, diathermy applications or magnetic resonance tomographs.

NIBP100D-HD NONINVASIVE BLOOD PRESSURE SYSTEM WITH HEMODYNAMICS

The NIBP100D-HD is a stand-alone noninvasive blood pressure monitoring system that provides a continuous, beat-to-beat, blood pressure signal recorded from the fingers of a subject. Simple and noninvasive—finger sensor provides accurate & immediate feedback: arterial BP, cardiac output, fluid and hemodynamic status.



- Measure noninvasive BP parameters (BP, sBP, dBP, mBP, and PR) plus hemodynamic parameters (PPV, SVV, CO, CI, SV, SI, SVR, and SVRI).
- 2 analog output channels: BP waveform, MAP.
- Comfortable & user-friendly.
- Simple setup & quick calibration.
- Plug & play integration into all common data acquisition systems and subject monitors.
- Easily integrates with AcqKnowledge software displays the blood pressure signal, plus systolic, diastolic, mean blood pressure and heart rate. It will also provide a detailed beat-to-beat analysis of the blood pressure signal.

The NIBP100D-HD noninvasive blood pressure system is part of a complete [research system](#), interfacing with the [MP160/MP150](#) data acquisition and analysis platform and [AcqKnowledge](#) software, allowing advanced research for multiple [applications](#).

SET-UP: SIMPLE AND QUICK

- One finger sensor provides all parameters noninvasively—no placing of catheter or additional electrodes.
- Comfortable for subjects in short or long-term studies.

The NIBP100D-HD system is very user friendly and the initial setup and calibration period takes less than three minutes—that time includes placing the cuff around the upper arm and the sensor on the fingers. Placing the finger sensor is as simple as sliding the subject's fingers through the two cuffs.



RECORDING: IMMEDIATE FEEDBACK

- Real-time, continuous, noninvasive blood pressure displayed only shortly after startup.
- Enables accurate & immediate feedback on BP, PR.
- Proven solution for consistent, repeatable results.

INTERFACE: EASY DATA TRANSFER AND ANALYSIS WITH NIBP100D-HD

Interface with BIOPAC's MP160, MP150, or MP36R data acquisition systems or a third-party data acquisition system.

Interface cable CBLNIBP100D-HD is included with every NIBP100D-HD System.

- One end of the CBLNIBP100D-HD cable connects to the “AUX” port on the right side of the NIBP100D-HD unit.
- The other end terminates in 4 x 3.5 mm male connectors, labeled CH 1 BP, CH 2 MAP, CH 3 CO, and CH 4 Pulse, compatible with firmware version 5.2. (Cables shipped prior to June 2016 are labeled BP, MAP, CO, and PPV, and are compatible with NIBP firmware 5.0).

MP160 System: Connect CBLNIBP100D-HD to [AMI100D](#) or [HLT100C \(Rev 2\)](#); optionally, add 4 x INISOA for isolated (electrically safe) inputs.

Important! HLT100C Rev # is indicated on the part#/barcode label: “Rev 2” units ship with MP160 Systems and cannot physically be used with an MP150+UIM; older “Rev 1” units shipped with MP150 Systems.

MP150 System: Connect CBLNIBP100D-HD to [HLT100C \(Rev 1\)](#); optionally, add 4 x INISOA for isolated (electrically safe) inputs.

MP36R System: Add 4 x BSL-TCI5 mod phone jack interface to connect CBLNIBP100D-HD to the CH ports on the front of the unit.

Safety Note: When connecting this system to an A/D system, be aware that the outputs are NOT electrically isolated and will need to be isolated before going into the A/D system. This will keep the subject electrically safe. This is especially important when connecting electrically via ECG, EMG, EDA, EEG, etc. to the subject.

	CNAP [®] NIBP100D-HD Monitor Software Version		
	v3.7.2 and earlier	v5.0.x ¹	v5.2.x and later ^{1, 2}
Channel 1	BP waveform 0 – 500 mmHg 0 to 5V reference	BP waveform 0 – 500 mmHg	BP waveform 0 – 500 mmHg
Channel 2	BP waveform 0 – 500 mmHg -5 to 5 V reference	MAP 0 – 500 mmHg	selectable MAP ³ 0 – 300 mmHg Pulse 0 – 200 bpm
Channel 3	-	CO 1 – 100 l/min	selectable CO ³ 0 – 30 l/min SV 0 – 200 ml SVR 0 – 5000 dyn*s/cm ⁵
Channel 4	-	PPV 0 – 40 %	selectable PPV 0 – 40 % SVV 0 – 40 % Pulse ³ 0 – 200 bpm

- Starting from version 5.0.x the output voltage range (reference voltage) can be selected by the user between 0 to 5 V (default) and -5 to 5V (see operator’s manual – chapter 4.6.1).
- Since version 5.2.x the parameter output on channel 2, 3 and 4 can be configured by the user in the menu Setup | Measurement | Output Options.
- Default setting.

See also:

- [Continuous non-invasive arterial pressure shows high accuracy in comparison to invasive intra-arterial blood pressure measurement](#)  (Sackl-Pietsch E., Department of Anesthesiology, Landeskrankenhaus Bruck an der Mur, Austria)
- Continuous non-invasive blood pressure monitoring using concentrically interlocking control loops.** J. Fortin, W. Marte, R. Grullenberger, A. Hacker, W. Habenbacher, A. Heller, CH. Wagner, P. Wach, F. Skrabal Computers in Biology and Medicine – September 2006 (Vol. 36, Issue 9, Pages 941-957, DOI: 10.1016/j.compbimed.2005.04.003)
- BIOPAC blog: [Ensuring Error-Free NIBP Measurements and Data](#)
- BIOPAC blog: [Noninvasive Hemodynamic Monitoring in Research](#)
- BIOPAC [NIBP Free Webinar](#)

NIBP100D-HD Specifications

Parameter classification: Sys, Dia, Mean [mmHg] | Pulse [bpm]

Inflation pressure: Typical 120 mmHg (16 kPa) | Min. 30 mmHg (4 kPa) | Max. 300 ±10 mmHg (41.3 kPa ±1.3 kPa)

Measuring range: Systolic 40–250 mmHg (5.3–33.3 kPa) | Diastolic 3 –210 mmHg (4–28 kPa) | Mean 35–230 mmHg (4–30.6 kPa)

Heart rate indication range: 30-200 bpm

Excess pressure limit: 300 ±10 mmHg (40 kPa ±1.3 kPa)|

Response time: < 3 sec.

Deflation time: < 15 sec

Protection against electric shock: Type BF

Display resolution: 1 mmHg (0.1 kPa)

Measuring ranges:

CO: 0,0–99,9 l/min

SV: 0–500 ml

SVR: 0–9999 dyne*s/cm⁵

PPV: 0-40%

CI: 0,0–99,9 l/min/m²

SVI: 0–500 ml/m²

SVRI: 0–9999 dyne*s/cm⁵/m²

SVV: 0-40%

O-RING KIT FOR NIBP100D – RXNIBP100D-KIT

This O-ring repair kit for the NIBP100D Noninvasive Blood Pressure Monitor (CNAP® Monitor 500) allows the user to replace the O-rings on the main unit, sensor cable and sensor.

Kit includes 20 O-rings, a repair tool, and lubricant.

1. O-RING LUBRICATION

O-rings are used for leak-proof distribution of air throughout the CNAP® hardware. The O-ring bushings of the CNAP® finger cuff and the CNAP® cable (Figure 1) need to be lubricated regularly (every 12 months) in order to assure a free moving connection and avoid air leakage.



Figure 1

CNAP™ Error Codes associated with air leakage:
CNAP Fault Initial Pressure. Technical description: Self-Test Manifold Pump Does Not Reach Minimum Pressure Threshold
CNAP Fault Pump/Tubing/Valve Leaky. Technical description: Self-Test Manifold Pump/Tubing/Inlet Valve Leakage

Lubricate the O-ring bushings (air connectors) of CNAP® Monitor 500 with O-lube.

- a. Apply a small amount of O-lube to a Q-tip. (Figures 2-4). Avoid applying too much O-lube on the Q-tip (as in Figure 2) by distributing excess lube on the back of your hand (Figure 3). Figure 4 depicts the proper amount of lube.



Figure 2

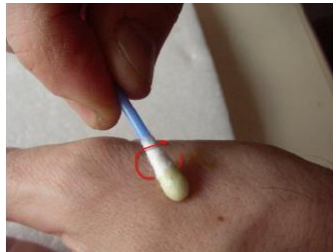

Figure 3



Figure 4

- b. Apply O-lube into each of the two bushings (lateral holes used for air supply) of the CNAP® finger cuff and the CNAP® cable (both ends) as shown in Figures 5 and 6.

IMPORTANT: The electrical connections in the middle of the connector must not come in contact with the O-lube.

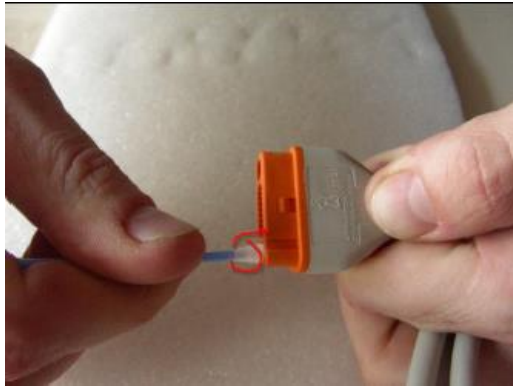

Figure 5



Figure 6

- c. Start the NIBP100D CNAP® Monitor and CNAP® hardware (CNAP® controller, CNAP® finger cuff and CNAP® cable). If the status message “CNAP initializing” is displayed upon startup, the connection is working properly. Otherwise, repeat Steps b and c.

2. O-RING INSTALLATION

O-rings are used in the CNAP® controller (four O-rings) and CNAP® cable port (two O-rings) to distribute leak-proof air throughout the CNAP® hardware.

How to change the O-rings (air connectors) on the NIBP100D CNAP® Monitor 500

- a. Remove the four red O-rings from the CNAP® controller. (Two O-rings for each connector, see Figures 7 and 8.)

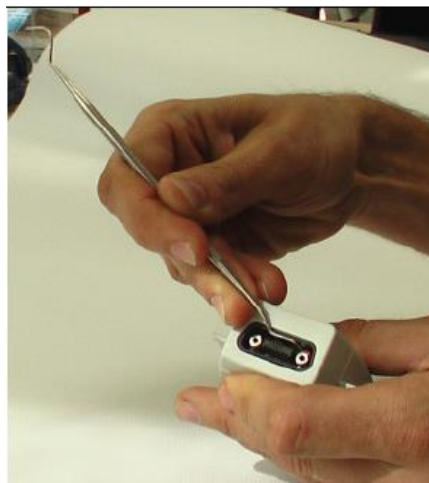

Figure 7



Figure 8

- b. Slide/roll O-ring onto the provided O-ring mounting tool (O-ring at the end of the conus, as shown in Figures 9 and 10).

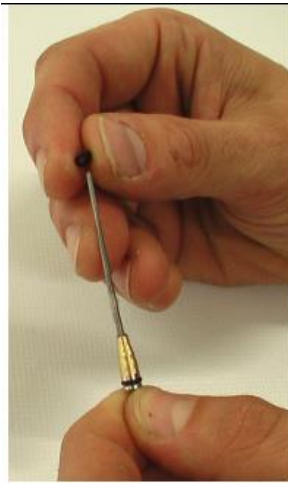

Figure 9

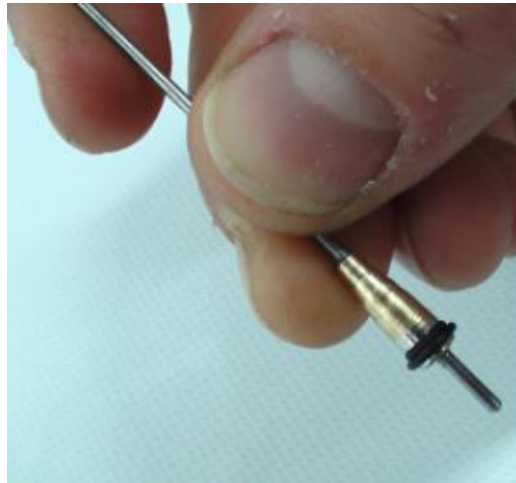

Figure 10

- c. Attach the O-ring mounting tool to one of the O-ring carriers (as shown in Figure 11). Then use the green O-ring plug socket to slide the O-ring onto the O-ring carrier (Figure 12). Make sure that the O-ring sits in position on the O-ring carrier.



Figure 11

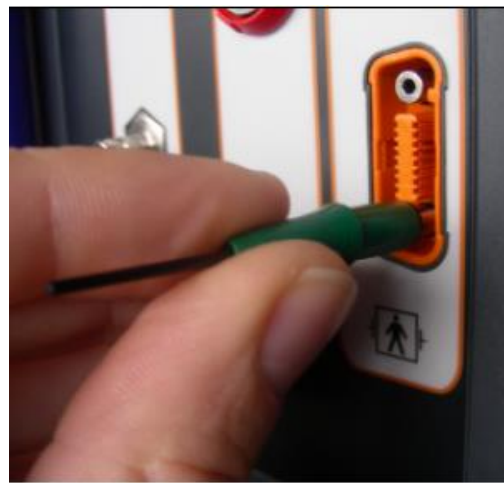

Figure 12

- d. Remove the O-ring plug socket and O-ring mounting tool.
- e. Repeat Steps a-d for all four O-rings of the CNAP® controller and the two O-rings of the cable port on the NIBP100D CNAP® Monitor 500.
- f. Lubricate all O-ring bushings as described in Section 1.

NON-INVASIVE SMALL ANIMAL TAIL BLOOD PRESSURE SYSTEMS

NIBP250 Blood Pressure Amplifier

NIBP200A Blood Pressure System

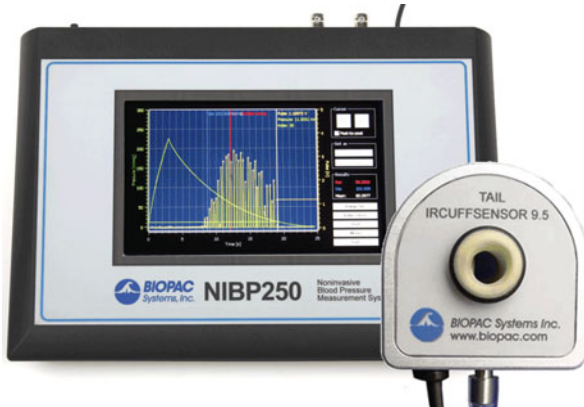

NIBP Amplifiers with built-in pump automatically inflate the tail cuff to occlude the vessel in the tail of a rat or similar small animal, and then slowly deflate the cuff when the inflation point is reached, providing a linear drop in pressure. A single control starts both the inflation and deflation cycles, making the system very operator-friendly. Amplifiers have two analog outputs for pressure and pulse waveforms, plus gain adjustment to amplify or attenuate the pulse signal. Systolic, diastolic, and mean BP values.

- **NIBP250** Touchscreen LCD controls and displays data for local analysis and storage. Use as a stand-alone system or interface to BIOPAC or third-party A/D hardware. USB 1.1 compatible flash memory port and SD card slot.
- **NIBP200A** Amplifier for use with Tail Cuff Sensor.

Systems include:

- Amplifier order NIBP250 or NIBP200A
- One tail cuff sensor (request size):
 - RXTCUFSENSOR9.5 = 9.5 mm, 100-220 g
 - RXTCUFSENSOR11 = 11 mm, 200-280 g
 - RXTCUFSENSOR13 = 13 mm, 250-350 g
- One small animal restrainer:
 - RXRESTRAINER-S, 70-150 g (small rat)
 - RXRESTRAINER-M, 150-200 g (medium rat)
 - RXRESTRAINER-L, 250-350 g (large rat)
- Optional MRI-conditional sensors available – add to an existing NIBP200A system
 - RXCUFSEN9.5-MRI = 9.5 mm, 100-220 g
 - RXCUFSEN11-MRI = 11 mm, 200-280 g
 - RXCUFSEN13-MRI = 13 mm, 250-350 g

MRI Use: MR Conditional

Condition: Animal use only; tested to MR field strength 3T

RXTCUFSENSOR 9.5/11/13 Components—MRI chamber room components only:

Sensor Housing: Delrin®

Cable: Dual Fiber Optical Cable

SensorType: Infrared

Air Line: Tygon® Tubing

Sensor Tubing: Latex

- Analog outputs: pressure 0-3 V DC, Pulse 0-4 V DC
- Output cables: pressure cable and pulse cable
- Interface cables: to BIOPAC or third-party A/D hardware
- User's Manual

Optional Tail Heater: TAILHEATA 110 V or TAILHEATB 220 V

SPECIFICATIONS

Cut-off Pressure Range:	100 – 300 mmHg (adjustable by 1mmHg steps)
Pressure Accuracy:	300 mmHg Full Scale 1%
Pressure Sensitivity:	0.1 mmHg
Pressure Signal output:	300 mmHg/3 Volt DC
Pulse Gain Levels:	x1, x2, x4, x5, x8, x16, x32 (adjustable)
Pulse Signal Output:	0 – 4 Volt DC
Pulse Display:	Pulse intensity is displayed on A2, derived from plethysmographic measure The tail sensor detects blood flow and pulse intensity is increased or decreased, depending on the flow ratio.
LCD Display:	7" 800 x 480 TFT (NIBP250)
User Interface:	Resistive Touch Panel (NIBP250)
Analog outputs:	Two BNC connectors for uncalibrated pressure and pulse signals
Triggers:	Two BNC connectors for TTL Compatible trigger in and out signals
Power Supply:	12 Volt 2 Amp – External

NIBP200A/NIBP250 SYSTEM CONNECTIONS



NIBP200A Front Panel



NIBP200A Rear Panel

1. Connect the CBL150-PRE cable (or CBL35-PRE cable for MP36/35 hardware).
 - a. BNC to the PRESSURE output on the back panel of the unit.
 - b. Other end to A1 on the front of the AMI100D/HLT100C/UIM100C (or CH 1 of the MP36/35 unit).
2. Connect the CBL150-PLS cable (or CBL35-PLS for MP36/35 hardware).
 - a. BNC to the PULSE output on the back panel of the unit.
 - b. Other end to A2 on the front of the AMI100D/HLT100C/UIM100C unit (or CH 2 of the MP36/35 unit).
3. Connect the IRSENSOR.
 - a. Black cord to the sensor input on the front panel of the NIBP200A (back panel on NIBP250).
 - b. Tubing in the cuff on the front panel of the NIBP200A (back panel on NIBP250).
4. Connect the power.
 - a. AC300 adapter to the 12 V DC input on the back panel of the NIBP200A.
 - b. AC300 to Mains power.
5. Switch the POWER on.

ANIMAL PREPARATION

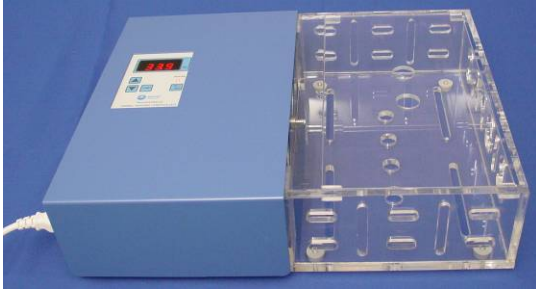

Optional Heating Chamber



Restrainer Animal Holders



Tail Cuff/Sensor

1. Turn the Animal Heating Chamber on.
2. Set the temperature value (press and hold P.Set and then press the up or down arrow to reach the desired value).
 - For accurate noninvasive blood pressure measurement, the animal or its tail should be warmed to 32° C.
3. Press the Heater button to start heating to the selected temperature value.
4. Place the animal inside the RESTRAINER “Animal Holder” (select the suitable size for the animal volume).
 - Leave the tail outside.
 - Adjust the length to obtain a position where the animal has limited movement.
5. Place the RESTRAINER (with the animal) in the heating section of the Animal Heating Chamber.
6. Wait approximately 30 minutes for the animal to reach the selected temperature.
7. Remove the RESTRAINER from the Animal Heating Chamber.
8. Connect the IRSENSOR to the tail of the animal inside the RESTRAINER.
9. Check if the sensor just fits to the tail. The sensor should be between the mid point of tail and tail end (spinal column). To achieve this, a suitable sensor should be selected.
10. Wait for the animal to relax and become inactive before starting measurements.



TIP Before starting the experiment, to condition the animal, put the animal inside the holder several times a day and repeat the heating each time.

SOFTWARE SETUP (AcqKnowledge 4.1 and higher)

1. Launch AcqKnowledge 4.x.
2. Select the “Create/Record a new experiment” option.
3. Select “MP160/150 > Set Up Data Acquisition > Channels > “Add New Module...”
 - a. From the new module list, select AMI100D-HLT100C-A1 (MP160) or UIM100C-A1(MP150), (or whichever channel CBL150-PRE pressure cable is connected to) and click “Add.”
 - b. From the AMI100D/HLT100C (MP160) or UIM100C (MP150) Transducer list, select “NIBP200A – Small Animal Tail BP, Pressure” or “NIBP250 – Small Animal Tail BP, Pressure” and click OK.
 - c. Click “Calibrate” in the resulting Calibration dialog.

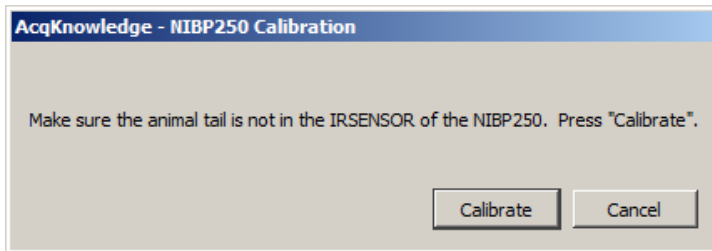

4. Repeat “Add New Module...” portion of Step 3.
 - a. From the new module list, select AMI100D-HLT100C-A2 (MP160) or UIM100C-A2 (MP150) (or whichever channel CBL150-PLS pulse cable is connected to) and click “Add.”
 - b. From the AMI100D/HLT100C (MP160) or UIM100C (MP150) Transducer list, select “NIBP200A – Small Animal Tail BP, Pulse” or “NIBP250 – Small Animal Tail, Pulse” and click OK.

SOFTWARE SETUP (AcqKnowledge 4.0 and earlier)

1. Launch the BIOPAC software.
2. Choose “MP menu > Set up Channels.”

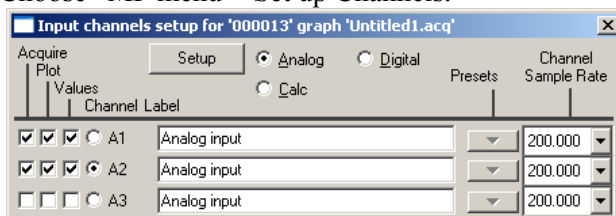

OR

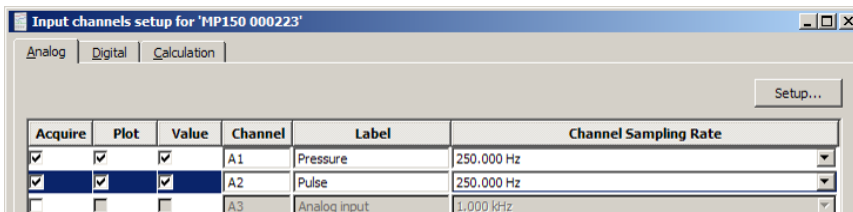

3. Enable analog inputs A1 and A2 and select the Acquire, Plot and Value options.
 - If desired, enter channel Labels: A1 Pressure and A2 Pulse.

4. Calibrate for the pressure measurement of IRSENSOR.
 - a. Select A1 (Pressure) and click Setup and establish these settings:

	Input volts	Scale (Map) value
Cal 1	0	0
Cal 2	1	100
Units Label:	mmHg	

The scaling must be adjusted as the cut-off pressure switch settings are changed. If the pressure switch is set to 300 mmHg, then the settings should be:

	Input volts	Scale (Map) value
Cal 1	0	0
Cal 2	3	300
Units Label:	mmHg	

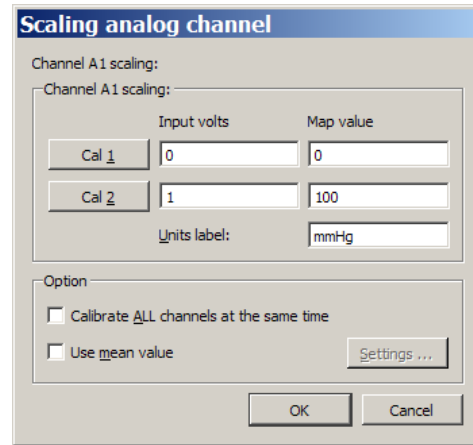

- b. Click OK as needed to close out of A1 setup.

5. Calibrate for the pulse measurement of IRSENSOR.

- a. Ensure that the tail is not inside the IRSENSOR and it is empty, and the sensor resides freely.
 - b. Select A2 (Pulse) and click Setup and establish these settings:

	Input volts	Scale (Map) value
Cal 1	0	0
Cal 2	1	4
Units Label:	Volts	

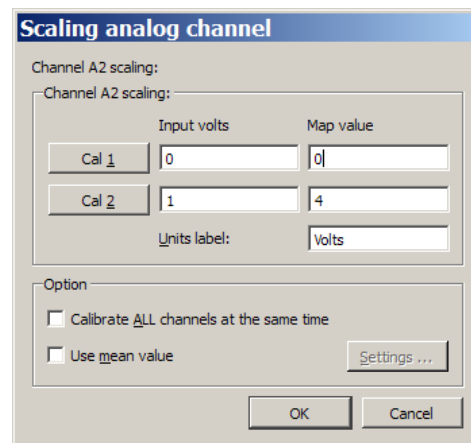

- c. Click OK as needed to close out of A2 setup and the Setup Channels dialog.

6. Choose "MP menu > Set up Acquisition" and establish the following settings:

Mode = Record and Append to Memory
 Sample Rate = 200 samples/second
 Total Length = 24 seconds
 Repeat = every 3 seconds for 10 times

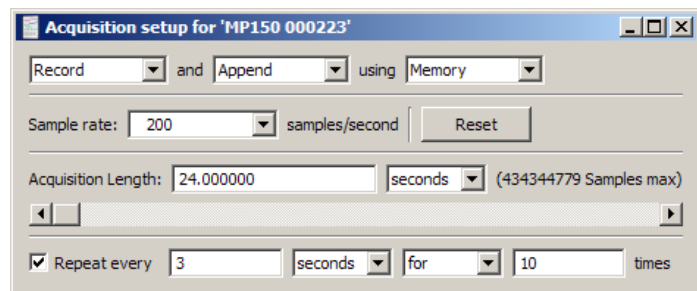

7. Exit Set up Acquisition dialog.

- Choose “MP menu > Setup Trigger” and establish the following settings:

Trigger = CH 1, Pos Edge
Trigger Level = 0.33 Volts
(based on 1 V \approx 100 mmHg)
Delay = 0 samples

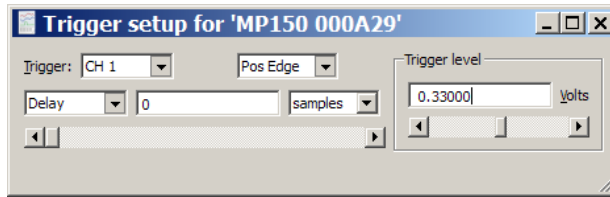

- Close out of Triggering dialog.

SOFTWARE SETUP for AcqKnowledge 4.x or BSL 4.x with MP3x Hardware

- Launch the software.
- Select the “Create/Record a new experiment” option.
- If necessary, choose “MP3x > Set up Data Acquisition > Channels.”
- Enable analog inputs CH1 and CH2 and select the Acquire, Plot and Value options.

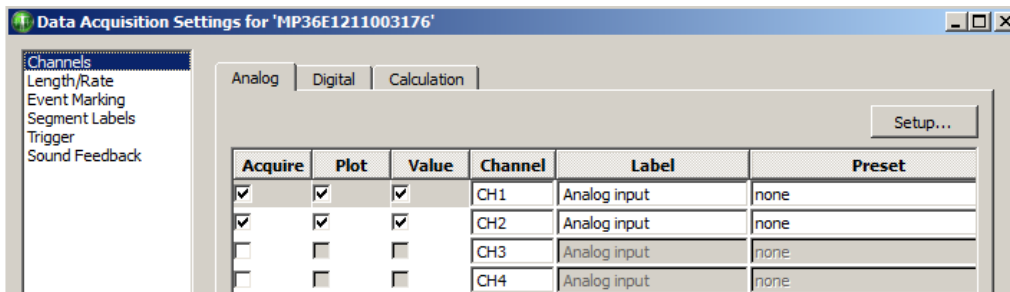

- Select CH1 and click “Setup.”
- Click “New Channel Preset,” enter “NIBP200A-Pressure” and click OK.
- Establish the following settings:

- Channel Preset = NIBP200A-Pressure
- Channel Label = CUFF PRESSURE
- Gain = x10
- Input Coupling = DC
- Filter = 1
- Type = Low Pass
- Frequency = 30
- Q = 0.5

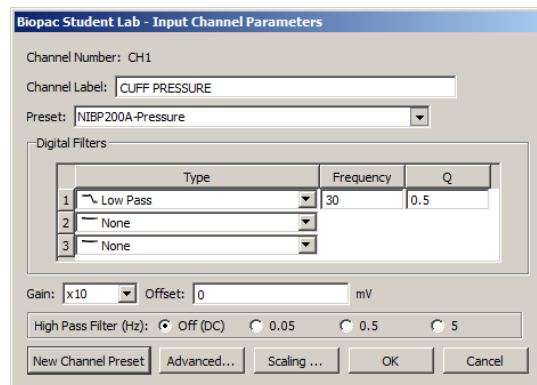

- Calibrate for the pressure measurement of IRSENSOR.
 - Click “Scaling” button and establish the following settings:
Map values
Cal1 = 0
Cal2 = 100
Units label = mmHg
 - Click the Cal 1 button.
 - Add “333” to the Cal 1 Input value, and enter the result in Cal 2 Input value (Cal 2 = Cal 1 + 333)
 - Click OK as needed to exit the CH1 “Scaling” and Input “Channel” setup dialogs.

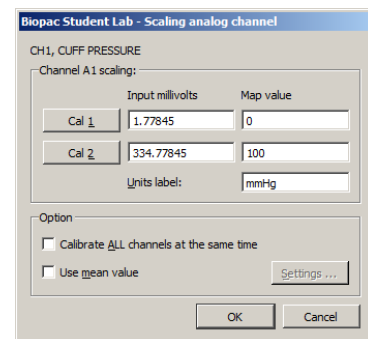

9. Select CH2 and click “Setup.”
10. Click “New Channel Preset,” enter “NIBP200A-Tail Pulse” and click OK.
11. Establish the following settings:

- Channel Preset = NIBP200A-Tail Pulse
- Channel Label = TAIL PULSE
- Gain = x10
- Input Coupling = DC
- Filter = 1
- Type = Low Pass
- Frequency = 50
- Q = 0.5

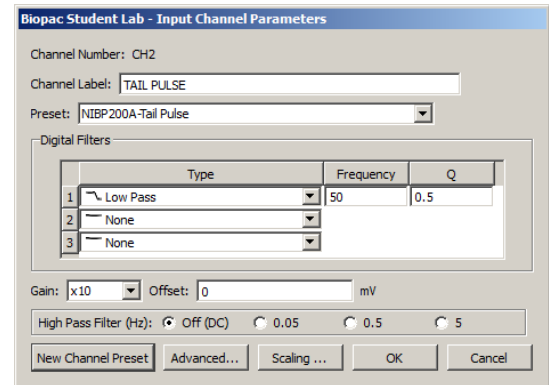

12. Calibrate for the pulse measurement of IRSENSOR.
 - a. Ensure that the tail is not inside the IRSENSOR, and that the sensor resides freely.
 - b. Click “Scaling” button and establish the following settings:

Map values

Cal 1 = 0

Cal 2 = 1000

Units label = mV

- c. Click the Cal 1 button.
 - d. Add “333” to the Cal 1 Input value and enter the result in Cal 2 Input value (Cal 2 = Cal 1 + 333)
 - e. Click OK as needed to exit the CH2 “Scaling” and “Input Channel” setup dialogs.

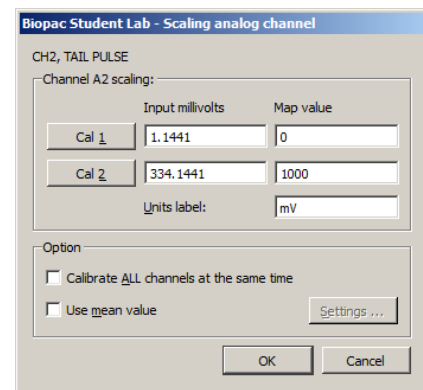

13. Choose “MP3x > Set Up Data Acquisition > Length/Rate” and establish the following settings:
 - Mode = Record and Append using Memory
 - Sample Rate = 200 samples/second
 - Acquisition Length = 24 seconds
 - Repeat = every 3 seconds for 10 times

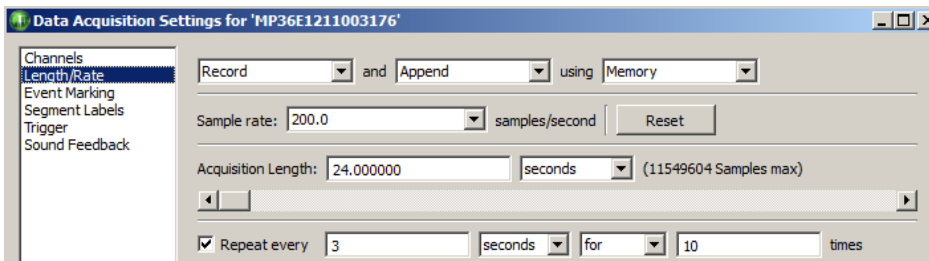

14. Choose “Trigger” and establish the following settings.

Trigger = CH 1, Pos Edge
Trigger Level = 30 mmHg

15. Exit the Data Acquisition Settings dialog.

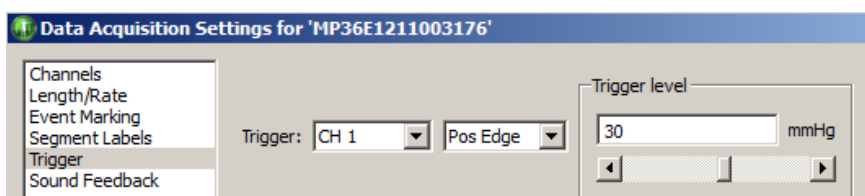

RECORDING

1. Confirm that the animal is ready and that the IRSENSOR is attached to the tail.
2. Click “Start” in the BIOPAC software window.
3. Press START button on the front panel of NIBP200A.
 - IRSENSOR will pump up the Cuff automatically.
 - When the Cuff Pressure on A1 reaches 30 mmHg, the cuff pressure and tail pulse signals will be generated.
 - The recording will stop automatically after 24 seconds.
4. Press START to continue with the next measurement and repeat as necessary.
5. Choose File > Save or Save as when done.

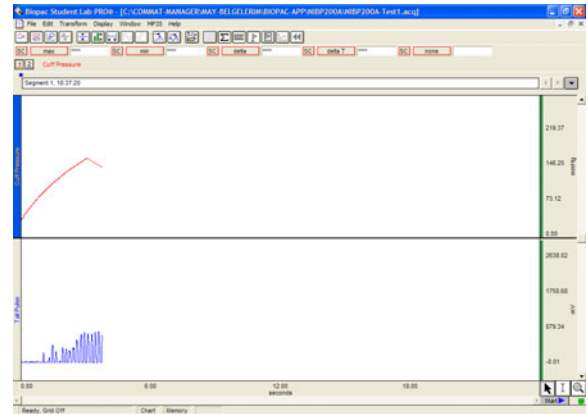

TIP A generally accepted application is that for each animal, 10 measurements are recorded and mean values are calculated. In the append mode, 10 consecutive measurements can be made in the same file.

NIBP200A ANALYSIS

Calculation of Systolic, Diastolic and Mean.

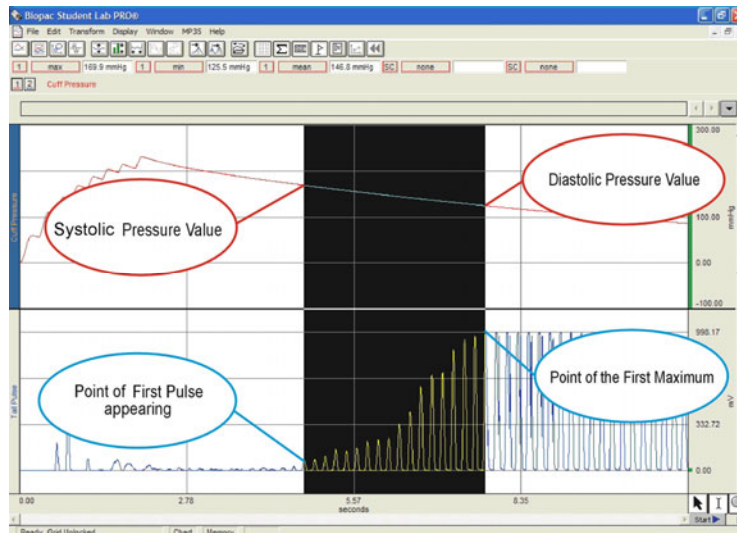

1. Click the Calculation Label.
2. Select from the list Max, Min, Mean for three different Labels.
3. Select Channel 1 as channel option.
4. Select cursor ‘I’ from the cursor option on the bottom right of the screen.
5. On the graphical display, starting from the point of first pulse, select an area to the maximum.
6. Review the results for Max (Systolic), Min (Diastolic), and Mean measurements.

Calculation of BPM Heart

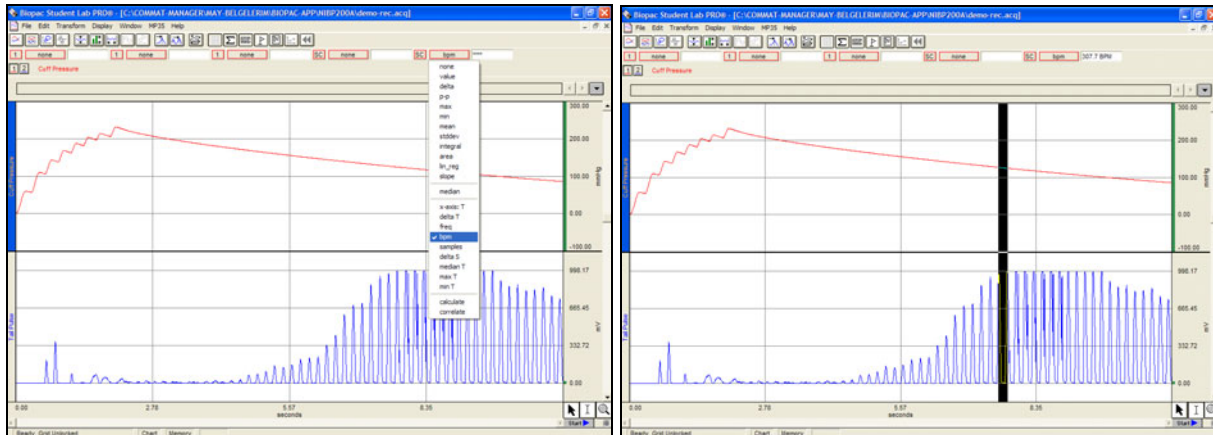

1. Set a measurement for **BPM**.
2. Use the I-beam cursor to select the maximum points of the peaks of the CH2 pulse waveform.
3. Review the results for BPM (Heart Rate value) for each peak.

NIBP250 QUICK GUIDE

PREPARE

- With unit turned off, attach the sensor and cuff connectors.
- Turn on unit and wait for the Main Screen to appear.
- Prepare the animal and attach sensor-cuff to tail.

ACQUIRE

- When preparation is complete: Press the “Start” button on the Main Screen. The button label changes to “Stop” and you can halt the acquisition at any time.
- When the acquisition starts, the unit automatically closes the leakage valve and begins inflating the cuff.
- After pressure reaches the maximum level, the pump stops and opens the leakage valve to release the pressure.
- After the pressure is fully released, the acquisition stops.

NIBP250 ANALYSIS

The NIBP250’s automated peak detection system marks the peak of each pulse with a white cross, and is enabled by selecting the "Peak by peak" option on the Main Screen. This feature makes it easier to identify the individual pulses. To determine the systolic and diastolic values:

1. Select the "Peak by peak" box on the main screen.
2. Use the right (or left) cursor button to locate the first pulse's white cross and press the "Systolic" button. (You may also place the cursor using the touch screen.) The system will record and display the systolic blood pressure value.
3. Use the cursor button (or touch screen) to move to the pulse with the highest peak and then press the "Diastolic" button. The system will record and display the diastolic blood pressure value..

You may change your cursor peak positions at anytime during the analysis.

After measurement is complete, press the Save button under “Results.” An automatically generated result code will be displayed at the top of the results section.

For analysis in BIOPAC AcqKnowledge or BSL PRO software, see previous page for NIBP200A.

SAVE RESULTS

- Previously saved results can be displayed by pressing the “Load” button under “Results.”
- Placing the cursor on a desired measurement and pressing OK will load the recorded pressure, pulse curves and previously calculated results.
- After loading is complete, you can easily evaluate the results and re-analyze any measurements.

TURN OFF

- Before turning off the unit, be sure that the current measurement was saved.
- Power off the unit by switching the power button on the back

TROUBLESHOOTING

Tail Pulse signals are not regular.

- The animal may be under stress, resulting in excessive tail movement. Remove the animal from the RESTRAINER holder until it calms down before continuing with the experiment.
- The tail may not be sufficiently warmed or cooled down. Put the animal in the Tail Heater Chamber and repeat the heating process. Make sure the tail temperature is 32° C.
- Tail Cuff sizing may be incorrect. Check Table 5 on the following page for sizing descriptions.
- Tail Cuff Sensor position may be incorrect. Try re-attaching the sensor in a different location on the tail. The optimal location is between the mid-point of tail and base of tail (spinal column).

Compressor is working continuously.

- Immediately turn off the NIBP system.
- Remove the Tubing from the Cuff connector on the panel of NIBP system
- Turn the system back on.
- Close the air outlet by pressing the finger on the Cuff output and press the “Start” button. The compressor will work for a few seconds and stop (please inform BIOPAC if the Compressor does not stop). The pressure chart should be viewable on the screen.
- If the Compressor stops automatically, it means that the system is working normally.

There is leakage in the tubing connections and Cuff of the IRSENSOR.

- Make sure the tubing is securely attached.

fNIR FUNCTIONAL NEAR INFRARED OPTICAL BRAIN IMAGING SYSTEMS



[fNIR 2000C Imager Systems](#)



[fNIR 2000E Imager Systems](#)



[fNIR2000S Imager Systems](#)



[fNIR2000P Imager Systems](#)



[fNIR2000M Imager Systems](#)

fNIR functional near infrared optical imaging systems measure oxygen level changes in the prefrontal cortex of human subjects. Each fNIR system provides real-time monitoring of tissue oxygenation in the brain as subjects take tests, perform tasks, or receive stimulation and allows researchers to quantitatively assess brain functions—such as attention, memory, planning, and problem solving—while individuals perform cognitive tasks. The fNIR device provides relative change in hemoglobin levels, calculated using a modified Beer-Lambert law.

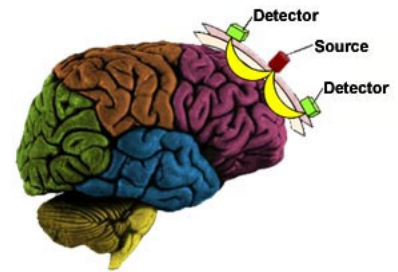

Subjects wear an fNIR sensor (IR light sources and detectors mounted in a flexible band) on the forehead that detects oxygen levels in the prefrontal cortex and provides real-time values for oxy-hemoglobin and deoxygenated hemoglobin. It provides a continuous and real-time display of the oxygen changes as the subject performs different tasks. The subject can sit in front of a computer and take a test or perform mobile tasks. It integrates with stimulus presentation systems and BIOPAC’s virtual reality products.

The powerful fNIR spectroscopy imaging tool measures NIR light absorbance in blood of hemoglobin with and without oxygen and provides information about ongoing brain activity similar to functional MRI studies. It eliminates many of the drawbacks of fMRI and provides a safe, affordable, noninvasive solution for cognitive function assessment. The technology empowers researchers by providing greater flexibility for study design, including working within complex lab environments and operating in non-traditional lab locations for field studies.

fNIR systems are suitable for a wide range of applications.

- Human Performance Assessment
- Brain Computer Interface
- Neurorehabilitation
- Pain Assessment
- Autism
- Virtual Reality
- Depth of Anesthesia Monitoring
- Credibility Assessment (lie detection)

fNIR Systems for continuous fNIR spectroscopy (NIRS) include COBI control unit software and fNIRSOFT analysis software to view the data in real time and save it to perform post acquisition analysis.

The fNIR device can produce digital TTL output signal through the BNC output port to synchronize any external device with data acquisition events. (2000M Output Sync port is JST PH-series instead of BNC.)

The fNIR data combines with other physiological variables such as ECG, respiration, cardiac output, blood pressure, electrodermal activity, and stimulus response markers. AcqKnowledge software provides automated analysis tools for event related potentials and ensemble averaging. Combining the fNIR data with the other physiological signals provides researchers with a detailed subject assessment.

FNIR SYSTEMS *Functional brain imaging systems for continuous fNIR spectroscopy (NIRS)***C Systems (with 2000C Imager)****fNIR103C Functional Near Infrared Brain Imaging System**

Stand-alone imaging system—includes a 2000C Imager¹, fNIRSoft Standard/COBI, and one 5-channel sensor pad with one sensor cable.

fNIR203C Functional Near Infrared Brain Imaging System

Stand-alone imaging system—includes a 2000C Imager, fNIRSoft Standard/COBI, and three 18-channel sensor pads with two sensor cables.

fNIR303C Functional Near Infrared Brain Imaging System

Stand-alone imaging system—includes a 2000C Imager, fNIRSoft Standard/COBI, three 18-channel sensor pads with two sensor cables, plus a Tablet Style computer with caddy.

¹The 2000C Imager is capable of supporting a maximum of 18 channels.

S Systems (with 2000S Imager)**fNIR103S Functional Near Infrared High-Density Brain Imaging System**

Stand-alone high-density imaging system—includes a 2000S Imager², fNIRSoft Pro/COBI, and three 18-channel sensor pads with two sensor cables.

fNIR203S Functional Near Infrared High-Density Brain Imaging System

Stand-alone high density imaging system—includes a 2000S Imager, fNIRSoft Pro/COBI, laptop computer with caddy, and three 18-channel sensor pads with two sensor cables.

fNIR303S Functional Near Infrared High-Density Brain Imaging System

Stand-alone high density imaging system—includes a 2000S Imager, fNIRSoft Pro/COBI, laptop computer, all-in-one computer with pole cart/shelf, three 18-channel sensor pads with two sensor cables, plus four additional sensors and Phantom sensor (mimics optical properties of brain tissue).

²The 2000S Imager is capable of supporting a maximum of 54 channels. For full 54 channel support, three sensor pads and six sensor cables are required.

M Systems (with 2000M Imager)**fNIR103M Functional Near Infrared Mobile Imaging System**

Stand-alone high-performance mobile imaging system—includes a 2000M Imager³, fNIRSoft Pro/COBI, three 18-channel sensor pads with two sensor cables, US/EU power supply/adaptor.

fNIR203M Functional Near Infrared Mobile Imaging System

All fNIR103M components PLUS one Notebook/Tablet Style computer.

fNIR303M Functional Near Infrared Mobile Brain Imaging System

All fNIR203M components PLUS additional sensors: two 5-Optode sensor pads; two 6-Optode sensor pads; one Phantom sensor (mimics optical properties of brain tissue).

³The 2000M Imager is capable of supporting a maximum of 18 channels.

P System (with 2000P Imager)**fNIR103P Wireless Pediatric Functional Near Infrared Brain Imaging System**

Wireless, stand-alone imaging system—includes a control unit, fNIRSoft Standard/COBI, and choice of one sensor: 2-channel Pediatric Sensor (RXFNIR-PED) or 4-channel Adult Sensor (RXFNIR4). The 2000P Imager supports a maximum of 4 channels. This system is backward-compatible to the fNIR Imager 1200.

The wireless fNIR103P provides users with an in-lab assessment of cognitive function. It eliminates a great many of the drawbacks of a functional MRI. The subject can sit in front of a computer and take a test or perform mobile tasks. It integrates with stimulus presentation systems and BIOPAC's virtual reality products.

fNIR103P is suitable for a wide range of applications: Human Performance Assessment, Depth of Anesthesia Monitoring, Brain Computer Interface, Virtual Reality, Neurorehabilitation, Autism, and Credibility Assessment (lie detection).

E System (with 2000E Imager)

fNIR103E Functional Near Infrared Mobile Imaging Education System

Easy to Use—Short Prep and Learning Curve, fNIRS Experiments included with Education System!

fS Education is a stand-alone software package designed to run fNIRS Experiments for with the 2000E Imager for Education Systems. Use fS viewer and data management tools to process, analyze, and visualize functional near infrared (fNIR) spectroscopy signals. View data in real time and perform post-acquisition analysis.

COBI Studio “Cognitive Optical Brain Imaging” software is designed for performing serial experiments and makes it easy to start recording, and to save all experimental data (fNIR, synchronization markers from external presentation stimuli, etc.) in a standardized way.

- **Imager 2000E control unit** (6-optodes max)
- **Sensor and Cable**
 - fNIR2000E includes one 6-channel sensor and one sensor cable (RXfNIR-CBL-2000L)
- **fNIR Soft Educational Software** for real-time data viewing and post-acquisition analysis
 - Lesson Experiments included: Cognitive Activity Monitoring; Systemic Signal Extraction; fNIRS Noise Analysis; Blood Flow Occlusion Test

For more details about the included Lesson Experiments, see the [fNIRE Education System Web Page](#).

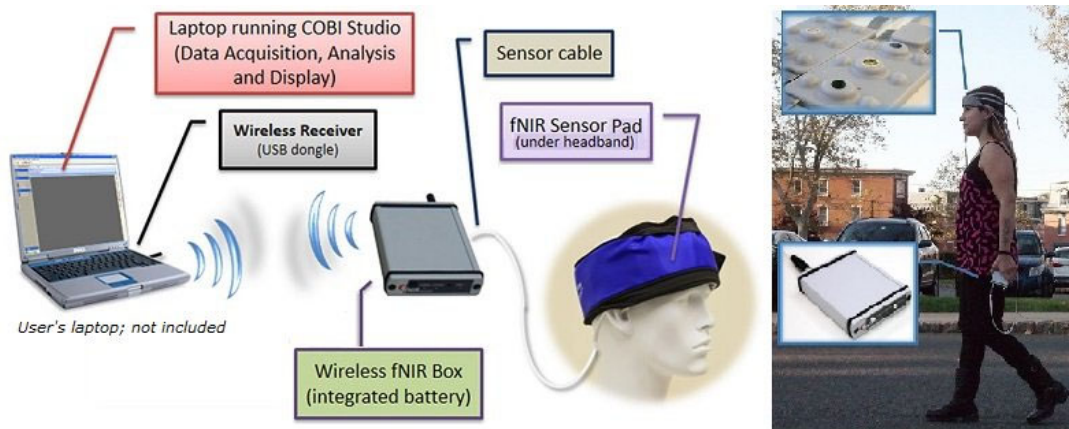

fNIR Sensor Transducers

- Silicon photodiode with integrated trans-impedance preamp
- 730 nm/850 nm dual wave-length LED
- Comfortable to wear for prolonged periods
- Silicone rubber over-molded
- Compatible with wired (fNIR 2000) Imager

RXfNIR2000-18

Adult 18 optode, 10 emitter, 4 detector, full-head forehead sensor pad. 25 mm inter-optode distance.

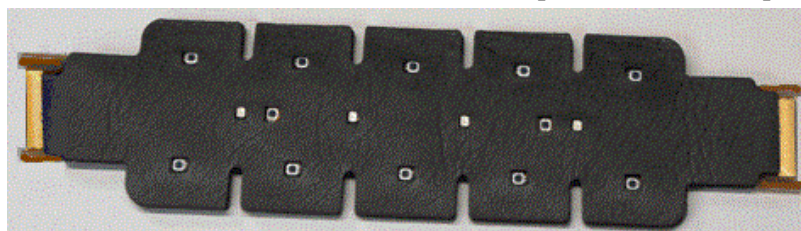

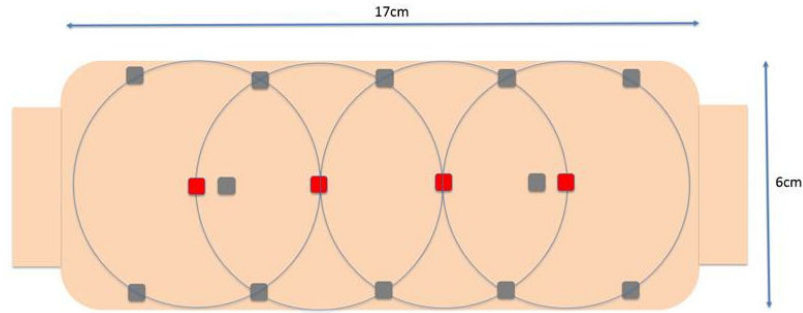

RXfNIR2000-18 optode sensor layout

RXfNIR2000-6

Adult 6 optode, 6 emitter, 2 detector forehead sensor pad. 25 mm inter-optode distance.

RXfNIR2000-5

Adult 5 optode, 5 detector, 1 emitter full-head forehead sensor pad. 25 mm inter-optode distance.

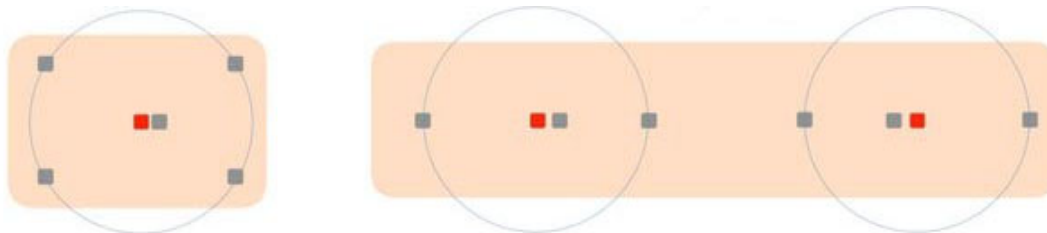

RXfNIR2000-5 and RXfNIR2000-6 optode sensor layout

All Sensors requires RXfNIR-CBL-2000 interface cable.

RXfNIR-CBL-2000L or RXfNIR-CBL-2000R Sensor Transmission Cable

This sensor cable set connects NIRS prefrontal cortex sensor pads to an *f*NIR Imager 2000 unit to provide real-time oxy-Hb, deoxy-Hb, and raw data values for each channel measurement area. Newer *f*NIR Systems include one Left-Right cable set and additional cables can be added for increased channels. *f*NIR 103C systems ship with one RXfNIR-CBL-2000L only.

When ordering, specify Left (RXfNIR-CBL-2000L) or Right (RXfNIR-CBL-2000R).

RXfNIR-2000-18TH Through Hair Sensor

*f*NIR Through Hair sensors separate the optodes and detectors; a brush-fiber optode at the light collection end allows individual optical fibers to easily thread through a subject's hair for direct contact with the scalp.

This item is the sensor pad only and requires the [RXFNIR-2000-CBL](#) Left-Right cable set included with *f*NIR 2000 Systems.

Note: Older *f*NIR Systems included RXFNIR-SEN-CBL cables for Imager 1100 or Imager 1200, which are not compatible with the -TH sensors.

RXfNIR-4 Adult Split Sensor

Adult 4-channel forehead sensor split into two pieces; each piece contains two channels.

- 2 photo-detectors
- 1 photo-emitter
- inter-optode distance: 25 mm
- optional sensor choice for wireless *f*NIR Systems
- compatible with wireless (*f*NIR2000W) and wired (*f*NIR1200) imagers



RXfNIR-PED Pediatric Sensor

Pediatric-sized fNIR optical brain imaging sensor.

- 2 photo-detectors: silicon photodiode with integrated trans-impedance preamp
- 1 photo-emitter: 730 nm/850 nm dual wave-length LED
- inter-optode distance: 20 mm
- silicone rubber over-molded
- comfortable to wear for prolonged periods
- optional sensor choice for wireless fNIR Systems
- compatible with wireless (fNIR2000W) and wired (fNIR1200) imagers



fNIR-Phantom Sensor

The phantom sensor is used to test the system to make sure that the fNIR sensor is detecting correctly. See the fNIR COBI Manual for details on how to run a Self-Check to test signal levels at each channel and generate a report that indicates performance on each channel.

- phantom sensor material mimics optical properties of brain tissue
- included with the fNIR303S and fNIR 303M Systems
- can be added to other fNIR Systems



fNIR Sensor Cleaning Instructions: Use an alcohol swab to gently wipe the surface of the fNIR sensor.

fNIR Software

NOTE: fNIRSOFT Standard and fNIRSOFT PRO software includes a maintenance agreement covering all upgrades and bug fixes for a period of one year. Beyond this period, extended maintenance can be optionally purchased to cover upgrades and bug fixes for an additional one year, two years, or five years.

fNIRSOFT-STD – fNIR Software Standard Edition

fNIRSOFT (fS) is a stand-alone software package designed to process, analyze and visualize functional near infrared (fNIR) spectroscopy signals through a graphical user interface and/or scripting (for automation).

fNIR Software **Standard Edition** offers the following functionality:

- Temporal visualization of fNIR Data
- Customizable display graphs by data type (voxel/channel/wavelength), sensor geometry, time period and multiple color palettes
- FilterDesigner tool: High pass filter design and application
- User interface for time series data analysis
- Lithograph and Oxygraph OptodeView: Ability to navigate with keyboard buttons
- Inspect and manage optodes/channels/time periods visually
- Automated and user-selectable co-registration of all event marker information
- Event related and epoch analysis with customizable block definitions through easy to use GUI
- Customizable hemodynamic response calculation applying Modified Beer Lambert Law (MBLL) for oxy-Hb, deoxy-Hb, oxy and total Hb
- Spatial visualization of fNIR Data
- Basic Noise reduction, pre-processing (Finite Impulse Response Filter Design and application) through GUI
- Through a wizard style tool, select and export time-series data in various formats
- Save/Send data in native binary format
- Through a wizard style tool, easily customizable template, import various types of text data
- Load/share data in native binary format
- fS Scripting Language (functional and data-oriented)
- Editor with syntax highlighting and quick access tools for command list and run toolbar
- History of commands and log operations in command pane (can save for future reference)
- Store procedures in script files (re-apply procedures to previously saved data blocks)

fNIRSOFT-STD-4

fNIRSOFT-STD-4 is a site license that adds four additional users to fNIRSOFT Standard Edition.

fNIRSOFT-STD-9

fNIRSOFT-STD-9 is a site license that adds nine additional users to fNIRSOFT Standard Edition.

fNIRSOFT-PRO – fNIR Software Professional Edition

fNIRSOFT (fS) Professional Edition analysis software includes all of the Standard Edition analysis tools plus extended functionality. Included in fNIR103S, 203S, 303S, 103M, 203M, and 303M or add [fNIRSOFT-PRO-U](#) to upgrade Standard:

- Automated signal quality inspection for elimination of saturated and problematic channels through GUI
- Advanced signal processing algorithms for feature extraction
- Motion artifact removal algorithms
- Left/right/dorsal view with thresholding, animation (temporal changes) or group/subject/condition average
- Export visualization (time-based for animation, or threshold based for evaluation)
- Spatial visualization of fNIR Data
- Apply Temporal and Spatial Processing actions (Averaging/Feature Extraction/Signal Conditioning) through GUI
- Apply Cell-by-cell Processing actions (Averaging/Signal Conditioning) through GUI
- Apply common statistical comparison and correlation through GUI
- Apply advanced Modified Beer Lambert Law (MBLL) oxygenation calculation through GUI

[Click for more feature information about fNIRSOFT PRO 4.10.](#)

fNIRSOFT-PRO-4

fNIRSOFT-PRO-4 is a site license that adds four additional users to fNIRSOFT PRO Edition.

fNIRSOFT-PRO-9

fNIRSOFT-PRO-9 is a site license that adds nine additional users to fNIRSOFT PRO Edition.

fNIR optical imaging technology measures hemodynamic response and neural activity in the prefrontal cortex

fNIR System	Type	Max CH†	Included Sensor	Software (*pre-loaded)	Computer/Stand	TTL	Isolation
fNIR103C	Tethered Imager 2000C	18	1 x RXFNIR-2000-5 + 1 x RXFNIR-CBL-2000L	fNIRSoft Standard and COBI	--	1 TTL	n/a
fNIR203C	Tethered Imager 2000C	18	3 x RXFNIR-2000-18 + 1 x RXFNIR-CBL-2000L + 1 x RXFNIR-CBL-2000R	fNIRSoft Standard and COBI	--	1 TTL	n/a
fNIR303C	Tethered Imager 2000C	18	3 x RXFNIR-2000-18 + 1 x RXFNIR-CBL-2000L + 1 x RXFNIR-CBL-2000R	fNIRSoft Standard and COBI	Tablet Style Computer + Caddy	1 TTL	n/a
fNIR103S	Tethered Imager 2000S	54†	3 x RXFNIR-2000-18 + 1 x RXFNIR-CBL-2000L + 1 x RXFNIR-CBL-2000R	fNIRSoft Pro and COBI	--	1 TTL	n/a
fNIR203S	Tethered Imager 2000S	54†	3 x RX-2000-18 + 1 x RXFNIR-CBL-2000L + 1 x RXFNIR-CBL-2000R	fNIRSoft Pro and COBI	Laptop + Caddy	3 TTL	n/a
fNIR303S	Tethered Imager 2000S	54†	3 x RX-2000-18 + 1 x RXFNIR-CBL-2000L + 1 x RXFNIR CBL-2000R 2 X RX-2000-5 + 2 X RX-2000-6 + FNIR-PHANTOM	fNIRSoft Pro and COBI	Laptop + All-in-one Computer + Pole Cart with Shelf	3 TTL, 1 Serial, 1 Parallel	n/a
fNIR103M	Wireless Imager 2000M	18	3 x RX-2000-18 + 1 x RXFNIR-CBL-2000L + 1 x RXFNIR CBL-2000R + US/EU Power Adapter	fNIRSoft Pro and COBI	--	1 TTL	n/a
fNIR203M	Wireless Imager 2000M	18	3 x RX-2000-18 + 1 x RXFNIR-CBL-2000L + 1 x RXFNIR CBL-2000R + US/EU Power Adapter	fNIRSoft Pro and COBI	Notebook/Tablet Style Computer	1 TTL	n/a
fNIR303M	Wireless Imager 2000M	18	3 x RX-2000-18 + 1 x RXFNIR-CBL-2000L + 1 x RXFNIR CBL-2000R 2 X RX-2000-5 + 2 X RX-2000-6 + FNIR-PHANTOM + US/EU Power Adapter	fNIRSoft Pro and COBI	Notebook/Tablet Style Computer	1 TTL	n/a
fNIR103P	Wireless Pediatric Imager 2000P/1200	4	RXFNIR-PED or RXFNIR-4 for Adults	fNIRSoft Standard and COBI*	--	--	n/a
fNIR103E	Tethered Imager 2000E	6	1 x RXFNIR-2000-6 + 1 x RXFNIR-CBL-2000L	fNIRSoft Education and COBI	--		n/a

Forehead Sensor (<i>prefrontal cortex</i>):	†Real-time oxy-Hb, deoxy-Hb, and raw data values for each channel measurement area					
	Fit	Channels	Detectors	Emitters	Inter-optode distance	Compatible
RXFNIR-2000-18	Adult	18	12	4	25 mm	tethered only
RXFNIR-2000-6	Adult	6	6	2	25 mm	tethered only
RXFNIR2000-5	Adult	5	5	1	25 mm	tethered only
RXFNIR-4:	Adult Split	4	4	2	25 mm	wireless
RXFNIR-PED:	Pediatric	2	2	1	20 mm	wireless
FNIR-PHANTOM:	Phantom	--	--	--	--	all
Photo-detectors:	Silicon photodiode with integrated trans-impedance preamp					
Photo-emitters:	730 nm/850 nm dual wave-length LED					
Material:	Silicone rubber over-molded					
Time resolution of measurements:	Imager S = 100 ms, Imager C = 200 ms, Pediatric Imager = 250 ms					
Trigger in/out (wired Imager only):	TTL level positive-going pulse at start of the device, baseline, and data collection.					
PC connection:	USB 2.0 cable			fNIR103P: wireless (IEEE 802.15.4 radio link)		
Ext. Extension Cable(s):	2 x RJ45 1.5 m			fNIR103P: 1 x 1.5 m 14-conductor		
Operating environment:	0 to 50° C, 10% to 90% R.H. non-condensing					
Imager S dimensions :	234 mm (W) x 89 mm (H) x 286 mm (D)					
Imagers C and E dimensions :	106 mm (W) x 32 mm (H) x 160 mm (D)					
Imager M dimensions :	96 mm (W) x 85 mm (H) x 32 mm (D)					
Pediatric Imager Dimensions :	85 mm (W) x 25 mm (H) x 105 mm (D)					
Power requirements:	90-264 VAC, 50/60 Hz, 250 mA			fNIR103P: 90-264 VAC, 50/60 Hz, 10 W		
Manuals (digital):	fNIRSoft User Manual - step-by-step guide for using fS Standard and Pro fNIRSoft Scripting Manual - automation programming and command line options					
Warranties:	Imager: 12-month			Sensor: 3-month limited		
fNIR Computer Requirements	CPU (processor):		I5 or better, quad-core recommended			
	Memory (system RAM):		1 GB minimum, 2 GB or more recommended			
	Operating Systems:		Windows 10/8/x/7			
	fNIR Imager interface:		USB 2.0 ports			
	Network interface:		Wireless or LAN Network adapter			
<p>*Pediatric systems ship with one sensor, specify choice of pediatric 2-channel sensor (RX-FNIR-PED) or adult split 4-channel sensor (RXFNIR-4); pediatric and adult split sensors are also compatible with Imager 1200 or greater.</p> <p>†To record 54 channels, use three (3) 18 optode sensors.</p> <p>**Phantom sensor is compatible with all Imager 1200 Systems or greater and is used to test sensor performance</p>						

➡ Click to view the [fNIR Wired System Diagram](#)

Click to view the [fNIR Wireless System Diagram](#)

B-ALERT WIRELESS EEG HEADSET SYSTEMS

B-Alert Wireless EEG 9-Channel System – B-ALERT110-WA

B-Alert Wireless EEG with AcqKnowledge plus Cognitive State Software – B-ALERT110-CS-WA

B-Alert Cognitive State Software – B-Alert-SFT-W (add-on software)

B-Alert Accessories, see page 3

B-ALERT WIRELESS EEG 9-CHANNEL SYSTEM



This complete system includes the B-Alert X10 for **wireless** acquisition of 9 channels of high fidelity EEG plus ECG, head movement & position, AcqKnowledge software with powerful analysis tools, including automated scoring and reporting options, and B-Alert Cognitive State software.

- Set up in less than 5 minutes
- Comfortable and nonintrusive—low profile fits comfortably under headgear
- Data quality monitoring and feedback simplifies acquisition for non-technical personnel
- Cognitive state classification for engagement, confusion/distraction, drowsiness, workload and stress
- Patented real-time artifact decontamination

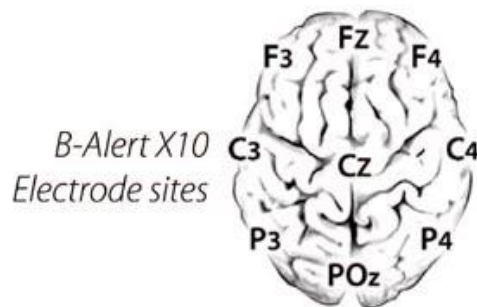

Standard Signals

9 mono-polar EEG with impedance
2-lead ECG
Heart rate
Head movement
PSD by channel

Optional signals

Differential signals for B-Alert and workload

B-ALERT X10 WIRELESS SYSTEMS

The B-Alert X10 mobile-wireless EEG system delivers real-time measurements for a variety of research and engineering applications, including closed-loop performance monitoring and simulation training; HCI design assessment; situational awareness and team dynamics monitoring; tools for productivity and training enhancement; and fatigue management.

➡ Click to view the [B-Alert System Sample Diagram](#)

OVERVIEW

1. Prepare the B-Alert System.
2. Fill the foam sensors.
3. Apply X10 System to Participant.
4. Applying Mastoid and ECG Sensors.
5. Start Data Collection.
6. Remove X10 from Participant.
7. Clean X10 System.

PLUS—CLASSIFY COGNITIVE STATES

This system includes the B-Alert Cognitive State software with proprietary metrics for real-time monitoring of subject fatigue, stress, confusion, engagement and workload (classify data from B-Alert Wireless EEG systems). The GUI intuitively represents both the raw and processed data for easy understanding by even the untrained user and up to six systems can run simultaneously on a single PC—*Windows 10/8/7 OS only*.

To facilitate both real-time and offline analysis, the B-Alert Athena gauges are fully customizable to fit the requirements of the user. In the standard format (shown below), the easy-to-read dashboard gauges (*Top Left*) and time series (*Bottom*) windows present B-Alert's highly validated second by second metrics: Engagement, Workload and Drowsiness (along with Heart Rate). Heat maps (*Top Right*) display EEG power spectral densities (PSD) in both spatial and temporal maps for the traditional Hz bands (Beta, Alpha, Theta, Gamma).

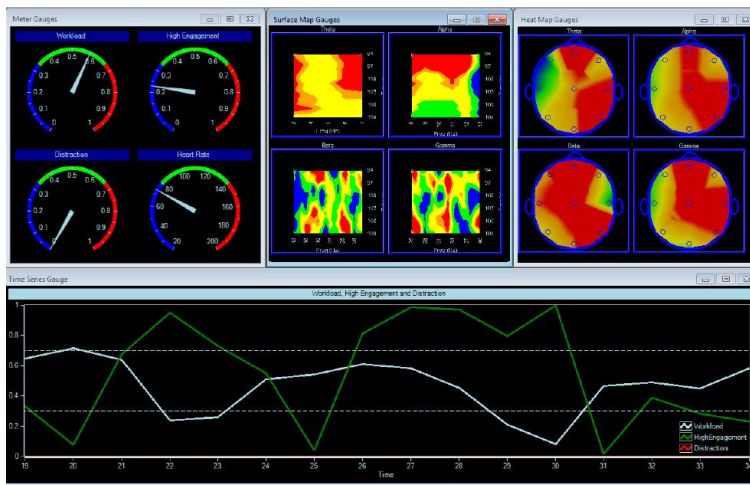

B-Alert Wireless EEG bio-metrics are normalized to an individual subject using 5-minutes of baseline data from three distinct tasks with the sleep onset class predicted from the baseline PSD values. A probability-of-fit is then generated for each of the four classes for each epoch with the sum of the probabilities across the four classes equaling 1.0 (e.g., 0.45 high engagement, 0.30 low engagement, 0.20 distraction and 0.05 sleep onset). Cognitive State for a given second represents the class with the greatest probability. B-Alert cognitive state metrics are derived for each one-second epoch using 1 Hz power spectra densities (PSD) bins from differential sites FzPO and CzPO in a four-class quadratic discriminant function analysis (DFA) that is fitted to the individual's unique EEG patterns. The table briefly describes each baseline task and the B-Alert classification.

Baseline task	Action	B-Alert Class probabilities
3-choice vigilance task (~7-min; optional 20-min)	Choose between primary vs. secondary or tertiary task every 1.5 to 3-seconds	High Engagement
Eyes open (5-min)	Respond to visual probe every 2-seconds	Low Engagement
Eyes closed (5-min)	Respond to audio tone every 2-seconds	Distraction if episodic Drowsy if sequential
None	Derived by regression from other three tasks	Sleep Onset

B-ALERT COGNITIVE STATE SOFTWARE (ADD-ON, SOFTWARE ONLY)

Classify Cognitive States with this analysis software add-on for B-Alert Systems (Windows 10/8/7 OS only)

B-ALERT ACCESSORIES

Disposable Study Kits

RXB-ALERT-KIT-S or RXB-ALERTKITA-S

small 32.0-34.5 cm (approx. 12.6-13.6")

RXB-ALERT-KIT-M or RXB-ALERTKITA-M

medium > 34.5 cm

Each disposable study kit for the B-Alert X10 Wireless EEG System contains:

- one sensor strip
- foam sensors
- one Neoprene sensor strap with Velcro
- disposable electrodes (for mastoid) for 25 studies
- gel and pads for 25 studies



Order kit based on size and B-Alert headset style:



HARDWARE SPECIFICATIONS:

Channels:	9 EEG with fixed gain referenced to linked mastoids; 1 auxiliary differential channel with programmable gain
Sampling rate:	256 samples/second – all channels
Dynamic range:	+/- ± 1,000-2000 μ V
Resolution:	16 bit, CMRR 105 dB
Input impedance:	500 M Ω , typical
Common mode rejection ratio:	-115 dB, typical
Bandpass characteristics:	0.1 Hz HPF Firmware, and 67 Hz LPF hardware
Noise:	3 μ V peak-to-peak typical
Head movement/position:	Angles obtained with 3-axis 12-bit accelerometer
RF Band:	Bluetooth 2.4 to 2.48 GHz (ISM band), latency < 340 ms
Transmission mode:	Bluetooth SPP 2.0 via USB dongle or external synching unit
Data transmission range:	~ 10 meters, line of sight with onboard antenna
Transmission power:	Class 2 +4 dBm
System power consumption:	~ 60 mAh
Battery capacity:	Standard 2 x Li-ION batteries - 600 mAh, 11-hours of continuous use
Battery charging:	Via USB cable connected to USB port or USB wall charger
On-line impedance monitoring:	Initiated by host computer using Bluetooth
Head unit dimensions:	Size 6.83 cm (L) x 4.83 cm (W) x 2.03 cm (H); Weight 57 g
User control:	On/Off
Indicator LEDs:	Green/Amber
Software Compatibility:	Windows 10, 8 and 7, PC with 2.0 GHz or higher processor 1 GB of RAM
Sensor Headset & Accessories	
Sensor sites:	Referential: Fz, F3, F4, Cz, C3, C4, POz, P3, P4
Sensor strip sizes:	X-small, Small, & Medium – each site \pm 1 cm of 10-20 system Medium = Nasion to Inion ~36 cm
Electrode cream:	Highly conductive, electrolytes and preservatives in hypoallergenic base, buffered to skin pH

CBLX10 – B-ALERT X10 TO UIM100C ANALOG OUT

Use the CBLX10 to connect the analog output of the UIM100C and MP150 System to the ECG input of an ABM B-Alert X10 headset. The cable allows for the injection of signals that may be used to align data recordings between the two independent units. CBLX10 provides both signal attenuation and isolation between the MP150 unit and the B-Alert headset.

Interface AMI100D/HLT100C/MP160 (requires included adapter CBL122) or UIM100C/MP150.

This cable is required in order to use the B-Alert X10 with the “Master Sync Device” mode available in *AcqKnowledge* 4.3 or above.

Cable length is 2 m from case to AMI100D/HLT100C or UIM100C connection and 2 m from case to B-Alert connection.

To connect the CBLX10:

1. Plug the black connector into an Analog Output of the AMI100D, HLT100C, or UIM100C module connected to the MP160 or MP150. (With AMI100D/HLT100C, the included adapter CBL122 must be used.)
2. Plug the blue connector into the 2-pin (ECG) input on the top of the B-Alert unit.
3. In *AcqKnowledge*, choose “MP1xx > Set Up Linked Acquisitions” and select “Use the master synchronization” as the synchronization method to pair and synchronize data obtained during linked MP1xx and B-Alert X10 acquisitions. This is the only configuration where the “Master Sync Device” radio button is active.

IMPORTANT: About 10-12 seconds after starting a linked MP1xx/B-Alert X10 acquisition, disconnect the CBLX10 from the B-Alert headset to avoid introducing extraneous noise into the B-Alert signal being plotted on the screen.

See the *AcqKnowledge* Software Guide and the [Tutorial](#) video for a detailed explanation of Linked Acquisitions.

B-ALERT ELECTRONIC SYNCH UNIT B-ALERT-ESU

Multi-Channel External Synchronization

Synchronize B-Alert X10 EEG with Stimulus Presentation & Third-party Hardware

The optional B-Alert ESU is a multi-channel external synchronization unit that features serial + parallel ports and serves as a communication interface between the B-Alert X10 device and a computer. It allows for precise synchronization of data between the B-Alert hardware and other third party data acquisition devices.

The B-Alert X10 mobile-wireless EEG system delivers real-time measurements for a variety of research and engineering applications, including closed-loop performance monitoring and simulation training; HCI design assessment; situational awareness and team dynamics monitoring; tools for productivity and training enhancement; and fatigue management.

The B-Alert X10 Wireless EEG system is an ideal platform for adding neuroscience to any study in real-world or simulated environments.

Before configuring the ESU settings, the ESU must be paired with the B-Alert unit via a Bluetooth connection.

- B-Alert headsets are shipped paired to either a B-Alert Dongle or an ESU. If the pairing is lost, the devices must be re-paired in the *AcqKnowledge* software’s “B-Alert > Pair to Bluetooth Dongle” menu.
- For more information, see “Connecting the ESU Unit” section in the B-Alert with *AcqKnowledge* Quick Guide.

To configure the ESU in *AcqKnowledge* 5.0.5 or above:

1. Connect the B-Alert ESU device to the computer that will run *AcqKnowledge* to record data from the B-Alert headset. A blue LED will blink inside the ESU box.
Note When the ESU device is being used with the B-Alert headset the B-Alert Bluetooth dongle is not required. The headset will communicate directly with the ESU.
2. Connect the COM port and /or Parallel port between the computer and the ESU device.
3. Turn on the B-Alert headset. When the headset is interfaced with the ESU unit, the blue LED inside the ESU unit will stop blinking and the LED on the B-Alert headset will turn solid green.
4. Launch *AcqKnowledge*.
5. Select B-Alert > Set Up Data Acquisition > Channels and enable the required channels.
 - The COM port channels are displayed on Analog channels A11-A13 and the Parallel port channels are digital channels D0-D7.
 - One channel of EEG must be selected for the system to work even when testing the ESU marker system.

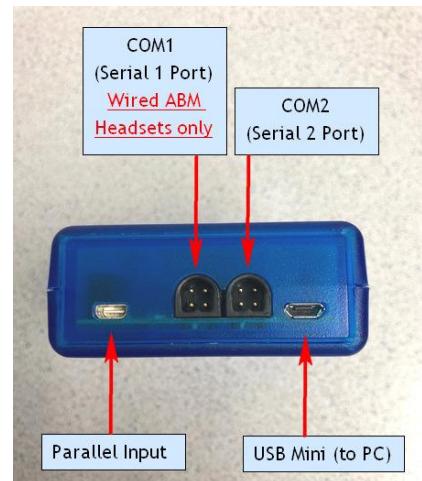

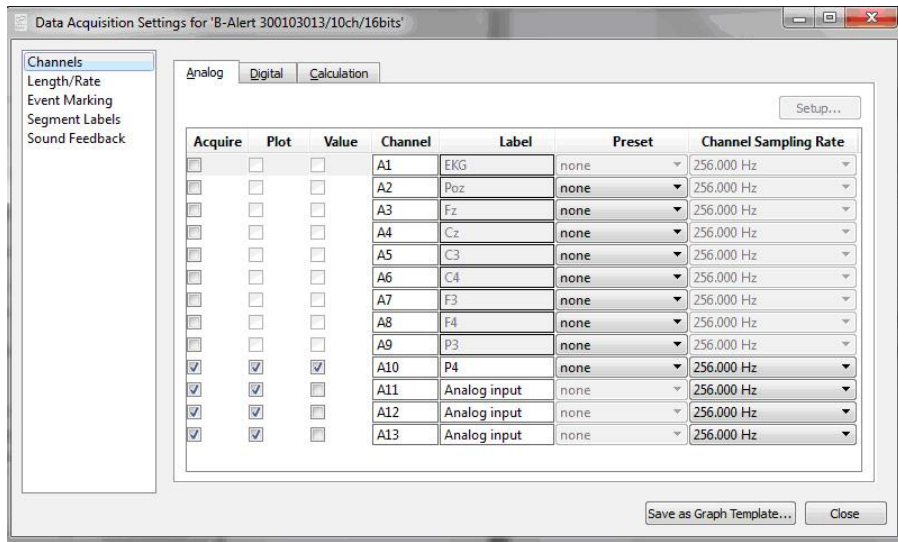

6. Select B-Alert > Set Up Data Acquisition > Length/Rate and open the ABM data file location option.

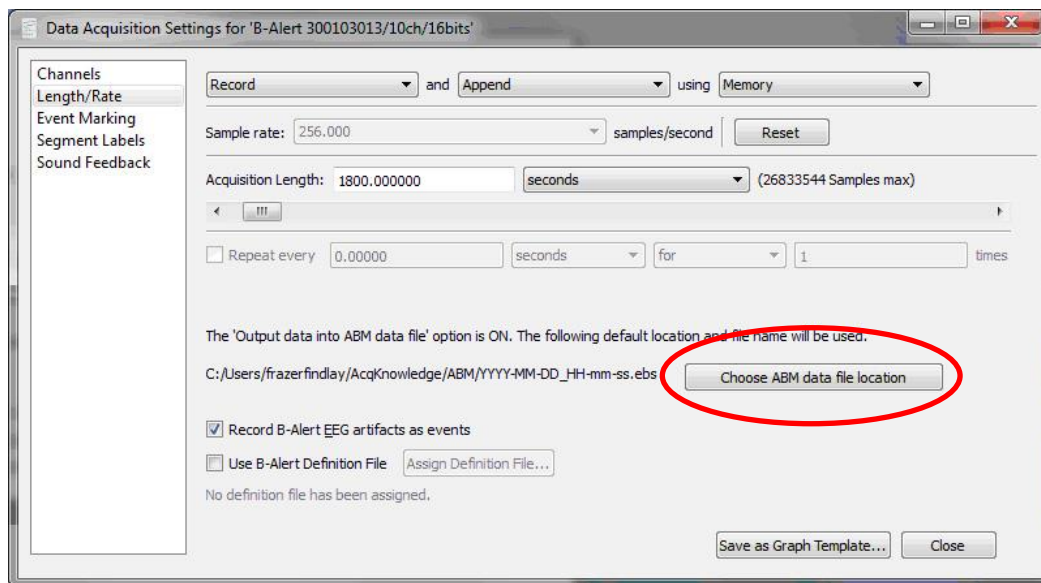

7. Select the Output data into ABM data file and choose default location or explicit location for the file.

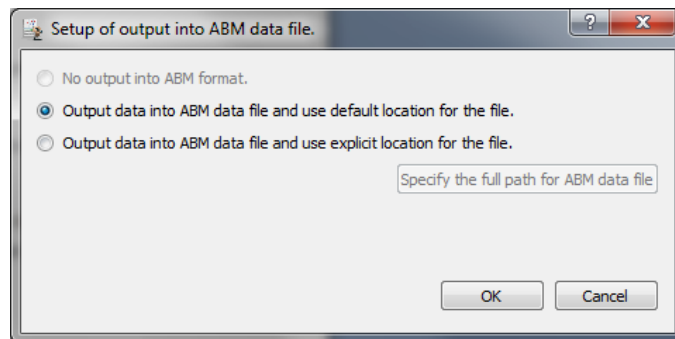

8. Click the AcqKnowledge Start button and the system will record and display the EEG data and the event marker information from the ESU.

EPOCH SYSTEMS

Dual-Channel Wireless EEG Systems

EPOCH-MSE-SYS Mouse EEG System

EPOCH-RAT-SYS Rat EEG System

EPOCH-PUP-EEG-S Pup EEG System

EEG Wireless 2 Channel Sensors

EPTX-10128, EPTX-10129, EPTX-10165,
EPTX-10212, EPTX-10213

EEG Wireless 4 Channel Sensors

EPTX-10211, EPTX-10210, EPTX-10238

EEG Wireless 6 Channel Sensors

EPTX-10208, EPTX-10209

EPOCH Differential Sensors

EPTX-10215, EPTX-10216, EPTX-10264,
EPTX-10265, EPTX-10266, EPTX-10267

Wireless Telemetry Receiver Tray

EPRCVR-P4-100, EP2RCVR-M2-1/1,
EP2RCVR-M2-1/2, EP2RCVR-M2-2/2,
EP6RCVR-M6-60, EP2RCVR-R2-1/1,
EP2RCVR-R2-1/2, EP2RCVR-R2-2/2,
EP6RCVR-R6-60

Single-Channel Wireless ECG Systems

EPOCH-M-ECG-SYS Mouse ECG System

EPOCH-R-ECG-SYS Rat ECG System

ECG Sensors

EPOCH-M-ECG-SEN Mouse ECG Sensor

EPOCH-R-ECG-SEN Rat ECG Sensor

EPOCH Sensor Activator

EPOCH-ACTI Epoch Sensor Activation Utility

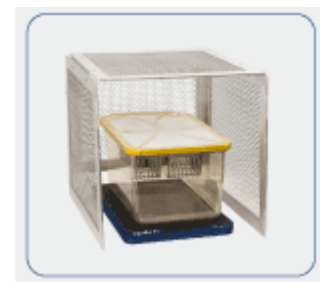

Complete system includes a receiver tray, two 2-channel implantable EEG sensors, and interface cables (2 x CBL102 for MP150/UIM, 2 x CBL123 for MP160/HTL, or CBL125+SS9LA for MP36/36R) to collect data from a mouse or rat housed in an industry standard home cage. To record, the animal's cage is simply placed on top of the receiver tray with the implanted animal inside of the cage. EEG data from the sensor is telemetered to the receiving tray and then sent to the data acquisition system.

Complete ECG system includes a receiver tray, two single-channel implantable ECG sensors, and interface cables (2 x CBL102 for MP150/UIM, 2 x CBL123 for MP160/AMI/HTL, or CBL125+SS9LA for MP36/36R).

Epoch EEG Sensors amplify and transmit of high-fidelity EEG data and are available with two, four, or six channels. Implants are small enough to be implanted into mice as young as P21. The receiver tray has BNC connections that easily connect to a BIOPAC MP160/MP150 data acquisition system (via the AMI100D, HLT100C, or UIM100C) or third-party devices capable of accepting signals within the ± 5 V range.

Sensors are shipped with the default Gain setting; other Gain settings are available if requested before order is placed. AcqKnowledge software includes the scale settings for each sensor Gain option.

Use the [EPOCH Wizard](http://www.biopac.com/epoch-wizard) to check compatible/recommended system components: www.biopac.com/epoch-wizard

Click to view an [Epoch System Diagram with MP Hardware](#).

When used with an MP Research System, use the power of *AcqKnowledge* software's automation and scoring tools to identify seizures, predefine and control recording protocols, or set triggers based on external events (dosing, light changes, etc.). After recording, use automated EEG or ECG analysis routines to quickly score multiple channels of data simultaneously. Derive frequency bands, complete a Frequency analysis, look at Alpha RMS, etc., all with guided automated routines.

For more options, add SleepSign (SSA100W) for complete sleep data analysis or use Camera Systems (CAMSYS4 or 8) to monitor and record protocols and animal behavior. Recorded video will be time synchronized to the physiological signals in *AcqKnowledge* for easy investigation of key areas of interest.

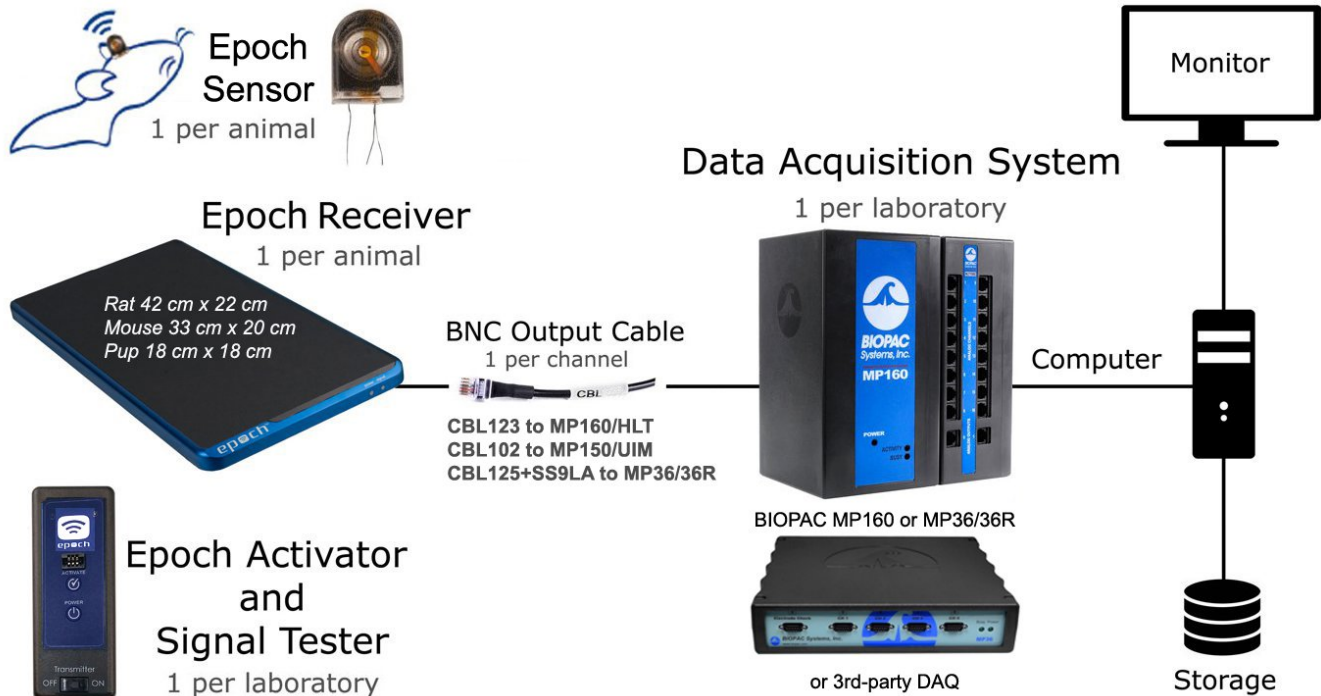

Use the [EPOCH Wizard](http://www.biopac.com/epoch-wizard) to check compatible/recommended system components: www.biopac.com/epoch-wizard
Implantable EEG Sensors (2 CH, EPTX-10128, EPTX-10129, EPTX-10165, EPTX-10212, EPTX-10213, 4 CH, EPTX-10211, EPTX-10210, EPTX-10238, 6 CH, EPTX-10208, EPTX-10209

Sensors require an EPOCH-MSE-SYS, EPOCH-RAT-SYS or EPOCH-PUP-EEG-S to operate.

Implantable EEG/Neural wireless sensors for pup, mouse, or rat. These wireless sensors amplify and transmit two, four, or six channels of high-fidelity EEG data to an EPOCH System receiver tray for long-term wireless EEG recording from small animals in their home cages.

- small implants uniquely suited for neonatal and adult rodent recording
- two-week sensors suitable for pre-weaned rodents (< postnatal day 21)
- two-month sensors suitable for rats as young as postnatal day 7 and older
- two-month sensors suitable for mice as young as postnatal day 12 and older
- six-month sensors suitable for adult rats and mice
- sensor mounts to the skull with cyanoacrylate
- reduces surgical time to tens of minutes
- Teflon insulated platinum electrode wires are shipped at 10 cm and can be truncated to desired length; custom longer lengths available on request.

Sensors ship deactivated; EPOCH-ACTI required for sensor activation.

Use the [EPOCH Wizard](http://www.biopac.com/epoch-wizard) to check compatible/recommended system components: www.biopac.com/epoch-wizard

Reusable EEG Sensor – EPTX-10217, EPTX-10214

This two-channel reusable sensor can be used multiple times in multiple animals—easily activate/deactivate with the EPOCH-ACTI Sensor Activation Utility.

Bandwidth: 0.1-200 Hz

Battery life: 2 months (12 month shelf-life prior to activation)

Footprint: 8 mm x 13 mm Height: 28.55 mm* Weight: 2.5 g Volume: 1.34 cc

Compatibility: Select sensor based on Receiver Tray EPOCH Classic, - or- EPOCH2, or EPOCH6 Receiver

Interface: Includes [Plastics1](#) MS333/3-A/SPC ELECT SS .005" 3C UNTW

*Height off the Plastics1 electrode. Height of Plastics1 electrode off the skull depends on how electrode is user-implanted.

Use the [EPOCH Wizard](#) to check compatible/recommended system components: www.biopac.com/epoch-wizard



EPOCH-ACTI Epoch Sensor Activation Utility

This is an activation and test utility for Epoch sensors (EEG, ECG, EMG or reusable).

Sensors are shipped from the factory deactivated and this reusable utility is required to start a sensor battery. The reusable activator is battery operated and can be used for any deactivated sensor.

The activator utility can also output two independent channels of data (sine waves) for testing purposes.

- Allows users to start the battery when they are ready to use the sensor.
Sensors must be activated within 6 months of shipment to ensure the full active battery-life.



NOTE: The Activator was updated in April 2017 to include an ON/OFF switch for reusable sensors. If you purchased the ORIGINAL and want to use reusable sensors, contact BIOPAC to discuss options.

Differential Sensors – EPTX-10215, EPTX-10216, EPTX-10264, EPTX-10265, EPTX-10266, EPTX-10267

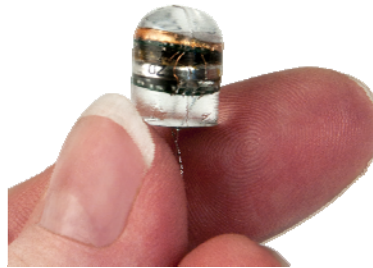

Epoch differential sensors enable wireless recording of two different biopotentials with their own reference.

Record long-term EEG+EEG, EEG+ECG, EEG+EMG, or ECG+EMG.

Sensors amplify biopotentials and wirelessly transmit data to a receiver tray placed under each animal cage for continuous wireless recording of rats, mice, or pups. There is no crosswalk between cages, unlike other types of implantable sensors that use RF.

Sensors ship deactivated—activate with EPOCH-ACTI when ready to start recording.

Choose sensor size/battery life: 2-week (P10), 2-month, or 6-month.

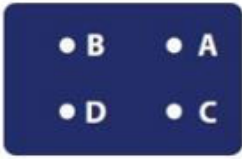
Differential Reference Electrode Layout	Differential Signals	Signal Bandwidth	Compatible Receiver Tray
<p><i>Looking up at bottom of Sensor</i></p>  <p>Example 2-CH CH 1 = A - B CH 2 = C - D</p>	1-CH EEG + 1 CH EEG	0.1-100 Hz 0.1-100 Hz	EP2RCVR-x-1/1
	1-CH EEG + 1 CH ECG	0.1-100 Hz 0.1-200 Hz	EP2RCVR-x-1/2
	1-CH EEG + 1 CH EMG	0.1-100 Hz 0.1-200 Hz	
	1-CH ECG + 1 CH EMG	0.1-200 Hz 0.1-200 Hz	EP2RCVR-x-2/2

Use the [EPOCH Wizard](http://www.biopac.com/epoch-wizard) to check compatible/recommended system components: www.biopac.com/epoch-wizard

EEG and ECG Sensor Specifications

Implant Weight:	2 week: 0.5 g	2 month: 2.3 g	6 month: 4 g
Sensor Footprint:	2 week: 4 mm x 6 mm	2 month: 7 mm x 9 mm	6 month: 7 mm x 12 mm
Volume:	2 week: 0.192 cubic cm	2 month: 0.756 cubic cm	6 month: 1.344 cubic cm
Electrode Wire Length:	Default 10 cm (truncate to desired length; longer lengths available upon request)		
Electrode Wire Material:	Teflon insulated platinum material		
Implant Material:	Medical Grade Epoxy		
System Gain Options:	2000x – (± 1.0 mV range, 1.0 mV in = 2 V out) - EEG and ECG 800x – (± 2.5 mV range, 2.5 mV in = 2 V out) - <u>EEG version only</u>		
Bandwidth:	EEG: 0.1 – 100 Hz per channel		
Input:	5 M Ω impedance		
Operating Temperature:	30 – 45° C		
Dimensions (LxWxH):	Pup: 181 mm x 175 mm x 21 mm (7.125" x 6.875" x .83") + Faraday 203 mm x 254 mm (8" x 10")		
Receiver Tray + Faraday Cage	Mouse: 345 mm x 210 mm x 21 mm (13.6" x 8.25" x .83") + Faraday 356 mm x 305 mm x 305 mm (14" x 12" x 12") Rat: 429 mm x 216 mm x 21 mm (16.9" x 8.5" x .83") + Faraday 508 mm x 365 mm x 365 mm (20" x 14.37" x 14.37")		
Receiver Tray Power (Classic/blue):	16 VDC, 500 mA		
Maximum Animal Size:	1 kg		
Maximum Output:	± 4 V peak-to-peak		

Epoch System FAQs

1. *Are EEG and ECG receiver trays interchangeable?*

No, receiver trays are not interchangeable (signal optimization requires hardware and firmware changes). EEG system receivers work with EEG sensors only, and ECG system receivers work with ECG sensors only.

2. *Does the 2-channel EEG sensor have the same battery life as the previous single channel system?*

Yes, the 2-channel system has a 2 or 6 month battery life, similar to what was previously available for the 1-channel system. (2 weeks for pup system.)

3. *How many electrodes does the 2-channel sensor use?*

The 2-channel device has three electrodes - one ground/reference electrode, and the two recording electrodes. The recording electrodes are measured with respect to the ground/reference electrode.

4. *Is it possible to implant one or two electrodes in deep brain structures for recording LFPs? Can you explain the procedure for that case?*

Yes, we have several users that attach the implant to their stereotactic frame and insert the electrode(s) in the hippocampus, and then glue the implant in place. A surgery manual that demonstrates implanting the Epoch sensor in deep brain structures is available. See the Support tab on the [EPOCH EEG System](#) page.

5. *Is one receiver tray required per sensor/subject?*

Yes. It is not possible to use one receiver tray with multiple animals in a single cage. The rat and mouse size implants and trays are also completely interoperable. For example, if a customer wants to buy a rat size tray for a large mouse setup, this is not a problem. Each tray provides an analog output between ± 4 volts.

6. *Is the battery life determined from the time a sensor is activated?*

Yes, the battery life starts when the sensor is activated. An EPOCH-ACTI activator unit is required because the sensors are always shipped in an off state. An activated sensor cannot be deactivated and reactivated at a later time. The sensor must be activated within 6 months of shipment to ensure the full 2-month or 6-month active battery-life.

7. *Does each sensor provide a maximum of two EEG, ECoG, or LFP signals?*

Yes. It is possible to change the gain of the sensor on a custom basis without degrading recording time. This gain setting can be chosen on the order form provided to customers.

8. *Are consultants available to provide surgical training to new Epoch customers when needed?*

Yes, surgical training can be provided by staff that are well trained in the procedures by contacting [BIOPAC](#).

9. *Is it possible to have adjacent cages or should there be a minimum distance between cages, in order to prevent crosstalk?*

The receiver trays can be placed adjacent to each other without picking up any crosstalk.

10. *Is it possible to reuse the implants?*

The implants are technically reusable, though not recommended. Typically, a user explants the sensor, trims the leads, soaks the entire sensor in acetone, rinses with H₂O, and lets it air dry.

11. *I have a special treatment chamber. Is it compatible with the Epoch system?*

Yes, as long as the animal is positioned over a receiver within 1" it will detect the sensor. However, we recommend using the Faraday enclosure at all times. Outer dimensions of the mouse Faraday enclosure are 14.25" x 12.5" x 12.5". (L x W x H) and rat Faraday cage are 20.25" x 14.5" x 14.5". For information about custom Faraday enclosures, contact [BIOPAC](#).

12. *Will my data acquisition system work with the Epoch?*

In general, yes. The output of the Epoch receiver is +/-4 V max. Most DAQs can handle this type of input, though BIOPAC recommends checking the manufacturer specifications first. BIOPAC can provide guidance as well. The Epoch receiver uses standard BNC-style connectors and an adapter may be necessary for certain DAQ systems.

13. *What type of amplifier do I need?*

The Epoch system does not need an amplifier between the Epoch receiver and your data acquisition system.

14. *Is the Epoch system compatible with other wireless systems?*

In general, no. However, if you have a wireless system that uses a separate data acquisition unit, it may be possible to use the Epoch system with that unit.

15. *I need to video my animals during the recordings. Is this possible?*

Yes. Contact [BIOPAC](#) for information about setting up a Faraday enclosure for recording video at the desired angle.

16. *Can the Epoch system record ECG?*

ECG recording functionality is now supported with the single-channel ECG System.

17. *Where and how is the ECG sensor implanted?*

For sensor implant surgical guides, see the Support tab on the [EPOCH ECG System](#) page. Manuals are available for adult rat, adult mouse and rat pup post-natal 18. See page 8 of the Epoch User Manual to view an ECG sensor placement diagram.

18. *Can the Epoch system be used with neonatal pups similar to the previous 1-channel system?*

Receiver trays and sensors for use with neonatal rodents as small as P6 pups are available by contacting [BIOPAC](#).

19. *Can the Epoch system be used with other devices, such as a drug infusion cannula?*

Yes. The only constraint is that the sensor must be exposed to work properly.

FOTS100 FIBER OPTIC TEMPERATURE SYSTEM

FOTS100 Control Unit

TSD180/182/181 Fiber Optic Temperature Probes

This is a stand alone system, but it can also be interfaced to BIOPAC modules using BIOPAC interface cables.

Use with high-accuracy, MRI-conditional fiber optic temperature probes TSD180, TSD182 or TSD181.

FOTS100 includes control unit with RS-232 port, ± 5 V analog output, and rubber boot; power via 12 V AC/DC wall transformer adapter. (Battery operation no longer supported.)

The analog output parameters comprise the scale factor and the offset. The scale factor corresponds to the physical unit per Volt (unit/V) outputted by the system, while the offset corresponds to the physical value at which the user wants the analog output to be at zero volt.

For example, with a scale factor set to $10^{\circ}\text{C} / \text{V}$ and the offset set to 5°C , the temperature as a function of the analog output voltage is given by:

$$\text{Temperature} = [\text{Voltage output}] \times 10^{\circ}\text{C} / \text{V} + 5^{\circ}\text{C}.$$

The default value of the scale factor is $50^{\circ}\text{C} / \text{V}$ (or its equivalent in $^{\circ}\text{F}$) and the default value of the offset is 0°C (or its equivalent in $^{\circ}\text{F}$). During a No Signal condition, the analog output and the serial ports output constant values as follow:

<u>Output</u>	<u>No Signal condition output value</u>
Analog	0 Volt
RS-232	65 536.0

For more details, please see the complete [FOTS100 User Manual](#), available online.

FOTS100 Specifications

Output interface:	Display, ± 5 Volts Analog output, and RS-232 standard
Interface for MP160 System:	Add CBL101 3.5 mm mono phone plug to male RCA + CBL122 unisolated RJ11 to 3.5 mm jack (purchased separately)
Interface for MP150/100 System:	Add CBL101 3.5 mm mono phone plug to male RCA (purchased separately)
Interface for MP36/35 System:	Add SS70LA isolated BNC interface and a BNC-to-RCA cable (purchased separately)
Channels:	One
Compatibility:	TSD180, TSD182 and TSD181 high accuracy fiber-optic temperature sensors
Accuracy:	$\pm 0.3^{\circ}\text{C}$ (Total accuracy - includes both signal conditioner and transducer errors)
Temperature range:	20°C to 60°C (higher range also available)
Resolution:	0.1°C
Sampling rate:	50 Hz (20 ms)
Communication protocol:	SCPI (default)
Input power:	12 VDC (AC/DC wall-transformer adapter included)
Consumption:	1.8 Watts typical
Enclosure:	Plastic casing with a removable rubber boot protection
Dimensions (without rubber boot protection):	45 mm (H) x 105 mm (W) x 165 mm (L)
Storage temperature:	-40°C to 65°C
Operating temperature:	0°C to 45°C
Humidity:	95% non condensing
Light source life span:	> 150,000 hours (> 17 years) MTBF

TSD180 & TSD182 RECTAL TEMP PROBE: 420 µm OD Polyimide tubing, 8 m (TSD180), 3 m (TSD182)

MRI Use: MR Conditional

Condition: Max MR field strength 3T; FOTS100 module stays in the control room.

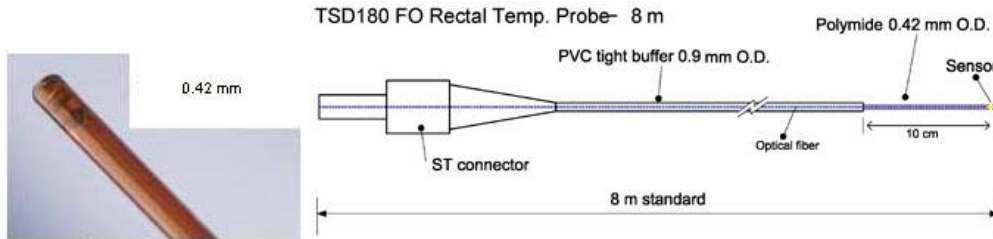

- The Polyimide round tubing protects the sensing element its flexibility and rigidity provide excellent pushability.

TSD181 SURFACE TEMP PROBE: Sensor 1 mm OD, PFA tubing 0.9 mm OD, 8 m

- Cable sheath rated up to 85° C.



TSD180, TSD182 and TSD181 Specifications

SPECS	TSD180 and TSD182	TSD181
Temperature range:	0° C to +85° C (other ranges AUR)	
Response Time:	250 ms and better	1.5 sec. typical
Temperature operating & calibrated range:	20° C to 45° C (other ranges AUR)	
Accuracy:	±0.2° C (Total accuracy over the calibrated range including both signal conditioner and sensor errors)	±0.3° C (Total accuracy over the calibrated range including both signal conditioner and sensor errors)
Resolution:	0.05° C	
Operating humidity range:	0-100%	
MRI/EMI/RFI susceptibility:	Complete immunity	
Calibration:	NIST traceable	
Optical connector:	ST standard	
Cable sheathing:	420 µm OD of Polyimide tubing; 900 µm OD tight buffer PVC	3 mm OD Kevlar reinforced PVC cable
Cable length:	8 m (TSD180/181) 3 m (TSD182)	
Signal conditioner compatibility:	FOTS100 system	
Interface:	FOTS100 is a stand alone Fiber Optic Temperature System	
Optional interface:	MP160 or MP150 System via FOTS100 and CBL101	

FOTS200 STAND-ALONE HIGH FIELD FIBER OPTIC SYSTEM



The FOTS200 Control Unit is a single-channel signal conditioner specifically designed for measuring physiological temperature. The system is designed to perform in stringent environments by offering the highest temperature accuracy and resolution in the industry. The unit interfaces with TSD380 and TSD381 high accuracy MR Conditional temperature sensor transducers for high field strength MRI applications. It should be used instead of the FOTS100 when customers want to measure temperature inside the scanner and the MRI field strength is greater than 3T.

This is a stand-alone system, but it can also be interfaced to BIOPAC MP Systems:

- MP160 or MP150 System via included Analog output cables: CBL102 + CBL106

The analog output parameters comprise the scale factor and the offset. The scale factor corresponds to the physical unit per Volt (unit/V) output by the system, while the offset corresponds to the physical value at which the user wants the analog output to be at zero volts. For example, with a scale factor set to 10° C / V and the offset set to 5° C, the temperature as a function of the analog output voltage is given by:

$$\text{Temperature } [\text{Voltage output}] \times 10 \text{ C / V } 5 \text{ C}$$

Default values: *Scale factor* 50° C / V (or its equivalent in ° F); *Offset* 0° C (or its equivalent in ° F).

FOTS200 includes: Single channel control unit with 20 Hz sampling rate, RS-232 output interface, ±5 V analog output, AC wall adapter. For more details, please see the complete [FOTS200 User Manual](#).

FOTS200 Specifications

Number of Channels:	1 (4- or 8-channel modules are available—contact BIOPAC to discuss)
Compatibility:	TSD380, TSD381 temperature sensors
Accuracy:	±0.15° C (Total accuracy over the full range from 20° C to 45° C including both signal conditioner and sensor errors)
Resolution:	0.01° C
Sampling Rate:	20 Hz standard
Channel Rate Scan:	6.67 Hz (channel to channel measurement time = 150 ms)
Output Interface:	±5 V and RS-232 standard
No Signal Values:	<i>Analog</i> 0 Volt; <i>RS-232</i> 65 536.0
Input Power and Consumption:	12 to 30 VDC – 1.8 W (AC adapter included)
Dimensions:	95 mm (H) x 190 mm (W) x 239 mm (L)
Storage Temperature:	-40° C to 70° C
Operating Temperature:	10° C to 35° C
Humidity:	95% non-condensing
Light Source Life Span:	40,000 hours MTBF

TSD380/TSD381 HIGH FIELD FIBER OPTIC TEMPERATURE SENSORS



The TSD380 Rectal temperature sensor and TSD381 Surface temperature sensor are high accuracy fiber optic temperature probes. Both sensors are suitable for use in high field MRI environments greater than 3T.

MRI Use: MR Conditional

Condition: MR field strength > 3T; FOTS200 module stays in the control room.

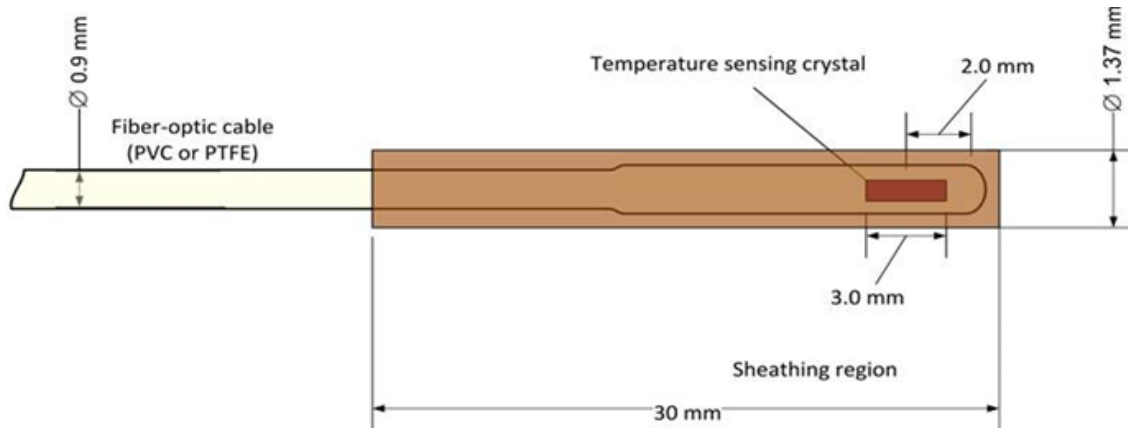

TSD380/381 Specifications

Cable Sheath (OD):	TSD380: 0.9 mm, TSD381: 3.0 mm
Cable Length:	8.0 meters
Sensor Tip Material:	GT standard; 1.2 mm OD
Sensor Tip Material Length:	7.0 mm
Connector:	SC connector to FOTS200 System
Temperature Operating Range:	0° C to 85° C
Specific Calibrated Range:	20° C to 40° C

VPG HARDWARE



TSD204



TCIPPG2

TSD204 – Vaginal Plethysmograph Transducer

The TSD204 VPG vaginal plethysmography transducer measures vaginal pulse amplitude (VPA) and vaginal blood volume (VBV).

Insert tip: length 5.25 cm (2.5"); circumference 4.5 cm (1.8")

Stopper (L x W x D): 9 cm x 2.4 cm x 1 cm (3.5" x 0.94" x 0.39")

Cable: 3 m cable (9.8 feet); terminates in connector for TCIPPG2

Weight: 0.15 kg (5.3 oz) including cable; tip only ~0.10 kg (0.35 oz)

TCIPPG2 – Interface VPG Transducer to PPG100C for MP160/150

Plethysmograph interface for VPG transducer (TSD204) to PPG100C for MP160/150 System.

TSDVPG – Vaginal Plethysmograph Transducer + One Interface

This TSDVPG kit includes one VPG Transducer (TSD204) and interface: TCIPPG2 to PPG100C for MP160/150 System.

VPG Transducer Specifications

Electronics

Photodiode:	Photodiode with integrated amplifier 340-950 nm response 80 mV / mW / cm ² Typical output voltage 3 V
LED: (Visible red probe)	3 mm Red/Orange LED 90 med @ 20 mA, peak wavelength 620 nm View angle 60° Used at 4.50 mA (approx. 25 med)
Resistor:	680 ohm, 1% metal film (visible RED probe)
Sterilization:	Cidex™ OPA Solution (20-45 minutes)

Materials

Probe:	PLEXIGLAS SG-10, FDA section 21 CFR 177.1010; suited for internal use
Connecting cable:	Silicone Sheeting Quality 7480/061 – Compliant with the FDA Regulation meeting the requirements of the 3-A Sanitary Standard, Class III FDA section CFR 177.2600
Placement device:	Silicone Sheeting Quality 7480/061 – Compliant with the FDA Regulation meeting the requirements of the 3-A Sanitary Standard, Class III FDA section CFR 177.2600

PNPG HARDWARE

TSD205 Series – Penile Pulse Plethysmography Transducer (PNPG)

The TSD205-size series penile plethysmography transducer is an easy-to-use liquid metal (Indium Gallium) strain gauge. The transducer is available in a variety of circumference sizes ranging from 6.0 cm to 12.5 cm. The gauge is designed for single use or same client only and is sold in 0.5 cm size increments. Minimum order of five transducers required.



TSD205



TCI111A

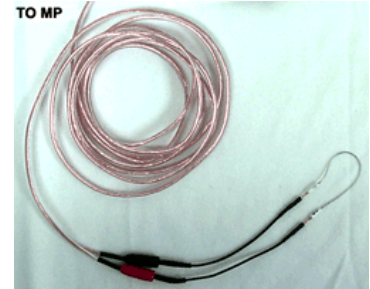

BSL-TCI18

TSD205 Series Available Sizes

Transducer	Circumference		Transducer	Circumference
TSD205-6.0	6.0 cm		TSD205-9.5	9.5 cm
TSD205-6.5	6.5 cm		TSD205-10	10.0 cm
TSD205-7.0	7.0 cm		TSD205-10.5	10.5 cm
TSD205-7.5	7.5 cm		TSD205-11	11.0 cm
TSD205-8.0	8.0 cm		TSD205-11.5	11.5 cm
TSD205-8.5	8.5 cm		TSD205-12	12 cm
TSD205-9.0	9.0 cm		TSD205-12.5	12.5 cm

Additional TSD205 Specs

Length: 40 cm nominal
 Connectors: 2 female Touchproof
 Gauge Impedance: 1-3 Ohms nominal

TCI111A – Interface PNP Transducer to DA100C for MP160/150

Plethysmograph interface for PNP Transducer (TSD205) to DA100C for MP160/150 System.

BSL-TCI18 – Interface 2 mm HG Strain to 2 x CBL201 for MP36R

Plethysmograph interface for PNP Transducer (TSD205) to MP36R System analog CH input.

TSDPNPG – Penile Plethysmography Transducer + One Interface

This TSDPNPG kit includes one PNP Transducer (TSD205) and choice of one interface: TCI111A to DA100C for MP160/150 System or BSL-TCI18 to 2 x CBL201 for MP36R analog CH input.

MICRO PRESSURE MEASUREMENT SYSTEM

- MPMS200 Micro Pressure System
- TSD280 - MPMS Sensor, 5 cm 2 m
- TSD281 - MPMS MRI Sensor, 5 cm 2 m
- TSD282 - MPMS Sensor, 15 cm 2 m
- TSD283 - MPMS MRI Sensor, 15 cm 2 m
- MPMS200 - EXT MPMS MRI Sensor Extension, 8 m

The MPMS200 is a single-channel, hand-held fiber optic micro pressure measurement system for physiological pressure monitoring: intra vascular blood pressure; Urodynamic; Intra cranial pressure; Intra uterine pressure; Intra ocular; Cardiac assist applications; etc.

- Use with TSD280 Series sensors—tip diameter 0.30 mm (1 French)
- Compact and rugged design
- High resolution and precision
- Easily interfaces with BIOPAC or 3rd-party DAQs
- [MR Safe](#) sensors available
- Automatic atmospheric pressure correction



The amplifier unit provides an analog output signal in the ± 5 V range and has a 250 Hz frequency range. The system includes a CBL101 cable to interface directly with the UIM100C for Research Systems. (CBL122 also included for MP160 Systems with AMI100D or HLT100C). The unit includes a mains power transformer.

MPMS200 Physical Connections

1. Connect the CBL101 cable (included) between the MPMS200 and the UIM100C, AMI100D, or HLT100C module.
2. Launch *AcqKnowledge* and select Set Up Data Acquisition from the Hardware menu.
3. Add a new channel, select UIM100C (*AcqKnowledge* 4.x with MP150) or AMI100D/HLT100C (*AcqKnowledge* 5 with MP160), and choose the MPMS200 option from the transducer list.

AcqKnowledge will automatically calibrate the signal to mmHg and display the correct units when recording data. See the Opsens LifeSens Manual for further information about the amplifier and sensor.

Specifications

Number of channels:	One
Compatibility:	TSD280 Series fiber optic pressure sensors (other sensors upon request)
Full scale*:	-50 mmHg to 300 mmHg relative to atm. (wider range also available)
Resolution*:	0.5 mmHg (no averaging)
Precision*:	1% FS or 1 mmHg (whichever is greater)
Sampling rate:	250 Hz standard
Connector compatibility:	SC connector (SCPROM connector compatible)
Internal manometer:	Included for automatic atmospheric pressure correction
Analog Output:	± 5 V (1 V/100 mmHg)
Input power and consumption:	9 to 24 VDC - 1.8 W (wall-transformer adapter included)
Dimensions - (without rubber boot protection):	45 mm (H) x 105 mm (W) x 165 mm (L)
Display:	large LCD
Storage temperature:	-40° C to 70° C
Operating temperature:	0° C to 45° C
Humidity:	95% non-condensing
Light source life span:	40000 hours MTBF

* Specifications include the effect of both the signal conditioner errors and the sensor errors.

The Micro Pressure Measurement System utilizes Opsens technology and benefits from Opsens' White Light Polarization Interferometry (WLPI) technology (Patent# 7,259,862).

TSD280 Series Micro Pressure Sensors for MPMS200 System

The MPMS200 system is used with TSD280 series fiber optic sensors that have an optional extension cable for MRI applications. The probes are suitable for work on small animals (up to the frequency response 250 Hz limit; contact BIOPAC for higher frequency response options).

- TSD280 - MPMS Sensor 5 cm 2 m
- TSD281 - MPMS MRI Sensor 5 cm 2 m
- TSD282 - MPMS Sensor 15 cm 2 m
- TSD283 - MPMS MRI Sensor 15 cm 2 cm

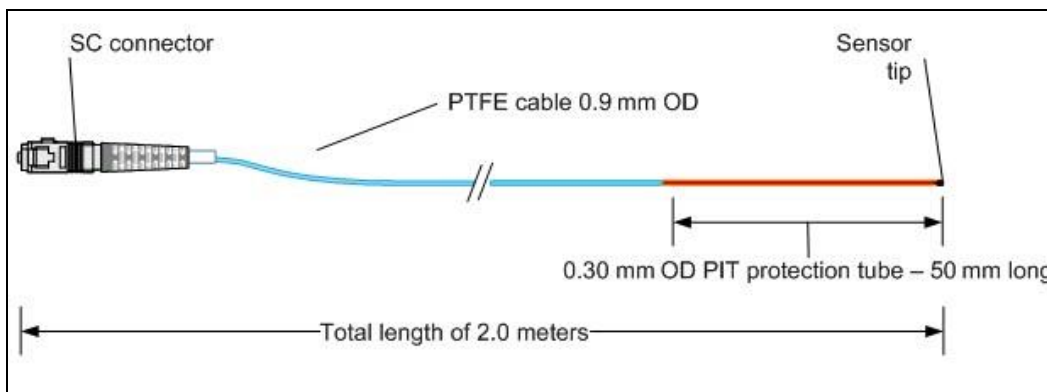

The TSD280 and TSD282 are micro pressure sensors that connect directly to the MPMS200 unit.

MRI Use: The TSD281 and TSD283 are **MR Safe** to 9.6T without any artifact because there is no metallic part in the sensor (see Specifications below for components).

TSD280 Series Specifications

	TSD280	TSD281	TSD282	TSD283
Sensor tip diameter:	0.30 mm OD (1.0 French)			
Sensor tip material:	PIT 3 tube			
Sensor tip material length:	50 mm	50 mm	150 mm	150 mm
Connector:	SC connector	F2.5 ferrule connector	SC connector	F2.5 ferrule connector
Cable length:	2.0 meter			
Cable sheath:	PTFE			
Operating range:	Operating range: P1 (-50 mmHg to +300 mmHg (relative to atmospheric pressure))			

MPMS200 EXT - MPMS MRI Sensor Extension 8 M

This **MR Safe** extension cable can be used to connect the MPMS200 Micro Pressure Measurement unit in the MRI control room to a TSD281 or TSD283 micro pressure sensor in the MRI chamber room.

- Cable: 3 mm OD Kevlar reinforced PVC optical cable
- Fiber core: 62.5 µm core
- Cable length: 8.0 meters
- Sensor end connector: F2.5 to TSD281 or TSD283
- System end connector: SC to MPMS200

TISSUE BATH 1, 2, 4, 8 TISSUE BATH STATIONS

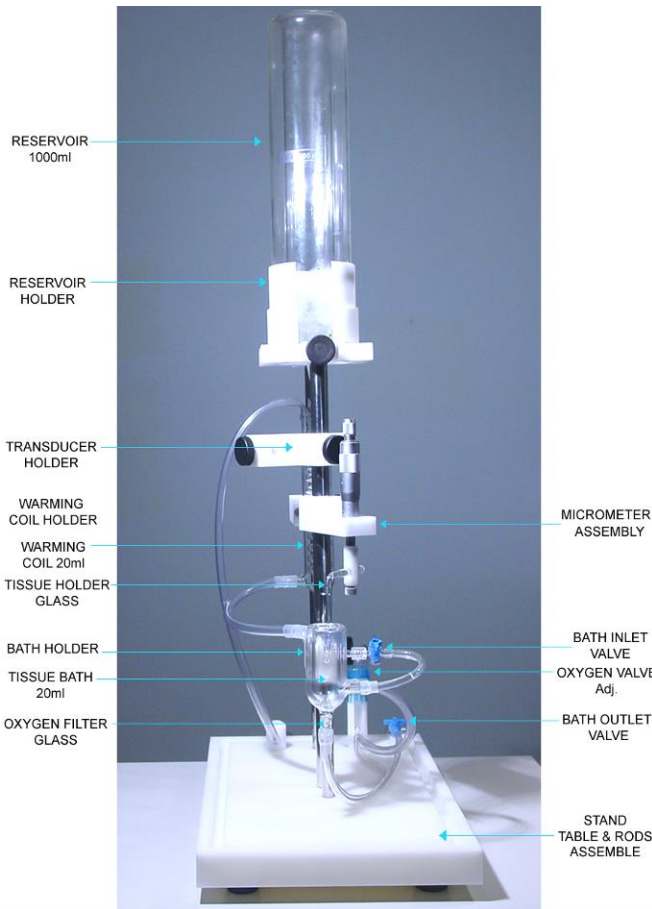

The Tissue Bath Station is completely modular, and can be purchased in multiples of one unit. The System includes all of the glassware, tubing, reservoir, tissue hooks and mounting accessories, force transducer and micrometer tension adjuster.

The ergonomic design of the station allows the tissue bath to be lowered away from the tissue holder so that mounting of the tissue preparation is very easy. The taps for filling and draining the bath are mounted on the tubing to avoid the risk of accidental bath breakage. The entire station is mounted on a convenient base stand, which creates a sturdy platform for the experiment. The unique design makes it easy to add or remove stations to provide the optimal solution for the requirements.

When a system is ordered, the size of the tissue bath and heating coil must be specified.

Each **Tissue Bath** station includes:

- 1 Reservoir (specify 400 ml warming reservoir or 1000 ml reservoir)
- 1 Reservoir Holder
- 1 Transducer Holder
- 1 Warming Coil Holder
- 1 Warming Coil (specify 5 ml, 10 ml, 20 ml, or 30 ml size)
- 1 Tissue Holder (glass; left)
- 1 Tissue Holder (stainless steel; right)
- 2 Triangle Tissue Holder (stainless steel)
- 2 Tissue Clip (stainless steel)
- 1 Bath Holder
- 1 Tissue Bath (specify 5 ml, 10 ml, 20 ml size)
- 1 Oxygen Filter (glass)
- 1 Micrometer Assembly
- 1 Mount Accessories Kit
- 1 Base Station with Support Rods
- 1 For MP160/MP150 System with DA100C, TSD125 Force Transducer (specify TSD125 model C, D, E or F)
- 1 For MP36/MP35 System, SS83L Force Transducer

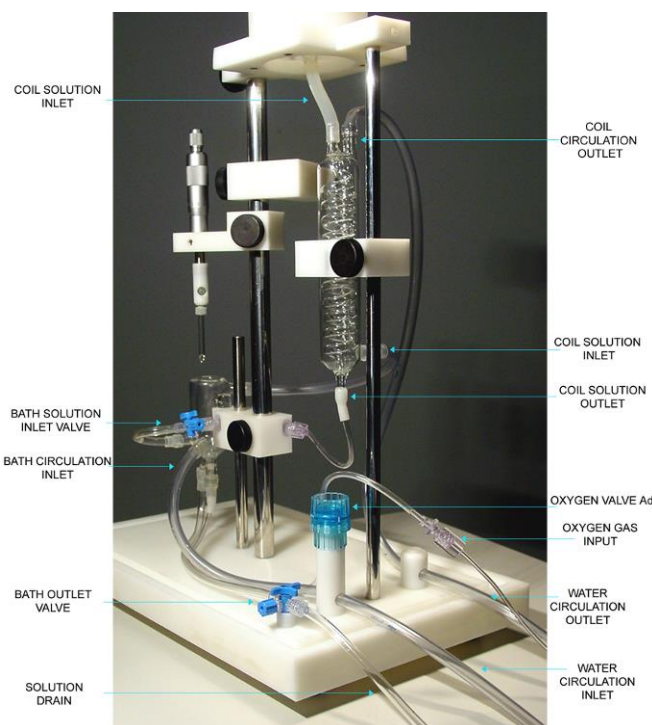

See also: BIOPAC Circulators, or use an existing system.

TISSUE BATH ACCESSORIES / REORDER PARTS

Tissue Holders



Tissue Clips



Warming Coil



Oxygen Filter



Tissue Bath



Reservoir



Mount Accessories

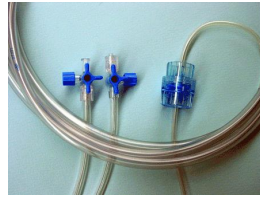

Field Stimulation Electrode

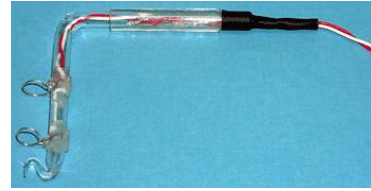

- RXHOLDER-S** Tissue Holder (stainless steel)
- RXHOLDER-G** Tissue Holder (glass)
- RXHOLDER-TR** Triangle Tissue Holder (stainless)
- RXCLIP** Tissue Clip (stainless steel)
- RXCLIP-TRI** Triangle Tissue Clip for Rings (stainless steel)
- RXWARMING** Replacement Warming Reservoir 400 ml

- RXCOIL** Warming Coil
- RXO2FILTER** Oxygen Filter (glass)
- RXBATH** Tissue Bath (5 ml, 10 ml, 20 ml, 30 ml)
- RXRESERVOIR** Reservoir 1000ml
- RXMOUNT** Mount Accessories Kit
- STIMHOLDER** Field Stimulation Electrode for use with STM100C
- BSLSTIMHLD** Field Stimulation Electrode with BNC cable termination for use with BSL Stimulator

TISSUE BATH ACCESSORIES SPECIFICATIONS

- 1 x Tissue Holder—stainless steel; 15 mm high x 9 mm wide; reorder as RXHOLDER-TR
- 1 x Tissue Holder—glass; 67.46 mm high x 57.85 mm wide; reorder as RXHOLDER-G;
- 1 x Tissue Holder —stainless steel; 77.34 mm high x 55.06 mm wide; reorder as RXHOLDER-S
- 2 x Tissue Clip—stainless steel; 15 mm high x 5 mm wide: reorder as RXCLIP
- 2 x Triangle Tissue Clip—stainless steel; 15 mm high x 12 mm wide; reorder as RXCLIP-TRI
- 1 x Replacement Warming Reservoir 400 ml: reorder as RXWARMING
- 1 x Integrated heater—1,600 ml volume, programmable temp. 20° - 44° C
- 1 x Circulator pump—15 W; 500 ml/min

- 1 x Warming Coil; reorder as RXCOIL
- 1 x Oxygen Filter; reorder as RXO2FILTER
- 1 x Bath —reorder as RXBATH5 (5 ml,) RXBATH10 (10 ml,) RXBATH20 (20 ml), RXBATH30 (30 ml)
- 1 x Reservoir—1000 ml; reorder as RXRESERVOIR
- Mount Accessories Kit; reorder as RXMOUNT
- Field Stimulation Electrode; reorder as STIMHOLDER for STM100C, BSLSTIMHLD for BSL Stimulator
- 1 x Micrometer-transducer assembly
- 1 x 3 way Rotary Valve
- 1 x Power Supply – 110V/60 Hz or 220V/50 Hz

CIRCULATOR A/B HEATING CIRCULATORS

Heating circulators are used with Tissue Bath Stations and include a digital temperature display and the following controls:

- Preset**
- Temperature**
- Power**
- Heater**
- Circulation**

Inlet and **Outlet** ports are on the back, along with the power cord.

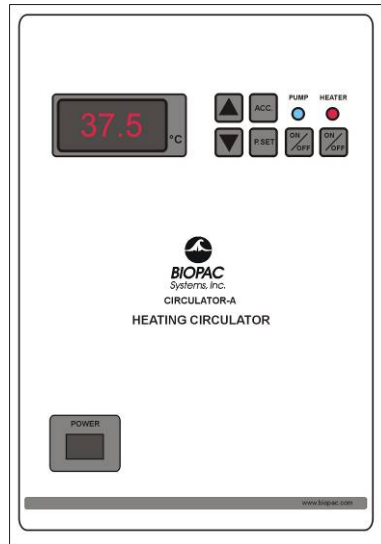

Circulator A:
110 V, 60 Hz

Circulator B:
220 V, 50 Hz

CIRCULATOR SETUP AND USAGE GUIDE

BIOPAC Heating Circulators will maintain water temperature at a preset value in the range 30° C to 45° C and circulate the water through tissue baths.

Heating circulators include a digital temperature display and the following controls:

- Preset**
- Temperature**
- Power**
- Heater**
- Circulation**

CALIBRATION

Although the offset value for the temperature sensor is factory-calibrated, the user can calibrate the controller's internal temperature sensor. To calibrate the sensor:

1. Install a calibrated reference thermometer in the bath.
2. Adjust the offset value to zero.
3. Adjust the preset value to an appropriate temperature.
4. Once the bath reaches the preset value and stabilizes, calculate the offset value by noting the difference between the reference thermometer value and the preset value.
5. Enter this value as an offset.

ERROR CODES

Display Indication

Lo Water in the bath is not enough or the bath is empty.

Sen Microprocessor cannot communicate with the temperature sensor.

CIRCULATOR SETUP & USAGE GUIDELINES

1. Connect a hose from the INLET on the back of the circulator to the tissue bath OUTPUT.
 - For more than one tissue bath, connect the tissue baths serially.
2. Connect a hose from the OUTLET on the back of the circulator to the tissue bath INPUT.
3. Fill the stainless steel water bath with 4.5 liters of water.
 - A buzzer sound warning will be emitted if there is not enough water in the bath when the Circulator is powered on. See *Error Codes* above.
4. Place the glass lid on the bath to close.
5. Plug the power cord from the back of the Circulator to a power source.
6. Press the **POWER** key to turn on the circulator.
7. To see the preset temperature value, press the **P.SET** key.
 - To change the preset temperature value, hold down the P.SET key and, at the same time, repeatedly press the UP or DOWN arrow keys to increase or decrease the preset value.
8. To see the acceleration value of the Circulator, press the **ACC** key.
 - To change the preset acceleration value, hold down the ACC key and, at the same time, repeatedly press the UP or DOWN arrow keys to increase or decrease the preset value. The higher values for acceleration indicate more rapid heating.
9. To see the offset temperature value, press the ACC and P.SET keys at the same time.
 - This is a factory-calibrated value. To calibrate the temperature sensor, see *Calibration* above.
 - All preset values are written to non-volatile memory.
10. Press the **PUMP ON/OFF** key to start the circulation pump.
 - Check that the **blue** Pump Status LED is ON. The pump should begin circulating water.
11. Check that the water goes out of the circulator and flows through the waterway of the tissue bath(s).
 - With initial setup, some air may remain in the circulator pump. See *Troubleshooting* below.
12. Press the **P.SET** button and confirm the set value of the desired temperature.
13. Press the **HEATER ON/OFF** key to turn on the heater.
 - Check that the **red** Heater Status LED is ON.
 - Check that the Heater Display LED is on to confirm that the heater inside the bath is working.
 - Circulator will maintain the preset temperature of water in the bath; variations of $\pm 0.2^{\circ}\text{C}$ are acceptable.
14. Check the water level periodically and add water to the bath if the level drops below 4 liters.
 - **Caution:** Over time, the water level inside the bath may decrease. Do not operate the circulator with less than 4 liters of water in the bath.
15. To turn the PUMP and HEATER on and off individually, press their respective ON/OFF keys.
16. To stop operation, press ON/OFF keys.
 - Power down equipment in the following order: PUMP, HEATER, POWER.

TROUBLESHOOTING

- **There is no water circulation or very little.**

1. Check the hose connections and be sure they are connected to the correct positions.
2. Check that the hoses are not bent or twisted (which might impede the flow of water).
3. Confirm that there is at least 4 liters of water in the bath.

- **There is some air in the waterway.**

To remove the air:

1. Press the PUMP ON/OFF key to **OFF** stop the circulator pump.
2. Disconnect the hose from the INPUT of tissue bath. (Leave other end connected to the Circulator OUTLET.)
3. Put the end of the hose in a bucket to catch the water flow.
4. Press the PUMP ON/OFF to **ON** to start the circulator pump.
5. Operate the circulator pump for a few 1-2 second cycles.
6. Press the PUMP ON/OFF key to **OFF** stop the circulator pump.
7. Reconnect the hose to the INPUT of the tissue bath.
8. Press the PUMP ON/OFF to **ON** to start the circulator pump and continue with normal operation.

TECHNICAL SPECIFICATIONS

Dimensions:	40 cm (L) x 20 cm (W) x 29 cm (H)
Temperature Range:	30° C to 44° C
Reading Sensitivity:	0.1° C
Display:	3 digit (LED Display)
Water Bath Volume:	4.5 liters (Stainless Steel)
Circulation Flow:	2 liter/min.
Heater Resistance:	1000 Watt
Circulation Pump:	110 V 100 W Plastic Head
Supply Voltage:	
CIRCULATA:	110 Volt 60 Hz (1000 Watt)
CIRCULATB:	220 V 50 Hz (1100 Watt)
Inlet/Outlet	OD 8.5 mm, ID 6.3 mm Tubing
Temperature Offset Range:	0° C to 1.2° C
Acceleration Levels:	0 to 5

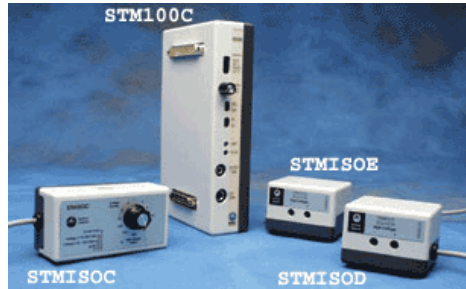

STM100C STIMULATOR MODULE

The STM100C is a single channel stimulation amplifier that was designed for use in the following applications:

Stimulus and Response Testing

Auditory brainstem response testing

Visual evoked response testing

Somatosensory response testing

Nerve conduction velocity and latency recording

Biofeedback Procedures

Auditory, visual or mechanical feedback from biophysical signals

The STM100C incorporates manual and automatic attenuation and polarity controls. Automatic attenuation can be effected in 1-dB steps over a 128-dB range. The STM100C has dual stimulus outputs. The **50 Ω Output** can be AC or DC coupled. The **Ext Stim** output is a very low-impedance, high-power, AC coupled output that can be used to drive headphones, speakers and other low impedance devices like lights and solenoids.

The STM100C can amplify and condition signals from four possible sources:

Analog (D/A) Output 0

Pulse (Digital I/O 15)

Analog (D/A) Output 1

Analog Input CH 16

IMPORTANT!

- STM100C is connected to the **left side** of the AMI100D, HLT100C, or UIM100C (compared to other 100C-series amplifier modules, which are connected to the right side of the UIM100C).
- Check the “**Stim 100**” option in the Manual Control dialog box (accessed via the MP menu). See the *AcqKnowledge* Software Guide for Manual Control details
- After connecting the STM100C to the AMI100D, HLT100C, or UIM100C, other amplifier modules (such as the ERS100C,) snap onto right side of the AMI100D, HLT100C, or UIM100C.

See diagram on the following page for an example connection of the STM100C to the MP unit and other modules.

See also: Application Note [AH162](#)—Using the Stimulation Features of the MP System



STIMULUS RESPONSE TESTING

In stimulus response testing, the **STM100C** is commonly used with the **ERS100C** and the **MP System**. (In the case of the **STMEPM-MRI** Programmable Stimulation System for E-Prime, the **STM100C** is paired with the **IPS100C** in place of the **MP System**). The **ERS100C** is a very low noise biopotential amplifier, with sufficient bandwidth ranges to accommodate the variety of evoked potential testing.

For most types of evoked response testing, the **MP** unit will be operating in averaging mode. Typically, the stimulus output waveform is generated in the stimulator setup window and ported through either analog output 0 or analog output 1, and the output device (such as the **OUT101** Tubephone) is connected to the external stimulus jack on the **STM100C**. This allows for complex pulses, tones, ramp waves and arbitrary shaped analog waveforms to be used as stimulus signals.



*STM100C connection to MP device,
UIM100C and ERS100C*

See the *AcqKnowledge* Software Guide for stimulator setup window details.

IMPORTANT!

- **The Current Feedback Monitor Cable (CBLCFMA)** is recommended for use with any voltage stimulator; to isolate CBLCFMA output, use INISOA and AMI100D/HLT100C. Always make sure to place the electrodes on the participant at least 10 minutes before starting any electrical stimulation. Use a CBLCFMA to monitor and record the actual current delivered to the participant at ALL times. A large enough change in current delivered to the participant will alter the subjective perception of the stimulation. Thus, an unpleasant shock may become painful if more current starts being delivered or become ineffectual if less current is being delivered than during threshold identification. Changes in the levels of delivered current are due to changes in impedance. Changes in impedance could be due to a number of factors: gel saturating the skin over time; gel drying up – over longer period of times; hydration level of participant; sweating; decoupling of electrodes and skin due to motion artifacts; etc.
- Make sure that the settings on the **STM100C** match those in the stimulator setup windows (i.e., the output channel in the stimulator window matches the output channel selected on the **STM100C**).

AUDITORY EVOKED POTENTIALS

Auditory evoked potentials, like the **ABR** can be implemented using the **STM100C**. The **STM100C** is used to present the auditory pulse or “click” to an auditory stimulator, like the *Tubephone* (**OUT101**). The **OUT101** or headphones (**OUT100**) plug directly into the **EXT STIM** jack on the **STM100C**. “Clicks” can be either rarefaction or condensation (positive or negative pulses). “Click” attenuation can be controlled manually or via the computer in 1-dB steps over a 128-dB range.

SOMATOSENSORY RESPONSE TESTS

These tests are very similar to **ABR** and **VEP** tests, except the stimulation source is usually an electrical pulse or mechanical impulse applied at some point along the leg or arm. Somatosensory tests are used to characterize the perception of touch. By connecting a solenoid to the **EXT STIM** output of the **STM100C**, a mechanical pulse can be generated for peripheral nervous system stimulation.

GENERAL NERVE CONDUCTION VELOCITY TESTS

General nerve conduction velocity tests are evoked potential tests, but they generally do not require extensive signal averaging like the ABR or EP tests. The STM100C can perform this type of test, however the STM100C output is limited to a 20-Volt pk-pk signal. In the case of *in vitro* or *in vivo* experimentation, the 20-Volt range of the STM100C is typically adequate. For surface electrode stimulators, higher voltage is often required.

→ For higher voltage outputs, use the STMISOD or STMISOE (with the STM100C) to boost the voltage stimulus signal to 100 V or 200 V, respectively.

BIOFEEDBACK PROCEDURES

The STM100C can be used to condition and amplify the signals coming from any biopotential or transducer amplifier. The source amplifier must have its output switched to CH 16 (last channel), and the STM100C SOURCE switch needs to be placed on CH 16 as well. With the headphones or speaker plugged into the EXT STIM jack, biopotential signals like EMG can be heard directly. The EXT STIM output can also be used to drive visual indicators directly, so rhythmic or pulsatile signals (like ECG or respiration) can be easily observed. Mechanical actuators like relays and solenoids can be directly connected to the STM100C.

CALIBRATION: None required

STM100C SPECIFICATIONS

Stimulus Output Voltage:	20 Volts (p-p) maximum.
Voltages of up to 200 V are possible by connecting STMISO Series to the Ext Stim output on the STM100C.	
Current Output Drives:	
50 Ω Output:	\pm 200 mA (3.5 mm phone jack)
Ext. Stim. Output:	\pm 1.0 amp (6.35 mm [1/4"] phono jack)
Ext. Stim Z (out):	Less than 0.1 Ω
Input Sources:	D/A0, D/A1, PULSE (DIG I/O 15), CH 16 (Analog)
Polarity Control:	Manual or digital control (DIG I/O 7, H-POS, L-NEG)
Attenuation Control:	Manual or digital control
Attenuation Control Range:	128 dB (Digital I/O 0-6, LSB-MSB)
Attenuation Step Resolution:	1 dB
LED Indicators:	Limit*, Pulse*
Uniphasic Pulse Width:	10 μ s (min) with 5 μ s resolution
Biphasic Pulse Width:	MP160/150: 20 μ s (min)
Biphasic Pulse Resolution:	MP160/150: 10 μ s
Arbitrary Wave Resolution:	MP160/150: 10 μ s
Weight:	380 grams
Dimensions:	4 cm (wide) x 11 cm (deep) x 19 cm (high)

*The LIMIT LED is primarily for troubleshooting. Under normal operation, this LED should never illuminate. If the LIMIT LED shines red, too much current is flowing TO system ground via the 50 ohm output. If green, too much current is flowing FROM system ground. Generally, observation of green/red LED LIMIT activity indicates a failure to drive the device connected to the 50 ohm output.

The PULSE LED indicates the state of digital channel 15 in the MP150/MP160 system. The LED is illuminated (red) when D15 is in the low (0) state and is off when D15 is in the high (5) state. Note that the state of D15 is only relevant to STM100C operation when "SOURCE" switch is set to "PULSE".

Users of MP160 with Smart Amplifiers should be aware that Digital channel 15 must be high or floating when *AcqKnowledge* is launched and when data acquisition begins. To combine Smart Amplifiers with STM100C using "PULSE" as SOURCE, hardware should hold D15 high with LEVEL control knob set to 0% until data are being acquired. Then D15 may be set low to prepare for pulses that will control stimulator, and LEVEL control knob may be adjusted to desired position.

TSD190 HAPTIC (TACTILE) STIMULATOR

The TSD190 is a haptic (tactile) stimulator. The TSD190 is ergonomically designed to strap onto a variety of body locations and it incorporates an internal electromagnetically actuated plunger which can be used to mechanically stimulate a 1.5 mm diameter area of skin surface. Both plunger force and travel can be infinitely adjusted between zero and a specified maximum value. Applications include somatosensory and other types of tactile sensory tests. It's possible to employ the TSD190 in an averaging-type sensory nerve test to determine the speed of propagation and activation threshold of somatosensory nerves.



The TSD190 connects directly to the STM100C stimulation module. Plunger activation force, width of stimulus pulse, and pulse repetition rate are established via the *AcqKnowledge* Set up Stimulator window. To output a stimulus waveform which has a precisely controlled rate-of-change in both onset and offset, ramp up or down the applied stimulus voltage to the TSD190. The TSD190 will respond to any kind of applied waveform, such as square, triangle, sinusoidal or arbitrary.

Visual or audio cues can be replaced or augmented with haptic feedback. For one example, see *Kahol K., French, J., et al. (2006). Evaluating the Role of Visio-Haptic Feedback in Multimodal Interfaces through EEG Analysis. Augmented Cognition: Past, Present and Future. D. Schmorrow, K. Stanney and L. Reeves. Arlington, VA, Strategic Analysis, Inc.: 289-296.*

TSD190 SPECIFICATIONS

Stimulus Plunger Diameter:	1.5 mm
Stimulus Pulse Widths:	1 msec (min) to 100 msec (max)
Waveform Stimulus Types:	Digital or Analog Drive
Stroke length:	(0-3 mm) - set screw adjustable
Force:	(0-1.5 Newton) - adjustable via applied stimulus voltage (0-24 V)
Interface:	Connects directly to STM100C Stimulator (External Stim Port)
Input Connector:	6.35 mm male phono plug
Cable length:	2 meters
Velcro Omni® Strap (included):	30 cm long x 25 mm wide
Weight:	39 grams
Length:	62 mm
Diameter:	22 mm

STM200 CONSTANT VOLTAGE STIMULATOR – UNIPOLAR PULSE

The STM200 can be used to stimulate any preparation or subject*, including:

- Pain and stress studies that require lower voltages and wider pulse widths.
- Tissue baths (range 0-100 V at 0.1-200 ms pulse width).
- Nerve or muscle stimulation that requires higher energy than a STMISOC/D/E can deliver.

*IMPORTANT:

- For MRI Applications, when possibly considering the use of the STM200 for associated electrical stimulation of human subjects, please refer to BIOPAC [Application Note 257](#) for context, warnings and details.
- **The Current Feedback Monitor Cable (CBLCFMA) is recommended** for use with any voltage stimulator; to isolate CBLCFMA output, use INISOA and AMI100D/HLT100C. Always make sure to place the electrodes on the participant at least 10 minutes before starting any electrical stimulation. Use a CBLCFMA to monitor and record the actual current delivered to the participant at ALL times. A large enough change in current delivered to the participant will alter the subjective perception of the stimulation. Thus, an unpleasant shock may become painful if more current starts being delivered or become ineffectual if less current is being delivered than during threshold identification. Changes in the levels of delivered current are due to changes in impedance. Changes in impedance could be due to a number of factors: gel saturating the skin over time; gel drying up – over longer period of times; hydration level of participant; sweating; decoupling of electrodes and skin due to motion artifacts; etc.

Controls Connections

Front Panel



Range

Establishes the stimulus pulse output level range in Volts (0-10 Volts or 0-100 Volts).

- Turn right to select a range of 0-10 Volts.
- Turn left to select a range of 0-100 Volts.
- Remove the key for added safety and control.

If the Range is changed before recording begins, the scaling must also be changed (MP menu > Set Up Channels) to maintain direct Level recordings.

If the Range is changed during recording, the user should manually enter a software marker to note the change (Esc). The pulse Level could then be determined by (mentally) moving the decimal place to the right or left, depending on how the Range was changed.

Reference

Refers to the pulse width of the signal on the Reference Output (on the back panel).

- Actual reflects the actual output width.
- Fixed (15 ms) establishes a pulse width of 15 ms, regardless of the actual pulse width.

The Reference control only affects the pulse width; in either case, the pulse level reflects the actual output level.

- Level** Level is used in conjunction with Range to set the stimulus pulse output level. Turn the Level control (right to increase, left to decrease) to establish the desired Level, as indicated on the digital display.
- Output** Standard BNC connector to output the stimulus pulse to external electrodes or other devices.
- LCD light** The red LCD is activated when the DC adapter is plugged in and the power switch on the back panel is turned ON, and flashes when the stimulus pulse is active.
- Back Panel**

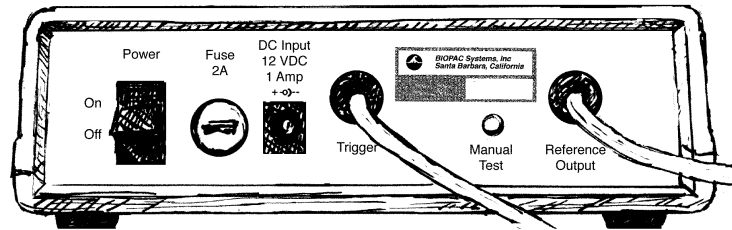

- Power** Rocker switch for turning the STM200 power ON and OFF.
- Fuse** If the fuse blows and must be replaced, use a screwdriver to open (counterclockwise) and close (clockwise) the fuse cap.
- DC Input** Socket for DC adapter (AC300A or equivalent).
- Trigger** This cable terminates in a 3.5 mm mono plug for connection to the UIM100C Analog Output 0 or the STM100C 50 ohm output.
- Manual Test** Used to diagnose problems with the STM200 stimulator unit. With Trigger cable disconnected, press the Manual Test button to initiate a stimulus with a fixed pulse width of 1 millisecond.
- Reference Out** This output cable terminates in an RJ-11 plug for connection to the AMI100D/HLT100C. The cable reports the stimulator marker pulse to the MP System, via the channel it is connected to. A marker pulse will be generated each time the stimulator generates a pulse. The front panel Reference switch determines the marker amplitude:
- Actual varies between 0-1 V and maps to 0-100 V or 0-10 V
 - Fixed is 15 ms

Software Setup

The stimulation waveform must be created using stimulator setup (MP menu > Set Up Stimulator or MP Menu > Set Up Data Acquisition > Stimulator). The output waveform should be designed so that it has

- One or more pulses
- Baseline of 0 V
- Pulse amplitude of 5 V
- Pulse length from 0.1 ms to 200 ms
- Related pulse duty cycle should not normally exceed 10%; higher duty cycles are supportable in certain circumstances.

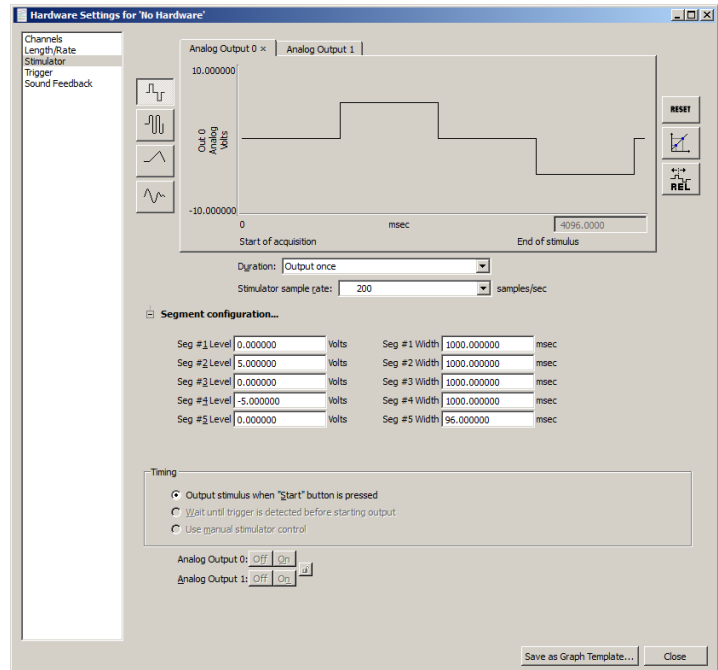

Calibration

The “Reference Output” signal should be calibrated to optimize results.

1. With the STM200 connected and ON, turn the Level control counter-clockwise until the display reads 0 (or as close to 0 as possible).
2. MP > Set Up Data Acquisition > Channels > View by Channels and click the Setup button for the stimulator channel.

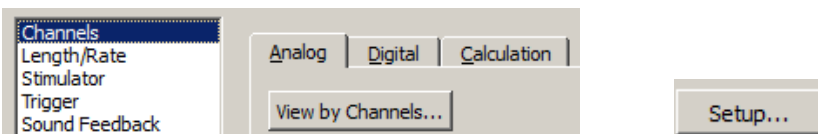

3. Press **Cal 1** to get the signal representing 0 V out of the stimulator.

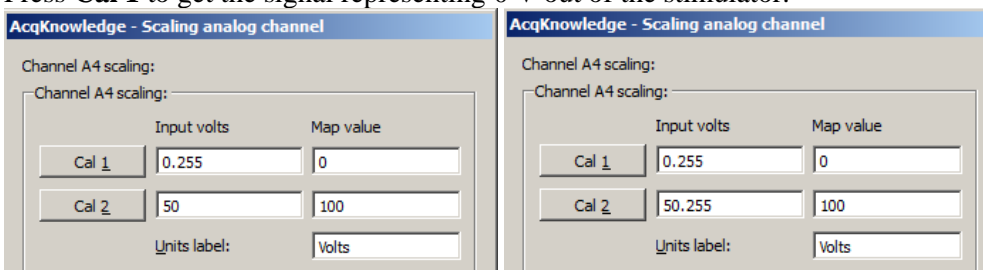

4. Add the Input value found with Cal 1 to the Input Value displayed for **Cal 2**.
 - For example, if “Cal 1” is pressed and returns an Input Value of .255 V, .255 V should be added to the existing 50 V and manually entered as the total value of 50.255 V for Cal 2 Input Value.

Note Even if the Cal 1 Input Value is negative, it must still be “added” to the number for Cal 2 (which essentially subtracts it) to arrive at the proper value.

5. Click **OK** to close out of the Scaling window.

Optional: Click **Save as Graph Template** to save these new scale settings. As long as neither the MP unit nor stimulator changes, the calibration should not need to be repeated.

6. Close out of the Setup window.

STM200 SPECIFICATIONS

(This new unit has digital display and a keyed range switch)

Pulse width

Controlled by:	Computer software (<i>AcqKnowledge</i>)
Range:	.01 – 200 milliseconds
Resolution:	10 µsec (minimum) based on waveform output rate of 100 kHz**

Pulse Repetition

Controlled by:	Computer software (<i>AcqKnowledge</i>)
Pattern:	Fully arbitrary pulse sequence
Resolution:	10 µsec (minimum) based on waveform output rate of 100 kHz

Pulse level

Control:	Manual (10 turn potentiometer)
Range (selectable with <i>Key Switch</i>):	<i>Range 1:</i> .025 - 10 Volts <i>Range 2:</i> .12 - 100 Volts Infinite (potentiometer adjustable) range
Current Output:	1 ms pulse: 500 ma 100 µs pulse: 1000 ma
Accuracy:	5% accuracy to digital readout

Reference Output

Corresponds to actual pulse output (Requires Calibration)

Pulse width:	Fixed (15 millisecond) or Direct (follows actual pulse output)
Amplitude:	0 - 50 mV correlates to 0 - 10 V actual output or 0 - 100 V actual output.

Manual Test Pulse(Button on back panel)
Note: Will only function when “Trigger” cable is not connected to the MP System.

Pulse Width:	1 millisecond
--------------	---------------

Stimulator isolation

Volts:	2,000 Volts DC (HI POT test)
Capacitance coupling:	60 pF

Power requirements

12 Volts DC adapter (included), 1 Amp

Fuse

250 V, 2 A, fast blow

Fuse Dimensions:	1.25” length × .25” diameter
------------------	------------------------------

Module Weight

610 grams

Module Dimensions

16 cm x 16 cm x 5 cm

****IMPORTANT NOTE!** To set pulse width on STM200, assume that STM200 adds 40 µsec to the pulse width signal from *AcqKnowledge*. Example: For 100 µsec pulse width at output of STM200, set output pulse width to 60 µsec.

Read [Safe Use of Electrical Stimulators](#) – Application Note 257 for Comprehensive Safety Guidelines for Performing Electrical Stimulation on Subjects.

STMISOLA LINEAR ISOLATED STIMULATOR

The Constant Current and Constant Voltage Isolated Linear Stimulator (STMISOLA) will connect to any analog output signal drive (± 10 V input) and provides considerable flexibility in stimulation protocols:

- **Voltage and current stimulator (unipolar or bipolar)**—

The STMISOLA connects directly to the STM100C (OUTPUT 50 Ω port) or the AMI100D/HLT100C/UIM100C (Analog Output 0 or 1 port) associated with the MP160/150 system.

Interface STMISOLA to MP36R or MP36R Analog Out port; the DSUB9 to 3.5 mm mono jack allows the MP36R/MP36 to be used with the STMISOLA for arbitrary stimulus output. Works with AcqKnowledge 4.4.2 or above (MP36R) or BSL 4.1.2 or above (MP36).

Linear stimulator—the STMISOLA can be used to generate stimulation signals that can have arbitrary waveshape. Typically, stimulators can only generate simple unipolar or bipolar pulses. The STMISOLA, however, can output unipolar or bipolar arbitrary waves such as pulse (single or train), square, sine, triangle, exponentially decaying, modulated envelopes, and fully user-specified types.

The STMISOLA can output either voltage or current waveforms.

- **Voltage (V) mode**—the STMISOLA multiplies the Control Input Voltage by a factor of 20, to present that amplified signal at the STMISOLA output.
 - In the case of a maximum ± 10 V input control signal, the STMISOLA will output a ± 200 V signal, with an output of either 100 ohms or 1 K ohms. These output impedance settings will act to limit the available output current.
- **Current (I) mode**—two settings.

The STMISOLA provides two options for output current mode.

- 1) High current mode (Zout switch set to 100 ohms), provides a gain factor of 10 ma/volt.
- 2) Low current mode (Zout switch set to 1 K ohms), provides a gain factor of 1 ma/volt. Low current mode permits much improved control for currents less than 10 ma.

The STMISOLA multiplies the Control Voltage by the factor indicated (K in ma/V) to present that associated output current at the STMISOLA output.

In the case of a maximum ± 10 V Control Input Voltage, for:

- Zout = 100 ohms, K=10 ma/V: the STMISOLA will output ± 100 ma
- Zout = 1000 ohms, K=1 ma/V: the STMISOLA will output ± 10 ma
- In both cases, the voltage compliance is ± 200 V.

There are two basic **stimulation modes** for the STMISOLA:

- Voltage
- Current

In voltage mode, the STMISOLA has two different output impedance (Zout) settings (100 ohms and 1 K ohms). Depending on the setting, the output voltage (Vout) on the electrode impedance load (Ze) will be subject to the following formula:

- $V_{out} = [Z_e / (Z_e + Z_{out})] * V_c * 20$
- Where: Vc is the input control voltage

In current mode, electrode load impedance does not impact STMISOLA gain accuracy. The STMISOLA will simply output the specified current (subject to the applied control voltage), despite the electrode load impedance, up to the point of maximum voltage compliance (± 200 volts).



Isolation characteristics—The STMISOLA isolates the Control Input Voltage from the stimulus output to 1500 VDC HiPot and approximately 1000 pF of coupling capacitance.

This *very high degree of input/output isolation* helps ensure subject safety and helps to substantially reduce, or eliminate, stimulus artifact.

Stimulus artifact results when some percentage of electrical current from the stimulation site is directed to the recording site due to electrical leakage paths intrinsic to the stimulation/recording equipment. In the case of the STMISOLA, the leakage conductance and capacitance that permit this artifact to occur are reduced to very small values.

Power ON Safety—when you Power ON the STMISOLA, you must also hold Reset for at least 3 seconds. This forces the unit into an "operational but no output state" and protects the subject if accidentally connected to electrodes on power up.

Operating Details

→ Review Important Notes and Safety Notes before operating the STMISOLA

Important Notes

- A) **The Current Feedback Monitor Cable (CBLCFMA) is recommended** for use with any voltage stimulator; to isolate CBLCFMA output, use INISOA and AMI100D/HLT100C. Always make sure to place the electrodes on the participant at least 10 minutes before starting any electrical stimulation. Use a CBLCFMA to monitor and record the actual current delivered to the participant at ALL times. A large enough change in current delivered to the participant will alter the subjective perception of the stimulation. Thus, an unpleasant shock may become painful if more current starts being delivered or become ineffectual if less current is being delivered than during threshold identification. Changes in the levels of delivered current are due to changes in impedance. Changes in impedance could be due to a number of factors: gel saturating the skin over time; gel drying up – over longer period of times; hydration level of participant; sweating; decoupling of electrodes and skin due to motion artifacts; etc.
- B) In Current (I) Mode stimulation, if the output has a load (typically high impedance) that induces railing for the specific output current, the STMISOLA will immediately go into “Protect” mode. In the case of an unloaded output, this state will happen as soon as the STMISOLA is placed into Current (I) Mode stimulation. This happens because an “unloaded” STMISOLA output simply means that an arbitrarily high resistance load is attached to the STMISOLA. To correctly operate in Current (I) Mode stimulation, the proper load must be placed between stimulation electrodes and then “Reset” pushbutton must be pressed to 3 seconds to activate the unit.
- C) In either stimulation mode (V or I), the output level (OL) will directly be a function of the applied Control Input Voltage (CIV). The conversion ratios are as follows:
 - Voltage (V) Mode: $CIV \text{ (volts)} * 20 \text{ (volts/volts)} = OL \text{ (volts)}$
 - Current (I) Modes: $Z_{out} = 100 \text{ ohms: } CIV \text{ (volts)} * 10 \text{ (ma/volts)} = OL \text{ (ma)}$
 $Z_{out} = 1 \text{ K ohms: } CIV \text{ (volts)} * 1 \text{ (ma/volts)} = OL \text{ (ma)}$
- D) When an output waveform is present, the output waveform indicator—**red** LED just above BNC output connector—will glow. Waveform output level indication can be observed as an increasing intensity of this red LED. This output waveform indicator is designed to provide a visual indication of output, even if the wave duration is extremely short, so it may be possible that this indicator shows a waveform output for some brief period of time after the output wave has already passed.

Safety Notes

1. Never place the stimulation electrodes so that it’s possible for stimulation current to pass through the subject’s heart. This can happen if electrodes are placed so that the leads “straddle” to the left and right sides of the subject’s body. Place the stimulation electrodes close together on the SAME (left or right) side of the subject’s body appendage. Only place stimulation electrodes so they are on the appendage of interest. For example, for left leg stimulation, only place stimulation electrodes on the left leg and on NO other location on the body.

2. Do not power ON or OFF the STMISOLA unit while electrodes attached to the subject. Always be sure to place the STMISOLA in VOLTAGE mode, with zero volts applied to input, before attaching/removing electrodes to/from the subject. Zero volts is automatically applied to the STMISOLA input if the STMISOLA input cable is unplugged from any signal source.
3. For MRI Applications, when possibly considering the use of the STMISOLA for associated electrical stimulation of human subjects, please refer to BIOPAC [Application Note 257](#) for context, warnings and details.
4. It is ideal to use the STM100C for stimulation control, because it permits manual control of the stimulation level. To use the STM100C:
 - Plug the Control Input Voltage line for the STMISOLA into the 50 ohm output of the STM100C.
 - Before stimulation begins, turn the Output Level Control knob to 0%.
 - Initiate stimulation in the AcqKnowledge software (see Application Note AH162).
 - After stimulation is initiated, slowly turn the STM100C Output Level Control to the desired level.
 - When the stimulation session is ended, turn the STM100C Output Level Control back to 0%.
5. **Do not remove electrodes** while in current (I) mode; it's possible for subjects to receive a shock if they remove electrodes while the STMISOLA is in current (I) mode because the STMISOLA responds to the impedance increase and causes the current source to swing to a positive or negative rail.

STMISOLA: Additional Notes Regarding Use of Current Mode Output

Current Mode stimulus output can appear to demonstrate non-intuitive behavior. This behavior is very different than Voltage Mode stimulus output.

The STMISOLA is a voltage-controlled stimulation system. In the case of Current Mode output, options exist to map the stimulus output current to the input control voltage. These two options are:

Option 1

+10 V input control voltage maps to +100 ma stimulus output current

-10 V input control voltage maps to -100 ma stimulus output current

Option 2

+10 V input control voltage maps to +10 ma stimulus output current

-10 V input control voltage maps to -10 ma stimulus output current

For both Option 1 or 2, the behavior is essentially the same, even though the stimulus output current range is different. When the input control voltage is close to 0 V, the stimulus output current is also proportionally close to 0 ma.

IMPORTANT NOTE:

When attempting to set the input control voltage to zero volts, the resulting voltage will most certainly never be exactly zero volts. Instead of zero, the input voltage will simply be close to zero, perhaps on the order of +0.001 V or -0.00001 V.

So, if the input control voltage is non-zero, the current output will also be non-zero!

Example A:

A non-zero input control voltage of 0.001 V will result in a non-zero stimulus output current of 0.001ma, assuming STMISOLA is set to Option 2. If the STMISOLA stimulus output is connected to an infinite (or very large) impedance, the STMISOLA will attempt to drive 0.001 ma through this very large impedance. Assuming the large impedance is 200 Mohm, then:

$$0.001 \text{ ma} \times 200,000,000 \text{ ohms} = 200 \text{ V (estimate)}$$

Accordingly, in practical operation, if the STMISOLA is used in current mode and is attached to electrodes that are making intermittent contact to the tissue of the subject, intermittent shocks may be felt by subject, even if 0 V is applied to the input control voltage. This is because the STMISOLA will drive directly to the compliance voltage limit and start to behave as a voltage stimulator.

Intermittent contact with electrodes will result in intermittent +/- 200 V shocks being applied to the subject. These possible transient shocks may be felt, but only when skin electrodes dislodge and reconnect to the subject's tissue.

This possible +/- 200 V stimulus will be present on STMISOLA output leads at the point when the electrodes reconnect with the tissue, assuming the electrodes had dislodged previously. At the point of reconnect, the voltage level falls back below the compliance threshold and the errant stimulus goes away, but this process takes a few microseconds. If transient connects and reconnects happen over a period of time, many bursts of voltage will impact the electrode sites.

This potential safety issue can be mitigated through a couple of methods:

1. Employ a bipolar voltage clamp across the stimulus output current leads.
2. Employ an added parallel resistance across the stimulus output current leads.

In method 1, the bipolar voltage clamp simply limits the compliance voltage to a deemed safe level.

Two, oppositely directed, diode and Zener diode series circuits are used to define the voltage clamp maximum value, assuming the stimulus electrodes may become dislodged.

In method 2, the maximum load impedance will be dictated by the chosen added parallel resistance.

Also, these two methods can be used together, for additional safety consideration.

Components and Connections:

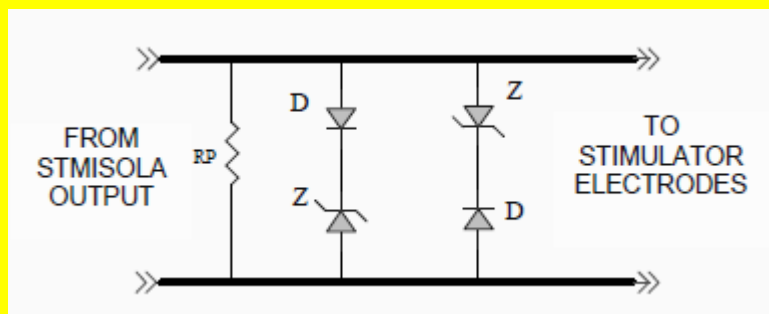

Choose:

Rp: Resistor; should have value much larger than resistance through intended load (e.g., subject).

Z: Zener diode; breakdown voltage should be equal to desired voltage limit.

D = Switching signal diode (suggest 1N4148 TYP)

Example B:

Using the Example A, also assume that a parallel resistance of 1 Mohm is employed across the stimulus output current leads. Accordingly, the reference equation becomes:

$$0.001 \text{ ma} \times 1,000,000 \text{ ohms} = 1 \text{ V (estimate)}$$

In this case, the maximum stimulus voltage received by the subject, in the event of sporadic electrode contact, would be on the order of 1 V, instead of 200 V. Alternatively, if the parallel loading represented by the additional 1 Mohm resistance is not desired, a voltage clamp could be used to limit the maximum output voltage level in the event of sporadic electrode contact.

The STMISOLA has the capability of acting as a nearly ideal current stimulator, with very high performance. Adding a parallel resistance or a voltage clamp reduces performance from ideal, but enhances safety. Please contact BIOPAC Systems, Inc. at www.biopac.com for more information.

Operating Procedure

→ Review Important Notes and Safety Notes before operating the STMISOLA

The included 3.5 mm mono splitter (3.5 mm male mono phone plug to two 3.5 mm female mono sockets) and one CBL100 (3.5 mm mono male to 3.5 mm mono male cable) permit the analog drive signal to be directed to two locations. The drive signal – usually from DA0 or DA1 – is typically directed to the splitter cable. One socket output of the splitter cable is directed to the STMISOLA input.

The other socket output of the splitter cable is looped back to drive an available MP input, via CBL100, through the UIM100C or AMI100D/HLT100C (CBL122 adapter required for AMI100D/HLT100C). In this manner, during acquisition, the stimulus level and timing will be indicated on the recording.

1. Plug AC300 into back of STMISOLA unit.
2. Connect Control Input (3.5 mm male phono plug) to output: AMI100D/HLT100C/UIM100C (Analog Out 0 or 1) or STM100C (50 ohms) or MP36 Analog Out (via OUT5 adapter) or external signal generator.
3. **Before powering ON the STMISOLA** (turning from OFF to ON), make sure that stimulation electrodes are not attached to the subject.
4. Power ON STMISOLA.
 - Note that “Protect” red LED on front panel is ON, when STMISOLA is powered ON.
5. Set “Output Mode” switch to **V** for Voltage stimulation.
6. Press “Reset” pushbutton switch for 3 seconds to enable STMISOLA.
7. Make sure that STMISOLA input voltage is Zero volts.
8. Connect electrodes to subject and then to STMISOLA output.
9. Place STMISOLA in Current (I) mode, if desired.
 - Note that if output is unloaded and if STMISOLA is in Current (I) Mode, then the “Protect” light will stay ON, thus activating shutdown protection (see Important Note A).
10. Send Control Voltage (STMISOLA input) to affect desired wave output (see *AcqKnowledge* Software Guide or BIOPAC Application Notes AH162 and AS200).
11. When stimulation session is ended, place STMISOLA in Voltage (V) Mode and make sure that STMISOLA unit input control voltage is Zero volts.
12. **Before powering OFF the STMISOLA** (turning from ON to OFF), remove stimulation leads and/or electrodes from subject.

WARNING: Do not remove electrodes while in current (I) mode; it's possible for subjects to receive a shock if they remove electrodes while the STMISOLA is in current (I) mode because the STMISOLA responds to the impedance increase and causes the current source to swing to a positive or negative rail.
13. Power OFF STMISOLA after making sure that stimulation electrodes are not attached to the subject.

STMISOLA Specifications

The STMISOLA is a linear, isolated, constant voltage or constant current stimulator. The STMISOLA has one output voltage mode and two output current modes. The output voltage mode multiplies the input control voltage (± 10 V) by a factor of 20 to the output. When operating in output current mode, there are two options: Low current mode ($Z_{out}=1$ K ohm) and High current mode ($Z_{out} = 100$ ohms). In Low current mode there is a 1:1 relationship between the input control voltage (in volts) and output current (in ma). In High current mode there is a 1:10 relationship between the input control voltage (in volts) and output current (in ma). The Z_{out} selector switch determines the output impedance of the STMISOLA is voltage mode (100 ohms or 1 K ohms). The Z_{out} selector switch determines the output current range (± 100 ma for $Z_{out} = 100$ ohms) or (± 10 ma for $Z_{out} = 1$ K ohms). The Z_{out} switch has different operation, depending on output mode of STMISOLA. In Voltage output mode, the Z_{out} setting simply specifies the output impedance of the STMISOLA. In Current output mode, the Z_{out} setting determines the gain factor (K) which sets the desired current range, either ± 100 ma or ± 10 ma. The STMISOLA is also well-suited for transcranial direct current stimulation (tDCS). tDCS is a form of neuro-stimulation which employs the use of low level (typically under 10 ma) constant, unipolar, direct current.

The STMISOLA will support arbitrarily long, constant, non-varying, direct output currents, so long as the associated voltage compliance is 100 VDC or less. The tDCS level is adjusted by holding a stable voltage to the control voltage input of the STMISOLA. This control voltage can be set in *AcqKnowledge*, to be output to STMISOLA via analog output, or can be provided by any 3rd party power supply or signal generator.

Control Voltage Input: ± 10 V maximum input

Control Voltage Impedance: 1 Mohm

Control Voltage Input Interface: Male 3.5 mm mono phone plug

Isolation: Control Voltage Ground to Isolated Output Ground: 1000 pF at 1500 VDC HiPot

Isolated Output Ground to Mains Ground: 2000 pF at 1500 VDC HiPot

OUTPUT:

Stimulation Voltage (V) Mode: 200 V with:

Zout = 100 ohms: ±100 ma compliance; Output Impedance = 100 ohms

Zout = 1 Kohm: ±10 ma compliance; Output Impedance = 1000 ohms

Current (I) Mode: 200 V compliance Output Impedance - 1 Gohm

Zout = 100 ohms: ±100 ma

Zout = 1 K ohm: ±10 ma

Input to Output Ratio:

Voltage (V) Mode:

±10 V DC input creates output of ±200 VDC (1:20 ratio - V/V) for Zout either 100 ohms or 1 K ohms

Current (I) Mode:

±10 V DC input creates output of:

Zout = 100 ohms ±100 mA (1:10 ratio - V/ma)

Zout = 1 K ohms ±10 mA (1:1 ratio - V/ma)

Rise Time Measurement Setup:

Load: 1 K ohm

Input Control Signal: 0-1 Volt (1 µsec rise time or less)

Current Monitor: CBLCFMA Current Monitor (in series with stimulus output current)

Rise Times (10%-90% stimulus output current amplitude levels indicate rise time)

1) Voltage mode (Zout = 100 ohms or 1 K ohms): 10 µsec nominal

2) Current mode (Zout = 100 ohms – 15 µsec nominal, Zout = 1 K ohms – 10 µsec nominal)

Max output pulse width: Less than 100 VDC (voltage output or compliance level) – arbitrarily long

More than 100 VDC (voltage output or compliance level) – 100 ms typical

Max sine frequency: 30 kHz (-3 dB)

Input Control Voltage: ±10 V max

Physical Interface: 3.5 mm male mono phone plug

Compatibility MP: UIM100C (Analog Out 0 or 1), AMI100D or HLT100C (Analog Out 0 or 1 via CBL122 cable adapter), STM100C (50 ohm output), Generic signal generator w/ ±10 V output range

Voltage or Current output noise (rms): nominally +/-0.02% of Full Scale Range (FSR)

Accuracy: Voltage or Current output (Zout is 100 ohms or 1 K ohms): ± 1%

Linearity: ± 0.1%

Output Pulse Duration: Output or current compliance voltage (Vout < 100 V) - fully arbitrary, no limit to wave (pulse) duration, subject to user-supplied control voltage signal drive

Output or current compliance voltage (Vout 100 V) : 100 msec typical and limiting to 20 ms at 100 ma current output

Current Limiting: ±350 ma (short circuit)

Voltage Limiting: ±210 V (nominal)

Reset Push Button: Required with each power ON – push in for 3 seconds to Reset

Manual Test Voltage Output Pulse: 100 V for 2 msec

Current Output Pulse:

Zout = 100 ohms: 50 ma for 2 msec

Zout = 1 K ohms: 5 ma for 2 msec

Full Scale Range:

Voltage mode: ±200 V (Zout = 100 ohms or 1 K ohms)

Current mode:

±100 ma (Zout = 100 ohms)

±10 ma (Zout = 1 K ohms)

Output Indicator: ON for P-P amplitudes > 1% FSR

Fuse: 2 amp fast blow

Power Adapter: 12 VDC at 1 amp (AC300A)

CBLLIMIT2 CURRENT LIMITING CABLE



The CBLLIMIT2 establishes unipolar current limiting (2 ma minimum, 3 ma maximum), for a compliance voltage range of ± 200 volts and is primarily used with STMISOLA for tDCS stimulation as a safety precaution. The cable is factory tunable for a range of current limits and may have other uses in situations where a maximum current limit is required.

NOTE: The CBLLIMIT2 cable will permit any unipolar current between 0 and 2 ma to pass. If more than 2 ma is injected through the cable, the compliance voltage across the CBLLIMIT2 will rapidly rise, thus constricting current flow. When used in conjunction with the STMISOLA, the maximum current that can be injected through the CBLLIMIT2 is 3 ma, as this current will result in the CBLLIMIT2 hitting the STMISOLA 200 volt compliance limit.

- 15 cm long
- Male 1.5 mm Touchproof (pin) connector on one end, female 1.5 mm Touchproof (socket) connector on the other
- Connects to the electrode drive of any stimulators made by BIOPAC: STMISOLA, STM200, STMISOC, STMISOD, STMISOE, BSLSTMB

CBLCFMA

Current Feedback Monitor Cable

This cable will permit current sampling and can be used with any BIOPAC Stimulator for current verification. CBLCFMA is recommended for use with any voltage stimulator.



To connect the CBLCFMA to a STMISO Stimulator:

1. Connect the female 1.5 mm Touchproof lead to the “-” input of the Stimulator.
2. Connect the male 1.5 mm Touchproof lead to the electrode lead.
3. Connect the 3.5 mm mono phone plug to the UIM100C*, STMISO or INISOA/AMI100D/HLT100C. (Direct connection to STMISO. Other Stimulator types require adapters.)

*3.5 mm mono phone plug should be connected to an unused Analog Channel of the MP160/150 system. If no other electrical connections are made to the subject, then this connection may be made directly to the UIM100C. If other electrical connections are made (for instance, for ECG, EDA, EMG, etc.) then CBLCFMA should be connected through INISOA to an AMI100D or HLT100C.

IMPORTANT: Always make sure to place the electrodes on the participant at least 10 minutes before starting any electrical stimulation. Use a CBLCFMA to monitor and record the actual current delivered to the participant at ALL times. A large enough change in current delivered to the participant will alter the subjective perception of the stimulation. Thus, an unpleasant shock may become painful if more current starts being delivered or become ineffectual if less current is being delivered than during threshold identification. Changes in the levels of delivered current are due to changes in impedance. Changes in impedance could be due to a number of factors: gel saturating the skin over time; gel drying up—over longer period of times; hydration level of participant; sweating; decoupling of electrodes and skin due to motion artifacts; etc.

SPECIFICATIONS

Feedback constant: $1 \text{ V} = 10 \text{ ma}$

Leads: Male 1.5 mm Touchproof and Female 1.5 mm Touchproof

Resistor: 100 ohm 1% MF 1 Watt resistor (in series between TP leads)

Connector: 3.5 mm mono phone plug

Cable: 2 m (6' 6¾")

See also: [STMISOLA Stimulator](#) and [STMEPM-MRI System](#)

STMISO STIMULUS ISOLATION ADAPTERS

See also: Stimulator Setup notes in AcqKnowledge Software Guide

BIOPAC offers three stimulus isolation adapters:

STMISOC	constant current <u>or</u> constant voltage (5X / 10X) stimulation
STMISOD	multiplies STM100C voltage by 5
STMISOE	multiplies STM100C voltage by 10

IMPORTANT SAFETY NOTES!

When using the STMISOC, STMISOD, or STMISOE, it is possible to generate voltages as high as 200 v p-p. These voltages are potentially dangerous, especially if the stimulator's high voltage outputs are connected across the subject's heart. Across the heart means that the heart is potentially in the electrical path from lead to lead. This situation occurs when the stimulation electrodes are placed on opposite sides of the subject's body.

NEVER PLACE STIMULATION ELECTRODES ON OPPOSITE SIDES OF THE SUBJECT'S BODY!

Always use the stimulator with the leads placed in relatively close proximity to each other and relatively far from the heart, and with the leads placed only on the **SAME** side of the body. The figure to the right illustrates correct connection techniques when using the STMISOC/D/E.

Example of correct stimulation electrode placement:

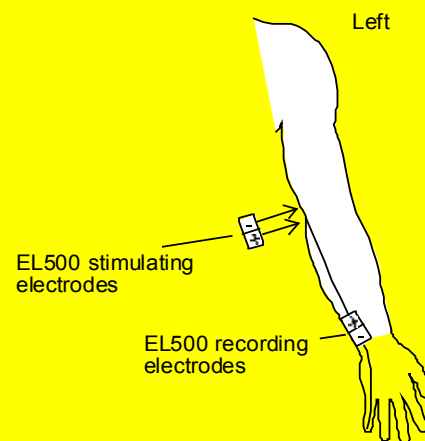

STMISO SAFETY

The harmonized, international regulatory standard relating to the safety of nerve and muscle stimulators is **IEC 60601-2-10:2015**. Certain stimulation equipment is excluded from this standard, such as stimulators intended for cardiac defibrillation; however, for the purposes of defining relevant safety metrics for STMISOC, STMISOD, or STMISOE stimulation units, this standard is quite relevant.

STMISOC, STMISOD, and STMISOE stimulation units are designed in such a manner that the power available to stimulate the subject is limited. This limitation of power is achieved through the use of stimulus isolation transformers which have physical constraints (due to their size and construction) which absolutely—in accordance to known physical laws—constrain the maximum transferable power to be no more than a specific level.

The IEC 60601-2-10:2015 standard clearly specifies the **limitation of output power** for a variety of wave types.

- * For stimulus pulse outputs, the maximum energy per pulse shall not exceed 300mJ, when applied to a load resistance of 500 ohms,
- * For stimulus pulse outputs, the maximum output voltage shall not exceed a peak value of 500 V, when measured under open circuit conditions.

STMISOC, STMISOD, and STMISOE units employ stimulus isolation transformers that limit the output pulse width to 2 ms maximum, under 500 ohm load conditions. In addition, the highest available output voltage is 200 V pk-pk (STMISOC or STMISOE) under open circuit conditions.

For the pulse energy calculation for STMISOC and STMISOE:

$$\text{Joules} = \text{Watts} \times \text{Seconds}$$

$$\text{Watts (instantaneous maximum)} = (200 \text{ V} \times 200 \text{ V}) / 500 \text{ ohms} = 80$$

$$\text{Joules} = 80 \text{ W} \times 0.002 \text{ seconds} = 0.16 \text{ Joules} = 160 \text{ mJ}$$

Accordingly, the highest possible energy output using the STMISOC or STMISOE is **160 mJ**.

The remaining stimulus isolation unit, STMISOD, has a maximum voltage output of 100 V. In this case, the maximum energy output is:

$$\text{Watts (instantaneous maximum)} = (100 \text{ V} \times 100 \text{ V}) / 500 \text{ ohms} = 20$$

$$\text{Joules} = 20 \text{ W} \times 0.002 \text{ seconds} = 0.04 \text{ Joules} = 40 \text{ mJ}$$

In all cases the maximum available energy, from the STMISO series stimulus isolation units, is limited to be considerably **less than the 300 mJ maximum** as specified by IEC 60601-2-10:2015.

CAUTIONS FOR USE!

Even the safest stimulation units, if used incorrectly, can cause serious harm. The following points illustrate fundamental rules for using stimulus isolation units to stimulate subjects.

1) **NEVER APPLY THE STIMULUS SIGNAL IN SUCH A MANNER AS TO CAUSE CURRENT TO FLOW THROUGH THE HEART.**

Primarily considered, this rule implies that stimulation leads should never be split apart so as to be able to touch opposing sides of the body surrounding the heart.

For example: NEVER CONNECT THE STIMULUS ISOLATION UNIT SO THAT ONE LEAD TOUCHES THE LEFT ARM AND THE OTHER LEAD TOUCHES THE RIGHT ARM.

Both stimulus leads [(+) and (-)], should be applied to the SAME side (left or right) of the subject's body. Furthermore, always stimulate AWAY from the heart. Stimulation probes (such as BIOPAC's EL350 or the EL351), which constrain the distance from the positive stimulation output to the negative stimulation output, should always be used for skin surface stimulation of nerve or muscle.

The EL350 or the EL351 stimulation probes fix the distance between stimulation outputs to 35mm. It is not recommended that this distance be increased for skin surface stimulation of nerve or muscle. An increase in this distance simply allows stimulation currents to circulate over a larger area, which is usually not necessary for nerve or muscle stimulation scenarios.

2) **Always start the stimulation process with the stimulator control set the LOWEST possible level.** The control for the STMISO series stimulus isolation units is located on the STM100C stimulation module. Set the control knob to the 0% level, prior to the onset of the stimulation protocol. During the protocol, increase the stimulus intensity by SLOWLY turning the control knob towards the 100% level. Stop increasing the intensity at the first sign of subject discomfort.

IMPORTANT NOTES!

- A) It takes as little as **15 micro-amps** directed across the heart to instigate ventricular fibrillation. This situation can be readily achieved by using sub-surface stimulation needle electrodes that insert directly into the heart. It is considerably more difficult to achieve ventricular fibrillation on the same heart using surface electrodes, but it is possible to do so, evidenced by the performance of cardiac defibrillation units used in hospitals or by paramedics.
- B) **Qualified experienced professionals** should supervise any protocols where electrical stimulation is applied to human subjects. Electrical stimulation protocols are not simple. Please contact BIOPAC Systems for any questions regarding the use of BIOPAC's stimulation units or accessories.

STMISOC CONSTANT VOLTAGE OR CONSTANT CURRENT STIMULUS ISOLATION ADAPTER

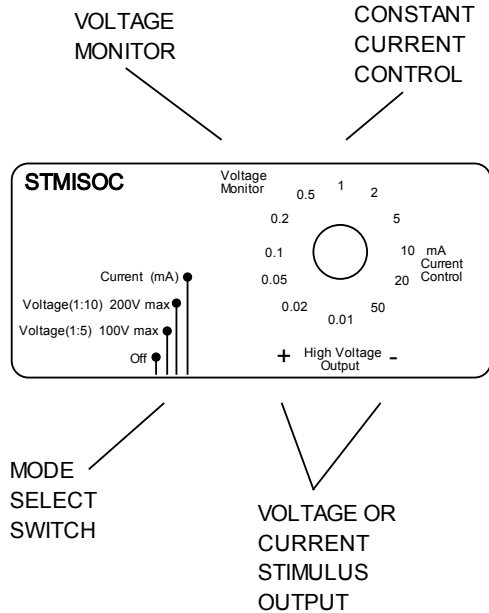

To use the STMISOC, an MP System with (minimally) one STM100C Stimulator module is required.

Plug the STMISOC directly into the EXT STIM jack on the STM100C module.

Use two LEAD110 electrode leads to connect the stimulus output to the subject. The LEAD110 electrode leads are required because they have the proper plug type for the new safety lead standard used on the STMISOC module. (1.6 mm pin connectors)

In the Voltage mode, the STMISOC can be used with bipolar stimulation and with different waveform types (square, sine, triangle).

See also: [Safety Notes](#)

STMISOC Mode	Signal output if LEVEL control is set to 100%
OFF	No signal will be output from the STMISOC.
Voltage (1:5) 100 V Max	Signal output will be 5x the values shown in the Stimulator Setup dialog (acts like a STMISOD).
Voltage (1:10) 200 V Max	Signal output will be 10x the values shown in the Stimulator Setup dialog (acts like a STMISOE).
Current	<p>Signal output will be positive constant current output; set signal value with the Current Control rotary switch.</p> <p>It's important to output positive pulses only. Pulses should have a height of at least 10 V because pulse height output determines the voltage compliance of the current stimulation signal. The compliance of the current stimulation signal is determined by multiplying the pulse voltage amplitude by 10. For a 10 V pulse, the compliance would be 100 V. This means that the STMISOC can output a current of up to 100 V/R load. If R load = 5 k ohms, in this case the maximum output current would be 100 V/5 k = 20 ma. The maximum pulse height can be as much as 20 V, so it's possible to have a compliance as high as 200 V.</p>

STMISOC SPECIFICATIONS

Stimulus Pulse Width:	50 μ sec to 2 msec (voltage and current)
Stimulus Sine Wave Range:	100 Hz to 5kHz (voltage only)
Step Up Voltage Ratio:	Selectable: (1:5) or (1:10)
Maximum Output Voltage:	(1:5) mode 100 V (p-p); (1:10) mode 200 V (p-p) into 5 k \pm load
Constant Current Range:	0.01, 0.02, 0.05, 0.1, 0.2, 0.5, 1.0, 2.0, 5.0, 10.0, 20.0, 50.0 ma (unipolar only)
Current Source Compliance:	200 V maximum
Current stimulation mode:	Positive current only
Isolation Capacitance:	150 pf
Isolation Voltage:	1500 VDC (from amplifier ground)
Cable Length:	1.8 meters
Weight:	190 grams
Dimensions:	10 cm (wide) x 5 cm (deep) x 4.5 cm (high)
Interface:	STM100C
Off mode:	Turns off Voltage or Current stimulation to subject.
Voltage Monitor output:	
Output via	3.5 mm mono phono jack
(1:5) mode	1:10 of stimulation voltage
(1:10) mode	1:20 of stimulation voltage
Current mode	disabled
OFF Reports a signal of approximately 50% of the voltage indicated in the stimulator setup window	

STMISOD (5X VOLTAGE)
STMISOE (10X VOLTAGE)

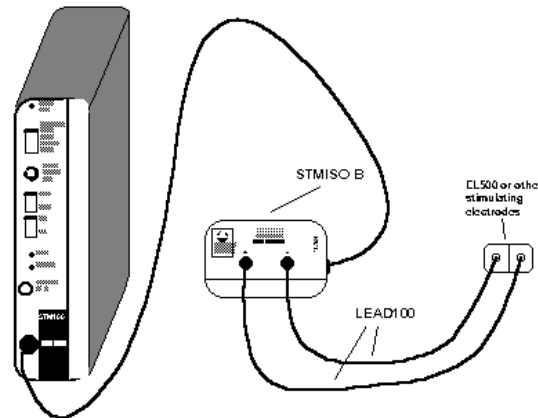

See Safety Notes

STMISOD/E setup for EL500 electrodes

The STMISOD/E plugs into the STM100C external stimulus output to provide an isolated voltage stimulus for response studies requiring a voltage stimulus (nerve conduction, somatosensory, etc.).

STMISOD adapter boosts the voltage of the STM100C by a multiple of **5x** to provide a stimulus of up to ± 50 V (or 100 V pk-pk).

STMISOE adapter boosts the voltage of the STM100C by a multiple of **10x** to provide a stimulus of up to ± 100 V (or 200 V pk-pk).

The front of the STMISOD/E has two 1.6 mm pin plugs that accept any of BIOPAC’s “safe lead” electrode leads, including bar electrodes, needle electrodes, and reusable electrodes.

The STMISOD/E has 1.6 mm “safe lead” pin plug outputs to accept most needle or stimulating electrodes. For voltage stimulus applications, the EL500 bar electrode or the EL500 electrodes with two of the LEAD110 electrode leads are recommended.

The STMISOD/E comes with an attached 2-meter cable that has a 1/4” phone plug on the end that connects to the EXT STIM output on the STM100C.

STMISOD/E CALIBRATION

To use the STMISOD/E, simply set up the stimulator in the software, and hook the STMISOD/E adapter as shown in the previous figure. Then, hook the stimulating electrodes of the choice to the two 1.6 mm “safe lead” pin plugs.

The STMISOD/E provides an additional barrier of galvanic isolation between the MP160/150 and the stimulating electrodes. When using the STMISOD/E to create a pulsed voltage stimulus output, the pulse width must be between 50 μ sec and 2 msec.

If the pulse is narrower than 10 μ sec, the STMISOD/E will not reproduce the pulse well, due to rise-time constraints.

If the pulse is greater than 2 msec, the pulse output will sag due to lower frequency response limits. The pulse may sag before 2 msec, depending on load and drive levels.

When using the STMISOD/E for voltage stimulus applications, turn the level control to 0% on the STM100C, then, after stimulation has begun, turn the level control up slowly. This approach will help to determine the appropriate voltage level for stimulating the subject.

STMISOD/E SPECIFICATIONS

Stimulus Pulse Width:	50 μ sec to 2 msec (voltage only)
Stimulus Sine Wave Range:	100 Hz to 5 kHz (voltage only)
Step Up Voltage Ratio:	STMISOD (1:5) STMISOE (1:10)
Maximum Output Voltage:	STMISOD 100 V (p-p) into 5 k ohm load STMISOE 200 V (p-p) into 5 k ohm load
Isolation Capacitance:	120 pf
Isolation Voltage:	1500 VDC (from amplifier ground)
Cable Length:	1.8 meters
Weight:	140 grams
Dimensions (WxDxH):	6.5 cm x 5 cm x 4.8 cm
Interface:	STM100C

STMEPM PROGRAMMABLE STIMULATOR FOR E-PRIME

The STMEPM Programmable Stimulation System for E-Prime allows a user to interface the STMISOLA Stimulator with E-Prime to control the stimulus frequency and stimulus intensity for real-time stimulus delivery changes based on a subject's responses.

The system includes

- STMISOLA Constant Current and Constant Voltage Linear Isolated Stimulator
- USB 4-ch D/A Unit
- Software Utility (STMISOLA<--> E-Prime) with sample E-Prime experiment
- Interface cables



The sample E-Prime experiment provides the necessary interface commands to communicate with the D/A unit. The D/A unit provides the STMISOLA with the appropriate voltage levels to stimulate a subject. The system supports up to four STMISOLA (and includes one).

IMPORTANT: The Current Feedback Monitor Cable ([CBLCFMA](#)) is recommended for use with any voltage stimulator; to isolate CBLCFMA output, use INISOA and AMI100D/HLT100C. Always make sure to place the electrodes on the participant at least 10 minutes before starting any electrical stimulation. Use a CBLCFMA to monitor and record the actual current delivered to the participant at ALL times. A large enough change in current delivered to the participant will alter the subjective perception of the stimulation. Thus, an unpleasant shock may become painful if more current starts being delivered or become ineffectual if less current is being delivered than during threshold identification. Changes in the levels of delivered current are due to changes in impedance. Changes in impedance could be due to a number of factors: gel saturating the skin over time; gel drying up – over longer period of times; hydration level of participant; sweating; decoupling of electrodes and skin due to motion artifacts; etc. Read [Safe Use of Electrical Stimulators](#) – Application Note 257 for Comprehensive Safety Guidelines for Performing Electrical Stimulation on Subjects

SPECIFICATIONS

STMISOLA: see Constant Current and Constant Voltage Linear Isolated Stimulator specs

CBLEPM connection cable x 4: 3.5 mm to 2 x tinned wire (STMISOLA to D/A card)

D/A Unit: High-speed multifunction module with eight 13-bit, 1 MS/s analog inputs and four 12-bit, 1 MS/s analog outputs

- Four 12-bit, ± 10 V analog outputs with 1 MS/s update rate
- USB-bus powered (type: 2.0 high speed; compatibility: 1.1 or 2.0)
- 8 single-ended/4 differential analog inputs
- 13-bit resolution
- 1 MS/s sample rate
- Single-ended ranges: ± 10 V, ± 5 V, ± 2.5 V or 0 to 10 V
- Differential ranges: ± 20 V, ± 10 V, or ± 5 V
- 16 digital I/O lines
- Two 32-bit counters
- One 32-bit PWM timer output

MRI COMPATIBILITY

The STMEPM should **not** be used in an MRI and should not be used in stimulating subjects who are to be placed in an MRI. For electrical stimulation requirements in MRI or fMRI, use STMEPM-MRI.

STMEPM-MRI – ELECTRICAL STIMULATION SYSTEM DESIGNED FOR MRI OR FMRI

The STMEPM-MRI Programmable Stimulation System for E-Prime allows a user to interface the STM100C Stimulator with E-Prime to control the stimulus frequency and stimulus intensity for real-time stimulus delivery changes based on a subject's responses. It is also possible to hardcode the stimulus intensity levels in the presentation so that predefined stimulus levels are delivered during the E-Prime presentation. This MRI system is similar to the standard STMEPM but adds requisite elements to make it fully functional for stimulation requirements in fMRI and MRI.



The **STMEPM-MRI System** includes

- STM100C Stimulator Module
- STMISOC Stimulus Isolation Adapter
- Measurement Computing USB 4-ch D/A Unit
- Software Utility (STM100C<--> E-Prime) with sample E-Prime experiment
- IPS100C Isolated Power Supply
- MECMRI-STMISO MRI Filter/Cable Set
- Interface Cables: CBLEPM for E-Prime; CBL100 3.5 mm
- CBLCFMA Current Feedback Cable
- LEAD108C Electrode Leads (2)
- EL509 Disposable Dry Electrodes
- GEL104 Salt-free, Chloride-free Electrically Conductive Gel

The sample E-Prime experiment provides the necessary interface commands to communicate with the D/A unit. The D/A unit provides the STM100C with the appropriate voltage levels to stimulate a subject. The system supports up to four STM100C (and includes one).

IMPORTANT: The Current Feedback Monitor Cable ([CBLCFMA](#)) is recommended for use with any voltage stimulator; to isolate CBLCFMA output, use INISOA and AMI100D/HLT100C. Always make sure to place the electrodes on the participant at least 10 minutes before starting any electrical stimulation. Use a CBLCFMA to monitor and record the actual current delivered to the participant at ALL times. A large enough change in current delivered to the participant will alter the subjective perception of the stimulation. Thus, an unpleasant shock may become painful if more current starts being delivered or become ineffectual if less current is being delivered than during threshold identification. Changes in the levels of delivered current are due to changes in impedance. Changes in impedance could be due to a number of factors: gel saturating the skin over time; gel drying up – over longer period of times; hydration level of participant; sweating; decoupling of electrodes and skin due to motion artifacts; etc.

SPECIFICATIONS

STM100C Stimulator Module: see specs [here](#)

STMISOC Stimulus Isolation Adapter: see specs [here](#)

IPS100C Isolated Power Supply: see specs [here](#)

MECMRI-STMISO MRI Filter/Cable Set: see specs [here](#)

CBLCFMA Current Feedback Cable: see specs [here](#)

CBLEPM connection cable x 4: 3.5 mm to 2 x tinned wire (STMISOLA to D/A card)

D/A Unit: High-speed multifunction module with eight 13-bit, 1 MS/s analog inputs and four 12-bit, 1 MS/s analog outputs

Four 12-bit, ± 10 V analog outputs with 1 MS/s update rate

USB-bus powered (type: 2.0 high speed; compatibility: 1.1 or 2.0)

8 single-ended/4 differential analog inputs

13-bit resolution

1 MS/s sample rate

LEAD108C Electrode Lead: see specs [here](#)

EL509 Disposable Electrode: see specs [here](#)

GEL104 Conductive Gel: see specs [here](#)

Single-ended ranges: ± 10 V, ± 5 V, ± 2.5 V or 0 to 10 V

Differential ranges: ± 20 V, ± 10 V, or ± 5 V

16 digital I/O lines

Two 32-bit counters

One 32-bit PWM timer output

STMEPM-MRI is not subject to the same possible errant stimulation issues as the standard [STMEPM](#) might be if suitable patch panel filtering is not constructed. STMEPM-MRI setup is restricted in terms of pulse width (2 ms max) and only voltage controlled voltage stimulation is possible; stimulation of differing intensity can be generated under E-Prime control.

For implementation of subject electrical stimulation in the fMRI and MRI for the purposes of psychophysiological research, see [Application Note 282](#).

IMPORTANT! Read [Safe Use of Electrical Stimulators](#) - Application Note 257 for Comprehensive Safety Guidelines for Performing Electrical Stimulation on Subjects.

STP100C ISOLATED DIGITAL INTERFACE



STP100C (center) connected to MP160 and HLT100C (not included)

The STP100C provides 8 lines for digital data inputs and 8 lines for digital data outputs. All inputs and outputs associated with the STP100C safely isolate connections to the MP System to 1500 VDC isolation.

- MP System Digital Input Lines: I/O 8-15
- MP System Digital Output Lines: I/O 0-7

The STP100C is used to safely isolate digital input and output lines to and from the MP System (MP160 and MP150).

The STP100C connects the MP System to computers running SuperLab, E-Prime,

Inquisit, DirectRT, and other psychophysiological stimulation applications. The STP100C also includes output to drive solid state relay and incorporates a BNC accessible External Trigger input line. The STP100C module can also be used to connect digital signals (standard logic level) from any mains powered external equipment to the MP System when the system also connects to electrodes attached to humans.

- **STP100C** Digital I/O card 37-pin connector pins (10-3) map to I/O15 - I/O8 on MP unit.

NOTE: To interface the STP100C with devices that use BNC outputs, such as the fNIR System trigger ports, use the CBL125 BNC-to-BNC cable.

SuperLab Interface (uses Digital I/O card with 37 pin DSUB connector)

The STP100C optical interface can be used to interface to the MP System when SuperLab™ and the Digital I/O card with the Support Pack are already available. The STP100C interface connects between the SuperLab™ Digital I/O card and the AMI100D/HLT100C module. (Or UIM100C module if using MP150 hardware.)

PORT A - Input to SuperLab: (pins 37-30) connect to MP System Digital I/O lines 0-7

PORT B - Output from SuperLab: (pins 3-10) connect to MP System Digital I/O lines 8-15

5 V power provided on pin 20

Parallel Port Interface (uses standard PC printer port with DSUB 25 connector)

Output from E-Prime: (pins 2-9) connect to MP System Digital I/O lines 8-15

Input to E-Prime: (pins 13, 12, 11, and 10) connect to MP System Digital I/O lines 4, 5, 7, and 6.

5 V power provided on pin 15

Output Drives (for relays or general purpose logic level outputs)

The STP100C can drive up to four (4) solid state relays directly via the MP System Digital I/O lines 0-3.

MP Digital I/O Line	Corresponding BNC Output
0	1
1	2
2	3
3	4

MP System Digital I/O line 4 is used as an enable to activate these drive lines.

ON = low (0 V) signal on I/O line 4

OFF = high (5 V) signal on I/O line 4

The output drives (for relays or general purpose logic level outputs) have 0 to 5 V output voltages and are current limited with 200 Ω resistors. This means that for solid state relay drive requirements, output current will be limited to approximately 20 mA, assuming an optically isolated solid state relay input diode drop of 1.2 V. Nearly all solid state relays can operate with as little as 5 mA of current drive.

Digital Inputs

The STP100C is designed to work with digital inputs in the range of 0-3.0 V, 0-3.3 V and 0-5.0 V. The STP100C Digital inputs pull high and require current sinking ability of 4 ma to drive low. Digital high inputs must be greater than 2.5 V and Digital low input voltage must be less than 0.5 V.

MP160 Hardware with AMI100D

For recognition of AMI100D and Smart Amplifier hardware, Digital channel 15 must be set high. When no external hardware controls the channel, it is normally held high. If connecting to hardware that affects Digital channel 15 (e.g., parallel port or parallel port adapter), third party software must be configured to allow D15 to remain high during three critical periods: (1) when *AcqKnowledge* is launched, (2) during channel setup when *AcqKnowledge* is asked to detect Smart Amplifiers, and (3) when the "Start" button is pressed either to commence acquisition or to begin waiting for a trigger.

Isolated External Trigger Input

The optically isolated external trigger input is standard logic level compatible. This line is accessible via a BNC female connector (labeled TRIG on the front of the STP100C)* and connects to the MP unit External Trigger input via optical isolation, compliant to 1500 VDC. The voltage range for this drive can support digital triggers in the range of 0-3.0 V, 0-3.3 V and 0-5.0 V.

*Alternatively, the isolated trigger input is also accessible via pin 12 of the DB-37 connector on the rear panel. (STP100C units manufactured after May of 2017 only.)

When the STP100C trigger is unused, it is pulled to a high state (+5 V) via an internal 100 k Ω resistor. To properly drive this line, connect a standard logic level driver to this port. For non-logic level type drivers, the low voltage applied to a trigger should ideally be between 0 and 1.0 V. The high voltage applied to the trigger should ideally be between 3.5 and 5 V. The maximum recommended source impedance of the driver should not exceed 1 k Ω . The trigger will accommodate logic levels anywhere in ± 10 V range, but low level should be less than 1.0 V and high level should be greater than 3.5 V.

The pulse width to the STP100C trigger input should be greater than 100 μ sec and can be high going or low going. The MP system can be set up via *AcqKnowledge* to trigger on positive or negative edges.

Additionally, to use the STP100C external trigger in a manual mode, the input can be pulled low with an external switch connected between the trigger input and ground.

To externally trigger MP Unit acquisition, send a logic level signal to the External Trigger of the STP100C (TRIG). This line connects to the MP Unit External Trigger via optical isolation.

MP150 Hardware with UIM100C only:

To use an MP System line normally dedicated to an I/O input (lines 8-15) to sample the External Trigger drive, use a JUMP100 jumper wire to connect that line directly to External Trigger (EXT T) on the back of the UIM100C. To increase the speed of the trigger response, place a 500 Ω resistor from TRIG to 5 V on the back of the UIM100C with STP100C connected. This will allow the STP100C to process pulse widths as narrow as 1 msec.

STP100C Instructions

1. Snap the STP100C module DSUB I/O connectors on the left side of the AMI100D, HLT100C, or UIM100C module.
2. Use the 3-meter ribbon cable to connect the STP100C module (computer I/O 37-pin connector) to the digital I/O card in the PC.
 - Connects Port A (inputs; pins 37-30) on the digital I/O card to digital I/O lines 0-7 on the MP unit.
 - Connects Port B (outputs; pins 3-10) on the digital I/O card to digital I/O lines 8-15 on the MP unit.
3. For debugging purposes, ground pins are:
 - 37-pin digital I/O cable (CBL110A): pins 19 and 21 are GND.
 - 25-pin printer port cable (CBL110C): pins 18 and 25 are GND.

Application example — P300 visual evoked response test

To set up the STP100W with an MP System to perform a P300 visual evoked response test:

1. Connect two **SuperLab** outputs to the respective MP System digital inputs.
 - These **SuperLab** outputs are assigned to respective images that will be presented to the subject during the recording session. Typically, image presentation occurs within a statistical framework, i.e., *Image 1* is presented 20% of the time and *Image 2* is presented 80%. The **SuperLab** outputs will be tightly (1 ms) synchronized to the respective image presentation.
2. Set the MP System up to record EEG and the two **SuperLab** outputs, which should be directed to the MP System digital inputs.
3. After the recording session has been completed, use *AcqKnowledge* to perform specific averaging on the collected EEG data.
 - a) Use the digital input corresponding to **SuperLab** output 1 as a “Control Channel” in the Find Peak Averaging Setup; all the responses resulting from *Image 1* presentation will be averaged together to create the composite response for *Image 1* presentation.
 - b) Repeat the above procedure with the “Control Channel” assigned to **SuperLab** Output 2 to create the composite response for *Image 2* presentation.

For more information on setting up the **Find Cycle (Cycle Detector) Off-line Averaging** for this kind of measurement, see the *AcqKnowledge* Software Guide.pdf.

STP-IO ISOLATED DIGITAL I/O BOARD



The STP-IO allows for access to the isolated digital input and output lines of the STP100C module. This digital breakout board connects directly to the 37-pin connector on the STP100C, providing access to digital channels 0-7 for digital output and digital channels 8-15 for digital input.

- The first digital input channel is on pin 3 with the final digital input on pin 10.
- The first digital output channel is on pin 37 and the final digital output channel is on pin 30.
- Ground is available on pin 19 and pin 21.

If a connection to SuperLab is required at the same time the STP-IO needs to be used, use CBLSTP-IO to connect both simultaneously.

CBLSTP-IO SUPERLAB + STP-IO ADAPTER CABLE

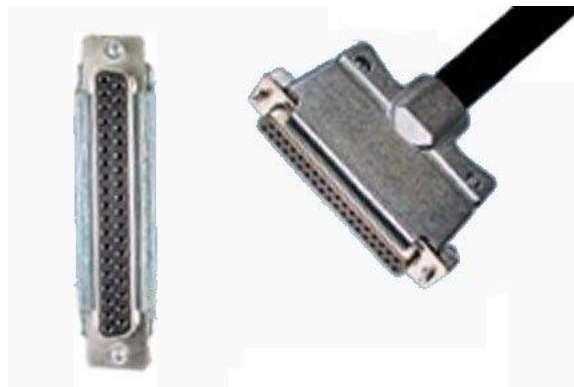

Use CBLSTP-IO to connect both a SuperLab system and an STP-IO digital I/O breakout board simultaneously to the 37-pin connector of the STP100C.

One female 37-pin connector is attached to the back of the STP100C. Two male 37 pin connectors then provide one to connect to the STP-IO board and a second for the cable to the SuperLab system.

The length of this “Y” cable is measured from tip to tip. The “Y” cable legs exit the DB37 male Common backshell and are jointly covered for the first three inches for extra strain relief. Please note this when determining a length for your application.

OUT SERIES

Headphones

- OUT1 High Fidelity Headphones
- OUT1A Ultra-Wide Frequency Response Headphones
- OUT100 Monaural Headphone
- 40HP Monaural Headphones

LED

- OUT4 Visual Stimulus: Controllable LED
- OUT103 LED Cable

- OUT2 BNC Output Adapter
- OUT3 *for TT pulses only—see [Stimulators](#)*
- OUT5 *see [STMISOLA](#)*
- OUT101 Tubeophone
- OUT01E Foam Ear Inserts:
- OUT101R Plastic Tubes
- OUT102 Piezo Audio Transducer
- OUT6 DSUB9 to RJ11 Output Adapter

OUT1 HIGH-FIDELITY HEADPHONES

These wide response high-fidelity headphones are used for auditory stimulus (short tones or clicks) or to listen to physiological signals (like EMG) directly. The Headphones are comfortable and lightweight (3 ounces) and include a 2 meter cable so the Subject can be seated a comfortable distance from the acquisition unit.

Unlike other Smart Sensors that connect to the MP3X, the OUT1 connects to the “Analog out” port on the back panel of the MP3X.



OUT1 SPECIFICATIONS

- Cable Length: 2 meters
- Connector Type: 9 Pin DIN (female)

OUT1A WIDE-FREQUENCY RESPONSE HEADPHONES

These ultra-wide frequency response headphones connect directly to the headphone port on the MP36 or MP36R data acquisition unit.

Features of these multi-purpose headphones include:

- High dynamic range
- High-resolution capsule
- 1/8" connector plus 1/4" adapter included
- Single-sided cord
- Oval-shaped ear cups
- Comfortable headband
- High-quality components and exceptionally rugged construction



OUT1A SPECIFICATIONS

- Connector: 1/8" TRS connector plus 1/4" TRS adapter
- Interface: MP36 or MP36R (not compatible with other MP units)
- Frequency response: 20 Hz - 20 kHz

- Max. power handling: 100 mW
- Impedance: 32 Ohm
- Sensitivity: 105 dB @ 1 kHz
- Cord length: 2 meters
- Dimensions: 11-3/4" x 9-3/4" x 8-1/4"

OUT100 MONAURAL HEADPHONES

These monaural headphones can be used with the STM100C stimulator module to deliver a tone signal while recording data for startle response or other stimulus-response studies. The headphones can also be used to listen to raw signals (such as EMG), piped through the STM100C from an amplifier output. The OUT100 is a wide response, high efficiency headphone, weighing 85 grams and is equipped with a 1.8 meter cord terminated in a 6.3 mm (1/4") phone plug.

OUT100 SPECIFICATIONS

Weight:	85 grams
Connector Type:	6.3 mm (1/4")
Cable length:	1.8 meters
Speaker:	28 mm dia 32 ohm dynamic Mylaar
Impedance:	16 Ohm @ 1.0 kHz
Power Handling:	100 mW max
Frequency response:	20 Hz - 20 kHz
Average SPL:	108 dB ± 4 dB
Adapter (included):	1/4" mono adapter plug



40HP MONAURAL HEADPHONES

These monaural headphones are used with Biopac Science Lab MP40 and Biopac Student Lab MP45 for stimulus response experiments and to listen to EMG signals. The 40HP is a wide-response, high-efficiency headphone.

40HP SPECIFICATIONS

Cable Length:	5 meters
Connector Type:	3.5 mm phone plug



OUT2 BNC (M) OUTPUT ADAPTER

This BNC adapter is designed to output signals from the MP3X unit to other devices (such as external amplified speakers and scopes). This 2-meter adapter cable terminates in a male BNC for easy connections.

See also: SS9LA BNC Input Adapter

OUT2 SPECIFICATIONS

Cable Length:	2 meters
Connector Type:	BNC (male)



OUT4 VISUAL STIMULUS: CONTROLLABLE LED

The OUT4 is a controllable high-brightness LED output device mounted on an angled stand intended to provide a good viewing angle for subjects. Use OUT4 for visual stimulus presentation in Biopac Student Lab Lesson 11A Reaction Time - Visual Stimulus, Visual Evoked Potential experiments, and more. Set LED intensity via Use MP Menu > Output Control > Visual Stim Controllable LED - OUT4; set flash rate/sequence via MP Menu > Output Control > Pulse Sequence.



OUT4 SPECIFICATIONS

LED:	White, Relative Luminous Intensity up to ~5000 mcd, adjustable
Interface:	MP36 or MP35 "Analog Out" port* (Pulse Out 0-5 V)
Cable:	2 meters

- * OUT4 is not compatible with a) Research System MP36R at this time because AcqKnowledge 4.4 and below does not include the required output control, b) with MP45, c) with MP30 except if used in place of SS10L in BSL Lesson 11.

OUT5 STMISOLA INTERFACE FOR MP36/36R

This DSUB9 to 3.5 mm mono jack interface allows the MP36/36R to be used with the STMISOLA isolated linear stimulator for arbitrary stimulus output (range -10 V to +10 V). The 1 m interface connects the MP36/36R Analog Out and the STMISOLA 3.5 mm mono plug/cable.

Compatible with:

- MP36 with BSL 4.1.2 and above
- MP36R with AcqKnowledge 4.4.2 and above

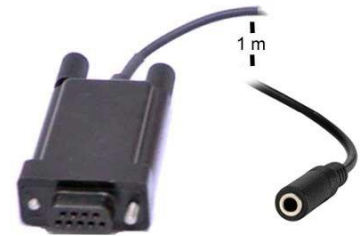

OUT6 DSUB9 TO RJ11 OUTPUT ADAPTER

Use this DSUB9 to RJ11 jack Output Adapter to map the analog output of an MP36 or MP36R to an RJ jack; allows stimulators designed with AMI/HLT-compatible connections to be connected to MP36/36R units. Control the STMTHERM, or other stimulators that have RJ11 input cables.



OUT101 TUBEPHONE

- **OUT101E** Replacement Foam Ear Inserts: pkg. of 50
- **OUT101T** Replacement Plastic Tubes: pkg. of 4

OUT101 Components: one Tubephone, plastic tube and 50 foam ear inserts

Use the OUT101 tubephone to deliver clicks and tones in auditory evoked response applications (i.e. ABR).

The tubephone design consists of a monaural acoustic transducer attached to a short, flexible, plastic tube, which fits into the subject's ear with the aid of a foam tip.

Use of the tubephone reduces ambient noise and bone conduction problems, which can interfere with auditory response recordings. Furthermore, because the Tubephone provides a 1 msec acoustic signal delay (due to plastic tube), it automatically separates true response from electromagnetic artifact resulting from speaker activation.



MP36 and MP36R interface options:

- BSL System stimulator (model BSLSTM): use BSLCBL6 and Radio Shack P/N 274-047 ¼" to 1/8" phono adapter
- BSL MP36 data acquisition unit Analog Out port: use OUT3 plus BSLCBL6 and Radio Shack P/N 274-047 ¼" to 1/8" phono adapter
- MP36 headphone port: use Radio Shack P/N 274-047 ¼" to 1/8" phono adapter; note—volume may not reach the same levels as the Analog Out port

Calibration for Auditory Brainstem Response Studies

To calibrate the OUT101 Tubephone, use an [Etymotic ER-7C Probe Microphone](#)—this microphone provides a calibrated output voltage which is a function of applied Sound Pressure Level (SPL). The sensitivity is 50 mV/Pascal (-46 dB re: 1 V/uBar): 0 dB SPL = 0 dBuV. Place the Probe Microphone insert tube in the auditory canal prior to the insertion of the OUT101 foam tip.

The OUT101 Tubephone sound delivery tube and the Probe Microphone sound input tube will then be exposed to the same auditory chamber. Accordingly, the SPL is recorded, via the Probe Microphone, simultaneously with applied auditory stimulus from the OUT101 Tubephone.

OUT101 SPECIFICATIONS

Response:	Compares to TDH-39, 49 or 50 audiometric headphones
Acoustic signal delay:	1 msec
Dimensions:	3.8 cm (wide) x 5 cm (high) x 1 cm (thick)
Cable termination:	6.3 mm (1/4") phone plug
Cable length:	1.8 meters
Cable clip:	Yes; clip attaches to fabric or fixtures

OUT102 PIEZO AUDIO TRANSDUCER

The OUT102 Piezo transducer may be connected directly to the STM100C stimulator module 50 ohm output. When the stimulator module output rises above 1.5 volts, the Piezo indicator will emit a constant audible signal (3.0 kHz @ 80 dB). Accordingly, the device is very useful for providing an audible stimulus, or alarm, when a physiological signal passes a certain threshold. As such, the OUT102 makes an excellent audible BPM indicator for ECG, blood pressure or respiration signals. The device can also be used to indicate when temperature or other slowly moving variable (e.g. electrodermal response) passes a certain threshold. The threshold for the OUT102 is determined by adjusting the amplitude control on the STM100C module. The specific Biopotential or Transducer amplifier signal monitored can be recorded while simultaneously directed through the STM100C module. To operate as described here, the source amplifier needs to be set to CH16, STM100C is set to CH16 input, and source signal must be able to reach at least +1.5v of amplitude. Source signal gain can typically be sufficiently adjusted by using the gain switch on the source amplifier module. STM100C amplitude control can be used to attenuate the source signal, as required, to help activate the Piezo transducer on only the desired source signal portions.

The OUT102 also connects directly to the UIM100C digital I/O ports for operation with Control Channel outputs. The OUT102 measures 2.5 cm (dia) x 1 cm (high) and comes equipped with a 1.8 m cable terminated in a 3.5 mm phone plug. An adapter is included for connecting the OUT102 to the UIM100C digital I/O ports.

The included 3.5 mm mono splitter (3.5 mm male mono phone plug to two 3.5 mm female mono sockets) and one CBL100 (3.5 mm mono male to 3.5 mm mono male cable) permit the analog drive signal to be directed to two locations. The drive signal – usually from DA0 or DA1 – is typically directed to the splitter cable. One socket output of the splitter cable is directed to the OUT102 input. The other socket output of the splitter cable is looped back to drive an available MP input, via CBL100, through the UIM100C. In this manner, during acquisition, the stimulus level and timing will be indicated on the recording.

OUT102 SPECIFICATIONS

Dimensions:	2.5 cm (dia) x 1 cm (high)
Cable Length:	1.8 meters
Connector Type:	3.5 mm phone plug + adapter for the UIM100C digital I/O ports

OUT103 LED CABLE

Use this LED cable to synchronize a light flash. The 3 meter cable makes it easy to use the LED for a variety of protocols. Terminates for connection to Analog OUT 0/1 and includes adapter for connection to Digital I/O. **Media synchronization** - Windows only - AcqKnowledge 4.1 and above.

The included 3.5 mm mono splitter (3.5 mm male mono phone plug to two 3.5 mm female mono sockets) and one CBL100 (3.5 mm mono male to 3.5 mm mono male cable) permit the analog drive signal to be directed to two locations. The drive signal – usually from DA0 or DA1 – is typically directed to the splitter cable. One socket output of the splitter cable is directed to the OUT103 input. The other socket output of the splitter cable is looped back to drive an available MP input, via CBL100, through the UIM100C. In this manner, during acquisition, the stimulus level and timing will be indicated on the recording.



Option 1: MP150 and UIM100C setup using an Analog Output

- a. Connect the OUT103's 3.5 mm phone plug from the LED to one of the arms of the included Y-cable.
- b. Connect the included CBL100 to the other arm of the Y-cable.
- c. Connect the stem of the Y-cable to one of the two Analog Output connections near the bottom of the front face of the UIM100C.
- d. Connect the other end of the CBL100 to an otherwise unused Analog Channel also on the front face of the UIM100C.
- e. Use "MP160/150 > Set Up Channels..." (in *AcqKnowledge* 4.4, choose "Channels" in the left pane after choosing "MP160/150 > Set Up Data Acquisition...") and acquire and plot the analog channel to which the CBL100 is connected.
- f. Use "MP160/150 > Set Up Stimulator..." (in *AcqKnowledge* 4.4, choose "Stimulator" in the left pane after choosing "MP160/150 > Set Up Data Acquisition...") to send 5 volt pulses through the Analog Output.

Option 1: MP160 and AMI100D/HLT100C setup using an Analog Output

- a. Connect the OUT103's 3.5 mm phone plug from the LED to one of the arms of the included Y-cable.
- b. Connect the included CBL100 to the other arm of the Y-cable.
- c. Connect the stem of the Y-cable to a CBL122 connected to one of the two Analog Output connections near the bottom of the front face of the AMI100D/HLT100C.
- d. Connect the other end of the CBL100 to a CBL122 connected to an otherwise unused Analog Channel also on the front face of the AMI100D/HLT100C.
- e. Use "MP160 > Set Up Channels..." (in *AcqKnowledge* 5, choose "Channels" in the left pane after choosing "MP160 > Set Up Data Acquisition...") and acquire and plot the analog channel to which the CBL100 is connected.
- f. Use "MP160 > Set Up Stimulator..." (in *AcqKnowledge* 5, choose "Stimulator" in the left pane after choosing "MP160 > Set Up Data Acquisition...") to send 5 volt pulses through the Analog Output.

Option 2: MP150 and UIM100C setup using a Digital I/O Channel

- a. Connect the OUT103 2 mm pin adapter to the 3.5 mm plug on the OUT103 cable.
- b. Connect the red OUT103 2 mm pin to a Digital I/O channel on the rear of the UIM100C and the black pin to GND D on the rear of the UIM100C.
- c. Use MP150 > Set Up Channels to acquire and plot the Digital I/O channel the OUT103 is connected to.
- d. Set MP150 > Show Manual Control
 - Set for 'Output.'
 - Enable the 'Set immediately' option.
 - Click the Digital I/O channel the OUT103 was connected to toggle between 0 and 1.

If necessary, click the 'Set' button to update the manual control and output a digital pulse.

MP36R setup - additional items required

- a. Connect an OUT3 (BNC adapter) to the 'Analog Out' port on the rear of the MP36R.
- b. Connect a BSLCBL6 (interface cable: BNC to 3.5 mm) to the OUT3.
- c. Connect the OUT103 3.5 mm plug to the BSLCBL6 3.5 mm socket.
- d. Set MP36 > Output Control 'Low Voltage Stim' option
 - Set Pulse width to 100 msec.
 - Set Pulse level to 5 volts – set Reference Channel to any digital channel.
 - Click the D'ON' button to output a digital pulse.

STM THERM THERMAL STIMULATOR



STM THERM Thermal Stimulator Unit (SCU) and TSD191 Transducer Probe (Thermode)

The STM THERM is a thermal stimulator that can deliver a range of hot and cold temperature stimulation to a subject, and can be used to identify participant thermoreceptor response thresholds for a variety of applications. The STM THERM consists of two parts, the Stimulator Unit (SCU) and the included TSD191 Thermal Stimulation Transducer (Thermode).

The TSD191 has a 30 mm x 30 mm contact area and includes a hook-and-loop strap to hold it in place. The STM THERM is an “open-loop” thermal stimulator, so there is no temperature feedback incorporated into the design. Accordingly, the STM THERM behaves similarly to a conventional voltage stimulator where the electrical applied stimulus is a function of drive level and associated loading. In the context of the STM THERM, the thermal stimulus temperature at the Thermode contact area is impacted by the heat-carrying capacity of the stimulus area.

In order to obtain an accurate measure of the specific stimulus temperature at the stimulus area, BIOPAC recommends use of the SKT100C Skin Temperature Amplifier Module and TSD202A Temperature Transducer, where the TSD202A is placed between the Thermode and the stimulus area.

The STM THERM is controlled via a voltage signal (Peltier thermoelectric method) and the Thermode temperature can be increased or decreased in a linear or step-change fashion. The STM THERM also has two manual pushbutton test modes that deliver a five-second step increase or decrease, respectively, to the present stimulus temperature.

The analog control input signal range is ± 10 volts, where negative voltages lower the temperature of the Thermode and positive voltages increase the temperature of the Thermode. An LED indicator on the front of the SCU turns red when the Thermode is being heated and blue when it is being cooled. The intensity of the LED indicates the relative amount of heating/cooling being applied via the control voltage.

The SCU interfaces directly to one of the AMI100D or HLT100C analog output ports for MP160 Systems, an HLT100C-MP150 analog output port for MP150 Systems, or with added OUT6 for MP36/MP36R Systems. The SCU can be controlled using AcqKnowledge software “Stimulator Setup” or “Manual Control” features.

Output interface: Use the Thermode (TSD191) to deliver temperature stimuli to participants. The transducer has a thermal stimulation area of 30 mm x 30 mm and includes a three-meter cable. The transducer incorporates a heat sink and cooling fan. Proper operation of the TSD191 requires that the fan airflow not be obstructed.

WARNING: When applying thermal stimulus to skin, DO NOT set the STM THERM control voltages at the -10 V or +10 V limits for longer than 5 seconds.

STM THERM THERMAL STIMULATOR Specifications

(Includes Stimulator Control Unit (SCU) & TSD191 Thermal Stimulation Transducer (Thermode))

SCU Weight	470 grams
Dimensions	Enclosure: 15.4 cm (wide) x 15.8 cm (deep) x 4.8 cm (high)
Cable MP160 MP150 MP36/36R	to AMI100D or HLT100D, 6-pin, RJ11, 2 meters long to HLT100C-MP150 via RJ11 via OUT6 (DSUB9 to RJ11) adapter
Control	- via <i>AcqKnowledge</i> arbitrary waveform stimulator window or external voltage source (range ± 10 V) - via "HOT PULSE" and "COLD PULSE" manual pushbuttons (each generates a 5 second thermal stimulus at 50% of maximum level; equivalent to ± 5 V fixed-step control voltage drive)
Fuse	3.5 amps
Power Supply	AC400 (12 V @ 5 amps)
Control Voltage Range	± 10 V (via HLT100D, AMI100D, MP36/36R, <i>AcqKnowledge</i> or external voltage source)
Operation	Voltage controlled thermal stimulation (Peltier thermoelectric)
Dynamic Range	± 10 V (20 V p-p) maps to 67.5° C p-p unloaded
Max Rate of Change	For 20 V p-p input, $\Delta T/\text{sec}$ max is 7.6° C/sec

The STM THERM can be easily controlled via the **Manual Control** window in *AcqKnowledge* software (MP1xx menu > Show Manual Control).

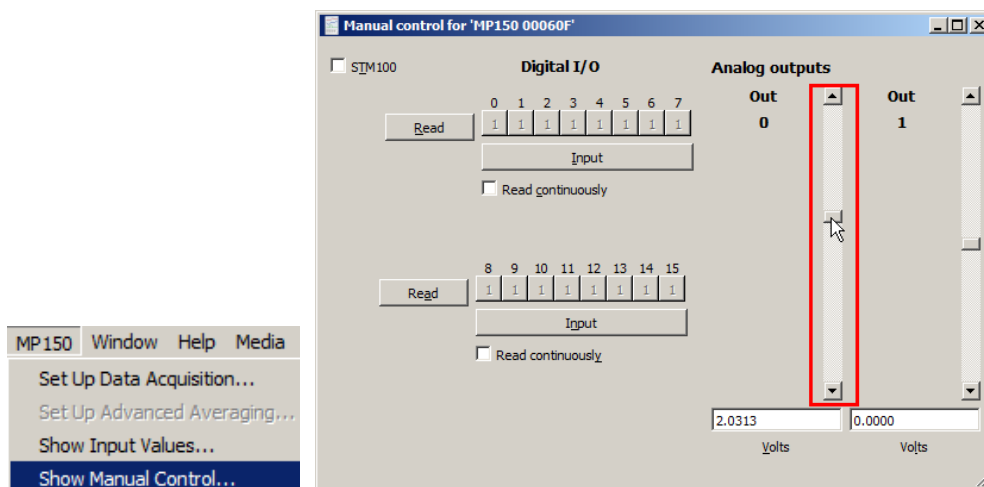

AcqKnowledge Manual Control Window

Adjust the vertical voltage slider to change the stimulus temperature. Up to two STM THERM Systems can be used with a single MP160/150 System.

Characteristic Voltage vs. Temperature Curves

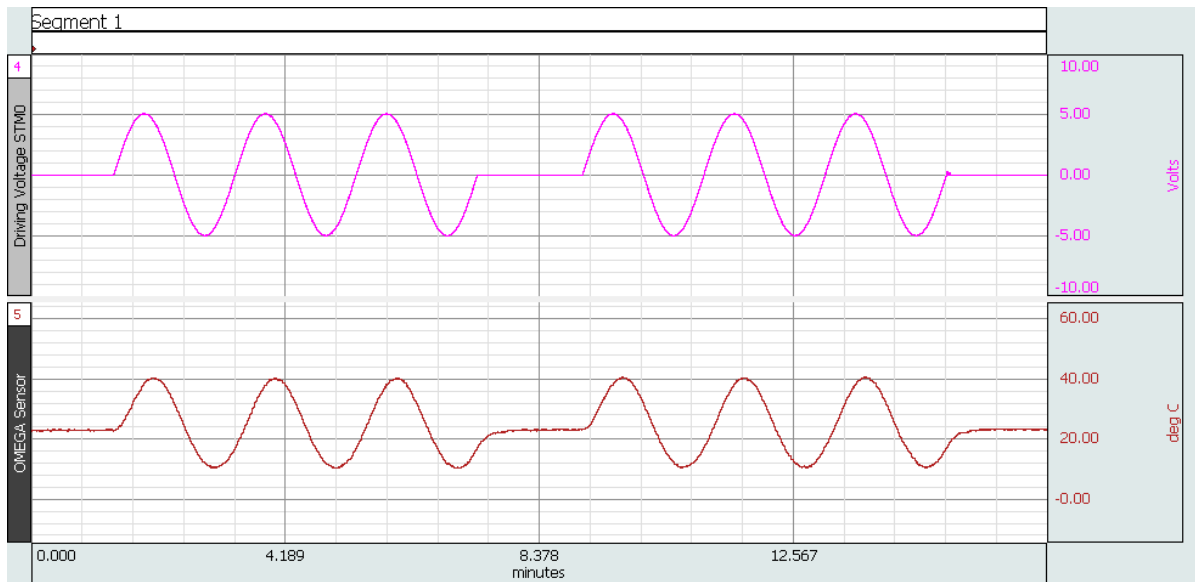

Figure 1: STM THERM driven by a sine wave (top trace) with voltage limits of +/- 5 V and frequency of 0.008333 Hz. Peak thermal signal (bottom trace) = 40.3 °C; minimum signal = 10.3° C. Delay between drive signal and thermal response ~ 9 – 10 sec.

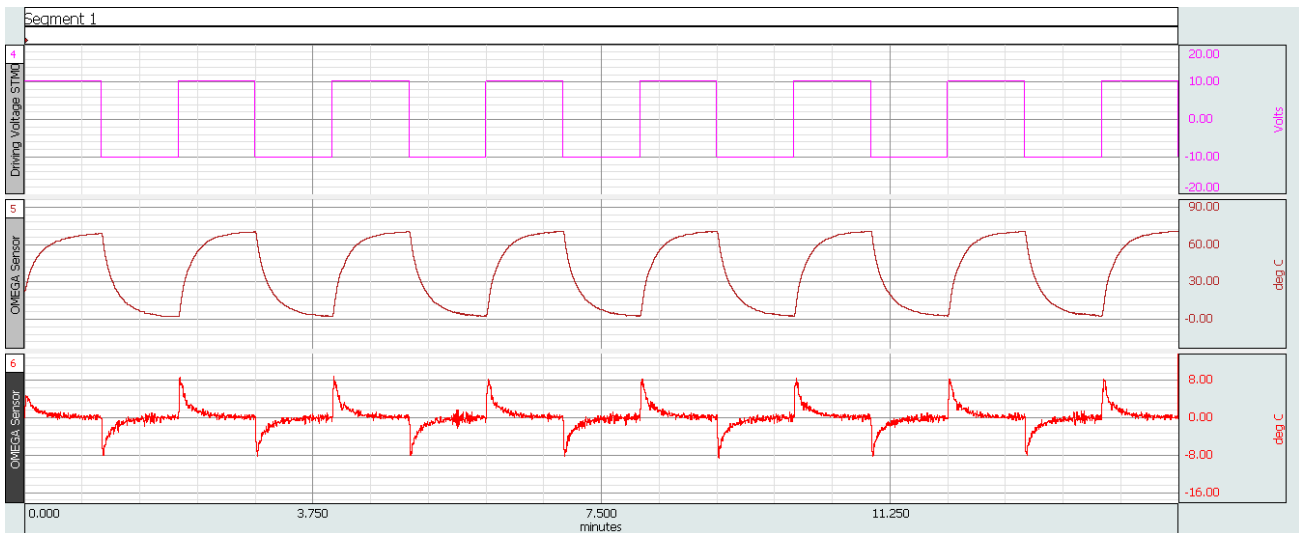

Figure 2: Unloaded response (no skin contact, using non-contact thermal imager) of the STM THERM to +/- 10 V stimulus waveform for High Temperature Range. **Stimulus cycle is 1 minute 10V, 1 minute -10 V.**

The **peak derivative of the response is 7.6 (C/sec)** and the **output temperature swing Δ = 67.51 (°C)**.

Top curve: stimulus, middle curve: response, bottom curve: derivative of response.

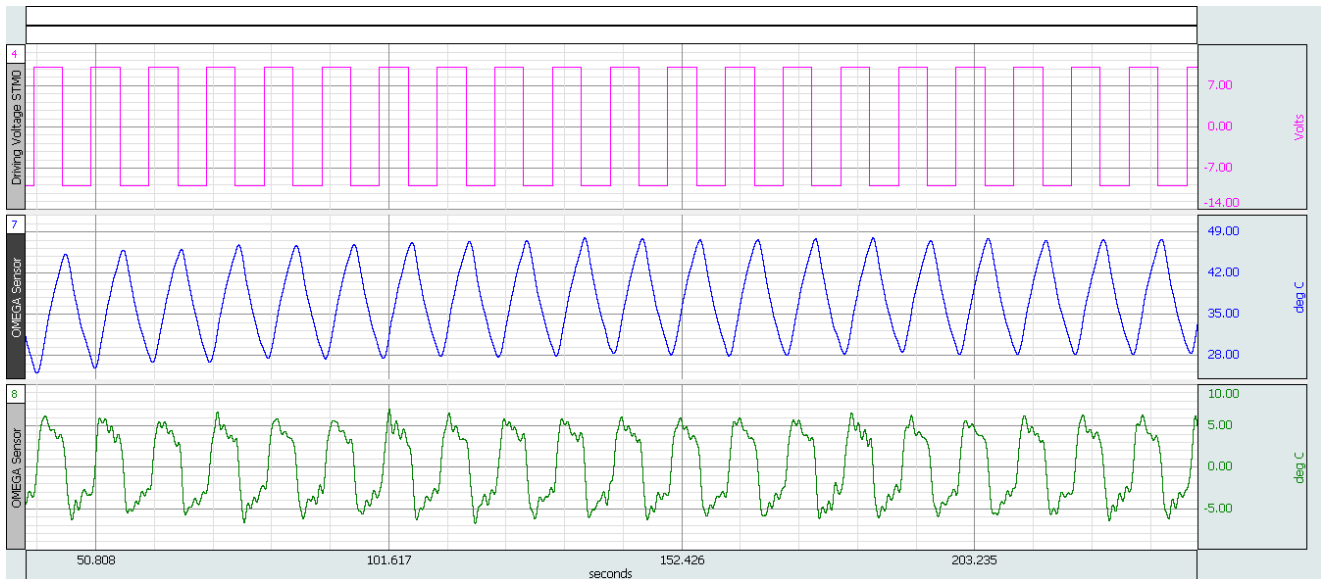

Figure 3: Unloaded response (no skin contact, using non-contact thermal imager) of the STM THERM to +/- 10 V stimulus waveform for High Temperature Range. **Stimulus cycle is 5 sec 10 V, 5 sec -10 V.**
 The **average derivative of the response is 4.3 (C/sec)** and the **output temperature swing $\Delta = 19.84$ ($^{\circ}\text{C}$).**
 Top curve: stimulus, middle curve: response, bottom curve: derivative of response.

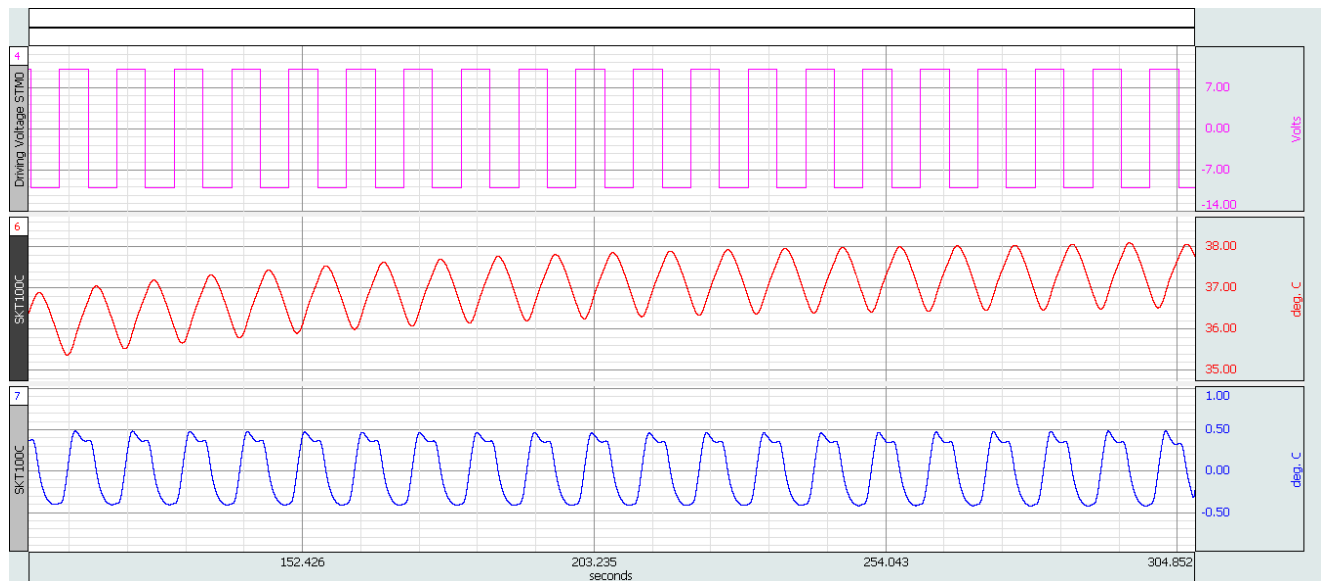
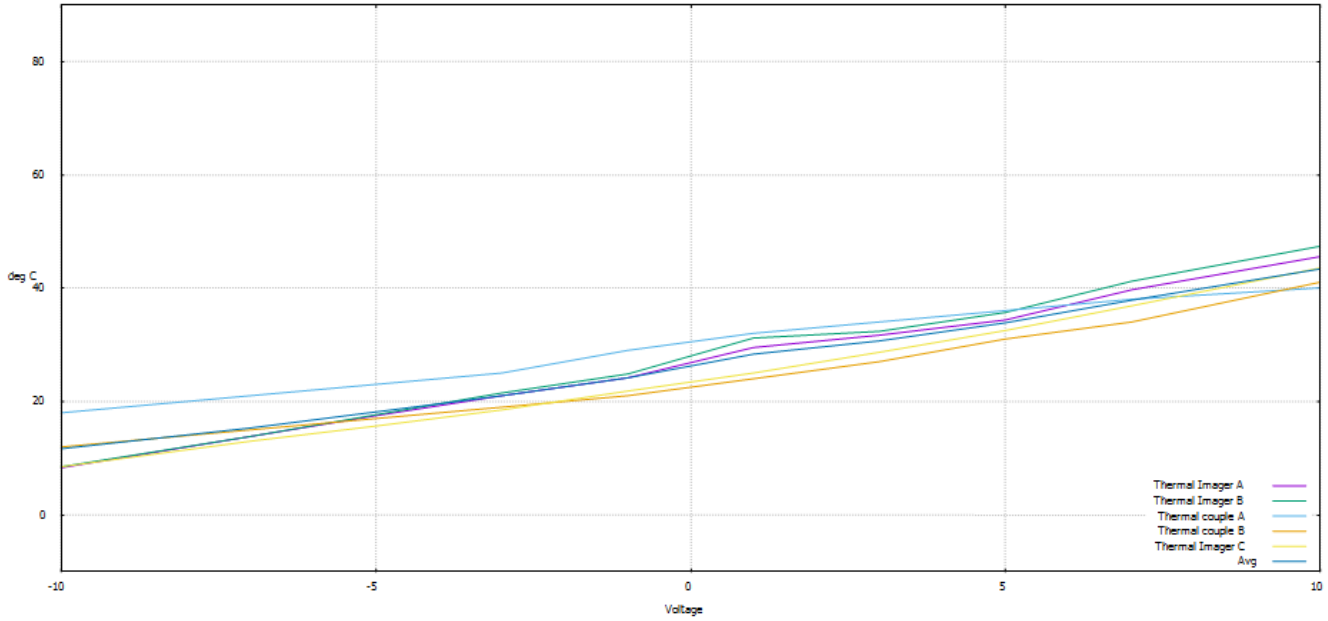
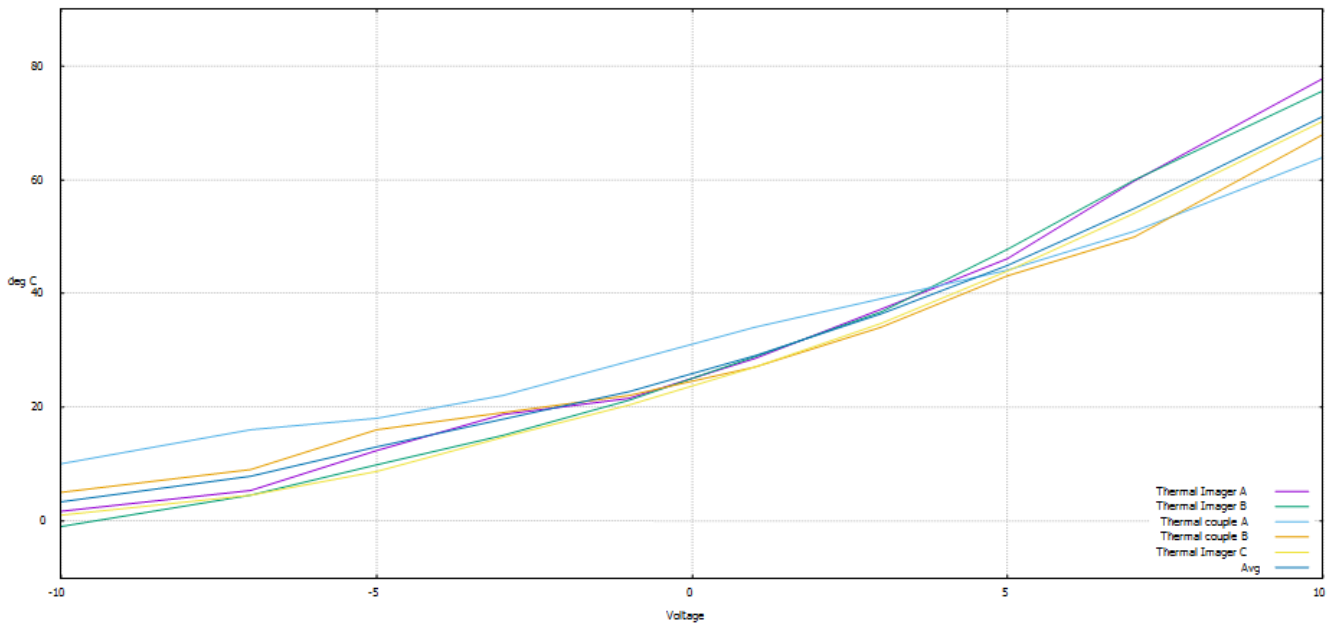

Figure 4: Loaded response (skin contact using TSD202A thermistor) of the STM THERM to +/- 10 V stimulus waveform for High Temperature Range. **Stimulus cycle is 5 sec 10 V, 5 sec -10 V.**
 The **average derivative of the response is 0.393 (C/sec)** and the **output temperature swing $\Delta = 1.64$ ($^{\circ}\text{C}$).**
 Top curve: stimulus, middle curve: response, bottom curve: derivative of response.



**Figure 5: STMTHERM Temperature Curves (Low Temperature Range)
Measured Performance Unloaded**



**Figure 6: STMTHERM Temperature Curves (High Temperature Range)
Measured Performance Unloaded**

Temperature Curve Legend

Thermal Imager A	Ryobi IR non-contact temperature probe
Thermal Imager B	FLIR IR imager
Thermocouple A	Thermocouple probe (Fluke meter) – Trial 1
Thermocouple B	Thermocouple probe (Fluke meter) – Trial 2
Thermal Imager C	OMEGA OS35 IR non-contact temperature probe

TSD191 THERMAL STIMULATION TRANSDUCER (THERMODE)

The TSD191 Thermode has a 30 mm x 30 mm contact area to deliver hot/cold thermal stimulus pulses when driven by the Stimulation Control Unit (SCU). The TSD191 Thermode is included with the STM THERM Thermal Stimulator but may also be ordered separately.

The Thermode incorporates a built-in heat sink and fan; the venting areas between the stimulation area and the heat sink should remain unobstructed to ensure proper operation.

The Thermode's response baseline will be the resting (normal) temperature of the Thermode in its ambient environment.

WARNING: When applying thermal stimulus to skin, DO NOT set the STM THERM control voltages at the -10 V or +10 V limits for longer than 5 seconds.

TSD191 SPECIFICATIONS:

Weight:	190 grams
Dimensions:	Enclosure: 59 mm (wide) x 51 mm (long) x 32 mm (high)
Cable:	6-pin mini DIN connector, 3 meter cable to STM THERM
Cooling:	Incorporates 50 mm x 50 mm fan
Thermode Active Area:	30 mm x 30 mm
Attachment:	Hook/loop fastening straps (34 cm long x 2.5 cm wide)

EPM100W STIMULUS PRESENTATION SYSTEMS WITH E-PRIME 3

These stimulus presentation packages include E-Prime experiment generator and an isolated digital interface (STP100C) with parallel port cable (CBL110C).



E-Prime provides experiment generation and millisecond precision data collection through data handling and processing. E-Prime is a powerful suite of applications combining precise millisecond timing, a user-friendly environment, and the flexibility to create simple to complex experiments for both advanced and novice users.

- EPM100W includes E-Prime 3.0
- EPM100 – E-Prime 3.0 software only

Use the *AcqKnowledge* Digital inputs to stim events tool to automatically score and label digital event marks from the E-Prime presentation. The digital channels are interpreted as a binary number. Each stimulus event placed into the graph has the corresponding number included with its label. This allows further analysis to distinguish between different types of stimulus events for automated event related analysis.

NEW WITH E-PRIME 3.0

- Support for tablets and touchscreens
- SlideButton sub-object for an area of response collection without using script
- SlideChoice sub-object to design multiple choice surveys, recognitions, recalls
- SlideSlider sub-object to design scales and sliders
- Slide Layout Templates for quick design
- Improved interface with tabbed workspace and easier access to windows
- Find and replace properties in an experiment
- Run an experiment in a floating window for quicker inspection and debugging
- Run desired List rows at runtime with Interactive order selection
- Interactively run List rows for debugging purposes
- Create conditional Task Events using subroutines in User Script
- Improved Audio/Video playback and load times
- Start an experiment from any List object
- Play movie and audio files in additional formats
- Online Experiment Library
- E-Prime Command Reference and online documentation
- New experiment design templates
- Access Full and User Script in the Structure window
- Automatically generate text data files upon completion of experiment
- Save a definition of columns of interest in E-DataAid
- Correct, Incorrect, Omission Task Events
- Check for Update checks web and prompts when updates are available

The E-Prime suite of applications includes:

- E-Studio – Drag and drop graphical interface for experiment design.
- E-Basic – Underlying scripting language of E-Prime (nearly identical to Visual Basic for Applications™).
- E-Run – Once experiment design is complete, a single mouse click generates it into an E-Basic script. E-Run then affords you the millisecond precision of stimulus presentation, synchronizations, and data collection.
- E-Merge – Quickly and easily combines your single session data files for group analysis.
- E-DataAid – Data management utility that allows you to filter, edit, analyze, and export your data.
- E-Recovery – Recovers data files in the event of early terminated experiments, or lost or corrupted files.

INTERFACE TO BIOPAC

Research Systems: MP160 or MP150 System—Use the Isolated Digital Interface ([STP100C](#)) to safely isolate digital inputs (in the range of 0-3.3 V or 0-5.0 V) and outputs; STP100C includes CBL110C, a 3-meter DB25 M/F ribbon cable to interface with E-Prime via the printer port.

Education Systems: MP36 or MP35 System—Use the [STP35A](#) DB25 M/F 3-meter ribbon cable to interface the computer printer port to the I/O Port on the back panel of the MP unit.

SYSTEM REQUIREMENTS

For E-Prime system requirements see:

- [Current release E-Prime 3](#)
- [Legacy versions E-Prime 1 and E-Prime 2](#)

See also: [STP100C](#), [STMEPM](#)

USB-TTL INTERFACE

USB-TTL Interface is a USB module which provides 16 TTL I/O lines that can have up to millisecond accuracy. It may be used to replace parallel port interfaces, which are no longer common on computers. This interface may be used for custom programming or for sending/receiving information from E-Prime, SuperLab, or other stimulus presentation programs.

USB TTL Module: Millisecond accurate* event marking across up to 16 I/O lines.

Gender Changer: Use to connect the USB-TTL to an STP100C for MP160/150 System, I/O Port on MP36/36R, or other 25-pin male device.

USB Lead: Use to connect the USB-TTL Module to the Host PC.

Key features:

- 16 Digital +5 V TTL Lines
 - 8 TTL Input
 - 8 TTL Output
- TTL Input Lines configured as an 8 bit port
- TTL Output Lines configured as an 8 bit port
- Change detection on TTL Input lines
- TTL Input to 2 hex bytes conversion representing 255 possible states
- Event marking: 2 hex bytes to TTL Output across 8 bit port representing 255 possible states
- TTL Output lines automatically latch once set
- Works out of the box with PCs/Macs/Linux—fully plug in & play
- Appears as a Virtual Com Port (VCP)
- Compatible with all Psychology experiment generators, e.g., E-Prime, SuperLab, Presentation, Inquisit, DMDX, ERTS, DirectRT, PsyScope, PsychoPy, OpenSesame, etc.
- Works with any software that can access a standard serial port
- Comes complete with timing validation software which checks round trip timing on your PC
- Fully documented API complete with examples
- Small and unobtrusive—Dimensions (WxHxD): 67.1 mm x 28.2 mm x 67.1 mm
- LED indicators for Input (green) and Output (red)
- Full-speed USB 2.0 (compatible with USB 3.0)
- Scans for TTL I/O changes 109,000 times each second
- Millisecond accurate TTL event marking*
- Utilizes The Black Box Toolkit technology

*Accuracy may be limited by PC and experiment generation software selected for stimulus presentation.

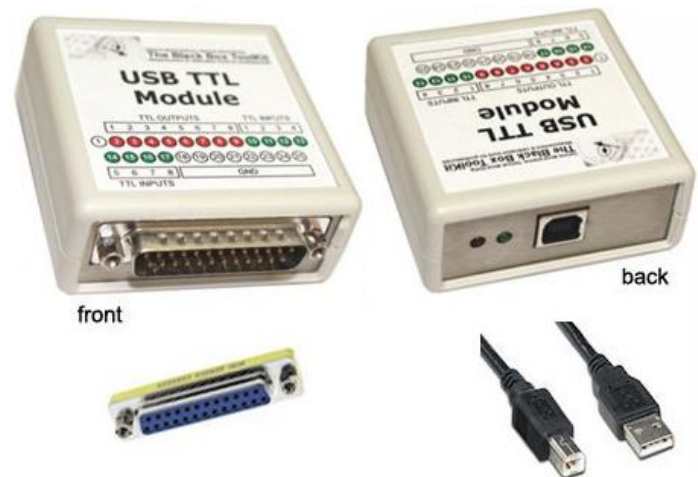

STM-CHRONOS

A Multifunctional Response and Stimulus Device



Chronos is a powerful new USB-based response and stimulus device. Chronos allows the accurate collection and verification of tactile, auditory, visual, and analog responses along with the precise source of audio and generic analog output timing. The Chronos graphical user interface allows for user-friendly implementation of the system's wide range of features.

Chronos features millisecond accuracy and consistent sound output latencies across machines. Chronos includes 16 digital inputs and 16 digital outputs, eliminating the need for a parallel port. All responses collected are synchronous to the E-Prime time domain. Multiple Chronos devices can be connected to a single PC using E-Prime 3 or 2 Professional. Chronos also introduces a large set of Task Events to facilitate the design of basic to complex experiments without the use of script (E-Prime 3 or 2 Professional).

Response Features

Keys

- 5 buttons
- 16 digital inputs
- Voice key
- n-key rollover
- Programmable debounce intervals

Audio Recording

- Stream and save vocal responses
- Start recording at object onset OR when speaking begins

Voice

- Sound-activated response (voice key)
- Condenser or dynamic microphone compatible
- Configurable audio input gain
- Configurable threshold settings for incoming audio responses and recording
- Detect sound to silence (offset threshold/post-silence interval)

Analog Input

- 3 Analog Inputs (plus Photo Sensor) with configurable onset and offset thresholds

Stimulus Presentation Features

LEDs

- 5 LEDs with programmable RGB color values (>4,000 colors per LED)
- Assign color values as response mapping verification, stimuli, or as feedback based on accuracy

Audio Output

- Present auditory stimuli with accurate and precise sound output latencies of 1 ms (Mix Mode 1) or a fixed latency of 6 ms (Mix Mode 2) across different machine hardware
- Configurable onset and offset output thresholds per channel

Analog Output

- 4 Analog Outputs
- Generate sine, saw tooth, square, triangle, and custom waveforms

Pulse Generator

- Generate square waveforms of configurable frequency

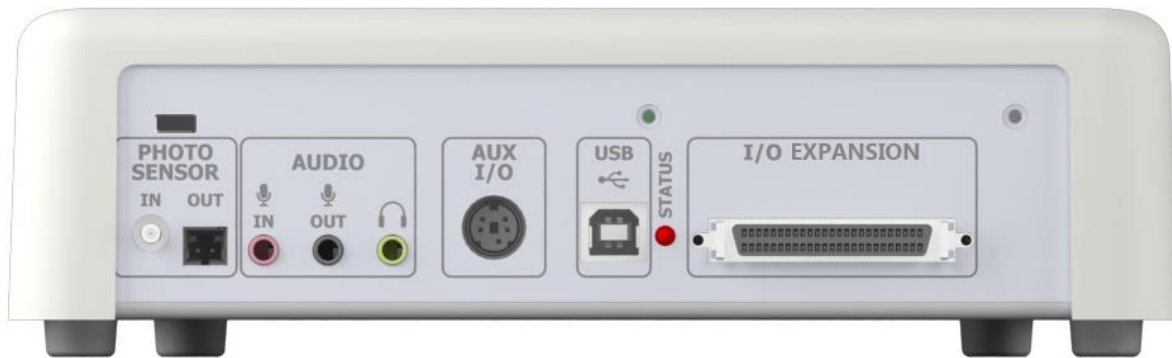

Chronos Console Chronos Photosensor Chronos Microphone Chronos USB Cable Chronos I/O Expander

STM-CHRONOS Systems Include:

- Chronos Console (20.32 cm x 16.51 cm x 6.03 cm)
- Microphone (10.16 cm x 24.77 cm)
- Photo Sensor
 - The Photo Sensor accessory can be used on CRT, LCD, and projection displays to detect stimulus onset events, refreshes, and measure rise and fall times
 - High speed photodiode adapted to human eye sensitivity
- USB cable (1.8 m)
- BIOPAC Interface Cable—choose for Smart Center, MP36/36R, or STP100C
 - **STM-CHRONOS-1** Chronos with Smart Center cable (HDMI I/O to 8 tinned wires)
 - **STM-CHRONOS-2** Chronos with MP36/36R cable (DSUB25 to 8 tinned wires)
 - **STM-CHRONOS-3** Chronos with STP100C cable (DSUB25 to 8 tinned wires)
- Auxiliary I/O breakout cable assembly
 - 2 digital inputs, 2 digital outputs, 1 power (5 V), 1 digital ground, 1 analog input, and 1 analog ground
- I/O Expander
 - Provides access to 16 digital inputs, 16 digital outputs, 1 pulse generator, digital powers and grounds, 3 analog inputs, 4 analog outputs, analog grounds
- Demonstration Equipment
- Samples and Tutorials
- Kensington® lock support (lock not included)

System Requirements

- Windows 8.1/8, 64-bit, Windows 7, 64 & 32-bit
- Pentium-compatible Dual-Core or Multi-Core processor, 2 Ghz
- 2 GB RAM
- USB 2.0, 3.0, or powered hub port
- E-Prime 3 or 2 Standard/Professional

Auxiliary I/O Breakout Cable Information

The Auxiliary I/O Breakout cable enables connection of up to two digital inputs, two digital outputs, and one analog input. The table below specifies the corresponding function and wire colors. Note that the outputs are zero-based while the inputs are one-based.

Pin	Color	Function	Description	Response Mapping (Pseudo Button)
1	Light Blue	+5V	+5V	n/a
2	Light Green	OUT14 (base 0)	Digital Output	n/a
3	Purple	OUT15	Digital Output	n/a
4	White	Digital Ground	Digital Ground	n/a
5	Orange	Analog Ground	Analog Ground	n/a
6	Yellow	IN16 (base 1)	Digital Input	G
7	Brown	IN15 (base 1)	Digital Input	F
8	Red	ADC1	Analog Input	9

I/O Expander Pin Assignments

The I/O Expander Connector is used to facilitate communication with a variety of devices. The image below shows the location on the Push-in Terminal Block for the 16 digital outputs, 16 digital inputs, one pulse generator (see block labeled “P”), four analog outputs and three analog inputs. Note when using E-Prime, that the outputs are zero-based while the inputs are one-based. For example, digital output 7 is referenced in E-Basic script as Chronos.DigitalOut.SetBit 6. Users who purchase the Custom Expansion Kit may also communicate with the I/O external interfaces.

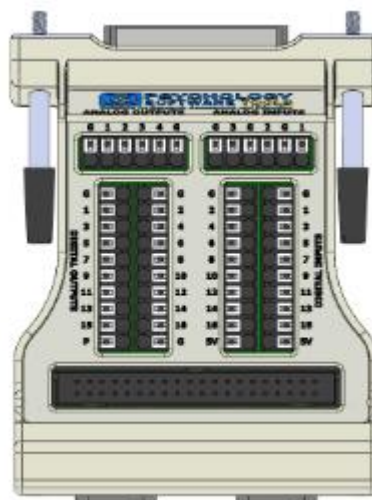

I/O Expander 40-pin Header Pin Assignments

Users who purchase the Custom Expansion Kit may also communicate with the I/O Expander. In addition to the Push-in Terminal Blocks, the 40-pin header on the IO Expander can be used to connect Chronos digital inputs 1-16 and digital outputs 1-16 directly to the Custom Expansion Kit using the kit's included ribbon cable. This enables the 16 inputs and outputs to be configured with the LEDs and switches that can be ordered with the kit.

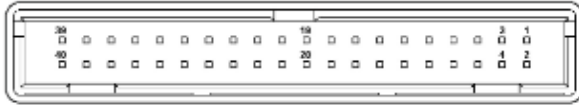

I/O Expander 40 Pin Assignments (1-20)	
PIN NUMBER	DESCRIPTION
1	5V @ 150 mA
2	Ground
3	Digital Input 1
4	Digital Input 2
5	Digital Input 3
6	Digital Input 4
7	Digital Input 5
8	Digital Input 6
9	Digital Input 7
10	Digital Input 8
11	Digital Input 9
12	Digital Input 10
13	Digital Input 11
14	Digital Input 12
15	Digital Input 13
16	Digital Input 14
17	Digital Input 15
18	Digital Input 16
19	5V @ 150 mA
20	Ground

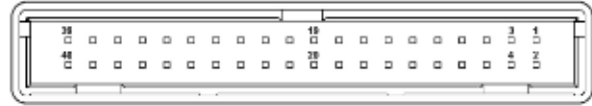

I/O Expander 40 Pin Assignments (21-40)	
PIN NUMBER	DESCRIPTION
21	Ground
22	Ground
23	Digital Out 1
24	Digital Out 2
25	Digital Out 3
26	Digital Out 4
27	Digital Out 5
28	Digital Out 6
29	Digital Out 7
30	Digital Out 8
31	Digital Out 9
32	Digital Out 10
33	Digital Out 11
34	Digital Out 12
35	Digital Out 13
36	Digital Out 14
37	Digital Out 15
38	Digital Out 16
39	Ground
40	Ground

STIMTRACKER DUO, STIMTRACKER QUAD

Mark. Sync. Audit.

STK100-DUO-IO, STK100-DUO-STP, STK100-QUAD-IO, STK100-QUAD-STP

StimTracker Duo and Quad autonomously detect the onset of events to avoid operating system delays. The Quad adds direct TTL output, support for vocal response onset (voice key), more light sensors, and the option to install a Raspberry Pi board.



Onset of Auditory Stimuli—Pass the audio via StimTracker, set threshold, and let it do the rest.

Onset of Visual Stimuli—Fast light sensors included.

Event Codes via USB—Send event codes from your stimulus presentation computer for added information

Onset of Key Response—Compatible with RB response pads (Quad model also accepts TTL input)

Onset of Vocal Response—It's like getting a free voice key device (Quad model only).

StimTracker uses m-pod to deliver its signals, which means you can choose which types of events are sent to the recorder.

Jitter Free USB

When sending event markers via USB, StimTracker delivers them with jitter free precision when used with SuperLab 6 or with our open source Python or C++ libraries. Delay is guaranteed to be 2 milliseconds exactly, every time. Other software packages may not deliver jitter free performance; for instance, E-Prime E-Basic code precision is 5 to 8 ms.

Power Packed

The combination of powerful 32-bit microprocessors and our software makes possible the following features:

Async Output

To send a 10 ms long event marker with other I/O devices, an app needs to raise the output line, wait 10 ms, then lower the line. With StimTracker, all the software needs to do is send a command and resume working while microprocessors take care of delivering the pulse.

Scheduler

A truly unique feature: tell StimTracker when to send pulses at a later time, e.g. to mark emotional points during a movie presentation.

Pattern Generator

Use StimTracker as a signal generator on an output line or as a more complex pattern generator.

Use the AcqKnowledge Digital inputs to stim events tool to automatically score and label digital event marks from the SuperLab presentation. The digital channels are interpreted as a binary number. Each stimulus event placed into the graph has the corresponding number included with its label. This allows further analysis to distinguish between different types of stimulus events for automated event related analysis.

StimTracker	Quad	Duo
Marks onset of visual stimuli	✓	✓
Number of light sensor inputs On Quad model, you can use 3 light sensors and a microphone (for voice key), or 4 light sensors and no microphone.	3 + 1	2
Marks onset of auditory stimuli	✓	✓
Marks onset of RB-x40 response pads key presses	✓	✓
Marks onset participant vocal response via microphone	✓	—
Accepts external TTL input	✓	—
Time-stamped output via USB	✓	✓
Number of simultaneous m-pod outputs	3	2
Direct TTL output <small>m-pod delivers TTL output as well.</small>	✓	—
Optional Raspberry Pi support	✓	—

M-PODS AND C-PODS

Map any Input Signal to any Output Pin—Event Markers sent USB

STM-M-POD-IO for MP36/36R Systems

STM-M-POD-STP for STP100C and MP160 Systems



STM-M-POD-IO



STM-M-POD-STP

Use m-pod to map any input signal to any output pin, or combine any number of input signals to a single output pin and build your very own custom output table. With its speedy microprocessor, this translation power adds a minuscule 50 μ s delay.

Use m-pods to get all, or only, the desired signals. In some experiments, it may be appropriate to mark the onset of participants' key presses. In others, these markers get in the way and it may be preferable to have more data bits available for markers sent via USB. Or even a mix of both.

No more fussing over the right connector size, gender, and pin assignments—just choose the m-pod for the specific interface and enjoy instant compatibility:

- interface directly to the I/O port on MP36 and MP36R units, or
- interface to an STP100C for MP160 Systems

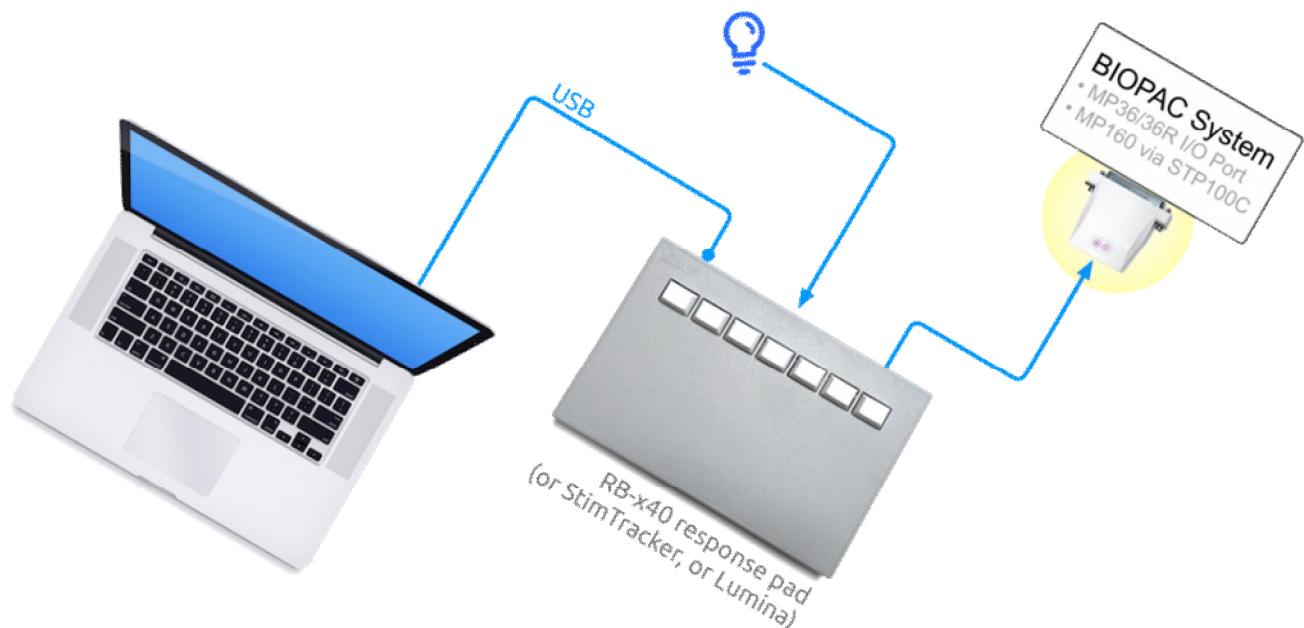

Easily Send Event Markers from Computer to Recording Devices—Affordable Jitter-Free Precision

STM-C-POD-IO for MP36/36R Systems

STM-C-POD-STP for STP100C and MP160 Systems



STM-C-POD-IO



STM-C-POD-STP

Send event markers via USB with high precision. c-pods simplify connection & timing details and deliver guaranteed jitter-free performance.

- Asynchronous Output
- Scheduler
- Pattern Generation
- Mixed output
- 32-bit microprocessor
- Interface directly to I/O port on MP36 and MP36R units, or to an STP100C for MP160 Systems.

Asynchronous Output

With traditional I/O cards, software programs used for sending pulses need to wait for the duration of the pulse before work can resume. Imagine sending a postcard to a friend and then not being able to do anything else until that postcard is delivered. It's a lot of wasted time. This is synchronous delivery.

c-pod can deliver signals asynchronously—an application sends a command that includes the pulse duration and then resumes working, e.g. to present a stimulus or look for participant response. c-pod takes care of completing the pulse delivery.

Scheduler

c-pod takes the idea of asynchronous output a step further. Instead of delivering a pulse now, why not deliver it later? Better yet, why not deliver multiple pulses later?

This is a useful feature that answers the following question: when presenting a movie or sound, how can I mark certain points precisely during playback?

With the scheduling feature, it's possible to preload c-pod with a list of times for pulse delivery, the length of the pulse, and the output line(s) that it should be delivered on. A subsequent command can be sent at the onset of the movie or sound to start executing the schedule.

Pattern Generation

c-pod can function as a pattern generator as well, sending periodic pulses out on a user-defined output line, or even pulses of different periods on multiple output lines. This is useful for applications requiring strobing, or where the intensity of light or a motor is controlled using pulse width modulation (PWM).

Mixed Output

And more: the features described above are not mutually exclusive. For example, while a schedule is being executed on output lines 1, 2, and 3, an async pulse command can be sent at any time on the remaining lines 4 through 8.

Similarly, while a pattern is being generated on some lines, an asynchronous pulse command can be sent on the remaining lines. c-pod will not skip a beat.

32-Bit Microprocessor

Inside the c-pod is a computer with a speedy 32-bit engine, humming with useful, well-polished software.

	c-pod	m-pod <i>+ using an existing response pad</i>	StimTracker
Send Pulses Asynchronously	✓	✓	✓
Signal / Pattern Generator	✓	✓	No
Pulse Scheduler Feature	✓	✓	No
Marks Onset of Participant Key Presses	No	✓	No
Marks Onset of Visual Stimuli	No	✓	✓
Marks Onset Of Auditory Stimuli	No	No	✓
Marks Onset of External TTL Input	No	No	✓
Voice Key	No	No	✓
Number of Simultaneous Outputs	1	1	2

M-POD EVENT PRESENTATION & MARKING SYSTEMS

STM-M-POD-SYS-IO (for MP36/36R Systems)

STM-M-POD-SYS-STP (for MP160 Systems)

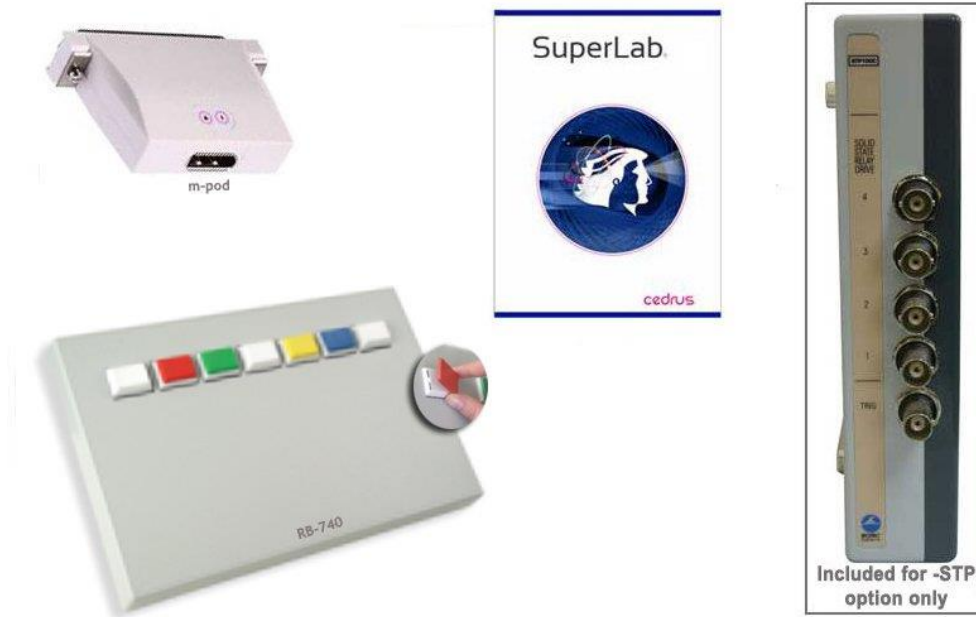

These Event Presentation & Marking Systems include m-pod, SuperLab Pro Stimulus Presentation Software, Response Pad (RB-740), and BIOPAC interface cable (option to interface MP160 System also includes Isolated Digital Interface STP100C).

SuperLab offers a host of powerful features, including

- Playing movies
- Stimulus lists
- Support for JPEG, GIF, PNG, and TIFF files
- Built-in support for RSVP and self-paced reading
- Improved support for fMRI and EEG/ERP
- Trial variables
- Conditional branching (if/then/else)
- Multiple input devices in the same experiment
- Unicode application that handles Japanese, Chinese, and other international fonts just as easily as it handles English fonts.

See also: Product description and specs for m-pod, StimTracker, SuperLab, and STP100C.

STP100W STIMULUS PRESENTATION SYSTEM (SUPERLAB™)

The STP100W system includes:

- SuperLab™ Pro Software (Windows)
- STP100C Optical Interface (w/3-meter ribbon cable)*

- ✓ Measures physiological responses to stimuli
- ✓ Permits up to eight synchronization signals (input or output) between the STP100W and the MP System

STM-C-POD-STP for MP160

Pushbutton Keycap Color Change Kit

Six Pushbutton Response Box

- ✓ Performs accurate (1 ms resolution) reaction time measurements

The STP100W is a stand-alone system that measures subject responses to visual or auditory stimuli. It can present visual stimuli on a computer screen, or auditory stimuli via headphones or speakers, and simultaneously (1ms resolution) send trigger signals to an MP System on a different computer for data synchronization and collection purposes.

The SuperLab™ Pro software can change the placement of visual stimuli on the screen or change the screen's background color. It offers a variety of input and timing options, and will provide feedback based on the subject's response or reaction time. Different trigger channels can be paired to different visual or auditory stimuli to perform sophisticated evoked response averaging tests (e.g. P300).

Second PC required— The synchronization signal(s) coming from the STP100W can be directed to an MP System running on a Mac or PC, but it's not possible to run the STP100W on the same computer as the MP System. The STP100W requires that the SuperLab™ software and a STM-C-POD-STP be placed on a PC.

*To interface the STP100C with devices that use BNC outputs, such as the fNIR System trigger ports, use the CBL125 BNC-to-BNC cable.

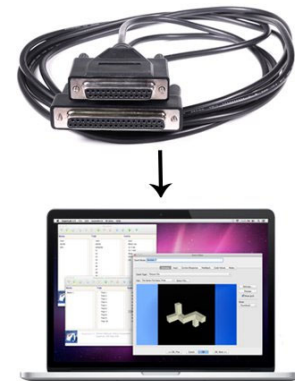
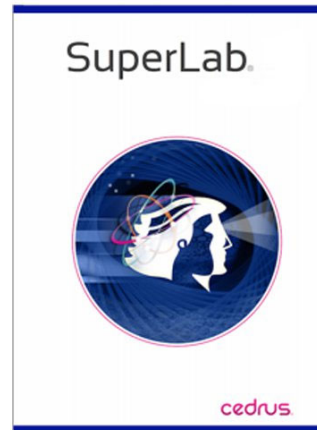

Analog						Digital	Calculation	
Acquire	Plot	Value	Channel	Label				
<input type="checkbox"/>	<input type="checkbox"/>	<input type="checkbox"/>	D0	Digital input	2,000 kHz			
<input type="checkbox"/>	<input type="checkbox"/>	<input type="checkbox"/>	D1	Digital input	2,000 kHz			
<input type="checkbox"/>	<input type="checkbox"/>	<input type="checkbox"/>	D2	Digital input	2,000 kHz			
<input type="checkbox"/>	<input type="checkbox"/>	<input type="checkbox"/>	D3	Digital input	2,000 kHz			
<input type="checkbox"/>	<input type="checkbox"/>	<input type="checkbox"/>	D4	Digital input	2,000 kHz			
<input type="checkbox"/>	<input type="checkbox"/>	<input type="checkbox"/>	D5	Digital input	2,000 kHz			
<input type="checkbox"/>	<input type="checkbox"/>	<input type="checkbox"/>	D6	Digital input	2,000 kHz			
<input type="checkbox"/>	<input type="checkbox"/>	<input type="checkbox"/>	D7	Digital input	2,000 kHz			
<input checked="" type="checkbox"/>	<input checked="" type="checkbox"/>	<input type="checkbox"/>	D8	SuperLab Channel 1	2,000 kHz			
<input checked="" type="checkbox"/>	<input checked="" type="checkbox"/>	<input type="checkbox"/>	D9	SuperLab Channel 2	2,000 kHz			
<input checked="" type="checkbox"/>	<input checked="" type="checkbox"/>	<input type="checkbox"/>	D10	SuperLab Channel 3	2,000 kHz			
<input checked="" type="checkbox"/>	<input checked="" type="checkbox"/>	<input type="checkbox"/>	D11	SuperLab Channel 4	2,000 kHz			
<input checked="" type="checkbox"/>	<input checked="" type="checkbox"/>	<input type="checkbox"/>	D12	SuperLab Channel 5	2,000 kHz			
<input checked="" type="checkbox"/>	<input checked="" type="checkbox"/>	<input type="checkbox"/>	D13	SuperLab Channel 6	2,000 kHz			
<input checked="" type="checkbox"/>	<input checked="" type="checkbox"/>	<input type="checkbox"/>	D14	SuperLab Channel 7	2,000 kHz			
<input checked="" type="checkbox"/>	<input checked="" type="checkbox"/>	<input type="checkbox"/>	D15	SuperLab Channel 8	2,000 kHz			

SuperLab Set up

1. Connect the **SuperLab** output card via the STP100C to the AMI100D, HLT100C, or UIM100C and the BIOPAC MP160 or MP150 System.
2. Create the presentation using the appropriate digital outputs from the **SuperLab** PC to the MP160/150.
 - See the **SuperLab Manual** for instructions on how to create the presentation.
3. Setup digital channels 8-15 (as used in the presentation) using the MP160/150>Setup Channels>Digital dialog.
 - The **SuperLab** stimulus output synchronization signals will be output on digital lines 8 through 15. In order to record the changes and use the stimulus for analysis purposes, the appropriate channels must have “Acquire” enabled.

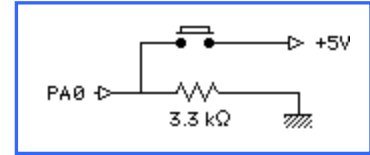

- ✓ **SuperLab** employs a STM-C-POD-STP that uses Port A for input and Port B for output (Port C is unused). For input, lines must be “pulled low” (connected to ground by a resistor). The diagram illustrates how this is done for line A0 (pin 37). The same diagram applies for lines A1 to A7. The resistor’s value may range from 2.2 kilo-ohm to 5 kilo-ohm.

Cedrus highly recommends that all lines on Port A are pulled low even if all 8 input lines will not be used. **Better yet:** connect unused lines directly to ground.

To add other digital inputs and outputs to the system, simply remove the 2 mm pin plugs from the STP100C Interface Module. The 2 mm pins are screwed in and can be removed and added to mirror the particular application.

STP35W SUPERLAB SYSTEM FOR MP36R/MP36/MP35



- STP35W Components**
- SuperLab Software
 - STM-C-POD-IO marking unit for MP3x
 - STP35B Interface Cable
 - Six-button Response Box
 - Pushbutton Keycap Color Kit

The STP35W is a stand-alone system that measures subject responses to visual or auditory stimuli. It can present visual stimuli on a computer screen, or auditory stimuli via headphones or speakers, and simultaneously (1ms resolution) send trigger signals to an MP36R/MP36/MP35 System for data synchronization and collection purposes. The STP35W system includes:

- **SuperLab** – present visual stimuli on a computer screen, or auditory stimuli via headphones or speakers, and simultaneously (1 ms resolution) send trigger signals for data synchronization and collection purposes to an MP36/35 BSL System or MP36R Research System.
- **c-pod marking unit** – for measuring physiological responses to stimuli, the c-pod marking unit synchronizes multiple signals (input) between the STP35W and the MP36/36R/35 System. The c-pod will send event markers via USB with high precision. Features include Asynchronous Output; Scheduler; Pattern Generation; Mixed output, 32-bit microprocessor. c-pods simplify connection & timing details and deliver guaranteed jitter-free performance.
- **Interface** – use the included STP35B for MP36/36R/35 to parallel port connections
- **Response Box** – Use the six-pushbutton response box for performing accurate (1 ms resolution) reaction time measurements.

NOTE: Second PC required. The synchronization signal(s) coming from the **STP35W** can be directed to a BIOPAC System running on a PC or a Mac, but it's not possible to run the **STP35W** on the same computer as the BSL MP36/35 System or MP36R Research System. The **STP35W** requires that the SuperLab software and c-pod be placed on a PC running Windows 7/Vista/XP; Mac OS X setups require a StimTracker ([STK100](#)).

See BSL *PRO* Lesson H30 Stroop Effect for details of the classic psychology experiment and a sample of how SuperLab works with the BSL System.

STP35 MP36R/MP36/MP35 TO SUPERLAB



For users who already have SuperLab and an MP3X unit, the STP35 Interface Cable can be used to connect the two systems. The STP35 cable interfaces with the I/O port of the rear of the MP36R/MP36/MP35 unit.

STP35B MP36R/MP36/MP35 TO PARALLEL



MP36R/MP36 or MP35 to E-Prime, Direct RT, MediaLab, Inquisit, and other systems that connect via the parallel port.

TSD122 SERIES STROBOSCOPE



The TSD122 Stroboscope connects directly to the UIM100C or STM100C for Visual Evoked Response applications. This battery-operated device will provide 360,000 flashes between charges. The unit will go from zero to a maximum of 12,000 flashes per minute. It has external TTL synchronization and Trigger facilities for interfacing with the MP System and other equipment.

The TSD122 can be used for:

- Single pass or averaging type visual evoked response applications.
- Synchronize the stroboscope to an averaging pass.
- Trigger the stroboscope during acquisition or during an averaging pass.
- Trigger an acquisition or an averaging pass with the stroboscope.
- Use a digital input to acquire the signal synchronized with the stroboscope.
- Use an analog input to acquire the signal synchronized with the stroboscope.

The TSD122 connects to the AMI100D or HLT100C via the CBL122 (3.5 mm to RJ11) cable adapter.

The TSD122 can also be used to trigger the MP System, via the External Trigger terminal block (on the back of the UIM100C).

TSD122A Stroboscope 120 V/60Hz

To use the TSD122 Stroboscope with a BSL or MP36R unit, order as TSD122C (includes BSLCBL5); see BSL *PRO* Lesson H22 Visual Evoked Potentials for setup guidelines.

TSD122C Stroboscope 120 V/60Hz

TSD122 SPECIFICATIONS

Display:	Digital LCD
Battery:	Built-in, rechargeable
Battery Life:	60 hours at 100 strobes/sec (360,000 strobes between charges)
Flash duration:	30 μ sec
Flash energy:	180 mJoule
External TTL:	Sync/Trigger
Weight:	1.1 kg
Body Dimensions:	9.3 cm (wide) 9 cm (high) x 23 cm (long)
Reflector Housing:	12.2 cm (dia)
Handle:	10.8 cm (long)
I/O Ports:	TTL (Sync input and output)—3.5 mm phone jacks
Cables:	CBL102, CBL122, and CBL106 or BSLCBL5
Interface:	AMI100D, HLT100C, UIM100C or MP36R STM100C (triggered)

BIOHARNESS WITH ACQKNOWLEDGE

BioHarness Data Logger and Telemetry Physiology Monitoring System

BioHarness-5 Data Logger and Telemetry Physiology Monitoring System (five-system package)

- Go to www.biopac.com for a video of BioHarness in use
- Complete [BioHarness Users Guide](#) is online

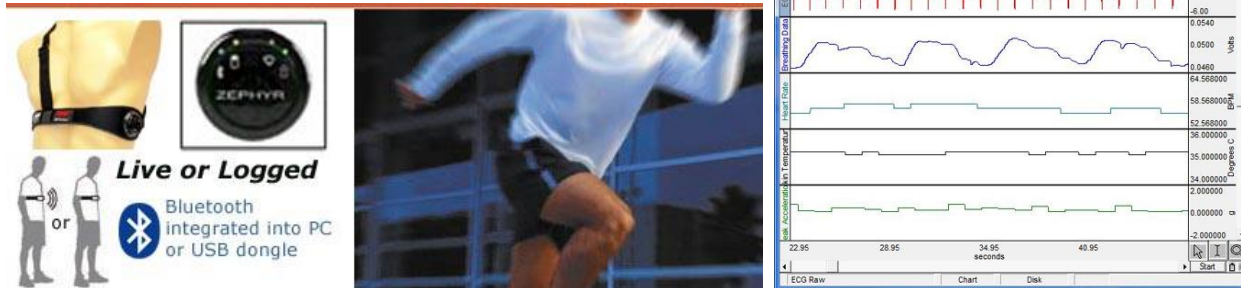

BioHarness™ with AcqKnowledge® software is a state-of-the-art lightweight portable biological data logger and telemetry system. It monitors, analyzes and records a variety of physiological parameters including ECG, respiration, temperature, posture, and acceleration. The BioHarness operates in RF (Radio Frequency) transmitting mode for live viewing of data or data logging mode. In the data logging mode, the BioHarness logs the data for later download to the AcqKnowledge software using the USB docking and charging cradle that comes with the system. BioHarness applications include physiology, psychology, psychophysiology, exercise physiology, ergonomics, human factors, and more.

BioHarness-5

This five-system BioHarness solution is ideal for small group studies.

BioHarness Data Channels

- ECG – Raw
- Breathing
- RR Interval
- Heart Rate
- Respiration Rate
- Posture
- Vector Magnitude
- Peak Acceleration
- Breathing Wave Amplitude
- X axis acceleration min
- X axis acceleration peak
- Y axis acceleration min
- Y axis acceleration peak
- Z axis acceleration peak
- Z axis acceleration min

Live data viewing features include a variety of selectable waveforms and trend data including:

- ECG
- Heart Rate
- RR values
- Respiration
- Tri-axial accelerometer (X, Y & Z)
- Activity level
- Posture (attitude of device in degrees from vertical)

BioHarness™ is a trademark of Zephyr Technology Limited.

Specifications

- Acceleration** Highpass 0; Low pass limited to 10.5 Hz, and sampled at 18 Hz. The maximum and minimum measured in each second are reported.
- Posture** Highpass 0. Based on the accelerometer with a 6.5 Hz low pass filter to limit the noise resulting from movement and provide a stable reading.
- Activity** Requires the magnitude of the AC components of each axis; uses a digital 0.1 Hz highpass filter and a 10.5 Hz lowpass hardware filter. Sampled at 18 Hz and accumulated for 1 second reporting.
- Respiration** Detect breathing rates from 3 BPM to 70 BPM (0.05 Hz to 1.166 Hz)
- ECG** In hardware, the signal is filtered with a highpass filter at 15 Hz and a low pass filter at 78 Hz. The low end filter cut-off enables heart rate measurement under vigorous activity (high resistance to motion artifact). The sample frequency is 250 Hz.

Smart Fabric Strap

- Chest Strap: Adjustable, Velcro® fastening
- Material: Elasticized webbing incorporating Zephyr Smart Fabric sensors
- Width: 50 mm
- Weight: 50 grams
- Size: BioHarness ships with a small-to-medium strap
Additional straps are available:
RXBHSTRAP-S-M (small to medium size frames, 69-84 cm; 27-33")
RXBHSTRAP-M-XL (medium to extra-large size frames, 84-104 cm; 33-41")

BioHarness Transmitter/Logger

- BioHarness or BioHarness 5 (five bundled systems for small group studies)
- Frequency: Bluetooth 2.4 to 2.835 GHz
- Sample Rate: 250 Hz Max.
- Memory Capacity: ~480 hours
- Transmit Range: Up to 100 m, environment and antenna dependent
- Weight: 18 grams
- Size: 28 mm (diameter) x 7 mm

Battery Life

- ~ 12-28 hours transmitting
 - ~ 35 hours logging
- Charging is intelligent - the device cannot be overcharged
- Quick Charge (90%): 1 hour from fully discharged
 - Full charge (100%): 3 hours from fully discharged

Connectivity

- USB (either built-in chip or USB Bluetooth dongle)

Compliance

- This device complies with Part 15 of the FCC Rules. Operation is subject to the following two conditions:
1. This device may not cause harmful interference.
 2. This device must accept any interference received, including interference that may cause undesired operation.

BIOHARNESS TEAM SYSTEMS

- TEAMSYSTEM-1A – Team System Physiology Monitoring for 1 Subject
- TEAMSYSTEM-1B – Team System Base (50 Charger)
- TEAMSYSTEM-10 – Team System Physiology Monitoring for 10 Subjects
- TEAMSYSTEM-30 – Team System Physiology Monitoring for 30 Subjects
- TEAMSYSTEM-50 – Team System Physiology Monitoring for 50 Subjects



TEAMSYSTEM-1A

TEAMSystem-1A is an RF telemetry physiology monitoring system for one person. The TEAM System can be expanded to simultaneously monitor multiple people in real time, anywhere in a stadium, field or other wide-area setting. Each subject wears a BioHarness system that telemeters heart rate, respiration rate, posture, activity, and acceleration back to a central TEAM central recording station. A single TEAM recording station can receive data from multiple subjects.

Key TEAM BioHarness™ features:

- Radio built in and memory for 24 days
- Works under extreme activity
- Fabric-based, dry contacts—no skin break down
- Comfortable over long periods, washable
- Unobtrusive, light and small
- No wires
- Logging or Radio
- Detect ventilatory (anaerobic) threshold
- Fitness and fatigue using well known methods
- Heart Rate reduction at end of activity Anaerobic threshold detection
- Biomechanical markers give context (at rest vs. active)
- Individually configurable thresholds and bio alarm algorithms for prioritization

TEAMSYSTEM-1A Components

BioHarness Unit x 1
 BioHarness Charger
 Smart Fabric™ strap - specify size when ordering:
 Small fits 71-97 cm (28-38 inches) or Large fits 91-122 cm (36-48 inches)

USB Power
 5 m USB ext cable
 1 m USB A to miniB cable
 Support Docs (Quick, Installation and User Guides)
 Team System CD

TEAMSYSTEM-1B

The TEAM System Base is designed for customers monitoring a large number of subjects—up to 50 simultaneously—who want the convenience of a single, organized case for charging.

The system includes a large case that contains 50 charging stations, OmniSense software, gateway transmitter, repeater to extend range, and a barcode scanner.

Range extender for the ECHO system allows for far afield usage to cover the maximum amount of area on the market. Using four (4) ECHO Repeaters allow teams and users to measure up to over 4M2 feet live.

Barcode Scanner makes it easy to quickly assign and allocate participants and equipment in a hurry without touching the computer.



TEAM SYSTEMS FOR WIRELESS MULTI-SUBJECT, MULTI-MEASUREMENT SOLUTIONS

Simultaneously capture comprehensive physiological and biomechanical data from 10, 30, even 50 or more active subjects in real-world situations.

Heart Rate, R-R Interval, breathing rate, Respiration, 3-Axis Accelerometry, Posture, Activity Level & More!

Zephyr™ TEAM Systems provide advanced physiological monitoring that incorporates class three BlueTooth Low Energy (BTLE) technology in a small form factor. Transmit via mobile and fixed data networks—with an unmatched 1,000 ft range!—for genuine remote monitoring of human performance and condition in the real world.

OmniSense 4.0 software provides in-depth analysis of the data gathered by the BioModule.

Ideal for exercise physiology, sports conditioning, human factors, public health, and psychological studies.

OmniSense 4.0 software now offers new advanced capabilities including: Readiness Metric and protocol which calculates a Readiness Score of 0-10 so you can identify times of peak performance looking at each individual athlete's mechanical load whether in training or in action. Google Maps for graphical representation on path lines, heat maps, distance markers and shuttle function of position for comparison of multiple players/members simultaneously. Embedded Accelerometry provides instant feedback on athletes' performance and associated graphs and reports enable you to develop individual and team training strategies. ECHO Live Modes: two new Live ECHO modes which provide 1-second updates for twenty (20) subjects or 5-second updates for one hundred (100) subjects.

Data Logging must be enabled to download data. OmniSense 4.0 Software required.

ECHO Gateway for data transmission range of up to 1,000 ft (contact BIOPAC for repeater options to extend range if necessary).

TEAM Compression Shirts make connecting your BioModule a snap! Simply pop the sensor directly into the chest receptacle. Shirt provides data parameters to measure Heart Rate, Heart Rate Recovery, Heart Rate Variability, Accelerometry, Intensity & Load, and more. Respiration is currently not supported by Team Compression Shirt; if you need support for Respiration measurements, use the side strap.

- Smooth fabric provides complete comfort without restriction
- Compression fit bolsters muscle support and increases circulation
- Moves moisture away from the body for ultimate comfort
- Built specifically to let the Zephyr BioModule sensor snap straight in
- Machine Washable



TEAMSYSTEM-10

10 Subject ADVANTAGE Pack includes:

- 10 Echo Modules
- 10 Large and 2 Small Straps
- 3 TEAM Shirts (Med, Lg, Extra Lg)
- Accessory Case
- OmniSense 4.0 Software
- Two 5 Bay Chargers

TEAMSYSTEM-30

30 Subject ADVANTAGE Pack includes:

- 30 Echo Modules
- 30 Large and 5 Small Straps
- 3 TEAM Shirts (Med, Lg, Extra Lg)
- 50 Bay Multicharger Case
- Wired Bar Code Scanner
- OmniSense 4.0 Software

TEAMSYSTEM-50

50 Subject ADVANTAGE Pack includes:

- 50 Echo Modules
- 54 Large and 6 Small Straps
- 3 TEAM Shirts (Med, Lg, Extra Lg)
- 50 Bay Multicharger Case
- Wired Bar Code Scanner
- OmniSense 4.0 Software

TEAM ECHO-L – Team BioHarness Device with Large Strap

TEAM BioHarness device with large strap for use with TEAM System station. Large strap holds BioHarness device and fits 91-122 cm (36-48").



TEAM ECHO-S – Team BioHarness Device with Small Strap

TEAM BioHarness device with small strap for use with TEAM System station. Small strap holds BioHarness device and fits 71-97 cm (28-38").

See also: [BioHarness Data Logger and Telemetry System](#)

Notes:

- BioHarness requires a computer with integrated Bluetooth or an external USB Bluetooth dongle (not included with system purchase).
- The TEAMSystem-4A was discontinued in April of 2016.

IN-LINE POWER SUPPLIES



AC150A Power Supply



AC137A Power Supply

All AC series in-line power supplies are CE marked for the EC Low Voltage Directive and EMC Directive, and all have UL and TUV approval. The AC150A has standard IEC power input plugs and operate over mains power ratings of 100-240 VAC, 50-60 Hz. AC150A includes a USA, EURO, or Chinese power cord. (ACCORD US/EURO/CN).

- | | | |
|---------------|-------------------------------|--|
| AC101A | ± 12 volt, +5 volt, 1 amp | Connects the LDF100C to the AC mains wall outlet. One supply is included with each LDF100C module. |
| AC137A | +6 volt, 1.5 amp | Powers the heating element for any of the TSD137 series pneumotachs. The AC137A has fixed built-in USA-style power prongs and does not need a power adapter cord for USA operation. Interchangeable prongs are included for international use. |
| AC150A | +12 volt, 3.4 amp | Connects the MP160/150 System or GASSYSTEM2 to the AC mains wall outlet. One supply is included with each MP160/150 Starter system or GASSYSTEM2. |
| AC300A | +12 volt, 1.25 amp | Connects the MP to mains wall outlet. One supply is included with each MP36/35 system. |

See also: IPS100C Isolated Power Supply

NOTE: The older style AC137A with the ACCORD US/EURO power cord was discontinued in October of 2017.

BAT100A RECHARGEABLE BATTERY PACK



BAT100A with Recharger

The BAT100A is a high energy density and lightweight battery pack designed to operate MP160/150 or MP3X Systems. A universal input voltage 3 amp battery charger is also included. The battery pack is lightweight and comes with a supplied carrying case with integral shoulder strap. The carrying case holds battery pack, charger and all associated cords.

The BAT100A chemistry is Lithium Iron Phosphate (LiFePO₄). A key advantage over other lithium-ion batteries is the superior thermal and chemical stability, which provides better safety characteristics than other lithium-ion batteries with different cathode materials. Due to the significantly stronger bonds between oxygen atoms in the phosphate, oxygen is not readily released, and as a result, lithium iron phosphate cells are virtually incombustible in the event of mishandling during charge or discharge, and can handle high temperatures without decomposing. Ships as USA or EURO version based on delivery address.

BAT100A replaces BAT100 effective June 2011.

Operation

1. Only charge the BAT100A (12 V @ 15 AH LiFePO₄) using the included charger.
2. Discontinue use of the BAT100A when the performance of the MP System begins to deteriorate.

Charging the Battery Pack

1. When the BAT100A is being charged, the charger will indicate a **RED** charging LED.
2. When the BAT100A is fully charged, the charger will indicate a **GREEN** charging LED.

Storage

1. Store the Battery Pack in a fully charged condition.
2. Store the Battery Pack in a cool place (normal room temperature or lower).

BAT100A BATTERY PACK SPECIFICATIONSBattery

Chemistry:	LiFePO ⁴ (Lithium Iron Phosphate)
Output Capacity:	12 V @ 15 amp-hours
Working Output Voltage Range:	13.2 V – 12 V
Output Connector:	DC Barrel Plug (5.5 mm OD, 2.1 mm ID – Center positive)
Operating Time:	MP3X with 4 sensors: 26 hours nominal MP160/150 with 4 modules: 16 hours nominal
Charge Time:	5 hours (nominal)
Recharge Cycles: (number of cycles to 80% of original capacity):	1500 (typical minimum)
Operating Temperature Range:	0° C to 45° C
Storage Temperature Range:	-20° C to 60° C
Weight:	2.45 kg
Dimensions: (includes carrying case)	14 cm (high) x 19 cm (wide) x 14 cm (deep)

Battery Charger (For BAT100A only)

Maximum Nominal Charge Voltage:	14.4 V @ 3.0 amps (Charges at 3 amps to 14.4 V, then potentiostatic at 14.4 V until current is less than 0.5 amps)
Input:	120/240 VAC @ 50/60 Hz (USA or EURO power cord)
Output Connector:	DC Barrel Socket (5.5 mm OD, 2.1 mm ID – Center positive)
Operating Temperature Range:	0° C to 45° C
Storage Temperature Range:	-20° C to 60° C
Weight:	285 grams
Dimensions:	3.8 cm (high) x 6.4 cm (wide) x 15 cm (long)

CBL100 SERIES ANALOG CONNECTION CABLES

The CBL100 Series analog connection cables are used to connect the stand-alone equipment to the MP System. Analog outputs (from chart recorders, force plates, pre-amplifiers, oscilloscopes, etc.) can be connected to the AMI100D, HLT100C, UIM100C module or other MP System modules. It's also possible to use these cables to connect amplifier outputs or D/A outputs to external equipment inputs.

When signal isolation is required, use the INISOA or OUTISOA adapter with the cable. The other end of the isolation adapter connects to the appropriate MP unit channel via the AMI100D/HLT100C module. Select the cable number with the plug corresponding to the equipment's input or output jack. Use one cable per recording channel.

CBL100 2 meter; 3.5 mm mono phone plug to 3.5 mm mono phone plug



CBL101 2 meter; 3.5 mm mono phone plug to male RCA



CBL102 2 meter; 3.5 mm mono phone plug to male BNC



CBL105 2 meter; 3.5 mm mono phone plug to 6.35 mm (1/4") mono phone plug



CBL106 10 cm; 2 mm pin plugs to female BNC



The CBL106 is a multi-purpose adapter that can be used to:
Connect BNC terminated equipment to the DA100C
Connect a BNC cable to the digital I/O lines on the UIM100C
Connect the STM100C to nerve conduction chambers (via the CBL102)

CBL107 10 meter, 3.5 mm mono plug to 3.5 mm mono phone plug



CBL108 60 meter, 3.5 mm mono plug to 3.5 mm mono phone plug



CBL110A DB37 F/F Ribbon Cable. Use this 3-meter ribbon cable to interface a SuperLab presentation system with the STP100C Isolated Digital Interface for an MP1xx System. Pins 19 and 21 are GND; pin 20 is +5 V.



CBL110C DB25 M/F Ribbon Cable. Use this 3-meter ribbon cable to send digital I/O info to the STP100C Isolated Digital Interface to interface visual presentation systems that use a computer's parallel printer port (E-Prime, DirectRT, MediaLab, Inquisit, etc.) with an MP1xx System. Pins 18 and 25 are GND.



CBL110C-Y This Y-adapter for the CBL110C parallel port cable allows users to interface the output from a parallel port with two devices, the STP100C and another piece of hardware. DB25 parallel male/dual female Y-splitter; 20 cm (8”).



- CBL117** 10 meter lightweight coaxial cable with RCA male plug to RCA male R/A plug is included with the following systems; TEL100C, VR100PHYS-W, VR100INTRO-W, VR100ADV-W, VR100ULT.



- CBL118** 60 meter lightweight coaxial cable with RCA male plug to RCA male R/A plug for TEL100C.



- CBL121** This cable will connect Biodex System 4 or System 3 rev2 and above devices to a BIOPAC MP160/150 System to report Torque, Velocity, Position, and Sync values. One end of the 3 meter cable terminates with a dSUB15 male connector to interface the Biodex device, and the other end terminates with four 3.5 mm phone inputs to connect to the MP150 via UIM100C (assuming no MP150 isolation needed) or INISOA to MP160/150 via AMI100D/HLT100C (assuming MP160/150 isolation is required). Isolation is recommended if the MP160/150 system is also connected to subject-connected biopotential modules, such as EMG100C, ECG100C, etc.



Additional details for use with Biodex devices available in [BIODEX EMG/ANALOG SIGNAL ACCESS CONFIGURATION UTILITY SOFTWARE](#) – Addendum for System 3 Revision 2 and System 4 Dynamometers.

Important Safety Note: Biodex devices are mains powered equipment. If any other wired (non-BioNomadix) connections from the MP160/150 to the subject exist, this cable must be used with INISOA Input Signal Isolation Adapter with AMI100D/HLT100 High-level Transducer Amp to maintain proper isolation.

CBL122 **Unisolated** male RJ11 to 3.5 mm female jack, allows a mono 3.5 mm male cable to be interfaced with the AMI100D/HLT100C so connections previously made through the UIM100C can function with the MP160+HLT100C. This **cable is unisolated** and must not be used with external equipment when a human subject is connected to the MP system unless the external equipment has its own built in isolation. The short (~3 cm) adapter is designed to be connected to another cable.



CBL123 **Unisolated** RJ11 to BNC Male, 1.8 m cable allows equipment with BNC outputs to connect directly to an AMI100D/HLT100C when no isolation is required (e.g., animal) without any additional adapters. This **cable is unisolated** and must not be used with external equipment when a human subject is connected to the MP system unless the external equipment has its own built in isolation.



CBL124 **Unisolated** RJ11 to two 2 mm sockets, this Switch Adapter allows a digital switch (i.e., TSD116A or TSD116B) to be connected to an analog input of the AMI100D/HLT100C. When the switch is open the channel will read zero volts; when the switch is pressed/closed the channel will read 5 volts. This **cable is unisolated** and should not be used to connect external mains powered equipment or other switches that make electrical contact with the subject.

CBL125 BNC male to BNC male, Nickel Plated, 2 m RG59 Coax cable; typically used to interface the STP100C or STP100C-C to devices that use BNC (Bayonet Neill-Concelman), such as FNIR Imager trigger ports. Typically applied for frequencies below 3 GHz; Ohm Rating: 75.



CBL126 BNC male to female right angle T-Adapter allows the connection of two BNC female connectors. Use this adapter when you want to use a trigger input and record the actual trigger on one of the digital I/O lines. Run an external trigger to the STP100C, via this coupler, to start data acquisition and then run a CBL125 + CBL106 to the STP-IO. Connector A: BNC male, Connector B: BNC female, Connector C: BNC female. 50 Ohm. Brass with nickel plating.



Compatibility with MP160/150 Research Systems

If a different interface is required, contact BIOPAC to discuss custom options. All brand or product names are the trademarks or registered trademarks of their respective holders.

Custom cables are available from BIOPAC for connectors not listed.

Company	Device	Connector Type	BIOPAC cable
AMTI	MSA-6: Force Plate Amp (Use AMTI cable 5405C) MCA: Force Plate Amp (Use AMTI cable 5405C)	BNC female	CBL102
Axon	All Amplifiers	BNC female	CBL102
Buxco	MAX II	3.5 mm mini-phone jack	CBL100
Data Sciences International	Physio Tel Receiver with ART Analog Adapter	BNC female	CBL102
Gould	6600 Series	BNC female	CBL102
Grass	Model 7 (J6)	3.5 mm mini-phone jack	CBL100
	P55, P122, and P511 Series	BNC female	CBL102
Harvard	HSE PLUGSYS AH 69-0026 Dissolved Oxygen Meter	BNC female	CBL102
	AH 60-2994-2999 Research Grade Isometric Transducers AH 6-03000/3001 Research Grade Isotonic Transducers	4 mm double banana jack	CBL102 with CBL106
Kent	TRN(001-012) Amplifiers	BNC female	CBL102
Kissler	Force Plates	BNC female	CBL102
Millar	TCB600: Transducer Control Unit	¼" phone jack	CBL105
	TC-510 (Specify Grass Cable interface #850-3028)	6-pin	TC100 (to DA100C)
Sonometrics	Sonomicrometer Systems with Optional Adapter	BNC female	CBL102
Transonic	T106, T206, T106U, T206U: Animal Research Flowmeters T110: Lab Tubing Flowmeter BLF21D/21: Laser Doppler Meters	BNC female	CBL102
Triton	CBI System System 6	¼" phone jack	CBL105
Tucker Davis	All Digital BioAmp Systems	BNC female	CBL102
WPI	705: Electro 705 Electrometer 721: Cyto 721 Electrometer 767: Intra 767 Electrometer 773: Duo 773 Electrometer DAM50: Bio-amplifier DBA Series Digital Biological Amps DVC-1000: Voltage Current Clamp EVC-4000-(1-4): Voltage Clamp FD223: Dual Electrometer ISO2: Dissolved Oxygen Meter & Electrode ISODAM: Low Noise Preamplifier ISO-DAM8A-(1-8): Bio-amplifier System NOMK2: ISO-NO Mark II Nitric Oxide Meter TRN001, TRN002, TRN011, TRN012: Isometric Transducers VF-4: 4-Channel Buffer Amplifier	BNC female	CBL102
	DAM60, DAM70, DAM80: Bio-amplifiers	3.5 mm mini-phone jack	CBL100
Biodex	System 3 rev2 and above (with 15 pin female dSUB) System 4 (with 15 pin female dSUB)	3.5 mm mini-phone jack	CBL121

CBL200 SERIES LEAD CONNECTOR CONVERSION CABLES

See also: Guide to [External Device Interfaces](#) for connections to common devices



CBL200 CBL200 consists of a 2 mm female socket leading to a 1.5 mm female Touchproof socket. This 10 cm extension is required when converting an old-style 2 mm pin electrode or transducer lead to a 1.5 mm Touchproof socket for connection to any of the 100C-series Biopotential or Transducer amplifiers or STMISO series modules. One CBL200 is required for each old-style 2 mm pin.

CBL201 CBL201 is a 2 mm male pin leading to a 1.5 mm male Touchproof pin and is 10 cm long. Use CBL201 to:

- Connect a female socket 1.5 mm Touchproof electrode lead to the DA100C amplifier.
- Connect a ground electrode lead (e.g. LEAD110A) to the UIM100C module—required when using the TSD150 active electrodes.
- Convert a 1.5 mm Touchproof female socket electrode or transducer lead to an old-style 2 mm pin, for connection to any of the 100B-series Biopotential or Transducer amplifier modules.

One CBL201 is required for each 1.5 mm Touchproof socket. *For MP36/35/45 Systems* CBL201 is used to update older model SS1L Shielded Lead Adapters.

CBL202 CBL202 consists of a female mono 6.3 mm (1/4”) phone socket leading to two 2 mm male pins. This multi-purpose adapter is 10 cm long and can be used to:

- Connect a 6.3 mm male mono phone cable to the digital I/O lines on the UIM100C.
- Connect microphones or signal sources that terminate in a 6.3 mm male mono phone plug to the DA100C.
- Connect the STM100C to nerve conduction chambers (CBL105 required).

CBL203 CBL203 consists of a female mono 6.3 mm (1/4”) phone socket leading to two female 1.5 mm Touchproof sockets and is 10 cm long.

CBL203 is primarily designed to connect YSI 400 series biomedical temperature probes to the SKT100C temperature amplifier, but it can also be used to connect male mono 6.3 mm (1/4”) phone plug terminated cables or transducers to 100C-series Biopotential or Transducer amplifiers.

- Blue heat shrink = tip of 1/4” mono connector, Black = sleeve of 1/4” mono connector.
- Connect to SKT100C Vin+ and Vin- ports (either socket to either port); thermistors do not make electrical contact so GND is not required for safety.
 - If using a 3rd-party probe with metal casing, the ground lead from the probe can be connected to SKT100C GND.

- CBL204** CBL204 consists of a single female 1.5 mm Touchproof socket leading to two male 1.5 mm Touchproof pins and is 25 cm long.
CBL204 plugs into any 100C series Biopotential amplifier input or STMISO series stimulator output and provides two sockets to connect to electrode leads terminating in a 1.5 mm Touchproof “Y” electrode lead adapter.
This 1.5 mm Touchproof “Y” electrode lead adapter is required when multiple electrode sites are to be connected to a single amplifier input or stimulator output.
Multiple CBL204s can be plugged together to reference three or more electrode leads to the same input or output.
- CBL204-MRI** This “Y” cable is functionally identical to the CBL204, but designed for use in the MRI environment when referencing two or more electrodes to a single biopotential amplifier input. Primarily used for NICO (noninvasive cardiac output) measurements in the MRI. Two 1.5 mm Touchproof male inputs to one 1.5 mm Touchproof female input, cable length 5 cm.
MRI Use: **MR Conditional to 9T**
Components: Carbon composition, tin plated and gold plated brass connectors
- For two or more amplifier inputs to one electrode, use [JUMP100C-MRI](#); two 1.5 mm Touchproof female to one 1.5 mm Touchproof male—MRI equivalent of [JUMP100C](#).
- CBL205** CBL205 is a 1.5 mm Touchproof male to female 1.5 mm AC-coupled electrode lead adapter and is 10 cm long. One end of the adapter plugs into the ground on the biopotential amplifier and the other end accepts the electrode lead. (LEAD110)
Use CBL205 when more than one ground is required while recording EDA (electrodermal activity) and other biopotential(s).
- CBL205-MRI** CBL205-MRI is functionally identical to CBL205, but designed for recording in the MRI or fMRI environment.
- MR Safe carbon composite construction
 - 16.5 cm long with 7.6 mm diameter
 - Plugs into LEAD108B/C
- CBL205/CBL205-MRI:** To record EDA with other biopotential signals (ECG, EEG, EOG, EGG, EMG, ERS), BIOPAC recommends using CBL205/CBL205-MRI connected to one ground on any of the biopotential amplifiers. The subject will be grounded through the Vin- of the EDA electrodes, but in some cases, it is necessary to have more than one ground; in such cases, use an AC-coupled lead adapter (CBL205/CBL205-MRI) to prevent galvanic ground loops.
For example, if—while recording a biopotential and EDA—the EDA electrode is removed during a stage of the experiment, you will want to maintain ground for the biopotential. To always have a ground and no ground loops: connect the Vin- lead of the EDA as ground and connect an AC-coupled ground to the biopotential amplifier GND.
- Safety Note**—If using any two EDA100C modules at the same time on the same MP System, ground loops can be a problem due to non-isolation between module excitation currents. A solution is to record with one module connected to a separate IPS100C/D and AMI100D/HLT100C, and the remaining module to the MP System. Use OUTISO signal isolators to connect the first module outputs (via AMI100D/HLT100C) to the UIM100C on the MP System side.
- CBL206** Lead junction TPF to 4X TPM. Reference four electrodes from one. Connect via the MEC110C to the NICO100C and EBI100C cardiac output amplifier modules.

CBL207 1 m, BNC (m) to 2 x 1.5 mm TP (m).

Use with:

- 1.5 mm Touchproof (f) electrodes
- STM200 Unipolar Pulse Stimulator Module
- MECMRI-STIMISO cable/filter system to connect to STM200 in the MRI control room

CBL229 ~3 cm, RJ11 to Touchproof female socket adapter

Allows a ground lead (such as LEAD110 or LEAD110A) to be connected to the subject if active electrodes TSD150A or TSD150B are being used when no other wired ground is present.

Safety Note—This adapter is required if only active electrodes are being used and no other wired signals are being recorded; if there is another C-series biopotential amplifier that has a ground connection to the subject, this adapter is not required.

CBL231-MRI



This adapter is an MR Safe carbon composite radio translucent electrode lead that connects a non-ferrous 2 mm pin to a Touchproof 1.5 mm female connector, 46 cm (18") long.

Use for tDCS systems in an fMRI environment or connecting other MR Safe electrodes and cables that use a 2 mm socket interface.

MR Conditional: Use during fMRI or MRI scanning sequences (including multi-band) up to 7T.

CBL237

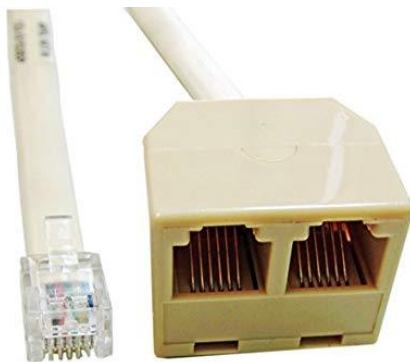

The **Smart Amp Output "Y" Adapter** allows for the signals from a 100D-Series Smart Amplifier connected to either an AMI100D or an IPS100D to be sent to other equipment. An RJ12 cable plugs into either the AMI100D or IPS100D, the Smart Amplifier to one port of the adapter, and either an OUTISOA for connecting signals to mains powered equipment or another cable if Unisolated connections are needed (such as CBL123).

Works with 100D-Series Smart Amplifiers, 100C-Series Amplifiers, BioNomadix Receivers, STP100C Isolated Digital Interface, or the STM100C Stimulator Module as part of an MP160 Research System.

Important: Only one Smart Amplifier should be connected to the adapter at a time. Connecting more than one Smart Amplifier to a single channel input is not supported.

EXTENSION CABLES

CBLEXT Serial Extension Cable

Use this 3.6 meter extension cable to increase the distance between the MP100 or MP30 and your computer. The CBLEXT is used to extend the length of CBLSERA (use only one CBLEXT per MP100 or MP30 System).



CBLHLT1 Phono Plug Extension Cable

Use this 7.6 meter extension cable with phono connectors for

- AMI100D/HLT100C high level transducer module.
- NIBP100D Noninvasive Blood Pressure System (cable included) between the TCI105 and NIBP100D connector.



OXY100E-200 EXT Pulse Oximeter Extension Cable

Use this 3 meter extension cable to increase the distance between SpO₂ transducers (TSD124 Series *human* or TSD270 Series *veterinary*) and an OXY100E or OXY200E SpO₂ Amplifier.



MEC SERIES MODULE EXTENSION CABLES

FOR MOST 100C SERIES MODULES

- MEC100C** 100C-series Transducer amplifiers to 1.5 mm male Touchproof pins
- MEC110C** 100C-series Biopotential amplifiers to 1.5 mm male Touchproof pins
- MEC111C** 100C-series Biopotential amplifiers to 1.5 mm male Touchproof pins—*Protected*



FOR LESS COMMON OR 100B SERIES MODULES

- MEC100** DA100C or 100B-series Biopotential or Transducer amplifiers to 2 mm socket inputs
- MEC101** 100B-Series Biopotential amplifiers to 2 mm socket inputs – Protected
- MEC110** 100B-series Biopotential or Transducer amplifiers to 1.5 mm Touchproof inputs
- MEC111** 100B-series Biopotential amplifiers to 1.5 mm Touchproof inputs—*Protected*

These module extension cables are used to increase the distance between subject and recording system, allowing increased subject movement and comfort. Each extension cable attaches to one amplifier; electrodes and transducers plug into the extension cable's molded plastic input plug. The 3-meter extension includes a clip for attaching to a subject's belt loop or clothing.

The MEC100C is designed for Transducer amplifiers. The MEC110C and MEC111C are designed for Biopotential amplifiers. Use the MEC100C or MEC110C to increase the lead length to the amplifier.

The MEC111C is required for the protection of a system and Biopotential amplifiers when electrocautery or defibrillation equipment is used while recording data.

Protection There are passive protection circuits built into MEC111C. These protective elements are designed to protect the biopotential amplifier from damage, assuming heart defibrillation pulses are introduced to the monitored subject. The MEC111C design incorporates 10 kohm series resistance elements, on each conductor, that also terminate in a transient absorber. With this design, potentially harmful defibrillation pulses are suppressed prior to encountering the biopotential amplifier input.

All other cables support direct point-to-point wiring, and incorporate no active or passive protective components.

The MEC series extension cables contain no ferrous parts (less the removable clothing clip).

IMPORTANT SAFETY NOTES

1. MEC series cables are not to be used on humans when they are undergoing electrosurgery or defibrillation. In fact, no BIOPAC equipment should be connected to human subjects during the course of defibrillation or electrosurgery.
2. When MEC series cables are used, be careful to preserve the isolation of MP system during defibrillation. No external lab equipment should be connected directly to the UIM100C, IPS100C or any included amplifier module. To preserve MP system isolation, all connections of this type should be made using INISOA or OUTISOA with the AMI100D/HLT100C. To verify that the isolation of the recording system is intact, use a multimeter to measure resistance from subject ground (on biopotential amplifier) to mains ground; there should be no DC conductivity.
3. Do not connect the electrode leads attached to the MEC series cables directly to defibrillator paddles. When using MEC cables, electrode leads should be connected to the subject directly and not via the defibrillator paddles.

HMD1B HEAD-MOUNTED DISPLAY



HMD1B with 3 DOF Tracker

Optimize the VR experience with immersive 2D or 3D on dual HD OLED displays—known for outstanding brightness, contrast, color and clarity—plus built-in virtual 5.1-channel surround sound.

The HMD1B does not include a head tracker; a head tracker will be required for worlds that demand motion. [Orientation Tracker \(3 DOF\) - TRACK2](#) recommended.

The HMD1B with tracker provides precision 3-DOF orientation tracking for head tracking—yaw, pitch, and roll. USB connection, and connects directly to the VR Toolkit that is included in all [VR Workstations](#).

HMD1B SPECIFICATIONS

3D Ready

Display

Aspect Ratio: 16:09

Display Device: OLED Panel x 2

Display Resolution: 1280 x 720

Field of View: 45 degree

Gradation: RGB 24-bit

Virtual Image Size: 750 inches at 65 feet distance (effectively 150" at 12 feet)

Video Features

Picture Mode: Standard; Cinema; Dynamic; Custom

Picture Settings: Clear Black; Picture; Brightness; Color temperature; Sharpness

Picture control for dark adaptation: Yes

Pure Image Realizer: reduction for Frame noise, Block noise, and Mosquito noise

SBM for Video: Yes

Audio Features

Linear PCM : 2/ 5.1

Preset Audio Mode : Standard; Cinema; Game; Pure AV; Off (2 ch)

Virtual Surround : Yes (5.1)

Headphones

Driver Unit: Open air dinamic

Frequency Response: 12-24,000 Hz

Impedance: 24 Ω

Maximum Input: 1,000 mW (IEC)

Sensitivity: 106 dB/mW

Convenience Features

Lens Span Adjustment: 5 steps

Adjust forehead and headband straps to customize for small to large heads

Forehead Supporter

Nose Supporter

Shield for Outside Light

Auto Power Off (6 hours)

Prolonged Viewing Warning (3 hours)

Video Pass-through Function (when Glasses are off)

Wearing Sensor

Lock

HMD2A HEAD-MOUNTED DISPLAY—HIGH RES

The HMD2A* offers virtual and augmented reality developers and users a high-fidelity head-mounted display with unprecedented visual clarity and acuity at an affordable price.

The HMD2A is built around a high-contrast Organic Light Emitting Diode (OLED) microdisplay. The microdisplay provides 1280 x 1024 pixels per eye in a low-power, compact design. The patent-pending eyepieces display the image across a 50° diagonal field-of-view with <2% distortion, making the see-through compatible optics ideal for professional augmented reality applications that require precision alignment between real and virtual environments. The HMD2A works equally well as a see-through or fully immersive display. A removable cover can be quickly applied to allow users the flexibility to develop both virtual and augmented reality applications using the same HMD. And the HMD2A supports standard motion tracking devices from InterSense, Ascension, Polhemus, and others via a tracker platform mounted on the back of the HMD.

The simplicity and performance of this HMD is at the forefront of immersive display technology and development. Unsurpassed visual fidelity is designed into a lightweight, ergonomically friendly device that is both easy to use and comfortable to wear. HDMI cables from the HMD plug directly into the image source with no additional video processing electronics. Stereo headphones, built-in microphone, and programmable buttons compliment the high-resolution visuals to provide the rich, immersive experience required in the most demanding training and simulation applications.



HMD2A SPECIFICATIONS

Optical	FOV	Vertical 32°	
	FOV	Horizontal 40°	
	FOV	Binocular (diagonal) 50°	
	See-Thru Transmission	44%	
	Pupil Size	10, Non-Real mm	
	Eye Relief	23 mm	
	Geometric Distortion	-2% Maximum (Barrel)	
	Brightness (MAX)	23 fL	
	Contrast	10000:1	
	Image Defect Criteria	available on request	
	Spatial Resolution	1.88 arcmin/pxl	
	Microdisplay	Display Technology	Organic Light-Emitting Diode (OLED)
		Resolution	SXGA 1280 x 1024
Color Depth		24-BIT (8 bits per R,G,B)	
Video	Video Input Format	SXGA 1280 x 1024 @ 60 Hz	
	Video Interface	DVI over HDMI	
	Latency	< 0.002 ms	
Audio	Headphone Response	15-25,000 Hz	
	Headphone Impedance	60 Ohms	
	Microphone	Standard Integrated, Shell-mounted Microphone	
	Mic Transducer Principle	Electret	
Controls	Interpupillary Distance (IPD)	Range: 53-73 (Independent left and right) mm	
Power	Power Supply	Input: 100-240 VAC, 0.3A 50-60 Hz. Output: +5 V DC, 2 A min	
Physical	Size (envelope)	14.2 L x 9.0 W x 8.6 H max in	
	Mass	1050 g	
	Compliance	CE Compliance	CE Compliant
RoHS Compliance		RoHS Compliant	
Mfg Warranty	Included: one year	additional 1-year warranty add-ons available up to 3 years max	

*nVIS nVisor ST50

Specifications are subject to change without notice

TRACK2 ORIENTATION TRACKER (3 DOF)



This multi-purpose subminiature 3D orientation sensor is designed for use in real-time orientation tracking applications. It includes three types of sensing elements (tri-axial MEMS gyros, tri-axial MEMS accelerometers, and tri-axial magneto-resistive magnetometers) and comes equipped with an onboard processor and embedded orientation algorithms allowing for direct integration into systems without interfacing a PC. For PC-based integrations, the system comes with a set of libraries that allow users to modify algorithm and/or sensor parameters on-the-fly to suit individual protocols.

TRACK2 interfaces via USB and connects directly to the VR Toolkit included in all [VR Workstations](#); intro, advanced, and ultimate Workstations include one TRACK2.

Also available pre-mounted to high-res head mounted display—see [HMD1B-TRACK](#).

Use additional sensors to track limb movement.

SPECIFICATIONS

Output data: Quaternion, Euler angles, Raw data (angular rate, acceleration, magnetic field strength)

Internal update rate: 500 Hz

Start-up time: < 1 sec

Range (pitch, roll, yaw): full 3D

Angular Resolution: = 0.01 deg

Static Accuracy: yaw = 1 deg; pitch, roll = 0.2 deg

Repeatability Accuracy (yaw): < 0.5 deg

Gyro Range: ± 1200 deg/sec

Accelerometer range: ± 2 or 6 g

Magnetometer range: ± 2 gauss

Operating temperature: -40° to $+85^{\circ}$ C

Storage temperature: -40° to $+85^{\circ}$ C

Electrical Supply voltage: 3.5 to 5.7 V

Power consumption: < 300 mW

Interface

Standard: TIA/EIA-485A (half-duplex)

Baud Rate: 1,000,000 bps

Byte Size: 8 bits

Stop Bites: 1 bits

Parity: No

Dimensions: 50.7 × 14.5 × 9.2 mm

HDS100 HAPTIC DELIVERY SYSTEM



Replacement actuators/isolators available as **RXHDS**.

The HDS100 haptic delivery system provides tactile feedback during virtual reality experiments and includes:

- audio amplifier that connects to a computer sound card
- actuators & isolators (2 each) that vibrate based on the sound from the sound card
- interface cables: HDS100 amplifier to an existing sound card, HDS100 amplifier to actuators, and signal to HDS100 amplifier *and* speakers

Actuators are placed under chair legs or on a platform and deliver vibrations based on the VR environment (e.g. movement of elevators). Install in less than 15 minutes with no modifications to flooring or furniture required.

The system is compatible with SuperLab, E-Prime, Vizard VR Toolkit, and other presentation systems that interface the computer's sound card.

HDS100 SPECIFICATIONS

Includes:



- **1 amplifier**
 - Drives up to four Shadow-8 (T108S) Actuators with 500 W rms (700 W peak)
 - Control-system compatible with rear-mounted IR Input
 - Included stainless steel remote control
 - Filter and gain control for limitless personalization (40-160 Hz)
 - 12 V trigger or auto on
 - Remote control presets: Movie, Music
 - Two phase settings for a perfect match with subwoofer (0 or 180 degrees)
 - Rack mountable with supplied removable ears
 - From extreme to subtle, delivers accurate and perfectly time aligned motion
 - Size 1U 4.3 cm (4.8 cm including feet) x 43 cm x 26 cm (28 cm including speaker connections)
 - Weight 9 kg (20 lbs)
- **2 linear actuators**—Patented electromagnetic motors deliver extraordinarily accurate low-frequency motion to a wide range of furnishings. These updated actuators deliver improved performance, especially when producing infrasonic frequencies (below 20 Hz). New magnet structure with a vented center pole allows air to move in and out more efficiently. The Shadow-8 also sports a new 8 ohm drive coil and an increased range of motion. Actuators are constructed with rare earth magnets and grained and anodized aluminum.
- **2 motion isolators**—These motion isolators dramatically reduce the amount of tactile motion transmitted to the floor and surrounding environment, effectively isolating the tactile sensation to the couch or chair. Motion Isolators are made of a high quality mark-free rubber.
- **Interface cables**



- HDS100 to an existing sound card: 3.5 mm stereo phone plug to dual RCA Y (CBL120)
- HDS100 to actuators: 18 gauge, 7.3 mm
- signal to HDS100 *and* speakers: stereo splitter, 13.5 mm

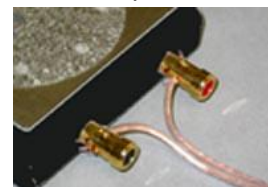

SDS100 SCENT DELIVERY SYSTEM

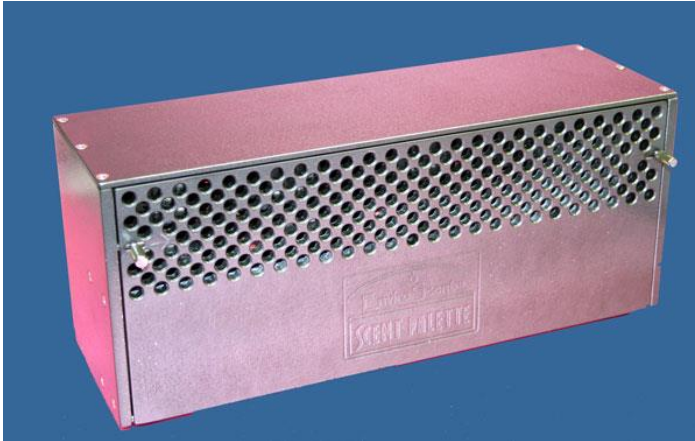

Self contained scent dispersal system—no compressor needed!

Compact, computer-controlled (USB), eight-cartridge scent* machine uses compressed air to project different scents on cue for a predetermined time followed by a burst of unscented air to clear for the next scent.

System includes software to control the delivery and duration of scents from the SDS100 unit. Scents can be triggered from a virtual reality environment. Dispersed scent covers approximately 3-6 meters in front of unit, depending on how many fans are used.

*Scent cartridges not included; order as [SCENT](#)—over 100 scent options available.

SDS100 SPECIFICATIONS

Scent receptacles: 8

Scent dispersement*: 3 m - 6 m

Scent control: See :: [App Note 238 - Software options for controlling the SDS100 Scent Delivery System](#)

Power:

Description Wall Mount AC Adapter (2-prong flat blade)

Input 100-240 V, 0.7 amps, 47-63 Hz

Output 12 V, 2.1 amps

Shipping Weight: 4.08 kg (9 lbs.)

Product Dimensions (L x W x H): 33.2 cm x 13.0 cm x 15.6 cm (13.1" x 5.1" x 6.1")

NOTE: SDS100 Scent Delivery System is not available for sale to countries in the European Union.

VIRTUAL REALITY SYSTEMS

<i>VR System Type</i>	<i>VizMove Turnkey VR</i>	<i>VizMove + Biofeedback Utility</i>	<i>VizMove + MP System with wireless BioNomadix + Biofeedback Utility</i>
Seated Systems	VR-SEAT	VR-SEAT-BIO	VR-SEAT-MP
Standing Systems	VR-STAND	VR-STAND-BIO	VR-STAND-MP
Walking Systems	VR-WALK	VR-WALK-BIO	VR-WALK-MP
Projection Systems	VR-PROJ	VR-PROJ-BIO	VR-PROJ-MP



BIOPAC VR solutions record and analyze physiological, behavioral, and subjective response data in realistic, immersive environments that would be impossible or prohibitively expensive in the real world. Systems are provided to meet specific research needs and lab space for single or multiple users: participants can be seated, standing, walking or viewing a projection.

VizMove Virtual Reality Systems allow you to start running a high-res virtual reality lab from the moment you unpack the box. A great solution for starter VR labs needing to expand stimulus delivery capabilities, VizMove Systems include everything required to create and experience interactive virtual reality applications for a variety of protocols. VizMove is available on its own, with a biofeedback utility (see BIO systems), or with an MP Research System (see MP systems). Add olfactory, haptic, and electrical stimulus for an incredible degree of realism.

System Components:	VR-SEAT Seated	VR-STAND Standing	VR-WALK Walking	VR-PROJ Projection
High performance rendering computer	x	x	x	x
VR Headset: Latest state-of-the-art headset and VizConnect output interface	x	x	x	-
3D Projectors & 3D Glasses	-	-	-	2 x shorthrow 5 x glasses
Controller: Navigate the virtual world while seated	gamepad	wand	wand	wand
PPT Motion Tracking System: max estimated tracking area	-	2 cameras up to 3m ²	4 cameras up to 7m ²	3 cameras
Vizard: Build complete, interactive VR applications and dozens of environments	x	x	x	x
Portable (laptop) option available	x	x	x	-

VR BIOFEEDBACK SYSTEMS: VR-SEAT-BIO, VR-STAND-BIO, VR-WALK-BIO, VR-PROJ-BIO

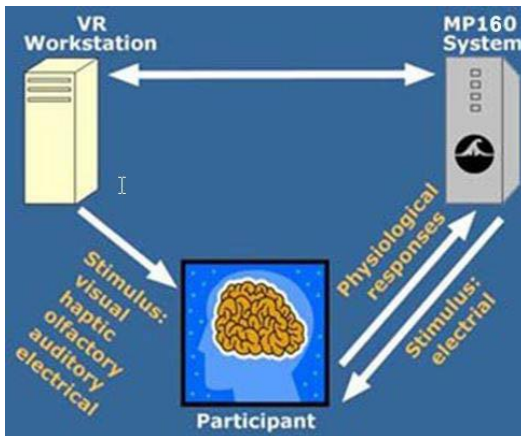

These VR Systems combine VizMove Virtual Reality Systems with a biofeedback linking utility to tightly synchronize VR world events with real-time physiological response data from your existing MP160/150 Research System, allowing you to change the environment in real time, based on the participant's responses.

VR WITH MP SYSTEM: VR-SEAT-MP, VR-STAND-MP, VR-WALK-MP, VR-PROJ-MP



These VR systems include VizMove plus an MP Research System (MP160 hardware and AcqKnowledge software) with two wireless BioNomadix dual-channel signal sets of your choice for real-time wireless ECG, EMG, EDA, accelerometry, or other biometrics.

🔗 Click to view a [VR System Diagram](#)

VIZARD VR DEVELOPMENT PLATFORM

Vizard's user-friendly IDE enables anyone to build sophisticated VR simulations. Vizard comes equipped with beginner tutorials to get you started.

Rapidly create a wide range of immersive 3D experiences with the most powerful, innovative virtual reality development platform. Vizard has everything you need to build complete, interactive VR applications. The software supports all standard VR hardware and easily integrates with other 3rd party software.

- Build applications quickly with easy-to-learn Python, the world's most accessible and powerful scripting language.
- Create enterprise-level VR environments with co-presence and clustering capabilities.
- Import 3D models with industry standard formats through our simple art workflow.

VIZARD'S CORE FEATURES

Rapid Application Development: Powerful simulation engine enables fast development of VR applications and includes a large variety of VR specific libraries.

- **Sophisticated Vizard IDE:** Embedded interactive simulation engine enables rapid development of virtual reality applications.
- **Large variety of VR specific libraries:** Saves development time, easily extend pre-built functionality.
- **Integrated editor:** Transform content from different sources, assemble and modify your world. Includes built-in intelligent code completion, and visual debugging.
- **EXE publishing:** Share and demonstrate your applications without the need for additional software.
- **Scene editor and inspector tool:** 3D model viewer lets you quickly view assets, examine graph structures, see stats on polygon and texture usage, and preview animations.

Extensibility - Third Party Support

- **VizConnect:** Build once, deploy everywhere. Visual configurator allows you to easily connect third party VR hardware such as analog controllers, haptic devices, motion capture suits, projection systems, biofeedback devices, and more. Includes visual tools for authoring interaction behaviors such as grabbing, vehicle modes (airplane, helicopter, magic carpet), avatar inverse kinematics, and inspection tools such as a measuring tape.
- **Display Flexibility:** Render to single and multi-screen 3D projection systems including curved surfaces. Readily connect to a multitude of 3D stereoscopic devices.
- **Clustering:** Leverage advanced real-time rendering and processing of large worlds and heavy simulations. Connect up to 64 separate computers.
- **Art Workflow:** Import industry standard 2D and 3D formats. Implement advanced material shading techniques including the ability to add your own GLSL shader code.

ADVANCED FEATURES

Collaboration/Co-Presence

- yyLink together VizMove VR systems to join people together in the virtual world.
- Interact with team members in real time over a local network.

Physics Engine

- Access high performance library for simulating rigid body dynamics.
- Simulate vehicle and object interactions in virtual environments. Create robotics simulation applications.
- Utilize advanced joint types and integrated collision detection with friction.

SDK/Extendability

- Extend the functionality in C++ using the SDK included in Vizard.
- Create plug-ins that can interface with Vizard virtual reality scripts.

EYE TRACKING SYSTEMS

BIOPAC offers an array of monocular and binocular eye tracking systems that are easily integrated with stimulus presentations, VR environments and other media.

Systems	Monocular Part Numbers	Binocular Part Numbers
Fixed System with HeadLock™ positioner and 90 Hz, 220 Hz, or 400 Hz camera	EYEFIXMONOCLAMP	EYEFIXBINOCLAMP
Movable Head for HMD1	EYETRAKHMD1B-M90	EYETRAKHMD1B-B90
Movable Head for HMD2	EYETRAKHMD2MONO	EYETRAKHMD2BINO
Movable Head for 3 rd -party HMD	EYETRAKHMD3RDMO	EYETRAKHMD3RDBI
Frame Mounted Scene Camera	EYEFRAMESCENEMO	EYEFRAMESCENEBI

The following Analog output and Interface cables are included with all Eye Tracking packages:

- Analog output (4 channels)—real-time analog voltage signals
 - 4-Channel 12-Bit Analog Output Board with 48-Bits of Digital I/O
 - AnalogOut software for use with ViewPoint PC-6
 - 0.61 meter 100 Pin High Density Connector to 2 50 Pin IDC
 - 50 Pin Universal Screw Terminal and screws
 - TTL capabilities
- Interface cables to MP System: CBL100 x 4 and CBLEPM x 4
 - Use the full power of the MP Research System and AcqKnowledge software.
 - To record biopotential signals in the same record while maintaining subject isolation, add an AMI100D/HLT100C and one INISOA for each eye track channel

FIXED HEAD SYSTEMS (Monocular-EYEFIXMONOCLAMP, Binocular-EYEFIXBINOCLAMP)

These turnkey monocular or binocular eye tracking systems include the HeadLock™ positioner with 90 Hz, 220 Hz, or 400 Hz camera(s). The fixed head system provides a real-time display of gaze point history, gaze period, fixation duration, pupil size. The system interfaces with BIOPAC data acquisition and analysis systems to combine eye tracking information with other physiological data and stimulus presentation markers.



Fixed Head Binocular System with Clamp (EYEFIXBINOCLAMP)

Includes:

- USB capture device
- Close Focus Camera (90 Hz, 220 Hz, or 400 Hz) and illuminator system (2 cameras for Binocular system)
- ViewPoint PC-60 software—record vertical position, horizontal position, pupil size, etc. (Binocular option enabled for Binocular system)

MOVABLE HEAD SYSTEMS (Monocular- EYETRAKHM1B-M90, Binocular- EYETRAKHM1B-B90)

These turnkey systems include everything you need for monocular or binocular HMD eye tracking—including the Sony HMZ-1 head mounted display with eye tracking cameras and illuminator systems installed.



Monocular Movable Head System

Includes:

- Sony HMZ-1 (HMD1B)
- USB capture device
- ViewPoint PC-60 software—record vertical position, horizontal position, pupil size, etc.
- One eye camera and illuminator system (x 2 cameras and illuminator systems for Binocular system)
 - 90 Hz USB 2.0 camera
 - Eye camera(s) and illuminator system(s) include either a color 70° horizontal field of view scene camera or a black and white 60° horizontal field of view scene camera
- Universal power supply with country-specific adapter and 10 m video and power cable
- Waist pack cable holder (not shown)
- Additional hardware specs as shown

MOVABLE HEAD - HMD2 (Monocular-EYETRAKHMD2MONO, Binocular-EYETRAKHMD2BINO)

This turnkey system provides everything required to add monocular/binocular HMD eye tracking to an nVis SX HMD, including hardware, software, and professional mounting to the HMD at the factory. The system can be added to a new nVis SX purchased from BIOPAC (HMD2) or to an existing nVis SX HMD; if the system is being added to an existing nVis SX, the unit must be returned to BIOPAC for modification.

Part numbers:

MOVABLE HEAD - FOR 3RD PARTY HMD (Monocular-EYETRAKHMD3RDMO, Binocular-EYETRAKHMD3RDBI)

This system includes everything you need to mount monocular HMD eye tracking to existing third-party HMD.

SCENE CAMERA (Monocular-EYEFramesCENEMO, Binocular-EYEFramesSCENEBI)

Monocular & Binocular Viewpoint PC-60 Scene Camera Versions with EyeFrame hardware.

***Binocular Scene Camera System***

Includes:

- USB capture device
- ViewPoint PC-60 software scene camera version—record vertical position, horizontal position, pupil size, etc. (Binocular version enabled for Binocular system)
- Eye camera(s) and illuminator system(s) mounted to the EyeFrame hardware
 - EyeFrame hardware includes eye camera and illuminator system and either a color 70° horizontal field of view scene camera or a black and white 60° horizontal field of view scene camera
- Universal power supply with country specific adaptor and 10 M video and power cable.
- Waist pack cable holder (not shown)
- Additional hardware specs as shown

EYE TRACKING SYSTEM SPECIFICATIONS

Real-time display	Gaze point history, gaze trace, fixation duration, pupil size and ROIs, can be graphically displayed over stimulus image. Visible to the user and / or the subject for fixed and HMD options. Real-time pen plots of X and Y position of gaze, velocity, ocular torsion, pupil width and pupil aspect ratio.
Allowable head movement	Fixed and HMD options: Small movements allowed. Subject's pupil and corneal reflection must remain within the camera image. Scene camera options: unlimited
Tracking Method	Infrared video. Monocular or binocular options. Pupil tracking—Fixed and HMD options = bright or dark pupil; scene camera options = dark pupil.
Visual range	Fixed options: <i>Horizontal</i> $\pm 44^\circ$ of visual arc, <i>Vertical</i> $\pm 20^\circ$ of visual arc HMD options: tracking will depend on the field of view of the HMD. Scene camera options, included with the system either: Color 70° horizontal field of view or B&W 60° horizontal field of view.
Measurement principle	The user can select between three methods: Pupil only, corneal reflection only, or both together (both provides greater tolerance to head movements for the fixed and HMD options).
Accuracy*	Approximately 0.25° - 1.0° visual arc
Spatial resolution*	Approximately 0.15° visual arc
Temporal resolution	between 60 Hz and 30 Hz, user-selectable
Blink suppression	Automatic blink detection and suppression
Pupil size resolution	Measures pupil height and width to better than 0.03 mm instantaneous (no averaging).
Auto threshold	The program scans over the video image for the pupil and / or for the corneal reflection. Little or no manual adjustment required. luminance threshold can be adjusted auto threshold feature provides good threshold levels automatically
Real-time communication	Same computer: Software Developers Kit (SDK) supplies everything required for seamless interface between ViewPoint and the program. This includes: DLL with shared memory, .h and .lib files plus sample source code written in C Language. Serial port: Sends eye data packets and asynchronous packets equivalent to information in ASCII data files at rates of up to 56K. Receive real time data from other programs and store it asynchronously into data files. AnalogOut option: Selectable unipolar or bipolar voltage ranges: +/- 10, 5, 2.5. Selectable data items: position of gaze (x,y), pupil (h,w), velocity (dx,dy), and raw pupil, glint or vector data. TTL capabilities. 2 or 4 channel options. TTL in/out option: Eight TTL input channels are interfaced to place marker codes into the ViewPoint data file. Eight TTL output channels that indicate when the position of gaze is inside ViewPoint region of interest areas ROI-0 to ROI-7. Ethernet: full real-time synchronization across machines via the Ethernet.

Stimulus Presentation	Pictures and movies can be displayed in full stimulus windows or in user specified ROIs. Auditory cues can be integrated. Gaze contingent stimulus presentation via state logic.
Data recorded	Data is stored in ASCII files. Eye data: X, Y position of gaze, pupil height and width, ocular torsion, delta time, total time, and regions of interest (ROI). Asynchronous records include: State transition markers, key presses, data from other programs.
Calibration	Fixed and HMD options: ViewPoint starts in a roughly calibrated state that is adequate for determining screen quadrants or other relative movement measurement such as objective preference-of-looking tasks. Scene camera options: Calibration is performed relative to the pixels of the CCD array, not the image content. This is analogous to calibrating relative to the CRT screen and not the image displayed on it. New subject setup time between 1-5 minutes. For accurate position of gaze, calibration is required only once per subject—settings can be stored and reused each time a subject returns. Easy Slip Correction feature and re-presentation of stray calibration points.
System requirements:	OS: Windows 7/Vista or XP Machine: Fixed and HMD options—Pentium compatible Scene camera options—2.8 GHz Pentium or higher, or Athlon XP 2800+ or higher

Fee-based consulting for integration can be provided.

These eye tracking systems use **Arrington Research**[®] technology and include cables required to interface to a BIOPAC MP system—MP160 or MP150 data acquisition unit and AcqKnowledge software.

EYE-TRACK-BAR

REMOTE SCREEN-BASED EYE TRACKING



Robust Eye Tracking in a Compact Module

Eye Tracking Fully Integrated with *AcqKnowledge*

Large head motion box & reliable fixed data rate

40 Hz • 60 Hz • 120 Hz • 200 Hz

This mini screen-based remote eye tracking bar provides gaze position, dwell time, blink rate, pupil size, and more. Use with an *AcqKnowledge* Eye Tracking Integration License ([ACK100W-EYE](#)) to access valuable eye tracking metrics: Gaze Path, Gaze Plot, Heat Map, and Attention Map. Create user-defined Areas of Interest (AOI) and select Scarf Plot, String Plot, Pie Chart, and Key Performance Indicator (KPI) metrics. For concurrent physiological data such as Heart Rate, EDA, SCR/SCL, etc., record biometrics from a Wireless Smart Center, MP160, MP36R Research System, or other BIOPAC hardware.

- **Small and Rugged** The housing is an inch shorter than its predecessor and has the USB connection in the back where it is protected from bumps and knocks.
- **Increased Head Motion Tolerance** New 10 mm lens provides a 15% increase in head motion box.
- **Improved Accuracy Outdoors** Strobing IR lights enable robust tracking in all types of lighting. In addition, an optical filter integrated into the front cover improves tracking near windows and other tough lighting conditions.
- **Less Distraction** Smaller tracking indicator lights on the front reduce distraction.
- **Compatible** with [Microsoft Eye Control](#).

AEye Technology Benefits

AEye technology consists of the latest generation of EyeTech Digital Systems' algorithms, software, and hardware, as well as offers a superior experience for users. This includes robust tracking performance, instant acquisition, and a greater tolerance for head motion.

- **Fast** - Faster acquisition and reacquisition of the eyes—ideal for those who have a lot of head motion.
- **Reliable** - Robust tracking over a range of users and environments.
- **Smart** - The AEye hardware comes in a compact, low-power design with all the processing being done on the camera board - relieving the host device of the processing burden.

Technical Specifications

- Method: Dark pupil, single or binocular tracking
- Speed FPS: select 40, 60, 120 or 200 Hz
- Operating distance: 50-70 cm
- Head motion box (W x H x D): 31.5 x 15 x 20 cm
- Accuracy: 0.5°
- Dimensions: 25.4 x 2.6 x 3.2 cm
- Connection type: USB
- Power supply: USB port
- Weight: 0.21 kg
- Certification: CE and FCC

System Requirements

- Microsoft Windows 8 or 10, 64-bit
- USB Port(s)
- Up to 22 inch monitors

AcqKnowledge Integration

- Add Eye Tracking License ACK100W-EYE

EYE-TRACK-BAR-XL

REMOTE SCREEN-BASED EYE TRACKING FOR LARGE MONITORS



Robust Eye Tracking in a Compact Module

Eye Tracking Fully Integrated with *AcqKnowledge*

Large head motion box & reliable fixed data rate

60 Hz – Screen size up to 190 cm – Distance up to 200 cm

This XL screen-based remote eye tracking bar provides gaze position, dwell time, blink rate, pupil size, and more for applications with increased distance and screen size. Allows for long distance tracking, accurately providing data and interactive excitement from up to 3 m (10') away. Good choice for interactive exhibits and research projects. Use with an *AcqKnowledge* Eye Tracking Integration License ([ACK100W-EYE](#)) to access valuable eye tracking metrics: Gaze Path, Gaze Plot, Heat Map, and Attention Map. Create user-defined Areas of Interest (AOI) and select Scarf Plot, String Plot, Pie Chart, and Key Performance Indicator (KPI) metrics. For concurrent physiological data such as Heart Rate, EDA, SCR/SCL, etc., record biometrics from a Wireless Smart Center, MP160, MP36R Research System or other BIOPAC hardware.

- **Small and Rugged** The housing is an inch shorter than its predecessor and has the USB connection in the back where it is protected from bumps and knocks.
- **Increased Head Motion Tolerance** New 10 mm lens provides a 15% increase in head motion box.
- **Improved Accuracy Outdoors** Strobing IR lights enable robust tracking in all types of lighting. In addition, an optical filter integrated into the front cover improves tracking near windows and other tough lighting conditions.
- **Less Distraction** Smaller tracking indicator lights on the front reduce distraction.
- **Compatible** with [Microsoft Eye Control](#).

AEye Technology Benefits

AEye technology consists of the latest generation of EyeTech Digital Systems' algorithms, software, and hardware, as well as offers a superior experience for users. This includes robust tracking performance, instant acquisition, and a greater tolerance for head motion.

- **Fast** - Faster acquisition and reacquisition of the eyes—ideal for those who have a lot of head motion.
- **Reliable** - Robust tracking over a range of users and environments.
- **Smart** - The AEye hardware comes in a compact, low-power design with all of the processing being done on the camera board - relieving the host device of the processing burden.

Technical Specifications

- Method: Dark pupil, single or binocular tracking
- Speed FPS: 60 Hz
- Operating distance: 120-200 cm
- Head box (W x H x D): 22.5 x 17 x 30 cm
- Accuracy: 0.5°
- Dimensions: 96 x 5 x 8 cm
- Connection type: USB
- Power supply: External power supply
- Weight: 1.8 kg
- Certification: CE and FCC

System Requirements

- Microsoft Windows 8 or 10, 64-bit
- USB Port
- Up to 190 cm (75") monitors

AcqKnowledge Integration

- Add Eye Tracking License ACK100W-EYE

CAMERA SYSTEMS - MULTI-SUBJECT VIDEO MONITORING

Multi-Subject Video Monitoring Systems are available with Four or Eight Cameras

Camera System 4 (CAMSYS4) and Camera System 8 (CAMSYS8) include everything needed to record 4-8 channels of video data for integration with existing MP160 or MP150 System and AcqKnowledge software.*

The Camera Systems record multiple subjects or camera angles and AcqKnowledge media functionality synchronizes the video to any physiological data being recorded with the MP160 or MP150 Research System. The cameras work well in low-light conditions, making them very well-suited for long-term recordings, sleep studies, animal studies, and more.

View the video capture window and physiology in AcqKnowledge in real-time during recording—and scroll through the linked data in either the AcqKnowledge graph file or video playback viewer for review and analysis. Scrolling through one file will automatically advance the linked file to the same location.

During recording, the video capture window is capable of displaying all camera views at once in a stacked display. The included multiplexer allows the user to toggle between cameras, or cycle through all views. This allows the researcher to focus on a particular camera view during recording when necessary, and then easily revert back to the stacked camera view.

*Camera Systems work with AcqKnowledge Version 4.1 or above, Windows Operating System only.

CAMSYS4
Four Camera System



CAMSYS8
Eight Camera System



CAMSYSUPG
System Upgrade



Upgrade a CAMSYS4 four camera system to a CAMSYS8 eight camera system.

NEW CAMSYS Video Monitoring Packages from BIOPAC interface to the MP160 Research System with AcqKnowledge!

Components

Cameras	4	8	4
Tripods	4	8	4
Gooseneck Adapter	4	8	4
Camera Power Splitter	1 to 4 splitter	1 to 8 splitter	1 to 8 splitter
General Power Splitter	1 to 2 splitter	1 to 2 splitter	—
8 Channel Multiplexer	included	included	—
A/D Converter	included	included	—

For a video demo/tutorial of Camera System setup and operation, click [here](#).

VIDEO MONITORING APPLICATIONS

Exercise Physiology

Examine ventilation, oxygen uptake, carbon dioxide production, biopotentials, temp., and biomechanical signals simultaneously. Record wirelessly with BioNomadix.

Psychophysiology

Record BP, ECG, EDA, EMG, EEG, EOG, RSP, etc. Interface to stimulus presentation programs and use automated analysis routines to easily score and analyze data.

Remote Monitoring

BioNomadix modules provide high quality, full-bandwidth data for a variety of signals—ECG, EEG, EGG, EMG, EOG, PPG, RSP, SKT, Accelerometry, Cardiac Output and Gyro.

Sleep Studies

Long term recordings with up to 16 channels of data. Record EEG, EOG, EMG, respiration, temp., sound, limb position and more. Filter out EEG frequencies to score sleep stages.

Virtual Reality

Synchronize events from a virtual world with physiological data from an MP160/150 system. Use feedback loops for greater control and automation—change the VR world in real time.

For tips on synchronizing video data, see [Application Note 270](#)

CAMERA SYSTEM UPGRADE - CAMSYSUPG

The CAMSYSUPG package comes with four additional cameras, tripod stands, gooseneck adapters, and required cables to upgrade a CAMSYS4 package to the equivalent of a CAMSYS8 package.



CAMSYSUPG Package

CAMSYSUPG Upgrade from 4 to 8 Camera System Contains:

- 4 x Cameras (see additional camera specs below)
- 4 Tripod stands (1-2 meter range)
- 4 x 19" black gooseneck adapters for tripod stands
- Power Splitter (1 female to 8 male 5.5 mm x 2.1 mm)

ADDITIONAL CAMERA SPECIFICATIONS

1/4" Color CMOS Image Sensor
Cable Length: 60'
420 TV Lines, Horizontal
6 mm Lens
Signal: NTSC
Night Vision Min. Light: 0 Lux (IR On)
IR Irradiation Distance: up to 30'
Operation Temperature: -5° F ~ 120° F
Power: 12 V DC
Power Supply: 12 V 1500 mA 4 Port

ADDITIONAL MULTIPLEXER SPECIFICATIONS

Supported Resolution NTSC: 720 (H) x 480 (V)
8 channel video signal input, 1 Vp-p, 75 Ohms
Video Output
Power Consumption 5 W (400 mA)
Operation Temperature -10 to 60
Operational Humidity within 85% RH
Power Supply: DC 12 V
Dimension 210 mm (L) x 130 mm (W) x 40 mm (H)

1. Tripod Assembly (for each tripod)

A. Attach Gooseneck to Tripod

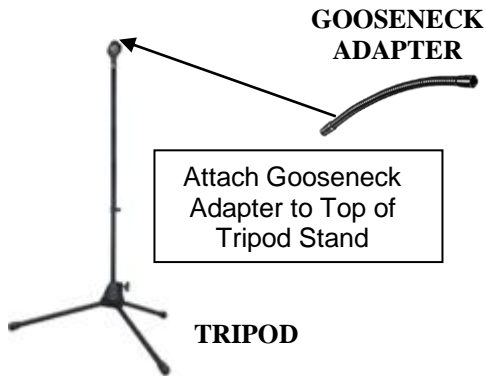

B. Attach Camera to Gooseneck

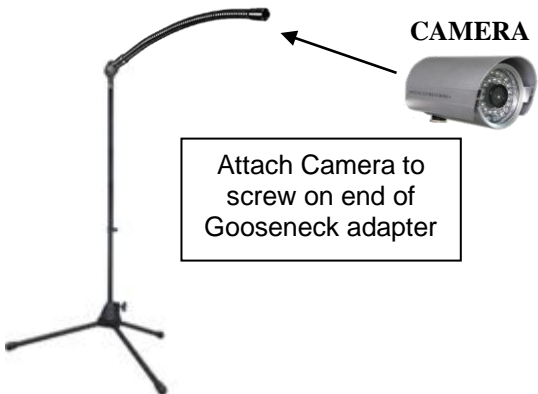

2. Cable Connections (for each camera)

A. Connect End #1 of 18 m Cable to Camera

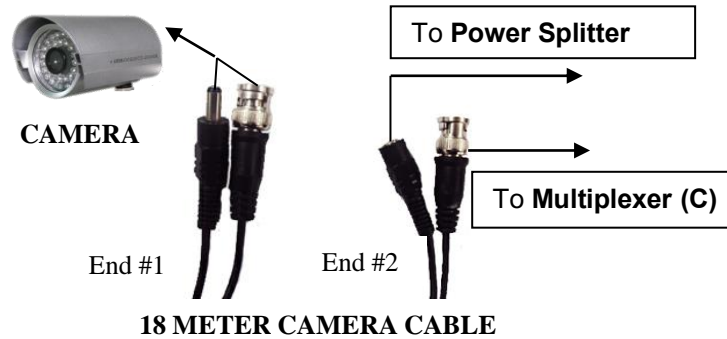

B. Connect Camera and Multiplexer to Power Splitters

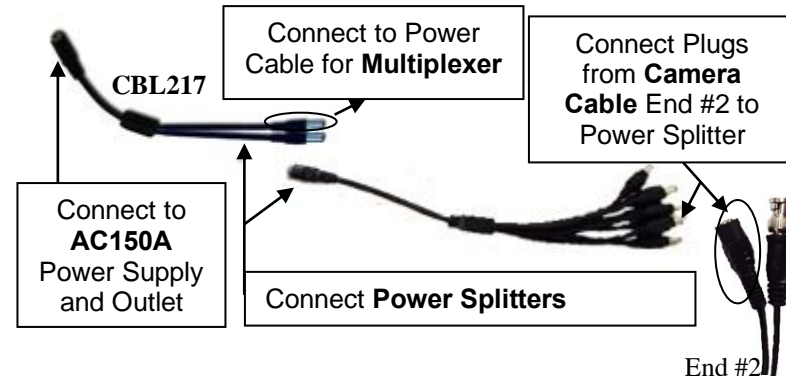

C. Connect End #2 of 18 m Cable to Multiplexer

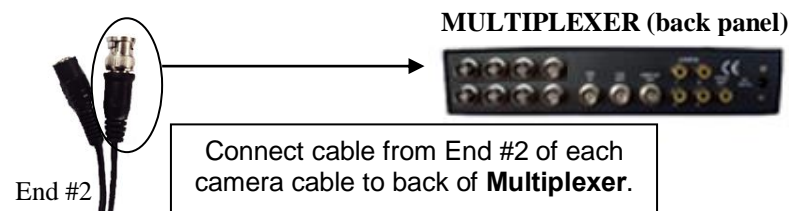

3. Computer Connections

A. Connect Multiplexer to Computer

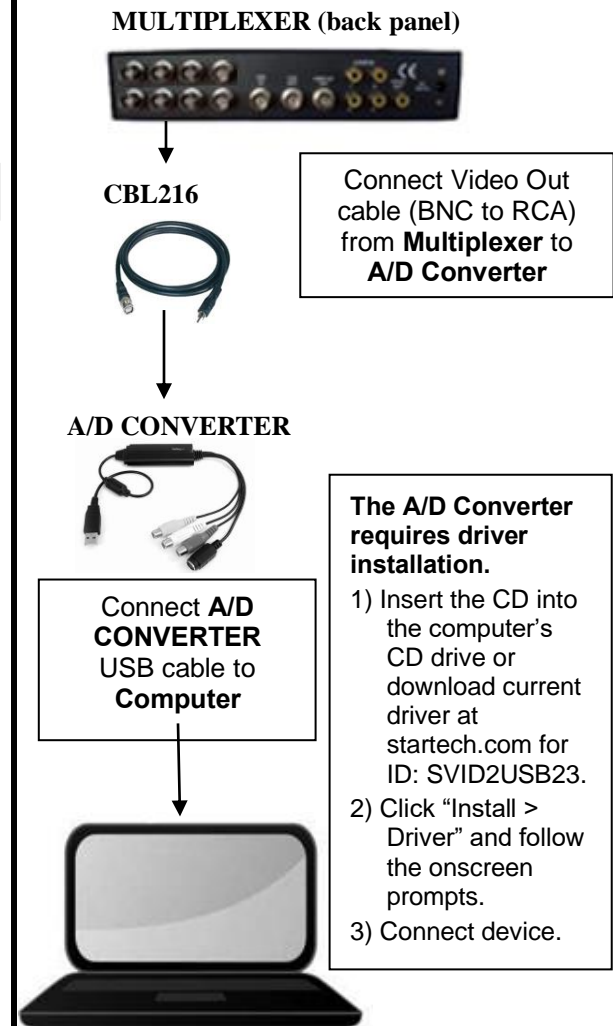

Once Camera System connections are completed, select cameras from the **Media Menu in *AcqKnowledge*. Next, synchronize the cameras with the **MP160/MP150 System** using **OUT103** LED light. For more information on synchronization, see Application Note 270 available on BIOPAC online **Support**

CAM-HFR-A HIGH FRAME RATE CAMERA

Tightly synchronize high frame rate video—up to 100 FPS—with physiological data recorded with a BIOPAC MP160 or MP150 Research System.

Included Components

- High Frame Rate Camera (CAM-HFR-A)
- Camera Lens, 6 mm (LENS-CAM-A)
- GigE Network Interface Card (ETHCARD3)
- CAT6 Ethernet Cable (CBLETH3)
- AC Power Supply, cord and Trigger Cable (AC300A and CBLHFR)
- Camera Tripod Kit with Mount (TRIPOD-KIT-CAM)

Requires Windows-based computer and AcqKnowledge 4.3.1 or above for Windows to support GigE camera; does not require auxiliary synchronization methods.

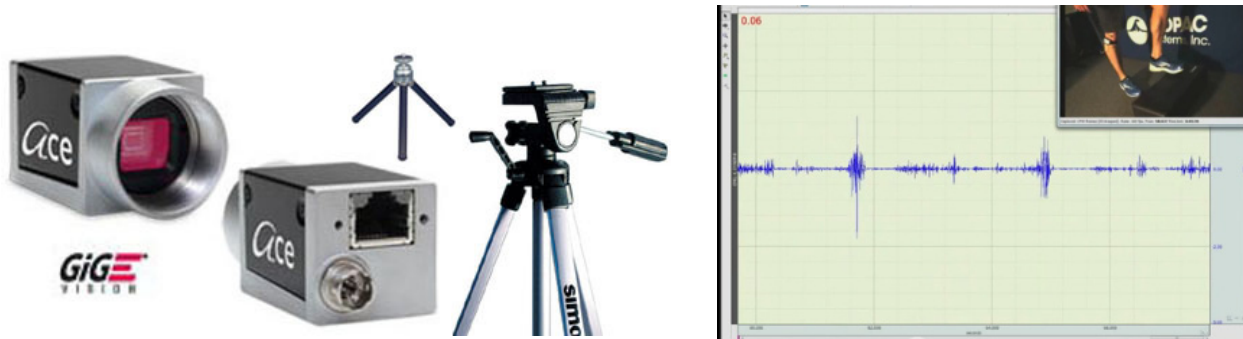

Use the High Frame Rate Camera System to capture precise movement activity at 100 frames-per-second (640 x 480 resolution) in conjunction with other recorded physiological variables.

With CAM-HFR-A and AcqKnowledge media tools, it's possible to obtain synchronization within 1 video frame (10 ms) between physiological data and video data, running at a rate of 100 frames per second, up to the computer's memory capacity. This very high performance video recording option incorporates automatic synchronizing between the video data and the physiological data, so no external synchronization marker is required. Furthermore, the high speed camera in CAM-HFR-A can be controlled from AcqKnowledge for exposure times as short as 1 ms, running at 100 frames per second. This combination of high frame rate, automatic synchronization, and precise control over camera exposure times results in the ability to precisely characterize physical activity in relation to simultaneously recorded physiological data, such as EMG, Acceleration, Goniometry, Respiration, and more.

Media functionality allows users to capture and playback video and synchronize it with physiological information from an MP device. The key functionality is the strong link between the video and data cursor when physiological data graphs and associated video are reviewed in post-acquisition mode; changing the selection in the graph window will automatically jump the video to the time corresponding to the cursor position in the physiological data graph. The reverse connection is also in place where scrolling through the video will move the data cursor to the corresponding point in the physiological data graph.

Data streams from the video digitizer and the MP unit are automatically synchronized. In this manner—there is no requirement that the user create a visible synchronization marker to align physiological data with video. The combined CAM-HFR-A and AcqKnowledge System is very simple to use!

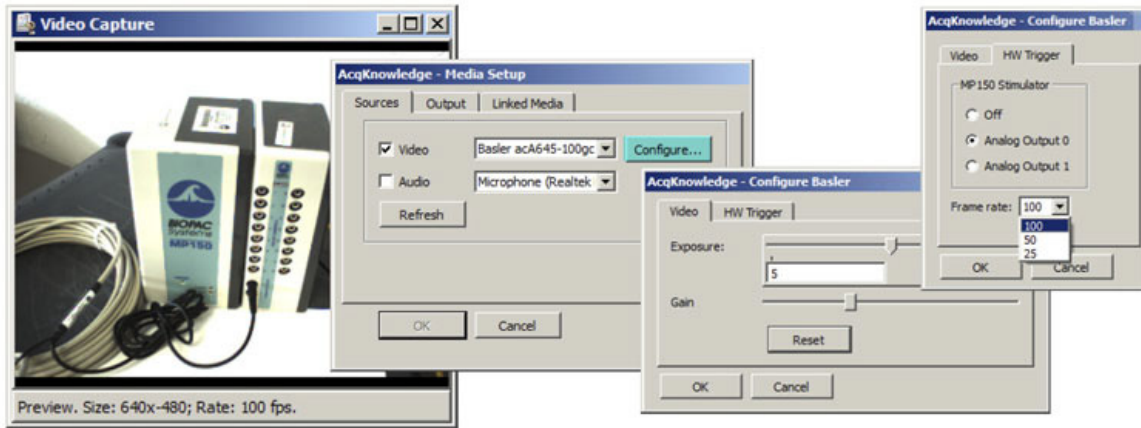

AcqKnowledge 4.3.1 and above automatically recognizes the HFR camera and simplifies setup for tight synchronization

The video capture field is a function of the lens placed on the high-speed camera. BIOPAC has included a high quality Navitar lens, suitable for nearly all sports science and exercise physiology applications. The provided C-mount lens will permit a 1.8 meter high x 2.4 meter wide field of view at a camera distance of 2.5 meters.

To perform close-up videos of heads, hands or feet, simply pull the camera in towards the subject. To capture movement of many subjects at once, just pull the camera away from the subjects. For exotic measurements, as when videoing a distant subject or performing an extreme close-up, simply switch out the provided lens for the appropriate C-mount lens.

The camera iris control can be adjusted to accommodate a range of ambient lighting conditions. Furthermore, the camera exposure time can be controlled from the *AcqKnowledge* software to allow for the sharpest imaging possible under fast subject movement conditions. When using short exposure times, video frames will hold very crisp images to allow for precise identification of subject position as a function of simultaneously collected physiological data.

System Requirements

Recommended	Minimum
Core i7 Quad Core or Xeon E3/E5 processor, 2.40 GHz	Core 2 Duo processor, 2.13 GHz
8 GB DDR2 memory, dedicated card for video capture	4 GB DDR2 memory
RAID0/RAID10 with enterprise grade "RAID Edition" hard disks, or Non-RAID 10,000 RPM (such as VelociRaptor®,) or 15,000 RPM, (such as Seagate Cheetah) > 125 MB/s sequential write speed	SAS/SATA III, 6 GB/s, 7200 RPM > 90 MB/s sequential write speed
<ul style="list-style-type: none"> Windows <i>AcqKnowledge</i> 4.3.1 or above is required for high frame rate camera support. To insure stable 100 fps frame rate, use the provided GigE Network Interface Card. 	

Specifications

Resolution horizontal/vertical:	658 pixels x 492 pixels
Pixel Size horizontal/vertical:	9.9 µm x 9.9 µm
Frame Rate/Resolution:	25, 50 or 100 fps at 640 x 480 resolution
Mono/Color:	Color
Interface:	Gigabit Ethernet
Video Output Format:	Mono 8, Bayer BG 8, Bayer BG 12, Bayer BG 12 Packed, YUV 4:2:2 Packed, YUV 4:2:2 (YUYV) Packed
Communications:	GigE (system includes GigE ethernet card for Windows based processor)
Synchronization & Triggering:	Camera is frame-rate controlled from MP160/150 System via included triggering cable
Optics:	Navitar 2/3" lens, 6 mm, 1.4 f-stop with manual focus, iris and locking screws, C-mount
Field of View:	Nominally 1.8 meters high x 2.4 meters wide at 2.5 meters distant from camera
Pixel Bit Depth:	12 bits
Synchronization:	External trigger, free-run, Ethernet connection
Exposure Control:	Programmable via the camera API, external trigger signal
Housing Size (L x W x H) in mm:	42 x 29 x 29
Housing Temperature:	0° C – 50° C
Lens Mount:	C-mount, CS-mount
Digital Input:	1
Digital Output:	1
Power Requirements:	PoE or 12 VDC
Power Consumption (typical):	3.3 W
Power Consumption PoE:	3.6 W
Weight (typical):	90 g
Conformity:	CE, RoHS, GenICam, IP30, UL, FCC, PoE 802.3 af
Sensor Vendor:	Sony
Sensor Name:	ICX414
Sensor Technology:	Progressive Scan CCD, global shutter
Sensor Size (optical):	1/2 inch
Sensor Type:	CCD
Sensor Size (mm):	6.52 mm x 4.89 mm
Tripods:	Standard tripod 54" and mini-tripod 6¼"

Connecting Camera Hardware:



Before you begin:

Make sure the camera drivers and the provided ETHCARD3 Network Interface Card are installed.

1. Connect the CBLHFR 6-pin-connector to the camera input.
2. Connect the female end of the CBLHFR connector to the AC300A power supply adapter cable.
3. Plug the AC300A power supply cord into wall socket.
4. Connect the Ethernet cable between the camera's Ethernet port and the ETHCARD3 network interface card supplied with your system. Attach the 6 mm lens to camera (included as LENS-CAM-A).

Launch the pylon IP Configuration Tool from the Desktop shortcut to verify camera/network connection. If successful, the camera's network settings will appear in the IP configuration window as shown below. (Make sure the IP configuration is set to DHCP.)

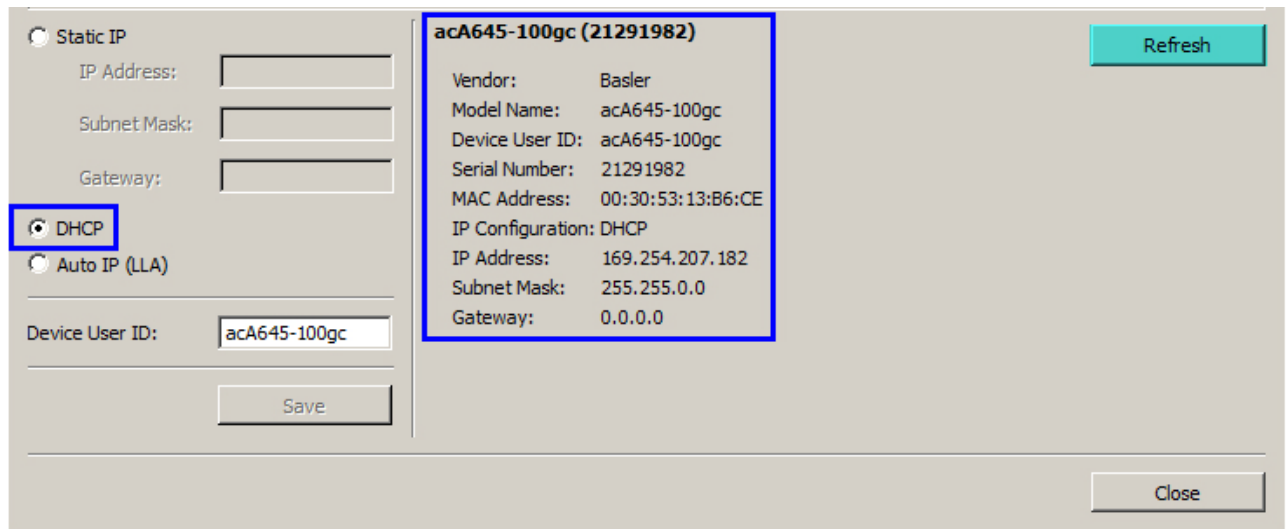

NOTE: If the camera's network settings don't appear in the pylon IP Tool Configuration window, click the "Refresh" button and highlight the camera device from the list at the top of the Configuration Tool. If the camera's network settings still don't appear, or appear in the pylon IP Configuration Tool window as "unreachable", reset the IP configuration to Static IP.

Set Up Camera Configuration in AcqKnowledge Software:

1. Launch AcqKnowledge and select Media > Set Up. The Basler camera should appear as selected in the "Video" list.
2. Check the "Video" option (and "Audio" if sound is to be recorded).

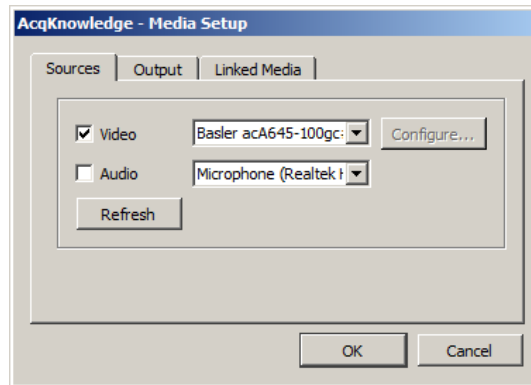

3. Click the "Output" tab and type in a media file name.
4. Click "Browse" and choose a format (*.wmv or *.avi) and directory for the new media file.

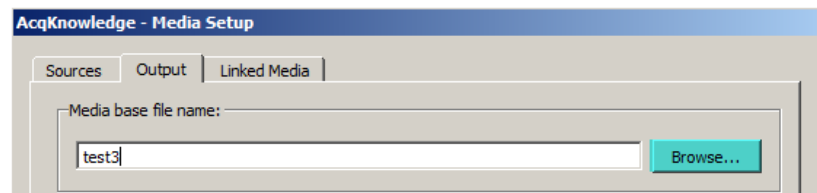

5. Click "Save".

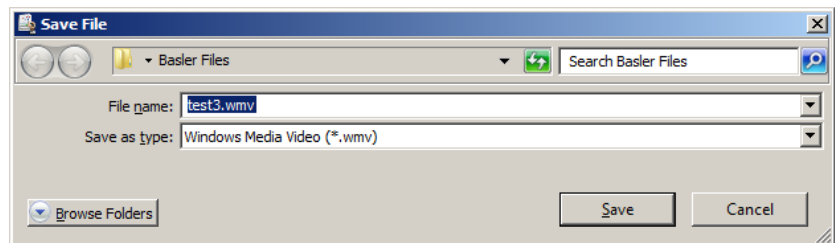

6. Click "OK" to bring up the Video Capture Viewer. This is useful for determining proper camera positioning, lighting, etc...
7. To access the "Video" properties (Exposure or Gain controls,) go to Media > Set Up and click the "Configure" button.

NOTE: The "Configure" button is not active until the Media > Set Up dialog is dismissed with "OK" and reopened.

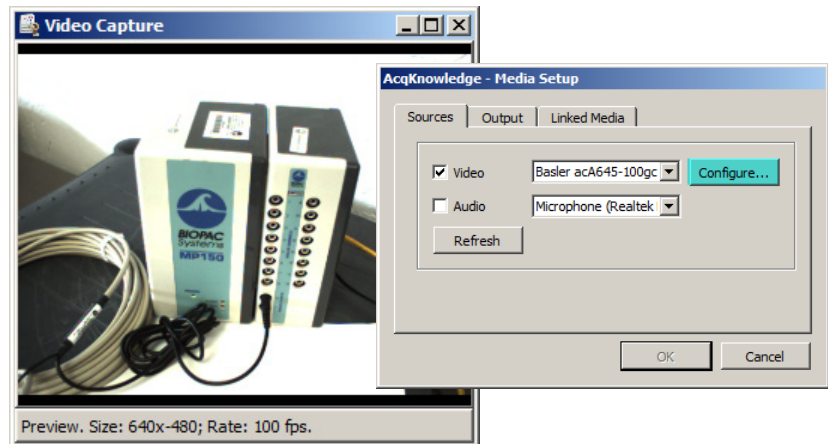

8. Click the "HW Trigger" tab to:
 - Use the MP160/150 Stimulator to trigger and synchronize the camera recording with AcqKnowledge.
 - Set the camera frame rate. (25, 50, or 100 fps.)

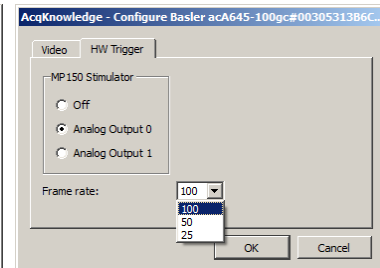
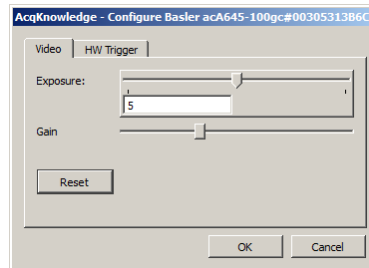

For Support contact: support@biopac.com or visit the Support page at www.biopac.com

APPENDIX**SHIELD DRIVE OPERATION**

ECG100C	EGG100C	EOG100C	MCE100C*
EEG100C	EMG100C	ERS100C	TEL100C

The shield drive for BIOPAC biopotential front-end differential amplifiers is developed as the arithmetic mean of the voltages sensed on the positive and negative differential inputs with respect to Ground. Given that interfering noise sources (usually 50 Hz / 60 Hz) nearly always appear as high level voltage signals of similar value on the positive and negative differential inputs, creating a shield drive for the positive and negative input leads will act to increase the amplifier's Common Mode Rejection Ratio (CMRR) via capacitance reduction of the differential input to its respective shield. Because the shield drive is introduced identically to the differential inputs, additive noise from the shield drive will have a tendency to cancel out due to the operation of the differential amplifier front end.

Generally, it's helpful to have an active shield drive for interfering noise reduction. However, in special cases, it may be worthwhile to ground the cable shields connecting to the amplifier's differential inputs or to dispense with shielding altogether. Any BIOPAC biopotential front-end differential amplifier can be user-adapted to satisfy these special cases; please contact BIOPAC Systems, Inc. for details.

* The MCE100C shield drive is independent for both (V_{in}^{+}) and (V_{in}^{-}) inputs.

APPENDIX

HYSTERESIS SPECIFICATION FOR HAND DYNAMOMETERS

Devices affected: TSD121B-MRI, SS25LA, SS25LB

Specification: Hysteresis: Nominal Test Case - For an applied force (~FSR/2 = 27.2155 kgf) over 4 seconds, the residual force (hysteresis) ≤ 1.3%. FSR for this device = 50 kgf.

Error = (residual/applied force) * 100

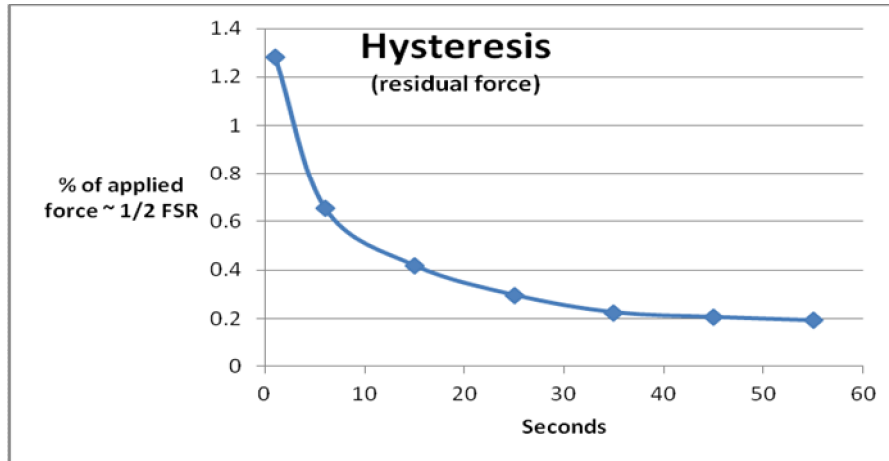

Figure 1: Residual force (hysteresis) due to viscoelasticity after application of force ~ 1/2 FSR (27.2155 kgf).



Figure 2: Delrin handle within the test fixture. Red arrow indicates placement of applied force which is at a single point; not distributed across the handle.

APPENDIX

AMPLIFIER FREQUENCY RESPONSE CHARACTERISTICS

The following frequency response plots illustrate the frequency response selections available on the indicated amplifier modules. LP is low pass, HP is high pass, and the N suffix indicates the notch setting. Modules (except for the DA100C) can be set for 50 or 60 Hz notch options, depending on the destination country.

Setting	Modules
0.1 Hz LP	EGG100C
1 Hz LP	EGG100C, GSR100C, SKT100C
3Hz LP	PPG100C, RSP100C
10 Hz LP	DA100C, EB1100C, GSR100C, PPG100C, RSP100C, SKT100C
35 Hz LPN (with 50 Hz notch)	ECG100C, EEG100C, EOG100C, TEL100C
35 Hz LPN (with 60 Hz notch)	ECG100C, EEG100C, EOG100C, TEL100C
100 Hz LP	EB1100C, EEG100C, EOG100C
150 Hz LP	ECG100C
100 Hz HPN (with 50 Hz notch)	EMG100C, ERS100C, MCE100C
100 Hz HPN (with 60 Hz notch)	EMG100C, ERS100C, MCE100C
300 Hz LP	DA100C
500 Hz LP	EMG100C, TEL100C
3,000 Hz LP	ERS100C, MCE100C
5000 Hz LP	DA100C, EMG100C
10 kHz LP	ERS100C
30 kHz LP	MCE100C

See also: Sample Plots

100C SERIES

100C Series Amplifiers - Sample Frequency Response Plots

0.1 Hz LP

EGG100C

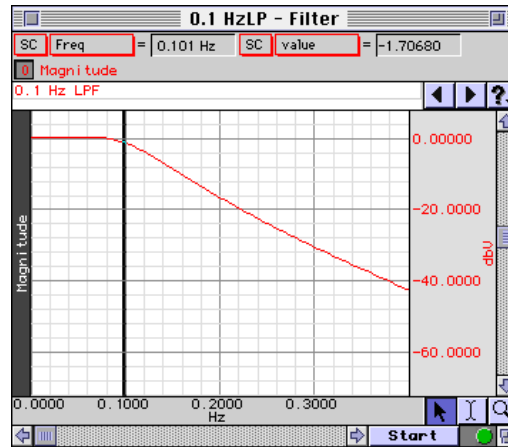

1 Hz LP

EGG100C
 GSR100C
 SKT100C

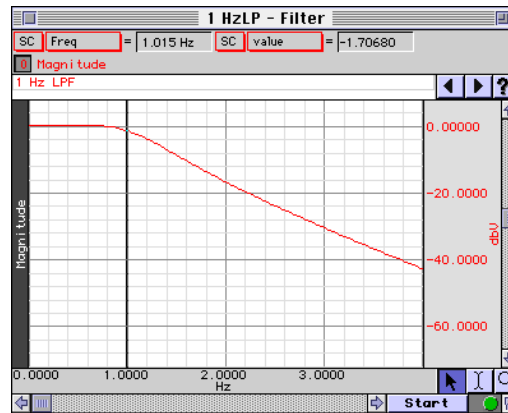

3 Hz LP

PPG100C
 RSP100C

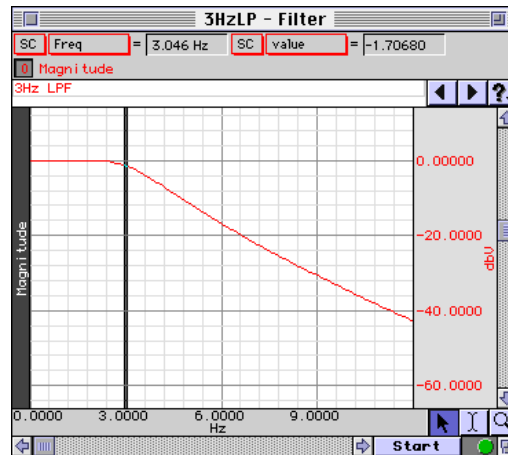

100C Series Amplifiers - Sample Frequency Response Plots

10 Hz LP

DA100C
 EBI100C
 GSR100C
 PPG100C
 RSP100C
 SKT100C

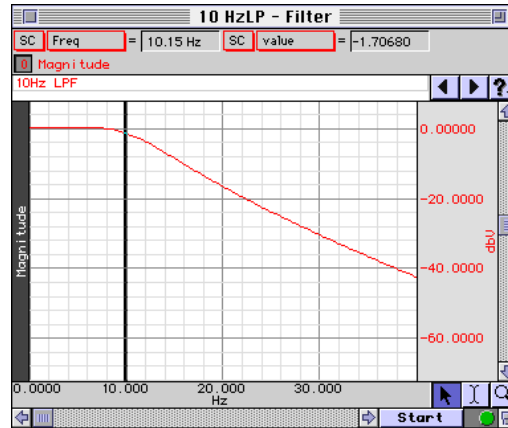

35 Hz LPN (with 50 Hz notch enabled)

ECG100C
 EEG100C
 EOG100C
 TEL100C

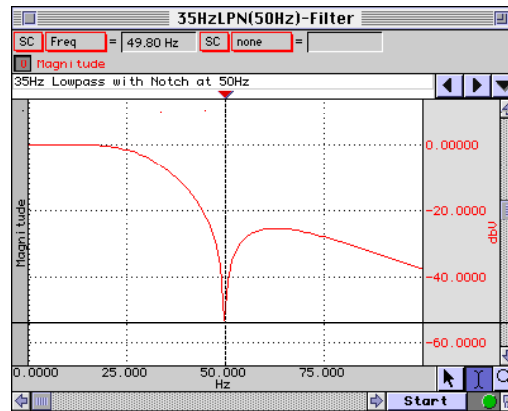

35 Hz LPN (with 60 Hz notch enabled)

ECG100C
 EEG100C
 EOG100C
 TEL100C

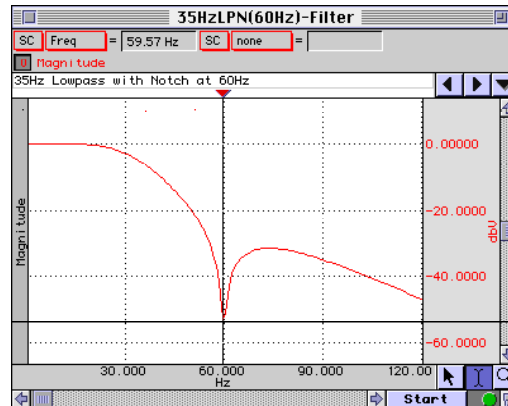

100C Series Amplifiers - Sample Frequency Response Plots

100 Hz LP

- EBI100C
- EEG100C
- EOG100C
- NICO100C

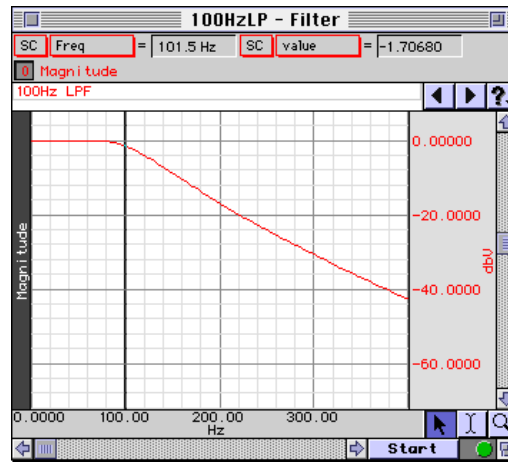

150 Hz LP

- ECG100C

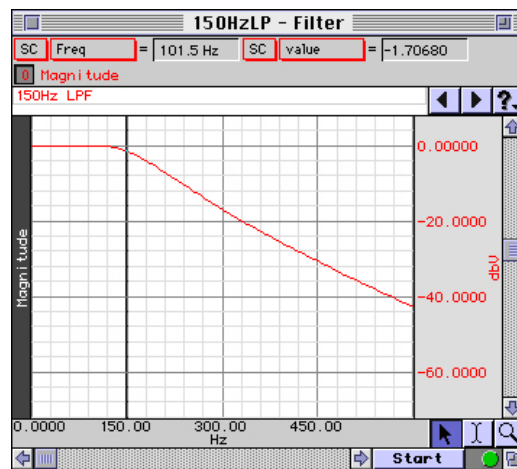

100 Hz HPN (with 50 Hz notch enabled)

- EMG100C
- ERS100C
- MCE100C

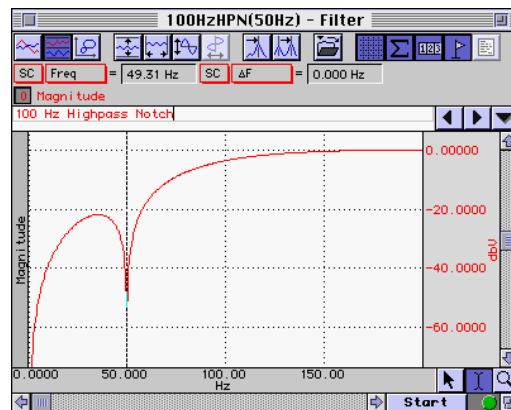

100C Series Amplifiers - Sample Frequency Response Plots

100 Hz HPN
 (with 60 Hz notch enabled)

MCE100C

EMG100C

ERS100C

MCE100C

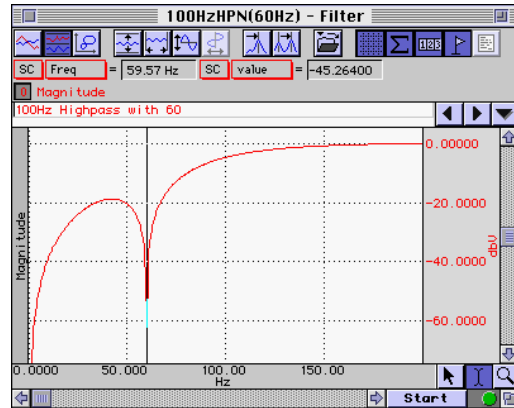

300 Hz LP

DA100C

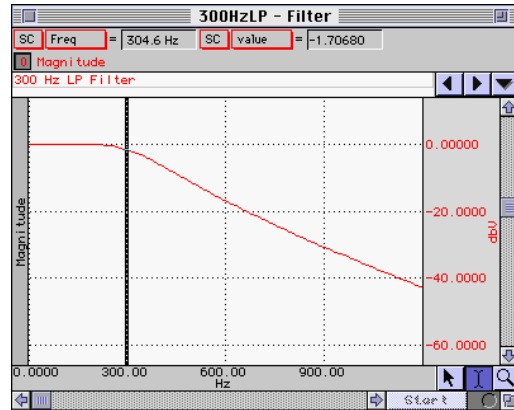

500 Hz LP

EMG100C

TEL100

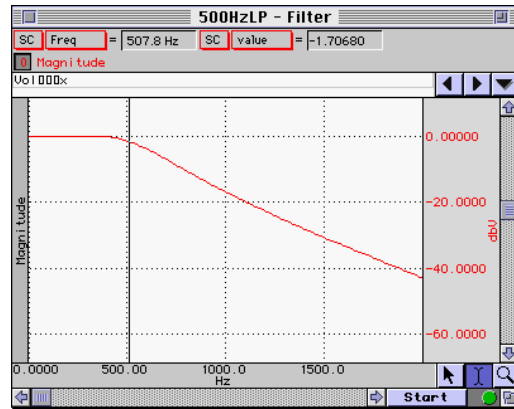

3,000 Hz LP

ERS100C

MCE100

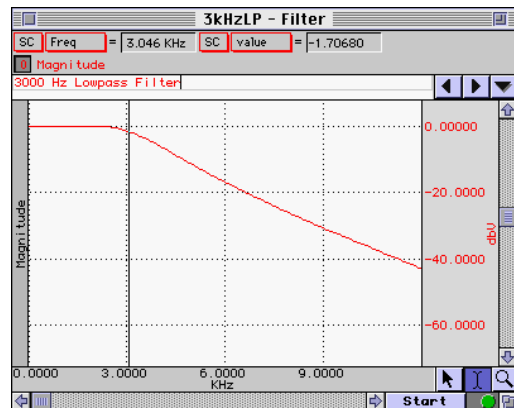

100C Series Amplifiers - Sample Frequency Response Plots

5000 Hz LP

DA100C
EMG100C

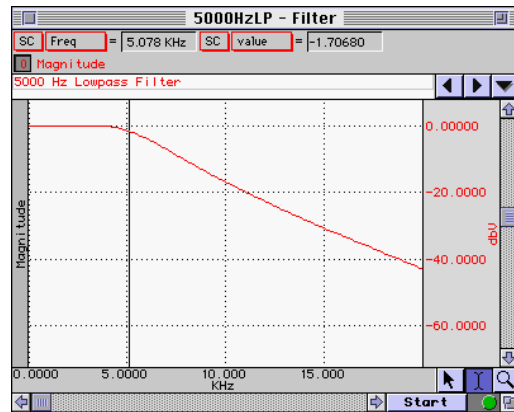

10 kHz LP

ERS100C

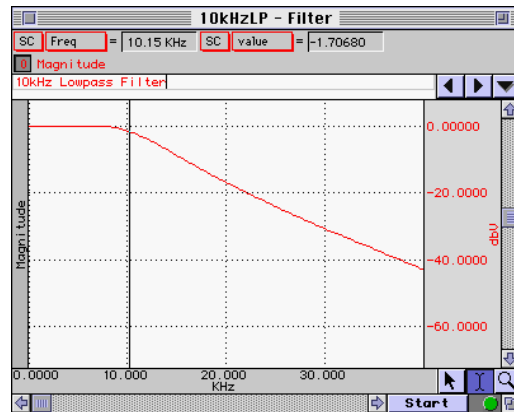

30 kHz LP

MCE100C

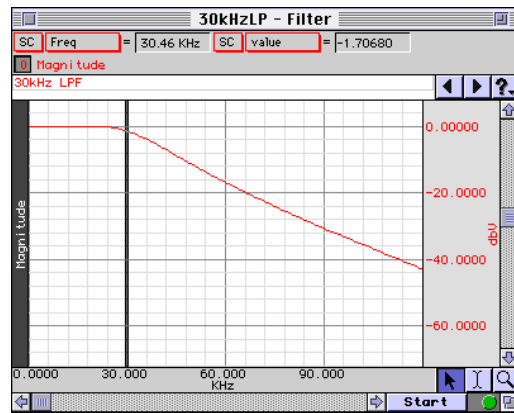

APPENDIX

AMPLIFIER MODULE FILTER RESPONSE TIMES

The MP series amplifier modules incorporate a variety of filtering options. The low pass filtering options have an effect on the signal response time, which is sometimes referred to as signal delay.

Signal delay is often plotted as the function “group delay” versus frequency. This type of plot shows the typical delay the filter will have for a wide range of frequencies. The group delay plot is the derivative of the filter phase plot with respect to frequency. If the filter is perfectly linear phase, the group delay plot will be a straight horizontal line, because the derivative of a constant (linear) slope is a constant.

In practice it’s often difficult to utilize a group delay plot to get a quick and simple handle on essential filter signal delay, unless one is experienced in reading such plots. Instead, it’s typically better to show the filter response to a well-understood input signal, such as a step function.

The following plots illustrate the delay times for a variety of low pass filter settings.

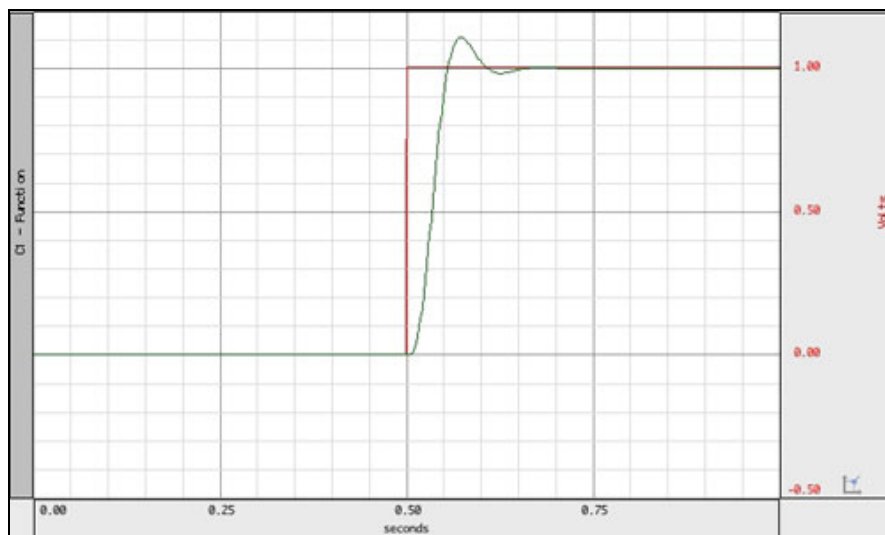

10 Hz Low Pass Filter – 4 pole Besselworth

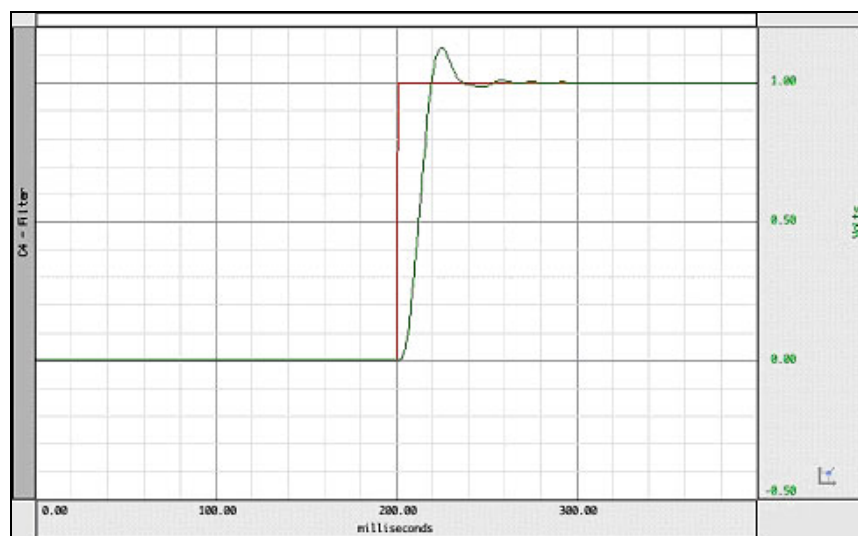

35 Hz Low Pass Notch Filter – 4 pole Besselworth – Notch at 60 Hz

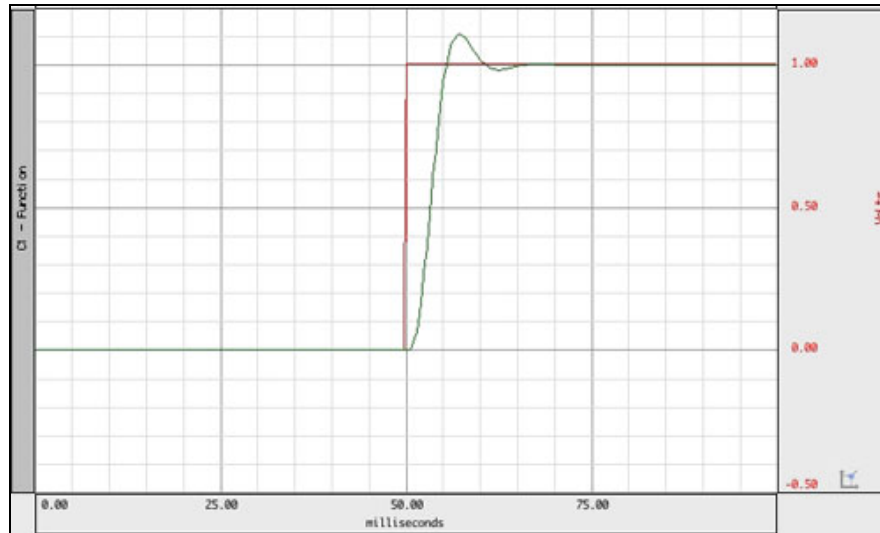

100 Hz Low Pass Filter – 4 pole Besselworth

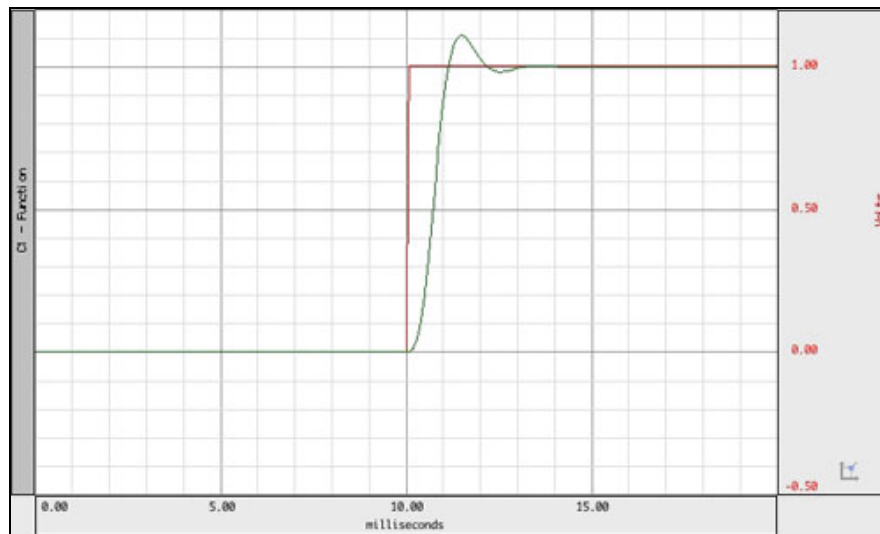

500 Hz Low Pass Filter – 4 pole Besselworth

Note that signal delay is proportional to the cut-off frequency for any particular 4 pole low pass Besselworth filter. The one minor exception is the 35 Hz LPN filter, because it consists of a 4 pole Besselworth filter and a 60 Hz Notch (band reject) filter. This additional filter adds a small additional delay.

Step Response Signal Delay (approximate)

Filter Type:	10 Hz LP	35 Hz LP	100 Hz LP	500 Hz LP
Delay at 50% (approximate):	30 ms	11 ms	3 ms	0.6 ms

BioNomadix Transmitter-Receiver Modules - Sample Frequency Response Plots

Note BioNomadix frequency responses are identified either by -3 dB or -6 dB inflection points, which are representative of 0.707 or 0.5 respectively of the mid band gain.

BN-ECG2

1 Hz HP
 35 Hz LP

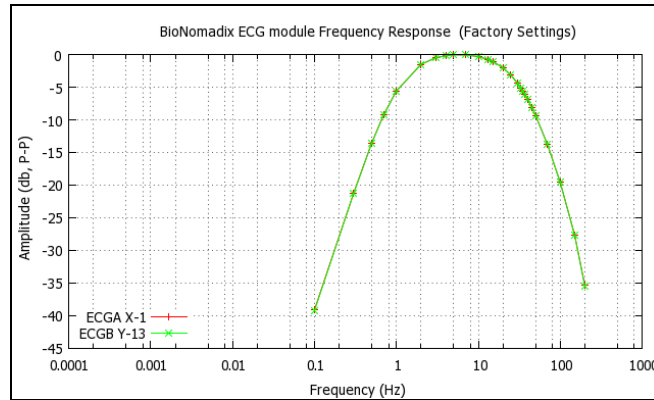

0.05 Hz HP
 150 Hz LP

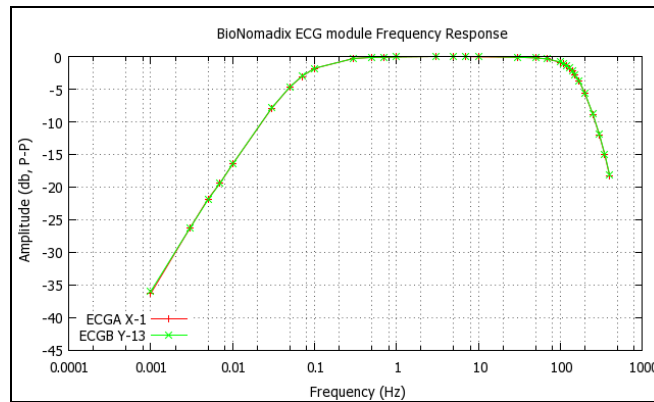

BN-EOG2

0.005 Hz HP
 35 Hz LP

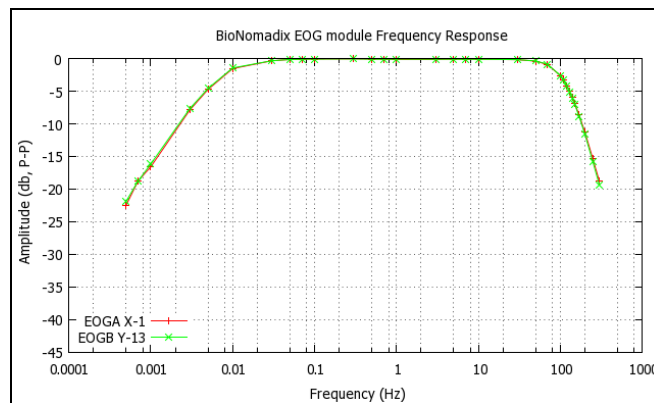

0.005 Hz HP
 100 Hz LP

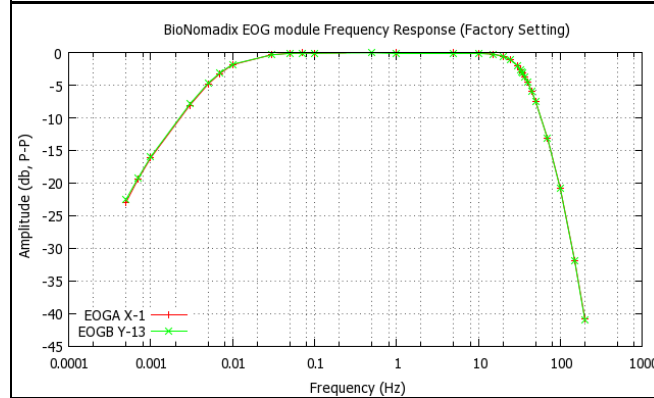

BioNomadix Transmitter-Receiver Modules - Sample Frequency Response Plots

BN-EMG2

10 Hz HP
500 Hz LP

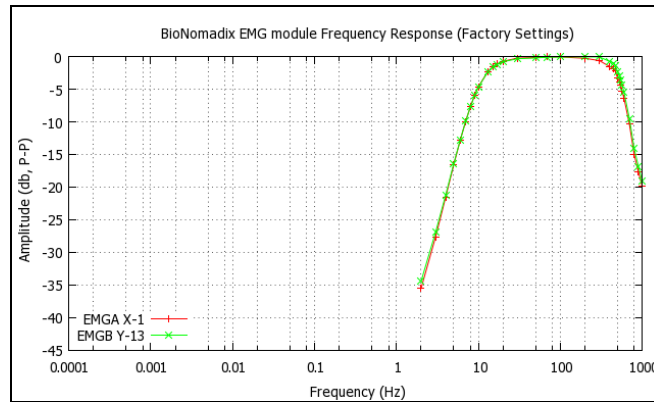

5 Hz HP
500 Hz LP

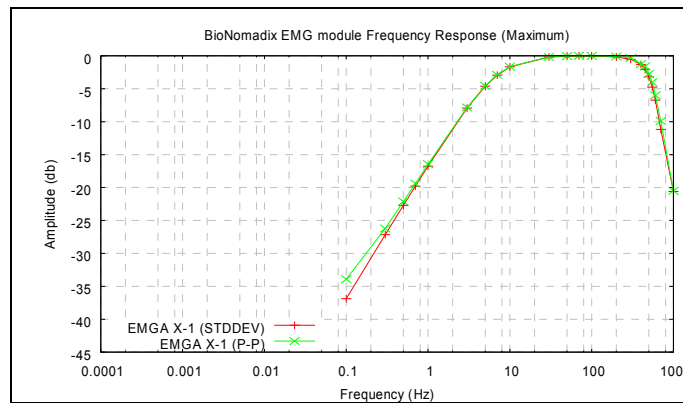

BN-EGG2

0.005 HP
1 Hz LP

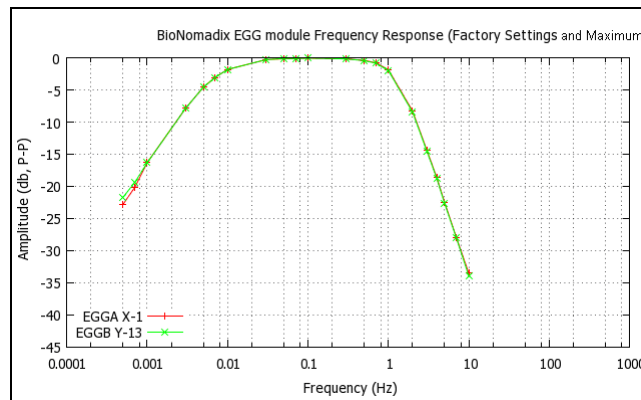

BioNomadix Transmitter-Receiver Modules - Sample Frequency Response Plots

BN-EEG2

0.5 HP
 35 Hz LP

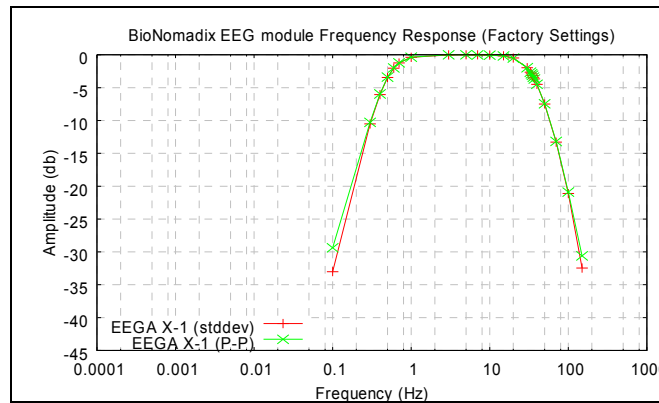

0.1 HP
 100 Hz LP

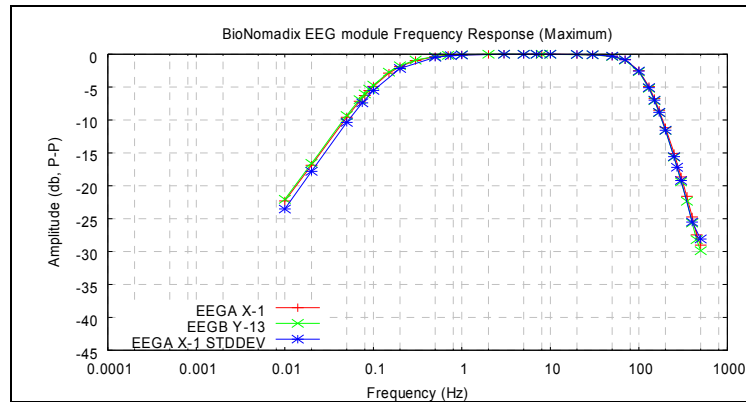

LIMITED WARRANTY

BIOPAC Systems, Inc. guarantees its equipment against all defects in materials and workmanship to the original purchaser for a period of 12 months from the date of shipment unless otherwise stated below; effective 1-1-2015, BIOPAC MP36 units are guaranteed against defects in materials and workmanship to the original purchaser for a period of 60 months (5 years) from the date of shipment.

If BIOPAC Systems, Inc. receives notice of such defects during the warranty period, BIOPAC Systems, Inc. will at its option, either repair or replace the hardware products that prove to be defective in materials or workmanship. This warranty applies only if your BIOPAC Systems, Inc. product fails to function properly under normal use and within the manufacturer's specifications. This warranty does not apply if, in the sole opinion of BIOPAC Systems, Inc., your BIOPAC Systems, Inc. product has been damaged by alteration, accident, abuse, misuse, neglect, improper packing, shipping, modification or servicing, by any party other than BIOPAC Systems, Inc. If a problem arises, please contact us for authorization before returning an item.

Any returns should be supported by a Return Mail Authorization (RMA) number issued by BIOPAC Systems, Inc. BIOPAC Systems, Inc. reserves the right to refuse to accept delivery of any shipment containing any shipping carton which does not have the RMA number(s) displayed on the outside. The Buyer will prepay transportation charges to the BIOPAC Systems, Inc. designated site. The warranty period for repairs and for used equipment purchased from BIOPAC is 90 days.

BIOPAC Systems, Inc. makes no other warranty or representation, either expressed or implied, with respect to any hardware or software product, its quality, performance, merchantability, or fitness for a particular purpose.

BIOPAC Systems, Inc. will not be liable for direct, indirect, special, incidental, or consequential damages resulting from any defect in a hardware or software product or its documentation, even if advised of the possibility of such damages, or for damage of any equipment connected to a BIOPAC Systems, Inc. product.

TRADEMARKS

AcqKnowledge is a registered trademark of BIOPAC Systems, Inc.

Windows is a registered trademark of Microsoft Corporation in the United States and other countries.

Mac and MacBook are trademarks of Apple Computer, Inc., registered in the U.S. and other countries.