



PENTEK®





Important Safety Instructions

SAVE THESE INSTRUCTIONS - This manual contains important instructions that should be followed during installation, operation, and maintenance.

 This is the safety alert symbol. When you see this symbol in this manual, look for one of the following signal words and be alert to the potential for personal injury!

 **DANGER** indicates a hazard which, if not avoided, will result in death or serious injury.

 **WARNING** indicates a hazard which, if not avoided, could result in death or serious injury.

 **CAUTION** indicates a hazard which, if not avoided, could result in minor or moderate injury.

NOTICE addresses practices not related to personal injury.

Carefully read and follow all safety instructions in this manual.

Keep safety labels in good condition. Replace missing or damaged safety labels.

California Proposition 65 Warning

 **WARNING** This product and related accessories contain chemicals known to the State of California to cause cancer, birth defects or other reproductive harm.

Handling and Installation Instruction

LIFTING

-  **WARNING Heavy Object.** Lifting equipment must be capable of lifting motor and attached equipment. Check over all tools, especially the hoisting gear, for wear or damage before hoisting the unit.
- If the total length of the pump and motor unit (without any riser pipe attached) exceeds 10ft (3m), support the unit with a girder while hoisting (see Figure 1). Do not remove the supporting girder until the unit is standing vertically in the hoist. Check for damage.

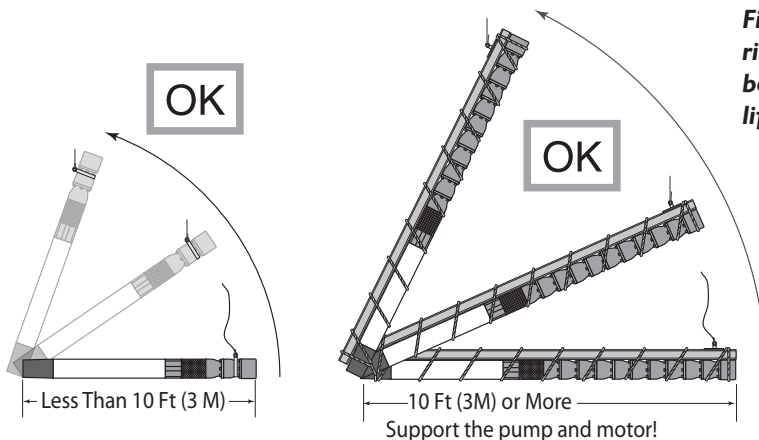

ELECTRICAL

(See Pages 5 & 6, for Product Specifications)

-  **WARNING Risk of electrical shock if the cable is damaged.** Inspect the motor cable for any nicks or cuts. Do not use the motor cable to pull, lift, or handle the motor. Protect the motor cable during storage, handling, moving, and installation of the motor.
- Inspect the motor to determine that it is the correct horsepower, voltage, and size for the job and that there is no shipping damage. Verify that the motor nameplate voltage matches the available power supply voltage. The nameplate rated voltage must not vary more than $\pm 10\%$ from the power supply voltage.
- On all new installations and after the motor has sat idle for a long period of time, check the motor's internal electrical resistance with a megohmmeter with lead wires connected. Prior to installation, the motor should have an insulation value of at least 500 megohms. After installation, the motor and power cable should have a minimum insulation value of 1 megohm. If the minimum values are below the listed values, contact the factory before starting the motor.
- Fuses or circuit breakers and overload protection are required. Fuses or circuit breakers and overloads must be sized in accordance with National Electrical Code (NEC) or Canadian Electrical Code (CEC) requirements, as applicable, and with all applicable local codes and ordinances. See page 6 for more information on fuse and breaker sizing.
- Wire and ground the motor in accordance with National Electrical Code (NEC) or Canadian Electrical Code (CEC) requirements, as applicable, and with all applicable local codes and ordinances.

Figure 1: When the pump and motor together (without any riser pipe) are 10ft (3m) long or more, support the assembly before lifting to avoid bending it in the middle. Never try to lift the motor or pump by the motor cables.

MOTOR STORAGE AND INSTALLATION

1. The motor is filled at the factory with anti-freeze which will protect it in temperatures down to -22°F (-30°C). Do not install, transport or store the motor below these temperatures if the motor is filled. If storage is necessary at temperatures below -22°F (-30°C), drain the anti-freeze from the motor.
2. Verify that the motor is full before installing. If not, fill it with clean water (see below). Installing a motor that is not filled with liquid will void the warranty. Before installation, check all water fill and drain plugs, mounting bolts, and cable connections for tightness. Refill the motor with clean water as follows:
 - A. Stand the motor on end (vertically) and remove the fill plug with a 5mm hexagonal screw driver.
 - B. Turn the motor shaft by hand while rocking the motor back and forth (see Figure 2).
 - C. Pour in clean water until the motor is as full as possible.
 - D. Repeat the turning/rocking procedure.
 - E. Check the liquid level. If necessary, add more clean water.
 - F. When the motor is full, re-install the fill plug. Tighten it with the 5mm hexagonal screw driver.

CAUTION Support motor while rocking to prevent motor from falling over.

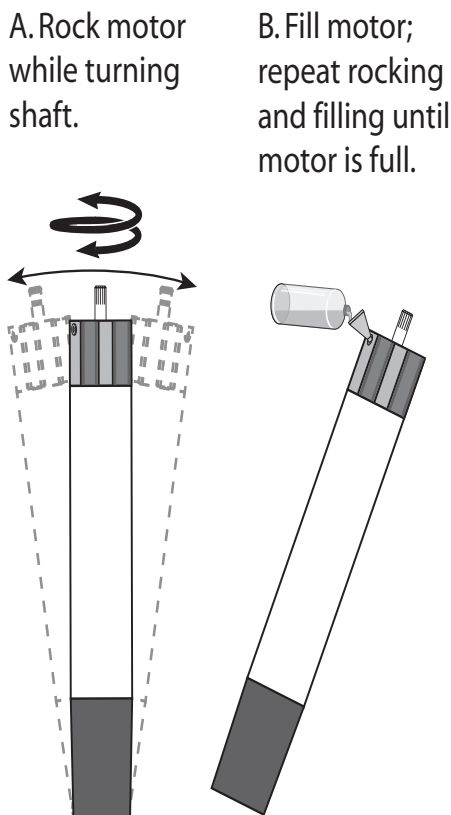

Figure 3: Rock Motor gently from side to side while turning shaft by hand (A), then fill with clean water (B). Repeat until full.

- NOTICE** To avoid damaging the motor thrust bearing, do not hammer on the shaft, coupling, or slinger. Check the motor rotation by hand to make sure that it turns freely.
3. To avoid damage to the motor diaphragm, make sure that the bottom of the motor does not touch the dirt or mud at the bottom of the well. Install the motor at least 10' above the well bottom.
 4. To install the motor horizontally, lay it down with the lead wires at 12 o'clock when you are facing the motor shaft. To prevent any load on the shaft and bearings and to avoid any damaging vibrations to the motor, mount the motor solidly on the pump end and make sure that the pump and motor are accurately aligned.
 5. Install the motor so that during operation water flows past all parts of it at a rate of at least 0.5 fps (0.15 mps). If the well will not provide this flow, install a sleeve on the motor to channel water past it (see Figure 3). Do not try to operate the motor in mud or sand. To do so will damage the motor and void the warranty.
 6. Electrical connections: Connect the three motor leads to the three hot motor leads (red/yellow/black or black, brown, and blue) in the incoming cable. Connect the ground wire (green or green and yellow) in accordance with NEC or CEC requirements (as applicable) and in accordance with all applicable local codes and ordinances. Apply power momentarily to check rotation. If the motor runs backwards, interchange any two power leads to reverse direction of rotation.

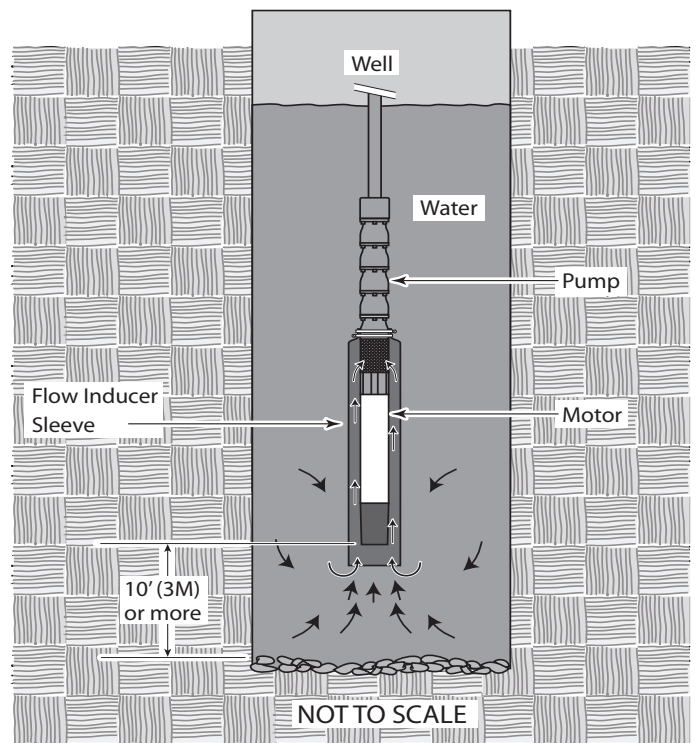

Figure 2: If flow past motor is less than .5 fps (0.15 mps), install a flow inducer sleeve as shown. Flow must be at least .5 fps (0.15 mps) for adequate motor cooling. The flow inducer sleeve should not touch the side of the motor.

APPLICATION LIMITS

Maximum Immersion Depth: 985 ft. (300 m)

Maximum Water Temperature: 95°F (35°C)

pH content of the water: 6.5–8

Minimum Cooling Flow Rate: 0.5 feet per second (fps)
(0.15meters per second (mps)).

Required line voltage at the motor under operating conditions ($\pm 10\%$).

NOTICE When calculating voltage at the motor, be sure to allow for voltage drop in the cable.

The sum of the absolute values of the voltage and frequency must not vary from the sum of the nominal values by more than $\pm 10\%$.

Operating with current unbalanced on the three legs of the circuit can overheat and damage the motor and will void the warranty. Current imbalance must not exceed 5% maximum.

Maximum Sand Content: 50ppm (max. size 0.1–0.25mm)

Maximum Chlorine Ion Content: 500ppm

Problem	Possible Causes	Solution
Motor does not start, but does not blow fuses or trip circuit breaker	Defective fuses or circuit breakers Loose or corroded terminals Damaged or defective connections No incoming power	Replace fuses or circuit breakers. Clean and tighten connections and motor lead terminals. Repair or replace connections. Contact power company.
Motor starts, but fuses blow or circuit breakers trip	Wrong voltage Incorrect fuses or relay Incorrect connections Locked rotor or pump Insufficient insulation on motor cables	Make sure that nameplate rated voltage matches nominal power supply, and that actual supply voltage is within $\pm 10\%$ of nameplate voltage. Install correct fuses or relay. Re-connect motor wires correctly. Make sure that motor is at least 10ft above bottom of well, check well for sand. Install new motor cables; recheck resistance with Megohmmeter.
Motor starts and runs, then blows fuse or trips circuit breaker	Incoming voltage more than 10% high or low Sand in well	Confirm high or low voltage in motor cable, consult power company. Pull the pump and clean the well.
Motor does not start, but fuse blows or circuit breaker trips	locked rotor or pump	Check for sand in well. Make sure that motor is at least 10ft above the bottom of the well. Pull pump and check for mechanical obstruction in the pump and for free rotation of the motor.

Description	PENTEK Model #	HP	KW	HZ	VOLTS	Rated (Service Factor 1.00)		Service Factor 1.15		Locked Rotor Amps	Length			Weight				
						AMPS	Eff. %	P.F. %	AMPS		Eff. %	P.F. %	in*	mm*	in**	mm**	lbs	kg
6" 230V / 60Hz / 3Ø	6PM2-5-2	5	3.7			15.2	75	83	16.4	77	85	22.7	577	21.1	535	90	41	
	6PM2-7-2	7-1/2	5.5			21.2	79	85	23.2	79	86	24.9	632	22.7	577	102	46	
	6PM2-10-2	10	7.5			30.8	77	81	33.0	78	83	29.2	741.5	24.9	632	116	53	
	6PM2-15-2	15	11.0	60	230	43.2	78	84	47.0	78	86	31.8	807.5	27.5	698	121	55	
	6PM2-20-2	20	15.0			57.4	79	85	63.0	79	87	35.1	892.5	35.1	892.5	147	67	
	6PM2-25-2	25	18.5			69.0	81	86	76.0	80	88	38.0	964.5	38.0	964.5	165	75	
6" 380V / 50Hz / 3Ø or 460V / 60Hz / 3Ø	6PM2-30-2	30	22.0			76.6	84	88	85.0	84	89	41.8	1060.5	41.1	1044.5	198	86	
	6PM2-5-4	5	3.7	50	380	8.9	75	87				22.7	577	21.1	535	90	41	
				60	460	7.6	75	83	8.2	77	85							
	6PM2-7-4	7-1/2	5.5	50	380	12.5	79	87				24.9	632	22.7	577	102	46	
				60	460	10.6	79	85	11.6	79	86							
	6PM2-10-4	10	7.5	50	380	17.8	78	85				29.2	741.5	24.9	632	116	53	
				60	460	15.4	77	81	16.5	78	83							
	6PM2-15-4	15	11.0	50	380	25.6	77	87				31.8	807.5	27.5	698	131	55	
				60	460	21.6	78	84	23.5	78	86							
	6PM2-20-4	20	15.0	50	380	34.0	78	89				35.1	892.5	35.1	892.5	147	67	
				60	460	28.5	79	85	31.5	79	87							
	6PM2-25-4	25	18.5	50	380	41.0	79	89				38.0	964.5	38.0	964.5	165	75	
			60	460	34.5	81	86	38.0	80	88								
6PM2-30-4	30	22.0	50	380	46.0	83	90				41.8	1060.5	41.1	1044.5	190	86		
			60	460	38.0	84	88	42.5	84	89								
6PM2-40-4	40	30	50	380	62.5	83	90				47.1	1197	44.7	1134.5	209	95		
			60	460	52.7	84	88	58.0	84	89								
6PM2-50-4	50	37	50	380	73.6	83	90				49.9	1267	47.4	1204.5	292	132		
			60	460	64.3	85	87	70.8	85	89								

* = Motors with serial numbers beginning with 200, and serial numbers between 20105213xxxx and 20109113xxxx, are equipped with a 4-stud, "single-flange"-style mounting bracket.
 ** = Motors with serial numbers beginning with 20109213xxxx are equipped with a "dual-flange"-style mounting bracket.

Description	PENTEK Model #	KVA Code	Thrust Load (lbs)	Winding Resistance (ohm)	RPM	Volts and Circuit Breaker Amps			Generator Sizing				
						Standard Fuse	Dual Element (time delay) Fuse	Inverse Time Breaker	Externally		Internally		
									KW	KVA	KW	KVA	
6" 230V / 60Hz / 3ø	6PM2-5-2	J	1763	0.7873	3460	45	25	40	15	18.75	7.5	9.4	
	6PM2-7-2	J		0.5389	3460	60	40	50	20	25	10	12.5	
	6PM2-10-2	J	3485	0.3964	3440	90	50	80	30	37.5	15	18.75	
	6PM2-15-2	J		0.2782	3450	125	80	110	40	50	20	25	
	6PM2-20-2	J		0.2101	3450	175	110	150	60	75	25	31	
	6PM2-25-3	J		0.1605	3450	225	125	175	75	94	30	37.5	
	6PM2-30-3	K		0.1445	3500	250	125	200	100	125	40	50	
	6" 380V / 50Hz / 3ø or 460V / 60Hz / 3ø	6PM2-5-4	G	1763	2.9674	2820	20	10	20	15	18.75	7.5	9.4
		6PM2-7-4	J		1.9828	3460	30	20	25	20	25	10	12.5
		6PM2-10-4	G	3485	1.4648	2800	45	25	40	30	37.5	15	18.75
6PM2-15-4		F	0.9916		3450	70	40	50	40	50	20	25	
6PM2-20-4		J	0.7192		2810	90	50	70	60	75	25	31	
6PM2-25-4		G	0.5640		3450	110	60	90	75	94	30	37.5	
6PM2-30-4		J		0.5036	2880	125	70	100	100	125	40	50	
6PM2-40-4		H	6182	0.3958	2860	150	100	125	100	125	50	62.5	
6PM2-50-4		K		0.3295	3490	200	110	175	150	188	60	75	

6" PENTEK® Submersible Motors

CABLE SELECTION

COPPER CABLE SIZE - From Service Entrance to Motor (Feet)

60°C

VOLTS /Hz	MOTOR			AWG														MCM											
	HP	KW	FUSE																										
			STD	Dual Element	14	12	10	8	6	4	3	2	1	0	00	000	0000	250	300	350	400	500							
THREE PHASE																													
230 V 60Hz	5	3.7	45	25	154	245	391	620	965	1538	1933	2442	3076	3883	4899	6184	7791	9198											
	7.5	5.5	60	40		174	277	438	682	1087	1367	1726	2174	2745	3463	4372	5508	6502	7806	9124									
	10	7.5	90	50				308	479	764	961	1213	1529	1930	2434	3073	3872	4571	5488	6415	7334	9125							
	15	11	125	80				216	337	537	675	852	1073	1355	1709	2158	2719	3210	3853	4504	5149	6407							
	20	15	175	110					251	400	503	636	801	1011	1275	1610	2028	2394	2874	3360	3842	4780							
	25	18.5	225	125						332	417	527	664	838	1057	1334	1681	1985	2383	2785	3184	3962							
30	22	250	125							373	471	593	749	945	1193	1503	1775	2130	2490	2847	3543								
460 V 60 Hz or 380 V 50 Hz	5	3.7	20	10	617	982	1566	2480	3859	6152	7734	9767																	
	7.5	5.5	30	20	436	694	1107	1753	2728	4349	5467	6904	8698																
	10	7.5	15	25	307	488	778	1233	1918	3057	3844	4854	6115	7719	9738														
	15	11	70	40		343	546	865	1347	2147	2699	3408	4293	5419	6837	8631													
	20	15	90	50			408	646	1005	1601	2013	2543	3203	4043	5101	6439	8113	9578											
	25	18.5	110	60				535	833	1328	1669	2108	2655	3351	4228	5338	6725	7939	9531										
30	22	125	70				479	745	1187	1492	1884	2374	2997	3781	4773	6013	7099	8522	9961										
40	30	150	100					546	870	1093	1381	1740	2196	2770	3497	4406	5202	6244	7299	8345									
50	37	200	110						713	896	1131	1425	1799	2269	2865	3609	4261	5116	5980	6837	8506								

Lengths only meet the US National Electrical Code ampacity requirements for individual conductors rated 60° C in free air or water, NOT in magnetic enclosures, conduit or direct buried. Refer to NEC Table 310.15(B)(17) for more information.

6" PENTEK® Submersible Motors

CABLE SELECTION

COPPER CABLE SIZE - From Service Entrance to Motor (Feet)

75°C

VOLTS /Hz	MOTOR			AWG														MCM												
	HP	KW	FUSE																											
			STD	Dual Element	14	12	10	8	6	4	3	2	1	0	00	000	0000	250	300	350	400	500								
THREE PHASE																														
230 V 60Hz	5	3.7	45	25		245	391	620	965	1538	1933	2442	3076	3883	4899	6184	7791	9198												
	7.5	5.5	60	40		174	277	438	682	1087	1367	1726	2174	2745	3463	4372	5508	6502	7806	9124										
	10	7.5	90	50				308	479	764	961	1213	1529	1930	2434	3073	3872	4571	5488	6415	7334	9125								
	15	11	125	80					337	537	852	1073	1355	1709	2158	2719	3210	3853	4504	5149	5842	6407								
	20	15	175	110					400	636	801	1011	1275	1610	2028	2394	2874	3360	3842	4780										
	25	18.5	225	125					417	527	664	838	1057	1334	1681	1985	2383	2785	3184	3962										
30	22	250	125					471	593	749	945	1193	1503	1775	2130	2490	2847	3543												
460 V 60 Hz or 380 V 50 Hz	5	3.7	20	10	617	982	1566	2480	3859	6152	7734	9767																		
	7.5	5.5	30	20	436	694	1107	1753	2728	4349	5467	6904	8698																	
	10	7.5	15	25		488	778	1233	1918	3057	3844	4854	6115	7719	9738															
	15	11	70	40			546	865	1347	2147	2699	3408	4293	5419	6837	8631														
	20	15	90	50				646	1005	1601	2013	2543	3203	4043	5101	6439	8113	9578												
	25	18.5	110	60				535	833	1328	1669	2108	2655	3351	4228	5338	6725	7939	9531											
30	22	125	70					745	1187	1492	1884	2374	2997	3781	4773	6013	7099	8522	9961											
40	30	150	100					870	1093	1381	1740	2196	2770	3497	4406	5202	6244	7299	8345											
50	37	200	110					896	1131	1425	1799	2269	2865	3609	4261	5116	5980	6837	8506											

Lengths only meet the US National Electrical Code ampacity requirements for individual conductors rated 75° C in free air or water, NOT in magnetic enclosures, conduit or direct buried. Refer to NEC Table 310.15(B)(17) for more information.

6" PENTEK® Submersible Motors																						
CABLE SELECTION																						
COPPER CABLE SIZE - From Service Entrance to Motor (Feet)																						
VOLTS /Hz	MOTOR			AWG												MCM						
	HP	KW	FUSE	14	12	10	8	6	4	3	2	1	0	00	000	0000	250	300	350	400	500	
			STD	Dual Element																		
230 V 60Hz	5	3.7	45	25		391	620	965	1538	1933	2442	3076	3883	4899	6184	7791	9198					
	7.5	5.5	60	40		277	438	682	1087	1367	1726	2174	2745	3463	4372	5508	6502	7806	9124			
	10	7.5	90	50				479	764	961	1213	1529	1930	2434	3073	3872	4571	5488	6415	7334	9125	
	15	11	125	80					537	675	852	1073	1355	1709	2158	2719	3210	3853	4504	5149	6407	
	20	15	175	110						503	636	801	1011	1275	1610	2028	2394	2874	3360	3842	4780	
	25	18.5	225	125								527	664	838	1057	1334	1681	1985	2383	2785	3184	3962
30	22	250	125									593	749	945	1193	1503	1775	2130	2490	2847	3543	
460 V 60 Hz or 380 V 50 Hz	5	3.7	20	10	617	982	1566	2480	3859	6152	9767											
	7.5	5.5	30	20	436	694	1107	1753	2728	4349	6904	8698										
	10	7.5	15	25		778	1233	1918	3057	3844	4854	6115	7719	9738								
	15	11	70	40		546	865	1347	2147	2699	3408	4293	5419	6837	8631							
	20	15	90	50			646	1005	1601	2013	2543	3203	4043	5101	6439	8113	9578					
	25	18.5	110	60				833	1328	1669	2108	2655	3351	4228	5338	6725	7939	9531				
30	22	125	70				745	1187	1492	1884	2374	2997	3781	4773	6013	7099	8522	9961				
40	30	150	100						1093	1381	1740	2196	2770	3497	4406	5202	6244	7299	8345			
50	37	200	110								1131	1425	1799	2269	2865	3609	4261	5116	5980	6837	8506	

Lengths meet the US National Electric Code ampacity requirements for either individual conductors or jacketed rated 60°C cable and can be in conduit or direct buried. Flat molded and web/ribbon cable are considered jacketed cable. Refer to NEC Table 310.15(B)(16) for more information.

6" PENTEK® Submersible Motors

CABLE SELECTION

COPPER CABLE SIZE - From Service Entrance to Motor (Feet)

75°C

VOLTS /Hz	MOTOR			AWG														MCM						
	HP	KW	FUSE		14	12	10	8	6	4	3	2	1	0	00	000	0000	250	300	350	400	500		
			STD	Dual Element																				
230 V 60Hz	5	3.7	45	25	245	391	620	965	1538	1933	2442	3076	3883	4899	6184	7791	9198							
	7.5	5.5	60	40		277	438	682	1087	1367	1726	2174	2745	3463	4372	5508	6502	7806	9124					
	10	7.5	90	50			308	479	764	961	1213	1529	1930	2434	3073	3872	4571	5488	6415	7334	9125			
	15	11	125	80				337	537	675	852	1073	1355	1709	2158	2719	3210	3853	4504	5149	6407			
	20	15	175	110					400	503	636	801	1011	1275	1610	2028	2394	2874	3360	3842	4780			
	25	18.5	225	125						417	527	664	838	1057	1334	1681	1985	2383	2785	3184	3962			
	30	22	250	125							471	593	749	945	1193	1503	1775	2130	2490	2847	3543			
460 V 60 Hz or 380 V 50 Hz	5	3.7	20	10	617	982	1566	2480	3859	6152	7734	9767												
	7.5	5.5	30	20	436	694	1107	1753	2728	4349	5467	6904	8698											
	10	7.5	15	25		488	778	1233	1918	3057	3844	4854	6115	7719	9738									
	15	11	70	40			546	865	1347	2147	2699	3408	4293	5419	6837	8631								
	20	15	90	50				646	1005	1601	2013	2543	3203	4043	5101	6439	8113	9578						
	25	18.5	110	60				535	833	1328	1669	2108	2655	3351	4228	5338	6725	7939	9531					
	30	22	125	70				745	1187	1492	1884	2374	2997	3781	4773	6013	7099	8522	9961					
	40	30	150	100					870	1093	1381	1740	2196	2770	3497	4406	5202	6244	7299	8345				
	50	37	200	110						896	1131	1425	1799	2269	2865	3609	4261	5116	5980	6837	8506			

Lengths meet the US National Electric Code ampacity requirements for either individual conductors or jacketed rated 75°C cable and can be conduit or direct buried. Flat molded and web/ribbon cable are considered jacketed cable. Refer to NEC Table 310.15(B)(16) for more information.

THIS PAGE INTENTIONALLY LEFT BLANK

Limited Warranty

PENTAIR warrants to the original consumer purchaser (“Purchaser” or “You”) of the products listed below, that they will be free from defects in material and workmanship for the Warranty Period shown below.

Product	Warranty Period
Water Systems Products — jet pumps, small centrifugal pumps, submersible pumps and related accessories	<i>whichever occurs first:</i> 12 months from date of original installation, 18 months from date of manufacture
PENTEK INTELLIDRIVE™	12 months from date of original installation, or 18 months from date of manufacture
Pro-Source™ Composite Tanks	5 years from date of original installation
Pro-Source™ Steel Pressure Tanks	5 years from date of original installation
Pro-Source™ Epoxy-Line Tanks	3 years from date of original installation
Sump/Sewage/Effluent Products	12 months from date of original installation, or 18 months from date of manufacture
Submersible Motors, 6” diameter and larger	12 months from date of original installation, or 18 months from date of manufacture

Our warranty will not apply to any product that, in our sole judgment, has been subject to negligence, misapplication, improper installation, or improper maintenance. Without limiting the foregoing, operating a three phase motor with single phase power through a phase converter will void the warranty. Note also that three phase motors must be protected by three-leg, ambient compensated, extra-quick trip overload relays of the recommended size or the warranty is void.

Your only remedy, and PENTAIR’s only duty, is that PENTAIR repair or replace defective products (at PENTAIR’s choice). You must pay all labor and shipping charges associated with this warranty and must request warranty service through the installing dealer as soon as a problem is discovered. No request for service will be accepted if received after the Warranty Period has expired. This warranty is not transferable.

PENTAIR IS NOT LIABLE FOR ANY CONSEQUENTIAL, INCIDENTAL, OR CONTINGENT DAMAGES WHATSOEVER.

THE FOREGOING LIMITED WARRANTIES ARE EXCLUSIVE AND IN LIEU OF ALL OTHER EXPRESS AND IMPLIED WARRANTIES, INCLUDING BUT NOT LIMITED TO IMPLIED WARRANTIES OF MERCHANTABILITY AND FITNESS FOR A PARTICULAR PURPOSE. THE FOREGOING LIMITED WARRANTIES SHALL NOT EXTEND BEYOND THE DURATION PROVIDED HEREIN.

Some states do not allow the exclusion or limitation of incidental or consequential damages or limitations on how long an implied warranty lasts, so the above limitations or exclusions may not apply to You. This warranty gives You specific legal rights and You may also have other rights which vary from state to state.

This Limited Warranty is effective June 1, 2011 and replaces all undated warranties and warranties dated before June 1, 2011.

PENTAIR
293 Wright St., Delavan, WI 53115
Phone (262) 728-5551 • Fax (262) 728-7323



Declaration of Conformity CE

Please follow the EN 60335-1/2-41 to manufacture and add relevant protection in the pumps by the pump builder.

We, Pentair Flow Technologies, LLC (293 Wright Street, Delavan, Wisconsin, USA) declare under our sole responsibilities that the submersible motor products described under this manual are in conformity with the following Directive or standardization document: Low Voltage Directive 2006/95/EC and EN 60034-1.

PENTEK®



Instrucciones importantes sobre la seguridad

GUARDE ESTAS INSTRUCCIONES - Este manual contiene instrucciones importantes que se deben observar durante la instalación, la operación y el mantenimiento del producto.

⚠ Este es el símbolo de alerta de seguridad. ¡Cuando vea este símbolo en este manual, busque alguna de las siguientes palabras de advertencia y esté alerta a la posibilidad de lesiones personales!

⚠ PELIGRO indica un peligro que, si no se evita, resultará en muerte o lesiones graves.

⚠ ADVERTENCIA indica un peligro que, si no se evita, podría resultar en muerte o lesiones graves.

⚠ PRECAUCIÓN indica un peligro que, si no se evita, podría resultar en lesiones menores o moderadas.

AVISO indica prácticas que no están relacionadas con lesiones personales.

Lea y siga cuidadosamente todas las instrucciones de seguridad de este manual.

Mantenga las etiquetas de seguridad en buen estado. Reemplace las etiquetas de seguridad faltantes o dañadas.

Advertencia de la Proposición 65 de California

⚠ ADVERTENCIA Este producto y los accesorios asociados contienen sustancias químicas que, según el Estado de California, pueden provocar cáncer, defectos de nacimiento u otros daños reproductivos.

Instrucciones para el manejo y la instalación

ELEVAR

- ⚠ ADVERTENCIA** Objeto pesado. El equipo de elevación debe ser capaz de elevar el motor y el equipo adjunto. Inspeccione todas las herramientas, especialmente el mecanismo del montacargas y verifique que no haya desgaste ni averías antes de levantar la unidad.
- Si la longitud total de la unidad de bomba y motor (sin ningún tubo ascendente conectado) sobrepasa los 10 pies (3 metros), soporte la unidad con una viga mientras la esté izando (consulte la Figura 1). No retire la viga de soporte hasta que la unidad esté parada en posición vertical en el montacargas. Verifique que no haya averías.

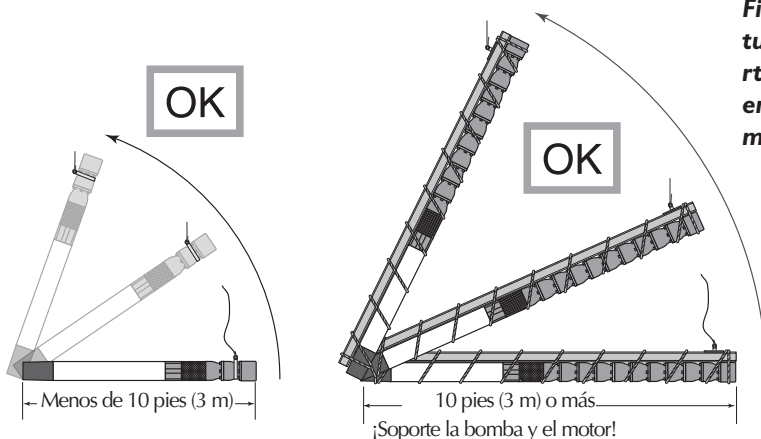

ASPECTOS ELÉCTRICOS

(Consulte el Cuadro 1, página 5 & 6, sobre las Especificaciones)

- ⚠ ADVERTENCIA** Peligro de choque eléctrico si el cable está dañado. Inspeccione el cable del motor para cerciorarse de que no tenga muescas ni cortes. No utilice el cable del motor para jalar, levantar o manipular el motor. Proteja el cable del motor durante el almacenamiento, la manipulación, el movimiento y la instalación del motor.
- Inspeccione el motor para determinar que sea de la potencia, la tensión (voltaje) y del tamaño correctos para la tarea y que no se haya dañado durante el envío. Verifique que la tensión en la placa de fábrica del motor concuerde con la tensión de suministro de energía disponible. La tensión nominal de la placa de fábrica no debe variar más de $\pm 10\%$ de la tensión de suministro de energía.
- En toda nueva instalación, y después de que el motor haya estado inactivo por un largo periodo de tiempo, verifique la resistencia eléctrica interna del motor con un megóhmetro con cables conductores conectados. Antes de la instalación, el motor debe tener un valor de aislamiento de por lo menos 500 megohmios. Después de la instalación, el motor y el cable deberán tener un valor mínimo de aislamiento de 1 megohmio. Si los valores mínimos se encuentran por debajo de los valores indicados, comuníquese con la fábrica antes de encender el motor.
- Es necesario contar con fusibles o disyuntores y protección contra sobrecarga. Los fusibles o disyuntores y los dispositivos de sobrecarga deben ser del tamaño conforme a los requerimientos del National Electrical Code (NEC) o del Canadian Electrical Code (CEC), según el caso, y conforme a toda otra norma y regla local aplicable. Consulte la página 5 para obtener más información sobre los tamaños de los fusibles y disyuntores.
- El motor se debe cablear y conectar a tierra conforme a los requerimientos del National Electrical Code (NEC) o del Canadian Electrical Code (CEC), según el caso, y conforme a toda otra norma y regla local aplicable.

Figura 1: Cuando la bomba y el motor juntos (sin ningún tubo ascendente) miden 10 pies (3 m) de largo o más, soporte la unidad antes de levantarla para evitar que se curve en medio. Nunca trate de levantar el motor o la bomba por medio de los cables del motor.

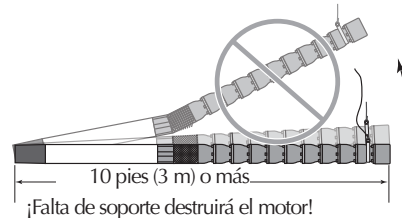

ALMACENAMIENTO E INSTALACIÓN DEL MOTOR

1. El motor viene de fábrica lleno de anticongelante, lo cual lo protegerá en temperaturas de hasta -22° F (-30° C). No instale, transporte ni guarde el motor por debajo de estas temperaturas si el motor está lleno. Si es necesario guardarlo a temperaturas por debajo de los -22° F (-30° C), drene el anticongelante del motor.
2. Verifique que el motor esté lleno antes de instalarlo. De lo contrario, llénelo con agua limpia (ver abajo). La instalación de un motor que no esté lleno de líquido invalidará la garantía. Antes de la instalación verifique la hermeticidad de todos los tapones de llenado y drenaje de agua, de los pernos de montaje y de las conexiones de los cables. Llène el motor con agua limpia de la siguiente manera:
 - A. Coloque el motor parado sobre un extremo (posición vertical) y saque el tapón de llenado con un destornillador hexagonal de 5 mm.
 - B. Gire el eje del motor a mano mientras balancea el motor hacia adelante y hacia atrás (consulte la Figura 2).
 - C. Vierta agua limpia hasta que el motor quede tan lleno como sea posible.
 - D. Repita el procedimiento de girar y balancear.
 - E. Chequee el nivel del líquido. De ser necesario, añada más agua limpia.
 - F. Cuando el motor esté lleno, vuelva a colocar el tapón de llenado. Apriételo con un destornillador hexagonal de 5 mm.

CAUTION Soporte el motor mientras lo esté balanceando para impedir que se caiga.

- AVISO** - Para evitar dañar el cojinete de empuje del motor, no martille el eje, el empalme ni el deflector. Chequee la rotación del motor a mano para cerciorarse de que gire libremente.
3. Para evitar dañar el diafragma del motor, asegúrese de que el fondo del motor no toque la tierra ni el lodo en el fondo del pozo. Instale el motor por lo menos a 10 pies de altura a partir del fondo del pozo.
 4. Para instalar el motor en posición horizontal, colóquelo acostado con los cables conductores en la posición de las 12 horas mientras esté mirando hacia el eje del motor. Para impedir una carga sobre el eje o los cojinetes y evitar vibraciones perjudiciales en el motor, coloque el motor firmemente sobre el extremo de la bomba y asegúrese de que la bomba y el motor estén debidamente alineados
 5. Instale el motor de manera que, durante la operación, el agua corra por todas sus partes a una velocidad de al menos 0.5 fps (0.15 mps). Si el pozo no puede proporcionar este flujo, instale una camisa en el motor para canalizar el agua a través del mismo (consulte la Figura 3). No trate de operar el motor en lodo o arena, ya que esto dañará al motor e invalidará la garantía.
 6. Conexiones eléctricas: Conecte los tres conductores del motor a los tres conductores cargados del motor (rojo, amarillo y negro o negro, marrón y azul) en el cable de entrada. Conecte el cable de puesta a tierra (verde o verde y amarillo) conforme a los requerimientos de NEC o CEC (según el caso) y conforme a toda otra norma y regla local aplicable. Aplique energía por un momento para verificar la rotación. Si el motor marcha de reversa, intercambie dos conductores eléctricos cualesquiera para invertir la dirección de la rotación.



Figura 3: Balancear el motor suavemente de un lado al otro mientras se hace girar el eje a mano (A), luego llenarlo con agua limpia (B). Repetir hasta que esté lleno.



Figura 2: Si el flujo que pasa por el motor es inferior a 0.5 fps (0.15 mps), se debe instalar una camisa inductora de flujo como se ilustra. El flujo debe ser al menos de 0.5 fps (0.15 mps) para permitir un enfriamiento adecuado del motor. La camisa inductora de flujo no debe tocar el costado del motor.

LÍMITES DE APLICACIÓN

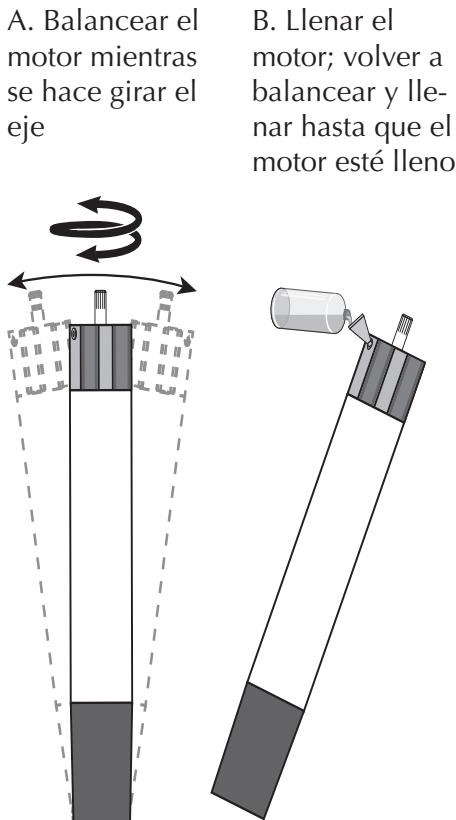
Máxima profundidad de inmersión: 985 ft. (300 m)

Máxima temperatura del agua: 95° F (35° C)

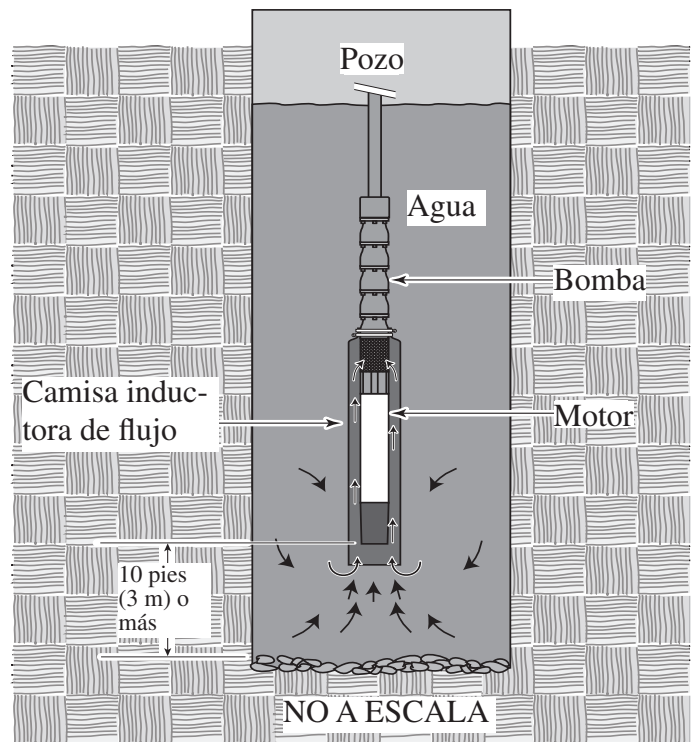
Contenido de pH del agua: 6.5–8

Mínimo caudal de enfriamiento: 0.5 pies por segundo (fps) (0.15 metros por segundo (mps)).

Línea de tensión requerida en el motor bajo condiciones de operación ($\pm 10\%$).

AVISO - Cuando calcule la tensión en el motor, es necesario tener en cuenta la caída de tensión en el cable.

La suma de los valores absolutos de la tensión y la frecuencia no deben variar más de $\pm 10\%$ de la suma de los valores nominales.

La operación con una corriente desequilibrada en las tres partes del circuito puede recalentar y dañar al motor e invalidará la garantía. El desequilibrio de corriente no debe sobrepasar un máximo de 5%.

Máximo contenido de arena: 50 ppm (tamaño máximo 0.1–0.25 mm)

Máximo contenido de iones de cloro: 500 ppm

Problema	Causas Posibles	Solución
El motor no arranca, pero no quema fusibles ni activa el disyuntor	Fusibles o disyuntores defectuosos Bornes flojos o corroídos Conexiones dañadas o defectuosas No hay entrada de energía	Cambiar los fusibles o disyuntores. Limpiar y apretar las conexiones y los bornes conductores del motor Reparar o reemplazar las conexiones. Comunicarse con la empresa de suministro de energía.
El motor arranca, pero quema fusibles o activa disyuntores	Tensión equivocada Fusibles o relé incorrectos Conexiones incorrectas Rotor o bomba trabados Insuficiente aislamiento en los cables del motor	Verificar que la tensión nominal en la placa de fábrica concuerde con el suministro nominal de energía, y que la tensión real de suministro se encuentre dentro de $\pm 10\%$ de la tensión indicada en la placa de fábrica. Instalar fusibles o relé correctos. Volver a conectar los cables del motor correctamente. Cerciorarse de que el motor esté al menos a 10 pies sobre el fondo del pozo, verificar que no haya arena en el pozo. Instalar nuevos cables del motor; volver a chequear la resistencia con un megóhmetro
El motor arranca y marcha, luego quema fusibles o activa el disyuntor	Tensión de entrada más del 10% más alta o más baja - Arena en el pozo	Confirmar tensión alta o baja en el cable del motor, consultar con la empresa de suministro de energía. Sacar la bomba y limpiar el pozo.
El motor no arranca, pero quema fusibles o activa el disyuntor	Rotor o bomba trabados	Verificar que no haya arena en el pozo. - Cerciorarse de que el motor esté al menos a 10 pies sobre el fondo del pozo. - Sacar la bomba y chequear si hay obstrucciones de tipo mecánico en la bomba y cerciorarse de que el motor pueda rotar libremente.

Descripción	No. de Modelo PENTEK	HP	KW	HZ	VOLTS	Nominal (Factor de servicio 1,00)			Factor de servicio 1,15			Amperios de rotor trabajado				Largo				Peso	
						amperios	%eff.	%p.f.	amperios	%eff.	%p.f.	amperios	mm*	pulg.**	mm**	pulg.**	mm**	lbs	kg		
6" 230V / 60Hz / 3ø	6PM2-5-2	5	3,7			15,2	75	83	16,4	77	85	102,1	22,7	577	21,1	535	90	41			
	6PM2-7-2	7-1/2	5,5			21,2	79	85	23,2	79	86	146,4	24,9	632	22,7	577	102	46			
	6PM2-10-2	10	7,5			30,8	77	81	33,0	78	83	187,6	29,2	741,5	24,9	632	116	53			
	6PM2-15-2	15	11,0	60	230	43,2	78	84	47,0	78	86	281,8	31,8	807,5	27,5	698	121	55			
	6PM2-20-2	20	15,0			57,4	79	85	63,0	79	87	394,5	35,1	892,5	35,1	892,5	147	67			
	6PM2-25-2	25	18,5			69,0	81	86	76,0	80	88	480,2	38,0	964,5	38,0	964,5	165	75			
	6PM2-30-2	30	22,0			76,6	84	88	85,0	84	89	614,2	41,8	1060,5	41,1	1044,5	198	86			
6" 380V / 50Hz / 3ø o 460V / 60Hz / 3ø	6PM2-5-4	5	3,7	50	380	8,9	75	87				45,6	22,7	577	21,1	535	90	41			
				60	460	7,6	75	83	8,2	77	85	51,1									
	6PM2-7-4	7-1/2	5,5	50	380	12,5	79	87				66,8	24,9	632	22,7	577	102	46			
				60	460	10,6	79	85	11,6	79	86	73,2									
	6PM2-10-4	10	7,5	50	380	17,8	78	85				85,6	29,2	741,5	24,9	632	116	53			
				60	460	15,4	77	81	16,5	78	83	93,8									
	6PM2-15-4	15	11,0	50	380	25,6	77	87				127,0	31,8	807,5	27,5	698	131	55			
				60	460	21,6	78	84	23,5	78	86	140,9									
	6PM2-20-4	20	15,0	50	380	34,0	78	89				170,2	35,1	892,5	35,1	892,5	147	67			
				60	460	28,5	79	85	31,5	79	87	197,3									
6PM2-25-4		25	18,5	50	380	41,0	79	89				219,0	38,0	964,5	38,0	964,5	165	75			
				60	460	34,5	81	86	38,0	80	88	240,1									
	6PM2-30-4	30	22,0	50	380	46,0	83	90				276,8	41,8	1060,5	41,1	1044,5	190	86			
				60	460	38,0	84	88	42,5	84	89	307,1									
	6PM2-40-4	40	30	50	380	62,5	83	90				393,1	47,1	1197	44,7	1134,5	209	95			
				60	460	52,7	84	88	58,0	84	89	439,7									
6PM2-50-4		50	37	50	380	73,6	83	90				449,8	49,9	1267	47,4	1204,5	292	132			
				60	460	64,3	85	87	70,8	85	89	500,5									

* = Los motores con números de serie que comienzan con 200, y números de serie entre 20105213xxxx y 20109113xxxx, vienen con un soporte de montaje de 4 pernos, tipo brida singular.

** = Los motores con números de serie que comienzan con 20109213xxxx viene con un soporte de montaje tipo brida doble.

Motores sumergibles PENTEK® DE 6"

SELECCIÓN DE CABLE

60°C

TAMAÑO DEL CABLE DE COBRE - Desde la entrada de servicio al motor (pies)

VOLTIOS /Hz	MOTOR		AWG												MCM									
	HP	KW	FUSIBLE		14	12	10	8	6	4	3	2	1	0	00	000	0000	250	300	350	400	500		
			ESTÁNDAR	Elemento doble																				
TRIFÁSICO																								
230V 60Hz	5	3,7	45	25	154	245	391	620	965	1538	1933	2442	3076	3883	4899	6184	7791	9198						
	7,5	5,5	60	40		174	277	438	682	1087	1367	1726	2174	2745	3463	4372	5508	6502	7806	9124				
	10	7,5	90	50				308	479	764	961	1213	1529	1930	2434	3073	3872	4571	5488	6415	7334	9125		
	15	11	125	80				216	337	537	675	852	1073	1355	1709	2158	2719	3210	3853	4504	5149	6407		
	20	15	175	110					251	400	503	636	801	1011	1275	1610	2028	2394	2874	3360	3842	4780		
	25	18,5	225	125					332	417	527	664	838	1057	1334	1681	2130	2490	2847	3543				
30	22	250	125							373	471	593	749	945	1193	1503	1775	2130	2490	2847	3543			
460V 60 Hz o 380V 50 Hz	5	3,7	20	10	617	982	1566	2480	3859	6152	7734	9767												
	7,5	5,5	30	20	436	694	1107	1753	2728	4349	5467	6904	8698											
	10	7,5	15	25	307	488	778	1233	1918	3057	3844	4854	6115	7719	9738									
	15	11	70	40		343	546	865	1347	2147	2699	3408	4293	5419	6837	8631								
	20	15	90	50			408	646	1005	1601	2013	2543	3203	4043	5101	6439	8113	9578						
	25	18,5	110	60				535	833	1328	1669	2108	2655	3351	4228	5338	6725	7939	9531					
30	22	125	70				479	745	1187	1492	1884	2374	2997	3781	4773	6013	7099	8522	9961					
40	30	150	100					546	870	1093	1381	1740	2196	2770	3497	4406	5202	6244	7299	8345				
50	37	200	110					713	896	1131	1425	1799	2269	2865	3609	4261	5116	5980	6837	8506				

Las longitudes sólo cumplen con los requerimientos de ampacidad del US National Electrical Code para conductores individuales clasificados para 60° C en aire o agua libre, NO en recintos magnéticos, conductos o enterrados directamente. Consultar el Cuadro NEC 310.15(B)(17) para obtener más información.

Motores sumergibles PENTEK® DE 6"

SELECCIÓN DE CABLE

75°C

TAMAÑO DEL CABLE DE COBRE - Desde la entrada de servicio al motor (pies)

VOLTIOS /Hz	MOTOR		AWG												MCM									
	HP	KW	FUSIBLE		14	12	10	8	6	4	3	2	1	0	00	000	0000	250	300	350	400	500		
			ESTÁNDAR	Ele-mento doble																				
TRIFÁSICO																								
230V 60Hz	5	3,7	45	25	245	391	620	965	1538	1933	2442	3076	3883	4899	6184	7791	9198							
	7,5	5,5	60	40	174	277	438	682	1087	1367	1726	2174	2745	3463	4372	5508	6502	7806	9124					
	10	7,5	90	50			308	479	764	961	1213	1529	1930	2434	3073	3872	4571	5488	6415	7334	9125			
	15	11	125	80				337	537	675	852	1073	1355	1709	2158	2719	3210	3853	4504	5149	6407			
	20	15	175	110					400	503	636	801	1011	1275	1610	2028	2394	2874	3360	3842	4780			
	25	18,5	225	125						417	527	664	838	1057	1334	1681	1985	2383	2785	3184	3962			
30	22	250	125							471	593	749	945	1193	1503	1775	2130	2490	2847	3543				
460V 60 Hz or 380V 50 Hz	5	3,7	20	10	617	982	1566	2480	3859	6152	9767													
	7,5	5,5	30	20	436	694	1107	1753	2728	4349	6904	8698												
	10	7,5	15	25		488	778	1233	1918	3057	4854	6115	7719	9738										
	15	11	70	40			546	865	1347	2147	3408	4293	5419	6837	8631									
	20	15	90	50				646	1005	1601	2013	2543	3203	4043	5101	6439	8113	9578						
	25	18,5	110	60				535	833	1328	1669	2108	2655	3351	4228	5338	6725	7939	9531					
30	22	125	70					745	1187	1492	1884	2374	2997	3781	4773	6013	7099	8522	9961					
40	30	150	100					870	1093	1381	1740	2196	2770	3497	4406	5202	6244	7299	8345					
50	37	200	110						896	1131	1425	1799	2269	2865	3609	4261	5116	5980	6837	8506				

Las longitudes sólo cumplen con los requerimientos de ampacidad del US National Electrical Code para conductores individuales clasificados para 75° C en aire o agua libre, NO en recintos magnéticos, conductos o enterrados directamente. Consultar el Cuadro NEC 310.15(B)(17) para obtener más información.

Motores sumergibles PENTEK® DE 6"

SELECCIÓN DE CABLE

60°C

TAMAÑO DEL CABLE DE COBRE - Desde la entrada de servicio al motor (pies)

VOLTIOS /Hz	MOTOR		AWG												MCM									
	HP	KW	FUSIBLE		14	12	10	8	6	4	3	2	1	0	00	000	0000	250	300	350	400	500		
			ESTÁNDAR	Elemento doble																				
230 V 60Hz	5	3,7	45	25			391	620	965	1538	1933	2442	3076	3883	4899	6184	7791	9198						
	7,5	5,5	60	40			277	438	682	1087	1367	1726	2174	2745	3463	4372	5508	6502	7806	9124				
	10	7,5	90	50					479	764	961	1213	1529	1930	2434	3073	3872	4571	5488	6415	7334	9125		
	15	11	125	80						537	675	852	1073	1355	1709	2158	2719	3210	3853	4504	5149	6407		
	20	15	175	110							503	636	801	1011	1275	1610	2028	2394	2874	3360	3842	4780		
	25	18,5	225	125									527	664	838	1057	1334	1681	1985	2383	2785	3184	3962	
30	22	250	125										593	749	945	1193	1503	1775	2130	2490	2847	3543		
460 V 60 Hz o 380 V 50 Hz	5	3,7	20	10	617	982	1566	2480	3859	6152	7734	9767												
	7,5	5,5	30	20	436	694	1107	1753	2728	4349	5467	6904	8698											
	10	7,5	15	25			778	1233	1918	3057	3844	4854	6115	7719	9738									
	15	11	70	40			546	865	1347	2147	2699	3408	4293	5419	6837	8631								
	20	15	90	50				646	1005	1601	2013	2543	3203	4043	5101	6439	8113	9578						
	25	18,5	110	60					833	1328	1669	2108	2655	3351	4228	5338	6725	7939	9531					
30	22	125	70					745	1187	1492	1884	2374	2997	3781	4773	6013	7099	8522	9961					
40	30	150	100							1093	1381	1740	2196	2770	3497	4406	5202	6244	7299	8345				
50	37	200	110									1131	1425	1799	2269	2865	3609	4261	5116	5980	6837	8506		

Las longitudes cumplen con los requerimientos de ampacidad del US National Electrical Code para conductores individuales o cables revestidos clasificados para 60°C y pueden estar en conductos o enterrados directamente. Los cables de moldeado plano y de red/cinta se consideran como cables revestidos. Consultar el Cuadro NEC 310.15(B)(16) para obtener más información.

Motores sumergibles PENTEK® DE 6"

SELECCIÓN DE CABLE

75°C

TAMAÑO DEL CABLE DE COBRE - Desde la entrada de servicio al motor (pies)

VOLTIOS/ Hz	MOTOR			AWG												MCM								
	HP	KW	FUSIBLE		14	12	10	8	6	4	3	2	1	0	00	000	0000	250	300	350	400	500		
			ESTÁNDAR	Ele- mento doble																				
230 V 60Hz	5	3,7	45	25	245	391	620	965	1538	1933	2442	3076	3883	4899	6184	7791	9198							
	7,5	5,5	60	40	277	438	682	1087	1367	1726	2174	2745	3463	4372	5508	6502	7806	9124						
	10	7,5	90	50		308	479	764	961	1213	1529	1930	2434	3073	3872	4571	5488	6415	7334	9125				
	15	11	125	80				337	537	675	852	1073	1355	1709	2158	2719	3210	3853	4504	5149	6407			
	20	15	175	110					400	503	636	801	1011	1275	1610	2028	2394	2874	3360	3842	4780			
	25	18,5	225	125						417	527	664	838	1057	1334	1681	1985	2383	2785	3184	3962			
30	22	250	125							471	593	749	945	1193	1503	1775	2130	2490	2847	3543				
460 V 60 Hz o 380 V 50 Hz	5	3,7	20	10	617	982	1566	2480	3859	6152	9767													
	7,5	5,5	30	20	436	694	1107	1753	2728	4349	6904	8698												
	10	7,5	15	25	488	778	1233	1918	3057	3844	4854	6115	7719	9738										
	15	11	70	40		546	865	1347	2147	2699	3408	4293	5419	6837	8631									
	20	15	90	50			646	1005	1601	2013	2543	3203	4043	5101	6439	8113	9578							
	25	18,5	110	60			535	833	1328	1669	2108	2655	3351	4228	5338	6725	7939	9531						
30	22	125	70				745	1187	1492	1884	2374	2997	3781	4773	6013	7099	8522	9961						
40	30	150	100					870	1093	1381	1740	2196	2770	3497	4406	5202	6244	7299	8345					
50	37	200	110						896	1131	1425	1799	2269	2865	3609	4261	5116	5980	6837	8506				

Las longitudes cumplen con los requerimientos de ampacidad del US National Electrical Code para conductores individuales o cables revestidos clasificados para 75° C y pueden estar en conductos o enterrados directamente. Los cables de moldeado plano y de red/cinta se consideran como cables revestidos. Consultar el Cuadro NEC 310.15(B)(16) para obtener más información.

ESTA PAGINA EN BLANCO

Garantía limitada

PENTAIR le garantiza al comprador/consumidor original (“Comprador” o “Usted”) de los productos enumerados abajo, que estos estarán libres de defectos en material y mano de obra durante el Período de Garantía indicado a continuación.

Producto	Período de garantía
Productos de sistemas de agua — bombas de chorro, pequeñas bombas centrífugas, bombas sumergibles y accesorios asociados	<i>lo que ocurra primero:</i> 12 meses desde la fecha de la instalación inicial, o 18 meses desde la fecha de fabricación
PENTEK INTELLIDRIVE™	12 meses desde la fecha de la instalación inicial, o 18 meses desde la fecha de fabricación
Tanques de compuesto Pro-Source™	5 años desde la fecha de la instalación inicial
Tanques a presión de acero Pro-Source™	5 años desde la fecha de la instalación inicial
Tanques con revestimiento epoxídico Pro-Source™	3 años desde la fecha de la instalación inicial
Productos para sumideros/aguas residuales/efluente	12 meses desde la fecha de la instalación inicial, o 18 meses desde la fecha de fabricación

Nuestra garantía no se aplicará a ningún producto que, a nuestro sólo juicio, haya sido sometido a negligencia, mal uso, instalación inadecuada o mal mantenimiento. Sin perjuicio a lo que antecede, la garantía quedará anulada en el caso en que un motor trifásico se haya usado con una fuente de alimentación monofásica, a través de un convertidor de fase. Es importante indicar que los motores trifásicos deben estar protegidos por relés de sobrecarga de disparo extra-rápido, con compensación ambiental de tres etapas, del tamaño recomendado, de lo contrario, la garantía quedará anulada.

Su único recurso, y la única obligación de PENTAIR es que PENTAIR repare o reemplace los productos defectuosos (a juicio de PENTAIR). Usted deberá pagar todos los cargos de mano de obra y de envío asociados con esta garantía y deberá solicitar el servicio bajo garantía a través del concesionario instalador tan pronto como se descubra un problema. No se aceptará ninguna solicitud de servicio bajo garantía que se reciba después del vencimiento del Período de Garantía. Esta garantía no se puede transferir.

PENTAIR NO SE HARÁ RESPONSABLE DE NINGÚN DAÑO CONSECUENTE, INCIDENTAL O CONTINGENTE.

LAS GARANTÍAS LIMITADAS QUE ANTECEDEN SON EXCLUSIVAS Y EN LUGAR DE TODA OTRA GARANTÍA EXPLÍCITA E IMPLÍCITA, INCLUYENDO, PERO SIN LIMITARSE A LAS GARANTÍAS IMPLÍCITAS DE COMERCIABILIDAD E IDONEIDAD PARA UN FIN ESPECÍFICO. LAS GARANTÍAS LIMITADAS QUE ANTECEDEN NO SE EXTENDERÁN MÁS ALLÁ DEL PERÍODO DE DURACIÓN INDICADO EN LA PRESENTE.

Algunos estados no permiten la exclusión o limitación de daños incidentales o consecuentes o de limitaciones de tiempo sobre garantías implícitas, de modo que es posible que las limitaciones o exclusiones que preceden no correspondan en su caso. Esta garantía le otorga derechos legales específicos y es posible que usted también tenga otros derechos que pueden variar de un estado al otro.

Esta Garantía Limitada entra en vigor el 1 de junio de 2011 y sustituye toda garantía sin fecha o garantía con fecha anterior al 1 de junio de 2011.

PENTAIR
293 Wright St., Delavan, WI 53115
Teléfono (262) 728-5551 • Fax (262) 728-7323



Declaración de Conformidad CE

Siga las instrucciones en EN 60335-1/2-41 para fabricar y agregar protección pertinente en las bombas por el constructor de bombas.

Nosotros, Pentair Flow Technologies, LLC (293 Wright Street, Delavan, Wisconsin, USA) declaramos bajo nuestra exclusiva responsabilidad, que los productos de motores sumergibles descritos en este manual cumplen con la siguiente Directiva o documento de estandarización: Directiva de baja tensión 2006/95/EC y EN 60034-1.