

Make your space work.

HON®



2021 List Pricer

SHARED SPACES

Tables | Education | Seating | Workplace Tools

Supersedes HON List Pricer

Dated January 2020

LIST PRICER

Effective Date: January 2021

- All illustrations and specifications in this publication are based on the latest product information available at the time of print. For the most recent version, please go to <https://www.hon.com/pricer>.
- Software support packages furnished to the customer, either by The HON Company or by another source, which support the sale of HON products are superseded by printed price lists.
- All dimensions shown in this publication are nominal.
- Pricing is subject to change without notice.
- All orders are subject to prices in effect at the time of order.
- Ordering information appears at the beginning of a section complete with examples on how to specify. These specifying information pages are referenced at the bottom center of product pages.
- HON Full Lifetime Warranty applies unless otherwise noted.
- HON nationwide customer service:
Phone: (800) 833-3964

HON LIST PRICER

Table of Contents

INTRODUCTION

Table of Contents.....	1-3
Additions.....	5
Discontinuations.....	6
HON Full Lifetime Warranty Information.....	8
HON Limited 5-Year Warranty Information.....	9
Ordering Information.....	10
Integrated Design Solutions.....	11
Tailored Solutions Ordering Information.....	12
Customer's Own Material Ordering Information.....	13-14
Partnership Textile Information.....	15
Paint Program.....	16
Environmental Statement.....	17
Important Information.....	18
Legend.....	19
Fabric Patterns & Codes.....	20
Lead Times.....	21
Fabric Patterns & Codes.....	22-24
Panel Fabric Patterns & Codes.....	25-26

TABLES

Arrange®	27
Arrange® Café Tables Ordering Information	28
Arrange® Café Table Tops.....	29
Arrange® Café Table Bases.....	30
Arrange® Café Accessories.....	31
Between™ Tables	32
Between™ Ordering Information	33
Between™ Table Tops.....	34
Between™ Table Bases.....	35
Between™ Rectangular Table Tops.....	36
Between™ Table Bases for Rectangular Tops.....	36
Between™ Nesting Tables.....	37
Between™ Shared Components.....	37
Between™ Accessories.....	38
Birk™ Tables	39
Birk™ Ordering Information	40
Birk™ Table Tops.....	41
Birk™ Bases.....	42
Birk™ Personal Table.....	43
Cantilever Table	44
Coordinate™	45
Coordinate™ Ordering Information	46
Coordinate™ Height Adjustable Bases — Two-Leg.....	47
Coordinate™ Height Adjustable Bases — Three-Leg.....	48
Coordinate™ Height Adjustable Bases — Simple Specification.....	49
Coordinate™ Screens.....	50
Coordinate™ Accessories.....	51
Coordinate™ Worksurfaces.....	52-55
Systems Worksurfaces 120 Degree Corner.....	56
Coordinate™ Shared Components.....	57
Coordinate™ Desktop Riser & Sit-to-Stand Devices.....	58
Coordinate™ Accessories.....	59
Flock®	60
Flock® Collaborative Tables Ordering Information	61
Flock® Collaborative Solutions Table Specifying Information	62

Flock® Collaborative Laminate Table Tops.....	63
Flock® Collaborative Table Bases.....	64
Flock® Collaborative Tables.....	65-66
Flock® Collaborative Accessories.....	67
Gravitation Power Beam	68
Gravitation Power Beam Ordering Information	69-70
Gravitation 48"W Bundles.....	71
Gravitation 60"W Bundles.....	72
Gravitation 72"W Bundles.....	73
Gravitation Power Beam.....	74-76
Gravitation Power Beam Electrical.....	77
Gravitation Power Beam Screens.....	78
Huddle	79
Huddle Ordering Information	80
Huddle Multi-Purpose Tables	81
Huddle Typical.....	82-83
Huddle Multi-Purpose Table Tops.....	84-85
Huddle Multi-Purpose Table Bases.....	86
Huddle Mobile Laptop Table.....	87
Huddle Table Accessories.....	88
Cable Management.....	88
Interlink IQ Electrical.....	89
4-Trac Hardwire Electrical System.....	90-91
Huddle Power and Cable Management.....	92
Occasional Tables	93
Laminate Occasional Tables Options	94
Laminate Occasional Tables.....	95
Laminate Contemporary Occasional Tables.....	96
Motivate®	97
Motivate® Tables Specifying Information	98
Motivate® Fixed Height Tables.....	99
Motivate® Nesting Tables.....	100
Motivate® Adjustable Height Tables.....	101
Motivate® Shared Components.....	102-103
Interlink IQ Electrical.....	104
4-Trac Hardwire Electrical System.....	105-106
Optional Electrical Accessories.....	107
Preside®	109
Preside® Ordering Information	110
Preside® Specifying Information	111-120
Preside® Grommet Cutout Placement.....	121
Preside® Laminate Table Tops.....	122-123
Preside® Laminate Bases.....	124-125
Preside® Metal Bases.....	126-128
Preside® Laminate Bases.....	129
Preside® Metal Bases.....	130
Preside® Collaborative Tables.....	131
Preside® Ganging Tables.....	132
Preside® Collaborative Tables.....	133
Preside® Ganging Tables.....	134
Preside® Mobile Collaborative Tables.....	135
Preside® Team Touchdown Tables.....	136
Preside® Ancillary.....	137
Preside® Laminate Storage.....	138-139
Modular Components.....	140
Modular Components Back Panels.....	140
Wall Mount Storage.....	141-142
Preside® Laminate Shared Components.....	143

Cable Management.....	144
Preside® Table Power Accessories.....	145-146
Preside® Laminate Tables.....	147
Preside® Laminate Tables — Pre-defined Typical.....	148
Scramble™ Occasional Tables	149
Scramble™ Options	150
Scramble™ Laminate Coffee Tables.....	151
Scramble™ Laminate End Tables.....	152
66000 Series / The StationMaster®	153
66000 Series Ordering Information	154
66000 Series The StationMaster®.....	155
Utility Tables	156
Utility Tables Ordering Information	157
Utility Tables.....	158

EDUCATION

Cross Reference by Application	160-161
Build™	162
Build™ Ordering Information	163
Build™ Shape Matrix.....	164
Build™ Table Configurations.....	165-167
Build™ Table Tops.....	168-170
Build™ Tables.....	171
Build™ Nesting Tables.....	172
Build™ Accessories.....	173
Build™ Student Desk Surface Dimensions.....	174
Build™ Student Desk Configurations.....	175-176
Build™ Student Desks.....	177-178
Build™ Student Desk Accessories.....	179
Build™ Makerspace Table.....	180-182
Build™ Makerspace Table Accessories.....	183
Build™ Makerspace Stools.....	184
Revel™	185
Revel™ Stool.....	186
SmartLink®	187
SmartLink® Ordering Information	188
SmartLink® Specifying Information	189-194
SmartLink® Student Desks.....	195
SmartLink® Value Series Student Desks.....	196
SmartLink® Student Accessories.....	197
SmartLink® Chairs.....	198-201
SmartLink® Teacher Stations.....	202
SmartLink® Value Teacher Stations.....	203
SmartLink® Teacher Station Accessories.....	204
SmartLink® Modular Storage.....	205-206
SmartLink® Modular Storage and Accessories.....	207
SmartLink® Wall Rail System.....	208
SmartLink® Wall Rail System Accessories.....	209
SmartLink® Value Mobile Storage.....	210-212

WORKPLACE TOOLS

Workplace Tools	213
Workplace Tools Ordering Information	214
Monitor Arms.....	215-216
CPU Holders.....	217
Keyboard Trays.....	218-219
Corner Sleeves.....	220
Center Drawers.....	221-222
Coordinate™ Desktop Riser.....	223

For information regarding HON registered and unregistered trademarks, please go to hon.com/protected-marks. Haworth®, Herman Miller®, Knoll®, and Steelcase® are registered trademarks of their respective owners and use of the marks do not imply affiliation or endorsement of The HON Company or its products.

LIST PRICER

Effective Date: January 2021

- All illustrations and specifications in this publication are based on the latest product information available at the time of print. For the most recent version, please go to <https://www.hon.com/pricer>.
- Software support packages furnished to the customer, either by The HON Company or by another source, which support the sale of HON products are superseded by printed price lists.
- All dimensions shown in this publication are nominal.
- Pricing is subject to change without notice.

- All orders are subject to prices in effect at the time of order.
- Ordering information appears at the beginning of a section complete with examples on how to specify. These specifying information pages are referenced at the bottom center of product pages.
- HON Full Lifetime Warranty applies unless otherwise noted.
- HON nationwide customer service:
Phone: (800) 833-3964

HON LIST PRICER

Table of Contents

Ergonomic Solutions	224	Endorse®	312-316	Mav™	402
Chair Mats	225	Endorse® Accessories	317	Mav™ Finish Options	403
Task Lights	226-227	Entire™ Mesh Chairs	318	Mav™	404-408
Paper Management & Organizational Tools	228-231	Exposure™ Mesh Chairs	319	Merit™	409
Interlink IQ Electrical	232-233	Flock®	320	Merit™ Executive Conference Chair	410
4-Trac Hardwire Electrical System	234-235	Flock® Options	321-322	Motivate® Chairs	411
Power & Cable Management	236	Flock® Fabric Options	323	Motivate® Task Chair Options	412
Power	237-239	Flock® Collaborative	324-328	Motivate® Task Chair Fabric Options	413
Power & Cable Management	240	Flock® Dual Fabric Collaborative	329-333	Motivate® Task Chairs	414
Healthy Workplace Tools	241-242	Flock® Base Frames and Legs	334	Motivate® High-Density Sled Base Chair Options	415
SEATING		Flock® Options	335	Motivate® High-Density Sled Base Chairs	416-417
Seating Functions	244-245	Flock® Fabric Options	336	Motivate® 4-Leg Chair Options	418
Ordering Information	246-247	Flock® Collaborative	337-339	Motivate® 4-Leg Chair Fabric Options	419
Fire Code/Compliant Seating	248-251	Flock® Dual Fabric Collaborative	340	Motivate® 4-Leg Chairs	420-421
Accommodate®	252	Flock® Options	341	Motivate® Nesting/Stacking Flex-Back Chair Options	422
Accommodate® Options	253	Flock® Mini Cube and Cylinders	342	Motivate® Nesting/Stacking Flex-Back Chair Fabric Options	423
Accommodate® Fabric Options	254	Flock® Dual Fabric Mini Cube and Cylinder	343	Motivate® Nesting/Stacking Flex-Back Chairs	424
Accommodate®	255-258	Gateway™	345	Motivate® Chair with Tablet Arm Options	425
Adjustable Task/Lab Stools	259	Gateway™ Fabric Options	346	Motivate® Chair with Tablet Arm Fabric Options	426
Assemble™ Nesting/Stacking Chairs	260	Gateway™ Standard Task Chair	347	Motivate® Chair with Tablet Arm	427
Astir™ Collaborative Work Seating	261	Gateway™ Value Task Chair	348	Motivate® Flex-Back Chair with Tablet Arm Options	428
Astir™ Options	262	Grove®	349	Motivate® Flex-Back Chair with Tablet Arm Fabric Options	429
Astir™ Finish Options	263	Grove® Options	350-351	Motivate® Flex-Back Chair with Tablet Arm	430
Astir™ Collaborative Work Seating	264-275	Grove® Fabric Options	352	Network™	431
Astir™ Power	276	Grove®	353-355	Neutralize™	432
Boda™	277	Grove® Accessories	356	Neutralize™ Mesh Chair	433
Boda™	278	Grove® Dual Fabric	357-360	Nucleus®	434
Cambia™ 2160 Series	279	Grove® Accessories	361	Nucleus® Task Chair Options	435
Cambia™ 2160 Series Options	280	GuestStacker® 4030 Series	362	Nucleus® Multi-Purpose and Café Chair Options	436
Cambia™ 2160 Series	281	GuestStacker® 4030 Series	363	Nucleus® Fabric Options	437
Ceres®	282	Ignition™	364	Nucleus®	438-439
Ceres® Task Chair Options	283	Ignition™ Options	365-366	High-Density Olson Stacker® 4040 Series	440
Ceres® Multi-Purpose Chair Options	284	Ignition™ Task Chair Options	367	High-Density Olson Stacker® 4040 Series	441
Ceres® Fabric Options	285	Ignition™ Fabric Options	368	Pagoda®	442
Ceres®	286-287	Ignition®	369-372	Pagoda® Options	443-444
Charge™	288	Ignition® Accessories	373	Pagoda® 4070 Series	445-446
Circulate™ Club/Lounge	289	Ignition® 2.0 Options	374	Pagoda® 4090 Series	447-448
Client™	290	Ignition® 2.0 Dimensions	375	Pagoda® 4070/4090 Series	449
Cliq™	291	Ignition® 2.0	376-377	Park Avenue Collection® 5000 Series	450
Cliq™ Fabric Options	292	Ignition® 2.0 ReActiv®	378-379	Park Avenue Collection® 5000 Series Options	451
Cliq™	293	Ignition® 2.0 Upholstered	380-381	Park Avenue Collection® 5000 Series	452
ComforTask® 5900 Series	294	Ignition® 2.0 Accessories	382	Perch™ Active Seating	453
ComforTask® 5900 Series Options	295	Ignition® Guest Chair Options	383	Perpetual® Nesting Chairs	454
ComforTask® 5900 Series Fabric Options	296	Ignition®	384-387	Perpetual® Nesting Chairs Options	455
ComforTask® 5900 Series	297-298	Instigate™ Mesh Guest Chairs	388	Perpetual® Nesting Chairs	456
Convergence®	299	Invitation™ 2110 Series	389	Pillow-Soft® 2090 Series	457
Convergence® Options	300	Invitation™ 2110 Series Options	390	Pillow-Soft® 2090 Series Options	458
Convergence® Fabric Options	301	Invitation® 2110 Series	391	Pillow-Soft® 2090 Series	459
Convergence® Standard Task Chairs	302	Invitation® 2110 Series Connectors	392	Pillow-Soft® 2190 Series	460
Convergence® Value Task Chairs	303	Invitation™ Lounge	393	Pillow-Soft® 2190 Series Options	461
Corral™ Contemporary Lounge	304	Invitation™ Lounge Options	394	Pillow-Soft® 2190 Series	462
Contemporary Occasional Tables	305	Invitation® Lounge	395	Prominent™ Mesh Chairs	463-464
Crio Mesh Chairs	306	Lota®	396	Ruck™	465
Define™ Executive Chairs	307	Lota® Options	397	Ruck™ Options	466
Endorse® Collection	308	Lota® Fabric Options	398		
Endorse® Options	309	Lota®	399		
Endorse® Dimensions	310	Matter™	400		
Endorse® Fabric Options	311	Matter™ Multi-Purpose Chairs	401		

For information regarding HON registered and unregistered trademarks, please go to hon.com/protected-marks. Haworth®, Herman Miller®, Knoll®, and Steelcase® are registered trademarks of their respective owners and use of the marks do not imply affiliation or endorsement of The HON Company or its products.

LIST PRICER

Effective Date: January 2021

- All illustrations and specifications in this publication are based on the latest product information available at the time of print. For the most recent version, please go to <https://www.hon.com/pricer>.
- Software support packages furnished to the customer, either by The HON Company or by another source, which support the sale of HON products are superseded by printed price lists.
- All dimensions shown in this publication are nominal.
- Pricing is subject to change without notice.
- All orders are subject to prices in effect at the time of order.
- Ordering information appears at the beginning of a section complete with examples on how to specify. These specifying information pages are referenced at the bottom center of product pages.
- HON Full Lifetime Warranty applies unless otherwise noted.
- HON nationwide customer service:
Phone: (800) 833-3964

HON LIST PRICER

Table of Contents

Ruck™ Laminate Seating	467	Tilt™ Active Seating	499	Wave™ Mesh Chairs.....	520
Ruck™ Wood Seating	468	TopFlight™ Wood Seating.....	500	West Hill™ Casual Lounge Seating.....	521
Ryder™	469	Torch™ Mesh Chairs.....	501	West Hill™ Options	522
Ryder™ Sport Executive Chairs	470	Traction™ Executive Chairs.....	502	West Hill™ Finish Options	523
Scatter™ Guest Chairs.....	471	Validate™	503	West Hill™ Casual Lounge Seating	524-529
Skip	472	ValuTask®.....	504	West Hill™ Ottomans.....	530
Skip Collaborative Chair	473	Versant® Tandem	505	West Hill™ Casual Lounge Seating	531-532
Solutions Seating® 4000 Series	474	Versant® Tandem Options	506-507	Throw Pillows	533
Solutions Seating® 4000 Series Options	475	Versant® Tandem Laminate Occasional Finish Options	508	West Hill™ Accessories	534
Solutions Seating® 4000 Series	476	Versant® Tandem	509	Executive Chairs	535-536
Solve®	477	Versant® Tandem Laminate Occasional Tables	510	Guest Chairs	537
Solve® Options	478-480	Versant® Tandem	511	Mesh Chairs	538
Solve®	481-487	Volt®	512	Nesting Chairs	539
Solve® Accessories.....	488	Volt® 5700/5710 Series Options	513	Task Chairs	540
Soothe®	489	Volt® 5700 Series	514	Collaborative Chairs Modular Lounge.....	541
Soothe® Options	490-491	Volt® 5710 Series	515	Workplace Tools Ergonomic Solutions.....	542
Soothe® Table Finish Options	492	Volt® 5720/5730 Series Options	516	Workplace Tools Chair Mats	543
Soothe®	493	Volt® 5720/5730 Series Fabric Options	517		
Soothe® Dual Fabric	494-495	Volt® 5720 Series	518	INDEX	
Soothe® Benches.....	496	Volt® 5730 Series	519	Cross Reference Index	544-550
Soothe® Tables.....	497			Information on Ordering Parts	560
Soothe® Brackets	498				

NOTES

ADDITIONS

NEW ADDITIONS: PRODUCTS

Tables	Effective Date
Birk™ Models: HCWTRND30J, HCWTRND36J, HCWTRND42J, HCWTSQR30J, HCWTSQR36J, HCWTSQR42J, HCWTSFTS30J, HCWTSFTS36J, HCWTSFTS42J, HCWTB3656J, HCWTB3684J, HCWTSR3656J, HCWTSR3584J, HCWTRND30G, HCWTRND36G, HCWTRND42G, HCWTSQR30G, HCWTSQR36G, HCWTSQR42G, HCWTSFTS30G, HCWTSFTS36G, HCWTSFTS42G, HCWTB3656G, HCWTB3684G, HCWTSR3656G, HCWTSR3684G, HCWTSBM18, HCWTSBM27, HCWTSBM29, HCWTSBM36, HCWTSBM42, HCWTSBL18, HCWTSBL27, HCWTSBL29, HCWTSBL36, HCWTSBL42, HCWTD5BM27, HCWTD5BM29, HCWTD5BM36, HCWTD5BM42, HCWPT	July 1, 2020
Coordinate™ Models: HREC2S2LTF, HREC2S2LCF, HREC3S2LTF, HREC3S2LCF, HMREC3S2LTF, HREC3S3LTF, HREC3S3LCF, HFTPDL	July 1, 2020
Gravitation Models: HBEAM48, HBEAM60, HBEAM72, HBCONU, HBLEG23, HBENDCP, HBPRTCV, HBSCRAOMTL48, HBSCRAOMTL60, HBSCRAOMTL72	July 1, 2020
Gravitation Models: HHSWINFEED, HBEORH23, HBEORT23, HBEORL23, HBILNH23, HBILNX23, HBILNT23, HB96PP, HBPPSK, HBPPCK, HBPEK, HBPPMK, HBVWM, HBVWMKIT, HBFA, HBBDL148, HBBDL160, HBBDL172, HBBDL248, HBBDL260, HBBDL270, HBBDL348, HBBDL360, HBBDL372, HBBDL448, HBBDL460, HBBDL472	October 1, 2020
Gravitation Models: HUVDSBS2048, HUVDSBS2060, HUVDSBS2072	December 1, 2020
Huddle Models: HPHAP2028E , HPHAP2028G	January 1, 2021
Preside® Models: HT27FB3060, HT29FB3060, HT36FB3060, HT42FB3060, HT27FB3672, HT29FB3672, HT36FB3672, HT42FB3672, HT27FB4284, HT29FB4284, HT36FB4284, HT42FB4284, HT27FB4896, HT29FB4896, HT36FB4896, HT42FB4896, HT27FB48108, HT29FB48108, HT36FB48108, HT42FB48108, HT27FB48120, HT29FB48120, HT36FB48120, HT42FB48120, HT27FB48144, HT29FB48144, HT36FB48144, HT42FB48144, HT27FB48168, HT29FB48168, HT36FB48168, HT42FB48168, HT27FB48180, HT29FB48180, HT36FB48180, HT42FB48180, HT27FB48192, HT29FB48192, HT36FB48192, HT42FB48192, HT27FB48216, HT29FB48216, HT36FB48216, HT42FB48216, HT27FB48240, HT29FB48240, HT36FB48240, HT42FB48240, HT27FBM, HT29FBM, HT36FBM, HT42FBM, HTFX27, HTFX27P, HTFX29, HTFX29P, HTFXS27, HTFXS27P, HTFXS29, HTFXS29P, HTFXS36, HTFXS36P, HTFXS42, HTFXS42P, HTFXM27, HTFXM27P, HTFXM27C, HTFXM29, HTFXM29P, HTFXM29C, HTFXM36, HTFXM36P, HTFXM36C, HTFXM42, HTFXM42P, HTFXM42C, HTFXL27, HTFXL27P, HTFXL27C, HTFXL29, HTFXL29C, HTFXL36, HTFXL36P, HTFXL36C, HTFXL42, HTFXL42P, HTFXL42C, HTFXMGR27, HTFXMGR29, HTFXMGR36, HTFXMGR42, HT29AL60, HT29AL60, HT29AL72, HT29AL84, HT29AL96, HT29AL108, HT29AL120, HT29AL144, HT29AL168, HT29AL180, HT29AL192, HT29AL216, HT29AL240, HT29ALM, HT42AL60, HT42AL72, HT42AL84, HT42AL96, HTALWMGR29, HTALWMGR42, HTLA4296, HTLA42108, HTLA42120, HTLA42144, HTLA42168, HTLA42180, HTLA42192, HTLB42116, HTLB42240, HTLB4296, HTLC42108, HTLC42120, HTLC42144, HTLC42168, HTLC42180, HTLC42192, HTLC42216, HTLC42240, HTLE4296, HTLE42108, HTLE42120, HTLE42144, HTLE42168, HTLE42180, HTLE42192, HTLE42216, HTLE42240, HTLM4272, HTLD24, HTLD30, HTLD60, HTLS24, HTLS30, HTLSFT24, HTLSFT30, HTLSFT36, HTLSFT42, HTLSFT48, HTLC3060LCTP, HTLC3072LCTP, HTLC3096LCTP, HTLC3060HCTP, HTLC3072HCTP, HTLC3096HCTP, HTLC3060LCTFP, HTLC3072LCTFP, HTLC3096LCTFP, HTLC3060HCTFP, HTLC3072HCTFP, HTLC3096HCTFP, HTLC3060LCTHP, HTLC3072LCTHP, HTLC3096LCTHP, HTLC3060HCTHP, HTLC3072HCTHP, HTLC3096HCTHP, HTLC3060LCTPR, HTLC3072LCTPR, HTLC3096LCTPR, HTLC3060HCTPR, HTLC3072HCTPR, HTLC3096HCTPR, HTLC3060LCTFPL, HTLC3072LCTFPL, HTLC3096LCTFPL, HTLC3060HCTFPL, HTLC3072HCTFPL, HTLC3096HCTFPL, HTLC4260LCTP, HTLC4260HCTP, HTLC4260LCTFP, HTLC4260HCTFP, HTLC4260LCTHP, HTLC4260HCTHP, HTLC4260LCTPR, HTLC4272LCTPR, HTLC4296LCTPR, HTLC4260HCTPR, HTLC4272HCTPR, HTLC4296HCTPR, HTLC4260LCTFPR, HTLC4272LCTFPR, HTLC4296LCTFPR, HTLC4260HCTFPR, HTLC4272HCTFPR, HTLC4296HCTFPR, HTLC4260LCTPL, HTLC4272LCTPL, HTLC4296LCTPL, HTLC4260HCTPL, HTLC4272HCTPL, HTLC4296HCTPL, HTLC4260LCTFPL	April 1, 2021

Tables	Effective Date
Preside® (continued) Models: HTLC4272LCTFPL, HTLC4296LCTFPL, HTLC4260HCTFPL, HTLC4272HCTFPL, HTLC4296HCTFPL, HTMC304260, HTMC304272, HTMC304296, HTMC424260, HTMC424272, HTMC424296, HTLCRED72, HTLCRED72S, HTLCRED57, HTLCRED57S, HTLCRED42, HTLCRED42S, HTLBENCH30, HTLBENCH48, HTLBENCH60, HTLBENCHCUSH30, HTLBENCHCUSH48, HTLBENCHCUSH60, HGROMIBLANK, HGROM2BLANK, HTLMTLBACK, HTLMTHBACK, HTLMT4260HFR, HTLMT4272HFR, HTLMT4260H, HTLMT4272H, HTLMT4260L, HTLMT4272L, HTLMTTV, HTLD36, HTLD42, HTLD48, HTLS36, HTLS42, HTLS48	April 1, 2020
Preside® Models: HTMC304260BB, HTMC304272BB, HTMC304296BB, HTMC424260BB, HTMC424272BB, HTMC424296BB	July 1, 2020
Scramble™ Models: HSCCSR2448LM, HSCCSS36LM, HSCCSS48LM, HSCCSR36LM, HSCCR48LM, HSCCSS24LM, HSCSER24LM, HSCCSR2448WBASE, HSCCSS36WBASE, HSCCSS48WBASE, HSCCR36WBASE, HSCCR48WBASE, HSCCSS24WBASE, HSCSER24WBASE, HSCCSR2448LMTOP, HSCCSS36LMTOP, HSCCSR36LMTOP, HSCCR36LMTOP, HSCCR48LMTOP, HSCCSS24LMTOP, HSCSER24LMTOP	May 15, 2020
Education	Effective Date
Build™ Models: HESH6066E, HEHP3660E, HESY3654E, HESW3654FE, HESY3654FE, HBSDRECT2038, HBSDRECT2031, HBSDRBN2231, HBSDTRP2040, HBSDCSNT2832, HBSDFN3030, HBSDSPY2636, HBSD-RECT2038, HBSD-RECT2031, HBSD-RBN2231, HBSD-TRP2040, HBSD-CSNT2832, HBSD-FN3030, HBSD-SPY2636, HESW-3654E-NS, HESY-3654E-NS, HEHY4LEG, HEBS4LEG, HEBS4LEGG, HEBS4LEGL, HESPCR	January 1, 2020
Build™ Models: HEMKR426029L, HEMKR427229L, HEMKR426029BB, HEMKR427229BB, HEMKR426042L, HEMKR427242L, HEMKR426042BB, HEMKR427242BB, HEMKREND29-SP, HEMKREND29-F, HEMKREND42-SP, HEMKREND42-F, HEMKRSHLF, HEMKRDIVIDER, HE4LSTL18, HE4LSTL30	October 1, 2020
Revel™ Model: HEFSO1	October 1, 2020
Smartlink® Models: HSS4L-24B, HSS4L-30B	October 1, 2020
Workplace Tools	Effective Date
Healthy Workplace Tools Models: HHC-SANSTND, HHC-SANSTND-TRAY-HHC-SANSTND2, HHC-PPESTND, HHC-PPEWALL, HHC-FOOTPULL5, HHC-FOOTPULL15, HHC-ARMPULL5, HHC-ARMPULL15	June 1, 2020
Interlink IQ Models: HQH5-E-3P3B, HQH5-E-3PIU2B, HQH5-E-3PIE, HQH5-P-3P1B	July 1, 2020
Power Accessories Models: HTG2PWR-3P-1E, HTG2PWR-4P-2B, HTG2PWR-3P-2B-2U, HTG2PWR-3P-1U-W, HTGIPWR-3P-1B, HPWRMOD4WC, HSPWR-1P-2U, HUMPWR-1P-2U, HPWRMOB1	July 1, 2020
Seating	Effective Date
Astir™ Models: HASLB1, HASLB1MF, HASLBTC, HASLBTCMF, HASLB2, HASLB2MF, HASLB3, HASLB3MF, HASHB1, HASHB1CF, HASHBTC, HASHBTCMF, HASHB2, HASHB2MF, HASHB3, HASHB3MF, HASBSS, HASBSSMF, HASB2, HASB2MF, HASB3, HASB3MF, HASSP, HASGBSL, HASGGC	October 1, 2020
Cliq Models: HCLQT, HCLQTF, HCLQSF	January 1, 2021
Mav Models: HMAVMN, HMAVMNMF, HMAVMA, HMAVMAMF, HMAVHM, HMAVHMNF, HMAVHA, HMAVHAMF, HMAVO, HMAVOMF	October 1, 2020
Ruck™ Models: HRUCK1W, HRUCK1L, HRUCK5W, HRUCK5L	July 1, 2020
West Hill™ Models: HWH1SS, HWH1SSMF, HWH1SP, HWH1SPMF, HWH1C, HWH1CMF, HWH1TCS, HWH1TCSMF, HWH1TCP, HWH1TCPMF, HWH2SS, HWH2SSMF, HWH3SP, HWH3SPMF, HWH3SS, HWH3SSMF, HWH3SP, HWH3SPMF, HWH3P, HWH3PMF, HWH4CPS, HWH4CPP, HWH4BCPS, HWH4BCPP, HWH4LP, HWH4SP18	April 1, 2020

DISCONTINUATIONS

Workplace Tools	Effective Date	Seating	Effective Date
CPU Holder Model: HCPU	June 30, 2020	Executive Chairs Model: HVL601.VA90	December 31, 2020
Keyboard Trays Models: H2516, H2107, H1706	June 30, 2020	Exposure™ Model: HVL721.SB11	December 31, 2020
Monitor Arms Models: H5220, H5210	June 30, 2020	Lota* Models: H2283, H2284	December 31, 2020
Power & Cable Management Models: HTPWRGROM1, HTPWRGROM2, HTPWRGROM4, HTPWRGROM5	December 31, 2020	Park Avenue Collection® 5020 Series Models: H5021, H5022, H5023, H5021FC, H5022FC, H5023FC	December 31, 2020
		Prominent™ Model: HVL530	June 30, 2020
		Model: HVL536.MST3	December 31, 2020
		Quotient® Models: HQTMM, HQTSM, HQTMMFC, HQTSMFC	December 31, 2020

HON FULL LIFETIME WARRANTY INFORMATION



FULL LIFETIME WARRANTY

YOUR HON FULL LIFETIME WARRANTY

Every time you purchase a HON product, you're making an investment in your future. We're proud to play a part in that future, and you can trust us to do our best for as long as you need us.

The HON Full Lifetime Warranty is our assurance to you that the HON desks, workstations, seating, tables, or storage you purchase will be free from defective material or workmanship for the life of the product.

In the unlikely event that any HON product or component covered by the HON Full Lifetime Warranty should fail under normal workplace use as a result of defective material or workmanship, HON shall repair or replace with comparable product (at HON's discretion), free of charge.

WHAT'S COVERED BY THE HON FULL LIFETIME WARRANTY?

Your HON Full Lifetime Warranty applies to product manufactured after January 1, 2011. All HON product lines, materials, and components are covered by the HON Full Lifetime Warranty except for the items described below.

The specific product lines, materials, and components listed below are covered under HON's Full 12-Year, Full 10-Year, and Full 5-Year Warranties (from date of purchase).

HON'S FULL 12-YEAR WARRANTY

- Electrical components (LED task lights, lamps and ballasts are not covered)
- 4-Way Stretch Mesh
- Seating controls
- Pneumatic Cylinders
- Wood Seating
- Accessories
- Laminate Surfaces
- Veneer Surfaces

HON'S FULL 10-YEAR WARRANTY

- Soothe® Patient Recliner Mechanism

HON'S FULL 7-YEAR WARRANTY

- Coordinate™ Height Adjustable Bases

HON'S FULL 5-YEAR WARRANTY

- All LED task lights
- Panel and seating textiles
- Electric Height Adjustable Bases (Including Memory Control)
- Coordinate™ Desktop Sit-to-Stand Risers
- Soothe® Patient Recliner Central Lock Mechanism
- Soothe® Patient Recliner Pivoting Arm
- Between™ Multi-Purpose Table
- Acoustic Solutions by Unika Vaev
- Mod

These warranties apply to HON products sold within the United States of America, U.S. Territories, and Canada, as well as U.S. Military and Federal Agency purchases (regardless of location).

IS ANYTHING NOT COVERED?

There are a few exclusions to the HON Full Lifetime Warranty and to the 12-, 10-, and 5-year warranties. These exclusions are:

- All HON products that are covered under a separate 5-year warranty.
- Color-fastness or matching of colors, woodgrains, or textures occurring in wood, leather, or other materials that naturally exhibit inherent color variations.
- Customer's own materials (COM) selected by and used at the request of the user.
- Modifications or attachments to the product that are not approved by The HON Company and product failures resulting from such modifications or attachments.
- Product normal wear and tear, which are to be expected over the course of ownership.
- Products that were not installed, used, or maintained in accordance with product instructions and warnings.
- Products used for rental purposes.
- Damage caused by cleaning chemicals.
- Dye transfer caused by external contaminants (including clothing and accessory dyes such as those used on denim jeans) may migrate to lighter colors. This phenomenon is increased by humidity and temperature and is irreversible.
- Fabric pattern match seat to back or chair to chair. If pattern match is needed, please submit a Tailored Solutions request or contact HON Customer Support/Tailored Solutions with questions.

WARRANTY REQUESTS OR QUESTIONS?

Your HON Dealer is our mutual partner in supporting your warranty requests. To obtain service under this warranty, please contact your HON dealer. If you are not sure who your dealer is, please call HON Customer Support at 800.833.3964.

THAT'S YOUR HON FULL LIFETIME WARRANTY AS AN OWNER OF HON PRODUCT, THE WARRANTY EXPLAINED HERE IS YOUR SOLE AND EXCLUSIVE REMEDY. THERE ARE SOME EXCEPTIONS IF YOU PURCHASED THE PRODUCT FOR HOME OR PERSONAL USE WHICH ARE EXPLAINED BELOW. TO THE EXTENT ALLOWED BY LAW, THE HON COMPANY MAKES NO OTHER WARRANTY, EITHER EXPRESS OR IMPLIED, INCLUDING ANY WARRANTY OF MERCHANTABILITY OR FITNESS FOR A PARTICULAR PURPOSE. THE HON COMPANY WILL NOT BE LIABLE FOR ANY CONSEQUENTIAL OR INCIDENTAL DAMAGES.

A WORD ABOUT PURCHASES FOR HOME OR PERSONAL USE

Please note, this section only applies if you purchased your HON product for your home or for your own personal or family use. HON's warranties give you specific legal rights and you may have other rights, which vary from state to state. As a consumer purchaser, the complete exclusion of implied warranties noted in the above paragraph does not apply to you, however, to the extent allowed by applicable state law, the implied warranties are limited to the applicable term of the warranty. Some states do not allow the exclusion or limitation of incidental or consequential damages, so the above exclusion or limitation may not apply to you.

HON LIMITED 5-YEAR WARRANTY INFORMATION



LIMITED 5-YEAR WARRANTY

The HON Company promises to repair or replace HON products or components covered under this warranty that are found to be defective in material or workmanship within five (5) years from the date of original purchase so long as you, the original purchaser, still owns it. This is your sole and exclusive remedy. This warranty is subject to the provisions below. It applies to the products listed here manufactured after January 1, 2018.

LIMITATIONS:

- Upholstery on chairs is warranted for two years from date of purchase.
- Damage caused by the carrier in-transit is handled under separate terms.

EXCLUSIONS:

This warranty does not apply and no other warranty applies to:

- Normal wear and tear, which are to be expected over the course of ownership.
- Modifications or attachments to the product that are not approved by The HON Company.
- Products that were not installed, used or maintained in accordance with product instructions and warnings.
- Products used for rental purposes.

SEATING USAGE

Normal commercial use for seating is identified as the equivalent of a single shift, forty-(40) hour workweek. To the extent that a seating product is used in a manner exceeding this, the applicable warranty period will be reduced in a pro-rata manner.

A WORD ABOUT COLOR VARIATIONS, FABRICS AND FINISHES:

The HON Company does not warrant the color-fastness or matching of colors, grains or textures of covering materials.

CUSTOMER'S OWN MATERIAL (COM)

Not available on HON products covered under the HON 5-year warranty.

TO THE EXTENT ALLOWED BY LAW, THE HON COMPANY MAKES NO OTHER WARRANTY, EITHER EXPRESS OR IMPLIED, INCLUDING ANY WARRANTY OF MERCHANTABILITY OR FITNESS FOR A PARTICULAR PURPOSE. THE HON COMPANY WILL NOT BE LIABLE FOR ANY CONSEQUENTIAL OR INCIDENTAL DAMAGES.

NOTICE TO PURCHASERS FOR HOME OR PERSONAL USE:

Federal law does not permit the exclusion of certain implied warranties for consumer products. Therefore, if you are purchasing this product for home or personal use, the exclusion of implied warranties noted in the above paragraph does not apply to you. Some states do not allow the exclusion or limitation of incidental or consequential damages, so the above limitation or exclusion may not apply to you. This warranty gives you specific legal rights, and you may also have other rights which vary from state to state.

This warranty applies only to products sold within the United States of America and the Commonwealth of Canada.

TO OBTAIN SERVICE UNDER THIS WARRANTY:

Your HON® Dealer is our mutual partner in supporting your warranty requests. By following the procedures outlined below, you can be assured of the best level of service. Please note: Consent of The HON Company must be obtained before any warranty work is performed. To obtain consent, please take the following steps:

1. Contact the Dealer from whom the product was purchased within 30 days of discovery of the defect. Be prepared to affirm that you are the original purchaser of the product and to provide the serial number(s) from the product in question.
2. Your Dealer will gather all pertinent information regarding the claim, inspect the product and contact a HON Company customer service representative. (Please allow a reasonable amount of time for inspection and review.)
3. If The HON Company affirms that the product in question is eligible under the conditions of the warranty as stated above, the customer service representative or another representative of the Company will determine whether to provide replacement parts, authorize repairs or replace the product.

ORDERING INFORMATION

ORDERING

Electronic ordering is the standard order process for HON. HON supports the following primary methods for the electronic transmission of orders and order related documents:

Electronic Ordering

Available in the HONReady portal at honready.hon.com. There are multiple options available for processing orders electronically.

Integration with the standard Office Furniture business systems or other pre-approved proprietary software packages.

SIF file upload using fully optioned SIF files into the electronic ordering applications.

Manual entry of line items into the electronic ordering application.

EDI-System to System Integration

With standard Office Product systems or other pre-approved proprietary software systems.

Training, technical set-up and support is available through our Dealer Operations Team at honready@honcompany.com.

ORDER REQUIREMENTS

- Customer must provide complete and correct information, including complete model number, finishes, colors, options, and quantity.
- If a bid quotation or other special pricing applies, such information must be clearly stated on the order with applicable bid number or contract number.
- Order Management contact name and phone number.
- Delivery Appointment contact name and phone number at the dealership or installation company. HON does not accept orders with end user appointment contacts.
- Dealer Sales Representative, primary or multiple DSRs.
- “Best Date Available” for the entire order is standard service for HON. If eligible, other Date Requests may be requested and must be submitted with the order. Other Date Requests are subject to review by HON prior to acceptance:
 - “Ship After” requests are eligible on all order sizes
 - “Deliver On” requests are eligible for full truckload orders
- Additional services outside of HON’s standard services may be available through HON’s ‘Enhanced Services’ for a corresponding fee. Requested services from ‘Enhanced Services’ must be provided at time of order placement.
- The Company reserves the right to require electronic orders or charge \$50 fee per Purchase Order (PO) for manual order processing.
- Failure to provide complete and accurate information results in delayed order entry and acknowledgment. Incomplete orders will not be produced and will be returned to Dealer for correction.

ACKNOWLEDGMENT SERVICE

- E-mailed acknowledgments are available by customer request.
- An acknowledgment will be emailed the morning of the next business day, unless order is placed on credit or other order hold.
- The order will not receive an acknowledged shipment date until all order holds are released.

ORDER CHANGES OR CANCELLATIONS

For Order Changes or Cancellations, please contact Customer Support at 800-833-3964.

TERMS AND CONDITIONS

See **HON NOW** on honready.hon.com for more information about HON NOW delivery, services and ordering information.

INTEGRATED DESIGN SOLUTIONS

HON INTEGRATED DESIGN SOLUTIONS

Need design assistance? We can help! Our expert design staff will create a professional design package that is sure to put you one step ahead of the competition. And the best part is – it's free!

AUDIT

We will check your drawing and parts list for accuracy. We verify quantity, specification accuracy, product compatibility and structural support.

PLAN & SPECIFY

We will provide a professional design package including a CAD furniture plan, 3-D line drawing and complete parts list based on the rough sketch and work order forms you supply.

VALUE ENGINEERING

We will optimize workstation layouts and propose potential cost saving measures to help your customer save money and make you more competitive and profitable.

RENDERING

We will create a photo realistic rendering of your furniture plan to help your customer visualize what their desired office space will look like.

*SPACE PLANNING (BILLABLE SERVICE)

Let our team do the creative work for you. Our low rates and expert staff will create a furniture layout and design that best suits your customer.

PLANNING TYPICALS

Quick planning ideas to share with your clients. Various settings showcasing desks, tables and workstations available in multiple formats. View them today under Design Resources on the HON Ready Portal.

CONTACT INTEGRATED DESIGN SOLUTIONS

Questions? Please reach out to your region's dedicated designer. Not sure how to reach your designer? Send us a note at the email below.

E-Mail: integrateddesign@honcompany.com



Solve® Chair shown with Coordinate™ Height Adjustable Table.

Project Space

A place for all HON Project Services

Project Space provides one platform to access the full portfolio of HON services including:

- Plan & Specify
- Audit
- Product Modification
- Special Laminates
- Value Engineering
- Rendering
- Customer's Own Material
- Dual Fabric Applications
- Space Planning
- Special Paints
- Project Bid Pricing

Submit your request on the Community powered by HNI, Projects.

Project Space Lead Time: 1-3 business days depending on complexity and size of your project.

TAILORED SOLUTIONS ORDERING INFORMATION

PRODUCT MODIFICATIONS

Modifications include structural and dimensional modifications to existing product and Dual Fabric Applications, when standard model is not available.

The HON Company, at its own discretion, may modify standard products to meet specific needs. Product specials can be requested on HON brand product only.

List prices contained in published list pricers are for standard catalog items only. Changes or alterations to catalog items other than those listed as catalog options are subject to additional charges. Pricing will only be furnished upon approval of the special request.

Requests to have the product produced in more than one fabric (e.g., fabric on the seat is different than the fabric on the back), are considered a Dual Fabric Applications request and follow the Product Modification request process within MyProjects.

SPECIAL LAMINATES

Special laminates include requests for laminates not available as part of The HON Company's standard offering. Requests for special laminates are subject to manufacturing approval and minimum order quantities. The HON Company approved special laminates will be subject to a designated upcharge per unit.

Requests for special laminates should be submitted through the MyProjects Application on the HON Ready portal. Pricing will only be furnished upon approval of the special request.

SPECIAL PAINTS

- The HON Company's paint matching equipment can match almost any color, excluding some metallic and whites.
- Special paint requests must be submitted on the HON Ready Portal MyProjects application.
- In order to request a paint sample, the customer must have a minimum order of 10 like product units. Any requests with less than that amount will not be processed.
 - For each new paint request, there will be a \$500 net charge. A sample of the exact color desired is required for matching and approval. The HON Company will match the color and provide a production sample for the customer to review and approve.

- Once the signed paint sample is received at The HON Company, the request will be approved.
- Each unique color or finish combination incurs a designated upcharge per color per order (all standard discounts/competitive project pricing applies).

Special note: Some special colors could fall outside of this program due to production costs or not meeting The HON Company's quality standards. The HON Company may apply additional charges to some colors which are costly to apply, and refuse some orders on colors that cannot meet The HON Company's high quality standards. The HON Company will notify the customer upon completion of The HON Company's evaluation if a change in price is required or rejection of the order.

DISCONTINUED PRODUCT

Requests for discontinued product require engineering evaluation, safety review, and testing to current standards prior to approval. Many discontinued products are not available for order. Requests for discontinued products should be submitted through the MyProjects Application on the HON Ready portal.

LEAD TIMES FOR SPECIALS PRODUCT

Lead times on orders containing specials are subject to production capacity and material availability. When possible, the customer should order special products separately to avoid extended lead times for standard products. Extended lead times will be noted on the specials request.

CHANGES TO SPECIALS PRODUCT

A special model will be provided for each approved special item to process orders. Once an order is placed, no changes or cancellations can be made to the order without approval from Tailored Solutions.

CONTACT TAILORED SOLUTIONS

Phone: 800.833.3964 and listen for Tailored Solutions offering on the menu.

Email: HONSpecials@honcompany.com

CUSTOMER'S OWN MATERIAL ORDERING INFORMATION

CUSTOMER'S OWN MATERIAL (COM) PROGRAM

Customer's Own Material (COM) is a request to use fabrics not available as part of HON's standard fabric offering. Manufacture to Supply (MTS) and Dealer to Supply (DTS) are the two ordering methods. The HON Company has partnered with fabric manufacturers to provide competitive pricing and selection through the MTS program. MTS will be the standard offering unless The HON Company is unable to procure the fabric. If there is a DTS request submitted, The HON Company will advise at the time of the request if DTS is available.

CUSTOMER WARRANTY EXCLUSION

The HON Company shall have no responsibility for the condition, quality, value, performance, physical properties, or any other aspects of the COM.

The HON Company shall have no liability for any damages, injuries, or losses to the customer or to any third party that shall be caused by any COM or product modification, and the customer shall hold The HON Company harmless for all liability.

The HON Company assumes no responsibility for the overall appearance, flammability, normal durability, colorfastness, or any other quality of the COM or product modification after its application on a HON product beyond normal quality standards. The HON Company reserves the right to reject a COM fabric if the quality of the COM is not satisfactory for the product. Should this occur, the customer will be notified with an explanation of the issue.

The HON Company is not responsible for fabric that has become obsolete at the COM supplier, that is of poor quality, or that is delivered late to The HON Company from the COM supplier. The HON Company is not responsible for excess yardage created by DTS orders and reserves the right to dispose of the excess fabric.

As a standard HON does not pattern match any standard, partnership or COM fabric, therefore pattern match is not applicable under warranty. If pattern match is needed please submit a Tailored Solutions request or contact HON Customer Support/Tailored Solutions once your COM has been approved.

COM TESTING

As a result of recent legal requirements, The HON Company will need to obtain specific information from the fabric supplier about treatments and chemicals used in the fabric. To the extent the supplier is unwilling or unable to provide the necessary information, which could extend the testing lead time of the request.

To check if a COM has been tested previously, utilize the COM Search Tool on the HON Ready Portal > Design Resources > Textiles & Finishes section using the following information:

- COM Supplier's Name
- Fabric Pattern Name
- Color Name
- If the COM fabric has been tested and previously approved, the COM will not need to be re-tested unless testing

standards have changed, fabric is to be used on a different series, or direction of the fabric has changed from what was previously approved. Please note that Panel product must be approved for each model and color.

- If the pattern has previously been tested and approved, but not in the specific requested color, the customer will need to request an order code for that color only. No further testing will be necessary since the pattern has already been approved.

If the fabric has not previously been tested, the customer must enter the COM request on the HON Ready Portal > Textiles & Finishes > COM Search Tool.

Complete the Supplier Name, Pattern, and Color drop-down fields. For quicker results in these fields, type the first letter of the (supplier, pattern, color) name and, when done, click Add and then Submit. (Multiple series can be added to the same request if they are the same supplier, pattern, and color.)

An email will be sent to the requestor stating the COM Request was successfully submitted. Up to four emails could be received: submitted, in testing, testing materials requested, and final approval/denial with price grade and fabric code. The testing process takes approximately 48 hours.

COM yardage in the pricer is shown as pattern cut only.

COM TESTING — CAL 133 TESTING INFORMATION

The customer is responsible for ensuring that the COM fabric is certified to meet all flame-retardant requirements. All COM seating fabric must, at minimum, meet CAL 117 requirements. If the customer requires the chair be tested to meet the fire safety standards of CAL 133, additional testing and information is required.

All CAL 133 requests must be submitted through the MyProjects application on the HON Ready Portal. Each request must be entered separately since each request will need to be tested individually.

Once the supplier provides the requirements to The HON Company, testing will begin. The customer will receive approval or denial information upon completion of testing.

If the test is approved, a specific model number including "FC" at the end will be provided with an appropriate price.

MTS COM

As previously mentioned, MTS is the primary COM method.

If the COM fabric has not been tested, a COM request must be submitted on the HON Ready Portal.

For MTS orders, The HON Company will procure fabric needed for production. Should The HON Company not be able to obtain fabric yardage, the customer will be contacted.

CUSTOMER'S OWN MATERIAL ORDERING INFORMATION

When testing has been completed, the customer will be notified by the COM team of the test results. If the COM is approved, The HON Company will provide a COM tracking order code for MTS. That tracking code is required on the order in place of the standard fabric code.

If approved, MTS product will be assigned an appropriate fabric grade for pricing. The pricing can be found on the HON Ready Portal > Design Resources > Textiles & Finishes. (All standard discounts/competitive project pricing applies).

Written COM price quotes are valid for 90 days after the issue date.

DTS COM

DTS COM is only available if the COM fabric cannot be procured by The HON Company. If the fabric can be procured by The HON Company, the customer will be contacted to switch to MTS or cancel the request.

If your fabric is not listed as approved, and it is not a Partnership fabric you may request a "Dealer to Supply" code. Select the "Request COM Test" link on the COM Search website. Complete the Supplier Name, Pattern, and Color drop-down fields. For quicker results in these fields, type the first letter of the (supplier, pattern, color) name and, when done, click Add and then Submit. (Multiple series can be added to the same request if they are the same supplier, pattern, and color.)

An email will be sent to the requestor stating the COM Request was successfully submitted. Up to four emails could be received: submitted, in testing, testing materials requested, and final approval/denial with price grade and fabric code. It's rare actual test yardage is required. Testing is mainly done by reviewing the attributes of the fabric. The testing process takes approximately 48 hours.

If the COM has not been tested, a COM request must be submitted on the HON Ready Portal > Design Resources > Textiles & Finishes.

When testing has been completed, the customer will be notified by the COM team of the test results. If the COM is approved, The HON Company will provide a COM tracking order code. That tracking code is required on the order in the place of the standard fabric code.

DTS product is priced at the following grades (all standard discounts/competitive project pricing applies):

- Chairs are a Grade 4
- Panel product is a Grade D

Written COM price quotes are valid for 90 days after the issue date.

COM LEAD TIME

Ship dates will be based on fabric receipt and The HON Company's standard lead time. All fabric must be properly tagged and shipped to the appropriate producing location (provided in the approval email).

- Specific to DTS orders, COM orders will not receive a ship (acknowledged) date until The HON Company has the fabric in its possession for production.
- Specific to DTS orders, the customer may send the required yardage for the order to the address listed on the approval email to arrive no sooner than 4 weeks in advance of the acknowledgment date.

HON will make every effort to locate mis-directed COM shipments on behalf of the customer. However, The HON Company will not be responsible for any COM received without a tracking number or incorrectly shipped by the fabric vendor to an incorrect producing facility.

COM ORDERING INFORMATION

The following information must appear on or accompany the product purchase order:

- Approval tracking number and the customer's purchase order number
- COM supplier, pattern, and color name/number

The packing list for the COM must include the following information when The HON Company receives the shipment for production:

- Dealer or Wholesaler Name
- Purchase order number submitted to The HON Company
- Fabric name
- Yardage shipped
- Approval ordering code

If The HON Company receives fabric with incorrect labeling that cannot be linked to an order, The HON Company will hold the fabric for up to 7 days while the COM team attempts to identify the order. After 7 days, The HON Company will return the fabric to the sender.

Specific to DTS orders; the customer should send only the amount needed for the order. Excess yardage will be disposed of at The HON Company's discretion.

CHANGES TO COM PRODUCT

Once a COM product is ordered, no changes or cancellations can be made to the COM product without approval from the HON COM team.

CONTACT COM TEAM

Phone: 800.833.3964 and listen for COM TEAM offering on the menu.

COM Email: HONCOMTeam@honcompany.com

PARTNERSHIP TEXTILE INFORMATION

Partnership Textiles is the result of The HON Company's partnership with textile industry leaders Camira, Maharam, Stinson, and Ultrafabrics, LLC. The extensive collection of design-driven textiles create a superior offering at a great value. Partnership Textiles significantly updates HON's offering, expanding it with fresh and exciting options.

- **Fabric Warranty:** Partnership Textiles are covered by HON's Full Lifetime Warranty.
- **Lead Times:** Orders specified with Partnership Textiles will be acknowledged based on the supplier's availability and delivery schedule.
- **Availability:** The HON Company will regularly introduce new Partnership Textiles and reserves the right to change the offering at any time.
- **Fabric Cards:** A curated set of Partnership Textiles are carded jointly by HON and the supplier.

Camira

- Blazer

HBF Textiles

- Everyday Textures

Maharam

- Apt
- Bluff
- Collection 1
- Lariat
- Meld
- 6M

Stinson

- Edge
- Flow
- Reliance IV
- Square One

Ultrafabrics, LLC

- Brisa
- Ultraleather Pro

Fabric Memo Samples: Please contact the supplier directly:

Camira: memos@camirafabrics.com

HBF Textiles: Phone: +1 (877) 494-5727, orders@hbftextiles.com

Maharam: (800) 645-3943

Stinson: (800) 841-6279

Ultrafabrics: (877) 309-6648

HON BRANDED, PARTNERSHIP AND COM PATTERN MATCH

- **Pattern matching** provides alignment of patterns or stripes across individual chair surfaces. Additional yardage may be required depending on pattern repeat. If Pattern Match is needed, please contact HON Customer Support/Tailored Solutions.
- **Chair to Chair Pattern Match** provides identical pattern alignment from unit to unit and is available with an upcharge. Chair to Chair Pattern Match is reviewed on a case by case basis as several factors are reviewed to determine additional yardage required, including repeat and pattern direction. If Chair to Chair Pattern Match is needed, please contact HON Customer Support/Tailored Solutions.



PAINT PROGRAM

The HON Company has established paint grades to allow customers flexibility and ease in doing business with HON. HON has three paint grades P1, P2, and P3.

P1 PAINT COLORS

HON has established P1 paints which are available on a majority of core products.

P2 PAINT COLORS

Please see individual pricer pages for eligible series and upcharges for P2 paints. P2 paints are listed in the pricer pages under the column P2. Upcharges vary by product (all standard discounts/competitive project pricing applies). No minimum quantity required.

P3 PAINT COLORS

Please see individual pricer pages for eligible series and upcharges for P3 paints. P3 paints are listed in the pricer pages under the column P3. Upcharges vary by product (all standard discounts/competitive project pricing applies). No minimum quantity required.

SPECIAL PAINT COLORS (P4-P6)

With The HON Company's state of the art color matching equipment just about any color can be matched, excluding some metallic and whites. A sample of the exact color desired is required for matching and approval.

- For each newly requested paint, a net fee of \$500 will be charged to cover costs associated with the matching process.
- For existing, previously matched paints, there is no matching fee, however there is a \$100 net fee for sample panels required for the approval process. Refer to MyProjects on the HON Portal for a list of approved special paints.

For all special paint requests, HON will send a production sample for the customer to review and approve. Once the signed paint sample is received at HON the order can be entered. Upcharges vary by product (all standard discounts/competitive project pricing applies). A quantity of 10 like-model minimum order is required for special paints. For complete program details, access Tailored Solutions on the HON Ready Portal at honready.hon.com.

Some special colors could fall outside of this program due to production costs or not meeting HON quality standards. The HON Company may apply additional charges to some colors which are costly to apply, and deny some orders on colors that cannot meet our high quality standards. We will notify the customer upon completion of our evaluation if a change in price is required or if the request is denied.

ENVIRONMENTAL STATEMENT

We continually reevaluate our purpose and processes, from fostering transparency and circularity in our supply chain to empowering our members to do and be better. We do it so the environments you create will be safer, more socially responsible, and more sustainable.

We've pursued product certifications to help communicate our commitment to developing sustainable products.

Clearing the air.

In 2006, The HON Company became one of the first office furniture manufacturer to have products certified under the Indoor Advantage™ program. Virtually all manufactured products emit chemical compounds into the air. Indoor Advantage™ certification helps assure customers that certified products will help improve the air quality within their offices and workspaces.

Developed by SCS Global Services, Indoor Advantage™ evaluates products against indoor air quality standards, like ANSI/BIFMA Furniture Emissions Standard, X7.1 and CDPH. The ANSI/BIFMA X7.1 standard allows manufacturers to test individual components, as well as complete products for emissions from volatile organic compounds (VOCs). This allows us to identify problematic materials and phase them out of our products.

Indoor Advantage™ certified products meet the LEED v4 credits for low-emitting materials.

Indoor Advantage™ offers two levels of certification, including Indoor Advantage™ and Indoor Advantage™ Gold.



On the LEVEL®.

LEVEL®, the certification program for the BIFMA e3 Sustainability Standard, was developed in response to increasing demand for proof that manufacturers were living up to their environmental claims. LEVEL® is a multi-attribute sustainability certification label for products that have met criteria in four categories of impact: Materials, Energy and Atmosphere, Human and Ecosystem Health, and Social Responsibility.

LEVEL® offers three levels of certification:



Evaluating Our Impacts.

HON has begun studying the impacts our products have on the environment through lifecycle assessments and creating Environmental Product Declarations (EPDs). EPDs provide an understandable report of how a product impacts natural resources, the environment, and the atmosphere throughout its lifecycle.

Products that meet these specifications are identified throughout this publication with the following icons:

Certified SCS Indoor Advantage™



LEVEL® certified to the BIFMA e3 Sustainability Standard



Environmental Product Declarations

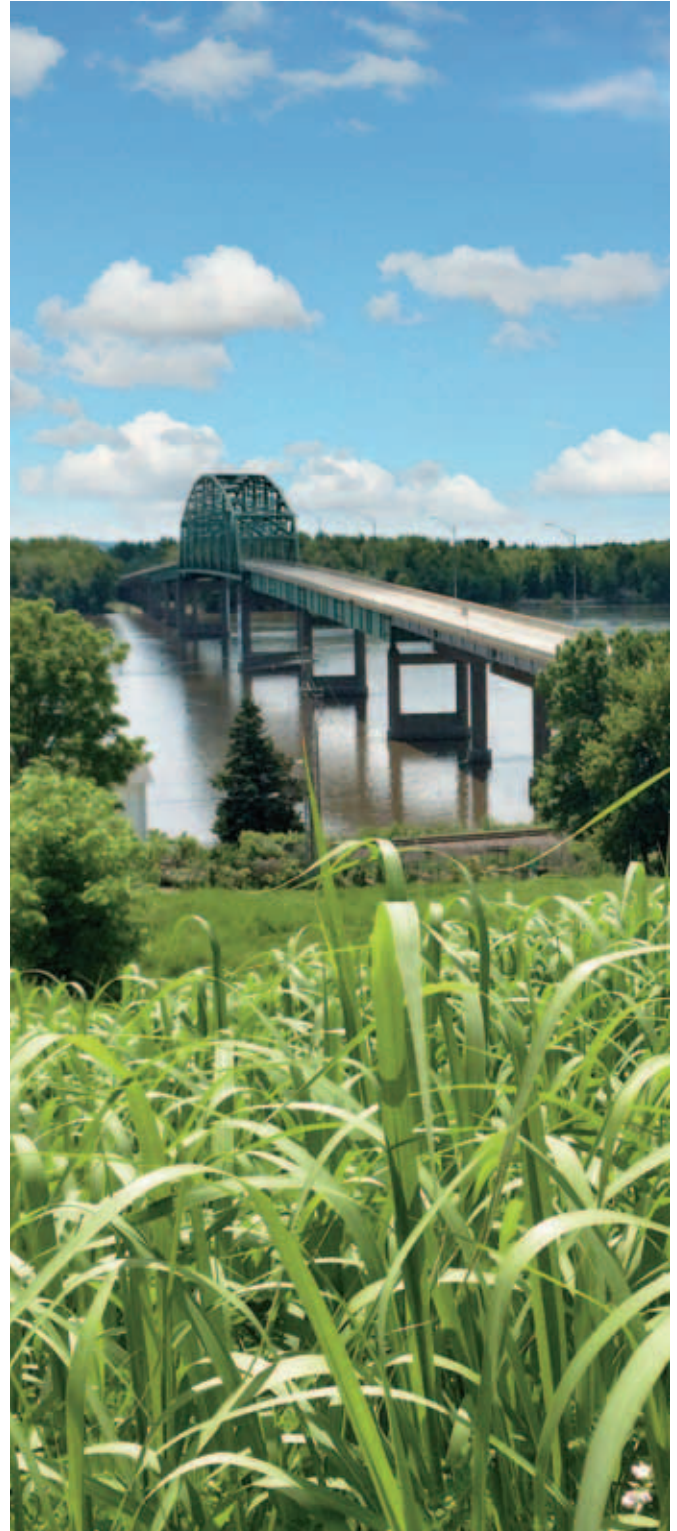

IMPORTANT INFORMATION

HON NOW™

We are inspired by the way you work. The chair you sit in. The space you choose to get it all done. We believe that well-designed office furniture should not only look good but be delivered quickly. Why wait for what you want and what you need right **NOW**?

HON NOW™ offers you a simple way to get the office solutions you need delivered with speed in mind. The office is changing and we are here to help you keep pace. No matter what space you are shopping for or product you need, HON NOW™ is made for the way you work.

GSA CONTRACT INFORMATION

Model numbers identified with the verbiage “**Open Market**” are not offered on HON’s GSA contract GS-27F-0015S. Model numbers identified with the following verbiage “Must be purchased with a configurable end product. If ordered separately, not on GSA contract” is to mean that these configurable components or options:

- Have no functionality or capability without being integrated into an end product, and
- Are not separately orderable; an eligible Schedule ordering activity may only purchase them with a configured system that is on contract.

HON CUSTOMER SUPPORT CONTACT INFORMATION

Nationwide CS Phone – (800) 833-3964

Nationwide CS Email – HONTeamBox@honcompany.com

Nationwide Order Entry – email: HONOE@honcompany.com

Government CS Phone – (800) 466-8694

GSA Team: HONGSATEAM@honcompany.com

GSA Order Entry: HONGSAOE@honcompany.com

Integrated Design Solutions – integrateddesign@honcompany.com

Online Order and Tool Support – HONReady@honcompany.com

DASH (transportation and delivery assistance) – (800) 334-8057

HON Literature Fulfillment Phone – (800) 466-4808



Nationwide CS Phone

800-833-3964

THE FOLLOWING ICONS MAY BE USED THROUGHOUT THIS PUBLICATION

	Meets or exceeds ANSI/BIFMA and ISTA performance standards		Readily Available. For additional lead time information see page 21.
	Certified SCS Indoor Advantage™ See page 17 for more details.		Available within a “standard” or “extended” lead time. For additional lead time information see page 21.
	Complies to the BIFMA e3 Sustainability Standard. See page 17 for more details.		May have extended lead times. For additional lead time information see page 21.
	Caution		Product shipped two to a carton
	Easy to assemble		Product shipped four to a carton
	Shippable by small-package carrier		Fire Code
	Wheel-chair compatible		Core Product Line
	Soft-tread caster option available		ColorCorrect® Eligible Product
	HON “One Key” Interchangeable core removable locks (see the Accessories section in the 2021 Shared Spaces Pricer).		Product scheduled for discontinuation
	Omit core removable lock option available. Allows keyed alike workstations (see the Accessories section in the 2021 Shared Spaces Pricer).		DE-EMPHASIZED: Product or fabric/surface material is de-emphasized, effective date as noted. Not carded. View online at honready.hon.com
	Base models available on the HON NOW Quickship Program with select options and finishes. View the entire NOW collection at honready.hon.com .		Warranted for multiple shift use, 24 hours a day 7 days a week

FABRIC PATTERNS & CODES



FABRIC PATTERNS & CODES

- For additional HON to Supply COM fabric grade pricing, go to honready.hon.com and search on the HON to Supply COM link.
- All specifications in this publication are based on the latest product information available at the time of print.
- Certain dyes (including clothing and accessory dyes such as those used on denim jeans) may migrate to lighter colors. This phenomenon is increased by humidity and temperature and is irreversible. The HON Company LLC does not assume responsibility for dye transfer caused by external contaminants.
- COM Ordering Information and pricing on page 14.
- See page 15 for Partnership Textile program information.
- All standard fabrics are carded. Cards are available through HON Literature Fulfillment.
- Remember to add an FC to the base model number when fire code fabric is selected. New Models with FC Fire Code suffix meet CA Technical Bulletin 133. See pages 248-251 for available models/fabrics.
- Fabrics and foam meet requirements for CAL-TB 117-2013.
- Fire Code fabrics with FC foam meet requirements for CA Technical Bulletin 133.
- ❗ Different fabrics and finishes have different recommended cleaning and maintenance methods. For the correct product care for all finishes view the HON Product Care guide at hon.com/customer-support/product-care.

LEAD TIMES

THE FOLLOWING ICONS ARE USED TO DENOTE FABRIC OPTION LEAD TIMES

FABRIC/FINISH LEAD TIME INDICATOR



Fabric is readily available. Products using these fabrics will receive the best available product lead time and are a good option for standards programs as they will be in the HON portfolio for several years. Go to honready.hon.com and use **Compass** for product lead times by series.



Fabric is available within standard lead times. Products using these fabrics will receive a “standard” or “extended” lead time. The lead time will be determined by the combination of product and fabric. Go to honready.hon.com and use **Compass** for product lead times by series.



Fabric may have extended lead times. Products using these fabrics will typically have a 4+ week lead time. Go to honready.hon.com and use the **Compass** tool for product lead times by series.

HON EXPRESS QUICK SHIP PROGRAM

For the full list of products delivered in 5 business days or less, visit honready.hon.com.

PRODUCT LEAD TIMES

Standard lead times for products are between 2-4 weeks. For current exceptions to our standard lead time, go to honready.hon.com and use the **Compass** tool.

In order to establish accurate expectations for your project, please review this listing prior to submitting your purchase order.

Lead time calculation begins when order is free from any holds (i.e., bad lines, material, credit, etc.).

Please note, these production lead time estimates do NOT include delivery time. All published lead times are estimates, not guarantees of delivery.

For further information concerning lead times, please contact HON Customer Support via email HONTeamBox@honcompany or by phone at **800-833-3964**.

FABRIC PATTERNS & CODES

GRADE 1		GRADE 1 <i>continued</i>		GRADE 1 <i>continued</i>		GRADE 1 <i>continued</i>	
APEX	APX	COMPASS	COMP	DAPPER	DAPR	HAMILTON	HAML
◆ Basalt	APX25	◆ Beach	COMP16	◆ Ash	DAPR20	◆ Azure	HAML10
◆ Beet	APX12	◆ Bittersweet	COMP46	◆ Azalea	DAPR95	◆ Biscotti	HAML11
◆ Blackberry	APX20	◆ Chocolate	COMP49	◆ Breeze	DAPR06	◆ Cabernet	HAML08
◆ Chive	APX05	◆ Ink	COMP10	◆ Canvas	DAPR25	◆ Carolina	HAML21
◆ Iris	APX03	◆ Meadow	COMP82	◆ Charcoal	DAPR01	◆ Charcoal	HAML17
◆ Kiwi	APX06	◆ Midnight	COMP90	◆ Clover	DAPR22	◆ Chocolate	HAML13
◆ Lemonade	APX08	◆ Putty	COMP22	◆ Currant	DAPR00	◆ Cloud	HAML18
◆ Navy	APX13	◆ Ruby	COMP62	◆ Emerald	DAPR75	◆ Dane	HAML16
◆ Papaya	APX09	◆ Sterling	COMP19	◆ Fawn	DAPR35	◆ Dusty Rose	HAML07
◆ Pumice	APX23	◆ Taupe	COMP26	◆ Fern	DAPR85	◆ Esmeralda	HAML06
◆ Rain	APX19	◆ Tide	COMP96	◆ Gerbera	DAPR16	◆ Fern	HAML04
◆ Resort	APX15			◆ Grape	DAPR33	◆ Fresh	HAML03
◆ Royal	APX14	COMPASS FOAM*	COMF	◆ Jewel	DAPR08	◆ Granola	HAML19
◆ Tiki	APX29	◆ Bittersweet	COMF46	◆ Marigold	DAPR65	◆ Lilac	HAML14
◆ Tomato	APX11	◆ Ink	COMF10	◆ Onyx	DAPR10	◆ Lime	HAML05
		◆ Meadow	COMF82	◆ Orchid	DAPR90	◆ Lipstick	HAML09
		◆ Midnight	COMF90	◆ Parrot	DAPR59	◆ Oxford	HAML20
		◆ Putty	COMF22	◆ Peony	DAPR50	◆ Passion Fruit	HAML02
		◆ Sterling	COMF19	◆ Pool	DAPR05	◆ Pepper	HAML15
				◆ Poppy	DAPR19	◆ Powder	HAML12
				◆ Rose	DAPR40	◆ Sunrise	HAML01
				◆ Sapphire	DAPR07		
ATTIRE	AI			◆ Scarlet	DAPR45	INERTIA	NR
◆ Blaze *	AI42	CONTOURETT	UR	◆ Sepia	DAPR30	◆ Amethyst	NR61
◆ Blue Lagoon *	AI90	◆ Baltic	UR94	◆ Sky	DAPR44	◆ Calypso	NR98
◆ Crimson *	AI62	◆ Beach	UR23	◆ Slate	DAPR15	◆ Cherry	NR66
◆ Fatigue *	AI76	◆ Black	UR10	◆ Sorbet	DAPR55	◆ Cobalt	NR91
◆ Ivy *	AI82	◆ Bordeaux	UR63	◆ Spice	DAPR60	◆ Coffee	NR49
◆ Lithium *	AI19	◆ Buff	UR22	◆ Spring	DAPR80	◆ Fog	NR19
◆ Onyx *	AI10	◆ Cloud	UR18	◆ Terracotta	DAPR13	◆ Fuchsia	NR63
◆ Sable *	AI49	◆ Coffee Bean	UR49	◆ Titanium	DAPR17	◆ Gecko	NR76
◆ Taupe *	AI26	◆ Crater	UR51	◆ Varsity	DAPR09	◆ Glow	NR27
◆ Turquoise *	AI96	◆ Flame	UR62	◆ Zest	DAPR70	◆ Leaf	NR75
		◆ Graphite	UR19			◆ Lime	NR82
		◆ Iron	UR20	ENSEMBLE	ENSB	◆ Loft	NR22
BLACK FABRIC	ACCF	◆ Luggage	UR26	◆ Aquamarine	ENSB30	◆ Mandarin	NR47
◆ Black	ACCF10	◆ Marine	UR92	◆ Ash	ENSB39	◆ Meteor	NR30
		◆ Navy	UR95	◆ Greige	ENSB36	◆ Mustard	NR26
BLACK MESH	ACCM	◆ Nimbus	UR93	◆ Harbor	ENSB34	◆ Nickel	NR23
◆ Black	ACCM10	◆ Ocean	UR96	◆ Navy	ENSB35	◆ Onyx	NR10
		◆ Pumpkin	UR42	◆ Oat	ENSB37	◆ Regatta	NR90
CENTURION	CU	◆ Quarry	UR24	◆ Pear	ENSB33	◆ Shadow	NR20
◆ Apricot	CU47	◆ Red	UR64	◆ Sand	ENSB38	◆ Surf	NR96
◆ Bark	CU25	◆ Safari	UR27	◆ Scarlet	ENSB32	◆ Tangelo	NR46
◆ Black	CU10	◆ Sage	UR82	◆ Slate	ENSB31		
◆ Espresso	CU49	◆ Steel	UR21	◆ Stone	ENSB40	OPTIC	OP
◆ Fog	CU03	◆ Storm	UR17			◆ Aurora	OP72
◆ Frost	CU22	◆ Taupe	UR28			◆ Bark	OP24
◆ Goldenrod	CU27	◆ Trunk	UR50			◆ Canopy	OP84
◆ Indigo	CU06					◆ Char	OP49
◆ Iris	CU50					◆ Ruby	OP42
◆ Iron Ore	CU19					◆ Sand	OP17
◆ Jade	CU83					◆ Sky	OP83
◆ Marsala	CU63					◆ Slate	OP19
◆ Morel	CU24					◆ Sprout	OP74
◆ Navy	CU98					◆ Starry Night	OP11
◆ Peacock	CU97					◆ Storm	OP56
◆ Pear	CU84					◆ Wildfire	OP66
◆ Ruby	CU67						
◆ Sapphire	CU09						

* Fabric is de-emphasized.

FABRIC PATTERNS & CODES

GRADE 3

IN SEASON	ISN
◇ Black	ISN001
◇ Blue Jay	ISN007
◇ Fire	ISN004
◇ Jungle	ISN008
◇ Lake	ISN006
◇ Lead	ISN002
◇ Limestone	ISN041
◇ Ocean	ISN005
◇ Silver	ISN003
◇ Smoke	ISN020
◇ Tundra	ISN011

MOXIE

SX

◆ Barnwood	SX09
◆ Basalt	SX23
◆ Bayou	SX02
◆ Biscotti	SX08
◆ Blackberry	SX48
◆ Blarney	SX49
◆ Blueberry	SX05
◆ Bonsai	SX20
◆ Carob	SX24
◆ Chalk	SX50
◆ Chartreuse	SX34
◆ Cherry	SX38
◆ Cinnamon	SX13
◆ Cobalt	SX01
◆ Coconut	SX06
◆ Concrete	SX43
◆ Cumin	SX32
◆ Dragonfly	SX44
◆ Earl Grey	SX40
◆ Elysian	SX04
◆ Evergreen	SX21
◆ Fatigue	SX18
◆ Fawn	SX30
◆ Flint	SX39
◆ Hazel	SX31
◆ Hemp	SX45
◆ Hickory	SX25
◆ Holly	SX51
◆ Jam	SX16
◆ Kelly	SX33
◆ Lemongrass	SX19
◆ Lime	SX41
◆ Macintosh	SX12
◆ Mulberry	SX15
◆ Parchment	SX07
◆ Peacock	SX03
◆ Pineapple	SX42
◆ Plum	SX17
◆ Punch	SX46
◆ Riverstone	SX47
◆ Russet	SX14
◆ Smokestack	SX22
◆ Tangerine	SX37
◆ Terracotta	SX11
◆ Thicket	SX35
◆ Walnut	SX10

GRADE 3

continued

PARKER	PRKR
◇ Aloe	PRKR01
◆ Cumulus	PRKR05
◆ Cyan	PRKR06
◆ Domino	PRKR07
◆ Fossil	PRKR10
◆ Graphite	PRKR11
◇ Grass	PRKR12
◆ Grenadine	PRKR13
◆ Griffin	PRKR14
◆ Kiln	PRKR16
◆ Magnesium	PRKR18
◆ Magnet	PRKR19
◆ Mica	PRKR20
◆ Mink	PRKR21
◆ Nightfall	PRKR22
◆ Paprika	PRKR24
◆ Pine	PRKR25
◆ Rapids	PRKR28
◆ Rioja	PRKR30

PURL

PURL

◇ Alpaca	PURL08
◇ Braid	PURL10
◆ Deep	PURL12
◆ Graze	PURL05
◆ Loom	PURL06
◆ Needle	PURL07
◆ Pasture	PURL02
◆ Ranch	PURL04
◆ Shuttle	PURL09
◆ Skein	PURL01
◆ Thistle	PURL11
◆ Yearling	PURL03

QUILL

QUL

◇ Aviary	QUL03
◆ Feather	QUL02
◆ Fountain	QUL06
◆ Ink	QUL05
◆ Metal	QUL04
◆ Reed	QUL08
◆ Scroll	QUL01
◆ Well	QUL07

GRADE L1

DENVER LEATHER	SS
◆ Black	SS11

For a complete list of fabrics, including partnership fabrics, go to hon.com/fabricsandfinishes.

PANEL FABRIC PATTERNS & CODES

PRICE CODE AA		PRICE CODE A		PRICE CODE A <i>continued</i>		PRICE CODE A <i>continued</i>	
FACTOR	FACT	APPOINT	APN	ETCH*	ECH	REFLECTIONS*	REF
◆ Bark	FACT20	◆ Artichoke	APN11	◆ Axis	ECH13	◆ Galvanized	REF29
◆ Barley	FACT15	◆ Blackberry	APN32	◆ Blend	ECH14	◆ Ice	REF20
◆ Cascade	FACT25	◆ Bronze	APN22	◆ Cast	ECH12	◆ Loggia	REF21
◆ Feather	FACT30	◆ Carbon	APN28	◆ Highlight	ECH10	◆ Mistral	REF28
		◆ Chai	APN12	◆ Midtone	ECH11	◆ Moonstone	REF23
		◆ Cherry	APN30	◆ Outline	ECH08	◆ Pewter	REF22
		◆ Dark Pewter	APN17	◆ Shade	ECH09	◆ Stainless	REF24
		◆ Dune	APN15	◆ Tonal	ECH16	◆ Vanilla	REF25
		◆ Espresso	APN23	◆ Vanish	ECH15	◆ Winter	REF27
		◆ Framboise	APN31				
		◆ Frost	APN34	EXCHANGE*	EXG	REFUGE*	RFG
		◆ Jet	APN27	◆ Iron	EXG916	◆ Artesian	RFG96
		◆ Lawn	APN25	◆ Nickel	EXG914	◆ Dune	RFG92
		◆ Mandarin	APN29	◆ Pistachio	EXG910	◆ Eclipse	RFG90
		◆ Morel	APN09	◆ Root	EXG913	◆ Frost	RFG93
		◆ Nimbus	APN16	◆ Rupee	EXG903	◆ Glacier	RFG91
		◆ Platinum	APN24	◆ Shadow	EXG911	◆ Mineral	RFG98
		◆ Turquoise	APN26	◆ Silver	EXG915	◆ Tidal	RFG94
				◆ Sisal	EXG917		
				◆ Stone	EXG912		
		CENTURION	CU	LANDSCAPE*	LN	SARTO*	SRT
		◆ Apricot	CU47	◆ Azure	LN55	◆ Ash	SRT88
		◆ Bark	CU25	◆ Cornsilk	LN15	◆ Fog	SRT14
		◆ Black	CU10	◆ Drift	LN05	◆ Lemongrass	SRT49
		◆ Espresso	CU49	◆ Khaki	LN20	◆ Mist	SRT45
		◆ Fog	CU03	◆ Sheen	LN10	◆ Mushroom	SRT76
		◆ Frost	CU22	◆ Slate	LN35	◆ Oyster	SRT18
		◆ Goldenrod	CU27	◆ Umber	LN25	◆ Reef	SRT64
		◆ Indigo	CU06	◆ Urban	LN30	◆ Sesame	SRT93
		◆ Iris	CU50			◆ Shale	SRT52
		◆ Iron Ore	CU19	LUCY*	LC	TEMPEST*	TP
		◆ Jade	CU83	◆ Aspen	LC32	◆ Dragonfly	TP30
		◆ Marsala	CU63	◆ Cornsilk	LC30	◆ Frost	TP15
		◆ Morel	CU24	◆ Dusk	LC22	◆ Full Stream	TP80
		◆ Navy	CU98	◆ Fawn	LC33	◆ Gold Rush	TP10
		◆ Peacock	CU97	◆ Graphite	LC34	◆ Slate	TP45
		◆ Pear	CU84	◆ Mist	LC20	◆ Tumbleweed	TP70
		◆ Ruby	CU67	◆ Neutra	LC24	◆ Wind Chill	TP40
		◆ Sapphire	CU09	◆ Pewter	LC35	◆ Zebra	TP35
				◆ Snowdrop	LC28		

NOTES: Centurion fabrics not available on panels that exceed a width and height of 54"H.

Exchange is applied pattern cut and is not available on 78"W tackboards, Voi® screens, and Empower®.

Disperse is applied pattern cut and is not available on 72"W Accelerate® panels and not available on 66"W tackboards, Voi® screens, and Empower®.

◆◆◆ For lead time information see page 19.

* Directional fabrics

PANEL FABRIC PATTERNS & CODES

PRICE CODE B

ANALOG	ANLG
<i>Not available on Accelerate®</i>	
◆ Album	ANLG06
◆ Cartridge	ANLG04
◆ Cassette	ANLG09
◆ Dial	ANLG02
◆ Media	ANLG08
◆ Reel	ANLG07
◆ Signal	ANLG03
◆ Stereo	ANLG01
◆ Track	ANLG05

COAST*

COAST*	COA
<i>Not available on Accelerate®</i>	
◆ Channel	COA14
◆ Dune	COA03
◆ Headlands	COA10
◆ Marsh	COA02
◆ Pebble	COA12
◆ Pier	COA13
◆ Shoal	COA01
◆ Silt	COA06
◆ Tide	COA08

PRICE CODE B *continued*

DISPERSE*	DISP
◆ Autumn	DISP03
◆ Branch	DISP10
◆ Coffee Bean	DISP13
◆ Dusk	DISP09
◆ Emerald City	DISP08
◆ Gold Rush	DISP02
◆ Igloo	DISP11
◆ Ink	DISP06
◆ Mist	DISP12
◆ Oatmeal	DISP15
◆ Prince	DISP07
◆ Reservoir	DISP01
◆ Rose	DISP04
◆ Spring	DISP05
◆ Steel	DISP16
◆ Taupe	DISP14

MICA*

MICA*	MCA
◆ Anthracite	MCA11
◆ Breeze	MCA18
◆ Bronze	MCA13
◆ Buff	MCA14
◆ Cremini	MCA17
◆ Crystal	MCAWIT
◆ Dew	MCA20
◆ Dove	MCA12
◆ Fresh	MCA16
◆ Mineral	MCA15
◆ Nectar	MCA19
◆ Shale	MCA10

PRICE CODE B *continued*

SPIN*	SPIN
◆ Alabaster	SPIN02
◆ Cavern	SPIN03
◆ Cobblestone	SPIN04
◆ Ember	SPIN06
◆ Flame	SPIN07
◆ Heron	SPIN13
◆ Oat	SPIN01
◆ Ocean	SPIN12
◆ Plum	SPIN15
◆ Pool	SPIN11
◆ Raven	SPIN10
◆ Rhubarb	SPIN14
◆ Tropic	SPIN08
◆ Willow	SPIN05

TERRAIN*

TERRAIN*	TRRN
◆ Bay	TRRN05
◆ Bayou	TRRN35
◆ Canyon	TRRN30
◆ Cliff	TRRN45
◆ Crest	TRRN25
◆ Delta	TRRN10
◆ Plateau	TRRN15
◆ Ridge	TRRN20
◆ Valley	TRRN40

NOTES: Exchange is applied pattern cut and is not available on 78"W tackboards, Voi® screens, and Empower®.

Disperse is applied pattern cut and is not available on 72"W Accelerate® panels and not available on 66"W tackboards, Voi® screens, and Empower®.

◆◆◆ For lead time information see page 19.

* Directional fabrics

ARRANGE®



Arrange® Tables shown with Flock® Seating.

ARRANGE®

Non-traditional workspace? Transform it with Arrange tables. Ideal for cafés and other collaborative spaces, Arrange tables are available in seated, counter and standing-heights, and can accommodate anywhere from two to eight people. With four tabletop shapes and more than 40 different finish options, you can create a unique and usable space that brings people together.



FEATURES

- Simple, clean design coordinates nicely with other HON furniture.
- The traditional x-base can be updated with a disc shroud.
- Tables come with optional cord grommets and outlets to accommodate a wide range of technical needs — or none at all.
- Aluminum bases are durable, long-lasting and lightweight, making it easy to move and rearrange floor plans.
- Laminate surfaces are durable and resist scratches, spills and stains.

ARRANGE® CAFÉ TABLES ORDERING INFORMATION

LAMINATE

TOPS/L1 LAMINATES CODES

Woodgrain

- ◆ Bourbon Cherry **H**
- ◆ Cognac **COGN**
- ◆ Florence Walnut **LFW1**
- ◆ Harvest **C**
- ◆ Kingswood Walnut **LKI1**
- ◆ Mahogany **N**
- ◆ Mocha **MOCH**
- ◆ Natural Maple **D**
- ◆ Pinnacle **PINC**
- ◆ Shaker Cherry **F**
- ◆ Sterling Ash **LSA1**

Solid

- ◆ Black **P**
- ◆ Charcoal **S**
- ◆ Designer White **LDW1**
- ◆ Loft **LOFT**

Patterned

- ◆ Sheer Mesh **A5**
- ◆ Silver Mesh **B9**
- ◆ Steel Mesh **A9**
- ◇ Canyon Zephyr **K9**
- ◇ Desert Zephyr **K8**
- ◇ Shadow Zephyr **K1**
- ◆ Gray **G2**
- ◆ Grey Tigris **L6**
- ◇ White **G1**
- ◆ Whitestone **K4**

TOPS/L2 LAMINATES CODES

Woodgrain

- ◆ Lowell Ash **LLA1**
- ◆ Natural Recon **LNR1**
- ◆ Phantom Ecreu **LPE1**
- ◆ Portico Teak **LPT1**
- ◆ Skyline Walnut **LSW1**

PAINT

PAINT CODES

P1

- ◆ Textured Black **BLCK**
- ◆ Textured Brownstone **P7J**
- ◆ Textured Charcoal **P7A**
- ◆ Textured Designer White ... **PK7**
- ◆ Textured Loft **P7L**
- ◆ Textured Muslin **P7M**
- ◆ Textured Titanium **P8V**

P2

- ◆ Solar Black **P8X**
- ◆ Textured Platinum
Metallic **PLAT**
- ◆ Textured Silver **PR8**

EDGEBAND

EDGEBAND CODES

- ◆ Black **P**
- ◆ Bourbon Cherry **H**
- ◆ Charcoal **S**
- ◆ Cognac **COGN**
- ◆ Designer White **DW**
- ◆ Florence Walnut **FW**
- ◇ Greige **R**
- ◆ Harvest **C**
- ◆ Kingswood Walnut **KI**
- ◆ Loft **LOFT**
- ◆ Lowell Ash **DL**
- ◆ Mahogany **N**
- ◆ Mocha **MOCH**
- ◇ Muslin **T**
- ◆ Natural Maple **D**
- ◆ Natural Recon **NR**
- ◆ Phantom Ecreu **PE**
- ◆ Pinnacle **PINC**
- ◇ Platinum **K**
- ◆ Portico Teak **DP**
- ◆ Shadow * **SHDW**
- ◆ Shaker Cherry **F**
- ◆ Skyline Walnut **SW**
- ◆ Sterling Ash **SA**

Recommended Edgeband Color Selection:

Laminate		Edgeband	
Bourbon Cherry	H	Bourbon Cherry	H
Cognac	COGN	Cognac	COGN
Florence Walnut	LFW1	Florence Walnut	FW
Grey Tigris	L6	Greige	R
Harvest	C	Harvest	C
Kingswood Walnut	LKI1	Kingswood Walnut	KI
Mahogany	N	Mahogany	N
Mocha	MOCH	Mocha	MOCH
Natural Maple	D	Natural Maple	D
Pinnacle	PINC	Pinnacle	PINC
Shaker Cherry	F	Shaker Cherry	F
Sterling Ash	LSA1	Sterling Ash	SA
Black	P	Black	P
Charcoal	S	Charcoal	S
Designer White	LDW1	Designer White	DW
Whitestone	K4	Muslin	T
Sheer Mesh	A5	Muslin	T
Silver Mesh	B9	Loft	LOFT
Steel Mesh	A9	Charcoal	S
Canyon Zephyr	K9	Greige	R
Desert Zephyr	K8	Greige	R
Shadow Zephyr	K1	Loft	LOFT
Lowell Ash	LLA1	Lowell Ash	DL
Natural Recon	LNR1	Natural Recon	NR
Phantom Ecreu	LPE1	Phantom Ecreu	PE
Portico Teak	LPT1	Portico Teak	DP
Skyline Walnut	LSW1	Skyline Walnut	SW
Loft	LOFT	Loft	LOFT



◆◆◆ For lead time information see page 19.

* De-emphasized

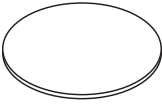
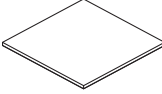

Icon Legend on page 19

ARRANGE® Café Table Tops

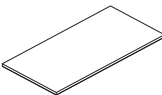
	DESCRIPTION	MODEL	SHIP WEIGHT	CUBE	LIST PRICE BY LAMINATE GRADE	
					L1	L2
	Café Round Table Tops					
	24"W Round Top	HCTRND24	19	1.9	\$314	\$329
	30"W Round Top	HCTRND30	31	2.9	\$338	\$353
	36"W Round Top	HCTRND36	44	4.0	\$368	\$383
	42"W Round Top	HCTRND42	57	5.4	\$436	\$456
	48"W Round Top	HCTRND48	71	7.2	\$475	\$495
	Square Table Tops					
	24"W Square Top	HCTSQR24	19	2.2	\$298	\$313
	30"W Square Top	HCTSQR30	31	2.9	\$322	\$337
	36"W Square Top	HCTSQR36	44	4.1	\$350	\$365
	42"W Square Top	HCTSQR42	57	5.6	\$417	\$437
	Soft Square Table Tops					
	24"W Soft Square Top	HCTSFT24	19	1.9	\$314	\$329
	30"W Soft Square Top	HCTSFT30	31	2.9	\$338	\$353
	36"W Soft Square Top	HCTSFT36	44	4.0	\$368	\$383
	42"W Soft Square Top	HCTSFT42	57	5.4	\$436	\$456
	48"W Soft Square Top	HCTSFT48	71	7.2	\$475	\$495
	Rectangle Table Tops					
	24"W x 48"D Rectangle Top	HCTRECT2448	36	3.6	\$355	\$370
	24"W x 60"D Rectangle Top	HCTRECT2460	44	4.4	\$389	\$404
	24"W x 72"D Rectangle Top	HCTRECT2472	56	4.9	\$413	\$433
	30"W x 48"D Rectangle Top	HCTRECT3048	51	4.4	\$368	\$383
	30"W x 60"D Rectangle Top	HCTRECT3060	63	5.4	\$413	\$428
	30"W x 72"D Rectangle Top	HCTRECT3072	75	6.0	\$457	\$477

NOTES:

- 2 grommet cutouts on Rectangles which will be positioned over the installed bases.

HOW TO SPECIFY

<p>Select Model Number</p> <p>H C T R N D 2 4 .</p>	<p>Select Grommet Option</p> <p>G Round Grommet (\$15 upcharge) N No Grommet Upcharge doubles for HCTRECT models</p> <p>G .</p>	<p>Select Laminate</p> <p>See page 28</p> <p>C .</p>	<p>Select Edge Color</p> <p>See page 28</p> <p>C</p>
--	--	---	---

ARRANGE[®]

Café Table Bases

GSA SIN 33721

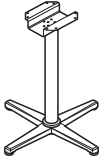

Icon Legend on page 19

**DESCRIPTION****MODEL****SHIP WEIGHT****CUBE****LIST PRICE****P2
UPCHARGE****Café Table Bases — X-Base**

Seated-Height X-base for 24"-30"D Surfaces

HCT29SX

22

3.3

\$476**\$20**

Seated-Height X-base for 36"D Surfaces

HCT29MX

23

3.3

\$529**\$20**

Seated-Height X-base for 42"-48"D Surfaces

HCT29LX

25

3.3

\$581**\$20**

Counter-Height X-base for 24"-30"D Surfaces

HCT36SX

24

4.6

\$529**\$20**

Counter-Height X-base for 36"D Surfaces

HCT36MX

25

4.6

\$581**\$20**

Counter-Height X-base for 42"-48"D Surfaces

HCT36LX

27

4.6

\$634**\$20**

Bar-Height X-base for 24"-30"D Surfaces

HCT42SX

25

4.6

\$581**\$20**

Bar-Height X-base for 36"D Surfaces

HCT42MX

26

4.6

\$634**\$20**

Bar-Height X-base for 42"-48"D Surfaces

HCT42LX

27

4.6

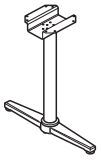
\$686**\$20****Café Table Bases — T-Leg Base**

Seated-Height T-legs for 24"D Surfaces (2 bases incl.)

HCT29ST

33

3.3

\$645**\$20**

Seated-Height T-legs for 30"D Surfaces (2 bases incl.)

HCT29MT

34

3.3

\$718**\$20**

Counter-Height T-legs for 24"D Surfaces (2 bases incl.)

HCT36ST

36

4.6

\$693**\$20**

Counter-Height T-legs for 30"D Surfaces (2 bases incl.)

HCT36MT

37

4.6

\$748**\$20**

Bar-Height T-legs for 24"D Surfaces (2 bases incl.)

HCT42ST

37

4.6

\$743**\$20**

Bar-Height T-legs for 30"D Surfaces (2 bases incl.)

HCT42MT

38

4.6

\$797**\$20****NOTES:**

- Wire management is standard through table column.
- Adjustable glides available on all feet.

HOW TO SPECIFY**Select
Model Number**

HCT29SX.

**Select
Paint Color**



See page 28

BLCK

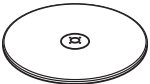

Icon Legend on page 19

ARRANGE[®] Café Accessories

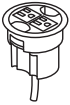
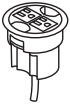
	DESCRIPTION	MODEL	SHIP WEIGHT	CUBE	LIST PRICE
 SIN 33721 	Café Table Bases — Disc Shroud Small Disc Shroud for bases that support 24"-30" Surfaces Medium Disc Shroud for bases that support 36" Surfaces Large Disc Shroud for bases that support 42"-48" Surfaces	HCTSDS HCTMDS HCTLDS	9.0 12.0 17.0	2.0 2.4 3.4	\$94 \$109 \$126
	NOTES: Shroud is used as an optional accessory to provide the aesthetic of a disc base. Shroud can be added to existing X-base configurations to provide a new and updated aesthetic. Shroud is made of 18 gauge steel.				
	! Shroud to be used in conjunction with X-bases only and cannot be used with a T-leg configuration.				
	! Shroud cannot be used as a support piece by itself.				
	Power Hub, 3" Grommet Mount, 6' Cord	HGRMTAC	1.3	0.2	\$116
	NOTES: For additional information see page 236. ! Available in black only (no color designation so use .X - Specify: HGRMTAC.X).				
	Power Hub, 3" Grommet Mount, 10' Cord	HGRMTAC2	1.5	0.2	\$148
	NOTES: For additional information see page 236. ! Available in black finish only, no specification needed.				

NOTES:

! HGRMTUSB2 is not compatible with Arrange[®] bases.

HOW TO SPECIFY

<p>Select Model Number</p>	<p>Select Paint Color</p> <p><i>For HCTSDS, HCTMDS and HCTLDS models only</i></p> <p>See page 28</p>
<p>H C T S D S .</p>	<p>B L C K</p>

BETWEEN™ TABLES



Between™ Tables shown with Ignition® ReActiv® Back Seating.

BETWEEN™ TABLES

The rise of mobile workers. Increased desire for socialization. Escalating real estate costs. These trends are driving inventive ways of getting the job done. This new approach requires getting the most out of every inch of space by adding versatile tables that add value and increase productivity. Whether you're working here, there or anywhere Between, this table collection's got you covered.



FEATURES

- Choose from round, square and soft square tops.
- 1/8" thick worksurface provides a sturdy foundation for work.
- Scratch-, spill- and stain-resistant laminate stands up to heavy use.
- Easily attach a base using pre-drilled holes.

BETWEEN™ ORDERING INFORMATION

LAMINATE

TOPS/L1 LAMINATES CODES

Woodgrain

- ◆ Bourbon Cherry H
- ◆ Cognac COGN
- ◆ Florence Walnut LFW1
- ◆ Harvest C
- ◆ Kingswood Walnut LK11
- ◆ Mahogany N
- ◆ Mocha MOCH
- ◆ Natural Maple D
- ◆ Pinnacle PINC
- ◆ Shaker Cherry F
- ◆ Sterling Ash LSA1

Solid

- ◆ Black P
- ◆ Charcoal S
- ◆ Designer White LDW1
- ◆ Loft LOFT

Patterned

- ◆ Sheer Mesh A5
- ◆ Silver Mesh B9
- ◆ Steel Mesh A9
- ◇ Canyon Zephyr K9
- ◇ Desert Zephyr K8
- ◇ Shadow Zephyr K1
- ◇ Whitestone K4

TOPS/L2 LAMINATES CODES

Woodgrain

- ◆ Lowell Ash LLA1
- ◆ Natural Recon LNRI
- ◆ Phantom Ecru LPE1
- ◆ Portico Teak LPT1
- ◆ Skyline Walnut LSW1

SEATED-, STANDING-, AND X-BASES

PAINT CODES

P1

- ◆ Black Mica Texture P6P
- ◆ Textured Brownstone P7J
- ◆ Textured Charcoal P7A
- ◆ Textured Designer White ... PK7
- ◆ Textured Loft P7L
- ◆ Textured Muslin P7M
- ◆ Textured Titanium P8V

P2

- ◆ Textured Silver PR8

FIXED AND NESTING BASES

PAINT CODES

P1

- ◆ Black P71
- ◆ Brownstone P7D
- ◆ Charcoal P02
- ◆ Designer White PJW
- ◆ Fossil P28
- ◆ Greige T5
- ◆ Loft LOFT
- ◆ Muslin T3
- ◆ Titanium P8T

P2

- ◆ Silver PR6

EDGE BAND

EDGE BAND CODES

- ◆ Black P
- ◆ Bourbon Cherry H
- ◆ Charcoal S
- ◆ Cognac COGN
- ◆ Designer White DW
- ◆ Florence Walnut FW
- ◇ Greige R
- ◆ Harvest C
- ◆ Kingswood Walnut KI
- ◆ Loft LOFT
- ◆ Lowell Ash DL
- ◆ Mahogany N
- ◆ Mocha MOCH
- ◇ Muslin T
- ◆ Natural Maple D
- ◆ Natural Recon NR
- ◆ Phantom Ecru PE
- ◆ Pinnacle PINC
- ◆ Platinum K
- ◆ Portico Teak DP
- ◇ Shadow* SHDW
- ◆ Shaker Cherry F
- ◆ Skyline Walnut SW
- ◆ Sterling Ash SA

Recommended Edgeband Color Selection:

Laminate		Edgeband	
Bourbon Cherry	H	Bourbon Cherry	H
Cognac	COGN	Cognac	COGN
Florence Walnut	LFW1	Florence Walnut	FW
Harvest	C	Harvest	C
Kingswood Walnut	LK11	Kingswood Walnut	KI
Mahogany	N	Mahogany	N
Mocha	MOCH	Mocha	MOCH
Natural Maple	D	Natural Maple	D
Pinnacle	PINC	Pinnacle	PINC
Shaker Cherry	F	Shaker Cherry	F
Sterling Ash	LSA1	Sterling Ash	SA
Black	P	Black	P
Charcoal	S	Charcoal	S
Designer White	LDW1	Designer White	DW
Whitestone	K4	Muslin	T
Sheer Mesh	A5	Muslin	T
Silver Mesh	B9	Loft	LOFT
Steel Mesh	A9	Charcoal	S
Canyon Zephyr	K9	Greige	R
Desert Zephyr	K8	Greige	R
Shadow Zephyr	K1	Loft	LOFT
Lowell Ash	LLA1	Lowell Ash	DL
Natural Recon	LNRI	Natural Recon	NR
Phantom Ecru	LPE1	Phantom Ecru	PE
Portico Teak	LPT1	Portico Teak	DP
Skyline Walnut	LSW1	Skyline Walnut	SW
Loft	LOFT	Loft	LOFT

◆◆◆ For lead time information see page 19.

* De-emphasized

BETWEEN™ Table Tops

GSA SIN 33721



Icon Legend on page 19

	DESCRIPTION	MODEL	SHIP WEIGHT	CUBE	LIST PRICE BY LAMINATE GRADE	
					L1	L2
	Round Table Tops					
	30"W Round Top	HBTRND30	31	2.9	\$316	\$331
	36"W Round Top	HBTRND36	44	4.0	\$345	\$361
	42"W Round Top	HBTRND42	57	5.4	\$409	\$429
	Square Table Tops					
	30"W Square Top	HBTSQR30	31	2.9	\$301	\$315
	36"W Square Top	HBTSQR36	44	4.1	\$329	\$345
	42"W Square Top	HBTSQR42	57	5.6	\$391	\$410
	Soft Square Table Tops					
	30"W Soft Square Top	HBTSFT30	31	2.9	\$316	\$331
	36"W Soft Square Top	HBTSFT36	44	4.0	\$345	\$361
	42"W Soft Square Top	HBTSFT42	57	5.4	\$409	\$429

HOW TO SPECIFY

Select Model Number HBTRND30	Select Grommet Option N No Grommet	Select Laminate See page 33 C	Select Edge Color See page 33 C
--	--	--	--









Icon Legend on page 19

BETWEEN™ Table Bases

	DESCRIPTION	MODEL	SHIP WEIGHT	CUBE	LIST PRICE
 <p>SIN 33721</p>	X-Base				
	Seated-Height X-base for Support of 30", 36" Tops	HBTTX30S	27	5.2	\$304
	Seated-Height X-base for Support of 42" Tops	HBTTX30L	29	5.2	\$445
	Bar-Height X-base for Support of 30", 36" Tops	HBTTX42S 	30	5.2	\$365
	Bar-Height X-base for 42" Tops	HBTTX42L 	34	5.2	\$510

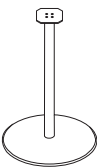
NOTES:

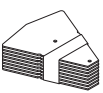
- Seated-Height (30¾" to top of surface).
- Bar-Height (42¼" to top of surface).
- Adjustable glides with ¼" adjustment available on all feet.

	Seated-Height Disc Base  Disc Base not for use with 42" square top.	HBTTD30	24	3.3	\$366
	Standing-Height Disc Base  Disc Base not for use with 42" square top.	HBTTD42	27	3.3	\$432
	Counterweight Kit for Disc Base  Required when using disc base with 42" round and soft square tops. Optional for smaller top sizes.	HBTTCW	16	0.2	\$145

NOTES:

- Seated-Height (29" to top of surface).
- Bar-Height (42" to top of surface).
- Counterweight Kit required when using disc base with 42" round or soft square tops. Kit can be used for added stability on 30" or 36" round, square, and soft square tops if desired.

HOW TO SPECIFY

<p>Select Model Number</p> <p>HBTTX30S .</p>	<p>Select Paint Color</p> <p>See page 33</p> <p>PR8</p>
---	--

BETWEEN™ Rectangular Table Tops

OPEN MARKET



Icon Legend on page 19

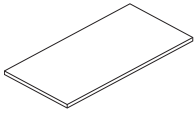

DESCRIPTION	MODEL	SHIP WEIGHT	CUBE	LIST PRICE BY LAMINATE GRADE	
				L1	L2
Rectangular Table Tops					
48"W x 24"D	HMPTT2448	45	3.7	\$353	\$370
60"W x 24"D	HMPTT2460	57	4.5	\$391	\$410
72"W x 24"D	HMPTT2472	68	5.0	\$432	\$453
48"W x 30"D	HMPTT3048	57	4.4	\$368	\$386
60"W x 30"D	HMPTT3060	71	5.4	\$403	\$423
72"W x 30"D	HMPTT3072	85	6.0	\$460	\$482

NOTES:

- HON 5-Year Limited Warranty.

HOW TO SPECIFY

<p>Select Model Number</p> <p>HMPTT2448</p>	<p>Select Grommet Option</p> <p>N No Grommet</p> <p>N</p>	<p>Select Laminate</p> <p>See page 33</p> <p>C</p>	<p>Select Edge Color</p> <p>See page 33</p> <p>C</p>
--	--	---	---

BETWEEN™ Table Bases for Rectangular Tops

OPEN MARKET



Icon Legend on page 19

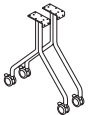

DESCRIPTION	MODEL	SHIP WEIGHT	CUBE	LIST PRICE
Fixed Leg	HMPTBFX	27	6.3	\$268

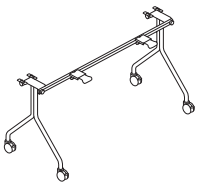

Nesting Base				
For use with 48"W Rectangular Tops	HMPTBNSS	18	6.3	\$309
For use with 60"W and 72"W Rectangular Tops	HMPTBNSL	19	6.3	\$330

NOTES:

- Tops and bases ship in separate cartons.
- HON 5-Year Limited Warranty.

HOW TO SPECIFY

<p>Select Model Number</p> <p>HMPTBFX</p>	<p>Select Paint Color</p> <p>See page 33</p> <p>P71</p>
--	--

OPEN MARKET



Icon Legend on page 19

BETWEEN™ Nesting Tables

TABLES

	DESCRIPTION	MODEL	SHIP WEIGHT	CUBE	LIST PRICE
	Nesting Table				
	48"W x 24"D	HMPT2448NS	69	8.9	\$596
	60"W x 24"D	HMPT2460NS Ⓢ	81	10.7	\$648
	72"W x 24"D	HMPT2472NS Ⓢ	92	12.4	\$685
	48"W x 30"D	HMPT3048NS	81	10.9	\$609
	60"W x 30"D	HMPT3060NS	95	13.1	\$660
	72"W x 30"D	HMPT3072NS	109	15.0	\$710

NOTES:

- Top and base ship in one carton.
- Limited finishes available on single-carton tables.
- **HON 5-Year Limited Warranty.**

HOW TO SPECIFY

<p>Select Model Number</p> <p>HMPT2448NS</p>	<p>Select Grommet Option</p> <p>N No Grommet</p> <p>N</p>	<p>Select Laminate/Edge</p> <p>B9LOFT Silver Mesh/Loft Edge FF Shaker Cherry/Shaker Cherry Edge PINCINC Pinnacle/Pinnacle Edge</p> <p>B9LOFT</p>	<p>Select Base Paint</p> <p>P71 Black</p> <p>P71</p>
---	--	---	---

GSA SIN 33721



Icon Legend on page 19

BETWEEN™ Shared Components

	DESCRIPTION	MODEL	SHIP WEIGHT	CUBE	LIST PRICE BY PAINT GRADE	
					P1	P2
	Universal Modesty Panel					
	For 48"W Between™ Tables	HMTUMOD38	11	2.2	\$223	\$243
	For 60"/72"W Between™ Tables	HMTUMOD50	14	3.1	\$244	\$264

NOTES:

- Table Modesty Panels are hinged for use with Nesting Table models.

HOW TO SPECIFY

<p>Select Model Number</p> <p>HMTUMOD38</p>	<p>Select Paint Color</p> <p>See page 98</p> <p>T1</p>
--	---

BETWEEN™ Accessories

GSA SIN 33721



Icon Legend on page 19



DESCRIPTION

Under Worksurface Power Module

NOTES: For additional information see page 237.

MODEL

HPWRMOD2

SHIP WEIGHT

1.5

CUBE

0.2

LIST PRICE

\$401

HOW TO SPECIFY

Select
Model Number

HPWRMOD2

BIRK™ TABLES



Birk™ Tables

BIRK™ TABLES

Why complicate matters when you can keep it simple? Offering a modern, minimalist design, Birk tables have a look that's as streamlined as its specification process. Whether you're looking for something well-rounded or think it's hip to be square, Birk is there for you with a variety of top shapes, sizes, and table heights. It's the support system you need to help people come together, collaborate, and socialize — anywhere.



FEATURES

- Ideal for informal meeting spaces and hospitality areas.
- Modern, minimalist design makes it easy to match a variety of styles.
- Designed for use with HON chairs, stools, and soft seating.
- Five different base heights outfit a variety of spaces.
- Five unique top shapes and sizes coordinate seamlessly with any surrounding aesthetic.
- The personal table is light in scale and gives people the ability to take notes and work in a lounge setting.

BIRK™ ORDERING INFORMATION

LAMINATE

L1 LAMINATES CODES

Woodgrain

- ◆ Bourbon Cherry **H**
- ◆ Cognac **COGN**
- ◆ Florence Walnut **LFW1**
- ◆ Harvest **C**
- ◆ Kingswood Walnut **LK11**
- ◆ Mahogany **N**
- ◆ Mocha **MOCH**
- ◆ Natural Maple **D**
- ◆ Pinnacle **PINC**
- ◆ Shaker Cherry **F**
- ◆ Sterling Ash **LSA1**

Solid

- ◆ Black **P**
- ◆ Charcoal **S**
- ◆ Designer White **LDW1**
- ◆ Loft **LOFT**

Patterned

- ◆ Sheer Mesh **A5**
- ◆ Silver Mesh **B9**
- ◆ Steel Mesh **A9**

L2 LAMINATES CODES

Woodgrain

- ◆ Lowell Ash **LLA1**
- ◆ Natural Recon **LNRI**
- ◆ Phantom Ecru **LPE1**
- ◆ Portico Teak **LPT1**
- ◆ Skyline Walnut **LSW1**

EDGE BAND

EDGE BAND CODES

- ◆ Black **P**
- ◆ Bourbon Cherry **H**
- ◆ Charcoal **S**
- ◆ Cognac **COGN**
- ◆ Designer White **DW**
- ◆ Florence Walnut **FW**
- ◆ Greige **R**
- ◆ Harvest **C**
- ◆ Kingswood Walnut **KI**
- ◆ Loft **LOFT**
- ◆ Lowell Ash **DL**
- ◆ Mahogany **N**
- ◆ Mocha **MOCH**
- ◆ Muslin **T**
- ◆ Natural Maple **D**
- ◆ Natural Recon **NR**
- ◆ Phantom Ecru **PE**
- ◆ Pinnacle **PINC**
- ◆ Platinum **K**
- ◆ Portico Teak **DP**
- ◆ Shaker Cherry **F**
- ◆ Skyline Walnut **SW**
- ◆ Sterling Ash **SA**

PAINT

PAINT CODES

P1

- ◆ Black Mica Texture **P6P**
- ◆ Textured Brownstone **P7J**
- ◆ Textured Charcoal **P7A**
- ◆ Textured Designer White ... **PK7**
- ◆ Textured Loft **P7L**
- ◆ Textured Muslin **P7M**
- ◆ Textured Titanium **P8V**

P2

- ◆ Solar Black **P8X**
- ◆ Textured Silver **PR8**

Recommended Edgeband Color Selection:

Laminate	Edgeband
Bourbon Cherry H	Bourbon Cherry H
Cognac COGN	Cognac COGN
Florence Walnut LFW1	Florence Walnut FW
Harvest C	Harvest C
Kingswood Walnut LK11	Kingswood Walnut KI
Mahogany N	Mahogany N
Mocha MOCH	Mocha MOCH
Natural Maple D	Natural Maple D
Pinnacle PINC	Pinnacle PINC
Shaker Cherry F	Shaker Cherry F
Sterling Ash LSA1	Sterling Ash SA
Black P	Black P
Charcoal S	Charcoal S
Designer White LDW1	Designer White DW
Sheer Mesh A5	Muslin T
Silver Mesh B9	Loft LOFT
Steel Mesh A9	Charcoal S
Lowell Ash LLA1	Lowell Ash DL
Natural Recon LNRI	Natural Recon NR
Phantom Ecru LPE1	Phantom Ecru PE
Portico Teak LPT1	Portico Teak DP
Skyline Walnut LSW1	Skyline Walnut SW
Loft LOFT	Loft LOFT



Icon Legend on page 19

	DESCRIPTION	MODEL	SHIP WEIGHT	CUBE	LIST PRICE BY LAMINATE GRADE	
					L1	L2
	Round Tops with Knife Edge					
	30"W Round Top	HCWTRND30J	28	2.8	\$446	\$469
	36"W Round Top	HCWTRND36J	38	3.8	\$486	\$511
	42"W Round Top	HCWTRND42J	50	5.1	\$574	\$603
	Round Tops with Flat Edge					
	30"W Round Top	HCWTRND30G	28	2.8	\$343	\$360
	36"W Round Top	HCWTRND36G	38	3.8	\$374	\$393
	42"W Round Top	HCWTRND42G	50	5.1	\$442	\$464
	Square Tops with Knife Edge					
	30"W Square Top	HCWTSQR30J	34	2.6	\$395	\$415
	36"W Square Top	HCWTSQR36J	47	3.8	\$463	\$486
	42"W Square Top	HCWTSQR42J	62	5.0	\$548	\$576
	Square Tops with Flat Edge					
	30"W Square Top	HCWTSQR30G	34	2.6	\$305	\$321
	36"W Square Top	HCWTSQR36G	47	3.8	\$356	\$374
	42"W Square Top	HCWTSQR42G	62	5.0	\$422	\$443
	Soft Square Tops with Knife Edge					
	30"W Soft Square Top	HCWTSFTS30J	34	2.6	\$446	\$469
	36"W Soft Square Top	HCWTSFTS36J	47	3.8	\$486	\$511
	42"W Soft Square Top	HCWTSFTS42J	62	5.0	\$574	\$603
	Soft Square Tops with Flat Edge					
	30"W Soft Square Top	HCWTSFTS30G	34	2.6	\$343	\$360
	36"W Soft Square Top	HCWTSFTS36G	47	3.8	\$374	\$393
	42"W Soft Square Top	HCWTSFTS42G	62	5.0	\$442	\$464
	Booth Tops with Knife Edge					
	56"W x 36"D Booth Top	HCWTB3656J	90	5.6	\$618	\$649
	84"W x 36"D Booth Top	HCWTB3684J	150	8.2	\$933	\$980
	Booth Tops with Flat Edge					
	56"W x 36"D Booth Top	HCWTB3656G	90	5.6	\$475	\$499
	84"W x 36"D Booth Top	HCWTB3684G	150	8.2	\$718	\$754
	Soft Rectangle Tops with Knife Edge					
	56"W x 36"D Soft Rectangle Top	HCWTSR3656J	90	5.6	\$644	\$676
	84"W x 36"D Soft Rectangle Top	HCWTSR3684J	150	8.2	\$959	\$1007
	Soft Rectangle Tops with Flat Edge					
	56"W x 36"D Soft Rectangle Top	HCWTSR3656G	90	5.6	\$495	\$520
	84"W x 36"D Soft Rectangle Top	HCWTSR3684G	150	8.2	\$738	\$775

NOTES:

- Tops configured with pilot holes for easy installation of base.

HOW TO SPECIFY

<p>Select Model Number</p> <p>H C W T S Q R 3 6 J .</p>	<p>Select Grommet Option</p> <p>N No Grommet</p> <p>N .</p>	<p>Select Laminate</p> <p>See page 40</p> <p>L S A 1 .</p>	<p>Select Edge Color</p> <p>See page 40</p> <p>S A</p>
--	--	---	---

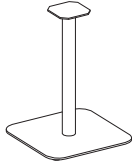
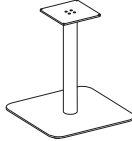
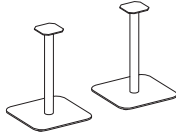

	DESCRIPTION	MODEL	SHIP WEIGHT	CUBE	LIST PRICE BY PAINT GRADE	
					P1	P2
	Single Pedestal, Medium					
	Occasional-Height Single Pedestal Base	HCWTSBM18	60	3.3	\$548	\$603
	Working Lounge-Height Single Pedestal Base	HCWTSBM27	60	3.3	\$552	\$608
	Seated-Height Single Pedestal Base	HCWTSBM29	60	3.3	\$557	\$613
	Counter-Height Single Pedestal Base	HCWTSBM36	62	3.3	\$562	\$619
	Bar-Height Single Pedestal Base	HCWTSBM42	66	3.6	\$570	\$628
	Single Pedestal, Large					
	Occasional-Height Single Pedestal Base	HCWTSBL18	95	3.8	\$720	\$792
	Working Lounge-Height Single Pedestal Base	HCWTSBL27	95	3.8	\$745	\$820
	Seated-Height Single Pedestal Base	HCWTSBL29	95	3.8	\$779	\$857
	Counter-Height Single Pedestal Base	HCWTSBL36	98	3.8	\$791	\$870
	Bar-Height Single Pedestal Base	HCWTSBL42	101	4.2	\$806	\$887
	Double Pedestal, Medium					
	Working Lounge-Height Double Pedestal Base	HCWTDSBM27	120	6.5	\$1104	\$1216
	Seated-Height Double Pedestal Base	HCWTDSBM29	120	6.5	\$1114	\$1226
	Counter-Height Double Pedestal Base	HCWTDSBM36	124	6.5	\$1124	\$1238
	Bar-Height Double Pedestal Base	HCWTDSBM42	132	7.2	\$1140	\$1256

NOTES:

- See application matrix for top and base compatibility.
- Bases feature 1/4"H non-leveling slide glides.
- Some assembly required.

		Top				
		Round, Square, Soft Square			Booth, Soft Rectangle	
		30"W	36"W	42"W	56"W	84"W
Base	Single Pedestal, Medium	•	•			
	Single Pedestal, Large			•		
	Double Pedestal, Medium				•	•

HOW TO SPECIFY

<p>Select Model Number</p> <p>HCWTSBL36</p>	<p>Select Paint Color</p> <p>See page 40</p> <p>PR8</p>
--	--



Icon Legend on page 19

BIRK™ Personal Table



DESCRIPTION

Personal Table
17"W x 15"D x 28"H

MODEL	SHIP WEIGHT	CUBE	LIST PRICE BY LAMINATE GRADE	
			L1	L2
HCWPT	18	2.7	\$315	\$325

NOTES:

- Top features flat edge on all sides.
- Top configured with pilot holes for easy installation of base.
- Some assembly required.

HOW TO SPECIFY

<p>Select Model Number</p> <p>HCWPT</p>	<p>Select Laminate</p> <p>See page 40</p> <p>LSA1</p>	<p>Select Edge Color</p> <p>See page 40</p> <p>SA</p>	<p>Select Paint Color</p> <p>See page 40</p> <p>P2 upcharge + \$12</p> <p>PR8</p>
--	--	--	--

CANTILEVER TABLE

OPEN MARKET



Icon Legend on page 19

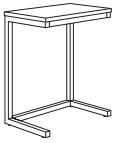

DESCRIPTION

Cantilever Table
 17½"W x 9¼"D x 20¾"H

MODEL	SHIP WEIGHT	CUBE	LIST PRICE
HML8858	12.8	1.1	\$189

NOTES:

- HON 5-Year Limited Warranty.

HOW TO SPECIFY

<p>Select Model Number</p> <p>H M L 8 8 5 8 .</p>	<p>Select Finish</p> <p>P Black</p>
--	--

COORDINATE™



Coordinate™ Height Adjustable Base shown with Ignition® 2.0 Seating and 10500 Series™ Desking.

COORDINATE™

Sit-to-stand working is easy when you have a table with the power to move with you. The human body wasn't meant to sit for hours on end; and as your body's needs change throughout the day, these height adjustable tables change with you.

Warranty is 7 years.



FEATURES

- The standard memory preset, basic up and down, hands-free foot pedal, rotator, or paddle control options allow for quick and easy adjustments throughout your day.
- Telescoping table base can accommodate work surfaces from 42"-72" wide on the 2-leg model, and from 24"-30" deep.
- Available in 2- or 3-leg, rectangle C- and T-shaped foot options to accommodate your layout preferences.
- Nickel, Black, White finishes match any neutral HON paint or finish color.
- All bases are compatible with electrical accessories and select worksurfaces.

COORDINATE™ ORDERING INFORMATION

LAMINATE

L1 LAMINATES CODES

Woodgrain

- ◆ Bourbon Cherry H
- ◆ Cognac COGN
- ◆ Florence Walnut LFW1
- ◆ Harvest C
- ◆ Kingswood Walnut LK11
- ◆ Mahogany N
- ◆ Mocha MOCH
- ◆ Natural Maple D
- ◆ Pinnacle PINC
- ◆ Shaker Cherry F
- ◆ Sterling Ash LSA1

Solid

- ◆ Black P
- ◆ Charcoal S
- ◆ Designer White LDW1
- ◆ Loft LOFT

Patterned

- ◆ Sheer Mesh A5
- ◆ Silver Mesh B9
- ◆ Steel Mesh A9
- ◇ Canyon Zephyr K9
- ◇ Desert Zephyr K8
- ◇ Shadow Zephyr K1
- ◆ Gray G2
- ◆ Grey Tigris L6
- ◇ White G1
- ◆ Whitestone K4

L2 LAMINATES CODES

Woodgrain

- ◆ Lowell Ash LLA1
- ◆ Natural Recon LNR1
- ◆ Phantom Ecru LPE1
- ◆ Portico Teak LPT1
- ◆ Skyline Walnut LSW1

EDGE

EDGE CODES

Woodgrain

- ◆ Bourbon Cherry H
- ◆ Cognac COGN
- ◆ Florence Walnut FW
- ◆ Harvest C
- ◆ Kingswood Walnut KI
- ◆ Light Gray Q
- ◆ Lowell Ash DL
- ◆ Mahogany N
- ◆ Mocha MOCH
- ◆ Natural Maple D
- ◆ Natural Recon NR
- ◆ Phantom Ecru PE
- ◆ Pinnacle PINC
- ◆ Portico Teak DP
- ◆ Shaker Cherry F
- ◆ Skyline Walnut SW
- ◆ Sterling Ash SA

Solid

- ◇ Black P
- ◆ Charcoal S
- ◆ Designer White DW
- ◇ Greige R
- ◆ Loft LOFT
- ◆ Muslin T
- ◇ Platinum K

SCREEN PAINT

PAINT CODES

P1

- ◇ Black P
- ◆ Brownstone P7D
- ◆ Charcoal S
- ◆ Designer White PJW
- ◆ Fossil P28
- ◆ Greige T5
- ◆ Light Gray Q
- ◆ Loft LOFT
- ◆ Muslin T3
- ◆ Putty L
- ◆ Shadow * SHDW
- ◆ Titanium P8T

P2

- ◆ Champagne Metallic T4
- ◆ Platinum Metallic T1
- ◆ Silver PR6
- ◆ Solar Black PBX

P3

- ◆ Atom P8S
- ◆ Bullseye PJF
- ◆ Ember P8P
- ◆ Ion P8N
- ◆ Iris P8J
- ◆ Krypton P8F
- ◆ Regatta P8M

LEG OPTIONS



Rectangle Leg, T Foot



Rectangle Leg, C Foot

CONTROL OPTIONS



UD Basic Up/Down



MEM Memory Preset



PDL Paddle



RTG Rotating



FPD Foot Pedal

◆◆◆ For lead time information see page 19.

* De-emphasized



COORDINATE™ Height Adjustable Bases — Two-Leg

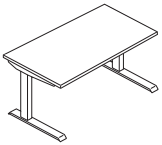
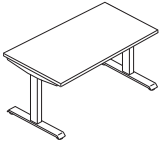

DESCRIPTION

Coordinate™ Height Adjustable Base – 2 Stage

- 2-Leg Rectangle T Foot
- 2-Leg Rectangle C Foot

MODEL

- HREC2S2LTF**
- HREC2S2LCF**

SHIP WEIGHT

- 66
- 66

CUBE

- 2.4
- 2.4

LIST PRICE

- \$950**
- \$950**

NOTES:

- Base is a dual motor 2-stage design. Legs raise from 25⁵/₈" to 45¹/₄".
- Base telescopes to accommodate any rectangular worksurface between 24"D x 42"W and 30"D x 72"W.
- Supports weight capacity of 250 lbs. (excluding worksurface weight). Foundation™, Systems, Voi®, 10500, and Preside® all have worksurfaces within this range.
- Control Box: 120V, 4A, 60Hz, 400W.
- 9' grounded power cord.
- 1¹/₈" / second travel speed.
- <50 dB noise rating.
- **HON 7-Year Limited Warranty.**

Coordinate™ Height Adjustable Base – Max 3 Stage

- 2-Leg Rectangle T Foot

HMREC3S2LTF

66

2.4

\$1173

NOTES:

- Base is a dual motor 2-stage design. Legs raise from 21⁵/₈" to 47³/₄".
- Base telescopes to accommodate any rectangular worksurface between 24"D x 42"W and 30"D x 96"W.
- Supports weight capacity of 350 lbs. (excluding worksurface weight). Foundation™, Systems, Voi®, 10500, and Preside® all have worksurfaces within this range.
- Control Box: 120V, 4A, 60Hz, 400W.
- 9' grounded power cord.
- 1¹/₈" / second travel speed.
- <50 dB noise rating.
- **HON 7-Year Limited Warranty.**

Coordinate™ Height Adjustable Base – 3 Stage

- 2-Leg Rectangle T Foot
- 2-Leg Rectangle C Foot

- HREC3S2LTF**
- HREC3S2LCF**

- 66
- 66

- 2.4
- 2.4

- \$1047**
- \$1047**

NOTES:

- Base is a dual motor 3-stage design. Legs raise from 21⁵/₈" to 47³/₄".
- Base telescopes to accommodate any rectangular worksurface between 24"D x 42"W and 30"D x 72"W.
- Supports weight capacity of 250 lbs. (excluding worksurface weight). Foundation™, Systems, Voi®, 10500, and Preside® all have worksurfaces within this range.
- Control Box: 120V, 4A, 60Hz, 400W.
- 9' grounded power cord.
- 1¹/₈" / second travel speed.
- <50 dB noise rating.
- **HON 7-Year Limited Warranty.**

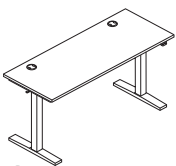

Coordinate™ Easy to Assemble 2-Leg Height Adjustable Base – 2 Stage

- 24"D Feet

HHABETA2S2L

77

4.0

\$728

NOTES:

- **Legs raise from 26¹/₄" to 43¹/₂", excluding worksurface.**
- Base telescopes to accommodate rectangular worksurfaces between 24"D x 48"W and 30"D x 60"W.
- Supports weight capacity of 180 lbs.
- Control Box: 100-240V, 3.6A, 50/60Hz, 400W.
- 9' grounded power cord.
- 1¹/₂" / second travel speed.
- **HON 5-Year Limited Warranty.**

Available in SVR Silver finish only.

Available with Basic Up/Down control only.

NOTES:

- Compatible with select rectangular Voi® and Systems Worksurfaces. See page 52 for more information.

HOW TO SPECIFY

<p>Select Model Number</p> <p>H R E C 2 S 2 L T F .</p>	<p>Select Paint Color</p> <p>P71 Black P8L Nickel PD8 White SVR Silver</p> <p><i>Available on model HHABETA2S2L only</i></p> <p>P 7 1 .</p>	<p>Select Foot</p> <p>X Standard Foot</p> <p>X .</p>	<p>Select Keypad</p> <p>UD Basic Up/Down MEM Memory Preset PDL Paddle RTG Rotating (\$50 upcharge) FPD Foot Pedal (\$175 upcharge)</p> <p>M E M</p>
--	--	---	--

COORDINATE™ Height Adjustable Bases — Three-Leg

OPEN MARKET



Icon Legend on page 19

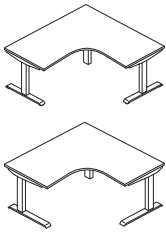

DESCRIPTION

Coordinate™ Height Adjustable Base – 3 Stage
 3-Leg Rectangle T Foot
 3-Leg Rectangle C Foot

MODEL

HREC3S3LTF
HREC3S3LCF

SHIP WEIGHT

91
 91

CUBE

3.6
 3.6

LIST PRICE

\$1729
\$1729

NOTES:

- Base is a three motor 3-stage design. Legs raise from 21⁵/₈" to 47³/₄".
- Base telescopes to accommodate worksurfaces between 24"D x 42"W¹ x 60"W² and 30"D x 72"W¹ x 72"W².
- Supports weight capacity of 375 lbs. (excluding worksurface weight). Can be used with 48" 120 degree and worksurface models.
- Control Box: 120V, 4A, 60Hz, 400W.
- 9' grounded power cord.
- 1¹/₂" / second travel speed.
- <50 dB noise rating.
- **HON 7-Year Limited Warranty.**

NOTES:

- Compatible with select Corner Cove Worksurfaces. See page 53 for more information.
- All bases are compatible with electrical accessories on page 51.
- ! When using two worksurfaces, a flat bracket is required. Bracket purchased separately — HHN831124, HHN831130 — for additional information see the Workstations section in the 2021 Workspaces Pricer.
- ! Telescoping horizontal frame will extend just over 2" from underside of the worksurface.

HOW TO SPECIFY

<p>Select Model Number</p> <p>H R E C 3 S 3 L T F .</p>	<p>Select Paint Color</p> <p>P71 Black P8L Nickel PD8 White</p> <p>P 7 1 .</p>	<p>Select Foot</p> <p>X Standard Foot</p> <p>X .</p>	<p>Select Keypad</p> <p>UD Basic Up/Down MEM Memory Preset PDL Paddle RTG Rotating (\$50 upcharge) FPD Foot Pedal (\$175 upcharge)</p> <p>M E M</p>
--	---	---	--



Height Adjustable Bases — Simple Specification

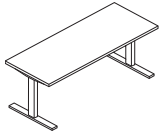

Base shown with work surface attached.



DESCRIPTION

Coordinate™ Height Adjustable Base – 2 Stage
24”D Feet and Worksurface Brackets

MODEL SHIP WEIGHT CUBE LIST PRICE

HHAB2S2L 63 2.4 \$1006

NOTES:

- Base is a dual motor 2-stage design. Legs raise from 25⁵/₈” to 45¹/₄”.
- Base telescopes to accommodate any rectangular work surface between 24”D x 42”W and 30”D x 72”W.
- Supports weight capacity of 250 lbs. (excluding work surface weight). See page 52 for Voi® Worksurfaces. See page 52 for Systems Worksurfaces. For Height Adjustable Base Accessories see page 51. Foundation™, Systems, Voi®, 10500, and Preside® all have work surfaces within this range.
- Comes standard with one-touch, four memory controller with digital display; no specification needed, available in black finish only.
- **HON 7-Year Limited Warranty.**

! When attaching a Keyboard Tray, remember to also specify a Keyboard Spacer Kit (HKBS).

! Telescoping horizontal frame will extend just over 2” from underside of the work surface.

! Removal of stretcher bars in Coordinate™ base is required when pairing with a 42”W work surface.

SPECIFYING EXAMPLE: HHAB2S2L.P8L

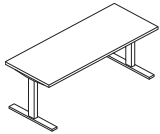

Base shown with work surface attached.



Coordinate™ Height Adjustable Base – 3 Stage
24”D Feet and Worksurface Brackets

HHAB3S2L 67 2.4 \$1120

NOTES:

- Base is a dual motor 3-stage design. Legs raise from 21⁵/₈” to 47³/₄”.
- Base telescopes to accommodate any rectangular work surface between 24”D x 42”W and 30”D x 72”W.
- Supports weight capacity of 250 lbs. (excluding work surface weight). Foundation™, Systems, Voi®, 10500, and Preside® all have work surfaces within this range.
- Comes standard with one-touch, four memory controller with digital display; no specification needed, available in black finish only.
- **HON 7-Year Limited Warranty.**

! Telescoping horizontal frame will extend just over 2” from underside of the work surface.

! Removal of stretcher bars in Coordinate™ base is required when pairing with a 42”W work surface.

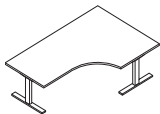

Base shown with work surface attached.



Coordinate™ 3-Leg Height Adjustable Base – 3 Stage
24”D Feet and Worksurface Brackets

HHAB3S3L 91 3.6 \$1896

NOTES:

- Base is a three motor 3-stage design. Legs raise from 21⁵/₈” to 47³/₄”.
- Base telescopes to accommodate work surfaces between 24”D x 42”W¹ x 60”W² and 30”D x 72”W¹ x 72”W².
- Supports weight capacity of 330 lbs. (excluding work surface weight). Can be used with 48” 120 degree and work surface models.
- Comes standard with one-touch, four memory controller with digital display; no specification needed, available in black finish only.
- **HON 7-Year Limited Warranty.**

! When using two work surfaces, a flat bracket is required. Bracket purchased separately — HHN831124, HHN831130 — for additional information see the Workstations section in the 2021 Workspaces Pricer.

! Telescoping horizontal frame will extend just over 2” from underside of the work surface.

NOTES:

- Compatible with select Rectangle and Corner Cove Worksurfaces. See pages 52 and 53 for more information.
- Control Box: 120V, 4A, 60Hz, 400W.
- 9’ grounded power cord.
- 1¹/₂”/second travel speed.
- <50 dB noise rating.

! Coordinate™ Height Adjustable Bases not compatible with 36”D rectangular work surfaces.

* De-emphasized.

HOW TO SPECIFY

<p>Select Model Number</p> <p>HHAB2S2L .</p>	<p>Select Finish</p> <p>P71 Black P8L Nickel PD8 White</p> <p>P8L</p>
---	--

COORDINATE™ Screens

OPEN MARKET



Icon Legend on page 19

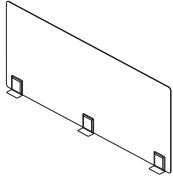

DESCRIPTION	MODEL	SHIP WEIGHT	CUBE	LIST PRICE BY PAINT GRADE		
				P1	P2	P3
Above Screens						
20"H x 45½"W, for 48"W Surfaces	HMTLSCRN2048	36.4	5.5	\$643	\$663	\$683
20"H x 51½"W, for 54"W Surfaces	HMTLSCRN2054	39.7	6.1	\$675	\$695	\$715
20"H x 57½"W, for 60"W Surfaces	HMTLSCRN2060	43.1	6.7	\$710	\$730	\$750
20"H x 63½"W, for 66"W Surfaces	HMTLSCRN2066	46.4	7.3	\$745	\$765	\$785
25"H x 45½"W, for 48"W Surfaces	HMTLSCRN2548	42.8	6.7	\$707	\$727	\$747
25"H x 51½"W, for 54"W Surfaces	HMTLSCRN2554	46.9	7.4	\$743	\$763	\$783
25"H x 57½"W, for 60"W Surfaces	HMTLSCRN2560	51.1	8.2	\$780	\$800	\$820
25"H x 63½"W, for 66"W Surfaces	HMTLSCRN2566	55.3	9.0	\$819	\$839	\$859

NOTES:

- Above screens are single-piece steel construction.
- Screens mount by using double stick tape, which provides the ability to mount to any surface.

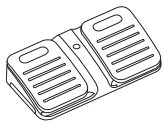

DESCRIPTION	MODEL	SHIP WEIGHT	CUBE	LIST PRICE
Foot Control Pedal	HFTPDL	5	0.1	\$177

NOTES:



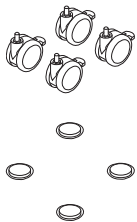







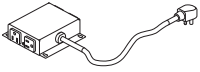



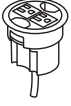

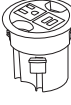



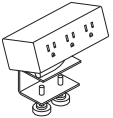

- Provides hands-free method for height adjustment.
- No specification needed.
- Pedal can be ordered with table or to retrofit on a current table.

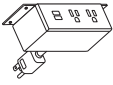

DESCRIPTION	MODEL	SHIP WEIGHT	CUBE	LIST PRICE
Caster 4-Pack	HHABCSTRPK	1 Ⓢ	0.1	\$75
ⓘ Field installable. Not available on model HHABETA2S2L. No specification needed.				
Slide Glide 4-Pack	HHABGLIDE	1 Ⓢ	0.1	\$60
ⓘ Field installable. When placed under base, allows table to be pushed/pulled to move. No specification needed.				

HOW TO SPECIFY

Select Model Number	Select Frame Paint	Select Bracket Paint
HMTLSCRN2054.	P8T.	P8T

	DESCRIPTION	MODEL	SHIP WEIGHT	CUBE	LIST PRICE
 SIN 33721  	Under Worksurface Power Module – 4 Outlets, 10' Cord • Includes 10' cord with three-prong plug. • Fits in cable management troughs. See page 88. • 4 outlets on side create easy access. NOTES: Power Modules will also work with standing-height applications for 10500 Series™ and Voi® desks. For additional information see page 237.  Available in black finish only, no specification needed.	HPWRMOD2	1.5	0.2	\$401
 SIN 33721T 	3" Round Power Grommet – 2 Outlets, 10' Cord • Includes 10' cord with three-prong plug. • Fits in 3" round grommet holes. • Two grounded AC power outlets. • Field installed with Plug-and-play ease.  Available in black finish only, no specification needed.	HGRMTAC2	1.5	0.2	\$148
 SIN 33721T 	Power/USB Hub, 3" Grommet Mount • One grounded AC power outlet with 2 USB ports. • UL Listed. NOTES: For additional information see page 236.  Available in black only (no color designation so use .X – Specify: HGRMTUSB2.X).	HGRMTUSB2	1.3 	0.2	\$226
 OPEN MARKET	Wire Managers for Height Adjustable Trough to Floor HMPHATFWML		2.0	0.3	\$251
 Model HPWRMOD3WC shown SIN 33721	Dean Power Modules with Worksurface Clamp 3 Receptacles 2 Receptacles, 2 USB 2 Receptacles, 2 USB with Qi Wireless Charging Top • 6' power cord with standard three-prong plug. • Worksurface clamp models work on any top with a 4" overhang. • UL Listed.	HPWRMOD3WC  HPWRMOD2WC  HPWRMOD4WC	2.3  2.3  2.3 	0.2	\$310 \$496 \$690
 Model HPWRMOD2UWM shown SIN 33721	Dean Power Modules with Under-Worksurface Mounting Bracket 3 Receptacles 2 Receptacles, 2 USB • 6' power cord with standard three-prong plug. • Under-worksurface mounting bracket models work with any top that has a 5" x 5" square clearance. • UL Listed.	HPWRMOD3UWM HPWRMOD2UWM	2.3  2.3 	0.2	\$310 \$496
 SIN 33721 	Power & Data Center 2 Receptacles 2 Data Accessory • Standard with two receptacles and openings for two data ports. • 6' power cord with standard three-prong plug. • Fits on any worksurface with a 4" overhang. • UL Listed. NOTES: For additional information see page 237.  Color finish coordinates with HON's Loft. Specify LOFT when ordering. Example: HCOMDOME2.LOFT.	HCOMDOME2	2.5 	0.2	\$296

HOW TO SPECIFY

Select Model Number

H	P	W	R	M	O	D	2
---	---	---	---	---	---	---	---

COORDINATE™ Worksurfaces

GSA SIN 33721



Icon Legend on page 19

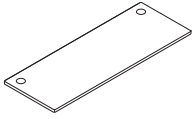

DESCRIPTION	MODEL	SHIP WEIGHT	CUBE	LIST PRICE BY LAMINATE GRADE	
				L1	L2
Systems Rectangle Worksurfaces for Height Adjustable Bases					
46¾"W x 23"D	HHAW2448P	58	3.3	\$429	\$444
52"W x 23"D	HHAW2454P	64	4.0	\$451	\$471
58"W x 23"D	HHAW2460P	70	4.0	\$499	\$519
64"W x 23"D	HHAW2466P	86	4.8	\$535	\$555
70"W x 23"D	HHAW2472P	89	4.8	\$552	\$572

ⓘ Must be used as worksurfaces on Coordinate™ Height Adjustable Bases within Panel Systems, as these are 1" shorter in width on each side to provide clearance between panels and other worksurfaces.

ⓘ Available in all standard systems' laminate and edgebanding options. Only offered with grommets.

Specify Model.LaminateColor.EdgeColor.GrommetColor SPECIFYING EXAMPLE: HHAW2448P.A5.K.T1

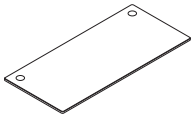

DESCRIPTION	MODEL	SHIP WEIGHT	CUBE	LIST PRICE BY LAMINATE GRADE	
				L1	L2
Systems Rectangle Worksurfaces for Height Adjustable Bases					
46¾"W x 29"D	HHAW3048P	68	4.0	\$458	\$473
52"W x 29"D	HHAW3054P	80	5.0	\$491	\$511
58"W x 29"D	HHAW3060P	101	5.0	\$544	\$564
64"W x 29"D	HHAW3066P	105	6.0	\$578	\$598
70"W x 29"D	HHAW3072P	105	6.0	\$616	\$636

ⓘ Must be used as worksurfaces on Coordinate™ Height Adjustable Bases within Panel Systems, as these are 1" shorter in width on each side to provide clearance between panels and other worksurfaces.

ⓘ Available in all standard systems' laminate and edgebanding options. Only offered with grommets.

Specify Model.LaminateColor.EdgeColor.GrommetColor SPECIFYING EXAMPLE: HHAW3048P.A5.K.T1

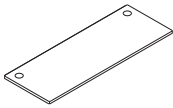

DESCRIPTION	MODEL	SHIP WEIGHT	CUBE	LIST PRICE BY LAMINATE GRADE	
				L1	L2
Voi® Rectangle Worksurfaces for Height Adjustable Bases					
48"W x 24"D	HLSLR2448	61	3.4	\$306	\$321
54"W x 24"D	HLSLR2454	68	4.2	\$330	\$350
60"W x 24"D	HLSLR2460	75	4.2	\$358	\$378
66"W x 24"D	HLSLR2466	82	5.0	\$389	\$409
72"W x 24"D	HLSLR2472	89	5.0	\$402	\$422
48"W x 30"D	HLSLR3048	75	4.2	\$330	\$345
54"W x 30"D	HLSLR3054	84	5.1	\$367	\$387
60"W x 30"D	HLSLR3060	92	5.1	\$410	\$430
66"W x 30"D	HLSLR3066	101	6.1	\$441	\$461
72"W x 30"D	HLSLR3072	110	6.1	\$480	\$500

ⓘ For use with Coordinate™ Height Adjustable Bases only in Freestanding Applications, which are applications where the tables/desks are not attached or adjacent to another unit, table/desk or systems panel. The widths are true to stated dimensions. If used with Panel Systems or other than in Freestanding Applications, worksurfaces will not provide proper clearance between panels or other worksurfaces, and may cause injury or work surface damage (not covered by warranty).

ⓘ Coordinate™ Height Adjustable Bases not compatible with 36"D rectangular worksurfaces

ⓘ For additional information see the Desks section in the 2021 Workspaces Pricer.

NOTES:

- Systems Rectangle Worksurfaces for Height Adjustable Bases designed for use in panel systems. Work surface is 2" shorter in width and 1" shorter in depth to provide clearance between panels and other worksurfaces.

HOW TO SPECIFY

<p>Select Model Number</p> <p>HHAW2448P HLSLR2448</p>	<p>Select Laminate</p> <p>See page 163 *For Voi® Worksurfaces only. See page 173 in the 2021 Workspaces Pricer.</p> <p>A5 NN</p>	<p>Select Edge Color</p> <p>See page 163 Specify for Systems Worksurfaces only</p> <p>K</p>	<p>Select Grommet Color</p> <p>See page 163 Specify for Systems Worksurfaces only</p> <p>T1</p>	<p>Select Grommet Option and Color</p> <p>Specify for Voi® Worksurfaces only X No Grommet G Grommet If choosing the grommet option Select Grommet Color P Black Grommet DW Designer White T5 Greige Grommet T1 Platinum Grommet</p> <p>GT5</p>
--	---	--	--	---

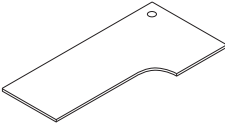
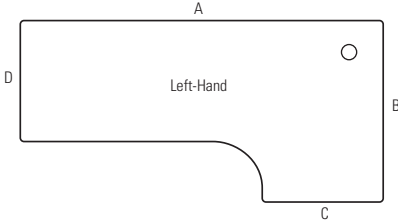
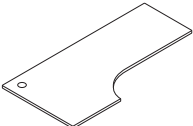
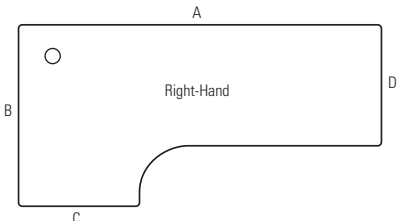

	DESCRIPTION	MODEL	SHIP WEIGHT	CUBE	L1 LIST PRICE	L2 LIST PRICE	
	Corner Cove Worksurfaces for Height Adjustable Bases, Left Hand						
	58" A x 34" B x 23" C x 23" D	HHAWV603624LP	67	6.1	\$606	\$631	
	70" A x 34" B x 23" C x 23" D	HHAWV723624LP	75	6.8	\$664	\$694	
	58" A x 46" B x 23" C x 23" D	HHAWV604824LP	85	7.4	\$664	\$694	
	58" A x 46" B x 29" C x 29" D	HHAWV604830LP	99	7.4	\$713	\$743	
	70" A x 46" B x 23" C x 23" D	HHAWV724824LP	105	8.8	\$830	\$865	
	70" A x 46" B x 29" C x 29" D	HHAWV724830LP	112	8.8	\$880	\$915	
							
		Corner Cove Worksurfaces for Height Adjustable Bases, Right Hand					
		58" A x 34" B x 23" C x 23" D	HHAWV603624RP	67	6.1	\$606	\$631
70" A x 34" B x 23" C x 23" D		HHAWV723624RP	75	6.8	\$664	\$694	
58" A x 46" B x 23" C x 23" D		HHAWV604824RP	85	7.4	\$664	\$694	
58" A x 46" B x 29" C x 29" D		HHAWV604830RP	99	7.4	\$713	\$743	
70" A x 46" B x 23" C x 23" D		HHAWV724824RP	105	8.8	\$830	\$865	
70" A x 46" B x 29" C x 29" D		HHAWV724830RP	112	8.8	\$880	\$915	
							

NOTES:

- Corner Cove Worksurfaces for Height Adjustable Bases designed for use in panel systems. Worksurface is 1" shorter in width and 1" shorter in depth on side of corner to provide clearance between panels and other worksurfaces.
- Use the 3-Leg Coordinate™ Base when specifying Coordinate™ Corner Cove Surfaces.

HOW TO SPECIFY

Select Model Number H H A W V 6 0 3 6 2 4 L P .	Select Laminate See page 46 A 5 .	Select Edge Color See page 46 K .	Select Grommet Color See page 46 T 1
---	--	--	---

COORDINATE™ Worksurfaces

OPEN MARKET



Icon Legend on page 19

	DESCRIPTION	MODEL	SHIP WEIGHT	CUBE	LIST PRICE BY LAMINATE GRADE	
					L1	L2
	Rectangle Worksurfaces with External Stiffener					
	84"W x 24"D	HHAW2484PS	97	5.4	\$851	\$871
	96"W x 24"D	HHAW2496PS	100	5.7	\$890	\$910
	84"W x 30"D	HHAW3084PS	113	6.6	\$901	\$921
	96"W x 30"D	HHAW3096PS	116	7.0	\$940	\$960
	Rectangle Worksurfaces with External Stiffener, No Grommet					
	84"W x 24"D	HHAW2484PNS	97	5.4	\$851	\$871
	96"W x 24"D	HHAW2496PNS	100	5.7	\$890	\$910
	84"W x 30"D	HHAW3084PNS	113	6.6	\$901	\$921
	96"W x 30"D	HHAW3096PNS	116	7.0	\$940	\$960

NOTES:

ⓘ For use with Max Base, model HMREC3S2LTF, only.

HOW TO SPECIFY

<p>Select Model Number</p> <p>HHAW3084PS</p>	<p>Select Laminate</p> <p>See page 46</p> <p>LK11</p>	<p>Select Edge Color</p> <p>See page 46</p> <p>KI</p>	<p>Select Grommet Color</p> <p><i>Specify for worksurfaces with grommets only</i></p> <p>P Black S Charcoal Q Light Gray DW Designer White T5 Greige LOFT Loft T3 Muslin T1 Platinum</p> <p>P</p>
---	--	--	---

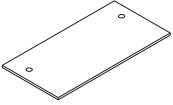
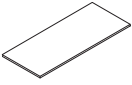

	DESCRIPTION	MODEL	SHIP WEIGHT	CUBE	L1 LIST PRICE	L2 LIST PRICE
	Concinnity™ Rectangle Worksurfaces					
	48"W x 24"D	HNLRC2448	40	3.1	\$280	\$295
	60"W x 24"D	HNLRC2460	50	3.9	\$333	\$353
	66"W x 24"D	HNLRC2466	55	4.2	\$361	\$381
	72"W x 24"D	HNLRC2472	60	4.6	\$374	\$394
	48"W x 30"D	HNLRC3048	50	3.9	\$307	\$322
	60"W x 30"D	HNLRC3060	62	4.7	\$376	\$396
	66"W x 30"D	HNLRC3066	69	5.2	\$403	\$423
	72"W x 30"D	HNLRC3072	75	5.6	\$438	\$458
		10500 Series™ Rectangle Worksurfaces				
48"W x 24"D		H105R2448	44	3.4	\$264	\$279
60"W x 24"D		H105R2460	55	4.2	\$311	\$331
66"W x 24"D		H105R2466	61	4.9	\$331	\$351
72"W x 24"D		H105R2472	66	4.9	\$342	\$362
48"W x 30"D		H105R3048	55	4.1	\$286	\$301
60"W x 30"D		H105R3060	69	5.2	\$349	\$369
66"W x 30"D		H105R3066	76	6.1	\$374	\$394
72"W x 30"D		H105R3072	83	6.1	\$402	\$422

NOTES:

- ❗ For use with Coordinate™ Height Adjustable Bases only in freestanding applications, which are applications where the tables/desks are not attached or adjacent to another unit, table/desk, or systems panel. The widths are true to stated dimensions. If used with Panel Systems or other than in freestanding applications, worksurfaces will not provide proper clearance between panels or other worksurfaces, and may cause injury or worksurface damage (not covered by warranty).
- ❗ Coordinate™ Height Adjustable Bases are not compatible with 36"D rectangular worksurfaces.

HOW TO SPECIFY

<p>Select Model Number</p> <p>H N L R C 2 4 4 8</p> <p>H 1 0 5 R 2 4 4 8</p>	<p>Select Worksurface Laminate and Edge Color</p> <p><i>For Concinnity™ Worksurfaces, see page 29 in the 2021 Workspaces Pricer</i> <i>For 10500 Series™ Worksurfaces, see page 236 in the 2021 Workspaces Pricer</i></p> <p>B H</p> <p>N N</p>	<p>Select Worksurface Grommet Finish</p> <p><i>Specify for Concinnity™ Worksurfaces only</i></p> <p>P Black TI Platinum X No Grommet</p> <p>P</p>	<p>Select Worksurface Color</p> <p><i>For Concinnity™ Worksurfaces, see page 29 in the 2021 Workspaces Pricer</i></p> <p>H</p>
---	---	--	---

SYSTEMS WORKSURFACES

120 Degree Corner

GSA SIN 33721



Icon Legend on page 19

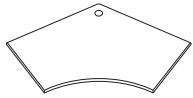

W=panel width
D=worksurface depth

DESCRIPTION	MODEL	SHIP WEIGHT	CUBE	L1 LIST PRICE	L2 LIST PRICE
Around® and Accelerate® 120 Degree Corner Worksurfaces with Curved User Edge					
42"W x 24"D	HBWCT4224P	96	9.2	\$833	\$848
48"W x 24"D	HBWCT4824P	107	9.2	\$965	\$980
42"W x 30"D	HBWCT4230P	102	11.4	\$1094	\$1109
48"W x 30"D	HBWCT4830P	112	11.4	\$1164	\$1179

• One small worksurface bracket standard with each worksurface.

❗ Corner worksurfaces must match exactly the panel behind them, i.e.: a 42" panel must be used on the back two sides of model HBWCT4224P.

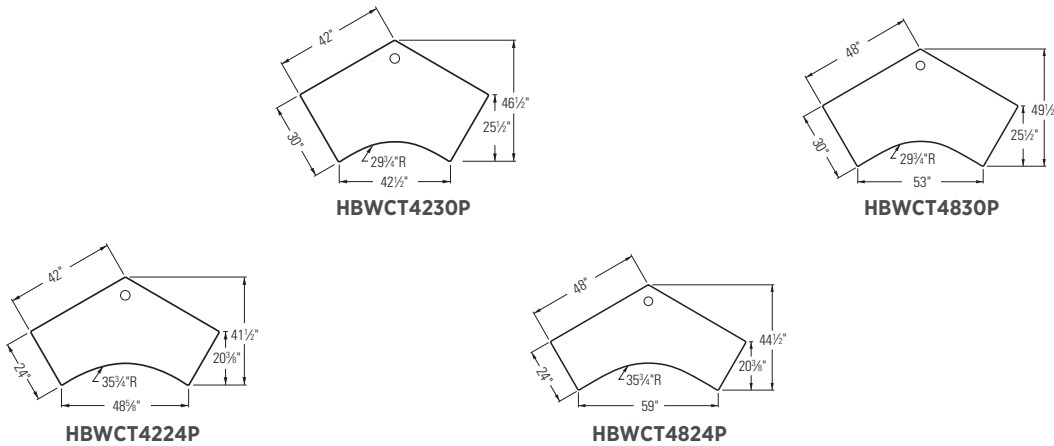

NOTES:

- Worksurfaces are constructed of laminate on 1/8" solid core high-performance particleboard.
- Add suffix **"N"** to Model Number for worksurfaces with no grommets. No upcharge.
- Cannot use keyboard tray or pedestal under 120 degree corner worksurface.
- Refer to Worksurface Supports in the Workstations section in the 2021 Workspaces Pricer.
- If used at an end of run, full end panel needs to be ordered — for additional information see the Workstations section in the 2021 Workspaces Pricer.

HOW TO SPECIFY

<p>Select Model Number</p> <p>No Grommet option: Add "N" suffix (no upcharge)</p> <p>HBWCT4224P .</p> <p>HBWCT4224PN .</p>	<p>Select Laminate</p> <p>See page 455 in the 2021 Workspaces Pricer</p> <p>AS .</p> <p>AS .</p>	<p>Select Edge Color</p> <p>See page 455 in the 2021 Workspaces Pricer</p> <p>K .</p> <p>K .</p>	<p>Select Grommet Color</p> <p>See page 455 in the 2021 Workspaces Pricer</p> <p>T1</p>
--	---	---	--



COORDINATE™ Shared Components

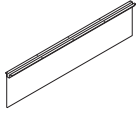

DESCRIPTION	MODEL	SHIP WEIGHT	CUBE	L1	L2
				LIST PRICE	UPCHARGE
Laminate Floating Modesty Panel					
30"W x 14"H	HLSL3014L	10	0.8	\$173	\$10
36"W x 14"H	HLSL3614L	12	0.8	\$183	\$10
42"W x 14"H	HLSL4214L	14	0.8	\$195	\$10
48"W x 14"H	HLSL4814L	16	1.1	\$215	\$12
54"W x 14"H	HLSL5414L	18	1.1	\$235	\$12
60"W x 14"H	HLSL6014L	20	1.1	\$253	\$12

NOTES: The attachment bracket and modesty panel are packaged separately.
Specify: Model.Laminate.Paint

SPECIFYING EXAMPLE: HLSL3014L.N.P (Black is the only paint option for this model)

- ⓘ When specifying the 54"W or 60"W Laminate Floating Modesty Panel, it is not necessary to specify an external channel.
- ⓘ 30"W and 36"W screens attach with L-brackets, not the external channel.

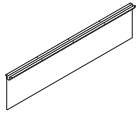

DESCRIPTION	MODEL	SHIP WEIGHT	CUBE	LIST PRICE
Mixed Material Floating Modesty Panel				
30"W x 14"H	HLSL3014MM	8	2.0	\$689
36"W x 14"H	HLSL3614MM	8	2.0	\$739
42"W x 14"H	HLSL4214MM	9	2.3	\$826
48"W x 14"H	HLSL4814MM	11	2.6	\$914
54"W x 14"H	HLSL5414MM	13	3.3	\$992
60"W x 14"H	HLSL6014MM	13	3.3	\$1134

NOTES: The attachment bracket and modesty panel are packaged separately.
Specify: Model.Mixed Material.Paint

SPECIFYING EXAMPLE: HLSL3014MM.FT01.P (Frosted Translucent mixed material and Black paint are the only options for this model)

- ⓘ When specifying the 54"W or 60"W Mixed Material Floating Modesty Panel, it is not necessary to specify an external channel.

FLOATING MODESTY PANELS – MODEL SELECTION GUIDE				
Rectangle Worksurface Width				
72 in	66 in	60 in	48 in	42 in
HLSL6014	HLSL5414	HLSL4814	HLSL3614	HLSL3014

NOTES:

- When using a floating modesty panel under the worksurface, the depth clearance for center drawers and keyboard platforms decreases by 8".

HOW TO SPECIFY

<p>Select Model Number</p> <p>HLSL3014MM.</p>	<p>Select Mixed Material</p> <p>FT01 Frosted Translucent</p> <p>FT01</p>
--	---

COORDINATE™ Desktop Riser & Sit-to-Stand Devices

OPEN MARKET

Icon Legend on page 19

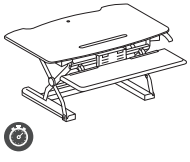
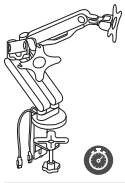
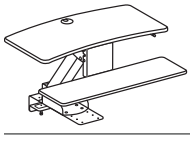
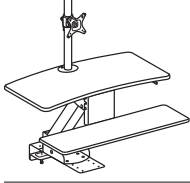
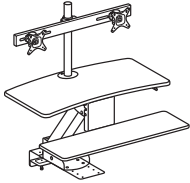
	DESCRIPTION	MODEL	SHIP WEIGHT	CUBE	LIST PRICE
	Portable Desktop Riser 31"D x 5'-16½"H x 35"W NOTES: Available in Black (BLK) or White (WHT) finish. Desktop riser dimensions (without keyboard tray): 22"D x 5'-16½"H x 35"W. Keyboard tray dimensions: 9"D x 30"W. Max loading capacity is 33 lbs for the desktop riser surface and 4 lbs for the keyboard tray. Easily transition from seated to standing positions throughout the workday. Sits atop an existing desk to create sit-to-stand functionality by raising the computer. Includes keyboard tray and surface for computer monitors. HON 5-Year Limited Warranty. ⓘ Not intended for use on mobile workstations.	HBXRISER	54.0	4.1	\$619
	Dual Monitor Arm with 2 USB Ports NOTES: Easy adjustment. Height adjusts to 17" tall. Monitor tilt and swivel capability. Enclosed cable management. Grommet or desktop mounting. Clean appearance. In some applications the Monitor Arms may extend 12 or more inches into the worksurface. For additional information see page 216. HON 5-Year Limited Warranty. ⓘ No specification needed.	HBDMAUSB	41.9	2.6	\$383
	Mounted Desktop Riser NOTES: Does not include a monitor arm and is suitable for laptops and/or monitors on their original stands. ⓘ No specification needed.	HS1100	60.0 ⓘ	3.2	\$664
	Mounted Desktop Riser with Single Monitor Arm NOTES: Includes a monitor arm for a single monitor. ⓘ No specification needed.	HS1101	62.0 ⓘ	3.2	\$777
	Mounted Desktop Riser with Dual Monitor Arm NOTES: Includes a monitor arm for dual monitors. ⓘ No specification needed.	HS1102	63.0 ⓘ	3.2	\$883

NOTES FOR HS1100, HS1101, HS1102:

- These products are designed to allow the user to transition from seating position to standing position throughout the workday.
- Gas-assist lever-operated mechanism with positive stop.
- Clamp mount compatible with worksurfaces depths of 20"-30". 20" is for systems only.
- Clamp requires 3.5" of clearance along back edge of worksurface.
- Black seamless worksurfaces.
- Silver powder coated metal components.
- Lowers below worksurface level on 24" and 30"D worksurfaces.
- All models contain a large primary worksurface and a smaller keyboard / mouse surface.
- Beveled edges for sleek appearance and comfort while typing.
- Monitor arms include height, width, and swivel adjustment.

- Not for use under overhead storage, with flush mounted modesty panels, or worksurfaces thinner than 1".

ⓘ Not recommended for use on mobile (castered) worksurfaces.

MOUNTING AND COMPATIBILITY FOR HS1100, HS1101, HS1102:

- This product is intended to be installed on commercial-grade worksurfaces in good condition.
- Compatible with freestanding worksurfaces 24"-30"D or panel-supported worksurfaces 24"-30"D.
- Not for use on mobile worksurfaces.

Clamp Mount

Use when 3.5" minimum overhang is available

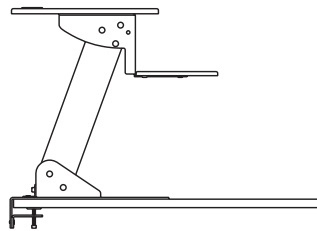

Screw Mount

Use when no overhang is available. Worksurface must be minimum 1" thick.

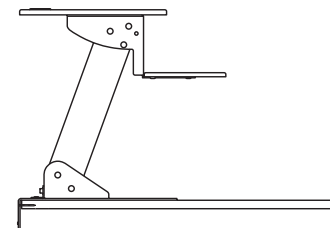

HOW TO SPECIFY

Select Model Number



HBXRISER.

Select Finish

BLK Black
WHT White

BLK

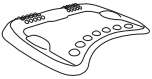
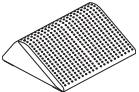

	DESCRIPTION	MODEL	SHIP WEIGHT	CUBE	LIST PRICE
	Rectangle Wobble Board — Anti-Fatigue Mat 18"D x 3"H x 22¼"W ⓘ Available in Black (T) finish ONLY. Recommended weight capacity not to exceed 250 pounds. HON 5-Year Limited Warranty. SPECIFYING EXAMPLE: HVL981.T	HVL981	10.0 Ⓔ	0.9	\$121
	Round Wobble Board — Anti-Fatigue Mat 18½"D x 2⅝"H x 18½"W ⓘ Available in Black (T) finish ONLY. Recommended weight capacity not to exceed 250 pounds. HON 5-Year Limited Warranty. SPECIFYING EXAMPLE: HVL982.T	HVL982	5.8 Ⓔ	0.6	\$103
	Ergonomic Anti-Fatigue Mat 25"D x 2¾"H x 29⅞"W ⓘ Available in Black ONLY. No specification needed. HON 5-Year Limited Warranty. SPECIFYING EXAMPLE: HBEAFM1	HBEAFM1	7.0	1.4	\$219
	Footrest — Anti-Slip Cover 13¾"D x 5½"H x 16"W ⓘ Available in Black (T) finish ONLY. Recommended weight capacity not to exceed 250 pounds. HON 5-Year Limited Warranty. SPECIFYING EXAMPLE: HVL991.T	HVL991	7.0 Ⓔ	0.9	\$82

HOW TO SPECIFY

Select Model Number H V L 9 8 1 .	Select Finish T Black
---	---------------------------------

FLOCK®



Flock® Tables and Seating.

FLOCK®

Great things happen when people come together, and Flock Collaborative Tables create the places that help make that possible. Quiet corners. Vibrant communal areas. Beautiful, comfortable spaces where clean lines and distinctive geometric design improve productivity and inspire big ideas. Choose from a variety of mix-and-match shapes and sizes to design spaces where your Flock will flourish.



FEATURES

- Flock Tables coordinate seamlessly with Flock Seating to support collaborative areas in any workplace.
- Choose from Square, Round, Rectangle or Racetrack shaped table tops.
- Table bases available in multiple heights and styles.
- Add convenient options like integrated power, cord grommets and tablet pedestals, and Flock is ready to work.
- Configurable and scalable, Flock Tables offer smaller footprints to better fit compact spaces.

COLLABORATIVE TABLES ORDERING INFORMATION

LAMINATE

TOPS/L1 LAMINATES CODES

Woodgrain

- ◆ Bourbon Cherry **H**
- ◆ Cognac **COGN**
- ◆ Florence Walnut **LFW1**
- ◆ Harvest **C**
- ◆ Kingswood Walnut **LK11**
- ◆ Mahogany **N**
- ◆ Mocha **MOCH**
- ◆ Natural Maple **D**
- ◆ Pinnacle **PINC**
- ◆ Shaker Cherry **F**
- ◆ Sterling Ash **LSA1**

Solid

- ◆ Black **P**
- ◆ Charcoal **S**
- ◆ Designer White **LDW1**
- ◆ Loft **LOFT**

Patterned

- ◆ Sheer Mesh **A5**
- ◆ Silver Mesh **B9**
- ◆ Steel Mesh **A9**
- ◇ Canyon Zephyr **K9**
- ◇ Desert Zephyr **K8**
- ◇ Shadow Zephyr **K1**
- ◇ Whitestone **K4**

TOPS/L2 LAMINATES CODES

Woodgrain

- ◆ Lowell Ash **LLA1**
- ◆ Natural Recon **LNR1**
- ◆ Phantom Ecu **LPE1**
- ◆ Portico Teak **LPT1**
- ◆ Skyline Walnut **LSW1**

PAINT

PAINT CODES

- P1**
- ◆ Textured Charcoal **P7A**
- P2**
- ◆ Textured Silver **PR8**

EDGE BAND

EDGE BAND CODES

- ◆ Black **P**
- ◆ Bourbon Cherry **H**
- ◆ Charcoal **S**
- ◆ Cognac **COGN**
- ◆ Designer White **DW**
- ◆ Florence Walnut **FW**
- ◇ Greige **R**
- ◆ Harvest **C**
- ◆ Kingswood Walnut **KI**
- ◆ Loft **LOFT**
- ◆ Lowell Ash **DL**
- ◆ Mahogany **N**
- ◆ Mocha **MOCH**
- ◆ Muslin **T**
- ◆ Natural Maple **D**
- ◆ Natural Recon **NR**
- ◆ Phantom Ecu **PE**
- ◆ Pinnacle **PINC**
- ◇ Platinum **K**
- ◆ Portico Teak **DP**
- ◇ Shadow* **SHDW**
- ◆ Shaker Cherry **F**
- ◆ Skyline Walnut **SW**
- ◆ Sterling Ash **SA**

Recommended Edgeband Color Selection:

Laminate		Edgeband	
Bourbon Cherry	H	Bourbon Cherry	H
Cognac	COGN	Cognac	COGN
Florence Walnut	LFW1	Florence Walnut	FW
Harvest	C	Harvest	C
Kingswood Walnut	LK11	Kingswood Walnut	KI
Mahogany	N	Mahogany	N
Mocha	MOCH	Mocha	MOCH
Natural Maple	D	Natural Maple	D
Pinnacle	PINC	Pinnacle	PINC
Shaker Cherry	F	Shaker Cherry	F
Sterling Ash	LSA1	Sterling Ash	SA
Black	P	Black	P
Charcoal	S	Charcoal	S
Designer White	LDW1	Designer White	DW
Whitestone	K4	Muslin	T
Sheer Mesh	A5	Muslin	T
Silver Mesh	B9	Loft	LOFT
Steel Mesh	A9	Charcoal	S
Canyon Zephyr	K9	Greige	R
Desert Zephyr	K8	Greige	R
Shadow Zephyr	K1	Loft	LOFT
Lowell Ash	LLA1	Lowell Ash	DL
Natural Recon	LNR1	Natural Recon	NR
Phantom Ecu	LPE1	Phantom Ecu	PE
Portico Teak	LPT1	Portico Teak	DP
Skyline Walnut	LSW1	Skyline Walnut	SW
Loft	LOFT	Loft	LOFT

◆◆◆ For lead time information see page 19.

* De-emphasized

FLOCK®

COLLABORATIVE SOLUTIONS TABLE SPECIFYING INFORMATION

TOP SHAPES

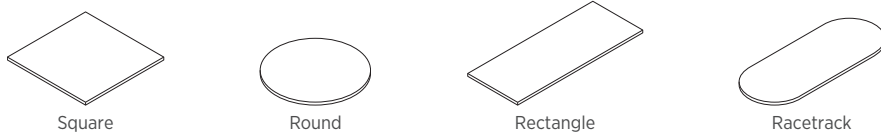
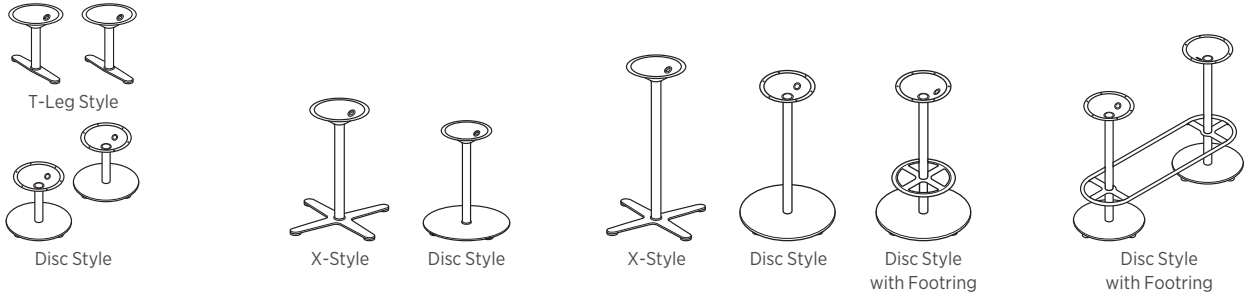

TABLE BASES

For Occasional-Height Tables

For Seated-Height Tables

For 41" H Bar-Height Tables



OCCASIONAL TABLES

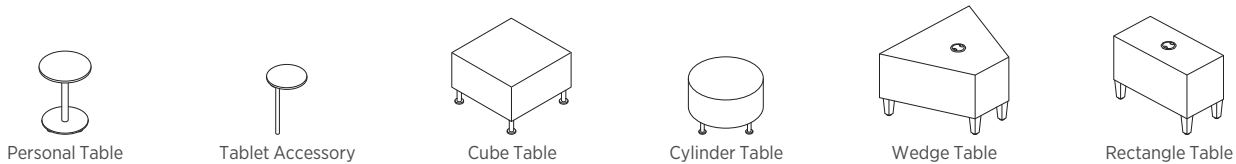

GROMMET MATRIX — ALL TABLES/TOPS

TOP WIDTH	NO GROMMET	1-3" ROUND GROMMET CENTERED	2-3" ROUND GROMMET LEFT & RIGHT
SIF OPTION CODE	N	G	G
24" Cube	YES	YES	N/A
26" Cylinder	YES	YES	N/A
18" Personal	N/A	N/A	N/A
30" Square/Round	YES	YES	N/A
36" Square/Round	YES	YES	N/A
60" Rectangle/Racetrack	YES	N/A	YES
72" Rectangle/Racetrack	YES	N/A	YES
84" Rectangle/Racetrack	YES	N/A	YES
96" Rectangle/Racetrack	YES	N/A	YES

NOTES: 3" round grommet color will need to be specified for tops. Grommet will coordinate with paint color specified for cube/cylinder tables. Charcoal grommets will be used with Textured Charcoal paint and Platinum Metallic grommets will be used with Textured Silver paint.

Grommet options can be used in conjunction with accessory ports on cube/cylinder tables. Grommet models HGRMTAC and HGRMTDATA on page 67 can also be used with Flock® tables.

3" ROUND GROMMET LOCATIONS

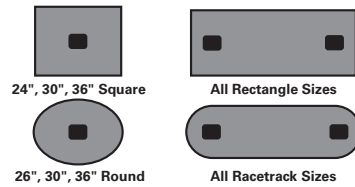

ACCESSORY PORT LOCATIONS

Only applies to models HFTLS24 and HFTLD26.

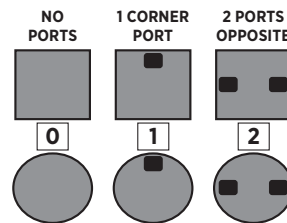

NOTES:
 Port location 1 allows for one tablet accessory — see model on pages 65-66.
 Port location 2 allows for two tablet accessories — see model on pages 65-66.



Icon Legend on page 19

FLOCK® Collaborative Laminate Table Tops

	DESCRIPTION	MODEL	SHIP WEIGHT	CUBE	LIST PRICE BY LAMINATE GRADE	
					L1	L2
	Laminate Table Tops					
	36" Square Top	HFTLS36	45	1.2	\$437	\$457
	30" Square Top	HFTLS30	32	1.0	\$388	\$408
	36" Round Top	HFTLD36	35	1.2	\$437	\$457
	30" Round Top	HFTLD30	25	1.0	\$388	\$408
	96"W x 33"D Rectangle Top	HFTLC3396	105	2.9	\$772	\$807
	84"W x 33"D Rectangle Top	HFTLC3384	90	2.5	\$661	\$691
	72"W x 33"D Rectangle Top	HFTLC3372	78	2.2	\$553	\$578
	60"W x 24"D Rectangle Top	HFTLC2460	47	1.3	\$404	\$419
	96"W x 33"D Racetrack Top	HFTLA3396	101	2.9	\$772	\$807
	84"W x 33"D Racetrack Top	HFTLA3384	83	2.5	\$661	\$691
	72"W x 33"D Racetrack Top	HFTLA3372	70	2.2	\$553	\$578
	60"W x 24"D Racetrack Top	HFTLA2460	43	1.3	\$404	\$419

NOTES:

- Grommet models HGRMTAC and HGRMTDATA on page 67 can also be used with Flock® tables.
- Rectangle and Racetrack tops come with 2 grommet cutouts if specified with Round grommet.
- For a complete line of compatible Flock® collaborative seating solutions, please see pages 320-343.

HOW TO SPECIFY





<p>Select Model Number</p> <p>HFTLS36</p>	<p>Select Edge Detail</p> <p>G 2mm Edge</p> <p>Select Edge Color</p> <p>See page 61</p> <p>GK</p>	<p>Select Grommet Option</p> <p>N No Grommet G Round Grommet (\$15 upcharge per grommet cutout)</p> <p>See page 62 for Grommet placement</p> <p>Select Grommet Color</p> <p>S Charcoal T1 Platinum Metallic</p> <p>GT1</p>	<p>Select Laminate Color</p> <p>See page 61</p> <p>K7</p>
--	---	--	--

FLOCK® Collaborative Table Bases

GSA SIN 33721

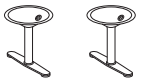
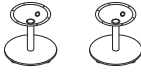

Icon Legend on page 19

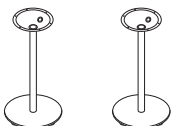
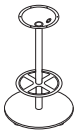
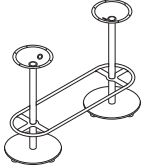
	DESCRIPTION	MODEL	SHIP WEIGHT	CUBE	LIST PRICE BY PAINT GRADE	
					P1	P2
	Base T-Leg Style — For 18”H Tables For 60”W x 24”D Rectangle or Racetrack Table Tops • Two bases shipped in separate cartons.	HFTB17N	40	6.0	\$968	\$988
	Base Disc Style — For 18”H Tables • Use with 60”W x 24”D Racetrack or Rectangle table tops only. • Two bases shipped in separate cartons.	HFDB17N	74	6.0	\$1062	\$1082
	Base Disc Style — For 18”H Tables For 30” and 36” Round or Square Table Tops	HFDB17B	37	3.0	\$523	\$543
	Base X-Style — For 29½”H Tables For 30” Round or Square Table Tops For 36” Round or Square Table Tops Use with 33”D x 72”W x 84”W and 96”W Rectangle or Racetrack Table Tops • Two bases shipped in separate cartons	HFXB29A 40 16.1 \$608 \$628 HFXB29B 53 16.1 \$643 \$663 HFXB29AN 80 32.2 \$1210 \$1250				
	Base X-Style — For 18”H Tables For 30” and 36” Round or Square Table Tops	HFXB17B	37	3.0	\$523	\$543
	Base Disc Style — For 29½”H Tables For 30” Round or Square Table Tops For 36” Round or Square Table Tops Use with 33”D x 72”W x 84”W and 96”W Rectangle or Racetrack Table Tops • Two bases shipped in separate cartons	HFDB29A 40 16.1 \$608 \$618 HFDB29B 56 16.1 \$643 \$663 HFDB29AN 80 32.2 \$1210 \$1230				
	Base X-Style — For 41”H Standing-Height Tables • Use with 33”D x 72”W, 84”W and 96”W Rectangle or Racetrack Table Tops • Two bases shipped in separate cartons	HFXB42AN	84	36.4	\$1268	\$1308
	Base X-Style — For 41”H Standing-Height Tables For 30” Round or Square Table Tops For 36” Round or Square Table Tops	HFXB42A 42 18.2 \$638 \$658 HFXB42B 55 16.1 \$673 \$693				
	Base Disc Style — For 41”H Standing-Height Tables • Use with 33”D x 72”W, 84”W and 96”W Rectangle or Racetrack table tops, when a Footring is not desired • Two bases shipped in separate cartons	HFDB42AN	92	19.0	\$1230	\$1270
	Base Disc Style — For 41”H Standing-Height Tables For 30” Round or Square Table Tops For 36” Round or Square Table Tops	HFDB42A 46 9.5 \$618 \$638 HFDB42B 62 13.5 \$657 \$677				
	Base Disc Style with Footring — For 41”H Standing-Height Tables For 30” Round or Square Table Tops For 36” Round or Square Table Tops Use with 33”D x 72”W x 84”W and 96”W Rectangle or Racetrack Table Tops • Two bases shipped in separate cartons	HFDB42AF 56 9.5 \$802 \$822 HFDB42BF 68 13.5 \$840 \$860 HFDB42AFN 112 32.2 \$1594 \$1634				
	Base Disc Style with Footring — For 41”H Standing-Height Tables For 33”D x 96”W Rectangle or Racetrack Table Tops For 33”D x 84”W Rectangle or Racetrack Table Tops For 33”D x 72”W Rectangle or Racetrack Table Tops NOTES: Includes two bases and a single oval footring that spans both tables. Two bases and footring shipped in three separate cartons.	HFDB42AF96 121 19.7 \$1841 \$1881 HFDB42AF84 123 19.8 \$1781 \$1821 HFDB42AF72 125 19.9 \$1750 \$1790				

NOTES:
 • Each base includes adjustable leveling glides.

HOW TO SPECIFY

Select Model Number HFTB17N .	Select Paint Color PR8 Textured Silver P7A Textured Charcoal PR8
---	--



FLOCK® Collaborative Tables

	DESCRIPTION	MODEL	SHIP WEIGHT	CUBE	L1 LIST PRICE	L2 UPCHARGE
	Laminated Personal Table 18" Dia. x 25"H	HFTPTL18	36	4.5	\$631	\$12

HOW TO SPECIFY

Select Model Number HFTPTL18	Select Edge Detail G 2mm Edge Select Edge Color See page 61 GK	Select Laminate Top Color See page 61 H	Select Base Paint Color PR8 Textured Silver P7A Textured Charcoal PR8
--	--	--	---

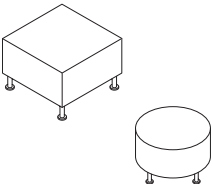
	DESCRIPTION	MODEL	SHIP WEIGHT	CUBE	L1 LIST PRICE	L2 UPCHARGE
	Laminated Collaborative Cube and Cylinder Tables 24" Laminated Cube Table — 24"W x 24"D x 17 1/8"H 26" Laminated Cylinder Table — 26" Dia. x 17 1/8"H	HFTLS24 HFTLD26	44 39	5.0 5.0	\$758 \$696	\$30 \$30
	NOTES: Accessory port quantity and configuration on tables should correspond to the accessories planned for the table. For grommet and port information, see page 62.					

NOTES:

- Accessory port options on the collaborative cube and cylinder tables allow for tablet accessory to be added.
- For grommet and port information, see page 62.
- HGRMTAC and HGRMTDATA on page 67 can also be used with Flock® tables.
- Standard Leg (L) can be adjusted for leveling.
- For a complete line of compatible Flock® collaborative seating solutions, please see pages 320-343.

HOW TO SPECIFY

Select Model Number HFTLS24	Select Grommet Option See page 62 for Grommet placement N No Grommet G Round Grommet — centered (\$15 upcharge)	Select Accessory Port Option See page 62 for Port placement 0 No Port 1 One Corner Port 2 Two Ports — Opposite (\$10 upcharge per port)	Select Laminate See page 61 H	Select Leg Option L Standard Leg Leg Options TR Tapered Round Leg TS Tapered Square Leg	Select Paint Color PR8 Textured Silver P7A Textured Charcoal PR8
---	---	--	--	---	--

FLOCK® Collaborative Tables

GSA SIN AS NOTED



Icon Legend on page 19

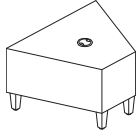

Shown with Round Grommet

OPEN MARKET

DESCRIPTION

Laminate Wedge Table
22.17"W x 29.43"D x 17"H

MODEL

HFTLW45

SHIP WEIGHT

34

CUBE

7.7

L1 LIST PRICE

\$724

L2 UPCHARGE

\$30

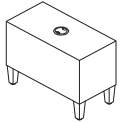

Shown with Round Grommet

OPEN MARKET

Laminate Rectangle Table
24"W x 12"D x 17"H

HFTLR12

29

3.9

\$504

\$20



SIN 33721

Laminate Tablet Accessory
14" Dia. x 10"H from table top

HFTAL14

6

2.5

\$376

\$15

NOTES: Use with Collaborative Cube and Cylinder tables for additional workspace. Attaches to tables through ports. Multiple port location options are available. Tablet pivots/swivels toward the user.

NOTES:

- Accessory Port options on the Collaborative Cube and Cylinder Tables allow for Tablet Accessory to be added.
- For grommet and port information, see page 62.
- HGRMTAC and HGRMTDATA on page 67 can also be used with Flock® tables.
- Standard Leg (L) can be adjusted for leveling.
- For a complete line of compatible Flock® collaborative seating solutions, please see pages 320-343.

HOW TO SPECIFY



<p>Select Model Number</p> <p>HFTLW45</p>	<p>Select Grommet Option</p> <p>See page 62 for Grommet placement</p> <p>N No Grommet G Round Grommet — centered (\$15 upcharge)</p> <p>N</p>	<p>Select Accessory Port Option</p> <p>See page 62 for Port placement</p> <p>O No Port</p> <p>O</p>	<p>Select Laminate Top Color</p> <p>See page 61</p> <p>N</p>	<p>Select Leg Option</p> <p>L Standard Leg Leg Options TR Tapered Round Leg TS Tapered Square Leg</p> <p>TS</p>	<p>Select Paint Color</p> <p>PR8 Textured Silver P7A Textured Charcoal</p> <p>P7A</p>
--	--	---	---	--	--

<p>Select Model Number</p> <p>HFTTAL14</p>	<p>Select Edge Detail</p> <p>G 2mm Edge</p> <p>Select Edge Color</p> <p>See page 61</p> <p>GK</p>	<p>Select Laminate Top Color</p> <p>See page 61</p> <p>H</p>	<p>Select Paint Color</p> <p>PR8 Textured Silver P7A Textured Charcoal</p> <p>PR8</p>
---	--	---	--

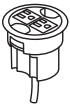
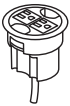

Icon Legend on page 19

Collaborative Accessories

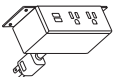
	DESCRIPTION	MODEL	SHIP WEIGHT	CUBE	LIST PRICE
	<p>Power Hub, 3" Grommet Mount, 6' Cord</p> <ul style="list-style-type: none"> • Fits in 3" round grommet holes • Field installed with Plug-and-play ease • Two grounded AC power outlets • Includes 6' cord with three-prong plug • Available in Black only. <i>Specify X when ordering. Example: HGRMTAC.X.</i> <p>NOTES: For additional information see page 236.</p>	HGRMTAC	1.3	0.2	\$116
	<p>3" Round Power Grommet - 2 Outlets, 10' Cord</p> <ul style="list-style-type: none"> • Includes 10' cord with three-prong plug. • Fits in 3" round grommet holes. • Two grounded AC power outlets. • Field installed with Plug-and-play ease. <p>NOTES: For additional information see page 236.</p> <p>⚠ Available in black finish only, no specification needed.</p>	HGRMTAC2	1.5	0.2	\$148
	<p>Power/USB Hub, 3" Grommet Mount</p> <ul style="list-style-type: none"> • One grounded AC power outlet with 2 USB ports • UL Listed <p>NOTES: For additional information see page 236.</p> <p>⚠ Available in black only (no color designation so use .X - Specify: HGRMTUSB2.X).</p>	HGRMTUSB2	1.3 Ⓢ	0.2	\$226
	<p>Data Grommet</p> <p>Blank grommet kit that includes adapters for a variety of manufacturers jacks and couplers.</p> <ul style="list-style-type: none"> • Fits in existing 3" round grommet housing • Available in Black only. <i>Specify P when ordering. Example: HGRMTDATA.P.</i> <p>NOTES: For additional information see page 236.</p>	HGRMTDATA	0.2	0.2	\$20
	<p>Power Modules</p> <p>3 Receptacles with Under-Worksurface Mounting Bracket</p> <p>2 Receptacles 2 USB with Under-Worksurface Mounting Bracket</p> <ul style="list-style-type: none"> • 6' power cord with standard three-prong plug. • Under-worksurface mounting bracket models work with any top that has a 5" x 5" square clearance. • Worksurface clamp models work on any top with a 4" overhang. • UL Listed. <p>NOTES: For additional information see page 237.</p> <p>⚠ Finish choices coordinate with HON's Charcoal or Designer White. <i>Specify STRM for Storm or SNW for Snow. Example: HPWRMOD3UWM.SNW.</i></p>	<p>HPWRMOD3UWM</p> <p>HPWRMOD2UWM</p>	<p>2.3 Ⓢ</p> <p>2.3 Ⓢ</p>	<p>0.2</p> <p>0.2</p>	<p>\$310</p> <p>\$496</p>

SIN 33721

Model HPWRMOD2UWM shown

SIN 33721

GRAVITATION POWER BEAM



Gravitation Power Beam shown with Coordinate™ Height Adjustable Tables, Fuse™ Storage, Astir™, Mav, and Solve® Seating.

POWER BEAM

Bringing power and privacy to individual workspaces and team areas, Gravitation Beam offers a sleek look and multiple aesthetic options to complement any environment. Designed for movement and flexibility, it adapts to changing needs with ease.



FEATURES

- Pairs perfectly with height adjustable tables or alongside soft seating.
- Offered in a variety of paint options.
- Available in 3 widths: 48", 60", and 72".
- Create L, X, and T configurations using universal connectors.
- Painted metal screens available to provide privacy and space division.

GRAVITATION POWER BEAM ORDERING INFORMATION

PAINT

PAINT CODES

P1

- ◆ Black P71
- ◆ Brownstone P7D
- ◆ Charcoal P02
- ◆ Designer White PJW
- ◆ Fossil P28
- ◆ Greige T5
- ◆ Loft LOFT
- ◆ Muslin T3
- ◆ Shadow * SHDW
- ◆ Titanium P8T

P2

- ◆ Champagne Metallic T4
- ◆ Silver PR6
- ◆ Solar Black P8X

P3

- ◆ Atom P8S
- ◆ Bullseye PJF
- ◆ Ember P8P
- ◆ Ion P8N
- ◆ Iris P8J
- ◆ Krypton P8F
- ◆ Regatta P8M

P6

- ◆ Markerboard MKB

Duplex Color Recommended to Coordinate with Paint Color

Paint Color	Paint Code	Duplex Color	Duplex Code
Black	P	Black	P
Brownstone	P7D	Brownstone	EY
Charcoal	S	Charcoal	S
Designer White	PJW	Designer White	DW
Fossil	P28	Charcoal	S
Greige	T5	Muslin	T3
Light Gray	Q	Loft	LOFT
Loft	LOFT	Loft	LOFT
Muslin	T3	Muslin	T3
Putty	L	Black	P
Shadow	SHDW	Muslin	T3
Silver	PR6	Titanium	TI
Titanium	P8T	Titanium	TI
Champagne Metallic	T4	Muslin	T3
Platinum Metallic	T1	Titanium	TI

◆◆◆ For lead time information see page 19.

* De-emphasized

GRAVITATION POWER BEAM ORDERING INFORMATION

Gravitation Ordering Checklist

When specifying Gravitation Power Beams for your workspace, follow the ordering checklist below to ensure full functionality.

- Beams (HBEAM48, 60, or 72).
- Legs to go with beams based on how the beams will be connected (HBLEG23).
- Electrical Harnesses, Receptacles, and In-feeds.
- Specify connectors, power hubs, and/or power poles (HBEORH23, HBEORT23, HBILNH23, HBCONU, etc.).
- Port Covers (for any power/data ports left unused).
- Metal Screens (if desired).

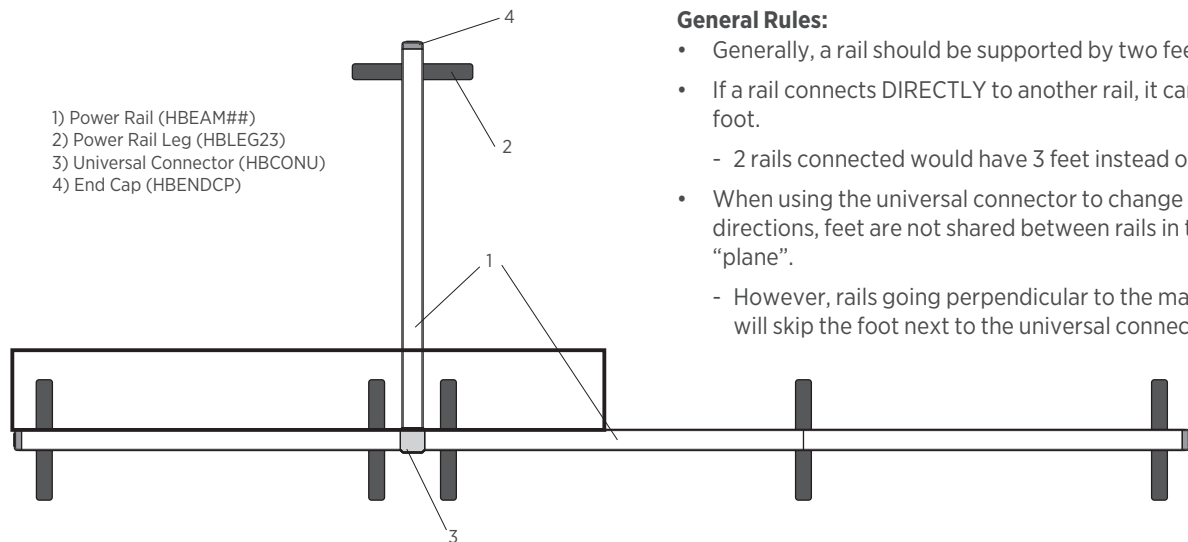

General Rules:

- Generally, a rail should be supported by two feet.
- If a rail connects DIRECTLY to another rail, it can share a foot.
 - 2 rails connected would have 3 feet instead of 4.
- When using the universal connector to change directions, feet are not shared between rails in the same "plane".
 - However, rails going perpendicular to the main line will skip the foot next to the universal connector.

❗ When two rails share a leg, the leg is centered between the legs in the "outer slot". When the leg is positioned **at the end of a run of rails** (i.e., the rail doesn't connect to another rail), the leg will be inset $1\frac{1}{8}$ " from the end of the rail, not the end cap, in the "inner slot".

Cable Capacity

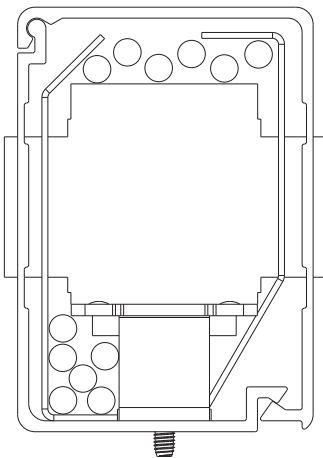

- The Power Rail housing allows continuous voice and data lines to run without interruption.
- Lay-in is provided for environments where systems furniture or cabling are subject to frequent change.
- Lower cavity allows for 6 voice/data cables ($\frac{1}{4}$ " diameter).
- Upper cavity lay-in allows 6 voice/data cables ($\frac{1}{4}$ " diameter).



Icon Legend on page 19

GRAVITATION 48"W Bundles

QTY	DESCRIPTION	MODEL	LIST PRICE	PRICE EXTENSION
1	Gravitation Power Beam 48"W	HBEAM48	\$359	\$359
2	Gravitation Legs 23"H	HBLEG23	\$125	\$250
1	End of Run Power Harness	HMPEEK48	\$225	\$225
4	Duplexes	HH873501	\$42	\$168
2	Gravitation Power Beam End Cap	HBENDCP	\$66	\$132
TOTAL:			\$1,134	

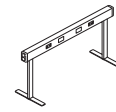
**1-PACK — 48"W**

QTY	DESCRIPTION	BUNDLE SKU	LIST PRICE BY PAINT GRADE		
			P1	P2	P3
1	1-PACK BUNDLE	HBDL148	\$1,098	\$1,169	\$1,204

SPECIFYING EXAMPLE: Model.Paint

QTY	DESCRIPTION	MODEL	LIST PRICE	PRICE EXTENSION
2	Gravitation Power Beam 48"W	HBEAM48	\$359	\$718
3	Gravitation Legs 23"H	HBLEG23	\$125	\$375
1	End of Run Power Harness	HMPEEK48	\$225	\$225
1	Power Harness	HH871248	\$216	\$216
4	Duplexes	HH873501	\$42	\$168
4	Duplexes	HH873502	\$42	\$168
2	Gravitation Power Beam End Cap	HBENDCP	\$66	\$132
TOTAL:			\$2,002	

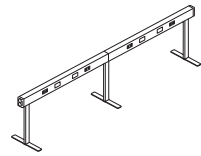
**2-PACK — 48"W**

QTY	DESCRIPTION	BUNDLE SKU	LIST PRICE BY PAINT GRADE		
			P1	P2	P3
1	2-PACK BUNDLE	HBDL248	\$1,949	\$2,067	\$2,125

SPECIFYING EXAMPLE: Model.Paint

QTY	DESCRIPTION	MODEL	LIST PRICE	PRICE EXTENSION
3	Gravitation Power Beam 48"W	HBEAM48	\$359	\$1,077
4	Gravitation Legs 23"H	HBLEG23	\$125	\$500
1	End of Run Power Harness	HMPEEK48	\$225	\$225
2	Power Harness	HH871248	\$216	\$432
4	Duplexes	HH873501	\$42	\$168
4	Duplexes	HH873502	\$42	\$168
4	Duplexes	HH873503	\$42	\$168
2	Gravitation Power Beam End Cap	HBENDCP	\$66	\$132
TOTAL:			\$2,870	

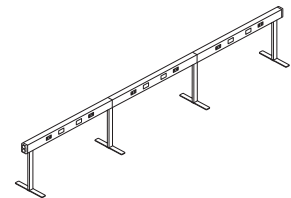
**3-PACK — 48"W**

QTY	DESCRIPTION	BUNDLE SKU	LIST PRICE BY PAINT GRADE		
			P1	P2	P3
1	3-PACK BUNDLE	HBDL348	\$2,800	\$2,965	\$3,046

SPECIFYING EXAMPLE: Model.Paint

QTY	DESCRIPTION	MODEL	LIST PRICE	PRICE EXTENSION
4	Gravitation Power Beam 48"W	HBEAM48	\$359	\$1,436
5	Gravitation Legs 23"H	HBLEG23	\$125	\$625
1	End of Run Power Harness	HMPEEK48	\$225	\$225
3	Power Harness	HH871248	\$216	\$648
4	Duplexes	HH873502	\$42	\$168
4	Duplexes	HH873503	\$42	\$168
4	Duplexes	HH873504	\$42	\$168
2	Gravitation Power Beam End Cap	HBENDCP	\$66	\$132
TOTAL:			\$3,570	

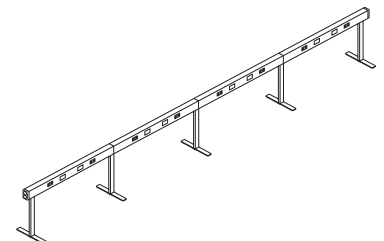
**4-PACK — 48"W**

QTY	DESCRIPTION	BUNDLE SKU	LIST PRICE BY PAINT GRADE		
			P1	P2	P3
1	4-PACK BUNDLE	HBDL448	\$3,651	\$3,863	\$3,967

SPECIFYING EXAMPLE: Model.Paint

! Power in-feeds and port covers are not included in Bundles and must be specified separately.

GRAVITATION

60"W Bundles



Icon Legend on page 19

QTY	DESCRIPTION	MODEL	LIST PRICE	PRICE EXTENSION
1	Gravitation Power Beam 60"W	HBEAM60	\$396	\$396
2	Gravitation Legs 23"H	HBLEG23	\$125	\$250
1	End of Run Power Harness	HMPEEK60	\$225	\$225
4	Duplexes	HH873501	\$42	\$168
2	Gravitation Power Beam End Cap	HBENDCP	\$66	\$132
TOTAL:			\$1,171	

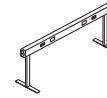
**1-PACK — 60"W**

QTY	DESCRIPTION	BUNDLE SKU	LIST PRICE BY PAINT GRADE		
			P1	P2	P3
1	1-PACK BUNDLE	HBBDL160	\$1,133	\$1,207	\$1,244

SPECIFYING EXAMPLE: Model.Paint

QTY	DESCRIPTION	MODEL	LIST PRICE	PRICE EXTENSION
2	Gravitation Power Beam 60"W	HBEAM60	\$396	\$792
3	Gravitation Legs 23"H	HBLEG23	\$125	\$375
1	End of Run Power Harness	HMPEEK60	\$225	\$225
1	Power Harness	HH871260	\$216	\$216
4	Duplexes	HH873501	\$42	\$168
4	Duplexes	HH873502	\$42	\$168
2	Gravitation Power Beam End Cap	HBENDCP	\$66	\$132
TOTAL:			\$2,076	

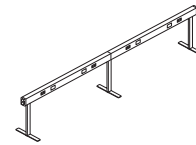
**2-PACK — 60"W**

QTY	DESCRIPTION	BUNDLE SKU	LIST PRICE BY PAINT GRADE		
			P1	P2	P3
1	2-PACK BUNDLE	HBBDL260	\$2,019	\$2,143	\$2,205

SPECIFYING EXAMPLE: Model.Paint

QTY	DESCRIPTION	MODEL	LIST PRICE	PRICE EXTENSION
3	Gravitation Power Beam 60"W	HBEAM60	\$396	\$1,188
4	Gravitation Legs 23"H	HBLEG23	\$125	\$500
1	End of Run Power Harness	HMPEEK60	\$225	\$225
2	Power Harness	HH871260	\$216	\$432
4	Duplexes	HH873501	\$42	\$168
4	Duplexes	HH873502	\$42	\$168
4	Duplexes	HH873503	\$42	\$168
2	Gravitation Power Beam End Cap	HBENDCP	\$66	\$132
TOTAL:			\$2,981	

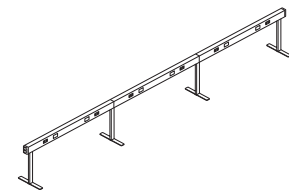
**3-PACK — 60"W**

QTY	DESCRIPTION	BUNDLE SKU	LIST PRICE BY PAINT GRADE		
			P1	P2	P3
1	3-PACK BUNDLE	HBBDL360	\$2,905	\$3,079	\$3,166

SPECIFYING EXAMPLE: Model.Paint

QTY	DESCRIPTION	MODEL	LIST PRICE	PRICE EXTENSION
4	Gravitation Power Beam 60"W	HBEAM60	\$396	\$1,584
5	Gravitation Legs 23"H	HBLEG23	\$125	\$625
1	End of Run Power Harness	HMPEEK60	\$225	\$225
3	Power Harness	HH871260	\$216	\$648
4	Duplexes	HH873502	\$42	\$168
4	Duplexes	HH873503	\$42	\$168
4	Duplexes	HH873504	\$42	\$168
2	Gravitation Power Beam End Cap	HBENDCP	\$66	\$132
TOTAL:			\$3,718	

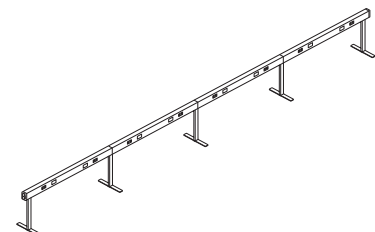
**4-PACK — 60"W**

QTY	DESCRIPTION	BUNDLE SKU	LIST PRICE BY PAINT GRADE		
			P1	P2	P3
1	4-PACK BUNDLE	HBBDL460	\$3,791	\$4,015	\$4,127

SPECIFYING EXAMPLE: Model.Paint

! Power in-feeds and port covers are not included in Bundles and must be specified separately.



Icon Legend on page 19

GRAVITATION 72"W Bundles

QTY	DESCRIPTION	MODEL	LIST PRICE	PRICE EXTENSION
1	Gravitation Power Beam 72"W	HBEAM72	\$463	\$463
2	Gravitation Legs 23"H	HBLEG23	\$125	\$250
1	End of Run Power Harness	HMPEEK72	\$225	\$225
4	Duplexes	HH873501	\$42	\$168
2	Gravitation Power Beam End Cap	HBENDCP	\$66	\$132
TOTAL:			\$1,238	

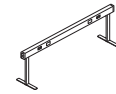

1-PACK – 72"W

QTY	DESCRIPTION	BUNDLE SKU	LIST PRICE BY PAINT GRADE		
			P1	P2	P3
1	1-PACK BUNDLE	HBDL172	\$1,198	\$1,279	\$1,319

SPECIFYING EXAMPLE: Model.Paint

QTY	DESCRIPTION	MODEL	LIST PRICE	PRICE EXTENSION
2	Gravitation Power Beam 72"W	HBEAM72	\$463	\$926
3	Gravitation Legs 23"H	HBLEG23	\$125	\$375
1	End of Run Power Harness	HMPEEK72	\$225	\$225
1	Power Harness	HH871272	\$216	\$216
4	Duplexes	HH873501	\$42	\$168
4	Duplexes	HH873502	\$42	\$168
2	Gravitation Power Beam End Cap	HBENDCP	\$66	\$132
TOTAL:			\$2,210	

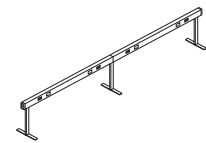

2-PACK – 72"W

QTY	DESCRIPTION	BUNDLE SKU	LIST PRICE BY PAINT GRADE		
			P1	P2	P3
1	2-PACK BUNDLE	HBDL272	\$2,149	\$2,287	\$2,355

SPECIFYING EXAMPLE: Model.Paint

QTY	DESCRIPTION	MODEL	LIST PRICE	PRICE EXTENSION
3	Gravitation Power Beam 72"W	HBEAM72	\$463	\$1,389
4	Gravitation Legs 23"H	HBLEG23	\$125	\$500
1	End of Run Power Harness	HMPEEK72	\$225	\$225
2	Power Harness	HH871272	\$216	\$432
4	Duplexes	HH873501	\$42	\$168
4	Duplexes	HH873502	\$42	\$168
4	Duplexes	HH873503	\$42	\$168
2	Gravitation Power Beam End Cap	HBENDCP	\$66	\$132
TOTAL:			\$3,182	

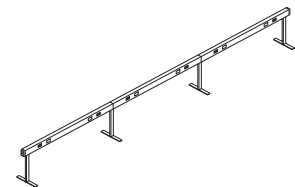

3-PACK – 72"W

QTY	DESCRIPTION	BUNDLE SKU	LIST PRICE BY PAINT GRADE		
			P1	P2	P3
1	3-PACK BUNDLE	HBDL372	\$3,100	\$3,295	\$3,391

SPECIFYING EXAMPLE: Model.Paint

QTY	DESCRIPTION	MODEL	LIST PRICE	PRICE EXTENSION
4	Gravitation Power Beam 72"W	HBEAM72	\$463	\$1,852
5	Gravitation Legs 23"H	HBLEG23	\$125	\$625
1	End of Run Power Harness	HMPEEK72	\$225	\$225
3	Power Harness	HH871272	\$216	\$648
4	Duplexes	HH873502	\$42	\$168
4	Duplexes	HH873503	\$42	\$168
4	Duplexes	HH873504	\$42	\$168
2	Gravitation Power Beam End Cap	HBENDCP	\$66	\$132
TOTAL:			\$3,986	

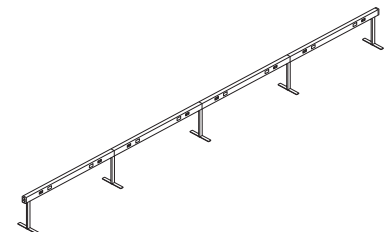

4-PACK – 72"W

QTY	DESCRIPTION	BUNDLE SKU	LIST PRICE BY PAINT GRADE		
			P1	P2	P3
1	4-PACK BUNDLE	HBDL472	\$4,051	\$4,303	\$4,427

SPECIFYING EXAMPLE: Model.Paint

! Power in-feeds and port covers are not included in Bundles and must be specified separately.

GRAVITATION POWER BEAM

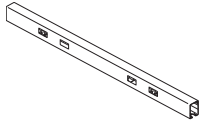

Icon Legend on page 19

DESCRIPTION	MODEL	SHIP WEIGHT	CUBE	LIST PRICE BY PAINT GRADE		
				P1	P2	P3
 <p>Power Beam 48"W 60"W 72"W</p>	HBEAM48	7	0.6	\$359	\$394	\$411
	HBEAM60	9	0.7	\$396	\$434	\$453
	HBEAM72	11	0.9	\$463	\$508	\$530

 <p>Beam Legs 23"H</p>	HBLEG23	5	0.6	\$125	\$134	\$139
---	----------------	---	-----	--------------	--------------	--------------

NOTES:

- Beams and legs specified separately.
- Order power harness separately to corresponding beam length.
- Beams ship with mounting brackets for 8-Trac electrical to be installed in the field.
- Beams ship with internal guides to retain power/data wires during installation (internal wire management).
- 2 ports for electrical and 2 ports for data are provided on each side of the rail, total of 8 ports.
- Electrical in-feed can also be accomplished through an electrical knockout (not data) in the face of the rail using a base in-feed.
- Beam height when installed is 23"H. This height aligns with the Empower® height adjustable trough. Gravitation and Coordinate™ can be used as single-sided height adjustable benching.
- 2-Pack metal port covers specified separately to cover unused power/data ports.
- Electrical harnesses, duplexes, and power feeds ordered separately.
- Leveling capability of 1/4" internal to rail for clean aesthetic.
- ! With in-line connections between beams, one leg can be shared. Requires one more leg than the number of beams.
- ! Specify paint; not available in Putty (L), Platinum Metallic (T1), and Champagne Metallic (T4).
- ! When two rails share a leg, the leg is centered between the legs in the "outer slot". When the leg is positioned **at the end of a run of rails** (i.e., the rail doesn't connect to another rail), the leg will be inset 1/8" from the end of the rail, not the end cap, in the "inner slot".

 <p>Power Beam End Cap</p>	HBENDCP	1	0.1	\$66	\$72	\$75
---	----------------	---	-----	-------------	-------------	-------------

NOTES:

- Power can enter into the beam from the floor, wall, or ceiling.
- When using the power pole, please note attachment to beam is up to the installer, as well as field-cutting the power pole to access power and data wires.
- End caps have integral knockout ports with plastic grommets to allow for power/data in-feed (without sharp edges).
- End caps add 1" to the length of the run.

HOW TO SPECIFY

<p>Select Model Number</p> <p>H B E A M 6 0 .</p>	<p>Select Paint Color</p> <p>See page 69</p> <p>P R 8</p>
--	--



Icon Legend on page 19

GRAVITATION POWER BEAM

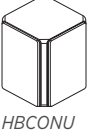
	DESCRIPTION	MODEL	SHIP WEIGHT	CUBE	LIST PRICE BY PAINT GRADE		
					P1	P2	P3
 HBPRTCV	Knockout Port Covers, Metal	HBPRTCV	0.5	0.1	\$24	\$26	\$27
 HBCONU	Universal Connector ! Used to change direction of beam (L, T, X). Cannot bring in-feed into Universal Connector; use Power Hubs in these instances (HBXXX23).	HBCONU	2.0	0.1	\$188	\$202	\$209

NOTES:

- Universal Connector is used to change beam direction when power is not coming in at that location. Power Hub will be used to bring in power at a change of connection.
- Port Covers used to cover open power or data ports if not in use, as desired.
- Able to connect rails in T-, X-, or L-configurations.

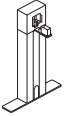
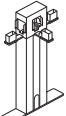
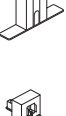
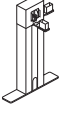
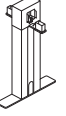
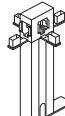
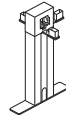
	DESCRIPTION	MODEL	SHIP WEIGHT	CUBE	LIST PRICE BY PAINT GRADE		
					P1	P2	P3
	Power Hub End of Run Power Hub	HBEORH23	10	4.0	\$236	\$260	\$271
	End of Run Power Hub, T	HBEORT23	14	4.0	\$260	\$286	\$299
	End of Run Power Hub, L	HBEORL23	13	4.0	\$230	\$253	\$265
	In-Line Power Hub	HBILNH23	13	4.0	\$248	\$273	\$285
	In-Line Power Hub, X	HBILNX23	15	4.0	\$263	\$289	\$302
	In-Line Power Hub, T	HBILNT23	14	4.0	\$251	\$276	\$289
	! Power Hub is used when electrical needs to enter at a connection. For change of direction only (not bringing in power) use Universal Connector.						

NOTES:

- Hub connectors allow power to enter the beam by bringing it through the bottom of the hub or knocking out the mouse hole in the hub.
- Specify correct hub based on desired location of power entering the beam.
- ! Power Hub is used when electrical needs to enter at a connection. For change of direction only (not bringing in power) use Universal Connector (HBCONU).
- ! Hubs are dual use — change of direction “connector” (when choosing L, T, or X hubs) and to bring power to the beam; choose Universal Connector if change of direction is needed **without** bringing power to the beam (HBCONU).
- ! Power can enter the beam in six different ways.
 1. Bring in-feed from floor or wall into end of beam with no cover (see local electrical codes to ensure the use of this solution) — metal flexible (HH871912) or Sealtight (HMP144) conduit available based on code compliance.
 2. HH870070 freestanding Power Pole at end of run.
 3. Vertebrae Wire Manager (HBVWM) from end of beam.
 4. 96” Power Pole (HB96PP) with beam Power Pole Connectors (HBPP*K).
 5. Power Hubs (HBXXX23, see above).
 6. Power Hubs (HBXXX23, see above) with 96” Power Pole (HB96PP) with Hub Connectors (HBPPCK).

HOW TO SPECIFY

<p>Select Model Number</p> <p>H B C O N U .</p>	<p>Select Paint Color</p> <p>See page 69</p> <p>P R 8</p>
--	--

GRAVITATION POWER BEAM



SIN 33721

DESCRIPTION	MODEL	SHIP WEIGHT	CUBE	LIST PRICE
Power Pole — w/o Receptacles 10'5" NOTES: For ceiling in-feed, utilize a freestanding Power Pole placed adjacent to the Power Beam. Power Pole runs to the floor. Specify paint. ⓘ Must be field cut. ⓘ Does not ship with attachment hardware, it is up to the installer to attach Power Pole to the beam.	HH870070	14	0.5	\$433



DESCRIPTION	MODEL	SHIP WEIGHT	CUBE	LIST PRICE BY PAINT GRADE		
				P1	P2	P3
Power Pole 96"H NOTES: Power Pole connects to hub or with Mid or End Cap connectors. Power Pole terminates at beam or hub height (does not run to the floor).	HB96PP	5.0	0.9	\$663	\$729	\$762

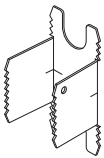

Power Pole Splice Kit NOTES: Use Splice Kit to join two Power Poles when one pole does not meet the required ceiling height.	HBPPSK	0.25 ⓘ	0.1	\$50	N/A	N/A
--	---------------	--------	-----	-------------	------------	------------

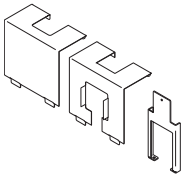

Power Pole Power Hub Connector NOTES: Specify when bringing Power Pole into Power Hub.	HBPPCK	1.0 ⓘ	0.1	\$50	\$55	\$58
--	---------------	-------	-----	-------------	-------------	-------------

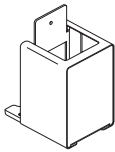

Power Pole End Cap Connector NOTES: Specify when bringing Power Pole into the end of a beam.	HBPPEK	1.5 ⓘ	0.1	\$50	\$55	\$58
--	---------------	-------	-----	-------------	-------------	-------------

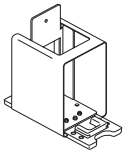

Power Pole Mid Connector NOTES: Specify when bringing Power Pole into junction of two beams.	HBPPMK	1.5 ⓘ	0.1	\$50	\$55	\$58
--	---------------	-------	-----	-------------	-------------	-------------



Vertebrae Wire Manager NOTES: Connects to end of beam — Vertebrae conceals cords entering the beam.	HBVWM	1.8 ⓘ	0.2	\$271	\$298	\$312
---	--------------	-------	-----	--------------	--------------	--------------









Floor Anchor Bracket NOTES: Used to connect beam to the floor in situations where the beam needs to be tethered to the ground so users cannot move it.	HBFAB	0.2 ⓘ	0.1	\$20	\$22	\$23
--	--------------	-------	-----	-------------	-------------	-------------

HOW TO SPECIFY

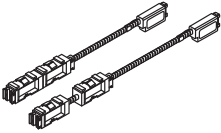
Select Model Number HB96PP	Select Paint Color See page 69 PR8
--------------------------------------	---

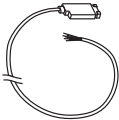
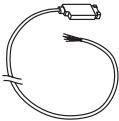
GRAVITATION POWER BEAM

Electrical

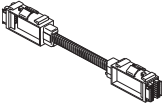
	DESCRIPTION	MAX. RECEPT. CAP. PER PANEL SIDE	MODEL		SHIP WEIGHT	CUBE	LIST PRICE
			FOUR-CIRCUIT 3 + 1 2 + 2	THREE-CIRCUIT, SEPARATE NEUTRALS			
	Electrical Power Harnesses, Frames — w/duplex capacity						
	For 48"W	2	HH871248	HH871248A	3.0 Ⓞ	0.5	\$216
	For 60"W	2	HH871260	HH871260A	3.0 Ⓞ	0.5	\$216
	For 72"W	2	HH871272	HH871272A	5.0 Ⓞ	0.5	\$216
 Each marked with Circuit Number	Abund® Duplex Receptacles						
	Circuit 1		HH873501	HH873501A	0.5 Ⓞ	0.1	\$42
	Circuit 2		HH873502	HH873502A	0.5 Ⓞ	0.1	\$42
	Circuit 3		HH873503	HH873503A	0.5 Ⓞ	0.1	\$42
	Circuit 4		HH873504		0.5 Ⓞ	0.1	\$42
	Circuit 1 — 20 amp outlet Circuit 3 (2 + 2)		HH871601 HH873506	HH871601A	1.0 Ⓞ 0.5 Ⓞ	0.1 0.1	\$42 \$42
	Specify color.						
	Ceiling In-Feed						
	144" long conduit, Flex Cable — 7/8" dia.		HH871912	HH871912A	4.0 Ⓞ	0.5	\$238
	216" long conduit, Flex Cable — 7/8" dia.		HH871918	HH871918A	4.0 Ⓞ	0.5	\$310
	ⓘ Must be used with Power Pole. Power in-feed models HH871912 and HH871918 plug into the end of any power block. No portion of the cable can be exposed after installation.						
	DESCRIPTION		MODEL	SHIP WEIGHT	CUBE	LIST PRICE	
	Power In-Feed — Sealtight						
	144" long conduit, Sealtight Cable — 7/8" diameter		HMP144	7	1.2	\$333	
	NOTES: For use as ceiling, floor and wall in-feed. If three-circuit, separate neutral in-feed is required, please contact Tailored Solutions.						
	ⓘ Bend radius of Sealtight in-feed is limited — use in straight entrance applications.						
 HHTADF3  HHTADF4  HHTADJ5 Black only	AMP Data Faceplates						
	Three-port flex-mode faceplate		HHTADF3	1 Ⓞ	0.2	\$26	
	Four-port flex-mode faceplate		HHTADF4	1 Ⓞ	0.2	\$26	
		ⓘ Data faceplates available in Black (E4) only.					
	AMP RJ45 CAT 5E Jack — Black (P)		HHTADJ5	1 Ⓞ	0.1	\$42	
	AMP RJ45 CAT 6 Jack — Black (P)		HHTADJ6	1 Ⓞ	0.1	\$57	
	Models HHTADJ5 and HHTADJ6 snap into faceplate.						
	NOTES: AMP Data Faceplates attach to bottom of panel or at worksurface height in front of baserail covers for easy cable routing. Faceplates cannot be installed back-to-back in a panel application.						
	End of Run Electrical Kit						
	48"W		HMPEEK48	3	0.5	\$225	
	60"W		HMPEEK60	3	0.5	\$225	
	72"W		HMPEEK72	5	0.5	\$225	

HOW TO SPECIFY

Select
Model Number

HH871248

GRAVITATION POWER BEAM Screens

OPEN MARKET

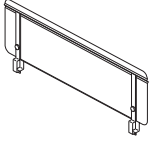

DESCRIPTION	MODEL	SHIP WEIGHT	CUBE	LIST PRICE BY PAINT GRADE		
				P1	P2	P3
Graviton Metal Screen 48"W x 18¾"H	HBSCRAOMTL48	10.3	3.1	\$354	\$388	\$405
60"W x 18¾"H	HBSCRAOMTL60	12.0	3.7	\$427	\$468	\$489
72"W x 18¾"H	HBSCRAOMTL72	15.7	4.4	\$458	\$502	\$524

NOTES:

- A screen can be mounted above the beam to add privacy.
- Screens ship with mounting hardware.
- Screens are wipeable.
- Screens are magnetic.
- Also available in Markerboard paint.

HOW TO SPECIFY

<p>Select Model Number</p> <p>HBSCRAOMTL60 .</p>	<p>Select Paint Color</p> <p>See page 69</p> <p>P71</p>
--	---

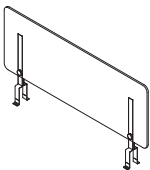

DESCRIPTION	MODEL	SHIP WEIGHT	CUBE	LIST PRICE BY PAINT GRADE		
				P1	P2	P3
Graviton Beam PET Screen 48"W x 20"H	HUVDSBS2048	3.5 Ⓞ	4.1	\$472	\$476	\$492
60"W x 20"H	HUVDSBS2060	4.4 Ⓞ	5.0	\$524	\$528	\$544
72"W x 20"H	HUVDSBS2072	5.3 Ⓞ	5.9	\$582	\$586	\$602

HOW TO SPECIFY

<p>Select Model Number</p> <p>HUVDSBS2060 .</p>	<p>Select PET Color</p> <p>DDB1 Dark Blue DGN1 Green DGY4 Dark Gray DGY3 Medium Gray</p> <p>DGN1 .</p>	<p>Select Paint Color</p> <p>See page 69</p> <p>PR6</p>
---	--	---

HUDDLE



Huddle Tables shown with Motivate® Seating.

HUDDLE

These sturdy, versatile tables link and unlink to quickly transform a space. Temporary workstation? Done. Impromptu conference table? Easy! Training session? No problem. Huddle helps you maximize time and square footage — not costs. And for today's businesses, that's a nice change of pace.



FEATURES

- 1½" thick solid core top is made from durable high-performance particleboard.
- Heavy-grade, warp-resistant particleboard tops and bases withstand heavy activity.
- Mobile nesting base option lets tables fold up and roll away until you need them.
- Choose wiring and power options so Huddle tables are ready to work when you are.
- Modesty panels offer the added level of privacy your employees want.
- Two edge profiles in over 20 colors and patterns to accommodate differing tastes.
- **Height adjustable laptop table offers a mobile, personal table for working anywhere.**

HUDDLE ORDERING INFORMATION

LAMINATE

TOPS/L1 LAMINATES CODES

Woodgrain

- ◆ Bourbon Cherry H
- ◆ Cognac **COGN**
- ◆ Florence Walnut **LFW1**
- ◆ Harvest C
- ◆ Kingswood Walnut **LK11**
- ◆ Mahogany N
- ◆ Mocha **MOCH**
- ◆ Natural Maple D
- ◆ Pinnacle **PINC**
- ◆ Shaker Cherry F
- ◆ Sterling Ash **LSA1**

Solid

- ◆ Black P
- ◆ Charcoal S
- ◆ Designer White **LDW1**
- ◆ Loft **LOFT**

Patterned

- ◆ Sheer Mesh **A5**
- ◆ Silver Mesh **B9**
- ◆ Steel Mesh **A9**
- ◇ Canyon Zephyr **K9**
- ◇ Desert Zephyr **K8**
- ◇ Shadow Zephyr **K1**
- ◆ Battleship **LBT1***
- ◆ Gray **G2**
- ◆ Grey Tigris **L6**
- ◆ Moroccan **LMN1***
- ◆ Mushroom **LMH1***
- ◆ Neon Carrot **LNC1***
- ◆ Tennis Ball **LTB1***
- ◇ White **G1**
- ◇ Whitestone **K4**

TOPS/L2 LAMINATES CODES

Woodgrain

- ◆ Lowell Ash **LLA1**
- ◆ Natural Recon **LNRI**
- ◆ Phantom Ecu **LPE1**
- ◆ Portico Teak **LPT1**
- ◆ Skyline Walnut **LSW1**

EDGE BAND

EDGES/ EDGE BAND (2MM) CODES

- ◆ Black P
- ◆ Bourbon Cherry H
- ◆ Charcoal S
- ◆ Cognac **COGN**
- ◆ Designer White **DW**
- ◆ Florence Walnut **FW**
- ◇ Greige R
- ◆ Harvest C
- ◆ Kingswood Walnut **KI**
- ◆ Loft **LOFT**
- ◆ Lowell Ash **DL**
- ◆ Mahogany N
- ◆ Mocha **MOCH**
- ◆ Muslin T
- ◆ Natural Maple D
- ◆ Natural Recon **NR**
- ◆ Phantom Ecu **PE**
- ◆ Pinnacle **PINC**
- ◇ Platinum K
- ◆ Portico Teak **DP**
- ◇ Shadow * **SHDW**
- ◆ Shaker Cherry F
- ◆ Skyline Walnut **SW**
- ◆ Sterling Ash **SA**

T-MOLD

T-MOLD CODES

- ◆ Atom **AT***
- ◆ Black P
- ◆ Bullseye **BY***
- ◆ Charcoal **S***
- ◆ Designer White **DW**
- ◆ Ember **MR***
- ◇ Greige R
- ◆ Ion **IO***
- ◆ Iris **IR***
- ◆ Krypton **KT***
- ◆ Loft **LOFT**
- ◆ Lowell Ash **DL**
- ◆ Muslin T
- ◆ Natural Recon **NR**
- ◆ Phantom Ecu **PE**
- ◇ Platinum K
- ◆ Portico Teak **DP**
- ◆ Regatta **RE***
- ◇ Shadow * **SHDW**
- ◆ Skyline Walnut **SW**

PAINT

BASE PAINT CODES

P1

- ◆ Black P
- ◆ Brownstone **P7D**
- ◆ Charcoal S
- ◆ Designer White **PJW**
- ◆ Fossil **P28**
- ◆ Greige T5
- ◆ Light Gray Q
- ◆ Loft **LOFT**
- ◆ Muslin T3
- ◆ Putty L
- ◆ Shadow * **SHDW**
- ◆ Titanium **P8T**

P2

- ◆ Champagne Metallic T4
- ◆ Platinum Metallic T1
- ◆ Silver **PR6**

P3

- ◆ Atom **P8S**
- ◆ Bullseye **PJF**
- ◆ Ember **P8P**
- ◆ Ion **P8N**
- ◆ Iris **P8J**
- ◆ Krypton **P8F**
- ◆ Regatta **P8M**

Recommended Edgeband Color Selection:

Laminate		Edge	
Bourbon Cherry	H	Bourbon Cherry	H
Cognac	COGN	Cognac	COGN
Florence Walnut	LFW1	Florence Walnut	FW
Harvest	C	Harvest	C
Kingswood Walnut	LK11	Kingswood Walnut	KI
Mahogany	N	Mahogany	N
Mocha	MOCH	Mocha	MOCH
Natural Maple	D	Natural Maple	D
Pinnacle	PINC	Pinnacle	PINC
Shaker Cherry	F	Shaker Cherry	F
Sterling Ash	LSA1	Sterling Ash	SA
Black	P	Black	P
Charcoal	S	Charcoal	S
Designer White	LDW1	Designer White	DW
Loft	LOFT	Loft	LOFT
Whitestone	K4	Muslin	T
Sheer Mesh	A5	Muslin	T
Silver Mesh	B9	Loft	LOFT
Steel Mesh	A9	Charcoal	S
Canyon Zephyr	K9	Greige	R
Desert Zephyr	K8	Greige	R
Shadow Zephyr	K1	Loft	LOFT
Gray	G2	Charcoal	S
Grey Tigris	L6	Greige	R
White	G1	Charcoal	S
Lowell Ash	LLA1	Lowell Ash	DL
Natural Recon	LNRI	Natural Recon	NR
Phantom Ecu	LPE1	Phantom Ecu	PE
Portico Teak	LPT1	Portico Teak	DP
Skyline Walnut	LSW1	Skyline Walnut	SW

* Available on Laptop Table only.

◆◆◆ For lead time information see page 19.

* De-emphasized

HUDDLE Multi-Purpose Tables

Huddle Multi-Purpose Tables are ready to jump into action for training, meetings, collaboration and more. Thoughtful design, flexibility and plenty of base, edge and finish options, make Huddle tables capable of meeting the needs of smart, agile businesses.

Tops - Rectangle

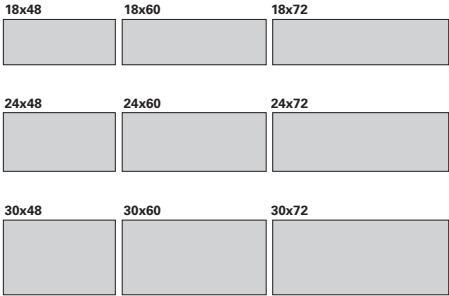

Edge Options

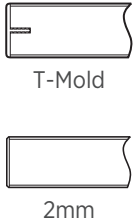

Tops - Half-Round and Extended Half-Round

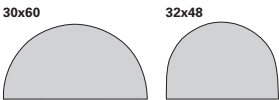

Bases

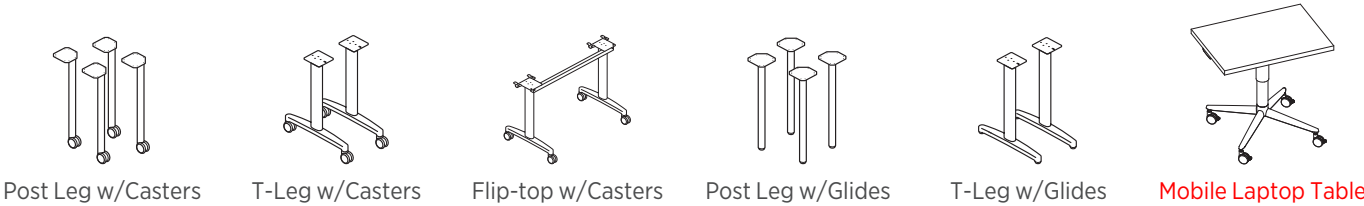

Accessories

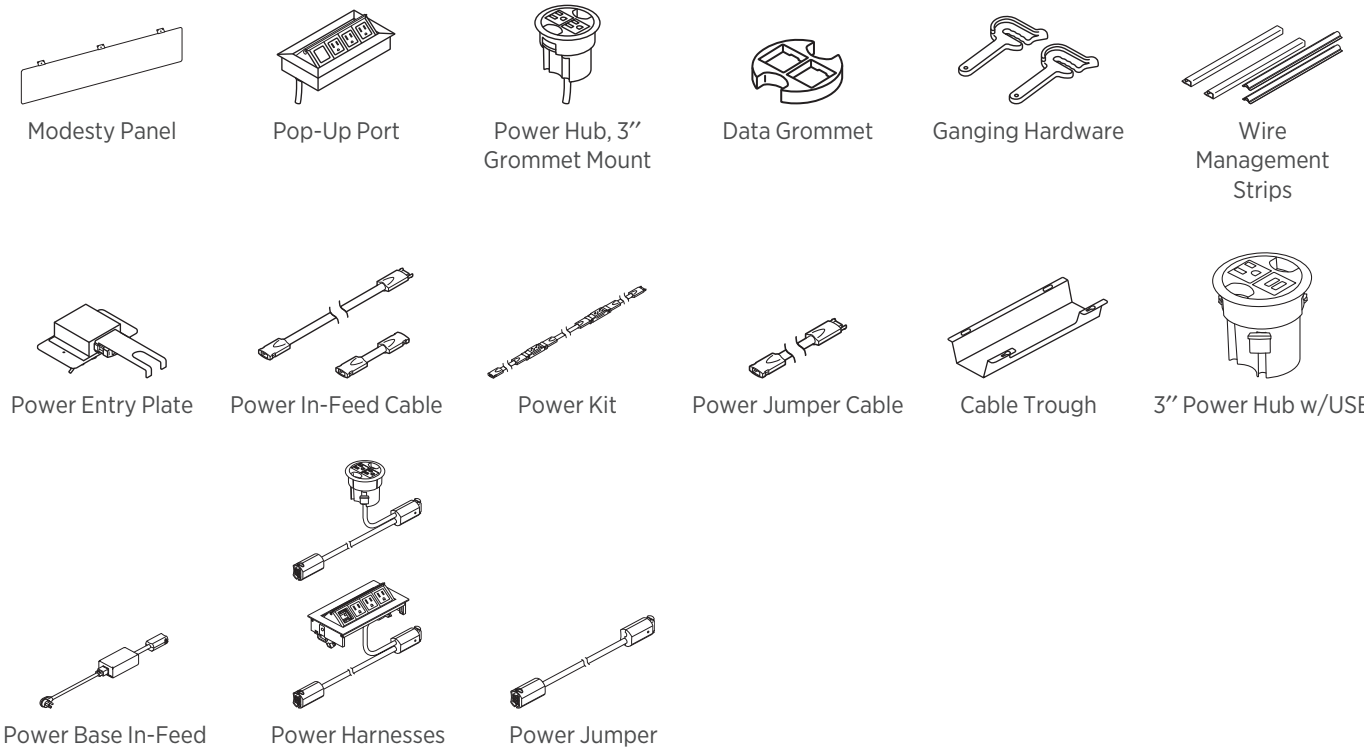

HUDDLE Typicals



Icon Legend on page 19

QTY	DESCRIPTION	MODEL	LIST PRICE	PRICE EXTENSION
12	Rectangular Table Top 60"W x 24"D	HMT2460G	\$389	\$4,668
12	Flip-top Base	HMBFLIP24L.C	\$626	\$7,512
21	Perpetual® Nesting Chair	HPN1	\$694	\$14,574
TOTAL:				\$26,754

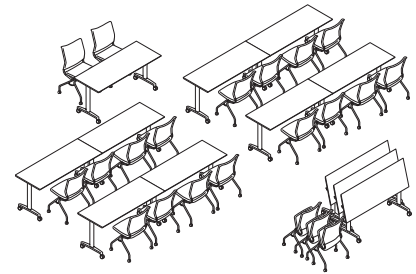

TRAINING

QTY	DESCRIPTION	MODEL	LIST PRICE	PRICE EXTENSION
4	Rectangular Table Top 72"W x 30"D	HMT3072G	\$458	\$1,832
4	Post Leg Base	HMBPOST	\$359	\$1,436
8	Perpetual® Nesting Chair	HPN1	\$694	\$5,552
TOTAL:				\$8,820

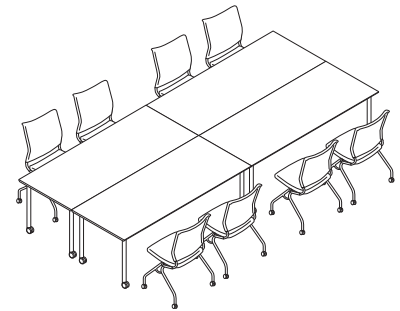

MEETING/CONFERENCE

QTY	DESCRIPTION	MODEL	LIST PRICE	PRICE EXTENSION
2	Rectangular Table Top 72"W x 30"D	HMT3072G	\$458	\$916
2	Half-round Table Top	HMTHR3060G	\$441	\$882
2	Flip-top Base	HMBFLIP30L	\$626	\$1,252
2	Flip-top Base	HMBFLIP24S	\$626	\$1,252
4	Perpetual® Nesting Chair	HPN1	\$694	\$2,776
TOTAL:				\$7,078

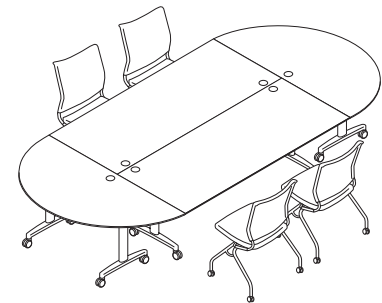

MEETING



Icon Legend on page 19

HUDDLE Typicals

QTY	DESCRIPTION	MODEL	LIST PRICE	PRICE EXTENSION
8	Rectangular Table Top 60"W x 30"D	HMT3060G	\$401	\$3,208
8	Fixed Height T-Leg Base with Casters	HMBTLEG24.C	\$426	\$3,408
8	Perpetual® Nesting Chair	HPN1	\$694	\$5,552
TOTAL:				\$12,168

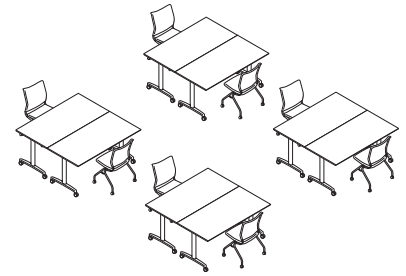

GROUP BREAKOUT

QTY	DESCRIPTION	MODEL	LIST PRICE	PRICE EXTENSION
6	Rectangular Table Top 72"W x 24"D	HMT2472G	\$430	\$2,580
6	Fixed Height T-Leg Base with Casters	HMBTLEG24.C	\$426	\$2,556
12	Perpetual® Nesting Chair	HPN1	\$694	\$8,328
TOTAL:				\$13,464

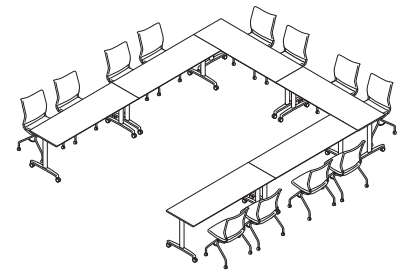

PRESENTATION

HUDDLE

Multi-Purpose Table Tops

GSA SIN 33721



Icon Legend on page 19

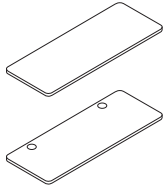

HMT1848E

DESCRIPTION

Rectangular T-Mold Table Tops

48"W x 18"D
60"W x 18"D
72"W x 18"D

48"W x 24"D
60"W x 24"D
72"W x 24"D

48"W x 30"D
60"W x 30"D
72"W x 30"D

MODEL

HMT1848E
HMT1860E
HMT1872E

HMT2448E
HMT2460E
HMT2472E

HMT3048E
HMT3060E
HMT3072E

SHIP WEIGHT CUBE

34 2.9
42 3.5
51 3.9

45 3.7
57 4.5
68 5.0

57 4.4
71 5.4
85 6.0

LIST PRICE BY LAMINATE GRADE

L1 L2

\$312 \$322
\$332 \$347
\$408 \$423

\$351 \$366
\$389 \$409
\$430 \$450

\$366 \$381
\$401 \$421
\$458 \$478

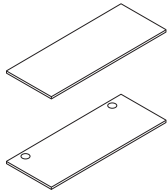

HMT1848G

Rectangular Edgeband Table Tops

48"W x 18"D
60"W x 18"D
72"W x 18"D

48"W x 24"D
60"W x 24"D
72"W x 24"D

48"W x 30"D
60"W x 30"D
72"W x 30"D

HMT1848G
HMT1860G
HMT1872G

HMT2448G
HMT2460G ⓘ
HMT2472G

HMT3048G
HMT3060G
HMT3072G

34 2.9
42 3.5
51 3.9

45 3.7
57 4.5
68 5.0

57 4.4
71 5.4
85 6.0

\$312 \$322
\$332 \$347
\$408 \$423

\$351 \$366
\$389 \$409
\$430 \$450

\$366 \$381
\$401 \$421
\$458 \$478

NOTES:



- Table tops are 1½" thick.
- When post legs are used with 18"D tops, post leg to be specified with glides only.
- ⓘ Round grommets available in Black only.
- ⓘ Pop-up Port option (G1) is unfinished. Insert accessory must be ordered separately.

HOW TO SPECIFY

<p>Select Model Number</p> <p>HMT1848G</p>	<p>Select Grommet Option</p> <p>N No Grommet G 2 Grommets (Black only) (\$30 upcharge) G1 Cutout for Pop-up Port (\$40 upcharge). Order port separately.</p> <p>N</p>	<p>Select Laminate</p> <p>See page 80</p> <p>D</p>	<p>Select Edge Color</p> <p>See page 80</p> <p>D</p>
---	---	---	---

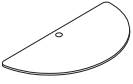

HUDDLE Multi-Purpose Table Tops

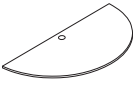
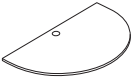
	DESCRIPTION	MODEL	SHIP WEIGHT	CUBE	LIST PRICE BY LAMINATE GRADE	
					L1	L2
 HMTHR3060E	Half-Round and Extended Half-Round T-Mold Table Tops 60"W x 30"D, Half-Round Table Tops (use bases: HMBFLIP24S or HMBTLEG24 or HMBPOST)	HMTHR3060E	69	6.1	\$441	\$461
	48"W x 32"D, Extended Half-Round Table Tops (use bases: HMBFLIP24S or HMBTLEG24)	HMTHR3248E	57	6.1	\$430	\$450
 HMTHR3248E	Half-Round and Extended Half-Round Edgeband Table Tops 60"W x 30"D, Half-Round Table Tops (use bases: HMBFLIP24S or HMBTLEG24 or HMBPOST)	HMTHR3060G	69	6.1	\$441	\$461
	48"W x 32"D, Extended Half-Round Table Tops (use bases: HMBFLIP24S or HMBTLEG24)	HMTHR3248G	57	6.1	\$430	\$450
 HMTHR3060G						
 HMTHR3248G						

NOTES:

- Table tops are 1½" thick.
- ⓘ Round grommets available in Black only.
- ⓘ Pop-up Port option (G1) is unfinished. Insert accessory must be ordered separately.

HOW TO SPECIFY

<p>Select Model Number</p> <p>H M T H R 3 2 4 8 G .</p>	<p>Select Grommet Option</p> <p>N No Grommet G 1 Grommet (Black only) (\$15 upcharge) G1 Cutout for Pop-up Port (\$40 upcharge). Order port separately.</p> <p>N .</p>	<p>Select Laminate</p> <p>See page 80</p> <p>D .</p>	<p>Select Edge Color</p> <p>See page 80</p> <p>D .</p>
--	--	---	---

HUDDLE

Multi-Purpose Table Bases

GSA SIN 33721



Icon Legend on page 19

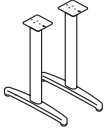

DESCRIPTION

Fixed Height T-Leg Base (Includes 2 T-legs)
 For 18"D Table Tops
 For 24"D and 30"D Table Tops

MODEL

HMBTLEG18
HMBTLEG24

SHIP WEIGHT

12
 14

CUBE

3.6
 3.6

LIST PRICE BY PAINT GRADE

P1	P2	P3
\$426	\$446	\$456
\$426	\$446	\$456



Flip-top Base (Includes 1 Complete Base)

For 18"D x 48"W Rectangular Table Tops
 For 18"D x 60"W, 72"W Rectangular Table Tops
 For 24"D x 48"W and 32"D x 48"W Rectangular Table Tops and 30"D x 60"W Half-Round Table Tops
 For 24"D x 60"W, 72"W Rectangular Table Tops
 For 30"D x 48"W Rectangular Table Tops
 For 30"D x 60"W, 72"W Rectangular Table Tops

HMBFLIP18S
HMBFLIP18L
HMBFLIP24S

HMBFLIP24L
HMBFLIP30S
HMBFLIP30L

23
 26
 24

 27
 24
 27

4.1
 4.1
 4.1

 4.1
 4.1
 4.1

P1	P2	P3
\$626	\$646	\$656
\$626	\$646	\$656
\$626	\$646	\$656
\$626	\$646	\$656
\$626	\$646	\$656
\$626	\$646	\$656

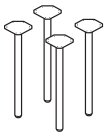

Post Leg Base (Includes 4 Post Legs)
 For all Tops

HMBPOST

18
 2.3

P1	P2	P3
\$359	\$379	\$389

Table Top to Base Compatibility Chart:

	Flip-Top	T-Leg	Post Leg
18"D x 48"W	HMBFLIP18S	HMBTLEG18	HMBPOST*
18"D x 60"W	HMBFLIP18L	HMBTLEG18	HMBPOST*
18"D x 72"W	HMBFLIP18L	HMBTLEG18	HMBPOST*
24"D x 48"W	HMBFLIP24S	HMBTLEG24	HMBPOST
32"D x 48"W HR	HMBFLIP24S	HMBTLEG24	N/A
30"D x 60"W HR	HMBFLIP24S	HMBTLEG24	HMBPOST
24"D x 60"W	HMBFLIP24L	HMBTLEG24	HMBPOST
24"D x 72"W	HMBFLIP24L	HMBTLEG24	HMBPOST
30"D x 48"W	HMBFLIP30S	HMBTLEG24	HMBPOST
30"D x 60"W	HMBFLIP30L	HMBTLEG24	HMBPOST
30"D x 72"W	HMBFLIP30L	HMBTLEG24	HMBPOST

*Post legs should be specified with glides for use on 18"D worksurfaces.
 NOTE: Glides/casters are NOT interchangeable on Post Leg and T-base.

NOTES:

- When glides are specified, adjustable range is 1".
- Flip-top base is standard with casters.
- When post legs are used with 18"D tops, post leg to be specified with glides only.



HOW TO SPECIFY

<p>Select Model Number</p> <p>H M B T L E G 1 8</p>	<p>Select Glide/Caster Option</p> <p>G Glide C Caster</p> <p>Flip-top base is available with casters only When post legs are used with 18"D tops, specify with glides only</p> <p>G</p>	<p>Select Paint Color</p> <p>See page 80 \$20 upcharge per model, for P2 paint \$30 upcharge per model, for P3 paint</p> <p>T 1</p>
--	--	--



Icon Legend on page 19

HUDDLE Mobile Laptop Table

	DESCRIPTION	MODEL	SHIP WEIGHT	CUBE	LIST PRICE	UPCHARGE BY LAMINATE/PAINT GRADE			
						L2	L5	P2	P3
	T-Mold 28"W x 20"D	HPHAP2028E	59	8.7	\$809	\$20	\$80	\$20	\$30
	Edgeband 28"W x 20"D	HPHAP2028G	59	8.7	\$809	\$20	\$80	\$20	\$30

NOTES:

- Tables adjust from 26"-33"H.
- Pneumatic height adjustment so no electricity is required to adjust height of table.

HOW TO SPECIFY

<p>Select Model Number</p> <p>HPHAP2028E</p>	<p>Select Laminate</p> <p>See page 80</p> <p>LFW1</p>	<p>Select Edge Color</p> <p>See page 80</p> <p>FW</p>	<p>Select Paint Color</p> <p>See page 80</p> <p>P8T</p>
---	--	--	--



HUDDLE

Table Accessories

GSA SIN 33721

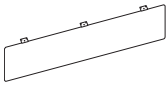

Icon Legend on page 19

	DESCRIPTION	MODEL	SHIP WEIGHT	CUBE	LIST PRICE BY PAINT GRADE		
					P1	P2	P3
	Universal Modesty Panel						
	For 48"W Huddle Tables For 60"W & 72"W Huddle Tables	HMTUMOD32 HMTUMOD44	9 12	1.9 2.5	\$214 \$234	\$234 \$254	\$244 \$264
	NOTES: Universal Modesty Panels nest between the table legs.						
	Ganging Hardware	HMAGANG	1 	0.1	\$94		
	<ul style="list-style-type: none"> Includes two ganging links and two screws No color designator when specifying. <i>Example: HMAGANG.</i> 						

NOTES:

- Ganging Hardware must be ordered and installed on tables when using 4-trac electrical systems.
- Ganging hardware attaches to underside of table in pre-drilled pilot holes.
- Vertical Wire Management Strips must be trimmed when applied to legs of T-Leg and Flip-Top Bases with casters.







HOW TO SPECIFY

Select Model Number	Select Paint Color
H M T U M O D 3 2 .	See page 98
	S

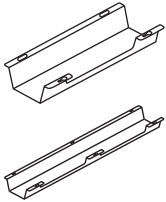
GSA SIN AS NOTED

CABLE MANAGEMENT

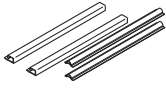
Icon Legend on page 19

	DESCRIPTION	MODEL	SHIP WEIGHT	CUBE	LIST PRICE
	Cable Management Troughs				
	17"W — Single 17"W — 10-Pack 36"W — Single 36"W — 10-Pack	HCTROUGH17 HCTROUGH1710 HCTROUGH36 HCTROUGH3610	3  14  5  30 	0.5 0.5 0.9 0.9	\$67 \$620 \$113 \$1045
	<ul style="list-style-type: none"> Metal Cable Management Troughs ship flat Troughs attach to underside of worksurface with screws Cutouts in trough allow access to power without the need to detach from surface. 17"W = 1 cutout; 36"W = 2 cutouts. Graphite only, no need to specify Slim profile design 				
	NOTES: For additional information see page 240.				
	Wire Management Strips	HBTMS	3 	0.2	\$119
	Includes: 2 - 24" vertical strips 2 - 24" horizontal strips <ul style="list-style-type: none"> Available in Black only. <i>Specify P when ordering. Example: HBTMS.P.</i> HON 5-Year Limited Warranty. 				

HOW TO SPECIFY

Select Model Number
H C T R O U G H 1 7

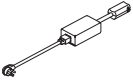
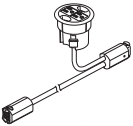
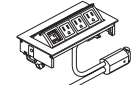
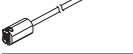
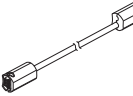
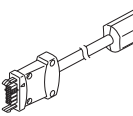

INTERLINK IQ ELECTRICAL

	DESCRIPTION	MODEL	SHIP WEIGHT	CUBE	LIST PRICE
	Power Base In-Feed • 12 amp circuit breaker is built in to the Power Base In-Feed. • Available in Black finish, no specification needed.	HQB	2	0.2	\$525
	Power Harness – 1’ Power Hub, 3” Round Grommet Mount • Available in Black finish, no specification needed.	HQH1-3	2	0.2	\$172
	Power Harness – 5’ Power Hub, 3” Round Grommet Mount • Available in Black finish, no specification needed.	HQH5-3	2	0.2	\$193
	Power Harness – 5’ with 4” x 8” Pop-Up Port (3 Power, 1 Blank) • For use with tables G1 grommet. Specify paint.	HQH5-P-3P1B	3	0.3	\$378
	Power Jumper – 3’ • Available in Black finish, no specification needed.	HQJ3	2	0.2	\$107
	IQ 1.0 Backward Compatible Jumper 36” • Available in Black finish, no specification needed. • Use when connecting Interlink IQ 1.0 power harness (rectangle end) to Interlink IQ 2.0 (oval end) power harness. ! If using Interlink IQ 2.0 in-feed with Interlink IQ 1.0 power harness please contact Customer Support.	HQBCJ36	2	0.2	\$82

Specification guide for IQ Electrical on Huddle tables

Determine table width, the type of power access being used (3” grommet or 4x8 pop-up) and the desired number per table (Columns 1, 2 or 3). The table will then identify the type and quantity of components needed per table along with the maximum table run. Note that this is in addition to the Power base in-feed which is needed for each run. For example, a 48”W table with two 3” power grommets per table will require (1) HQH5-3 harness and (1) HQH1-3 harness per table with a maximum run of four tables.

Top Width	POWER ONE (1) PER TABLE 3” ROUND POWER GROMMET		POWER TWO (2) PER TABLE 3” ROUND POWER GROMMETS		POWER ONE (1) PER TABLE 4x8 POP-UP PORT	
	36”	(1) HQH5-3	8 Table Run Maximum	N/A	N/A	(1) HQH5-P
42”	(1) HQH5-3	8 Table Run Maximum	N/A	N/A	(1) HQH5-P	8 Max Table Run
48”	(1) HQH5-3	8 Table Run Maximum	(1) HQH5-3 (1) HQH1-3	4 Max Table Run	(1) HQH5-P	8 Max Table Run
54”	(1) HQH5-3	8 Table Run Maximum	(1) HQH5-3 (1) HQH1-3	4 Max Table Run	(1) HQH5-P	8 Max Table Run
60”	(1) HQH5-3	8 Table Run Maximum	(1) HQH5-3 (1) HQH1-3	4 Max Table Run	(1) HQH5-P	8 Max Table Run
66”	(1) HQH5-3 (1) HQJ3	4 Table Run Maximum	(1) HQH5-3 (1) HQH1-3	4 Max Table Run	(1) HQH5-P (1) HQJ3	4 Max Table Run
72”	(1) HQH5-3 (1) HQJ3	4 Table Run Maximum	(1) HQH5-3 (1) HQH1-3	4 Max Table Run	(1) HQH5-P (1) HQJ3	4 Max Table Run
84”	(1) HQH5-3 (1) HQJ3	4 Table Run Maximum	(2) HQH5-3	4 Max Table Run	(1) HQH5-P (1) HQJ3	4 Max Table Run
96”	(1) HQH5-3 (1) HQJ3	4 Table Run Maximum	(2) HQH5-3	4 Max Table Run	(1) HQH5-P (1) HQJ3	4 Max Table Run
Half-Round (all sizes)	(1) HQH1-3	2 Tables Maximum	N/A	N/A	(1) HQH5-P	2 Max Table Run
Trapezoid (all sizes)	(1) HQH5-3	8 Table Run Maximum	N/A	N/A	(1) HQH5-P	8 Max Table Run

NOTES:

- Interlink IQ Electrical is a pluggable, single circuit electrical system.
- All electrical models include wire management clips and hardware.
- Interlink IQ Electrical is non-sequential/non-directional. It can be installed in any direction.
- Interlink IQ Electrical is UL Recognized as a Powered Table System and meets the requirements of UL 962.

! 40’ maximum run, or no more than 8 units, whichever comes first. Interlink IQ system will automatically shut off if maximum requirements are exceeded. Maximum run is based upon electrical harness width, not table width.

HOW TO SPECIFY

Select Model Number HQH5-P-3P1B	Select Paint Color FOG Fog SVR Silver BLK Black SVR
---	--

4-TRAC HARDWIRE ELECTRICAL SYSTEM

4-Trac Electrical System

The 4-Trac Electrical System is a UL-recognized Manufactured Wiring System that seamlessly passes power from one worksurface to another. This low-profile non-sequential electrical system allows tables to be “daisy-chained” together in any desired order and allows users to reconfigure quickly due to simple connectable/disconnectable links.

- Meets requirements of UL 183 and National Electric Code Article 604
- 4-Wires, 2-circuits, 20 Amps each (Circuit 1 and Circuit 2 only)
- 13 Duplex Receptacles per circuit, 26, 15 Amp Duplex receptacle per power in-feed
- Electrical system attaches directly to underside of worksurface with included brackets
- Up to twelve tables can be linked together

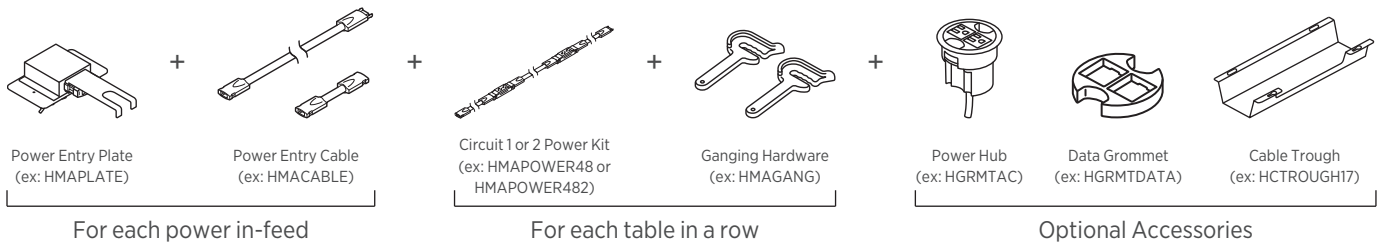

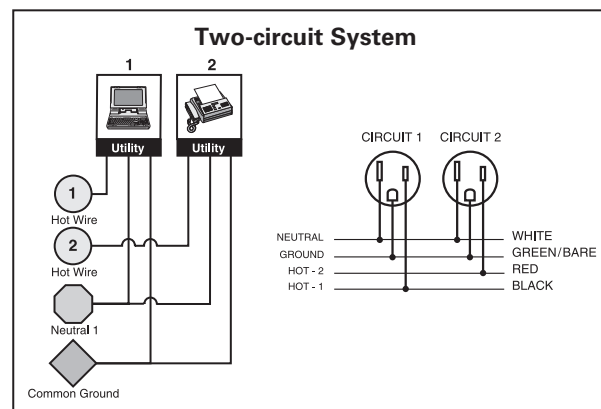
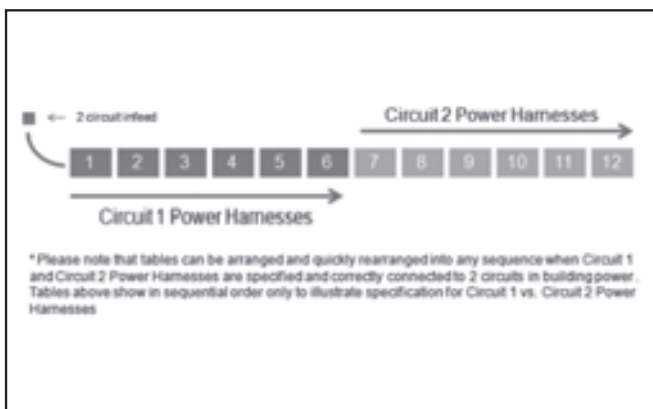

Steps for Electrical Specifications:

- Determine how many rows of tables are needed and order the following:
 - One HMAPLATE per row (or power in-feed)
 - One HMAPOWER48 per row (or power in-feed)
- Order one power harness per table in each row
 - For 1-6 tables in a row (see illustration 1)
 - Order Circuit 1 Power Harnesses (ex. If powering six 24x60 tables order six sets of HMAPOWER60)
 - For 7-12 tables in a row (see illustration 1)
 - Order Circuit 1 Power Harness for first six tables and Circuit 2 Power Harness for remaining tables (ex. If powering eight 24x60 tables, order six sets of HMAPOWER60 and two sets of HMAPOWER602)
- Order one set of ganging hardware per table (ex. HMAGANG)
- Determine which accessories are needed:
 - Power Hub model HGRMTAC — to access power at worksurface.
 - Data Grommet model HGRMTDATA — to access data at worksurface.
 - Wire Management strips model HBTMS — for vertical and horizontal wire management.

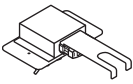
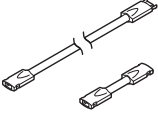

4-TRAC HARDWIRE ELECTRICAL SYSTEM

	DESCRIPTION	MODEL	SHIP WEIGHT	CUBE	LIST PRICE
	Power Entry Plate	HMAPLATE	1.0	0.2	\$94
	Power Entry Cable • 6' power entry cable with male/female adapter. • Connects table to power entry plate.	HMACABLE	1.8	0.2	\$147
	Power Jumper Cable To connect tables front to front	HMAJUMP	0.5	0.3	\$50
	Circuit 1 Power Kit for 48" W Table	HMAPOWER48	1.8	0.3	\$272
	Circuit 1 Power Kit for 60" W Table	HMAPOWER60	2.0	0.3	\$280
	Circuit 1 Power Kit for 72" W Table	HMAPOWER72	2.2	0.3	\$286
	Circuit 1 Power Kit for 84" W Table	HMAPOWER84	2.4	0.3	\$297
	Circuit 1 Power Kit for 96" W Table	HMAPOWER96	2.6	0.3	\$306
	Circuit 2 Power Kit for 48" W Table	HMAPOWER482	1.8	0.3	\$272
	Circuit 2 Power Kit for 60" W Table	HMAPOWER602	2.0	0.3	\$280
	Circuit 2 Power Kit for 72" W Table	HMAPOWER722	2.2	0.3	\$286
	Circuit 2 Power Kit for 84" W Table	HMAPOWER842	2.4	0.3	\$297
	Circuit 2 Power Kit for 96" W Table	HMAPOWER962	2.6	0.3	\$306

NOTES:

- Ganging Hardware must be ordered and installed on tables when using 4-trac electrical systems. See page 88 for Ganging Hardware.
- Each power kit includes two duplex receptacles and attaches to the underside of the worksurface with included brackets.

HOW TO SPECIFY

Select
Model Number

H M A P L A T E









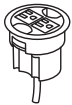
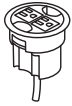

HUDDLE

Power and Cable Management

GSA SIN AS NOTED

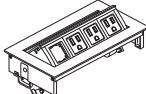
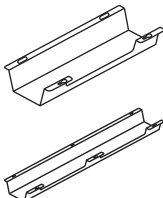

Icon Legend on page 19

	DESCRIPTION	MODEL	SHIP WEIGHT	CUBE	LIST PRICE
 SIN 33721T	Power Hub, 3" Grommet Mount, 6' Cord <ul style="list-style-type: none"> Fits in 3" round grommet holes. Field installed with Plug-and-play ease. Two grounded AC power outlets. Includes 6' cord with three-prong plug. Available in Black only. <i>Specify X when ordering. Example: HGRMTAC.X.</i> NOTES: For additional information see page 236.	HGRMTAC	1.3	0.2	\$116
 SIN 33721T	3" Round Power Grommet - 2 Outlets, 10' Cord <ul style="list-style-type: none"> Includes 10' cord with three-prong plug. Fits in 3" round grommet holes. Two grounded AC power outlets. Field installed with Plug-and-play ease. NOTES: Power Modules will also work with standing-height applications for 10500 Series™ and Voi® desks.  Available in black finish only, no specification needed.	HGRMTAC2	1.5	0.2	\$148
 SIN 33721T	Power/USB Hub, 3" Grommet Mount <ul style="list-style-type: none"> One grounded AC power outlet with 2 USB ports. UL Listed. NOTES: For additional information see page 236.  Available in black only (no color designation so use .X - Specify: HGRMTUSB2.X).	HGRMTUSB2	1.3 	0.2	\$226
 SIN 33721	Data Grommet <p>Blank grommet kit that includes adapters for a variety of manufacturers jacks and couplers.</p> <ul style="list-style-type: none"> Fits in existing 3" round grommet housing. Available in Black only. <i>Specify P when ordering. Example: HGRMTDATA.P.</i> NOTES: For additional information see page 236.	HGRMTDATA	0.2	0.2	\$20
 SIN 33721	MhoB 4" x 8" Pop-up Port <ul style="list-style-type: none"> Specify G1 cutout in table top. Pop-up Port provides three power ports and one blank data receptacle. Sits flush with worksurface when closed. Includes 6' cord with three-prong plug. 	HTG1PWR-3P-1B	5.0	0.3	\$396
 SIN 33721	Cable Management Troughs <p>17"W - Single 17"W - 10-Pack 36"W - Single 36"W - 10-Pack</p> <ul style="list-style-type: none"> Cable management troughs ship flat packed. The troughs attach to underneath the worksurface with screws. Cutouts in trough allow access to power without the need to detach from surface. 17"W = 1 cutout; 36"W = 2 cutouts. Color: Graphite. NOTES: For additional information see page 240.	HCTROUGH17 HCTROUGH1710 HCTROUGH36 HCTROUGH3610	2.7  14.0  4.9  30.0 	0.5 0.5 0.9 0.9	\$67 \$620 \$113 \$1045

HOW TO SPECIFY

Select Model Number

HGRMTAC

Select Model Number

HTG1PWR-3P-1B

Select Paint Color

FOG Fog
SVR Silver
BLK Black

SVR

OCCASIONAL TABLES



Occasional Tables shown with Ceres® Seating.

OCCASIONAL TABLES

Durable materials and construction make HON Occasional Tables ideal for high-traffic areas such as lobbies, reception areas and lounges. The versatile design also dresses up any corner of the executive office where casual, but important, conversations are held. Use them to hold lamps, magazines and more. They're available in 14 woodgrain, patterned or solid color laminates to coordinate with any decor.



FEATURES

- A high-quality solution for any organization wanting to make a great impression on clients and visitors.
- Scratch-, spill- and stain-resistant laminate stands up to heavy use.
- Heavy-grade, warp-resistant particleboard features high recycled content.
- Complement many interiors and furniture designs.
- Brings people together comfortably in reception areas, lounges and offices.

LAMINATE OCCASIONAL TABLES OPTIONS

H80191, H80192, H80193

L1 LAMINATES CODES

Woodgrain

- ◆ Bourbon Cherry H
- ◆ Cognac COGN
- ◆ Florence Walnut LFW1
- ◆ Harvest C
- ◆ Kingswood Walnut LK11
- ◆ Mahogany N
- ◆ Mocha MOCH
- ◆ Natural Maple D
- ◆ Pinnacle PINC
- ◆ Shaker Cherry F
- ◆ Sterling Ash LSA1

Solid

- ◆ Black P
- ◆ Charcoal S
- ◆ Designer White LDW1
- ◆ Loft LOFT

Patterned Top*

- ◆ Canyon Zephyr K9
- ◆ Desert Zephyr K8
- ◆ Grey Tigris L6
- ◆ Sheer Mesh A5
- ◆ Silver Mesh A9

H80170, H80180

L1 LAMINATES CODES

Woodgrain

- ◆ Bourbon Cherry H
- ◆ Cognac COGN
- ◆ Florence Walnut LFW1
- ◆ Harvest C
- ◆ Kingswood Walnut LK11
- ◆ Mahogany N
- ◆ Mocha MOCH
- ◆ Natural Maple D
- ◆ Pinnacle PINC
- ◆ Shaker Cherry F
- ◆ Sterling Ash LSA1

Solid

- ◆ Black P
- ◆ Charcoal S
- ◆ Designer White LDW1
- ◆ Loft LOFT

Two-Tone Options for Laminate Occasional Tables (H80191, H80192 and H80193)







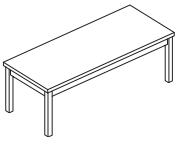

Black/Charcoal (PS)	Harvest/Black (CP)
Black/Designer White (PLDW1)	Harvest/Charcoal (CS)
Bourbon Cherry/Black (HP)	Harvest/Designer White (CLDW1)
Bourbon Cherry/Charcoal (HS)	Kingswood Walnut/Black (LK11P)
Bourbon Cherry/Designer White (HLDW1)	Kingswood Walnut/Charcoal (LK11S)
Charcoal/Black (SP)	Kingswood Walnut/Designer White (LK11LDW1)
Charcoal/Designer White (SLDW1)	Kingswood Walnut/Loft (LK11LOFT)
Cognac/Black (COGNP)	Mahogany/Black (NP)
Cognac/Charcoal (COGNS)	Mahogany/Charcoal (NS)
Cognac/Designer White (COGNLDW1)	Mahogany/Designer White (NLDW1)
Designer White/Black (LDW1P)	Mocha/Black (MOCHP)
Designer White/Bourbon Cherry (LDW1H)	Mocha/Charcoal (MOCHS)
Designer White/Charcoal (LDW1S)	Mocha/Designer White (MOCHLDW1)
Designer White/Cognac (LDW1COGN)	Natural Maple/Black (DP)
Designer White/Harvest (LDW1C)	Natural Maple/Charcoal (DS)
Designer White/Mahogany (LDW1N)	Natural Maple/Designer White (DLDW1)
Designer White/Mocha (LDW1MOCH)	Pinnacle/Black (PINCP)
Designer White/Natural Maple (LDW1D)	Pinnacle/Charcoal (PINCS)
Designer White/Pinnacle (LDW1PINC)	Pinnacle/Designer White (PINCLDW1)
Designer White/Shaker Cherry (LDW1F)	Shaker Cherry/Black (FP)
Florence Walnut/Black (LFW1P)	Shaker Cherry/Charcoal (FS)
Florence Walnut/Charcoal (LFW1S)	Shaker Cherry/Designer White (FLDW1)
Florence Walnut/Designer White (LFW1LDW1)	Sterling Ash/Black (LSA1P)
Florence Walnut/Loft (LFW1LOFT)	Sterling Ash/Charcoal (LSA1S)
	Sterling Ash/Designer White (LSA1LDW1)

* NOTE: For patterned top laminates, select one of the following for the edgeband around the top, apron, and legs — Black (P), Bourbon Cherry (H), Charcoal (S), Cognac (COGN), Designer White (LDW1), Florence Walnut (LFW1), Harvest (C), Kingswood Walnut (LK11), Mahogany (N), Mocha (MOCH), Natural Maple (D), Pinnacle (PINC), Shaker Cherry (F), Sterling Ash (LSA1).

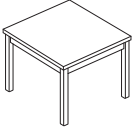
◆◆◆ For lead time information see page 19.

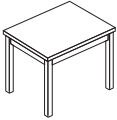
LAMINATE

Occasional Tables

	DESCRIPTION	MODEL	SHIP WEIGHT	CUBE	LIST PRICE
 	Coffee Table 48"W x 20"D x 16"H	H80191	48 	3.4	\$486
 	Corner Table 24"W x 24"D x 20"H	H80192	35 	2.1	\$419
 	End Table 24"W x 20"D x 20"H	H80193	29 	1.8	\$400
	Cylinder Table 20" Diameter x 20"H	H80170	40	6.2	\$655
	Cube Table 24"W x 24"D x 20"H	H80180	55	8.6	\$709

NOTES:

- Durable material and construction make laminate occasional tables ideal for high traffic areas such as lobbies, reception rooms and lounges. Versatile design is also well suited to private offices.
- Coffee, Corner and End Tables feature top-over-apron styling with square corner detail, which complements many interiors and furniture designs, including the 10500 Series.
- Tables accommodate lamps, magazines, plants, laptops and more.
- Tops are abrasion- and stain-resistant laminate over 1½" thick solid core high-performance particleboard.
- Cylinder and cube tables have recessed black plinth base with tack glides. Tops and sides are covered with high-pressure laminate.

H80191, H80192, H80193
Edge Detail**HOW TO SPECIFY**

Select Model Number H 8 0 1 9 1 .	Select Laminate See page 94 for Select Laminate noted with each model N N
---	--

LAMINATE

Contemporary Occasional Tables

OPEN MARKET



Icon Legend on page 19

**DESCRIPTION**

Laminate Corner Table
24"W x 24"D x 17½"H

MODEL

HML8851

SHIP WEIGHT

24

CUBE

1.7

LIST PRICE

\$201

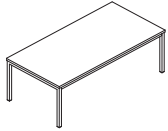

Laminate Coffee Table
48"W x 24"D x 15½"H

HML8852

38

3.1

\$251

NOTES:

- Silver frame.
- **HON 5-Year Limited Warranty.**
- ! Metal leg occasional tables available in Black laminate ONLY.

HOW TO SPECIFY**Select Model Number**

H M L 8 8 5 1 .

Select Laminate

P Black

P

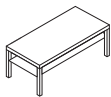
**DESCRIPTION**

Coffee Table
42"W x 20"D x 16"H

MODEL

HBLH3160

SHIP WEIGHT

24

CUBE

3.0

LIST PRICE

\$298

**DESCRIPTION**

Corner Table
24"W x 24"D x 20"H

HBLH3170

9

1.7

\$232

NOTES:

Square
Edge Detail
(Laminate)



- **HON 5-Year Limited Warranty.**
- Ideal for reception areas, lounges and offices.
- Laminate tops have a hollow core honeycomb substructure, making them extremely light weight.
- 2" thick top.
- Sleek contemporary design.
- Models HBLH3160 and HBLH3170 available in Black finish only.

HOW TO SPECIFY**Select Model Number**

H B L H 3 1 6 0 .

Select Laminate

P Black

P

MOTIVATE®



Motivate® Tables and Chairs with Voi® Desks.

MOTIVATE®

Motivate tables were designed with flexible spaces in mind. Work patterns can change throughout the day. Task areas become collaborative areas. Learning areas become conference areas. Created for HON by designer Wolfgang Deisig, Motivate tables are mobile, lightweight and ready to support the many ways you work — adapting and reacting to your needs with ease. Because flexible spaces make for dynamic workplaces.



FEATURES

- 1½" thick solid core top is made from durable high-performance particleboard.
- Motivate Tables are available in three base options — fixed, nesting and height adjustable.
- Optional modular power can be ganged together without any tools.
- Motivate Tables coordinate perfectly with Motivate chairs — an ideal fit for flexible spaces.

MOTIVATE® TABLES SPECIFYING INFORMATION

LAMINATE

L1 LAMINATES CODES

- Woodgrain**
- ◆ Bourbon Cherry **H**
 - ◆ Cognac **COGN**
 - ◆ Florence Walnut **LFW1**
 - ◆ Harvest **C**
 - ◆ Kingswood Walnut **LK11**
 - ◆ Mahogany **N**
 - ◆ Mocha **MOCH**
 - ◆ Natural Maple **D**
 - ◆ Pinnacle **PINC**
 - ◆ Shaker Cherry **F**
 - ◆ Sterling Ash **LSA1**
- Solid**
- ◆ Black **P**
 - ◆ Charcoal **S**
 - ◆ Designer White **LDW1**
 - ◆ Loft **LOFT**
- Patterned**
- ◆ Sheer Mesh **A5**
 - ◆ Silver Mesh **B9**
 - ◆ Steel Mesh **A9**
 - ◆ Canyon Zephyr **K9**
 - ◆ Desert Zephyr **K8**
 - ◆ Shadow Zephyr **K1**
 - ◆ Gray **G2**
 - ◆ White **G1**
 - ◆ Whitestone **K4**

L2 LAMINATES CODES

- Woodgrain**
- ◆ Lowell Ash **LLA1**
 - ◆ Natural Recon **LNR1**
 - ◆ Phantom Ecu **LPE1**
 - ◆ Portico Teak **LPT1**
 - ◆ Skyline Walnut **LSW1**

EDGE BAND

EDGE BAND 2mm CODES

- ◆ Black **P**
- ◆ Bourbon Cherry **H**
- ◆ Charcoal **S**
- ◆ Cognac **COGN**
- ◆ Designer White **DW**
- ◆ Florence Walnut **FW**
- ◆ Greige **R**
- ◆ Harvest **C**
- ◆ Kingswood Walnut **KI**
- ◆ Loft **LOFT**
- ◆ Lowell Ash **DL**
- ◆ Mahogany **N**
- ◆ Mocha **MOCH**
- ◆ Muslin **T**
- ◆ Natural Maple **D**
- ◆ Natural Recon **NR**
- ◆ Phantom Ecu **PE**
- ◆ Pinnacle **PINC**
- ◆ Platinum **K**
- ◆ Portico Teak **DP**
- ◆ Shadow * **SHDW**
- ◆ Shaker Cherry **F**
- ◆ Skyline Walnut **SW**
- ◆ Sterling Ash **SA**

ERGO

ERGO-EDGE CODES

- ◆ Black **P**
- ◆ Platinum **K**

PAINT

PAINT CODES

- P1**
- ◆ Black **P**
 - ◆ Brownstone **P7D**
 - ◆ Charcoal **S**
 - ◆ Designer White **PJW**
 - ◆ Fossil **P28**
 - ◆ Greige **T5**
 - ◆ Loft **LOFT**
 - ◆ Muslin **T3**
 - ◆ Putty **L**
 - ◆ Textured Black **BLCK**
 - ◆ Titanium **P8T**
- P2**
- ◆ Champagne Metallic **T4**
 - ◆ Platinum Metallic **T1**
 - ◆ Silver **PR6**
 - ◆ Solar Black **P8X**
 - ◆ Textured Platinum Metallic **PLAT**
 - ◆ Textured Silver **PR8**
- P3**
- ◆ Atom **P8S**
 - ◆ Bullseye **PJF**
 - ◆ Ember **P8P**
 - ◆ Ion **P8N**
 - ◆ Iris **P8J**
 - ◆ Krypton **P8F**
 - ◆ Regatta **P8M**

Recommended Edgeband Color Selection:





Laminate		Edgeband	
Bourbon Cherry	H	Bourbon Cherry	H
Cognac	COGN	Cognac	COGN
Florence Walnut	LFW1	Florence Walnut	FW
Harvest	C	Harvest	C
Kingswood Walnut	LK11	Kingswood Walnut	KI
Mahogany	N	Mahogany	N
Mocha	MOCH	Mocha	MOCH
Natural Maple	D	Natural Maple	D
Pinnacle	PINC	Pinnacle	PINC
Shaker Cherry	F	Shaker Cherry	F
Sterling Ash	LSA1	Sterling Ash	SA
Black	P	Black	P
Charcoal	S	Charcoal	S
Designer White	LDW1	Designer White	DW
Whitestone	K4	Muslin	T
Sheer Mesh	A5	Muslin	T
Silver Mesh	B9	Loft	LOFT
Steel Mesh	A9	Charcoal	S
Canyon Zephyr	K9	Greige	R
Desert Zephyr	K8	Greige	R
Shadow Zephyr	K1	Loft	LOFT
Gray	G2	Charcoal	S
White	G1	Charcoal	S
Lowell Ash	LLA1	Lowell Ash	DL
Natural Recon	LNR1	Natural Recon	NR
Phantom Ecu	LPE1	Phantom Ecu	PE
Portico Teak	LPT1	Portico Teak	DP
Skyline Walnut	LSW1	Skyline Walnut	SW
Loft	LOFT	Loft	LOFT

◆◆◆ For lead time information see page 19.
* De-emphasized



Icon Legend on page 19

MOTIVATE® Fixed Height Tables

DESCRIPTION	MODEL	SHIP WEIGHT	CUBE	LIST PRICE BY LAMINATE GRADE				
				"G" 2MM EDGE		"R" ERGO EDGE		
				L1	L2	L1	L2	
Rectangular Tables, Fixed Base								
 72"W x 18"D	HMVR-1872(?) -FX	80	6.6	\$950	\$965	\$1259	\$1274	
60"W x 18"D	HMVR-1860(?) -FX	70	6.0	\$874	\$889	\$1142	\$1157	
48"W x 18"D	HMVR-1848(?) -FX	54	5.3	\$866	\$876	\$1106	\$1116	
 96"W x 24"D	HMVR-2496(?) -FX	118	8.8	\$1217	\$1242	N/A	N/A	
84"W x 24"D	HMVR-2484(?) -FX	109	8.1	\$1167	\$1192	N/A	N/A	
72"W x 24"D	HMVR-2472(?) -FX	96	7.3	\$970	\$990	\$1295	\$1315	
66"W x 24"D	HMVR-2466(?) -FX	90	7.3	\$951	\$971	N/A	N/A	
60"W x 24"D	HMVR-2460(?) -FX	83	6.6	\$930	\$950	\$1223	\$1243	
54"W x 24"D	HMVR-2454(?) -FX	71	6.6	\$911	\$931	N/A	N/A	
48"W x 24"D	HMVR-2448(?) -FX	65	5.8	\$892	\$907	\$1155	\$1170	
42"W x 24"D	HMVR-2442(?) -FX	60	5.4	\$872	\$887	N/A	N/A	
36"W x 24"D	HMVR-2436(?) -FX	54	5.1	\$857	\$872	N/A	N/A	
96"W x 30"D	HMVR-3096(?) -FX	145	10.7	\$1317	\$1342	N/A	N/A	
84"W x 30"D	HMVR-3084(?) -FX	131	10.7	\$1305	\$1330	N/A	N/A	
72"W x 30"D	HMVR-3072(?) -FX	115	9.8	\$1057	\$1077	\$1401	\$1421	
66"W x 30"D	HMVR-3066(?) -FX	108	9.8	\$1027	\$1047	N/A	N/A	
60"W x 30"D	HMVR-3060(?) -FX	100	8.9	\$1002	\$1022	\$1318	\$1338	
54"W x 30"D	HMVR-3054(?) -FX	87	8.9	\$982	\$1002	N/A	N/A	
48"W x 30"D	HMVR-3048(?) -FX	80	7.9	\$968	\$983	\$1246	\$1261	
42"W x 30"D	HMVR-3042(?) -FX	73	7.4	\$946	\$961	N/A	N/A	
36"W x 30"D	HMVR-3036(?) -FX	65	6.9	\$926	\$941	N/A	N/A	
72"W x 36"D	HMVR-3672(?) -FX	131	10.8	\$1210	\$1235	N/A	N/A	
60"W x 36"D	HMVR-3660(?) -FX	114	9.7	\$1122	\$1147	N/A	N/A	
48"W x 36"D	HMVR-3648(?) -FX	91	9.7	\$1049	\$1069	N/A	N/A	
Half-Round Tables, Fixed Base								
 72"W x 36"D	HMVH-3672(?) -FX	103	10.8	\$1260	\$1285	N/A	N/A	
60"W x 30"D	HMVH-3060(?) -FX	75	7.6	\$982	\$1007	\$1318	\$1343	
48"W x 24"D	HMVH-2448(?) -FX	56	5.8	\$918	\$938	\$1201	\$1221	
Trapezoid Tables, Fixed Base								
 72"W x 36"D	HMVT-3672(?) -FX	91	10.8	\$1281	\$1306	N/A	N/A	
60"W x 30"D	HMVT-3060(?) -FX	66	7.6	\$992	\$1017	\$1333	\$1358	
48"W x 24"D	HMVT-2448(?) -FX	56	5.8	\$936	\$956	\$1222	\$1242	

NOTES:

- Specification includes top and base, however, top and base are boxed separately.
- Ergo edge is a bullnose on user side and 3mm on all other sides.
- Tops are 1½" thick.
- Fixed Height base is standard 29½" seated-height.
- See grommet matrix on page 104 for grommet location/placement.
- 36"-42" tops and all half-round and trapezoid tops standard with one 3" round grommet, 48"-96" tops standard with two 3" round grommets. When G1 grommet is selected, all tops standard with one cutout.

Edge Treatments

• HOW TO ORDER

- 1) Select desired model numbers.
- 2) Select desired top edge treatment.
- 3) Replace the (?) after each model number with the suffix representing the chosen top edge treatment.



"G" 2mm Edge



"R" Ergo Edge

HOW TO SPECIFY

Select Model Number	Select Grommet Option	Select Laminate	Select Edge Color	Select Caster/Glide Option	Select Base Paint Color
N	No Grommet G Grommet (\$15 upcharge PER grommet) G1 Electrical Port (\$40 upcharge)	See page 98	See page 98	C Multi-Surface Caster G Glide	See page 98 \$20 upcharge per model, for P2 paint
HMVR-1872G-FX	N	C	C	T	C

MOTIVATE® Nesting Tables

GSA SIN 33721



Icon Legend on page 19



DESCRIPTION	MODEL	SHIP WEIGHT	CUBE	LIST PRICE BY LAMINATE GRADE			
				"G" 2MM EDGE		"R" ERGO EDGE	
				L1	L2	L1	L2
Rectangular Nesting Tables							
72"W x 18"D	HMVR-1872(?) -NS	90	8.5	\$1251	\$1266	\$1560	\$1575
60"W x 18"D	HMVR-1860(?) -NS	79	7.6	\$1171	\$1186	\$1423	\$1438
48"W x 18"D	HMVR-1848(?) -NS	60	6.5	\$1166	\$1176	\$1401	\$1411
96"W x 24"D	HMVR-2496(?) -NS	134	11.4	\$1498	\$1523	N/A	N/A
84"W x 24"D	HMVR-2484(?) -NS	122	10.4	\$1468	\$1493	N/A	N/A
72"W x 24"D	HMVR-2472(?) -NS	106	9.2	\$1271	\$1291	\$1596	\$1616
66"W x 24"D	HMVR-2466(?) -NS	100	9.1	\$1248	\$1268	N/A	N/A
60"W x 24"D	HMVR-2460(?) -NS	92	8.2	\$1227	\$1247	\$1520	\$1540
54"W x 24"D	HMVR-2454(?) -NS	80	8.2	\$1212	\$1232	N/A	N/A
48"W x 24"D	HMVR-2448(?) -NS	73	7.2	\$1187	\$1202	\$1450	\$1465
42"W x 24"D	HMVR-2442(?) -NS	67	6.6	\$1169	\$1184	N/A	N/A
36"W x 24"D	HMVR-2436(?) -NS	60	6.3	\$1152	\$1167	N/A	N/A
96"W x 30"D	HMVR-3096(?) -NS	161	13.3	\$1639	\$1664	N/A	N/A
84"W x 30"D	HMVR-3084(?) -NS	144	13.0	\$1627	\$1652	N/A	N/A
72"W x 30"D	HMVR-3072(?) -NS	125	11.7	\$1379	\$1399	\$1723	\$1743
66"W x 30"D	HMVR-3066(?) -NS	118	11.6	\$1345	\$1365	N/A	N/A
60"W x 30"D	HMVR-3060(?) -NS	109	10.5	\$1320	\$1340	\$1622	\$1642
54"W x 30"D	HMVR-3054(?) -NS	96	10.5	\$1304	\$1324	N/A	N/A
48"W x 30"D	HMVR-3048(?) -NS	88	9.3	\$1284	\$1299	\$1562	\$1577
42"W x 30"D	HMVR-3042(?) -NS	80	8.1	\$1264	\$1279	N/A	N/A
36"W x 30"D	HMVR-3036(?) -NS	71	8.1	\$1242	\$1257	N/A	N/A
72"W x 36"D	HMVR-3672(?) -NS	141	12.7	\$1532	\$1557	N/A	N/A
60"W x 36"D	HMVR-3660(?) -NS	123	11.3	\$1440	\$1465	N/A	N/A
48"W x 36"D	HMVR-3648(?) -NS	99	11.1	\$1365	\$1385	N/A	N/A
Half-Round Nesting Tables							
72"W x 36"D	HMVH-3672(?) -NS	111	12.2	\$1576	\$1601	N/A	N/A
60"W x 30"D	HMVH-3060(?) -NS	82	8.8	\$1359	\$1384	\$1695	\$1720
48"W x 24"D	HMVH-2448(?) -NS	62	7.0	\$1213	\$1233	\$1496	\$1516
Trapezoid Nesting Tables							
72"W x 36"D	HMVT-3672(?) -NS	98	12.0	\$1599	\$1624	N/A	N/A
60"W x 30"D	HMVT-3060(?) -NS	72	8.8	\$1287	\$1312	\$1614	\$1639
48"W x 24"D	HMVT-2448(?) -NS	57	7.0	\$1239	\$1259	\$1517	\$1537

NOTES:

- Ergo edge is a bullnose on user side and 3mm on all other sides.
- Tops are 1 1/8" thick.
- Specification includes top and base, however, top and base are boxed separately.
- See grommet matrix on page 104 for grommet location/ placement.
- 36"-42" tops and all half-round and trapezoid tops standard with one 3" round grommet, 48"-96" tops standard with two 3" round grommets. When G1 grommet is selected, all tops standard with one cutout.

Edge Treatments

• HOW TO ORDER

- Select desired model numbers.
- Select desired top edge treatment.
- Replace the (?) after each model number with the suffix representing the chosen top edge treatment.



"G" 2mm Edge



"R" Ergo Edge



HOW TO SPECIFY

<p>Select Model Number</p> <p>HMVR-1872G-NS</p>	<p>Select Grommet Option</p> <p>N No Grommet G Grommet (\$15 upcharge PER grommet) G1 Electrical Port (\$40 upcharge)</p> <p>N</p>	<p>Select Laminate</p> <p>See page 98</p> <p>C</p>	<p>Select Edge Color</p> <p>See page 98</p> <p>C</p>	<p>Select Caster/Glide Option</p> <p>C Multi-Surface Caster G Glide</p> <p>C</p>	<p>Select Base Paint Color</p> <p>See page 98 \$20 upcharge per model, for P2 paint</p> <p>T1</p>
--	---	---	---	---	--

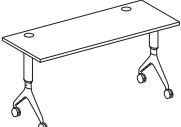

Icon Legend on page 19

MOTIVATE® Adjustable Height Tables

DESCRIPTION	MODEL	SHIP WEIGHT	CUBE	LIST PRICE BY LAMINATE GRADE			
				"G" 2MM EDGE		"R" ERGO EDGE	
				L1	L2	L1	L2
Rectangular Tables, Adjustable Height Base							
 72"W x 18"D	HMVR-1872(?) -AH	83	6.6	\$1237	\$1252	\$1546	\$1561
60"W x 18"D	HMVR-1860(?) -AH	73	6.0	\$1161	\$1176	\$1429	\$1444
48"W x 18"D	HMVR-1848(?) -AH	57	5.3	\$1153	\$1163	\$1393	\$1403
 72"W x 24"D	HMVR-2472(?) -AH	99	7.3	\$1257	\$1277	\$1582	\$1602
66"W x 24"D	HMVR-2466(?) -AH	93	7.3	\$1238	\$1258	N/A	N/A
60"W x 24"D	HMVR-2460(?) -AH	86	6.6	\$1217	\$1237	\$1510	\$1530
54"W x 24"D	HMVR-2454(?) -AH	74	6.6	\$1198	\$1218	N/A	N/A
48"W x 24"D	HMVR-2448(?) -AH	68	5.8	\$1179	\$1194	\$1442	\$1457
42"W x 24"D	HMVR-2442(?) -AH	63	5.4	\$1159	\$1174	N/A	N/A
36"W x 24"D	HMVR-2436(?) -AH	57	5.1	\$1144	\$1159	N/A	N/A
72"W x 30"D	HMVR-3072(?) -AH	118	9.8	\$1365	\$1385	\$1709	\$1729
66"W x 30"D	HMVR-3066(?) -AH	111	9.8	\$1335	\$1355	N/A	N/A
60"W x 30"D	HMVR-3060(?) -AH	103	8.9	\$1310	\$1330	\$1626	\$1646
54"W x 30"D	HMVR-3054(?) -AH	90	8.9	\$1290	\$1310	N/A	N/A
48"W x 30"D	HMVR-3048(?) -AH	83	7.9	\$1276	\$1291	\$1554	\$1569
42"W x 30"D	HMVR-3042(?) -AH	76	7.4	\$1254	\$1269	N/A	N/A
36"W x 30"D	HMVR-3036(?) -AH	68	6.9	\$1234	\$1249	N/A	N/A
72"W x 36"D	HMVR-3672(?) -AH	134	10.8	\$1518	\$1543	N/A	N/A
60"W x 36"D	HMVR-3660(?) -AH	117	9.7	\$1430	\$1455	N/A	N/A
48"W x 36"D	HMVR-3648(?) -AH	94	9.7	\$1357	\$1377	N/A	N/A

NOTES:

- Ergo edge is a bullnose on user side and 3mm on all other sides.
 - Tops are 1/8" thick.
 - Specification includes top and base, however, top and base are boxed separately.
 - Seated height adjustment from 27 1/2" - 32 1/2" in 1" increments.
 - See grommet matrix on page 104 for grommet location/placement.
 - 36"-42" tops and all half-round and trapezoid tops standard with one 3" round grommet, 48"-96" tops standard with two 3" round grommets. When G1 grommet is selected, all tops standard with one cutout.
- !** No tool required, adjustable bases have ratchet style adjustment mechanism.

Edge Treatments

HOW TO ORDER

- Select desired model numbers.
- Select desired top edge treatment.
- Replace the (?) after each model number with the suffix representing the chosen top edge treatment.



"G" 2mm Edge



"R" Ergo Edge

HOW TO SPECIFY

<p>Select Model Number</p>	<p>Select Grommet Option</p> <p>N No Grommet G Grommet (\$15 upcharge PER grommet) G1 Electrical Port (\$40 upcharge)</p>	<p>Select Laminate</p> <p>See page 98</p>	<p>Select Edge Color</p> <p>See page 98</p>	<p>Select Caster/Glide Option</p> <p>C Multi-Surface Caster G Glide</p>	<p>Select Base Paint Color</p> <p>See page 98 \$20 upcharge per model, for P2 paint</p>
<p>H M V R - 1 8 7 2 G - A H .</p>	<p>N .</p>	<p>C .</p>	<p>C .</p>	<p>C .</p>	<p>P .</p>

MOTIVATE® Shared Components

GSA SIN 33721



Icon Legend on page 19

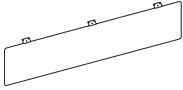

DESCRIPTION	MODEL	SHIP WEIGHT	CUBE	LIST PRICE BY PAINT GRADE	
				P1	P2
Universal Modesty Panel					
For 96"W Motivate® Tables	HMTUMOD86	21	4.8	\$283	\$303
For 84"W Motivate® Tables	HMTUMOD74	20	4.4	\$273	\$293
For 72"W Motivate® Tables	HMTUMOD62	17	3.6	\$263	\$283
For 66"W Motivate® Tables	HMTUMOD56	16	3.4	\$253	\$273
For 60"W Motivate® Tables	HMTUMOD50	14	3.1	\$244	\$264
For 54"W Motivate® Tables	HMTUMOD44	12	2.5	\$234	\$254
For 48"W Motivate® Tables	HMTUMOD38	11	2.2	\$223	\$243
For 42"W Motivate® Tables	HMTUMOD32	9	1.9	\$214	\$234
For 36"W Motivate® Tables	HMTUMOD26	8	1.7	\$204	\$224

NOTES:







- Modesty Panels are hinged to nest along with Nesting Tables. Modesty Panels can be used with all base types.
- ! Use field installed Table Modesty Panels with all table widths 36"-96". Cannot be used with Half-Round or Trapezoid tables.

HOW TO SPECIFY

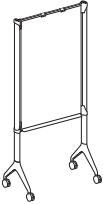
<p>Select Model Number</p>	<p>Select Paint Color</p> <p>See page 98</p> <p>\$20 upcharge per model, for P2 paint</p>
<div style="border: 1px solid black; padding: 2px; display: inline-block;">HMTUMOD86</div>	<div style="border: 1px solid black; padding: 2px; display: inline-block;">T1</div>

MOTIVATE®

Shared Components

	DESCRIPTION	MODEL	SHIP WEIGHT	CUBE	LIST PRICE
	Mobile Markerboard 36"W x 72"H 30"W x 72"H Actual Markerboard size: HMVMB-3672WW – 36¼"W x 42"H HMVMB-3072WW – 30¼"W x 42"H NOTES: 2-Sided Mobile Markerboard is porcelain over steel with four locking casters. Mobile Markerboard includes marker tray and flip-chart paper clips. Porcelain Markerboard cleaning instructions: For everyday cleaning, use Clorox wipes. Use a citrus cleaner if a permanent marker is used by accident. ⓘ A citrus cleaner is not recommended for everyday use as it leaves residue. ⓘ \$20 list upcharge for P2 paint. Specify Model.Base.Casters.Paint SPECIFYING EXAMPLE: HMVMB-3072WW.C.P	HMVMB-3672WW HMVMB-3072WW	59 53	7.9 7.1	\$1475 \$1449
		Presentation Cart, Concave Front, Fixed Leg 18"D x 30"W x 35"H, 2mm Edge 18"D x 30"W x 35"H, Ergo Edge NOTES: Presentation Cart tops are 1⅝" thick with a concave user side. Choose from a 2mm or Ergo edge. ⓘ \$10 list upcharge for L2 laminates. Specify Model.Caster.TopLaminate.EdgeColor.Paint SPECIFYING EXAMPLE: HMVPCF-1830G.C.D.D.TI	HMVPCF-1830G HMVPCF-1830R	38 38	3.9 3.9
	Presentation Cart, Concave Front, Seated Height Adjustable-Leg 18"D x 30"W x 27½"-34½"H, 2mm Edge 18"D x 30"W x 27½"-34½"H, Ergo Edge ⓘ \$10 list upcharge for L2 laminates. Specify Model.Caster.TopLaminate.EdgeColor.Paint SPECIFYING EXAMPLE: HMVPCA1-1830G.C.D.D.TI	HMVPCA1-1830G ⓘ HMVPCA1-1830R	40 40	3.9 3.9	\$1201 \$1538
	Presentation Cart, Concave Front, Standing-Height Adjustable-Leg 18"D x 30"W x 31½"-38½"H, 2mm Edge 18"D x 30"W x 31½"-38½"H, Ergo Edge NOTES: Presentation Cart tops are 1⅝" thick with a concave user side. Choose from a 2mm or Ergo edge. ⓘ \$10 list upcharge for L2 laminates. Specify Model.Caster.TopLaminate.EdgeColor.Paint SPECIFYING EXAMPLE: HMVPCA1-1830G.C.D.D.TI	HMVPCA2-1830G HMVPCA2-1830R	42 42	3.9 3.9	\$1201 \$1538
	Presentation Cart, Modesty Panel Specify Model.Paint SPECIFYING EXAMPLE: HMVPC-MP.P	HMVPC-MP	6	1.4	\$185
	Presentation Cart, Storage Shelves Single, 4" Open Back Double, 4" Open Back / 4" Closed Back Double, 4" Open Back / 9" Closed Back Single, 4" Closed Back Double, 4" Closed Back / 4" Closed Back Double, 4" Closed Back / 9" Closed Back NOTES: Storage Shelves for Presentation Carts are available in three preconfigured sizes and may be used on fixed or adjustable height models. Specify Model.Paint SPECIFYING EXAMPLE: HMVPCSS-40.TI	HMVPCSS-40 HMVPCSS-404C HMVPCSS-409C HMVPCSS-4C HMVPCSS-4C4C ⓘ HMVPCSS-4C9C	8 17 20 9 18 21	1.4 2.6 3.6 1.4 2.6 3.6	\$94 \$193 \$301 \$102 \$201 \$310
	Presentation Cart Desk Top Lectern, 2mm Edge NOTES: Desk Top Lectern may be used on the Presentation Cart or is removable for use on table tops. ⓘ \$15 list upcharge for L2 laminates. ⓘ Desktop Lectern only available with 2mm edge. Specify Model.LaminateTop.EdgeColor.Paint SPECIFYING EXAMPLE: HMVPC-DTLG.D.D.TI	HMVPC-DTLG	16	2.4	\$347





HOW TO SPECIFY

Select
Model Number

H M V M B - 3 6 7 2 W W

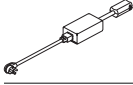

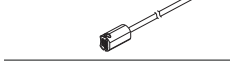
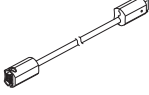
INTERLINK IQ ELECTRICAL

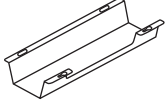
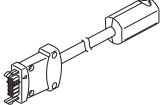
	DESCRIPTION	MODEL	SHIP WEIGHT	CUBE	LIST PRICE
	Power Base In-Feed • 12 amp circuit breaker is built in to the Power Base In-Feed. • Available in Black finish, no specification needed.	HQB	2.0	0.2	\$525
	Power Harness – 1' Power Hub, 3'' Round Grommet Mount • Available in Black finish, no specification needed.	HQH1-3	2.0	0.2	\$172
	Power Harness – 5' Power Hub, 3'' Round Grommet Mount • Available in Black finish, no specification needed.	HQH5-3	2.0	0.2	\$193
	Power Harness – 5' with 4'' x 8'' Pop-Up Port (3 Power, 1 Blank) • For use with tables G1 grommet. Specify paint.	HQH5-P-3P1B	3.0	0.3	\$378
	Power Jumper – 3' • Available in Black finish, no specification needed.	HQJ3	2.0	0.2	\$107
	Ganging Hardware • Includes two ganging links and two screws. • No color designator when specifying. <i>Example: HMAGANG.</i>	HMAGANG	1.0	0.1	\$94
	Cable Management Troughs 17''W – Single 17''W – 10-Pack • Available in Graphite finish, no specification needed. NOTES: For additional information see page 240.	HCTROUGH17 HCTROUGH1710	2.7 14.0	0.5 0.5	\$67 \$620
	IQ 1.0 Backward Compatible Jumper 36'' • Available in Black finish, no specification needed. • Use when connecting Interlink IQ 1.0 power harness (rectangle end) to Interlink IQ 2.0 (oval end) power harness. ! If using Interlink IQ 2.0 in-feed with Interlink IQ 1.0 power harness please contact Customer Support.	HQBCJ36	2.0	0.2	\$82

Specification guide for IQ Electrical on Motivate® tables

Determine table width, the type of power access being used (3'' grommet or 4x8 pop-up) and the desired number per table (Columns 1, 2 or 3). The table will then identify the type and quantity of components needed per table along with the maximum table run. Note that this is in addition to the Power base in-feed which is needed for each run. For example, a 48''W table with two 3'' power grommets per table will require (1) HQH5-3 harness and (1) HQH1-3 harness per table with a maximum run of four tables.

Top Width	POWER ONE (1) PER TABLE 3'' ROUND POWER GROMMET		POWER TWO (2) PER TABLE 3'' ROUND POWER GROMMETS		POWER ONE (1) PER TABLE 4x8 POP-UP PORT	
	Quantity	Table Run Maximum	Quantity	Table Run Maximum	Quantity	Table Run Maximum
36''	(1) HQH5-3	8	N/A	N/A	(1) HQH5-P	8
42''	(1) HQH5-3	8	N/A	N/A	(1) HQH5-P	8
48''	(1) HQH5-3	8	(1) HQH5-3 (1) HQH1-3	4 Max Table Run	(1) HQH5-P	8 Max Table Run
54''	(1) HQH5-3	8	(1) HQH5-3 (1) HQH1-3	4 Max Table Run	(1) HQH5-P	8 Max Table Run
60''	(1) HQH5-3	8	(1) HQH5-3 (1) HQH1-3	4 Max Table Run	(1) HQH5-P	8 Max Table Run
66''	(1) HQH5-3 (1) HQJ3	4 Table Run Maximum	(1) HQH5-3 (1) HQH1-3	4 Max Table Run	(1) HQH5-P (1) HQJ3	4 Max Table Run
72''	(1) HQH5-3 (1) HQJ3	4 Table Run Maximum	(1) HQH5-3 (1) HQH1-3	4 Max Table Run	(1) HQH5-P (1) HQJ3	4 Max Table Run
84''	(1) HQH5-3 (1) HQJ3	4 Table Run Maximum	(2) HQH5-3	4 Max Table Run	(1) HQH5-P (1) HQJ3	4 Max Table Run
96''	(1) HQH5-3 (1) HQJ3	4 Table Run Maximum	(2) HQH5-3	4 Max Table Run	(1) HQH5-P (1) HQJ3	4 Max Table Run
Half-Round (all sizes)	(1) HQH1-3	2 Tables Maximum	N/A	N/A	(1) HQH5-P	2 Max Table Run
Trapezoid (all sizes)	(1) HQH5-3	8 Table Run Maximum	N/A	N/A	(1) HQH5-P	8 Max Table Run

NOTES:

- Interlink IQ Electrical is a pluggable, single circuit electrical system.
- All electrical models include wire management clips and hardware.
- Interlink IQ Electrical is non-sequential/non-directional.

- Interlink IQ Electrical is UL Recognized as a Powered Table System and meets the requirements of UL 962 when paired with Motivate® or Huddle tables.

! 40' maximum run, or no more than 8 units, whichever comes first. Interlink IQ system will automatically shut off if maximum requirements are exceeded. Maximum run is based upon electrical harness width, not table width.

HOW TO SPECIFY

Select Model Number

H Q H 5 - P - 3 P 1 B .

Select Paint Color

FOG Fog
SVR Silver
BLK Black

S V R

4-TRAC HARDWIRE ELECTRICAL SYSTEM

4-Trac Electrical System

The 4-Trac Electrical System is a UL-recognized Manufactured Wiring System that seamlessly passes power from one worksurface to another. This low-profile non-sequential electrical system allows tables to be “daisy-chained” together in any desired order and allows users to reconfigure quickly due to simple connectable/disconnectable links.

- Meets requirements of UL 183 and National Electric Code Article 604
- 4-Wires, 2-circuits, 20 Amps each (Circuit 1 and Circuit 2 only)
- 13 Duplex Receptacles per circuit, 26, 15 Amp Duplex receptacle per power in-feed
- Electrical system attaches directly to underside of worksurface with included brackets
- Up to twelve tables can be linked together

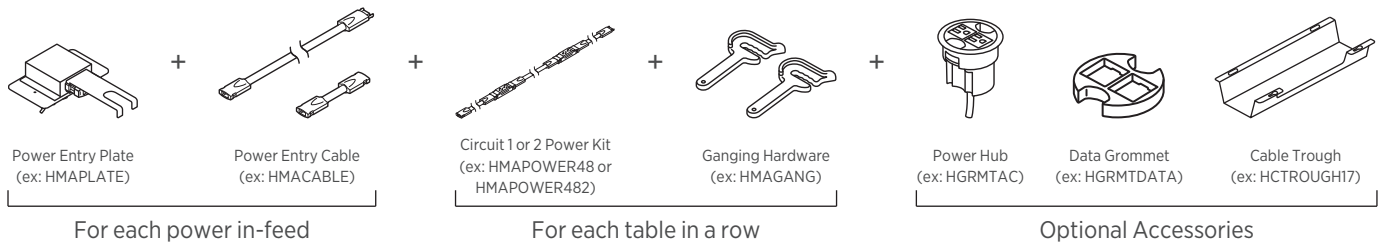

Steps for Electrical Specifications:

- Determine how many rows of tables are needed and order the following:
 - One HMAPLATE per row (or power in-feed)
 - One HMACABLE per row (or power in-feed)
- Order one power harness per table in each row
 - For 1-6 tables in a row (see illustration 1)
 - Order Circuit 1 Power Harnesses (ex. If powering six 24x60 tables order six sets of HMAPOWER60)
 - For 7-12 tables in a row (see illustration 1)
 - Order Circuit 1 Power Harness for first six tables and Circuit 2 Power Harness for remaining tables (ex. If powering eight 24x60 tables, order six sets of HMAPOWER60 and two sets of HMAPOWER602)
- Order one set of ganging hardware per table (ex. HMAGANG)
- Determine which accessories are needed:
 - Power Hub model HGRMTAC — to access power at worksurface.
 - Data Grommet model HGRMTDATA — to access data at worksurface.
 - Wire Management strips model HBTMS — for vertical and horizontal wire management.

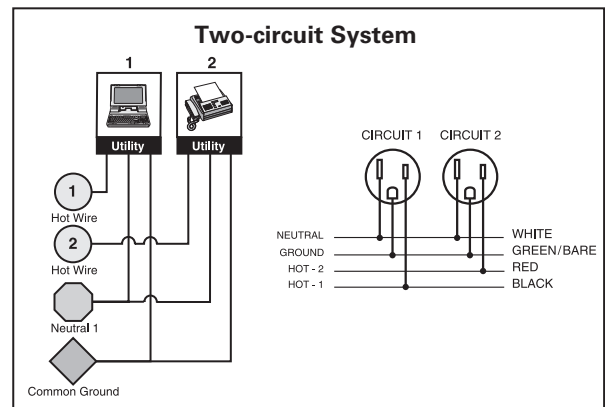
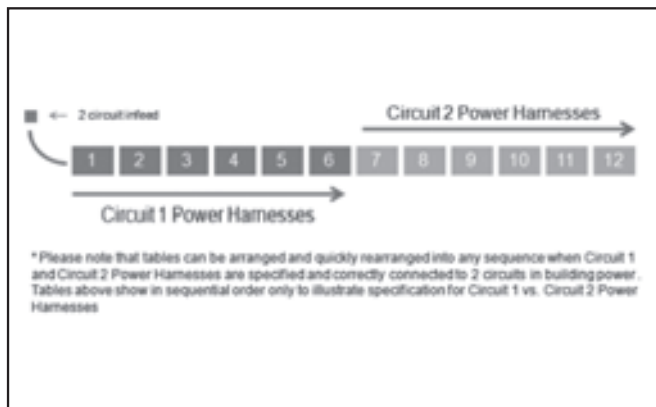

4-TRAC HARDWIRE ELECTRICAL SYSTEM

Icon Legend on page 19

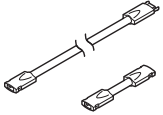
	DESCRIPTION	MODEL	SHIP WEIGHT	CUBE	LIST PRICE
	Power Entry Plate	HMAPLATE	1.0	0.2	\$94
	Power Entry Cable • 6' power entry cable with male/female adapter. • Connects table to power entry plate.	HMACABLE	1.8	0.2	\$147
	Power Jumper Cable To connect tables front to front	HMAJUMP	0.5	0.3	\$50
	Circuit 1 Power Kit for 36" W Table	HMAPOWER36	1.5	0.3	\$267
	Circuit 1 Power Kit for 42" W Table	HMAPOWER42	1.8	0.3	\$270
	Circuit 1 Power Kit for 48" W Table	HMAPOWER48	1.8	0.3	\$272
	Circuit 1 Power Kit for 54" W Table	HMAPOWER54	2.0	0.3	\$277
	Circuit 1 Power Kit for 60" W Table	HMAPOWER60	2.0	0.3	\$280
	Circuit 1 Power Kit for 66" W Table	HMAPOWER66	2.2	0.3	\$284
	Circuit 1 Power Kit for 72" W Table	HMAPOWER72	2.2	0.3	\$286
	Circuit 1 Power Kit for 84" W Table	HMAPOWER84	2.4	0.3	\$297
	Circuit 1 Power Kit for 96" W Table	HMAPOWER96	2.6	0.3	\$306
	Circuit 2 Power Kit for 36" W Table	HMAPOWER362	1.5	0.3	\$267
	Circuit 2 Power Kit for 42" W Table	HMAPOWER422	1.8	0.3	\$270
	Circuit 2 Power Kit for 48" W Table	HMAPOWER482	1.8	0.3	\$272
	Circuit 2 Power Kit for 54" W Table	HMAPOWER542	2.0	0.3	\$277
	Circuit 2 Power Kit for 60" W Table	HMAPOWER602	2.0	0.3	\$280
	Circuit 2 Power Kit for 66" W Table	HMAPOWER662	2.2	0.3	\$284
	Circuit 2 Power Kit for 72" W Table	HMAPOWER722	2.2	0.3	\$286
	Circuit 2 Power Kit for 84" W Table	HMAPOWER842	2.4	0.3	\$297
	Circuit 2 Power Kit for 96" W Table	HMAPOWER962	2.6	0.3	\$306

NOTES:

- Each power kit includes two duplex receptacles and attaches to the underside of the worksurface with included brackets.
- Power Kits are compatible with various base types including nesting bases.

HOW TO SPECIFY

Select
Model Number

HMAPLATE



Icon Legend on page 19

OPTIONAL ELECTRICAL ACCESSORIES

	DESCRIPTION	MODEL	SHIP WEIGHT	CUBE	LIST PRICE
 SIN 33721T	Power Hub, 3" Grommet Mount, 6' Cord <ul style="list-style-type: none"> • Fits in 3" round grommet holes. • Field installed with Plug-and-play ease. • Two grounded AC power outlets. • Includes 6' cord with three-prong plug. • Available in Black only. <i>Specify X when ordering. Example: HGRMTAC.X.</i> <p>NOTES: For additional information see page 236.</p>	HGRMTAC	1.3	0.2	\$116
 SIN 33721T	3" Round Power Grommet - 2 Outlets, 10' Cord <ul style="list-style-type: none"> • Includes 10' cord with three-prong plug. • Fits in 3" round grommet holes. • Two grounded AC power outlets. • Field installed with Plug-and-play ease. <p>NOTES: Power Modules will also work with standing-height applications for 10500 Series™ and Voi® desks.</p> <p> Available in black finish only, no specification needed.</p>	HGRMTAC2	1.5	0.2	\$148
	Data Grommet <p>Blank grommet kit that includes adapters for a variety of manufacturers jacks and couplers.</p> <ul style="list-style-type: none"> • Fits in existing 3" round grommet housing. • Available in Black only. <i>Specify P when ordering. Example: HGRMTDATA.P.</i> <p>NOTES: For additional information see page 236.</p>	HGRMTDATA	0.2	0.2	\$20
	Cable Management Troughs <p>17"W — Single 17"W — 10-Pack 36"W — Single 36"W — 10-Pack</p> <ul style="list-style-type: none"> • Cable management troughs ship flat packed. • The troughs attach to underneath the worksurface with screws. • Cutouts in trough allow access to power without the need to detach from surface. 17"W = 1 cutout; 36"W = 2 cutouts. • Color: Graphite. <p>NOTES: For additional information see page 240.</p>	HCTROUGH17 HCTROUGH1710 HCTROUGH36 HCTROUGH3610	2.7  14.0  4.9  30.0 	0.5 0.5 0.9 0.9	\$67 \$620 \$113 \$1045

HOW TO SPECIFY

Select Model Number

H T P W R G R O M 1

NOTES

PRESIDE®



Preside® tables and bench shown with Flock® guest seating.

PRESIDE®

Whether you're craving social interaction or breaking away for some "me time", Preside tables support the work activities you need to get it done. Versatile enough for touchdown spaces, meeting rooms, and even cafés, Preside offers everything from a contemporary light-scale vibe to a more classic aesthetic. Add in optional power for a dynamic table collection that lets you work your way.



FEATURES

- Preside offers a complete line of conference accessories, including presentation cabinets, hospitality and more.
- Optional flip-top and pop-up ports provide options today and for future data and power needs.
- Scratch-, spill- and stain-resistant laminate will look great for years to come.
- Add a splash of color to Preside using Colorwav™ paints to brighten any space.
- Enhanced aesthetics with power management options to keep the workspace tidy and looking its best.

PRESIDE® ORDERING INFORMATION

LAMINATE GROUP A

L1 LAMINATES CODES

- Woodgrain**
- ◆ Bourbon Cherry H
 - ◆ Cognac COGN
 - ◆ Florence Walnut LFW1
 - ◆ Harvest C
 - ◆ Kingswood Walnut LK11
 - ◆ Mahogany N
 - ◆ Mocha MOCH
 - ◆ Natural Maple D
 - ◆ Pinnacle PINC
 - ◆ Shaker Cherry F
 - ◆ Sterling Ash LSA1

- Solid**
- ◆ Black P
 - ◆ Charcoal S
 - ◆ Designer White LDW1
 - ◆ Loft LOFT

- Patterned**
- ◆ Sheer Mesh A5
 - ◆ Silver Mesh B9
 - ◆ Steel Mesh A9
 - ◆ Canyon Zephyr K9
 - ◆ Desert Zephyr K8
 - ◆ Gray G2
 - ◆ Grey Tigris L6
 - ◆ White G1
 - ◆ Whitestone K4

L2 LAMINATES CODES

- Woodgrain**
- ◆ Lowell Ash LLA1
 - ◆ Natural Recon LNR1
 - ◆ Phantom Ecrú LPE1
 - ◆ Portico Teak LPT1
 - ◆ Skyline Walnut LSW1

LAMINATE GROUP B

L1 LAMINATES CODES

- Woodgrain**
- ◆ Bourbon Cherry H
 - ◆ Cognac COGN
 - ◆ Florence Walnut LFW1
 - ◆ Harvest C
 - ◆ Kingswood Walnut LK11
 - ◆ Mahogany N
 - ◆ Mocha MOCH
 - ◆ Natural Maple D
 - ◆ Pinnacle PINC
 - ◆ Shaker Cherry F
 - ◆ Sterling Ash LSA1

- Solid**
- ◆ Black P
 - ◆ Charcoal S
 - ◆ Designer White LDW1
 - ◆ Loft LOFT

L2 LAMINATES CODES

- Woodgrain**
- ◆ Lowell Ash LLA1
 - ◆ Natural Recon LNR1
 - ◆ Phantom Ecrú LPE1
 - ◆ Portico Teak LPT1
 - ◆ Skyline Walnut LSW1

LAMINATE GROUP C

L1 LAMINATES CODES

- Woodgrain**
- ◆ Bourbon Cherry H
 - ◆ Cognac COGN
 - ◆ Florence Walnut LFW1
 - ◆ Harvest C
 - ◆ Kingswood Walnut LK11
 - ◆ Mahogany N
 - ◆ Mocha MOCH
 - ◆ Natural Maple D
 - ◆ Pinnacle PINC
 - ◆ Shaker Cherry F
 - ◆ Sterling Ash LSA1

- Solid**
- ◆ Black P
 - ◆ Charcoal S
 - ◆ Designer White LDW1
 - ◆ Loft LOFT
 - ◆ Platinum LEPI

L2 LAMINATES CODES

- Woodgrain**
- ◆ Lowell Ash LLA1
 - ◆ Natural Recon LNR1
 - ◆ Phantom Ecrú LPE1
 - ◆ Portico Teak LPT1
 - ◆ Skyline Walnut LSW1

LAMINATE GROUP D

L1 LAMINATES CODES

- Woodgrain**
- ◆ Mahogany N

PAINT GROUP A

P1 CODES

- ◆ Black P
- ◆ Brownstone P7D
- ◆ Charcoal S
- ◆ Designer White PJW
- ◆ Fossil P28
- ◆ Greige T5
- ◆ Loft LOFT
- ◆ Muslin T3
- ◆ Titanium P8T

P2 CODES

- ◆ Champagne Metallic T4
- ◆ Platinum Metallic T1
- ◆ Silver PR6
- ◆ Solar Black P8X

P3 CODES

- ◆ Atom P8S
- ◆ Bullseye PJF
- ◆ Ember P8P
- ◆ Ion P8N
- ◆ Iris P8J
- ◆ Krypton P8F
- ◆ Regatta P8M

HON BRANDED FABRICS

GRADE 1

- Apex
- Attire
- Centurion
- Compass
- Contourett
- Dapper
- Ensemble
- Hamilton
- Inertia
- Optic
- Pebble

GRADE 2

- Appoint Seating
- Blume
- Clyde
- Dotty
- Rush
- Spin
- Whisper Vinyl

GRADE 3

- In Season
- Silvertex™ Vinyl

NOTES: Fabrics on Preside® bench cushion are upholstered in the railroad direction.

◆◆◆ For lead time information see page 19.

PRESIDE® SPECIFYING INFORMATION

EDGE BAND OPTIONS	CODES	2mm (G)	Knife (J)	T-Mold (E)	Traditional (T)
Bourbon Cherry	H	•	•		
Cognac	COGN	•	•	•	
Florence Walnut	FW	•	•	•	
Harvest	C	•	•		
Kingswood Walnut	KI	•	•	•	
Mahogany	N	•	•	•	•
Mocha	MOCH	•	•	•	
Natural Maple	D	•	•		
Shaker Cherry	F	•	•		
Sterling Ash	SA	•	•	•	
Black	P	•	•	•	
Charcoal	S	•	•	•	
Designer WHIT	DW	•	•	•	
Greige	R	•	•	•	
Loft	LOFT	•	•	•	
Muslin	T	•	•	•	
Pinnacle	PINC	•	•	•	
Platinum	K	•	•		
Lowell Ash	DL	•	•		
Natural Recon	NR	•	•		
Phantom Ecu	PE	•	•		
Portico Teak	DP	•	•		
Skyline Walnut	SW	•	•		

Recommended Edgeband Color Selection:

Laminate		Edge	
Bourbon Cherry	H	Bourbon Cherry	H
Cognac	COGN	Cognac	COGN
Florence Walnut	LFW1	Florence Walnut	FW
Harvest	C	Harvest	C
Kingswood Walnut	LKIT	Kingswood Walnut	KI
Mahogany	N	Mahogany	N
Mocha	MOCH	Mocha	MOCH
Natural Maple	D	Natural Maple	D
Pinnacle	PINC	Pinnacle	PINC
Shaker Cherry	F	Shaker Cherry	F
Sterling Ash	LSA1	Sterling Ash	SA
Black	P	Black	P
Charcoal	S	Charcoal	S
Designer White	LDW1	Designer White	DW
Loft	LOFT	Loft	LOFT
Whitestone	K4	Muslin	T
Sheer Mesh	A5	Muslin	T
Silver Mesh	B9	Loft	LOFT
Steel Mesh	A9	Charcoal	S
Canyon Zephyr	K9	Greige	R
Desert Zephyr	K8	Greige	R
Shadow Zephyr	K1	Loft	LOFT
Gray	G2	Charcoal	S
Grey Tigris	L6	Greige	R
White	G1	Charcoal	S
Lowell Ash	LLA1	Lowell Ash	DL
Natural Recon	LNRI	Natural Recon	NR
Phantom Ecu	LPE1	Phantom Ecu	PE
Portico Teak	LPT1	Portico Teak	DP
Skyline Walnut	LSW1	Skyline Walnut	SW

PRESIDE® SPECIFYING INFORMATION

Statement of Line

TOP SHAPES



Square



Round



Soft Square



Rectangle

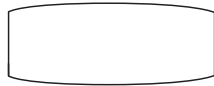

Boat



Racetrack



Arc End

TOP EDGE PROFILES

For Laminate Tops

Square/2mm Edgeband (1/8")



Knife Edge (1/8")



Traditional Edge (1/8")

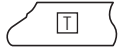

T-Mold Edge (1/8")



BASES

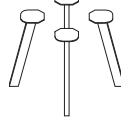
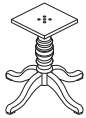
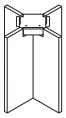
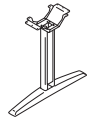
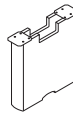
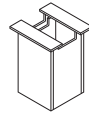
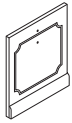
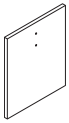

ANCILLARY COMPONENTS

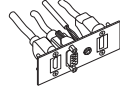
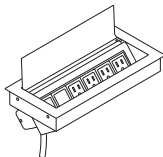
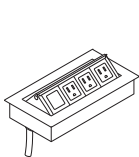
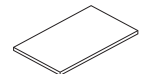
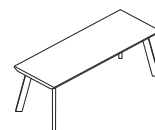
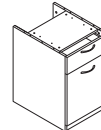
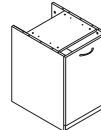
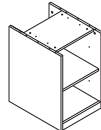
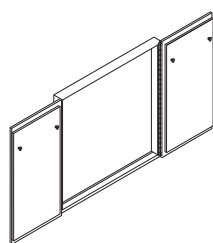
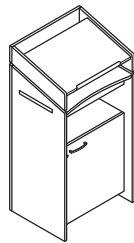
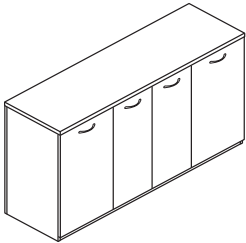













PRESIDE[®] SPECIFYING INFORMATION

Preside conference tops come in single piece or multi-piece sections depending on specified size. See below for top sizes, sections, and suggested seating capacity.





Product Reference: Sizes, Sections, Seating Capacity

Multi-piece tops: Rectangle, Racetrack, Boat, and Arc End Tops.



















Notes: Single- and two-piece tops ship in one carton, three-piece tops ship in two cartons.
Three-piece tops and larger will not contain grain match for all pieces.

	Feet	Inches	42"D	48"D	54"D	Suggested Capacity
	30	360"	6 6 6 6 6	6 6 6 6 6	6 6 6 6 6	28-30
	28	336"	5 6 6 6 5	5 6 6 6 5	5 6 6 6 5	26-28
	26	312"	7 6 6 7	7 6 6 7	7 6 6 7	24-26
	24	288"	6 6 6 6	6 6 6 6	6 6 6 6	22-24
	22	264"	5 6 6 5	5 6 6 5	5 6 6 5	20-22
	20	240"	7 6 7	7 6 7	7 6 7	18-20
	18	216"	6 6 6	6 6 6	6 6 6	16-18
	16	192"	5 6 5	5 6 5	5 6 5	14-16
	15	180"	4½ 6 4½	4½ 6 4½	4½ 6 4½	14-16
	14	168"	7 7	7 7	7 7	12-14
	12	144"	6 6	6 6	6 6	10-12
	10	120"	5 5	5 5	5 5	8-10
	9	108"	4½ 4½	4½ 4½	4½ 4½	8-10

Single-piece tops: Rectangle, Racetrack, Boat, and Arc End Tops

	Feet	Inches	30"D	36"D	42"D	48"D	Suggested Capacity
	8	96"			8	8	6-8
	7	84"			7		4-6
	6	72"		6			4-6
	5	60"	5				4-6

Single-piece tops: Round, Square, and Soft Square

		24"	30"	36"	42"	48"	60"*	Suggested Capacity
	Round							2-4 (*2-5)
	Square							2-4
	Soft Square							2-4

PRESIDE® SPECIFYING INFORMATION

Material	Type	Shape	Size					
			24"	30"	36"	42"	48"	60"
Laminate	Cylinder	Round	N/A	N/A	● ○ ○ ○ ○ ● ○ ○ ○ ○	○ ○ ○ ○ ○ ○ ○ ● ○ ○ ○ ○	○ ○ ○ ○ ○ ○ ○ ○ ○ ● ○ ○ ○ ○ ○ ○	N/A
		Square	N/A	N/A	○ ○ ○ ○ ○ ○ ○ ● ○ ○ ○ ○ ○ ○	○ ○ ○ ○ ○ ○ ○ ○ ○ ● ○ ○ ○ ○ ○ ○	○ ○ ○ ○ ○ ○ ○ ○ ○ ○ ○ ● ○ ○ ○ ○ ○ ○ ○ ○	
		Soft Square	N/A	N/A	○ ○ ○ ○ ○ ○ ○ ● ○ ○ ○ ○ ○ ○	○ ○ ○ ○ ○ ○ ○ ○ ○ ● ○ ○ ○ ○ ○ ○	○ ○ ○ ○ ○ ○ ○ ○ ○ ○ ○ ● ○ ○ ○ ○ ○ ○ ○ ○	
	Cube	Round	N/A	N/A	N/A	N/A	○ ○ ○ ○ ○ ○ ○ ○ ○ ● ○ ○ ○ ○ ○ ○ ○ ○	○ ○ ○ ○ ○ ○ ○ ○ ○ ○ ○ ● ○ ○ ○ ○ ○ ○ ○ ○
		Square	N/A	N/A	N/A	N/A	○ ○ ○ ○ ○ ○ ○ ○ ○ ○ ○ ● ○ ○ ○ ○ ○ ○ ○ ○	
		Soft Square	N/A	N/A	N/A	N/A	○ ○ ○ ○ ○ ○ ○ ○ ○ ○ ○ ● ○ ○ ○ ○ ○ ○ ○ ○	
	X-Base	Round	N/A	N/A	○ ○ ○ ○ ○ ○ ○ ● ○ ○ ○ ○ ○ ○	○ ○ ○ ○ ○ ○ ○ ○ ○ ● ○ ○ ○ ○ ○ ○ ○ ○	○ ○ ○ ○ ○ ○ ○ ○ ○ ○ ○ ● ○ ○ ○ ○ ○ ○ ○ ○	N/A
		Square	N/A	N/A	○ ○ ○ ○ ○ ○ ○ ● ○ ○ ○ ○ ○ ○	○ ○ ○ ○ ○ ○ ○ ○ ○ ● ○ ○ ○ ○ ○ ○ ○ ○	○ ○ ○ ○ ○ ○ ○ ○ ○ ○ ○ ● ○ ○ ○ ○ ○ ○ ○ ○	
		Soft Square	N/A	N/A	○ ○ ○ ○ ○ ○ ○ ● ○ ○ ○ ○ ○ ○	○ ○ ○ ○ ○ ○ ○ ○ ○ ● ○ ○ ○ ○ ○ ○ ○ ○	○ ○ ○ ○ ○ ○ ○ ○ ○ ○ ○ ● ○ ○ ○ ○ ○ ○ ○ ○	
	Traditional X-Base	Round	N/A	N/A	○ ○ ○ ○ ○ ○ ○ ● ○ ○ ○ ○ ○ ○	○ ○ ○ ○ ○ ○ ○ ○ ○ ● ○ ○ ○ ○ ○ ○ ○ ○	○ ○ ○ ○ ○ ○ ○ ○ ○ ○ ○ ● ○ ○ ○ ○ ○ ○ ○ ○	N/A
		Square	N/A	N/A	○ ○ ○ ○ ○ ○ ○ ● ○ ○ ○ ○ ○ ○	○ ○ ○ ○ ○ ○ ○ ○ ○ ● ○ ○ ○ ○ ○ ○ ○ ○	N/A	
		Soft Square	N/A	N/A	○ ○ ○ ○ ○ ○ ○ ● ○ ○ ○ ○ ○ ○	○ ○ ○ ○ ○ ○ ○ ○ ○ ● ○ ○ ○ ○ ○ ○ ○ ○	N/A	

●	●	●	●
○	○	○	○
27H	29H	36H	42H
Working Lounge	Seated	Counter	Standing
● Available			
○ Unavailable or Not Compatible			

PRESIDE® SPECIFYING INFORMATION

		Rectangle - Boat - Racetrack - Arc End													
Material	Type	Width	60"	72"	84"	96"	108"	120"	144"	168"	180"	192"	216"	240"	72" Adder
		Depth													
Painted	Footed Y-Base	30"	●●●●●												
		36"		●●●●●											
		42"			●●●●●	●●●●●	●●●●●	●●●●●	●●●●●	●●●●●	●●●●●	●●●●●	●●●●●	●●●●●	●●●●●
		48"				●●●●●	●●●●●	●●●●●	●●●●●	●●●●●	●●●●●	●●●●●	●●●●●	●●●●●	●●●●●
		54"					N/A	N/A	N/A	N/A	N/A	N/A	N/A	N/A	N/A
	Angled Leg	30"	○●●●●												
		36"		○●●●●											
		42"			○●●●●	○●●●●	○●●●●	○●●●●	○●●●●	○●●●●	○●●●●	○●●●●	○●●●●	○●●●●	○●●●●
		48"				○●●●●	○●●●●	○●●●●	○●●●●	○●●●●	○●●●●	○●●●●	○●●●●	○●●●●	○●●●●
		54"					○●●●●	○●●●●	○●●●●	○●●●●	○●●●●	○●●●●	○●●●●	○●●●●	○●●●●
	T-Leg	30"	○●●●●												
		36"		○●●●●											
		42"			○●●●●	○●●●●	○●●●●	○●●●●	○●●●●	○●●●●	○●●●●	○●●●●	○●●●●	○●●●●	○●●●●
		48"				○●●●●	○●●●●	○●●●●	○●●●●	○●●●●	○●●●●	○●●●●	○●●●●	○●●●●	○●●●●
		54"					○●●●●	○●●●●	○●●●●	○●●●●	○●●●●	○●●●●	○●●●●	○●●●●	○●●●●

	<ul style="list-style-type: none"> ● Available ○ Unavailable or Not Compatible
<p>27H 29H 36H 42H</p> <p>Working Lounge Seated Counter Standing</p>	

PRESIDE® SPECIFYING INFORMATION

		Rectangle - Boat - Racetrack - Arc End													
Material	Type	Width	60"	72"	84"	96"	108"	120"	144"	168"	180"	192"	216"	240"	72" Adder
		Depth													
Laminate	Panel	30"	● ○ ○ ○ ○ ○												
		36"		○ ○ ○ ○ ○ ○ ○ ○											
		42"			○ ○ ○ ○ ○ ○ ○ ○ ○ ○	○ ○ ○ ○ ○ ○ ○ ○ ○ ○	○ ○ ○ ○ ○ ○ ○ ○ ○ ○	○ ○ ○ ○ ○ ○ ○ ○ ○ ○	○ ○ ○ ○ ○ ○ ○ ○ ○ ○	○ ○ ○ ○ ○ ○ ○ ○ ○ ○	○ ○ ○ ○ ○ ○ ○ ○ ○ ○	○ ○ ○ ○ ○ ○ ○ ○ ○ ○	○ ○ ○ ○ ○ ○ ○ ○ ○ ○	○ ○ ○ ○ ○ ○ ○ ○ ○ ○	
		48"				○ ○ ○ ○ ○ ○ ○ ○ ○ ○	○ ○ ○ ○ ○ ○ ○ ○ ○ ○	○ ○ ○ ○ ○ ○ ○ ○ ○ ○	○ ○ ○ ○ ○ ○ ○ ○ ○ ○	○ ○ ○ ○ ○ ○ ○ ○ ○ ○	○ ○ ○ ○ ○ ○ ○ ○ ○ ○	○ ○ ○ ○ ○ ○ ○ ○ ○ ○	○ ○ ○ ○ ○ ○ ○ ○ ○ ○	○ ○ ○ ○ ○ ○ ○ ○ ○ ○	○ ○ ○ ○ ○ ○ ○ ○ ○ ○
		54"					○ ○ ○ ○ ○ ○ ○ ○ ○ ○	○ ○ ○ ○ ○ ○ ○ ○ ○ ○	○ ○ ○ ○ ○ ○ ○ ○ ○ ○	○ ○ ○ ○ ○ ○ ○ ○ ○ ○	○ ○ ○ ○ ○ ○ ○ ○ ○ ○	○ ○ ○ ○ ○ ○ ○ ○ ○ ○	○ ○ ○ ○ ○ ○ ○ ○ ○ ○	○ ○ ○ ○ ○ ○ ○ ○ ○ ○	○ ○ ○ ○ ○ ○ ○ ○ ○ ○
	Traditional Panel	30"	N/A												
		36"		○ ○ ○ ○ ○ ○ ○ ○											
		42"			○ ○ ○ ○ ○ ○ ○ ○ ○ ○	○ ○ ○ ○ ○ ○ ○ ○ ○ ○	○ ○ ○ ○ ○ ○ ○ ○ ○ ○	○ ○ ○ ○ ○ ○ ○ ○ ○ ○	○ ○ ○ ○ ○ ○ ○ ○ ○ ○	N/A	N/A	N/A	N/A	N/A	
		48"				○ ○ ○ ○ ○ ○ ○ ○ ○ ○	○ ○ ○ ○ ○ ○ ○ ○ ○ ○	○ ○ ○ ○ ○ ○ ○ ○ ○ ○	○ ○ ○ ○ ○ ○ ○ ○ ○ ○	N/A	N/A	N/A	N/A	N/A	
		54"					○ ○ ○ ○ ○ ○ ○ ○ ○ ○	○ ○ ○ ○ ○ ○ ○ ○ ○ ○	○ ○ ○ ○ ○ ○ ○ ○ ○ ○	N/A	N/A	N/A	N/A	N/A	
	Hollow Panel	30"	N/A												
		36"		N/A											
		42"			N/A	N/A	N/A	N/A	N/A	N/A	N/A	N/A	N/A	N/A	N/A
		48"				○ ○ ○ ○ ○ ○ ○ ○ ○ ○	○ ○ ○ ○ ○ ○ ○ ○ ○ ○	○ ○ ○ ○ ○ ○ ○ ○ ○ ○	○ ○ ○ ○ ○ ○ ○ ○ ○ ○	○ ○ ○ ○ ○ ○ ○ ○ ○ ○	○ ○ ○ ○ ○ ○ ○ ○ ○ ○	○ ○ ○ ○ ○ ○ ○ ○ ○ ○	○ ○ ○ ○ ○ ○ ○ ○ ○ ○	○ ○ ○ ○ ○ ○ ○ ○ ○ ○	
		54"					○ ○ ○ ○ ○ ○ ○ ○ ○ ○	○ ○ ○ ○ ○ ○ ○ ○ ○ ○	○ ○ ○ ○ ○ ○ ○ ○ ○ ○	○ ○ ○ ○ ○ ○ ○ ○ ○ ○	○ ○ ○ ○ ○ ○ ○ ○ ○ ○	○ ○ ○ ○ ○ ○ ○ ○ ○ ○	○ ○ ○ ○ ○ ○ ○ ○ ○ ○	○ ○ ○ ○ ○ ○ ○ ○ ○ ○	

	<p>● Available</p> <p>○ Unavailable or Not Compatible</p>
--	---

PRESIDE® SPECIFYING INFORMATION

Specify Preside tables with two steps—select a top and select a base.

1. Select desired top size, shape, and edge profile.

Multi-piece Tops:

Multi-piece tops are made of 108", 120", 144" and 168" two-piece "starter-sections" in rectangle, boat, arc end, or racetrack shapes in 42", 48", or 54" depths. For tables up to 20', models are preconfigured for you. If you need a table top longer than 20', add as many 72" adder sections as you need. The examples below illustrate preconfigured sizes as well as how starter section and adder section tops can be used to create tables in virtually any length. **Please note that 2-piece tops, in woodgrain colors, will not have exact grain alignment in the center where the two halves meet, a reasonable match can be expected. For tops utilizing an adder section, there will not be a grain match for those pieces.**

Preconfigured and Modular Size Examples

	Feet	Inches	Ex. Top Starter Section	Quantity	Adder Section	Quantity	Total Number of Top Sections
Preconfigured Sizes	9'	108"	HTLC48108	1	n/a	n/a	2
	10'	120"	HTLC48120	1	n/a	n/a	2
	12'	144"	HTLC48144	1	n/a	n/a	2
	14'	168"	HTLC48168	1	n/a	n/a	2
	15'	180"	HTLC48180	1	n/a	n/a	3
	16'	192"	HTLC48192	1	n/a	n/a	3
	18'	216"	HTLC48216	1	n/a	n/a	3
	20'	240"	HTLC48240	1	n/a	n/a	3
Modular Sizes	22'	264"	HTLC48120	1	HTLM4872	2	4
	24'	288"	HTLC48144	1	HTLM4872	2	4
	26'	312"	HTLC48168	1	HTLM4872	2	4
	28'	336"	HTLC48120	1	HTLM4872	3	5
	30'	360"	HTLC48144	1	HTLM4872	3	5

Note: Beyond 30', tables can be configured in 6' increments to any length.

Illustrations of Preconfigured Tops

48" x 108" Table Top (9')

54"	54"
-----	-----

Ex: HTLC48108

48" x 120" Table Top (10')

60"	60"
-----	-----

Ex: HTLC48120

48" x 144" Table Top (12')

72"	72"
-----	-----

Ex: HTLC48144

48" x 168" Table Top (14')

84"	84"
-----	-----

Ex: HTLC48168

48" x 180" Table Top (15')

54"	72"	54"
-----	-----	-----

Ex: HTLC48180

48" x 192" Table Top (16')

60"	72"	60"
-----	-----	-----

Ex: HTLC48192

48" x 216" Table Top (18')

72"	72"	72"
-----	-----	-----

Ex: HTLC48216

48" x 240" Table Top (20')

84"	72"	84"
-----	-----	-----

Ex: HTLC48240

Illustrations of User Configured Modular Tops

48" x 72" Adder Section

72"

Ex: HTLM4872

48"D x 360"W Table Top (30')

72"	72"	72"	72"	72"
-----	-----	-----	-----	-----

Ex: HTLC48144 + HTLM4872 + HTLM4872 + HTLM4872

PRESIDE® SPECIFYING INFORMATION

2. Select desired base style and identify model that coincides with top length.

Bases for Tops in Preconfigured Sizes

Bases include the appropriate number of supports for tables up to 20'. Simply identify the length of the table top in inches and specify the base with the same length in the model number. The example below illustrates how to select a base for a preconfigured size top.

Examples of Base for Preconfigured Top Size

Example top: HTLC48240 Top Description: 240" Rectangle Top
 Example base: HTLHP240 Base Description: Hollow Panel Base for 240" Top

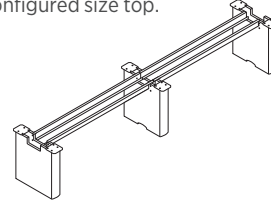

Example: HTLHP240

Bases for Tops in User Configured Modular Sizes

If you need a table top longer than 20', add as many 72" adder section bases as needed. The examples below illustrate preconfigured sizes as well as how starter section and adder section bases can be used to create tables in any desired length.

Examples of Tops and Bases for User Configured Modular Top

	Feet	Inches	Ex. Top Starter Section		Ex. Top Adder Section		Ex. Base Starter Section		Ex. Base Adder Section		Total # of Top Sections
			Quantity	Quantity	Quantity	Quantity	Quantity	Quantity			
Preconfigured Sizes	9'	108"	HTLC48108	1	n/a	n/a	HTLHP108	1	n/a	n/a	2
	10'	120"	HTLC48120	1	n/a	n/a	HTLHP120	1	n/a	n/a	2
	12'	144"	HTLC48144	1	n/a	n/a	HTLHP144	1	n/a	n/a	2
	14'	168"	HTLC48168	1	n/a	n/a	HTLHP168	1	n/a	n/a	2
	15'	180"	HTLC48180	1	n/a	n/a	HTLHP180	1	n/a	n/a	3
	16'	192"	HTLC48192	1	n/a	n/a	HTLHP192	1	n/a	n/a	3
	18'	216"	HTLC48216	1	n/a	n/a	HTLHP216	1	n/a	n/a	3
	20'	240"	HTLC48240	1	n/a	n/a	HTLHP240	1	n/a	n/a	3
Modular Sizes	22'	264"	HTLC48120	1	HTLM4872	2	HTLHP120	1	HTLHPM	2	4
	24'	288"	HTLC48144	1	HTLM4872	2	HTLHP144	1	HTLHPM	2	4
	26'	312"	HTLC48168	1	HTLM4872	2	HTLHP168	1	HTLHPM	2	4
	28'	336"	HTLC48120	1	HTLM4872	3	HTLHP120	1	HTLHPM	3	5
	30'	360"	HTLC48144	1	HTLM4872	3	HTLHP144	1	HTLHPM	3	5

Note: Tables can be configured to any desired length beyond 30' in 6' increments.

Note: Preconfigured bases include the appropriate number of supports for tables up to 20'. Depending on base type, number of required supports varies. For information regarding total number of supports please refer to chart below.

Feet	Inches	HTLP	HTLT	HTTLEG	HTLHP	HTLCUBE/S	HTLR/C	HTYLEG	HTALEG
9'	108"	2	2	2	2	2	2	3	6
10'	120"	2	2	2	2	2	2	3	6
12'	144"	2	2	2	2	2	2	3	6
14'	168"	3	3	3	3	2	2	3	6
15'	180"	3	n/a	3	3	3	3	4	8
16'	192"	3	n/a	3	3	3	3	4	8
18'	216"	3	n/a	3	3	3	3	4	8
20'	240"	4	n/a	4	3	3	3	4	8

Base Model Descriptions

HTLP = Panel Base
 HTLT = Traditional Panel Base
 HTTLEG = Aluminum T-Leg
 HTLHP = Hollow Panel Base
 HTLCUBE = Cube Base
 HTLCUBES = Standing-Height Cube Base
 HTLR = Cylinder Base
 HTLRC = Wire Management Cylinder Base
 HTYLEG = Footed Y-Leg Base
 HTALEG = Angled Leg

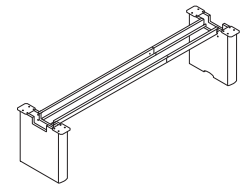

Example: HTHLP168

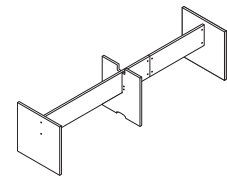

Example: HTLP168

PRESIDE® Grommet Cutout Placement

Tops specified with a grommet cutout get one cutout per section of top, centered in both directions. Cutouts do not include blank or powered inserts. Inserts must be specified separately.

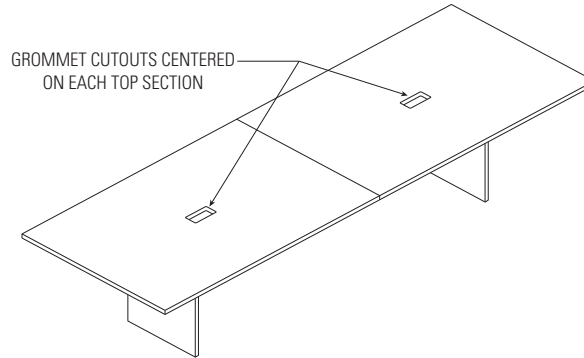

Upcharges for grommet cutouts (\$15 per G cutout, \$40 per G1 cutout, \$50 per G2 cutout)

Top Width	# Cutouts	G	G1	G2
24"	1	\$15	N/A	N/A
30"	1	\$15	N/A	N/A
36"	1	N/A	\$40	\$50
42"	1	N/A	\$40	\$50
48"	1	N/A	\$40	\$50
60"	1	N/A	\$40	\$50
72"	1	N/A	\$40	\$50
84"	1	N/A	\$40	\$50
96"	1	N/A	\$40	\$50
108"	2	N/A	\$80	\$100
120"	2	N/A	\$80	\$100
144"	2	N/A	\$80	\$100
168"	2	N/A	\$80	\$100
180"	3	N/A	\$120	\$150
192"	3	N/A	\$120	\$150
216"	3	N/A	\$120	\$150
240"	3	N/A	\$120	\$150

PRESIDE® Laminate Table Tops

GSA SIN 33721



Icon Legend on page 19

	DESCRIPTION	MODEL	SHIP WEIGHT	CUBE	LIST PRICE BY EDGE TREATMENT				L2 UPCHARGE
					"E"	"G"	"J"	"T"	
 A = Racetrack Not available in "T" edge option	Laminate Boat, Racetrack, Rectangle and Arc End Shaped Tops								
	240"W x 54"D	HTL(?)54240	425	25.1	N/A	\$2787	\$4592	N/A	\$125
	216"W x 54"D	HTL(?)54216	384	23.3	N/A	\$2433	\$3907	N/A	\$105
	192"W x 54"D	HTL(?)54192	345	21.4	N/A	\$2267	\$3708	N/A	\$100
	180"W x 54"D	HTL(?)54180	442	21.4	N/A	\$2267	\$3708	N/A	\$100
	168"W x 54"D	HTL(?)54168	300	13.5	\$1736	\$1884	\$3003	N/A	\$85
	144"W x 54"D	HTL(?)54144	259	11.6	\$1417	\$1530	\$2318	N/A	\$65
	120"W x 54"D	HTL(?)54120	220	9.8	\$1258	\$1363	\$2118	N/A	\$60
	108"W x 54"D	HTL(?)54108	324	9.8	\$1258	\$1363	\$2118	N/A	\$60
	 B = Boat Not available in "T" edge option	240"W x 48"D	HTL(?)48240	392	21.9	N/A	\$2263	\$3729	N/A
216"W x 48"D		HTL(?)48216	351	19.7	N/A	\$1980	\$3186	N/A	\$90
192"W x 48"D		HTL(?)48192	312	18.1	N/A	\$1848	\$3025	N/A	\$85
180"W x 48"D		HTL(?)48180	300	18.6	N/A	\$1848	\$3025	N/A	\$85
168"W x 48"D		HTL(?)48168	281	12.1	\$1387	\$1507	\$2400	\$3859	\$70
144"W x 48"D		HTL(?)48144	240	9.8	\$1134	\$1224	\$1857	\$3351	\$55
120"W x 48"D		HTL(?)48120	201	8.2	\$1007	\$1092	\$1696	\$2713	\$50
108"W x 48"D		HTL(?)48108	203	9.8	\$1007	\$1092	\$1696	N/A	\$50
96"W x 48"D		HTL(?)4896	153	13.2	\$855	\$886	\$1355	\$2093	\$50
 C = Rectangle		240"W x 42"D	HTL(?)42240	382	27.1	\$1975	\$2080	\$3328	N/A
	216"W x 42"D	HTL(?)42216	350	25.8	\$1763	\$1851	\$2971	N/A	\$88
	192"W x 42"D	HTL(?)42192	317	22.2	\$1657	\$1737	\$2793	N/A	\$83
	180"W x 42"D	HTL(?)42180	302	22.2	\$1657	\$1737	\$2793	N/A	\$83
	168"W x 42"D	HTL(?)42168	255	18.7	\$1324	\$1429	\$2228	N/A	\$66
	144"W x 42"D	HTL(?)42144	223	17.4	\$1111	\$1199	\$1870	N/A	\$55
	120"W x 42"D	HTL(?)42120	190	13.8	\$1005	\$1085	\$1692	N/A	\$50
	108"W x 42"D	HTL(?)42108	175	13.8	\$1005	\$1085	\$1692	N/A	\$50
	96"W x 42"D	HTL(?)4296	159	22.8	N/A	\$894	\$1363	N/A	\$40
	84"W x 42"D	HTL(?)4284	157	12.1	\$855	\$886	\$1355	N/A	\$40
 E = Arc End Not available in "T" edge option	72"W x 36"D	HTL(?)3672	90	7.9	\$570	\$624	\$1031	\$1092	\$30
	60"W x 30"D	HTL(?)3060	63	5.6	\$450	\$493	\$829	N/A	\$20
	Laminate Adder Section for Boat, Racetrack, Rectangle and Arc Shaped Tops								
	72"W x 54"D	HTLM5472	125	11.6	N/A	\$911	\$1597	N/A	\$40
	72"W x 48"D	HTLM4872	111	9.8	N/A	\$761	\$1334	N/A	\$35
	72"W x 42"D	HTLM4272	127	8.4	\$657	\$709	\$1106	N/A	\$33
	M = Mid-section Adder	Adder section cannot be used as stand-alone table. Only long edges are finished.							

NOTES:

- Tops with E, G, and T edge details feature durable laminate tops over solid core high-performance particleboard. Tops with J edge feature an MDF core.
- Laminate tops with Traditional (T) edge feature high gloss laminate and wood edge to coordinate with 94000 Series Desks.
- Tops with E edge detail have 3" radius corners. All other edge details have 90 degree corners.
- See page 121 for number of cutouts for each table top size.

! Tops with Traditional edge available in Mahogany only.

! See pages 113-118 for top and base compatibility.

HOW TO SPECIFY

<p>Select Model Number</p> <p>For laminate tops with Traditional (T) edge, place a "T" at the end of the base model.</p> <p>HTLC4296</p> <p>Traditional Edge</p> <p>HTLC4896T</p>	<p>Select Edge Detail and Edge Color</p> <p>See page 111</p> <p>For laminate tops with Traditional (T) edge, select edge color ONLY.</p> <p>J C</p> <p>N</p>	<p>Select Cutout Option</p> <p>N No Cutout</p> <p>G1 Cutout for Pop-up Port (\$40 upcharge per cutout)</p> <p>G2 Cutout for Flip-top Port (\$50 upcharge per cutout) Flip-top Port cannot be specified for Round or Square tops</p> <p>G 2</p> <p>G 2</p>	<p>Select Laminate</p> <p>See page 110, Laminate Group A</p> <p>D</p> <p>See page 110, Laminate Group D</p> <p>N</p>
---	---	--	---



PRESIDE® Laminate Table Tops



D = Round

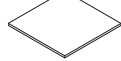

S = Square



SFT = Soft Square

DESCRIPTION	MODEL	SHIP WEIGHT			LIST PRICE BY EDGE TREATMENT					L2 UPCHARGE
		ROUND	SQUARE	SOFT SQUARE	CUBE	"E"	"G"	"J"	"T"	
Laminate Round, Square, and Soft Square Tops										
60" Round Top	HTLD60	95	N/A	N/A	10.1	\$612	\$661	\$1030	N/A	\$31
48" Top	HTL(?)48	66	76	80	6.3	\$489	\$529	\$874	\$993	\$25
42" Top	HTL(?)42	51	61	61	4.9	\$435	\$478	\$814	\$868	\$20
36" Top	HTL(?)36	36	46	46	3.7	\$381	\$440	\$696	\$783	\$20
30" Top	HTL(?)30	28	33	33	3.0	\$344	\$372	\$579	N/A	\$17
24" Top	HTL(?)24	19	23	23	2.1	\$319	\$345	\$537	N/A	\$

NOTES: Tops are available in three shapes: Round (D), Square (S), and Soft Square (SFT). Replace the (?) shown in each model with D, S, or SFT to specify shape.

❗ 60" top only available in Round (D) shape.

NOTES:

- Tops with E, G, and T edge details feature durable laminate tops over solid core high-performance particleboard. Tops with J edge feature an MDF core.
- Laminate tops with Traditional (T) edge feature high gloss laminate and wood edge to coordinate with 94000 Series Desks.
- Tops with E edge detail have 3" radius corners. All other edge details have 90 degree corners.
- See page 121 for number of cutouts for each table top size.

❗ Tops with Traditional edge available in Mahogany only.

❗ See pages 113-118 for top and base compatibility.

HOW TO SPECIFY

Select Model Number	Select Edge Detail and Edge Color	Select Cutout Option	Select Laminate
See page 111	See page 111	See page 111	See page 110, Laminate Group A
HTLD48	J C	G 1	D
Traditional Edge			
HTLD48T	N	G 1	N

PRESIDE® Laminate Bases

GSA SIN 33721



Icon Legend on page 19

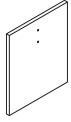

DESCRIPTION	PANELS INCLUDED PER KIT	MODEL	SHIP WEIGHT	CUBE	LIST PRICE BY LAMINATE GRADE	
					L1	L2
Laminate Seated-Height Panel Base for Tops 60" or Wider						
For 240"W Table Tops	4	HTLP240	197	16.4	\$1388	\$1468
For 216"W Table Tops	3	HTLP216	158	12.4	\$1063	\$1120
For 192"W Table Tops	3	HTLP192	147	11.6	\$1063	\$1120
For 180"W Table Tops	3	HTLP180	147	11.6	\$1063	\$1120
For 168"W Table Tops	3	HTLP168	136	10.6	\$926	\$981
For 144"W Table Tops	2	HTLP144	97	6.6	\$601	\$633
For 120"W Table Tops	2	HTLP120	86	5.8	\$601	\$633
For 108"W Table Tops	2	HTLP108	86	5.8	\$601	\$633
For 96"W Table Tops	2	HTLP96	75	4.9	\$601	\$633
For 84"W Table Tops	2	HTLP84	75	5.0	\$601	\$633
For 72"W Table Tops	2	HTLP72	25	2.9	\$566	\$598
For 60"W Table Tops	2	HTLP60	25	2.9	\$566	\$598
For 72" Adder Section	1	HTLPM	61	5.8	\$462	\$487

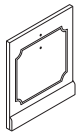

Laminate Seated-Height Traditional Panel Base for Tops 72" or Wider						
For 168"W Table Tops	3	HTLT168	145	12.1	\$1155	N/A
For 144"W Table Tops	2	HTLT144	106	8.2	\$830	N/A
For 120"W Table Tops	2	HTLT120	95	7.3	\$830	N/A
For 96"W Table Tops	2	HTLT96	62	4.6	\$830	N/A
For 72"W Table Tops	2	HTLT72	84	6.5	\$762	N/A

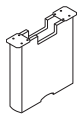

Laminate Seated-Height Hollow Panel Base for Tops 84" or Wider						
For 240"W Table Tops	3	HTLHP240	206	17.5	\$3039	\$3159
For 216"W Table Tops	3	HTLHP216	204	17.3	\$2958	\$3078
For 192"W Table Tops	3	HTLHP192	202	17.1	\$2890	\$3010
For 180"W Table Tops	3	HTLHP180	202	17.1	\$2890	\$3010
For 168"W Table Tops	3	HTLHP168	193	16.9	\$2797	\$2917
For 144"W Table Tops	2	HTLHP144	133	11.4	\$1919	\$1999
For 120"W Table Tops	2	HTLHP120	131	11.2	\$1851	\$1931
For 108"W Table Tops	2	HTLHP108	131	11.2	\$1851	\$1931
For 96"W Table Tops	2	HTLHP96	125	11.0	\$1784	\$1864
For 84"W Table Tops	2	HTLHP84	125	11.0	\$1784	\$1864
For 72" Adder Section	1	HTLHPM	71	5.9	\$1039	\$1079

NOTES:

- Tops and bases are sold and shipped separately.
- End caps for Hollow Panel bases can be matched to woodgrain finishes or specified in select solid colors.
- Bases ship with appropriate number of supports for table width. See page 120 for details.
- Laminate panel bases feature sturdy 1½" thick x 12"H particleboard support beam in matching finish.
- Traditional panel base for 168"W Top includes two traditional panels and one standard panel.

- ! Traditional style bases available in Mahogany (N) only.
- ! For Base and Top compatibility, see base information on pages 113-120.

HOW TO SPECIFY**Select
Model Number**

HTLHP240

**Select
Laminate**

See page 110, Laminate Group B

D

**Select
Endcap/Inlay Option**See page 110, Laminate Group C
(Specify for Hollow Panel Bases only)

LFW1



PRESIDE® Laminate Bases

DESCRIPTION	PANELS INCLUDED PER KIT	MODEL	SHIP WEIGHT	CUBE	LIST PRICE BY LAMINATE GRADE	
					L1	L2
Laminate Seated-Height Cube Base for Tops 84" or Wider						
For 240"W Table Tops	3	HTLCUBE240	278	29.2	\$3633	\$3768
For 216"W Table Tops	3	HTLCUBE216	276	29.0	\$3552	\$3687
For 192"W Table Tops	3	HTLCUBE192	274	28.8	\$3484	\$3619
For 180"W Table Tops	3	HTLCUBE180	274	28.8	\$3484	\$3619
For 168"W Table Tops	2	HTLCUBE168	183	19.4	\$2396	\$2486
For 144"W Table Tops	2	HTLCUBE144	181	19.2	\$2315	\$2405
For 120"W Table Tops	2	HTLCUBE120	179	19.0	\$2247	\$2337
For 108"W Table Tops	2	HTLCUBE108	179	19.0	\$2247	\$2337
For 96"W Table Tops	2	HTLCUBE96	164	18.2	\$1990	\$2080
For 84"W Table Tops	2	HTLCUBE84	164	18.2	\$1990	\$2080
For 72" Adder Section	1	HTLCUBEM	95	9.8	\$1237	\$1282
Laminate Standing-Height Cube Base for Tops 48" or Wider						
For 240"W Table Tops	3	HTLCUBES240	302	45.7	\$4392	\$4557
For 216"W Table Tops	3	HTLCUBES216	300	45.5	\$4311	\$4476
For 192"W Table Tops	3	HTLCUBES192	298	45.3	\$4243	\$4408
For 180"W Table Tops	3	HTLCUBES180	298	45.3	\$4243	\$4408
For 168"W Table Tops	2	HTLCUBES168	199	30.4	\$2902	\$3012
For 144"W Table Tops	2	HTLCUBES144	197	30.2	\$2821	\$2931
For 120"W Table Tops	2	HTLCUBES120	195	30.0	\$2753	\$2863
For 108"W Table Tops	2	HTLCUBES108	195	30.0	\$2753	\$2863
For 96"W Table Tops	2	HTLCUBES96	180	29.2	\$2496	\$2606
For 72" Adder	1	HTLCUBESM	103	15.3	\$1490	\$1545
Laminate Seated-Height Cylinder Base for Tops 84" or Wider						
For 240"W Table Tops	3	HTLR240	191	51.9	\$2946	\$3051
For 216"W Table Tops	3	HTLR216	189	51.7	\$2865	\$2970
For 192"W Table Tops	3	HTLR192	187	51.5	\$2797	\$2902
For 180"W Table Tops	3	HTLR180	187	51.5	\$2797	\$2902
For 168"W Table Tops	2	HTLR168	125	34.5	\$1938	\$2008
For 144"W Table Tops	2	HTLR144	123	34.3	\$1857	\$1927
For 120"W Table Tops	2	HTLR120	121	34.1	\$1789	\$1859
For 108"W Table Tops	2	HTLR108	121	34.1	\$1789	\$1859
For 96"W Table Tops	2	HTLR96	106	33.3	\$1532	\$1602
For 84"W Table Tops	2	HTLR84	106	33.3	\$1532	\$1602
For 72" Adder Section	1	HTLRM	66	17.4	\$1008	\$1043
Laminate Seated-Height Cylinder Base with Wire Management for Tops 84" or Wider						
For 240"W Table Tops	3	HTLRC240	191	51.9	\$3828	\$3963
For 216"W Table Tops	3	HTLRC216	189	51.7	\$3747	\$3882
For 192"W Table Tops	3	HTLRC192	187	51.4	\$3679	\$3814
For 180"W Table Tops	3	HTLRC180	187	51.4	\$3679	\$3814
For 168"W Table Tops	2	HTLRC168	125	34.5	\$2526	\$2616
For 144"W Table Tops	2	HTLRC144	123	34.3	\$2445	\$2535
For 120"W Table Tops	2	HTLRC120	121	34.1	\$2377	\$2467
For 108"W Table Tops	2	HTLRC108	121	34.1	\$2377	\$2467
For 96"W Table Tops	2	HTLRC96	106	33.3	\$2120	\$2210
For 84"W Table Tops	2	HTLRC84	106	33.3	\$2120	\$2210
For 72" Adder	1	HTLRM	66	17.4	\$1302	\$1347

NOTES:

- Tops and bases are sold and shipped separately.
 - Bases ship with appropriate number of supports for table width. See page 120 for details.
 - Standing-height Cube Bases are 39"H.
 - Laminate cube bases for tops 120"W and greater feature dual aluminum support beams with integrated wire management.
 - Cube bases feature removable door to allow access to cables and enable wire routing.
 - Standing-Height Bases feature a hinged door for easy access and for cable routing through the base.
- ① Seated Cube Base requires 150 lbs. of sand or other ballast in each base for stability (not supplied). Standing-height Cube Base does not require additional ballast.
- ② For Base and Top compatibility, see base information on pages 113-120.

HOW TO SPECIFY

Select Model Number	Select Laminate
	See page 110, Laminate Group B
HTLCUBE180	LFW1

PRESIDE® Metal Bases

OPEN MARKET



Icon Legend on page 19

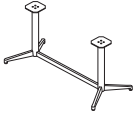

DESCRIPTION	MODEL	SHIP WEIGHT	CUBE	LIST PRICE BY PAINT GRADE		
				P1	P2	P3
Footed Y-Base for Tops 60" or Wider						
42½"H Standing Height Base for 42" and 48" x 240" Tops	HT42FB48240	88	10.8	\$2509	\$2759	\$2885
42½"H Standing Height Base for 42" and 48" x 216" Tops	HT42FB48216	85	10.4	\$2398	\$2638	\$2758
42½"H Standing Height Base for 42" and 48" x 192" Tops	HT42FB48192	82	10.1	\$2310	\$2541	\$2656
42½"H Standing Height Base for 42" and 48" x 180" Tops	HT42FB48180	82	10.1	\$2310	\$2541	\$2656
42½"H Standing Height Base for 42" and 48" x 168" Tops	HT42FB48168	67	9.3	\$1774	\$1951	\$2040
Counter Height Bases						
36½"H Counter Height Base for 42" and 48" x 240" Tops	HT36FB48240	86	10.8	\$2449	\$2695	\$2817
36½"H Counter Height Base for 42" and 48" x 216" Tops	HT36FB48216	83	10.4	\$2338	\$2574	\$2690
36½"H Counter Height Base for 42" and 48" x 192" Tops	HT36FB48192	80	10.1	\$2250	\$2477	\$2588
36½"H Counter Height Base for 42" and 48" x 180" Tops	HT36FB48180	80	10.1	\$2250	\$2477	\$2588
36½"H Counter Height Base for 42" and 48" x 168" Tops	HT36FB48168	65	9.3	\$1729	\$1903	\$1989
Seated Height Bases						
29½"H Seated Height Base for 42" and 48" x 240" Tops	HT29FB48240	84	10.8	\$2389	\$2627	\$2749
29½"H Seated Height Base for 42" and 48" x 216" Tops	HT29FB48216	81	10.4	\$2278	\$2506	\$2622
29½"H Seated Height Base for 42" and 48" x 192" Tops	HT29FB48192	78	10.1	\$2190	\$2409	\$2520
29½"H Seated Height Base for 42" and 48" x 180" Tops	HT29FB48180	78	10.1	\$2190	\$2409	\$2520
29½"H Seated Height Base for 42" and 48" x 168" Tops	HT29FB48168	63	9.3	\$1684	\$1852	\$1938
Working Lounge Bases						
27¼"H Working Lounge Base for 42" and 48" x 240" Tops	HT27FB48240	82	10.8	\$2349	\$2583	\$2701
27¼"H Working Lounge Base for 42" and 48" x 216" Tops	HT27FB48216	79	10.4	\$2238	\$2462	\$2574
27¼"H Working Lounge Base for 42" and 48" x 192" Tops	HT27FB48192	76	10.1	\$2150	\$2365	\$2472
27¼"H Working Lounge Base for 42" and 48" x 180" Tops	HT27FB48180	76	10.1	\$2150	\$2365	\$2472
27¼"H Working Lounge Base for 42" and 48" x 168" Tops	HT27FB48168	61	9.3	\$1654	\$1819	\$1902

NOTES:

- Tops and bases are sold and shipped separately.
- Bases ship with appropriate number of supports for table width.
- ! Footed base not to be used on 54"D conference tables.
- ! See pages 113-118 for top and base compatibility.

HOW TO SPECIFY

<p>Select Model Number</p> <p>HT27FB48168 .</p>	<p>Select Paint Color</p> <p>See page 110, Paint Group A</p> <p>T1</p>
--	---



Icon Legend on page 19

PRESIDE[®] Metal Bases

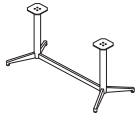

DESCRIPTION

MODEL

SHIP WEIGHT CUBE

LIST PRICE BY PAINT GRADE

P1 P2 P3

Footed Y-Base for Tops 60" or Wider

42½"H Standing Height Base for 42" and 48" x 144" Tops	HT42FB48144	64	8.9	\$1663	\$1830	\$1913
42½"H Standing Height Base for 42" and 48" x 120" Tops	HT42FB48120	61	8.7	\$1575	\$1733	\$1811
42½"H Standing Height Base for 42" and 48" x 108" Tops	HT42FB48108	61	8.7	\$1575	\$1733	\$1811
42½"H Standing Height Base for 42" and 48" x 96" Tops	HT42FB4896	37	4.9	\$1065	\$1171	\$1225
42½"H Standing Height Base for 42" x 84" Tops	HT42FB4284	36	4.8	\$1050	\$1155	\$1208
42½"H Standing Height Base for 36" x 72" Tops	HT42FB3672	27	4.2	\$860	\$946	\$989
42½"H Standing Height Base for 30" x 60" Tops	HT42FB3060	25	4.2	\$830	\$913	\$955
36½"H Counter Height Base for 42" and 48" x 144" Tops						
36½"H Counter Height Base for 42" and 48" x 144" Tops	HT36FB48144	62	8.9	\$1618	\$1782	\$1862
36½"H Counter Height Base for 42" and 48" x 120" Tops	HT36FB48120	59	8.7	\$1530	\$1685	\$1760
36½"H Counter Height Base for 42" and 48" x 108" Tops	HT36FB48108	59	8.7	\$1530	\$1685	\$1760
36½"H Counter Height Base for 42" and 48" x 96" Tops	HT36FB4896	36	4.9	\$1035	\$1139	\$1191
36½"H Counter Height Base for 42" x 84" Tops	HT36FB4284	35	4.8	\$1020	\$1123	\$1174
36½"H Counter Height Base for 36" x 72" Tops	HT36FB3672	26	4.2	\$830	\$914	\$955
36½"H Counter Height Base for 30" x 60" Tops	HT36FB3060	24	4.2	\$800	\$881	\$921
29½"H Seated Height Base for 42" and 48" x 144" Tops						
29½"H Seated Height Base for 42" and 48" x 144" Tops	HT29FB48144	60	8.9	\$1573	\$1731	\$1811
29½"H Seated Height Base for 42" and 48" x 120" Tops	HT29FB48120	57	8.7	\$1485	\$1634	\$1709
29½"H Seated Height Base for 42" and 48" x 108" Tops	HT29FB48108	57	8.7	\$1485	\$1634	\$1709
29½"H Seated Height Base for 42" and 48" x 96" Tops	HT29FB4896	35	4.9	\$1005	\$1105	\$1157
29½"H Seated Height Base for 42" x 84" Tops	HT29FB4284	34	4.8	\$990	\$1089	\$1140
29½"H Seated Height Base for 36" x 72" Tops	HT29FB3672	25	4.2	\$800	\$880	\$921
29½"H Seated Height Base for 30" x 60" Tops	HT29FB3060	23	4.2	\$770	\$847	\$885
27¼"H Working Lounge Base for 42" and 48" x 144" Tops						
27¼"H Working Lounge Base for 42" and 48" x 144" Tops	HT27FB48144	58	8.9	\$1543	\$1698	\$1775
27¼"H Working Lounge Base for 42" and 48" x 120" Tops	HT27FB48120	55	8.7	\$1455	\$1601	\$1673
27¼"H Working Lounge Base for 42" and 48" x 108" Tops	HT27FB48108	55	8.7	\$1455	\$1601	\$1673
27¼"H Working Lounge Base for 42" and 48" x 96" Tops	HT27FB4896	34	4.9	\$985	\$1083	\$1133
27¼"H Working Lounge Base for 42" x 84" Tops	HT27FB4284	33	4.8	\$970	\$1067	\$1116
27¼"H Working Lounge Base for 36" x 72" Tops	HT27FB3672	24	4.2	\$780	\$858	\$897
27¼"H Working Lounge Base for 30" x 60" Tops	HT27FB3060	22	4.2	\$750	\$825	\$863

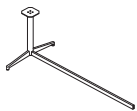

Footed Base Adder for 72"W or Wider Tops

42"H	HT42FBM	40	4.9	\$1198	\$1318	\$1378
36"H	HT36FBM	39	4.9	\$1168	\$1286	\$1344
29"H	HT29FBM	38	4.9	\$1138	\$1252	\$1310
27"H	HT27FBM	37	4.9	\$1118	\$1230	\$1286



Wire Manager

Manager for 42"H Footed Base — 1-Pack	HTFWMGR42	2	0.3	\$146	\$161	\$168
Manager for 36"H Footed Base — 1-Pack	HTFWMGR36	1	0.3	\$138	\$152	\$159
Manager for 29"H Footed Base — 1-Pack	HTFWMGR29	1	0.4	\$130	\$143	\$150
Manager for 27"H Footed Base — 1-Pack	HTFWMGR27	1	0.4	\$122	\$134	\$140

NOTES:

- Tops and bases are sold and shipped separately.
- Bases ship with appropriate number of supports for table width.
- To conceal any power cords from table top to floor, specify wire manager based on table height. Wire manager adheres to the vertical column of the base.

- ❗ Footed base not to be used on 54"D conference tables.
- ❗ See pages 113-118 for top and base compatibility.

HOW TO SPECIFY

<p>Select Model Number</p>	<p>Select Paint Color</p> <p>See page 110, Paint Group A</p>
<p>H T 2 9 F B 4 8 1 4 4 .</p>	<p>T 1</p>

PRESIDE® Metal Bases

GSA SIN 33721 EXCEPT AS NOTED



Icon Legend on page 19

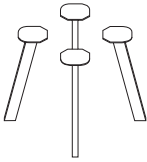

OPEN MARKET

DESCRIPTION	MODEL	SHIP		LIST PRICE BY PAINT GRADE		
		WEIGHT	CUBE	P1	P2	P3
Angled Leg						
42½"H Standing Height Base for Round, Square, and Soft Square Tops	HT42ALEG	32	2.6	\$1608	\$1768	\$1848
29½"H Seated Height Base for Round, Square, and Soft Square Tops	HT29ALEG	25	2.6	\$1306	\$1436	\$1502
42½"H Standing Height Base for 96"W Tops	HT42AL96	32	2.6	\$2412	\$2652	\$2772
42½"H Standing Height Base for 84"W Tops	HT42AL84	41	3.1	\$1798	\$1977	\$2067
42½"H Standing Height Base for 72"W Tops	HT42AL72	32	2.6	\$1608	\$1768	\$1848
42½"H Standing Height Base for 60"W Tops	HT42AL60	32	2.6	\$1608	\$1768	\$1848
29½"H Seated Height Base for 240"W Tops	HT29AL240	57	4.5	\$3260	\$3585	\$3749
29½"H Seated Height Base for 216"W Tops	HT29AL216	55	4.2	\$3179	\$3496	\$3656
29½"H Seated Height Base for 192"W Tops	HT29AL192	53	4.0	\$3111	\$3421	\$3578
29½"H Seated Height Base for 180"W Tops	HT29AL180	53	4.0	\$3111	\$3421	\$3578
29½"H Seated Height Base for 168"W Tops	HT29AL168	44	3.8	\$2365	\$2601	\$2720
29½"H Seated Height Base for 144"W Tops	HT29AL144	42	3.5	\$2284	\$2512	\$2627
29½"H Seated Height Base for 120"W Tops	HT29AL120	40	3.3	\$2216	\$2437	\$2549
29½"H Seated Height Base for 108"W Tops	HT29AL108	40	3.3	\$2216	\$2437	\$2549
29½"H Seated Height Base for 96"W Tops	HT29AL96	37	3.3	\$1498	\$1645	\$1720
29½"H Seated Height Base for 84"W Tops	HT29AL84	34	3.1	\$1496	\$1645	\$1721
29½"H Seated Height Base for 72"W Tops	HT29AL72	25	2.6	\$1306	\$1436	\$1502
29½"H Seated Height Base for 60"W Tops	HT29AL60	25	2.6	\$1306	\$1436	\$1502
29½"H Seated Height Base for 72"W Adder	HT29ALM	38	3.3	\$895	\$984	\$1029



OPEN MARKET

DESCRIPTION	MODEL	SHIP WEIGHT	SHIP CUBE	P1	P2	P3
Wire Manager						
Angled Leg Wire Manager for 42½"H Leg	HTALWMGR42	3	4.0	\$96	\$106	\$111
Angled Leg Wire Manager for 29½"H Leg	HTALWMGR29	2	4.0	\$76	\$84	\$88

DESCRIPTION	LEGS INCLUDED PER KIT	MODEL	SHIP		LIST PRICE BY PAINT GRADE		
			WEIGHT	CUBE	P1	P2	P3
Aluminum T-Leg for Tops 60" or Wider							
For 240"W Table Tops	4	HTTLEG240	76	8.9	\$1904	N/A	N/A
For 216"W Table Tops	3	HTTLEG216	65	8.6	\$1521	N/A	N/A
For 192"W Table Tops	3	HTTLEG192	63	8.4	\$1453	N/A	N/A
For 180"W Table Tops	3	HTTLEG180	63	8.4	\$1453	N/A	N/A
For 168"W Table Tops	3	HTTLEG168	54	8.2	\$1360	N/A	N/A
For 144"W Table Tops	2	HTTLEG144	39	4.5	\$953	N/A	N/A
For 120"W Table Tops	2	HTTLEG120	37	4.3	\$885	N/A	N/A
For 108"W Table Tops	2	HTTLEG108	37	4.2	\$885	N/A	N/A
For 96"W Table Tops	2	HTTLEG96	31	4.0	\$818	N/A	N/A
For 84"W Table Tops	2	HTTLEG84	31	4.0	\$818	N/A	N/A
For 72"W Table Tops	2	HTTLEG72	26	3.5	\$628	N/A	N/A
For 60"W Table Tops	2	HTTLEG60	22	3.5	\$628	N/A	N/A
For 72" Adder Section	1	HTTLEGM	26	4.2	\$568	N/A	N/A

NOTES:

- Tops and bases are sold and shipped separately.
- Bases ship with appropriate number of supports for table width.
- To conceal any power cords from table top to floor, specify wire manager based on table height. Angled leg wire manager is friction fit with magnets to hold in place.
- ❗ Aluminum T-legs for tops 84" and greater feature dual aluminum support beams with integrated wire management. Aluminum T-legs for 60" and 72" tops do not include aluminum beams.
- ❗ Footed base not to be used on 54"D conference tables.
- ❗ See pages 113-118 for top and base compatibility.

HOW TO SPECIFY

<p>Select Model Number</p> <p>HT42ALEG.</p>	<p>Select Paint Color</p> <p>See page 110, Paint Group A</p> <p>PR6</p>
---	---



PRESIDE® Laminate Bases

	DESCRIPTION	BASES INCLUDED PER KIT	MODEL	SHIP WEIGHT	CUBE	LIST PRICE BY LAMINATE GRADE	
						L1	L2
	Laminate Cube Base for Round, Square, and Soft Square Tops For 60" Round and all 48" Tops, Seated-Height	1	HTLCUBE48	82	9.1	\$995	\$1040
	For 60" Round and all 48" Tops, Standing-Height	1	HTLCUBES48	90	14.6	\$1248	\$1303
	Laminate Cylinder Base for Round, Square, and Soft Square Tops For 48" Tops	1	HTLR48	53	16.7	\$766	\$801
	For 42" Tops	1	HTLR42	42	11.6	\$691	\$726
	For 36" Tops	1	HTLR36	42	11.6	\$691	\$726
	For 48" Tops, with Wire Management	1	HTLR48	53	16.7	\$1060	\$1105
	Laminate Panel X-Base	1	HTLXP48	54	5.2	\$444	\$464
		1	HTLXP42	54	5.2	\$444	\$464
		1	HTLXP36	47	4.7	\$413	\$433
	NOTES: Can be used with 36", 42" and 48" Round and Soft Square Tops, and 36" and 42" Square Tops.						
	NOTES: Not compatible with cutouts or power ports.						
	Traditional X-Base for Round, Square, and Soft Square Tops	1	H94011	40	5.4	\$841	N/A
	NOTES: Can be used with 36", 42" and 48" Round Tops and 36" and 42" Square Tops.						
	NOTES: Not compatible with cutouts or power ports.						
	NOTES: Available in Mahogany (N) Veneer only.						
	NOTES: Must be ordered with a configurable end product. If ordered separately, not on GSA Contract.						

NOTES:

- Tops and bases are sold and shipped separately.
- Cube base features removable door for wire management.
- Cube Base requires 150 lbs. of sand or other ballast in each base for stability (not supplied).
- See pages 113-118 for top and base compatibility.

HOW TO SPECIFY

<p>Select Model Number</p> <p>HTLCUBE48</p> <p>H94011</p>	<p>Select Laminate</p> <p>See page 110, Laminate Group B</p> <p>D</p> <p>Select Traditional Base Laminate</p> <p>See page 110, Laminate Group D</p> <p><i>Specify for Traditional X-Base only</i></p> <p>LFW1</p>
--	---

PRESIDE® Metal Bases

GSA SIN 33721 EXCEPT AS NOTED



Icon Legend on page 19



DESCRIPTION

Aluminum X-Leg Base for Round, Square, and Soft Square Tops

MODEL

HTXLEG

SHIP WEIGHT

16

CUBE

3.5

LIST PRICE

\$501

P2 LIST PRICE

\$521



Standing-Height Aluminum X-Leg Base for 36" and 42" Round, Square, and Soft Square Tops

HTXLEGSH

17

3.5

\$626

\$646



OPEN MARKET

DESCRIPTION

Footed Café X-Base

42½"H Standing Height X-Base for 48" Tops
 42½"H Standing Height X-Base for 36" and 42" Tops
 42½"H Standing Height X-Base for 30" Tops
 36½"H Counter Height X-Base for 48" Tops
 36½"H Counter Height X-Base for 36" and 42" Tops
 36½"H Counter Height X-Base for 30" Tops
 29½"H Seated Height X-Base for 48" and 60" Tops
 29½"H Seated Height X-Base for 36" and 42" Tops
 29½"H Seated Height X-Base for 30" Tops
 29½"H Seated Height X-Base for 24" Tops
 27¼"H Working Lounge X-Base for 48" and 60" Tops
 27¼"H Working Lounge X-Base for 36" and 42" Tops
 27¼"H Working Lounge X-Base for 30" Tops
 27¼"H Working Lounge X-Base for 24" Tops

MODEL

HTFXL42
 HTFXM42
 HTFXS42
 HTFXL36
 HTFXM36
 HTFXS36
 HTFXL29
 HTFXM29
 HTFXS29
 HTFXT29
 HTFXL27
 HTFXM27
 HTFXS27
 HTFXT27

SHIP WEIGHT

32
 31
 30
 31
 30
 29
 30
 29
 28
 27
 29
 28
 27
 26

CUBE

3.7
 3.7
 3.7
 3.7
 3.7
 3.7
 3.7
 3.7
 3.7
 3.7
 3.7
 3.7
 3.7
 3.7

LIST PRICE BY PAINT GRADE

P1	P2	P3
\$692	\$761	\$795
\$632	\$695	\$726
\$541	\$595	\$622
\$647	\$711	\$743
\$584	\$642	\$671
\$505	\$555	\$580
\$576	\$633	\$662
\$531	\$584	\$610
\$470	\$517	\$540
\$430	\$473	\$494
\$526	\$578	\$604
\$480	\$528	\$552
\$425	\$467	\$488
\$404	\$444	\$464

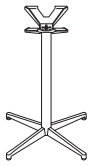

OPEN MARKET

Footed Café X-Base w/Power

42½"H Standing Height X-Base for 48" Tops
 42½"H Standing Height X-Base for 36" and 42" Tops
 42½"H Standing Height X-Base for 30" Tops
 36½"H Counter Height X-Base for 48" Tops
 36½"H Counter Height X-Base for 36" and 42" Tops
 36½"H Counter Height X-Base for 30" Tops
 29½"H Seated Height X-Base for 48" and 60" Tops
 29½"H Seated Height X-Base for 36" and 42" Tops
 29½"H Seated Height X-Base for 30" Tops
 29½"H Seated Height X-Base for 24" Tops
 27¼"H Working Lounge X-Base for 48" and 60" Tops
 27¼"H Working Lounge X-Base for 36" and 42" Tops
 27¼"H Working Lounge X-Base for 30" Tops
 27¼"H Working Lounge X-Base for 24" Tops

HTFXL42P
 HTFXM42P
 HTFXS42P
 HTFXL36P
 HTFXM36P
 HTFXS36P
 HTFXL29P
 HTFXM29P
 HTFXS29P
 HTFXT29P
 HTFXL27P
 HTFXM27P
 HTFXS27P
 HTFXT27P

32
 31
 30
 31
 31
 29
 30
 29
 28
 27
 29
 28
 27
 26

3.7
 3.7
 3.7
 3.7
 3.7
 3.7
 3.7
 3.7
 3.7
 3.7
 3.7
 3.7
 3.7
 3.7

P1	P2	P3
\$692	\$761	\$795
\$632	\$695	\$726
\$541	\$595	\$622
\$647	\$711	\$743
\$584	\$642	\$671
\$505	\$555	\$580
\$576	\$633	\$662
\$531	\$584	\$610
\$470	\$517	\$540
\$430	\$473	\$494
\$526	\$578	\$604
\$480	\$528	\$552
\$425	\$467	\$488
\$404	\$444	\$464



OPEN MARKET

Footed Café X-Base w/Casters

42½"H Standing Height X-Base for 48" Tops
 42½"H Standing Height X-Base for 36" and 42" Tops
 36½"H Counter Height X-Base for 48" Tops
 36½"H Counter Height X-Base for 36" and 42" Tops
 29½"H Seated Height X-Base for 48" Tops
 29½"H Seated Height X-Base for 36" and 42" Tops
 27¼"H Working Lounge X-Base for 48" Tops
 27¼"H Working Lounge X-Base for 36" and 42" Tops

HTFXL42C
 HTFXM42C
 HTFXL36C
 HTFXM36C
 HTFXL29C
 HTFXM29C
 HTFXL27C
 HTFXM27C

32
 31
 31
 30
 30
 29
 29
 28

3.7
 3.7
 3.7
 3.7
 3.7
 3.7
 3.7
 3.7

P1	P2	P3
\$718	\$789	\$825
\$657	\$722	\$755
\$672	\$739	\$772
\$610	\$671	\$701
\$601	\$661	\$691
\$556	\$611	\$639
\$551	\$606	\$633
\$505	\$555	\$580

NOTES:

- Tops and bases are sold and shipped separately.
- HTXLEG and HTXLEGSH allow wires to pass through the center of the leg.
- Grommet cutouts not compatible with Footed Café X-Base and Footed Café X-Base with Casters.
- ! Footed Café X-Base with Power allows wires to pass through the center of the leg except when using HTPWRGROM2.
- ! Cannot specify grommet cutouts in top when using footed X-base and footed X-base with casters. Utilize footed X-base with power for situations where power/grommet cutouts are needed.
- ! See pages 113-118 for top and base compatibility.

HOW TO SPECIFY

<p>Select Model Number</p> <p>HTFXL42</p>	<p>Select Paint Color</p> <p>See page 110, Paint Group A</p> <p>PJW</p>
---	---



Icon Legend on page 19

PRESIDE® Collaborative Tables

	DESCRIPTION	MODEL	SHIP WEIGHT	CUBE	LIST PRICE BY LAMINATE GRADE	
					L1	L2
	Seated-Height, Collaborative Table with Partial Modesty Panel					
	60"W x 42"D	HTLC4260LCTP	152	2.8	\$1163	\$1185
	72"W x 42"D	HTLC4272LCTP	167	14.5	\$1386	\$1416
	96"W x 42"D	HTLC4296LCTP	122	18.3	\$1707	\$1737
	Standing-Height, Collaborative Table with Partial Modesty Panel					
	60"W x 42"D	HTLC4260HCTP	187	3.7	\$1328	\$1350
	72"W x 42"D	HTLC4272HCTP	187	15.7	\$1551	\$1581
	96"W x 42"D	HTLC4296HCTP	242	19.4	\$1872	\$1902
	Seated-Height, Collaborative Table with Full Modesty Panel					
	60"W x 42"D	HTLC4260LCTFP	167	13.4	\$1163	\$1185
	72"W x 42"D	HTLC4272LCTFP	175	14.9	\$1386	\$1416
	96"W x 42"D	HTLC4296LCTFP	233	18.8	\$1707	\$1737
	Standing-Height, Collaborative Table with Full Modesty Panel					
	60"W x 42"D	HTLC4260HCTFP	202	17.0	\$1328	\$1350
	72"W x 42"D	HTLC4272HCTFP	211	17.9	\$1551	\$1581
	96"W x 42"D	HTLC4296HCTFP	275	22.4	\$1872	\$1902
	Seated-Height, Collaborative Table with Power Management, No Modesty Panel					
	60"W x 42"D	HTLC4260LCTHP	153	10.8	\$1441	\$1463
	72"W x 42"D	HTLC4272LCTHP	196	13.6	\$1662	\$1692
	96"W x 42"D	HTLC4296LCTHP	244	16.0	\$1982	\$2012
NOTES: Wire management available underneath top and through the base. Bases include a removable door to access cords at any time.						
	Standing-Height, Collaborative Table with Power Management, No Modesty Panel					
	60"W x 42"D	HTLC4260HCTHP	173	12.0	\$1771	\$1793
	72"W x 42"D	HTLC4272HCTHP	236	15.8	\$1992	\$2022
	96"W x 42"D	HTLC4296HCTHP	284	18.3	\$2312	\$2342
NOTES: Wire management available underneath top and through the base. Bases include a removable door to access cords at any time.						

NOTES:

- Tops feature 2mm flat edge.
- Partial modesty models will feature different modesty heights than units produced on or before March 16, 2020.
- ! Tables with partial and full modesty panels always feature cutout in modesty panel to accommodate grommet inserts in the top. However, top cutout is optional. Wire management is not included in legs.
- ! Collaborative Tables with power management will not have modesty panels.

HOW TO SPECIFY

<p>Select Model Number</p> <p>HTLC4272LCTP</p>	<p>Select Cutout Option</p> <p>N No Cutout G1 Cutout for Pop-up Port (\$40 upcharge) G2 Cutout for Flip-top Port (\$50 upcharge)</p> <p>N</p>	<p>Select Top Laminate Color</p> <p>See page 110, Laminate Group A</p> <p>H</p>	<p>Select Base Laminate Color</p> <p>See page 110, Laminate Group B</p> <p>H</p>	<p>Select Modesty Laminate Color</p> <p>See page 110, Laminate Group B</p> <p><i>Do not specify for Power Management models</i></p> <p>LDW1</p>	<p>Select 2mm Edge Color</p> <p>See page 111</p> <p>H</p>
---	---	--	---	--	--

PRESIDE® Ganging Tables

OPEN MARKET



Icon Legend on page 19

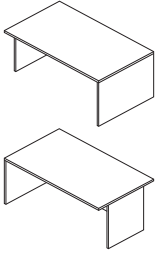

DESCRIPTION	MODEL	SHIP WEIGHT	CUBE	LIST PRICE BY LAMINATE GRADE	
				L1	L2
Seated-Height, Partial Modesty — Full Right Leg					
60"W x 42"D	HTLC4260LCTPR	165	13.8	\$1169	\$1191
72"W x 42"D	HTLC4272LCTPR	170	14.2	\$1392	\$1422
96"W x 42"D	HTLC4296LCTPR	223	38.9	\$1713	\$1756
Seated-Height, Partial Modesty — Full Left Leg					
60"W x 42"D	HTLC4260LCTPL	165	13.8	\$1169	\$1191
72"W x 42"D	HTLC4272LCTPL	170	14.2	\$1392	\$1422
96"W x 42"D	HTLC4296LCTPL	223	38.9	\$1713	\$1756
Standing-Height, Partial Modesty — Full Right Leg					
60"W x 42"D	HTLC4260HCTPR	207	16.2	\$1336	\$1358
72"W x 42"D	HTLC4272HCTPR	216	16.9	\$1559	\$1589
96"W x 42"D	HTLC4296HCTPR	274	41.6	\$1880	\$1923
Standing-Height, Partial Modesty — Full Left Leg					
60"W x 42"D	HTLC4260HCTPL	207	16.2	\$1336	\$1358
72"W x 42"D	HTLC4272HCTPL	216	16.9	\$1559	\$1589
96"W x 42"D	HTLC4296HCTPL	274	41.6	\$1880	\$1923

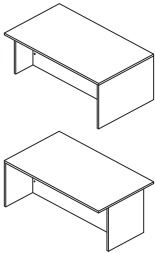

Seated-Height, Full Modesty — Full Right Leg					
60"W x 42"D	HTLC4260LCTFPR	180	14.2	\$1169	\$1191
72"W x 42"D	HTLC4272LCTFPR	188	14.2	\$1392	\$1422
96"W x 42"D	HTLC4296LCTFPR	247	39.3	\$1713	\$1756
Seated-Height, Full Modesty — Full Left Leg					
60"W x 42"D	HTLC4260LCTFPL	180	14.2	\$1169	\$1191
72"W x 42"D	HTLC4272LCTFPL	188	14.2	\$1392	\$1422
96"W x 42"D	HTLC4296LCTFPL	247	39.3	\$1713	\$1756
Standing-Height, Full Modesty — Full Right Leg					
60"W x 42"D	HTLC4260HCTFPR	223	18.0	\$1336	\$1358
72"W x 42"D	HTLC4272HCTFPR	234	18.9	\$1559	\$1589
96"W x 42"D	HTLC4296HCTFPR	299	44.7	\$1880	\$1923
Standing-Height, Full Modesty — Full Left Leg					
60"W x 42"D	HTLC4260HCTFPL	223	18.0	\$1336	\$1358
72"W x 42"D	HTLC4272HCTFPL	234	18.9	\$1559	\$1589
96"W x 42"D	HTLC4296HCTFPL	299	44.7	\$1880	\$1923

NOTES:

- Maximum of 2 ganging tables can be used together. However, different widths may be combined to optimize your space (i.e., 60"W left-hand and 96"W right-hand can be combined).
- Ganging tables ship with all required hardware and light gap filler strip for use between the two partial legs.
- Tops feature 2mm flat edge.

⚠ Tables with partial and full modesty panels always feature cutout in modesty panel to accommodate grommet inserts in the top. However, top cutout is optional. Wire management is not included in legs.

HOW TO SPECIFY

<p>Select Model Number</p> <p>HTLC4260LCTPR</p>	<p>Select Grommet Cutout</p> <p>N No Grommet G1 G1 Grommet (centered, + \$40 upcharge) G2 G2 Grommet (centered, + \$50 upcharge)</p> <p>G1</p>	<p>Select Top Laminate Color</p> <p>See page 110, Laminate Group A</p> <p>LSA1</p>	<p>Select Base Laminate Color</p> <p>See page 110, Laminate Group B</p> <p>H</p>	<p>Select Modesty Laminate Color</p> <p>See page 110, Laminate Group B</p> <p><i>Do not specify for Power Management models</i></p> <p>LSA1</p>	<p>Select 2mm Edge Color</p> <p>See page 111</p> <p>H</p>
--	--	---	---	--	--



PRESIDE® Collaborative Tables

	DESCRIPTION	MODEL	SHIP WEIGHT	CUBE	LIST PRICE BY LAMINATE GRADE	
					L1	L2
	Seated-Height, Collaborative Table with Partial Modesty Panel					
	60"W x 30"D	HTLC3060LCTP	136	11.1	\$985	\$1004
	72"W x 30"D	HTLC3072LCTP	150	12.6	\$1189	\$1215
	96"W x 30"D	HTLC3096LCTP	184	15.7	\$1479	\$1516
	Standing-Height, Collaborative Table with Partial Modesty Panel					
	60"W x 30"D	HTLC3060HCTP	174	13.1	\$1127	\$1146
	72"W x 30"D	HTLC3072HCTP	192	14.8	\$1331	\$1357
	96"W x 30"D	HTLC3096HCTP	232	18.0	\$1621	\$1658
	Seated-Height, Collaborative Table with Full Modesty Panel					
	60"W x 30"D	HTLC3060LCTFP	151	11.5	\$985	\$1004
	72"W x 30"D	HTLC3072LCTFP	168	13.1	\$1189	\$1215
	96"W x 30"D	HTLC3096LCTFP	208	16.1	\$1479	\$1516
	Standing-Height, Collaborative Table with Full Modesty Panel					
	60"W x 30"D	HTLC3060HCTFP	190	14.8	\$1127	\$1146
	72"W x 30"D	HTLC3072HCTFP	210	16.9	\$1331	\$1357
	96"W x 30"D	HTLC3096HCTFP	256	21.1	\$1621	\$1658
	Seated-Height, Collaborative Table with Power Management, No Modesty Panel					
	60"W x 30"D	HTLC3060LCTHP	133	8.3	\$1224	\$1243
	72"W x 30"D	HTLC3072LCTHP	135	9.1	\$1426	\$1452
	96"W x 30"D	HTLC3096LCTHP	164	11.3	\$1715	\$1752
NOTES: Wire management available underneath top and through the base. Bases include a removable door to access cords at any time.						
	Standing-Height, Collaborative Table with Power Management, No Modesty Panel					
	60"W x 30"D	HTLC3060HCTHP	156	9.8	\$1508	\$1545
	72"W x 30"D	HTLC3072HCTHP	158	10.5	\$1710	\$1736
	96"W x 30"D	HTLC3096HCTHP	187	12.8	\$1999	\$2036
NOTES: Wire management available underneath top and through the base. Bases include a removable door to access cords at any time.						

NOTES:

- Tops feature 2mm flat edge.
- ! Tables with partial and full modesty panels always feature cutout in modesty panel to accommodate grommet inserts in the top. However, top cutout is optional. Wire management is not included in legs.
- ! Collaborative Tables with power management will not have modesty panels.

HOW TO SPECIFY

<p>Select Model Number</p> <p>HTLC3060LCTP .</p>	<p>Select Cutout Option</p> <p>N No Cutout G1 Cutout for Pop-up Port (\$40 upcharge) G2 Cutout for Flip-top Port (\$50 upcharge)</p> <p>N .</p>	<p>Select Top Laminate Color</p> <p>See page 110, Laminate Group A</p> <p>H .</p>	<p>Select Base Laminate Color</p> <p>See page 110, Laminate Group B</p> <p>H .</p>	<p>Select Modesty Laminate Color</p> <p>See page 110, Laminate Group B</p> <p><i>Do not specify for Power Management models</i></p> <p>LDW1 .</p>	<p>Select 2mm Edge Color</p> <p>See page 111</p> <p>H</p>
---	---	--	---	--	--

PRESIDE® Ganging Tables

OPEN MARKET



Icon Legend on page 19

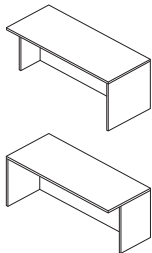
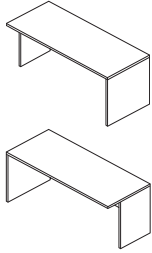

DESCRIPTION	MODEL	SHIP WEIGHT	CUBE	LIST PRICE BY LAMINATE GRADE	
				L1	L2
Seated-Height, Partial Modesty — Full Right Leg					
60"W x 30"D	HTLC3060LCTPR	128	11.1	\$985	\$1004
72"W x 30"D	HTLC3072LCTPR	175	12.6	\$1189	\$1215
96"W x 30"D	HTLC3096LCTPR	286	15.7	\$1479	\$1516
Seated-Height, Partial Modesty — Full Left Leg					
60"W x 30"D	HTLC3060LCTPL	128	11.1	\$985	\$1004
72"W x 30"D	HTLC3072LCTPL	175	12.6	\$1189	\$1215
96"W x 30"D	HTLC3096LCTPL	286	15.7	\$1479	\$1516
Standing-Height, Partial Modesty — Full Right Leg					
60"W x 30"D	HTLC3060HCTPR	163	13.1	\$1127	\$1146
72"W x 30"D	HTLC3072HCTPR	180	14.8	\$1331	\$1357
96"W x 30"D	HTLC3096HCTPR	220	18.0	\$1621	\$1658
Standing-Height, Partial Modesty — Full Left Leg					
60"W x 30"D	HTLC3060HCTPL	163	13.1	\$1127	\$1146
72"W x 30"D	HTLC3072HCTPL	180	14.8	\$1331	\$1357
96"W x 30"D	HTLC3096HCTPL	220	18.0	\$1621	\$1658
Seated-Height, Full Modesty — Full Right Leg					
60"W x 30"D	HTLC3060LCTFPR	143	11.5	\$985	\$1004
72"W x 30"D	HTLC3072LCTFPR	160	13.1	\$1189	\$1215
96"W x 30"D	HTLC3096LCTFPR	200	16.1	\$1479	\$1516
Seated-Height, Full Modesty — Full Left Leg					
60"W x 30"D	HTLC3060LCTFPL	143	11.5	\$985	\$1004
72"W x 30"D	HTLC3072LCTFPL	160	13.1	\$1189	\$1215
96"W x 30"D	HTLC3096LCTFPL	200	16.1	\$1479	\$1516
Standing-Height, Full Modesty — Full Right Leg					
60"W x 30"D	HTLC3060HCTFPR	178	14.8	\$1127	\$1146
72"W x 30"D	HTLC3072HCTFPR	199	16.9	\$1331	\$1357
96"W x 30"D	HTLC3096HCTFPR	245	21.1	\$1621	\$1658
Standing-Height, Full Modesty — Full Left Leg					
60"W x 30"D	HTLC3060HCTFPL	178	14.8	\$1127	\$1146
72"W x 30"D	HTLC3072HCTFPL	199	16.9	\$1331	\$1357
96"W x 30"D	HTLC3096HCTFPL	245	21.1	\$1621	\$1658

NOTES:

- Maximum of 2 ganging tables can be used together. However, different widths may be combined to optimize your space (i.e., 60"W left-hand and 96"W right-hand can be combined).
- Ganging tables ship with all required hardware and light gap filler strip for use between the two partial legs.
- Tops feature 2mm flat edge.
- ⚠ Tables with partial and full modesty panels always feature cutout in modesty panel to accommodate grommet inserts in the top. However, top cutout is optional. Wire management is not included in legs.
- ⚠ Collaborative Tables with power management will not have modesty panels.

HOW TO SPECIFY

Select Model Number	Select Grommet Cutout	Select Top Laminate Color	Select Base Laminate Color	Select Modesty Laminate Color	Select 2mm Edge Color
N G1 G2	No Grommet G1 G1 Grommet (centered, + \$40 upcharge) G2 G2 Grommet (centered, + \$50 upcharge)	See page 110, Laminate Group A	See page 110, Laminate Group B	See page 110, Laminate Group B	See page 111
HTLC3060LCTPR	G1	LSA1	H	LSA1	H

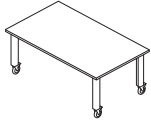

DESCRIPTION	MODEL	SHIP WEIGHT	CUBE	LIST PRICE BY LAMINATE GRADE	
				L1	L2
Mobile Collaborative Tables					
42" x 96" Seated	HTMC304296	205	16.5	\$2174	\$2217
42" x 72" Seated	HTMC304272	167	13.4	\$1906	\$1943
42" x 60" Seated	HTMC304260	147	12.1	\$1658	\$1686
42" x 96" Standing	HTMC424296	219	17.8	\$2247	\$2290
42" x 72" Standing	HTMC424272	181	14.6	\$1979	\$2016
42" x 60" Standing	HTMC424260	161	13.3	\$1731	\$1759

DESCRIPTION	MODEL	SHIP WEIGHT	CUBE	BUTCHER BLOCK
42" x 96" Seated	HTMC304296BB	206	9.6	\$3296
42" x 72" Seated	HTMC304272BB	191	7.6	\$2825
42" x 60" Seated	HTMC304260BB	167	7.1	\$2476
42" x 96" Standing	HTMC424296BB	220	10.9	\$3369
42" x 72" Standing	HTMC424272BB	205	8.9	\$2898
42" x 60" Standing	HTMC424260BB	181	8.5	\$2549

NOTES:

- Mobile collaborative tables standard with 4 locking 5" casters.
- Laminate tops feature 2mm flat edge.
- Butcher block top is 1½" thick and features 1½" radius corners.
- Butcher block tops will naturally feature variation between tops due to the nature of the real wood finish. Constructed of natural Birch wood, no two tops are exactly alike. Top is coated in a clear polyurethane finish for maximum durability.

HOW TO SPECIFY

<p>Select Model Number</p> <p>HTMC304296</p>	<p>Select Grommet Cutout</p> <p>N No Grommet</p> <p>N</p>	<p>Select Top Laminate Color</p> <p>See page 110, Laminate Group A</p> <p>LSA1</p>	<p>Select Edge Color</p> <p>See page 111</p> <p>LSA1</p>	<p>Select Caster</p> <p>C With Caster</p> <p>C</p>	<p>Select Paint Color</p> <p>See page 110</p> <p>T1</p>
---	--	---	---	---	--

<p>Select Model Number</p> <p>HTMC304296BB</p>	<p>Select Grommet Cutout</p> <p>N No Grommet</p> <p>N</p>	<p>Select Wood</p> <p>LH903 Butcher Block</p> <p>LH903</p>	<p>Select Caster</p> <p>C With Caster</p> <p>C</p>	<p>Select Paint Color</p> <p>See page 110</p> <p>T1</p>
---	--	---	---	--

PRESIDE® Team Touchdown Tables

OPEN MARKET



Icon Legend on page 19

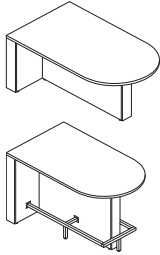

DESCRIPTION	MODEL	SHIP WEIGHT	CUBE	LIST PRICE BY LAMINATE GRADE	
				L1	L2
Team Touchdown Tables					
42" x 72" Seated Table	HTLMT4272L	202	12.5	\$1316	\$1351
42" x 60" Seated Table	HTLMT4260L	170	10.0	\$1086	\$1114
42" x 72" Standing Table	HTLMT4272H	246	14.2	\$1617	\$1652
42" x 60" Standing Table	HTLMT4260H	208	11.4	\$1342	\$1370
42" x 72" Standing Table w/ Footring	HTLMT4272HFR	272	24.5	\$2650	\$2685
42" x 60" Standing Table w/ Footring	HTLMT4260HFR	231	19.6	\$2206	\$2234
Back Panel for Seated Team Touchdown Table	HTLMTLBACK	23	3.2	\$300	\$315
Back Panel for Standing Team Touchdown Table	HTLMTBACK	33	4.5	\$339	\$356

NOTES: Specify Laminate, see page 110, Laminate Group B.
SPECIFYING EXAMPLE: HTLMTLBACK.LSA1

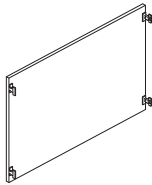

NOTES:

- Team Touchdown Tables feature open back standard. If closed back is desired, back panels must be specified separately.
- Back panel provides clearance for TV mount.
- Tops feature 2mm flat edge.

HOW TO SPECIFY

<p>Select Model Number</p> <p>HTLMT4272L</p>	<p>Select Grommet Cutout</p> <p>N No Grommet G1 G1 Grommet (centered, + \$40 upcharge) G2 G2 Grommet (centered, + \$50 upcharge)</p> <p>G1</p>	<p>Select Top Laminate Color</p> <p>See page 110, Laminate Group A</p> <p>LSA1</p>	<p>Select Edge Color</p> <p>See page 111</p> <p>LSA1</p>	<p>Select Chassis Laminate</p> <p>See page 110, Laminate Group B</p> <p>LSA1</p>	<p>Select Paint Color</p> <p><i>Footring only available on FR models in P6P only</i></p> <p>P6P</p>
---	--	---	---	---	--

DESCRIPTION	MODEL	SHIP WEIGHT	CUBE	LIST PRICE BY PAINT GRADE	
				P1	P2
TV Mount	HTLMTTV	4	1.0	\$303	\$333

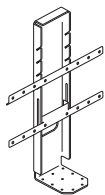

NOTES:

- TV mount is used to mount a television to the flat end of a Team Touchdown Table.
- Mounting hardware provided for television sizes 32" to 50" with VESA mounts of 100x100 to 200x200; for some televisions, additional hardware will be required (not provided).

HOW TO SPECIFY

<p>Select Model Number</p> <p>HTLMTTV</p>	<p>Select Paint Color</p> <p>P Black</p> <p>P</p>
--	---

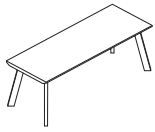

DESCRIPTION

Benches

18"D x 60"W
18"D x 48"W
18"D x 30"W

MODEL

HTLBENCH60
HTLBENCH48
HTLBENCH30

SHIP WEIGHT CUBE

23 2.3
21 1.8
18 1.8

LIST PRICE BY PAINT GRADE

P1	P2
\$1481	\$1581
\$1206	\$1286
\$880	\$938

L2 UPCHARGE

\$24
\$20
\$15

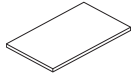

DESCRIPTION

Bench Cushion

18"D x 60"W
18"D x 48"W
18"D x 30"W

MODEL

HTLBENCHCUSH60
HTLBENCHCUSH48
HTLBENCHCUSH30

SHIP WEIGHT CUBE

16 3.6
12 2.9
8 1.9

LIST PRICE BY FABRIC GRADE

1	2	3	4	5	6
\$338	\$382	\$455	\$475	\$532	\$592
\$301	\$340	\$406	\$424	\$474	\$528
\$255	\$288	\$344	\$359	\$402	\$447

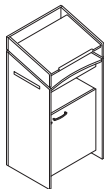

DESCRIPTION

Laminate Lectern

- Overall cabinet dimensions 24"W x 18"D x 50"H.
- Adjustable top worksurface features 3 tilt positions.
- Top of lectern can be removed and used on table top.
- Laptop shelf slides left or right.
- Includes 2 locking and 2 non-locking casters.
- Includes adjustable shelf in storage compartment.
- Features scallops in rear of lectern to route and conceal cables and wires.
- Metal components standard in black finish.

MODEL SHIP WEIGHT CUBE

HTLLECTA 132 15.6

LIST PRICE BY LAMINATE GRADE

L1	L2
\$1519	\$1584

NOTES:

- Bench features knife edge along two long sides of seat; depth edges of top features flat edge allowing benches to be placed side by side without gaps.
- Bench cushions attach to bench seat with hook and loop.
- Fabric for bench cushions is upholstered in the railroad direction.

HOW TO SPECIFY

<p>Select Model Number</p> <p>HTLBENCH48</p>	<p>Select Top Laminate Color</p> <p>See page 110, Laminate Group A</p> <p>LSA1</p>	<p>Select Edge Color</p> <p>See page 111</p> <p>SA</p>	<p>Select Paint Color</p> <p>See page 110, Paint Group A</p> <p>T1</p>
<p>Select Model Number</p> <p>HTLBENCHCUSH48</p>	<p>Select Fabric</p> <p>See page 110</p> <p>PBLE09</p>		
<p>Select Model Number</p> <p>HTLLECTA</p>	<p>Select Laminate</p> <p>See page 110, Laminate Group B</p> <p>H</p>	<p>Select Pull</p> <p>J Loop Satin Nickel G Loop Black</p> <p>G</p>	

PRESIDE® Laminate Storage

GSA SIN AS NOTED



Icon Legend on page 19

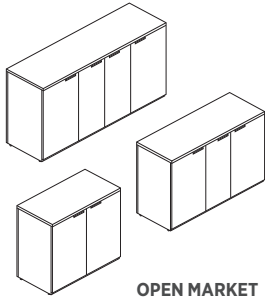

OPEN MARKET

DESCRIPTION

Hospitality Credenza
20\"/>

MODEL	SHIP WEIGHT	CUBE	LIST PRICE BY LAMINATE GRADE	
			L1	L2
HTLCRED72	301	40.0	\$2831	\$2881
HTLCRED57	250	31.8	\$2455	\$2495
HTLCRED42	200	23.7	\$1954	\$2051

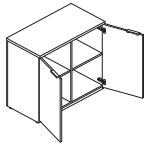

OPEN MARKET

Hospitality Credenza with Shelves

20\"/>

HTLCRED72S	311	41.5	\$2970	\$3020
HTLCRED57S	260	33.3	\$2594	\$2634
HTLCRED42S	210	25.2	\$2094	\$2191

NOTES: Hospitality credenzas with shelves ship with 2 shelves in separate cartons. Additional shelves can be ordered separately if desired.

HOW TO SPECIFY

Select Model Number	Select Top Laminate Color	Select 2mm Edge Color	Select Chassis Laminate	Select Pull	Select Back Cutout	Select Shelf Laminate
See page 110, Laminate Group A	See page 110, Laminate Group B	See page 111	See page 110, Laminate Group B	J Loop Satin Nickel G Loop Black 3 Rounded Square Matte Chrome 4 Rounded Square Black VP HLSL Voi® Pull Black VPJW HLSL Voi® Pull Designer White VT4 HLSL Voi® Pull Champagne Metallic VT1 HLSL Voi® Pull Platinum Metallic VPR6 HLSL Voi® Pull Silver VP8X HLSL Voi® Pull Solar Black	C Vent Cutout (+ \$50) N No Cutout	See page 110, Laminate Group B <i>Specify for shelf models only</i>
HTLCRED57S	LSA1	SA	LSA1	J	C	T1

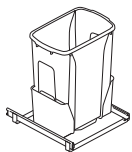

OPEN MARKET

DESCRIPTION

Trash Bin Slide
 • Holds a 35 quart bin.
 • Trash bin is included with model.
 • Can be used in outer compartments of credenza models above.

MODEL	SHIP WEIGHT	CUBE	L1 LIST PRICE	L2 UPCHARGE
HTBINSLIDE	15	3.5	\$211	N/A

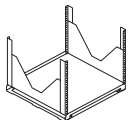

SIN 33721

Mounted AV Rack

• Can be used in outer compartments of credenza models above.

HTRACK	15	4.8	\$1918	N/A
---------------	----	-----	---------------	------------



SIN 33721

Laminate Credenza Shelf

• Shelf can be utilized in the outer compartments of the credenza.
 • 3 mounting locations within outer compartment on the credenza.
 • Mounting locations are 6\"/>

HTLSHELF	10	1.5	\$71	\$10
-----------------	----	-----	-------------	-------------

HOW TO SPECIFY

Select Model Number	Select Laminate
See page 110, Laminate Group B	See page 110, Laminate Group B
HTLSHELF	H



Icon Legend on page 19

PRESIDE® Laminate Storage

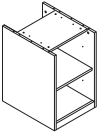
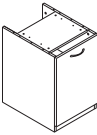
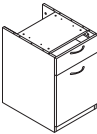
	DESCRIPTION	MODEL	SHIP WEIGHT	CUBE	LIST PRICE BY LAMINATE GRADE	
					L1	L2
 <i>Model HTLMC1828O shown</i>	Modular Pedestal, Bookshelf, No Door	HTLMC1828O	70	9.8	\$554	\$579
 <i>Model HTLMC1828L shown</i>	Modular Pedestal, Bookshelf, with Door (left)	HTLMC1828L	70	9.8	\$676	\$706
	Modular Pedestal, Bookshelf, with Door (right)	HTLMC1828R	70	9.8	\$676	\$706
 <i>Model HTLMC1828DR shown</i>	Modular Pedestal, Box Drawer, Cabinet Door (left)	HTLMC1828DL	70	9.8	\$719	\$749
	Modular Pedestal, Box Drawer, Cabinet Door (right)	HTLMC1828DR	70	9.8	\$719	\$749

NOTES:

- Use Concinnity™ laminate tops and backs with Preside® modular storage for a finished look. See page 140.

HOW TO SPECIFY

<p>Select Model Number</p> <p>HTLMC1828L</p>	<p>Select Pull Option</p> <p>J Loop Satin Handle G Loop Back 3 Rounded Square Matte Chrome 4 Rounded Square Black X No Pull (for model HTLMC1828O only)</p> <p>J</p>	<p>Select Laminate</p> <p>See page 110, Laminate Group B</p> <p>N</p>
---	---	--

MODULAR COMPONENTS

OPEN MARKET



Icon Legend on page 19

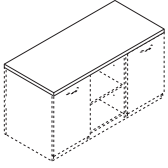

DESCRIPTION	MODEL	SHIP WEIGHT	CUBE	LIST PRICE BY LAMINATE GRADE	
				L1	L2
Concinnity™ Rectangle Worksurface with Horizontal Grain					
90"W x 24"D	HNLRC2490	75	5.5	\$533	\$563
72"W x 24"D	HNLRC2472	60	4.6	\$374	\$394
54"W x 24"D	HNLRC2454	45	3.5	\$305	\$325
36"W x 24"D Rectangle Worksurface/Pedestal Top	HNLRC2436	30	2.4	\$235	\$250

NOTES: Use Concinnity™ laminate tops and backs with Preside® modular storage for a finished look.

- ! Grain direction on all rectangle worksurfaces runs horizontal (side-to-side) except as follows: 30"W - 36"W - 42"W - 48"W - 54"W - 60"W x 24"D tops can be specified with horizontal (side-to-side) or vertical (front-to-back) grain.
- ! 42"W and 48"W x 20"D tops are available with vertical (front-to-back) grain only.

HOW TO SPECIFY

Select
Model Number

H N L R C 2 4 9 0 .

Select
Edge Profile and Edge Color

See page 29 in the 2021 Workspaces Pricer

B H .

Select
Worksurface Grommet Finish

P Black
T1 Platinum
X No Grommet

P .

Select
Worksurface Color

See page 29 in the 2021 Workspaces Pricer

H

MODULAR COMPONENTS

Back Panels

OPEN MARKET



Icon Legend on page 19

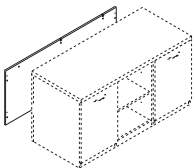

DESCRIPTION	MODEL	SHIP WEIGHT	CUBE	LIST PRICE BY LAMINATE GRADE	
				L1	L2
Concinnity™ Modesty/Back Panels — Full-Length					
90"W x 27 ⁷ / ₈ "H	HNLMP9028	58	6.7	\$428	\$453
72"W x 27 ⁷ / ₈ "H	HNLMP7228	46	5.3	\$292	\$312
54"W x 27 ⁷ / ₈ "H	HNLMP5428	34	4.0	\$240	\$260
36"W x 27 ⁷ / ₈ "H Modesty/Pedestal Back Panel	HNLMP3628	22	2.8	\$193	\$205

NOTES: Component is 3/4" thick. Provide approach-side kneespace privacy for user seated at desks, credenzas, returns, and bridges.

HOW TO SPECIFY

Select
Model Number

H N L M P 7 2 2 8 .

Select
Grommet

P Black
X No Grommet

X .

Select
Laminate Color

See page 29 in the 2021 Workspaces Pricer

H



WALL MOUNT STORAGE

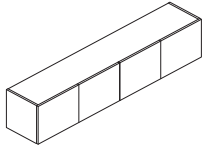

DESCRIPTION

Concinnity™ Wall Mount Storage, Laminate Doors

- 78"W x 15"D x 15"H — 4 doors, 2 compartments
- 72"W x 15"D x 15"H — 4 doors, 2 compartments
- 66"W x 15"D x 15"H — 4 doors, 2 compartments
- 60"W x 15"D x 15"H — 4 doors, 2 compartments
- 48"W x 15"D x 15"H — 3 doors, 2 compartments
- 42"W x 15"D x 15"H — 2 doors, 1 compartment
- 36"W x 15"D x 15"H — 2 doors, 1 compartment
- 30"W x 15"D x 15"H — 2 doors, 1 compartment

MODEL	SHIP WEIGHT	CUBE	L1 LIST	L2 UPCHARGES	
				CHASSIS	FRONTS
HNL1578LD	126	17.1	\$1270	\$35	\$20
HNL1572LD	118	15.9	\$1180	\$25	\$20
HNL1566LD	109	14.6	\$1124	\$25	\$20
HNL1560LD	100	13.3	\$1009	\$25	\$20
HNL1548LD	83	10.9	\$910	\$20	\$20
HNL1542LD	68	9.7	\$860	\$20	\$10
HNL1536LD	60	8.4	\$785	\$20	\$10
HNL1530LD	51	7.2	\$725	\$20	\$10

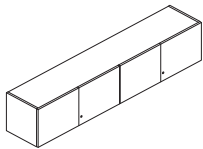

Concinnity™ Wall Mount Storage, Laminate Locking Doors

- 78"W x 15"D x 15"H — 4 doors, 2 compartments
- 72"W x 15"D x 15"H — 4 doors, 2 compartments
- 66"W x 15"D x 15"H — 4 doors, 2 compartments
- 60"W x 15"D x 15"H — 4 doors, 2 compartments
- 48"W x 15"D x 15"H — 3 doors, 2 compartments
- 42"W x 15"D x 15"H — 2 doors, 1 compartment
- 36"W x 15"D x 15"H — 2 doors, 1 compartment
- 30"W x 15"D x 15"H — 2 doors, 1 compartment

HNL1578LL	126	17.1	\$1354	\$35	\$20
HNL1572LL	118	15.9	\$1264	\$25	\$20
HNL1566LL	109	14.6	\$1208	\$25	\$20
HNL1560LL	100	13.3	\$1093	\$25	\$20
HNL1548LL	83	10.9	\$973	\$20	\$20
HNL1542LL	68	9.7	\$902	\$20	\$10
HNL1536LL	60	8.4	\$827	\$20	\$10
HNL1530LL	51	7.2	\$767	\$20	\$10

! Lock available in Black (P) or Satin (SA) finish. Lock is core removable. Keyed alike cores must be ordered separately. For stack-on and wall mount storage with locking hinged doors, specify model HF27B (Black) or HF27S (Satin) and the key number, see the Desks section in the 2021 Workspaces Pricer. Model HNL1548LL has one lock, which secures two of the three doors.

NOTES:

- Preside® tables pair well with Concinnity™ Wall Mounted Storage to create a complete conference or collaborative layout.
- Convenient off-the-worksurface storage requires no additional floor space.
- Available with laminate doors, frosted/silver doors, or sliding door.
- Doors are sized to overlap the top, end panels and light valance, to provide a clean design.
- Laminate and frosted/silver door units are equipped with self-closing, adjustable hinges.
- Laminate hinged door units are available with or without a lock.
- For tackboards, see the Desks section in the 2021 Workspaces Pricer.
- For task lights, see the Desks section in the 2021 Workspaces Pricer.
- For paper organizers, see the Desks section in the 2021 Workspaces Pricer.
- **IMPORTANT: See installation guidelines in the Desks section in the 2021 Workspaces Pricer.**

HOW TO SPECIFY

<p>Select Model Number</p> <p>H N L 1 5 7 8 L D</p>	<p>Select Chassis Color</p> <p>See page 29 in the 2021 Workspaces Pricer</p> <p>H</p>	<p>Select Door Front Color</p> <p>See page 29 in the 2021 Workspaces Pricer</p> <p>H</p>
<p>Select Model Number</p> <p>H N L 1 5 7 8 L L</p>	<p>Select Lock Finish</p> <p>See page 29 in the 2021 Workspaces Pricer</p> <p>P</p>	<p>Select Chassis Color</p> <p>See page 29 in the 2021 Workspaces Pricer</p> <p>H</p>
		<p>Select Door Front Color</p> <p>See page 29 in the 2021 Workspaces Pricer</p> <p>H</p>

WALL MOUNT STORAGE

OPEN MARKET



Icon Legend on page 19

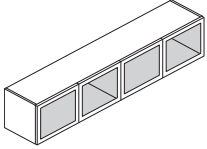

DESCRIPTION

Concinnity™ Wall Mount Storage, Frosted Doors with Silver Frame

- 78"W x 15"D x 15"H — 4 doors, 2 compartments
- 72"W x 15"D x 15"H — 4 doors, 2 compartments
- 66"W x 15"D x 15"H — 4 doors, 2 compartments
- 60"W x 15"D x 15"H — 4 doors, 2 compartments
- 48"W x 15"D x 15"H — 3 doors, 2 compartments
- 42"W x 15"D x 15"H — 2 doors, 1 compartment
- 36"W x 15"D x 15"H — 2 doors, 1 compartment
- 30"W x 15"D x 15"H — 2 doors, 1 compartment

MODEL	SHIP WEIGHT	CUBE	L1 LIST	L2 UPCHARGES	
				CHASSIS	FRONTS
HNL1578FD	106	17.1	\$1921	\$35	N/A
HNL1572FD	99	15.9	\$1829	\$25	N/A
HNL1566FD	92	14.6	\$1773	\$25	N/A
HNL1560FD	85	13.3	\$1657	\$25	N/A
HNL1548FD	71	10.9	\$1397	\$20	N/A
HNL1542FD	57	9.7	\$1187	\$20	N/A
HNL1536FD	50	8.4	\$1112	\$20	N/A
HNL1530FD	43	7.2	\$1051	\$20	N/A

❗ Frosted door models do not have a lock option.

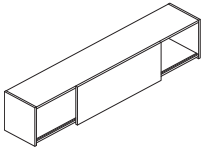

Concinnity™ Wall Mount Storage, Sliding Door

- 78"W x 15"D x 15"H
- 72"W x 15"D x 15"H
- 66"W x 15"D x 15"H
- 60"W x 15"D x 15"H
- 48"W x 15"D x 15"H

HNL1578SD	114	17.1	\$1236	\$35	\$20
HNL1572SD	107	15.9	\$1135	\$25	\$20
HNL1566SD	99	14.6	\$1058	\$25	\$20
HNL1560SD	91	13.3	\$961	\$25	\$20
HNL1548SD	76	10.9	\$900	\$20	\$20

NOTES: One door per unit. Standard with black lock, which is located on the inside vertical support panel.

NOTES:

- Preside® tables pair well with Concinnity™ Wall Mounted Storage to create a complete conference or collaborative layout.
- Convenient off-the-worksurface storage requires no additional floor space.
- Available with laminate doors, frosted/silver doors, or sliding door.
- Doors are sized to overlap the top, end panels and light valance, to provide a clean design.
- Laminate and frosted/silver door units are equipped with self-closing, adjustable hinges.
- Laminate hinged door units are available with or without a lock.
- For tackboards, see the Desks section in the 2021 Workspaces Pricer.
- For task lights, see the Desks section in the 2021 Workspaces Pricer.
- For paper organizers, see the Desks section in the 2021 Workspaces Pricer.
- **IMPORTANT: See installation guidelines in the Desks section in the 2021 Workspaces Pricer.**

HOW TO SPECIFY

<p>Select Model Number</p> <div style="border: 1px solid black; display: flex; justify-content: space-between; padding: 2px;"> HNL1578FD </div>	<p>Select Chassis Color</p> <p>See page 29 in the 2021 Workspaces Pricer</p> <div style="border: 1px solid black; display: flex; justify-content: space-between; padding: 2px;"> H </div>	
<p>Select Model Number</p> <div style="border: 1px solid black; display: flex; justify-content: space-between; padding: 2px;"> HNL1578SD </div>	<p>Select Chassis Color</p> <p>See page 29 in the 2021 Workspaces Pricer</p> <div style="border: 1px solid black; display: flex; justify-content: space-between; padding: 2px;"> H </div>	<p>Select Door Front Color</p> <p>See page 29 in the 2021 Workspaces Pricer</p> <div style="border: 1px solid black; display: flex; justify-content: space-between; padding: 2px;"> H </div>



Icon Legend on page 19

PRESIDE® Laminate Shared Components

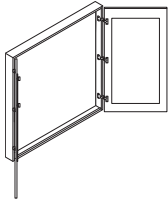

DESCRIPTION

Laminate Presentation Cabinet

- Overall cabinet dimensions 48⁷/₈"W x 5"D x 49¹/₂"H.
- Mounts to wall.
- Presentation cabinet features one magnetic white board, one tackboard and one paper pad.
- Self-adjusting hinges ensure doors are in alignment.

MODEL	SHIP WEIGHT	CUBE	LIST PRICE BY LAMINATE GRADE	
			L1	L2
HTLPRES	169	10.9	\$1664	\$1744

HOW TO SPECIFY

<p>Select Model Number</p> <p>H T L P R E S .</p>	<p>Select Laminate</p> <p>See page 110, Laminate Group B</p> <p>D</p>
---	---

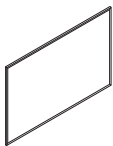

DESCRIPTION

Markerboard

- Overall markerboard dimensions 48"W x 31"H.
- Mounts on wall. Can be mounted horizontally or vertically.
- Markerboard is magnetic.
- No specification required.

MODEL	SHIP WEIGHT	CUBE	LIST PRICE
HLSL4831MB	44.0	3.4	\$664

OPEN MARKET

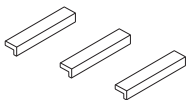

Field Installable Drawer/Door Handle Kits

- Linear, Black, 1-pack
- Linear, Matte Chrome, 1-pack
- Linear, Black, 8-pack
- Linear, Matte Chrome, 8-pack
- Arch, Black, 1-pack
- Arch, Matte Chrome, 1-pack
- Arch, Black, 8-pack
- Arch, Matte Chrome, 8-pack

HLINEARA1	0.5	1.4	\$34
HLINEARC1	0.5	1.4	\$34
HLINEARA8	0.5	1.4	\$183
HLINEARC8	0.5	1.4	\$183
HARCHA1	0.5	1.4	\$34
HARCHC1	0.5	1.4	\$34
HARCHA8	0.5	1.4	\$183
HARCHC8	0.5	1.4	\$183

HOW TO SPECIFY

<p>Select Model Number</p> <p>H L I N E A R A 1</p>	
---	--

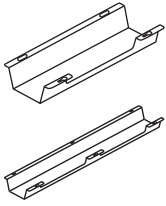

CABLE MANAGEMENT

**DESCRIPTION****Cable Management Troughs**

17"W — Single
 17"W — 10-Pack
 36"W — Single
 36"W — 10-Pack

- Cable management troughs ship flat packed.
- The troughs attach to underneath the worksurface with screws.
- Cutouts in trough allow access to power without the need to detach from surface. 17"W = 1 cutout; 36"W = 2 cutouts.
- Color: Graphite.
- Material: Metal.
- TAA Compliant.

MODEL**SHIP WEIGHT****CUBE****LIST PRICE****HCTROUGH17**

2.7

0.5

\$67**HCTROUGH1710**

14.0

0.5

\$620**HCTROUGH36**

4.9

0.9

\$113**HCTROUGH3610**

30.0

0.9

\$1045

HOW TO SPECIFY

Select
 Model Number

H C T R O U G H 1 7



Icon Legend on page 19

PRESIDE® Table Power Accessories

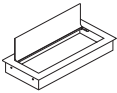
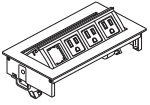
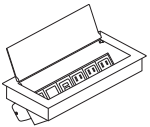
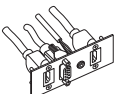
	DESCRIPTION	MODEL	SHIP WEIGHT	CUBE	LIST PRICE
	Blank G1 Cutout Insert	HGROM1BLANK	2	0.2	\$152
	Blank G2 Cutout Insert	HGROM2BLANK	2	0.2	\$233
	! Grommets available in BLK, FOG, and SVR only.				
	MhoB 4" x 8" Pop-up Port	HTG1PWR-3P-1B	5	0.3	\$396
	<ul style="list-style-type: none"> Specify G1 cutout in table top. Pop-up Port provides three power ports and one blank data receptacle. Sits flush with worksurface when closed. Includes 6' cord with three-prong plug. 				
	ElloraB 5" x 11" Flip-top Port	HTG2PWR-4P-2B	5	0.3	\$585
	<ul style="list-style-type: none"> Specify G2 cutout in table top. Flip-top Port provides four power ports and two blank data receptacles. Conceals wires and allows power cords to be plugged in while in use. Includes 10' cord with three-prong circuit breaker plug. <p>NOTES: Two circuit breaker plugs do not fit into one duplex.</p>				
	ElloraB 5" x 11" Flip-top Port	HTG2PWR-3P-1E	5	0.3	\$718
	<ul style="list-style-type: none"> Specify G2 cutout in table top. Flip-top Port provides one blank for Extron plate and three power ports. Extron AAP plates can be integrated into grommet to support changing technology. Conceals wires and allows power cords to be plugged in while in use. Includes 10' cord with three-prong plug. 				
	ElloraB 5" x 11" Flip-top Port	HTG2PWR-3P-2B-2U	5	0.3	\$850
	<ul style="list-style-type: none"> Specify G2 cutout in table top. Flip-top Port provides 3 Power, 1 USB, and 2 Blank Data Ports. Conceals wires and allows power cords to be plugged in while in use. Includes 10' cord with three-prong plug. 				
	ElloraB 5" x 11" Flip-top Port	HTG2PWR-3P-1U-W	5	0.3	\$870
	<ul style="list-style-type: none"> Specify G2 cutout in table top. Flip-top Port provides 3 Power, 1 USB, and Qi wireless charging lid. Conceals wires and allows power cords to be plugged in while in use. Includes 10' cord with three-prong plug. 				
	Extron Plate (Double Space) — VGA, HDMI, HDMI, Audio	HTPLATEVHAU	1	0.1	\$400
	<p>NOTES: 1 Double Space plate can be used in a single HTPWRGROM4 flip-top port.</p> <p>! Extron plates can be retrofitted to be used on HTPWRGROM4.</p>				

HOW TO SPECIFY

<p>Select Model Number</p>	<p>Select Paint Color</p> <p>FOG Fog SVR Silver BLK Black</p>
<p>H T G 2 P W R - 4 P - 2 B .</p>	<p>S V R</p>

PRESIDE® Table Power Accessories

GSA SIN 33721



Icon Legend on page 19

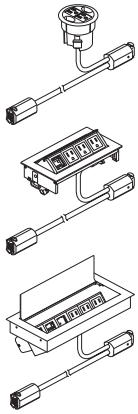

DESCRIPTION	MODEL	SHIP WEIGHT	CUBE	LIST PRICE
Interlink IQ Power Harness – 1' Power Hub, 3" Round Grommet Mount • Available in Black finish, no specification needed.	HQH1-3	2 Ⓞ	0.2	\$172
Interlink IQ Power Harness – 5' Power Hub, 3" Round Grommet Mount • Available in Black finish, no specification needed.	HQH5-3	2 Ⓞ	0.2	\$193
Interlink IQ Power Harness – 5' with 4" x 8" Pop-Up Port (3 Power, 1 Blank) • For use with tables G1 grommet. Specify paint.	HQH5-P-3P1B	3 Ⓞ	0.3	\$378
Interlink IQ Power Harness – 5' with 5" x 11" Flip-Top Port (3 Power, 3 Blank) • For use with Preside® G2 grommet. Specify paint.	HQH5-E-3P3B	5 Ⓞ	0.2	\$398
Interlink IQ Power Harness – 5' with 5" x 11" Flip-Top Port (3 Power, 1 Extron Double Space) • For use with Preside® G2 grommet. Specify paint.	HQH5-E-3P1E	5 Ⓞ	0.2	\$419
Interlink IQ Power Harness – 5' with 5" x 11" Flip-Top Port (3 Power, 2 USB, 2 Blank) • For use with Preside® G2 grommet. Specify paint.	HQH5-E-3P1U2B	5 Ⓞ	0.2	\$439

Hardwire Power System:

The hardwire power system is only needed if 6' power cables from power ports are not long enough to reach an outlet, or if there is a need to route power below entire length of worksurface from one power in-feed. By specifying one power kit for each top section, there will be two duplex receptacles below each top section. For technical details regarding 2-circuit power system, see page 90.

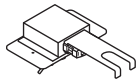

4-Trac Power Entry Plate • Connects to wall to route power to table.	HMAPLATE	1.0	0.2	\$94
--	-----------------	-----	-----	-------------

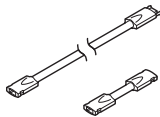

4-Trac Power Entry Cable • 6' power entry cable with male/female adapter. • Connects table to power entry plate.	HMACABLE	1.8	0.2	\$147
---	-----------------	-----	-----	--------------

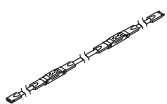

4-Trac Circuit 1 Power Kit for 60" W Top Section	HMAPOWER60	2.0	0.3	\$280
4-Trac Circuit 1 Power Kit for 72" W Top Section	HMAPOWER72	2.2	0.3	\$286
4-Trac Circuit 1 Power Kit for 84" W Top Section	HMAPOWER84	2.4	0.3	\$297
4-Trac Circuit 1 Power Kit for 96" W Top Section	HMAPOWER96	2.6	0.3	\$306

HOW TO SPECIFY

<p>Select Model Number</p> <p>HQH5-E-3P3B</p>	<p>Select Paint Color</p> <p>FOG Fog SVR Silver BLK Black</p> <p>SVR</p>
---	--

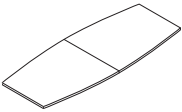
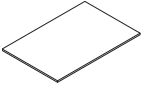
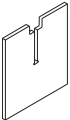

PRESIDE® Laminate Tables

	DESCRIPTION	MODEL	SHIP WEIGHT	CUBE	LIST PRICE
	Laminate Boat Shaped Table Tops with Stretcher				
	168"W x 48"D	HTLB16848P	319	11.9	\$1464
	144"W x 48"D	HTLB14448P	266	9.8	\$1163
	120"W x 48"D	HTLB12048P	217	8.2	\$1054
	Laminate Adder Section with Stretcher 72"W x 48"D	HTLM7248P	144	9.8	\$772
	Laminate Bases				
	Laminate Panel Bases, Double Pack	HTLPB	53	3.1	\$418
	Laminate Panel Bases, Single Pack	HTLPBS	28	3.1	\$252

	With Panel Base
HTLB12048P HTLB14448P	1 x HTLPB (Laminate Panel Base)
HTLB16848P	1 x HTLPB (Laminate Panel Base) 1 x HTLPBS (Laminate Panel Mid-Base)
HTLM7248P	1 x HTLPBS (Laminate Panel Mid-Base)

NOTES:

- Tops and Modesty Panels are 1/8" Melamine.
- 168"W Boat-Shaped Top needs 3 bases; 72"W Middle Adder needs 1 base. All other tops need 2 bases.
- 120", 144", and 168"W Tops ship in 2 pieces to facilitate handling and installation; these top sizes will not have an exact grain alignment where the two halves meet, a reasonable match can be expected.
- ! Tops with Stretcher and Adder Section with Stretcher available in Harvest (C) and Mahogany (N) finishes only.
- ! Tops available in Boat Shape with G edge (2mm self edge) only; Middle Adder is rectangular with G edge.
- ! Edge finish always matches top finish.

HOW TO SPECIFY

<p>Select Model Number</p> <p>H T L B 1 6 8 4 8 P .</p>	<p>Select Grommet Option</p> <p>N No grommet (only option)</p> <p>N .</p>	<p>Select Laminate</p> <p>C Harvest N Mahogany</p> <p>C</p>
--	--	--

PRESIDE® Laminate Tables — Pre-defined Typicals

GSA SIN 33721



Icon Legend on page 19

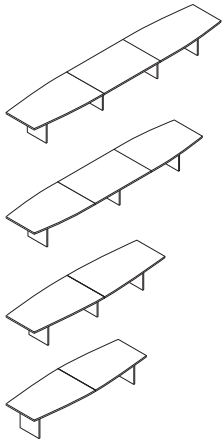

DESCRIPTION	MODEL	SHIP WEIGHT	CUBE	LIST PRICE
Boat Shape Laminate Tables with Panel Base				
240"W x 48"D	HTLB2048LP	572	31.0	\$3138
216"W x 48"D	HTLB1848LP	491	25.9	\$2589
192"W x 48"D	HTLB1648LP	442	24.3	\$2481
168"W x 48"D	HTLB1448LP	400	18.1	\$2120
144"W x 48"D	HTLB1248LP	319	12.9	\$1571
120"W x 48"D	HTLB1048LP	270	11.3	\$1463

NOTES: Order entire typical with one model number to get desired table size. Table top and bases are included.

NOTES:

- Tops and Modesty Panels are 1 1/8" Melamine.
- 168"W Boat-Shaped Top needs 3 bases; 72"W Middle Adder needs 1 base. All other tops need 2 bases.
- 120", 144", and 168"W Tops ship in 2 pieces to facilitate handling and installation; these top sizes will not have an exact grain alignment where the two halves meet, a reasonable match can be expected.
- ! Available in Harvest (C) and Mahogany (N) finishes only.
- ! Tops available in Boat Shape with G edge (2mm self edge) only; Middle Adder is rectangular with G edge.
- ! Edge finish always matches top finish.

HOW TO SPECIFY

<p>Select Model Number</p> <p>HTLB2048LP</p>	<p>Select Grommet Option</p> <p>N No grommet (only option)</p> <p>N</p>	<p>Select Laminate</p> <p>C Harvest N Mahogany</p> <p>C</p>	<p>Select Edge Color</p> <p>C Harvest N Mahogany</p> <p>C</p>
---	--	--	--

SCRAMBLE™ OCCASIONAL TABLES



Scramble™ Coffee Table shown with West Hill™ Casual Lounge Seating.

SCRAMBLE™

For every tablet, coffee mug, or notepad there's a need for an occasional table. Don't scramble to find an open meeting room when you can move to where relaxed productivity happens whether it's a lounge, commons, or nook area. Designed to coordinate with any of HON's soft seating lines, Scramble occasional tables fit in any space you need to work comfortably.



FEATURES

- Select from Soft Rectangle, Soft Square, and Round top shapes.
- Multiple size ranges available from side to large coffee tables.
- Coordinate with any of HON's soft seating series to create a space that works.
- Angled hardwood legs with metal stretcher bars provide a mid-century feel.
- Assorted leg and stretcher bar finishes available to match any aesthetic.

SCRAMBLE™ Options

MODEL OPTIONS

HSCCSR2448LM

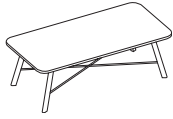

Coffee Table
Soft Rectangle

HSCCSS36LM
HSCCSS48LM



Coffee Table
Soft Square

HSCCR36LM
HSCCR48LM



Coffee Table
Round

HSCCESS24LM



End Table
Soft Square

HSCER24LM



End Table
Round

Available Laminates and Corresponding Edge:

Laminate		Edgeband	
Charcoal	S	Charcoal	S
Designer White	LDW1	Designer White	DW
Florence Walnut	LFW1	Florence Walnut	FW
Kingswood Walnut	LKI1	Kingswood Walnut	KI
Lowell Ash	LLA1	Lowell Ash	DL
Natural Maple	D	Natural Maple	D
Natural Recon	LNRI	Natural Recon	NR
Phantom Ecu	LPE1	Phantom Ecu	PE
Pinnacle	PINC	Pinnacle	PINC
Portico Teak	LPT1	Portico Teak	PT
Skyline Walnut	LSW1	Skyline Walnut	SW
Sterling Ash	LSA1	Sterling Ash	SA

WOOD LEG OPTIONS

CODE	DESCRIPTION	PRICE
LFW1	Florence Walnut	+\$0
LKI1	Kingswood Walnut	+\$0
LLA1	Lowell Ash	+\$0
D	Natural Maple	+\$0
LNRI	Natural Recon	+\$0
LPE1	Phantom Ecu	+\$0
PINC	Pinnacle	+\$0
LPT1	Portico Teak	+\$0
LSW1	Skyline Walnut	+\$0
LSA1	Sterling Ash	+\$0



STRETCHER BAR PAINT OPTIONS

CODE	DESCRIPTION	PRICE
Grade P1		
P7A	Textured Charcoal	+\$0
P8V	Textured Titanium	+\$0
Grade P2		
PR5	Champagne Metallic	+\$20
P8X	Solar Black	+\$20



Icon Legend on page 19

SCRAMBLE™ Laminate Coffee Tables

	DESCRIPTION	MODEL	SHIP WEIGHT	CUBE	LIST PRICE BY LAMINATE GRADE	
					L1	L2
	Coffee Table, Soft Rectangle 24"D x 48"W x 16"H	HSCCSR2448LM	46.5	9.7	\$1256	\$1276
	Coffee Table, Soft Square 36"D x 36"W x 16"H 48"D x 48"W x 16"H	HSCCSS36LM HSCCSS48LM	48.5 80.5	9.0 12.8	\$1206 \$1306	\$1226 \$1326
	Coffee Table, Round 36"D x 16"H 48"D x 16"H	HSCCR36LM HSCCR48LM	41.0 70.0	8.8 12.6	\$1206 \$1306	\$1226 \$1326

HOW TO SPECIFY

<p>Select Model Number</p> <p>H S C C S R 2 4 4 8 L M .</p>	<p>Select Laminate and Edge</p> <p>See page 150</p> <p>L S A 1 S A .</p>	<p>Select Leg Finish</p> <p>See page 150</p> <p>L S A 1 .</p>	<p>Select Stretcher Bar Paint Color</p> <p>See page 150</p> <p>P 8 V</p>
--	---	--	---

SCRAMBLE™ Laminate End Tables

OPEN MARKET



Icon Legend on page 19



DESCRIPTION
End Table, Soft Square
24"W x 24"D x 22"H

MODEL	SHIP WEIGHT	CUBE	LIST PRICE BY LAMINATE GRADE	
			L1	L2
HSCSS24LM	34.5	19.0	\$1156	\$1176



DESCRIPTION
End Table, Round
24"D x 22"H

MODEL	SHIP WEIGHT	CUBE	L1	L2
HSCER24LM	32.0	19.0	\$1156	\$1176

HOW TO SPECIFY

<p>Select Model Number</p> <p>H S C E S S 2 4 L M .</p>	<p>Select Laminate and Edge</p> <p>See page 150</p> <p>L S A 1 S A .</p>	<p>Select Leg Finish</p> <p>See page 150</p> <p>L S A 1 .</p>	<p>Select Stretcher Bar Paint Color</p> <p>See page 150</p> <p>P 8 V</p>
--	---	--	---

66000 SERIES / THE STATIONMASTER®



StationMaster® shown with ComforTask® Chair.

66000 SERIES / THE STATIONMASTER®

StationMaster tables from HON are ideal for use both as training tables and as desks. The laminate tops stand up to activity. The sturdy C-style legs provide kneespace. Wire management keeps technology in place.



FEATURES

- Thick laminate worksurface stands up to daily wear and tear.
- Integrated grommets neatly route cables and cords directly to the worksurface.
- Leveling glides compensate for uneven floors.

66000 SERIES ORDERING INFORMATION

LAMINATE

TOPS/L1 LAMINATES CODES

Woodgrain

- ◆ Bourbon Cherry H
- ◆ Harvest C
- ◆ Mahogany N
- ◆ Natural Maple D
- ◆ Shaker Cherry F

Solid

- ◆ Black P
- ◆ Charcoal S
- ◆ Designer White LDW1

Patterned

- ◆ Sheer Mesh A5
- ◆ Silver Mesh B9
- ◆ Steel Mesh A9
- ◆ Canyon Zephyr K9
- ◆ Desert Zephyr K8
- ◆ Shadow Zephyr K1
- ◆ Gray G2
- ◆ Grey Tigris L6
- ◆ White G1
- ◆ Whitestone K4

PAINT

BASE PAINT CODES

P1

- ◆ Black P
- ◆ Brownstone P7D
- ◆ Charcoal S
- ◆ Designer White PJW
- ◆ Fossil P28
- ◆ Greige T5
- ◆ Light Gray Q
- ◆ Loft LOFT
- ◆ Muslin T3
- ◆ Putty L
- ◆ Shadow * SHDW
- ◆ Titanium P8T

P2

- ◆ Champagne Metallic T4
- ◆ Platinum Metallic T1

Recommended Edgeband Color Selection:

Laminate		Edge	
Bourbon Cherry	H	Bourbon Cherry	H
Harvest	C	Harvest	C
Mahogany	N	Mahogany	N
Natural Maple	D	Natural Maple	D
Shaker Cherry	F	Shaker Cherry	F
Black	P	Black	P
Charcoal	S	Charcoal	S
Designer White	LDW1	Designer White	DW
Whitestone	K4	Muslin	T
Sheer Mesh	A5	Muslin	T
Silver Mesh	B9	Loft	LOFT
Steel Mesh	A9	Charcoal	S
Canyon Zephyr	K9	Greige	R
Desert Zephyr	K8	Greige	R
Shadow Zephyr	K1	Loft	LOFT
Gray	G2	Charcoal	S
Grey Tigris	L6	Greige	R

◆◆◆ For lead time information see page 19.

* De-emphasized



66000 SERIES

The StationMaster®

	DESCRIPTION	MODEL	SHIP		LIST PRICE BY PAINT GRADE	
			WEIGHT	CUBE	P1	P2
	Desk 29½"H					
	72"W x 29½"D	H66591	129	11.0	\$1221	\$1295
	66"W x 29½"D	H66581	122	10.1	\$1188	\$1262
	60"W x 29½"D	H66571	113	9.2	\$1152	\$1226
	48"W x 29½"D	H66551	95	7.5	\$1073	\$1147
	42"W x 29½"D	H66531	88	6.6	\$1027	\$1101
	36"W x 29½"D	H66541	76	5.7	\$989	\$1063
	Desk 29½"H					
	72"W x 24"D	H66597	116	9.1	\$1181	\$1255
	66"W x 24"D	H66582	111	8.1	\$1152	\$1226
	60"W x 24"D	H66577	99	7.7	\$1097	\$1171
	48"W x 24"D	H66557	88	5.7	\$1023	\$1097
	42"W x 24"D	H66537	82	5.6	\$975	\$1049
	36"W x 24"D	H66547	77	4.3	\$936	\$1010
	Corner Desk					
	29½"H with 24" sides	H66280	96	10.3	\$1473	\$1547
	29½"H with 29½" sides	H66282	104	12.3	\$1552	\$1626

NOTES:

- Tops are 1/8" thick.
 - Two leveling glides per leg with 3/4" adjustability.
 - Laminate tops have low-glare surfaces and black grommets for wire management.
 - Wire management in C-legs is concealed.
 - For additional accessories and design information see the Tables section in the 2021 Workspaces Pricer.
- ! 66000 Series Tables produced on or after November 2018 will feature 2mm flat edgeband tops and round grommets. Tables produced before November 2018 feature bullnose edge tops and oval grommets.

HOW TO SPECIFY

<p>Select Model Number</p> <p>H 6 6 5 9 1</p>	<p>Select Edge Detail</p> <p>G 2mm Edge</p> <p>Select Edge Color</p> <p>See page 154</p> <p>G K</p>	<p>Select Laminate</p> <p>See page 154</p> <p>S</p>	<p>Select Paint</p> <p>See page 154</p> <p>S</p>
--	---	--	---

UTILITY TABLES



Utility Tables shown with Accommodate® Seating.

UTILITY TABLES

All-purpose Utility Tables from HON have a place in every work and educational setting. The Chrome steel legs and square edge detail complement HON 34000 Series desks. The top is scratch-, spill-, and stain-resistant laminate. Adjustable glides won't mar hard-surface floors.



FEATURES

- Scratch-, spill- and stain-resistant laminate stands up to heavy use and is specially treated to withstand boiling liquids.
- Heavy-grade, warp-resistant particleboard withstands high activity.
- Formed steel legs and perimeter frame are built to endure frequent moves and high activity.
- Leveling glides compensate for uneven floors.

UTILITY TABLES ORDERING INFORMATION

LAMINATE

LAMINATES CODES

Woodgrain

- ◆ Bourbon Cherry **H**
- ◆ Cognac **COGN**
- ◆ Florence Walnut **LFW1**
- ◆ Harvest **C**
- ◆ Kingswood Walnut **LKI1**
- ◆ Mahogany **N**
- ◆ Mocha **MOCH**
- ◆ Natural Maple **D**
- ◆ Pinnacle **PINC**
- ◆ Shaker Cherry **F**
- ◆ Sterling Ash **LSA1**

Solid

- ◆ Designer White **LDW1**
- ◆ Loft **LOFT**

Patterned

- ◆ Gray **G2**

PAINT

BASE PAINT CODES

P1

- ◆ Black **P**
- ◆ Brownstone **P7D**
- ◆ Charcoal **S**
- ◆ Designer White **PJW**
- ◆ Fossil **P28**
- ◆ Greige **T5**
- ◆ Loft **LOFT**
- ◆ Muslin **T3**
- ◆ Putty **L**
- ◆ Shadow* **SHDW**
- ◆ Titanium **P8T**

LEG FINISH

BASE PAINT CODES

- ◆ Black **P**
- ◆ Chrome **CHR**

Recommended Edgeband Color Selection:

Laminate		Edge	
Bourbon Cherry	H	Bourbon Cherry	H
Cognac	COGN	Cognac	COGN
Florence Walnut	LFW1	Florence Walnut	FW
Harvest	C	Harvest	C
Kingswood Walnut	LKI1	Kingswood Walnut	KI
Mahogany	N	Mahogany	N
Mocha	MOCH	Mocha	MOCH
Natural Maple	D	Natural Maple	D
Pinnacle	PINC	Pinnacle	PINC
Shaker Cherry	F	Shaker Cherry	F
Gray	G2	Charcoal	S

◆◆◆ For lead time information see page 19.

* De-emphasized

UTILITY TABLES

GSA SIN 33721



Icon Legend on page 19



DESCRIPTION

Rectangle Shaped Utility Table — Metal
72"W x 18"D x 29"H

40"W x 20"D x 29"H
60"W x 20"D x 29"H

60"W x 24"D x 29"H

60"W x 30"D x 29"H
72"W x 30"D x 29"H

72"W x 36"D x 29"H

MODEL

SHIP WEIGHT

CUBE

LIST PRICE

MODEL	SHIP WEIGHT	CUBE	LIST PRICE
HUTM1872	73	4.8	\$544
HUTM2040	50	3.3	\$450
HUTM2060	68	4.9	\$503
HUTM2460	81	5.6	\$535
HUTM3060	88	6.5	\$550
HUTM3072	106	7.2	\$686
HUTM3672	116	10.4	\$728

NOTES:

- 1½" thick top with self-edge.
 - Adjustable non-marring leveling floor glides.
 - 90-degree square corners.
 - Legs secured to top with steel corner brace.
- 1¼" square Chrome or Black painted legs ONLY.

HOW TO SPECIFY

<p>Select Model Number</p> <p>HUTM1872</p>	<p>Select Laminate</p> <p>See page 157</p> <p>MOCH</p>	<p>Select Paint Color</p> <p>See page 157</p> <p>P</p>	<p>Select Leg Paint Color or Finish</p> <p>P Black CHR Chrome</p> <p>CHR</p>
---	---	---	---

CROSS REFERENCE BY APPLICATION

	Page
CLASSROOM	
Student Desks	
SmartLink® Student Desks	195-197
Teacher/Administration Desks	
SmartLink® Teacher Stations	202-204
Voi®	<i>See the Desks section in the 2021 Workspaces Pricer.</i>
10700 Series™	<i>See the Desks section in the 2021 Workspaces Pricer.</i>
10500 Series™	<i>See the Desks section in the 2021 Workspaces Pricer.</i>
Mentor® Series Desks	<i>See the Desks section in the 2021 Workspaces Pricer.</i>
38000 Series™	<i>See the Desks section in the 2021 Workspaces Pricer.</i>
Seating	
SmartLink® Seating	198-201
Perpetual® Nesting	454-456
Olson Stacker® - 4040 Series	
High-Density	440-441
Motivate® Seating	411-430
Volt® - 5700/5710/5720/5730 Series	512-519
ComforTask® - 5900 Series	294-298
Ignition®/Ignition® 2.0	364-387
Solve®	477-488
Convergence®	299-303
Storage & Files	
SmartLink® Modular Storage	205-207
Brigade® 800 Series Lateral Files	<i>See the Storage section in the 2021 Workspaces Pricer.</i>
Brigade® 700 Series Lateral Files	<i>See the Storage section in the 2021 Workspaces Pricer.</i>
Brigade® 600 Series Lateral Files	<i>See the Storage section in the 2021 Workspaces Pricer.</i>
Lateral File Accessories	<i>See the Storage section in the 2021 Workspaces Pricer.</i>
310 Series Vertical Files - 26½"D	<i>See the Storage section in the 2021 Workspaces Pricer.</i>
510 Series Vertical Files - 25"D	<i>See the Storage section in the 2021 Workspaces Pricer.</i>
Flagship® Bookcases and Storage Cabinets	<i>See the Storage section in the 2021 Workspaces Pricer.</i>
Brigade® Storage Cabinets	<i>See the Storage section in the 2021 Workspaces Pricer.</i>
Brigade® Steel Bookcases	<i>See the Storage section in the 2021 Workspaces Pricer.</i>
10500 Series™ Bookcases	<i>See the Storage section in the 2021 Workspaces Pricer.</i>
1870 Series Bookcases	<i>See the Storage section in the 2021 Workspaces Pricer.</i>
Tables	
Huddle Multi-Purpose Tables	81-88
Motivate® Tables	99-103
Utility Tables	156-158
Learning Applications	
SmartLink® Wall Rail System	208-209
Motivate® Mobile Markerboards	103

COMPUTER LAB

Tables	
Huddle Multi-Purpose Tables	81-88
Motivate® Tables	99-103
Between™ Tables	34-38
66000 Series/The StationMaster®	155
Seating	
Motivate® Seating	411-430
Perpetual® Nesting	454-456

	Page
CAFETERIA	
Seating	
SmartLink® Seating	198-201
Motivate® Seating	411-430
Olson Stacker® - 4040 Series	
High-Density	440-441
Tables	
Huddle Multi-Purpose Tables	81-88
Motivate® Tables	99-103
Between™ Tables	34-38

COMMON AREAS

Reception Seating	
Flock® Lounge	320-343
Grove®	349-361
Accommodate®	252-258
Invitation® - 2110 Series	389-392
Cambia™ - 2160 Series	279-281
Pagoda® - 4070/4090 Series	442-449
Invitation® Lounge	393-395
Tables	
Huddle Multi-Purpose Tables	81-88
Motivate® Tables	99-103
Laminate Occasional Tables	95
Flock®	62-67
Between™ Tables	34-38

LIBRARY / MEDIA CENTER

Storage	
Flagship® Bookcases	<i>See the Storage section in the 2021 Workspaces Pricer.</i>
Brigade® Steel Bookcases	<i>See the Storage section in the 2021 Workspaces Pricer.</i>
SmartLink® Modular Storage	205-207
Reception Seating	
Flock® Lounge	320-343
Grove®	349-361
Accommodate®	252-258
Invitation® - 2110 Series	389-392
Cambia™ - 2160 Series	279-281
Pagoda® - 4070/4090 Series	442-449
Invitation® Lounge	393-395
Student Seating	
SmartLink® Seating	198-201
Motivate® Seating	411-430
Accommodate®	252-258
Tables	
Huddle Multi-Purpose Tables	81-88
Motivate® Tables	99-103
Laminate Occasional Tables	95
Flock®	62-67
Between™ Tables	34-38

CROSS REFERENCE BY APPLICATION

	Page
ART ROOM	
Seating	
Motivate® Seating	411-430
Storage	
SmartLink® Modular Storage	205-207
Flagship® Storage Cabinets	<i>See the Storage section in the 2021 Workspaces Pricer.</i>
Brigade® Storage Cabinets	<i>See the Storage section in the 2021 Workspaces Pricer.</i>
Flagship® Bookcases	<i>See the Storage section in the 2021 Workspaces Pricer.</i>
Brigade® Steel Bookcases	<i>See the Storage section in the 2021 Workspaces Pricer.</i>
10500 Series™ Bookcases	<i>See the Storage section in the 2021 Workspaces Pricer.</i>
1870 Series Bookcases	<i>See the Storage section in the 2021 Workspaces Pricer.</i>
Tables	
Huddle Multi-Purpose Tables	81-88
Motivate® Tables	99-103

	Page
TEACHER PLANNING	
Desks	
SmartLink® Teacher Stations	202-204
Voi®	<i>See the Desks section in the 2021 Workspaces Pricer.</i>
10700 Series™	<i>See the Desks section in the 2021 Workspaces Pricer.</i>
10500 Series™	<i>See the Desks section in the 2021 Workspaces Pricer.</i>
Mentor® Series Desks	<i>See the Desks section in the 2021 Workspaces Pricer.</i>
38000 Series™ ...	<i>See the Desks section in the 2021 Workspaces Pricer.</i>
Seating	
Volt® - 5700/5710/5720/5730 Series	512-519
ComforTask® - 5900 Series	294-298
Ignition®/Ignition® 2.0	364-387
Solve®	477-488
Convergence®	299-303
Storage	
SmartLink® Modular Storage	205-207
Brigade® 800 Series Lateral Files	<i>See the Storage section in the 2021 Workspaces Pricer.</i>
Brigade® 700 Series Lateral Files	<i>See the Storage section in the 2021 Workspaces Pricer.</i>
Brigade® 600 Series Lateral Files	<i>See the Storage section in the 2021 Workspaces Pricer.</i>
Flagship® Lateral Files	<i>See the Storage section in the 2021 Workspaces Pricer.</i>
400 Series Lateral Files	<i>See the Storage section in the 2021 Workspaces Pricer.</i>
Lateral File Accessories	<i>See the Storage section in the 2021 Workspaces Pricer.</i>
210 Series Vertical Files - 28½"D	<i>See the Storage section in the 2021 Workspaces Pricer.</i>
310 Series Vertical Files - 26½"D	<i>See the Storage section in the 2021 Workspaces Pricer.</i>
510 Series Vertical Files - 25"D	<i>See the Storage section in the 2021 Workspaces Pricer.</i>
Vertical File Accessories	<i>See the Storage section in the 2021 Workspaces Pricer.</i>
Flagship® Storage Cabinets	<i>See the Storage section in the 2021 Workspaces Pricer.</i>
Brigade® Storage Cabinets	<i>See the Storage section in the 2021 Workspaces Pricer.</i>
Flagship® Bookcases	<i>See the Storage section in the 2021 Workspaces Pricer.</i>
Brigade® Steel Bookcases	<i>See the Storage section in the 2021 Workspaces Pricer.</i>
10500 Series™ Bookcases	<i>See the Storage section in the 2021 Workspaces Pricer.</i>
1870 Series Bookcases	<i>See the Storage section in the 2021 Workspaces Pricer.</i>

	Page
TEACHER PLANNING (continued)	
Tables	
Huddle Multi-Purpose Tables	81-88
Motivate® Tables	99-103
Flock®	62-67
Between™ Tables	34-38
ADMINISTRATION	
Desks	
10700 Series™	<i>See the Desks section in the 2021 Workspaces Pricer.</i>
10500 Series™	<i>See the Desks section in the 2021 Workspaces Pricer.</i>
Mentor® Series Desks	<i>See the Desks section in the 2021 Workspaces Pricer.</i>
38000 Series™ ...	<i>See the Desks section in the 2021 Workspaces Pricer.</i>
Reception Seating	
Invitation® - 2110 Series	389-392
Cambia™ - 2160 Series	279-281
Pagoda® - 4070/4090 Series	442-449
Task / Administrative Seating	
Ignition®/Ignition® 2.0	364-387
Motivate® Seating	411-430
Pillow-Soft® - 2190 Series	460-462
Volt® - 5700/5710/5720/5730 Series	512-519
ComforTask® - 5900 Series	294-298
Solve®	477-488
Convergence®	299-303
Storage & Files	
SmartLink® Modular Storage	205-207
Brigade® 800 Series Lateral Files	<i>See the Storage section in the 2021 Workspaces Pricer.</i>
Brigade® 700 Series Lateral Files	<i>See the Storage section in the 2021 Workspaces Pricer.</i>
Brigade® 600 Series Lateral Files	<i>See the Storage section in the 2021 Workspaces Pricer.</i>
Lateral File Accessories	<i>See the Storage section in the 2021 Workspaces Pricer.</i>
310 Series Vertical Files - 26½"D	<i>See the Storage section in the 2021 Workspaces Pricer.</i>
510 Series Vertical Files - 25"D	<i>See the Storage section in the 2021 Workspaces Pricer.</i>
Flagship® Bookcases and Storage Cabinets	<i>See the Storage section in the 2021 Workspaces Pricer.</i>
Brigade® Storage Cabinets	<i>See the Storage section in the 2021 Workspaces Pricer.</i>
Brigade® Steel Bookcases	<i>See the Storage section in the 2021 Workspaces Pricer.</i>
10500 Series™ Bookcases	<i>See the Storage section in the 2021 Workspaces Pricer.</i>
1870 Series Bookcases	<i>See the Storage section in the 2021 Workspaces Pricer.</i>
Tables	
Huddle Multi-Purpose Tables	81-88
Motivate® Tables	99-103
Flock®	62-67
Between™ Tables	34-38
Occasional Tables	
Laminate Occasional Tables	95
Flock®	62-67



Build™ Student Desks and Tables shown with SmartLink® Seating and Storage.

BUILD™

Inspiring the next generation takes a higher degree of mobility and hands-on learning. The Build™ series, an educational product collection of tables, student desks, and seating, is lightweight, durable, reconfigurable, and customizable. Build encourages creativity and adaptability so students can support collaboration and social interaction or create personal space for focused study time. Build supports the movers and shakers, the hands-on doers, and the leaders who crave creativity. The future of education takes shape with Build.



FEATURES

- 15 table shapes and 6 student desk shapes make reconfiguration fun and easy.
- In addition to all standard HON laminates, Build tops are available in bright, bold laminates and a dry-erase markerboard finish to enhance any learning environment. Or try Butcher Block tops on Makerspace tables.
- Table legs are available in multiple height adjustable ranges and nesting bases to accommodate different user applications.
- Adjustable height student desk legs accommodate any students in K-12 grades and beyond.
- The durable Makerspace table features à la carte storage accessories and allows you to keep a creative space clean, organized, and customizable.

BUILD™ ORDERING INFORMATION

LAMINATE GROUP A (TOP LAMINATES)

L1 LAMINATES CODES

Woodgrain

- ◆ Bourbon Cherry H
- ◆ Cognac COGN
- ◆ Florence Walnut LFW1
- ◆ Harvest C
- ◆ Kingswood Walnut LKI1
- ◆ Loft LOFT
- ◆ Mahogany N
- ◆ Mocha MOCH
- ◆ Natural Maple D
- ◆ Pinnacle PINC
- ◆ Shaker Cherry F
- ◆ Sterling Ash LSA1

Solid

- ◆ Black P
- ◆ Charcoal S
- ◆ Designer White LDW1
- ◆ Loft LOFT

Patterned

- ◆ Sheer Mesh A5
- ◆ Silver Mesh B9
- ◆ Steel Mesh A9
- ◆ Canyon Zephyr K9
- ◆ Desert Zephyr K8
- ◆ Shadow Zephyr K1
- ◆ Battleship LBT1
- ◆ Gray G2
- ◆ Grey Tigris L6
- ◆ Moroccan LMN1
- ◆ Mushroom LMH1
- ◆ Neon Carrot LNC1
- ◆ Tennis Ball LTB1
- ◆ White G1
- ◆ Whitestone K4

L2 LAMINATES CODES

Woodgrain

- ◆ Lowell Ash LLA1
- ◆ Natural Recon LNR1
- ◆ Phantom Ecru LPE1
- ◆ Portico Teak LPT1
- ◆ Skyline Walnut LSW1

L5 LAMINATES CODES

- ◆ White Markerboard FMQ1

LAMINATE GROUP B (SHELF LAMINATES)

L1 LAMINATES CODES

Woodgrain

- ◆ Bourbon Cherry H
- ◆ Cognac COGN
- ◆ Florence Walnut LFW1
- ◆ Harvest C
- ◆ Kingswood Walnut LKI1
- ◆ Mahogany N
- ◆ Natural Maple D
- ◆ Pinnacle PINC
- ◆ Shaker Cherry F
- ◆ Sterling Ash LSA1

Solid

- ◆ Black P
- ◆ Charcoal S
- ◆ Designer White LDW1
- ◆ Loft LOFT

L2 LAMINATES CODES

Woodgrain

- ◆ Lowell Ash LLA1
- ◆ Natural Recon LNR1
- ◆ Phantom Ecru LPE1
- ◆ Portico Teak LPT1
- ◆ Skyline Walnut LSW1

PAINT GROUP A (TABLE AND STUDENT DESK LEG PAINT)

PAINT CODES

- P1**
- ◆ Black P
- P2**
- ◆ Platinum Metallic T1

PAINT GROUP B (MAKERSPACE TABLE BASE AND STOOL)

PAINT CODES

P1

- ◆ Black P
- ◆ Brownstone P7D
- ◆ Charcoal S
- ◆ Designer White PJW
- ◆ Fossil P28
- ◆ Greige T5
- ◆ Loft LOFT
- ◆ Muslin T3
- ◆ Titanium P8T

P2

- ◆ Champagne Metallic T4
- ◆ Platinum Metallic T1
- ◆ Silver PR6

P3

- ◆ Atom P8S
- ◆ Bullseye PJF
- ◆ Ember P8P
- ◆ Ion P8N
- ◆ Iris P8J
- ◆ Krypton P8F
- ◆ Regatta P8M

PAINT GROUP C (MAKERSPACE TABLE END PANEL)

PAINT CODES

P1

- ◆ Black P
- ◆ Brownstone P7D
- ◆ Charcoal S
- ◆ Designer White PJW
- ◆ Fossil P28
- ◆ Greige T5
- ◆ Loft LOFT
- ◆ Muslin T3
- ◆ Titanium P8T

P2

- ◆ Champagne Metallic T4
- ◆ Platinum Metallic T1
- ◆ Silver PR6

P3

- ◆ Atom P8S
- ◆ Bullseye PJF
- ◆ Ember P8P
- ◆ Ion P8N
- ◆ Iris P8J
- ◆ Krypton P8F
- ◆ Regatta P8M

P6

- ◆ Markerboard MKB

MAKERSPACE BUTCHER BLOCK

- ◆ Butcher Block LH903

EDGE

EDGE CODES

Woodgrain

- ◆ Cognac COGN
- ◆ Florence Walnut FW
- ◆ Kingswood Walnut KI
- ◆ Lowell Ash DL
- ◆ Mahogany N
- ◆ Mocha MOCH
- ◆ Natural Maple D
- ◆ Natural Recon NR
- ◆ Phantom Ecru PE
- ◆ Pinnacle PINC
- ◆ Portico Teak DP
- ◆ Shaker Cherry F
- ◆ Skyline Walnut SW
- ◆ Sterling Ash SA















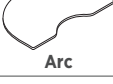

Solid

- ◆ Atom AT
- ◆ Black P
- ◆ Bullseye BY
- ◆ Charcoal S
- ◆ Designer White DW
- ◆ Ember MR
- ◆ Greige R
- ◆ Ion IO
- ◆ Iris IR
- ◆ Krypton KT
- ◆ Loft LOFT
- ◆ Muslin T
- ◆ Platinum K
- ◆ Regatta RE

◆◆◆ For lead time information see page 19.

BUILD™ Shape Matrix

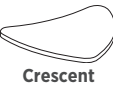
EDUCATION

Top Shape/Model	Tables				Student Desks
	Youth Height Leg Adjusts 13'-18"	Standard Height Leg Adjusts 22'-34"	Standing Height Leg Adjusts 30'-42"	Nesting Base	Seated Height Leg Adjusts 22'-34"
 Kite	X	X	X		
 Ribbon	X	X	X	X	X
 Wisp	X	X	X		
 Snap	X	X	X		
 Rectangle	X	X	X		X
 Half-Round	X	X	X		
 Arc	X	X	X		
 Round	X	X	X		
 Square	X	X	X		
 Trapezoid	X	X	X		X
 Horseshoe	X	X	X		
 Home Plate	X	X	X		
 Spooky	X	X	X	X	X
 Tide	X	X	X		
 Dart	X	X	X	X	
 Crescent					X
 Fin					X

Snap



3 PEOPLE/1 TABLE

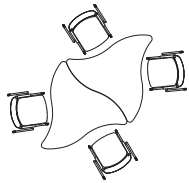

4 PEOPLE/2 TABLES

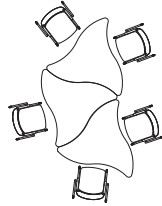

5 PEOPLE/3 TABLES

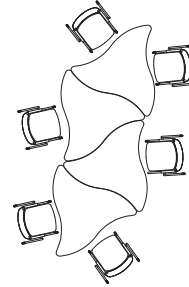

6 PEOPLE/4 TABLES

Tide

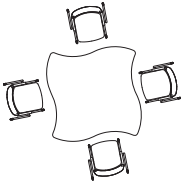

4 PEOPLE/1 TABLE

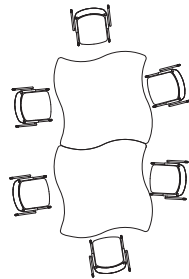

6 PEOPLE/2 TABLES

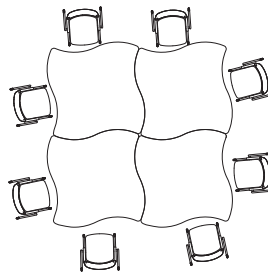

8 PEOPLE/4 TABLES

Kite



2 PEOPLE/1 TABLE

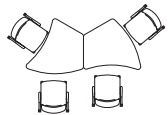

4 PEOPLE/2 TABLES

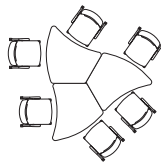

6 PEOPLE/3 TABLES

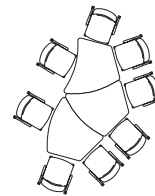

8 PEOPLE/3 TABLES

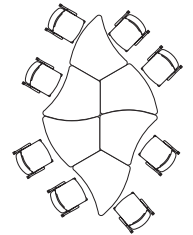

8 PEOPLE/6 TABLES

Dart

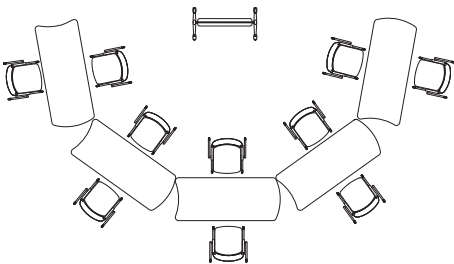

10 PEOPLE/5 TABLES

BUILD™ Table Configurations

EDUCATION

Wisp



4 PEOPLE/1 TABLE

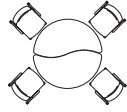

4 PEOPLE/2 TABLES



6 PEOPLE/3 TABLES

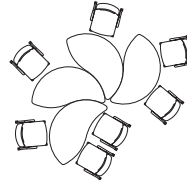

7 PEOPLE/4 TABLES

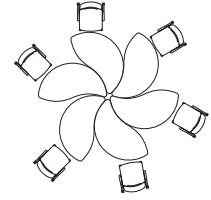

6 PEOPLE/6 TABLES

Ribbon

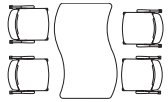

4 PEOPLE/1 TABLE

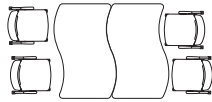

4 PEOPLE/2 TABLES

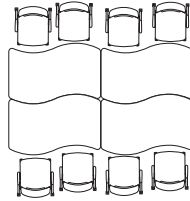

8 PEOPLE/4 TABLES

Home Plate

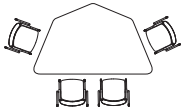

4 PEOPLE/1 TABLE

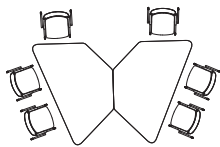

6 PEOPLE/2 TABLES

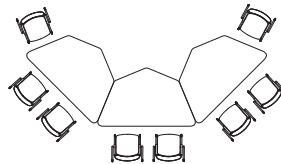

8 PEOPLE/3 TABLES

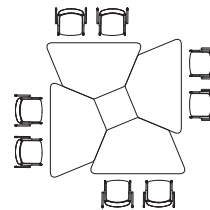

8 PEOPLE/4 TABLES

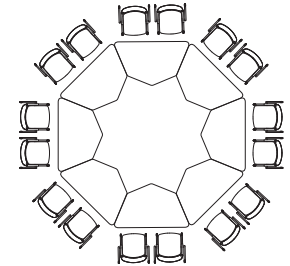

16 PEOPLE/8 TABLES

Horseshoe

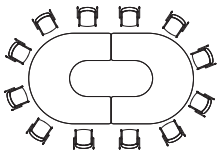

12 PEOPLE/2 TABLES

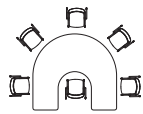

6 PEOPLE/1 TABLE

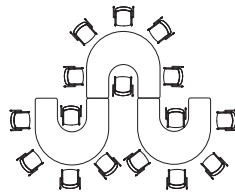

16 PEOPLE/3 TABLES

BUILD™ Table Configurations

Spooky



2 PEOPLE/1 TABLE

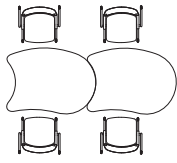

4 PEOPLE/2 TABLES

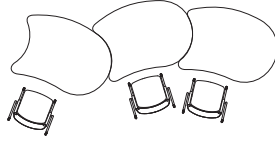

3 PEOPLE/3 TABLES

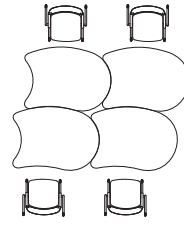

4 PEOPLE/4 TABLES

Combinations

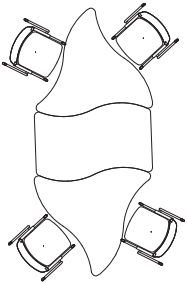

4 PEOPLE/3 TABLES
Ribbon and Snap

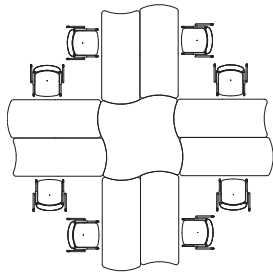

8 PEOPLE/9 TABLES
Tide and Dart

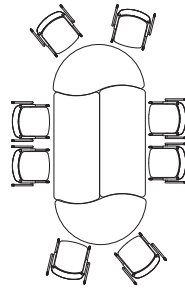

8 PEOPLE/4 TABLES
Dart and Wisp





BUILD™ Table Tops

GSA SIN 33721

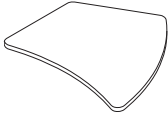

Icon Legend on page 19

EDUCATION

	DESCRIPTION	MODEL	LEGS REQUIRED	SHIP WEIGHT	CUBE	LIST PRICE BY LAMINATE GRADE		
						L1	L2	L5
	Snap Table Top 54"W x 34"D	HESNP54E	3	46	2.8	\$478	\$501	\$590
	Kite Table Top 40"W x 24"D	HESA2440E	4	30	3.9	\$458	\$473	\$518
	50"W x 30"D	HESA3050E	4	50	5.8	\$478	\$498	\$558
	Wisp Table Top 54"W x 30"D	HESN3054E	4	63	4.6	\$463	\$483	\$543
	Half-Round Table Top 60"W x 30"D	HESH3060E	4	69	6.0	\$441	\$461	\$521
	Spooky Table Top 36"W x 54"D	HESY3654E	4	61	14.4	\$415	\$435	\$513
	Ribbon Table Top 54"W x 30"D	HESW3054E	4	65	5.4	\$413	\$433	\$493

NOTES:

- Quick set bracket factory installed for easy leg location and installation.
- Top and legs specified separately.

HOW TO SPECIFY

Select Model Number H E S H 3 0 6 0 E	Select Grommet N No Grommet	Select Top Laminate See page 163, Group A L D W 1	Select Edge Color See page 163 L D W 1
---	---------------------------------------	--	---



BUILD™ Table Tops

	DESCRIPTION	MODEL	LEGS REQUIRED	SHIP WEIGHT	CUBE	LIST PRICE BY LAMINATE GRADE		
						L1	L2	L5
	Rectangle Table Top							
	48"W x 24"D	HETR2448E	4	71.0	3.6	\$350	\$365	\$410
	60"W x 24"D	HETR2460E	4	57.0	4.4	\$388	\$408	\$468
	72"W x 24"D	HETR2472E	4	68.0	4.9	\$430	\$450	\$510
	48"W x 30"D	HETR3048E	4	62.0	4.4	\$366	\$381	\$426
	60"W x 30"D	HETR3060E	4	71.0	5.4	\$400	\$420	\$480
	72"W x 30"D	HETR3072E	4	85.0	4.9	\$457	\$477	\$537
	Round Table Top							
	42" Diameter	HERD42E	4	51.0	4.7	\$313	\$328	\$386
	48" Diameter	HERD48E	4	66.0	6.1	\$352	\$369	\$434
	Square Table Top							
	36"W x 36"D	HESQ36E	4	46.0	3.7	\$266	\$279	\$328
	42"W x 42"D	HESQ42E	4	61.0	4.9	\$341	\$357	\$421
	48"W x 48"D	HESQ48E	4	76.0	6.2	\$373	\$391	\$460
	Tide Table Top							
	54"W x 54"D	HETD54E	4	106.0	9.2	\$586	\$614	\$723
	Trapezoid Table Top							
		HETZ3060E	4	58.1	4.8	\$331	\$347	\$408
	Home Plate Table Top							
	36"W x 60"D	HEHP3660E	4	64.0	15.9	\$400	\$420	\$480

NOTES:

- Quick set bracket factory installed for easy leg location and installation.
- Top and legs specified separately.

HOW TO SPECIFY

<p>Select Model Number</p> <p>H E T R 2 4 4 8 E</p>	<p>Select Grommet</p> <p>N No Grommet</p> <p>N</p>	<p>Select Top Laminate</p> <p>See page 163, Group A</p> <p>L D W 1</p>	<p>Select Edge Color</p> <p>See page 163</p> <p>L D W 1</p>
--	---	---	--



BUILD™ Table Tops

GSA SIN 33721

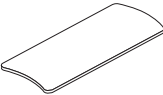

Icon Legend on page 19

EDUCATION

	DESCRIPTION	MODEL	LEGS REQUIRED	SHIP WEIGHT	CUBE	LIST PRICE BY LAMINATE GRADE		
						L1	L2	L5
	Dart Table Top 36"W x 60"D	HEDRT2766E	4	86	4.3	\$418	\$438	\$516
	Arc Table Top 72"W x 48"D	HESKD4872E	4	112	8.2	\$670	\$690	\$750
	Horseshoe Table Top 60"W x 66"D	HESH6066E	4	103	21.7	\$795	\$835	\$954



NOTES:

- Quick set bracket factory installed for easy leg location and installation.
- Top and legs specified separately.

HOW TO SPECIFY

<p>Select Model Number</p> <p>H E S H 6 0 6 6 E .</p>	<p>Select Grommet</p> <p>N No Grommet</p> <p>N .</p>	<p>Select Top Laminate</p> <p>See page 163, Group A</p> <p>L D W 1 .</p>	<p>Select Edge Color</p> <p>See page 163</p> <p>L D W 1</p>
--	---	---	--

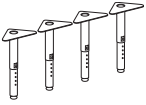
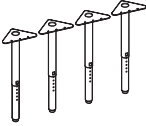

	DESCRIPTION	MODEL	HEIGHT RANGE	SHIP WEIGHT	CUBE	LIST PRICE P1/P2
	Build™ Table Adjustable Height Leg Pack Youth Height Legs, Pack of 4	HEBY4LEG	13"-18"	19	0.9	\$150
	Build™ Table Adjustable Height Leg Pack Standard Table Height Legs, Pack of 4	HEB4LEG	22"-34"	19	1.2	\$198
	Build™ Table Adjustable Height Leg Pack Standing Height Legs, Pack of 4	HEBS4LEG	30"-42"	25	2.2	\$244

NOTES:

- Specify paint for upper portion of leg. Bottom is chrome.

CASTER COMPATIBILITY CHART		
	Yes	No
Standing		X
Youth	X	
Table	X	

! See pages 168-170 for number of legs required per top. Legs always ship 4 per carton. Use chart below for quantity of 4-leg packs required for shapes that utilize three legs.

DESKS	LEGS NEEDED	ADJUSTABLE POST LEGS 4-PACKS
1	3	1
2	6	2
3	9	3
4	12	3
5	15	4
6	18	5
7	21	6
8	24	6
9	27	7
10	30	8

HOW TO SPECIFY

Select Model Number	Select Paint Color
	See page 163, Paint Group A
H E B S 4 L E G .	T 1

BUILD™ Nesting Tables

GSA SIN 33721



Icon Legend on page 19

EDUCATION



DESCRIPTION

Dart Table with Nesting Base
66"W x 27"D

MODEL

HEDRT-2766E-NS

SHIP WEIGHT

113

CUBE

8.7

LIST PRICE BY LAMINATE GRADE

L1

\$1044

L2

\$1064

L5

\$1142

NOTES: Ribbon, Wisp, Snap, Tide and Dart can all be used together.

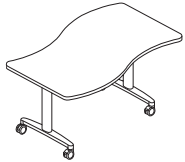

Ribbon Nesting Table
54"W x 30"D

HESW-3054E-NS

89

8.1

\$1035

\$1055

\$1115



Spooky Nesting Table
54"W x 36"D

HESY-3654E-NS

85

17.1

\$1041

\$1061

\$1139

DESCRIPTION

Nesting Spacer Kit

MODEL

HESPCR

SHIP WEIGHT

2 Ⓞ

CUBE

0.1

LIST PRICE

\$51

NOTES: Use with Build™ standard height post legs and nesting bases to create even table heights. Specify 1 kit per nesting table.

ⓘ Available in P Black only. Specify: HESPCR.P.

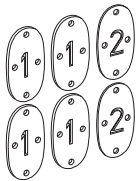







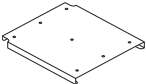
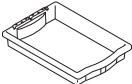

NOTES:

ⓘ Nesting bases are not intended to be used in combination with youth, standing, or desk post-legs.

ⓘ Nesting bases have a height difference of 1/2" when used with Build™ Standard Table Height Post Leg models. Use Nesting Spacer Kit HESPCR to create even table heights.

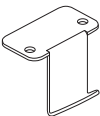
<p>Select Model Number</p> <p>HEDRT-2766E-NS</p>	<p>Select Grommet</p> <p>N No Grommet</p> <p>N</p>	<p>Select Laminate Color</p> <p>See page 163, Group A</p> <p>LBA1</p>	<p>Select Edge Color</p> <p>See page 163</p> <p>K</p>	<p>Select Caster</p> <p>C Caster ONLY</p> <p>C</p>	<p>Select Paint Color</p> <p>See page 163, Paint Group A</p> <p>T1</p>
---	---	--	--	---	---



	DESCRIPTION	MODEL	SHIP WEIGHT	CUBE	LIST PRICE
 OPEN MARKET	Book Box Bracket NOTES: Use with HFMBIN3 trays. Specify 1 bracket per tray. ⓘ Available in P Black only. No specification needed. ⓘ Minimum mounting clearance required: 13½"W x 15"D.	HEBBXRL	2.1	0.6	\$41
 SIN 33721	Accessories — Tray Kit 3"H, 2 bins and 4 rails ⓘ Semi-translucent white. No specification needed. ⓘ Bins ship with rails intended for use in storage. When bins are used with Book Box Bracket, rails will not be used.	HFMBIN3	7.0 ⓘ	4.0	\$52
 SIN 33721 	Locking Casters, 4-Pack <ul style="list-style-type: none"> • Black only • 4 casters per pack • Caster pack adds 1⅞" to the overall height. • All casters lockable • Threaded attachment bolts • Can retrofit on Build™ units with glides. ⓘ For use on youth and standard table post legs only. * On 4-leg Build™ tables, can utilize 2 casters and 2 glides for easy repositioning of tables.	HHABCASTER*	1.0	0.1	\$75
 SIN 33721	Ganging Hardware <ul style="list-style-type: none"> • Includes two ganging links and two screws • No color designator when specifying. <i>Example: HMAGANG.</i> 	HMAGANG	1.0 ⓘ	0.1	\$94
 OPEN MARKET    	Back Pack Hook (10 per carton) 12"W x 14½"D x 1½"H NOTES: Attaches to bottom of surface with 2 screws, included. ⓘ Available in Platinum Metallic finish only, no specification needed.	HCLA65	10.0 ⓘ	0.1	\$95

NOTES:

ⓘ See Workplace Tools Pricer for compatible electrical components.

HOW TO SPECIFY

Select Model Number

H	H	A	B	C	A	S	T	E	R
---	---	---	---	---	---	---	---	---	---

BUILD™ Student Desk Surface Dimensions

EDUCATION

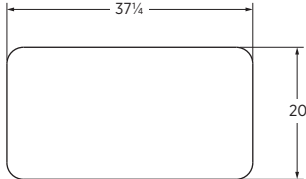
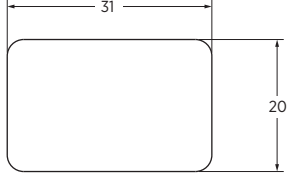
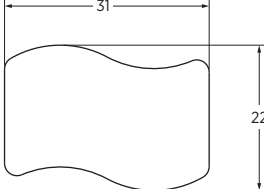
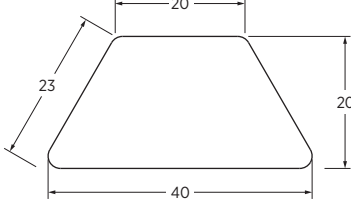
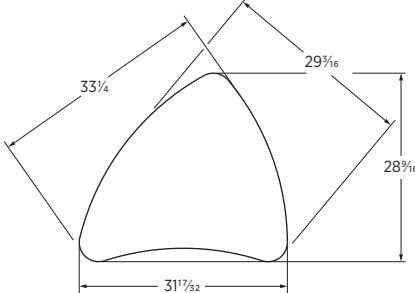
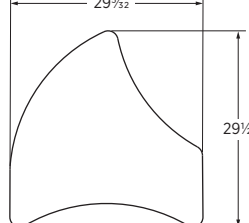
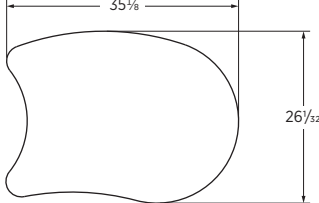
Name	Model	Dimensions
Rectangle	HBSDRECT2038	
Rectangle	HBSDRECT2031	
Ribbon	HBSDRBN2231	
Trapezoid	HBSDTRP2040	
Crescent	HBSDCSNT2832	
Fin	HBSDFN3030	
Spooky	HBSDSPY2636	

Fin

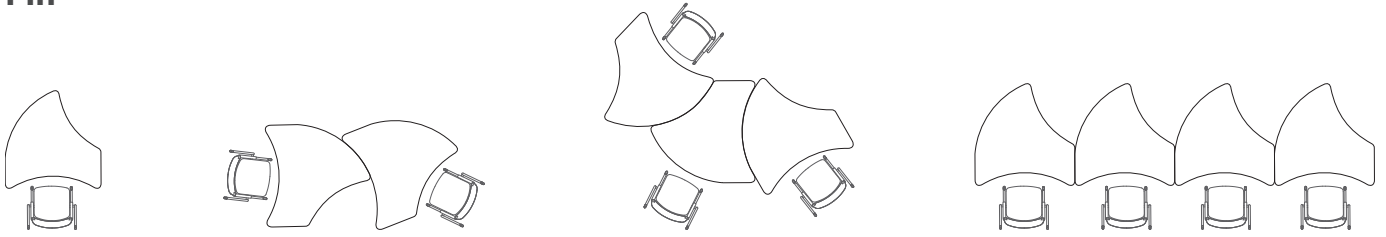

Crescent

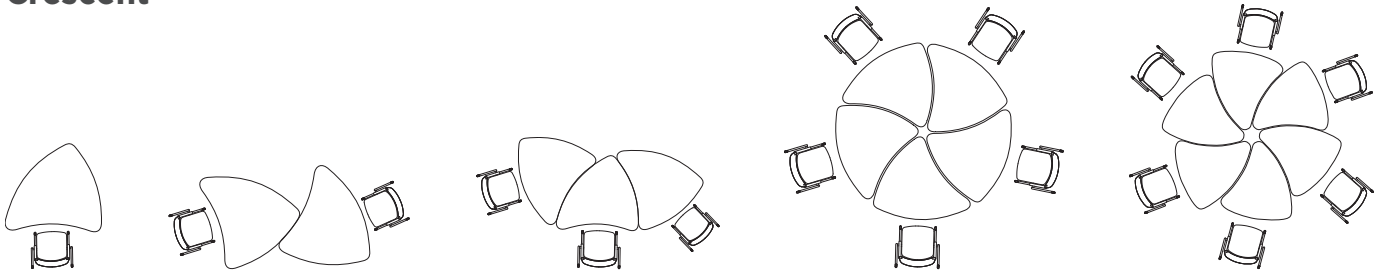

Trapezoid

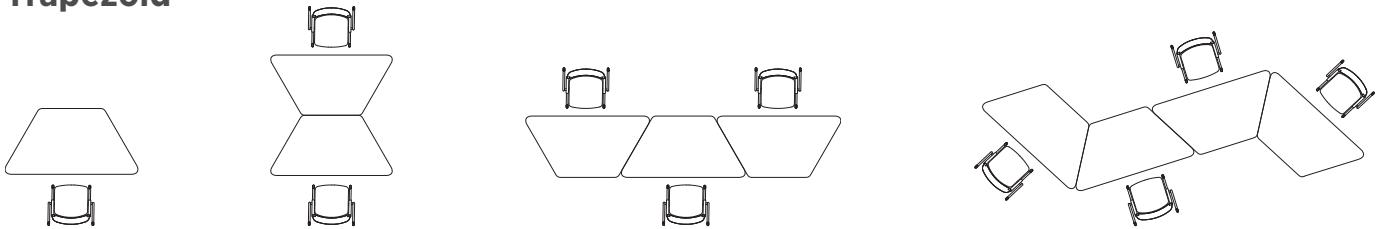

Spooky

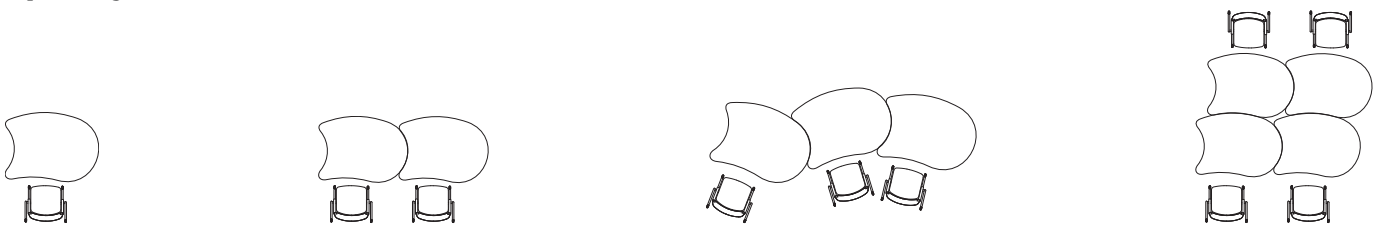

BUILD™ Student Desk Configurations

Rectangle

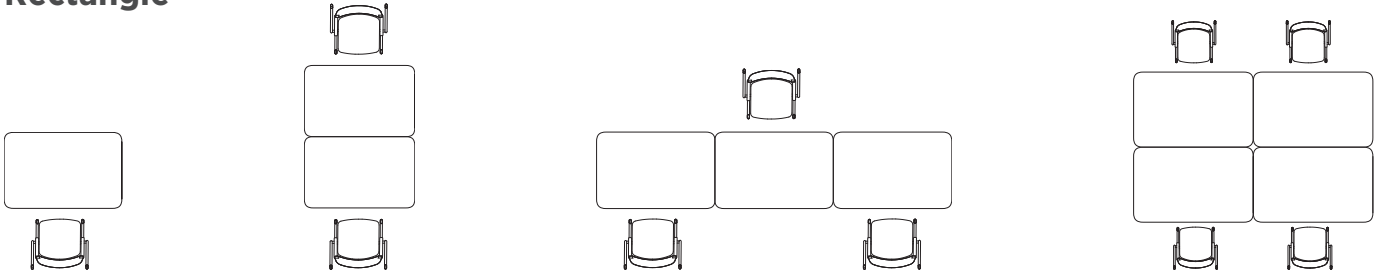

Ribbon

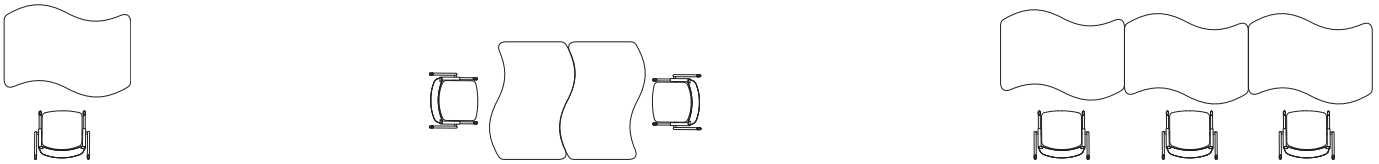



BUILD™ Student Desks

	DESCRIPTION	MODEL	LEGS REQUIRED	SHIP WEIGHT	CUBE	LIST PRICE BY LAMINATE GRADE		
						L1	L2	L5
	Rectangle Student Desk Top 31"W x 20"D	HBSDRECT2031	4	29	2.4	\$172	\$181	\$207
	38"W x 20"D	HBSDRECT2038*	4	33	2.0	\$176	\$185	\$211
* HBSDRECT2038 desk is wheelchair friendly.								
	Trapezoid Student Desk Top 40"W x 20"D	HBSDTRP2040	4	29	5.8	\$199	\$209	\$239
	Ribbon Student Desk Top 31"W x 22"D	HBSDRBN2231	4	27	2.2	\$176	\$185	\$211
	Spooky Student Desk Top 36"W x 26"D	HBSDSPY2636	4	32	6.5	\$199	\$209	\$239
	Fin Student Desk Top 30"W x 30"D	HBSDFN3030	3	26	5.7	\$196	\$206	\$235
	Crescent Student Desk Top 32"W x 28"D	HBSDCNT2832	3	28	5.7	\$196	\$206	\$235

NOTES:

- Top and legs specified separately.

HOW TO SPECIFY

<p>Select Model Number</p> <p>H B S D R B N 2 2 3 1 .</p>	<p>Select Grommet</p> <p>N No Grommet</p> <p>N .</p>	<p>Select Top Laminate</p> <p>See page 163, Group A</p> <p>L D W 1 .</p>	<p>Select Edge Color</p> <p>See page 163</p> <p>D W</p>
--	---	---	--

BUILD™ Student Desks

OPEN MARKET



Icon Legend on page 19

DESCRIPTION

Student Desk Leg, 4-Pack

MODEL

HEBSD4LEG

HEIGHT RANGE

22"-34"

SHIP WEIGHT

15

CUBE

1.1

LIST PRICE P1/P2

\$176



NOTES:

- Specify paint for upper portion of leg. Bottom is chrome.

⚠ Student desk legs not compatible with casters.

⚠ See page 177 for number of legs required per top. Legs always ship 4 per carton. Use chart below for quantity of 4-leg packs required for shapes that utilize three legs.

DESKS	LEGS NEEDED	ADJUSTABLE POST LEGS 4-PACKS
1	3	1
2	6	2
3	9	3
4	12	3
5	15	4
6	18	5
7	21	6
8	24	6
9	27	7
10	30	8

HOW TO SPECIFY



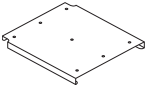

<p>Select Model Number</p> <p>HEBSD4LEG</p>	<p>Select Paint Color</p> <p>See page 163, Paint Group A</p> <p>T1</p>
---	--

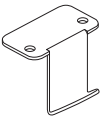

	DESCRIPTION	MODEL	SHIP WEIGHT	CUBE	LIST PRICE
 OPEN MARKET	Book Box Bracket NOTES: Use with HFMBIN3 trays. Specify 1 bracket per tray. ⓘ Available in P Black paint only. ⓘ Minimum mounting clearance required: 13½"W x 15"D.	HEBBXRL	2.1	0.6	\$41
	Accessories — Tray Kit 3"H, 2 bins and 4 rails ⓘ Semi-translucent white. No specification needed. ⓘ Bins ship with rails intended for use in storage. When bins are used with Book Box Bracket, rails will not be used.	HFMBIN3	7.0 ⓘ	4.0	\$52

NOTES:

- Front and rear handles are integrated for easy handling/transport.
- Translucent material provides visibility to contents.

	DESCRIPTION	MODEL	SHIP WEIGHT	CUBE	LIST PRICE
 OPEN MARKET    	Back Pack Hook (10 per carton) 12"W x 14½"D x 1½"H NOTES: Attaches to bottom of surface with 2 screws, included. ⓘ Available in Platinum Metallic finish only, no specification needed.	HCLA65	10 ⓘ	0.1	\$95

HOW TO SPECIFY

Select Model Number H E B B X R L .	Select Paint Color P
--	-------------------------

BUILD™ Makerspace Table

GSA SIN 33721



Icon Legend on page 19

EDUCATION



DESCRIPTION	MODEL	SHIP WEIGHT	CUBE	LIST PRICE	UPCHARGE BY LAMINATE/PAINT GRADE				
					L2	L5	P2	P3	
Seated-Height Table with Laminate Top									
60"W x 42"D x 29"H	HEMKR426029L	153	9.4	\$1698	\$34	\$133	\$32	\$52	
72"W x 42"D x 29"H	HEMKR427229L	169	9.7	\$1851	\$41	\$163	\$32	\$52	
Seated-Height Table with Butcher Block Top									
60"W x 42"D x 29"H	HEMKR426029BB	179	9.9	\$2406	N/A	N/A	\$32	\$52	
72"W x 42"D x 29"H	HEMKR427229BB	201	10.4	\$2678	N/A	N/A	\$32	\$52	



Standing-Height Table with Laminate Top									
60"W x 42"D x 42"H	HEMKR426042L	173	11.4	\$1756	\$34	\$133	\$33	\$55	
72"W x 42"D x 42"H	HEMKR427242L	189	11.7	\$1909	\$41	\$163	\$33	\$55	
Standing-Height Table with Butcher Block Top									
60"W x 42"D x 42"H	HEMKR426042BB	199	11.9	\$2464	N/A	N/A	\$33	\$55	
72"W x 42"D x 42"H	HEMKR427242BB	221	12.4	\$2736	N/A	N/A	\$33	\$55	

NOTES:

- Laminate top is 1/8" thick and features 3" radius corners.
- Butcher Block top is 1 1/2" thick and features 1 1/2" radius corners with 1/8" radius around entire perimeter of top.
- Butcher Block tops will naturally feature variation between tops due to the nature of the real wood finish. Constructed of natural Birch wood, no two tops are exactly alike. Top is coated in a clear polyurethane finish for maximum durability.
- Both laminate and Butcher Block tops include threaded metal inserts for easy base connection. This also allows for easy base removal and reconnection if table needs to be moved through standard doorways.
- Up to 4 SmartLink® bins will fit between lower foot rails on standing-height table if desired. Compatible with all 3 heights.

HOW TO SPECIFY

Select Model Number H E M K R 4 2 7 2 2 9 L	Select Grommet N No Grommet	Select Laminate Color See page 163, Group A L S A 1	Select Edge Color See page 163 S A	Select Caster C Casters	Select Paint Color See page 163, Paint Group B P
---	---------------------------------------	--	---	-----------------------------------	---

Select Model Number H E M K R 4 2 7 2 2 9 B B	Select Grommet N No Grommet	Select Wood LH903 Butcher Block L H 9 0 3	Select Caster C Casters	Select Paint Color See page 163, Paint Group B P
---	---------------------------------------	--	-----------------------------------	---

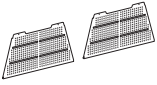
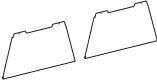

BUILD™ Makerspace Table

	DESCRIPTION	MODEL	SHIP WEIGHT	CUBE	LIST PRICE BY PAINT GRADE			
					P1	P2	P3	P6
	Slotted/Pegboard End Panels For Seated-Height (2/pack)	HEMKREND29-SP	29	2.6	\$437	\$451	\$459	\$525
	For Standing-Height (2/pack)	HEMKREND42-SP	33	3.3	\$546	\$563	\$574	\$655
	Solid Full End Panels For Seated-Height (2/pack)	HEMKREND29-F	29	2.6	\$437	\$451	\$459	\$525
	For Standing-Height (2/pack)	HEMKREND42-F	33	3.3	\$546	\$563	\$574	\$655

NOTES:

- Panels ship 2 per carton.
- Slotted/pegboard end panels accept Fuse™ hanging accessories or any standard ¼" pegboard accessory.
- End panels are magnetic.
- End panels feature welded vertical stiffener on inside of panel for maximum rigidity.
- End panels are installed after table is fully built allowing you to add on to table base at a later date if desired.
- End panels are non-handed.

STANDING-HEIGHT TABLES	
Top Slot	8¾"W
2nd Slot	10¼"W
3rd Slot	11¾"W
4th Slot	13¼"W

SEATED HEIGHT TABLES	
Top Slot	12¼"W
Bottom Slot	13¾"W

HOW TO SPECIFY

<p>Select Model Number</p> <p>HEMKREND29-SP.P</p>	<p>Select Paint Color</p> <p>See page 163, Paint Group C</p>
--	---

BUILD™ Makerspace Table

GSA SIN 33721



Icon Legend on page 19

EDUCATION

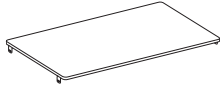

DESCRIPTION	MODEL	SHIP WEIGHT	CUBE	LIST PRICE	UPCHARGE BY LAMINATE/PAINT GRADE		
					L2	P2	P3
Makerspace Table Shelf 50½"W x 31"D ⓘ For use with standing-height tables only.	HEMKRSHELF	39	1.1	\$632	\$21	\$7	\$11

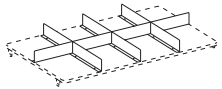

DESCRIPTION	MODEL	SHIP WEIGHT	CUBE	LIST PRICE BY PAINT GRADE		
				P1	P2	P3
Shelf Divider	HEMKRDIVIDER	10	0.6	\$158	\$163	\$166

NOTES:

- Shelves are ¾" thick thermal-fused laminate with 1mm edgeband. Edge color is predetermined by and matches laminate selection.
- Shelf can be used with or without divider (specified separately).
- Shelf always contains small pilot through-holes for shelf divider installation.

HOW TO SPECIFY

Select Model Number HEMKRSHELF	Select Laminate Color See page 163, Laminate Group B LDW1	Select Paint Color See page 163, Paint Group B P
--	--	---

Select Model Number HEMKRDIVIDER	Select Paint Color See page 163, Paint Group B P
--	---





Icon Legend on page 19

Makerspace Table Accessories

	DESCRIPTION	MODEL	SHIP WEIGHT	CUBE	LIST PRICE
	Side Saddle 12¼"W x 2½"D x 4"H	HAESS	0.6	0.1	\$39
	Hook 1½"W x 2¼"D x 3¼"H	HAECBH	0.1	0.1	\$26
	Hot File 12¼"W x 3⅞"D x 9½"H	HAEHF	0.7	1.5	\$58

NOTES:

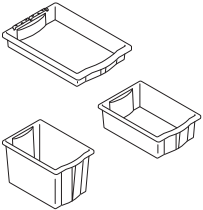
- Hook weight limit 20 lbs.

	DESCRIPTION	MODEL	SHIP WEIGHT	CUBE	LIST PRICE
	Accessories — Tray Kit				
	3"H, 2 bins and 4 rails	HFMBIN3	7 	4.0	\$52
	6"H, 2 bins and 4 rails	HFMBIN6	10 	4.5	\$64
	12"H, 2 bins and 4 rails	HFMBIN12	12 	5.0	\$75

SIN 33721

NOTES:

-  Semi-translucent white. No specification needed.
-  Bins ship with rails intended for use in storage. When bins are installed with shelf or foot rails on Makerspace table, rails will not be used.

HOW TO SPECIFY

Select Model Number	Select Color
HAESS	DW Designer White

BUILD™ Makerspace Stools

OPEN MARKET



Icon Legend on page 19

EDUCATION



MODEL/DESCRIPTION	DEPTH	WIDTH	HEIGHT	SHIP		LIST PRICE BY PAINT GRADE		
				WEIGHT	CUBE	P1	P2	P3
HE4LSTL18 Seated-Height Stool				12	3.3	\$145	\$150	\$153
Maximum:	15½	15½	18					
Seat:	12	12	18					
Seat to Floor:			18					
Usable Seat Depth:	12							



HE4LSTL30 Café-Height Stool				17	7.6	\$196	\$202	\$206
Maximum:	16⅞	16⅞	30					
Seat:	12	12	30					
Seat to Floor:			30					
Usable Seat Depth:	12							

NOTES:

- Weight Rating: 300 lbs.
- Features non-leveling nylon glides.
- Stackable up to 4-high.

HOW TO SPECIFY

Select Model Number	Select Paint Color
	See page 163, Paint Group B
HE4LSTL18	T1

REVEL™



Revel™ Fidget Stools shown with Build™ Student Desks and SmartLink® Seating.

REVEL™

Revel in the movement and give classroom fidgeting a new meaning. Move side to side, back and forth, or spin in a full circle. Revel brings movement and mobility to active learners.



FEATURES

- Seat available in 3 colors, base available in 1.
- Adjust stool height with the push of a button. Stool ranges in height from 13¾"H-18½"H.
- With a slip resistant base and plastic body, you can feel comfortable using the stool in your most creative space with easy cleanup afterwards.
- Tested to hold up to 250 lbs.
- Backed by the HON Full Lifetime Warranty.

REVEL™ Stool

OPEN MARKET



Icon Legend on page 19

HEFS01

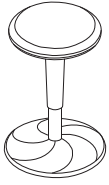

ADJUSTABLE HEIGHT FIDGET STOOL

DIMENSIONS

Depth:	15 ³ / ₈	Seat Height:	13 ³ / ₄ -18 ¹ / ₂
Width:	15 ³ / ₈	Ship Weight:	20.1
Height:	13 ³ / ₄ -18 ¹ / ₂	Cube:	1.4
Seat Depth:	15 ³ / ₈	Weight Rating:	250 lbs.
Seat Width:	15 ³ / ₈		

LIST PRICE

\$250

NOTES: Two buttons integrated in underside of seat for height adjustment control while maintaining a clean aesthetic. Stool seat and base are all plastic for easy cleanability. Anti-slip rubber attached to underside of base allows for comfortable movement of user while maintaining contact with floor. Base color is similar to HON Loft.

EDUCATION

HOW TO SPECIFY

Select
Model Number

Select
Seat Color

- BZ** Breeze
- S** Charcoal
- BL** Black

H E F S 0 1 .

B L

SMARTLINK®



SmartLink® Student Desks, Seating, and Teacher Desk.

SMARTLINK®

As our research indicates, traditional lecture formats are giving way to group sessions and mentoring. This demands environments that are open, accessible, and accommodate the need for a variety of learning opportunities. HON designed SmartLink to be lightweight and mobile, which helps teachers respond to the ways students learn today, and adapt to new ways of learning tomorrow.



FEATURES

- Put teachers in control of their storage, technology and environment.
- Worksurface shape supports creative configurations.
- Designed to the unique ways students sit and move throughout the day.
- Organize lesson plans and make the most of unused wall space.
- Move educational tools wherever the activities demand.
- SmartLink chairs warranted for users up to 300 lbs.

SMARTLINK® ORDERING INFORMATION

TEACHER DESK & MODULAR STORAGE

LAMINATES CODES

- L1**
 ◆ Harvest **CC**
 ◆ Natural Maple **DD**
 ◆ Sheer Mesh **A5**
 ◆ Silver Mesh **B9**

PAINTS CODES

- P1**
 ◆ Charcoal **S**
- P2**
 ◆ Platinum Metallic **T1**

EDGE CODES

- ◆ Charcoal **S**
 ◆ Platinum **K**

STUDENT DESK

PLASTIC CODES

- ◆ Breeze **G9**
 ◆ Harvest **CC**
 ◆ Natural Maple **DD**
 ◆ Sand **G8**
 ◆ White **G1**

PAINTS CODES

- P1**
 ◆ Charcoal **S**
- P2**
 ◆ Platinum Metallic **T1**

VALUE MOBILE STORAGE

PAINTS CODES

- P1**
 ◆ Black **P**
 ◆ Brownstone **P7D**
 ◆ Charcoal **S**
 ◆ Designer White **PJW**
 ◆ Fossil **P28**
 ◆ Greige **T5**
 ◆ Loft **LOFT**
 ◆ Muslin **T3**
 ◆ Shadow * **SHDW**
 ◆ Titanium **P8T**

- P2**
 ◆ Champagne Metallic **T4**
 ◆ Platinum Metallic **T1**
 ◆ Silver **PR6**

- P3**
 ◆ Atom **P8S**
 ◆ Bullseye **PJF**
 ◆ Ember **P8P**
 ◆ Ion **P8N**
 ◆ Iris **P8J**
 ◆ Krypton **P8F**
 ◆ Regatta **P8M**

VALUE TEACHER DESK

LAMINATES CODES

- L1**
 ◆ Black **P**
 ◆ Bourbon Cherry **H**
 ◆ Charcoal **S**
 ◆ Cognac **COGN**
 ◆ Designer White **LDW1**
 ◆ Florence Walnut **LFW1**
 ◆ Harvest **C**
 ◆ Kingswood Walnut **LK11**
 ◆ Loft **LOFT**
 ◆ Mahogany **N**
 ◆ Mocha **MOCH**
 ◆ Natural Maple **D**
 ◆ Pinnacle **PINC**
 ◆ Shaker Cherry **F**
 ◆ Sheer Mesh **A5**
 ◆ Silver Mesh **B9**
 ◆ Steel Mesh **A9**
 ◆ Sterling Ash **LSA1**

- L2**
 ◆ Lowell Ash **LLA1**
 ◆ Natural Recon **LNRI**
 ◆ Phantom Ecru **LPE1**
 ◆ Portico Teak **LPT1**
 ◆ Skyline Walnut **LSW1**

PAINTS CODES

- P1**
 ◆ Charcoal **S**
 ◆ Designer White **PJW**

- P2**
 ◆ Platinum Metallic **T1**
 ◆ Silver **PR6**

- P3**
 ◆ Atom **P8S**
 ◆ Bullseye **PJF**
 ◆ Ember **P8P**
 ◆ Ion **P8N**
 ◆ Iris **P8J**
 ◆ Krypton **P8F**
 ◆ Regatta **P8M**

EDGE CODES

- ◆ Atom **AT**
 ◆ Bullseye **BY**
 ◆ Charcoal **S**
 ◆ Ember **MR**
 ◆ Ion **IO**
 ◆ Iris **IR**
 ◆ Krypton **KT**
 ◆ Platinum **K**
 ◆ Regatta **RE**

VALUE STUDENT DESK

PLASTIC CODES

- ◆ Breeze **G9**
 ◆ Harvest **CC**
 ◆ Natural Maple **DD**
 ◆ Sand **G8**
 ◆ White **G1**

PAINTS CODES

- P1**
 ◆ Charcoal **S**

- P2**
 ◆ Platinum Metallic **T1**

- P3**
 ◆ Atom **P8S**
 ◆ Bullseye **PJF**
 ◆ Ember **P8P**
 ◆ Ion **P8N**
 ◆ Iris **P8J**
 ◆ Krypton **P8F**
 ◆ Regatta **P8M**

UNIVERSAL MODESTY PANEL

PAINTS CODES

- P1**
 ◆ Black **P**
 ◆ Brownstone **P7D**
 ◆ Charcoal **S**
 ◆ Designer White **PJW**
 ◆ Fossil **P28**
 ◆ Greige **T5**
 ◆ Light Gray **Q**
 ◆ Loft **LOFT**
 ◆ Muslin **T3**
 ◆ Putty **L**
 ◆ Shadow * **SHDW**
 ◆ Textured Black Mica **BLCK**
 ◆ Titanium **P8T**

- P2**
 ◆ Champagne Metallic **T4**
 ◆ Platinum Metallic **T1**
 ◆ Silver **PR6**
 ◆ Solar Black **P8X**
 ◆ Textured Platinum
 Metallic **PLAT**
 ◆ Textured Silver **PR8**

- P3**
 ◆ Atom **P8S**
 ◆ Bullseye **PJF**
 ◆ Ember **P8P**
 ◆ Ion **P8N**
 ◆ Iris **P8J**
 ◆ Krypton **P8F**
 ◆ Regatta **P8M**

4-LEG, CANTILEVER CHAIR, TASK CHAIR, STOOL SHELLS

SHELL CODES

- ◆ Calypso **CP**
 ◆ Cherry **CR**
 ◆ Lava **LA**
 ◆ Lime **LM**
 ◆ Mulberry **MB**
 ◆ Onyx **ON**
 ◆ Platinum **PT**
 ◆ Regatta **RE**
 ◆ Shadow **SD**
 ◆ Surf **BU**
 ◆ Tangelo **RG**

4-LEG AND CANTILEVER CHAIR AND STOOL FRAME

PAINTS CODES

- P1**
 ◆ Designer White Texture **PK7**
 ◆ Textured Charcoal **P7A**

- P2**
 ◆ Platinum Metallic Texture **PLAT**
 ◆ Silver Texture **PR8**

- P3**
 ◆ Atom **P8S**
 ◆ Bullseye **PJF**
 ◆ Ember **P8P**
 ◆ Ion **P8N**
 ◆ Iris **P8J**
 ◆ Krypton **P8F**
 ◆ Regatta **P8M**

- P4**
 ◆ Polished Chrome* **Y**

*\$52 upcharge. Polished Chrome not available on models HSS4L-06A, HSS4L-24B, and HSS4L-30B.

◆◆◆ For lead time information see page 19.

* De-emphasized





SMARTLINK® SPECIFYING INFORMATION

FINDING THE RIGHT FIT FOR YOUR STUDENT DESK & CHAIR

With the SmartLink® student desk's innovative shape, you can create dynamic learning environments and every space can be tailored to fit the lesson plan whether the need is for individual, student/group collaboration or teacher centered layouts. In addition to the desk's innovative top shape you can also select from three leg configurations to meet your specific needs for classroom or collaborative spaces.



STEP 1

Choose a grade range to find the recommended SmartLink® desk height.

 <p>K-2nd Seated 22"-27" Standing 24"-30"</p>	 <p>3rd-5th Seated 23"-29" Standing 29"-35"</p>	 <p>6th-8th Seated 25"-30" Standing 32"-40"</p>	 <p>9th & Up Seated 29"-30" Standing 38"-43"</p>
---	---	--	--

STEP 2

Pick the SmartLink® model that meets the student height needs.

 <p>Model: HLD-M3A Adjustable Height 23"-33" Height Range</p>	<p>Use the color-coated circles in the chart on the right to find a compatible chair.</p>
 <p>Model: HLD-M3F Fixed Height 30" Fixed Height</p>	
 <p>Model: HLD-M3T Sit-to-Stand 30"-43" Height Range</p>	

STEP 3

Determine the suggested chair height within your desk size range.

Desk Height	Chair Seat Height	Type of Chair
22" ●	12"	4-Leg, Cantilever or Task
23-24" ●		
25-27" ●	14"	
28-29" ●	16-18"	
30" ●○●	18"	Stool
31-33" ●○	22-24"	
34-41" ○	24-31"	
42-43" ○	30-32"	

SMARTLINK® SPECIFYING INFORMATION

Individual Layouts

- The non-handed top allows the desk to be positioned to better support right-handed or left-handed individuals or be used in a forward position.



LH Position



Forward Position



RH Position

Group/Collaborative Layouts

Below are examples of how the student desks can be configured to support multiple students or group activities.

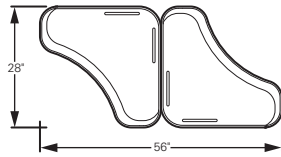

Student Desk
2-Desk Configuration

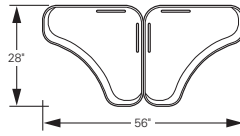

Opposing Student Desk
2-Desk Configuration

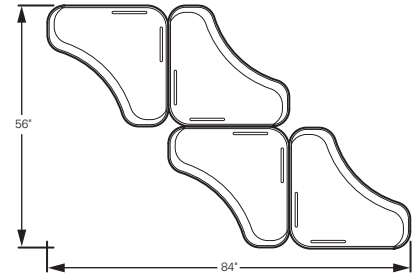

Student Desk
4-Desk Configuration

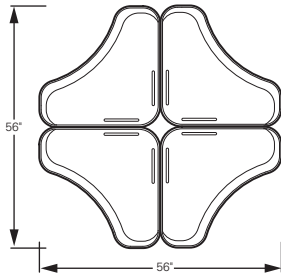

Student Desk
4-Desk Cluster Configuration

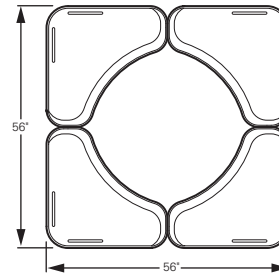

Student Desk
4-Desk Work Group Configuration
Can accommodate up to 8 students

Teacher Centered Layouts

- Reverse the layout and use the student desks to create layouts for teacher centers that can accommodate up to 6 students.
- 23 $\frac{5}{8}$ " distance between legs when used from either side.

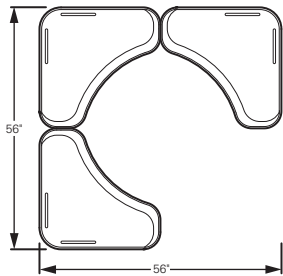

Teacher Centered Layout

Standard Row Layout

While a variety of classroom configurations are possible, a standard row layout shown below with 25 student desks utilizes a footprint of 199" deep by 284" wide. A 30 student desk row layout (5 rows deep by 6 rows wide) will require a footprint of 199" deep by 348" wide.

These dimensions are based upon 36"W aisles. Actual dimensions should be based upon local building codes.

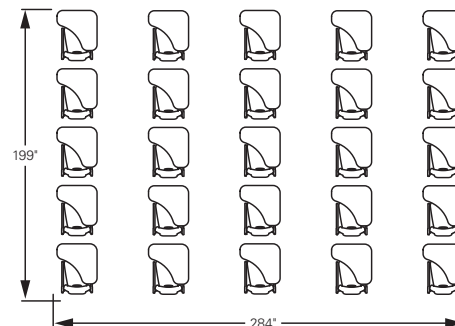

SMARTLINK® SPECIFYING INFORMATION

TEACHER STATION

SmartLink®

The following planning and specifying information is intended to help you imagine and create stimulating SmartLink classrooms that can integrate technology while helping rooms stay adaptable, organized and attractive. SmartLink offers you everything you need to create flexible, clutter-free learning environments for students of all ages.

Teacher Station – Standard Double Pedestal

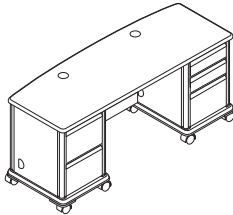

HLT2672-23.C

Storage

- Box/box/file pedestal is always standard on the right-hand side. Pedestal is locking.
- Available kneespace is 33¼" W x 20" D for all models.
- Non-locking Center Drawer (HD8X) may be field installed in the kneespace. Tops are pre-drilled to accept the drawer.
- Center drawers and CPU holders cannot be installed together.

Cable Management

- Both the left-hand and right-hand end panels may be removed to provide access to power and cable management within the side power cabinet.
- Grommets are standard in each removable end panel allow a power cord to exit and be plugged into a floor or wall outlet.
- Two "Smart Grommets" with a wireway cover are standard on each station's top surface.

Teacher Station – Standard Single Pedestal

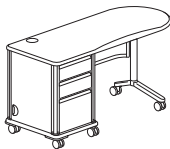

HLT2460-L3.C

Storage

- Single pedestal desk available in Left-hand or Right-hand pedestal/storage configurations.
- Pedestal options include Box/Box/File locking.

Cable Management

- The pedestals end panel may be removed to provide access to power and cable management within the side power cabinet.
- A grommet is standard in the removable end panel to allow a power cord to exit and be plugged into a floor or wall outlet.
- A single "Smart Grommet" with a wireway cover is standard on each station's top surface.

Teacher Station – Value Double Pedestal

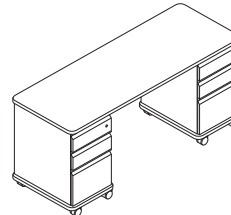

HLTV2466T-33

- Larger top size provides ample work/conference area or space for equipment.
- Standard with Heavy-duty 3", 360-degree swivel casters, 4-locking, 4-non-locking.
- Storage options include: Locking box/box/file.
- Kneewell space accommodates optional (specified separately) and field installed non-locking center drawer and CPU holders (see page 204).
- Modesty specified separately.
- Power modules can be ordered separately and mounted to the desk. See Power & Cable Management page 236.

Teacher Station – Value Single Pedestal

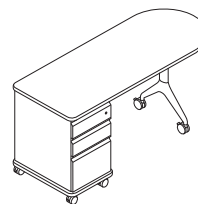

HLTV2460T-3

- Standard with Heavy-duty 3", 360-degree swivel casters, 4-locking, 4-non-locking.
- Storage options include: Locking box/box/file.
- Kneewell space accommodates optional (specified separately) and field installed non-locking center drawer and CPU holders (see page 204).
- Right or left assembled in the field.
- D-shape top encourages conferencing and provides ample work and conference area.
- Modesty specified separately.
- Power modules can be ordered separately and mounted to the desk. See Power & Cable Management page 236.

SMARTLINK® SPECIFYING INFORMATION

MODULAR STORAGE

SmartLink® Modular Storage is comprised of cases, accessories and support rails. However, only the cases and accessories need to be specified. The following guidelines should help you plan and specify SmartLink Storage.

Planning Notes

Cases

- A laminate top with a soft feel vinyl edge provides a classic look with exceptional durability.
- **Storage cases do NOT include accessories. Accessories are specified and sold separately.**
- Case configurations are based off of 12"W or 30"W columns.
- Internal case configurations cannot be changed (i.e., cannot change an HLSF52-3 to a HLSF52-21).
- Cases are designed to allow the users to create a variety of accessory configurations using different tray heights and shelves.
- Cases can be specified with or without locking doors.
- Door models may be converted to non-door models in the field.

Accessories

- Accessories include trays in 3", 6" and 12" heights, shelves in 12" and 30" widths and a 12"W coat rod.
- **All accessories are sold and specified separately as kits and include 1 pair of storage rails per tray or shelf.**
- The support rails simple "no tool" attachment method allows users to easily install and change rail (tray or shelf) positions as needed.
- Kits include:

Accessory	Quantity Per Kit	Where Used
3"H trays	7 trays / 14 support rails	12"W columns only
6"H trays	4 trays / 8 support rails	12"W columns only
12"H trays	2 trays / 4 support rails	12"W columns only
12"W shelf	2 shelves / 4 support rails	12"W columns only
30"W shelf	2 shelves / 4 support rails	30"W columns only
Coat Rod	1 coat rod	12"W columns — Full Height case only

- Cabinet Whiteboard Bracket kit is available which allows whiteboards to be mounted to the back of the full height cabinets. Kit includes upper and lower rails with integrated marker tray and attachment hardware. Use wall rail sliding whiteboards. Rails will accept one (1) 48" x 48" board or two (2) 24" x 48" boards.

Specification Notes

- Number of accessory openings
- SmartLink storage cases are available in six (6) standard case types that feature combinations of 12" or 30" internal column widths. The following illustration shows the number of openings by column width for each case configuration.

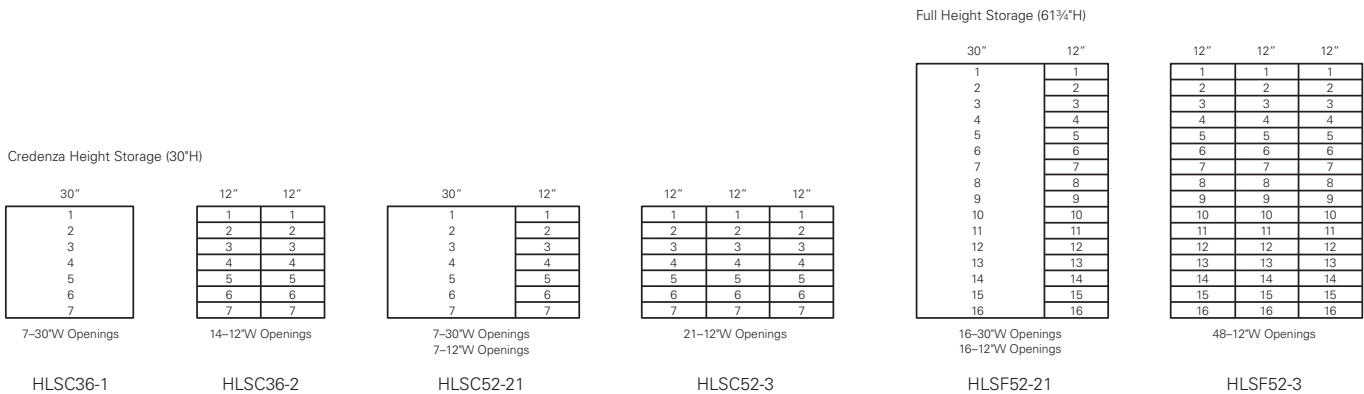

SMARTLINK® SPECIFYING INFORMATION

- Openings used by Accessory type:

Accessory	Openings used per Accessory
3”H tray	1
6”H tray	2
12”H tray	4
12”W shelf	1
30”W shelf	1

- Any combination of trays or shelves (of common width) can be used as long as the openings used equal the total number of openings available per column. The following illustrations show a variety of tray configuration options. Numbers shown in the opening refers to the tray size.

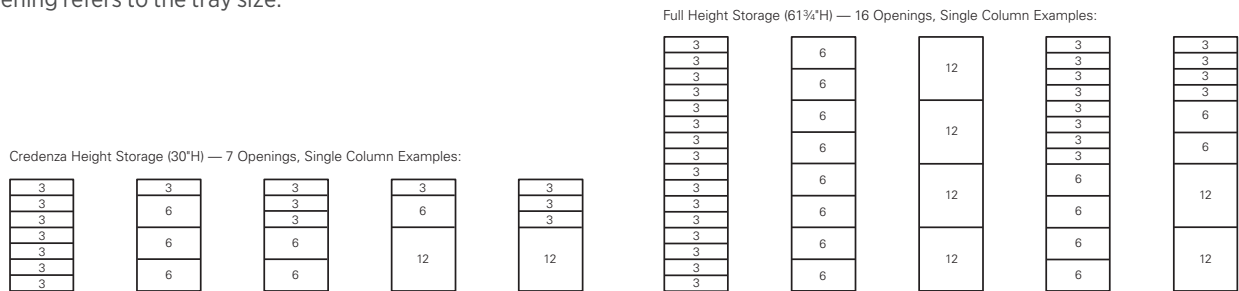

Using the information above, follow these guidelines to help determine accessory quantities.

1. Determine the total number of available “openings” by width (12”, 30”) for each case type.
Example: HLSF52T-3F has 3 columns of 16 openings, total 48 openings
2. On a PER COLUMN basis, determine the desired tray/shelf configurations total number of openings used so they equal the total openings available per column. Total accessory quantities per case then multiply by the total number of like cases.
Example: If each column will have 2-12” trays, 2-6” trays and 4-3” trays. The number of openings used for this column combination is 16. Assuming all three columns are the same total tray quantities for this case will be 12-3”, 6-6” and 6-12”.
3. Once total tray and shelf quantities are determined, simply divide by the kit quantity to determine the number of kits required.
Example: 3” trays = $12 \div 7 = 2$ kits, 6” trays = $6 \div 4 = 2$ kits, 12” trays = $6 \div 2 = 3$ kits

• Shelf Spacing

The clearance between shelves is approximately 3⅜” for every support rail that is not used between shelves. The following illustration shows the clearance between shelves when 0-4 support rail positions are not utilized.

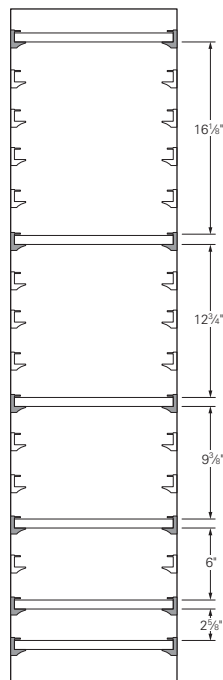

SMARTLINK® SPECIFYING INFORMATION

WALL RAIL SYSTEM

The SmartLink® wall rail is a multi-layered, multi-functional system that can accommodate a variety of presentation boards and accessories. The multiple tracks allow boards to be easily positioned and changed to support today's interactive learning environments.

Planning Notes

- Installation of the wall rail system over existing white or chalkboards is not recommended.
- The rail and wall bracket provide three separate tracks for the Learning boards. The REAR or wall/bracket track is occupied by the fixed wall board. The MIDDLE and FRONT tracks are for sliding boards.
- To allow for greater utilization of the rear fixed board a maximum width of 96" of sliding boards on the middle or front track is recommended.

The illustration below shows the overall wall space requirements for the rail system and recommended mounting height for use in K-12 classroom applications.

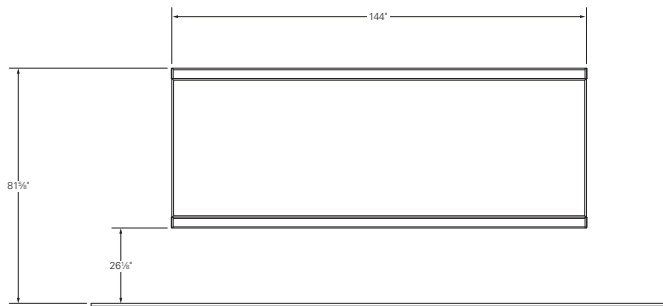

Sliding boards are removable and reversible so a wide variety of layouts are possible. The following illustrations highlight a couple of the more common applications. Layouts 2A and 2B provide the greatest amount of board space and overall flexibility. When used with rail mounted worksurfaces, use 24"W boards on the front rail as shown in 2C in front of each worksurface to provide information specific to that work area. Boards could then be added to the middle rail for information/work to be shared between the stations.

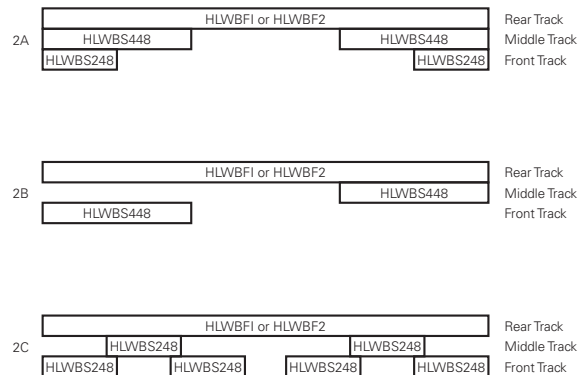







Specification Notes

- Boards are specified individually.
- Hardware to mount to the wall brackets is not provided by HON and MUST BE SOURCED LOCALLY.
- Learning board only applications require two (2) HLWR-12 rails to be specified.
- REFER TO PRODUCT INSTALLATION INSTRUCTIONS FOR DETAILED INSTALLATION INFORMATION.

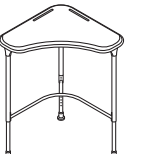

SMARTLINK® Student Desks



	DESCRIPTION	MODEL	SHIP WEIGHT	CUBE	LIST PRICE
	Student Desk, Fixed Height 28"W x 28"W, User side 36¼"W 30" Fixed Height Hard Plastic Top Ships  Ships Assembled Ships Assembled with HLDA-15 Book Box attached	HLD-M3F	63	5.5	\$742
		HLD-M3FA	58	17.9	\$783
		HLD-M3FB	65	17.9	\$903
	Student Desk, Adjustable Height 28"W x 28"W, User side 36¼"W Adjustable: 23"-33" height adjustment range. Legs ship pre-set for 30" overall desk height when factory installed. Hard Plastic Top Ships  Ships Assembled Ships Assembled with HLDA-15 Book Box attached	HLD-M3A	63 	5.5	\$742
		HLD-M3AA	58	17.9	\$783
		HLD-M3AB	65	17.9	\$903
 	Student Desk, Sit-to-Stand 28"W x 28"W, User side 36¼"W Adjustable: 30"-43" height adjustment range. Leg height is set during field installation. Hard Plastic Top	HLD-M3T	65	5.5	\$1055

NOTES:

- Non-handed desk top constructed of ¾" hard plastic, includes dual pencil grooves.
- Hard plastic top features comfort edge on user side and soft radius with rounded corners on all sides.
- May also be specified to ship fully assembled, with or without HLDA-15 Book Box.
- Upper leg is painted, lower leg standard chrome finish on Adjustable and Sit-to-Stand models.
- Nylon swivel glides are standard on adjustable and fixed leg models.
- 29.60" distance between legs on user side. Outside distance between legs is 23⅜".
- Sit-to-Stand model features bell glides.
- Sit-to-Stand is height adjustable from 30"-43"H and includes a footrest.
- Accepts optional book box (HLDA-15) and backpack hooks (HCLA65).

SPECIFICATION TIP: Consider available kneespace when specifying under desk storage Wire Book Box. Available kneespace will vary significantly given set desk height. Use the following example to calculate the available and usable kneespace.

EXAMPLE: HLDV-M3A Student Desk, HLDA-15 Wire Book Box
 (user set desk height – top thickness – seat height = available kneespace)
 (29"H – 1" thickness – 18" seat height = 10" available kneespace)
 (available kneespace – book basket/box height = usable kneespace)
 (10" available kneespace – 5" basket height = 5" usable kneespace)

-  Field installed felt glide caps (HGDK3-F) are recommended for use on VCT flooring.
-  All Student Desks are ordered and shipped two (2) desks per carton. Legs and cross-brace ship unattached on  models. Pricing shown is per carton. Ordering two of model HLD-M3A or HLD-M3T will result in 2 cartons being shipped, giving you 4 desks.

HOW TO SPECIFY

Select Model Number H L D - M 3 A	Select Glide Option E Hard-Surface (no upcharge) (Fixed or Adjustable models only) G Bell Glide (Sit-to-stand model only)	Select Top Color See page 188 G 9	Select Upper Leg Color See page 188 S
---	--	--	--

SMARTLINK® Value Series Student Desks

GSA SIN 33721T



Icon Legend on page 19

EDUCATION



DESCRIPTION

Student Desk, Fixed Height

28"W x 28"W, User side 36¼"W
30" Fixed Height

Hard Plastic Top

MODEL

HLDV-M3F

SHIP WEIGHT

63

CUBE

18.0

LIST PRICE BY PAINT GRADE

P1

\$606

P2

\$606

P3

\$636

NOTES: The cross-brace is installed to maximize kneespace but will not allow for book basket (HLDA-15) installation. The cross-brace orientation can be switched in the field to allow for book basket install.

🔧 Student Desks are ordered and shipped two (2) desks per carton. Legs and cross-brace ship attached. The cross-brace is installed to maximize kneespace but will not allow for book basket (HLDA-15) installation. Pricing shown is per carton. Ordering two of model HLDV-M3F will result in 2 cartons being shipped, giving you 4 desks.



Student Desk, Adjustable Height

28"W x 28"W, User side 36¼"W
Adjustable: 23"-33" height adjustment range.

Hard Plastic Top

HLDV-M3A

59

12.5

\$606

\$606

\$636

NOTES: Accepts book basket (HLDA-15) installation without repositioning crossbar.

🔧 Student Desks are ordered and shipped two (2) desks per carton. Upper leg and cross-brace ship attached. Lower adjustable legs ship unattached for field installation. Pricing shown is per carton. Ordering two of model HLDV-M3A will result in 2 cartons being shipped, giving you 4 desks.

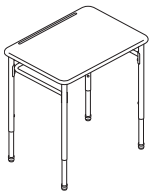

Rectangle Student Desk, Adjustable Height

20"W x 26"D
Adjustable: 23"-33" height adjustment range.

HLDV-MRECT2026A

57

9.19

\$606

\$606

\$636

NOTES: Accepts book basket (HLDA-15) installation without repositioning crossbar.

🔧 Student Desks are ordered and shipped two (2) desks per carton. Legs and cross-brace ship attached. Pricing shown is per carton. Ordering two of model HLDV-MRECT2026A will result in 2 cartons being shipped, giving you 4 desks.

NOTES:

- Upper leg is painted, lower leg standard chrome finish on Adjustable Height models.
- Non-handed desk top constructed of 3/4" hard plastic.
- Hard plastic tops include pencil grooves.
- Nylon swivel glides are standard on adjustable and fixed leg models.
- Fixed Height models ship fully assembled. Adjustable models have the upper leg and cross-brace installed. The lower leg ships unattached for field installation.
- 29.60" distance between legs on user side. Outside distance between legs is 23 3/8".
- Accepts optional backpack hooks (HCLA65).
- Book boxes are only available as an accessory for field installation on Value Series desks.

SPECIFICATION TIP: Consider available kneespace when specifying under desk storage Wire Book Box. Available kneespace will vary significantly given set desk height. Use the following example to calculate the available and usable kneespace.

EXAMPLE: HLDV-M3A Student Desk, HLDA-15 Wire Book Box

(user set desk height – top thickness – seat height = available kneespace)

(29"H – 1" thickness – 18" seat height = 10" available kneespace)

(available kneespace – book basket/box height = usable kneespace)

(10" available kneespace – 5" basket height = 5" usable kneespace)

🔧 Field installed felt glide caps (HGDK3-F) are recommended for use on VCT flooring.







🔧 All Student Desks are ordered and shipped two (2) desks per carton. Ordering two of any model will result in 2 cartons being shipped, giving you 4 desks.

HOW TO SPECIFY

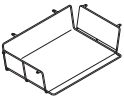
Select Model Number H L D V - M 3 F .	Select Glide Option E Hard-Surface (no upcharge)	Select Top Color See page 188 G 9 .	Select Upper Leg Color See page 188 S
---	--	--	--

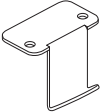





SMARTLINK® Student Accessories

	DESCRIPTION	MODEL	SHIP WEIGHT	CUBE	LIST PRICE
 SIN 33721T  	Wire, Book Box (4 per carton) 19½"W x 13"D x 5"H NOTES: Attaches to bottom of desk with 6 screws, included. Field installed. For use on model HLD-M3A, HLD-M3F, HLDV-MRECT2026A or HLD-M3T. Features integrated, full-width pencil holder. Bent wire and perforated steel construction for durability and visibility. ⓘ Platinum finish only. Must be ordered with a configurable end product. If ordered separately, not on GSA Contract.	HLDA-15	15	2.0	\$261
 OPEN MARKET  	Back Pack Hook (10 per carton) NOTES: Assembly: attaches to bottom of desk with (2) screws, included. ⓘ Available in Platinum Metallic finish only, no specification needed.	HCLA65	10	0.1	\$95
 OPEN MARKET	Glide Kit — Felt Glide Caps <ul style="list-style-type: none"> • Recommended for use on VCT flooring. • Caps easily and securely snap over existing nylon swivel glide. • Kit includes 100 caps. • Field installed. ⓘ Not designed to be used with Sit-to-Stand Bell Glides (model HLD-M3T). Must be ordered with a configurable end product. If ordered separately, not on GSA Contract.	HGDK3-F	2	0.2	\$125

HOW TO SPECIFY

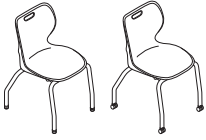
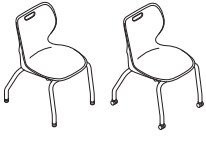
Select Model Number

H	L	D	A	-	1	5
---	---	---	---	---	---	---

MODEL/DESCRIPTION	DEPTH	WIDTH	HEIGHT	SHIP		PER CARTON LIST	
				WEIGHT	CUBE		
 HSS4L-18B 18"H 4-Leg Chair, Armless	Maximum:	19 ⁵ / ₈	19 ¹ / ₂	31	58	15.6	P1 \$583 (reference single unit @ \$145.75)
	Seat:	16 ¹ / ₄	16 ¹ / ₂	18			
	Back:		15 ³ / ₈	13 ³ / ₈			
	Seat to Floor:			18			
	Usable Seat Depth:	16 ¹ / ₈					
 HSS4L-16B 16"H 4-Leg Chair, Armless	Maximum:	19 ⁵ / ₈	19 ¹ / ₄	29	54	15.6	P1 \$583 (reference single unit @ \$145.75)
	Seat:	16 ¹ / ₄	16 ¹ / ₂	16			
	Back:		15 ³ / ₈	13 ³ / ₈			
	Seat to Floor:			16			
	Usable Seat Depth:	16 ¹ / ₈					
 HSS4L-14A 14"H 4-Leg Chair, Armless	Maximum:	17	17	25 ¹ / ₂	49	11.9	P1 \$555 (reference single unit @ \$138.75)
	Seat:	14 ¹ / ₄	14 ³ / ₈	14			
	Back:		13 ³ / ₈	11 ⁵ / ₈			
	Seat to Floor:			14			
	Usable Seat Depth:	14					
 HSS4L-12A 12"H 4-Leg Chair, Armless	Maximum:	17	17	23 ¹ / ₂	45	11.9	P1 \$555 (reference single unit @ \$138.75)
	Seat:	14 ¹ / ₄	14 ³ / ₈	12			
	Back:		13 ³ / ₈	11 ⁵ / ₈			
	Seat to Floor:			12			
	Usable Seat Depth:	14					
 HSS4L-06A 6"H 4-Leg Chair, Armless	Maximum:	17	17	17 ¹ / ₂	37	8.6	P1 \$541 (reference single unit @ \$135.25)
	Seat:	14 ¹ / ₄	14 ³ / ₈	6			
	Back:		13 ³ / ₈	11 ⁵ / ₈			
	Seat to Floor:			6			
	Usable Seat Depth:	14					
							P3 \$583 (reference single unit @ \$145.75)
							P3 \$568 (reference single unit @ \$142.00)

NOTES:





- High strength tubular steel frame.
- Seat Shell is one-piece injection molded.
- 16"H and 18"H models accept Wire Storage Basket model HSSA-WB1618.
- Casters are available on 16"H and 18"H chairs only.
- 4-Leg models stack 5-high on floor.
- Nylon or steel glides accept felt glide caps (HGDK3-F) which are recommended for use on VCT flooring.
- Durable textured powder coated paint finish or chrome option finish.

SmartLink® 4-Leg Chairs are ordered and shipped four (4) chairs per carton. Pricing shown is per carton. Each set of four chairs (one carton) must have the same shell/frame color combination. Ordering 2 of Model HSS4L-06A, HSS4L-12A, HSS4L-14A, HSS4L-16B or HSS4L-18B will result in 2 cartons being shipped, giving you 8 chairs.

HOW TO SPECIFY

<p>Select Model Number</p> <p>H S S 4 L - 1 2 A</p>	<p>Select Glide Option</p> <p>E Nylon Glide N Nickel Steel Glide C Caster (\$196 upcharge)</p> <p>Caster option not available for models HSS4L-06A, HSS4L-12A or HSS4L-14A</p> <p>E</p>	<p>Select Shell Color</p> <p>See page 188</p> <p>R G</p>	<p>Select Frame Color</p> <p>See page 188</p> <p>P4 option Polished Chrome (Y) \$52 upcharge</p> <p>P L A T</p>
--	--	---	---

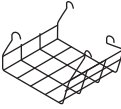



	MODEL/DESCRIPTION	DEPTH	WIDTH	HEIGHT	SHIP WEIGHT	CUBE	LIST PRICE BY PAINT GRADE		
							P1	P2	P3
	HSS4L-24B 24" H 4-Leg Stool, Armless Maximum: Seat: Back: Seat to Floor: Usable Seat Depth:	21½	22	38¼	30	16.8	\$283	\$283	\$298
	HSS4L-30B 30" H 4-Leg Stool, Armless Maximum: Seat: Back: Seat to Floor: Usable Seat Depth:	23½	22½	43¾	31	19.1	\$298	\$298	\$313
	Wire Storage Basket (4 per carton) 15¾"W x 12¼"D x 9¾"H For 16" and 18" 4-Leg Chairs only. Chrome finish only, no specification needed. Chairs cannot be stacked when utilizing Wire Storage Basket. Not compatible with 4-Leg Stools or Cantilever Chairs.								
	Felt Cap Glide Kit for 4-Leg SmartLink® Recommended for use on VCT flooring. Caps easily and securely snap over the existing nylon swivel glide. Kit includes 100 caps for 25 chairs or desks. Field installed. Must be ordered with a configurable end product. If ordered separately, not on GSA Contract.								
	DESCRIPTION				MODEL	SHIP WEIGHT	CUBE	LIST PRICE	
					HSSA-WB1618	14	1.6	\$140	
					HGDK3-F	2	0.2	\$125	

NOTES:

- 4-Leg Stools may stack up to 5-high on floor.
- Lead times may vary by shell color.

HOW TO SPECIFY

<p>Select Model Number</p> <p>H S S 4 L - 2 4 B</p>	<p>Select Glide Option</p> <p>E Nylon Glide N Nickel Steel Glide</p> <p>E</p>	<p>Select Shell Color</p> <p>See page 188</p> <p>R G</p>	<p>Select Frame Color</p> <p>See page 188 P4 option Chrome (Y) \$52 upcharge</p> <p>P L A T</p>
--	--	---	--

	MODEL/DESCRIPTION	DEPTH	WIDTH	HEIGHT	SHIP		PER CARTON LIST	
					WEIGHT	CUBE		
	HSSCL-18B 18"H Cantilever Base Chair, Armless	Maximum: Seat: Back: Seat to Floor: Usable Seat Depth:	21¾ 16⅞ 16½ 15⅜ 16⅞	22¾ 16½ 15⅜	31¼ 18 13⅜ 18¼	80	23.7	P1 \$846 (reference single unit @ \$211.50) P2 \$846 (reference single unit @ \$211.50) P3 \$888 (reference single unit @ \$222.00)
	HSSCL-16B 16"H Cantilever Base Chair, Armless	Maximum: Seat: Back: Seat to Floor: Usable Seat Depth:	21¾ 16⅞ 16½ 15⅜ 16⅞	22¾ 16½ 15⅜	29¼ 16 13⅜ 16¼	55	16.8	P1 \$804 (reference single unit @ \$201.00) P2 \$804 (reference single unit @ \$201.00) P3 \$844 (reference single unit @ \$211.00)
	HSSCL-14A 14"H Cantilever Base Chair, Armless	Maximum: Seat: Back: Seat to Floor: Usable Seat Depth:	21¾ 16⅞ 16½ 15⅜ 16⅞	22¾ 16½ 15⅜	27¼ 14 13⅜ 14¼	52	16.8	P1 \$789 (reference single unit @ \$197.25) P2 \$789 (reference single unit @ \$197.25) P3 \$828 (reference single unit @ \$207.00)

NOTES:



- High strength tubular steel frame.
- Glides available with nylon or felt inserts. See ordering information below.
- Seat shell is one-piece injection molded.
- Cantilever models stack 5-high on floor.
- Durable textured powder coated paint or chrome option finish.

 SmartLink® Cantilever Chairs are ordered and shipped four (4) chairs per carton. Pricing shown is per carton. Each set of four chairs (one carton) must have the same shell/frame color combination. Ordering 2 of Model HSSCL-18B will result in 2 cartons being shipped, giving you 8 chairs.

HOW TO SPECIFY

<p>Select Model Number</p> <p>H S S C L - 1 8 B .</p>	<p>Select Glide Option</p> <p>E All-purpose Glide Insert (no upcharge) F Felt Glide Insert (\$36 list upcharge; \$9 per single unit see page 197)</p> <p>E .</p>	<p>Select Shell Color</p> <p>See page 188</p> <p>R G .</p>	<p>Select Frame Color</p> <p>See page 188 P4 option Polished Chrome (Y) \$52 upcharge</p> <p>P L A T</p>
--	---	---	---



	MODEL/DESCRIPTION	DEPTH	WIDTH	HEIGHT	SHIP WEIGHT	CUBE	PER CARTON LIST
	HSSTK-18B 18"H Task Swivel Chair, Pneumatic Seat Height Adjustment ⓘ Black frame only.	Maximum: 22 ⁵ / ₈ Seat: 16 ¹ / ₄ Back: 15 ³ / ₈ Seat to Floor: 16-21 Usable Seat Depth: 16 ¹ / ₈	22 ¹ / ₂ 16 ¹ / ₂ 15 ³ / ₈	34 ³ / ₄ 18 13 ³ / ₈ 16-21	23	5.2	\$317
	HSSST-18B 18"H Task Swivel Stool, Pneumatic Seat Height Adjustment, Footring Adjustment ⓘ Black frame only.	Maximum: 24 ¹ / ₄ Seat: 16 ¹ / ₄ Back: 15 ³ / ₈ Seat to Floor: 22-32 Usable Seat Depth: 16 ³ / ₈	25 ³ / ₄ 16 ¹ / ₂ 15 ³ / ₈	45 ¹ / ₂ 18 13 ³ / ₈ 22-32	28	12.8	\$390

NOTES:

- Seat Shell is one-piece injection molded.
- Task Swivel Chair has a pneumatic seat height adjustment.
- Choose between hard and soft casters (no upcharge) or bell glide (\$25 upcharge) options.
- Stool has an adjustable footring.
- Swivel Task Chair and Stool ship one per carton.
- ⓘ Swivel Task Chair and Stool are available with a black frame only.

HOW TO SPECIFY

<p>Select Model Number</p> <p>H S S T K - 1 8 B</p>	<p>Select Glide Option</p> <p>S Soft Caster (no upcharge) H Hard Caster (no upcharge) G Bell Glide (\$25 upcharge)</p> <p>S</p>	<p>Select Shell Color</p> <p>See page 188</p> <p>R G</p>
---	--	--

SMARTLINK® Teacher Stations

GSA SIN 33721T



Icon Legend on page 19

EDUCATION

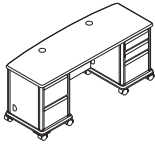

DESCRIPTION

Teacher Station
72"W x 26"D x 30"H
File/File Pedestal, Left
Box/Box/File Pedestal, Right

MODEL

HLT2672T-23

SHIP WEIGHT

254

CUBE

37.2

LIST PRICE

\$2209



Teacher Station
60"W x 24"D x 30"H
Box/Box/File Storage, Single Pedestal, Right

HLT2460T-R3

136

29.3

\$1989

Teacher Station
60"W x 24"D x 30"H
Box/Box/File Storage, Single Pedestal, Left

HLT2460T-L3

136

29.3

\$1989

NOTES:

- Tops/Bases are Laminate with T-mold edge.
- Larger top size provides ample work/conference area or space for equipment.
- Standard with Heavy-duty 3", 360-degree swivel casters, 4-locking, 4-non-locking.
- Storage options include: Locking box/box/file and locking file/file.
- Kneewell space accommodates separately specified and field installed non-locking center drawer and CPU holders (see page 204).
- End panels are removable to access standard power management cabinets on both ends of the station for safe and secure storage of plug-strips, power cords and cables.
- Removable end panels have one outside cord management grommet.
- Full width cable management system provides easy access to and from each side cabinet.
- Standard with two Smart Grommets with wireway covers.
- Smart Grommets accept optional power inserts (see page 204).
- Single pedestal available in right and left handed configurations.
- D-shape top encourages conferencing and provides ample work and conference area.
- Standard with modesty panel.
- Modesty and column leg will match the specified metal surface color.

HOW TO SPECIFY

Select Model Number HLT2672T-23	Select Casters C Hard-Surface (no upcharge)	Select Top and Base Color Laminate See page 188 B9	Select T-Mold and Paint Color See page 188 T1
---	---	--	--

DESCRIPTION

Accessory Rail (Side Mount)
21"W x 1/2"D x 1/2"H

MODEL

HLTA-TR24

SHIP WEIGHT

3 Ⓞ

CUBE

0.3

LIST PRICE

\$162

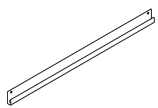

NOTES:

- Field installed.
- 21" Usable width.
- Specify paint.
- Mounts to either side of the Teacher Station or Storage Cases.
- Accepts file folder, Pencil holder, or other accessories (see page 209).



HOW TO SPECIFY

Select Model Number HLTA-TR24	Select Frame Color S Charcoal T1 Platinum (\$12 upcharge) S
---	---

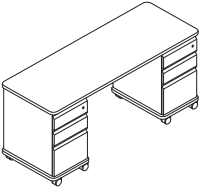

Icon Legend on page 19

SMARTLINK® Value Teacher Stations

	DESCRIPTION	MODEL	SHIP WEIGHT	CUBE	LIST PRICE BY PAINT GRADE		
					P1	P2	P3
	Value Teacher Station 66"W x 24"D x 30"H Box/Box/File Pedestal, Left Box/Box/File Pedestal, Right	HLTV2466T-33	240	21.1	\$1814	\$1846	\$1868
 	Value Teacher Station 60"W x 24"D x 30"H Box/Box/File Storage	HLTV2460T-3	158	14.18	\$1377	\$1403	\$1420

NOTES:

- Tops/Bases are Laminate with T-mold edge.
- Standard with Heavy-duty 3", 360-degree swivel casters, 4-locking, 4-non-locking.
- Storage options include: Locking box/box/file.
- Kneewell space accommodates separately specified and field installed non-locking center drawer and CPU holders (see page 204).
- D-shape top encourages conferencing and provides ample work and conference area.
- Right or left assembled in the field.
- Modesty specified separately.
- Power modules can be ordered separately and mounted to the desk.

HOW TO SPECIFY

Select Model Number	Select Top and Base Color Laminate See page 188	Select T-Mold Color See page 188	Select Paint Color See page 188
H L T V 2 4 6 6 T - 3 3 .	B 9 .	K .	T 1

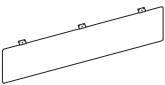
	DESCRIPTION	MODEL	SHIP WEIGHT	CUBE	LIST PRICE BY PAINT GRADE		
					P1	P2	P3
	Universal Modesty Panel	HMTUMOD32	9	1.9	\$214	\$234	\$244

SIN 33721

HOW TO SPECIFY

Select Model Number	Select Paint Color See page 188
H M T U M O D 3 2 .	S

SMARTLINK® Teacher Station Accessories

GSA SIN 33721T EXCEPT AS NOTED



Icon Legend on page 19

EDUCATION

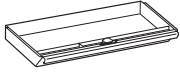

(Angled front)

DESCRIPTION

Metal Center Drawer, Non-Locking
24¾"W x 14¾"D x 3"H

MODEL	SHIP WEIGHT	CUBE	LIST PRICE BY PAINT GRADE	
			P1	P2
HD8X	12 Ⓞ	1.2	\$235	\$245

NOTES: Not for use on 24" x 60" Teacher's Stations. Field installed. Non-locking. Minimum clearance for mounting: 27¾"W x 19¼"D. Specify paint. Available in Charcoal (S) or Platinum (T1) \$10 upcharge.

SPECIFYING EXAMPLE: HD8X.S

DESCRIPTION

360° Swivel CPU Holder with Adjustable Straps

- Supports CPUs 3¾" wide up to 64" perimeter and holds up to 75 lbs.
- 360° rotation.
- Ships complete and includes necessary mounting hardware and instruction sheet.

ⓘ Available in Black only, no specification needed.

MODEL	SHIP WEIGHT	CUBE	LIST PRICE
HCPU1	7.0 Ⓞ	0.2	\$243

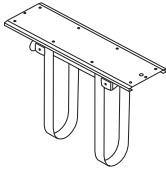

SIN 33721

Power Hub, 3" Grommet Mount, 6' Cord

- Fits in 3" round grommet holes.
- Two grounded AC power outlets.
- Includes 6' cord with three-prong plug.
- Field installed with Plug-and-play ease.

NOTES: For additional information see page 236.

ⓘ Available in black only (no color designation so use .X - Specify: HGRMTAC.X).

MODEL	SHIP WEIGHT	CUBE	LIST PRICE
HGRMTAC	1.3	0.2	\$116

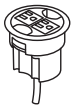

3" Round Power Grommet - 2 Outlets, 10' Cord

- Includes 10' cord with three-prong plug.
- Fits in 3" round grommet holes.
- Two grounded AC power outlets.
- Field installed with Plug-and-play ease.

ⓘ Available in black finish only, no specification needed.

MODEL	SHIP WEIGHT	CUBE	LIST PRICE
HGRMTAC2	1.5	0.2	\$148

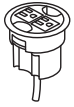

Power/USB Hub, 3" Grommet Mount

- One grounded AC power outlet with 2 USB ports.
- Two cord pass-through holes in cap.
- Includes 6' cord with three-prong plug.
- Field installed; easy plug-and-play.
- UL Listed.

NOTES: For additional information see page 236.

ⓘ Available in black only (no color designation so use .X - Specify: HGRMTUSB2.X).

MODEL	SHIP WEIGHT	CUBE	LIST PRICE
HGRMTUSB2	1.3 Ⓞ	0.2	\$226



HOW TO SPECIFY

Select Model Number	Select Paint
P Black	LOFT Loft
P7D Brownstone	T3 Muslin
PJW Designer White	L Putty
S Charcoal	SHDW Shadow ⓘ
P28 Fossil	P8T Titanium
T5 Greige	T4 Champagne Metallic (\$10 upcharge)
Q Light Grey	T1 Platinum Metallic (\$10 upcharge)

HD8X.S

ⓘ De-emphasized

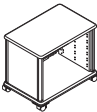
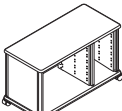

	DESCRIPTION	MODEL	SHIP WEIGHT	CUBE	LIST PRICE
	Modular Storage Cabinet, Credenza Height 1 – 30"W Column 36 ³ / ₄ "W x 24 ¹ / ₄ "D x 30"H	HLSC36T-1N	98	17.7	\$1259
	Modular Storage Cabinet, Credenza Height 2 – 12"W Columns 36 ³ / ₄ "W x 24 ¹ / ₄ "D x 30"H	HLSC36T-2N	103	17.7	\$1377
	Modular Storage Cabinet, Credenza Height 1 – 30"W Left-hand Column 1 – 12"W Right-hand Column 52 ³ / ₄ "W x 24 ¹ / ₄ "D x 30"H	HLSC52T-21N	154	25.3	\$1618
	Modular Storage Cabinet, Credenza Height 3 – 12"W Columns 52 ³ / ₄ "W x 24 ¹ / ₄ "D x 30"H	HLSC52T-3N	159	25.3	\$1738
	Modular Storage Cabinet, Full Height 1 – 30"W Left-hand Column 1 – 12"W Right-hand Column 52 ³ / ₄ "W x 24 ¹ / ₄ "D x 61 ³ / ₄ "H	HLSF52T-21N	254	51.4	\$2194
	Modular Storage Cabinet, Full Height 3 – 12"W Columns 52 ³ / ₄ "W x 24 ¹ / ₄ "D x 61 ³ / ₄ "H	HLSF52T-3N	164	51.4	\$2430

NOTES:

- Cases will accept a variety of storage accessories including trays, shelves, and coat rods. Refer to pages 192-193 for capacity specification/planning guidelines by cabinet size.
- Specify trays, shelves, or coat rod accessories separately, see page 207.
- Standard with Heavy-duty 3", 360-degree swivel casters, 36" with case includes four casters (2-locking, 2-non-locking), 52"W cases include six casters (3-locking, 3-non-locking).

HOW TO SPECIFY

Select Model Number HLSC36T-1N	Select Casters C Hard-Surface (no upcharge)	Select Top and Base Color Laminate See page 188 DD	Select T-Mold and Paint Color See page 188 T1
---	--	--	---

SMARTLINK® Modular Storage

GSA SIN 33721T



Icon Legend on page 19

EDUCATION

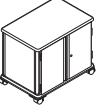
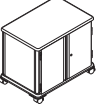
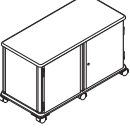
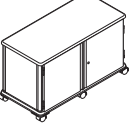
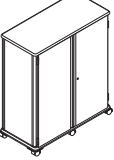
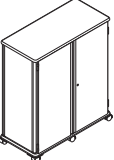
	DESCRIPTION	MODEL	SHIP WEIGHT	CUBE	LIST PRICE
	Modular Storage Cabinet, Credenza Height 1 – 30”W Column 36¾”W x 24¼”D x 30”H	HLSC36T-1D	114	17.7	\$1424
	Modular Storage Cabinet, Credenza Height 2 – 12”W Columns 36¾”W x 24¼”D x 30”H	HLSC36T-2D	119	17.7	\$1537
	Modular Storage Cabinet, Credenza Height 1 – 30”W Left-hand Column 1 – 12”W Right-hand Column 52¾”W x 24¼”D x 30”H	HLSC52T-21D	174	25.3	\$1740
	Modular Storage Cabinet, Credenza Height 3 – 12”W Columns 52¾”W x 24¼”D x 30”H	HLSC52T-3D	179	25.3	\$1852
	Modular Storage Cabinet, Full Height 1 – 30”W Left-hand Column 1 – 12”W Right-hand Column 52¾”W x 24¼”D x 61¾”H	HLSF52T-21D	286	51.4	\$2348
	Modular Storage Cabinet, Full Height 3 – 12”W Columns 52¾”W x 24¼”D x 61¾”H	HLSF52T-3D	296	51.4	\$2565

NOTES:

- Cases will accept a variety of storage accessories including trays, shelves, and coat rods. Refer to pages 192-193 for capacity specification/planning guidelines by cabinet size.
- Specify trays, shelves, or coat rod accessories separately, see page 207.
- Standard with Heavy-duty 3”, 360-degree swivel casters, 36” with case includes four casters (2-locking, 2-non-locking), 52”W cases include six casters (3-locking, 3-non-locking).

HOW TO SPECIFY

<p>Select Model Number</p> <p>HLSC36T-1D</p>	<p>Select Casters</p> <p>C Hard-Surface (no upcharge)</p> <p>C</p>	<p>Select Top and Base Color</p> <p>Laminate</p> <p>See page 188</p> <p>DD</p>	<p>Select T-Mold and Paint Color</p> <p>See page 188</p> <p>T1</p>
---	---	---	---



SMARTLINK® Modular Storage and Accessories

	DESCRIPTION	MODEL	SHIP WEIGHT	CUBE	LIST PRICE
	Tray Kits				
	3"H x 12"W, 7 trays and 14 rails per kit	HLSA-TK3	12.0	2.7	\$197
	6"H x 12"W, 4 trays and 8 rails per kit	HLSA-TK6	10.0	2.7	\$136
	12"H x 12"W, 2 trays and 4 rails per kit	HLSA-TK12	7.0	2.7	\$102
	NOTES: Field installed. See pages 192-193 for specifying guidelines. Semi-translucent white SPECIFYING EXAMPLE: HLSA-TK3.X				
	Shelf Kits, 2 shelves and 4 rails per kit				
	12"W x 24"D 30"W x 24"D	HLSA-SK1220T HLSA-SK3020T	14.0 28.0	0.6 1.2	\$294 \$427
	NOTES: Field installed. See pages 192-193 for specifying guidelines. Specify color.				
	Coat Rod, Single Unit 12"W x 1" diameter	HLSA-CR12	0.5	0.1	\$102
	NOTES: Use with Full-height cases, 12" columns only. Field installed. Anodized finish only.				
	Hanging Folder Rail Kit 12"W Rails 4 rails per kit, each tray uses 2 rails	HLSA-HRK	0.5	0.2	\$41
	NOTES: Use with 12" trays only. Field installed. Anodized finish only.				
	Cabinet Whiteboard Mounting Bracket 52"W Includes 1 pair (upper and lower) of rails and mounting hardware.	HLSA-WBK52	5.0	0.3	\$181
	<ul style="list-style-type: none"> Accommodates: 1 – 48" x 48" Sliding Board or 2 – 24" x 48" Sliding Boards Compatible Sliding Boards (see page 208) HLWBS-448WW HLWBS-248WW HLWBS-448WT HLWBS-248WT Requires field installation. NOTES: For use on full-height cabinets only. Rails feature an integrated marker tray. Specify Charcoal (S) or Platinum (T1) color. SPECIFYING EXAMPLE: HLSA-WBK52.S				

NOTES:

- Mounting bracket model HLSA-WBK52 mounts whiteboard to back of full-height Modular Storage unit.
- For use in Modular Storage cases.
- Trays for use in 12" width columns only. Shelves are available for use in 12" and 30" width columns.
- Trays and shelves hang off a pair of accessory rails.
- Trays and shelves are sold in "kit quantities" and include necessary accessory rails for installation.
- 12" trays accept rails to accommodate hanging file folders (side-to-side).
- All accessories are field installed.
- Trays feature front and rear handles for easy handling and are semi-translucent white for visibility to contents.
- All shelves feature an integrated finger pull and safety mechanism to prevent accidental removal.
- See pages 192-193 for specifying details.

HOW TO SPECIFY

Select Model Number H L S A - S K 1 2 2 0 T . C	Select Shelf Color C Harvest D Natural Maple LDW1 Designer White LOFT Loft
---	---

SMARTLINK® Wall Rail System

GSA SIN 33721T



Icon Legend on page 19

EDUCATION

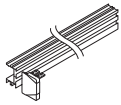

DESCRIPTION	MODEL	SHIP WEIGHT	CUBE	LIST PRICE
Wall Rail 144"	HLWR-12	22	1.4	\$780

NOTES: Rail model includes: 1 – 144" rail, 9 – wall mounting brackets and 2 – rail end caps.

- ! Must be mounted in accordance with published installation instructions. Wall mounting hardware NOT INCLUDED. Must be sourced locally.
- ! Must order Quantity 2 rails when using with Whiteboards and Whiteboards/Tackboards.
- ! Platinum finish only.

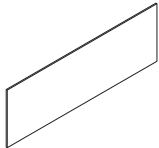

Learning Board, Fixed Whiteboard, 1-sided 144"W x 48"H, Quantity 1	HLWBF1-1248W	124	13.0	\$1866
--	---------------------	-----	------	---------------

SPECIFYING EXAMPLE: HLWBF-1248W.X

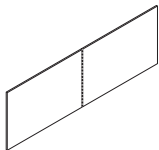

Learning Board, Fixed Whiteboards, 1-sided 72"W x 48"H, Quantity 2 with spacer (included)	HLWBF2-1248W	125	6.7	\$1866
---	---------------------	-----	-----	---------------

NOTES: Includes center cover/spacer.
SPECIFYING EXAMPLE: HLWBF2-1248W.X

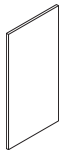

Learning Board, Sliding Whiteboard/Whiteboard 48"W x 48"H	HLWBS-448WW	47	4.6	\$900
24"W x 48"H	HLWBS-248WW	26	2.5	\$575

NOTES: May be used with HLSA-WBK52 to mount to the back of full-height Mobile Cabinets. (See page 207.)

SPECIFYING EXAMPLE: HLWBS-448WW.X

Model HLWBS-248WW shown

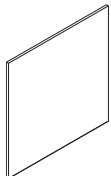

Learning Board, Sliding Whiteboard/Tackboard 48"W x 48"H	HLWBS-448WT	64	4.6	\$936
24"W x 48"H	HLWBS-248WT	34	2.5	\$600

NOTES: May be used with HLSA-WBK52 to mount to the back of full-height Mobile Cabinets. (See page 207.)

Tackboard Side available in the following fabric: Lucy Neutra (LC24).

SPECIFYING EXAMPLE: HLWBS-448WT.X.LC24

Model HLWBS-448WT shown

NOTES:

- Multi-functional wall rails can accommodate whiteboards, worksurfaces and organizational accessories. See above and page 209.
- Sliding learning boards may be attached to the back of Mobile, full-height cabinets with bracket kit HLSA-WBK52 (see page 207).
- Multi-track rail allows for up to three layers of whiteboards. Rear track supports a fixed board, middle and front tracks support sliding boards. Outer rail channel is for attachment of worksurfaces and organizational accessories.
- Sliding learning boards are removable and reversible.
- All fixed and sliding boards:
 - Require two (upper and lower) rails for installation.
 - Feature a full aluminum frame.
 - Are high quality porcelain over steel and non-shadowing.
 - Are low gloss for projection use and allows for use of magnets.





HOW TO SPECIFY

Select Model Number <div style="border: 1px solid #ccc; padding: 2px; display: flex; gap: 5px;"> HLWBS-448WT </div>	Select Side A Color <div style="border: 1px solid #ccc; padding: 2px; display: flex; gap: 5px;"> X </div>	Select Tackboard Fabric <div style="border: 1px solid #ccc; padding: 2px; display: flex; gap: 5px;"> LC24 </div>
--	--	--

LC24 Lucy Neutra
Specify for models HLWBS-448WT and HLWBS-248WT only



SMARTLINK® Wall Rail System Accessories

	DESCRIPTION	MODEL	SHIP WEIGHT	CUBE	LIST PRICE BY PAINT GRADE		
					P1	P2	P3
	Marker Tray (Single Pack) 7"W x 3½"D x 2"H NOTES: Holds dry-erase markers, push pins and other small objects.	HPPMMT	1	0.2	\$89	\$101	\$112
	Paper Clip (2 per carton) 5"W x 2"H NOTES: Use individually for artwork or smaller items. Use in pairs for larger notepad size pieces of paper.	HPPMPC	1	0.2	\$93	\$105	\$116
	All-Purpose Hook (10 per carton) NOTES: Use for hanging back-packs, coats and other items. Hooks slide horizontally and cannot be removed without first removing the rail end cap. ! Specify paint — Platinum Metallic only.	HPPMHK	1	0.2	N/A	\$209	N/A
 SIN 33721	CD/Pencil Holder 5¼"W x 1½"D x 5"H NOTES: Installs on the Wall Rail or Accessory Rail (HLTA-TR24) for use on the Teacher's Desk or Storage Cases. May also be mounted on Folder Bins.	HPPMPB	1	0.2	\$103	\$115	\$126
 SIN 33721	Folder Bin 12¼"W x 1¼"D x 9"H NOTES: Installs on the Wall Rail or Accessory Rail (HLTA-TR24) for use on the Teacher's Desk or Storage Cases. Folder Bin may be mounted (stacked) to each other.	HPPMFB	2	0.3	\$103	\$115	\$126

NOTES:

- Accessories above to be used on the Wall Rail System — see page 208.
- All accessories mount on the rail's outer channel and may be used with sliding boards.
- All accessories may be mounted and moved to any position along the width of the rail.
- All accessories may be easily removed from the rail with the exception of the All-Purpose Hook. All-Purpose Hook can slide horizontally along the rail but cannot be removed without removing a rail end cap.

HOW TO SPECIFY

<p>Select Model Number</p> <p>H P P M M T . T 1</p>	<p>Select Paint Color</p> <p>See page 188 Model HPPMHK available in Platinum Metallic only</p>
--	---

SMARTLINK® Value Mobile Storage

GSA SIN 33721 EXCEPT AS NOTED



Icon Legend on page 19

EDUCATION

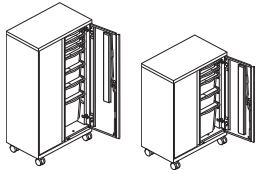

HLVMSC5630R HLVMSC4330R

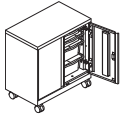

HLVMSC3330R

DESCRIPTION

Mobile Storage Cabinet with Bins

18"D x 30"W x 32¼"H
18"D x 30"W x 42¼"H
18"D x 30"W x 56"H

MODEL

HLVMSC3330R
HLVMSC4330R Ⓞ
HLVMSC5630R

SHIP WEIGHT

152.6
171.6
209.6

CUBE

13.4
18.0
23.5

LIST PRICE BY PAINT GRADE

P1 P2 P3

\$1452 \$1496 \$1525
\$1597 \$1645 \$1677
\$1837 \$1892 \$1929

OPEN MARKET

NOTES:

- Full radius "R" handle on doors.
- Units include 2 locking and 2 non-locking casters.
- Equipped with HON "One Key" interchangeable core removable locks.

ⓘ Pre-configured trays and rails included in mobile storage cabinets with bins. See chart below for configurations and capacity. Additional bin and rail kits may be purchased separately.

DESCRIPTION

Accessories — Tray Kit

3"H, 2 bins and 4 rails
6"H, 2 bins and 4 rails
12"H, 2 bins and 4 rails

NOTES: Modular storage cabinets come with rails and bins. Additional bins and rails may be ordered in sets of 2. Availability and usage are outlined below.

ⓘ Semi-translucent white.

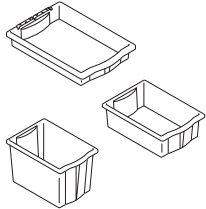

MODEL

HFMBIN3
HFMBIN6
HFMBIN12

SHIP WEIGHT

7 Ⓞ
10 Ⓞ
12 Ⓞ

CUBE

4.0
4.5
5.0

LIST PRICE

\$52
\$64
\$75

Pre-Configured Cabinets/Tray Kits

56"H Cabinet

1	2
3	4
5	6
1	2
3	4
5	6
1	2

42¼"H Cabinet

1	2
3	4
1	2
3	4
1	2

32¼"H Cabinet

1	2
3	4
1	2
3	4

56"H Cabinet

1	14
2	15
3	16
4	17
5	18
6	19
7	20
8	21
9	22
10	23
11	24
12	25
13	26

42¼"H Cabinet

1	11
2	12
3	13
4	14
5	15
6	16
7	17
8	18
9	19
10	20

32¼"H Cabinet

1	7
2	8
3	9
4	10
5	11
6	12

Hanging Slots 12"H Bin 6"H Bin 3"H Bin

1			
2			
3			
4			

26 - 12"W Openings

20 - 12"W Openings

12 - 12"W Openings

HOW TO SPECIFY

Select Model Number

H L V M S C 3 3 3 0 R .

Select Lock Option

- L Lock (no upcharge)
- X Omit Lock (deduct \$20)

L .

Select Paint Color

See page 188

P J W



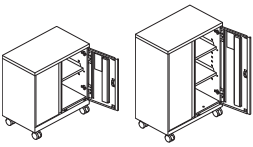
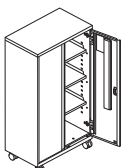

Icon Legend on page 19

SMARTLINK® Value Mobile Storage

	DESCRIPTION	MODEL	SHIP WEIGHT	CUBE	LIST PRICE BY PAINT GRADE		
					P1	P2	P3
 HLVSC3330R HLVSC4330R	Mobile Storage Cabinet without Bins 18"D x 30"W x 32¼"H 18"D x 30"W x 42¼"H 18"D x 30"W x 56"H	HLVSC3330R HLVSC4330R HLVSC5630R	152.6 171.6 209.6	13.4 18.0 23.5	\$1321 \$1452 \$1742	\$1361 \$1496 \$1794	\$1387 \$1525 \$1829
	 HLVSC5630R						

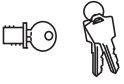
- NOTES:**
- Full radius "R" handle on doors.
 - Units include 2 locking and 2 non-locking casters.
 - Includes shelves which are adjustable in 2" increments.
 - Equipped with HON "One Key" interchangeable core removable locks.
 - Wire management grommet in back of unit.

	DESCRIPTION	MODEL	SHIP WEIGHT	CUBE	LIST PRICE
 SIN 33721	Chrome Removable Lock Core Kit (for metal casegoods) • Use when specifying omit lock application. • Specify quantity of each key number from 101E-225E. • Includes: 1-core, 2-keys, 1-core removal tool and instructions. • Removable lock core kits with specific key number must be ordered to facilitate keying alike in the field. • For specific models, look for the Omit Lock Core icon throughout this publication.	HF23C	0.1 	0.1	\$44
	NOTES: If key number isn't specified, number will be at random. Core matches manufactured lock on metal casegoods product but can be used with Contain® and laminate product.				

HOW TO SPECIFY

<p>Select Model Number</p> <p>HLVSC3330R</p>	<p>Select Lock Option</p> <p>L Lock (no upcharge) X Omit Lock (deduct \$20)</p> <p>L</p>	<p>Select Paint Color</p> <p>See page 188</p> <p>PJW</p>
---	--	---

EDUCATION

SMARTLINK® Value Mobile Storage

OPEN MARKET



Icon Legend on page 19

EDUCATION

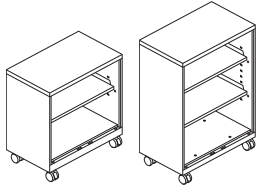

HLVBC3330

HLVBC4330

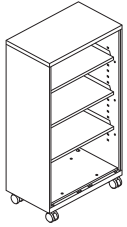

HLVBC5630

DESCRIPTION

Mobile Bookcases

18"D x 30"W x 31¼"H

18"D x 30"W x 42¼"H

18"D x 30"W x 56"H

MODEL	SHIP WEIGHT	CUBE	LIST PRICE BY PAINT GRADE		
			P1	P2	P3
HLVBC3330	118.6	13.4	\$1200	\$1236	\$1260
HLVBC4330	134.6	18.0	\$1321	\$1361	\$1387
HLVBC5630	157.6	23.5	\$1584	\$1632	\$1663

NOTES:

- Units include 2 locking and 2 non-locking casters.
- Shelves adjust in 2" increments.
- Wire management grommet in back of unit.

HOW TO SPECIFY

Select Model Number

HLVBC3330

Select Paint Color

See page 188

PJW

WORKPLACE TOOLS



Flock® Modular Seating with Dean Power Module Under-Surface Mount.

WORKPLACE TOOLS

Workplace tools provide the finishing touch on any high-performance workspace. From storage options to technological tools and lighting solutions, HON's Workplace Tools deliver organization and efficiency to the office. Workplace Tools put everything you need to be productive within arm's reach, provide easy access to the connectivity you need to be successful and help you keep your workspace neat.



PRODUCT CATEGORIES

- Monitor Arms
- Keyboard Trays and Center Drawers
- Paper Management and Organizational Tools
- Task Lights
- Electrical and Power Management Accessories
- Ergonomic and Healthy Workplace Solutions

WORKPLACE TOOLS ORDERING INFORMATION

LAMINATE CENTER DRAWERS, LAMINATE PAPER MANAGEMENT MODELS HLVP1/HLDST1/ HLSL1472LS/HLSL1460LS

L1 LAMINATES CODES

Woodgrain

- ◆ Bourbon Cherry H
- ◆ Cognac COGN
- ◆ Florence Walnut LFW1
- ◆ Harvest C
- ◆ Kingswood Walnut LK11
- ◆ Mahogany N
- ◆ Mocha MOCH
- ◆ Natural Maple D
- ◆ Pinnacle PINC
- ◆ Shaker Cherry F

Solid

- ◆ Black P
- ◆ Charcoal S
- ◆ Designer White LDW1
- ◆ Loft LOFT

L2 LAMINATES CODES

Woodgrain

- ◆ Lowell Ash LLA1
- ◆ Natural Recon LNR1
- ◆ Phantom Ecru LPE1
- ◆ Portico Teak LPT1
- ◆ Skyline Walnut LSW1

LAMINATE KEYBOARD PLATFORM MODELS H4022/HE4022

L1 LAMINATES CODES

Woodgrain

- ◆ Bourbon Cherry H
- ◆ Cognac COGN
- ◆ Florence Walnut LFW1
- ◆ Harvest C
- ◆ Kingswood Walnut LK11
- ◆ Mahogany N
- ◆ Mocha MOCH
- ◆ Natural Maple D
- ◆ Pinnacle PINC
- ◆ Shaker Cherry F

Solid

- ◆ Black P
- ◆ Charcoal S
- ◆ Designer White LDW1
- ◆ Whitestone K4

Patterned

- ◆ Sheer Mesh A5
- ◆ Silver Mesh B9
- ◆ Steel Mesh A9
- ◆ Canyon Zephyr K9
- ◆ Desert Zephyr K8
- ◆ Shadow Zephyr K1
- ◆ Gray G2
- ◆ Grey Tigris L6
- ◆ White G1

L2 LAMINATES CODES

Woodgrain

- ◆ Lowell Ash LLA1
- ◆ Natural Recon LNR1
- ◆ Phantom Ecru LPE1
- ◆ Portico Teak LPT1
- ◆ Skyline Walnut LSW1

METAL PAPER MANAGEMENT MODELS HHPS1 AND HDPS1

PAINT CODES

P1

- ◆ Black P
- ◆ Brownstone P7D
- ◆ Charcoal S
- ◆ Designer White PJW
- ◆ Fossil P28
- ◆ Loft LOFT
- ◆ Muslin T3
- ◆ Titanium P8T

P2

- ◆ Champagne Metallic T4
- ◆ Platinum Metallic T1
- ◆ Silver PR6

P3

- ◆ Atom P8S
- ◆ Bullseye PJF
- ◆ Ember P8P
- ◆ Ion P8N
- ◆ Iris P8J
- ◆ Krypton P8F
- ◆ Regatta P8M

METAL CENTER DRAWERS*, CORNER SLEEVES, METAL KEYBOARD PLATFORM, STORAGE CUBES, DRAWER ORGANIZER, HAND SANITIZER STATION

PAINT CODES

P1

- ◆ Black P
- ◆ Brownstone P7D
- ◆ Charcoal S
- ◆ Designer White PJW
- ◆ Fossil P28
- ◆ Greige T5
- ◆ Light Gray Q
- ◆ Loft LOFT
- ◆ Muslin T3
- ◆ Putty L
- ◆ Shadow * SHDW
- ◆ Titanium P8T

P2

- ◆ Champagne Metallic T4
- ◆ Platinum Metallic T1
- ◆ Silver PR6
- ◆ Solar Black P8X

P3

- ◆ Atom P8S
- ◆ Bullseye PJF
- ◆ Ember P8P
- ◆ Ion P8N
- ◆ Iris P8J
- ◆ Krypton P8F
- ◆ Regatta P8M

* Metal center drawer models HD2 and HD8 limited to P1 Paints, Champagne Metallic, and Platinum Metallic.

◆◆◆ For lead time information see page 19.

* De-emphasized

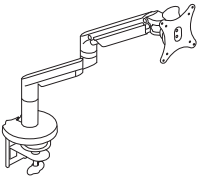
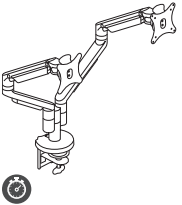
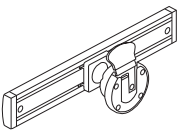
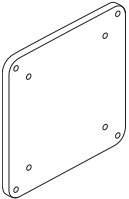

MONITOR ARMS

	DESCRIPTION	MODEL	SHIP WEIGHT	CUBE	LIST PRICE
	<p>Single Dynamic Monitor Arm</p> <ul style="list-style-type: none"> • 180° of rotation at base with optional 360° rotation. • Arms extend 22" and retract up to 3". • Monitor mount rotates 180° and tilts +/-30°. • Monitor can be rotated from landscape to portrait position. <p>! Arms hold monitors from 6.2-18 lbs. Optional counterweight HPACW available to support monitors as low as 5 lbs.</p>	HMASTS	11.5	0.8	\$468
	<p>Dual Dynamic Monitor Arm</p> <ul style="list-style-type: none"> • 150° of rotation at base with optional 360° rotation. • Arms extend 22" and retract up to 3". • Monitor mount rotates 180° and tilts +/-30°. • Monitor can be rotated from landscape to portrait position. <p>! Arms hold monitors from 6.2-18 lbs. Optional counterweight HPACW available to support monitors as low as 5 lbs.</p>	HMASD	17.0	1.1	\$900
	<p>Sliding Mount for Monitor Arm</p> <ul style="list-style-type: none"> • Supports monitors up to 18 lbs. • Compatible with VESA 75mm and 100mm mounts. • Compatible with models HMASTS, HMASD, HPASD, HPADD, and HPATF. • Available in two paint finishes, Silver (SVR) and Black (BLK). Plastic components ship in like color with specified paint finish. 	HPACSM	3.0	0.3	\$192
	<p>Monitor Arm Counterweight</p> <ul style="list-style-type: none"> • Optional counterweight for monitors as low as 5 lbs. • Minimum weight for monitors without counterweight is 6.2 lbs. <p>! Available in Black only, no specification needed.</p> <p>! Compatible with models HMASTS, HPASD, HMASD, HPADD, and HPATF.</p>	HPACW	3.0	0.1	\$27

SIN 33721

WORKPLACE TOOLS

HOW TO SPECIFY

Select Model Number	Select Finish
	SVR Silver BLK Black
HMASTS	SVR



MONITOR ARMS

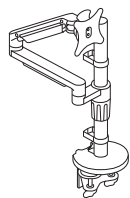

DESCRIPTION

Post Mount with Single Dynamic Arm

- Arm has 180° of rotation at base with optional 360° rotation.
- Monitor mount rotates 180° and tilts +/-30°.
- Monitor can be rotated from landscape to portrait position.
- Arm extends up to 20".
- Arm has 17¾" of vertical adjustment.

ⓘ Available in Silver (SVR) finish only.

ⓘ Arms hold monitors from 6.2-18 lbs. Optional counterweight HPACW available to support monitors as low as 5 lbs. (see page 215).

MODEL

HPASD

SHIP WEIGHT

15.5 Ⓢ

CUBE

1.3

LIST PRICE

\$684

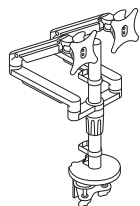

Post Mount with Dual Dynamic Arms

- Arms have 180° of rotation at base with optional 360° rotation.
- Monitor mount rotates 180° and tilts +/-30°.
- Monitor can be rotated from landscape to portrait position.
- Arms extend up to 20".
- Arms have 17¾" of vertical adjustment.

ⓘ Available in Silver (SVR) finish only.

ⓘ Arms hold monitors from 6.2-18 lbs. Optional counterweight HPACW available to support monitors as low as 5 lbs. (see page 215).

HPADD

19.5 Ⓢ

1.3

\$996

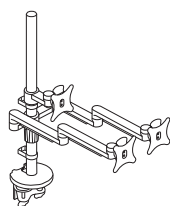

Post Mount with Triple Fixed Arms

- Features two fixed extended arms and one fixed center mount.
- Arms have 180° of rotation at base with optional 360° rotation.
- Monitor mount rotates 180° and tilts +/-30°.
- Monitor can be rotated from landscape to portrait position.
- Arms extend up to 20".
- Arms have 27½" of vertical adjustment.

ⓘ Available in Silver (SVR) finish only.

ⓘ Arms hold monitors from 6.2-18 lbs. Optional counterweight HPACW available to support monitors as low as 5 lbs. (see page 215).

HPATF

22.0 Ⓢ

1.9

\$1140

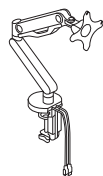

Single Monitor Arm with 2 USB Ports

NOTES: Easy adjustment. Height adjusts to 17" tall. Monitor tilt and swivel capability. Enclosed cable management. Grommet or desktop mounting. Clean appearance. **HON 5-Year Limited Warranty.**

ⓘ No specification needed.

ⓘ Cannot be used in Empower® height adjustable applications.

HBSMAUSB

38.6

2.4

\$255



Dual Monitor Arm with 2 USB Ports

NOTES: Easy adjustment. Height adjusts to 17" tall. Monitor tilt and swivel capability. Enclosed cable management. Grommet or desktop mounting. Clean appearance. In some applications the Monitor Arms may extend 12 or more inches into the worksurface. **HON 5-Year Limited Warranty.**

ⓘ No specification needed.

ⓘ Cannot be used in Empower® height adjustable applications.

HBDMAUSB

41.9

2.6

\$383

HOW TO SPECIFY

<p>Select Model Number</p> <p>HPASD.</p>	<p>Select Finish</p> <p>SVR Silver</p> <p>SVR</p>
--	---



CPU HOLDERS

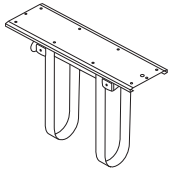

DESCRIPTION

360° Swivel CPU Holder with Adjustable Straps

- Supports CPUs 3¼" wide up to 64" perimeter and holds up to 75 lbs.
- 360° rotation.
- Ships complete and includes necessary mounting hardware and instruction sheet.

ⓘ Available in Black only, no specification needed.

MODEL	SHIP WEIGHT	CUBE	LIST PRICE
HCPU1	7	0.2	\$243



HOW TO SPECIFY

Select Model Number

H C P U 1

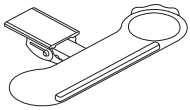

KEYBOARD TRAYS

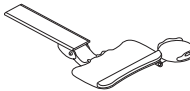
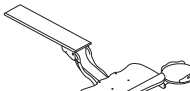
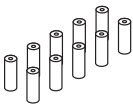
	DESCRIPTION	MODEL	SHIP WEIGHT	CUBE	LIST PRICE
	Short Track and Keyboard Platform <ul style="list-style-type: none"> Height adjustable total of 5$\frac{3}{4}$" (1$\frac{3}{4}$" above and 4" below). +10°, -20° of tilt adjustment. 360° rotation. 	HKTSHORT	10 	0.8	\$563
	Mid Track with Keyboard and Mouse Platform <ul style="list-style-type: none"> Height adjustable total of 8" (3" above and 5" below). +10°, -20° of tilt adjustment. 360° rotation. 	HKT MID	17	1.2	\$518
	Sit to Stand Long Track with Keyboard and Mouse <ul style="list-style-type: none"> Height adjustable total of 12$\frac{1}{2}$" (7$\frac{1}{2}$" above and 5" below). +10°, -20° of tilt adjustment. 360° rotation. 	HKTLONG	17	0.8	\$605
	Keyboard Spacer <ul style="list-style-type: none"> Used when attaching HKT MID or HKTLONG to Coordinate™ and Voi® or Systems Worksurface with an external channel. The kit includes ten cylinder spacers and ten screws. Spacers are $\frac{3}{4}$"W x 2$\frac{1}{8}$"H. Specify one kit per keyboard tray. 	HKBS	1	0.8	\$92

NOTES:

-  Black finish only, no specification needed.

HOW TO SPECIFY

Select
Model Number

H K T M I D



Icon Legend on page 19

KEYBOARD TRAYS

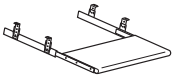
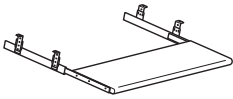
	DESCRIPTION	MODEL	SHIP WEIGHT	CUBE	LIST PRICE BY LAMINATE GRADE	
					L1	L2
	Laminate Keyboard Platform <ul style="list-style-type: none"> Laminate Tray dimensions: 21½"W x 10"D x 1⅛" Thick. Minimum clearance for mounting: 22⅞"W x 17"D. Surface can be positioned 2", 2½", 3" or 3½" below bottom of worksurface. Will not fit on a 37" x 24" Corner worksurface. Specify laminate. 	H4022	10	0.6	\$213	\$228
	Laminate Keyboard Platform with Extended Tray <ul style="list-style-type: none"> Laminate Tray dimensions: 30"W x 10"D x 1⅛" Thick. Minimum clearance for mounting: 32½"W x 17"D. Surface can be positioned 2", 2½", 3" or 3½" below bottom of worksurface. Will not fit on a 37" x 24" Corner worksurface. Ball-bearing slide; slide and brackets are Black. 	HE4022	12	0.7	\$302	\$317

HOW TO SPECIFY

Select Model Number <input type="text" value="H4022"/>	Select Laminate See page 214 <input type="text" value="H"/>
--	--

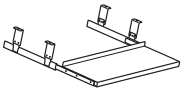
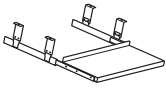
	DESCRIPTION	MODEL	SHIP WEIGHT	CUBE	LIST PRICE BY PAINT GRADE		
					P1	P2	P3
	Metal Keyboard Platforms 30"W Metal Keyboard and Mouse Tray <ul style="list-style-type: none"> Designed to hold keyboards and allow room for mouse pads. Tray dimensions: 30"W x 10"D. Minimum clearance for mounting: 32½"W x 15"D. Surface is positioned 3" below bottom of worksurface. Non-articulating, only movement is front-to-back. Does not tilt or swivel. Specify paint color. 	H4028	11	1.5	\$153	\$163	\$171
	24"W Metal Keyboard Tray <ul style="list-style-type: none"> Designed to hold ONLY keyboards. Tray dimensions: 24"W x 10"D. Minimum clearance for mounting: 26½"W x 15"D. Surface is positioned 3" below bottom of worksurface. Non-articulating, only movement is front-to-back. Does not tilt or swivel. Specify paint color. 	H4029	11	1.5	\$138	\$148	\$156

HOW TO SPECIFY

Select Model Number <input type="text" value="H4028"/>	Select Paint Color See page 214 <input type="text" value="P"/>
--	---

WORKPLACE TOOLS



CORNER SLEEVES

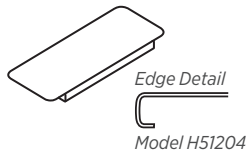

DESCRIPTION

Metal Corner Sleeves

22½"W Leading Edge x 9"D

- Fits 1⅝" thick square edge detail.
- Smaller design is more aesthetically pleasing.

MODEL	SHIP WEIGHT	CUBE	LIST PRICE BY PAINT GRADE		
			P1	P2	P3
H51204	10	1.5	\$161	\$168	\$175

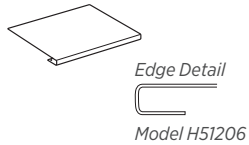

22½"W Leading Edge x 18"D

- Fits 1⅝" thick square edge detail.

H51206	10	1.5	\$161	\$171	\$178
--------	----	-----	-------	-------	-------

NOTES:

- Corner sleeve connects intersecting worksurfaces to create "corner desk" work areas.
- Specify paint color.

HOW TO SPECIFY

Select
Model Number

H 5 1 2 0 4 .

Select
Paint Color

See page 214

P



CENTER DRAWERS

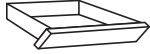

Angled front

DESCRIPTION

Laminate Center Drawer

22"W x 15³/₈"D x 2¹/₂"H

Specify laminate.

26"W x 15³/₈"D x 2¹/₂"H

Specify laminate.

- Ball-bearing slide suspension.
- 12" drawer extension (3/4).
- Inside drawer dimension for H1522: 18⁷/₈"W x 15¹/₂"D x 1¹/₂"H.
- Inside drawer dimension for H1526: 22³/₄"W x 15¹/₂"D x 1¹/₂"H.
- Minimum clearance for mounting H1522: 22³/₄"W x 18¹/₂"D compatible with 72"W x 36"D, 66"W x 30"D, 60"W x 30"D Double Pedestal Desks, 72"W x 36"D, 66"W x 30"D Single Pedestal Desks, Bullet and P-Shaped Peninsulas, 72"W x 24"D, 66"W x 24"D, 60"W x 24"D Credenza w/Kneespace, 72"W x 24"D, 66"W x 24"D Single Pedestal Credenzas, 48"W x 24"D, 42"W x 24"D Returns
- Minimum clearance for mounting H1526: 27¹/₄"W x 18¹/₂"D compatible with 72"W x 36"D, 66"W x 30"D, 60"W x 30"D Double Pedestal Desks, 72"W x 24"D, 66"W x 24"D, 60"W x 24"D Credenza w/Kneespace, 48"W x 24"D Return
- Designed for use with Concinnity™, Voi®, Valido®/11500, 10700 and 10500 Series™.
- Includes pencil tray.

NOTES: For 60"W x 30"D Modular Desk Shells with two 15⁵/₈"W Storage Pedestals or 60"W x 24"D Modular Credenza Shells with two 15⁵/₈"W Storage Pedestals, use center drawer H1522.

MODEL	SHIP WEIGHT	CUBE	L1	L2
			LIST PRICE	LIST PRICE
H1522	11	1.1	\$184	\$199
H1526	12	1.2	\$198	\$213

HOW TO SPECIFY

Select Model Number	Select Laminate
	See page 214
H 1 5 2 2 .	H



Icon Legend on page 19

CENTER DRAWERS

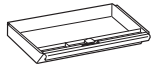

Angled front

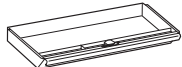

Angled front



DESCRIPTION

Metal Center Drawer w/Lock

19"W x 14³/₄"D x 3"H

Specify paint color.

- Ball-bearing slide suspension.
- 12" drawer extension (3/4).
- Inside drawer dimension: 19"W x 13"D x 2³/₈"H.
- Minimum clearance for mounting: 21³/₄"W x 19¹/₄"D.
- Core removable lock.

24³/₄"W x 14³/₄"D x 3"H

Specify paint color.

- Ball-bearing slide suspension.
- 12" drawer extension (3/4).
- Inside drawer dimension: 24¹/₂"W x 13"D x 2³/₈"H.
- Minimum clearance for mounting: 27³/₈"W x 19¹/₄"D.
- Core removable lock.

MODEL	SHIP WEIGHT	CUBE	LIST PRICE BY PAINT GRADE	
			P1	P2

HD2	9	1.0	\$263	\$273
-----	---	-----	-------	-------

HDB	12	1.2	\$263	\$273
-----	----	-----	-------	-------

DESCRIPTION

Polymer Center Drawer

- Color: Black.
- Material: ABS.
- Minimum clearance for mounting: 23"W x 16¹/₄"D x 2"H.
- Retracts on 16" ball-bearing slides.
- Can be used on worksurfaces with Coordinate™ Height Adjustable Bases as long as it is attached with spacer model HKBS.
- Can store up to 25 lbs.

Black finish only, no specification needed.

MODEL	SHIP WEIGHT	CUBE	LIST PRICE
-------	-------------	------	------------

HCD1	7	0.5	\$111
------	---	-----	-------

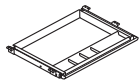

OPEN MARKET

NOTES:

- All metal center drawers feature pencil trays with three compartments for storage.
- All metal center drawers feature core removable locks for greater personal and departmental security.

HOW TO SPECIFY

<p>Select Model Number</p> <p>HD2 .</p>	<p>Select Paint Color</p> <p>See page 214</p> <p>P</p>
---	--

COORDINATE™ Desktop Riser

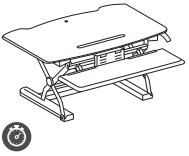
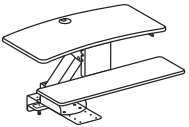
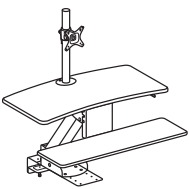
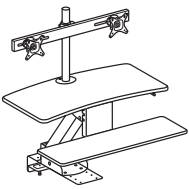
	DESCRIPTION	MODEL	SHIP WEIGHT	CUBE	LIST PRICE
	Portable Desktop Riser 31"D x 5"-16½"H x 35"W NOTES: Available in Black (BLK) or White (WHT) finish. Desktop riser dimensions (without keyboard tray): 22"D x 5"-16½"H x 35"W. Keyboard tray dimensions: 9"D x 30"W. Max loading capacity is 33 lbs for the desktop riser surface and 4 lbs for the keyboard tray. Easily transition from seated to standing positions throughout the workday. Sits atop an existing desk to create sit-to-stand functionality by raising the computer. Includes keyboard tray and surface for computer monitors. HON 5-Year Limited Warranty. ⓘ Not intended for use on mobile workstations.	HBXRISER	54	4.1	\$619
	Mounted Desktop Riser NOTES: Does not include a monitor arm and is suitable for laptops and/or monitors on their original stands. ⓘ No specification needed.	HS1100	60 Ⓢ	3.2	\$664
	Mounted Desktop Riser with Single Monitor Arm NOTES: Includes a monitor arm for a single monitor. ⓘ No specification needed.	HS1101	62 Ⓢ	3.2	\$777
	Mounted Desktop Riser with Dual Monitor Arm NOTES: Includes a monitor arm for dual monitors. ⓘ No specification needed.	HS1102	63 Ⓢ	3.2	\$883

NOTES FOR HS1100, HS1101, HS1102:

- These products are designed to allow the user to transition from seating position to standing position throughout the workday.
 - Gas-assist lever-operated mechanism with positive stop.
 - Clamp mount compatible with worksurfaces depths of 20"-30". 20" is for systems only.
 - Clamp requires 3.5" of clearance along back edge of worksurface.
 - Black seamless worksurfaces.
 - Silver powder coated metal components.
 - Lowers below worksurface level on 24" and 30"D worksurfaces.
 - All models contain a large primary worksurface and a smaller keyboard / mouse surface.
 - Beveled edges for sleek appearance and comfort while typing.
 - Monitor arms include height, width, and swivel adjustment.
 - Not for use under overhead storage, with flush mounted modesty panels, or worksurfaces thinner than 1".
- ⓘ Not recommended for use on mobile (castered) worksurfaces.

MOUNTING AND COMPATIBILITY FOR HS1100, HS1101, HS1102:

- This product is intended to be installed on commercial-grade worksurfaces in good condition.
- Compatible with freestanding worksurfaces 24"-30"D or panel-supported worksurfaces 24"-30"D.
- Not for use on mobile worksurfaces.

Clamp Mount

Use when 3.5" minimum overhang is available

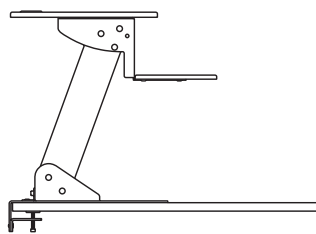

Screw Mount

Use when no overhang is available. Worksurface must be minimum 1" thick.

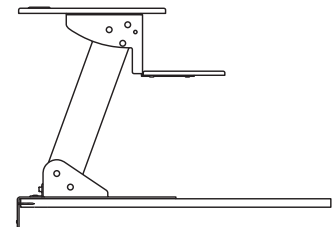

HOW TO SPECIFY

<p>Select Model Number</p> <p>HBXRISER.</p>	<p>Select Finish</p> <p>BLK Black WHT White</p> <p>BLK</p>
--	---



ERGONOMIC SOLUTIONS

	DESCRIPTION	MODEL	SHIP WEIGHT	CUBE	LIST PRICE
	Rectangle Wobble Board — Anti-Fatigue Mat 18"D x 3"H x 22½"W ⓘ Available in Black (T) finish ONLY. Recommended weight capacity not to exceed 250 pounds. HON 5-Year Limited Warranty. SPECIFYING EXAMPLE: HVL981.T	HVL981	10.0 Ⓢ	0.9	\$121
	Round Wobble Board — Anti-Fatigue Mat 18½"D x 2⅝"H x 18½"W ⓘ Available in Black (T) finish ONLY. Recommended weight capacity not to exceed 250 pounds. HON 5-Year Limited Warranty. SPECIFYING EXAMPLE: HVL982.T	HVL982	5.8 Ⓢ	0.6	\$103
	Ergonomic Anti-Fatigue Mat 25"D x 2¾"H x 29⅞"W ⓘ Available in Black ONLY. No specification needed. HON 5-Year Limited Warranty. SPECIFYING EXAMPLE: HBEAFM1	HBEAFM1	7.0	1.4	\$219
	Footrest — Anti-Slip Cover 13¾"D x 5½"H x 16"W ⓘ Available in Black (T) finish ONLY. Recommended weight capacity not to exceed 250 pounds. HON 5-Year Limited Warranty. SPECIFYING EXAMPLE: HVL991.T	HVL991	7.0 Ⓢ	0.9	\$82

WORKPLACE TOOLS

HOW TO SPECIFY

Select Model Number	Select Finish
H V L 9 8 1 .	T Black

CHAIR MATS

	DESCRIPTION	MODEL	SHIP WEIGHT	CUBE	LIST PRICE
	Lipped Chair Mat with Studs 60"W x 46"D 48"W x 36"D	HCM4660LS	13.9	1.0	\$146
		HCM3648LS	8.8	0.6	\$88
	Lipped Chair Mat without Studs 60"W x 46"D 48"W x 36"D	HCM4660LN	13.2	0.5	\$146
		HCM3648LN	8.3	0.3	\$88

NOTES:

- Available with studs for carpet and without studs for hard-surface floors.
 - Ships rolled.
 - **HON 5-Year Limited Warranty.**
- ⓘ Clear finish only. No specification needed.

HOW TO SPECIFY

Select Model Number

H	C	M	4	6	6	0	L	S
---	---	---	---	---	---	---	---	---



TASK LIGHTS



DESCRIPTION

Articulating Desk Lamp

Articulating Desk Lamp w/ Occupancy Sensor

- Full-range dimming from 10% to 100%.
- Designed for 50,000 hours of life.
- Occupancy sensor is built into the head of the lamp and will automatically shut the lamp off after 6 minutes of undetected movement.
- Base swivel is 180 degrees.
- Uses only 5 watts of energy.
- Light comes with a silver 9' 4" power cord.
- Base diameter is 7.5".
- 3500K Color Temperature.
- 80 Color Rendering Index.
- TAA Compliant.

! Available in Matte Silver finish only, no specification needed.

MODEL

SHIP WEIGHT

CUBE

LIST PRICE

HLED1

1.2

6.5

\$402

HLED1OC

1.2

6.5

\$490



Task Desk Lamp

- Full-range dimming from 10% to 100%.
- Designed for 50,000 hours of life.
- Lamp is 15.83" tall.
- Desk lamp does not articulate at base. The pivoting head provides custom positioning, as it can be twisted 360 degrees.
- Uses only 5 watts of energy.
- Light comes with a silver 9' 4" power cord.
- Base diameter is 6.7".
- 3500K Color Temperature.
- 80 Color Rendering Index.
- TAA Compliant.

! Available in Brushed Nickel finish only, no specification needed.

HLED2

0.7

3.0

\$348

HOW TO SPECIFY

Select
Model Number

HLED1



TASK LIGHTS

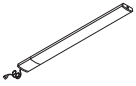

DESCRIPTION

LED Task Lights

17" LED Light with Power Supply (Single)
31" LED Light with Power Supply (Single)

17" LED Light with Power Supply for Daisy-chain (Starter)
31" LED Light with Power Supply for Daisy-chain (Starter)

17" LED Light with 8" Jumper Cord for Daisy-chain (Follower)
31" LED Light with 8" Jumper Cord for Daisy-chain (Follower)

Undercabinet Occupancy Sensor with 1" End to End Connector

NOTES: To use the daisy chain application, must start with model HLED17A or HLED31A. No finish specification required. Attaches magnetically to underside of overhead storage, or attaches with provided screws or double-sided tape. Occupancy sensor attaches to a single or starter LED light and will automatically turn the light off after no motion is detected for 30 minutes. Just like all the LED light models, the occupancy sensor features a soft-touch on/off switch. LED task lights have a lifetime of 50,000 hours and have a dimmer feature that allows the user to adjust the amount of light output.

MODEL SHIP WEIGHT CUBE LIST PRICE

MODEL	SHIP WEIGHT	CUBE	LIST PRICE
HLED17AS	1.2	0.05	\$420
HLED31AS	1.5	0.09	\$564
HLED17A	1.0	0.05	\$461
HLED31A	1.4	0.09	\$619
HLED17AUO	1.0	0.03	\$377
HLED31AUO	1.0	0.05	\$503
HLEDOSA	0.2	0.01	\$89



Recessed Task Lights

- Color: Black.
- Slim profile design.
- Mount to stack-on storage and wall mounted storage cabinets.
- Electronic ballast for increased energy efficiency.
- T5 fluorescent bulb included, which contains less mercury.
- 9-foot black cord and switch off right rear corner.

18 ³ / ₈ "W x 3 ¹ / ₁₆ "D x 1 ¹ / ₈ "H	HH870924	5.0	0.40	\$227
Chicago code version (with fused plug)	HH870924CH	5.0	0.40	\$287
22 ⁷ / ₈ "W x 3 ¹ / ₁₆ "D x 1 ¹ / ₈ "H	HH870930	7.0	0.60	\$231
Chicago code version (with fused plug)	HH870930CH	7.0	0.60	\$301
34 ⁵ / ₈ "W x 3 ¹ / ₁₆ "D x 1 ¹ / ₈ "H	HH870942	10.0	0.90	\$250
Chicago code version (with fused plug)	HH870942CH	10.0	0.90	\$317
46 ¹ / ₂ "W x 3 ¹ / ₁₆ "D x 1 ¹ / ₈ "H	HH870960	12.0	1.10	\$270
Chicago code version (with fused plug)	HH870960CH	12.0	1.10	\$337

HOW TO SPECIFY

Select Model Number

HH870924

PAPER MANAGEMENT & ORGANIZATIONAL TOOLS

GSA SIN 33721



Icon Legend on page 19

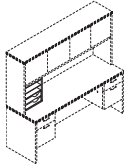

Not available in two-tone laminate

DESCRIPTION	MODEL	SHIP WEIGHT	CUBE	LIST PRICE BY LAMINATE GRADE	
				L1	L2
Vertical Paper Manager 14 ⁷ / ₈ "W x 10 ⁷ / ₈ "D x 19 ³ / ₈ "H NOTES: Keeps papers, files, and books neatly organized and within easy reach from a seated position. Designed for desk, credenza, and return tops. Fits under stack-on storage models. Two pullout drawers and three fixed shelves. Not available in pattern laminate colors. Ships fully assembled. ⓘ Requires 19 ³ / ₄ "H minimum of clear space between underside of overhead storage unit and worksurface. SPECIFYING EXAMPLE: HLVPM1.N	HLVPM1	27	2.8	\$327	\$337

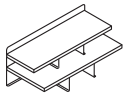

Not available in two-tone laminate



Desktop Storage Terrace 26 ¹ / ₂ "W x 12 ¹ / ₂ "D x 10 ¹ / ₂ "H NOTES: For use on the tops of 29 ¹ / ₂ "H desks, credenzas, and returns. Features six storage sections plus top display shelf. Keeps work-in-process, priority files, loose pages, and mail neatly organized and in view. Mixed material design comprised of sturdy laminate shelves with metal back and support panels. Not available in two-tone laminate combination or pattern laminate colors. Choose from Platinum Metallic (T1), Black (P), and Charcoal (S) for the metal components. Sized to fit in stack-on and wall mount storage cabinets in 10500, 10700, Valido, Concinnity, 94000, and 38000 Series. Fits in Concinnity and Voi sliding door models, except for 48"W or smaller models. Specify: Model.Laminate.Paint SPECIFYING EXAMPLE: HLDST1.N.T1	HLDST1	24	1.1	\$306	\$316
--	---------------	----	-----	--------------	--------------

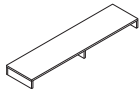

Layering Shelf 72"W x 14 ¹ / ₂ "D x 5 ¹ / ₂ "H 60"W x 14 ¹ / ₂ "D x 5 ¹ / ₂ "H NOTES: Layering shelf works with lower credenzas to provide additional storage areas. ⓘ Layering Shelves cannot be stacked. ⓘ Cannot add a hutch on top of a layering shelf.	HLSL1472LS	50	4.6	\$444	\$454
	HLSL1460LS	39	1.3	\$372	\$382

WORKPLACE TOOLS

HOW TO SPECIFY

Select Model Number HLVP M1 . N	Select Laminate See page 214
---	--



PAPER MANAGEMENT & ORGANIZATIONAL TOOLS

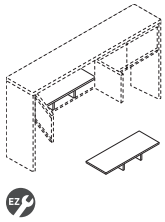

DESCRIPTION

Stacked Paper Management
32 1/2"W x 12 5/8"D x 4 1/4"H

MODEL SHIP WEIGHT CUBE LIST PRICE

HLVPM2 22 1.25 \$163

NOTES: Segments and organizes stack-on and wall mount storage compartments, as well as bookcase shelves. Unit can be used in Models H105327, H10534, H105322, H105321, H105382 and H105381.

- ! Available in Black finish only, no specification needed.
- ! In some cases, installation of Stacked Paper Management may require removing the stack-on or wall mount storage doors.

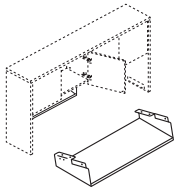

DESCRIPTION

Hanging Paper Shelf
28 1/16"W x 11 1/16"D x 4 3/16"H

MODEL SHIP WEIGHT CUBE LIST PRICE BY PAINT GRADE
P1 P2 P3

HHPS1 7 2.9 \$198 \$206 \$218

NOTES: Attaches quickly and easily (screws included). Maximizes worksurface space; de-clutters desktop while placing priority communications and active project folders within easy reach. Angled design allows contents to be distinguished at a glance. Mixed material styling features strong painted metal frame with a frosted shelf.

Attaches quickly and easily to laminate stack-on and wall mount storage models (except the 36"W Voi® overhead hutch with O-legs or panel mount brackets). Not for use with 38000 Series™ and Systems.

Specify: Model.Paint

SPECIFYING EXAMPLE: HHPS1.T1

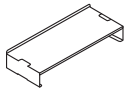

Desktop Paper Shelf
28 1/16"W x 11 5/16"D x 5"H

HDPS1 7 2.9 \$198 \$206 \$218

NOTES: Desktop Paper Shelf and Storage Terrace include protective, non-slip pads on the base. Paper Shelf can stack two-high. Organizer shelf provides a place and space for work-in-process and piling to keep worksurfaces neat and tidy. Convenient, scalable design with interlocking side supports allow two units to be stacked and integrated. Durable painted metal frame with a frosted shelf; mixed material styling matches hanging paper shelf.

Can also be used inside select overhead storage, including the following stack-on with clearance and hinged door models: 10500 and Valido 36", 42", 66", 72", 78"W and 10700 68 5/8"W.

Specify: Model.Paint

SPECIFYING EXAMPLE: HDPS1.T1

HOW TO SPECIFY

Select Model Number	Select Paint Color						
	See page 214						
<table border="1" style="display: inline-table;"> <tr> <td>H</td> <td>H</td> <td>P</td> <td>S</td> <td>1</td> </tr> </table>	H	H	P	S	1	<table border="1" style="display: inline-table;"> <tr> <td>P</td> </tr> </table>	P
H	H	P	S	1			
P							

PAPER MANAGEMENT & ORGANIZATIONAL TOOLS

GSA SIN 33721 EXCEPT AS NOTED



Icon Legend on page 19



DESCRIPTION

Storage Cube
12"W x 12"D
SPECIFYING EXAMPLE: HLSL1212.P8S

MODEL

HLSL1212

SHIP WEIGHT

1

CUBE

0.3

LIST PRICE BY PAINT GRADE

P1

\$294

P2

\$294

P3

\$294

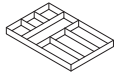

Drawer Organizer
12"W x 14½"D x 1½"H

SPECIFYING EXAMPLE: HSLDRWORG.P8F

HSLDRWORG

1

0.5

\$156

\$156

\$156

DESCRIPTION

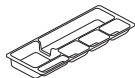
Optional Pencil Tray

 ⓘ For use with mobile and freestanding pedestal models.
 ⓘ No specification required.

MODEL

HV-UT1

SHIP WEIGHT

0.5

CUBE

0.1

LIST PRICE

\$69

Back Pack Hook (10 per carton)

12"W x 14½"D x 1½"H
 NOTES: Assembly: attaches to bottom of desk with (2) screws, included.
 ⓘ Available in Platinum Metallic finish only, no specification needed.

HCLA65

10.0 ⓘ

0.1

\$95

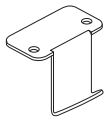

OPEN MARKET



WORKPLACE TOOLS

HOW TO SPECIFY

Select Model Number

H L S L 1 2 1 2 .

Select Paint Color

See page 214
 Only specify for models HLSL1212 and HSLDRWORG

P 8 S



Icon Legend on page 19

PAPER MANAGEMENT & ORGANIZATIONAL TOOLS

	DESCRIPTION	MODEL	SHIP WEIGHT	CUBE	LIST PRICE
	Wall Mount Tackboard				
	36"W x 35¼"H	HNL3636TB	20	2.9	\$300
	30"W x 35¼"H	HNL3630TB	16	2.9	\$256
	36"W x 48⅝"H	HNL4936TB	27	5.5	\$334
	30"W x 48⅝"H	HNL4930TB	22	3.7	\$290
	NOTES: When positioned above 29½"H floor-standing storage, the sizes align with overhead storage height options. Can be positioned side-by-side with corresponding wall mount markerboard sizes. Easy to install; includes mounting hardware. Attaches to wall with horizontally mounted, interlocking Z-clip brackets. For the space directly below stack-on and wall mount storage cabinets, use the 18"H tackboard models listed in the Desks section in the 2021 Workspaces Pricer. SPECIFYING EXAMPLE: HNL3636TB.APN15				
	Wall Mount Markerboard				
	36"W x 35¼"H	HNL3636WB	16	2.9	\$205
	30"W x 35¼"H	HNL3630WB	14	2.9	\$191
	36"W x 48⅝"H	HNL4936WB	22	5.5	\$251
	30"W x 48⅝"H	HNL4930WB	20	3.7	\$231
	NOTES: Smooth, white, magnetic surface. Metal material produces clear graphics and cleans easily. Compatible for use with dry- or wet-erase markers. When positioned above 29½"H floor-standing storage, the sizes align with overhead storage height options. Can be positioned side-by-side with corresponding wall mount tackboard sizes. Easy to install; includes mounting hardware. Attaches to wall with horizontally mounted, interlocking Z-clip brackets. SPECIFYING EXAMPLE: HNL3636WB				
	Markerboard				
	48"W x 31"H	HLSL4831MB	44	3.4	\$664
NOTES: Wall mounted. No specification required.					
OPEN MARKET 					

WORKPLACE TOOLS

HOW TO SPECIFY

Select Model Number H N L 3 6 3 6 T B	Select Fabric Color See pages 25-26 A P N 1 1
--	---

INTERLINK IQ ELECTRICAL

Specification guide for IQ Electrical on Training tables

Determine table width, the type of power access being used (3" grommet or 4x8 pop-up) and the desired number per table (Columns 1, 2 or 3). The table will then identify the type and quantity of components needed per table along with the maximum table run. Note that this is in addition to the Power base in-feed which is needed for each run. For example, a 48"W table with two 3" power grommets per table will require (1) HQH5-3 harness and (1) HQH1-3 harness per table with a maximum run of four tables.



Top Width	POWER ONE (1) PER TABLE 3" ROUND POWER GROMMET		POWER TWO (2) PER TABLE 3" ROUND POWER GROMMETS		POWER ONE (1) PER TABLE 4x8 POP-UP PORT	
	Component	Quantity	Component	Quantity	Component	Quantity
36"	(1) HQH5-3	8 Table Run Maximum	N/A	N/A	(1) HQH5-P	8 Max Table Run
42"	(1) HQH5-3	8 Table Run Maximum	N/A	N/A	(1) HQH5-P	8 Max Table Run
48"	(1) HQH5-3	8 Table Run Maximum	(1) HQH5-3 (1) HQH1-3	4 Max Table Run	(1) HQH5-P	8 Max Table Run
54"	(1) HQH5-3	8 Table Run Maximum	(1) HQH5-3 (1) HQH1-3	4 Max Table Run	(1) HQH5-P	8 Max Table Run
60"	(1) HQH5-3	8 Table Run Maximum	(1) HQH5-3 (1) HQH1-3	4 Max Table Run	(1) HQH5-P	8 Max Table Run
66"	(1) HQH5-3 (1) HJQJ3	4 Table Run Maximum	(1) HQH5-3 (1) HQH1-3	4 Max Table Run	(1) HQH5-P (1) HJQJ3	4 Max Table Run
72"	(1) HQH5-3 (1) HJQJ3	4 Table Run Maximum	(1) HQH5-3 (1) HQH1-3	4 Max Table Run	(1) HQH5-P (1) HJQJ3	4 Max Table Run
84"	(1) HQH5-3 (1) HJQJ3	4 Table Run Maximum	(2) HQH5-3	4 Max Table Run	(1) HQH5-P (1) HJQJ3	4 Max Table Run
96"	(1) HQH5-3 (1) HJQJ3	4 Table Run Maximum	(2) HQH5-3	4 Max Table Run	(1) HQH5-P (1) HJQJ3	4 Max Table Run
Half-Round (all sizes)	(1) HQH1-3	2 Tables Maximum	N/A	N/A	(1) HQH5-P	2 Max Table Run
Trapezoid (all sizes)	(1) HQH5-3	8 Table Run Maximum	N/A	N/A	(1) HQH5-P	8 Max Table Run

NOTES:

- Interlink IQ Electrical is a pluggable, single circuit electrical system.
 - All electrical models include wire management clips and hardware.
 - Interlink IQ Electrical is non-sequential/non-directional.
 - Interlink IQ Electrical is UL Recognized as a Powered Table System and meets the requirements of UL 962 when paired with Motivate® or Huddle tables.
- ⓘ 40' maximum run, or no more than 8 units, whichever comes first. Interlink IQ system will automatically shut off if maximum requirements are exceeded. Maximum run is based upon electrical harness width, not table width.

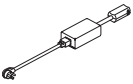
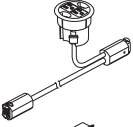
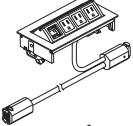
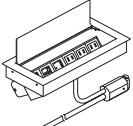
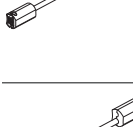
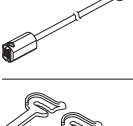
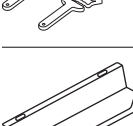
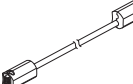

INTERLINK IQ ELECTRICAL

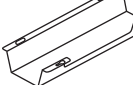
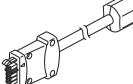
	DESCRIPTION	MODEL	SHIP WEIGHT	CUBE	LIST PRICE
	Power Base In-Feed <ul style="list-style-type: none"> 12 amp circuit breaker is built in to the Power Base In-Feed. Available in Black finish, no specification needed. 	HQB	2.0	0.2	\$525
	Power Harness – 1' Power Hub, 3" Round Grommet Mount <ul style="list-style-type: none"> Available in Black finish, no specification needed. 	HQH1-3	2.0	0.2	\$172
	Power Harness – 5' Power Hub, 3" Round Grommet Mount <ul style="list-style-type: none"> Available in Black finish, no specification needed. 	HQH5-3	2.0	0.2	\$193
	Power Harness – 5' with 4" x 8" Pop-Up Port (3 Power, 1 Blank) <ul style="list-style-type: none"> For use with tables G1 grommet. Specify paint. 	HQH5-P-3P1B	3.0	0.3	\$378
	Power Harness – 5' with 5" x 11" Flip-Top Port (3 Power, 3 Blank) <ul style="list-style-type: none"> For use with Preside® G2 grommet. Specify paint. 	HQH5-E-3P3B	5.0	0.2	\$398
	Power Harness – 5' with 5" x 11" Flip-Top Port (3 Power, 1 Extron Double Space) <ul style="list-style-type: none"> For use with Preside® G2 grommet. Specify paint. 	HQH5-E-3P1E	5.0	0.2	\$419
	Power Harness – 5' with 5" x 11" Flip-Top Port (3 Power, 2 USB, 2 Blank) <ul style="list-style-type: none"> For use with Preside® G2 grommet. Specify paint. 	HQH5-E-3P1U2B	5.0	0.2	\$439
	Power Jumper – 3' <ul style="list-style-type: none"> Available in Black finish, no specification needed. 	HQJ3	2.0	0.2	\$107
	Ganging Hardware <ul style="list-style-type: none"> Includes two ganging links and two screws. No color designator when specifying. <i>Example: HMAGANG.</i> 	HMAGANG	1.0	0.1	\$94
	Cable Management Troughs 17"W – Single 17"W – 10-Pack <ul style="list-style-type: none"> Available in Graphite finish, no specification needed. NOTES: For additional information see page 240.	HCTROUGH17 HCTROUGH1710	2.7 14.0	0.5 0.5	\$67 \$620
	IQ 1.0 Backward Compatible Jumper 36" <ul style="list-style-type: none"> Available in Black finish, no specification needed. Use when connecting Interlink IQ 1.0 power harness (rectangle end) to Interlink IQ 2.0 (oval end) power harness. ! If using Interlink IQ 2.0 in-feed with Interlink IQ 1.0 power harness please contact Customer Support.	HQBCJ36	2.0	0.2	\$82

NOTES:

- Use HQH5-P models with G1 table top cutouts and HQH5-E models with G2 table top cutouts.
- Interlink IQ Electrical is a pluggable, single circuit electrical system.
- All electrical models include wire management clips and hardware.
- Interlink IQ Electrical is non-sequential/non-directional.
- Interlink IQ Electrical is UL Recognized as a Powered Table System and meets the requirements of UL 962 when paired with Motivate® or Huddle tables.
- !** 40' maximum run, or no more than 8 units, whichever comes first. Interlink IQ system will automatically shut off if maximum requirements are exceeded. Maximum run is based upon electrical harness width, not table width.

HOW TO SPECIFY

Select Model Number H Q H 5 - E - 3 P 3 B .	Select Paint Color FOG Fog SVR Silver BLK Black S V R
---	--

4-TRAC HARDWIRE ELECTRICAL SYSTEM

4-Trac Electrical System

The 4-Trac Electrical System is a UL-recognized Manufactured Wiring System that seamlessly passes power from one worksurface to another. This low-profile non-sequential electrical system allows tables to be “daisy-chained” together in any desired order and allows users to reconfigure quickly due to simple connectable/disconnectable links.

- Meets requirements of UL 183 and National Electric Code Article 604
- 4-Wires, 2-circuits, 20 Amps each (Circuit 1 and Circuit 2 only)
- 13 Duplex Receptacles per circuit, 26, 15 Amp Duplex receptacle per power in-feed
- Electrical system attaches directly to underside of worksurface with included brackets
- Up to twelve tables can be linked together

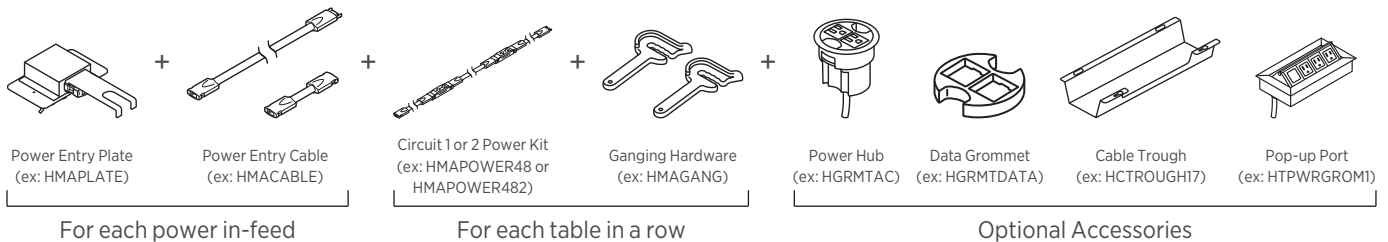

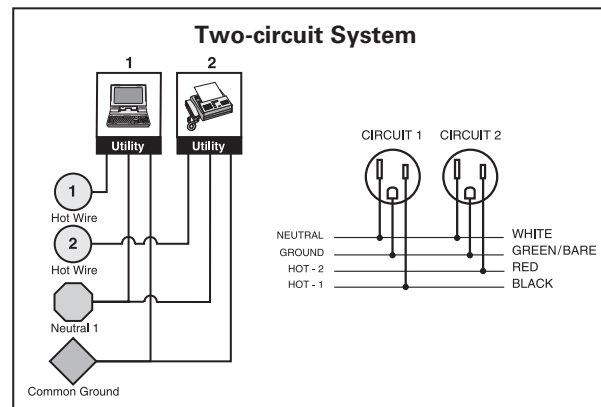
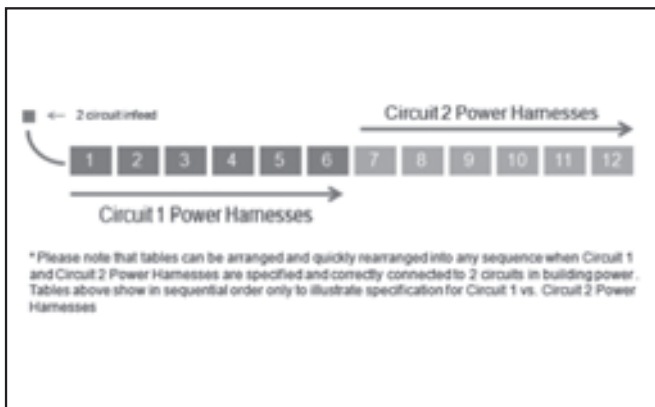

Steps for Electrical Specifications:

- Determine how many rows of tables are needed and order the following:
 - One HMAPLATE per row (or power in-feed)
 - One HMACABLE per row (or power in-feed)
- Order one power harness per table in each row
 - For 1-6 tables in a row (see illustration 1)
 - Order Circuit 1 Power Harnesses (ex. If powering six 24x60 tables order six sets of HMAPOWER60)
 - For 7-12 tables in a row (see illustration 1)
 - Order Circuit 1 Power Harness for first six tables and Circuit 2 Power Harness for remaining tables (ex. If powering eight 24x60 tables, order six sets of HMAPOWER60 and two sets of HMAPOWER602)
- Order one set of ganging hardware per table (ex. HMAGANG)
- Determine which accessories are needed:
 - Power Hub model HGRMTAC — to access power at worksurface.
 - Data Grommet model HGRMTDATA — to access data at worksurface.
 - Wire Management strips model HBTMS — for vertical and horizontal wire management.

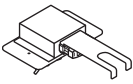
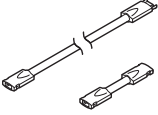

4-TRAC HARDWIRE ELECTRICAL SYSTEM

	DESCRIPTION	MODEL	SHIP WEIGHT	CUBE	LIST PRICE
	Power Entry Plate	HMAPLATE	1.0	0.2	\$94
	Power Entry Cable • 6' power entry cable with male/female adapter. • Connects table to power entry plate.	HMACABLE	1.8	0.2	\$147
	Power Jumper Cable To connect tables front to front	HMAJUMP	0.5	0.3	\$50
	Circuit 1 Power Kit for 36" W Table	HMAPOWER36	1.5	0.3	\$267
	Circuit 1 Power Kit for 42" W Table	HMAPOWER42	1.8	0.3	\$270
	Circuit 1 Power Kit for 48" W Table	HMAPOWER48	1.8	0.3	\$272
	Circuit 1 Power Kit for 54" W Table	HMAPOWER54	2.0	0.3	\$277
	Circuit 1 Power Kit for 60" W Table	HMAPOWER60	2.0	0.3	\$280
	Circuit 1 Power Kit for 66" W Table	HMAPOWER66	2.2	0.3	\$284
	Circuit 1 Power Kit for 72" W Table	HMAPOWER72	2.2	0.3	\$286
	Circuit 1 Power Kit for 84" W Table	HMAPOWER84	2.4	0.3	\$297
	Circuit 1 Power Kit for 96" W Table	HMAPOWER96	2.6	0.3	\$306
	Circuit 2 Power Kit for 36" W Table	HMAPOWER362	1.5	0.3	\$267
	Circuit 2 Power Kit for 42" W Table	HMAPOWER422	1.8	0.3	\$270
	Circuit 2 Power Kit for 48" W Table	HMAPOWER482	1.8	0.3	\$272
	Circuit 2 Power Kit for 54" W Table	HMAPOWER542	2.0	0.3	\$277
	Circuit 2 Power Kit for 60" W Table	HMAPOWER602	2.0	0.3	\$280
Circuit 2 Power Kit for 66" W Table	HMAPOWER662	2.2	0.3	\$284	
Circuit 2 Power Kit for 72" W Table	HMAPOWER722	2.2	0.3	\$286	
Circuit 2 Power Kit for 84" W Table	HMAPOWER842	2.4	0.3	\$297	
Circuit 2 Power Kit for 96" W Table	HMAPOWER962	2.6	0.3	\$306	

NOTES:





- Each power kit includes two duplex receptacles and attaches to the underside of the worksurface with included brackets.
- Power Kits are compatible with various base types including nesting bases.
- Available in Black finish, no specification needed.

HOW TO SPECIFY

Select
Model Number

H M A P L A T E

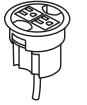
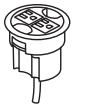
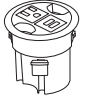
POWER & CABLE MANAGEMENT

	DESCRIPTION	MODEL	SHIP WEIGHT	CUBE	LIST PRICE
 Black only SIN 33721	Black Field Installable Grommet with One Access Hole <ul style="list-style-type: none"> Intended for use in tops and end panels to route/hide cords and facilitate reaching wall electrical outlets. Requires a 2½" diameter hole saw and drill for installation (not included). Grommet cap measures 3" diameter and includes a ¾" diameter cord access hole. Grommet sleeve measures 2½" O.D. x ¾" thick. Includes instructions to locate grommet position for desks, credenzas, returns and bridges. <p>⚠ The grommet is not designed to be used with the following HON Series: 94000, 38000, Mentor®, Metro Classic or 34000.</p>	HFLDGRMT	0.1 Ⓢ	0.01	\$32
 SIN 33721	Black Field Installable Grommet with Two Access Holes <ul style="list-style-type: none"> Requires a 3" diameter hole saw and drill for installation (not included). Grommet outside dimensions measures 3½" diameter. Grommet sleeve measures 3" O.D. x 1" thick. Includes instructions to locate grommet position for desks, credenzas, returns and bridges. 	HFLDGRMT3	0.1 Ⓢ	0.3	\$32
 OPEN MARKET	Platinum Field Installable Grommet with Two Access Holes <ul style="list-style-type: none"> Requires a 3" diameter hole saw and drill for installation (not included). Outside dimension measures 3½" diameter. Sleeve hole in worksurface measures 3" O.D. x 1" thick. Includes instructions to locate grommet position for desks, credenzas, returns, and bridges. 	HFLDGRMT4	0.1	0.01	\$32
 SIN 33721T	Power Hub, 3" Grommet Mount, 6' Cord <ul style="list-style-type: none"> Fits in 3" round grommet holes. Two grounded AC power outlets. Includes 6' cord with three-prong plug. Field installed with Plug-and-play ease. <p>⚠ Available in black only (no color designation so use .X - Specify: HGRMTAC.X).</p>	HGRMTAC	1.3	0.2	\$116
 SIN 33721T	3" Round Power Grommet - 2 Outlets, 10' Cord <ul style="list-style-type: none"> Includes 10' cord with three-prong plug. Fits in 3" round grommet holes. Two grounded AC power outlets. Field installed with Plug-and-play ease. <p>NOTES: Power Modules will also work with standing-height applications for 10500 Series™ and Voi® desks. Optional Memory Control allows preset worksurface heights for consistency. Ships separately. Dynamic load capacity when worksurface is moving is 300 lbs.</p> <p>⚠ Available in black finish only, no specification needed.</p>	HGRMTAC2	1.5	0.2	\$148
 SIN 33721T	Power/USB Hub, 3" Grommet Mount <ul style="list-style-type: none"> One grounded AC power outlet with 2 USB ports. UL Listed. <p>⚠ Available in black only (no color designation so use .X - Specify: HGRMTUSB2.X).</p> <p>⚠ Not compatible with Arrange® tables.</p>	HGRMTUSB2	1.3 Ⓢ	0.2	\$226
 SIN 33721	Data Grommet <ul style="list-style-type: none"> Blank grommet kit that includes adapters for a variety of manufacturers jacks and couplers. Fits in existing 3" round grommet housing. <p>⚠ Available in black only. Specify P when ordering. Example: HGRMTDATA.P.</p>	HGRMTDATA	0.2	0.2	\$20

HOW TO SPECIFY

Select
Model Number

H F L D G R M T



Icon Legend on page 19

POWER



Model HPWRMOD3WC shown

DESCRIPTION

Dean Power Modules with Worksurface Clamp

- 3 Receptacles
- 2 Receptacles, 2 USB
- 2 Receptacles, 2 USB with Qi Wireless Charging Top
- 6' power cord with standard three-prong plug.
- Worksurface clamp models work on any top with a 4" overhang.
- UL Listed.

MODEL

- HPWRMOD3WC
- HPWRMOD2WC
- HPWRMOD4WC

SHIP WEIGHT

- 2.3
- 2.3
- 2.3

CUBE

- 0.2
- 0.2
- 0.2

LIST PRICE

- \$310
- \$496
- \$690

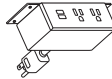

Model HPWRMOD2UWM shown

Dean Power Modules with Under-Worksurface Mounting Bracket

- 3 Receptacles
- 2 Receptacles, 2 USB
- 6' power cord with standard three-prong plug.
- Under-worksurface mounting bracket models work with any top that has a 5" x 5" square clearance.
- UL Listed.

- HPWRMOD3UWM
- HPWRMOD2UWM

- 2.3
- 2.3

- 0.2
- 0.2

- \$310
- \$496

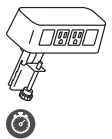

Power & Data Center

- 2 Receptacles 2 Data Accessory
- Standard with two receptacles and openings for two data ports.
- 6' power cord with standard three-prong plug.
- Fits on any worksurface with a 4" overhang.
- UL Listed.

HCOMDOME2

2.5

0.2

\$296

! Color finish coordinates with HON's Loft. Specify LOFT when ordering. Example: HCOMDOME2.LOFT.

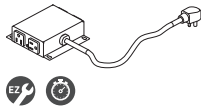

Under Worksurface Power Module — 4 Outlets, 10' Cord

- Includes 10' cord with three-prong plug.
- Fits in cable management troughs. See page 240.
- 4 outlets on side create easy access.

HPWRMOD2

1.5

0.2

\$401

NOTES: Power Modules will also work with standing-height applications for 10500 Series™ and Voi® desks.

! Available in black finish only, no specification needed.

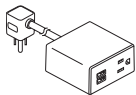

OPEN MARKET

Miki Surface Sit Power Module

- Includes 6' cord with three-prong plug.
- 1 Receptacle, 2 USB
- Unit features non-slip grip on underside.

HSMPOWER-1P-2U

2.0

0.6

\$155

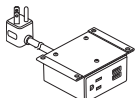

OPEN MARKET

Miki Under-Worksurface Power Module

- Includes 6' cord with three-prong plug.
- 1 Receptacle, 2 USB

HUMPWR-1P-2U

2.0

0.6

\$178



OPEN MARKET

Vesta Mobile Power Station

- Includes 10' retractable cord with three-prong plug.
- 3 AC, 1 Dual USB-A, 1 USB-C at top
- 2 AC at base
- Specify Paint and Plastic.

HPWRMOB1

14.0

3.3

\$1029

SPECIFYING EXAMPLE: HPWRMOB1.BLK.STRM

HOW TO SPECIFY

<p>Select Model Number</p> <p>H S M P W R - 1 P - 2 U .</p>	<p>Select Plastic</p> <p>Specify for Dean and Miki models</p> <p>STRM Storm</p> <p>SNW Snow</p> <p>S N W</p>	
<p>Select Model Number</p> <p>H P W R M O B 1 .</p>	<p>Select Exterior Paint Color</p> <p>Specify for model HPWRMOB1 only</p> <p>FOG Fog</p> <p>STRM Storm</p> <p>BLK Black</p> <p>SNW Snow</p> <p>B L K .</p>	<p>Select Paint Color</p> <p>Specify for model HPWRMOB1 only</p> <p>FOG Fog</p> <p>STRM Storm</p> <p>BLK Black</p> <p>SNW Snow</p> <p>S T R M</p>

WORKPLACE TOOLS



POWER

DESCRIPTION **MODEL** **SHIP WEIGHT** **CUBE** **LIST PRICE**



MhoB 4" x 8" Pop-up Port **HTG1PWR-3P-1B** 5 0.3 **\$396**

- Specify G1 cutout in table top.
- Pop-up Port provides three power ports and one blank data receptacle.
- Sits flush with worksurface when closed.
- Includes 6' cord with three-prong plug.

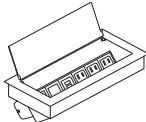

ElloraB 5" x 11" Flip-top Port **HTG2PWR-4P-2B** 5 0.3 **\$585**

- Specify G2 cutout in table top.
- Flip-top Port provides four power ports and two blank data receptacles.
- Conceals wires and allows power cords to be plugged in while in use.
- Includes 10' cord with three-prong circuit breaker plug.

NOTES: Two circuit breaker plugs do not fit into one duplex.

ElloraB 5" x 11" Flip-top Port **HTG2PWR-3P-1E** 5 0.3 **\$718**

- Specify G2 cutout in table top.
- Flip-top Port provides one blank for Extron plate and three power ports.
- Extron AAP plates can be integrated into grommet to support changing technology.
- Conceals wires and allows power cords to be plugged in while in use.
- Includes 10' cord with three-prong plug.

ElloraB 5" x 11" Flip-top Port **HTG2PWR-3P-2B-2U** 5 0.3 **\$850**

- Specify G2 cutout in table top.
- Flip-top Port provides 3 Power, 1 USB, and 2 Blank Data Ports.
- Conceals wires and allows power cords to be plugged in while in use.
- Includes 10' cord with three-prong plug.

ElloraB 5" x 11" Flip-top Port **HTG2PWR-3P-1U-W** 5 0.3 **\$870**

- Specify G2 cutout in table top.
- Flip-top Port provides 3 Power, 1 USB, and Qi wireless charging lid.
- Conceals wires and allows power cords to be plugged in while in use.
- Includes 10' cord with three-prong plug.

WORKPLACE TOOLS

HOW TO SPECIFY

<p>Select Model Number</p> <p>HTG2PWR-4P-2B.</p>	<p>Select Paint Color</p> <p>SVR Silver BLK Black FOG Fog</p> <p>BLK</p>
--	--

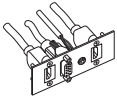

DESCRIPTION

Extron Plate (Double Space) — VGA, HDMI, HDMI, Audio

MODEL

HTPLATEVHAU

SHIP WEIGHT

1

CUBE

0.1

LIST PRICE

\$400

NOTES:

- 1 Double Space Plate can be used with HTG2PWR-3P-1E or HTPWRGROM4 Flip-top Port.
- ⓘ Available in Black finish only, no specification needed.

HOW TO SPECIFY

Select Model Number

HTPLATEVHAU



Icon Legend on page 19

POWER & CABLE MANAGEMENT

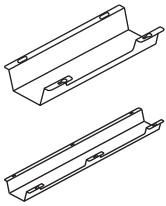

DESCRIPTION

Cable Management Troughs

- 17"W — Single
- 17"W — 10-Pack
- 36"W — Single
- 36"W — 10-Pack

- Cable management troughs ship flat packed.
- The troughs attach to underneath the worksurface with screws.
- Cutouts in trough allow access to power without the need to detach from surface. 17"W = 1 cutout; 36"W = 2 cutouts.
- Color: Graphite.
- Material: Metal.
- TAA Compliant.

MODEL

SHIP WEIGHT

CUBE

LIST PRICE

HCTROUGH17	2.7	0.5	\$67
HCTROUGH1710	14.0	0.5	\$620
HCTROUGH36	4.9	0.9	\$113
HCTROUGH3610	30.0	0.9	\$1045



OPEN MARKET

O-Leg Cord Clips

- Clips for 28½" Worksurface O-Legs — 8-Pack
- Clips for Stack-on Storage, Hutch and Layering O-Legs — 4-Pack

HWMCLIPLG

0.8

0.1

\$99

HWMCLIPSM

0.5

0.1

\$65

NOTES: Wire clips work with 7" Low Credenza O-leg and 29"H Support O-leg. Wire clips also work with the 50" and 65" Overhead O-leg supports.

Available in frosted plastic material only.

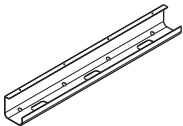

Black only

Cable Management Tray

- 24"
- 36"

Available in Black only.

HHCMT24

2.0

0.3

\$74

HHCMT36

3.0

0.4

\$91



Vertical Wire Management Vertebrae

HMPVWM28

3.0

0.3

\$223

NOTES: 30"H x 3½"W x 1½"D. Ships unassembled.

Clear finish. Specify "X" for finish option.

SPECIFYING EXAMPLE: HMPVWM28.X

WORKPLACE TOOLS

HOW TO SPECIFY

Select Model Number

Select Paint Color

P Black

H H C M T 2 4 .

P

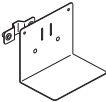
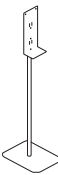
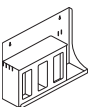

HEALTHY WORKPLACE TOOLS

	DESCRIPTION	MODEL	SHIP WEIGHT	CUBE	LIST PRICE BY PAINT GRADE		
					P1	P2	P3
	Hand Sanitizer Station Mounting Area: 6"W x 12"H Base: 12"W x 16"H NOTES: Freestanding. Stand is compatible with most manufacturers' automatic hand sanitizer dispensers, sold separately. No assembly required. Metal base for added stability.	HHC-SANSTND	15	6.1	\$259	\$285	\$297
	Retrofit Tray Kit for Sanitizer Station NOTES: Allows for easy conversion of HHC-SANSTND to HHC-SANSTND2. Adjustable strap allows for usage with most hand sanitizer bottles with pump or wipe containers.	HHC-SANSTND-TRAY	8	0.2	\$76	\$89	\$95
	Hand Sanitizer Station with Tray NOTES: Freestanding. Stand is compatible with most manufacturers' automatic hand sanitizer dispensers, sold separately. Adjustable strap allows for usage with most hand sanitizer bottles with pump or wipe containers. No assembly required. Metal base for added stability.	HHC-SANSTND2	15	6.1	\$298	\$324	\$336
	Freestanding PPE Stand NOTES: Freestanding. 3 closed compartments fit most manufacturers' boxed PPE, including gloves, masks, wipes, and tissues. Closed compartments have adjustable back to best fit. Each closed compartment measures 5"W x 5¼"D x 10"H. Open space can accommodate most manufacturers' automatic hand sanitizer dispensers, hand sanitizer bottles, or wipe containers, sold separately.	HHC-PPESTND	39	7.7	\$561	\$613	\$637
	Wall Mounted PPE Stand NOTES: Wall mounted. 3 closed compartments fit most manufacturers' boxed PPE, including gloves, masks, wipes, and tissues. Closed compartments have adjustable back to best fit. Each closed compartment measures 5"W x 5¼"D x 10"H. Open space can accommodate most manufacturers' automatic hand sanitizer dispensers, hand sanitizer bottles, or wipe containers, sold separately. ⓘ Model does not come equipped with wall mounted hardware.	HHC-PPEWALL	14	2.2	\$314	\$353	\$371

WORKPLACE TOOLS

HOW TO SPECIFY

Select Model Number HHC-SANSTND	Select Finish P8T
------------------------------------	----------------------

HEALTHY WORKPLACE TOOLS

OPEN MARKET



Icon Legend on page 19

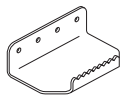

DESCRIPTION

Metal Foot Pull

5"W x 3¾"D x 1½"HK

Pack of 5

Pack of 15

MODEL

HHC-FOOTPULL5

HHC-FOOTPULL15

SHIP WEIGHT

8

23

CUBE

0.7

0.7

LIST PRICE

\$334

\$936

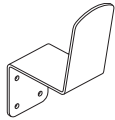

Metal Arm Pull

2½"W x 4½"D x 7½"H

Pack of 5

Pack of 15

HHC-ARMPULL5

HHC-ARMPULL15

8

23

0.7

0.7

\$334

\$936

NOTES:

- Pulls are made from 10-gauge steel.
- Mounting hardware included for attaching to steel and wood doors.
- Available in Textured Black and Textured Titanium.
- Available in 5-packs and 15-packs.

WORKPLACE TOOLS

HOW TO SPECIFY

<p>Select Model Number</p>	<p>Select Finish</p> <p>P6P Textured Black P8V Textured Titanium</p>
<p>H H C - F O O T P U L L 5 .</p>	<p>P 6 P</p>

SEATING FUNCTIONS

Work/task chairs need to be adjusted to deliver optimum support. Cross-reference the letter key below to identify the chairs in this section that best meet your needs.

PROPORTIONAL ADJUSTMENTS

These controls adapt the dimensions of the chair to fit the user.



A. Pneumatic seat height adjustment — Regulates height of chair relative to floor.

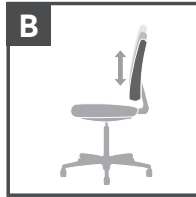

B. Back height adjustment — Positions lumbar support within a fixed range.

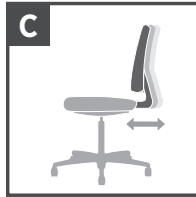

C. Seat depth adjustment — Positions chair back relative to seat.

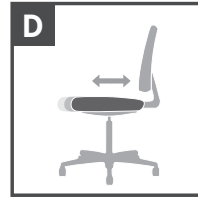

D. Seat slide mechanism — Seat cushion travels forward and back, then locks into position.

ARM OPTIONS

These adjustments accommodate different sized users and support keyboarding.



Q. Adjustable height arms — Provide improved upper-torso support. Can be adjusted periodically to relieve strain and provide variety.

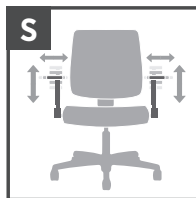

S. Height and width adjustable arms — Controls both height and width of arms for optimum comfort.



T. Loop arms — Largely specified for aesthetics. Frequently used in management settings.

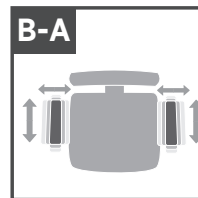

B-A. All-adjustable arms — Arms adjust in height, width, and depth.

POSTURE CONTROLS

The controls modify the position and angle of the seat and back to respond to changing tasks.



E. 360° Swivel

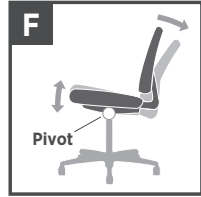

F. Tilt — Pivot point located directly above center of chair base.

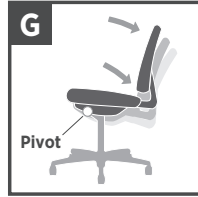

G. Mid-range knee tilt — Pivot point located slightly ahead of center of chair base. Allows user to recline at a slightly more relaxed angle than conventional tilt.

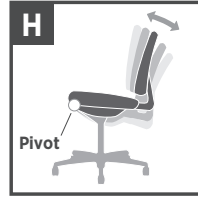

H. Knee tilt — Pivot point located near front edge of chair. Allows user to keep feet flat on floor while chair reclines.

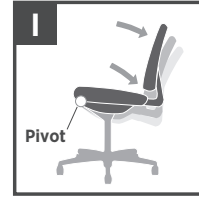

I. Synchronized knee tilt — Back reclines at a 2-to-1 ratio to seat angle. Pivot point located near front edge of chair.

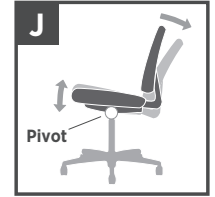

J. Synchro-tilt — Back reclines at a 2-to-1 ratio to seat angle. Allows user to recline while keeping seat cushion relatively level to floor.



K. Tilt tension — Controls rate and ease of recline.



L. Tilt lock — Locks out tilt function.



M. Posture mechanism/lock — Back angle adjusts independently of seat, and can be locked in an infinite number of positions within a fixed range.



N. Multi-task control — Adjusts seat and back angles independently with a single lever (infinite locking within a fixed range).



O. Asynchronous control — High performance system with three levers to modify: angle of back relative to seat, tilt (free float or infinite locking) and forward tilt.

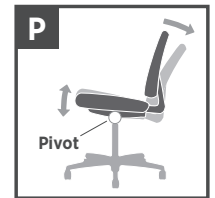

P. Weight-activated synchro-tilt — Back reclines at a 2 to 1 ratio to seat angle. Tilt tension automatically adjusts to user's body weight as user reclines.



W. Integral lumbar support — Easily adjusts to enhance comfort.



X. Dual-clutch posture control — Adjusts seat and back angles independently with two levers (infinite locking within a fixed range).

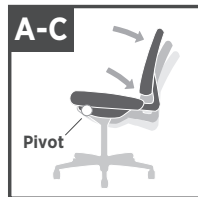

A-C. Synchronized tilt — Back reclines at a 2.5 to 1 ratio to seat angle. Variable lock.

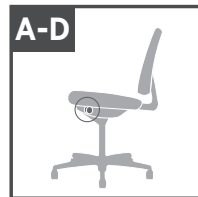

A-D. Side tilt tension — Controls rate and ease of recline. Conveniently located on the right side.



A-E. Back reclines at a 2 to 1 ratio to seat angle. Back angle adjusts independently of seat and can be locked in infinite number of positions within a fixed range.

ORDERING INFORMATION

Seating	Standard Fabric Selections by Series with Price Code and Fabric Material																																			
	1	1	1	1	1	1	1	1	1	1	1	1	1	1	1	1	2	2	2	2	2	2	2	2	2	3	3	3	3	3	L					
Model/Series	APX	AI	EB	VA	GA	MM	EA	CU	COMP	COMF	UR	DAPR	ENSB	HAML	NR	OP	PBLE	PNS	BLME	CLYD	DOT	RUSH	SED	SPNN	WP	ISN	SX	PRKR	PURL	QUIL	SS					
Apex																																				
Attire																																				
Black & Burgundy Vinyl																																				
Black, Charcoal, & Navy Fabric																																				
Black & Navy Fabric																																				
Black Sandwich Mesh Fabric																																				
Black Vinyl																																				
Centurion																																				
Compass																																				
Compass Foam																																				
Contourett																																				
Dapper																																				
Ensemble																																				
Hamilton																																				
Inertia																																				
Optic																																				
Pebble																																				
Appoint Seating																																				
Blume																																				
Clyde																																				
Dotty																																				
Rush																																				
Seed																																				
Spin Seating																																				
Whisper Vinyl																																				
In Season																																				
Moxie																																				
Parker																																				
Purl																																				
Quill																																				
Denver Leather***																																				
Accommodate®	*	*						*	*		*	*	*	*	*	*	*	*	*	*	*	*	*	*	*	*	*	*	*	*	*	*	*	*		
Adjustable Task/Lab Stool							*																													
Astir™	*	*						*	*		*	*	*	*	*	*	*	*	*	*	*	*	*	*	*	*	*	*	*	*	*	*	*	*	*	
Boda™						*																														
Ceres® Series	*	*						*	*		*	*	*	*	*	*	*	*	*	*	*	*	*	*	*	*	*	*	*	*	*	*	*	*	*	
Clig™	*	*						*	*		*	*	*	*	*	*	*	*	*	*	*	*	*	*	*	*	*	*	*	*	*	*	*	*	*	
ComforTask® 5900 Series	*	*						*	*		*	*	*	*	*	*	*	*	*	*	*	*	*	*	*	*	*	*	*	*	*	*	*	*	*	
Convergence®	*	*						*	*		*	*	*	*	*	*	*	*	*	*	*	*	*	*	*	*	*	*	*	*	*	*	*	*	*	
Endorse® Task****	*	*						*	*		*	*	*	*	*	*	*	*	*	*	*	*	*	*	*	*	*	*	*	*	*	*	*	*	*	
Flock**	*	*						*	*		*	*	*	*	*	*	*	*	*	*	*	*	*	*	*	*	*	*	*	*	*	*	*	*	*	
Flock® Round Lounge HFLRC1/DF and Stool HFSS7	*							*	*		*	*	*	*	*	*	*	*	*	*	*	*	*	*	*	*	*	*	*	*	*	*	*	*	*	
Grove®	*	*						*	*		*	*	*	*	*	*	*	*	*	*	*	*	*	*	*	*	*	*	*	*	*	*	*	*	*	
Ignition® Series	*	*						*	*		*	*	*	*	*	*	*	*	*	*	*	*	*	*	*	*	*	*	*	*	*	*	*	*	*	
Invitation® Lounge Series	*	*						*	*		*	*	*	*	*	*	*	*	*	*	*	*	*	*	*	*	*	*	*	*	*	*	*	*	*	
Lota® H2281 / H2285				*																																
Lota® H2282	*	*						*	*		*	*	*	*	*	*	*	*	*	*	*	*	*	*	*	*	*	*	*	*	*	*	*	*	*	
Mav™	*	*						*	*		*	*	*	*	*	*	*	*	*	*	*	*	*	*	*	*	*	*	*	*	*	*	*	*	*	
Motivate®	*	*						*	*		*	*	*	*	*	*	*	*	*	*	*	*	*	*	*	*	*	*	*	*	*	*	*	*	*	
Nucleus® Series	*	*						*	*		*	*	*	*	*	*	*	*	*	*	*	*	*	*	*	*	*	*	*	*	*	*	*	*	*	
Pagoda® 4070/4090 Series**	*	*						*	*		*	*	*	*	*	*	*	*	*	*	*	*	*	*	*	*	*	*	*	*	*	*	*	*	*	
Perpetual® Nesting	*	*						*	*		*	*	*	*	*	*	*	*	*	*	*	*	*	*	*	*	*	*	*	*	*	*	*	*	*	
Pillow-Soft® 2090 Series	*	*	*					*	*		*	*	*	*	*	*	*	*	*	*	*	*	*	*	*	*	*	*	*	*	*	*	*	*	*	
Solutions Seating® 4000 Series	*	*						*	*		*	*	*	*	*	*	*	*	*	*	*	*	*	*	*	*	*	*	*	*	*	*	*	*	*	
Solve®	*	*						*	*	*	*	*	*	*	*	*	*	*	*	*	*	*	*	*	*	*	*	*	*	*	*	*	*	*	*	(Seat Only)
Soothe®	*	*						*	*		*	*	*	*	*	*	*	*	*	*	*	*	*	*	*	*	*	*	*	*	*	*	*	*	*	
Soothe® High-Back																																				
Volt® 5700/5710 Series				*																																
Volt® 5720/5730 Series	*	*						*	*		*	*	*	*	*	*	*	*	*	*	*	*	*	*	*	*	*	*	*	*	*	*	*	*	*	
West Hill™	*	*						*	*		*	*	*	*	*	*	*	*	*	*	*	*	*	*	*	*	*	*	*	*	*	*	*	*	*	
Credenza/Pedestal Cushions	*	*						*	*		*	*	*	*	*	*	*	*	*	*	*	*	*	*	*	*	*	*	*	*	*	*	*	*	*	

SEATING

*Flock® chair model HFLRC1 has fabric limitations, please see the Flock® seating pages 324-333 for details.
 **Pagoda® wood back models available in Harvest (C), Natural Maple (D), Shaker Cherry (F), Bourbon Cherry (H) and Mahogany (N) only.
 ***Denver Leather (SS) may not be available on every model within a specific series, please refer to the model's page for details.
 ****Attire and Pebble available on Endorse® Task as seat option only.

ORDERING INFORMATION

- Seating pages are now arranged in alpha, then numeric, order.
- **All specifications in this publication are based on the latest product information available at the time of print.**
- COM Ordering Information and pricing on page 14.
- Remember to add an FC to the base model number when fire code fabric is selected. New Models with FC Fire Code suffix meet CA Technical Bulletin 133. See pages 248-251 for available models/fabrics.
- Wood components are well-seasoned select hardwoods, chosen for their strength, their ability to machine well and their superior uniformity of stain and finish.
- Chairs with leather feature matching vinyl backs and vinyl seat bottom when applicable (Non-contact areas are vinyl).

FIRE CODE (CAL133)

Refer to CAL133 Compliant Seating matrices on pages 248-251 for a list of compliant models and fabrics. Add FC to the base model number.

Examples:

STANDARD: H2111.N.CU10

FIRE CODE: H2111FC.N.CU10

Wood Seating	Finish Codes							Standard Fabric Selections by Series with Price Code and Fabric Material																		
	Bourbon Cherry	Cognac	Harvest	Mahogany	Mocha	Natural Maple	Pinnacle	Shaker Cherry	1 AI	1 EB	1 CU	1 COMP	1 DAPR	1 HAML	1 NR	1 OP	2 PNS	2 CLYD	2 DOT	2 RUSH	2 SED	2 SPNN	2 WP	3 ISN	3 PURL	L SS
Cambia™ 2160 Series	H	COGN	C	N	MOCH	D	PINC	F	•		•	•	•	•	•	•	•	•	•	•	•	•	•	•	•	•
Invitation® 2110 Series	H	COGN	C	N	MOCH	D	PINC	F	•		•	•	•	•	•	•	•	•	•	•	•	•	•	•	•	•
Park Avenue Collection® 5000 Series	H	COGN	C	N	MOCH	D	PINC	F			•	•	•	•	•	•	•	•	•	•	•	•	•	•	•	•
Pillow-Soft® 2190 Series	H	COGN	C	N	MOCH	D	PINC	F		•	•	•	•	•	•	•	•	•	•	•	•	•	•	•	•	•
Versant® Tandem Wood	H	COGN	C	N	MOCH	D	PINC	F	•		•	•	•	•	•	•	•	•	•	•	•	•	•	•	•	•

Note: Gathers and creases may be more visible with AI and OP fabrics due to the inherent design and construction of these fabrics.

FIRE CODE/COMPLIANT SEATING

FIRE SAFETY WITHOUT COMPROMISE

Elevate Fire Safety to a Higher Standard

- You asked for more seating choices that meet the CAL 133 standard. Here they are. Many of The HON Company's most popular chair models are now available in an array of fabrics that include an advanced barrier of fire protection. This barrier helps HON chairs comply with CAL 133 (California Technical Bulletin 133), the industry's most stringent test for fire-retardant furniture.

Definitive Protection

- The resilient filling materials used in upholstered seating manufactured by The HON Company meet or exceed the flame retardant requirements of the State of California, Department of Consumer Affairs, Bureau of Electronic and Home Appliance Repair, Home Furnishings and Thermal Insulation Technical Bulletin 117-2013. The label attached to the seat bottom indicates compliance with these requirements.
- For public buildings with at least 10 chairs in use, CAL 133 sets the bar as the accepted standard of fire safety. The CAL-TB 117-2013 standard referenced above evaluates the fire resistance of fabric, but only CAL 133 tests the entire assembled chair. Result: Greater assurance that your seating will not accelerate an actual fire.

How to Order

- To ensure that the chairs you order comply with CAL 133, specify one of the fabrics listed here on any of the seating models from the pages that follow. Then simply add "FC" to the model number when ordering.

SPECIFYING EXAMPLE: HSGS6FC.N.E.CU10.BLCK.

A standard upcharge of \$90 will be applied per seat model for all single seat chairs.

For Lounge Seating, the following upcharges will apply: (Please note, the lounge upcharges do not apply to the Ignition® or Versant® seating lines. For these models, the \$90 per seat applies.)

Single Seat/Club Lounge: \$250 list

2-Seat/Love Seat Lounge: \$325 list

3-Seat/Sofa: \$400 list

MOISTURE BARRIER

- This extra layer of protection prevents moisture from penetrating the foam to improve cleanability and extend product longevity. Moisture barrier is available as an option for the seat only. The recliner gets moisture barrier on seat and footrest.
- Moisture barrier is not available for the fire code models.**

How to Order

- Fire Code:** To ensure that the chairs you order comply with CAL 133, specify one of the fabrics listed here on any of the seating models from the pages that follow. Then simply add "FC" to the model number when ordering.

SPECIFYING EXAMPLE: HHCG11FC.S.AI90.PR8.

- Moisture Barrier:** When specifying Moisture Barrier simply add "MB" to the model number when ordering.

SPECIFYING EXAMPLE: HHCG11MB.S.AI90.P6N.PR8.

Upcharges for Fire Code and Moisture Barrier on Soothe® models

Model	Fire Code	Moisture Barrier
HHCG11	\$90	\$80
HHCG50	\$90	\$120
HHCG21	\$180	\$160
HHCGB21	\$180	\$160
HHCGB31	\$270	\$240
HHCP1	\$90	\$80

FIRE CODE/COMPLIANT SEATING

CAL 133 COMPLIANT FABRIC

GRADE 1

AI	Attire
APX	Apex
COMP	Compass
CU	Centurion
DAPR	Dapper
ENSB	Ensemble
HAML	Hamilton
NR	Inertia
OP	Optic

GRADE 2

BLME	Blume
CLYD	Clyde
DOT	Dotty
PNS	Appoint Seating
RUSH	Rush
SED	Seed
SPNN	Spin
WP	Whisper Vinyl

GRADE 3

ISN	In Season
PURL	Purl
QUL	Quill

GRADE L

SS	Leather
-----------	---------

Motivate®, Olson® and GuestStacker® shell chairs available in CAL 133 compliant color options as of June 2014. Please see matrix below.

SHELL COLOR	MOTIVATE®	OLSON® H4041	GUESTSTACKER® H4031
Onyx (ON)	X*	X	X
Lava (LA)		X	X
Regatta (RE)		X	X
Mulberry (MB)		X	X
Shadow (SD)		X	
Platinum (PT)		X	
Lime (LM)		X	
Tangelo (RG)		X	
Surf (BU)		X	
Calypso (CP)		X	
Loft (LO)		X	
Cherry (CR)		X	
White (WT)		X	

Creases and gathers may be visible with CAL 133 Fire Code seating due to the construction of the fire barrier material used.

*CA Technical Bulletin 133 Compliant available on Motivate® only in Onyx as a Standard Special. Contact HON Tailored Solutions Team for availability.

FIRE CODE/COMPLIANT SEATING

To ensure that the chairs you order comply with CAL 133, choose one of these seating fabrics with the seating models listed here. Then simply add "FC" to the model number when ordering as shown here: **HIWM2FC.A.H.M.CU10.T.SB. A standard upcharge of \$90 will be applied per seat. Example, HMG2 has 2 seats @ \$90 per seat, \$180 upcharge.**

CAL 133 Compliant Seating

ALL MODELS INCLUDED IN THIS PROGRAM ARE LISTED BELOW.

Fabric Grade	1	1	1	1	1	2	2	2	L
Series/Model Numbers	Attire	Centurion	Compass	Inertia	Optic	Appoint	Dotty	Whisper Vinyl	Leather*
	AI	CU	COMP	NR	OP	PNS	DOT	WP	SS/SR
Accommodate®									
HSGS6FC, HSGS6DFFC, HSCS1FC	•	•	•	•	•	•	•	•	
HSCS1DFFC, HSCS2FC, HSCS2DFFC	•	•	•	•	•	•	•	•	
HSB50FC, HSB50DFFC	•	•	•	•	•	•	•	•	
Cambia™									
H2164FC, H2165FC	•	•	•	•	•	•	•	•	•
Ceres®									
HCW1FC, HCG6FC	•	•	•	•	•	•	•	•	•
Cliq™									
HCLQTFC	•	•	•	•	•	•	•	•	
ComforTask®									
H5901FC, H5902FC, H5903FC	•	•	•	•	•	•	•	•	
H5905FC	•	•	•	•	•	•	•	•	
Endorse®									
HLWMFC	•	•	•	•	•	•	•	•	
HLWMBTFC, HLTSMFC, HLTMFC	•	•	•	•	•	•	•	•	
HLWUFC, HLTUFC, HLEUFC	•	•	•	•	•	•	•	•	
HLWUBTFC, HLEUBTFC, HLTSUFC	•	•	•	•	•	•	•	•	
Flock® Seating									
HFLSC1FC, HFLMC1FC, HFLML1FC	•	•	•	•	•	•	•		•
HFLMR1FC, HFLSO1FC	•	•	•	•	•	•	•		•
HFLRC1FC		•	•	•	•	•		•	•
Grove®									
HML1SFC, HML1SDFFC, HML2SFC		•	•	•	•	•	•		•
HML2SDFFC, HML3SFC, HML3SDFFC		•	•	•	•	•	•		•
HML2STFC, HML2STDFFC		•	•	•	•	•	•		•
Ignition® Seating									
HIEH1FC, HIEH2FC, HIEH3FC	•	•	•	•	•	•	•	•	•
HIWM1FC, HIWM2FC, HIWM3FC	•	•	•	•	•	•	•	•	•
HIWM8FC, HITL1FC, HITL2FC	•	•	•	•	•	•	•	•	•
HITL3FC, HITS5FC, HIGCLFC	•	•	•	•	•	•	•	•	•
HIGS6FC, HISB6FC, HICS7FC	•	•	•	•	•	•	•	•	•
HIB50FC, HITLMFC, HIWMMFC	•	•	•	•	•	•	•	•	•
HITSMFC	•	•	•	•	•	•	•	•	•
Invitation®									
H2111FC, H2112FC	•	•	•	•	•	•	•	•	
Invitation® Lounge									
HFAA01FC, HFAL02FC, HFAS03FC	•	•	•	•	•	•	•		•

*Denver Leather (SS) may not be available on every model within a specific series, please refer to the model's page for details.

FIRE CODE/COMPLIANT SEATING

To ensure that the chairs you order comply with CAL 133, choose one of these seating fabrics with the seating models listed here. Then simply add “FC” to the model number when ordering as shown here: **HIWM2FC.A.H.M.CU10.T.SB. A standard upcharge of \$90 will be applied per seat. Example, HMG2 has 2 seats @ \$90 per seat, \$180 upcharge.**

CAL 133 Compliant Seating

ALL MODELS INCLUDED IN THIS PROGRAM ARE LISTED BELOW.

Fabric Grade	1	1	1	1	1	2	2	2	L
Series/Model Numbers	Attire	Centurion	Compass	Inertia	Optic	Appoint	Dotty	Whisper Vinyl	Leather*
	AI	CU	COMP	NR	OP	PNS	DOT	WP	SS/SR
Nucleus® Seating									
HN1FC, HN6FC, HN7FC	•	•	•	•	•	•	•	•	
Pagoda®									
H4071FC, H4073FC, H4075FC	•	•	•	•	•	•	•	•	
H4077FC, H4079FC, H4091FC	•	•	•	•	•	•	•	•	
H4093FC, H4095FC, H4097FC	•	•	•	•	•	•	•	•	
H4099FC	•	•	•	•	•	•	•	•	
Park Avenue Collection®									
H5001FC, H5002FC		•	•	•	•	•			•
Perpetual® Nesting Chairs									
HPN1FC, HPN2FC	•	•	•	•	•	•	•	•	
Pillow-Soft®									
H2091FC, H2092FC, H2191FC		•	•	•	•	•			•
H2192FC		•	•	•	•	•			•
H2093FC, H2194FC		•	•	•	•	•	•	•	•
Solutions Seating®									
H4001FC, H4002FC	•	•	•	•	•	•			
H4003FC, H4008FC	•	•	•	•	•	•	•	•	
Solve®									
HSLVSMMF, HSLVSMMSFC	•	•	•	•	•	•	•	•	•
HSLVTMMF, HSLVTMMSFC	•	•	•	•	•	•	•	•	•
Soothe®									
HHCG11FC, HHCG50FC, HHCG21FC	•	•	•	•	•		•	•	•
HHCGB21FC, HHCGB31FC	•	•	•	•	•		•	•	•
HHCP1FC									
Versant®									
HHCT01FC, HHCT12FC, HHCT02FC	•	•	•	•	•	•	•	•	•
HHCB50FC, HHB02FC, HHB03FC	•	•	•	•	•	•	•	•	•

*Denver Leather (SS) may not be available on every model within a specific series, please refer to the model's page for details.

ACCOMMODATE®



Accommodate® Café-Height Stools shown in Centurion Black.

ACCOMMODATE®

The key to designing a collaborative environment is to support productivity throughout the space. From waiting areas and cafés to meeting spaces and offices, Accommodate creates opportunities for people to get work done in a comfortable, casual setting. Cluster together. Form neat rows. Stack four high. With guest and bariatric chairs, as well as café and counter-height stools, Accommodate brings greater comfort, versatility and continuity throughout your space with a seating collection that adapts to your environment, people and budget.



FEATURES

- Thin profile seat cushion conforms to your body.
- Contoured back ergonomically supports the spine.
- Chairs can stack up to four high.
- Chairs can gang together to form neat rows.
- Waterfall seat edge enhances leg circulation.
- Lightweight frame is easy to move.
- Nylon glides slide effortlessly on hard surfaces.
- Tube rolled steel frame adds durability.
- Wall-saver design protects walls and cabinets.
- Warranted for users up to 300 lbs. (Models HSB50 and HSB50DF are warranted for users up to 500 lbs.)
- Available in Seated-, Counter-, and Café-heights.

MODEL OPTIONS

HSGS6
HSGS6DF - Dual Fabric



Guest Chair

HSCS1
HSCS1DF - Dual Fabric



Counter-Height Stool

HSCS2
HSCS2DF - Dual Fabric



Café-Height Stool

HSB50
HSB50DF - Dual Fabric

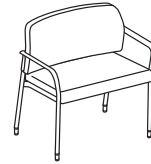

Bariatric Chair

ARM STYLE

CODE	DESCRIPTION	PRICE
N	Armless	+\$0
F	Fixed Arms	+\$30



FRAME

CODE	DESCRIPTION	PRICE
BLCK	Textured Black Mica	+\$0
PK7	Textured Designer White	+\$0
P7J	Textured Brownstone	+\$0
P7A	Textured Charcoal	+\$0
P7L	Textured Loft	+\$0
P7M	Textured Muslin	+\$0
PR8	Textured Silver	+\$0
P8V	Textured Titanium	+\$0



CASTERS/ GLIDES

CODE	DESCRIPTION	PRICE
E	Standard Nylon Glide	+\$0
H	Black Hard Caster	+\$0
S	Black All-Surface Caster	+\$20
B	Both Hard Casters and Standard Nylon Glides	+\$20



*Options H, S & B available for HSGS6 and HSGS6DF models only

ACCOMMODATE®

Fabric Options

HON BRANDED FABRICS

GRADE 1

Apex
Attire
Centurion
Compass
Contourett
Dapper
Ensemble
Hamilton
Inertia
Optic
Pebble

GRADE 2

Appoint Seating
Blume
Clyde
Dotty
Rush
Seed
Spin
Whisper Vinyl

GRADE 3

In Season
Moxie
Parker
Purl
Quill

For a complete list of fabrics, including partnership fabrics, go to hon.com/fabricsandfinishes.

Reference Fabric Color Combinations on pages 20-24 for color codes and legend on page 21 for lead times.

 For Fire Code model, availability and ordering method, refer to pages 248-251. Available on select models, contact HON Customer Support for availability.



ACCOMMODATE®

HSGS6

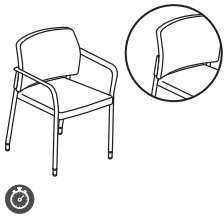

GUEST CHAIR

Set of Two Guest Chairs

DIMENSIONS

Depth:	22¼	Seat to Floor Height:	18¼
Height:	31½	Usable Seat Depth:	17
Seat Depth:	20¾	Ship Weight (with arms):	50
Seat Width:	17½	Ship Weight (armless):	48
Back Width:	19¾	Cube (with arms):	15.8
Back Height:	16¼	Cube (armless):	15.8
Width (with arms):	23½	COM (per 2 pack):	3.0
Width (armless):	19¾	Weight Rating:	300 lbs.
Arm Width:	20¼		

FABRIC PRICE CODES

1	\$770	8	\$1184
2	\$842	9	\$1238
3	\$914	10	\$1292
4	\$968	11	\$1346
5	\$1022	12	\$1400
6	\$1076	L	—
7	\$1130		

NOTES: For Ganging Brackets see page 258. Accommodate® Guest Chairs stack 4-high.

HSCS1

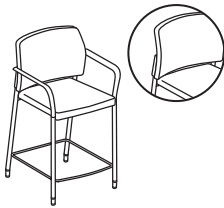

COUNTER-HEIGHT STOOL

DIMENSIONS

Depth:	23½	Seat to Floor Height:	25½
Height:	38¾	Usable Seat Depth:	17
Seat Depth:	20¾	Ship Weight (with arms):	36
Seat Width:	17½	Ship Weight (armless):	35
Back Width:	19¾	Cube (with arms):	15.8
Back Height:	16¼	Cube (armless):	15.8
Width (with arms):	23½	COM:	2.0
Width (armless):	19¾	Weight Rating:	300 lbs.
Arm Width:	20¼		

FABRIC PRICE CODES

1	\$467	8	\$674
2	\$503	9	\$701
3	\$539	10	\$728
4	\$566	11	\$755
5	\$593	12	\$782
6	\$620	L	—
7	\$647		

HSGANG

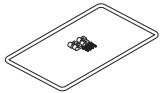

GANGING BRACKET

(hardware included)

DIMENSIONS

Ship Weight: 5 Ⓞ

LIST PRICE

\$34

NOTES: For use on models HSGS6 and HSGS6DF.

! No specification required for bracket. The ganging bracket is only available in black. The ganging bracket does not work on the bariatric unit.

HON Recommendation: HSGS6.N.E.CU__PR8 - List Price \$770

HOW TO SPECIFY

<p>Select Model Number</p>	<p>Select Arm Type</p> <p>N Armless F Fixed Arms (+ \$30 per chair)</p>	<p>Select Caster/Glide</p> <p>E Standard Nylon Glide H Hard Caster S Soft Caster (+ \$20 per chair) B Both Hard Casters and Standard Nylon Glides (+ \$20 per chair)</p> <p><i>Options H, S & B available for HSGS6 model only</i></p>	<p>Select Fabric</p> <p>See page 254</p>	<p>Select Frame</p> <p>See page 253</p>
H S G S 6 .	N .	E .	C U 1 0 .	P R 8

ACCOMMODATE®



Icon Legend on page 19

HSCS2

CAFÉ-HEIGHT STOOL

DIMENSIONS

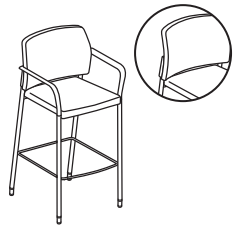

Depth:	24½	Seat to Floor Height:	31½
Height:	44¾	Usable Seat Depth:	17
Seat Depth:	20¾	Ship Weight (with arms):	38
Seat Width:	17½	Ship Weight (armless):	37
Back Width:	19¾	Cube (with arms):	19.1
Back Height:	16¼	Cube (armless):	19.1
Width (with arms):	23½	COM:	2.0
Width (armless):	19¾	Weight Rating:	300 lbs.
Arm Width:	20¼		

FABRIC PRICE CODES

1	\$512	8	\$719
2	\$548	9	\$746
3	\$584	10	\$773
4	\$611	11	\$800
5	\$638	12	\$827
6	\$665	L	—
7	\$692		

HSB50

BARIATRIC CHAIR

DIMENSIONS

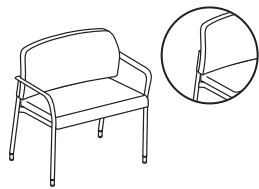

Depth:	21½	Seat to Floor Height:	19
Height:	32½	Usable Seat Depth:	16¾
Seat Depth:	20¼	Ship Weight (with arms):	50
Seat Width:	28	Ship Weight (armless):	49
Back Width:	29	Cube (with arms):	27.2
Back Height:	16½	Cube (armless):	27.2
Width (with arms):	33½	COM:	2.0
Width (armless):	30	Weight Rating:	500 lbs.
Arm Width:	30		

FABRIC PRICE CODES

1	\$826	8	\$1102
2	\$874	9	\$1138
3	\$922	10	\$1174
4	\$958	11	\$1210
5	\$994	12	\$1246
6	\$1030	L	—
7	\$1066		

HON Recommendation: HSCS2.N.E.CU__PR8 - List Price \$512

HOW TO SPECIFY

Select Model Number

H S C S 2 .

Select Arm Type

- N Armless
- F Fixed Arms (+ \$30 per chair)

N .

Select Caster/Glide

- E Standard Nylon Glide

E .

Select Fabric

See page 254

C U 1 0 .

Select Frame

See page 253

P R 8



ACCOMMODATE®

HSGS6DF

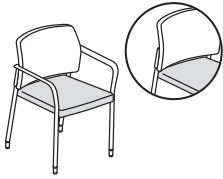

GUEST CHAIR

Dual Fabric
Set of Two Guest Chairs

DIMENSIONS

Depth:	22¼	Seat to Floor Height:	18¼
Height:	31½	Usable Seat Depth:	17
Seat Depth:	20¾	Ship Weight (with arms):	50
Seat Width:	17½	Ship Weight (armless):	48
Back Width:	19¾	Cube (with arms):	15.8
Back Height:	16¼	Cube (armless):	15.8
Width (with arms):	23½	COM (Seat, per 2 pack):	1.5
Width (armless):	19¾	COM (Back, per 2 pack):	1.5
Arm Width:	20¼	Weight Rating:	300 lbs.

FABRIC PRICE CODES

1	\$927	
<i>Add to Base Price Above</i>		
	Back	Seat
2	\$36	\$36
3	\$72	\$72
4	\$99	\$99
5	\$126	\$126
6	\$153	\$153
7	\$180	\$180
8	\$207	\$207
9	\$234	\$234
10	\$261	\$261
11	\$288	\$288
12	\$315	\$315

NOTES: For Ganging Brackets see page 258. Accommodate® Guest Chairs stack 4-high.

HSCS1DF

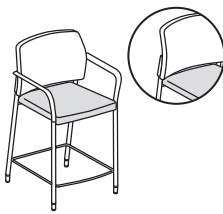

COUNTER-HEIGHT STOOL

Dual Fabric

DIMENSIONS

Depth:	23½	Seat to Floor Height:	25½
Height:	38¾	Usable Seat Depth:	17
Seat Depth:	20¾	Ship Weight (with arms):	36
Seat Width:	17½	Ship Weight (armless):	35
Back Width:	19¾	Cube (with arms):	15.8
Back Height:	16¼	Cube (armless):	15.8
Width (with arms):	23½	COM (Seat):	1.0
Width (armless):	19¾	COM (Back):	1.0
Arm Width:	20¼	Weight Rating:	300 lbs.

FABRIC PRICE CODES

1	\$548	
<i>Add to Base Price Above</i>		
	Back	Seat
2	\$18	\$18
3	\$36	\$36
4	\$50	\$50
5	\$63	\$63
6	\$77	\$77
7	\$90	\$90
8	\$104	\$104
9	\$117	\$117
10	\$131	\$131
11	\$144	\$144
12	\$158	\$158

HON Recommendation: HSGS6DF.N.E.CU__CU__PR8 - List Price \$927

HOW TO SPECIFY

<p>Select Model Number</p> <p>H S G S 6 D F</p>	<p>Select Arm Type</p> <p>N Armless F Fixed Arms (+ \$30 per chair)</p> <p>N</p>	<p>Select Caster/Glide</p> <p>E Standard Nylon Glide H Hard Caster S Soft Caster (+ \$20 per chair) B Both Hard Casters and Standard Nylon Glides (+ \$20 per chair)</p> <p><i>Options H, S & B available for HSGS6DF model only</i></p> <p>E</p>	<p>Select Back Fabric</p> <p>See page 254</p> <p>C U 2 2</p>	<p>Select Seat Fabric</p> <p>See page 254</p> <p>C U 1 0</p>	<p>Select Frame</p> <p>See page 253</p> <p>P R 8</p>
--	---	--	---	---	---

ACCOMMODATE®



Icon Legend on page 19

HSCS2DF



CAFÉ-HEIGHT STOOL

Dual Fabric

DIMENSIONS

Depth:	24½	Seat to Floor Height:	31½
Height:	44¾	Usable Seat Depth:	17
Seat Depth:	20¾	Ship Weight (with arms):	38
Seat Width:	17½	Ship Weight (armless):	37
Back Width:	19¾	Cube (with arms):	19.1
Back Height:	16¼	Cube (armless):	19.1
Width (with arms):	23½	COM (Seat):	1.0
Width (armless):	19¾	COM (Back):	1.0
Arm Width:	20¼	Weight Rating:	300 lbs.

FABRIC PRICE CODES

1 \$594

Add to Base Price Above

	Back	Seat
2	\$18	\$18
3	\$36	\$36
4	\$50	\$50
5	\$63	\$63
6	\$77	\$77
7	\$90	\$90
8	\$104	\$104
9	\$117	\$117
10	\$131	\$131
11	\$144	\$144
12	\$158	\$158

HSB50DF

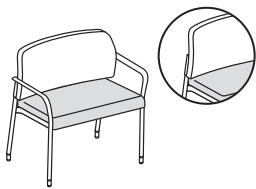

BARIATRIC CHAIR

Dual Fabric

DIMENSIONS

Depth:	21½	Seat to Floor Height:	19
Height:	32½	Usable Seat Depth:	16¾
Seat Depth:	20¼	Ship Weight (with arms):	50
Seat Width:	28	Ship Weight (armless):	49
Back Width:	29	Cube (with arms):	27.2
Back Height:	16½	Cube (armless):	27.2
Width (with arms):	33½	COM (Seat):	1.0
Width (armless):	30	COM (Back):	1.0
Arm Width:	30	Weight Rating:	500 lbs.

FABRIC PRICE CODES

1 \$906

Add to Base Price Above

	Back	Seat
2	\$24	\$24
3	\$48	\$48
4	\$66	\$66
5	\$84	\$84
6	\$102	\$102
7	\$120	\$120
8	\$138	\$138
9	\$156	\$156
10	\$174	\$174
11	\$192	\$192
12	\$210	\$210

HSGANG

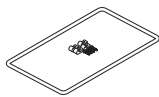

GANGING BRACKET

(hardware included)

DIMENSIONS

Ship Weight: 5 Ⓞ

LIST PRICE

\$34

NOTES: For use on models HSGS6 and HSGS6DF.

ⓘ No specification required for bracket. The ganging bracket is only available in black. The ganging bracket does not work on the bariatric unit.

HON Recommendation: HSCS2DF.N.E.CU__CU__PR8 - List Price \$594

HOW TO SPECIFY

Select Model Number	Select Arm Type	Select Caster/Glide	Select Back Fabric	Select Seat Fabric	Select Frame
	N Armless F Fixed Arms (+ \$30)	E Standard Nylon Glide	See page 254	See page 254	See page 253
H S C S 2 D F .	N .	E .	C U 2 2 .	C U 1 0 .	P R 8



Icon Legend on page 19

ADJUSTABLE TASK/LAB Stools

HMTS01

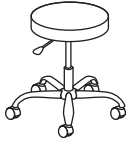

TASK/LAB STOOL

without Back
 Pneumatic
 Swivel
 Functions: **A, E**
 (Function Key on pages 244-245)

DIMENSIONS

Depth:	27¼	Seat to Floor Height:	17¾-22
Width:	24⅝	Usable Seat Depth:	16
Height:	17¾-22	Ship Weight:	22
Seat:	16" Dia.	Cube:	2.5
		Weight Rating:	250 lbs.

FABRIC PRICE CODE

1 \$366

NOTES: EA vinyl is a healthcare covering that meets AATCC Test Method 147-2004.
 ⓘ Available in polished base ONLY. Available in Grade 1, Black, EA11 fabric ONLY.

HMTS11

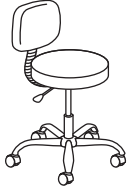

TASK/LAB STOOL

with Back
 Pneumatic
 Back Height
 Seat Depth
 Swivel
 Functions: **A, B, C, E**
 (Function Key on pages 244-245)

DIMENSIONS

Depth:	27¼	Seat to Floor Height:	17¾-22
Width:	24⅝	Usable Seat Depth:	14¾-16
Height:	31½-38	Ship Weight:	29
Seat:	16" Dia.	Cube:	2.7
Back Width:	15½	Weight Rating:	250 lbs.
Back Height:	8¾-16		

FABRIC PRICE CODE

1 \$490

NOTES: EA vinyl is a healthcare covering that meets AATCC Test Method 147-2004.
 ⓘ Available in polished base ONLY. Available in Grade 1, Black, EA11 fabric ONLY.

HOW TO SPECIFY

Select Model Number	Select Fabric
	EA11 Black, Grade 1 (only)
H M T S 0 1 .	E A 1 1

ASSEMBLE™ Nesting/Stacking Chairs

OPEN MARKET



Icon Legend on page 19

HVL304



NESTING/STACKING

Upholstered Seat and Mesh
Back
Casters
Armless
Ships 2 per Carton

DIMENSIONS

Depth:	24	Seat to Floor Height:	17
Width:	24	Usable Seat Depth:	17
Height:	34¾	Ship Weight:	57
Seat Depth:	17	Cube:	9.0
Seat Width:	18	Weight Rating:	250 lbs.
Back Width:	16¾		

LIST PRICE PER CARTON

\$573
(reference single unit @
\$286.50

NOTES: Stacks 4-high. Comfortable and breathable mesh back. Armless. Black fabric seat. Specify Black (T) or Silver (X) frame. Ships two per carton. **HON 5-Year Limited Warranty.**

ⓘ Mesh Nesting Chairs are ordered and shipped two (2) chairs per carton. Pricing shown is per carton. Each set of two chairs (one carton) must have the same fabric/frame color. Ordering 2 of any model will result in 2 cartons being shipped, giving you 4 chairs.

HON Recommendation: HVL304.VA10.T - List Price \$573

HVL314



NESTING/STACKING

Upholstered Seat and Mesh
Back
Casters
Arms
Ships 2 per Carton

DIMENSIONS

Depth:	24	Arm Width:	18
Width:	24	Seat to Floor Height:	17
Height:	34¾	Usable Seat Depth:	17
Seat Depth:	17	Ship Weight:	57
Seat Width:	18	Cube:	9.2
Back Width:	16¾	Weight Rating:	250 lbs.

LIST PRICE PER CARTON

\$599
(reference single unit @
\$299.50

NOTES: Stacks 4-high. Comfortable and breathable mesh back. With arms. Black fabric seat. Specify Black (T) or Silver (X) frame. Ships two per carton. **HON 5-Year Limited Warranty.**

ⓘ Mesh Nesting Chairs are ordered and shipped two (2) chairs per carton. Pricing shown is per carton. Each set of two chairs (one carton) must have the same fabric/frame color. Ordering 2 of any model will result in 2 cartons being shipped, giving you 4 chairs.

HON Recommendation: HVL314.VA10.T - List Price \$599

SEATING

HOW TO SPECIFY

Select
Model Number

H V L 3 0 4 .

Select
Fabric

VA10 Black

V A 1 0 .

Select
Frame

T Black
X Silver

T

ASTIR™ COLLABORATIVE WORK SEATING



Astir™ Collaborative Work Seating shown with Birk™ Tables and Acoustic Solutions by Unika Vaev.

ASTIR™

Astir™ Collaborative Work answers the call for soft seating solutions while providing separate work spaces and sturdy posture support for those looking to step away from their desks. The line provides a soft yet upright sit to keep employees engaged and working comfortably at a table setting. High back and side options help keep private conversations private — so teams don't have to be confined in close quarters, such as a conference room. And a unique, single-seat style with high screens on three sides creates a quiet, secure and comfortable space for individual focus.



FEATURES

- Seat height and back angle are scaled for more of an upright working posture.
- Choose from One+, Two- or Three-Seat Lounges in low- or high-back options.
- High-back screens available in knit mesh or fabric options and provide visual privacy on back and sides.
- Fabric high-back screen option available in cleanable fabrics (see HON's cleaning guide for instructions).
- Choose from three different leg styles to customize your look.
- Two- or Three-Seat Benches add extra seating for commons or reception areas.
- Pouf model functions as both impromptu seating and a place to kick up your feet.
- Replaceable seat cushion enhances comfort and cleanability, and allows for easy changing.
- With the multi-fabric options, seat cushion and frame can be specified in different fabrics for a modern aesthetic.
- Add an optional power module to route power directly underneath the seat.

ASTIR™ Options

MODEL OPTIONS

**HASLB1, HASLB1MF -
Multi-Fabric**



Lounge
One+ Seat, Low-Back

**HASLB2, HASLB2MF -
Multi-Fabric**

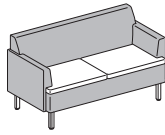

Lounge
Two-Seat, Low-Back

**HASLB3, HASLB3MF -
Multi-Fabric**

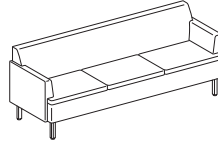

Lounge
Three-Seat, Low-Back

**HASLBTC, HASLBTCMF -
Multi-Fabric**

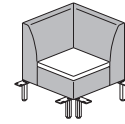

Lounge
True Corner, Low-Back

**HASHB1, HASHB1MF -
Multi-Fabric**

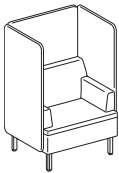

Lounge
One+ Seat, High-Back Screen

**HASHB2, HASHB2MF -
Multi-Fabric**

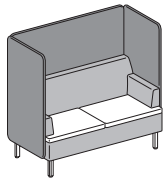

Lounge
Two-Seat, High-Back Screen

**HASHB3, HASHB3MF -
Multi-Fabric**

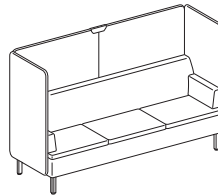

Lounge
Three-Seat, High-Back Screen

**HASHBTC, HASHBTCMF -
Multi-Fabric**

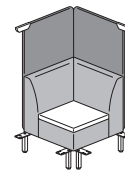

Lounge
True Corner, High-Back Screen

**HASB2, HASB2MF -
Multi-Fabric**

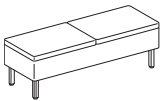

Bench
Two-Seat Bench

**HASB3, HASB3MF -
Multi-Fabric**

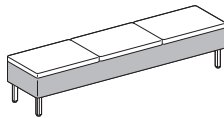

Bench
Three-Seat Bench

**HASPSS, HASPSSMF -
Multi-Fabric**



Pouf

Low-Back, Multi-Fabric



High-Back, Multi-Fabric



HON BRANDED FABRICS

GRADE 1	GRADE 2	GRADE 3	KNIT
Apex	Appoint Seating	Moxie	Light
Centurion	Blume	Purl	Medium
Contourett	Clyde	Quill	Dark
Dapper	Rush		
Ensemble	Seed		
Hamilton	Whisper Vinyl		
Inertia			
Pebble			
			FABRICS
			Apex
			Blume
			Contourett
			Moxie
			Pebble
			Whisper Vinyl

SCREEN FABRIC OPTIONS

LEG STYLE

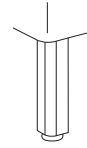

CODE	DESCRIPTION	PRICE
PM	Post Metal	+ \$50
<i>Available in the following finishes:</i>		
P8V	Textured Titanium	
P7A	Textured Charcoal	
P8X	Solar Black	+ \$20
PR5	Champagne Metallic	+ \$20

For a complete list of fabrics, including partnership fabrics, go to hon.com/fabricsandfinishes.

Reference Fabric Color Combinations on pages 20-24 for color codes and legend on page 21 for lead times.

LEG STYLE

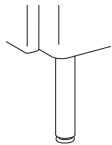

CODE	DESCRIPTION	PRICE
DW	Dowel Wood	+ \$0
<i>Available in the following finishes:</i>		
LFW1	Florence Walnut	
LKI1	Kingswood Walnut	
LLA1	Lowell Ash	
D	Natural Maple	
LNRI	Natural Recon	
LPE1	Phantom Ecrú	
PINC	Pinnacle	
LPT1	Portico Teak	
LSW1	Skyline Walnut	
LSA1	Sterling Ash	

LEG STYLE

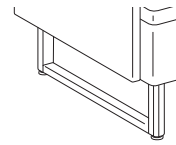

CODE	DESCRIPTION	PRICE
SW	Sled Wood	+ \$100
<i>Available in the following finishes:</i>		
LFW1	Florence Walnut	
LKI1	Kingswood Walnut	
LLA1	Lowell Ash	
D	Natural Maple	
LNRI	Natural Recon	
LPE1	Phantom Ecrú	
PINC	Pinnacle	
LPT1	Portico Teak	
LSW1	Skyline Walnut	
LSA1	Sterling Ash	

MULTI-FABRIC COM YARDAGE

Due to fabric pattern nesting and potential reduction of fabric yield, some multi-fabric models may require more total yardage than standard models.

MODEL	COM (ARMLESS)			COM (ONE ARM/SIDE)			COM (BOTH ARMS/SIDES)		
	Seat	Back/Frame	Screen	Seat	Back/Frame	Screen	Seat	Back/Frame	Screen
HASLB1	—	—	—	—	—	—	6.5		
HASLB1MF	—	—	—	—	—	—	1.5	5.0	—
HASLBTC	5.0	—	—	—	—	—	—	—	—
HASLBTCMF	1.5	4.0	—	—	—	—	—	—	—
HASLB2	7.0	—	—	8.0	—	—	9.0		
HASLB2MF	3.0	4.5	—	3.0	5.5	—	3.0	6.5	—
HASLB3	10.0	—	—	11.0	—	—	12.0		
HASLB3MF	4.0	6.0	—	4.0	7.5	—	4.0	8.5	—
HASHB1	—	—	—	—	—	—	4.5	—	8.0
HASHB1MF	—	—	—	—	—	—	1.5	3.5	8.0
HASHBTC	5.0	—	5.5	—	—	—	—	—	—
HASHBTCMF	1.5	4.0	5.5	—	—	—	—	—	—
HASHB2	7.0	—	5.5	7.0	—	8.0	7.0	—	11.0
HASHB2MF	3.0	4.5	5.5	3.0	4.5	8.0	3.0	4.5	11.0
HASHB3	10.5	—	5.5	10.5	—	8.0	10.5	—	11.0
HASHB3MF	4.0	7.0	5.5	4.0	7.0	8.0	4.0	7.0	11.0
HAS PSS	2.0	—	—	—	—	—	—	—	—
HAS PSSMF	1.0	1.5	—	—	—	—	—	—	—
HASB2	4.5	—	—	—	—	—	—	—	—
HASB2MF	3.0	2.0	—	—	—	—	—	—	—
HASB3	6.5	—	—	—	—	—	—	—	—
HASB3MF	4.0	2.5	—	—	—	—	—	—	—

ASTIR™ Collaborative Work Seating

OPEN MARKET



Icon Legend on page 19

HASLB1

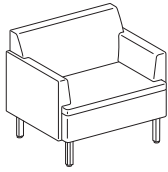

ONE+ SEAT — LOW-BACK DIMENSIONS

Depth:	29	Back Height:	16
Height:	32	Back Width:	33½
Width:	36½	Arm Height:	7½
Usable Seat Depth:	19¾	Ship Weight:	95
Seat to Floor Height:	18¾	Cube:	21.2
Seat Width:	27	COM:	See page 263
		Weight Rating:	300 lbs.

FABRIC PRICE CODES

1	\$1980	8	\$2745
2	\$2072	9	\$2868
3	\$2164	10	\$2990
4	\$2256	11	\$3113
5	\$2378	12	\$3235
6	\$2500	L	—
7	\$2623		

HASLB1MF

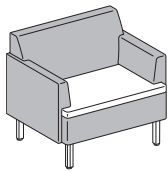

ONE+ SEAT — LOW-BACK, MULTI-FABRIC DIMENSIONS

Depth:	29	Back Height:	16
Height:	32	Back Width:	33½
Width:	36½	Arm Height:	7½
Usable Seat Depth:	19¾	Ship Weight:	95
Seat to Floor Height:	18¾	Cube:	21.2
Seat Width:	27	COM:	See page 263
		Weight Rating:	300 lbs.

FABRIC PRICE CODES

1	\$2130	
<i>Add to Base Price Above</i>		
	Seat	Frame/Back
2	\$23	\$77
3	\$46	\$153
4	\$69	\$230
5	\$99	\$332
6	\$130	\$434
7	\$161	\$536
8	\$191	\$638
9	\$222	\$740
10	\$253	\$842
11	\$283	\$944
12	\$314	\$1046

HON Recommendation: HASLB1.B.PURL__DW__ - List Price \$2164

HOW TO SPECIFY

<p>Select Model Number</p> <p>HASLB1MF</p>	<p>Select Arm Type</p> <p>B Both Arms</p>	<p>Select Fabric</p> <p>See page 263 Specify for Single Fabric model only</p>	<p>Select Seat Cushion Fabric</p> <p>See page 263 Specify for MF model only</p>	<p>Select Back and Frame Fabric</p> <p>See page 263 Specify for MF model only</p>	<p>Select Leg and Color</p> <p>DW Dowel Wood PM Post Metal (+ \$50) SW Sled Wood (+ \$100) See page 263 for colors</p>
HASLB1MF	B	PBLE07	PBLE09	PBLE06	PMP8V



ASTIR™ Collaborative Work Seating

HASHB1

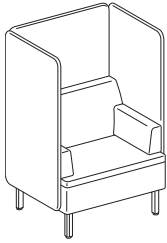

ONE+ SEAT — HIGH-BACK SCREEN

DIMENSIONS

Depth:	29¾	Back Height:	16
Height:	54	Back Width:	33½
Width:	35	Arm Height:	7½
Usable Seat Depth:	19¾	Ship Weight*:	124
Seat to Floor Height:	18¾	Cube:	24.1
Seat Width:	25½	COM:	See page 263
		Weight Rating:	300 lbs.

FABRIC PRICE CODES

1		\$2700
<i>Add to Base Price Above</i>		
	Unit	Screen
		Knit
		—
1	—	1 \$150
2	\$69	2 \$280
3	\$138	3 \$410
4	\$207	4 \$540
5	\$298	5 \$714
6	\$390	6 \$887
7	\$482	7 \$1061
8	\$574	8 \$1234
9	\$666	9 \$1408
10	\$758	10 \$1581
11	\$849	11 \$1755
12	\$941	12 \$1928

*Ships in two cartons.

HASHB1MF

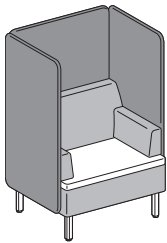

ONE+ SEAT — HIGH-BACK SCREEN, MULTI-FABRIC

DIMENSIONS

Depth:	29¾	Back Height:	16
Height:	54	Back Width:	33½
Width:	35	Arm Height:	7½
Usable Seat Depth:	19¾	Ship Weight*:	124
Seat to Floor Height:	18¾	Cube:	24.1
Seat Width:	25½	COM:	See page 263
		Weight Rating:	300 lbs.

FABRIC PRICE CODES

1		\$2850		
<i>Add to Base Price Above</i>				
	Seat	Back/Frame	Knit	Screen
			—	
1	—	—	1	\$150
2	\$23	\$54	2	\$280
3	\$46	\$107	3	\$410
4	\$69	\$161	4	\$540
5	\$99	\$232	5	\$714
6	\$130	\$304	6	\$887
7	\$161	\$375	7	\$1061
8	\$191	\$446	8	\$1234
9	\$222	\$518	9	\$1408
10	\$253	\$589	10	\$1581
11	\$283	\$661	11	\$1755
12	\$314	\$732	12	\$1928

*Ships in two cartons.

HON Recommendation: HASHB1.B.PURL__KMD.DW__ - List Price \$2838

HOW TO SPECIFY

Select Model Number HASHB1MF	Select Arm Type B Both Side Screens	Select Fabric See page 263 <i>Specify for Single Fabric model only</i>	Select Seat Cushion Fabric See page 263 <i>Specify for MF model only</i>	Select Back and Frame Fabric See page 263 <i>Specify for MF model only</i>	Select Screen Knit or Fabric Knit Options: KLT Light KMD Medium KDK Dark See page 263 for all options	Select Leg and Color DW Dowel Wood PM Post Metal (+ \$50) SW Sled Wood (+ \$100) See page 263 for colors
HASHB1MF	B	PBLE07	PBLE09	PBLE06	KMD	PMP8V

ASTIR™ Collaborative Work Seating

OPEN MARKET



Icon Legend on page 19

HASLB2

TWO-SEAT LOUNGE — LOW-BACK

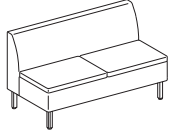

Armless

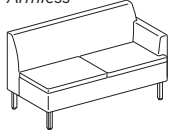

Left

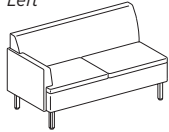

Right

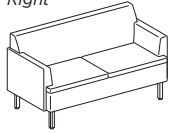

Both Arms

DIMENSIONS

Depth:	29	Back Height:	16
Height:	32	Back Width:	56½
Width (armless):	56½	Arm Height:	7½
Width (one arm):	58	Ship Weight (armless):	113
Width (both arms):	59½	Ship Weight (one arm):	122
Usable Seat Depth:	19¾	Ship Weight (both arms):	131
Seat to Floor Height:	18¾	Cube:	35.1
Seat Width (armless):	56½	COM:	See page 263
Seat Width (one arm):	53¼	Weight Rating:	300 lbs. (per seat)
Seat Width (both arms):	50		

FABRIC PRICE CODES

1	\$2210	8	\$3358
2	\$2348	9	\$3542
3	\$2486	10	\$3725
4	\$2623	11	\$3909
5	\$2807	12	\$4093
6	\$2991	L	—
7	\$3174		

HASLB2MF

TWO-SEAT LOUNGE — LOW-BACK, MULTI-FABRIC

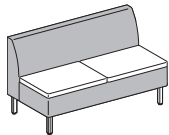

Armless

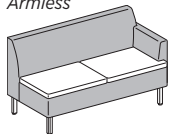

Left

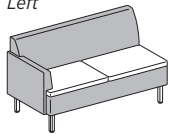

Right

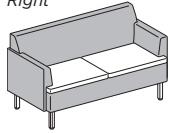

Both Arms

DIMENSIONS

Depth:	29	Back Height:	16
Height:	32	Back Width:	56½
Width (armless):	56½	Arm Height:	7½
Width (one arm):	58	Ship Weight (armless):	113
Width (both arms):	59½	Ship Weight (one arm):	122
Usable Seat Depth:	19¾	Ship Weight (both arms):	131
Seat to Floor Height:	18¾	Cube:	35.1
Seat Width (armless):	56½	COM:	See page 263
Seat Width (one arm):	53¼	Weight Rating:	300 lbs. (per seat)
Seat Width (both arms):	50		

FABRIC PRICE CODES

1	\$2360		
<i>Add to Base Price Above</i>			
		Seat	Frame/Back
2	\$46	\$107	
3	\$92	\$214	
4	\$138	\$321	
5	\$199	\$464	
6	\$260	\$607	
7	\$321	\$750	
8	\$383	\$893	
9	\$444	\$1036	
10	\$505	\$1179	
11	\$566	\$1321	
12	\$628	\$1464	

HON Recommendation: HASLB2.B.PURL__DW__ - List Price \$2936

HOW TO SPECIFY

Select Model Number HASLB2MF	Select Arm Type N Armless L Left Side (+ \$225) R Right Side (+ \$225) B Both Arms (+ \$450)	Select Fabric See page 263 Specify for Single Fabric model only	Select Seat Cushion Fabric See page 263 Specify for MF model only	Select Back and Frame Fabric See page 263 Specify for MF model only	Select Leg and Color DW Dowel Wood PM Post Metal (+ \$50) SW Sled Wood (+ \$100) See page 263 for colors
HASLB2MF	B	PBLE07	PBLE09	PBLE06	PMP8V

SEATING



ASTIR™ Collaborative Work Seating

HASHB2

TWO-SEAT LOUNGE — HIGH-BACK SCREEN

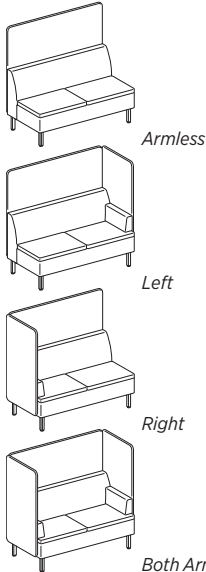

DIMENSIONS

Depth:	29¾	Back Height:	16
Height:	54	Back Width:	56½
Width (armless):	56½	Arm Height:	7½
Width (one arm):	57¼	Ship Weight* (armless):	136
Width (both arms):	58	Ship Weight* (one arm):	156
Usable Seat Depth:	19¾	Ship Weight* (both arms):	176
Seat to Floor Height:	18¾	Cube:	29.4
Seat Width (armless):	56½	COM:	See page 263
Seat Width (one arm):	52¼	Weight Rating:	300 lbs. (per seat)
Seat Width (both arms):	48¼		

FABRIC PRICE CODES

1	\$3110		
<i>Add to Base Price Above</i>			
	Unit	Knit	Screen
1	—	1	\$150
2	\$122	2	\$334
3	\$245	3	\$517
4	\$367	4	\$701
5	\$531	5	\$946
6	\$694	6	\$1191
7	\$857	7	\$1436
8	\$1020	8	\$1681
9	\$1184	9	\$1925
10	\$1347	10	\$2170
11	\$1510	11	\$2415
12	\$1673	12	\$2660

*Ships in two cartons.

HASHB2MF

TWO-SEAT LOUNGE — HIGH-BACK SCREEN, MULTI-FABRIC

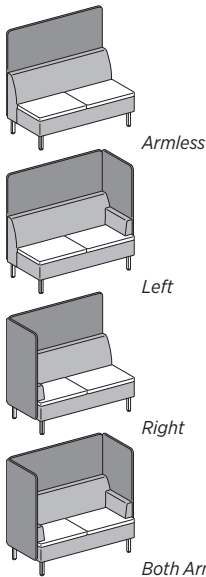

DIMENSIONS

Depth:	29¾	Back Height:	16
Height:	54	Back Width:	56½
Width (armless):	56½	Arm Height:	7½
Width (one arm):	57¼	Ship Weight* (armless):	136
Width (both arms):	58	Ship Weight* (one arm):	156
Usable Seat Depth:	19¾	Ship Weight* (both arms):	176
Seat to Floor Height:	18¾	Cube:	29.4
Seat Width (armless):	56½	COM:	See page 263
Seat Width (one arm):	52¼	Weight Rating:	300 lbs. (per seat)
Seat Width (both arms):	48¼		

FABRIC PRICE CODES

1	\$3260		
<i>Add to Base Price Above</i>			
	Seat	Back/Frame	Knit Screen
1	—	—	1 \$150
2	\$46	\$77	2 \$334
3	\$92	\$153	3 \$517
4	\$138	\$230	4 \$701
5	\$199	\$332	5 \$946
6	\$260	\$434	6 \$1191
7	\$321	\$536	7 \$1436
8	\$383	\$638	8 \$1681
9	\$444	\$740	9 \$1925
10	\$505	\$842	10 \$2170
11	\$566	\$944	11 \$2415
12	\$628	\$1046	12 \$2660

*Ships in two cartons.

HON Recommendation: HASHB2.B.PURL__KMD.DW__ - List Price \$4255

HOW TO SPECIFY

Select Model Number	Select Arm Type	Select Fabric	Select Seat Cushion Fabric	Select Back and Frame Fabric	Select Screen Knit or Fabric	Select Leg and Color
	N Armless L Left Side (+ \$450) R Right Side (+ \$450) B Both Side Screens (+ \$900)	See page 263 <i>Specify for Single Fabric model only</i>	See page 263 <i>Specify for MF model only</i>	See page 263 <i>Specify for MF model only</i>	Knit Options: KLT Light KMD Medium KDK Dark See page 263 for all options	DW Dowel Wood PM Post Metal (+ \$50) SW Sled Wood (+ \$100) See page 263 for colors
H A S H B 2 M F .	B .	P B L E 0 7 .	P B L E 0 9 .	P B L E 0 6 .	K M D .	P M P 8 V

ASTIR™ Collaborative Work Seating

OPEN MARKET



Icon Legend on page 19

HASLB3

THREE-SEAT LOUNGE — LOW-BACK

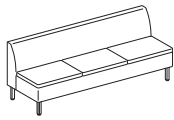

Armless

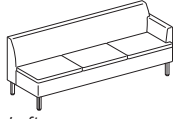

Left

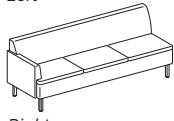

Right

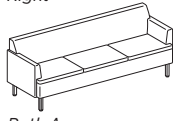

Both Arms

DIMENSIONS

Depth:	29	Back Height:	16
Height:	32	Back Width:	84½
Width (armless):	84½	Arm Height:	7½
Width (one arm):	86	Ship Weight (armless):	152
Width (both arms):	87½	Ship Weight (one arm):	161
Usable Seat Depth:	19¾	Ship Weight (both arms):	170
Seat to Floor Height:	18¾	Cube:	47.9
Seat Width (armless):	84½	COM:	See page 263
Seat Width (one arm):	81¼	Weight Rating:	300 lbs. (per seat)
Seat Width (both arms):	78		

FABRIC PRICE CODES

1	\$2920	8	\$4451
2	\$3104	9	\$4695
3	\$3287	10	\$4940
4	\$3471	11	\$5185
5	\$3716	12	\$5430
6	\$3961	L	—
7	\$4206		

HASLB3MF

THREE-SEAT LOUNGE — LOW-BACK, MULTI-FABRIC

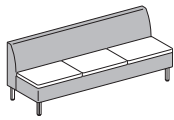

Armless

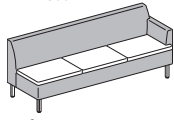

Left

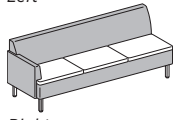

Right

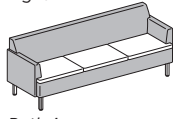

Both Arms

DIMENSIONS

Depth:	29	Back Height:	16
Height:	32	Back Width:	84½
Width (armless):	84½	Arm Height:	7½
Width (one arm):	86	Ship Weight (armless):	152
Width (both arms):	87½	Ship Weight (one arm):	161
Usable Seat Depth:	19¾	Ship Weight (both arms):	170
Seat to Floor Height:	18¾	Cube:	47.9
Seat Width (armless):	84½	COM:	See page 263
Seat Width (one arm):	81¼	Weight Rating:	300 lbs. (per seat)
Seat Width (both arms):	78		

FABRIC PRICE CODES

1	\$3070	
<i>Add to Base Price Above</i>		
	Seat	Frame/Back
2	\$61	\$138
3	\$122	\$276
4	\$184	\$413
5	\$265	\$597
6	\$347	\$781
7	\$429	\$964
8	\$510	\$1148
9	\$592	\$1332
10	\$673	\$1515
11	\$755	\$1699
12	\$837	\$1883

HON Recommendation: HASLB3.B.PURL__DW__ - List Price \$3737

HOW TO SPECIFY

Select Model Number HASLB3MF	Select Arm Type N Armless L Left Side (+ \$225) R Right Side (+ \$225) B Both Arms (+ \$450)	Select Fabric See page 263 Specify for Single Fabric model only	Select Seat Cushion Fabric See page 263 Specify for MF model only	Select Back and Frame Fabric See page 263 Specify for MF model only	Select Leg and Color DW Dowel Wood PM Post Metal (+ \$50) SW Sled Wood (+ \$100) See page 263 for colors
HASLB3MF	B	PBLE07	PBLE09	PBLE06	PMP8V

SEATING



HASHB3

THREE-SEAT LOUNGE — HIGH-BACK SCREEN

DIMENSIONS

FABRIC PRICE CODES

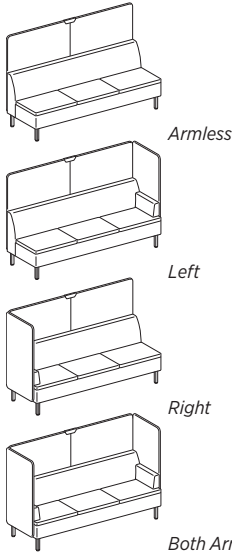

Depth:	29¾	Back Height:	16
Height:	54	Back Width:	84½
Width (armless):	84½	Arm Height:	7½
Width (one arm):	85¼	Ship Weight* (armless):	185
Width (both arms):	86	Ship Weight* (one arm):	205
Usable Seat Depth:	19¾	Ship Weight* (both arms):	225
Seat to Floor Height:	18¾	Cube:	39
Seat Width (armless):	84½	COM:	See page 263
Seat Width (one arm):	80½	Weight Rating:	300 lbs. (per seat)
Seat Width (both arms):	76½		

1 \$4250

Add to Base Price Above

	Unit	Knit	Screen
	1	1	—
	2	2	\$150
	3	3	\$334
	4	4	\$517
	5	5	\$701
	6	6	\$946
	7	7	\$1191
	8	8	\$1436
	9	9	\$1681
	10	10	\$1925
	11	11	\$2170
	12	12	\$2415

Both Arms *Ships in two cartons.

HASHB3MF

THREE-SEAT LOUNGE — HIGH-BACK SCREEN, MULTI-FABRIC

DIMENSIONS

FABRIC PRICE CODES

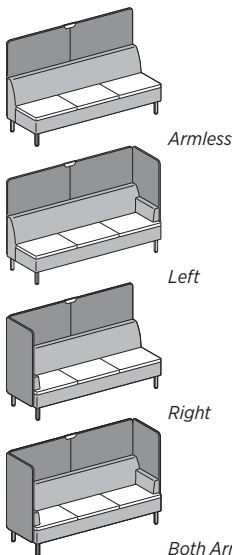

Depth:	29¾	Back Height:	16
Height:	54	Back Width:	84½
Width (armless):	84½	Arm Height:	7½
Width (one arm):	85¼	Ship Weight* (armless):	185
Width (both arms):	86	Ship Weight* (one arm):	205
Usable Seat Depth:	19¾	Ship Weight* (both arms):	225
Seat to Floor Height:	18¾	Cube:	39
Seat Width (armless):	84½	COM:	See page 263
Seat Width (one arm):	80½	Weight Rating:	300 lbs. (per seat)
Seat Width (both arms):	76½		

1 \$4400

Add to Base Price Above

	Seat	Back/ Frame	Knit	Screen	
	1	—	1	—	
	2	\$61	\$107	2	\$334
	3	\$122	\$214	3	\$517
	4	\$184	\$321	4	\$701
	5	\$265	\$464	5	\$946
	6	\$347	\$607	6	\$1191
	7	\$429	\$750	7	\$1436
	8	\$510	\$893	8	\$1681
	9	\$592	\$1036	9	\$1925
	10	\$673	\$1179	10	\$2170
	11	\$755	\$1321	11	\$2415
	12	\$837	\$1464	12	\$2660

Both Arms *Ships in two cartons.

HON Recommendation: HASHB3.B.PURL__KMD.DW__ - List Price \$5471

HOW TO SPECIFY

<p>Select Model Number</p> <p>H A S H B 3 M F .</p>	<p>Select Arm Type</p> <p>N Armless L Left Side (+ \$450) R Right Side (+ \$450) B Both Side Screens (+ \$900)</p> <p>B .</p>	<p>Select Fabric</p> <p>See page 263 Specify for Single Fabric model only</p> <p>P B L E 0 7 .</p>	<p>Select Seat Cushion Fabric</p> <p>See page 263 Specify for MF model only</p> <p>P B L E 0 9 .</p>	<p>Select Back and Frame Fabric</p> <p>See page 263 Specify for MF model only</p> <p>P B L E 0 6 .</p>	<p>Select Screen Knit or Fabric</p> <p>Knit Options: KLT Light KMD Medium KDK Dark See page 263 for all options</p> <p>K M D .</p>	<p>Select Leg and Color</p> <p>DW Dowel Wood PM Post Metal (+ \$50) SW Sled Wood (+ \$100) See page 263 for colors</p> <p>P M P 8 V</p>
--	--	---	---	---	---	--

SEATING

ASTIR™ Collaborative Work Seating

OPEN MARKET



Icon Legend on page 19

HASLBTC

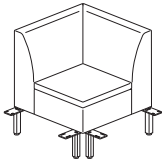

TRUE CORNER LOUNGE — LOW-BACK

DIMENSIONS

Depth:	29	Back Height:	16
Height:	32	Back Width:	29
Width:	29	Ship Weight:	90
Usable Seat Depth:	19¾	Cube:	21.2
Seat to Floor Height:	18¾	COM:	See page 263
Seat Width:	20¼	Weight Rating:	300 lbs.

FABRIC PRICE CODES

1	\$2070	8	\$2708
2	\$2147	9	\$2810
3	\$2223	10	\$2912
4	\$2300	11	\$3014
5	\$2402	12	\$3116
6	\$2504	L	—
7	\$2606		

NOTES: True Corner uses legs from adjacent units, and can work with all leg styles. For adjacent units with sled legs, pick a single leg option for the True Corner rear leg.

- ! True Corner designed to act as a corner between two adjacent units, not as a stand-alone unit.
- ! True Corner leg selection refers to back corner leg only, and ships with only that leg.

HASLBTCMF

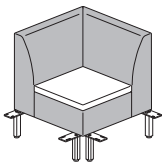

TRUE CORNER LOUNGE — LOW-BACK, MULTI-FABRIC

DIMENSIONS

Depth:	29	Back Height:	16
Height:	32	Back Width:	29
Width:	29	Ship Weight:	90
Usable Seat Depth:	19¾	Cube:	21.2
Seat to Floor Height:	18¾	COM:	See page 263
Seat Width:	20¼	Weight Rating:	300 lbs.

FABRIC PRICE CODES

1	\$2220	
<i>Add to Base Price Above</i>		
	Seat	Frame/Back
2	\$15	\$61
3	\$31	\$122
4	\$46	\$184
5	\$66	\$265
6	\$87	\$347
7	\$107	\$429
8	\$128	\$510
9	\$148	\$592
10	\$168	\$673
11	\$189	\$755
12	\$209	\$837

NOTES: True Corner uses legs from adjacent units, and can work with all leg styles. For adjacent units with sled legs, pick a single leg option for the True Corner rear leg.

- ! True Corner designed to act as a corner between two adjacent units, not as a stand-alone unit.
- ! True Corner leg selection refers to back corner leg only, and ships with only that leg.

HON Recommendation: HASLBTC.PURL__DW__ - List Price \$2223

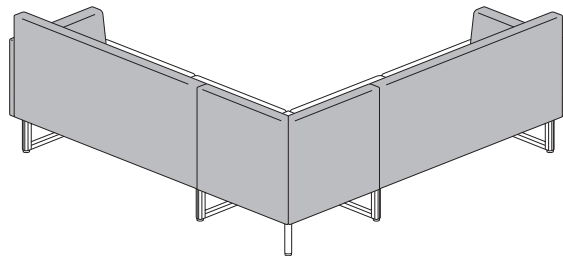
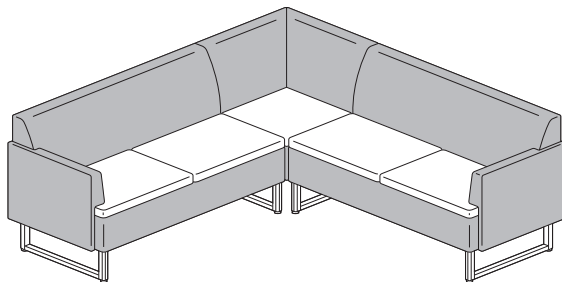

SEATING

HOW TO SPECIFY

Select Model Number

Select Fabric

See page 263
Specify for Single Fabric model only

Select Seat Cushion Fabric

See page 263
Specify for MF model only

Select Back and Frame Fabric

See page 263
Specify for MF model only

Select Leg and Color

DW Dowel Wood
PM Post Metal (+ \$50)
See page 263 for colors

HASLBTCMF .

PBLE07 .

PBLE09 .

PBLE06 .

PMP8V



ASTIR™ Collaborative Work Seating

HASHBTC

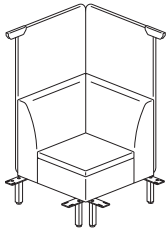

TRUE CORNER LOUNGE — HIGH-BACK SCREEN

DIMENSIONS

Depth:	29¾	Back Height:	16
Height:	54	Back Width:	29
Width:	29¾	Ship Weight:	119
Usable Seat Depth:	19¾	Cube:	28.1
Seat to Floor Height:	18¾	COM:	See page 263
Seat Width:	20¼	Weight Rating:	300 lbs.

FABRIC PRICE CODES

1 \$2850			
<i>Add to Base Price Above</i>			
	Unit	Knit	Screen
1	—	1	\$150
2	\$77	2	\$242
3	\$153	3	\$334
4	\$230	4	\$426
5	\$332	5	\$548
6	\$434	6	\$670
7	\$536	7	\$793
8	\$638	8	\$915
9	\$740	9	\$1038
10	\$842	10	\$1160
11	\$944	11	\$1283
12	\$1046	12	\$1405

NOTES: True Corner uses legs from adjacent units, and can work with all leg styles. For adjacent units with sled legs, pick a single leg option for the True Corner rear leg.

- ❗ True Corner designed to act as a corner between two adjacent units, not as a stand-alone unit.
- ❗ True Corner leg selection refers to back corner leg only, and ships with only that leg.

HASHBTCMF

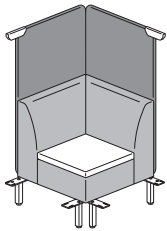

TRUE CORNER LOUNGE — HIGH-BACK SCREEN, MULTI-FABRIC

DIMENSIONS

Depth:	29¾	Back Height:	16
Height:	54	Back Width:	29
Width:	29¾	Ship Weight:	119
Usable Seat Depth:	19¾	Cube:	28.1
Seat to Floor Height:	18¾	COM:	See page 263
Seat Width:	20¼	Weight Rating:	300 lbs.

FABRIC PRICE CODES

1 \$3000			
<i>Add to Base Price Above</i>			
	Seat	Back/Frame	Knit Screen
1	—	—	1 \$150
2	\$15	\$61	2 \$242
3	\$31	\$122	3 \$334
4	\$46	\$184	4 \$426
5	\$66	\$265	5 \$548
6	\$87	\$347	6 \$670
7	\$107	\$429	7 \$793
8	\$128	\$510	8 \$915
9	\$148	\$592	9 \$1038
10	\$168	\$673	10 \$1160
11	\$189	\$755	11 \$1283
12	\$209	\$837	12 \$1405

NOTES: True Corner uses legs from adjacent units, and can work with all leg styles. For adjacent units with sled legs, pick a single leg option for the True Corner rear leg.

- ❗ True Corner designed to act as a corner between two adjacent units, not as a stand-alone unit.
- ❗ True Corner leg selection refers to back corner leg only, and ships with only that leg.

HON Recommendation: HASHBTC.PURL___.KMD.DW__ - List Price \$3003

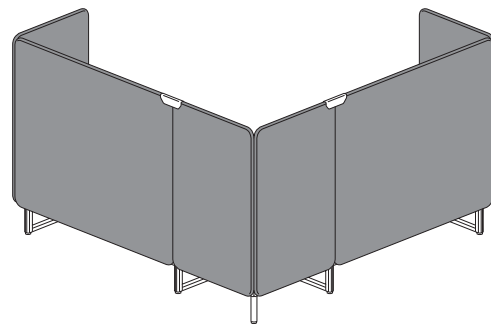
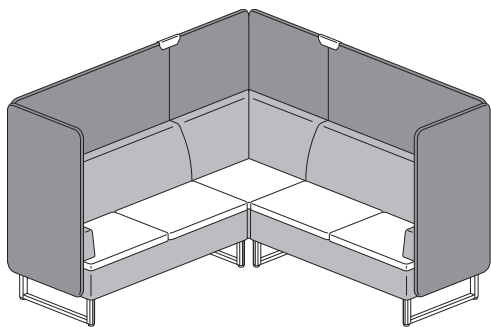

HOW TO SPECIFY

<p>Select Model Number</p> <p>H A S H B T C M F .</p>	<p>Select Fabric</p> <p>See page 263 <i>Specify for Single Fabric model only</i></p> <p>P B L E 0 7 .</p>	<p>Select Seat Cushion Fabric</p> <p>See page 263 <i>Specify for MF model only</i></p> <p>P B L E 0 9 .</p>	<p>Select Back and Frame Fabric</p> <p>See page 263 <i>Specify for MF model only</i></p> <p>P B L E 0 6 .</p>	<p>Select Screen Knit or Fabric</p> <p>Knit Options: KLT Light KMD Medium KDK Dark See page 263 for all options</p> <p>K M D .</p>	<p>Select Leg and Color</p> <p>DW Dowel Wood PM Post Metal (+ \$50) See page 263 for colors</p> <p>P M P 8 V</p>
--	--	--	--	--	---

SEATING

ASTIR™ Collaborative Work Seating

OPEN MARKET



Icon Legend on page 19

HASB2

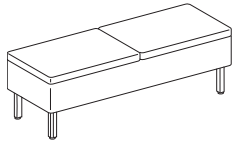

TWO-SEAT BENCH

DIMENSIONS

Depth:	20¼	Seat Width:	56¼
Height:	19	Ship Weight:	46
Width:	56½	Cube:	8.7
Usable Seat Depth:	20¼	COM:	See page 263
Seat to Floor Height:	18¾	Weight Rating:	300 lbs. (per seat)

FABRIC PRICE CODES

1	\$2000	8	\$2574
2	\$2069	9	\$2666
3	\$2138	10	\$2758
4	\$2207	11	\$2849
5	\$2298	12	\$2941
6	\$2390	L	—
7	\$2482		

HASB2MF

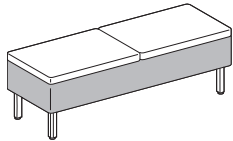

TWO-SEAT BENCH, MULTI-FABRIC

DIMENSIONS

Depth:	20¼	Seat Width:	56¼
Height:	19	Ship Weight:	46
Width:	56½	Cube:	8.7
Usable Seat Depth:	20¼	COM:	See page 263
Seat to Floor Height:	18¾	Weight Rating:	300 lbs. (per seat)

FABRIC PRICE CODES

1	\$2150
<i>Add to Base Price Above</i>	
	Seat Frame
2	\$46 \$31
3	\$92 \$61
4	\$138 \$92
5	\$199 \$133
6	\$260 \$173
7	\$321 \$214
8	\$383 \$255
9	\$444 \$296
10	\$505 \$337
11	\$566 \$378
12	\$628 \$418

HON Recommendation: HASB2.PURL__DW__ - List Price \$2138

SEATING

HOW TO SPECIFY

<p>Select Model Number</p> <p>See page 263</p> <p><i>Specify for Single Fabric model only</i></p>	<p>Select Fabric</p> <p>See page 263</p> <p><i>Specify for Single Fabric model only</i></p>	<p>Select Seat Cushion Fabric</p> <p>See page 263</p> <p><i>Specify for MF model only</i></p>	<p>Select Frame Fabric</p> <p>See page 263</p> <p><i>Specify for MF model only</i></p>	<p>Select Leg and Color</p> <p>DW Dowel Wood PM Post Metal (+ \$50) SW Sled Wood (+ \$100) See page 263 for colors</p>
<p>H A S B 2 M F .</p>	<p>P B L E 0 7 .</p>	<p>P B L E 0 9 .</p>	<p>P B L E 0 6 .</p>	<p>P M P 8 V</p>



HASB3

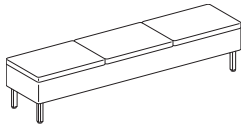

THREE-SEAT BENCH

DIMENSIONS

Depth:	20¼	Seat Width:	84½
Height:	19	Ship Weight:	61
Width:	84½	Cube:	12.2
Usable Seat Depth:	20¼	COM:	See page 263
Seat to Floor Height:	18¾	Weight Rating:	300 lbs. (per seat)

FABRIC PRICE CODES

1	\$2500	8	\$3393
2	\$2607	9	\$3536
3	\$2714	10	\$3679
4	\$2821	11	\$3821
5	\$2964	12	\$3964
6	\$3107	L	—
7	\$3250		

HASB3MF

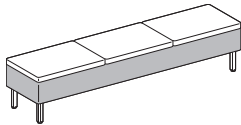

THREE-SEAT BENCH, MULTI-FABRIC

DIMENSIONS

Depth:	20¼	Seat Width:	84½
Height:	19	Ship Weight:	61
Width:	84½	Cube:	12.2
Usable Seat Depth:	20¼	COM:	See page 263
Seat to Floor Height:	18¾	Weight Rating:	300 lbs. (per seat)

FABRIC PRICE CODES

1	\$2650		
<i>Add to Base Price Above</i>			
	Seat	Frame	
2	\$61	\$38	
3	\$122	\$77	
4	\$184	\$115	
5	\$265	\$166	
6	\$347	\$217	
7	\$429	\$268	
8	\$510	\$319	
9	\$592	\$370	
10	\$673	\$421	
11	\$755	\$472	
12	\$837	\$523	

HON Recommendation: HASB3.PURL___.DW__ - List Price \$2714

HOW TO SPECIFY

<p>Select Model Number</p> <p>HASB3MF</p>	<p>Select Fabric</p> <p>See page 263 <i>Specify for Single Fabric model only</i></p> <p>PBLE07</p>	<p>Select Seat Cushion Fabric</p> <p>See page 263 <i>Specify for MF model only</i></p> <p>PBLE09</p>	<p>Select Frame Fabric</p> <p>See page 263 <i>Specify for MF model only</i></p> <p>PBLE06</p>	<p>Select Leg and Color</p> <p>DW Dowel Wood PM Post Metal (+ \$50) SW Sled Wood (+ \$100) See page 263 for colors</p> <p>PMP8V</p>
--	---	---	--	--

ASTIR™ Collaborative Work Seating

OPEN MARKET



Icon Legend on page 19

HASPSS

POUF

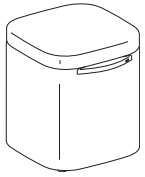

DIMENSIONS

Depth:	17¼	Seat Width:	16½
Height:	18¾	Ship Weight:	25
Width:	16½	Cube:	3.5
Usable Seat Depth:	16½	COM:	See page 263
Seat to Floor Height:	17½	Weight Rating:	300 lbs. (per seat)

FABRIC PRICE CODES

1	\$595	8	\$786
2	\$618	9	\$817
3	\$641	10	\$848
4	\$664	11	\$878
5	\$694	12	\$909
6	\$725	L	—
7	\$756		

HASPSSMF

POUF, MULTI-FABRIC

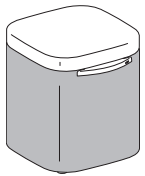

DIMENSIONS

Depth:	17¼	Seat Width:	16½
Height:	18¾	Ship Weight:	25
Width:	16½	Cube:	3.5
Usable Seat Depth:	16½	COM:	See page 263
Seat to Floor Height:	17½	Weight Rating:	300 lbs. (per seat)

FABRIC PRICE CODES

1	\$745	
<i>Add to Base Price Above</i>		
	Seat	Frame
2	\$15	\$31
3	\$31	\$61
4	\$46	\$92
5	\$66	\$133
6	\$87	\$173
7	\$107	\$214
8	\$128	\$255
9	\$148	\$296
10	\$168	\$337
11	\$189	\$378
12	\$209	\$418

HON Recommendation: HASPSS.PURL__H.BL - List Price \$641

SEATING

HOW TO SPECIFY

<p>Select Model Number</p> <p>H A S P S S .</p>	<p>Select Fabric</p> <p>See page 263</p> <p>P B L E 0 7 .</p>	<p>Select Leg and Color</p> <p>HG Hidden Glide H Caster</p> <p>H G .</p>	<p>Select Handle Color</p> <p>BL Black Handle</p> <p>B L</p>
---	---	--	--

HOW TO SPECIFY

<p>Select Model Number</p> <p>H A S P S S M F .</p>	<p>Select Seat Cushion Fabric</p> <p>See page 263</p> <p>P B L E 0 7 .</p>	<p>Select Frame Fabric</p> <p>See page 263</p> <p>P B L E 0 6 .</p>	<p>Select Leg and Color</p> <p>HG Hidden Glide H Caster</p> <p>H G .</p>	<p>Select Handle Color</p> <p>BL Black Handle</p> <p>B L</p>
---	--	---	--	--



ASTIR™ Collaborative Work Seating

HASSP

HIGH-BACK SCREEN — SIDE PRIVACY

DIMENSIONS

Ship Weight: 3.2
 Cube: 3.2
 COM: 3.0

LIST PRICE

Knit \$1500

1	\$1550	7	\$1881
2	\$1596	8	\$1933
3	\$1642	9	\$1994
4	\$1688	10	\$2055
5	\$1749	11	\$2116
6	\$1810	12	\$2178

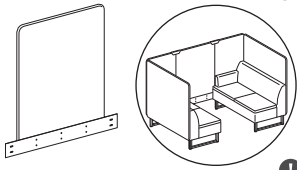

ⓘ Requires High-Back Screen units with arms on each unit.

HASGBSL

SHARED LEG GANGING BRACKET

DIMENSIONS

Ship Weight: 4
 Cube: 0.1

LIST PRICE

\$200

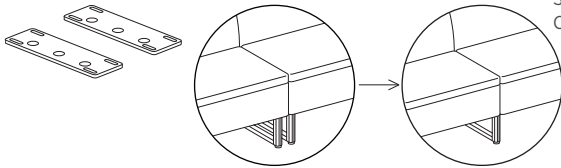

NOTES: Uses existing legs on units being ganged. No specification needed.
SPECIFYING EXAMPLE: HASGBSL

HASSGC

SCREEN GANGING CLIP

DIMENSIONS

Ship Weight: 1
 Cube: 0.1

LIST PRICE

\$100

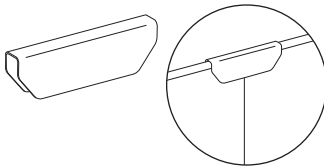

ⓘ Required when ganging multiple high-back units together.
 ⓘ Already included on individual units where applicable.



HOW TO SPECIFY

<p>Select Model Number</p> <p>HASSP.</p>	<p>Select Screen Knit or Fabric</p> <p>Knit Options: KLT Light KMD Medium KDK Dark See page 263 for all options</p> <p>KMD</p>
---	--

HOW TO SPECIFY

<p>Select Model Number</p> <p>HASSGC.</p>	<p>Select Paint Color</p> <p>P7A Textured Charcoal</p> <p>P7A</p>
--	---

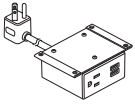

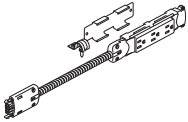
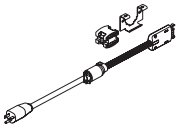
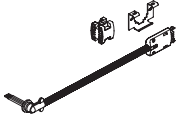
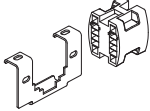
	DESCRIPTION	MODEL	SHIP WEIGHT	CUBE	LIST PRICE
	Miki Under-Mount Power Module <ul style="list-style-type: none"> Includes 6' cord with three-prong plug. 1 Receptacle, 2 USB Available in STRM Storm and SNW Snow. SPECIFYING EXAMPLE: HUMPWR-1P-2U.STRM	HUMPWR-1P-2U	2	0.6	\$178
	Vesta Mobile Power Station <ul style="list-style-type: none"> Includes 10' retractable cord with three-prong plug. 3 AC, 1 Dual USB-A, 1 USB-C at top Specify Paint and Plastic. SPECIFYING EXAMPLE: HPWRMOB1.BLK.STRM	HPWRMOB1	14	3.3	\$1029
	Triplex Electrical Harness 48"W, Circuit 1 60"W, Circuit 1 72"W, Circuit 1 48"W, Circuit 2 60"W, Circuit 2 72"W, Circuit 2	HTPKIT48 HTPKIT60 HTPKIT72 HTPKIT482 HTPKIT602 HTPKIT722	5 5 5 5 5 5	0.3 0.3 0.3 0.3 0.3 0.3	\$200 \$205 \$210 \$200 \$205 \$210
	Triplex Corded In-Feed 48"W Corded In-feed 72"W Corded In-feed NOTES: Corded in-feed ships with (1) 4-way splitter, (1) 4-way splitter mounting bracket, (1) conduit clip, and (1) in-feed. Utilizes standard 3-prong plug for easy setup and installation. Use with circuit 1 harnesses only. Corded in-feed not UL listed.	HTPCIF48 HTPCIF72	5 5	0.3 0.3	\$260 \$275
	Triplex Hardwire In-Feed 48"W Hardwire In-feed NOTES: Hardwire in-feed ships with (1) 4-way splitter, (1) 4-way splitter mounting bracket, (1) conduit clip, and (1) in-feed. Hardwire in-feed must be installed by a licensed electrician.	HTPHWIF72	5	0.3	\$225
	Triplex 4-Way Splitter 4-Way Splitter NOTES: 4-way splitter utilized in instances where one power harness feeds into 2-3 power harnesses.	HTPSPLIT	5	0.3	\$68

NOTES:

- Triplex is a 4-trac system with 3 connected simplexes per harness.
- Choose either a corded or hardwire in-feed.
- UL listed as a manufactured wiring system (UL 183) when hardwire in-feed is used.
- cUL Certified for Canada with hardwire in-feed.
- Hardwire in-feed complies with municipal standards such as in New York, Los Angeles, and San Francisco. However, it is customer's responsibility to verify local code compliance.
- Plug in any standard 2- or 3-prong plug accessory to triplex simplexes to get power to where you need it most.

HOW TO SPECIFY

Select Model Number <div style="border: 1px solid black; padding: 2px; display: inline-block;">H P W R M O B 1 .</div>	Select Exterior Paint Color <i>Specify for model HPWRMOB1 only</i> FOG Fog STRM Storm BLK Black SNW Snow <div style="border: 1px solid black; padding: 2px; display: inline-block;">B L K .</div>	Select Paint Color <i>Specify for model HPWRMOB1 only</i> FOG Fog STRM Storm BLK Black SNW Snow <div style="border: 1px solid black; padding: 2px; display: inline-block;">S T R M</div>
--	--	---

BODA™



Shown with 10700 Series™ desks.

BODA™

Look cool. Stay cool. Boda task chairs rely on breathable mesh that increases airflow to prevent hot spots and maximize comfort. Each high-back task chair features a mesh back with a choice of mesh seat or upholstered seat for maximum comfort. To take the comfort to an even higher level, the 2-to-1 synchro-tilt recline control provides a stable, comfortable ride, making it perfect for executive offices and meeting spaces.



FEATURES

- Breathable mesh back delivers all-day comfort.
- Mesh seat option is breathable and offers all-day support.
- Upholstered seat option includes ample foam cushioning.
- Responsive synchro-tilt control provides a smooth, natural recline.
- Arms move up or down for shoulder and upper body support.
- Tilt tension controls the rate and ease of recline.
- Tilt lock allows the user to lock out the tilt function.
- One-touch seat height adjustment easily moves the seat up and down.
- 360-degree swivel provides freedom of movement in any direction.
- Warranted for users up to 275 lbs.

HMH01



TASK CHAIR

High-back
 Pneumatic
 Synchro-tilt
 Tilt Tension
 Tilt Lock
 Height-adjustable Arms
 Mesh Sandwich Fabric Seat and Mesh Back

Functions: **A, E, J, K, L, Q**
 (Function Key on pages 244-245)

NOTES: Model HMH01 available with Black Mesh back and Black Sandwich Mesh fabric seat.

! Titanium frame only available on both models.

DIMENSIONS

Depth:	35½	Arm Width:	19¼
Width:	27¾	Seat to Floor Height:	18¼-22½
Height:	44	Usable Seat Depth:	17⅞
Seat Depth:	17⅞	Ship Weight:	43
Seat Width:	20¾	Cube:	5.1
Back Width:	19¾	Weight Rating:	275 lbs.
Back Height:	24¼		

LIST PRICE

\$879

HMH02



TASK CHAIR

High-back
 Pneumatic
 Synchro-tilt
 Tilt Tension
 Tilt Lock
 Height-adjustable Arms
 Mesh Seat and Back

Functions: **A, E, J, K, L, Q**
 (Function Key on pages 244-245)

NOTES: HMH02 available with Black Mesh seat and back.

! Titanium frame only available on both models.

DIMENSIONS

Depth:	35½	Arm Width:	17½
Width:	27	Seat to Floor Height:	18½-22¾
Height:	44¼	Usable Seat Depth:	18¼
Seat Depth:	18¼	Ship Weight:	44
Seat Width:	20	Cube:	5.1
Back Width:	19¾	Weight Rating:	275 lbs.
Back Height:	24¾		

LIST PRICE

\$1014

HON Recommendation: HMH01.MM10.C - List Price \$879

HOW TO SPECIFY

<p>Select Model Number</p> <p>HMH01</p>	<p>Select Seat</p> <p>MM10 Black Sandwich Mesh — (HMH01 ONLY) MST1 Black Mesh — (HMH02 ONLY)</p> <p>MM10</p>	<p>Select Frame</p> <p>C Titanium</p> <p>C</p>
--	--	--

CAMBIA™ 2160 SERIES



Cambia Upholstered Back Guest Chairs shown with Preside® table.

CAMBIA™ 2160 SERIES

Cambia's comfort and style is a warm invitation for any guest or coworker. With two back variations and arm options, this is a guest chair collection designed to adapt. Each back option offers a choice of a wood slat design or upholstered panel to suit any space or personal taste. Choose from eight rich hardwood finishes and hundreds of quality HON fabrics to express your style and reflect your brand.



FEATURES

- Wood slat back panel complements a variety of surroundings.
- Upholstered seat and back features cushioning for additional comfort and support.
- Personalize your space with a choice of back styles.
- Fixed arms enhance take pressure off the upper body and shoulders.
- Solid hardwood in one of eight attractive finishes.
- Available in hundreds of quality HON fabrics.
- Warranted for users up to 250 lbs.

CAMBIA™ 2160 Series Options

MODEL OPTIONS

H2164



Guest Chair

Upholstered Back, Leg Base,
Arch Arms

H2165



Guest Chair

Wood Slat Back, Leg Base,
Arch Arms

AVAILABLE FINISHES

Cambia™ 2160 Series Seating is available in 8 wood finishes.

WOOD FINISHES

Bourbon Cherry (H)

Cognac (COGN)

Harvest (C)

Mahogany (N)

Mocha (MOCH)

Natural Maple (D)

Pinnacle (PINC)

Shaker Cherry (F)

HON BRANDED FABRICS

GRADE 1

Apex
Attire
Centurion
Compass
Contourett
Dapper
Ensemble
Hamilton
Inertia
Optic
Pebble

GRADE 2

Appoint Seating
Blume
Clyde
Dotty
Rush
Seed
Spin
Whisper Vinyl

GRADE 3

In Season
Moxie
Parker
Purl
Quill

GRADE L

Denver Leather

For a complete list of fabrics, including partnership fabrics, go to hon.com/fabricsandfinishes.

Reference Fabric Color Combinations on pages 20-24 for color codes and legend on page 21 for lead times. For additional HON to Supply COM fabric grade pricing, go to honready.hon.com and click on the HON to Supply COM link.

 For Fire Code model, availability and ordering method, refer to pages 248-251. Available on select models, contact HON Customer Support for availability.



CAMBIA™ 2160 Series

H2164



GUEST CHAIR

Upholstered Back
Leg Base
Arch Arms

DIMENSIONS

Depth:	24¼	Arm Width:	19
Width:	21¾	Seat to Floor Height:	19
Height:	31¾	Usable Seat Depth:	21
Seat Depth:	21	Ship Weight:	30
Seat Width:	21¾	Cube:	22.6
Back Width:	21¾	COM:	1.5
Back Height:	13¾	Weight Rating:	250 lbs.

FABRIC PRICE CODES

1	\$734	8	\$1079
2	\$794	9	\$1124
3	\$854	10	\$1169
4	\$899	11	\$1214
5	\$944	12	\$1259
6	\$989	L	\$1234
7	\$1034		

H2165



GUEST CHAIR

Wood Slat Back
Leg Base
Arch Arms

DIMENSIONS

Depth:	24¼	Arm Width:	19
Width:	21¾	Seat to Floor Height:	19
Height:	31¾	Usable Seat Depth:	21
Seat Depth:	21	Ship Weight:	30
Seat Width:	21¾	Cube:	22.6
Back Width:	21¾	COM:	1.3
Back Height:	13¾	Weight Rating:	250 lbs.

FABRIC PRICE CODES

1	\$773	8	\$980
2	\$809	9	\$1007
3	\$845	10	\$1034
4	\$872	11	\$1061
5	\$899	12	\$1088
6	\$926	L	\$1073
7	\$953		

HON Recommendation: H2164.MOCH.CU__ - List Price \$734

HOW TO SPECIFY

<p>Select Model Number</p> <p>H 2 1 6 4 .</p>	<p>Select Finish</p> <p>See page 280</p> <p>M O C H .</p>	<p>Select Fabric</p> <p>See page 280</p> <p>C U 1 0 .</p>
--	--	--



Task Seating shown with Coordinate™ and Flock®.

CERES®

Seating is personal. At the same time, it's also universal. Ceres is designed to bridge that gap by creating a holistic seating family that allows everyone to stay in control of their own comfort. As the result of exhaustive ergonomic research, the stunning Ceres collection of task and guest chairs feature total support for anyone and any space. The comfort contours cradle you throughout the workday, while projecting the right personality for your brand.



GUEST FEATURES

- 4-Way Stretch mesh back is available in seven colors.
- Model HCG6 is a four-leg multi-purpose chair with a pivoting back for added comfort.
- Model HCG6 stacks up to four high on the floor.
- Guest chairs are available with or without arms.
- Available in dual fabric.
- Warranted for users up to 300 lbs.

TASK CHAIR FEATURES

- Height- and width-adjustable arms provide a custom fit.
- Seat depth adjustment adapts to users of various heights.
- One-touch seat height adjustment easily moves the seat up and down.
- Tilt tension controls the rate and ease of recline.
- Tilt lock allows the user to lock the back in multiple recline positions.
- Warranted for users up to 300 lbs.

CERES® Task Chair Options



MODEL OPTION



HCW1







Task Chair

Pneumatic, Swivel, Synchro-tilt,
Seat Glide Tilt Tension, Height,
Width and Depth Adjustable Arms

ARM STYLE	CODE	DESCRIPTION	PRICE
	ABLCK	Textured Black	+\$0
	APLAT	Textured Platinum Metallic	+\$0
	APA	Polished Aluminum	+\$50

CASTERS	CODE	DESCRIPTION	PRICE
	H	Black Hard Caster	+\$0
	S	Black All-Surface Caster	+\$30

BACK STYLE	CODE	DESCRIPTION	PRICE
	PB	Upholstered in-back	+\$0
<i>4-Way Stretch options:</i>			
	IM	Black	+\$0
	IB	Breeze	+\$0
	IK	Brownstone	+\$0
	IH	Chai *	+\$0
	IC	Charcoal	+\$0
	IF	Fog	+\$0
	IY	Navy *	+\$0
	IR	Regatta	+\$0
	IT	Titanium	+\$0

BASE	CODE	DESCRIPTION	PRICE
	SB	Standard Base	+\$0
	PA	Polished Aluminum	+\$110

FRAME	CODE	DESCRIPTION	PRICE
	T	Black	+\$0

* Fabric is de-emphasized.

SEATING

CERES® Multi-Purpose Chair Options

MODEL OPTION

HCG6



Multi-Purpose

Four-leg stacking frame with pivoting back

HCG6DF - Dual Fabric



Multi-Purpose

Four-leg stacking frame with pivoting back

ARM STYLE

CODE	DESCRIPTION	PRICE
N	Armless	+\$0
F	Fixed Arms	+\$55



BACK STYLE

CODE	DESCRIPTION	PRICE
PB	Upholstered in-back	+\$0



4-Way Stretch options:

IM	Black	+\$0
IB	Breeze	+\$0
IK	Brownstone	+\$0
IH	Chai *	+\$0
IC	Charcoal	+\$0
IF	Fog	+\$0
IY	Navy *	+\$0
IR	Regatta	+\$0
IT	Titanium	+\$0



CASTERS/ GLIDE

CODE	DESCRIPTION	PRICE
H	Black Hard Caster	+\$0
S	Black All-Surface Caster	+\$20
E	Glide	+\$0



FRAME

CODE	DESCRIPTION	PRICE
BLCK	Textured Black Mica	+\$0
PLAT	Textured Platinum Metallic	+\$0

SEATING

* Fabric is de-emphasized.

HON BRANDED FABRICS

GRADE 1	GRADE 2	GRADE 3	GRADE L
Apex	Appoint Seating	In Season	Denver Leather*
Attire	Blume	Moxie	
Centurion	Clyde	Parker	
Compass	Dotty	Purl	
Contourett	Rush	Quill	
Dapper	Seed		
Ensemble	Spin		
Hamilton	Whisper Vinyl		
Inertia			
Optic			
Pebble			

For a complete list of fabrics, including partnership fabrics, go to hon.com/fabricsandfinishes.

Reference Fabric Color Combinations on pages 20-24 for color codes and legend on page 21 for lead times. For additional HON to Supply COM fabric grade pricing, go to honready.hon.com and click on the HON to Supply COM link.

*Denver Leather (SS) may not be available on every model within a specific series, please refer to the model's page for details.

 For Fire Code model, availability and ordering method, refer to pages 248-251. Available on select models, contact HON Customer Support for availability.



HCW1



TASK CHAIR

- Pneumatic
- Swivel
- Synchro-tilt
- Seat Glide Tilt Tension
- Height, Width and Depth
- Adjustable Arms

Functions:
A, D, E, A-C, A-D, B-A
 (Function Key on pages 244-245)

DIMENSIONS

Depth:	27¾	Seat to Floor Height:	17-21½
Width:	27½	Usable Seat Depth:	17-19½
Height:	43⅞	Ship Weight (upholstered back):	39
Seat Depth:	19	Ship Weight (mesh back):	39
Seat Width:	20	Cube (upholstered back):	11.3
Back Width:	16½	Cube (mesh back):	11.3
Back Height:	22½	COM (upholstered back):	1.0
Arm Width:	17½-21	COM (mesh back):	1.0
		Weight Rating:	300 lbs.

FABRIC PRICE CODES

1	\$1334	8	\$1472
2	\$1358	9	\$1490
3	\$1382	10	\$1508
4	\$1400	11	\$1526
5	\$1418	12	\$1544
6	\$1436	L	\$1534
7	\$1454		

HON Recommendation: HCW1.ABLCK.H.IM.CU__SB.T - List Price \$1334

HOW TO SPECIFY

Select Model Number	Select Arm Option	Select Caster/Glide	Select Back Option	Select Fabric	Select Base	Select Frame
HCW1	Adjustable Arms Finishes ABLCK Textured Black APLAT Textured Platinum Metallic APA Polished Aluminum (+ \$50)	H Black Hard Caster S Black All-Surface Caster (+ \$30)	PB Upholstered in-back Mesh Back Options IM Black IB Breeze IK Brownstone IH Chai * IC Charcoal IF Fog IY Navy * IR Regatta IT Titanium	See page 285	SB Standard Base PA Polished Aluminum (+ \$110)	T Black
HCW1	ABLCK	H	IM	CU10	SB	T

* Fabric is de-emphasized.



HCG6

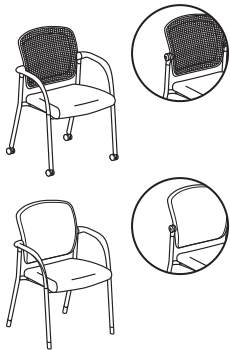

MULTI-PURPOSE

Four-leg stacking frame with pivoting back

DIMENSIONS

Depth:	25	Seat to Floor Height:	18¾
Width:	24½	Usable Seat Depth:	17¼
Height:	35	Ship Weight (upholstered back):	22
Seat Depth:	19½	Ship Weight (mesh back):	22
Seat Width:	20	Cube (upholstered back):	15.2
Back Width:	17½	Cube (mesh back):	15.2
Back Height:	17	COM (upholstered back):	1.0
Arm Width:	20¼	COM (mesh back):	1.0
		Weight Rating:	300 lbs.

FABRIC PRICE CODES

1	\$545	8	\$683
2	\$569	9	\$701
3	\$593	10	\$719
4	\$611	11	\$737
5	\$629	12	\$755
6	\$647	L	\$745
7	\$665		

NOTES: Multi-purpose model HCG6, with or without arms, stacks up to 4-high.

HON Recommendation: HCG6.F.H.IM.CU__BLCK - List Price \$600

HOW TO SPECIFY

Select Model Number	Select Arm Option	Select Caster/Glide	Select Back Option	Select Fabric	Select Frame
	F Fixed Arms (+ \$55) N Armless	E Glide H Black Hard Caster S Black All-Surface Caster (+ \$20)	PB Upholstered in-back Mesh Back Options IM Black IB Breeze IK Brownstone IH Chai * IC Charcoal IF Fog IY Navy * IR Regatta IT Titanium	See page 285	BLCK Textured Black Mica PLAT Textured Platinum Metallic
HCG6	F	H	IM	CU10	BLCK

* Fabric is de-emphasized.

HCG6DF

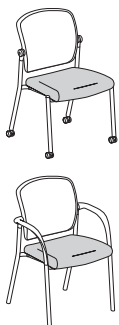

MULTI-PURPOSE

Dual Fabric
Four-leg stacking frame with pivoting back

DIMENSIONS

Depth:	25	Arm Width:	20¼
Width:	24½	Seat to Floor Height:	18¾
Height:	35	Usable Seat Depth:	17¼
Seat Depth:	19½	Ship Weight (upholstered back):	22
Seat Width:	20	Cube (upholstered back):	15.2
Back Width:	17½	COM (back):	0.8
Back Height:	17	COM (seat):	1.0
		Weight Rating:	300 lbs.

FABRIC PRICE CODES

1	\$620		
<i>Add to Base Price Above</i>			
		Back	Seat
2	\$18	\$24	
3	\$36	\$48	
4	\$50	\$66	
5	\$63	\$84	
6	\$77	\$102	
7	\$90	\$120	
8	\$104	\$138	
9	\$117	\$156	
10	\$131	\$174	
11	\$144	\$192	
12	\$158	\$210	
L	\$150	\$200	

NOTES: Multi-purpose model HCG6DF, with or without arms, stacks up to 4-high.

HON Recommendation: HCG6DF.F.H.PB.CU__CU__BLCK - List Price \$717

HOW TO SPECIFY

Select Model Number	Select Arm Option	Select Caster/Glide	Select Back Option	Select Back Fabric	Select Seat Fabric	Select Frame
	F Fixed Arms (+ \$55) N Armless	E Glide H Black Hard Caster S Black All-Surface Caster (+ \$20)	PB Upholstered in-back	See page 285	See page 285	BLCK Textured Black Mica PLAT Textured Platinum Metallic
HCG6DF	F	H	PB	CU22	CU10	BLCK

CHARGE™

OPEN MARKET



Icon Legend on page 19

HVL643



GUEST CHAIR

4-Leg Base
Padded Arms

DIMENSIONS

Depth:	28¼	Arm Width:	18½
Width:	24½	Seat to Floor Height:	19½
Height:	34½	Usable Seat Depth:	19½
Seat Depth:	19½	Ship Weight:	36
Seat Width:	19	Cube:	4.5
Back Width:	21¼	Weight Rating:	250 lbs.
Back Height:	18		

PRICE CODE

Leather **\$355**

NOTES: Black SofThread™ Leather with pleated stitching detail. Black frame. **HON 5-Year Limited Warranty.**

HON Recommendation: HVL643.SB11 - List Price \$355

SEATING

HOW TO SPECIFY

Select
Model Number

Select
Fabric

SB11 Black SofThread™ Leather

H V L 6 4 3 .

S B 1 1



HVL871

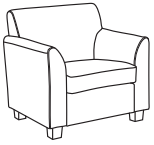

CLUB CHAIR

DIMENSIONS

Depth:	28¾	Arm Width:	21½
Width:	33	Seat to Floor Height:	18½
Height:	32	Usable Seat Depth:	21
Seat Depth:	21	Ship Weight:	51
Seat Width:	21½	Cube:	20.7
Back Width:	30	Weight Rating:	250 lbs.
Back Height:	18½		

PRICE CODE

Leather **\$1305**

NOTES: Legs available in Black. Legs ship unattached. Available in SB11 SofThread™ Leather only. **HON 5-Year Limited Warranty.**

HON Recommendation: HVL871.SB11 - List Price \$1305

HVL872

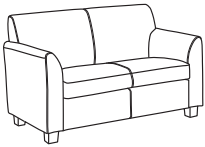

LOVE SEAT

DIMENSIONS

Depth:	28¾	Arm Width:	42
Width:	53½	Seat to Floor Height:	18½
Height:	32	Usable Seat Depth:	21
Seat Depth:	21	Ship Weight:	76
Seat Width:	42	Cube:	33.1
Back Width:	50	Weight Rating:	250 lbs.
Back Height:	18½		

PRICE CODE

Leather **\$1655**

NOTES: Legs available in Black. Legs ship unattached. Available in SB11 SofThread™ Leather only. **HON 5-Year Limited Warranty.**

HON Recommendation: HVL872.SB11 - List Price \$1655

HVL873

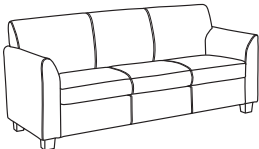

SOFA

DIMENSIONS

Depth:	28¾	Arm Width:	61½
Width:	73	Seat to Floor Height:	18½
Height:	32	Usable Seat Depth:	21
Seat Depth:	21	Ship Weight:	122
Seat Width:	61½	Cube:	45.0
Back Width:	70	Weight Rating:	250 lbs.
Back Height:	18½		

PRICE CODE

Leather **\$2068**

NOTES: Legs available in Black. Legs ship unattached. Available in SB11 SofThread™ Leather only. **HON 5-Year Limited Warranty.**

HON Recommendation: HVL873.SB11 - List Price \$2068

HOW TO SPECIFY

Select Model Number

Select Fabric

SB11 Black SofThread™ Leather

H V L 8 7 1 .

S B 1 1



HVL691



HIGH-BACK

Pneumatic
Swivel
Tilt
Tilt Tension
Tilt Lock
Fixed Padded Arms

Functions: **A, E, F, K, L**
(Function Key on pages 244-245)

DIMENSIONS

Depth:	28¾	Arm Width:	21
Width:	27	Seat to Floor Height:	18¾-21¾
Height:	47¼	Usable Seat Depth:	17¾
Seat Depth:	20¼	Ship Weight:	50
Seat Width:	21½	Cube:	7.2
Back Width:	21½	Weight Rating:	250 lbs.
Back Height:	27		

PRICE CODE

Leather \$598

NOTES: Black SofThread™ Leather. Sturdy textured black frame. Fixed padded loop arms. Built-in lumbar support. Use with coordinating Guest Chair model HVL693 shown below. **HON 5-Year Limited Warranty.**

HON Recommendation: HVL691.SB11 - List Price \$598

HVL693



GUEST CHAIR

Sled Base
Padded Arms

DIMENSIONS

Depth:	26	Arm Width:	18½
Width:	24¾	Seat to Floor Height:	18¼
Height:	33½	Usable Seat Depth:	18¼
Seat Depth:	18¼	Ship Weight:	38
Seat Width:	20¾	Cube:	5.2
Back Width:	21	Weight Rating:	250 lbs.
Back Height:	16¼		

PRICE CODE

Leather \$387

NOTES: Black SofThread™ Leather with tailored stitching detail. Sturdy textured black frame. Built-in lumbar support. Use with coordinating Executive Chair model HVL691 shown above. **HON 5-Year Limited Warranty.**

HON Recommendation: HVL693.SB11 - List Price \$387

HOW TO SPECIFY

Select Model Number

Select Fabric

SB11 Black SofThread™ Leather

H V L 6 9 1 .

S B 1 1



Cliq™ Seating shown with Preside® Table and Credenza.

CLIQ™

Some of the best work results from a collaborative effort. That's why Cliq brings people together. Designed with a weight-activated control that responds to your body and its movements, Cliq just gets you — providing instant comfort without a lot of adjustments. It's light-scaled for a modern look that's also easy to maneuver around wherever the group discussion takes you. Intuitive, stylish, and supportive — it just clicks with any collaborative environment.



FEATURES

- Intuitive functionality and design provides comfort and support without the need for multiple adjustments.
- Weight-activated control automatically adjusts to you as you sit.
- Thin profile provides a modern aesthetic, while a wide range of frame, mesh, and fabric choices ensures the perfect look within any space.
- 4-Way Stretch Mesh flexes in every direction to dynamically move with you.
- Choose between fixed arms or armless to get exactly the look you want.
- Available with a conference cylinder or task cylinder so you can choose the chair that best fits your space.
- One-touch seat height adjustment easily moves the seat up and down.
- Choose from 3 frame options: Black, Titanium, and Designer White.

CLIQ™ Fabric Options

HON BRANDED FABRICS

GRADE 1

Apex
Attire
Centurion
Compass
Contourett
Dapper
Ensemble
Hamilton
Inertia
Optic
Pebble

GRADE 2

Appoint Seating
Blume
Clyde
Dotty
Rush
Seed
Spin Seating
Whisper Vinyl

GRADE 3

In Season
Moxie
Parker
Purl
Quill

For a complete list of fabrics, including partnership fabrics, go to hon.com/fabricsandfinishes.

Reference Fabric Color Combinations on pages 20-24 for color codes and legend on page 21 for lead times.

 For Fire Code model, availability and ordering method, refer to pages 248-251. Available on select models, contact HON Customer Support for availability.



HCLQT



LIGHT TASK CHAIR

Mesh Back

- Pneumatic
- Swivel
- Synchro-tilt
- Weight-activated
- Tilt Lock

Functions: **A, E, J, L, P**
 (Function Key on pages 244-245)

DIMENSIONS

Depth:	27	Seat to Floor Height	
Width:	27	(Task Cylinder):	17-22
Height:	41	Seat to Floor Height	
Seat Depth:	17	(Conference Cylinder):	15 ⁵ / ₈ -19 ³ / ₈
Seat Width:	19 ¹ / ₄	Usable Seat Depth:	17
Back Width:	19 ¹ / ₄	Ship Weight:	45
Back Height:	21	Cube:	10.7
		Weight Rating:	300 lbs.

FABRIC PRICE CODES

1	\$595	8	\$733
2	\$619	9	\$751
3	\$643	10	\$769
4	\$661	11	\$787
5	\$679	12	\$805
6	\$697	L	—
7	\$715		

NOTES: When selecting the Conference Cylinder, the maximum arm height from floor is 28¹/₈".

HON Recommendation: HCLQT.W0.TC2.F.S.IT.CU__NL.SB.TI - List Price \$660

HOW TO SPECIFY

Select Model Number	Select Control Type	Select Cylinder	Select Arm Type	Select Caster	Select Back Option	Select Fabric	Select Lumbar	Select Base	Select Frame
W0 Weight-Activated	TC2 Task Cylinder CC1 Conference Cylinder	N Armless F Fixed (+ \$30)	S Black All-Surface Caster	IM Black IB Breeze IK Brownstone IC Charcoal IF Fog IR Regatta IT Titanium	See page 292	NL No Lumbar	SB Standard Base PA Polished Aluminum (+ \$110)	T Black TI Titanium (+ \$35) DW Designer White (+ \$35)	
HCLQT	W0	TC2	F	S	IT	CU19	NL	SB	TI

COMFORTASK® 5900 SERIES



ComforTask Chair shown with Metro Classic desks.

COMFORTASK® 5900 SERIES

What's in a name? If it's ComforTask, it's the support you need to get the job done. ComforTask seating is a proven office performer, with cushioning in all the right places, a waterfall seat edge and the customizable comfort that allows everyone to create a personal fit. Advanced controls such as back height and seat depth adjustments take the personalization to an even higher level, earning fans throughout the office.



FEATURES

- Back height adjustment moves the back up or down to provide a custom fit.
- Seat depth adjustment on model H5901 adapts to users of various heights.
- Contoured seat and back provide targeted support.
- Waterfall seat edge encourages leg circulation.
- One-touch seat height adjustment easily moves the seat up and down.
- 360-degree swivel provides freedom of movement in any direction.
- Molded polymer outer back for added durability.
- Available in hundreds of quality HON fabrics.
- Warranted for users up to 300 lbs.

COMFORTASK® 5900 Series Options

MODEL OPTIONS

H5901



Task Chair

Pneumatic, Back Height, Seat Depth, Swivel

H5902



Task Chair

Pneumatic, Back Height, Swivel, Tilt, Tilt Tension, Tilt Lock

H5903



Task Chair

Pneumatic, Back Height, Swivel, Multi-task

H5905



Task Stool

Pneumatic, Back Height, Swivel, Adjustable Height Footring

CASTERS/ GLIDE



CODE	DESCRIPTION	PRICE
H	Black Hard Caster	+\$0



S	Black All-Surface Caster	+\$30
----------	--------------------------	--------------



G	Bell Glide	+\$25
----------	------------	--------------

*G only available on model H5905

FRAME

CODE	DESCRIPTION	PRICE
T	Black	+\$0

COMFORTASK®

5900 Series Fabric Options

HON BRANDED FABRICS

GRADE 1

Apex
Attire
Centurion
Compass
Contourett
Dapper
Ensemble
Hamilton
Inertia
Optic
Pebble

GRADE 2

Appoint Seating
Blume
Clyde
Dotty
Rush
Seed
Spin
Whisper Vinyl

GRADE 3

In Season
Moxie
Parker
Purl
Quill

For a complete list of fabrics, including partnership fabrics, go to hon.com/fabricsandfinishes.

Reference Fabric Color Combinations on pages 20-24 for color codes and legend on page 21 for lead times. COM yardage shown is for Pattern Cut only. Contact Customer Service for Railroaded yardage requirements. For additional HON to Supply COM fabric grade pricing, go to honready.hon.com and click on the HON to Supply COM link.

 For Fire Code model, availability and ordering method, refer to pages 248-251. Available on select models, contact HON Customer Support for availability.



Icon Legend on page 19

COMFORTASK® 5900 Series

H5901



TASK

Pneumatic
Back Height
Seat Depth
Swivel
Functions: **A, B, C, E**
(Function Key on pages 244-245)

NOTES: Seat depth adjustment.

DIMENSIONS

Depth: 28¾" Seat to Floor Height: 14⅞"-19¾"
Width: 23" Usable Seat Depth: 16⅝"-18⅞"
Height: 38¼" Ship Weight: 30
Seat Depth: 18" Cube: 7.8
Seat Width: 20" COM: 1.0
Back Width: 16¼" Weight Rating: 300 lbs.
Back Height: 17¾"

FABRIC PRICE CODES

1	\$296	8	\$434
2	\$320	9	\$452
3	\$344	10	\$470
4	\$362	11	\$488
5	\$380	12	\$506
6	\$398	L	—
7	\$416		

H5902



TASK

Pneumatic
Back Height
Swivel
Tilt
Tilt Tension
Tilt Lock
Functions: **A, B, E, F, K, L**
(Function Key on pages 244-245)

DIMENSIONS

Depth: 27¾" Seat to Floor Height: 17-22
Width: 23" Usable Seat Depth: 16¾"
Height: 39¾" Ship Weight: 30
Seat Depth: 18" Cube: 7.8
Seat Width: 20" COM: 1.0
Back Width: 16¼" Weight Rating: 300 lbs.
Back Height: 21"

FABRIC PRICE CODES

1	\$316	8	\$454
2	\$340	9	\$472
3	\$364	10	\$490
4	\$382	11	\$508
5	\$400	12	\$526
6	\$418	L	—
7	\$436		

H5903



TASK

Pneumatic
Back Height
Swivel
Multi-task
Functions: **A, B, E, N**
(Function Key on pages 244-245)

DIMENSIONS

Depth: 34¼" Seat to Floor Height: 16¼"-20⅞"
Width: 24" Usable Seat Depth: 13¾"-17"
Height: 40½" Ship Weight: 32
Seat Depth: 18" Cube: 7.8
Seat Width: 20" COM: 1.0
Back Width: 16¼" Weight Rating: 300 lbs.
Back Height: 20¼"

FABRIC PRICE CODES

1	\$446	8	\$584
2	\$470	9	\$602
3	\$494	10	\$620
4	\$512	11	\$638
5	\$530	12	\$656
6	\$548	L	—
7	\$566		

HON Recommendation: H5901.H.CU__T with optional H5995 - List Price \$413

HOW TO SPECIFY

<p>Select Model Number</p> <p>H 5 9 0 1 .</p>	<p>Select Caster/Glide</p> <p>H Black Hard Caster S Black All-Surface Caster (+ \$30)</p> <p>H .</p>	<p>Select Fabric</p> <p>See page 296</p> <p>C U 1 0 .</p>	<p>Select Frame</p> <p>T Black</p> <p>T</p>
--	---	--	--

COMFORTASK® 5900 Series

GSA SIN 33721



Icon Legend on page 19

H5905



TASK STOOL

Pneumatic
Back Height
Swivel
Adjustable Height Footring
Functions: **A, B, E**
(Function Key on pages 244-245)

DIMENSIONS

Depth:	30	Seat to Floor Height:	21¾-31⅞
Width:	26¾	Footring Width:	20
Height:	49¾	Footring Height:	12-14½
Seat Depth:	18	Usable Seat Depth:	17
Seat Width:	20	Ship Weight:	34
Back Width:	16¼	Cube:	10.4
Back Height:	17¾	COM:	1.0
		Weight Rating:	300 lbs.

FABRIC PRICE CODES

1	\$431	8	\$569
2	\$455	9	\$587
3	\$479	10	\$605
4	\$497	11	\$623
5	\$515	12	\$641
6	\$533	L	—
7	\$551		

NOTES: Available with optional Bell Glides.

H5991



T-ARMS

Fixed Position

DIMENSIONS

Arm Width:	18¾
Height from Seat:	8½
Ship Weight:	6
Cube:	1.0

LIST PRICE

\$80

H5995



ADJUSTABLE HEIGHT ARMS

Functions: **Q**
(Function Key on pages 244-245)

DIMENSIONS

Arm Width:	18¾
Height from Seat:	6½-8¾
Ship Weight:	8
Cube:	0.6

LIST PRICE

\$117

HOW TO SPECIFY

<p>Select Model Number</p> <p>H 5 9 0 5 .</p>	<p>Select Caster/Glide</p> <p>H Black Hard Caster S Black All-Surface Caster (+ \$30)</p> <p>G Bell Glide (+ \$25) <i>Specify for model H5905 only</i></p> <p>H .</p>	<p>Select Fabric</p> <p>See page 296</p> <p>C U 1 0 .</p>	<p>Select Frame</p> <p>T Black</p> <p>T</p>
--	---	--	---

CONVERGENCE®



Convergence® Task Chairs shown with Empower® Height-Adjustable Workstations.

CONVERGENCE®

What happens when support and affordability come together? Convergence. This is the task chair that is as attainable as is it comfortable with customizable features. Lumbar support that adds a little extra lower back comfort. Thick seat cushions to take the stress off the lower body throughout the day. Arm choices that let you decide how much upper body support you want. A breathable mesh back that flexes and responds to your movements. Convergence puts all the features you're looking for into one low-priced task chair.



FEATURES

- Choice of swivel tilt or synchro-tilt control with seat slide.
- Black mesh back is breathable for all-day comfort and support.
- Comfort options include adjustable lumbar support, adjustable arms, seat glide and synchro-tilt.
- Three arm options.
- Two control options.
- Integrated handle on the back makes it easy to move and reposition the chair.
- Hard casters move effortlessly on any surface.
- Black frame sits atop a durable five-star base.
- Warranted for users up to 275 lbs.
- 3" thick seat cushion.

CONVERGENCE®

Options

BACK OPTIONS

HCT1MM



Mid-back

Mesh Task Chair
with Adjustable
Lumbar Support

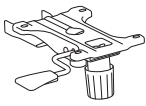
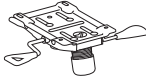
MECHANISM	CODE	FUNCTIONS	PRICE
	Z1	Swivel-Tilt Control A, E, F, K, L, W	+\$0
	Y1	Limited Synchro-Tilt A, D, E, J, K, L, W	+\$35

(See pages 244-245 for Seating Functions.)

ARM STYLE	CODE	DESCRIPTION	PRICE
	N	Armless	+\$0
	H	Height-Adjustable Arms	+\$45
	A	Height and Width Adjustable Arms	+\$75

CASTERS	CODE	DESCRIPTION	PRICE
	H	Black Hard Caster	+\$0

BACK STYLE	CODE	DESCRIPTION	PRICE
	M	Mesh	+\$0

BASE	CODE	DESCRIPTION	PRICE
	SB	Standard Base	+\$0

LUMBAR	CODE	DESCRIPTION	PRICE
	AL	Adjustable Lumbar	+\$0

FRAME	CODE	DESCRIPTION	PRICE
	T	Black	+\$0

HON BRANDED FABRICS

GRADE 1

Apex
Attire
Centurion
Compass
Contourett
Dapper
Ensemble
Hamilton
Inertia
Optic
Pebble

GRADE 2

Appoint Seating
Blume
Clyde
Dotty
Rush
Seed
Spin
Whisper Vinyl

GRADE 3

In Season
Moxie
Parker
Purl
Quill

For a complete list of fabrics, including partnership fabrics, go to hon.com/fabricsandfinishes.

Reference Fabric Color Combinations on pages 20-24 for color codes and legend on page 21 for lead times. For additional HON to Supply COM fabric grade pricing, go to honready.hon.com and click on the HON to Supply COM link.

CONVERGENCE®

Standard Task Chairs

OPEN MARKET



Icon Legend on page 19

HCT1MM



MID-BACK TASK

Mesh Back
Pneumatic
Swivel
Tilt Tension
Tilt Lock
Adjustable Lumbar Support

Functions: **A, E, K, L, W**
(Function Key on pages 244-245)

DIMENSIONS

Depth:	27½	Adjustable Arms Width:	20
Width:	27¾	Seat to Floor Height:	15¾-20
Height:	42	Usable Seat Depth:	17-19
Seat Depth:	19	Ship Weight:	44
Seat Width:	20	Cube:	5.8
Back Width:	18	COM:	1.0
Back Height:	22	Weight Rating:	275 lbs.

FABRIC PRICE CODES

1	\$345	7	\$405
2	\$357	8	\$414
3	\$369	9	\$423
4	\$378	10	\$432
5	\$387	11	\$441
6	\$396	12	\$450

NOTES: Arm width adjustment range is 3" (from 17"-20"). Lumbar adjustment is 3". Seat depth range is only for Y1 control. Seat depth on Z1 control is 19".

HSCASTER

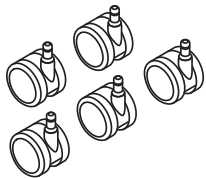

SET OF 5 ALL-SURFACE CASTERS

DIMENSIONS

Size: 60mm
Ship Weight: 2
Cube: 0.1

LIST PRICE

\$51

Available in Black finish only, no specification needed.

HON Recommendation: HCT1MM.Y1.A.H.M.CU10.AL.SB.T - List Price \$455

SEATING

HOW TO SPECIFY

Select Model Number	Select Control Type	Select Arm Type	Select Caster	Select Back Type	Select Upholstery	Select Lumbar	Select Base	Select Frame
Z1 Swivel-Tilt Control Y1 Simple Synchro-Tilt w/ Seat Slide Control (+ \$35)	N Armless H Height-Adjustable Arms (+ \$45) A Height & Width Adjustable Arms (+ \$75)	H Black Hard Casters	M Mesh	See page 301	AL Adjustable Lumbar	SB Standard Base	T Black	
HCT1MM	Y1	A	H	M	CU10	AL	SB	T



CONVERGENCE® Value Task Chairs

HCAT1MM



MID-BACK TASK VALUE MODEL

Mesh Back

- Pneumatic
- Swivel
- Tilt Tension
- Tilt Lock
- Adjustable Lumbar Support

Functions: **A, E, K, L, W**
(Function Key on pages 244-245)

NOTES: Lumbar adjustment is 3". Seat depth range is only for Y1 control. Seat depth on Z1 control is 19".

DIMENSIONS

Depth:	27½	Adjustable Arms Width:	17-20
Width:	27¾	Seat to Floor Height:	15¾-20
Height:	42	Usable Seat Depth:	17-19
Seat Depth:	19	Ship Weight:	44
Seat Width:	20	Cube:	5.8
Back Width:	18	Weight Rating:	275 lbs.
Back Height:	22		

LIST PRICE

\$398

HSCASTER

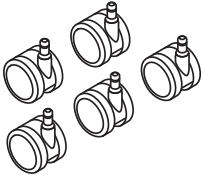

SET OF 5 ALL-SURFACE CASTERS

DIMENSIONS

Size:	60mm
Ship Weight:	2 Ⓢ
Cube:	0.1

LIST PRICE

\$51

ⓘ Available in Black finish only, no specification needed.

HON Recommendation: HCAT1MM.Z1.A.H.M.ACCF10.AL.SB.T - List Price \$398

HOW TO SPECIFY

Select Model Number	Select Control Type	Select Arm Type	Select Caster	Select Back Type	Select Upholstery	Select Lumbar	Select Base	Select Frame
Z1 Swivel-Tilt Control Y1 Simple Synchro-Tilt w/ Seat Slide Control (+ \$35)	A Height & Width Adjustable Arms	H Black Hard Casters	M Mesh	ACCF10 Black	AL Adjustable Lumbar	SB Standard Base	T Black	
H C A T 1 M M .	Y 1 .	A .	H .	M .	A C C F 1 0 .	A L .	S B .	T

CORRAL™ Contemporary Lounge

OPEN MARKET



Icon Legend on page 19

HVL887



CLUB CHAIR

DIMENSIONS

Depth:	28	Arm Width:	22¼
Width:	31½	Seat to Floor Height:	17⅞
Height:	30½	Usable Seat Depth:	19¾
Seat Depth:	19¾	Ship Weight:	51 Ⓢ
Seat Width:	22¼	Cube:	8.9
Back Width:	22¼	Weight Rating:	250 lbs.
Back Height:	17½		

PRICE CODE

Leather **\$1000**

NOTES: Legs available in Platinum. Legs and back ship unattached. Pair with contemporary occasional tables on page 305. **HON 5-Year Limited Warranty.**

ⓘ Available in SB11 SofThread™ Leather only.

HON Recommendation: HVL887.SB11 - List Price \$1000

HVL888

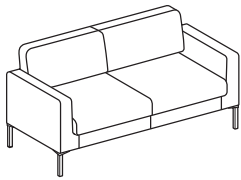

SOFA

DIMENSIONS

Depth:	28	Arm Width:	55
Width:	67	Seat to Floor Height:	17⅞
Height:	30½	Usable Seat Depth:	19¾
Seat Depth:	19¾	Ship Weight:	78
Seat Width:	55	Cube:	18.3
Back Width:	55	Weight Rating:	250 lbs.
Back Height:	17½		

PRICE CODE

Leather **\$1282**

NOTES: Legs available in Platinum. Legs and back ship unattached. Pair with contemporary occasional tables on page 305. **HON 5-Year Limited Warranty.**

ⓘ Available in SB11 SofThread™ Leather only.

HON Recommendation: HVL888.SB11 - List Price \$1282

SEATING

HOW TO SPECIFY

Select
Model Number

Select
Fabric

SB11 Black SofThread™ Leather

H V L 8 8 7 .

S B 1 1



CONTEMPORARY OCCASIONAL TABLES

HML8851

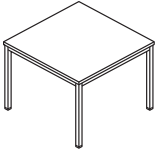

LAMINATE CORNER TABLE DIMENSIONS

Depth:	24	Ship Weight:	24
Width:	24	Cube:	1.7

LIST PRICE

\$201

NOTES: Metal leg occasional tables available in Black laminate. Choose from Corner or Coffee Table options. **HON 5-Year Limited Warranty.**

HON Recommendation: HML8851.P - List Price \$201

HML8852

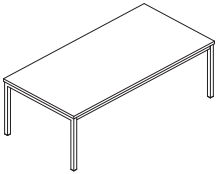

LAMINATE COFFEE TABLE DIMENSIONS

Depth:	24	Ship Weight:	38
Width:	48	Cube:	3.1

LIST PRICE

\$251

NOTES: Metal leg occasional tables available in Black laminate. Choose from Corner or Coffee Table options. **HON 5-Year Limited Warranty.**

HON Recommendation: HML8852.P - List Price \$251

HOW TO SPECIFY

Select Model Number	Select Laminate
H M L 8 8 5 1 .	P Black
	P

CRIO Mesh Chairs

OPEN MARKET



Icon Legend on page 19

HVL581



HIGH-BACK

Pneumatic
Swivel
Tilt
Tilt Tension
Tilt Lock
Height and Width Adjustable
Arms
Adjustable Lumbar

Functions: **A, E, F, K, L, S, W**
(Function Key on pages 244-245)

NOTES: Comfortable and breathable mesh back. Black fabric or Black SofThread™ Leather. Black frame. Height and width adjustable arms. Adjustable lumbar. **HON 5-Year Limited Warranty.**

HON Recommendation: HVL581.ES10.T - List Price \$379

DIMENSIONS

Depth:	25½	Arm Width:	19⅞
Width:	28¾	Seat to Floor Height:	16½-20¼
Height:	42⅞	Usable Seat Depth:	17¼
Seat Depth:	17¼	Ship Weight:	39.8
Seat Width:	20¼	Cube:	4.8
Back Width:	18½	Weight Rating:	250 lbs.

PRICE CODE

Fabric	\$379
Leather	\$404

HVL582



HIGH-BACK

Pneumatic
Swivel
Tilt
Tilt Tension
Tilt Lock
Asynchronous Control
Seat Glide Mechanism
Adjustable Lumbar
Height and Width Adjustable
Arms

Functions: **A, E, F, L, O, S, W**
(Function Key on pages 244-245)

NOTES: Comfortable and breathable mesh back. Black fabric or Black SofThread™ Leather. Black frame. Height and width adjustable arms. Seat glide mechanism. Asynchronous control with independent seat and back angle adjustment. Adjustable lumbar. **HON 5-Year Limited Warranty.**

HON Recommendation: HVL582.ES10.T - List Price \$467

DIMENSIONS

Depth:	27½	Arm Width:	19⅞
Width:	28¾	Seat to Floor Height:	20½-22⅞
Height:	43¾	Usable Seat Depth:	17¼
Seat Depth:	17¼	Ship Weight:	50.4
Seat Width:	19⅞	Cube:	6.8
Back Width:	18½	Weight Rating:	250 lbs.

PRICE CODE

Fabric	\$467
Leather	\$492

HVL585



EXECUTIVE BIG AND TALL

Pneumatic
Swivel
Tilt
Tilt Tension
Tilt Lock
Height and Width Adjustable
Arms
Adjustable Lumbar

Functions: **A, E, F, K, L, S, W**
(Function Key on pages 244-245)

NOTES: Large scale model HVL585 will support 450 lbs with normal use. Black fabric. Black frame. Height and width adjustable arms. Adjustable lumbar. **HON 5-Year Limited Warranty.**

📌 Available in Black fabric only.

HON Recommendation: HVL585.ES10.T - List Price \$658

DIMENSIONS

Depth:	29⅞	Arm Width:	20½
Width:	28¾	Seat to Floor Height:	17⅞-21¾
Height:	45⅞	Usable Seat Depth:	19⅞
Seat Depth:	19⅞	Ship Weight:	55.4
Seat Width:	22	Cube:	7.2
Back Width:	20⅞	Weight Rating:	450 lbs.

PRICE CODE

Fabric	\$658
---------------	--------------

SEATING

HOW TO SPECIFY

Select Model Number

H V L 5 8 1 .

Select Fabric

ES10 Black
SB11 Black SofThread™ Leather
Available on HVL581 and HVL582 only

E S 1 0 .

Select Frame

T Black

T



DEFINE™ Executive Chairs

HVL108



HIGH-BACK

Pneumatic
Swivel
Synchro-tilt
Height-adjustable Arms
Functions: **A, E, J, K, Q**
(Function Key on pages 244-245)

DIMENSIONS

Depth:	29¾	Arm Width:	19½
Width:	29¾	Seat to Floor Height:	17⅞-21⅜
Height:	46⅞	Usable Seat Depth:	17½
Seat Depth:	17½	Ship Weight:	47.3
Seat Width:	21	Cube:	7.2
Back Width:	20	Weight Rating:	250 lbs.
Back Height:	26½		

PRICE CODE

Leather **\$585**

NOTES: Available in Black SofThread™ Leather. Polished base. Polished arm accents. Height-adjustable arms. **HON 5-Year Limited Warranty.**

HON Recommendation: HVL108.SB11 - List Price \$585

HOW TO SPECIFY

Select Model Number	Select Fabric
	SB11 Black SofThread™ Leather
H V L 1 0 8 .	S B 1 1

ENDORSE® COLLECTION



Endorse® Mid-Back Task Chair
shown with Preside® Conference Table.

ENDORSE® COLLECTION

You need inviting, comfy seats up front, and task chairs that support productivity in workstations. Achieve harmony throughout your space with a multi-functional collection of Endorse task seating. Endorse supports the diversity of applications throughout your workplace with sophisticated design. Varied options. Diverse materials. Simply pick the model that suits your space and people. Add the options that fit your needs. Then get ready to Endorse a higher level of productivity.

SEATING



TASK CHAIR FEATURES

- Available in high-, mid- and low-back options.
- Available in three different back materials — upholstered, mesh and plastic outer back.
- Comfort options include adjustable lumbar support, adjustable arms, seat glide, multi-position tilt and synchro-tilt.
- Optional seat slide adjustment adapts to users of various heights.
- Control options include limited synchro-tilt, advanced synchro-tilt, advanced synchro-tilt with independent back angle and weight-activated control.
- Arm options include fixed, armless, height- and width-adjustable and all-adjustable.
- Caster options include hard, All-Surface and roll control.
- Available in hundreds of quality HON fabrics.
- Warranted for users up to 300 lbs.
(450 lbs. for Big and Tall chairs)

BACK OPTIONS

HLEU
HLEUBT - Big & Tall



High-back

Upholstered with Adjustable Lumbar Support

HLWU
HLWUBT - Big & Tall



Mid-back

Upholstered with Adjustable Lumbar Support

HLWM
HLWMBT - Big & Tall

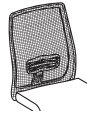

Mid-back

Mesh with Adjustable Lumbar Support

HLTU
HLTSU - Stool



Low-back

Upholstered with Adjustable Lumbar Support

HLTM
HLTSM - Stool



Low-back

Mesh with Adjustable Lumbar Support

HLTP
HLTSP - Stool



Low-back

Upholstered with Plastic Outer Back and Adjustable Lumbar Support

MESH BACK COLOR CODES (no upcharge): Black - **IM** Breeze - **IB** Brownstone - **IK** Chai ☉ - **IH** Charcoal - **IC** Fog - **IF**
Navy ☉ - **IY** Regatta - **IR** Titanium - **IT**

MECHANISM

MECHANISM	CODE	FUNCTIONS	PRICE
	S0	Limited Recline Synchro-Tilt A, E, J, K, L	+\$0
	S1	Limited Recline Synchro-Tilt w/ Seat Slider (available on Stools only) A, D, E, J, K, L	+\$20
	Y2	Advanced Synchro-Tilt A, D, E, J, L, W, A-D	+\$65
	Y3	Advanced Synchro-Tilt with Independent Back Angle A, D, E, J, L, W, A-E	+\$105
	Y4	Synchro-Tilt A, D, E, J, L, W, A-D (Big and Tall models only)	+\$0
	W5	Weight-Activated A, D, E, L, W, A-D	+\$150

(See pages 244-245 for Seating Functions.)

BASE

BASE	CODE	DESCRIPTION	PRICE
	SB	Standard Base	+\$0
	PA	Polished Aluminum	+\$110

ARM STYLE

ARM STYLE	CODE	DESCRIPTION	PRICE
	N	Armless	+\$0
	F	Fixed - Black	+\$65
	A	Height and Width Adjustable Arms	+\$75
	V	All-Adjustable Arms - includes pivot	+\$115
	P	Fixed - Polished Alum.	+\$150

CASTERS

CASTERS	CODE	DESCRIPTION	PRICE
	A	Black All-Surface Caster (High-back and Big and Tall models only)	+\$0
	H	Black Hard Caster	+\$0
	S	Black All-Surface Caster	+\$30
	R	Black Roll Control Caster	+\$50

* Fabric is de-emphasized.

ENDORSE® Dimensions

TASK DIMENSIONS

MODEL		HLEU	HLWU	HLWM	HLTU	HLTM	HLTP
Overall Width Armless		28½	28½	28½	28½	28½	28½
Overall Width with Arms	A/V	28½	28½	28½	28½	28½	28½
	F/P	28½	28½	28½	28½	28½	28½
Overall Depth		28½	28½	28½	28½	28½	28½
Overall Height	S0	49	45½	45½	42	42	42
	Y2	49¾	46¼	46¼	42¾	42¾	42¾
	Y3	49½	46	46	42½	42½	42½
	W5	49	48⅜	48⅜	43	43	43
Seat Width		20	20	20	19	19	19
Seat Depth		18½	18½	18½	18⅝	18⅝	18⅝
Usable Seat Depth	S0	17¾	17¾	17¾	17⅝	17⅝	17⅝
	Y2	15½-18	15½-18	15½-18	15½-18	15½-18	15½-18
	Y3	15¼-18¼	15¼-18¼	15¼-18¼	15¼-18¼	15¼-18¼	15¼-18¼
	W5	15½-17¾	15½-17¾	15½-17¾	15½-17¾	15½-17¾	15½-17¾
Seat Height (mechanism)	S0	17-21½	17-21½	17-21½	17-21½	17-21½	17-21½
	Y2	17¾-22¼	17¾-22¼	17¾-22¼	17¾-22¼	17¾-22¼	17¾-22¼
	Y3	17½-22	17½-22	17½-22	17½-22	17½-22	17½-22
	W5	17¼-21¾	17¼-21¾	17¼-21¾	17¼-21¾	17¼-21¾	17¼-21¾
Back Width		21⅝	21¼	19¼	19¾	18	19¾
Back Height		29¾	25	25	22¾	21¼	22¾
Ship Weight Armless	S0	52	43	40	49	41	50
	Y2	57	48	45	54	46	56
	Y3	60	52	48	58	50	59
	W5	56	47	44	54	45	55
Weight with Arms	S0	60	51	48	57	49	58
	Y2	65	56	53	62	54	64
	Y3	68	60	56	66	58	67
	W5	64	55	52	62	53	63
Between Arms	A/V	17½-20	17½-20	17½-20	16¾-19¼	16¾-19¼	16¾-19¼
	F/P	20½	20½	20½	20½	20½	20½
COM		2.0	2.0	1.0	2.0	1.0	2.0
Weight Capacity		300 lbs	300 lbs	300 lbs	300 lbs	300 lbs	300 lbs

BIG & TALL & STOOL DIMENSIONS

MODEL		HLEUBT	HLWUBT	HLWMBT	HLTSU	HLTSM	HLTSP
Overall Width Armless		28½	28½	28½	28½	28½	28½
Overall Width with Arms	A/V	28½	28½	28½	28½	28½	28½
	F/P	28½	28½	28½	28½	28½	28½
Overall Depth		28½	28½	28½	28½	28½	28½
Overall Height	S0/S1	-	-	-	53	53	53
	Y4	49	49	49	-	-	-
Seat Width		23	23	23	19	19	19
Seat Depth	S0/S1	-	-	-	18⅝	18⅝	18⅝
	Y4	20¼	20¼	20¼	-	-	-
Usable Seat Depth	S0	-	-	-	17⅝	17⅝	17⅝
	S1	-	-	-	15¼-18¼	15¼-18¼	15¼-18¼
	Y4	17¾-19¼	17¾-19¼	17¼-18¾	-	-	-
Seat Height (mechanism)	S0/S1	-	-	-	22¾-32¾	22¾-32¾	22¾-32¾
	Y4	17½-22	17½-22	17½-22	-	-	-
Back Width		23¼	23½	22½	19¾	19¾	19¾
Back Height		28¼	25	25¾	22¾	22¾	22¾
Ship Weight Armless	S0	-	-	-	50	42	51
	S1	-	-	-	52	44	53
	Y4	57	57	57	-	-	-
Weight with Arms	S0	-	-	-	58	50	59
	S1	-	-	-	60	52	61
	Y4	65	65	65	-	-	-
Between Arms	A/V	20½-23	20½-23	20½-23	16¾-19¼	16¾-19¼	16¾-19¼
	F/P	23½	23½	23½	20½	20½	20½
COM		2.0	2.0	1.5	2.0	2.0	2.0
Weight Capacity		450 lbs	450 lbs	450 lbs	300 lbs	300 lbs	300 lbs

HON BRANDED FABRICS *(For Seating)*

GRADE 1	GRADE 2	GRADE 3
Apex	Appoint Seating	In Season
Attire	Blume	Moxie
Centurion	Clyde	Parker
Compass	Dotty	Purl
Contourett	Rush	Quill
Dapper	Seed	
Ensemble	Spin Seating	
Hamilton	Whisper Vinyl	
Inertia		
Optic		
Pebble		

For a complete list of fabrics, including partnership fabrics, go to hon.com/fabricsandfinishes.

Reference Fabric Color Combinations on pages 20-24 for color codes and Legend on page 21 for lead times. For additional HON to Supply COM fabric grade pricing, go to honready.hon.com and click on the HON to Supply COM link.

 For Fire Code model, availability and ordering method, refer to pages 248-251. Available on select models, contact HON Customer Support for availability.

ENDORSE®



Icon Legend on page 19

HLEU

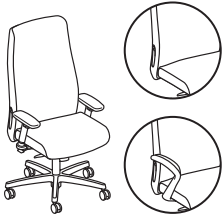

EXECUTIVE HIGH-BACK

Upholstered Back

- Pneumatic
- Swivel
- Synchro-tilt
- Tilt Tension
- Tilt Lock
- Integral Lumbar Support
- Optional Seat Glide

Functions: **A, E, J, K, L, W**
 (Function Key on pages 244-245)

! See page 310 for additional specifications and dimensions.

DIMENSIONS

Depth:	31½	Back Width:	21⅝
Width:	31½	Back Height:	29¾
Height:	47¾	Cube:	16.0
Seat Depth:	15¾	COM:	2.0
Seat Width:	19¾	Weight Rating:	300 lbs.

FABRIC PRICE CODES

1	\$772	8	\$1048
2	\$820	9	\$1084
3	\$868	10	\$1120
4	\$904	11	\$1156
5	\$940	12	\$1192
6	\$976	L	—
7	\$1012		

HON Recommendation: HLEU.Y2.A.A.CU__SB - List Price \$912

HOW TO SPECIFY

Select Model Number	Select Control Type	Select Arm Type	Select Caster/Glide	Select Fabric	Select Base
<p>S0 Limited Recline Synchro-Tilt</p> <p>Y2 Advanced Synchro-Tilt (+ \$65)</p> <p>Y3 Synchro-Tilt with Independent Back Angle (+ \$105)</p> <p>W5 Weight-Activated (+ \$150)</p>	<p>N Armless</p> <p>F Fixed Arms - Black (+ \$65)</p> <p>A Height and Width Adjustable Arms (+ \$75)</p> <p>V All-Adjustable Arms (includes pivot) (+ \$115)</p> <p>P Fixed Arms - Polished (+ \$150)</p>	<p>A Black All-Surface Caster</p>	<p>See page 311</p>	<p>SB Standard Base</p> <p>PA Polished Aluminum (+ \$110)</p>	
HLEU	Y2	A	A	CU10	SB



Icon Legend on page 19

HLWU

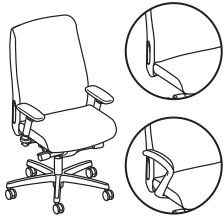

TASK MID-BACK

Upholstered Back

- Pneumatic
- Swivel
- Synchro-tilt
- Tilt Tension
- Tilt Lock
- Integral Lumbar Support
- Optional Seat Glide

Functions: **A, E, J, K, L, W**
(Function Key on pages 244-245)

! See page 310 for additional specifications and dimensions.

DIMENSIONS

Depth:	28½	Back Width:	21¼
Width:	28½	Back Height:	25
Height:	44½	Cube:	10.8
Seat Depth:	15¾	COM:	2.0
Seat Width:	19¾	Weight Rating:	300 lbs.

FABRIC PRICE CODES

1	\$742	8	\$1018
2	\$790	9	\$1054
3	\$838	10	\$1090
4	\$874	11	\$1126
5	\$910	12	\$1162
6	\$946	L	—
7	\$982		

HLWM



TASK MID-BACK

4-Way Stretch Back

- Pneumatic
- Swivel
- Synchro-tilt
- Tilt Tension
- Tilt Lock
- Integral Lumbar Support
- Optional Seat Glide

Functions: **A, E, J, K, L, W**
(Function Key on pages 244-245)

NOTES: For Mesh Back models, specify the 4-Way Stretch back option below. Headrest available on Mid-back 4-Way Stretch models only - Black only.

! See page 310 for additional specifications and dimensions.

DIMENSIONS

Depth:	28½	Back Width:	19
Width:	28½	Back Height:	25
Height:	44½	Cube:	10.8
Seat Depth:	15¾	COM:	1.0
Seat Width:	19¾	Weight Rating:	300 lbs.

FABRIC PRICE CODES

1	\$742	8	\$880
2	\$766	9	\$898
3	\$790	10	\$916
4	\$808	11	\$934
5	\$826	12	\$952
6	\$844	L	—
7	\$862		

HON Recommendation: HLWM.Y2.A.H.IM.CU__SB.N - List Price \$882

HOW TO SPECIFY

Select Model Number	Select Control Type	Select Arm Type	Select Caster/Glide	Select Mesh Back	Select Fabric	Select Base	Select Headrest
S0 Limited Recline Synchro-Tilt	Y2 Advanced Synchro-Tilt (+ \$65)	N Armless	H Black Hard Caster	4-Way Stretch options	See page 311	SB Standard Base	N No Headrest
Y2 Advanced Synchro-Tilt (+ \$65)	Y3 Synchro-Tilt with Independent Back Angle (+ \$105)	F Fixed Arms - Black (+ \$65)	S Black All-Surface Caster (+ \$30)	IM Black		PA Polished Aluminum (+ \$110)	HR Headrest (+ \$80)
Y3 Synchro-Tilt with Independent Back Angle (+ \$105)	W5 Weight-Activated (+ \$150)	A Height and Width Adjustable Arms (+ \$75)	R Black Roll Control Caster (+ \$50)	IB Breeze			<i>Black only. Specify for model HLWM only</i>
		V All-Adjustable Arms (includes pivot) (+ \$115)		IK Brownstone			
		P Fixed Arms - Polished (+ \$150)		IH Chai *			
				IC Charcoal			
				IF Fog			
				IY Navy *			
				IR Regatta			
				IT Titanium			
				<i>Specify the back for Mesh Back models only</i>			
HLWM	Y2	A	H	IM	CU10	SB	N

* Fabric is de-emphasized.

ENDORSE®



Icon Legend on page 19

HLTU

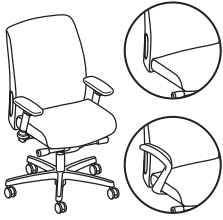

TASK LOW-BACK

- Upholstered Back**
- Pneumatic
- Swivel
- Synchro-tilt
- Tilt Tension
- Tilt Lock
- Integral Lumbar Support
- Optional Seat Glide

Functions: **A, E, J, K, L, W**
(Function Key on pages 244-245)

DIMENSIONS

Depth:	28½	Back Width:	19¾
Width:	28½	Back Height:	22¾
Height:	41¼	Cube:	10.8
Seat Depth:	15⅝	COM:	2.0
Seat Width:	18⅞	Weight Rating:	300 lbs.

FABRIC PRICE CODES

1	\$690	8	\$966
2	\$738	9	\$1002
3	\$786	10	\$1038
4	\$822	11	\$1074
5	\$858	12	\$1110
6	\$894	L	—
7	\$930		

! Do not need to specify back option for Upholstered Back models. See page 310 for additional specifications and dimensions.

HLTM

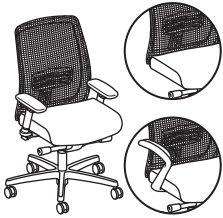

TASK LOW-BACK

- 4-Way Stretch Back**
- Pneumatic
- Swivel
- Synchro-tilt
- Tilt Tension
- Tilt Lock
- Integral Lumbar Support
- Optional Seat Glide

Functions: **A, E, J, K, L, W**
(Function Key on pages 244-245)

DIMENSIONS

Depth:	28½	Back Width:	17¾
Width:	28½	Back Height:	21¾
Height:	40¼	Cube:	10.8
Seat Depth:	15⅝	COM:	1.0
Seat Width:	18⅞	Weight Rating:	300 lbs.

FABRIC PRICE CODES

1	\$690	8	\$828
2	\$714	9	\$846
3	\$738	10	\$864
4	\$756	11	\$882
5	\$774	12	\$900
6	\$792	L	—
7	\$810		

NOTES: For Mesh Back models, specify the 4-Way Stretch back option below.

! See page 310 for additional specifications and dimensions.

HLTP

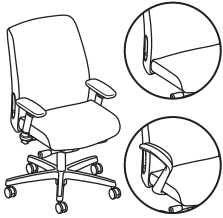

TASK LOW-BACK

- Plastic Outer Back**
- Pneumatic
- Swivel
- Synchro-tilt
- Tilt Tension
- Tilt Lock
- Integral Lumbar Support
- Optional Seat Glide

Functions: **A, E, J, K, L, W**
(Function Key on pages 244-245)

DIMENSIONS

Depth:	28½	Back Width:	19¾
Width:	28½	Back Height:	22¾
Height:	41¼	Cube:	10.8
Seat Depth:	15⅝	COM:	2.0
Seat Width:	18⅞	Weight Rating:	300 lbs.

FABRIC PRICE CODES

1	\$747	8	\$1023
2	\$795	9	\$1059
3	\$843	10	\$1095
4	\$879	11	\$1131
5	\$915	12	\$1167
6	\$951	L	—
7	\$987		

! Do not need to specify back option for Plastic Outer Back models. See page 310 for additional specifications and dimensions.

HON Recommendation: HLTM.Y2.A.H.IM.CU__SB - List Price \$830

HOW TO SPECIFY

Select Model Number	Select Control Type	Select Arm Type	Select Caster/Glide	Select Mesh Back	Select Fabric	Select Base
S0 Limited Recline Synchro-Tilt	Y2 Advanced Synchro-Tilt (+ \$65)	N Armless	H Black Hard Caster	4-Way Stretch options	See page 311	SB Standard Base
Y2 Advanced Synchro-Tilt (+ \$65)	Y3 Synchro-Tilt with Independent Back Angle (+ \$105)	F Fixed Arms - Black (+ \$65)	S Black All-Surface Caster (+ \$30)	IM Black		PA Polished Aluminum (+ \$110)
Y3 Synchro-Tilt with Independent Back Angle (+ \$105)	W5 Weight-Activated (+ \$150)	A Height and Width Adjustable Arms (+ \$75)	R Black Roll Control Caster (+ \$50)	IB Breeze		
		V All-Adjustable Arms (includes pivot) (+ \$115)		IK Brownstone		
		P Fixed Arms - Polished (+ \$150)		IH Chai *		
				IC Charcoal		
				IF Fog		
				IY Navy *		
				IR Regatta		
				IT Titanium		
				Specify the back for Mesh Back models only		
HLTM	Y2	A	H	IM	CUT0	SB

* Fabric is de-emphasized.



Icon Legend on page 19

HLWUBT

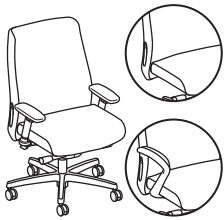

TASK MID-BACK

Big and Tall Upholstered Back

- Pneumatic
- Seat-glide
- Swivel
- Synchro-tilt
- Tilt Lock
- Side Tilt Tension
- Integral Lumbar Support

Functions: **A, D, E, A-D, J, L, W**
(Function Key on pages 244-245)

! Do not need to specify back option for Upholstered Back models.

DIMENSIONS

Depth:	31½	Adjustable Arms Width:	21½-23¾
Width:	31½	Fixed Arms Width:	24
Height:	44⅝	Seat to Floor Height:	18-22¼
Seat Depth:	21	Usable Seat Depth:	17¾-19¼
Seat Width:	23	Ship Weight:	65
Back Width:	23½	Cube:	15.3
Back Height:	25	COM:	2.0
		Weight Rating:	450 lbs.

FABRIC PRICE CODES

1	\$1234	8	\$1510
2	\$1282	9	\$1546
3	\$1330	10	\$1582
4	\$1366	11	\$1618
5	\$1402	12	\$1654
6	\$1438	L	—
7	\$1474		

HLWMBT

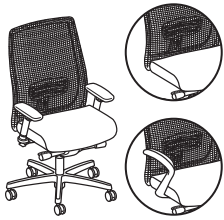

TASK MID-BACK

Big and Tall 4-Way Stretch Back

- Pneumatic
- Seat-glide
- Swivel
- Synchro-tilt
- Tilt Lock
- Side Tilt Tension
- Integral Lumbar Support

Functions: **A, D, E, A-D, J, L, W**
(Function Key on pages 244-245)

NOTES: For Mesh Back models, specify the 4-Way Stretch back option below. Headrest available on Mid-back 4-Way Stretch models only - Black only.

DIMENSIONS

Depth:	31½	Adjustable Arms Width:	21½-23¾
Width:	31½	Fixed Arms Width:	24
Height:	44⅝	Seat to Floor Height:	18-22¼
Seat Depth:	21	Usable Seat Depth:	17¼-18¾
Seat Width:	23	Ship Weight:	75
Back Width:	22½	Cube:	15.3
Back Height:	25¾	COM:	1.5
		Weight Rating:	450 lbs.

FABRIC PRICE CODES

1	\$1234	8	\$1441
2	\$1270	9	\$1468
3	\$1306	10	\$1495
4	\$1333	11	\$1522
5	\$1360	12	\$1549
6	\$1387	L	—
7	\$1414		

HLEUBT

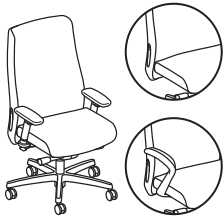

EXECUTIVE HIGH-BACK

Big and Tall Upholstered Back

- Pneumatic
- Seat-glide
- Swivel
- Synchro-tilt
- Tilt Lock
- Side Tilt Tension
- Integral Lumbar Support

Functions: **A, D, E, A-D, J, L, W**
(Function Key on pages 244-245)

! Executive High-back Big and Tall models are available with an upholstered back only.

DIMENSIONS

Depth:	31½	Adjustable Arms Width:	21½-23¾
Width:	31½	Fixed Arms Width:	24
Height:	46⅝	Seat to Floor Height:	18-22¼
Seat Depth:	21	Usable Seat Depth:	17¾-19¼
Seat Width:	23	Ship Weight:	74
Back Width:	23¼	Cube:	16.0
Back Height:	28¼	COM:	2.0
		Weight Rating:	450 lbs.

FABRIC PRICE CODES

1	\$1263	8	\$1539
2	\$1311	9	\$1575
3	\$1359	10	\$1611
4	\$1395	11	\$1647
5	\$1431	12	\$1683
6	\$1467	L	—
7	\$1503		

HON Recommendation: HLWMBT.Y4.A.A.IM.CU__SB.N - List Price \$1309

HOW TO SPECIFY

Select Model Number	Select Control Type	Select Arm Type	Select Caster/Glide	Select Mesh Back	Select Fabric	Select Base	Select Headrest
HLWMBT	Y4 <i>Y4 is the only control option for the Big and Tall models</i>	A N Armless F Fixed Arms - Black (+ \$65) A Height and Width Adjustable Arms (+ \$75) V All-Adjustable Arms (includes pivot) (+ \$115) P Fixed Arms - Polished (+ \$150)	A A Black All-Surface Caster	IM 4-Way Stretch option <i>Black only</i> IM Black <i>Specify the back for Mesh Back models only</i>	CU10 See page 311	SB SB Standard Base	N N No Headrest HR Headrest (+ \$80) <i>Black only. Specify for model HLWMBT only</i>

ENDORSE®



Icon Legend on page 19

HLTSU



STOOL

Upholstered Back

- Pneumatic
- Swivel
- Synchro-tilt
- Tilt Tension
- Tilt Lock
- Integral Lumbar Support

Functions: **A, E, J, K, L, W**
(Function Key on pages 244-245)

❗ Do not need to specify back option for Upholstered Back models. See page 310 for additional specifications and dimensions.

DIMENSIONS

Depth:	28½	Back Width:	19¾
Width:	28½	Back Height:	22¾
Height:	53½	Cube:	10.8
Seat Depth:	15½	COM:	2.0
Seat Width:	18¾	Weight Rating:	300 lbs.

FABRIC PRICE CODES

1	\$824	8	\$1100
2	\$872	9	\$1136
3	\$920	10	\$1172
4	\$956	11	\$1208
5	\$992	12	\$1244
6	\$1028	L	—
7	\$1064		

HLTSM



STOOL

4-Way Stretch Back

- Pneumatic
- Swivel
- Synchro-tilt
- Tilt Tension
- Tilt Lock
- Integral Lumbar Support

Functions: **A, E, J, K, L, W**
(Function Key on pages 244-245)

NOTES: For Mesh Back models, specify the 4-Way Stretch back option below. See page 310 for additional specifications and dimensions.

DIMENSIONS

Depth:	28½	Back Width:	17¾
Width:	28½	Back Height:	21¾
Height:	52½	Cube:	10.8
Seat Depth:	15½	COM:	1.0
Seat Width:	18¾	Weight Rating:	300 lbs.

FABRIC PRICE CODES

1	\$824	8	\$962
2	\$848	9	\$980
3	\$872	10	\$998
4	\$890	11	\$1016
5	\$908	12	\$1034
6	\$926	L	—
7	\$944		

HLTSP



STOOL

Plastic Outer Back

- Pneumatic
- Swivel
- Synchro-tilt
- Tilt Tension
- Tilt Lock
- Integral Lumbar Support

Functions: **A, E, J, K, L, W**
(Function Key on pages 244-245)

❗ Do not need to specify back option for Outer Back models. See page 310 for additional specifications and dimensions.

DIMENSIONS

Depth:	28½	Back Width:	19¾
Width:	28½	Back Height:	22¾
Height:	52½	Cube:	10.8
Seat Depth:	15½	COM:	2.0
Seat Width:	18¾	Weight Rating:	300 lbs.

FABRIC PRICE CODES

1	\$881	8	\$1157
2	\$929	9	\$1193
3	\$977	10	\$1229
4	\$1013	11	\$1265
5	\$1049	12	\$1301
6	\$1085	L	—
7	\$1121		

HON Recommendation: HLTSM.S1.A.H.IM.CU__SB - List Price \$919

HOW TO SPECIFY

Select Model Number	Select Control Type	Select Arm Type	Select Caster/Glide	Select Mesh Back	Select Fabric	Select Base
S0 Limited Recline Synchro-Tilt	S1 Limited Recline Synchro-Tilt w/ Seat Slider (+ \$20)	N Armless F Fixed Arms - Black (+ \$65) A Height and Width Adjustable Arms (+ \$75) V All-Adjustable Arms (includes pivot) (+ \$115) P Fixed Arms - Polished (+ \$150)	H Black Hard Caster S Black All-Surface Caster (+ \$30) R Black Roll Control Caster (+ \$50)	4-Way Stretch options IM Black IB Breeze IK Brownstone IH Chai * IC Charcoal IF Fog IY Navy * IR Regatta IT Titanium <i>Specify the back for Mesh Back models only</i>	See page 311	SB Standard Base PA Polished Aluminum (+ \$110)
HLTSM	S1	A	H	IM	CU10	SB

* Fabric is de-emphasized.



Icon Legend on page 19

HL2DARM

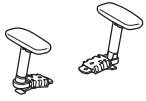

ADJUSTABLE T-ARMS

Height and Width

Functions: **S**
(Function Key on pages 244-245)

! Available in Black only. No need to specify.

DIMENSIONS

Adjustable Arms Width: 16¾-19¼
Height from Seat: 7¼-11
Ship Weight: 8
Cube: 1.0

LIST PRICE

\$123

HL4DARM



ALL-ADJUSTABLE ARMS

Height, Width, Depth and Pivot

! Available in Black only. No need to specify.

DIMENSIONS

Adjustable Arms Width: 16¾-19¼
Height from Seat: 7¼-11
Ship Weight: 8
Cube: 1.0

LIST PRICE

\$166

HI2FHA

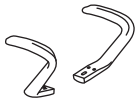

FIXED HEIGHT ARMS

Fixed Height

DIMENSIONS

Arm Width: 20
Height from Seat: 9½
Ship Weight: 7
Cube: 1.0

LIST PRICE

\$115

HIPAA

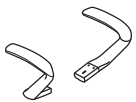

POLISHED ALUMINUM ARMS

DIMENSIONS

Arm Width: 20
Height from Seat: 9½
Ship Weight: 10
Cube: 1.0

LIST PRICE

\$190

HLMSHHR



MESH HEADREST

! Available in Black Mesh (IM) only. For use with Mesh Mid-back models only.

DIMENSIONS

Mesh Width: 12
Mesh Height: 6
Ship Weight: 3
Cube: 1.0

QA DIMENSIONS

(Attachment Mechanism)

Width: 12
Depth: 6
Height: 12

LIST PRICE

\$138

HSCASTER

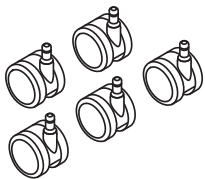

OPEN MARKET

SET OF 5 ALL-SURFACE CASTERS

DIMENSIONS

Size: 60mm
Ship Weight: 2
Cube: 0.1

! Available in Black finish only, no specification needed.

LIST PRICE

\$51

ENTIRE™ Mesh Chairs

OPEN MARKET



Icon Legend on page 19

HVL541



HIGH-BACK

Pneumatic
Swivel
Tilt
Tilt Tension
Tilt Lock
Adjustable Lumbar
Height-adjustable Arms

Functions: **A, E, F, K, L, Q, W**
(Function Key on pages 244-245)

DIMENSIONS

Depth:	28 ³ / ₈	Arm Width:	19 ³ / ₄
Width:	28 ³ / ₈	Seat to Floor Height:	17 ³ / ₄ -22 ¹ / ₂
Height:	43 ³ / ₈	Usable Seat Depth:	19 ¹ / ₄
Seat Depth:	19 ¹ / ₄	Ship Weight:	44
Seat Width:	19 ⁵ / ₈	Cube:	4.0
Back Width:	16 ³ / ₄	Weight Rating:	250 lbs.
Back Height:	22 ³ / ₄		

PRICE CODE

Fabric **\$433**

NOTES: Comfortable and breathable mesh back. Black fabric seat. Black frame. Height-adjustable arms. **HON 5-Year Limited Warranty.**

HON Recommendation: HVL541.LH10 - List Price \$433

SEATING

HOW TO SPECIFY

Select
Model Number

H V L 5 4 1 .

Select
Fabric

LH10 Black Fabric

L H 1 0



Icon Legend on page 19

EXPOSURE™ Mesh Chairs

HVL721



HIGH-BACK

Pneumatic
Swivel
Synchronized Tilt
Tilt Tension
Tilt Lock
Seat Glide Mechanism
Adjustable Lumbar
Height and Width Adjustable
Arms

Functions: **A, D, E, J, K, L, S, W**
(Function Key on pages 244-245)

DIMENSIONS

Depth:	26¾	Arm Width:	16½-18¾
Width:	26½	Seat to Floor Height:	18¼-22¾
Height:	42½	Usable Seat Depth:	17½-19½
Seat Depth:	17½-19½	Ship Weight:	40
Seat Width:	19½	Cube:	5.5
Back Width:	18½	Weight Rating:	250 lbs.
Back Height:	24¼		

PRICE CODE

Fabric **\$595**

NOTES: Available in Black fabric with Black accents. Comfortable and breathable mesh back. Adjustable seat glide mechanism. Height and width adjustable arms. Adjustable lumbar support. **HON 5-Year Limited Warranty.**

HON Recommendation: HVL721.LH10 - List Price \$595

SEATING

HOW TO SPECIFY

Select Model Number	Select Fabric
	LH10 Black Fabric
H V L 7 2 1 .	L H 1 0

FLOCK®



Flock® Seating and Tables.

FLOCK®

Break away. Come together. Wherever people migrate within a space, Flock is designed to support their needs. With a full collection of modular and comfortable seating elements and coordinating collaborative tables that work seamlessly together, you can make the most of every square inch of your space. Modular lounge chairs and ottomans stand alone or combine to create large arrangements. Multi-purpose stools and chairs add comfort to open spaces. Collaborative tables that bring the whole group together. Flock helps people interact with each other, challenge one another, and receive the support they need.



CHAIR FEATURES

- Round and square lounge chairs are fully-upholstered.
- The contemporary aesthetic easily matches a variety of surroundings.
- Support everything from one-on-one conversations to large meetings.
- Choose from four leg options — standard, tapered round, tapered square or hard casters — or a 5-star base.
- Available in hundreds of quality HON fabrics.
- Warranted for users up to 300 lbs.

COLLABORATIVE TABLES

- Choose from round, square, rectangle or racetrack shaped table tops.
- Optional grommets neatly route cords.
- Bases available in disc, T-leg and X-leg styles.
- Choose bases with or without footrings.

MODEL OPTIONS

HFLSC1
HFLSC1DF - Dual Fabric

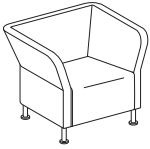

Lounge Chair
Square

HFLRC1
HFLRC1DF - Dual Fabric

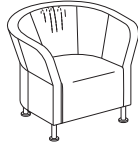

Lounge Chair
Round

HFLMC1
HFLMC1DF - Dual Fabric

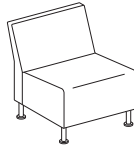

Modular Chair

HFLML1
HFLML1DF - Dual Fabric

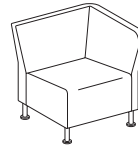

Modular
Left End

HFLMR1
HFLMR1DF - Dual Fabric

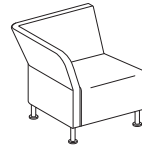

Modular
Right End

HFLCC1
HFLCC1DF - Dual Fabric

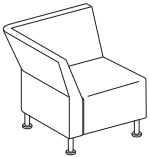

True Chair
Corner

HFLW145
HFLW145DF - Dual Fabric

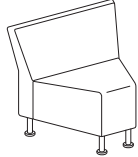

Wedge
Inside

HFLW045
HFLW045DF - Dual Fabric



Wedge
Outside

HFL450

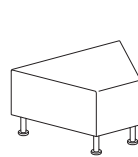

Wedge Ottoman

HFLSC1S
HFLSC1SDF - Dual Fabric

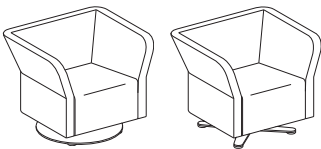

Square Lounge Chair
Swivel Base or X-Base

HFLRC1S
HFLRC1SDF - Dual Fabric

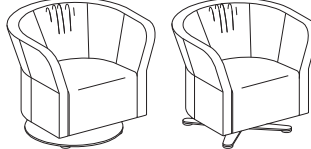

Round Lounge Chair
Swivel Base or X-Base

HFLMC1S
HFLMC1SDF - Dual Fabric

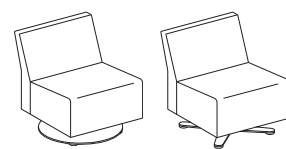

Modular Chair
Swivel Base or X-Base

LEG STYLE



CODE	DESCRIPTION	PRICE
L	Standard Leg	+\$0



TS	Tapered Square	+\$0
-----------	----------------	-------------



TR	Tapered Round	+\$0
-----------	---------------	-------------



H	Hard Casters	+\$0
----------	--------------	-------------

LEG COLOR

CODE	DESCRIPTION	PRICE
PR8	Textured Silver	+\$0
P7A	Textured Charcoal	+\$0

**Specify PR8 & P7A for Standard Legs and Tapered Round & Tapered Square Legs only*

T	Black Hard Caster	+\$0
----------	-------------------	-------------

**Specify for Hard Caster option only*

FLOCK® Options

MODEL OPTIONS

HFLB2

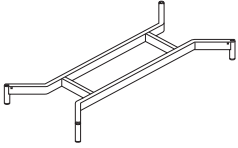

Two-Seat Base Frame

HFLB3

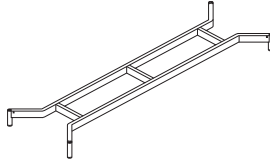

Three-Seat Base Frame

HTSSRD



Tapered Square
Leg - Shroud Pack

COMPATIBLE MODELS

HFLMC1
HFLMC1DF - Dual Fabric

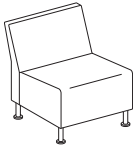

Modular Chair

HFLML1
HFLML1DF - Dual Fabric

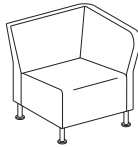

Modular
Left End

HFLMR1
HFLMR1DF - Dual Fabric

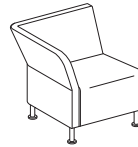

Modular
Right End

HFLCC1
HFLCC1DF - Dual Fabric

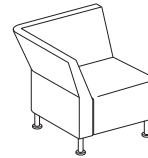

True Chair
Corner

HFLSO1

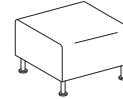

Square Ottoman

LEG STYLE



CODE	DESCRIPTION	PRICE
RS	Round Straight Leg	+\$0

Available in the following finishes:

PR8	Textured Silver
P7A	Textured Charcoal



TS	Tapered Square	+\$75
-----------	----------------	--------------

Available in the following finishes:

PR8	Textured Silver
P7A	Textured Charcoal

HON BRANDED FABRICS

GRADE 1	GRADE 2	GRADE 3	GRADE L
Apex	Appoint Seating	In Season	Denver Leather*
Attire	Blume	Moxie	
Centurion	Clyde	Parker	
Compass	Dotty	Purl	
Contourett	Rush	Quill	
Dapper	Seed		
Ensemble	Spin Seating		
Hamilton	Whisper Vinyl		
Inertia			
Optic			
Pebble			

For a complete list of fabrics, including partnership fabrics, go to hon.com/fabricsandfinishes.

Flock® chair model HFLRC1 has fabric limitations, please see the Flock® seating pages 324-333 for details.

Reference Fabric Color Combinations on pages 20-24 for color codes and legend on page 21 for lead times.

*Denver Leather (SS) may not be available on every model within a specific series, please refer to the model's page for details.

🔥 For Fire Code model, availability and ordering method, refer to pages 248-251. Available on select models, contact HON Customer Support for availability.

⚠️ Due to the inherent characteristics of upholstery materials, the seat of Flock® may become more relaxed to show wrinkles over time.

FLOCK® ROUND LOUNGE HFLRC1/DF HON BRANDED FABRICS

GRADE 1	GRADE 2	GRADE 3	GRADE L
Apex	Appoint Seating	In Season	Denver Leather**
Centurion	Blume	Moxie	
Compass	Clyde	Parker	
Contourett	Rush	Purl	
Dapper	Seed*	Quill	
Ensemble	Spin Seating*		
Hamilton	Whisper Vinyl		
Inertia			
Optic			
Pebble			

For a complete list of fabrics, including partnership fabrics, go to hon.com/fabricsandfinishes.

Reference Fabric Color Combinations on pages 20-24 for color codes and legend on page 21 for lead times.

*Available on seat only.

**Denver Leather (SS) may not be available on every model within a specific series, please refer to the model's page for details.

🔥 For Fire Code model, availability and ordering method, refer to pages 248-251. Available on select models, contact HON Customer Support for availability.

⚠️ Due to the inherent characteristics of upholstery materials, the seat of Flock® may become more relaxed to show wrinkles over time.



HFLSC1

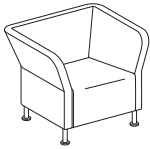

LOUNGE CHAIR

Square

DIMENSIONS

Depth:	28½	Arm Width:	27½
Width:	34¼	Seat to Floor Height:	17
Height:	28	Usable Seat Depth:	20½
Seat Depth:	20½	Ship Weight:	79
Seat Width:	21½	Cube:	21.9
Back Width:	21½	COM:	5.0
Back Height:	18½	Weight Rating:	300 lbs.

FABRIC PRICE CODES

1	\$1822	8	\$2443
2	\$1930	9	\$2524
3	\$2038	10	\$2605
4	\$2119	11	\$2686
5	\$2200	12	\$2767
6	\$2281	L	\$2722
7	\$2362		

! Leg options – Standard Leg (L), Tapered Square (TS) and Tapered Round (TR) are available in Textured Silver (PR8) and Textured Charcoal (P7A) only. Hard Casters (H) are available on Black (T) only.

HFLRC1



Due to the inherent design of the Round Lounge chair, material gathers will be present in the back.

LOUNGE CHAIR

Round

DIMENSIONS

Depth:	29	Arm Width:	27½
Width:	33½	Seat to Floor Height:	17
Height:	28	Usable Seat Depth:	20½
Seat Depth:	20½	Ship Weight:	57
Seat Width:	20½	Cube:	21.9
Back Width:	20½	Weight Rating:	300 lbs.
Back Height:	18½		

FABRIC PRICE CODES

1	\$1904	8	\$2456
2	\$2000	9	\$2528
3	\$2096	10	\$2600
4	\$2168	11	\$2672
5	\$2240	12	\$2744
6	\$2312	L	\$2704
7	\$2384		

! Round Lounge models HFLRC1 / HFLRC1DF are offered in select fabrics; for availability, please see the Fabric Matrix on page 323. Also approved in limited Partnership Fabrics. Leg options – Standard Leg (L), Tapered Square (TS) and Tapered Round (TR) are available in Textured Silver (PR8) and Textured Charcoal (P7A) only. Hard Casters (H) are available on Black (T) only.
! Customer's Own Material (COM) is not available on Flock® model HFLRC1.

HON Recommendation: HFLSC1.TS.PNS___.PR8 - List Price \$1930

HOW TO SPECIFY

<p>Select Model Number</p> <p>HFLSC1</p>	<p>Select Leg Option</p> <p>L Standard Leg TS Tapered Square TR Tapered Round H Hard Casters</p> <p>TS</p>	<p>Select Fabric</p> <p>See page 323</p> <p>PNS007</p>	<p>Select Leg Color</p> <p>PR8 Textured Silver P7A Textured Charcoal</p> <p><i>Specify for Standard, Tapered Round and Tapered Square legs only</i></p> <p>T Black Hard Caster <i>Specify for Hard Caster option only</i></p> <p>PR8</p>
---	---	---	---



HFLMC1



MODULAR CHAIR

DIMENSIONS

Depth:	28½	Seat to Floor Height:	17
Width:	25	Usable Seat Depth:	20½
Height:	28	Ship Weight:	54
Seat Depth:	20½	Cube:	21.9
Seat Width:	25	COM:	3.0
Back Width:	25	Weight Rating:	300 lbs.
Back Height:	18½		

FABRIC PRICE CODES

1	\$1335	8	\$1749
2	\$1407	9	\$1803
3	\$1479	10	\$1857
4	\$1533	11	\$1911
5	\$1587	12	\$1965
6	\$1641	L	\$1935
7	\$1695		

! Leg options – Standard Leg (L), Tapered Square (TS) and Tapered Round (TR) are available in Textured Silver (PR8) and Textured Charcoal (P7A) only. Hard Casters (H) are available on Black (T) only.

HFLML1

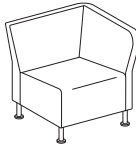

MODULAR

Left End

DIMENSIONS

Depth:	28½	Seat to Floor Height:	17
Width:	28½	Usable Seat Depth:	20½
Height:	28	Ship Weight:	72
Seat Depth:	20½	Cube:	21.9
Seat Width:	22¼	COM:	4.0
Back Width:	22¼	Weight Rating:	300 lbs.
Back Height:	18½		

FABRIC PRICE CODES

1	\$1575	8	\$2127
2	\$1671	9	\$2199
3	\$1767	10	\$2271
4	\$1839	11	\$2343
5	\$1911	12	\$2415
6	\$1983	L	\$2375
7	\$2055		

! Leg options – Standard Leg (L), Tapered Square (TS) and Tapered Round (TR) are available in Textured Silver (PR8) and Textured Charcoal (P7A) only. Hard Casters (H) are available on Black (T) only.

HFLMR1



MODULAR

Right End

DIMENSIONS

Depth:	28½	Seat to Floor Height:	17
Width:	28½	Usable Seat Depth:	20½
Height:	28	Ship Weight:	72
Seat Depth:	20½	Cube:	21.9
Seat Width:	22¼	COM:	4.0
Back Width:	22¼	Weight Rating:	300 lbs.
Back Height:	18½		

FABRIC PRICE CODES

1	\$1575	8	\$2127
2	\$1671	9	\$2199
3	\$1767	10	\$2271
4	\$1839	11	\$2343
5	\$1911	12	\$2415
6	\$1983	L	\$2375
7	\$2055		

! Leg options – Standard Leg (L), Tapered Square (TS) and Tapered Round (TR) are available in Textured Silver (PR8) and Textured Charcoal (P7A) only. Hard Casters (H) are available on Black (T) only.

HON Recommendation: HFLMC1.TS.PNS___.PR8 - List Price \$1407

HOW TO SPECIFY

<p>Select Model Number</p> <p>H F L M C 1 .</p>	<p>Select Leg Option</p> <p>L Standard Leg TS Tapered Square TR Tapered Round H Hard Casters</p> <p>T S .</p>	<p>Select Fabric</p> <p>See page 323</p> <p>P N S 0 0 7 .</p>	<p>Select Leg Color</p> <p>PR8 Textured Silver P7A Textured Charcoal</p> <p><i>Specify for Standard, Tapered Round and Tapered Square legs only</i></p> <p>T Black Hard Caster <i>Specify for Hard Caster option only</i></p> <p>P R 8</p>
--	---	--	---



HFLCC1

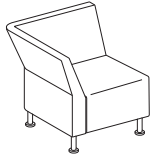

TRUE CORNER CHAIR

DIMENSIONS

Depth:	28½	Seat to Floor Height:	17
Width:	28½	Usable Seat Depth:	20½
Height:	28	Ship Weight:	60
Seat Depth:	20½	Cube:	21.9
Seat Width:	20½	COM:	4.0
Back Width:	22¼	Weight Rating:	300 lbs.
Back Height:	18½		

FABRIC PRICE CODES

1	\$1568	8	\$2352
2	\$1664	9	\$2476
3	\$1760	10	\$2600
4	\$1856	11	\$2724
5	\$1980	12	\$2848
6	\$2104	L	\$2368
7	\$2228		

! Leg options – Standard Leg (L), Tapered Square (TS) and Tapered Round (TR) are available in Textured Silver (PR8) and Textured Charcoal (P7A) only.

HFLWI45

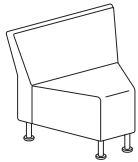

INSIDE WEDGE

DIMENSIONS

Depth:	26¼	Seat to Floor Height:	17
Width:	31½	Usable Seat Depth:	19
Height:	28	Ship Weight:	45
Seat Depth:	19½	Cube:	21.9
Seat Width:	25¾	COM:	3.0
Back Width:	31½	Weight Rating:	300 lbs.
Back Height:	18½		

FABRIC PRICE CODES

1	\$1567	8	\$2351
2	\$1663	9	\$2475
3	\$1759	10	\$2599
4	\$1855	11	\$2723
5	\$1979	12	\$2847
6	\$2103	L	\$2367
7	\$2227		

! Leg options – Standard Leg (L), Tapered Square (TS) and Tapered Round (TR) are available in Textured Silver (PR8) and Textured Charcoal (P7A) only.

HFLWO45

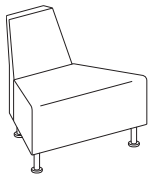

OUTSIDE WEDGE

DIMENSIONS

Depth:	26¼	Seat to Floor Height:	17
Width:	32	Usable Seat Depth:	19
Height:	28	Ship Weight:	35
Seat Depth:	19½	Cube:	21.9
Seat Width:	32	COM:	3.0
Back Width:	16¼	Weight Rating:	300 lbs.
Back Height:	18½		

FABRIC PRICE CODES

1	\$1567	8	\$2351
2	\$1663	9	\$2475
3	\$1759	10	\$2599
4	\$1855	11	\$2723
5	\$1979	12	\$2847
6	\$2103	L	\$2367
7	\$2227		

! Leg options – Standard Leg (L), Tapered Square (TS) and Tapered Round (TR) are available in Textured Silver (PR8) and Textured Charcoal (P7A) only.

HON Recommendation: HFLCC1.TS.PNS__PR8 - List Price \$1568

HOW TO SPECIFY

<p>Select Model Number</p> <p>HFLCC1</p>	<p>Select Leg Option</p> <p>L Standard Leg TS Tapered Square TR Tapered Round</p> <p>TS</p>	<p>Select Fabric</p> <p>See page 323</p> <p>PNS007</p>	<p>Select Leg Color</p> <p>PR8 Textured Silver P7A Textured Charcoal</p> <p><i>Specify for Standard, Tapered Round and Tapered Square legs only</i></p> <p>PR8</p>
---	--	---	---



HFL450

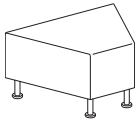

WEDGE OTTOMAN

DIMENSIONS

Depth:	23½	Usable Seat Depth:	23½
Width:	32	Ship Weight:	33
Height:	17	Cube:	12.6
Seat Depth:	23½	COM:	2.0
Seat Width:	32	Weight Rating:	300 lbs.
Seat to Floor Height:	17		

FABRIC PRICE CODES

1	\$768	8	\$1160
2	\$816	9	\$1222
3	\$864	10	\$1284
4	\$912	11	\$1346
5	\$974	12	\$1408
6	\$1036	L	\$1168
7	\$1098		

! Leg options – Standard Leg (L), Tapered Square (TS) and Tapered Round (TR) are available in Textured Silver (PR8) and Textured Charcoal (P7A) only.

HFLS01

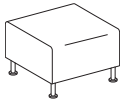

OTTOMAN

Square

DIMENSIONS

Depth:	25	Ship Weight:	30.0
Width:	25	Cube:	7.5
Height:	17	COM:	2.0
Seat Depth:	25	Weight Rating:	300 lbs.
Seat Width:	25		

FABRIC PRICE CODES

1	\$780	8	\$1056
2	\$828	9	\$1092
3	\$876	10	\$1128
4	\$912	11	\$1164
5	\$948	12	\$1200
6	\$984	L	\$1180
7	\$1020		

! Leg options – Standard Leg (L), Tapered Square (TS) and Tapered Round (TR) are available in Textured Silver (PR8) and Textured Charcoal (P7A) only. Hard Casters (H) are available on Black (T) only.

! While the top surface of the ottoman is flat, modular models (pages 325-326 and 330-332) have a slight angle to their seats. Therefore, there will not be alignment between these units when placed side-by-side.

HFLGANG



GANGING BRACKET

For Flock® Modular Seating Models

- Can be used for in-line ganging ONLY
- Use bracket set to connect two models. Do not connect more than four models.
- No specification required for bracket

DIMENSIONS

Ship Weight:	0.5
Cube:	0.1

LIST PRICE

\$34

HON Recommendation: HFLS01.TS.PNS__PR8 - List Price \$828

HOW TO SPECIFY

<p>Select Model Number</p> <p>H F L S 0 1 .</p>	<p>Select Leg Option</p> <p>L Standard Leg TS Tapered Square TR Tapered Round H Hard Casters</p> <p>T S .</p>	<p>Select Fabric</p> <p>See page 323</p> <p>P N S 0 0 7 .</p>	<p>Select Leg Color</p> <p>PR8 Textured Silver P7A Textured Charcoal</p> <p><i>Specify for Standard, Tapered Round and Tapered Square legs only</i></p> <p>T Black Hard Caster <i>Specify for Hard Caster option only</i></p> <p>P R 8</p>
--	---	--	---



HFLSC1S

SQUARE LOUNGE CHAIR W/ SWIVEL BASE

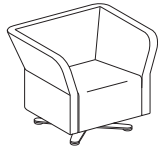

X-Base

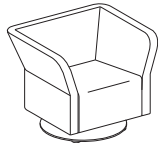

Disc Base

DIMENSIONS

Depth:	28 ⁹ / ₁₆	Arm Width:	27 ¹ / ₂
Width:	34 ⁵ / ₃₂	Seat to Floor Height:	17
Height:	28	Usable Seat Depth:	20 ¹ / ₂
Seat Depth:	20 ⁷ / ₃₂	Ship Weight (X-base):	116
Seat Width:	21 ¹ / ₂	Ship Weight (Round base):	148
Back Width:	21 ¹ / ₂	Cube:	21.9
Back Height:	18 ¹ / ₂	COM:	5.0
		Weight Rating:	300 lbs.

FABRIC PRICE CODES

1	\$2371	8	\$2992
2	\$2479	9	\$3073
3	\$2587	10	\$3154
4	\$2668	11	\$3235
5	\$2749	12	\$3316
6	\$2830	L	\$3271
7	\$2911		

HFLRC1S

ROUND LOUNGE CHAIR W/ SWIVEL BASE



X-Base

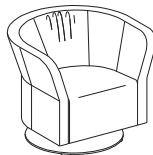

Disc Base

DIMENSIONS

Depth:	29 ¹ / ₁₆	Arm Width:	27 ¹ / ₂
Width:	33 ⁵ / ₃₂	Seat to Floor Height:	17
Height:	28	Usable Seat Depth:	20 ¹ / ₂
Seat Depth:	20 ¹ / ₂	Ship Weight (X-base):	94
Seat Width:	20 ¹ / ₂	Ship Weight (Round base):	126
Back Width:	20 ¹ / ₂	Cube:	21.9
Back Height:	18 ¹ / ₂	Weight Rating:	300 lbs.

FABRIC PRICE CODES

1	\$2459	8	\$3011
2	\$2555	9	\$3083
3	\$2651	10	\$3155
4	\$2723	11	\$3227
5	\$2795	12	\$3299
6	\$2867	L	\$3259
7	\$2939		

- ! Round Lounge model HFLRC1S is offered in select fabrics; for availability please see Fabric matrix on page 323. Also approved in limited Partnership Fabrics. Base options are available in Textured Silver (PR8) and Textured Charcoal (P7A) only.
- ! Customer's Own Material (COM) is not available on HFLRC1S.

HFLMC1S

MODULAR CHAIR W/ SWIVEL BASE



X-Base



Disc Base

DIMENSIONS

Depth:	28 ¹ / ₂	Seat to Floor Height:	17
Width:	25	Usable Seat Depth:	20 ¹ / ₂
Height:	28	Ship Weight (X-base):	91
Seat Depth:	20 ¹ / ₂	Ship Weight (Round base):	123
Seat Width:	25	Cube:	21.9
Back Width:	25	COM:	3.0
Back Height:	18 ¹ / ₂	Weight Rating:	300 lbs.

FABRIC PRICE CODES

1	\$1761	8	\$2175
2	\$1833	9	\$2229
3	\$1905	10	\$2283
4	\$1959	11	\$2337
5	\$2013	12	\$2391
6	\$2067	L	\$2361
7	\$2121		

HON Recommendation: HFLMC1S.X.PNS__PR8 - List Price \$1761

HOW TO SPECIFY

Select Model Number H F L M C 1 S .	Select Swivel Option X X Base D Disc Base X .	Select Fabric See page 323 P N S 0 0 7 .	Select Base Color PR8 Textured Silver P7A Textured Charcoal P R 8
---	---	---	---



Dual Fabric Collaborative

HFLSC1DF

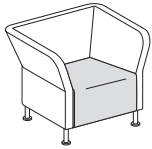

LOUNGE CHAIR

Dual Fabric
Square

DIMENSIONS

Depth:	28½	Arm Width:	27½
Width:	34¼	Seat to Floor Height:	17
Height:	28	Usable Seat Depth:	20½
Seat Depth:	20½	Ship Weight:	48
Seat Width:	21½	Cube:	27.0
Back Width:	21½	COM:	See page 341
Back Height:	18½	Weight Rating:	300 lbs.

FABRIC PRICE CODES

1	\$1902	
<i>Add to Base Price Above</i>		
	Back	Seat
2	\$80	\$28
3	\$160	\$56
4	\$220	\$77
5	\$280	\$98
6	\$340	\$119
7	\$400	\$140
8	\$460	\$161
9	\$519	\$183
10	\$579	\$204
11	\$639	\$225
12	\$699	\$246
L	\$666	\$234

For dual fabric models, start with the base price, then add the additional amount for the back and seat from the corresponding matrix to determine the final list price. Choose any combination of fabric grades for the back and seat.

Example: HFLSC1DF base price (\$1902) + Grade 2 back fabric (add \$80) + Grade 4 seat fabric (add \$77) = Total \$2059 List
 HFLSC1DF base price (\$1902) + Grade 5 back fabric (add \$280) + Grade 3 seat fabric (add \$56) = Total \$2238 List

HFLRC1DF

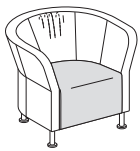

LOUNGE CHAIR

Dual Fabric
Round

DIMENSIONS

Depth:	29	Arm Width:	27½
Width:	33½	Seat to Floor Height:	17
Height:	28	Usable Seat Depth:	20½
Seat Depth:	20½	Ship Weight:	39
Seat Width:	20½	Cube:	27.0
Back Width:	20½	Weight Rating:	300 lbs.
Back Height:	18½		

FABRIC PRICE CODES

1	\$1984	
<i>Add to Base Price Above</i>		
	Back	Seat
2	\$71	\$25
3	\$142	\$50
4	\$195	\$69
5	\$249	\$87
6	\$302	\$106
7	\$355	\$125
8	\$408	\$144
9	\$462	\$162
10	\$515	\$181
11	\$568	\$200
12	\$622	\$218
L	\$592	\$208

NOTES: Due to the inherent design of the Round Lounge chair, material gathers will be present in the back.
 ⓘ Round Lounge models HFLRC1 / HFLRC1DF are offered in select fabrics; for availability, please see the Fabric Matrix on page 323. Also approved in limited Partnership Fabrics.

For dual fabric models, start with the base price, then add the additional amount for the back and seat from the corresponding matrix to determine the final list price. Choose any combination of fabric grades for the back and seat.

Example: HFLRC1DF base price (\$1984) + Grade 2 back fabric (add \$71) + Grade 4 seat fabric (add \$69) = Total \$2124 List
 HFLRC1DF base price (\$1984) + Grade 5 back fabric (add \$249) + Grade 3 seat fabric (add \$50) = Total \$2283 List

HON Recommendation: HFLSC1DF.TS.PNS__PNS__PR8 - List Price \$2010

HOW TO SPECIFY

<p>Select Model Number</p> <p>HFLSC1DF</p>	<p>Select Leg Option</p> <p>L Standard Leg TS Tapered Square TR Tapered Round H Hard Casters</p> <p>TS</p>	<p>Select Back Fabric</p> <p>See page 323</p> <p>PNS004</p>	<p>Select Seat Fabric</p> <p>See page 323</p> <p>PNS007</p>	<p>Select Leg Color</p> <p>PR8 Textured Silver P7A Textured Charcoal</p> <p><i>Specify for Standard, Tapered Round and Tapered Square legs only</i></p> <p>T Black Hard Caster <i>Specify for Hard Caster option only</i></p> <p>PR8</p>
---	--	--	--	---

FLOCK® Dual Fabric Collaborative

GSA SIN 33721



Icon Legend on page 19

HFLMC1DF

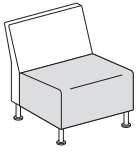

MODULAR CHAIR

Dual Fabric

DIMENSIONS

Depth:	28½	Seat to Floor Height:	17
Width:	25	Usable Seat Depth:	20½
Height:	28	Ship Weight:	52
Seat Depth:	20½	Cube:	24.0
Seat Width:	25	COM:	See page 341
Back Width:	25	Weight Rating:	300 lbs.
Back Height:	18½		

FABRIC PRICE CODES

1	\$1416	
	<i>Add to Base Price Above</i>	
	Back	Seat
2	\$36	\$36
3	\$72	\$72
4	\$99	\$99
5	\$126	\$126
6	\$153	\$153
7	\$180	\$180
8	\$207	\$207
9	\$234	\$234
10	\$261	\$261
11	\$288	\$288
12	\$315	\$315
L	\$300	\$300

HFLML1DF

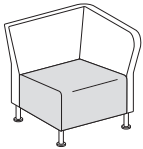

MODULAR LEFT END

Dual Fabric

DIMENSIONS

Depth:	28½	Seat to Floor Height:	17
Width:	28½	Usable Seat Depth:	20½
Height:	28	Ship Weight:	72
Seat Depth:	20½	Cube:	24.0
Seat Width:	22¼	COM:	See page 341
Back Width:	22¼	Weight Rating:	300 lbs.
Back Height:	18½		

FABRIC PRICE CODES

1	\$1655	
	<i>Add to Base Price Above</i>	
	Back	Seat
2	\$71	\$25
3	\$142	\$50
4	\$195	\$69
5	\$249	\$87
6	\$302	\$106
7	\$355	\$125
8	\$408	\$144
9	\$462	\$162
10	\$515	\$181
11	\$568	\$200
12	\$622	\$218
L	\$592	\$208

HON Recommendation: HFLMC1DF.TS.PNS__PNS__PR8 - List Price \$1488

SEATING

HOW TO SPECIFY

<p>Select Model Number</p>	<p>Select Leg Option</p> <p>L Standard Leg TS Tapered Square TR Tapered Round H Hard Casters</p>	<p>Select Back Fabric</p> <p>See page 323</p>	<p>Select Seat Fabric</p> <p>See page 323</p>	<p>Select Leg Color</p> <p>PR8 Textured Silver P7A Textured Charcoal</p> <p><i>Specify for Standard, Tapered Round and Tapered Square legs only</i></p> <p>T Black Hard Caster</p> <p><i>Specify for Hard Caster option only</i></p>
HFLMC1DF	TS	PNS004	PNS007	PR8



Dual Fabric Collaborative

HFLMR1DF

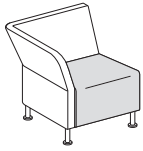

MODULAR RIGHT END

Dual Fabric

DIMENSIONS

Depth:	28½	Seat to Floor Height:	17
Width:	28½	Usable Seat Depth:	20½
Height:	28	Ship Weight:	72.0
Seat Depth:	20½	Cube:	24.0
Seat Width:	22¼	COM:	See page 341
Back Width:	22¼	Weight Rating:	300 lbs.
Back Height:	18½		

FABRIC PRICE CODES

1	\$1655	
<i>Add to Base Price Above</i>		
	Back	Seat
2	\$71	\$25
3	\$142	\$50
4	\$195	\$69
5	\$249	\$87
6	\$302	\$106
7	\$355	\$125
8	\$408	\$144
9	\$462	\$162
10	\$515	\$181
11	\$568	\$200
12	\$622	\$218
L	\$592	\$208

HON Recommendation: HFLMR1DF.TS.PNS__PNS__PR8 - List Price \$1751

HOW TO SPECIFY

<p>Select Model Number</p> <p>HFLMR1DF .</p>	<p>Select Leg Option</p> <p>L Standard Leg TS Tapered Square TR Tapered Round H Hard Casters</p> <p>TS .</p>	<p>Select Back Fabric</p> <p>See page 323</p> <p>PNS004 .</p>	<p>Select Seat Fabric</p> <p>See page 323</p> <p>PNS007 .</p>	<p>Select Leg Color</p> <p>PR8 Textured Silver P7A Textured Charcoal</p> <p><i>Specify for Standard, Tapered Round and Tapered Square legs only</i></p> <p>T Black Hard Caster</p> <p><i>Specify for Hard Caster option only</i></p> <p>PR8</p>
---	--	--	--	---

FLOCK® Dual Fabric Collaborative

GSA SIN 33721



Icon Legend on page 19

HFLCC1DF

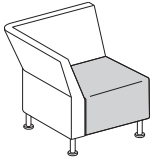

TRUE CORNER CHAIR

Dual Fabric

DIMENSIONS

Depth:	28½	Seat to Floor Height:	17
Width:	28½	Usable Seat Depth:	21
Height:	28	Ship Weight:	60
Seat Depth:	20½	Cube:	21.9
Seat Width:	20½	COM:	See page 341
Back Width:	22¼	Weight Rating:	300 lbs.
Back Height:	18½		

FABRIC PRICE CODES

1	\$1647	
	<i>Add to Base Price Above</i>	
	Back	Seat
2	\$48	\$48
3	\$96	\$96
4	\$144	\$144
5	\$206	\$206
6	\$268	\$268
7	\$330	\$330
8	\$392	\$392
9	\$454	\$454
10	\$516	\$516
11	\$578	\$578
12	\$640	\$640
L	\$400	\$400

! Leg options – Standard Leg (L), Tapered Square (TS) and Tapered Round (TR) are available in Textured Silver (PR8) and Textured Charcoal (P7A) only. Hard Casters (H) are available on Black (T) only.

HFLWI45DF

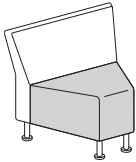

INSIDE WEDGE

Dual Fabric

DIMENSIONS

Depth:	26¼	Seat to Floor Height:	17
Width:	31½	Usable Seat Depth:	19
Height:	28	Ship Weight:	45
Seat Depth:	19½	Cube:	21.9
Seat Width:	25¾	COM:	See page 341
Back Width:	31½	Weight Rating:	300 lbs.
Back Height:	18½		

FABRIC PRICE CODES

1	\$1647	
	<i>Add to Base Price Above</i>	
	Back	Seat
2	\$48	\$48
3	\$96	\$96
4	\$144	\$144
5	\$206	\$206
6	\$268	\$268
7	\$330	\$330
8	\$392	\$392
9	\$454	\$454
10	\$516	\$516
11	\$578	\$578
12	\$640	\$640
L	\$400	\$400

! Leg options – Standard Leg (L), Tapered Square (TS) and Tapered Round (TR) are available in Textured Silver (PR8) and Textured Charcoal (P7A) only. Hard Casters (H) are available on Black (T) only.

HFLWO45DF

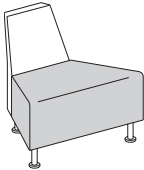

OUTSIDE WEDGE

Dual Fabric

DIMENSIONS

Depth:	26¼	Seat to Floor Height:	17
Width:	32	Usable Seat Depth:	19
Height:	28	Ship Weight:	35
Seat Depth:	19½	Cube:	21.9
Seat Width:	32	COM:	See page 341
Back Width:	16¼	Weight Rating:	300 lbs.
Back Height:	18½		

FABRIC PRICE CODES

1	\$1647	
	<i>Add to Base Price Above</i>	
	Back	Seat
2	\$48	\$48
3	\$96	\$96
4	\$144	\$144
5	\$206	\$206
6	\$268	\$268
7	\$330	\$330
8	\$392	\$392
9	\$454	\$454
10	\$516	\$516
11	\$578	\$578
12	\$640	\$640
L	\$400	\$400

! Leg options – Standard Leg (L), Tapered Square (TS) and Tapered Round (TR) are available in Textured Silver (PR8) and Textured Charcoal (P7A) only. Hard Casters (H) are available on Black (T) only.

HOW TO SPECIFY **HON Recommendation: HFLCC1DF.TS.PNS__PNS__PR8 - List Price \$1743**

Select Model Number HFLCC1DF	Select Leg Option L Standard Leg TS Tapered Square TR Tapered Round H Hard Casters	Select Back Fabric See page 323	Select Seat Fabric See page 323	Select Leg Color PR8 Textured Silver P7A Textured Charcoal <i>Specify for Standard, Tapered Round and Tapered Square legs only</i> T Black Hard Caster <i>Specify for Hard Caster option only</i>
HFLCC1DF	TS	PNS004	PNS007	PR8



HFLSC1SDF

SQUARE LOUNGE CHAIR W/ SWIVEL BASE

DIMENSIONS

FABRIC PRICE CODES

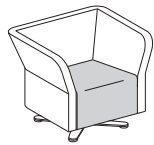

X-Base

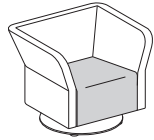

Disc Base

Dual Fabric

Depth:	28 ⁹ / ₁₆	Arm Width:	27 ¹ / ₂
Width:	34 ³ / ₃₂	Seat to Floor Height:	17
Height:	28	Usable Seat Depth:	20 ¹ / ₂
Seat Depth:	20 ¹⁷ / ₃₂	Ship Weight (X-base):	116
Seat Width:	21 ¹ / ₂	Ship Weight (Round base):	148
Back Width:	21 ¹ / ₂	Cube:	21.9
Back Height:	18 ¹ / ₂	COM:	See page 341
		Weight Rating:	300 lbs.

1	\$2457	
<i>Add to Base Price Above</i>		
	Back	Seat
2	\$80	\$28
3	\$160	\$56
4	\$220	\$77
5	\$280	\$98
6	\$340	\$119
7	\$400	\$140
8	\$460	\$161
9	\$519	\$183
10	\$579	\$204
11	\$639	\$225
12	\$699	\$246
L	\$666	\$234

HFLRC1SDF

ROUND LOUNGE CHAIR W/ SWIVEL BASE

DIMENSIONS

FABRIC PRICE CODES



X-Base

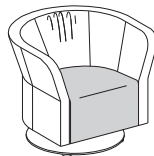

Disc Base

Dual Fabric

Depth:	29 ¹ / ₁₆	Arm Width:	27 ¹ / ₂
Width:	33 ³ / ₃₂	Seat to Floor Height:	17
Height:	28	Usable Seat Depth:	20 ¹ / ₂
Seat Depth:	20 ¹ / ₂	Ship Weight (X-base):	94
Seat Width:	20 ¹ / ₂	Ship Weight (Round base):	126
Back Width:	20 ¹ / ₂	Cube:	21.9
Back Height:	18 ¹ / ₂	Weight Rating:	300 lbs.

1	\$2544	
<i>Add to Base Price Above</i>		
	Back	Seat
2	\$71	\$25
3	\$142	\$50
4	\$195	\$69
5	\$249	\$87
6	\$302	\$106
7	\$355	\$125
8	\$408	\$144
9	\$462	\$162
10	\$515	\$181
11	\$568	\$200
12	\$622	\$218
L	\$592	\$208

NOTES: Due to the inherent design of the Round Lounge chair, material gathers will be present in the back.

! Round Lounge model HFLRC1SDF is offered in select fabrics; for availability, please see the Fabric Matrix on page 323. Also approved in limited Partnership Fabrics.

For dual fabric models, start with the base price, then add the additional amount for the back and seat from the corresponding matrix to determine the final list price. Choose any combination of fabric grades for the back and seat.

Example: HFLRC1SDF base price (\$2544) + Grade 2 back fabric (add \$71) + Grade 4 seat fabric (add \$69) = Total \$2684 List

HFLMC1SDF

MODULAR CHAIR W/ SWIVEL BASE

DIMENSIONS

FABRIC PRICE CODES



X-Base

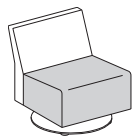

Disc Base

Dual Fabric

Depth:	28 ¹ / ₂	Seat to Floor Height:	17
Width:	25	Usable Seat Depth:	20 ¹ / ₂
Height:	28 ¹ / ₂	Ship Weight (X-base):	91
Seat Depth:	20 ¹ / ₂	Ship Weight (Round base):	123
Seat Width:	25	Cube:	21.9
Back Width:	25	COM:	See page 341
Back Height:	18 ¹ / ₂	Weight Rating:	300 lbs.

1	\$1843	
<i>Add to Base Price Above</i>		
	Back	Seat
2	\$36	\$36
3	\$72	\$72
4	\$99	\$99
5	\$126	\$126
6	\$153	\$153
7	\$180	\$180
8	\$207	\$207
9	\$234	\$234
10	\$261	\$261
11	\$288	\$288
12	\$315	\$315
L	\$300	\$300

HOW TO SPECIFY

HON Recommendation: HFLMC1SDF.X.PNS__PNS__PR8 - List Price \$1915

<p>Select Model Number</p> <p>HFLMC1SDF</p>	<p>Select Swivel Option</p> <p>X X Base D Disc Base</p> <p>X</p>	<p>Select Back Fabric</p> <p>See page 323</p> <p>PNS004</p>	<p>Select Seat Fabric</p> <p>See page 323</p> <p>PNS007</p>	<p>Select Base Color</p> <p>PR8 Textured Silver P7A Textured Charcoal</p> <p>PR8</p>
---	--	---	---	--

FLOCK® Base Frames and Legs

OPEN MARKET



Icon Legend on page 19

	DESCRIPTION	MODEL	SHIP WEIGHT	CUBE	LIST PRICE
	Two-Seat Base Frame	HFLB2	25	5.9	\$412
	Three-Seat Base Frame	HFLB3	33	7.8	\$515

HOW TO SPECIFY

<p>Select Model Number</p> <p>H F L B 2 .</p>	<p>Select Leg Option</p> <p>RS Round Straight Leg TS Tapered Square Leg (+ \$75)</p> <p>Select Leg Color</p> <p>PR8 Textured Silver P7A Textured Charcoal</p> <p>R S P R 8</p>
--	--

	DESCRIPTION	MODEL	SHIP WEIGHT	CUBE	LIST PRICE
	Tapered Square Leg — Shroud Pack	HTSSRD	2	1.0	\$78

HOW TO SPECIFY

<p>Select Model Number</p> <p>H T S S R D .</p>	<p>Select Leg Color</p> <p>PR8 Textured Silver P7A Textured Charcoal</p> <p>P R 8</p>
--	--

MODEL OPTIONS

HFSS7



Stool

HFCG6
HFCG6DF - Dual Fabric



Guest Chair
Casual

HFCL2
HFCL2DF - Dual Fabric



Wide Lounge Chair
With 4-Star Return-to-Center

HFLSC2
HFLSC2DF - Dual Fabric



Square Chair
With 4-Star Return-to-Center

HFSS74L
HFSS74LDF - Dual Fabric



Stool
4-Leg

SHELL COLOR

CODE	DESCRIPTION	PRICE
LA	Lava	+\$0
ON	Onyx	+\$0
PT	Platinum	+\$0
SD	Shadow	+\$0

**Available for model HFSS7 only*

FRAME

CODE	DESCRIPTION	PRICE
4S	4-Star Return-to-Center*	+\$0

**Available for models HFCL2 and HFLSC2 only*

Available in the following finishes:

PR8	Textured Silver
P7A	Textured Charcoal

FLOCK® Fabric Options

HON BRANDED FABRICS

GRADE 1	GRADE 2	GRADE 3	GRADE L
Apex	Appoint Seating	In Season	Denver Leather*
Attire	Blume	Moxie	
Centurion	Clyde	Parker	
Compass	Dotty	Purl	
Contourett	Rush	Quill	
Dapper	Seed		
Ensemble	Spin Seating		
Hamilton	Whisper Vinyl		
Inertia			
Optic			
Pebble			

For a complete list of fabrics, including partnership fabrics, go to hon.com/fabricsandfinishes.

Flock® chair models HFLRC1 and HFLRC1DF have fabric limitations, please see the Flock® seating pages 324-333 and 337 for details. Reference Fabric Color Combinations on pages 20-24 for color codes and legend on page 21 for lead times.

*Denver Leather (SS) may not be available on every model within a specific series, please refer to the model's page for details.

FLOCK® SQUARE CHAIR HFLSC2/DF HON BRANDED FABRICS

GRADE 1	GRADE 2	GRADE 3	GRADE L
Apex	Appoint Seating	In Season	Denver Leather**
Centurion	Blume	Moxie	
Compass	Clyde	Parker	
Contourett	Rush	Purl	
Dapper	Seed*	Quill	
Ensemble	Spin Seating*		
Hamilton	Whisper Vinyl		
Inertia			
Optic*			
Pebble			

For a complete list of fabrics, including partnership fabrics, go to hon.com/fabricsandfinishes.

Flock® chair model HFLSC2/DF has fabric limitations, please see the Flock® seating pages 338-340 for details.

*Available on seat only.

**Denver Leather (SS) may not be available on every model within a specific series, please refer to the model's page for details.

Reference Fabric Color Combinations on pages 20-24 for color codes and legend on page 21 for lead times.



HFSS7

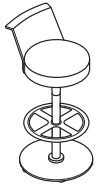

STOOL

DIMENSIONS

Depth:	18	Seat to Floor Height:	31
Width:	18	Usable Seat Depth:	15¾
Height:	39⅞	Ship Weight:	57
Seat Depth:	15¾	Cube:	11.0
Seat Width:	15¾	Weight Rating:	300 lbs.
Back Width:	15¾		
Back Height:	8		

FABRIC PRICE CODES

1	\$831	8	\$1038
2	\$867	9	\$1065
3	\$903	10	\$1092
4	\$930	11	\$1119
5	\$957	12	\$1146
6	\$984	L	—
7	\$1011		

! Customer's Own Material (COM) is not available on Flock® models HFLRC1 or HFSS7.

HON Recommendation: HFSS7.PT.PNS__PR8 - List Price \$867

HOW TO SPECIFY

Select Model Number HFSS7	Select Shell Color LA Lava ON Onyx PT Platinum SD Shadow PT	Select Fabric See page 336 PNS007	Select Frame PR8 Textured Silver P7A Textured Charcoal PR8
---	---	--	--

HFSG6



GUEST CHAIR

Casual

DIMENSIONS

Depth:	23⅙	Seat to Floor Height:	18¼
Width:	19	Usable Seat Depth:	16⅞
Height:	32½	Ship Weight:	24
Seat Depth:	16⅞	Cube:	10.4
Seat Width:	19	COM:	1.8
Back Width:	19	Weight Rating:	300 lbs.
Back Height:	14¼		

FABRIC PRICE CODES

1	\$617	8	\$893
2	\$665	9	\$929
3	\$713	10	\$965
4	\$749	11	\$1001
5	\$785	12	\$1037
6	\$821	L	\$1017
7	\$857		

HFSS74L



STOOL

4-Leg

DIMENSIONS

Depth:	21⅞	Seat to Floor Height:	30
Width:	18	Usable Seat Depth:	15⅞
Height:	40⅞	Ship Weight:	35
Seat Depth:	15⅞	Cube:	21.8
Seat Width:	18	COM:	1.9
Back Width:	18	Weight Rating:	300 lbs.
Back Height:	10⅞		

FABRIC PRICE CODES

1	\$776	8	\$1052
2	\$824	9	\$1088
3	\$872	10	\$1124
4	\$908	11	\$1160
5	\$944	12	\$1196
6	\$980	L	\$1176
7	\$1016		

HON Recommendation: HFSS74L.PNS__PR8 - List Price \$824

HOW TO SPECIFY

Select Model Number HFSS74L	Select Fabric See page 336 PNS007	Select Frame PR8 Textured Silver PR8
---	--	---



HFCL2



WIDE LOUNGE CHAIR

with 4-Star Return-to-Center

DIMENSIONS

Depth:	27½	Seat to Floor Height:	17
Width:	26¾	Usable Seat Depth:	19
Height:	32¼	Ship Weight:	53
Seat Width:	26	Cube:	25.1
Back Width:	25½	COM:	2.5
Back Height:	19½	Weight Rating:	300 lbs.

FABRIC PRICE CODES

1	\$1050	8	\$1464
2	\$1122	9	\$1518
3	\$1194	10	\$1572
4	\$1248	11	\$1626
5	\$1302	12	\$1680
6	\$1356	L	\$1650
7	\$1410		

HFLSC2



SQUARE CHAIR

with 4-Star Return-to-Center

DIMENSIONS

Depth:	26½	Seat to Floor Height:	18
Width:	27½	Usable Seat Depth:	18¾
Height:	32¼	Ship Weight:	46
Seat Width:	17½	Cube:	25.1
Back Width:	16	COM:	3.0
Back Height:	17¾	Weight Rating:	300 lbs.

FABRIC PRICE CODES

1	\$1515	8	\$1929
2	\$1587	9	\$1983
3	\$1659	10	\$2037
4	\$1713	11	\$2091
5	\$1767	12	\$2145
6	\$1821	L	\$2115
7	\$1875		

HON Recommendation: HFLSC2.PNS__4SPR8 - List Price \$1515

HOW TO SPECIFY

Select Model Number

HFLSC2

Select Fabric

See page 336

PNS007

Select Base Option

4S 4-Star Return-to-Center

Select Base Color

PR8 Textured Silver
P7A Textured Charcoal

4SPR8



HFCG6DF



CASUAL GUEST CHAIR

Dual Fabric

DIMENSIONS

Depth:	23 ⁵ / ₁₆	Seat to Floor Height:	18 ¹ / ₄
Width:	19	Usable Seat Depth:	16 ⁷ / ₈
Height:	32 ¹ / ₂	Ship Weight:	24
Seat Depth:	16 ⁷ / ₈	Cube:	10.4
Seat Width:	19	COM:	See page 341
Back Width:	19	Weight Rating:	300 lbs.
Back Height:	14 ¹ / ₄		

FABRIC PRICE CODES

1	\$699	
<i>Add to Base Price Above</i>		
	Back	Seat
2	\$24	\$24
3	\$48	\$48
4	\$66	\$66
5	\$84	\$84
6	\$102	\$102
7	\$120	\$120
8	\$138	\$138
9	\$156	\$156
10	\$174	\$174
11	\$192	\$192
12	\$210	\$210
L	\$200	\$200

HFSS74LDF



4-LEG STOOL

Dual Fabric

DIMENSIONS

Depth:	21 ¹ / ₈	Seat to Floor Height:	30
Width:	18	Usable Seat Depth:	15 ¹ / ₈
Height:	40 ⁷ / ₈	Ship Weight:	35
Seat Depth:	15 ¹ / ₈	Cube:	21.8
Seat Width:	18	COM:	See page 341
Back Width:	18	Weight Rating:	300 lbs.
Back Height:	10 ⁷ / ₈		

FABRIC PRICE CODES

1	\$860	
<i>Add to Base Price Above</i>		
	Back	Seat
2	\$24	\$24
3	\$48	\$48
4	\$66	\$66
5	\$84	\$84
6	\$102	\$102
7	\$120	\$120
8	\$138	\$138
9	\$156	\$156
10	\$174	\$174
11	\$192	\$192
12	\$210	\$210
L	\$200	\$200

HON Recommendation: HFSS74LDF.PNS___.PNS___.PR8 - List Price \$908

HOW TO SPECIFY

<p>Select Model Number</p> <p>HFSS74LDF</p>	<p>Select Back Fabric</p> <p>See page 336</p> <p>PNS004</p>	<p>Select Seat Fabric</p> <p>See page 336</p> <p>PNS007</p>	<p>Select Frame</p> <p>PR8 Textured Silver (only)</p> <p>PR8</p>
--	--	--	---

FLOCK® Dual Fabric Collaborative

OPEN MARKET



Icon Legend on page 19

HFCL2DF



WIDE LOUNGE CHAIR

with 4-Star Return-to-Center

DIMENSIONS

Depth:	27½	Seat to Floor Height:	17
Width:	26¾	Usable Seat Depth:	19
Height:	32¼	Ship Weight:	53
Seat Width:	26	Cube:	25.1
Back Width:	25½	COM:	See page 341
Back Height:	19½	Weight Rating:	300 lbs.

FABRIC PRICE CODES

1	\$1125	
<i>Add to Base Price Above</i>		
	Back	Seat
2	\$36	\$36
3	\$108	\$108
4	\$162	\$162
5	\$216	\$216
6	\$270	\$270
7	\$324	\$324
8	\$378	\$378
9	\$432	\$432
10	\$486	\$486
11	\$540	\$540
12	\$594	\$594
L	\$300	\$300

HFLSC2DF



SQUARE CHAIR

with 4-Star Return-to-Center

DIMENSIONS

Depth:	26½	Seat to Floor Height:	18
Width:	27½	Usable Seat Depth:	18¾
Height:	32¼	Ship Weight:	46
Seat Width:	17½	Cube:	25.1
Back Width:	16	COM:	See page 341
Back Height:	17¾	Weight Rating:	300 lbs.

FABRIC PRICE CODES

1	\$1591	
<i>Add to Base Price Above</i>		
	Back	Seat
2	\$48	\$24
3	\$120	\$96
4	\$174	\$150
5	\$228	\$204
6	\$282	\$258
7	\$336	\$312
8	\$390	\$366
9	\$444	\$420
10	\$498	\$474
11	\$552	\$528
12	\$606	\$582
L	\$400	\$200

HON Recommendation: HFLSC2DF.PURL__PURL__4SPR8 - List Price \$1807

SEATING

HOW TO SPECIFY

<p>Select Model Number</p> <p>HFLSC2DF</p>	<p>Select Back Fabric</p> <p>See page 336</p> <p>PURL12</p>	<p>Select Seat Fabric</p> <p>See page 336</p> <p>PURL12</p>	<p>Select Base Option</p> <p>4S 4-Star Return-to-Center</p> <p>Select Base Color</p> <p>PR8 Textured Silver P7A Textured Charcoal</p> <p>4SPR8</p>
---	--	--	--

MODEL OPTIONS

HFLC01
HFLC01DF - Dual Fabric

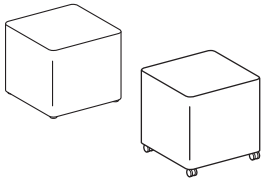

Mini Cube

HFLY01
HFLY01DF - Dual Fabric

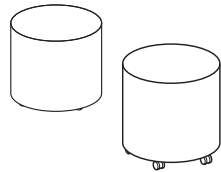

Mini Cylinder

CASTER/ GLIDES

CODE	DESCRIPTION	PRICE
A	Active Base*	+\$75
<i>*Available on models HFLY01 and HFLY01DF only</i>		
H	Hard Caster	+\$0
HG	Hidden Glide	+\$0
LPR8	Textured Silver Disc Glide	+\$45
LP7A	Textured Charcoal Disc Glide	+\$45

DUAL FABRIC COM YARDAGE

Due to fabric pattern nesting and potential reduction of fabric yield, some dual fabric models may require more total yardage than standard models.

MODEL	BACK COM	SEAT COM
HFLMC1DF	1.6	1.5
HFLML1DF	2.9	1.4
HFLMR1DF	2.9	1.4
HFCG6DF	1.8	1.9
HFSS74LDF	1.4	1.9
HFLWI45DF	2.3	1.4
HFLWO45DF	1.0	1.4
HFLCC1DF	2.3	1.4
HFLSC1SDF	3.6	1.4
HFLMC1SDF	1.6	1.5
HFCL2DF	1.5	2.0
HFLSC2DF	2.5	3.0
	TOP	SIDE
HFLC01DF	0.7	1.2
HFLY01DF	0.7	1.2

HON BRANDED FABRICS

GRADE 1	GRADE 2	GRADE 3	GRADE L
Apex	Appoint Seating	In Season	Denver Leather
Attire	Blume	Moxie	
Centurion	Clyde	Parker	
Compass	Dotty	Purl	
Contourett	Rush	Quill	
Dapper	Spin Seating		
Ensemble	Whisper Vinyl		
Hamilton			
Inertia			
Optic			
Pebble			

For a complete list of fabrics, including partnership fabrics, go to hon.com/fabricsandfinishes.

Reference Fabric Color Combinations on pages 20-24 for color codes and legend on page 21 for lead times.

For Fire Code model, availability and ordering method, refer to pages 248-251. Available on select models, contact HON Customer Support for availability.

FLOCK® Mini Cube and Cylinders

GSA SIN 33721



Icon Legend on page 19

HFLCO1

MINI CUBE

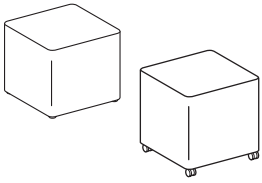

DIMENSIONS

Depth:	18½	Seat to Floor Height:	17
Width:	18½	Usable Seat Depth:	18½
Height:	17	Ship Weight:	15
Seat Depth:	18½	Cube:	5.0
Seat Width:	18½	COM:	2.0
		Weight Rating:	300 lbs.

FABRIC PRICE CODES

1	\$467	8	\$674
2	\$503	9	\$701
3	\$539	10	\$728
4	\$566	11	\$755
5	\$593	12	\$782
6	\$620	L	\$767
7	\$647		

HFLY01

MINI CYLINDER

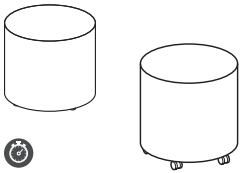

DIMENSIONS

Depth:	18½	Seat to Floor Height:	17
Width:	18½	Usable Seat Depth:	18½
Height:	17	Ship Weight:	13
Seat Depth:	18½	Cube:	5.0
Seat Width:	18½	COM:	2.0
		Weight Rating:	300 lbs.

FABRIC PRICE CODES

1	\$466	8	\$673
2	\$502	9	\$700
3	\$538	10	\$727
4	\$565	11	\$754
5	\$592	12	\$781
6	\$619	L	\$766
7	\$646		

HON Recommendation: HFLY01.LPR8.PNS__ - List Price \$547

SEATING

HOW TO SPECIFY

Select Model Number

HFLY01

Select Base

- A** Active Base* (+ \$75)
- *Available on model HFLY01 only*
- H** Caster
- HG** Hidden Glide
- LPR8** Textured Silver Disc Glide (+ \$45)
- LP7A** Textured Charcoal Disc Glide (+ \$45)

LPR8

Select Fabric

See page 341

PNS007



Dual Fabric Mini Cube and Cylinder

HFLCO1DF

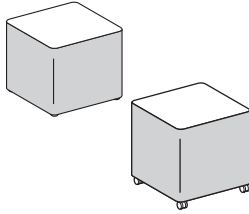

MINI CUBE

Dual Fabric

DIMENSIONS

Depth:	18½	Seat to Floor Height:	17
Width:	18½	Usable Seat Depth:	18½
Height:	17	Ship Weight:	15
Seat Depth:	18½	Cube:	5.0
Seat Width:	18½	COM:	See page 341
		Weight Rating:	300 lbs.

FABRIC PRICE CODES

1	\$547	
<i>Add to Base Price Above</i>		
	Top	Sides
2	\$11	\$25
3	\$22	\$50
4	\$30	\$69
5	\$38	\$88
6	\$46	\$107
7	\$54	\$126
8	\$62	\$145
9	\$70	\$164
10	\$78	\$183
11	\$86	\$202
12	\$95	\$221
L	\$90	\$210

HFLYO1DF

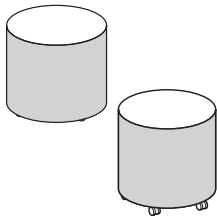

MINI CYLINDER

Dual Fabric

DIMENSIONS

Depth:	18½	Seat to Floor Height:	17
Width:	18½	Usable Seat Depth:	18½
Height:	17	Ship Weight:	13
Seat Depth:	18½	Cube:	5.0
Seat Width:	18½	COM:	See page 341
		Weight Rating:	300 lbs.

FABRIC PRICE CODES

1	\$546	
<i>Add to Base Price Above</i>		
	Top	Sides
2	\$11	\$25
3	\$22	\$50
4	\$30	\$69
5	\$38	\$88
6	\$46	\$107
7	\$54	\$126
8	\$62	\$145
9	\$70	\$164
10	\$78	\$183
11	\$86	\$202
12	\$95	\$221
L	\$90	\$210

HON Recommendation: HFLCO1DF.HG.PNS___.PNS__ - List Price \$583

HOW TO SPECIFY

<p>Select Model Number</p>	<p>Select Base</p> <p>A Active Base* (+ \$75) *Available on model HFLYO1DF only</p> <p>H Caster HG Hidden Glide LPR8 Textured Silver Disc Glide (+ \$45) LP7A Textured Charcoal Disc Glide (+ \$45)</p>	<p>Select Top Fabric</p> <p>See page 341</p>	<p>Select Side Fabric</p> <p>See page 341</p>
<p>H F L C O 1 D F .</p>	<p>H G .</p>	<p>P N S 0 0 7 .</p>	<p>P N S 0 0 4 .</p>

NOTES

GATEWAY™



Gateway™ Chairs shown with Huddle Tables.

GATEWAY™

So you need a new chair, but it has to look as cool as it is comfortable. We've got you covered. Gateway takes the complexity out of finding the perfect chair by focusing on exactly what you're looking for. Cool, breathable mesh. Personalized seat fabrics. Targeted back support. Just what you need. Nothing you don't. All at a price you'll have to look at twice to make sure it's not a typo.



FEATURES

- Seat has comfortable, waterfall edge.
- Mesh back material flexes for a relaxed fit.
- Adjustable lumbar.
- Adjustable tilt to recline based on body type.
- Three arm options.
- Carton is 2 cubic feet smaller than the industry average.

GATEWAY™ Fabric Options

HON BRANDED FABRICS

GRADE 1

Centurion
Contourett

GRADE 2

Dotty

For a complete list of fabrics, including partnership fabrics, go to hon.com/fabricsandfinishes.

Reference Fabric Color Combinations on pages 20-24 for color codes and legend on page 21 for lead times.

 For Fire Code model, availability and ordering method, refer to pages 248-251. Available on select models, contact HON Customer Support for availability.



GATEWAY™ Standard Task Chair

HGTMM

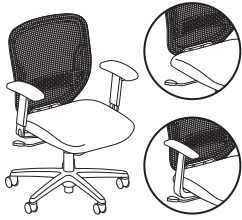

TASK CHAIR

Mesh Back
 Pneumatic
 Swivel
 Tilt Tension
 Tilt Lock
 Adjustable Lumbar Support
 Functions: **A, E, F, K, L, W**
 (Function Key on pages 244-245)
 NOTES: **HON 5-Year Limited Warranty.**

DIMENSIONS

Depth:	25¼	Seat to Floor Height:	17-22
Width:	27	Usable Seat Depth:	19
Height:	38	Ship Weight:	35
Seat Depth:	19	Cube:	3.4
Seat Width:	18½	Weight Rating:	250 lbs.
Back Width:	18		
Back Height:	18½		

FABRIC PRICE CODES

1	\$273
2	\$285

HOW TO SPECIFY

Select Model Number	Select Control Type	Select Arm Type	Select Caster	Select Back Type	Select Fabric	Select Lumbar	Select Base	Select Frame
Z1 Swivel-Tilt Control	N Armless F Fixed Arms (+ \$35) H Height-Adjustable Arms (+ \$45)	H Black Hard Caster	M Mesh	See page 346	AL Adjustable Lumbar	SB Standard Base	T Black	
HGTMM	Z1	H	H	M	CU10	AL	SB	T

GATEWAY™ Value Task Chair

OPEN MARKET



Icon Legend on page 19

HGV1MM



TASK CHAIR VALUE MODEL

- Mesh Back**
- Pneumatic
- Swivel
- Tilt Tension
- Tilt Lock
- Adjustable Lumbar Support

Functions: **A, E, F, K, L, W**
(Function Key on pages 244-245)

NOTES: **HON 5-Year Limited Warranty.**

DIMENSIONS

Depth:	25¼	Seat to Floor Height:	17-22
Width:	27	Usable Seat Depth:	19
Height:	38	Ship Weight:	35
Seat Depth:	19	Cube:	3.4
Seat Width:	18½	Weight Rating:	250 lbs.
Back Width:	18		
Back Height:	18½		

LIST PRICE

\$244

HOW TO SPECIFY

Select Model Number	Select Control Type	Select Arm Type	Select Caster	Select Back Type	Select Fabric	Select Lumbar	Select Base	Select Frame
Z1 Swivel-Tilt Control	N Armless F Fixed Arms (+ \$35) H Height-Adjustable Arms (+ \$45)	H Black Hard Caster	M Mesh	ACCF10 Black	AL Adjustable Lumbar	SB Standard Base	T Black	
HGV1MM	Z1	H	H	M	ACCF10	AL	SB	T

GROVE®



Grove® Lounge shown with Flock® Table.

GROVE®

Find a comfy place to put your feet up, huddle up and power up. Grove is the versatile lounge seating designed to help you greet, meet, focus, relax and accomplish more. This change-of-pace collection delivers the comfort people crave, while encouraging focus and interaction throughout the workplace. Grove's attractive design is rivaled only by its flexibility. Models include a single seat, two-seat, three-seat, and two-seat with table — all with three arm style and two leg style options, as well as accessories that support connectivity and collaboration. Grove has the look you're going for, and the comfort and versatility people have been waiting for.



FEATURES

- Each model can be combined to create arrangements suitable for any space.
- Optional integrated worksurfaces create more personal space and provide a convenient worksurface.
- Design complements Flock ottomans and tables.
- Integrated power grommets keep laptops and phone powered up anywhere.
- The dual fabric option coordinates two high-quality HON fabrics for a contemporary look.
- Choose from Single Seat, Two-Seat, Three-Seat Lounge, or Two-Seat with Table options.
- Choose from 3 arm options — Armless (N), Straight Arms (A), or Tapered Arm (B).
- Table available with two grommets and an accessory port option.
- Offers a table between the seats that provides separation and a usable worksurface.
- Warranted for users up to 300 lbs.

MODEL OPTIONS

HML1S
HML1SDF - Dual Fabric

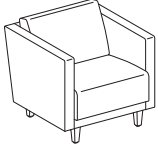

Lounge
Single Seat

HML2S
HML2SDF - Dual Fabric

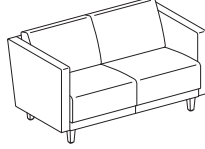

Lounge
Two-Seat

HML3S
HML3SDF - Dual Fabric

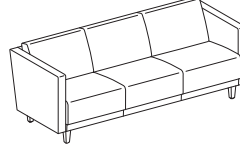

Lounge
Three-Seat

HML2ST
HML2STDF - Dual Fabric

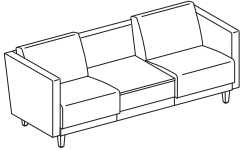

Lounge
Two-Seat with Table

ARM STYLE

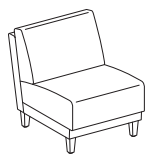

CODE	DESCRIPTION	PRICE
N	Armless	+\$0

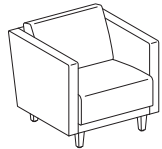

A	Straight Arms	+\$300
----------	---------------	---------------

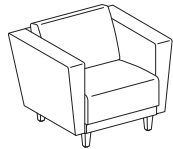

B	Tapered Arms	+\$350
----------	--------------	---------------

L1 LAMINATE

COLOR CODE

Black	P
Bourbon Cherry	H
Designer White	LDW1
Charcoal	S
Cognac	COGN
Florence Walnut	LFW1
Harvest	C
Kingswood Walnut	LK11
Loft	LOFT
Mahogany	N
Mocha	MOCH
Natural Maple	D
Pinnacle	PINC
Shaker Cherry	F

L2 LAMINATE

COLOR CODE

Lowell Ash	LLA1
Natural Recon	LNR1
Phantom Ecu	LPE1
Portico Teak	LPT1
Skyline Walnut	LSW1

*Specify for models HML2ST and HML2STDF only

LEG STYLE



CODE	DESCRIPTION	PRICE
TS	Tapered Square	+\$0



TR	Tapered Round	+\$0
-----------	---------------	-------------

LEG COLOR

CODE	DESCRIPTION	PRICE
PR8	Textured Silver	+\$0
P7A	Textured Charcoal	+\$0
H	Bourbon Cherry	+\$100
F	Shaker Cherry	+\$100
N	Mahogany	+\$100
C	Harvest	+\$100
D	Natural Maple	+\$100
LK11	Kingswood Walnut	+\$100
LSA1	Sterling Ash	+\$100

CUT OUT

CODE	DESCRIPTION	PRICE
N	No Cutout	+\$0
G	Round Grommet Cutout	+\$30
G1	Pop-Up Port Cutout	+\$40

*Specify for models HML2ST and HML2STDF only

ACCESSORY PORT LOCATION

CODE	DESCRIPTION	PRICE
0	No Port	+\$0
2	Two Tablet Ports Opposite	+\$20

*Specify for models HML2ST and HML2STDF only

GROVE® Fabric Options

HON BRANDED FABRICS

GRADE 1	GRADE 2	GRADE 3	GRADE L
Apex	Appoint Seating	In Season	Denver Leather
Centurion	Blume	Moxie	
Compass	Clyde	Parker	
Contourett	Dotty	Purl	
Dapper	Rush	Quill	
Ensemble	Seed		
Hamilton	Spin Seating		
Inertia	Whisper Vinyl		
Optic			
Pebble			

For a complete list of fabrics, including partnership fabrics, go to hon.com/fabricsandfinishes.

Reference Fabric Color Combinations on pages 20-24 for color codes and legend on page 21 for lead times. For additional HON to Supply COM fabric grade pricing, go to honready.hon.com and click on the HON to Supply COM link.

 For Fire Code model, availability and ordering method, refer to pages 248-251. Available on select models, contact HON Customer Support for availability.

 Due to the inherent characteristics of upholstery materials, the seat of Grove® may become more relaxed to show wrinkles over time.

DUAL FABRIC COM YARDAGE

Due to fabric pattern nesting and potential reduction of fabric yield, some dual fabric models may require more total yardage than standard models.

MODEL	COM (ARMLESS)		COM (w/ STRAIGHT ARMS)		COM (w/ TAPERED ARMS)	
	Back	Seat	Back	Seat	Back	Seat
HML1S	3		5		5	
HML1SDF	1.5	2	4	2	4	2
HML2S	5		7.5		7.5	
HML2SDF	2	3.5	4	3.5	4	3.5
HML2ST	6		8		8	
HML2STDF	3	3.5	5.5	3.5	5.5	3.5
HML3	7.5		9		9.5	
HML3DF	3	5	5.5	5	5.5	5



HML1S

LOUNGE

Single Seat



Armless

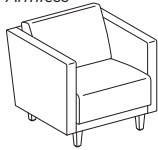

Straight Arms

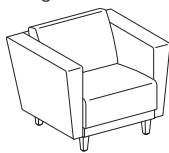

Tapered Arms

DIMENSIONS

Depth:	31½	Ship Weight (armless):	61
Height:	35	Ship Weight (with straight arms):	77
Seat Width:	23½	Ship Weight (with tapered arms):	85
Back Width:	23½	Cube (armless):	19.8
Back Height:	19	Cube (with straight arms):	19.8
Width (armless):	23½	Cube (with tapered arms):	19.8
Width (with straight arms):	29¾	COM:	See
Width (with tapered arms):	35		page
Arm Width:	23½		352
Seat to Floor Height:	16	Weight Rating:	300 lbs.
Usable Seat Depth:	18¾		(per seat)

FABRIC PRICE CODES

1	\$1348	8	\$1762
2	\$1420	9	\$1816
3	\$1492	10	\$1870
4	\$1546	11	\$1924
5	\$1600	12	\$1978
6	\$1654	L	\$1948
7	\$1708		

HML2S

LOUNGE

Two-Seat

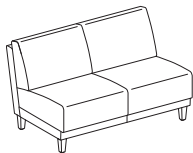

Armless

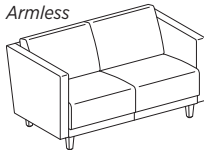

Straight Arms

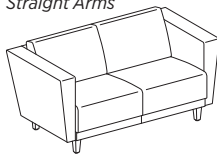

Tapered Arms

DIMENSIONS

Depth:	31½	Ship Weight (armless):	100
Height:	35	Ship Weight (with straight arms):	116
Seat Width:	48	Ship Weight (with tapered arms):	124
Back Width:	48	Cube (armless):	35.6
Back Height:	19	Cube (with straight arms):	35.6
Width (armless):	48	Cube (with tapered arms):	35.6
Width (with straight arms):	54¼	COM:	See
Width (with tapered arms):	59½		page
Arm Width:	48		352
Seat to Floor Height:	16	Weight Rating:	300 lbs.
Usable Seat Depth:	18¾		(per seat)

FABRIC PRICE CODES

1	\$2130	8	\$2820
2	\$2250	9	\$2910
3	\$2370	10	\$3000
4	\$2460	11	\$3090
5	\$2550	12	\$3180
6	\$2640	L	\$3130
7	\$2730		

HON Recommendation: HML1S.A.PNS__TS.P7A - List Price \$1720

HOW TO SPECIFY

<p>Select Model Number</p>	<p>Select Arm Type</p> <p>N Armless A Straight Arms (+ \$300) B Tapered Arms (+ \$350)</p>	<p>Select Fabric</p> <p>See page 352</p>	<p>Select Leg Type</p> <p>TS Tapered Square TR Tapered Round</p>	<p>Select Leg Color</p> <p>PR8 Textured Silver P7A Textured Charcoal H Bourbon Cherry (+ \$100) F Shaker Cherry (+ \$100) N Mahogany (+ \$100) C Harvest (+ \$100) D Natural Maple (+ \$100) LKI1 Kingswood Walnut (+ \$100) LSA1 Sterling Ash (+ \$100)</p>
<p>H M L 1 S .</p>	<p>A .</p>	<p>P N S 0 0 7 .</p>	<p>T S .</p>	<p>P 7 A</p>

! Leg options - Tapered Square (TS) and Tapered Round (TR) are available in 2 poly and 13 woodgrain options.

HML3S

LOUNGE

Three-Seat

DIMENSIONS

Depth:	31½	Ship Weight (armless):	141
Height:	35	Ship Weight (with straight arms):	157
Seat Width:	71½	Ship Weight (with tapered arms):	165
Back Width:	71½	Cube (armless):	48.9
Back Height:	19	Cube (with straight arms):	48.9
Width (armless):	71½	Cube (with tapered arms):	48.9
Width (with straight arms):	77½	COM:	See
Width (with tapered arms):	82½		page
Arm Width:	71½		352
Seat to Floor Height:	16	Weight Rating:	300 lbs.
Usable Seat Depth:	18¾		(per seat)

FABRIC PRICE CODES

1	\$2858	8	\$3893
2	\$3038	9	\$4028
3	\$3218	10	\$4163
4	\$3353	11	\$4298
5	\$3488	12	\$4433
6	\$3623	L	\$4358
7	\$3758		

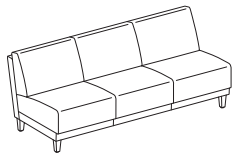

Armless

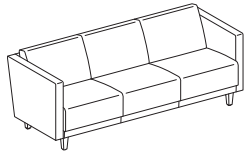

Straight Arms

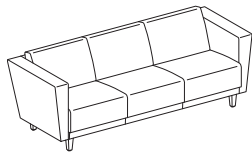

Tapered Arms

HON Recommendation: HML3S.A.PNS__TS.P7A - List Price \$3338

HOW TO SPECIFY

<p>Select Model Number</p>	<p>Select Arm Type</p> <p>N Armless A Straight Arms (+ \$300) B Tapered Arms (+ \$350)</p>	<p>Select Fabric</p> <p>See page 352</p>	<p>Select Leg Type</p> <p>TS Tapered Square TR Tapered Round</p>	<p>Select Leg Color</p> <p>PR8 Textured Silver P7A Textured Charcoal H Bourbon Cherry (+ \$100) F Shaker Cherry (+ \$100) N Mahogany (+ \$100) C Harvest (+ \$100) D Natural Maple (+ \$100) LK11 Kingswood Walnut (+ \$100) LSA1 Sterling Ash (+ \$100)</p>
<p>H M L 3 S -</p>	<p>A -</p>	<p>P N S 0 0 7 -</p>	<p>T S -</p>	<p>P 7 A</p>

! Leg options - Tapered Square (TS) and Tapered Round (TR) are available in 2 poly and 13 woodgrain options.



HML2ST

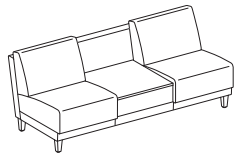

Armless

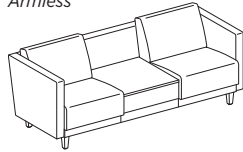

Straight Arms

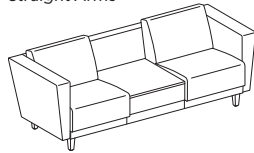

Tapered Arms

LOUNGE

Two-Seat with Table

DIMENSIONS

Depth:	31½	Ship Weight (armless):	146
Height:	35	Ship Weight (with straight arms):	162
Seat Width:	71½	Ship Weight (with tapered arms):	170
Back Width:	71½	Cube (armless):	48.9
Back Height:	19	Cube (with straight arms):	48.9
Width (armless):	71½	Cube (with tapered arms):	48.9
Width (with straight arms):	77½	COM:	See
Width (with tapered arms):	82½		page
Arm Width:	71½		352
Seat to Floor Height:	16	Weight Rating:	300 lbs.
Usable Seat Depth:	18¾		(per seat)

FABRIC PRICE CODES

1	\$3079	8	\$3907
2	\$3223	9	\$4015
3	\$3367	10	\$4123
4	\$3475	11	\$4231
5	\$3583	12	\$4339
6	\$3691	L	\$4279
7	\$3799		

NOTES: Offers a table between the seats that provides separation and a usable workspace. Table available with two grommet and an accessory port option.

HON Recommendation: HML2ST.A.PNS__TS.P7A.N.G1.0 - List Price \$3563

HOW TO SPECIFY

Select Model Number	Select Arm Type	Select Fabric	Select Leg Type	Select Leg Color	Select Laminate	Select Cut Out	Accessory Port Location
	N Armless A Straight Arms (+ \$300) B Tapered Arms (+ \$350)	See page 352	TS Tapered Square TR Tapered Round	PR8 Textured Silver P7A Textured Charcoal H Bourbon Cherry (+ \$100) F Shaker Cherry (+ \$100) N Mahogany (+ \$100) C Harvest (+ \$100) D Natural Maple (+ \$100) LK11 Kingswood Walnut (+ \$100) LSA1 Sterling Ash (+ \$100)	<i>See Chart on page 351</i> L2 (+ \$125)	N No Cutout G Round Grommet Cutout (+ \$30) G1 Pop-Up Port Cutout (+ \$40)	0 No Port 2 Two Tablet Ports Opposite (+ \$20)
HML2ST	A	PNS007	TS	P7A	N	G1	0

! Leg options - Tapered Square (TS) and Tapered Round (TR) are available in 2 poly and 8 woodgrain options.

HGRMTAC

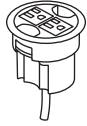

SIN 33721T

POWER HUB

3" Grommet Mount, 6' Cord

DIMENSIONS

Ship Weight: 1.3
Cube: 0.2

LIST PRICE

\$116

NOTES: Fits in 3" round grommet holes. Field installed with Plug-and-play ease. Two grounded AC power outlets. Includes 6' cord with three-prong plug.

ⓘ Available in black only (no color designation so use .X)

HGRMTAC2

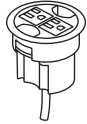

SIN 33721T

3" ROUND POWER GROMMET

2 Outlets, 10' Cord

DIMENSIONS

Ship Weight: 1.5
Cube: 0.2

LIST PRICE

\$148

NOTES: Power Modules will also work with standing-height applications for 10500 Series™ and Voi® desks. Optional Memory Control allows preset worksurface heights for consistency. Ships separately. Dynamic load capacity when worksurface is moving is 300 lbs. Includes 10' cord with three-prong plug. Fits in 3" round grommet holes on the following product lines: Coordinate™, Huddle, Motivate®, all laminate and veneer casegoods series, and Systems Worksurfaces. Two grounded AC power outlets. Field installed with Plug-and-play ease.

ⓘ Available in black finish only, no specification needed.

HGRMTUSB2



SIN 33721T

POWER/USB HUB

3" Grommet Mount

DIMENSIONS

Ship Weight: 1.3 ⓘ
Cube: 0.2

LIST PRICE

\$226

NOTES: One grounded AC power outlet with 2 USB ports. UL Listed.

ⓘ Available in black only (no color designation so use .X)

HFTTAL14



SIN 33721

TABLET ACCESSORY

Laminate

DIMENSIONS

Diameter: 14 Ship Weight: 6.0
Height from Table Top: 10 Cube: 2.5

LIST PRICE

\$376

NOTES: Use with Collaborative Cube and Cylinder tables for additional workspace. Attaches to tables through ports. Multiple port location options are available. Tablet pivots/swivels toward the user.

HTG1PWR-3P-1B

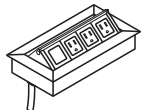

SIN 33721

POP-UP PORT

DIMENSIONS

Ship Weight: 5.0
Cube: 0.3

LIST PRICE

\$396

NOTES: Fits into 4" x 8" cutout. Specify G1 cutout in table top. Pop-up Port provides three power ports and one blank data receptacle. Sits flush with worksurface when closed. Finish is anodized aluminum. Includes 6' cord with three-prong plug.

HON Recommendation: HTG1PWR-3P-1B - List Price \$396

HOW TO SPECIFY

Select
Model Number

H G R M T A C



HML1SDF

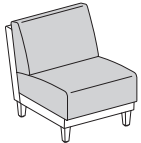

Armless

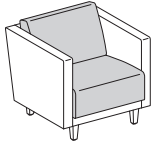

Straight Arms

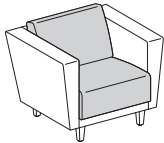

Tapered Arms

SINGLE SEAT LOUNGE DIMENSIONS

Dual Fabric

Depth:	31½	Ship Weight (armless):	61
Height:	35	Ship Weight (with straight arms):	77
Seat Width:	23½	Ship Weight (with tapered arms):	85
Back Width:	23½	Cube (armless):	19.8
Back Height:	19	Cube (with straight arms):	19.8
Width (armless):	23½	Cube (with tapered arms):	19.8
Width (with straight arms):	29¾	COM:	See
Width (with tapered arms):	35		page
Arm Width:	23½		352
Seat to Floor Height:	16	Weight Rating:	300 lbs.
Usable Seat Depth:	18¾		(per seat)

FABRIC PRICE CODES

1	\$1433		
<i>Add to Base Price Above</i>			
		Frame/ Arms	Back/Seat Cushions
2	\$36		\$48
3	\$72		\$96
4	\$99		\$132
5	\$126		\$168
6	\$153		\$204
7	\$180		\$240
8	\$207		\$276
9	\$234		\$312
10	\$261		\$348
11	\$288		\$384
12	\$315		\$420
L	\$300		\$400

For dual fabric models, start with the base price, then add the additional amount for the back and seat from the corresponding matrix to determine the final list price. Choose any combination of fabric grades for the back and seat.

Example: HML1SDF base price (\$1433) + Grade 2 frame/arms fabric (add \$36) + Grade 4 back/seat fabric (add \$132) = Total \$1601 List
 HML1SDF base price (\$1433) + Grade 5 frame/arms fabric (add \$126) + Grade 3 back/seat fabric (add \$96) = Total \$1655 List

HON Recommendation: HML1SDF.A.PNS___.PNS___.TS.P7A - List Price \$1817

HOW TO SPECIFY

Select Model Number H M L 1 S D F .	Select Arm Type N Armless A Straight Arms (+ \$300) B Tapered Arms (+ \$350)	Select Frame/Arms Fabric See page 352	Select Back/Seat Cushions Fabric See page 352	Select Leg Type TS Tapered Square TR Tapered Round	Select Leg Color PR8 Textured Silver P7A Textured Charcoal H Bourbon Cherry (+ \$100) F Shaker Cherry (+ \$100) N Mahogany (+ \$100) C Harvest (+ \$100) D Natural Maple (+ \$100) LK11 Kingswood Walnut (+ \$100) LSA1 Sterling Ash (+ \$100)
HML1SDF.	A.	PNS004.	PNS007.	TS.	P7A

! Leg options - Tapered Square (TS) and Tapered Round (TR) are available in 2 poly and 8 woodgrain options.

GROVE® Dual Fabric

GSA SIN 33721



Icon Legend on page 19

HML2SDF

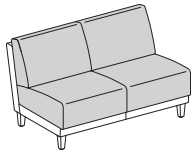

Armless

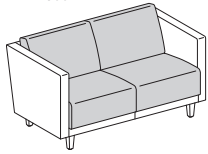

Straight Arms

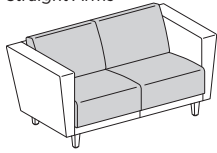

Tapered Arms

TWO-SEAT LOUNGE

Dual Fabric

DIMENSIONS

Depth:	31½	Ship Weight (armless):	100
Height:	35	Ship Weight (with straight arms):	116
Seat Width:	48	Ship Weight (with tapered arms):	124
Back Width:	48	Cube (armless):	35.6
Back Height:	19	Cube (with straight arms):	35.6
Width (armless):	48	Cube (with tapered arms):	35.6
Width (with straight arms):	54¼	COM:	See
Width (with tapered arms):	59½		page
Arm Width:	48		352
Seat to Floor Height:	16	Weight Rating:	300 lbs.
Usable Seat Depth:	18¾		(per seat)

FABRIC PRICE CODES

1 \$2140

Add to Base Price Above

	Frame/ Arms	Back/Seat Cushions
2	\$60	\$84
3	\$120	\$168
4	\$165	\$231
5	\$210	\$294
6	\$255	\$357
7	\$300	\$420
8	\$345	\$483
9	\$390	\$546
10	\$435	\$609
11	\$480	\$672
12	\$525	\$735
L	\$500	\$700

For dual fabric models, start with the base price, then add the additional amount for the back and seat from the corresponding matrix to determine the final list price. Choose any combination of fabric grades for the back and seat.

Example: HML2SDF base price (\$2140) + Grade 2 frame/arms fabric (add \$60) + Grade 4 back/seat fabric (add \$231) = Total \$2431 List
 HML2SDF base price (\$2140) + Grade 5 frame/arms fabric (add \$210) + Grade 3 back/seat fabric (add \$168) = Total \$2518 List

HON Recommendation: HML2SDF.A.PNS__PNS__TS.P7A - List Price \$2584

HOW TO SPECIFY

Select Model Number	Select Arm Type	Select Frame/Arms Fabric	Select Back/Seat Cushions Fabric	Select Leg Type	Select Leg Color
HML2SDF	N Armless A Straight Arms (+ \$300) B Tapered Arms (+ \$350)	See page 352	See page 352	TS Tapered Square TR Tapered Round	PR8 Textured Silver P7A Textured Charcoal H Bourbon Cherry (+ \$100) F Shaker Cherry (+ \$100) N Mahogany (+ \$100) C Harvest (+ \$100) D Natural Maple (+ \$100) LK11 Kingswood Walnut (+ \$100) LSA1 Sterling Ash (+ \$100)
HML2SDF	A	PNS004	PNS007	TS	P7A

! Leg options - Tapered Square (TS) and Tapered Round (TR) are available in 2 poly and 8 woodgrain options.



HML3SDF

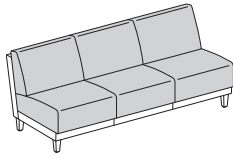

Armless

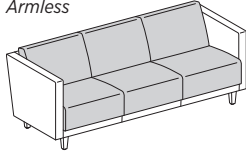

Straight Arms

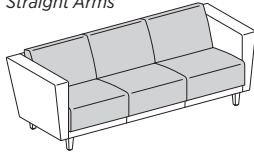

Tapered Arms

THREE-SEAT LOUNGE

Dual Fabric

DIMENSIONS

Depth:	31½	Ship Weight (armless):	141
Height:	35	Ship Weight (with straight arms):	157
Seat Width:	71½	Ship Weight (with tapered arms):	165
Back Width:	71½	Cube (armless):	48.9
Back Height:	19	Cube (with straight arms):	48.9
Width (armless):	71½	Cube (with tapered arms):	48.9
Width (with straight arms):	77½	COM:	See
Width (with tapered arms):	82½		page
Arm Width:	71½		352
Seat to Floor Height:	16	Weight Rating:	300 lbs.
Usable Seat Depth:	18¾		(per seat)

FABRIC PRICE CODES

1	\$2946		
<i>Add to Base Price Above</i>			
		Frame/ Arms	Back/Seat Cushions
2	\$72		\$132
3	\$144		\$264
4	\$198		\$363
5	\$252		\$462
6	\$306		\$561
7	\$360		\$660
8	\$414		\$759
9	\$468		\$858
10	\$522		\$957
11	\$576		\$1056
12	\$630		\$1155
L	\$600		\$1100

For dual fabric models, start with the base price, then add the additional amount for the back and seat from the corresponding matrix to determine the final list price. Choose any combination of fabric grades for the back and seat.

Example: HML3SDF base price (\$2946) + Grade 2 frame/arms fabric (add \$72) + Grade 4 back/seat fabric (add \$363) = Total \$3381 List
 HML3SDF base price (\$2946) + Grade 5 frame/arms fabric (add \$252) + Grade 3 back/seat fabric (add \$264) = Total \$3462 List

HON Recommendation: HML3SDF.A.PNS__PNS__.TS.P7A - List Price \$3450

HOW TO SPECIFY

Select Model Number	Select Arm Type	Select Frame/Arms Fabric	Select Back/Seat Cushions Fabric	Select Leg Type	Select Leg Color
HML3SDF	N Armless A Straight Arms (+ \$300) B Tapered Arms (+ \$350)	See page 352	See page 352	TS Tapered Square TR Tapered Round	PR8 Textured Silver P7A Textured Charcoal H Bourbon Cherry (+ \$100) F Shaker Cherry (+ \$100) N Mahogany (+ \$100) C Harvest (+ \$100) D Natural Maple (+ \$100) LK11 Kingswood Walnut (+ \$100) LSA1 Sterling Ash (+ \$100)
HML3SDF	A	PNS004	PNS007	TS	P7A

! Leg options - Tapered Square (TS) and Tapered Round (TR) are available in 2 poly and 8 woodgrain options.

GROVE® Dual Fabric

GSA SIN 33721



Icon Legend on page 19

HML2STDF

TWO-SEAT WITH TABLE

Dual Fabric

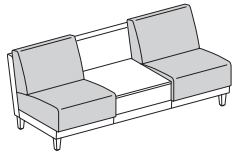

Armless

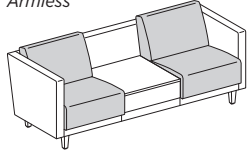

Straight Arms

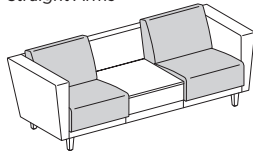

Tapered Arms

DIMENSIONS

Depth:	31½	Ship Weight (armless):	146
Height:	35	Ship Weight (with straight arms):	162
Seat Width:	71½	Ship Weight (with tapered arms):	170
Back Width:	71½	Cube (armless):	48.9
Back Height:	19	Cube (with straight arms):	48.9
Width (armless):	71½	Cube (with tapered arms):	48.9
Width (with straight arms):	77½	COM:	See page 352
Width (with tapered arms):	82½	Weight Rating:	300 lbs. (per seat)
Arm Width:	71½		
Seat to Floor Height:	16		
Usable Seat Depth:	18¾		

FABRIC PRICE CODES

1	\$3166	
<i>Add to Base Price Above</i>		
	Frame/Arms	Back/Seat Cushions
2	\$72	\$84
3	\$144	\$168
4	\$198	\$231
5	\$252	\$294
6	\$306	\$357
7	\$360	\$420
8	\$414	\$483
9	\$468	\$546
10	\$522	\$609
11	\$576	\$672
12	\$630	\$735
L	\$600	\$700

NOTES: Offers a table between the seats that provides separation and a usable worksurface. Table available with two grommet and an accessory port option.

HON Recommendation: HML2STDF.A.PNS__PNS__TS.P7A.N.G1.0 - List Price \$3662

HOW TO SPECIFY

Select Model Number	Select Arm Type	Select Frame/Arms Fabric	Select Back/Seat Cushions Fabric	Select Leg Type	Select Leg Color	Select Laminate	Select Cut Out	Accessory Port Location
	N Armless A Straight Arms (+ \$300) B Tapered Arms (+ \$350)	See page 352	See page 352	TS Tapered Square TR Tapered Round	PR8 Textured Silver P7A Textured Charcoal (+ \$100) H Bourbon Cherry (+ \$100) F Shaker Cherry (+ \$100) N Mahogany (+ \$100) C Harvest (+ \$100) D Natural Maple (+ \$100) LK11 Kingswood Walnut (+ \$100) LSA1 Sterling Ash (+ \$100)	See Chart on page 351 L2 (+ \$125)	N No Cutout G Round Grommet Cutout (+ \$30) G1 Pop-Up Port Cutout (+ \$40)	0 No Port 2 Two Tablet Ports Opposite (+ \$20)
HML2STDF	A	PNS004	PNS007	TS	P7A	N	G1	0

! Leg options - Tapered Square (TS) and Tapered Round (TR) are available in 2 poly and 8 woodgrain options.

SEATING



HGRMTAC

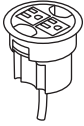

SIN 33721T

POWER HUB

3" Grommet Mount, 6' Cord

DIMENSIONS

Ship Weight: 1.3
Cube: 0.2

LIST PRICE

\$116

NOTES: Fits in 3" round grommet holes. Field installed with Plug-and-play ease. Two grounded AC power outlets. Includes 6' cord with three-prong plug.

ⓘ Available in black only (no color designation so use .X)

HGRMTAC2

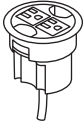

SIN 33721T

3" ROUND POWER GROMMET

2 Outlets, 10' Cord

DIMENSIONS

Ship Weight: 1.5
Cube: 0.2

LIST PRICE

\$148

NOTES: Power Modules will also work with standing-height applications for 10500 Series™ and Voi® desks. Optional Memory Control allows preset worksurface heights for consistency. Ships separately. Dynamic load capacity when worksurface is moving is 300 lbs. Includes 10' cord with three-prong plug. Fits in 3" round grommet holes on the following product lines: Coordinate™, Huddle, Motivate®, all laminate and veneer casegoods series, and Systems Worksurfaces. Two grounded AC power outlets. Field installed with Plug-and-play ease.

ⓘ Available in black finish only, no specification needed.

HGRMTUSB2

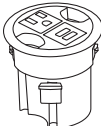

SIN 33721T

POWER/USB HUB

3" Grommet Mount

DIMENSIONS

Ship Weight: 1.3 ⓘ
Cube: 0.2

LIST PRICE

\$226

NOTES: One grounded AC power outlet with 2 USB ports. UL Listed.

ⓘ Available in black only (no color designation so use .X)

HFTTAL14



SIN 33721

TABLET ACCESSORY

Laminate

DIMENSIONS

Diameter: 14 Ship Weight: 6.0
Height from Table Top: 10 Cube: 2.5

LIST PRICE

\$376

NOTES: Use with Collaborative Cube and Cylinder tables for additional workspace. Attaches to tables through ports. Multiple port location options are available. Tablet pivots/swivels toward the user.

HTG1PWR-3P-1B

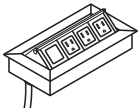

SIN 33721

POP-UP PORT

DIMENSIONS

Ship Weight: 5.0
Cube: 0.3

LIST PRICE

\$396

NOTES: Fits into 4" x 8" cutout. Specify G1 cutout in table top. Pop-up Port provides three power ports and one blank data receptacle. Sits flush with worksurface when closed. Finish is anodized aluminum. Includes 6' cord with three-prong plug.

HON Recommendation: HTG1PWR-3P-1B - List Price \$396

HOW TO SPECIFY

Select Model Number

H	G	R	M	T	A	C
---	---	---	---	---	---	---

GUESTSTACKER® 4030 Series



GuestStacker Stacking Chair shown in Regatta.

GUESTSTACKER® 4030 SERIES

Support your people with a comfortable chair whenever needed, then quickly clear the room. GuestStacker helps you make the most of valuable floor space by stacking six high on the floor or 28 high on a cart. Each set of four chairs provides ergonomic support to users with a contoured seat and back that are molded to fit the natural curves of your body. When you need to put guests at ease for any length of time, you need GuestStacker chairs.



FEATURES

- Ships four chairs per carton.
- Chairs stack six high on the floor.
- Copolymer resin seat and back shell.
- Integrated lumbar support delivers long-lasting comfort.
- Wall-saver design protects walls and cabinets.
- Tubular steel frame adds durability.
- Optional ganging glides create straight rows.
- Stacks up to 28 high on HON Model 4033 Cart.
- Ships fully assembled.
- Warranted for users up to 300 lbs.



GUESTSTACKER® 4030 Series

H4031



STACKING CHAIRS

Textured Copolymer Seat & Back
Painted Legs — Black (T) ONLY

DIMENSIONS

Depth:	21½	Seat to Floor Height:	17½
Width:	21	Usable Seat Depth:	17½
Height:	31	Ship Weight:	51
Seat Depth:	19	Cube:	12.9
Seat Width:	18	Weight Rating:	300 lbs.
Back Width:	20		
Back Height:	11		

LIST PRICE PER CARTON

\$633
(reference single unit @ \$158.25)

- ⊕ 4030 Series is ordered and shipped four (4) chairs per carton. Pricing shown is per carton. Each set of four (one carton), must have the same shell/frame color combination. Ordering 2 of Model H4031 will result in 2 cartons being shipped, giving you 8 chairs.
- ⚠ Shipped fully assembled — 4 chairs per carton. All GuestStacker® shell colors are CA Technical Bulletin 133 compliant (no upcharge).

H4033



CART FOR STACKING CHAIRS

DIMENSIONS

Depth:	35½	Ship Weight:	40 Ⓢ
Width:	21¾	Cube:	8.9
Height:	37¾		

LIST PRICE

\$531

- NOTES: Holds 28 stack chairs (6'-8"), some assembly required. (Chairs stack 6 high without cart.)
- ⚠ Specify Black paint (T) ONLY.

H4039

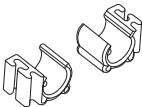

GANGING CHAIR GLIDES

DIMENSIONS

Box of 48	Ship Weight:	1 Ⓢ
	Cube:	0.04

LIST PRICE

\$106

HON Recommendation: H4031.LA.T - List Price \$633

HOW TO SPECIFY

<p>Select Model Number</p> <p>H 4 0 3 1 .</p>	<p>Select Shell Color</p> <p>LA Lava MB Mulberry ON Onyx RE Regatta</p> <p>L A .</p>	<p>Select Frame</p> <p>T Black</p> <p>T</p>
--	---	--

IGNITION®



Ignition® 2.0 Task Chair shown with Coordinate™ Height Adjustable Table and 10500 Series™ Desking.

IGNITION®

People come in all shapes and sizes, which is why Ignition does as well. From guest and lounge chairs to executive seating, Ignition allows you to mix and match adjustment features, back height, lumbar, and other options to fit your chair to your needs. It's the easy, affordable way to furnish an entire workplace in style and comfort. Ignition fits who you are, where you work and how you work.



FEATURES

IGNITION®

- Ignition Series seating addresses the needs of the total office with Executive, Task, Stool, Guest and Lounge Seating Solutions.
- Three different back sizes, three different controls and multiple arm options to fit you and how you work.
- Back height adjustment moves the back up or down to fit various body sizes.
- Contoured back on multi-purpose seating offers greater comfort than typical stack chairs or stools.
- Warranted for users up to 300 lbs. (450 lbs. for Big and Tall)
- Multi-purpose chair stacks four high.

IGNITION® 2.0

- Choice of upholstered, 4-Way Stretch mesh or ReActiv® back options.
- ReActiv® back features zonal comfort that delivers optimal support and flexibility.
- The unique hammock-like inner support allows the upholstered back version to feature a slim profile and provide built-in comfort.
- Optional adjustable lumbar allows users to tailor their support.
- **8 different adjustable lumbar colors available on 4-Way Stretch mesh and ReActiv® task chair models.**
- Passive movement back adjusts with you.
- Multiple arm options to accommodate user requirements.
- Available in 7 colors of 4-Way Stretch mesh and **3** ReActiv® colors.
- Molded foam seat for better support and added comfort.
- **Black, Titanium, and Designer White frame.**
- Warranted for users up to 300 lbs.



MODEL OPTIONS

HITL1



Task Low-Back

Pneumatic, Back Height Adjustment, Swivel, Tilt, Tilt Tension, Tilt Lock

HITL2



Task Low-Back

Pneumatic, Back Height Adjustment, Synchro-tilt, Tilt Tension, Tilt Lock, Seat Glide

HITL3



Task Low-Back

Pneumatic, Back Height Adjustment, Synchro-tilt, Back Angle Adjustment, Tilt Tension, Tilt Lock, Seat Glide

HITS5



Task Stool

Pneumatic, Swivel Back Height Adjustment, Adjustable Footrest

HIWM1



Mid-Back

Pneumatic, Back Height Adjustment, Swivel, Tilt, Tilt Tension, Tilt Lock

HIWM2



Mid-Back

Pneumatic, Back Height Adjustment, Synchro-tilt, Tilt Tension, Tilt Lock, Seat Glide

HIWM3



Mid-Back

Pneumatic, Back Height Adjustment, Synchro-tilt, Back Angle Adjustment, Tilt Tension, Tilt Lock, Seat Glide

HIEH1



Executive High-Back

Pneumatic, Back Height Adjustment, Swivel, Tilt, Tilt Tension, Tilt Lock

HIEH2



Executive High-Back

Pneumatic, Back Height Adjustment, Synchro-tilt, Tilt Tension, Seat Glide

HIEH3



Executive High-Back

Pneumatic, Back Height Adjustment, Synchro-tilt, Back Angle Adjustment, Tilt Tension, Seat Glide

HIWM8



Task Mid-Back

Big and Tall, Pneumatic, Swivel-tilt, Tilt Tension

HITLM



Task Low-Back

4-Way Stretch Mesh Back, Pneumatic, Swivel, Synchro-tilt, Tilt Tension, Tilt Lock, Optional Lumbar Support

HITSM

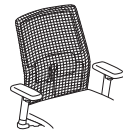

Task Low-Back Stool

4-Way Stretch Mesh Back, Pneumatic, Swivel, Synchro-tilt, Tilt Tension, Tilt Lock, Optional Lumbar Support

HITLRA



Task Low-Back ReActiv®

ReActiv® Back, Pneumatic, Swivel, Synchro-tilt, Tilt Tension, Tilt Lock, Optional Lumbar Support

HITSRA



Task Low-Back Stool ReActiv®

ReActiv® Back, Pneumatic, Swivel, Synchro-tilt, Tilt Tension, Tilt Lock, Optional Lumbar Support

HIWMM



Task Mid-Back

4-Way Stretch Mesh Back, Pneumatic, Swivel, Synchro-tilt, Tilt Tension, Tilt Lock, Optional Lumbar Support

HIWMRA



Task Mid-Back ReActiv®

ReActiv® Back, Pneumatic, Swivel, Synchro-tilt, Tilt Tension, Tilt Lock, Optional Lumbar Support

HIWMU

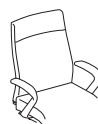

Upholstered Mid-Back

Upholstered Back, Pneumatic, Swivel, Synchro-tilt, Tilt Tension, Tilt Lock

HIWMUL



Upholstered Mid-Back with Lumbar Support

Upholstered Back, Pneumatic, Swivel, Synchro-tilt, Tilt Tension, Tilt Lock, Adjustable Lumbar

IGNITION® Options

MODEL OPTIONS

HIGCL



Guest Chair

Fixed Arms, Glides

HIB50

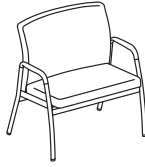

Bariatric Lounge

Fixed Arms, Glides

HIGS6

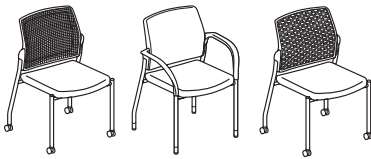

Multi-Purpose

Four Legs

HISB6

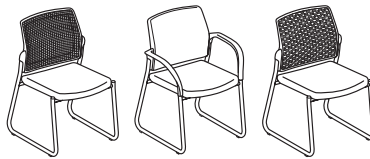

Multi-Purpose

Sled Base

HICS7

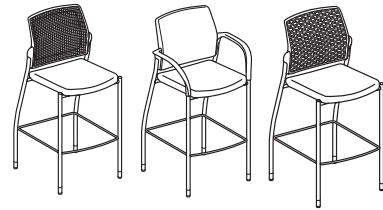

Café-Height Stool

Four Legs

HIGS6DF - Dual Fabric

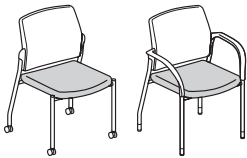

Multi-Purpose

Four Legs

HISB6DF - Dual Fabric

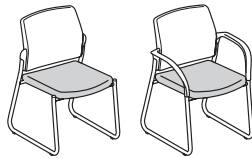

Multi-Purpose

Sled Base

HICS7DF - Dual Fabric

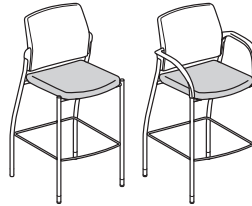





Café-Height Stool



Four Legs

IGNITION® Task Chair Options

ARM STYLE	CODE	DESCRIPTION	PRICE
	N	Armless	+\$0
	F	Fixed Arms	+\$65
	A	Height and Width Adjustable Arms	+\$75
	V	All-Adjustable Arms (includes Pivot)	+\$115
	P	Fixed Polished Aluminum Arms	+\$150

CASTERS	CODE	DESCRIPTION	PRICE
	A	Black All-Surface Caster <i>*Must specify for model HIWM8 only</i>	+\$0
	H	Black Hard Caster	+\$0
	S	Black All-Surface Caster	+\$30

BACK STYLE	CODE	DESCRIPTION	PRICE
	U	Upholstered	+\$0
	M	Mesh	+\$0

BASE	CODE	DESCRIPTION	PRICE
	SB	Standard Base	+\$0
	PA	Polished Aluminum	+\$110

IGNITION® Fabric Options

HON BRANDED FABRICS

GRADE 1	GRADE 2	GRADE 3	GRADE L
Apex	Appoint Seating	In Season	Denver Leather*
Attire	Blume	Moxie	
Centurion	Clyde	Parker	
Compass	Dotty	Purl	
Contourett	Rush	Quill	
Dapper	Seed**		
Ensemble	Spin Seating		
Hamilton	Whisper Vinyl		
Inertia			
Optic			
Pebble			

For a complete list of fabrics, including partnership fabrics, go to hon.com/fabricsandfinishes.

Reference Fabric Color Combinations on pages 20-24 for color codes and legend on page 21 for lead times. For additional HON to Supply COM fabric grade pricing, go to honready.hon.com and click on the HON to Supply COM link.

*Denver Leather (SS) may not be available on every model within a specific series, please refer to the model's page for details.

**Not available as a back upholstery on Ignition® 2.0.

 For Fire Code model, availability and ordering method, refer to pages 248-251. Available on select models, contact HON Customer Support for availability.



Icon Legend on page 19

HITL1



TASK LOW-BACK

Pneumatic
Back Height Adjustment
Swivel
Tilt
Tilt Tension
Tilt Lock
Functions: **A, B, E, J, K, L**
(Function Key on pages 244-245)

DIMENSIONS

Upholstered Back
Width: 17½
Upholstered Back
Height: 18¾-21¾
Mesh Back Width: 17½
Mesh Back Height: 20¾-23¼
Depth: 36
Width: 27½
Height: 41
Seat Depth: 17
Seat Width: 19

Adjustable Arms Width: 17-19½
Fixed Arms Width: 20
Seat to Floor Height: 17-21½
Usable Seat Depth: 15¾
Ship Weight (upholstered back): 50
Ship Weight (mesh back): 45
Cube (upholstered back): 10.8
Cube (mesh back): 10.8
COM (upholstered back): 2.0
COM (mesh back): 1.0
Weight Rating: 300 lbs.

FABRIC PRICE CODES

1	\$594	8	\$870
2	\$642	9	\$906
3	\$690	10	\$942
4	\$726	11	\$978
5	\$762	12	\$1014
6	\$798	L	—
7	\$834		

NOTES: See page 373 for arm packs.

HITL2



TASK LOW-BACK

Pneumatic
Back Height Adjustment
Synchro-tilt
Tilt Tension
Tilt Lock
Seat Glide
Functions:
A, B, D, E, J, A-D, L
(Function Key on pages 244-245)

DIMENSIONS

Upholstered Back
Width: 17½
Upholstered Back
Height: 19½-22½
Mesh Back Width: 17½
Mesh Back Height: 20¾-23¼
Depth: 38½
Width: 27½
Height: 43
Seat Depth: 16-18
Seat Width: 19

Adjustable Arms Width: 17-19½
Fixed Arms Width: 20
Seat to Floor Height: 17-21½
Usable Seat Depth: 15½-17½
Ship Weight (upholstered back): 54
Ship Weight (mesh back): 49
Cube (upholstered back): 10.8
Cube (mesh back): 10.8
COM (upholstered back): 2.0
COM (mesh back): 1.0
Weight Rating: 300 lbs.

FABRIC PRICE CODES

1	\$669	8	\$945
2	\$717	9	\$981
3	\$765	10	\$1017
4	\$801	11	\$1053
5	\$837	12	\$1089
6	\$873	L	—
7	\$909		

NOTES: See page 373 for arm packs.

HITL3



TASK LOW-BACK

Pneumatic
Back Height Adjustment
Synchro-tilt
Back Angle Adjustment
Tilt Tension
Tilt Lock
Seat Glide
Functions:
A, B, D, E, A-D, A-E, L
(Function Key on pages 244-245)

DIMENSIONS

Upholstered Back
Width: 17½
Upholstered Back
Height: 20¾-23¾
Mesh Back Width: 17½
Mesh Back Height: 20¾-23¼
Depth: 39
Width: 27
Height: 44
Seat Depth: 16-18
Seat Width: 19

Adjustable Arms Width: 17-19½
Fixed Arms Width: 20
Seat to Floor Height: 17-21½
Usable Seat Depth: 14½-16½
Ship Weight (upholstered back): 58
Ship Weight (mesh back): 53
Cube (upholstered back): 10.8
Cube (mesh back): 10.8
COM (upholstered back): 2.0
COM (mesh back): 1.0
Weight Rating: 300 lbs.

FABRIC PRICE CODES

1	\$714	8	\$990
2	\$762	9	\$1026
3	\$810	10	\$1062
4	\$846	11	\$1098
5	\$882	12	\$1134
6	\$918	L	—
7	\$954		

NOTES: See page 373 for arm packs.

HON Recommendation: HITL1.A.H.M.CU__T.SB - List Price \$669

HOW TO SPECIFY

<p>Select Model Number</p> <p>HITL1</p>	<p>Select Arm Type</p> <p>N Armless F Fixed Arms - Black (+ \$65) A Height and Width Adjustable Arms (+ \$75) V All-Adjustable Arms (includes Pivot) (+ \$115) P Fixed Arms - Polished (+ \$150)</p> <p>A</p>	<p>Select Caster/Glide</p> <p>H Black Hard Caster S Black All-Surface Caster (+ \$30)</p> <p>H</p>	<p>Select Back Type</p> <p>U Upholstered M Mesh</p> <p>M</p>	<p>Select Fabric</p> <p>See page 368</p> <p>CU10</p>	<p>Select Frame</p> <p>T Black</p> <p>T</p>	<p>Select Base</p> <p>SB Standard Base PA Polished Aluminum (+ \$110)</p> <p>SB</p>
--	---	---	---	---	---	--

IGNITION®



Icon Legend on page 19

HIWM1



MID-BACK

Pneumatic
Back Height Adjustment
Swivel
Tilt
Tilt Tension
Tilt Lock
Functions: **A, B, E, J, K, L**
(Function Key on pages 244-245)

DIMENSIONS

Upholstered Back Width: 18½
Upholstered Back Height: 21-24
Mesh Back Width: 19
Mesh Back Height: 21½-24
Depth: 35½
Width: 27
Height: 44
Seat Depth: 18
Seat Width: 20
Adjustable Arms Width: 18-20½
Fixed Arms Width: 20
Seat to Floor Height: 17-21½
Usable Seat Depth: 17½
Ship Weight (upholstered back): 54
Ship Weight (mesh back): 48
Cube (upholstered back): 10.8
Cube (mesh back): 10.8
COM (upholstered back): 2.0
COM (mesh back): 1.0
Weight Rating: 300 lbs.

FABRIC PRICE CODES

1	\$652	8	\$928
2	\$700	9	\$964
3	\$748	10	\$1000
4	\$784	11	\$1036
5	\$820	12	\$1072
6	\$856	L	\$952
7	\$892		

NOTES: See page 373 for arm packs.

HIWM2



MID-BACK

Pneumatic
Back Height Adjustment
Synchro-tilt
Tilt Tension
Tilt Lock
Seat Glide
Functions:
A, B, D, E, J, A-D, L
(Function Key on pages 244-245)

DIMENSIONS

Upholstered Back Width: 18½
Upholstered Back Height: 21-24
Mesh Back Width: 19
Mesh Back Height: 21½-24
Depth: 38
Width: 27
Height: 46½
Seat Depth: 17-19
Seat Width: 20
Adjustable Arms Width: 18-20½
Fixed Arms Width: 20
Seat to Floor Height: 17¼-21¾
Usable Seat Depth: 16¼-18¼
Ship Weight (upholstered back): 58
Ship Weight (mesh back): 52
Cube (upholstered back): 10.8
Cube (mesh back): 10.8
COM (upholstered back): 2.0
COM (mesh back): 1.0
Weight Rating: 300 lbs.

FABRIC PRICE CODES

1	\$722	8	\$998
2	\$770	9	\$1034
3	\$818	10	\$1070
4	\$854	11	\$1106
5	\$890	12	\$1142
6	\$926	L	\$1022
7	\$962		

NOTES: See page 373 for arm packs.

HIWM3



MID-BACK

Pneumatic
Back Height Adjustment
Synchro-tilt
Back Angle Adjustment
Tilt Tension
Tilt Lock
Seat Glide
Functions:
A, B, D, E, A-D, A-E, L
(Function Key on pages 244-245)

DIMENSIONS

Upholstered Back Width: 18½
Upholstered Back Height: 21-24
Mesh Back Width: 19
Mesh Back Height: 21½-24
Depth: 39
Width: 27
Height: 44
Seat Depth: 17-19
Seat Width: 20
Adjustable Arms Width: 18-20½
Fixed Arms Width: 20
Seat to Floor Height: 17¼-21¾
Usable Seat Depth: 15¼-17¼
Ship Weight (upholstered back): 63
Ship Weight (mesh back): 58
Cube (upholstered back): 10.8
Cube (mesh back): 10.8
COM (upholstered back): 2.0
COM (mesh back): 1.0
Weight Rating: 300 lbs.

FABRIC PRICE CODES

1	\$770	8	\$1046
2	\$818	9	\$1082
3	\$866	10	\$1118
4	\$902	11	\$1154
5	\$938	12	\$1190
6	\$974	L	\$1070
7	\$1010		

NOTES: See page 373 for arm packs.

HON Recommendation: HIWM2.A.H.M.CU__T.SB - List Price \$797

SEATING

HOW TO SPECIFY

Select Model Number HIWM1	Select Arm Type N Armless F Fixed Arms - Black (+ \$65) A Height and Width Adjustable Arms (+ \$75) V All-Adjustable Arms (includes Pivot) (+ \$115) P Fixed Arms - Polished (+ \$150)	Select Caster/Glide H Black Hard Caster S Black All-Surface Caster (+ \$30)	Select Back Type U Upholstered M Mesh	Select Fabric See page 368	Select Frame T Black	Select Base SB Standard Base PA Polished Aluminum (+ \$110)
HIWM1	A	H	M	CU10	T	SB



Icon Legend on page 19

HIEH1



EXECUTIVE HIGH-BACK

Pneumatic
Back Height Adjustment
Swivel
Tilt
Tilt Tension
Tilt Lock
Functions: **A, B, E, F, K, L**
(Function Key on pages 244-245)

DIMENSIONS

Depth: 38½ Arm Width: 20
Width: 27 Seat to Floor Height: 16¾-21¼
Height: 47½ Usable Seat Depth: 17⅞
Seat Depth: 18 Ship Weight: 56
Seat Width: 20 Cube: 16.0
Back Width: 20 COM: 2.5
Back Height: 24¾-27¾ Weight Rating: 300 lbs.

FABRIC PRICE CODES

1	\$675	8	\$951
2	\$723	9	\$987
3	\$771	10	\$1023
4	\$807	11	\$1059
5	\$843	12	\$1095
6	\$879	L	\$975
7	\$915		

NOTES: See page 373 for arm packs.

HIEH2



EXECUTIVE HIGH-BACK

Pneumatic
Back Height Adjustment
Synchro-tilt
Tilt Tension
Seat Glide
Functions: **A, B, D, E, J, A-D, L**
(Function Key on pages 244-245)

DIMENSIONS

Depth: 41 Arm Width: 20
Width: 27 Seat to Floor Height: 17-21½
Height: 49 Usable Seat Depth: 16½-18
Seat Depth: 17-19 Ship Weight: 61
Seat Width: 20 Cube: 16.0
Back Width: 19½ COM: 2.5
Back Height: 24¾-27¾ Weight Rating: 300 lbs.

FABRIC PRICE CODES

1	\$750	8	\$1026
2	\$798	9	\$1062
3	\$846	10	\$1098
4	\$882	11	\$1134
5	\$918	12	\$1170
6	\$954	L	\$1050
7	\$990		

NOTES: See page 373 for arm packs.

HIEH3



EXECUTIVE HIGH-BACK

Pneumatic
Back Height Adjustment
Synchro-tilt
Back Angle Adjustment
Tilt Tension
Seat Glide
Functions: **A, B, D, E, A-D, A-E, L**
(Function Key on pages 244-245)

DIMENSIONS

Depth: 45½ Arm Width: 20
Width: 27 Seat to Floor Height: 17-21½
Height: 49 Usable Seat Depth: 15¼-17¼
Seat Depth: 17-19 Ship Weight: 65
Seat Width: 20 Cube: 16.0
Back Width: 19½ COM: 2.5
Back Height: 24¾-27¾ Weight Rating: 300 lbs.

FABRIC PRICE CODES

1	\$795	8	\$1071
2	\$843	9	\$1107
3	\$891	10	\$1143
4	\$927	11	\$1179
5	\$963	12	\$1215
6	\$999	L	\$1095
7	\$1035		

NOTES: See page 373 for arm packs.

HON Recommendation: HIEH1.F.H.U.CU__T.SB - List Price \$740

HOW TO SPECIFY

Select Model Number	Select Arm Type	Select Caster/Glide	Select Back Type	Select Fabric	Select Frame	Select Base
N Armless F Fixed Arms - Black (+ \$65) A Height and Width Adjustable Arms (+ \$75) V All-Adjustable Arms (includes Pivot) (+ \$115) P Fixed Arms - Polished (+ \$150)	H Black Hard Caster S Black All-Surface Caster (+ \$30)	U Upholstered	See page 368	T Black	SB Standard Base PA Polished Aluminum (+ \$110)	
H I E H 1	F	H	U	C U 1 0	T	S B



HITS5



TASK STOOL

Pneumatic
Swivel Back Height
Adjustment
Adjustable Footrest
Functions: **A, B, E**
(Function Key on pages
244-245)

DIMENSIONS

Upholstered Back Width:	17½	Adjustable Arms Width:	17-19½
Upholstered Back Height:	18¾-21¾	Fixed Arms Width:	20
Mesh Back Width:	17½	Seat to Floor Height:	23⅝-33⅝
Mesh Back Height:	20¾-23¾	Usable Seat Depth:	15¾
Depth:	27½	Ship Weight (upholstered back):	56 Ⓔ
Width:	27	Ship Weight (mesh back):	51 Ⓔ
Height:	44	Cube (upholstered back):	10.8
Seat Depth:	17	Cube (mesh back):	10.8
Seat Width:	19	COM (upholstered back):	2.0
		COM (mesh back):	1.0
		Weight Rating:	300 lbs.

FABRIC PRICE CODES

1	\$701	8	\$977
2	\$749	9	\$1013
3	\$797	10	\$1049
4	\$833	11	\$1085
5	\$869	12	\$1121
6	\$905	L	—
7	\$941		

NOTES: See page 373 for arm packs.

HIWM8



TASK MID-BACK

Big and Tall
Pneumatic
Swivel-tilt
Tilt Tension
Functions: **A, E, F, K, L**
(Function Key on pages
244-245)

DIMENSIONS

Depth:	28	Arm Width:	23-25½
Width:	32¼	Seat to Floor Height:	17⅞-20⅝
Height:	43⅞	Usable Seat Depth:	19½
Seat Depth:	19½	Ship Weight:	60
Seat Width:	23½	Cube:	16.0
Back Width:	23½	COM:	3.0
Back Height:	23	Weight Rating:	450 lbs.

FABRIC PRICE CODES

1	\$1291	8	\$1705
2	\$1363	9	\$1759
3	\$1435	10	\$1813
4	\$1489	11	\$1867
5	\$1543	12	\$1921
6	\$1597	L	—
7	\$1651		

NOTES: See page 373 for arm packs.

HON Recommendation: HITS5.A.H.M.CU__T.SB - List Price \$776

HOW TO SPECIFY

Select Model Number	Select Arm Type	Select Caster/Glide	Select Back Type	Select Fabric	Select Frame	Select Base
N Armless F Fixed Arms - Black (+ \$65) A Height and Width Adjustable Arms (+ \$75) V All-Adjustable Arms (includes Pivot) (+ \$115) P Fixed Arms - Polished (+ \$150)	H Black Hard Caster S Black All-Surface Caster (+ \$30) A Black All-Surface Caster (available on model HIWM8 only) <i>H and S caster options not available on model HIWM8</i>	U Upholstered M Mesh <i>Mesh back not available on HIWM8</i>	See page 368	T Black	SB Standard Base	
HITS5	A	H	M	CU10	T	SB



Icon Legend on page 19

HI2ATA

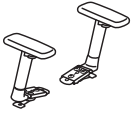

ADJUSTABLE ARMS

Height and Width
Functions: **S**
(Function Key on pages 244-245)

DIMENSIONS

Adjustable Arms Width: 17-19½
Height from Seat: 8-11
Ship Weight: 8
Cube: 1.0

LIST PRICE

\$125

HI2AAA

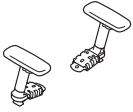

ALL-ADJUSTABLE ARMS

Height, Width, Depth and Pivot

DIMENSIONS

Adjustable Arms Width: 17-20
Height from Seat: 7-11
Ship Weight: 8
Cube: 1.0

LIST PRICE

\$168

HI2FHA

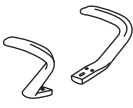

FIXED HEIGHT ARMS

DIMENSIONS

Arm Width: 20
Height from Seat: 9½
Ship Weight: 7
Cube: 1.0

LIST PRICE

\$115

HIPAA

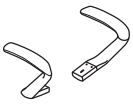

POLISHED ALUMINUM ARMS

Fixed Height

DIMENSIONS

Arm Width: 20
Height from Seat: 9½
Ship Weight: 10
Cube: 1.0

LIST PRICE

\$190

HSCASTER

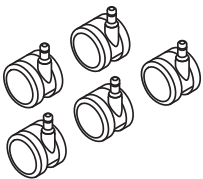

SET OF 5 ALL-SURFACE CASTERS

DIMENSIONS

Size: 60mm
Ship Weight: 2
Cube: 0.1

LIST PRICE

\$51

ⓘ Available in Black finish only, no specification needed.





OPEN MARKET

HOW TO SPECIFY



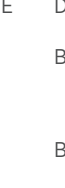
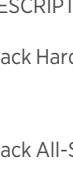

<p>Select Model Number</p>	<p>Select Frame</p> <p><i>Specify for models HI2ATA, HI2AAA, and HI2HFA</i></p> <p>T Black DWX Designer White TI Titanium</p>
<p>HI2ATA.</p>	<p>T</p>

IGNITION® 2.0 Options

ARM STYLE	CODE	DESCRIPTION	PRICE
	N	Armless	+\$0
	F	Fixed Arms	+\$65
	A	Height and Width Adjustable Arms	+\$75
	V	All-Adjustable Arms (includes Pivot)	+\$115
	P	Fixed Polished Aluminum Arms	+\$150



MECHANISM	CODE	DESCRIPTION	PRICE
	Y0	Synchro-Tilt A, E, J, K, L	+\$0
	Y1	Synchro-Tilt w/ Seat Slider A, D, E, J, K, L	+\$20
	Y2	Advanced Synchro-Tilt A, D, E, J, L, A-D	+\$65
	Y3	Synchro-Tilt with Independent Back Angle A, D, E, J, L, A-E	+\$105
	S0	Limited Recline Synchro-Tilt A, E, J, K, L	+\$0
	S1	Limited Recline Synchro-Tilt w/ Seat Slider A, D, E, J, K, L	+\$20

**Only available on HITSM*

CASTERS	CODE	DESCRIPTION	PRICE
	H	Black Hard Caster	+\$0
	S	Black All-Surface Caster	+\$30
	R	Black Roll Control Caster	+\$50
	TS	Titanium All-Surface Caster	+\$30

LUMBAR	CODE	DESCRIPTION	PRICE
	NL	No Lumbar	+\$0
	BL	Black Adjustable Lumbar	+\$30
	BY	Bullseye Adjustable Lumbar	+\$30
	DW	Designer White Adjustable Lumbar	+\$30
	MR	Ember Adjustable Lumbar	+\$30
	IR	Iris Adjustable Lumbar	+\$30
	KT	Krypton Adjustable Lumbar	+\$30
	RE	Regatta Adjustable Lumbar	+\$30
	TL	Titanium Adjustable Lumbar	+\$30

**Adjustable Lumbar not available on CAL 133 (FC) models*

BASE	CODE	DESCRIPTION	PRICE
	SB	Standard Base	+\$0
	PA	Polished Aluminum	+\$110

BACK STYLE	CODE	DESCRIPTION	PRICE
<i>4-Way Stretch mesh back options:</i>			
	IM	Black	+\$0
	IB	Breeze	+\$0
	IK	Brownstone	+\$0
	IH	Chai ☉	+\$0
	IC	Charcoal	+\$0
	IF	Fog	+\$0
	IY	Navy ☉	+\$0
	IR	Regatta	+\$0
	IT	Titanium	+\$0
<i>ReActiv® back options:</i>			
	OS	Charcoal	+\$0
	DWR	Designer White	+\$0
	TI	Titanium	+\$0

FRAME	CODE	DESCRIPTION	PRICE
	T	Black Frame	+\$0
	DWX	Designer White	+\$35
	TI	Titanium Frame	+\$35

☉ Fabric is de-emphasized.

IGNITION® 2.0

Dimensions

TASK DIMENSIONS

MODEL	HIWMM, HIWMRA, HIWMMU, & HIWMUL	HITLM & HITLRA	HITSM & HITSRA	HITLMKD & HITLRAKD	HIWMMKD, HIWMRAKD, HIWMMUKD, & HIWMULKD
Overall Width Armless	21	20	20	20	21
Overall Width with Arms	A	27	26	26	27
Overall Depth	24	22	22	22	24
Overall Height	S0/S1	-	-	52½	-
	Y0/Y1	43¾	40½	-	43¾
	Y2	44½	41¼	-	-
	Y3	44½	41¼	-	-
	W5	45¼	41½	-	-
Seat Width	20	18½	18½	18½	20
Seat Depth	18¾	17¾	17¾	17¾	18¾
Usable Seat Depth	S0	-	-	16¾	-
	S1	-	-	15½-16⅞	-
	Y0	17¾	16¾	-	17¾
	Y1	17½-19½	15½-17½	-	17½-19½
	Y2	16¼-19¼	15¾-18½	-	-
	Y3	16½-19½	16¼-18¾	-	-
	W5	17½-20	16¾-18¾	-	-
Seat Height	S0/S1	-	-	22⅞-31¾	-
	Y0/Y1	16¾-21¼	16¾-21¼	-	16¾-21¼
	Y2	17⅞-21½	17⅞-21½	-	-
	Y3	17½-21½	17¾-21¾	-	-
	W5	16¾-21⅞	16¾-21½	-	-
Back Width	19	17½	17½	17½	19
Back Height	23	19	19	19	23
Ship Weight Armless	S0	-	-	44 Ⓢ	-
	S1	-	-	46 Ⓢ	-
	Y0	38 Ⓢ	38 Ⓢ	-	38 Ⓢ
	Y1	38 Ⓢ	38 Ⓢ	-	38 Ⓢ
	Y2	42 Ⓢ	42 Ⓢ	-	-
	Y3	46 Ⓢ	45 Ⓢ	-	-
	W5	45 Ⓢ	44 Ⓢ	-	-
Ship Weight with Arms	S0	-	-	51 Ⓢ	-
	S1	-	-	53 Ⓢ	-
	Y0	45 Ⓢ	45 Ⓢ	-	45 Ⓢ
	Y1	45 Ⓢ	45 Ⓢ	-	45 Ⓢ
	Y2	49 Ⓢ	49 Ⓢ	-	-
	Y3	53 Ⓢ	52 Ⓢ	-	-
	W5	52 Ⓢ	51 Ⓢ	-	-
Width Between Arms	F	20¼	19	19	20¼
	P	20¼	19	19	20¼
	A	18-20½	17-19½	17-19½	18-20½
	V	12½-27½	11½-26½	11½-26½	12½-27½
Cube	10.8	10.8	10.8	5.6	6.3
Cube with Y3 Control	12.0	12.0	-	-	-
COM	1.0	1.0	1.0	-	-
Weight Capacity	300 lbs	300 lbs	300 lbs	300 lbs	300 lbs

IGNITION® 2.0



Icon Legend on page 19

HITLM

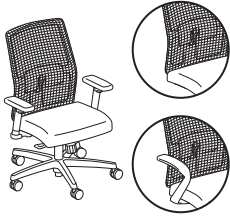

TASK LOW-BACK

- 4-Way Stretch Mesh Back
- Pneumatic
- Swivel
- Synchro-tilt
- Tilt Tension
- Tilt Lock
- Optional Lumbar Support

DIMENSIONS

Depth:	22	Width (with arms):	26
Height:	40½	Width (armless):	20
Seat Depth:	16	Cube:	10.8
Seat Width:	18½	COM:	1.0
Back Width:	17½	Weight Rating:	300 lbs.
Back Height:	19		

FABRIC PRICE CODES

1	\$504	8	\$642
2	\$528	9	\$660
3	\$552	10	\$678
4	\$570	11	\$696
5	\$588	12	\$714
6	\$606	L	\$704
7	\$624		

! See page 375 for additional specifications and dimensions.

HIWMM

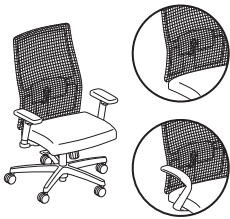

TASK MID-BACK

- 4-Way Stretch Mesh Back
- Pneumatic
- Swivel
- Synchro-tilt
- Tilt Tension
- Tilt Lock
- Optional Lumbar Support

DIMENSIONS

Depth:	24	Width (with arms):	27
Height:	43¾	Width (armless):	21
Seat Depth:	17¾	Cube:	10.8
Seat Width:	20	COM:	1.0
Back Width:	19	Weight Rating:	300 lbs.
Back Height:	23		

FABRIC PRICE CODES

1	\$552	8	\$690
2	\$576	9	\$708
3	\$600	10	\$726
4	\$618	11	\$744
5	\$636	12	\$762
6	\$654	L	\$752
7	\$672		

! See page 375 for additional specifications and dimensions.

HITSM



TASK LOW-BACK STOOL

- 4-Way Stretch Mesh Back
- Pneumatic
- Swivel
- Synchro-tilt
- Tilt Tension
- Tilt Lock
- Optional Lumbar Support

DIMENSIONS

Depth:	22	Width (with arms):	26
Height:	52½	Width (armless):	20
Seat Depth:	16	Cube:	10.8
Seat Width:	18½	COM:	1.0
Back Width:	17½	Weight Rating:	300 lbs.
Back Height:	19		

FABRIC PRICE CODES

1	\$603	8	\$741
2	\$627	9	\$759
3	\$651	10	\$777
4	\$669	11	\$795
5	\$687	12	\$813
6	\$705	L	\$803
7	\$723		

! See page 375 for additional specifications and dimensions.

! Not available in Polished Aluminum Base.

HON Recommendation: **HIWMM.Y2.A.H.IM.CU__BL.SB.T** - List Price \$722

HOW TO SPECIFY

Select Model Number	Select Control Type	Select Arm Type	Select Caster	Select Mesh	Select Fabric	Select Lumbar	Select Base	Select Frame
Y0 Synchro-Tilt	N Armless	H Black Hard Caster	IM Black	See page 368	NL No Lumbar	SB Standard Base	T Black	
Y1 Synchro-Tilt w/ Seat Slider (+ \$20)	A Height and Width Adjustable Arms (+ \$75)	S Black All-Surface Caster (+ \$30)	IB Breeze		BL Black Adjustable Lumbar (+ \$30)	PA Polished Aluminum (+ \$110)	DWX Designer White (+ \$35 for HITLM and HIWMM; + \$55 for HITSM)	
Y2 Advanced Synchro-Tilt (+ \$65)	V All-Adjustable Arms (includes pivot) (+ \$115)	TS Titanium All-Surface Caster (+ \$30)	IK Brownstone		BY Bullseye Adjustable Lumbar (+ \$30)		TI Titanium (+ \$35 for HITLM and HIWMM; + \$55 for HITSM)	
Y3 Synchro-Tilt with Independent Back Angle (+ \$105)	F Fixed Arms (+ \$65)	R Black Roll Control Caster (+ \$50)	IH Chai *		DW Designer White Adjustable Lumbar (+ \$30)			
S0 Limited Recline Synchro-Tilt (for HITSM only)	P Fixed Arms - Polished (+ \$150)		IC Charcoal		MR Ember Adjustable Lumbar (+ \$30)			
S1 Limited Recline Synchro-Tilt w/ Seat Slider (+ \$20 for HITSM only)			IF Fog		IR Iris Adjustable Lumbar (+ \$30)			
			IY Navy *		KT Krypton Adjustable Lumbar (+ \$30)			
			IR Regatta		RE Regatta Adjustable Lumbar (+ \$30)			
			IT Titanium		TL Titanium Adjustable Lumbar (+ \$30)			

* Fabric is de-emphasized.



IGNITION® 2.0

HITLMKD



TASK LOW-BACK

- 4-Way Stretch Mesh Back**
- Pneumatic
- Swivel
- Synchro-tilt
- Tilt Tension
- Tilt Lock
- Optional Lumbar Support

DIMENSIONS

Depth:	22	Back Height:	19
Height:	40½	Width (with arms):	26
Seat Depth:	16	Width (armless):	20
Seat Width:	18½	Cube:	5.6
Back Width:	17½	Weight Rating:	300 lbs.

FABRIC PRICE CODES

1	\$464
2	\$488
3	\$512

! See page 375 for additional specifications and dimensions.

HIWMMKD



TASK MID-BACK

- 4-Way Stretch Mesh Back**
- Pneumatic
- Swivel
- Synchro-tilt
- Tilt Tension
- Tilt Lock
- Optional Lumbar Support

DIMENSIONS

Depth:	24	Back Height:	23
Height:	43¾	Width (with arms):	27
Seat Depth:	17¾	Width (armless):	21
Seat Width:	20	Cube:	6.3
Back Width:	19	Weight Rating:	300 lbs.

FABRIC PRICE CODES

1	\$512
2	\$536
3	\$560

! See page 375 for additional specifications and dimensions.

HON Recommendation: HIWMMKD.Y2.A.H.IM.CU__BL.SB.T - List Price \$682

HOW TO SPECIFY

Select Model Number	Select Control Type	Select Arm Type	Select Caster	Select Mesh	Select Fabric	Select Lumbar	Select Base	Select Frame
	Y1 Synchro-Tilt w/ Seat Slider (+ \$20) Y2 Advanced Synchro-Tilt (+ \$65)	A Height and Width Adjustable Arms (+ \$75)	H Black Hard Caster	IM Black IF Fog IC Charcoal	See page 368	NL No Lumbar BL Black Adjustable Lumbar (+ \$30) BY Bullseye Adjustable Lumbar (+ \$30) DW Designer White Adjustable Lumbar (+ \$30) MR Ember Adjustable Lumbar (+ \$30) IR Iris Adjustable Lumbar (+ \$30) KT Krypton Adjustable Lumbar (+ \$30) RE Regatta Adjustable Lumbar (+ \$30) TL Titanium Adjustable Lumbar (+ \$30)	SB Standard Base	T Black DWX Designer White (+ \$35) TI Titanium (+ \$35)
H I W M M K D	Y 2	A	H	I M	C U 1 0	B L	S B	T

SEATING

IGNITION® 2.0

ReActiv®

OPEN MARKET



Icon Legend on page 19

HITLRA

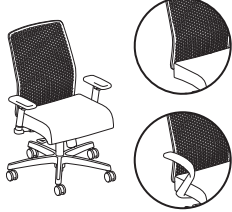

TASK LOW-BACK

ReActiv® Back
Pneumatic
Swivel
Synchro-tilt
Tilt Tension
Tilt Lock
Optional Lumbar Support

DIMENSIONS

Depth: 22
Height: 40½
Seat Depth: 16
Seat Width: 18½
Back Width: 17½
Back Height: 19
Width (with arms): 26
Width (armless): 20
Cube: 10.8
COM: 1.0
Weight Rating: 300 lbs.

FABRIC PRICE CODES

1	\$539	8	\$677
2	\$563	9	\$695
3	\$587	10	\$713
4	\$605	11	\$731
5	\$623	12	\$749
6	\$641	L	\$739
7	\$659		

See page 375 for all other control specifications.

HIWMRA

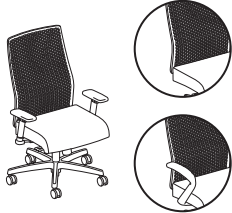

TASK MID-BACK

ReActiv® Back
Pneumatic
Swivel
Synchro-tilt
Tilt Tension
Tilt Lock
Optional Lumbar Support

DIMENSIONS

Depth: 24
Height: 43¾
Seat Depth: 17¾
Seat Width: 20
Back Width: 19
Back Height: 23
Width (with arms): 27
Width (armless): 21
Cube: 10.8
COM: 1.0
Weight Rating: 300 lbs.

FABRIC PRICE CODES

1	\$587	8	\$725
2	\$611	9	\$743
3	\$635	10	\$761
4	\$653	11	\$779
5	\$671	12	\$797
6	\$689	L	\$787
7	\$707		

See page 375 for all other control specifications.

HITSRA

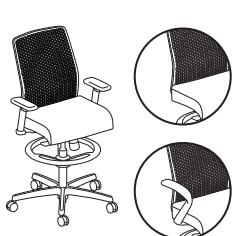

TASK LOW-BACK STOOL

ReActiv® Back
Pneumatic
Swivel
Synchro-tilt
Tilt Tension
Tilt Lock
Optional Lumbar Support

DIMENSIONS

Depth: 22
Height: 52½
Seat Depth: 16
Seat Width: 18½
Back Width: 17½
Back Height: 19
Width (with arms): 26
Width (armless): 20
Cube: 10.8
COM: 1.0
Weight Rating: 300 lbs.

FABRIC PRICE CODES

1	\$638	8	\$776
2	\$662	9	\$794
3	\$686	10	\$812
4	\$704	11	\$830
5	\$722	12	\$848
6	\$740	L	\$838
7	\$758		

See page 375 for all other control specifications.

Not available in Polished Aluminum Base.

HON Recommendation: HIWMRA.Y2.A.H.___CU__BL.SB.T - List Price \$757

HOW TO SPECIFY

Select Model Number	Select Control Type	Select Arm Type	Select Caster	Select Back Color	Select Fabric	Select Lumbar	Select Base	Select Frame
Y0 Synchro-Tilt	N Armless	H Black Hard Caster	OS Charcoal ReActiv®	See page 368	NL No Lumbar	SB Standard Base	T Black	
Y1 Synchro-Tilt w/ Seat Slider (+ \$20)	A Height and Width Adjustable Arms (+ \$75)	S Black All-Surface Caster (+ \$30)	DWR Designer White		BL Black Adjustable Lumbar (+ \$30)	PA Polished Aluminum (+ \$110)	DWX Designer White (+ \$35 for HITLRA and HIWMRA; + \$55 for HITSRA)	
Y2 Advanced Synchro-Tilt (+ \$65)	V All-Adjustable Arms (includes pivot) (+ \$115)	TS Titanium All-Surface Caster (+ \$30)	TI Titanium ReActiv®		BY Bullseye Adjustable Lumbar (+ \$30)		TI Titanium (+ \$35 for HITLRA and HIWMRA; + \$55 for HITSRA)	
Y3 Synchro-Tilt with Independent Back Angle (+ \$105)	F Fixed Arms (+ \$65)	R Black Roll Control Caster (+ \$50)			DW Designer White Adjustable Lumbar (+ \$30)			
S0 Limited Synchro-Tilt (for HITSRA only)	P Fixed Arms - Polished (+ \$150)				MR Ember Adjustable Lumbar (+ \$30)			
S1 Limited Synchro-Tilt w/ Seat Slider (+ \$20 for HITSRA only)					IR Iris Adjustable Lumbar (+ \$30)			
<i>Specify S0 or S1 for HITSRA model ONLY</i>					KT Krypton Adjustable Lumbar (+ \$30)			
					RE Regatta Adjustable Lumbar (+ \$30)			
					TL Titanium Adjustable Lumbar (+ \$30)			

HITLRA . Y2 . A . H . OS . CU10 . BL . SB . T



Icon Legend on page 19

IGNITION® 2.0 ReActiv®

HITLRAKD

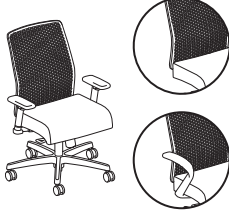

TASK LOW-BACK

ReActiv® Back
Pneumatic
Swivel
Synchro-tilt
Tilt Tension
Tilt Lock
Optional Lumbar Support

DIMENSIONS

Depth: 22
Height: 40½
Seat Depth: 16
Seat Width: 18½
Back Width: 17½
Back Height: 25½
Width (with arms): 26
Width (armless): 20
Cube: 5.6
Weight Rating: 300 lbs.

FABRIC PRICE CODES

1 \$499
2 \$523
3 \$547

! See page 375 for all other control specifications.

HIWMRAKD

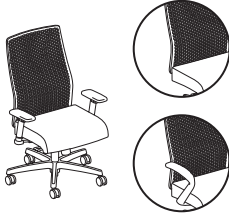

TASK MID-BACK

ReActiv® Back
Pneumatic
Swivel
Synchro-tilt
Tilt Tension
Tilt Lock
Optional Lumbar Support

DIMENSIONS

Depth: 24
Height: 43¾
Seat Depth: 17¾
Seat Width: 20
Back Width: 19
Back Height: 29
Width (with arms): 27
Width (armless): 21
Cube: 6.3
Weight Rating: 300 lbs.

FABRIC PRICE CODES

1 \$547
2 \$571
3 \$595

! See page 375 for all other control specifications.

HON Recommendation: HIWMRAKD.Y2.A.H.___CU___.BL.SB.T - List Price \$717

HOW TO SPECIFY

Select Model Number	Select Control Type	Select Arm Type	Select Caster	Select Back Color	Select Fabric	Select Lumbar	Select Base	Select Frame
	Y1 Synchro-Tilt w/ Seat Slider (+ \$20) Y2 Advanced Synchro-Tilt (+ \$65)	N Armless A Height and Width Adjustable Arms (+ \$75)	H Black Hard Caster	OS Charcoal ReActiv® DWR Designer White ReActiv® TI Titanium ReActiv®	See page 368	NL No Lumbar BL Black Adjustable Lumbar (+ \$30) BY Bullseye Adjustable Lumbar (+ \$30) DW Designer White Adjustable Lumbar (+ \$30) MR Ember Adjustable Lumbar (+ \$30) IR Iris Adjustable Lumbar (+ \$30) KT Krypton Adjustable Lumbar (+ \$30) RE Regatta Adjustable Lumbar (+ \$30) TL Titanium Adjustable Lumbar (+ \$30)	SB Standard Base	T Black DWX Designer White (+ \$35) TI Titanium (+ \$35)
H I W M R A K D .	Y 2 .	A .	H .	O S .	C U I 0 .	B L .	S B .	T

IGNITION® 2.0 Upholstered

GSA SIN 33721



Icon Legend on page 19

HIWMU



TASK MID-BACK

Upholstered Back
Pneumatic
Swivel
Synchro-tilt
Tilt Tension
Tilt Lock

DIMENSIONS

Depth: 24
Height: 43¾
Seat Depth: 17¾
Seat Width: 20
Back Width: 19
Back Height: 23
Width (with arms): 27
Width (armless): 21
Cube: 10.8
COM: 3.0
Weight Rating: 300 lbs.

FABRIC PRICE CODES

1	\$552	7	\$852
2	\$612	8	\$897
3	\$672	9	\$942
4	\$717	10	\$987
5	\$762	11	\$1032
6	\$807	12	\$1077

! See page 375 for additional specifications and dimensions.

HIWMUL

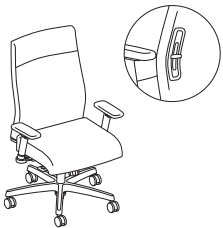

TASK MID-BACK WITH ADJUSTABLE LUMBAR

Upholstered Back
Pneumatic
Swivel
Synchro-tilt
Tilt Tension
Tilt Lock
Adjustable Lumbar

DIMENSIONS

Depth: 24½
Height: 43¾
Seat Depth: 17¾
Seat Width: 20
Back Width: 19
Back Height: 23
Width (with arms): 27
Width (armless): 21
Cube: 10.8
COM: 3.0
Weight Rating: 300 lbs.

FABRIC PRICE CODES

1	\$583	7	\$883
2	\$643	8	\$928
3	\$703	9	\$973
4	\$748	10	\$1018
5	\$793	11	\$1063
6	\$838	12	\$1108

! See page 375 for additional specifications and dimensions.

HON Recommendation: HIWMU.Y2.A.H.CU__NL.SB.T - List Price \$692

HOW TO SPECIFY

Select Model Number	Select Control Type	Select Arm Type	Select Caster	Select Fabric	Select Lumbar	Select Base	Select Frame
Y0 Synchro-Tilt Y1 Synchro-Tilt w/ Seat Slider (+ \$20) Y2 Advanced Synchro-Tilt (+ \$65) Y3 Synchro-Tilt with Independent Back Angle (+ \$105)	N Armless A Height and Width Adjustable Arms (+ \$75) V All-Adjustable Arms (+ \$115) F Fixed Arms (+ \$65) P Fixed Arms - Polished (+ \$150)	H Black Hard Caster S Black All-Surface Caster (+ \$30) TS Titanium All-Surface Caster (+ \$30) R Black Roll Control Caster (+ \$50)	See page 368	NL No Lumbar <i>Specify for model HIWMU only</i> AL Adjustable Lumbar <i>Specify for model HIWMUL only</i>	SB Standard Base PA Polished Aluminum (+ \$110)	T Black DWX Designer White (+ \$35) TI Titanium (+ \$35)	
HIWMU	Y2	A	H	CU10	NL	SB	T



Icon Legend on page 19

IGNITION® 2.0 Upholstered

HIWMUKD



TASK MID-BACK

Upholstered Back

- Pneumatic
- Swivel
- Synchro-tilt
- Tilt Tension
- Tilt Lock

DIMENSIONS

Depth:	24	Back Height:	23
Height:	43¾	Width (with arms):	27
Seat Depth:	17¾	Width (armless):	21
Seat Width:	20	Cube:	6.3
Back Width:	19	Weight Rating:	300 lbs.

FABRIC PRICE CODES

1	\$512
2	\$572
3	\$632

! See page 375 for additional specifications and dimensions.

HIWMULKD

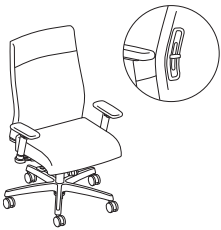

TASK MID-BACK WITH ADJUSTABLE LUMBAR

Upholstered Back

- Pneumatic
- Swivel
- Synchro-tilt
- Tilt Tension
- Tilt Lock
- Adjustable Lumbar

DIMENSIONS

Depth:	24½	Back Height:	23
Height:	43¾	Width (with arms):	27
Seat Depth:	17¾	Width (armless):	21
Seat Width:	20	Cube:	6.3
Back Width:	19	Weight Rating:	300 lbs.

FABRIC PRICE CODES

1	\$543
2	\$603
3	\$663

! See page 375 for additional specifications and dimensions.

HON Recommendation: HIWMUKD.Y2.A.H.CU__NL.SB.T - List Price \$652

HOW TO SPECIFY

Select Model Number	Select Control Type	Select Arm Type	Select Caster	Select Fabric	Select Lumbar	Select Base	Select Frame
HIWMUKD	Y1 Synchro-Tilt w/ Seat Slider (+ \$20) Y2 Advanced Synchro-Tilt (+ \$65)	N Armless A Height and Width Adjustable Arms (+ \$75)	H Black Hard Caster	See page 368	NL No Lumbar <i>Specify for model HIWMUKD only</i> AL Adjustable Lumbar <i>Specify for model HIWMULKD only</i>	SB Standard Base	T Black DWX Designer White (+ \$35) TI Titanium (+ \$35)
	Y2	A	H		NL	SB	T

IGNITION® 2.0 Accessories

GSA SIN 33721 EXCEPT AS NOTED



Icon Legend on page 19

HI2ATA

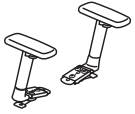

ADJUSTABLE ARMS

Height and Width
Functions: **S**
(Function Key on pages 244-245)

DIMENSIONS

Adjustable Arms Width: 17-19½
Height from Seat: 8-11
Ship Weight: 8
Cube: 1.0

LIST PRICE

\$125

HI2AAA

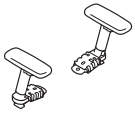

ALL-ADJUSTABLE ARMS

Height, Width, Depth and Pivot

DIMENSIONS

Adjustable Arms Width: 17-20
Height from Seat: 7-11
Ship Weight: 8
Cube: 1.0

LIST PRICE

\$168

HI2FHA



FIXED HEIGHT ARMS

DIMENSIONS

Arm Width: 20
Height from Seat: 9½
Ship Weight: 7
Cube: 1.0

LIST PRICE

\$115

HIPAA

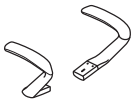

POLISHED ALUMINUM ARMS

Fixed Height

DIMENSIONS

Arm Width: 20
Height from Seat: 9½
Ship Weight: 10
Cube: 1.0

LIST PRICE

\$190

HILMBR

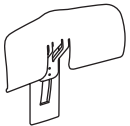

LUMBAR SUPPORT

DIMENSIONS

Ship Weight: 8
Cube: 1.0

LIST PRICE

\$33

HSCASTER

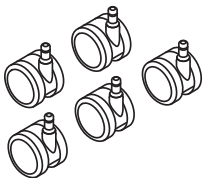

SET OF 5 ALL-SURFACE CASTERS

DIMENSIONS

Size: 60mm
Ship Weight: 2
Cube: 0.1

LIST PRICE

\$51

ⓘ Available in Black finish only, no specification needed.

OPEN MARKET

SEATING

HOW TO SPECIFY

Select Model Number	Select Frame
	<p>T Black</p> <p>DWX Designer White</p> <p>TI Titanium</p> <p><i>Not specified for model HIPAA</i></p>
HI2ATA.	T

HOW TO SPECIFY

Select Model Number	Select Lumbar Color
	<p>BL Black MR Ember RE Regatta</p> <p>BY Bullseye IR Iris TL Titanium</p> <p>DW Designer White KT Krypton</p>
HILMBR.	BL

IGNITION®

Guest Chair Options

ARM STYLE	CODE	DESCRIPTION	PRICE
	N	Armless	+\$0
	F	Fixed Arms	+\$30



CASTERS/ GLIDE	CODE	DESCRIPTION	PRICE
-------------------	------	-------------	-------



H	Black Hard Caster	+\$0
----------	-------------------	-------------



S	Black All-Surface Caster	+\$20
----------	--------------------------	--------------



E	Glide	+\$0
----------	-------	-------------

Casters only available on HIGS6

BACK STYLE	CODE	DESCRIPTION	PRICE
	IM	Black	+\$0
	IB	Breeze	+\$0
	IK	Brownstone	+\$0
	IH	Chai*	+\$0
	IC	Charcoal	+\$0
	IF	Fog	+\$0
	IY	Navy*	+\$0
	IR	Regatta	+\$0
	IT	Titanium	+\$0
	U	Upholstered	+\$0

FRAME	CODE	DESCRIPTION	PRICE
	T	Black	+\$0
	BLCK	Textured Black Mica	+\$0
	PK7	Textured Designer White	+\$35
	PLAT	Textured Platinum Metallic	+\$0
	PR8T	Textured Silver	+\$35

By selecting PR8T, unit will be produced with titanium colored arm caps, back frame, & glides

By selecting PK7, unit will be produced with Designer White colored arm caps, back frame, & glides

* Fabric is de-emphasized.

HIGCL



GUEST CHAIR

Fixed Arms
Glides

DIMENSIONS

Depth:	24	Arm Width:	19¼
Width:	23	Seat to Floor Height:	18½
Height:	35½	Usable Seat Depth:	16¾
Seat Depth:	18	Ship Weight:	42
Seat Width:	19½	Cube:	15.2
Back Width:	19½	COM:	2.0
Back Height:	20	Weight Rating:	300 lbs.

FABRIC PRICE CODES

1	\$465	8	\$741
2	\$513	9	\$777
3	\$561	10	\$813
4	\$597	11	\$849
5	\$633	12	\$885
6	\$669	L	\$765
7	\$705		

HON Recommendation: HIGCL.E.U.CU__T - List Price \$465

HOW TO SPECIFY

Select Model Number HIGCL	Select Glide E Glide E	Select Back Type U Upholstered U	Select Fabric See page 368 CU10	Select Frame T Black BLCK Textured Black Mica PLAT Textured Platinum Metallic T
---	-------------------------------------	---	--	--

HIB50

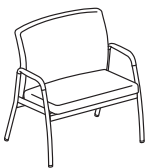

BARIATRIC LOUNGE

Fixed Arms
Glides

DIMENSIONS

Depth:	25½	Arm Width:	30
Width:	33¾	Seat to Floor Height:	20
Height:	35¾	Usable Seat Depth:	18¾
Seat Depth:	18¾	Ship Weight:	70
Seat Width:	29¾	Cube:	27.5
Back Width:	29	COM:	2.5
Back Height:	19¼	Weight Rating:	500 lbs.

FABRIC PRICE CODES

1	\$1353	8	\$1698
2	\$1413	9	\$1743
3	\$1473	10	\$1788
4	\$1518	11	\$1833
5	\$1563	12	\$1878
6	\$1608	L	—
7	\$1653		

HOW TO SPECIFY

Select Model Number HIB50	Select Arm Type F Fixed Arms F	Select Glide E Glide E	Select Back Type U Upholstered U	Select Fabric See page 368 CU10	Select Frame T Black BLCK Textured Black Mica PLAT Textured Platinum Metallic T
---	---	-------------------------------------	---	--	--



HIGS6

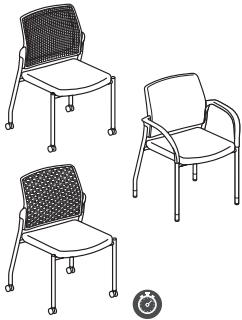

MULTI-PURPOSE

Four Legs

DIMENSIONS

Depth:	21¾	Seat to Floor Height:	18¾
Width:	25	Usable Seat Depth:	17¾
Height:	33½	Ship Weight:	28
Seat Depth:	17¾	Cube:	15.1
Seat Width:	18¾	COM (upholstered back):	1.5
Back Width:	18¼	COM (mesh/ReActiv® back):	1.0
Back Height:	18½	Weight Rating:	300 lbs.
Arm Width:	21½		

FABRIC PRICE CODES

1	\$441	8	\$648
2	\$477	9	\$675
3	\$513	10	\$702
4	\$540	11	\$729
5	\$567	12	\$756
6	\$594	L	\$741
7	\$621		

NOTES: Stacks 4-high.

- ! Ganging brackets work with armless Guest/Multi-purpose models only.
- ! ReActiv® back option not available on FC models.

HISB6



MULTI-PURPOSE

Sled Base

DIMENSIONS

Depth:	23¾	Seat to Floor Height:	18¾
Width:	25	Usable Seat Depth:	17¾
Height:	33½	Ship Weight:	30
Seat Depth:	17¾	Cube:	15.1
Seat Width:	18¾	COM (upholstered back):	1.5
Back Width:	18¼	COM (mesh/ReActiv® back):	1.0
Back Height:	18½	Weight Rating:	300 lbs.
Arm Width:	21½		

FABRIC PRICE CODES

1	\$441	8	\$648
2	\$477	9	\$675
3	\$513	10	\$702
4	\$540	11	\$729
5	\$567	12	\$756
6	\$594	L	\$741
7	\$621		

- ! Ganging brackets work with armless Guest/Multi-purpose models only.
- ! ReActiv® back option not available on FC models.

HICS7



CAFÉ-HEIGHT STOOL

Four Legs

DIMENSIONS

Depth:	23	Seat to Floor Height:	31
Width:	25	Usable Seat Depth:	17¾
Height:	46½	Ship Weight:	37
Seat Depth:	17¾	Cube:	21.8
Seat Width:	18¾	COM (upholstered back):	1.5
Back Width:	18¼	COM (mesh/ReActiv® back):	1.0
Back Height:	18½	Weight Rating:	300 lbs.
Arm Width:	21½		

FABRIC PRICE CODES

1	\$557	8	\$764
2	\$593	9	\$791
3	\$629	10	\$818
4	\$656	11	\$845
5	\$683	12	\$872
6	\$710	L	\$857
7	\$737		

- ! Ganging brackets work with armless Guest/Multi-purpose models only.
- ! ReActiv® back option not available on FC models.

HON Recommendation: HIGS6.F.H.IM.CU__T - List Price \$471

HOW TO SPECIFY

Select Model Number	Select Arm Type	Select Glide	Select Back Type	Select Fabric	Select Frame
F Fixed Arms (+ \$30) N Armless	E Glide H Black Hard Caster S Black All-Surface Caster (+ \$20) <i>Casters available on HIGS6 only</i>	IM Black IB Breeze IK Brownstone IH Chai IC Charcoal OS Charcoal ReActiv® (+ \$30) DWR Designer White ReActiv® (+ \$30)	IF Fog IY Navy IR Regatta IT Titanium TI Titanium ReActiv® (+ \$30) U Upholstered	See page 368	T Black BLCK Textured Black Mica PK7 Textured Designer White (+ \$35) PLAT Textured Platinum Metallic PR8T Textured Silver (+ \$35)
H I G S 6 .	F .	H .	I M .	C U 1 0 .	T

* Fabric is de-emphasized.

HIGS6DF

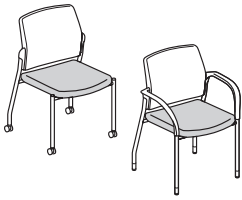

MULTI-PURPOSE

Dual Fabric
Four Legs

DIMENSIONS

Depth:	21 ³ / ₄	Arm Width:	21 ¹ / ₂
Width:	25	Seat to Floor Height:	18 ³ / ₈
Height:	33 ¹ / ₂	Usable Seat Depth:	17 ³ / ₈
Seat Depth:	17 ³ / ₈	Ship Weight (upholstered back):	28
Seat Width:	18 ³ / ₄	Cube (upholstered back):	15.1
Back Width:	18 ¹ / ₄	COM (back):	0.75
Back Height:	18 ¹ / ₈	COM (seat):	0.75
		Weight Rating:	300 lbs.

FABRIC PRICE CODES

1	\$516	
<i>Add to Base Price Above</i>		
	Back	Seat
2	\$18	\$18
3	\$36	\$36
4	\$50	\$50
5	\$63	\$63
6	\$77	\$77
7	\$90	\$90
8	\$104	\$104
9	\$117	\$117
10	\$131	\$131
11	\$144	\$144
12	\$158	\$158
L	\$150	\$150

NOTES: Stacks 4-high.

! Ganging brackets work with armless Guest/Multi-purpose models only.

HISB6DF

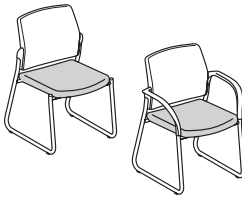

MULTI-PURPOSE

Dual Fabric
Sled Base

DIMENSIONS

Depth:	23 ³ / ₄	Arm Width:	21 ¹ / ₂
Width:	25	Seat to Floor Height:	18 ³ / ₈
Height:	33 ¹ / ₂	Usable Seat Depth:	17 ³ / ₈
Seat Depth:	17 ³ / ₈	Ship Weight (upholstered back):	30
Seat Width:	18 ³ / ₄	Cube (upholstered back):	15.1
Back Width:	18 ¹ / ₄	COM (back):	0.75
Back Height:	18 ¹ / ₈	COM (seat):	0.75
		Weight Rating:	300 lbs.

FABRIC PRICE CODES

1	\$516	
<i>Add to Base Price Above</i>		
	Back	Seat
2	\$18	\$18
3	\$36	\$36
4	\$50	\$50
5	\$63	\$63
6	\$77	\$77
7	\$90	\$90
8	\$104	\$104
9	\$117	\$117
10	\$131	\$131
11	\$144	\$144
12	\$158	\$158
L	\$150	\$150

! Ganging brackets work with armless Guest/Multi-purpose models only.

HON Recommendation: HIGS6DF.F.H.U.CU__UR__.T - List Price \$546

HOW TO SPECIFY

<p>Select Model Number</p> <p>HIGS6DF</p>	<p>Select Arm Type</p> <p>F Fixed Arms (+ \$30) N Armless</p> <p>F</p>	<p>Select Glide</p> <p>E Glide H Black Hard Caster S Black All-Surface Caster (+ \$20) <i>Casters available on HIGS6DF only</i></p> <p>H</p>	<p>Select Back Type</p> <p>U Upholstered</p> <p>U</p>	<p>Select Back Fabric</p> <p>See page 368</p> <p>CU10</p>	<p>Select Seat Fabric</p> <p>See page 368</p> <p>UR10</p>	<p>Select Frame</p> <p>T Black BLCK Textured Black Mica PK7 Textured Designer White (+ \$35) PLAT Textured Platinum Metallic PR8T Textured Silver (+ \$35)</p> <p>T</p>
--	---	---	--	--	--	--



HICS7DF

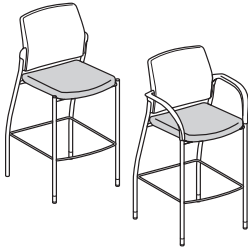

CAFÉ-HEIGHT STOOL

Dual Fabric
Four Legs

DIMENSIONS

Depth:	23	Arm Width:	21½
Width:	25	Seat to Floor Height:	31
Height:	46½	Usable Seat Depth:	17¾
Seat Depth:	17¾	Ship Weight (upholstered back):	37
Seat Width:	18¾	Cube (upholstered back):	21.8
Back Width:	18¼	COM (back):	0.75
Back Height:	18½	COM (seat):	0.75
		Weight Rating:	300 lbs.

FABRIC PRICE CODES

1	\$632	
<i>Add to Base Price Above</i>		
	Back	Seat
2	\$18	\$18
3	\$36	\$36
4	\$50	\$50
5	\$63	\$63
6	\$77	\$77
7	\$90	\$90
8	\$104	\$104
9	\$117	\$117
10	\$131	\$131
11	\$144	\$144
12	\$158	\$158
L	\$150	\$150

! Ganging brackets work with armless Guest/Multi-purpose models only.

HIGB1



GANGING BRACKET

- For Armless Guest Chairs
- 24 per package

DIMENSIONS

Ship Weight:	1 Ⓢ
Cube:	0.1

LIST PRICE

\$82

HON Recommendation: HICS7DF.F.H.U.CU__UR__.T - List Price \$662

HOW TO SPECIFY

Select Model Number	Select Arm Type	Select Glide	Select Back Type	Select Back Fabric	Select Seat Fabric	Select Frame
	F Fixed Arms (+ \$30) N Armless	E Glide	U Upholstered	See page 368	See page 368	T Black BLCK Textured Black Mica PK7 Textured Designer White (+ \$35) PLAT Textured Platinum Metallic PR8T Textured Silver (+ \$35)
HICS7DF.	F.	E.	U.	CU10.	UR10.	T

INSTIGATE™ Mesh Guest Chairs

OPEN MARKET



Icon Legend on page 19

HVL508



GUEST CHAIR

Leg Base
Armless
Stacks up to Four High

DIMENSIONS

Depth:	22¼	Back Height:	19
Width:	24	Seat to Floor Height:	18¾
Height:	35¾	Usable Seat Depth:	17½
Seat Depth:	17½	Ship Weight:	18.8
Seat Width:	18½	Cube:	3.1
Back Width:	17½	Weight Rating:	250 lbs.

PRICE CODE

Fabric **\$228**

NOTES: Mesh back. Black fabric seat. Double cross bar frame increases strength and durability. Stackable up to 4-high. **HON 5-Year Limited Warranty.**

HON Recommendation: HVL508.ES10 - List Price \$228

HVL518



GUEST CHAIR

Leg Base
Arms
Stacks up to Four High

DIMENSIONS

Depth:	22¼	Arm Width:	20¼
Width:	24	Seat to Floor Height:	17¾
Height:	35¾	Usable Seat Depth:	17½
Seat Depth:	17½	Ship Weight:	22.2
Seat Width:	18½	Cube:	3.2
Back Width:	17½	Weight Rating:	250 lbs.
Back Height:	19		

PRICE CODE

Fabric **\$253**

NOTES: Mesh back. Fixed arms. Double cross bar frame increases strength and durability. Stackable up to 4-high. Black fabric seat. **HON 5-Year Limited Warranty.**

HON Recommendation: HVL518.ES10 - List Price \$253

HVL528



CAFÉ STOOL

Leg Base
Armless

DIMENSIONS

Depth:	23¾	Back Height:	19
Width:	20½	Seat to Floor Height:	33⅞
Height:	49¾	Usable Seat Depth:	17½
Seat Depth:	17½	Ship Weight (armless):	40.0
Seat Width:	18½	Cube (armless):	7.0
Back Width:	17½	Weight Rating:	250 lbs.

PRICE CODE

Fabric
Per Carton **\$643**
Single Unit **\$321.50**

NOTES: Mesh back. Black fabric seat. Ships two per carton. **HON 5-Year Limited Warranty.**

Instigate™ HVL538 and HVL528 are ordered and shipped two (2) stools per carton. Pricing shown is per carton. Each set of two (one carton), must have the same fabric/frame color. Ordering 2 of any model will result in 2 cartons being shipped, giving you 4 stools.

HON Recommendation: HVL528.ES10 - List Price \$643

HVL538



CAFÉ STOOL

Leg Base
Arms

DIMENSIONS

Depth:	23¾	Arm Width:	20¼
Width:	20½	Seat to Floor Height:	33⅞
Height:	49¾	Usable Seat Depth:	17½
Seat Depth:	17½	Ship Weight:	44.5
Seat Width:	18½	Cube:	7.8
Back Width:	17½	Weight Rating:	250 lbs.
Back Height:	19		

PRICE CODE

Fabric
Per Carton **\$678**
Single Unit **\$339.00**

NOTES: Mesh back. Black fabric seat. Fixed arms. Ships two per carton. **HON 5-Year Limited Warranty.**

HON Recommendation: HVL538.ES10 - List Price \$678

SEATING

HOW TO SPECIFY

Select Model Number	Select Fabric
HVL518	ES10 Black Fabric (only)

INVITATION® 2110 SERIES



Invitation Guest Chairs
and Table Connectors.

INVITATION® 2110 SERIES

Invitation brings the comforts of home into the workplace. Enjoy the simple pleasure of welcoming guests in arm chairs with integrated tables. Invitation guest chairs coordinate with Invitation lounge seating to make any space more comfortable and cohesive. Arrange in rows, groups or any configuration to suit your space or needs. The practical design and long-lasting comfort adds up to a stylish Invitation.



FEATURES

- Contoured back rest on guest chairs delivers ergonomic comfort.
- Floating back design enables easy wipe-out cleaning.
- Guest chairs can be ganged together to create straight rows.
- Molded polymer seat shell increases comfort and durability.
- Solid hardwood in one of eight attractive finishes.
- Warranted for users up to 250 lbs.

INVITATION® 2110 Series Options

MODEL OPTIONS

H2111



Guest Chair

Leg Base, Arms

H2112

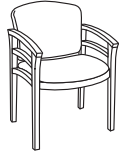

Guest Chair

Leg Base, Double
Rail Arms

HON BRANDED FABRICS

GRADE 1

Apex
Attire
Centurion
Compass
Contourett
Dapper
Ensemble
Hamilton
Inertia
Optic
Pebble

GRADE 2

Appoint Seating
Blume
Clyde
Dotty
Rush
Seed
Spin Seating
Whisper Vinyl

GRADE 3

In Season
Moxie
Parker
Purl
Quill

AVAILABLE FINISHES

Invitation® 2110 Series Seating is available in 8 wood finishes.

WOOD FINISHES

Bourbon Cherry (H)

Cognac (COGN)

Harvest (C)

Mahogany (N)

Mocha (MOCH)

Natural Maple (D)

Pinnacle (PINC)

Shaker Cherry (F)

For a complete list of fabrics, including partnership fabrics, go to hon.com/fabricsandfinishes.

Reference Fabric Color Combinations on pages 20-24 for color codes and legend on page 21 for lead times. COM yardage shown is for Pattern Cut only. Contact Customer Service for Railroaded yardage requirements. For additional HON to Supply COM fabric grade pricing, go to honready.hon.com and click on the HON to Supply COM link.

 For Fire Code model, availability and ordering method, refer to pages 248-251. Available on select models, contact HON Customer Support for availability.



INVITATION® 2110 Series

H2111



GUEST CHAIR

Leg Base
Arms

DIMENSIONS

Depth:	22	Arm Width:	18 ⁷ / ₈
Width:	23 ¹ / ₂	Seat to Floor Height:	18 ¹ / ₂
Height:	33 ³ / ₈	Usable Seat Depth:	17
Seat Depth:	17	Ship Weight:	24
Seat Width:	20	Cube:	15.0
Back Width:	21	COM:	1.5
Back Height:	16	Weight Rating:	250 lbs.

FABRIC PRICE CODES

1	\$904	8	\$1111
2	\$940	9	\$1138
3	\$976	10	\$1165
4	\$1003	11	\$1192
5	\$1030	12	\$1219
6	\$1057	L	—
7	\$1084		

H2112



GUEST CHAIR

Leg Base
Double Rail Arms

DIMENSIONS

Depth:	22	Arm Width:	18 ⁷ / ₈
Width:	23 ¹ / ₂	Seat to Floor Height:	18 ¹ / ₂
Height:	33 ³ / ₈	Usable Seat Depth:	17
Seat Depth:	17	Ship Weight:	28
Seat Width:	20	Cube:	15.0
Back Width:	21	COM:	1.5
Back Height:	16	Weight Rating:	250 lbs.

FABRIC PRICE CODES

1	\$993	8	\$1200
2	\$1029	9	\$1227
3	\$1065	10	\$1254
4	\$1092	11	\$1281
5	\$1119	12	\$1308
6	\$1146	L	—
7	\$1173		

HON Recommendation: H2111.MOCH.CU__ - List Price \$904

HOW TO SPECIFY

<p>Select Model Number</p> <p>H 2 1 1 1 .</p>	<p>Select Finish</p> <p>See page 390</p> <p>M O C H .</p>	<p>Select Fabric</p> <p>See page 390</p> <p>C U 1 0 .</p>
--	--	--

INVITATION® 2110 Series Connectors

GSA SIN 33721



Icon Legend on page 19

H2141



CONNECTORS

for Model H2111
One connector per two chairs

DIMENSIONS

Depth: 13⁵/₁₆ Ship Weight: 2.0
Width: 4⁷/₁₆ Cube: 0.3
Height: 1 Weight Rating: 300 lbs.

LIST PRICE

\$63

H2142

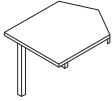

CORNER TABLE CONNECTOR

for Model H2111

DIMENSIONS

Depth: 28 Ship Weight: 25.5
Width: 28 Cube: 2.6
Height: 17¹/₄ Weight Rating: 300 lbs.

LIST PRICE

\$558



! Customer or dealer must attach leg to table.

H2143

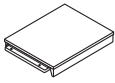

STRAIGHT TABLE CONNECTOR

for Model H2111

DIMENSIONS

Depth: 17¹/₈ Ship Weight: 16.5
Width: 21 Cube: 1.5
Height: 17¹/₄ Weight Rating: 300 lbs.

LIST PRICE

\$403

H2144



CONNECTORS

for Model H2112
One connector per two chairs

DIMENSIONS

Depth: 13⁵/₁₆ Ship Weight: 2.0
Width: 4⁷/₁₆ Cube: 0.3
Height: 1⁵/₁₆ Weight Rating: 300 lbs.

LIST PRICE

\$63

H2145

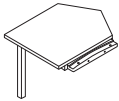

CORNER TABLE CONNECTOR

for Model H2112

DIMENSIONS

Depth: 28 Ship Weight: 25.5
Width: 28 Cube: 2.6
Height: 17¹/₄ Weight Rating: 300 lbs.

LIST PRICE

\$558



! Customer or dealer must attach leg to table.

H2146

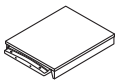

STRAIGHT TABLE CONNECTOR

for Model H2112

DIMENSIONS

Depth: 17¹/₈ Ship Weight: 16.5
Width: 21 Cube: 1.5
Height: 17¹/₄ Weight Rating: 300 lbs.

LIST PRICE

\$403

SEATING

HOW TO SPECIFY

Select Model Number <div style="border: 1px solid black; padding: 2px; display: flex; gap: 5px;"> H2141 </div>	Select Finish See page 390 <div style="border: 1px solid black; padding: 2px; display: flex; gap: 5px;"> H </div>
---	---

INVITATION® LOUNGE



Invitation Lounge.

INVITATION® LOUNGE

Welcome your guests in professional style. Enjoy the simple pleasure of relaxing on a sofa with a laptop or welcoming guests in plush arm chairs. The Invitation lounge collection combines gracefully sloping arms, tapered wood legs and the deep-foam comfort of separate seat cushions.



FEATURES

- Transitional design blends contemporary lines and traditional details.
- Clean lines and refined scale easily adapt to any private office or lobby.
- Contemporary tapered legs are offered in Platinum metallic or Black finish.
- Impressive design and fine craftsmanship in an affordably priced lounge chair.
- Removable seat cushion is deeply padded for added comfort.
- Warranted for users up to 250 lbs.

INVITATION® Lounge Options

MODEL OPTIONS

HFAA01



Arm Chair

HFALO2

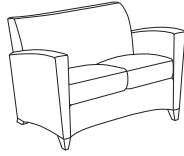

Love Seat

HFAS03

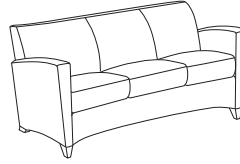

Sofa

LEG COLOR



CODE	DESCRIPTION	PRICE
T	Black	+\$0



T1	Platinum Metallic	+\$0
----	-------------------	------

CARTON

CODE	DESCRIPTION	PRICE
BC	Carton	+\$0

HON BRANDED FABRICS

GRADE 1

Apex
Attire
Centurion
Compass
Contourett
Dapper
Ensemble
Hamilton
Inertia
Optic
Pebble

GRADE 2

Appoint Seating
Blume
Clyde
Dotty
Rush
Seed
Spin Seating
Whisper Vinyl

GRADE 3

In Season
Moxie
Parker
Purl
Quill

GRADE L

Denver Leather

For a complete list of fabrics, including partnership fabrics, go to hon.com/fabricsandfinishes.

Reference Fabric Color Combinations on pages 20-24 for color codes and legend on page 21 for lead times. For additional HON to Supply COM fabric grade pricing, go to honready.hon.com and click on the HON to Supply COM link.

⚠ For Fire Code model, availability and ordering method, refer to pages 248-251. Available on select models, contact HON Customer Support for availability.



HFAA01

ARM CHAIR



DIMENSIONS

Depth:	31½	Arm Width:	20
Width:	30	Seat to Floor Height:	18
Height:	34	Usable Seat Depth:	20
Seat Depth:	20	Ship Weight:	73
Seat Width:	20	Cube:	27.0
Back Width:	20	COM:	5.0
Back Height:	16	Weight Rating:	250 lbs.

FABRIC PRICE CODES

1	\$1953	8	\$2643
2	\$2073	9	\$2733
3	\$2193	10	\$2823
4	\$2283	11	\$2913
5	\$2373	12	\$3003
6	\$2463	L	\$2953
7	\$2553		

HFAL02

LOVE SEAT

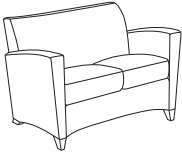

DIMENSIONS

Depth:	31¾	Arm Width:	40¼
Width:	50¼	Seat to Floor Height:	18
Height:	34¼	Usable Seat Depth:	20
Seat Depth:	20	Ship Weight:	112
Seat Width:	40¼	Cube:	55.7
Back Width:	40¼	COM:	6.5
Back Height:	16	Weight Rating:	250 lbs.

FABRIC PRICE CODES

1	\$2683	8	\$3580
2	\$2839	9	\$3697
3	\$2995	10	\$3814
4	\$3112	11	\$3931
5	\$3229	12	\$4048
6	\$3346	L	\$3983
7	\$3463		

HFAS03

SOFA

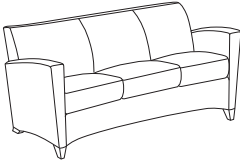

DIMENSIONS

Depth:	32	Arm Width:	60½
Width:	70½	Seat to Floor Height:	18
Height:	34½	Usable Seat Depth:	20
Seat Depth:	20	Ship Weight:	140
Seat Width:	60½	Cube:	72.0
Back Width:	60½	COM:	8.5
Back Height:	16	Weight Rating:	250 lbs.

FABRIC PRICE CODES

1	\$3414	8	\$4587
2	\$3618	9	\$4740
3	\$3822	10	\$4893
4	\$3975	11	\$5046
5	\$4128	12	\$5199
6	\$4281	L	\$5114
7	\$4434		

HON Recommendation: HFAA01.PNS__T.BC - List Price \$2073

HOW TO SPECIFY

<p>Select Model Number</p> <p>HFAA01</p>	<p>Select Fabric</p> <p>See page 394</p> <p>PNS007</p>	<p>Select Leg Color</p> <p>T Black T1 Platinum Metallic</p> <p>T</p>	<p>Select Carton Option</p> <p>BC Carton</p> <p>BC</p>
---	---	---	---



Lota Mesh Back Work and Side Chair with Voi® desks.

LOTA®

If you're looking for all-day comfort without breaking the bank, look no further than Lota. This mesh back family of task and guest chairs offer advanced features for customizable comfort that make it an upscale choice at an affordable price. Lota's control mechanism uses your own weight to provide perfect balance while reclining, and the pivoting arms put upper body support right where it's needed. If you sit for hours on end, put yourself in more control over your comfort.



FEATURES

- Weight-activated control responds naturally to your body's movements without any adjustments.
- 3-way arms adjust to various heights, depths and pivot positions.
- Multi-purpose chairs feature black arms and base.
- One-touch seat height adjustment easily moves the seat up and down.
- Tilt lock allows the user to lock out the tilt function.
- 360-degree swivel provides freedom of movement in any direction.
- Model H2281 available in black, charcoal and navy fabrics.
- Model H2282 available in hundreds of HON fabric options.
- H2285 available in black fabric only.
- Multi-purpose chairs stack four high on the floor.
- Warranted for users up to 275 lbs.

MODEL OPTIONS

H2281



Mid-Back Work (Mesh Back)

Pneumatic, Tilt Lock, Weight-Activated Control, Height, Depth, Pivot Adjustable Arms, Black Arms and Base

H2285



Multi-Purpose (Mesh Back)

4-Leg Stacking Frame, Fixed Arms

H2282



Mid-Back Work (Mesh Back)

Pneumatic, Tilt Lock, Weight-Activated Control, Height, Depth, Pivot Adjustable Arms, Black Arms and Base

CASTERS



CODE	DESCRIPTION	PRICE
H	Black Hard Caster	+ \$0



S	Black All-Surface Caster	+ \$30
---	--------------------------	--------

*Casters available on H2282 only

FRAME

CODE	DESCRIPTION	PRICE
T	Black	+ \$0

LOTA[®] Fabric Options

LOTA[®] MID-BACK WORK H2281

GRADE 1

Black Fabric
Charcoal Fabric
Navy Fabric

GRADE 2

GRADE 3

LOTA[®] MID-BACK WORK H2282 HON BRANDED FABRICS

GRADE 1

Apex
Attire
Centurion
Compass
Contourett
Dapper
Ensemble
Hamilton
Inertia
Optic
Pebble

GRADE 2

Appoint Seating
Blume
Clyde
Dotty
Rush
Seed
Spin Seating
Whisper Vinyl

GRADE 3

In Season
Moxie
Parker
Purl
Quill

For a complete list of fabrics, including partnership fabrics, go to hon.com/fabricsandfinishes.

Reference Fabric Color Combinations on pages 20-24 for color codes and legend on page 21 for lead times.

MULTI-PURPOSE H2285 HON BRANDED FABRICS

GRADE 1

Black Fabric

GRADE 2

GRADE 3



H2281



MID-BACK WORK CHAIR

DIMENSIONS

Mesh Back
 Pneumatic
 Tilt Lock
 Weight-activated Control
 Height, Depth, Pivot Adjustable
 Arms
 Black Arms and Base

Depth: 27¾
 Width: 26¾
 Height: 43½
 Seat Depth: 17¼
 Seat Width: 19½
 Back Width: 17¾
 Back Height: 23½
 Arm Width: 20⅞
 Seat to Floor Height: 17⅞-21⅞
 Usable Seat Depth: 17¼
 Ship Weight: 50
 Cube: 6.5
 Weight Rating: 250 lbs.

LIST PRICE

\$772

Functions: **A, E, F, L, Q**
 (Function Key on pages 244-245)

ⓘ Black Mesh back only.

HON Recommendation: H2281.VA10.T - List Price \$772

H2282



MID-BACK WORK CHAIR

DIMENSIONS

Mesh Back
 Pneumatic
 Tilt Lock
 Weight-activated Control
 Height, Depth, Pivot Adjustable
 Arms
 Black Arms and Base

Depth: 27¾
 Width: 26¾
 Height: 43½
 Seat Depth: 17¼
 Seat Width: 19½
 Back Width: 17¾
 Back Height: 23½
 Arm Width: 20⅞
 Seat to Floor Height: 17⅞-21⅞
 Usable Seat Depth: 17¼
 Ship Weight: 50
 Cube: 6.5
 Weight Rating: 250 lbs.

FABRIC PRICE CODES

1	\$896	8	\$1034
2	\$920	9	\$1052
3	\$944	10	\$1070
4	\$962	11	\$1088
5	\$980	12	\$1106
6	\$998	L	—
7	\$1016		

Functions: **A, E, F, L, Q**
 (Function Key on pages 244-245)

ⓘ Black Mesh back only.

HON Recommendation: H2282.H.CU__T - List Price \$896

H2285



MULTI-PURPOSE CHAIR

DIMENSIONS

Mesh Back
 4-Leg Stacking Frame
 Fixed Arms

Depth: 24¾
 Width: 23
 Height: 34½
 Seat Depth: 17¾
 Seat Width: 18⅞
 Back Width: 17⅞
 Back Height: 17¾
 Arm Width: 19⅞
 Seat to Floor Height: 19⅞
 Usable Seat Depth: 17¾
 Ship Weight: 20
 Cube: 2.8
 Weight Rating: 250 lbs.

LIST PRICE

\$395

NOTES: Casters and glides ship packaged together for customer's assembly choice. Stacks 4-high on floor.

ⓘ Available in VA10 Black fabric seat and Black frame only. Black Mesh back only.

HOW TO SPECIFY

<p>Select Model Number</p> <p>H 2 2 8 2 .</p>	<p>Select Caster</p> <p>Specify for model H2282 only</p> <p>H Black Hard Caster S Black All-Surface Caster (+ \$30)</p> <p>H .</p>	<p>Select Fabric</p> <p>See page 398 for available fabrics for H2282</p> <p>VA10 Black Fabric <i>Specify for models H2281 and H2285 only</i> VA19 Charcoal Fabric <i>Specify for model H2281 only</i> VA90 Navy Fabric <i>Specify for model H2281 only</i></p> <p>CU19 .</p>	<p>Select Frame</p> <p>T Black</p> <p>T</p>
--	--	---	---

MATTER™



Matter™ Upholstered Chair with 5-Star Base with Preside® Table.

MATTER™

This modern take on the traditional task chair combines the comfort of a lounge chair and posture of a task chair. The **swivel**-tilt control allows you to find that reclining position that's just right for you, and the five-star base lets you move around effortlessly. The chrome accents with Gray fabric not only create a truly modern aesthetic, they compliment any workspace.



FEATURES

- Brings a modern design aesthetic into any reception or guest area.
- **Swivel**-tilt mechanism offers a full range of reclining positions.
- Chrome base provides a contemporary accent.
- 360-degree swivel.
- Available in a 5-star base and 4-leg natural wood base.
- Easily assembled in minutes.
- Backed by HON 5-year limited warranty.



Icon Legend on page 19

MATTER™ Multi-Purpose Chairs

HVL232



GRAY UPHOLSTERED CHAIR

with 5-Star Base
Swivel
Tilt

DIMENSIONS

Depth:	24 ⁴ / ₈	Arm Width:	3
Width:	23	Seat to Floor Height:	19
Height:	34	Usable Seat Depth:	18
Seat Depth:	18 ³ / ₁₀	Ship Weight:	21
Seat Width:	16 ¹ / ₂	Cube:	5.6
Back Width:	23	Weight Rating:	250 lbs.
Back Height:	12 ² / ₈		

LIST PRICE

\$475

NOTES: **HON 5-Year Limited Warranty.**

HVL238



GRAY UPHOLSTERED CHAIR

Wood Leg Base
Harvest Wood Legs
4-Leg Wood Base

DIMENSIONS

Depth:	24 ⁴ / ₈	Arm Width:	3
Width:	23	Seat to Floor Height:	19
Height:	34	Usable Seat Depth:	18
Seat Depth:	18 ³ / ₁₀	Ship Weight:	21
Seat Width:	16 ¹ / ₂	Cube:	5.6
Back Width:	23	Weight Rating:	250 lbs.
Back Height:	12 ² / ₈		

LIST PRICE

\$438

NOTES: **HON 5-Year Limited Warranty.**

HOW TO SPECIFY

Select Model Number	Select Fabric
	GRY01 Light Gray
H V L 2 3 8 .	G R Y 0 1



Mav™ Single Lounge shown with West Hill™ Seating and Scramble™ Coffee Table.

MAV™

With plenty of base, back, and seat options offset with mid-century flair and richly colored fabrics, the Mav Single Lounge Series is designed to function well in virtually any space. Whether it's configured for a multi-use zone or to stand alone as a statement piece, Mav is an ideal place for impromptu or collaborative gatherings, a quick break, or focused, heads-down work.



FEATURES

- Subtle seat and back contours and refined details create an inviting, contemporary aesthetic.
- Choose from a mid-back or high-back option.
- Contoured arms provide support and create a striking look.
- Armless models offer a range of seated postures.
- High-back models available with a 4-star metal base with return-to-center, 4-leg wood base, or 5-star base with **swivel knee tilt**.
- Mid-back models offered in 4-star metal base with return-to-center, 4-leg wood base, wire sled base, or 5-star base with **swivel knee tilt**.
- Multi-fabric option — seat cushion and frame can be specified in different fabrics for a modern aesthetic.
- Ottoman lets you kick up your feet or use as impromptu seating.
- Seat cushion attaches with Velcro for easy cleaning or replacement.
- Available in a wide range of cleanable fabrics to achieve the perfect look (see HON's Cleaning Guide).
- Choose from 10 wood base or 4 metal base finish options.

HON BRANDED FABRICS

GRADE 1

Apex
Attire*
Centurion
Compass
Contourett**
Dapper
Ensemble
Hamilton
Inertia
Optic*
Pebble

GRADE 2

Appoint Seating
Blume
Clyde
Dotty
Rush
Seed*
Spin Seating
Whisper Vinyl**

GRADE 3

In Season
Moxie
Parker
Purl
Quill

For a complete list of fabrics, including partnership fabrics, go to hon.com/fabricsandfinishes.

Reference Fabric Color Combinations on pages 20-24 for color codes and legend on page 21 for lead times.

*Not available on Single Fabric models or as multi-fabric frame option.

**Due to the inherent design of Mav™ high-back chairs, coated fabrics may show material gathers, particularly around the headrest.

LEG STYLE

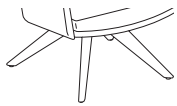

CODE	DESCRIPTION	PRICE
WD	Wood	+\$250

Available in the following finishes:

LFW1	Florence Walnut
LK11	Kingswood Walnut
LLA1	Lowell Ash
D	Natural Maple
LNRI	Natural Recon
LPE1	Phantom Ecru
PINC	Pinnacle
LPT1	Portico Teak
LSW1	Skyline Walnut
LSA1	Sterling Ash

LEG STYLE

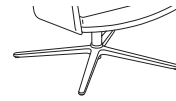

CODE	DESCRIPTION	PRICE
4S	4-Star Return-to-Center	+\$0
<i>Available in the following finishes:</i>		
P8V	Textured Titanium	
P7A	Textured Charcoal	
P8X	Solar Black	+\$20
Y	Polished	+\$50

LEG STYLE

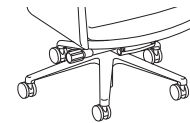

CODE	DESCRIPTION	PRICE
5S	5-Star w/Swivel Knee Tilt, Hard Caster	+\$25
5SS	5-Star w/Swivel Knee Tilt, All-Surface Caster	+\$55
<i>Available in the following finishes:</i>		
P8V	Textured Titanium	
P7A	Textured Charcoal	
P8X	Solar Black	+\$20
Y	Polished	+\$50

LEG STYLE



CODE	DESCRIPTION	PRICE
SD	Sled*	+\$0
<i>Available in the following finishes:</i>		
P8V	Textured Titanium	
P7A	Textured Charcoal	
P8X	Solar Black	+\$20
Y	Polished	+\$50

*Available on Mid-Back models only

Low-Back, Multi-Fabric



High-Back, Multi-Fabric





HMAVMN



MID-BACK SINGLE LOUNGE, ARMLESS

DIMENSIONS

Depth (4-Star, 5-Star, & Wood):	28¾	Back Height:	18¾
Depth (Sled):	27½	Back Width:	20
Height (4-Star):	29½	Ship Weight:	45
Height (5-Star):	33½-37¼	Ship Weight (5-Star):	55
Height (Wood):	30	Cube:	20.1
Height (Sled):	30¾	COM:	3.5
Width:	24	Weight Rating:	300 lbs.
Usable Seat Depth:	19		
Seat to Floor Height:	17¾		
Seat to Floor Height (5-Star):	17¼-21		
Seat Width:	21		

FABRIC PRICE CODES

1	\$1375	8	\$1821
2	\$1429	9	\$1893
3	\$1482	10	\$1964
4	\$1536	11	\$2036
5	\$1607	12	\$2107
6	\$1679	L	\$2607
7	\$1750		

HMAVMNMF



MID-BACK SINGLE LOUNGE, ARMLESS, MULTI-FABRIC

DIMENSIONS

Depth (4-Star, 5-Star, & Wood):	28¾	Back Height:	18¾
Depth (Sled):	27½	Back Width:	20
Height (4-Star):	29½	Ship Weight:	45
Height (5-Star):	33½-37¼	Ship Weight (5-Star):	55
Height (Wood):	30	Cube:	20.1
Height (Sled):	30¾	COM (Seat Cushion):	1.5
Width:	24	COM (Back/Frame):	2.5
Usable Seat Depth:	19	Weight Rating:	300 lbs.
Seat to Floor Height:	17¾		
Seat to Floor Height (5-Star):	17¼-21		
Seat Width:	21		

FABRIC PRICE CODES

1	\$1525		
		<i>Add to Base Price Above</i>	
		Seat	Frame
2	\$15	\$15	\$38
3	\$31	\$31	\$77
4	\$46	\$46	\$115
5	\$66	\$66	\$166
6	\$87	\$87	\$217
7	\$107	\$107	\$268
8	\$128	\$128	\$319
9	\$148	\$148	\$370
10	\$168	\$168	\$421
11	\$189	\$189	\$472
12	\$209	\$209	\$523

HON Recommendation: HMAVMNMF.PURL__PURL__4S__ - List Price \$1633

HOW TO SPECIFY

<p>Select Model Number</p> <p>See page 403</p> <p><i>Specify for single fabric model only</i></p>	<p>Select Fabric</p> <p>See page 403</p> <p><i>Specify for single fabric model only</i></p>	<p>Select Seat Fabric</p> <p>See page 403</p> <p><i>Specify for multi-fabric model only</i></p>	<p>Select Frame Fabric</p> <p>See page 403</p> <p><i>Specify for multi-fabric model only</i></p>	<p>Select Base and Base Color</p> <p>See page 403</p> <p>4S 4-Star Return-to-Center 5S 5-Star, Hard Caster (+ \$25) 5SS 5-Star, All-Surface Caster (+ \$55) WD Wood (+ \$250) SD Sled</p>
HMAVMNMF	PURL05	PURL05	PURL03	4SP7A



HMAVMA



MID-BACK SINGLE LOUNGE, ARMS

DIMENSIONS

Depth (4-Star, 5-Star, & Wood):	28¾	Back Height:	18¾
Depth (Sled):	27½	Back Width:	20
Height (4-Star):	29½	Arm Height:	8½
Height (5-Star):	33½-37¼	Ship Weight:	53
Height (Wood):	30	Ship Weight (5-Star):	63
Height (Sled):	30¾	Cube:	20.1
Width:	25	COM:	4.0
Usable Seat Depth:	19	Weight Rating:	300 lbs.
Seat to Floor Height:	17¾		
Seat to Floor Height (5-Star):	17¼-21		
Seat Width:	21		

FABRIC PRICE CODES

1	\$1725	8	\$2044
2	\$1763	9	\$2095
3	\$1802	10	\$2146
4	\$1840	11	\$2197
5	\$1891	12	\$2248
6	\$1942	L	\$3133
7	\$1993		

HMAVMAMF



MID-BACK SINGLE LOUNGE, ARMS, MULTI-FABRIC

DIMENSIONS

Depth (4-Star, 5-Star, & Wood):	28¾	Back Height:	18¾
Depth (Sled):	27½	Back Width:	20
Height (4-Star):	29½	Arm Height:	8½
Height (5-Star):	33½-37¼	Ship Weight:	53
Height (Wood):	30	Ship Weight (5-Star):	63
Height (Sled):	30¾	Cube:	20.1
Width:	25	COM (Seat Cushion):	1.5
Usable Seat Depth:	19	COM (Back/Frame):	4.0
Seat to Floor Height:	17¾	Weight Rating:	300 lbs.
Seat to Floor Height (5-Star):	17¼-21		
Seat Width:	21		

FABRIC PRICE CODES

1	\$1875		
<i>Add to Base Price Above</i>			
		Seat	Back
2	\$15	\$46	\$46
3	\$31	\$92	\$92
4	\$46	\$138	\$138
5	\$66	\$199	\$199
6	\$87	\$260	\$260
7	\$107	\$321	\$321
8	\$128	\$383	\$383
9	\$148	\$444	\$444
10	\$168	\$505	\$505
11	\$189	\$566	\$566
12	\$209	\$628	\$628

HON Recommendation: HMAVMAMF.PURL__PURL__4S__ - List Price \$1998

HOW TO SPECIFY

<p>Select Model Number</p> <p>See page 403</p> <p><i>Specify for single fabric model only</i></p>	<p>Select Fabric</p> <p>See page 403</p> <p><i>Specify for single fabric model only</i></p>	<p>Select Seat Fabric</p> <p>See page 403</p> <p><i>Specify for multi-fabric model only</i></p>	<p>Select Frame Fabric</p> <p>See page 403</p> <p><i>Specify for multi-fabric model only</i></p>	<p>Select Base and Base Color</p> <p>See page 403</p> <p>4S 4-Star Return-to-Center</p> <p>5S 5-Star w/Swivel Knee Tilt, Hard Caster (+ \$25)</p> <p>5SS 5-Star w/Swivel Knee Tilt, All-Surface Caster (+ \$55)</p> <p>WD Wood (+ \$250)</p> <p>SD Sled</p>
HMAVMAMF	PURL05	PURL05	PURL03	4SP7A



HMAVHN

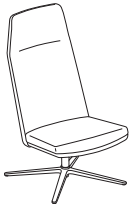

HIGH-BACK SINGLE LOUNGE, ARMLESS

DIMENSIONS

Depth:	30¼	Back Height:	32½
Height (4-Star):	43½	Back Width:	20
Height (5-Star):	47-50¾	Ship Weight:	50
Height (Wood):	44	Ship Weight (5-Star):	59
Width:	24	Cube:	29
Usable Seat Depth:	19	COM:	4.0
Seat to Floor Height:	17¾	Weight Rating:	300 lbs.
Seat to Floor Height (5-Star):	17¼-21		
Seat Width:	21		

FABRIC PRICE CODES

1	\$1550	8	\$1996
2	\$1604	9	\$2068
3	\$1657	10	\$2139
4	\$1711	11	\$2211
5	\$1782	12	\$2282
6	\$1854	L	\$2782
7	\$1925		

HMAVHNMF

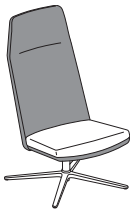

HIGH-BACK SINGLE LOUNGE, ARMLESS, MULTI-FABRIC

DIMENSIONS

Depth:	30¼	Back Height:	32½
Height (4-Star):	43½	Back Width:	20
Height (5-Star):	47-50¾	Ship Weight:	50
Height (Wood):	44	Ship Weight (5-Star):	59
Width:	24	Cube:	29
Usable Seat Depth:	19	COM (Seat Cushion):	1.5
Seat to Floor Height:	17¾	COM (Back/Frame):	3.5
Seat to Floor Height (5-Star):	17¼-21	Weight Rating:	300 lbs.
Seat Width:	21		

FABRIC PRICE CODES

1	\$1700		
<i>Add to Base Price Above</i>			
	Seat	Frame	
2	\$15	\$38	
3	\$31	\$77	
4	\$46	\$115	
5	\$66	\$166	
6	\$87	\$217	
7	\$107	\$268	
8	\$128	\$319	
9	\$148	\$370	
10	\$168	\$421	
11	\$189	\$472	
12	\$209	\$523	

HON Recommendation: HMAVHNMF.PURL__PURL__4S__ - List Price \$1808

HOW TO SPECIFY

<p>Select Model Number</p> <p>See page 403</p> <p><i>Specify for single fabric model only</i></p>	<p>Select Fabric</p> <p>See page 403</p> <p><i>Specify for single fabric model only</i></p>	<p>Select Seat Fabric</p> <p>See page 403</p> <p><i>Specify for multi-fabric model only</i></p>	<p>Select Frame Fabric</p> <p>See page 403</p> <p><i>Specify for multi-fabric model only</i></p>	<p>Select Base and Base Color</p> <p>See page 403</p> <p>4S 4-Star Return-to-Center 5S 5-Star w/Swivel Knee Tilt, Hard Caster (+ \$25) 5SS 5-Star w/Swivel Knee Tilt, All-Surface Caster (+ \$55) WD Wood (+ \$250)</p>
HMAVHNMF .	PURL05 .	PURL05 .	PURL03 .	4SP7A



HMAVHA



HIGH-BACK SINGLE LOUNGE, ARMS

DIMENSIONS

Depth:	30¼	Back Height:	32½
Height (4-Star):	43½	Back Width:	20
Height (5-Star):	47-50¾	Arm Height:	8½
Height (Wood):	44	Ship Weight:	59
Width:	25	Ship Weight (5-Star):	67
Usable Seat Depth:	19	Cube:	29
Seat to Floor Height:	17¾	COM:	5.0
Seat to Floor Height (5-Star):	17¼-21	Weight Rating:	300 lbs.
Seat Width:	21		

FABRIC PRICE CODES

1	\$1900	8	\$2410
2	\$1961	9	\$2492
3	\$2022	10	\$2573
4	\$2065	11	\$2655
5	\$2165	12	\$2737
6	\$2247	L	\$3308
7	\$2329		

HMAVHAMF



HIGH-BACK SINGLE LOUNGE, ARMS, MULTI-FABRIC

DIMENSIONS

Depth:	30¼	Back Height:	32½
Height (4-Star):	43½	Back Width:	20
Height (5-Star):	47-50¾	Arm Height:	8½
Height (Wood):	44	Ship Weight:	59
Width:	25	Ship Weight (5-Star):	67
Usable Seat Depth:	19	Cube:	29
Seat to Floor Height:	17¾	COM (Seat Cushion):	1.5
Seat to Floor Height (5-Star):	17¼-21	COM (Back/Frame):	4.0
Seat Width:	21	Weight Rating:	300 lbs.

FABRIC PRICE CODES

1	\$2050	
<i>Add to Base Price Above</i>		
	Seat	Frame
2	\$15	\$46
3	\$31	\$92
4	\$46	\$138
5	\$66	\$199
6	\$87	\$260
7	\$107	\$321
8	\$128	\$383
9	\$148	\$444
10	\$168	\$505
11	\$189	\$566
12	\$209	\$628

HON Recommendation: HMAVHAMF.PURL__PURL__4S__ - List Price \$2173

HOW TO SPECIFY

<p>Select Model Number</p> <p>See page 403</p>	<p>Select Fabric</p> <p>See page 403</p> <p><i>Specify for single fabric model only</i></p>	<p>Select Seat Fabric</p> <p>See page 403</p> <p><i>Specify for multi-fabric model only</i></p>	<p>Select Frame Fabric</p> <p>See page 403</p> <p><i>Specify for multi-fabric model only</i></p>	<p>Select Base and Base Color</p> <p>See page 403</p> <p>4S 4-Star Return-to-Center 5S 5-Star w/Swivel Knee Tilt, Hard Caster (+ \$25) 5SS 5-Star w/Swivel Knee Tilt, All-Surface Caster (+ \$55) WD Wood (+ \$250)</p>
HMAVHAMF	PURL05	PURL05	PURL03	4SP7A



HMAVO



SINGLE LOUNGE OTTOMAN

DIMENSIONS

Depth:	22	Ship Weight:	33
Height:	15	Cube:	9.5
Width:	24	COM:	3.5
Usable Seat Depth:	24	Weight Rating:	300 lbs.
Seat to Floor Height:	15		
Seat Width:	22		

FABRIC PRICE CODES

1	\$850	8	\$1360
2	\$911	9	\$1442
3	\$972	10	\$1523
4	\$1034	11	\$1605
5	\$1115	12	\$1687
6	\$1197	L	\$2258
7	\$1279		

HMAVOMF



SINGLE LOUNGE OTTOMAN, MULTI-FABRIC

DIMENSIONS

Depth:	22	Ship Weight:	33
Height:	15	Cube:	9.5
Width:	24	COM (Seat Cushion):	1.5
Usable Seat Depth:	24	COM (Frame):	2.5
Seat to Floor Height:	15	Weight Rating:	300 lbs.
Seat Width:	22		

FABRIC PRICE CODES

1	\$925	
<i>Add to Base Price Above</i>		
	Seat	Frame
2	\$15	\$46
3	\$31	\$92
4	\$46	\$138
5	\$66	\$199
6	\$87	\$260
7	\$107	\$321
8	\$128	\$383
9	\$148	\$444
10	\$168	\$505
11	\$189	\$566
12	\$209	\$628

HON Recommendation: HMAVOMF.PURL__PURL__4S__ - List Price \$1048

HOW TO SPECIFY

Select Model Number

Select Fabric

See page 403
Specify for single fabric model only

Select Seat Fabric

See page 403
Specify for multi-fabric model only

Select Frame Fabric

See page 403
Specify for multi-fabric model only

Select Base and Base Color

See page 403
4S 4-Star

HMAVOMF .

PURL05 .

PURL05 .

PURL03 .

4SP7A



Merit™ Executive Conference Chair with Voi® Desks.

MERIT™

Merit™ is the answer for anyone who wants the experience of sitting in a refined executive chair combined with the sleek look of a European conference chair. A channel stitched back and polished aluminum arm and base accents provide the initial attraction, but the supreme comfort of the weight-activated control makes them stay. This modern, streamlined look is complemented by a luxurious sitting experience.



FEATURES

- Weight-activated tilt-control mechanism provides natural, ergonomic reclining position.
- Leather wrapped back includes channel stitching for upscale look. Available in Black or Gray.
- Color-matched soft arm cap.
- Pneumatic seat height adjustment.
- Molded foam seat and back.
- Padded headrest.
- Weight rating of 275 lbs.

MERIT™ Executive Conference Chair

OPEN MARKET



Icon Legend on page 19

HME3



EXECUTIVE CONFERENCE CHAIR

Pneumatic
Swivel
Weight-activated Control
Tilt Lock
Fixed Arms

Functions: **A, E, F, L, T**
(Function Key on pages 244-245)

DIMENSIONS

Depth:	27¼	Arm Width:	20½
Width:	27¼	Seat to Floor Height:	18-21
Height:	49¾	Usable Seat Depth:	20
Seat Depth:	20	Ship Weight:	47.5
Seat Width:	20½	Cube:	14.3
Back Width:	19	Weight Rating:	275 lbs.
Back Height:	29¼		

LIST PRICE

Leather \$1045

NOTES: Black or Gray leather options. Detailed channel stitching on back. Polished arms and base. Fixed arms with color-matched soft arm cap.

HON Recommendation: HME3.W5.P.H.LR58.PA - List Price \$1045

SEATING

HOW TO SPECIFY

Select Model Number HME3	Select Control Type W5 Weight-Activated	Select Arm Type P Fixed Arms - Polished	Select Caster H Black Hard Caster	Select Fabric LR58 Black Leather LR29 Gray Leather	Select Base PA Polished Aluminum
---	--	--	--	---	---

MOTIVATE® CHAIRS



Motivate® 4-Leg Stacking Chairs and Between™ Table.

MOTIVATE® CHAIRS

A presentation in the morning. A training session in the afternoon. Today's multi-purpose spaces are in constant flux, and need an adaptable seating solution that delivers instant comfort for all, while easily moving around to support various activities. Motivate task chairs, stacking/nesting chairs and guest chairs create a streamlined collection of seating that intuitively responds to your body's natural movements and curves. Whether sitting for five minutes or five hours, when you Motivate your team you put everyone at ease.



FEATURES

- Choose plastic, upholstered or 4-Way Stretch mesh back.
- Easily move chairs around the space for quick rearrangement.
- HMN1 nesting/stacking chairs stack four high on the floor.
- HMS1 sled base chairs stack 12 high on the floor or 40 high on a cart.
- HMS2 sled base chairs stack six high on the floor.
- Dynamic flex-zone motion in seat and back provides balance and lumbar support.
- Model HMT5 task stool features an adjustable footring.
- Plastic shell is available in 13 colors.
- Available in hundreds of quality HON fabrics.
- Warranted for users up to 300 lbs.

TASK CHAIR FEATURES

- One-touch seat height adjustment easily moves the seat up and down.
- 360-degree swivel provides freedom of movement in any direction.
- Warranted for users up to 300 lbs.

MOTIVATE® Task Chair Options

MODEL OPTIONS

HMT1



Flex-back

Upholstered Seat,
Pneumatic, Swivel

HMT5



Flex-back

Upholstered Seat,
Pneumatic, Swivel
Adjustable Footring

ARM STYLE

CODE	DESCRIPTION	PRICE
N	Armless	+\$0
A	Adjustable Arms	+\$70

CASTERS

CODE	DESCRIPTION	PRICE
H	Hard Caster	+\$0
S	Soft Caster	+\$30

BACK STYLE

CODE	DESCRIPTION	PRICE
<i>Plastic/Upholstered Options:</i>		
PS	Plastic Shell	+\$0
PB	Upholstered	+\$70

4-Way Stretch Options:

IM	Black	+\$80
IB	Breeze	+\$80
IK	Brownstone	+\$80
IH	Chai *	+\$80
IC	Charcoal	+\$80
IF	Fog	+\$80
IY	Navy *	+\$80
IR	Regatta	+\$80
IT	Titanium	+\$80

PLASTIC SHELL COLOR CODES (no upcharge):

Tangelo - **RG**
Regatta - **RE**
Lava - **LA**

Cherry - **CR**
Mulberry - **MB**
Onyx - **ON**

Lime - **LM**
Loft - **LO**
White - **WT**

Calypso - **CP**
Platinum - **PT**

Surf - **BU**
Shadow - **SD**

BASE

CODE	DESCRIPTION	PRICE
SB	Standard Base	+\$0



* Fabric is de-emphasized.

FRAME COLOR

CODE	DESCRIPTION	PRICE
T	Black	+\$0

MOTIVATE[®]

Task Chair Fabric Options

HON BRANDED FABRICS

GRADE 1

Apex
Attire
Centurion
Compass
Contourett
Dapper
Ensemble
Hamilton
Inertia
Optic
Pebble

GRADE 2

Appoint Seating
Blume
Clyde
Dotty
Rush
Seed
Spin Seating
Whisper Vinyl

GRADE 3

In Season
Moxie
Parker
Purl
Quill

GRADE L

Denver Leather

For a complete list of fabrics, including partnership fabrics, go to hon.com/fabricsandfinishes.

Reference Fabric Color Combinations on pages 20-24 for color codes and legend on page 21 for lead times.

📌 CA Technical Bulletin 133 Compliant available only in Onyx as a Standard Special. Please reach out to our Tailored Solutions Team.

MOTIVATE® Task Chairs

GSA SIN 33721



Icon Legend on page 19

HMT1

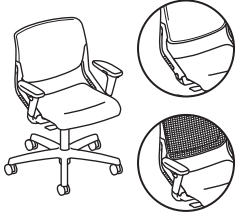

TASK CHAIR

Flex-back
Upholstered Seat
Pneumatic
Swivel

DIMENSIONS

Depth:	27½	Seat to Floor Height:	17-22½
Width:	27½	Usable Seat Depth:	18
Height:	37½	Ship Weight (upholstered back):	39
Seat Depth:	18	Ship Weight (plastic/mesh back):	38
Seat Width:	17½	Seat to Floor Height:	10.0
Back Width:	19½	Cube (upholstered back):	10.0
Back Height:	17¾	Cube (plastic/mesh back):	10.0
Arm Width:	18½-20	COM (upholstered back):	1.5
		COM (plastic/mesh back):	1.0
		Weight Rating:	300 lbs.

FABRIC PRICE CODES

1	\$451	8	\$658
2	\$487	9	\$685
3	\$523	10	\$712
4	\$550	11	\$739
5	\$577	12	\$766
6	\$604	L	—
7	\$631		

❗ When a Plastic Shell (PS) or Upholstered Back (PB) option is chosen, you must select a shell color. If the mesh back option is chosen, the shell color is not specified.

HMT5

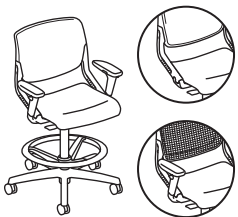

TASK STOOL

Flex-back
Upholstered Seat
Pneumatic
Swivel Adjustable Footring

DIMENSIONS

Depth:	28¼	Seat to Floor Height:	22½-32½
Width:	28¼	Usable Seat Depth:	18
Height:	50½	Ship Weight (upholstered back):	44
Seat Depth:	18	Ship Weight (plastic/mesh back):	43
Seat Width:	17½	Cube (upholstered back):	10.0
Back Width:	19½	Cube (plastic/mesh back):	10.0
Back Height:	17¾	COM (upholstered back):	1.5
Arm Width:	18½-20	COM (plastic/mesh back):	1.0
		Weight Rating:	300 lbs.

FABRIC PRICE CODES

1	\$512	8	\$719
2	\$548	9	\$746
3	\$584	10	\$773
4	\$611	11	\$800
5	\$638	12	\$827
6	\$665	L	—
7	\$692		

NOTES: Stool model has adjustable footring.

❗ When a Plastic Shell (PS) or Upholstered Back (PB) option is chosen, you must select a shell color. If the mesh back option is chosen, the shell color is not specified.

HON Recommendation: HMT1.A.H.IM.CU__SB.T - List Price \$601

HOW TO SPECIFY

Select Model Number	Select Arm Type	Select Caster	Select Back Type/Color	Select Fabric	Select Base	Select Frame
HMT1	A Adjustable Arms (+ \$70) N Armless	H Hard Caster S Soft Caster (+ \$30)	PS Plastic Shell PB Upholstered (+ \$70) If PS or PB options are chosen, select shell color. Plastic Shell Colors RG Tangelo LO Loft CR Cherry PT Platinum LM Lime SD Shadow CP Calypso LA Lava BU Surf ON Onyx RE Regatta WT White MB Mulberry 4-Way Stretch options (+ \$80) IM Black IF Fog IB Breeze IY Navy * IK Brownstone IR Regatta IH Chai * IT Titanium IC Charcoal	See page 413	SB Standard Base	T Black
HMT1	A	H	IM	CU10	SB	T
HMT1	A	H	PSLA	CU10	SB	T

* Fabric is de-emphasized.

MOTIVATE® High-Density Sled Base Chair Options

MODEL OPTIONS

HMS1



High-Density Stacker

Sled Leg Base

HMS2



High-Density Stacker

Upholstered Seat, Sled Leg Base

ARM STYLE

CODE	DESCRIPTION	PRICE
F	Fixed Arms	+\$30
N	Armless	+\$0



FRAME

CODE	DESCRIPTION	PRICE
Y	Chrome	+\$0
P1 PAINT:		+\$0
BLCK	Textured Black Mica	
P7J	Textured Brownstone	
P7A	Textured Charcoal	
PK7	Textured Designer White	
P7L	Textured Loft	
P7M	Textured Muslin	
P8V	Textured Titanium	
P2 PAINT:		+\$0
PLAT	Textured Platinum Metallic	
PR8	Textured Silver	
P3 PAINT:		+\$30
P8S	Atom	
PJF	Bullseye	
P8P	Ember	
P8N	Ion	
P8J	Iris	
P8F	Krypton	
P8M	Regatta	

PLASTIC SHELL COLOR CODES (no upcharge):					
Tangelo - RG	Cherry - CR	Lime - LM	Calypso - CP	Surf - BU	
Regatta - RE	Mulberry - MB	Loft - LO	Platinum - PT	Shadow - SD	
Lava - LA	Onyx - ON	White - WT			

! For CA Technical Bulletin 133, Onyx (ON) shell color is available as a Standard Special through HON's Tailored Solutions program. Please see pages 248-251 or contact HON Customer Support for more information.

HON BRANDED FABRICS

GRADE 1	GRADE 2	GRADE 3
Apex	Appoint Seating	In Season
Attire	Blume	Parker
Centurion	Clyde	Purl
Compass	Dotty	Quill
Contourett	Rush	
Dapper	Seed	
Ensemble	Spin Seating	
Hamilton	Whisper Vinyl	
Inertia		
Optic		
Pebble		

For a complete list of fabrics, including partnership fabrics, go to hon.com/fabricsandfinishes.

Reference Fabric Color Combinations on pages 20-24 for color codes and legend on page 21 for lead times.

! For CA Technical Bulletin 133, Onyx (ON) shell color is available as a Standard Special through HON's Tailored Solutions program. Please see pages 248-251 or contact HON Customer Support for more information.

MOTIVATE® High-Density Sled Base Chairs

GSA SIN 33721



Icon Legend on page 19

HMS1

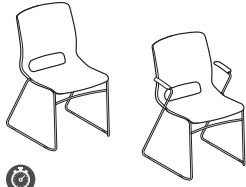

HIGH-DENSITY STACKER

Sled Leg Base

DIMENSIONS

Depth:	23	Arm Width:	18 $\frac{1}{8}$
Width:	21	Seat to Floor Height:	17 $\frac{3}{4}$
Height:	32 $\frac{1}{4}$	Usable Seat Depth:	18 $\frac{1}{4}$
Seat Depth:	18 $\frac{1}{4}$	Ship Weight:	72
Seat Width:	17 $\frac{3}{4}$	Cube:	15.2
Back Width:	17 $\frac{1}{4}$	Weight Rating:	300 lbs.
Back Height:	18		

LIST PRICE PER CARTON

\$860

(reference single unit @
\$215.00)

NOTES: HMS1 Sled Base chairs stack 12-high on the floor, or 40-high on the chair cart model HMSCART. Field installed glides snap-on using existing locations on the sled base frames.

⚠ Ganging Chair Glides are designed for use on armless models of the Motivate® High-Density Sled Base Chairs only. Not for use on models specified with arms.

📦 Ships four (4) chairs per carton.

HMS2

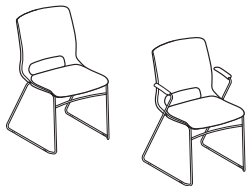

HIGH-DENSITY STACKER

Upholstered Seat
Sled Leg Base
Set of 4

DIMENSIONS

Depth:	23	Arm Width:	18 $\frac{1}{8}$
Width:	21	Seat to Floor Height:	18 $\frac{1}{4}$
Height:	32 $\frac{1}{4}$	Usable Seat Depth:	18 $\frac{1}{4}$
Seat Depth:	18 $\frac{1}{4}$	Ship Weight:	80
Seat Width:	17 $\frac{3}{4}$	Cube:	15.2
Back Width:	17 $\frac{1}{4}$	COM (per 4 pack):	1.6
Back Height:	17 $\frac{1}{2}$	Weight Rating:	300 lbs.

FABRIC PRICE CODES

1	\$1102	8	\$1240
2	\$1126	9	\$1258
3	\$1150	10	\$1276
4	\$1168	11	\$1294
5	\$1186	12	\$1312
6	\$1204	L	—
7	\$1222		

NOTES: HMS2 Sled Base chairs stack 6-high on the floor. Field installed glides snap-on using existing locations on the sled base frames.

⚠ Ganging Chair Glides are designed for use on armless models of the Motivate® High-Density Sled Base Chairs only. Not for use on models specified with arms. Upholstered seat model HMS2 is not designed to be stacked on the HMSCART.

📦 Motivate® Sled Base Chairs are ordered and shipped four (4) chairs per carton. Pricing shown is per carton. Each set of four chairs (one carton), must have the same shell/frame color combination. Ordering 2 of Model HMS1, HMS2 will result in 2 cartons being shipped, giving you 8 chairs.

HMSCART



CART FOR HMS1 STACKING CHAIRS

DIMENSIONS

Depth:	34 $\frac{1}{4}$	Ship Weight:	40
Width:	21 $\frac{3}{8}$	Cube:	7.8
Height:	36 $\frac{3}{8}$		

LIST PRICE

\$493

NOTES: Holds up to 40 Stacking Chairs.

HON Recommendation: HMS1.N.ON.Y - List Price \$860

SEATING

HOW TO SPECIFY

<p>Select Model Number</p> <p>HMS1 .</p> <p>HMS2 .</p>	<p>Select Arm Type</p> <p>F Fixed Arms (+ \$30 per chair)</p> <p>N Armless</p> <p>N .</p> <p>N .</p>	<p>Select Shell Color</p> <p>RG Tangelo LO Loft</p> <p>CR Cherry PT Platinum</p> <p>LM Lime SD Shadow</p> <p>CP Calypso LA Lava</p> <p>BU Surf ON Onyx</p> <p>RE Regatta WT White</p> <p>MB Mulberry</p> <p>ON .</p> <p>ON .</p>	<p>Select Fabric</p> <p>See page 415</p> <p>Not specified for HMS1 models</p> <p>CUT0 .</p>	<p>Select Frame</p> <p>See page 415</p> <p>BLCK</p> <p>BLCK</p>
---	---	---	--	--



MOTIVATE® High-Density Sled Base Chairs

HMSGLD

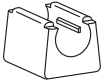

GLIDES FOR MOTIVATE® HIGH-DENSITY STACKER

- Kit includes 48 glides for 12 chairs
- Field installed
- Snap-on using existing locations on frames

DIMENSIONS

Ship Weight: 1
Cube: 0.2

LIST PRICE

\$65

HMSFLTGLD



FELT GLIDES FOR MOTIVATE® HIGH-DENSITY STACKER

- Kit includes 48 glides for 12 chairs
- Field installed
- Snap-on using existing locations on frames

DIMENSIONS

Ship Weight: 1
Cube: 0.2

LIST PRICE

\$167

HMSSTLGLD



STEEL GLIDES FOR MOTIVATE® HIGH-DENSITY STACKER

- Kit includes 48 glides for 12 chairs
- Field installed
- Snap-on using existing locations on frames

DIMENSIONS

Ship Weight: 1
Cube: 0.2

LIST PRICE

\$167

HMSGANG

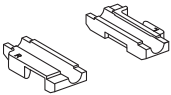

GANGING CONNECTORS FOR MOTIVATE® HIGH-DENSITY STACKER

- 48 ganging connectors
- Requires 4 connectors per ganging connection
- For use on HMS1.N and HMS2.N only (armless models)
- Field installed
- Snap-on using existing locations on frames

DIMENSIONS

Ship Weight: 1
Cube: 0.2

LIST PRICE

\$122

Floor Covering	TYPE OF GLIDE		
	Polycarbonate/Nylon	Felt	Steel
Carpet	Best	Not Recommended	Good
Polished concrete	Best	Good	Not Recommended
Hard wood	Not Recommended	Best	Not Recommended
Vinyl (includes LVT)	Best	Better	Good
VCT	Best	Good	Not Recommended
Tile (Porcelain/Ceramic)	Best	Good	Not Recommended







HOW TO SPECIFY

Select Model Number

H M S G L D

MOTIVATE® 4-Leg Chair Options

MODEL OPTIONS

HMG1	HMG2	HMG3	HMG4	HMG5	HMG7
					
Stack Chair Four Legs, Set of 2	Stack Chair Four Legs, Upholstered Seat, Set of 2	Counter-Height Stool Four Legs	Counter-Height Stool Four Legs, Upholstered Seat	Café-Height Stool Four Legs	Café-Height Stool Four Legs, Upholstered Seat

ARM STYLE	CODE	DESCRIPTION	PRICE
	F	Fixed Arms	+\$30
	N	Armless	+\$0

CASTERS/ GLIDES	CODE	DESCRIPTION	PRICE
	H	Hard Caster	+\$0
	S	Soft Caster	+\$20

**Casters only available on HMG1 and HMG2*

FRAME	CODE	DESCRIPTION	PRICE
	P1 PAINT:		+\$0
	BLCK	Textured Black Mica	
	P7J	Textured Brownstone	
	P7A	Textured Charcoal	
	PK7	Textured Designer White	
	P7L	Textured Loft	
	P7M	Textured Muslin	
	P8V	Textured Titanium	
	P2 PAINT:		+\$0
	PLAT	Textured Platinum Metallic	
	PR8	Textured Silver	
	P3 PAINT:		+\$30
	P8S	Atom	
	PJF	Bullseye	
	P8P	Ember	
	P8N	Ion	
	P8J	Iris	
	P8F	Krypton	
	P8M	Regatta	

	E	Standard Nylon Glide	+\$0
	F	Felt Glide	+\$30
	R	Rubber Glide	+\$30
	T	Steel Glide	+\$30

PLASTIC SHELL COLOR CODES (no upcharge):	Tangelo - RG	Cherry - CR	Lime - LM	Calypso - CP	Surf - BU
	Regatta - RE	Mulberry - MB	Loft - LO	Platinum - PT	Shadow - SD
	Lava - LA	Onyx - ON	White - WT		

❗ For CA Technical Bulletin 133, Onyx (ON) shell color is available as a Standard Special through HON's Tailored Solutions program. Please see pages 248-251 or contact HON Customer Support for more information.

MOTIVATE[®]

4-Leg Chair Fabric Options

HON BRANDED FABRICS

GRADE 1

Apex
Attire
Centurion
Compass
Contourett
Dapper
Ensemble
Hamilton
Inertia
Optic
Pebble

GRADE 2

Appoint Seating
Blume
Clyde
Dotty
Rush
Seed
Spin Seating
Whisper Vinyl

GRADE 3

In Season
Moxie
Parker
Purl
Quill

For a complete list of fabrics, including partnership fabrics, go to hon.com/fabricsandfinishes.

Reference Fabric Color Combinations on pages 20-24 for color codes and legend on page 21 for lead times.

❗ For CA Technical Bulletin 133, Onyx (ON) shell color is available as a Standard Special through HON's Tailored Solutions program. Please see pages 248-251 or contact HON Customer Support for more information.

MOTIVATE® 4-Leg Chairs

GSA SIN 33721



Icon Legend on page 19

HMG1

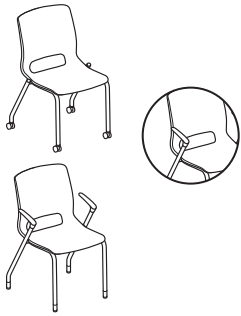

STACK CHAIR

Four Legs
Set of 2

DIMENSIONS

Depth:	23	Arm Width:	18
Width:	21	Seat to Floor Height:	17¾
Height:	32¼	Usable Seat Depth:	18¼
Seat Depth:	18¼	Ship Weight:	38
Seat Width:	17¾	Cube:	13.0
Back Width:	17¼	Weight Rating:	300 lbs.
Back Height:	18		

LIST PRICE PER CARTON

\$559
(reference single unit @
\$279.50

NOTES: 4-Leg chairs stack 6-high on the floor.

Ships two (2) chairs per carton.

HMG2

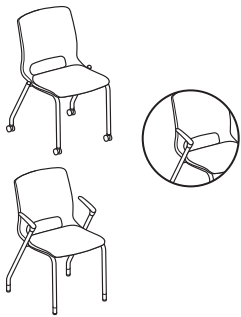

STACK CHAIR

Four Legs
Upholstered Seat
Set of 2

DIMENSIONS

Depth:	23	Arm Width:	18
Width:	21	Seat to Floor Height:	18¼
Height:	32¼	Usable Seat Depth:	18¼
Seat Depth:	18¼	Ship Weight:	44
Seat Width:	17¾	Cube:	13.0
Back Width:	17¼	COM (per 2 pack):	1.0
Back Height:	17½	Weight Rating:	300 lbs.

FABRIC PRICE CODES

1	\$688	8	\$826
2	\$712	9	\$844
3	\$736	10	\$862
4	\$754	11	\$880
5	\$772	12	\$898
6	\$790	L	—
7	\$808		

NOTES: 4-Leg chairs stack 6-high on the floor.

Motivate® 4-leg Chairs are ordered and shipped two (2) chairs per carton. Pricing shown is per carton. Each set of two chairs (one carton), must have the same shell/frame color combination. Ordering 2 of Model HMG1, HMG2 will result in 2 cartons being shipped, giving you 4 chairs. 4-Leg chairs stack 6-high on the floor.

HON Recommendation: HMG1.N.H.ON.PLAT - List Price \$559

HOW TO SPECIFY

Select Model Number	Select Arm Type	Select Caster/Glide	Select Shell Color	Select Fabric	Select Frame
F Fixed Arms (+ \$30 per chair) N Armless	H Hard Caster S Soft Caster (+ \$20 per chair) <i>Casters only available on HMG1 and HMG2</i> E Standard Nylon Glide F Felt Glide (+ \$30 per chair) R Rubber Glide (+ \$30 per chair) T Steel Glide (+ \$30 per chair)	RG Tangelo CR Cherry LM Lime CP Calypso BU Surf RE Regatta MB Mulberry	LO Loft PT Platinum SD Shadow LA Lava ON Onyx WT White	See page 419 <i>Not specified for models HMG1 and HMG5</i>	See page 418
HMG1 .	N .	H .	ON .		PLAT
HMG2 .	N .	H .	ON .	CU10 .	PLAT



MOTIVATE® 4-Leg Chairs

HMG3

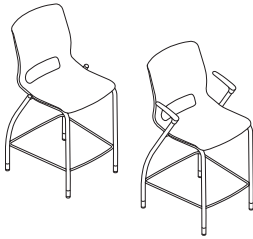

COUNTER-HEIGHT STOOL

Four Legs

DIMENSIONS

Depth:	23	Arm Width:	18
Width:	21	Seat to Floor Height:	24½
Height:	40½	Usable Seat Depth:	18½
Seat Depth:	18½	Ship Weight:	26
Seat Width:	17¾	Cube:	13.8
Back Width:	17¼	Weight Rating:	300 lbs.
Back Height:	18		

LIST PRICE

\$392

HMG4

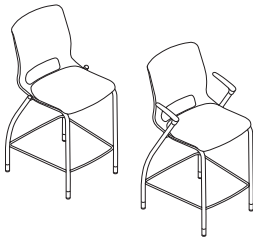

COUNTER-HEIGHT STOOL

Four Legs
Upholstered Seat

DIMENSIONS

Depth:	23	Arm Width:	18
Width:	21	Seat to Floor Height:	25
Height:	40½	Usable Seat Depth:	18¼
Seat Depth:	18½	Ship Weight:	26
Seat Width:	17¾	Cube:	13.8
Back Width:	17¼	COM:	1.0
Back Height:	17½	Weight Rating:	300 lbs.

FABRIC PRICE CODES

1	\$465	8	\$603
2	\$489	9	\$621
3	\$513	10	\$639
4	\$531	11	\$657
5	\$549	12	\$675
6	\$567	L	—
7	\$585		

HMG5

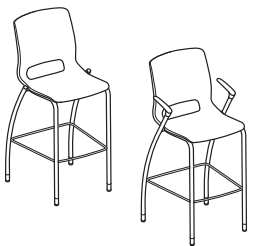

CAFÉ-HEIGHT STOOL

Four Legs

DIMENSIONS

Depth:	23	Arm Width:	18
Width:	21	Seat to Floor Height:	30
Height:	44½	Usable Seat Depth:	18½
Seat Depth:	18½	Ship Weight:	30
Seat Width:	17¾	Cube:	19.3
Back Width:	17¼	Weight Rating:	300 lbs.
Back Height:	18		

LIST PRICE

\$412

HMG7

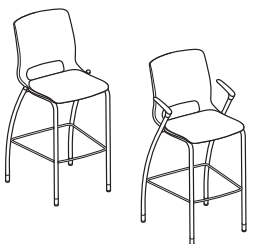

CAFÉ-HEIGHT STOOL

Four Legs
Upholstered Seat

DIMENSIONS

Depth:	23	Arm Width:	18
Width:	21	Seat to Floor Height:	30½
Height:	44½	Usable Seat Depth:	18¼
Seat Depth:	18½	Ship Weight:	34
Seat Width:	17¾	Cube:	19.3
Back Width:	17¼	COM:	1.0
Back Height:	17½	Weight Rating:	300 lbs.

FABRIC PRICE CODES

1	\$488	8	\$626
2	\$512	9	\$644
3	\$536	10	\$662
4	\$554	11	\$680
5	\$572	12	\$698
6	\$590	L	—
7	\$608		

HON Recommendation: HMG5.N.E.ON.PLAT - List Price \$412

HOW TO SPECIFY

Select Model Number	Select Arm Type	Select Glide	Select Shell Color	Select Fabric	Select Frame
F Fixed Arms (+ \$30 per chair) N Armless	E Standard Nylon Glide F Felt Glide (+ \$30 per chair) R Rubber Glide (+ \$30 per chair) T Steel Glide (+ \$30 per chair)	RG Tangelo CR Cherry LM Lime CP Calypso BU Surf RE Regatta MB Mulberry	LO Loft PT Platinum SD Shadow LA Lava ON Onyx WT White	See page 419 <i>Not specified for models HMG1 and HMG5</i>	See page 418
HMG5	N	E	ON		PLAT
HMG7	N	E	ON	CU10	PLAT

MOTIVATE® Nesting/Stacking Flex-Back Chair Options

MODEL OPTIONS

HMN1



HMN2



Flex-back

Nesting/Stacking,
Four Legs

Flex-back

Nesting/Stacking, Four
Legs, Upholstered Seat

ARM STYLE

CODE	DESCRIPTION	PRICE
F	Fixed Arms	+\$50



N	Armless	+\$0
----------	---------	-------------



CASTERS/ GLIDE

CODE	DESCRIPTION	PRICE
H	Hard Caster	+\$0



S	Soft Caster	+\$20
----------	-------------	--------------



E	Standard Nylon Glide	+\$0
----------	----------------------	-------------



BACK STYLE

CODE	DESCRIPTION	PRICE
<i>Plastic/Upholstered Options:</i>		
PS	Plastic Shell	+\$0



PB	Upholstered	+\$70
-----------	-------------	--------------



**PB only available on HMN2*

4-Way Stretch Options:

IM	Black	+\$80
IF	Fog	+\$80
IC	Charcoal	+\$80
IH	Chai *	+\$80
IY	Navy *	+\$80



FRAME

CODE	DESCRIPTION	PRICE
P1 PAINT:		+\$0

BLCK	Textured Black Mica
P7J	Textured Brownstone
P7A	Textured Charcoal
PK7	Textured Designer White
P7L	Textured Loft
P7M	Textured Muslin
P8V	Textured Titanium

P2 PAINT:		+\$0
------------------	--	-------------

PLAT	Textured Platinum Metallic
PR8	Textured Silver

P3 PAINT:		+\$30
------------------	--	--------------

P8S	Atom
PJF	Bullseye
P8P	Ember
P8N	Ion
P8J	Iris
P8F	Krypton
P8M	Regatta

PLASTIC SHELL COLOR CODES (no upcharge):		Tangelo - RG	Cherry - CR	Lime - LM	Calypso - CP	Surf - BU
	Regatta - RE	Mulberry - MB	Loft - LO	Platinum - PT	Shadow - SD	
	Lava - LA	Onyx - ON	White - WT			

❗ For CA Technical Bulletin 133, Onyx (ON) shell color is available as a Standard Special through HON's Tailored Solutions program. Please see pages 248-251 or contact HON Customer Support for more information.

* Fabric is de-emphasized.

Nesting/Stacking Flex-Back Chair Fabric Options

HON BRANDED FABRICS

GRADE 1

Apex
Attire
Centurion
Compass
Contourett
Dapper
Ensemble
Hamilton
Inertia
Optic
Pebble

GRADE 2

Appoint Seating
Blume
Clyde
Dotty
Rush
Seed
Spin Seating
Whisper Vinyl

GRADE 3

In Season
Moxie
Parker
Purl
Quill

For a complete list of fabrics, including partnership fabrics, go to hon.com/fabricsandfinishes.

Reference Fabric Color Combinations on pages 20-24 for color codes and legend on page 21 for lead times.

❗ For CA Technical Bulletin 133, Onyx (ON) shell color is available as a Standard Special through HON's Tailored Solutions program. Please see pages 248-251 or contact HON Customer Support for more information.

MOTIVATE® Nesting/Stacking Flex-Back Chairs

GSA SIN 33721



HMN1

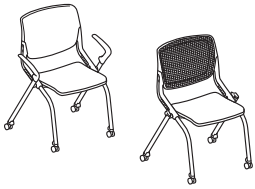

CHAIR

Flex-back
Nesting/Stacking
Four Legs

DIMENSIONS

Depth:	23 ³ / ₈	Arm Width:	24
Width:	26 ³ / ₄	Seat to Floor Height:	18 ¹ / ₄
Height:	34	Usable Seat Depth:	16 ³ / ₄
Seat Depth:	16 ³ / ₄	Ship Weight:	27
Seat Width:	17	Cube:	15.1
Back Width:	19 ¹ / ₂	Weight Rating:	300 lbs.
Back Height:	19		

LIST PRICE

\$468

NOTES: Stack 4-high on floor.

ⓘ When selecting the mesh back option, seat shell will be in the specified shell color chosen but the frame around the mesh will always be black.

HMN2



CHAIR

Flex-back
Nesting/Stacking
Four Legs
Upholstered Seat

DIMENSIONS

Depth:	23 ³ / ₈	Seat to Floor Height:	19 ¹ / ₄
Width:	26 ³ / ₄	Usable Seat Depth:	17
Height:	34	Ship Weight (upholstered back):	29
Seat Depth:	17	Ship Weight (plastic/mesh back):	28
Seat Width:	17 ³ / ₈	Cube (upholstered back):	15.1
Back Width:	19 ¹ / ₂	Cube (plastic/mesh back):	15.1
Back Height:	18 ³ / ₈	COM (upholstered back):	1.0
Arm Width:	24	COM (plastic/mesh back):	1.0
		Weight Rating:	300 lbs.

FABRIC PRICE CODES

1	\$533	8	\$671
2	\$557	9	\$689
3	\$581	10	\$707
4	\$599	11	\$725
5	\$617	12	\$743
6	\$635	L	—
7	\$653		

NOTES: Stack 4-high on floor.

ⓘ When selecting the mesh back option, seat shell will be in the specified shell color chosen but the frame around the mesh will always be black.

HON Recommendation: HMN1.N.H.IM.ON.CU__PLAT - List Price \$548

HOW TO SPECIFY

Select Model Number	Select Arm Type	Select Caster/Glide	Select Back Type	Select Shell Color	Select Fabric	Select Frame
F Fixed Arms (+ \$50) N Armless	E Standard Nylon Glide H Hard Caster S Soft Caster (+ \$20)	PS Plastic Shell PB Upholstered (+ \$70) <i>PB option available on HMN2 only</i> 4-Way Stretch options (+ \$80) IM Black IF Fog IC Charcoal IH Chai * IY Navy *	RG Tangelo CR Cherry LM Lime CP Calypso BU Surf RE Regatta MB Mulberry	LO Loft PT Platinum SD Shadow LA Lava ON Onyx WT White	See page 423 <i>Specify for model HMN2 only</i>	See page 422
HMN1	N	H	IM	ON		PLAT
HMN2	N	H	PB	ON	CU10	PLAT

* Fabric is de-emphasized.

MOTIVATE® Chair with Tablet Arm Options

MODEL OPTIONS

HMG1



with Tablet Arm

Four Legs

HMG2



with Tablet Arm

Four Legs, Upholstered Seat

CASTERS/ GLIDES



CODE	DESCRIPTION	PRICE
H	Hard Caster	+\$0



S	Soft Caster	+\$20
----------	-------------	--------------



E	Standard Nylon Glide	+\$0
F	Felt Glide	+\$30
R	Rubber Glide	+\$30
T	Steel Glide	+\$30

TABLET SIDE



CODE	DESCRIPTION	PRICE
RT	Right Side	+\$0
LT	Left Side	+\$0



TABLET COLOR

CODE	DESCRIPTION	PRICE
T	Black	+\$0
D	Natural Maple	+\$0

FRAME

CODE	DESCRIPTION	PRICE
P1 PAINT:		+\$0
BLCK	Textured Black Mica	
P7J	Textured Brownstone	
P7A	Textured Charcoal	
PK7	Textured Designer White	
P7L	Textured Loft	
P7M	Textured Muslin	
P8V	Textured Titanium	
P2 PAINT:		+\$0
PLAT	Textured Platinum Metallic	
PR8	Textured Silver	
P3 PAINT:		+\$30
P8S	Atom	
PJF	Bullseye	
P8P	Ember	
P8N	Ion	
P8J	Iris	
P8F	Krypton	
P8M	Regatta	

PLASTIC SHELL COLOR CODES (no upcharge):	Tangelo - RG	Cherry - CR	Lime - LM	Calypso - CP	Surf - BU
	Regatta - RE	Mulberry - MB	Loft - LO	Platinum - PT	Shadow - SD
	Lava - LA	Onyx - ON	White - WT		

! For CA Technical Bulletin 133, Onyx (ON) shell color is available as a Standard Special through HON's Tailored Solutions program. Please see pages 248-251 or contact HON Customer Support for more information.

MOTIVATE[®]

Chair with Tablet Arm Fabric Options

HON BRANDED FABRICS

GRADE 1

Apex
Attire
Centurion
Compass
Contourett
Dapper
Ensemble
Hamilton
Inertia
Optic
Pebble

GRADE 2

Appoint Seating
Blume
Clyde
Dotty
Rush
Seed
Spin Seating
Whisper Vinyl

GRADE 3

In Season
Moxie
Parker
Purl
Quill

For a complete list of fabrics, including partnership fabrics, go to hon.com/fabricsandfinishes.

Reference Fabric Color Combinations on pages 20-24 for color codes and legend on page 21 for lead times.

❗ For CA Technical Bulletin 133, Onyx (ON) shell color is available as a Standard Special through HON's Tailored Solutions program. Please see pages 248-251 or contact HON Customer Support for more information.



MOTIVATE® Chair with Tablet Arm

HMGT1

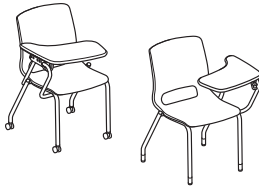

CHAIR

with Tablet Arm
Four Legs

DIMENSIONS

Depth:	30	Back Width:	17¼
Width:	21	Back Height:	18
Height:	32¼	Seat to Floor Height:	17¾
Seat Depth:	18¼	Tablet Height from Floor:	28¾
Seat Width:	17¾	Ship Weight:	41
		Cube:	18.4
		Weight Rating:	300 lbs.

LIST PRICE PER CARTON

\$546

NOTES: Tablet can be specified on right or left side.

HMGT2

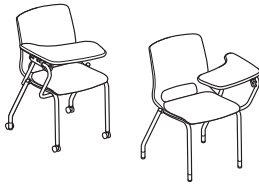

CHAIR

with Tablet Arm
Four Legs
Upholstered Seat

DIMENSIONS

Depth:	30	Back Width:	17¼
Width:	21	Back Height:	17½
Height:	32¼	Seat to Floor Height:	18¼
Seat Depth:	18¼	Tablet Height from Floor:	28¾
Seat Width:	17¾	Ship Weight:	43
		Cube:	18.4
		Weight Rating:	300 lbs.

FABRIC PRICE CODES

1	\$615	8	\$753
2	\$639	9	\$771
3	\$663	10	\$789
4	\$681	11	\$807
5	\$699	12	\$825
6	\$717	L	—
7	\$735		

NOTES: Tablet can be specified on right or left side.

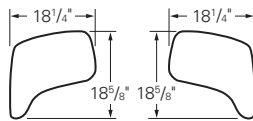

HON Recommendation: HMGT1.E.ON.RT.D.PLAT - List Price \$546

HOW TO SPECIFY

Select Model Number	Select Caster/Glide	Select Shell Color	Select Fabric	Select Tablet Side	Select Tablet Color	Select Frame
H S E F R T	Hard Caster Soft Caster (+ \$20 per chair) Standard Nylon Glide Felt Glide (+ \$30 per chair) Rubber Glide (+ \$30 per chair) Steel Glide (+ \$30 per chair)	RG Tangelo CR Cherry LM Lime CP Calypso BU Surf RE Regatta MB Mulberry LO Loft PT Platinum SD Shadow LA Lava ON Onyx WT White	See page 426 <i>Not specified for HMGT1 models</i>	RT Right Side LT Left Side	T Black D Natural Maple	See page 425
HMGT1	E	ON		RT	D	PLAT
HMGT2	E	ON	CU10	RT	D	PLAT

MOTIVATE® Flex-Back Chair with Tablet Arm Options

MODEL OPTIONS

HMNT1



Flex-back with Tablet Arm

HMNT2



Flex-back with Tablet Arm

Upholstered Seat

CASTERS/ GLIDE



CODE	DESCRIPTION	PRICE
H	Hard Caster	+\$0



S	Soft Caster	+\$20
----------	-------------	--------------



E	Standard Nylon Glide	+\$0
----------	----------------------	-------------

TABLET SIDE



CODE	DESCRIPTION	PRICE
RT	Right Side	+\$0
LT	Left Side	+\$0



BACK STYLE



CODE	DESCRIPTION	PRICE
<i>Plastic/Upholstered Options:</i>		
PS	Plastic Shell	+\$0



PB	Upholstered	+\$70
-----------	-------------	--------------

TABLET COLOR

CODE	DESCRIPTION	PRICE
T	Black	+\$0
D	Natural Maple	+\$0

FRAME

CODE	DESCRIPTION	PRICE
P1 PAINT:		+\$0
BLCK	Textured Black Mica	
P7J	Textured Brownstone	
P7A	Textured Charcoal	
PK7	Textured Designer White	
P7L	Textured Loft	
P7M	Textured Muslin	
P8V	Textured Titanium	
P2 PAINT:		+\$0
PLAT	Textured Platinum Metallic	
PR8	Textured Silver	
P3 PAINT:		+\$30
P8S	Atom	
PJF	Bullseye	
P8P	Ember	
P8N	Ion	
P8J	Iris	
P8F	Krypton	
P8M	Regatta	

4-Way Stretch Options:

IM	Black	+\$80
IF	Fog	+\$80
IC	Charcoal	+\$80
IH	Chai *	+\$80
IY	Navy *	+\$80



SEATING

PLASTIC SHELL COLOR CODES (no upcharge): Tangelo - **RG** Cherry - **CR** Lime - **LM** Calypso - **CP** Surf - **BU**
Regatta - **RE** Mulberry - **MB** Loft - **LO** Platinum - **PT** Shadow - **SD**
Lava - **LA** Onyx - **ON** White - **WT**

! For CA Technical Bulletin 133, Onyx (ON) shell color is available as a Standard Special through HON's Tailored Solutions program. Please see pages 248-251 or contact HON Customer Support for more information.

* Fabric is de-emphasized.

Flex-Back Chair with Tablet Arm Fabric Options

HON BRANDED FABRICS

GRADE 1

Apex
Attire
Centurion
Compass
Contourett
Dapper
Ensemble
Hamilton
Inertia
Optic
Pebble

GRADE 2

Appoint Seating
Blume
Clyde
Dotty
Rush
Seed
Spin Seating
Whisper Vinyl

GRADE 3

In Season
Moxie
Parker
Purl
Quill

For a complete list of fabrics, including partnership fabrics, go to hon.com/fabricsandfinishes.

Reference Fabric Color Combinations on pages 20-24 for color codes and legend on page 21 for lead times.

❗ For CA Technical Bulletin 133, Onyx (ON) shell color is available as a Standard Special through HON's Tailored Solutions program. Please see pages 248-251 or contact HON Customer Support for more information.

MOTIVATE® Flex-Back Chair with Tablet Arm

GSA SIN 33721



HMNT1

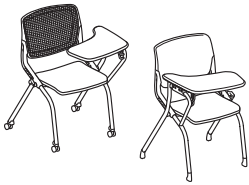

CHAIR

Flex-back with Tablet Arm

DIMENSIONS

Depth:	30 ³ / ₈	Seat to Floor Height:	18 ¹ / ₄
Width:	23 ¹ / ₂	Tablet Height from Floor:	29 ¹ / ₂
Height:	34	Ship Weight:	41
Seat Depth:	17 ¹ / ₄	Cube:	18.4
Seat Width:	17	Weight Rating:	300 lbs.
Back Width:	19 ¹ / ₂		
Back Height:	19		

LIST PRICE

\$735

NOTES: Tablet can be specified on right or left side.

! Model HMNT1 is not available with an upholstered back.

! When selecting the mesh back option, seat shell will be in the specified shell color chosen but the frame around the mesh will always be black.

HMNT2

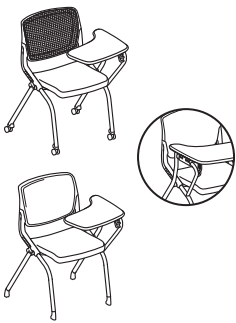

CHAIR

Flex-back with Tablet Arm
Upholstered Seat

DIMENSIONS

Depth:	30 ³ / ₈	Seat to Floor Height:	19 ¹ / ₄
Width:	23 ¹ / ₂	Tablet Height from Floor:	29 ¹ / ₂
Height:	34	Ship Weight:	42
Seat Depth:	17 ⁵ / ₈	Cube:	18.4
Seat Width:	17 ⁵ / ₈	Weight Rating:	300 lbs.
Back Width:	19 ¹ / ₂		
Back Height:	18 ³ / ₈		

FABRIC PRICE CODES

1	\$809	8	\$947
2	\$833	9	\$965
3	\$857	10	\$983
4	\$875	11	\$1001
5	\$893	12	\$1019
6	\$911	L	—
7	\$929		

NOTES: Tablet can be specified on right or left side.

! When selecting the mesh back option, seat shell will be in the specified shell color chosen but the mesh will always be black.

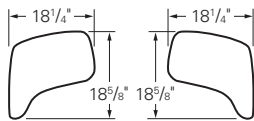

HON Recommendation: HMNT1.E.IM.ON.RT.D.PLAT - List Price \$815

HOW TO SPECIFY

Select Model Number	Select Caster/Glide	Select Back Type	Select Shell Color	Select Fabric	Select Tablet Side	Select Tablet Color	Select Frame
<p>E Standard Nylon Guide</p> <p>H Hard Caster</p> <p>S Soft Caster (+ \$20)</p>	<p>PS Plastic Shell</p> <p>PB Upholstered (+ \$70)</p> <p><i>PB option not available on HMNT1</i></p> <p>4-Way Stretch options (+ \$80)</p> <p>IM Black</p> <p>IF Fog</p> <p>IC Charcoal</p> <p>IH Chai *</p> <p>IY Navy *</p>	<p>RG Tangelo</p> <p>CR Cherry</p> <p>LM Lime</p> <p>CP Calypso</p> <p>BU Surf</p> <p>RE Regatta</p> <p>MB Mulberry</p> <p>LO Loft</p> <p>PT Platinum</p> <p>SD Shadow</p> <p>LA Lava</p> <p>ON Onyx</p> <p>WT White</p>	<p>See page 429</p> <p><i>Specify for model HMNT2 only</i></p>	<p>RT Right Side</p> <p>LT Left Side</p>	<p>T Black</p> <p>D Natural Maple</p>	<p>See page 428</p>	
<p>HMNT1</p>	<p>E</p>	<p>IM</p>	<p>ON</p>	<p></p>	<p>RT</p>	<p>D</p>	<p>PLAT</p>
<p>HMNT2</p>	<p>E</p>	<p>PB</p>	<p>ON</p>	<p>CU10</p>	<p>RT</p>	<p>D</p>	<p>PLAT</p>

* Fabric is de-emphasized.



HVL281



LOW-BACK TASK CHAIR

DIMENSIONS

Upholstered	Depth: 25½	Back Width: 17¾
Swivel-tilt	Width: 25½	Back Height: 17¾
Armless	Height: 37½	Seat to Floor Height: 17-21½
Functions: A, E, F, K, L	Seat Depth: 16½	Ship Weight: 27.9
(Function Key on pages 244-245)	Seat Width: 18½	Cube: 4.3
		Weight Rating: 250 lbs.

LIST PRICE

\$271

NOTES: **HON 5-Year Limited Warranty.**

HON Recommendation: HVL281.Z1.VA10.T - List Price \$271

HVL282



MID-BACK TASK CHAIR

DIMENSIONS

Upholstered	Depth: 25¼	Arm Width: 18½
Swivel-tilt	Width: 26½	Seat to Floor Height: 18¾-22¾
Height and Width Adjustable	Height: 43¾	Ship Weight: 47.0
Arms	Seat Depth: 16¾	Cube: 6.0
Height-adjustable Back	Seat Width: 19⅞	Weight Rating: 250 lbs.
Functions: A, B, E, F, K, L, S	Back Width: 19⅞	
(Function Key on pages 244-245)	Back Height: 20½	

LIST PRICE

Swivel-tilt \$388
Asynchronous \$443

NOTES: **HON 5-Year Limited Warranty.**

HON Recommendation: HVL282.Z1.VA10.T - List Price \$388

HVL283



HIGH-BACK TASK CHAIR

DIMENSIONS

Upholstered	Depth: 25¼	Arm Width: 17¾
Asynchronous with Seat Slide	Width: 26½	Seat to Floor Height: 18¾-22¾
Height and Width Adjustable	Height: 47¼	Ship Weight: 53.3
Arms	Seat Depth: 17⅞	Cube: 6.9
Functions: A, D, E, O, S	Seat Width: 19⅞	Weight Rating: 250 lbs.
(Function Key on pages 244-245)	Back Width: 20⅞	
	Back Height: 23¾	

LIST PRICE

\$542

NOTES: **HON 5-Year Limited Warranty.**

HON Recommendation: HVL283.A2.VA10.T - List Price \$542

HVL289



ADJUSTABLE ARM PACK

DIMENSIONS

Height and Width Available in Black (T)	Adjustable Arm Width: 18¼
Functions: S	Height from Seat: 7⅞-10⅞
(Function Key on pages 244-245)	Ship Weight: 9.8
	Cube: 0.8

LIST PRICE

\$84

HON Recommendation: HVL289.T - List Price \$84

HOW TO SPECIFY

<p>Select Model Number</p> <p>H V L 2 8 1 .</p>	<p>Select Control</p> <p>Z1 Swivel Tilt <i>Available on HVL281 and HVL282 only</i></p> <p>A2 Asynchronous with Seat Slide <i>Available on HVL282 and HVL283 only</i></p> <p>Z 1 .</p>	<p>Select Fabric</p> <p>VA10 Black Fabric</p> <p>V A 1 0 .</p>	<p>Select Frame</p> <p>T Black</p> <p>T</p>
--	--	--	---

NEUTRALIZE™



Neutralize™ Mesh Task Chair with Empower® Desks and Fuse™ Storage.

NEUTRALIZE™

Don't adjust your sitting preferences to fit your chair, make it fit your needs. Neutralize™ adjusts practically everywhere to perfectly fit your body and your work style. The breathable mesh back is made up of three articulating sections to fit anyone, including an adjustable headrest. The synchro-tilt control and fully adjustable arms support your body in any posture or position.



FEATURES

- Contemporary segmented mesh back enhancing support and increasing airflow.
- Height, width, depth, and pivot arms provide support right where you want it.
- Adjustable headrest delivers executive-level comfort.
- Mesh seat and seat slide conform to your body to reduce pressure points.
- HON 5-Year Limited Warranty.



NEUTRALIZE™ Mesh Chair

HVL791



MESH TASK CHAIR

- Pneumatic
- Swivel
- Synchronized Tilt
- Tilt Tension
- Tilt Lock
- Seat Glide Mechanism
- Adjustable Headrest
- All-Adjustable Arms

Functions: **A, D, E, J, K, L, B-A**
(Function Key on pages 244-245)

DIMENSIONS

Depth:	28¼	Arm Width:	20½
Width:	26¾	Seat to Floor Height:	18-21
Height:	52¼	Usable Seat Depth:	20
Seat Depth:	17¼-19¼	Ship Weight:	47.5
Seat Width:	19½	Cube:	7.8
Back Width:	20¼	Weight Rating:	250 lbs.
Back Height:	32		

LIST PRICE

\$825

NOTES: Comfortable and breathable mesh seat and back. Black frame with subtle chrome accents. Adjustable seat glide mechanism. Height, width, depth and pivot adjustable arms. Adjustable headrest. **HON 5-Year Limited Warranty.**

HON Recommendation: HVL791.BM.SB - List Price \$825

SEATING

HOW TO SPECIFY

<p>Select Model Number</p> <div style="border: 1px solid #ccc; padding: 5px; display: flex; justify-content: space-between; align-items: center;"> HVL791 </div>	<p>Select Fabric</p> <p>BM Black Mesh</p> <div style="border: 1px solid #ccc; padding: 5px; display: flex; justify-content: space-between; align-items: center;"> BM </div>	<p>Select Base</p> <p>SB Standard Base</p> <div style="border: 1px solid #ccc; padding: 5px; display: flex; justify-content: space-between; align-items: center;"> SB </div>
---	---	--

NUCLEUS®



Nucleus Work Chairs shown with Preside® Conference Table.

NUCLEUS®

Enjoy seating that delivers comfort from the inside out. Nucleus task and guest chairs adapt to everyone's unique body types to create a custom fit and targeted support. The back flexes with the spine. The seat cradles you like a hammock. The sophisticated aesthetic makes a stylish statement. Nucleus is the powerhouse seating family that brings cool and comfortable together.

SEATING



GUEST CHAIR FEATURES

- Stacking chairs stack up to four high on the floor.
- HN6 guest chair available with glides, hard or all-surface casters.
- Available in hundreds of quality HON fabrics.
- Warranted for users up to 300 lbs.

TASK CHAIR FEATURES

- Advanced suspension material in the seat combines with molded foam to create unparalleled support.
- Choose between the 4-Way Stretch mesh back or an upholstered suspension back.
- 4-Way Stretch mesh back is available in seven colors.
- Choose between armless, fixed arms or height- and width-adjustable arms.
- Responsive synchro-tilt control provides a smooth, natural recline.
- Available in Black or Polished Aluminum base.
- Tilt tension controls the rate and ease of recline.
- Tilt lock allows the user to lock the back in multiple recline positions.
- Available in hundreds of quality HON fabrics.
- Warranted for users up to 300 lbs.

NUCLEUS® Task Chair Options

MODEL OPTIONS

HN1



Task Chair (4-Way Stretch Back)

Pneumatic, Swivel, Seat Glide, Synchro-tilt, Tilt Tension, Tilt Lock, Armless

HN1U



Task Chair (Upholstered Back)

Pneumatic, Swivel, Seat Glide, Synchro-tilt, Tilt Tension, Tilt Lock, Armless

ARM STYLE

CODE	DESCRIPTION	PRICE
N	Armless	+\$0
A	Height and Width Adjustable Arms	+\$75
P	Fixed Arms - Polished	+\$150

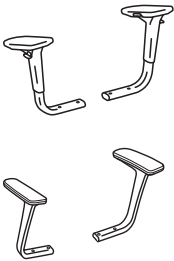

BASE

CODE	DESCRIPTION	PRICE
SB	Standard Base	+\$0
PA	Polished Aluminum	+\$110

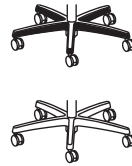

FRAME

CODE	DESCRIPTION	PRICE
T	Black	+\$0

CASTERS

CODE	DESCRIPTION	PRICE
H	Black Hard Caster	+\$0
S	Black All-Surface Caster	+\$30



BACK STYLE

CODE	DESCRIPTION	PRICE
<i>4-Way Stretch mesh back options:</i>		
IM	Black	+\$0
IB	Breeze	+\$0
IK	Brownstone	+\$0
IH	Chai *	+\$0
IC	Charcoal	+\$0
IF	Fog	+\$0
IY	Navy *	+\$0
IR	Regatta	+\$0
IT	Titanium	+\$0

* Fabric is de-emphasized.

SEATING

NUCLEUS® Multi-Purpose and Café Chair Options

MODEL OPTIONS

HN6



**Multi-Purpose Stack Chair
(4-Way Stretch Back)**

Four Legs

HN7



**Café-Height Stool (4-Way Stretch
Back)**

Four Legs

ARM STYLE



CODE	DESCRIPTION	PRICE
N	Armless	+\$0
F	Fixed Arms	+\$30

CASTERS/ GLIDE



CODE	DESCRIPTION	PRICE
H	Black Hard Caster	+\$0

**Not available on HN7*



S	Black All-Surface Caster	+\$20
----------	--------------------------	--------------

**Not available on HN7*



E	Glide	+\$0
----------	-------	-------------

BACK STYLE

CODE	DESCRIPTION	PRICE
<i>4-Way Stretch mesh back options:</i>		
IM	Black	+\$0
IB	Breeze	+\$0
IK	Brownstone	+\$0
IH	Chai *	+\$0
IC	Charcoal	+\$0
IF	Fog	+\$0
IY	Navy *	+\$0
IR	Regatta	+\$0
IT	Titanium	+\$0

FRAME

CODE	DESCRIPTION	PRICE
T	Black	+\$0
T1	Platinum Metallic	+\$0

* Fabric is de-emphasized.

HON BRANDED FABRICS

GRADE 1

Apex
Attire
Centurion
Compass
Contourett
Dapper
Ensemble
Hamilton
Inertia
Optic
Pebble

GRADE 2

Appoint Seating
Blume
Clyde
Dotty
Rush
Seed
Spin Seating
Whisper Vinyl

GRADE 3

In Season
Moxie
Parker
Purl
Quill

For a complete list of fabrics, including partnership fabrics, go to hon.com/fabricsandfinishes.

Reference Fabric Color Combinations on pages 20-24 for color codes and Legend on page 21 for lead times. For additional HON to Supply COM fabric grade pricing, go to honready.hon.com and click on the HON to Supply COM link.

 For Fire Code model, availability and ordering method, refer to pages 248-251. Available on select models, contact HON Customer Support for availability.

NUCLEUS®



Icon Legend on page 19

HN1



TASK CHAIR

4-Way Stretch Back

Pneumatic
Swivel
Seat Glide
Synchro-tilt
Tilt Tension
Tilt Lock
Armless

Functions:

A, D, E, A-C, A-D, J, L

(Function Key on pages 244-245)

HON Recommendation: HN1.A.H.IM.CU__SB.T - List Price \$940

DIMENSIONS

Depth:	25¾	Arm Width:	17-20
Width:	28¾	Seat to Floor Height:	17-22
Height:	45¼	Usable Seat Depth:	16½-19
Seat Depth:	20	Ship Weight:	52
Seat Width:	20	Cube:	11.3
Back Width:	19¼	COM:	1.0
Back Height:	25¼	Weight Rating:	300 lbs.

FABRIC PRICE CODES

1	\$865	8	\$1003
2	\$889	9	\$1021
3	\$913	10	\$1039
4	\$931	11	\$1057
5	\$949	12	\$1075
6	\$967	L	—
7	\$985		

HOW TO SPECIFY

Select Model Number	Select Arm Type	Select Caster/Glide	Select Back Type	Select Fabric	Select Base	Select Frame
	N Armless A Height and Width Adjustable Arms (+ \$75) P Fixed Arms - Polished (+ \$150)	H Black Hard Caster S Black All-Surface Caster (+ \$30)	4-Way Stretch options IM Black IB Breeze IK Brownstone IH Chai * IC Charcoal IF Fog IY Navy * IR Regatta IT Titanium	See page 437	SB Standard Base PA Polished Aluminum (+ \$110)	See page 435 T Black
HN1	A	H	IM	CU10	SB	T

* Fabric is de-emphasized.

HN1U



TASK CHAIR

Upholstered Back

Pneumatic
Swivel
Seat Glide
Synchro-tilt
Tilt Tension
Tilt Lock
Armless

Functions:

A, D, E, A-C, A-D, J, L

(Function Key on pages 244-245)

HON Recommendation: HN1U.A.H.CU__SB.T - List Price \$940

DIMENSIONS

Depth:	26	Arm Width:	19⅞
Width:	28¾	Seat to Floor Height:	17-22
Height:	44¼	Usable Seat Depth:	16-18½
Seat Depth:	20	Ship Weight:	49
Seat Width:	20	Cube:	12.6
Back Width:	18¼	COM:	2.0
Back Height:	25½	Weight Rating:	300 lbs.

FABRIC PRICE CODES

1	\$865	8	\$1141
2	\$913	9	\$1177
3	\$961	10	\$1213
4	\$997	11	\$1249
5	\$1033	12	\$1285
6	\$1069	L	—
7	\$1105		

HOW TO SPECIFY

Select Model Number	Select Arm Type	Select Caster/Glide	Select Fabric	Select Base	Select Frame
	N Armless A Height and Width Adjustable Arms (+ \$75) P Fixed Arms - Polished (+ \$150)	H Black Hard Caster S Black All-Surface Caster (+ \$30)	See page 437	SB Standard Base PA Polished Aluminum (+ \$110)	See page 435 T Black
HN1U	A	H	CU10	SB	T



Icon Legend on page 19

HN6

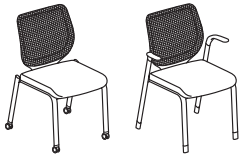

MULTI-PURPOSE STACK CHAIR

4-Way Stretch Back
Four Legs

DIMENSIONS

Depth:	26¼	Arm Width:	21½
Width:	27	Seat to Floor Height:	18½
Height:	37½	Usable Seat Depth:	18½
Seat Depth:	19	Ship Weight:	31
Seat Width:	19	Cube:	15.2
Back Width:	18	COM:	1.0
Back Height:	18½	Weight Rating:	300 lbs.

FABRIC PRICE CODES

1	\$530	8	\$668
2	\$554	9	\$686
3	\$578	10	\$704
4	\$596	11	\$722
5	\$614	12	\$740
6	\$632	L	—
7	\$650		

HN7

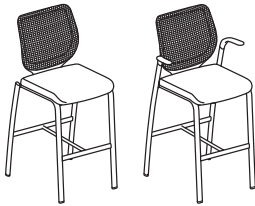

CAFÉ-HEIGHT STOOL

4-Way Stretch Back
Four Legs

DIMENSIONS

Depth:	24½	Arm Width:	21½
Width:	25	Seat to Floor Height:	30
Height:	46½	Usable Seat Depth:	18½
Seat Depth:	19	Ship Weight:	40
Seat Width:	19	Cube:	21.4
Back Width:	18	COM:	1.0
Back Height:	18½	Weight Rating:	300 lbs.

FABRIC PRICE CODES

1	\$577	8	\$715
2	\$601	9	\$733
3	\$625	10	\$751
4	\$643	11	\$769
5	\$661	12	\$787
6	\$679	L	—
7	\$697		

HON Recommendation: HN6.F.H.IM.CU__T - List Price \$560

HOW TO SPECIFY

Select Model Number	Select Arm Type	Select Caster/Glide	Select Back Type	Select Fabric	Select Frame
HN6	F Fixed Arms (+ \$30) N Armless	E Glide H Black Hard Caster S Black All-Surface Caster (+ \$20) <i>Casters available on HN6 only</i>	4-Way Stretch options IM Black IB Breeze IK Brownstone IH Chai * IC Charcoal IF Fog IY Navy * IR Regatta IT Titanium	See page 437	T Black T1 Platinum Metallic
HN6	F	H	IM	CU10	T

* Fabric is de-emphasized.

HNATA

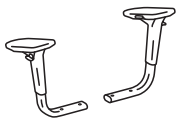

ADJUSTABLE ARM PACK

Height and Width
Functions: **S**
(Function Key on pages 244-245)

DIMENSIONS

Arm Width:	17-20
Height from Seat:	6⅞-10⅞
Ship Weight:	7.5 S
Cube:	1.0

LIST PRICE

\$123

HNFPA



POLISHED ALUMINUM ARM PACK

Fixed Height

DIMENSIONS

Arm Width:	19⅞
Height from Seat:	7¼
Ship Weight:	7.5 S
Cube:	1.0

LIST PRICE

\$193

OPEN MARKET

HOW TO SPECIFY

Select Model Number
HNATA

HIGH-DENSITY OLSON STACKER® 4040 SERIES



Olson Stacker.

HIGH-DENSITY OLSON STACKER® 4040 SERIES

Adaptable spaces such as multi-purpose and training areas demand a chair equally flexible. Olson stacking chairs fit that bill with a lightweight frame that is easy to move throughout a space. Chairs stack up to 12 high on the floor or up to 40 high on their specially designed cart to maximize floor space when not in use. A convenient cutout in the back makes it easy to pick up and move, while the molded seat shells deliver surprising comfort. Olson stacking chairs ship in sets of four to accommodate large groups. With Olson, the benefits really stack up.



FEATURES

- Chairs ship four per carton.
- Contoured seat and back shell provide targeted support.
- Integrated lumbar support delivers long-lasting comfort.
- Integrated handle makes chair easy to carry.
- Optional ganging brackets connect chairs to form neat rows.
- Stacks up to 12 high without cart.
- Stacks up to 40 high on cart.
- Shell colors are CA Technical Bulletin 133 compliant.
- Warranted for users up to 300 lbs.



Icon Legend on page 19

HIGH-DENSITY OLSON STACKER® 4040 Series

H4041



POLYMER SEAT AND BACK DIMENSIONS

7/16" Steel Rod Frame
Chrome Legs

Depth:	21 5/8	Seat to Floor Height:	17 3/4
Width:	19 1/8	Usable Seat Depth:	17
Height:	30 5/8	Ship Weight:	57
Seat Depth:	18 1/4	Cube:	10.6
Seat Width:	17 3/4	Weight Rating:	300 lbs.
Back Width:	17 1/2		
Back Height:	16 1/4		

LIST PRICE PER CARTON

\$711
(reference single unit @ \$177.75)

⊕ 4040 Series is ordered and shipped four (4) chairs per carton. Pricing shown is per carton. Each set of four (one carton), must have the same shell color. Ordering 2 of Model H4041 will result in 2 cartons being shipped, giving you 8 chairs.

⚠ Shipped fully assembled — 4 chairs per carton. All High-Density Olson Stacker® shell colors are CA Technical Bulletin 133 compliant (no upcharge).

🔥 For Fire Code model, availability and ordering method, refer to pages 248-251.

H4043

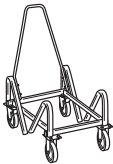

CART FOR STACKING CHAIRS

DIMENSIONS

Depth:	35 1/2	Ship Weight:	34
Width:	21 5/8	Cube:	7.8
Height:	37		

LIST PRICE

\$495

NOTES: Holds 40 stack chairs (6'-8"), some assembly required. (Chairs stack 12 high without cart.)

⚠ Specify Black paint (T) ONLY.

H4048

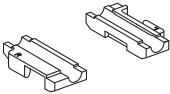

GANGING CHAIR GLIDES

DIMENSIONS

Box of 48 For use on models H4041, HG51 and HG52	Ship Weight: 1 Cube: 0.04
--	------------------------------

LIST PRICE

\$126

H4049

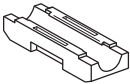

NON-GANGING CHAIR GLIDES

DIMENSIONS

Box of 48 For use on models H4041, HFLEX01, HG51 and HG52	Ship Weight: 1 Cube: 0.04
---	------------------------------

LIST PRICE

\$99

HOW TO SPECIFY

<p>Select Model Number</p> <p>H 4 0 4 1 .</p>	<p>Select Shell Color</p> <table border="0"> <tr> <td>RG Tangelo</td> <td>LO Loft</td> </tr> <tr> <td>CR Cherry</td> <td>PT Platinum</td> </tr> <tr> <td>LM Lime</td> <td>SD Shadow</td> </tr> <tr> <td>CP Calypso</td> <td>LA Lava</td> </tr> <tr> <td>BU Surf</td> <td>ON Onyx</td> </tr> <tr> <td>RE Regatta</td> <td>WT White</td> </tr> <tr> <td>MB Mulberry</td> <td></td> </tr> </table> <p>ON .</p>	RG Tangelo	LO Loft	CR Cherry	PT Platinum	LM Lime	SD Shadow	CP Calypso	LA Lava	BU Surf	ON Onyx	RE Regatta	WT White	MB Mulberry		<p>Select Frame</p> <p>Y Chrome</p> <p>Y</p>
RG Tangelo	LO Loft															
CR Cherry	PT Platinum															
LM Lime	SD Shadow															
CP Calypso	LA Lava															
BU Surf	ON Onyx															
RE Regatta	WT White															
MB Mulberry																

PAGODA®



Pagoda® Guest Chairs with
Preside® Tables Café Stools.

PAGODA®

Roll out the welcome mat with Pagoda guest chairs. Reception areas. Private offices. Anywhere in between. Pagoda is a coordinated, versatile collection of stacking chairs and stools that easily match any environment and offer comfort for any type of activity. Standard-height chairs stack up to five high to clear valuable floor space whenever needed. Counter-height stools are great for cafés or common areas. Wherever comfort and style are equally important, Pagoda will create the look and feel you need.



FEATURES

- Guest chairs stack up to five high on the floor.
- Fully-upholstered outer back.
- Molded seat underpan protects seat fabric and creates a finished appearance when stacked.
- Optional fixed arms are gently sloped for maximum comfort.
- Tube rolled steel frame adds durability.
- Create a contemporary mixed material aesthetic.
- Optional wood veneer back is available in five attractive finishes.
- Available in hundreds of quality HON fabrics.
- Warranted for users up to 250 lbs.

MODEL OPTIONS

H4071



Stacking Arm Guest Chairs
Set of Two

H4073



Stacking Armless Guest Chairs
Set of Two

H4075



Stacking Arm Guest Chairs
Set of Two

H4077



Mobile Stacking Armless Guest Chairs
Set of Two

H4091



Stacking Arm Guest Chairs (Wood Back)
Set of Two

H4093



Stacking Armless Guest Chairs (Wood Back)
Set of Two

H4095



Stacking Arm Guest Chairs (Wood Back)
Set of Two

H4097



Mobile Stacking Armless Guest Chairs (Wood Back)
Set of Two

H4099

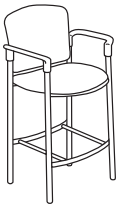

Café-Height Stool (Wood Back)
Footrest, Arms

H4079



Café-Height Stool (Upholstered Back)
Footrest, Arms

PAGODA® Options

CASTERS



CODE	DESCRIPTION	PRICE
H	Hard Caster	+\$0



S	Soft Caster	+\$20
----------	-------------	--------------

*Specify for models H4075 and H4077 only

FINISH

CODE	DESCRIPTION	PRICE
C	Harvest	+\$0
D	Natural Maple	+\$0
F	Shaker Cherry	+\$0
H	Bourbon Cherry	+\$0
N	Mahogany	+\$0

*Specify for models H4091, H4093, H4095, H4097 and H4099 only

FRAME

CODE	DESCRIPTION	PRICE
T	Black	+\$0
T1	Platinum Metallic	+\$0

HON BRANDED FABRICS

GRADE 1

Apex
Attire
Centurion
Compass
Contourett
Dapper
Ensemble
Hamilton
Inertia
Optic
Pebble

GRADE 2

Appoint Seating
Blume
Clyde
Dotty
Rush
Seed
Spin Seating
Whisper Vinyl

GRADE 3

In Season
Moxie
Parker
Purl
Quill

For a complete list of fabrics, including partnership fabrics, go to honesty.com/fabricsandfinishes.

**Pagoda® wood back models available in Harvest (C), Natural Maple (D), Shaker Cherry (F), Bourbon Cherry (H) and Mahogany (N) only.

Reference Fabric Color Combinations on pages 20-24 for color codes and legend on page 21 for lead times. For additional HON to Supply COM fabric grade pricing, go to honesty.com and click on the HON to Supply COM link.

🔥 For Fire Code model, availability and ordering method, refer to pages 248-251. Available on select models, contact HON Customer Support for availability.



PAGODA® 4070 Series

H4071



STACKING ARM GUEST CHAIRS

Set of Two

DIMENSIONS

Depth:	22½	Arm Width:	23¾
Width:	27¼	Seat to Floor Height:	18
Height:	33	Usable Seat Depth:	16¾
Seat Depth:	19¾	Ship Weight:	56
Seat Width:	20¼	Cube:	19.6
Back Width:	21¼	COM (per 2 pack):	2.5
Back Height:	16¼	Weight Rating:	250 lbs.

FABRIC PRICE CODES

	Per Carton List Price	Single Unit List Price
1	\$971	\$485.50
2	\$1019	\$509.50
3	\$1067	\$533.50
4	\$1103	\$551.50
5	\$1139	\$569.50
6	\$1175	\$587.50
7	\$1211	\$605.50
8	\$1247	\$623.50
9	\$1283	\$641.50
10	\$1319	\$659.50
11	\$1355	\$677.50
12	\$1391	\$695.50
L	—	—

NOTES: Use Model H4069 Ganging Connectors on page 449. Ships two to a container. See shipping notes on page 446.

H4073



STACKING ARMLESS GUEST CHAIRS

Set of Two

DIMENSIONS

Depth:	22½	Seat to Floor Height:	18
Width:	21¼	Usable Seat Depth:	16¾
Height:	33	Ship Weight:	52
Seat Depth:	19¾	Cube:	18.9
Seat Width:	20¼	COM (per 2 pack):	2.5
Back Width:	21¼	Weight Rating:	250 lbs.
Back Height:	16¼		

FABRIC PRICE CODES

	Per Carton List Price	Single Unit List Price
1	\$906	\$453.00
2	\$954	\$477.00
3	\$1002	\$501.00
4	\$1038	\$519.00
5	\$1074	\$537.00
6	\$1110	\$555.00
7	\$1146	\$573.00
8	\$1182	\$591.00
9	\$1218	\$609.00
10	\$1254	\$627.00
11	\$1290	\$645.00
12	\$1326	\$663.00
L	—	—

NOTES: Use Model H4069 Ganging Connectors on page 449. Ships two to a container. See shipping notes on page 446.

HOW TO SPECIFY

<p>Select Model Number</p> <p>H 4 0 7 1 .</p>	<p>Select Fabric</p> <p>See page 444</p> <p>C U 1 0 .</p>	<p>Select Frame</p> <p>T Black T1 Platinum Metallic</p> <p>T</p>
--	--	---

PAGODA® 4070 Series

GSA SIN 33721



Icon Legend on page 19

H4075



STACKING ARM GUEST CHAIRS

Set of Two

DIMENSIONS

Depth:	22½	Arm Width:	23¾
Width:	27¼	Seat to Floor Height:	18
Height:	33	Usable Seat Depth:	16¾
Seat Depth:	19¾	Ship Weight:	56
Seat Width:	20¼	Cube:	19.6
Back Width:	21¼	COM (per 2 pack):	2.5
Back Height:	16¼	Weight Rating:	250 lbs.

FABRIC PRICE CODES

	Per Carton List Price	Single Unit List Price
1	\$1088	\$544.00
2	\$1136	\$568.00
3	\$1184	\$592.00
4	\$1220	\$610.00
5	\$1256	\$628.00
6	\$1292	\$646.00
7	\$1328	\$664.00
8	\$1364	\$682.00
9	\$1400	\$700.00
10	\$1436	\$718.00
11	\$1472	\$736.00
12	\$1508	\$754.00
L	—	—

H4077



MOBILE STACKING ARMLESS GUEST CHAIRS

Set of Two

DIMENSIONS

Depth:	22½	Seat to Floor Height:	18
Width:	21¼	Usable Seat Depth:	16¾
Height:	33	Ship Weight:	56
Seat Depth:	19¾	Cube:	19.5
Seat Width:	20¼	COM (per 2 pack):	2.5
Back Width:	21¼	Weight Rating:	250 lbs.
Back Height:	16¼		

FABRIC PRICE CODES

	Per Carton List Price	Single Unit List Price
1	\$1024	\$512.00
2	\$1072	\$536.00
3	\$1120	\$560.00
4	\$1156	\$578.00
5	\$1192	\$596.00
6	\$1228	\$614.00
7	\$1264	\$632.00
8	\$1300	\$650.00
9	\$1336	\$668.00
10	\$1372	\$686.00
11	\$1408	\$704.00
12	\$1444	\$722.00
L	—	—

4070 Series is ordered and shipped two (2) chairs per carton. Pricing shown is per carton. Each set of two (one carton), must have the same fabric/frame color. (COM yardage shown is for two chairs.) Ordering 2 of any model will result in 2 cartons being shipped, giving you 4 chairs.

HOW TO SPECIFY

Select Model Number

H 4 0 7 5 .

Select Caster

H Hard Caster
S Soft Caster (+ \$20)
Specify for models H4075 and H4077 only

H .

Select Fabric

See page 444

C U 1 0 .

Select Frame

T Black
TI Platinum Metallic

T



PAGODA® 4090 Series

H4091



STACKING ARM GUEST CHAIRS

Wood Back
Set of Two

DIMENSIONS

Depth:	22½	Arm Width:	23¾
Width:	27¼	Seat to Floor Height:	18
Height:	32½	Usable Seat Depth:	16¾
Seat Depth:	19¾	Ship Weight:	51
Seat Width:	20¼	Cube:	19.6
Back Width:	21¼	COM (per 2 pack):	1.0
Back Height:	16¼	Weight Rating:	250 lbs.

FABRIC PRICE CODES

	Per Carton List Price	Single Unit List Price
1	\$1129	\$564.50
2	\$1153	\$576.50
3	\$1177	\$588.50
4	\$1195	\$597.50
5	\$1213	\$606.50
6	\$1231	\$615.50
7	\$1249	\$624.50
8	\$1267	\$633.50
9	\$1285	\$642.50
10	\$1303	\$651.50
11	\$1321	\$660.50
12	\$1339	\$669.50
L	—	—

NOTES: Use Model H4069 Ganging Connectors on page 449.

! Ships two per carton. See note on page 448 for ordering.

H4093



STACKING ARMLESS GUEST CHAIRS

Wood Back
Set of Two

DIMENSIONS

Depth:	22½	Seat to Floor Height:	18
Width:	21¼	Usable Seat Depth:	16¾
Height:	32½	Ship Weight:	49
Seat Depth:	19¾	Cube:	18.9
Seat Width:	20¼	COM (per 2 pack):	1.0
Back Width:	20½	Weight Rating:	250 lbs.
Back Height:	16¼		

FABRIC PRICE CODES

	Per Carton List Price	Single Unit List Price
1	\$1064	\$532.00
2	\$1088	\$544.00
3	\$1112	\$556.00
4	\$1130	\$565.00
5	\$1148	\$574.00
6	\$1166	\$583.00
7	\$1184	\$592.00
8	\$1202	\$601.00
9	\$1220	\$610.00
10	\$1238	\$619.00
11	\$1256	\$628.00
12	\$1274	\$637.00
L	—	—

NOTES: Use Model H4069 Ganging Connectors on page 449.

! Ships two per carton. See note on page 448 for ordering.

! Pagoda® wood back models available in Harvest (C), Natural Maple (D), Shaker Cherry (F), Bourbon Cherry (H) and Mahogany (N) only.

HOW TO SPECIFY

<p>Select Model Number</p> <p style="text-align: center;">H 4 0 9 1 .</p>	<p>Select Finish Color</p> <p style="text-align: center;">See page 444</p> <p style="text-align: center;">H .</p>	<p>Select Fabric</p> <p style="text-align: center;">See page 444</p> <p style="text-align: center;">C U 1 0 .</p>	<p>Select Frame</p> <p>T Black TI Platinum Metallic</p> <p style="text-align: center;">T</p>
--	--	--	---

PAGODA® 4090 Series

GSA SIN 33721



Icon Legend on page 19

H4095



STACKING ARM GUEST CHAIRS

Wood Back
Set of Two

DIMENSIONS

Depth:	22½	Arm Width:	23¾
Width:	27¼	Seat to Floor Height:	18
Height:	32½	Usable Seat Depth:	16¾
Seat Depth:	19¾	Ship Weight:	53
Seat Width:	20¼	Cube:	19.6
Back Width:	20½	COM (per 2 pack):	1.0
Back Height:	16¼	Weight Rating:	250 lbs.

FABRIC PRICE CODES

	Per Carton List Price	Single Unit List Price
1	\$1248	\$624.00
2	\$1272	\$636.00
3	\$1296	\$648.00
4	\$1314	\$657.00
5	\$1332	\$666.00
6	\$1350	\$675.00
7	\$1368	\$684.00
8	\$1386	\$693.00
9	\$1404	\$702.00
10	\$1422	\$711.00
11	\$1440	\$720.00
12	\$1458	\$729.00
L	—	—

! Ships two per carton. See note below for ordering.

H4097



MOBILE STACKING ARMLESS GUEST CHAIRS

Wood Back
Set of Two

DIMENSIONS

Depth:	22½	Seat to Floor Height:	18
Width:	21¼	Usable Seat Depth:	16¾
Height:	32½	Ship Weight:	51
Seat Depth:	19¾	Cube:	19.6
Seat Width:	20¼	COM (per 2 pack):	1.0
Back Width:	20½	Weight Rating:	250 lbs.
Back Height:	16¼		

FABRIC PRICE CODES

	Per Carton List Price	Single Unit List Price
1	\$1184	\$592.00
2	\$1208	\$604.00
3	\$1232	\$616.00
4	\$1250	\$625.00
5	\$1268	\$634.00
6	\$1286	\$643.00
7	\$1304	\$652.00
8	\$1322	\$661.00
9	\$1340	\$670.00
10	\$1358	\$679.00
11	\$1376	\$688.00
12	\$1394	\$697.00
L	—	—

! Ships two per carton. See note below for ordering.

- ? 4090 Series is ordered and shipped two (2) chairs per carton. Pricing shown is per carton. Each set of two (one carton), must have the same fabric/frame color. (COM yardage shown is for two chairs.) Ordering 2 of any model will result in 2 cartons being shipped, giving you 4 chairs.
- ! Pagoda® wood back models available in Harvest (C), Natural Maple (D), Shaker Cherry (F), Bourbon Cherry (H) and Mahogany (N) only.

HOW TO SPECIFY

<p>Select Model Number</p> <p>H 4 0 9 5 .</p>	<p>Select Finish Color</p> <p>See page 444</p> <p>H .</p>	<p>Select Fabric</p> <p>See page 444</p> <p>C U 1 0 .</p>	<p>Select Frame</p> <p>T Black TI Platinum Metallic</p> <p>T</p>
--	--	--	---



PAGODA® 4070/4090 Series

H4099

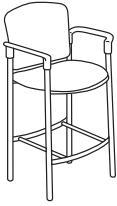

CAFÉ-HEIGHT STOOL

Wood Back
Footrest
Arms

DIMENSIONS

Depth:	22½	Arm Width:	23¾
Width:	27¼	Seat to Floor Height:	29⅝
Height:	44⅝	Usable Seat Depth:	16¾
Seat Depth:	19¾	Ship Weight:	34
Seat Width:	20¼	Cube:	19.3
Back Width:	20½	COM:	1.0
Back Height:	16¼	Weight Rating:	250 lbs.

FABRIC PRICE CODES

Single Unit List Price	
1	\$728.00
2	\$752.00
3	\$776.00
4	\$794.00
5	\$812.00
6	\$830.00
7	\$848.00
8	\$866.00
9	\$884.00
10	\$902.00
11	\$920.00
12	\$938.00
L	—

NOTES: Model H4099 is ordered and shipped one (1) per carton.

H4079

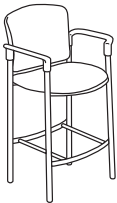

CAFÉ-HEIGHT STOOL

Upholstered Back
Footrest
Arms

DIMENSIONS

Depth:	22½	Arm Width:	23¾
Width:	27¼	Seat to Floor Height:	29⅝
Height:	44⅝	Usable Seat Depth:	16¾
Seat Depth:	19¾	Ship Weight:	39
Seat Width:	20¼	Cube:	19.3
Back Width:	21¼	COM:	1.0
Back Height:	16¼	Weight Rating:	250 lbs.

FABRIC PRICE CODES

Single Unit List Price	
1	\$634.00
2	\$682.00
3	\$730.00
4	\$766.00
5	\$802.00
6	\$838.00
7	\$874.00
8	\$910.00
9	\$946.00
10	\$982.00
11	\$1018.00
12	\$1054.00
L	—

NOTES: Upholstered back. Model H4079 is ordered and shipped one (1) per carton.

H4069



GANGING CONNECTORS

(hardware included)

DIMENSIONS

Ship Weight:	2 Ⓢ
Cube:	0.05

LIST PRICE

\$67.00

NOTES: Specify Chairs frame color: Black (T)
! For use on models H4071, H4073, H4091 and H4093.

HOW TO SPECIFY

<p>Select Model Number</p> <p>H 4 0 7 9 .</p> <p>H 4 0 9 9 .</p>	<p>Select Finish Color</p> <p>See page 444 Specify for model H4099 only</p> <p>H .</p>	<p>Select Fabric</p> <p>See page 444</p> <p>C U 1 0 .</p> <p>C U 1 0 .</p>	<p>Select Frame</p> <p>T Black T1 Platinum Metallic</p> <p>T</p> <p>T</p>
---	---	---	--

PARK AVENUE COLLECTION® 5000 SERIES



Park Avenue Executive High-Back Chair shown with 94000 Series™ Desk and Credenza.

PARK AVENUE COLLECTION® 5000 SERIES

Park Avenue seating is your address for elegance. Task chairs feature inlaid wood accents, as well as an elegant tuxedo back design that creates a sophisticated look.



TASK CHAIR FEATURES

- Mid-range knee-tilt mechanism allows for a natural, comfortable recline.
- Pneumatic seat height adjustment moves the seat up and down to adapt to various body heights.
- Tilt tension controls the rate and ease of recline.
- Tilt lock allows the user to lock out the tilt function.
- Arms feature a urethane top pad.
- Base features a steel substrate with hardwood base caps.
- Warranted for users up to 275 lbs.

PARK AVENUE COLLECTION®

5000 Series Options

MODEL OPTIONS

H5001



Executive High-Back

Pneumatic, Swivel, Mid-range
Knee Tilt, Tilt Tension, Tilt Lock,
Open Loop Arms

H5002



Managerial Mid-Back

Pneumatic, Swivel, Mid-range
Knee Tilt, Tilt Tension, Tilt Lock,
Open Loop Arms

AVAILABLE FINISHES

Park Avenue Collection® 5000 Series
Seating is available in 8 wood finishes.

WOOD FINISHES

Bourbon Cherry (H)

Cognac (COGN)

Harvest (C)

Mahogany (N)

Mocha (MOCH)

Natural Maple (D)

Pinnacle (PINC)

Shaker Cherry (F)

HON BRANDED FABRICS

GRADE 1

Apex
Centurion
Compass
Contourett
Dapper
Ensemble
Hamilton
Inertia
Optic
Pebble

GRADE 2

Appoint Seating
Clyde
Dotty
Rush
Seed
Spin Seating
Whisper Vinyl

GRADE 3

Moxie
Parker
Purl

GRADE L

Denver Leather

For a complete list of fabrics, including partnership fabrics, go to hon.com/fabricsandfinishes.

Reference Fabric Color Combinations on pages 20-24 for color codes and legend on page 21 for lead times. For additional HON to Supply COM fabric grade pricing, go to honready.hon.com and click on the HON to Supply COM link.

For Fire Code model, availability and ordering method, refer to pages 248-251. Available on select models, contact HON Customer Support for availability.

PARK AVENUE COLLECTION®

5000 Series

GSA SIN 33721



Icon Legend on page 19

H5001



EXECUTIVE HIGH-BACK

Pneumatic
Swivel
Mid-range Knee Tilt
Tilt Tension
Tilt Lock
Open Loop Arms
Functions: **A, E, G, K, L**
(Function Key on pages 244-245)

DIMENSIONS

Depth: 29
Width: 26
Height: 44½
Seat Depth: 19½
Seat Width: 20
Back Width: 20
Back Height: 26¼
Arm Width: 20
Seat to Floor Height: 17¾-22½
Usable Seat Depth: 17⅝
Ship Weight: 61
Cube: 23.7
COM: 3.0
Weight Rating: 250 lbs.

FABRIC PRICE CODES

1	\$1090	8	\$1504
2	\$1162	9	\$1558
3	\$1234	10	\$1612
4	\$1288	11	\$1666
5	\$1342	12	\$1720
6	\$1396	L	\$1690
7	\$1450		

NOTES: Arms are selected hardwood with urethane top pads.

H5002



MANAGERIAL MID-BACK

Pneumatic
Swivel
Mid-range Knee Tilt
Tilt Tension
Tilt Lock
Open Loop Arms
Functions: **A, E, G, K, L**
(Function Key on pages 244-245)

DIMENSIONS

Depth: 29
Width: 26
Height: 39½
Seat Depth: 19½
Seat Width: 20
Back Width: 20
Back Height: 19¼
Arm Width: 20
Seat to Floor Height: 17¾-22½
Usable Seat Depth: 17⅝
Ship Weight: 57
Cube: 18.5
COM: 2.5
Weight Rating: 250 lbs.

FABRIC PRICE CODES

1	\$1062	8	\$1407
2	\$1122	9	\$1452
3	\$1182	10	\$1497
4	\$1227	11	\$1542
5	\$1272	12	\$1587
6	\$1317	L	\$1562
7	\$1362		

NOTES: Arms are selected hardwood with urethane top pads.

HON Recommendation: H5001.MOCH.CU__ - List Price \$1090

HOW TO SPECIFY

Select Model Number

H5001

Select Finish

See page 451

MOCH

Select Fabric

See page 451

CU10



PERCH™ Active Seating

HVLPERCH

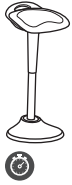

PERCH STOOL

Pneumatic
Swivel
Pivot Base

DIMENSIONS

Depth:	16½	Seat to Floor Height:	23¾-35
Width:	15¾	Usable Seat Depth:	14½
Seat Depth:	14½	Ship Weight:	22 Ⓢ
Seat Width:	14½	Cube:	3.13
		Weight Rating:	250 lbs.

PRICE CODE

Fabric **\$532**

NOTES: Fabric seat in Black and Charcoal. Built-in handle. Active pivot base. Silver frame. **HON 5-Year Limited Warranty.**
HON Recommendation: HVLPERCH.ASF10.X - List Price \$532

HVL991

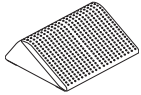

FOOTREST

Anti-Slip Cover

DIMENSIONS

Depth:	13¾	Ship Weight:	7 Ⓢ
Width:	16	Cube:	0.9
Height:	5½	Weight Rating:	250 lbs.

LIST PRICE

\$82

! Available in Black (T) finish ONLY. **HON 5-Year Limited Warranty.**
SPECIFYING EXAMPLE: HVL991.T

HBEAFM1

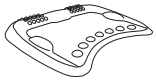

ANTI-FATIGUE MAT

Ergonomic

DIMENSIONS

Depth:	25	Ship Weight:	7
Width:	29⅞	Cube:	1.4
Height:	2¾		

LIST PRICE

\$219

! Available in Black ONLY. No specification needed. **HON 5-Year Limited Warranty.**
SPECIFYING EXAMPLE: HBEAFM1

HOW TO SPECIFY

<p>Select Model Number</p> <p>H V L P E R C H .</p>	<p>Select Fabric</p> <p>ASF10 Black Fabric ASF19 Charcoal Fabric</p> <p>A S F 1 0 .</p>	<p>Select Frame</p> <p>X Silver</p> <p>X</p>
--	--	---

PERPETUAL® NESTING CHAIRS



Perpetual Nesting Chairs and Huddle® Tables.

PERPETUAL® NESTING CHAIRS

Always attractive, always supportive — that's Perpetual. Provide full-time comfort to even part-time workers with the Perpetual line of multi-purpose seating. The flip-up seat design maximizes space by allowing Perpetual to be easily nested. The passive back design moves with the user to deliver added comfort for all day meetings. Save space without sacrificing comfort with Perpetual.



FEATURES

- Flip-up seat allows chairs to nest and save floor space.
- Backrest reclines for added comfort.
- Tube rolled steel frame adds durability.
- Underside of seat is fully-upholstered for a clean appearance when nested.
- All-surface casters roll effortlessly and silently.
- Available in hundreds of quality HON fabrics.
- Warranted for users up to 300 lbs.

PERPETUAL[®] Nesting Chairs Options

MODEL OPTIONS

HPN1



Nesting Chair (Flex-back)

Armless, Four Legs

HPN2



Nesting Chair (Flex-back)

Fixed Arms, Four Legs

CASTER/ GLIDE



CODE	DESCRIPTION	PRICE
A	All-Surface	+\$0
G	Bell Glide	+\$25

FRAME

CODE	DESCRIPTION	PRICE
T	Black	+\$0
T1	Platinum Metallic	+\$0

BACK STYLE



CODE	DESCRIPTION	PRICE
UU	Upholstered Back	+\$0

HON BRANDED FABRICS

GRADE 1

Apex
Attire
Centurion
Compass
Contourett
Dapper
Ensemble
Hamilton
Inertia
Optic
Pebble

GRADE 2

Appoint Seating
Blume
Clyde
Dotty
Rush
Seed
Spin Seating
Whisper Vinyl

GRADE 3

Moxie
Parker
Purl
Quill

For a complete list of fabrics, including partnership fabrics, go to hon.com/fabricsandfinishes.

Reference Fabric Color Combinations on pages 20-24 for color codes and legend on page 21 for lead times. For additional HON to Supply COM fabric grade pricing, go to honready.hon.com and click on the HON to Supply COM link.

For Fire Code model, availability and ordering method, refer to pages 248-251. Available on select models, contact HON Customer Support for availability.

PERPETUAL® Nesting Chairs

GSA SIN 33721



Icon Legend on page 19

HPN1



Model HPN1A UU shown

NESTING CHAIR

Flex-back
Armless
Four Legs

DIMENSIONS

Depth:	26	Seat to Floor Height:	19 $\frac{1}{8}$
Width:	26	Usable Seat Depth:	16 $\frac{1}{2}$
Height:	36	Ship Weight:	38
Seat Depth:	17 $\frac{3}{4}$	Cube:	15.2
Seat Width:	17	COM:	1.5
Back Width:	17 $\frac{1}{2}$	Weight Rating:	300 lbs.
Back Height:	15 $\frac{3}{4}$		

FABRIC PRICE CODES

1	\$694	8	\$901
2	\$730	9	\$928
3	\$766	10	\$955
4	\$793	11	\$982
5	\$820	12	\$1009
6	\$847	L	—
7	\$874		

HPN2



Model HPN2A UU shown

NESTING CHAIR

Flex-back
Fixed Arms
Four Legs

DIMENSIONS

Depth:	26	Arm Width:	20 $\frac{3}{4}$
Width:	26	Seat to Floor Height:	19 $\frac{1}{8}$
Height:	36	Usable Seat Depth:	16 $\frac{1}{2}$
Seat Depth:	17 $\frac{3}{4}$	Ship Weight:	41
Seat Width:	17	Cube:	15.2
Back Width:	17 $\frac{1}{2}$	COM:	1.5
Back Height:	15 $\frac{3}{4}$	Weight Rating:	300 lbs.

FABRIC PRICE CODES

1	\$768	8	\$975
2	\$804	9	\$1002
3	\$840	10	\$1029
4	\$867	11	\$1056
5	\$894	12	\$1083
6	\$921	L	—
7	\$948		

HOW TO SPECIFY

<p>Select Model Number</p> <p>HPN1</p>	<p>Select Caster/Glide</p> <p>A All-Surface G Glide (+ \$25)</p> <p>A</p>	<p>Select Back Type</p> <p>UU Upholstered Back</p> <p>UU</p>	<p>Select Fabric</p> <p>Note: For models with upholstered back, seat and back are always matching fabric See page 455</p> <p>C U 1 0</p>	<p>Select Frame</p> <p>T Black T1 Platinum Metallic</p> <p>T</p>
---	--	---	---	---

PILLOW-SOFT® 2090 SERIES



Pillow-Soft High-Back Executive and Sled Base Guest Chairs shown with 10700 Series™ desks.

PILLOW-SOFT® 2090 SERIES

Pillow-Soft chairs combine comfort, style and selection to deliver the ultimate seating experience. Each executive chair in the collection combines thick memory foam cushioning with built-in lumbar support to reduce fatigue and increase comfort. Besides the full body support, it adds an authoritative presence to the office. The plush tufted leather or fabric will add a touch of sophistication to your office.



FEATURES

- Responsive memory foam eliminates pressure points and provides lasting comfort.
- Loop arms relieve stress on the shoulder and neck.
- Fully-upholstered outer back.
- Memory foam seat cushion reduces pressure points and responds to contours of the body for lasting comfort.
- Task chairs come standard with pneumatic seat height adjustment, tilt, tilt tension and tilt lock.
- Dual-wheel casters roll effortlessly and silently.
- Warranted for users up to 300 lbs.
- H2095 model warranted for users up to 275 lbs.

PILLOW-SOFT® 2090 Series Options

MODEL OPTIONS

H2091



Executive High-Back

Pneumatic, Swivel, Tilt, Tilt Tension, Tilt Lock, Arms

H2095



Executive High-Back

Pneumatic, Swivel, Tilt, Tilt Tension, Tilt Lock, Arms

H2092



Managerial Mid-Back

Pneumatic, Swivel, Tilt, Tilt Tension, Tilt Lock, Arms

H2093



Guest Chair

Sled Base, Arms

CASTERS



CODE	DESCRIPTION	PRICE
H	Black Hard Caster	+ \$0



S	Black All-Surface Caster	+ \$30
---	--------------------------	--------

HON BRANDED FABRICS

GRADE 1

Apex
Black Vinyl
Burgundy Vinyl
Centurion
Compass
Contourett
Dapper
Ensemble
Hamilton
Inertia
Optic
Pebble

GRADE 2

Appoint Seating
Blume
Clyde
Dotty
Rush
Seed
Spin Seating
Whisper Vinyl

GRADE 3

Moxie
Parker
Purl
Quill

For a complete list of fabrics, including partnership fabrics, go to honesty.com/fabricsandfinishes.

Reference Fabric Color Combinations on pages 20-24 for color codes and legend on page 21 for lead times. For additional HON to Supply COM fabric grade pricing, go to honesty.com and click on the HON to Supply COM link.

⚠ For Fire Code model, availability and ordering method, refer to pages 248-251. Available on select models, contact HON Customer Support for availability.



Icon Legend on page 19

PILLOW-SOFT® 2090 Series

H2091



EXECUTIVE HIGH-BACK

Pneumatic
Swivel
Tilt
Tilt Tension
Tilt Lock
Arms

Functions: **A, E, F, K, L**
(Function Key on pages 244-245)

DIMENSIONS

Depth:	29¾	Arm Width:	20¼
Width:	26¼	Seat to Floor Height:	16¾-21¼
Height:	46½	Usable Seat Depth:	18½
Seat Depth:	21	Ship Weight:	57
Seat Width:	22	Cube:	16.0
Back Width:	22	COM:	3.0
Back Height:	25	Weight Rating:	300 lbs.

FABRIC PRICE CODES

1	\$660	8	\$1074
2	\$732	9	\$1128
3	\$804	10	\$1182
4	\$858	11	\$1236
5	\$912	12	\$1290
6	\$966	L	\$810
7	\$1020		

NOTES: When selecting leather, the 2090 Series uses SR Leather only. All models are also available in Grade 1 EB vinyl (which matches SR Leather).

H2095



OPEN MARKET

EXECUTIVE HIGH-BACK

Pneumatic
Swivel
Tilt
Tilt Tension
Tilt Lock
Padded Loop Arms

Functions: **A, E, F, K, L**
(Function Key on pages 244-245)

DIMENSIONS

Depth:	29½	Arm Width:	21
Width:	26¾	Seat to Floor Height:	16-21
Height:	47½	Usable Seat Depth:	17½
Seat Depth:	17½	Ship Weight:	57
Seat Width:	21	Cube:	7.1
Back Width:	21	COM:	N/A
Back Height:	29½	Weight Rating:	275 lbs.

FABRIC PRICE CODES

Fabric		
PWST10	\$522	(Black)
SofThread™ Leather		
PWST11	\$542	(Black)

NOTES: When selecting upholstery, the H2095 is only available in PWST10 (Black fabric) and PWST11 (Black SofThread™ Leather).

H2092



MANAGERIAL MID-BACK

Pneumatic
Swivel
Tilt
Tilt Tension
Tilt Lock
Arms

Functions: **A, E, F, K, L**
(Function Key on pages 244-245)

DIMENSIONS

Depth:	28¾	Arm Width:	20¼
Width:	26¼	Seat to Floor Height:	16¾-21¼
Height:	41¾	Usable Seat Depth:	18½
Seat Depth:	21	Ship Weight:	54
Seat Width:	22	Cube:	16.0
Back Width:	22	COM:	3.0
Back Height:	19½	Weight Rating:	300 lbs.

FABRIC PRICE CODES

1	\$631	8	\$1045
2	\$703	9	\$1099
3	\$775	10	\$1153
4	\$829	11	\$1207
5	\$883	12	\$1261
6	\$937	L	\$781
7	\$991		

NOTES: When selecting leather, the 2090 Series uses SR Leather only. All models are also available in Grade 1 EB vinyl (which matches SR Leather).

H2093



GUEST CHAIR

Sled Base
Arms

DIMENSIONS

Depth:	27¾	Arm Width:	19¾
Width:	23¼	Seat to Floor Height:	19½
Height:	36	Usable Seat Depth:	19
Seat Depth:	21½	Ship Weight:	38
Seat Width:	20¾	Cube:	16.1
Back Width:	21½	COM:	2.5
Back Height:	19¼	Weight Rating:	300 lbs.

FABRIC PRICE CODES

1	\$503	8	\$848
2	\$563	9	\$893
3	\$623	10	\$938
4	\$668	11	\$983
5	\$713	12	\$1028
6	\$758	L	\$653
7	\$803		

NOTES: When selecting leather, the 2090 Series uses SR Leather only. All models are also available in Grade 1 EB vinyl (which matches SR Leather).

HOW TO SPECIFY

HON Recommendation: H2091.H.SR11.T - List Price \$810

<p>Select Model Number</p> <p>H 2 0 9 1 .</p>	<p>Select Caster</p> <p>H Black Hard Caster S Black All-Surface Caster (+ \$30) <i>Does not apply to models H2093 or H2095</i></p> <p>H .</p>	<p>Select Fabric</p> <p>See page 458 <i>H2095 only available in 2 fabric options. See above for pricing and selection.</i></p> <p>S R 1 1 .</p>	<p>Select Frame</p> <p>T Black</p> <p>T</p>
--	--	--	---

SEATING

PILLOW-SOFT® 2190 SERIES



Pillow-Soft Executive High-Back and Guest Chairs shown with Park Avenue Collection® Laminate desks.

PILLOW-SOFT® 2190 SERIES

Pillow-Soft chairs combine comfort, style and selection to deliver the ultimate seating experience. Each executive chair in the collection combines thick memory foam cushioning with built-in lumbar support to reduce fatigue and increase comfort. Besides the full body support, it adds an authoritative presence to the office. The plush tufted leather or fabric and optional hardwood accents will add a touch of sophistication to your office.



FEATURES

- Responsive memory foam eliminates pressure points and provides lasting comfort.
- Loop arms relieve stress on the shoulder and neck.
- Fully-upholstered outer back.
- Base features a steel substrate with hardwood base caps.
- Memory foam seat cushion reduces pressure points and responds to contours of the body for lasting comfort.
- Dual-wheel casters roll effortlessly and silently.
- Solid hardwood in one of eight attractive finishes.
- Warranted for users up to 275 lbs.

PILLOW-SOFT® 2190 Series Options

MODEL OPTIONS

H2191



Executive High-Back

Pneumatic, Swivel, Tilt, Tilt Tension, Tilt Lock, Open Padded Loop Arms

H2192



Managerial Mid-Back

Pneumatic, Swivel, Tilt, Tilt Tension, Tilt Lock, Open Padded Loop Arms

H2194



Guest Chair

4-Leg Base, Open Loop Arms

AVAILABLE FINISHES

Pillow-Soft® 2190 Series Seating is available in 8 wood finishes.

WOOD FINISHES

Bourbon Cherry (H)

Cognac (COGN)

Harvest (C)

Mahogany (N)

Mocha (MOCH)

Natural Maple (D)

Pinnacle (PINC)

Shaker Cherry (F)

HON BRANDED FABRICS

GRADE 1

Apex
Black Vinyl
Burgundy Vinyl
Centurion
Compass
Contourett
Dapper
Ensemble
Hamilton
Inertia
Optic
Pebble

GRADE 2

Appoint Seating
Blume
Clyde
Dotty
Rush
Seed
Spin Seating
Whisper Vinyl

GRADE 3

Moxie
Parker
Purl
Quill

For a complete list of fabrics, including partnership fabrics, go to hon.com/fabricsandfinishes.

Reference Fabric Color Combinations on pages 20-24 for color codes and legend on page 21 for lead times. For additional HON to Supply COM fabric grade pricing, go to honready.hon.com and click on the HON to Supply COM link.

🔥 For Fire Code model, availability and ordering method, refer to pages 248-251. Available on select models, contact HON Customer Support for availability.

PILLOW-SOFT® 2190 Series

GSA SIN 33721



Icon Legend on page 19

H2191



EXECUTIVE HIGH-BACK

Pneumatic
Swivel
Tilt
Tilt Tension
Tilt Lock
Open Padded Loop Arms
Functions: **A, E, F, K, L**
(Function Key on pages 244-245)

DIMENSIONS

Depth: 29¾
Width: 26¼
Height: 46½
Seat Depth: 21
Seat Width: 22
Back Width: 22
Back Height: 25
Arm Width: 22¼
Seat to Floor Height: 16¾-21¼
Usable Seat Depth: 18½
Ship Weight: 60
Cube: 16.0
COM: 3.0
Weight Rating: 250 lbs.

FABRIC PRICE CODES

1	\$1035	8	\$1449
2	\$1107	9	\$1503
3	\$1179	10	\$1557
4	\$1233	11	\$1611
5	\$1287	12	\$1665
6	\$1341	L	\$1185
7	\$1395		

NOTES: Arms are laminated hardwood with urethane top pads. Also available in Grade 1 vinyl EB11 and EB69. (EB matching vinyl used with SR Leather).

H2192



MANAGERIAL MID-BACK

Pneumatic
Swivel
Tilt
Tilt Tension
Tilt Lock
Open Padded Loop Arms
Functions: **A, E, F, K, L**
(Function Key on pages 244-245)

DIMENSIONS

Depth: 28¾
Width: 26¼
Height: 41¾
Seat Depth: 21
Seat Width: 22
Back Width: 22
Back Height: 19⅝
Arm Width: 22¼
Seat to Floor Height: 16¾-21¼
Usable Seat Depth: 18½
Ship Weight: 57
Cube: 16.0
COM: 2.5
Weight Rating: 250 lbs.

FABRIC PRICE CODES

1	\$1006	8	\$1351
2	\$1066	9	\$1396
3	\$1126	10	\$1441
4	\$1171	11	\$1486
5	\$1216	12	\$1531
6	\$1261	L	\$1156
7	\$1306		

NOTES: Arms are laminated hardwood with urethane top pads. Also available in Grade 1 vinyl EB11 and EB69. (EB matching vinyl used with SR Leather).

H2194



GUEST CHAIR

4-Leg Base
Open Loop Arms

DIMENSIONS

Depth: 27½
Width: 23¼
Height: 35½
Seat Depth: 21½
Seat Width: 20¾
Back Width: 21½
Back Height: 19¼
Arm Width: 19¾
Seat to Floor Height: 19½
Usable Seat Depth: 19
Ship Weight: 49
Cube: 17.3
COM: 2.5
Weight Rating: 250 lbs.

FABRIC PRICE CODES

1	\$819	8	\$1164
2	\$879	9	\$1209
3	\$939	10	\$1254
4	\$984	11	\$1299
5	\$1029	12	\$1344
6	\$1074	L	\$969
7	\$1119		

NOTES: Guest Chairs available in 4-Leg Base. Also available in Grade 1 vinyl EB11 and EB69. (EB matching vinyl used with SR Leather).

HON Recommendation: H2191.MOCH.CU__ - List Price \$1035

HOW TO SPECIFY

Select
Model Number

H 2 1 9 1 .

Select
Finish

See page 461

MOCH .

Select
Fabric

See page 461

CU 1 0 .



PROMINENT™ Mesh Chairs

HVL531



HIGH-BACK

Pneumatic
Swivel
Tilt
Tilt Tension
Tilt Lock
Height-adjustable Arms

Functions: **A, E, F, K, L, Q**
(Function Key on pages 244-245)

DIMENSIONS

Depth:	27	Arm Width:	20¼
Width:	27	Seat to Floor Height:	18-22
Height:	42½	Usable Seat Depth:	18
Seat Depth:	18	Ship Weight:	36
Seat Width:	21½	Cube:	5.1
Back Width:	18¾	Weight Rating:	250 lbs.
Back Height:	23		

PRICE CODE

Sandwich Mesh	\$418
Leather	\$443

NOTES: Comfortable and breathable mesh back. Black Sandwich Mesh or Black SofThread™ Leather seat. Black frame. Height-adjustable arms. **HON 5-Year Limited Warranty.**

HON Recommendation: HVL531.MM10 - List Price \$418

HVL532



HIGH-BACK

Mesh Back
Pneumatic
Swivel
Asynchronous Control
Tilt
Tilt Tension
Tilt Lock
Seat Glide Mechanism
Back Height Adjustment
Height and Width Adjustable Arms

Functions: **A, B, D, E, F, L, O, S**
(Function Key on pages 244-245)

DIMENSIONS

Depth:	26	Back Height:	23¼-24½
Width:	30¾	Arm Width:	18-22½
Height:	44½	Seat to Floor Height:	17-20½
Seat Depth:	17⅞-20⅞	Ship Weight:	50
Seat Width:	20½	Cube:	6.5
Back Width:	19⅞	Weight Rating:	250 lbs.

PRICE CODE

Sandwich Mesh	\$498
Leather	\$523

NOTES: Comfortable and breathable mesh back. Black Sandwich Mesh or Black SofThread™ Leather seat. Black frame. Height and width adjustable arms. Seat glide mechanism. Asynchronous control with independent seat and back angle adjustment. **HON 5-Year Limited Warranty.**

HON Recommendation: HVL532.MM10 - List Price \$498

HOW TO SPECIFY

Select Model Number

Select Fabric

MM10 Black Sandwich Mesh Fabric
SB11 Black SofThread™ Leather

H V L 5 3 1 .

M M 1 0

PROMINENT™ Mesh Chairs

OPEN MARKET



Icon Legend on page 19

HVL534



HIGH-BACK

Pneumatic
Swivel
Tilt
Tilt Tension
Tilt Lock
Height-adjustable Arms

Functions: **A, E, F, K, L, Q**
(Function Key on pages 244-245)

DIMENSIONS

Depth:	27	Arm Width:	19 ⁵ / ₈
Width:	27	Seat to Floor Height:	17 ¹ / ₈ -20 ³ / ₄
Height:	41 ¹ / ₈	Usable Seat Depth:	19 ¹ / ₈
Seat Depth:	19 ¹ / ₈	Ship Weight:	40.6 Ⓢ
Seat Width:	20 ¹ / ₈	Cube:	5.7
Back Width:	19 ¹ / ₈	Weight Rating:	250 lbs.
Back Height:	22 ³ / ₈		

PRICE CODE

Mesh **\$513**

NOTES: Prominent™ HVL534. Comfortable and breathable mesh back. Black Mesh seat. Height-adjustable arms. **HON 5-Year Limited Warranty.**

HON Recommendation: HVL534.MST3 - List Price \$513

HVL537



HIGH-BACK

Mesh Back
Synchro-tilt with Seat Slide
Back Height Adjustment
Height and Width Adjustable
Arms
Mesh Seat

Functions: **A, B, D, E, J, S**
(Function Key on pages 244-245)

DIMENSIONS

Depth:	26 ¹ / ₂	Arm Width:	18 ³ / ₄
Width:	26 ¹ / ₂	Seat to Floor Height:	17 ³ / ₄ -21
Height:	44 ¹ / ₄	Usable Seat Depth:	17 ³ / ₄
Seat Depth:	17 ³ / ₄	Ship Weight:	46.0
Seat Width:	20 ³ / ₄	Cube:	5.0
Back Width:	17 ¹ / ₈	Weight Rating:	250 lbs.
Back Height:	22 ¹ / ₄		

PRICE CODE

Mesh **\$548**

NOTES: **HON 5-Year Limited Warranty.**

HON Recommendation: HVL537.MST3 - List Price \$548

HVL539



TASK STOOL

Mesh Back
Pneumatic
Swivel
Height and Width Adjustable
Arms
Adjustable Footring

Functions: **A, E, S**
(Function Key on pages 244-245)

DIMENSIONS

Depth:	27 ⁷ / ₁₆	Arm Width:	18 ¹ / ₈
Width:	28 ⁷ / ₃₂	Seat to Floor Height:	21 ¹⁹ / ₃₂ -28 ⁵ / ₃₂
Height:	50	Usable Seat Depth:	17 ¹ / ₈
Seat Depth:	17 ¹ / ₈	Ship Weight:	44.0 Ⓢ
Seat Width:	20 ¹⁹ / ₃₂	Cube:	5.7
Back Width:	17 ¹ / ₈	Weight Rating:	250 lbs.
Back Height:	22 ²⁷ / ₃₂		

PRICE CODE

Sandwich Mesh **\$457**

NOTES: Prominent™ HVL539. Black upholstered seat. Height and width adjustable arms. **HON 5-Year Limited Warranty.**

HON Recommendation: HVL539.MM10 - List Price \$457

SEATING

HOW TO SPECIFY

Select
Model Number

Select
Fabric

MM10 Black Sandwich Mesh Fabric
Specify for model HVL539 only
MST3 Black Mesh
Specify for models HVL534 and HVL537 only

H V L 5 3 4 .

M S T 3



Ruck™ Seating shown with West Hill™ Casual Lounge, Scramble™ Occasional Tables, and Unika Vaev Screens.

RUCK™

Easy on the eyes and even easier to move and stack, Ruck™ seating brings effortless style to working alone or together. Available in a variety of finishes in both seated and stool heights, Ruck clicks with its surroundings — whether that’s in a collaborative area, café setting, or as a side chair in a private office. Crafted with gentle, molded contours, Ruck makes being on the edge of your seat a more comfortable place to be.



FEATURES

- Available in both a seated and stool-height option.
- Lightweight frame can be easily moved to rearrange seating configurations.
- Waterfall seat edge promotes better leg circulation.
- Glides move effortlessly on hard surfaces.
- Both the chair and stool stack six high on the floor to maximize space.
- Single piece shell can be quickly wiped down for easy maintenance.
- Choose from 6 laminate and 4 veneer shell colors.
- Legs are available in a variety of finish options to match or complement other HON product lines.
- Backed by HON’s industry-leading Lifetime Warranty.

RUCK™ Options

MODEL OPTIONS

HRUCK1L



Chair

Laminate Shell

HRUCK5L



Stool

Laminate Shell

HRUCK1W



Chair

Wood Shell

HRUCK5W



Stool

Wood Shell

AVAILABLE FINISHES

Ruck Seating is available in 6 laminate finishes and 4 wood finishes.

LAMINATE FINISHES

Charcoal (S)

Designer White (LDW1)

Florence Walnut (LFW1)

Kingswood Walnut (LK11)

Natural Maple (D)

Pinnacle (PINC)

WOOD FINISHES

Black Wash (QA997)

Natural (QA447)

Pinnacle Walnut (QA679)

White Wash (QA921)

FRAME

CODE	DESCRIPTION	PRICE
P6P	Textured Black Mica	+\$0
P7J	Textured Brownstone	+\$0
P7A	Textured Charcoal	+\$0
PK7	Textured Designer White	+\$0
P7L	Textured Loft	+\$0
P7M	Textured Muslin	+\$0
P8V	Textured Titanium	+\$0



HRUCK1L



CHAIR, LAMINATE SHELL

DIMENSIONS

Depth:	22 ⁵ / ₈	Seat to Floor Height:	17 ³ / ₄
Width:	21 ⁵ / ₈	Usable Seat Depth:	18 ¹ / ₄
Height:	32 ⁵ / ₁₆	Ship Weight:	24
Seat Depth:	18 ¹ / ₄	Cube:	15.8
Seat Width:	17 ¹ / ₂	Weight Rating:	300 lbs.
Back Width:	17		
Back Height:	15 ⁵ / ₈		

LIST PRICE

\$500

HRUCK5L



STOOL, LAMINATE SHELL

DIMENSIONS

Depth:	22 ⁵ / ₈	Seat to Floor Height:	30
Width:	21 ⁵ / ₈	Usable Seat Depth:	18 ¹ / ₄
Height:	44 ¹ / ₂	Ship Weight:	32
Seat Depth:	18 ¹ / ₄	Cube:	22.2
Seat Width:	17 ¹ / ₂	Weight Rating:	300 lbs.
Back Width:	17		
Back Height:	15 ⁵ / ₈		

LIST PRICE

\$600

HON Recommendation: HRUCK1L.PINC.P8V - List Price \$500

HOW TO SPECIFY

<p>Select Model Number</p> <p>HRUCK1L</p>	<p>Select Laminate</p> <p>See page 466</p> <p>PINC</p>	<p>Select Frame</p> <p>See page 466</p> <p>P8V</p>
--	---	---

RUCK™ Wood Seating

OPEN MARKET



Icon Legend on page 19

HRUCK1W

CHAIR, WOOD SHELL

DIMENSIONS

LIST PRICE



Depth:	22 ⁵ / ₈	Seat to Floor Height:	17 ³ / ₄
Width:	21 ⁵ / ₈	Usable Seat Depth:	18 ¹ / ₄
Height:	32 ⁵ / ₁₆	Ship Weight:	24
Seat Depth:	18 ¹ / ₄	Cube:	15.8
Seat Width:	17 ¹ / ₂	Weight Rating:	300 lbs.
Back Width:	17		
Back Height:	15 ⁵ / ₈		

\$525

HRUCK5W

STOOL, WOOD SHELL

DIMENSIONS

LIST PRICE



Depth:	22 ⁵ / ₈	Seat to Floor Height:	30
Width:	21 ⁵ / ₈	Usable Seat Depth:	18 ¹ / ₄
Height:	44 ¹ / ₂	Ship Weight:	32
Seat Depth:	18 ¹ / ₄	Cube:	22.2
Seat Width:	17 ¹ / ₂	Weight Rating:	300 lbs.
Back Width:	17		
Back Height:	15 ⁵ / ₈		

\$625

HON Recommendation: HRUCK1W.QA997.P8V - List Price \$525

SEATING

HOW TO SPECIFY

Select
Model Number

HRUCK1W

Select
Finish

See page 466

QA997

Select
Frame

See page 466

P8V

RYDER™



Ryder™ Sport Executive Chair with Voi® Desks and Fuse™ Storage.

RYDER™

Take your comfort to the extreme, and elevate the entire office with this high energy chair. The Ryder™ executive chair is the sporty answer to your grandfather's office seating. The unexpected curves and unconventional styling create uncommon comfort. SofThread™ leather paired with carbon fiber pattern creates a sleek look for any modern office.



FEATURES

- Synchro-tilt mechanism offers full range of reclining positions.
- Height-adjustable arms put the support right where you want it.
- Backed by the HON 5-Year Limited Warranty.

RYDER™ Sport Executive Chairs

OPEN MARKET



Icon Legend on page 19

HVL149



SPORT EXECUTIVE CHAIR

DIMENSIONS

Pneumatic	Depth: 29	Arm Width: 21
Swivel	Width: 27¾	Seat to Floor Height: 18-22
Synchronized Tilt	Height: 52¼	Usable Seat Depth: 19½
Tilt Tension	Seat Depth: 19½	Ship Weight: 53
Tilt Lock	Seat Width: 23	Cube: 8.5
Height-adjustable Arms	Back Width: 22	Weight Rating: 250 lbs.
Functions: A, E, J, K, L, Q	Back Height: 32	

(Function Key on pages 244-245)

NOTES: Black SofThread™ Leather with tailored stitching and mock carbon fiber detail. Black frame. Height-adjustable arms. Integrated headrest support. **HON 5-Year Limited Warranty.**

ⓘ Available in Black SofThread™ Leather only.

LIST PRICE

\$539

HON Recommendation: HVL149.SB11 - List Price \$539

SEATING

HOW TO SPECIFY

Select
Model Number

Select
Fabric

SB11 Black SofThread™ Leather

H V L 1 4 9 .

S B 1 1



HVL606



GUEST CHAIR

Leg Base
Armless
Stacks up to Four High

DIMENSIONS

Depth:	21	Seat to Floor Height:	19
Width:	21¼	Usable Seat Depth:	17½
Height:	32¾	Ship Weight:	16
Seat Depth:	17½	Cube:	2.1
Seat Width:	19	Weight Rating:	250 lbs.
Back Width:	18½		
Back Height:	16		

PRICE CODE

Fabric	\$157
Leather	\$187

NOTES: Fabric or Black SofThread™ Leather. Stackable up to four high. Round tube construction. Frame available in Black. Casters and glides ship packaged together for customer's assembly choice. **HON 5-Year Limited Warranty.**

HON Recommendation: HVL606.VA10 - List Price \$157

HVL616



GUEST CHAIR

Leg Base
Arms
Stacks up to Four High

DIMENSIONS

Depth:	21	Arm Width:	20⅞
Width:	23¼	Seat to Floor Height:	19
Height:	32¾	Usable Seat Depth:	17½
Seat Depth:	17½	Ship Weight:	18
Seat Width:	19	Cube:	2.1
Back Width:	18½	Weight Rating:	250 lbs.
Back Height:	16		

PRICE CODE

Fabric	\$177
Leather	\$207

NOTES: Fabric or Black SofThread™ Leather. Stackable up to four high. Round tube construction. Frame available in Black. Casters and glides ship packaged together for customer's assembly choice. **HON 5-Year Limited Warranty.**

HON Recommendation: HVL616.VA10 - List Price \$177

HOW TO SPECIFY

Select
Model Number

H V L 6 0 6 .

Select
Fabric

- SB11** Black SofThread™ Leather
- VA10** Black Fabric
- VA19** Charcoal Fabric
- VA90** Navy Fabric

V A 1 0

SKIP



Skip shown with Flock® Cylinder Table.

SKIP

It's hard to get creative when you're feeling all buttoned up. That's why workplaces are adding less formal, more dynamic spaces to foster more creativity and connection between workers. Designed to put the fun back in functional, Skip seating offers an engaging, active sit that lets you rock a meeting — literally. When it comes to casual and collaborative seating that's as lively as it is practical, this chair doesn't Skip a beat.



FEATURES

- Built-in handle makes it easy to move around.
- Textured finish is durable, easy to clean, UV resistant, and suitable for outdoor sitting.
- Optional cushion stays in place but is not permanently affixed.
- Cushion fabric is easy to wipe clean.



SKIP Collaborative Chair

HQQ1



COLLABORATIVE CHAIR

DIMENSIONS

Depth:	35½	Seat to Floor Height:	17
Width:	28	Usable Seat Depth:	17
Height:	31	Ship Weight:	35
Seat Depth:	18	Cube:	20.0
Seat Width:	28	Weight Rating:	275 lbs.
Back Width:	28		
Back Height:	21		

LIST PRICE

\$809

NOTES: **HON 5-Year Limited Warranty.**

HQQ1CUSH



CUSHION

DIMENSIONS

Depth:	17½	Ship Weight:	5
Width:	25¾	Cube:	2.0
Height:	1½		

LIST PRICE

\$155

NOTES: **HON 5-Year Limited Warranty.**

HOW TO SPECIFY

Select Model Number

HQQ1

HOW TO SPECIFY

Select Model Number

HQQ1CUSH.

Select Fabric

SLT Slate
NVY Navy

SLT

SOLUTIONS SEATING® 4000 SERIES



Solutions Managerial Mid-Back Chair shown with 34000 Series Desk and Brigade® 700 Series Lateral Files.

SOLUTIONS SEATING® 4000 SERIES

Looking for the perfect answer for your task and guest chair needs? HON has four Solutions for everything from workstations to open areas. The Solutions series includes a high-back and mid-back task chair, as well as matching four-leg and sled base guest chairs. The floating backrest provides ergonomic support for your spine. The tilt mechanism delivers a natural recline. Solutions are the chairs that really live up to their name.



GUEST CHAIR FEATURES

- Guest chairs feature molded polymer outer back shell for added durability.
- Back cushion enhances lumbar support and minimizes fatigue.
- Available in hundreds of quality HON fabrics.
- Warranted for users up to 300 lbs.

TASK CHAIR FEATURES

- One-touch seat height adjustment easily moves the seat up and down.
- Tilt tension controls the rate and ease of recline.
- Tilt lock allows the user to lock out the tilt function.
- 360-degree swivel provides freedom of movement in any direction.
- Model H4001 has a fully-upholstered outer back.
- Model H4002 has a molded polymer outer back shell.
- Back cushion enhances lumbar support and minimizes fatigue.
- Dual-wheeled casters roll effortlessly and quietly.
- Available in hundreds of quality HON fabrics.
- Warranted for users up to 300 lbs.

SOLUTIONS SEATING®

4000 Series Options

MODEL OPTIONS

H4001



Executive High-Back

Pneumatic, Swivel, Tilt, Tilt Tension, Tilt Lock, Loop Arms

H4002



Managerial Mid-Back

Pneumatic, Swivel, Tilt, Tilt Tension, Tilt Lock, Loop Arms

H4003



Guest Chair

Leg Base, Arms

H4008



Guest Chair

Sled Base, Arms

CASTERS



CODE	DESCRIPTION	PRICE
H	Black Hard Caster	+ \$0



S	Black All-Surface Caster	+ \$30
---	--------------------------	--------

*Specify for models H4001 and H4002 only

FRAME

CODE	DESCRIPTION	PRICE
T	Black	+ \$0

HON BRANDED FABRICS

GRADE 1

Apex
Attire
Centurion
Compass
Contourett
Dapper
Ensemble
Hamilton
Inertia
Optic
Pebble

GRADE 2

Appoint Seating
Blume
Clyde
Dotty
Rush
Seed
Spin Seating
Whisper Vinyl

GRADE 3

In Season
Moxie
Parker
Purl
Quill

For a complete list of fabrics, including partnership fabrics, go to hon.com/fabricsandfinishes.

Reference Fabric Color Combinations on pages 20-24 for color codes and legend on page 21 for lead times. COM yardage shown is for Pattern Cut only. Contact Customer Service for Railroaded yardage requirements. For additional HON to Supply COM fabric grade pricing, go to honready.hon.com and click on the HON to Supply COM link.

🔥 For Fire Code model, availability and ordering method, refer to pages 248-251. Available on select models, contact HON Customer Support for availability.

SOLUTIONS SEATING®

4000 Series

GSA SIN 33721



Icon Legend on page 19

H4001



EXECUTIVE HIGH-BACK

Pneumatic
Swivel
Tilt
Tilt Tension
Tilt Lock
Loop Arms
Functions: **A, E, F, K, L**
(Function Key on pages 244-245)

DIMENSIONS

Depth: 27
Width: 26
Height: 39¾
Seat Depth: 18
Seat Width: 20
Back Width: 20½
Back Height: 20¾
Arm Width: 20¼
Seat to Floor Height: 16¾-21¾
Usable Seat Depth: 17¾
Ship Weight: 45
Cube: 10.3
COM: 1.5
Weight Rating: 250 lbs.

FABRIC PRICE CODES

1	\$496	8	\$703
2	\$532	9	\$730
3	\$568	10	\$757
4	\$595	11	\$784
5	\$622	12	\$811
6	\$649	L	—
7	\$676		

H4002

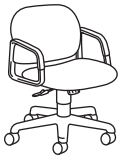

MANAGERIAL MID-BACK

Pneumatic
Swivel
Tilt
Tilt Tension
Tilt Lock
Loop Arms
Functions: **A, E, F, K, L**
(Function Key on pages 244-245)

DIMENSIONS

Depth: 26¼
Width: 26
Height: 35½
Seat Depth: 18
Seat Width: 20
Back Width: 21
Back Height: 15
Arm Width: 18¾
Seat to Floor Height: 16¾-21¾
Usable Seat Depth: 17¾
Ship Weight: 38
Cube: 8.6
COM: 1.0
Weight Rating: 250 lbs.

FABRIC PRICE CODES

1	\$441	8	\$579
2	\$465	9	\$597
3	\$489	10	\$615
4	\$507	11	\$633
5	\$525	12	\$651
6	\$543	L	—
7	\$561		

H4003



GUEST CHAIR

Leg Base
Arms

DIMENSIONS

Depth: 24½
Width: 23½
Height: 32
Seat Depth: 18
Seat Width: 20
Back Width: 21
Back Height: 15
Arm Width: 18¾
Seat to Floor Height: 19¼
Usable Seat Depth: 18¼
Ship Weight: 29
Cube: 12.6
COM: 1.0
Weight Rating: 250 lbs.

FABRIC PRICE CODES

1	\$334	8	\$472
2	\$358	9	\$490
3	\$382	10	\$508
4	\$400	11	\$526
5	\$418	12	\$544
6	\$436	L	—
7	\$454		

H4008



GUEST CHAIR

Sled Base
Arms

DIMENSIONS

Depth: 25½
Width: 23½
Height: 32½
Seat Depth: 18
Seat Width: 20
Back Width: 21
Back Height: 15
Arm Width: 19
Seat to Floor Height: 19¼
Usable Seat Depth: 18¼
Ship Weight: 33
Cube: 12.6
COM: 1.0
Weight Rating: 250 lbs.

FABRIC PRICE CODES

1	\$373	8	\$511
2	\$397	9	\$529
3	\$421	10	\$547
4	\$439	11	\$565
5	\$457	12	\$583
6	\$475	L	—
7	\$493		

HON Recommendation: H4001.H.CU__T - List Price \$496
H4008.CU__T - List Price \$373

SEATING

HOW TO SPECIFY

Select Model Number

H4008

Select Caster

H Black Hard Caster
S Black All-Surface Caster (+ \$30)
Specify for models H4001 and H4002 only

H

Select Fabric

See page 475

CU10

Select Frame

T Black

T

SOLVE®



Solve Task Chairs and Stools.

SOLVE®

If you want to make a powerful statement, simply have a seat. With three back materials and an optional adjustable lumbar support, Solve answers the need for a higher level of personalization. Solve task chairs feature a geometric ReActiv® back to create a contemporary look, while the 4-Way Stretch mesh back offers a softer, more relaxed feel. The synchronized seat and back move in harmony with the user to provide continuous comfort that can be customized. Helping anyone achieve optimal balance, proper alignment and lumbar support, Solve is an ideal solution for everywhere and everybody.



FEATURES

- Synchronized seat and back create continuous comfort.
- Waterfall seat edge encourages leg circulation.
- Optional seat depth adjustment adapts to users of various heights.
- ReActiv® back design moves with your body to provide continuous support and airflow for lasting comfort.
- Available with three control types — synchro-tilt, synchro-tilt with seat slider and advanced synchro-tilt.
- Choose from four different arm options — armless, fixed, height- and width-adjustable or all-adjustable arms.
- Optional lumbar support delivers long-lasting comfort.
- Available with bell glides, hard casters or all-surface casters.
- Upholstered ReActiv® back offers all the benefits of the ReActiv® back with a fabric cover for additional comfort.
- Back upholstery available in one of six attractive fabrics.
- Choose from 3 frame options: Black, Titanium and White.
- Available in seven mesh back and seven lumbar colors and thousands of fabrics.
- Warranted for users up to 300 lbs.

SOLVE[®] Options

MODEL OPTIONS

HSLVTMM



Mid-Back Task (4-Way Stretch Back)

Pneumatic, Swivel, Synchro-tilt, Tilt Tension, Tilt Lock

HSLVSMM



Stool (4-Way Stretch Back)

Pneumatic, Swivel, Synchro-tilt, Tilt Tension, Tilt Lock

HSLVTMMS



Mid-Back Task (4-Way Stretch Back) with Designer White frame

Pneumatic, Swivel, Synchro-tilt, Tilt Tension, Tilt Lock

HSLVSMMS



Stool (4-Way Stretch Back) with Designer White frame

Pneumatic, Swivel, Synchro-tilt, Tilt Tension, Tilt Lock

HSLVTMR



Mid-Back Task (ReActiv[®] Back)

Pneumatic, Swivel, Synchro-tilt, Tilt Tension, Tilt Lock

HSLVSMR



Stool (ReActiv[®] Back)

Pneumatic, Swivel, Synchro-tilt, Tilt Tension, Tilt Lock

HSLVTMRS



Mid-Back Task (ReActiv[®] Back) with Designer White frame

Pneumatic, Swivel, Synchro-tilt, Tilt Tension, Tilt Lock

HSLVSMRS



Stool (ReActiv[®] Back) with Designer White frame

Pneumatic, Swivel, Synchro-tilt, Tilt Tension, Tilt Lock

HSLVTMU



Mid-Back Task (Upholstered Back)

Pneumatic, Swivel, Synchro-tilt, Tilt Tension, Tilt Lock

HSLVSMU



Stool (Upholstered Back)

Pneumatic, Swivel, Synchro-tilt, Tilt Tension, Tilt Lock

HSLVTMUS



Mid-Back Task (Upholstered Back) with Designer White frame

Pneumatic, Swivel, Synchro-tilt, Tilt Tension, Tilt Lock

HSLVSMUS







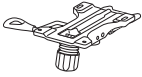
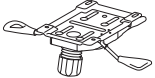
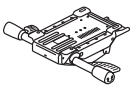

Stool (Upholstered Back) with Designer White frame

Pneumatic, Swivel, Synchro-tilt, Tilt Tension, Tilt Lock

MECHANISM	CODE	DESCRIPTION	PRICE
	Y0	Synchro-Tilt A, E, J, K, L	+\$0
	Y1	Synchro-Tilt w/Seat Slider A, D, E, J, K, L	+\$20
	Y2	Advanced Synchro-Tilt A, D, E, J, L, A-D	+\$65

*Y2 control not available on stool models

ARM STYLE	CODE	DESCRIPTION	PRICE
	N	Armless	+\$0
	F	Fixed Arms	+\$65
	<i>*Not available on Designer White models</i>		
	A	Height and Width Adjustable Arms	+\$75
	V	All-Adjustable Arms (includes Pivot)	+\$115
	<i>*Not available on Designer White models</i>		

CASTERS/ GLIDE	CODE	DESCRIPTION	PRICE
	H	Black Hard Caster	+\$0
	S	Black All-Surface Caster	+\$30
	R	Roll Control Caster	+\$50
	G	Bell Glide	+\$25

BACK STYLE	CODE	DESCRIPTION	PRICE
	<i>4-Way Stretch mesh back options:</i>		
	IM	Black	+\$0
	IB	Breeze	+\$0
	IK	Brownstone	+\$0
	IH	Chai ☉	+\$0
	IC	Charcoal	+\$0
	IF	Fog	+\$0
	IY	Navy ☉	+\$0
	IR	Regatta	+\$0
	IT	Titanium	+\$0

ReActiv® back options:

	OS	Charcoal	+\$0
	DW	Designer White	+\$0
	TI	Titanium	+\$0

Fabric options:

	COMF46	Bittersweet	+\$0
	COMF10	Ink	+\$0
	COMF82	Meadow	+\$0
	COMF90	Midnight	+\$0
	COMF22	Putty	+\$0
	COMF19	Sterling	+\$0

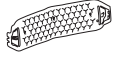
LUMBAR	CODE	DESCRIPTION	PRICE
	NL	No Lumbar	+\$0
	BL	Black Adjustable Lumbar	+\$30
	BY	Bullseye Adjustable Lumbar	+\$30
	DW	Designer White Adjustable Lumbar	+\$30
	KT	Krypton Adjustable Lumbar	+\$30
	MR	Ember Adjustable Lumbar	+\$30
	RE	Regatta Adjustable Lumbar	+\$30
	TL	Titanium Adjustable Lumbar	+\$30

BASE	CODE	DESCRIPTION	PRICE
	SB	Standard Base	+\$0

FRAME	CODE	DESCRIPTION	PRICE
	T	Black	+\$0
	TI	Titanium	+\$35
	DW	Designer White	+\$35

☉ Fabric is de-emphasized.

SOLVE[®] Options

HON BRANDED FABRICS

GRADE 1	GRADE 2	GRADE 3	GRADE L
Apex	Appoint Seating	In Season	Denver Leather (Seat Only)
Attire	Blume	Moxie	
Centurion	Clyde	Parker	
Compass	Dotty	Purl	
Compass Foam	Rush	Quill	
Contourett	Seed		
Dapper	Spin Seating		
Ensemble	Whisper Vinyl		
Hamilton			
Inertia			
Optic			
Pebble			































For a complete list of fabrics, including partnership fabrics, go to hon.com/fabricsandfinishes.

Reference Fabric Color Combinations on pages 20-24 for color codes and legend on page 21 for lead times.

 For Fire Code model, availability and ordering method, refer to pages 248-251. Available on select models, contact HON Customer Support for availability.

DIMENSIONS

NOTE: When selecting the .TI Titanium or .DW Designer White frame option, the chair's back frame, arms, and base will match. 4-Way Stretch, ReActiv[®], and/or lumbar color must be selected separately.

MODEL		HSLVTMM /HSLVTMMS	HSLVSMM /HSLVSMMS	HSLVTMR /HSLVTMRS	HSLVSMR /HSLVSMRS	HSLVTMU /HSLVTMUS	HSLVSMU /HSLVSMUS
Overall Width Armless		29½"	29½"	29½"	29½"	29½"	29½"
Overall Width with Arms	(A)	29½"	29½"	29½"	29½"	29½"	29½"
Overall Depth		29½"	29½"	29½"	29½"	29½"	29½"
Overall Height - Max	(Y0/Y1)	41¾"	52¾"	41¾"	52¾"	41¾"	52¾"
	(Y2)	42½"	—	42½"	—	42½"	—
Seat Width		19"	19"	19"	19"	19"	19"
Seat Depth (Cushion)		19¼"	19¼"	19¼"	19¼"	19¼"	19¼"
Usable Seat Depth	(Y0)	17⅝"	17⅝"	17⅝"	17⅝"	17⅝"	17⅝"
	(Y1)	16¼"-18½"	16¼"-18½"	16¼"-18½"	16¼"-18½"	16¼"-18½"	16¼"-18½"
	(Y2)	16¼"-19¼"	—	16¼"-19¼"	—	16¼"-19¼"	—
Seat Height	(Y0/Y1)	16¾"-21¾"	22¾"-32¾"	16¾"-21¾"	22¾"-32¾"	16¾"-21¾"	22¾"-32¾"
	(Y2)	17½"-22½"	—	17½"-22½"	—	17½"-22½"	—
Back Width		18¼"	18¼"	18¼"	18¼"	18¼"	18¼"
Back Height		21½"	21½"	21½"	21½"	21½"	21½"
Ship Weight Armless	(Y0)	40 	45 	41 	46 	41 	46 
	(Y1)	42 	47 	43 	48 	43 	48 
	(Y2)	45 	—	46 	—	46 	—
Ship Weight with Arms	(Y0)	44 	49 	45 	50 	45 	50 
	(Y1)	46 	51 	47 	52 	47 	52 
	(Y2)	49 	—	50 	—	50 	—
Width Between Arms		17½"-20"	17½"-20"	17½"-20"	17½"-20"	17½"-20"	17½"-20"
COM		1.0	1.0	1.0	1.0	1.0	1.0
Weight Capacity		300 lbs	300 lbs	300 lbs	300 lbs	300 lbs	300 lbs



Icon Legend on page 19

HSLVTMM

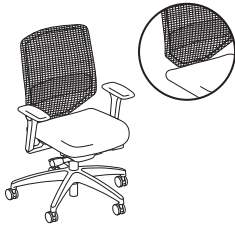

MID-BACK TASK

- 4-Way Stretch Back**
- Pneumatic
- Swivel
- Synchro-tilt
- Tilt Tension
- Tilt Lock

DIMENSIONS

- Seat Depth: 19¼
- Seat Width: 19
- Back Width: 18¼
- Back Height: 21½
- Arm Width: 17½-20
- Cube: 10.8
- Weight Rating: 300 lbs.

FABRIC PRICE CODES

1	\$477	8	\$546
2	\$489	9	\$555
3	\$501	10	\$564
4	\$510	11	\$573
5	\$519	12	\$582
6	\$528	L	\$577
7	\$537		

NOTES: Please reference pages 479-480 for additional specifications and mechanism information.

HSLVTMMS

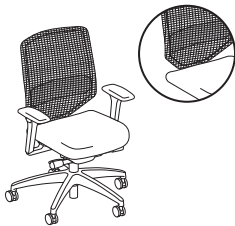

MID-BACK TASK IN DESIGNER WHITE

- 4-Way Stretch Back**
- Pneumatic
- Swivel
- Synchro-tilt
- Tilt Tension
- Tilt Lock

DIMENSIONS

- Seat Depth: 19¼
- Seat Width: 19
- Back Width: 18¼
- Back Height: 21½
- Arm Width: 17½-20
- Cube: 10.8
- Weight Rating: 300 lbs.

FABRIC PRICE CODES

1	\$477	8	\$546
2	\$489	9	\$555
3	\$501	10	\$564
4	\$510	11	\$573
5	\$519	12	\$582
6	\$528	L	\$577
7	\$537		

OPEN MARKET

NOTES: Please reference pages 479-480 for additional specifications and mechanism information.

HON Recommendation: HSLVTMM.Y1.A.S.IM.CU__BL.SB.T - List Price \$632

HOW TO SPECIFY

Select Model Number	Select Control Type	Select Arm Type	Select Caster/Glide	Select Mesh Back	Select Fabric	Select Lumbar	Select Base	Select Frame
<p>Y0 Synchro-Tilt</p> <p>Y1 Synchro-Tilt w/ Seat Slider (+ \$20)</p> <p>Y2 Advanced Synchro-Tilt (+ \$65)</p>	<p>HSLVTMM Options</p> <p>N Armless</p> <p>F Fixed Arms (+ \$65)</p> <p>A Height and Width Adjustable Arms (+ \$75)</p> <p>V All-Adjustable Arms (includes pivot) (+ \$115)</p> <p>HSLVTMMS Options</p> <p>ADW Height and Width Adjustable Arms (+ \$75) Available for model HSLVTMMS only</p>	<p>H Black Hard Caster</p> <p>S Black All-Surface Caster (+ \$30)</p> <p>G Bell Glide (+ \$25)</p> <p>R Black Roll Control Caster (+ \$50)</p>	<p>4-Way Stretch options</p> <p>IM Black</p> <p>IB Breeze</p> <p>IK Brownstone</p> <p>IH Chai *</p> <p>IC Charcoal</p> <p>IF Fog</p> <p>IY Navy *</p> <p>IR Regatta</p> <p>IT Titanium</p>	See page 480	<p>NL No Lumbar</p> <p>BL Black Adjustable Lumbar (+ \$30)</p> <p>BY Bullseye Adjustable Lumbar (+ \$30)</p> <p>DW Designer White Adjustable Lumbar (+ \$30)</p> <p>KT Krypton Adjustable Lumbar (+ \$30)</p> <p>MR Ember Adjustable Lumbar (+ \$30)</p> <p>RE Regatta Adjustable Lumbar (+ \$30)</p> <p>TL Titanium Adjustable Lumbar (+ \$30)</p>	<p>SB Standard Base</p>	<p>HSLVTMM Options</p> <p>T Black</p> <p>TI Titanium (+ \$35)</p> <p>HSLVTMMS Options</p> <p>DW Designer White (+ \$35) Available for model HSLVTMMS only</p>	
H S L V T M M .	Y 1 .	A .	S .	I M .	C U I O .	B L .	S B .	T

* Fabric is de-emphasized.





HSLVSMM

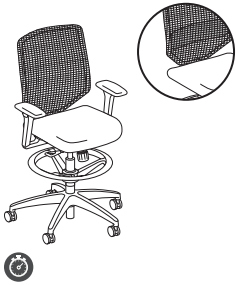

STOOL

- 4-Way Stretch Back
- Pneumatic
- Swivel
- Synchro-tilt
- Tilt Tension
- Tilt Lock

DIMENSIONS

Seat Depth:	19¼	Arm Width:	17½-20
Seat Width:	19	Cube:	10.8
Back Width:	18¼	Weight Rating:	300 lbs.
Back Height:	21½		

FABRIC PRICE CODES

1	\$534	8	\$603
2	\$546	9	\$612
3	\$558	10	\$621
4	\$567	11	\$630
5	\$576	12	\$639
6	\$585	L	\$634
7	\$594		

NOTES: Please reference pages 479-480 for additional specifications and mechanism information.

HSLVSMMS



STOOL IN DESIGNER WHITE

- 4-Way Stretch Back
- Pneumatic
- Swivel
- Synchro-tilt
- Tilt Tension
- Tilt Lock

DIMENSIONS

Seat Depth:	19¼	Arm Width:	17½-20
Seat Width:	19	Cube:	10.8
Back Width:	18¼	Weight Rating:	300 lbs.
Back Height:	21½		

FABRIC PRICE CODES

1	\$534	8	\$603
2	\$546	9	\$612
3	\$558	10	\$621
4	\$567	11	\$630
5	\$576	12	\$639
6	\$585	L	\$634
7	\$594		

NOTES: Please reference pages 479-480 for additional specifications and mechanism information.

OPEN MARKET

HON Recommendation: HSLVSMM.Y1.A.S.IM.CU__BL.SB.T - List Price \$689

HOW TO SPECIFY

Select Model Number	Select Control Type	Select Arm Type	Select Caster/Glide	Select Mesh Back	Select Fabric	Select Lumbar	Select Base	Select Frame
YO Synchro-Tilt YI Synchro-Tilt w/ Seat Slider (+ \$20)	HSLVSMM Options N Armless F Fixed Arms (+ \$65) A Height and Width Adjustable Arms (+ \$75) V All-Adjustable Arms (includes pivot) (+ \$115)	H Black Hard Caster S Black All-Surface Caster (+ \$30) G Bell Glide (+ \$25) R Black Roll Control Caster (+ \$50)	4-Way Stretch options IM Black IB Breeze IK Brownstone IH Chai * IC Charcoal IF Fog IY Navy * IR Regatta IT Titanium	See page 480	NL No Lumbar BL Black Adjustable Lumbar (+ \$30) BY Bullseye Adjustable Lumbar (+ \$30) DW Designer White Adjustable Lumbar (+ \$30) KT Krypton Adjustable Lumbar (+ \$30) MR Ember Adjustable Lumbar (+ \$30) RE Regatta Adjustable Lumbar (+ \$30) TL Titanium Adjustable Lumbar (+ \$30)	SB Standard Base	HSLVSMM Options T Black TI Titanium (+ \$35) HSLVSMMS Options DW Designer White (+ \$35) <i>Available for model HSLVSMMS only</i>	
H S L V S M M	Y I	A	S	I M	C U I O	B L	S B	T

* Fabric is de-emphasized.



Icon Legend on page 19

HSLVTMR



MID-BACK TASK

- ReActiv[®] Back**
- Pneumatic
- Swivel
- Synchro-tilt
- Tilt Tension
- Tilt Lock

DIMENSIONS

- Seat Depth: 19¼
- Seat Width: 19
- Back Width: 18¼
- Back Height: 21½
- Arm Width: 17½-20
- Cube: 10.8
- Weight Rating: 300 lbs.

FABRIC PRICE CODES

1	\$512	8	\$581
2	\$524	9	\$590
3	\$536	10	\$599
4	\$545	11	\$608
5	\$554	12	\$617
6	\$563	L	\$612
7	\$572		

NOTES: Please reference pages 479-480 for additional specifications and mechanism information.

HSLVTMRS

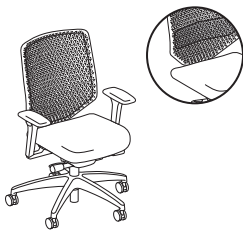

MID-BACK TASK IN DESIGNER WHITE

- ReActiv[®] Back**
- Pneumatic
- Swivel
- Synchro-tilt
- Tilt Tension
- Tilt Lock

DIMENSIONS

- Seat Depth: 19¼
- Seat Width: 19
- Back Width: 18¼
- Back Height: 21½
- Arm Width: 17½-20
- Cube: 10.8
- Weight Rating: 300 lbs.

FABRIC PRICE CODES

1	\$512	8	\$581
2	\$524	9	\$590
3	\$536	10	\$599
4	\$545	11	\$608
5	\$554	12	\$617
6	\$563	L	\$612
7	\$572		

OPEN MARKET

NOTES: Please reference pages 479-480 for additional specifications and mechanism information.

HON Recommendation: HSLVTMR.Y1.A.H.OS.CU__NL.SB.T - List Price \$607

HOW TO SPECIFY

Select Model Number	Select Control Type	Select Arm Type	Select Caster/Glide	Select Back Color	Select Fabric	Select Lumbar	Select Base	Select Frame
<p>Y0 Synchro-Tilt</p> <p>Y1 Synchro-Tilt w/ Seat Slider (+ \$20)</p> <p>Y2 Advanced Synchro-Tilt (+ \$65)</p>	<p>HSLVTMR Options</p> <p>N Armless</p> <p>F Fixed Arms (+ \$65)</p> <p>A Height and Width Adjustable Arms (+ \$75)</p> <p>V All-Adjustable Arms (includes pivot) (+ \$115)</p> <p>HSLVTMRS Options</p> <p>ADW Height and Width Adjustable Arms (+ \$75) Available for model HSLVTMRS only</p>	<p>H Black Hard Caster</p> <p>S Black All-Surface Caster (+ \$30)</p> <p>G Bell Glide (+ \$25)</p> <p>R Black Roll Control Caster (+ \$50)</p>	<p>OS Charcoal</p> <p>TI Titanium</p> <p>DW Designer White</p>	See page 480	<p>NL No Lumbar</p> <p>BL Black Adjustable Lumbar (+ \$30)</p> <p>BY Bullseye Adjustable Lumbar (+ \$30)</p> <p>DW Designer White Adjustable Lumbar (+ \$30)</p> <p>KT Krypton Adjustable Lumbar (+ \$30)</p> <p>MR Ember Adjustable Lumbar (+ \$30)</p> <p>RE Regatta Adjustable Lumbar (+ \$30)</p> <p>TL Titanium Adjustable Lumbar (+ \$30)</p>	<p>SB Standard Base</p>	<p>HSLVTMR Options</p> <p>T Black</p> <p>TI Titanium (+ \$35)</p> <p>HSLVTMRS Options</p> <p>DW Designer White (+ \$35) Available for model HSLVTMRS only</p>	
H S L V T M R .	Y 1 .	A .	H .	O S .	C U 1 0 .	N L .	S B .	T

SEATING



HSLVSMR



STOOL

ReActiv® Back
Pneumatic
Swivel
Synchro-tilt
Tilt Tension
Tilt Lock

DIMENSIONS

Seat Depth: 19¼ Arm Width: 17½-20
Seat Width: 19 Cube: 10.8
Back Width: 18¼ Weight Rating: 300 lbs.
Back Height: 21½

FABRIC PRICE CODES

1	\$569	8	\$638
2	\$581	9	\$647
3	\$593	10	\$656
4	\$602	11	\$665
5	\$611	12	\$674
6	\$620	L	\$669
7	\$629		

NOTES: Please reference pages 479-480 for additional specifications and mechanism information.

HSLVSMRS

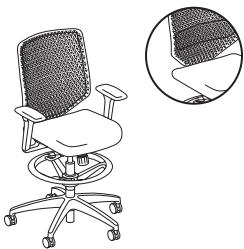

STOOL IN DESIGNER WHITE

ReActiv® Back
Pneumatic
Swivel
Synchro-tilt
Tilt Tension
Tilt Lock

DIMENSIONS

Seat Depth: 19¼ Arm Width: 17½-20
Seat Width: 19 Cube: 10.8
Back Width: 18¼ Weight Rating: 300 lbs.
Back Height: 21½

FABRIC PRICE CODES

1	\$569	8	\$638
2	\$581	9	\$647
3	\$593	10	\$656
4	\$602	11	\$665
5	\$611	12	\$674
6	\$620	L	\$669
7	\$629		

OPEN MARKET

NOTES: Please reference pages 479-480 for additional specifications and mechanism information.

HON Recommendation: HSLVSMR.Y1.A.H.OS.CU__NL.SB.T - List Price \$664

HOW TO SPECIFY

Select Model Number	Select Control Type	Select Arm Type	Select Caster/Glide	Select Back Color	Select Fabric	Select Lumbar	Select Base	Select Frame
YO Synchro-Tilt Y1 Synchro-Tilt w/ Seat Slider (+ \$20)	H Black Hard Caster S Black All-Surface Caster (+ \$30) G Bell Glide (+ \$25) R Black Roll Control Caster (+ \$50)	OS Charcoal TI Titanium DW Designer White	See page 480	NL No Lumbar BL Black Adjustable Lumbar (+ \$30) BY Bullseye Adjustable Lumbar (+ \$30) DW Designer White Adjustable Lumbar (+ \$30) KT Krypton Adjustable Lumbar (+ \$30) MR Ember Adjustable Lumbar (+ \$30) RE Regatta Adjustable Lumbar (+ \$30) TL Titanium Adjustable Lumbar (+ \$30)	SB Standard Base	HSLVSMR Options T Black TI Titanium (+ \$35) HSLVSMRS Options DW Designer White (+ \$35) <i>Available for model HSLVSMRS only</i>		
A	HSLVSMR Options N Armless F Fixed Arms (+ \$65) A Height and Width Adjustable Arms (+ \$75) V All-Adjustable Arms (includes pivot) (+ \$115) HSLVSMRS Options ADW Height and Width Adjustable Arms (+ \$75) <i>Available for model HSLVSMRS only</i>	H	OS	CU10	NL	SB	T	



Icon Legend on page 19

HSLVTMU

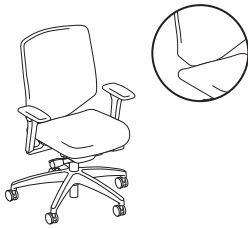

MID-BACK TASK

- Upholstered Back**
- Pneumatic
- Swivel
- Synchro-tilt
- Tilt Tension
- Tilt Lock

DIMENSIONS

- Seat Depth: 19¼
- Seat Width: 19
- Back Width: 18¼
- Back Height: 21½
- Arm Width: 17½-20
- Cube: 10.8
- Weight Rating: 300 lbs.

FABRIC PRICE CODES

- | | | | |
|---|-------|----|-------|
| 1 | \$525 | 8 | \$594 |
| 2 | \$537 | 9 | \$603 |
| 3 | \$549 | 10 | \$612 |
| 4 | \$558 | 11 | \$621 |
| 5 | \$567 | 12 | \$630 |
| 6 | \$576 | L | \$625 |
| 7 | \$585 | | |

NOTES: Please reference pages 479-480 for additional specifications and mechanism information.

HSLVTMUS

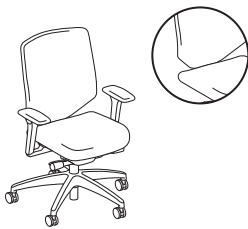

MID-BACK TASK IN DESIGNER WHITE

- Upholstered Back**
- Pneumatic
- Swivel
- Synchro-tilt
- Tilt Tension
- Tilt Lock

DIMENSIONS

- Seat Depth: 19¼
- Seat Width: 19
- Back Width: 18¼
- Back Height: 21½
- Arm Width: 17½-20
- Cube: 10.8
- Weight Rating: 300 lbs.

FABRIC PRICE CODES

- | | | | |
|---|-------|----|-------|
| 1 | \$525 | 8 | \$594 |
| 2 | \$537 | 9 | \$603 |
| 3 | \$549 | 10 | \$612 |
| 4 | \$558 | 11 | \$621 |
| 5 | \$567 | 12 | \$630 |
| 6 | \$576 | L | \$625 |
| 7 | \$585 | | |

OPEN MARKET

NOTES: Please reference pages 479-480 for additional specifications and mechanism information.

HON Recommendation: HSLVTMU.Y1.A.H.OS.COMF10.COMP10.NL.SB.T - List Price \$620

HOW TO SPECIFY

Select Model Number	Select Control Type	Select Arm Type	Select Caster/Glide	Select Back Color	Select Back Fabric	Select Seat Fabric	Select Lumbar	Select Base	Select Frame
	Y0 Synchro-Tilt Y1 Synchro-Tilt w/ Seat Slider (+ \$20) Y2 Advanced Synchro-Tilt (+ \$65)	HSLVTMU Options N Armless F Fixed Arms (+ \$65) A Height and Width Adjustable Arms (+ \$75) V All-Adjustable Arms (includes pivot) (+ \$115)	H Black Hard Caster S Black All-Surface Caster (+ \$30) G Bell Glide (+ \$25) R Black Roll Control Caster (+ \$50)	OS Charcoal TI Titanium DW Designer White	COMF46 Bittersweet COMF10 Ink COMF82 Meadow COMF90 Midnight COMF22 Putty COMF19 Sterling	See page 480	NL No Lumbar BL Black Adjustable Lumbar (+ \$30) BY Bullseye Adjustable Lumbar (+ \$30) DW Designer White Adjustable Lumbar (+ \$30) KT Krypton Adjustable Lumbar (+ \$30) MR Ember Adjustable Lumbar (+ \$30) RE Regatta Adjustable Lumbar (+ \$30) TL Titanium Adjustable Lumbar (+ \$30)	SB Standard Base	HSLVTMU Options T Black TI Titanium (+ \$35)
		HSLVTMUS Options ADW Height and Width Adjustable Arms (+ \$75) <i>Available for model HSLVTMUS only</i>							HSLVTMUS Options DW Designer White (+ \$35) <i>Available for model HSLVTMUS only</i>
H S L V T M U	Y 1	A	H	O S	C O M F 1 0	C O M P 1 0	N L	S B	T

SEATING



HSLVSMU

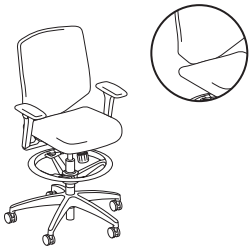

STOOL

Upholstered Back
Pneumatic
Swivel
Synchro-tilt
Tilt Tension
Tilt Lock

DIMENSIONS

Seat Depth: 19¼ Arm Width: 17½-20
Seat Width: 19 Cube: 10.8
Back Width: 18¼ Weight Rating: 300 lbs.
Back Height: 21½

FABRIC PRICE CODES

1	\$582	8	\$651
2	\$594	9	\$660
3	\$606	10	\$669
4	\$615	11	\$678
5	\$624	12	\$687
6	\$633	L	\$682
7	\$642		

NOTES: Please reference pages 479-480 for additional specifications and mechanism information.

HSLVSMUS



STOOL IN DESIGNER WHITE

Upholstered Back
Pneumatic
Swivel
Synchro-tilt
Tilt Tension
Tilt Lock

DIMENSIONS

Seat Depth: 19¼ Arm Width: 17½-20
Seat Width: 19 Cube: 10.8
Back Width: 18¼ Weight Rating: 300 lbs.
Back Height: 21½

FABRIC PRICE CODES

1	\$582	8	\$651
2	\$594	9	\$660
3	\$606	10	\$669
4	\$615	11	\$678
5	\$624	12	\$687
6	\$633	L	\$682
7	\$642		

OPEN MARKET

NOTES: Please reference pages 479-480 for additional specifications and mechanism information.

HON Recommendation: HSLVSMU.Y1.A.H.OS.COMF10.COMP10.NL.SB.T - List Price \$677

HOW TO SPECIFY

Select Model Number	Select Control Type	Select Arm Type	Select Caster/Glide	Select Back Color	Select Back Fabric	Select Seat Fabric	Select Lumbar	Select Base	Select Frame
	Y0 Synchro-Tilt Y1 Synchro-Tilt w/ Seat Slider (+\$20)	HSLVSMU Options N Armless F Fixed Arms (+\$65) A Height and Width Adjustable Arms (+\$75) V All-Adjustable Arms (includes pivot) (+\$115)	H Black Hard Caster S Black All-Surface Caster (+\$30) G Bell Glide (+\$25) R Black Roll Control Caster (+\$50)	OS Charcoal TI Titanium DW Designer White	COMF46 Bittersweet COMF10 Ink COMF82 Meadow COMF90 Midnight COMF22 Putty COMF19 Sterling	See page 480	NL No Lumbar BL Black Adjustable Lumbar (+\$30) BY Bullseye Adjustable Lumbar (+\$30) DW Designer White Adjustable Lumbar (+\$30) KT Krypton Adjustable Lumbar (+\$30) MR Ember Adjustable Lumbar (+\$30) RE Regatta Adjustable Lumbar (+\$30) TL Titanium Adjustable Lumbar (+\$30)	SB Standard Base	HSLVSMU Options T Black TI Titanium (+\$35)
		HSLVSMUS Options ADW Height and Width Adjustable Arms (+\$75) <i>Available for model HSLVSMUS only</i>							HSLVSMUS Options DW Designer White (+\$35) <i>Available for model HSLVSMUS only</i>
H S L V S M U	Y 1	A	H	O S	C O M F 1 0	C O M P 1 0	N L	S B	T

SEATING



HSLVTMMKD

MID-BACK TASK

DIMENSIONS

FABRIC PRICE CODES



- 4-Way Stretch Back**
- Pneumatic
- Swivel
- Synchro-tilt
- Tilt Tension
- Tilt Lock

- Seat Depth: 19¼
- Seat Width: 19
- Back Width: 18¼
- Back Height: 21½
- Arm Width: 17½-20
- Cube: 5.6
- Weight Rating: 300 lbs.

- 1 \$437**
- 2 \$449**
- 3 \$461**

NOTES: Please reference pages 479-480 for additional specifications and mechanism information.

HSLVTMRKD

MID-BACK TASK

DIMENSIONS

FABRIC PRICE CODES

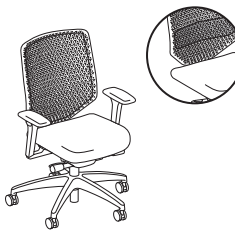

- ReActiv[®] Back**
- Pneumatic
- Swivel
- Synchro-tilt
- Tilt Tension
- Tilt Lock

- Seat Depth: 19¼
- Seat Width: 19
- Back Width: 18¼
- Back Height: 21½
- Arm Width: 17½-20
- Cube: 5.6
- Weight Rating: 300 lbs.

- 1 \$472**
- 2 \$484**
- 3 \$496**

NOTES: Please reference pages 479-480 for additional specifications and mechanism information.

HSLVTMUKD

MID-BACK TASK

DIMENSIONS

FABRIC PRICE CODES

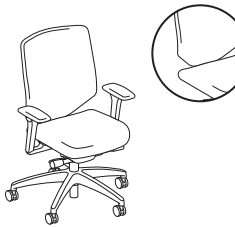

- Upholstered Back**
- Pneumatic
- Swivel
- Synchro-tilt
- Tilt Tension
- Tilt Lock

- Seat Depth: 19¼
- Seat Width: 19
- Back Width: 18¼
- Back Height: 21½
- Arm Width: 17½-20
- Cube: 5.6
- Weight Rating: 300 lbs.

- 1 \$485**
- 2 \$497**
- 3 \$509**

NOTES: Please reference pages 479-480 for additional specifications and mechanism information.

HON Recommendation: HSLVTMMKD.Y1.A.H.IM.CU__BL.SB.T - List Price \$562

HOW TO SPECIFY

Select Model Number	Select Control Type	Select Arm Type	Select Caster	Select Mesh Back	Select Back Color	Select Back Fabric	Select Seat Fabric	Select Lumbar	Select Base	Select Frame
	Y1 Synchro-Tilt w/ Seat Slider (+ \$20)	A Height and Width Adjustable Arms (+ \$75)	H Black Hard Caster	4-Way Stretch options IM Black <i>Specify for model HSLVTMMKD only</i>	OS Charcoal TI Titanium <i>Specify for models HSLVTMRKD and HSLVTMUKD only</i>	COMF46 Bittersweet COMF10 Ink COMF82 Meadow COMF90 Midnight COMF22 Putty COMF19 Sterling <i>Specify for model HSLVTMUKD only</i>	See page 480	NL No Lumbar BL Black Adjustable Lumbar (+ \$30)	SB Standard Base	T Black
HSLVTMMKD	Y1	A	H	IM			CU10	BL	SB	T
HSLVTMRKD	Y1	A	H		OS		CU10	BL	SB	T
HSLVTMUKD	Y1	A	H		OS	COMF46	CU10	BL	SB	T



HSLVLMBR

LUMBAR PACK

DIMENSIONS

LIST PRICE

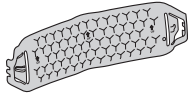

Ship Weight: 1
Cube: 0.2

\$34

HOW TO SPECIFY

Select Model Number

Select Color

- BY** Bullseye Adjustable Lumbar
- DW** Designer White Adjustable Lumbar
- KT** Krypton Adjustable Lumbar
- MR** Ember Adjustable Lumbar
- RE** Regatta Adjustable Lumbar
- T** Black
- TI** Titanium

H S L V L M B R . T

HSLVFAP

FIXED ARM PACK

DIMENSIONS

LIST PRICE



Ship Weight: 6
Cube: 1.0

\$113

HSLV2DAP

ADJUSTABLE ARM PACK

DIMENSIONS

LIST PRICE



Height and Width

Adjustable Arms Width: 17½-20
Height from Seat: 7¼-11¼
Ship Weight: 6
Cube: 1.0

\$123

HSLV4DAP

ALL-ADJUSTABLE ARM PACK

DIMENSIONS

LIST PRICE



Including Pivot

Ship Weight: 6
Cube: 1.0

\$166

HSCASTER

SET OF 5 ALL-SURFACE CASTERS

DIMENSIONS

LIST PRICE

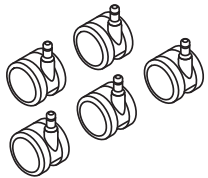

Size: 60mm
Ship Weight: 2
Cube: 0.1

\$51

ⓘ Available in Black finish only, no specification needed.

HOW TO SPECIFY

Select Model Number

Select Color

- T** Black
- TI** Titanium
- DW** Designer White (available on HSLV2DAP only)

H S L V 2 D A P . T

SOOTHE®



Soothe Guest
Chairs and Tables.

SOOTHE®

Soothe offers the comfort and versatility to support a variety of healthcare and waiting environments. This family of patient and guest seats are constructed from durable materials and thoughtfully designed to be easily cleaned. The entire collection maximizes comfort along the patient's journey to recovery, enhances functionality for the caregiver, and creates the versatility required to deliver a higher level of care. Soothe simply helps create happier patients and better caregivers.



FEATURES

- Select Charcoal Urethane or solid hardwood arms in one of eight finishes.
- Wipeout space at the back of the seat allows for easy maintenance.
- Model HHCP1 has a responsive design back that moves with the patient for added comfort.
- Bench seating is available in two-seat or three-seat options.
- Choose Textured Charcoal or Textured Satin Chrome frame.
- Dual fabric option offers endless color combinations.
- Chairs can be ganged together to create straight rows.
- Warranted for users up to 350 lbs. (Model HHCG50 bariatric chair warranted for 750 lbs.)

SOOTHE[®] Options

MODEL OPTIONS

HHCG11
HHCG11DF - Dual Fabric



Guest Chair

HHCG21
HHCG21DF - Dual Fabric

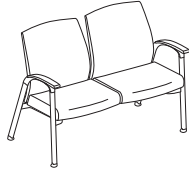

Two-Seat Chair

HHCG50
HHCG50DF - Dual Fabric

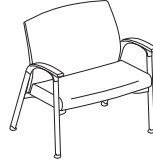

Bariatric Chair

HHCP1
HHCP1DF - Dual Fabric



High-Back Patient Chair

HHCGB21

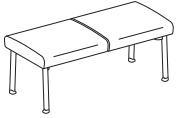

Two-Seat Bench

HHCGB31

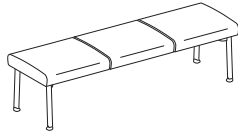

Three-Seat Bench

FINISH	CODE	DESCRIPTION	PRICE	FRAME	CODE	DESCRIPTION	PRICE
	S	Charcoal Urethane	+\$0		GRADE P1		
	H	Bourbon Cherry	+\$100		P6P	Textured Black Mica	+\$0
	F	Shaker Cherry	+\$100		PK7	Textured Designer White	+\$0
	C	Harvest	+\$100		P7A	Textured Charcoal	+\$0
	D	Natural Maple	+\$100		P7J	Textured Brownstone	+\$0
	N	Mahogany	+\$100		P7L	Textured Loft	+\$0
	MOCH	Mocha	+\$100		P7M	Textured Muslin	+\$0
	COGN	Cognac	+\$100		P8V	Textured Titanium	+\$0
	PINC	Pinnacle	+\$100		GRADE P2		
	LKI1	Kingswood Walnut	+\$100		PR8	Textured Silver	+\$0
	LFW1	Florence Walnut	+\$100				

HON BRANDED FABRICS

GRADE 1

Apex
Attire
Centurion
Compass
Contourett
Dapper
Ensemble
Hamilton
Inertia
Optic
Pebble

GRADE 2

Appoint Seating
Blume
Clyde
Dotty
Rush
Seed
Spin Seating
Whisper Vinyl

GRADE 3

In Season
Moxie
Parker
Purl
Quill

For a complete list of fabrics, including partnership fabrics, go to hon.com/fabricsandfinishes.

Reference Fabric Color Combinations on pages 20-24 for color codes and legend on page 21 for lead times. For Fire Code and Moisture Barrier model availability and ordering method, refer to pages 248-251. For additional HON to Supply COM fabric grade pricing, go to honready.hon.com and click on the HON to Supply COM link.

 For Fire Code model, availability and ordering method, refer to pages 248-251. Available on select models, contact HON Customer Support for availability.

DUAL FABRIC COM YARDAGE

Due to fabric pattern nesting and potential reduction of fabric yield, some dual fabric models may require more total yardage than standard models.

	SEAT	BACK
HHCG11DF	1.4 yd	1.5 yd
HHCG21DF	1.7 yd	2.3 yd
HHCG50DF	1.4 yd	2.3 yd
HHCP1DF	1.4 yd	1.9 yd

SOOTHE[®]

Table Finish Options

AVAILABLE FINISHES

Soothe[®] Tables are available in 14 laminate colors. Each laminate has a specific selection of edges available.

LAMINATE TOP COLORS	EDGE BAND COLORS
Designer White (LDW1)	Designer White (DW)
Charcoal (S)	Charcoal (S)
Silver Mesh (B9)	Loft (LOFT)
Bourbon Cherry (H)	Bourbon Cherry (H), Muslin (T), White (DW)
Mahogany (N)	Mahogany (N), Loft (LOFT)
Natural Maple (D)	Natural Maple (D), Muslin (T), White (DW), Loft (LOFT)
Shaker Cherry (F)	Shaker Cherry (F), Muslin (T), White (DW), Loft (LOFT)
Harvest (C)	Harvest (C), Muslin (T), White (DW), Loft (LOFT)
Cognac (COGN)	Cognac (COGN), Muslin (T), White (DW)
Mocha (MOCH)	Mocha (MOCH), Muslin (T), White (DW), Loft (LOFT)
Pinnacle (PINC)	Pinnacle (PINC), Muslin (T), White (DW), Loft (LOFT)
Florence Walnut (LFW1)	Florence Walnut (FW)
Kingswood Walnut (LK11)	Kingswood Walnut (KI)
Sterling Ash (LSA1)	Sterling Ash (SA)



Icon Legend on page 19

HHCG11

GUEST CHAIR



DIMENSIONS

Depth:	27	Arm Width:	20½
Width:	25½	Seat to Floor Height:	18⅞
Height:	35	Usable Seat Depth:	18
Seat Depth:	18	Ship Weight:	55
Seat Width:	21½	Cube:	14.9
Back Width:	21	COM:	2.0
Back Height:	20½	Weight Rating:	350 lbs.

FABRIC PRICE CODES

1	\$1051	8	\$1327
2	\$1051	9	\$1363
3	\$1147	10	\$1399
4	\$1183	11	\$1435
5	\$1219	12	\$1471
6	\$1255	L	—
7	\$1291		

HHCG21

TWO-SEAT CHAIR

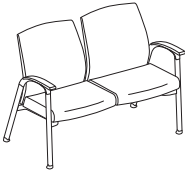

Outside Arms

DIMENSIONS

Depth:	27	Arm Width:	42¾
Width:	48	Seat to Floor Height:	18⅞
Height:	35	Usable Seat Depth:	18
Each Seat Depth:	18	Ship Weight:	109
Each Seat Width:	21½	Cube:	33.8
Each Back Width:	21	COM:	3.4
Each Back Height:	20¼	Weight Rating:	350 lbs.

FABRIC PRICE CODES

1	\$1738	8	\$2221
2	\$1822	9	\$2284
3	\$1906	10	\$2347
4	\$1969	11	\$2410
5	\$2032	12	\$2473
6	\$2095	L	—
7	\$2158		

HHCG50

BARIATRIC CHAIR



DIMENSIONS

Depth:	26	Arm Width:	29½
Width:	34½	Seat to Floor Height:	18⅞
Height:	35	Usable Seat Depth:	18
Seat Depth:	18	Ship Weight:	80
Seat Width:	30½	Cube:	25.1
Back Width:	30	COM:	3.0
Back Height:	20½	Weight Rating:	750 lbs.

FABRIC PRICE CODES

1	\$1320	8	\$1803
2	\$1404	9	\$1866
3	\$1488	10	\$1929
4	\$1551	11	\$1992
5	\$1614	12	\$2055
6	\$1677	L	—
7	\$1740		

! HHCG50 is a Single Seat Bariatric chair warranted to 750 lbs.

HHCP1

HIGH-BACK PATIENT CHAIR

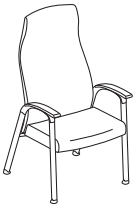

DIMENSIONS

Depth:	27	Arm Width:	20½
Width:	25½	Seat to Floor Height:	18⅞
Height:	46½	Usable Seat Depth:	18
Seat Depth:	18	Ship Weight:	61
Seat Width:	21½	Cube:	19.1
Back Width:	21	COM:	2.4
Back Height:	32	Weight Rating:	350 lbs.

FABRIC PRICE CODES

1	\$1172	8	\$1655
2	\$1256	9	\$1718
3	\$1340	10	\$1781
4	\$1403	11	\$1844
5	\$1466	12	\$1907
6	\$1529	L	—
7	\$1592		

! Only available in Moxie and In Season under HON's Standard Fabric. Healthcare Grade Partnership Fabrics are available. For a complete list, please visit the Fabrics and Finishes page at HON.com.

OPEN MARKET

HOW TO SPECIFY

<p>Select Model Number</p> <p>HHCG11</p>	<p>Select Finish</p> <p>S Charcoal Urethane H Bourbon Cherry (+ \$100) F Shaker Cherry (+ \$100) C Harvest (+ \$100) D Natural Maple (+ \$100) N Mahogany (+ \$100) MOCH Mocha (+ \$100) COGN Cognac (+ \$100) PINC Pinnacle (+ \$100) LK11 Kingswood Walnut (+ \$100) LFW1 Florence Walnut (+ \$100)</p> <p>S</p>	<p>Select Fabric</p> <p>See page 491</p> <p>A190</p>	<p>Select Frame</p> <p>See page 491</p> <p>PR8</p>
---	---	---	---

SOOTHE® Dual Fabric

GSA SIN 33721



Icon Legend on page 19

HHCG11DF



GUEST CHAIR

Dual Fabric

DIMENSIONS

Depth:	27	Arm Width:	20½
Width:	25½	Seat to Floor Height:	18⅞
Height:	35	Usable Seat Depth:	18
Seat Depth:	18	Ship Weight:	55
Seat Width:	21½	Cube:	14.9
Back Width:	21	COM:	See page 491
Back Height:	20½	Weight Rating:	350 lbs.

FABRIC PRICE CODES

1 **\$1134**

Add to Base Price Above

	Back	Seat
2	\$24	\$24
3	\$48	\$48
4	\$66	\$66
5	\$84	\$84
6	\$102	\$102
7	\$120	\$120
8	\$138	\$138
9	\$156	\$156
10	\$174	\$174
11	\$192	\$192
12	\$210	\$210

NOTES: For dual fabric models, start with the base price, then add the additional amount for the back and seat from the corresponding matrix to determine final price. Choose any combination of fabric grades for back and seat. See examples below:
HHCG11DF base price (\$1134) + Grade 2 back fabric (add \$24) + Grade 4 seat fabric (add \$66) = Total \$1224 List

HHCG21DF

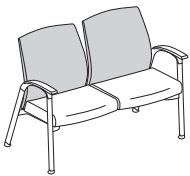

TWO-SEAT CHAIR

Dual Fabric
Outside Arms

DIMENSIONS

Depth:	27	Arm Width:	42¾
Width:	48	Seat to Floor Height:	18⅞
Height:	35	Usable Seat Depth:	18
Each Seat Depth:	18	Ship Weight:	109
Each Seat Width:	21½	Cube:	33.8
Each Back Width:	21	COM:	See page 491
Each Back Height:	20¼	Weight Rating:	350 lbs.

FABRIC PRICE CODES

1 **\$1820**

Add to Base Price Above

	Back	Seat
2	\$48	\$36
3	\$96	\$72
4	\$132	\$99
5	\$168	\$126
6	\$203	\$154
7	\$239	\$181
8	\$275	\$208
9	\$311	\$235
10	\$347	\$262
11	\$383	\$289
12	\$419	\$316

NOTES: For dual fabric models, start with the base price, then add the additional amount for the back and seat from the corresponding matrix to determine final price. Choose any combination of fabric grades for back and seat. See examples below:
HHCG21DF base price (\$1820) + Grade 2 back fabric (add \$48) + Grade 4 seat fabric (add \$99) = Total \$1967 List

HOW TO SPECIFY

<p>Select Model Number</p>	<p>Select Finish</p> <p>S Charcoal Urethane H Bourbon Cherry (+ \$100) F Shaker Cherry (+ \$100) C Harvest (+ \$100) D Natural Maple (+ \$100) N Mahogany (+ \$100) MOCH Mocha (+ \$100) COGN Cognac (+ \$100) PINC Pinnacle (+ \$100) LK11 Kingswood Walnut (+ \$100) LFW1 Florence Walnut (+ \$100)</p>	<p>Select Back Fabric</p> <p>See page 491</p>	<p>Select Seat Fabric</p> <p>See page 491</p>	<p>Select Frame</p> <p>See page 491</p>
<p>HHCG11DF .</p>	<p>S .</p>	<p>A190 .</p>	<p>RS14 .</p>	<p>PR8</p>



SOOTHE® Dual Fabric

HHCG50DF

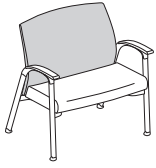

SIN 33721

BARIATRIC CHAIR

Dual Fabric

DIMENSIONS

Depth:	26	Arm Width:	29½
Width:	34½	Seat to Floor Height:	18⅝
Height:	35	Usable Seat Depth:	18
Seat Depth:	18	Ship Weight:	80
Seat Width:	30½	Cube:	25.1
Back Width:	30	COM:	See page 491
Back Height:	20½	Weight Rating:	750 lbs.

FABRIC PRICE CODES

1	\$1402	
<i>Add to Base Price Above</i>		
	Back	Seat
2	\$48	\$36
3	\$96	\$72
4	\$132	\$99
5	\$168	\$126
6	\$203	\$154
7	\$239	\$181
8	\$275	\$208
9	\$311	\$235
10	\$347	\$262
11	\$383	\$289
12	\$419	\$316

NOTES: For dual fabric models, start with the base price, then add the additional amount for the back and seat from the corresponding matrix to determine final price. Choose any combination of fabric grades for back and seat. See examples below:

HHCG50DF base price (\$1402) + Grade 2 back fabric (add \$48) + Grade 4 seat fabric (add \$99) = Total \$1549 List

! HHCG50DF is a Single Seat Bariatric chair warranted to 750 lbs.

HHCP1DF

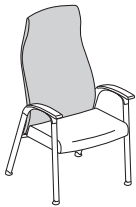

OPEN MARKET

HIGH-BACK PATIENT CHAIR

Dual Fabric

DIMENSIONS

Depth:	27	Arm Width:	20½
Width:	25½	Seat to Floor Height:	18⅝
Height:	46½	Usable Seat Depth:	18
Seat Depth:	18	Ship Weight:	61
Seat Width:	21½	Cube:	19.1
Back Width:	21	COM:	See page 491
Back Height:	32	Weight Rating:	350 lbs.

FABRIC PRICE CODES

1	\$1253	
<i>Add to Base Price Above</i>		
	Back	Seat
2	\$60	\$24
3	\$119	\$49
4	\$164	\$67
5	\$209	\$85
6	\$253	\$104
7	\$298	\$122
8	\$343	\$140
9	\$388	\$158
10	\$432	\$177
11	\$477	\$195
12	\$522	\$213

NOTES: For dual fabric models, start with the base price, then add the additional amount for the back and seat from the corresponding matrix to determine final price. Choose any combination of fabric grades for back and seat. See examples below:

HHCP1DF base price (\$1253) + Grade 2 back fabric (add \$60) + Grade 4 seat fabric (add \$67) = Total \$1380 List

! Only available in Moxie and In Season under HON's Standard Fabric. Healthcare Grade Partnership Fabrics are available. For a complete list, please visit the Fabrics and Finishes page at HON.com.

HOW TO SPECIFY

<p>Select Model Number</p>	<p>Select Finish</p> <p>S Charcoal Urethane H Bourbon Cherry (+ \$100) F Shaker Cherry (+ \$100) C Harvest (+ \$100) D Natural Maple (+ \$100) N Mahogany (+ \$100) MOCH Mocha (+ \$100) COGN Cognac (+ \$100) PINC Pinnacle (+ \$100) LK11 Kingswood Walnut (+ \$100) LFW1 Florence Walnut (+ \$100)</p>	<p>Select Back Fabric</p> <p>See page 491</p>	<p>Select Seat Fabric</p> <p>See page 491</p>	<p>Select Frame</p> <p>See page 491</p>
<p>HHCG50DF</p>	<p>S</p>	<p>A190</p>	<p>RS14</p>	<p>PR8</p>



HHCGB21

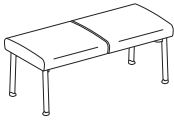

TWO-SEAT BENCH

DIMENSIONS

Depth:	20½	Seat to Floor Height:	17¾
Width:	44	Usable Seat Depth:	17¼
Height:	18¾	Ship Weight:	55
Seat Width:	22	Cube:	18.4
		COM:	1.9
		Weight Rating:	350 lbs.

FABRIC PRICE CODES

1	\$1260	8	\$1467
2	\$1296	9	\$1494
3	\$1332	10	\$1521
4	\$1359	11	\$1548
5	\$1386	12	\$1575
6	\$1413	L	—
7	\$1440		

ⓘ Benches cannot be ganged.

HHCGB31

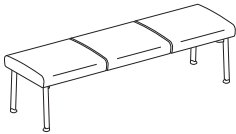

THREE-SEAT BENCH

DIMENSIONS

Depth:	20½	Seat to Floor Height:	17¾
Width:	66	Usable Seat Depth:	17¼
Height:	18¾	Ship Weight:	69
Seat Width:	22	Cube:	25.7
		COM:	2.6
		Weight Rating:	350 lbs.

FABRIC PRICE CODES

1	\$1621	8	\$1828
2	\$1657	9	\$1855
3	\$1693	10	\$1882
4	\$1720	11	\$1909
5	\$1747	12	\$1936
6	\$1774	L	—
7	\$1801		

ⓘ Benches cannot be ganged.

HOW TO SPECIFY

Select Model Number

HHCGB21 .

Select Fabric

See page 491

RS14 .

Select Frame

See page 491

PR8



HHCTS



IN-LINE TABLE TOP

DIMENSIONS

Depth:	22	Ship Weight:	8
Width:	16	Cube:	1.7
Height:	1½		

LIST PRICE

\$355

NOTES: Can be ganged between two chairs or freestanding.

HHCTC



90-DEGREE RADIUS CORNER TABLE TOP

DIMENSIONS

Depth:	29	Ship Weight:	15
Width:	29	Cube:	2.4
Height:	1½		

LIST PRICE

\$445

! Freestanding only.

HHCTRT



RECTANGLE TABLE TOP

DIMENSIONS

Depth:	22	Ship Weight:	20
Width:	40	Cube:	2.7
Height:	1½		

LIST PRICE

\$592

! Freestanding only.

HHCTL4

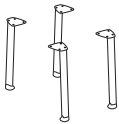

TABLE LEGS

Set of 4

DIMENSIONS

Ship Weight:	8
Cube:	0.4

LIST PRICE

\$239

NOTES: Can be attached to any of the table tops above to create a freestanding table.

HOW TO SPECIFY

Select Model Number	Select Laminate and Edge See page 492
HHCTS.	DWHIT

HOW TO SPECIFY

Select Model Number	Select Frame Color See page 491
HHCTL4.	PR8



HHCGBRCH

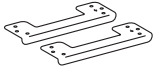

GANGING BRACKET

DIMENSIONS

Ship Weight: 2
Cube: 0.2

LIST PRICE

\$80

NOTES: For chair to chair connection. Does not connect a bench to other type of seating. Ganging brackets can be used with the seating models on pages 493-495. Bench models do not gang. Brackets are Charcoal only.

HHCGBR

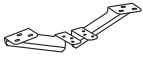

GANGING BRACKET

DIMENSIONS

Ship Weight: 5
Cube: 0.2

LIST PRICE

\$118

NOTES: For chair to table connection. Ganging brackets can be used with the seating models on pages 493-495. Bench models do not gang. Brackets are Charcoal only.

HOW TO SPECIFY

Select
Model Number

H H C G B R C H



Icon Legend on page 19

TILT™ Active Seating

HVL951



MID-BACK

360° Motion
Pneumatic
Swivel
Tilt

Functions: **A, E, F, K, L**
(Function Key on pages 244-245)

DIMENSIONS

Depth:	25 ⁵ / ₈	Seat to Floor Height:	17 ⁷ / ₈ -21 ¹ / ₂
Width:	26 ¹ / ₄	Usable Seat Depth:	18 ¹ / ₈
Height:	39 ³ / ₄	Ship Weight:	36
Seat Depth:	18 ⁷ / ₈	Cube:	5.3
Seat Width:	19 ¹ / ₈	Weight Rating:	250 lbs.
Back Width:	18 ¹ / ₄		

PRICE CODE

Fabric **\$589**

NOTES: Model HVL951 is a mesh-back task chair with an active pivoting 5-star base. Armless. Chrome base cap. Black frame. **HON 5-Year Limited Warranty.**

HON Recommendation: HVL951.ES10.T - List Price \$589

SEATING

HOW TO SPECIFY

<p>Select Model Number</p> <p>H V L 9 5 1 .</p>	<p>Select Fabric</p> <p>ES10 Black</p> <p>E S 1 0 .</p>	<p>Select Frame</p> <p>T Black</p> <p>T</p>
---	---	---

TOPFLIGHT™ Wood Seating

OPEN MARKET



Icon Legend on page 19

HVL844



HIGH-BACK

Pneumatic
Swivel
Tilt
Tilt Tension
Tilt Lock
Fixed Padded Wood Arms and Base

Functions: **A, E, F, K, L**
(Function Key on pages 244-245)

DIMENSIONS

Depth:	30	Arm Width:	20¼
Width:	28	Seat to Floor Height:	17 ³ / ₁₆ -21 ¹ / ₁₆
Height:	47 ⁵ / ₁₆	Usable Seat Depth:	17½
Seat Depth:	18½	Ship Weight:	58
Seat Width:	20½	Cube:	6.4
Back Width:	20½	Weight Rating:	250 lbs.
Back Height:	27½		

PRICE CODE

Leather **\$707**

NOTES: Wood accents available in Mahogany. High-back design. SofThread™ Leather. Tailored padded back design provides strong lumbar support. Fixed padded loop arms. Use with coordinated Guest Chair models HVL852 and HVL853 shown below. **HON 5-Year Limited Warranty.**

HON Recommendation: HVL844.N.SB11 - List Price \$707

HVL852



GUEST CHAIR

Leg Base
Arms
Upholstered Back
Wood Frame

DIMENSIONS

Depth:	22	Arm Width:	20
Width:	22½	Seat to Floor Height:	18½
Height:	31	Usable Seat Depth:	17
Seat Depth:	17	Ship Weight:	26
Seat Width:	20	Cube:	3.4
Back Width:	20	Weight Rating:	250 lbs.
Back Height:	13		

PRICE CODE

Leather **\$443**

NOTES: Wood frames available in Mahogany. Black SofThread™ Leather inset in back and on seat. Black SofThread™ Leather. Easier assembly – seat now attached to frame. **HON 5-Year Limited Warranty.**

HON Recommendation: HVL852.N.SB11 - List Price \$443

HVL853

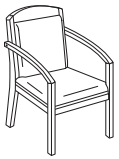

GUEST CHAIR

Leg Base
Arms
Upholstered Back
Wood Frame

DIMENSIONS

Depth:	23¾	Arm Width:	20¼
Width:	23¾	Seat to Floor Height:	19½
Height:	36¾	Usable Seat Depth:	18¼
Seat Depth:	18¼	Ship Weight:	35
Seat Width:	22	Cube:	6.9
Back Width:	18½	Weight Rating:	250 lbs.
Back Height:	15¼		

PRICE CODE

Leather **\$537**

NOTES: Wood frames available in Mahogany. Black SofThread™ Leather on fully-upholstered back panel and on seat. High-back design. **HON 5-Year Limited Warranty.**

HON Recommendation: HVL853.N.SB11 - List Price \$537

SEATING

HOW TO SPECIFY

<p>Select Model Number</p> <p>H V L 8 4 4 .</p>	<p>Select Wood Finish</p> <p>N Mahogany</p> <p>N .</p>	<p>Select Fabric</p> <p>SB11 Black SofThread™ Leather</p> <p>S B 1 1</p>
--	---	---



TORCH™ Mesh Chairs

HVL511



MID-BACK

Pneumatic
Swivel
Tilt
Tilt Tension
Tilt Lock
Fixed Arms

Functions: **A, E, F, K, L**
(Function Key on pages 244-245)

DIMENSIONS

Depth:	26	Arm Width:	18¾
Width:	26	Seat to Floor Height:	16⅝-20⅝
Height:	40½	Usable Seat Depth:	18¾
Seat Depth:	18¾	Ship Weight:	30
Seat Width:	19½	Cube:	3.8
Back Width:	17¾	Weight Rating:	250 lbs.
Back Height:	21¾		

PRICE CODE

Fabric **\$295**

NOTES: Mid-back Mesh chair. Comfortable and breathable mesh back. Black fabric seat. Black frame. Fixed arms. **HON 5-Year Limited Warranty.**

HON Recommendation: HVL511.LH10 - List Price \$295

HVL515

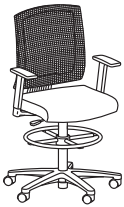

TASK STOOL

Pneumatic
Swivel
Fixed Arms

Functions: **A, E**
(Function Key on pages 244-245)

DIMENSIONS

Depth:	26	Arm Width:	18¾
Width:	26	Seat to Floor Height:	23⅝-33
Height:	52	Usable Seat Depth:	18¾
Seat Depth:	18¾	Ship Weight:	38
Seat Width:	19½	Cube:	4.6
Back Width:	17¾	Weight Rating:	250 lbs.
Back Height:	21¾		

PRICE CODE

Fabric **\$412**

NOTES: Comfortable and breathable mesh back. Black fabric seat. Fixed arms. **HON 5-Year Limited Warranty.**

HON Recommendation: HVL515.LH10 - List Price \$412

HOW TO SPECIFY

Select Model Number	Select Fabric
	LH10 Black Fabric
H V L 5 1 1 .	L H 1 0

TRACTION™ Executive Chairs

OPEN MARKET



Icon Legend on page 19

HVL103



HIGH-BACK

Pneumatic
Swivel
Tilt
Tilt Tension
Tilt Lock
Fixed Padded Arms

Functions: **A, E, F, K, L**
(Function Key on pages 244-245)

DIMENSIONS

Depth:	28 ³ / ₄	Arm Width:	18 ⁷ / ₈
Width:	26 ³ / ₄	Seat to Floor Height:	17 ¹ / ₄ -21
Height:	42 ¹ / ₂	Usable Seat Depth:	18 ¹ / ₄
Seat Depth:	18 ¹ / ₄	Ship Weight:	36.0
Seat Width:	19 ¹ / ₂	Cube:	4.1
Back Width:	19 ¹ / ₂	Weight Rating:	250 lbs.
Back Height:	24 ⁷ / ₈		

PRICE CODE

Leather \$455

NOTES: Black SofThread™ Leather. Red SofThread™ and White SofThread™ Leather options. Polished base. Fixed, padded arms. **HON 5-Year Limited Warranty.**

HON Recommendation: HVL103.SB11 - List Price \$455

HVL102



HIGH-BACK MODERN GUEST CHAIR

Padded Arms
Cantilever Base

DIMENSIONS

Depth:	27 ¹¹ / ₆₄	Arm Width:	18 ⁴⁵ / ₆₄
Width:	20 ⁵ / ₆₄	Seat to Floor Height:	18 ²⁹ / ₃₂
Height:	39 ³ / ₈	Usable Seat Depth:	18 ⁷ / ₆₄
Seat Depth:	18 ⁷ / ₆₄	Ship Weight:	36.8
Seat Width:	19 ¹¹ / ₁₆	Cube:	4.4
Back Width:	18 ²⁹ / ₃₂	Weight Rating:	250 lbs.
Back Height:	24 ³⁹ / ₆₄		

PRICE CODE

Leather \$343

NOTES: Black SofThread™ Leather. Polished, cantilever base. Padded arms. **HON 5-Year Limited Warranty.**

HON Recommendation: HVL102.SB11 - List Price \$343

HOW TO SPECIFY

Select Model Number

HVL103

Select Fabric

- SB11** Black SofThread™ Leather
Specify for models HVL102 and HVL103 only
- SB06** White SofThread™ Leather
Specify for model HVL103 only
- SB42** Red SofThread™ Leather
Specify for model HVL103 only

SB11



HVL604



HIGH-BACK

Pneumatic
Swivel
Tilt
Tilt Tension
Tilt Lock
Fixed Arms

Functions: **A, E, F, K, L, T**
(Function Key on pages 244-245)

DIMENSIONS

Depth:	26½	Arm Width:	20½
Width:	25	Seat to Floor Height:	16¼-20¾
Height:	46½	Usable Seat Depth:	18¾
Seat Depth:	18¾	Ship Weight:	40
Seat Width:	19¾	Cube:	4.1
Back Width:	20	Weight Rating:	250 lbs.
Back Height:	26½		

PRICE CODE

Leather \$292

NOTES: Available in Black SofThread™ Leather SB11. High-back Executive Chair. Black frame. Fixed, tapered loop arms. Coordinating guest chair HVL605. **HON 5-Year Limited Warranty.**

ⓘ Available in Black SofThread™ Leather SB11 only.

HON Recommendation: HVL604.SB11 - List Price \$292

HVL605



GUEST CHAIR

Leg Base
Arms
Stacks up to Four High

DIMENSIONS

Depth:	24	Arm Width:	19½
Width:	23½	Seat to Floor Height:	18½
Height:	34½	Usable Seat Depth:	17½
Seat Depth:	17½	Ship Weight:	22.2
Seat Width:	18½	Cube:	3.0
Back Width:	18½	Weight Rating:	250 lbs.
Back Height:	17¾		

PRICE CODE

Leather \$280

NOTES: Validate™ HVL605 Guest Chair. Waterfall seat edge. Wall-saver design. Fixed arms. Stackable up to 4-high. Contemporary rectilinear steel frame in Matte Black. Use with coordinating Executive Chair model HVL604. **HON 5-Year Limited Warranty.**

HON Recommendation: HVL605.SB11 - List Price \$280

HVL685



HIGH-BACK

Pneumatic
Swivel
Tilt Tension
Tilt Lock
Fixed Padded Arms

Functions: **A, E, K, L**
(Function Key on pages 244-245)

DIMENSIONS

Depth:	32	Back Height:	28½
Width:	27½	Seat to Floor Height:	18¾-21¾
Height:	45	Usable Seat Depth:	20
Seat Depth:	20	Ship Weight:	67
Seat Width:	22¼	Cube:	9.5
Back Width:	21	Weight Rating:	450 lbs.

PRICE CODE

Leather \$942

NOTES: Large scale model HVL685 will support up to 450 lbs with normal use. Available in Black SofThread™ Leather SB11. **HON 5-Year Limited Warranty.**

HON Recommendation: HVL685.SB11 - List Price \$942

HOW TO SPECIFY

Select Model Number	Select Fabric
	SB11 Black SofThread™ Leather
H V L 6 0 4 .	S B 1 1



Icon Legend on page 19

VALUTASK®

HVL205



LOW-BACK

Pneumatic
Swivel
Tilt
Tilt Tension
Tilt Lock

DIMENSIONS

Depth:	23	Back Height:	18
Width:	23	Seat to Floor Height:	15¼-19¼
Height:	39½	Usable Seat Depth:	18
Seat Depth:	18	Ship Weight:	29
Seat Width:	19	Cube:	3.2
Back Width:	18	Weight Rating:	250 lbs.

PRICE CODE

Mesh **\$254**

NOTES: Comfortable and breathable mesh back. Black Sandwich Mesh seat. Black frame. **HON 5-Year Limited Warranty.**

HON Recommendation: HVL205.MM10.T - List Price \$254

HVL210



TASK LOW-BACK

Pneumatic
Swivel
Tilt
Tilt Tension
Tilt Lock
Functions: **A, E, F, K, L**
(Function Key on pages 244-245)

DIMENSIONS

Depth:	33½	Back Height:	20¼
Width:	24½	Seat to Floor Height:	17-20½
Height:	38¼	Usable Seat Depth:	17¾
Seat Depth:	17¾	Ship Weight:	31
Seat Width:	19¾	Cube:	3.6
Back Width:	19¾	Weight Rating:	250 lbs.

PRICE CODE

Sandwich Mesh **\$242**

NOTES: Black Sandwich Mesh. Sturdy textured black frame. HVL995 optional arm pack available. **HON 5-Year Limited Warranty.**

HON Recommendation: HVL210.MM10 - List Price \$242

HVL215

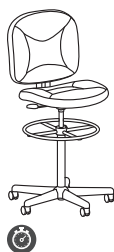

TASK STOOL

Pneumatic
Swivel
Functions: **A, E**
(Function Key on pages 244-245)

DIMENSIONS

Depth:	33½	Back Height:	19
Width:	24½	Seat to Floor Height:	24½-33½
Height:	51⅞	Usable Seat Depth:	17¾
Seat Depth:	17¾	Ship Weight:	37
Seat Width:	19¾	Cube:	5.7
Back Width:	19¾	Weight Rating:	250 lbs.

PRICE CODE

Sandwich Mesh **\$337**

NOTES: Black Sandwich Mesh. Sturdy textured black frame. HVL995 optional arm pack available. **HON 5-Year Limited Warranty.**

HON Recommendation: HVL215.MM10 - List Price \$337

HVL995

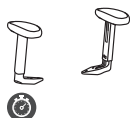

HEIGHT-ADJUSTABLE ARMS

Functions: **Q**
(Function Key on pages 244-245)

DIMENSIONS

Adjustable Arms Width:	18¾
Height from Seat:	8-11
Ship Weight:	7
Cube:	0.6

LIST PRICE

\$100

NOTES: Arm color is black. Height-adjustable. Compatible with HVL205, HVL210, and HVL215. **HON 5-Year Limited Warranty.**

HON Recommendation: HVL995 - List Price \$100

SEATING

HOW TO SPECIFY

<p>Select Model Number</p> <p>H V L 2 0 5 .</p>	<p>Select Fabric</p> <p>MM10 Black Sandwich Mesh Fabric</p> <p>M M 1 0 .</p>	<p>Select Frame</p> <p>T Black Specify frame color for model HVL205 only</p> <p>T</p>
--	---	--

VERSANT® TANDEM



Versant® Tandem Seating and Laminate Occasional Tables.

VERSANT® TANDEM

Everyone deserves a break from time to time, and a comfy seat in which to enjoy one. Bring stylish support to your welcome areas, public spaces and break rooms with Versant. With a combination of tandem seats and bariatric chairs, it's ideal for both healthcare environments and offices. Arched arms support the upper body and padded seats put people at ease for longer periods of time. Versant brings versatility to every corner of your space.



FEATURES

- Stylish arched arm offers greater upper body support.
- Seats are removable for easy cleaning and replacement.
- Contrasting covers are available as special order (please contact customer service).
- Solid hardwood in one of eight attractive finishes.
- Available in hundreds of quality HON fabrics.
- Warranted for users up to 350 lbs. (Model HHCB50 is warranted for users up to 500 lbs.)

VERSANT[®] Tandem Options

MODEL OPTIONS

HHB02

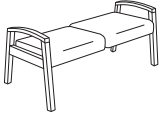

Two-Seat Bench

HHB03

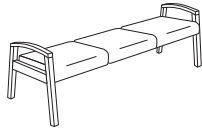

Three-Seat Bench

HHCT01

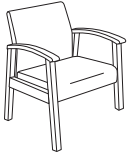

Single Seat

Leg Base, Arms

HHCT02

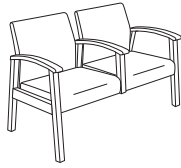

Two-Seat

Leg Base, Center Arm, Arms

HHCT12

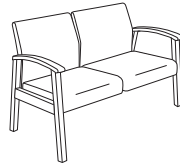

Two-Seat

Leg Base, Arms

HHCB50

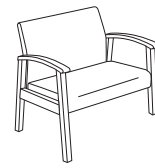

Bariatric Chair

Leg Base, Arms

AVAILABLE FINISHES

Versant® Tandem Seating is available in 8 wood finishes.

WOOD FINISHES

Bourbon Cherry (H)

Cognac (COGN)

Harvest (C)

Mahogany (N)

Mocha (MOCH)

Natural Maple (D)

Pinnacle (PINC)

Shaker Cherry (F)

HON BRANDED FABRICS

GRADE 1

Apex
Attire
Centurion
Contourett
Dapper
Ensemble
Hamilton
Inertia
Optic
Pebble

GRADE 2

Appoint Seating
Blume
Clyde
Dotty
Rush
Seed
Spin Seating
Whisper Vinyl

GRADE 3

In Season
Moxie
Parker
Purl
Quill

For a complete list of fabrics, including partnership fabrics, go to hon.com/fabricsandfinishes.

Reference Fabric Color Combinations on pages 20-24 for color codes and legend on page 21 for lead times. Contrasting covers on seat and back are available as special order. Please contact Customer Service. For additional HON to Supply COM fabric grade pricing, go to honready.hon.com and click on the HON to Supply COM link.

 For Fire Code model, availability and ordering method, refer to pages 248-251. Available on select models, contact HON Customer Support for availability.

AVAILABLE LAMINATES

Versant® Tandem Laminate Occasional Tables are available in 8 laminates.

LAMINATES

Bourbon Cherry (H)

Cognac (COGN)

Harvest (C)

Mahogany (N)

Mocha (MOCH)

Natural Maple (D)

Pinnacle (PINC)

Shaker Cherry (F)



VERSANT® TANDEM

HHB02

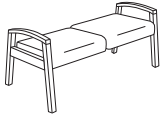

TWO-SEAT BENCH

DIMENSIONS

Depth:	20 ³ / ₈	Seat to Floor Height:	19 ¹ / ₂
Width:	45 ¹ / ₂	Usable Seat Depth:	19 ³ / ₄
Height:	23	Ship Weight:	62
Each Seat Depth:	20 ³ / ₈	Cube:	16.2
Each Seat Width:	21 ¹ / ₂	COM:	2.0
Arm Width:	42 ¹ / ₂	Weight Rating:	350 lbs. (per seat)

FABRIC PRICE CODES

1	\$1704	8	\$1980
2	\$1752	9	\$2016
3	\$1800	10	\$2052
4	\$1836	11	\$2088
5	\$1872	12	\$2124
6	\$1908	L	\$2104
7	\$1944		

HHB03

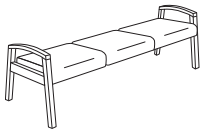

THREE-SEAT BENCH

DIMENSIONS

Depth:	20 ³ / ₈	Seat to Floor Height:	19 ¹ / ₂
Width:	66 ¹ / ₂	Usable Seat Depth:	19 ³ / ₄
Height:	23	Ship Weight:	80
Each Seat Depth:	20 ³ / ₈	Cube:	24.5
Each Seat Width:	21 ¹ / ₂	COM:	2.5
Arm Width:	63 ¹ / ₂	Weight Rating:	350 lbs. (per seat)

FABRIC PRICE CODES

1	\$2190	8	\$2535
2	\$2250	9	\$2580
3	\$2310	10	\$2625
4	\$2355	11	\$2670
5	\$2400	12	\$2715
6	\$2445	L	\$2690
7	\$2490		

HON Recommendation: HHB02.MOCH.SX__ - List Price \$1800

HOW TO SPECIFY

<p>Select Model Number</p> <p>HHB02</p>	<p>Select Finish</p> <p>See page 507</p> <p>MOCH</p>	<p>Select Seat Fabric</p> <p>See page 507</p> <p>SX05</p>
--	---	--

VERSANT® TANDEM

Laminate Occasional Tables

OPEN MARKET



Icon Legend on page 19

HHCT048

COFFEE TABLE

DIMENSIONS

Length: 48 Ship Weight: 44
 Width: 20 Cube: 3.0
 Height: 17

LIST PRICE

\$690

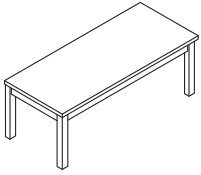

HHCT024

CORNER TABLE

DIMENSIONS

Length: 24 Ship Weight: 20
 Width: 24 Cube: 1.4
 Height: 17

LIST PRICE

\$577

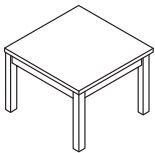

HHCT020

END TABLE

DIMENSIONS

Length: 24 Ship Weight: 22
 Width: 20 Cube: 1.4
 Height: 17

LIST PRICE

\$542

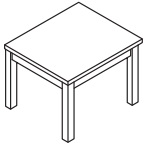

HON Recommendation: HHCT024.MOCH - List Price \$577

SEATING

HOW TO SPECIFY

Select Model Number

Select Laminate

See page 508

HHCT048

MOCH



VERSANT® TANDEM

HHCT01

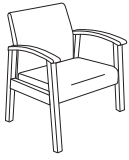

SINGLE SEAT

Leg Base
Arms

DIMENSIONS

Depth:	27	Arm Width:	20½
Width:	25	Seat to Floor Height:	18
Height:	34	Usable Seat Depth:	19¼
Seat Depth:	20¼	Ship Weight:	57
Seat Width:	21	Cube:	20.1
Back Width:	21	COM:	2.0
Back Height:	17	Weight Rating:	350 lbs.

FABRIC PRICE CODES

1	\$1299	8	\$1575
2	\$1347	9	\$1611
3	\$1395	10	\$1647
4	\$1431	11	\$1683
5	\$1467	12	\$1719
6	\$1503	L	\$1699
7	\$1539		

HHCT02

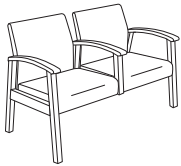

TWO-SEAT

Leg Base
Center Arm
Arms

DIMENSIONS

Depth:	27	Seat to Floor Height:	18
Width:	47½	Usable Seat Depth:	19¼
Height:	34	Ship Weight:	87
Each Seat Depth:	20¼	Cube:	33.7
Each Seat Width:	21	COM:	3.5
Each Back Width:	21	Weight Rating:	350 lbs.
Each Back Height:	17		(per seat)

FABRIC PRICE CODES

1	\$2268	8	\$2751
2	\$2352	9	\$2814
3	\$2436	10	\$2877
4	\$2499	11	\$2940
5	\$2562	12	\$3003
6	\$2625	L	\$2968
7	\$2688		

HHCT12

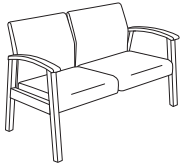

TWO-SEAT

Leg Base
Arms

DIMENSIONS

Depth:	27	Arm Width:	41½
Width:	46	Seat to Floor Height:	18
Height:	34	Usable Seat Depth:	19¼
Each Seat Depth:	20¼	Ship Weight:	87
Each Seat Width:	21	Cube:	33.0
Each Back Width:	21	COM:	3.5
Each Back Height:	17	Weight Rating:	350 lbs.
			(per seat)

FABRIC PRICE CODES

1	\$2170	8	\$2653
2	\$2254	9	\$2716
3	\$2338	10	\$2779
4	\$2401	11	\$2842
5	\$2464	12	\$2905
6	\$2527	L	\$2870
7	\$2590		

HHCB50

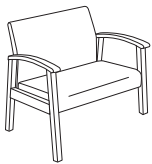

BARIATRIC SINGLE SEAT

Leg Base
Arms

DIMENSIONS

Depth:	27	Arm Width:	29
Width:	33½	Seat to Floor Height:	18
Height:	34	Usable Seat Depth:	19¼
Each Seat Depth:	20¼	Ship Weight:	80
Each Seat Width:	30	Cube:	29.0
Each Back Width:	30	COM:	3.0
Each Back Height:	17	Weight Rating:	500 lbs.

FABRIC PRICE CODES

1	\$1944	8	\$2358
2	\$2016	9	\$2412
3	\$2088	10	\$2466
4	\$2142	11	\$2520
5	\$2196	12	\$2574
6	\$2250	L	\$2544
7	\$2304		

HON Recommendation: HHCT01.MOCH.SX__ - List Price \$1395

HOW TO SPECIFY

<p>Select Model Number</p> <p>HHCT01</p>	<p>Select Finish</p> <p>See page 507</p> <p>MOCH</p>	<p>Select Seat Fabric</p> <p>See page 507</p> <p>SX05</p>
---	---	--



Volt® Task Chairs and Stools shown with Voi® Desks.

VOLT®

Customizable comfort, distinctive styling and an affordable price point make Volt the family of task seating that supports your body and your budget. The stylish V-shaped back design can be specified in fabric, leather or breathable mesh, giving you more control over your look and feel. The personalized controls and generously proportioned seat and back deliver support to a wider variety of users. Volt delivers the look you desire, the comfort you demand, and the quality you expect. That's the power of practicality.



FEATURES

- Optional synchro-tilt control provides a smooth, natural recline.
- Optional height-adjustable arms provide a custom fit.
- Optional mesh back offers breathable support.
- Task stools feature an adjustable footring for additional lower body support.
- One-touch seat height adjustment easily moves the seat up and down.
- Tilt tension controls the rate and ease of recline.
- Tilt lock allows the user to lock out the tilt function.
- 360-degree swivel provides freedom of movement in any direction.
- Select models available in hundreds of quality HON fabrics.
- Warranted for users up to 275 lbs.

VOLT® 5700/5710 Series Options

MODEL OPTIONS

H5701



Task Chair

Pneumatic, Swivel, Tilt, Tilt Tension, Tilt Lock

H5703



Task Chair

Pneumatic, Swivel, Synchro-tilt, Tilt Tension, Tilt Lock

H5705



Task Stool

Pneumatic, Swivel, Adjustable Footring

H5711



Task Chair (Mesh Back)

Pneumatic, Swivel, Tilt, Tilt Tension, Tilt Lock

H5713



Task Chair (Mesh Back)

Pneumatic, Swivel, Synchro-tilt, Tilt Tension, Tilt Lock

H5715



Task Stool (Mesh Back)

Pneumatic, Swivel, Adjustable Footring

HON BRANDED FABRICS

GRADE 1

Black Fabric
Navy Fabric

GRADE 2

GRADE 3

For a complete list of fabrics, including partnership fabrics, go to hon.com/fabricsandfinishes.

Navy only available on select models.

Reference Fabric Color Combinations on pages 20-24 for color codes and legend on page 21 for lead times.

⚠ For Fire Code model, availability and ordering method, refer to pages 248-251. Available on select models, contact HON Customer Support for availability.

VOLT® 5700 Series

OPEN MARKET



Icon Legend on page 19

H5701



TASK CHAIR

Pneumatic
Swivel
Tilt
Tilt Tension
Tilt Lock
Functions: **A, E, F, K, L**
(Function Key on pages 244-245)

DIMENSIONS

Depth: 25³/₄
Width: 26
Height: 40
Seat Depth: 18³/₄
Seat Width: 18¹/₂
Back Width: 17¹/₄
Back Height: 18³/₄
Seat to Floor Height: 18-22¹/₄
Usable Seat Depth: 18³/₄
Ship Weight: 29
Cube: 5.1
Weight Rating: 275 lbs.

FABRIC PRICE CODES

1 \$295 L \$325

H5703



TASK CHAIR

Pneumatic
Swivel
Synchro-tilt
Tilt Tension
Tilt Lock
Functions: **A, E, J, K, L**
(Function Key on pages 244-245)

DIMENSIONS

Depth: 25³/₄
Width: 26
Height: 40
Seat Depth: 18³/₄
Seat Width: 18¹/₂
Back Width: 17¹/₄
Back Height: 18³/₄
Seat to Floor Height: 18-22¹/₄
Usable Seat Depth: 18³/₄
Ship Weight: 29
Cube: 5.1
Weight Rating: 275 lbs.

FABRIC PRICE CODES

1 \$343 L \$373

H5705



TASK STOOL

Pneumatic
Swivel
Adjustable Footring
Functions: **A, E**
(Function Key on pages 244-245)

DIMENSIONS

Depth: 29¹/₂
Width: 27
Height: 49⁷/₈
Seat Depth: 20
Seat Width: 19
Back Width: 16¹/₂
Back Height: 20
Seat to Floor Height: 22⁷/₈-32³/₈
Usable Seat Depth: 18
Ship Weight: 36
Cube: 6.0
Weight Rating: 275 lbs.

FABRIC PRICE CODES

1 \$484 L \$514

H5795

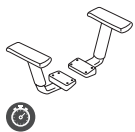

HEIGHT-ADJUSTABLE ARMS

Non-upholstered
Functions: **Q**
(Function Key on pages 244-245)

DIMENSIONS

Adjustable Arms Width: 17³/₈
Height from Seat: 7⁵/₈-10⁵/₈
Ship Weight: 5
Cube: 0.6

LIST PRICE

\$92

HON Recommendation: H5703.GA10.T with H5795 Arm Pack - List Price \$435

HOW TO SPECIFY

Select
Model Number

H 5 7 0 3 .

Select
Fabric

SB11 Black Leather
GA10 Black
GA90 Navy (only available on H5701)

G A 1 0 .

Select
Frame

T Black

T



VOLT® 5710 Series

H5711



TASK CHAIR

Mesh Back
Pneumatic
Swivel
Tilt
Tilt Tension
Tilt Lock
Functions: **A, E, F, K, L**
(Function Key on pages 244-245)

DIMENSIONS

Depth: 25³/₄
Width: 26
Height: 38³/₄
Seat Depth: 18³/₄
Seat Width: 19¹/₄
Back Width: 18
Back Height: 18³/₄
Seat to Floor Height: 18³/₄-22³/₈
Usable Seat Depth: 18
Ship Weight: 29
Cube: 5.1
COM: 1.5
Weight Rating: 275 lbs.

FABRIC PRICE CODES

1 \$408 L \$438

H5713



TASK CHAIR

Mesh Back
Pneumatic
Swivel
Synchro-tilt
Tilt Tension
Tilt Lock
Functions: **A, E, J, K, L**
(Function Key on pages 244-245)

DIMENSIONS

Depth: 25³/₄
Width: 26
Height: 38¹/₂
Seat Depth: 18³/₄
Seat Width: 19¹/₄
Back Width: 18
Back Height: 18³/₄
Seat to Floor Height: 17³/₈-21¹/₈
Usable Seat Depth: 17⁷/₈
Ship Weight: 32
Cube: 5.1
COM: 1.5
Weight Rating: 275 lbs.

FABRIC PRICE CODES

1 \$459 L \$489

H5715



TASK STOOL

Mesh Back
Pneumatic
Swivel
Adjustable Footring
Functions: **A, E**
(Function Key on pages 244-245)

DIMENSIONS

Depth: 28
Width: 26
Height: 49⁷/₈
Seat Depth: 20
Seat Width: 19
Back Width: 18
Back Height: 18¹/₂
Seat to Floor Height: 22⁷/₈-32³/₈
Usable Seat Depth: 18
Ship Weight: 36
Cube: 6.0
COM: 1.5
Weight Rating: 275 lbs.

FABRIC PRICE CODES

1 \$603 L \$633

H5795

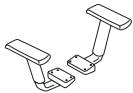

HEIGHT-ADJUSTABLE ARMS

Non-upholstered
Functions: **Q**
(Function Key on pages 244-245)

DIMENSIONS

Adjustable Arms Width: 17³/₈
Height from Seat: 7³/₈-10⁵/₈
Ship Weight: 5
Cube: 0.6

LIST PRICE

\$92

HON Recommendation: H5713.GA10.T with H5795 Arm Pack - List Price \$551

HOW TO SPECIFY

<p>Select Model Number</p> <p>H 5 7 1 3</p>	<p>Select Fabric</p> <p>SB11 Black Leather GA10 Black</p> <p>G A 1 0</p>	<p>Select Frame</p> <p>T Black</p> <p>T</p>
--	---	---

VOLT® 5720/5730 Series Options

MODEL OPTIONS

H5721



Task Chair

Pneumatic, Swivel, Tilt, Tilt Tension, Tilt Lock

H5723



Task Chair

Pneumatic, Swivel, Synchro-tilt, Tilt Tension, Tilt Lock

H5725



Task Stool

Pneumatic, Swivel, Adjustable Footring

H5731



Task Chair (Mesh Back)

Pneumatic, Swivel, Tilt, Tilt Tension, Tilt Lock

H5733



Task Chair (Mesh Back)

Pneumatic, Swivel, Synchro-tilt, Tilt Tension, Tilt Lock

H5735



Task Stool (Mesh Back)

Pneumatic, Swivel, Adjustable Footring

CASTERS



CODE	DESCRIPTION	PRICE
H	Black Hard Caster	+ \$0



S	Black All-Surface Caster	+ \$30
---	--------------------------	--------

FRAME

CODE	DESCRIPTION	PRICE
T	Black	+ \$0

5720/5730 Series Fabric Options

HON BRANDED FABRICS

GRADE 1

Apex
Attire
Centurion
Compass
Contourett
Dapper
Ensemble
Hamilton
Inertia
Optic
Pebble

GRADE 2

Appoint Seating
Blume
Clyde
Dotty
Rush
Seed
Spin Seating
Whisper Vinyl

GRADE 3

In Season
Moxie
Parker
Purl
Quill

For a complete list of fabrics, including partnership fabrics, go to hon.com/fabricsandfinishes.

Reference Fabric Color Combinations on pages 20-24 for color codes and legend on page 21 for lead times. For additional HON to Supply COM fabric grade pricing, go to honready.hon.com and click on the HON to Supply COM link.

 For Fire Code model, availability and ordering method, refer to pages 248-251. Available on select models, contact HON Customer Support for availability.

VOLT® 5720 Series

GSA SIN 33721 EXCEPT AS NOTED



Icon Legend on page 19

H5721



TASK CHAIR

Pneumatic
Swivel
Tilt
Tilt Tension
Tilt Lock
Functions: **A, E, F, K, L**
(Function Key on pages 244-245)

DIMENSIONS

Depth: 25³/₄ Seat to Floor Height: 17¹/₄-22¹/₄
Width: 25³/₄ Usable Seat Depth: 18³/₄
Height: 40 Ship Weight: 36
Seat Depth: 18³/₄ Cube: 5.1
Seat Width: 18¹/₂ Weight Rating: 275 lbs.
Back Width: 17¹/₄
Back Height: 18³/₄

FABRIC PRICE CODES

1	\$388	8	\$526
2	\$412	9	\$544
3	\$436	10	\$562
4	\$454	11	\$580
5	\$472	12	\$598
6	\$490	L	—
7	\$508		

H5723



TASK CHAIR

Pneumatic
Swivel
Synchro-tilt
Tilt Tension
Tilt Lock
Functions: **A, E, J, K, L**
(Function Key on pages 244-245)

DIMENSIONS

Depth: 25³/₄ Seat to Floor Height: 17¹/₄-22¹/₄
Width: 25³/₄ Usable Seat Depth: 18³/₄
Height: 40 Ship Weight: 38
Seat Depth: 18³/₄ Cube: 5.1
Seat Width: 18¹/₂ Weight Rating: 275 lbs.
Back Width: 17¹/₄
Back Height: 18³/₄

FABRIC PRICE CODES

1	\$432	8	\$570
2	\$456	9	\$588
3	\$480	10	\$606
4	\$498	11	\$624
5	\$516	12	\$642
6	\$534	L	—
7	\$552		

H5725

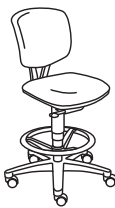

TASK STOOL

Pneumatic
Swivel
Adjustable Footring
Functions: **A, E**
(Function Key on pages 244-245)

DIMENSIONS

Depth: 29¹/₂ Seat to Floor Height: 22⁷/₈-32³/₈
Width: 27 Usable Seat Depth: 18³/₄
Height: 49⁷/₈ Ship Weight: 39
Seat Depth: 20 Cube: 6.0
Seat Width: 19 Weight Rating: 275 lbs.
Back Width: 17¹/₄
Back Height: 18³/₄

FABRIC PRICE CODES

1	\$563	8	\$701
2	\$587	9	\$719
3	\$611	10	\$737
4	\$629	11	\$755
5	\$647	12	\$773
6	\$665	L	—
7	\$683		

H5795

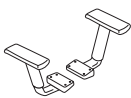

OPEN MARKET

HEIGHT-ADJUSTABLE ARMS

Non-upholstered
Functions: **Q**
(Function Key on pages 244-245)

DIMENSIONS

Adjustable Arms Width: 17³/₈
Height from Seat: 7⁷/₈-10⁵/₈
Ship Weight: 5
Cube: 0.6

LIST PRICE

\$92

HSCASTER

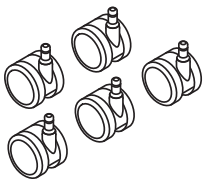

OPEN MARKET

SET OF 5 ALL-SURFACE CASTERS

Available in Black finish only, no specification needed.

DIMENSIONS

Size: 60mm
Ship Weight: 2
Cube: 0.1

LIST PRICE

\$51

HON Recommendation: H5723.H.CU__T with H5795 Arm Pack - List Price \$524

HOW TO SPECIFY

Select Model Number H 5 7 2 3 .	Select Caster H Black Hard Caster S Black All-Surface Caster (+ \$30)	Select Fabric See page 517 CU 1 0 .	Select Frame T Black
---	--	--	--------------------------------



H5731



TASK CHAIR

Mesh Back
Pneumatic
Swivel
Tilt
Tilt Tension
Tilt Lock
Functions: **A, E, F, K, L**
(Function Key on pages 244-245)

DIMENSIONS

Depth: 25³/₄ Seat to Floor Height: 18³/₄-22³/₈
Width: 26 Usable Seat Depth: 18
Height: 38³/₄ Ship Weight: 29
Seat Depth: 18³/₄ Cube: 5.1
Seat Width: 19¹/₄ COM: 1.5
Back Width: 18 Weight Rating: 275 lbs.
Back Height: 18³/₄

FABRIC PRICE CODES

1	\$504	8	\$573
2	\$516	9	\$582
3	\$528	10	\$591
4	\$537	11	\$600
5	\$546	12	\$609
6	\$555	L	—
7	\$564		

H5733



TASK CHAIR

Mesh Back
Pneumatic
Swivel
Synchro-tilt
Tilt Tension
Tilt Lock
Functions: **A, E, J, K, L**
(Function Key on pages 244-245)

DIMENSIONS

Depth: 25³/₄ Seat to Floor Height: 17³/₈-21¹/₈
Width: 26 Usable Seat Depth: 17⁷/₈
Height: 38¹/₂ Ship Weight: 32
Seat Depth: 18³/₄ Cube: 5.1
Seat Width: 19¹/₄ COM: 1.5
Back Width: 18 Weight Rating: 275 lbs.
Back Height: 18³/₄

FABRIC PRICE CODES

1	\$551	8	\$620
2	\$563	9	\$629
3	\$575	10	\$638
4	\$584	11	\$647
5	\$593	12	\$656
6	\$602	L	—
7	\$611		

H5735



TASK STOOL

Mesh Back
Pneumatic
Swivel
Adjustable Footring
Functions: **A, E**
(Function Key on pages 244-245)

DIMENSIONS

Depth: 28 Seat to Floor Height: 22⁷/₈-32³/₈
Width: 26 Usable Seat Depth: 18
Height: 49⁷/₈ Ship Weight: 36
Seat Depth: 20 Cube: 6.0
Seat Width: 19 COM: 1.5
Back Width: 18 Weight Rating: 275 lbs.
Back Height: 18¹/₂

FABRIC PRICE CODES

1	\$685	8	\$754
2	\$697	9	\$763
3	\$709	10	\$772
4	\$718	11	\$781
5	\$727	12	\$790
6	\$736	L	—
7	\$745		

H5795

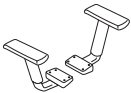

HEIGHT-ADJUSTABLE ARMS

Non-upholstered
Functions: **Q**
(Function Key on pages 244-245)

DIMENSIONS

Adjustable Arms Width: 17³/₈
Height from Seat: 7³/₈-10³/₈
Ship Weight: 5
Cube: 0.6

LIST PRICE

\$92

HSCASTER

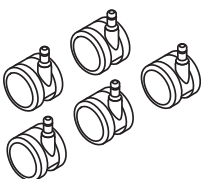

SET OF 5 ALL-SURFACE CASTERS

i Available in Black finish only, no specification needed.

DIMENSIONS

Size: 60mm
Ship Weight: 2
Cube: 0.1

LIST PRICE

\$51

HON Recommendation: H5733.H.CU__T with H5795 Arm Pack - List Price \$643

HOW TO SPECIFY

<p>Select Model Number</p> <p>H 5 7 3 3</p>	<p>Select Caster</p> <p>H Black Hard Caster S Black All-Surface Caster (+ \$30)</p> <p>H</p>	<p>Select Fabric</p> <p>See page 517</p> <p>C U 1 0</p>	<p>Select Frame</p> <p>T Black</p> <p>T</p>
--	---	--	--

WAVE™ Mesh Chairs

GSA SIN AS NOTED



Icon Legend on page 19

HVL701



SIN 33721

HIGH-BACK

Pneumatic
Swivel
Knee Tilt
Tilt Tension
Infinite Tilt Lock
Adjustable Lumbar
Height-adjustable Arms

Functions: **A, E, H, K, L, Q, W**
(Function Key on pages 244-245)

DIMENSIONS

Depth:	28	Arm Width:	19½
Width:	27½	Seat to Floor Height:	18½-21¼
Height:	44⅝	Usable Seat Depth:	19¼
Seat Depth:	20¾	Ship Weight:	53
Seat Width:	22	Cube:	5.8
Back Width:	23	Weight Rating:	250 lbs.
Back Height:	23¾		

PRICE CODE

Leather \$701

NOTES: Comfortable and breathable mesh back. Sturdy textured black frame. HVL701 has a Black leather upholstered seat with side mesh panels. Adjustable lumbar support. **HON 5-Year Limited Warranty.**

HON Recommendation: HVL701.SB11 - List Price \$701

HVL702



OPEN MARKET

HIGH-BACK

Pneumatic
Swivel
Synchro-tilt
Tilt Tension
Tilt Lock
Height-adjustable Arms

Functions: **A, E, J, K, L, Q**
(Function Key on pages 244-245)

DIMENSIONS

Depth:	26½	Arm Width:	19½
Width:	26½	Seat to Floor Height:	18½-23½
Height:	40½	Usable Seat Depth:	19¾
Seat Depth:	19¾	Ship Weight:	40
Seat Width:	21	Cube:	5.0
Back Width:	19½	Weight Rating:	250 lbs.
Back Height:	24		

PRICE CODE

Sandwich Mesh \$569

NOTES: Black Sandwich Mesh seat and mesh back. **HON 5-Year Limited Warranty.**

HON Recommendation: HVL702.MM10 - List Price \$569

HVL705



OPEN MARKET

EXECUTIVE BIG AND TALL

Pneumatic
Knee Tilt
Tilt Tension
Tilt Lock
Height and Width Adjustable Arms
Integrated Lumbar Support

Functions: **A, E, H, K, L, S**
(Function Key on pages 244-245)

DIMENSIONS

Depth:	25⅝	Back Height:	28
Width:	30¼	Seat to Floor Height:	18¾-23¾
Height:	43⅞	Usable Seat Depth:	18¾
Seat Depth:	18¾	Ship Weight:	59
Seat Width:	21⅝	Cube:	6.1
Back Width:	22¾	Weight Rating:	450 lbs.

PRICE CODE

Mesh \$837

NOTES: Large scale model HVL705 will support up to 450 lbs with normal use. Available in Black Mesh fabric VM10. **HON 5-Year Limited Warranty.**

HON Recommendation: HVL705.VM10 - List Price \$837

HVL712



SIN 33721

MID-BACK

Pneumatic
Swivel
Synchro-tilt
Tilt Tension
Tilt Lock
Height-adjustable Arms

Functions: **A, E, J, K, L, Q**
(Function Key on pages 244-245)

DIMENSIONS

Depth:	28½	Arm Width:	18⅝
Width:	29½	Seat to Floor Height:	18-22¼
Height:	41¾	Usable Seat Depth:	18
Seat Depth:	18½	Ship Weight:	39
Seat Width:	19¾	Cube:	5.4
Back Width:	20½	Weight Rating:	250 lbs.
Back Height:	20¾		

PRICE CODE

Sandwich Mesh \$480

NOTES: Black Sandwich Mesh seat and mesh back. **HON 5-Year Limited Warranty.**

HON Recommendation: HVL712.MM10 - List Price \$480

HOW TO SPECIFY

Select Model Number

Select Fabric

- SB11** Black SofThread™ Leather
Specify for model HVL701 only
- MM10** Black Sandwich Mesh Fabric
Specify for models HVL702 and HVL712 only
- VM10** Black Mesh Fabric
Specify for model HVL705 only

HVL701.

SB11

WEST HILL™ CASUAL LOUNGE SEATING



West Hill™ Casual Lounge Seating shown with Scramble™ Coffee Table.

WEST HILL™

Whether you're a thought leader, innovator, or highly-motivated team player, West Hill casual lounge creates an inviting space that inspires relaxed productivity, sustains concentration, and sparks creativity.

With solid construction, a multitude of back cushion styling, and seating options from a single seat to three or more, and choices in leg styles, fabrics, and configurations, West Hill makes it easier to make your space exceptional.



FEATURES

- Contoured seat cushion design brings living room comfort to the work space.
- Choose between a Square Back or sink into a comfy Pillow Back cushion.
- Semi-attached back and seat cushions make replacement easy.
- Square, welted back cushion creates a modern look while providing casual comfort.
- The Contrasting Fabric option allows you to specify up to three fabrics on one model.
- Select one of two square metal leg options or hardwood cone feet in one of 10 finishes.
- Order an optional Throw Pillow to add a little extra comfort or a splash of color.
- Cushion packs available in both Standard and Pillow Back, apply to both side and back applications.
- Each seat is warranted for users up to 300 pounds.
- Pair with Scramble™ Occasional Tables to complete the modern aesthetic.

WEST HILL™ Options

MODEL OPTIONS

HWH1SS, HWH1SP
HWH1SSCF, HWH1SPCF -
Contrasting Fabric



Lounge
Single Seat

HWH2SS, HWH2SP
HWH2SSCF, HWH2SPCF -
Contrasting Fabric

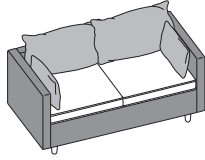

Lounge
Two-Seat

HWH3SS, HWH3SP
HWH3SSCF, HWH3SPCF -
Contrasting Fabric

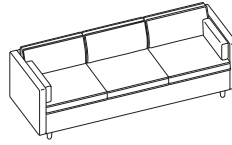

Lounge
Three-Seat

HWHITCS, HWHITCP
HWHITCSCF, HWHITPCF -
Contrasting Fabric

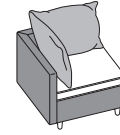

Lounge
True Corner

HWH1C
HWH1CCF - Contrasting Fabric



Ottoman

HWHACPS, HWHACPP

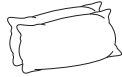

Arm Cushion Pack

HWHBCPS, HWHBCPP

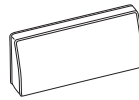

Back Cushion Pack

HWHLP, HWHSP18



**Lumbar and 18" Square
Throw Pillow**

Pillow Back Option, Contrasting Fabric



Standard Back Option, Contrasting Fabric

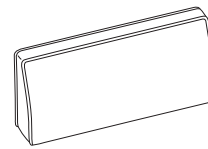
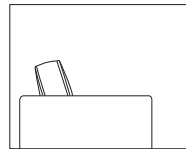
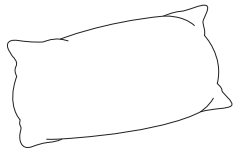
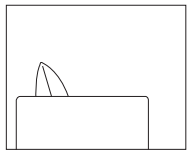

Choose from standard Single Fabric or Contrasting Fabric options.
Specify up to three fabrics with the Contrasting Fabric option.

HON BRANDED FABRICS

GRADE 1	GRADE 2	GRADE 3
Apex	Appoint Seating	In Season
Centurion	Blume	Moxie
Contourett	Clyde	Parker
Dapper	Dotty	Purl
Ensemble	Rush	Quill
Hamilton	Seed*	
Inertia*	Spin Seating	
Pebble	Whisper Vinyl*	

For a complete list of fabrics, including partnership fabrics, go to hon.com/fabricsandfinishes.

Reference Fabric Color Combinations on pages 20-24 for color codes and legend on page 21 for lead times.

*Because of the differing upholstery process for the standard back and pillow back options, these fabrics are not available as an option for the pillow back. Contact your HON representative for questions.

i Due to the inherent characteristics of upholstery materials and the casual nature of West Hill™, fabric may relax to show wrinkles over time especially on the pillow back options.

LEG STYLE	CODE	DESCRIPTION	PRICE	LEG STYLE	CODE	DESCRIPTION	PRICE
	CW	Cone Wood	+\$0		SM	Square Metal	+\$50
		<i>Available in the following finishes:</i>				<i>Available in the following finishes:</i>	
	LFW1	Florence Walnut			P7A	Textured Charcoal	
	LK11	Kingswood Walnut			P8V	Textured Titanium	
	LLA1	Lowell Ash					
	D	Natural Maple					
	LNR1	Natural Recon					
	LPE1	Phantom Ecru					
	PINC	Pinnacle					
	LPT1	Portico Teak					
	LSW1	Skyline Walnut					
	LSA1	Sterling Ash					

CONTRASTING FABRIC COM YARDAGE

Due to fabric pattern nesting and potential reduction of fabric yield, some contrasting fabric models may require more total yardage than standard models.

MODEL	COM (ARMLESS)			COM (ONE ARM)			COM (BOTH ARMS)		
	Seat	Frame	Back	Seat	Frame	Back	Seat	Frame	Back
HWH1SS		—			—			7.0	
HWH1SSCF	—	—	—	—	—	—	1.5	5.0	2.5
HWH1SP		—			—			7.0	
HWH1SPCF	—	—	—	—	—	—	1.5	5.0	1.5
HWH2SS		8.5			9.5			10.5	
HWH2SSCF	3.0	4.0	2.5	3.0	5.0	3.0	3.0	6.0	3.0
HWH2SP		8.5			9.5			11.0	
HWH2SPCF	3.0	4.0	2.0	3.0	5.0	2.5	3.0	6.0	3.0
HWH3SS		12.0			13.0			14.0	
HWH3SSCF	4.0	5.5	3.0	4.0	6.5	3.5	4.0	7.5	3.5
HWH3SP		12.5			13.5			14.5	
HWH3SPCF	4.0	5.5	3.0	4.0	6.5	3.5	4.0	7.5	4.0
HWH1C		3.0			—			—	
HWH1CCF	1.5	2.0	—	—	—	—	—	—	—
HWH1TCS		6.0			—			—	
HWH1TCSCF	1.5	3.5	2.5	—	—	—	—	—	—
HWH1TCP		7.0			—			—	
HWH1TCPF	1.5	3.5	2.0	—	—	—	—	—	—

WEST HILL™ Casual Lounge Seating

OPEN MARKET



Icon Legend on page 19

HWH1SS

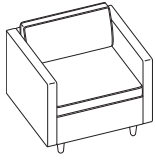

SINGLE SEAT LOUNGE — STANDARD CUSHION

DIMENSIONS

Depth:	30½	Back Height:	12
Height:	29¾	Back Width:	26¾
Width:	33¾	Arm Height:	8
Usable Seat Depth:	19	Ship Weight:	81
Seat to Floor Height:	17¾	Cube:	18.4
Seat Width:	26¾	COM:	See page 523
		Weight Rating:	300 lbs.

FABRIC PRICE CODES

1	\$2106	8	\$2900
2	\$2201	9	\$3027
3	\$2296	10	\$3154
4	\$2392	11	\$3281
5	\$2519	12	\$3408
6	\$2646	L	—
7	\$2773		

HWH1SP

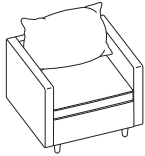

SINGLE SEAT LOUNGE — PILLOW CUSHION

DIMENSIONS

Depth:	30½	Back Height:	13¾
Height:	31½	Back Width:	26¾
Width:	33¾	Arm Height:	8
Usable Seat Depth:	16½	Ship Weight:	81
Seat to Floor Height:	17¾	Cube:	18.4
Seat Width:	26¾	COM:	See page 523
		Weight Rating:	300 lbs.

FABRIC PRICE CODES

1	\$2106	8	\$2900
2	\$2201	9	\$3027
3	\$2296	10	\$3154
4	\$2392	11	\$3281
5	\$2519	12	\$3408
6	\$2646	L	—
7	\$2773		

HON Recommendation: HWH1SP.B.PURL__CW__ - List Price \$2296

SEATING

HOW TO SPECIFY

Select
Model Number

HWH1SP

Select
Arm Type

B Both Arms

B

Select
Fabric

See page 523

PBLE03

Select
Foot and Foot Color

SM Square Metal (+ \$50)

CW Cone Wood

See page 523 for colors

SMP8V



WEST HILL™ Casual Lounge Seating

HWH1SSCF

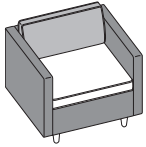

**SINGLE SEAT LOUNGE —
STANDARD CUSHION,
CONTRASTING FABRIC**

DIMENSIONS

Depth:	30½	Back Height:	12
Height:	29¾	Back Width:	26¾
Width:	33¾	Arm Height:	8
Usable Seat Depth:	19	Ship Weight:	81
Seat to Floor Height:	17¾	Cube:	18.4
Seat Width:	26¾	COM:	See page 523
		Weight Rating:	300 lbs.

FABRIC PRICE CODES

1 \$2268

Add to Base Price Above

	Seat	Frame	Back
2	\$25	\$63	\$25
3	\$51	\$127	\$51
4	\$76	\$190	\$76
5	\$110	\$275	\$110
6	\$144	\$360	\$144
7	\$178	\$444	\$178
8	\$212	\$529	\$212
9	\$246	\$614	\$246
10	\$279	\$698	\$279
11	\$313	\$783	\$313
12	\$347	\$868	\$347

HWH1SPCF

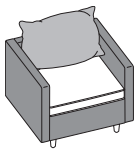

**SINGLE SEAT LOUNGE —
PILLOW CUSHION,
CONTRASTING FABRIC**

DIMENSIONS

Depth:	30½	Back Height:	13¾
Height:	31½	Back Width:	26¾
Width:	33¾	Arm Height:	8
Usable Seat Depth:	16½	Ship Weight:	81
Seat to Floor Height:	17¾	Cube:	18.4
Seat Width:	26¾	COM:	See page 523
		Weight Rating:	300 lbs.

FABRIC PRICE CODES

1 \$2268

Add to Base Price Above

	Seat	Frame	Back
2	\$25	\$63	\$25
3	\$51	\$127	\$51
4	\$76	\$190	\$76
5	\$110	\$275	\$110
6	\$144	\$360	\$144
7	\$178	\$444	\$178
8	\$212	\$529	\$212
9	\$246	\$614	\$246
10	\$279	\$698	\$279
11	\$313	\$783	\$313
12	\$347	\$868	\$347

HON Recommendation: HWH1SPCF.B.PURL___.PURL___.PURL___.CW__ - List Price \$2497

HOW TO SPECIFY

<p>Select Model Number</p> <p>HWH1SPCF .</p>	<p>Select Arm Type</p> <p>B Both Arms</p> <p>B .</p>	<p>Select Seat Fabric</p> <p>See page 523</p> <p>PBLE07 .</p>	<p>Select Frame Fabric</p> <p>See page 523</p> <p>PBLE03 .</p>	<p>Select Back Fabric</p> <p>See page 523</p> <p>PBLE01 .</p>	<p>Select Foot and Foot Color</p> <p>SM Square Metal (+ \$50) CW Cone Wood See page 523 for colors</p> <p>SMP8V</p>
---	---	--	---	--	--

WEST HILL™ Casual Lounge Seating

OPEN MARKET



Icon Legend on page 19

HWH2SS

TWO SEAT LOUNGE — STANDARD CUSHION

DIMENSIONS

Depth:	30½	Back Height:	12
Height:	29¾	Back Width:	53¾
Width (armless):	53¾	Arm Height:	8
Width (one arm):	57	Ship Weight (armless):	107
Width (both arms):	60¼	Ship Weight (one arm):	121
Usable Seat Depth:	19	Ship Weight (both arms):	135
Seat to Floor Height:	17¾	Cube:	34.0
Seat Width (armless):	53¾	COM:	See page 523
Seat Width (one arm):	49½	Weight Rating:	300 lbs. (per seat)
Seat Width (both arms):	45¼		

FABRIC PRICE CODES

1	\$2862	8	\$4238
2	\$3027	9	\$4458
3	\$3192	10	\$4678
4	\$3357	11	\$4898
5	\$3577	12	\$5118
6	\$3797	L	—
7	\$4018		



Armless

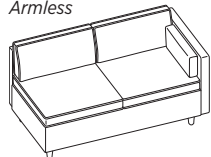

Left

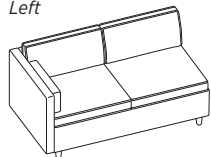

Right

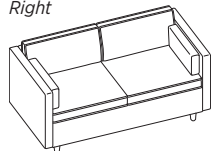

Both Arms

NOTES: Includes semi-attached arm cushions as shown.

HWH2SP

TWO SEAT LOUNGE — PILLOW CUSHION

DIMENSIONS

Depth:	30½	Back Height:	13¾
Height:	29¾	Back Width:	53¾
Width (armless):	53¾	Arm Height:	8
Width (one arm):	57	Ship Weight (armless):	107
Width (both arms):	60¼	Ship Weight (one arm):	121
Usable Seat Depth:	16½	Ship Weight (both arms):	135
Seat to Floor Height:	17¾	Cube:	34.0
Seat Width (armless):	53¾	COM:	See page 523
Seat Width (one arm):	48½	Weight Rating:	300 lbs. (per seat)
Seat Width (both arms):	43¾		

FABRIC PRICE CODES

1	\$2862	8	\$4238
2	\$3027	9	\$4458
3	\$3192	10	\$4678
4	\$3357	11	\$4898
5	\$3577	12	\$5118
6	\$3797	L	—
7	\$4018		



Armless



Left

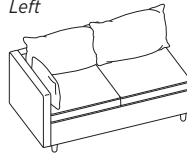

Right

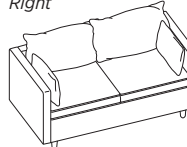

Both Arms

NOTES: Includes semi-attached arm cushions as shown.

SEATING

HOW TO SPECIFY

HON Recommendation: **HWH2SP.B.PURL__CW__** - List Price \$3542

Select Model Number HWH2SP	Select Arm Type N No Arms L Left Arm Only (+ \$175) R Right Arm Only (+ \$175) B Both Arms (+ \$350)	Select Fabric See page 523 PBLE03	Select Foot and Foot Color SM Square Metal (+ \$50) CW Cone Wood See page 523 for colors SMP8V
--------------------------------------	---	--	---



WEST HILL™ Casual Lounge Seating

HWH2SSCF

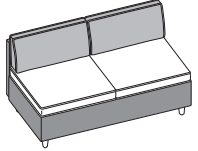

Armless

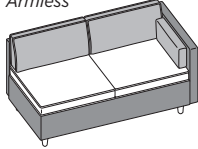

Left

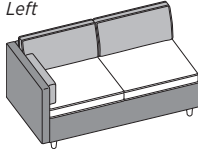

Right

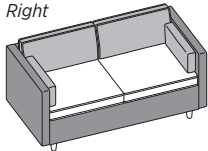

Both Arms

TWO SEAT LOUNGE — STANDARD CUSHION, CONTRASTING FABRIC

DIMENSIONS

Depth:	30½	Back Height:	12
Height:	29¾	Back Width:	53¾
Width (armless):	53¾	Arm Height:	8
Width (one arm):	57	Ship Weight (armless):	107
Width (both arms):	60¼	Ship Weight (one arm):	121
Usable Seat Depth:	19	Ship Weight (both arms):	135
Seat to Floor Height:	17¾	Cube:	34.0
Seat Width (armless):	53¾	COM:	See page 523
Seat Width (one arm):	49½	Weight Rating:	300 lbs. (per seat)
Seat Width (both arms):	45¼		

FABRIC PRICE CODES

1	\$3024		
<i>Add to Base Price Above</i>			
	Seat	Frame	Back
2	\$51	\$83	\$51
3	\$102	\$165	\$102
4	\$152	\$248	\$152
5	\$220	\$358	\$220
6	\$288	\$468	\$288
7	\$356	\$578	\$356
8	\$423	\$688	\$423
9	\$491	\$798	\$491
10	\$559	\$908	\$559
11	\$626	\$1018	\$626
12	\$694	\$1128	\$694

NOTES: Includes semi-attached arm cushions as shown.

HWH2SPCF

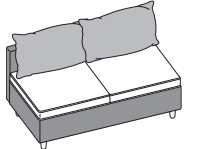

Armless



Left

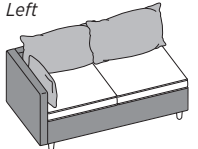

Right

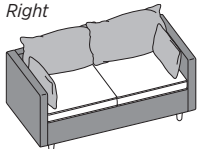

Both Arms

TWO SEAT LOUNGE — PILLOW CUSHION, CONTRASTING FABRIC

DIMENSIONS

Depth:	30½	Back Height:	13¾
Height:	29¾	Back Width:	53¾
Width (armless):	53¾	Arm Height:	8
Width (one arm):	57	Ship Weight (armless):	107
Width (both arms):	60¼	Ship Weight (one arm):	121
Usable Seat Depth:	16½	Ship Weight (both arms):	135
Seat to Floor Height:	17¾	Cube:	34.0
Seat Width (armless):	53¾	COM:	See page 523
Seat Width (one arm):	48½	Weight Rating:	300 lbs. (per seat)
Seat Width (both arms):	43¼		

FABRIC PRICE CODES

1	\$3024		
<i>Add to Base Price Above</i>			
	Seat	Frame	Back
2	\$51	\$83	\$51
3	\$102	\$165	\$102
4	\$152	\$248	\$152
5	\$220	\$358	\$220
6	\$288	\$468	\$288
7	\$356	\$578	\$356
8	\$423	\$688	\$423
9	\$491	\$798	\$491
10	\$559	\$908	\$559
11	\$626	\$1018	\$626
12	\$694	\$1128	\$694

NOTES: Includes semi-attached arm cushions as shown.

HON Recommendation: HWH2SPCF.B.PURL__PURL__PURL__CW__ - List Price \$3743

HOW TO SPECIFY

Select Model Number HWH2SPCF	Select Arm Type N No Arms L Left Arm Only (+ \$175) R Right Arm Only (+ \$175) B Both Arms (+ \$350)	Select Seat Fabric See page 523	Select Frame Fabric See page 523	Select Back Fabric See page 523	Select Foot and Foot Color SM Square Metal (+ \$50) CW Cone Wood See page 523 for colors
HWH2SPCF	B	PBLE07	PBLE03	PBLE01	SMP8V

SEATING

WEST HILL™ Casual Lounge Seating

OPEN MARKET



Icon Legend on page 19

HWH3SS

THREE SEAT LOUNGE — STANDARD CUSHION

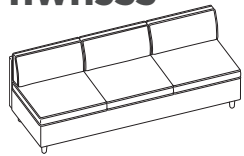

Armless

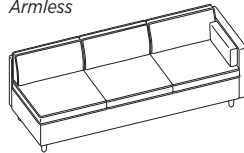

Left

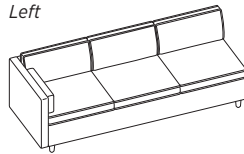

Right

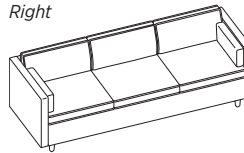

Both Arms

DIMENSIONS

Depth:	30½	Back Height:	12
Height:	29¾	Back Width:	80¾
Width (armless):	80¾	Arm Height:	8
Width (one arm):	84	Ship Weight (armless):	146
Width (both arms):	87¼	Ship Weight (one arm):	160
Usable Seat Depth:	19	Ship Weight (both arms):	174
Seat to Floor Height:	17¾	Cube:	46.5
Seat Width (armless):	80¾	COM:	See page 523
Seat Width (one arm):	76½	Weight Rating:	300 lbs. (per seat)
Seat Width (both arms):	72¼		

FABRIC PRICE CODES

1	\$3888	8	\$5687
2	\$4104	9	\$5975
3	\$4320	10	\$6263
4	\$4536	11	\$6550
5	\$4823	12	\$6838
6	\$5111	L	—
7	\$5399		

NOTES: Includes semi-attached arm cushions as shown.

HWH3SP

THREE SEAT LOUNGE — PILLOW CUSHION



Armless



Left

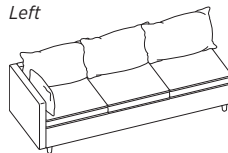

Right

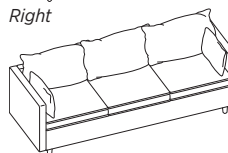

Both Arms

DIMENSIONS

Depth:	30½	Back Height:	13¾
Height:	31½	Back Width:	80¾
Width (armless):	80¾	Arm Height:	8
Width (one arm):	84	Ship Weight (armless):	146
Width (both arms):	87¼	Ship Weight (one arm):	160
Usable Seat Depth:	16½	Ship Weight (both arms):	174
Seat to Floor Height:	17¾	Cube:	46.5
Seat Width (armless):	80¾	COM:	See page 523
Seat Width (one arm):	75½	Weight Rating:	300 lbs. (per seat)
Seat Width (both arms):	70¼		

FABRIC PRICE CODES

1	\$3888	8	\$5687
2	\$4104	9	\$5975
3	\$4320	10	\$6263
4	\$4536	11	\$6550
5	\$4823	12	\$6838
6	\$5111	L	—
7	\$5399		

NOTES: Includes semi-attached arm cushions as shown.

HON Recommendation: HWH3SP.B.PURL__CW__ - List Price \$4670

HOW TO SPECIFY

Select Model Number HWH3SP	Select Arm Type N No Arms L Left Arm Only (+ \$175) R Right Arm Only (+ \$175) B Both Arms (+ \$350)	Select Fabric See page 523 PBLE03	Select Foot and Foot Color SM Square Metal (+ \$50) CW Cone Wood See page 523 for colors SMP8V
--------------------------------------	---	--	---



WEST HILL™ Casual Lounge Seating

HWH3SSCF

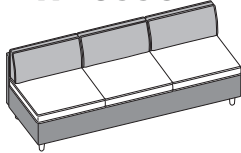

Armless

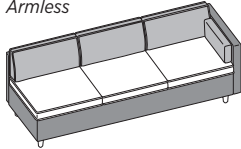

Left

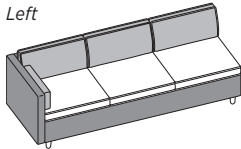

Right

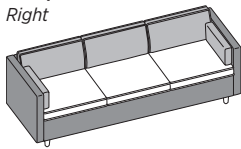

Both Arms

THREE SEAT LOUNGE — STANDARD CUSHION, CONTRASTING FABRIC

DIMENSIONS

Depth:	30½	Back Height:	12
Height:	29¾	Back Width:	80¾
Width (armless):	80¾	Arm Height:	8
Width (one arm):	84	Ship Weight (armless):	146
Width (both arms):	87¼	Ship Weight (one arm):	160
Usable Seat Depth:	19	Ship Weight (both arms):	174
Seat to Floor Height:	17¾	Cube:	46.5
Seat Width (armless):	80¾	COM:	See page 523
Seat Width (one arm):	76½	Weight Rating:	300 lbs. (per seat)
Seat Width (both arms):	72¼		

FABRIC PRICE CODES

1	\$4050		
<i>Add to Base Price Above</i>			
	Seat	Frame	Back
2	\$51	\$102	\$76
3	\$102	\$203	\$152
4	\$152	\$305	\$229
5	\$220	\$440	\$330
6	\$288	\$576	\$432
7	\$356	\$711	\$533
8	\$423	\$847	\$635
9	\$491	\$982	\$737
10	\$559	\$1117	\$838
11	\$626	\$1253	\$940
12	\$694	\$1388	\$1041

NOTES: Includes semi-attached arm cushions as shown.

HWH3SPCF

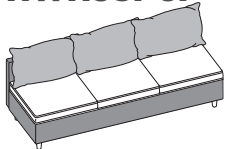

Armless

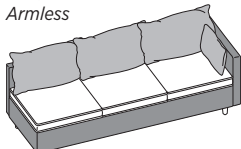

Left

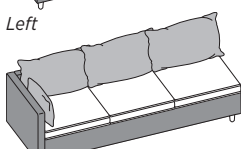

Right

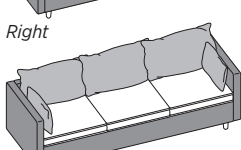

Both Arms

THREE SEAT LOUNGE — PILLOW CUSHION, CONTRASTING FABRIC

DIMENSIONS

Depth:	30½	Back Height:	13¾
Height:	31½	Back Width:	80¾
Width (armless):	80¾	Arm Height:	8
Width (one arm):	84	Ship Weight (armless):	146
Width (both arms):	87¼	Ship Weight (one arm):	160
Usable Seat Depth:	16½	Ship Weight (both arms):	174
Seat to Floor Height:	17¾	Cube:	46.5
Seat Width (armless):	80¾	COM:	See page 523
Seat Width (one arm):	75½	Weight Rating:	300 lbs. (per seat)
Seat Width (both arms):	70¼		

FABRIC PRICE CODES

1	\$4050		
<i>Add to Base Price Above</i>			
	Seat	Frame	Back
2	\$51	\$102	\$76
3	\$102	\$203	\$152
4	\$152	\$305	\$229
5	\$220	\$440	\$330
6	\$288	\$576	\$432
7	\$356	\$711	\$533
8	\$423	\$847	\$635
9	\$491	\$982	\$737
10	\$559	\$1117	\$838
11	\$626	\$1253	\$940
12	\$694	\$1388	\$1041

NOTES: Includes semi-attached arm cushions as shown.

HON Recommendation: HWH3SPCF.B.PURL__PURL__PURL__CW__ - List Price \$4857

HOW TO SPECIFY

<p>Select Model Number</p> <p>HWH3SPCF</p>	<p>Select Arm Type</p> <p>N No Arms L Left Arm Only (+ \$175) R Right Arm Only (+ \$175) B Both Arms (+ \$350)</p> <p>B</p>	<p>Select Seat Fabric</p> <p>See page 523</p> <p>PBLE07</p>	<p>Select Frame Fabric</p> <p>See page 523</p> <p>PBLE03</p>	<p>Select Back Fabric</p> <p>See page 523</p> <p>PBLE01</p>	<p>Select Foot and Foot Color</p> <p>SM Square Metal (+ \$50) CW Cone Wood See page 523 for colors</p> <p>SMP8V</p>
---	--	--	---	--	--

WEST HILL™ Ottomans

OPEN MARKET



Icon Legend on page 19

HWH1C

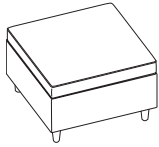

OTTOMAN

DIMENSIONS

Depth:	27¼	Ship Weight:	47
Height:	17¾	Cube:	18.4
Width:	27¼	COM:	See page 523
Usable Seat Depth:	27¼	Weight Rating:	300 lbs.
Seat to Floor Height:	17¾		
Seat Width:	27¼		

FABRIC PRICE CODES

1	\$1242	8	\$1612
2	\$1286	9	\$1672
3	\$1331	10	\$1731
4	\$1375	11	\$1790
5	\$1435	12	\$1849
6	\$1494	L	—
7	\$1553		

HWH1CCF

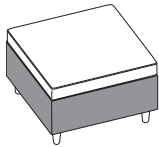

OTTOMAN, CONTRASTING FABRIC

DIMENSIONS

Depth:	27¼	Ship Weight:	47
Height:	17¾	Cube:	18.4
Width:	27¼	COM:	See page 523
Usable Seat Depth:	27¼	Weight Rating:	300 lbs.
Seat to Floor Height:	17¾		
Seat Width:	27¼		

FABRIC PRICE CODES

1	\$1404	
<i>Add to Base Price Above</i>		
	Seat	Frame
2	\$25	\$25
3	\$51	\$51
4	\$76	\$76
5	\$110	\$110
6	\$144	\$144
7	\$178	\$178
8	\$212	\$212
9	\$246	\$246
10	\$279	\$279
11	\$313	\$313
12	\$347	\$347

HON Recommendation: HWH1C.PURL___.CW__ - List Price \$1331

HOW TO SPECIFY

<p>Select Model Number</p> <p>HWH1CCF .</p>	<p>Select Fabric</p> <p>See page 523</p> <p>PBLE03 .</p>	<p>Select Seat Fabric</p> <p><i>Specify for model HWH1CCF only</i></p> <p>PBLE03 .</p>	<p>Select Frame Fabric</p> <p><i>Specify for model HWH1CCF only</i></p> <p>PBLE07 .</p>	<p>Select Foot and Foot Color</p> <p>SM Square Metal (+ \$50) CW Cone Wood</p> <p>See page 523 for colors</p> <p>SMP8V</p>
--	---	---	--	---



WEST HILL™ Casual Lounge Seating

HWH1TCS

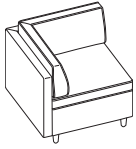

TRUE CORNER — STANDARD CUSHION

DIMENSIONS

Depth:	30½	Ship Weight:	73
Height:	29¾	Cube:	18.4
Width:	30½	COM:	See page 523
Usable Seat Depth:	19	Weight Rating:	300 lbs.
Seat to Floor Height:	17¾		
Back Height:	12		

FABRIC PRICE CODES

1	\$2106	8	\$2953
2	\$2208	9	\$3088
3	\$2309	10	\$3223
4	\$2411	11	\$3359
5	\$2546	12	\$3494
6	\$2682	L	—
7	\$2817		

HWH1TCP

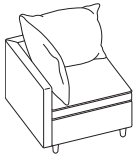

TRUE CORNER — PILLOW CUSHION

DIMENSIONS

Depth:	30½	Ship Weight:	73
Height:	31½	Cube:	18.4
Width:	30½	COM:	See page 523
Usable Seat Depth:	16½	Weight Rating:	300 lbs.
Seat to Floor Height:	17¾		
Back Height:	13¾		

FABRIC PRICE CODES

1	\$2106	8	\$2953
2	\$2208	9	\$3088
3	\$2309	10	\$3223
4	\$2411	11	\$3359
5	\$2546	12	\$3494
6	\$2682	L	—
7	\$2817		

HON Recommendation: HWH1TCP.PURL__CW__ - List Price \$2309

HOW TO SPECIFY

Select
Model Number

HWH1TCP

Select
Fabric

See page 523

PBLE03

Select
Foot and Foot Color

SM Square Metal (+ \$50)

CW Cone Wood

See page 523 for colors

SMP8V

WEST HILL™ Casual Lounge Seating

OPEN MARKET



Icon Legend on page 19

HWH1TCSCF

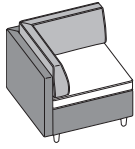

**TRUE CORNER —
STANDARD CUSHION,
CONTRASTING FABRIC**

DIMENSIONS

Depth:	30½	Ship Weight:	73
Height:	29¾	Cube:	18.4
Width:	30½	COM:	See page 523
Usable Seat Depth:	19	Weight Rating:	300 lbs.
Seat to Floor Height:	17¾		
Back Height:	12		

FABRIC PRICE CODES

1 \$2268

Add to Base Price Above

	Seat	Frame	Back
2	\$25	\$51	\$32
3	\$51	\$102	\$63
4	\$76	\$152	\$95
5	\$110	\$220	\$138
6	\$144	\$288	\$180
7	\$178	\$356	\$222
8	\$212	\$423	\$265
9	\$246	\$491	\$307
10	\$279	\$559	\$349
11	\$313	\$626	\$392
12	\$347	\$694	\$434

HWH1TCPF

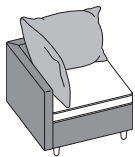

**TRUE CORNER —
PILLOW CUSHION,
CONTRASTING FABRIC**

DIMENSIONS

Depth:	30½	Ship Weight:	73
Height:	31½	Cube:	18.4
Width:	30½	COM:	See page 523
Usable Seat Depth:	16½	Weight Rating:	300 lbs.
Seat to Floor Height:	17¾		
Back Height:	13¾		

FABRIC PRICE CODES

1 \$2268

Add to Base Price Above

	Seat	Frame	Back
2	\$25	\$51	\$32
3	\$51	\$102	\$63
4	\$76	\$152	\$95
5	\$110	\$220	\$138
6	\$144	\$288	\$180
7	\$178	\$356	\$222
8	\$212	\$423	\$265
9	\$246	\$491	\$307
10	\$279	\$559	\$349
11	\$313	\$626	\$392
12	\$347	\$694	\$434

HON Recommendation: HWH1TCPF.PURL__PURL__PURL__CW__ - List Price \$2484

HOW TO SPECIFY

Select
Model Number

HWH1TCPCF

Select
Seat Fabric

See page 523

PBLE07

Select
Frame Fabric

See page 523

PBLE03

Select
Back Fabric

See page 523

PBLE01

Select
Foot and Foot Color

SM Square Metal (+ \$50)
CW Cone Wood
See page 523 for colors

SMP8V



THROW PILLOWS

HWHLP



LUMBAR THROW PILLOW

DIMENSIONS

Height:	10
Width:	18
COM:	1.0
Ship Weight:	2.5
Cube:	2.3

FABRIC PRICE CODES

1	\$146	8	\$199
2	\$152	9	\$207
3	\$159	10	\$216
4	\$165	11	\$224
5	\$174	12	\$233
6	\$182	L	—
7	\$190		

HWHSP18



18" SQUARE THROW PILLOW

DIMENSIONS

Height:	18
Width:	18
COM:	1.0
Ship Weight:	3.0
Cube:	2.3

FABRIC PRICE CODES

1	\$179	8	\$285
2	\$192	9	\$302
3	\$204	10	\$319
4	\$217	11	\$336
5	\$234	12	\$353
6	\$251	L	—
7	\$268		

HOW TO SPECIFY

<p>Select Model Number</p> <div style="border: 1px solid black; padding: 5px; display: flex; gap: 5px;"> HWHSP18 </div>	<p>Select Fabric</p> <p>See page 523</p> <div style="border: 1px solid black; padding: 5px; display: flex; gap: 5px;"> PBLE03 </div>
--	--



HWHACPS



ARM CUSHION PACK — STANDARD

DIMENSIONS

COM: 1.0
Ship Weight: 4.1
Cube: 3.9

FABRIC PRICE CODES

1	\$216	8	\$375
2	\$235	9	\$400
3	\$254	10	\$426
4	\$273	11	\$451
5	\$299	12	\$476
6	\$324	L	—
7	\$349		

NOTES: Includes both L and R Arm Cushions.

ⓘ Cushion arm cushions can be replaced or switched out with these cushion packs.

HWHACPP



ARM CUSHION PACK — PILLOW

DIMENSIONS

COM: 1.0
Ship Weight: 5.7
Cube: 3.9

FABRIC PRICE CODES

1	\$216	8	\$375
2	\$235	9	\$400
3	\$254	10	\$426
4	\$273	11	\$451
5	\$299	12	\$476
6	\$324	L	—
7	\$349		

NOTES: Includes both L and R Arm Cushions.

ⓘ Cushion arm cushions can be replaced or switched out with these cushion packs.

HWHBCPS

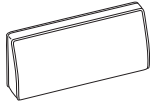

BACK CUSHION PACK — STANDARD

DIMENSIONS

COM: 2.5
Ship Weight: 8.1
Cube: 3.9

FABRIC PRICE CODES

1	\$216	8	\$375
2	\$235	9	\$400
3	\$254	10	\$426
4	\$273	11	\$451
5	\$299	12	\$476
6	\$324	L	—
7	\$349		

NOTES: Includes a single Standard Back Cushion.

ⓘ Cushion backs can be replaced or switched out with these cushion packs.

HWHBCPP



BACK CUSHION PACK — PILLOW

DIMENSIONS

COM: 1.5
Ship Weight: 8.1
Cube: 3.9

FABRIC PRICE CODES

1	\$216	8	\$375
2	\$235	9	\$400
3	\$254	10	\$426
4	\$273	11	\$451
5	\$299	12	\$476
6	\$324	L	—
7	\$349		

NOTES: Includes a single Pillow Back Cushion.

ⓘ Cushion backs can be replaced or switched out with these cushion packs.

HWHGB

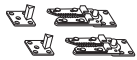

GANGING BRACKET

DIMENSIONS

Ship Weight: 1.0
Cube: 0.1

LIST PRICE

\$54

SPECIFYING EXAMPLE: HWHGB

HOW TO SPECIFY

<p>Select Model Number</p> <p>HWHBCPP</p>	<p>Select Fabric</p> <p>See page 523</p> <p>PBLE03</p>
---	--



EXECUTIVE CHAIRS

HVL105



HIGH-BACK

Pneumatic
Swivel
Tilt
Tilt Tension
Tilt Lock
Fixed Padded Arms

Functions: **A, E, F, K, L**
(Function Key on pages 244-245)

DIMENSIONS

Depth:	27½	Arm Width:	19
Width:	25	Seat to Floor Height:	17½-20¼
Height:	45¾	Usable Seat Depth:	20¼
Seat Depth:	20¼	Ship Weight:	46.0
Seat Width:	19½	Cube:	6.6
Back Width:	20½	Weight Rating:	250 lbs.
Back Height:	28¾		

PRICE CODE

Leather **\$529**

NOTES: Black SofThread™ Leather. Polished base. Fixed, padded arms. **HON 5-Year Limited Warranty.**

HON Recommendation: HVL105.SB11 - List Price \$529

HVL131



HIGH-BACK

Pneumatic
Swivel
Tilt
Tilt Tension
Tilt Lock
Fixed Padded Loop Arms

Functions: **A, E, F, K, L, T**
(Function Key on pages 244-245)

DIMENSIONS

Depth:	40	Arm Width:	20½
Width:	28½	Seat to Floor Height:	18½-22
Height:	45½	Usable Seat Depth:	18¼
Seat Depth:	18¼	Ship Weight:	42
Seat Width:	20¾	Cube:	6.3
Back Width:	20¾	Weight Rating:	250 lbs.
Back Height:	26⅞		

PRICE CODE

Vinyl **\$463**

NOTES: Black vinyl with contrasting top stitch. Black frame. Padded loop arms. **HON 5-Year Limited Warranty.**

HON Recommendation: HVL131.EN11 - List Price \$463

HVL151



HIGH-BACK

Pneumatic
Swivel
Tilt
Tilt Tension
Tilt Lock
Fixed Padded Loop Arms

Functions: **A, E, F, K, L, T**
(Function Key on pages 244-245)

DIMENSIONS

Depth:	37½	Arm Width:	20½
Width:	27	Seat to Floor Height:	17¾-21½
Height:	45½	Usable Seat Depth:	18⅝
Seat Depth:	18⅝	Ship Weight:	38
Seat Width:	20½	Cube:	5.1
Back Width:	20½	Weight Rating:	250 lbs.
Back Height:	27¼		

PRICE CODE

Leather **\$400**

NOTES: Black SofThread™ Leather. Black frame. Padded loop arms. **HON 5-Year Limited Warranty.**

HON Recommendation: HVL151.SB11 - List Price \$400

HOW TO SPECIFY

Select
Model Number

Select
Fabric

- SB11** Black SofThread™ Leather
Specify for models HVL105 and HVL151 only
- EN11** Black Vinyl
Specify for model HVL131 only

H V L 1 0 5 .

S B 1 1



Icon Legend on page 19

EXECUTIVE CHAIRS

HVL161



HIGH-BACK

Pneumatic
Swivel
Tilt
Tilt Tension
Tilt Lock
Fixed Padded Loop Arms

Functions: **A, E, F, K, L, T**

(Function Key on pages 244-245)

DIMENSIONS

Depth:	39¼	Arm Width:	19
Width:	25½	Seat to Floor Height:	18¾-22½
Height:	45	Usable Seat Depth:	18¾
Seat Depth:	18¾	Ship Weight:	35
Seat Width:	19	Cube:	4.8
Back Width:	19	Weight Rating:	250 lbs.
Back Height:	26¾		

PRICE CODE

Leather **\$375**

NOTES: Black SofThread™ Leather. Black frame. Padded loop arms. **HON 5-Year Limited Warranty.**

HON Recommendation: HVL161.SB11 - List Price \$375

HVL171



MID-BACK

Pneumatic
Swivel
Tilt
Tilt Tension
Tilt Lock
Fixed Loop Arms

Functions: **A, E, F, K, L, T**

(Function Key on pages 244-245)

DIMENSIONS

Depth:	34½	Arm Width:	19¾
Width:	25¾	Seat to Floor Height:	16¾-20½
Height:	38¾	Usable Seat Depth:	17¾
Seat Depth:	17¾	Ship Weight:	26
Seat Width:	19¾	Cube:	3.9
Back Width:	18¾	Weight Rating:	250 lbs.
Back Height:	21¾		

PRICE CODE

Leather **\$305**

NOTES: Black SofThread™ Leather. Black frame. Loop arms. **HON 5-Year Limited Warranty.**

HON Recommendation: HVL171.SB11 - List Price \$305

HVL402



HIGH-BACK

Pneumatic
Swivel
Tilt
Tilt Tension
Tilt Lock
Fixed Padded Loop Arms

Functions: **A, E, F, K, L, T**

(Function Key on pages 244-245)

DIMENSIONS

Depth:	28	Arm Width:	19½
Width:	26	Seat to Floor Height:	16½-20½
Height:	45½	Usable Seat Depth:	17½
Seat Depth:	17½	Ship Weight:	44
Seat Width:	19½	Cube:	6.1
Back Width:	19	Weight Rating:	250 lbs.
Back Height:	24½		

PRICE CODE

Vinyl **\$445**

NOTES: Available in Black and Brown vinyl with contrasting top stitch. EN11 features silver frame. EN45 features black frame. Padded loop arms. **HON 5-Year Limited Warranty.**

HON Recommendation: HVL402.EN11 - List Price \$445

HVL601



HIGH-BACK

Pneumatic
Swivel
Tilt
Tilt Tension
Tilt Lock
Loop Arms

Functions: **A, E, F, K, L, T**

(Function Key on pages 244-245)

DIMENSIONS

Depth:	27	Arm Width:	20½
Width:	26½	Seat to Floor Height:	16¾-20½
Height:	44	Usable Seat Depth:	17
Seat Depth:	17	Ship Weight:	38
Seat Width:	20½	Cube:	4.1
Back Width:	20½	Weight Rating:	250 lbs.
Back Height:	26½		

PRICE CODE

Fabric **\$294**

Leather **\$324**

NOTES: Tailored stitching detail in Black SofThread™ Leather or Black fabric. Fixed loop arms. Black frame. **HON 5-Year Limited Warranty.**

HON Recommendation: HVL601.SB11 - List Price \$324

HOW TO SPECIFY

Select Model Number

Select Fabric

SB11 Black SofThread™ Leather
Specify for models HVL161, HVL171, and HVL601 only

EN11 Black Vinyl
Specify for model HVL402 only

EN45 Brown Vinyl
Specify for model HVL402 only

VA10 Black Fabric
Specify for model HVL601 only

HVL161

SB11



GUEST CHAIRS

HVL653



GUEST CHAIR

Sled Base
Padded Arms

DIMENSIONS

Depth:	23	Arm Width:	17 ³ / ₄
Width:	22 ¹ / ₄	Seat to Floor Height:	17 ⁵ / ₈
Height:	32	Usable Seat Depth:	16 ³ / ₄
Seat Depth:	17	Ship Weight:	28
Seat Width:	20 ¹ / ₄	Cube:	3.1
Back Width:	18 ¹ / ₂	Weight Rating:	250 lbs.
Back Height:	12		

PRICE CODE

Leather **\$258**

NOTES: Black SofThread™ Leather with tailored stitching detail. Frame features steel tubular construction. Black frame.

HON Recommendation: HVL653.SB11 - List Price \$258

HOW TO SPECIFY

Select Model Number	Select Fabric
	SB11 Black SofThread™ Leather
H V L 6 5 3 .	S B 1 1



MESH CHAIRS

HVL521



MID-BACK

Pneumatic
Swivel
Tilt
Tilt Tension
Tilt Lock
Arms

Functions: **A, E, F, K, L**

(Function Key on pages 244-245)

DIMENSIONS

Depth:	35¼	Arm Width:	18½
Width:	26¼	Seat to Floor Height:	17½-22
Height:	41	Usable Seat Depth:	17¾
Seat Depth:	17¾	Ship Weight:	30
Seat Width:	19½	Cube:	4.1
Back Width:	18¾	Weight Rating:	250 lbs.
Back Height:	21½		

PRICE CODE

Fabric **\$348**

NOTES: Comfortable and breathable mesh back. Black fabric seat. Sturdy textured black frame. Fixed-height arms. **HON 5-Year Limited Warranty.**

HON Recommendation: HVL521.VA10 - List Price \$348

HVL525



HIGH-BACK

Pneumatic
Swivel
Tilt
Tilt Tension
Tilt Lock
Fixed Loop Arms

Functions: **A, E, F, K, L, T**

(Function Key on pages 244-245)

DIMENSIONS

Depth:	26	Arm Width:	20⅞
Width:	26	Seat to Floor Height:	16¾-21¼
Height:	42¾	Usable Seat Depth:	19
Seat Depth:	19	Ship Weight:	33
Seat Width:	19¾	Cube:	3.8
Back Width:	19¾	Weight Rating:	250 lbs.
Back Height:	23		

PRICE CODE

Fabric **\$354**

NOTES: Comfortable and breathable mesh back. Black upholstered seat. Fixed, loop arms. **HON 5-Year Limited Warranty.**

HON Recommendation: HVL525.ES10 - List Price \$354

HOW TO SPECIFY

Select Model Number

Select Fabric

VA10 Black Fabric
Specify for model HVL521 only

ES10 Black Fabric
Specify for model HVL525 only

H V L 5 2 1 .

V A 1 0



NESTING CHAIRS

HVL303



SANDWICH MESH BACK AND SEAT

Upholstered Seat and Back
Casters
Arms

DIMENSIONS

Depth:	23 ³ / ₄	Back Height:	16
Width:	23 ³ / ₄	Seat to Floor Height:	19 ¹ / ₄
Height:	33 ¹ / ₂	Usable Seat Depth:	18 ¹ / ₂
Seat Depth:	18 ¹ / ₂	Ship Weight:	27
Seat Width:	19 ¹ / ₂	Cube:	2.1
Back Width:	19 ¹ / ₂	Weight Rating:	250 lbs.

LIST PRICE

\$314

NOTES: Seat and back upholstered in comfortable and breathable Black Sandwich Mesh. Specify Black (T) or Silver (X) frame. Ships one per carton. **HON 5-Year Limited Warranty.**

HON Recommendation: HVL303.MM10.T - List Price \$314

HOW TO SPECIFY

<p>Select Model Number</p> <p>H V L 3 0 3 .</p>	<p>Select Fabric</p> <p>MM10 Black Sandwich Mesh Fabric (only)</p> <p>M M 1 0 .</p>	<p>Select Frame</p> <p>T Black X Silver</p> <p>T</p>
--	--	---

TASK CHAIRS

OPEN MARKET



Icon Legend on page 19

HVL220

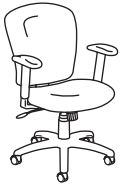

TASK MID-BACK

Pneumatic
Swivel
Tilt
Tilt Tension
Tilt Lock
Height-adjustable Arms

Functions: **A, E, F, K, L, Q**
(Function Key on pages 244-245)

DIMENSIONS

Depth:	34½	Arm Width:	17¾
Width:	26¾	Seat to Floor Height:	17½-21¼
Height:	41	Usable Seat Depth:	16¾
Seat Depth:	16¾	Ship Weight:	35
Seat Width:	20	Cube:	3.7
Back Width:	20¼	Weight Rating:	250 lbs.
Back Height:	22½		

PRICE CODE

Fabric **\$375**

NOTES: Black fabric. Sturdy textured black frame. Height-adjustable arms. **HON 5-Year Limited Warranty.**

HON Recommendation: HVL220.VA10 - List Price \$375

SEATING

HOW TO SPECIFY

Select
Model Number

H V L 2 2 0 .

Select
Fabric

VA10 Black Fabric

V A 1 0



COLLABORATIVE CHAIRS

Modular Lounge

HVL864

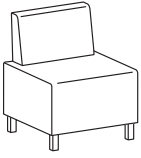

MODULAR CHAIR

DIMENSIONS

Depth:	25	Arm Width:	25
Width:	25	Seat to Floor Height:	17¼
Height:	30⅞	Usable Seat Depth:	18½
Seat Depth:	18½	Ship Weight:	33
Seat Width:	25	Cube:	5.5
Back Width:	21½	Weight Rating:	250 lbs.
Back Height:	15⅝		

PRICE CODE

Leather \$765

NOTES: Thick cushioning and individually pocketed coil springs provide long-lasting comfort. Lightweight frame. Easier assembly – no tools required. SofThread™ leather.

HON Recommendation: HVL864.SB11 - List Price \$765

HVL862

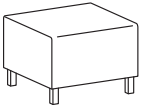

OTTOMAN

DIMENSIONS

Depth:	25	Seat to Floor Height:	17¼
Width:	25	Usable Seat Depth:	25
Height:	18¼	Ship Weight:	31
Seat Depth:	25	Cube:	5.5
Seat Width:	25	Weight Rating:	250 lbs.

PRICE CODE

Leather \$557

NOTES: Thick cushioning and individually pocketed coil springs provide long-lasting comfort. Functions as footrest, seat or side table. SofThread™ leather. Easier assembly – no tools required.

HON Recommendation: HVL862.SB11 - List Price \$557

HOW TO SPECIFY

Select Model Number	Select Fabric
	SB11 Black SofThread™ Leather (only)
H V L 8 6 4 .	S B 1 1

WORKPLACE TOOLS

Ergonomic Solutions

OPEN MARKET



Icon Legend on page 19

HVL981



RECTANGLE WOBBLE BOARD

Anti-Fatigue Mat

DIMENSIONS

Depth: 18
Width: 22¼
Height: 3

Ship Weight: 10.0 Ⓢ
Cube: 0.9
Weight Rating: 250 lbs.

LIST PRICE

\$121

NOTES: HON 5-Year Limited Warranty.

ⓘ Available in Black (T) finish ONLY.

SPECIFYING EXAMPLE: HVL981.T

HVL982



ROUND WOBBLE BOARD

Anti-Fatigue Mat

DIMENSIONS

Depth: 18½
Width: 18½
Height: 2½

Ship Weight: 5.8 Ⓢ
Cube: 0.6
Weight Rating: 250 lbs.

LIST PRICE

\$103

NOTES: HON 5-Year Limited Warranty.

ⓘ Available in Black (T) finish ONLY.

SPECIFYING EXAMPLE: HVL982.T

HBEAFM1

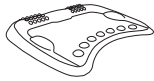

ANTI-FATIGUE MAT

Ergonomic

DIMENSIONS

Depth: 25
Width: 29⅞
Height: 2¾

Ship Weight: 7.0
Cube: 1.4

LIST PRICE

\$219

NOTES: HON 5-Year Limited Warranty.

ⓘ Available in Black ONLY. No specification needed.

SPECIFYING EXAMPLE: HBEAFM1

HVL991

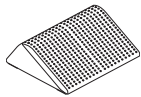

FOOTREST

Anti-Slip Cover

DIMENSIONS

Depth: 13¾
Width: 16
Height: 5½

Ship Weight: 7.0 Ⓢ
Cube: 0.9
Weight Rating: 250 lbs.

LIST PRICE

\$82

NOTES: HON 5-Year Limited Warranty.

ⓘ Available in Black (T) finish ONLY.

SPECIFYING EXAMPLE: HVL991.T

HSCASTER

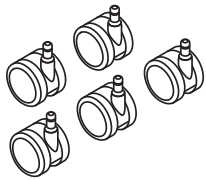

SET OF 5 SOFT CASTERS

DIMENSIONS

Size: 60mm
Ship Weight: 2 Ⓢ
Cube: 0.1

LIST PRICE

\$51

ⓘ Available in Black finish only, no specification needed.

SEATING

HOW TO SPECIFY

Select Model Number	Select Finish
H V L 9 8 1 .	T Black
	T



WORKPLACE TOOLS

Chair Mats

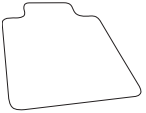
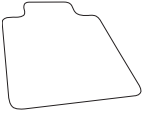
	DESCRIPTION	MODEL	SHIP WEIGHT	CUBE	LIST PRICE
	Lipped Chair Mat with Studs 60"W x 46"D 48"W x 36"D NOTES: Clear finish only. Available in 60"W x 46"D and 48"W x 36"D sizes. Features rectangle and lipped shapes. Available with studs for carpet and without studs for hard-surface floors. Ships rolled. HON 5-Year Limited Warranty. ⓘ Clear finish only. No specification needed.	HCM4660LS	13.9	1.0	\$146
		HCM3648LS	8.8	0.6	\$88
	Lipped Chair Mat without Studs 60"W x 46"D 48"W x 36"D NOTES: Clear finish only. Available in 60"W x 46"D and 48"W x 36"D sizes. Features rectangle and lipped shapes. Available with studs for carpet and without studs for hard-surface floors. Ships rolled. HON 5-Year Limited Warranty. ⓘ Clear finish only. No specification needed.	HCM4660LN	13.2	0.5	\$146
		HCM3648LN	8.3	0.3	\$88

HOW TO SPECIFY

Select Model Number

H C M 4 6 6 0 L S

CROSS REFERENCE INDEX

MODEL	PAGE	MODEL	PAGE	MODEL	PAGE	MODEL	PAGE
H105R2448	55	H5713	515	HASPSS	274	HCG6	287
H105R2460	55	H5715	515	HASPSSMF	274	HCG6DF	287
H105R2466	55	H5721	518	HASSGC	275	HCLA65	173, 179, 197, 230
H105R2472	55	H5723	518	HASSP	275	HCLQT	293
H105R3048	55	H5725	518	HB96PP	76	HCM3648LN	225, 543
H105R3060	55	H5731	519	HBCONU	75	HCM3648LS	225, 543
H105R3066	55	H5733	519	HBDMAUSB	58, 216	HCM4660LN	225, 543
H105R3072	55	H5735	519	HBEAFM1	59, 224, 453, 542	HCM4660LS	225, 543
H1522	221	H5795	514, 515, 518, 519	HBEAM48	74	HCOMDOME2	51, 237
H1526	221	H5901	297	HBEAM60	74	HCPU1	204, 217
H2091	459	H5902	297	HBEAM72	74	HCTIMM	302
H2092	459	H5903	297	HBENDCP	74	HCT29LX	30
H2093	459	H5905	298	HBEORH23	75	HCT29MT	30
H2095	459	H5991	298	HBEORL23	75	HCT29MX	30
H2111	391	H5995	298	HBEORT23	75	HCT29ST	30
H2112	391	H66280	155	HBFAB	76	HCT29SX	30
H2141	392	H66282	155	HBILNH23	75	HCT36LX	30
H2142	392	H66531	155	HBILNT23	75	HCT36MT	30
H2143	392	H66537	155	HBILNX23	75	HCT36MX	30
H2144	392	H66541	155	HBLEG23	74	HCT36ST	30
H2145	392	H66547	155	HBLH3160	96	HCT36SX	30
H2146	392	H66551	155	HBLH3170	96	HCT42LX	30
H2164	281	H66557	155	HBPPCK	76	HCT42MT	30
H2165	281	H66571	155	HBPPEK	76	HCT42MX	30
H2191	462	H66577	155	HBPPEK	76	HCT42ST	30
H2192	462	H66581	155	HBPPEK	76	HCT42SX	30
H2194	462	H66582	155	HBPRTCV	75	HCTLDS	31
H2281	399	H66591	155	HBSCRAOMTL48	78	HCTMDS	31
H2282	399	H66597	155	HBSCRAOMTL60	78	HCTRECT2448	29
H2285	399	H80170	95	HBSCRAOMTL72	78	HCTRECT2460	29
H4001	476	H80180	95	HBSDCSNT2832	177	HCTRECT2472	29
H4002	476	H80191	95	HBSDFN3030	177	HCTRECT3048	29
H4003	476	H80192	95	HBSDRBN2231	177	HCTRECT3060	29
H4008	476	H80193	95	HBSDRECT2031	177	HCTRECT3072	29
H4022	219	H94011	129	HBSDRECT2038	177	HCTRND24	29
H4028	219	HAECBH	183	HBSDSPY2636	177	HCTRND30	29
H4029	219	HAEHF	183	HBSDTRP2040	177	HCTRND36	29
H4031	363	HAESS	183	HBSMAUSB	216	HCTRND42	29
H4033	363	HARCHA1	143	HBTMS	88	HCTRND48	29
H4039	363	HARCHA8	143	HBTTCW	35	HCTROUGH17	88, 92, 104, 107, 144, 233, 240
H4041	441	HARCHC1	143	HBTTD30	35	HCTROUGH1710	88, 92, 104, 107, 144, 233, 240
H4043	441	HARCHC8	143	HBTTD42	35	HCTROUGH36	88, 92, 107, 144, 240
H4048	441	HASB2	272	HBTTRND30	34	HCTROUGH3610	88, 92, 107, 144, 240
H4049	441	HASB2MF	272	HBTTRND36	34	HCTSDFS	31
H4069	449	HASB3	273	HBTTRND42	34	HCTSFT24	29
H4071	445	HASB3MF	273	HBTTSFT30	34	HCTSFT30	29
H4073	445	HASGBSL	275	HBTTSFT36	34	HCTSFT36	29
H4075	446	HASHB1	265	HBTTSFT42	34	HCTSFT42	29
H4077	446	HASHB1MF	265	HBTTSQR30	34	HCTSFT48	29
H4079	449	HASHB2	267	HBTTSQR36	34	HCTSQR24	29
H4091	447	HASHB2MF	267	HBTTSQR42	34	HCTSQR30	29
H4093	447	HASHB3	269	HBTTX30L	35	HCTSQR36	29
H4095	448	HASHB3MF	269	HBTTX30S	35	HCTSQR42	29
H4097	448	HASHBTC	271	HBTTX42L	35	HCW1	286
H4099	449	HASHBTCMF	271	HBTTX42S	35	HCWPT	43
H5001	452	HASLB1	264	HBVWM	76	HCWTB3656G	41
H5002	452	HASLB1MF	264	HBWCT4224P	56	HCWTB3656J	41
H51204	220	HASLB2	266	HBWCT4230P	56	HCWTB3684G	41
H51206	220	HASLB2MF	266	HBWCT4824P	56	HCWTB3684J	41
H5701	514	HASLB3	268	HBWCT4830P	56	HCVTDSBM27	42
H5703	514	HASLB3MF	268	HBXRISER	58, 223	HCVTDSBM29	42
H5705	514	HASLBTC	270	HCATIMM	303	HCVTDSBM29	42
H5711	515	HASLBTCMF	270	HCD1	222		

CROSS REFERENCE INDEX

MODEL	PAGE	MODEL	PAGE	MODEL	PAGE	MODEL	PAGE
HCWTD5BM36	42	HEMKRSHELF	182	HFLML1	325	HGROM2BLANK	145
HCWTD5BM42	42	HERD42E	169	HFLML1DF	330	HGTMM	347
HCWTRND30G	41	HERD48E	169	HFLMR1	325	HGV1MM	348
HCWTRND30J	41	HESA2440E	168	HFLMR1DF	331	HH870070	76
HCWTRND36G	41	HESA3050E	168	HFLRC1	324	HH870924	227
HCWTRND36J	41	HESH3060E	168	HFLRC1DF	329	HH870924CH	227
HCWTRND42G	41	HESH6066E	170	HFLRCIS	328	HH870930	227
HCWTRND42J	41	HESKD4872E	170	HFLRCISDF	333	HH870930CH	227
HCWTSBL18	42	HESN3054E	168	HFLSCI	324	HH870942	227
HCWTSBL27	42	HESNP54E	168	HFLSC1DF	329	HH870942CH	227
HCWTSBL29	42	HESPCR	172	HFLSCIS	328	HH870960	227
HCWTSBL36	42	HESQ36E	169	HFLSCISDF	333	HH870960CH	227
HCWTSBL42	42	HESQ42E	169	HFLSC2	338	HH871248	77
HCWTSBM18	42	HESQ48E	169	HFLSC2DF	340	HH871248A	77
HCWTSBM27	42	HESW-3054E-NS	172	HFLSO1	327	HH871260	77
HCWTSBM29	42	HESW3054E	168	HFLWI45	326	HH871260A	77
HCWTSBM36	42	HESY-3654E-NS	172	HFLWI45DF	332	HH871272	77
HCWTSBM42	42	HESY3654E	168	HFLWO45	326	HH871272A	77
HCWTSFTS30G	41	HETD54E	169	HFLWO45DF	332	HH871601	77
HCWTSFTS30J	41	HETR2448E	169	HFLYO1	343	HH871601A	77
HCWTSFTS36G	41	HETR2460E	169	HFLYO1DF	344	HH871912	77
HCWTSFTS36J	41	HETR2472E	169	HFMBIN12	183, 210	HH871912A	77
HCWTSFTS42G	41	HETR3048E	169	HFMBIN3	173, 179, 183, 210	HH871918	77
HCWTSFTS42J	41	HETR3060E	169	HFMBIN6	183, 210	HH871918A	77
HCWTSQR30G	41	HETR3072E	169	HFSS7	337	HH873501	77
HCWTSQR30J	41	HETZ3060E	169	HFSS74L	337	HH873501A	77
HCWTSQR36G	41	HF23C	211	HFSS74LDF	339	HH873502	77
HCWTSQR36J	41	HFAA01	395	HFTB17N	64	HH873502A	77
HCWTSQR42G	41	HFAL02	395	HFTLA2460	63	HH873503	77
HCWTSQR42J	41	HFAS03	395	HFTLA3372	63	HH873503A	77
HCWTSR3656G	41	HFCG6	337	HFTLA3384	63	HH873504	77
HCWTSR3656J	41	HFCG6DF	339	HFTLA3396	63	HH873506	77
HCWTSR3684G	41	HFCL2	338	HFTLC2460	63	HHAB2S2L	49
HCWTSR3684J	41	HFCL2DF	340	HFTLC3372	63	HHAB3S2L	49
HD2	222	HFDB17B	64	HFTLC3384	63	HHAB3S3L	49
HD8	222	HFDB17N	64	HFTLC3396	63	HHABCASTER	173
HD8X	204	HFDB29A	64	HFTLD26	65	HHABCTRPK	50
HDPS1	229	HFDB29AN	64	HFTLD30	63	HHABETA2S2L	47
HE4022	219	HFDB29B	64	HFTLD36	63	HHABGLIDE	50
HE4LSTL18	184	HFDB42A	64	HFTLR12	66	HHAW2448P	52
HE4LSTL30	184	HFDB42AF	64	HFTLS24	65	HHAW2454P	52
HEB4LEG	171	HFDB42AF72	64	HFTLS30	63	HHAW2460P	52
HEBBXRL	173, 179	HFDB42AF84	64	HFTLS36	63	HHAW2466P	52
HEBS4LEG	171	HFDB42AF96	64	HFTLW45	66	HHAW2472P	52
HEBSD4LEG	178	HFDB42AFN	64	HFTPLD	50	HHAW2484PNS	54
HEBY4LEG	171	HFDB42AN	64	HFTPTL18	65	HHAW2484PS	54
HEDRT-2766E-NS	172	HFDB42B	64	HFTTAL14	66, 356, 361	HHAW2496PNS	54
HEDRT2766E	170	HFDB42BF	64	HFXB17B	64	HHAW2496PS	54
HEFS01	186	HFL450	327	HFXB29A	64	HHAW3048P	52
HEHP3660E	169	HFLB2	334	HFXB29AN	64	HHAW3054P	52
HEMKR426029BB	180	HFLB3	334	HFXB29B	64	HHAW3060P	52
HEMKR426029L	180	HFLCC1	326	HFXB42A	64	HHAW3066P	52
HEMKR426042BB	180	HFLCC1DF	332	HFXB42AN	64	HHAW3072P	52
HEMKR426042L	180	HFLCO1	343	HFXB42B	64	HHAW3084PNS	54
HEMKR427229BB	180	HFLCO1DF	344	HGDK3-F	197, 199	HHAW3084PS	54
HEMKR427229L	180	HFLDGRMT	236	HGRMTAC	31, 67, 92, 107, 204, 236, 356, 361	HHAW3096PNS	54
HEMKR427242BB	180	HFLDGRMT3	236	HGRMTAC2	31, 51, 67, 92, 107, 204, 236, 356, 361	HHAW3096PS	54
HEMKR427242L	180	HFLDGRMT4	236	HGRMTAC2	31, 51, 67, 92, 107, 204, 236, 356, 361	HHAWV603624LP	53
HEMKRDIVIDER	182	HFLGANG	327	HGRMTDATA	67, 92, 107, 236	HHAWV603624RP	53
HEMKREND29-F	181	HFLMCI	325	HGRMTUSB2	51, 67, 92, 204, 236, 356, 361	HHAWV604824LP	53
HEMKREND29-SP	181	HFLMCI1DF	330	HGRMTUSB2	51, 67, 92, 204, 236, 356, 361	HHAWV604824RP	53
HEMKREND42-F	181	HFLMCIS	328	HGROMIBLANK	145	HHAWV604830LP	53
HEMKREND42-SP	181	HFLMCISDF	333	HGROMIBLANK	145	HHAWV604830RP	53

CROSS REFERENCE INDEX

MODEL	PAGE	MODEL	PAGE	MODEL	PAGE	MODEL	PAGE
HHAWV723624LP	53	HISB6DF	386	HLSA-TK3	207	HLVSC4330R	211
HHAWV723624RP	53	HITL1	369	HLSA-TK6	207	HLVSC5630R	211
HHAWV724824LP	53	HITL2	369	HLSA-WBK52	207	HLWBF1-1248W	208
HHAWV724824RP	53	HITL3	369	HLSC36T-1D	206	HLWBF2-1248W	208
HHAWV724830LP	53	HITLM	376	HLSC36T-1N	205	HLWBS-248WT	208
HHAWV724830RP	53	HITLMKD	377	HLSC36T-2D	206	HLWBS-248WW	208
HHB02	509	HITLRA	378	HLSC36T-2N	205	HLWBS-448WT	208
HHB03	509	HITLRAKD	379	HLSC52T-21D	206	HLWBS-448WW	208
HHC-ARMPULL15	242	HITS5	372	HLSC52T-21N	205	HLWM	313
HHC-ARMPULL5	242	HITSM	376	HLSC52T-3D	206	HLWMBT	315
HHC-FOOTPULL15	242	HITSRA	378	HLSC52T-3N	205	HLWR-12	208
HHC-FOOTPULL5	242	HIWM1	370	HLSF52T-21D	206	HLWU	313
HHC-PPESTND	241	HIWM2	370	HLSF52T-21N	205	HLWUBT	315
HHC-PPEWALL	241	HIWM3	370	HLSF52T-3D	206	HMACABLE	91, 106, 146, 235
HHC-SANSTND-TRAY	241	HIWM8	372	HLSF52T-3N	205	HMAGANG	88, 104, 173, 233
HHC-SANSTND	241	HIWMM	376	HLSL1212	230	HMAJUMP	91, 106, 235
HHC-SANSTND2	241	HIWMMKD	377	HLSL1460LS	228	HMAPLATE	91, 106, 146, 235
HHCB50	511	HIWMRA	378	HLSL1472LS	228	HMAPOWER36	106, 235
HHCG11	493	HIWMRAKD	379	HLSL3014L	57	HMAPOWER362	106, 235
HHCG11DF	494	HIWMU	380	HLSL3014MM	57	HMAPOWER42	106, 235
HHCG21	493	HIWMUKD	381	HLSL3614L	57	HMAPOWER422	106, 235
HHCG21DF	494	HIWMUL	380	HLSL3614MM	57	HMAPOWER48	91, 106, 235
HHCG50	493	HIWMULKD	381	HLSL4214L	57	HMAPOWER482	91, 106, 235
HHCG50DF	495	HKBS	218	HLSL4214MM	57	HMAPOWER54	106, 235
HHCGB21	496	HKTLONG	218	HLSL4814L	57	HMAPOWER542	106, 235
HHCGB31	496	HKTMID	218	HLSL4814MM	57	HMAPOWER60	91, 106, 146, 235
HHCGBR	498	HKTSHORT	218	HLSL4831MB	143, 231	HMAPOWER602	91, 106, 235
HHCGBRCH	498	HL2DARM	317	HLSL5414L	57	HMAPOWER66	106, 235
HHCMT24	240	HL4DARM	317	HLSL5414MM	57	HMAPOWER662	106, 235
HHCMT36	240	HLD-M3A	195	HLSL6014L	57	HMAPOWER72	91, 106, 146, 235
HHCP1	493	HLD-M3AA	195	HLSL6014MM	57	HMAPOWER722	91, 106, 235
HHCP1DF	495	HLD-M3AB	195	HLSLDRWORG	230	HMAPOWER84	91, 106, 146, 235
HHCT01	511	HLD-M3F	195	HLSLR2448	52	HMAPOWER842	91, 106, 235
HHCT02	511	HLD-M3FA	195	HLSLR2454	52	HMAPOWER96	91, 106, 146, 235
HHCT020	510	HLD-M3FB	195	HLSLR2460	52	HMAPOWER962	91, 106, 235
HHCT024	510	HLD-M3T	195	HLSLR2466	52	HMASD	215
HHCT048	510	HLDA-15	197	HLSLR2472	52	HMASTS	215
HHCT12	511	HLDST1	228	HLSLR3048	52	HMAVHA	407
HHCTC	497	HLDV-M3A	196	HLSLR3054	52	HMAVHAMF	407
HHCTL4	497	HLDV-M3F	196	HLSLR3060	52	HMAVHN	406
HHCTRT	497	HLDV-MRECT2026A	196	HLSLR3066	52	HMAVHNMF	406
HHCTS	497	HLED1	226	HLSLR3072	52	HMAVMA	405
HHPS1	229	HLED17A	227	HLT2460T-L3	202	HMAVMAMF	405
HHTADF3	77	HLED17AS	227	HLT2460T-R3	202	HMAVMN	404
HHTADF4	77	HLED17AUO	227	HLT2672T-23	202	HMAVMNMF	404
HHTADJ5	77	HLED10C	226	HLTA-TR24	202	HMAVO	408
HHTADJ6	77	HLED2	226	HLTM	314	HMAVOMF	408
HI2AAA	373, 382	HLED31A	227	HLTP	314	HMBFLIP18L	86
HI2ATA	373, 382	HLED31AS	227	HLTSM	316	HMBFLIP18S	86
HI2FHA	317, 373, 382	HLED31AUO	227	HLTSP	316	HMBFLIP24L	86
HIB50	384	HLEDOSA	227	HLTSU	316	HMBFLIP24S	86
HICS7	385	HLEU	312	HLTU	314	HMBFLIP30L	86
HICS7DF	387	HLEUBT	315	HLTV2460T-3	203	HMBFLIP30S	86
HIEH1	371	HLINEARA1	143	HLTV2466T-33	203	HMBPOST	86
HIEH2	371	HLINEARA8	143	HLVBC3330	212	HMBTLEG18	86
HIEH3	371	HLINEARC1	143	HLVBC4330	212	HMBTLEG24	86
HIGB1	387	HLINEARC8	143	HLVBC5630	212	HME3	410
HIGCL	384	HLMSHR	317	HLVMSC3330R	210	HMG1	420
HIGS6	385	HLSA-CR12	207	HLVMSC4330R	210	HMG2	420
HIGS6DF	386	HLSA-HRK	207	HLVMSC5630R	210	HMG3	421
HILMBR	382	HLSA-SK1220T	207	HLVPM1	228	HMG4	421
HIPAA	317, 373, 382	HLSA-SK3020T	207	HLVPM2	229	HMG5	421
HISB6	385	HLSA-TK12	207	HLVSC3330R	211	HMG7	421

CROSS REFERENCE INDEX

MODEL	PAGE	MODEL	PAGE	MODEL	PAGE	MODEL	PAGE
HMG1	427	HMT3060E	84	HMVR-2442(?)-FX	99	HN6	439
HMG2	427	HMT3060G	84	HMVR-2442(?)-NS	100	HN7	439
HMH01	278	HMT3072E	84	HMVR-2448(?)-AH	101	HNATA	439
HMH02	278	HMT3072G	84	HMVR-2448(?)-FX	99	HNFPFA	439
HML1S	353	HMT5	414	HMVR-2448(?)-NS	100	HNL1530FD	142
HML1SDF	357	HMTHR3060E	85	HMVR-2454(?)-AH	101	HNL1530LD	141
HML2S	353	HMTHR3060G	85	HMVR-2454(?)-FX	99	HNL1530LL	141
HML2SDF	358	HMTHR3248E	85	HMVR-2454(?)-NS	100	HNL1536FD	142
HML2ST	355	HMTHR3248G	85	HMVR-2460(?)-AH	101	HNL1536LD	141
HML2STDF	360	HMTLSCRN2048	50	HMVR-2460(?)-FX	99	HNL1536LL	141
HML3S	354	HMTLSCRN2054	50	HMVR-2460(?)-NS	100	HNL1542FD	142
HML3SDF	359	HMTLSCRN2060	50	HMVR-2466(?)-AH	101	HNL1542LD	141
HML8851	96, 305	HMTLSCRN2066	50	HMVR-2466(?)-FX	99	HNL1542LL	141
HML8852	96, 305	HMTLSCRN2548	50	HMVR-2466(?)-NS	100	HNL1548FD	142
HML8858	44	HMTLSCRN2554	50	HMVR-2472(?)-AH	101	HNL1548LD	141
HMNI	424	HMTLSCRN2560	50	HMVR-2472(?)-FX	99	HNL1548LL	141
HMN2	424	HMTLSCRN2566	50	HMVR-2472(?)-NS	100	HNL1548SD	142
HMNT1	430	HMTS01	259	HMVR-2484(?)-FX	99	HNL1560FD	142
HMNT2	430	HMTS11	259	HMVR-2484(?)-NS	100	HNL1560LD	141
HMP144	77	HMTUMOD26	102	HMVR-2496(?)-FX	99	HNL1560LL	141
HMPEEK48	77	HMTUMOD32	88, 102, 203	HMVR-2496(?)-NS	100	HNL1560SD	142
HMPEEK60	77	HMTUMOD38	37, 102	HMVR-3036(?)-AH	101	HNL1566FD	142
HMPEEK72	77	HMTUMOD44	88, 102	HMVR-3036(?)-FX	99	HNL1566LD	141
HMPHATFWML	51	HMTUMOD50	37, 102	HMVR-3036(?)-NS	100	HNL1566LL	141
HMPT2448NS	37	HMTUMOD56	102	HMVR-3042(?)-AH	101	HNL1566SD	142
HMPT2460NS	37	HMTUMOD62	102	HMVR-3042(?)-FX	99	HNL1572FD	142
HMPT2472NS	37	HMTUMOD74	102	HMVR-3042(?)-NS	100	HNL1572LD	141
HMPT3048NS	37	HMTUMOD86	102	HMVR-3048(?)-AH	101	HNL1572LL	141
HMPT3060NS	37	HMVH-2448(?)-FX	99	HMVR-3048(?)-FX	99	HNL1572SD	142
HMPT3072NS	37	HMVH-2448(?)-NS	100	HMVR-3048(?)-NS	100	HNL1578FD	142
HMPTBFX	36	HMVH-3060(?)-FX	99	HMVR-3054(?)-AH	101	HNL1578LD	141
HMPTBNSL	36	HMVH-3060(?)-NS	100	HMVR-3054(?)-FX	99	HNL1578LL	141
HMPTBNSS	36	HMVH-3672(?)-FX	99	HMVR-3054(?)-NS	100	HNL1578SD	142
HMPTT2448	36	HMVH-3672(?)-NS	100	HMVR-3060(?)-AH	101	HNL3630TB	231
HMPTT2460	36	HMVMB-3072WW	103	HMVR-3060(?)-FX	99	HNL3630WB	231
HMPTT2472	36	HMVMB-3672WW	103	HMVR-3060(?)-NS	100	HNL3636TB	231
HMPTT3048	36	HMVPC-DTLG	103	HMVR-3066(?)-AH	101	HNL3636WB	231
HMPTT3060	36	HMVPC-MP	103	HMVR-3066(?)-FX	99	HNL4930TB	231
HMPTT3072	36	HMVPCA1-1830G	103	HMVR-3066(?)-NS	100	HNL4930WB	231
HMPVWM28	240	HMVPCA1-1830R	103	HMVR-3072(?)-AH	101	HNL4936TB	231
HMREC3S2LTF	47	HMVPCA2-1830G	103	HMVR-3072(?)-FX	99	HNL4936WB	231
HMS1	416	HMVPCA2-1830R	103	HMVR-3072(?)-NS	100	HNLMP3628	140
HMS2	416	HMVPCF-1830G	103	HMVR-3084(?)-FX	99	HNLMP5428	140
HMSCART	416	HMVPCF-1830R	103	HMVR-3084(?)-NS	100	HNLMP7228	140
HMSFLTGLD	417	HMVPCSS-4C	103	HMVR-3096(?)-FX	99	HNLMP9028	140
HMSGANG	417	HMVPCSS-4C4C	103	HMVR-3096(?)-NS	100	HNLRC2436	140
HMSGLD	417	HMVPCSS-4C9C	103	HMVR-3648(?)-AH	101	HNLRC2448	55
HMSSTLGLD	417	HMVPCSS-4O	103	HMVR-3648(?)-FX	99	HNLRC2454	140
HMT1	414	HMVPCSS-4O4C	103	HMVR-3648(?)-NS	100	HNLRC2460	55
HMT1848E	84	HMVPCSS-4O9C	103	HMVR-3660(?)-AH	101	HNLRC2466	55
HMT1848G	84	HMVR-1848(?)-AH	101	HMVR-3660(?)-FX	99	HNLRC2472	55, 140
HMT1860E	84	HMVR-1848(?)-FX	99	HMVR-3660(?)-NS	100	HNLRC2490	140
HMT1860G	84	HMVR-1848(?)-NS	100	HMVR-3672(?)-AH	101	HNLRC3048	55
HMT1872E	84	HMVR-1860(?)-AH	101	HMVR-3672(?)-FX	99	HNLRC3060	55
HMT1872G	84	HMVR-1860(?)-FX	99	HMVR-3672(?)-NS	100	HNLRC3066	55
HMT2448E	84	HMVR-1860(?)-NS	100	HMVT-2448(?)-FX	99	HNLRC3072	55
HMT2448G	84	HMVR-1872(?)-AH	101	HMVT-2448(?)-NS	100	HPACSM	215
HMT2460E	84	HMVR-1872(?)-FX	99	HMVT-3060(?)-FX	99	HPACW	215
HMT2460G	84	HMVR-1872(?)-NS	100	HMVT-3060(?)-NS	100	HPADD	216
HMT2472E	84	HMVR-2436(?)-AH	101	HMVT-3672(?)-FX	99	HPASD	216
HMT2472G	84	HMVR-2436(?)-FX	99	HMVT-3672(?)-NS	100	HPATF	216
HMT3048E	84	HMVR-2436(?)-NS	100	HN1	438	HPHAP2028E	87
HMT3048G	84	HMVR-2442(?)-AH	101	HN1U	438	HPHAP2028G	87

CROSS REFERENCE INDEX

MODEL	PAGE	MODEL	PAGE	MODEL	PAGE	MODEL	PAGE
HPN1	456	HSLVSMRS	484	HT29FB48240	126	HTFXM42C	130
HPN2	456	HSLVSMU	486	HT29FB4896	127	HTFXM42P	130
HPPMFB	209	HSLVSMUS	486	HT29FBM	127	HTFXS27	130
HPPMHK	209	HSLVTMM	481	HT36FB3060	127	HTFXS27P	130
HPPMMT	209	HSLVTMMKD	487	HT36FB3672	127	HTFXS29	130
HPPMPB	209	HSLVTMMS	481	HT36FB4284	127	HTFXS29P	130
HPPMPC	209	HSLVTMR	483	HT36FB48108	127	HTFXS36	130
HPWRMOB1	237, 276	HSLVTMRKD	487	HT36FB48120	127	HTFXS36P	130
HPWRMOD2	38, 51, 237	HSLVTMRS	483	HT36FB48144	127	HTFXS42	130
HPWRMOD2UWM	51, 67, 237	HSLVTMU	485	HT36FB48168	126	HTFXS42P	130
HPWRMOD2WC	51, 237	HSLVTMUKD	487	HT36FB48180	126	HTFXT27	130
HPWRMOD3UWM	51, 67, 237	HSLVTMUS	485	HT36FB48192	126	HTFXT27P	130
HPWRMOD3WC	51, 237	HSMPWR-1P-2U	237	HT36FB48216	126	HTFXT29	130
HPWRMOD4WC	51, 237	HSS4L-06A	198	HT36FB48240	126	HTFXT29P	130
HQB	89, 104, 233	HSS4L-12A	198	HT36FB4896	127	HTG1PWR-3P-1B	92, 145, 238, 356, 361
HQBCJ36	89, 104, 233	HSS4L-14A	198	HT36FBM	127	HTG2PWR-3P-1E	145, 238
HQH1-3	89, 104, 146, 233	HSS4L-16B	198	HT42AL60	128	HTG2PWR-3P-1U-W	145, 238
HQH5-3	89, 104, 146, 233	HSS4L-18B	198	HT42AL72	128	HTG2PWR-3P-2B-2U	145, 238
HQH5-E-3PIE	146, 233	HSS4L-24B	199	HT42AL84	128	HTG2PWR-4P-2B	145, 238
HQH5-E-3PIU2B	146, 233	HSS4L-30B	199	HT42AL96	128	HTL(?)24	123
HQH5-E-3P3B	146, 233	HSSA-WB1618	199	HT42ALEG	128	HTL(?)30	123
HQH5-P-3PIB	89, 104, 146, 233	HSSCL-14A	200	HT42FB3060	127	HTL(?)3060	122
HQJ3	89, 104, 233	HSSCL-16B	200	HT42FB3672	127	HTL(?)36	123
HQQ1	473	HSSCL-18B	200	HT42FB4284	127	HTL(?)3672	122
HQQICUSH	473	HSSST-18B	201	HT42FB48108	127	HTL(?)42	123
HREC2S2LCF	47	HSSTK-18B	201	HT42FB48120	127	HTL(?)42108	122
HREC2S2LTF	47	HT27FB3060	127	HT42FB48144	127	HTL(?)42120	122
HREC3S2LCF	47	HT27FB3672	127	HT42FB48168	126	HTL(?)42144	122
HREC3S2LTF	47	HT27FB4284	127	HT42FB48180	126	HTL(?)42168	122
HREC3S3LCF	48	HT27FB48108	127	HT42FB48192	126	HTL(?)42180	122
HREC3S3LTF	48	HT27FB48120	127	HT42FB48216	126	HTL(?)42192	122
HRUCKIL	467	HT27FB48144	127	HT42FB48240	126	HTL(?)42216	122
HRUCKIW	468	HT27FB48168	126	HT42FB4896	127	HTL(?)42240	122
HRUCK5L	467	HT27FB48180	126	HT42FBM	127	HTL(?)4284	122
HRUCK5W	468	HT27FB48192	126	HTALWMGR29	128	HTL(?)4296	122
HS1100	58, 223	HT27FB48216	126	HTALWMGR42	128	HTL(?)48	123
HS1101	58, 223	HT27FB48240	126	HTBINSLIDE	138	HTL(?)48108	122
HS1102	58, 223	HT27FB4896	127	HTFWMGR27	127	HTL(?)48120	122
HSB50	256	HT27FBM	127	HTFWMGR29	127	HTL(?)48144	122
HSB50DF	258	HT29AL108	128	HTFWMGR36	127	HTL(?)48168	122
HSCASTER	302, 303, 317, 373, 382, 488, 518, 519, 542	HT29AL120	128	HTFWMGR42	127	HTL(?)48180	122
		HT29AL144	128	HTFXL27	130	HTL(?)48192	122
HSCCR36LM	151	HT29AL168	128	HTFXL27C	130	HTL(?)48216	122
HSCCR48LM	151	HT29AL180	128	HTFXL27P	130	HTL(?)48240	122
HSCCSR2448LM	151	HT29AL192	128	HTFXL29	130	HTL(?)4896	122
HSCCSS36LM	151	HT29AL216	128	HTFXL29C	130	HTL(?)54108	122
HSCCSS48LM	151	HT29AL240	128	HTFXL29P	130	HTL(?)54120	122
HSCER24LM	152	HT29AL60	128	HTFXL36	130	HTL(?)54144	122
HCESS24LM	152	HT29AL72	128	HTFXL36C	130	HTL(?)54168	122
HSCS1	255	HT29AL84	128	HTFXL36P	130	HTL(?)54180	122
HSCSIDF	257	HT29AL96	128	HTFXL42	130	HTL(?)54192	122
HSCS2	256	HT29ALEG	128	HTFXL42C	130	HTL(?)54216	122
HSCS2DF	258	HT29ALM	128	HTFXL42P	130	HTL(?)54240	122
HSGANG	255, 258	HT29FB3060	127	HTFXM27	130	HTLB1048LP	148
HSGS6	255	HT29FB3672	127	HTFXM27C	130	HTLB12048P	147
HSGS6DF	257	HT29FB4284	127	HTFXM27P	130	HTLB1248LP	148
HSLV2DAP	488	HT29FB48108	127	HTFXM29	130	HTLB14448P	147
HSLV4DAP	488	HT29FB48120	127	HTFXM29C	130	HTLB1448LP	148
HSLVFAP	488	HT29FB48144	127	HTFXM29P	130	HTLB1648LP	148
HSLVLMBR	488	HT29FB48168	126	HTFXM36	130	HTLB16848P	147
HSLVSMM	482	HT29FB48180	126	HTFXM36C	130	HTLB1848LP	148
HSLVSMMS	482	HT29FB48192	126	HTFXM36P	130	HTLB2048LP	148
HSLVSMR	484	HT29FB48216	126	HTFXM42	130	HTLBENCH30	137

CROSS REFERENCE INDEX

MODEL	PAGE	MODEL	PAGE	MODEL	PAGE	MODEL	PAGE
HTLBENCH48	137	HTLC4272HCTFPR	132	HTLHP240	124	HTLRMC	125
HTLBENCH60	137	HTLC4272HCTHP	131	HTLHP84	124	HTLRM	125
HTLBENCHCUSH30	137	HTLC4272HCTP	131	HTLHP96	124	HTLSHELF	138
HTLBENCHCUSH48	137	HTLC4272HCTPL	132	HTLHPM	124	HTLT120	124
HTLBENCHCUSH60	137	HTLC4272HCTPR	132	HTLLECTA	137	HTLT144	124
HTLC3060HCTFP	133	HTLC4272LCTFP	131	HTLM4272	122	HTLT168	124
HTLC3060HCTFPL	134	HTLC4272LCTFPL	132	HTLM4872	122	HTLT172	124
HTLC3060HCTFPR	134	HTLC4272LCTFPR	132	HTLM5472	122	HTLT96	124
HTLC3060HCTHP	133	HTLC4272LCTHP	131	HTLM7248P	147	HTLXP36	129
HTLC3060HCTP	133	HTLC4272LCTP	131	HTLMCI828DL	139	HTLXP42	129
HTLC3060HCTPL	134	HTLC4272LCTPL	132	HTLMCI828DR	139	HTLXP48	129
HTLC3060HCTPR	134	HTLC4272LCTPR	132	HTLMCI828L	139	HTMC304260	135
HTLC3060LCTFP	133	HTLC4296HCTFP	131	HTLMCI828O	139	HTMC304260BB	135
HTLC3060LCTFPL	134	HTLC4296HCTFPL	132	HTLMCI828R	139	HTMC304272	135
HTLC3060LCTFPR	134	HTLC4296HCTFPR	132	HTLMT4260H	136	HTMC304272BB	135
HTLC3060LCTHP	133	HTLC4296HCTHP	131	HTLMT4260HFR	136	HTMC304296	135
HTLC3060LCTP	133	HTLC4296HCTP	131	HTLMT4260L	136	HTMC304296BB	135
HTLC3060LCTPL	134	HTLC4296HCTPL	132	HTLMT4272H	136	HTMC424260	135
HTLC3060LCTPR	134	HTLC4296HCTPR	132	HTLMT4272HFR	136	HTMC424260BB	135
HTLC3072HCTFP	133	HTLC4296LCTFP	131	HTLMT4272L	136	HTMC424272	135
HTLC3072HCTFPL	134	HTLC4296LCTFPL	132	HTLMTHBACK	136	HTMC424272BB	135
HTLC3072HCTFPR	134	HTLC4296LCTFPR	132	HTLMTLBACK	136	HTMC424296	135
HTLC3072HCTHP	133	HTLC4296LCTHP	131	HTLMTTV	136	HTMC424296BB	135
HTLC3072HCTP	133	HTLC4296LCTP	131	HTLP108	124	HTPCIF48	276
HTLC3072HCTPL	134	HTLC4296LCTPL	132	HTLP120	124	HTPCIF72	276
HTLC3072HCTPR	134	HTLC4296LCTPR	132	HTLP144	124	HTPHWIF72	276
HTLC3072LCTFP	133	HTLCRED42	138	HTLP168	124	HTPKIT48	276
HTLC3072LCTFPL	134	HTLCRED42S	138	HTLP180	124	HTPKIT60	276
HTLC3072LCTFPR	134	HTLCRED57	138	HTLP192	124	HTPKIT72	276
HTLC3072LCTHP	133	HTLCRED57S	138	HTLP216	124	HTPKIT482	276
HTLC3072LCTP	133	HTLCRED72	138	HTLP240	124	HTPKIT602	276
HTLC3072LCTPL	134	HTLCRED72S	138	HTLP60	124	HTPKIT722	276
HTLC3072LCTPR	134	HTLCUBE108	125	HTLP72	124	HTPLATEVHAU	145, 239
HTLC3096HCTFP	133	HTLCUBE120	125	HTLP84	124	HTPSPLIT	276
HTLC3096HCTFPL	134	HTLCUBE144	125	HTLP96	124	HTRACK	138
HTLC3096HCTFPR	134	HTLCUBE168	125	HTLPB	147	HTSSRD	334
HTLC3096HCTHP	133	HTLCUBE180	125	HTLPBS	147	HTTLEG108	128
HTLC3096HCTP	133	HTLCUBE192	125	HTLPM	124	HTTLEG120	128
HTLC3096HCTPL	134	HTLCUBE216	125	HTLPRES	143	HTTLEG144	128
HTLC3096HCTPR	134	HTLCUBE240	125	HTLR108	125	HTTLEG168	128
HTLC3096LCTFP	133	HTLCUBE48	129	HTLR120	125	HTTLEG180	128
HTLC3096LCTFPL	134	HTLCUBE84	125	HTLR144	125	HTTLEG192	128
HTLC3096LCTFPR	134	HTLCUBE96	125	HTLR168	125	HTTLEG216	128
HTLC3096LCTHP	133	HTLCUBEM	125	HTLR180	125	HTTLEG240	128
HTLC3096LCTP	133	HTLCUBES108	125	HTLR192	125	HTTLEG60	128
HTLC3096LCTPL	134	HTLCUBES120	125	HTLR216	125	HTTLEG72	128
HTLC3096LCTPR	134	HTLCUBES144	125	HTLR240	125	HTTLEG84	128
HTLC4260HCTFP	131	HTLCUBES168	125	HTLR36	129	HTTLEG96	128
HTLC4260HCTFPL	132	HTLCUBES180	125	HTLR42	129	HTTLEGM	128
HTLC4260HCTFPR	132	HTLCUBES192	125	HTLR48	129	HTXLEG	130
HTLC4260HCTHP	131	HTLCUBES216	125	HTLR84	125	HTXLEGSH	130
HTLC4260HCTP	131	HTLCUBES240	125	HTLR96	125	HUMPWR-1P-2U	237, 276
HTLC4260HCTPL	132	HTLCUBES48	129	HTLRCI08	125	HUTM1872	158
HTLC4260HCTPR	132	HTLCUBES96	125	HTLRCI20	125	HUTM2040	158
HTLC4260LCTFP	131	HTLCUBESM	125	HTLRCI44	125	HUTM2060	158
HTLC4260LCTFPL	132	HTLD60	123	HTLRCI68	125	HUTM2460	158
HTLC4260LCTFPR	132	HTLHP108	124	HTLRCI80	125	HUTM3060	158
HTLC4260LCTHP	131	HTLHP120	124	HTLRCI92	125	HUTM3072	158
HTLC4260LCTP	131	HTLHP144	124	HTLRC216	125	HUTM3672	158
HTLC4260LCTPL	132	HTLHP168	124	HTLRC240	125	HUVDSBS2048	78
HTLC4260LCTPR	132	HTLHP180	124	HTLRC48	129	HUVDSBS2060	78
HTLC4272HCTFP	131	HTLHP192	124	HTLRC84	125	HUVDSBS2072	78
HTLC4272HCTFPL	132	HTLHP216	124	HTLRC96	125	HV-UT1	230

CROSS REFERENCE INDEX

MODEL	PAGE	MODEL	PAGE	MODEL	PAGE	MODEL	PAGE
HVL102	502	HVL515	501	HVL701	520	HWH1SPCF	525
HVL103	502	HVL518	388	HVL702	520	HWH1SS	524
HVL105	535	HVL521	538	HVL705	520	HWH1SSCF	525
HVL108	307	HVL525	538	HVL712	520	HWH1TCP	531
HVL131	535	HVL528	388	HVL721	319	HWH1TCPF	532
HVL149	470	HVL531	463	HVL791	433	HWH1TCS	531
HVL151	535	HVL532	463	HVL844	500	HWH1TCSCF	532
HVL161	536	HVL534	464	HVL852	500	HWH2SP	526
HVL171	536	HVL537	464	HVL853	500	HWH2SPCF	527
HVL205	504	HVL538	388	HVL862	541	HWH2SS	526
HVL210	504	HVL539	464	HVL864	541	HWH2SSCF	527
HVL215	504	HVL541	318	HVL871	289	HWH3SP	528
HVL220	540	HVL581	306	HVL872	289	HWH3SPCF	529
HVL232	401	HVL582	306	HVL873	289	HWH3SS	528
HVL238	401	HVL585	306	HVL887	304	HWH3SSCF	529
HVL281	431	HVL601	536	HVL888	304	HWHACPP	534
HVL282	431	HVL604	503	HVL951	499	HWHACPS	534
HVL283	431	HVL605	503	HVL981	59, 224, 542	HWHBCPP	534
HVL289	431	HVL606	471	HVL982	59, 224, 542	HWHBCPS	534
HVL303	539	HVL616	471	HVL991	59, 224, 453, 542	HWHGB	534
HVL304	260	HVL643	288	HVL995	504	HWHLP	533
HVL314	260	HVL653	537	HVLPERCH	453	HWHSP18	533
HVL402	536	HVL685	503	HWH1C	530	HWMCLIPLG	240
HVL508	388	HVL691	290	HWH1CCF	530	HWMCLIPSM	240
HVL511	501	HVL693	290	HWH1SP	524		

NOTES

NOTES

NOTES

NOTES

INFORMATION ON ORDERING PARTS

When parts are needed to repair HON products, the following guidelines should be followed to expedite the process.

1. Warranty orders are submitted on HON Ready via the Quick Claim tool. To purchase repair parts, please visit HONAccessories.com which can be found on HON.com.
2. There are no discounts applied to parts. Pricing quoted is the net value. Parts pricing is subject to change without notice.
3. For a part not covered by warranty applicable shipping charges will apply.
4. All keys are \$6.00 each plus a shipping and handling fee of \$3.00 per shipping location.
5. Parts may be paid for with an approved credit card. Approved Cards: MasterCard, VISA and American Express.
6. Payment terms for invoiced parts are Net 30 days.
7. Due to short leadtimes on parts, no changes will be accepted after the order has been placed.
8. When placing a **warranty** parts order:

If the product is under warranty, the product serial number must be provided. Most finished goods products have a serial number placed on them at the factory. The label containing the serial number is located:

Vertical Files — right side of the uppermost drawer

Lateral Files — left side of the uppermost drawer or shelf

Desk Towers — outside of top drawer

Desks, Credenzas, & Returns — on the outside, kneespace side of the top drawer. Fully extend the drawer to find it.

Desks, Credenzas, Corner Units, Bridges, Peninsulas & Returns without drawers — underside of top

Tables and Stands — underside of the top

Table Trucks — underside of side rail

Cabinets & Bookcases — left inner side of the case

Modular Component Top and Backs — underside of top

Modular End Panels — top inside surface

Reception Stations — top inside surface of back panel

Organizers — top inside surface of left end panel near back panel

Vertical Paper Manager — back panel inside surface near top

Pedestals — bottom drawer right side exterior

Seating — underside of the seat

Panels — underside of the top cap

Hutches, Storage Units, Overhead Storage — underside of the shelf

Hanging Bookshelves — underside of shelf

NOTE: Removal of the serial number tag from the product voids the warranty.

An important note regarding Product Serial Numbers:

HON desks, tables, chairs, files and systems components are tagged with a serial number. This number helps us identify *when and where your product was made*, and to identify and correct the root causes for the problem. NEITHER THE DEALER NOR THE CONSUMER SHOULD REMOVE THIS TAG UNDER ANY CIRCUMSTANCES. To do so immediately voids your Warranty coverage for that particular item *and prevents us from further identifying it*. Instead, please transcribe the number and call your Dealer.