

Fastback Scoring/ Creasing Machine - PPSM

Instruction Manual



Provided by

MyBinding.com

When Image Matters.

Call Us at 1-800-944-4573

**POWIS
PARKER**

SCORING MACHINE

SCORING MACHINE USER'S MANUAL



I	INTRODUCTION	2
II	FIRST TIME SETUP.....	3
	A. What's in the Box	3
	B. Setting Up	3
	A. Changing Die Holders	3
III	COMFORT & SAFETY.....	4
IV	HOW TO MAKE SCORES	5
	A. Simple Scoring	5
	B. Wraparound Cover Scoring	5
V	PERFECTBACK™ COVER BINDING STYLES.....	6
	A. Perfectback™ LF (lay flat) strips	6
	B. Perfectback™ PS (pressure sensitive) strips	6
	C. Perfectback™ TA (temperature activated) strips	6
VI	USING PERFECTBACK™ LF STRIPS.....	7
	A. Double Die Holder Use.....	7
	B. Single Die Holder Use.....	9
	C. Handheld Document Assembly.....	11
VII	USING PERFECTBACK™ PS STRIPS.....	12
	A. Double Die Holder Use.....	12
	B. Single Die Holder Use.....	14
VIII	USING PERFECTBACK™ TA STRIPS	16
	A. Double Die Holder Use	16
	B. Single Die Holder Use.....	17
IX	TIPS FOR BEST RESULTS	19

The cover for this manual was scored and assembled on this model Scorer. Binding was done on a Powis Parker Fastback® binder using a Perfectback™ LF strip.



I | INTRODUCTION

Meet your fabulous new Scorer!

This machine enables you to precisely add scores to most cover materials. These crisp and straight scores provide folding lines or cosmetic creases on your covers or card stock. Now you can make professional-looking bound books with pre-printed wraparound soft covers on your own desktop. Heat-sensitive materials and inks as well as toner-based digital printing may be used for your covers.

With our Fastback® Model 8 and 15xs series binders you can quickly and easily bind your document pages. Then our full line of Perfectback™ strip products allows you to complete the desktop production of your books — be it one or one thousand! Choose between a lay-flat binding style or a fully bound spine. (Details regarding binding methods are described on page 6.) You can also score folders and greeting cards — even party hats and paper airplanes, if you like. Like all Powis Parker products, this Scorer is fast, versatile and easy to use.

The unique transparent die holder allows you to see and control exactly where you are scoring your cover. Our patented Centering Guide enables you to easily center a title on the spine of books up to 1-1/2 inches thick.



Please read the COMFORT & SAFETY section on page 4 before using your Scorer.

BRIEFLY. . . .

The transparent **Die Holder** (D) allows you to see and position exactly where the metal **Scoring Die** (E) will put a score on your cover.

Pushing the **Lever** (B) to the left scores your cover. Pushing to the right clamps a cover in place on the **Platform** (A).

The **Centering Guide** (H) allows you to easily center a title on the spine of your book cover, for any thickness book.

The **Instructions** (G) describe how to score your cover for a centered spine title.

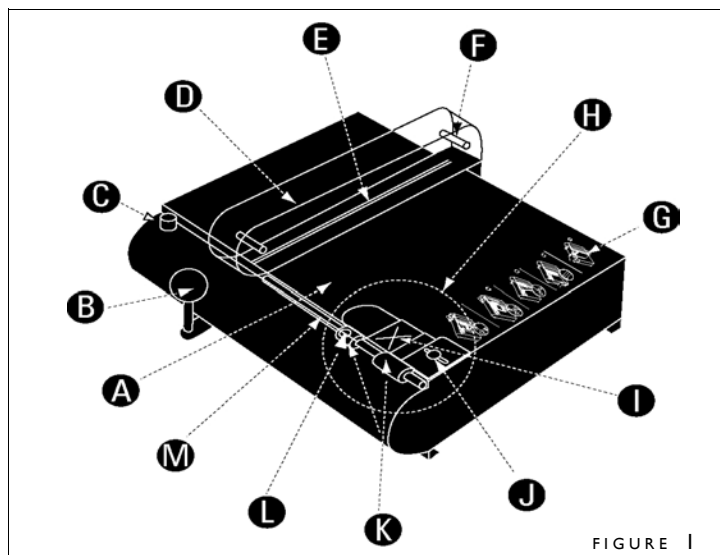

FIGURE 1

A	Platform	H	Centering Guide
B	Lever	I	Crosshairs
C	Left Stop	J	Book Thickness Locking Knob
D	Die Holder	K	Book Thickness Rings
E	Scoring Die(s)	L	Centering Guide Locking Knob
F	Die Holder Pin	M	Guide Rail
G	Instructions		

A. What's Included Inside the Box

Scoring Machine with Die Holder

Accessory Pack, which contains:

Starter kit of:

5 narrow Perfectback™ LF™ (layflat) strips

3 preprinted wraparound covers

1 Demonstration Cover

2 extra die holder pins

User's manual

If any of the preceding items are damaged or missing, contact your dealer immediately.

B. Setting Up

Place the machine on a flat, stable work surface. Cut the two shipping bands. Remove the cardboard Centering Guide retainer and the dark cover that is under the clear bar. Your Scorer is now ready to use!

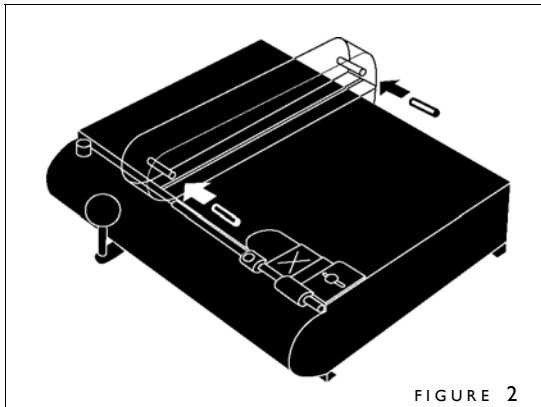

FIGURE 2

C. Changing Die Holders

Two metal pins attach the front and rear of the Die Holder to the machine (figure 2). To remove the Die Holder, push these pins out sideways with a pointed object such as a small screwdriver.

The Die Holder may now be lifted off — it is best removed by keeping it level while lifting. Because of the exacting fit of the parts, if the Die Holder gets slightly angled it may stick while being lifted. Should that happen, gently push it down and start again.

To install a different Die Holder make sure the fully rounded end of the clear bar faces the front of the machine. Maneuver the bar so it slides onto the two vertical shafts sticking up from the platform of the machine. Carefully lower it all the way down. Reinsert the front and rear pins from the side to secure the bar.



In recent years, medical attention on occupational injuries has identified common, seemingly harmless activities as potential causes of a wide range of problems collectively known as Repetitive Stress Injuries or Cumulative Trauma Disorders. It is now recognized that any repetitive motion may contribute to these health problems. Depending on how it is used, the prolonged or repetitive use of almost any machine might have a potential for discomfort or injury. As a user of this Scorer, you might also be at risk.

The most commonly accepted causes of this type of disorder are repeated, forceful actions, usually in an awkward position or posture, without sufficient rest to allow the body to recover. These repetitive actions may cause nerves, tendons, ligaments, and other soft body parts to become irritated and inflamed.

By paying attention to the way you perform your work, and do other activities, you can identify the behaviors that could put you at risk. The precautions outlined below are examples you can take to help reduce the likelihood of developing these problems and work more comfortably with your new Scorer. Keep in mind, however, that these are only suggestions. Comfort is personal and only you may be able to judge what works best for you.

- You may find that your body will be most comfortable and relaxed with the Scorer placed directly in front of you. The Scorer and your supplies should be within easy reach — avoid excessive stretching.
- When making a score, it is suggested that the Lever be used with the left hand while you steady your cover with your right hand. We suggest that the ball be lightly clasped throughout the scoring motion. Avoid pushing the ball with an open hand.
- The Scorer may be used in either a standing or seated position. If you are standing, make sure that the worksurface height that the Scorer is on does not require you to bend over in a way that you would strain your back or arms.
- If you are seated, adjust the height of your chair to your table so your body is naturally aligned and make sure you have adequate legroom. Stay relaxed and relatively upright. Don't force yourself into an uncomfortable position.
- Do not use excessive force when turning the Lever, for either scoring or clamping. You should try reducing the amount of force on the Lever to see how little is necessary to still get a good score.
- Do not bend your wrists unnaturally during use.
- Don't stay in one position for too long. Try changing hands and varying your posture.
- Take breaks. Frequent short breaks are probably better than a few long ones.

Many factors go into creating a comfortable work space, including proper placement and adjustment of furniture and equipment. A thorough work site analysis by a qualified expert is important in order to reduce the risk of repetitive motion injuries. If you experience pain, throbbing, aching, tingling, stiffness, a burning sensation, swelling, numbness, or weakness in your wrists, hands, arms or legs, see your physician immediately.

DO NOT IGNORE THESE WARNING SIGNS. Even if symptoms occur when you are not using the Scorer, they can be associated with painful and sometimes permanently disabling injuries or disorders of the nerves, muscles, tendons, or other parts of the body. These symptoms could mean that you are developing a repetitive stress injury that requires prompt medical attention. For more detailed information, consult your doctor.

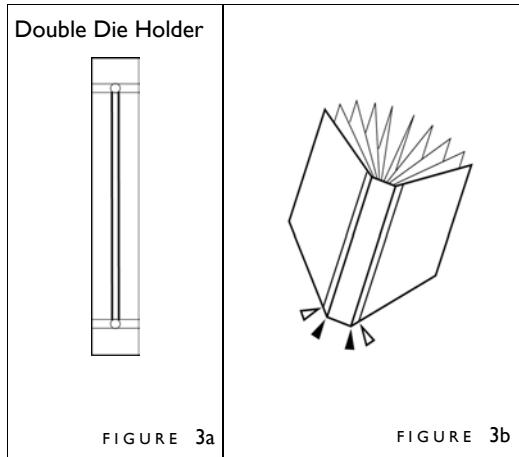

FIGURE 3a

FIGURE 3b

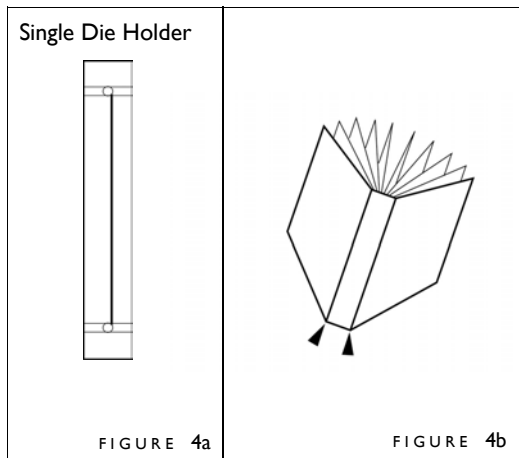

FIGURE 4a

FIGURE 4b

NOTE : The Single Die Holder is optional and may be ordered separately.

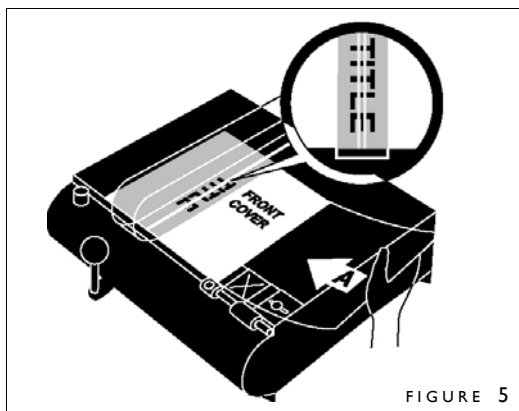

FIGURE 5

Generally, common paper card and cover stocks of approximately 20 points (.020 inches or .50 mm thick) can be nicely scored. For materials thicker than this, or of unusual or unknown composition, then their ability to be scored may be uncertain. Don't attempt to score materials over 23 points thick, as this could damage the machine if excess force is used. It is usually a good idea to try a practice score to see if the final score bends and looks satisfactory. Sheets measuring 13 x 20 inches (33 x 50 cm) are easily handled on the machine.

You can make either one (single) score or two (double) scores at a time — it depends on which Die Holder is installed on your machine.

To tell which Die Holder you have, look down into the top of the clear bar. If you see two silver lines (figure 3a), then you have the **Double Die Holder**, which makes two scores at a time. This enables you to create a cover with a “hinged” spine — for a book that opens easily and without wrinkling of the spine title area (this method is discussed in Section VI starting on page 7). Or, you can just have an extra crease line for a nice appearance detail near your spine. If you see a single silver line (figure 4a), then you have the **Single Die Holder**. This die makes one score at a time — perfect to create a greeting card or a single fold folder.

A. Simple Scoring

1. Slide your material under the transparent bar (figure 5). Make sure the bottom edge of your cover is resting against the front Guide Rail.
2. Look through the bar and position your cover to where you want your scores — they will be made right under the silver lines of the Scoring Dies.
3. Push the Lever to the left to make your scores.

B. Wraparound Cover Scoring

Figures 3b and 4b show two different scoring treatments for wraparound book covers. The scores shown by the dark arrows are the spine edge scores. Those shown by the outline arrows are scores.

With the **Double Die Holder** (standard with the machine) two scores are made at once. One is the spine edge score. The other is a secondary score (3/16" from the spine edge score on the front and rear covers). These two sets of scores are shown in figure 3b. You would perform **two** scoring actions to make this total of four scores.

With the **Single Die Holder** (P/N: K-405-3437 available separately — please contact your local dealer) all of your scores are made one at a time. To make the two spine edge scores for a cover (shown by the two dark arrows in figure 4b), it would take two scoring actions. If you wish to make all of the four scores you see in figure 3b, it would take **four** scoring actions.

See page 3 for instructions on changing die holders.

IV | PERFECTBACK™ COVER BINDING STYLES

Powis Parker offers three ways to bind books with great-looking wraparound covers. With our Fastback® binding system, you may use our Perfectback™ LF, PS, or TA strips. All are specially designed to be used with your Scorer. You can have a spine that is either fully bound to the edge of your book block **or** one that floats freely away from it when your book is opened.

The strips are available in three widths: Narrow, Medium and Wide (to accommodate books up to 350 sheets), and a variety of lengths, including 11" and A4. Custom lengths can also be provided. Ask your dealer for details.

You may use a wide variety of cover stocks to create the document look you want. Your covers may be offset, inkjet or laser printed. Heat-sensitive inks or toner-based digital printing are fine to use. Select the proper Perfectback™ binding strip for your application.

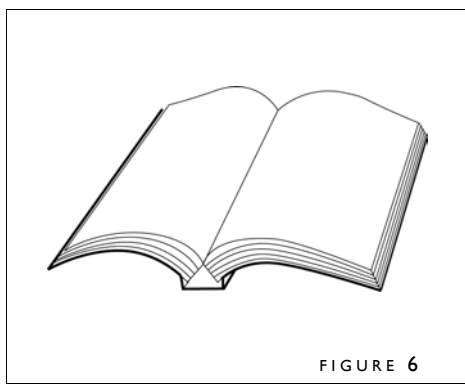
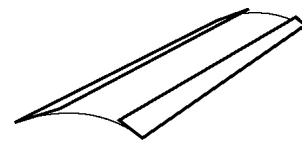

FIGURE 6

A. Perfectback™ LF strips

LF strips (patent pending) allow you to make wraparound covers where the spine of your book will **lay flat** when your opened — hence, the name LF. These binding strips are engineered to form a spine that hinges free from the bound spine of your book block (figure 6). You get a book that opens easily without creasing or damaging the title surface of your spine. You can also do the final binding of your cover to your book block without heat. — for the freedom to use cover materials or printing methods that are heat-sensitive without worry. **LF strips are identified by two thin release strips along both edges.**



This spine style requires two scores on the front and the back to create the unique 'hinge' at the cover's corners. These scores are best created by using the Double Die Holder on your Scorer.

B. Perfectback™ PS strips

PS strips (patent pending) have a **pressure sensitive** adhesive for assembling books — thus, the name PS. These strips enable you to use printing methods and cover materials for your wraparound covers that are heat-sensitive. The entire spine of the book you create is permanently bound to your book block (figure 7). **PS strips are identified by a single thin release strip along one edge.**

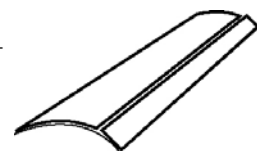

Either single or double scores on the front and back cover edges will work for this type of binding. Double scores add an attractive-looking visual or folding feature near the spine edge of your covers.

C. Perfectback™ TA strips

Perfectback™ TA strips bind your wraparound cover to your book block with an adhesive that is **temperature-activated** — this is why they are called TA strips. As with the binding of your book block, final binding of the cover is done on a Fastback® binder. Your cover is bound entirely to the bound spine of your book block (figure 7). Heat-sensitive cover materials or printing are not suitable for this method.

Patented Perfectback™ TA strips are identified by a single smooth surface on the back (curved out) side of the strip.



You can put either single or double scores on the front and back edges of your cover for this type of binding. Double scores add an attractive visual/folding feature near the spine of your cover.

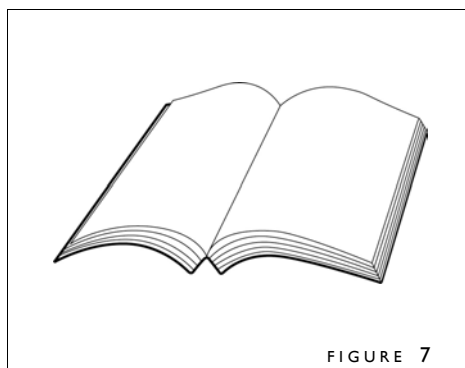

FIGURE 7

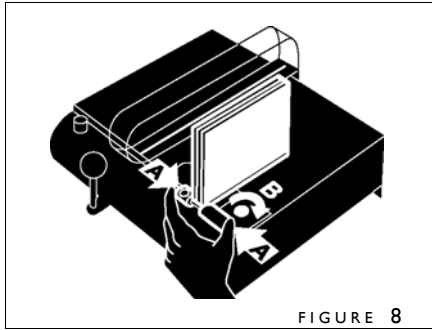

FIGURE 8

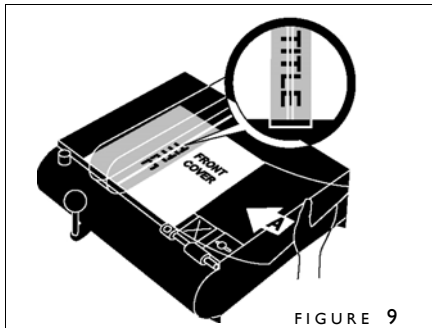

FIGURE 9

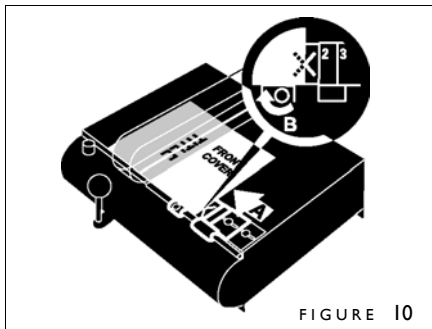

FIGURE 10

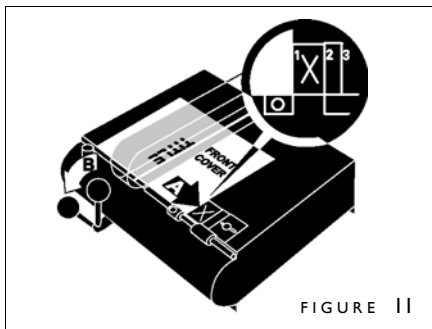

FIGURE 11

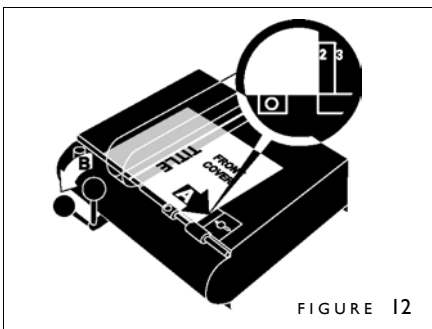

FIGURE 12

Perfectback™ LF strips produce a cover spine that hinges freely from the bound spine of your book block. Thus, the spine portion will **lay flat** when the book is opened. LF strips do not require heat for the final binding step, so you have the greatest freedom to choose your cover material or printing method.

These strips are easily identified by the two thin bands of release paper, one on each side of the back of the strip.

After binding your document pages in a Fastback® binder, with our Perfectback™ LF strip, you need to score your book cover so it fits nicely around your bound book block. Our Centering Guide enables you to easily and accurately locate scores for books up to 1-1/2 inches thick. This is especially helpful as your book thickness may be a bit different from what you expected due to the buildup of ink or paper thickness variations. The Centering Guide may be used with either the Single Die Holder or the Double Die Holder.

Operation with the Double Die Holder is the suggested mode and will be explained first. It makes your **spine edge** scores based on your document's thickness — it also simultaneously makes **secondary appearance** scores 3/16" from the spine edge on your front and rear covers.

A Demonstration Cover in your Accessory Pack summarizes how to prepare and assemble a book.

A. DOUBLE DIE HOLDER USE

Scoring Your Cover

1. With your Fastback® binder set in PERFECTBACK mode, bind only your pages with a Perfectback™ LF strip.
2. After it has cooled, place your bound book block between the Book Thickness Rings (figure 8). Push the two rings together (A) and tighten the Book Thickness Locking Knob (B). Remove your book block.
3. Slide your cover under the transparent bar until your title is centered between the two silver lines (figure 9). The bottom of your cover must rest against the Left Stop and the Guide Rail. Push the Lever to the right to clamp your cover in place.
4. With the Centering Guide Lock unlocked, slide the Centering Guide **under** your cover until the cover right edge (A) lines up with the middle of the X (figure 10). Then tighten the Centering Guide Locking Knob (B).
5. Bring the Lever upright to unclamp the cover. Slide the cover over so its right edge (A) stops against step 1 (figure 11). Push the Lever to the left (B) to make a score.
6. Slide your cover over again so its right edge (A) stops against step 2 (figure 12). Push the Lever to the left (B) to make a score.

The distance between the two middle scores on your cover is the same as the thickness of your book.

Assembling your Document

The instructions on the next page explain how to complete making your book by assembling your scored cover to your bound book block.

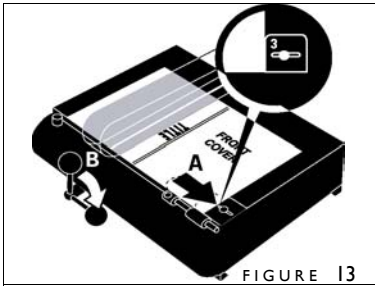

FIGURE 13

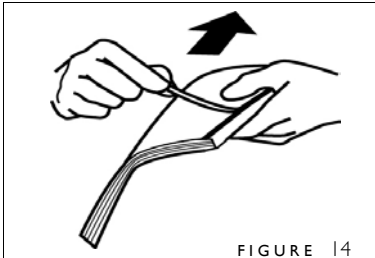

FIGURE 14

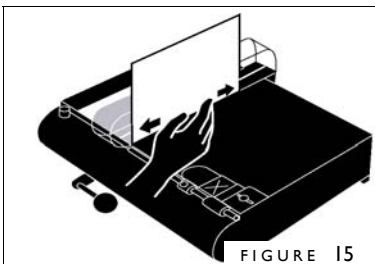

FIGURE 15

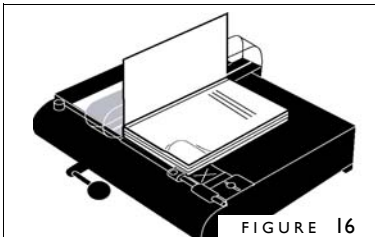

FIGURE 16

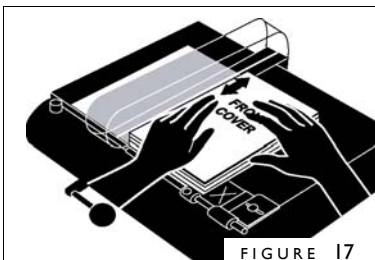

FIGURE 17

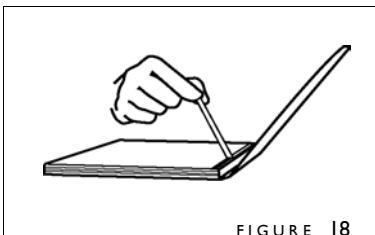

FIGURE 18

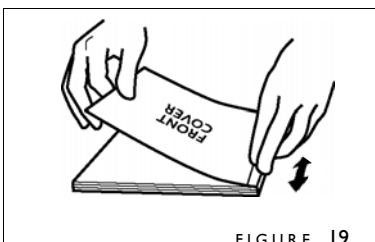

FIGURE 19

Assembling your Document

1. With your cover and the Centering Guide in their last positions, slide your cover over so its right edge (A) stops against step 3 (figure 13). Push the lever to the right to hold down your cover.
2. Peel off the thin release paper from the front of your bound book block (figure 14).
3. Fold your cover up to the left so it rests against the side of the Die Holder (figure 15). Run your finger back and forth at the bottom at the spine area of the cover so it makes a sharp fold at the bottom.
4. Lay the book block, front facing up, on the right side of the Platform with its bottom edge resting against the Guide Rail (figure 16). It is OK if part of it rests on top of the Centering Guide. Push the spine of the book block against the spine portion of your cover that is folded up.
5. With the book spine pushed fully and firmly to the left, fold the cover over your book block (figure 17). Starting at the middle, rub down back and forth to secure the cover to the adhesive.
6. Release the clamp by bringing the Lever to the upright position. Remove the partially bound book and turn over. On the back side remove the remaining release paper (figure 18).
7. Now fold the cover tightly all the way over the top of the book block. Rub back and forth on the top near the spine (figure 19) to secure the adhesive beneath the cover.
8. Trim the book ends as desired.

Handheld document assembly

This is an alternate method of assembly which some people prefer. It does not require an assist from the machine. Refer to page 11 for a description.

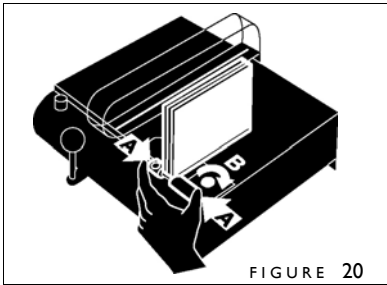

FIGURE 20

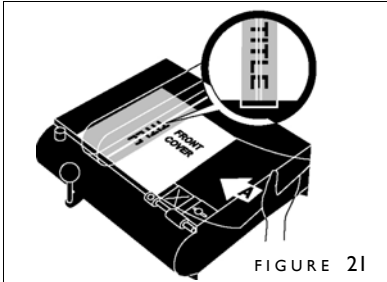

FIGURE 21

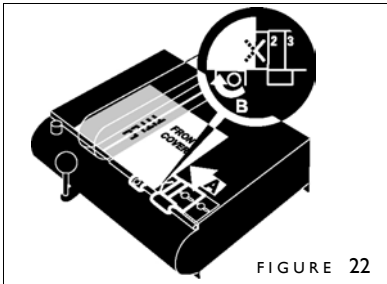

FIGURE 22

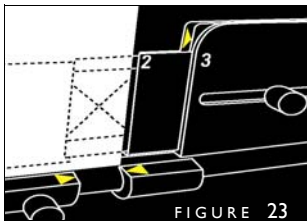

FIGURE 23

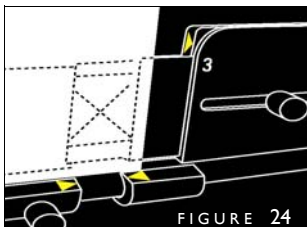

FIGURE 24

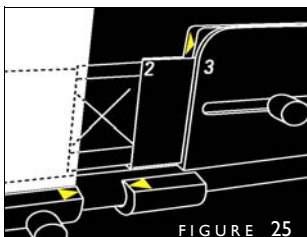

FIGURE 25

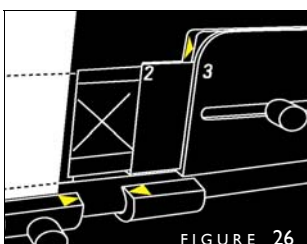

FIGURE 26

B. SINGLE DIE HOLDER USE

Scoring Your Cover

Using the Single Die Holder requires **one** scoring action for **each** score you want to make.

1. Set your Fastback® binder to PERFECTBACK mode. Bind your pages only with a Perfectback™ LF strip.
2. After it has cooled, place your bound book block between the Book Thickness Rings (Figure 20). Push the two rings together (A) and tighten the Book Thickness Lock knob (B). Remove your book block.
3. Slide your cover under the transparent bar until your title is centered under the single silver line (Figure 21). Make sure the bottom of your cover rests against the Left Stop and the Guide Rail. Push the Lever to the right so your cover will not move.
4. With the Centering Guide Locking Knob loosened, slide the Centering Guide under your cover until the right edge of the cover lines up with the middle of the X (Figure 22). Then tighten the centering Guide Locking Knob.
5. Bring the lever upright to unclamp your cover. Lean over the top of the Centering Guide to see the yellow arrows on the back side of the Book Thickness Rings. Slide your cover over so its right edge lines up with **the point** of the right arrow (Figure 23). Push the Lever to the left to score — you have just made your rear spine edge score.

To add a rear cover secondary score, move your cover to the other end of the same yellow arrow (figure 24) and execute another score.

6. To make your front spine edge score, slide your cover over so its right edge lines up with **the point** of the left yellow arrow on the back of the Book Thickness Rings (Figure 25). Push the Lever to the left to score.

To add a front cover secondary score, move your cover to the other end of that same arrow (figure 26) and execute another score.

The distance between the two middle scores on your cover is now the same as the thickness of your book.

Assembling your Document

The instructions on the next page explain how to complete making your book — with the assembly of your scored cover to the bound book block.

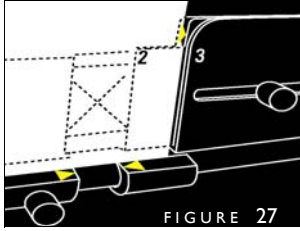

FIGURE 27

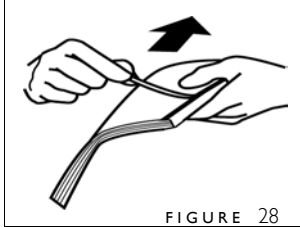

FIGURE 28

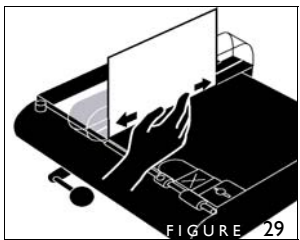

FIGURE 29

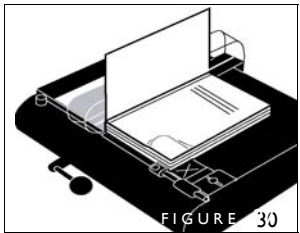

FIGURE 30

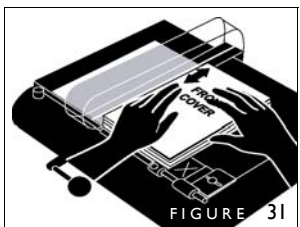

FIGURE 31

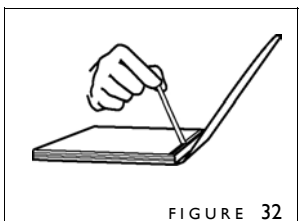

FIGURE 32

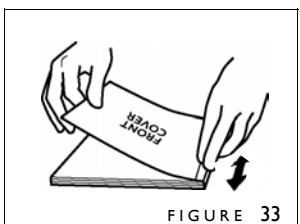

FIGURE 33

Assembling your Document (continued)

1. Your cover should still be under the transparent bar. With the Centering Guide in its last position, slide your cover over so its right edge bends down slightly, and stops against the partial step at the flat yellow triangle (figure 27). Push the lever to the right to hold down your cover.
2. On the **front** of your bound book block, peel off the thin release paper (figure 28).
3. Fold your cover up to the left so it rests against the side of the Die Holder (figure 29). Run your finger back and forth at the bottom at the spine area of the cover so it makes a sharp fold at the bottom.
4. Lay the book block, front facing up, on the right side of the Platform with its bottom edge resting against the Guide Rail (figure 30). It is OK if part of it rests on top of the Centering Guide. Push the spine of the book block against the spine portion of your cover that is folded up.
5. With the book spine pushed fully and firmly to the left, fold the cover over the front of your book block (figure 31). Starting at the middle, rub down back and forth to secure the cover to the adhesive.
6. Release the clamp by bringing the Lever to the upright position. Remove the partially bound book and turn over. On the back side remove the thin release paper (figure 32).
7. Now fold the cover tightly all the way over the top of the book block. Rub back and forth on the top near the spine (figure 33) to secure the adhesive beneath the cover.
8. Trim the book ends as desired.

Handheld document assembly

See the next page for an alternate method of assembly which some people prefer. It does not require an assist from the machine.

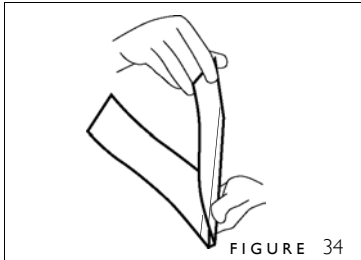

FIGURE 34

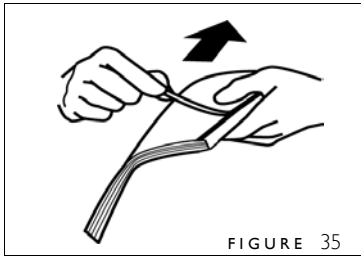

FIGURE 35

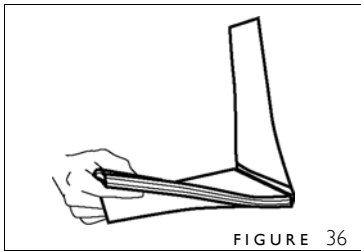

FIGURE 36

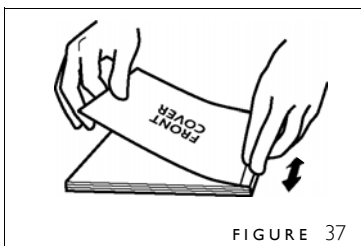

FIGURE 37

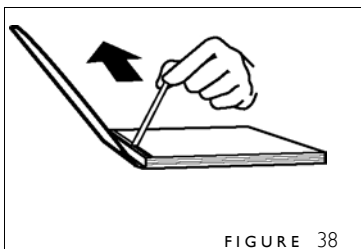

FIGURE 38

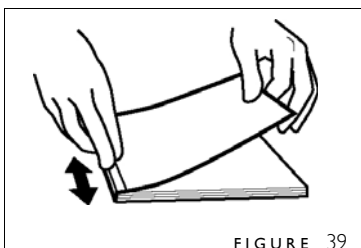

FIGURE 39

C. HANDHELD DOCUMENT ASSEMBLY

This is an alternate method of assembling your books using LF or PS strips. It does not require the Scorer for final assembly. This is the recommended method for low production or occasional use — it is a simple way to get great results.

1. Pre-fold your cover at the two scores that represent your spine edges (figure 34). **These are the scores that are the same distance apart as the thickness of your book block.**
2. Peel off the thin release paper at the **front** of your book block (figure 35).
3. Place your pre-folded cover on a flat surface with the front of the cover bent up from the **rear spine edge**. Insert your book block inside the front of your cover (figure 36). Position it so full and even contact is made in the spine area.
4. Fold your front cover tightly over the book block. Starting from the middle, rub back and forth to secure the cover to the adhesive strip beneath it. (figure 37).
5. Flip the book over. Open the back cover and remove the remaining release paper (figure 38).
6. Tightly pull the cover against the spine. Rub back and forth, starting from the middle, to bind the back cover to the adhesive beneath it (figure 39).
7. Trim the book ends as desired.

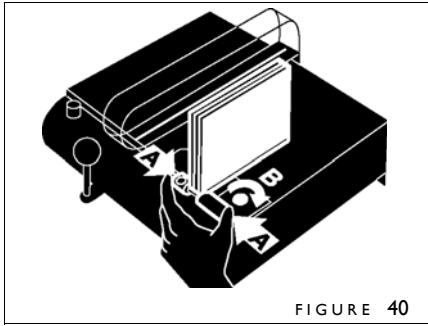

FIGURE 40

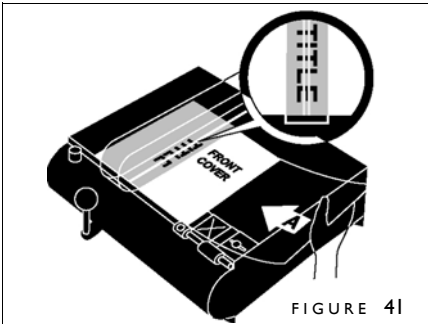

FIGURE 41

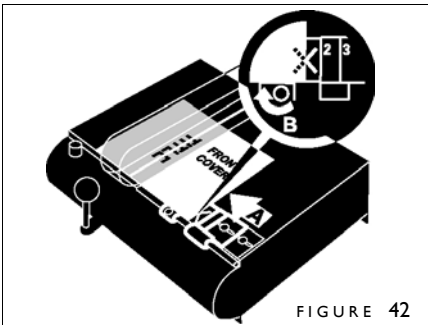

FIGURE 42

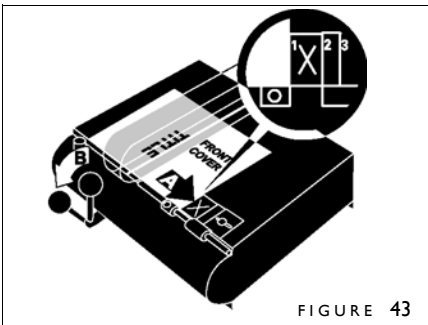

FIGURE 43

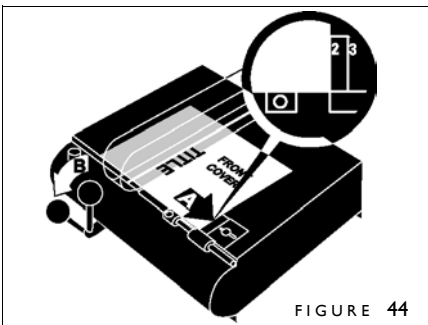

FIGURE 44

Perfectback™ PS strips produce a wraparound cover that bonds fully all around the spine of your book block. These strips use a **pressure sensitive** adhesive which doesn't require heat for the final binding step. This gives you the greatest freedom in selecting your cover material or printing method.

These strips can be identified by the single thin band of release paper along one side on the back of the strip.

After binding your pages in a Fastback® binder with our Perfectback™ PS strip, you need to score your book cover so it fits nicely around your bound book block. Our Centering Guide enables you to easily and accurately locate scores for books up to 1-1/2 inches thick. The Centering Guide may be used with either the Single or the Double Die Holder.

Operation with the Double Die Holder is the preferred mode and will be explained first. It makes your **spine edge** scores based on your document's thickness — it also simultaneously makes **secondary appearance** scores 3/16" from the spine edge on your front and rear covers.

A **Demonstration Cover** in your **Accessory Pack** summarizes how to prepare and assemble a book.

A. DOUBLE DIE HOLDER USE

Scoring Your Cover

1. Using your Fastback® binder in PERFECTBACK mode, bind only your pages with a Perfectback™ PS strip. Be sure to insert the strip into the binder with the thin paper backing piece facing the front of your pages.
2. After it has cooled, place your bound book block between the Book Thickness Rings (figure 40). Push the two rings together (A) and tighten the Book Thickness Locking Knob (B). Remove your book block.
3. Slide your cover under the transparent bar until your title is centered between the two silver lines (figure 41). The bottom of your cover must rest against the Left Stop and the Guide Rail. Push the Lever to the right to clamp your cover in place.
4. With the Centering Guide Lock unlocked, slide the Centering Guide **under** your cover until the cover right edge (A) lines up with the middle of the X (figure 42). Then tighten the Centering Guide Locking Knob (B).
5. Bring the Lever upright to unclamp the cover. Slide your cover over so its right edge (A) stops against step 1 (figure 43). Push the Lever to the left (B) to make a score.
6. Slide your cover over again so its right edge (A) stops against step 2 (figure 44). Push the Lever to the left (B) to make a score.

The distance between the two middle scores on your cover is the same as the thickness of your book.

Assembling your Document

The instructions on the next page explain how to complete making your book by assembling your scored cover to your bound book block.

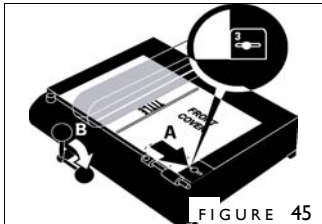

FIGURE 45

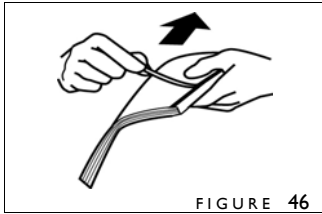

FIGURE 46

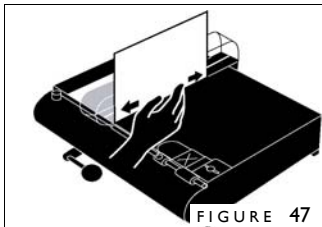

FIGURE 47

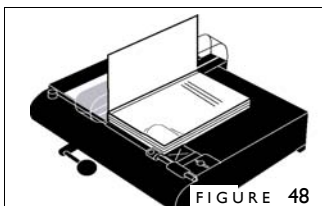

FIGURE 48

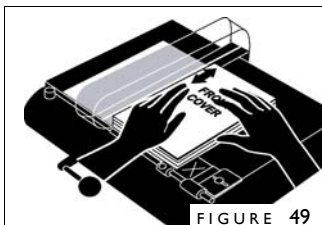

FIGURE 49

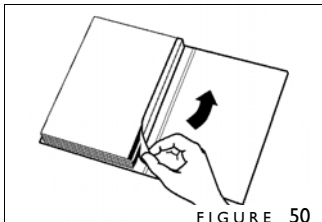

FIGURE 50

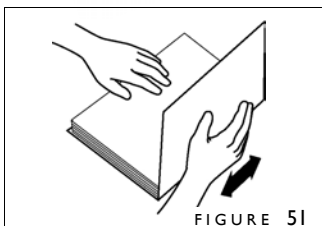

FIGURE 51

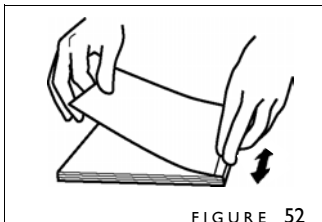

FIGURE 52

Assembling your Document

1. With your cover and the Centering Guide in their last positions, slide your cover over so its right edge stops against step 3 (figure 45). Push the lever to the right to hold down your cover.
2. Peel off the thin release paper (figure 46) from the **front** of your bound book block,
3. Fold your cover up to the left so it rests against the side of the Die Holder (figure 47). Run your finger back and forth at the bottom at the spine area of the cover so it makes a sharp fold at the bottom.
4. Lay the book block, front facing up, on the right side of the Platform with its bottom edge resting against the Guide Rail (figure 48). It is OK if part of it rests on top of the Centering Guide. Push the spine of the book block against the spine portion of your cover that is folded up.
5. With the book spine pushed fully and firmly to the left, fold the cover over your book block (figure 49). Starting at the middle, rub down back and forth to secure the cover to the adhesive.
6. Release the clamp by bringing the Lever to the upright position. Remove the partially bound book and turn over. On the back side remove the remaining wide release paper (figure 50).
7. Fold the back cover up tight against the book block spine end (figure 51). Rub back and forth to bind the cover to the adhesive beneath it.
8. Now fold the cover tightly all the way over the top of the book block. Rub back and forth on top near the spine to bind the adhesive beneath the cover (figure 52).
9. Trim the book ends as desired.

Handheld document assembly

This is an alternate method of assembly which some people prefer. It does not require an assist from the machine. Refer to page 11 for a description.

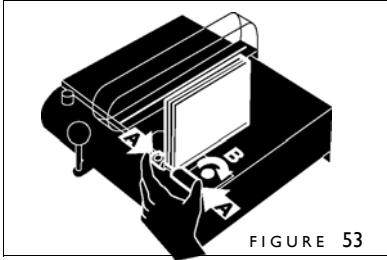

FIGURE 53

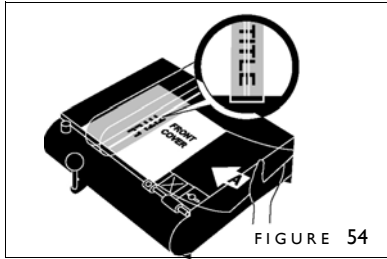

FIGURE 54

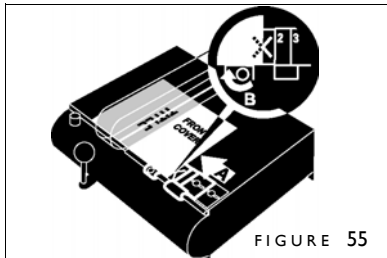

FIGURE 55

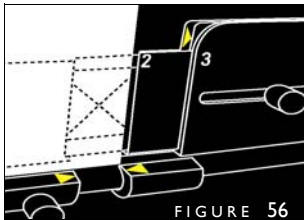

FIGURE 56

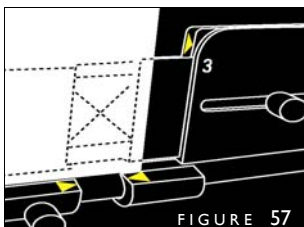

FIGURE 57

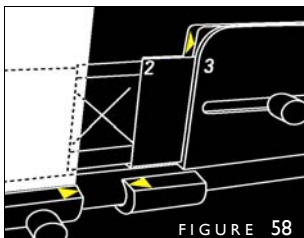

FIGURE 58

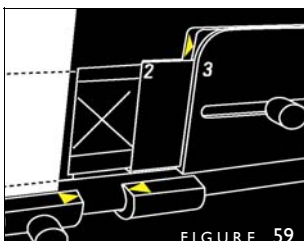

FIGURE 59

B. SINGLE DIE HOLDER USE

Scoring Your Cover

Using the Single Die Holder requires **one** scoring action for **each** score you want to make.

1. Set your Fastback® binder to PERFECTBACK mode. Bind your pages only with a Perfectback™ PS strip.
2. After it has cooled, place your bound book block between the Book Thickness Rings (Figure 53). Push the two rings together (A) and tighten the Book Thickness Locking Knob (B). Remove your book block.
3. Slide your cover under the transparent bar until your title is centered under the single silver line (Figure 54). Make sure the bottom of your cover rests against the Left Stop and the Guide Rail. Push the Lever to the right so your cover will not move.
4. With the Centering Guide Locking Knob loosened, slide the Centering Guide under your cover until the right edge of the cover lines up with the middle of the X (Figure 55). Then tighten the centering Guide Locking Knob.
5. Bring the lever upright to unclamp your cover. Lean over the top of the Centering Guide to see the yellow arrows on the back side of the Book Thickness Rings. Slide your cover over so its right edge lines up with **the point** of the right arrow (Figure 56). Push the Lever to the left to score — you have just made your rear spine edge score.

If you wish to add a rear cover secondary score, move your cover to the other end of the same yellow arrow (figure 57) and execute another score.

6. To make your front spine edge score, slide your cover over so its right edge lines up with **the point** of the left yellow arrow on the back of the Book Thickness Rings (Figure 58). Push the Lever to the left to score.

If you want to add a front cover secondary score, move your cover to the other end of that same yellow arrow (figure 59) and execute another score.

The distance between the two middle scores on your cover is now the same as the thickness of your book.

Assembling your Document

The instructions on the next page explain how to complete making your book with the assembly of your scored cover to the bound book block.

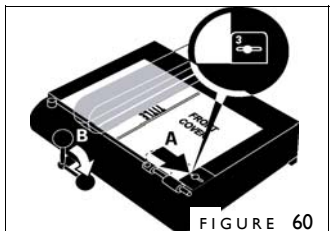

FIGURE 60

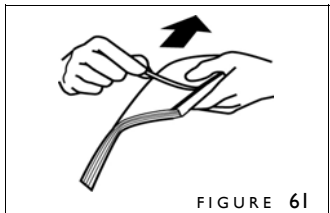

FIGURE 61

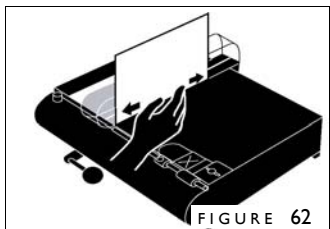

FIGURE 62

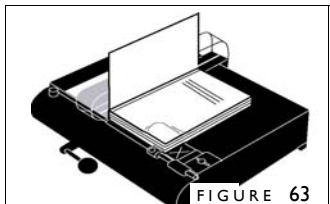

FIGURE 63

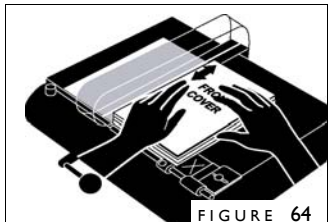

FIGURE 64

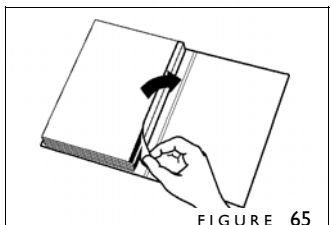

FIGURE 65

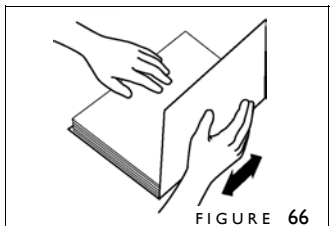

FIGURE 66

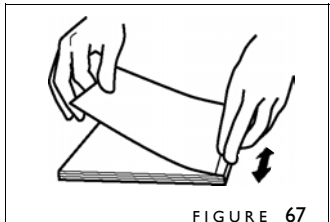

FIGURE 67

Assembling your Document

1. With your cover and the Centering Guide in their last positions, slide your cover over so its right edge stops against step 3 (figure 60). Push the lever to the right to hold down your cover.
2. Peel off the thin release paper (figure 61) from the **front** of your bound book block,
3. Fold your cover up to the left so it rests against the side of the Die Holder (figure 62). Run your finger back and forth at the bottom at the spine area of the cover so it makes a sharp fold at the bottom.
4. Lay the book block, front facing up, on the right side of the Platform with its bottom edge resting against the Guide Rail (figure 63). It is OK if part of it rests on top of the Centering Guide. Push the spine of the book block against the spine portion of your cover that is folded up.
5. With the book spine pushed fully and firmly to the left, fold the cover over your book block (figure 64). Starting at the middle, rub down back and forth to secure the cover to the adhesive.
6. Release the clamp by bringing the Lever to the upright position. Remove the partially bound book and turn over. On the back side remove the remaining wide release paper (figure 65).
7. Fold the back cover up tight against the book block spine end (figure 66). Rub back and forth to bind the cover to the adhesive beneath it. Now fold the cover tightly all the way over the top of the book block. Rub back and forth on top near the spine to bind the adhesive beneath the cover (figure 67).
8. Trim the book ends as desired.

Handheld document assembly

This is an alternate method of assembly which some people prefer. It does not require an assist from the machine. Refer to page 11 for a description.

NOTE: Figures 68 through 72 are the same instructions as printed on the Scorer.

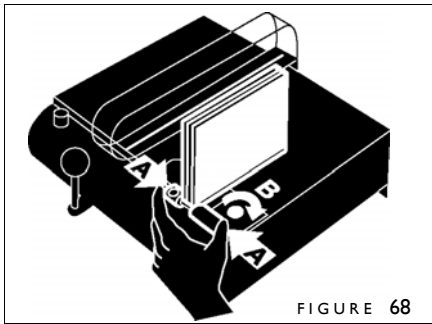

FIGURE 68

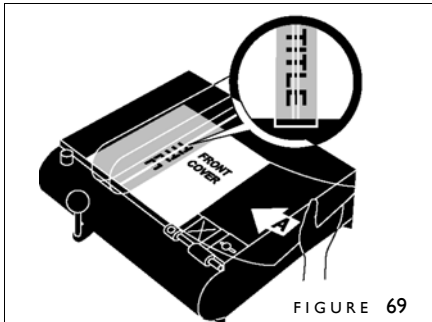

FIGURE 69

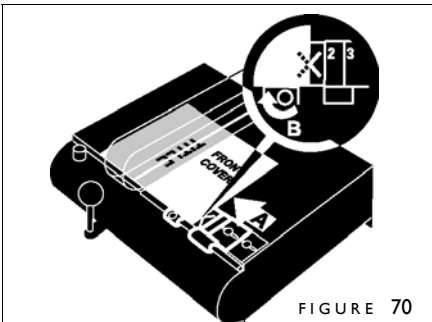

FIGURE 70

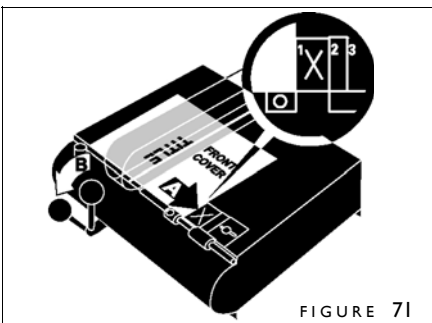

FIGURE 71

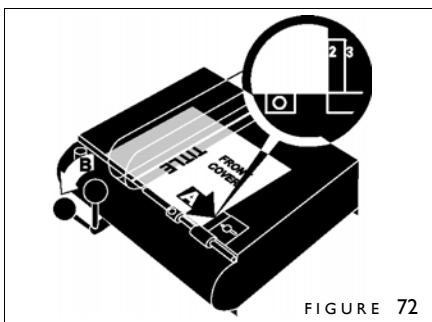

FIGURE 72

Perfectback™ TA strips bind your document without a gap between your cover spine and book block spine. Since the final binding is done at an elevated temperature in a Powis Parker Fastback® binder, you must use cover materials and printing methods that are not heat sensitive. (If that is not possible, then you can use our LF or PS strips — they do not use heat for the final binding step.) If you have any uncertainties, try a practice final binding to see if you get satisfactory results.

TA strips can be identified by the plain looking back of the strip. There are no release paper pieces.

After binding your pages, you need to score your book cover so it fits nicely around your bound book block. Our Centering Guide enables you to easily and accurately locate scores for books up to 1-1/2 inches thick. The Centering Guide may be used with either the Single Die Holder or the Double Die Holder.

Operation with the Double Die Holder is the preferred mode and will be explained first. It makes the **spine edge** scores based on your document's thickness — it also simultaneously makes **secondary appearance** scores 3/16" from the spine edge on your front and rear covers.

A Demonstration Cover in your Accessory Pack summarizes how to prepare and assemble a book.

A. DOUBLE DIE HOLDER USE

Scoring Your Cover

- Using your Fastback® binder in PERFECTBACK mode, bind only your pages with a Perfectback™ TA strip.
- After it has cooled, place your bound book block between the Book Thickness Rings (figure 68). Push the two rings together (A) and tighten the Book Thickness Locking Knob (B). Remove your book block.
- Slide your cover under the transparent bar until your title is centered between the two silver lines (figure 69). The bottom of your cover must rest against the Left Stop and the Guide Rail. Push the Lever to the right to clamp your cover in place.
- With the Centering Guide Lock unlocked, slide the Centering Guide **under** your cover until the cover right edge (A) lines up with the middle of the X (figure 70). Then tighten the Centering Guide Locking Knob (B).
- Bring the Lever upright to unclamp the cover. Slide your cover over so its right edge (A) stops against step 1 (figure 71). Push the Lever to the left (B) to score.
- Slide your cover over again so its right edge (A) stops against step 2 (figure 72). Push the Lever to the left (B) to make a score. Remove your cover.

The distance between the two middle scores on your cover is the same as the thickness of your book.

Assembling your Document

The instructions on the next page explain how to complete making your book — with the assembly of your scored cover to the bound book block.

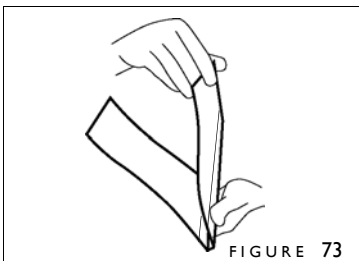

FIGURE 73

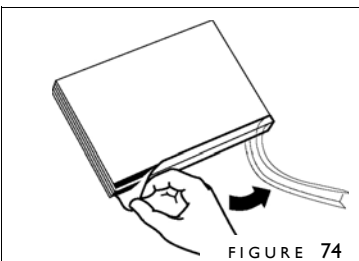

FIGURE 74

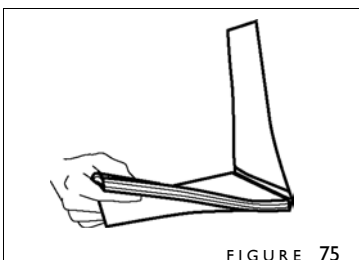

FIGURE 75

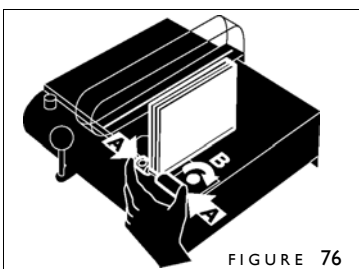

FIGURE 76

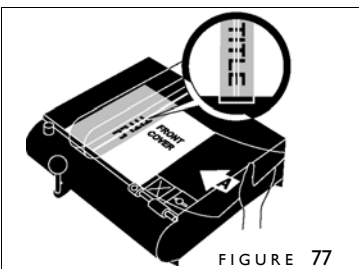

FIGURE 77

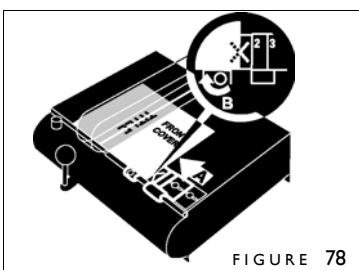

FIGURE 78

Assembling your Document (continued)

1. Your cover has a total of four scores in the spine region. Fold your cover at the two middle scores (figure 73). **These are the scores that are the same distance apart as the thickness of your book block.**
2. Peel off the release liner from the back of your cooled book block (figure 74). Then, insert the book block into your cover (figure 75). Make sure the front page is under the front of your cover.
3. With the PERFECTBACK setting on your Fastback® binder, bind your cover and book block together.
4. Trim the book ends as desired.

B. SINGLE DIE HOLDER USE

Scoring Your Cover

Using the Single Die Holder requires **one** scoring action for **each** score you want to make.

1. With your Fastback® binder set in PERFECTBACK mode, bind your pages only with a Perfectback™ TA strip.
2. After it has cooled, place your bound book block between the Book Thickness Rings (Figure 76). Push the two rings together (A) and tighten the Book Thickness Locking Knob (B). Remove your book block.
3. Slide your cover under the transparent bar until your title is centered under the single silver line (Figure 77). Make sure the bottom of your cover rests against the Left Stop and the Guide Rail. Push the Lever to the right so your cover will not move.
4. With the Centering Guide Locking Knob loosened, slide the Centering Guide under your cover until the right edge of the cover lines up with the middle of the X (Figure 78). Then tighten the Centering Guide Locking Knob (B).

(Continued on the next page)

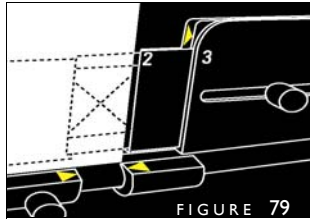

FIGURE 79

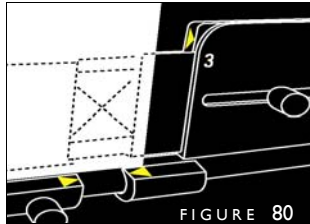

FIGURE 80

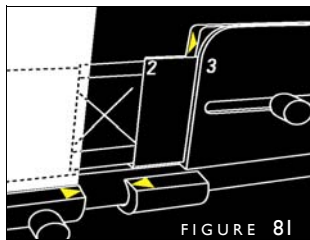

FIGURE 81

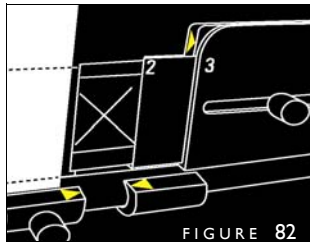

FIGURE 82

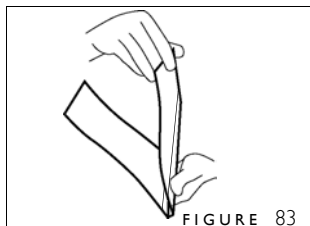

FIGURE 83

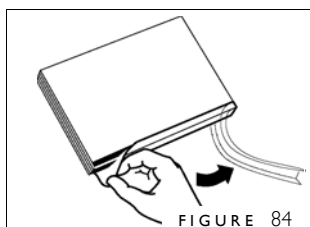

FIGURE 84

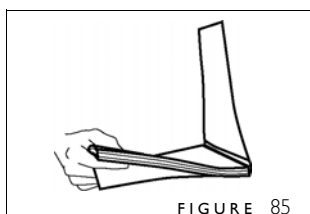

FIGURE 85

Scoring Your Cover (continued)

5. Bring the lever upright to unclamp your cover. Lean over the top of the Centering Guide to see the yellow arrows on the back side of the Book Thickness Rings. Slide your cover over so its right edge lines up with **the point** of the right arrow (Figure 79). Push the Lever to the left to score — you have just made your rear spine edge score.

To add a rear cover secondary score, move your cover to the other end of the same yellow arrow (figure 80) and execute another score.

6. To make your front spine edge score, slide your cover over so its right edge lines up with **the point** of the left yellow arrow on the back of the Book Thickness Rings (Figure 81). Push the Lever to the left to score.

To add a front cover secondary score, move your cover to the other end of that same arrow (figure 82) and execute another score.

The distance between the two middle scores on your cover is now the same as the thickness of your book.

Assembling your Document

1. Fold your cover at the two scores that represent your book's spine edges (figure 83) — **these are the scores that are the same distance apart as the thickness of your book block**. If your cover has a total of four scores in the spine region, these are the two middle scores.
2. Peel off the release liner from the back of your cooled book block (figure 84). Then, insert the book block into your cover (figure 85). Make sure the front page is under the front of your cover .
3. With the PERFECTBACK setting on your Fastback® binder, bind your cover and book block together.
4. Trim the book ends as desired.

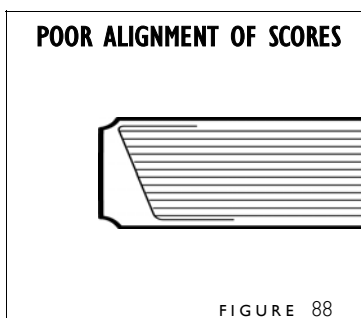
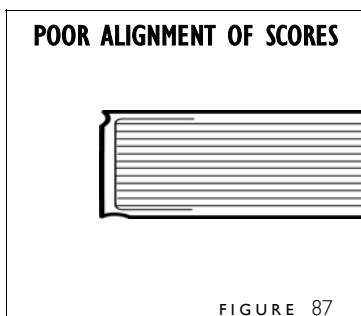
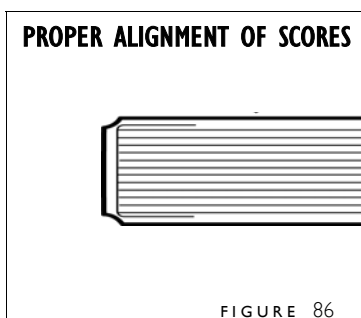

A Demonstration Cover in your Accessory Pack summarizes how to prepare and assemble a book.

It may take a couple of practice tries the first time you try to make a perfect book. Different cover materials, thicknesses and finishes give different results. We suggest you print up some extra covers (in black and white, if you wish) to perfect your technique, before you use your final printed cover.

Be sure to keep the bottom edge of your cover up against the front metal guides. This will keep your scores and folds properly aligned.

Covers should be scored in the sequence described. If you follow another sequence, then the scores you make may not line up well with the edges of your document's spine.

You do not have to put your full weight into pushing down on the lever. Excessive force can cause physical discomfort or shorten the life of the machine. It is only necessary to push down hard enough to make an adequate score in your material.

Figures 86, 87 and 88 show enlarged details of the edge of your book spine area. Your Scorer is calibrated to produce a cover where both edge scores fall right at the corners of your book (figure 86). Common errors in assembly technique could result in: your scores not aligning with your book corners (figure 87), or where your book block spine is at an angle to your cover spine (figure 88). If your book doesn't turn out exactly how you would like, you will see where you need to adjust your technique. Usually, medium and thicker books come out better than very thin books.

When making a book, you may prefer to have the sharpest spine corner on the **front** edge of your document. To do this using a Fastback™ Model 15x or 15xs binder, load the machine with the front of your document facing you. On the Fastback™ Model 8 you will want to load the machine with the front of your document facing away from you.

When assembling books smaller than 5-1/2 x 8-1/2 inches on the machine, it is easier if you slide the Centering Guide to the right so it is out of the way.

You may find that it is easier to get a snugger fit in the spine area by using the Handheld Assembly technique described on page 11.

Electric or manual guillotine cutters may be used to trim the edges of your book. Depending on the model, it is often best to place the book where the spine is facing to the right — away from the left stop of the cutter — so it is first cut by the blade. Also, you may want to put a piece of card stock over the pages area only (not over the spine) during trimming. This extra material thickness keeps the cutter clamp from squashing the spine of your book.

For questions about, or problems with machine operation, call your Fastback® dealer. They are there to help.

Care of the clear Die Holder

The clear Die Holder is precision machined and has polished external surfaces. It may be cleaned with a solution of mild soap or detergent and lukewarm water. Use a clean, soft cloth, applying only light pressure. Dry by blotting with a damp, soft cloth or chamois. Grease or oil may be removed with a good grade of hexane, aliphatic naphtha, or kerosene. These solvents may be obtained at a paint or hardware store and should be used in accordance with the manufacturer's recommendations. DO NOT USE window or glass cleaning sprays, kitchen scouring compounds, or solvents such as acetone, gasoline, benzene, alcohol, carbon tetrachloride or lacquer thinner. Dust with a soft, damp cloth or chamois. Dry or gritty cloths may scratch the surface.

Fine scratches can be removed by hand polishing. Apply a plastic scratch remover to a soft flannel pad and rub. When the scratches have disappeared, remove all residue and polish.

MISCELLANY

POWIS PARKER PART NUMBERS FOR REORDERING PARTS:

L3438	USER'S MANUAL
K-405-3437	SINGLE DIE HOLDER w/ DIE
K-405-2845	DOUBLE DIE HOLDER w/ DIES
K-115-3295	DIE HOLDER PIN
K-426-3292	LEVER WITH BALL

The Scorer does not contain any user serviceable parts.
Call your local Powis Parker dealer for repair or service.

Information for Your Reference:

Serial Number: _____

Purchase Date: _____

Dealer Name: _____

Dealer Phone: _____

**POWIS
PARKER**

Powis Parker, Incorporated
775 Heinz Avenue
Berkeley, CA 94710 U.S.A
1-800-321-2463

NOTES

NOTES

NOTES

NOTES