



USER MANUAL
VERSION: V1.0.3

PR01-RX

Precis PR01 Scaling Receiver



IMPORTANT SAFETY INSTRUCTIONS

1. READ these instructions.
2. KEEP these instructions.
3. HEED all warnings.
4. FOLLOW all instructions.
5. DO NOT use this apparatus near water.
6. CLEAN ONLY with dry cloth.
7. DO NOT block any ventilation openings. Install in accordance with the manufacturer's instructions.
8. DO NOT install near any heat sources such as radiators, heat registers, stoves, or other apparatus (including amplifiers) that produce heat.
9. DO NOT defeat the safety purpose of the polarized or grounding type plug. A polarized plug has two blades with one wider than the other. A grounding type plug has two blades and a third grounding prong. The wider blade or the third prong are provided for your safety. If the provided plug does not fit into your outlet, consult an electrician for replacement of the obsolete outlet.
10. PROTECT the power cord from being walked on or pinched, particularly at plugs, convenience receptacles, and the point where they exit from the apparatus.
11. ONLY USE attachments/accessories specified by the manufacturer.



12. USE ONLY with a cart, stand, tripod, bracket, or table specified by the manufacturer, or sold with the apparatus. When a cart is used, use caution when moving the cart/apparatus combination to avoid injury from tip-over.
13. UNPLUG this apparatus during lightning storms or when unused for long periods of time.
14. REFER all servicing to qualified service personnel. Servicing is required when the apparatus has been damaged in any way, such as power-supply cord or plug is damaged, liquid has been spilled or objects have fallen into the apparatus, the apparatus has been exposed to rain or moisture, does not operate normally, or has been dropped.
15. DO NOT expose this apparatus to dripping or splashing and ensure that no objects filled with liquids, such as vases, are placed on the apparatus.
16. To completely disconnect this apparatus from the AC Mains, disconnect the power supply cord plug from the AC receptacle.
17. Where the mains plug or an appliance coupler is used as the disconnect device, the disconnect device shall remain readily operable.
18. DO NOT overload wall outlets or extension cords beyond their rated capacity as this can cause electric shock or fire.



The exclamation point, within an equilateral triangle, is intended to alert the user to the presence of important operating and maintenance (servicing) instructions in the literature accompanying the product.



The lightning flash with arrowhead symbol within an equilateral triangle is intended to alert the user to the presence of uninsulated "dangerous voltage" within the product's enclosure that may be of sufficient magnitude to constitute a risk of electrical shock to persons.



ESD Warning: The icon to the left indicates text regarding potential danger associated with the discharge of static electricity from an outside source (such as human hands) into an integrated circuit, often resulting in damage to the circuit.

WARNING: To reduce the risk of fire or electrical shock, do not expose this apparatus to rain or moisture.

WARNING: No naked flame sources - such as candles - should be placed on the product.

WARNING: Equipment shall be connected to a MAINS socket outlet with a protective earthing connection.

WARNING: To reduce the risk of electric shock, grounding of the center pin of this plug must be maintained.

COPYRIGHT NOTICE

AMX© 2018, all rights reserved. No part of this publication may be reproduced, stored in a retrieval system, or transmitted, in any form or by any means, electronic, mechanical, photocopying, recording, or otherwise, without the prior written permission of AMX. Copyright protection claimed extends to AMX hardware and software and includes all forms and matters copyrightable material and information now allowed by statutory or judicial law or herein after granted, including without limitation, material generated from the software programs which are displayed on the screen such as icons, screen display looks, etc. Reproduction or disassembly of embodied computer programs or algorithms is expressly prohibited.

LIABILITY NOTICE

No patent liability is assumed with respect to the use of information contained herein. While every precaution has been taken in the preparation of this publication, AMX assumes no responsibility for error or omissions. No liability is assumed for damages resulting from the use of the information contained herein. Further, this publication and features described herein are subject to change without notice.

AMX WARRANTY AND RETURN POLICY

The AMX Warranty and Return Policy and related documents can be viewed/downloaded at www.amx.com.

ESD WARNING



To avoid ESD (Electrostatic Discharge) damage to sensitive components, make sure you are properly grounded before touching any internal materials.

When working with any equipment manufactured with electronic devices, proper ESD grounding procedures must be followed to make sure people, products, and tools are as free of static charges as possible. Grounding straps, conductive smocks, and conductive work mats are specifically designed for this purpose. These items should not be manufactured locally, since they are generally composed of highly resistive conductive materials to safely drain static discharges, with-out increasing an electrocution risk in the event of an accident.

Anyone performing field maintenance on AMX equipment should use an appropriate ESD field service kit complete with at least a dissipative work mat with a ground cord and a UL listed adjustable wrist strap with another ground cord.



CAUTION

RISK OF ELECTRICAL SHOCK
DO NOT OPEN



WARNING: Do Not Open! Risk of Electrical Shock. Voltages in this equipment are hazardous to life. No user-serviceable parts inside. Refer all servicing to qualified service personnel.

Place the equipment near a main power supply outlet and make sure that you can easily access the power breaker switch.

WARNING: This product is intended to be operated ONLY from the voltages listed on the back panel or the recommended, or included, power supply of the product. Operation from other voltages other than those indicated may cause irreversible damage to the product and void the products warranty. The use of AC Plug Adapters is cautioned because it can allow the product to be plugged into voltages in which the product was not designed to operate. If the product is equipped with a detachable power cord, use only the type provided with your product or by your local distributor and/or retailer. If you are unsure of the correct operational voltage, please contact your local distributor and/or retailer.

FCC AND CANADA EMC COMPLIANCE INFORMATION:

This device complies with part 15 of the FCC Rules.

Operation is subject to the following two conditions:

(1) This device may not cause harmful interference, and (2) this device must accept any interference received, including interference that may cause undesired operation.

NOTE: This equipment has been tested and found to comply with the limits for a Class A digital device, pursuant to part 15 of the FCC Rules. These limits are designed to provide reasonable protection against harmful interference in a commercial environment. This equipment generates, uses and can radiate radio frequency energy and, if not installed and used in accordance with the instructions, may cause harmful interference to radio communications. However, there is no guarantee that interference will not occur in a particular installation. If this equipment does cause harmful interference to radio or television reception, which can be determined by turning the equipment off and on, the user is encouraged to try to correct the interference by one or more of the following measures:

- Reorient or relocate the receiving antenna.
- Increase the separation between the equipment and receiver.
- Connect the equipment into an outlet on a circuit different from that to which the receiver is connected.
- Consult the dealer or an experienced radio/TV technician for help.

Approved under the verification provision of FCC Part 15 as a Class A Digital Device. Caution

Changes or modifications not expressly approved by the manufacturer could void the user's authority to operate this device. CAN ICES-3 (B)/NMB-3(B)

EU COMPLIANCE INFORMATION:

Eligible to bear the CE mark; Conforms to European Union Low Voltage Directive 2006/95/EC; European Union EMC Directive 2004/108/EC; European Union Restriction of Hazardous Substances Recast (RoHS2) Directive 2011/65/EU; European Union WEEE (recast) Directive 2012/19/EU; European Union Radio and Telecommunications Terminal Equipment (R&TTE) Directive 1999/5/EC

WEEE NOTICE:



This appliance is labeled in accordance with European Directive 2012/19/EU concerning waste of electrical and electronic equipment (WEEE). This label indicates that this product should not be disposed of with household waste. It should be deposited at an appropriate facility to enable recovery and recycling.

Table of Contents

- IMPORTANT SAFETY INSTRUCTIONS 2
- Overview 5
 - Features 5
 - Package Contents 5
- Specifications 6
- Front Panel Description 8
- Rear Panel Description..... 9
- Installation 10
- Wiring..... 11
- Connection Modes..... 13
- IR Operation 14
- RS232 Operation 16
- OSD 17
- NetLinx Programing 18
 - Device Number and Ports 18
 - Telnet Control via NetLinx Studio 19
 - Web UI Control 20
- Web UI Control..... 21
 - Connected Separately 21
 - Web UI Introduction..... 21
 - Connected with PR01-0808..... 27
 - Access the Web UI 27
 - Web UI Introduction..... 28
- Firmware Upgrade 29
 - Before Starting..... 29
 - Transferring KIT Files..... 29
 - Transferring KIT Files..... 29
- Troubleshooting..... 31
- NetLinx API Command Set..... 32
 - NetLinx API Commands 32
 - Telnet/SSH API Commands 38

Overview

The PR01-RX is designed to be used primarily with the PR01-0808 matrix switcher, serving as an HDBaseT output endpoint unit, giving the PR01-0808 fast switching ability. With its included scaling functionality, the PR01-RX allows scaling of the output video signal to the optimal resolution of any display. When paired with the PR01-RX, the HDBaseT matrix switcher and HDBaseT distribution amplifier can distribute 4K signal to several displays simultaneously regardless of the varying capabilities of the displays.

The PR01-RX also can be used as a standalone unit, serving as an HDBaseT Scaling Receiver.

The PR01-RX offers an ideal solution for a variety of applications where high-quality video scaling or 4K-1080P down-scaling is required when using a mix of displays with different aspect ratios or preferred timing characteristics.

Features

- HDBaseT receiver with 4K@60Hz scaler built-in
- HDMI 2.0/HDCP 2.2 compliant
- HDBT transmits 4K@30 4:4:4 signals up to 80m/262 ft, 1080P signal up to 100m/328ft over a shielded Cat 6a/7 cable
- Audio de-embedded output with S/PDIF or analog stereo options from an HDMI signal
- Built in 2-ports Ethernet switch with Telnet control
- Bi-directional IR, RS232 and Ethernet pass through
- Supports CEC to power ON/OFF displays with detection of signal status
- Supports fast switching when working with PR01-0808
- Supports scaling output adjusted by API commands
- Supports EDID management by API commands

Package Contents

- 1 x PR01-RX
- 1 x DC 12V Power Adapter (with US, UK, EU, AC Power Cords)
- 1 x IR Receiver Cable
- 2 x Phoenix Male Connector (3.5mm, 3 Pins)
- 1 x Phoenix Male Connector (3.5mm, 2 Pins)
- 2 x Mounting Bracket (with screws)

Specifications

Technical	
Input	1 x HDBT IN
Input Resolution Supported	<p>VESA: 800x600⁸, 1024x768⁸, 1280x768⁸, 1280x800⁸, 1280x960⁸, 1280x1024⁸, 1360x768⁸, 1366x768⁸, 1440x900⁸, 1600x900⁸, 1600x1200⁸, 1680x1050⁸, 1920x1200⁸</p> <p>SMPTE: 1280x720P^{6,7,8}, 1920x1080P^{6,7,8}, 3840x2160P^{2,3,5} 1 = at 23.98 Hz, 2 = at 24 Hz, 3 = at 25 Hz, 4 = at 29.97 Hz, 5 = at 30 Hz, 6 = at 50 Hz, 7 = at 59.94 Hz, 8 = 60 Hz;</p> <p>Established Timing including interlaced formats: 1280 x 1024 @ 75 Hz 1152 x 870 @ 75 Hz 1024 x 768 @ 60 Hz, 70 Hz, 75 Hz, 87 Hz 832 x 624 @ 75 Hz 800 x 600 @ 56 Hz, 60 Hz, 72 Hz, 75 Hz 720 x 400 @ 70 Hz, 88 Hz 640 x 480 @ 60 Hz, 67 Hz, 72 Hz, 75 Hz</p> <p>CEA Video Information Code (VIC) Formats: VIC = 1, 640 x 480p 59.94/60 Hz 4:3 VIC = 2, 720 x 480p 59.94/60 Hz 4:3 VIC = 3, 720 x 480p 59.94/60 Hz 16:9 VIC = 4, 1280 x 720p 59.94/60 Hz 16:9 VIC = 5, 1920 x 1080i 59.94/60 Hz 16:9 VIC = 6, 720(1440) x 480i 59.94/60 Hz 4:3 VIC = 7, 720(1440) x 480i 59.94/60 Hz 16:9 VIC = 14, 1440 x 480p 59.94/60 Hz 4:3 VIC = 15, 1440 x 480p 59.94/60 Hz 16:9 VIC = 16, Native 1920 x 1080p 59.94/60 Hz 16:9 VIC = 17, 720 x 576p 50 Hz 4:3 VIC = 18, 720 x 576p 50 Hz 16:9 VIC = 19, 1280 x 720p 50 Hz 16:9 VIC = 20, 1920 x 1080i 50 Hz 16:9 VIC = 21, 720(1440) x 576i 50 Hz 4:3 VIC = 22, 720(1440) x 576i 50 Hz 16:9 VIC = 29, 1440 x 576p 50 Hz 4:3 VIC = 30, 1440 x 576p 50 Hz 16:9 VIC = 31, 1920 x 1080p 50 Hz 16:9 VIC = 32, 1920 x 1080p 23.97/24 Hz 16:9 VIC = 33, 1920 x 1080p 25 Hz 16:9 VIC = 34, 1920 x 1080p 29.97/30 Hz 16:9 VIC = 39, 1920 x 1080i 50 Hz 16:9 VIC = 41, 1280 x 720p 100 Hz 16:9 VIC = 42, 720 x 576p 100 Hz 4:3 VIC = 43, 720 x 576p 100 Hz 16:9 VIC = 44, 720(1440) x 576i 100 Hz 4:3 VIC = 45, 720(1440) x 576i 100 Hz 16:9 VIC = 47, 1280 x 720p 119.88/120 Hz 16:9 VIC = 48, 720 x 480p 119.88/120 Hz 4:3 VIC = 49, 720 x 480p 119.88/120 Hz 16:9 VIC = 33, 1920 x 1080p 25 Hz 16:9 VIC = 34, 1920 x 1080p 29.97/30 Hz 16:9 VIC = 39, 1920 x 1080i 50 Hz 16:9 VIC = 41, 1280 x 720p 100 Hz 16:9 VIC = 42, 720 x 576p 100 Hz 4:3 VIC = 43, 720 x 576p 100 Hz 16:9 VIC = 44, 720(1440) x 576i 100 Hz 4:3 VIC = 45, 720(1440) x 576i 100 Hz 16:9 VIC = 47, 1280 x 720p 119.88/120 Hz 16:9</p>

	VIC = 48, 720 x 480p 119.88/120 Hz 4:3 VIC = 49, 720 x 480p 119.88/120 Hz 16:9
Input Audio Supported	PCM 2.0
Output	1 x HDMI Out 1 x S/PDIF Out 1 x Analog Audio Out
Output Resolutions Supported	VESA: 800x600 ⁸ , 1024x768 ⁸ , 1280x768 ⁸ , 1280x800 ⁸ , 1280x960 ⁸ , 1280x1024 ⁸ , 1360x768 ⁸ , 1366x768 ⁸ , 1440x900 ⁸ , 1600x900 ⁸ , 1600x1200 ⁸ , 1680x1050 ⁸ , 1920x1200 ⁸ , 3840x2160 ^{2,3,5,8} , 4096x2160 ^{2,3,5,8} and Auto Scaling SMPTE: 1280x720P ^{6,8} , 1920x1080P ^{6,8} , 1 = at 23.98 Hz, 2 = at 24 Hz, 3 = at 25 Hz, 4 = at 29.97 Hz, 5 = at 30 Hz, 6 = at 50 Hz, 7 = at 59.94 Hz, 8 = at 60 Hz;
Output Audio Supported	HDMI: PCM 2.0 S/PDIF Out: PCM 2.0 Analog Audio out: PCM 2.0
Maximum Data Rate	18Gbps

General	
Operating Temperature	0°C to 50°C (32°F to 125.6°F)
Storage Temperature	-10°C to 60°C (14°F to 140°F)
Humidity	5% to 85%, non-condensing
Power Supply	DC 12V 3A
Power Consumption (Max)	17W
ESD Protection	Human-body Model: ±10kV(Air-gap discharge) ±5kV(Contact discharge)
Device Dimension (W x H x D)	234.4mm x 25mm x 143mm/ 9.23" x 0.98" x 5.63"
Product Weight	0.4kg/0.98lb
Certification	CE/FCC/ETL/PSE/RCM

Transmission Distance

Cable Type	Range	Supported Video
Cat 6a/7	100m / 328 ft	1080P@60Hz
	80m / 262 ft	4K@30 4:4:4
HDMI Output	15m/49ft	1080P@60Hz 24bpp
	10m/33ft	4K@30Hz 4:2:0
	5m/16ft	4K@60Hz 4:4:4

Note: Straight-through T568B Ethernet cable is recommended.

Front Panel Description



No.	Name	Description
1	POWER LED (Green)	On: The receiver is powered on. Off: The receiver is powered off.
2	SCALER LED (Blue)	Blinking: The scaler module is working properly. Off: The scaler module is not working properly.
3	STATUS LED (Green)	Blinking: The receiver is working properly. Off: The receiver is not working properly.
4	HDCP LED (Yellow)	Blinking: HDCP-protected content is transmitted. Off: No HDCP-protected content is transmitted.
5	LINK LED (Green)	On: HDBT Link between transmitter and receiver is normal. Off/Blinking: No HDBT link or link error.

Rear Panel Description

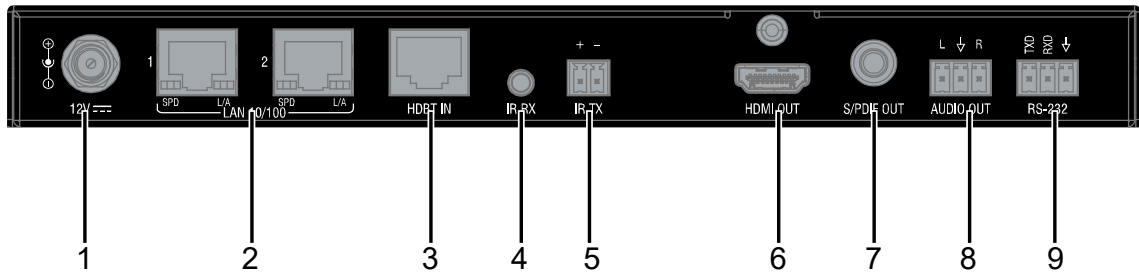

No.	Name	Description
1	12V	12V DC power input. Use the power supply provided.
2	LAN 10/100 1-2	Connect to Ethernet devices
3	HDBT IN	Connect to HDBT OUT of an HDBT transmitter (PR01-0808).
4	IR IN	Connect the IR receiver cable provided.
5	IR OUT	IR signal Output port.
6	HDMI OUT	Connect to an HDMI display device.
7	S/PDIF OUT	Connect to an audio device for de-embedding digital audio output (e.g. amplifier, audio system).
8	AUDIO OUT	Connect to an audio device for de-embedding analog audio output using the Phoenix Connector provided (e.g. amplifier, audio system).
9	RS232	For RS232 pass-through.

Installation

Warning: Before installation, ensure the device is disconnected from the power source.

Installation:

1. Attach the installation brackets to the enclosure using the screws provided.
2. The bracket is attached to the enclosure as shown. The bracket height can be adjusted Up/Down and the bracket can be positioned face Up or Down.

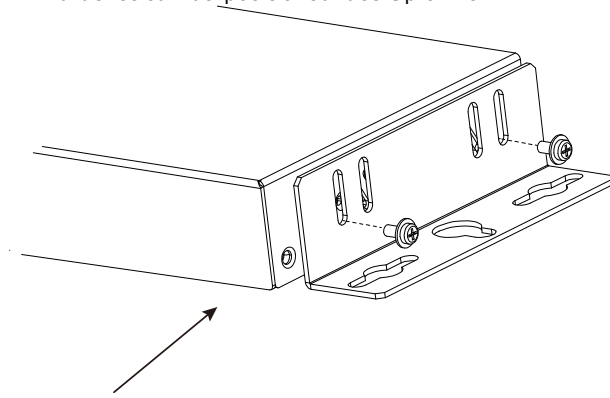

3. Repeat steps 1-2 for the other side of the unit.
4. Attach the brackets to a surface or suitable location with user supplied screws.

Wiring

Warning:

Before wiring, disconnect the power from all devices. Connect and disconnect the cables with care.

1. Connect video sources

Connect video source(s) (e.g. PC, Blu-ray player, Apple TV, 4K player, game console, etc.) to your transmitter (e.g., PRO1- 0808).

2. Connect HDBT

Connect HDBT OUT of the transmitter to HDBT IN of the PRO1-RX receiver with a Shielded Cat 6a/7 cable. Ensure the cable length is within the transmission range according to the Specification Section.

3. Connect HDMI OUT

Connect an HDMI display (e.g. projector, TV, LED/LCD display) to HDMI OUT of the PRO1-RX receiver with an HDMI cable.

4. Connect S/PDIF OUT and AUDIO OUT

Connect audio devices (e.g. amplifier, audio system) to S/PDIF OUT and AUDIO OUT of the receiver.

5. Connections for additional control options:

- IR pass-through to control display or source device: Connect an IR emitter (or IR receiver) to IR TX (or IR RX) of the receiver, and another IR receiver (or IR emitter) to IR RX (or IR TX) of a transmitter, to control the source or display device with the IR remote.
- NetLinx Control: Connect a PC or control system to Ethernet 1/2 to control a receiver and display through the NetLinx Studio setting.
- RS232 pass through: Connect a RS232 server (or client) Device to RS232 of the connected transmitter, and an RS232 client (or server) Device to RS232 of the receiver PRO1-RX. An RS232 server Device can control a master device with pass-through commands when all connections are completed.

Note: When the IR TX port is used for IR signal output, other IR devices are also available.

6. Connect an Ethernet device (e.g. router, Ethernet switch) to the receiver for network pass-through.

7. Connect the provided DC 12V power supply to the receiver.

8. Power on all units to start operation.

When the connections are complete, check if all LED indicators on the receiver are at their normal state to ensure a successful installation. For LED indication, refer to Panel Layout section.

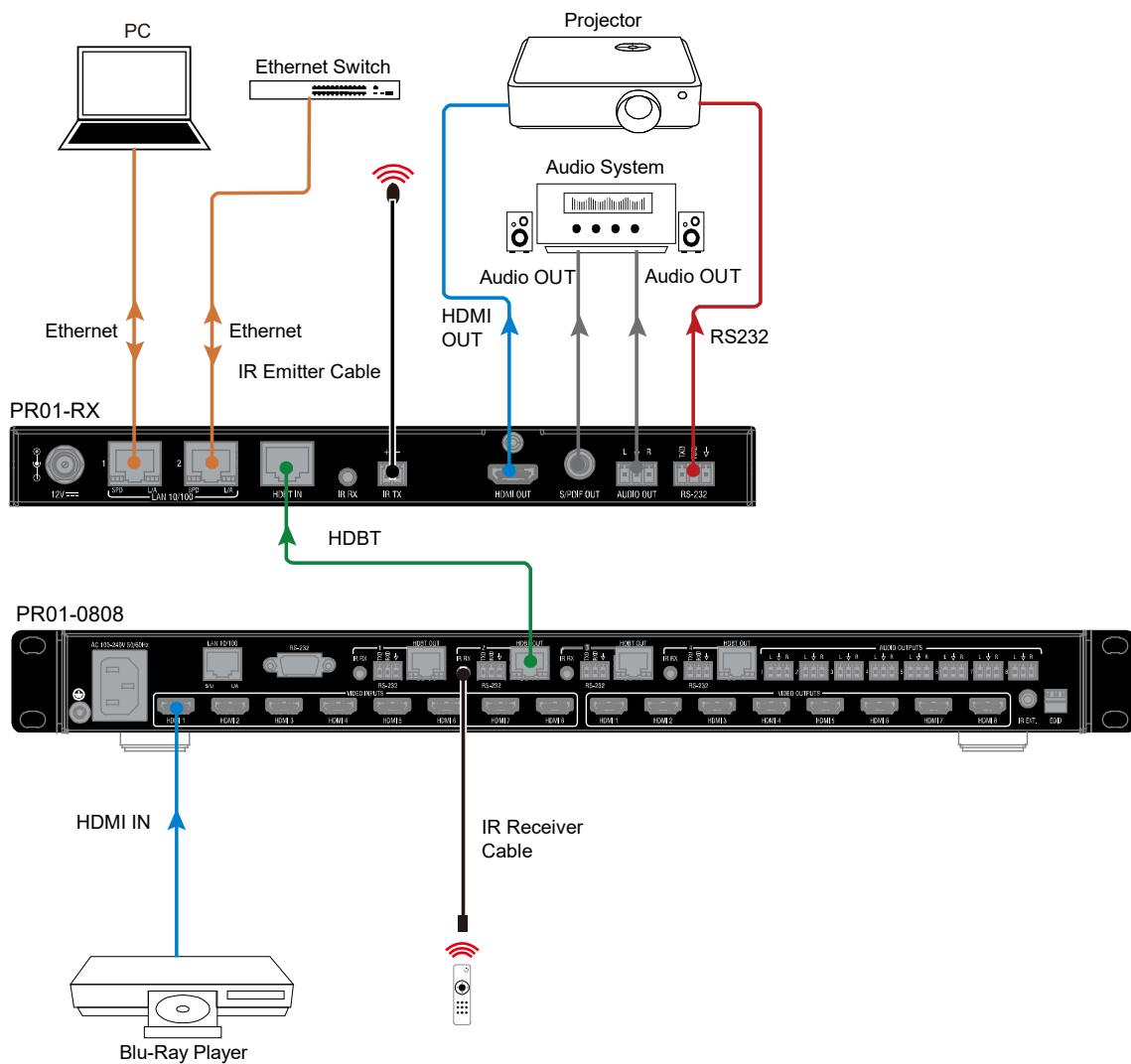

Connection Modes

Endpoint mode:

The PR01-RX will change to Endpoint mode when it detects the presence of a PR01-0808. Endpoint mode takes effect immediately without requiring a reboot.

Endpoint mode settings:

1. Copy EDID (always change EDID audio to 2CH, if sink EDID over 4K@30Hz 4:4:4 8 bit, it will be replaced by 4K@30Hz 4:4:4 8bit 2CH);
2. Get input HDCP info from PR01-0808;
3. Follow the PR01-0808 instructions to send CEC commands;
4. Receive API commands through Ethernet on PR01-RX to set scaling output and other features;
5. Upgrade FWs via Thor.

Standalone mode:

1. EDID controlled by API commands through Ethernet on the PR01-RX, copy EDID is the default setting (always change EDID audio to 2CH, if sink EDID over 4K@30Hz 4:4:4 8 bit, it will be replaced by 4K@30Hz 4:4:4 8bit 2CH)
 - 1) 3840 x 2160@30_2ch
 - 2) 1920 x 1200@60_2ch
 - 3) 1920 x 1080@60_2ch
 - 4) 1280 x 800@60_2ch
 - 5) 1280 x 720@60_2ch
 - 6) 1024 x 768@60_2ch
 - 7) Copy (Default)
2. PR01-RX gets input HDCP info on its own.
3. PR01-RX control CEC commands.
4. Receive API commands through Ethernet on PR01-RX to set scaling output and other features.
5. Upgrade FWs via Thor.

IR Operation

The PR01-RX allows IR pass-through over HDBaseT, allowing control of the source from the display location or control of the display from the source location. This function requires an HDBT Transmitter, e.g. PR01-0808.

Control the Display

1. To control the display from the source location:
2. Connect an HDMI Display device to HDMI OUT of the PR01-RX.
3. Connect an IR Emitter to IR TX of the PR01-RX.
4. Connect the IR Receiver provided and a source device to the HDBT Transmitter (e.g. PR01-0808).
5. Connect the PR01-RX and the HDBT transmitter.

When the connections are complete, the display can be controlled at the source and through a display remote.

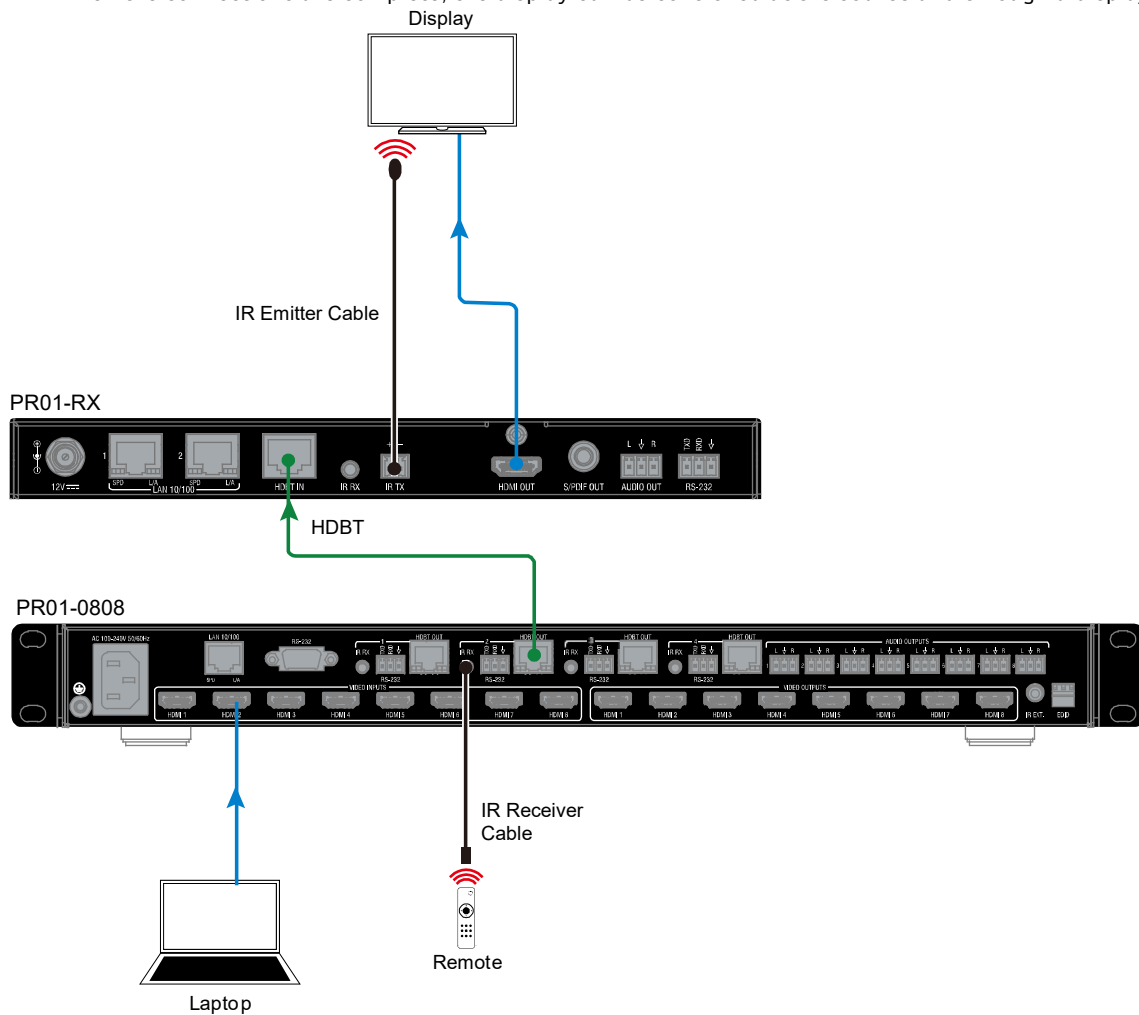

Control the Source

To control the source from the display location:

1. Connect the IR Receiver provided to IR RX of the PR01-RX;
2. Connect a display device to the HDMI OUT port of the PR01-RX.
3. Connect the IR Emitter provided and a source device to the HDBT Transmitter.
4. Connect PR01-RX and the HDBT Transmitter via HDBT.

When the connections are complete, the source can be controlled at the display location through a source device remote.

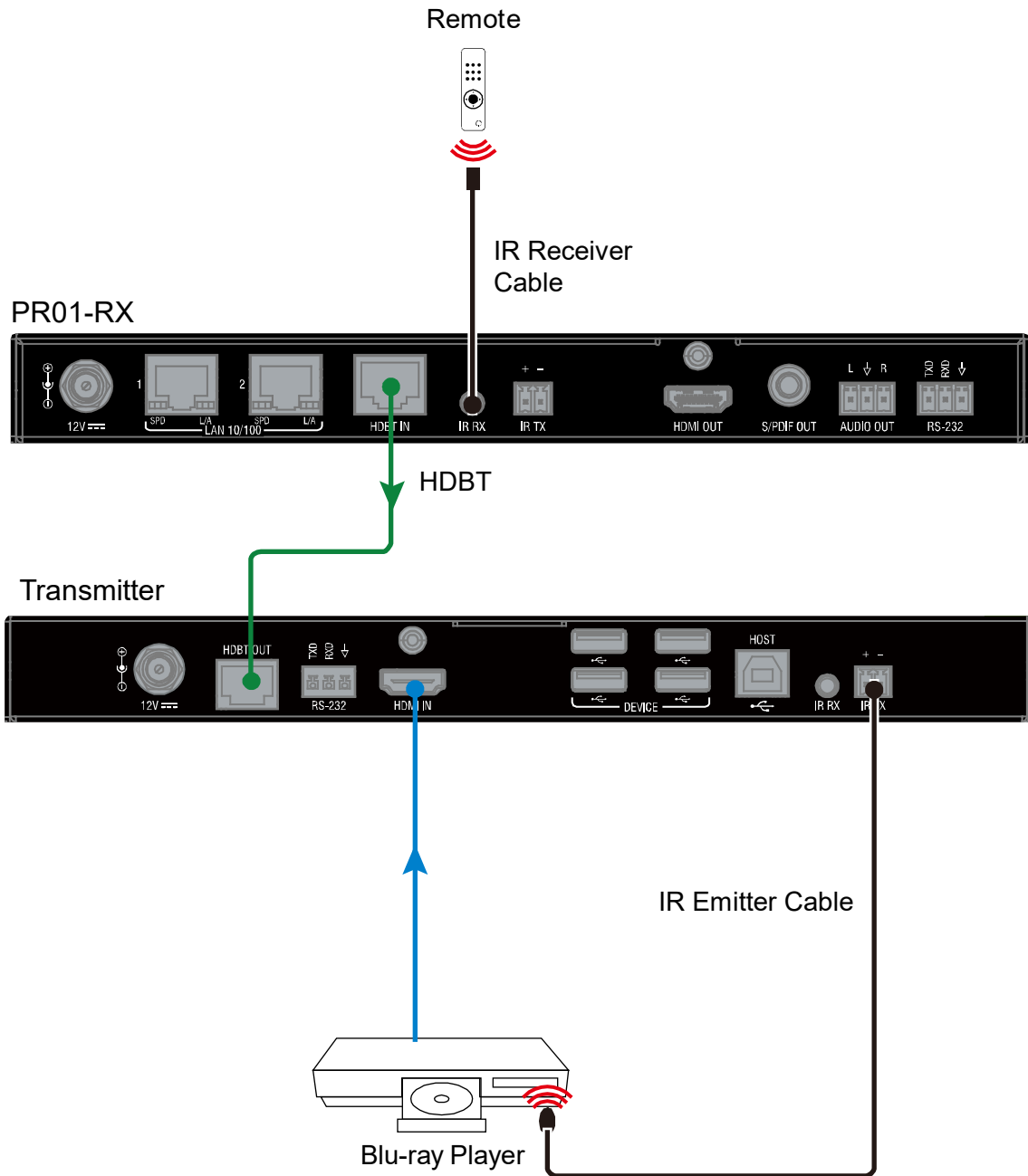

RS232 Operation

RS232 Pinout

The following figure shows the RS232 pinout. Connect with the provided Phoenix Connectors.

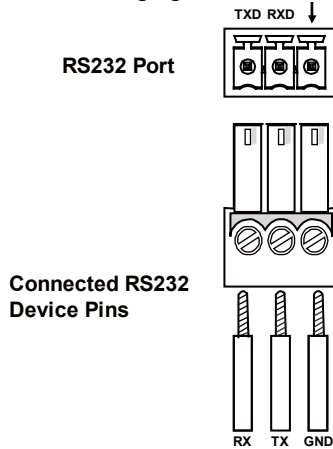

For RS232 Pass Through

The RS232 port of the PR01-RX can also be used for pass-through (Default) while working with a Transmitter device like PR01-0808. To initiate RS232 pass-through between the PR01-RX and a Transmitter (e.g. PR01-0808):

1. Connect an RS232 Device (RS232 Device 1) to the RS232 port of the PR01-RX using a **RS232** cable;
2. Connect another RS232 Device (RS232 Device 2) to the RS232 port of the Transmitter using an RS232 cable;
3. Connect **HDBT IN** of the PR01-RX and **HDBT OUT** of the Transmitter using a Cat X cable.
4. When the connections are complete, the RS232 Device 1 can be controlled at RS232 Device 2 or vice versa.

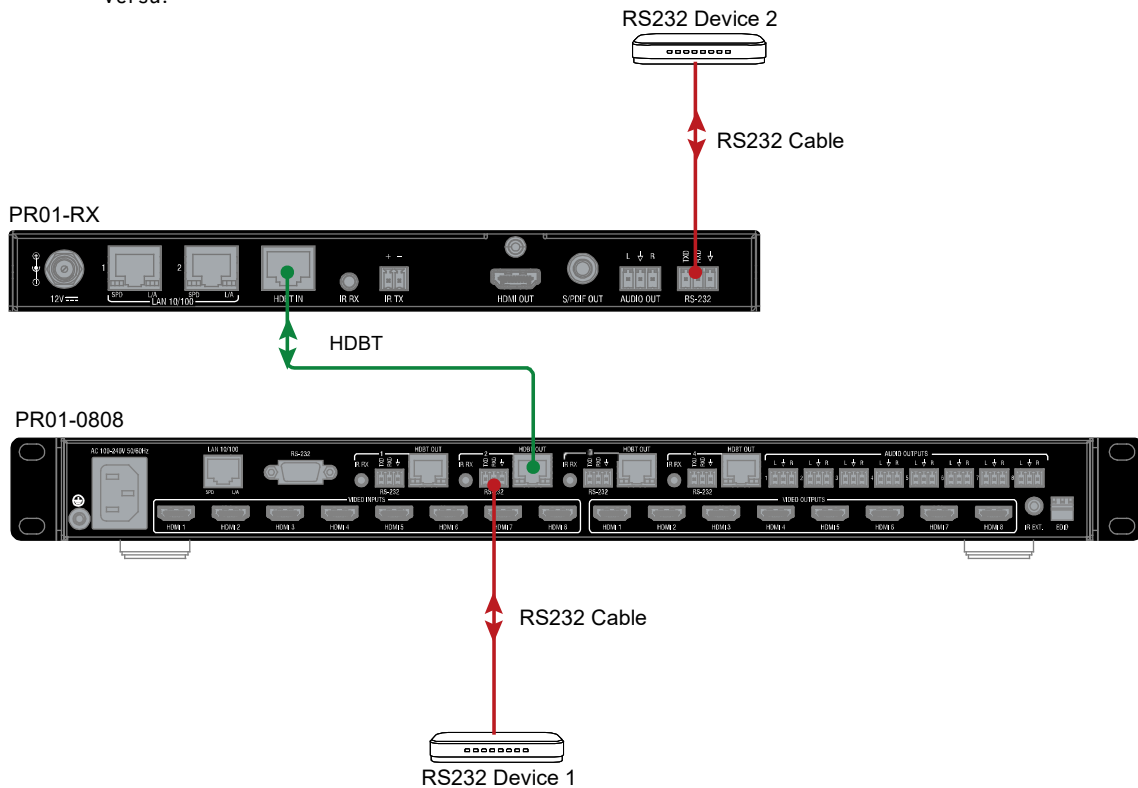

OSD

The PR01-RX device supports OSD (On Screen Display) to convey its IP address.

The following two methods can show the IP address on the displays connected to the PR01-RX.

- Connect the PR01-RX to the power adapter. The IP address will show on the upper right of the connected display's screen within 3 minutes, and last for 15s then disappear.
- After the PR01-RX is powered on, unplug and plug in the HDMI cable connected to the display. The IP address will show on the upper right of the connected display's screen within 10s, and last for 15s then disappear.

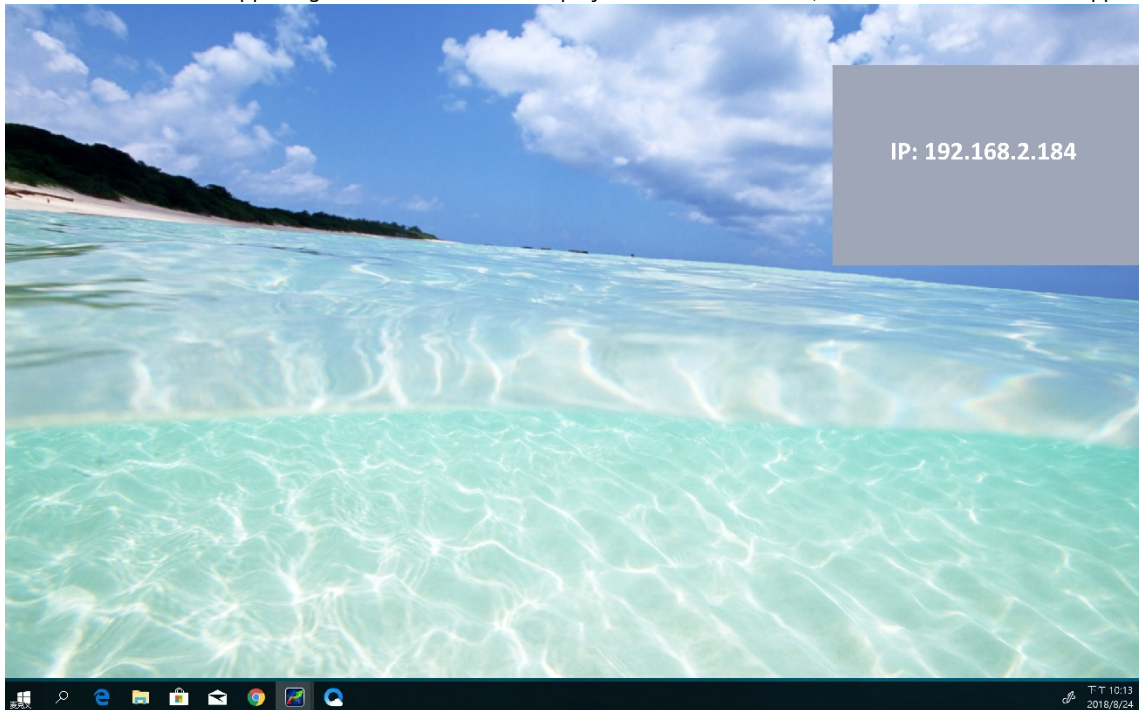

NetLinX Programing

Controlling the PR01-RX through NetLinX studio via Ethernet port.

Before launching NetLinX Studio, connect the PR01-0808 to RX, PC, and control system (e.g. NX-3200) to the same network.

Device Number and Ports

Each Module has its own Device Number (which is assigned when the unit is bound to a Control System) and the following ports.

Port 1: RS232

Port 2: Not used

Port 3: IR TX

Port 4: IR RX

Port 5: Not used

Port 6: Video/Audio Output

Port 7: Video/Audio Input

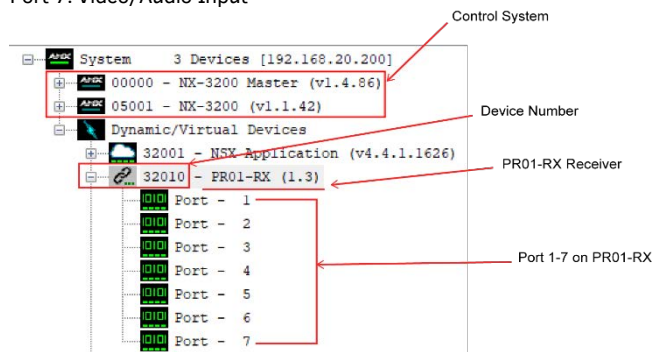

After configuring each port respectively, control commands can be sent to the chosen device. Click “**Diagnostics**” on the menu bar, choose “**Control a Device**”.

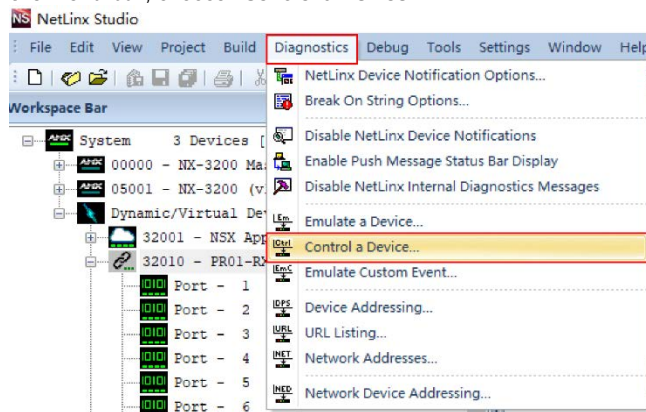

A window will display as follows, enter a command in the textbox, and click “**Send To Device**”. (For API commands, see the Section **API Command Set**.)

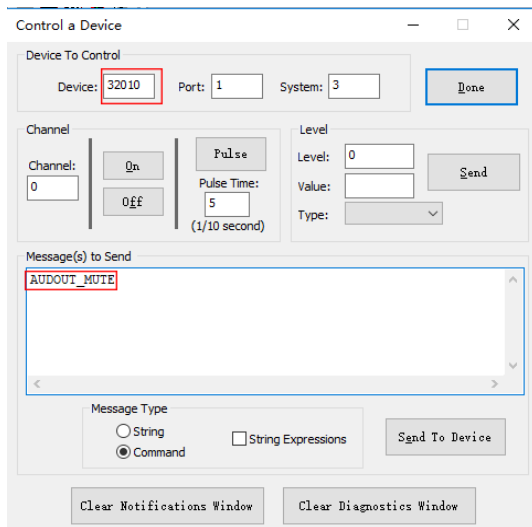

Telnet Control via NetLinX Studio

To launch Telnet Window,

1. Right click the Device Number in NetLinX Studio's Online Tree. Select **"TELNET Window"** – **"Launch TELNET Window via NetLinX Studio"** (or **"Launch TELNET Window via User Defined Program"**). *

Note: For API commands, see the Section **NetLinX API Command Set**.

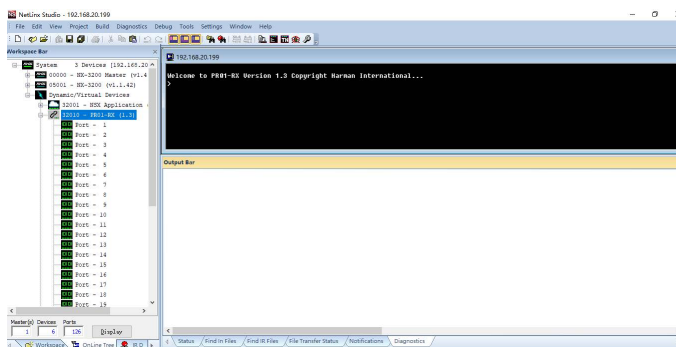
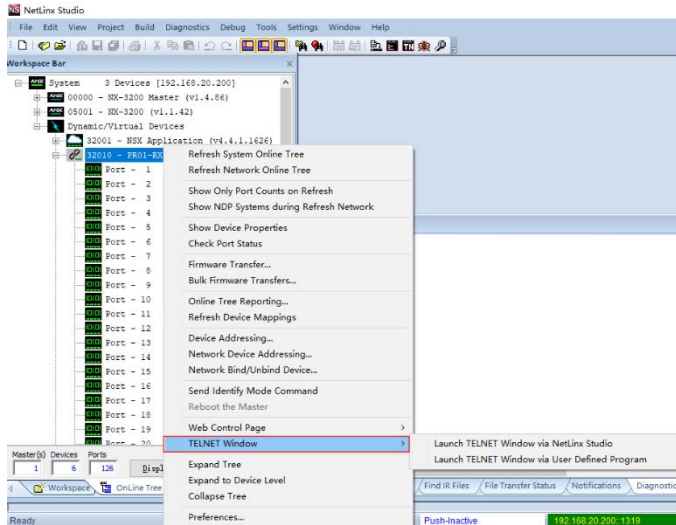

2. At the prompt (>), type the Telnet command and press Enter.

Selecting “**Launch TELENT Window via User Defined Program**”, may require enabling Telnet by completing the following:

- (1) Go to Start/Control Panel/Programs and Features;
- (2) On the left, select “**Turn Windows features on or off**”;
- (3) Select the check-boxes Telnet Client and Telnet Server, and click OK.

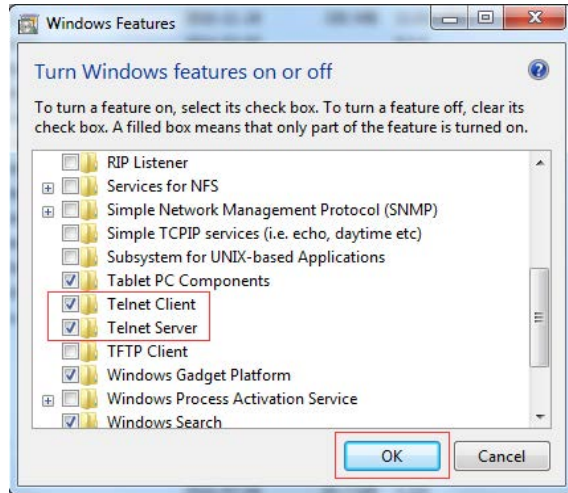

Web UI Control

The PR01-RX offers users a web interface for changing settings and controlling the matrix. Users can enter the Web UI Control Page via NetLinx Studio.

Choose the device to be controlled, right click, then choose “**Web Control Page**” -> “**Launch Web Control Page via NetLinx Studio/Launch Web Control Page via Default Browser**”, enter the Web UI Control Page.

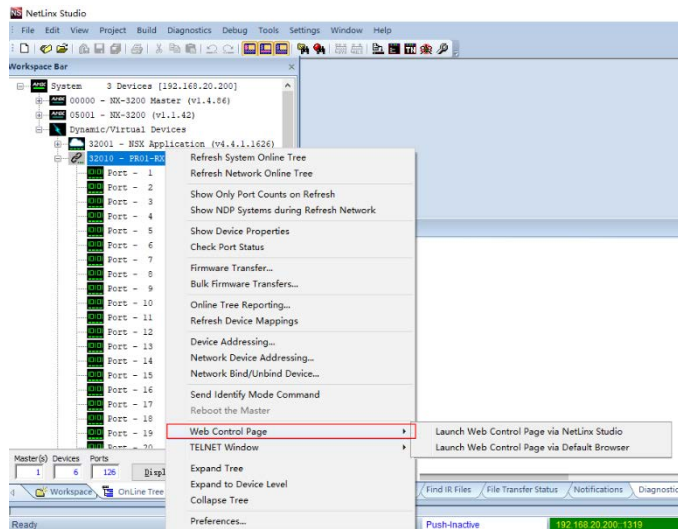

Web UI Control

The Web UI designed for the PR01-RX allows basic controls and advanced settings of the device. The Web UI page can be accessed through NetLinX Studio. The PR01-RX can be used separately or connected with the PR01-0808.

The RS232 port of the PR01-RX can also be used for pass-through (Default) while working with a Transmitter device like PR01-0808.

Connected Separately

Access the Web UI

To gain access to the Web UI:

1. Connect your PC and the LAN port of the PR01-RX to the same local area network.
2. In NetLinX Studio's Online Tree, select **“Web Control Page” – “Launch Web Control Page via NetLinX Studio” (or select**
3. **“Launch Web Control Page via Default Browser”**).

The following page will pop up. Enter the default password **“admin”** and click **“Login”**.

PR01-RX Control

Login

Password:

Remember Password

Login

After logging in, the following interface appears:

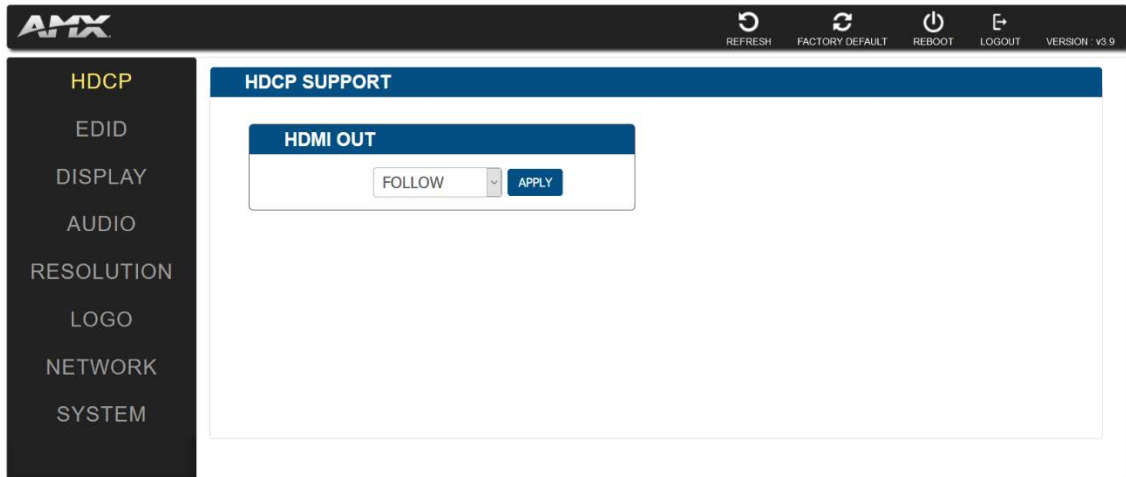

Web UI Introduction

The Interface includes 6 submenus:

- HDCP
- EDID
- DISPLAY
- AUDIO
- RESOLUTION
- LOGO
- NETWORK
- SYSTEM

At the top of the interface, REFRESH, FACTORY DEFAULT, REBOOT, UPGRADE STATUS and Firmware VERSION are included.

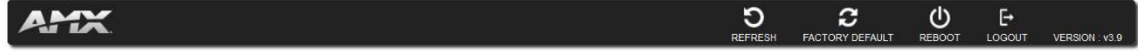

Refresh

Click  to refresh the status of the device in Web UI interface.

Factory Default

Click  to set the device to factory default. Click the button, the following window pops up.

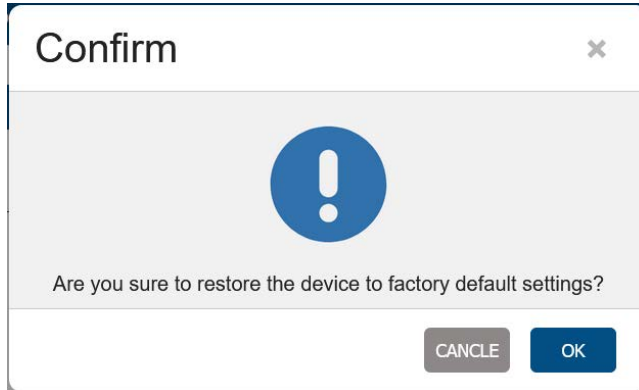

Click "OK" to take effect.

Reboot

Click  to reboot the device. Click the button, the following window pops up.

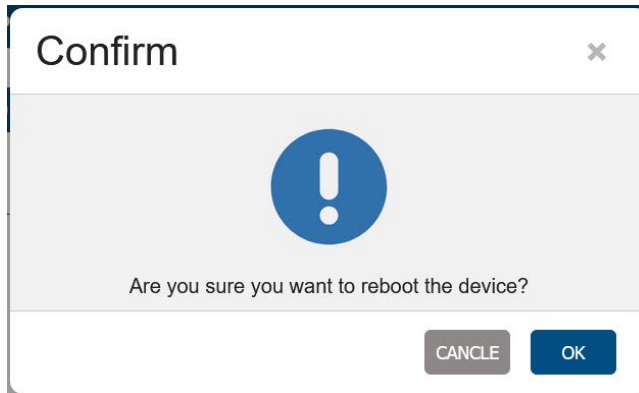

Click "OK" to take effect.

Logout

Click  to return to the **Login** page.

Firmware Version

To show the current firmware version click .

HDCP

In this column, set the HDCP for HDMI output. Click the drop-menu to select HDCP from HDCP 2.2, HDCP 1.4 and NO HDCP, click “Apply” to take effect.

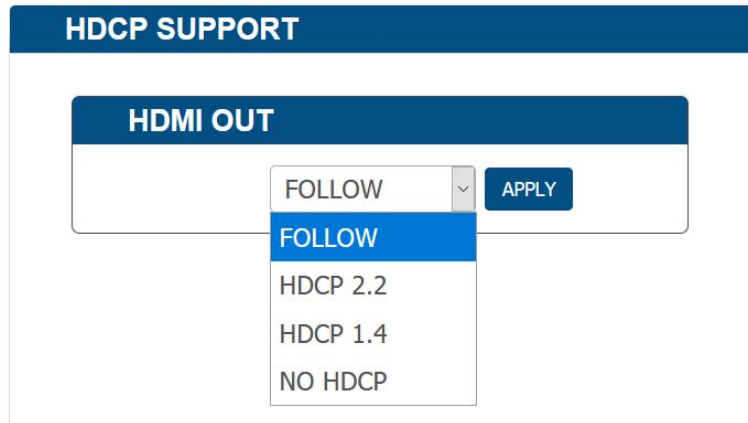

- **FOLLOW:** Select to follow the output display’s HDCP compatibility for the HDMI Out, which will transmit content with the same HDCP compatibility as that of the output display (default setting).
- **HDCP 2.2:** Select to transmit HDCP 2.2 protected content to the output display.
- **HDCP 1.4:** Select to transmit HDCP 1.4 protected content to the output display.
- **NO HDCP:** Select to transmit non-HDCP protected content to the output display.
- **Apply:** Click to make the selection to take effect.

Note: If “NO HDCP” is selected for HDMI OUT, when the HDCP protected signal is being input, the receiver will output no signal.

EDID

In this column, set the input EDID to meet requirements of the system. Click the drop-down menu to select resolution, click “Apply” to take effect.

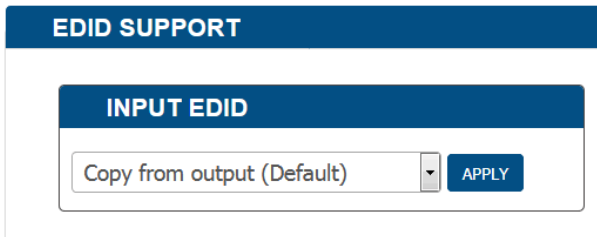

Display

In this column, control of the displays is available.

Auto Display Control

ON: Click to enable Auto Display Control. In this mode, setting of the delay time is enabled. For example: Set the Delay Time to 2 minutes. When there is no signal input for 2 mins, the display will automatically turn off.

OFF: Click to disable the Auto Display Control. (Default setting)

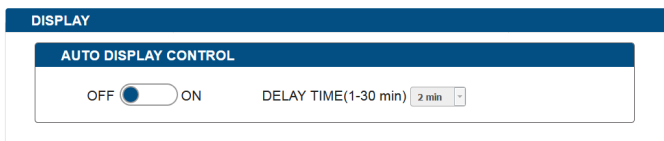

Audio

In this column, setting of the Volume Mute or Unmute is enabled.

Mute: Click the box next to “Mute”, the audio volume is set to mute.



Resolution

In this column, setting of the Output resolution AUTO or MANUAL is enabled. AUTO is default.

- **Auto:** Output resolution is automatically set.
- **Manual:** Select output resolution by manual control, then click “Apply” to take effect.

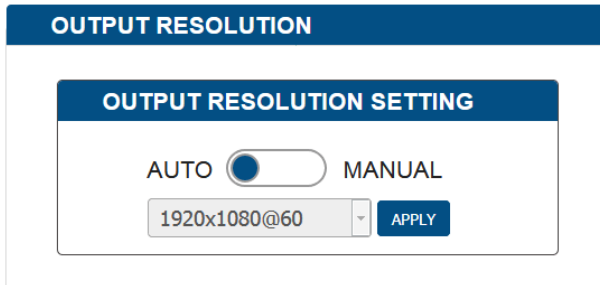

LOGO

This column enables you to load a logo to be shown on the display or set to show black screen when there is no signal output.

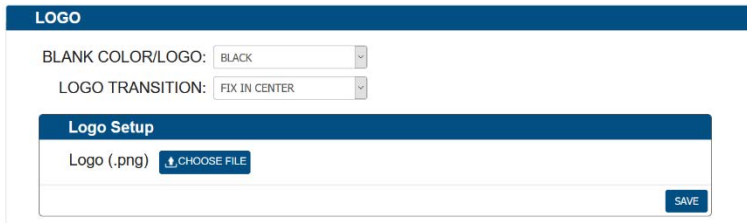

Logo section allows display content configuration for the display screen when there's no signal output to the display.

- **BLACK COLOR/LOGO:**
 - 1) **BLACK:** Select to set the display screen as black when there's no signal output to the display.
 - 2) **LOGO:** Select to set the display to show a logo picture when there's no signal output to the display.
- **LOGO TRANSITION:**
 - 1) **FIX IN CENTER:** Select to set the logo picture to be shown in the display screen's center when there's no signal output to the display. (Default setting)
 - 2) **DRAG TOP LEFT:** Select to set the logo picture to shuttle slowly between the center and the top left of the display screen when there's no signal output to the display.
 - 3) **DRAG TOP RIGHT:** Select to set the logo picture to shuttle slowly between the center and the top right of the display screen when there's no signal output to the display.
 - 4) **DRAG BOTTOM LEFT:** Select to set the logo picture to shuttle slowly between the center and the bottom left of the display screen when there's no signal output to the display.
 - 5) **DRAG BOTTOM RIGHT:** Select to set the logo picture to shuttle slowly between the center and the bottom right of the display screen when there's no signal output to the display.

- **Logo Setup**
 - 1) **CHOOSE FILE:** Click to upload a logo file to the CTP-1301 from your local computer.
 - 2) **SAVE:** Click to perform the logo file uploading.

Note:

- The logo file should be in .png format with size not larger than 1280x720, 60KB.
- When the logo is loaded to the device successfully, the device will reboot immediately.

LOGO

BLANK COLOR/LOGO:

LOGO TRANSITION:

Logo Setup

Logo (.png)

Network

Device IP Mode:

- **DHCP:** When enabled, the IP address of the PR01-RX will be assigned automatically by the connected DHCP server.
- **Static:** When the PR01-RX fails to obtain or detect an IP address from the network it's connected to, select "STATIC" to set up the IP address manually.
- **Apply:** Click to apply the network setting.

NETWORK

<div style="background-color: #0056b3; color: white; padding: 2px;">DEVICE IP MODE</div> <p><input type="radio"/> DHCP <input checked="" type="radio"/> STATIC</p>	<div style="background-color: #0056b3; color: white; padding: 2px;">MAC ADDRESS</div> <p>00:60:9f:a4:5e:fc</p>
<div style="background-color: #0056b3; color: white; padding: 2px;">DEVICE IP ADDRESS</div> <p><input type="text" value="192.168.1.3"/></p>	<div style="background-color: #0056b3; color: white; padding: 2px;">IP HOSTNAME</div> <p><input type="text" value="AMX-PR01-RX-A45EFC"/></p>
<div style="background-color: #0056b3; color: white; padding: 2px;">SUBNET MASK</div> <p><input type="text" value="255.255.255.0"/></p>	<div style="background-color: #0056b3; color: white; padding: 2px;">DNS 1</div> <p><input type="text" value="192.168.1.1"/></p>
<div style="background-color: #0056b3; color: white; padding: 2px;">DEFAULT GATEWAY</div> <p><input type="text" value="192.168.1.1"/></p>	<div style="background-color: #0056b3; color: white; padding: 2px;">DNS 2</div> <p><input type="text" value="8.8.8.8"/></p>

NOTE: LAN MODULE WILL AUTOMATICALLY REBOOT AFTER CHANGING NETWORK SETTING.

Note: Wait for 2-3 minutes for the device's LAN module to reboot and reconnect after the network setting is changed.

System

In this column, setting of the ICSP PARAMETER, LOGIN PASSWORD, TELNET/SSH ACCESS, TELNET ACCOUNT and SSH ACCOUNT are enabled.

ICSP Parameter

In this column, users can set the ICSP parameter.

- **Connection Mode:** Includes four options: NDP, Auto IP, URL/TCP, URL/UDP. The default setting is NDP. MASTER URL: Input the connected master's URL.
- **System Number:** Use the Online Tree to determine the System Number. By default, i configuration is disabled.
- **Device Number:** Use the Online Tree to determine the Device Number. By default, i configuration is disabled.
- **Apply:** Click “Apply” for settings to take effect.

ICSP PARAMETER

CONNECTION MODE:

MASTER URL:

SYSTEM NUMBER: (0-65535)

DEVICE NUMBER:

Login Password

In this column, the login password can be changed. Input the old password in “Old Password” box, and input a new password in “New Password” box, then click “Apply” to take effect.

LOGIN PASSWORD

OLD PASSWORD:

NEW PASSWORD:

Telnet/SSH Access

In this column, setting of the TELNET/SSH connection can be turned On/Off. The default setting is “ON”.

TELNET/SSH ACCESS

TELNET: OFF ON

SSH: OFF ON

Click “Apply” to initiate the setting.

Note: The device must be rebooted for the setting to take effect.

Telnet Account

Telnet Account is used to configure the User Name and Password of the account. For Telnet Account, the default user name and password are null.

Apply: Click to perform the setting.

TELNET ACCOUNT

USERNAME:

PASSWORD:

SSH Account

SSH Account is used to configure the User Name and Password of the account.

For SSH Account, the default user name is admin, the default password is **password**.

Note: The device must be rebooted for the setting to take effect.

Apply: click “Apply”, to initiate rebooting of the device.



UPLOAD CERTIFICATE

This section allows you to upload HTTPS Private Key and Certificate.

- **Password:** Enter the password of the certificate uploaded.
- **Private Key (.pem):** Click “CHOOSE FILE” to browse for the private key in .pem format of the https certificate in your local computer.
- **Certificate (.pem):** Click “CHOOSE FILE” to browse for the https certificate in .pem format in your local computer.
- **Upload:** Click to upload the https certificate and its private key to the device.

Note: When certificate upload is completed, the certificate module will reboot automatically.

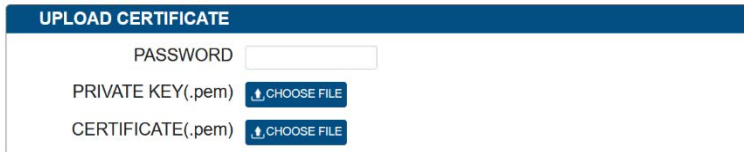

Connected with PR01-0808

Access the Web UI

When the PR01-RX is connected with the PR01-0808, the method of accessing web UI is the same as when the receiver is connected separately.

After logging in, the following interface appears:

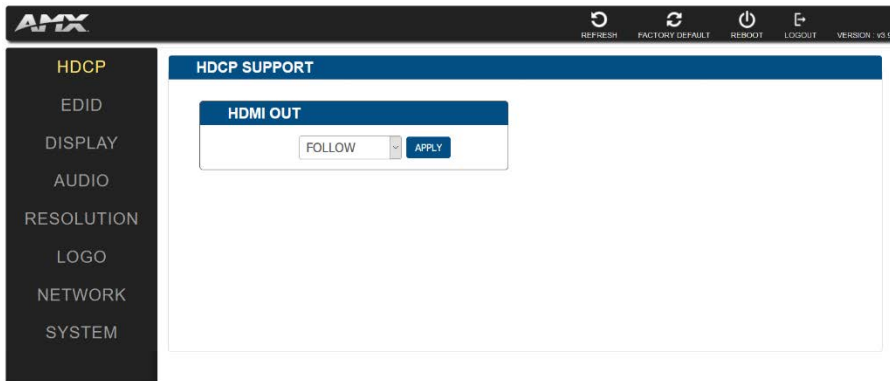

Web UI Introduction

When EDID and DISPLAY options are unavailable, other options of the web UI are the same as when the PR01-RX is connected separately.

EDID

EDID Support cannot be set. Refer to web UI EDID settings of the PR01-0808.

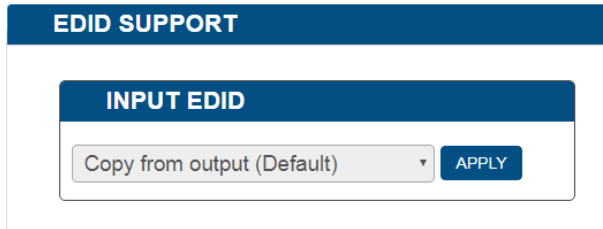

The screenshot shows a web UI section titled "EDID SUPPORT" in a blue header. Below the header is a sub-section titled "INPUT EDID" in a blue header. Underneath, there is a dropdown menu with the text "Copy from output (Default)" and a blue button labeled "APPLY".

Display

Auto Display Control cannot be set. Refer to web UI AUTO DISPLAY CONTROL settings of the PR01-0808.



The screenshot shows a web UI section titled "DISPLAY" in a blue header. Below the header is a sub-section titled "AUTO DISPLAY CONTROL" in a blue header. Underneath, there is a toggle switch labeled "OFF" and "ON" with a blue circle indicating it is currently turned "ON". To the right of the toggle is a label "DELAY TIME(1-30 min)" followed by a dropdown menu showing "1 min".

Firmware Upgrade

The PR01-RX uses KIT files for firmware upgrade.

Before Starting

1. Verify that you have the latest version of NetLinX Studio on your PC.
2. Download the latest firmware (KIT) file to your PC. (Place KIT files on a local drive for the fastest throughput.)
3. Verify the following:
 - 1) Verify that an Ethernet/RJ-45 cable is connected from the PR01-RX to the same network as the control system.
 - 2) Verify the PR01-RX unit is powered ON.
4. Launch NetLinX Studio and open the Online Tree.
5. Bind the target device to the integrated Master: select and right-click the PR01-RX: from the context sensitive menu, select Network Bind/Unbind Device (be sure the check box is selected), click **“OK”**.

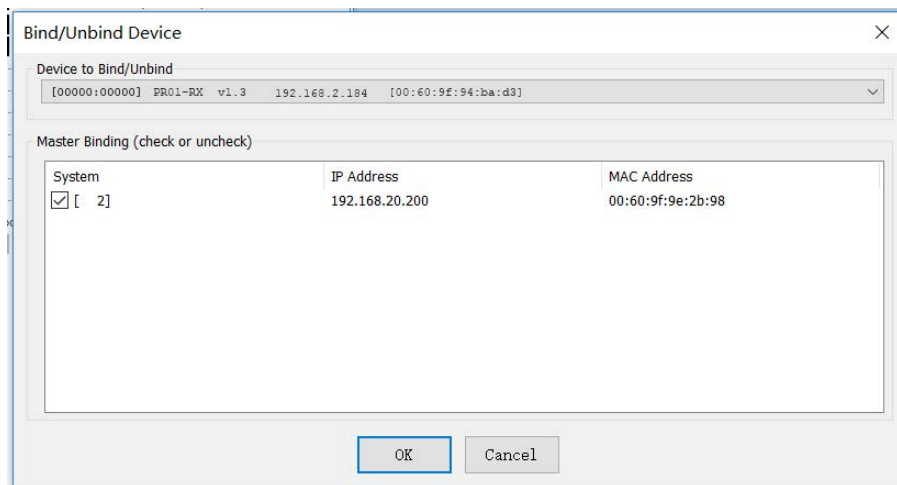

Transferring KIT Files

Important Upgrade Information:

Upgrading the firmware is a serious action in that if the upgrade fails, it can leave the system completely non-operational. Ensure no interruption of power and no power-off during the upgrade process.

Transferring KIT Files

The system will be non-operational during the upgrade procedure below.

1. In NetLinX Studio from the **Tools** menu, select **“Firmware Transfers > Send to NetLinX Device”**, select **“Stop Communications”** in the following box, and then enter the **Send to NetLinX Device** dialog box.
2. Click  to navigate to the target directory. The selected directory path is displayed in the Location text box. KIT files in the target directory display under File Name.
3. Select the appropriate KIT file from the list.

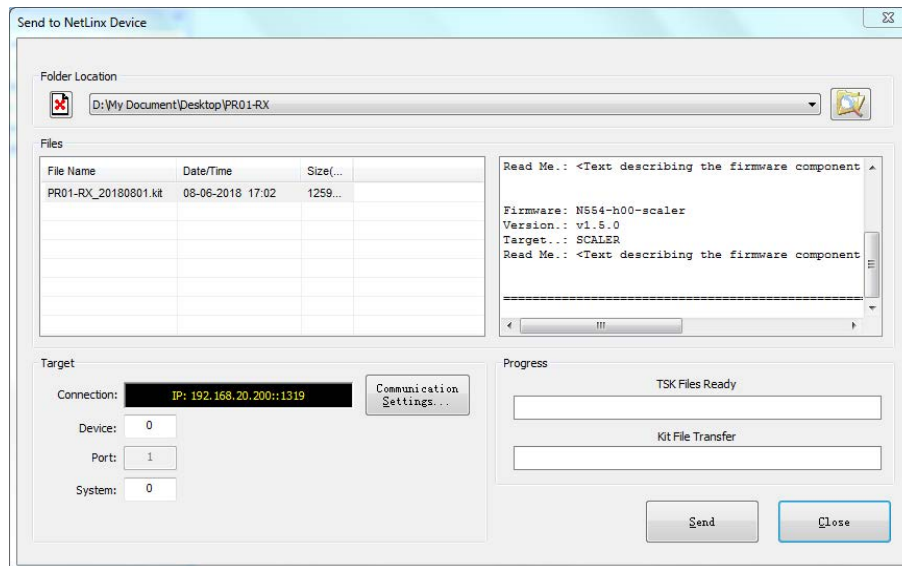

4. Enter the Device and System numbers (see **Device Number and Ports** part of **NetLinx Programming** section) for the target module in the Device and System text boxes.
 - The number of NetLinx Master is 3.
 - The Device number assigned to the integrated control ports is 32010.
5. Click **“Send”** to send the file to NetLinx Master and then upgrade the firmware on the PRO1-RX.
6. The device will restart automatically. There is no need to power cycle.

Note:

- The upgrade process will last 1 hour.
- Do not power off the device until it has been successfully upgraded.
- The device will restart two times to resume normal operation.

Troubleshooting

1. **Power:** Ensure all devices are powered on (sources, transmitter, receiver and display).
2. **Indicator:** Please make sure all LED indicators of the receiver is normal according to the user manual.
3. **Devices:** Ensure picture can be shown normally when directly connecting a source to a display device.
4. **Cable:** Plug in and out HDMI/Cat X cable or try another HDMI/Cat X cable.
 - Ensure cable length being used is within available transmission range according to the Specification Section.
 - Cat 5e/6/6a/7 cable is recommended. Do not use Cat 5 cable.
 - Ensure both connectors of each Cat X cable are the same standard (EIA/TIA 568B).
5. **Compatibility:** Test other source and display devices to determine correct compatibility.

NetLinx API Command Set

NetLinx API Commands

Device Port Name and Port Number:

Model name	Port name	Port No.
PRO1-RX	RS232	1
	IR TX	3
	IR RX	4
	Video/Audio Output	6
	Video/Audio Input	7

NetLinx API Command (cont.)

No.	FunctionDescription	Syntax	Example
1	Requests if the audio port addressed by the D:P:S is muted	<p>Command: SEND_COMMAND <DEV>, ""?AUDOUT_MUTE""</p> <p>Return: AUDOUT_MUTE-<enable disable></p> <p>Description: Audio Status is Mute or unMute</p>	<p>Command: SEND_COMMAND dxDev, ""?AUDOUT_MUTE""</p> <p>Return: AUDOUT_MUTE-enable</p> <p>Description: Audio Status is Mute</p>
2	Enable or disable audio muting on the audio port addressed by the D:P:S.	<p>Command: SEND_COMMAND <DEV>,""AUDOUT_MUTE-<setting>""</p> <p>Return: AUDOUT_MUTE-<setting></p> <p>Description: setting = desired mute state, either ENABLE or DISABLE</p>	<p>Command: SEND_COMMAND dxDev,""AUDOUT_MUTE-DISABLE""</p> <p>Return: AUDOUT_MUTE-DISABLE</p> <p>Description: Set Audio unmute</p>
3	Requests to see which scaling mode the video output port addressed by the D:P:S is using.	<p>Command: SEND_COMMAND <DEV>, ""?VIDOUT_SCALE""</p> <p>Return: VIDOUT_SCALE-<scale></p> <p>Description: scale = Auto, or Manual,</p>	<p>Command: SEND_COMMAND VIDEO_OUTPUT_1,""?VIDOUT_SCALE""</p> <p>Return: VIDOUT_SCALE-AUTO</p> <p>Description: Output Scale is Auto</p>

NetLinx API Command (cont.)

No.	FunctionDescription	Syntax	Example
4	Sets the scaling mode for the video output port addressed by D:P:S	<p>Command: SEND_COMMAND <DEV>,"VIDOUT_SCALE-<scale>"</p> <p>Return: VIDOUT_SCALE-<AUTO MANUAL></p> <p>Description: scale = Auto, or Manual,</p>	<p>Command: SEND_COMMAND VIDEO_OUTPUT_1,"VIDOUT_SCALE-AUTO"</p> <p>Return: VIDOUT_SCALE-AUTO</p> <p>Description: Set output Scale is Auto</p>
5	Requests to resolution of the video output port addressed by the D:P:S	<p>Command: SEND_COMMAND <DEV>, ""?VIDOUT_RES""</p> <p>Return: VIDOUT_RES-<h>x<v>,<rate></p>	<p>Command: SEND_COMMAND VIDEO_OUTPUT_1,"?VIDOUT_RES"</p> <p>Return: VIDOUT_RES-1920x1080,60</p> <p>Description: Output resolution is 1920x1080, 60</p>
6	Requests the resolution and refresh rate of the video output port addressed by the D:P:S.	<p>Command: SEND_COMMAND <DEV>, ""?VIDOUT_RES_REF""</p> <p>Return: VIDOUT_RES_REF-<h>x<v>,<rate></p>	<p>Command: SEND_COMMAND VIDEO_OUTPUT_1,"?VIDOUT_RES_REF"</p> <p>Return: VIDOUT_RES_REF-1920x1080,60</p> <p>Description: Output resolution is 1920x1080@60</p>

NetLinx API Command (cont.)

No.	FunctionDescription	Syntax	Example
7	Sets the resolution and refresh rate of the video output port addressed by D:P:S. Invalid combinations are ignored by the All-In-One Presentation Switcher	<p>Command: SEND_COMMAND <DEV>,"VIDOUT_RES_REF- <horizontal>x<vertical>,<refresh- rate>"</p> <p>Return: "VIDOUT_RES_REF- <horizontal>x<vertical>,<refresh-rate>"</p> <p>Description: 1: 4096X2160,60 2: 4096X2160,30 3: 4096X2160,25 4: 4096X2160,24 5: 3840X2160,60 6: 3840X2160,50 7: 3840X2160,30 8: 3840X2160,25 9: 3840X2160,24 10: 1920X1200,60 11: 1920X1080,60 12: 1920X1080,50 13: 1280X720,60 14: 1280X720,50 15: 1680X1050,60 16: 1600X1200,60 17: 1600X900,60 18: 1440X900,60 19: 1366X768,60 20: 1360X768,60 21: 1280X1024,60 22: 1280X960,60 23: 1280X800,60 24: 1280X768,60 25: 1024X768,60 26: 800X600,60</p> <p>horizontal = An integer value representing the horizontal. vertical = An integer value representing the vertical. May have an additional qualifier such as 'i' or 'p'. refresh-rate = An integer value representing the refresh rate.</p>	<p>Command: SEND_COMMAND VIDEO_OUTPUT_1,"VIDOUT_RES_REF- 1920x1080,60"</p> <p>Return: VIDOUT_RES_REF-1920x1080,60</p> <p>Description: Set output resolution is 1920x1080@60</p>

NetLinx API Command (cont.)

No.	FunctionDescription	Syntax	Example
8	Requests to see if VIDEO mute is enabled or disabled.	<p>Command: SEND_COMMAND <DEV>,""?VIDOUT_MUTE"</p> <p>Return: VIDOUT_MUTE<ENABLE DISABLE></p>	<p>Command: SEND_COMMAND SWITCHER,""?VIDOUT_MUTE"</p> <p>Return: VIDOUT_MUTE-ENABLE</p> <p>Description: Video output is mute</p>
9	Enables or disables the video output display.	<p>Command: SEND_COMMAND <DEV>,"?VIDOUT_MUTE-<ENABLE DISABLE>"</p> <p>Return: VIDOUT_MUTE<ENABLE DISABLE></p>	<p>Command: SEND_COMMAND SWITCHER,"?VIDOUT_MUTE-ENABLE"</p> <p>Return: VIDOUT_MUTE-ENABLE</p> <p>Description: Set video output is mute</p>
10	To cause a warm reboot	<p>Command: SEND_COMMAND <DEV>,"REBOOT"</p> <p>Return: REBOOT</p>	<p>Command: SEND_COMMAND DEVICE_1,"REBOOT"</p> <p>Return: REBOOT</p> <p>Description: Cause a warm reboot</p>
11	Requests the firmware version	<p>Command: SEND_COMMAND <DEV>,"?FWVERSION"</p> <p>Return: FWVERSION- <version-string></p>	<p>Command: SEND_COMMAND dvRX,"?FWVERSION"</p> <p>Return: FWVERSION-SCALER_V2.0-MCU_V1.2</p> <p>Description: The system's version</p>
12	To Set input EDID	<p>Command: SEND_COMMAND <DEV>,"VIDIN_PREF_EDID-<resolution>"</p> <p>Return: VIDIN_PREF_EDID-<resolution></p> <p>Description: E#: # = {1~7} { For HDMI Input 1: 3840x2160@30Hz 2CH 2: 1920x1200@60Hz 2CH 3: 1920x1080@60Hz 2CH 4: 1280x800@60Hz 2CH 5: 1280x720@60Hz 2CH 6: 1024x768@60Hz 2CH 7: COPY(Default) }</p>	<p>Command: SEND_COMMAND VIDEO_INPUT_2,"VIDIN_PREF_EDID-1920x1200,60"</p> <p>Return: VIDIN_PREF_EDID-1920x1200,60</p> <p>Description: Set fix EDID (1920x1200@60Hz 2CH) to TX_HDMI_IN</p>

NetLinx API Command (cont.)

No.	FunctionDescription	Syntax	Example
13	To Verify input EDID	<p>Command: SEND_COMMAND <DEV>,""?VIDIN_PREF_EDID"</p> <p>Return: VIDIN_PREF_EDID-<resolution></p> <p>Description: value#: (1~7) For HDMI Input 1: 3840x2160@30Hz 2CH 2: 1920X1200@60Hz 2CH 3: 1920X1080@60Hz 2CH 4: 1280X800@60Hz 2CH 5: 1280X720@60Hz 2CH 6: 1024X768@60Hz 2CH 7: COPY(Default) }</p>	<p>Command: SEND_COMMAND VIDEO_INPUT_1,""?VIDIN_PREF_EDID"</p> <p>Return: VIDIN_PREF_EDID-1920x1200,60</p> <p>Description: The EDID of the Input TX_HDMI_IN is fix EDID 1920x1200@60Hz 2CH</p>
14	Executes the sink power on/off	<p>Command: SEND_COMMAND <DEV>,"CEC_DISP_POWER-<ON OFF>"</p> <p>Return: CEC_DISP_POWER-<ON OFF></p>	<p>Command: SEND_COMMAND <DEV>,"CEC_DISP_POWER-OFF"</p> <p>Return: CEC_DISP_POWER-OFF</p> <p>Description: Executes the sink power off</p>
15	To define the display control automatically	<p>Command: SEND_COMMAND <DEV>,"CEC_DISP_AUTO-<ON OFF>"</p> <p>Return: CEC_DISP_AUTO-OFF</p>	<p>Command: SEND_COMMAND <DEV>,"CEC_DISP_AUTO-OFF"</p> <p>Return: CEC_DISP_AUTO-OFF</p> <p>Description: Turn off CEC auto display</p>
16	To verify the display control Status	<p>Command: SEND_COMMAND <DEV>,""?CEC_DISP_AUTO"</p> <p>Return: CEC_DISP_AUTO-<ON OFF></p>	<p>Command: SEND_COMMAND SWITCHER,""?CEC_DISP_AUTO"</p> <p>Return: CEC_DISP_AUTO-ON</p> <p>Description: Get the display control Status. The display control Status is on.</p>
17	To define a Delay Time to control the display off when on active signal	<p>Command: SEND_COMMAND <DEV>,"CEC_SLEEP_TIMEOUT-<time>"</p> <p>Return: CEC_SLEEP_TIMEOUT-<time></p> <p>Description: time#: #={1 ~ 30}</p>	<p>Command: SEND_COMMAND <DEV>,"CEC_SLEEP_TIMEOUT-5"</p> <p>Return: CEC_SLEEP_TIMEOUT-5</p> <p>Description: Set Delay Time is 5 Minutes</p>

NetLinx API Command (cont.)

No.	FunctionDescription	Syntax	Example
18	To verify Delay Time to control the display off when on active signal	<p>Command: SEND_COMMAND <DEV>,""?CEC_SLEEP_TIMEOUT"</p> <p>Return: CEC_SLEEP_TIMEOUT-<time></p> <p>Description: itime#: #={1 ~ 30}</p>	<p>Command: SEND_COMMAND SWITCHER,""?CEC_SLEEP_TIMEOUT"</p> <p>Return: CEC_SLEEP_TIMEOUT-5</p> <p>Description: Get Delay Time to control the display off when no active signal. The Delay Time is 5 Minutes.</p>
19	To verify Input signal status	<p>Command: SEND_COMMAND <DEV>,""?VIDIN_STATUS-<input>"</p> <p>Return: VIDIN_STATUS-<status string></p> <p>Description: input port = The source input port number. //{ VIDEO_INPUT_1: HDBT; } status string // { 0: NO SIGNAL; 1: VALID SIGNAL; }</p>	<p>Command: SEND_COMMAND VIDEO_INPUT_1,""?VIDIN_STATUS"</p> <p>Return: VIDIN_STATUS-NO SIGNAL</p> <p>Description: HDBT Input no signal.</p>
20	To Get Input HDCP Compliant Status	<p>Command: SEND_COMMAND <DEV>,""?VIDIN_HDCP<input>"</p> <p>Return: HDCP INPUT STATUS // { 0: HDCP_OFF 1: HDCP_1_4 2: HDCP_2_2 }</p> <p>Description: Input port: //{ VIDEO_INPUT_1: HDBT }</p>	<p>Command: SEND_COMMAND VIDEO_INPUT_1,""?VIDIN_HDCP"</p> <p>Return: VIDIN_HDCP-HDCP_OFF</p> <p>Description: HDBT HDCP OFF</p>
21	Set the video color space for the video output port	<p>Command: SEND_COMMAND <DEV>,""?VIDOUT_RGB-<ENABLE DISABLE>"</p> <p>Return: VIDOUT_RGB-<ENABLE DISABLE></p>	<p>Command: SEND_COMMAND SWITCHER,""?VIDOUT_RGB-ENABLE"</p> <p>Return: VIDOUT_RGB-ENABLE</p> <p>Description: Set Video out color space as RGB Device will reboot to take effect</p>

NetLinx API Command (cont.)

No.	FunctionDescription	Syntax	Example
22	Get the video color space for the video output port	Command: SEND_COMMAND <DEV>, ""?VIDOUT_RGB" Return: VIDOUT_RGB-<ENABLE DISABLE>	Command: SEND_COMMAND SWITCHER,""?VIDOUT_RGB" Return: VIDOUT_RGB-DISABLE Description: Video out color space is YUV.

Telnet/SSH API Commands

No.	Command	Description	Example
1	help	Displays all of the supported commands	>help cpu usage Displays the total CPU usage date Display the current date. dns list Show the DNS configuration of this device. get ip Show the IP configuration of this device.
2	cpu usage	Displays the total CPU usage usage: cpu usage	>cpu usage CPU usage is 25%
3	date	Display the current date. Usage: date	>date: The current date is: Thursday, January 1, 1970
4	get ip	Show the IP configuration of this device.	>get ip --- Current IP Settings --- Hostname: XXX IP Address: 192.168.2.201 Netmask: 255.255.240.0 DHCP: false
5	ping	Pings an address. Address may be an IP or URL.	>ping 192.16.2.203 PING 192.16.2.203 (192.16.2.203): 56 data bytes
6	reset factory	Resets configuration back to factory defaults.	>reset factory
7	set date	Set the current date.	>set date Usage: set date [day] [month] [year] Arguments: day: integer of day of the week between 1 and 31 month: integer of month between 1 and 12 year: integer value of year later than 1900 Example: set date 01 11 2016

Telnet/SSH API Commands (Cont.)

No.	Command	Description	Example
8	set ip	Setup the IP configuration of this device.	<p>>set ip:</p> <p>--- Enter New Values or just hit Enter to keep current settings ---</p> <pre> Enter IP Address 192.168.2.201 192.168.2.202 Enter Netmask 255.255.240.0 255.255.255.0 --- New settings --- IP Address 192.168.2.202 Netmask 255.255.255.0 Would you like to save the new settings? Y/N -> y New settings were saved.</pre>
9	set time	Set the current time.	<p>>set time:</p> <p>Usage: set time [hours] [minutes] [seconds]</p> <p>Arguments:</p> <pre> hours integer value of hours between 0 and 23 minutes integer value of minutes between 0 and 59 seconds integer value of seconds between 0 and 59</pre> <p>Example:</p> <pre>set time 13 30 00</pre>
10	show mem	Displays the memory usage for all memory types.	<p>>show mem</p> <pre> RAM available: 349634560 bytes RAM total: 406167552 bytes</pre>
11	time	Display the current time.	<p>>time:</p> <pre>The current time is: 11:57:09 PM</pre>
12	echo	Enables/disables echo of typed characters.	<p>>echo</p> <p>Usage: echo [argument]</p> <p>Arguments:</p> <pre> on Enable echo of typed characters off Disable echo of typed characters</pre> <p>Example:</p> <pre>echo on</pre>
13	exit	Close this terminal session.	<p>>exit</p>

Telnet/SSH API Commands (Cont.)

No.	Command	Description	Example
14	msg	Enables/Disables extended diagnostic messages.	<p>>msg</p> <p>Usage: msg [argument]</p> <p>This command allows system logs to be redirected to the terminal session. There are multiple log levels, which are described below.</p> <p>Arguments:</p> <ul style="list-style-type: none"> on Enable default [warning] system log level debug Enable all system debug messages info Enable info system log level warning Enable warning system log level error Enable error system log level off Disable system log output to terminal session <p>Example: msg on</p>
15	reboot	Reboots the device.	>reboot
16	set dns	Set DNS service	<p>>set dns</p> <p>--- Enter new values or keep current settings at the prompts ---</p> <p>-- Current DNS #1 -- Change the current value? Y/N -> y Enter DNS #1 192.168.2.1</p> <p>-- Current DNS #2 -- Change the current value? Y/N -> Y Enter DNS #2 192.168.3.1</p> <p>Would you like to save the new settings? Y/N -> Y</p> <p>New settings were saved...</p>
17	dns list	Display the current dns.	<p>>dns list</p> <p>Domain Name: amx.com DNS List: DNS #1: 192.168.2.1 DNS #2: 192.168.3.1</p>
18	set friendlyname	Set friendlyname	<p>>set friendlyname</p> <p>Please input friendlyname:</p> <p>Old friendlyname: New friendlyname: 111 Would you like to save this setting (Y/N) y Setting is ok, you should reboot that make it effective</p>

Telnet/SSH API Commands (Cont.)

No.	Command	Description	Example
19	set location	It's setting location.	>set location Please input location: Old location: New location: 333 Would you like to save this setting (Y/N) y Setting is ok, you should reboot that make it effective
20	set connection	Set the master connection settings.	>set connection --- Enter New Values or just hit Enter to keep current settings --- Enter Mode Type T for TCP/URL, U for UDP/URL, N for NDP or A for Auto and then Enter: Icsp_Auto A Enter Master System Number: 1 1 --- New settings --- System Number 1 Master Port 1319 Is this correct? Type Y or N and Enter -> Y Changed && Saved
21	get connection	Get the master connection settings.	>get connection Connection Mode: Icsp_Auto System Number: 1 Master Ip/URL Master Port: 1319
22	set telnet username	Set telnet service login username	>set telnet username Enter Telnet new username 123 Would you like to set this username (y/n) y (please set telnet password) Changed && Saved
23	set telnet password	Set telnet service login password	>set telnet password Enter Telnet new password 456 Would you like to set this password (y/n) y Changed && Saved
24	set ssh username	Set ssh service login username	>set ssh username Enter ssh new username admin admin Would you like to set this username (y/n) y Changed && Saved (you should reboot this device that make your setting active)

Telnet/SSH API Commands (Cont.)

No.	Command	Description	Example
25	set ssh password	Set ssh service login password	>set ssh password Enter ssh new password password pass Would you like to set this password (y/n) y Changed && Saved (you should reboot this device that make your setting active)



LAST REVISED: 2021-03-03

About AMX by HARMAN

Founded in 1982 and acquired by HARMAN in 2014, AMX® is dedicated to providing AV solutions for an IT World. AMX solves the complexity of managing technology with reliable, consistent and scalable systems comprising control, video switching and distribution, digital signage and technology management. AMX systems are deployed worldwide in conference rooms, classrooms, network operation/command centers, homes, hotels, entertainment venues and broadcast facilities, among others. AMX is part of the HARMAN Professional Group, the only total audio, video, lighting, and control vendor in the professional AV market. HARMAN designs, manufactures and markets premier audio, video, infotainment and integrated control solutions for the automotive, consumer and professional markets.

©2021 Harman. All rights reserved. Specifications subject to change.

www.amx.com | +1.469.624.7400 | 800.222.0193