

BRAND GUIDELINES



MAKING HARD WORK EASIER

WELCOME TO THE SENCO BRAND

For generations of professionals, the SENCO name has been synonymous with quality and craftsmanship. And while the world has changed dramatically since our founding, the qualities that made us an invaluable partner continue to define the SENCO brand.

More than just a name or a symbol, our brand is the overall impression people have when they think of SENCO. And in our brand-conscious world it's more important than ever that we present the SENCO brand in the best possible light in every communication and to every audience.

This will enable us to continue to build and strengthen partnerships with the professionals who rely on our fastening systems for their livelihoods. By clearly communicating that SENCO products make professionals' work easier, more efficient and more rewarding, we not only enhance brand loyalty among current customers, but help ensure that SENCO will be a preferred brand for future generations of professionals.

In the pages that follow, you will find guidelines for implementing the core elements of the SENCO brand to ensure that we optimize their impact. If you are involved in preparing communications for the company, it is important to understand and follow these guidelines.

By presenting ourselves and our products with a consistent and unified visual identity and message, we are building positive momentum—and a stronger future—for our brand.

If you need additional assistance or information on how to apply these guidelines, please contact Brand Marketing.

Thank you for your involvement in sustaining and building the SENCO brand.

Sincerely,

A handwritten signature in black ink, appearing to read "Pete Chatel". The signature is fluid and cursive, with the first name being more prominent.

Pete Chatel
Vice President - Marketing

CONTENTS

Brand Profile	4
Brand Toolbox	9
Logo	10
Tagline	16
Color Palette	22
Typography	26
Photography	33
Technical Drawing	39
Icon System	43
Building Boxes	48
Grid Structure	52
Building With Our Toolbox	55
Print Communications	56
Large-Scale and Tradeshow	73
Correspondence	75
Multimedia	79
Further Information	83

BRAND PROFILE



THE SENCO BRAND DIFFERENCE

At SENCO, providing fastening systems for the professional end user is what we do. It's the only thing we do.

For more than 60 years, the SENCO brand has stood for professional results and pride in a job well done. Our traditional commitment to quality goes back to a time when Made in America meant the highest quality. SENCO is proud to be the go-to choice for a comprehensive line of dependable workhorse fastening tools.

For seasoned pros who understand the importance of their tools, SENCO is a trusted partner. We have a tremendous opportunity to connect with younger professionals who have not yet developed allegiances to products and who are open to new tools and technologies.

Building the Partnership

We are true partners with those professionals who use our tools. That's why every SENCO fastening system is designed and engineered to deliver outstanding results and maximize productivity. By meeting with and listening to our end users we are able to make their lives and jobs as easy as possible by focusing on innovations that make fastening simpler and more efficient.

We want every end user to have a long, productive and safe career, so we design every tool with safety in mind. Because safety is a top priority, we have also developed resources and programs to promote safety.

As one of the few focused brands on the market, we don't want to be all things to all people. We build fastening solutions to make our end users' work safer and easier, and take the same pride in our work that they do.

THE SENCO BRAND PROMISE

SENCO will be a true partner for fastening solutions, focused on the professional end user's needs by providing expertise and innovations that make hard work easier.

THE SENCO BRAND ATTRIBUTES

SENCO is...

Professional

We don't do anything but fastening solutions for professionals, and that singular purpose is reflected in the high quality of our tools and fasteners.

Service-Oriented

We meet face-to-face with end users to get firsthand insight on what we can do to make their professional lives easier and more satisfying.

Responsively innovative

Rather than simply introducing flashy new features, we let workplace challenges and users' needs guide our intentional approach to innovation.

Safety-Focused

Through our tool design and safety programs, we are committed to the health and well-being of the professionals who use our tools.

Expert Problem Solvers

We promote the efficient use of SENCO tools through on-site training, instructional videos and open communication with our service team.

Accessible

We are increasing availability of products in-store, providing worksite access to SENCO experts, and expanding service centers to ensure that we are available wherever and whenever professionals need us.

Steeped in History

For more than 60 years, SENCO has been synonymous with craftsmanship, increased productivity and pride in a job well done.

Global

Every day, professionals around the world trust SENCO products to work in a wide range of demanding applications.

THE SENCO BRAND VOICE

The tone of all SENCO materials should reflect and reinforce who we are and communicate consistently with all audiences, both external and internal.

The SENCO voice is based on certain truths about our company:

SENCO is the brand the professionals use.

Our materials should communicate that we understand how challenging every day on the job can be. We speak as experts—not arrogant or boastful, but confident in our ability to solve a fastening challenge. We provide workhorse products that get the job done—with features that users really want and need to make their work easier and more rewarding.

SENCO is sensible, practical, down-to-earth.

Our messaging should reflect our reputation as partners that professionals can count on. There's nothing lightweight about our attitude or our tools. We build solid, dependable tools for hardworking professionals.

SENCO is a smart investment.

We understand that our customers' reputation is on the line with every fastener they drive. Our materials should reinforce why SENCO is the best at what we do and why that makes our fastening solutions the best value for today's professionals.

BRAND TOOLBOX

LOGO

Consistency of the logo in form and placement is imperative to establishing a consistent connection with the end user.

The SENCO logotype lives within a rounded containment shape, referencing the curvature of the letterforms and reinforcing the brand's uniformity and simplicity. The logotype, living in the containment shape, creates a strong "stamp."

This section details the logo's usage and production.

Logo with containment shape (A)

This is the preferred logo lockup, to be used in the majority of branded applications.

Logo without containment shape (B)

In some instances, the logotype will need to live separate from the containment shape on a field of red. This logo will be most frequently used in large-scale and digital applications, including vehicles, tradeshow displays and the website.

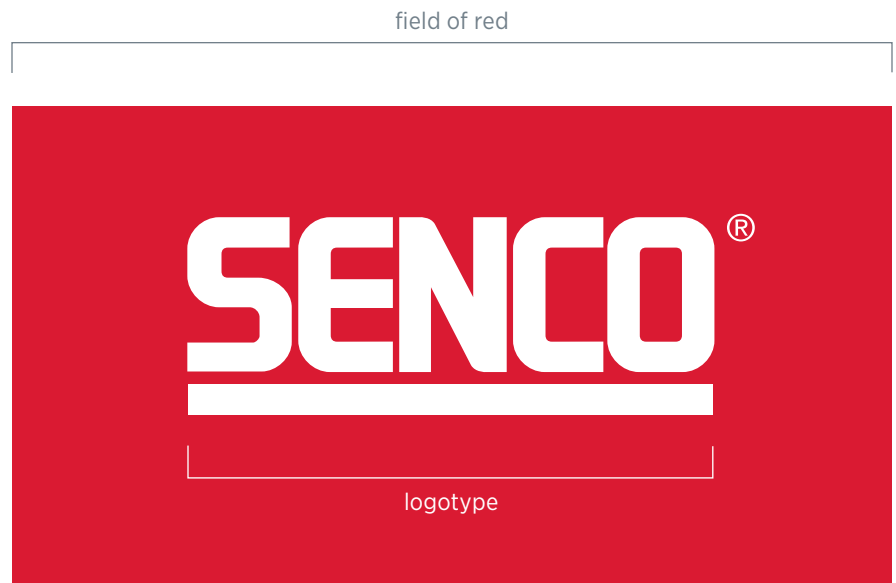

Logo clear space (A)

Allowing for clear space around the logo will ensure clarity in our message and stronger brand recognition from our end user.

The logo should always be surrounded by a clear space, which can be a quiet area of a photo or a brand color. Allow extra space when possible, especially next to a trim edge.

Logo minimum size (B)

The minimum size that the logo can appear is 0.25" tall. The logo cannot be used smaller for legibility reasons.

Logo construction

The bar underscoring the SENCO lettering has been designed at the same weight as the letterforms. Corner radius (0.17") has been designed to match the "s" corner radius. Do not recreate the logo. Contact our design team (page 82) for vector artwork.

Logo color

The logo has been designed in red (Pantone 186) and white.

When using the logo in a color application, the logo is always this red. This is essential for brand recognition.

When necessary, the logo must be converted to CMYK for 4-color printing, or to RGB or HTML for on-screen use. These breakdowns have been specified on page 23.

Logo in limited color situation (C)

In black-and-white applications, the logo is always printed in black.

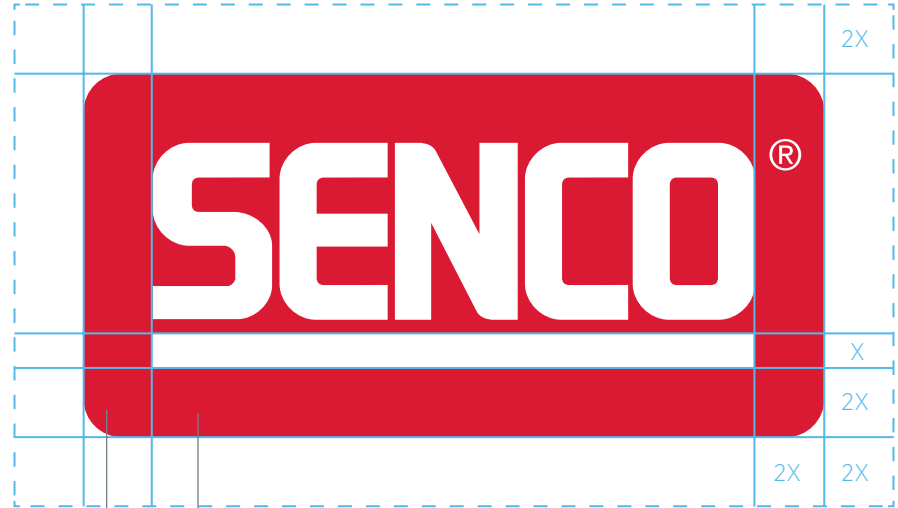

A

Pantone 186
C 2 M 100 Y 85 K 6
R 200 G 16 B 46
HTML C8102E

Corner Radius: 0.17"

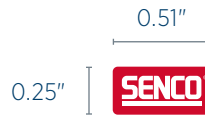

B



C

Logo placement

Logo can sit one of two ways: overlapping two background elements or sitting in the corner of the layout.

Logo can overlap two background elements, acting as a “fastener” within composition grid. Logo should always evenly overlap the two elements; the fastening line should hit the center point of the logo.

Logo can sit in a corner of the layout, part of layered composition. Logo should always sit within the layout’s margins.



Logo clear space (A)

Allowing for clear space around the logo will ensure clarity in our message and stronger brand recognition from our end user.

The logo should always be surrounded by a clear space on red. Allow extra space when possible, especially next to a trim edge.

Logo minimum size (B)

The minimum size that the logo can appear is 0.15625" wide. The logo cannot be used smaller for legibility reasons.

Logo construction

The bar underscoring the SENCO lettering has been designed at the same weight as the letterforms. Do not recreate the logo. Contact our design team (page 82) for vector artwork.

Logo color

The logo has been designed in red (Pantone 186) and white.

When using the logo in a color application, the logo is always this red. This is essential for brand recognition.

When necessary, the logo can be converted to CMYK for 4-color printing, or to RGB or HTML for on-screen use. These breakdowns have been specified on page 23.



A

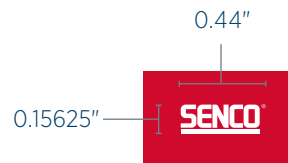

B

Logo don'ts

Do not alter the containment shape or create a new containment shape (A).

Do not use colors other than Pantone 186 and white within the logo (B).

Do not attach logo to page edge, or compromise the clear space of the logo (C).

Do not reverse out logo from a photo or a background. Reference guidelines on page 14 for using the logotype outside of the containment shape (D).

Do not use a drop shadow on any part of the logo (E).

Do not outline any part of the logo (F).

Do not separate, delete, scale or skew any part of the logo (G).

Do not place logo within a sentence to replace the word "SENCO" (H).

Do not place the logo over a busy area of an image, or over a background with too little contrast (I).

Do not overlap logo with design elements (J).

Do not fasten the logo to a design element that is also Pantone 186 (K).



A



B

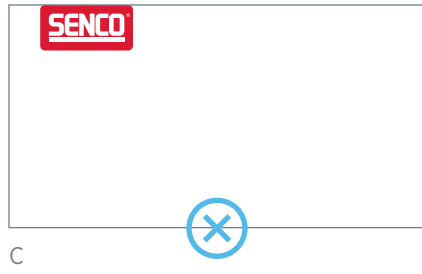

C



D



E



F



G



Making Hard Work Easier with

H



I

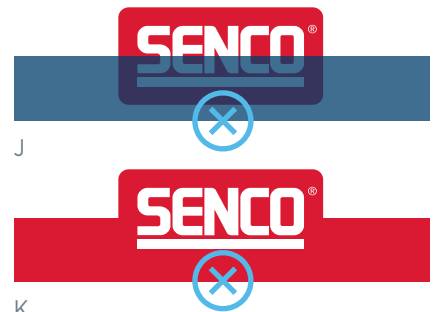

J

K

TAGLINE

Making Hard Work Easier.

SENCO stands for and delivers on making hard work easier for the end user. This distinguishes SENCO from its competitors in the market.

This section details the tagline's usage and production in combination with the logo and as a stand alone element.

Tagline logo lockup (A)

When locked up with the logo, the tagline and logo are always in red, and are always used in this configuration.

The tagline should always be surrounded by a clear space, which can be a quiet area of a photo or a brand color. Allow extra space when possible, especially next to a trim edge.

Tagline construction

The tagline has been designed to be the same width as the bar underscoring the SENCO lettering. It is always set in Forza Bold, all caps, and stacked in two lines for maximum legibility and consistency. Do not recreate the tagline. Contact our design team (page 82) for vector artwork.

Tagline logo lockup on red (B)

When used on a field of red in large-scale or digital applications, tagline logo lockup is white.

Tagline logo lockup min. size (C)

The minimum size that the tagline logo lockup can appear is 0.4375" tall. The logo cannot be used smaller for legibility reasons.

Tagline logo lockup in limited color situation (D)

In black-and-white applications, the logo is always printed in black.



A



B



C



D

Tagline logo lockup placement

The tagline logo lockup placement works best in areas with plenty of clear space, usually within a layout corner.

The lockup can overlay a photo (A) or brand color (B), but the logo and tagline must always be red.



A

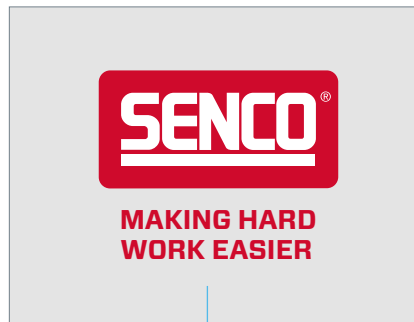

B



Tagline placement

The tagline can be used in red or white on top of a primary or secondary brand color (A). This could be in a header, footer, text box, etc. The tagline can also selectively be used in red on top of photography (B).

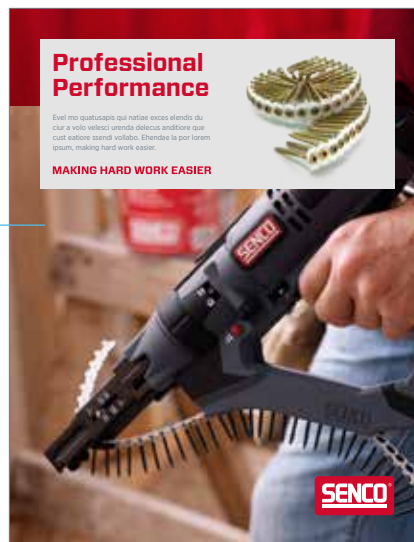

A



B

Tagline don'ts

Do not put a containment shape around the tagline (A).

Do not use colors other than Pantone 186 and white within the tagline (B).

Do not compromise the clear space of the tagline (C).

Do not reverse out tagline from a photo; the tagline should either be in red or reversed out of a primary or secondary brand color (D).

Do not use a drop shadow on any part of the tagline (E).

Do not outline any part of the tagline (F).

Do not separate, delete, scale or skew any part of the tagline (G).

Do not place the tagline over a busy area of an image, or over a background with too little contrast (H).

Do not overlap design elements over tagline (I).

Do not re-typeset the tagline, or create additional taglines (J). Always use the vector artwork of the tagline.



COLOR PALETTE

Grays and blues accentuate the signature SENCO red, and unite to establish a bright, powerful palette. These hues and their corresponding shades contribute to flat, layered compositions.

This section details how color can be used in solids, transparencies and tints, allowing for consistency and variation.

Solids

Primary Palette (A)

SENCO Red (Pantone 186) is used within design elements to accentuate important messaging (headlines, tagline, logo, etc.).

This red can be used in large quantities for dramatic impact, especially in large-scale and digital applications (i.e. vehicles, tradeshow displays, website).

This red should never be tinted; it is always to appear bright and strong. It is ownable to SENCO, and should be present in every brand touchpoint.

Secondary Palette (B)

These hues complement SENCO red and help it stand off the page.

These hues will most often be used within design elements at larger quantities than SENCO red, but always to accentuate not overpower the red.

Tertiary Palette (C)

These hues are used in small quantities only, usually within technical callouts and iconography.

Black is appropriate for body text and other situations using small quantities. It is not used as a flood color.

Color Consistency and Production

Always consider color's final output when producing artwork:

PANTONE: spot color, print application

CMYK: process color, print application

RGB: onscreen/electronic application

HTML: web application



C2 M100 Y85 K6
R201 G0 B23
HTML #C90017

A



C8 M100 Y70 K33
R153 G4 B0
HTML #990400



C100 M58 Y9 K46
R4 G31 B61
HTML #041F3D



C33 M18 Y13 K40
R100 G110 B117
HTML #646E75



C8 M5 Y7 K16
R200 G201 B199
HTML #C8C9C7

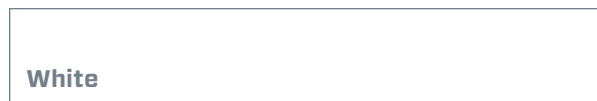

B



C60 M9 Y0 K0
R114 G202 B255
HTML #72CAFF



C0 M0 Y0 K100
R0 G0 B0
HTML #000000

C

Transparency and Tints

Purpose and overview

To reveal the building and layering of elements, specific hues can be used transparently and as tints.

Creating a transparent SENCOR red

For best communication of SENCOR red (Pantone 186) as transparent, color layering is recommended (A):

Layer 1: Image

Layer 2: White at 60% opacity

Layer 3: Pantone 186 at 100% multiplied

Using transparent secondary palette hues

Use palette hues only at 80% opacity (B).

Tints

Pantone 430 and Cool Grey 3 can be used as tints. Do not tint any other brand colors (C).

Note the specified percentages in which these hues can be tinted.



A-Creating a transparent red



B-Secondary palette at 80% opacity



C-Tints from secondary palette

Tint and transparency don'ts

Do not use transparent tints of hues (A).

Do not use hues at any other opacity other than 80% (B).

Do not use tertiary colors transparently (C).

Do not gradate hue; color should be evenly transparent throughout entire shape (D).

Do not use tints of colors that are not Pantone 430 or Cool Grey 3 (E).



TYPOGRAPHY

Letterforms themselves can communicate the character of a brand. Two distinct sans serif typefaces, Forza and Gotham Narrow, have been paired to communicate the strength and durability of SENCO products to the end user. These faces offer a range of weights to provide flexibility while maintaining consistency across marketing platforms. We also use Arial, a default font, for consistency across internal applications.

This section describes the typefaces available, and suggests best practices for usage.

Forza

This face showcases our brand character: strength, durability and versatility.

Forza is the preferred choice for headlines and subheads.

Italics can be used for emphasis when appropriate.

abcdefghijklmnopqrstuvwxyz
ABCDEFGHIJKLMNOPQRSTUVWXYZ
1234567890 .,?!

Thin

abcdefghijklmnopqrstuvwxyz
ABCDEFGHIJKLMNOPQRSTUVWXYZ
1234567890 .,?!

Light

abcdefghijklmnopqrstuvwxyz
ABCDEFGHIJKLMNOPQRSTUVWXYZ
1234567890 .,?!

Book

abcdefghijklmnopqrstuvwxyz
ABCDEFGHIJKLMNOPQRSTUVWXYZ
1234567890 .,?!

Medium

abcdefghijklmnopqrstuvwxyz
ABCDEFGHIJKLMNOPQRSTUVWXYZ
1234567890 .,?!

Bold

abcdefghijklmnopqrstuvwxyz
ABCDEFGHIJKLMNOPQRSTUVWXYZ
1234567890 .,?!

Black

Gotham Narrow

Condensed and clean, Gotham Narrow is to be used for short and long body copy, including specifications that are number-heavy. OpenType fractions and tabular figures are available for this face.

Italics can be used for emphasis when appropriate.

Do not use additional families of Gotham (Gotham, Gotham Rounded, Gotham Extra Narrow, Gotham Condensed). Use only Gotham Narrow.

abcdefghijklmnopqrstuvwxyz
ABCDEFGHIJKLMNOPQRSTUVWXYZ
1234567890 .,?!

Thin

abcdefghijklmnopqrstuvwxyz
ABCDEFGHIJKLMNOPQRSTUVWXYZ
1234567890 .,?!

Extra Light

abcdefghijklmnopqrstuvwxyz
ABCDEFGHIJKLMNOPQRSTUVWXYZ
1234567890 .,?! $\frac{1}{3}$ $\frac{2}{5}$ $\frac{1}{6}$ $\frac{3}{8}$ $\frac{7}{8}$

Light

abcdefghijklmnopqrstuvwxyz
ABCDEFGHIJKLMNOPQRSTUVWXYZ
1234567890 .,?! $\frac{1}{3}$ $\frac{2}{5}$ $\frac{1}{6}$ $\frac{3}{8}$ $\frac{7}{8}$

Book

abcdefghijklmnopqrstuvwxyz
ABCDEFGHIJKLMNOPQRSTUVWXYZ
1234567890 .,?! $\frac{1}{3}$ $\frac{2}{5}$ $\frac{1}{6}$ $\frac{3}{8}$ $\frac{7}{8}$

Medium

abcdefghijklmnopqrstuvwxyz
ABCDEFGHIJKLMNOPQRSTUVWXYZ
1234567890 .,?! $\frac{1}{3}$ $\frac{2}{5}$ $\frac{1}{6}$ $\frac{3}{8}$ $\frac{7}{8}$

Bold

Arial

Arial is our default font. It can be substituted for needs in Word, PowerPoint and online only.

Forza and Gotham Narrow should be used in advertising and print materials.

Online Usage

Webfonts are available for Forza and Gotham Narrow.

Arial can be used as a substitute face, if necessary.

abcdefghijklmnopqrstvwxyz
ABCDEFGHIJKLMNopQRSTUVWXYZ
1234567890 .,?! 1/2 1/4 3/4

Regular

**abcdefghijklmnopqrstvwxyz
ABCDEFGHIJKLMNopQRSTUVWXYZ
1234567890 .,?! 1/2 1/4 3/4**

Bold

**abcdefghijklmnopqrstvwxyz
ABCDEFGHIJKLMNopQRSTUVWXYZ
1234567890 .,?! 1/2 1/4 3/4**

Black

Recommended type specifications for print

These are some recommended uses from the weight variety of Forza and Gotham Narrow.

Forza: headlines and subheads
Gotham Narrow: body copy

Other weights within typeface may support additional needs.

Typesetting SENCO

When typesetting the company name, always use all caps (SENC0).

HEADLINE

Forza Bold

Headline Alternate

Forza Book

Subhead

Forza Book

SUBHEAD ALTERNATE

Forza Bold

Body Copy

Gotham Narrow Book

TECHNICAL DRAWING CALLOUT

Forza Bold

Technical Drawing Callout Alternate

Gotham Narrow Medium

Recommended type proportions for body copy

Gotham Narrow is the choice for body copy.

Body copy should have a leading of at least 130% proportionally.

Gotham Narrow Book 8/12 Lorem ipsum dolor sit amet, consectetur adipiscing elit. Ut nec massa tempus tortor mollis tempor eu sed tellus. Aenean eget erat dui. Mauris euismod elit eget sapien porttitor venenatis. Maecenas scelerisque pellentesque nisi, in velit sodales eu. Praesent viverra elementum purus, sed commodo lacus imperdiet sed.

Gotham Narrow Book 9/13 Lorem ipsum dolor sit amet, consectetur adipiscing elit. Ut nec massa tempus tortor mollis tempor eu sed tellus. Aenean eget erat dui. Mauris euismod elit eget sapien portti tor venenatis. Maece nas scelerisque pel lentesque nisi, in comm odo velit sodales eu. Praesent viverra el ementum purus, sed lacus imperdiet sed.

Gotham Narrow Book 10/14 Ut eu sem vitae lacus molestie tempus. Sed interdum convallis consequat. Morbi sit amet lorem lectus. Nullam nisi odio, grav ida sed tincidunt , pharetra nec ipsum. Cras sagittis, odio sit amet condimentum pellentesque, neque quam lacinia eros, vel luctus sapien.

Gotham Narrow Book 12/17 Ut eu sem vitae lacus molestie tempus. Sed interdum convallis consequat. Morbi sit amet lorem lectus. Nullam nisi odio, grav ida sed tincidunt , pharetra nec ipsum. Cras sagittis, odio sit amet condimentum pellentesque, neque quam lacinia eros, vel luctus sapien.

Gotham Narrow Book 15/20 Duis a metus lectus. Aenean so dales tellus nunc, vel com modo vehicula risus ut sol licitudin suscipit.

Typography don'ts

Do not use typefaces other than Forza, Gotham Narrow or Arial, no matter how “close” it looks or how it thematically works with the copy (A).

Do not put type on a curve or on an angle (B).

Do not layer type (C).

Do not create drop shadows or gradients on type (D).

Do not compromise the type's integrity by skewing, stretching, or scaling the type (E).

Do not let text sit on the edge of a containment shape (F).

Do not wrap text to a form (G).

Do not decrease the space between lines of text to a point of illegibility (H).

Making Hard Work Easier

A

Making Hard Work Easier

B

MAKING HARD WORK EASIER
MAKING HARD WORK EASIER

C

MAKING HARD WORK EASIER

D

MAKING HARD WORK EASIER

E

Xerorio endipis
imporporem remporest
enditatum Endam quas
molesti stiorum natiusa
musandiatum quunt, qui
accat porecus ullecto tatur,
ommodi officiiist

F

Pistis
sint unt,
susciistem
res imi, es
consorecus, optatur
aliqui di consed eum
fugit dolectia volum ditatem
et id magnis utaturit explitascus.
doluptatur mos sameni

G

Pistis sint unt, susciistem res imi, es conse
perum corendanimus es quatus excea as
ut aut landuci lignis sit lationse nus, sunt
exerorr orecus, optatur aliqui di consed eum
fugit dolectia volum ditatem et id magnis
utaturit explitas si dolut et est, con res
explita vita cus. Tus, tere, comnis incim etur
accus doluptatur mos sameni

H

PHOTOGRAPHY

End users respond most quickly to photography, giving this brand element power to engage and communicate. The warm and genuine photography style balances the cool, engineered color palette, conveying SENCO's quality products and commitment to its end users.

This section explains how photography can support the SENCO brand message.

End users in real work environments

Featuring workshops, factories and new construction sites, the environments are uncluttered yet genuine, and capture end users using products from beginning to finish of the job.

Images are candid, lighting is natural, and depth of field is used to bring focus to the end user and product.

Images are often used full-bleed within layout.

End users shown range in age and ethnicity (seasoned pros and young professionals), and are shown taking safety precautions.

End users are shown individually and in collaboration with SENCO representatives, depicting SENCO's commitment to onsite safety and product training.



Products in real work environments

Products are shown within a genuine environment, often being used or in the hands of the end user.

Photos should follow the same basic principles as end users in real work environments; see page 34 for more information.

Products shown in environments are never shown with diagrammatic callout facts.



Products shot in studio

Product can be shown within a brand color environment to highlight the tool's form and capabilities.

Logo should be clearly visible and well lit.

Product should be positioned at an angle that showcases its features while accurately representing the tool's size and proportion (A).

Do not shoot at angles that exaggerate or misrepresent the tool (B).

Products can be shot from side view and silhouetted. These shots are most commonly used for product specifications sheets (C).

Products can be shown side view, silhouetted, with nose down, for catalogs (D).



A-Acceptable



B-DO NOT



C-Side view



D-Side view, nose down

Products with technology callouts

Products can also be combined with diagrammatic callout facts and supportive icons (B). Shadows are not necessary. See page 43 for details on icon system.



B

Photography Usage

Do not use clip art; use a photo or a technical drawing instead (A).

Do not use black and white photography (B).

Do not use photography that is negative or overly emotional (C).

Do not use photos that use studio lighting, or “pose” end users. Photography should be candid, and as natural as possible (D).

Do not use photos with dark backgrounds, overly dramatic lighting, or exaggerated shadows (E).

Do not use product shots that use extreme or exaggerated angles (F).

ALL IMAGES ARE FOR REFERENCE ONLY. DO NOT USE ANY OF THESE IMAGES.



A



B



C



D



E



F

TECHNICAL DRAWING

Line drawings can be used to highlight SENCO's technical expertise and innovation. These elements help to explain product engineering.

This section shows how technical drawing can support product information to inform the end user.

Fastener drawings (A)

A library of fastener drawings are available for use to explain fastener specifications and tool compatibility. Contact our design team (page 82) for vector artwork.

Tool drawings (B)

Technical line drawings, developed in two line weights, show contours and mechanical details of the tool.

These drawings are used to show engineered expertise, and to provide more information on SENCO innovations.

Line is never used to create shading; the drawings are flat and contribute to the flat layered look of the brand.

Contact our design team (page 82) for guidance in creating vector artwork.

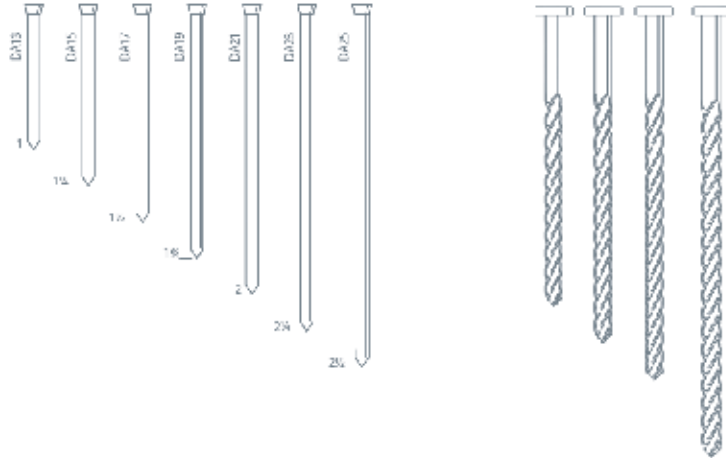

A

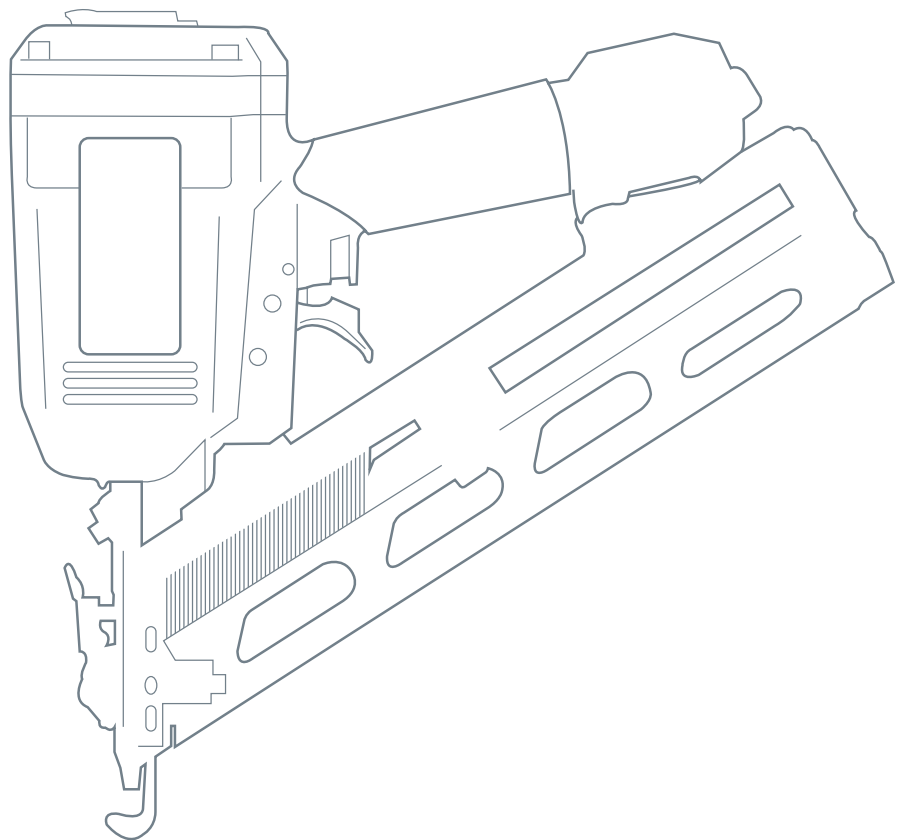

B

Technical drawings in use

Drawings of tools can be used to explain features unique to the products through diagrams (A).

Drawings of fasteners can be used to support technical information and measurements (B).

Example applications: product brochures, product sheets, product catalogs, website

DS212-18V

2" 2500 RPM Cordless Auto-Feed Screwdriver



2500 RPM

FICATI DIPSAMUS
nihil eos etusam quodite.

LITHIUM ION BATTERY
with xx screws per charge.

DURASPIN TECHNOLOGY

FICATI DIPSAMUS
Eos etusam quodite. Edis modi bernature inctibus mi, unt delenis aut di volorum quis

FICATI DIPSAMUS
nihil eos etusam quodite. Edis modi bernature pla inctiut di volorum quis

FICATI DIPSAMUS
nihil eos etusam quodite. Edis modi bernature pla inctiut di volorum quis. Is ipid modigen ihillas vitintia prent dolum. Eprae officil lecestiur audi omnicabore volupis pellab ipicipient utae eos minusape iur altititit officis maximin repedit. Laborae ent aboribusam quasperum, et allitionet mo totae nisiutiur, quatur rem as iliqui optia volupiendam rehendit ma volum

Attachments

FICATI DIPSAMUS
nihil eos etusam quodite. Edis modi bernature pla inctiut di volorum quis. Is ipid modigen ihillas vitintia prent dolum.

Includes

FICATI DIPSAMUS
nihil eos etusam quodite. Edis modi bernature pla inctiut di volorum quis. Cenat, vivius, cles con ta nenatus hendeoribus, cibus publiame atum

MAKING HARD WORK EASIER

A

FASTENER SPECIFICATIONS



Lengths 1"-2" (25-50mm)
Diameters #6-#10

B

Technical drawing don'ts

Do not use clip art; drawings of SENCO fasteners and tools should be drawn in two line weights (A).

Do not use line as shading or to create dimensionality (B).

Do not combine line drawings with textures (C).

Do not illustrate the end user (D).

ALL IMAGES ARE FOR REFERENCE ONLY. DO NOT USE ANY OF THESE IMAGES.

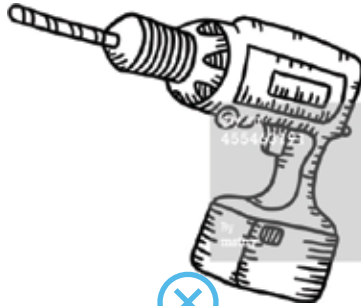

A



B



C

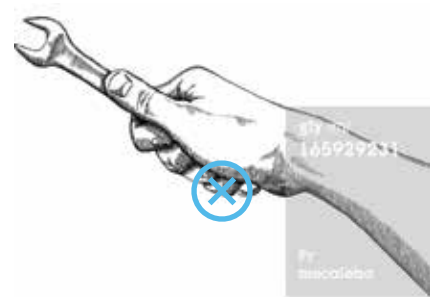

D

ICON SYSTEM

We strive to have our end users test out and stay loyal to SENCO products. Through a system of icons, product features are illustrated, clearly displaying why SENCO is the best choice.

This section explains how icons used to visually explain specifications, features, and technologies of products.

Specification icons

Icons communicate product information specific to its function:

Drive, head profile, threads, points (A)

Heads and collation (B)

Gauge and collation (C)

Tool RPM (D)

Appropriate icon use and size

When used together, icons must be consistent in color, size, spacing and placement.

Icons must be appropriate in size to support product measurements, technical drawing and imagery:

Product spreads for brochures and catalogs: small and supportive icons

Product ads: small and supportive icons

Shelf cards: icons are supportive, but used larger to provide information at a glance

Icons are not used in applications that are not product specific (i.e catalog covers).

QR codes should not be intermixed with icons. This is confusing and causes technical problems when accessing web content.

Additional icons

These icons are representational of the larger library of icons available, including additional languages. Contact our design team (page 82) for vector artwork.

Do not create additional icons.

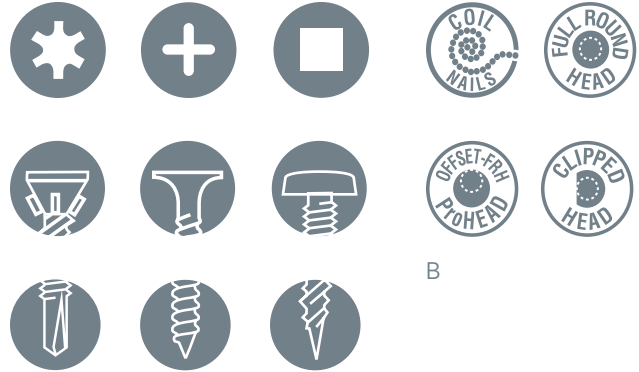

A

B

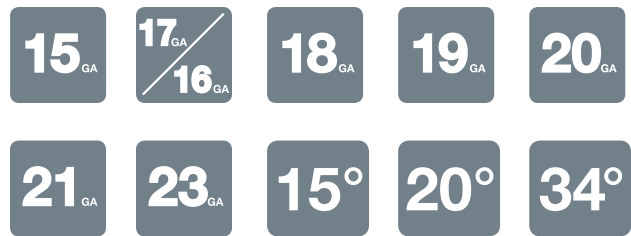

C



D

Product inclusions, attachments and technologies

Icons communicate product information specific to its “extras” and technologies:

- Warranties (A)
- Companion Fasteners (B)
- Containers (C)
- Tool Maintenance (D)
- SENCO Technologies (E)



A



B



C



D



E

Product icon usage

Icons are supportive within layout to describe product features (A).

Icons are consistent in size and placement, and support product measurements and image.



**15 Gauge 2 1/2" 34°
ANGLED FINISH NAILER**

This is the world's first cordless pneumatic Technology, lorem ipsum dolor sit amet lorem ipsum dolor sit.

Applications

- Finish & Trim
- Baseboard
- Cabinets
- Chair Rail
- Decorative Trim
- Door & Window Casing
- Furniture Trim

Features

- Robust Aluminum
- 18v Li-ion technology
- Patented Reflex-Sh
- Tool-free screw len
- Precise depth-of-d
- Storage bag includ
- Li-ion 8v charger in

Fastener

- Capacity: 110
- Gauge: 15
- Range: 1 1/4 – 2 1/2
- Chair Rail

Specifications

Item Number	5N0001N	Wt
Tool Weight	6.2 lbs (2.81 kg)	Ba





FINISH & TRIM

F-15

**15 Gauge 2 1/2" 34°
ANGLED FINISH NAILER**

This is the world's first cordless pneumatic featuring Fusion Technology, lorem ipsum dolor sit amet consectetur adipiscing lorem ipsum dolor sit.

Applications

- Finish & Trim
- Baseboard
- Cabinets
- Chair Rail
- Decorative Trim
- Door & Window Casing
- Furniture Trim

Features

- Robust Aluminum
- 18v Li-ion technology (Includes 2 Batteries)
- Patented Reflex-Sh
- Tool-free screw len
- Precise depth-of-d
- Storage bag includ
- Li-ion 8v charger in

Fastener

- Capacity: 110
- Gauge: 15
- Range: 1 1/4 – 2 1/2
- Chair Rail

Specifications

Item Number	5N0001N	Wt
Tool Weight	6.2 lbs (2.81 kg)	Ba

A

Social media Icons (A)

Icons are limited to Facebook, Twitter, and YouTube. They should appear as a group and evenly spaced.

Icons are always flat and one color, matching other iconography in layout.

Icons are never red-on-red, and are never outlined.

Social media icon usage (B)

Social media icons are not required, but can be featured once per application when appropriate. Consider how accessing social media would continue or enhance the application content.

Social media icons are secondary to content of application.



A



B

BUILDING BOXES

Building boxes provide compartments for content, and can be used in three ways: as a layout anchor, a background and a container. Used together, the boxes overlap and build on top of each other.

This section shows how simple boxes on the grid can be functional while communicating fastening to the end user.

Box as anchor (A)

This box is transparent (or communicates transparency with tints)—see page 24 for guidelines. It bleeds off of at least one side. It is most often a header or footer, and sometimes contains the tagline.

Box as background (B)

This box is full-bleed on all sides.

Box as container for (C)

This box is fixed to the grid and sits within the margins. It is always solid, overlapping other boxes within the layout, “fastening” them together. This box is often a tint of Pantone Cool Grey 3, and usually takes up no more than 1/3 of the page. Use only one container box per layout.

Logo used as fastener (D)

In place of a container, the logo can be use to “fasten” boxes in the layout. See page 13 for guidelines around logo placement.

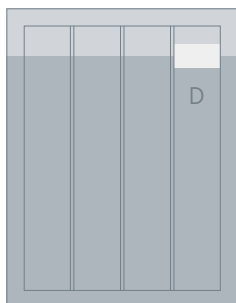
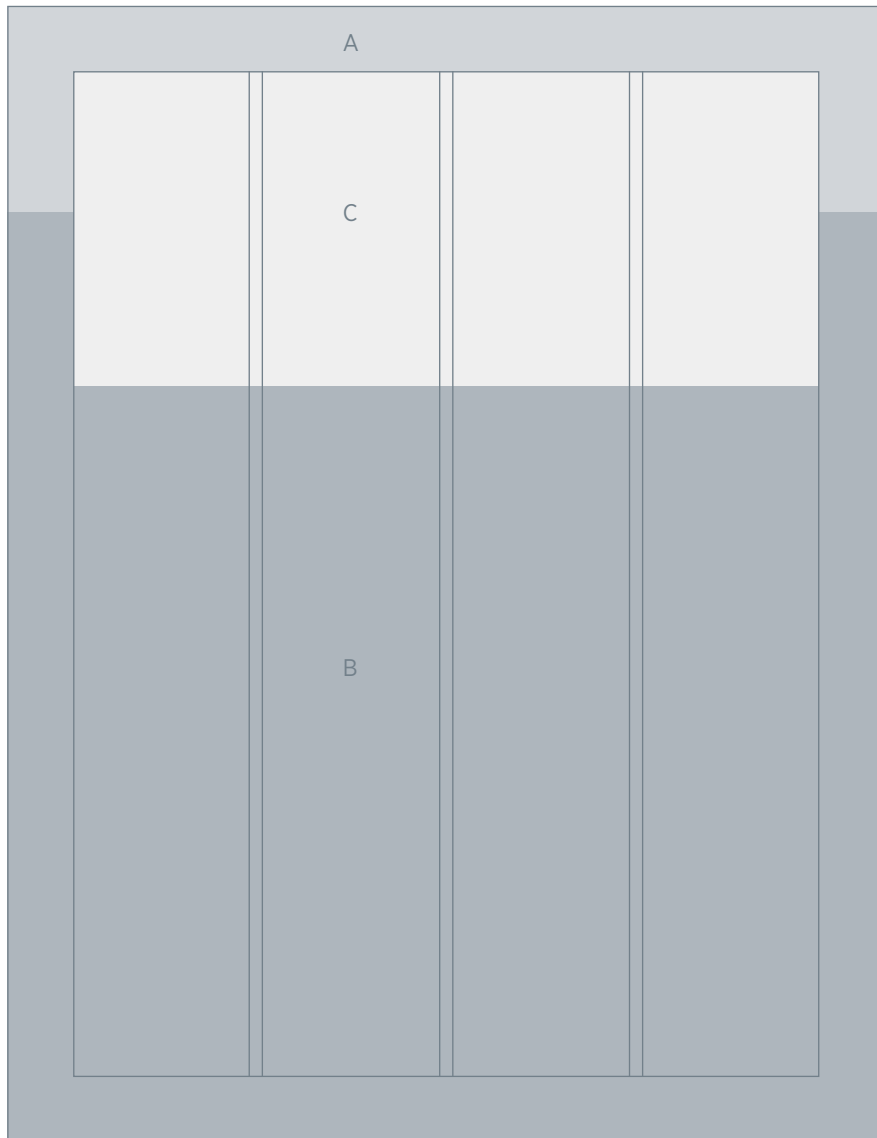

Building boxes in use

The transparent red box at the top of the page acts as an anchor (A), while the background image is revealed underneath (B). The grey container fastens the boxes together, and holds brief copy, a detail product shot, and the tagline (C).

The logo sits in the corner of the layout on the grid within the margins.

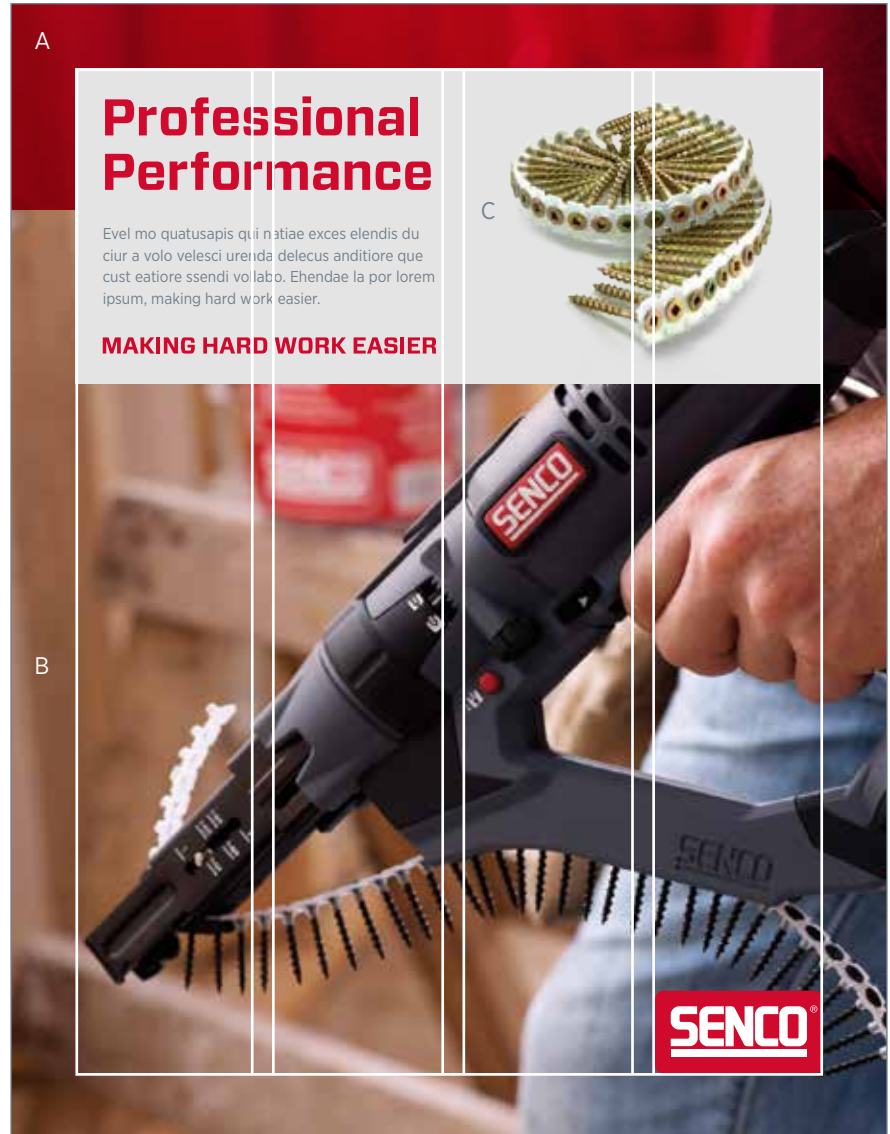

Other configurations for building boxes

There are countless building box configurations. The boxes can be adjusted in size and position to fit the needs of the content.

The number of columns can also be adjusted—see page 53 for guidelines.

Application examples are shown on page 55 of guidelines.

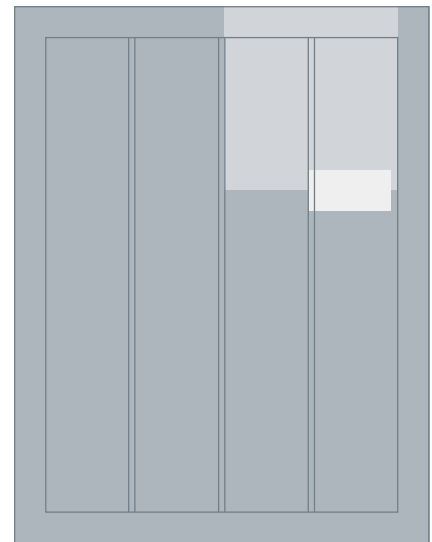
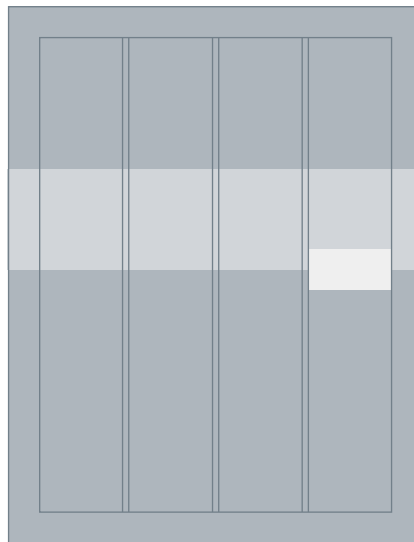
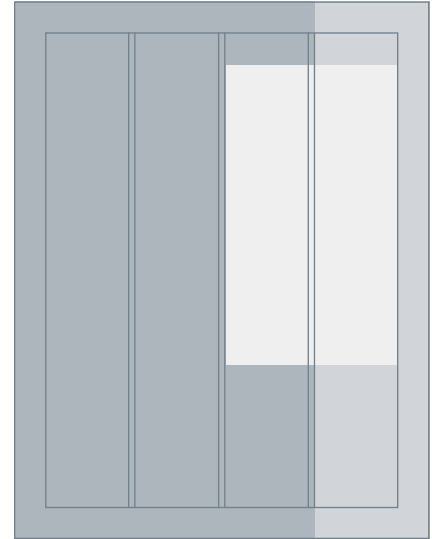
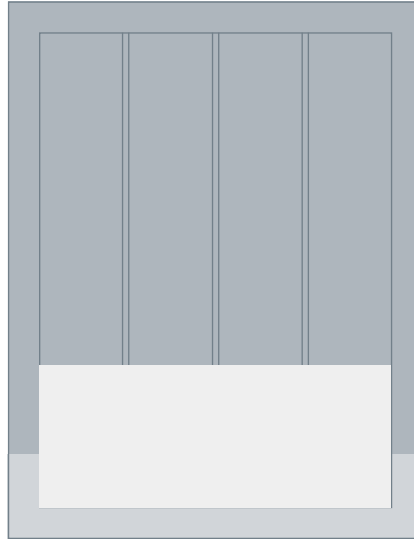

GRID STRUCTURE

To build a relationship with the end user, SENCO must establish a direct line of communication. In design, this means establishing an organized system to guide communications.

Layouts are built on a strong, unseen foundation—an underlying grid system—to provide order for building boxes aligned on top.

This section shows how a grid is used to organize content.

Column grid

Layout is built with multiple columns to anchor and arrange elements.

Layout margins are even and confine information to areas with the most legibility.

Structure for letter-size document:

Columns (A): 3–6

Margins (B): 0.5"–0.875"

Gutters (C): 0.125"–0.375"

These measurements can be scaled for applications for varying sizes.

D: Vertical letter-size ad

4-column grid (A)

0.625" margins (B)

0.125" gutters (C)

E: Horizontal letter-size ad

6-column grid (A)

0.5" margins (B)

0.1875" gutters (C)



D



E

Alignment to the grid

Building boxes and text are anchored to the grid to establish dominant alignments in the layout.

- A. Layouts with building boxes align boxes to the grid. Type must be inset in boxes, with an inner margin of 0.25" or more (B).
- C. Layouts without building boxes have type align to grid.

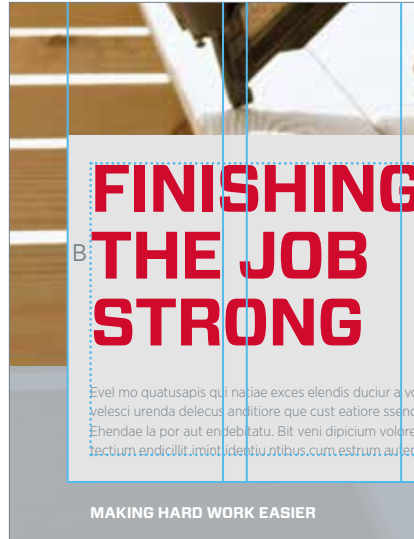

A-Type within building boxes



B-Type without building boxes



BUILDING WITH OUR TOOLBOX

PRINT COMMUNICATIONS

Ad Development: Messaging Principles

Headline is brief and powerful, designed to be read first. This is either a well crafted phrase or a testimonial.

Supportive copy is limited to 1-2 sentences.

Tagline is featured. No other taglines are used in order to keep “Making Hard Work Easier” the priority.

Ad Development: Design Principles

Layout built on underlying grid structure (see page 52).

Building boxes are layered on the grid, and contain selective image and copy.

Large photo features a specific product or reveals the end user with product in real work environment.

Technical drawing, photo or icon is used to support product when appropriate.

Logo overlaps elements or sits in a corner of the layered composition of the grid. Logo is never larger than ½ the width of the page.

Product Usage Ad

Messaging

Headline is brief and powerful, and supportive copy is limited.

Tagline sits in the transparent building box.

Design Elements

One large image communicates a real work environment. It shows the end user interacting with one SENCO product.

One technical drawing is supportive to the product shown.



**FINISHING
THE JOB
STRONG**



Evel mo quatusapis qui natiae excus elendis duciur a volo
velesci urenda delecus anditiore que cust eatiore ssendi vollarbo.
Ehendae la por aut endebitatu. Bit veni dipicium volorect. Hic
tectium endicillit imint identiu nribus cum estrum autem eiumet



SENCO

MAKING HARD WORK EASIER

Product Usage Ad

Messaging

Headline is brief and powerful, and supportive copy is limited.

Design Elements

One large image communicates a real work environment. It shows the end user interacting with one SENCO product.

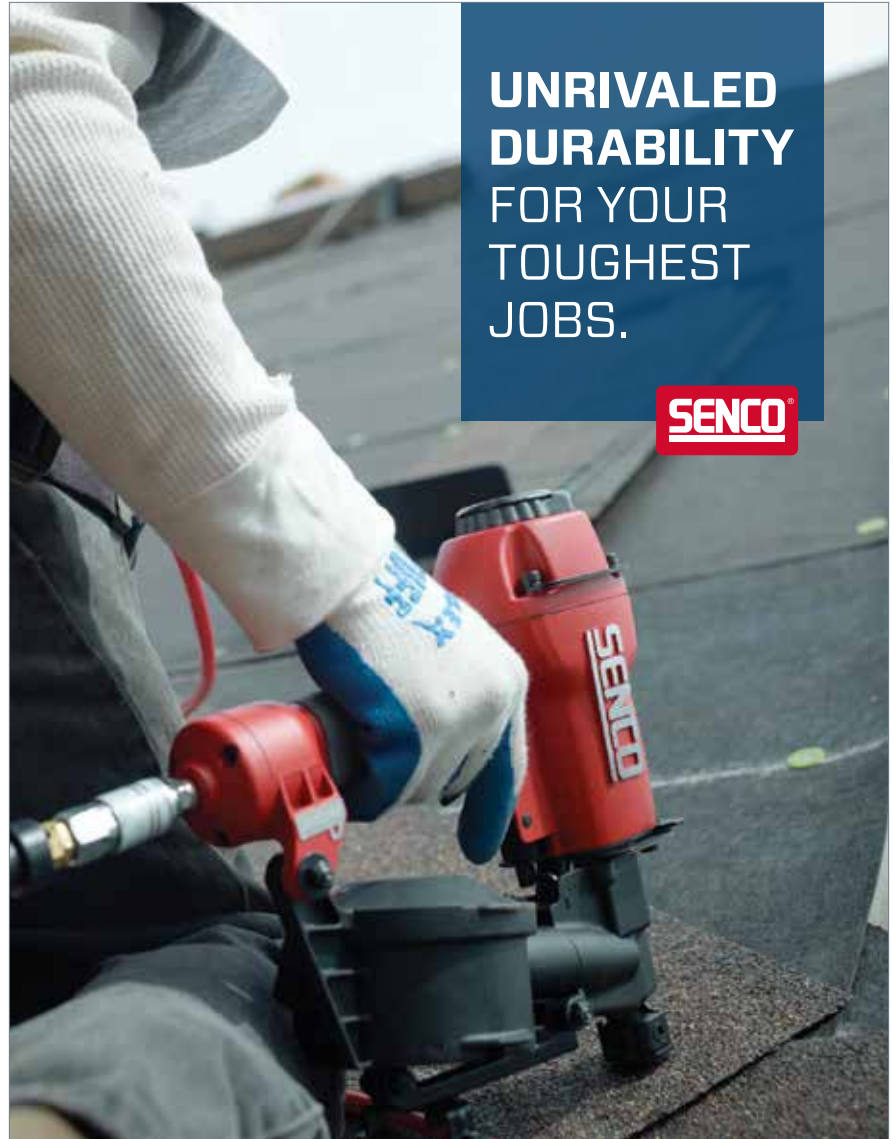

**UNRIVALED
DURABILITY
FOR YOUR
TOUGHEST
JOBS.**



Product Usage Ad

Messaging

Supportive copy is paired with an icon, speaking to the one tool featured.

Design Elements

Supportive imagery is unnecessary; multiple SENCO products are captured in one image.

Copy overlays image in negative space. It does not crowd the image.

A man wearing safety glasses and a black t-shirt is using a Senco power tool to work on a wall. The tool is red and black with 'SENCO' written on it. The background is a plain, light-colored wall.

Patented Reflex-Shot Design

A PERFECT FINISH, INSTANTLY

Atis invero voluptae. Nati sit, ex quos molorpo repedisj quatio. Genduntium ullesej sit uibusanimi, sum ex eatqu coritat adipiscing.Sument. Caboribus, ilisim ex ese et, tem alitibusam con ne re dolest quosaped quatur aliciae sum volor at es nonsent essecep editibeatem que que nam, accabor aliatis estrumquia et qua.

**FUSION
TECHNOLOGY**

SENCO

MAKING HARD WORK EASIER

Product Feature Ad

Messaging

Headline is brief and powerful.

Supportive copy is limited to a few words, and paired with an icon and diagrammatic lines to call out features specific to this tool.

Design Elements

One large product sits on a brand color background. It does not feature an end user or environment, in order to spotlight product features. It is the first thing you look at in the ad.

Supportive imagery is not used; the focus is on selling one specific tool.

Copy overlays image area in negative space. It does not crowd the image.



NEVER LUBE TECHNOLOGY
requires no tool oil

SHOCK RESISTANT DRIVER
made with high grade tool steel

EZ-CLEAR GUIDE BODY
to clear jams quickly

**POWERFUL
EFFICIENCY**

For The Professional

SENCO

MAKING HARD WORK EASIER

Testimonial Ad

Messaging

End user testimonial acts as a headline. The quote is to the point and shows a genuine loyalty to the product.



SENCO

I got the finish nailer by Senco for its speed. After using it every day for the past five years with no problems, I'm convinced it's the best option. Now, **SENCO is the only brand I'll buy.**

Evel mo quatusapis qui natiæ excus elendis duciur a volo velesci urenda delecus anditiore que cust eatiore ssendi vollabo. Ehendae la por aut endebitatu.

Evel mo quatusapis qui natiæ excus elendis duciur a volo velesci urenda delecus anditiore que cust eatiore ssendi vollabo. Ehendae la por aut endebitatu.

MAKING HARD WORK EASIER

Brochure Covers: Messaging Principles

Headline and subhead copy are limited to a few words. They are direct and clearly call out the brochure's content.

Brochure Covers: Design Principles

Layout built on underlying grid structure (see page 52).

Building boxes are layered on the grid, and contain selective image and copy.

Large photo features a specific product or reveals the end user with product in real work environment. The image is simple and cropped in an engaging way.

Supportive imagery and copy are not used; the cover is a "poster" for what is inside.

Logo overlaps elements or sits in a corner of the layered composition of the grid.

Trifold Brochure

Cover utilizes one full-bleed product image in an environment.

Logo fastens building boxes.



Trifold Brochure

Cover utilizes one full-bleed product image on a brand color.

Logo fastens two building boxes.



Product Catalog Cover

Cover utilizes one full-bleed image that features the end user with a SENCO product in a real work environment.

Tagline sits on the grid on top of the image in a clear area of the photo.

Two building boxes (one background box, one container box), are layered on the grid and fastened with the logo.



Product Catalog Cover

Cover utilizes one full-bleed product image on a brand color.

Logo tagline lockup sits on the grid in a clear area of the layout.



Catalog Interiors and Spec Sheets: Messaging Principles

Headline is descriptive and helpful in quickly understanding content, usually featuring the name of the tool.

Product SKUs are separated from tool name and consistently placed within the layout.

Introductions to products briefly explain distinguishing features.

Information is written and organized to be brief and scannable. It is structured for clarity, legibility and consistency.

Catalog Interiors and Spec Sheets: Design Principles

Layout built on underlying grid structure (see page 52).

Technical drawing, photo or icon is used to support text information. Tool images are large enough to show detail.

Logo is not always necessary in internal layouts.

Specific color palette available for categorizing products within select catalog layouts (see page 72).

Product Sheet: Front

Sheet establishes an easy system end users can quickly understand (they know where to look for information).

Layout is driven by large descriptive image of tool.

Detailed tool and fastener specifications live in a sidebar for easy access.



DS212-18V



TOOL SPECIFICATIONS

Item #	7X0001N
RPM	0-2500
Torque	90 inlb
Voltage	18
Weight	4.95 lbs. (2.24kg)
Height	9.5" (241 mm)
Length	15" (381 mm)
Width	3.4" (86 mm)
Drives per charge	500-700

FASTENER SPECIFICATIONS



Lengths	1"-2" (25-50mm)
Diameters	#6-#10

INCLUDES

- (2) 18v Li-ion batteries
- charger
- drywall nosepiece
- wood nosepiece
- storage bag
- (2) drive bits

SOLD SEPARATELY

- FC0822 Nosepiece
drives 1/4"-2" screws

REPLACEMENT DRIVE BITS

two per pack

- EA0297
- ⊕ EA0298
- ⊗ EA0299

2" 2500 RPM Cordless Auto-Feed Screwdriver

Battery powered high torque motor is a great fit for general contractors that need the versatility to do a wide variety of jobs. Added torque provides plenty of power for hard woods, cement board, and subfloor. Lower speed is ideal for applications where drill point screws are used to cut through heavy steel.

Applications

- underlayment and flooring
- fiberglass backed gypsum sheath
- sheathing to wood
- drywall to steel
- metal framing
- sheathing to steel
- drywall to wood
- wood decking
- cement board
- structural steel decking
- composite decking

Features & Benefits

- 2500 RPM high-torque motor
- 18v Li-ion technology (Includes 2 batteries)
- Patent pending corner-fit feed system
- Tool-free screw length adjustment
- Precise depth-of-drive adjustment with depth lock
- Quick slide button bit change
- Variable speed trigger with lock and reverse
- Belt hook -right or left handed adjustable

Product Sheet: Reverse

Large technical drawing of tool drives layout, using icons and short paragraphs of descriptive copy to describe tool features.

Color change separates the front and back content.

Product attachments and inclusions are consistently featured at the bottom of the layout, and use icons to support content when appropriate.

DS212-18V



2" 2500 RPM Cordless Auto-Feed Screwdriver



2500 RPM

FICATI DIPSAMUS
nihil eos etusam quodite.

DURASPIN TECHNOLOGY

FICATI DIPSAMUS
Eos etusam quodite. Edis modi bernature inctibus mi, unt delenis aut di volorum quis

LITHIUM ION BATTERY
with xx screws per charge.

FICATI DIPSAMUS
nihil eos etusam quodite. Edis modi bernature pla inctiut di volorum quis

FICATI DIPSAMUS
nihil eos etusam quodite. Edis modi bernature pla inctiut di volorum quis. Is ipid modigen ihillas vitintia prent dolum. Eprae officil lecestiur audi omnihicabore volupis pellab ipicipient utae eos minusape iur altisist officis maximin repedit. Laborae ent aboribusam quasperum, et alltionet mo totae nisiutiur, quatur rem as iliqui optia volupiendam rehendit ma volum

Attachments

Includes

FICATI DIPSAMUS
nihil eos etusam quodite. Edis modi bernature pla inctiut di volorum quis. Is ipid modigen ihillas vitintia prent dolum.

FICATI DIPSAMUS
nihil eos etusam quodite. Edis modi bernature pla inctiut di volorum quis. Is ipid modigen ihillas vitintia prent dolum.

FICATI DIPSAMUS
nihil eos etusam quodite. Edis modi bernature pla inctiut di volorum quis. Cenat. vivius, cles con ta nenatus hendeoribus, cibus publiame atum

⚙️ + 📦

MAKING HARD WORK EASIER

Product Catalog Spread

End user imagery is used to separate product categories.

Icons are used in grey (Pantone 430) and at the same height. This is recommended for clarity and consistency.



FINISH & TRIM

FINISH & TRIM



15 Gauge 2 1/2" 34° ANGLED FINISH NAILER F-15

This is the world's first cordless pneumatic featuring Fusion Technology, lorem ipsum dolor sit amet consectetur adipiscing lorem ipsum dolor sit.

Applications	Features
<ul style="list-style-type: none"> • Finish & Trim • Baseboard • Cabinets • Chair Rail • Decorative Trim • Door & Window Casing • Furniture Trim 	<ul style="list-style-type: none"> • Robust Aluminum Drive Cylinder • 18v Li-ion technology (includes 2 batteries) • Patented Reflex-Shot Design • Tool-free screw length adjustment • Precise depth-of-drive adjustment with depth lock • Storage bag included • Li-ion 8v charger included

Fastener		Specifications	
Capacity: 110	Range: 1 1/4" - 2 1/2"	Item Number	5N000IN
Gauge: 15	Chair Rail	Tool Weight	6.2 lbs (2.81 kg)
		Height	13" (330 mm)
		Length	13" (330 mm)
		Width	3" (76 mm)
		Battery	Li-ion 18v
		Charger	Drives up to 500 fasteners per charge



15 Gauge 2 1/2" 34° ANGLED FINISH NAILER F-15

This is the world's first cordless pneumatic featuring Fusion Technology, lorem ipsum dolor sit amet consectetur adipiscing lorem ipsum dolor sit.

Applications	Features
<ul style="list-style-type: none"> • Finish & Trim • Baseboard • Cabinets • Chair Rail • Decorative Trim • Door & Window Casing • Furniture Trim 	<ul style="list-style-type: none"> • Robust Aluminum Drive Cylinder • 18v Li-ion technology (includes 2 batteries) • Patented Reflex-Shot Design • Tool-free screw length adjustment • Precise depth-of-drive adjustment with depth lock • Storage bag included • Li-ion 8v charger included

Fastener		Specifications	
Capacity: 110	Range: 1 1/4" - 2 1/2"	Item Number	5N000IN
Gauge: 15	Chair Rail	Tool Weight	6.2 lbs (2.81 kg)
		Height	13" (330 mm)
		Length	13" (330 mm)
		Width	3" (76 mm)
		Battery	Li-ion 18v
		Charger	Drives up to 500 fasteners per charge



15 Gauge 2 1/2" 34° ANGLED FINISH NAILER F-15

This is the world's first cordless pneumatic featuring Fusion Technology, lorem ipsum dolor sit amet consectetur adipiscing lorem ipsum dolor sit.

Applications	Features
<ul style="list-style-type: none"> • Finish & Trim • Baseboard • Cabinets • Chair Rail • Decorative Trim • Door & Window Casing • Furniture Trim 	<ul style="list-style-type: none"> • Robust Aluminum Drive Cylinder • 18v Li-ion technology (Includes 2 batteries) • Patented Reflex-Shot Design • Tool-free screw length adjustment • Precise depth-of-drive adjustment with depth lock • Storage bag included • Li-ion 8v charger included

Fastener		Specifications	
Capacity: 110	Range: 1 1/4" - 2 1/2"	Item Number	5N000IN
Gauge: 15	Chair Rail	Tool Weight	6.2 lbs (2.81 kg)
		Height	13" (330 mm)
		Length	13" (330 mm)
		Width	3" (76 mm)
		Battery	Li-ion 18v
		Charger	Drives up to 500 fasteners per charge

71

Product Category Palette

In limited instances, it may be necessary to use an expanded color palette to distinguish product categories.

These colors are used for product categorization only.

Do not use other hues than these listed, including SENCO red, for categorization.



C0 M20 Y95 K0
R255 G203 B31



C0 M60 Y100 K0
R245 G130 B32



C30 M50 Y100 K0
R187 G135 B50



C30 M0 Y90 K0
R190 G215 B71



C80 M15 Y100 K0
R52 G158 B73



C90 M50 Y65 K20
R28 G95 B90



C35 M5 Y0 K0
R158 G210 B241



C60 M35 Y10 K0
R109 G147 B189



C75 M65 Y60 K25
R74 G79 B84

LARGE-SCALE AND TRADESHOW

Tradeshow Panel

Design is created on a grid and uses building boxes to hold content.

Logo is used without a containment shape on a large field of red for maximum impact within tradeshow environment.

Pantone 7427 from the secondary palette is used to create the look of transparent layering.



CORRESPONDENCE

Business Card

Layout uses Forza in red to call out name and “senco.com.”

Layout uses logo as a fastener between two building boxes to communicate the SENCO brand.

Reverse of card features logo and tagline.

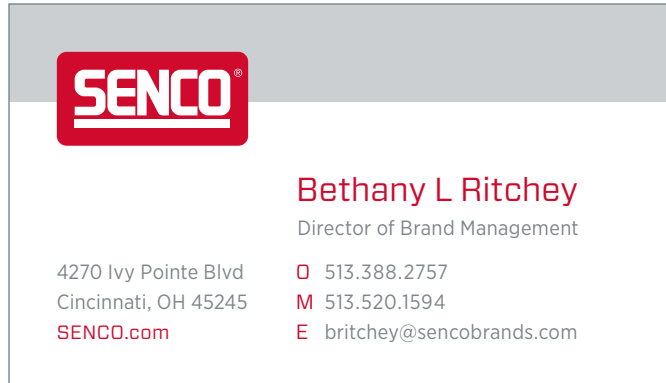

Letterhead

Includes logo, tagline, and contact information.

When referring to our company and brand in body copy, use all caps, writing our name as SENCO.

When writing the URL in body copy, use SENCO.com.

Full-bleed (A) and no-bleed (B) layouts.

Contact our design team (page 82) for artwork files.

Envelopes

SENCO-branded envelopes are available in the following sizes: #10 (C), #10 with window, 9 x 12 inches.

Contact our design team (page 82) for artwork files.

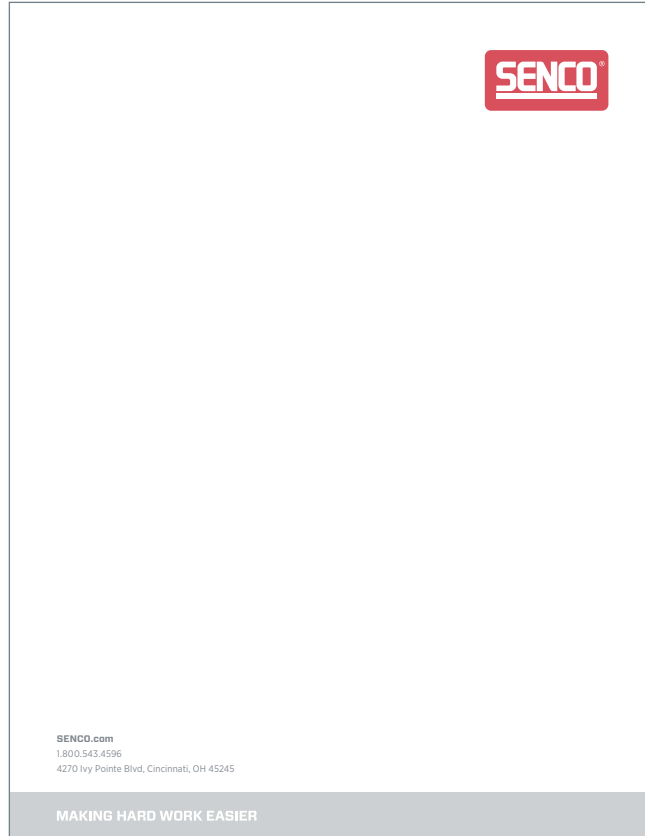

A

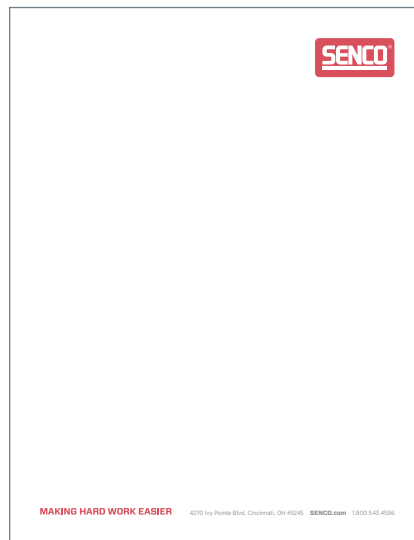

B

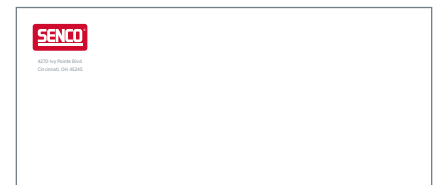

C

Email Signatures

Accessing Your Signature in Microsoft Outlook

1. Open a new message.
2. On the Message tab, in the Include group, click Signature, and then click Signatures.
3. On the E-mail Signature tab, click New.
4. Type a name for the signature, and then click OK.
5. In the Edit signature box, type the text that you want to include in the signature (see “Formatting your Signature”).
6. Finish creating the signature by clicking OK.

NOTE: The signature that you just created won't appear in the open message; it must be inserted into the message.

Formatting Your Signature

Copy and paste the example copy from the right into the Edit signature box, or follow the instructions below.

1. Type your name.
2. Press enter and type your title.
3. Press enter twice and list personal contact information, with office and mobile phone numbers first and then email.
4. Label phone numbers by typing an O or M (office or mobile), and insert two spaces before the number. Separate number groups with periods.
5. Press enter twice and type SENCO.
6. Type headquarters address as listed in the example.
7. Press enter and type senco.com.
8. Highlight your name, title, and SENCO, and change color to SENCO Red (R201 G0 B23) with the style and formatting buttons.
9. Highlight your remaining personal and corporate contact information, and change color to grey (R100 G110 B117) with the style and formatting buttons.

Other Notes

We are eliminating embedded images, favorite quotes, etc. in signatures. This will maintain consistency in corporate communication. Email body should be in Arial only and set at 14pt in black.

Example

Name
Title

O 513.123.4567
M 513.123.4567
name@sencobrands.com

SENCO
4270 Ivy Pointe Blvd
Cincinnati, OH 45245
senco.com

MULTIMEDIA

Website

Logo is used without a containment shape on a large field of red for maximum impact in the web environment.

Photo style is consistent with other applications, featuring the end user in real work environments, within large image areas.

Product details are supported by technical drawing and icons to communicate another level of information without words.

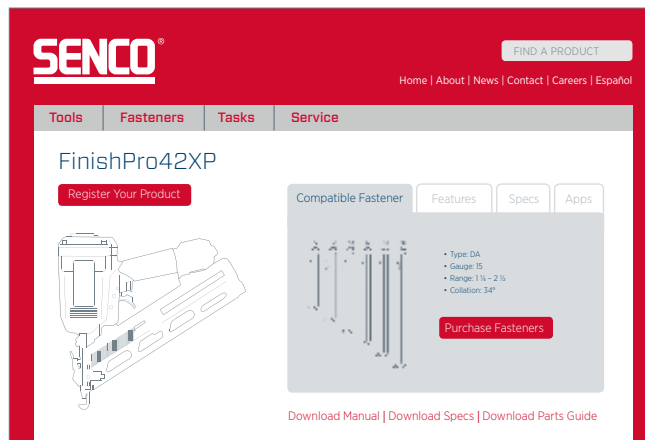
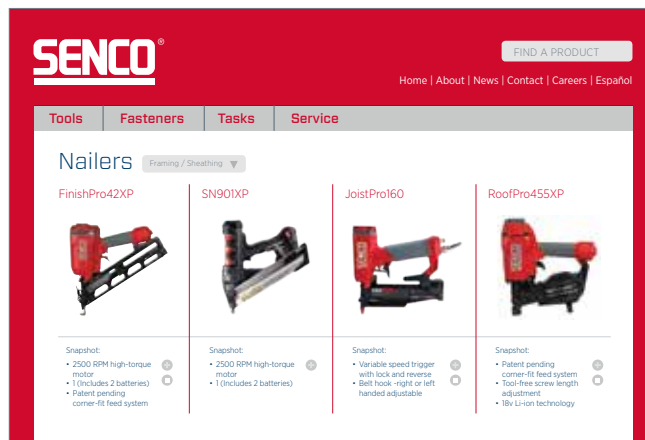

Video Guidelines

Videos are a great opportunity to bring to life our promise of being a true partner to the professional end user. Each video should provide relevant information and support, communicating our expertise and innovations.

Videos should be a maximum of 3-4 minutes in length. Videos must be free of any copyrighted materials unless permission is granted and documented, and must use the current SENCO brand identity guidelines and assets:

Logo

Use current standard logo, without animation, drop-shadows, etc. The logo may be used in the containment shape or on a field of red. It is recommended each video start and end with the standard SENCO logo.

Tagline

Use only the current Brand Tagline, Making Hard Work Easier, preferably as a sign-off to the video.

Color Palette

Use RGB builds of SENCO Brand colors as defined on page 23. Colors may use tints and transparencies to create visual interest.

Typography

Use brand fonts: Forza for headlines, Gotham Narrow for longer copy

Graphic elements

Use “building boxes” and layered elements, for content organization and interest.

Photography

Use current photography style: natural light when possible on job sites. In studio or indoor environments, use three-point lighting techniques.

Audio

Voice-overs may be used, but when possible, capture subjects speaking and interacting with each other and their work to add authenticity. Refer to the SENCO Brand Voice (page 8) for all scripts.

Technical Requirements

Videos should be professionally produced, shot at a resolution of 1080 or higher using CMOS style cameras with audio recorded in camera. All cameras should record digital to a drive and not tape. Backup copies of all acquisition files must be made within 24 hours of shooting.

QR Codes

QR codes should be used only when appropriate. Consider how this information would be relevant and helpful.

If used, QR code needs to lead to a site that is mobile-friendly, and have a payoff—special promotion, interactive experience, or a necessary deeper explanation of content.

SENCO web address

The SENC0 web address should always be written as “SENC0.com.”

FURTHER INFORMATION

We understand that there may be questions. If you encounter a situation where you are not sure about the usage you have in mind, please contact Bethany Ritchey, SENCO Director of Brand Management.

For Approvals

All designs must be approved by Bethany Ritchey at SENCO.

Bethany Ritchey
Director of Brand Management
britchey@sencobrands.com

For Access to Brand Assets

Please contact a member of our design team for access to logo files, technical drawings, icons, etc.

Chuck Crimmel
Senior Graphic Designer
ccrimmel@sencobrands.com

Cody Winesett
Graphic Designer
cwinesett@sencobrands.com