

User's Guide



Overview of Your Scanner Features

These features help you create the best possible scans, no matter what shape your original is in.



Placing Originals on the Scanner

Follow the steps here to place your original documents or photos on the scanner.



Scanning Special Projects

Follow the instructions here for specific scanning projects you may need to create.



Solving Problems

If you have a problem using your scanner or its software, check here for solutions.



Guide to the Scanner Parts

Check this section to identify the parts of your scanner.



Scanning Your Originals

Follow the step-by-step instructions here to scan your original documents or photos using any of the available scanning methods.



Maintenance

Follow the guidelines here to maintain and transport your scanner.



Technical Specifications

Check here for technical details about your scanner and its accessories.

- Safety
- Copyright and Trademarks
- Operating System Versions

[Home](#) > Overview of Your Scanner Features

Overview of Your Scanner Features

These features help you create the best possible scans, no matter what shape your original is in.

 [Text Enhancement](#)

 [Color Restoration](#)

 [Dust Removal](#)

 [Backlight Correction](#)

[Home](#) > [Guide to the Scanner Parts](#)

Guide to the Scanner Parts

Check these sections to identify the parts of your scanner.

 [Scanner Parts](#)

 [Lights and Buttons](#)

[Home](#) > [Placing Originals on the Scanner](#)

Placing Originals on the Scanner

Follow the steps here to place your original documents or photos on the scanner.

 [Placing Documents or Photos](#)

 [Loading Documents in the Automatic Document Feeder](#)

[Home](#) > [Scanning Your Originals](#)

Scanning Your Originals

Follow the step-by-step instructions here to scan your original documents or photos using any of the available scanning methods.

 [Starting Epson Scan](#)

 [Selecting an Epson Scan Mode](#)

 [Changing the Scan Mode](#)

 [Scanning in Office Mode](#)

 [Scanning in Home Mode](#)

 [Scanning in Professional Mode](#)

 [Selecting File Save Settings](#)

 [Detailed Setting Instructions](#)

 [Finishing the Scan](#)

[Home](#) > Scanning Special Projects

Scanning Special Projects

Follow these instructions for specific scanning projects you may need to create.

 [Text Enhancement](#)

 [Scanning to a PDF File](#)

 [Restoring Color](#)

 [Removing Dust Marks](#)

 [Fixing Backlit Photos](#)

 [Using the Scanner as a Copier](#)

 [Scanning Directly to an E-mail](#)

 [Converting Scanned Documents Into Editable Text](#)

 [Assigning a Program to a Scanner Button](#)

[Home](#) > Maintenance

Maintenance

Follow the guidelines here to maintain and transport your scanner.

 [Cleaning the Scanner](#)

 [Replacing the Scanner Light Source](#)

 [Transporting the Scanner](#)

[Home](#) > Solving Problems

Solving Problems

Troubleshooting

If you have a problem using your scanner or its software, check here for solutions.

[Scanner Problems](#)

[Automatic Document Feeder Problems](#)

[Scanning Problems](#)

[Scan Quality Problems](#)

[Uninstalling Your Scanning Software](#)

Where To Get Help

[Technical Support Web Site](#)

[Contacting Epson Support](#)

[Other Software Technical Support](#)

[Home](#) > [Technical Specifications](#)

Technical Specifications

Check here for technical details about your scanner and its accessories.

 [System Requirements](#)

 [Scanner Specifications](#)

[Home](#) > Safety

Important Safety Instructions

[Restrictions on Copying](#)

Read all these instructions, and follow all warnings and instructions marked on the scanner.

- In this document, warnings, cautions, and notes indicate the following:

Warnings

must be followed carefully to avoid bodily injury.

Cautions

must be observed to avoid damage to your equipment.

Notes

contain important information and useful tips on the operation of this product.

- Place the scanner close enough to the computer for the interface cable to reach it easily. Do not place or store the scanner or the AC adapter outdoors, near excessive dirt or dust, water, heat sources, or in locations subject to shocks, vibrations, high temperature or humidity, direct sunlight, strong light sources, or rapid changes in temperature or humidity. Do not use with wet hands.
- Place the scanner and the AC adapter near an electrical outlet where the adapter can be easily unplugged.

Caution:

Be sure the AC power cord meets the relevant local safety standards.

- The AC power cord should be placed to avoid abrasions, cuts, fraying, crimping, and kinking. Do not place objects on top of the AC power cord and do not allow the AC adapter or the AC power cord to be stepped on or run over. Be particularly careful to keep both of the AC power cords straight at the ends and the points where they enter the AC adapter.
- Use only the AC adapter that comes with your scanner. Using any other adapter could cause fire, electrical shock, or injury.
- The AC adapter is designed for use with the scanner with which it was included. Do not attempt to use it with other electronic devices unless specified.
- Use only the type of power source indicated on the scanner's label.
- When connecting this product to a computer or other device with a cable, ensure the correct orientation of the connectors. Each connector has only one correct orientation. Inserting a connector in the wrong orientation may damage both devices connected by the cable.
- Avoid using outlets on the same circuit as photocopiers or air control systems that regularly switch on and off.
- If you use an extension cord with the scanner, make sure the total ampere rating of the devices plugged into the extension cord does not exceed the cord's ampere rating. Also, make sure the total ampere rating of all devices plugged into the wall outlet does not exceed the wall outlet's ampere rating.

- Never disassemble, modify, or attempt to repair the AC adapter, scanner, or scanner option by yourself except as specifically explained in the scanner's guides.
- Do not insert objects into any opening as they may touch dangerous voltage points or short out parts. Beware of electrical shock hazards.
- If damage occurs to the plug, replace the cord set or consult a qualified electrician. If there are fuses in the plug, make sure you replace them with fuses of the correct size and rating.
- Unplug the scanner and the AC adapter, and refer servicing to qualified service personnel under the following conditions: The AC adapter or plug is damaged; liquid has entered the scanner or the AC adapter; the scanner or the AC adapter has been dropped or the case has been damaged; the scanner or the AC adapter does not operate normally or exhibits a distinct change in performance. (Do not adjust controls that are not covered by the operating instructions.)
- Unplug the scanner and the AC adapter before cleaning. Clean with a damp cloth only. Do not use liquid or aerosol cleaners.
- If you are not going to use the scanner for a long period, be sure to unplug the AC adapter from the electrical outlet.

Restrictions on Copying

Observe the following restrictions to ensure responsible and legal use of your scanner.

Copying of the following items is prohibited by law:

- Bank bills, coins, government-issued marketable securities, government bond securities, and municipal securities
- Unused postage stamps, pre-stamped postcards, and other official postal items bearing valid postage
- Government-issued revenue stamps, and securities issued according to legal procedure

Exercise caution when copying the following items:

- Private marketable securities (stock certificates, negotiable notes, checks, etc.), monthly passes, concession tickets, etc.
- Passports, driver's licenses, warrants of fitness, road passes, food stamps, tickets, etc.



Copying these items may also be prohibited by law.

Responsible use of copyrighted materials

Epson encourages each user to be responsible and respectful of the copyright laws when using any EPSON product. While some countries' laws permit limited copying or reuse of copyrighted material in certain circumstances, those circumstances may not be as broad as some people assume. Contact your legal advisor for any questions regarding copyright law.

Default Delay Times for Power Management for Epson products

This product will enter sleep mode after a period of nonuse. The time interval has been set at the factory to ensure that the product meets Energy Star standards of energy efficiency, and cannot be modified by the consumer.

Restriction on disassembling and decompiling

You may not disassemble, decompile or otherwise attempt to derive the source code of any software included with this product.

[Home](#) > Copyright and Trademarks

■ Copyright and Trademarks

No part of this publication may be reproduced, stored in a retrieval system, or transmitted in any form or by any means, electronic, mechanical, photocopying, recording, or otherwise, without the prior written permission of Seiko Epson Corporation. No patent liability is assumed with respect to the use of the information contained herein. Neither is any liability assumed for damages resulting from the use of the information contained herein.

Neither Seiko Epson Corporation nor its affiliates shall be liable to the purchaser of this product or third parties for damages, losses, costs, or expenses incurred by the purchaser or third parties as a result of: accident, misuse, or abuse of this product or unauthorized modifications, repairs, or alterations to this product.

Seiko Epson Corporation and its affiliates shall not be liable against any damages or problems arising from the use of any options or any consumable products other than those designated as Original Epson Products or Epson Approved Products by Seiko Epson Corporation.

EPSON® is a registered trademark, and EPSON EXCEED YOUR VISION or EXCEED YOUR VISION are trademarks of Seiko Epson Corporation.

Microsoft®, Windows®, and Windows Vista® are registered trademarks of Microsoft Corporation.

Adobe®, Adobe Reader®, Acrobat®, and Photoshop® are registered trademarks of Adobe Systems Incorporated.

Apple®, ColorSync®, Macintosh®, and Mac OS® are registered trademarks of Apple Inc.

PhotoImpression® is a registered trademark of ArcSoft Incorporated.

Presto! PageManager® is a registered trademark of NewSoft Corp.

ABBYY® and ABBYY FineReader® names and logos are registered trademarks of ABBYY Software House.

PRINT Image Matching™ and the PRINT Image Matching logo are trademarks of Seiko Epson Corporation.

Intel® is a registered trademark of Intel Corporation.

EPSON Scan Software is based in part on the work of the Independent JPEG Group.

libtiff

Copyright © 1988-1997 Sam Leffler

Copyright © 1991-1997 Silicon Graphics, Inc.

Permission to use, copy, modify, distribute, and sell this software and its documentation for any purpose is hereby granted without fee, provided that (i) the above copyright notices and this permission notice appear in all copies of the software and related documentation, and (ii) the names of Sam Leffler and Silicon Graphics may not be used in any advertising or publicity relating to the software without the specific, prior written permission of Sam Leffler and Silicon Graphics.

THE SOFTWARE IS PROVIDED "AS-IS" AND WITHOUT WARRANTY OF ANY KIND, EXPRESS, IMPLIED OR OTHERWISE, INCLUDING WITHOUT LIMITATION, ANY WARRANTY OF MERCHANTABILITY OR FITNESS FOR A PARTICULAR PURPOSE.

IN NO EVENT SHALL SAM LEFFLER OR SILICON GRAPHICS BE LIABLE FOR ANY SPECIAL, INCIDENTAL, INDIRECT OR CONSEQUENTIAL DAMAGES OF ANY KIND, OR ANY DAMAGES WHATSOEVER RESULTING FROM LOSS OF USE, DATA OR PROFITS, WHETHER OR NOT ADVISED OF THE POSSIBILITY OF DAMAGE, AND ON ANY THEORY OF LIABILITY, ARISING OUT OF OR IN CONNECTION WITH THE USE OR PERFORMANCE OF THIS SOFTWARE.

General Notice: Other product names used herein are for identification purposes only and may be trademarks of their respective companies.

This information is subject to change without notice.

12/12

Copyright © 2012 Seiko Epson Corporation. All rights reserved.

[Home](#) > Operating System Versions

■ Operating System Versions

In this manual, the following abbreviations are used.

Windows refers to Windows 8, 7, Vista, XP, and XP x64.

- Windows 8 refers to Windows 8 and Windows 8 Pro.
- Windows 7 refers to Windows 7 Home Basic, Windows 7 Home Premium, Windows 7 Professional, and Windows 7 Ultimate.
- Windows Vista refers to Windows Vista Home Basic Edition, Windows Vista Home Premium Edition, Windows Vista Business Edition, Windows Vista Enterprise Edition, and Windows Vista Ultimate Edition.
- Windows XP refers to Windows XP Home Edition, Windows XP Professional x64 Edition, and Windows XP Professional.

Macintosh refers to Mac OS X.

- Mac OS X refers to Mac OS X 10.5.8, 10.6.x, 10.7.x, and 10.8.x.

[Home](#) > [Overview of Your Scanner Features](#)

■ Text Enhancement

When you scan documents, you can sharpen the text and increase accuracy by using the **Text Enhancement** feature in Epson Scan.

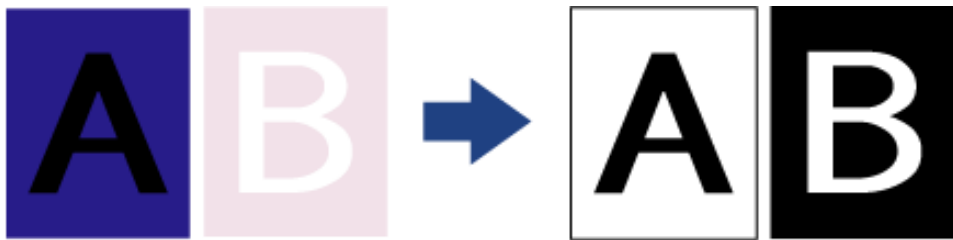



For instructions on using this feature, see [Text Enhancement](#).

[Home](#) > [Overview of Your Scanner Features](#)

■ Color Restoration

Using the **Color Restoration** feature in Epson Scan, you can transform an old, faded, or badly exposed photo into one with true-to-life color and sharpness.

Original image	Color Restoration applied
 A photograph of a shop interior, likely a liquor store, showing shelves stocked with bottles and two men in the foreground. The image is significantly faded and lacks color, appearing in shades of gray and muted tones.	 The same photograph as the original, but with color restoration applied. The colors are vibrant and true-to-life, and the overall image is sharper and clearer.

For instructions on using this feature, see [Restoring Color](#).

[Home](#) > [Overview of Your Scanner Features](#)

■ Dust Removal

Using the **Dust Removal** feature in Epson Scan, you can virtually “clean” the dust marks from your originals as you scan them.





For instructions on using this feature, see [Removing Dust Marks](#).

[Home](#) > [Overview of Your Scanner Features](#)

■ Backlight Correction

Using the **Backlight Correction** feature in your scanning software, you can remove shadows from photos that have too much background light.

Original image	Backlight Correction applied
 A photograph of a dog lying on a bed. The dog is mostly in shadow, with only its face and front paws clearly visible. The background is dark, and there are some vertical light streaks on the left side, possibly from curtains.	 The same photograph of the dog, but with backlight correction applied. The dog's fur is now much brighter and more detailed, and the shadows are significantly reduced. The background is also brighter and more uniform in color.

For instructions on using this feature, see [Fixing Backlit Photos](#).

[Home](#) > [Guide to the Scanner Parts](#)

Scanner Parts

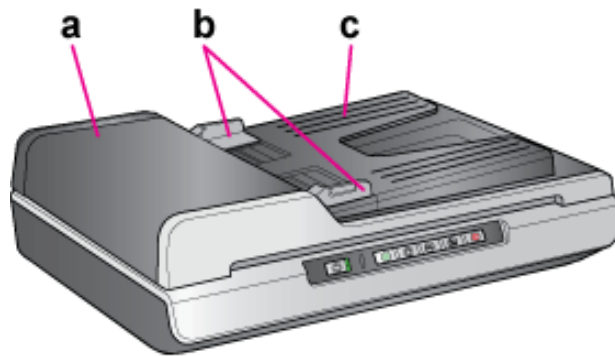

- a. automatic document feeder (ADF)
- b. edge guides
- c. input tray

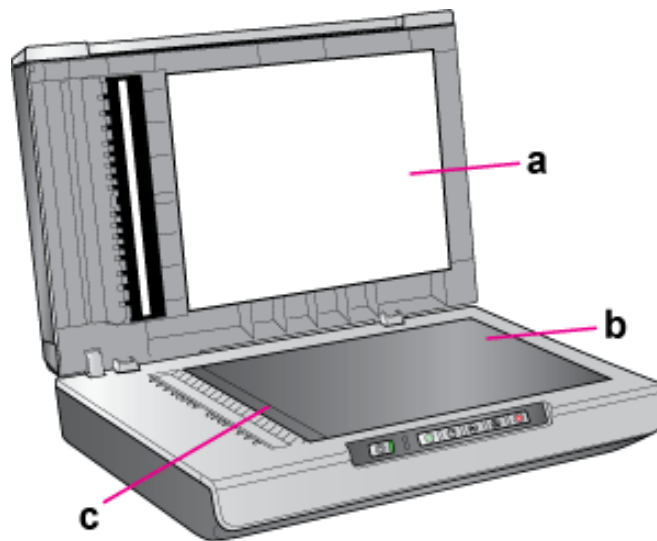

- a. underside of ADF
- b. document table
- c. carriage (in the document table)

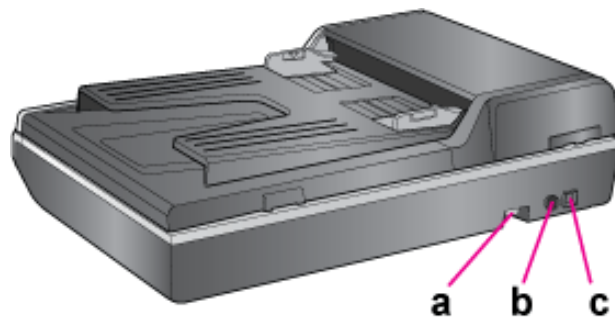

- a. transportation lock lever
- b. DC inlet
- c. USB interface connector

■ Lights and Buttons

☑ Lights

☑ Buttons

The scanner has two indicator lights and six buttons.

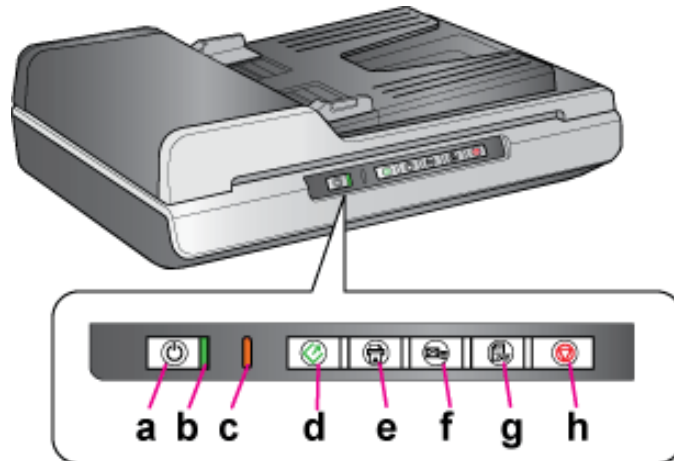

- a. Power button
- b. Ready light
- c. Error light
- d. Start button
- e. Copy button
- f. E-mail button
- g. PDF button
- h. Cancel button







Lights

The Ready light is next to the Power button and the Error light is between the Power button and the Start button.

Color	Light Status	Meaning
Green	On	Ready to scan images.
	Flashing	Initializing or scanning.
Orange	Flashing	An error has occurred. See The Lights Are Flashing for more information.
(None)	Off	The scanner is off.

Buttons

Before using the scanner buttons, make sure you have installed Epson Scan.

Button	Function
 Power	Turns the scanner on.
 Start	Epson Scan starts.
 Copy	The Copy Utility starts.
 E-mail	Epson Scan starts. After you scan, the Send File Via E-mail window appears.
 PDF	The Scan to PDF window appears.
 Cancel	Cancels scanning. If your document pages get jammed when you cancel scanning, see Paper Jams in the Automatic Document Feeder .

[Top](#) 

Home > Placing Originals on the Scanner

■ Placing Documents or Photos

▾ Placing Large or Thick Documents

⚠ Caution:

Do not place heavy objects on the document table glass and do not press the glass with too much force.

1 Open the scanner cover.

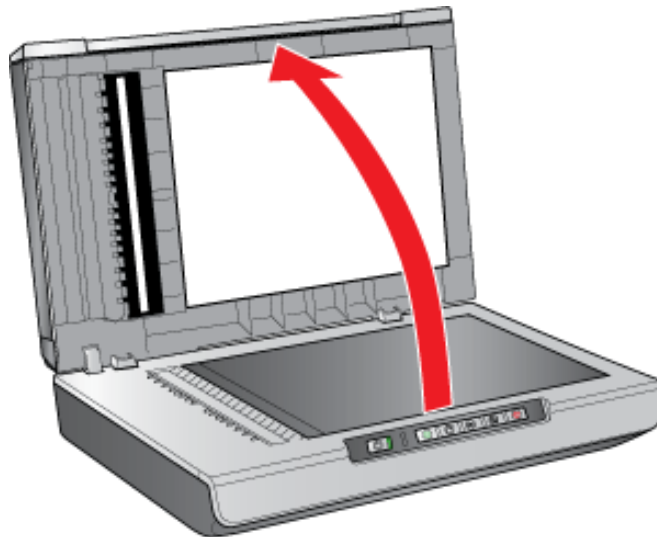

2 Place your document or photo face-down on the document table. Make sure the top of the document or photo is against the left edge and centered on the arrow mark.

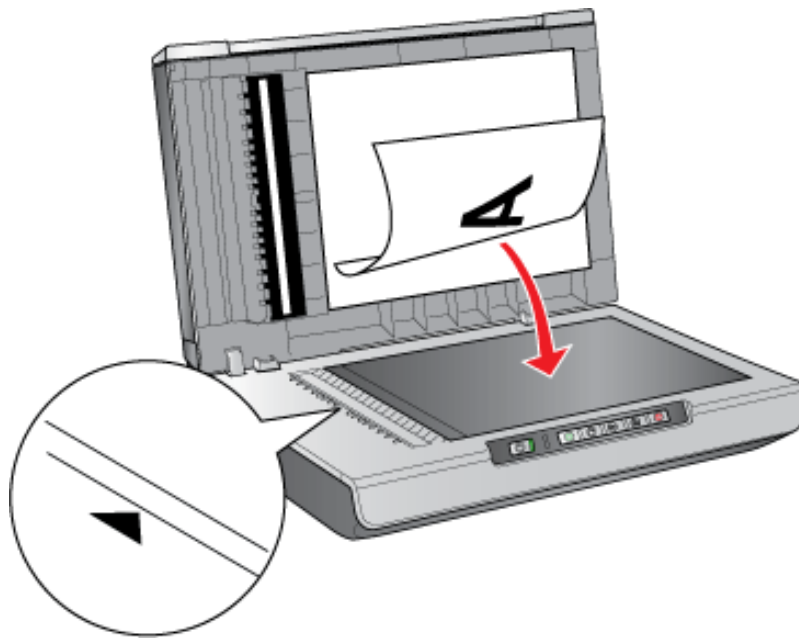

 **Note:**

If you are scanning multiple photos at once, position each photo at least 20 mm (0.8 inch) apart from the others.

3 Close the scanner cover gently so that your original does not move.

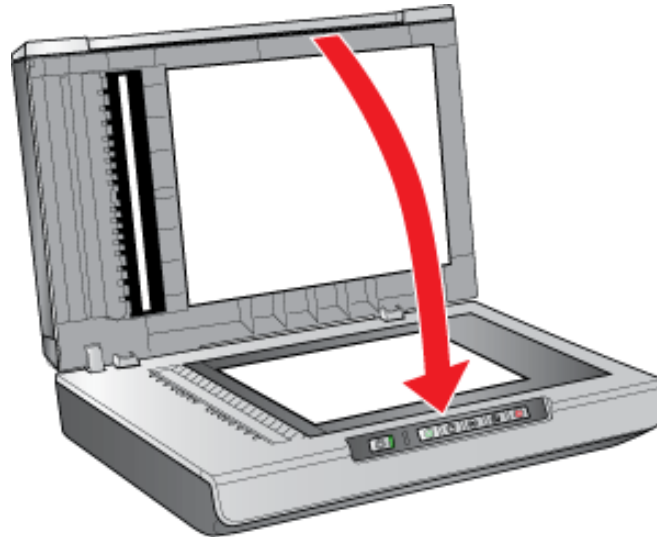

 **Note:**

- When closing the document cover, the scanner light source flashes to detect the size of the document. Do not look directly at the light source.
- Always keep the document table clean.
- Do not leave photos on the document table for an extended period of time as they may stick to the glass.

To start scanning, see [Starting Epson Scan](#) for instructions.

Placing Large or Thick Documents

Follow these steps to scan a large or thick document on the document table. Do not scan large or thick documents in the ADF.

- 1 Place a large or thick document on the document table.

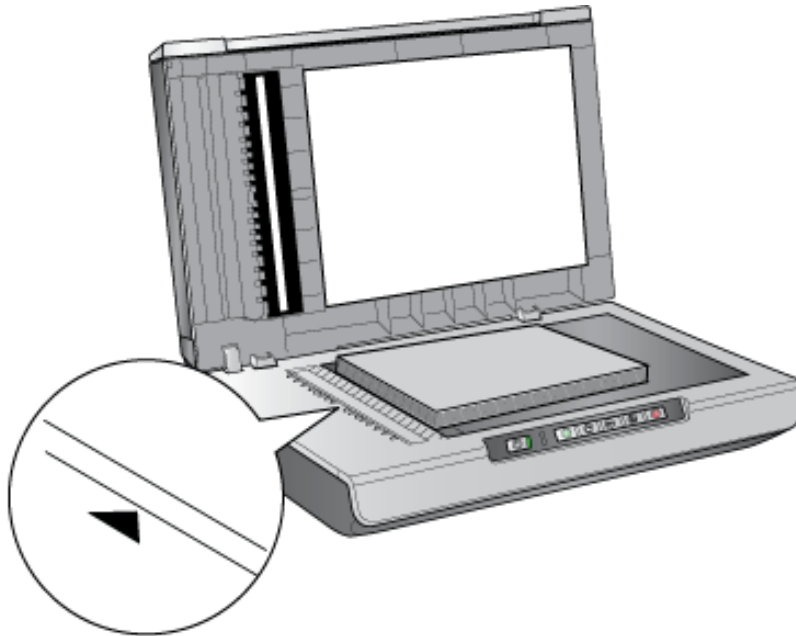

- 2 Close the ADF and hold it down firmly as you scan.

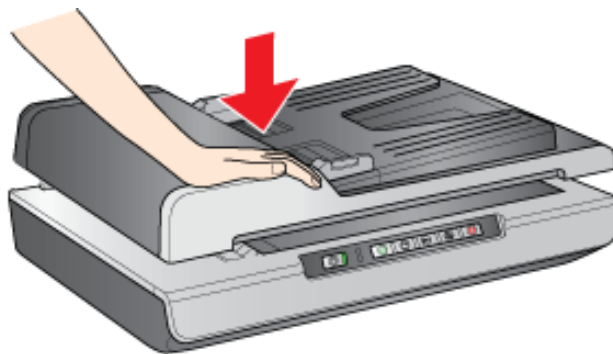

[Home](#) > [Placing Originals on the Scanner](#)

■ Loading Documents in the Automatic Document Feeder

[Document Specifications](#)

[Loading Documents in the ADF](#)

You can load your original documents in the ADF to scan multiple pages quickly.

Before loading documents in the ADF, see [Document Specifications](#) to make sure your original documents can be loaded in the ADF.

Document Specifications

The table below lists the sizes of paper you can load in the ADF. You can load up to 40 sheets (a stack thickness of 5.0 mm/0.2 inch or less) in the ADF.

Only load sheets that are all the same size in the ADF.

Paper size	Measurements
A4	210 × 297 mm (8.3 × 11.7 inches)
Letter	215.9 × 279.4 mm (8.5 × 11 inches)
Legal	215.9 × 355.6 mm (8.5 × 14 inches)
B5	182 × 257 mm (7.2 × 10.1 inches)
A5	148.5 × 210 mm (5.9 × 8.3 inches)
A6 (Portrait)	105 × 148.5 mm (4.1 × 5.9 inches)

Load only documents that meet the following specifications in the ADF.

Size	Width: 105 to 216 mm (4.1 to 8.5 inches) Length: 148.5 to 356 mm (5.9 to 14 inches)
Weight	50 to 120 g/m ²
Paper type	High-quality paper, Bond paper, Check paper, Recycled paper

Make sure your documents meet the following conditions before loading them into the ADF.

- The ink is dry.
- The document has no holes and is not ripped or wrinkled.
- The document has no staples, paper clips, or other objects attached to it; these may damage the feeder mechanism.
- The document has no folds.
- The document has no cut-out areas.
- The document is not a multi-part form or bound.
- The document has no rear carbon coating.

See [Loading Documents in the ADF](#) for instructions on loading your documents in the ADF.

Loading Documents in the ADF

Caution:

- Do not feed photographs or valuable original artwork into the ADF. Misfeeding may wrinkle or damage the original. Scan these documents on the document table instead.
- Do not load A6 documents in landscape orientation.
- Remove any documents from the document table and make sure there is no dust on the glass before loading documents in the ADF.

- 1 Slide the edge guides on the input tray of the ADF all the way outward.

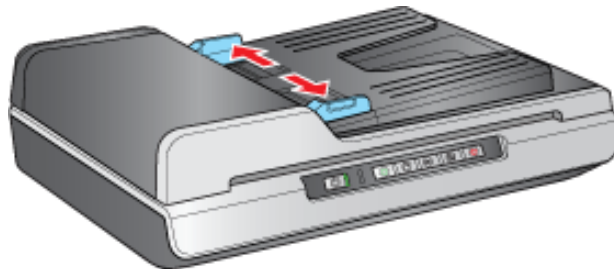

- 2 Place your document in the input tray with the printed side facing up and the top edge facing into the feeder. Slide the paper into the feeder until it meets resistance. Then slide the edge guides over to the edge of the paper.

To start scanning, see [Starting Epson Scan](#) for instructions.





Home > Scanning Your Originals

Starting Epson Scan

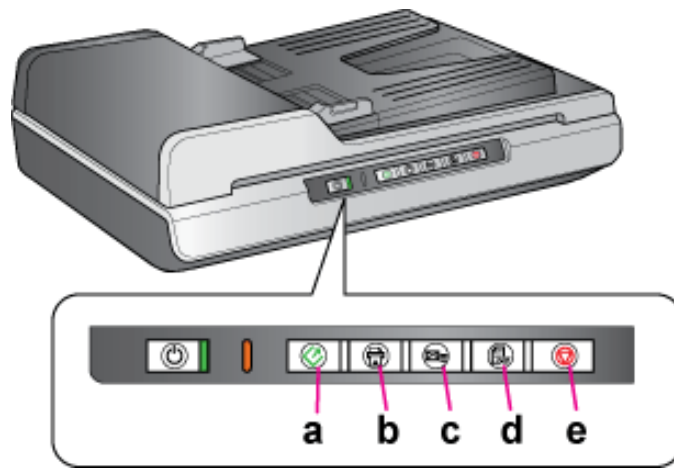
- ▾ Using the Scanner Buttons
- ▾ Using the EPSON Scan Icon
- ▾ Using Another Scanning Program





Using the Scanner Buttons



- a.  Start button
- b.  Copy button
- c.  E-mail button
- d.  PDF button
- e.  Cancel button

You can start Epson Scan just by pressing the  Start button on the scanner. The Epson Scan window automatically opens. See [Selecting an Epson Scan Mode](#) for instructions on selecting an Epson Scan mode.

You can also start scanning by pressing the following buttons on the scanner.

- The  Copy button lets you use your scanner along with a printer connected to your computer just like you would use a copy machine. See [Using the Scanner as a Copier](#) for instructions.
- The  E-mail button lets you scan and attach the image file to an e-mail message. See [Scanning Directly to an E-mail](#) for instructions.
- The  PDF button lets you scan multiple originals and save them as one PDF file on your computer. See [Scanning to a PDF File](#) for instructions.
- The  Cancel button lets you cancel a scan in progress.

Using the EPSON Scan Icon

You can start Epson Scan by double-clicking the **EPSON Scan** icon.

Windows 8:

Double-click the **EPSON Scan** icon on the desktop.

Or, navigate to the **Start** screen > **EPSON Scan**.

Windows 7/Vista/XP:

Double-click the **EPSON Scan** icon on the desktop.

Or, select the start button icon or **Start** > **All Programs** or **Programs** > **EPSON Scan** > **EPSON Scan**.

Mac OS X:

Select **Applications** > **EPSON Software** > **EPSON Scan**.

The Epson Scan window automatically opens. See [Selecting an Epson Scan Mode](#) for instructions on selecting an Epson Scan mode.

[Top](#) 

Using Another Scanning Program

You can use any TWAIN-compliant scanning program, such as Adobe Photoshop Elements, to scan with your scanner. You open the program, select Epson Scan, and scan. When you are finished scanning, the scanned image opens in your scanning program so you can modify, print, and save it.

- 1 Start a TWAIN-compliant scanning program. Double-click the program icon on the desktop, if it is available, or do one of the following.

Windows 8:

Navigate to the **Start** screen > program icon.

Windows 7/Vista/XP:

Select the start button or **Start** > **All Programs** or **Programs** > program folder > program icon.

Mac OS X:

Open the **Applications** in your hard drive, select the program folder, and double-click the program icon.

- 2 Do one of the following.

Adobe Photoshop Elements:

Windows:

Click **Edit and Enhance Photos**, open the **File** menu, select **Import**, and select your scanner.

Mac OS X:

Click **Close** in the Welcome window if it appears, open the **File** menu, select **Import**, and select your scanner.

ScanSoft PaperPort:

Windows:

Click the **Scan** icon, select your scanner, select your profile, and click the **Scan** button.

In some programs, you must select the scanner as the "source" first. If you see a Select Source option, select it and select your scanner there first.

Note for Windows:

Do not select a WIA option for your scanner from the Import or Acquire list; you will not be able to use all the features of your scanner.

The Epson Scan window automatically opens. See [Selecting an Epson Scan Mode](#) for instructions on selecting an Epson Scan mode.

[Top](#) 

[Home](#) > [Scanning Your Originals](#)

■ Selecting an Epson Scan Mode

Epson Scan offers several scanning modes to choose from.

- **Office Mode** lets you quickly select settings for scanning text documents and check their effects with a preview image. Epson Scan opens in this mode the first time you use it. Office Mode is best when you want to scan documents using the Automatic Document Feeder.
 - See [Changing the Scan Mode](#) for instructions on switching to Office Mode.
 - See [Scanning in Office Mode](#) for instructions on making settings in Office Mode.
- **Home Mode** lets you customize some scanning settings and check their effects with a preview image. Home Mode is best when you want to preview images of your originals before scanning them. You can size the image as you scan, adjust the scan area, and adjust many image settings, including color restoration, dust removal, and backlight correction.
 - See [Changing the Scan Mode](#) for instructions on switching to Home Mode.
 - See [Scanning in Home Mode](#) for instructions on making settings in Home Mode.
- **Professional Mode** gives you total control of your scanning settings and lets you check their effects with a preview image. Professional Mode is best when you want to preview your image and make extensive, detailed corrections to it before scanning. You can sharpen, color correct, and enhance your image with a full array of tools, including color restoration, dust removal, and backlight correction.
 - See [Changing the Scan Mode](#) for instructions on switching to Professional Mode.
 - See [Scanning in Professional Mode](#) for instructions on making settings in Professional Mode.

Home > Scanning Your Originals

■ Changing the Scan Mode

To change the scan mode, click the arrow in the **Mode** box in the upper right corner of the Epson Scan window. Then select the mode you want to use from the list that appears.

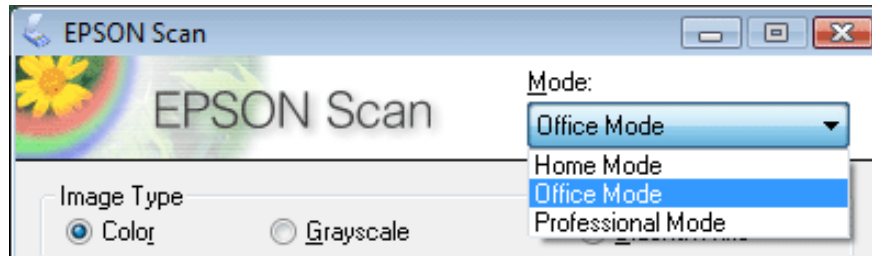

 **Note:**

The mode you select remains in effect when you start Epson Scan next time.

For instructions on scanning using these modes, see one of these sections.

Office Mode: [Scanning in Office Mode](#)

Home Mode: [Scanning in Home Mode](#)

Professional Mode: [Scanning in Professional Mode](#)

[Home](#) > [Scanning Your Originals](#)

■ Scanning in Office Mode

[Scanning in Office Mode Using the Document Table](#)

[Scanning in Office Mode Using the ADF](#)

When you start Epson Scan for the first time, it runs in Office Mode and displays the Epson Scan Office Mode window.

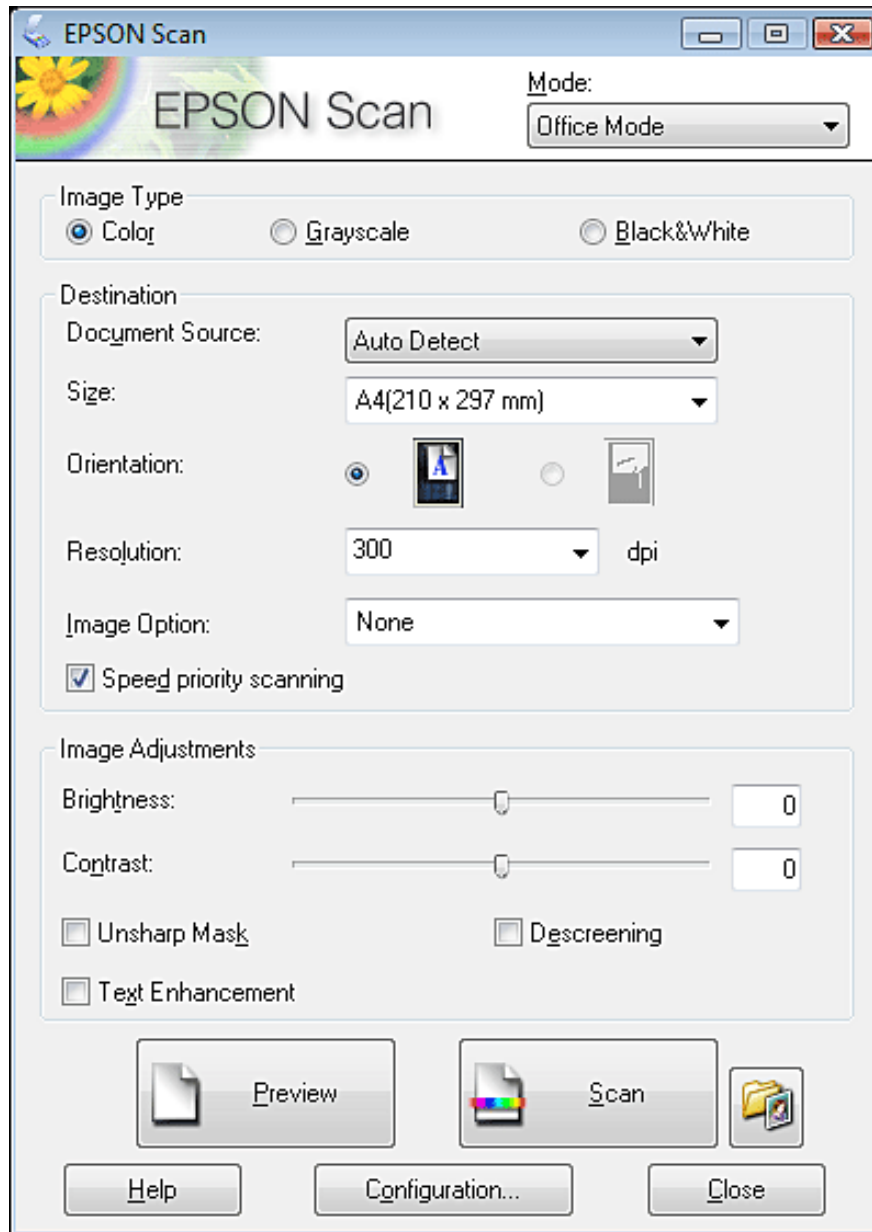

If you want to scan your documents by placing them on the document table, see [Scanning in Office Mode Using the Document Table](#) for instructions.

If you want to scan your documents by loading them in the ADF, see [Scanning in Office Mode Using the ADF](#) for instructions.

Scanning in Office Mode Using the Document Table

- 1 Place the original(s) on the document table. See [Placing Documents or Photos](#) for instructions.
- 2 Start Epson Scan. See [Starting Epson Scan](#) for instructions.
- 3 Select **Office Mode** in the Mode list. See [Changing the Scan Mode](#) for instructions.
- 4 Select **Color**, **Grayscale**, or **Black&White** as the Image Type setting.

Note:

If you select **Grayscale** or **Black&White**, you can also select an **Image Option** setting, as described below.

Image Option Setting	Description
None	No Image Option setting is applied.
Dropout: Red	Drops out red from the scan.
Dropout: Green	Drops out green from the scan.
Dropout: Blue	Drops out blue from the scan.
Color Enhance: Red	Enhances red in the scan.
Color Enhance: Green	Enhances green in the scan.
Color Enhance: Blue	Enhances blue in the scan.

- 5 Select **Document Table** as the Document Source setting.
- 6 Select the size of your original document as the Size setting.
- 7 Click the arrow to open the **Resolution** list and select an appropriate resolution for your original. See [Selecting the Scan Resolution](#) for instructions.
- 8 Click **Preview** to preview your image. The Preview window appears and displays your image. See [Previewing and Adjusting the Scan Area](#) for instructions.
- 9 Modify the image quality if necessary. See [Adjusting the Color and Other Image Settings](#) for instructions.
- 10 Click **Scan**.

What happens next depends on how you started your scan. See [Finishing the Scan](#) for instructions.

Top 

Scanning in Office Mode Using the ADF

- 1 Load the first page of your documents in the ADF. See [Loading Documents in the Automatic Document Feeder](#) for instructions.
- 2 Start Epson Scan. See [Starting Epson Scan](#) for instructions.
- 3 Select **Office Mode** in the Mode list. See [Changing the Scan Mode](#) for instructions.
- 4 Select **Color**, **Grayscale**, or **Black&White** as the Image Type setting.

 **Note:**

If you select **Grayscale** or **Black&White**, you can also select an **Image Option** setting, as described below.

Image Option Setting	Description
None	No Image Option setting is applied.
Dropout: Red	Drops out red from the scan.
Dropout: Green	Drops out green from the scan.
Dropout: Blue	Drops out blue from the scan.
Color Enhance: Red	Enhances red in the scan.
Color Enhance: Green	Enhances green in the scan.
Color Enhance: Blue	Enhances blue in the scan.

- 5 Select one of these settings as the Document Source setting.
 - **Auto Detect:** This setting automatically determines whether to load your document from the ADF or scan it from the document table.
 - **ADF:** Select this setting when you use the ADF to load your documents.
- 6 Select the size of your original document as the Size setting.
- 7 Click the arrow to open the **Resolution** list and select an appropriate resolution for your original. See [Selecting the Scan Resolution](#) for instructions.
- 8 Click **Preview** to preview your image(s). The ADF loads your first document page, then Epson Scan prescans it and displays it in the Preview window. The ADF then ejects your first page.
- 9 If necessary, you can draw a marquee (a line marking the scan area) around the portion of your document page that you want to scan in the Preview window. See [Creating a Marquee on a Preview Image](#) for instructions.
- 10 Change any necessary Image Adjustment settings. See [Adjusting the Color and Other Image Settings](#) for details.
- 11 Place your first document page on top of the rest of the pages, then load the entire document (up to 40 pages) into the ADF.
- 12 Click **Scan**.

 **Note:**

If you need to stop scanning, press the  Cancel button on the scanner. Your document pages may get jammed in the ADF. See [Paper Jams in the Automatic Document Feeder](#) for instructions on removing the pages.

What happens next depends on how you started your scan. See [Finishing the Scan](#) for instructions.

If you have problems while scanning using the ADF, see [Automatic Document Feeder Problems](#).

Top 

Home > Scanning Your Originals

■ Scanning in Home Mode

When you select **Home Mode**, you see the Epson Scan Home Mode window.

 **Note:**

In Home Mode, you can only scan from the document table. If you want to scan using the ADF, change to Office Mode or Professional Mode. See [Changing the Scan Mode](#) for details.

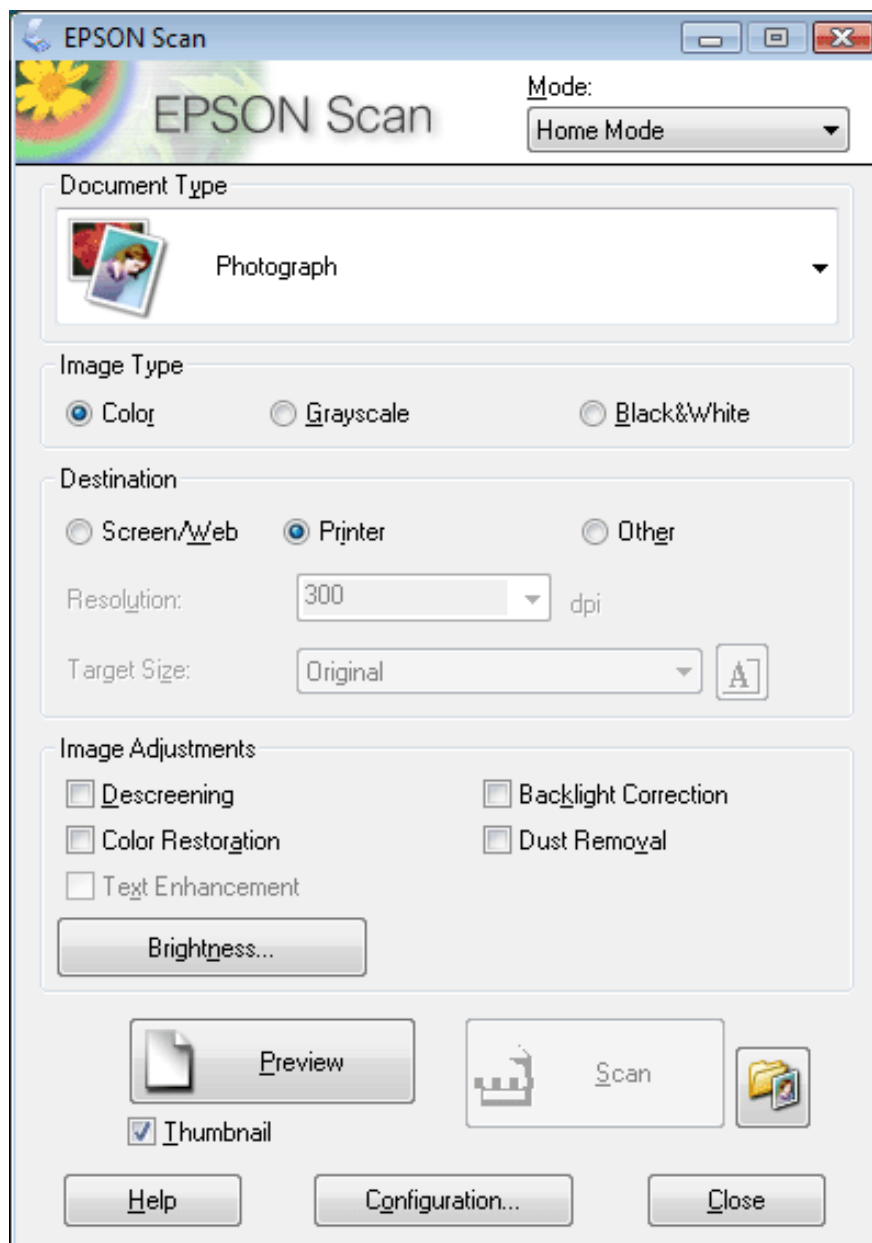

- 1 Place your original(s) on the document table. See [Placing Documents or Photos](#) for instructions.
- 2 Start Epson Scan. See [Starting Epson Scan](#) for instructions.
- 3 Select **Home Mode** in the Mode list. See [Changing the Scan Mode](#) for instructions.
- 4 Click the arrow to open the **Document Type** list, and select the type of your original(s) you are scanning.
- 5 Select **Color**, **Grayscale**, or **Black&White** as the Image Type setting.
- 6 In the Destination box, click the button for the way you plan to use the scanned image(s).
 - **Screen/Web** for images you will view only on a computer screen or post on the web.
 - **Printer** for image(s) you will be printing or converting to editable text with an OCR (Optical Character Recognition) program.
 - **Other** if you want to select a specific resolution for other purposes.

Epson Scan selects a default resolution setting based on the Destination setting you select. If you selected **Other** as the Destination setting to select a specific resolution, see [Selecting the Scan Resolution](#) for instructions.
- 7 Click **Preview** to preview your image(s). The Preview window appears and displays your image(s). See [Previewing and Adjusting the Scan Area](#) for instructions.
- 8 Modify the image quality, if necessary. See [Adjusting the Color and Other Image Settings](#) for instructions.
- 9 Click the arrow to open the **Target Size** list to select the size of the scanned image(s), if necessary. You can scan your images at their original size, or you can reduce or enlarge their size by selecting Target Size. See [Selecting the Scan Size](#) for instructions.
- 10 Click **Scan**.

What happens next depends on how you started your scan. See [Finishing the Scan](#) for instructions.

[Home](#) > [Scanning Your Originals](#)

■ Scanning in Professional Mode

[Scanning in Professional Mode Using the Document Table](#)

[Scanning in Professional Mode Using the ADF](#)

When you select **Professional Mode**, you see the Epson Scan Professional Mode window.

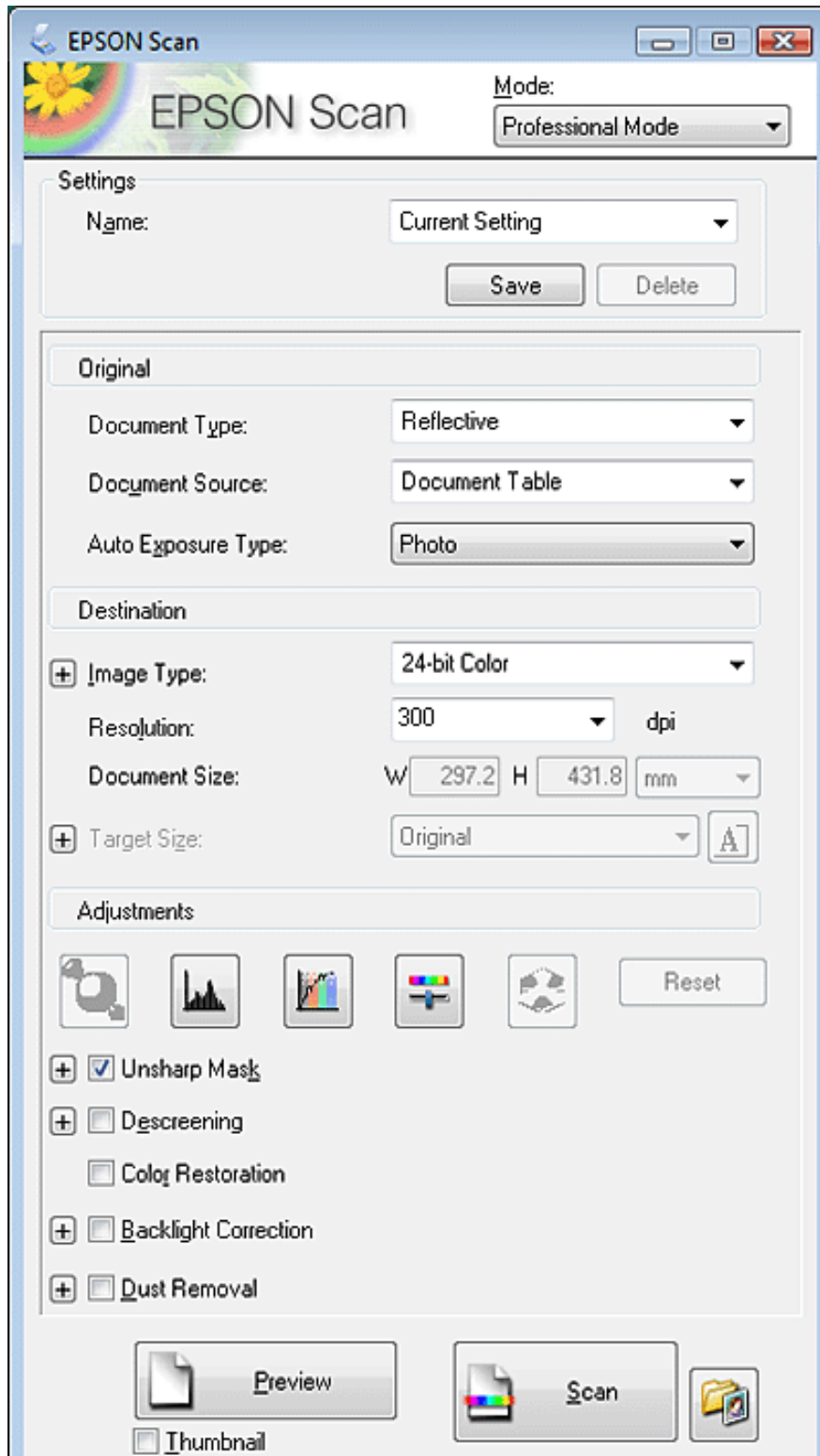

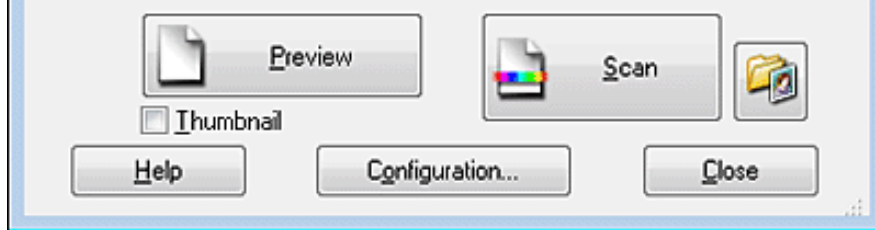

If you want to scan your original(s) in Professional Mode by placing them on the document table, see [Scanning in Professional Mode Using the Document Table](#) for instructions.

If you want to scan your documents in Professional Mode by loading them in the ADF, see [Scanning in Professional Mode Using the ADF](#) for instructions.

Scanning in Professional Mode Using the Document Table

- 1 Place your original(s) on the document table. See for instructions.
- 2 Start Epson Scan. See [Starting Epson Scan](#) for instructions.
- 3 Select **Professional Mode** in the Mode list. See [Changing the Scan Mode](#) for instructions.
- 4 Click the arrow to open the **Document Type** list and select **Reflective**.
- 5 Click the arrow to open the **Document Source** list and select **Document Table**.
- 6 Click the arrow to open the **Auto Exposure Type** list and select **Document** or **Photo**.
- 7 Click the arrow to open the **Image Type** list and select the detailed image type you are scanning.

Image Type setting	Type of image you are scanning
48-bit Color	Color photos that you may want to modify in a 48-bit image-editing program
24-bit Color	Color photos
Color Smoothing	Color graphics, such as a chart or graph
16-bit Grayscale	Black-and-white photos with many shades of gray
8-bit Grayscale	Black-and-white photos with just a few shades of gray
Black & White	Documents with black text and/or line art

- 8 Click the arrow to open the **Resolution** list and select an appropriate resolution for your original(s). See [Selecting the Scan Resolution](#) for instructions.
- 9 Click **Preview** to preview your image(s). The Preview window appears and displays your image(s). See [Previewing and Adjusting the Scan Area](#) for instructions.
- 10 Modify the image quality, if necessary. See [Adjusting the Color and Other Image Settings](#) for instructions.
- 11 Click the arrow to open the **Target Size** list to select the size you want for the scanned image(s), if necessary. You can scan your images at their original size, or you can reduce or enlarge their size by selecting Target Size. See [Selecting the Scan Size](#) for instructions.

12 Click **Scan**.

What happens next depends on how you started your scan. See [Finishing the Scan](#) for instructions.

Top 

Scanning in Professional Mode Using the ADF

- 1 Load the first page of your documents in the ADF. See [Loading Documents in the Automatic Document Feeder](#) for instructions.
- 2 Start Epson Scan. See [Starting Epson Scan](#) for instructions.
- 3 Select **Professional Mode** in the Mode list. See [Changing the Scan Mode](#) for instructions.
- 4 Click the arrow to open the **Document Type** list and select **Reflective**.
- 5 Click the arrow to open the **Document Source** list and select **ADF**.
- 6 Click the arrow to open the **Auto Exposure Type** list and select **Document**.
- 7 Click the arrow to open the **Image Type** list and select the detailed image type you are scanning.

Image Type setting	Type of image you are scanning
48-bit Color	Color photos that you may want to modify in a 48-bit image-editing program
24-bit Color	Color photos
Color Smoothing	Color graphics, such as a chart or graph
16-bit Grayscale	Black-and-white photos with many shades of gray
8-bit Grayscale	Black-and-white photos with just a few shades of gray
Black & White	Documents with black text and/or line art

- 8 Click the arrow to open the **Resolution** list and select an appropriate resolution for your original(s). See [Selecting the Scan Resolution](#) for instructions.
- 9 Click **Preview** to preview your image(s). The Preview window appears and displays your image(s). See [Previewing and Adjusting the Scan Area](#) for instructions.
- 10 Click the arrow to open the **Target Size** list to select the size you want for the scanned image(s), if necessary. You can scan your images at their original size, or you can reduce or enlarge their size by selecting Target Size. See [Selecting the Scan Size](#) for instructions.
- 11 Modify the image quality, if necessary. See [Adjusting the Color and Other Image Settings](#) for instructions.
- 12 Place your first document page on top of the rest of the pages, then load the entire document (up to 40 pages) into the ADF.
- 13 Click **Scan**.

 **Note:**

If you need to stop scanning, press the  Cancel button on the scanner. Your document pages may get jammed in the ADF. See [Paper Jams in the Automatic Document Feeder](#) for instructions on removing the pages.

What happens next depends on how you started your scan. See [Finishing the Scan](#) for instructions.

Top 

Home > Scanning Your Originals

Selecting File Save Settings

When you see the File Save Settings window, you can select the location, name, and format of the scanned image file.

1 Click the  File Save Settings icon to the right of the Scan button.

The File Save Settings window appears.

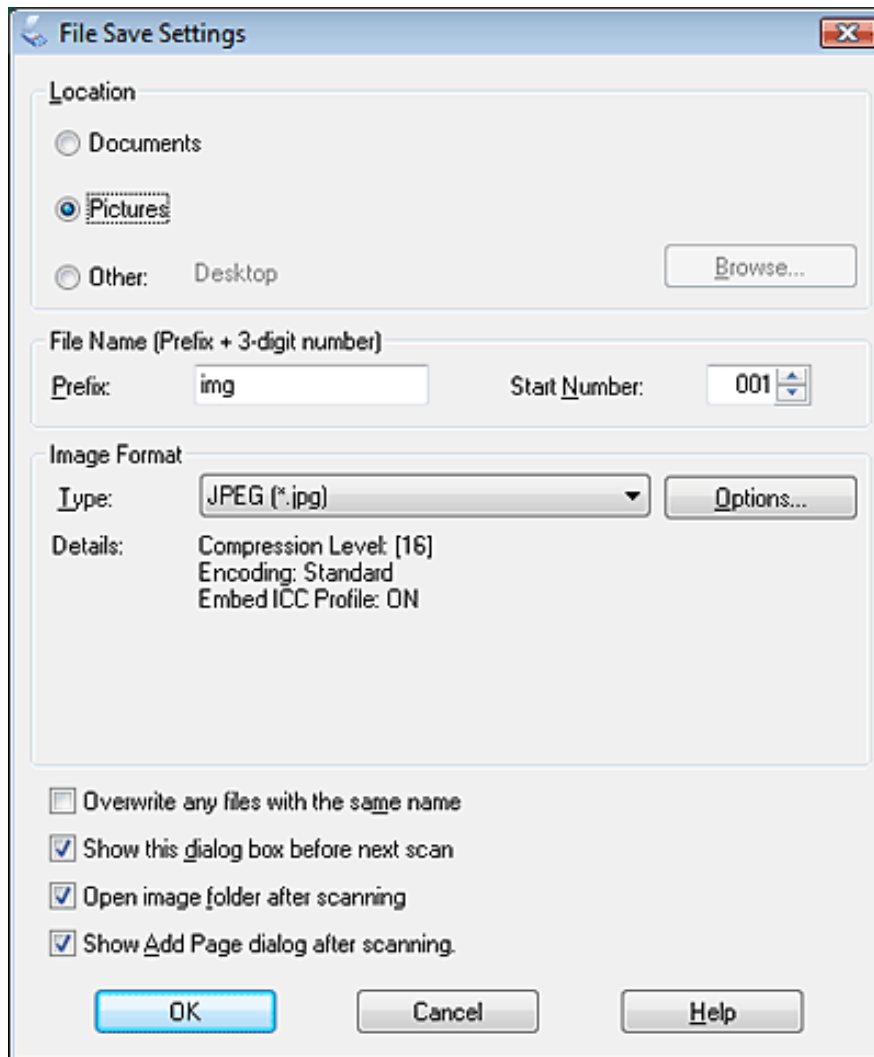

 **Note:**

If you start Epson Scan from a TWAIN-compliant program, such as Adobe Photoshop Elements, the



File Save Settings icon does not appear.

- 2 In the File Save Settings window, specify the file folder in which you want to save your scanned image. Click the **Documents** or **Pictures** radio button, or the **My Documents** or **My Pictures** radio button. If you want to select another folder, click the **Other** radio button, then click **Browse** (Windows) or **Choose** (Mac OS X) and select the folder. If you want to save your image on the desktop, simply click the **Other** radio button.

- 3 Specify a file name prefix with an alphanumeric character string. A 3-digit number is automatically added to the file name, but you can change the Start Number if you like. If you are scanning multiple images at once, each image will receive a different 3-digit number.

 **Note:**

The following characters cannot be used in the prefix.

Windows: \, /, :, _, *, ?, ", <, > ,

Mac OS X: :

- 4 Click the arrow to open the Type list and select a file format as described in the following table. Depending on the format, the Options button may be available for making detailed settings.

Format (File Extension)	Description
BITMAP (*.bmp) (Windows only)	A standard image file format for Windows. Most Windows programs, including word processing programs, can read and prepare images in this format.
JPEG (*.jpg)	A compressed file format in which the compression level can be selected. The JPEG format lets you highly compress image data. However, the higher the compression, the lower the image quality. Any lost image quality data cannot be restored, and the quality deteriorates each time the data is saved. The TIFF format is recommended when modification and retouching are required.
Multi-TIFF (*.tif)	A TIFF format where multiple pages are saved to the same file. You can also edit the scanned images before saving them. See Epson Scan Help for details. To open Multi-TIFF files, you need a program that supports it.
PDF (*.pdf)	A document format that can be read on both Windows and Macintosh systems (platform independent). To use PDF documents in Windows, you need Adobe Reader or Acrobat. Multi-page documents can be saved as one PDF file. When you save color or grayscale images in PDF, you can select a compression level.
PICT (*.pct) (Macintosh only)	A standard image file format for Macintosh. Most Macintosh programs, including word processing programs, can read and prepare images in this format.
PRINT Image Matching II JPEG (*.jpg) or TIFF (*.tif)	A file format that includes PRINT Image Matching II data for enhanced quality and a wider color range. Print Image Matching II compatible printers can then print this data for brilliant, true-to-life results. (PRINT Image Matching data does not affect the way the image displays on the screen.) Available in JPEG or TIFF format.
TIFF (*.tif)	A file format created for exchanging data between many programs, such as graphic and DTP software. When scanning black & white images, you can specify the compression type.

- 5 The check boxes at the bottom of the window give you these options.

• **Overwrite any files with the same name**

Select this option if you want to reuse the selected file name and location and overwrite previous files with the same names.

• **Show this dialog box before next scan**

Select this option if you want the File Save Settings window to appear automatically before you scan. If you

deselect it, you must click the  File Save Settings icon to open the window before clicking the Scan button.

■ **Open image folder after scanning**

Select this option if you want Windows Explorer or the Macintosh Finder to automatically open the folder where your scanned image file is saved when Epson Scan finishes scanning.

■ **Show Add Page dialog after scanning**

Select this option if you want the Add Page Confirmation window to appear automatically after each scan in PDF or multi-Tiff. The Add Page Confirmation window includes the **Add page**, **Edit page**, and **Save file** buttons.

6 Click **OK**.

[Home](#) > [Scanning Your Originals](#)

■ Detailed Setting Instructions

- [Selecting the Scan Resolution](#)
- [Previewing and Adjusting the Scan Area](#)
- [Adjusting the Color and Other Image Settings](#)
- [Selecting the Scan Size](#)

Selecting the Scan Resolution

You can select a specific Resolution setting for your images. Keep in mind that higher resolution settings increase scanning time, so do not select a higher resolution than you need. See the following table to reference the appropriate resolution setting to use so that you do not have to take more time than necessary.

What you will do with the scanned image	Suggested scan resolution
Send via e-mail, upload to web, or view only on the screen	96 to 150 dpi
Print	300 dpi
Print, or convert to editable text (OCR) (for documents only)	300 dpi
Fax	200 dpi
Enlarge after scanning at 100%	Increase Resolution setting by same amount you will increase image size after scanning. For example, if the resolution is 300 dpi, but you will increase the image size to 200%, change the resolution setting to 600 dpi.

To select the resolution setting, see one of these sections.

Home Mode: [Selecting the Resolution in Home Mode](#)

Office Mode or **Professional Mode:** [Selecting the Resolution in Office Mode or Professional Mode](#)

Selecting the Resolution in Home Mode

To change the resolution, first select **Other** as the Destination setting.

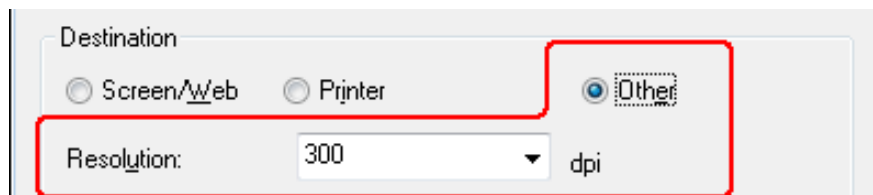

Click the arrow next to the **Resolution** list and select the number of dpi (dots per inch) at which you want to scan.

Selecting the Resolution in Office Mode or Professional Mode

You can select the resolution you want at any time.

Office Mode

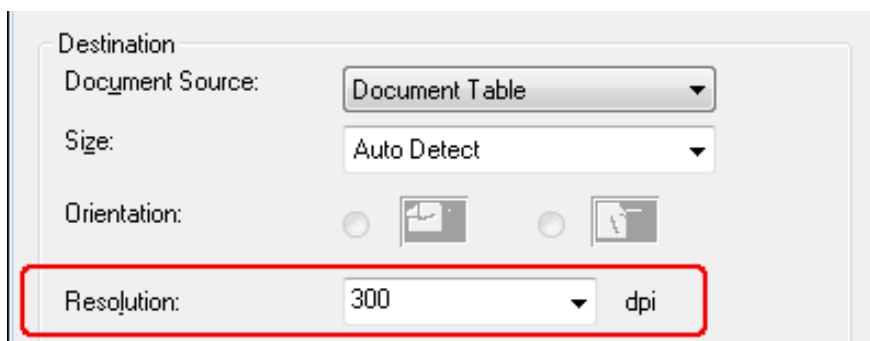

Professional Mode

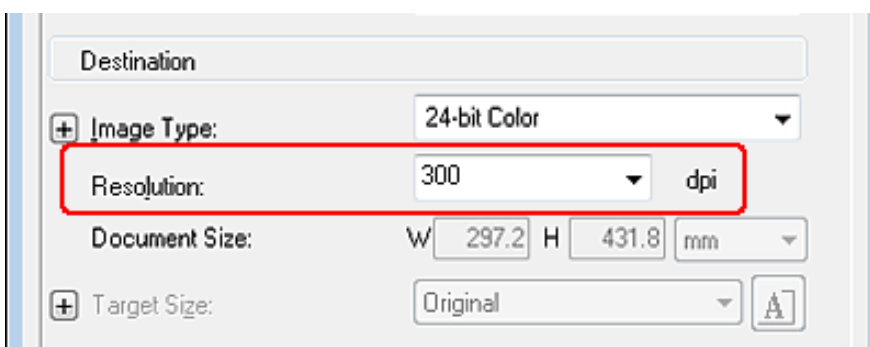

Click the arrow next to the **Resolution** list and select the number of dpi (dots per inch) at which you want to scan.

[Top](#) 

Previewing and Adjusting the Scan Area

Once you have selected your basic settings and resolution, you can preview your image and select or adjust the image area of the image(s) in a separate Preview window on your screen. There are two types of preview.

- Normal preview displays your previewed image(s) in their entirety. You must select the scan area and make any image quality adjustments manually.
- Thumbnail preview displays your previewed image(s) as thumbnail(s). Epson Scan automatically locates the edges of your scan area, applies automatic exposure settings to the image(s), and rotates the image(s) if necessary.

Note:

If you are using Office Mode or scanning from the ADF, the thumbnail preview is not available. You must use the normal preview.

- 1 Click **Preview**. If you want to change the preview type, click the **Thumbnail** check box under the Preview button, if it is available.

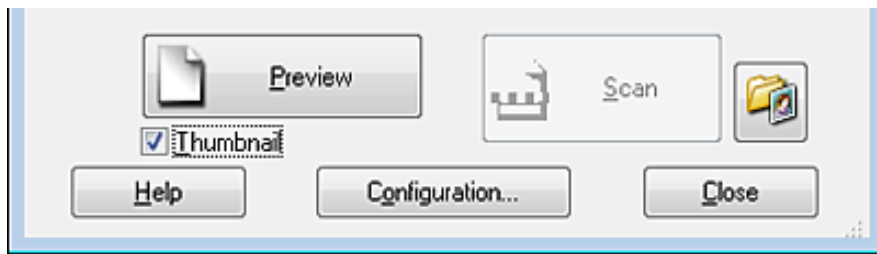

 **Note:**

Depending on your document type and other settings, you may not be able to change the preview type.

Epson Scan prescans your image(s) and displays them in one of the following Preview windows.

Normal preview

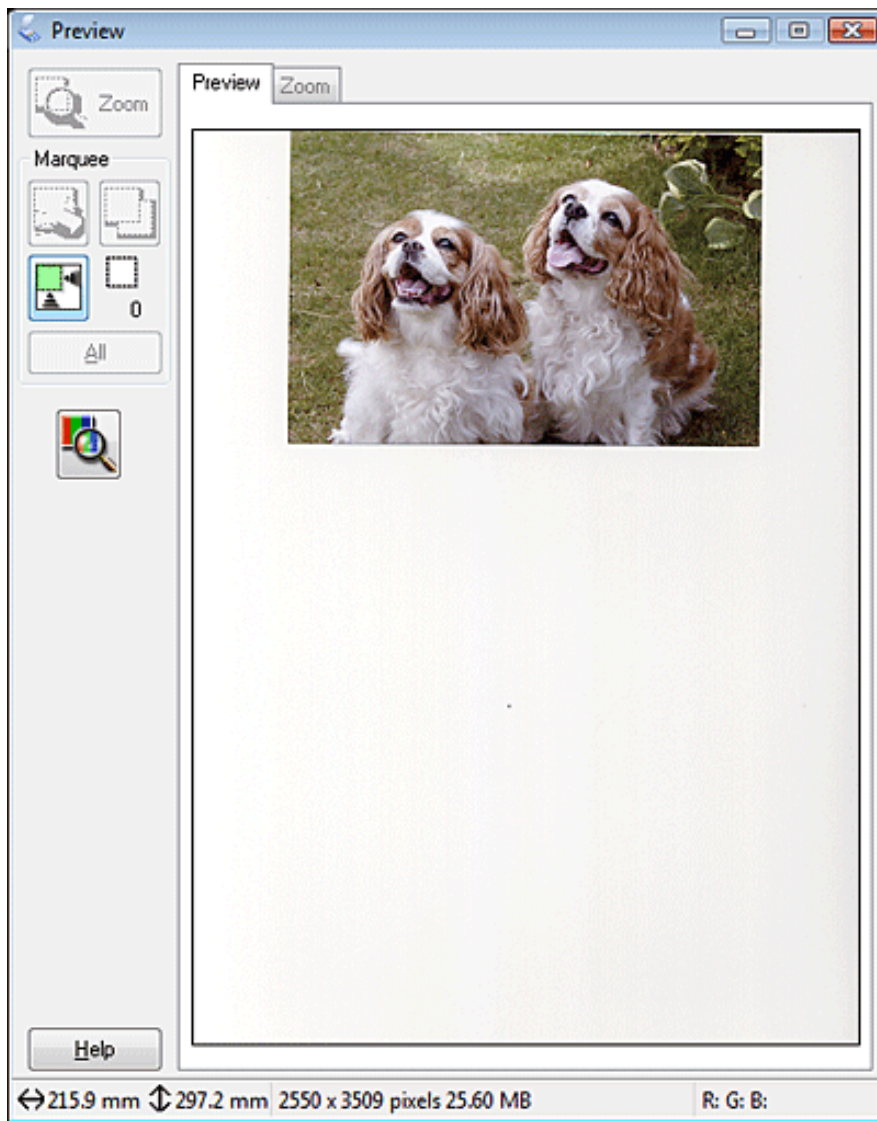

Thumbnail preview

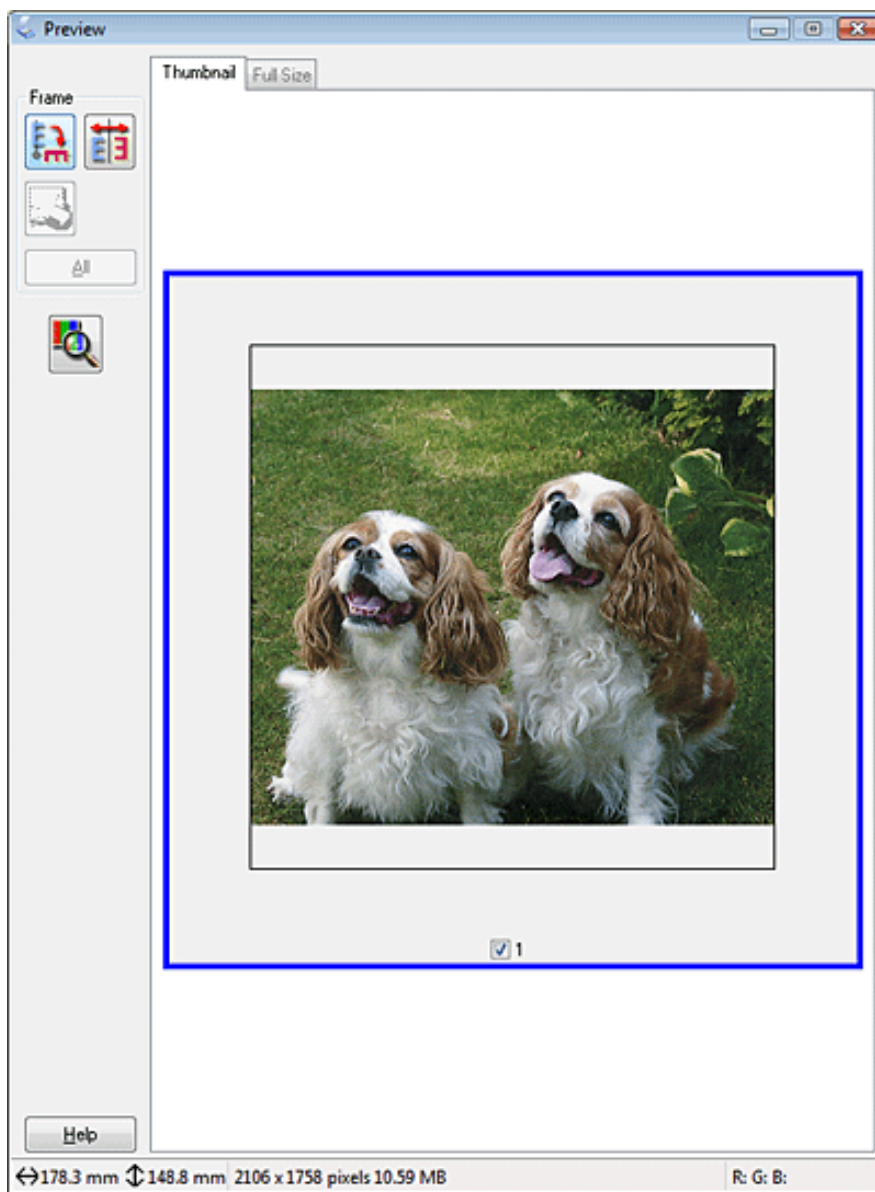

2 If you are viewing the normal preview, you can do the following to adjust the image(s).

- To select your scan area, click the  auto locate icon to create a marquee that marks the edges of your image area. You can move the marquee to change the scan area. See [Creating a Marquee on a Preview Image](#) for instructions.



 **Note:**

If you are going to scan at a different size than your original, you must first select your **Target Size** and automatically create a marquee that is proportioned to that size. See [Selecting the Scan Size](#) for instructions. You can then copy the marquee and place it on each image you will scan at that size.

- To zoom in on an image, click inside the scan area and click the **Zoom** button. Epson Scan prescans again and displays a larger preview on the Zoom tab.
- To adjust the image quality, click the scan area(s) you want to modify and make the adjustments. See [Adjusting the Color and Other Image Settings](#) for instructions.

If you are viewing the thumbnail preview, you can do the following to adjust the image(s).

-

- ▮ To zoom in on an image, double-click its thumbnail, or click the thumbnail and then click the **Full Size** tab near the top of Preview window. (This feature is only available when you are scanning multiple images at the same time.)
- ▮ To rotate an image or flip it horizontally (like a mirror image), click its thumbnail and then click the  rotation icon or  mirroring icon.

 **Note:**

If your image is not rotated correctly, see [Images are Rotated Incorrectly](#).

- ▮ To adjust the scan area to crop your image differently, you can create and move a marquee that marks the edges of your scan. See [Creating a Marquee on a Preview Image](#) for instructions.
- ▮ To adjust the image quality, click the image(s) or scan area(s) you want to modify and make the adjustments. See [Adjusting the Color and Other Image Settings](#) for instructions. If you want to apply the adjustments you have made to all of your images, click **All**.

Creating a Marquee on a Preview Image

A marquee is a moving dotted line that appears on the edges of your preview image to indicate the scan area.

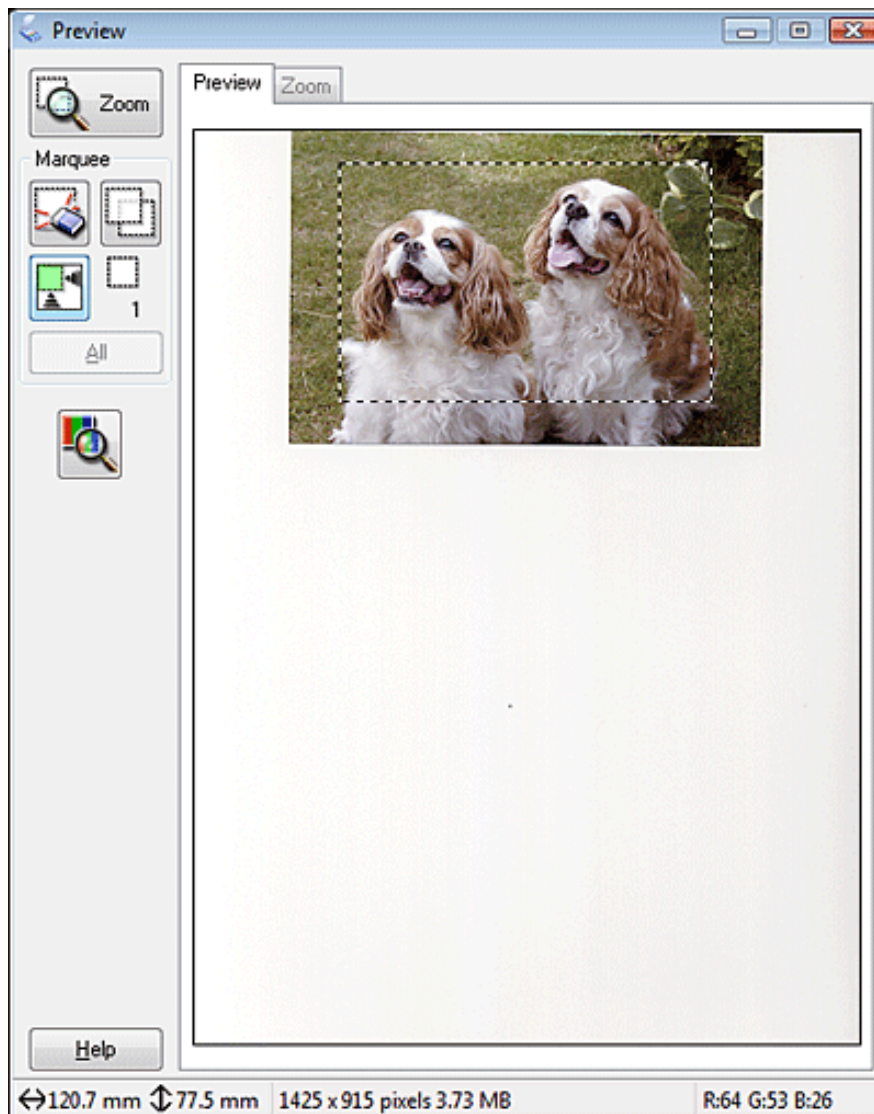

You can move the marquee and adjust its size. If you are viewing the normal preview, you can create multiple marquees

(up to 50) on each image to scan different image areas in separate scan files.

- 1 To draw a marquee, move your cursor over a preview image. The pointer becomes a set of cross-hairs.

 **Note:**

If you are viewing the normal preview and you only have one photo on the document table, you can click the  auto locate icon to automatically draw a marquee, then skip to step 3.

- 2 Position the pointer in the area where you want to place the corner of your marquee and click. Hold down the mouse button and drag the cross-hairs over the image to the opposite corner of the desired scan area. Then release the mouse button. You see the moving dotted line of the marquee.



- 3 Do one of the following to adjust the marquee.

- To move the marquee, position your cursor inside the marquee. The pointer becomes a hand. Click and drag the marquee to desired location.



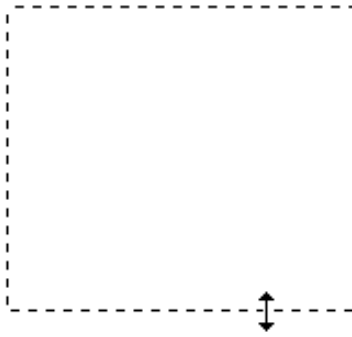

- To resize the marquee, position your cursor over the edge or corner of the marquee. The pointer becomes a straight or angled double-arrow. Click and drag the edge or corner to the desired size.



 **Note:**

- To restrict the movement of the marquee to vertical or horizontal only, hold down the **Shift** key as you move the marquee.
- To restrict the size of the marquee to the current proportions, hold down the **Shift** key as you resize the marquee.
- For best results and image exposure, make sure all sides of the marquee are located inside the preview image. Do not include any of the area around the preview image in the marquee.

4 If you are viewing the normal preview, you can create multiple marquees (up to 50). Just draw them as described in steps 1 through 3, or click the  copy marquee icon to create additional marquees of the same size. You can move and resize all the marquees as described in step 3. To delete a marquee, click inside it and click the  delete marquee icon.

 **Note:**

If you draw multiple marquees, make sure you click **All** in the Preview window before you scan. Otherwise, only the area inside the last marquee you drew will be scanned.

Top 

Adjusting the Color and Other Image Settings

Once you have previewed your image(s) and adjusted the scan area, you can modify the image quality, if necessary. Epson Scan offers a variety of settings for improving color, sharpness, contrast, and other aspects affecting image quality. Before you make adjustments, be sure to click the image or marquee for the area you want to adjust.

To adjust the color and other image settings, see one of these sections.

Office Mode: [Making Color Adjustments and Other Image Settings in Office Mode](#)

Home Mode: [Making Color Adjustments and Other Image Settings in Home Mode](#)

Professional Mode: [Making Color Adjustments and Other Image Settings in Professional Mode](#)

Making Color Adjustments and Other Image Settings in Office Mode

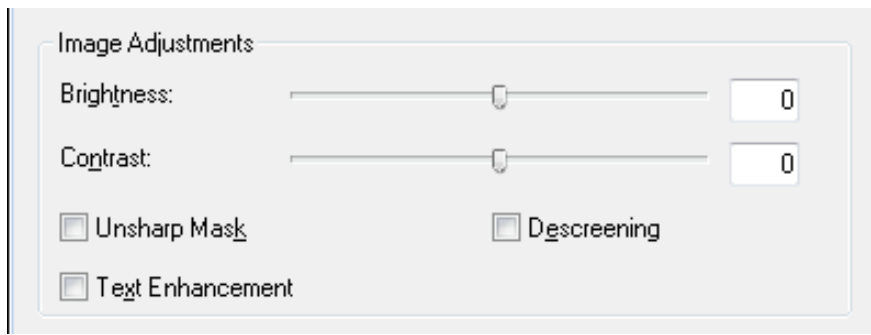

The table below describes the settings available in Office Mode. For details on adjusting these settings, see Epson Scan Help.

 **Note:**

If you are scanning multiple images at the same time and you want to apply the image adjustments to all of your images or scan areas, click **All** in the Preview window before you begin making your adjustments.

Setting	Description
Brightness	Adjusts the overall image lightness and darkness. This setting is available only when the Image Type is set to Color or Grayscale.
Contrast	Adjusts the difference between the light and dark areas of the overall image. This setting is available only when the Image Type is set to Color or Grayscale.
Unsharp Mask	Turn on to make the edges of image areas clearer for an overall sharper image. Turn off to leave softer edges. This setting is available only when the Image Type is set to Color or Grayscale.
Descreening	Removes the rippled pattern that can appear in subtly-shaded image areas, such as in skin tones. Also improves results when scanning magazine or newspaper images which include screening in their original print processes. This setting is available only when the Image Type is set to Color or Grayscale. The results of descreening do not appear in the preview, only in your scanned image.
Text Enhancement	Enhances text recognition when scanning text documents.
Threshold	Adjusts the level at which the black areas in text and line art are delineated, improving text recognition in OCR programs. This setting is available only when the Image Type is set to Black&White.

 **Note:**

- To view the red, green, and blue levels at particular points in your preview image as you make adjustments, click the  densitometer icon in the Preview window and move your cursor over an image area. See Epson Scan Help for details.
- Certain settings may not be available, or may be automatically selected, depending on the type of image you are previewing and other settings you have selected.
- You can customize how certain Epson Scan settings behave by clicking **Configuration** and changing settings in the window that appears. See Epson Scan Help for details.
- To undo any image quality adjustments you make to the preview image, click **Reset** if available, turn off the settings, or preview your image again.

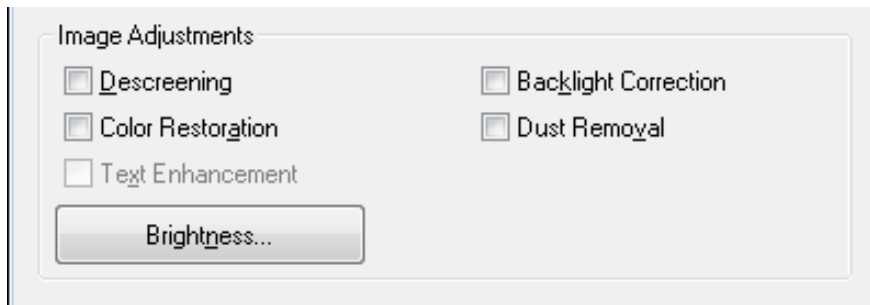

The table below describes the settings available in Home Mode. For details on adjusting these settings, see Epson Scan Help.

 **Note:**

If you are scanning multiple images at the same time and you want to apply the image adjustments to all of your images or scan areas, click **All** in the Preview window before you begin making your adjustments.

Setting	Description
Descreening	Removes the rippled pattern that can appear in subtly-shaded image areas, such as in skin tones. Also improves results when scanning magazine or newspaper images which include screening in their original print processes. This setting is available only when the Image Type is set to Color or Grayscale. The results of descreening do not appear in the preview, only in your scanned image.
Color Restoration	Restores the colors in faded photos automatically.
Text Enhancement	Enhances text recognition when scanning text documents. Available only when you select Magazine, Newspaper, or Text/Line Art as the Document Type setting.
Backlight Correction	Removes shadows from photos that have too much background light.
Dust Removal	Removes dust marks from your originals automatically. The results of Dust Removal do not appear in the preview, only in your scanned image.
Brightness	Adjusts the overall image lightness and darkness. Click Brightness to access the Brightness setting.
Contrast	Adjusts the difference between the light and dark areas of the overall image. Click Brightness to access the Contrast setting.
Threshold	Adjusts the level at which the black areas in text and line art are delineated, improving text recognition in OCR programs. Available only when you select Black & White as the Image Type setting. Click Brightness to access the Threshold setting.

 **Note:**

- To view the red, green, and blue levels at particular points in your preview image as you make adjustments, click the  densitometer icon in the Preview window and move your cursor over an image area. See Epson Scan Help for details.
- Certain settings may not be available, or may be automatically selected, depending on the type of image you are previewing and other settings you have selected.
- You can customize how certain Epson Scan settings behave by clicking **Configuration** and changing settings in the window that appears. See Epson Scan Help for details.
- To undo any image quality adjustments you make to the preview image, click **Reset** if available, turn off the settings, or preview your image again.



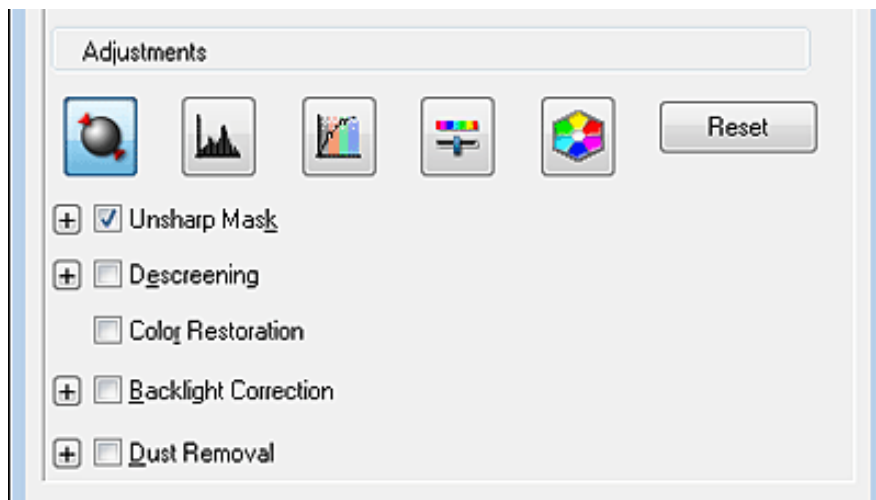



Making Color Adjustments and Other Image Settings in Professional Mode





The table below describes the settings available in Professional Mode. For details on adjusting these settings, see Epson Scan Help.

Note:

- You may need to scroll down to view the Adjustments area of the Professional Mode window.
- If you are scanning multiple images at the same time and you want to apply the image adjustments to all of your images or scan areas, click **All** in the Preview window before you begin making your adjustments.

Setting	Description
Auto Exposure	Click the  Auto Exposure icon. To turn it on continuously, click Configuration , click the Color tab and select Continuous auto exposure . You can adjust the level of exposure adjustment using the slider.
Histogram	Provides a graphical interface for adjusting highlight, shadow, and gamma levels individually. For advanced users only. Click the  Histogram Adjustment icon to access the Histogram setting.
Tone Correction	Provides a graphical interface for adjusting tone levels individually. For advanced users only. Click the  Tone Correction icon to access the Tone Correction setting.
Color Balance	Adjusts the balance of red, green, and blue colors in the overall image. Click the  Image Adjustment icon to access the Color Balance settings.
Color Palette	Provides a graphical interface for adjusting mid-tone levels, such as skin tones, without affecting the highlight and shadow areas of the image. For advanced users only. See Using the Color Palette Feature (for Professional Mode Only) for more information. Click the  Color Palette icon to use the Color Palette settings.
Brightness	Adjusts the overall image lightness and darkness. Click the  Image Adjustment icon to access the Brightness setting.

Contrast	Adjusts the difference between the light and dark areas of the overall image. Click the  Image Adjustment icon to access the Contrast setting.
Saturation	Adjusts the density of colors in the overall image. Click the  Image Adjustment icon to access the Saturation setting.
Unsharp Mask	Turn on to make the edges of image areas clearer for an overall sharper image. The level of sharpness is adjustable. Turn off to leave softer edges.
Descreening	Removes the rippled pattern that can appear in subtly shaded image areas, such as skin tones. Also improves results when scanning magazine or newspaper images that include screening in their original print processes. The results of descreening do not appear in the preview, only in your scanned image. The level of descreening is adjustable.
Color Restoration	Restores the colors in faded photos automatically.
Backlight Correction	Removes shadows from photos that have too much background light. The level of backlight correction is adjustable.
Dust Removal	Removes dust marks from your originals automatically. The results of Dust Removal do not appear in the preview, only in your scanned image. The level of dust removal is adjustable.
Threshold	Adjusts the level at which the black areas in text and line art are delineated, improving text recognition in OCR programs. (Available only when you select Black & White as the Image Type setting.)

 **Note:**

- To view red, green, and blue levels at particular points in your preview image as you make adjustments, click the  densitometer icon in the Preview window and move your cursor over an image area. See Epson Scan Help for details.
- Certain settings may not be available, or may be automatically selected, depending on the type of image you are previewing and other settings you have selected.
- You can customize how certain Epson Scan settings behave by clicking **Configuration** and changing settings in the window that appears. See Epson Scan Help for details.
- To undo any image quality adjustments you make to the preview image, click **Reset** if available, turn off the setting, or preview your image again.

Top 

Selecting the Scan Size

You can scan your images at their original size, or you can reduce or enlarge their size as you scan them. You do this using the **Target Size** setting.

If you are going to scan your image to a specific size, you should select the **Target Size** setting after previewing it, but before adjusting your scan area indicated by creating a marquee. This sets the scan area to correct proportions so your image will not be cropped unexpectedly.

To select the scan size, see one of these sections.

Home Mode: [Selecting the Scan Size in Home Mode](#)

Professional Mode: [Selecting the Scan Size in Professional Mode](#)

Selecting the Scan Size in Home Mode

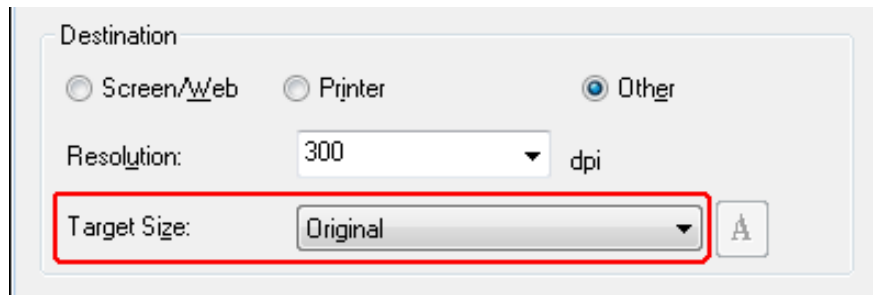

- 1 You can select a predefined scan size from the **Target Size** list. Click the arrow to open the list and select the size you want. A marquee (dotted line) proportioned for that size appears on your preview image.

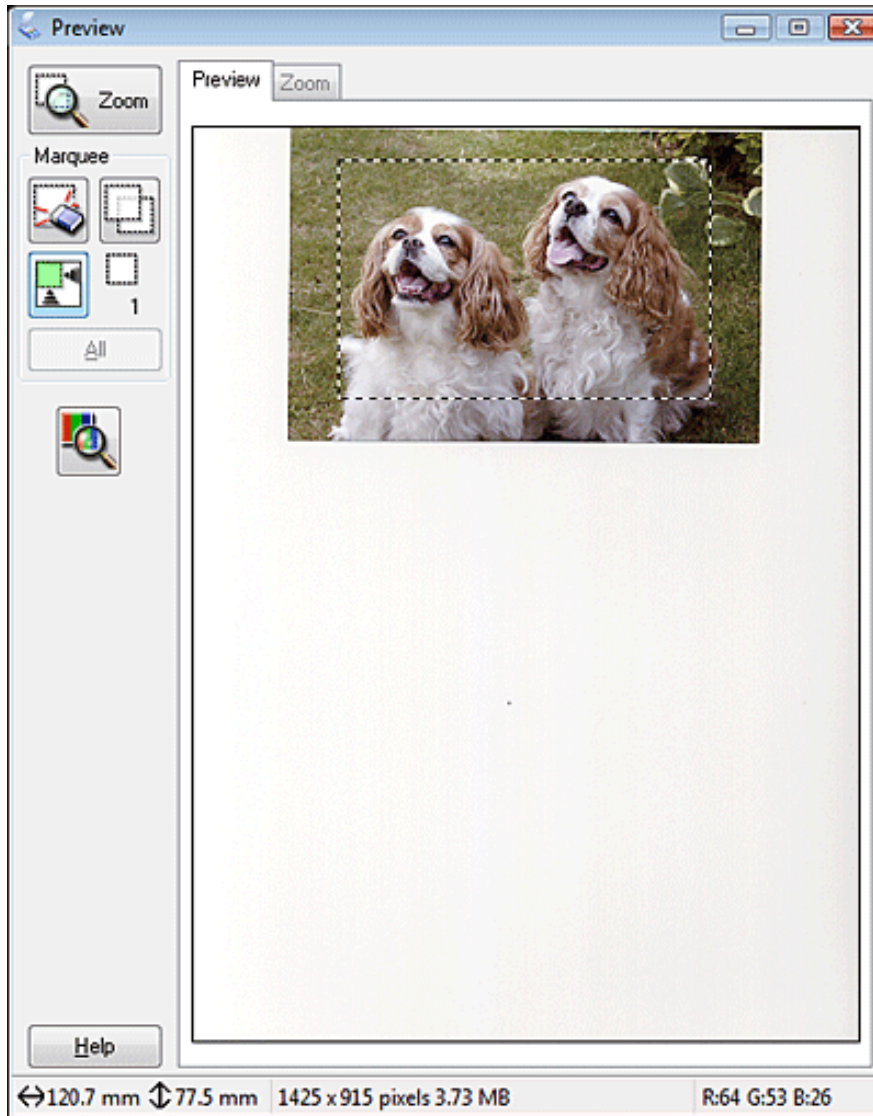

- 2 If you need to create a scan size that is not in the Target Size list, you can create a custom size. Click the arrow to open the list and select **Customize**. You see the Target Size window.

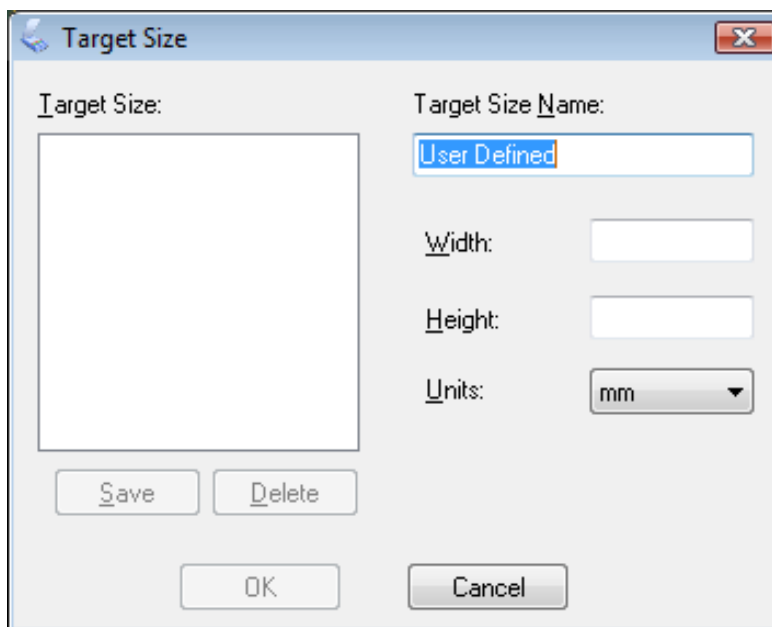

- 3 Type a name for your custom size, enter the size, click **Save**, then click **OK**. Your new size appears in the Target Size list.
- 4 Once you have selected your scan size, you can click and drag the marquee to the area in the image you want to scan. For details, see [Creating a Marquee on a Preview Image](#). The marquee proportions are retained as you adjust it.

If you need to rotate the marquee for a landscape or portrait image without changing its aspect ratio, click the



orientation icon.

 **Note:**



The orientation icon is not available if you selected **Original** as the Target Size setting.

Selecting the Scan Size in Professional Mode

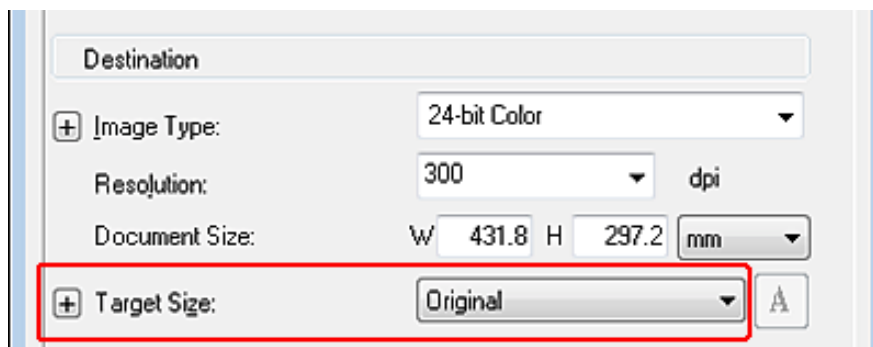

- 1 You can select a predefined scan size from the **Target Size** list. Click the arrow to open the list and select the size you want. A marquee (dotted line) proportioned for that size appears on your preview image.

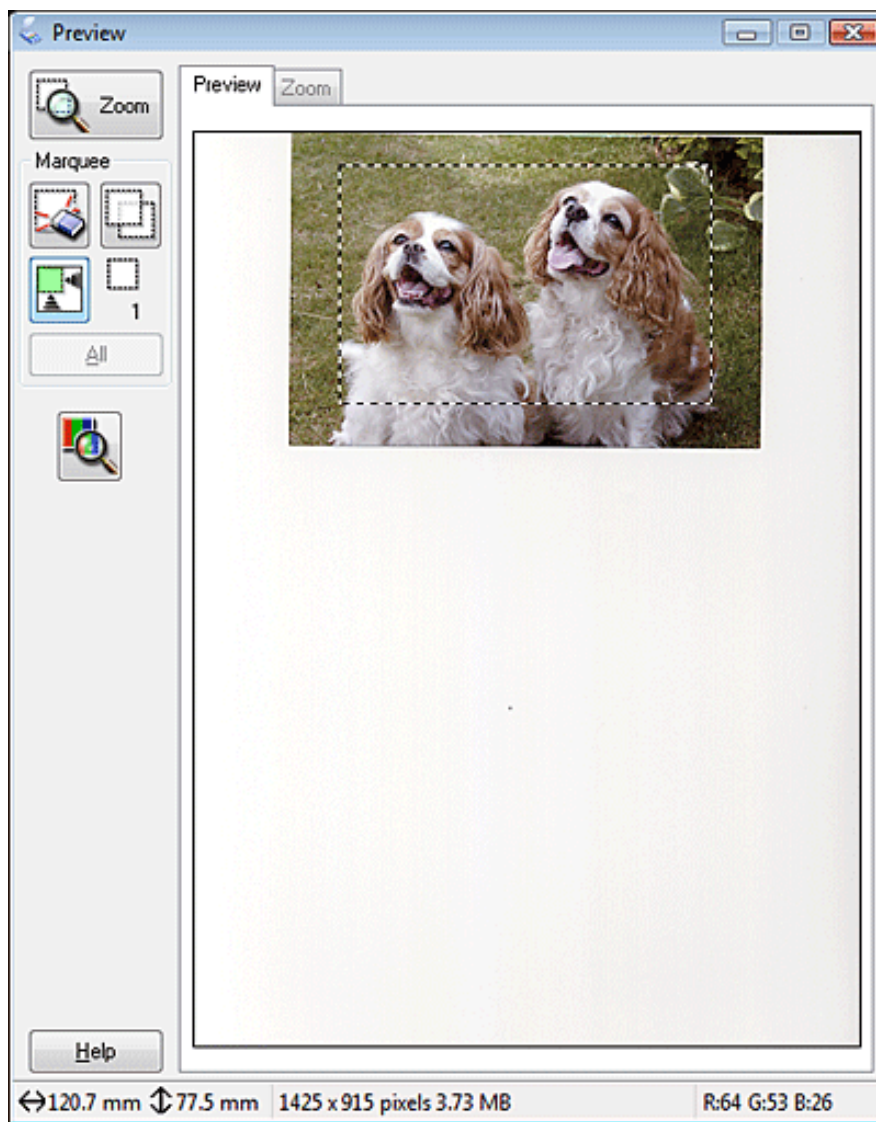

- 2 If you need to create a scan size that is not in the Target Size list, you can create a custom size. Click the arrow to open the list and select **Customize**. You see the Target Size window.

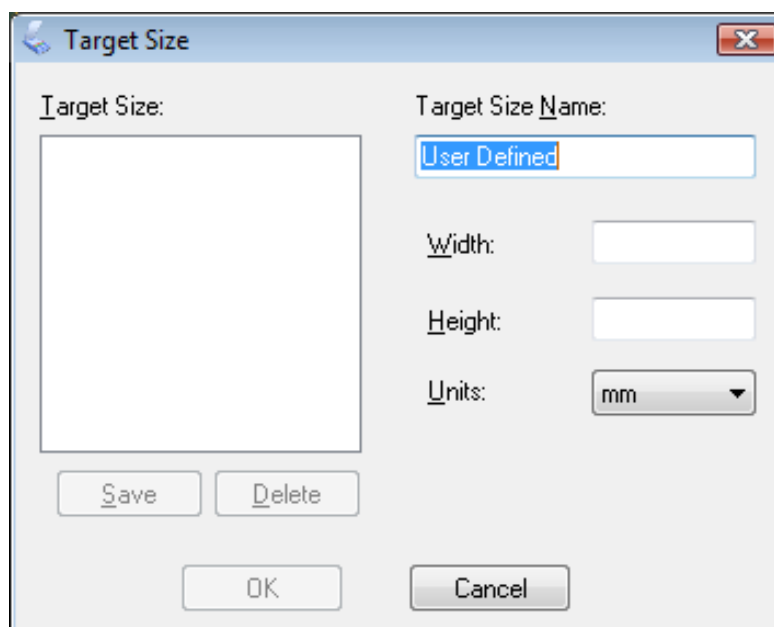

3 Type a name for your custom size, enter the size, click **Save**, then click **OK**. Your new size appears in the Target Size list.

4 You can fine-tune the size using additional tools. Click the + (Windows) or ▶ (Mac OS X) button next to **Target Size** to display these tools.

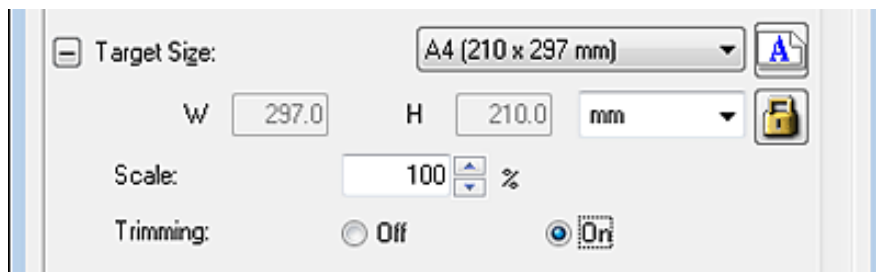

- To size your image by a certain percentage, adjust the **Scale** value.
- To change the way your image is cropped, turn **Trimming** on or off. See Epson Scan Help for details.

■ To unlock the proportions of your scan size, click the  lock icon. Then adjust the marquee or enter new width/height measurements.

5 Once you have selected your scan size, you can click and drag the marquee to the area in the image you want to scan. For details, see [Creating a Marquee on a Preview Image](#). The marquee proportions are retained as you adjust it.

If you want to rotate the marquee for a landscape or portrait image without changing its aspect ratio, click the  orientation icon.

 **Note:**

The  orientation icon is not available if you selected **Original** as the Target Size setting.

[Home](#) > [Scanning Your Originals](#)

Finishing the Scan

What happens after you scan depends on how you started your scan.

- If you started your scan by running Epson Scan from the EPSON Scan icon or by pressing the  Start button on the scanner, you see the File Save Settings window. This lets you select the name and location of your saved scan files. See [Selecting File Save Settings](#) for details. After you select these settings, Epson Scan starts scanning.
- If you started your scan from a TWAIN-compliant program such as Adobe Photoshop Elements, your scanned image(s) opens in the program window. If Epson Scan does not automatically close after scanning, click **Close** to exit the Epson Scan window and view your image(s) in the program.

Home > Scanning Special Projects

■ Text Enhancement

☑ Text Enhancement Using the PDF Button

☑ Text Enhancement in Office Mode

☑ Text Enhancement in Home Mode

When you scan documents, you can sharpen the text and increase accuracy by using the **Text Enhancement** feature in Epson Scan.

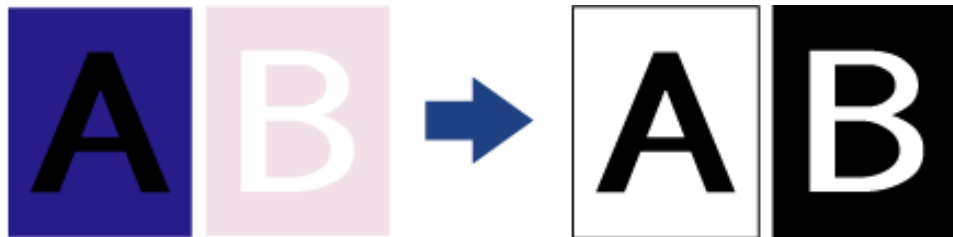

☑ Note:

You can enhance text only when you scan using a resolution of 600 dpi or less.

See one of these sections for instructions on text enhancement.

[Text Enhancement Using the PDF Button](#)

Office Mode: [Text Enhancement in Office Mode](#)

Home Mode: [Text Enhancement in Home Mode](#)

☑ Note:



The instructions in these sections are for scanning to a PDF file, but text enhancement is also effective when you convert scanned documents into editable text. See [Converting Scanned Documents Into Editable Text](#) for details.

Text Enhancement Using the PDF Button

- 1 Place your document on the document table or in the ADF. See [Placing Documents or Photos](#) or [Loading Documents in the Automatic Document Feeder](#) for instructions.
- 2 Press the  PDF button on the scanner.
- 3 When you see the Scan to PDF window, click **Settings**. You see the Scan to PDF Settings window.

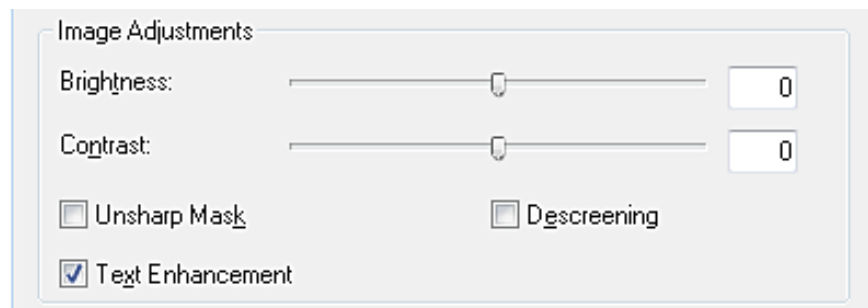
- 4 In the Scan to PDF Settings window, select the Image Type and Destination settings. For details, see [Scanning Using the PDF Button](#).
- 5 Click the **Text Enhancement** check box.



- 6 Make any other necessary image adjustments. See [Adjusting the Color and Other Image Settings](#) for details.
- 7 Click **File Save Settings**. Make file save settings as necessary and click **OK**. See [Scanning Using the PDF Button](#) for details.
- 8 Click **Close** to close the Scan to PDF Settings window, then click **Scan** or press the  Start button on the scanner. Epson Scan scans your page.
- 9 When you are finished scanning all of your pages, click **Finish** or press the  PDF button on the scanner. Your document is saved as a PDF file in the Pictures or My Pictures folder, or in the location you selected in the File Save Settings window.

Top 

Text Enhancement in Office Mode

- 1 Place your document on the document table or in the ADF. See [Placing Documents or Photos](#) or [Loading Documents in the Automatic Document Feeder](#) for instructions.
- 2 Start Epson Scan. See [Starting Epson Scan](#) for instructions.
- 3 In the Office Mode window, select the **Image Type**, **Document Source**, **Size**, and **Resolution** settings. For details, [Scanning in Office Mode](#).
- 4 Click the **Text Enhancement** check box.

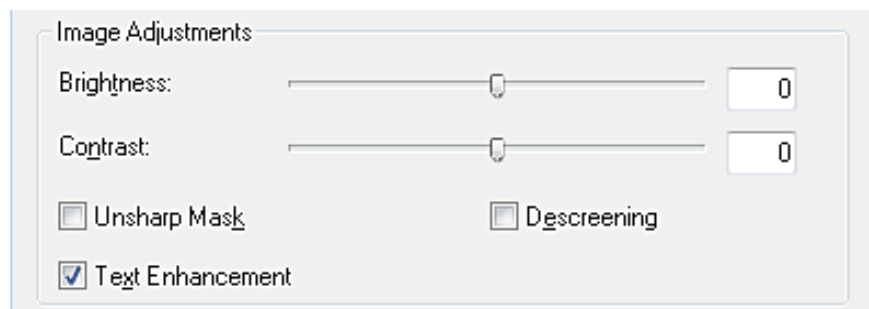

- 5 Click **Preview** to preview your document, then select your scan area. For details, see [Previewing and Adjusting the Scan Area](#).
- 6 Make any other necessary image adjustments. See [Adjusting the Color and Other Image Settings](#) for details.
- 7 Click **Scan**. The File Save Settings window appears.
- 8 Make File Save and PDF settings as necessary. See [Scanning to a PDF File in Office Mode](#) for details.
- 9 Click **OK**. Epson Scan scans your document.

Top

Text Enhancement in Home Mode

- 1 Place your document on the document table. See [Placing Documents or Photos](#) for instructions.
- 2 Start Epson Scan. See [Starting Epson Scan](#) for instructions.
- 3 In the Home Mode window, select the **Document Type**, **Image Type**, and **Destination** settings. For details, see [Scanning in Home Mode](#).
- 4 Click the **Text Enhancement** check box.

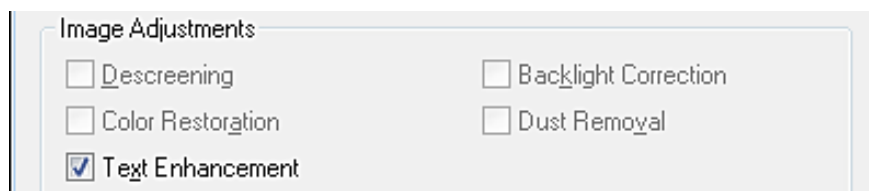

- 5 Click **Preview** to preview your document, then select your scan area. For details, see [Previewing and Adjusting the Scan Area](#).
- 6 Make any other necessary image adjustments. See [Adjusting the Color and Other Image Settings](#) for details.
- 7 Click **Scan**. The File Save Settings window appears.
- 8 Make File Save and PDF settings as necessary. See [Scanning to a PDF File in Home Mode](#) for details.



Click **OK**. Epson Scan scans your document.

[Top](#) 

Home > Scanning Special Projects

Scanning to a PDF File

- Scanning Using the PDF Button
- Scanning to a PDF File in Office Mode
- Scanning to a PDF File in Home Mode
- Scanning to a PDF File in Professional Mode
- Double-sided Scanning

The easiest way to scan multiple document pages to a PDF file is to press the  PDF button on the scanner. See [Scanning Using the PDF Button](#) for instructions.

Using Epson Scan, you can create a PDF file with the following features.

Scanning multiple document pages into a single PDF file: You can scan multiple document pages and save them in a single PDF file.

Creating a searchable PDF file: You can create a PDF file with search functionality, so that you can look for words in the file. (This feature may not be available in some countries.)

Assigning document security settings: You can assign password settings to the PDF file.

Specifying the number of pages in a single PDF file: You can specify the maximum number of pages that can be included in one PDF file. For example, if you are scanning a 20-page document, and specify the page number to be included in one PDF as 4, 5 PDF files are automatically created.

Note:

You need ABBYY FineReader that came with your scanner to use some of these features. If you have installed your scanning software as described in the paper manual, it has already been installed. (ABBYY FineReader may not be available in some countries.)

See one of these sections to start scanning to a PDF file.

[Scanning Using the PDF Button](#)

Office Mode: [Scanning to a PDF File in Office Mode](#)

Home Mode: [Scanning to a PDF File in Home Mode](#)

Professional Mode: [Scanning to a PDF File in Professional Mode](#)

Scanning Using the PDF Button

- 1 Place your document on the document table or in the ADF. See [Placing Documents or Photos](#) or [Loading Documents in the Automatic Document Feeder](#) for instructions.
- 2 Press the  PDF button on the scanner. You see the Scan to PDF window.

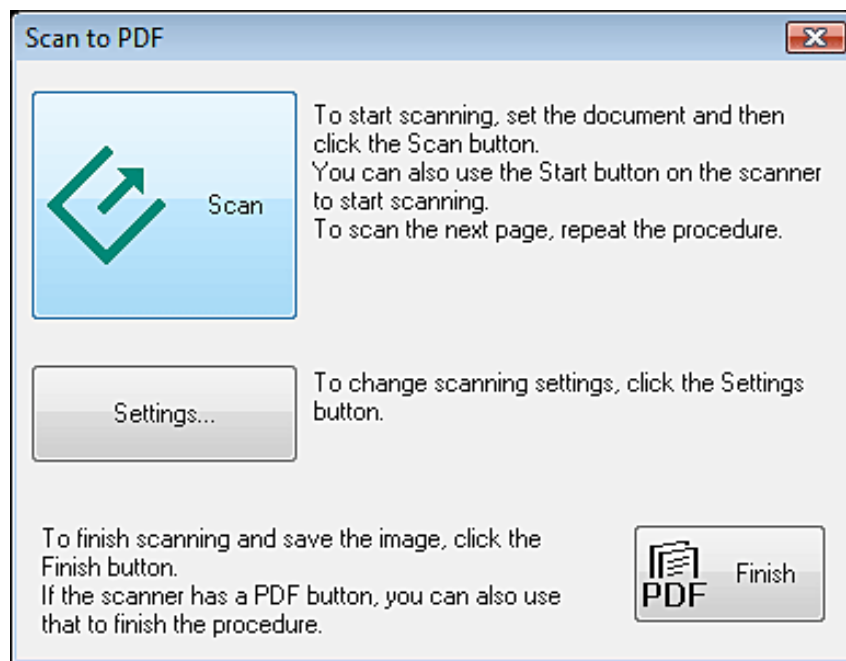

3 Click **Settings**. You see the Scan to PDF Settings window.

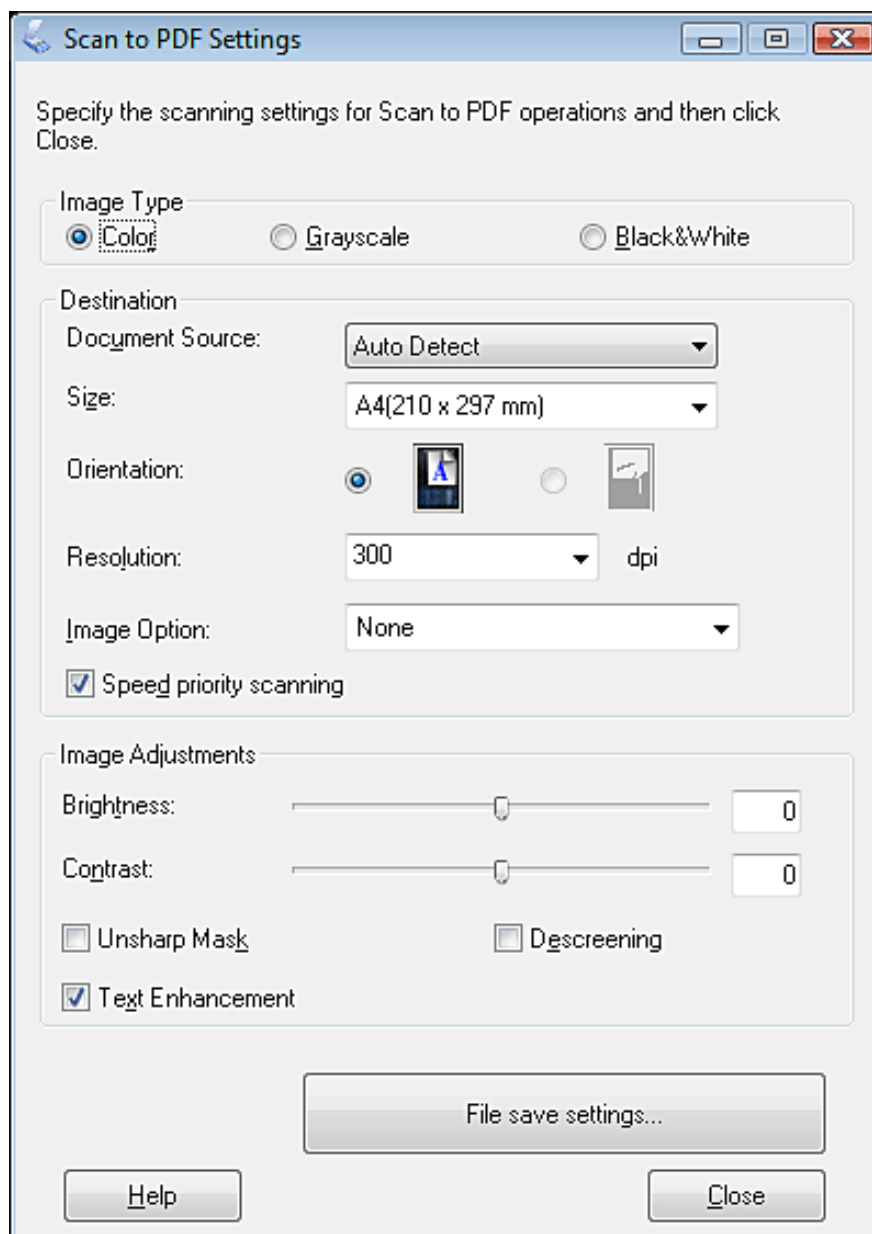

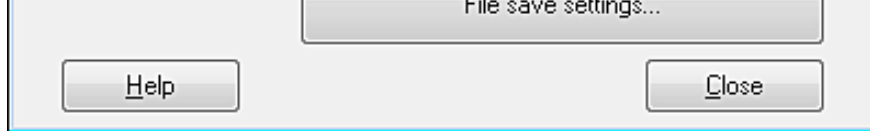

- 4 Select **Color**, **Grayscale**, or **Black&White** as the Image Type setting to select the colors in the original.
- 5 Select one of these settings as the Document Source setting.
 - **Auto Detect:** This setting automatically determines whether to load your document from the ADF or scan it from the document table.
 - **Document Table:** Select this setting when you want to scan using the document table.
 - **ADF:** Select this setting when you want to scan using the ADF.
- 6 Click the arrow to open the **Size** list and select the size of your original(s).
- 7 If you need to select a size that is not in the Size list, you can create a custom size. Click the arrow in the Size list and select **Customize**. You see the Source Size window.

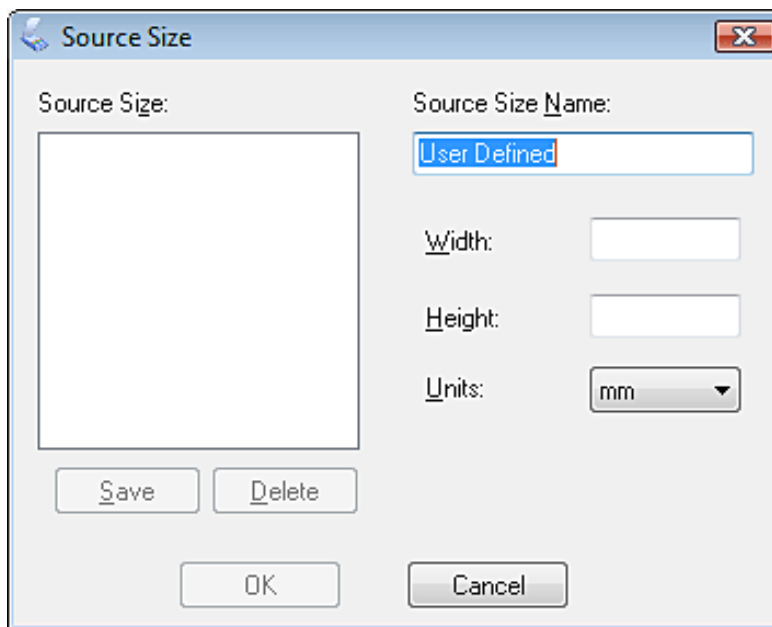

Type a name for your custom size, enter the size, click **Save**, then click **OK**. Your new size appears in the Size list.

- 8 Click the arrow next to the **Resolution** list and select the number of dots per inch at which you want to scan. See the table below for guidelines.

What you will do with the scanned image	Suggested scan resolution
Send via e-mail, upload to web, view only on the screen	96 to 150 dpi
Fax	200 dpi
Print	300 dpi

- 9 Use the settings in the Image Adjustments area of the window to modify the image quality if necessary. See the table below for guidelines.

Setting	Description

Brightness	Adjusts the overall image lightness and darkness. This setting is available only when the image type is set to Color or Grayscale.
Contrast	Adjusts the difference between the light and dark areas of the overall image. This setting is available only when the image type is set to Color or Grayscale.
Unsharp Mask	Turn on to make the edges of image areas clearer for an overall sharper image. Turn off to leave softer edges. This setting is available only when the image type is set to Color or Grayscale.
Descreening	Removes the rippled pattern that can appear in subtly shaded image areas, such as skin tones. Also improves results when scanning magazine or newspaper images that include screening in their original print process. This setting is available only when the image type is set to Color or Grayscale.
Text Enhancement	Enhances text recognition when scanning text documents.
Threshold	Adjusts the level at which the black areas in text and line art are delineated, improving text recognition in OCR programs. This setting is available only when the image type is set to Black&White.

10 Click **File Save Settings**. The File Save Settings window appears. The current Paper Size, Orientation, Margin, and other settings are displayed below it.

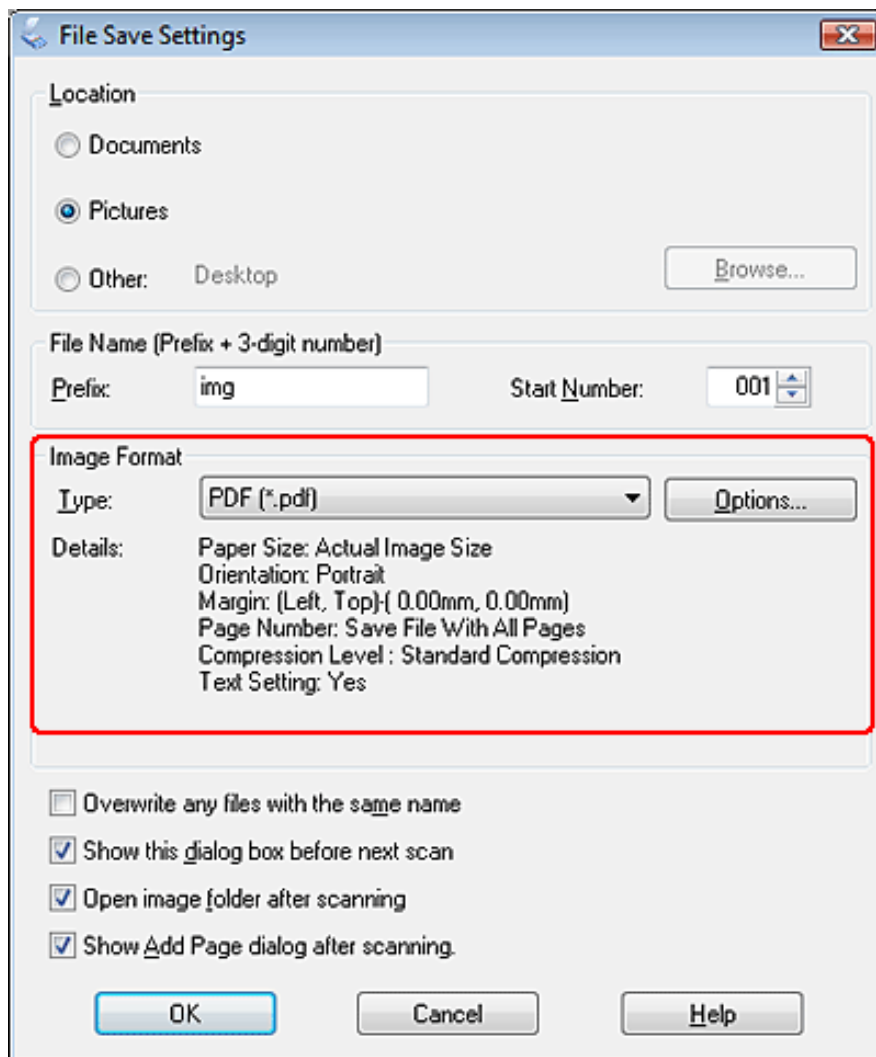

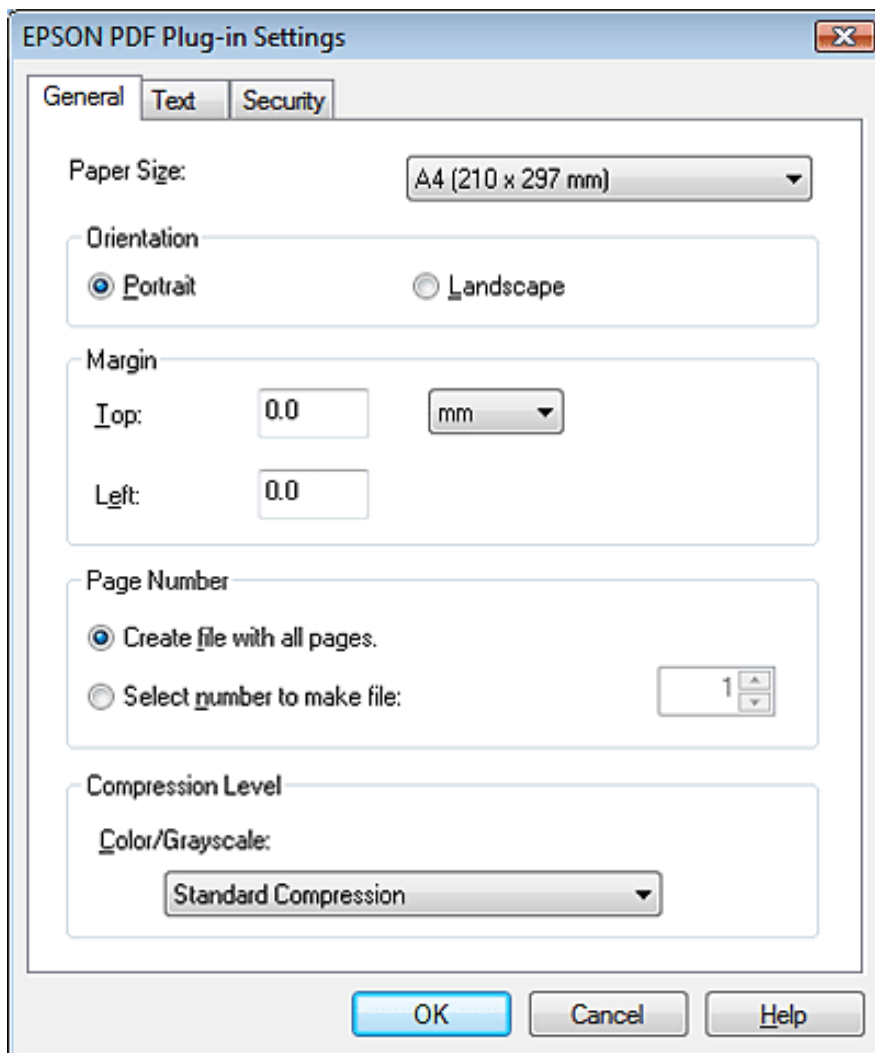

- 11 If you need to change any of the current PDF settings, click **Options**. You see the EPSON PDF Plug-in Settings window.





Select the settings that match your document and click **OK**. You return to the File Save Settings window.

 **Note:**

The Text tab is available only when ABBYY FineReader is installed. If ABBYY FineReader is not available in your country, you will not see the Text tab.

- 12 Make any other file save settings, and click **OK**.
- 13 Click **Close** to close the Scan to PDF Settings window, then click **Scan** or press the  Start button on the scanner. Epson Scan scans your page.
- 14 If you are scanning multiple pages using the document table, replace the first page on the document table with the second page and click **Scan** or press the  Start button again. Repeat this step for each page in your document.

If you are scanning more than 40 pages, you can load the rest of the pages into the ADF and click **Scan** or press the  Start button again to continue.

- 15** When you are finished, click **Finish** or press the  PDF button on the scanner. Your document is saved as a PDF file in the Pictures or My Pictures folder, or in the location you selected in the File Save Settings window.

Top 

Scanning to a PDF File in Office Mode

- 1** Place your document on the document table or in the ADF. See [Placing Documents or Photos](#) or [Loading Documents in the Automatic Document Feeder](#) for instructions.
- 2** Start Epson Scan. See [Starting Epson Scan](#) for instructions.
- 3** In the Office Mode window, select the **Image Type**, **Document Source**, **Size**, and **Resolution** settings. For details, [Scanning in Office Mode](#).
- 4** Click **Preview** to preview your image(s), then select your scan area. For details, see [Previewing and Adjusting the Scan Area](#).
- 5** Make any other necessary image adjustments. See [Adjusting the Color and Other Image Settings](#) for details.
- 6** Click **Scan**. The File Save Settings window appears.
- 7** Select **PDF** as the Type setting. The current Paper Size, Orientation, Margin, Page Number, Compression Level, and Text Setting settings are displayed below it.

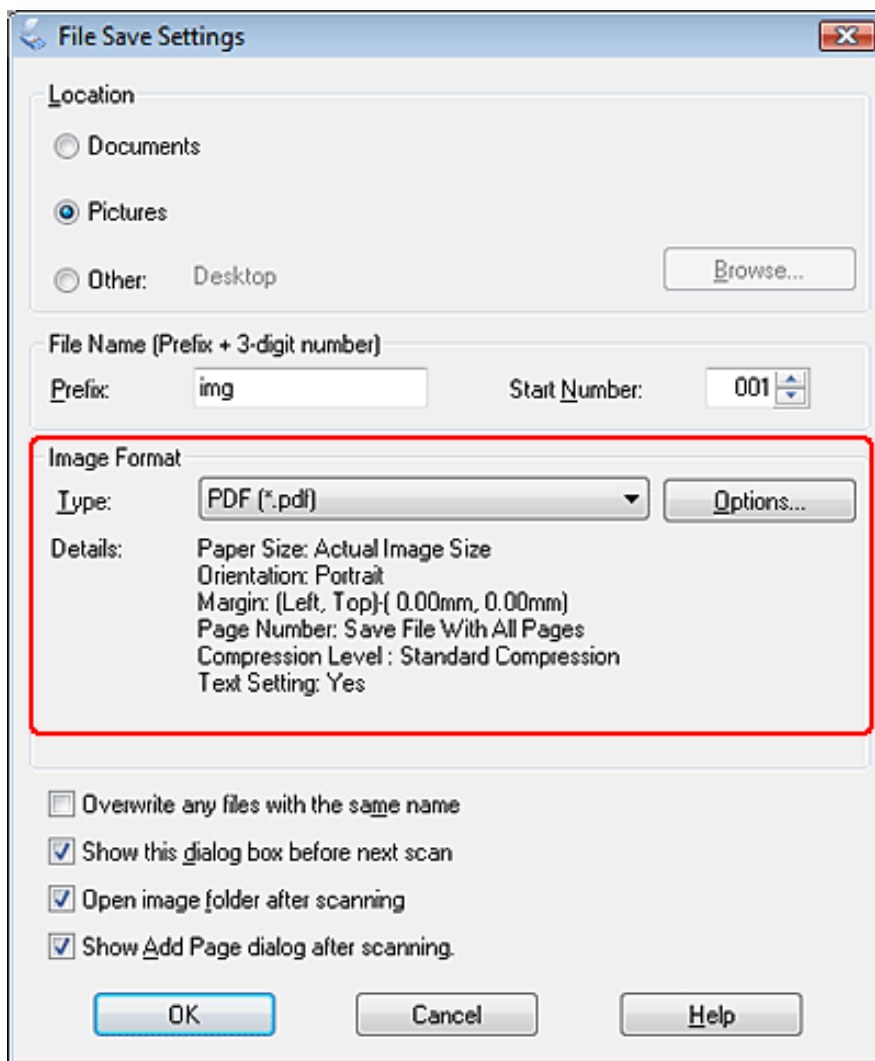

8

Click **Options**. You see the EPSON PDF Plug-in Settings window.

To create a searchable PDF file, click the **Text** tab, select the **Create searchable PDF** check box, then select your language from the **Text Language** list.

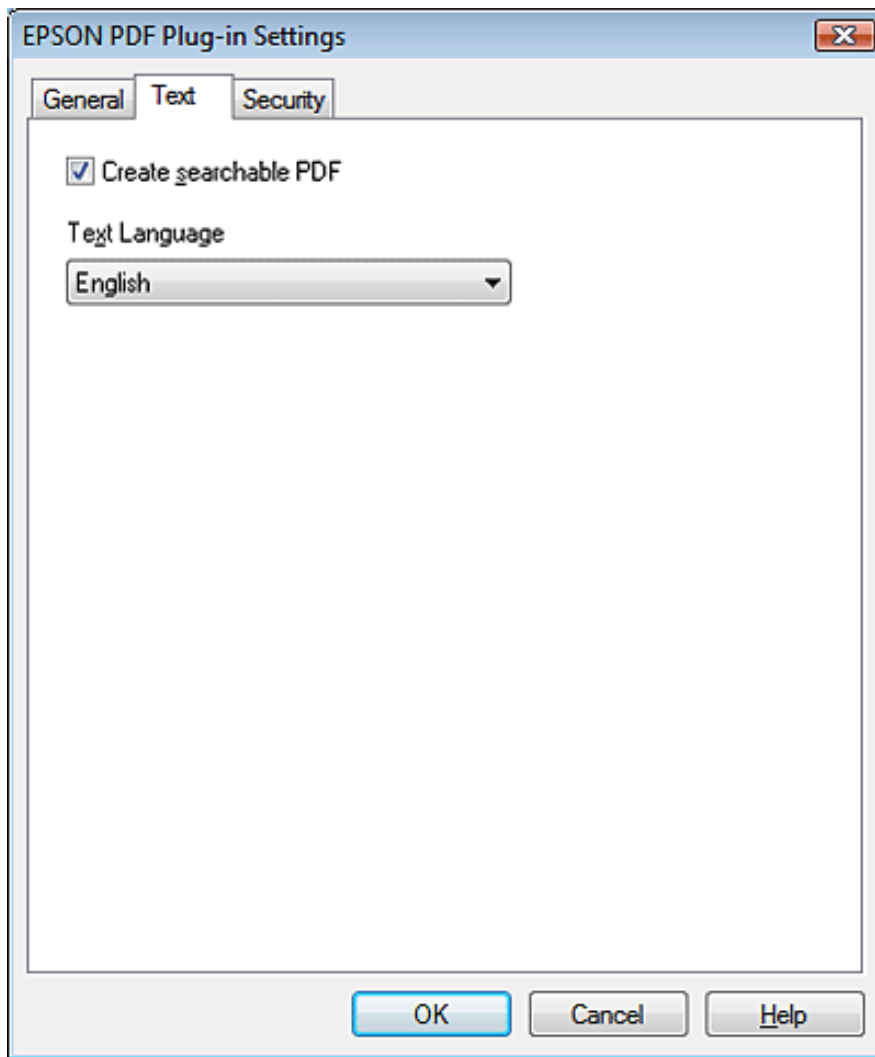

 **Note:**

The Text tab is available only when ABBYY FineReader is installed. If ABBYY FineReader is not available in your country, you will not see the Text tab.

To assign password settings to the PDF file, click the **Security** tab and select the password settings.

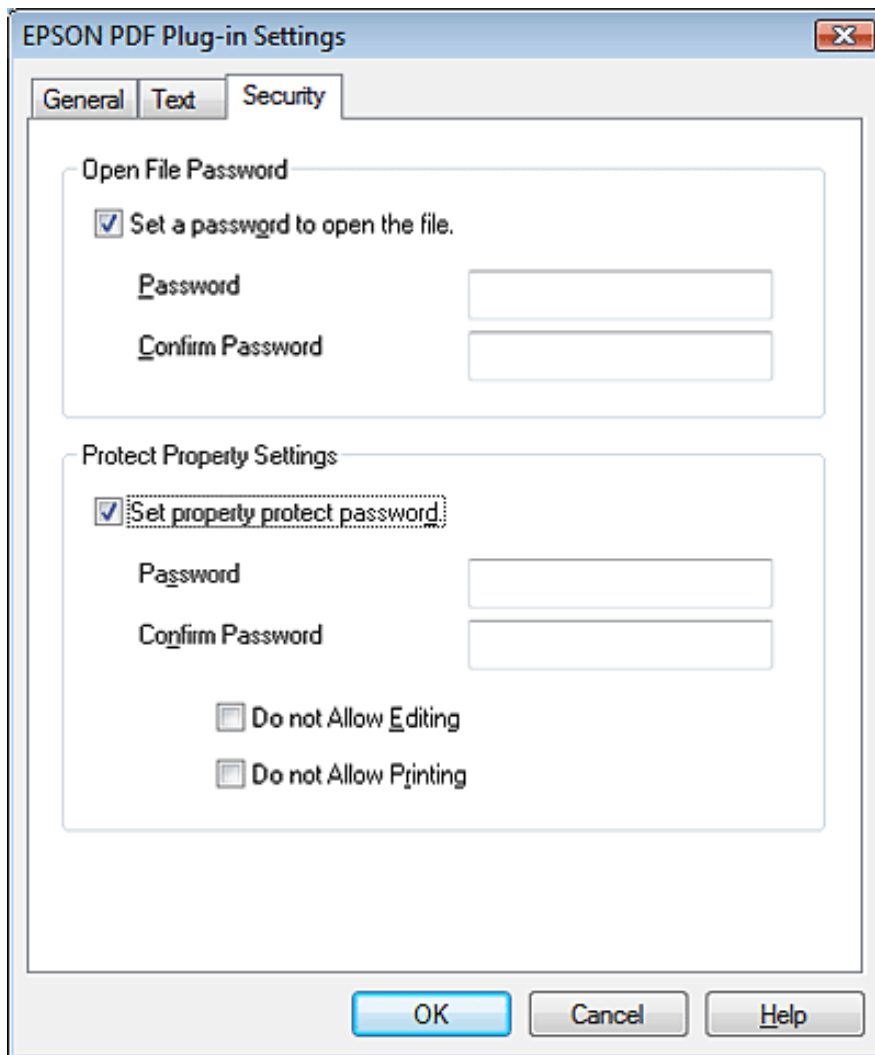

To specify the maximum number of pages that can be included in one PDF file, click the **General** tab and adjust the **Select number to make file** setting.

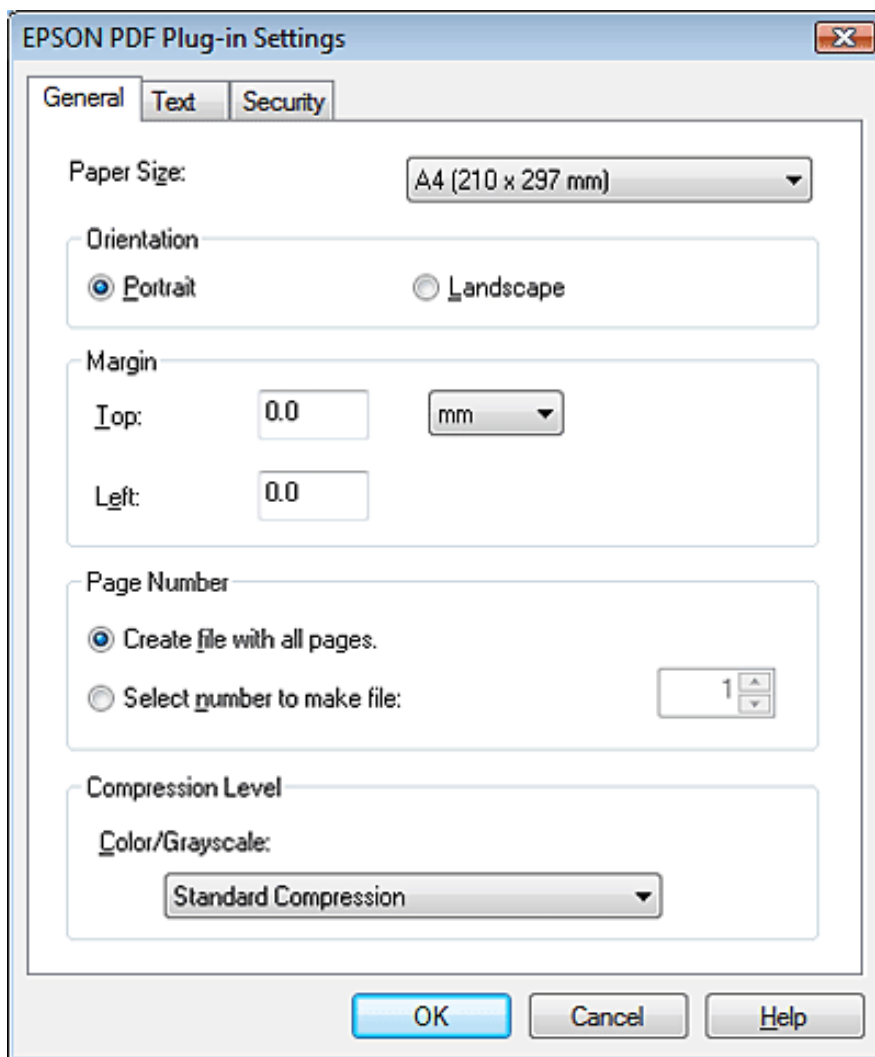

For other settings in the EPSON PDF Plug-in Settings window, see Epson Scan Help for details.

- 9 Select the settings that match your document and click **OK**. You return to the File Save Settings window.
- 10 Make any other file save settings, and click **OK**. Epson Scan scans your document and displays the window below.

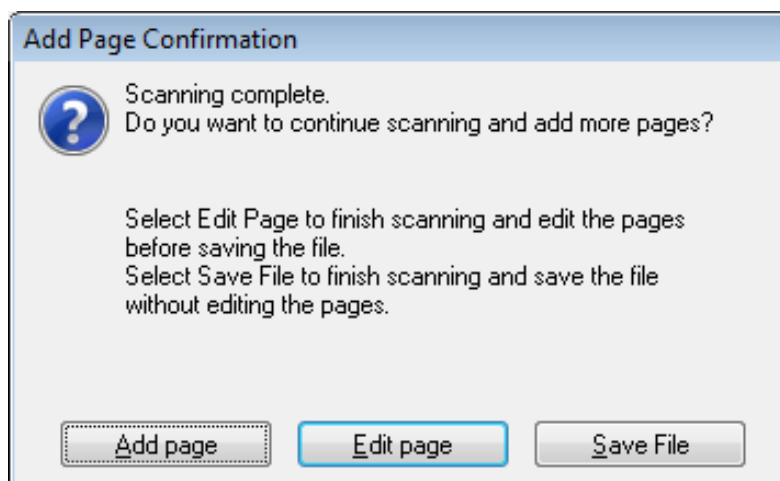

 **Note:**

If you deselect the **Show Add Page dialog after scanning** check box in the File Save Settings window, this window does not appear and Epson Scan automatically saves your document.

11 Select one of the following options.



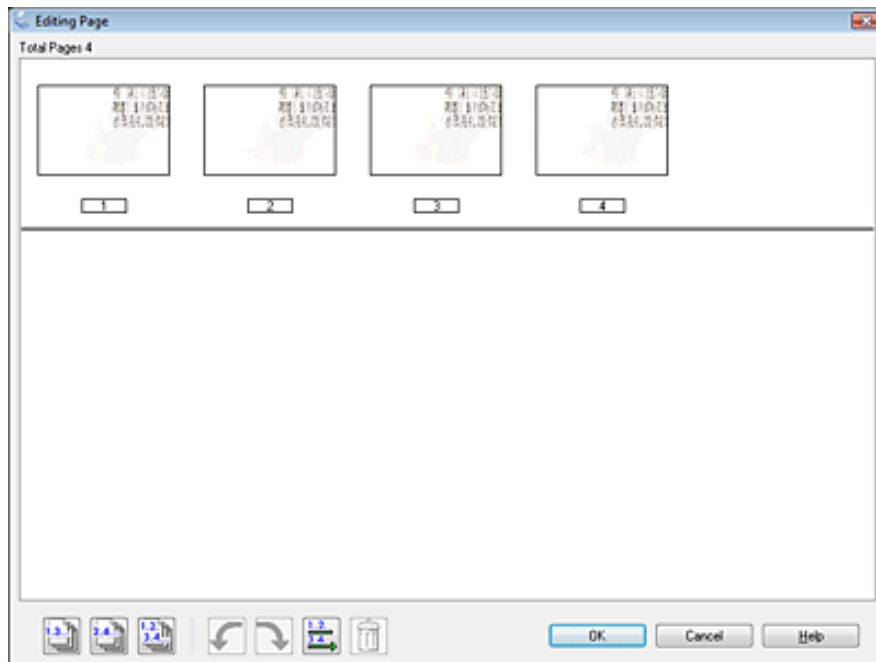

- **Add page:** Click this button to scan the next page of your document. Replace the first page on the document table with the next page, and click **Scan**. Repeat this step for each page in your document. When you are finished, click **Edit page** and go to step 12.
- **Edit page:** Click this button if you have scanned all the necessary pages so you can edit the scanned pages before saving them in one PDF file. Then go to step 12.
- **Save File:** Click this button when you are ready to finish scanning and save the scanned pages into one PDF without editing them. Then go to step 14.



12 You see the Editing Page window displaying thumbnail images of each scanned page.



Use the tools at the bottom of the Editing Page window to select, rotate, reorder, and delete pages.

If you want to include all the document pages in your PDF files as they currently look, go to step 13.

If you want to rotate pages, click the pages, or use the  odd pages,  even pages, or  all pages icon to select the pages, then click the  left or  right rotate icon to rotate them.

If you want to delete pages, click the pages, or use the  odd pages, or  even pages icon to select the pages, then click the  delete icon to delete them.

 **Note:**

The  delete icon is not available when all pages are selected.

For further details on the tools in the Editing Page window, see Epson Scan Help.

13 When you have finished editing your pages, click **OK**. The pages are saved in one PDF file in Pictures, My Pictures, or the location you selected in the File Save Settings window, and you return to the Office Mode window.

14 Click **Close** to exit Epson Scan.

Top 

Scanning to a PDF File in Home Mode

1 Place your document on the document table. See [Placing Documents or Photos](#) for instructions.

 **Note:**

In Home Mode you can only scan from the document table. If you want to scan using the ADF, change to Office Mode or Professional Mode. See [Changing the Scan Mode](#) for details.

2 Start Epson Scan. See [Starting Epson Scan](#) for instructions.

3 In the Home Mode window, select the **Document Type**, **Image Type**, and **Destination** settings. For details, see [Scanning in Home Mode](#).

4 Click **Preview** to preview your image(s), then select your scan area. For details, see [Previewing and Adjusting the Scan Area](#).

5 Make any other necessary image adjustments. See [Adjusting the Color and Other Image Settings](#) for details.

6 Size your image as necessary. See [Selecting the Scan Size](#) for details.

7 Click **Scan**. The File Save Settings window appears.

8 Select **PDF** as the Type setting. The current Paper Size, Orientation, Margin, Page Number, Compression Level, and Text Setting settings are displayed below it.

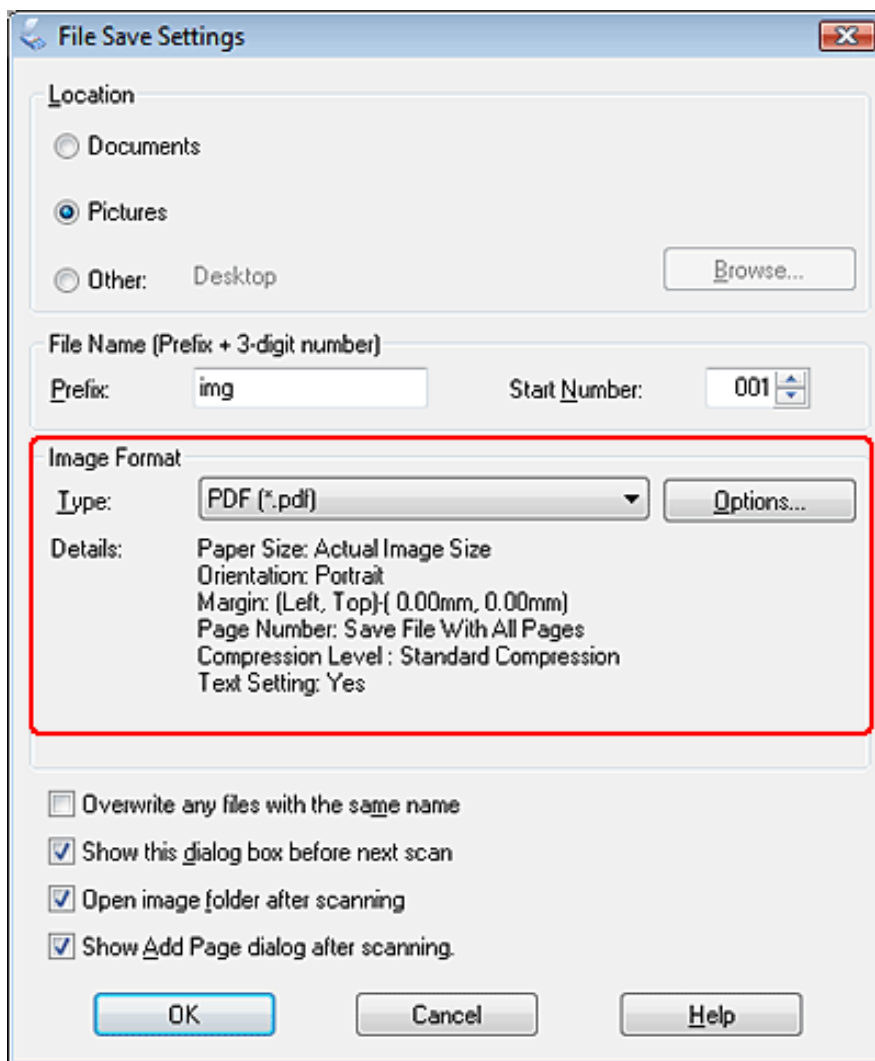

9 Click **Options**. You see the EPSON PDF Plug-in Settings window.

To create a searchable PDF file, click the **Text** tab, select the **Create searchable PDF** check box, then select your language from the **Text Language** list.

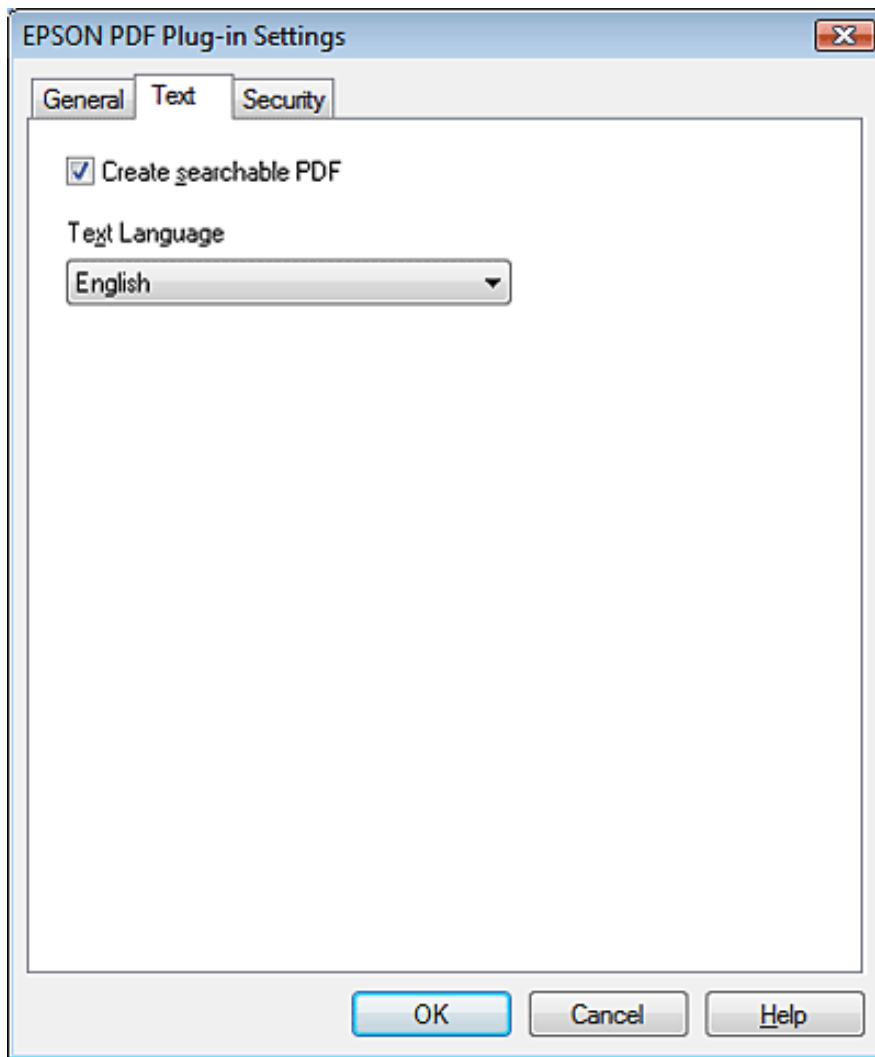

 **Note:**

The Text tab is available only when ABBYY FineReader is installed. If ABBYY FineReader is not available in your country, you will not see the Text tab.

To assign password settings to the PDF file, click the **Security** tab and select the password settings.

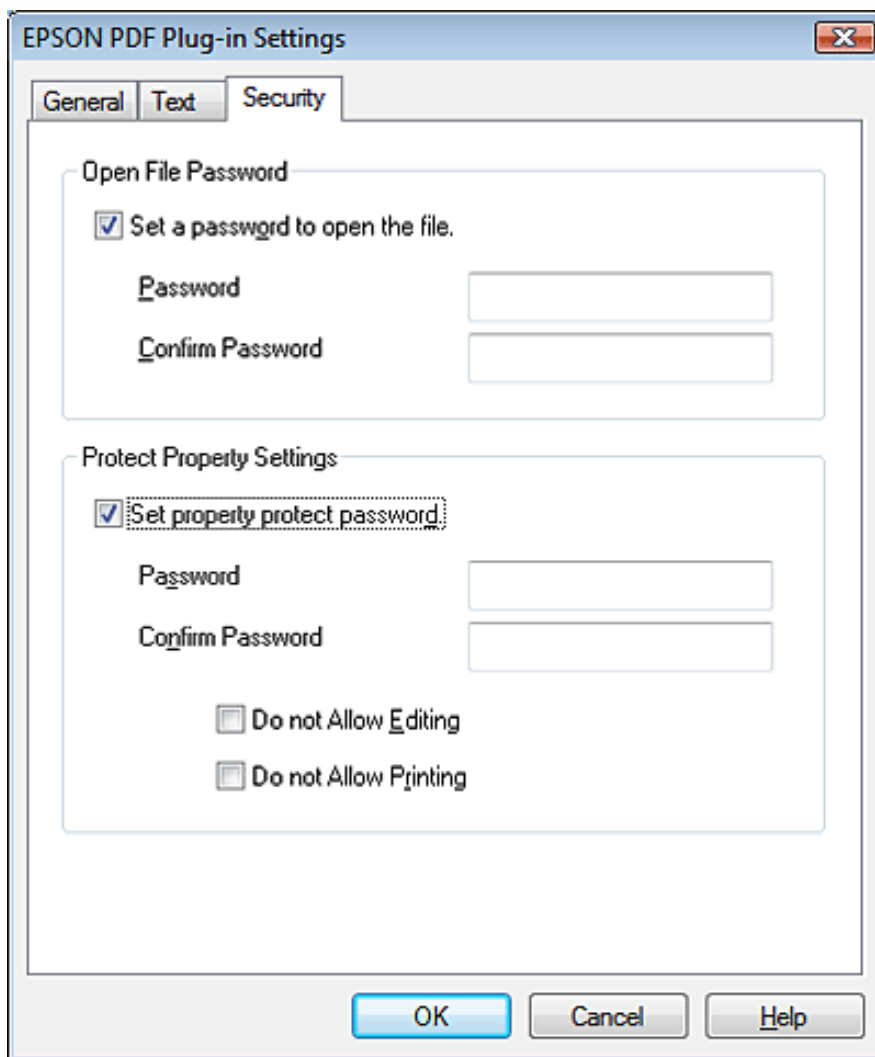

To specify the maximum number of pages that can be included in one PDF file, click the **General** tab and adjust the **Select number to make file** setting.

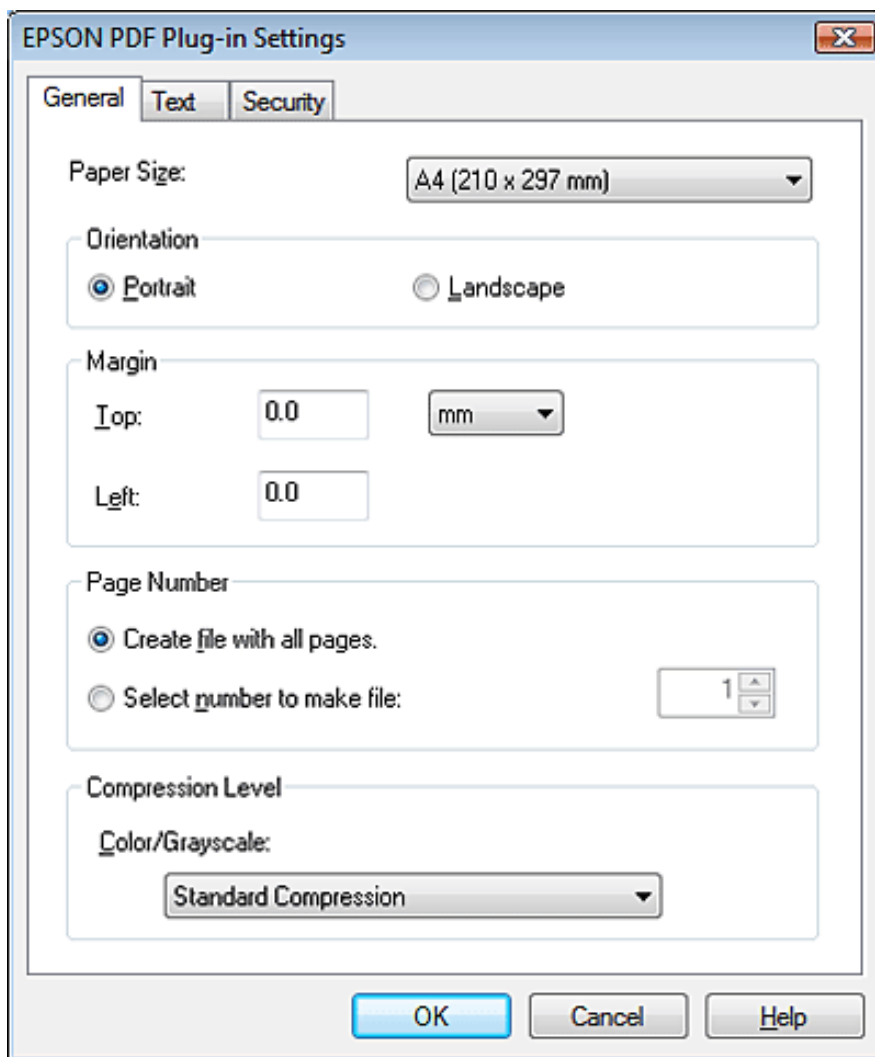

For other settings in the EPSON PDF Plug-in Settings window, see Epson Scan Help for details.

- 10 Select the settings that match your document and click **OK**. You return to the File Save Settings window.
- 11 Make any other file save settings, and click **OK**. Epson Scan scans your document and displays the window below.

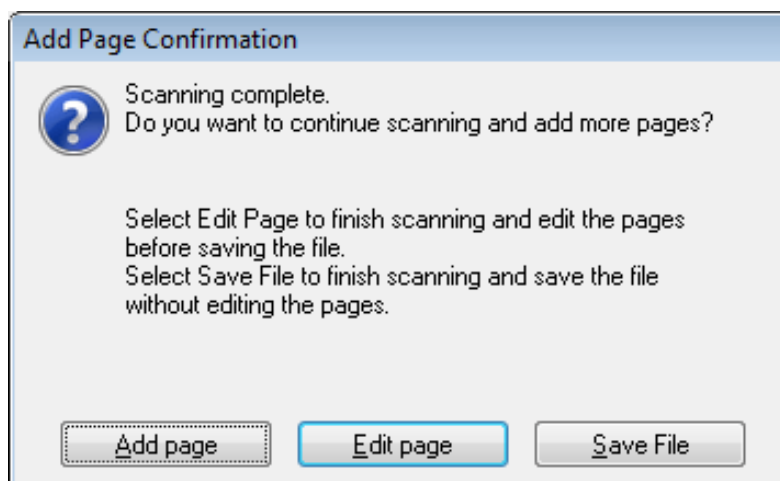

 **Note:**

If you deselect the **Show Add Page dialog after scanning** check box in the File Save Settings window, this window does not appear and Epson Scan automatically saves your document.

12 Select one of the following options.



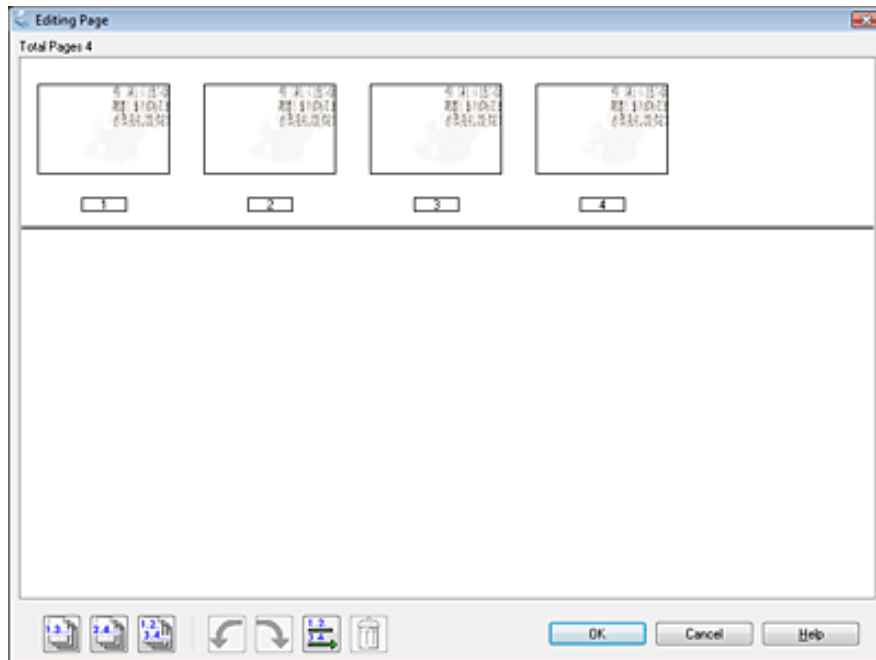

- **Add page:** Click this button to scan the next page of your document. Replace the first page on the document table with the next page, and click **Scan**. Repeat this step for each page in your document. When you are finished, click **Edit page** and go to step 13.
- **Edit page:** Click this button if you have scanned all the necessary pages so you can edit the scanned pages before saving them in one PDF file. Then go to step 13.
- **Save File:** Click this button when you are ready to finish scanning and save the scanned pages into one PDF without editing them. Then go to step 15.



13 You see the Editing Page window displaying thumbnail images of each scanned page.



Use the tools below the Editing Page window to select, rotate, reorder, and delete pages.

If you want to include all the document pages in your PDF files as they currently look, go to step 14.

If you want to rotate pages, click the pages, or use the  odd pages,  even pages, or  all pages icon to select the pages, then click the  left or  right rotate icon to rotate them.

If you want to delete pages, click the pages, or use the  odd pages or,  even pages icon to select the pages, then click the  delete icon to delete them.

 **Note:**

The  delete icon is not available when all pages are selected.

For further details on the tools in the Editing Page window, see Epson Scan Help.

14 When you have finished editing your pages, click **OK**. The pages are saved in one PDF file in Pictures, My Pictures, or the location you selected in the File Save Settings window, and you return to the Home Mode window.

15 Click **Close** to exit Epson Scan.

Top 

Scanning to a PDF File in Professional Mode

1 Place your document on the document table or in the ADF. See [Placing Documents or Photos](#) or [Loading Documents in the Automatic Document Feeder](#) for instructions.

2 Start Epson Scan. See [Starting Epson Scan](#) for instructions.

3 In the Professional Mode window, select the **Document Type**, **Document Source**, **Auto Exposure Type**, **Image Type**, and **Resolution** settings. For details, see [Scanning in Professional Mode](#).

4 Click **Preview** to preview your image(s), then select your scan area. For details, see [Previewing and Adjusting the Scan Area](#).

5 Make any other necessary image adjustments. See [Adjusting the Color and Other Image Settings](#) for details.

6 Size your image as necessary. See [Selecting the Scan Size](#) for details.

7 Click **Scan**. The File Save Settings window appears.

8 Select **PDF** as the Type setting. The current Paper Size, Orientation, Margin, Page Number, Compression Level, and Text Setting settings are displayed below it.

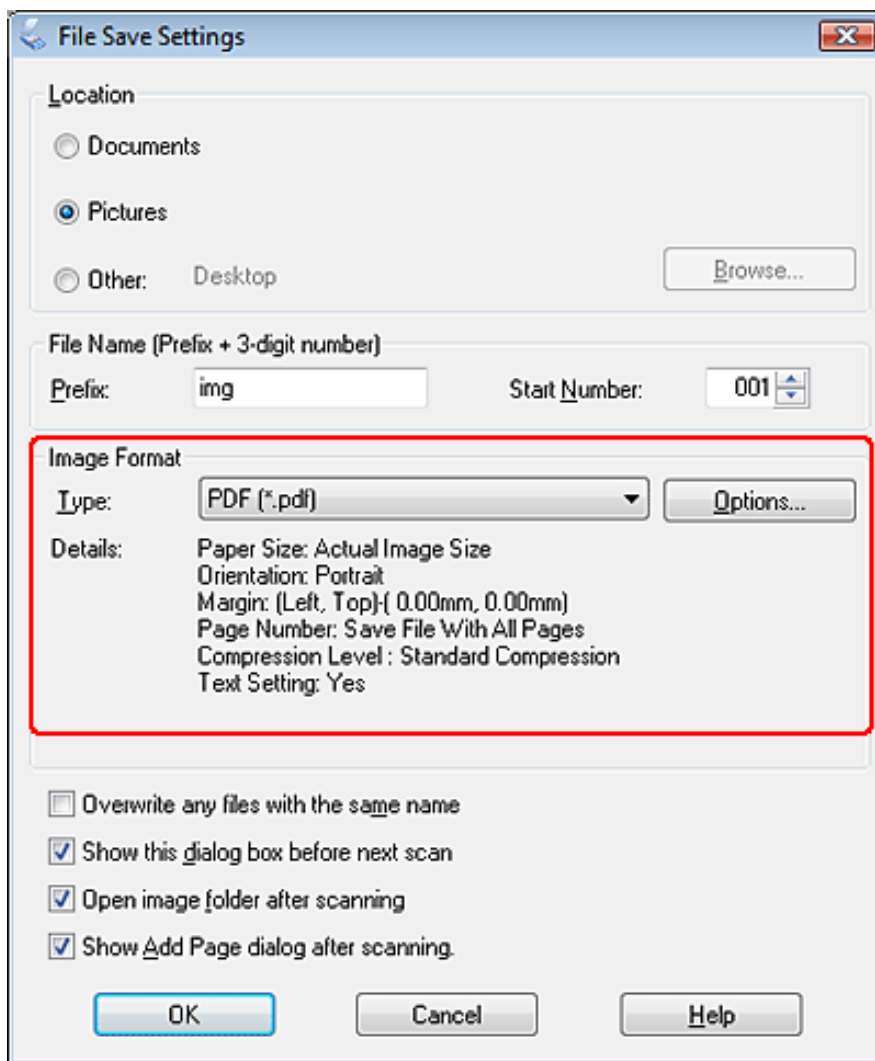

9 Click **Options**. You see the EPSON PDF Plug-in Settings window.

To create a searchable PDF file, click the **Text** tab, select the **Create searchable PDF** check box, then select your language from the **Text Language** list.

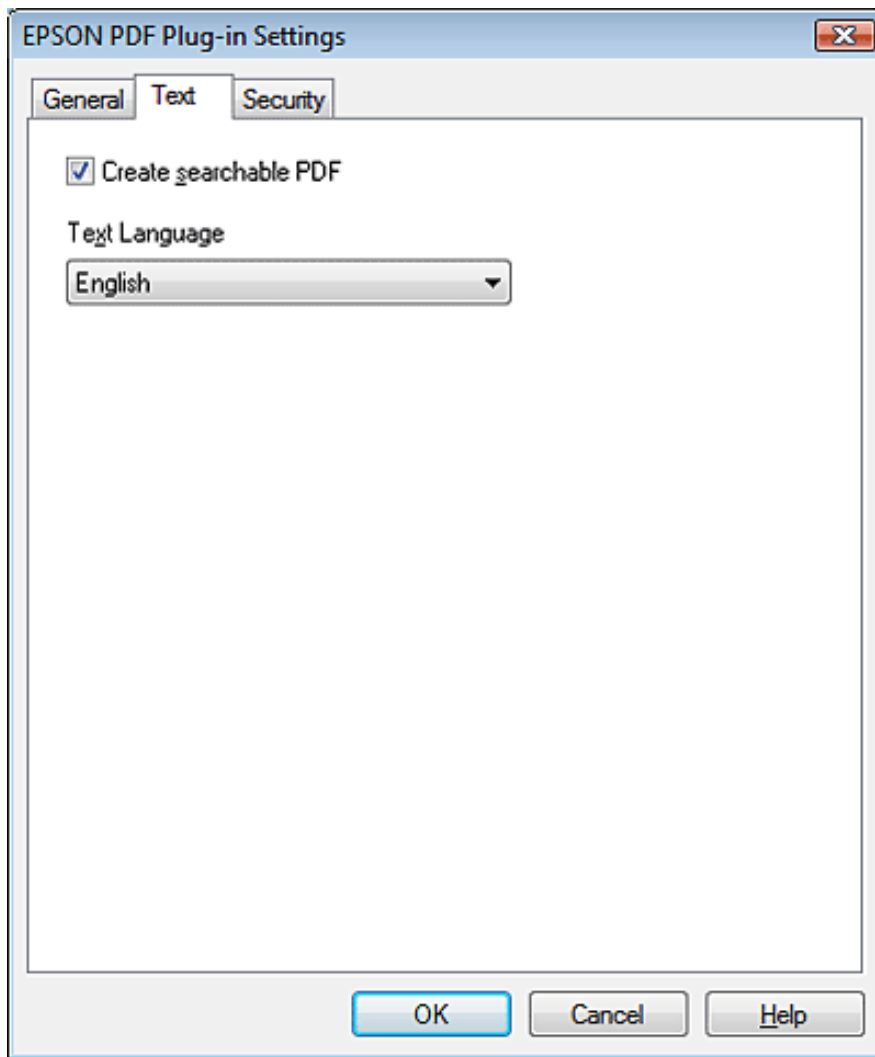

 **Note:**

The Text tab is available only when ABBYY FineReader is installed. If ABBYY FineReader is not available in your country, you will not see the Text tab.

To assign password settings to the PDF file, click the **Security** tab and select the password settings.

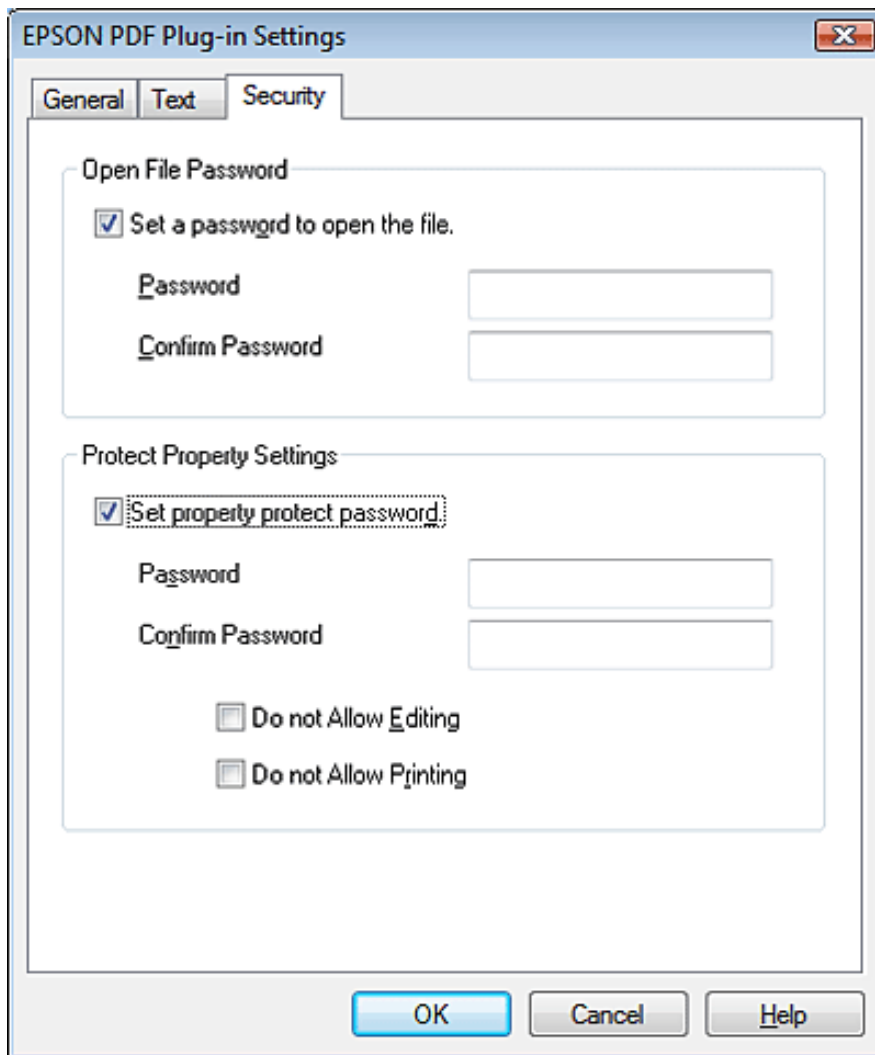

To specify the maximum number of pages that can be included in one PDF file, click the **General** tab and adjust the **Select number to make file** setting.

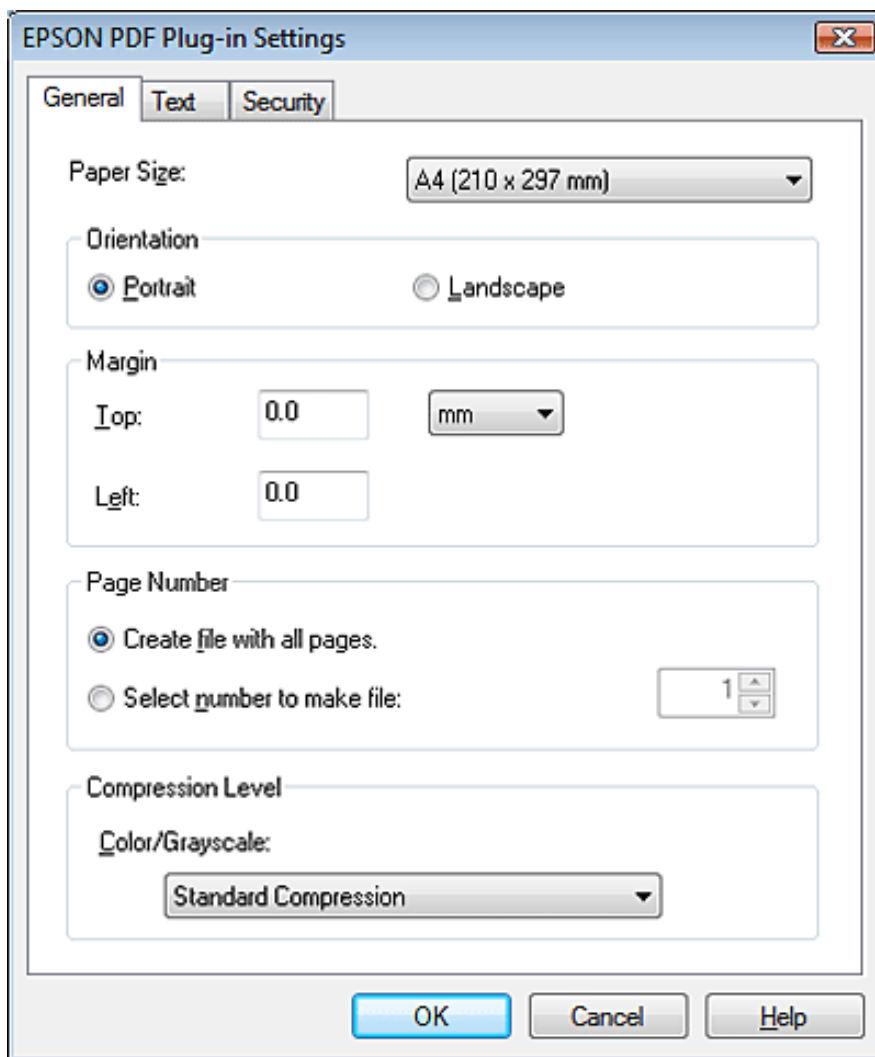

For other settings in the EPSON PDF Plug-in Settings window, see Epson Scan Help for details.

- 10 Select the settings that match your document and click **OK**. You return to the File Save Settings window.
- 11 Make any other file save settings, and click **OK**. Epson Scan scans your original and displays the window below.

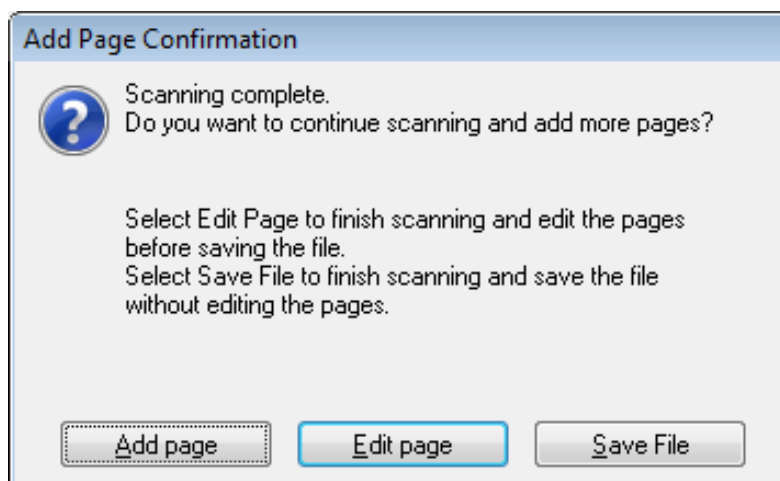

 **Note:**

If you deselect the **Show Add Page dialog after scanning** check box in the File Save Settings window, this window does not appear and Epson Scan automatically saves your document.

12 Select one of the following options.



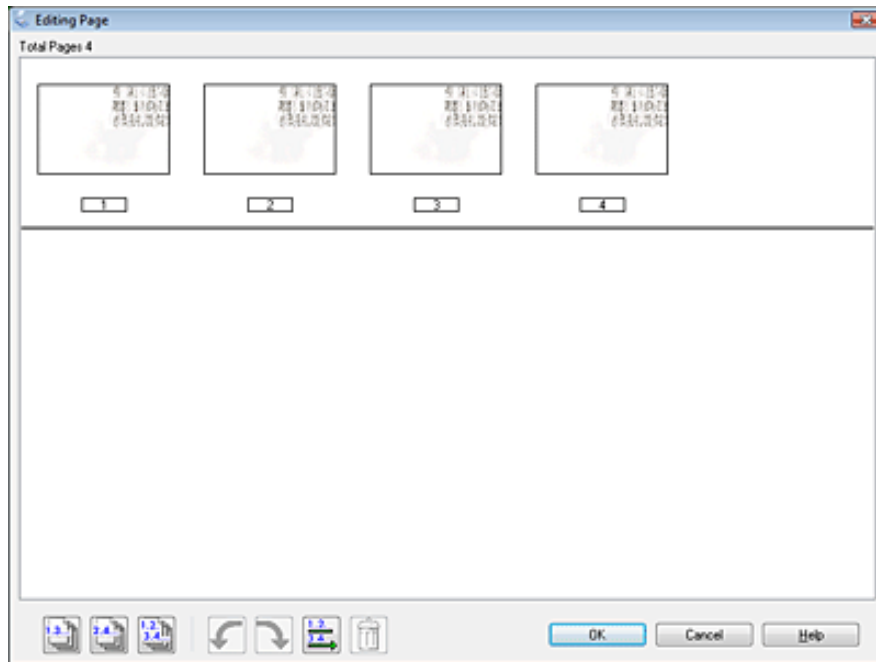

- **Add page:** Click this button to scan the next page of your document. Replace the first page on the document table with the next page, and click **Scan**. When you are finished, click the **Edit page** button and go to step 13.
- **Edit page:** Click this button if you have scanned all the necessary pages so you can edit the scanned pages before saving them in one PDF file. Then go to step 13.
- **Save File:** Click this button when you are ready to finish scanning and save the scanned pages into one PDF without editing them. Then go to step 15.



13 You see the Editing Page window displaying thumbnail images of each scanned page.



Use the tools below the Editing Page window to select, rotate, reorder, and delete pages.

If you want to include all the document pages in your PDF files as they currently look, click the  all pages icon, then go to step 14.

If you want to rotate pages, click the pages, or use the  odd pages,  even pages, or  all pages icon to select the pages, then click the  left or  right rotate icon to rotate them.

If you want to delete pages, click the pages, or use the  odd pages or,  even pages icon to select the pages, then click the  delete icon to delete them.

 **Note:**

The  delete icon is not available when all pages are selected.

For further details on the tools in the Editing Page window, see Epson Scan Help.

- 14 When you have finished editing your pages, click **OK**. The pages are saved in one PDF file in Pictures, My Pictures, or the location you selected in the File Save Settings window, and you return to the Professional Mode window.
- 15 Click **Close** to exit Epson Scan.

Top 

Double-sided Scanning

You can scan a 2-sided document using the ADF. First you scan the odd-numbered pages, then you turn the document over and scan the even-numbered pages. Then you can use the Editing Page window to automatically sort the pages.



Note:

The following steps are for double-sided scanning in Office Mode.

- 1 Place the first page of your document in the ADF. See [Loading Documents in the Automatic Document Feeder](#) for instructions.
- 2 Start Epson Scan. See [Starting Epson Scan](#) for instructions.
- 3 Select **Office Mode** in the Mode list. See [Changing the Scan Mode](#) for instructions.
- 4 In the Office Mode window, select the **Image Type**, **Size**, and **Resolution** settings. For details, see [Scanning in Office Mode](#).
- 5 Select **Auto Detect** or **ADF** as the Document Source setting.
- 6 Click **Preview**. The ADF loads your first document page, then Epson Scan prescans it and displays it in the Preview window. The ADF then ejects your first page.
- 7 Make any necessary image adjustments. See [Adjusting the Color and Other Image Settings](#) for details.
- 8 Place your first document page on top of the rest of the pages, then load the entire document (up to 40 pages) into the ADF.
- 9 Click **Scan**. The File Save Settings window appears.
- 10 Select **PDF** as the Type setting. The current Paper Size, Orientation, Margin, Page Number, Compression Level, and Text Setting settings are displayed below it.

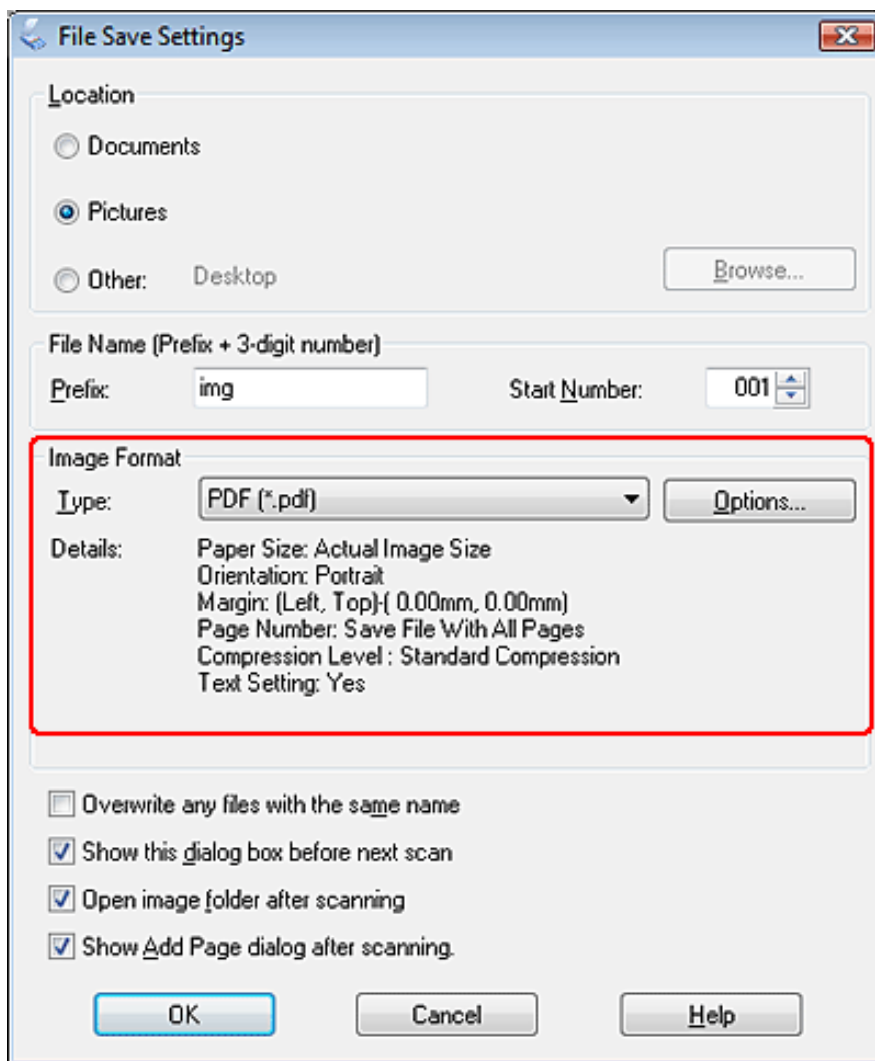

11 Click **Options**. You see the EPSON PDF Plug-in Settings window.

To create a searchable PDF file, click the **Text** tab, select the **Create searchable PDF** check box, then select your language from the **Text Language** list.

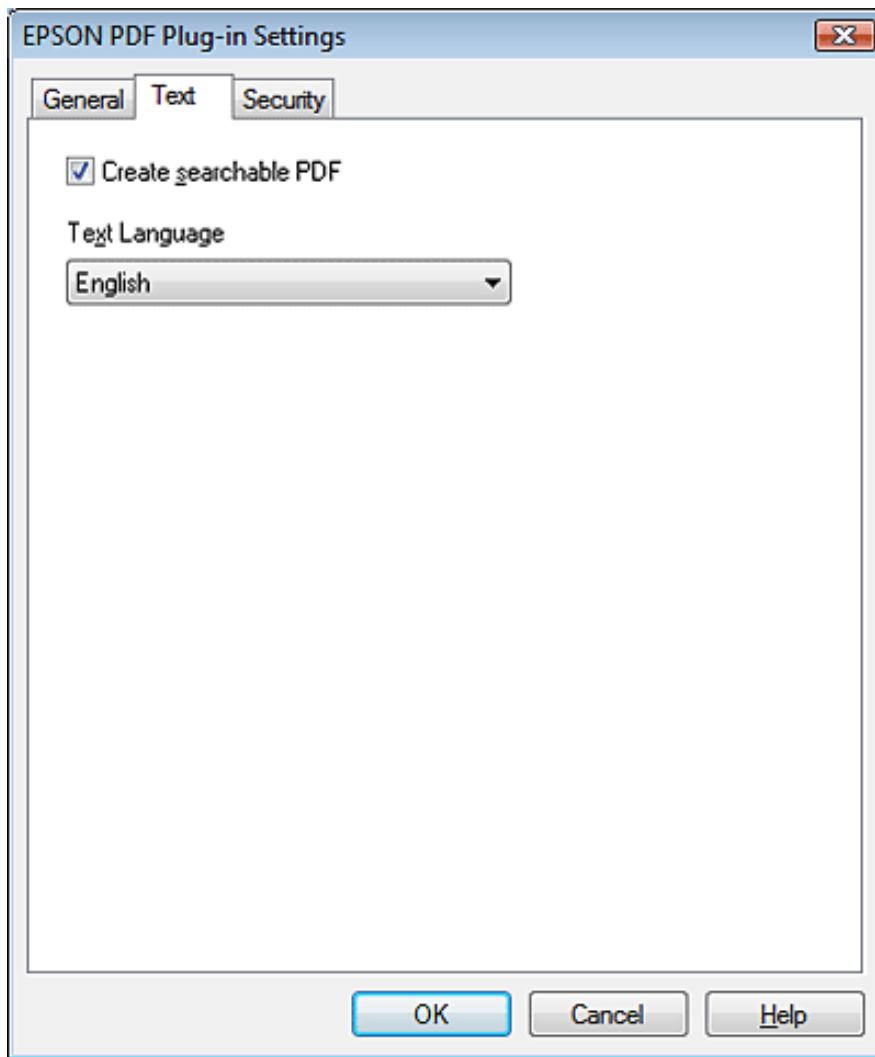

 **Note:**

The Text tab is available only when ABBYY FineReader is installed. If ABBYY FineReader is not available in your country, you will not see the Text tab.

To assign password settings to the PDF file, click the **Security** tab and select the password settings.

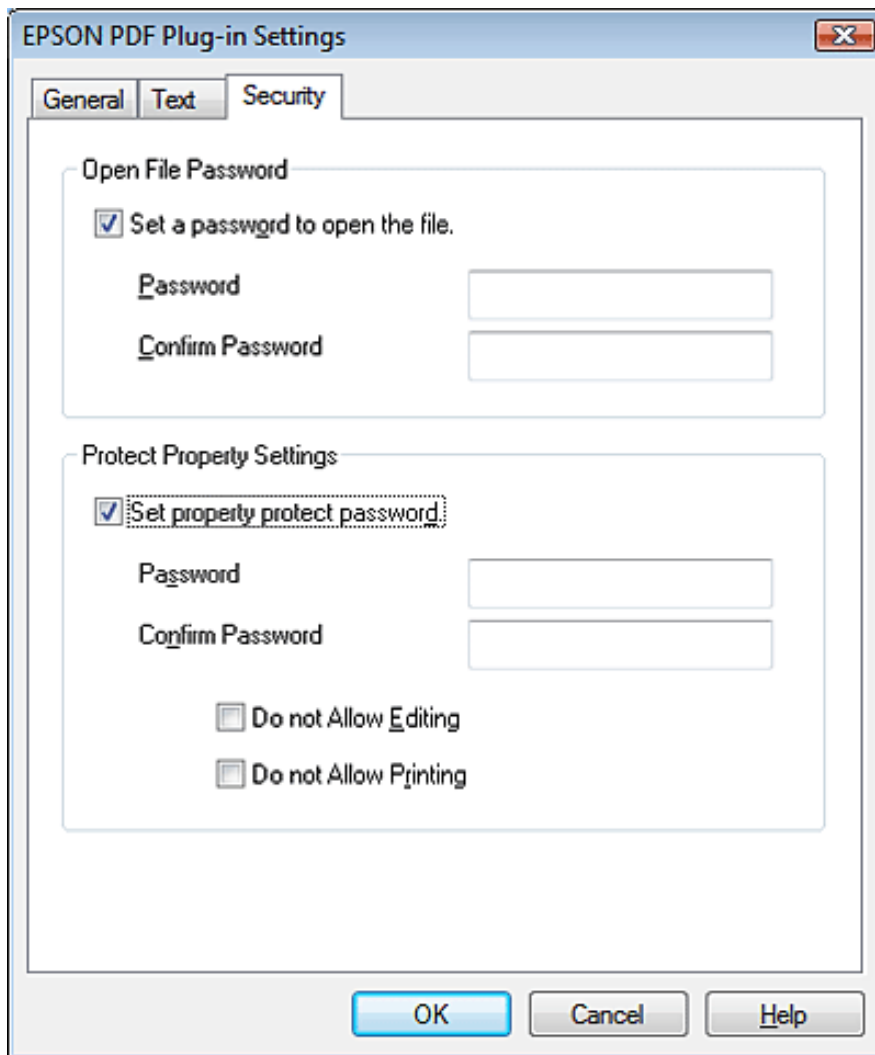

To specify the maximum number of pages that can be included in one PDF file, click the **General** tab and adjust the **Select number to make file** setting.

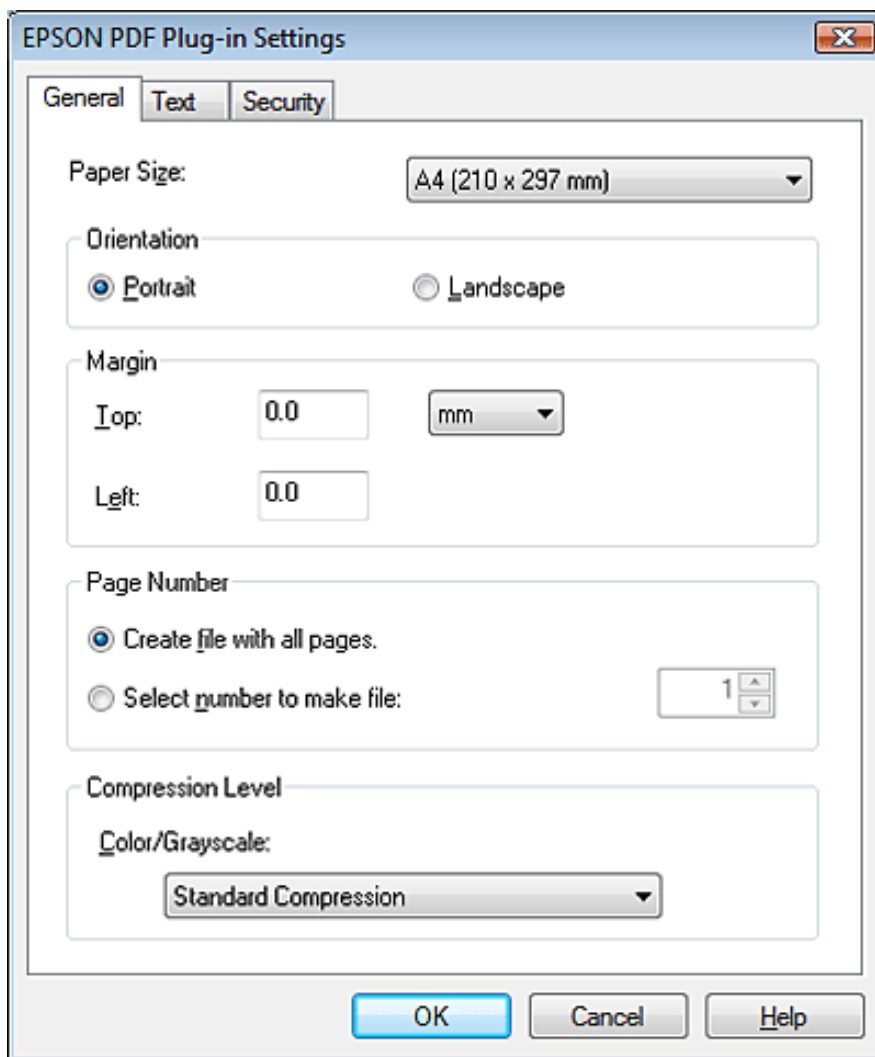

For other settings in the EPSON PDF Plug-in Settings window, see Epson Scan Help for details.

- 12 Select the settings that match your document and click **OK**. You return to the File Save Settings window.
- 13 Make any other file save settings, and click **OK**. Epson Scan scans your document and displays the window below.

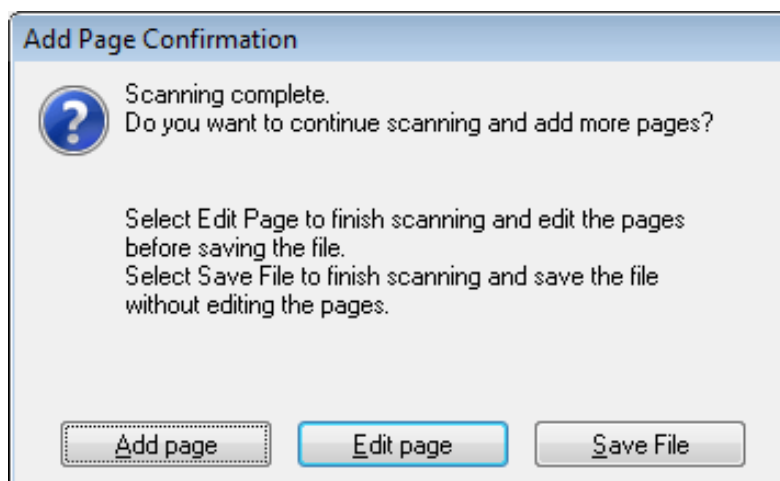

 **Note:**

If you deselect the **Show Add Page dialog after scanning** check box in the File Save Settings window, this window does not appear.

- 14 Click **Add page**.
- 15 Remove the document from the ADF. Turn it around and load it in the input tray with the last page on top.
- 16 Click **Scan**. The even-numbered pages are scanned, and you see the Add Page Confirmation window again.
- 17 Click **Edit page**.
- 18 You see the Editing Page window displaying thumbnail images of each scanned page.

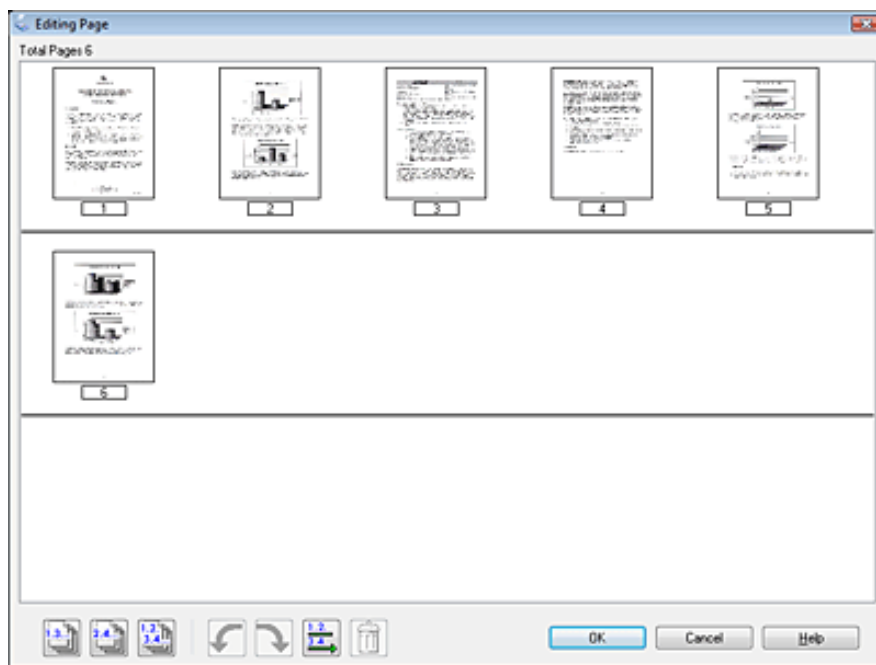

- 19 Click the  Sort by Page Number button. Your pages are automatically sorted into the correct order.
- 20 Click **OK**. The pages are saved in one PDF file in Pictures, My Pictures, or the location you selected in the File Save Settings window, and you return to the Office Mode window.
- 21 Click **Close** to exit Epson Scan.

[Home](#) > [Scanning Special Projects](#)

Restoring Color

- [Color Restoration in Home Mode](#)
- [Color Restoration in Professional Mode](#)
- [Using the Color Palette Feature \(for Professional Mode Only\)](#)

Using the **Color Restoration** feature in Epson Scan, you can transform old, faded, or badly exposed photos into ones with true-to-life color and sharpness. You can restore printed photos automatically as you scan them.

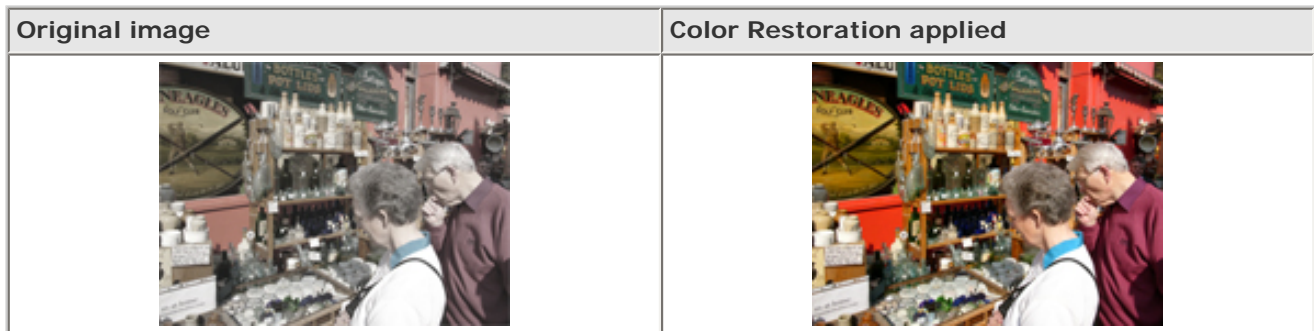

See one of these sections for instructions on restoring colors.

Office Mode: This feature is not available in Office Mode. Change the scan mode to Home Mode or Professional Mode. See [Changing the Scan Mode](#) for instructions.

Home Mode: [Color Restoration in Home Mode](#)

Professional Mode: [Color Restoration in Professional Mode](#)

Color Restoration in Home Mode

- 1** Place your original(s) on the document table. See [Placing Documents or Photos](#) for instructions.
- 2** Start Epson Scan. See [Starting Epson Scan](#) for instructions.
- 3** In the Home Mode window, select the **Document Type**, **Image Type**, and **Destination** settings. For details, see [Scanning in Home Mode](#).
- 4** Click **Preview** to preview your image(s), then select your scan area. See [Previewing and Adjusting the Scan Area](#) for details.
- 5** Click the **Color Restoration** check box.

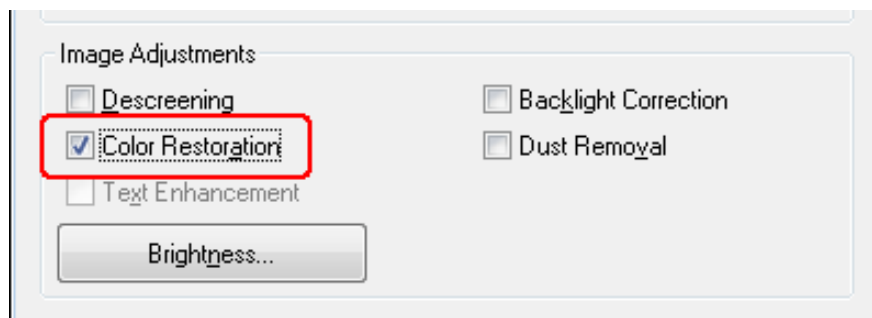

 **Note:**

If you are scanning multiple images at the same time and you want to apply the Color Restoration feature to all of your images or scan areas, click **All** in the Preview window before you click the check box.

- 6 Make any other necessary image adjustments. See [Adjusting the Color and Other Image Settings](#) for details.
- 7 Size your image(s) as necessary. See [Selecting the Scan Size](#) for details.
- 8 Click **Scan**.

What happens next depends on how you started Epson Scan. See [Finishing the Scan](#) for instructions.

Top 

Color Restoration in Professional Mode

- 1 Place your original(s) on the document table. See [Placing Documents or Photos](#) for instructions.
- 2 Start Epson Scan. See [Starting Epson Scan](#) for instructions.
- 3 In the Professional Mode window, select the **Document Type**, **Document Source**, **Auto Exposure Type**, **Image Type**, and **Resolution** settings. For details, see [Scanning in Professional Mode](#).
- 4 Click **Preview** to preview your image(s), then select your scan area. See [Previewing and Adjusting the Scan Area](#) for details.
- 5 Scroll down to the Adjustments area and click the **Color Restoration** check box.

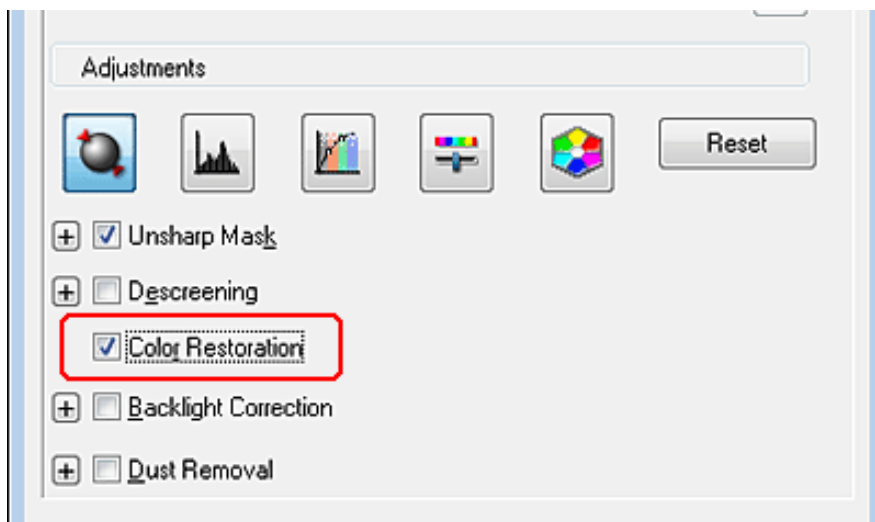

 **Note:**

If you are scanning multiple images at the same time and you want to apply the Color Restoration feature to all of your images or scan areas, click **All** in the Preview window before you click the check box.

- 6 Make any other necessary image adjustments. See [Adjusting the Color and Other Image Settings](#) for details.
- 7 If you want to make more precise color adjustments, click the  Color Palette icon. See [Using the Color Palette Feature \(for Professional Mode Only\)](#) for instructions.
- 8 Size your image(s) as necessary. See [Selecting the Scan Size](#) for details.
- 9 Click **Scan**.

What happens next depends on how you started Epson Scan. See [Finishing the Scan](#) for instructions.

Top 

Using the Color Palette Feature (for Professional Mode Only)

Follow the steps in these sections to fine-tune the colors in your image using the Color Palette feature in Professional Mode.

This feature is available only after previewing your images, so make sure to click **Preview** to activate this feature.

Sampling a Color from an Image

- 1 Click the  Color Palette icon.

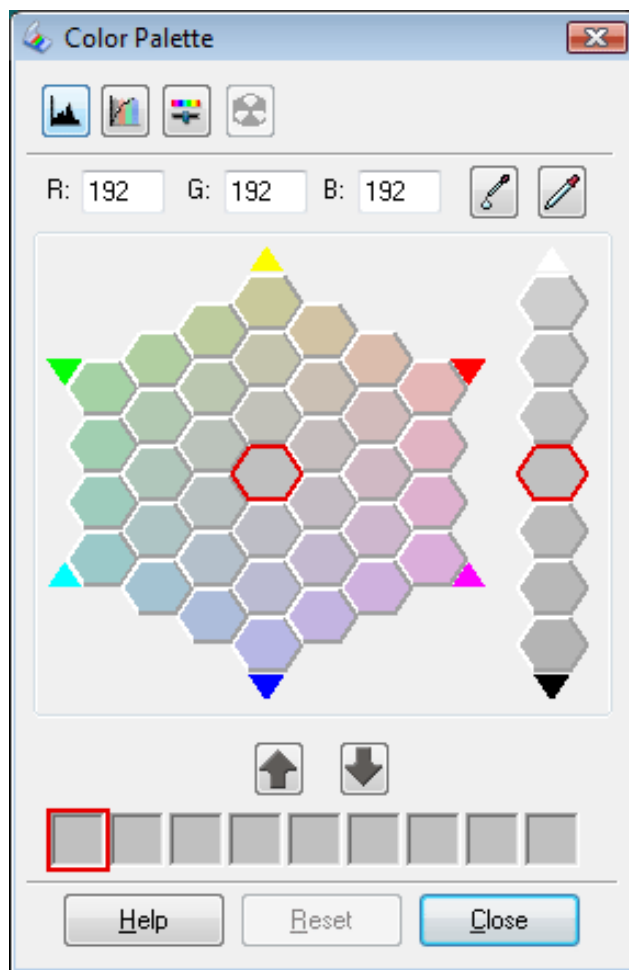

2 Click the  color extractor icon. Your cursor changes to an eye dropper.

3 In the Preview window, click on the color in your image that needs adjustment.

The color you selected is moved to the center cell in the Color Palette window with variations in hue in the surrounding cells.

4 Select the cell that contains the hue you would like to use to adjust the color in your image. This color now becomes the color of the center cell and the color change is reflected in your image.

 **Note:**

You can also use the cells to the right of the adjustment area to change the brightness, if necessary.

5 If you want to continue adjusting the color, repeat step 4.

If you want to save the color for future scans, click the  save icon. The color appears in the save area.

 **Note:**

To load a previously saved color, select the color and click the  apply to palette icon.

- 6 When you are finished adjusting the color, click **Close** to return to the Professional Mode window.

For further details on using the Color Palette feature, see Epson Scan Help.

Applying a Color to an Image

- 1 Click the  Color Palette icon.

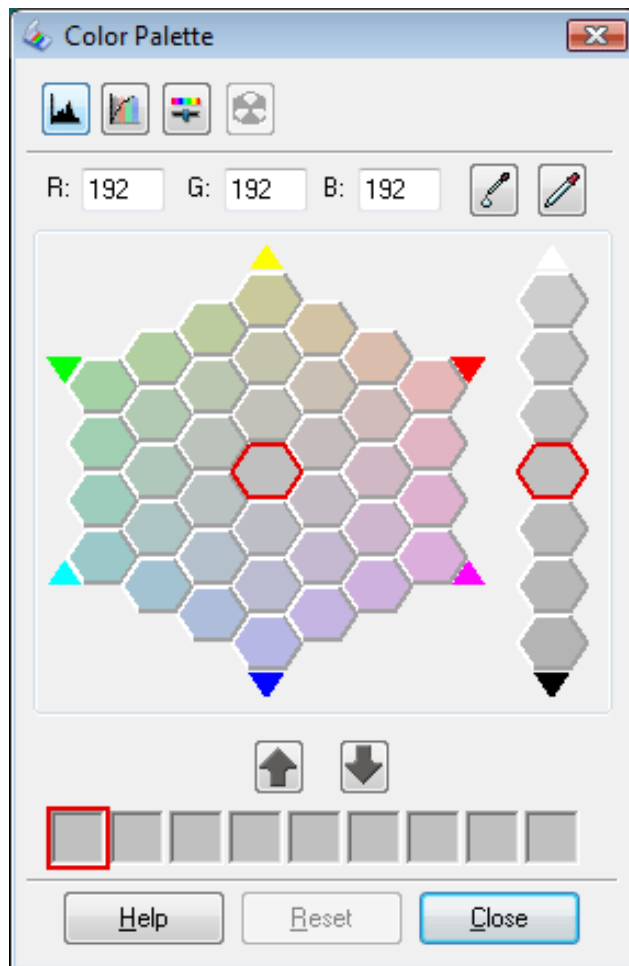

- 2 Select the cell that contains the hue you would like to use to adjust the color in your image. This color now becomes the color of the center cell.

 **Note:**

You can also use the cells to the right of the adjustment area to change the brightness, if necessary.

- 3 Click the  color applicator icon. Your cursor changes to a droplet.
- 4 In the Preview window, click on the color in your image that needs adjustment. The color change is reflected in your image.
- 5 If you want to continue adjusting the color, repeat steps 2 through 4.

If you want to save the color for future scans, click the  save icon. The color appears in the save area.

 **Note:**

To load a previously saved color, select the color and click the  apply to palette icon.

6 When you are finished adjusting the color, click **Close** to return to the Professional Mode window.

For further details on using the Color Palette feature, see Epson Scan Help.

[Top](#) 

Home > Scanning Special Projects

■ Removing Dust Marks

☑ Dust Removal in Home Mode

☑ Dust Removal in Professional Mode

Using the **Dust Removal** feature in Epson Scan, you can virtually “clean” the dust marks from your originals as you scan them.

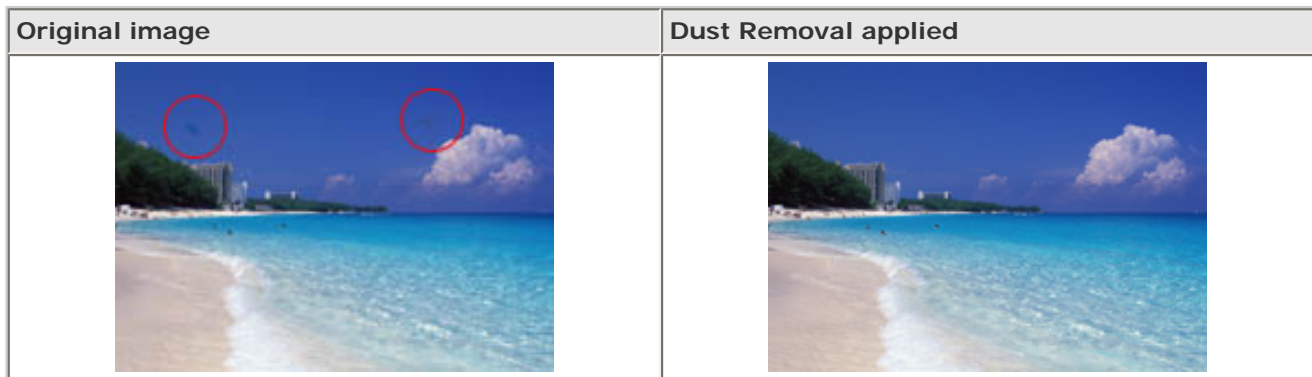

✓ Note:

- Before scanning your originals, carefully remove any dust that you can see on them.
- Do not use Dust Removal to scan your originals that do not contain dust or scratch marks; otherwise your scanned image may be distorted or blurred.

See one of these sections for instructions on removing dust marks from your original(s).

Office Mode: This feature is not available in Office Mode. Change the scan mode to Home Mode or Professional Mode. See [Changing the Scan Mode](#) for instructions.

Home Mode: [Dust Removal in Home Mode](#)

Professional Mode: [Dust Removal in Professional Mode](#)

Dust Removal in Home Mode

- 1 Place your original(s) on the document table. See [Placing Documents or Photos](#) for instructions.
- 2 Start Epson Scan. See [Starting Epson Scan](#) for instructions.
- 3 In the Home Mode window, select the **Document Type**, **Image Type**, and **Destination** settings. For details, see [Scanning in Home Mode](#).
- 4 Click **Preview** to preview your image(s), then select your scan area. See [Previewing and Adjusting the Scan Area](#) for details.

- 5 Click the **Dust Removal** check box.

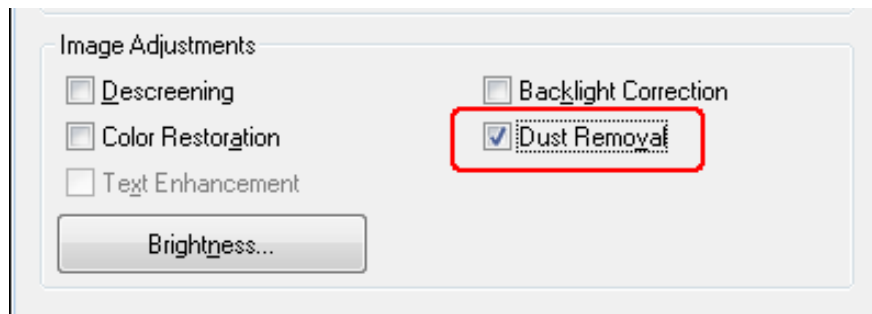

 **Note:**

- The result of the Dust Removal does not appear in the image(s) in the Preview window.
- If you are scanning multiple images at the same time and you want to apply the Dust Removal feature to all of your images or scan areas, click **All** in the Preview window before you click the check box.

- 6 Make any other necessary image adjustments. See [Adjusting the Color and Other Image Settings](#) for details.
- 7 Size your image(s) as necessary. See [Selecting the Scan Size](#) for details.
- 8 Click **Scan**.

What happens next depends on how you started Epson Scan. See [Finishing the Scan](#) for instructions.

Top 

Dust Removal in Professional Mode

- 1 Place your original(s) on the document table. See [Placing Documents or Photos](#) for instructions.
- 2 Start Epson Scan. See [Starting Epson Scan](#) for instructions.
- 3 In the Professional Mode window, select the **Document Type**, **Document Source**, **Auto Exposure Type**, **Image Type**, and **Resolution** settings. For details, see [Scanning in Professional Mode](#).
- 4 Click **Preview** to preview your image(s), then select your scan area. See [Previewing and Adjusting the Scan Area](#) for details.
- 5 Scroll down to the Adjustments area and click the **Dust Removal** check box. If you want to increase or decrease the level of the dust removal effect, click the + (Windows) or ► (Mac OS X) button next to the option and select a setting in the **Level** list.

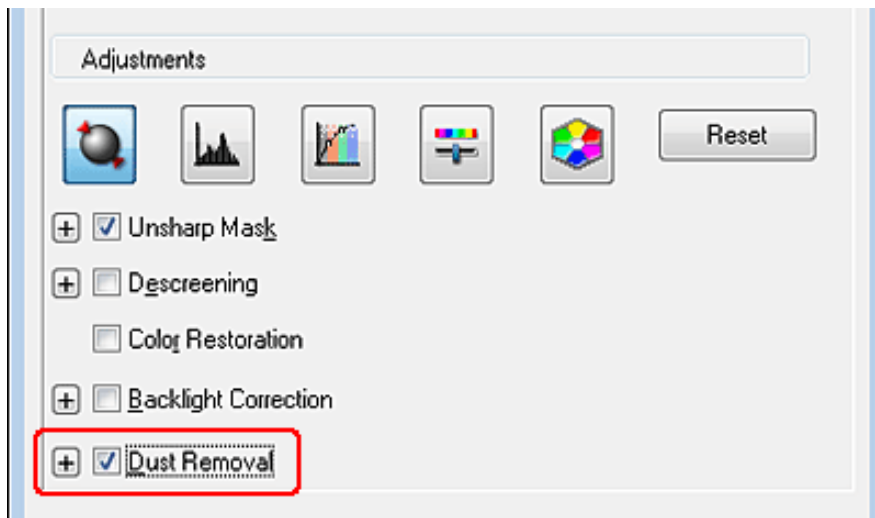

 **Note:**

- The result of the Dust Removal does not appear in the image(s) in the Preview window.
- If you are scanning multiple images at the same time and you want to apply the Dust Removal feature to all of your images or scan areas, click **All** in the Preview window before you click the check box.

- 6** Make any other necessary image adjustments. See [Adjusting the Color and Other Image Settings](#) for instructions.
- 7** Size your image(s) as necessary. See [Selecting the Scan Size](#) for instructions.
- 8** Click **Scan**.

What happens next depends on how you started Epson Scan. See [Finishing the Scan](#) for instructions.

[Home](#) > [Scanning Special Projects](#)

■ Fixing Backlit Photos

[Backlight Correction in Home Mode](#)

[Backlight Correction in Professional Mode](#)

Using the **Backlight Correction** feature in Epson Scan, you can remove shadows from photos that have too much background light. You can fix printed photos automatically as you scan them.

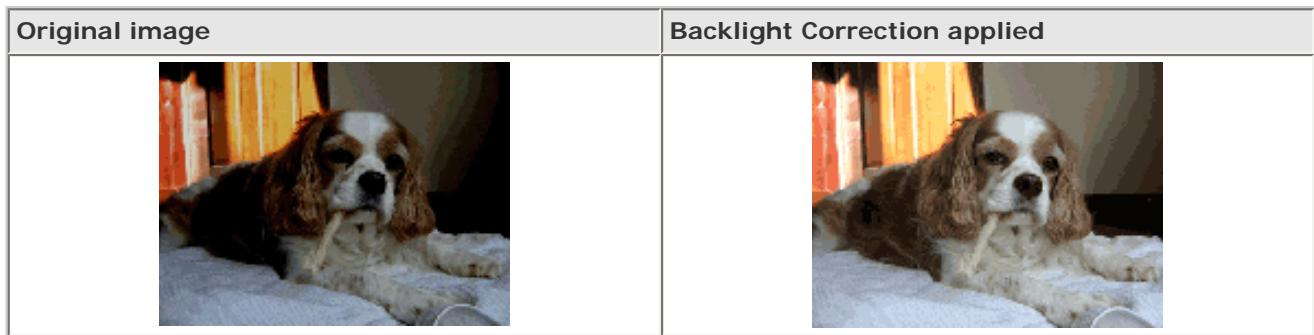

See one of these sections for instructions on fixing backlit photos.

Office Mode: This feature is not available in Office Mode. Change the scan mode to Home Mode or Professional Mode. See [Changing the Scan Mode](#) for instructions.

Home Mode: [Backlight Correction in Home Mode](#)

Professional Mode: [Backlight Correction in Professional Mode](#)

Backlight Correction in Home Mode

- 1 Place your original(s) on the document table. See [Placing Documents or Photos](#) for instructions.
- 2 Start Epson Scan. See [Starting Epson Scan](#) for instructions.
- 3 In the Home Mode window, select the **Document Type**, **Image Type**, and **Destination** settings. For details, see [Scanning in Home Mode](#).
- 4 Click **Preview** to preview your image(s), then select your scan area. See [Previewing and Adjusting the Scan Area](#) for details.
- 5 Click the **Backlight Correction** check box.

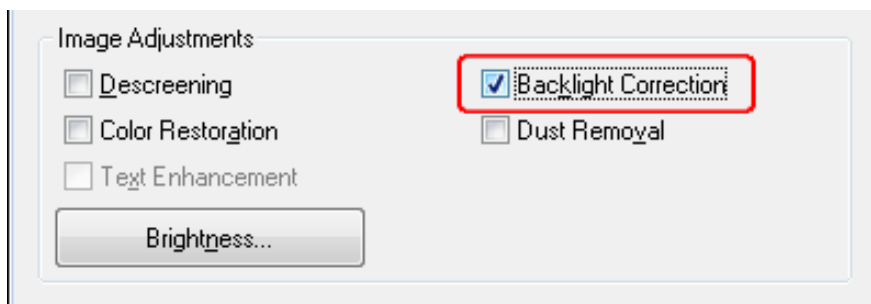

 **Note:**

If you are scanning multiple images at the same time and you want to apply the Backlight Correction feature to all of your images or scan areas, click **All** in the Preview window before you click the check box.

- 6 Make any other necessary image adjustments. See [Adjusting the Color and Other Image Settings](#) for details.
- 7 Size your image(s) as necessary. See [Selecting the Scan Size](#) for details.
- 8 Click **Scan**.

What happens next depends on how you started Epson Scan. See [Finishing the Scan](#) for instructions.

Top 

Backlight Correction in Professional Mode

- 1 Place your original(s) on the document table. See [Placing Documents or Photos](#) for instructions.
- 2 Start Epson Scan. See [Starting Epson Scan](#) for instructions.
- 3 In the Professional Mode window, select the **Document Type**, **Document Source**, **Auto Exposure Type**, **Image Type**, and **Resolution** settings. For details, see [Scanning in Professional Mode](#).
- 4 Click **Preview** to preview your image(s), then select your scan area. See [Previewing and Adjusting the Scan Area](#) for details.
- 5 Scroll down to the Adjustments area and click the **Backlight Correction** check box. If you want to increase or decrease the level of the backlight correction effect, click the + (Windows) or  (Mac OS X) button next to the option and select a setting in the **Level** list.

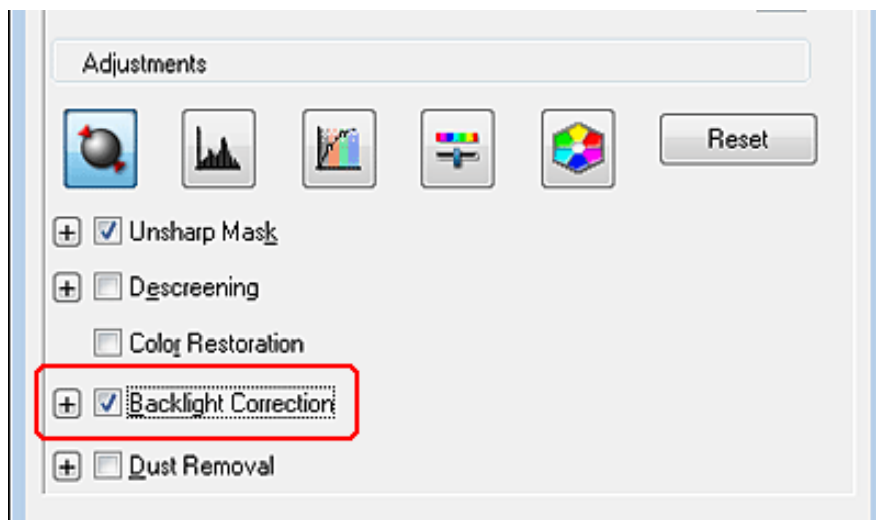

 **Note:**

If you are scanning multiple images at the same time and you want to apply the Backlight Correction feature to all of your images or scan areas, click **All** in the Preview window before you click the check box.

- 6** Make any other necessary image adjustments. See [Adjusting the Color and Other Image Settings](#) for details.
- 7** Size your image(s) as necessary. See [Selecting the Scan Size](#) for details.
- 8** Click **Scan**.

What happens next depends on how you started Epson Scan. See [Finishing the Scan](#) for instructions.

Home > Scanning Special Projects

Using the Scanner as a Copier

You can use your scanner along with a printer connected to your computer just like you would use a copy machine. You can even enlarge and reduce, enhance text, and adjust image brightness as you copy.

- 1 Load the first page of your documents on the document table or in the ADF. See or [Loading Documents in the Automatic Document Feeder](#) for instructions.
- 2 Start the Copy Utility in one of these ways.
 - Press the  Copy button on the scanner.
 - Do one of the following.
 - **Windows 8:** Navigate to the **Start** screen > **Copy Utility**.
 - **Windows (other versions):** Select the start button or **Start** > **Programs** or **All Programs** > **EPSON Software** > **Copy Utility**.
 - **Mac OS X:** Select **Applications** > **EPSON Software** > **Copy Utility**, and double-click the **Copy Utility** icon.

You see the Copy Utility window.

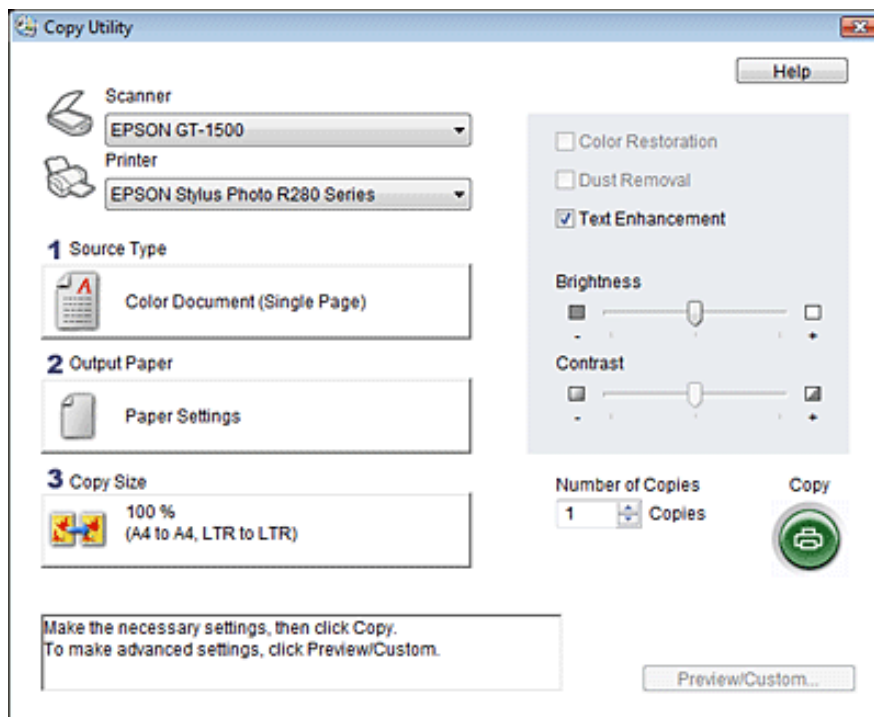

- 3 Select your scanner from the **Scanner** list at the top of the window.
- 4 Select your printer from the **Printer** list.

- 5 Click the **Source Type** box, select the type of original(s) you are copying, and click **OK**. See the table below for guidance.

Source Type setting	Type of document
Color Document (Single Page)	One-page color documents containing text or text and graphics, such as a flyer.
Black & White Document (Single Page)	One-page black and white documents containing text or text and graphics, such as a letter.
Color Document (Multiple Pages)	Multiple page color documents containing text or text and graphics, such as a brochure.
Black & White Document (Multiple Pages)	Multiple page black and white documents containing text or text and graphics, such as a manual.
Photos	Photographs or other continuous-tone graphics.

- 6 Click the **Output Paper** box, select the type and size of paper you loaded in your printer, and click **OK**.

 **Note:**

If you are printing on certain Epson printers, you see the printer settings window. See your printer documentation for instructions on selecting settings.

- 7 If you want to enlarge or reduce your image(s) as you copy it, click the **Copy Size** box, select the enlargement/reduction, and click **OK**.
- 8 If you are copying a color or black-and-white document, you can improve the definition of text and line art by leaving the **Text Enhancement** check box checked. It is available only when the Source Type is **Color Document (Single Page)**, **Black & White Document (Single Page)**, **Color Document (Multiple Pages)**, or **Black & White Document (Multiple Pages)**.
- 9 If you need to adjust the lightness or darkness of your original(s) as you copy, click the slider beneath the **Brightness** setting.
- 10 Click the arrow in the **Number of Copies** box to select the number of copies you want, if necessary.
- 11 When you are ready to scan and print, click **Copy**.

[Home](#) > [Scanning Special Projects](#)

■ Scanning Directly to an E-mail

You can scan and automatically attach scanned image file(s) to an e-mail message with the  E-mail button on the scanner.

- 1 Place your document on the document table or in the ADF. See [Placing Documents or Photos](#) or [Loading Documents in the Automatic Document Feeder](#) for instructions.
- 2 Press the  E-mail button on the scanner.

 **Note:**

Epson Scan starts in the last mode you used. The following steps are for Office Mode. For instructions on using other modes, see [Scanning in Home Mode](#) or [Scanning in Professional Mode](#).

- 3 In the Office Mode window, select the **Image Type**, **Document Source**, **Size**, and **Resolution** settings. For details, see [Scanning in Office Mode](#).
- 4 Click **Preview** to preview your image(s), then select your scan area. For details, see [Previewing and Adjusting the Scan Area](#).
- 5 Make any other necessary image adjustments. See [Adjusting the Color and Other Image Settings](#) for details.
- 6 Click **Scan**. The File Save Settings window appears. For details, see [Selecting File Save Settings](#).
- 7 Click **OK**. Epson Scan scans your document or photo and displays the Send File Via E-mail window.

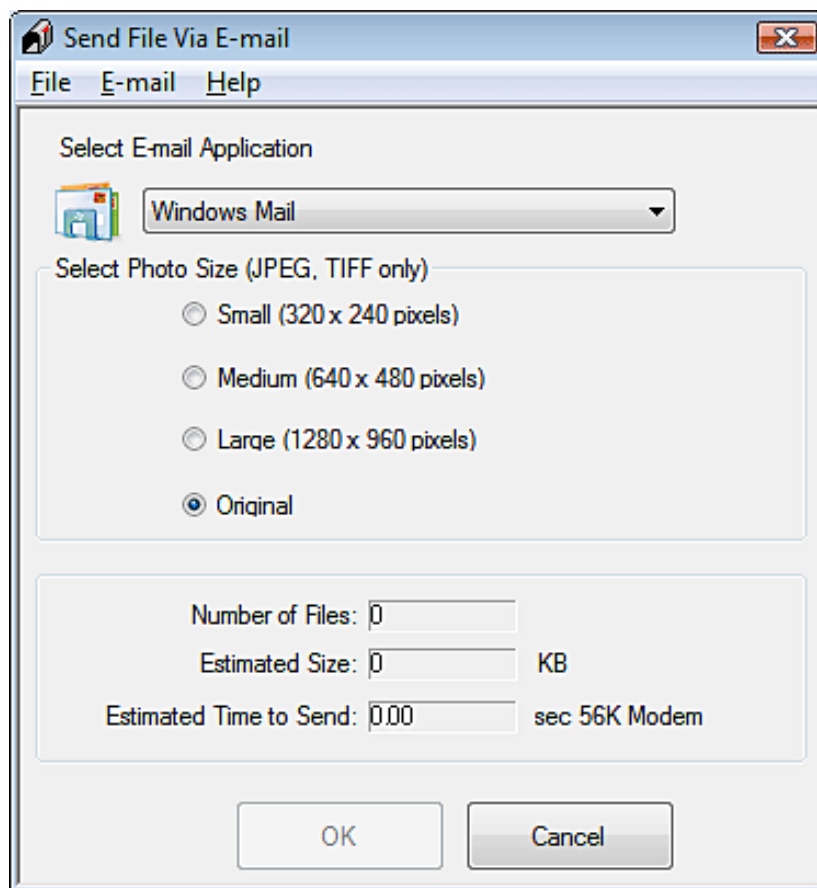

- 8 Select the e-mail program you use in the Select E-mail Application list.
- 9 If you scanned photos and want to resize them, choose an option under Select Photo Size.

 **Note:**

The box at the bottom of the window displays information about the image file(s) you are attaching to the e-mail message.

- 10 Click **OK**. Your e-mail program is opened and any scanned images you selected are attached to a new e-mail message. See your e-mail program help if you need instructions on sending your e-mail message.

[Home](#) > [Scanning Special Projects](#)

Converting Scanned Documents Into Editable Text

- [Converting into Editable Text in Office Mode](#)
- [Converting into Editable Text in Home Mode](#)
- [Converting into Editable Text in Professional Mode](#)

You can scan a document and convert the text into a format that you can edit with a word processing program. This process is called OCR (Optical Character Recognition). To scan and use OCR, you need to use an OCR program, such as the ABBYY FineReader program that came with your scanner.

Note:

ABBYY FineReader may not be included in some countries.

OCR software cannot recognize or has difficulty recognizing the following types of documents or text:

- Handwritten characters
- Items that have been copied from other copies
- Faxes
- Text with tightly spaced characters or line pitch
- Text that is in tables or underlined
- Cursive or italic fonts, and font sizes less than 8 points

See one of these sections to scan and convert text using ABBYY FineReader.

Office Mode: [Converting into Editable Text in Office Mode](#)

Home Mode: [Converting into Editable Text in Home Mode](#)

Professional Mode: [Converting into Editable Text in Professional Mode](#)

Converting into Editable Text in Office Mode

Windows

- 1** Place your document on the document table or in the ADF. See [Placing Documents or Photos](#) or [Loading Documents in the Automatic Document Feeder](#) for instructions.
- 2** Do one of the following to start ABBYY FineReader.

Windows 8: Navigate to the **Start** screen and select **ABBYY FineReader 9.0 Sprint**.

Windows 7/Vista/XP: Select the start button or **Start** > **Programs** or **All Programs** > **ABBYY FineReader 9.0 Sprint** > **ABBYY FineReader 9.0 Sprint**.

You see this window:

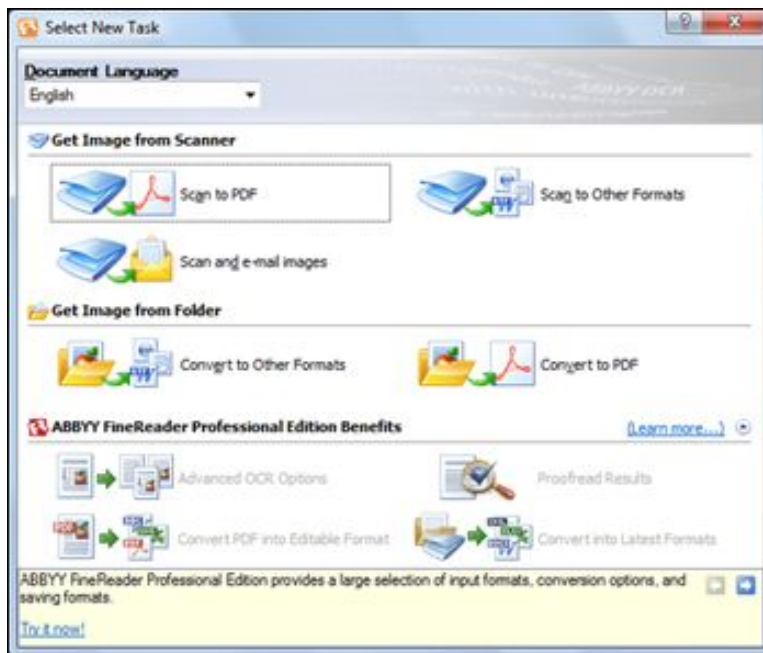

- 3 Select the language used in the document you are going to scan as the Document Language setting.
- 4 Click either the Scan to Other Formats icon or the icon that corresponds with the program you want to scan to.
- 5 If you see the Select Scanner window, select your product and click OK.

 **Note:**

Do not select a WIA option for your product; it will not work correctly.

- 6 Select your scan settings.
- 7 Click Preview and adjust the area you want to scan, if necessary.
- 8 Click Scan.

 **Note:**

To scan a multi-page document, select settings in the Multi-Page Scanning section and click Scan for each page.

- 9 When you are finished scanning, click Close. Your document is scanned and processed into editable text, then you see the Save As window.
- 10 Select a name and a file format for your document and click Save. The file is saved and then opened in an application associated with the file type you selected, if available on your system.

Mac OS X

- 1 Place your document on the document table or in the ADF. See [Placing Documents or Photos](#) or [Loading Documents in the Automatic Document Feeder](#) for instructions.
- 2 Select **Applications > ABBYY FineReader 8.0 Sprint**.

You see this window:



- 3 Select your scanner from the **Get Images From** list.
- 4 Select the language used in the document you are going to scan as the **Document Language** setting.
- 5 Click the icon for the type of document you want to scan to. Epson Scan starts in the last mode you used.
- 6 Change the scan mode to **Office Mode** if necessary. See [Changing the Scan Mode](#) for instructions.
- 7 Select **Color**, **Grayscale**, or **Black & White** as the Image Type setting.
- 8 Select one of these options to the Document Source setting.
 - **Auto Detect:** This setting automatically determines whether to load your document from the ADF or scan it from the document table.
 - **Document Table:** Select this setting when you want to scan using the document table.
 - **ADF:** Select this setting when you want to scan using the ADF.

- 9 Select the size of your original document as the Size setting.
- 10 Select **300** as the Resolution setting.
- 11 Click **Preview** to preview your document. The Preview window appears and displays your document. See [Previewing and Adjusting the Scan Area](#) for instructions.
- 12 Modify the image quality if necessary. See [Adjusting the Color and Other Image Settings](#) for instructions.
- 13 Click Scan. Your document is scanned and processed into editable text.

 **Note:**

If the characters in your text are not recognized very well, you can improve recognition by selecting the **Text Enhancement** check box or adjusting the **Threshold** setting. See [Adjusting the Color and Other Image Settings](#) for instructions.

- 14 When you see the Document Conversion window with the finished message, click **Close** in the Epson Scan window.
- 15 Follow the instructions in ABBYY FineReader Help to edit and save your document.

Top 

Converting into Editable Text in Home Mode

Windows

- 1 Place your document on the document table or in the ADF. See [Placing Documents or Photos](#) or [Loading Documents in the Automatic Document Feeder](#) for instructions.
- 2 Do one of the following to start ABBYY FineReader.

Windows 8: Navigate to the **Start** screen and select **ABBYY FineReader 9.0 Sprint**.

Windows 7/Vista/XP: Select the start button or **Start > Programs** or **All Programs > ABBYY FineReader 9.0 Sprint > ABBYY FineReader 9.0 Sprint**.

You see this window:

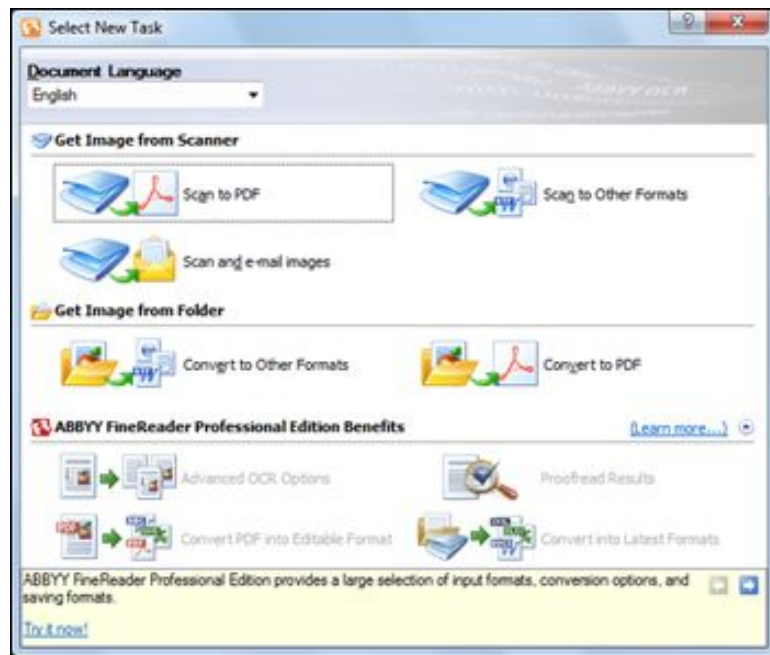

- 3 Select the language used in the document you are going to scan as the Document Language setting.
- 4 Click either the Scan to Other Formats icon or the icon that corresponds with the program you want to scan to.
- 5 If you see the Select Scanner window, select your product and click OK.

 **Note:**

Do not select a WIA option for your product; it will not work correctly.

- 6 Select your scan settings.
- 7 Click Preview and adjust the area you want to scan, if necessary.
- 8 Click Scan.

 **Note:**

To scan a multi-page document, select settings in the Multi-Page Scanning section and click Scan for each page.

- 9 When you are finished scanning, click Close. Your document is scanned and processed into editable text, then you see the Save As window.
- 10 Select a name and a file format for your document and click Save. The file is saved and then opened in an application associated with the file type you selected, if available on your system.

Mac OS X

- 1 Place your document on the document table or in the ADF. See [Placing Documents or Photos](#) or [Loading Documents in the Automatic Document Feeder](#) for instructions.
- 2 Select **Applications > ABBYY FineReader 8.0 Sprint**.

You see this window:



- 3 Select your scanner from the **Get Images From** list.
- 4 Select the language used in the document you are going to scan as the **Document Language** setting.
- 5 Click the icon for the type of document you want to scan to. Epson Scan starts in the last mode you used.
- 6 Change the scan mode to **Home Mode** if necessary. See [Changing the Scan Mode](#) for instructions.
- 7 Select **Magazine**, **Newspaper**, or **Text/Line Art** as the Document Type setting.
- 8 Select **Black and White** or **Color** as the Image Type setting.
- 9 Select **Printer** or **Other** as the Destination setting.

 **Note:**

If you select **Other**, select **300** as the Resolution setting.

- 10 Click **Preview** to preview your document. The Preview window appears and displays your document. See [Previewing and Adjusting the Scan Area](#) for instructions.
- 11 Modify the image quality if necessary. See [Adjusting the Color and Other Image Settings](#) for instructions.
- 12 Click **Scan**. Your document is scanned and processed into editable text.

 **Note:**

If the characters in your text are not recognized very well, you can improve recognition by selecting the **Text Enhancement** check box or adjusting the **Threshold** setting. See [Adjusting the Color and Other Image Settings](#) for instructions.

- 13 When you see the Document Conversion window with the finished message, click **Close** in the Epson Scan window.
- 14 Follow the instructions in ABBYY FineReader Help to edit and save your document.

Top 

Converting into Editable Text in Professional Mode

Windows

- 1 Place your document on the document table or in the ADF. See [Placing Documents or Photos](#) or [Loading Documents in the Automatic Document Feeder](#) for instructions.
- 2 Do one of the following to start ABBYY FineReader.

Windows 8: Navigate to the **Start** screen and select **ABBYY FineReader 9.0 Sprint**.

Windows 7/Vista/XP: Select the start button or **Start > Programs** or **All Programs > ABBYY FineReader 9.0 Sprint > ABBYY FineReader 9.0 Sprint**.

You see this window:

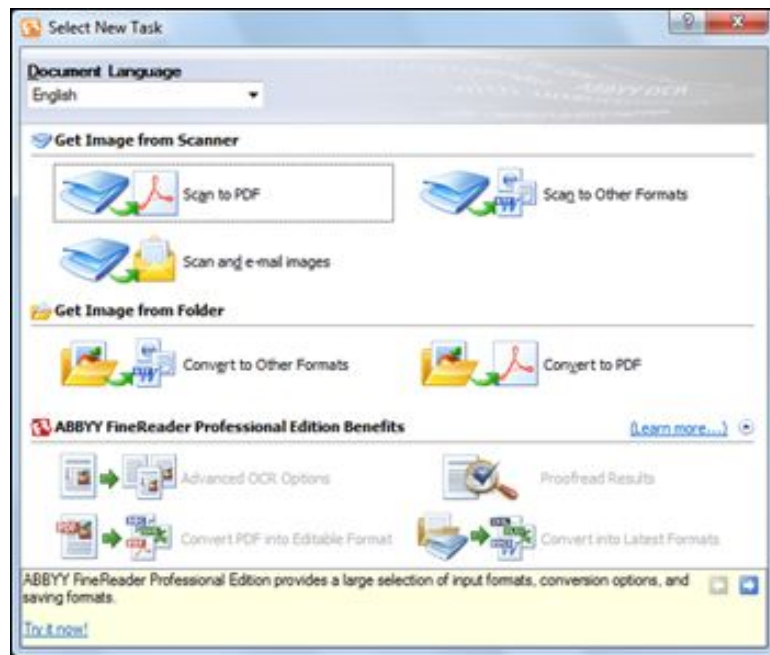

- 3 Select the language used in the document you are going to scan as the Document Language setting.
- 4 Click either the Scan to Other Formats icon or the icon that corresponds with the program you want to scan to.
- 5 If you see the Select Scanner window, select your product and click OK.

 **Note:**

Do not select a WIA option for your product; it will not work correctly.

- 6 Select your scan settings.
- 7 Click Preview and adjust the area you want to scan, if necessary.
- 8 Click Scan.

 **Note:**

To scan a multi-page document, select settings in the Multi-Page Scanning section and click Scan for each page.

- 9 When you are finished scanning, click Close. Your document is scanned and processed into editable text, then you see the Save As window.
- 10 Select a name and a file format for your document and click Save. The file is saved and then opened in an application associated with the file type you selected, if available on your system.

Mac OS X

- 1 Place your document on the document table or in the ADF. See [Placing Documents or Photos](#) or [Loading Documents in the Automatic Document Feeder](#) for instructions.
- 2 Select **Applications > ABBYY FineReader 8.0 Sprint**.

You see this window:



- 3 Select your scanner from the **Get Images From** list.
- 4 Select the language used in the document you are going to scan as the **Document Language** setting.
- 5 Click the icon for the type of document you want to scan to. Epson Scan starts in the last mode you used.
- 6 Change the scan mode to **Professional Mode** if necessary. See [Changing the Scan Mode](#) for instructions.
- 7 Select **Reflective** as the Document Type setting.
- 8 Select one of these options to the Document Source setting.
 - **Document Table:** Select this setting when you want to scan using the document table.
 - **ADF:** Select this setting when you want to scan using the ADF.

- 9 Select **Document** as the Auto Exposure Type setting.
- 10 Select **24-bit Color** or **8-bit Grayscale** as the Image Type setting.
- 11 Select **300** as the Resolution setting.
- 12 Click **Preview** to preview your document. The Preview window appears and displays your document. See [Previewing and Adjusting the Scan Area](#) for instructions.
- 13 Modify the image quality if necessary. See [Adjusting the Color and Other Image Settings](#) for instructions.
- 14 Click Scan. Your document is scanned and processed into editable text.

 **Note:**

If the characters in your text are not recognized very well, you can improve recognition by selecting the **Text Enhancement** check box or adjusting the **Threshold** setting. See [Adjusting the Color and Other Image Settings](#) for instructions.





- 15 When you see the Document Conversion window with the finished message, click **Close** in the Epson Scan window.
- 16 Follow the instructions in ABBYY FineReader Help to edit and save your document.

[Home](#) > [Scanning Special Projects](#)

Assigning a Program to a Scanner Button

[Assigning a Project Program in Epson Event Manager to a Scanner Button](#)

Each scanner button opens a pre-selected program when you press it. The default programs they open and the default actions they perform are described in the table below.

Button	Default action
 Start	Epson Scan starts.
 Copy	Epson Copy Utility starts.
 E-mail	Epson Scan starts. After you scan, the Send File Via E-mail window appears.
 PDF	The Scan to PDF window appears.

Assigning a Project Program in Epson Event Manager to a Scanner Button

You can assign any of the scanner buttons to open a program in the Epson Event Manager to make scanning your projects even quicker.

1 Do one of the following to start Epson Event Manager:

Windows 8: Navigate to the **Start** screen > **Event Manager**.

Windows 7/Vista/XP: Select the start button or **Start** > **Programs** or **All Programs** > **Epson Software** > **Event Manager**.

Mac OS X: Select **Applications** > **Epson Software**, and double-click the **Launch Event Manager** icon.

You see the Button Settings tab in Epson Event Manager.

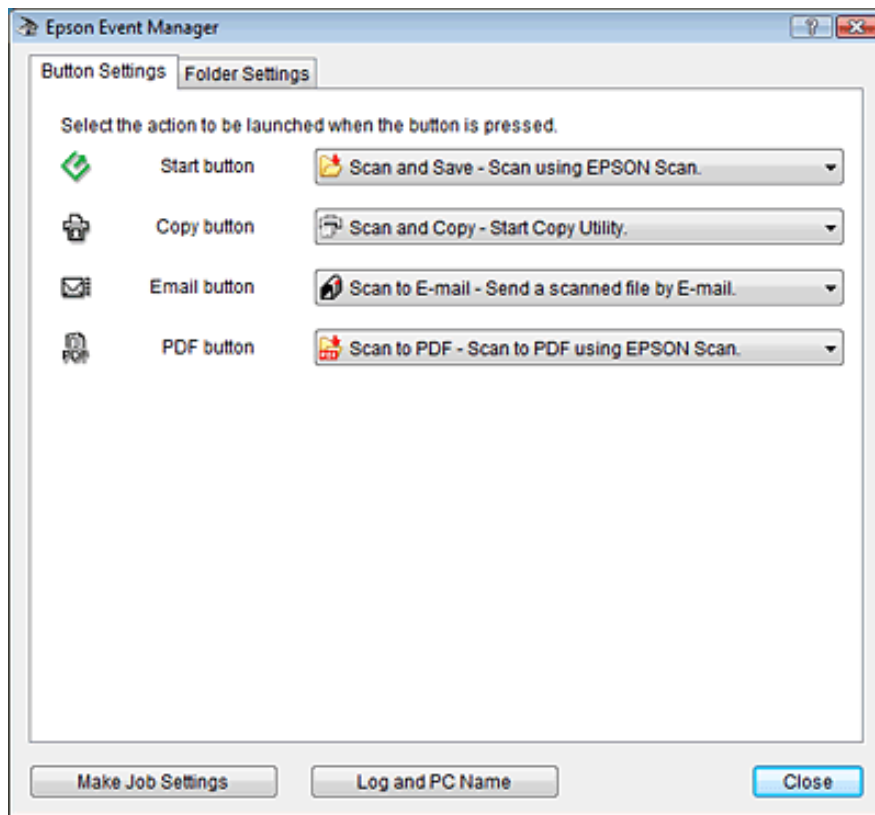

2 Click the arrow in the list next to the button name, then select the action you want to assign.

3 Click **Close** to close the Epson Event Manager window.

Now whenever you press the button you assigned, the action you selected opens.

 **Note:**

If you need help using Epson Event Manager, click the  icon in the upper right corner of the screen.

[Home](#) > [Maintenance](#)

Cleaning the Scanner

To keep your scanner operating at its best, clean it periodically using the following procedure.

 **Caution:**

- Do not press the glass surface of the document table with any force.
- Be careful not to scratch or damage the glass surface of the document table, and do not use a hard or abrasive brush to clean it. A damaged glass surface can decrease the scan quality.
- Never use alcohol, thinner, or corrosive solvent to clean the scanner. These chemicals can damage the scanner components and the case.
- Be careful not to spill liquid into the scanner mechanism or electronic components. This could permanently damage the mechanism and circuitry.
- Do not spray lubricants inside the scanner.
- Never open the scanner case.

- 1 Turn off the scanner.
- 2 Unplug the AC adapter from the scanner.
- 3 Clean the outer case with a cloth dampened with mild detergent and water.
- 4 If the glass surface of the document table gets dirty, clean it with a soft, dry cloth. If the glass surface is stained with grease or some other hard-to-remove material, use a small amount of glass cleaner on a soft cloth to remove it. Wipe off all remaining liquid.

 **Caution:**

Do not spray glass cleaner directly on the scanner glass.

Make sure that no dust builds up on the surface of the document table. Dust can cause spots in your scanned images.

- 5 If the underside of the ADF gets dirty, clean it as described in Step 4. Also, be sure to clean the left side of the document table.

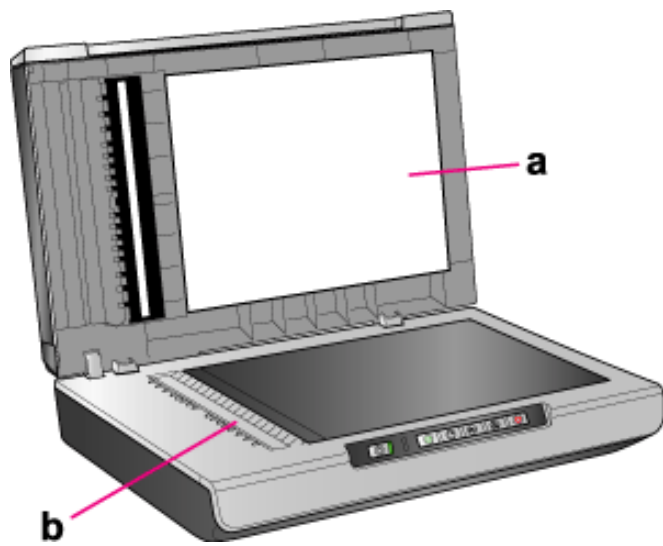

- a. underside of ADF
- b. left side of document table

[Home](#) > [Maintenance](#)

■ Replacing the Scanner Light Source

The luminosity of the scanner light source declines over time. If the light source breaks or becomes too dim to operate normally, the scanner stops working and both the Ready and Error lights rapidly flash. When this happens, the light source assembly must be replaced by a professional. For details, contact Epson. See [Contacting Epson Support](#) for more information.



Caution:

Never open the scanner case. If you think repairs or adjustments are necessary, contact Epson.

[Home](#) > [Maintenance](#)

■ Transporting the Scanner

Before you transport the scanner for a long distance or store it for an extended period of time, you need to lock the scanner's carriage to prevent damage.

- 1 Make sure the carriage is in the home position on the left side of the scanner. If the carriage is not in the home position, turn on the scanner and wait until the carriage moves to the home position.
- 2 Turn off the scanner, then unplug the AC adapter cord.
- 3 Disconnect all the cables from the scanner.
- 4 Push in the transportation lock on the back of the scanner.

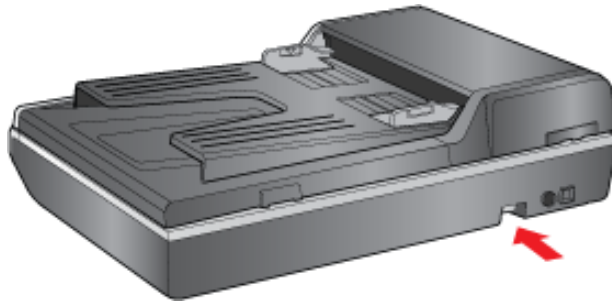

- 5 Attach the packing materials that came with the scanner, then repack the scanner in its original box or a similar box that fits the scanner snugly.

[Home](#) > [Solving Problems](#)

Scanner Problems

- [The Lights Are Flashing](#)
- [The Scanner Does Not Turn On](#)
- [The Scanner Does Not Turn Off](#)
- [The Scanner Turns Off](#)
- [You Cannot Start Epson Scan](#)
- [Pressing the Start Button Does Not Start the Correct Program](#)

The Lights Are Flashing

When an error occurs, the scanner cancels operating and the Error and Ready lights indicate the error type.

Error light (Orange)	Ready light (Green)	Meaning
Flashing	Off	<p>An error has occurred.</p> <ul style="list-style-type: none">■ Make sure the transportation lock is unlocked.■ Make sure the scanner is connected to your computer properly. See the Start Here sheet for instructions on connecting the scanner to your computer.■ Make sure the scanner software is fully installed. See the Start Here sheet for instructions on installing the scanner software.■ Paper is jammed in the ADF. Remove the jammed paper from the ADF. See Paper Jams in the Automatic Document Feeder.■ Turn off the scanner and turn it on again. If the Error and Ready lights are still flashing, the scanner may be malfunctioning, or the scanner light source may need to be replaced. See Contacting Epson Support for details.

[Top](#) 

The Scanner Does Not Turn On

- Make sure your scanner's AC adapter is securely connected to the scanner and a working electrical outlet.
- Make sure the electrical outlet works. If necessary, test it by plugging in another electrical device and turn it on.

[Top](#) 

The Scanner Does Not Turn Off

Make sure the scanning software is not running.

The Scanner Turns Off

This behavior is expected. This product will enter sleep mode after a period of time. This setting can not be changed.

You Cannot Start Epson Scan

- Make sure the scanner is turned on.
- Turn off the scanner and computer, then check the interface cable connection between them to make sure it is secure.
- Use the USB cable that came with your scanner or that is indicated in [USB Interface](#).

Note:

A USB cable is not bundled with the scanner in some areas.

- Connect the scanner directly to the computer's USB port or through one USB hub only. The scanner may not work properly when connected to the computer through more than one USB hub.
- Make sure your computer supports USB.
- If you are using any TWAIN-compliant program, such as Adobe Photoshop Elements, make sure that the correct scanner is selected as the Scanner or Source setting.
- If you upgraded your computer's operating system, you need to reinstall Epson Scan. Uninstall Epson Scan as described in [Uninstalling Your Scanning Software](#), then reinstall it as described in the Start Here sheet.

For Windows only:

Make sure your scanner's name appears under Imaging device without a (?) or an exclamation (!) mark in the Device Manager window. If the scanner's name appears with one of these marks or as an Unknown device, uninstall Epson Scan as described in [Uninstalling Your Scanning Software](#), then reinstall it as described in the Start Here sheet.

Pressing the Start Button Does Not Start the Correct Program

- Make sure Epson Scan is installed correctly.
- **Windows Vista and XP:** Click the **Events** tab in your scanner's Properties window and make sure **Take no action** is not selected. Also, make sure the **Start Button** is selected in the Select an event list box, and **Start this program** is selected.
- **Mac OS X:** Make sure you are logged on as the user who installed the scanner software. Other users must first start Epson Scanner Monitor in the Applications folder and then press the  Start button to scan.

[Home](#) > [Solving Problems](#)

Automatic Document Feeder Problems

- [You Cannot Scan Using the ADF](#)
- [Paper Jams in the Automatic Document Feeder](#)

You Cannot Scan Using the ADF

- Make sure you have selected either **Office Mode** or **Professional Mode** in Epson Scan. See [Changing the Scan Mode](#) for instructions.
- Make sure **Auto Detect** (Office Mode only) or **ADF** is selected as the Document Source setting in Epson Scan. See [Scanning in Office Mode Using the ADF](#) or [Scanning in Professional Mode Using the ADF](#) for instructions.
- Do not feed photographs, valuable original artwork, or documents printed on thick media into the ADF as it may cause a jam, damage the ADF feed mechanism, or damage the original.
- If the ADF is open, close it and try scanning again.

[Top](#) 

Paper Jams in the Automatic Document Feeder

If paper jams inside the ADF, open the ADF and remove any paper from the document table. Then look to see if paper is extending from either end of the feeder.

Do not feed photographs, valuable original artwork, or documents printed on thick media into the ADF as it may cause a jam, damage the ADF feed mechanism, or damage the original.

If paper is still jammed, follow these steps.

- 1** Turn off the scanner.
- 2** If the ADF is open, close it.
- 3** Open the top cover of the ADF.

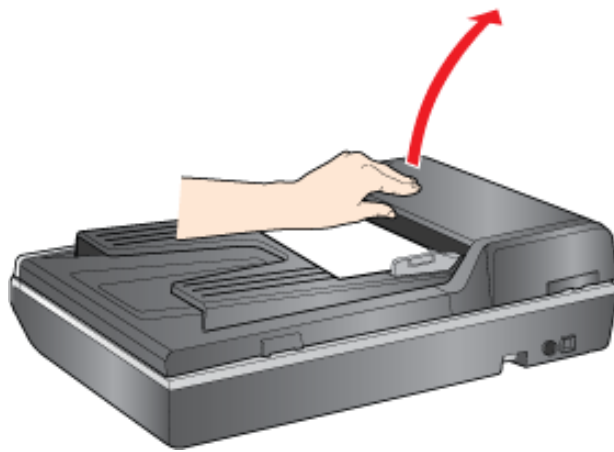

- 4 Remove the jammed paper.

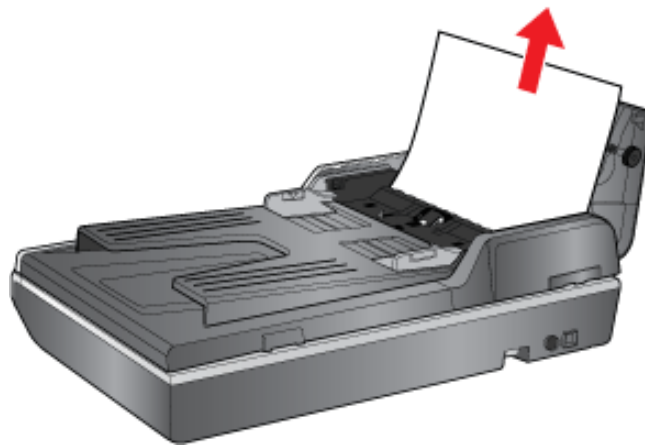

 **Note:**

Remove any pages remaining in the input tray.

- 5 If more of the paper extends into the output tray, gently pull the paper out in the direction shown.

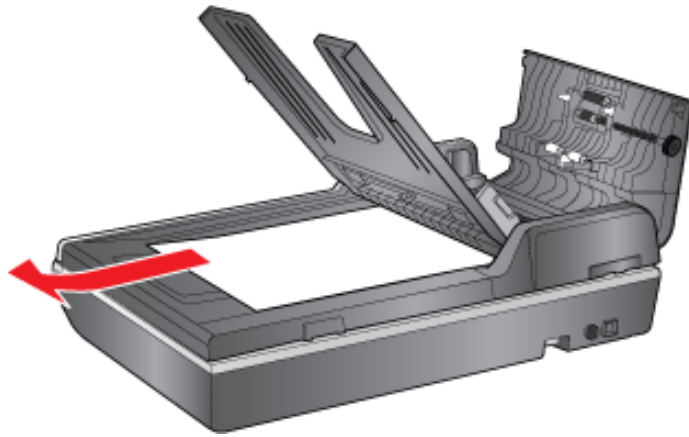

6 Close the input tray.

7 After you have removed the paper, close the top cover of the ADF.

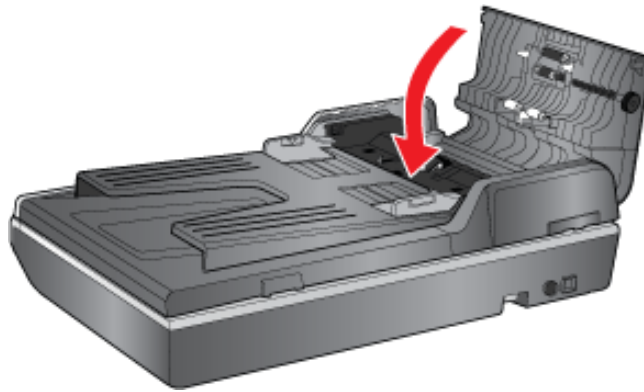

Home > Solving Problems

■ Scanning Problems

- ▾ You Cannot Scan Using the Thumbnail Preview
- ▾ You Have Trouble Adjusting the Scan Area in the Thumbnail Preview
- ▾ You Cannot Scan Multiple Images at One Time
- ▾ Scanning Takes a Long Time

You Cannot Scan Using the Thumbnail Preview

- If you are using Office Mode, the thumbnail preview is not available. Change the scan mode to Home Mode or Professional Mode. See [Changing the Scan Mode](#) for instructions.
- If you are scanning images with a very dark or bright background, use normal preview and create marquees on the area you want to scan. See [Previewing and Adjusting the Scan Area](#) for instructions.
- If you are scanning a large size document, use normal preview and create marquees on the area you want to scan. See [Previewing and Adjusting the Scan Area](#) for instructions.
- Make sure the **Document Type** setting is correct. See [Scanning in Home Mode](#) or [Scanning in Professional Mode](#) for instructions.
- Click **Configuration**, select the **Preview** tab, and adjust the thumbnail cropping area using the **Thumbnail Cropping Area** slider in the Preview menu. See Epson Scan Help for details.

Top 

You Have Trouble Adjusting the Scan Area in the Thumbnail Preview

- Create a marquee or adjust the existing marquee to select the area you want to scan. See [Creating a Marquee on a Preview Image](#) for instructions.
- Click **Configuration**, select the **Preview** tab, and adjust the thumbnail cropping area using the **Thumbnail Cropping Area** slider in the Preview menu. See Epson Scan Help for details.
- Use the normal preview and create marquees on the area you want to scan. See [Adjusting the Color and Other Image Settings](#) for instructions.

Top 

You Cannot Scan Multiple Images at One Time

Position photos at least 20 mm (0.8 inch) apart from each other on the document table.

Top 

Scanning Takes a Long Time

- Try scanning your original at a lower resolution setting to speed up scanning. See [Selecting the Scan Resolution](#) for instructions.
- Computers with USB 2.0 (high speed) ports can scan faster than those with USB 1.1 ports. If you are using a USB 2.0 port with your scanner, make sure it meets the system requirements. See [System Requirements](#) for details.

[Top](#) 

[Home](#) > [Solving Problems](#)

■ Scan Quality Problems

- ▾ [The Edges of Your Original Are Not Scanned](#)
- ▾ [You See Only a Few Dots in Your Scanned Image](#)
- ▾ [A Line or Line of Dots Always Appears in Your Scanned Images](#)
- ▾ [Straight Lines in Your Image Come Out Crooked](#)
- ▾ [Your Image Is Distorted or Blurred](#)
- ▾ [Colors Are Patchy or Distorted at the Edges of Your Image](#)
- ▾ [Your Scanned Image Is Too Dark](#)
- ▾ [An Image on the Back of Your Original Appears in Your Scanned Image](#)
- ▾ [Ripple Patterns Appear in Your Scanned Image](#)
- ▾ [Characters Are Not Recognized Well When Converted into Editable Text \(OCR\)](#)
- ▾ [Scanned Colors Differ From the Original Colors](#)
- ▾ [Images are Rotated Incorrectly](#)

The Edges of Your Original Are Not Scanned

Move the document or photo about 2.5 mm (0.1 inch) away from the horizontal and vertical edges of the document table to avoid cropping.

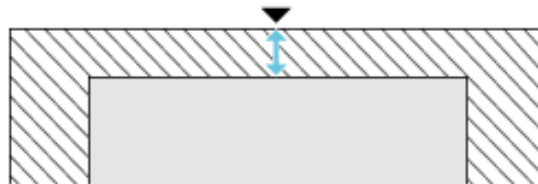

[Top](#)

You See Only a Few Dots in Your Scanned Image

- Make sure the document or photo is placed on the document table with the side to be scanned facing down. See [Placing Documents or Photos](#) for details.
- When scanning with the **Black & White** setting, change the **Threshold** setting. See [Adjusting the Color and Other Image Settings](#) for instructions.

[Top](#)

A Line or Line of Dots Always Appears in Your Scanned Images

The document table may need cleaning. Clean the document table. See [Cleaning the Scanner](#).

If you still have the problem, the document table may be scratched. Contact Epson for assistance. See [Contacting Epson Support](#).

For Lines that run the whole length of the document from the ADF only:

Carefully inspect the small glass window on the left side of the document table (Area a). Any debris or scratches on the small glass may result in a line running the length of the scanned document.

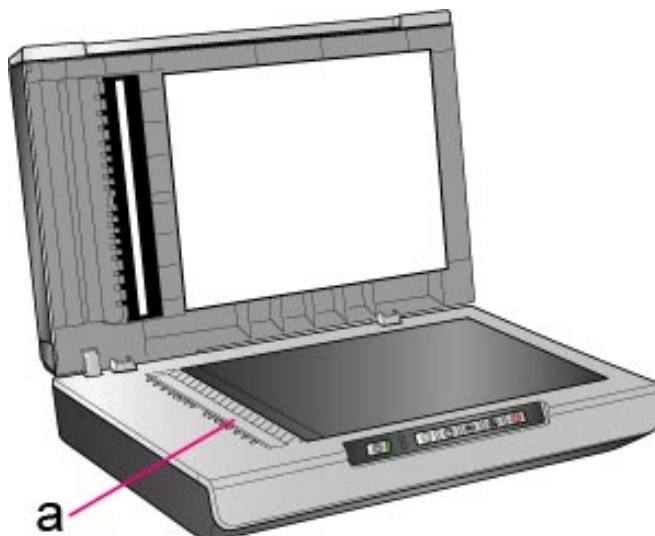

[Top](#) 

Straight Lines in Your Image Come Out Crooked

Make sure the document lies perfectly straight on the document table.

[Top](#) 

Your Image Is Distorted or Blurred



- Make sure the document or photo lies flat on the document table. Also make sure your document or photo is not wrinkled or warped.
- Make sure you do not move the document or photo, or your scanner while scanning.
- Make sure the scanner is placed on a flat, stable surface.
- Select **Unsharp Mask** check box in Office Mode or Professional Mode window. See [Adjusting the Color and Other Image Settings](#) for instructions.
- Adjust the **Auto Exposure** setting in Professional Mode window. See [Adjusting the Color and Other Image](#)

[Settings](#) for instructions.

- Click **Configuration**, select the **Color** tab, and select **Color Control** and **Continuous auto exposure** in the Color menu. See Epson Scan Help for details.
- Click **Configuration**, select the **Color** tab, and click **Recommended Value** to return the Auto Exposure setting to the default. See Epson Scan Help for details.
- Increase the resolution setting. See [Selecting the Scan Resolution](#) for instructions.

[Top](#) 

Colors Are Patchy or Distorted at the Edges of Your Image



If your document is very thick or curled at the edges, cover the edges with paper to block external light as you scan.

[Top](#) 

Your Scanned Image Is Too Dark



- If your original is too dark, try using the **Backlight Correction** feature in Home Mode or Professional Mode. See [Fixing Backlit Photos](#) for instructions.
- Check the **Brightness** setting. See Epson Scan Help for details.
- Click **Configuration**, select the **Color** tab, and change the **Display Gamma** setting to match your output device, such as a monitor or printer, in the Color menu. See Epson Scan Help for details.
- Click **Configuration**, select the **Color** tab, and select **Color Control** and **Continuous auto exposure** in the Color menu. See Epson Scan Help for details.
- Click the **Configuration** button, select the **Color** tab, and click **Recommended Value** to return the Auto Exposure setting to the default. See Epson Scan Help for details.
- Click the  Histogram Adjustment icon in Professional Mode to adjust the brightness.
- Check the brightness and contrast settings of your computer monitor.

[Top](#) 

An Image on the Back of Your Original Appears in Your Scanned Image

If your original is printed on thin paper, images on the back may be visible to the scanner and appear in your scanned image. Try scanning the original with a piece of black paper placed on the back of it. Also make sure the **Document Type** and **Image Type** settings are correct for your original. See [Scanning in Home Mode](#) or [Scanning in Professional Mode](#) for instructions.

Top 

Ripple Patterns Appear in Your Scanned Image

A ripple or cross-hatch pattern (called moiré) may appear in a scanned image of a printed document. It is caused by interference from the differing pitches in the scanner's screen and the halftone screen in your original.

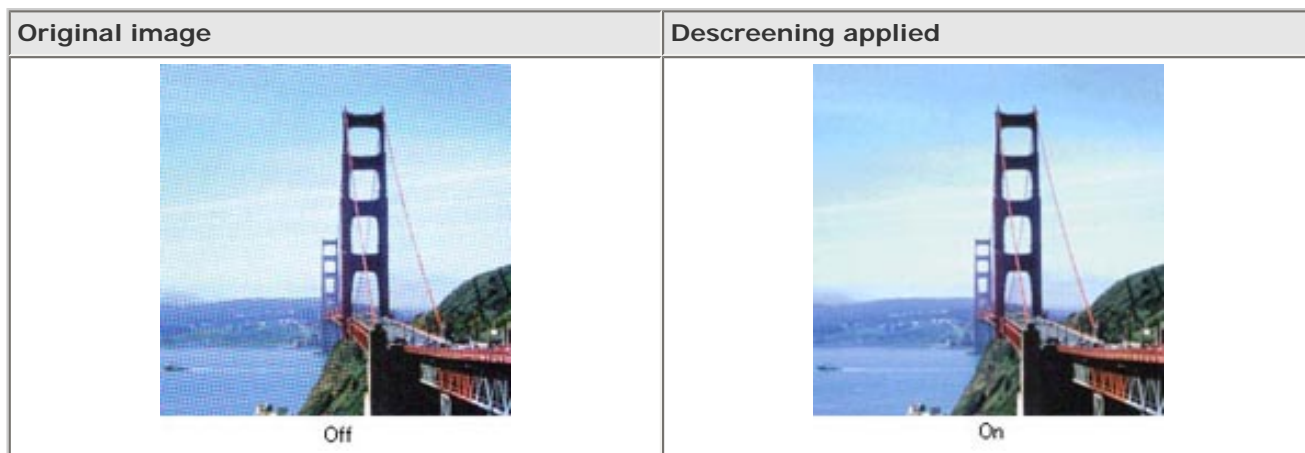

- Select the **Descreening** check box. In Professional Mode, select an appropriate **Screen Ruling** for the Descreening and deselect the **Unsharp Mask** setting. See [Adjusting the Color and Other Image Settings](#) for instructions.
- Select a lower resolution setting. See [Selecting the Scan Resolution](#) for instructions.

Note:

You cannot remove ripple patterns when you are scanning using a resolution higher than 600 dpi.

Top 

Characters Are Not Recognized Well When Converted into Editable Text (OCR)

- Make sure the document lies perfectly straight on the document table.
- In Office Mode or Home Mode, select the **Text Enhancement** check box.
- Adjust the **Threshold** setting.
 - **Office Mode** or **Home Mode:** Select **Black&White** as the Image Type setting. Then try adjusting the **Threshold** setting. See [Converting Scanned Documents Into Editable Text](#) for instructions.
 - **Professional Mode:** Click the + (Windows) or  (Mac OS X) button next to **Image Type** and make the appropriate Image Option setting. Then try adjusting the **Threshold** setting. See [Converting Scanned Documents Into Editable Text](#) for instructions.
- Check your OCR software manual to see if there are any settings you can adjust in your OCR software.

Scanned Colors Differ From the Original Colors

- Make sure the **Image Type** setting is correct. See [Scanning in Office Mode](#), [Scanning in Home Mode](#), or [Scanning in Professional Mode](#) for instructions.
- Click **Configuration**, select the **Color** tab, and change the **Display Gamma** setting to match your output device, such as a monitor or printer, in the Color menu. See Epson Scan Help for details.
- Adjust the **Auto Exposure** setting in Professional Mode. Also try selecting a different **Tone Correction** setting. See [Adjusting the Color and Other Image Settings](#) for instructions.
- Click **Configuration**, select the **Color** tab, and select **Color Control** and **Continuous auto exposure** in the Color menu. See Epson Scan Help for details.
- Click **Configuration**, select the **Color** tab, and click **Recommended Value** to return the Auto Exposure setting to the default. See Epson Scan Help for details.
- Click **Configuration**, select the **Preview** tab, and turn off the **Fast Preview** setting in the Preview menu. See Epson Scan Help for details.
- Make sure to enable the **Embed ICC Profile** setting. In the File Save Settings window, select **JPEG** or **TIFF** as the Type setting. Click **Options**, then select the **Embed ICC Profile** check box. To access the File Save Settings window, see [Selecting File Save Settings](#).
- Check the color matching and color management capabilities of your computer, display adapter, and software. Some computers can change the palette of colors on your screen. See your software and hardware manuals for details.
- **Windows:** Use the color management system for your computer, ICM. Add a color profile that matches your monitor to improve on-screen color matching. Exact color matching is very difficult. Check your software and monitor documentation for information on color matching and calibration.
- **Mac OS X:** Use the color management system for your computer, ColorSync. Exact color matching is very difficult. Check your software and monitor documentation for information on color matching and calibration.
- Printed colors can never exactly match the colors on your monitor because printers and monitors use different color systems: monitors use RGB (red, green, and blue) and printers typically use CMYK (cyan, magenta, yellow, and black).

Images are Rotated Incorrectly

- Make sure the documents or photos are placed on the document table correctly. See [Placing Documents or Photos](#) for instructions.
- If you are scanning using thumbnail previews, select the image and click the  rotation icon to rotate it. See [Previewing and Adjusting the Scan Area](#) for instructions.
- Try disabling or enabling the **Auto Photo Orientation** setting. In Home Mode or Professional mode, click **Configuration**, select the **Preview** tab, and select or deselect **Auto Photo Orientation**.

Note:

- The Auto Photo Orientation feature will not work when you scan newspaper or magazine pages, documents, illustrations, or line art. The feature will also not work when you scan images that are 5.1 cm (2 inches) or smaller on any side.
- The Auto Photo Orientation feature may not work correctly if the faces in your image are very small or not looking straight ahead, or if the faces are of infants. The feature may also not work correctly if you scan an indoor image that contains no faces, an outdoor image in which the sky is not at the top, or any image containing bright spots or objects in locations other than the top of your image.

[Home](#) > [Solving Problems](#)

Uninstalling Your Scanning Software

 [For Windows](#)

 [For Mac OS X](#)

You may need to uninstall and then reinstall your scanner software to solve certain problems or if you upgrade your operating system.

For Windows

 **Note:**

- For Windows 8, Windows 7, and Vista, you need an administrator account and password if you log on as a standard user.
- For Windows XP, you must log on to a Computer Administrator account.

1 Turn off the scanner.

2 Disconnect the scanner's interface cable from your computer.

3 Do one of the following.

Windows 8: Navigate to the **Start** screen, right-click and select **All apps**. Select **Control Panel**.

Windows 7 and Vista: Click the start button and select **Control Panel**.

Windows XP: Click **Start** and select **Control Panel**.

4 Do one of the following.

Windows 8: Select **Programs**, then select **Programs and Features**.

Windows 7 and Vista: Click **Uninstall a program** from the Programs category.

Windows XP: Double-click the **Add or Remove Programs** icon.

5 Select the software you want to uninstall such as EPSON Scan, your scanner's Manual, and the application from the list displayed.

6 Do one of the following.

Windows 8/Windows 7: Click **Uninstall/Change**.

Windows Vista: Click **Uninstall/Change**, and then click **Continue** in the User Account Control window.

Windows XP: Click **Change/Remove**.

7 When the confirmation window appears, click **Yes**.

8 Follow the on-screen instructions.

In some cases, a message may appear to prompt you to restart your computer. If so, make sure **I want to restart my computer now** is selected and click **Finish**.

Top 

For Mac OS X

In most cases, you do not need to uninstall your product software before reinstalling it. However, you can download the Uninstall Center utility from the Epson support website to uninstall your product software as described here.



Note:

- If you find that reinstalling your product software does not solve a problem, contact Epson.

1 To download the Uninstall Center utility, visit the Epson download site ([U.S. downloads](#) or [Canadian downloads](#)).

2 Follow the instructions on the screen to install the Uninstall Center.

3 Quit all applications currently running on your Mac.

4 Double click the **Uninstall Center** icon.

5 Select the checkbox for each software program you want to uninstall.

6 Click **Uninstall**.

7 Follow the on-screen instructions to uninstall the software.

Top 

[Home](#) > [Solving Problems](#)

■ **Technical Support Web Site**

Epson's Technical Support Web Site provides help with problems that cannot be solved using the troubleshooting information in your product documentation and has the the latest drivers, FAQs, manuals, and other downloadables. If you have a Web browser and can connect to the Internet, access the site at:

<http://www.epson.com/support/> (U.S.) or <http://www.epson.ca/support/> (Canada)

[Home](#) > [Solving Problems](#)

Contacting Epson Support

- [Before Contacting Epson](#)
- [Help for Users in North America](#)
- [Help for Users in Latin America](#)

Before Contacting Epson

If your Epson product is not operating properly and you cannot solve the problem using the troubleshooting information in your product documentation, contact Epson support services for assistance.

Epson support will be able to help you much more quickly if you give them the following information:

- Product serial number
(The serial number label is usually on the back of the product.)
- Product model
- Product software version
(Click **About**, **Version Info**, or similar button in the product software.)
- Brand and model of your computer
- Your computer operating system name and version
- Names and versions of the software applications you normally use with your product

[Top](#) 

Help for Users in North America

Epson provides the technical support services listed below.

Internet Support

Visit Epson's support website at <http://epson.com/support> (US) or <http://epson.ca/support> (Canada) and select your product for solutions to common problems. You can download drivers and documentation, get FAQs and troubleshooting advice, or e-mail Epson with your questions.

Speak to a Support Representative

Dial: (562) 276 4382 (U.S.), or (905) 709-3839 (Canada), 6 am to 8 pm, Pacific Time, Monday through Friday, and 7 am to 4 pm, Pacific Time, Saturday. Days and hours of support are subject to change without notice. Toll or long distance charges may apply.

Before you call Epson for support, please have the following information ready:

- Product name
- Product serial number
- Proof of purchase (such as a store receipt) and date of purchase
-

- Computer configuration
- Description of the problem

 **Note:**

For help using any other software on your system, see the documentation for that software for technical support information.

Purchase Supplies and Accessories

You can purchase genuine Epson ink cartridges, ribbon cartridges, paper, and accessories from an Epson authorized reseller. To find the nearest reseller, call 800-GO-EPSON (800-463-7766). Or you can purchase online at <http://www.epsonstore.com> (U.S. sales) or <http://www.epson.ca> (Canadian sales).

Top 

Help for Users in Latin America

Electronic support services are available 24 hours a day at the following websites:

Service	Access
World Wide Web	From the Internet, you can reach Epson's Latin American website at http://www.latin.epson.com In Brazil, you can reach Epson at http://www.epson.com.br

To speak with a support representative, call one of the numbers below:

Country	Telephone number
Argentina	(54 11) 5167-0300
Bolivia*	800-100-116
Brazil	State capitals and metropolitan areas: 4003-0376 Other areas: 0800-880-0094
Chile	(56 2) 484-3400
Colombia	(57 1) 523-5000
Costa Rica	800-377-6627
Dominican Republic*	1-888-760-0068
Ecuador*	1-800-000-044
El Salvador*	800-6570
Guatemala*	1-800-835-0358
Honduras**	800-0122 Code: 8320
Mexico	Mexico City: (52 55) 1323-2052 Other cities: 01-800-087-1080
Nicaragua*	00-1-800-226-0368
Panama*	00-800-052-1376
Peru	Lima: (51 1) 418-0210 Other cities: 0800-10126
Uruguay	00040-5210067

Venezuela	(58 212) 240-1111
-----------	-------------------

* Contact your local phone company to call this toll free number from a mobile phone.

** Dial first 7 digits, wait for a message, then enter code.

If your country does not appear in the list, contact the sales office in the nearest country. Toll or long distance charges may apply.

[Top](#) 

[Home](#) > [Solving Problems](#)

■ Other Software Technical Support

Nuance ScanSoft PaperPort

(407) 241-0618, <http://support.nuance.com>

ABBYY FineReader

(408) 457-9777, <http://www.abbyy.com>, support@abbyyusa.com

EMC ISIS

(800) 782-4362 (U.S.), (800) 543-4782 (Canada), <http://powerlink.emc.com>

Top 

[Home](#) > [Technical Specifications](#)

■ System Requirements

[Windows System Requirements](#)

[Macintosh System Requirements](#)

Make sure your system meets the requirements in these sections before using it with your scanner.

Windows System Requirements

System	Microsoft Windows 8, Windows 7, Windows Vista, Windows XP
Interface	USB port (Type A) built into the main board
Display	Color monitor with 800 × 600 screen resolution or higher, and 24-bit (Full Color) color (Color and tone reproduction are subject to the display capability of your computer system, including the video card, display monitor, and software. See your system documentation for details.)

[Top](#) 

Macintosh System Requirements

System	Mac OS X 10.5.8, Mac OS X 10.6.x, OS X Lion (10.7.x), OS X Mountain Lion (10.8.x) or later.
Interface	Macintosh USB
Display	Color monitor with 800 × 600 screen resolution or higher, and millions of colors (Color and tone reproduction are subject to the display capability of your computer system, including the video card, display monitor, and software. See your system documentation for details.)







 **Note:**

Epson Scan does not support the UNIX File System (UFS) for Mac OS X. You must install Epson Scan on a disk or in a partition that does not use UFS.

[Top](#) 

[Home](#) > [Technical Specifications](#)

Scanner Specifications

-  [General](#)
-  [Mechanical](#)
-  [Electrical](#)
-  [Environmental](#)
-  [Interfaces](#)
-  [Standards and Approvals](#)

 **Note:**

Specifications are subject to change without notice.

General

Scanner type	Flatbed color
Photoelectric device	Color CCD line sensor
Effective pixels	10,200 × 14,040 pixels at 1200 dpi
Document size	216 × 297 mm (8.5 × 11.7 inches) A4 or US letter size
ADF paper input	Face-up loading
ADF paper output	Face-down ejection
ADF paper capacity	40 sheets of paper at 75 g/m ²
Scanning resolution	1200 dpi (main scan) 2400 dpi with Micro Step (sub scan)
Output resolution	50 to 4800 dpi
Image data	16 bits per pixel per color internal 1 to 16 bits per pixel per color external
Interface	One USB 2.0 Hi-speed port
Light source	White LED

 **Note:**

Optional optical resolution is the maximum scan resolution of the CCD elements, using the definition of ISO 14473. ISO 14473 defines optical resolution as the fundamental sampling rate of the scan sensor.

[Top](#) 

Mechanical

Dimensions	Width: 470.0 mm (18.5 inches) Depth: 318.0 mm (12.5 inches) Height: 121.0 mm (4.8 inches) with ADF
Weight	Approx. 3.9 kg (8.6 lb)

[Top](#) 

Electrical

Note:

Check the label on the AC adapter or on the back of the scanner for voltage information.

Scanner

Rated voltage	DC 24.0 V
Rated input current	1.3 A
Power consumption	12.5 W operating 2.4 W or lower in sleep mode 0.5 W or lower in power off mode

AC Adapter

	100-120 V model	220-240 V model
AC adapter model	A411B	A411E
Rated input voltage	AC 100 to 120 V	AC 220 to 240 V
Rated input current	1.0 A	0.5 A
Rated input frequency	50 to 60 Hz	
Rated output voltage	DC 24.0 V	
Rated output current	1.3 A	

Note:

The AC adapter model varies in certain locations.

[Top](#) 

Environmental

Temperature	Operating	10 to 35 °C (50 to 95 °F)
	Storage	-25 to 60 °C (-13 to 140 °F)
Humidity	Operating	10 to 80%, without condensation

	Storage	10 to 85%, without condensation
Operating conditions		Ordinary office or home conditions. Avoid operating the scanner in direct sunlight, near a strong light source, or in extremely dusty conditions.

[Top](#) 

Interfaces

USB Interface

Interface type	Universal Serial Bus Specification Revision 2.0
Electrical standard	Full Speed mode (12 Mbits per second) and Hi-Speed mode (480 Mbits per second) of Universal Serial Bus Specification Revision 2.0.
Connector type	One Type B port

[Top](#) 

Standards and Approvals

Scanner

EMC	FCC Part 15 Subpart B Class B CAN/CSA-CEI/IEC CISPR22 Class B
-----	--

AC Adapter

Safety	UL60950-1 CAN/CSA-C22.2 No. 60950-1
EMC	FCC Part 15 Subpart B Class B CAN/CSA-CEI/IEC CISPR22 Class B

[Top](#) 