

JEANNEAU 57



OWNER'S MANUAL



090282
Index E

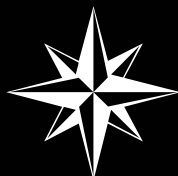

JEANNEAU YACHTS

WELCOME ABOARD

Madam, Sir,

You have just taken delivery of your new JEANNEAU boat and we thank you for the confidence you have shown us in ordering a vessel of our brand. The whole JEANNEAU team welcomes you aboard.

A JEANNEAU is made to last, in order to bring you all the pleasure you expect from a vessel over a period of many years. Each boat is subject to the utmost attention to detail from the design stage right through to launching.

This manual is meant to help you to enjoy your boat comfortably and safely. It includes the boat specifications, the equipment provided or installed, the systems and tips on her operation and maintenance. Some of the equipment described in this manual may be optional.

Your JEANNEAU dealer will be able to help and advise you in the use and maintenance of your boat.

Read this user's guide/owner's manual carefully and get to know your boat before using it.

The better you know your vessel the more pleasure you will get from being at the helm.

The sea is a source for learning. Caution based on a knowledge of one's own limits and those of the boat is the pre-requisite for an accomplished sailor.

Even when your boat has been adapted for them, the sea and wind conditions corresponding to the design categories A, B, C and D may vary, ranging from severe conditions to strong storms subject to the risks of exceptional waves and gusts of wind, this meaning they are dangerous conditions in which only an experienced, fit and well trained crew manoeuvring a well maintained boat can sail in a satisfactory manner.

This user's guide/owner's manual is not a course in safety at sea or about sailing sense. If this is your first boat or if you change to a new type of boat which you are not used to, get some training in boat control and sailing to ensure your safety and comfort. Your dealer, your international sailing association or your yacht club will be very happy to recommend local sailing schools or professional instructors.

Make sure the sea and wind conditions will correspond to the category of your boat and you and your crew are able to handle the boat in these conditions.

Always listen to the weather forecast before you put out to sea.

Keep this user's guide/owner's manual in a safe place and hand it over to the new owner if you sell your boat.

You are advised to keep all the instructions and manuals provided by the boat equipment manufacturers (accessories...) in the same place as this manual.



INTRODUCTION

THE USERS OF THE BOAT ARE INFORMED OF THE FOLLOWING:

■ This user guide/owner's manual is not a maintenance or repair guide. In case of difficulty do not hesitate to call on the services of your concessionaire JEANNEAU.

■ Any alterations which may affect the safety specifications of the boat must be assessed, carried out and recorded by persons qualified to do so. Any change in the distribution of the vessel's mass (adding a radar, altering the mast, changing an engine, etc) may affect the stability, trim and performance of your boat.

The SPBI shipyards may not be held responsible for any alterations which they have not approved.

■ The complete crew must be equipped appropriately.

■ In numerous countries, a licence, an authorization or a training course is requested. Make sure you have this legal authorization before you use your boat.

■ Adapt the use of your boat to her condition that wears out with time and use.

■ Any boat, however solid she may be, may be severely damaged if badly used. This is not compatible with safe navigation. Always adapt the speed and direction of your boat to the conditions of the sea.

■ The boat shall not be loaded more with than the maximum load recommended by the builder, in particular the total weight of the food supplies, of the different equipment that are not supplied by the builder and of the persons on board.

■ The weight of the boat shall be properly distributed.

■ The stability is reduced when you add weight in the upper parts.

■ In case of heavy weather, the hatches, lockers and doors shall be closed in order to minimize the risk of water coming in.

■ Breaking waves are a serious threat to stability.

■ The water in the bilge shall be kept at its minimum.

■ The stability may be reduced when you tow a boat or when you lift heavy weights with the davits or the boom.

■ If your boat is equipped with a liferaft, carefully read the instructions. The boat must have on board all the proper safety equipment (lifejackets, buoys, harness, flares, liferafts, etc.) depending on the type of vessel, its certification, the country, the weather conditions encountered, etc.

■ The crew must be familiar with the use of all the safety equipment and the emergency safety procedures (MOB, towing etc.). Sailing schools organise regular training sessions.

■ Anyone on the deck shall wear a life jacket or a buoyancy aid.

The safety regulations as defined by the sailing code and enforced by the "COLREG" should be observed.

NAME PLATE:

Some of the data is shown on the manufacturer's plate fixed to the boat. The explanation of the data is given in the appropriate chapters of this manual.

IDENTIFICATION OF VESSEL:

The vessel's identification is found on the builder's certificate delivered with the boat and is engraved on the starboard aft side.

So as to be able to continuously improve their product the SPBI shipyards reserve the right to make any alterations in design, layout or equipment which they judge necessary.

That is the reason why the specifications and information given are not contractual, they may be modified without prior notice or updates.

This owner's manual is designed in accordance with the ISO 10240 standard requirements, it has a general purpose and it may sometimes list some equipment or accessories or deal with some points or questions that are not relevant to your own boat.

The different warnings used throughout this guide are broken down as follows.



DANGER

Indicates the existence of a serious inherent danger with a high risk of death or serious injury if the appropriate precautions are not taken.



WARNING

Indicates the existence of a danger which could lead to injury or death if the appropriate precautions are not taken.

PRECAUTION

Indicates a reminder of safety practice or draws attention to dangerous practices which could cause injury to persons or damage to the vessel or to its components.

ADVICE - RECOMMENDATION

Indicates a recommendation or advice for carrying out manoeuvres appropriate for the planned manoeuvres.



HISTORY OF UPDATES

•Index A	01/2010
•Index B	02/2010
•Index C	09/2010
•Index D	03/2011
•Index E	08/2012

CONTENTS

JEANNEAU 57 Anglais
Update 08/2012
Index E

Code: 090282

Total number of pages: 148

INTRODUCTION

Chapter 1 SPECIFICATIONS AND WARRANTY	Page 7
Chapter 2 SAFETY	Page 13
Chapter 3 HULL	Page 31
Chapter 4 DECK	Page 35
Chapter 5 STEERING SYSTEM	Page 45
Chapter 6 RIGGING AND SAILS	Page 49
Chapter 7 INTERIOR	Page 69
Chapter 8 WATER AND SEWAGE WATER	Page 77
Chapter 9 ELECTRICAL EQUIPMENT	Page 91
Chapter 10 ENGINE	Page 127
Chapter 11 LAUNCHING	Page 139
Chapter 12 WINTER STORAGE	Page 143

PERSONAL NOTES



SPECIFICATIONS AND WARRANTY

TECHNICAL SPECIFICATIONS

CERTIFICATION

DESIGN CATEGORY

YOUR BOAT

TECHNICAL SPECIFICATIONS

L.O.A.....	17.78 m
Hull length.....	17.28 m
L.W.L.	15.35 m
Overall width.....	5.00 m
Beam.....	5.00 m
Waterline beam.....	4.14 m
Air draught (Version Jib reefer / Performance) - Empty vessel.....	24.20 m
Draught Deep draught keel - Maximum.....	2,50 m
Ballast weight Deep draught keel.....	6 100 kg
Draught Shallow draught keel - Maximum.....	2,10 m
Ballast weight shallow draught.....	6 500 kg
Light displacement.....	21 422 kg
Displacement with maximum load.....	27 766 kg
Maximum load recommended by the builder.....	6 344 kg
Including the mass of the persons who are authorized on board (75 kg/165 lbs per adult), the supplies, the liquids that can be used (fresh water and fuel) in fixed completely full tanks, the additional loads, the optional equipments, the liferaft and the scope for load.	
Total mass of liquids (all tanks full).....	1 834 l
Freshwater capacity.....	3 x 310 l
Fuel oil tank capacity.....	420 l + 310 l
Refrigeration unit capacity.....	300 l
Sewage water capacity (in each bathroom).....	80 l
Recommended maximum power.....	110 kW
Maximum motorisation mass.....	265 kg
Battery capacity - Service (24V system).....	4 x 120 A
Battery capacity - Spare batteries - (24V system).....	4 x 120 A
Battery capacity - Service (12V system).....	50 A
Battery capacity - Engine.....	60 A
Battery capacity - Bow thruster.....	4 x 50 A
Battery capacity - Generator.....	50 A
Cabins.....	3/4/5
Architect.....	Philippe BRIAND
Design.....	Garroni Design

Note: The capacities indicated are maximum (including options).



SAILS	JIB REEFER	PERFORMANCE
Mainsail (classic).....	58 m ²	73 m ²
Genoa	88 m ²	88 m ²
Gennaker	170 m ²	170 m ²
Asymmetric spinnaker.....	202 m ²	202 m ²
Symmetric spi.....	/	220 m ²
Staysail.....	46 m ²	46 m ²
I.....	21,00 m	21,00 m
J.....	6,68 m	6,68 m
P.....	19,59 m	19,80 m
E.....	6,40 m	6,40 m

The sails are the main propulsion means of the JEANNEAU 57

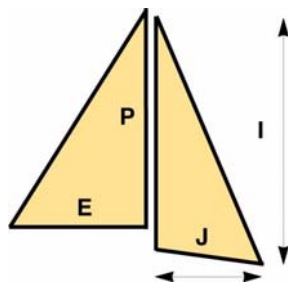

CERTIFICATION

CE Category	Persons Maximum
A	13
B	14
C	16
D	16

DESIGN CATEGORY

Design category	Wind force (Beaufort scale)	Significant height of waves to be considered (in metres H 1/3)
Vessel designed for navigation: A - "At high sea" B - "In open sea" C - "Near to the coast" D - "In sheltered waters"	Over 8 Up to and including 8 Up to and including 6 Up to and including 4	Over 4 Up to and including 4 Up to and including 2 Up to and including 0,3

The JEANNEAU 57 model conforms to the directive 2003/44/CE.

Category A: At high sea

This craft is designed to operate in winds that may exceed wind force 8 (Beaufort scale) and in significant wave heights of 4 m and above.

This craft is largely self-sufficient. Abnormal conditions such as hurricanes are excluded. Such conditions may be encountered on extended voyages, for example across oceans, or inshore when unsheltered from the wind and waves for several hundred nautical miles.

Category B: In open sea

This craft is designed to operate in winds up to Beaufort force 8 and the associated wave heights (significant wave height up to 4 m, see Note 1 below).

Such conditions may be encountered on offshore voyages of sufficient length, or on coastal waters when unsheltered from the wind and waves for several dozens of nautical miles.

These conditions may also be experienced on inland seas of sufficient size for the wave height to be generated.

Category C: Near to the coast

This craft is designed to operate in winds up to Beaufort force 6 and the associated wave heights (significant wave height up to 2 m, see Note 1 below). You may meet with such conditions in exposed inland waters, in estuaries and in coastal waters with moderate weather conditions.

Category D: In sheltered waters

This craft is designed to operate in winds up to Beaufort force 4 and the associated wave heights (occasional maximum waves of 0,5 m height).

Such conditions may be encountered in sheltered inland waters, and in coastal waters in fine weather.

NOTE:

- The significant wave height is the mean height of the highest one-third of the waves, which approximately corresponds to the wave height estimated by an experienced observer. Some waves will be double this height.

- The creation of different design categories results from the need to distinguish between different levels of risk according to the construction of the boats.

The parameters for the characteristics are established to define the conditions of navigation which each category may encounter; they serve purely to evaluate the boat designs and are not to be used to limit the geographical areas in which these boats may operate..

- One boat may be classed in several design categories at the same time, each with their different maximum capabilities.

YOUR BOAT



Version

NAME OF THE BOAT

NAME OF THE OWNER

ADDRESS

HULL NUMBER

SERIAL NUMBER

REGISTRATION NUMBER

DELIVERY DATE

DOOR KEY NUMBER

MAKE OF ENGINE

ENGINE SERIAL NUMBER

ENGINE KEY NUMBER

SPECIFICATIONS AND WARRANTY

Your agent



JEANNEAU YACHTS

JEANNEAU (Establishment of the company SPBI)
BP 529 - 85505 LES HERBIERS cedex - FRANCE
Tel. (33) 02 51 64 20 20 - Fax (33) 02 51 67 37 65
Internet : [http://www.jeanneau.com\(fr\)](http://www.jeanneau.com(fr)).





SAFETY

SAFETY EQUIPMENT

GENERAL INFORMATION

GAS SYSTEM

RECOMMENDATIONS FOR GAS

FIGHT AGAINST FIRE

BILGE PUMP SYSTEM

EMERGENCY TILLER

SAFETY EQUIPMENT



Swimming ladder (means of coming back onboard) (Reference 1)

Opening - Swimming ladder



Swimming ladder in position



Swimming ladder / Garage Open



Note: If over 10 persons on board, 2 liferafts compulsory

Liferaft (Reference 2) - not supplied



GENERAL INFORMATION



DANGERS

The major hazards concern:

- The gas system.
- The electrical system.
- Manoeuvring the vessel and the sails.
- The motorisation.

Please refer to the relevant paragraphs.

SAFETY

DANGER



- Fuel leaks or vapour represent a danger of fire and explosion.
- Leave the engine compartment ventilated for a long time before starting the engine.
- There may be danger of fire or explosion if direct current systems are incorrectly used. Refer to chapter Electricity.
- Some boats are equipped with a retractable ladder or removable. Make sure the ladder is in place and deployed as soon as you are on board.
- Reduce speed in waves.

WARNING



- Before you sail, list the compulsory safety equipment.
- Don't exceed the number of persons indicated in the chapter 'Specifications'.
- The total weight of the persons and equipment must never exceed the maximum load recommended by the manufacturer.
- Use the seats provided.



ADVICE - RECOMMENDATION

- When sailing, never padlock or lock the liferaft locker.
- Before putting to sea, carefully read the launching instructions shown on the liferaft.
- Close the deck hatches and portholes before each trip (including the companionway hatch in heavy weather).
- Don't store anything below the floorboards.
- Ensure that movable items are firmly secured when the boat is under way.

GAS SYSTEM

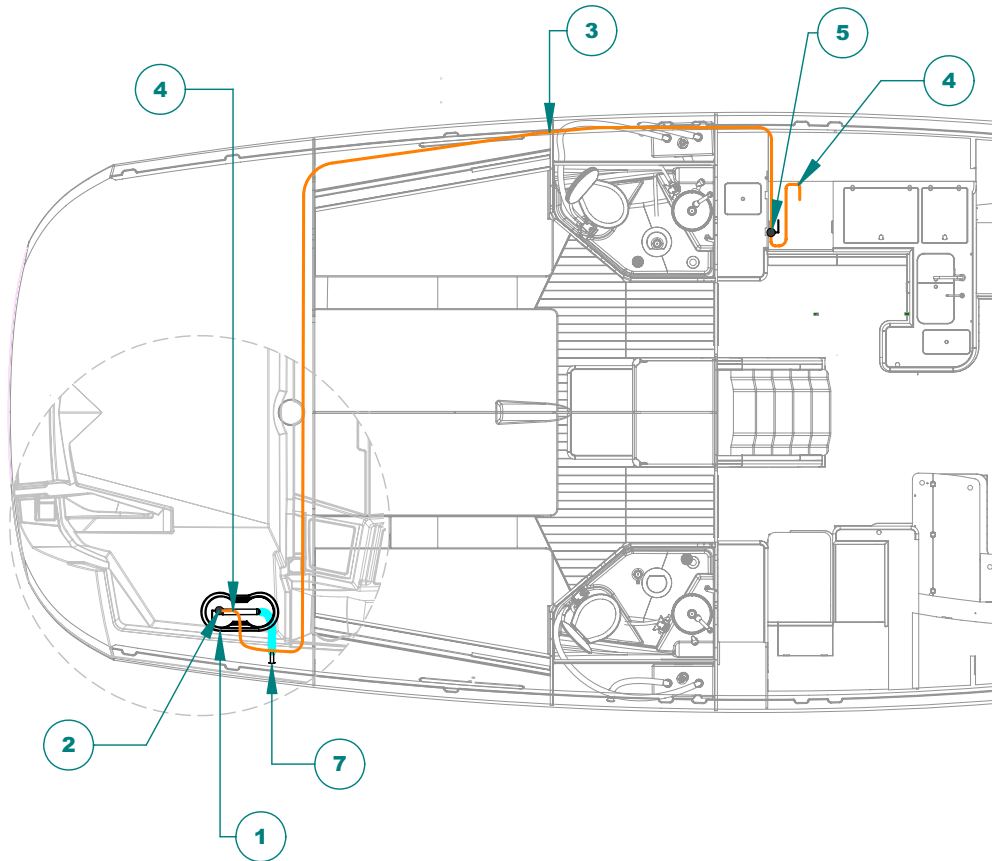
LOCATION



	Gas
	Vent hole

REF	Designation
1	Gas cylinder locker
2	Gas kill valve on bottle
3	Gas pipe
4	Gas rubber tubing
5	Tap to turn off the gas
7	Gas vent



Opening valve / Reheating gas closing
(Reference 1)

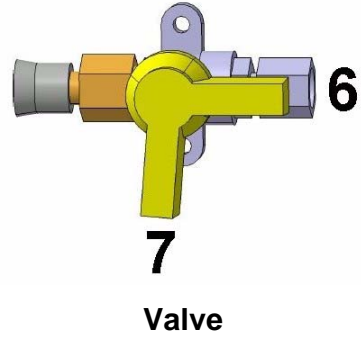

Valve

SAFETY

REF	Designation
6	Open valve
7	Closed valve



Gas cylinder locker (Reference 2)

Note: Same position for the other layouts.

GAS SYSTEM - VERSION US
Schematic diagram

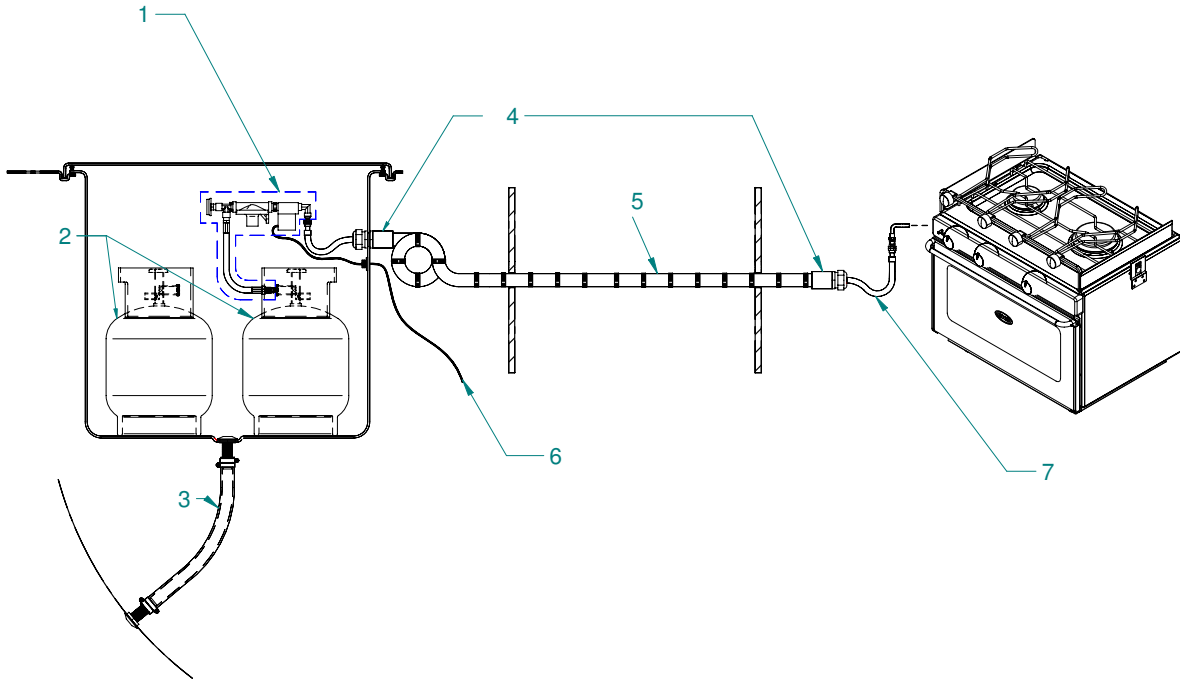

REF	Designation
1	Regulator valve 24V
2	Gas cylinder
3	Drain
4	Stuffing box
5	PVC girdled sleeve
6	Electromagnetic valve for gas 24V
7	Pipe Propane Plastic

RECOMMENDATIONS FOR GAS



Type of cylinder: butane, service pressure 10 kg/cm² or according to current standards of your country).

Close the valves on the system and on the cylinder when the appliances are not used. Close the valves before you change cylinders and immediately in case of emergency.

Never leave unattended an appliance that is working. Don't install or store flammable materials above or over the stove (curtains, papers, napkins etc.).

Make sure that the valves of the appliances are closed before you open the cylinder or hose valve.

In case you smell gas or find that the burners have gone out (although appliance models cut off automatically if the flames go out), turn off the valves of the appliances. Do ventilate the boat in order to get rid of any residual gas. Find the cause of the problem.

Regularly test the gas system in order to detect any gas leak.

Check all the connections using water and soap or detergent, closing the valves of the appliances and opening the valve on the cylinder.

If you detect a leak, close the valve of the cylinder and repair before you use it again.

The appliances use the oxygen of the cabin and release combustible gases. Ventilate your boat when using appliances.

Don't obstruct the air vents and at least leave the door open. Don't use the oven or stove as back up heaters.

Lock the stove oven when being not used in order to avoid damaging the tubes when sailing..



WARNING

- For all recommendations concerning gas: Refer to chapter 2, «Safety».
- Don't use a solution containing ammonia.
- Don't use a flame to detect leaks.
- Don't smoke, don't use a naked flame when you change the gas cylinder.

ADVICE - RECOMMENDATION

- Shut off the gas supply at the bottle as well as the cooker tap.
- When changing the cylinder, refit the cap in place on the regulator threaded section (to avoid corrosion).
- For winter storage instructions and precautions, refer to Chapter 13.

SCHEMA GAS - VERSION EUROPE

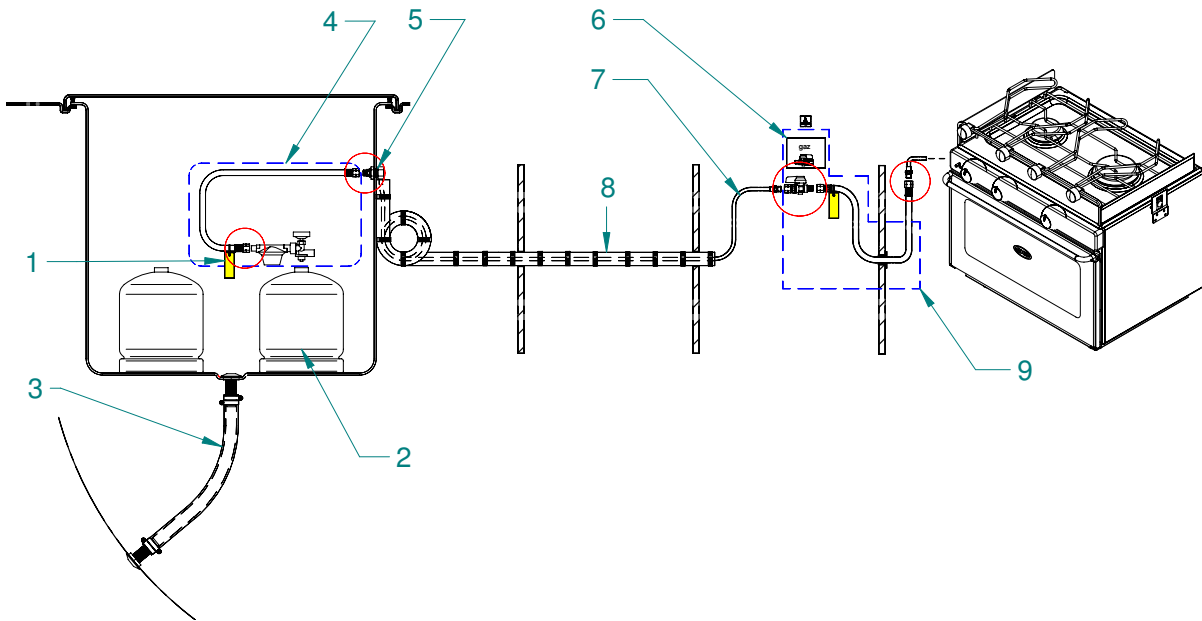

REF	Designation
1	Regulator valve
2	Gas cylinder
3	Drain
4	Connection kit gas bottle
5	Rubber washers
6	Pictogram
7	Connection kit gas copper
8	PVC girdled sleeve
9	Gas appliance connection kit

Never obstruct the fast access to the components of the gas system. Keep the taps of the empty cylinders turned off and the cylinders disconnected.

Keep the protection, lids, covers and taps in their places.

Don't use the gas cylinder storage place to store other equipment. Only use the proper locker to store the gas cylinders.

Regularly check and replace the rubber tubings that link the cylinder to one end of the circuit and the stove to the other one, depending on the norms and regulations in force in your country.

Pay particular attention to keep in good condition the screw thread of the cylinder on which the regulator is. Check the condition of the regulator every year and change it if necessary. Use regulators identical to the ones that are fitted.

Have the repairs carried out by someone skilled.



POSITION OF GAS BOTTLE

The locker for storing gas bottles can be reached through the cockpit. The locker can accommodate 2 gas bottles. The locker is equipped with bottle fastening straps.

FIGHT AGAINST FIRE

It is the owner's or the skipper's responsibility:

- To have the extinguishers checked in pursuance of the instructions given.
- Use extinguisher replacements with equivalent features (same capacity and fire resistance) if the ones in place are out of date or have been used.
- To tell the crew:
 - where the extinguishers are and how they work,
 - where the release aperture is situated in the engine compartment,
 - where the emergency exits are.
- Make sure the extinguishers can be reached easily when people are on board.
- Make sure that the ventilation openings in the engine (and generator, if installed) compartment are well cleared.

Keep the bilge clean. Regularly check that there is no fuel or gas vapour.

For protection of the deck, the vessel owner/user should provide at least one fire bucket complete with rope in an immediately accessible position.

Do not store combustible materials in the engine compartment.

If non-combustible materials are stored in the engine compartment they must be secured so there is no danger of them falling on machinery and they do not obstruct access to and from the compartment.

Exits other than the doors and hatches of the main companionway, equipped with permanently fitted ladders, are identified with a symbol.



WARNING

- Keep an extinguisher handy in case the fire should start again.
- Fire fighting equipment (portable extinguishers, fire blankets and buckets) must be permanently and immediately accessible.

POSITION OF PORTABLE EXTINGUISHERS (not supplied)

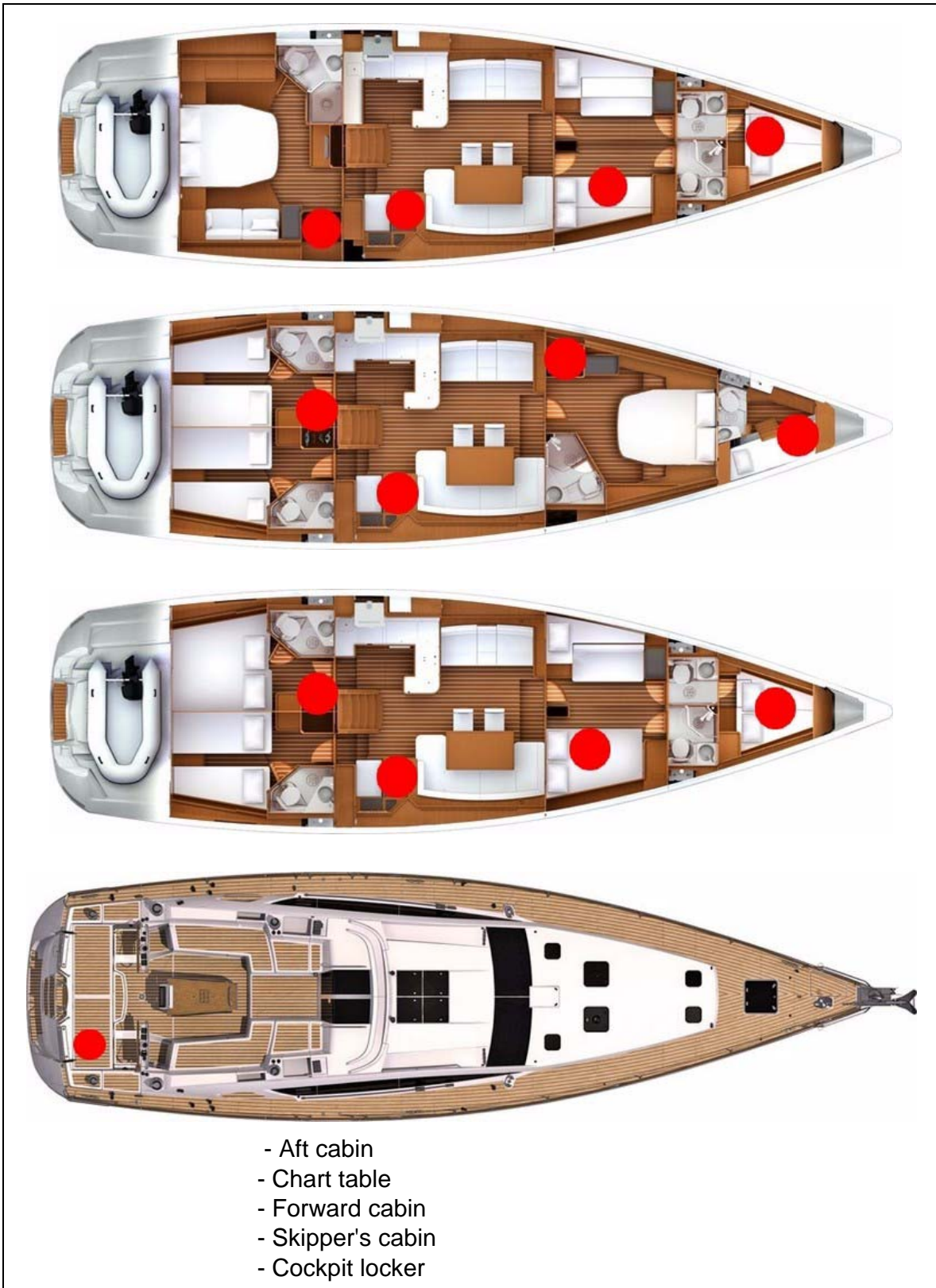



EXTINGUISHERS

The extinguishers are part of the compulsory equipment.

An extinguisher and a fire blanket must be placed less than 2 m from any naked flame appliance.

Extinguishers must be placed less than 5 m from any berth.

It is compulsory for an extinguisher to be placed less than 2 m away from the extinguisher aperture of the engine compartment.

An extinguisher shall be less than 1 m from the steering station.

The extinguishers must be in position (see "Extinguisher positions" diagram).

Extinguisher, per unit, minimum capacity 5 A/34 B.

For the Jeanneau 57: 25 A/170 B (5 extinguishers of this minimum capacity).



DANGER

- There may be danger of fire or explosion if direct or alternating current systems are incorrectly used (Refer to chapter Electricity).



WARNING

- Do not obstruct the ways to the emergency exits.
- Do not obstruct the safety controls (fuel oil valves, gas valves, power switches).
- Do not block the extinguishers placed on shelves.
- Do not leave the vessel unattended when a cooker or heater is in use.
- Do not use gas lamps in the vessel.
- Do not alter the vessel systems (electrical, gas or fuel).
- Do not fill up a tank or change a gas cylinder when an engine is running or a cooker or heater is on.
- Do not smoke while handling fuels or gas.



WARNING

- The **CO²** extinguishers shall be used only to fight **electrical fires**.
- Clear the area immediately after use in order to avoid suffocation.
- Air before entering.

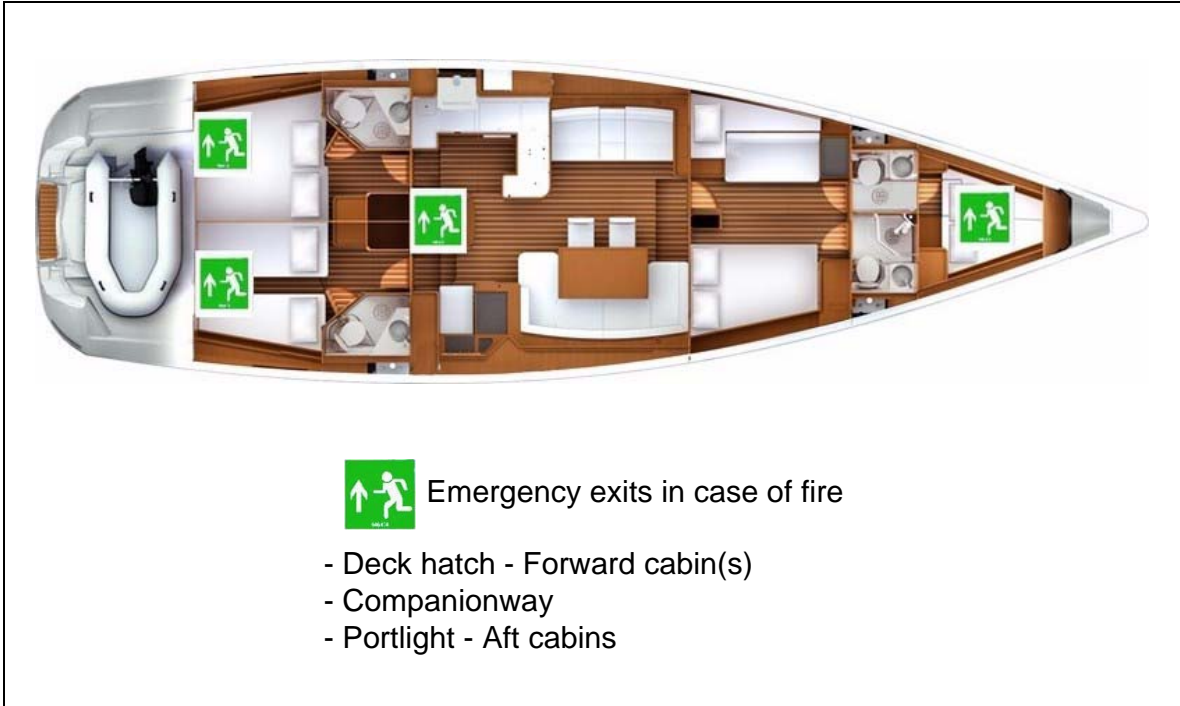

PROCEDURE TO EXIT THROUGH THE FORWARD CABIN DECK HATCH

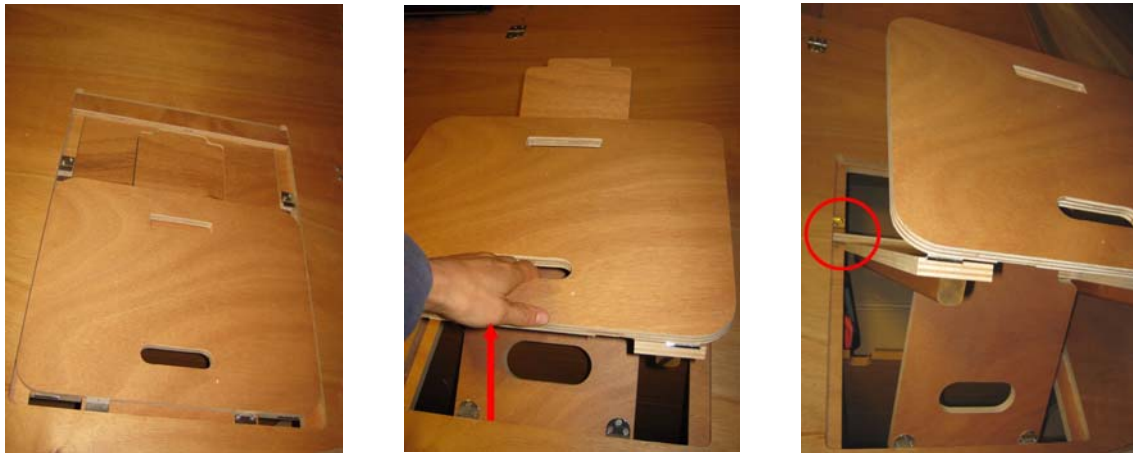

1. Remove the mattresses and the deck panel.
2. Lift up the still folded step.
3. Check the obstruction.
4. Open the deck hatch.
5. Exit.



SUPPLY VALVE FUEL

SAFETY

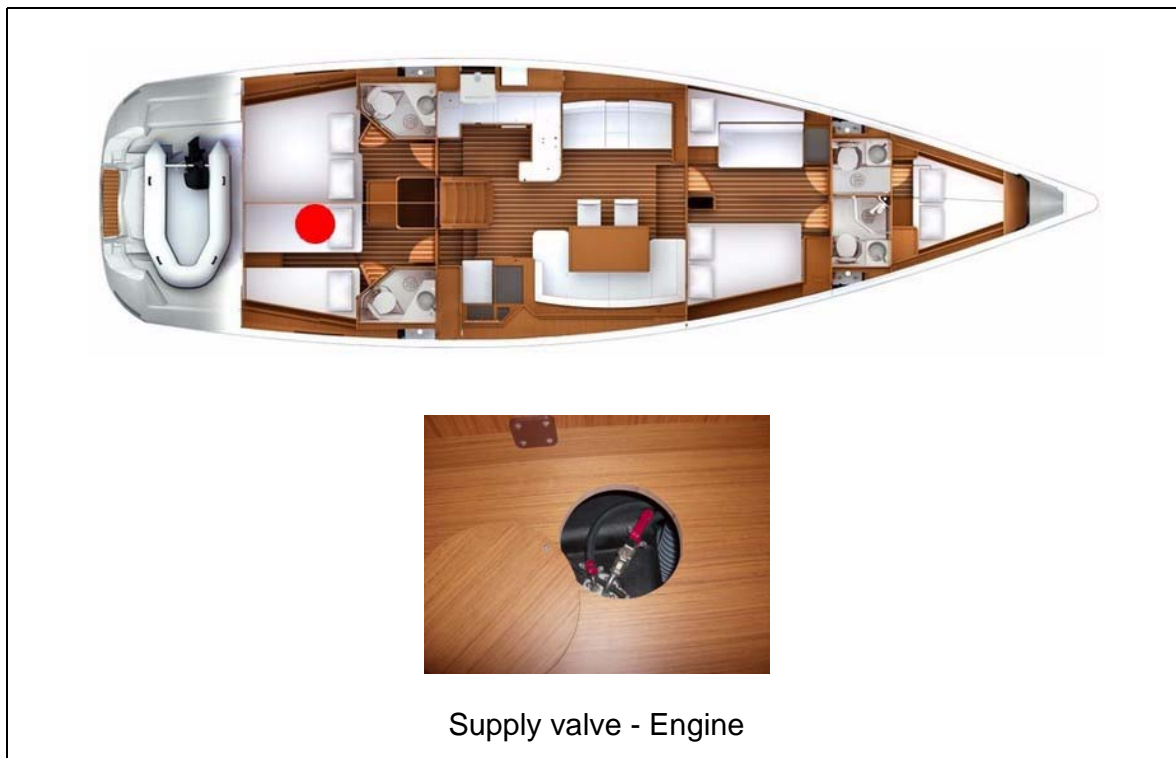

Supply valve - Engine

Note: Same position for the other layouts.

The engine compartment has a port that makes it possible to inject the extinguishing product inside without opening the usual access hatches.

INSTRUCTIONS TO FOLLOW IN CASE OF A FIRE IN THE ENGINE COMPARTMENT BILGE:

- Stop the engine.
- Switch off power and stop fuel supply.
- Block off the air supply from the air inlets and outlets of the engine.
- Inject the extinguishing product through the aperture.
- Wait.
- Open the access hatches and repair.

EXTINGUISHER ORIFICE UNDER THE STARBOARD COMPANION LADDER

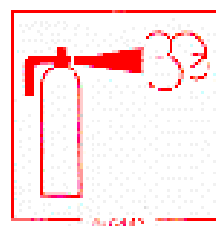
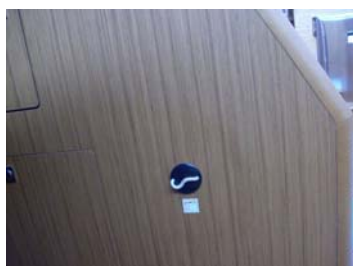

A pictogram helps to locate it easily



MANUAL BILGE PUMP



Location



Operation



Capacity: 40,5 litre / minute.

BILGE PUMP SYSTEM

PROCEDURE TO BE FOLLOWED

- Switch on the electric bilge pump.
- If necessary activate the manual pump.
- Identify the source of the leak by tasting the water and decide on the relevant action to be taken:
 - freshwater = watertank leak.
 - seawater = breach of hull.



ELECTRIC BILGE PUMPS

Location: Forward cabin
Capacity: 70,8 litre / minute



1. Electric bilge pump -
Capacity: 20 litre / minute
2. Automatic bilge pump -
Capacity: 110 litre / minute



Operation:

The electric bilge pumps are connected to the 12V service circuit. To enable operation the 12V circuit must be activated by turning on the battery switches.

You can energize the electric bilge pump from the electrical panel.

On the electrical panel - three possible positions : OFF / Automatic / Mechanically operated.

In the automatic position each pump is set off automatically by a trip switch located in the sump area or in the bottom of the hull.

MANUAL BILGE PUMP

The manual bilge pump is in the cockpit.

The control arm of the pump shall be kept accessible whatever the circumstances.

WARNING



- The bilge pump system is not designed to provide buoyancy to the boat in case of damage.
- The bilge pump system is designed to drive out the water being either sea spray or leaks but absolutely not the water coming through a hole in the hull, this hole being the result of a damage.
- Do not let the pumps run while dry, this may cause them damage.
- The water in the bilge shall be kept at its minimum.
- Check the functioning of each bilge pump regularly.

SAFETY PRECAUTIONS

- Clean off debris which could block the pump intake points or strainers. If the watertight partitions which seal off the fore and aft points are fitted with valves they must be closed at all times and only opened to drain water into the main bilge.

Emergency tiller - Stowage



SECTOR ACCESS PORT



Operation





EMERGENCY TILLER

The emergency tiller is in an aft locker and shall be easy to get to.

To operate the tiller:

- Use a winch handle and unscrew the tiller cover situated at the back of the cockpit.
- Insert the tiller into the rudder stock and make sure it is fully secure in the square.
- If the automatic pilot is connected and is working after the tiller damage, use it.
- Disconnect all apparatus linked to the rudder stock to use the emergency tiller.

SAFETY

ADVICE - RECOMMENDATION

The emergency tiller is designed only to be able to continue underway at a reduced speed in case of steering gear failure.



HULL

MAINTENANCE OF THE HULL

LIFTING

LIFTING



Wetted area: 72 m²

WATER LINE

These measurements are for 'light boat'.

Measurements are expressed in mm.

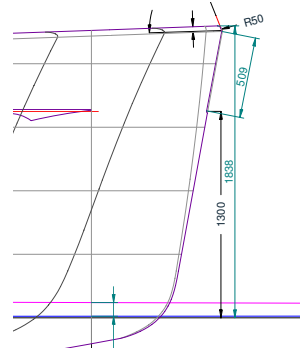
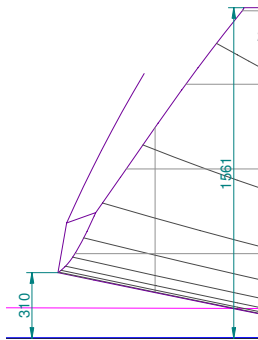

PRECAUTION

- Consult the harbourmaster's office to find out the conditions of water use and the maintenance area for cleaning your vessel.
- It is necessary to seek the advice of your concessionnaire with regard to gel-coat repairs.

PRECAUTION

- When applying the anti-fouling paint do not paint over the electronic instrument sensors nor the anodes.

ADVICE - RECOMMENDATION

- When in dry dock check the anode on the propeller shaft line.
- See "Motorisation" chapter.
- When the boat is stored at a dry dock, the corrosion protection is not as effective due to oxidation of the anodes: even the new anodes oxidize the surface. Before returning the boat into the water, clean the anodes.
- Cleaning anodes: Use sandpaper.
Do not use metal brushes or steel tools to clean the boat, it may damage the galvanic protection.
- Replacing the anodes: The anodes are fastened with screws and nuts. First, remove the screws and nuts that hold the anode, then clean the contact surface. Press the new anode to obtain a good electrical contact.

MAINTENANCE OF THE HULL

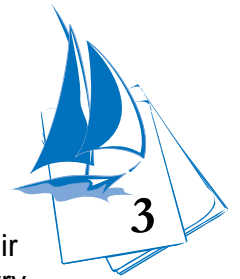

The materials and equipments of your boat have been selected because of their high quality and performance and ease of maintenance. However you shall carry out a minimum maintenance in order to protect your boat from outside attacks (salt, sun, electrolysis ...).

Preferably wash your boat on shore.

Use as few cleaning agents as possible.

Don't use solvents or aggressive detergent agents. Don't discharge cleaning agents into the water.

HULL

LIFTING

The lower hull of your boat should be covered with an anti-fouling paint which will prevent the adhesion of marine growth.

The nature of the water in which the boat sails will determine the choice of the anti-fouling paint as well as the frequency of hull stripping and painting. Do not hesitate to take advice from your specialists.

Refer to chapter 12 for launching instructions.

PRECAUTION

Before applying anti-fouling paint never:

- Do any sandblasting.
- Use any other solvents than ethylic alcohol.
- Use detergents under pressure.
- Use scrapers.
- Do any sanding other than a light rubbing down by hand with a grade 400 wet abrasive paper (for the first application).

If cleaning of the anti-fouling paint has to be done with a high pressure hose:

- The water temperature must not exceed 15 °C.
- The water pressure must not exceed 150 bars.
- The distance between the hose nozzle and the hull must not be less than 10 centimetres.

Follow the supplier's instructions very closely when applying the anti-fouling paint.

All these hull maintenance operations can be carried out by your dealer.



DECK

NAVIGATION

STABILITY

PREVENTION OF MAN OVERBOARD

MOORING LINES

TOWING

GROUND TACKLE

MAINTENANCE OF THE DECK

NAVIGATION

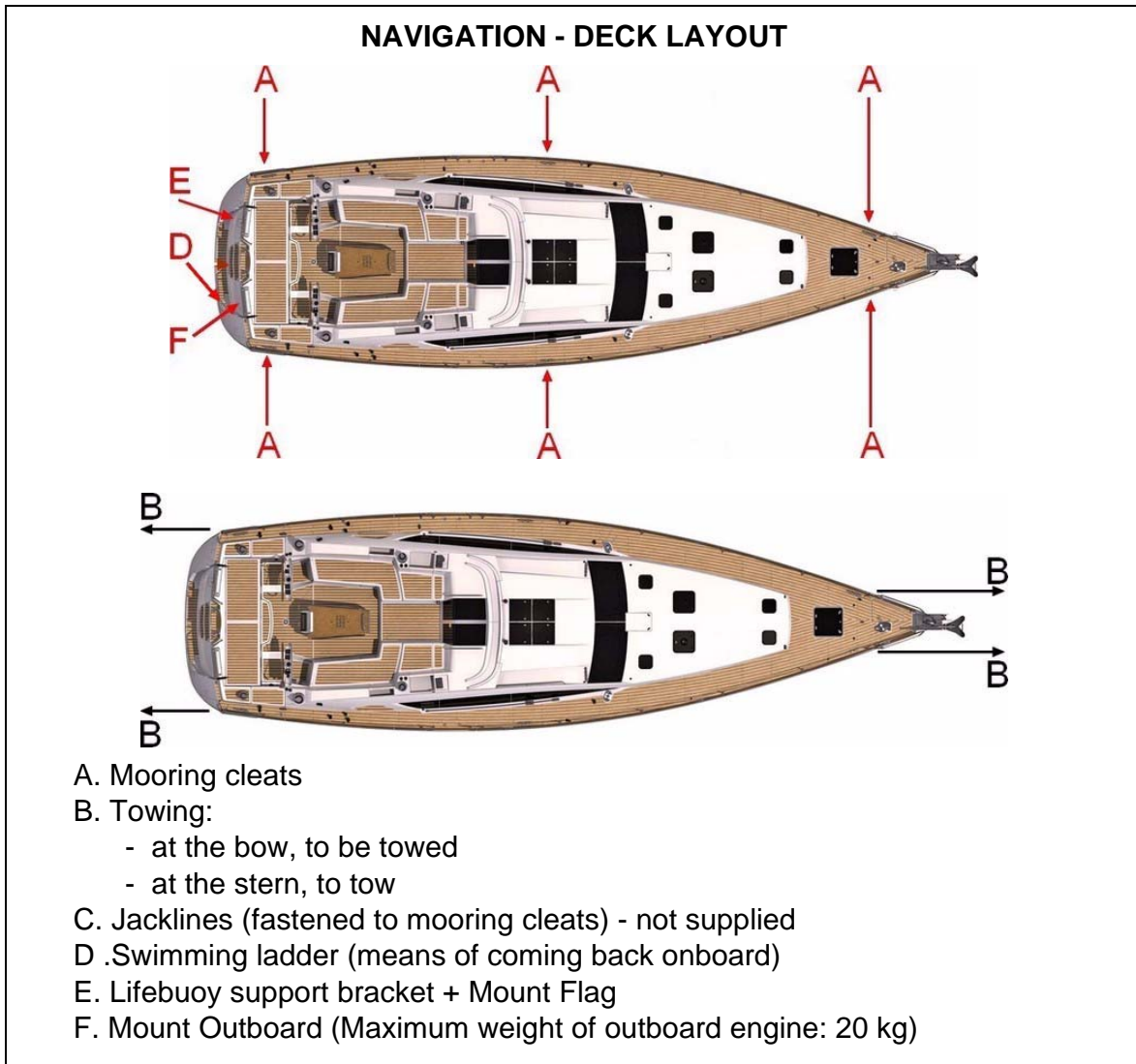

DANGER



- Wear your life jacket.
- In heavy weather, wear your safety harness and fasten yourself to the boat.
- When at sea close the guardrail side-opening or openings.
- Do not try to stop the boat using a boat hook or your foot, your hand or any other part of the body.

WARNING



The sudden closing of a locker due to a gust of wind or movement of the boat could result in injury.

ADVICE - RECOMMENDATION

Close the deck hatches and portholes before each trip (including the companionway hatch in heavy weather).

STABILITY

Breaking waves represent a serious danger for stability and for taking in water. Close the companionway doors and hatches in heavy seas.

During sailing keep all the portholes, windows and doors closed.

- The stability is reduced when you add weight in the upper parts.
- Stability may be reduced when towing a boat or when heavy weights are lifted with the davits.



PREVENTION OF MAN OVERBOARD

Regularly check the guard-rails:

- With metal guard-rails, watch for corrosion particularly at connecting points.
- With synthetic guard-rails, change them as soon as they show signs of wear due to chafing or UV.

Areas forbidden when sailing:

- Aft quarterdeck
- Roof



DECK



DANGER

It is prohibited to open or leave open the garage while sailing.

Maximum number of persons authorized on the back beach: 5 persons / 400 kg.

MOORING LINES

A sufficient number of mooring lines suitably sized and suitable for the environment shall be on board for mooring your boat.

- Always manoeuvre your boat using the engine.
- Make allowance for the current and wind when you handle your boat.
- Protect your boat to the highest degree with suitably sized fenders.
- Always keep the mooring ropes unfouled and stored away.
- Handle your boat at a reduced speed.
- Pass warps through the fairleads provided for this purpose.

FAIRLEAD



AFTER MOORING

- Protect the mooring lines against chafing with plastic sleeves.
- Make allowance for the variations in tides if need be.

Opening / Closure - Companionway



To maintain fixed navigation

Opening Deck hatches



Opening Portlight



Closure Hatch cover



Cockpit table



Mechanism
Opening / Closure





TOWING

TOWING BOAT

- Tow another boat at a reduced speed and as smoothly as you can.
- Pay particular attention when you throw or catch the towing rope (it may foul on the propeller).

Note: *The stability may be reduced when you tow a boat.*

TOWED BOAT

Keep steering your boat and see to it that you stay in the wake of the towing boat.

Inappropriate towing can damage your vessel.

GROUND TACKLE

As a rule, set the anchor in at least 3 times the depth of water.

ANCHORING WITHOUT WINDLASS

- Have your boat pointed into the wind and without speed.
- Pay out the chain while moving back slowly.
- Once the anchor snags, make it fast by reversing slightly.
- Secure the hawser or the chain to the cleat.

ANCHORING WITH ELECTRIC WINDLASS

- Turn on the boat engine.
- Check that the electrical supply of the windlass is switched on (battery switch, circuit breaker).
- Use the remote control to activate the windlass in lowering mode. Let the chain feed out by keeping the lowering button on the remote control pressed down.
- Let the chain out while moving backwards slowly and as straight as possible.
- Once the anchor snags, make it fast by reversing slightly.

PRECAUTION

- Before anchoring check the depth of water, the power of the current and the nature of the sea bed.
- Anchoring manoeuvres with the electric windlass can only be carried out with the engine running.

WARNING



Windlass operations are dangerous:

- Always keep the anchor chain or rode free and unfouled.
- Always proceed with care, using gloves and always wearing shoes.
- If your boat is equipped with the twin control optional extra, make sure you use **only one** control at the same time.

LOCATION

ELECTRIC WINDLASS - BREAKER 120A - FUSE



1. Mooring locker
2. Bow fitting
3. Drum head
4. Chain lifter 12mm diameter
5. Clinch
6. Handle storage
7. Remote control
8. Handle position
9. Windlass 24V 2000W



ANCHORING BY HAND WITH USE OF A MANUAL WINDLASS

- Release the windlass brake using the handle located in the chain locker so as to allow the chain lifter to turn freely and to release the anchor from the stem fitting
- Re-engage the brake and let the anchor hang until the mooring position is reached.
- Have the boat pointed into the wind and without speed.
- Release the brake and pay out the chain slowly.
- Control the speed of anchor lowering using the brake.
- Once the anchor has taken hold re-engage the brake and secure the hawser to the cleat.

HEAVING UP THE ANCHOR

- Lock the cable lifter snubber.
- Ensure the chain is properly set on the cable lifter.
- Slowly go near the anchor, using your engine (Don't use your windlass to winch the boat).
- Heave the anchor completely.
- Visually check the last meters till the anchor gets into contact with the davit.
- If you just change berth, check the position of the anchor on the stem fitting.
- For sailing, store the anchor in the chain locker or fasten the anchor to its roller.
- For electrical windlasses cut off the power supply as soon as the anchor has been lifted.

STERN ANCHORING

Stern anchoring shall be performed with the engine declutched.

- Secure the required length of cablet on the mooring cleat.
- Pay out the anchor line slowly.
- Take care not to damage the propeller or the rudder.

ADVICE - RECOMMENDATION

- After each trip rinse the windlass and anchor chain or rode with fresh water.
- Refer to the manufacturer's instructions for windlass maintenance at the beginning or end of the season.
- Check the swinging area once the boat is at anchor.

OPERATION

The windlass is connected to the 24V service batteries.

The boat engine must be running to permit windlass operation



Breaker 120A
Location: Starboard saloon



Battery switch 24V
Location: Saloon

1. - Common
2. + Service









Operation relay
Under the bed - Forward cabin



WARNING

Refer to the manufacturer's instructions for use and maintenance.

GARAGE / AFT QUARTERDECK

<p>Alarm Location: Garage</p> 	<p>Control Location: Port cockpit locker</p> 
<p>Mechanism Opening / Closure</p>	
	
	

OPERATION



DANGER

It is prohibited to open or leave open the garage while sailing.
Maximum working load: 5 persons / 400 kg.

ADVICE - RECOMMENDATION

- Be careful of the open quarterdeck if there is a risk of waves (port or anchoring).: a wave could hit the quarterdeck from underneath and might damage the system.
- Coming alongside with dinghy: Be careful of waves. There is a danger of the dinghy getting stuck under the open quarterdeck.
- Make sure that no person or object can get in the way of the garage opening/closing, particularly the swimming ladder.

MAINTENANCE OF THE DECK

Preferably wash your boat on shore.

Use as few cleaning agents as possible.

Don't use solvents or aggressive detergent agents (Refer to chapter 3 "Hull").

Don't discharge cleaning agents into the water.

Regularly brush the deck with a degreasing shampoo and fresh water.

DECK FITTING

- Rinse thoroughly all your equipments with fresh water.
- Periodically lubricate turnbuckles, winches, tracks and travellers with water-repellent grease. Thoroughly and frequently wash off the pulleys and sheaves with clear water.

SOLID WOOD ON EXTERIOR WOODEN PANELLING

Regularly clean the woodworks with fresh water using a sponge (if need be add some gentle soap).

PLEXIGLAS

- Rinse plexiglas with fresh water.
- Use a polish paste for thin scratches.
- Consult your dealer concerning deep scratches.

STAINLESS STEEL

Stainless steel is not incorruptible and requires a minimum of upkeep:

- The use of chrome tools is preferable whenever handling stainless steel.
- Re-nourish the protective film regularly with passivation paste (consult your dealer).

EXTERIOR CUSHIONS

Bring the removable cushions inside (washed with soapy water then dried) when the vessel is unoccupied.

PRECAUTION

- Consult the harbourmaster's office to find out the conditions of water use and the maintenance area for cleaning your vessel.
- Don't use solvent, alcohol, acetone on plexiglas.

ADVICE - RECOMMENDATION

- Use only products similar to the ones that are included in the maintenance case you have been delivered with your boat.
- Don't use a pressure washer.



STEERING SYSTEM

STEERING GEAR

STEERING GEAR



CABLE ADJUSTMENT - STEERING SYSTEM

The steering gear is assembled and pre-adjusted at the factory, however, only actual use at sea will enable the steering cable to find its definitive position around the wheel drum. For this reason, it is necessary to re-adjust the gear after the first few sea outings.

The adjustment is made on the nut and bolt system integral with the steering cable at the join with the profile. To check the adjustment exert a perpendicular force on the cable between the wheel drum and the return sheaves located on the hull. The slack in the cable should not exceed 10 mm. The adjustment is carried out in the same way on the 2 sides of the cable(see diagram).



WARNING

- The steering system is a feature of sailing safety and for this reason must be verified at least once a year.
- **THE STEERING CABLE MUST BE CHANGED EVERY 4 YEARS.**

MAINTENANCE

- Regularly check:
 - The tension in the steering cables.
 - The tightness of the steering system components.
- Don't tighten the steering cables excessively.
- Lubricate all the elements.

Maintain the nylon, ertalon or teflon bushes with only a suitable lubricant.

Note: Do not hesitate to consult your dealer about system maintenance.



WARNING

- Refer to chapter 2 "Safety" for use of the emergency tiller.

ADVICE - RECOMMENDATION

- The emergency tiller is designed only to be able to continue underway at a reduced speed in case of steering gear failure.

ACCESS - STEERING COMPONENTS



Sheaves - Port side



Sheaves - Starboard





RIGGING AND SAILS

STANDING RIGGING

RUNNING RIGGING

WINCHES

SETTING THE SAILS

SAILS

STANDING RIGGING

MAST WITH IN-MAST FURLING

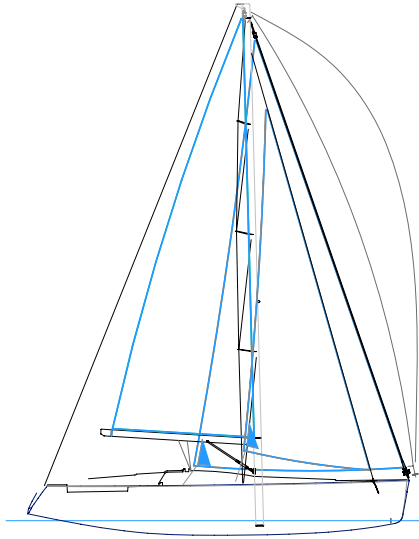

CLASSICAL MAST

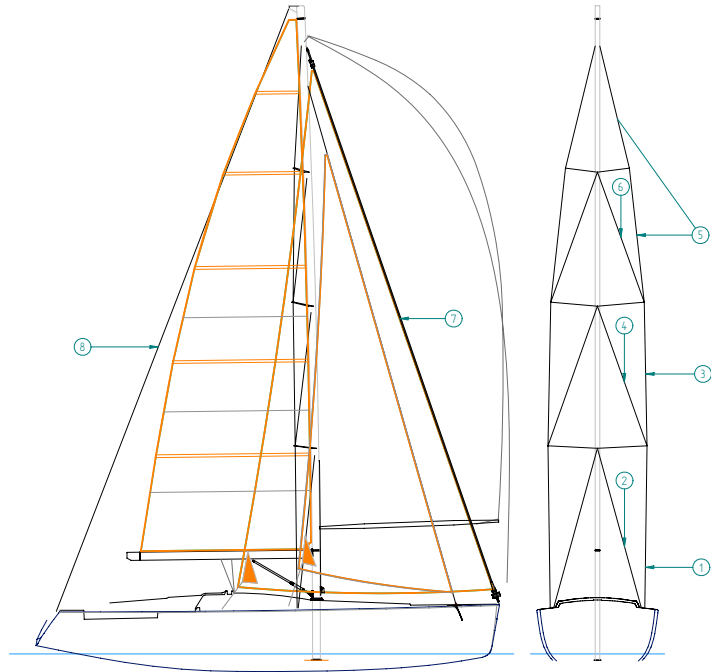

ALL VERSIONS

Reference	Designation	Quantity
1	V1	2
2	D1	2
3	V2	2
4	D2	2
5	V3D4	2
6	D3	2
7	Forestay	1
8	Backstay	2



STANDING RIGGING

Your JEANNEAU dealer was responsible for stepping the mast of your boat. After masting your vessel and after having sailed for the first time it is necessary to seek the help of a qualified specialist in order to carry out a rigging check.

MAINTENANCE

Before each trip, carefully inspect the mast from top to bottom.

Periodically check the rigging tightening and the lock nut or pin locking (you should check it for the first time after a few days sailing in all types of weather).



DANGER

- To hoist a crew member up to the top of the mast, make a bowline with the halyard directly on the bosun's chair ring (never use the halyard snap shackle or shackle).
- Do not hoist a crew member when sailing in heavy weather.

ADVICE - RECOMMENDATION

Your dealer JEANNEAU can carry out all maintenance operations or recommend a skilled specialist to do so.

Backstay - Hydraulic
(optional)
Cable adjustment



Tank - oil
Access



**RIGGING DIAGRAM
CLASSICAL MAST**

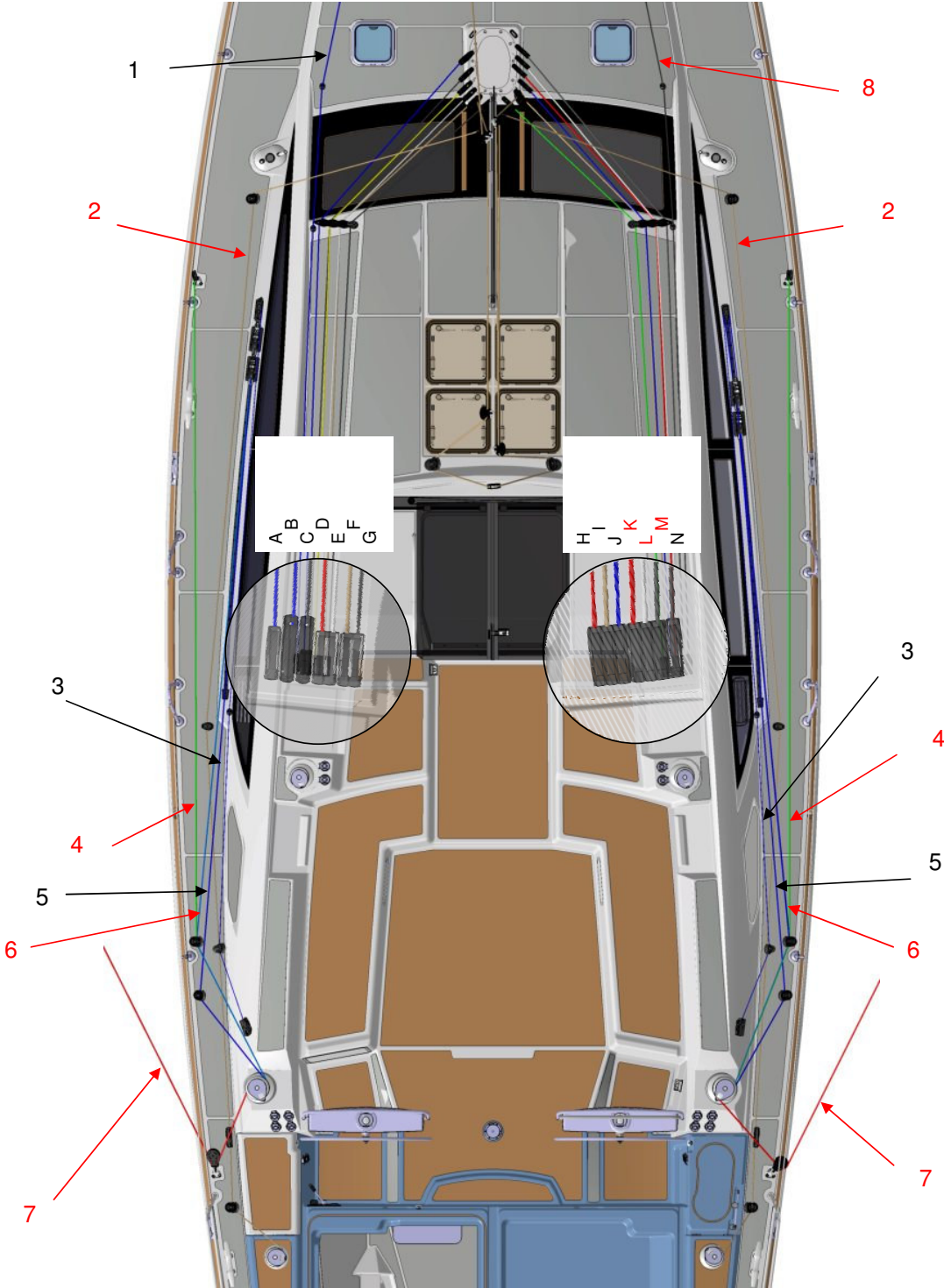



ALL VERSIONS

Reference	Designation
1	Genoa furler line
2	Mainsail sheet
3	genoa car adjustment
4	Spinnaker guy
5	Genoa sheet
6	SHEET - Staysail
7	Spinnaker sheet
8	Spinnaker boom downhaul (Symmetric spi) OR Spinnaker tack (Asymmetric spinnaker)

CLASSICAL MAST

Reference	Designation
A	Genoa furler line
B	Genoa halyard
C	Main halyard
D	Reef 1
E	Mainsail foot
F	Mainsail sheet
G	Kicking strap
H	Reef 2
I	Mainsail sheet
J	Reef 3
K	Spinnaker halyard
L	Spinnaker lift OR Fore stay sail halyard
M	Halyard - Fore stay
N	Spinnaker boom downhaul (Symmetric spi) OR Spinnaker tack (Asymmetric spinnaker)

RIGGING DIAGRAM
MAST WITH IN-MAST FURLING

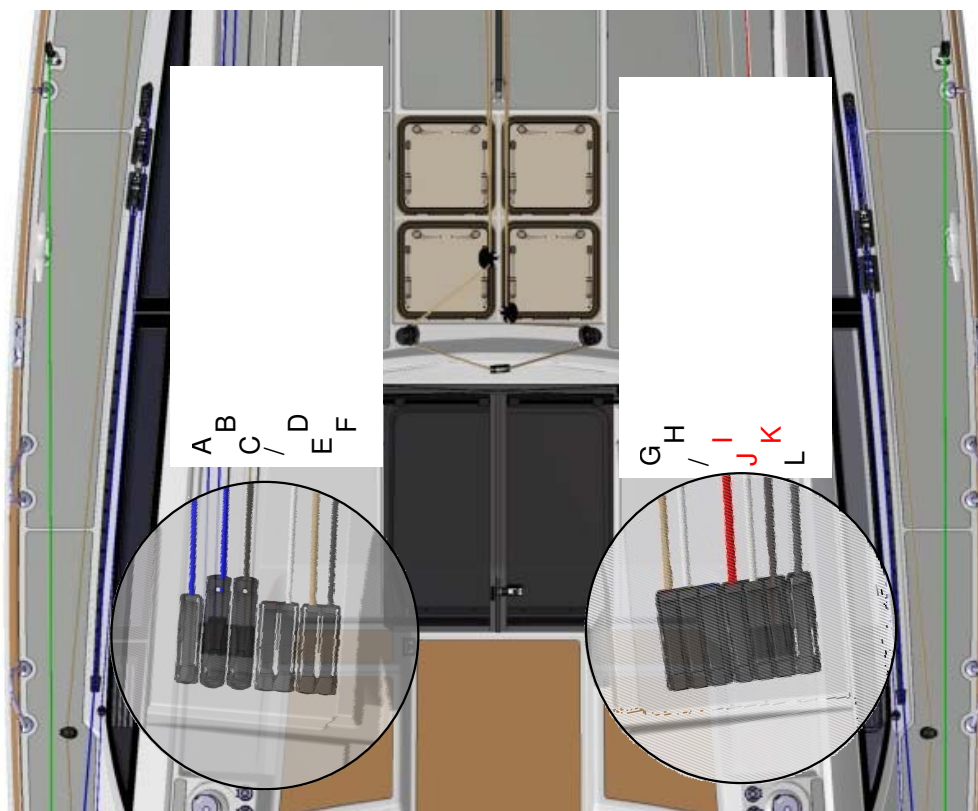

MAST WITH IN-MAST FURLING

Reference	Designation
A	Genoa furler line
B	Genoa halyard
C	Main halyard / Available
D	Main furling line
E	Mainsail sheet
F	Kicking strap
G	Mainsail sheet
H	Mainsail foot / Available
I	Spinnaker halyard
J	Spinnaker lift OR Fore stay sail halyard
K	Halyard - Fore stay
L	Spinnaker boom downhaul (Symmetric spi) OR Spinnaker tack (Asymmetric spinnaker)



RUNNING RIGGING

MAINTENANCE

Change any distorted or dented sheave. Inspect the pins of the sheaves at the top of the mast once a year.

Lightly grease the sheave pins.

Regularly check the condition of the jam cleat jaws.

Inspect the halyards for wear and condition.

Regularly clean the pulleys off (old grease, traces of rust) with clear water.

Slightly lubricate the block pins.

Avoid aggressive gybing in order to reduce premature wear on the sheets, attachment points and the gooseneck.

SYSTEM - MAST FOOT CLASSICAL MAST

PORT SIDE

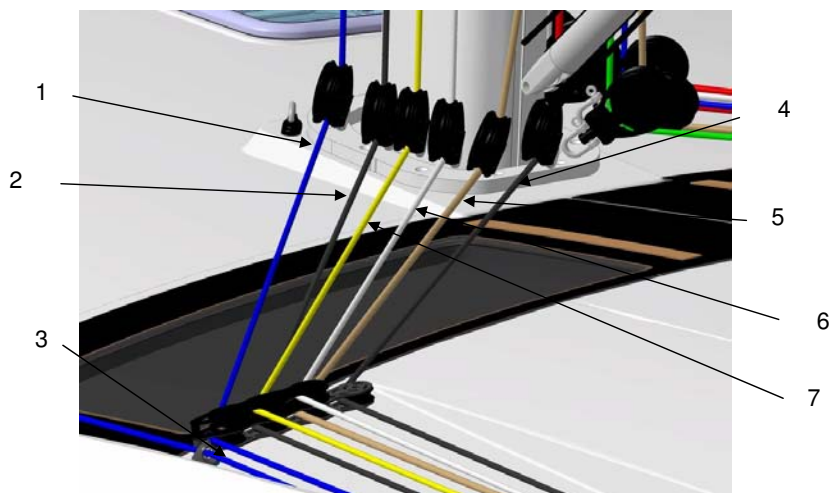

STARBOARD

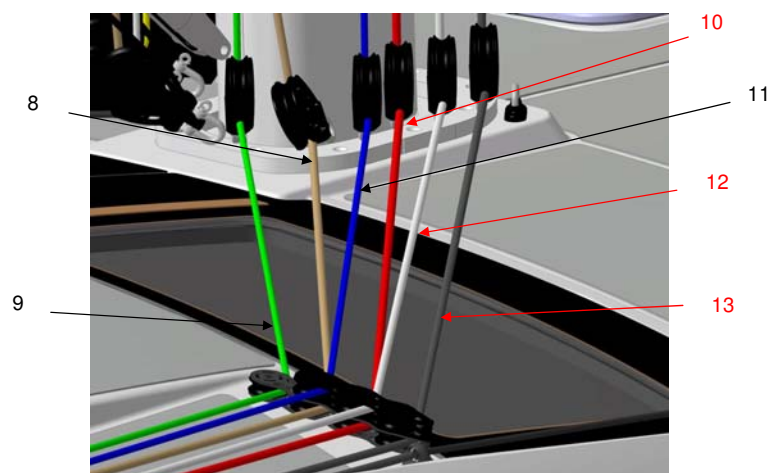

**SYSTEM - MAST FOOT
MAST WITH IN-MAST FURLING
PORT SIDE**

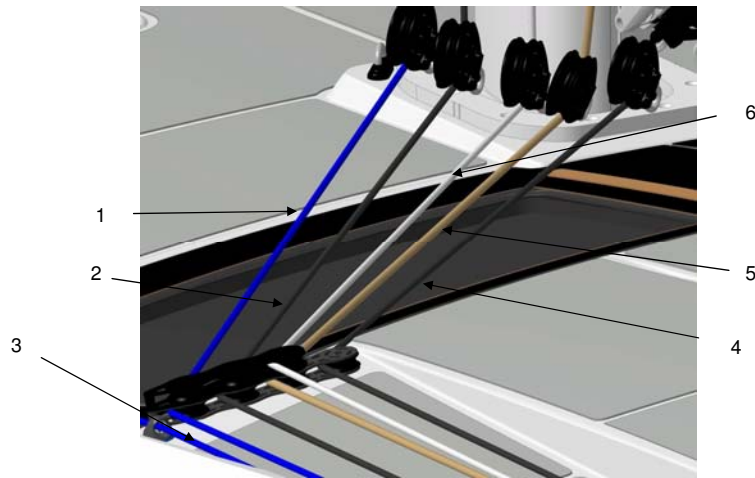

STARBOARD

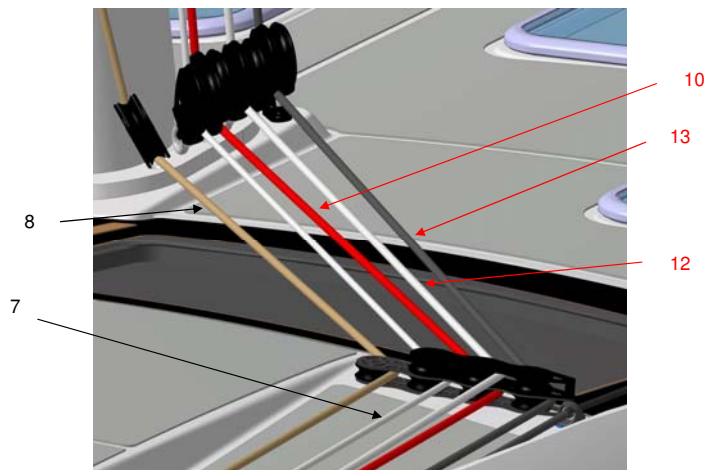

Reference	Designation
1	Genoa halyard
2	Main halyard
3	Genoa furler line
4	Kicking strap
5	Mainsail sheet
6	Mainsail foot (Classical mast) / Mainsail safety block stopper (Mast with in-mast furling)
7	Reef 1 (Classical mast) / Mainsail foot (Mast with in-mast furling)
8	Mainsail sheet
9	Reef 3 (Classical mast)
10	Spinnaker halyard
11	Reef 2 (Classical mast)
12	Spinnaker lift OR Fore stay sail halyard
13	Halyard - Fore stay

WINCHES



OPERATION

Avoid rope jamming during winch handling. Do not leave loose ropes on the winches but make them fast on cleats (except on the "Self Tailing" winches).

SETTING THE SAILS

CLASSICAL MAINSAIL

With the mainsail being on the deck:

- Screw the pins of the mast sliders for battens into their boxes.
- Slide in the battens through the leech.
- Screw the box cap until you get the required tension (the tightening screw shall not project beyond the sail).
- Do not forget the small locking screw.
- Put the mainsail into the lazy-bag.
- Fit the mainsail onto its slides, begin with the headboard and finish with the tack.



WARNING

- Refer to the manufacturer's instructions to remove the winches and put them back.
Improper refitting may result in accidents (e.g. kick of the crank handle).

SYSTEM - MAINSAIL (CLASSIC)

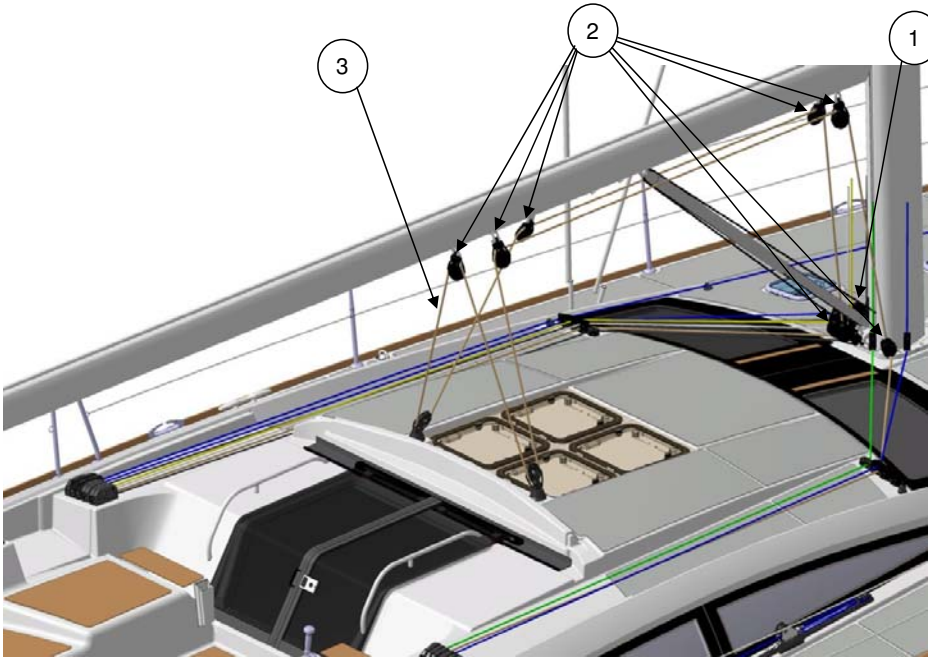

Reference	Designation
1	Kicker tackle
2	Swivel single pulley - 100 mm diameter
3	Mainsail sheet (D 12mm L 45 m)



SYSTEM - MAINSAIL (CLASSIC) "GERMAN SHEETING"

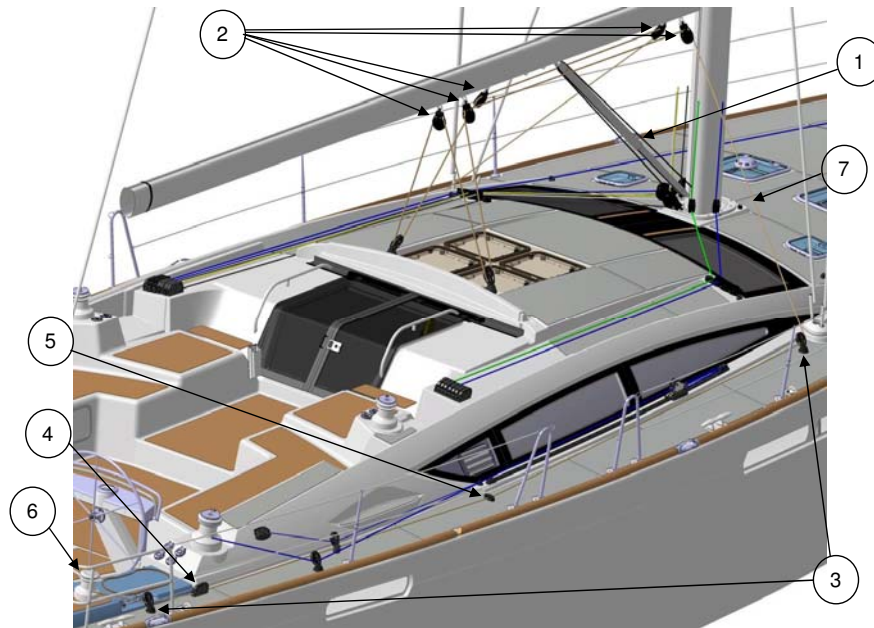

Reference	Designation
1	Kicker tackle
2	Swivel single pulley - 100 mm diameter
3	Pulley - Vertical
4	Single clutch
5	Cheek block - 57 mm diameter
6	Winches
7	Mainsail sheet (D 12mm L 45 m)

SYSTEM - GENOA & STAYSAIL

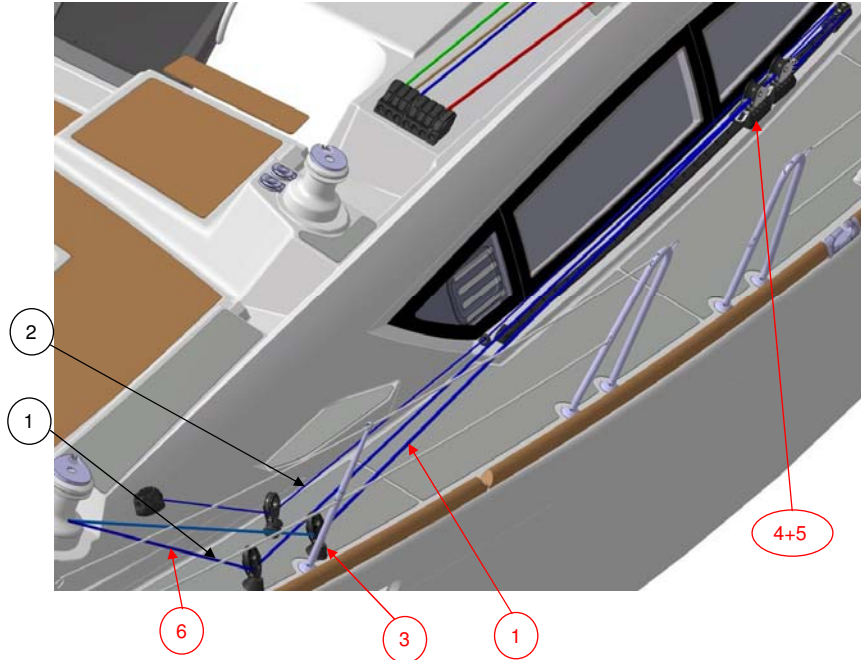

Reference	Designation
1	SHEET - Staysail (D 14mm L 25 m)
2	Cable adjustment - Genoa sheet (D 8mm L 21 m)
3	Pulley - Vertical
4	Traveller - double
5	Genoa car
6	Genoa sheet (D 14mm L 35 m)



SYSTEM - STAYSAIL TAKE-UP DRUM

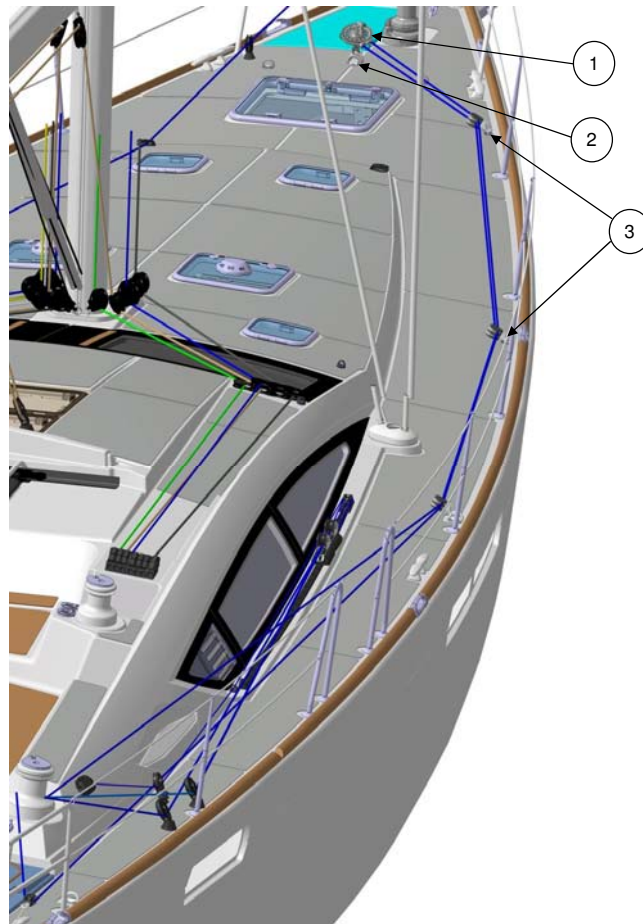

Reference	Designation
1	Staysail take-up drum
2	Swivel plates - D 10mm
3	Swivel plates - D 6mm

FURLING MAINSAIL

- Remove the hatch giving access to the furling mechanism.
- Spread out the sail on the deck.
- Fasten the head (strap) to the shackle of the upper swivel. Pay attention to the winding direction.
- Insert the foot adjustment line into the clew block.
- Slowly hoist the sail. Guide the bolt rope (sometimes the groove leading edges may be insufficiently smoothed off).
- When the sail is up, tack it to the lower shackle.
- Gently sweat up the halyard.
- Refit the hatch.
- Furl the sail facing the wind and keeping a very slight tension on the foot. The mainsail downhaul and sheet shall be eased off.

ADVICE - RECOMMENDATION

- Carry out the complete maintenance of the winches regularly (before and during the sailing season).
- Rinse the winches off regularly during the season.



FURLING GENOA

- Secure the head and halyard to the swivel. Secure the tack to the drum and sheets.
- Insert the bolt rope into the hole and hoist it and take care that you do not tear it.
- Have the halyard taut enough but hoist less taut than a sail on a normal stay. Hoist it until the horizontal creases disappear (Adjust the tension of the luff after a few sea trips).
- Pull on the line from the cockpit to furl the genoa.
- Before getting under way take advantage of a windless period of time and hoist the genoa.
- Hand pre-roll the drum to set the furling line on it.

Pay attention to the drum winding direction: The sacrificial strip of the genoa shall be wrapped outside.

Never force it in case it seizes when you furl or unfurl the head sails. Make sure that no ropes are caught in the furler.

MAINTENANCE

- Regularly rinse the drum and swivel.
- Lubricate the bearings if recommended by the manufacturer.
- Remove the sails if your boat is not to be used for a long time.

LAZY-BAG: FITTING

- Spread out the lazy-bag on the deck.
- Slide the battens in and close the batten pockets.
- Hank on the lazy-bag until you have the front part about level with the gooseneck.
- Fasten the lazy-bag to the tack with the strap provided.
- Stretch the lazy-bag from the back before you fasten the lazy-jacks.
- Put the mainsail into the lazy-bag.

ADVICE - RECOMMENDATION

- When you are not sailing, slacken the genoa halyard.
- Install the lazy-bag before the mainsail.
- When the sail is unfurled, adjust the halyard tightness.
- Too much tightness may cause furling problems.
- After taking in a reef for the first time mark the halyard position at the clutch (marker pen or light stitched label) in order to be able to let out the sheet with precision in subsequent manoeuvres.

AUTOMATIC IN-MAST REEFING BLOCK DIAGRAM

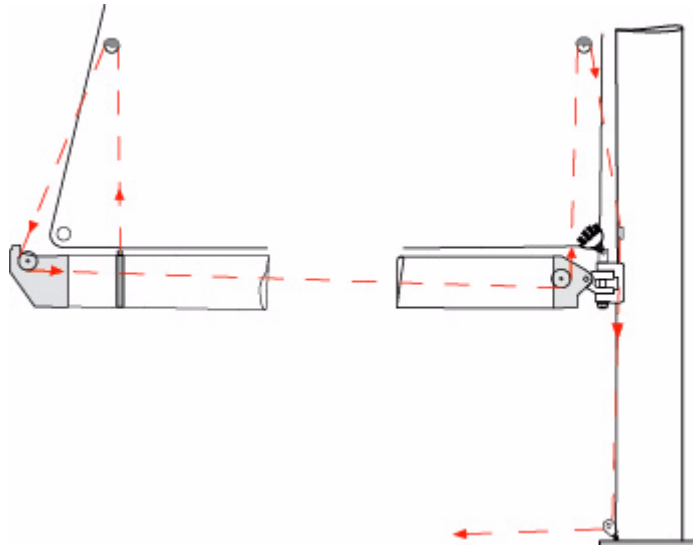

ADVICE - RECOMMENDATION

- At the end of the sailing season, and if possible before winter, leave your sails to a specialist to have efficient maintenance and repairs.

Reef 1



Reef 2



Reef 3

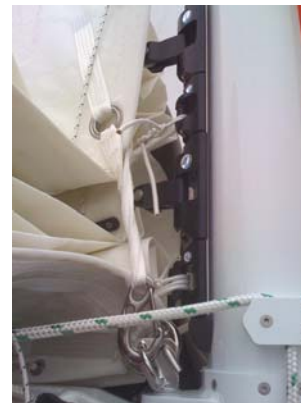



SYSTEM - SYMMETRIC SPI

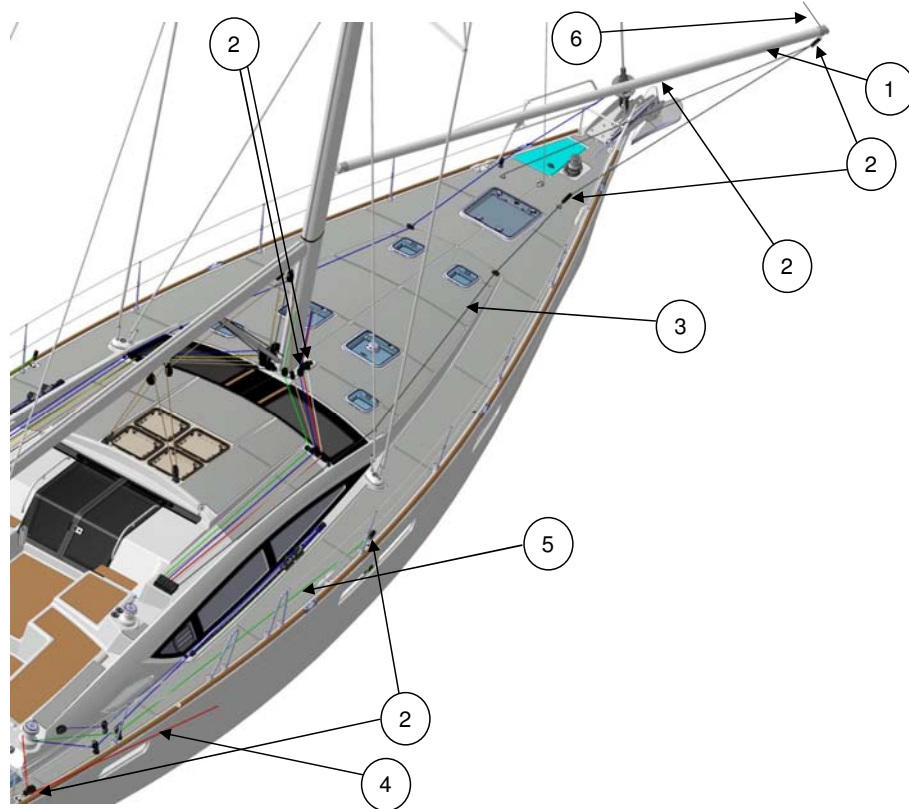

Reference	Designation
1	Boom
2	Swivel single pulley - 100 mm diameter
3	Spinnaker boom downhaul (D 12mm L 30 m)
4	Spinnaker sheet (D 14mm L 40 m)
5	Spinnaker guy (D 14mm L 40 m)
6	Boom lift (D 12mm L 48 m)

SYSTEM - ASYMMETRIC SPINNAKER

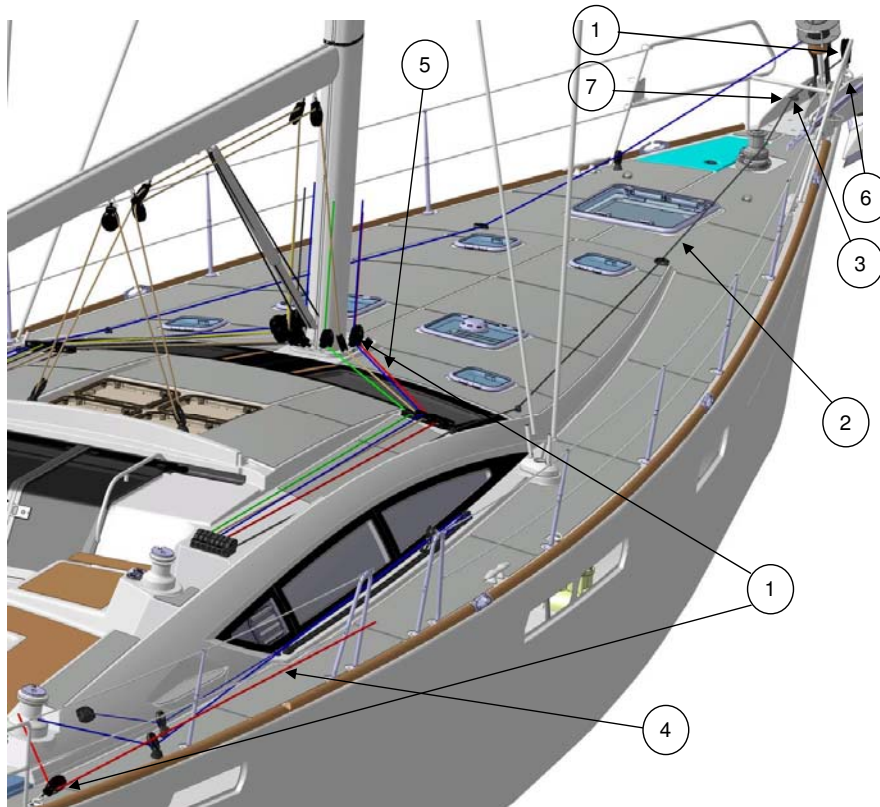

Reference	Designation
1	Swivel single pulley - 100 mm diameter
2	Spinnaker tack (D 12mm L 18 m)
3	Tackle block
4	Spinnaker sheet (D 14mm L 40 m)
5	Spinnaker halyard (D 12mm L 55 m)
6	Bobstay
7	Acorn nut

SAILS



The working life of a sail mainly depends on its being regularly maintained.

When sailing, trim the sails properly in accordance with the stresses in order to reduce the harmful strains on the fabric.

Avoid wear and tear: Use protective items against chafing on the the accessories with rough surfaces (protective items for spreaders, stanchions etc.).

Have a sail maker's kit and a user's manual so that you may carry out the emergency repairs waiting for the sailmaker's assistance.

AUTOMATIC REEFING SYSTEM

When you reef down automatically, the mainsail halyard shall not be too loose, otherwise the reefing blocks take up improper positions.

The diagram shows the path of the automatic reef line and does not indicate the standard take system.

SHORTENING THE STANDARD MAINSAIL

To shorten sail:

- Head into the wind.
- Slacken off the kick strap.
- Slightly slacken the mainsail sheet.
- Slightly slacken the mainsail halyard.
- Take in the reef line.
- Take up the slack in the mainsail halyard.
- Reset the mainsail sheet.
- Take up the kick strap slack if necessary.

SHORTENING THE FURLING MAINSAIL

To reduce the surface area of the mainsail:

- Gradually take in the mainsail furling line while letting out the foot tack line (keep the boom perpendicular to the mast).

CLEANING AND MAINTENANCE

Rinse the sails with fresh water from time to time and dry quickly in order to avoid mildew.

Avoid drying the sails to windward when on the mast (when the sails lift, the seams are worn, the sails may be torn by the rigging).

HAULING DOWN THE STANDARD MAINSAIL

To haul down the mainsail:

- Haul up.
- Slacken off the kick strap.
- Take up the slack in the Lazy bag ropes.
- Slacken off the mainsail halyard while taking up the reef lines to control the mainsail descent.
- Fold the mainsail into its lazy-bag.
- Take up the mainsail sheet to immobilise the boom.
- Immobilise the mainsail halyard.

SAIL STORAGE/FOLDING

Avoid storing a wet sail to prevent the appearance of mould and mildew.

Flake the sail parallel to the foot, then roll it up to the bag dimensions.

PROTECTION

UV rays are harmful to polyester and nylon. If the sails remain on the mast, even for 24 h, protect them with a cover or a protection fabric placed on the leech and foot of the furled sails.

Our distributor network offers you accessories that have been selected by the yard and are consistent with your needs.



INTERIOR

INTRODUCTION

INTERIOR MAINTENANCE

MAINTENANCE OF FABRICS

INTRODUCTION

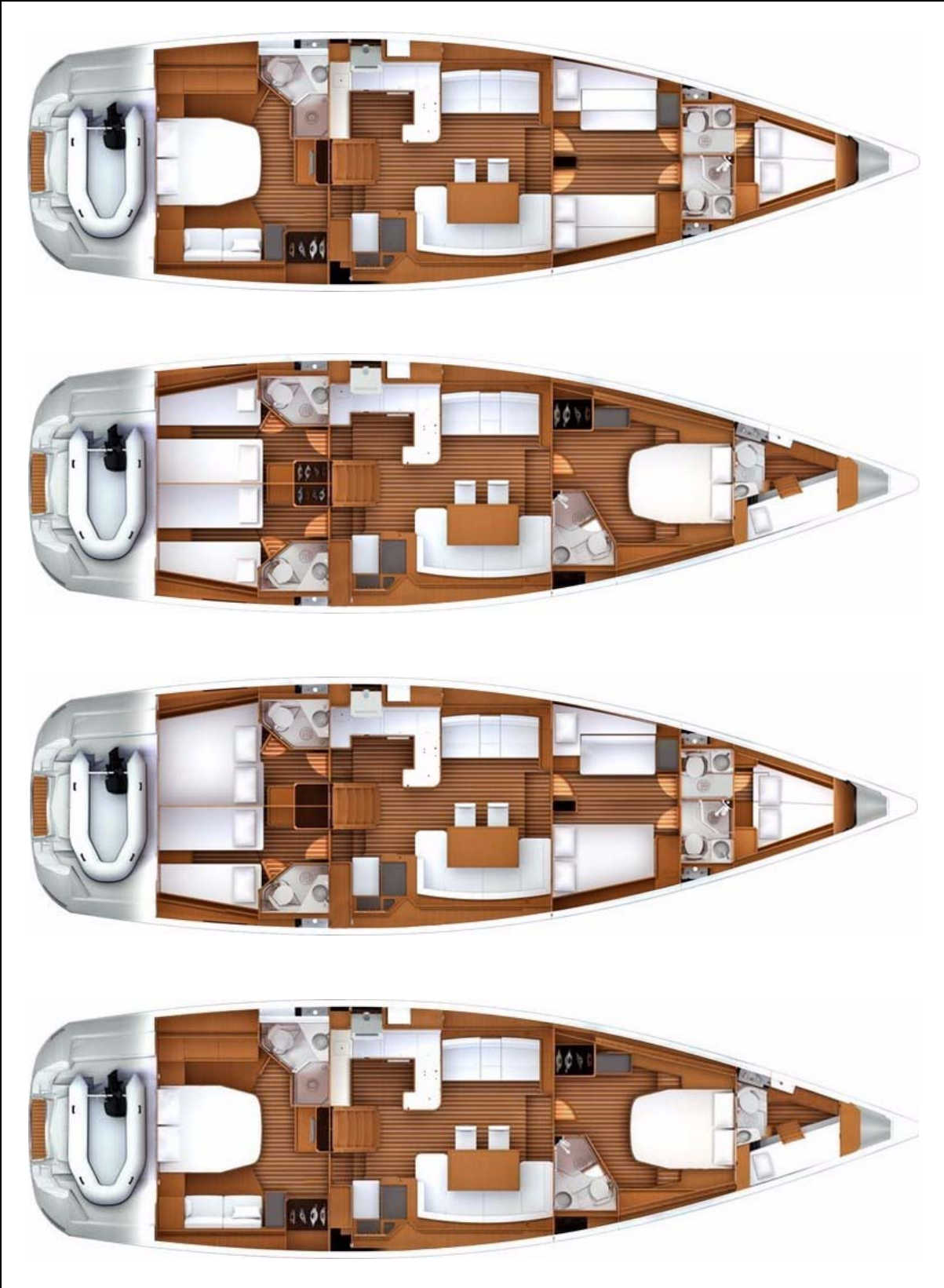



INTERIOR MAINTENANCE

INTERIOR

- Take advantage of the fine weather to take the settee and berth cushions out.
- Put the cushions vertically if you leave the boat for long.
- Use blinds to protect the inside of the boat against UV rays.
- Carefully remove all crumbs.
- Make sure the bilges are clean and dry.

INSIDE VARNISH

- Rinse the inside varnish with fresh water mixed with spot remover and shampoo.
- Polish the interior varnishing with a chamois leather.

MAINTENANCE OF FABRICS

STAIN REMOVAL

- Dab with a clean rag.
- Remove the stain with a solvent poured onto a clean rag. Never pour the solvent directly over the stain.
- Rub with a clean and dry rag.
- Brush the fabric against the grain.
- Use the vacuum cleaner when the fabric is dry.

PVC OR COATED FABRICS

- Use a sponge and water and soap (household soap type).

ADVICE - RECOMMENDATION

- Preferably wash your boat on shore.
- Use as few cleaning agents as possible.
- Don't discharge cleaning agents into the water.
- Take the removable upholstery inside when the vessel is not being used.
- Place protective covers/awnings.
- Mark up each cover and foam when dismantling.

PRECAUTION

- For the PVC fabrics, don't use any solvent or solvent based product (pure alcohol, acetone, trichloroethylene).

Armrest - Saloon



Mechanism Opening / Closure - Dining table



**Blackout curtain
Companionway**



Side portholes



Deck hatch





WARNING

Handle the blackout curtains with care.
Do not use the companionway sun visor in strong winds, rain or while sailing.

INTERIOR

100% POLYESTER/DRALON JACQUARD

If you cannot remove the fabric:

- Clean with the vacuum cleaner.
- Clean with a foam for synthetic fabrics (please refer to the product instructions).

If you can remove the fabric:

- Hand wash with an ordinary washing powder at 30° C.

In both cases, dry cleaning is possible. Remove the stains as soon as possible with a damp rag.

COTTON JACQUARD

- Dry clean.
- Do not iron.
- Do not use hypochlorite.
- Remove the stains with fractionated petrol.

Sink + Draining rack - Galley



Vegetable bin



Access - Engine compartment

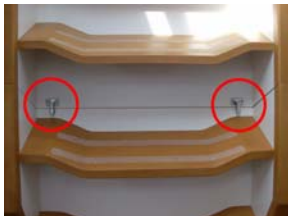

Danger:
Must be closed while sailing.

Safe

Location: Port aft cabin



Adjustable berth - Port forward cabin

Bench seat



Berth



Fixing





Adjustable berth - Starboard forward cabin

Extensions - Bed



Fixing



Cooker





WATER AND SEWAGE WATER

WATER TANKS

WATER SYSTEM - DISTRIBUTION

WATER SYSTEM - DRAINAGE

SEWAGE

WATER TANKS

Location: Saloon
Capacity: 3 x 310l



Gauge



Position / Number of water tanks

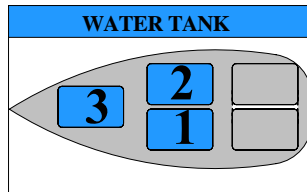
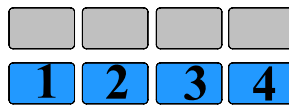

Deck filler



Selection valve - Water tank
Location: Plumbing board



1. Supply - Water tank - Starboard forward
2. Supply - Water tank - Port forward
3. Supply - Water tank - Starboard aft



OPERATION

In order to prevent any handling mistakes, never fill the water and fuel tanks at the same time.

During filling, avoid handling contaminants near the fillers.

Open and close the filler caps with the suitable key.

Check the filler cap seals for condition during filling.

The tanks are fitted with overflow outlets and vents.

Never insert the water filling hose deep down into the system in order to prevent any over-pressure in the systems.

ADVICE - RECOMMENDATION

- Pay attention to the quality of the water for the filling up. Check if it is drinking water.
- It is possible to sterilize the tanks with a Clonazione tablet (sold at the Chemist's).
- If the boat is not used for long, purify the tanks and pipes with acetic acid (or white vinegar).
- For winter storage instructions and precautions, refer to Chapter 13.



WARNING

- The tanks' nominal capacity cannot be fully used due to the load and the need to maintain the correct trim. A 20% reserve should be kept

WATER PUMP 24V
Location: Saloon - Central



220V 60L WATER HEATER
Location: Saloon - Starboard



SOCKET - SHORE WATER
Location



Operation: The intake functions with a check valve, no valve.



WARNING

- Turn off shore water before leaving the vessel.



PUMP FOR DECK WASHING

Location: Forward cabin



1. Pump for deck washing - 12V
2. Filter

Seawater inlet / Stuffing box

Location: Forward cabin



Connection

Location: Mooring locker



WATER SYSTEM - DISTRIBUTION

PRECAUTION

- Never operate the water system equipment when the valve is closed or the tank is empty (the electrical equipment may be damaged).
- Check the water filter for condition (refer to manufacturer's instructions).
- Close the taps of empty tanks.

USE OF THE WASHBASINS AND SHOWERS

- Close the valves and turn off the taps after use.

SEA WATER FOOT PUMP / FRESH WATER

The footpump makes either seawater or freshwater available at the sink. The tap is located at the corner of the sink cupboard and the aft cabin door.

Operate the 3-way valve (to choose water) and push down on the pump pedal.

The 3-way valve is located under the floor in front of the cupboard.

Valve selection of water board / Sea water



Spout



Control - Foot pump





DECK SHOWER

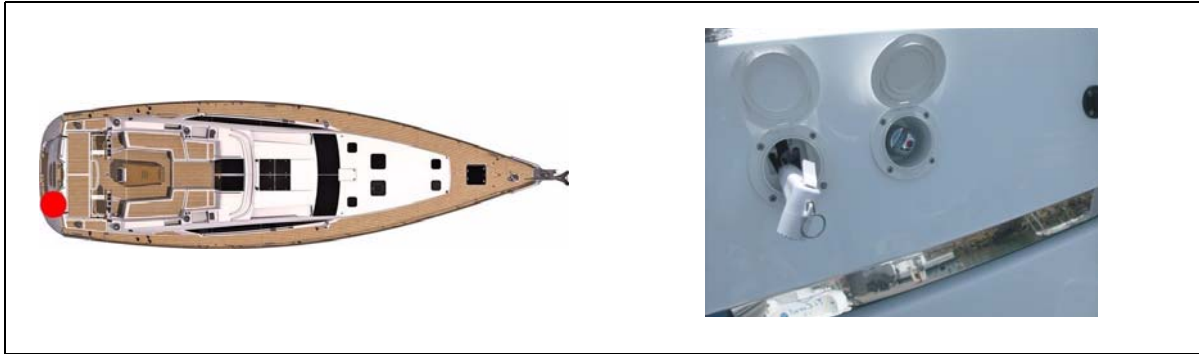

WARNING

- Bleed the cockpit shower water system to avoid freezing.

WATER SYSTEM DRAINAGE

OPERATION

Waste water from the sink, washbasins and heads is drained off by thru-hull fittings with ball valves (the valve is closed when the valve handle is perpendicular to the hose, the valve is open when the valve handle is in line with the hose).

All the floors have holes (limber holes) for the water flow.

A watertight bilge tray under the engine receives the possible oil leaks.

A main sump located above the ballast receives water from the bilges.

The main sump is partially drained by an electric or a manual pump. Regularly dry the sump with a sponge.

ADVICE - RECOMMENDATION

- Regularly check the valves and thru-hull seacocks for proper operation and watertightness.
- Turn off the valves when the water system is not in use.
- Visually check the water pump flow.
- Check the clamps and flexible hose connections for tightness.
- Pay attention to the seals for condition.
- Regularly make sure that the strum box and bilge are perfectly clean.
- Immediately switch off the electric system in case a pump is running while all the water supplies are turned off.
- In case of a leak check the system.



Drainage - Galley sink + Draining rack

Icebox drainage: directly to well.



Drainage - Dishwasher:
Connector to sink drain in kitchen cabinet.

Drainage - Head version

Shower + Washbasin
Port aft head compartment



Ordering evacuation shower



Shower + Washbasin
Starboard aft head compartment



Drainage - Washer: Starboard saloon





SEWAGE

USE OF THE MARINE HEADS

Before you use the heads, check that the water intake valve and draining valve are open.

To empty the bowl:

- Set the control lever of the pump slantwise (FLUSH).
- Operate the pump.

To dry the bowl:

- Set the lever back vertical (DRY).
- Operate the pump.

To avoid blocking the toilets only use absorbent paper in reasonable quantities.

Schedule a regular rinsing through of the heads with fresh water.

Close the valves after each use (in particular when the boat is unattended).

ELECTRIC TOILET

The electric toilets operate with seawater only. A switch enables the water intake and drain cycle of the bowl to be activated. A switch enables the bowl to be rinsed.

ADVICE - RECOMMENDATION

- When you are in a marina, use the club-house sanitary facilities (if there are).
- Since it is prohibited to discharge sewage water in certain marinas or countries it may be necessary to use the foul water holding tank ('WHT').

TOILET OPERATION QUIET FLUSH (OPTIONAL)



Control WC quiet flush

1. Rinsing out the bowl
2. Water filling to the left and bowl draining to the right

Pump Seawater inlet + Filter



1. Seawater inlet - WC
2. Filter
3. Pump - WC

USE OF MARINE HEADS EQUIPPED WITH A WASTE HOLDING TANK (WHT)

Open the water intake valve (valve handle parallel to the pipe).

In the case of a direct discharge into the sea: Open the draining valve.

In case you store the waste waters in the tank: Make sure the draining valve is closed (valve handle perpendicular to the pipe).

To drain the bowl, set the control lever of the pump slantwise (FLUSH) then operate the pump.

To dry the bowl, set the lever vertical (DRY) then operate the pump.



In order to avoid clogging the heads:

- Only use absorbent paper in reasonable quantities.
- Schedule a regular rinsing through of the system with fresh water.
- Always retain a little water in the bottom of the bowl to avoid smells

To empty the tank:

- In an authorized area, open the draining valve.
- In a marina equipped with a system to suck the waste waters, put the sucking hose into the tank through the deck filler. Start the pump of the sucking system. The filler caps are opened and closed with an appropriate key. When the tank is empty, check the cap seal for condition then close the filler.



WARNING

- Ask for information about the laws in force in your country or your marina about discharging your waste waters into the sea.

PRECAUTION

- Close the valves after each use and above all when the boat is unattended.

PRECAUTION

- Regular check the tank level. High pressure due to too high a level may cause leaks or more unpleasant troubles.

ADVICE - RECOMMENDATION

- To prevent odors caused by organic waste in pipes one should clarify the circuit after each use. For this procedure, drive about ten times the manual pump of the toilet or for a minute if it is an electrical pump
- .When you leave the ship for several days, flush the toilets circuit assembly with fresh water. Purify with specific products (for example a health additive to clean, disinfect and neutralize odors).

RESPECT OF THE ENVIRONMENT

- Remain informed of local regulations concerning the environment and follow the codes of best practice.
- Do not drain the contents of the sewage tank near the coast or in zones where it is forbidden.
- Make use of the port or marina pump facilities to drain the sewage tank before leaving port.
- Find out the international regulations against marine pollution (Marpol) and follow them as far as possible.

ADVICE - RECOMMENDATION

- Completely empty the black water system before leaving the vessel unattended in temperatures below freezing.



Detail - Tank
Capacity: 80 litre
Location: in each bathroom



Excrement tank gauge +
Control - Drain to sea
Location: Cupboard - Head version

Fore washroom



Aft washroom



1. Drain to sea
2. Seawater inlet - WC



Deck drainage

Version 2 aft cabin(s) - 1 Forward cabin - 1 Skipper's cabin



Version 1 aft cabin - 3 Forward cabins



Version 2 aft cabin(s) - 3 Forward cabins



WATER AND SEWAGE WATER

EXECREMENT TANKS

SCHEMATIC DIAGRAM

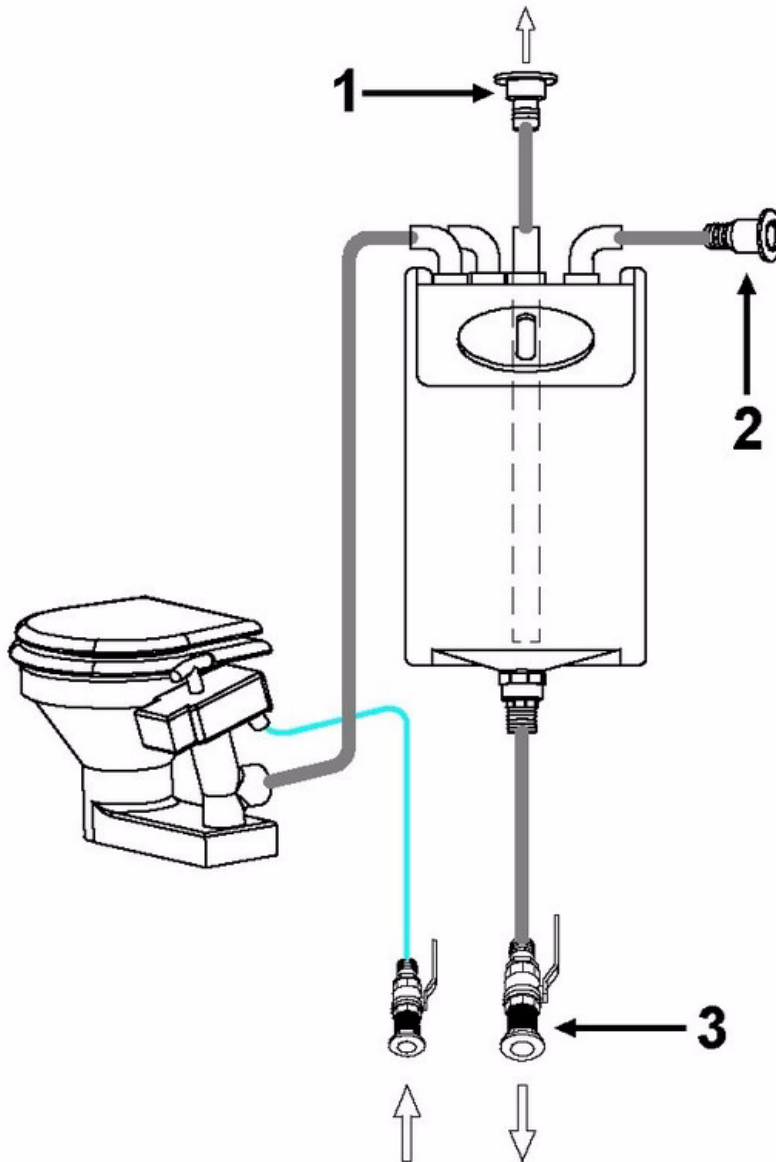

1. Deck filler - Suction and Rinsing
2. Tank vent hole
3. Thru-hull seacock



ELECTRICAL EQUIPMENT

GENERAL INFORMATION

12 V DC SYSTEM

24 V DC SYSTEM

110-220 V AC SYSTEM

EQUIPMENT

ELECTRICAL EQUIPMENT - 12V

BATTERY SWITCH - 12V Location: Companionway - Starboard



1. Common negative
2. Service positive
3. Positive engine

BATTERY SET - 12V Location: Chart table



1. Engine: 60A
2. Service: 50A

BATTERY CHARGERS - 12V 25A Location: Companionway - Starboard and port



BATTERY CHARGER

Operation

The battery charger operates based on a signal processor that converts alternating current (220V or 110V) into a direct current (12V). The operation of the charger is fully automatic, after selecting the type of battery and load type (Refer to the instructions for use).

VOLTMETER - 12V Location: Electrical panel



GENERAL FUSE - 12V SYSTEM





12V BREAKER
Location: Electrical panel

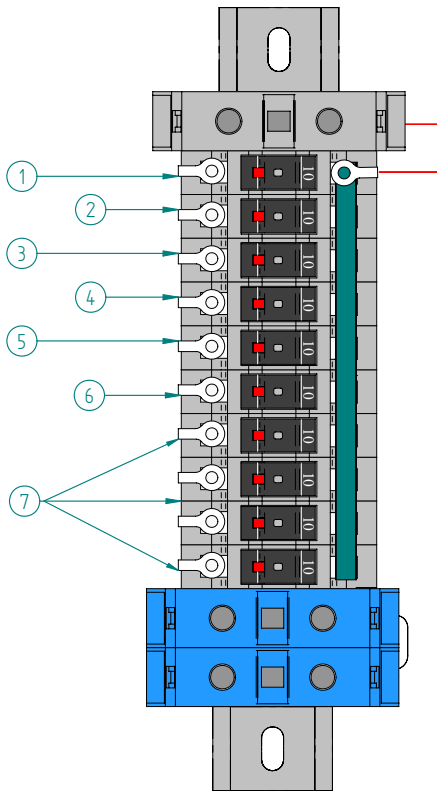

- 1. Sockets 12V - Cockpit + Electrical panel
- 2. Sockets 12V - Forward cabin
- 3. Sockets 12V - Aft cabin
- 4. Hifi
- 5. Amp - TV
- 6. VHF
- 7. Available

Mechanism



Circuit breakers are resettable.

Press the tab manually on black back on the road circuit (see photo)

Breaker disarmed



Armed breaker



GENERAL INFORMATION

ELECTRICAL PANEL

The electrical switchboard does not require any routine maintenance. In case an electric appliance is not energized, check:

- The main power supply (batteries, battery switches).
- The switches and circuit breakers on the line.
- the relevant electrical unit.

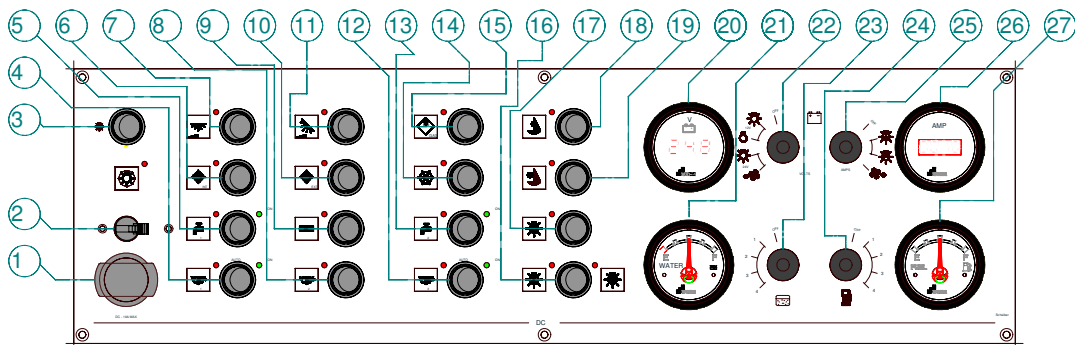

- | | |
|--|---|
| 1. 12V socket | 15. Control - Solenoid - Gas |
| 2. "Interior lighting" general circuit-breaker | 16. Control - Navigation lights & Mooring light |
| 3. Switch - Backlighting - Panel | 17. Forcing - Steaming light |
| 4. Control - Forward bilge pump | 18. Control - Projector boom bar |
| 5. Control - Water unit | 19. Control - Deck searchlight |
| 6. Control - Fridge - Galley | 20. Indicator - Voltage |
| 7. Control - Saloon lighting 1 | 21. Indicator - Water level |
| 8. Control - Bilge pump - Saloon - Auxiliary | 22. Master switch - Measurement - Voltage |
| 9. Control - Freezer - Galley | 23. Master switch - Water level measure |
| 10. Control - Fridge - Chart table | 24. Master switch - Measurement - Level Fuel |
| 11. Control - Saloon lighting 2 | 25. Master switch - Current measurement |
| 12. Control - Bilge pump - Principal - Saloon | 26. Display - Current measurement |
| 13. Control - Pump for deck washing | 27. Display - Measurement - Level Fuel |
| 14. Control - Navigation electronics | |

ELECTRICAL CIRCUIT, 24 V



GENERAL RECOMMENDATIONS

- Never work on a live electric fitting.
- The batteries must be strongly fastened.
- Do not block the battery ventilation ducts, some of them may give off hydrogen which represents a danger of explosion.
- The batteries must be handled with care. In the case of contact with electrolyte thoroughly rinse off the affected part of the body and consult a doctor.
- To avoid short-circuiting between the battery poles do not store conducting objects near to the batteries (metal tools, etc...).
- Turn off the electrical circuit with the battery switches when installing batteries or during their connection/disconnection.
- Never modify the specifications of power overload protection devices.
- Never modify an installation. Use the services of a qualified marine electricity technician.
- Never install or replace the electric appliances (or any electric equipment) by components exceeding the capacity (amperage) of the circuit.
- Do not leave the vessel unattended when the electrical system is switched on .
- Certain lights represent a significant heat source, be careful of surrounding objects.

Note, the son of the 24 V circuit are white or brown for the blue and more for less.



DANGER

- There may be danger of fire or explosion if direct current systems are incorrectly used.



WARNING

- Handle the batteries with care (Please refer to the manufacturer's instructions).
- In case of electrolyte splashing, thoroughly rinse the part of the body that has been in contact with it. Obtain medical advice.

ADVICE - RECOMMENDATION

- Keep the batteries clean and dry in order to avoid premature wear.
- Periodically check the electrolyte level. Add distilled water when needed.
- Tighten and maintain the terminal connectors by greasing them regularly.
- Disconnect the batteries during winter storage or long periods of inactivity.

BATTERIES

Battery charging is achieved through the alternator coupled to the engine or through use of the 220 V shore charger.

Keep the batteries charged enough (essential to ensure them a correct service life).

Make the most of time alongside to use the 220 V shore charger so as to start out sailing with fully charged batteries.

Always check the condition of the batteries and charge system before putting to sea.

Be sure to always recharge the 24 V battery set after a day's navigation under sail.

Battery set: 24V

Location: Starboard saloon
Service: 4 x 120A



Location: under the kitchen
Spare battery: 4 x 120A



Battery chargers - 2 x 24V 60A
Location: Under map table



Voltmeter - 24V
Location: Electrical panel



General fuse - 24V system





BATTERY SWITCH

The electricity onboard is 24V DC.

The electrical system consists of service batteries.

The batteries supply power to all the functions on board.

Switch on the electricity by turning the positive and negative battery switches.

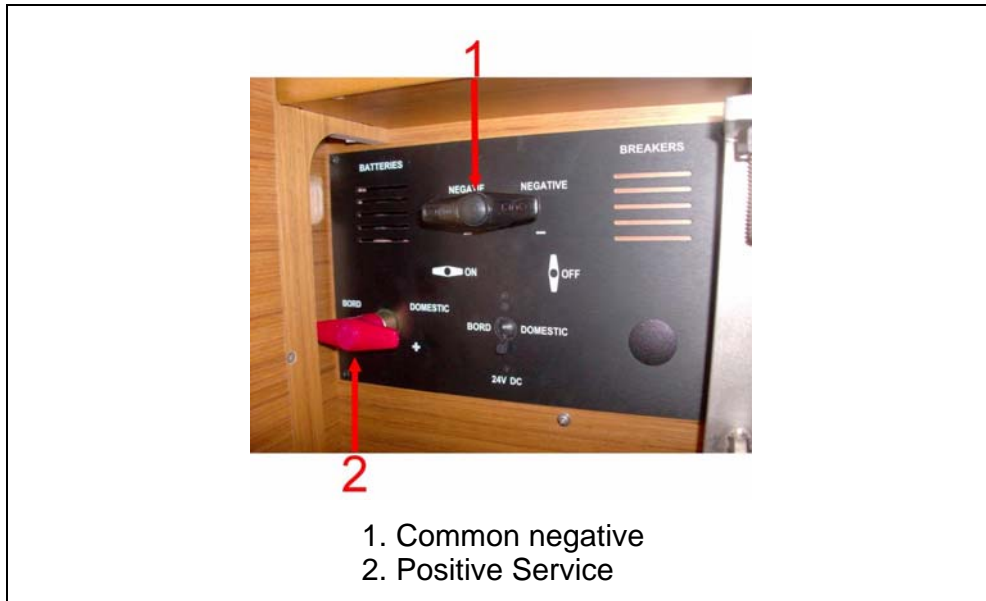

1. Common negative
2. Positive Service



WARNING

- Never work on a live electric fitting.
- Do not touch battery terminals, risk of electric shock.

PRECAUTION

- Switch off the electrical system with the battery switches when the boat is unattended.
- Never leave the vessel unattended with the mains electricity switched on.
- Turn off the electrical system with the battery switches and circuit breakers before gaining access to the rear of the electrical panels.
- Check the level of maintainable lead batteries.

ADVICE - RECOMMENDATION

- It is recommended that you switch off all electrical devices before turning off the battery switches.

BOW THRUSTER

LOCATION

FORWARD CABIN

1. Battery set - 4 x 50A
2. Fuse - 250A
3. Electric battery switch - Positive



Bow thruster - 24V



Nozzle



OPERATION

The thruster works with the vessel's engine running.

The bow thruster control is supplied by the 24V service batteries.

Controls in the cockpit



WARNING



Refer to the apparatus instructions for use and maintenance.



WINCHES ELECTRIC

LOCATION

Spinnaker sheet winches
Access - Relay box: Garage



Genoa sheet winches
Engine - 24V + Relay box
Access: Deckhead - Cabins



Circuit breakers
Location: Starboard saloon
Genoa sheet winches - 100A
Spinnaker sheet winches - 60A
Rigging winches - 60A



ELECTRICAL EQUIPMENT

OPERATION

Electrical contactors - in the cockpit



WARNING

Refer to the apparatus instructions for use and maintenance.
Heavy use is made of the batteries when operating the electrical winches.
Be sure to always recharge the 24 V battery set after a day's navigation under sail.

FRIDGE

LOCATION

Refrigeration unit - Under the kitchen cupboard Exchanger - Under saloon floor Port side



Fridge - Cockpit Drainage Fridge - In the sump well



Location: Garage - Starboard

1. Exchanger
2. Refrigeration unit



WARNING



- Refer to the apparatus instructions for use and maintenance.
- Defrost the fridge regularly / Cool boxes.
- During long absence leave the fridge and icebox doors open to avoid mould developing.

Inverter - 24V / 220V
Location: Starboard saloon



1. Differential circuit breaker 16A
2. Inverter 1800W

Control box



Earthing plate - Galley floor



Fuse - 200A



WARNING



- Defrost the fridge regularly / Cool boxes.
- During long absence leave the fridge and icebox doors open to avoid mould developing.



CIRCUIT BREAKERS 24V

LOCATION

Back of electrical panel

1. Saloon lighting	10. Plus after contact
2. Kitchen lighting - Chart table	11. Windlass
3. Lighting - Aft locker - Cockpit - Engine compartment	12. Bow thruster
4. Cabins & Heads version - forward	13. Navigation instrument
5. Cabins & Heads version - aft	14. Shower pump - aft
6. Navigation lights	15. Shower pump - forward
7. Mooring light	16. Gangway
8. Deck searchlight	17. Gauge dial - Sewage tank
9. Projector boom bar	18. Available

Mechanism

Circuit breakers are resettable.
Press the tab manually on black back on the road circuit (see photo).

Breaker disarmed	Armed breaker

RELAY BOX

Location: Back of electrical panel



24V 10A

24V 25A

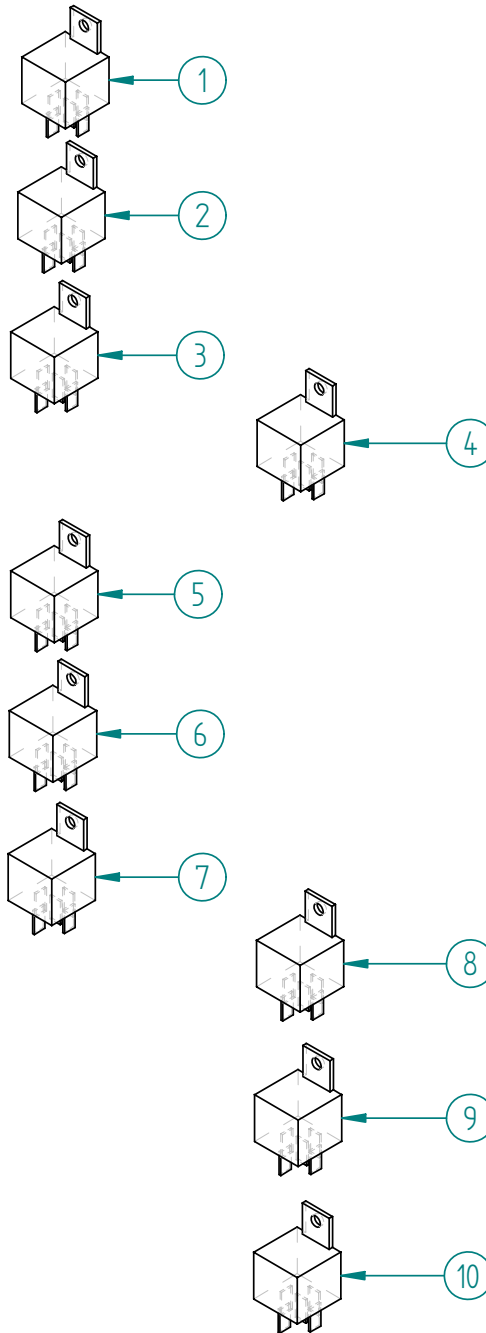

1. Lighting - Gangway - Saloon
2. Lighting - Deckhead - Saloon
3. Navigation lights
4. Steaming light
5. Mooring light
6. Deck searchlight
7. Projector boom bar
8. Authorization windlass
9. Authorization Propulsion
10. Electronic

WARNING



Always replace a fuse with one of the same size.

GANGWAY
Location: Garage

Electrical cabinet



Engine 24V + Tank



Gangway



Breaker 125A
Location: Port saloon

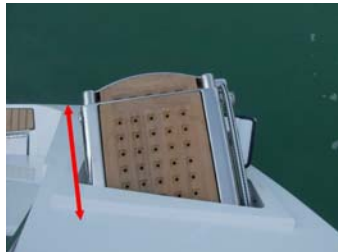

Control



Operation

The gateway combines the functions of gateway and davit.

Maximum load: 150 kg

Open length: 1,875 m



WARNING

- Refer to the manufacturer's instructions for use and maintenance.

TELEVISION / HOME CINEMA

Wave inverters 24V / 220V
Location: Electrical panel



TV aerial amplifier
Location: Saloon



Bass speaker
Location: Port saloon



OPERATION

The televisions power, supplied by a transformer which is powered with batteries of service, operates at 12V.

Starting up: First turn on the circuit breaker, then switch on the TV. The transformer is switched on and off automatically when you turn on or off the breaker..

ELECTRIC GENOA FURLING SYSTEM

Electronics box
Location: Forward cabin



Breaker 50A
Location: Port saloon



Control



GARAGE

Garage opening - Control
Location: Port cockpit locker



Garage Open



DANGER

It is prohibited to open or leave open the garage while sailing.
Maximum working load: 5 persons or 400 kg.

Remote control	WINCH Relay box	Location
		

Function SWELLING	SWELLING Location: Garage	Function DEFLATER
		

Refer to the apparatus instructions for use and maintenance.

LAUNCHING RAMP Attachment to open quarterdeck

SHORE POWER SOCKET



Socket 220V 50A / 32A



Breaker 220V 63A /32A - Port aft locker





ADVICE - RECOMMENDATION

In order to reduce the risks of electric shock and fire:

- Before you plug in or unplug the boat/shore supply cable, switch off the shut off device connected to the shore supply.
- Plug in the boat/shore supply cable in the boat before you plug it into the shore supply socket.
- Unplug the boat/shore supply cable on shore first. Close the shore socket cover.
- Do not modify the connections of the boat/shore supply cable.



DANGER

Unplug the dock before leaving the dock.

ELECTRICAL CIRCUIT, 110-220 V

GENERAL RECOMMENDATIONS

Certain vessels are equipped (as either standard or optional features depending on the model) with a 110 V or 220 V circuit.

The following measures are recommended in order to avoid the danger of electrical shock and fire:

- Never work on a live electric fitting.
- Plug in the boat/shore supply cable in the boat before you plug it into the shore supply socket.
- Never let the end of the boat/shore supply cable hang in the water.
- Turn off the shore supply with the onboard cut-off switch before connecting or disconnecting the vessel/shore supply line.
- Disconnect the ship/shore power cable at the shore socket first.
- Check the polarity indicator for the shore connections.
- If the reverse polarity indicator is activated immediately disconnect the cable. Rectify the polarity fault before using the vessel's electrical installation.
- Close the shore supply input cover firmly after use (Version/Optional equipment 115V AC).
- Do not modify the vessel/shore supply line connections; only use compatible connections.
- Do not alter the vessel's electrical system. The installation, modifications and maintenance must be carried out by a qualified marine electricity technician. Check the system at least twice a year.
- Disconnect the vessel supply when the system is not being used. This is to prevent the danger of fire.
- Use double insulated or earthed appliances.



WARNING

- Handle the batteries with care (Please refer to the manufacturer's instructions).
- In case of electrolyte splashing, thoroughly rinse the part of the body that has been in contact with it. Obtain medical advice.



Note that the live wires are brown, the neutral ones are blue and the earth wires are green and yellow.



DANGER

- Never let the end of the boat/shore supply cable hang in the water: The result may be an electric field liable to hurt or kill the swimmers nearby.
- There may be danger of electrocution if alternating current systems are incorrectly used.

PRECAUTION

- Never modify an electric fitting and relevant diagrams yourself.
- Call in a technician skilled in marine electricity to carry out any electric modification.
- Never change the breaking capacity (amperage) of the overcurrent safety devices.
- Never install or replace the electric appliances (or any electric equipment) by components exceeding the capacity (amperage) of the circuit (Watt for bulbs).

Circuit breakers 220V / Master switch - Shore / Generator
Location: Chart table unit

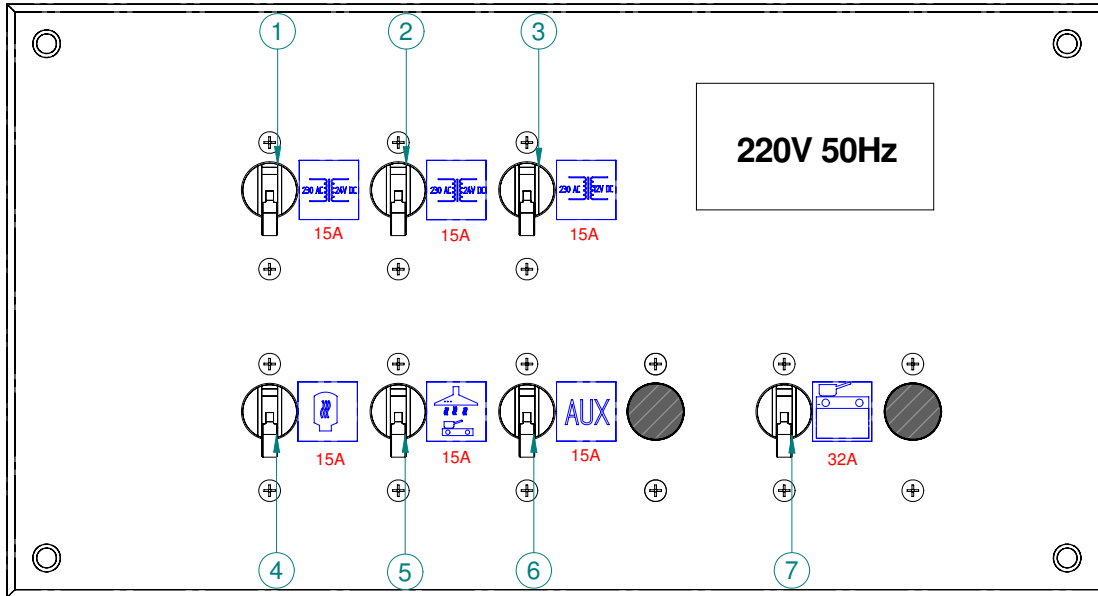

1. Battery charger 24V
2. Battery charger 24V
3. Battery charger 12V
4. Water heater
5. Extractor hood
6. Available
7. Ceramic hob





Circuit breakers 220V / Master switch - Shore / Generator
Location: Chart table unit

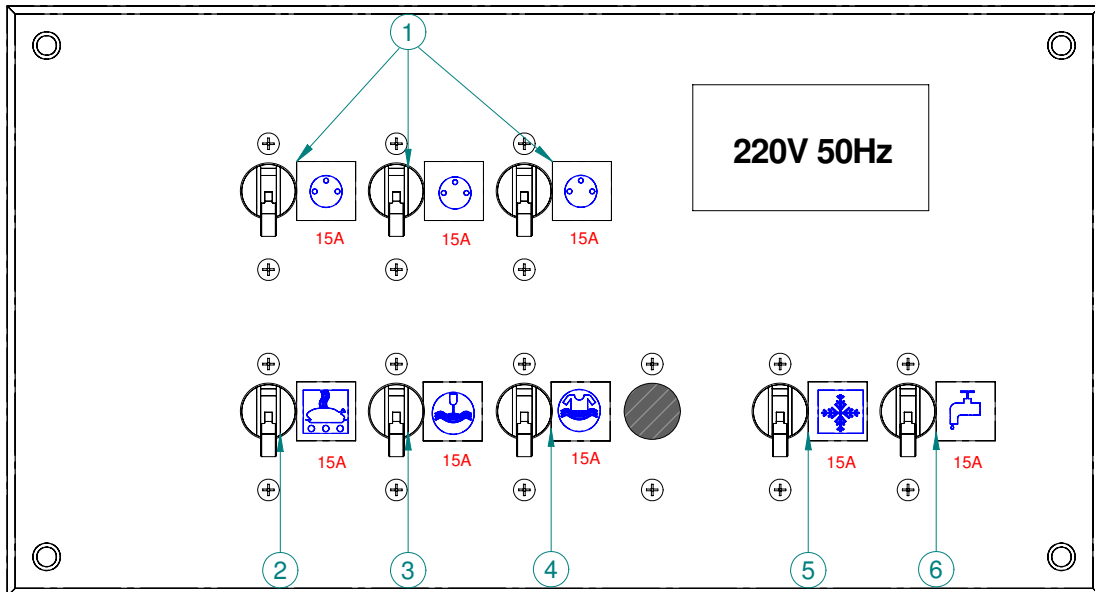

1. Sockets x 3
2. Microwave
3. Dishwasher
4. Washer
5. Ice maker
6. Water maker



Circuit breakers 110V
Location: Chart table unit

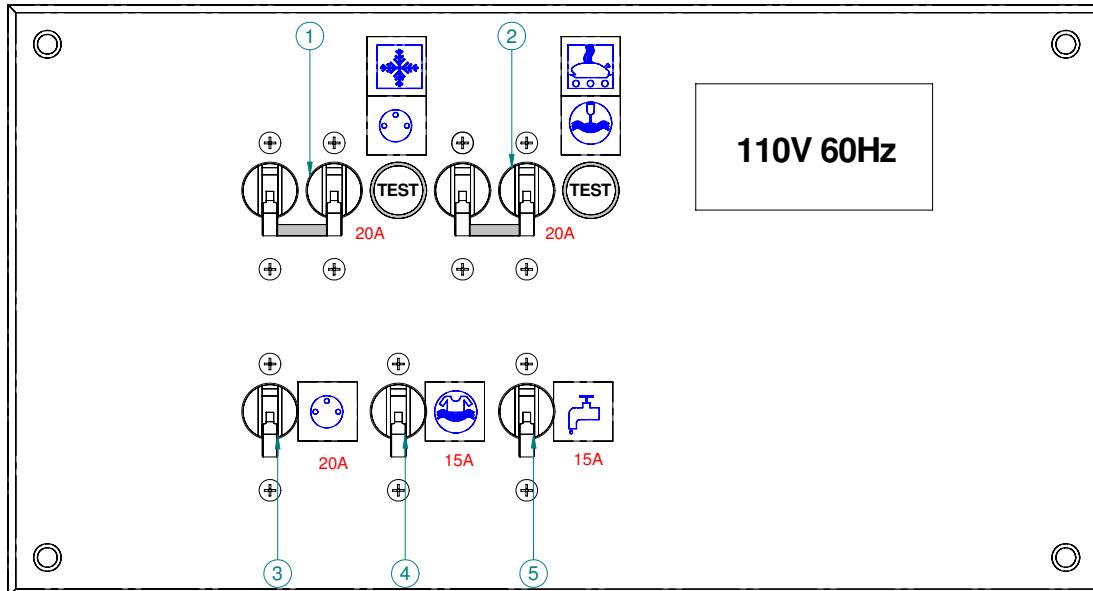

1. Ice maker + Sockets
2. Oven + Dishwasher
3. Socket
4. Washer
5. Water maker

EQUIPMENT

GENERAL INTRODUCTION

(As far as possible) use electric appliances with double insulation or with three conductors (Neutral-Live wire-Ground).



ELECTRONIC

Wire runs are available to complete the boat equipment.

Do not install electronic instruments or repeaters less than 1,50 m away from the radio loudspeakers.

Advice: *For further information refer to the appliance instructions.*

LEAD LINES

The log and depth sounder sensors are located under the forward cabin floor. Keep the log sensor cowl close to the instrument so as to be able to intervene in complete safety.

Do not store material on top of the sensors.

AUTO PILOT

The pilot consists of several elements listed as follows:

- Repeater in the cockpit.
- Compass in the aft starboard cabin closet. A pictogram helps to locate it easily.
- Valve, hydraulic pump, rudder blade on either side of the bar sector in the rear locker (access via one of the two cockpit lockers aft cabin port).
- To supply power to all elements switch on the "Navigation" circuit breaker on the electrical panel.
- For use and maintenance of the material consult the manufacturer instructions.

MAINTENANCE

Clean the transducer probe during each dry dock and the log sensor regularly. Read the instructions for maintenance recommendations.

Refer to chapter 12 "Launching" for the precautions to be taken concerning the sensors during hoisting.

ADVICE - RECOMMENDATION

- For best results, remove any metal compass..
- Do not store material close to the calculator and electrical connections.

MAINTENANCE

Clean the repeater dials with freshwater. Refer to the instructions before using any other produce. The use of alcohol must be avoided.

ADVICE - RECOMMENDATION

- Place the protective covers on the repeaters when unused for long periods.
- When sailing store the protective covers inside the boat to avoid losing them.
- The various repeater displays are back-lit.
- The onboard radio is fitted with two outside speakers.
- When mooring be careful to adjust the sound so as not to disturb your neighbours.

TRANSDUCER LOCATION

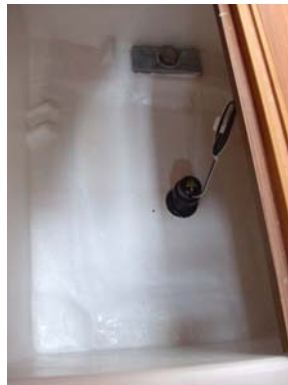



AUTO PILOT
Layout of components



Auto pilot (Reference 1)



Gyrocompass (Reference 2)



Vessel Management Unit (Reference 3)



GENERATOR

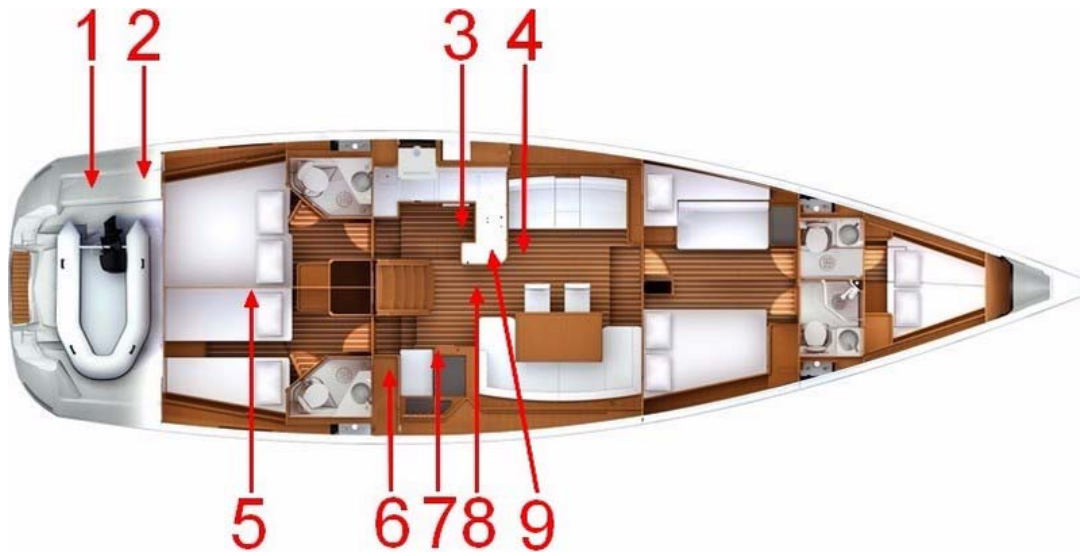

Electrical earthing
Location: Galley floor



Drainage - Sea water (Reference 1)



Tank - Cooling liquid + 220V breaker (Reference 4)



WARNING



- Refer to the manufacturer's manual given with your boat.



GENERATOR SYNOPTIC

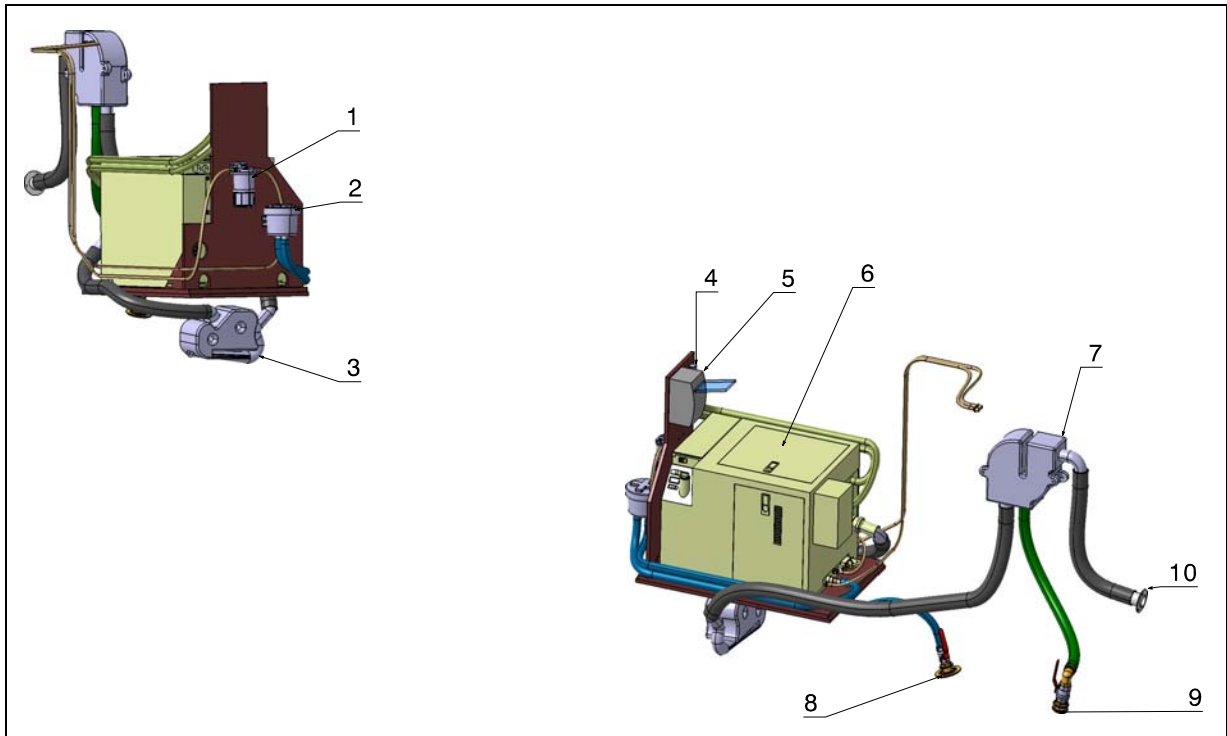

ELECTRICAL EQUIPMENT

REF	Designation
1	Fuel filter
2	Sea water filter
3	Water trap
4	Anti-siphon valve
5	Differential circuit breaker
6	Generator
7	Water - Gas separator
8	Seawater inlet
9	Drainage - Sea water
10	Outlet

Water - Gas separator (Reference 2)



Quilting on reservoir (Reference 5)



Seawater inlet (Reference 3)



Remote control (Reference 6)



Battery (Reference 7)



**Generator + + diesel filter
Battery switch (Reference 8)**



Anti-siphon valve (Reference 9)





GENERATOR - SCHEMA

GENERAL POINTS:

A generator is a device that can produce electricity (220V or 110V) from a mechanical energy (fuel). The generator will feed the onboard equipment operating at 220V or 110V, moored or sailing.

OPERATION:

- Open the raw water intake valves and evacuation valves.
- Turn the generator's battery switch to the ON position.
- Switch the generator breaker (reference 5) ON.
- Turn the generator on by remote control (located on the nautical chart table) or your own generator.
- Check that any device is not running 220V or 110V. Then set the shore power/ generator switch (located on the chart table).

OPERATION:

- Supply - Diesel:

The generator is fed by fuel through the fuel tank port. The fuel filter (reference 1) is located at the generator circuit.

- Refrigeration:

The generator is cooled::

by seawater (inlet valve reference 8 sea water and sea water filter reference 2) ;

and by air (air exhaust duct, that runs through a ventilator and through the fresh air inlet).

- Electricity:

The generator includes its own battery to start the engine. The generator is earthed by an earthing plate which is located under the hull.

- Rejection:

The cooling water and exhaust gases are separated in the separator (reference 7) to avoid noise pollution.

The seawater is discharged below the waterline (Ref 9). The exhaust- pipe is located above the waterline (Ref 10).

AIR CONDITIONING

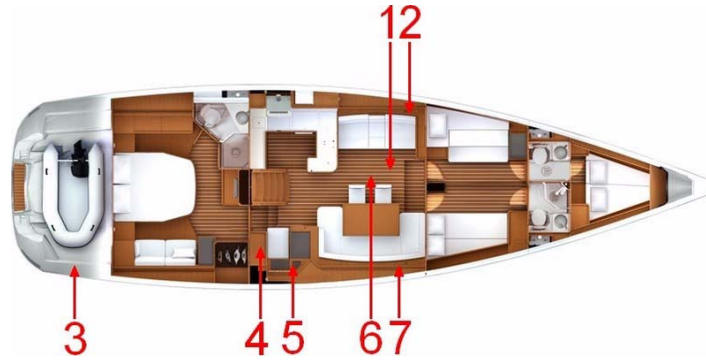

GENERAL POINTS:

The air-conditioning cools the air temperature inside the boat (only when the boat is floating in water).

The cooling circuit consists of one or more compressors that operate independently. A compressor is called "reversible" because it can heat the boat if the sea water temperature exceeds 10°C.

In winter, you can programme the dehumidifier function on the airconditioning controls.

The refrigeration compressors are made by one or two seawater pumps. These pumps are powered by 220V or 110V and are guided by one or two relay boxes.

Sea water is evacuated through a through-hull fitting equipped with a valve, located above the waterline.

Each compressor has its own through-hull evacuation fitting. It is advisable to check the flow of water visually once the air conditioning starts running.

OPERATION:

Before starting the engine::

- Open the raw water intake valves and evacuation valves.
- Use the switch on the chart table to select the power source (shore power or generator).

If using shore power: plug into the shore power socket ;

If using the generator: before turning on the air conditioning, leave the generator running for about 3 minutes.

The air conditioning is running:

- Switch the circuit breakers 220V ,from the air conditioning,ON.
- Select the temperature of each compressor using the control units.

WARNING



- Refer to the apparatus instructions for use and maintenance.
- Never start the generator when the climate function is already on.
- Always turn off the air conditioning before turning off the generator.
- Regularly check and clean the sea water filter placed on the sea water intake through-hull fitting.
- Clean the air filter (located in the compressor) regularly for maximum performance of the installation.



Box - Circuit breakers (Reference 4)

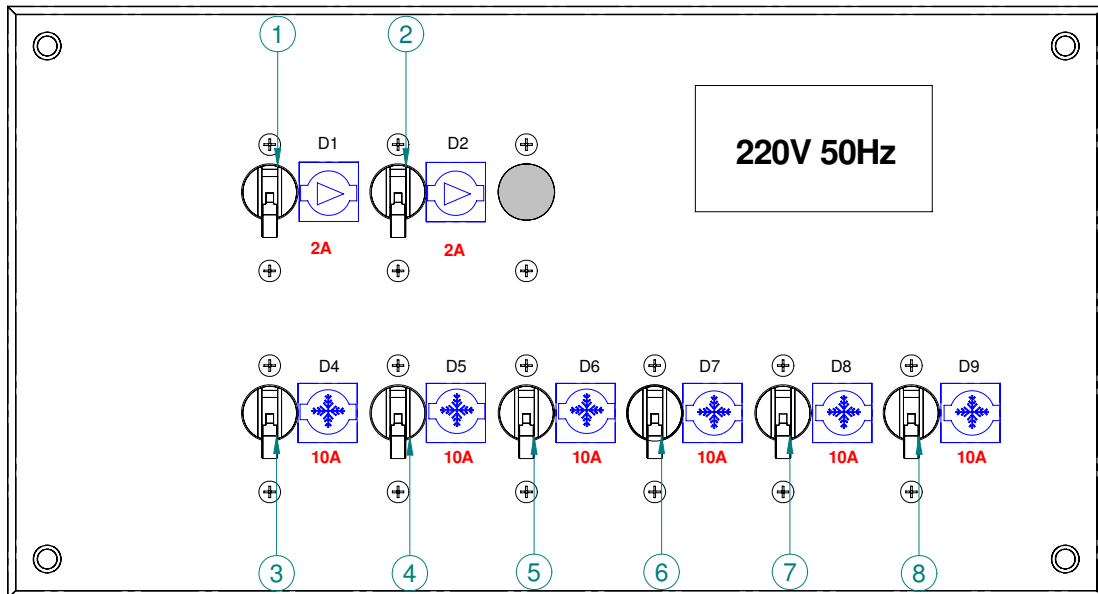

1. Pump - Port saloon
2. Pump - Starboard saloon
3. Compressor - Port saloon
4. Compressor - Starboard saloon
5. Compressor - Port forward cabin
6. Compressor - Starboard aft cabin (owner or rear)
7. Compressor - Port forward cabin
8. Compressor - Starboard forward cabin (or prior owner)

LOCATION - COMPRESSORS

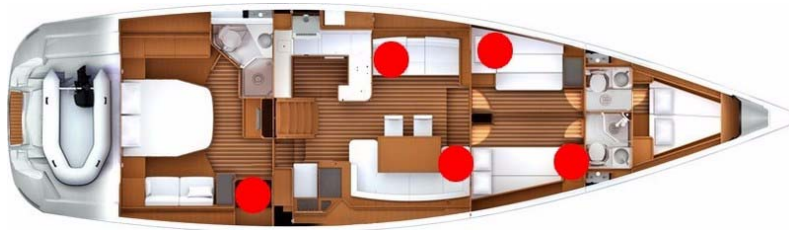

Pump - Seawater inlet (Reference 1 and 6)



Maintenance of filters (to engage in regular):

- Close valves taken seawater.
- Unscrew the top of the filter.
- Clean the strainer.
- Put everything back in place.

Drainage - Sea water Forward port cabin and port saloon compressor (Reference 2)



Drainage - Sea water Compressor - Aft cabin (Reference 3)



Pump relays - Sea water (Reference 5)



Drainage - Sea water Starboard saloon and forward starboard cabin compressor (Reference 7)



Control





OPERATION

Electricity: The heater circuit is powered by 12V thanks to the battery backup.

Diesel: Quilting on reservoir.

STARTING UP

- Verify that the circuit * 1V is turned on.
- Open the heater outlet.
- Turn the control box at ON.
- Adjust the temperature of the heater using the thermostat.

HEATING
Layout of components

Heater (Reference 1) **Diesel pump + Supply valve (Reference 2)**

Control (Reference 3)

DISHWASHER
Layout of components

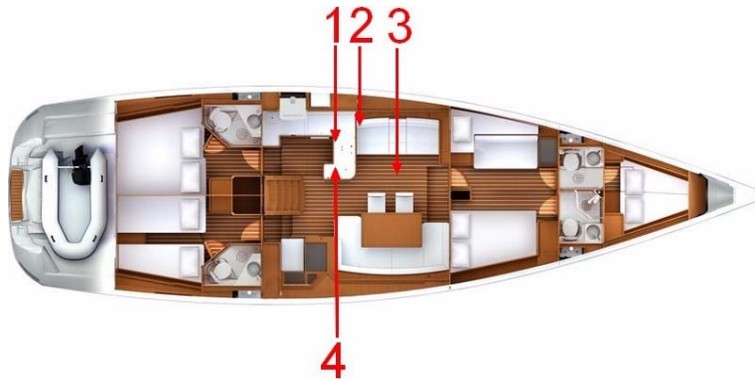

Dishwasher (Reference 1)



220V socket (Reference 2)



Supply valve - House water (Reference 3)



Drainage - System - Sink (Reference 4)



WASHER
Layout of components

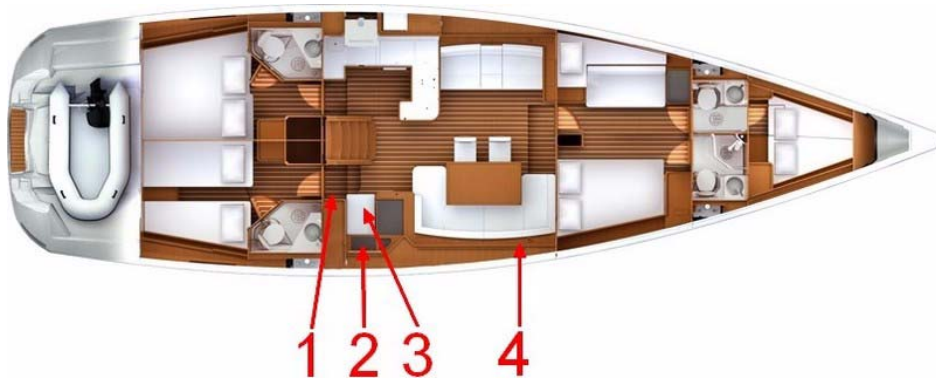

Filter
(Reference 1)



220V socket + Supply valve - House water
(Reference 2)



Washer (Reference 3)



Drainage (Reference 4)



EXTRACTOR HOOD





ENGINE

GENERAL INFORMATION

ENGINE FITTING

Diesel tank
Capacity: 420 l
Location: Aft cabin



Diesel tank additional (Replace the water reservoir)
Capacity: 310 l
Location: Port saloon

Supply valve - Detail

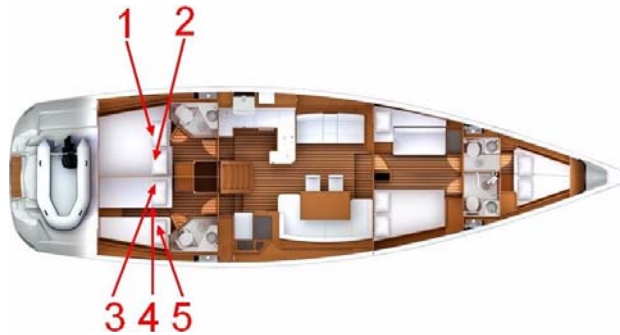

- 1. Heater - Port side
- 2. Heater - Starboard
- 3. Generator
- 4. Engine
- 5. Diesel transfer

Deck filler



Gauge
Location: Electrical panel



Position / Name of fuel tanks

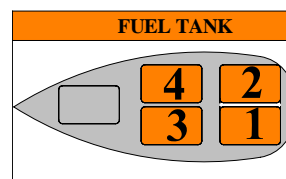

GENERAL INFORMATION



TYPE OF MOTORISATION

Your vessel is fitted with an in-board diesel engine.

The transmission is of a shaftline type.

PRECAUTIONS OF USE, OPERATING ADVICE

General point

- In this vessel, do not install an engine with a greater power and weight than that recommended, this will create a danger for its stability.
- Fuel which is stored elsewhere than in the fuel-tanks (portable tanks, jerrycans, etc...) must be kept in a ventilated space.
- Make sure that the engine compartment is clean and dry.
- Avoid contact between inflammable substances and the hot parts of the engine.
- Locate the extinguisher hole which allows access to the engine compartment if a fire should break out. (Refer to chapter 2).

Filling

Take the general precautions stated in chapter 8 about the water tank filling.

Fill the fuel tank using the filler. In order to protect the deck from possible fuel splash, wet the area around the filler with sea water before you remove the filler cap. In case of splashing rinse the deck thoroughly (deck filler closed).

The fuel level is transmitted from the dipstick to the gauge located on the house electrical panel.



DANGER

- Stop the engine and refrain from smoking during fuel tank filling.
- Make sure that the ventilation openings in the engine (and generator, if installed) compartment are well cleared.

PRECAUTION

- Never run the engine when the boat is hauled out.

ADVICE - RECOMMENDATION

- Carefully read the engine instructions given with your boat.



WARNING

- The tanks' nominal capacity cannot be fully used due to the load and the need to maintain the correct trim. A 20% reserve should be kept.

PRECAUTION

- Stop the engine before you open the companionway hatch and side hatches.
- In case of an intervention when the engine is running:
- Stay away from belts and hot or mobile parts.
 - Be careful with full clothes, long hair, rings etc. (you may be caught).
 - Wear appropriate clothes (gloves, caps etc.).

ENGINE FITTING



ENGINE

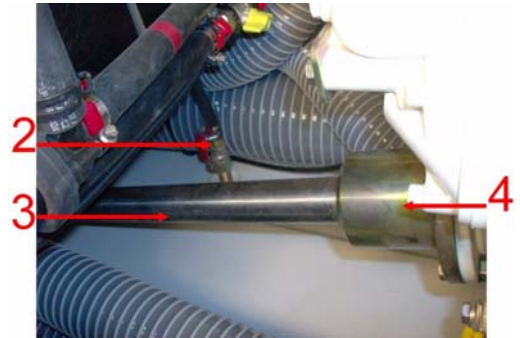

1. Anti-siphon valve (Cupboard - Starboard aft cabin)
2. Stern frame join
3. Propeller shaft
4. Flange
5. Sea water filter
6. Filter - Diesel
7. Engine compartment ventilator

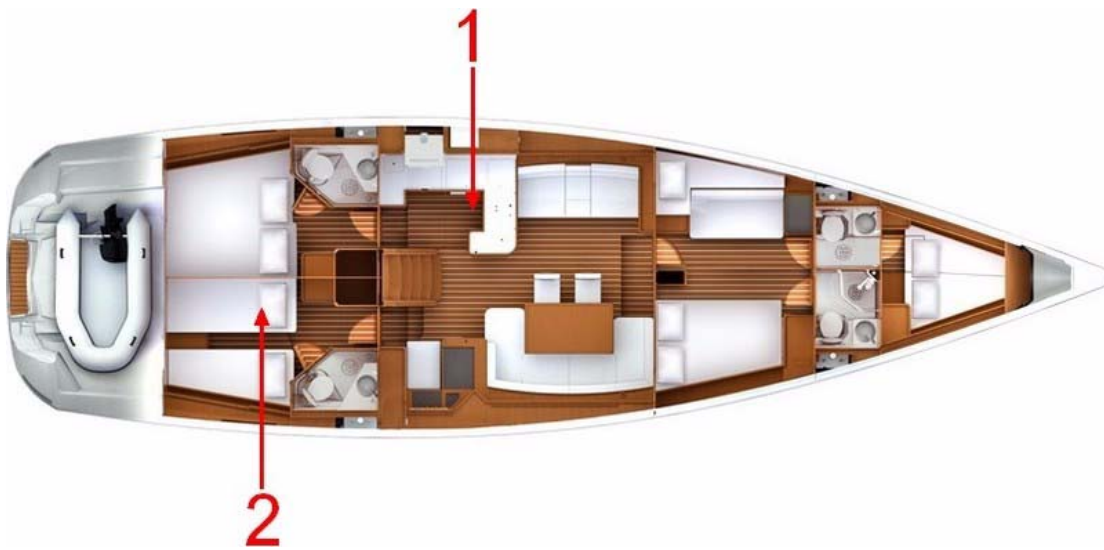

Engine supply valves / Access (Reference 2)



Valve - Sea water inlet valve for engine (Reference 1)



Engine

These instructions give detailed explanations on proper operation of the engine.

- Refill before the fuel tanks have almost run dry (the fuel system may be stopped for lack of fuel).
- Make sure you have enough fuel before sailing.

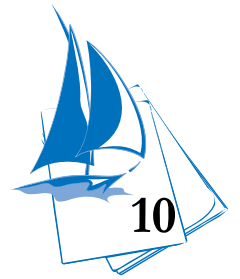

Access to the engine

Access to the engine is via the companionway and the saloon and the aft cabins.

You can check the main parts via side and aft hatches.

Engine water intake valve

The water inlet valve of the engine is essential in the engine operation.

- Keep the strainer under the hull as clean as possible.
- Brush the strainer whenever the boat is lifted out.
- Do not cover the strainer with antifouling paint.

It is essential that this valve is open before the engine is started (danger of rapid wear and substantial damage to engine installation).

If water does not flow out:

- Stop the engine immediately.
- Check that the valve is open.

Close the water inlet valve if the boat is unattended for long.

Inspect and clean the water filter regularly.

Engine operation

Before starting the engine:

- Turn on the fuel valve.
- Open the valve of the engine cooling system and the valve of the stuffing box (see stuffing box paragraph).
- Operate the battery switches and energise the electric system.
- Disengage the reverse gear (it will make the acceleration possible when in neutral).



DANGER

- Always start the engine with the control lever in neutral.

ADVICE - RECOMMENDATION

- Get used to checking immediately after starting the engine if water is expelled with the exhaust gases.



WARNING

- Never switch off or de-energise the electric system when the engine is running.
- Imperatively operate the stop pull handle (or button) before using the ignition key to switch off a diesel engine.

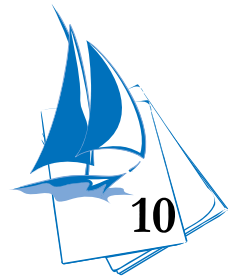

Fuel filter

Engine running problems may have different origins, including dirty fuel. The injection pump may wear out if there is water in the system.

The water results either from the condensation resulting from an insufficiently filled tank, or from a filler cap either not closed properly or with a damaged seal.

In order to prevent any water infiltration, the fuel runs through two filters:

- One filter is an integral part of the engine, its role is to filter fuel very finely. To know when you have to intervene and how frequently you have to change it, please refer to the engine's manual.
- The second filter is on the pipe that links the tank to the engine, it plays the role of a water decanter and prefilter.

Drain by undoing the knurled screw at the base of the decantation bowl (but not removing it).

Allow to flow into a box till the fuel looks clean.

Do this several times a year.

Change the pre-filter at least once a year (access to it when you remove the bowl).

As for the procedures in case of fire, refer to Chapter 2.

Stuffing box

You have access to the stuffing box through the central technical compartment behind the engine.

Lubricate the seal every 200 running hours (or at least once a year).

Apply the grease the manufacturer recommends in his instructions.

After launching the boat, drive the air out from the sleeve pinching it with your fingers.



DANGER

- Never obstruct access to the fuel valve.

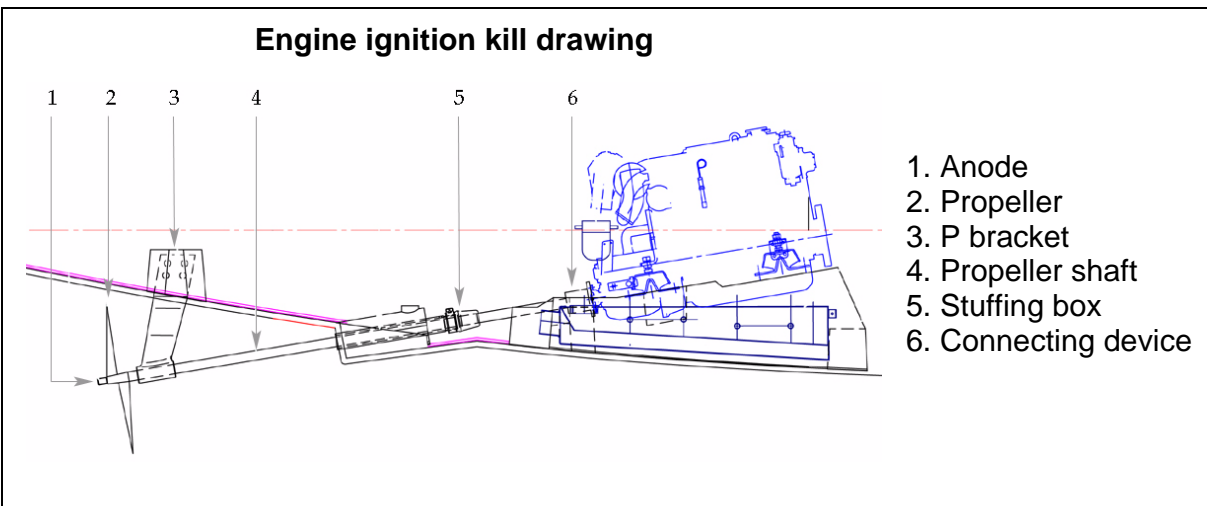
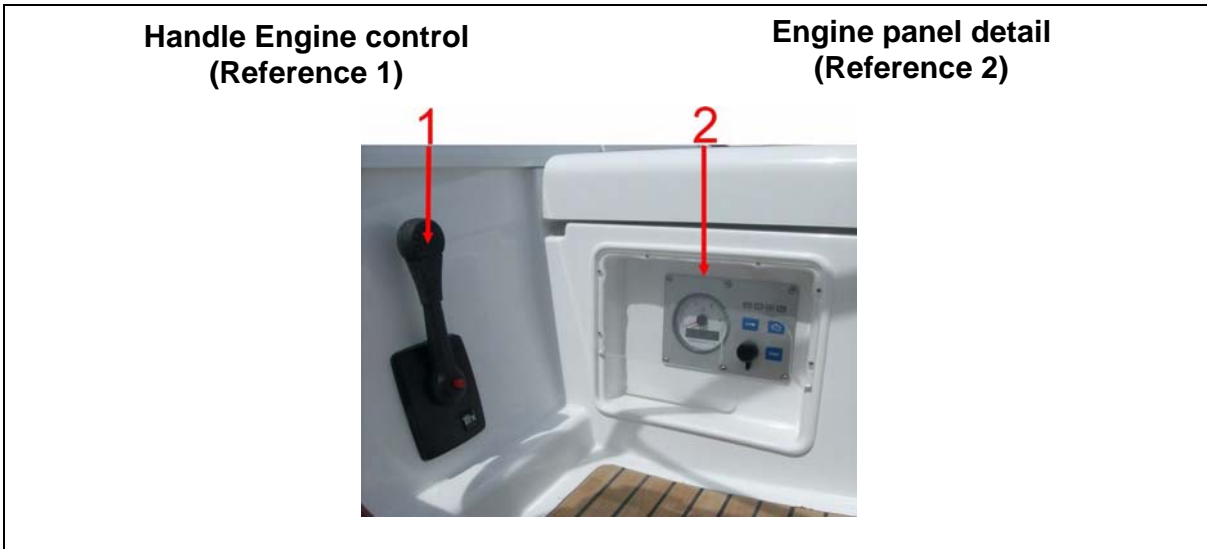

The instrument panel has all the testing functions of the engine and it does not require any special precaution (refer to engine leaflet).

Check the clutch and accelerator cables (lubricate the end fittings and forks).

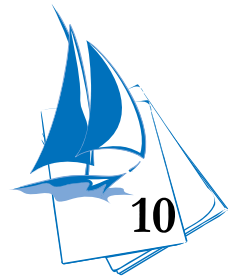

VISIBILITY FROM THE STEERING STATION

The international regulations to prevent collision at sea (COLREG) and the course regulations make mandatory a permanent and proper surveillance and the respect of priority.

Make sure there is no other boat on your way.

The visibility from the steering station may be obstructed in the following conditions:

- Speed.
- Position of the upper and side awnings.
- Boat heeling over, the sails reduce visibility under wind.
- Load and load distribution.
- Sea conditions, rain, spray, fog or darkness.
- Lights on inside the boat.
- Persons and removable equipment in the helmsman's field of visibility.

ADVICE - RECOMMENDATION

- When the engine is running, avoid making noise and chops near the other users.
- Respect speed limits.
- If this boat is equipped with a fixed blade propeller, when sailing at speeds over 8 knots it is essential to leave the reverse gear control in neutral.
- To start the engine again, reduce the speed of the boat when sailing (in order to be able to disengage the clutch before starting it again).

PRECAUTION

- Do not change the propeller without specialist's advice.
- Regularly check the anode (at the end of the drive shaft) for corrosion, at least 2 times a year.

ADVICE - RECOMMENDATION

- Change the anode if necessary (Before it lost 50% of its weight).
- Use anodes corresponding to the zone of navigation of the boat (fresh water / sea water).
- If bases are raised, anodes are outside the water: respect the recommendations of the motoriste.

WARNING



- Change systematically anodes at the end of the first 3 or 4 months of launch of the new boat: their wear is accelerated during this period.

NAVIGATION: REMINDER OF SOME ADVICE

Stability

During sailing keep all the portholes, windows and doors closed.

- The stability is reduced when you add weight in the upper parts.
- Stability may be reduced when towing a boat or when heavy weights are lifted with the davits.
- Breaking waves represent a serious danger for stability and for taking in water. Close the companionway doors and hatches in heavy seas.

Prevention of man overboard

Regularly check the guard-rails:

- With metal guard-rails, watch for corrosion particularly at connecting points.
- With synthetic guard-rails, change them as soon as they show signs of wear due to chafing or UV.

Propeller

The propeller supplied as a standard with your boat is the result of tests carried out jointly with the engine manufacturer.

ADVICE - RECOMMENDATION

- Check the whole propeller shaft several times a year.
- Check and change the cutlass bearing if necessary.
- Have the whole driving and steering systems checked and maintained by a professional.
- Refer to the manufacturers' instructions supplied with your boat.
- Regularly check the O ring of the filler for good condition (in order to prevent water entries).
- Do not turn off the fuel tap after each use (except in case the boat is unattended for long).
- Keep the fuel tank as full as possible (to avoid condensation).
- Every year check the fuel system for condition (hose, valves, etc.).
- Have a professional to carry out the works on the damaged parts of the fuel system.
- Refer to the manufacturer's manual given with your boat.
- Be careful with any possible risk of oil and fuel spillage.



LAUNCHING

LAUNCHING RECOMMENDATIONS

STEPPING THE MAST

POSITIONING DIAGRAM FOR HOISTING CRADLE AND STRAPS



Note: Measurements are expressed in mm.

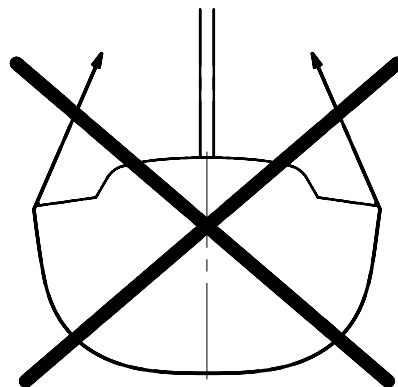
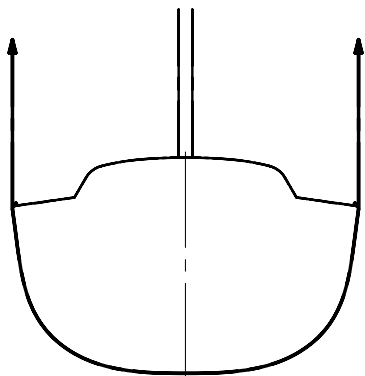

LAUNCHING RECOMMENDATIONS



A lot of skill and care is required to commission your JEANNEAU boat. The proper working of all your boat's equipment is the result of the quality of the commissioning operations.

In order to remain completely under guarantee in the case of any failure of parts or materials the first launching and the first trials of different equipment must be carried out by your JEANNEAU dealer.

If later you have to launch your boat yourself, you should take the following precautions:

BEFORE LAUNCHING

- If your boat is to be fitted with sounder and speedometer, allow for the relevant fittings and their installation.
- Check the water intake strain box for cleanliness.
- Check the engine and reduction gear oil levels (refer to engine manual).
- Turn off the engine cooling water drain valves.
- Retract the speedometer into its housing (it may be damaged by the handling belts).
- For the on-line engines, check the anode at the end of the shaft is in place. Check the nut tightening (the lock washer shall be turned over onto the nut). The anode shall not be painted.
- Turn off all the water inlet and drain valves (sink, washbasin, heads, engine).

HANDLING

- Install a fore rope, a rear rope and fenders.
- When craning, check that no device is crushed by the belts (sounder, speedometer, shaft, etc.).
- Locate the strap positions using the stick-on markers. The belt position will be useful during the craning for a future launching.



WARNING

- Do not stay on board or under the boat during hoisting.

ADVICE - RECOMMENDATION

- The proper working of all your boat's equipment is the result of the quality of the commissioning operations.

AFTER LAUNCHING

- Check the sounder and speedometer fittings for tightness if need be.
- Open the valves and make sure that they are tight with the hull and relevant hose.
- Check the stuffing box for watertightness (Refer to chapter 11 "Stuffing box").

Before starting the engine, refer to chapter 11 "Engine".

STEPPING THE MAST

Please contact your dealer.



WINTER STORAGE

LAYING UP

PROTECTION AND MAINTENANCE

LAYING UP

- Take ashore all the ship's log, the ropes that are not used for mooring, the galley equipment, supplies, clothes, the safety equipment, batteries, the gas cylinder.
- Mark again the safety equipment, check the expiration dates, have the liferaft overhauled.
- Take advantage of this laying up to draw up a complete inventory of the equipment.

PROTECTION AND MAINTENANCE

INTERIOR

- Drain all the fresh water pipes and rinse them with water and vinegar (do not use a chlorine based product).
- Lubricate and close all the water inlet valves and thru-hull fittings. Rinse and completely drain the heads bowls and pumps.
- Remove the depth sounder and log sensors.
- Installed in the square of a dehumidifier air leaving the cabin doors and open storage (cupboards, coolers).
- Leave the cushions outside for long before putting them back into the boat in the upright and side position in order to have minimum contact surfaces.

EXTERIOR

- Thoroughly rinse the hull and deck.
- Grease all moving and mechanical parts (latches, hinges, locks, etc).
- Protect all ropes and mooring lines against chafing.
- Protect the boat as well as possible with fenders.
- Make sure the boat is properly moored.

This is not an exhaustive list of recommendations. .

ADVICE - RECOMMENDATION

- You alone know all the particularities of your boat and its equipment:
- To lay up your vessel carefully and methodically is the best guarantee to avoid problems when re-fitting out.
- This is not an exhaustive list of recommendations. Your dealer will give you the advice you need and will carry out the technical maintenance of your boat.
- Take advantage of this laying up to draw up a complete inventory of the equipment.



ENGINE

The engine winterization shall be carried out by a professional. Depending on the boat location, afloat or ashore, winterization is different.

Here are a few major tasks to carry out:

Afloat

- Drain the cooling system and fill it with antifreeze.
- Shut off the battery switches, grease the terminals and check the battery voltage.
- Fill the fuel tanks to a maximum in order to avoid condensation.
- Please refer to the engine manual for anything relating to the engine.

Ashore

- Take the batteries ashore and keep them on maintenance charge.
- Change the anode.
- Carry out the winterization operations specified by the manufacturer, keeping in mind that the freeze hazard is more significant when the boat is ashore.
- Slacken the a.c. generator and pump belts.

