

RMS – ROTRONIC MONITORING SYSTEM

The Rotronic continuous Monitoring System allows users to monitor anything from anywhere using an on-premise or cloud (SaaS) solution.

Strongly regulated applications

- Fridges
- Cold rooms
- Freezers
- Transport with dry ice
- Cryogenics with nitrogen tanks
- Blood banks
- Clean rooms
- Warehouses

Less regulated applications such as:

- Museums
- Archives
- Storage areas
- And much more...



CUSTOMIZE YOUR OWN RMS ARCHITECTURE

MULTIPLE PARAMETER MONITORING

RMS monitors various parameters to ensure that the environment meets the required specifications for any application.

1. Digital probes give access to a complete audit trail and easy digital calibration thanks to the probe hot swap possibility:

- Relative humidity
- Temperature
- CO₂
- Differential pressure



2. Other inputs and outputs for third party devices (particle counters, air flow and other such parameters):

- 0/4...20mA for the integration of existing devices or other parameters
- 0...10V for the integration of existing devices or other parameters
- Digital inputs for door contacts, leak detectors, etc.
- Digital outputs to switch alarm beacons
 - Webcams to enable a snap shot to add to automatically generated reports and see the application in real time (mouse-over)

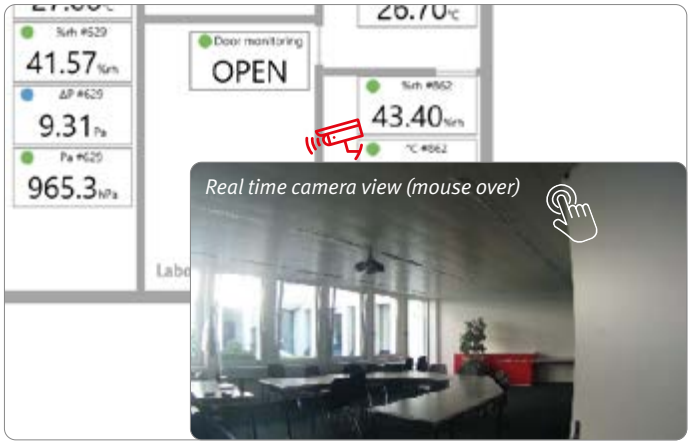

- Any 3rd party devices with a documented protocol
- LoRa devices via the API function

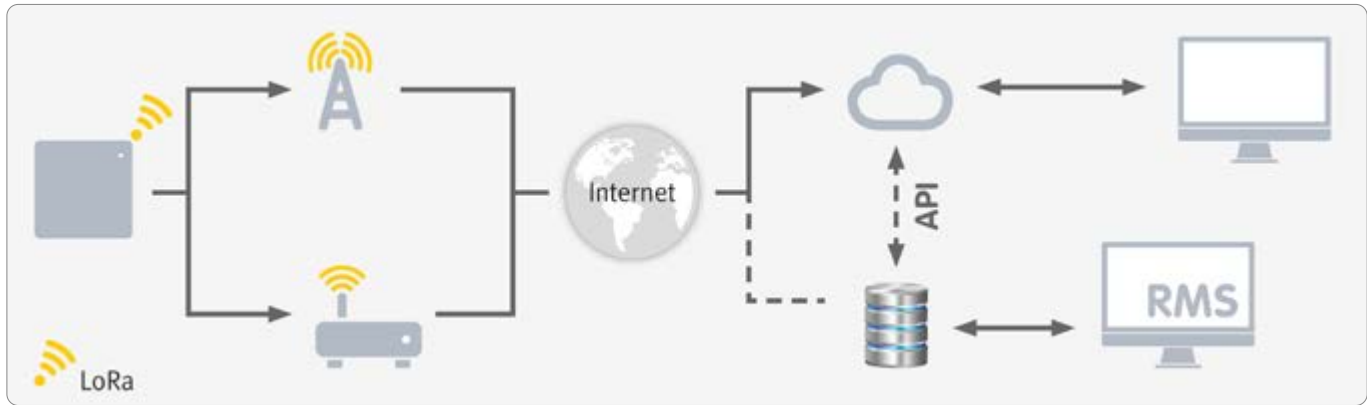

WIRELESS OR WIRED SECURE DATA COMMUNICATION

1. Wireless:

- Data stored on the logger with a battery backup and 24V power supply
- Redundant or parallel operation with various gateways
- Decrease wiring costs
- No more looking for errors in cabling
- Projects accomplished faster due to no cable requirements
- Easy to relocated physical measuring points
- Fast and easy implementation of new measuring points
- Monitor mobile equipment
- 868 or 915 MHz

2. Wired:

- Data stored on the logger with a backup battery, PoE and 24V power supply
- No loss of communication for high risk applications
- Link up to the existing Ethernet network

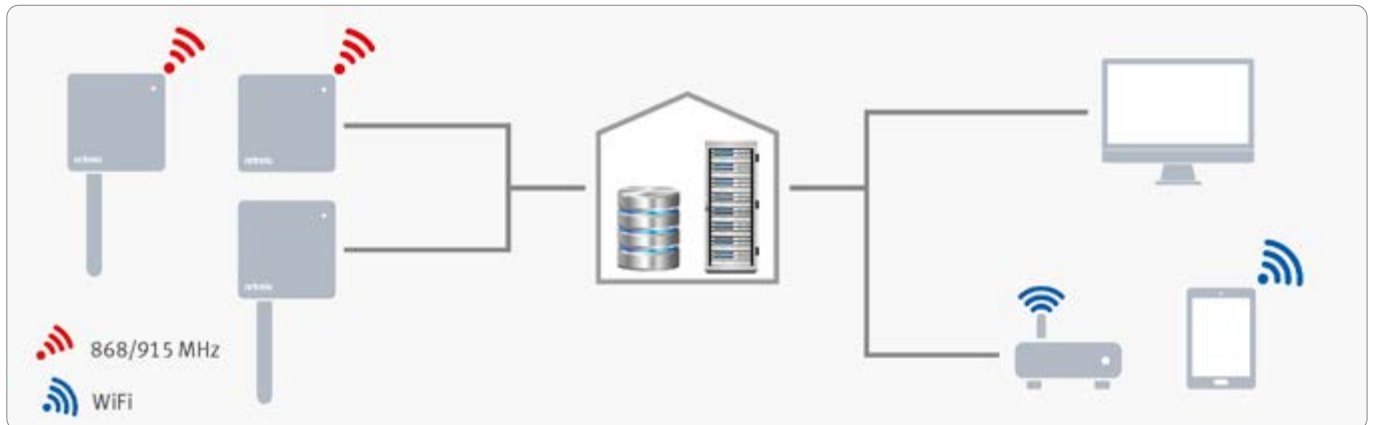

COMPLIANCE

1. Validatable software (new releases on a 6 months basis)
2. FDA CFR 21 Part 11 compliant
3. EU Annex 11 compliant
4. Developed based upon the GAMP[®]5 recommendations
5. Complete GxP documentation and an IQ testing script (from the URS to the IQ/OQ/PQ)



REAL TIME MONITORING AND ALARMING

The RMS software will inform you in real time via E-Mail, SMS and telephone call should a measurement point be out of limits! Automatic reporting allow for a hassle free solution and a quick login via mobile phone, tablet, PC or laptop will give you either a chart, table or a layout overview of the current situation, with short cuts to all events listed within the audit trail.

MONITORING SOFTWARE

MAIN SOFTWARE FEATURES

- Alarm overview – see directly how many alarms are active and where they are coming from
- Receive alerts via interactive phone, SMS's and E-Mails
- Audit trail to see exactly what happened and when
- Monitor multiple locations – one system for all your monitoring locations
- Input floor plans – get a real overview of the setup
- Scalable – perfect for single points in small installations to thousands of points in worldwide installations
- Automatic report generation
- Integration of Rotronic and any third party hardware – analog and digital
- Automatic validation scripts – for fast and effective OQ validation
- Continuously developing based around customer feedback
- Create custom dashboards per user
- FDA 21 CFR Part 11 & EU Annex 11 complaint
- GAMP[®]5 conform for GxP applications

ADDITIONAL FEATURES

- Calibrate all of your measuring points, possibility to adjust all of the Rotronic devices
- Archive all measuring points that are no longer needed, keeping access to the data for as long as necessary
- Save all your documents in the system: user manuals, data sheets, calibration certificates, SOP's...

MAIN SOFTWARE BENEFITS

- Compliance, audit and risk management
- Time saving with automatic data collection and report generation
- 24/7 real-time centralised monitoring of all operations
- All critical measurements in one system
- Real time alarming for critical measuring points

SOFTWARE SOLUTIONS

1. Fast & Easy with the Rotronic SaaS Cloud solution

Forget the hassle of having to maintain your IT infrastructure and focus only on what is crucial to your application. You can setup multiple measurement points in various locations and access the data from any device with a browser and internet connection. Setup alarms and notifications to be sure that you are always informed of what is happening!

2. Remain compliant to GxP regulations with the Rotronic Exclusive SaaS Cloud solution

Hosted on a high security and redundant datacentre with your own virtual server, you can run the Rotronic category 4 software in the cloud throughout each and every GxP compliant facility. Equip your worldwide facilities with the RMS hardware and access all of the data, including the audit trail, alarming and data analysis functions from a completely validated system.

3. Take advantage of your own IT infrastructure with the RMS on-premise solution

Run the RMS software with an SQL database on your own IT infrastructure and have complete control over your entire system and comply to your own internal regulations, access the interface via most browsers.

SYSTEM OVERVIEW

RMS offers different views/tabs to present your system data, customised to your needs.

- **Chart** – measured values graphically and numerically and direct notification status
- **Table** – measured values numerically and various other data
- **Layout** – measured values numerically with placement in a room layout
- **Dashboard** – individual dashboard for each and every user
- **Events** – audit logs, alarms, warnings and system messages

Chart view

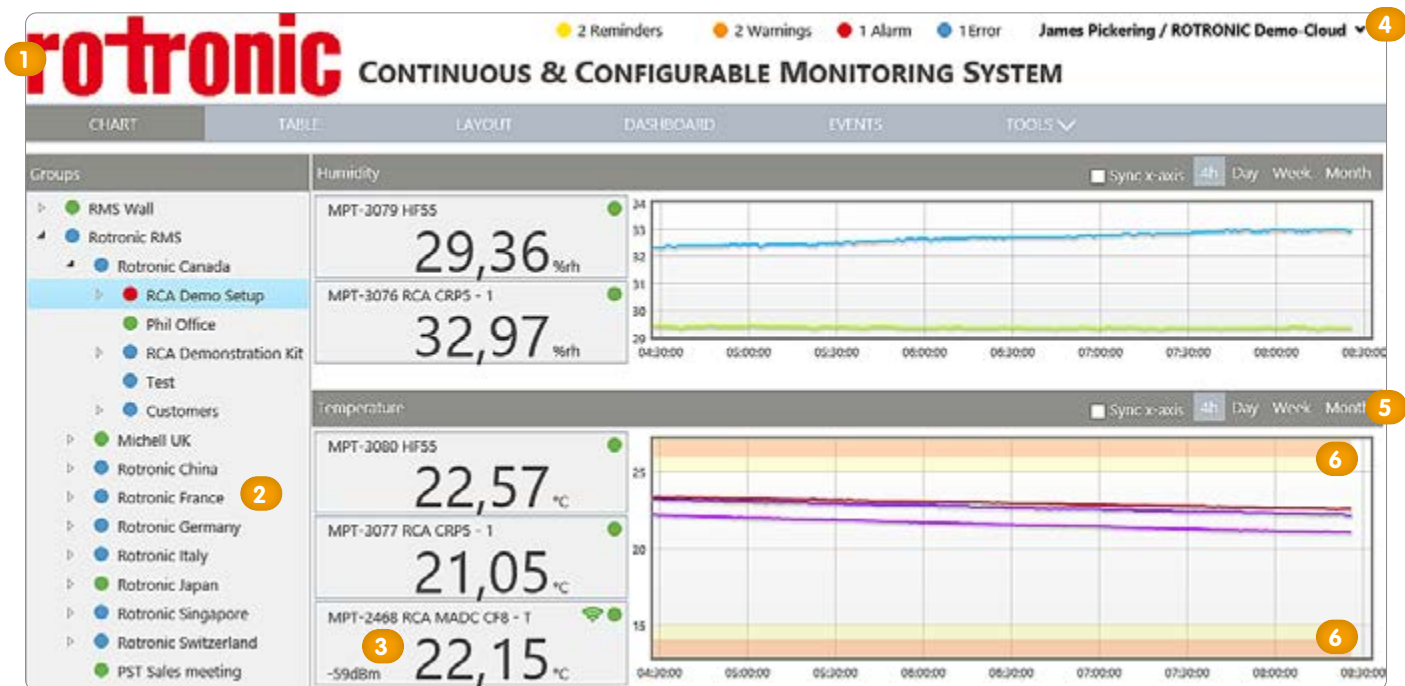

- 1 Upload your company logo
- 2 Group information by location, room...
- 3 Real-time measurement value and live status
- 4 Current logged on user, and notification overview
- 5 Historical overview
- 6 Alarms bands for a visual depiction of warnings and alarms

LAYOUT VIEW

The layout view displays a floor plan with several rooms: HGV, Loading Room, Storage, Cold Storage, Animal Room, Cleanroom, Room, RMS, Technical Area, and Coffee Corner. Monitoring points are indicated by green dots. A detailed pop-up for measuring point #652 shows the following information:

- Status: OK
- Device: (Un)packing
- Serial number: 61624652
- Position: (Un)packing
- Last refresh: 50s
- Battery: 79%
- RSSI: -51dBm
- Measuring point ID: MPT-1029
- Name: °C #652
- Regulation status: GDP
- Comment: SOP-3421
- High alarm threshold
- High warning threshold
- Low warning threshold
- Low alarm threshold

Three numbered callouts indicate: 1. Mouse over detailed measurement point; 2. Standard measurement point overview; 3. Mouse over IP camera for a snap shot of the current situation. A real-time camera view of the 'Coffee Corner' is shown in the bottom right, with a hand icon indicating mouse interaction.

- 1 Mouse over detailed measurement point
- 2 Standard measurement point overview
- 3 Mouse over IP camera for a snap shot of the current situation

DASHBOARD VIEW: USER DEFINED

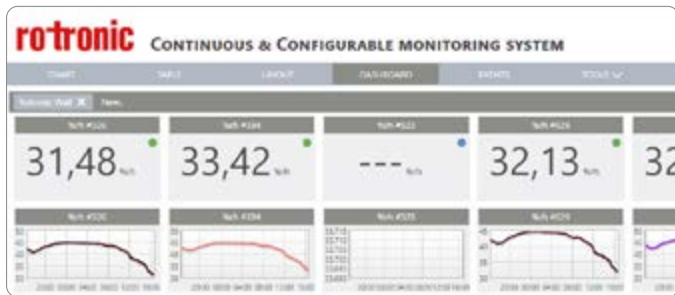

EVENTS VIEW (AUDIT TRAIL)

The events view (audit trail) shows a list of system events. The table has columns for ID, Date, Status, Description, and Target. A search filter is visible at the top right. Three numbered callouts indicate: 1. Filter the audit trail based upon your requirements; 2. See the actual status and user inputs of each individual event; 3. Define the notifications shown in the audit trail.

ID	Date	Status	Description	Target
1001	2023-10-27 15:45:12	OK	Temperature sensor #652	Room
1002	2023-10-27 15:45:12	Warning	Battery level low for sensor #652	Room
1003	2023-10-27 15:45:12	OK	Humidity sensor #629	Room
1004	2023-10-27 15:45:12	Warning	Pressure sensor #629	Room

- 1 Define the notifications shown in the audit trail
- 2 See the actual status and user inputs of each individual event
- 3 Filter the audit trail based upon your requirements

DATACENTER



RMS DATABASE SECURITY

When purchasing the RMS SaaS solution, Rotronic works together with the company 4Net. They provide a virtual data centre for the Rotronic Monitoring System server and database. 4Net uses the Interxion data centre. Interxion's Zurich data centre provides an ultra-secure, known location for storing and processing data in line with Swiss data protection regulations. Like all Interxion data centres, Zurich operates in full accordance with the ITILv3 framework and has ISO 27001 and ISO 22301 certification. Their compliance with the FINMA circular 07/8 is externally audited.

Operational excellence:

- 99.999% availability SLA
- 2N or N+1 configurations for all critical systems
- 24x7 operation and monitoring

Sustainability:

- 100% renewable energy
- Carbon neutral, certified by myclimate®

Security:

- Monitored 24x7 by CCTV and security patrols

Resilience and business continuity:

- 24x7 monitoring and alarms for every critical system
- Connectivity: quadruple-entry fibre from separate carrier main routes and rapidly installed cross connects
- Power: secured grid supply from two sub-stations from two different power providers, two power feeds for all equipment, each independently equipped with a power supply and generator backup with full load capacity for indefinite running
- Environment: SLAs on temperature and humidity in line with ASHRAE recommendations, N+1 cooling, sophisticated water and very early smoke detection systems, Inergen® gas fire suppression in line with local regulations and designed for maximum safety and minimum damage
- Backups saved in a second data centre also located in Switzerland but 80 km away from the main one

ALARMING

Rotronic Monitoring System alarm protocols were set up to ensure that critical alarms cannot be missed. Notifications can be triggered based upon the risk level.

Four levels of alarming are available, activation is based on the defined risk:

- Reminder for events that are non-urgent:
 - Low battery (device)
 - Simulator connected (measuring point)
 - Reminder that a calibration is due
 - Data gap after downloading missing measured values
- Warning for measured values that are out of limit (measuring point)
- Alarming for measured values that are out of limit (measuring point)
- Error for urgent hardware errors:
 - Device timeout (device)
 - Sensor error (measuring point)

An overview of the alarms can be seen once the user has logged into the system. The user only sees the alarms relevant to his granted access rights. Each measuring point, if not conforming, will be attributed a different colour based upon the alarm status:

● 2 Reminders
 ● 7 Warnings
 ● 13 Alarms
 ● 1 Error
 James Pickering / ROTRONIC Demo-Cloud ▼

Critical alarms can also be set up with a warning before alarms are activated. Hysteresis and a delay can be set up for the warning, with upper and lower limits defined, as well as for the alarming.

<div style="display: flex; justify-content: space-between;"> ● Warning <input checked="" type="checkbox"/> Enabled </div> <p>Lower limit: <input type="text" value="20"/></p> <p>Upper limit: <input type="text" value="26"/></p> <p>Hysteresis: <input type="text" value="0.5"/></p> <p>Delay: <input type="text" value="0"/> [min]</p>	<div style="display: flex; justify-content: space-between;"> ● Alarm <input checked="" type="checkbox"/> Enabled </div> <p>Lower limit: <input type="text" value="18"/></p> <p>Upper limit: <input type="text" value="30"/></p> <p>Hysteresis: <input type="text" value="0.5"/></p> <p>Delay: <input type="text" value="0"/> [min]</p>
---	--

All alarms are clearly shown in the audit trail indicating the unique ID for the event, the time and date of the alarm, information about what the alarm is, the target (the measuring point or device) as well as additional details.

Viewing the audit trail, it is easily possible to see if an alarm has been either acknowledged, or if it has ended. If an alarm is acknowledged, the time, date, name of the user who acknowledged the alarm as well as the alarm details are also saved and visible within the audit trail. Within the audit trail, it is also possible to close or inhibit an alarm.

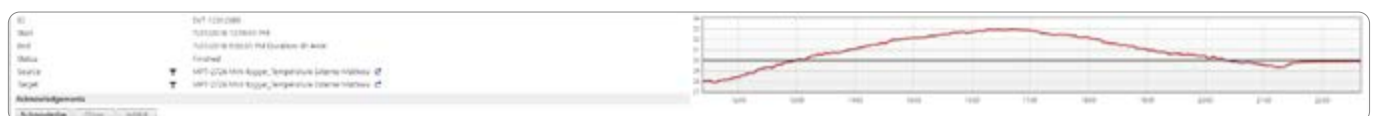

Alarms can be set up based upon either the measuring point, or via an alarm scheme. For alarms based upon the measuring point the choice of options is limited. Within an alarm scheme the user has the possibility to set a condition such as an active time as well as a warning. An action can be configured in both situations.

The various alarms can be notified in different ways and can be sent to just one or multiple users.

- E-Mail
- SMS *
- Telephone call *
- Switch relay
- Send data via TCP

* The user's telephone number must be added to the system.

E-Mail alarm: When setting the system up with a TCP/IP based camera, a snap-shot can be added to the E-Mail with a chart (either as a PDF or included in the body of the E-Mail).

SMS alarm: The alarm will be sent out in the language in which the software is configured.

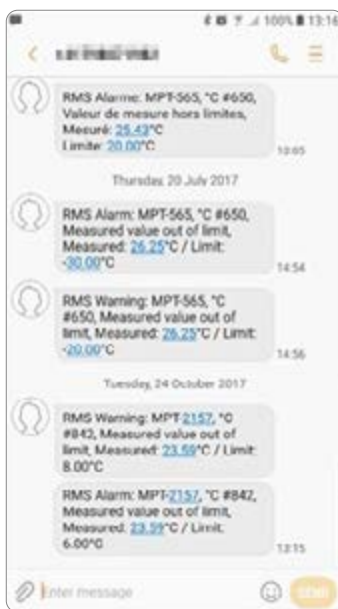

Telephone call: Within the system settings, the user can decide the information stated during the telephone call, from the device/measuring point ID to a measuring point comment. For the telephone call, if various users are selected, the system will call the first user on the list and continue through the list. Only when one user inhibits the alarm via the telephone will calling stop. The inhibition time from the telephone call is also set up within the system settings.

Switch relay: If a device with a relay is included in the system, then with the alarm scheme, it is possible to trigger that alarm to action either a visual or audible alarm, or another type.

Send data via TCP: Data can be transmitted to a TCP/IP device to switch a device to either On or Off.

It is also possible to set up IF-THEN scripts to trigger actions on the basis of one or more defined pre-conditions.

HARDWARE

LAN AND WIRELESS SYSTEM

All RMS components are connected via a LAN or a wireless interface. All data is transmitted to the SQL database and visualised via a web browser.



RMS Wall module

The RMS wall module is designed for applications where the module is visible to users: simple and practical. The module can be fixed to the wall and easily wiped clean. The RMS Wall module is available with either a LAN or a wireless (868 or 915MHz) interface. The module can be powered either via PoE (LAN version only), 24V or battery and can store 44'000 data points.



Wall module devices:

- [RMS-LOG-L / 868 / 915](#)
- [RMS-GW-868 / 915](#)



The RMS Wall module also exists with display.

Wall module with display devices:

- [RMS-D-L](#)



The RMS Mini module

The RMS Mini module is only available with a wireless interface (868 or 915MHz) and battery powered, with a storage of up to 12'000* data points.

Mini module devices:

- [RMS-MLOG-T-868 / 915](#)
- [RMS-MLOG-T10-868 / 915](#)
- [RMS-MDI-868](#)
- [RMS-MLOG-B-868 / 915](#)
- [RMS-MADC-868-A / 915-A](#)
- [RMS-MADC-868-V](#)
- [RMS-MLOG-LGT-868](#)



RMS Din Rail module

The RMS Din Rail module is for installation where esthetics are not crucial to the application. The RMS Din Rail module is available with either a LAN or a wireless (868 or 915MHz) interface. The module can be powered either via PoE (LAN version only), 24V or battery and can store 44'000 data points.

Din Rail module devices:

- [RMS-DI-L-R](#)
- [RMS-DO-L-R](#)



RMS Converter

The RMS Converter allows for integration of digital third party devices with an Ethernet connection. The converter will translate the digital protocol and send it to the database, the values are then visible via the web browser. The converter also has an onboard 7 day memory** should the network go down. The device is limited to 100 devices.

RMS converter:

- [RMS-CONVERTER-100](#)

* Please check each device individually for the data storage possibilities.

** The converter should be on the same network as the third party device.

DATA SECURITY / -INTEGRITY / FDA CONFORMITY

Data security, data integrity, data availability: these three terms play a central role in monitoring systems. The RMS reassuringly scores in all these fields.

Data Security

Data security means the data cannot be accessed by unauthorized persons. This is achieved through encryption during data transfer and storage.

Data Security in RMS

The monitoring system provides encryption of the data during transfer. This means the data can neither be tapped or manipulated by so-called retry attacks. The security of the stored database in RMS is ensured by the IT structure. The Rotronic Cloud is protected by certified IT data centers. If the database is located in the customer's server center, the customer defines the security infrastructure. Rotronic then offers IT support.

FDA/GMP Requirements

Regulators in the pharmaceutical and food industries demand that all relevant events are recorded so they are traceable. This is achieved through the electronic marking of all calibration measurements and verification processes. The so-called "electronic recording" requires unique identification of certificates. This means that every calibration certificate with a date and inspection stamp must be traceable such that the calibration chain can be verified.

Audit Trail

When a monitoring system is commissioned, it is calibrated and validated. In this way the operator assures his Quality department that the system works correctly. During subsequent operation, all relevant changes must be recorded in full. The audit trail guarantees recording of all changes in the system such as, for example, change in measurement probes, user activities, battery change. This in turn ensures that all events can be tracked at a later date.

Data Availability

For some manufacturer's systems, data availability can contradict data security because secure data are difficult to access. The user must authenticate themselves and use secure connections or verified platforms. Nevertheless, the trend is clearly moving towards worldwide data accessibility allowing platform-independent viewing and evaluation.

Data Integrity

Ensuring data integrity means guaranteeing secure transmission and storage. A measured value must not change during transmission because of disruptions. Data transmission and storage must therefore be safe from manipulation. This is achieved with CRC checksums and intermediate storage during data transmission. In this way, faulty data communication is recognized and the data stored in the buffer memory are sent again until the transmission has been finished.

All data in RMS are sent with CRC checksums and confirmed by the recipient after receipt. Faulty data transmission is thus ruled out. Should the data not arrive with the recipient, they are stored intermediately by the logger and can then be transmitted at a later point in time when the connection has been restored.

RMS Communications

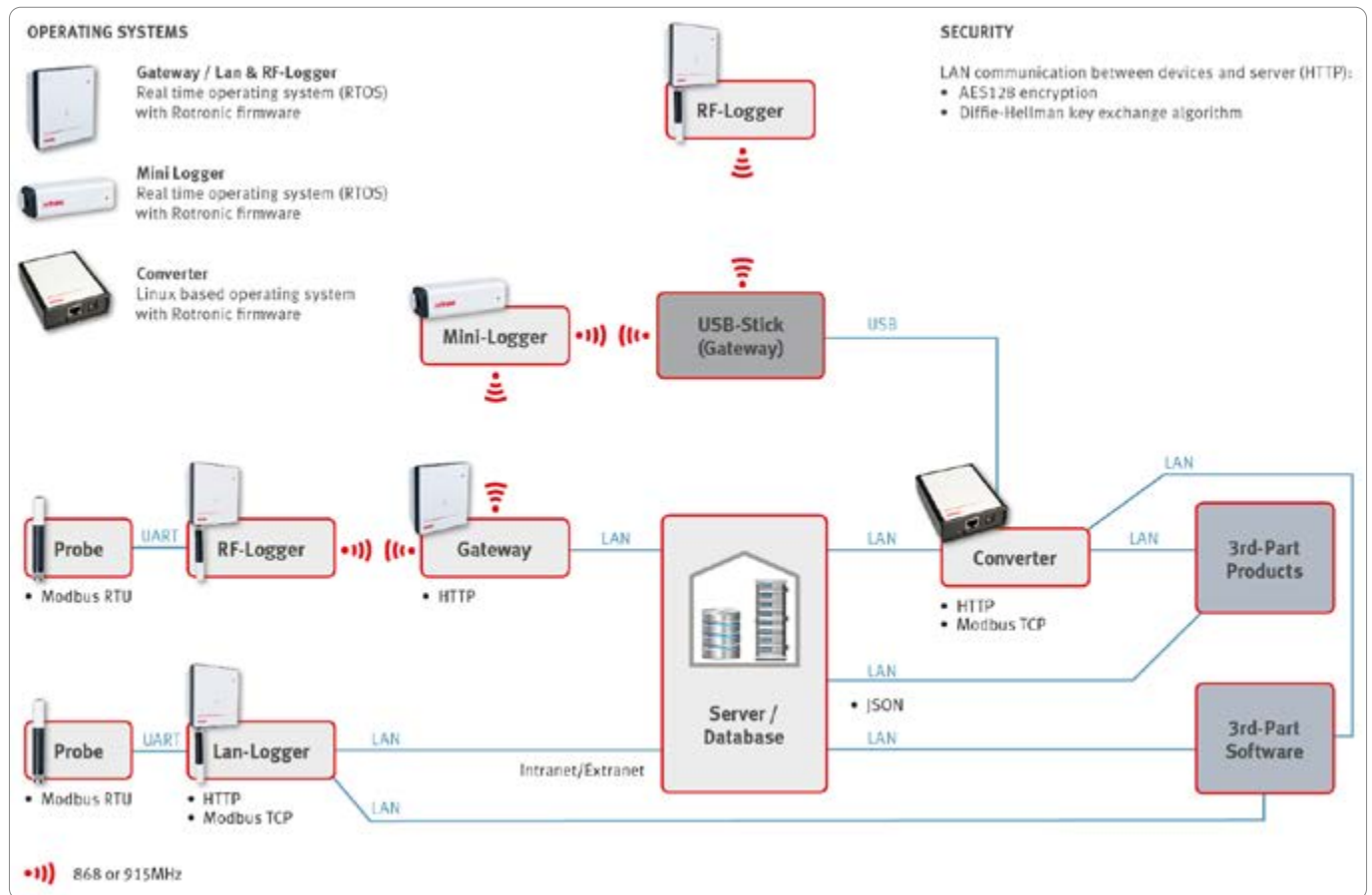

RMS SERVICES

Project Procedure

The Rotronic Monitoring System (RMS) is a hardware and software solution adjustable to your requirements for a continuous monitoring system. The complete system conforms to GAMP5, Rotronic is well aware that our support is crucial to your project, so we offer a complete solution. From the user requirement specifications to the IQ/OQ/PQ with our detailed documentation finishing off with tailor made training for your employees.

Furthermore the RMS software is delivered as a GAMP software category 4 system. Our main goal is to fully understand your requirements and deliver the best continuous monitoring system for you and your company.

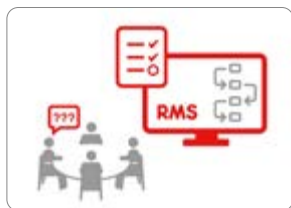

Review of the URS

Rotronic has designed a functional description document explaining each and every function of the RMS software. This description will help you create your own URS, but it might also help you adapt the one you already have striving to provide the best risk based approach to compliant GxP computerised systems. Don't know exactly how to build up your URS? No need to worry, Rotronic have the knowledge and documentation required to help support you in any case.

The continuous monitoring system RMS is a very flexible solution both on the hardware and the software side (R&D and production in the Headquarters in Switzerland). You have a problem, let us work together to give you the perfect solution. A personal discussion is of the utmost importance though, only when speaking to you can we really understand your requirements for a continuous monitoring system!

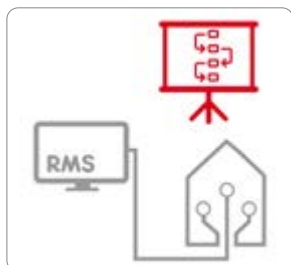

Design Concept

After fully understanding your requirements, a project is setup at Rotronic. Each and every step is listed, costs evaluated and an initial time line defined. A crucial point is software adaptations, any adaptations are follow a stringent testing process within Rotronic, so project timing is a key to a successful roll out of your continuous monitoring project.

Rotronic has the possibility to carry out the complete monitoring system project, from the heat mapping of the various areas to the physical installation of the devices. Internally, the project team needs to understand your requirements in order to deliver your solution based upon your time line. Our main aim is an optimised communication based upon information transfer to the entire team: sales, product management, inside sales, after sales, production and R&D are all involved already in this initial process.

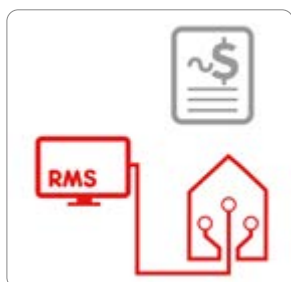

Conceptual Offer

Rotronic will give you an initial quotation based upon your URS and the project planning. This initial quotation is rarely the final quotation, but a ball park figure that will help you to get a feeling for the costs of a project. Products will be added and removed, services will be adapted... The initial quotation will help you get a feel for the market and already an understanding of what working with Rotronic is like. We are more than happy to invest time in a project, so that you get the best continuous monitoring solution possible!



On site Demo Installation

Pricing and promises in hand, we consider it important that customers actually try out the RMS. Be it via our cloud solution or our server software, our engineering team will offer you a solution based upon your requirements. When you start to play with the software, very quickly, thanks to its simple and effective design, you can work your way through the different functions and get a real understanding for what the system can offer.

With just a few measurement points, you can already get a feeling for what is going on in the various locations that you monitor. Increase of CO₂, people are in the room, a temperature decrease might mean that the heating has been cut off, the lux increase, the sun is coming up... Everything of course can be verified by adding an IP camera next to the measurement point to confirm what you are seeing.

You can get a feel for the alarming functions, an overview of how the audit trail actually works and what data you can extract from the system! We will support for the optimal installation of your demonstration, you need to test it to understand the flexibility of what Rotronic can offer you. After seeing the demo, new ideas will appear and will help

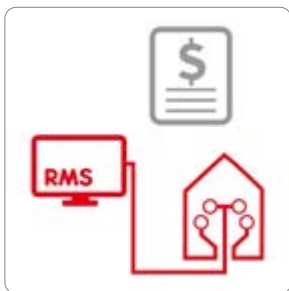

Final Offer

You now understand that the sky is not the limit with our universal RMS. You've had new ideas, seen new potential and have accordingly updated your URS. Rotronic has been with you throughout this process and can now give you a tailor made quotation responding to your exact detailed requirements for a continuous monitoring system.



Verification from the Customer

Of course, a market comparison is necessary! The flexibility and quality of RMS, the professionalism of our team and the complete package that we can offer will be sure to make Rotronic a very competitive partner for your project. Need more details from our side, don't hesitate to give us a call. Remember, we are FDA 21 CFR Part 11 and GAMP 5 conform for the most demanding applications, but we can also help you with smaller projects where these regulations are not required. With the Rotronic Monitoring System, we have a shoe that fits every foot.



Installation /Commissioning

Congratulations on choosing to partner with Rotronic on your project! After a review of the project planning and time lines, we can start with the physical installation of the devices, the setup of the software and SQL database on your server, the configuration of the software and the hardware (this is as well something that you can choose to do on your own, we are always happy to offer a helping hand). The heat mapping or the wireless signal mapping can both be carried out with the helping hand of Rotronic should this be a necessity.



Validation

The software is validatable, so time to validate your continuous monitoring system. If you did the URS with the Rotronic documentation, then we can also offer the rest of the validation documentation, the validation master plan, the risk assessment, the functional requirement specifications, the configuration specification, the requirement traceability matrix, the validation script specification, the installation qualification, the operation qualification and the performance qualification of course followed by your tailor made training.

This validation model is based upon the GAMP5 standard and is recognised throughout the pharmaceutical world. The entire validation will prove that your system replies to your URS. Even if you didn't use the Rotronic URS, you can still use the Rotronic documentation as guidelines. With our team of trained professionals, Rotronic can carry out the validation of your system partially or fully if required.



Maintenance and Support

Who better to receive support from but from the manufacturer?

Maintaining your system is crucial for the running of your processes. Rotronic offers packages from ISO-17025 and ISO-9001 calibrations only (temperature, relative humidity, dew point, differential pressure) to hardware and software maintenance contracts, build around your requirements. The software is also setup in a way that it makes hardware changes ever so simple and effective. Like the system our support is already very flexible!

RMS CONTRACT MODULES

CREATE YOUR TAILORED VERSION BASED ON THE VARIOUS MODULES

Software	Hardware	General Support	Installation Services	Onsite Maintenance	Premium Support
PURCHASE	PURCHASE	INCLUSIVE	OPTIONAL	OPTIONAL	COMPULSARY
RENT	PURCHASE	INCLUSIVE	OPTIONAL	OPTIONAL	INCLUSIVE
PURCHASE	RENT	INCLUSIVE	OPTIONAL	OPTIONAL	COMPULSARY
RENT	RENT	INCLUSIVE	OPTIONAL	OPTIONAL	INCLUSIVE

WHAT WE CAN OFFER



Fast & Easy Software only Solution

Take advantage of our SaaS solution, freeing you from complex software and IT hardware management and benefit from our outstanding IT infrastructure with a state of the art security and data redundancy setup. You are guaranteed to have a 99.01% availability of your data with no hidden costs! You will also benefit from free software improvements and upgrades throughout the lifetime of your monitoring system.

Contract
SaaS Software only



Carefree Hardware Solution

You also have the possibility to also rent the hardware from us! Rotronic will keep an inventory of relevant measurement product for you so that you do not have to manage anything other than returning the defective units to us. Should a product fail or break, it will be replaced within 24 working hours¹. No more issues with making room in your warehouse, finding the devices when you need them and no more cash tied up in possibly never used stock.

Contract
SaaS Software & Hardware



Carefree Installation Service

You and your team are too busy or you do not have access to qualified personnel. Your configurable environmental monitoring system can be setup to run, exactly how you want it to as soon as the devices are delivered. Let us install and configure your hardware and software; you will not have to lift a finger!

Overview
Service



Carefree Maintenance SLA

Once your system is up and running, who better than Rotronic to service your system. We can calibrate (ISO-17025 or traceable) your devices on a yearly basis, calibrations on site are also possible. At the same time change filters, O-rings and make sure that hardware is running the latest firmware. To guarantee data redundancy, we can also change batteries and ensure that your system is running smoothly.

SLA
Onsite Maintenance

¹ For customers in Switzerland.



Fully Compliant Exclusive Contract

For GxP compliant systems that require validation, Rotronic offers a turnkey solution from A to Z. Let us know what your user requirement specifications are and let us provide you with the solution!

**Contract
Exclusive SaaS**



On-Premise Support

If you already have solid IT infrastructure in place, responding to your security policies and up to date with the latest norms, we also offer all of the above with an on-premise software solution.

**Overview
Support**



Stay up to date premium Support

Stay up to date and improve your monitoring with the latest software updates and features sent out to you on a regular basis.

**SLA
Premium Support**

DATA SHEETS

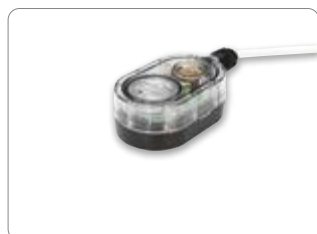
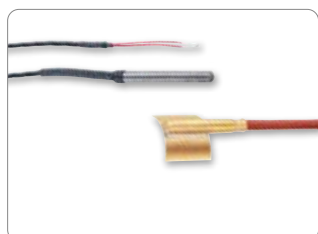
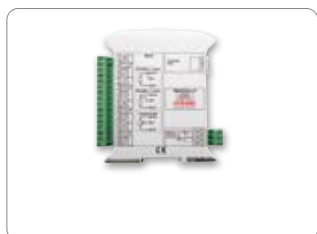

RMS-HCD



RMS-HCD-S



RMS-HCD-IC102
RMS-HCD-IC105

ADVANTAGES

- Measures relative humidity and temperature
- Outstanding accuracy, repeatability and long-term stability
- Advanced probe housing and construction
- Compatible with RMS loggers and RMS Software
- Low power

APPLICATIONS

- Pharmaceutical Monitoring
- Food Monitoring
- Museum Monitoring
- Monitoring conform to GxP and FDA CFR PART 11



The Hydroclip Digital RMS-HCD was specifically designed for use as part of the [Rotronic Monitoring System \(RMS\)](#). Building upon our experience we improved the power consumption so that it is usable by battery powered system like the RMS wireless data loggers. Having less cabling reduces installation cost and increases the flexibility of the installation.

Standard

Compatible with the following with RMS data loggers such as the RMS-LOG-L (LAN data logger), RMS-LOG-868 (Wireless and RMS-LOG-915).

- Application Range 0...100 %RH, -40...85 °C
- Accuracy ±0.8 %RH, ±0.1 K @ 23°C
- Factory-adjustment @ 23°C and 10, 35, 80 %RH
- Humidity Sensor HYGROMER HT-1
- Long-term stability < 1% RH /year

Order Code	Type
RMS-HCD-S	Black Probe
RMS-HCD-S3	White Probe

Industrie

Industry probes have a sensor head separated from the measurement electronic by a cable. This allows a higher application range for the sensor head.

- Application Range sensor head 0...100 %RH, -100...190 °C
- Application Range electronic 0...100 %RH, -40...85 °C
- Accuracy ±0.8 %RH, ±0.1 K @ 23°C
- Factory-adjustment @ 23°C and 10, 35, 80 %RH
- Materials PPS, stainless steel 1.4301
- Humidity Sensor HYGROMER HT-1
- Long-term stability < 1% RH /year

Order Code	Cable length
RMS-HCD-IC102	2 m
RMS-HCD-IC105	5 m

Possible Filters

Order Code	Filter carrier	Filter Element	Pore size	Application Range
SPA-PCB-PE	Polycarbonate, black	Polyethylene, white	40-50 µm	-50...100 °C
SPA-PCB-PTFE		PTFE, white	10 µm	
SPA-PCB-WM		Wire mesh 1.4401		
SPA-PCW-PE	Polycarbonate, white	Polyethylene, white	40-50 µm	
SPA-PCW-PTFE		PTFE, white	10 µm	
SPA-PCW-WM		Wire mesh 1.4401		
SPA-PE	No filter carrier, only filter	Polyethylene	40-50 µm	-100...200 °C
SPA-PTFE		PTFE, white	10 µm	

Possible Extension Cables

It is possible to extend the distance between the probe and its reading device with extension cable.

- Passive connection are possible up to 5m (see table below for possible options).

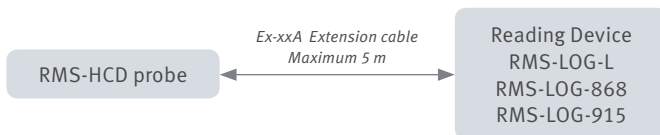

Order Code	Cable Length	Color
E2-01A	1 m	Black
E2-02A	2 m	
E2-05A	5 m	
E3-01A	1 m	White
E3-02A	2 m	
E3-05A	5 m	

TECHNICAL INFORMATION

RMS-HCD-S, RMS-HCD-S3

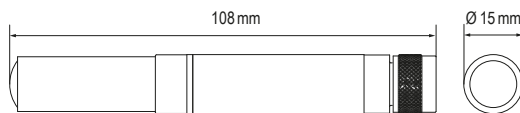

RMS-HCD-IC102, RMS-HCD-IC105

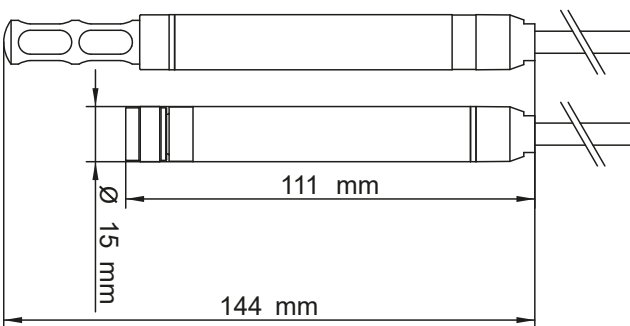

Technical Data

Humidity sensor	HYGROMER HT-1
Temperature sensor	PT1000, Class 1/3 B (RMS-HCD-S) PT100, Class 1/3 B (RMS-HCD-IC)
Operating humidity	0...100 %RH
Operating temperature	-40...+85 °C RMS-HCD-S -40...+85 °C RMS-HCD-IC electronic -100...190 °C RMS-HCD-IC sensor head
Accuracy @ 23 °C	±0.8 %RH ±0.1 K
Supply voltage	2.5...5.5 VDC
Current consumption	5 mA (RMS-HCD-S) 12 mA (RMS-HCD-IC)
Protection rating	IP65
Digital communication	UART
Compatible devices	RMS-LOG-L RMS-LOG-868 RMS-LOG-915
Compliance	GAMP5 FDA 21 CFR Part 11

Subject to technical change without notice. Printing and other errors reserved.

RMS-PCD-S-XXX



ADVANTAGES

- High-precision measurement and long-term stability
- With ambient pressure compensation
- Large overload range
- With flow or diaphragm sensor technology
- Compatible with RMS logger, RMS On-premises software and SaaS solutions

APPLICATIONS

- HVAC
- Cleanroom



TECHNICAL INFORMATION

The Rotronic differential pressure probes are ideal for clean rooms, operating theaters and applications where even minor differences in pressure can have a big effect. Thanks to our two different measurement methods (thermal mass flow measurement and diaphragm measurement), we offer the perfect solution for every requirement. Together with other measurement parameters, these probes can be integrated in RMS perfectly.

Compatible with

- RMS-LOG: Wireless \geq V1.5/LAN data loggers \geq V1.4

Dimensions

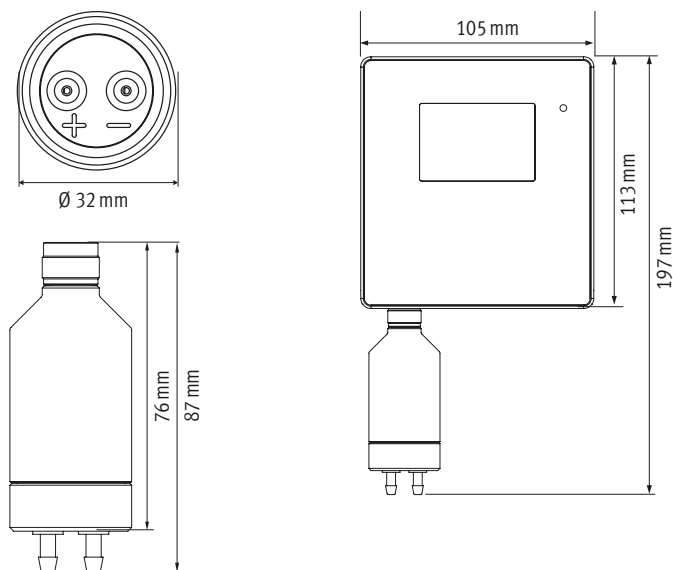

TECHNICAL INFORMATION

General specifications

Sensor type	Flow	Membrane
Parameter	Differential pressure	
Accuracy ¹ at 23 °C ±3 K	±1% FS	±1% FS ²
Long-term stability ³	±0.1% FSS/year	±2% FSS/year for ±25Pa probe ±1% FSS/year for ±50Pa probe ±0.5% FSS/year for ±100Pa probe ±0.25% FSS/year for ±250Pa und ±500Pa probes
Zero point compensation ⁴	Automatic, 1x per measurement interval	Manual, with external tube; via RMS software ⁵
Medium	Air	Air & non-aggressive gases
Ambient pressure compensation	Automatic	Not necessary
Adjustment and calibration	Factory adjustment/calibration: 5 points Customer adjustment: max. 9 points	
Measurement range	-25...+25 Pa / -50...+50 Pa / -100...+100 Pa / -250...+250 Pa / -500...+500 Pa	
Pressure resistance (burst pressure)	5 bar	0.7 bar
Leak rate	<180 µl/min.	0 µl/min.
Startup time	<0.5 s	
Measurement interval	1 s probe ≥10s RMS / 1s Modbus	
Response time τ ₆₃	<1 s	
Range of application	-20...+80°C (0...+70°C temp.-comp.) 0...95% RH non-condensing	
Voltage	3.3 – 5.5 V	
Current consumption	30 mA (avg.)	12 mA (avg.)
Battery life RMS wireless logger	60d @ 10s interval	130d @ 10s interval
	350d @ 60s interval	650d @ 60s interval
Battery life LAN logger	70d @ 10s interval	180d @ 10s interval
	395d @ 60s interval	840d @ 60s interval
Protocols	Modbus RTU	

¹ Please see the device manual for detailed considerations.

² For maximum accuracy, Rotronic recommends strongly to perform a zero point compensation after the installation and initial operation and to repeat it annually. For aggressive environments / gas media, a more frequent zero point compensation is advised. Please see the device manual for detailed considerations.

³ Highly reducible by a zero point compensation of the RMS-PCD-S-Mxx (membrane sensor).

⁴ A zero point adjustment is recommended for every installation or position change.

⁵ Please see the device manual for detailed considerations.

FDA & GAMP compatibility

FDA / GAMP directives	FDA CFR21 Part 11 / GAMP5
-----------------------	---------------------------

Housing / Mechanical parts

Housing material	Polycarbonate (housing) Stainless steel DIN 1.4305 (nuts, connectors)
Fire protection class	Corresponds to UL94-HB
Dimensions	Ø 32 mm x 87 mm
Pressure connections	Tubing connector internal Ø 4 mm x 10 mm
Weight	60 g
IP protection class	IP65

RMS-CCD-S-XX



ADVANTAGES

- High-precision measurement and long-term stability
- With ambient pressure compensation
- Large measurement range
- With automatic CO₂ calibration
- Compatible with RMS-Logger, RMS On-premises software and SaaS solutions

APPLICATIONS

- Open-Plan Offices
- Classrooms
- Shopping Centers



TECHNICAL INFORMATION

The Rotronic CO₂ probes are ideal for office rooms and applications where the quality of room air has a big effect. Together with other measurement parameters, these probes can be integrated in RMS perfectly.

Compatible with

- RMS-LOG: Wireless \geq V1.5/LAN data loggers \geq V1.4

Dimensions

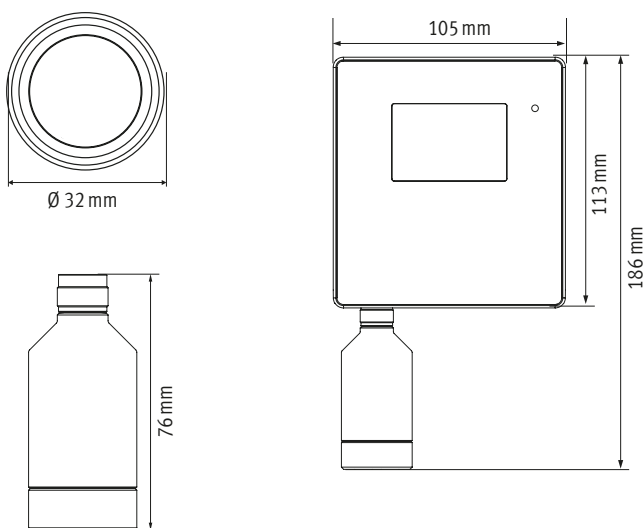

Measurement principle	Infrared (NDIR)
Parameter	CO ₂ concentration (ppm / %)
Accuracy @ 25 °C \pm 10 K, 20–60 %RH (after min. 3 weeks ABC) ¹	\pm 50 ppm \pm 3 % of read value @ 0–2000 ppm \pm 10 % of read value @ 2000–10,000 ppm
Medium	Air & non-aggressive gases
Ambient pressure & temperature compensation	Automatic (300–1100hPa)
Adjustment and calibration	Factory adjustment/calibration: 1 point Customer adjustment: max. 9 points
Measurement range	0...2000ppm / 5000ppm / 10'000ppm
Resolution	1 ppm
Startup time	\leq 300s
Measurement interval	16s probe
Response time τ 63	130s @ level descending 87s @ level ascending
Range of application	0...50°C, 0...95%RH non-condensing
Voltage	3.3–5.5V
Current consumption (16 s interval)	20 mA (avg.) / peak 260 mA
Battery life (RMS wireless/LAN logger)	2.7d @ 10s/60s interval
Interface	UART
Protocols	Modbus RTU
FDA / GAMP directives	FDA CFR21 Part 11 / GAMP5
Housing material	Polycarbonate (housing) Stainless steel DIN 1.4305 (nuts)
Fire protection class	Corresponds to UL94-V2
Dimensions	\varnothing 32mm x 87mm
Weight	55g
IP protection class	IP40

¹ Accuracy relates to the uncertainty of calibration mixtures \pm 1 %

RMS DATA LOGGER



ADVANTAGES

- 44,000 data point memory
- Fail-safe, thanks to internal battery
- Wireless or LAN interface
- Compatible with RMS Gateway, RMS Server Software and RMS Cloud
- Conforms to FDA CFR 21 Part 11 / GAMP 5

APPLICATIONS

- Pharma monitoring
- Food monitoring
- Museum monitoring

RMS

TECHNICAL INFORMATION

The data logger is the flexible component between the probe and the database in the Rotronic Monitoring System. It stores 44,000 pairs of measured values from the interchangeable CO₂, differential pressure, humidity or low dew point probe, and transmits them to the RMS database via LAN or wireless link. It guarantees absolute data protection, even if power supply and communications should break down temporarily.

Compatible with:

- CCD-S CO₂ probe
- PCD-S Differential pressure probe
- HCD-S Humidity and temperature probe
- RMS-GW Gateway
- RMS-WEB On-premises software
- RMS-CLD SaaS solutions

Dimensions

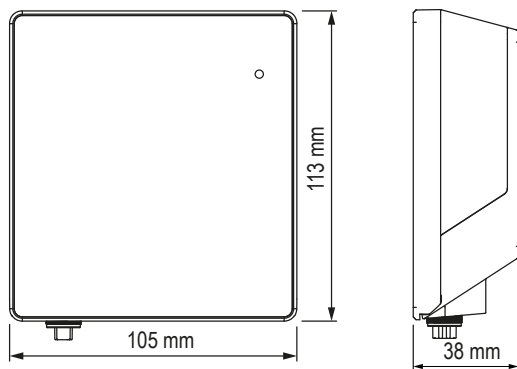

General specifications			
Measured parameters	Humidity & temperature, CO ₂ , differential pressure, LDP		
Range of application	-40..70 °C / 0..100 %RH		
Storage conditions	-40..30 °C / 0..95 %RH		
Maximum altitude	2000 m ASL		
Power supply	24 VDC ±10 % / <100 mA / Battery: RMS-BAT (2xAA, LiSocI2) / PoE: 802.3af-2003, Class 1		
AC adapter requirements	24 VDC ±10 % / 4 W nominal / <15 W power-limited		
Battery life	3 years (at 23 °C, measurement interval 1 min., HCD-S probe)		
Device data			
Measurement interval	10 s to 15 min.		
Startup time	< 10 s		
Order code	RMS-LOG-L	RMS-LOG-868	RMS-LOG-915
Interfaces	Ethernet	ISM 868 MHz	ISM 915 MHz
Indoor wireless range	-	20..50 meters	15..25 meters
Protocols	HTTP / MODBUS TCP		
Ethernet cable requirement	Min. Cat. 5, SFTP, max. 30 m		
Conformity with standards			
FDA / GAMP directives	FDA CFR21 Part 11 / GAMP 5		
Housing / Mechanics			
Housing material	ABS		
Fire protection class	UL94 -V2		
Dimensions	105 x 113 x 38 mm		
IP protection class	IP65		
Weight	200 g		

Subject to technical change without notice. Printing and other errors reserved.

59057E/2018-04

RMS MINI WIRELESS LOGGER



ADVANTAGES

- Saves up to 10,000 measured values
- Fail-safe thanks to internal battery and battery monitoring
- Battery life up to 3 years
- Conforms to FDA 21 CFR Part 11 / GAMP5
- ISM band 868 MHz / 915 MHz

APPLICATIONS

- Environmental chambers
- Pharmaceutical industry
- Analog third-party devices
- Incubators



TECHNICAL INFORMATION

Compatible with

- RMS-GW-868: Firmware V1.0
- RMS-GW-915: Firmware V1.5
- Software V1.2: RMS-MLOG-T10-868
- Software V1.2.1: 915 MHz devices

Dimensions / Connections

Top view

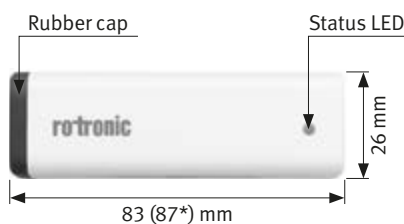

Rubber cap (front view)

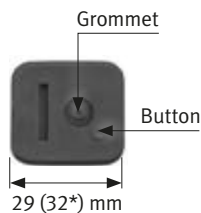



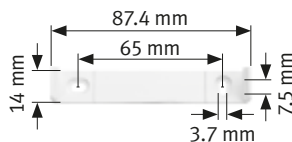

























Wall bracket



* with wall bracket

General specifications	
Device type	RMS Mini Wireless Logger
Memory size	10,000 measured values 13,000 data points (RMS-MLOG-B)
Range of application (electronics)	-30...85 °C / 0...100 %RH -40...85 °C / 0...100 %RH (RMS-MLOG-B)
Storage conditions	-30...30 °C / 0...95 %RH
Battery	RMS-BAT
Battery life	3 years (at 23 °C and 1 minute interval) 2.7 years (RMS-MLOG-B)
Measurement interval	10 s to 15 min (software dependant)
Wireless interface	ISM 868 MHz ISM 915 MHz
Indoor wireless range	20...50 meters 15...25 meters
Conformity with standards	
FDA / GAMP directives	FDA 21 CFR Part 11 / GAMP5
Housing / Mechanics	
Housing material	ABS
Dimensions	83 x 29 x 29 mm
IP protection class	IP65, IP30 (RMS-LOG-B)
Fire protection class	UL94-V2

TECHNICAL INFORMATION

	Type	Range / Accuracy																																			
Temperature & humidity 	RMS-MLOG-B-868 RMS-MLOG-B-915 	-40...85 °C (± 0.5 °C @ 25 °C / ± 1 °C @ 0...70 °C / ± 3.5 °C @ rest of temperature range) / 0...100 %RH (± 3 %RH @ 25 °C)																																			
Temperature 	RMS-MLOG-T-868 RMS-MLOG-T-915 	-30...85 °C (± 0.4 °C @ 25 °C) Details: see page 3																																			
Temperature with external probe (NTC)  Further NTC probes available in various lengths. Please contact Rotronic.	RMS-MLOG-T10-868 RMS-MLOG-T10-915 	<table border="1"> <thead> <tr> <th>Item no.</th> <th>T10-0001</th> <th>T10-0002</th> <th>T10-0003</th> <th>T10-0004</th> </tr> </thead> <tbody> <tr> <td></td> <td></td> <td></td> <td></td> <td></td> </tr> <tr> <td>Application</td> <td>Cryotechnology</td> <td>Freezers, dry ice...</td> <td>Standard</td> <td>Cable duct monitoring</td> </tr> <tr> <td>Probe operating range</td> <td>-196...-90 °C</td> <td>-80...200 °C</td> <td>-50...200 °C</td> <td>-50...200 °C</td> </tr> <tr> <td>NTC accuracy range</td> <td>-196...-90 °C</td> <td>-80...150 °C</td> <td>-50...120 °C</td> <td>-50...120 °C</td> </tr> <tr> <td>Dimensions / Housing</td> <td colspan="4">$\varnothing 6 \times 50$ mm / stainless steel</td> </tr> <tr> <td>Cable length</td> <td colspan="4">2 m</td> </tr> </tbody> </table>	Item no.	T10-0001	T10-0002	T10-0003	T10-0004						Application	Cryotechnology	Freezers, dry ice...	Standard	Cable duct monitoring	Probe operating range	-196...-90 °C	-80...200 °C	-50...200 °C	-50...200 °C	NTC accuracy range	-196...-90 °C	-80...150 °C	-50...120 °C	-50...120 °C	Dimensions / Housing	$\varnothing 6 \times 50$ mm / stainless steel				Cable length	2 m			
Item no.	T10-0001	T10-0002	T10-0003	T10-0004																																	
																																					
Application	Cryotechnology	Freezers, dry ice...	Standard	Cable duct monitoring																																	
Probe operating range	-196...-90 °C	-80...200 °C	-50...200 °C	-50...200 °C																																	
NTC accuracy range	-196...-90 °C	-80...150 °C	-50...120 °C	-50...120 °C																																	
Dimensions / Housing	$\varnothing 6 \times 50$ mm / stainless steel																																				
Cable length	2 m																																				
Power input 	RMS-MADC-868-V (0...10 V) RMS-MADC-868-A RMS-MADC-915-A (0...20 mA) 	0...10 VDC (± 0.1 V @ 25 °C) 0...20 mA or 4...20 mA (shunt 110 Ohm) ± 0.2 mA @ 25 °C																																			
Digital input 	RMS-MDI-868 	<table border="1"> <thead> <tr> <th>Item no.</th> <th>DC-0001</th> </tr> </thead> <tbody> <tr> <td></td> <td></td> </tr> <tr> <td>Application</td> <td>Door contact / magnetic trigger</td> </tr> <tr> <td>Switch</td> <td>Normally open</td> </tr> <tr> <td>Cable length</td> <td>30 cm</td> </tr> <tr> <td>Mounting</td> <td>M3 screws</td> </tr> <tr> <td>IP</td> <td>IP65</td> </tr> </tbody> </table>	Item no.	DC-0001			Application	Door contact / magnetic trigger	Switch	Normally open	Cable length	30 cm	Mounting	M3 screws	IP	IP65																					
Item no.	DC-0001																																				
																																					
Application	Door contact / magnetic trigger																																				
Switch	Normally open																																				
Cable length	30 cm																																				
Mounting	M3 screws																																				
IP	IP65																																				
Illumination 	RMS-MLOG-LGT-868 	The RMS-MLOG-LGT detects light, meaning that it is possible to monitor the difference between dark and light. The LUX measurement values are not precise and are only used for scaling. The device is not designed for an accurate LUX measurement. 																																			

TEMPERATURE ACCURACY

RMS-MLOG-T & T10 ACCURACY OVERVIEW

The RMS-MLOG-T10-XXX allows users to implement their own NTC sensor. It is possible to add the NTC nominal value and B constant within the RMS software. For NTC's from Rotronic, simply choose the NTC from the dropdown list (as of Software V1.2).

The RMS-MLOG-T10-XXX can be calibrated and adjusted (2 points) via the RMS software. When using external NTC's, please account for the accuracy of the RMS-MLOG electronics.

Accuracy overview

T10-0001*	
Accuracy between -196...-90 °C	±2.5 °C
T10-0002*	
Accuracy at 25 °C	±0.2 °C
Accuracy at -80...-30 °C	±1 °C
Accuracy at -30...40 °C	±0.5 °C
Accuracy at 40...70 °C	±1 °C
Accuracy at 70...200 °C	±3 °C
T10-0003* and T10-0004*	
Accuracy at 25 °C	±0.4 °C
Accuracy at -50...0 °C	±1 °C
Accuracy at 0...30 °C	±0.5 °C
Accuracy at 30...60 °C	±1 °C
Accuracy at 60...90 °C	±1.5 °C
Accuracy at 90...200 °C	±3.2 °C
RMS-MLOG-T-XXX	
Accuracy at 25 °C	±0.4 °C
Accuracy at -30...0 °C	±1.3 °C
Accuracy at 0...40 °C	±1 °C
Accuracy at 40...85 °C	±1.5 °C
RMS-MLOG-T10-XXX electronic measurement accuracy	
Accuracy at 25 °C	±0.1 °C
Accuracy at -200...-40 °C	±0.4 °C
Accuracy at -40...150 °C	±0.3 °C
Accuracy at 150...200 °C	±0.6 °C
RMS-MLOG-T10-XXX electronic temperature accuracy	
Accuracy at 25 °C	±0.0 °C
Accuracy at -30...85 °C	±0.3 °C

To calculate the total accuracy of the RMS-MLOG-T10-XXX, it is necessary to add all variables together.

* NTC accuracy

Examples at various temperatures

Use of the T10-0002 at 25 °C and the RMS-MLOG-T10-XXX at 25 °C	
T10-0002 accuracy at 25 °C	±0.2 °C
RMS-MLOG-T10-XXX electronic measurement accuracy at 25 °C	±0.1 °C
RMS-MLOG-T10-XXX electronic temperature accuracy at 25 °C	±0.0 °C
Total accuracy at 25 °C	±0.3 °C
Use of the T10-0001 at -196 °C and the RMS-MLOG-T10-XXX at 25 °C	
T10-0001 accuracy at -196 °C	±2.5 °C
RMS-MLOG-T10-XXX electronic measurement accuracy at -196 °C	±0.4 °C
RMS-MLOG-T10-XXX electronic temperature accuracy at 25 °C	±0.0 °C
Total accuracy with the sensor at -196 °C and the logger at 25 °C	±2.9 °C
Use of the T10-0003 at 35 °C and the RMS-MLOG-T10-XXX at 35 °C	
T10-0003 accuracy at 35 °C	±1 °C
RMS-MLOG-T10-XXX electronic measurement accuracy at 35 °C	±0.3 °C
RMS-MLOG-T10-XXX electronic temperature accuracy at 35 °C	±0.3 °C
Total accuracy at 35 °C	±1.6 °C

Improvement in accuracy:

When using the data logger with the internal NTC or any of the NTC's provided by Rotronic, it is possible to carry out a 1 or 2 point adjustment in order to improve the measurement accuracy.

1 point adjustment:

- Adjustment range: -25...125 °C
- Accuracy: ±0.3 °C
- Accuracy range: adjustment point ±10 °C

2 point adjustment:

- Adjustment range: -25...125 °C
- Accuracy: ±0.3 °C
- Maximum span of the 2 adjustment points: 80 °C

RMS GATEWAY



ADVANTAGES

- Connects 60 wireless data loggers simultaneously
- 5 wireless channels for parallel and redundant operation
- Compatible with RMS Wireless Data Loggers, RMS Server Software and RMS Cloud
- Conforms to FDA CFR 21 Part 11 / GAMP 5

APPLICATIONS

- Monitoring of mobile equipment
- Extensible applications
- For redundant requirements

RMS

TECHNICAL INFORMATION

The gateway is the interface between the wireless data logger and the server software. It can manage up to 60 data loggers simultaneously, collecting all wireless-logger measurement data, and passing them on to the server software. When several gateways are used in the same network, they are configured redundantly. If one gateway should fail, the measurement values are automatically sent to the server software via another gateway.

Compatible with:

- RMS LOG RMS data logger
- RMS MLOG RMS mini-logger
- RMS-WEB On-premises software
- RMS-CLD SaaS solutions

Dimensions

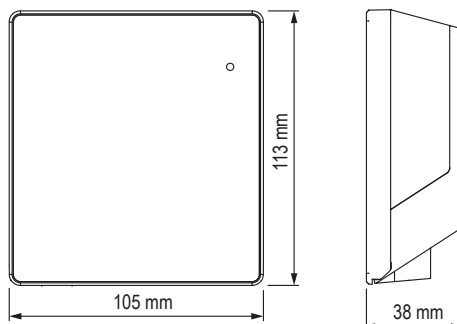

General specifications	
Range of application	-40..70 °C, 0..100 %RH
Storage conditions	-40..30 °C, 0..95 %RH
Maximum altitude	2000 m ASL
Power supply	24 VDC ±10 % / <100 mA / PoE: 802.3 af-2003, Class 1
AC adapter requirements	24 VDC ±10 % / 4 W nominal / <15 W power-limited
Device data	
Measurement interval	10 s to 15 min.
Startup time	< 10 s
Order code	RMS-GW-868 RMS-GW-915
Interfaces	Ethernet & ISM868 MHz Ethernet & ISM 915 MHz
Indoor wireless range	20..50 meters 15..25 meters
Protocols	HTTP
Ethernet cable requirement	Min. Cat. 5, SFTP, max. 30 m
Conformity with standards	
FDA / GAMP directives	FDA CFR21 Part 11 / GAMP 5
Housing / Mechanics	
Housing material	ABS
Fire protection class	UL94 -V2
Dimensions	105 x 113 x 38 mm
IP protection class	IP65
Weight	200 g

Subject to technical change without notice. Printing and other errors reserved.

59058E/2018-03

RMS DISPLAY



ADVANTAGES

- Shows up to 4 measured values
- Automatic adjustment of backlight on alarm
- Compatible with RMS data loggers, RMS On-premise and RMS SaaS
- Conforms to FDA CFR 21 Part 11 / GAMP 5

APPLICATIONS

- Critical places
- Cleanrooms

RMS

TECHNICAL INFORMATION

The LAN display is a freely configurable display. As a remote display, it can be placed optimally where it suits the viewer best. It is able to show the measured values, states and alarms of RMS products. The display shows up to four measured values. Two measured values are shown at a time. If more than 2 measured values have been selected, the display alternates between the values that are to be displayed every 5 seconds.

Compatible with:

- All measuring points
- RMS-GW RMS Gateway
- RMS-WEB RMS On-premise
- RMS-CLD RMS SaaS

Dimensions

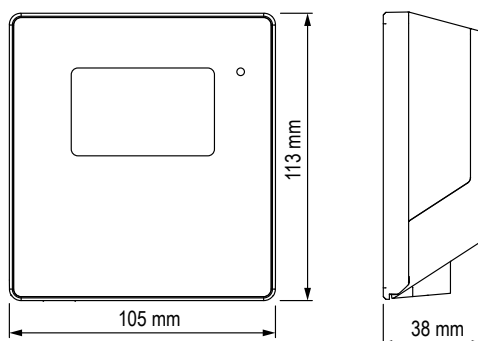

General specifications	
Device type	RMS Display
Display of measuring points	Up to 4 measuring points
Range of application	-20...70 °C / 0...100 %RH
Storage conditions	-20...30 °C / 0...95 %RH
Power supply	24 VDC ±10 % / <100 mA / PoE: 802.3 af-2003, Class 1
AC adapter requirements	24 VDC ±10 % / >4 W / power-limited
Measurement interval	10 s
Interface	Ethernet
Protocols	HTTP
Conformity with standards	
FDA / GAMP directives	FDA CFR21 Part 11 / GAMP5
Housing / Mechanical parts	
Housing material	PC, ABS
Fire protection class	UL94-V2
Dimensions	105 x 113 x 38 mm
Display diagonal	2.26 inch
IP protection class	IP65
Weight	206 g

Subject to technical change without notice. Printing and other errors reserved.

59070E/2018-01

RMS-DI-L-R



ADVANTAGES

- Two input channels
- Data logging of up to 75,000 measured values
- Compatible with RMS-Config, RMS On-Premise and RMS SaaS
- Conforms to FDA CFR 21 Part 11 / GAMP 5

APPLICATIONS

- Monitoring / Process control
- Safety and automation
- Direct condition control

RMS

TECHNICAL INFORMATION

The digital input module stores all measured data on an event basis and sends it to the database via Ethernet. The minimum pulse time is 100 ms. Should the connection be lost, the module stores the data intermediately to protect data integrity and fills up the data gaps when the connection has been restored. The device has a battery so that logging of measured data is also ensured in the event of a failure in the external power supply.

Compatible with:

- RMS-Config
- RMS-WEB On-Premise
- RMS-CLD SaaS solutions

Dimensions

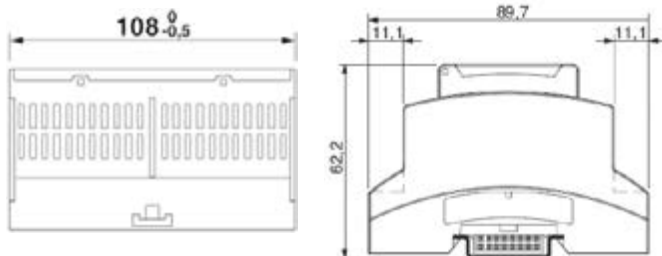

General specifications	
Device type	RMS-DI-L-R
Number of inputs	2 independent digital inputs
Range of application	-40..70 °C / 0..100 %RH non-condensing
Storage conditions	-40..30 °C / 0..95 %RH
Maximum altitude	2000 m ASL
Power supply	24 VDC ±10 % / <100 mA / PoE: 802.3 af-2003, Class 1
AC adapter requirements	24 VDC ±10 % / 4 W nominal / <15 W power-limited
Battery type	RMS-BAT
Battery life	3 years at 23 °C
Device data	
Input frequency	Max. 0.833 Hz or 1.2 s
Pulse recognition	>100 ms (periodically > 1.2 s)
Input circuit	Logic level: 0 V / 5-24 V
	Trigger threshold: ~3.77 V
	Current consumption: <1 mA
Reed circuit	Max. load at input 100 kΩ
Max. cable length at input	<3 m
Measurement interval	Event-based & interval (10 s to 15 min.)
Storage capacity	75,000 data points
Interface	Ethernet
Protocols	HTTP
Conformity with standards	
FDA / GAMP directives	FDA CFR21 Part 11 / GAMP 5
Housing / Mechanical parts	
Housing material	Polycarbonate (PC)
Fire protection class	UL94-V0
Dimensions	89.7 x 62.2 x 108 mm
IP protection class	IP20
Weight	206 g

Subject to technical change without notice. Printing and other errors reserved.

59071E/2018-01

RMS-DO-L-R



ADVANTAGES

- Two output channels
- Compatible with RMS-Config, RMS On-Premise and RMS SaaS
- Conforms to FDA CFR 21 Part 11 / GAMP 5

APPLICATIONS

- Monitoring / Process control
- Building automation
- Industrial automation



TECHNICAL INFORMATION

The digital output module serves to display information, issue alarms and control events. The relays can be interrogated or set via Modbus TCP or the RMS software. It is possible to define the conditions in the RMS software and to actuate the outputs on the basis of them.

Compatible with:

- RMS-Config
- RMS-WEB On-Premise
- RMS-CLD SaaS solutions

Dimensions

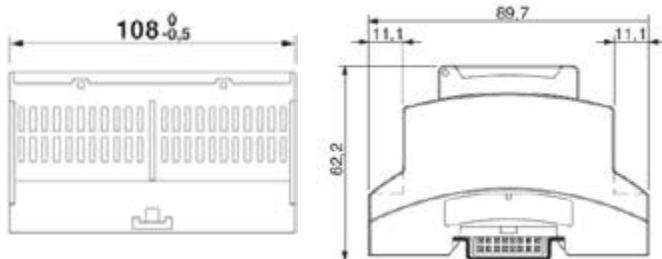

General specifications	
Device type	RMS-DO-L-R
Number of outputs	2, polarity-independent
Range of application	-40..70 °C / 0..100 %RH non-condensing
Storage conditions	-40..30 °C / 0..95 %RH
Maximum altitude	2000 m ASL
Power supply	24 VDC ±10 % / <100 mA / PoE: 802.3 af-2003, Class 1
AC adapter requirements	24 VDC ±10 % / 4 W nominal / <15 W power-limited
Device data	
Interface	Digital signal / galvanically isolated
Relay switching capacity	50 VAC (peak) 1 A / 50 VDC/1 A, polarity-independent
Voltage output (VEX)	24 VDC (Note: The maximum current available depends on the external power supply connected.)
Max. cable length at input	<3 m
Measurement interval	>=10 s
Interface	Ethernet
Protocols	HTTP
Conformity with standards	
FDA / GAMP directives	FDA CFR21 Part 11 / GAMP 5
Housing / Mechanical parts	
Housing material	Polycarbonate (PC)
Fire protection class	UL94-V0
Dimensions	89.7 x 62.2 x 108 mm
IP protection class	IP20
Weight	155 g

RMS-CONVERTER



ADVANTAGES

- Integrates digital devices seamlessly into RMS
- Integrates Rotronic digital devices into RMS
- No loss of accuracy due to A/D converters, show up to 5 decimal values
- Conforms to FDA 21 CFR Part 11 / GAMP5



TECHNICAL INFORMATION

The RMS Converter allows you to easily integrate existing devices and networks into RMS. The RMS Converter acts as an interface, gathering the data from digital devices and sending them to the RMS server software/MS SQL database. With a USB dongle, the Converter can be enhanced to a Gateway, and can connect to wireless data loggers. In addition, third party digital devices can be integrated if the communication protocol is available. However, this function requires support from the Rotronic R&D. Where ever possible Rotronic would recommend replacing previous networks with RMS devices in the long term.

Dimensions

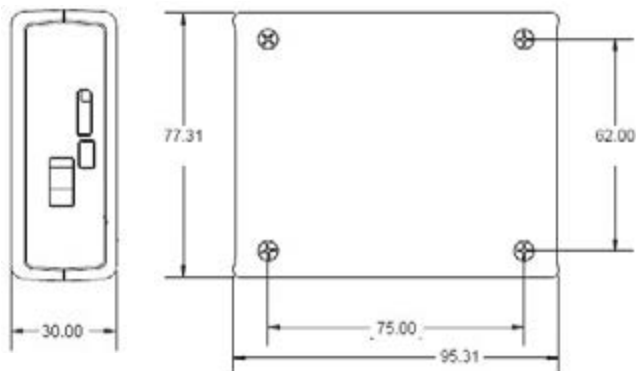

General specifications	
Device type	RMS Converter
Number of measuring points	Integration of up to 100
Range of application	-0 .. 50 °C / 0 .. 95 %RH
Storage conditions	-0 .. 50 °C / 0 .. 95 %RH
Electrical Supply	5 VDC (universal mains adapter included)
Measurement interval	10 s to 15 min
Interface	Ethernet
Protocols	Modbus TCP RoASCII HTTP SNMP Customer-specific enhancements
Supported webcams	D-Link DCS-2121
Conformity with Standards	
FDA / GAMP directives	FDA 21 CFR Part 11 / GAMP5
Housing / Mechanical parts	
Dimensions	94 x 78 x 30 mm
IP protection class	IP20

Subject to technical change without notice. Printing and other errors reserved.

59060E/2018-11

TECHNICAL INFORMATION

Compatible with (LAN connection)

- HL-NT with Ethernet docking station
- HygroLog NT with Ethernet docking station
- HF4 .. HF8 with Ethernet connection
- PF4 with Ethernet connection
- RMS-WEB
- RMS-CLD
- CRP5
- RMS-8ADC-L-R-A/V
- RMS-4RTD-L-R
- Lighthouse APEX R5 with Ethernet connection

- Data logger
- Data logger
- Transmitter
- Transmitter
- RMS On-Premise
- RMS SaaS solutions
- Clean room panel
- Analogue to digital converter
- RTD to digital converter
- Particle counter

NETWORK ARCHITECTURE WITH THE RMS CONVERTER

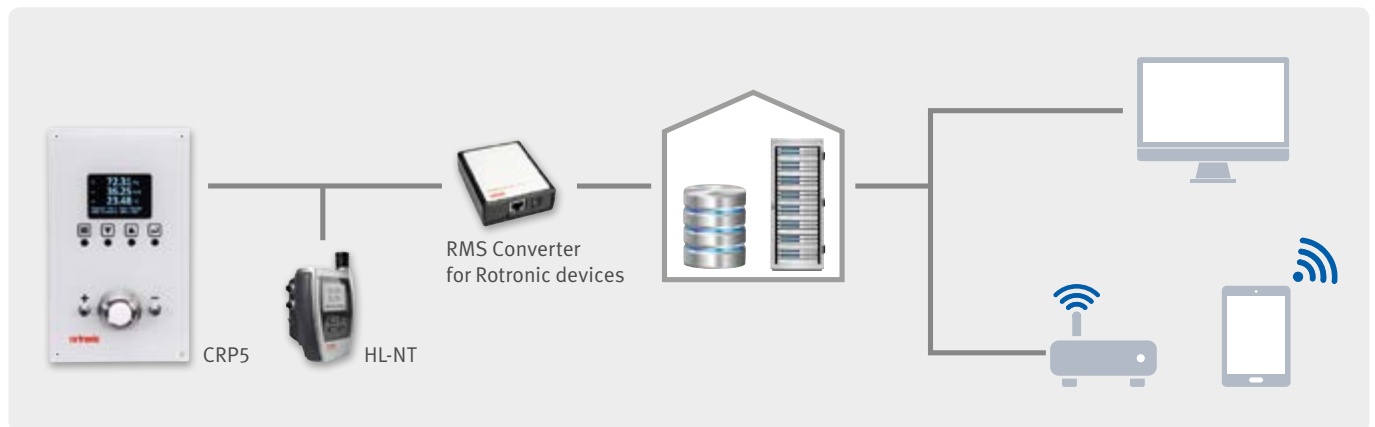

RMS-8ADC-L-R-A



ADVANTAGES

- 8 isolated input channels
- Passive input up to $\pm 20\text{mA}$
- Programmable via the RMS software
- Signal LED

APPLICATIONS

- Monitoring / Process control
- Building automation
- Industrial automation



TECHNICAL INFORMATION

RMS 8 input, analogue to digital converter

The 8 input, analogue to digital converter was designed to implement all analogue outputs into the digital world of RMS. The 8 inputs offer the flexibility of using a current system with one of the newest and most flexible monitoring systems on the market today.

Attention

Function only with RMS-Converter-XXX.

Analog inputs

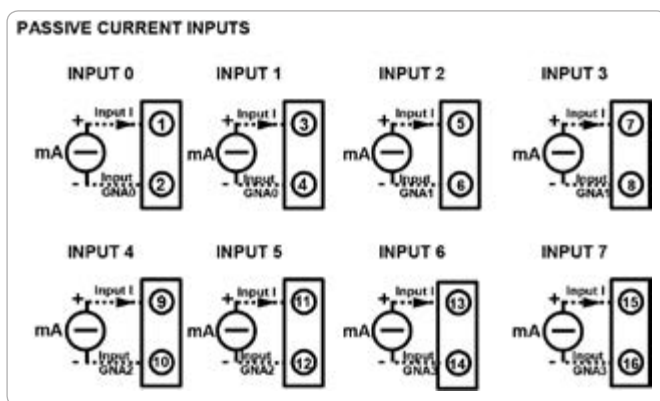

Notes:

Terminals "2" and "4" connected internally between them (neg. reference "GNA0").
 Terminals "6" and "8" connected internally between them (neg. reference "GNA1").
 Terminals "10" and "12" connected internally between them (neg. reference "GNA2").
 Terminals "14" and "16" connected internally between them (neg. reference "GNA3").
 The references "GNA0", "GNA1", "GNA2" and "GNA3" are isolated from each other.

Dimensions

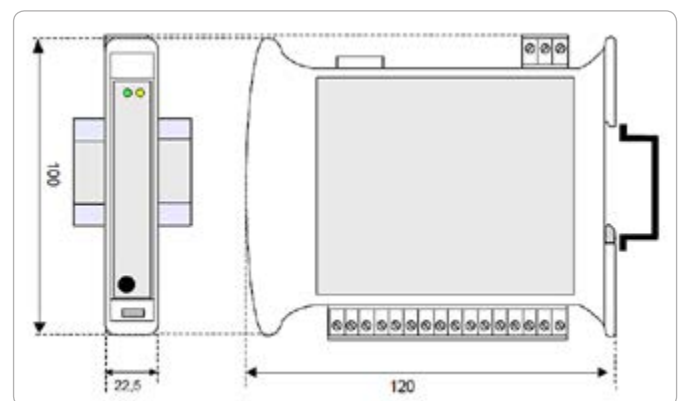

Power supply

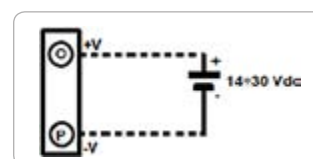

TECHNICAL INFORMATION

Light signalling

LED	Colour	State	Description
PWR	Green	On	Device powered
		Off	Device not powered
		Blink	Watchdog alarm
STS	Yellow	Off	Device in RUN modality
		Blink	Device in INIT modality

General specifications	
Device type	RMS-8ADC-L-R-A
Measured parameters	Current
Memory size	7 days memory with the RMS-Extension
Range of application	-10...60°C, 0...90%rh
Storage conditions	-40...85°C, 0...90%rh
Maximum altitude	2000 m ASL
Electrical supply voltage	14...30VDC
Device Data	
Analog inputs	8 isolated inputs, 0/4...20 mA
Input accuracy mA	±0.05%fs
Linearity mA	±0.1%fs
Thermal drift FS	±0.01%/°C
Measurement interval	10 s to 15 min (dependant on software account)
Interface output	Ethernet RJ-45
Protocol	Modbus TCP
Ethernet cable requirement	Min. Cat 5, SFTP, max. 100m
Interface input	Removable screw-terminals
Housing / Mechanical parts	
Mounting	Din-rail
Dimensions	100 x 120 x 22.5mm
Weight	160 g
IP protection class	IP20
Installation recommendation	Seperated by at least 5mm
Defaut IP configuration	192.168.1.100

Subject to technical change without notice. Printing and other errors reserved.

RMS-8ADC-L-R-V

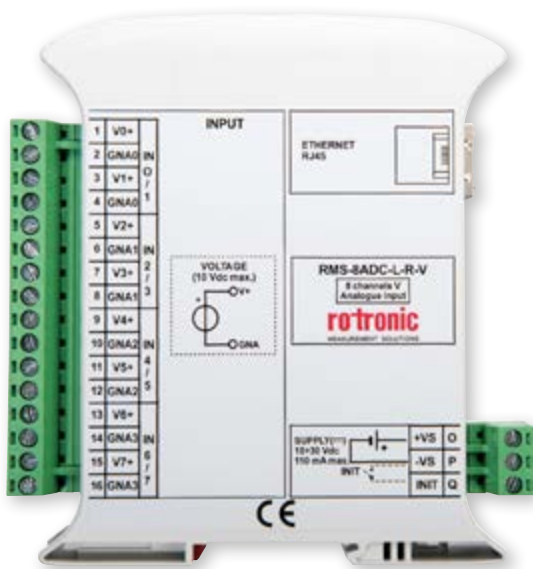

ADVANTAGES

- 8 isolated input channels
- Passive input up to $\pm 10\text{ V}$
- Programmable via the RMS software
- Signal LED

APPLICATIONS

- Monitoring / Process control
- Building automation
- Industrial automation



TECHNICAL INFORMATION

RMS 8 input, analogue to digital converter

The 8 input, analogue to digital converter was designed to implement all analogue outputs into the digital world of RMS. The 8 inputs offer the flexibility of using a current system with one of the newest and most flexible monitoring systems on the market today.

Attention

Function only with RMS-Converter-XXX.

Analog inputs

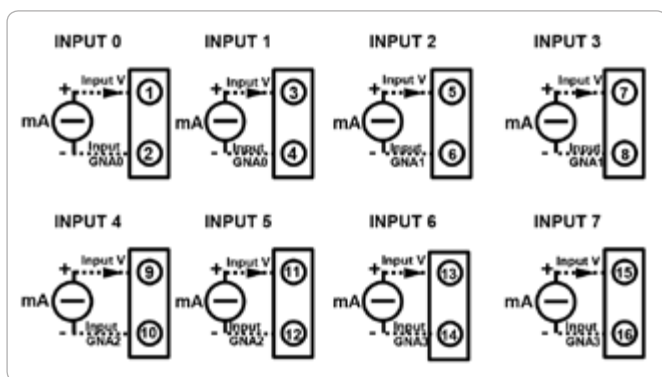

Notes:

Terminals "2" and "4" connected internally between them (neg. reference "GNA0").
 Terminals "6" and "8" connected internally between them (neg. reference "GNA1").
 Terminals "10" and "12" connected internally between them (neg. reference "GNA2").
 Terminals "14" and "16" connected internally between them (neg. reference "GNA3").
 The references "GNA0", "GNA1", "GNA2" and "GNA3" are isolated from each other.

Dimensions

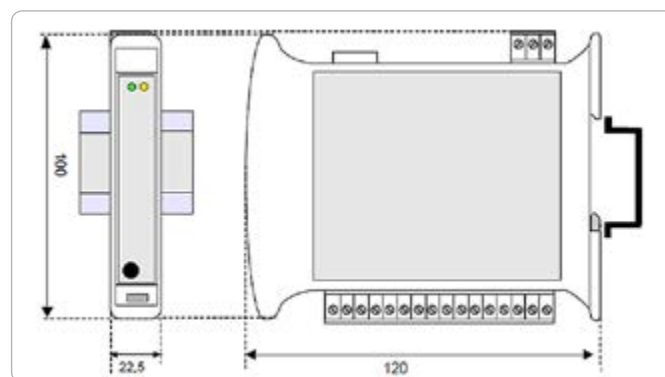

Power supply

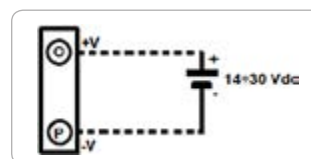

TECHNICAL INFORMATION

Light signalling

LED	Colour	State	Description
PWR	Green	On	Device powered
		Off	Device not powered
		Blink	Watchdog alarm
STS	Yellow	Off	Device in RUN modality
		Blink	Device in INIT modality

General specifications	
Device type	RMS-8ADC-L-R-V
Measured parameters	Voltage
Memory size	7 days memory with the RMS-Extension
Range of application	-10...60°C, 0...90%rh
Storage conditions	-40...85°C, 0...90%rh
Maximum altitude	2000 m ASL
Electrical supply voltage	14...30VDC
Device Data	
Analog inputs	8 isolated inputs, 0...10V
Input accuracy Voltage	±0.05%fs
Linearity Voltage	±0.1%fs
Thermal drift FS	±0.01%/°C
Measurement interval	10 s to 15 min (dependant on software account)
Interface output	Ethernet RJ-45
Protocol	Modbus TCP
Ethernet cable requirement	Min. Cat 5, SFTP, max. 100m
Interface input	Removable screw-terminals
Housing / Mechanical parts	
Mounting	Din-rail
Dimensions	100 x 120 x 22.5mm
Weight	160 g
IP protection class	IP20
Installation recommendation	Seperated by at least 5mm
Defaut IP configuration	192.168.1.100

Subject to technical change without notice. Printing and other errors reserved.

RMS-4RTD-L-R

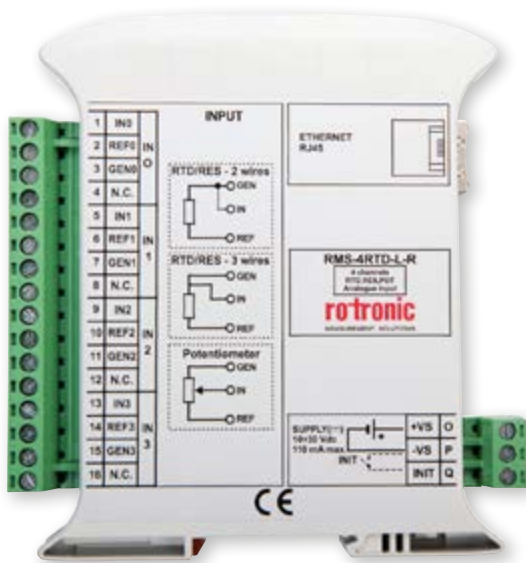

ADVANTAGES

- 4 isolated input channels
- Input for PT100 & PT1000
- Programmable via the RMS software
- Signal LED

APPLICATIONS

- Monitoring / Process control
- Building automation
- Industrial automation



TECHNICAL INFORMATION

RMS analogue to digital converter with 4 inputs

The 4-input analogue to digital converter was developed to implement all temperature sensors in the digital world of RMS. The 4 inputs offer the flexibility of using a modern system with one of the newest and most flexible monitoring systems on the market today.

Attention

Function only with RMS-Converter-XXX.

Analog inputs

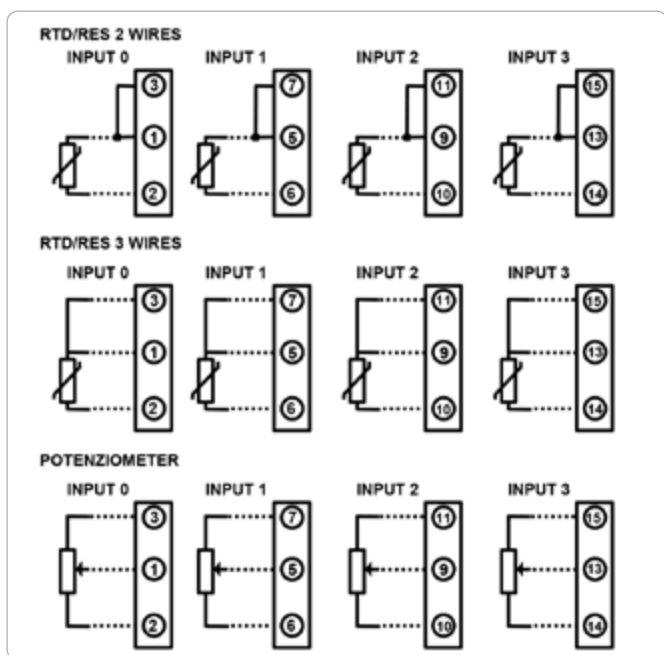

Dimensions

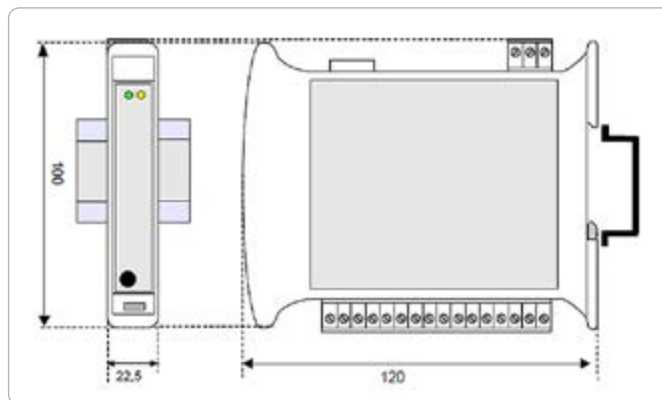

Power supply

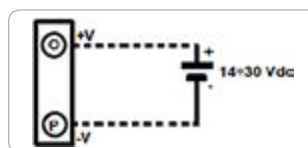

TECHNICAL INFORMATION

Light signals

LED	Color	State	Description
PWR	Green	On	Device powered
		Off	Device not powered
		Flashing	Watchdog alarm
STS	Yellow	Off	Device in RUN mode
		Flashing	Device in INIT mode

Input type

RTD 2/3-wire	Min.	Max.
PT100	-200 °C	850 °C
PT1000	-200 °C	200 °C
NI100	-60 °C	180 °C
NI1000	-60 °C	150 °C
RES 2/3-wire		
Low	0 Ω	500 Ω
High	0 Ω	2000 Ω
Potentiometer	20 Ω	50 kΩ

General specifications	
Device type	RMS-4RTD-L-R
Measured parameters	PT100, PT1000, potentiometer
Memory size	7-day memory with RMS-Extension
Application range	-10..60 °C, 0..90 %RH
Storage conditions	-40..85 °C, 0..90 %RH
Maximum altitude	2000 m ASL
Power supply	14..30 VDC
Device data	
Analog inputs	4 isolated inputs
Input accuracy RTD, resistance, potentiometer	±0.05 %FS
Linearity RTD	±0.1 %FS
Influence line resistance RTD/resistance 3-wire	±0.05 %FS/Ω
RTD field current	0.370 mA
Thermal drift FS	±0.01 %/°C
Start-up time	3 min.
Measurement interval	10 s to 15 min. (dependant on software account)
Interface output	Ethernet RJ-45
Protocol	Modbus TCP
Ethernet cable requirement	Min. Cat. 5, SFTP, max. 100 m
Interface input	Removable screw terminals
Housing / Mechanical parts	
Mounting	DIN rail
Dimensions	100 x 120 x 22.5 mm
Weight	160 g
IP protection	IP20
Installation recommendation	Separated by at least 5 mm
Default IP configuration	192.168.1.100

Technical specifications (typical @ 25 °C and normal environment).

Subject to technical change without notice. Printing and other errors reserved.

RMS ACCESSORIES

OVERVIEW TEMPERATURE PROBES

The T10 temperature sensors are NTC (Negative Temperature Coefficient) thermistors, meaning that the resistance of the NTC decreases with increasing temperature. The T10 temperature sensors are compatible with the RMS-MLOG-T10-868/915 data loggers. The data logger temperature range is limited from -35...80°C.

The RMS temperature portfolio will cover a various array of applications, from the coldest such as liquid nitrogen tanks and cryogenic freezers to freezers, refrigerators and cold rooms to hotter ones such as water baths, incubators, ovens and autoclaves. Certain probes are also designed for specific applications for monitoring legionella within water pipes and monitoring room temperature.

It is crucial when setting up your RMS-MLOG-T10-868/915 with the T10 temperature probe to configure the logger accordingly with the software as the characteristic curve of each NTC is stored within the firmware. Please see for each probe below.

This list is not extensive and other probes, diameters and cable lengths are available on demand.

For accuracy information please see the RMS-MLOG data sheet.



		
<p>T10-0001</p> <ul style="list-style-type: none"> • Applications: liquid nitrogen, cryogenics... • Application range: -196...-90°C • Cable length: 2m • Probe diameter: 6mm • Probe length: 50mm • IP65 • Select NTC T10-0001 within RMS 	<p>T10-0002</p> <ul style="list-style-type: none"> • Applications: Dry ice, freezers... • Application range: -80...150°C • Cable length: 2m • Probe diameter: 6mm • Probe length: 50mm • IP65 • Select NTC T10-0002 within RMS 	<p>T10-0003</p> <ul style="list-style-type: none"> • Applications: freezers, fridges, cold rooms, water baths, incubators, ovens... • Application range: -50...120°C • Cable length: 2m • Probe diameter: 6mm • Probe length: 50mm • IP65 • Select NTC T10-0003/4/6 within RMS
		
<p>T10-0004</p> <ul style="list-style-type: none"> • Applications: pipe monitoring (legionella) • Application range: -50...120°C • Cable length: 2m • Probe: duct wrap • Probe length: 50mm • IP65 • Select NTC T10-0003/4/6 within RMS 	<p>T10-0005</p> <ul style="list-style-type: none"> • Applications: Dry ice, freezers... • Application range: -90...0°C • Cable length: 4m • Probe diameter: 6mm • Probe length: 50mm • IP65 • Select NTC T10-0005 within RMS 	<p>T10-0006</p> <ul style="list-style-type: none"> • Applications: freezers, fridges, cold rooms, water baths, incubators, ovens... • Application range: -50...120°C • Cable length: 4m • Probe diameter: 6mm • Probe length: 50mm • IP65 • Select NTC T10-0003/4/6 within RMS

OVERVIEW ACCESSORIES

E2-xxA extension cable

- Applications: Improved probe access for calibration purposes
- Available in 01, 02 and 05m (replace xx with the desired length)
- Compatibility: RMS-LOG-L/868/915 and HCD, PCD and CCD

E2-xxXX extension cable with open ends

- Applications: Various
- Available in 01, 02 and 05m (replace xx with the desired length)
- Compatibility: RMS-LOG-L/868/915

AC0001 Ethernet patch cable

- Applications: Ethernet wiring
- 3m
- White
- Compatibility: RMS-LOG-L, RMS-GW-868, RMS-DI/DO-L-R

AC0005 Ethernet patch cable

- Applications: Ethernet wiring
- 3m
- Red
- Compatibility: RMS-LOG-L, RMS-GW-868, RMS-DI/DO-L-R

AC1319 holder

- Applications: RMS probe wall mounting module
- Compatibility: HCD probes

AC1321 mounting kit

- Applications: RMS wall module mounting
- Mounting cone (to bring the Ethernet cable through the joint)
- Allen key
- Compatibility: RMS-LOG-L & RMS-GW-868

AC1322 holder

- Applications: RMS probe wall mounting module
- Compatibility: PCD and CCD probes

RMS-AC-0001 holder for RMS-Monitor-7

- Holder to attach the RMS-Monitor-7 to a wall
- Compatibility: RMS-Monitor-7

AC6001/XX tubing

- Applications: Tubing for differential pressure monitoring
- Diameter: 4mm
- Compatibility: PCD-S, PF4 & CRP5

WC-0001 Webcam

- Applications: Monitoring applications together with a snap shot, PDF report together with a snap shot
- Application range: 0...40°C
- Resolution: 640 x 480
- Connectivity: RJ45
- Power supply: 5V

RMS-DONGLE-868

- Applications: configures 868 wireless devices with RMS-Config
- Compatibility: All 868 wireless devices

RMS-BAT batteries

- Applications: Fail safe power supply
- Model: ER14505M
- Application range: -55°C...80°C
- Compatibility: RMS-LOG-L/868/915, RMS-GW-868/915, RMS-MLOG range & RMS-DI-L-R

RMS-NPK network planning kit

- Applications: Planning of a wireless network
- RMS-MLOG and wireless USB dongle to check the wireless communication
- Compatibility: RMS-Config

21.99.1196 5 port power over Ethernet Switch

- Applications: Setting up a PoE network
- Add up to 4 RMS LAN devices

21.99.1197 8 port power over Ethernet Switch

- Applications: Setting up a PoE network
- Add up to 7 RMS LAN devices

RMS-PS & RMS-PS-R power supplies

- RMS-PS: 24VDC, 0.5A, 15W with connector
- RMS-PS-R: 24VDC, 60mA, 15W, Din rail
- Compatibility: RMS-LOG-L/868/915, RMS-GW-868/915, RMS-DO/DI-L-R

DC-0001 Magnetic door contact

- Applications: Door open/close monitoring for rooms, fridges, freezers...
- Application range: -20...70°C
- Compatibility: RMS-MDI-868/915 & RMS-DI-L-R

WB-0001 Leak detector module

- Applications: Leak monitoring for archives, storage areas...
- Application range: 0...50°C
- Battery powered
- Visual alarm
- Audible alarm
- Compatibility: RMS-MDI-868/915 & RMS-DI-L-R

AD-0001 Signal beacon

- Applications: Signal alarms to users via light and sound
- Application range: -20...50°C
- Visual alarm
- Audible alarm
- Compatibility: RMS-DO-L-R

RMS-PS-CONV

- Applications: power supply for the RMS-Converter
- Compatibility: RMS-CONVERTER-100



AC1000 naturally ventilated weather shield

- Applications: protect your outdoor temperature and relative humidity measurement
- Application range: protection against wind speeds of up to 70m/s and horizontal precipitation
- Compatibility: HCD-S

OVERVIEW FILTERS







Description









Filter carriers protect the humidity and temperature sensors against mechanical damage. Filters act as a protective barrier against contaminants/pollutants that can influence the sensor. When choosing the correct combination of filter carrier and filter there are many factors to consider. Specific conditions such as high air velocities, pollutants in the air, disinfection and cleaning routines, mechanical impacts, high bioactivity, condensation, airborne chemical contaminants and required response time are some of the many considerations.

Plastic filter carrier	Metal filter carrier
<ul style="list-style-type: none"> Maximum temperature 100 °C Mechanical protection 	<ul style="list-style-type: none"> Maximum temperature 200 °C Mechanical protection 

Overview filters	Teflon filters	Polyethylene filters	Sintered steel filters (stainless steel)	Wire mesh filters (metal)
Maximum temperature (consider range of application of filter carrier)	200 °C	100 °C	200 °C	200 °C
Protection against particulates	✓✓	✓✓	✓	✓
Protection against abrasives in the air			✓✓✓	✓
Pore size	10 µm	40 µm	25 µm	10 µm
Max. air velocity [m/s] (continuous load)	50	50	70	50

✓ = low / ✓✓ = medium / ✓✓✓ = high

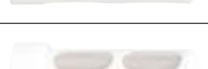
Order code	Filter carrier	Filter element	Pore size	Range of application	
SPA-SS	1.4301	No filter, only filter carrier		-50...100 °C	
SPA-SS-PE		Polyethylene, white	40-50 µm		
SPA-SS-PTFE		PTFE, white	10 µm		
SPA-SS-WM		Wire mesh 1.4401	10 µm		
SPA-SSS	Filter carrier incl. filter	Sintered steel 1.4404	25 µm	-100...200 °C	
SPA-WM	No filter carrier, only filter	Wire mesh 1.4401	10 µm		

Order code	Filter carrier	Filter element	Pore size	Range of application	
SPA-PCB	Polycarbonate, black	No filter, only filter carrier		-50...100 °C	
SPA-PCB-PE		Polyethylene, white	40-50 µm		
SPA-PCB-PTFE		PTFE, white	10 µm		
SPA-PCB-WM		Wire mesh 1.4401	10 µm		
SPA-PCW	Polycarbonate, white			-50...100 °C	
SPA-PCW-PE		Polyethylene, white	40-50 µm		
SPA-PCW-PTFE		PTFE, white	10 µm		
SPA-PCW-WM		Wire mesh 1.4401	10 µm		
SPA-PE	No filter carrier, only filter	Polyethylene, white	40-50 µm		
SPA-PTFE	No filter carrier, only filter	PTFE, white	10 µm	-100...200 °C	

WB-0001



ADVANTAGES

- Detect leaks as soon as they occur
- Visual and audible alarm
- Battery powered
- Adjustable sensing height
- Relay output

APPLICATIONS

- Protecting equipment from water damage
- Drip pans in air handler units
- Raised floors in data centers, museums, archives and cellars

TECHNICAL INFORMATION

The WB-0001 detects the presence of water or conductive fluids once it reaches a level that bridges the two conductive strips on the bottom of the housing. Once the strips are bridged, audible and visual alerts as well as an internal switch are triggered. The sensing height can be adjusted from 0.08 mm to 13.5 mm using the included adjustable mounting bracket (that can be attached to any flat surface by either using the attached adhesive strips or mounting screws).

Compatible with

- RMS-MDI-868/915
- RMS-DI-L-R

Dimensions

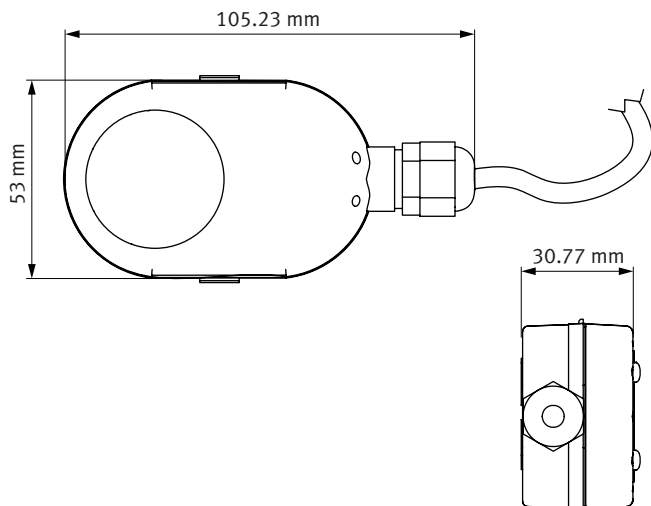

General specifications	
Parameters	Water or conductive fluids
Range of application	0...50 °C
Power supply	3V CR2450 lithium metal battery
Battery lifetime	5 years steady state / 48 hours during alarm condition
Power consumption	0.9 mA steady state / 3.0 mA during alarm condition
Dimensions	53 x 105.23 x 30.77 mm
Housing	ABS and polycarbonate
Cable length	1.5 m
IP protection class	Water tight up to 3/4 of the body height
Weight	137.5 g
Delivery package	1 CR2450 lithium metal battery Short instruction manual
Technical Information / Functions	
Switch type	SPST NO SSR
Audible alarm	At least 85dB @30 cm distance
Visual alarm	Red LED for water level, Yellow LED for low battery

CF632-W-INC-20



ADVANTAGES

- Measure 0...20% CO₂ (other ranges also available)
- With ambient pressure and temperature compensation
- Non dispersive Infra-red measurement principle

APPLICATIONS

- Incubators



TECHNICAL INFORMATION

The Rotronic CF6 transmitters are ideal for incubators working at high levels of CO₂. The CF6 generates enough heat to help avoid condensation on the mirrors that are required using the NDIR measurement principle. The transmitter is delivered with a ribbon cable to facilitate the integration of the unit through the incubator door.

Compatible with

- RMS-MADC-868/915-A data logger
- RMS-8ADC-L-R-A converter

Dimensions

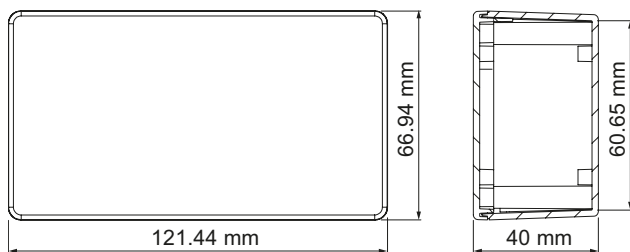

General specifications	
Measurement principle	Non Dispersive Infra-Red (NDIR), Dual wavelength
Measurement range	0...20% CO ₂
Gas supply	By diffusion (atmospheric pressure)
Dimensions	121.44 x 66.94 x 40 mm
Warm-up time	< 2 minutes (start up time) < 30 minutes (full specification)

Measuring response (2)	
Response time (t90)	Appr. 30 s
Digital resolution (@ zero)	1 ppm / 0.1 % LEL / 0.01 Vol.-% (1) = ±1000ppm
Detection Limit (3 s)	≤ 1 % FS(3) (typically)
Repeatability	≤ ± 1 % FS(3)
Linearity error (4)	≤ ± 2 % FS
Long term stability (zero) (5)	≤ ± 2 % FS over 12 month period
Long term stability (span) (5)	≤ ± 2 % FS over 12 month period
Influencing variable	
Temp. dependence (zero)	≤ ± 0.1 % FS per °C
Temp. dependence (span)	≤ ± 0.2 % FS per °C
Pressure dependence (zero)	-
Pressure dependence (span)	0.1 % to 0.2 % value per hPa (1)
Electrical inputs and outputs	
Supply voltage	5 V DC ± 5 % or 6 V DC ± 5 % (1)
Supply current	70 mA average, max. 140 mA
Power consumption	< 1 Watt
Output signal	4...20 mA
Calibration	Zero and span by SW

- 1) Dependent on the gas and the measurement range
- 2) Relating to atmospheric pressure 1013 hPa absolute and 25°C ambient temperature
- 3) FS = Full scale
- 4) Stated linearity error excludes calibration gas tolerance of ± 2 %
- 5) For dry and clean test gas at 25°C and 1013hPa absolute - depending on the operating and ambient conditions values may differ
- 6) Relating to calibration conditions (see final check). At first initiation and depending on application and ambient conditions recalibration is recommended. Recurring cycles of recalibration are recommended.