



VELVAC[®]

Quality Driven Vehicle Components Since 1934

PRODUCT CATALOG 2009-2010



800.783.8871
www.velvac.com

NEW AT VELVAC!

Velvac is continually expanding and upgrading our six broad product categories to meet the needs of our customer base and changing markets. With our acquisition of K-10, and the development and addition of several new mirror product families, this catalog includes over 1200 new part numbers that are identified by the NEW symbol and red part numbers. Additionally, look for our expanded line of POP's, displays and Plan-O-Grams in the back of the catalog.



Mirrors

(ref. page)

- Navistar / International West Coast mirrors and brackets (4)
- K-10 Eyeball mirrors and blind spot bracket systems (8)
- HHR Spotter stick-on convex and GM camper mirror (9)
- Colorado pick-up mirrors (15)
- 2020 wide body mirrors with integrated cameras (18)
- 2020 XG van and pick-up wide body mirror systems (19)
- Model 2020 SS door / fender mirrors for shuttle bus (24)
- K-10 safety and observation mirrors (28)
- Cameras and monitors (33)

Air Products

- Over 20 new gladhands, grips and seals (37)
- Slider air hose assemblies (40)
- Rubber air line hose and air brake hose repair kit (41)
- 20' coiled air lines and cab blower kit (42)
- Shear Seal height control valves (51)
- Compact four-way air control valves (59)

Electrical Products

- 20' straight ABS electrical (67)
- Battery cables including 800A booster cable (74)
- Protective battery washers (76)
- New lines of back up alarms and switches (78)
- High amp breakers, ATM and Maxi circuit breakers (87)
- Heatless butt connectors (91)
- Rubber cushion clamps (100)
- Silicon Self-fusing tape (103)

Hose and Cable Support and Accessories

- Replacement tracker bar kits (105)
- King pin lock (106)
- Tarp straps and emergency triangle kit (108)
- Wiper blades (109)

Fittings and Fuel Products

- Larger sizes and different styles of Push-Lock fittings (111)
- Barb fittings, hose splicer and new bulkhead fittings (116)
- Muffler, flat band and guillotine style hose clamps (124)
- Radiator caps (126)
- Fuel Cap Additions (130)
- Anti-Siphon Tubes (132)

Retail Merchandising

- Air/electrical and brass fitting POP racks (137)
- Counter top bucket and display bin box (139)
- Carton Floor display (140)
- Four-sided generic carousel and wiper blade display (141)
- Plan-o-grams (143)



TABLE OF CONTENTS

Mirrors		Electrical Products		Fittings and Hardware	
West Coast Mirrors	3	Cable & Plug Assemblies	67	Push-Lock Air Brake Fittings	111
Blind Spot Convex Mirrors	6	Electrical Plugs	69	Nylon Air Brake Tube Fittings	113
Accessory Mirrors	9	Plug Adapters and Accessories	70	Air Brake Compression Fittings	114
Wide Angle Mirrors	10	Electrical Sockets & Accessories	71	Reusable Air Hose Fittings	115
Hood Mount Mirrors	11	Electrical Cable	73	Discharge Hose Fittings	117
Hood Mount Tripod Mirrors	12	Battery Cable	74	Pipe Fittings	118
Rear Cross View Mirror Systems	13	Battery Lugs	75	SAE 45° Flare Fittings	119
Van and Cab Chassis Mirrors	15	Battery Terminals	76	Inverted Flare Fittings	120
Truck and Tractor Mirrors	16	Back-Up Alarms	78	Truck and Trailer Repair Kits	121
Walk-in Van Mirrors	17	Switches and Solenoids	81	Fitting Display and Assortments	122
2020 Van and Cab Chassis Mirrors	18	Signal Flashers	86	Hose Clamp and Coolant Valves	123
2020 Mirror Replacement Parts	25	Circuit Breakers	87	Heavy Duty Truck Radiator Caps	126
Class A RV, Bus and Truck Mirrors	26	Fuses and Accessories	88	Clevis and Clevis Pins	127
Safety Mirrors	28	Terminals & Connectors	91		
Brackets, Clamps and Accessories	30	Primary Wire & Accessories	97	Fuel System Products	
Camera and Observation Systems	33	Heat Shrink Tubing	98	Fuel Caps	129
		Tie Straps, Grommets & Wire Clips	100	Anti-Siphon Tubes	132
		Shop Tools & Accessories	101	Fuel Tank Valves	133
		Tape Products	103	Electric Fuel Tank Selector Valves	135
Air Products		Hose Support Products		Retail Merchandising	
Gladhands	37	Hose & Cable Support	105	Air and Fittings Displays	137
Air Brake Hose and Tubing	40	Pogo Sticks	107	Fittings Displays	138
Air Brake Valves	43	Document Holders & Accessories	108	Bucket and Counter Boxes	139
Air Accessory Valves	49	Wiper Blades	109	Hose and Air Displays	140
Pressure Switches and Indicators	55			Floor Standing Displays	141
Air Tank Accessories	56			Mirror Retail Merchandising	142
Air Tanks, Brake Chambers & Diaphragms	58			Plan-O-Grams	143
Air Cylinder Control Valves	59			PART NO. INDEX	145
Air Cylinders	60				
Air Cylinder Tailgate Lock Kits	63				
Lift Axle & Suspension Valves	64				

For quantity and packaging information, refer to Velvac price list



Indicates an original Velvac® product



Indicates a new product added to catalog

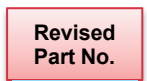

Indicates a revised part number defining "-xx" package quantity.
Refer to price list for price per package.

Customer Service:

800.783.8871

Fax:

262.786.4101

E-mail:

sales@velvac.com

NOTE: The information and photographs in this catalog are believed to be accurate and factual as of the print date. Velvac assumes no responsibility for information that may be incorrect or has changed since press time. Product specifications and offerings subject to change without notice.

*Velvac, DuraBall, K-10, Eyeball, and Wall-Eye are registered trademarks of Velvac, Inc.
Hi-Torque, Constant-Torque, and Euro-Seal are registered trademarks of Breeze Industrial Products Corp.
Shear-Seal is a registered trademark of Barksdale Control Products
Stant is a registered trademark of Stant Mfg. Inc.
Energy Suspension is a registered trademark of Energy Suspension
Plexiglas is a registered trademark of Evonik Industries
Teflon is a registered trademark of E.I. duPont de Nemours and Company
Lexan is a registered trademark of SABIC Innovations Plastics
Aero-Bell, ALL STAR, ClearCam, Enforcer, Gladhandl, Glad-Lock, Guardian, Mod Pod, Pacifier, Revolution, RXV, Star, Stow-A-Way, Superstar, Top Hat, Viper, V-MAX, V-MAX III, Wedge and Capkeeper are trademarks of Velvac, Inc.*



MIRRORS 3-35

Table of Contents	PAGE
West Coast Mirrors	3
Blind Spot Convex Mirrors	6
Accessory Mirrors	9
Wide Angle Mirrors	10
Hood Mount Mirrors	11
Rear Cross View Mirror Systems	13
Van and Cab Chassis Mirrors	15
Truck and Tractor Mirrors	16
Walk-in Van Mirrors	17
2020 Van and Cab Chassis Mirrors	18
2020 Mirror Replacement Parts	25
Class A RV, Bus and Truck Mirrors	26
Safety Mirrors	28
Brackets, Clamps and Accessories	30
Camera and Observation Systems	33

VELVAC Original Indicates an original Velvac product.

NEW Indicates a new product added to catalog.

Revised Part No. Indicates a revised part number defining “-xx” package quantity.
Refer to price list for price per package.

For quantity and packaging information, refer to our price list.

Customer Service: 800.783.8871
Fax: 262.786.4101
Email: sales@velvac.com



NOTE: The information and photographs in this catalog are believed to be accurate and factual as of the print date. Velvac assumes no responsibility for information that may be incorrect or has changed since press time. Product specifications and offerings subject to change without notice.

Velvac, DuraBall, K-10, Eyeball, and Wall-Eye are registered trademarks of Velvac, Inc. Plexiglas is a registered trademark of Evonik Industries. Aero-Bell, ALL STAR, ClearCam, Mod Pod, Revolution, RXV, Superstar, Top Hat, V-MAX, V-MAX III, and Wedge are trademarks of Velvac, Inc.



Velvac's 2010 West Coast Mirror Offers the Widest Viewing Area Available!

- Larger glass 2010 mirrors feature over 106 square inch viewing area
- Designed to fit any standard 17-1/2" span loop
- Replaceable 1/8" FSC mirror glass
- 4 amp, temperature-controlled heating element provides quick, even defrosting and prevents mirror glass from overheating
- Polished 300 series stainless steel outer shell and heavy-duty ABS plastic inner housing combine to ensure durability and good looks
- Optional marker light provides additional safety by indicating the widest point of the vehicle to oncoming drivers
- Mounting hardware included

Motorized 2010 Mirror features

- Heavy-duty, 1.5 RPM motor for fast smooth adjustments
- Sealed motor housing for protection against moisture and contaminants
- Automatic slip clutch for manual adjustments without gear damage
- Interchangeable wire harness for convenient retrofitting



Part No.	Description
REPLACEMENT PARTS	
708309	Heated Glass w/ Bezel
709329	Motor
747386	Lighted Heater Switch
747387	Momentary Motor Switch
747451	4 Conductor Harness 124"

Left Side Part No.	Right Side Part No.	Description
MIRRORS WITH 10' WIRE HARNESS AND HEATER SWITCH*		
(*Motorized models also include a momentary motor switch)		
708209	708210	Heated and Manual
708211	708212	Heated and Motorized
708369	708368	Heated, Motorized and Lighted
MIRRORS WITHOUT HARNESS OR SWITCHES		
708209-4	—	Heated and Manual
708211-4	708212-4	Heated and Motorized

7" x 16" V-back Mirrors

- Popular V-back design available in three different versions to meet all customer requirements and price points
- Over 96 square inches of viewing area
- Available in both stainless steel and painted versions, all with 5/16" hardware



VELVAC Original



BEST- OEM Mirror

Better

Good

APPLICATIONS

Popular replacement mirror for many OE applications

Cost effective version of OEM mirror

Cost effective mirror for high replacement application

CONSTRUCTION

HD support bands and gasket surround the front surface chrome glass for added strength and durability

Gasket surrounds silvered glass for durability and edge shock protection. Front surface chrome glass used on heated mirrors

Gasket surrounds silvered glass for durability and edge shock protection

GLASS

Replaceable

Replaceable

Not replaceable

PAINTED FINISH

Powder coated to meet OEM requirements

Powder Coated to meet OEM requirements

Standard painted finish

HARDWARE

All stainless steel hardware

Plated hardware

Plated hardware

PACKAGING

Individually packaged in plain box

Individually Packaged in display box

Ind. Packaged in display box

Description	Part No.	Part No.	Part No.
Black	—	708001	705114
Black Heated	—	—	705115
White	708020	708003	705116
Stainless Steel	708022	708005	705112
Stainless Steel Heated	708046	708008	705113

REPLACEMENT PARTS

Glass, non-heated	702042	702044	—
Glass, heated	702047	702045	—

Navistar/International West Coast Mirror



NEW

- OEM replacement mirror fits International S-series and other trucks
- 7" x 16" aluminum housing - heated and non heated versions available
- Non-heated version fits left or right sides of the vehicle
- Order 713198 AL loop and brkt kit separately to replace existing OE mtg

Part No.	Description	Fleetrite Part No.	Navistar Part No.	Cham-Cal Part No.
708335	Non-Heated Mirror	MIR4070	1657021C91 1657048C91	20000
708336	Htd Mirror, Right	MIR4071	1667899C91	20090
708337	Htd Mirror, Left	MIR4074	1669515C91	20080
713198	Loop and bracket Assembly			

International style plug

West Coast Mirrors

- Quality West Coast Mirrors for new vehicle installation, replacement and retrofit
- Designed with 1/8" silvered glass and 5/16" - 18 plated hardware - mounting fasteners are included
- All West Coast mirrors are packaged in a display box except the Economy Angle Back mirrors



Angle Back Round Corner - Full Flat or Split Glass

Angle Back Square Corner



Pillow Back

Rib Back

Economy Angle Back - Full Flat or Split Glass

Flat Glass / Convex Glass

Part No.	Size	Description	Finish	Area Square-Inches
ANGLE BACK - ROUND CORNER				
705333	7" x 16"	Standard Glass	Polished SS	93
705335	7" x 16"	Heated Glass	Polished SS	93
708331	7" x 16"	Heated w/ Marker Light	Polished SS	93
708334	7" x 16"	Split Glass	Polished SS	64 Flat / 26 Convex
ANGLE BACK - SQUARE CORNER				
708526	7" x 16"	Standard Glass	Polished SS	99
708525	7" x 16"	Heated Glass	Polished SS	99
705332	7" x 16"	Heated w/ Marker Light	Polished SS	99
705108	6.5" x 16"	Standard Glass	Polished SS	84
PILLOW BACK				
705101	6.5" x 16"	Standard Glass	Black	81
705102	6.5" x 16"	Standard Glass	Polished SS	81
705103	6.5" x 16"	Standard Glass	White	81
RIB BACK				
705104	6.5" x 16"	Standard Glass	Black	88
705117	6.5" x 16"	Heated Glass	Black	88
705105	6.5" x 16"	Standard Glass	White	88
ALUMINUM ECONOMY ANGLE BACK				
705038*	6" x 16"	Standard Glass	Aluminum	94
705107*	6" x 16"	Split Glass	Aluminum	66 Flat / 21 Convex
705111**	6" x 16"	Standard Glass	Aluminum	94

*705038, 705107 have black plastic end caps. **705111 has heavy duty metal end caps for added strength.

Velvac offers a wide variety of convex mirrors including DuraBall®, K-10® Eyeball®, Three Screw Ball Stud and specialty convex. These mirrors are available in several finishes and materials including stainless steel, chrome, powder coat and painted. Standard convex, heated convex and Wide View lenses provide the right mirror for all your blind spot or cross view applications.

DuraBall® Convex



8.5" diameter



6" diameter



5" diameter

VELVAC
Original



8.5" diameter



10" diameter

Wide View

- Velvac's DuraBall® mirror and pivot system features a HD nylon inner and outer ball with stainless bolt and locking "L" bracket for easy mounting and operation
- Heavy gage stainless steel or powder coated galvanized steel construction protects mirrors against corrosion
- Rolled edge on 5" and 8.5" diameter mirrors - outer gasket on 6" diameter mirrors
- Available in popular 10", 8.5", 6" and 5" diameters with several lens options. 8.5" is also available with center mount or offset mount
- Designed for long lasting operation. DuraBall mirrors are guaranteed against shell cracking and breaking for 5 years
- Mirrors other than Wide View include mounting "L" bracket or tube bracket, mounting hardware and come in an attractive display box

Three Screw and Specialty Convex Mirror



8.5" diameter



7.5" diameter



8.5" diameter
Part No. 708558



5" and 6" diameter

- Three screw ball stud offers secure mounting and easy adjustment
- Available in high luster stainless steel, chrome plated steel or painted steel finishes
- 8.5", 7.5", 6" and 5" diameters with standard convex and heated options. 8.5" and 7.5" are also available either center mount or offset mount
- Includes mounting "L" bracket, mounting hardware and comes in an attractive open display box
- 708558 convex features high luster chrome plated stainless steel shell and heavy duty nylon ball stud, bracket not included

DuraBall®, Eyeball® and K-10® are registered trademarks of Velvac, Inc.



BLIND SPOT CONVEX MIRRORS (cont.)

DuraBall



8.5" diameter



8.5" diameter



8.5" Wide View

Three Screw Ball Stud / Specialty Convex



7.5" diameter



8.5" diameter

Finish

Lens Option

Lens Option

	Standard	Heated Glass	Wide View Convex	Standard Glass	Heated Glass
10" CENTER MOUNT			Plexiglas® Lens		
Stainless Steel			709218		
Black			709216		
White			709217		
Post Office White			709226		
8.5" CENTER MOUNT					
Stainless Steel	708441	708453	708448	708501	708559
Black	708442	708455	708449	708503	
White			708450		
Post Office White			708463		
Chrome				708556	
Chrome Plated Stainless				708558 *	
8.5" OFFSET MOUNT					
Stainless Steel	708444	708457		708502	708560
Black	708446			708504	
Chrome				708557	
7.5" CENTER MOUNT					
Stainless Steel				708508	
Black				708510	
Chrome				708554	
7.5" OFFSET MOUNT					
Stainless Steel				708509	
Black				708511	
Chrome				708555	
6" CENTER MOUNT					
Stainless Steel	708478			708515	
SS with Tube Bracket**	708476				
Black	708479			708516	
Chrome				708553	
5" CENTER MOUNT					
Stainless Steel	708470			708520	
Stainless Steel-Flat Glass	708473			708514	
Black				708521	
Black - Flat Glass				708513	
Chrome				708552	
Chrome ABS				708551	

Helpful Hint:

Mirror head diameter and ROC (Radius of Curvature) help determine field of view coverage and image size provided by the convex mirror. Wide View convex mirrors are typically used for front and rear cross view applications where a wide field of view is desired. Standard convex mirrors are used for viewing targeted blind spots or passing lanes around the vehicle

Description	ROC
10" Wide View	8.5"
8.5" Wide View	5.5"
6" DuraBall	14"
5" DuraBall	10"
All other convex	13"

*Heavy Duty Nylon Ball Stud see page 6

**Stainless Steel tube bracket and clamp kit part No. 723057 also shown on page 30

NOTE: Plexiglas® is shatter resistant

***Plexiglas® is a registered trademark of Evonik Industries



ACCESSORY MIRRORS

The Wedge™ Stick-On Convex Mirror

NEW



- Unique wedge design provides more usable viewing area/larger image size than conventional stick on mirrors
- Universal design permits use on both driver and passenger mirrors
- Black plastic shell with rounded corners gives mirror a "built-in" look
- 3.25" overall size with 8.5 ROC
- Mounts easily and securely using attached adhesive pad

Part No.	Description
723068	Wedge Stick-on Mirror
723068-6	50 Pack Wedge Mirror

Stick-On Convex Spot Mirrors



- Lightweight aluminum shell
- Mount easily and securely using attached adhesive pad
- Attractive packaging displays easily on pegboards or wire display racks (See page 141 for wire display rack Part No. 091256)

Part No.	Size	ROC
723050*	2" Round	4.5"
723060	3" Round	4.5"
723065	3.75" Round	4.5"
723075	4" x 5.5" Rectangle	8.5"

* Order 723050-4 for a (12) pack

HHR Spotter Mirror

NEW



- Reduce blind spots on GM HHR
- Mounts directly to OE side mirrors*
- Lower portion of flat glass is open for passing lane viewing
- Size is approx 2.5" x 3.25" with 7.3 sq. in. viewing area, 8.5" ROC

Part No.	Description
718394-5	Pair - Right & Left Side
718392-5	Right Side Mirror
718393-5	Left Side Mirror

*Other applications include van, pickup and SUV mirrors

Interior Rearview Mirror



- Glass measures 9" x 2"
- Day/Night feature reduces night driving glare
- Dual ball joint adjustment
- Textured black housing
- Mounting pad and adhesive sold separately as mirror mounting kit
- Rearview mirror will fit on flange type mounting pads up to .90 wide

Part No.	Description
723095	Rearview Mirror
723097	Mirror Mounting Kit

Over Door Convex Mirror



- Mounts above exterior passenger side window for greater blind spot visibility
- Used as an accessory mirror on heavy trucks for better viewing directly below "peek-a-boo" window
- 4" x 8" convex mirror - 12"ROC
- Assembly includes stainless steel mirror head with mounting bracket

Part No.	Description
715198	Over Door Convex Mirror

Universal Strap-On/Off Mirrors



- Universal design fits either driver or passenger side mirrors on most vehicles
- Durable black mirrors strap quickly and securely to existing mirror for extended view around wide loads
- No tools required

Part No.	Description
715203	Strap-On Towing Mirror 5" x 7.5" mirror head

7.5" x 10.5" Camper Style Mirror Head

NEW



- Camper style mirror head for use on GM low mount van and cutaway mirror systems
- Direct replacement for Delbar HR-1164
- Stainless steel construction
- 63 square inch flat glass area
- Complete with 3/8" - 16 x 2.25" mounting bolt and hardware

Part No.	Description
716138-5	7.5" x 10.5" Camper Style

7.5" x 10.5" Center Bracket Flat Glass Mirror Heads



- Over 63 sq. in. viewing area
- 1/8" FSC glass
- Rolled edge design holds glass and gasket securely in place
- Mirror glass NOT replaceable

Part No.	Description
709002	Stainless Steel
709006	Stainless/Heated
709275	Flat Black
709276	White

800-783-8871

*The Wedge™ is a trademark of Velvac, Inc

www.velvac.com

Side Mount Wide Angle Mirror Heads



- The original Velvac wide angle mirror head for use on walk in van, cutaway van, cab chassis and a variety of other applications
- 5/16" - 18 threaded mounting port for a clean, easy installation. Use with mounting clamp 704068 on page 31
- 1/8" replaceable FSC glass on all flat glass models except UPS brown which is silvered. Silvered glass on all convex

6.5" x 6" Flat Glass

- Viewing Area 32 sq. in.



6.5" x 10" Flat Glass

- Viewing Area 55 sq. in.



6.5" x 6" Convex

- Viewing Area 32 sq. in.
- 21" ROC



Finish	Part No.	Glass	Gasket	Part No.	Glass	Gasket	Part No.	Glass	Gasket
STEEL									
Stainless	704093	702051	703005	709091	702076	703007	704095	702023	703005
Stainless - Heat	—	—	—	704325	702076	703007	704315	702023	703005
White	704078	702051	703005	704032	702076	703007	704077	702023	703005
PLASTIC									
White	704178-5	702051	703101	704132-5	702076	703102	704177-5	702057	703101
PO White	—	—	—	704122	702076	703102	704120	704121	703101
UPS Brown	704158	702051	703103	704154	702076	703104	704155	702057	703103
Black	704159	—	703103	704152-5	702076	703104	704153-5	702057	703103

Stud Mount Mirror Heads

- Center mount wide angle mirror heads feature Velvac's DuraBall nylon ball stud for superior strength and durability (see page 6 for DuraBall information)
- 5/16" - 18 mounting stud. Use with mounting clamp 704068 on page 31
- 1/8" replaceable FSC glass on flat glass models, 1/8" silvered glass on convex mirrors



6.5" x 6" Convex

- Viewing Area 32 sq. in.
- 21" ROC



6.5" x 10" Flat Glass

- Viewing Area 55 sq. in.



**Shatter Resistant
6.5" x 10" Convex**

- Viewing Area 55 sq. in.
- 40" ROC, shatter resistant backing on glass



Finish	Part No.	Glass	Gasket	Part No.	Glass	Gasket	Part No.	Glass	Gasket
Stainless	708156	702023	703006	708181	702076	703008	708198-5	702098-5	703008
White	—	—	—	—	—	—	708176-5	702098-5	703007
Ford White	704280	702023	703005	704268	702076	703007	—	—	—
Black	—	—	—	—	—	—	708197-5	702098-5	703008

Velvac's Mod Pod™ and K-10 Version-2 Hood Mount Assemblies







NEW

The popular Velvac Mod Pod and K-10 Version-2 (V-2) mirror systems incorporate a lock down feature that offers superior stability and easy adjustments. To position the mirror, simply loosen the set screw with a 5/32" allen wrench, lift and rotate the mirror arm into proper viewing or fold back position then retighten the set screw. Precision gears set at 12 degree intervals ensures a perfect view every time!

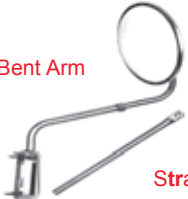

- Aerodynamic design - corrosion resistant stainless steel tubing brackets with chrome-plated die cast mounting base for long lasting attractive appearance
- (4) 1/4" - 20 mounting studs are factory assembled to the base for easy installation on either conventional or COE trucks
- Velvac Mod Pod mirror kits features Velvac's 8.5" DuraBall with nylon ball joint system, so superior it is guaranteed for five years against cracking or breaking (see page 6 and 7 for details)
- K-10 V-2 mirror kits feature an 8.5" Eyeball convex mirror (see page 8 for details)

Mod Pod™ is a trademark of Velvac, Inc.

	Description	VELVAC			K-10		
		Bracket Only	Kit w/8.5" DuraBall Convex	Kit w/8.5" DuraBall Wide View	Bracket Only	Kit w/8.5" Eyeball Mirror	Kit w/8.5" K-10 Convex
 	UNIVERSAL ADJUSTABLE						
	Kit with bent and straight arms	714622	714620	714621	—	—	—
	Kit with straight arm only	—	—	—	714646 (512929-V2)	—	—
	Kit with bent arm only	—	—	—	714647 (512659-V2)	716915 (V2659-50)	716914 (V2659-08)
	FIXED ARM DUAL VIEW						
	Right Side	714630	714626	714628	714648 (512658-V2)	716913 (V2658-50)	—
	Left Side	714631	714627	714629	715529 (512657-V3)	716922 (V2657-50)	—
	FIXED ARM SIDE VIEW						
	Lane Change	714625	714623	714624	—	—	—
	K-10 Slant Arm	—	—	—	714649 (512661-V2)	716917 (V2661-50)	716916 (V2661-08)
	K-10 Angle Arm	—	—	—	715620 (512662-V2)	716919 (V2662-50)	716918 (V2662-08)

For K-10 numbers order by Velvac Part Number

(K-10 Part No.)



HOOD MOUNT MIRRORS (cont.)

Velvac offers a full line of standard and short arm adjustable tripod mirror models to meet the needs of any vehicle or application. From our unique stylized Aero-Bell to our value tripod, we have the right mirror for your truck.

Aero-Bell™ Tripod



- Stylized single piece chrome plated ABS bells and molded nylon clamps help conceal hardware giving the mirror a clean, aerodynamic appearance
- Corrosion resistant materials eliminate rust keeping the mirror and truck looking great



Velvac Tripod



- All stainless steel construction and hardware
- Standard tripod for use on traditional hood styles - short tripod for slope nosed vehicles with shorter hoods

Value Tripod

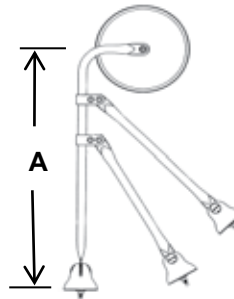

- All stainless steel construction with plated hardware
- Adjustable tripod fits most hood / fender applications

Product Specifications

Description	Aero - Bell Tripod	Velvac Tripod	Value Tripod
Tubing Braces	SS	SS	SS
Convex Mirror Head	8.5" SS DuraBall	8.5" SS DuraBall	8.5" SS Three Screw
Mounting Bells	Molded/Chrome Plate ABS	SS	SS
Tube Clamps	Molded Black Nylon	SS	SS
Hardware	SS	SS	Plated
Packaging	Display Box	Display Box	Plain Box

Standard Tripod

	Part No.	Dim "A"	Part No.	Dim "A"	Part No.	Dim "A"
Mirror and Bracket Kit	715150	21" to 32.75"	713444	21"-32.75"	715779	26" to 35"
Bracket Kit Only - head not included			713445		715778	

Short Tripod

Mirror and Bracket Kit	715148	17.5" to 24.5"	714721	17.5" to 24.5"
Bracket Kit Only - head not included			714720	



Fixed Arm Mirror / Bracket

Columbia & Century	715168	20.35"
Freightliner - FLD	715166	23.55"

Straight Van Chassis Applications

NEW

- Kits include mirror head, bracket and stainless steel mounting hardware
- Assemblies include either a Velvac 8.5" Wide View convex or an 8.5" K-10 Eyeball convex mirror

Vehicle	Finish-Head & Bracket	VELVAC		K-10 MIRRORS		
		Bracket/8.5" Wide View Convex	Bracket Only	Bracket/8.5" Eyeball Convex	Bracket Only	
Tripod Kits 	1992 and newer Ford E-Van	White	713120	713118	-	-
		SS	713121	713119	716908 <i>512648-50S</i>	713204 <i>512648</i>
	1997 and newer GM G Van	White	713796	-	-	-
		SS	713798	-	716909 <i>513993-50S</i>	713993 <i>513993</i>
Dodge & older GM & Ford Vans	White	712639	-	716929 <i>512646-50S</i>	712646 <i>512646</i>	
	SS	712640	712638	-	-	
	Sprinter Van	SS Brkt w/blk 10" ABS	-	-	716902 <i>512650SP-10ABS</i>	-

Walk-in Van Bodies

- Universal mounting bracket fits walk-in vans and vehicles with flat mounting surfaces
- Kits include mirror head, reinforced 3/4" O.D. tubing arm, heavy-duty mounting brackets and SS hardware
- Assemblies include either a 10" Velvac Wide View convex or a 10" K-10 Eyeball convex mirror.

Rear Van Door Styles



Roll-up Narrow



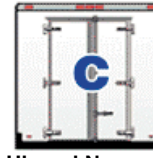

Roll-up Full

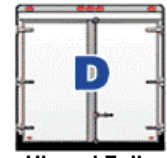

Hinged Narrow

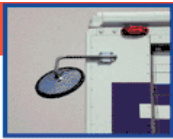

Hinged Full

Rear Door Style	Finish-Head & Bracket	VELVAC		K-10 MIRRORS NEW		
		Bracket/8.5" Wide View Convex	Bracket ONLY	Bracket/8.5" Eyeball	Bracket ONLY	
Rear Panel Standard Mount 	A or C	White	712644	712642	-	-
	A or C	SS	712643	712641	716906 <i>(512650SP-10ABS)</i>	712647 <i>(512647)</i>
Rear Panel Breakaway Mount 	A or C	SS			716907 <i>(512647-10S)</i>	713752 <i>(512647-2)</i>
Side Panel Mount 	D	SS			716903 <i>(512650SP-10S)</i>	715101 <i>(512650-SP)</i>
	D	SS with Blk ABS			716902 <i>(512650SP-10ABS)</i>	715101 <i>(512650-SP)</i>



REAR CROSS VIEW MIRROR SYSTEMS (cont.)

RXV™/Corner Rotator

NEW

- Designed to mount easily to structural rear corner of walk-in van or high cube bodies - fits on 90° corner with up to 1.5" radius
- Includes factory assembled spring loaded bracket with Velvac 10" Wide View or K-10 Eyeball convex mirror head
- Mirrors are designed to fold away either to the side or rear and can be rotated back to the preset viewing position



RXV /Corner Rotator

VELVAC				K-10 MIRRORS	
Rear Door Style	Finish-Head & Bracket	Bracket/10" Wide View Convex	Bracket Only	Bracket/10" Eyeball	Bracket Only
A,B or C	White	715213	-	-	-
A,B or C	SS	715212	-	716901 (512651-10S)	714403 (512651)
A,B or C	SS w/ blk ABS Head	-	-	716900 (512651-10ABS)	714403 (512651)

RXV™ is a tradename of Velvac, Inc.

VAN AND CAB CHASSIS MIRRORS

- Universal van and pick-up mirrors are designed to fit various straight van, cutaway van and pick-up truck bodies - single adjusting leg allows bracket to be properly oriented on different model doors
- Other assemblies shown below feature fixed 3/4" tubing brackets designed for specific vehicle types and provides a custom fit for those specified vehicles and applications
- Retractable mirrors can be folded away for storage or upon impact and then returned to the preset viewing position

Universal Van and Pick-Up Truck



Retractable

Part No.	Finish	Bracket Style	Body Type Width	Vehicles
714673	SS	Retractable	Straight Van	Ford E Van, GM G Van and Dodge Ram Van
714675	SS	Non Retractable	96" Cutaway	
714672	SS	Retractable	Pick-Up	Older model GM Silverado, Ford F Series and Dodge Ram Truck
714674	SS	Non Retractable	96" Cab Chassis	

Non-Retractable

Wide Body Cutaway Van



Part No.	Finish	Bracket Style	Body Type Width	Vehicles
713786	SS	Non Retractable	96" Cutaway	1997 & Newer GM G Van
713785	White	Non Retractable	96" Cutaway	
713113	SS	Non Retractable	96" Cutaway	1992 & Newer Ford E Van
713787	White	Non Retractable	96" Cutaway	

Straight Van



Part No.	Finish	Bracket Style	Body Type Width	Vehicles
713104	SS	Retractable	Straight Van	1992 & Newer Ford E Van
713105	White	Retractable	Straight Van	
713789	SS	Retractable	Straight Van	1997 & Newer GM G Van
713787	White	Retractable	Straight Van	

Wide Body



Part No.	Finish	Bracket Style	Body Type Width	Vehicles
713407	SS	Retractable	96" Cutaway Van	1980 - 1997 Ford E Van
712908	SS	Retractable	96" Cab Chassis	1987 - 1998 GM CK Truck

Part No. 713407

www.velvac.com



VAN AND CAB CHASSIS MIRRORS

Sprinter Van Body Mirror

- Powder coated loop and cast mounting ends fit directly into older OE mounting base (not included)
- Includes 6/5" x 10" upper flat glass head and 6.5" x 6" lower convex
- For use up to 86" wide body applications

NOTE : For Sprinter rear cross view mirror see page 13



Part No.	Application	Description	Finish
715407	Sprinter	Complete Pair	Black
Q781280		Loop with mounting ends	Black

Universal Low Mount Mirror System and Accessories

- Low mount mirror kit includes SS bracket system, solid SS elbow and 7.5" x 10.5" mirror head
- Wide angle conversion kit includes 6.5" x 6" convex and SS tube support for blind spot viewing
- Mirror heads provide over 63 square inches of flat viewing area. (See page 9 for more information)



Low mount Mirror Kit



Part No. 712245

Part No.	Description	Finish
712479	Low mount Mirror Kit -Brkt, Head Elbow - Pair	SS
748216	Replacement Elbow	SS
712245	Wide Angle Conversion Kit - One Side	SS

Door / Fender Mirror System

- Complete kit includes one door mount head / bracket and one fender mount head / bracket
- All stainless steel construction



Fender Mount Assembly



Door Mount Assembly

Part No.	Description
713883	1997 and Newer GM G Van - Door / Fender - Complete Pair
713154	1992 and Newer Ford E Van - Door / Fender - Complete Pair

Colorado Canyon Pickup Mirrors

NEW

Wide Body Mirror for Chevy Colorado and GMC Canyon Pick-Up Truck Chassis

- Provides views around 78" bodies to increase driver safety with enhanced view of passing lanes and blind spots
- Large 11.10 square inch convex with 12.5" ROC targets blind spots
- 56.62 square inch flat glass area
- Mirrors fold forward and back for easy storage
- Black finish for OE appearance



Part No.	Description
715885	Complete Pair
715886	Right Side Mirror
715887	Left Side Mirror
715888	Right Side Mirror Head with Convex
715889	Left Side Mirror Head with Convex
723106	Right Side Convex
723107	Left Side Convex
702086	Flat Glass Kit

* SS = Stainless Steel



TRUCK AND TRACTOR MIRRORS

Truck and Tractor Mirrors

- Versatile head and loop assembly for flat side mounting on fire trucks and other specialty vehicles
- Bracket mounting span of 31.5" x 8.18" from body leg length
- All stainless steel construction with preset pivot breakaway system



NOTE: See catalog page 3 for more information on motorized mirror head. See page 4 for OE V-back West Coast.

Part No.	Description	Finish	Upper Head	Lower Head
713760	Complete Pair	Stainless Steel	8" x 16" motorized heated West Coast Mirror	6.5" x 6" convex
713769	Complete Pair	Stainless Steel	7" x 16" OE V-back West Coast Mirror	6.5" x 6" convex
713759	Replacement loop bracket, Mounting feet and hardware	Stainless Steel	N/A	N/A

Universal Bracket Kit and Head / Loop System

- Universal SS bracket kit is fully adjustable to fit a variety of conventional straight truck and tractor doors, extends out a maximum of 20" from door
- Use head and loop assemblies in combination with universal bracket kit to produce a complete major system for conventional truck and tractors - loop span is 17.56"
- All kits shown below are packaged as pairs. Loop and clamp kits include both short clamps for use with split wide angle heads and long clamps for West Coast heads



Conventional Tractor Bracket Kit



Split Head*



West Coast **

Part No.	Description	Finish	Upper Head	Lower Head
700064	Universal conventional tractor bracket kit	Stainless Steel	N/A	N/A
701001	Head and loop - split head	White	6.5" x 10"	6.5" x 6"
701006	Head and loop - split head	Stainless Steel	6.5" x 10"	6.5" x 6"
701050	Head and loop - West Coast	White	7" x 16"	N/A
701054	Head and loop - West Coast	Stainless Steel	7" x 16"	N/A
701071	Loop and clamp kit	White	N/A	N/A
701072	Loop and clamp kit	Stainless Steel	N/A	N/A

*See page 10 for replacement mirror heads

**See page 5 for replacement mirror heads

Walk-In Van Mirrors

- Universal mirrors include an adjustable loop mounting bracket and will fit most walk-in van applications
- Fixed custom mirrors include a fixed loop bracket for specific mounting applications
- All mirrors include 6.5" x 10" upper flat glass head and 6.5" x 6" lower convex



Fixed Custom



Universal Adjustable Loop

Part No.	Application	Description	Finish	Mounting Centers	Loop Leg Length
Universal					
721090	Various	Complete Pair	Stainless Steel	22" to 36.5"	8"
721092	Various	Loop and brackets	Stainless Steel	22" to 36.5"	8"
Fixed Custom					
712323	Grumman (Morgan) Utilimaster	Complete Pair	Stainless Steel	30.57"	10.50"
713404	Utilimaster	Complete Pair	Stainless Steel	33.33"	11.69"
724007	Various	Complete Pair	Stainless Steel	30.37"	10.42"
724008	Various	Complete Pair	Stainless Steel	33"	8"
727067	Various	Complete Pair	White	33"	8"

United States Post Office Mirrors

NOTE: All UPSP Mirrors are manufactured to UPSP OE requirements and are USPS White



Front Cross view



Side Mirror

VELVAC Original



Rear Cross View

Replacement Flat

Replacement Convex

LLV Mirrors	Kit Part No.	Mirror Head	Dimension	Mirror Head	Dimension
Right Side Mirror	712896	704122	6.5" x 10"	704120	6.5" x 6"
Left Side Mirror	712897	704122	6.5" x 10"	704120	6.5" x 6"
Front Cross View Mirror	712898	—	—	723103	8" diameter
Rear Cross View Mirror	712900	—	—	709226	10" diameter

CRV Mirrors

Right Side Mirror	714782	704122	704120	6.5" x 6"
Left Side Mirror	714783	704122	704120	6.5" x 6"
Front Cross View Mirror	714784	—	723103	8" diameter
Rear Cross View Mirror	714785	—	709226	10" diameter

Other USPS Mirrors

Rear Cross View Mirror	714146	(Ford Aerostar)	708463	8.5" diameter
Rear Cross View Mirror	714147	(Ford Windstar)	708463	8.5" diameter
Rear Cross View Mirror	715786	(Dodge Caravan)	708463	8.5" diameter



2020 VAN AND CAB CHASSIS MIRRORS

Velvac's 2020 and 2020XG family of mirrors feature OE fit and styling, and provide outstanding visibility of passing lanes and blind spots areas around the vehicle making them the industry standard for wide body cutaway van and truck cab chassis applications. These mirrors mount directly to the OE sail area on the door for clean and easy installation. The modular design allows a single mirror style to be used across multiple van and truck platforms making them perfect for all OE and fleet applications.

In addition to the original 2020 mirrors, Velvac now offers a new 2020 Mini-LEM system with integrated camera options and our new 2020XG - the next generation in wide body mirror technology

Model 2020 Mirror System

Model 2020 mirrors are designed specifically for wide body applications such as high cube cutaway vans, rental trucks, Class C RV's and ambulances. The fixed length arms are designed to position the mirror beyond the body providing the driver with an unobstructed view of blind spots and passing lanes around the vehicle. These versatile mirrors are available in several body widths and finishes as well as manual or heated remote glass.

- Mirrors available for 86", 96" and 102" wide bodies
- Die cast arms and bases are e-coated and powder coated for corrosion resistance
- Available in black, white and black base/arm with chrome head
- Two mirror head options - **Standard** Head with lower Wedge convex - **Deluxe** Head with full width lower convex
- Fold away feature allows mirrors to fold forward and back for easy vehicle storage and protection against impacts



Unique pivot design



Standard Head



Deluxe Head

Model 2020 Mini-LEM Mirror System

Velvac has added the exclusive pre-positioned lower camera option to the 2020 mirror providing even greater coverage of the blind spot areas around the vehicle. These mirrors are available with either a black and white CCD camera or the featured CMOS color camera for even greater clarity and object detection.

- Camera image is reversed to provide a picture in the same orientation as the mirror image for seamless observation of blind spots and passing lanes
- CMOS color camera with infrared LED's provide greater image definition, truer colors and anti-blooming technology allowing drivers to quickly identify objects in a variety of light conditions
- Systems can be designed to integrate with back-up cameras for complete vehicle blind spot coverage. See catalog pages 33 and 34 for more information on Velvac's back-up cameras and CMOS camera technology



Mini-LEM Camera



2020 Mini-LEM with turn signal option in flat glass

A combination of styling, quality and performance make the 2020XG the new benchmark for wide body mirror systems. The fully integrated arm, base and mirror head not only look great, but work together as a system to reduce vibration, and provide large, clear views of the blind spots and passing lanes around the vehicle. Since these mirrors are designed specifically for 96" and 102" wide bodies, they provide a complete vision solution without the compromises found in many OE mirror offerings available today.

Model 2020XG Mirror Systems

Style/Value

- Fully integrated base, arm and mirror head for a clean OEM look
- "Swept back" design prepositions the mirror in the optimal location- no head adjustment necessary
- Stylized mirror base fits directly in the OEM "sail area" mounting holes
- Rigid design for better stability and image clarity
- Easily replaceable mirror head, glass and arm components help reduce downtime and service costs

Quality

- Die cast aluminum mounting base and upper arm are e-coated and powder coated for corrosion protection
- OE-approved plastic mirror shell and lower arm deliver durability and UV resistance
- Pivot system allows the mirror to be folded forward or back upon impact and returned easily to the normal driving position

Increased safety

- Advanced vibration dampening in mirror head keeps image steady even on rough road surfaces
- 63 sq. in. flat glass and 29.5 sq. in. convex glass with 18" radius of curvature provides great visibility of the passing lanes and blind spots around the vehicle



Field of View Coverage

Field of view diagram shows the superior vision and blind spot coverage provided by Velvac 2020 and 2020XG mirrors relative to typical OE mirrors used on a wide body applications. Velvac's 2020 and 2020XG mirrors can help to reduce blind spots and provide visibility of multiple passing lanes around the vehicle leading to better driving decisions and the reduction of costly accidents.

Most cutaway van and cab chassis OE mirrors are not designed for body widths that extend beyond 96 & 102 inches. Misuse of these narrow OE mirrors leads to obstructed views and dangerous blind spots and may not fully meet all DOT mirror requirements based on these applications.

Be confident that your wide body vehicle meets or exceeds FMVSS 111 requirements for Rear View Mirrors-

USE OR SPECIFY VELVAC 2020, 2020 MINI-LEM or 2020XG MIRRORS

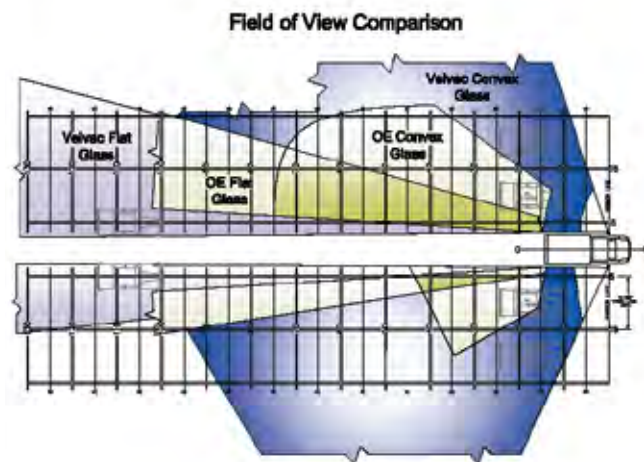

FOV coverage- Velvac (blue), OE (amber)

Information shown above represents a typical vision pattern when using Velvac 2020 or 2020XG mirrors compared to a typical OE option mirror



2020 VAN AND CAB CHASSIS MIRRORS (cont.)

Model 2020 and 2020XG Mirrors



Standard w/
Wedge
Convex



Deluxe w/ Full Convex



Camera



XG

	Model 2020	Model 2020 Mini-LEM	Model 2020 XG
Vehicle Applications	Ford E Van, GM G Van, GM 3500, Ford Superduty and 650 / 750	Ford E Van, GM G Van, GM 3500, Ford Superduty and 650 / 750	Ford E Van, GM G Van, GM 3500, Ford Superduty and 650 / 750
Standard Body Widths	78", 86", 96", 102"	86", 96", 102"	96", 102"
Finishes	White, Black, Black Arm & Base with Chrome Head	White, Black or Black Arm & Base with Chrome Head	White, Black or Black Arm & Base with Chrome Head
Head Styles Available	Standard and Deluxe	Deluxe	Integrated 2020 Head
Flat Glass	Standard 57 sq inch Deluxe 62 sq inch	62 sq inch	64 sq inch
Convex Glass	Wedge 10 sq inch 8" ROC Full Convex 30 sq inch 12" ROC	30 sq inches - 12" ROC	29 sq inches - 18" ROC
Glass Options	Standard Head - Manual or Heated Remote Deluxe Head-Manual or Heated Remote Flat / Heated Convex	Manual or Heated Remote Flat / Heated Convex	Manual or Heated Remote Flat / Heated Convex
Light Options	Lighted Arm	Lighted Arm or Signal Arrow in Glass	Lighted Head and/or Signal Arrow in Glass
Camera Option		Color or Black and White	

OEM OPTION CODES

Chassis	Option Code	Option Type	Mirror Type	Mirror Information
GM 610 Van	DHC	RPO	96" Black Manual 2020	Mirrors shipped in vehicle by GM
	6M2	SEO	78" Black Manual 2020	
C4500/ C5500	D28	SEO	Deletes OE Manual Mirror	Order a 2020, Mini-LEM or 2020XG mirror from Velvac- refer to information within this catalog for options and part numbers. Motorized mirrors are supplied with mirror and heater switch kit.
	D28 + CQ2	SEO	Deletes OE Motorized Mir	
Ford E-Series "SD" Cutaway	54F	RPO	Mirror Delete	
	54F + 903 + TBD (VSO)	Requires VSO Code	Mirror Delete with VSO Power Mirror Prep Package	Same as 54F except vehicle now comes equipped with Ford OEM motorized mirror four-way controls switch. Then contact Velvac for special mirror designed for Ford switch and harness*

* Need to submit inquiry to Ford for VSO option package

2003 and Newer Ford E Van Mirror Application Chart

NEW

Color	Body Width	Head Type*	Flt* Gls	Cx* Gls	Option*	2020 Mirror System			2020 Mini-LEM System with Color Camera			2020XG Mirror System ALL w/ 2020XG heads				
						Pair**	Rt Side	Lft Side	Pair**	Rt Side	Lft Side	Pair**	Rt Side	Lft Side		
Black	86"	Std	M			715401	715402	715403								
		Std	H/R			715419	715420	715421								
	96"	Std	M				715404	715406	715405							
		Std	H/R				715422	715424	715423							
		Std	H/R			Ltd.	715455	715456	715457							
		Deluxe	M	M			715449	715450	715451	716593	716594	716595	715899	715900	715901	
		Deluxe	H/R	H/M						716605	716606	716607	715905	715906	715907	
		Deluxe	H/R	H/M	Ltd.		715437	715438	715439	716641	716642	716643	716346	716348	716347	
		Deluxe	H/R	H/M	SO					716623	716624	716625	716343	716344	716345	
		Deluxe	H/R	H/M	SO Ltd.					716659	716660	716661				
	102"	Std	M				715407	715408	715409							
		Std	H/R				715425	715426	715427							
		Std	H/R			Ltd.	715458	715460	715459							
		Deluxe	M	M			715452	715454	715453	716590	716592	716591	715923	715924	715925	
		Deluxe	H/R	H/M						716602	716604	716603	715929	715930	715931	
		Deluxe	H/R	H/M	Ltd.		715440	715442	715441	716638	716640	716639	716322	716324	716323	
		Deluxe	H/R	H/M	SO					716620	716622	716621	716319	716320	716321	
		Deluxe	H/R	H/M	SO Ltd.					716656	716658	716657				
	White	86"	Std	M			715410	715412	715411							
			Std	H/R			715428	715430	715429							
		96"	Std	M				715413	715414	715415						
			Std	H/R				715431	715432	715433						
			Deluxe	M	M						716599	716600	716601	715902	715904	715903
			Deluxe	H/R	H/M						716611	716612	716613	715908	715910	715909
Deluxe			H/R	H/M	Ltd.		715443	715444	715445	716647	716648	716649	716382	716384	716383	
Deluxe			H/R	H/M	SO					716629	716630	716631	716379	716380	716381	
Deluxe			H/R	H/M	SO Ltd.					716665	716666	716667				
102"			Std	M				715416	715418	715417						
		Std	H/R				715434	715436	715435							
		Deluxe	M	M						716596	716598	716597	715926	715928	715927	
		Deluxe	H/R	H/M						716608	716610	716609	715932	715934	715733	
		Deluxe	H/R	H/M	Ltd.		715446	715448	715447	716644	716646	716645	716370	716372	716371	
		Deluxe	H/R	H/M	SO					716626	716628	716627	716367	716368	716369	
		Deluxe	H/R	H/M	SO Ltd.					716662	716664	716663				
		Chrm Head w/ Black Arm and Base	96"	Deluxe	H/R	H/M					716617	716618	716619	715953	715954	715955
Deluxe				H/R	H/M	Ltd.				716653	716654	716655	716414	716416	716415	
Deluxe				H/R	H/M	SO					716635	716636	716637	716411	716412	716413
Deluxe				H/R	H/M	SO Ltd.					716671	716672	716673			
102"			Deluxe	H/R	H/M						716614	716616	716615	715971	715972	715973
			Deluxe	H/R	H/M	Ltd.					716650	716652	716651	716394	716396	716395
			Deluxe	H/R	H/M	SO					716632	716634	716633	716391	716392	716393
			Deluxe	H/R	H/M	SO Ltd.					716668	716670	716669			

* Key to Chart Abbreviations: Std = Standard, M = Manual, H/R = Heated Remote Control Adjustable Glass, H/M = Heated Manual, Ltd. = Lighted Arm (2020), Lighted Head (2020XG), SO = Signal Arrow in Glass, Flt = Flat, Cx = Convex

** All motorized mirror PAIRS include switches and wire harnesses. These items are NOT included when motorized mirrors are sold as sides. **NOTE:** 2020XG Chrome = chrome head with black arm and base

NOTE: Pre-2003 mirror service parts can be found on www.velvac.com by searching with a keyword "1992-2002 Ford"



2020 VAN AND CAB CHASSIS MIRRORS (cont.)

GMC Savana, Express Van and Topkick Medium Duty Truck



Color	Body Width	2020 Head Type*	Flt* Gls	Cx* Gls	Option*	2020 Mirror System			2020 Mini-LEM System with Color Camera			2020XG Mirror System ALL w/ 2020XG heads			
						Pair**	Rt Side	Lft Side	Pair**	Rt Side	Lft Side	Pair**	Rt Side	Lft Side	
Black	78"	Deluxe	M	M		718389-5	718390-5	718391-5							
		Std	M			714601	714602	714603							
	86"	Std	H/R				714604	714606	714605						
		Deluxe	M	M			714591	714592	714593						
		Std	M				714557	714558	714559						
	96"	Std	H/R				714563	714564	714565						
		Std	H/R			Ltd.	714569	714570	714571						
		Deluxe	M	M			714545	714546	714547	716707	716708	716709	715911	715912	715913
		Deluxe	H/R	H/M						716719	716720	716721	715917	715918	715919
		Deluxe	H/R	H/M	Ltd.		714551	714552	714553	716755	716756	716757	716352	716354	716353
		Deluxe	H/R	H/M	SO					716737	716738	716739	716349	716350	716351
		Deluxe	H/R	H/M	SO Ltd					716773	716774	716775			
	102"	Std	M				714560	714562	714561						
		Std	H/R				714566	714568	714567						
		Std	H/R			Ltd.	714572	714574	714573						
		Deluxe	M	M			714548	714550	714549	716704	716706	716705	715935	715936	715937
		Deluxe	H/R	H/M						716716	716718	716717	715941	715942	715943
		Deluxe	H/R	H/M	Ltd.		714554	714556	714555	716752	716754	716753	716328	716330	716329
		Deluxe	H/R	H/M	SO					716734	716736	716735	716325	716326	716327
	White	96"	Deluxe	H/R	H/M	SO Ltd				716770	716772	716771			
			Std	H/R				714916	714918	714917					
102"		Std	M				714910	714912	714911						
		Deluxe	M	M						716713	716714	716715	715914	715916	715915
		Deluxe	H/R	H/M						716725	716726	716727	715920	715922	715921
		Deluxe	H/R	H/M	Ltd.		714904	714906	714905	716761	716762	716763	716388	716390	716389
		Deluxe	H/R	H/M	SO					716743	716744	716745	716385	716386	716387
		Deluxe	H/R	H/M	SO Ltd					716779	716780	716781			
96"		Std	M				714913	714914	714915						
		Std	H/R				714919	714920	714921						
		Deluxe	M	M						716710	716712	716711	715938	715940	715939
		Deluxe	H/R	H/M						716722	716724	716723	715944	715946	715945
		Deluxe	H/R	H/M	Ltd.		714907	714908	714909	716758	716760	716759	716376	716378	716377
		Deluxe	H/R	H/M	SO					716740	716742	716741	716373	716374	716375
	Deluxe	H/R	H/M	SO Ltd					716776	716778	716777				
102"	Deluxe	H/R	H/M						716731	716732	716733	715962	715964	715963	
	Deluxe	H/R	H/M	Ltd.					716767	716768	716769	716420	716422	716421	
	Deluxe	H/R	H/M	SO					716749	716750	716751	716417	716418	716418	
	Deluxe	H/R	H/M	SO Ltd					716785	716786	716787				
	Deluxe	H/R	H/M						716728	716730	716729	715980	715982	715981	
	Deluxe	H/R	H/M	Ltd.					716764	716766	716765	716435	716436	716437	
	Deluxe	H/R	H/M	SO					716746	716748	716747	716397	716398	716399	
Deluxe	H/R	H/M	SO Ltd					716782	716784	716783					

* Key to Chart Abbreviations: Std = Standard, M = Manual, H/R = Heated Remote Control Adjustable Glass, H/M = Heated Manual, Ltd. = Lighted Arm (2020), Lighted Head (2020XG), SO = Signal Arrow in Glass, Flt = Flat, Cx = Convex

** All motorized mirror PAIRS include switches and wire harnesses. These items are NOT included when motorized mirrors are sold as sides. **NOTE:** 2020XG Chrome = Chrome head with black arm and base.

NOTE: GMC Silverado mirror assemblies can be found on www.velvac.com by searching with a keyword "Silverado"

Ford Super Duty F-250 to F-750

NEW

Color	Body Width	2020 Head Type*	Fit* Gls	Cx* Gls	Option*	2020 Mirror System			2020XG Mirror System ALL w/ 2020XG heads			
						Pair**	Rt Side	Lft Side	Pair**	Rt Side	Lft Side	
Black	86"	Std	M			715141	715154	715153				
		Std	M			714527	714528	714529				
	96"	Std	H/R				714533	714534	714535			
		Std	H/R			Ltd.	714539	714540	714541			
		Deluxe	M	M			714515	714516	714517	716355	716356	716357
		Deluxe	H/R	H/M						716358	716360	716359
		Deluxe	H/R	H/M		Ltd.	714521	714522	714523	716364	716366	716365
		Deluxe	H/R	H/M		SO				716361	716362	716363
	102"	Std	M				714530	714532	714531			
		Std	H/R				714536	714538	714537			
		Std	H/R			Ltd.	714542	714544	714543			
		Deluxe	M	M			714518	714520	714519	716331	716332	716333
		Deluxe	H/R	H/M						716334	716336	716335
		Deluxe	H/R	H/M		Ltd.	714524	714526	714525	716340	716342	716341
White	102"	Deluxe	H/R	H/M	Ltd.	715131	715132	715133				
Chrme	96"	Deluxe	H/R	H/M					716423	716424	716425	
		Deluxe	H/R	H/M	Ltd.	715859	715860	715861	716429	716430	716431	
		Deluxe	H/R	H/M	SO				716426	716428	716427	
	102"	Deluxe	H/R	H/M					716402	716404	716403	
		Deluxe	H/R	H/M	Ltd.				716408	716410	716409	
		Deluxe	H/R	H/M	SO				716405	716406	716407	

* Key to Chart Abbreviations: Std = Standard, M = Manual, H/R = Heated Remote Control Adjustable Glass, H/M = Heated Manual, Ltd. = Lighted Arm, Chme = Chrome, SO = Signal Arrow in Glass

** All motorized mirror PAIRS include switches/harnesses. These items NOT included when motorized mirrors are sold as sides.

2020 Mini-LEM with Black & White Camera (see pages 21 and 22 for color cameras)

NEW

Color	Body Width	Head Type*	Fit* Gls	Cx* Gls	For 2003 and Newer Ford Econoline			For GMC Topkick Medium Duty Truck, Savana and Express Van		
					Pair**	Rt Side	Lft Side	Pair**	Rt Side	Lft Side
Black	96"	Deluxe	M	M	716563	716564	716565	716677	716678	716679
		Deluxe	H/R	H/M	716575	716576	716577	716689	716690	716691
	102"	Deluxe	M	M	716560	716562	716561	716674	716676	716675
		Deluxe	H/R	H/M	716572	716574	716573	716686	716688	716687
White	96"	Deluxe	M	M	716569	716570	716571	716683	716684	716685
		Deluxe	H/R	H/M	716581	716582	716583	716695	716696	716697
	102"	Deluxe	M	M	716566	716568	716567	716680	716682	716681
		Deluxe	H/R	H/M	716578	716580	716579	716692	716694	716693
Chrme	96"	Deluxe	H/R	H/M	716587	716588	716589	716701	716702	716703
	102"	Deluxe	H/R	H/M	716584	716586	716585	716698	716700	716699

* Key to Chart Abbreviations: Std = Standard, M = Manual, H/R = Heated Remote Control Adjustable Glass, H/M = Heated Manual, Ltd. = Lighted Arm (2020), Lighted Head (2020XG), SO = Signal Arrow in Glass, Flt = Flat, Cx = Convex

** All motorized mirror PAIRS include switches and wire harnesses. These items are NOT included when motorized mirrors are sold as sides.



2020 VAN AND CAB CHASSIS MIRRORS (cont.)

Model 2020SS Shuttle Mirror System

NEW

- Door / Fender mirror systems available to fit both GM G Van and Ford E Van Chassis
- Available in both 96" and 102" wide body widths (contact Velvac for other body width applications)
- Superstar™ manual mirror with unitized flat and convex glass system
 - 51.5 sq. in. flat glass
 - 23.5 sq. in. convex glass with 12" radius glass
- Deluxe mirror with independently adjustable flat and convex glass
 - 63 sq. in. flat glass
 - 30 sq. in. convex with 12" radius glass
 - Available options include
 - + Manual
 - + Heated Remote flat glass - heated convex
 - + Heated Remote flat and convex glass
 - + Turn signal arrow in flat glass*
 - + Integral camera in lower housing of mirror head*
- Complete mirror system includes left side door mirror, right side fender mirror, installation hardware and all necessary switches and wiring



Deluxe mirror head with integral camera and signal arrow

Superstar manual mirror head



Right Side Fender Mount with Spring Loaded Fold Away Pivot

Right Side Fender Mount with Spring Loaded Fold Away Pivot

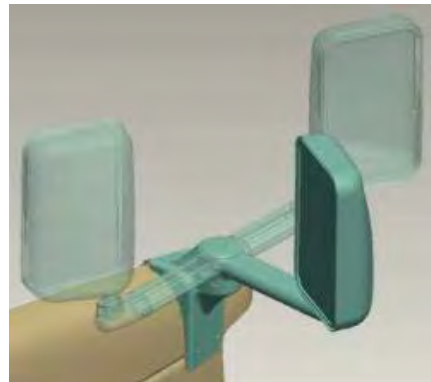

Left Side 2020 Door Mount Mirror with Deluxe Mirror Head

System Options Description	Head Type	Body Width	GM G VAN			FORD E VAN		
			Pair	RS	LS	Pair	RS	LS
Manual	Superstar	96"	718503	718502	718501	728503	728502	728501
		102"	718506	718504	718505	728506	728504	728505
Manual	Deluxe	96"	718525	718526	718527	728525	728526	728527
		102"	718530	718528	718529	728530	728528	728529
Remote Only - Flat Glass	Deluxe	96"	718509	718508	718507	728509	728508	728507
		102"	718512	718510	718511	728512	728510	728511
Heated Remote - Flat Glass - Heated Convex	Deluxe	96"	718515	718514	718513	728515	728514	728513
		102"	718518	718516	718517	728518	728516	728517
Heated Remote - Both Flat and Convex	Deluxe	96"	718521	718520	718519	728521	728520	728519
		102"	718524	718522	718523	728524	728522	728523

Superstar™ is a trademark of Velvac, Inc.

*Contact Velvac, Inc. for part numbers and availability

2020 and 2020XG Mirror Replacement Parts and Accessories

NEW



Deluxe Head



Standard Head



2020XG Mirror

MIRROR HEADS

	2020 Deluxe Head		2020 Standard Head		2020XG Mirror			
	RS	LS	RS	LS	RS	LS	RS	LS
White Manual			714576	714576	715988	715987	715988	715987
White H/R Flat - Man Convex	714590	714589	714578	714578	716054	716053	715992	715991
White H/R with lower marker lamp					716524	716523	716507	716506
White H/R with signal arrow					716518	716517	716500	716501
Black Manual	714580	714579	714575	714575	715986	715985	715986	715985
Black H/R Flat - Man. Convex	714582	714581	714577	714577	716012	716011	715990	715989
Black H/R with lower marker lamp					716522	716521	716505	716504
Black H/R with Signal Arrow					716516	716515	716498	716499
Chrome H/R Flat	714608	714607			716056	716055	715998	715997
Chrome H/R with lower marker lamp					716526	716525	716508	716509
Chrome H/R with Signal Arrow					716520	716519	716502	716503
Black 2015 Replacement Head***			714256	714256				
White 2015 Replacement Head***			714258	714258				

GLASS KITS

	2020 Deluxe Head		2020 Standard Head		2020XG Mirror			
	RS	LS	RS	LS	RS	LS	RS	LS
*Manual Flat Glass			709407	709407				
Htd Flat/for manual and htd glass	709448	709448	709748	709748	716104	716103	716104	716103
Heated Flat with Signal arrow	709674	709673			709994	709995	709994	709995
Htd Convex-for manual & htd glass	709449	709449			709932	709931	716106	716105
**Convex repair kit	709589	709589						
Wedge Stick on Convex Only			723068	723068				
Flat glass retaining clip					709422	709422	709422	709422
Convex glass retaining clip					709855	709855	709855	709855

*Includes bezel and Wedge convex

**Includes glass, inner housing, clip and actuator

H/R = heated/remote

***Model 2015 Replacement Head only, same head used for both left & right sides

Model 2020 Parts



Light



Harness



Switch Kit.

Part No.	Description
747524	Switch Kit Ford E Van
747632	Switch Kit GM G Van and C 3500
747633	Switch Kit Ford F Superduty 650 - 750
748304	12' HR Wire Harness Pass Door to Driver Door
747551	Marker light below elbow
709785	Cover Plate Kit for GMC Top Kit (includes plate, gasket and hardware)

www.velvac.com

Model 2020XG Parts

NEW



Switch Kit



Harness



Arm Covers

Part No.	Description
747855	Switch Kit Ford E Van
747856	Switch Kit GM G Van and C 3500
747901	Switch Kit Ford F Superduty 650 - 750
747863	12' HR Wire Harness Pass Door to Driver Door Fits Ford or GM
709993	Marker light

Part No.	Description
716107	Black 96" Arm Cover Kit*
716113	Black 102" Arm Cover Kit*
716109	White 96" Arm Cover Kit*
716115	White 102" Arm Cover Kit*

* Kit is for a pair, includes hardware



CLASS A RV, BUS AND TRUCK MIRRORS

Velvac's line of side mount and corner mount mirrors are designed with a focus on safety, quality and styling. Typical applications include Class A motorhomes, motorcoach, fire truck and rescue vehicles. Produced from high quality materials, these mirrors can be configured to meet specific customer and application requirements

Mirror Systems

Model 2025



Shown with Deluxe Head

Revolution™



Shown with V-MAX™ head

Model 2030



Shown with Deluxe Head and add-on Top Hat™ Convex

- Mirror system mounts to the flat side of the vehicle allowing the mirror to be viewed through the side window
- Mirror base pivot system mounts to flat side of vehicle and allows mirror to be folded forward or back upon impact of for vehicle storage
- Corner mounting base available with 9", 10", 11", 12" or 15" radius - contact Velvac for custom applications
- Mirror arm lengths available from 10", 12", 14" or 17". This allows mirrors to be viewed through the windshield or side windows

Available Features / Options

- Deluxe, V-MAX™ or V-MAX III™ mirror heads
- Top Hat™ add on convex for Deluxe head
- Chrome plated or powder coated finish
- Easily replaceable manual or heated remote glass
- Lower marker lamp on arm or Signal Arrow in the flat glass
- Lower LEM camera with LED marker lamp

Mirror Heads



Deluxe



V-MAX



V-MAX III



V-MAX III with LEM

Mirror Head	Flat Glass		Lower Convex Glass			Upper Convex Glass		
	Sq Inch	Size	Sq Inch	Size	Radius	Sq Inch	Size	Radius
Deluxe	62.3	8" x 8"	30	8" x 4"	12"	N/A	N/A	N/A
V-MAX	98.7	8" x 13"	30	8" x 4"	21"	N/A	N/A	N/A
V-MAX III	72.5	8" x 9"	30	8" x 4"	21"	26.4	8" x 3.3"	21"
Top Hat	N/A	N/A	N/A	N/A	N/A	17.8"	6" x 3.5"	12.5"

Revolution™, V-Max™, V-MaxIII™ and Top Hat™ are trademarks of Velvac, Inc.

Top Hat Add-On Convex Mirror

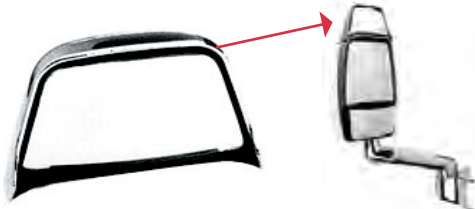

- Installs easily on top of Deluxe head for added visibility of blind spots or other vision targets
- Fits on either driver side or passenger side mirror

Part No.	Description
715372	Black Top Hat
715373	White Top Hat
715374	Chrome Top Hat



CLASS A RV, BUS AND TRUCK MIRRORS (cont.)

REPLACEMENT HEADS AND GLASS KITS

NEW

Finish				V-MAX LEM	V-MAX LEM	V-MAX III LEM	Top Hat
	Deluxe	V-MAX	V-MAX III	2025 Base	2030 Base	2030 Base	
White RS	714590	714946	—	—	—	—	715373**
White LS	714589	714947	—	—	—	—	—
Black RS	714582	714944	716146	716208	716190	716154	715372**
Black LS	714581	714945	716147	716207	716189	716155	—
Chrome RS	714608	714942	716144	716206	716188	716152	715374**
Chrome LS	714607	714943	716145	716205	716187	716153	—
GLASS KITS							
Heated Flat Right or Left	709448	709450	709732	709450	709732	709732	
Heated Flat with Blinker RS	709674	709624	709702	709624	709702	709702	
Heated Flat with Blinker LS	709673	709623	709701	709623	709701	709701	
Lower Convex RS / LS	709449	709650	709650	709650	709650	709650	
Upper Convex Glass	—	—	709733	—	709733	709733	
Lower Convex Housing RS / LS	709589	709651	709651	709651	709651	709651	

*RS = Right Side, LS=Left Side ** Top Hat fits either driver side or passenger side

NOTE: All heads shown are heated remote flat glass. Camera not included with replacement LEM heads see WWW.VELVAC.COM or contact us directly for additional service parts or assistance .

Mirror Covers / Bras and Wiper Covers

NEW

Fitted Covers and Bras

- Fitted covers and bras constructed from ultra Hi-grade, eight way stretch vinyl for durability and easy care
- Extreme duty plastic/stainless zipper for easy, quick on/off
- Protects mirror mechanisms and mirror chrome/finish from damaging air borne contaminants and salt build up
- Protects against bees, wasps, mud daubers and birds.
- Provides a glove-like custom fit
- The bra clips on to the side of the mirror- glass remains visible

Slipcovers and Wiper Covers

- Slipcovers and wiper covers are made of 100% Textilene, a woven polyester mesh fabric coated with PVC
- Blocks up to 80% harmful UV rays and heat
- Outdoor fabric for warmer climates, open weave allows the air to circulate and not retain moisture



Fitted Covers and Bras

Part No.	Description
744005	Standard Fitted Cover
744006	Deluxe Fitted Cover
744007	Triple Glass Fitted Cover
744008	V-MAX Fitted Cover
744009	V-MAX w/TH Fitted Cover
744012	Standard Head Bra
744013	Deluxe Head Bra
744014	Triple Glass Bra
744015	V-MAX Bra
744016	V-MAX with TH Bra

*TH = Top Hat



Slipcovers and Wiper Covers

Part No.	Description
744001	15" Black Slipover Cover
744002	20" Black Slipover Cover
744003	28" Wiper Blade Cover
744004	33" Wiper Blade Cover

See page 109 for our complete line-up of wiper blades!

Mirror Polish

NEW



Part No.	Description
747785	Flitz Metal Polish (5.29 oz)
747786	Flitz Microfiber Polishing cloth (16" x 16")

To help to keep your chrome mirrors looking GREAT we recommend the use of **Flitz chrome metal polish** It is specially important to clean the chrome prior to long vehicle storage or to remove road salts which can lead to oxidation or the loss of chrome adhesion

K-10® Hemisphere® Mirrors

NEW

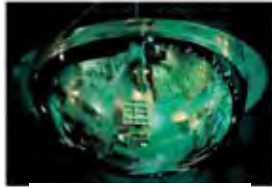

360° Hemisphere



180° Hemisphere

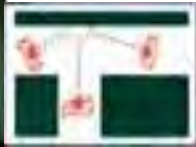

90° Hemisphere

- Provides a bright distortion-free view of an entire area, allowing in-plant vehicles and/or personnel to move safely through the facility
- 360 degree can be suspended from ceiling to see blind corners
- 180 degree for use in a 3-way "T" corridor and other areas where enhanced wide-angle viewing is required
- 90 degree for use in 2-way "L" hallways and intersections fitting perfectly against the ceiling for superb visibility around blind corners
- Pendulum-style hanging kit is available for 30-42" sizes. Smaller sizes attached to T-bar ceilings with specially provided mounting clips and are pre-drilled for screw mounting

Diameter	Degree View			Ceiling Ht
	90	180	360	
18"	—	730209 <i>HT18180</i>	730200 <i>HF18360</i>	Up to 8'
24"	730204 <i>HL24090</i>	730210 <i>HT24180</i>	730201 <i>HF24360</i>	8' to 10'
30"	730206 <i>HL30090</i>	730212 <i>HT30180</i>	730214 <i>HF30360</i>	10' to 12'
36"	—	730215 <i>HT36180</i>	730202 <i>HF36360</i>	12' to 15'
42"	—	730129 <i>HT42180</i>	730128 <i>HF42360</i>	15' and up

Ceiling Mirror Tile

Part No.	Description
702155 <i>HFT24360-T</i>	24" X 24" 360° Tile for suspended ceilings

Installation Kits

Part No.	Description
730194 <i>IK30</i>	30" Pendulum Style installation kit
730195 <i>IK36</i>	36" Pendulum Style installation kit
730196 <i>IK42</i>	42" Pendulum Style installation kit

K-10® Wall-Eye® Mirror

NEW



Conveniently flush mounted to the wall at eye-level, the K-10 Wall-Eye Mirror, provides more than 180° of enhanced visibility, enabling persons entering hallways and corridors to move safely through them. This new mirror concept provides the visibility of two convex mirrors mounted side-by-side and is easily installed where doorway headers obstruct traditional ceiling mounted mirrors.

Part No.	Description
730116 <i>WE18</i>	18" diameter, flush mount against the wall
730117 <i>WE18-HD</i>	18" diameter, ABS back includes adjustable mounting brackets

*K-10 Hemisphere® and Wall-Eye® are registered trademarks of Velvac, Inc

K-10 Convex Observation Mirrors

NEW



Full Round Indoor



Oblong Indoor



Heavy Duty*
Full Round
Outdoor



ABS back

Full Round Indoor Mirror

- Ideal wherever **detailed** observation and monitoring is required where employees and equipment cross paths. Includes hardware and swivel for mounting

Oblong Indoor Mirror

- Bright distortion-free images allow excellent safety vision and traffic control as well as quality inspection viewing of assembly lines or machinery production areas
- Ideal for overhead safety and detailed vision situations with limited space, includes hardware and mounting bracket

Heavy Duty Full Round Outdoor

- Perfect for **outdoor** safety and security. Installation in blind alleys, loading docks, parking ramps or garages. Includes ABS back and hardware for swivel mounting

Diameter	Indoor	Outdoor/HD	Oblong Indoor Only	
	Part No.	Part No.	Size	Part No.
12"	730101* (FRD012-HD)	730101* (FRD012-HD)	24" x 18"	730111 (OB2418)
16"	730102 (FRD016)	730103 (FRD016-HD)	30" x 24"	730112 (OB3024)
18"	730123 (FRD018)	730104 (FRD018-HD)	36" x 24"	730114 (OB3624)
24"	730124 (FRD024)	730105 (FRD024-HD)	36" x 30"	730115 (OB3630)
26"	730125 (FRD030)	730121 (FRD026-HD)	24" x 16"	730126 (OB2416-HD*)
30"	730106 (FRD030)	730122 (FRD030-HD)		
36"	730107 (FRD036)	730108 (FRD036-HD)		

*Custom for off-road equipment

*Part 730101 can be used indoor or outdoor

Mirror diameter in inches should be equal to viewing distance in feet. (For example, a 16" mirror should be used for viewing 16' away.) If mirror is to be used for security a larger diameter is recommended because of image clarity.

K-10 Observation Window

NEW



- Clear Polycarbonate bubble window
- 360 degrees
- Permits easy viewing of high stress areas before or without entering

Part No.	Size
702157 (PBW-18)	18" dia x 1/4" x 6" deep

K-10 Lift Truck Mirror

NEW



- Reduces lift truck operator blind spots
- Operator's image will not obstruct the view
- Driver not only sees to the side and behind, but can also see the load directly in front

Part No.	Description
716911 (ELBTS-45S-B)	8" Black Eyeball
708618	4.5" X 7.5" Standard Lift Truck Mirror



BRACKETS, CLAMPS AND ACCESSORIES

Clamp and Tubing Arm Kits for 6", 8" and 8-1/2" Mirror Heads



- Ideal for adding an auxiliary spot mirror to existing loop or brace
- For 3/4" O.D. tubing
- Plastic coated clamp for secure grip and mar resistance
- Overall length 6"

Part No.	Description
723057	Stainless Steel
748269	UPS Brown Power-Coated Galvanized Steel

"L" Style Locking Bracket



- Sturdy 1/8", 11 gauge construction
- Pivot hole accepts 5/16" and 3/8" bolts
- Slotted hole provides additional mirror head adjustment
- Ideal for mounting Velvac DuraBall® convex and all other convex mirrors

Part No.	Description
723100	Stainless Steel

Replaces Velvac Part No. 723080

Bracket Mount Mirror



- Attaches easily to West Coast mirror bracket on any truck
- All stainless steel construction

Part No.	Description
712648	Two Arm Bracket

Bracket and hardware ONLY- mirror head sold separately (see pages 6 - 8)

Clamp and Tubing Arm Kit for 5" and 6" Plastic Mirror Heads



- Stainless steel formed tube arm
- Zinc plated steel clamp
- Ideal for adding an auxiliary spot mirror to existing loop or brace
- For 5/8" and 3/4" O.D. tubing
- Overall length 5-7/16"

Part No.	Description
723049	Stainless Steel Tubing

Adjustable Tubing Arms



- Universal adjustable support
- 10-1/2" long threaded led with extension adjustment from 19" to 25"
- Threaded leg can be cut to reduce minimum overall length
- Available in stainless steel and powder-coated galvanized steel finishes

Part No.	Description
747070	Stainless Steel
747072	Black

Fender Mount Extension Bracket



- Adjustable from 13-1/2" to 17-1/2"
- Bell mount base provides extra support
- Stainless steel construction
- Mounting hardware included

Part No.	Description
723047	Fender Mt Ext Bracket

Bracket and hardware ONLY- mirror head sold separately (see pages 6 - 8)

6" Pivot Bolt Mounting Bracket



- Ideal for adding an auxiliary spot mirror below a West Coast mirror head
- Stainless steel construction
- Overall length 4-7/8"

Part No.	Description
723055	For 5/6" and 3/8" Pivot Bolts

Sleeve and Nut Kit



- For conventional and step van brace and adjustable bracket assemblies
- Brass sleeve and chrome nut

Part No.	Description
748215	Sleeve and Nut Kit

Switch Kit for Heated Mirrors



- Dash mounted kit controls one to two heated mirror heads

Part No.	Description
747053	Switch Kit for Htd Mirror



BRACKETS, CLAMPS AND ACCESSORIES (cont.)

Nylon Clamp Kit for 3/4" O.D. Tubing



- Non-corrosive black nylon clamp
- Recessed fasteners provide a custom look
- Kit includes clamp and hardware

Part No.	Description
748416	Clamp Kit - Includes Clamp and Hardware for 3/4" O.D. Tubing

Tubing Brace Clamp Kit for 3/4" O.D. Tubing



- Used to support tubing arms on loop assemblies - *not for installing mirror heads*
- Kit includes stainless steel clamp and mounting hardware

Part No.	Description
748029	Tubing Brace Clamp Kit for 3/4" O.D. Tubing

Flat Clamp Kit for 3/4" O.D. Tubing



- Used to mount West Coast mirror heads to 3/4" O.D. tubing - mounts on horizontal leg of loop
- Plastic coating for secure grip and mar resistance
- Kit includes stainless steel clamp and mounting hardware

Part No.	Description
704066	Flat Clamp Kit for 3/4" O.D. Tubing

Clamp Kit for 1" O.D. Tubing



- Used to mount side and stud mount mirror heads to 1" O.D. tubing
- Plastic coating for secure grip and mar resistance
- Kit includes stainless steel clamp and mounting bolt

Part No.	Description
704070	Clamp Kit for 1" O.D. Tubing

Clamp Kit for 3/4" O.D. Tubing



- Used to mount side and stud mount mirror heads to 3/4" O.D. tubing
- Plastic coating for secure grip and mar resistance
- Kit includes stainless steel clamp and mounting bolt

Part No.	Description
704068	Clamp Kit for 3/4" O.D. Tubing

Clamp Kit for 5/8" O.D. Tubing



- Used to mount side and center mount mirror heads to 5/8" O.D. tubing
- Kit includes two-piece aluminum clamp and stainless steel mounting hardware

Part No.	Description
704069	Clamp Kit for 5/8" O.D. Tubing

Standard Mounting Cabfeet Kits

- Used on non-preset style loops
- Heavy-duty 90° bracket permits a variety of mounting applications
- Cabfeet mounting holes are 2" on center
- Available in stainless steel and powder-coated galvanized steel finishes
- Kits include cabfeet and hardware to mount one pair of mirrors



Part No.	Description
757015	Stainless Steel
757016	White

Twist Clamp Kit for 3/4" O.D. Tubing



- Used to mount West Coast mirror heads to 3/4" O.D. tubing - mounts on vertical leg of loop
- Plastic coating for secure grip and mar resistance
- Kit includes stainless steel clamp and mounting hardware

Part No.	Description
704065	Twist Clamp Kit for 3/4" O.D. Tubing



BRACKETS, CLAMPS AND ACCESSORIES (cont.)

Non-Preset Pivot Kit



- Replacement kit for mirrors with Velvac non-preset pivot end and Velvac mirrors with standard pivot
- 5/16" - 18 x 1" stainless steel bolt
- Kit contains parts for one complete non-preset pivot end

Part No.	Description
748012	Non-Preset Pivot Kit

Rubber Preset Pivot Kit



- Replacement kit for mirrors with Velvac rubber preset pivots and Velvac mirrors with rubber washer style preset
- 5/16" - 18 x 1-1/2" stainless steel bolt
- Kit contains parts for one complete preset pivot end

Part No.	Description
748009	Rubber Preset Pivot Kit

Spring Preset Pivot Kit



- Replacement kit for mirrors with standard Velvac spring preset systems and UPS walk-in vans with Velvac mirrors
- Can be used to upgrade mirrors with rubber washer preset to a spring preset for improved pivot action
- Stainless steel rivet plate extends live of loop and improves pivot action on mirrors with worn preset rivets
- 5/16" - 18 x 2" stainless steel bolt
- Kit contains parts for one complete spring preset pivot end

Part No.	Description
712979	Spring Preset Pivot Kit

Preset Rivet Plate



- Designed for use on all Velvac preset loops except those with tension control stop preset as found in kit Part No. 748371
- Two stainless steel rivet plates extend life of loop and improve pivot action on mirrors with worn preset rivets
- Mounts easily between existing mirror loop and preset lock plate

Part No.	Description
748377	Preset Rivet Plate Kit

Heavy-Duty Preset and Pivot Upgrade Kit

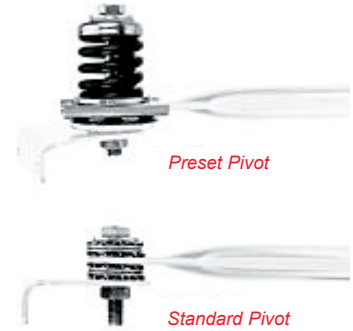

- Designed for use on all Velvac preset loops except those with tension control stop preset as found in kit Part No. 748371
- Improves pivot holding force on mirrors with large loops or large/heavy mirror head combinations
- Unique spring/washer combination retains pivot system torque to keep mirror in set viewing position until moved and provides superior detent action for foldaway applications
- Life cycle tested to over 50,000 pivot cycles
- Preset rivet plate fits over existing preset rivets to extend life of loop and improve cycle performance
- Easy retrofit - can be completed without taking mirror assembly off the vehicle
- 5/16" - 18 x 1-3/4" stainless steel pivot bolt and 5/16" - 18 x 2" stainless steel preset bolt
- Kit contains all upper and lower pivot hardware for one mirror assembly

Part No.	Description
748355	Heavy-Duty Preset and Pivot Upgrade Kit

NOTE : Kit can be used to upgrade mirror loops with standard rubber or spring preset systems (similar to Part No. 748009 or 712979 detailed on this page) order one Part No. 748355 per side

Camera and Observation Systems

- Building a camera and observation system is fast and easy.
- Follow the steps below by first determining the target areas you wish to view, and then select the cameras, brackets and monitors to meet those needs
- All components are designed to easily connect and work together to produce a seamless system to meet all your vision and blind spot viewing requirements

Determine which blind spot area you wish to see-side view, rear view or both



Side View



Rear View



Side and Rear View

Choose a camera or cameras to meet your viewing and blind spot needs

Side View Cameras

- Velvac offers both traditional mount side view cameras shown below, as well as side view CMOS cameras integrated into the Velvac 2020 Mini-LEM and V-MAX and V-MAX III LEM mirror systems



2020 Mini-LEM-see page 18-25



V-MAX III-see page 26



Fixed Side Mount

Fixed Side Mount Camera

- High resolution color
- LED low light enhancement
- Waterproof housing
- Viewing angle: 95° H, 75° V
- Power 12Vdc
- Cylindrical 3/4" through hole mount

NEW

Part No.	Side	Housing
709941	Left	Gray primer
709942	Right	Gray primer
709949	Left	Chrome
709948	Right	Chrome

Back-up Cameras

- Velvac offers a variety of rear vision cameras including our exclusive flush mount back-up camera as well as adjustable block style and fixed mount cameras
- Flush mount back-up and fixed top mount cameras feature digital CMOS* image processing while adjustable bracket cameras utilize CCD* image technology. While both provide great image clarity, CMOS cameras help to reduce blooming effects caused by headlights and direct sun. The addition of infrared LED provides visibility even in low light or no light conditions



Flush Mount Back-up Camera

Flush Mount Back-up Camera

- Integrated flush-mount provides clean appearance with no exposed wires or hardware
- Camera angle preset to provide the optimum visibility with no adjustments
- LED low light enhancement
- Excellent low light/high bright performance w/IR LED assist

NEW

- Utilizes high performance color optics Super CMOS technology with 95° vert FOV
- Includes backing plate, gasket and hardware

Part No.	Description
709910	Flush Mtd. Rear-view

* CMOS- Complimentary Metal Oxide Semiconductor, CCD- Charged Couple Device



CAMERA AND OBSERVATION SYSTEMS (cont.)

Adjustable Back-up Camera



Part No. 709952

NEW



Part No. 710011

- Manually adjustable camera mounting angle with external aluminum bracket and SS hardware
- Built-in microphone for enhanced safety with audio output (through the monitor) while backing
- LED low light enhancement
- Waterproof housing
- Power 12Vdc
- External bracket mount and mounting hardware included

Part No.	Color	Hsg. Camera	Viewing	
			H	V
709912	White	Color	104°	78°
709952	Black	Color	104°	78°
709964	White	B&W	120°	90°
709965	Black	B&W	120°	90°
710011	Black	Color	120°	90°

Fixed Top Mount Back-up Camera



NEW

- High resolution color
- LED low light enhancement
- Waterproof housing
- Integrated flush-mount provides clean appearance with no exposed wires or harnesses
- Viewing angle: 75°H, 95° V
- Power 12Vdc
- Cylindrical 3/4" through hole mtd

Part No.	Description
709950	Gray primer housing
709951	Chrome housing

Select a Monitor



Part No. 709915



Part No. 709916

NEW



Part No. 716314

- Velvac's color 5.6" and 7" LCD monitors are designed for heavy duty and commercial truck applications- built and tested to withstand extreme road conditions such as vibrations, electrostatic discharge, humidity and temperature changes and to deliver high quality images to the driver.
- 5", 5.6" and 7" monitors include audio speaker with volume
- Velvac's 3.5" color monitor in a rear view mirror provides the ultimate in safety and convenience. The image is invisible while in drive and only activates when the camera trigger is engaged.

Part No.	Screen	Camera Inputs	Power	Width	Height	Depth	Mounting
709915	5.6" Color LCD	(2) A/V	12V dc	5.875"	5.25"	1.25"	4-hole amps pattern
709916	7" Color LCD	(3) A/V	12V dc	7.75"	5.25"	1.25"	4-hole amps pattern
709953	7" Multi* Color LCD	(4) A/V	12V dc	7.75"	5.25"	1.25"	4-hole amps pattern
716314	3.5" Color LCD	(1) A/V	9-16V	9.45"	3.63"	1.5"	Universal windshield mt.

* Part No. 709953 includes multi-image view modes- split screen (2-way), tri-view (3-way), and quad view (4-way); ALL other monitors have single screen viewing capability

NOTE: Monitors 709915, 709916 and 709953 require the addition of mounting brackets shown on page 35.

Select a Monitor Mount and Cables

Cable quantity and length will vary based on number of cameras and distance from camera to monitor

Cable and Mounting Accessories



- Measure length from camera to monitor
- Select cable from chart below
- Cables can be connected together to create various lengths

Part No.	Description
747850	15' LCD cable
747864	25' LCD cable
747865	34' LCD cable
747866	50' LCD cable
747867	75' LCD cable
747881	24' CRT cable
747882	34' CRT cable
747883	65' CRT cable



Part No. 790563



Part No. 790564



Part No. 790567

NEW

Part No.	Description
790563	4" Single knuckle monitor mount (4-hole amps pattern) bracket with thumbscrew
790564	6" Double knuckle monitor mount (4-hole amps pattern) bracket with thumbscrew
790567	Dropdown Overhead 7" monitor mount bracket
790573	Stationary Overhead 7" monitor housing and bracket

Three Camera Controller



- Allows a single camera input monitor to be converted to accept (3) cameras simultaneously
- This controller allows different views to automatically engage based on triggers for left/right turn signals or reverse.

NEW

- This flexible control box can be wired for full time viewing of the rear camera, if needed

Part No.	Description
716318	(3) Camera Controller

Back-up Camera Kits

NEW



Part No. 709921

- Velvac has assembled several standard kits for ordering convenience—single part number ordering
- Contact Velvac for your custom kit requirements

Kit Part No.	Kit Includes Part No.	Back-up Camera Kit Description
709921	709912	Color Camera
	709915	5.6" monitor
	790563	4" monitor mt
	747865	34' cable
709954	709912	Color Camera
	709916	7" monitor
	790563	4" monitor mt
	747865	34' cable



AIR 37-65

Table of Contents	PAGE
Gladhands	37
Air Brake Hose and Tubing	40
Air Brake Valves	43
Air Accessory Valves	49
Pressure Switches and Indicators	55
Air Tank Accessories	56
Air Tank, Brake Chambers and Diaphragms	58
Air Cylinder Control Valves	59
Air Cylinders	60
Air Cylinder Tailgate Lock Kits	63
Lift Axle and Suspension Valves	64

VELVAC Original Indicates an original Velvac product.

NEW Indicates a new product added to catalog.

Revised Part No. Indicates a revised part number defining “-xx” package quantity.
Refer to price list for price per package.

For quantity and packaging information, refer to our price list.

Customer Service: 800.783.8871
Fax: 262.786.4101
Email: sales@velvac.com



NOTE: The information and photographs in this catalog are believed to be accurate and factual as of the print date. Velvac assumes no responsibility for information that may be incorrect or has changed since press time. Product specifications and offerings subject to change without notice.

Velvac is a trademark of Velvac, Inc.
 Shear-Seal is a registered trademark of Barksdale Control Products.
 Energy Suspension is a registered trademark of Energy Suspension.
 Teflon is a registered trademark of E.I. duPont de Nemours and Company.
 Enforcer, Gladhandl, Glad-Lock, Guardian, Pacifier, Stow-A-Way, and Viper are trademarks of Velvac, Inc.



Iron Gladhands with Polyurethane Seals



Lifetime guarantee covers both gladhands and seals!

- Solid, one-piece construction
- Service and emergency gladhand color-coated for easy identification
- Color-coded polyurethane seal included
- Positive, spring loaded locking mechanism keeps gladhand properly positioned
- 1/2" FPT port
- Gladhands meet SAE J318 requirements including breakaway requirement

Part No.	Description
035031	Universal Gladhand with Black Polyurethane Seal
035032	Emergency Gladhand with Red Polyurethane Seal
035033	Service Gladhand with Blue Polyurethane Seal

Shutoff Gladhands

NEW



- Lightweight die cast aluminum bodies
- Clamp plates are color-coded for easy identification
- Polyurethane seal included
- 1/2" or 3/8" nylon air tube fitting
- Emergency gladhand with 1/4" - 18NPT port for pintle hook air line fitting
- Meets SAE J318 requirements

Part No.	Description
035094	3/8" Service Gladhand
035095	3/8" Emergency Gladhand
035173	1/2" Service Gladhand
035174	1/2" Emergency Gladhand

Premium Powder Coated Gladhand

NEW



- Available in service and emergency color coding
- Powder coated aluminum improves corrosion resistance
- Polyurethane seals improve resistance to oil and chemicals
- Bright color coding allows for easy brake line identification
- Stainless steel wear plates are resistant to corrosion and improve service life
- Meets SAE J318
- 1/2" FPT port

Part No.	Description
035169	Powder Coated Service Gladhand with Polyurethane Seal
035170	Powder Coated Emergency Gladhand with Polyurethane Seal

Aluminum Gladhands



- Velvac's most economical Gladhand!
- Clamp plates are color-coded for easy identification
- All include flat rubber coupling seal
- 1/2" FPT port
- Meets SAE J318 requirements

Part No.	Description
035038	Universal Gladhand
035042	Emergency Gladhand
035045	Service Gladhand

HELPFUL HINT:
For the Greatest Corrosion Resistance Try Velvac's Powder Coated or Plated Style Gladhand

37° Bracket Mount Gladhands



- Lightweight die cast aluminum bodies
- Clamp plates are color-coded for easy identification
- Color-coded polyurethane seal included
- (2) 3/8" FPT ports (one plugged)
- (2) 11/32" diameter mounting holes
- Gladhands meet SAE J318 requirements

Part No.	Description
035092	Service Gladhand
035093	Emergency Gladhand

Shutoff Gladhands

NEW



- Lightweight die cast aluminum bodies
- Clamp plates are color-coded for easy identification
- Rubber seal included
- Includes mounting seal to prevent corrosion between gladhand and trailer
- Metal inner ball for increased wear ability
- Meets SAE J318 requirements
- 3/8" - 18 port

Part No.	Description
035152	Emergency Shutoff
035151	Service Shutoff

AIR

Pivoting Gladhands
NEW

- Spring loaded to safely swing out of the way when not in use
- Seals out contaminants when not in use
- 3/8" - 18 NPTF ports

Part No.	Description
035167	Blue - Service
035168	Red - Emergency

Polyurethane Gladhand Seals

- Color-coded seals will not crack or tear, reducing maintenance time and cost associated with rubber seal replacement
- Available in attractive display box with 25 sets of seals (set consists of 4 seals per bag, 2 red and 2 blue) See page 139.

Part No.	Description
035009	Red Polyurethane Seals
035010	Blue Polyurethane Seals
035011	Black Polyurethane Seals
035012	Display Box with Seals

HELPFUL HINTS:

Glad-hand seals are exposed to many different road chemicals and normal weathering effects, daily. Prevent unexpected failure by inspecting your glad-hand seals regularly and replace yearly. Velvac offers a wide variety of rubber and polyurethane seals including the new Energy Suspension® Seals.

Plated Aluminum Gladhands
NEW
With E-Coating

- E-Coated aluminum improves corrosion resistance and provides better protection than typical zinc plating
- E-Coated aluminum gladhand body with a full face plate
- Service and Emergency gladhands have a powder coated face plate for increased corrosion resistance
- Universal gladhand has a zinc plated face plate for increased corrosion resistance
- Rubber Seal
- Meets SAE J318 Specs
- Color coded for easy hose identification
- Emergency is polarized to eliminate incorrect hose connections
- Cost saving angle mount eliminates the need for extra mounting hardware

Part No.	Description	Replaces Haldex-Midland Number	Connection Thread
035143	Plated - Service	11452	1/2" Pipe Thread
035144	Plated - Emergency	11451	1/2" Pipe Thread
035145	Plated - Universal	11450	1/2" Pipe Thread
035146	Plated - 37° Service	11444	3/8" Pipe Thread
035147	Plated - 37° Emergency	11440	3/8" Pipe Thread

Rubber Gladhand Seals

Standard and Flat seal

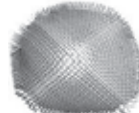
"Guardian™" Seal

Seal Screen

- Seals constructed of durable black Buna N compound
- "Guardian" seal with rubber flap and metal seal screen help protect air lines from debris

Part No.	Description
035005	Standard Seals
035007	Flat Seals
035140	Seal Screen
035141	Guardian™ Seal with Flap

"Guardian™" is a trade mark of Velvac, Inc.
Energy Suspension® Seals
NEW

- Could be the last seal you buy!
- Designed to fit all SAE approved gladhands
- Polyurethane seals improve resistance to oil and chemicals, increasing service life and decreasing down time
- Will not crack, dry out or tear like the conventional rubber seals
- Rated to -40°F
- 50 Seals per bag

Part No.	Description
035165	Blue Service Seal
035164	Red Emergency Seal
035166	Black Universal Seal

Energy Suspension® is a registered trademark of Energy Suspension

Gladhand Seals with Built-in Screens

NEW



- Polyurethane seals with stainless steel screens built in
- Traps harmful contaminants before they can cause an air break system failure
- Keeps bugs out of the air lines
- Available in blue, black and red

Part No.	Description
035175	Blue Service Seal with screen
035176	Red Emergency Service Seal with screen
035177	Black Universal Service Seal with screen

Stow-A-Way™ Gladhand and Plug Holder



- Makes gladhand and electrical hook ups at a 45° angle for easy insertion and extraction
- Allows cable and air line storage with both feet firmly on the ground when properly placed
- Designed for heavier ABS cables
- Standard mounting holes make it easy to replace older designs
- Glass-filled nylon, non-corrosive construction

Part No.	Description
580042	Stow-A-Way Gladhand and Plug Holder

GladhandL™ Gladhand Grips

NEW



Part No. 035070

Part No. 035178

- 1/2" NPTF
- Sold in pairs in an attractive display package with information header
- Part No. 035070, polyurethane style features a soft grip with a machined steel core
- Part No. 035178, solid aluminum style features an anodized body with a diamond knurl

Part No.	Description
035070	One Red and One Blue GladhandL™ Grip with Hardware, Polyurethane
035178	One Red and One Blue Solid Aluminum Gladhand Grip, Hardware not needed

Gladhand Holder Kit



- Designed to mount on all Velvac pogo sticks
- Holds and seals gladhands when tractor is disconnected from trailer
- Durable zinc-plated steel construction
- Single gladhand holder can be mounted directly to cab using 5/16" bolt holes
- Kit includes two gladhand holders and mounting hardware

Part No.	Description
581006	Gladhand Holder Kit
580009	Gladhand Holder Only

Dummy Coupling

NEW



Part No. 035036

Part No. 035100

- Durable zinc-plated steel construction for corrosion resistance
- 6-1/2" Coupling Length
- 8-1/2" Chain Length, 18" Cable

Part No.	Description
035036	Vented Dummy Coupling
035037	Non-Vented Dummy Coupling
035100	Dummy Shut-off gladhand

HELPFUL HINT:
Improve leverage and reduce air hose kinks by using one of the two styles of gladhand grips

Glad-Lock™



- Rugged polypropylene gladhand lock helps prevent unwanted connections to tractors and trailers
- Universal design for use on many types of aluminum or iron gladhands
- Two keys furnished with each lock

Part No.	Description
035150	Glad-Lock

GladhandL™, Glad-Lock™ and Stow-A-Way™ are trademarks of Velvac, Inc.

Line Identification Tags



- 22 gauge aluminum construction with bright red enamel lettering
- 7/8" diameter hole

Part No.	Description
035025	Emergency Tag
035026	Service Tag

AIR

Air Brake Hose



Part No.	Hose I.D.	Hose O.D.	Coil Length
022011	3/8"	3/4"	50'
022011-7	3/8"	3/4"	250'
022047	1/2"	7/8"	50'
022047-7	1/2"	7/8"	250'

See page 115 & 116 for applicable reusable fittings

- Manufactured to a minimum burst pressure of 870 psi
- Conforms to SAE J1402 and DOT -106 standards
- Performs within an operating temperature range of -40° to +200°F

Air Brake Hose Assemblies



- Brake hose assemblies meet SAEJ1402 requirements
- Fittings are permanently swaged

(L) Length Inches	3/8" I.D. Hose 1/4" Ends	3/8" I.D. Hose 3/8" Ends	3/8" I.D. Hose 3/8" Ends	1/2" I.D. Hose 3/8" Ends	1/2" I.D. Hose 3/8" Ends	1/2" I.D. Hose 1/2" & 3/8" Ends
	One End Fixed One End Swivel	One End Fixed One End Swivel	Both Ends Swivel	One End Fixed One End Swivel	Both Ends Swivel	One End Fixed-1/2" One End Swivel-3/8"
9	147009	—	—	—	—	—
12	147012	—	—	148012	—	—
16	147016	—	—	148016	—	—
18	147018	146018	146518	148018	148518	149018
20	147020	146020	146520	148020	148520	149020
22	147022	146022	146522	148022	148522	—
24	147024	146024	146524	148024	148524	149024
26	147026	146026	146526	148026	148526	149026
28	147028	146028	146528	148028	148528	149028
30	147030	146030	146530	148030	148530	149030
32	147032	146032	146532	148032	148532	149032
34	147034	146034	146534	148034	148534	149034
36	147036	146036	146536	148036	148536	149036
38	147038	146038	146538	148038	148538	—
40	147040	146040	146540	148040	148540	—
42	147042	146042	146542	148042	148542	149042
44	147044	146044	146544	148044	148544	—
46	147046	146046	146546	148046	148546	149046
48	147048	146048	146548	148048	148548	149048
54	147054	146054	146554	148054	148554	—
60	147060	146060	146560	148060	148560	149060
72	147072	146072	146572	148072	148572	149072
84	—	146084	146584	148084	148584	—
96	—	—	146596	148096	148596	—

See page 115 for replacement swivel body adapters

Slider Air Hose Assemblies with Spring Guard

NEW

Part No.	Length	Tube O.D.	Tube I.D.
149119	72"	3/8"	3/8"
149120	96"	3/8"	3/8"
149121	108"	3/8"	3/8"
149122	102'	3/8"	3/8"

Part No.	Length	Tube O.D.	Tube I.D.
149123	120"	3/8"	3/8"
149124	102"	1/2"	3/8"
149125	108"	1/2"	3/8"



Air Compressor Discharge Hose



- Stainless steel braided outer jacket
- Extruded inner Teflon® tube prevents carbon buildup
- Withstands extreme temperatures of -100° to + 450°F
- Hose and reusable fittings can be assembled to produce air compressor discharge hose assemblies

Part No.	I.D.	O.D.	Coil Length	Recommended Working Pressure (psi)	Minimum Bursting Pressure (psi)	Minimum Band Radius
142113	1/2"	5/8"	25'	1500	8500	6-1/2"
142113-7	1/2"	5/8"	100'	1500	8500	6-1/2"
142114	5/8"	3/4"	25'	1200	6000	7-3/4"

See page 117 for applicable reusable fittings

Air Compressor Discharge Hose Assemblies



- 5/8" straight tube x 5/8" compression fitting
- Hose measures 5/8" O.D., 1/2" I.D.

Part No.	Description
142118	18" Length
142124	24" Length
142130	30" Length
142136	36" Length
142148	48" Length



- 3/4" straight tube both ends
- Hose measures 3/4" O.D., 5/8" I.D.

Part No.	Description
142436	36" Length



- 5/8" straight tube both ends
- Hose measures 5/8" O.D., 1/2" I.D.

Part No.	Description
142324	24" Length
142336	36" Length



- Female swivel both ends
- Hose measures 5/8" O.D., 1/2" I.D.

Part No.	Description
142518	18" Length
142524	24" Length
142536	36" Length
142552	52" Length
142554	54" Length
142572	72" Length
142584	84" Length



- 5/8" compression fitting both ends
- Hose measures 5/8" O.D. 1/2" I.D.

Part No.	Description
142618	18" Length
142624	24" Length

Rubber Air Line Hose



NEW

- Tractor to trailer air line hose assy

Part No.	Length
140139	10'
140140	12'
140141	15'
140142	20'

Trailer Nose Box Hose Assembly



- Fits conventional and recessed trailer nose boxes
- Manufactured with 3/8" I.D., SAE Type A four spiral air brake hose
- One 1/2" swaged end fitting, one 1/2" reusable end fitting with spring
- 5-3/4" length
- Assembly meets SAE J1402 and FMVSS 106 requirements

Part No.	Description
140079	Trailer Nose Box Hose Assembly

NOTE: Replacement fitting assembly with spring available-see Part No. 500019 on page 116

Air Brake Hose Repair Fitting

NEW



- Kit for easy repair of 3/8" rubber air brake hose
- One package contains two fittings and one hex installation tool, all in a clamshell for retail display
- One Package will repair two 3/8" rubber air brake hoses
- Male fittings feature pre-applied sealant
- Meets DOT 106 SAE J1402 requirements

Part No.	Fitting Size	Sloan	Tectran	Tramec
500007	3/8"	431402	70-31402	31402
500008	1/2"	431403	70-31403	31403

Teflon® is a registered trademark of E.I. DuPont de Nemours and Co.

Coiled Nylon Tubing Assembly Kits

- Assemblies include permanently swaged 1/2" - 14 NPTF end fittings with heavy gauge spring for extra support
- Each Standard kit contains one Emergency (**RED**) and one Service (**BLUE**) 1/2" O.D. nylon tubing assembly
- Assemblies meet SAE J844 and FMVSS 106 requirements

12' Assembly Kit



- 6" lead on both ends

Part No.	Description
022002	Standard Kit
022000	Kit with Two Extra 3/8" End Fittings
022004	Emergency Only
022009	Service Only



15' Assembly Kit with Long Lead

- One 40" lead, one 12" lead

Part No.	Description
022001	Standard Kit
022005	Emergency Only
022008	Service Only



15' and 20' Assembly Kit

NEW

- 12" lead on both ends

Part No.	Length	Description
022025	15'	Standard Kit
022026	15'	Emergency Only
022027	15'	Service Only
022030	20'	Standard Kit
022031	20'	Emergency Only
022032	20'	Service Only

Nylon Tubing

For air brake systems only - NOT for fuel line applications



- SAE Type A tubing is single wall extruded non-reinforced nylon
- SAE Type B tubing has seamless extruded nylon core with fiber reinforced protective nylon cover
- Can be used with either air brake or nylon tube fittings 150 psi maximum working pressure
- Withstands temperatures of -40° to +200° F

Tubing meets SAE J844 and FMVSS 106 requirements

Part No.					Tube O.D.	SAE Type	Coil Length
Black	Blue	Green	Red	Yellow			
020062	020132	020142	—	—	1/8"	A	100'
020062-7	—	—	—	—	1/8"	A	1000'
020065	—	—	—	—	5/32"	A	100'
020065-7	—	—	—	—	5/32"	A	1000'
020066	—	—	—	—	3/16"	A	100'
020066-7	—	—	—	—	3/16"	A	1000'
020064	020134	020144	020154	020164	1/4"	A	100'
020064-6	020134-6	020144-6	020154-6	020164-6	1/4"	A	1000'
020052*	—	—	—	—	5/16"	A	100'
020053	020136	020146	020156	020166	3/8"	B	100'
020053-7	020136-7	—	020156-7	020166-7	3/8"	B	500'
020055	020138	—	020158	020168	1/2"	B	100'
020055-7	020138-7	—	020158-7	020168-7	1/2"	B	500'
020057	—	020157	—	—	5/8"	B	100'
020057-7	—	—	—	—	5/8"	B	250'
020059	—	—	—	—	3/4"	B	100'
020059-7	—	—	—	—	3/4"	B	250'

See pages 111 - 115 for applicable fittings
 * Does not meet DOT or SAE specifications

Tube Cutter



Part No.	Description
090028	Nylon Tube Cutter

Cab Blower Kit



NEW

Part #149001

Part #149003

- Designed for truck cab or low pressure shop use
- Air hose rated at 200 psi max recommended operating pressure
- Kit includes hose, economy air nozzle, tire inflator and gladhand

Part No.	Description
149001	Cab Blower Kit-Rubber
149002	Air Blow Gun Assembly
149003	Cab Blower Kit - coiled Nylon

Fifth Wheel Slider Coil



- Continuously returns to its original shape
- Flexes from 10" to 54"
- Includes (2) 1/4" tube 1/4" MPT fittings
- Temp range from -40° to 208°F
- Max. pressure rating of 150 psi
- Meets SAE J844 requirements

Part No.	Description
022028	Fifth Wheel Slider Coil

800-783-8871

Dash Control Valves (PP-1, PP-2, PP-3, PP-7 and PP-8 Styles)



Part No. 034015
(as shown; top portion **only** is different)

- PP-1 Style
- Automatic pressure release at 40 psi
- 1/8" NPT supply port
- Knob and mounting nut sold separately (see page 44)

Part No.	Delivery Ports	Replaces
034013	(2) 1/8" NPT	Bendix 275175, 276566, 276567 & Midland KN20021
034015*	(2) 1/8" NPT	Bendix 279786, 281587
034014	(2) 1/4" NPT	Bendix 287417, 287600

*Remote controlled - 1/4" - 20 female thread for knob or cable



- Direct replacement for Bendix 287238 & Midland KN20035
- PP-8 style
- Automatic pressure release at 20 psi
- 1/8" NPT supply, delivery (2) and exhaust ports

Part No.	Description
034019	Dash Control Valve



- Direct replacement for Bendix 275250, 276462
- PP-2 Style
- Automatic pressure release at 40 psi
- 1/8" NPT supply port
- (2) 1/8" NPT delivery ports
- 1/8" NPT brake valve port
- Knob and mounting nut sold separately (see page 44)

Part No.	Description
034016	Pressure Balanced Dash Control Valve



Part No. 034080
(as shown; top portion **only** is different)

- PP-7 style
- Automatic pressure release at 40 psi
- Non-override at 25 psi
- 1/8" NPT supply and control ports
- 1/4" NPT delivery port
- 1/4" threaded exhaust port on Part No. 034079
- Knob and mounting nut sold separately (see page 44)

Part No.	Shaft Diameter	Replaces
034051	3/8"	Bendix 288239, 288721 & Midland KN20025
034079	5/16"	Bendix 106113, 288241
034080*	1/2"	Bendix 288242

*Remote controlled - 1/4" - 20 female thread for knob or cable



Part No. 034017 Part No. 034018

- PP-3 Style
- Tripper exhausts at 30 psi and charges above 50 psi
- Plunger trips at 40 psi and charges manually
- 1/8" NPT supply port
- 1/4" NPT delivery port
- 1/4" NPT exhaust port
- Knob and mounting nut sold separately (see page 44)

Part No.	Description	Replaces
034017	Automatic Tripper Dash Control Valve	Bendix 288746
034018*	Automatic Tripper Dash Control Valve	Bendix 279787

*Remote controlled - 1/4" - 20 female thread for knob or cable

Push-Pull Dash Control Valve



- Direct replacement for Midland KN20030, KN20031
- Automatic pressure release at 25-35 psi
- All ports 1/4" NPT
- 1/4" - 28 thread size

Part No.	Description
034055	Dash Control Valve

Pressure Reducing Valve (RV-1 Style)



- Direct replacement for Bendix 283590
- Used where a constant set pressure lower than supply pressure is required

- Adjustable-factory preset at 70 psi
- 1/4" NPT supply and delivery ports

Part No.	Description
034085	Pressure Reducing Valve

Knob and Pin Kits

Part No.	Description	Replaces
034049	Trailer Air Supply Knob and Pin Kit for PP-7 Style Dash Control Valve	Bendix 290655 & Midland KN20900
034050	Parking Brake Knob and Pin Kit for PP-1 Style Dash Control Valves	Bendix 248433 & Midland KN20903
034052	Plain Black Knob and Pin	Bendix 241866
034053	Pull to Park/ Push to Release Parking Brake Knob and Pin Kit for PP-1, PP-2 and PP-3 Style Dash Control Valve	Bendix 240302
034054	Dash Control Valve Mounting Nut	Bendix 239357

NOTE: All knob kits include roll pin to secure to valve

Tractor Protection Valve (TP-3 Style)

- Direct replacement for Bendix 279000 & Midland KN34060
- 1/4" NPT tractor emergency port
- 3/8" NPT tractor service port
- 1/2" NPT trailer emergency and trailer service ports

Part No.	Description
034068	Tractor Protection Valve

NOTE: Always use this valve in conjunction with a PP-1, PP-3 or PP-7 style dash control valve (see page 43)

Tractor Protection Valve (TP-5 Style)

- Direct replacement for Bendix 288605
- Formerly VM-2 style control valve manifold
- 3/8" NPT service and trailer/ emergency supply ports (rear)
- 1/4" NPT stop light switch port
- 3/8" NPT trailer control port
- 1/2" NPT trailer service and trailer emergency supply ports

Part No.	Description
034082	Tractor Protection Valve

Dash Control Valve (MV-3 Style)

- Direct replacement for Bendix 065157, 800516
- Combination PP-1 and PP-7 valve
- 1/4" diameter horizontal mounting holes at 4-7/32" O.C.
- 1/4" diameter vertical mounting at 3" O.C. mounting holes

Part No.	Description
034081	Dash Control Valve

Modulating Relay Valve (R-7 Style)

- Direct replacement for Bendix 103081, 283932
- 3/8" NPT supply and delivery (2) ports
- 1/4" NPT control and balance ports
- Spring brake release pressure of 95 psi

Part No.	Description
034023	Modulating Relay Valve

Relay Valves (R-6 Style)

- 1/4" NPT service port
- (4) 3/8" NPT delivery ports

Part No.	Supply Port(s)	Replaces
034020	(1) 1/2" NPT	Bendix 279180, 280375
034021	(1) 3/4" NPT (in mounting flange) (1) 3/8" NPT	Bendix 279952

Relay Valve (R-8 Style)

- Direct replacement for Bendix 286370, 286371
- 1/4" NPT service port
- (2) 3/4" NPT supply ports
- (2) 1/2" NPT, (1) 1/4" NPT delivery ports
- 1/8" NPT balance port located under exhaust cover
- Cracking pressure 3 psi

Part No.	Description
034024	Relay Valve

Double Check Valve (DC-4 Style)

- Direct replacement for Bendix 278614 & Midland KN25060
- All ports 3/8" NPT
- May be mounted in any position

Part No.	Description
034062	Double Check Valve

Relay Valves (R-12 and R-14 Styles)

R-12 Style

*R-14 Style
1/2" NPT*

*R-14
1/8" NPT balance port
located under exhaust
cover*
Relay Valve

- Direct replacement for Midland KN28060
- 3/8" NPT control port
- (2) 1/2" NPT supply (reservoir) ports
- Crack pressure 4.6 psi
- (2) 3/8" delivery ports

Part No.	Style	Supply Port(s)	Delivery Ports	Replaces
034025	R-12	1/2" NPT	Vert.-(4) 1/2" NPT	Bendix 102166, 102626
034026	R-12	(2) 3/4" NPT	Horiz -(2) 1/2" NPT	Bendix 103009
034027	R-14	(2) 3/4" NPT	Horiz -(2) 1/2" NPT	Bendix 103010
034028	R-14	1/2" NPT	Vert.-(4) 1/2" NPT	Bendix 103028

Part No.	Description
034059	Relay Valve

Relay Valves (RG-2 Style)

- Fast, low cracking pressure - 5 psi
- 1/4" NPT control port

Part No.	Reservoir Ports	Delivery Ports	Replaces
034056	(2) 3/8"	(2) 3/8"	Midland KN28500
034057	(1) 3/8", (1) 1/2"	(2) 3/8"	Midland KN28510
034058	(2) 1/2"	(2) 1/2"	Midland KN28520

Relay Emergency Valve (RE-6 Style)

- Direct replacement for Bendix 281865
- 1/4" NPT service and emergency ports
- (1) 3/4" NPT, (1) 3/8" NPT supply ports
- (2) 3/8" NPT, (2) 1/4" NPT delivery ports

Part No.	Description
034029	Relay Emergency

Relay Emergency Valves

Part No. 034066

- 1/4" NPT delivery and service control ports
- 1/2" NPT supply port

Part No. 034067

- 1/4" NPT service and emergency inlets
- (4) 3/8" NPT delivery ports
- 3/4" NPT reservoir
- Crack pressure 3 psi

*Part No. 034069
(w/ratio feature)*

- (4) 3/8" NPT delivery ports
- 1/4" NPT emergency & service control ports
- 3/4" NPT reservoir port

Part No.	Description	Replaces
034066	Relay Emergency Valve	Sealco A-1000
034067	Relay Emergency Valve	Midland KN30400 & Wagner A99036
034069	Relay Emergency Valve	Sealco 110200

Multi-Function Trailer (RT-4 Style)

- Direct replacement for Midland KN26000
- 3/8" NPT trailer supply and control ports
- 1/2" NPT and 3/8" NPT reservoir ports

- (4) 3/8" NPT delivery ports
- PPV closing pressure at 55 psi

Part No.	Description
034063	Multi-Function Trailer Valve

Air Governors (D-2 Style)

- Factory preset opening and closing pressures of 100 to 120 psi
- (6) 1/8" NPT ports and two mounting holes
- Mounting gasket and (4) 1/8" socket head pipe plugs included
- High temperature governor designed with high temperature withstanding O-rings
- Individually boxed

Part No.	Description	Replaces
032131	Air Governor	Bendix 275491 & Midland KN18530
034083	High Temperature Air Governor	Bendix 284358 & Midland KN18534

Foot Valves (E-3, E-6 and E-7 Styles)

- Direct replacement for Bendix 277863 & Midland KN22100
- E-3 Style
- 1/2" NPT supply and delivery ports
- (2) 1/4" NPT auxiliary supply ports

Part No.	Description
034038	Single Circuit Brake Valve



- Direct replacement for Bendix 286171 & Midland KN22140 and KN22150
- E-6 Style
- 3/8" NPT supply and delivery ports

Part No.	Description
034039	Dual Circuit Brake Valve

Part No. 034040

Part No. 034077

- E-7 Style
- Dual circuit valves
- 1/2" exhaust port with diaphragm
- Three mounting holes-firewall mounted
- O-rings included

Part No.	Side Ports	Rear Ports	Application	Replaces
034040	(2) 1/4" Supply	No Threads	Ford	Bendix 284760
034077	(4) 1/4" Supply (4) 1/4" Delivery (Threaded)	1/8" Supply (2) 1/2" Supply (2) 1/2" Delivery	Navistar	Bendix 288383

Spring Brake Valve (SR-1 Style)

- Direct replacement for Bendix 286364
- 1/4" NPT reservoir, control, supply and delivery ports
- 55 psi reservoir trip pressure
- Bracket mounted

Part No.	Description
034030	Spring Brake Valve

Trailer Spring Brake Valves (SR-2 and SR-4 Styles)

Part No. 034031

Part No. 034032

- SR-2 style valves
- 1/4" NPT service reservoir (2) and trailer supply ports
- (4) 3/8" NPT delivery ports
- 1/4" NPT trailer service port on Part No. 034031

Part No.	Reservoir Port	Replaces
034031	1/2" MPT	Bendix 103061
034032*	3/4" MPT	Bendix 287376

*Does NOT have trailer service port for anti-compound



- SR-4 style valves
- 1/4" NPT reservoir charging (2), trailer supply and trailer service ports
- (4) 3/8" NPT delivery ports

Part No.	Reservoir Port	Replaces
034033	3/4" MPT	Bendix 101112
034034	1/2" MPT	Bendix 101622

Trailer Spring Brake Valve (SR-5 Style)

- Direct replacement for Bendix 065437
- 3/4" MPT reservoir mounting port
- 1/4" NPT service/spring brake reservoir, service, trailer supply and trailer service ports

- (4) 3/8" NPT delivery ports
- Anti-compounding

Part No.	Description
034035	Trailer Spring Brake Valve

In-Line Quick Release Valves

Part No. 032019



Part No. 032020

- Speeds up release of trailer service brakes when installed on service side gladhand
- Speeds up application of trailer parking brakes when installed on emergency side gladhand
- Suitable for use on double or triple trailers
- Durable zinc die cast bodies
- Flow Rate: Forward - 9.0 SCFM at 2 psi; Exhaust - 8.0 SCFM at 2 psi
- 1/2" - 14 MPT with Vibraseal thread sealer one end, 1/2" - 14 FPT other end.
- 1-1/2" diameter x 3-1/2" long

Part No.	Description
032019	Mounts Between Tractor Protection Valve and Air Lines
032020	Mounts at tractor Gladhand

Quick Release Valves (QR-1 Style)

- 3/8" NPT exhaust port
- (2) 11/32" mounting holes at 1-1/2" on center
- Cracking pressure of 1 psi

Part No.	Delivery Ports	Supply Ports	Replaces
032015	3/8" NPT	3/8" NPT	Bendix 229859, 288251 & Midland KN32005
032018	3/8" NPT	1/2" NPT	Bendix 229860 & Midland KN32011
034078	1/4" NPT	3/8" NPT	Bendix 229813

Quick Release/Double Check Valve (QR-1C Style)

- Direct replacement for Bendix 289714 & Midland KN32041
- 1/4" NPT supply and balance ports
- (2) 3/8" NPT delivery ports
- (2) 11/32" diameter mounting holes at 1-1/2" on center
- Supply and delivery differential is 1 psi max

Part No.	Description
034012	Quick Release Valve

Limiting and Quick Release Valves (LQ-2 and LQ-4 Styles)

- Direct replacement for Bendix 229505
- LQ-2 Style
- Limits front axle service brake application by 50% and serves as a quick release valve for that axle - commonly found on pre-121 (pre-1985) vehicles
- 3/8" NPT supply, delivery and exhaust ports
- 1/4" NPT control port
- 19/32" diameter mounting holes at 1-1/2" on center

Part No.	Description
034084	Limiting and Quick Release Valve



- Direct replacement for Bendix 289144
- LQ-4 Style
- For limiting front axle pressure
- 3/8" NPT supply and delivery ports
- (2) 19/32" diameter mounting holes at 1-1/2" on center
- Nominal hold off pressure of 4 psi
- Nominal equalizing pressure of 60 psi

Part No.	Description
034036	Limiting and Quick Release Valve

AIR

Air Tractor Control Kits

- Kits add hand and foot control to trucks with pre-FMVSS 121 air brakes hauling an air brake trailer (for trucks with FMVSS 121 air brakes, consult the truck manufacturer)
- Hose assembly jumper lines and support springs included with kit (kit No. 131012 only)
- Hand control valve included (except for Part No. 131016). This normally closed valve has 1/4" FPT inlet/outlet/exhaust ports and an 1/8" FPT pressure gauge port (180 psi

maximum supply pressure) - hand control valve also sold separately

- **NOT FOR ABS APPLICATIONS**



Part No.	Description
131012	Kit for Tractor Installations
131014	Kit for Dump Truck Installations
131016	Kit for Dump Truck Installations without Hand Valve
032051	Hand Control Valve

AIR ACCESSORIES VALVES

Universal Fan Clutch Drive Solenoid Kit

Five year guarantee against failure under normal operating conditions!



Nominal Voltages: 12 VDC
Working Voltage: 11 -16 VDC
Maximum Operating Pressure: 150 psi
Exposure Temperature: 200 ° F (max)
Mounting Hole: 3/8"
Ports: (3) 1/8"-27 FPT

- Universal kit replaces existing solenoids found on Kysor, Bendix and Horton fan clutches
- Kit includes valve, wire harness with Weather-Pack sealed connectors, exhaust shield, in-line filter and butt connectors

Part No.	Description
032192	Universal Solenoid Kit
032194*	Replacement Solenoid
032190	Replacement In-Line Filter
032191	Replacement 1/8" NPT Exhaust Vent

*Valve may also be used for shutter stat solenoid applications. Replaces Navistar numbers 450284C91 and 1692761C91 for this use

Three-Way Solenoid



- Provides on/off exhaust function
- Inlet port normally closed-
for intermittent use only
- (2) 1/4" FPT ports
- 12 VDC
- 100 - 120 psi operating pressure
- 2-9/32" diameter mounting holes on 2-1/2" centers

Part No.	Description
320051	Three-Way Solenoid

NOTE: Always use in conjunction with a momentary contact switch (see Part No. 090202 on page 81)

Air Solenoid Valve



- Direct replacement for Neway 90054075 (normally open)
- 12 VDC, 10 watts
- Intermittent use only
- 100psi maximum operating pressure
- 1/4" threads

Part No.	Description
034075	Air Solenoid Valve

Tag Axle Control Solenoid Valve



- Direct replacement for Midland/Haldex & Neway 90554662
- Operates auxiliary lift axle
- 3/8" NPT ports
- 12 VDC
- 72" lead
- 150 psi maximum operating pressure

Part No.	Description
034094	Solenoid Valve Assembly

Power Take-off and Dump Pump Control Valve Kit



- Replaces Chelsea 328388-79X
- Kit includes combo control valve with 1/4" built-in push-to-connect fittings, in-line fuse holder with 9 amp fuse, cable, pressure protection valve 1/4" nylon tubing (50') and fittings-control valve assembly also sold separately

Part No.	Description
032144	PTO and Dump Pump Control Valve Kit
032142	Combo Control Valve (Feathering Valve)
034073	PTO Cable
032086	Pressure Protection Valve

Power Take-Off Four-Way Control Valve



- Replaces Chelsea 328865X
- Panel-mounted, three position valve
- 1/8" - 27 NPTF
- 150 psi maximum operating pressure
- Operating temperature range from -20° to +200° F

Part No.	Description
032145	PTO Four-Way Control Valve Assembly

Power Take-Off Air Shift Kit



- Power take-off kit controls add-on air-controlled accessories
- Kit includes control valve, indicator light, 1/4" nylon tubing (50) and fittings, cable, bracket and pressure protection valve. Control valve assembly, indicator light and cable also sold separately

Part No.	Description
034070	Power Take-Off Air Shift Kit
034071	Air shift Valve Assembly
034072	Indicator Light
034073	PTO Cable
032086	Pressure Protection Valve

Power Take-Off Combo Control Valve with Shift Tower



- Combo valve controls PTO and dump pump operations
- 1/4" brass push-to-connect fittings included on valve assembly
- Shift tower measures 4-5/8" x 3-5/8" x 8" H overall with 2" access hole and mounting holes 4-1/4" on center

Part No.	Description	Replaces
032143	PTO Combo Valve with Shift Tower	-----
032142	Combo Control Valve (Feathering Valve)	Chelsea 329358X
032146	Control Valve Shift Tower	Chelsea 329219X

Air and Air-Electric Three-Way Toggle and Flipper Valves



Part No.	Photo	Description	Toggle Style	Lever Position	Primary Vehicle Application*
032225	A	Air-Electric Toggle Valve	Paddle	—	Kenworth, Volvo
032227	B	Air-Electric Toggle Valve	Blade	—	Mack
032228	C	Air-Electric Toggle Valve	Bat	—	Peterbilt
032229	D	Air Toggle Valve	Paddle	—	Kenworth, Volvo
032231	E	Air Toggle Valve	Blade	—	Mack
032232	F	Air-Electric Flipper Valve	—	Right Off	Freightliner
032234	F	Air-Electric Flipper Valve	—	Right Off	Navistar
032235	F	Air-Electric Flipper Valve	—	Right On	Navistar
032233	G	Air Flipper Valve	—	Right Off	Freightliner
032236	G	Air Flipper Valve	—	Right Off	Navistar

*These are only primary listings-valves are universal and suitable for a variety of applications

- Push-connect fittings mate easily with 1/4" nylon tubing for easy installation
- 150 psi maximum operating pressure
- ON-OFF Faceplate Part No. 032039 fits air-electric and flipper valves. Part Nos. 032232, 032233, 032234 and '032236 and installs using 10-24 x 1/4" screw

Air-Electric Valves Technical Information

Switch Off Position: No air flow, electrical contacts open

Switch On Position: Air flows through valve, electrical contacts closed

Amperage: 5 amp resistive current load at 12 VDC

Terminal Size: 1/4" blade Terminal Size

Pressure Switch: Open below 10 psi, closed above 35 psi

Transmission Selectors

NEW



Part No.	Description
032400	Trans Selector A4487
032401	Trans Selector A4490
032402	Trans Selector A4491

Transmission Range

NEW



Part No.	Description
032403	Range Value A-6909
032404	Range Value A-6913
032405	Range Value A-6915
032406	Range Value A-6918

Universal Air Accessory Dash Valves

- Two position, three-way air valves
- Include DOT compliant (FMVSS 106) push-to-connect fittings for 1/4" tubing
- Built-in standard four pin electrical connector for backlit function
- Additional rear port used to easily jumper air lines between valves
- Fit standard 22 mm x 44 mm openings, easily replacing valves found on many current model trucks

Operating Temperature: -10° to +160° F

Rated Pressure: 150 psi maximum

Rated Current Load: 1 amp at 14 VDC (max.)

Electric Connector: Valve connector mates with Metri-Pack 150 Series connector Part No. 12045813 with female terminals (for reference only-not available from Velvac and not included)

NEW



Part No.	Description
032247	Inter-Axle Differential Lock Dash Valve
032248	Fifth Wheel Slide Dash Valve
032249	Air Suspension Dump Dash Valve
032250	Power Take Off Dash Valve
032253	Universal Dash Valve
032022	Inter-Axle Differential Lock Dash Valve
032023	Differential Lock Dash Valve

Universal Three-Way Toggle Valve



- 1/8" NPT supply and delivery (2) ports
- Includes chrome-plated flip handle
- Faceplate sold separately-install using a 10-24 x 1/4" screw

Part No.	Description
032037	Universal Three-Way Toggle Valve
032039	Faceplate-On/Off

On/Off Air Control Toggle Valve



- Replaces Mack 20-QE39311
- 1/8" NPT inlet and outlet ports
- Includes mounting washer and nut

Part No.	Description
032138	On/Off Air Control Valve

Height Control Valves -

Standard Leveling Valve, Cab Leveling Valve and a Rapid Dump Feature valve

The Shear-Seal® Advantage

In the past industry expectations for commercial vehicle air suspension height control valves was limited. Designs were based on seals that wore rapidly, requiring frequent replacement. As the seals failed, height control performance deteriorated and air consumption increased. Valve replacement and downtime costs were rising with trucking demand.

The Shear-Seal® Solution:

- Provides breakthrough improvements in durability and performance
- Over 40 years of heavy duty demanding industry applications such as: steel and paper mills, oil exploration and processing and defense
- Zero lead technology reduces downtime and costly air loss

The Shear-Seal® Principle



- Based on the sliding of two precisely machined metal sealing surfaces across each other creating a zero-leak* seal
- Media passes through the center of the seals rather than across the seal surface preventing contamination from entering the seal areas
- As the valve shifts, the wiping action of the polished metal seals pushes away debris
- Precision engineering and manufacturing combine for unmatched performance and reliability
- These valves are actual OEM valves used in production

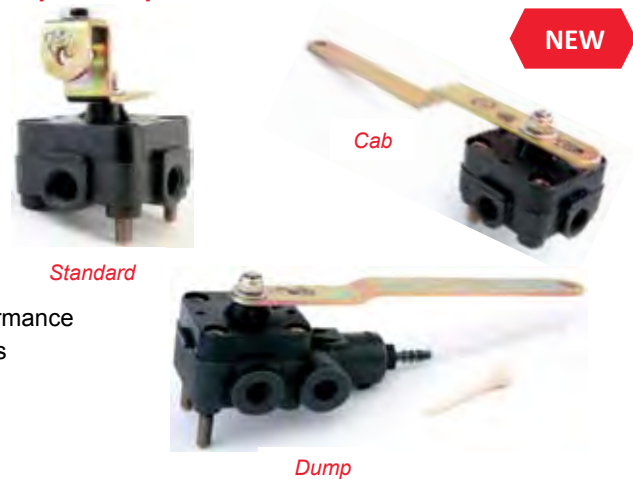

Part No.	Description	Ports	Replaces	Used with Vehicles
034101	Cab Valve	1/4" NPT	WABCO S464 007 004-0 Barksdale KD2355	International cab, Peterbilt cab
034111	Standard Chassis Valve	1/4" NPT	WABCO S464 002 443-0 Barksdale KD2356 Midland KN 27000	International chassis
034112	Standard Chassis Valve	1/4" NPT	Hadley/Neway 90054007, Barksdale KD2357	Kenworth chassis
034113	Standard Chassis Valve	1/4" NPT	Delco King of the Road 12C-1 (KOR 5549705) & 12-6-2 (KOR 5549706), Barksdale KD2373	Volvo chassis
034114	Standard Chassis Valve	1/4" NPT	Hadley H00450CE Barksdale KD2375	Volvo/ Mack chassis
034122	Dump Valve	1/4" NPT	Hadley H00500RS Barksdale KD2358	International chassis
034123	Dump Valve	1/4" NPT	WABCO 464 008 115-0 Barksdale KD2359	Volvo chassis
034124	Dump Valve	1/4" NPT	International 2506169C91 Hadley HAD500NS, Barksdale KD2360	International chassis w/dump, Peterbilt chassis w/dump
034126	Dump Valve	1/4" NPT	Hallex PR 90554950 & 90554945, Barksdale KD2374	Kenworth chassis w/dump Volvo chassis

NOTE: See photos on page 52

*Zero-leak is less than 4CC per minute

Shear-Seal® is a registered trademark of Barksdale Control Products

Shear-Seal® Height Control Valve

NEW



Part No.
034122



Part No.
034123



Part No.
034124



Part No.
034112



Part No.
034101



Part No.
034126



Part No.
034113



Part No.
034114



Part No.
034111

Shear-Seal® Height Control Valve Linkage and Hardware

NEW

Adjustable Linkage

- Adjusts for 8-3/4" to 14-1/2"
- 1/4" diameter mounting bolts
- Zinc plated steel rods
- Elastomer ends



Adjustable Linkage



Part No.
034135



Part No.
034136



Part No.
034134

Part No.	Description
034130	Adjustable Linkage - adjustment range 6.9-9.6 inches
034131	Adjustable Linkage - adjustment range 9.8-11.5 inches
034132	Adjustable Linkage - adjustment range 10.9-13.6 inches
034133	Adjustable Linkage - adjustment range 12.8-19.0 inches
034134	Linkage Hardware - 5/16-18 thread
034135	Linkage Hardware- 1/4-20 thread
034136	Linkage Hardware - 8mm course thread

Height Control Valves



Part No. 032139



Part No. 034065-Delayed Response**



Part No. 034064-Immediate Response



Part No. 032140



Part No. 032141-Immediate Response*

Part No.	Ports	Description	Replaces
032139	1/8" NPT	Includes Linkage and Brackets	Hadley H600
032140	1/4" NPT	Valve Only	Midland/Haldex & Neway 90554241
032141*	1/4" NPT	Includes Built-In Dump Valve	Midland/Haldex & Neway 90554271
034064	1/4" NPT	Includes Linkage Kit	Midland KN27000
034065**	1/8" NPT	Includes Fitting Package	Neway 90054007

* Normally open dump feature; needs air pressure to dump from air spring

**7-12 seconds prior to releasing air to air bags; also known as self-leveling

Air Horn Actuator Valves



- Direct replacements for air horn valves found on many trucks
- Replace similar valves from both Grover and Hadley
- Molded mounting bracket and push-connect fittings provide easy installation

Part No.	Photo	Description	Ports	Vehicle Application
032240	A	Single Outlet	(3) 1/4"	Kenworth
032241	A	Dual Outlet	(3) 1/4"	Kenworth
032242	B	Dual Outlet	(3) 1/4", (1) 3/8"	Freightliner
032243	B	Single Outlet	(3) 1/4", (1) 3/8"	Freightliner
032244	C	Medium-Duty	(2) 3/8"	Navistar
032245	D	Conventional Cab	(2) 3/8"	Navistar
032246	E	Cab over	(2) 3/8"	Navistar

Rapid Dump Air Suspension Valve



- Replaces Humphrey 250A N/O valves
- Pilot operated
- Dual delivery design allows for in-line plumbing of air spring lines and eliminates need for tee fittings
- (4) 1/8" FPT ports
- Mounts on either right or left frame rail using 1/4" mounting holes

Part No.	Description
032195	Rapid Dump Air Suspension Valve

Pressure Protection Valves



- Normally closed
- Nominal closing pressure 65-75 psi
- (2) 1/4" FPT ports
- 150 psi maximum operating pressure

Part No.	Description
032086	Pressure Protection Valve



PR-4 Style

- Direct replacement for Bendix 286500
- 1/4" NPT supply and delivery ports
- 85 psi nominal closing pressure
- Non-adjustable

Part No.	Description
034037	Pressure Protection Valve

Three-Way Pilot Valve



- Direct replacement for Neway 90054079
- For Neway suspension systems
- 1/4" NPT supply/delivery/exhaust ports

Part No.	Description
034074	Three-Way Pilot Valve



- Designed for convenient in-tank mounting on tanks with dual outlet ports
- All valves *except* Part No. 032221 include Vibraseal sealant on mounting thread for easy installation

Part No.	Inlet Port (NPTM)	Outlet Ports (NPTF)	Nominal Opening Pressure (psi)	Nominal Closing Pressure (psi)	Primary Vehicle Application*
032216	3/8"	3/8"	55	45	Freightliner
032217	3/8"	3/8"	85	67	Ford
032218	1/2"	3/8"	55	45	Freightliner
032219	1/2"	3/8"	85	67	Freightliner
032220	1/2"	1/4"	65	55	Peterbilt
032221	1/2"	1/4"	100 (max)	70 (min)	Kenworth
032222	1/4" (Hex Nipple)	1/4"	100 (max)	70 (min)	Mack**

* These are only primary listings-valves are universal and suitable for a variety of applications

** Replaces Mack number 20QE2326A

Height and Lumbar Control Seat Valves



- Valves control air ride truck seats and lumbar supports
- Available in push/pull and paddle type configurations
- Spring-loaded, three-way function
- Electro-pneumatic combination valve designed to operate air seats using an electric air compressor
- Designed to replace valves on seats by major manufacturers such as Bostrom, National and Sears

Part No.	Photo	Description	Ports	Primary Seat Application*
032110	A	End and Side Ported with Removable Chrome Knob	(2) 1/8" FPT	Various
032205	B	End Ported with Removable Chrome Knob	(2) 1/8" FPT	Various
032206	C	Electro-Pneumatic with Removable Black Knob and Two 1/4" Blade Terminals	(1) 1/8" FPT	Various
032201	D	Paddle Type	(2) 3/16" Barbs	Bostrom

*These are only primary listings-valves are universal and suitable for a variety of applications

Air Pressure Gauge



- 1-1/2" diameter dial
- Accommodates a 1/8" FPT port
- Pressure range of 0 - 160 psi

Part No.	Description
035065	Air Pressure Gauge

Pressure Regulator Valve



- A compact, high quality in-line pressure regulator with gauge and bracket kit, rated to 125 psi with 1/4" NPT ports

Part No.	Description
320149	Pressure Regulator Valve

Low Air Pressure Warning Light



- 12 volt red light
- Uses #57, 1895 or 293 bulb
- Mounts through 3/4" hole
- Complete with low air face plates

Part No.	Description
036049	Low Air Pressure Warning Light Assembly
002063	Replacement Red Pilot Light
036045	Replacement Faceplate

NOTE: Use in conjunction with a low pressure switch part Nos. 0304041, 034042 or 175043

Brake Light Switch (SL-4 Style)



- Direct replacement for Bendix 228600
- 1/4" NPT supply
- Actuates at 3-5 psi

Part No.	Description
036036	Stop Light Switch

Low Air Warning Buzzer



- 12 volt buzzer
- 9/32" diameter mounting holes

Part No.	Description
036043	Low Air Warning Buzzer

NOTE: Use in conjunction with a low pressure switch, Part No. 034041 or 034042

Pressure Regulator Valve



- Direct replacement for Bendix 217380 & Midland KN31070
- Non-exhaust type regulator
- 3/8" NPTF delivery and supply ports
- 10-125 psi adjustable pressure gauge

Part No.	Description
032060	Pressure Regulator Valve

Low Pressure Indicators (LP-3 Style)



- 1/4" NPT supply
- Automatic pressure release at 60 +/- 6 psi

Part No.	Description	Replaces
034041	Single Terminal	Bendix 279416
034042	Double Terminal	Bendix 228750

NOTE: Use in conjunction with either warning buzzer Part No. 036043 or warning light Part No. '036049

Air Dryer Replacement Cartridges



Part No. 034046



Part No. 034047



Part No. 034048

- All include seal rings

Part No.	Description	Replaces
034046	Fits AD-SP Type Air Dryers	Bendix 109994, Bosch 1-487-434-901 & WABCO 432-410-020-2, 432-420-220-2 (also fits System Saver 1200)
034047	Fits AD-4 Air Dryers	Bendix 103981, 104358
034048	Fits AD-9 Air Dryers	Bendix 107794, 107796

AD-9 Air Dryer Rebuild Purge Kits



Part No. 034087



Part Nos. 034088, 034089

- Installation instructions and all necessary lubricants included
- 12 and 24 VDC heater/thermostat kits also sold separately and include heater/thermostat assembly, seal rings and mounting hardware

Part No.	Description	Replaces
034087	Purge Valve Kit w/ Purge Piston Assembly	Bendix 5005037, 5004336, 5004337, 107798
034088	Purge Assembly Kit - 12 Volt (includes Aluminum Purge Housing, Purge Valve Kit and 12 V Heater/Thermostat Kit	Bendix 800405
034089	Purge Assembly Kit -- 24 Volt (includes Aluminum Purge Housing, Purge Valve Kit and 24V Heater/Thermostat Kit	Bendix 5004338
034092	Heater/Thermostat Kit Only - 12 Volt	Bendix 109578
034093	Heater/Thermostat Kit Only - 24 Volt	Bendix 109579

Air Dryer Wiring Harness



- Direct replacement for Bendix 109869, 109871, 298948
- Fits both 12 and 24 volt AD-9, AD-SP, AD-IP and System Saver 1200 units
- 22" leads

Part No.	Description
034091	Air Dryer Wiring Harness

Safety Valves (ST-3 and ST-4 Styles)



Part No. 030075

Part No. 030074

- ST-3 Style
- Automatic Pressure release at 150 psi
- 1/4" NPT
- Adjustable valve preset to 125 psi by factory; adjustable from 41-149 psi

Part No.	Description	Replaces
030075	Safety Valve	Bendix 284142 & Midland KN31200, KN31400

030074	Adjustable Safety Valve	Bendix 205105
--------	-------------------------	---------------

- ST-4 Style
- 1/4" NPT
- Automatic pressure release at 175 psi
- Low profile valve fits AD-9, AD-SP, AD-IP, and System Saver 1200 air dryers



Part No. 034090

Part No.	Description	Replaces
034090	Safety Valve	Bendix 800350

Automatic Reservoir Drain Valve (DV-2 Style)

- Direct replacement for Bendix 281923 & Midland KN24000
- All ports 3/8" NPT



Non-heated

Part No.	Description
034043	Automatic Reservoir Drain Valve

Single Check Valves



Part No.
034044

Part No. 320014

Part No. 320001

Part No. 034045

Part No. 320003

Part No.	Description	Replaces
034044	1/4" Threads	Bendix 229603, 800375
320014	3/8" Threads	Bendix 227870, 800373 & Midland KN23010
320001	1/2" Threads	Bendix 227717, 227788, 227871, 800372 & Midland KN23000
034045	1/2" Female Threads	Bendix 800370
320003	3/4" Threads	Midland KN23040

Air Tank Drain Cocks



Part No. 036003

Part No.
036019

Part No.
036021

- 1/4" MPT

Part No.	Description
036003	Lever Handle Drain Cock
036019	Back Seating Drain Cock
036021	Wing Handle Drain Cock

Drain Pull Valves



- Attached vinyl coated aircraft cable
- .075" diameter cable
- 1/4" MPT
- 120 psi maximum pressure

Part No.	Description
032135	Valve with 3' Cable
032058	Valve with 4' Cable
032082	Valve with 5' Cable
032160	Valve with 5' Cable Uncrimped on Free End- Includes One Extra Sleeve
032081	Valve Without Cable
032170	100' Bulk Cable
032083	Replacement 5' Cable and Sleeves
032185	Replacement Cable Sleeve

SLACK ADJUSTERS

Manual Slack Adjusters



- Straight arm, standard duty slack adjusters with bronze bushings
- 22,000 in.-lbs. Rating in accordance with SAE Test J1461 Draft 4

- Five rivet design
- 26,000 in.-lbs. maximum torque rating

Part No.	Spline	Drilling	Replaces
035120	1.60"-37	6"	Bendix 283411, Midland KN44041 & Euclid E1574HD
035121	1.60"-37	5", 6", 7"	Midland KN44042
035122	1.50"-28	5", 6"	Bendix 286965, Midland KN44051 & Euclid E2458
035123	1.50"-28	5-1/2", 6-1/2"	Bendix 288753, Midland KN44061 & Euclid E2459HD
035124	1.50"-28	5", 6", 7"	Bendix 288282, Midland KN44071 & Euclid E2458HD
035125	1.50"-10	5", 6", 7"	Bendix 278323, Midland KN47001 & Euclid E612HD
035126	1.50"-10	5-1/2", 6-1/2"	Bendix 278321, Midland KN47011 & Euclid E940HD
035127	1.50"-10	5", 6"	Bendix 278312, Midland KN47081 & Euclid E1063HD
035128	1.25"-10	5", 6"	Bendix 278303, Midland KN48001 & Euclid E939
035129	1.25"-10	5", 6", 7"	Bendix 278305 & Midland KN48002
035130	1.25"-10	4-1/2", 5-1/2"	Bendix 278302, Midland KN48031 & Euclid E4904
035131	1.25"-10	4-1/2", 5-1/2" (Right Hand Offset)	Bendix 278294, Midland KN49000 & Euclid E2762RH
035132	1.25"-10	4-1/2", 5-1/2" (Left Hand Offset)	Bendix 278295, Midland KN49010 & Euclid E2763LH

Air Tanks

AIR

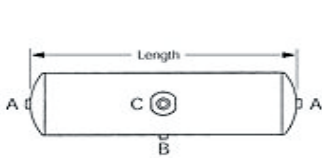

Type 1 - Bracket Mounted

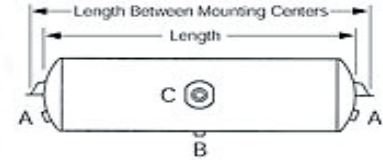

Type 2 - Flange Mounted

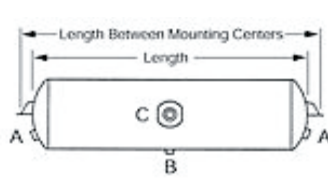

Type 3 - Flange Mounted

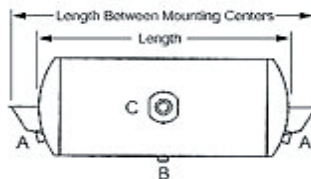

Type 4 - Flange Mounted

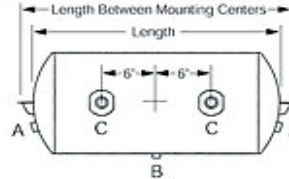

Type 5 - Flange Mounted

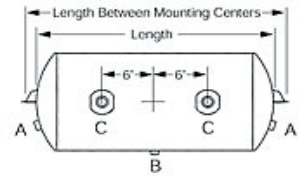

Type 6 - Flange Mounted

- All tanks feature dual main ports except Part No 035103
- All steel construction
- All tanks are water tested prior to shipping
- Dipped tanks are rust resistant and primer sealed
- Internally corrosion resistant
- Tanks meet SAE J10 requirements

Part No.	Tank Type	Diameter	Length	A	B	C	Cu. In. Capacity	Mounting Centers
035103*	1	8"	29-1/4"	1/2"	1/4"	3/4"	1425	—
035101	2	8"	29-1/4"	3/8"	1/4"	3/4"	1425	32"
035102	3	8"	29-1/4"	3/8"	1/4"	3/4"	1425	32"
035106	3	9-1/2"	22-1/2"	3/8"	1/4"	3/4"	1488	27-1/2"
035104	4	9-1/2"	22-1/2"	3/8"	1/4"	3/4"	1488	27-1/2"
035105	4	9-1/2"	22-1/2"	1/2"	1/4"	3/4"	1488	27-1/2"
035108	3	12"	27"	3/8"	1/4"	3/4"	2850	29-1/2"
035107**	5	12"	27"	3/8"	1/4"	3/4"	2850	29-1/2"
035109**	6	12"	27"	3/8"	1/4"	3/4"	2850	29-1/2"

* This tank can also be used for vacuum applications - see also mounting brackets

Part No. 501051

** Dual main ports on same side of tank-ports are 12" apart on center

Air Tank Check Valve Kit

- Provides a second dry air reservoir
- Kit includes 1425 cu. in. air tank, mounting brackets, one-way check valve, reducer bushing and 1/4" drain plug

Part No.	Description
131045	Air Tank Check Valve Kit

Air Tank Mounting Brackets



- For tanks up to 8-3/16" in diameter

Part No.	Description
501051	Air Tank Mounting Brackets

Air Brake Chambers



- Direct replacements for all popular service brake chambers
- Fully threaded shaft for maximum adjustability
- All include mounting hardware, clevis and cotter pin

Part No.	Diameter	Type	Working Stroke
030013	5.785"	12	1-3/4"
030015	6.5"	16	2-1/4"
030017	7"	20	2-1/4"
030019	7.5"	24	2-1/2"
030021	8.25"	30	2-1/2"
030024	9"	36	2-3/4"

Air Brake Diaphragms



- Gas and oil resistant
- Rubber/neoprene blend
- Fabric reinforced for extra strength and long life

Part No.	Diameter	Type
031021	6"	9
031023	5.5"	12
031025	6"	16
031027	6.5"	20
031031	7"	24
031033	8"	30
031035	9"	36

Anodized aluminum clear-coated bodies • Nitrile seals for long cycle life • High impact knobs
 Balanced spool design • Operating temperature range from -40 F to + 180 F
 •Stainless steel hardware • Normal operating pressure 100 psi

Four-Way Push/Pull Valves



Both faceplates included

- Aluminum shaft with stainless steel extension and delrin detent ring provides easy ID of valve position
- Threaded aluminum mounting boss for 1" dia. Through hole mounting (nuts included)
- (3) 9/32" dia. Body mounting holes
- (5) 1/4" -18 FPT ports
- Normal operating pressure 100 psi
- Includes two faceplates:
 Pull to Open/Push to Close
 Pull to Raise/Push to Lower

APPLICATIONS FOR VALVES

- Two position valve operates any double acting air cylinder
- Three position valve operates systems where full air or vacuum pressure must be isolated

Part No.	Description
320121	2-position valve
320122	3-pos, holding type valve
320125	Replacement knob, faceplates and nuts

Viper™ Four-Way Push/Pull



- One piece stainless steel shaft
- Can be mounted using (2) 3/16" dia. body mounting holes or through a 1/2" dia. through hole
- (3) 1/8"NPT ports, (2) 10-32 exhaust ports
- Includes faceplate

Part No.	Description
320124	"Viper" Four-Way Valve
320127	Replmt Knob and faceplate

Viper™ is a trademark of Velvac, Inc.

www.velvac.com

Four -Way Push/Pull Compact Design Valve

NEW



- The compact design fits into today's small dash board designs
- Pneumatic valve is designed to control the operations of a typical air cylinder
- 150 psi maximum air pressure
- 0.4 cv air flow
- Aluminum body and end caps stainless steel extension
- 40 micron filtration

Part No.	Description	Parker Ref
320011	4-way valve	410939002

Four-Way Rotary Handle Valve



- Three position valve
- (3) 1/4" - 18 FPT ports
- 1/4" NPT threaded exhaust ports
- (2) 1/4" dia body mounting holes at 1-15/16" on center
- Operating pressure to 150 psi
- Includes solid one-piece handle and two faceplates (Raise/Lower and Open/Close)

Part No.	Description
320123	Rotary Handle Valve
321034	Raise/Lower Faceplate
030092	Cone Filter 1/4"

Cone Filters



Four -Way Electronic Solenoid Valve



- Operates any single acting or pressure double acting air cylinder
- Air-piloted assist
- Actuated with a std on/off switch
- (5) 1/4" -18 FPT port
- (3) 9/32" dia valve body mtg holes
- Normal oper. pressure 100psi
- Exhaust cone filters included

Part No.	Description
320131	Four-way Solenoid
320132	Electrical Coil
320133	Solenoid Mounting Nut
030092	Cone Filter 1/4"
030084	Cone Filter- 1/8"

Four -Way Mini Electronic Solenoid Valve



- Compact design- 4" overall length
- Air-piloted assist
- 1/8" supply and delivery ports
- 10-32 exhaust ports
- 12VDC coil with low 2 watt draw
- Normal operation pressure 100 psi

Part No.	Description
320134	4-way Mini Solenoid
320135	Electrical Coil
030093	Cone Filter 10-32

Part No.	Description
030093	10-32 Cone Filter
030084	1/8" Cone Filter
030092	1/4" Cone Filter
030094	3/8" Cone Filter



Backed by a 3 year warranty

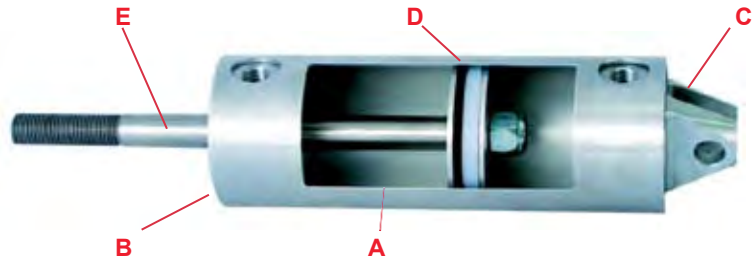

AIR

Velvac's heavy-duty Enforcer™ series of air cylinders are built tough for long life and made from some of the strongest materials available today!

- Machined from 6061 series aluminum, 303 stainless steel, with Nitrile "O" rings and a UHMW polyethylene wear band, they are the ultimate air cylinder!
- Cycle tested into the millions! The solid construction means they will keep on working even in extreme conditions where other air cylinders fail!
- These cylinders are available in push/pull, solenoid operated and spring return versions that will slam the door on the competition!

General

Information	Feature #	Feature/Benefit
Cylinder Construction	A	Aluminum cylinder tubing with a 16 RMS finish, lock ring construction secures end caps to tube
Front Cover	B	Solid aluminum with oilight bronze bushing, Delrin seal and 1/4" NPT port
Rear Cover	C	Solid aluminum with mounting hole for 1/2" clevis pin and 1/4" NPT port
Piston Cup	D	Solid aluminum with Nitrile "O" ring rated at -40° to 185° F and UHMW polyethylene wear band
Piston Rod	E	5/8" diameter 303 series stainless steel with 5/8" - 18 thread
Temp Rating		-40° to 185° F
Pressure Rating		10 psi minimum to 150 psi maximum Standard operating pressure 100 psi



2-1/2" Air Cylinder

Part No.	Cylinder Type	Stroke	Retracted Length	Extended Length	Thrust at 100 psi	Draw at 100 PSI
100204	Push/Pull	4"	9.89"	13.89"	491 lbs	460 lbs
100226	Spring Return	6"	13.75"	19.75"	251 lbs	460 lbs
100206	Push/Pull	6"	11.89"	17.89"	491 lbs	460 lbs
100228	Spring Return	8"	16.50"	24.50"	251 lbs	460 lbs
100208	Push/Pull	8"	13.89"	21.89"	491 lbs	460 lbs
101208	w/Solenoid	8"	13.89"	21.89"	491 lbs	460 lbs

3-1/2" Air Cylinders

100306	Push/Pull	6.68"	13.60"	20.28"	962 lbs	930 lbs
100326	Spring Return	6"	14.88"	20.88"	482 lbs	930 lbs
101306	w/Solenoid	6"	13.60"	20.28"	962 lbs	930 lbs
100308	Push/Pull	8.68"	15.60"	24.28"	962 lbs	930 lbs
100328	Spring Return	8"	17.88"	25.88"	482 lbs	930 lbs
101308	w/Solenoid	8.68"	15.66"	24.28"	962 lbs	930 lbs
100310	Bullet Type	10"	16.92"	26.95"	962 lbs	930 lbs

NOTE: Air cylinders and tailgate kits are designed to operate the locking linkage on dump bodies and are **NOT** to be used as a means of mechanically holding the tailgate shut. Custom kits are available - contact Velvac for more information.

Enforcer™ is a trademark of Velvac, Inc.

VELVAC
Original

Velvac's standard series of air cylinders are built for durability with a reputation for quality and affordability!

- These cylinders can be used in a wide variety of applications and conditions and can take the daily abuse associated with typical tailgate applications.
- They are backed with a 1 year warranty and are 100% tested!
- Available in push/pull, solenoid operated and spring return versions.

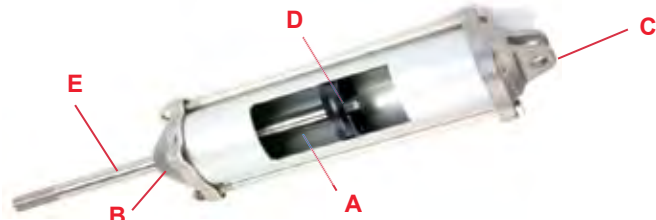

General Information	Feature #	Feature/Benefit
Cylinder Construction	A	Smooth cylinder grade aluminum tubing with a 32 RMS finish, tie rod construction secures end caps to tube
Front Cover	B	Die cast aluminum with Nitrile dirt wiper and pressure seal and oil impregnated bronze bushing and 1/4" NPT port
Rear Cover	C	Die cast aluminum with mounting hole for 1/2" clevis pin and 1/4" NPT port
Piston Cup	D	Emralon-coated, single piece, molded piston cup
Piston Rod	E	5/8" diameter 300 series stainless steel with 5/8" - 18 thread
Temp Rating		-20° to 185° F
Pressure		10 psi minimum to 120 psi maximum
Rating		Standard operating pressure 100 psi



2-1/2" Air Cylinder

- 2-1/2" Air Cylinders at 100 psi have a thrust of 483 lbs and a draw of 452 lbs
- 3-1/2" Air Cylinders at 100 psi have a thrust of 962 lbs and a draw of 918 lbs

Part No.	Cylinder Type	Stroke	Retracted	Extended
			Length	Length
100122	Push/Pull	4"	9.89"	13.89"
100125	Spring Return Norm. Ext.	4"	10.62"	14.62"
100123	Push/Pull	6"	11.89"	17.89"
100126	Spring Return Norm. Ext.	6"	13.89"	19.89"
100124	Push/Pull	8"	13.89"	21.89"

2-1/2" Cylinder Replacement Parts

Part No.	Description
101066	Front Cover Kit - includes front cover with bushing & seals installed & two cylinder gaskets
101067	Rear Cover Kit - includes rear cover & two cylinder gaskets
101068	Piston Cup Kit - includes piston cup, lock nut & two cylinder gaskets

3-1/2" Air Cylinders

100131	Push/Pull	6.68"	13.60"	20.28"
100132	Push/Pull	8.68"	15.6"	24.28"
100136	Push/Pull	8.68"	18.43"	27.12"
100137*	Push/Pull	8.68"	15.60"	24.28"

3-1/2" Cylinder Replacement Parts

Part No.	Description
101069	Front Cover Kit - Includes front cover with bushing & seals installed & two cylinder gaskets
101070	Rear Cover Kit - Includes rear cover & two cylinder gaskets
101071	Piston Cup Kit - Includes piston cup, lock nut & two cylinder gaskets

*Kit contains air cylinder Part No. 100132 and extended clevis kit #109051. Use this kit when replacing previous cylinder Part No. 101028

NOTE: Air cylinders and tailgate kits are designed to operate the locking linkage on dump bodies and are **NOT** to be used as a means of mechanically holding the tailgate shut. For tailgate kits see page 63. Custom kits are also available - contact Velvac for more information.



Backed by a 3 year warranty

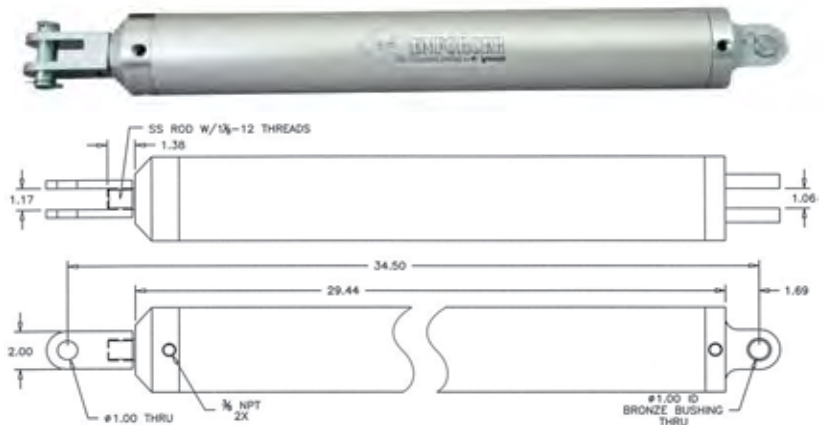

**High Lift Cylinder -
Made in the U.S.A.**

General Information Feature/Benefit

Cylinder Tube	Aluminum cylinder tubing with a 16 RMS finish
Front Cover	Solid aluminum with oil tight bronze brushing, Delrin seal and 3/8" NPT port
Rear Cover	Solid aluminum with mounting hole for 1" clevis pin and 3/8" NPT port
Piston Cup	Solid aluminum with Nitrile "O" ring rated at -40° to 185°F and UHMW polyethylene wear band
Temp Rating	40 below to 185 above
Pressure Rating	Standard operating pressure 100 psi 10 psi minimum to 150 psi maximum

Part No.	Bore	Cylinder Type	Stroke	Retracted Length	Extended Length	Thrust at 100 psi	Draw at 100 psi
100424	4"	Push/Pull	24"	34.50"	58.50"	1,275 lbs	1,158 lbs

Tailgate Cylinders - Made in U.S.A.



Backed by a 3 year warranty



Part No. 100613
Replaces MGM
R5A

Part No. 100614

- Velvac's Enforcer series of tailgate cylinders is the serious choice for your tailgate
- Machined from 6061 series aluminum, 5/8" diameter 303 stainless steel shaft with 5/8" - 18 threads, Nitrile "O" rings and a UHMW polyethylene wear band, they are the ultimate tailgate cylinder
- Direct replacements to Haldex and MGM
- These cylinders slam the door on the competition and keep it closed
- Standard operating pressure 100 psi 90 psi minimum to 150 psi maximum



Part No. 100615



Part No. 100603
Replaces Haldex
R3PT75

Part No.	Bore	Type	Cylinder Stroke	Retracted Length	Extended Length	Thrust at 100 psi	Draw at 100 psi
100603	6"	Spring Return	3"	16.18"	19.18"	400 lbs	2,400 lbs
100613	6"	Spring Return	4.38"	18.62"	23"	1,417 lbs	1,400 lbs
100614		*Bracket Kit for 100613					
100615		*Spacer kit for 100613					

NOTE: Extended/retracted lengths are measured from the tip of the shaft to the end of the cylinder

*The bracket kit is used for new MGM installations, while the spacer kit is used when replacing the existing MGM cylinder



Part No.	Cylinder Diameter/Stroke
100022	2-1/2" x 8" Kit, contents as shown
100028	2-1/2" x 8" Kit, contents as shown, plus 50' of 3/8" black nylon tubing and clips
101002	3-1/2" x 8" Kit, contents as shown, plus 50' of 3/8" black nylon tubing and clips and extended clevis kit Part No. 019015 (see page 127)



Part No.	Cylinder Diameter/Stroke
101054	2-1/2" x 8" Kit, contents as shown
101058	3-1/2" x 8" Kit, contents as shown



Part No.	Cylinder Diameter/Stroke
101055	2-1/2" x 8" Kit, contents as shown
101059	3-1/2" x 8" Kit, contents as shown



Part No.	Cylinder Diameter/Stroke
100144-7	3-1/2" x 8" Kit, contents as shown - designed to fit Ox bodies



Part No.	Cylinder Diameter/Stroke
100036	2-1/2" x 6" Kit
100037	2-1/2" x 8" Kit
101003	3-1/2" x 8" Kit with extended clevis, Part No. 019051
101004	3-1/2" x 6" Kit
101078	3-1/2" x 8" Kit with clevis Part No. 019049

- Solenoid operated cylinder kits allow the operator to electronically unlock tailgate without leaving the cab
- All kits include clevis and pins, electrical switch part No. 090177, cylinder with four-way solenoid attached

FIFTH WHEEL AIR CYLINDERS













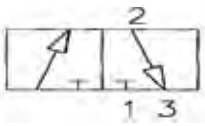

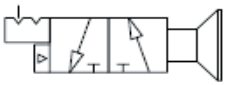
- Cast aluminum front and rear cover with 1/4" FTP port
- Mounting hole for 17/32" clevis, front and rear
- 100 psi operating pressure
- Gold anodized tube for corrosion resistance

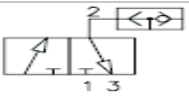
Part No.	Bore	Stroke	Replaces	Retracted Length	Extended Length
100101	2-1/2"	6-3/4"	Holland XA-2524-R	12-5/8"	19-13/32"
100102	3-1/2"	2"	Holland XA-2524-R-13-1	7-21/32"	9-21/32"

Manual Push/Pull Valves

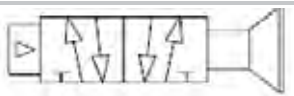
High flow dual pressure air valves for lift axles, suspension dump systems and tailgate control - solid aluminum construction - Nitrile seals for long cycle life - High impact knobs with face plates - Balanced stainless steel and aluminum spool design - Operating temperature range from -40° to +180° F - Stainless steel hardware - Normal operating pressure 100 psi

AIR

Part No.	Description	Valve Type	Ports	Air Flow	Applications	Schematic
 320129	"Mini" valve w/ built in exhaust filter	3 Way	1/4" NPT	1.5 Cv	A	
 320140	Valve w/ remote 1/4" NPT exhaust air pilot reset option	3 Way	3/8" NPT	2.2 Cv	A	
 320147	"Mini" valve with integrated shuttle and built in exhaust filter	3 Way	1/4" NPT	1.5 Cv	A	
 320128	3 position valve with center exhaust feature	4 Way	1/4" NPT	1.5 Cv	C	
 320141	2 position with soft detent and 1/8" NPT air pilot reset option	4 Way	1/4" NPT	1.5Cv	B	
 320146	2 position with soft detent and 1/8" NPT remote air pilot reset option	4 Way	3/8" NPT	2.2 Cv	A	
 320151	2 position with soft detent	4 Way	3/8" NPT	2.2 Cv	A	

A - Applications include single acting air cylinders, lift axles or suspension systems

B - Applications include single or double acting air cylinders lift axles

C - Applications include single or double acting air cylinders

Silicone Lubricant



- Specially formulated silicone lubricant protects and extends the life of air valves and air brake valves. Helps repair the drying effects caused by alcohol and antifreeze
- Light oil can be added directly into the air lines and the heavy oil can be added directly into the valves. Apply twice a year for a better operating system

HELPFUL HINT: To prevent damage to seals, premature air product failures, and possible warranty claim rejection, many OE manufacturers instruct customers to avoid the use of petroleum based products and de-icing agents in their air systems. It is recommended to change the air dryer filters regularly and use Velvac's line of silicone valve oils to help repair seal damage and extend the life of air valves.

Part No. Description

320170	Light Weight Oil - 4 oz bottle
320171	Light Weight Oil - 5 pack of 4 oz bottles
320172	Heavy Weight Oil - 4 oz bottle
320173	Heavy Weight Oil - 5 pack of 4 oz bottles

Brass Electric Coil Air Converter









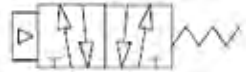

- Solenoid override adapter mounts on the coil and allows you to convert the electrical signal into an air signal
- 1/8" NPT ports
- Solid brass construction

Part No. Description

320148	Brass Electric Coil Air Converter
--------	-----------------------------------

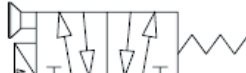
SOLENOID VALVES

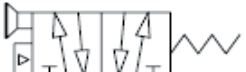
Solenoid valves allow the driver to operate single or double acting cylinders, lift axles or suspension dump systems electronically - Constructed with the same materials as Velvac's air accessory valves - The solenoid valves have a 12-volt power consumption coil that uses only 4.8 watts - Normal operating pressure 100 psi

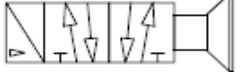





Part No.	Description	Valve Type	Ports	Air Flow	Applications	Schematic
 320130	Spring return valve with 1/8" NPT external pilot	4 Way	3/8" NPT	2.2 Cv	A	
 320136	Spring return valve with internal pilot assist	4 Way	3/8" NPT	2.2 Cv	A	
 320143	Spring return valve with internal manual override	4 Way	3/8" NPT	2.2 Cv	B	
 320144	Spring return valve with air operated external manual override	4 Way	3/8" NPT	2.2Cv	B	
 320145	Push-pull valve with solenoid air pilot return	4 Way	3/8" NPT	2.2Cv	C	

A - Applications include lift axles or suspension systems

B - Applications include lift axles

C - Applications include single or double acting air cylinders and lift axles

AIR-PILOT VALVES

Part No.	Description	Valve Type	Ports	Air Flow	Applications	Schematic
 320137	Air pilot spring return with 1/4" NPT air pilot supply support	3 Way	3/8" NPT	2.2 Cv	A	
 320138	Shuttle air pilot spring return valve	4 Way	3/8" NPT	2.2 Cv	B	
 320139	Air pilot spring return valve with 1/8" external pilot port	4 Way	3/8" NPT	2.2 Cv	B	

A - Applications include suspension systems

B - Applications include lift axles



ELECTRICAL 67-103

Table of Contents	PAGE
Cable and Plug Assemblies	67
Electrical Plugs	69
Plug Adapters and Accessories	70
Electrical Sockets and Accessories	71
Electrical Cable	73
Battery Cable	74
Battery Lugs	75
Battery Terminals	76
Back-up Alarms	78
Switches and Solenoids	81
Signal Flashers	86
Circuit Breakers	87
Fuses and Accessories	88
Terminals and Connectors	91
Primary Wire and Accessories	97
Heat Shrink Tubing	98
Tie Straps, Grommets and Wire Clips	100
Shop Tools and Accessories	101
Tape Products	103

VELVAC Original Indicates an original Velvac product.

NEW Indicates a new product added to catalog.

Revised Part No. Indicates a revised part number defining "-xx" package quantity.
Refer to price list for price per package.

For quantity and packaging information, refer to our price list.

Customer Service: 800.783.8871
Fax: 262.786.4101
Email: sales@velvac.com



NOTE: The information and photographs in this catalog are believed to be accurate and factual as of the print date. Velvac assumes no responsibility for information that may be incorrect or has changed since press time. Product specifications and offerings subject to change without notice.

Velvac is a registered trademark of Velvac, Inc.



Seven-Way ISO Coiled Cable Assemblies



- Used in tractor/trailer systems requiring ISO 3731 style connectors-ISO pin prevents connections with non-ISO sockets
- 1/8, 2/10, 4/12 gauge cable
- Durable yellow outer jacket resists abrasion, provides excellent coil retention and offers quick identification of auxiliary circuit lines
- Heavy-duty zinc die cast plugs with spring guards included

Part No.	Working Length	Description
590251	12'	12" Lead Both Ends
590252	15'	12" Lead Both Ends
590253	15'	48" Lead One End, 12" Lead One End
590254	15'	72" Lead One End, 12" Lead One End

Seven-Way ABS Coiled Cable Assemblies



NEW

- Assemblies include heavy gauge wire commonly used to power trailer and dolly ABS
- 1/8, 2/10, 4/12 gauge cable
- Durable green outer jacket resists abrasion, provides excellent coil retention and offers quick identification of ABS lines
- Heavy-duty zinc die cast plugs with spring guards included
- Cable meets SAE J2394 June 1998 Type F requirements

Part No.	Working Length	Description
590160	12'	12" Lead Both Ends
590161	15'	12" Lead Both Ends
590163	15'	40" Lead One End, 12" Lead One End
590080	20'	2-12" Leads
590081	20'	1-12" Leads 1-40" Leads

NOTE: See page 73 for ABS color code description

Seven-Way Coiled Cable Assemblies



- Durable black outer jacket resists abrasion and provides excellent coil retention
- Heavy-duty zinc die cast plugs with spring guards included
- Operating temperature range of -55° to +185° F

12' Working Length

12" lead both ends

Part No.	Description
590154	6/12, 1/10 Gauge
590156	6/14, 1/12 Gauge

15' Working Length

12" lead both ends

Part No.	Description
590155	6/12, 1/10 Gauge
590157	6/14, 1/12 Gauge

15' Working Length

72" lead one end, 12" lead one end

Part No.	Description
590159	6/12, 1/10 Gauge

Seven-Way Straight Cable Assemblies



- Heavy-duty zinc die cast plugs with spring guards included
- ABS assemblies include heavy gauge wire commonly used to power trailer and dolly ABS - ABS cable meets SAE J2394 June 1998 Type F requirements

- ISO assemblies used in tractor/trailer systems requiring ISO 3731 style connectors

Part No.	Working Length	Description
590036	8'	6/12, 1/10 Gauge
590046	12'	6/12, 1/10 Gauge
590177	10'	6/12, 1/10 Gauge
590178	15'	6/12, 1/10 Gauge

NEW

ABS Assemblies

1/8, 2/10, 4/12 Gauge

Part No.	Working Length
590165	12'
590166	15'
590179	20'

ISO Assemblies

1/8, 2/10, 4/12 Gauge

Part No.	Working Length
590255	12'
590256	15'

Six-Way Coiled Cable Assembly



- 12" working length
- Durable black outer jacket resists abrasion and has excellent coil memory
- Heavy-duty zinc die cast plugs with spring guards included

Part No.	Description
590061	6/14 Gauge
050029	Replacement Cable

Single Pole Coiled Cable Assemblies



Tailgate Lift Power Cable

For applications that require direct electrical power to trailer lift gates; **BLUE JACKETED**

- Rated at 265 amps intermittent service (30 seconds on/50 seconds off)
- Heavy-duty zinc die cast plugs with spring guards included
- 2 gauge cable

Part No.	Description
590135	12' Tailgate Lift Power Cable Assembly
590136	15' Tailgate Lift Power Cable Assembly



Tailgate Lift Battery Charging Cable

For applications where cables are used to charge trailer lift gate batteries; **GREEN JACKETED**, heavy-duty zinc die cast plugs with spring guards included

- 200 amp max for intermittent lift gate applications at 12 VDC
- 110 amp max for continuous applications at 12 VDC
- External ground option
- 4 gauge cable

Part No.	Description
590263	12' Tailgate Lift Battery Charging 4 Gauge Cable Assembly
590264	15' Tailgate Lift Battery Charging 4 Gauge Cable Assembly

Two Pole Coiled Cable Assemblies



- Rated at 200 amps for lift gate applications at 12 VDC
- 4 gauge cable
- Internally grounded
- Withstand temperatures of -85° to +185° F
- Durable black polyethylene outer jacket resists abrasions and chemical damage while offering excellent coil retention
- Heavy-duty zinc die cast plugs with springs guards included

Part No.	Description
590171	12' Two Pole Coiled Cable Assembly
590172	15' Two Pole Coiled Cable Assembly

Seven-Way Plugs



- Heavy-duty nickel-plated zinc die cast housings on all except plastic plug which has an unbreakable nylon housing
- Easy to remove interiors for quick replacements
- ATA color-coded wire terminals
- Internal clamp holds cable securely in place
- Standard seven-way plugs meet ATA and SAE J560 requirements; ISO plugs meet ISO 3731:1997 requirements

T-Grip Seven-Way Plugs

Part No.	Description
593057	Plug with Spring Guard
593101	ISO Plug with Spring Guard
593111	Plastic Plug with Weather Guard
593059	Replacement Interior for Part Nos. 593057, 593111
593060	Replacement Spring Guard

Single Grip Seven-Way Plugs

Part No.	Description
593022	Plug with Spring Guard
593024	Plug without Spring Guard
593017	Replacement Spring Guard
593019	Replacement Interior

Single Pole Plugs



- Used to provide power to heavy draw auxiliary trailer equipment
- Heavy-duty zinc die cast housings
- Power and ground terminals hold up to 1/0 gauge wire

Part No.	Description
591161	T-Grip Plug with Spring Guard
591105	Single Grip Plug without Spring Guard
591162	Replacement Interior for Part No. 591161
591109	Replacement Interior for Part No. 591105

Seven-Way Blade Type Plug



- Primarily used in RV applications
- Constructed of molded PVC for impact resistance

Part No.	Description
054001	Seven-Way Blade Type Plug

NOTE: See page 71 for seven-way blade type socket

Two Pole Plug



- 200 amp, 4 gauge wire capacity
- Heavy-duty zinc die cast housing
- Internal ground
- Spring guard supports and protects cable

Part No.	Description
593116	T-Grip Plug with Spring Guard

Four-Way and Six Way Plugs



- Heavy-duty zinc die cast housings
- Plug locking system works with socket door to ensure proper hookup and prevent unintentional disconnections
- Spring guard on Part No. 055049 supports and protects cable

Part No.	Description
055059	Four-Way Plug with Spring Guard
055054	Four-Way Plug without Spring Guard
055049	Six-Way Plug with Spring Guard
055050	Six-Way Plug without Spring Guard
055055	Replacement Interior for Four-Way Plug
055051	Replacement Interior for Six-Way Plug

Truck Tractor to Trailer Adapters



- Heavy-duty zinc die cast housing on Part Nos. 591009 and 591010; also include solid brass pins and terminals and a spring clip to lock adapter and plug together
- Part Nos. 591115, 591116 and 591117 constructed of molded PVC for impact resistance

Part No.	Description
591009	Seven-Way Pin to Six-Way Adapter
591010	Six-Way Round to Seven-Way Adapter
591115	Seven-Way Blade to Four-Way Flat Adapter
591116	Seven-Way Round to Four-Way Flat Adapter
591117	Six-Way Round to Four-Way Flat Adapter

Continuity Testers



- LED indicators quickly identify complete circuits by glowing red; no light means problem circuit
- Fit standard seven-way blade type, four-way flat connectors and seven-way round
- Constructed of molded PVC for impact resistance
- Internally grounded

Part No.	Description
057118	Seven-Way Plug Circuit Tester
057119	Seven-Way Socket Circuit Tester
057120	Seven-Way Blade Circuit Tester
057121	Four-Way Flat Circuit Tester

Four-Way Flat Set



- 48" lead (female) side and 12" lead (male) side
- Constructed of molded PVC for impact resistance
- ATA color-coded:
 - White: Ground
 - Green: Right Turn and Brake Lights
 - Yellow: Left Turn and Brake Lights
 - Brown: Tail Lights

Part No.	Description
090226	Four-Way Flat - Female
090227	Four-Way Flat - Male

Together these replace Velvac Part No. 054003

Seven-Way Plug Cleaner



- Stainless steel brushes quickly clean electrical contacts for improved conductivity
- Durable plastic body

Part No.	Description
055034	Seven-Way Plug Cleaner

Seven-Way Circuit Breaker Sockets and Adapter Boxes



Deep Adapter Box with Bottom Entry



Deep Adapter Box with Back Entry



- Non-corrosive, reinforced nylon housing for added durability
- Designed for #8 ring terminals (see page 93)
- ATA color-coded contacts (see page 73 for ATA color code chart)
- Solid brass split pins are zinc-plated for corrosion resistance
- Each socket includes automatic reset circuit breakers with positive snap open/snap closed action to eliminate arcing (unless otherwise noted)
- Mounting holes are 4-1/2" on center and include steel bushings for added housing protection
- Adhesive-backed mounting gasket included
- Circuit breaker sockets meet SAE J560 requirements

- Durable zinc die cast housings
- Solid brass split pin socket offers replaceable circuit breakers for circuit protection of trailer wiring systems
- Slanted door front for plug support
- Replaceable thermoplastic base plate with ATA color codes for quick identification
- Each socket includes automatic reset circuit breakers with positive snap open/snap closed action to eliminated arcing

Part No.	Description
055037	Socket with 20 Amp Circuit Breakers
055038	Socket with 30 Amp Circuit Breakers
055040	Socket without Circuit Breakers
055039	Replacement Cover Kit (includes Cover, Shaft Retainer, Steel Hinge Pin and Stainless Steel Spring)
055041*	Deep Adapter Box with Bottom Entry
055045*	Deep Adapter Box with Back Entry

Part No.	Description
593052	Socket with 20 Amp Circuit Breakers
593054	Socket with 30 Amp Circuit Breakers

*5/16" - 18"UNC cover plate studs and 2" inside depth

Seven-Way Blade Type Socket



Optional Mounting Bracket

- Screw-type socket primarily used in RV applications
- 6-24 VDC
- Mounting holes are 2-1/4" on center
- Constructed of molded PVC for impact resistance
- Optional zinc-plated mounting bracket available and sold separately

Part No.	Description
054002	Seven-Way Blade Type Socket
090216	Mounting Bracket

NOTE: See page 69 seven-way blade type plug

Single and Two Pole Sockets



- Durable zinc die cast housings
- Power and ground terminals on single pole socket hold up to 1/0 gauge wire
- 200 amp, 4 gauge wire capacity on two pole socket
- Two pole socket has internal ground
- Single pole socket may be soldered or crimped
- Mounting holes 3" on center
- Rear housing 1-3/4" O.D.

Part No.	Description
591113	Single Pole Socket
593121	Two Pole Socket
591090	Replacement Interior for Single Pole Socket
593122	Replacement Interior Two Pole Socket

Seven-Way Sockets



Two Hole Socket with Screw Terminals



Two Hole Socket with Push Terminals



Optional Terminal

- Non-corrosive, reinforced nylon housing for added durability
- Screw type socket with split pins designed for #8 ring terminals (see page 93)
- Push type socket with solid pins designed for 180° snap receptacles (see Part No. 056079 on page 94)
- Mounting holes are 3" on center
- Screw type socket includes screws and washers
- Gasket included on each socket
- Sockets meet SAE J560 requirements
- Protective rubber boot seals out moisture and contaminants - sold separately

Part No.	Description
055043	Two Hole Socket with Screw Terminals
055062	Two Hole Socket with Push Terminals
055063	Rubber Terminal Protector Boot

Part No. 593083



Optional Terminal Protector Boot

- Durable zinc die cast housings
- ABS plastic interior with ATA color codes for quick identification
- Solid brass pins
- Wires attached by set screw retainers
- Slanted door front for plug support
- Tongue and groove door design protects socket interior from dirt and moisture
- Mounting holes are 2-15/16" on center
- 1-13/16" rear housing length
- Terminal protector boot keeps terminals free from moisture and contaminants - sold separately
- Sockets meet SAE J560 requirements

Part No.	Description
593083	Socket with Solid Pins
593084	Socket with Split Pins
054017	Terminal Protector Boot
591022	Replacement Solid Pin Interior
591019	Replacement Cover Kit (includes Door, Hinge Pin & Spring)

ISO Seven-Way Socket



- Used in tractor/trailer systems requiring ISO 3731 style connectors - ISO socket prevents connections with non-ISO plugs
- ISO color-coded yellow, non-corrosive, reinforced nylon housing
- Wires secured by set screws
- Mounting holes are 2-15/16" on center

Part No.	Description
593106	ISO Socket
054017	Terminal Protector Boot

Four-Way and Six-Way Sockets



Optional Terminal Protector Boot



Optional Mounting Bracket

- Durable zinc die cast housings
- Solid brass split pins
- Locking system on door works with plug to ensure proper hook-up and prevent unintentional disconnections
- Optional protector boot keeps terminals free of moisture and contaminants - sold separately

Part No.	Description
055052	Six-Way Socket
055056	Four-Way Socket
090217	Mounting Bracket
090218	Terminal Protector Boot
055053	Replacement Six-Way Interior

Battery and Starter Cable

Red Jacketed

Part No.	Coil Length	Wire Gauge
058033	25'	6
058033-7	100'	6
058035	25'	4
058035-7	100'	4
058037	25'	2
058037-7	100'	2
058039	25'	1
058039-7	100'	1
058241	25'	1/0
058241-7	100'	1/0
058243	25'	2/0
058243-7	100'	2/0
058245	25'	3/0
058247	25'	4/0

Black Jacketed

Part No.	Coil Length	Wire Gauge
058233	25'	6
058233-7	100'	6
058235	25'	4
058235-7	100'	4
058237	25'	2
058237-7	100'	2
058239	25'	1
058239-7	100'	1
058041	25'	1/0
058041-7	100'	1/0
058043	25'	2/0
058043-7	100'	2/0
058045	25'	3/0
058047	25'	4/0





- Durable thermoplastic outer jacket keeps cable flexible at low temperatures and resists abrasion, ozone, oil and road salts
- Soft annealed stranded copper
- Cable meets SAE J1127 Type SGT requirements

Battery terminals and lugs sold separately (see pages 75 and 76)

ELECTRICAL

Multiple Conductor Cable





Seven-Way Conductor

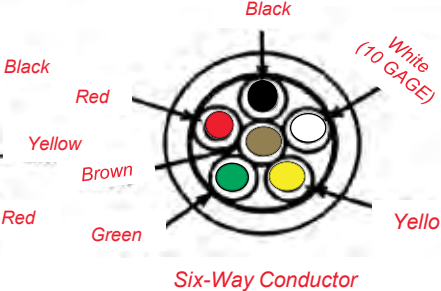

Six-Way Conductor

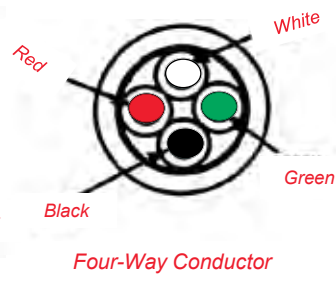

Four-Way Conductor

- ABS cable meets SAE J2394 June 1998 Type F requirements

ATA COLOR CODE CHART

White	Ground return to towing vehicle
Black	ICC required marker and clearance light
Yellow	Left-hand directional signal
Red	Stoptlights
Green	Right-hand directional signal
Brown	Tall lamps, 3-bar marker lamps
Blue	Auxiliary

Part No.	Jacket Color	Coil Length	Conductor	Gauge
050019	Black	100'	Seven	6/12, 1/10
050019-7	Black	500'	Seven	6/12, 1/10
050042	Black	100'	Seven	14
050042-7	Black	500'	Seven	14
050037	Green(ABS)	100'	Seven	1/8, 2/10, 4/12
050037-7	Green(ABS)	500'	Seven	1/8, 2/10, 4/12
050051	Yellow(ISO)	50'	Seven	1/8, 2/10, 4/12
050052	Yellow(ISO)	100'	Seven	1/8, 2/10, 4/12
050007	Black	100'	Six	14
050007-7	Black	500'	Six	14
050001	Black	100'	Four	14
050001-7	Black	500'	Four	14

Battery-to-Battery Crossover Cable



- 2/0 gauge wire
- Molded lead terminals and black neoprene outer jacket

Part No.	Description
058208	8" Battery Crossover Cable
058212	12" Battery Crossover Cable

Battery Cable



- 2/0 gauge wire
- Molded copper lug and lead terminal
- Black PVC outer jacket

Part No.	Description
058117	12" Battery Cable

Stud Top Battery Cable



- 2/0 gauge wire
- Molded tin-plated copper lugs and black PVC outer jacket

Part No.	Color	Description
058118	Black	8" Stud Top Battery Cable
058128	Red	8" Stud Top Battery Cable
058119	Black	12" Stud Top Battery Cable
058129	Red	12" Stud Top Battery Cable

Ground Strap



- 4 gauge wire
- Molded zinc-plated steel lugs and tin-plated copper stranding
- 7/16" diameter bolt hole

Part No.	Description
058116	Ground Strap (12" - 14")

800A Booster Cable



NEW

These heavy duty battery cables are rated at 800 amps and are designed to handle jump starting heavy duty equipment

- Solid copper parrot clamps for increased conductivity
- Tangle proof design
- Braided copper wire remains flexible even in subzero temperatures
- Includes strong plastic storage container to protect cables from damage when not in use

Part No.	Description
058151	800A Booster Cable

Switch-to-Starter Battery Cable



- 4 gauge wire
- Molded zinc-plated steel lugs and red PVC outer jacket

Part No.	Description
058115	18" Switch-to-Starter Cable

Battery Booster Cables



- Copper stranded, 4 gauge wire
- Rated at 400 amps
- Black PVC outer jacket
- Red and black vinyl coated clamps feature solid copper contacts and heavy springs for positive clamping

Part No.	Description
058152	16' Battery Booster Cable
058156	Replacement Clamp Set

- Fully annealed electrolytic copper construction provides excellent conductivity
 - Wire gauge identification marked on lug barrels
- Heat-shrink tubing should be used over all battery terminal connections (see page 98)

Standard Battery Lugs

- Unique flared barrel design eliminates wire strand hang-ups
- Unplated
- Crimpable

Part No.	Wire Gauge	Stud Size	Part No.	Wire Gauge	Stud Size
056033	6	1/4"	058082	1	1/2"
058073	6	5/16"	058083	1/0	5/16"
058074	6	3/8"	056037	1/0	3/8"
056034	4	1/4"	056038	1/0	1/2"
058076	4	5/16"	058084	2/0	5/16"
058077	4	3/8"	056039	2/0	3/8"
058078	4	1/2"	056040	2/0	1/2"
058079	2	5/16"	058086	3/0	3/8"
056035	2	3/8"	056041	3/0	1/2"
058081	1	5/16"	058088	4/0	3/8"
056036	1	3/8"	056042	4/0	1/2"

Heavy-Duty Battery Lugs

- Tin-plated for corrosion resistance
- Crimpable

Part No.	Wire Gauge	Stud Size	Part No.	Wire Gauge	Stud Size
058325	1/0	3/8"	058329	3/0	3/8"
058326	1/0	1/2"	058330	3/0	1/2"
058327	2/0	3/8"	058331	4/0	3/8"
058328	2/0	1/2"	058332	4/0	1/2"

Heavy-Duty Flared Lug Maintenance Kit

- Kit includes 50 lugs in ten varieties ranging from 6 to 4/0 gauge with stud sized of 1/4", 3/8" and 1/2"
- Packaged in a durable plastic case with product information shown on inside label for easy identification

Part No.	Qty	Part No.	Qty
056033	6	056038	4
056034	6	056039	4
056035	6	056040	4
056036	6	056041	4
056037	6	056042	4

Part No.	Description
057002	Heavy-Duty Flared Lug Maintenance Kit

Flared Butt Connectors

- Seamless construction
- Tin-plated for corrosion resistance

Part No.	Wire Gauge
058020	1
058021	1/0
058022	2/0
058023	3/0
058024	4/0

Crimpable or Solderable Battery Terminals

- One-piece, cast copper construction
- Lead-plated for corrosion resistance
- Cable size clearly designated on terminals to ensure correct size selection
- Polarity shown on terminals to avoid mixing positive and negative connections.
- Tool die and letter codes permanently marked on terminals to simplify installation with other manufacturers' tools
- Uniform wall thickness assures high reliability when connector is crimped on cable
- Long barrels for added strength and vibration resistance
- Heat-shrink tubing should be used over all battery terminal connections (See page 98)

HELPFUL HINT:

Most Velvac terminals are color-coded according to wire gauge specifications:

4 - Green	1/0 - Black
2 - Pink	2/0 - Orange
1 - Pink	3/0 - Purple
	4/0 - Yellow

ELECTRICAL

Straight Barrel Terminals



Part No.	Wire Gauge	Polarity
058050	4	Universal
057050	1	Positive
057051	1	Negative
058001	1/0	Positive
058002	1/0	Negative
057052	2/0	Positive
057053	2/0	Negative
057054	3/0	Positive
057055	3/0	Negative
058057	4/0	Positive
058058	4/0	Negative
058011	Replacement Nut and Bolt	

Right Angle Barrel Terminals



Part No.	Wire Gauge	Polarity
057056	2/0	Positive
057057	2/0	Negative
058055	3/0	Positive
058056	3/0	Negative
058011	Replacement Nut and Bolt	

Right Elbow Terminals

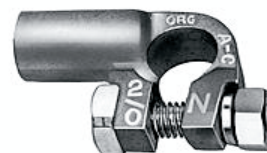

Part No.	Wire Gauge	Polarity
058052	1/0	Positive
058051	1/0	Negative
058005	2/0	Positive
058006	2/0	Negative
058009	3/0	Positive
058010	3/0	Negative
058011	Replacement Nut and Bolt	

Protective Battery Washers



NEW

- Washers seal out acid fumes protecting terminals from corrosion
- Packaged in convenient plastic screw top jars.

Part No.	Description
058094	Protective Battery washers - Red
058095	Protective Battery washers - Black

Left Elbow Terminals



Part No.	Wire Gauge	Polarity
058054	1/0	Positive
058053	1/0	Negative
058003	2/0	Positive
058004	2/0	Negative
058007	3/0	Positive
058008	3/0	Negative
058011	Replacement Nut and Bolt	

Battery Post and Terminal Cleaner



Part No.	Description
058046	Battery Post and Terminal Cleaner

Battery Stud Nut



- Stainless steel construction

Part No.	Description
058068	3/8" Battery Stud Nut

Medium-Duty Terminal



- For 6 to 2 gauge wire

Part No.	Description
058012	Medium-Duty Terminal

Side Post Terminal



- For 6 to 2 gauge wire

Part No.	Description
058013	Side Post Terminal

Heavy-Duty Terminal



- For 1" 4/0 gauge wire

Part No.	Description
058016	Heavy Duty Terminal

Three-Way Battery Terminals



- For 1 to 2/0 gauge wire
- Lead construction with zinc-plated steel bolts and nuts
- Both positive and negative terminals included

Part No.	Description
058071	Three-Way Battery Terminals

Marine Terminal



- 5/16" post

Part No.	Description
058019	Marine Terminal

Crimpable or Solderable Terminals for Stud Top Batteries



Base Terminal



Flag Terminal

Part No.	Wire Gauge	Polarity
058090	1/0	Universal
058091	2/0	Universal
058092	3/0	Universal
058093	4/0	Universal

Part No.	Wire Gauge	Polarity
058251	1/0	Universal
058252	2/0	Universal
058253	3/0	Universal
058254	4/0	Universal

OEM Battery Bolt



- Recessed groove permits attachment of battery charger or jumper cables
- Zinc-plated steel construction
- 3/8" - 16" UNC
- 1-3/16" long

Part No.	Description
058296	OEM Battery Bolt

Stud Mount To-Post Mount Conversion Terminals



- All lead construction
- Both positive and negative posts included

Part No.	Description
058017	Stud Mount-to-Post Mount Conversion Terminals

Velvac offers a complete line of back-up alarms, warning devices and switches to meet the needs of almost every application and work environment. From our heavy duty OEM style alarms with patented double reflex horn, to our broad line of speaker alarms, we have the right alarm to meet your needs and price targets.

Double Reflex Horn Style Back-up Alarms



Part Nos. 697002 and 697007



Part Nos. 697017, 697032, 697104, 697105 and 697106

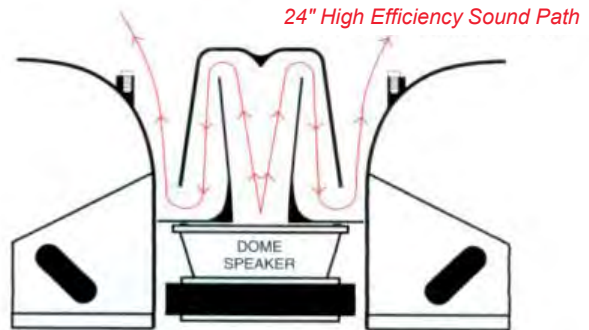

- Features patented double reflex horn speaker providing efficient, high output sound, with less power consumption and reduced heat for greater reliability and performance. 24" long folder horn allows alarm to run cooler by using about 1/2 the power consumption of conventional speaker alarms to achieve the same decibel output.
- High impact glass filled nylon housing meets high temperature demands of SAE J994 and UL requirements for flame testing. Provides durability needed for even tough work and vehicle environments.
- HD OEM style alarms incorporate a self-cleaning feature that "pumps" out contaminants from the sound chamber for increased reliability and an anti-tamper grill to help protect the alarm from damage
- 12-24 V dc - polarity and peak voltage protection, temperature range -40° to +85° C
- Slotted mounting centers with optional back or bottom mounting for easy installation
- Meets requirements of SAE J944, CE, e-Mark and UL, OSHA, MSHA, IP67
- 10 year warranty

NEW

Part No.	Decibels	Rated Current Amps	Connection Type	Mounting Bracket Type	Mounting Center	ECCO EQUIV	PRECO EQUIV
HD OEM							
697017	107	500	Wire	Metal	7"	787/872	360
697032	112	500	Wire	Metal	7"	876	110
697105	87-112*	300	Wire	Metal	7"	SA920	6010
697106	87-112*	300	Wire	Metal	6"	SA917	1040
697104	82-107*	300	Wire	Integrated Nylon	4"	SA901	1048
HD STANDARD							
697002	102	300	Wire	Integrated Nylon	3.25"	575	270
697007	107	300	Wire	Integrated Nylon	3.25"	575	270

* Self-adjusting alarm features a true, high sensitivity microphone to sense ambient noise levels around the alarm and automatically adjust the sound output to be 10 decibels above ambient

Heavy Duty External Switch

NEW



For use on vehicles that do not have back-up lights readily available

- Equiv: Preco SW30

Part No.	Voltage	Amp
697012	12-80V	10

External Switch



- Switch will cause alarm to activate when linkage is shifted into reverse
- Operating temperatures of -40 to +140° F
- 12-24 VDC
- **Not** for underwater use

Part No.	Description
697011	External Switch

Speaker Style Back-up Alarms

- High impact glass filled nylon housing meets high temperature demands of SAE J994 and UL requirements for flame testing. Provides durability needed for even tough work and vehicle environments
- Epoxy encapsulation protects electronics against moisture allowing steam cleaning or pressure washing. Thin coat epoxy process helps dissipate heat faster keeping the alarm cooler for longer product life.
- Manufactured with a polyethylimide (PEI) speaker cone for durability and performance
- 12-24 V dc- polarity and peak voltage protection
- Temperature range -40° to +85° C
- 3.25" slotted mounting centers with optional back or bottom mounting for easy installation
- Meets requirements of SAE J944, CE, e-Mark and UL, OSHA, MSHA, IP67
- 3 year warranty

NEW



Part Nos. 697287 & 697297



Part Nos. 699287 & 699297



Part No. 697103

Part No.	Decibels	Rated Current Amps	Connection Type	ECCO EQUIV	PRECO EQUIV
697287	87	100	Wire	—	—
697297	97	500	Wire	—	—
699287	87	500	Terminal	505	220/240
699297	97	500	Terminal	510/520	230/240
697103	82-102*	200	Wire	SA950	1020

*Self adjusting alarm features a true high sensitivity microphone to sense ambient noise levels around the alarm and automatically adjusts the sound output to be 10 decibels above ambient

Speaker Style Back-up Alarms

- High impact glass filled nylon housing meets high temperature demands of SAE J994 and provides durability needed for even tough work and vehicle environments.
- Epoxy encapsulation protects electronics against moisture allowing steam cleaning or pressure washing.
- Ground strap included on 699 Series terminal alarms - Two 9" x 16 gauge wires included on 697 series alarms 12 - 24 V dc - polarity and peak voltage protection.
- Temperature range -40° to +85° C
- Slotted mounting centers with optional back or bottom mounting for easy installation - dimensions in table below
- Meets SAE J944 requirements
- 1 year warranty



Part Nos. 697087, 697097 and 697107



Part Nos. 699087, 699097 and 699107



Part No. 699112



Part Nos. 697066 and 697112

Part No.	Decibels	Rated Current Amps	Connection Type	Mounting Centers	ECCO EQUIV	PRECO EQUIV
699087	87	200 - 300	Terminal	3.25	505	220/ELT 278
699097	97	200 - 300	Terminal	3.25	510/520	230/230LV/240
699107	107	200 - 300	Terminal	3.25	—	250
699112	112	200 - 300	Terminal	—	—	—
697087	87	100 - 200	Wire	3.25	—	—
697097	97	100 - 200	Wire	3.25	—	240C5
697107	107	400 - 500	Wire	3.25	575	270
697112	112	400 - 500	Wire	4.12	—	—
697066	87-112	400 - 500	Wire	4.12	SA901	1020

Flush Mount Back-Up Alarms

Flush mount alarms allow for fast and convenient mounting into either 1.75" or 4" diameter holes in the vehicle body.

- High impact glass filled nylon housing meets high temperature demands of SAE J994 requirements and provides durability needed for even tough work vehicle environments
- 12 - 24 V dc operation, temperature range -40° to +85° C
- 697124 and 697125 alarms are designed to mount flush into standard 4" hole on vehicle body. These alarms include rubber mounting boot and wire harness with mating connectors
- 697187 and 697197 features a compact design for mounting into 1/75" hole in vehicle body - overall unit depth is 1.28"
- Meets SAE J944 requirements



Part Nos. 697187 and 697197



Part Nos. 697124 and 697125

Part No.	Decibels	Rated Current Amps	Connection Type	Hole Diameter	ECCO EQUIV	PRECO EQUIV
697187	87	250	Wire	1.75"	—	—
697197	97	250	Wire	1.75"	—	—
697124	97	200 - 400	Wire Harness with Connector	4"	410/415	4030
697125	107	200 - 400	Wire Harness with Connector	4"	435	4050

Warning Devices

These warning devices are perfect for non back-up alarm applications such as warning of auxiliary equipment movement - ladder, boom, door or outrigger activation.

- Yellow colored nylon housings clearly identify these as warning devices
- 698055 alarm features manual adjusted volume control allowing the alarm to be set between 78 - 102 decibels
- 12 - 24 V dc operation - ground strap included on 696 series devices - 698055 includes two recessed back side terminals.
- Slotted mounting centers with optional back or bottom mounting for easy installation on 696 series devices - 698055 features four mounting holes on 4.18" diameter



Part No. 698055



Part Nos. 696087, 696097 and 696107

Part No.	Decibels	Rated Current Amps	Connection Type	Mounting Centers	ECCO EQUIV	PRECO EQUIV
696087	87	90 - 400	Terminal	3.25"	—	—
696097	97	150 - 400	Terminal	3.25"	DT500	D5232
696107	107	150 - 500	Terminal	3.25"	—	—
Manual Adjust						
698055	78-102	300 - 400	Terminal	(4) Holes/ 4.18" Dia.	—	—

NOTE: Warning devices do not meet SAE requirements and should not be used in place of a back-up alarm.

Heavy Duty Toggle Switches



- Frame and support constructed from steel with zinc chromate, brass terminals
- Neoprene-sealed toggles are moisture and dust resistant
- Fully assembled with locating ring/tongue nut (and On/Off faceplate on single pole switches only)
- 1/2" diameter recommended mounting hole- all toggles must be installed with provided hex nut behind panel to prevent damage during installation
- Packaging for all switches displays easily on pegboards or wire display racks (see page 141)

Part No.	Photo	Poles	Amp	VDC	Circuitry*	Terminals	Miscellaneous
SINGLE POLE							
090176	B	SPST	21A	14	On / Off	(2) 0.250" Flat Blade	
090177	A	SPST	21A	14	On / Off	(2) Screw	
090199	B	SPDT	21A	14	On / Off / On	(3) 0.250" Flat Blade	
090200	A	SPDT	21A	14	On / Off / On	(3) Screw	
090201	A	SPDT	21A	14	(On) / Off / (On)	(3) Screw	
090202	A	SPDT	21A	14	On / Off / (On)	(3) Screw	
090191	F	SPST	30A	12	On / Off	(3) 0.250" Flat Blade	Red LED handle****
090192	F	SPST	30A	12	On / Off	(3) 0.250" Flat Blade	Green LED handle****
090193	F	SPST	30A	12	On / Off	(3) 0.250" Flat Blade	Blue LED handle****
090186	D	SPST	50A	12	On / Off	(2) Screw	Black handle**
090187	D	SPST	50A	12	On / Off	(2) Screw	Red handle**
090188	D	SPST	50A	12	On / Off	(2) Screw	Chrome handle**
090189	E	SPST	50A	6/12/24	On / Off	(2) Screw	1-5/8" Chrome handle
090184	G	SPDT	50A	6/12/24	On / Off / On	(3) Screw	Chrome plated***
090040	—	SPDT	50A	6-24	On / On	(3) Screw	
090041	—	SPDT	50A	6-24	On / Off	(2) 0.250" Flat Blade	
090043	—	SPDT	50A	6-24	(On) / Off / (On)	(3) Screw	
DOUBLE POLE							
090203	A	DPST	21A	14	On / Off	(4) Screw	
090204	C	DPST	21A	14	On / Off	(4) 0.250" Flat Blade	
090048	H	DPDT	21A	14	On / On	(6) Screw	
090205	C	DPDT	21A	14	On / On	(6) 0.250" Flat Blade	
090206	C	DPDT	21A	14	On / Off / On	(6) 0.250" Flat Blade	
090208	A	DPDT	21A	14	(On) / Off / (On)	(6) Screw	
090209	C	DPDT	21A	14	(On) / Off / (On)	(6) 0.250" Flat Blade	
"O" RING SEALED							
090179	A	SPST	21A	14	On / Off	(2) Screw	
090194	A	SPST	21A	14	(On) / Off	(2) Screw	
090195	A	SPST	21A	14	On / (Off)	(2) Screw	
090196	A	SPDT	21A	14	On / On	(3) Screw	
090197	A	SPDT	21A	14	On / Off / On	(3) Screw	
090198	B	SPDT	21A	14	On / Off / On	(3) 0.250" Flat Blade	
090207	A	DPDT	21A	14	On / Off / On	(6) Screw	

* () indicates MOMENTARY ACTION

** Die cast housing with silver-plated contacts, heavy copper terminals, stems measure 15/32" dia. X 15/32" long

*** Paddle type handle

****Black toggle handles tipped with LED, min draw requirements for LED is 20 mA at 12 VDC

ELECTRICAL

Indicator Lights



- Chrome housing and nylon base
- LED's rated for 15mA at 12 VDC
- 100,000 hours estimated bulb life expectancy
- Temperature rating up to +185° F (85° C)
- 20 AWG lead wires
- 7/16" diameter recommended mounting hole

Part No.	LED Color
090213	Red
090214	Amber
090215	Green

Wiper Control Switch



Operating Temperature: -20° to +160° F

Washer Motor: 6 amps max. current draw

Nominal Voltage: 12 VDC (9 VDC min., 16VDC max.)

Terminal Configuration: 8 pin amp connector-mates with amp connector 770579-1 and 171639-1 socket terminals (not included and not available from Velvac)

- Integrates multi-speed wiper and washer functions into a single dashboard device
- Backlit for easy identification
- Fits standard 22 mm x 44 mm opening

Part No.	Description
090120	Wiper Control Switch

Toggle Accessories



- Protect toggle switches from moisture, dust and dirt
- UV-resistant, black silicon construction
- Built-in hex nut base screws on to most Velvac toggle switches
- Rated for -40° to +350° F (+180° C)

Part No.	Description
090210	Full Boot
090211	Half Boot



- Rugged, spring-loaded design provides protection against accident actuation
- Mounting hole accepts all standard Velvac toggles with 15/32" mounting stems

Part No.	Description
090212	Safety Cover

License/Utility Lights



- 12 VDC
- Weather-proof gasket
- 31" wire lead with .250" male disconnect
- 89 bulb
- Fits 1-1/4" mounting hole

Part No.	Description
090173	Twist-In License/Utility Light



- Fits GM/GMC trucks with step bumper
- 12 VDC
- 7-7'8" wire lead with protective boot where wire attaches to light and self-grounding single post adapter
- 67 bulb
- Mounting holes approx. 2-11/16" on center

Part No.	Description
090174	Bumper Mount License/Utility Light

Battery Disconnect Switch



- Single pole, two position: on/off
- Continuous rating 175 amps (max)
- Momentary rating 1000 amps (max)
- *Momentary use only* --- 15 sec. on/5 min. off
- Heavy gauge, plated steel casing
- Die cast lever
- 3/4" diameter mounting stem
- UL approved for 6 to 36 VDC

Part No.	Description
090104	Battery Disconnect Switch

Push Button Switch



- Rated for 50 amps at 12 VDC
- 5/8" - 32 UNS mounting bushing for panels up to 1/2" thick
- Push for momentary-on action
- Die cast with silver/copper contacts and two screw terminals
- Dust and moisture resistant; boot nut included

Part No.	Description
090190	Momentary Push Button Switch

Replaces Velvac Part No. 090075

Full Size Rocker Switches



Standard



Lighted

- 21 amps at 14 VDC
- Universal, snap-in design allows for easy installation
- Moisture and dust resistant
- .830" x 1.450" recommended mounting hole
- Packaging for all new switches displays easily on pegboards or wire display racks (see page 141 for Velvac wire display rack Part No. 091256)



Standard

Part No.	Poles	Circuitry	Terminals
090109	SPST	On / Off	(2) .250" Flat Blade
090133	SPST	On / Off	(2) Screw
090150	SPST	(On) / Off	(2) .250" Flat Blade
090151	SPST	(On) / Off	(2) Screw
090146	SPST	On / (Off)	(2) .250" Flat Blade
090147	SPST	On / (Off)	(2) Screw
090152	SPDT	On / (On)	(3) .250" Flat Blade
090153	SPDT	On / (On)	(3) Screw
090127	SPDT	On / Off / On	(3) Screw
090156	SPDT	On / Off / (On)	(3) .250" Flat Blade
090157	SPDT	On / Off / (On)	(3) Screw
090111	DPST	On / Off	(4) .250" Flat Blade
090134	DPST	On / Off	(4) Screw
090148	DPST	On / (Off)	(4) .250" Flat Blade
090149	DPST	On / (Off)	(4) Screw
090136	DPDT	On / On	(6) .250" Flat Blade
090135	DPDT	On / On	(6) Screw
090154	DPDT	On / (On)	(6) .250" Flat Blade
090155	DPDT	On / (On)	(6) Screw
090110	DPDT	On / Off / On	(6) .250" Flat Blade
090137	DPDT	On / Off / On	(6) Screw
090158	DPDT	On / Off / (On)	(6) .250" Flat Blade
090159	DPDT	On / Off / (On)	(6) Screw

Lighted

Part No.	Poles	Circuitry	Terminals	Light Color
090123	SPST	On / Off	(3) Screw	Red
090124	SPST	On / Off	(3) Screw	Green
090125	SPST	On / Off	(3) Screw	Amber
090128	SPST	On / Off	(3) .250" Flat Blade	Red
090132	SPDT	On / Off / On	(4) .250" Flat Blade	Amber

Accessories

Part No.	Description
090219	End Bracket
090220	Middle Bracket
090221	Single Bracket
090222	Panel Plug

() indicates MOMENTARY ACTION

On / Off Round Rocker Switch



- Single pole switches rated for 10 amps at 12 VDC
- 12 VDC illumination voltage
- Snap-in mounting design for easy installation in .79" diameter mounting hole



- Two positions (SPST) with two .187" silver-plated brass blade terminals
- On/Off designation permanently etched on rocker switch
- Snap-in mounting design for easy installation in .79" diameter mounting hole

Part No.	Poles	Terminals	Light Color
090167	SPST	(3) .187" Flat Blade	Red
090168	SPST	(3) .187" Flat Blade	Amber
090169	SPST	(3) .187" Flat Blade	Green

Part No.	Description
090166	Round Rocker Switch with On/Off Markings

Two-Speed Axle Switch and Automatic Terminal Block Switch



Terminal Block Switch

- Terminal block switch used in conjunction with axle switch to control two-speed electric axle shift
- Axle switch has red knob and uses (3) .156" female snap plugs (see page 94)

Push/Pull
Two Position
Axle Switch



Part No.	Description
090078	Two-Speed Axle Switch
090079	Automatic Terminal Block Switch

Three Wire Connector



Part No. 090225

NEW

Part No. 090085

- Use as a flasher socket or any other three wire application (see page 86 for flashers)
- 18 gauge 12" leads

Part No.	Description
090225	Three Wire Connector
090085	Three Wire Socket

Dimmer Switches and Socket Assemblies



Applications	Year
Chrysler - Floor Mounted (1841895, 1881938, 2097628, 2291202, CH-2437)	1959-83
Dodge Trucks	1959-79
AMC (3156124, 3160926)	1959-83

Part No.	Description
090073	Dimmer Switch
090083	Dimmer Switch Socket Assembly



Applications	Year
All Ford - Floor Mounted (COTF-130A024A COTZ-13A024A, SW-263)	1959-83

Part No.	Description
090081	Dimmer Switch
090083	Dimmer Switch Socket Assembly



Applications	Year
Vehicles without Auto Dimmer All GM - Floor Mounted (1997028, 1997037, 3841892, D808)	1961-83
All Jeep Floor Mounted (5461816)	1974-82

Part No.	Description
090080	Dimmer Switch
090082	Dimmer Switch Socket Assembly

Universal Solenoids



- Designed to operate a minimum of 50,000 cycles
- 125 amps at 12 VDC
- Continuous voltage
- SPST, normally off, one circuit off/on
- 5/16" side studs, #10 top stud/s
- Both include hardware

Part No.	Description
090054	Three Stud Universal Solenoid
090056	Four Stud Universal Solenoid

Universal Ignition Switch



Keys Included

- Single throw ignition
- 6 to 24 VDC
- 3/4" diameter mounting stem with two terminals

Part No.	Description
090076	Universal Ignition Switch

Push / Pull Switches



- Rated for 15 amps at 12 VDC, 25 amps at 6 VDC
- Heavy-duty, two position (SPST) push/pull switch with two brass screw terminals
- Brass and chrome construction
- 3-1/8" overall length x 7/8" wide
- Mounting stem measures 3/8" in diameter and 1-1/4" long
- Accommodates 1" panel with stainless steel springs

- Rated for 75 amps at 6 or 8 VDC
- Heavy-duty, two position (SPST) push/pull switch with two brass screw terminals
- Chrome-plated metal knob
- Mounting stem measures 15/32" in diameter and 5/8" long

Part No.	Description
090181	Push/Pull Switch

Replaces Velvac Part No. 090050

Part No.	Description
090180	Push/Pull Switch

Replaces Velvac Part No. 090077

RELAYS

Heavy-Duty Relay Kit



- Ideal for powering accessories with high voltage draws such as fog lights, power windows and fans
- Help ensure maximum power available to accessories and lights
- Kit includes heavy-duty relay, switch, switch mounting plate, 20' of 14 gauge wire and terminals

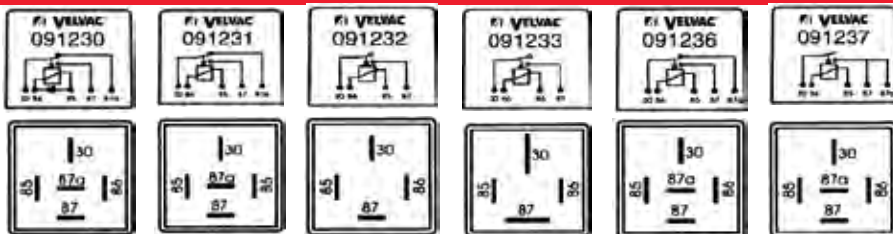

Part No	Description	Voltage	Amp Rating	Terminals	Mounting Tab
091230	Relay with Diode Application: Diode eliminates voltage spikes which can occur when the relay is shut off, can run up to 30 amps continuously	12	40	5	No
091231	Relay	12	40	5	Yes
091232	Relay Application: Used to run up to 30 amps continuously	12	40	4	Yes
091236	Relay	24	20	5	Yes
091237	Dual Relay Application: Controls two separate 20 amp accessories; also used as a single 40 amp relay	12	40	5	Yes
091233	Heavy-Duty Relay Application: Ideal for controlling larger devices; can run up to 50 amps continuously	12	70	4	Yes
091235	Heavy-Duty Relay Kit	12	70	4	Yes

In addition to standard package of one, all relays may also be ordered in Bulk Shop Packs of 25 by adding a -7 to the part number shown

Electro-Mechanical and Electronic Flashers



Style A
Electro-Mechanical



Style B
Electronic

- Designed and tested to perform in excess of one million cycles
- Audible signal indicates that flasher is activated
- Non-polarity sensitive
- 12 VDC operating range

Part No.	Style	Terminals	Color	Lamp Rating	Flash Rate FPM	Amp Rating
091215	A	2	Clear Smoke	1-10	60-120	25
091216	A	3	Clear Smoke	1-10	60-120	25
<i>Applications: Fits most American cars, older import cars and light trucks</i>						
091208	B	2	Red	2-12	70-120	25
091209	B	3	Clear Smoke	2-12	70-120	25
<i>Applications: Straight truck, single trailer, high flasher usage</i>						
091210	B	2	Clear Smoke	2-16	70-120	35
091211	B	3	Clear Smoke	2-16	70-120	35
<i>Applications: Straight truck, single or double trailer or any vehicle with high flasher usage</i>						
091212	B	2	Clear Smoke	2-20	70-120	45
091213	B	3	Black	2-20	70-120	45
<i>Applications: Severe duty, double or triple trailers or vehicles where flasher is frequently used</i>						
091214	B	3	Clear Smoke	10 Lamps/Side*	60-120	25
<i>Application: Alternating "Wig-Wag" headlight application for emergency vehicles and school buses</i>						

* 10 lamps per side (1156, 1157) or 4 (H4651) sealed beams
See page 84 for three wire flasher socket Part No. 090225

Thermal Flashers



- Flash two to three lamps for turn signals, two to six lamps for hazard warning

Part No.	Description
----------	-------------

091203	Two Terminal
--------	--------------

091204	Three Terminal
--------	----------------

NOTE: A thermal flasher (fixed load) is NOT recommended for use when a trailer is connected to a car or truck. A heavy-duty flasher (variable load) is recommended for this type of application

Solid State LED Flasher



- 6 amp flasher provides constant flash rate of 90 FPM for new LED lights
- Compact size fits standard two terminal flasher footprint - includes remote mount 36" long ground wire

Part No.	Description
091225	Solid State LED Flasher

Heavy-Duty Flashers



- 12 lamp and 25 amp rating
- Last five times longer than thermal flashers
- Three-terminal flasher for vehicles equipped with flashing dash lights
- Operate at voltages as low as 7 VDC

Part No.	Description
----------	-------------

091201	Two Terminal
--------	--------------

091202	Three Terminal
--------	----------------

Standard Circuit Breakers



- Copper colored battery stud provides easy identification
- "Waterproof" sealant and insert molded studs on waterproof breakers make them suitable for marine applications and trailer connections
- 12 VDC
- Meet applicable SAE J553 requirements
- Each circuit breaker includes two #10-32 nuts

Part No.		Description
Without Mounting Strap	With Mounting Strap	
091011	091051	10 Amp
091015	091052	15 Amp
091020	091053	20 Amp
091025	091054	25 Amp
091030	091055	30 Amp
091040	091056	40 Amp
091050	091057	50 Amp

Mack/Navistar Plug-In Circuit Breakers



- Fit Mack and Navistar breaker blocks
- 12 VDC
- -10° F (-23° C) to 150° F (65° C) operating temperature range
- Type II Modified Reset type breakers meet applicable SAE J553 requirements

Part No.		Description
Mack	Navistar	
091520	091530	10 Amp
091521	091531	15 Amp
091522	091532	20 Amp
091523	091533	25 Amp
091524	091534	30 Amp

Fuse Clip Circuit Breakers



- Replacement for 1/4" x 1-1/4" glass fuses
- 12 VDC
- -25° F (-32° C) to 180° F (82° C) operating temperature range
- Type II Modified Reset type breakers meet applicable SAE J553 requirements

Part No.	Description
091080	10 Amp
091081	15 Amp
091082	20 Amp
091083	30 Amp

High Amp Breaker



- Type III switchable breaker typically used in auxiliary and accessory circuits for trucks, buses, RVs and marine applications
- Flush mount with sems nut installed
- 30 VDC
- -25° F (-32° C) to 180° F (82° C) operating temperature range
- Measures 2" x 3" overall
- Meets SAE J1625 requirements

Part No.	Description
091005	60 High Amp
091006	80 High Amp
091007	100 High Amp
091008	120 High Amp
091003	150 High Amp
091004	Economic 150 Amp

Universal Snap-off Blade Type Circuit Breakers



- Replacement for ATC/ATO® blade type fuses
- Color-coded for easy identification
- 12 VDC
- Rated from 6 to 30 amps
- -40° F.C to 185° F (85° C) operating temperature range
- Type I Automatic Reset type breakers meet applicable SAE J553 requirements

Part No.	Description	Color
091076	6 Amp	Silver
091071	10 Amp	Red
091072	15 Amp	Blue
091073	20 Amp	Yellow
091074	25 Amp	Silver
091075	30 Amp	Green

ATM and MAXI™ Circuit Breakers



- Replacements for ATM/MINI® and MAXI™ blade type fuses
- 12 VDC, rated 5 to 30 amps
- -40° F/C to 185° F (85° C) operating temperature range
- ATM/MINI® Type II Modified Reset type breakers and MAXI™ Type I Automatic Reset type breakers meet applicable SAE J553 requirements

Part No.		Description
ATM/MINI®	MAXI™	
091500-3	—	5 Amp
091501	091510-10	10 Amp
091502	091511-10	15 Amp
091503	091512-10	20 Amp
091504	091513-10	25 Amp
091505	091514-10	30 Amp

NOTE: dash "-x" indicates package quantity

Fuses

AGC, AGX and SFE Fuses

Revised Part No.

Part No.			Description
AGC	AGX	SFE	
091131-5	—	—	1 Amp
091132-5	—	—	2 Amp
091133-5	—	—	3 Amp
—	—	See Below	4 Amp
091135-5	—	—	5 Amp
—	—	See Below	6 Amp
091137-5	—	See Below	7-1/2 Amp
—	—	See Below	9 Amp
091140-5	—	—	10 Amp
—	—	091170-5	14 Amp
091141-5	—	—	15 Amp
091142-5	See Below	091171-5	20 Amp
091143-5	—	—	25 Amp
091144-5	See Below	091172-5	30 Amp

AGX and SFE Fuse Assortments

Part No.	Description
091251	AGX 20-30 Amp Assortment includes (2) 20 Amp, (2) 25 Amp and (2) 30 Amp AGX Fuses
091252	SFE 4-9 Amp Assortment Includes (1) 4 Amp, (1) 6 Amp, (2) 7-1/2 Amp, (2) 9 Amp SFE Fuses
091253	SFE 14-30 Amp Assortment Includes (2) 14 Amp, (2) 20 Amp and (1) 30 Amp SFE Fuses

NOTE: dash "- xx" indicates package quantity

* In addition to display card packaging, fuses may also be ordered in bulk packs of 25 by adding a 25 to the part number shown



ATC/ATO®, ATM/MINI® and MAXI™ Fuses

Part No.			Description	Color
ATC/ATO®	ATM/MINI®	MAXI™		
—	091300-5	—	2 Amp	Gray
091173-5	091301-5	—	3 Amp	Violet
091174-5	091302-5	—	4 Amp	Pink
091175-5	091303-5	—	5 Amp	Tan
091177-5	091304-5	—	7-1/2 Amp	Brown
091180-5*	091305-5*	—	10 Amp	Red
091181-5*	091306-5*	—	15 Amp	Blue
091182-5*	091307-5*	091400-5	20 Amp	Yellow
091183-5*	091308-5*	—	25 Amp	Clear
091184-5*	091309-5*	091401-5	30 Amp	Green
—	—	091402-5	40 Amp	Orange
—	—	091403-5	50 Amp	Red
—	—	091404-5	60 Amp	Blue
—	—	091406-3	80 Amp	Natural

ELECTRICAL

ATC/ATO® Fuse Assortment with Combination Fuse Tester/Puller



- Assortment contains 42 ATC fuses—seven each of the six most popular fuses from 5 to 30 amps
- Combination fuse tester/puller tests and removes blade type and a variety of glass fuses
- Reclosable heavy-duty display pkg.

Part No.	Description
091254	Fuse Assortment with Tester

www.velvac.com

ATC/ATO® Fuse Panel



- Accepts blade-type fuses, auto or manual reset circuit breakers
- 6 circuits, 30 amps per circuit with quick connect terminals
- No top cover needed; recessed fuse contacts provide touch-safe protection
- Black thermoplastic construction - temperature rating of -20° F (29° C) to +150° F (65° C)
- Fuses/Circuit Breakers sold separately

Part No.	Description
091427	ATC/ATO® Fuse Panel

88

Electrical Junction Box



- Measures 6-9/16" x 3-1/4"
- Includes all fasteners and grommets

Part No.	Description
055060	Electrical Junction Box

800-783-8871

Universal In-Line Fuse holder



- Universal nylon twist-lock fuse holder for 1/4" x 1-1/4" AGC, AGA, AGW, AGX and SFE fuses
- 20 amp maximum load
- 14 gauge lead wire
- Fuse sold separately

Part No.	Description
091188	Universal In-Line Fuse holder

Heavy Duty In-Line Fuse holder



- Nylon heavy duty fuse holder for 1/4" x 1-1/4" glass fuses
- 30 amp maximum load
- 12 gauge lead wire
- Includes one 30 amp AGC fuse installed

Part No.	Description
091189	Heavy Duty In-Line Fuse holder with 30 Amp AGC Fuse

Heavy Duty ATC/ATO® In-Line Fuse holders



- Fit blade type fuses from 3 to 30 amps
- 12 gauge lead wire
- Part No. 091130 includes one 30 amp ATC fuse

Part No.	Description
091190	Heavy Duty ATC/ATO® In-Line Fuse holder without Fuse
091130	Heavy Duty ATC/ATO® In-Line Fuse holder with 30 Amp ATC Fuse

ATM/MINI® In-Line Fuse holder with Cover



- Fits ATM/MINI® blade type fuses from 2 to 30 amps
- 12 gauge lead wire
- Cover provides protection from harsh under-the-hood environmental elements
- Fuse sold separately

Part No.	Description
091426	ATM/MINI® In-Line Fuse holder with Cover

MAXI™ In-Line Fuse holder with Cover



- Fits MAXI blade type fuses from 20 to 60 amps
- 6 gauge lead wire
- Cover provides protection from harsh under-the-hood environmental elements
- Fuse sold separately

Part No.	Description
091425	MAXI In-Line Fuse holder with Cover

Add-A-Circuits

Part No. 091325



Part No. 091326

- Converts one circuit into two fuse protected circuits; plugs into fuse-block and accepts two fuses to provide protection for the existing circuit and the add-on circuit
- 10 amp maximum circuit load
- Fuse sold separately

Part No.	Description
091325	ATM/MINI® Add-A-Circuit
091326	ATC/ATO® Add-A-Circuit

Self-Stripping ATC/ATO® Fuse holder

- For use with ATC/ATO® blade type fuses up to 30 amps
- Easily attaches to wires ranging from 18 to 4 gauge
- Fuse sold separately



Part No.	Description
057003	Self-Stripping ATC/ATO® Fuse holder

In-Line Fuse holders (except MAXI) and Add-A-Circuits are display carded to fit on new wire display rack shown on page 141

ELECTRICAL

Fuse Kits



- Convenient, pre-packaged fuse assortments save time by keeping popular sized fuses close at hand
- Durable, see-through plastic cases with handy "locator" cards are easy to refill for using over and over
- Multi-functional kits can be displayed on the front counter to attract the impulse sale of single fuses or used as mini storage systems to save time and money by eliminating multiple trips to the shop for additional parts

Part No.	Description
091001	ATM/MINI® and MAXI fuse kit
091002	ATC/ATO®, AGC and ATM/MINI® fuse kit

Display assortment includes the following fuses:

ATM/MINI® and MAXI™ Fuse Kit

Part No.		Qty	Description
ATM/MINI®	MAXI™		
091300	—	10	2 Amp
091301	—	10	3 Amp
091303	—	10	5 Amp
091304	—	10	7-1/2 Amp
091305	—	10	10 Amp
091306	—	10	15 Amp
091307	—	10	20 Amp
091308	—	10	25 Amp
091309	—	10	30 Amp
—	091400	5	20 Amp
—	091401	5	30 Amp
—	091402	5	40 Amp
—	091403	5	50 Amp
—	091404	5	60 Amp
—	091406	5	80 Amp

ATC/ATO®, AGC and ATM/MINI® Fuse Kit

Part No.				
AGC	ATM	AGC	Qty	Description
091133	—	—	10	3 Amp
091135	—	—	10	5 Amp
091140	—	—	10	10 Amp
091141	—	—	10	15 Amp
091142	—	—	10	20 Amp
091144	—	—	10	30 Amp
—	091303	—	10	5 Amp
—	091305	—	10	10 Amp
—	091306	—	10	15 Amp
—	091307	—	10	20 Amp
—	091308	—	10	25 Amp
—	091309	—	10	30 Amp
—	—	091175	10	5 Amp
—	—	091180	10	10 Amp
—	—	091181	10	15 Amp
—	—	091182	10	20 Amp
—	—	091183	10	25 Amp
—	—	091184	10	30 Amp

DID YOU KNOW.....

Federal Motor Carrier Safety Regulation 393.95 requires every bus, truck, truck tractor and a drive-away tow-away operation to carry a replacement fuse for each kind and size in the vehicle?

Velvac offers a wide variety of terminals and connectors. For the same application the following terminals maybe available: crimp, crimp and seal, crimp/solder/seal, snap, or heatless connectors

Crimp Terminals and Connectors

- One-piece construction assures maximum electrical conductivity
- Electro bright, tin-plated annealed copper construction for maximum corrosion resistance
- Injection-molded insulation allows a funnel barrel construction for easy installation and ensures a consistent wall thickness for maximum reliability after crimping
- Crimp ridge on each terminal for positive location of crimp tool on terminal barrel - fewer mis-crimps
- Open end terminal design permits easy inspection of wire
- Designed to withstand temps of -40° to +221° F (+105° C)
- Heat-shrink tubing and electrical tape available and sold separately (see pages 98 and 99)



Crimp and Seal Terminals and Connectors

Simple three step installation reduces wiring time and costs ---

Insert wire

Crimp it

Heat to activate

Sealed



- Heat-shrink terminals combine color-coded, heat-shrink tubing with one-piece solderless terminals to produce fast, watertight, corrosion resistance wire connections
- UL approved
- Improved mechanical performance- provide improved pull-out strength and strain relief
- Designed to withstand temperatures of -67° F (-55° C) to +221° F (+150° C)
- Heat gun and electrical tape available and sold separately (see pages 98, 99 and 102)
- Resist abrasion, scoring, cut-through and the effects of long term aging

Crimp/Solder/Seal Terminals and Connectors

- Pre-inserted solder terminals reduce installation time and increase efficiency, while achieving the benefits of both crimp terminals and solder terminals
- Each terminal contains solder for increased strength and conductivity
- Adhesive-lined heat shrink tubing seals out moisture and contaminants
- Wire gauge is printed on each connector for easy ID

Insert wire

Crimp it

Heat to activate solder

NEW

Sealed



Heatless Terminals and Connectors-Revolutionary New Product

- A heat-less, solder-less terminal utilizing a revolutionary anaerobic sealing technology requires **NO HEAT**
- Simply strip the wire and crimp, activating the sealant that reacts when the copper wire is inserted into the connector to create an environmentally sealed connection
- Easily installs in a fraction of the time of comparable heat seal connectors
- Prevents the ingress of moisture and air that can result in corrosion
- Nylon insulation provides maximum abrasion and puncture resistant while seamless
- Reduces overall installation costs by eliminating the need for torches or heat guns, reducing the installation time and improving productivity

NEW

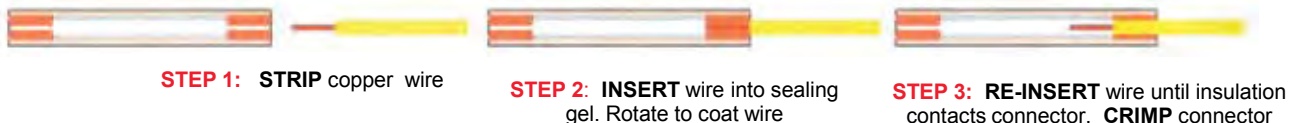

BUTT CONNECTORS

Wire Gauge	Crimp		Crimp/Seal		Crimp/Solder/Seal		Heatless		
	Part No.	Insulation	Part No.	Insulation	Part No.	Insulation	Part No.	Insulation	
<div style="border: 1px solid black; padding: 2px; width: fit-content;">Revised Part No.</div>									
	22-18	056051-50*	Vinyl-butted	058312-50*	Heat shrink	056144-25	Heat shrink	056111-5	Nylon
	22-18	057085-50	Nylon-smls**					056111-100	Nylon
	16-14	056052-50*	Vinyl-butted	058313-40*	Heat shrink	056145-25	Heat shrink	056112-5	Nylon
	16-14	057086-50*	Nylon-smls**					056112-100	Nylon
	12-10	056053-50*	Vinyl-butted	058314-40*	Heat shrink	056146-25	Heat shrink	056113-5	Nylon
12-10	057087-50*	Nylon-smls**					056113-100	Nylon	

		
22-18	058362-50*	None
16-14	058028-50*	None
12-10	058029-50*	None





		
		<i>Brazed Seam</i>
8	056054-10	Vinyl
6	056055-10	Vinyl
4	056056-10	Vinyl

HELPFUL HINT:

Terminal insulation is color-coded according to wire gauge specifications:

Red	-	22 - 18 AWG, 8 AWG
Blue	-	16 - 14 AWG, 6 AWG
Yellow	-	12 - 10 AWG, 4 AWG





SPADE CONNECTORS

Wire Gauge	Crimp		Crimp		Crimp/Seal		Crimp/Solder/Seal		
	Part No.	Stud Size, Insulation	Part No.	Stud Size, Insulation	Part No.	Stud Size	Part No.	Stud Size	
<div style="border: 1px solid black; padding: 2px; width: fit-content;">Revised Part No.</div>									
	22-18	056043-50	8-10, Vinyl	056046-50	4-6, Vinyl	058309-50	8-10		
	22-18			058345-50	6, Nylon			056155-25	10
	16-14	056044-50	8-10, Vinyl	056047-50*	4-6, Vinyl	058335-50	6		
	16-14	057082-50	8-10, Nylon	057084-50	4-6, Nylon	058310-50	8-10	056156-25	10
	16-14					058336-50	1/4"		
12-10	056045-50	8-10, Vinyl			058311-50	8-10	056157-25	10	
12-10	057083-50	8-10, Nylon			058337-50	1/4"			

NOTE: dash - "x" indicates package quantity

* Quantity (10) available with clam shell packaging to fit wire display rack (page 141) by adding "-10" to the base six digit number

**Seamless

RING TONGUE CONNECTORS								
Wire Gauge	Part No.	Crimp Stud Size, Insulation	Part No.	Crimp Stud Size, Insulation	Part No.	Crimp/Seal Stud Size	Part No.	Crimp/Solder/Seal Stud Size
Revised Part No.		<i>Butted Seam</i>		<i>Hooked Tongue-Butted</i>				
	22-18	056001-50	4-6, Vinyl	—		058334-50	6	—
	22-18	056002-50	8-10, Vinyl	—		058301-50	8-10	056147-25
	22-18	056003-50	12-1/4", Vinyl	—		—	—	—
	16-14	056004-50	4-6, Vinyl	056049-50	4-6, Vinyl	058302-50	4-6	—
	16-14	057075-50	4-6, Nylon	—		—	—	—
	16-14	056005-50*	8-10, Vinyl	056050-50	8-10, Vinyl	058303-50	8-10	056148-25
	16-14	057076-50*	8-10, Nylon	—		—	—	—
	16-14	056006-50*	12-1/4", Vinyl	—		058304-50	1/4"	056149-25
	16-14	057077-50	12-1/4", Nylon	—		—	—	—
	16-14	056007-50*	5/16", 3/8", Vinyl	—		058305-50	5/16", 3/8"	056150-25
	16-14	057078-50	5/16", 3/8", Nylon	—		—	—	—
	12-10	056008-50*	8-10, Vinyl	—		058306-50	8-10	056151-25
	12-10	057079-50	8-10, Nylon	—		—	—	—
	12-10	056009-50*	12-1/4", Vinyl	—		058307-50	1/4"	056152-25
	12-10	057080-50	12-1/4", Nylon	—		—	—	—
	12-10	056010-50	5/16", Vinyl	—		058308-50	5/16", 3/8"	056153-25
	12-10	057081-50	5/16", Nylon	—		—	—	—
12-10	056011-50*	3/8", Vinyl	—		—	—	056154-25	
12-10	056012-50	7/16", 1/2", Vinyl	—		—	—	—	

BRAZED SEAM			PIG TAILS			WIRE NUTS		
	<i>Brazed Seam</i>			NEW			NEW	
8	058349-50	8-10, Nylon						
8	058350-50	12-1/4", Nylon						
8	058351-50	5/16"-3/8", Nylon						
8	058352-50	7/16"-1/2", Nylon						
6	058353-50	12-1/4", Nylon						
6	058354-50	5/16"-3/8", Nylon	056184-50*	22 - 18	Nylon	058364-50	71B	Grey
6	058355-50	7/16"-1/2", Nylon	056185-50*	16 - 14	Nylon	058365-50	72B	Blue
4	058356-50	12-1/4", Nylon	056186-50*	12 - 10	Nylon	058366-40	73B	Orange
4	058357-50	5/16"-3/8", Nylon				058367-10	74B	Yellow
4	058358-50	7/16"-1/2", Nylon						

THREE AND FOUR WAY CONNECTORS							
Wire Gauge	Four-Way- Butted Part No.	Insulation	Three-Way- Butted Part No.	Stud Size,	Self Strip Connector Part No.	Wire Gauge	
Revised Part No.							
	22-18	058346-10	Vinyl	058363-10	Vinyl	056093-50*	18-14
	16-14	056084-10	Vinyl	056082-10	Vinyl	056094-10*	12-10 Run, 18-14 Tap
12-10	—	—	056083-10	Vinyl	—	—	





NOTE: dash- "x" indicates package quantity

*Quantity (10) available with clam shell packaging to fit wire display rack (page 141) by adding "-10" to the base six digit number.

MALE QUICK SLIDE TERMINALS AND CONNECTORS - TAB WIDTH .250"

Wire Gauge	Crimp		Crimp		Crimp/Seal		Crimp/Solder/Seal	
	Part No.	Insulation	Part No.	Insulation	Part No.	Insulation	Part No.	Insulation
Revised Part No.		Butted Seam-fully Insulated		Butted Seam		Fully Insulated		Fully Insulated
22-18	056069-50	Nylon	056063-50	Vinyl	058315-40	Ht Shrink	056169-25	Vinyl
16-14	056070-50	Nylon	056064-50*	Vinyl	058316-40	Ht Shrink	056159-25	Vinyl
16-14	—	—	057090-50	Nylon	—	—	—	—
12-10	056071-50	Nylon	056065-50*	Vinyl	058317-10	Ht Shrink	056164-25	Vinyl
12-10	—	—	057091-50	Nylon				
		Double Male to Female		90 Flag Butted				
	056088-50	None	056086-50	None				

FEMALE QUICK SLIDE TERMINALS AND CONNECTORS - TAB WIDTH .250"

Wire Gauge	Crimp		Crimp		Crimp/Seal		Crimp/Solder/Seal	
	Part No.	Insulation	Part No.	Insulation	Part No.	Insulation	Part No.	Insulation
Revised Part No.		Butted Seam-fully Insulated		T-tap Self Stripping		Fully insulated		Fully insulated
22-18	056066-50	Nylon	058347-40	Nylon	058318-50	Ht Shrink	056165-25	Ht Shrink
16-14	056067-50*	Nylon	057096-40	Nylon	058319-50	Ht Shrink	056166-25	Ht Shrink
12-10	056068-50*	Nylon	058348-40	Nylon	058320-10	Ht Shrink	056167-25	Ht Shrink
		Butted Seam						
22-18	056060-50	Vinyl					056168-25	Vinyl
16-14	056061-50*	Vinyl		—			—	—
16-14	057088-50*	Nylon		—			056158-25	Vinyl
12-10	056062-50*	Vinyl		—			056160-25	Vinyl
12-10	057089-50	Nylon		—				

SNAP TERMINALS AND CONNECTORS

Wire Gauge	Plugs-Butted Seam		Receptacles-Butted		Spades-Butted		Receptacles-Double	
	Part No.	Snap Dia, Insulation	Part No.	Snap Dia, Insulation	Part No.	Stud Size, Insulation	Part No.	Snap Dia, Insulation
Revised Part No.								
22-18	058338-50	0.156", Nylon	056076-50	0.156", Nylon			056080-50	0.157", Vinyl
22-18	058339-50	0.180", Nylon	058360-50	0.180", Nylon				
16-14	058340-50*	0.156", Nylon	056078-50	0.156", Nylon	057092-50	8, Vinyl		
16-14	058341-50	0.180", Nylon	056079-50	0.180", Nylon	057093-50	10, Vinyl		

NOTE: dash- "x" indicates package quantity

*Quantity (10) available with clam shell packaging to fit wire display rack (page 141) by adding "-10" to the base six digit number.

Terminal Kits

- Convenient, pre-packaged terminal assortments save time by keeping popular sized terminals close at hand
- Durable, see-through plastic cases with handy "locator" cards are easy to refill for using over and over
- Multi-functional kits can be displayed on the front counter to attract the impulse sale of single terminals or used as mini storage systems to save time and money by eliminating multiple trips to the shop for additional parts



Part No.	Description
056107	Solderless Terminal Kit
056108	Heat-Shrink Terminal Kit
056109	Electrical Connector Kit

ELECTRICAL

Electrical Connector Kit		
Part No.	Description	Pieces
Part No. 056109 Total Pieces 170		
056051	22-18 ga. Butt Conn	12
056052	16-14 ga. Butt Conn	12
056053	12-10 ga. Butt Conn	12
021007	3/8" tube O.D. clip	6
056091	22-14 ga. Pigtail	15
056093	18-14 Tap	10
056002	22-18 Ring Tongue	12
056005	16-14 Ring Tongue	12
056008	12-10 Ring Tongue	12
021009	1/2" tube O.D. tube clip	6
056092	18-10 ga. Pigtail	15
056094	12-10 run 18-14 tap	10
056043	22-18 Spade	12
056044	16-14 ga. Spade	12
056045	12-10 ga. Spade	12

Heat Shrink Terminal Kit		
Part No.	Description	Pieces
Part No. 056108 Total Pieces 132		
058312	22-18 ga. Butt Conn	8
058313	16-14 ga. Butt Conn	8
058314	12-10 ga. Butt Conn	8
058309	22-18 ga. Spade	8
058310	16-14 ga. Spade	8
058311	12-10 ga. Spade	8
058302	16-14 ga. Ring Tongue	8
058303	16-14 ga. Ring Tongue	8
058304	16-14 ga. Ring Tongue	8
058305	16-14 ga. Ring Tongue	8
058306	12-10 ga. Ring Tongue	8
058308	12-10 ga. Ring Tongue	8
058315	22-18 ga. M. Quick Slide	6
058316	16-14 ga. M. Quick Slide	6
058317	12-10 ga. M. Quick Slide	6
058318	22-18 ga. F. Quick Slide	12
058319	16-14 ga. F. Quick Slide	6
058320	12-10 ga. F. Quick Slide	6

Solderless Terminal Kit		
Part No.	Description	Pieces
Part No. 056107 Total Pieces 195		
057085	22-18 ga. Butt Conn	
	Tongue	12
057086	16-14 ga. Butt Conn	12
057087	12-10 ga. Butt Conn	12
056002	22-18 ga. Ring Tongue	12
056005	16-14 ga. Ring Tongue	12
056011	12-10 ga. Ring Tongue	12
056043	22-18 ga. Spade Tubing	12
056044	16-14 ga. Spade	12
056045	12-10 ga. Spade	12
057061	16-14 ga. Shrink Tubing	5
057062	12-10 ga. Shrink Tubing	5
057149	22-18 ga. Shrink Tubing	5
056061	16-14 ga. F. Quick	12
056062	12-10 ga. F Quick	12
056064	16-14 ga. M. Quick	12
056065	12-10 ga. M. Quick	12
058340	16-14 ga. Snap Plug	12
056078	16-14 ga. Snap Plug	12

Solderless Terminal Fleet Maintenance Kit

- Packaged in a heavy-duty steel box with 20 popular styles of solderless terminals and nylon tie straps

Revised
Part No.

Part No.	Description
056096	Kit with Crimping Tool
056097	Kit without Crimping Tool



Kit Includes:

Part No.	Qty	Part No.	Qty
056002-50	20	056044-50	20
056004-50	20	056047-50	20
056005-50	20	058340-50	20
056006-50	20	056078-50	20
056061-50	20	056074-50	20
056064-50	20	056092-50	20
056067-50	20	056093-50	20
056070-50	20	056050-50	20
056009-50	20	056051-50	20
056011-50	20	056052-50	20
090014-50	20	056053-50	20

NOTE: dash "-xx" indicates package quantity

Terminals also sold separately on pages 92 - 94
Tie straps sold separately on page 99. Crimping tool sold separately on page 101

PRIMARY WIRE AND ACCESSORIES

General Purpose Primary Wire



- Soft annealed copper strands
- PVC outer jacket
- Designed to withstand temperatures up to +250° F
- Wire meets SAE J1128 Type GPT requirements

Part No.	Gauge	Spool Size	Color
051101	18	100'	Black
051103	18	100'	Red
051105	18	100'	White
051117-6	16	1000'	Black
051121-6	16	1000'	Red
051123-6	16	1000'	White
051119-6	16	1000'	Green
051117	16	100'	Black
051121	16	100'	Red
051123	16	100'	White
051125	16	100'	Yellow
051127	16	100'	Blue
051129	16	100'	Brown
051119	16	100'	Green
051135-6	14	1000'	Black
051139-6	14	1000'	Red
051141-6	14	1000'	White
051143-6	14	1000'	Yellow
051145-6	14	1000'	Blue
051147-6	14	1000'	Brown
051137-6	14	1000'	Green
051135	14	100'	Black
051139	14	100'	Red
051141	14	100'	White

Part No.	Gauge	Spool Size	Color
051143	14	100'	Yellow
051145	14	100'	Blue
051147	14	100'	Brown
051137	14	100'	Green
051157-7	12	500'	Red
051159-7	12	500'	White
051161-7	12	500'	Yellow
051163-7	12	500'	Blue
051155-7	12	500'	Green
051153	12	100'	Black
051157	12	100'	Red
051159	12	100'	White
051161	12	100'	Yellow
051163	12	100'	Blue
051165	12	100'	Brown
051155	12	100'	Green
051175-7	10	500'	Black
051171-7	10	500'	Red
051177-7	10	500'	White
051175	10	100'	Black
051171	10	100'	Red
051177	10	100'	White
051173	10	100'	Blue

Primary Wire Rack



- Holds (12) 100' spools, (8) 100' and (2) 1000' spools or (4) 1000' spools
- Heavy gauge plated steel construction
- Wire spools sold separately

Part No.	Description
691015	Primary Wire Rack

Gray Jacketed Parallel Wire



Part No.			Spool Size
16 Gauge Black-White	14 Gauge Black-White	12 Gauge Black-White	
051050	051058	051066	100'
051050-7	051058-7	—	500'

Three-Way and Four-Way Bonded Parallel Wire*



Part No.		Conductor	Wire Color	Spool Size
16 Gauge	14 Gauge			
051052	051060	Three	Brown-Green-Yellow	100'
051054	051062	Four	Brown-Green Yellow-White	100'

NOTE: See page 73 for ATA color code description

**Round wire glued together*

ELECTRICAL

SPLIT LOOM

Convolved Split Loom



- High temperature loom suitable for engine compartment use
- Split seam permits easy insertion and repair or wire, tubing, cable, etc.
- Convolved black nylon allows for excellent pinch and abrasion resistance
- Designed to withstand temperatures from -40° to +200° F
- Meets FMVSS 302 requirements

Part No.		Loom I.D.
100' Coil	250' Coil	
020104-7	020104	1/4"
020106-7	020106	3/8"
020108-7	020108	1/2"
020110-7	020110	5/8"
020112-7	020112	3/4"
020116-7	—	1"
020117-7	—	1-1/4"
020118-7	—	1-1/2"
020119-7	—	1-7/8"

Heavy Wall Heat-Shrink Tubing With Liner

- Durable polyolefin construction
- Inner liner melts to produce a flexible, waterproof seal for the life of the connection
- UL Listed/CSA certified in direct buried applications
- Flame retardant
- 3:1 shrink ratio
- See page 121 for heat gun-recommended heat range is 250° F (120°) to 485° (250°C)

Revised Part No.



Part No.	Wire Gauge Range	Length	I.D. Pre-Shrink	I.D. After
057147-10	18-14	6"	.300"	.100"
057158-10	14-6	6"	.400"	.150"
057073-10	8-1	6"	.750"	.220"
057151-25	8-1	1-1/2"	.750"	.220"
057153-2	8-1	48"	.750"	.220"
057074-10	2-4/0	6"	1.100"	.375"
057098-25	2-4/0	1-1/2"	1.100"	.375"
057174-2	2-4/0	48"	1.100"	.375"

Revised Part No.



Part No.	Wire Gauge Range	Length	I.D. Pre-Shrink	I.D. After
057146-10	18-14	6"	.300"	.100"
057148-5	18-14	48"	.300"	.100"
057058-10	14-6	6"	.400"	.150"
057159-5	14-6	48"	.400"	.150"
057059-10	8-1	6"	.750"	.200"
057150-25	8-1	1-1/2"	.750"	.200"
057152-2	2-4/0	48"	.750"	.200"
057060-10	2-4/0	6"	1.100"	.375"
057097-25	2-4/0	1-1/2"	1.100"	.375"
057160-2	2-4/0	48"	1.100"	.375"

NOTE: dash "-x" indicates package quantity

Thin Wall Heat-Shrink Tubing Without Liner

- Durable polyolefin construction
- UL recognized and flame retardant
- Continuous operating temperature: -67° F (-55° C) to 275° F (135° C)
- Recommended heat range is 250° F (120° C) to 485° F (250° C)
- 2:1 shrink ration

Revised Part No.



Part No.	Wire Gauge Range	Length	Color	I.D. Pre-Shrink	I.D. After
057061-25	16-14	2"	Blue	.250"	.125"
057062-25	12-10	2"	Yellow	.375"	.187"
057149-25	22-18	6"	Red	.125"	.062"
057112-10	—	6"	Black	.190"	.093"
057113-10	—	6"	White	.250"	.125"
057114-10	—	6"	Red	.375"	.187"
057115-10	—	6"	Black	.500"	.250"
057116-10	—	6"	White	.750"	.370"
057117-10	—	6"	Red	1.00"	.500"

NOTE: dash "-x" indicates package quantity

Thin Wall Heat-Shrink Tubing

NEW

- Disk packaging for convenient storage and waste reduction
- Packaged for showroom display and impulse buying
- Available in three colors corresponding to NEMA color-code standards
- Convenient packaging easily fits in toolbox



Part No.	Description
057131	3/16" ID, Red
057132	1/4" ID, Blue
057133	5/16" ID, Yellow

Packaged in 8' rolls - one roll per disk pack

Heat-Shrink Tubing Kits



Part No. 057110

- Convenient, pre-packaged tubing assortments save time by keeping popular sized tubing in 6" lengths close at hand
- Durable, see-through plastic cases with handy "locator" cards are easy to refill for using over and over

Part No.	Description
057110	Heavy Wall Heat-Shrink Tubing Kit
057111	Thin Wall Heat-Shrink Tubing Kit

Heavy Wall Heat-Shrink Tubing Kit

Part No. 057110 Total Pieces 36

Part No.	Pieces	Description
057060	4 pcs	1.10" Black
057059	4 pcs	.750" Black
057058	10 pcs	.400" Black
057074	4 pcs	1.10" Red
057073	4 pcs	.750" Red
057158	10 pcs	.400" Red



Part No. 057111

Thin Wall Heat-Shrink Tubing Kit

Part No. 057111 Total Pieces 86

Part No.	Pieces	Description
057112	36 pcs	3/16" Black
057113	24 pcs	1/4" White
057114	12 pcs	3/8" Red
057115	6 pcs	1/2" Black
057116	4 pcs	3/4" White
057117	4 pcs	1" Red

TIE STRAPS, GROMMETS AND WIRE CLIPS

Cable Tie Straps



Part Nos. 090002, 090064



Part Nos. 090004, 090067



Part Nos. 090006, 090070



Part Nos. 090010, 090071



Part Nos. 090014, 090066

Part Nos. 090016, 090068

Part Nos. 090030, 090029

Revised Part No.

Part No.	Standard Tie Strap	Black UV Tie Strap	Length	Minimum Diameter	Maximum Diameter	Minimum Tensile Strength	Stud Size
090002-100	090064-100	090064-100	5"	1/16"	1-1/4"	30 lbs.	—
090004-100	090067-100	090067-100	7"	1/16"	1-3/4"	50lbs.	10
090006-25	090070-25	090070-25	14"	3/16"	4"	120 lbs.	—
090010-25	090071-25	090071-25	14"	3/16"	4"	120 lbs.	14
090014-100	090066-100	090066-100	7"	1/16"	1-3/4"	50 lbs.	—
090016-100	090068-100	090068-100	14"	1/16"	4"	50 lbs.	—
	090030-50	090030-50	24"			175 lbs.	
	090029-50	090029-50	36"			175 lbs.	

NOTE: dash "-xxx" indicates package quantity

NEW

Rubber Grommets

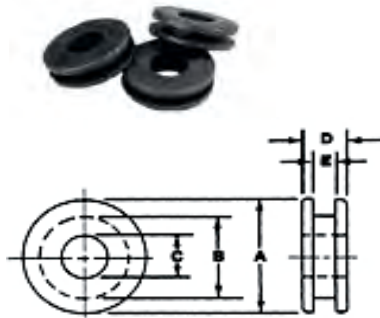

Part No.	A	B	C	D	E
021059	9/16"	7/16"	5/16"	3/16"	1/16"
021061	1-1/8"	7/8"	1/2"	7/16"	7/32"
021063	1-1/4"	31/32"	5/8"	3/8"	1/8"
021065	1-3/4"	1-3/16"	3/4"	1/2"	7/32"

Nylon Grommet



- Provides protection for 16, 14 and 12 gauge wires
- Fits into a 3/8" diameter mounting hole with wall thickness up to 1/8"

Part No.	Description
021070	Nylon Grommet

Wire Clips



- Spring tension clips are ideal for holding primary wire to truck frame
- Tips are vinyl coated for wire protection

Part No.	Description
021021	1/4" Wire Clip
021023	1/2" Wire Clip

Tube Clips



- Zinc-plated steel construction for corrosion resistance
- Rubber coating protects tubing and wires

Part No.	Tube O.D.	Mounting Bolt Size
021001	3/16"	1/4"
021003	1/4"	1/4"
021005	5/16"	1/4"
021007	3/8"	1/4"
021009	1/2"	1/4"
021011	5/8"	1/4"
021013	3/4"	3/8"
021015	7/8"	1/4"
021017	1"	1/4"
021019	1-1/4"	5/16"

Rubber Cushioned Clamps



NEW

Clamping Diameter	Part No. 3/8" Mounting Screw - 5/8" Wide	Part No. 1/4" Mounting Screw - 1/2" Wide
1/4"	021102	021114
3/8"	021103	021115
1/2"	021104	021116
5/8"	021100	021117
3/4"	021105	021118
1"	021106	021119
1-1/4"	021107	
1-1/2"	021108	
2"	021109	
2-1/2"	021110	
3"	021111	
4"	021112	
5"	021113	

Work Lights



- Incandescent light includes grounded metal swing-open bulb guard and 25' 16/3 outdoor all-weather power cord (cord remains flexible in sub-zero temperatures to -20°)
- On/Off switch, grounded three prong outlet and 13 amp resettable circuit breaker built into handle
- Metal hanging hook
- For use with up to 75 watt standard incandescent bulb (not included)

Part No.	Description
057123	Work light

Deluxe Crimping Tool



- Crimps terminals ranging in size from 26 to 6 gauge
- Five popular sized bolt cutting stations cleanly cut mild steel and nonferrous material

Part No.	Description
058026	Deluxe Crimping Tool

Short Tube Work Light 13 Watt



- Fluorescent light features new ergonomic handle, shatter resistant housing and 25' 16/3 attached cord
- Ballast, on/off switch and three prong tool outlet built into bottom end of handle
- Handle accepts 360° adjustable magnet mounting clip allowing lamp to adhere to metal surface
- Shatter resistant polycarbonate lens with 270° arc of light
- 360° adjustable swivel hanging hook
- No tools, easy bulb replacement - cool and energy efficient
- Includes 13 watt fluorescent twin tube

Part No.	Description
057125	Light - 13 Watt

Economy Crimping Tool



- Accepts 8 through 4/0 gauge uninsulated terminals, butt connectors, battery terminals and lugs
- Hammer required for operation

Part No.	Description
058030	Economy Crimping Tool

Long Tube Work Light 15 Watt



- Fluorescent light features shatter resistant lamp housing an 25' 18/2 attached power cord
- On/Off switch built into handle
- Plug-in ballast built into power cord plug
- Non-glare reflector
- 360° adjustable swivel hanging hook

Part No.	Description
057124	Light - 15 Watt

Heavy-Duty Crimping Tool



- For crimp-type terminals from 6 to 4/0 gauge
- Rotating, letter-coded crimping die
- Reference guides on handles for proper die settings

Part No.	Description
058171	Heavy-Duty Crimping Tool
058172	Replacement Left Jaw
058173	Replacement Right Jaw

Heat Gun



- Produces temperatures from 750° to 1100° F
- Built-in circuit breaker and three position switch (hot / off / fan only)

Part No.	Description
058160	Heat Gun

Copper Cable Cutter



- Capable of cutting up to 1" diameter copper stranded electrical cable
- 13" long steel handles with vinyl hand grips

Part No.	Description
057072	Copper Cable Cutter

Compact Cable Cutter



- Designed to cut copper wire and cable up to 4/0 gauge

Part No.	Description
057071	Compact Cable Cutter

25' Cord Reel



- Retractable 25' 16/3 cord rated at 10 amps, 125 VDC
- Housing constructed of high impact plastic with built-in grounded outlets (4), 10 amp resettable circuit breaker and a convenient wind-up knob
- When completely wound, reel fits easily into tool box or drawer
- Carrying handle attached for convenient portability

Part No.	Description
057126	25' Cord Reel

Triple Outlet All-Weather Extension Cord



- 50' 12/3 high visibility yellow cord rated at 15 amps, 125 VDC
- Heavy duty power block at female end with resettable 15 amp circuit breaker and three grounded outlets

Part No.	Description
057128	50' Extension Cord

50' Cord Reel



- Retractable 50' 14/3 yellow cord rated at 13 amps, 125 VDC to -40°
- Heavy duty cord includes heavy duty power block with built-in resettable 13 amp circuit breaker and three grounded outlets
- Industrial/Commercial grade, auto ratcheting plastic alloy reel housing built-in carrying handle
- Includes quick release wall/ceiling mounting bracket for portability
- All hardware and instructions are included

Part No.	Description
057127	50' Cord Reel

Conspicuity Tape



Red and White

Designed to mark the side and rear perimeter of trucks and trailers for enhanced visibility and detection
DOT-C2 certified and guaranteed to meet or exceed all FMVSS 108 and NHTSA requirements

- Alternates 11" of red and 7" of white
- Superior daytime visibility and nighttime reflectivity
- 3 year warranty

Part No.	Description
058370	2" x 150'



Yellow

School bus yellow tape is designed for retrofit applications. Enhanced daytime appearance and sight detection for safety. Withstands the abuse of mechanical and high pressure washings.

- Meets and exceeds 2000 National Standard for buses ASTM D4956-01 (Type V), FMVSS 131 and FMVSS 217
- 3 year warranty

Part No.	Description
058379	2" x 150"

General Purpose Vinyl Electrical Tape



- Rated to 176°F (80°C)
- Meets UL510 requirements for UV resistance
- UL listed 539H and meets Canadian Standards Association LR48769

Tape		
Part No.	Thickness	Roll Size
058368	7 mil	3/4" x 60'

ELECTRICAL

Conspicuity Strips and Reflective Circles



- DOT-C2 certified conspicuity strips
- Replaces damaged or worn out tape with cost efficient conspicuity strips
- Conspicuity tape is weather, solvent and UV resistant and applies easily to painted or non-painted surfaces
- SAE-A DOT reflective circles
- Add more visibility without adding costly lights
- Conveniently packaged in Polybags ready to display
- Four reflectors per package

Part No.	Description
058373	2" x 18" (7-11) Conspicuity Strips
058374	2" x 12" (7-11) White Conspicuity Strips
058377	2-3/4" Diameter Red Reflective Circles
058376	2-3/4" Diameter Orange Reflective Circles

Silicon Self-Fusing Tape

NEW



- Tape self fuses and cures in 24 hours to form a permanent moisture tight seal
- Has no adhesive lining leaving the application clean with no sticky residue
- Provides high tech alternative to heat shrink tubing
- Ideal for high temperature applications, such as battery terminals
- High dielectric strength
- Temperature range from -85 to +500 F
- Packaged in clamshell, 1" wide, 20' long rolls - quantity 1 clamshell

Part No.	Color	Description
058380*	Black	Silicon Self-Fusing Tape
058381*	Red	Silicon Self-Fusing Tape

*Add -4 to the part number for 10 piece bucket display on page 139.



HOSE 105-109

Table of Contents	PAGE
Hose and Cable Support Accessories	105
Pogo Sticks	107
Document Holders and Accessories	108
Wiper Blades	109

VELVAC Original Indicates an original Velvac product.

NEW Indicates a new product added to catalog.

Revised Part No. Indicates a revised part number defining “-xx” package quantity.
Refer to price list for price per package.

For quantity and packaging information, refer to our price list.

Customer Service: 800.783.8871
Fax: 262.786.4101
Email: sales@velvac.com



NOTE: The information and photographs in this catalog are believed to be accurate and factual as of the print date. Velvac assumes no responsibility for information that may be incorrect or has changed since press time. Product specifications and offerings subject to change without notice.

Velvac is a registered trademark of Velvac, Inc.
Lexan is a registered trademark of SABIC Innovations Plastics.
Capkeeper is a trademark of Velvac, Inc.



Hose and Cable Suspenders

Five year limited warranty!

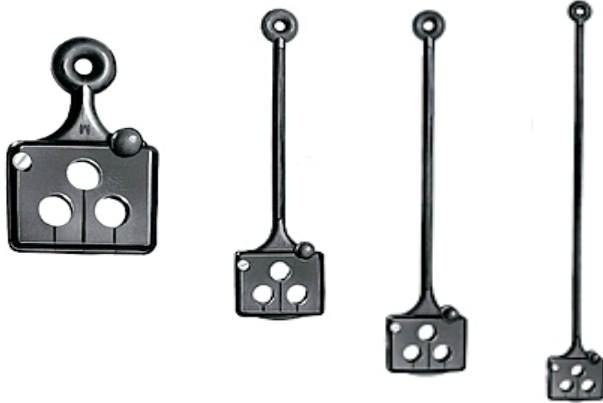

- Molded of durable rubber components which remain flexible to -40° F
- Will not stretch out or corrode like traditional steel support springs
- Reduce damage to cab body paint
- 3/4" diameter holes
- For use with hose brackets, pogo sticks and slide bars

Part No.	Description
580081	5" Overall Length
580082	12" Overall Length
580086	16" Overall Length
580094	24" Overall Length

US Patent No. 4,358,082

Replacement Tracker Bar Kits

NEW



Tracker bar tender kits are designed to hold air lines and electrical cables to prevent kinks and abrasions during normal highway use

KIT INCLUDES:

- 16" or 20" Spring- plated for added corrosion resistance and double looped ends for additional strength
- Snap Clip- rust resistant stainless steel which clips easily onto a tracker bar or pogo stick
- 3 Hose Holder Assembly- neatly holds two air hoses and an electrical cable
- Velvac Woven Mesh Jacket- protects spring from the elements while giving a clean look.

Part No.	Description
580111	Kit with 16" Spring
580112	Kit with 20" Spring
580107	Stainless Steel Snap Clip

HOSE

Slide Bar and Hose Suspender Kit



- Slide bar is 3/4" OD stainless steel tubing with 42-1/2" mounting centers
- Kit includes slide bar, 24" hose and cable suspender, nylon ring and zinc-plated steel "S" hook

Part No.	Description
580066	Complete Kit
580078	Replacement Ring with "S" hook
580067	Replacement Slide Bar

Hose Holders and Separators



Part No. 580037



Part No. 580038



Part No. 580039



Part No. 580040



Part No. 580041

- ABS plastic construction

Part No.	I.D.	Description
580037	3/8"	2 Hose Separator
580038	3/8"	4 Hose Separator
580039	1/2"	2 Hose Separator
580040	1/2"	3 Hose Separator
580041	1/2"	4 Hose Separator

Hose Support Springs



- Springs support either air or vacuum lines
- Heat-treated, zinc plated spring steel construction provide corrosion resistance
- Double wire loop ends add extra strength

Part No.	Description
038001	3/4" O.D. x 13' long
038003	1" O.D. x 13' long
038008	1-1/8" O.D. x 8' long
038005	1-1/8" O.D. x 28" long

Grab Handles



- 3/4" O.D. heavy gauge stainless steel tubing
- 5/16" diameter mounting holes

Part No.	Description	Grabbing Width
690021	12" Span	3"
690022	18" Span	2"
690023	24" Span	2"

NOTE: Span measurement taken between mounting holes

King Pin Lock

- Help deter UNWANTED trailer hookups
- Made of durable cast iron enhances protection against theft, breakage or damage
- Heavy duty zinc plated lock set helps deter rusting and extends service life
- Lock set includes two (2) keys

NEW



Part No.	Description
019032	King Pin Lock

Pogo Sticks

- Durable, zinc-plated steel bodies provide excellent support for air, vacuum and electrical lines
- Snubber chin assembly helps prevent pogo stick from coming in contact with cab
- Heavy-duty, polyester coated, oil-tempered steel springs can withstand 90° from vertical bends
- 5/8" - 11 stud and nut for extra support
- Heavy fabric hose holder strap included where pictured



Part No.	Description
581001	40" Pogo Stick with Snubber Chain
581005	40" Pogo Stick with Gladhand Holder and Snubber Chain
581006	Gladhand Holder Kit



- **NO SNUBBER CHAIN** for use only when pogo stick is at least 24" away from cab

Part No.	Description
581011	40" Pogo Stick
581015	40" Pogo Stick with Gladhand Holder
581006	Gladhand Holder Kit



Part No. 581038



- Combines popular 40" pogo stick with 5" rubber hose and cable suspender (see page 105 for hose and cable suspender)
- Adapter kit retrofits 5" hose and cable suspender on existing pogo sticks and includes "S" hook and eyebolt hardware (9/32" hole is required for installation of eyebolt)

Part No.	Description
581040	Pogo Stick and Hose Suspender Assembly with Snubber Chain
581038	Hose and Cable Adapter Kit

*Hose and Cable Suspender US
Patent No. 4,358,082*

HOSE

DOCUMENT HOLDERS

License and Permit Holder

- UV-resistant Lexan®
- Inside dimensions are 3-1/8" to 3-3/4" wide x 5-1/2" high x 1-1/4" deep
- Three 1/4" mounting posts
- Documents secured by a metal spring clip and plate



Part No.	Description
090060	License and Permit Holder
090061	Replacement Cover

*Lexan® is a registered trademark of SABIC Innovation Plastics

Tite-Seal Document Storage Case



Case with Bracket and CapKeeper™ Cable



Light Duty



Standard Case with Bracket

Mounting Bracket : 5-3/4" high x
2-13/16" wide x 4" deep
Mounting Holes : (5) 3/16" diameter
Tube Diameter : 1-5/8"

- Patented rubber caps create a watertight seal
- Aluminum mounting bracket features cushioned tube supports and pre-drilled mounting holes
- CapKeeper protective cable secures caps to mounting bracket

Part No.	Description
090113	Light Duty Aluminum Tube with Painted Steel Cap
090114	9" Aluminum Tube with Bracket
090115	9" Aluminum Tube with Bracket and CapKeeper Cable
090116	12" Aluminum Tube with Bracket and CapKeeper Cable
090119	Replacement Rubber Cap

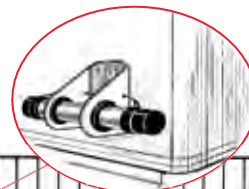

HOSE

Tarp Straps



NEW

- Made of molded rubber for ozone resistance and stretch resiliency
- Designed to hold tarp covers on trucks and trailers
- Hooks are crimped to prevent hook disconnection
- Straps will stretch up to twice their length
- Premium and DPM straps add increased UV protection

Rubber Tarp Part No.	Premium EDPM	Description
580113	580118	9" Length
580114	580119	15" Length
580115	580120	21" Length
580116	580121	31" Length
580117	580122	41" Length

CAUTION: RUBBER TARP STRAPS CAN HAVE A STRONG SPRING TENSION AND CAN CAUSE BODILY INJURY IF IT WERE TO COME UNHOOKED OR BREAK. SAFETY GLASSES ARE RECOMMENDED. TARP STRAPS ARE NOT TO BE USED TO RESTRAIN OR SECURE CARGO!

Emergency Triangle Kit



NEW

- Kit contains three triangles stored in a compact plastic box
- No tools needed
- Triangles are made of reflective plastic for day or night use
- No power use needed
- Weighted triangle base adds stability in windy conditions.
- Helps comply with DOT standard FMVSS 125

Part No.	Description
090008	Emergency Triangle Kit

CapKeepers™ is a trademark of Velvac, Inc.



UNIVERSAL WIPER BLADE: All makes heavy duty wiper blade replaces the Anco 31 Series blade, featuring an all steel frame construction, with compression molded-rubber for long life.

NEW



HIGH CURVE BLADE: Heavy duty blade used for highly curved windshield applications.



HEAVY DUTY FLEX BLADES: Designed for heavy duty arms that have less than 48 oz. of load. Can be used on flat or curved windshields, with narrow saddle arms.



UNIVERSAL WINTER HEAVY DUTY: Heavy duty steel construction is surrounded by a rubber boot to minimize the accumulation of snow and ice on the wiper blades.



PREMIUM UNIVERSAL WIPER BLADE: All makes PREMIUM heavy duty wiper blade replaces the Anco 91 Series heavy duty blade, featuring a riveted all steel frame and compression molded rubber blade for increased life and durability



HEAVY DUTY FLAT BLADE: Used in flat windshield applications. Stainless Steel rail. Typically used on heavy duty trucks, school buses, step vans and RV's.



WINTER HEAVY DUTY NARROW: Heavy duty steel frame, for narrow arms, is surrounded by a rubber boot, minimizes the accumulation of snow and ice.



TRANSIT BLADE: Typically used for bus and transit vehicle applications, with wide saddle arms.

Part No./Type	Length	Anco No.	Trico No.
Transit Blade			
13226	26"	52-27, 52-26	—
High Curve			
13718	18"	57-01	—
Premium Universal			
76-14	14"	91-14	—
76-15	15"	91-15	15-1
76-16	16"	91-16	16-1,16-2
76-18	18"	91-18	18-1,18-2
76-19	19"	91-19	19-1,19-2
76-20	20"	91-20	20-1,20-2,20-4,20-9
76-21	21"	91-21	21-1
76-22	22"	91-22	22-1,22-4,22-9
76-24	24"	91-24	24-1,24-4,24-9
76-28	28"	91-28	28-1
Universal			
75-14	14"	31-14	—
75-15	15"	31-15	—
75-16	16"	31-16	—
75-17	17"	31-17	—
75-18	18"	31-18	—
75-19	19"	31-19	—
75-20	20"	31-20	—
75-21	21"	31-21	—
75-22	22"	31-22	—
75-24	24"	31-24	—

Part No./Type	Length	Anco No.	Trico No.
Heavy Duty Flat			
71-13	13"	51-13	62-130
71-14	14"	51-14	61-140
71-15	15"	51-15	61-150
71-16	16"	51-16	61-160
71-18	18"	51-18	61-180
71-20	20"	51-20	61-200
Heavy Duty Flex			
72-15	15"	52-15	63-151,64-150
72-16	16"	52-16	63-161,64-160
72-18	18"	52-18	63-181,64-180
72-20	20"	52-20	63-121,64-200
Universal Winter			
W15	15"	30-15	37-151
W16	16"	30-16	37-160
W18	18"	30-18	37-180
W20	20"	30-20	37-205
W22	22"	30-22	37-225
W24	24"	30-24	37-245
W28	28"	—	—
Winter Heavy Duty Narrow Saddle			
WN13	13"	59-13	66-130
WN15	15"	59-15	66-150
WN16	16"	59-16	66-160
WN18	18"	59-18	66-180

HOSE

*Refer to www.velvac.com for all makes cross reference guide

**See page 141 for Part No. 690046 POP floor display



FITTINGS 111-127

Table of Contents	PAGE
Push-Lock Air Brake Fittings	111
Nylon Air Brake Tube Fittings	113
Air Brake Compression Fittings	114
Reusable Air Hose Fittings	115
Discharge Hose Fittings	117
Pipe Fittings	118
SAE 45° Flare Fittings	119
Inverted Flare Fittings	120
Truck and Trailer Repair Kits	121
Fittings Display and Assortments	122
Hose Clamp and Coolant Valves	123
Heavy Duty Truck Radiator Caps	126
Clevis and Clevis Pins	127

VELVAC Original Indicates an original Velvac product.

NEW Indicates a new product added to catalog.

Revised Part No. Indicates a revised part number defining “-xx” package quantity.
Refer to price list for price per package.

For quantity and packaging information, refer to our price list.

Customer Service: 800.783.8871
Fax: 262.786.4101
Email: sales@velvac.com



NOTE: The information and photographs in this catalog are believed to be accurate and factual as of the print date. Velvac assumes no responsibility for information that may be incorrect or has changed since press time. Product specifications and offerings subject to change without notice.

Velvac is a registered trademark of Velvac, Inc.
Hi-Torque, Constant-Torque, and Euro-Seal are registered trademarks of Breeze Industrial Products Corp.



- Designed for use with SAE J844 nylon tubing (see page 42)
- **DOT 49CFR 571.106 compliant**
High strength composite fittings offer weight savings over all brass style fittings-currently being used by many OE vehicle manufacturers
- Fittings meet performance requirements as stated in SAE J1131*
- Operating temperatures from -45° F to +140° F
- Maximum operating pressure 145 psi
- Elbows and male branch fittings with built-in swivel for positioning
- Engineered tube retention system and seal design for superior holding and side load retention capabilities
- Positive release bushing for easy insertion and removal of tubing
- Thread sealant applied to all male pipe threads to reduce installation time and expense

WARNING

Velvac's line of push-lock brake fittings and tubing are designed only for use in vehicles where air is utilized as the operating fluid. As such, Velvac's push-lock air brake fittings should only be used in a manner consistent with the manufacturer's specifications.

Using Velvac's push-lock fittings or tubing improperly or in a manner inconsistent with the manufacturer's specifications may result in serious injury or property damage. For example, Velvac's push-lock fittings and tubing are not intended for use in environments exceeding 145 psi and temperatures between -45° and +140° F. Velvac push-lock fittings and tubing are intended for use only as defined in 49CFR571.106.

Further, the U.S. Department of Transportation prohibits the use of push-lock fittings and nylon tubing as a connection between (I) a semi-tractor & trailer, or (II) a drive shaft and chassis.

NOTE: 1/8" push-lock fittings DO NOT meet DOT or SAE specifications for air brake applications.

45° Male Swivel Elbows

(Sealant Applied)

NEW



- Composite body with brass pipe fitting end

Part No.	Tube Size	Pipe Size
016412*	1/8"	1/8"
016442	1/4"	1/8"
016444	1/4"	1/4"
016446	1/4"	3/8"
016464	3/8"	1/4"
016466	3/8"	3/8"
016486	1/2"	3/8"
016947	3/8"	1/2"
016950	1/2"	1/2"

Full Unions

NEW



- Composite body

Part No.	Tube Size
016610*	1/8"
016620	5/32"
016630*	3/16"
016640	1/4"
016660	3/8"
016680	1/2"
016670	5/8"

90° Male Swivel Elbows

(Sealant Applied)

NEW



- Composite body with brass pipe fitting end

Part No.	Tube Size	Pipe Size
016212	1/8"	1/8"
016214	1/8"	1/4"
016222	5/32"	1/8"
016224	5/32"	1/4"
016242	1/4"	1/8"
016244	1/4"	1/4"
016246	1/4"	3/8"
016262	3/8"	1/8"
016264	3/8"	1/4"
016266	3/8"	3/8"
016268	3/8"	1/2"
016284	1/2"	1/4"
016286	1/2"	3/8"
016288	1/2"	1/2"
016276	3/4"	1/2"
016277	3/4"	3/4"
016278	5/8"	3/4"
016279	5/8"	3/8"
016281	5/8"	1/2"

Bulkhead Unions



- Brass Construction

Part No.	Tube Size
016810*	1/8"
016840	1/4"
016860	3/8"
016880	1/2"

* Indicates parts that do not meet DOT or SAE specification for air brake applications

Union "Y"

NEW



- Composite body

Part No.	Description
016289	1/4 x 1/4 x 1/4
016291	1/4 x 1/4 x 3/8
016290	3/8 x 3/8 x 3/8

Union Tees

NEW



- Composite body

Part No.	Tube Size
016910	1/8"
016920	5/32"
016930	3/16"
016940	1/4"
016960	3/8"
016980	1/2"
016985	1/2 x 1/2 x 3/8

Male Run Tee

NEW



Part No.	Tube Size	Pipe Size
016400	1/4"	1/8"
016401	1/4"	1/4"
016402	3/8"	1/4"
016403	3/8"	3/8"
016404	3/8"	1/2"
016405	1/2"	3/8"
016406	1/2"	1/2"
016407	5/8"	1/2"
016409	1/4"	3/8"

Female Bulkhead Connector

NEW



Part No.	Tube Size	Thread Size
016812	1/4"	1/4"
016813	3/8"	1/4"

Male Connectors (Sealant Applied)

NEW



- Brass Construction

Part No.	Tube Size	Pipe Size
016110*	1/8"	1/16"
016112*	1/8"	1/8"
016114*	1/8"	1/4"
016120	5/32"	1/16"
016122	5/32"	1/8"
016124	5/32"	1/4"
016142	1/4"	1/8"
016144	1/4"	1/4"
016146	1/4"	3/8"
016162	3/8"	1/8"
016164	3/8"	1/4"
016166	3/8"	3/8"
016168	3/8"	1/2"
016184	1/2"	1/4"
016186	1/2"	3/8"
016188	1/2"	1/2"
016151	3/4"	1/2"
016161	3/4"	3/4"
016163	5/8"	3/8"
016189	5/8"	1/2"
016187	3/4"	3/8"

*Except 1/8" fittings and 90° male elbow Part No. 016224 which do not meet DOT or SAE specifications for air brake applications

Female Elbow

NEW



Part No.	Tube	Thread
016247	1/4"	1/8"
016248	1/4"	1/4"
016249	3/8"	1/4"

Union 90° Elbow

NEW



Part No.	Tube Size
016282	5/32"
016283	1/4"
016285	3/8"
016287	1/2"

- Composite body

Male Branch Swivel Tees

(Sealant Applied)

NEW



- Composite body with brass pipe fitting end

Part No.	Tube Size	Pipe Size
016312*	1/8"	1/8"
016314*	1/8"	1/4"
016342	1/4"	1/8"
016344	1/4"	1/4"
016364	3/8"	1/4"
016366	3/8"	3/8"
016368	3/8"	1/2"
016386	1/2"	3/8"
016388	1/2"	1/2"
016408	5/8"	1/2"

* Indicates parts that do not meet DOT or SAE specification for air brake applications

- Designed for use with nylon air brake tubing (see page 42)
- **DOT compliant.** Fittings meet SAE J246 requirements
- Brass construction with internal stainless steel tube supports
- Pipe thread sealant featured on several fitting styles. This pre-applied sealant offers several benefits
 - Provides no-leak assembly instantly. Saves application time and expense
 - Will not contaminate systems like tape shredding or liquid sealant washout
 - Can be reused up to five times
 - Provides excellent thread

45° Elbows *(Sealant Applied)*



Part No.	Tube Size	Pipe Size
017842	1/4"	1/8"
017844	1/4"	1/4"
017862	3/8"	1/8"
017864	3/8"	1/4"
017866	3/8"	3/8"
017868	3/8"	1/2"
017886	1/2"	3/8"
017888	1/2"	1/2"
017816	5/8"	3/8"
017808	5/8"	1/2"

Tee Thread Branches

(Sealant Applied)



Part No.	Tube Size	Pipe Size
017242	1/4"	1/8"
017244	1/4"	1/4"
017262	3/8"	1/8"
017264	3/8"	1/4"
017266	3/8"	3/8"
017286	1/2"	3/8"
017288	1/2"	1/2"
017218	5/8"	1/2"

Female Elbows



Part No.	Tube Size	Pipe Size
017043	1/4"	1/8"
017046	1/4"	1/4"
017060	3/8"	1/8"
017064	3/8"	1/4"
017066	3/8"	3/8"
017086	1/2"	3/8"
017088	1/2"	1/2"

Sleeves



Part No.	Tube Size
016340	1/4"
016360	3/8"
016380	1/2"
016300	5/8"
016301	3/4"

NOTE: Fitting sleeves should NEVER be reused

Full Union



Part No.	Tube Size
016240	1/4"
016260	3/8"
016280	1/2"
016200	5/8"
016201	3/4"

Elbow Ends Tubes



Part No.	Tube Size
016540	1/4"
016560	3/8"
016580	1/2"
016510	5/8"

Tee Ends Tubes



Part No.	Tube Size
016440	1/4"
016460	3/8"
016480	1/2"

Female Connectors



Part No.	Tube Size	Pipe Size
016642	1/4"	1/8"
016644	1/4"	1/4"
016662	3/8"	1/8"
016664	3/8"	1/4"
016666	3/8"	3/8"
016686	1/2"	3/8"
016688	1/2"	1/2"
016616	5/8"	3/8"
016618	5/8"	1/2"

Male Elbows *(Sealant Applied)*



Part No.	Tube Size	Pipe Size
016942	1/4"	1/8"
016944	1/4"	1/4"
016946	1/4"	3/8"
016962	3/8"	1/8"
016964	3/8"	1/4"
016966	3/8"	3/8"
016968	3/8"	1/2"
016984	1/2"	1/4"
016986	1/2"	3/8"
016988	1/2"	1/2"
016916	5/8"	3/8"
016908	5/8"	1/2"
016918	3/4"	1/2"
016922	3/4"	3/4"

Nuts



Part No.	Tube Size
016140	1/4"
016160	3/8"
016180	1/2"
016100	5/8"
016101	3/4"

Bulkhead Unions



Part No.	Tube Size
016204	1/4"
016206	3/8"
016208	1/2"

Tee Thread Runs

(Sealant Applied)



Part No.	Tube Size	Pipe Size
017142	1/4"	1/8"
017144	1/4"	1/4"
017164	3/8"	1/4"
017166	3/8"	3/8"
017186	1/2"	3/8"
017188	1/2"	1/2"
017118	5/8"	1/2"

Male Connectors (Sealant Applied)



HELPFUL HINT

Refer to page 41 for Air Brake Hose Repair Fitting Kits 500007 and 500008

Part No.	Tube Size	Pipe Size
016842	1/4"	1/8"
016844	1/4"	1/4"
016846	1/4"	3/8"
016862	3/8"	1/8"
016864	3/8"	1/4"
016866	3/8"	3/8"
016868	3/8"	1/2"
016884	1/2"	1/4"
016886	1/2"	3/8"
016888	1/2"	1/2"
016806	5/8"	3/8"
016808	5/8"	1/2"
016818	3/4"	1/2"
016811	3/4"	3/4"

AIR BRAKE COMPRESSION FITTINGS

- Designed for use with nylon or copper air brake tubing (see page 42)
- **DOT compliant.** Fittings meet SAE J246 requirements
- All Brass Construction
- Pipe thread sealant featured on several fitting styles. This pre-applied sealant offers several benefits:
 - Provides no-leak assembly instantly. Saves application time and expense
 - Will not contaminate systems like tape shredding or liquid sealant
 - Can be reused up to five times
 - Provides excellent thread lubrication to prevent galling

45° Male Elbows

(Sealant Applied)



Part No.	Tube Size	Pipe Size
013075	3/8"	1/4"
013077	1/2"	3/8"

Female Connectors



Part No.	Tube Size	Pipe Size
011085	1/4"	1/4"
011091	3/8"	1/8"
011093	3/8"	1/4"

Male Connector (Sealant Applied)



Part No.	Tube Size	Pipe Size
012017	1/4"	1/8"
012021	1/4"	1/4"
012023	1/4"	3/8"
012035	3/8"	1/8"
012037	3/8"	1/4"
012041	3/8"	3/8"
012043	3/8"	1/2"
012045	1/2"	1/4"
012047	1/2"	3/8"
012049	1/2"	1/2"
012053	5/8"	3/8"
012055	5/8"	1/2"
012061	3/4"	1/2"

Tee Thread Branches



Part No.	Tube Size
011051	1/4"
011059	3/8"
011025	1/2"

Tee Thread Run

(Sealant Applied)



Part No.	Tube Size	Pipe Size
013041	3/8"	1/4"

Spherical Sleeves



Part No.	Tube Size
011001	1/4"
011003	3/8"
011005	1/2"
011007	5/8"
011009	3/4"

Elbow Ends Tube



Part No.	Tube Size
011073	3/8"

Tee Thread Branches

Sealant Applied)



Part No.	Tube Size	Pipe Size
013049	1/4"	1/8"
013057	3/8"	1/4"

NOTE: Fitting sleeves should NEVER be reused

Male Elbows

(Sealant Applied)



Part No.	Tube Size	Pipe Size
012067	1/4"	1/8"
012071	1/4"	1/4"
012073	1/4"	3/8"
012087	3/8"	1/8"
012091	3/8"	1/4"
012093	3/8"	3/8"
012095	3/8"	1/2"
012097	1/2"	1/4"
013001	1/2"	3/8"
013003	1/2"	1/2"
013011	5/8"	1/2"

Female Elbows



Part No.	Tube Size	Pipe Size
013026	1/4"	1/4"
013027	3/8"	1/4"

Compression Nuts



Part No.	Tube Size
011013	1/4"
011023	3/8"
011025	1/2"
011027	5/8"
011029	3/4"

NOTE: Tubing size stamped on each nut for easy identification

Full Unions



Part No.	Tube Size
011033	1/4"
011041	3/8"
011043	1/2"
011045	5/8"
011047	3/4"

Nylon Tubing Inserts



Part No.	Tube Size
010087	1/4"
010089	3/8"
010094	1/2"
010096	5/8"
010098	3/4"

REUSABLE AIR HOSE FITTINGS

- Designed for use with rubber air brake hose (see page 40)
- Bodies, sleeves and nuts are all brass construction for durability and corrosion resistance
- Zinc-plated steel springs have rounded ends to protect air hose

Nuts with & without Spring



NEW

Part No.	Description	Hose I.D.
500021	Spring & Nut	3/8"
500071	Spring & Nut	1/2"
500037	Nut Only	1/2"
500022	Nut Only	3/8"
500030	Spring Only	1/2"
500024	Spring Only	3/8"

Fitting Assemblies



Part No.	Hose I.D.	Pipe Size
500001	3/8"	1/2"
500009	3/8"	3/8"
500015	3/8"	1/4"
500050	1/2"	1/2"
500051	1/2"	3/8"

Fitting Bodies



Part No.	Hose I.D.	Pipe Size
500003	3/8"	1/2"
500011	3/8"	3/8"
500017	3/8"	1/4"
500053	1/2"	1/2"
500061	1/2"	3/8"

Swivel Fitting Assemblies with Spring



Part No.	Hose I.D.	Pipe Size
500035	3/8"	1/4"
500042	3/8"	3/8"

Union Assemblies



Part No.	Hose I.D.
500031	3/8"
500088	1/2"

Swivel Body Adapters



Part No.	Hose I.D.	Pipe Size	Straight Thread
140000	3/8"	1/4"	3/4"-20
142001	3/8"	3/8"	3/4"-20
500052	1/2"	3/8"	7/8"-20

Swivel Fitting Assemblies



Part No.	Hose I.D.	Pipe Size
500039	3/8"	1/4"
500046	3/8"	3/8"
500094	1/2"	3/8"

Fitting Sleeves



Part No.	Hose I.D.
500005	3/8"
500055	1/2"

NOTE: Fitting sleeves should NEVER be reused

Fitting Assemblies with Spring



Part No.	Hose I.D.	Pipe Size
500019	3/8"	1/2"
500025	3/8"	3/8"
500027	3/8"	1/4"
500070	1/2"	1/2"
500078	1/2"	3/8"

Nuts



Part No.	Hose I.D.
500004	3/8"
500054	1/2"

Dual Barb Male Fitting

NEW



Part No.	Hose Size	Tube Size
500079	1/4"	1/8"
500080	1/4"	1/4"
500081	5/16"	1/4"
500082	3/8"	1/4"
500083	3/8"	3/8"
500084	5/8"	1/2"
500085	3/4"	3/4"

Hose Splicer

NEW



Part No.	Hose Size
500062	1/8"
500063	3/8"
500064	1/2"
500065	5/8"
500066	3/4"

COUPLINGS

Frame Couplings



- Zinc-plated steel construction
- FPT both ends

Part No.	Description	Overall Length	Mounting Thread
035081	1/4" Frame Coupling	1-1/2"	3/4" - 16
035087	3/8" Frame Coupling	1-3/8"	1" - 14

Firewall Coupling



- Zinc-plated steel construction
- 1/4" FPT both ends
- 3/16" diameter mounting holes on 1-3/8" centers

Part No	Description
501071	Firewall Coupling

CLAMPING STUDS

Male Clamping Stud



- Zinc-plated steel construction
- 1/2" MPT each end, 1/4" FPT one end
- 1" - 14 mounting thread
- 2-3/8" overall length

Part No	Description
035021	Male Clamping Stud

Female Clamping Stud



- Zinc-plated steel construction
- 1/2" MPT, 1/4" FPT one end and 1/2" FPT other end
- 1"-14 mounting thread
- 2- 1/4" overall length

Part No	Description
035029	Female Clamping Stud

Frame Clamping Stud



- Zinc-plated steel construction
- 1/2" MPT one end, 3/8" FPT one end
- 1" - 14 mounting thread
- 1-7/8" overall length

Part No	Description
035079	Frame Clamping Stud

Bulkhead Fitting - Female to Nylon Tubing



- 3/8" NPTF thread

NEW

Part No.	Tube Size
017098	1/2"
017099	3/8"

- Designed for use with stainless steel braded discharge hose (see page 41)
- All brass bodies with brass sleeves and steel nuts

Straight Tubes



Part No.	Hose O.D.
142102	5/8"
142103	3/4"

Male Pipe Fitting



Part No.	Hose O.D.	Pipe Thread
142101	5/8"	1/2" - 14

Female Swivel Fittings



Part No.	Hose O.D.	Female Thread
142110	5/8"	7/8" - 14
142111	3/4"	1-1/16" - 14

Compression Fittings



Part No.	Hose O.D.	Male Thread
142106	5/8"	13/16" - 18
142107	3/4"	1" - 18

Fitting Sleeves



5/8" Hose O.D.	3/4" Hose O.D.	Description
Part No.	Part No.	
142104	142105	Sleeve
142108	142109	Nut

NOTE: Fitting sleeves should NEVER be reused

FULLER TRANSMISSION COMPRESSION FITTINGS

- Designed for use with polyethylene nylon and plastic tubing **NOT FOR AIR BRAKE USE**
- All brass construction

Insert



Part No.	Tube Size
010085	3/16"

NOTE: Nylon tubing inserts are required when using 3/16" tubing

Nuts

Part No. Tube Size

011012	1/8"
011014	3/16"
011016	5/32"



Full Unions



Part No.	Tube Size
011032	1/8"
011034	5/32"

Male Elbows



Part No.	Tube Size	Pipe Size
012064	5/32"	1/8"
012066	1/8"	1/8"
012068	3/16"	1/8"

Male Connectors



Part No.	Tube Size	Pipe Size
012016	1/8"	1/16"
012015	3/16"	1/8"
012012	5/32"	1/16"
012014	5/32"	1/8"
012022	1/8"	1/8"

Slotted Collets



Part No.	Tube Size
011000	1/8"
011020	5/32"

Sleeve

Part No. Tube Size

010093	3/16"
--------	-------

NOTE: Fitting sleeves should NEVER be reused



VACUUM HOSE FITTINGS

Elbows

- All brass construction



Part No.	Hose I.D.	Pipe Size
175033	1/2"	3/8"

Nipples



Part No.	Hose I.D.	Pipe Size
149005	1/2"	1/2"
149006	3/4"	1/2"

- Designed for low and medium pressure applications

Square Head Plugs



Part No.	Pipe Size	Material
017061	1/8"	Plated Steel
017063	1/4"	Plated Steel
017065	3/8"	Plated Steel
017067	1/2"	Plated Steel
017069	3/4"	Plated Steel
017059	3/4"	Brass

Close Nipples



Part No.	Pipe Size	Material
016051	1/8"	Brass
016052	1/4"	Brass
016053	3/8"	Brass
016054	1/2"	Brass
016065	3/4"	Malleable Iron

Cap - Female Pipe fittings



NEW

Part No.	Pipe Size
017223	1/8"
017224	1/4"
017225	3/8"
017226	1/2"
017227	3/4"

Hex Nipples



Part No.	Pipe Size	Material
018009	1/8"	Brass
018010	1/4"	Brass
018011	3/8"	Brass
018012	1/2"	Brass
018023	3/4"	Plated Steel

Pipe Elbows



Part No.	Pipe Size	Material
017003	1/8"	Brass
017004	1/4"	Brass
017005	3/8"	Brass
017006	1/2"	Brass
017013	3/4"	Malleable Iron

45° Street Elbows



Part No.	Pipe Size	Material
017023	1/8"	Brass
017025	1/4"	Brass
017027	3/8"	Brass
017029	1/2"	Brass

Street Tees



Part No.	Pipe Size	Material
017091	1/8"	Brass
017093	1/4"	Malleable Iron
017095	3/8"	Malleable Iron
017096	1/2"	Malleable Iron

Pipe Nipples



Part No.	Pipe		Material
	Size	Length	
016021	1/8"	1-1/2"	Brass
016025	1/4"	1-1/2"	Brass
016029	3/8"	1-1/2"	Brass
016033	1/2"	1-1/2"	Brass
016037	1/8"	2"	Malleable Iron
016038	1/4"	2"	Malleable Iron
016039	3/8"	2"	Malleable Iron
016040	1/2"	2"	Malleable Iron
016041	1/2"	3"	Malleable Iron
016042	3/4"	2"	Malleable Iron
016043	3/4"	3"	Malleable Iron

Reducer Couplings



Part No.	Pipe Size	Material
017081	1/4" x 1/8"	Brass
017083	3/8" x 1/4"	Brass
017085	1/2" x 3/8"	Brass

Pipe Tees



Part No.	Pipe Size	Material
016001	1/8"	Brass
016002	1/4"	Brass
016003	3/8"	Brass
016004	1/2"	Brass

Reducer Bushings



Part No.	Pipe Size	Material
016079	1/4" x 1/8"	Brass
016080	3/8" x 1/8"	Brass
016081	3/8" x 1/4"	Brass
016082	1/2" x 1/8"	Brass
016083	1/2" x 1/4"	Brass
016084	1/2" x 3/8"	Brass
016085	3/4" x 1/4"	Brass
016086	3/4" x 3/8"	Brass
016087	3/4" x 1/2"	Brass
017000	1" x 3/4"	Malleable Iron

Reducer Hex Nipples



Part No.	Pipe Size	Material
018013	1/4" x 1/8"	Brass
018025	3/8" x 1/4"	Plated Steel
018027	1/2" x 3/8"	Plated Steel
018029	3/4" x 1/2"	Plated Steel

Street Elbows



Part No.	Pipe Size	Material
017015	1/8"	Brass
017017	1/4"	Brass
017019	3/8"	Brass
017021	1/2"	Brass

Hex Head Plugs



Part No.	Pipe Size	Material
017051	1/8"	Brass
017053	1/4"	Brass
017055	3/8"	Brass
017057	1/2"	Brass

Pipe Cross



Part No.	Pipe Size	Material
017073	1/8"	Brass

Couplings



Part No.	Pipe Size	Material
016067	1/8"	Brass
016068	1/4"	Brass
016069	3/8"	Brass
016070	1/2"	Brass
016077	3/4"	Malleable Iron

Adapters



Part No.	Pipe Size	Material
018006	1/4" x 1/8"	Brass
018007	3/8" x 1/4"	Brass
018008	1/2" x 3/8"	Brass

SAE 45° FLARE FITTINGS

- Designed for use with flareable copper, brass, aluminum and welded steel hydraulic tubing
- All Brass construction
- UL compliant for flammable liquid and gas
- Fittings meet SAE J246 requirements

Long Nuts



Part No	Tube Size	Straight Thread
014103	3/16"	3/8"-24
014104	1/4"	7/16"-20
014105	5/16"	1/2"-20
014106	3/8"	5/8"-18
014108	1/2"	3/4"-16
014100	5/8"	7/8"-14

Unions



Part No	Tube Size	Straight Thread
014203	3/16"	3/8"-24
014204	1/4"	7/16"-20
014205	5/16"	1/2"-20
014206	3/8"	5/8"-18
014208	1/2"	3/4"-16
014200	5/8"	7/8"-14

45° Elbows



Part No	Tube Size	Pipe Size	Straight Thread
015942	1/4"	1/8"	7/16"-20
015944	1/4"	1/4"	7/16"-20
015964	3/8"	1/4"	5/8"-18
015966	3/8"	3/8"	5/8"-18
015986	1/2"	3/8"	3/4"-16
015988	1/2"	1/2"	3/4"-16
015906	5/8"	3/8"	7/8"-14
015908	5/8"	1/2"	7/8"-14
015918	3/4"	1/2"	1-1/16"-14

Union Tees



Part No	Tube Size	Straight Thread
014408	1/2"	3/4"-16
014400	5/8"	7/8"-14

Hose Barb to Female Flare Swivel



NEW

Part. No.	Hose Size	Tube Size
016945	3/8"	3/8"
016948	1/4"	1/4"

Male Connectors



Part No	Tube Size	Pipe Size	Straight Thread
014822	1/8"	1/8"	5/16"-24
014832	3/16"	1/8"	3/8"-24
014842	1/4"	1/8"	7/16"-20
014844	1/4"	1/4"	7/16"-20
014852	5/16"	1/8"	1/2"-20
014854	5/16"	1/4"	1/2"-20

Part No	Tube Size	Pipe Size	Straight Thread
014862	3/8"	1/8"	5/8"-18
014864	3/8"	1/4"	5/8"-18
014866	3/8"	3/8"	5/8"-18
014868	3/8"	1/2"	5/8"-18
014884	1/2"	1/4"	3/4"-16
014886	1/2"	3/8"	3/4"-16

Part No	Tube Size	Pipe Size	Straight Thread
014888	1/2"	1/2"	3/4"-16
014806	5/8"	3/8"	7/8"-14
014808	5/8"	1/2"	7/8"-14
014818	3/4"	1/2"	1-1/16"-14
014811	3/4"	3/4"	1-1/16"-14

Male Elbows

Part No	Tube Size	Pipe Size	Straight Thread	Part No	Tube Size	Pipe Size	Straight Thread	Part No	Tube Size	Pipe Size	Straight Thread
014932	3/16"	1/8"	3/8"-24	014962	3/8"	1/8"	5/8"-18	014988	1/2"	1/2"	3/4"-16
014942	1/4"	1/8"	7/16"-20	014964	3/8"	1/4"	5/8"-18	014906	5/8"	3/8"	7/8"-14
014944	1/4"	1/4"	7/16"-20	014966	3/8"	3/8"	5/8"-18	014908	5/8"	1/2"	7/8"-14
014946	1/4"	3/8"	7/16"-20	014968	3/8"	1/2"	5/8"-18	014901	5/8"	3/4"	7/8"-14
014952	5/16"	1/8"	1/2"-20	014984	1/2"	1/4"	3/4"-16	014918	3/4"	1/2"	1-1/16"-14
014954	5/16"	1/4"	1/2"-20	014986	1/2"	3/8"	3/4"-16	014911	3/4"	3/4"	1-1/16"-14

INVERTED FLARE FITTINGS

- Designed for use with flareable copper, brass, aluminum and welded steel hydraulic tubing
- All brass construction (unless otherwise noted)
- UL compliant for flammable liquid and gas
- Fittings meet SAE J246 requirements
- DOT Compliant

Nuts

Part No.	Tube Size	Straight Thread	Material
006103	3/16"	3/8"-24	Brass
006104	1/4"	7/16"-24	Brass
006105	5/16"	1/2"-20	Brass
006106	3/8"	5/8"-18	Brass
006108	1/2"	3/4"-18	Brass
006303	3/16"	3/8"-24	Plated Steel
006304	1/4"	7/16"-24	Plated Steel
006314*	1/4"	7/16"-24	Plated Steel
006305	5/16"	1/2"-24	Plated Steel
006306	3/8"	5/8"-18	Plated Steel

*006314 - Straight Thread is 7/16"-24 UNS-2A

Male Elbows

Part No.	Tube Size	Pipe Size	Straight Thread
006932	3/16"	1/8"	3/8"-24
006942	1/4"	1/8"	7/16"-24
006944	1/4"	1/4"	7/16"-24
006952	5/16"	1/8"	1/2"-20
006954	5/16"	1/4"	1/2"-20
006962	3/8"	1/8"	5/8"-18
006964	3/8"	1/4"	5/8"-18
006966	3/8"	3/8"	5/8"-18
006986	1/2"	3/8"	3/4"-18
006908	5/8"	1/2"	7/8"-14

Male Connectors

Part No.	Tube Size	Pipe Size	Straight Thread
006842	1/4"	1/8"	7/16"-24
006852	5/16"	1/8"	1/2"-20
006854	5/16"	1/4"	1/2"-20
006864	3/8"	1/4"	5/8"-18
006866	3/8"	3/8"	5/8"-18
006886	1/2"	3/8"	3/4"-16

Female Connectors

Part No.	Tube Size	Pipe Size	Straight Thread
006642	1/4"	1/8"	7/16"-24
006652	5/16"	1/8"	1/2"-20
006664	3/8"	1/4"	5/8"-18

Unions

Part No.	Tube Size	Straight Thread
006202	1/8"	5/16"-28
006203	3/16"	3/8"-24
006204	1/4"	7/16"-24
006205	5/16"	1/2"-20
006206	3/8"	5/8"-18
006208	1/2"	3/4"-18



Part No	Description
690031	In-Cab Air Line Repair Kit - Push Lock
690033	Air Brake Line Repair Kit - Push Lock
690035	Nylon Tubing Repair Kit - Push Lock
690037	Transmission Air Line Repair Kit -Push Lock
690050	NTA Fitting Kit

IN-CAB AIR LINE REPAIR KIT					
Part No 690031			24 Total Fittings		
016112 1/8 x 1/8 m. conn 2 pcs.	016114 1/8 x 1/4 m. conn 2 pcs.	016142 1/4 x 1/8 m. conn 2 pcs.	016144 1/4 x 1/4 m. conn 2 pcs.	016162 3/8 x 1/8 m. conn 1 pc.	016164 3/8 x 1/4 m. conn 1 pc.
016242 1/4 x 1/8 elbow 1 pc.	016244 1/4 x 1/4 elbow 1 pc.	016264 3/8 x 1/4 elbow 1 pc.	016910 1/8 tee 1 pc.	016930 3/16 tee 1 pc.	016940 1/4 tee 1 pc.
016610 1/8 union 2 pcs.	016630 3/16 union 2 pcs.	016640 1/4 union 2 pcs.	016660 3/8 union 1 pc.	016960 3/8 tee 1 pc.	OPEN

AIR BRAKE LINE REPAIR KIT					
Part No 690031			24 Total Fittings		
016166 3/8 x 3/8 m. conn 2 pcs.	016168 3/8 x 1/2 m. conn 1 pc.	016184 1/2 x 1/4 m. conn 1 pc.	016268 3/8 x 1/2 m. conn 1 pc.	016284 1/2 x 1/4 m. conn 1 pc.	016286 1/2 x 3/8 m. conn 1 pc.
016186 1/2 x 3/8 m. conn 2 pcs.	016188 1/2 x 1/2 m. conn 1 pc.	OPEN	016288 1/2 x 1/2 elbow 1 pc.	016960 3/8 tee 2 pcs.	016980 1/2 tee 2 pcs.
016660 3/8 union 2 pcs.	016680 1/2 union 2 pcs.	016266 3/8 x 3/8 elbow 2 pcs.			

NYLON TUBING REPAIR KIT					
Part No. 690035					
2 ft. section of each:			2 pcs. of each:		
020132	1/8" nylon tubing	Blue	016610	1/8" union	
020065	5/32" nylon tubing	Black	016620	5/32" union	
020066	3/16" nylon tubing	Black	016630	3/16" union	
020164	1/4" nylon tubing	Yellow	016640	1/4" union	
020156	3/8" nylon tubing	Red	016660	3/8" union	
020168	1/2" nylon tubing	Yellow	016680	1/2" union	
090014	7" nylon tie straps, 12 pcs.				
090028	nylon tube cutter, 1 pc.				

TRANSMISSION AIR LINE REPAIR KIT					
Part No 690037			11 Total Fittings		
016112 1/8 x 1/8 m. conn 1 pc.	016120 5/32 X 1/16 m. conn 2 pcs.	016122 5/32x1/8 m. conn 2 pcs.	016212 1/8 x 1/8 m. conn 1 pc.	016222 5/32x1/8 m. conn 1 pc.	090028 Nylon Tube Cutter
OPEN	OPEN	OPEN	OPEN	OPEN	OPEN
016610 1/8 union 1 pc.	016620 5/32 union 1 pc.	016630 3/16 union 1 pc.			

NYLON AIR BRAKE TUBE FITTING KIT					
Part No 690050			33 Total Fittings		
016842 1/4 x 1/8 m. conn 2 pcs.	016844 1/4 x 1/4 m. conn 3 pcs.	016240 1/4 full union 2 pcs.	016260 3/8 full union 2 pcs.	016280 1/2 full union 2 pcs.	016200 5/8 full union 2 pcs.
016864 3/8 x 1/4 m. conn 2 pcs.	016866 3/8 x 3/8 m. conn 1 pc.	016886 1/2 x 3/8 m. conn 1 pc.	016966 3/8 x 3/8 m. elbow 3 pcs.	016986 1/2 x 3/8 m. elbow 2 pcs.	016988 1/2 x 1/2 m. elbow 2 pcs.
016942 1/4 x 1/8 m. elbow 2 pcs.	016944 1/4 x 1/4 m. elbow 3 pcs.	016964 3/8 x 3/8 m. elbow 2 pcs.			

FITTINGS

Large Air Brake Fitting Assortment

Assortment includes the following part numbers and quantities plus rack part number 690090, P. 139

Part No.	Total Fittings
690059	583

Part No.	Qty.	Part No.	Qty.
010087	50	012021	10
010089	50	012035	5
010094	25	012037	20
010096	25	012041	10
010098	25	012043	5
011001	25	012045	10
011003	50	012047	10
011005	25	012049	5
011007	10	012053	3
011009	10	012055	3
011013	25	012067	10
011023	15	012071	10
011025	5	012087	5
011027	3	012091	20
011029	3	012093	5
011033	10	012095	5
011041	15	012097	5
011043	10	013001	10
011045	3	013003	5
011047	2	013011	3
011057	5	013041	5
011059	3	013057	5
011073	5	013075	5
012017	10	690090	1

Push-Lock Fitting Assortment

Assortment includes the following part numbers and quantities plus rack part number 690090, P. 139

Part No.	Total Fittings
690072	155

Part No.	Qty.	Part No.	Qty.
016112	5	016266	5
016114	5	016268	5
016120	5	016284	5
016122	5	016286	5
016142	5	016288	5
016144	5	016610	5
016162	5	016620	5
016164	5	016630	5
016166	5	016640	5
016168	5	016660	5
016184	5	016680	5
016186	5	016930	5
016188	5	016940	5
016242	5	016960	5
016244	5	016980	5
016264	5	690090	1

Nylon Air Brake Tube Fitting Assortment

Assortment includes the following part numbers and quantities plus rack part number 690090, P. 139

Part No.	Total Fittings
690071	304

Part No.	Qty.	Part No.	Qty.
016100	3	016866	5
016101	3	016884	5
016140	25	016886	5
016160	10	016888	5
016180	5	016908	3
016200	3	016916	5
016201	2	016918	2
016240	10	016922	5
016260	5	016942	10
016280	5	016944	10
016300	10	016962	5
016301	10	016964	5
016340	25	016966	5
016360	25	016968	5
016380	25	016984	5
016808	3	016986	5
016818	2	016988	5
016842	10	017264	5
016844	10	017266	5
016862	5	017286	3
016864	5	690090	1

Brass Pipe Fitting Assortment

Assortment includes the following part numbers and quantities plus rack part number 690090, P. 139

Part No.	Total Fittings
690064	340

Part No.	Qty.	Part No.	Qty.	Part No.	Qty.	Part No.	Qty.
016001	5	016069	5	017019	5	018006	10
016002	5	016070	5	017021	5	018007	10
016003	5	016079	10	017023	5	018008	10
016004	5	016080	10	017025	5	018009	10
016051	10	016081	30	017027	5	018010	20
016052	20	016083	5	017029	5	018011	10
016053	20	016084	5	017051	10	018012	5
016054	5	016087	5	017053	20	690090	1
016067	10	017015	5	017055	20		
016068	10	017017	5	017057	5		

See Pages
111 - 120
for fitting photos
and descriptions

Miniature/General Purpose Slotted/Liner/EuroSeal® Clamps



Miniature clamps ideal for use on air and fuel lines



General purpose slotted clamps meet applicable SAE J1508 requirements



Liner clamps designed with inner liner to protect silicone hose from extruding through band slots; unique construction allows more tightening torque to be delivered to the perforations while maximizing vibration resistance



Euro-Seal® clamps with embossed threads and rounded band edge to help eliminate hose abrasion and damage. Clamps meet or exceed international clamp specifications for material, corrosion resistance, sizing and torque.

- All clamps feature 300 series stainless steel bands
- Miniature, general purpose and liner clamps include yellow dichromate slotted hex head screws. Euro-Seal® clamps feature 300 series stainless steel screws

Miniature Clamps	General Purpose Slotted Clamps	Liner Clamps	Euro-Seal® Clamps	SAE Size	Clamping Range (in.)
022204	—	—	—	4	7/32 - 5/8
022206	022306	022106	022506	6	7/16 - 25/32
—	022308	022108	022508	8	1/2 - 29/32
—	022310	022110	022510	10	9/16 - 1-1/16
—	022312	022112	022512	12	11/16 - 1-1/4
—	022316	022116	022516	16	13/16 - 1-1/2
—	022320	022120	022520	20	13/16 - 1-3/4
—	022324	022124	022524	24	1-1/16 - 2
—	022328	022128	022528	28	1-5/16 - 2-1/4
—	022332	022132	022532	32	1-9/16 - 2-1/2
—	022336	022136	022536	36	1-13/16 - 2-3/4
—	022340	022140	022540	40	2-1/16 - 3
—	022344	022144	022544	44	2-5/16 - 3-1/4
—	022348	022148	022548	48	2-9/16 - 3-1/2
—	022352	—	022552	52	2-13/16 - 3-3/4
—	022356	—	022556	56	3-1/16 - 4
—	022360	—	—	60	3-5/16 - 4-1/4
—	022364	—	022564	64	3-9/16 - 4-1/2
—	022372*	—	022572	72	4-1/16 - 5
—	022380*	—	022680	80	4-9/16 - 5-1/2
—	022388*	—	022688	88	5-1/16 - 6
—	022396*	—	022696	96	5-9/16 - 6-1/2
—	022404*	—	022574	104	6-1/16 - 7

*These clamps may be made smaller than the clamping range shows in the table. Following are the smallest diameters for each of these clamps in the order shown on the chart: 1-7/8", 2-1/2", 3-1/8", 3-5/8", 4-1/8"

Euro-Seal® is a registered trademark of Breeze Industrial Products

Spring Loaded T-Bolt Clamps



- Eliminates "cold flow hose leaks" by automatically adjusting diameter for hose compression set or expansion/contraction of hose and fittings due to temperature changes
- Recommended for bus, truck and heavy-duty equipment air intake and coolant connectors
- 300 series stainless steel band, floating bridge liner and trunion
- Yellow dichromate-plated steel bolt, spring, washer and 1/2" lock-nut
- Clamps meet applicable SAE J1508 requirements

Part No.	Clamping Range (mm)	Clamping Range (in.)
022580	57-65	2-1/4 - 2-9/16
022581	67-77	2-3/4 - 3-1/16
022582*	78-86	3-1/16 - 3-3/8
022583	87-95	3-7/16 - 3-3/4
022584*	90-98	3-9/16 - 3-7/8
022585	98-106	3-7/8 - 4-3/16
022626*	103-111	4-1/16 - 4-3/8
022586	106-114	4-3/16 - 4-1/2
022627*	116-124	4-9/16 - 4-7/8

* Designed for change-air cooling applications

T-Bolt Clamps



- Applications include engine air intake, exhaust, hoses, filters and low pressure hydraulic connections
- 300 series stainless steel band, floating bridge liner and trunion
- Yellow dichromate-plated steel bolt and 7/16" locknut
- Clamps meet applicable SAE J1508 requirements

Part No.	Clamping Range (mm)	Clamping Range (in.)
022550	63 - 71	2-1/2 - 2-13/16
022551	67 - 77	2-3/4 - 3-1/16
022587	76 - 84	3 - 3-5/16
022588	83 - 90	3-1/4 - 3-9/16
022589	87 - 98	3-7/16 - 3-7/8
022591	95 - 103	3-3/4 - 4-1/16
022592	108 - 116	4-1/4 - 4-9/16
022593	121 - 128	4-3/4 - 5-1/16
022557	133 - 141	5-1/4 - 5-9/16
022594	146 - 154	5-3/4 - 6-1/16
022596	159 - 166	6-1/4 - 6-9/16
022597	184 - 192	7-1/4 - 7-9/16
022598	216 - 223	8-1/2 - 8-13/16

Flat Band Clamp

NEW



- Manufactured with a stainless steel band for corrosion protection
- Clamp assembly consists of a stainless steel band with one spacer, two bolts and one reaction block pre-attached to band with one spacer and two nuts packaged with the band

Part No.	Size
022059	4"
022060	5"

www.velvac.com

Constant-Torque® Clamps



- Patented Belleville spring design eliminates "cold flow hose leaks" by automatically adjusting diameter for hose compression set or expansion/contraction of hose and fittings due to temperature changes
- Specified by many top fleets for new vehicle installations
- Recommended for bus, truck and heavy-duty equipment air intake and coolant connections
- Extended inner liner covers worm gear slots to protect against extrusions and damage
- All stainless steel construction
- Extended adjustment range permits fewer stocked parts for complete coverage

Part No.	Clamping Range (mm)	Clamping Range (in.)
Torque Rated at 30-70 in./lbs.		
022410	14 - 27	9/16 - 1-1/16
022412	17 - 32	11/16 - 1-1/4
022416	21 - 38	13/16 - 1-1/2
022420	21 - 44	13/16 - 1-3/4
022424	27 - 51	1-1/16 - 2

Part No.	Clamping Range (mm)	Clamping Range (in.)
Torque Rated at 40-125 in./lbs.		
022400	32 - 54	1-1/4 - 2-1/8
022425	45 - 67	1-3/4 - 2-5/8
022430	57 - 79	2-7/4 - 3-1/8
022435	70 - 92	2-3/4 - 3-5/8
022440	83 - 105	3-1/4 - 4-1/8
022445	95 - 118	3-3/4 - 4-5/8
022450	108 - 130	4-1/4 - 5-1/8

NOTE: For proper installation, the Belleville spring washer stacks should be nearly collapsed flat and the screw tip should extend beyond 1/4". Using a torque wrench, tighten to recommended torque range

Constant-Torque® is a registered trademark of Breeze Industrial Products

Muffler Clamps/Saddle Clamps

NEW



- Heavy duty clamp with round 3/8-16
- Zinc plated for corrosion protection
- Complete with grade 2 serrated flange nuts
- Individually packaged

Part No.	Size
022048	1.75
022049	2
022050	2.5
022051	3
022052	3.5
022053	4
022054	4.5
022055	5

Guillotine Style Clamp

NEW



- Heavy-duty guillotine clamps are manufactured with a round 3/8-16 u-bolt and is zinc plated for corrosion protection
- Clamp contains a reinforced rib design for enhanced strength
- Packaged individually in a poly bag
- Complete with grade 2 serrated flange nuts

Part No.	Size
022056	4"
022057	4.5"
022058	5"

Turbo V-Band Clamps

NEW

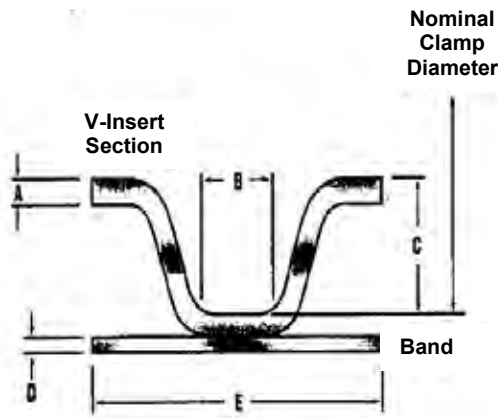
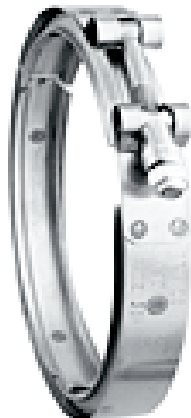

- Clamps connect vehicle exhaust pipe flange to turbo or engine manifold
- Built to withstand high temperatures produced by heavy-duty engines and turbos
- All stainless steel construction
- Clamps meet or exceed OEM specifications for material and quality standards

Part No.	Nominal (in.)	Clamp Dimensions (in.)					Applications
		A	B	C	D	E	
022470	3.82	.077	.207	.281	.040	.875	CAT, DDC, Ford, GMC, Navistar
022471	3.88	.050	.400	.281	.040	.875	Cummins, Ford, Volvo
022472	4.50	.077	.207	.281	.040	.875	DDC, GMC, Navistar
022473	4.61	.050	.156	.218	.035	.750	Mack, Switzer
022474	4.75	.077	.158	.310	.040	.875	Cummins, CAT, Freightliner, GMC, Navistar, Volvo, Western Star
022475	5.25	.050	.262	.141	.035	.750	DDC, Navistar, Freightliner
022476	5.88	.050	.400	.281	.040	.875	Cummins, DDC, CAT
022477	4.50	.050	.262	.141	.035	.750	Navistar
022478	3.21	.050	.262	.141	.035	.750	Cummins, Freightliner, Blue Bird bus, Ford, Oshkosh

AIR INTAKE SYSTEM

CHARGE AIR COOLING, AIR TO AIR AFTER-COOLING SYSTEM
use: Spring-Loaded T-Bolt

TURBO EXHAUST MANIFOLD
use: V-Band

FUEL LINE
use: Miniature

COOLANT SYSTEM
use: Constant Torque or Hi-Torque

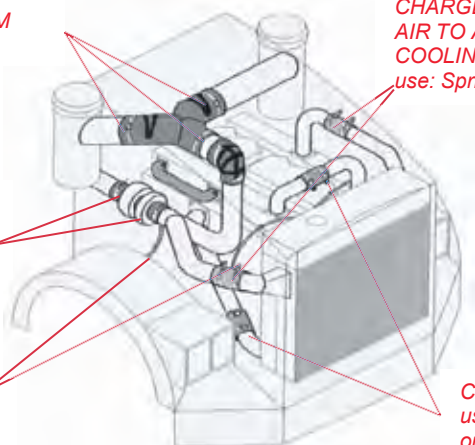

Hi-Torque® Clamps



- Heavy gauge housing engineered so eight screw threads are simultaneously engaged to provide over four times the recommended SAE torque requirements of standard worm drive clamps
- All stainless steel construction
- Extended diameter ranges allow coverage from 1-1/4" to 9-1/8" with only four clamps
- Clamps exceed applicable SAE J1508 requirements

Part No.	Clamping Range (mm)	Clamping Range (in.)
	022462	32 - 67
022463	54 - 105	2-1/8 - 4-1/8
022464	102 - 156	4 - 6-1/8
022465	156 - 232	6-1/8 - 9-1/8

Hi-Torque is a registered trademark of Breeze Industrial Products

Coolant Shutoff Valves

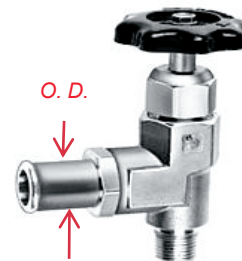

- All brass construction

Part No.	O.D.	Pipe Size
023066	3/8"	3/8"
023106	5/8"	3/8"
023108	5/8"	1/2"
023126	3/4"	3/8"
023128	3/4"	1/2"

Heavy Duty Radiator Caps

Velvac is now featuring All-Makes of Heavy Duty Truck radiator caps

NEW

Part No.	Deep Neck	Pressure (lbs)
10205	1"	4
10206	1"	7
10208	3/4"	4
10238	threaded filler neck	16
10308	34"	4



Part No. 10205



Part No. 10206



Part No. 10208



Part No. 10238



Part No. 10308



• For Radiator Overflow Reservoir Systems

NEW

Part No.	I.D. Size	Deep Neck	Pressure (lbs)
10227	32MM	16MM	13
10228	—	3/4"	7
10229	—	3/4"	13
10230	—	3/4"	16
10231	—	3/4"	16 vented
10233	32MM	16MM	16
10237	—	3/4"	10
10241	31MM	10MM	13
10242	31MM	10MM	16
10327	32MM	16MM	13
10328	—	3/4"	7
10329	—	3/4"	13
10330	—	3/4"	16
10331	—	3/4"	16 vented
10333	32MM	16MM	16
10337	—	3/4"	10

NOTE: Refer to www.velvac.com for all makes cross reference guide

FITTINGS

Part No.	O.D. Size	Deep Neck	Pressure (lbs)
10281	"B" 2-11/16"	3/4"	4
10282	"B" 2-11/16"	3/4"	7
10283	"B" 2-11/16"	3/4"	10
10292*	"B" 2-11/16"	3/4"	7
10293*	"B" 2-11/16"	3/4"	10
10294*	"B" 2-11/16"	3/4"	15

NEW



* For Radiator Overflow Reservoir Systems
Stant® is a registered trademark of Stant

NOTE: An industry leader: Stant®

Clevis and Clevis Pin Kits

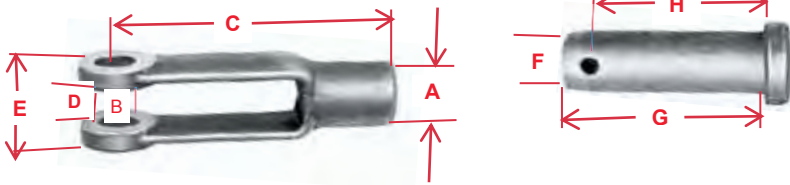

- Each kit includes one yoke, clevis pin and cotter pin
- Forged steel construction
- Zinc-plated for corrosion resistance

Part No.	A	B	C	D	E	F	G	H
019049	5/8" -18	1/2"	1-7/8"	9/16"	1-1/4"	1/2"	1-1/2"	1-3/8"
019050	1/2" -20	1/2"	1-7/8"	9/16"	1-1/4"	1/2"	1-1/2"	1-3/8"
019051	5/8" -18	1/2"	4-15/16"	9/16"	1-1/4"	1/2"	1-5/8"	1-3/8"
019088*	5/8" -18	1/2"	1-7/8"	9/16"	1-1/4"	1/2"	1-1/2"	1-11/32"

*Includes 3/8" x 1/4" reducer bushing and 5/8" - 18 hex nut

Standard Clevis Pins

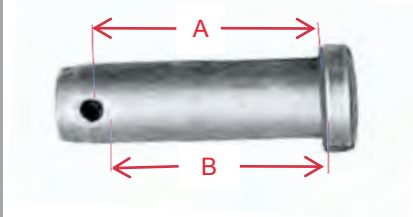

Nominal

Part No.	Size	A	B
019057	1/4	0.672	0.633
019059	5/16	0.812	0.757
019061	3/8	0.938	0.883
019065	1/2	1.203	1.133
019067	1/2	1.343	1.273
019069	1/2	1.593	1.523
019071	5/8	1.453	1.383
019073	5/8	1.593	1.523

Clevis

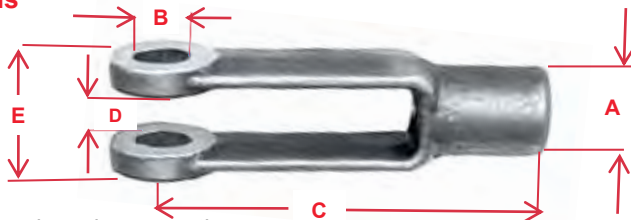

- Forged steel construction
- Zinc-plated for corrosion resistance

Part No.	A	B	C	D	E
019002	1/4" -28	1/4"	2"	9/32"	5/8"
019003	5/16" -24	5/16"	2-1/4"	11/32"	3/4"
019004	3/8" -24	3/8"	2-1/2"	7/16"	7/8"
019006	1/2" -20	1/2"	3"	9/16"	1-1/8"
019009	1/2" -20	1/2"	1-7/8"	9/16"	1-1/4"
019011	5/8" -18	1/2"	1-7/8"	9/16"	1-1/4"
019013	5/8" -18	1/2"	2-5/16"	9/16"	1-1/2"
019015	5/8" -18	5/8"	4-15/16"	11/16"	1-3/8"
019017	5/8" -18	5/8"	2-5/16"	9/16"	1-1/2"

Universal Clevis Pins

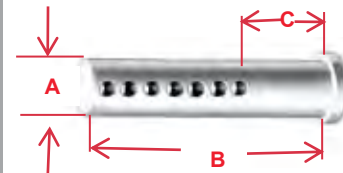

- Each includes cotter pin

Part No.	A	B	C*
019058	1/4"	2"	17/32"
019060	5/16"	2"	9/16"
019062	3/8"	2"	17/32"
019064	7/16"	2"	9/16"
019070	1/2"	2"	9/16"
019072	5/8"	3"	9/32"

*Holes are spaced at 1/4" intervals

Mechanics Wire



- Heavy-duty black annealed construction

Part No.	Wire Size	Roll Weight
090142	14 ga.	2 lb.
090145	14 ga.	5 lb.
090162	16 ga.	2 lb.
090165	16 ga.	5 lb.
090182	18 ga.	2 lb.
090185	18 ga.	5 lb.



FUEL 129-135

Table of Contents	PAGE
Fuel Caps	129
Anti-Siphon Tubes	132
Fuel Tank Valves	133
Electrical Fuel Tank Selector Valves	135

VELVAC Original Indicates an original Velvac product.

NEW Indicates a new product added to catalog.

Revised Part No. Indicates a revised part number defining “-xx” package quantity.
Refer to price list for price per package.

For quantity and packaging information, refer to our price list.

Customer Service: 800.783.8871
Fax: 262.786.4101
Email: sales@velvac.com



NOTE: The information and photographs in this catalog are believed to be accurate and factual as of the print date. Velvac assumes no responsibility for information that may be incorrect or has changed since press time. Product specifications and offerings subject to change without notice.

Velvac is a registered trademark of Velvac, Inc.



Gas / Diesel Fuel Caps

Vented aluminum caps meet 49 CFR 393.67 requirements for vehicles built after October 1985.

Vented brass caps are designed for use only on vehicles with non-vented fuel systems built prior to October 1985.

Non-vented brass caps are designed for use only on vehicles equipped with properly vented fuel systems. For complete information on current fuel tank system requirements, see Code of Federal Regulations 49 CFR 393.67



- Available in vented or non-vented feature.
- Fusible meltouts on brass fuel caps for thermal relief.
- Safety chains and crossbars are standard on all caps except Part No. 600009 which features a 14" exterior cable with an attached 3/16" I.D. ring
- Patented Loc-Gard on locking cap protects against moisture and contaminants (US Patent No. 4,706,841).
- All locking fuel caps are supplied with 2 keys.

Aluminum fuel caps are designed only for Diesel applications, whereas, Brass fuel caps are designed for gasoline, diesel and oil applications.

BRASS FUEL CAPS - Designed for Gasoline or Diesel applications
Brass Locking Fuel Caps

Part No.	Photo	Description	Nominal Size	Threads Per Inch	Across Threads	
					Cap	Filler Neck
600196-6	A	Female, Non-Vented	2	11-1/2	2-1/4"	2-5/16"

Brass Non-Locking Fuel Caps

Part No.	Photo	Description	Nominal Size	Threads Per Inch	Across Threads	
					Cap	Filler Neck
600009	B	Female, Non-Vented	2	11-1/2	2-1/4"	2-5/16"
600133	C	Female, Non-Vented	2	11-1/2	2-1/4"	2-5/16"
600007	C	Female, Vented	2	11-1/2	2-1/4"	2-5/16"
600017	D	Male, Vented	2-1/8"	12	2-1/8"	2-1/16"

REPLACEMENT PARTS FOR BRASS CAPS

Part No.	Description
600011	Replacement Gasket for Female Brass Caps
600021	Replacement Gasket for Male Brass Caps
600040	Replacement Chain and Crossbar for Brass Caps
600041	Replacement Lock Cam for Female Locking Brass Caps
601050	Replacement Loc-Gard Protection Cap for Female Locking Brass Caps
600176	Replacement Loc-Gard Cap for Female, Non-Vented Locking Brass Caps
600219	Replacement Key No. 19 for Female Locking Brass Fuel Cap
600220	Replacement Key No. 20 for Female Locking Brass Fuel Cap
600221	Replacement Key No. 21 for Female Locking Brass Fuel Cap

Aluminum Fuel Caps - Designed for Diesel Fuel Applications

Aluminum Non-Locking Fuel Caps

Part No.	Photo	Description	Nominal Size	Threads Per Inch	Across Threads Cap	Across Threads Filler Neck
600135	A	Female, Vented	2"	11-1/2	2-1/4"	2-5/16"
600198	B	Female, Non-Vented	2"	11-1/2	2-1/4"	2-5/16"
600136	C	Female, Vented	2-1/2"	8	2-1/2"	2-9/16"
600186	D	Female, Vented	2"	11-1/2	2-1/4"	2-5/16"
600184	E	Female, Vented Replaces Freightliner A03-12927-4 and Kenworth K071-398**	3"	8	3-3/8"	3-7/16"
600148	F	Female, 1/4 Turn Replaces Freightliner 03-37017-000	3"	N/A	3-1/2"	3-7/16"
600168	G	Female, Non-Vented	4"	8		
600180	H	Female, Vented	4"	8	4-1/2"	4"
600172	I	Male, Non-Vented	4-1/4"	8	4-1/4"	4-1/8"
601065	J	Bayonet Style	4"	N/A	3-7/8"	

REPLACEMENT PARTS FOR ALUMINUM CAPS

Part No.	Description
600081	Replacement Gasket for Female 3" Aluminum Fuel Cap
600041	Replacement Lock Cam for Female, Non-Vented, locking Cap
600053	Replacement Lock Cam for Male Locking Cap
600175	Replacement Loc-Gard Protection Cap for Male Locking Cap
600176	Replacement Loc-Gard Protection Cap for Female, Non-Vented, Locking Cap
601063	Replacement Chain and Crossbar for Non-Vented Cap
601069	Replacement Gasket for Non-Vented Cap
600219	Replacement Key No. 19 for Non-Vented, Locking Cap
600220	Replacement Key No. 20 for Non-Vented, Locking Cap
600221	Replacement Key No. 21 for Non-Vented, Locking Cap
601058	Replacement Lock Cam for Bayonet Fuel Cap
601063	Replacement Chain and Crossbar for Bayonet Fuel Cap

Non-Vented caps are designed for use only on vehicles with properly vented fuel systems. For Complete information on current fuel tank system requirements, see Code of Federal Regulations 49 CFR 393.67

* Freightliners after 1983 and Western Star after 1982 both with diesel fuel tanks with 3" male pipe filler necks.

** Freightliners prior to 1984 and Kenworth after 1984, Peterbilt prior to 1980 and Western Stars prior to 1983 all with diesel fuel tanks with 3" male pipe filler necks.

Aluminum Locking Fuel Caps



Part No.	Photo	Description	Nominal Size	Threads Per Inch	Across Threads Cap	Across Threads Filler Neck
600150	K	Female, Non-Vented Application: Freightliner M2	2.5"	8	4-3/8"	4-7/16"
600185-6***	L	Female, Vented Replaces Freightliner A03-12927-6 and Kenworth K071-385-1234**	3"	5-1/2	3-7/16"	3-1/2"
600183-6***	M	Female, Vented Replaces Freightliner A03-15682-6 and Western Star 43301-3403*	3"	8	3-3/8"	3-7/16"
600149	N	Female, 1/4 Turn Replaces Freightliner 03-37017-002	3"	N/A	3-1/2"	3-7/16"
600169-6	O	Female, Non-Vented	4"	8	4-3/8"	4-7/16"
600181-6	P	Female, Vented	4"	8	4-1/2"	4"
600173-6	Q	Male, Non-Vented	4-1/4"	8	4-1/4"	4-1/8"

***Keys not available separately

Filler Neck Adapter Kit

- Part No. 600191 allows 2" female fuel caps to be installed on filler necks with small inside diameters
- Part No. 600191 allows 2" female fuel caps to be installed on 2-1/2" male filler neck with 8 threads per inch.
- Kits include aluminum adapter, installation instructions and adhesive.

Part No.	Description
600112	Filler Neck Adapter Kit
600191	Filler Neck Adapter Kit

Saddle Tank Mounting Kit

- Complete kit for mounting one saddle tank.

Part No.	Description	
602002	Saddle Tank Mt. Kit	
Kit Contents:		
Part No.	Description	Qty
060033	Rubber Pad	4
060034	Spring	4
405049	Lock Nut	4
408060	Hex Bolt	4

FUEL

Anti-Siphon Tubes

NEW

Protect your fuel with Velvac's **Anti-Siphon Tube**



- Makes siphoning fuel impossible- patented aluminum extrusion in the tube
- Durable design- made from 6061 aircraft aluminum tubing with a 0.065" wall thickness
- Vented for fueling- fuel 20+ gallons per minute
- OEM approved design- fits almost every filler neck



Part No.	Dimension "B"	Diameter Filler Neck	Fits Application
600241	3-3/4 inches	3 inches	Fits Heavy Duty Volvo, International and Mack Trucks
600242	3-3/4 inches	2-1/2 inches	Fits Heavy Duty Volvo, International and Mack Trucks
600243	2-3/4 inches	2-1/2 inches	Fits Heavy Duty Kenworth
600244	2-3/4 inches	2-1/4 inches	Fits Heavy Duty Freightliner
600245	2-1/4 inches	2 inches	Fits Medium-Duty Trucks
600246	3-3/4 inches	1.87 inches	Fits Medium-Duty and Reefer trucks

EASY TO INSTALL

- 1 Measure the inside diameter of fuel tank filler neck.
- 2 Measure the length (**Dimension "A"**) of the fuel tank filler neck using a tape measure inside the neck.
- 3 Review the available anti-siphon tubes and their dimensions. (**Dimension "B"**) from the underside of the top lip to the tip of the last barb.
- 4 Select an anti-siphon tube with **Dimension B** greater than **Dimension A** to insure that when installed the barbs will catch on the bottom of the filler neck and prevent removal of the anti-siphon tube.
- 5 Insert properly sized anti-siphon tube into filler neck and press into place. If you pull back on the anti-siphon tube after installed and it can be easily removed, it is not sized properly. It is recommended that you re-check the above noted dimensions.

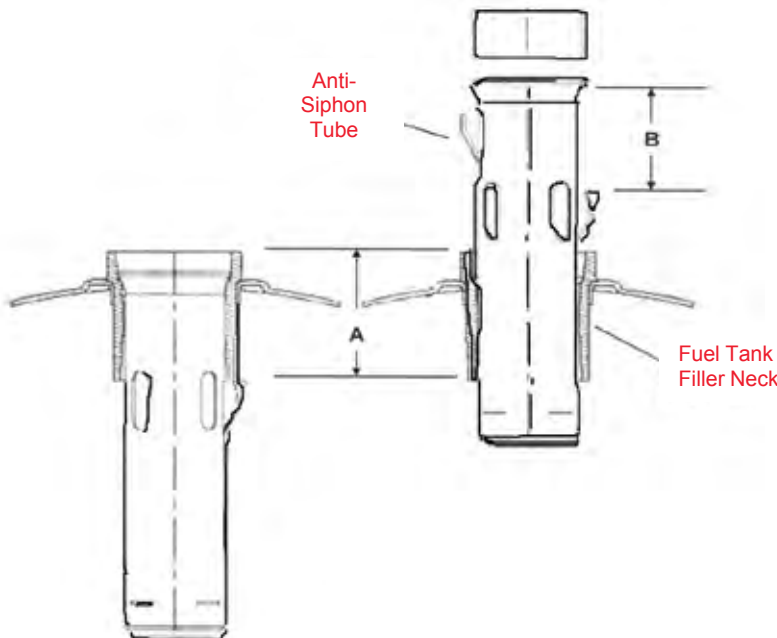

NOTE: CAN NOT BE REMOVED ONCE INSTALLED

Crossover Fuel Line Safety Valve



- Functions as a "fuse" in the fuel crossover line, automatically shutting off the flow of fuel if the line between a vehicle's main and auxiliary tanks is torn away or obstructed
- Separates before the crossover fuel line ruptures, preventing damage to fuel tank lines, fittings and valves

- Reduces the risk of fire and fuel slick by minimizing fuel loss if crossover fuel line is torn away
- Lightweight aluminum construction
- 3-1/8" length, 1-1/4" diameter

Part No.	Description
060056	Crossover Fuel Line Safety Valve

Technical Information

Flow -

4.0 gpm minimum at 1.0 psi differential pressure

Leakage -

Prior to actuation: zero leakage up to 5.0 psi

After actuation: maximum 1/2 oz. By weight up to 5.0 psi

Actuation -

Tension: minimum 450 lbs; maximum 700 in. / lbs

Environmental -

Meets all performance requirements during and after exposure to salt spray, vibration, blended fuels and hot or cold temperature variations typical of tractor operating conditions

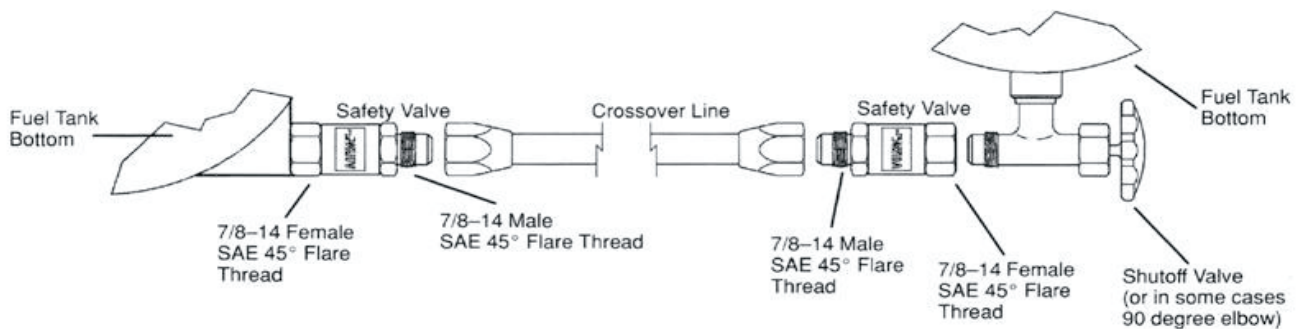

FUEL

Ball Valve

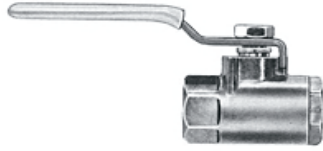

- Designed for fuel line shutoff in gasoline and diesel vehicles. May also be used for water and air service lines
- Heavy-duty forged brass body provides extended service
- Teflon® seats and seals provide positive sealing with easy opening and closing
- 600 psi water, oil or fuel
- 150 psi on/off saturated steam service lines
- 29 in. Hg vacuum service

Part No. Description

060050 Ball valve with 1/2" FPT both ends

Tank Cocks



Three-Way
Part No. 060004



Three-Way
Part No. 060012



Four-Way
Part No 060001 or
060007

- All brass bodies
- Mounting flanges with 1/4" bolt holes
- Standard 1-1/2" stems

Part No. Description

060004 Three-Way Tank Cock with 3/8" FPT Side Ports

060012 Three-Way Tank Cock with 1/4" FPT Bottom and Side Ports

060001 Four-Way Tank Cock with 3/8" FPT Bottom and Side Ports

060007 Four-Way Tank Cock with 1/4" FPT Bottom and Side Ports

Return Flow Splitters

- Designed for dual draw/dual return diesel fuel system
- Distributes fuel equally to both left and right tanks eliminating the need for crossover lines
- Durable zinc die cast bodies
- Convenient tee configuration for easy plumbing to each tank
- Applicable for marine use
- (3) 1/2" FPT ports
- (2) 1/4" mounting holes



Part No. Description Vehicle Applications

060070 Standard Flow Ford and Kenworth

060071 High Flow Navistar, Volvo, Mack, Peterbilt and Western Star

Diesel Fuel Valves



- All brass bodies provide added durability
- Neoprene seats make valves compatible with most liquids
- Both with 1/2" MPT bottom ports

Part No. Description

060026 Leveling Valve with 1/2" FPT Side Port

060027 Leveling Valve with 5/8" SAE 45" Male Flare Side Port

Six Port Motor-Driven Valve

(Not for marine use)

- Designed for systems with fuel or vapor return lines - not for use with fuel systems operating over 30 psi
- Reduces the possibility of fuel returning to incorrect tank as valve remains in actuated position after power is disconnected
- Permits high closing pressures
- Can be used for biodiesel, vegetable oil and olive oil
- 12 VDC
- Operating temperature range of -40° to 180° F
- 3/8" supply lines, 5/16" return lines
- Weatherproof electrical connector part No. 060046 is required for all new installations

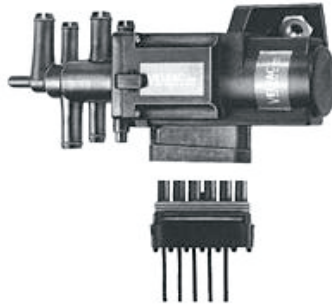

Part No.	Description
060047	Six Port Motor-Driven Valve
060049	Electrical Connector

Fuel Solenoid Shut Off Valve



- Direct replacement for Cummins 3035342, BM-69973
- 12 VDC
- Ports accept 1/4" tube
- 3" overall height
- Includes seal ring and port plug

Part No.	Description
034095	Fuel Solenoid Valve

FUEL TANK SAFETY VENTS



A



B



C



D



E



F

- Feature patented anti-spill protection
- Vents meet all applicable DOT requirements

Part No.	Photo	Thread Size	Barb Size (I.D. Hose)	Fuel Application	Vehicle Application
060060	A	1-1/4" PTF SAE Short	1/4"	Diesel	Peterbilt
060061	B	1/2"-14 PTF SAE Short	5/16"	Gasoline	Various
060062	C	1/2"-14 PTF SAE Short	5/16"	Diesel	Various
060063	D	1/4"-18" PTF	1/4"	Diesel	Various
Valves with Pressure and Thermal Relief Features					
060040	E	1/4"-18 PTF	N/A	Diesel	Pre-1992 Kenworth
060064	F	1/2"-14 PTF SAE Short	5/16"	Diesel	Kenworth

PTF = Pipe Thread Fuel



RETAIL 137-144

Table of Contents	PAGE
Air and Fittings Display Racks	137
Fittings Displays	138
Bucket and Counter Boxes	139
Hose and Air Displays	140
Floor Standing Displays	141
Mirror Retail Merchandising	142
Plan-O-Grams	143

VELVAC Original Indicates an original Velvac product.

NEW Indicates a new product added to catalog.

Revised Part No. Indicates a revised part number defining “-xx” package quantity.
Refer to price list for price per package.

For quantity and packaging information, refer to our price list.

Customer Service: 800.783.8871
Fax: 262.786.4101
Email: sales@velvac.com



NOTE: The information and photographs in this catalog are believed to be accurate and factual as of the print date. Velvac assumes no responsibility for information that may be incorrect or has changed since press time. Product specifications and offerings subject to change without notice.

Velvac is a registered trademark of Velvac, Inc.



Air and Electrical Display Rack



NEW

- Ships with an attractive Laminated Velvac Header
- Designed for more flexible product sets
- Bins are designed to accept dividers which increases storage possibilities
- Display is formed from 16-gauge steel for strength and stability
- Display is designed to hold up to 800 pounds
- Easy to assemble
- Ships with PLAN-O-GRAM

Display includes the following part numbers and quantity.

Part No.	Description
690201	Includes Rack and Bins, Air and Electrical Products, Plan-O-Gram header, and display and bin labels

Part No.	Qty	Part No.	Qty
035031	40	032082	5
035032	40	032058	5
035033	40	590160	4
035037	5	590161	4
035092	5	590163	4
035093	5	590155	4
035009	100	590157	4
035010	100	593057	5
035011	100	593022	5
035094	5	593083	5
035095	5	593084	5
035007	50	038001	5
035070	4	038003	5
022002	5	038005	5
022001	5	580037	10
022025	5	580039	5
		580040	5

Brass Fitting POP Display



NEW

- Designed for more flexibility and storage space
- Choose from 3 different bin sizes layouts
- Bins are designed to accept dividers which increases storage possibilities
- Frame is formed from 16-gauge steel for strength and stability
- Frame is formed from 16-gauge steel for strength and stability
- Frame is designed to hold up to 800 pounds
- Attractive header card puts the Velvac name in front of your customers

- Display assembly can be ordered in 3 different pre-designed configurations or by the individual pieces



Part No.	Description	Size
690187	Cabinet Frame Only	54"H x 36"W x 16"D (Header adds 10")
690188	Small Storage Bin	7-3/8"L x 4-1/8"W x 3"H (HOLDS: 50 seals, 5-10 drain plugs, 4-5 gladhands)
690189	Medium Storage Bin	10-3/4"L x 8-1/4"W x 7"H (HOLDS: 15 gladhands, 15 7-way plugs 10 sockets)
690190	Large Storage Bin	14-3/4"L x 16-1/2"W x 7"H (HOLDS: 2-3 coiled electric, 1-2 coiled air sets)
690191	Small Bin Divider	2-1/2"H x 6-3/4"L
690192	Medium Bin Divider	6-1/2"H x 10"L
690193	Large Bin Divider	6-1/2"H x 13-3/4"L
690194	Cabinet frame assy, Velvac header card, instruction sheet, 96 small bins and 48 small bin dividers	
690195	Cabinet frame assy, Velvac header card, instruction sheet, 56 small bins, 4 medium bins, 2 large bins, 28 small bin dividers, 2 medium bin dividers and 1 large bin divider	
690196	Cabinet frame assy, Velvac header card, instruction sheet, 40 small bins, 8 medium bins, 2 large bins, 20 small bin dividers, 4 medium bin dividers and 1 large bin divider	

Large Air Brake Fitting Assortment

Assortment includes the following part numbers and quantities plus rack part number 690090, P. 139

Part No.	Total Fittings
690059	583

Part No.	Qty	Part No.	Qty
010087	50	012021	10
010089	50	012035	5
010094	25	012037	20
010096	25	012041	10
010098	25	012043	5
011001	25	012045	10
011003	50	012047	10
011005	25	012049	5
011007	10	012053	3
011009	10	012055	3
011013	25	012067	10
011023	15	012071	10
011025	5	012087	5
011027	3	012091	20
011029	3	012093	5
011033	10	012095	5
011041	15	012097	5
011043	10	013001	10
011045	3	013003	5
011047	2	013011	3
011057	5	013041	5
011059	3	013057	5
011073	5	013075	5
012017	10	690052	1

Push-Lock Fitting Assortment

Assortment includes the following part numbers and quantities plus rack part number 690090, P. 139

Part No.	Total Fittings
690072	155

Part No.	Qty	Part No.	Qty
016112	5	016266	5
016114	5	016268	5
016120	5	016284	5
016122	5	016286	5
016142	5	016288	5
016144	5	016610	5
016162	5	016620	5
016164	5	016630	5
016166	5	016640	5
016168	5	016660	5
016184	5	016680	5
016186	5	016930	5
016188	5	016940	5
016242	5	016960	5
016244	5	016980	5
016264	5	690052	1

Nylon Air Brake Tube Fitting Assortment

Assortment includes the following part numbers and quantities plus rack part number 690090, P. 139

Part No.	Total Fittings
690071	304

Part No.	Qty	Part No.	Qty
016100	3	016866	5
016101	3	016884	5
016140	25	016886	5
016160	10	016888	5
016180	5	016908	3
016200	3	016916	5
016201	2	016918	2
016240	10	016922	5
016260	5	016942	10
016280	5	016944	10
016300	10	016962	5
016301	10	016964	5
016340	25	016966	5
016360	25	016968	5
016380	25	016984	5
016808	3	016986	5
016818	2	016988	5
016842	10	017264	5
016844	10	017266	5
016862	5	017286	3
016864	5	690052	1

Brass Pipe Fitting Assortment

Assortment includes the following part numbers and quantities plus rack part number 690090, P. 139

Part No.	Total Fittings
690064	340

Part No.	Qty	Part No.	Qty	Part No.	Qty	Part No.	Qty
016001	5	016069	5	017019	5	018006	10
016002	5	016070	5	017021	5	018007	10
016003	5	016079	10	017023	5	018008	10
016004	5	016080	10	017025	5	018009	10
016051	10	016081	30	017027	5	018010	20
016052	20	016083	5	017029	5	018011	10
016053	20	016084	5	017051	10	018012	5
016054	5	016087	5	017053	20	690052	1
016067	10	017015	5	017055	20		
016068	10	017017	5	017057	5		

See Pages
111 - 119
for fitting photos
and descriptions.

Fitting Assortments



- Steel cabinet with rust-resistant baked enamel finish
- Cabinet includes 18 drawer dividers and nine large steel drawers with "positive stop" feature, preventing drawers from being accidentally pulled out
- Measures 17-1/4" W x 10-7/8" H x 11-5/8" D
- Assortments come complete with all specified fittings, cabinet and drawer dividers

Part No.	Description	Total Fittings
690072	Push-Lock Fitting Assortment	155
690059	Large Air Brake Compression Fitting Assortment	583
690071	Nylon Air Brake Tube Fitting Assortment	304
690064	Brass Pipe Fitting Assortment	340
690090	Cabinet Only	—
690091	Replacement Drawer Dividers (Pkg. qty 12)	—

Counter Top Bucket Display

NEW



Front Side

Back Side

- A convenient way to display new products while increasing your inside store sales
- Round clear canister, 7" diameter x 7.5" height
- Sold complete with cover for easy shipping or fleet sales
- Product label includes an area to write in your part number, UPC code and price

Part No.	Description
035160	Black Poly Display
035161	Red Poly Display
035162	Blue Poly Display
035163	Black Rubber Display
058380-4	Silicon Self Fuse Tape (10) Black
058381-4	Silicon Self Fuse Tape (10) Red
056121	Heatless Butt Connectors including (50) 056111 (200) 056112 and (50) 056113. See page 92

Polyurethane Gladhand Seals



- Color-coded seals will not crack or tear, reducing maintenance time and costs associated with rubber seal replacement
- Available in attractive display box with 25 sets of seals (sets consists of four seals per bag, two red and two blue)

Part No.	Description
035012	Display Box with Seals
035009	Red Polyurethane Seals
035010	Blue Polyurethane Seals
035011	Black Polyurethane Seals

Display Bin Box

NEW



- Manufactured with corrugated cardboard for extra durability
- Great for store merchandising or storage of loose parts
- Fits on standard shelving or display units
- Complete with Velvac logo for store merchandising and brand recognition

Part No.	Description
690007	White 4" x 9"
690008	White 6" x 9"

Slotted Hose Clamp Rack and Assortment



- Sturdy, wall mount/counter rack ideal for displaying fast-moving miniature and general purpose hose clamps
- Assortment includes rack, header and 230 of the most popular slotted clamps
- Rack and header also sold separately

Assortment includes the following hose clamps:

Part No.	Description
022566	Hose Clamp Assortment with Rack and Header
022565	Rack and Header Only

Part No.	SAE Size	Quantity
022204	4 Mini	40
022206	6 Mini	40
022310	10	30
022312	12	30
022320	20	30
022328	28	30
022336	36	30

Large Hose Clamp Rack

NEW



- Attractive freestanding or wall mountable display
- Includes 270 of most popular clamps
- Rack dimensions 21.5" W x 23" H x 8" D

- Moveable hooks allow for various configurations

Part No.	Description
022628	Rack Only
022630	Hose Clamp Assortment with Rack and Header

Assortment Includes:

Part No.	Description	Quantity	Part No.	Description	Quantity
022204	Mini Clamp 7/32" x 5/8"	20	022336	Slotted Clamp 1-13/16" - 2-3/4"	20
022206	Mini Clamp 7/16" x 25/32"	20	022626	Spring T-Bolt Clamp 4-1/16" - 4-3/8"	15
022310	Slotted Clamp 9/16" x 1-1/16"	20	022581	Spring T-Bolt Clamp 2-3/4" - 3-1/16"	15
022312	Slotted Clamp 11/16" - 1-1/4"	20	022430	Constant Torq Clamp 2-1/4" - 3-1/8"	15
022320	Slotted Clamp 13/16" - 1-3/4"	20	022435	Constant Torq Clamp 2-3/4" - 3-5/8"	15
022324	Slotted Clamp 1-1/16" - 2"	20	022425	Constant Torq Clamp 1-3/4" - 2-5/8"	15
022328	Slotted Clamp 1-5/16" - 2-1/4"	20	022445	Constant Torq Clamp 3-3/4" - 4-5/8"	15
022332	Slotted Clamp 1-9/16" - 2-1/2"	20			

Air Brake Hose Assembly Display Rack



- For display and organization of 3/8" and 1/2" air hose assemblies
- 12 separate slots hold up to 48 hose assemblies
- Rack measures 21" W x 6" H x 6" D
- Air brake hose assemblies sold separately (see page 40 and 41)

Part No.	Description
691020	Display Rack*

*New redesigned graphics

www.velvac.com

Carton Floor Display



NEW

- Corrugated cardboard display
- Shipped with a pre-determined order size
- Easily assembled for an attractive point-of-purchase on your showroom floor

Part No.	Includes 18 Sets	Description
690197	022025	15' coiled nylon, 12" leads
690198	022001	15' coiled nylon, 40" x 12" leads
690199	590161	15' 7-way coiled, 12" leads
690200	590157	15' 7-way coiled, 5/14, 1/12

Four-Sided, Free Standing Carousel Display

NEW



- Designed for durability and flexibility of display on four sides
- Over 4500 sq. in. display area that fits a small 24" sq. ft. print
- Generic Velvac header allows for variety of Velvac products to be displayed on the same display
- Overall dimensions 73" H x 24" W x 24"D, Velvac header logo adds 12" to the height
- Ships complete with Velvac card header, a variety of display hooks, Plan-O-Grams and installation instructions
- Easy to assemble

Part No.	Description
690004	Four-sided, free-standing carousel display*

* Display only, for suggested Plan-O-Grams, contact Velvac

Wire Display Rack



- Attractive freestanding or wall mountable display constructed of sturdy heavy gauge steel
- Overall dimensions 16-1/2"H x 14-3/4"W x 6"D (header adds an approximately 5-1/4" to height measurement)

Part No.	Description
091256	Wire Display Rack Only

Wiper Blade Display Rack

NEW



- Attractive freestanding display provides an automatic point-of-purchase for Velvac wiper blades
- Ships complete with variety of wiper blades
- Display includes an application cross reference for typical heavy duty vehicle applications
- See page 109 for wiper blade information

Part No.	Description
690046	Wiper Blade Display Rack complete with a variety of wiper blades

Display assortment includes :

Part No	Description	QTY
76-28	28" Universal Blade	5
71-15	15" Narrow Blade	5
71-18	18" Narrow Blade	5
72-15	15" HD Curved Blade	5
72-16	16" HD Curved Blade	5
72-18	18" HD Curved Blade	5
75-16	16" Universal Blade	5
76-16	16" Prem Universal	5
75-18	18" Universal Blade	5
76-18	18" Prem Universal	5
75-20	20" Universal Blade	5
76-20	20" Prem Universal	5
75-22	22" Universal Blade	5
76-22	22" Prem Universal	5
690011	14 Prong Rack	1
--	HD Cross Reference	1

Velvac Mirror Display Packaging

Velvac offers attractive packaging displays that mount easily on pegboard or wire display racks. Plain box packaging options are also available for some versions.



Spot Mirror Boxes



The "Wedge" Stick-on Convex Mirror Package



Convex Mirror Display Box



Stick-on Convex Mirror Package



Stick-on Convex Mirror Package

West Coast and Spot Mirror Point-of-Purchase Display



- Ideal for presenting mirror products in an attractive and organized way on sales or showroom floors.
- Freestanding display constructed of heavy-duty cardboard with a UV coating for long life.
- Measures 5/8" high x 26" wide x 21" deep.
- Assortment (708500) comes complete with 36 stainless steel mirrors all in display boxes.

Display assortment includes:

Part No.	Qty.	Description
708525	6	7" x 16" Angle Back West Coast - Htd
705333	6	7" x 16" Angle Back West Coast
708501	4	8-1/2" Center Mount Convex
708502	4	8-1/2" Offset Mount Convex Spot
708508	4	7-1/2" Center Mount Convex
708509	4	7-1/2" Stainless Offset Mt. Convex
708515	4	6" Stainless Offset Mount Convex
708520	4	5" Stainless Center Mount Convex

Part No.	Description
708500	Display with Mirror Assortment
691013	Display Only

3 Foot End Cap Fixture or Wall Mirror Plan-O-Gram

NEW



CHROME MIRRORS

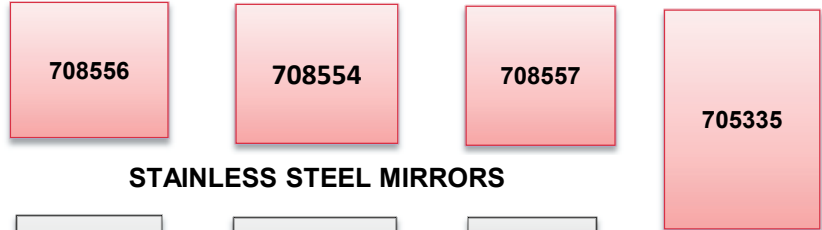

STAINLESS STEEL MIRRORS

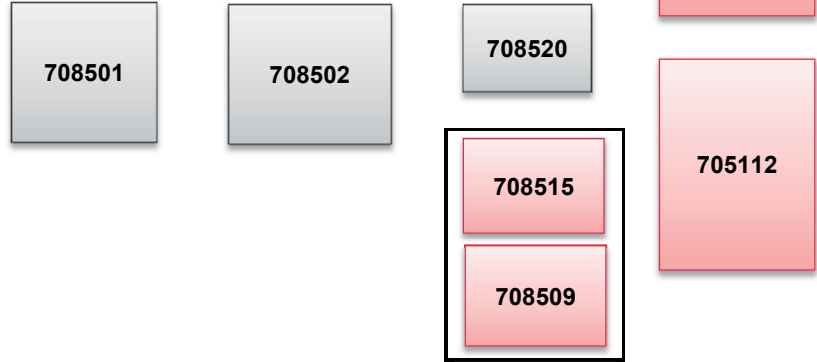

Alternate 708526

BOTTOM SHELF (Optional)



4 Foot Fixture or Wall Mirror Plan-O-Gram

NEW



BOTTOM SHELF (Optional)



DISPLAYED OPEN ON TOP ROW

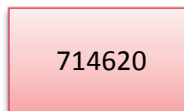

**4 Foot End Cap Fixture or Wall
Air and Electrical Plan-O-Gram**

NEW



035012	035012	035177	035175	035176	0	0	035150
					3	3	
					8	8	
					0	0	
					0	0	
					5	5	
							058112
							580111
580040	580081						
		038008					
			038003				
035070	035178						
500025	500019						
035007	035033	035032	035042	035038			
035092	035031	035170	035169	035045			
035092							

**Air and Electrical POP Rack
Display Plan-O-Gram**

NEW



032082	032058	032160	580039 580037	035011	035010	035009	035007
035070	035032, 035033 035031			038001 038003		035038 035037	
593084 593083		593057 593022		035094 035095		035092 035093	
590155, 590157				022025			
022002, 038005				022001			
590160				590163			

NOTE: Designed to be used with Velvac PO Display Part No. 690201

PART #	PG	PART #	PG	PART #	PG	PART #	PG	PART #	PG	PART #	PG	PART #	PG
002063	55	011033	115	014204	119	016039	118	016242	111	016486	111	016968	113
006103	120	011034	117	014205	119	016040	118	016244	111	016510	113	016980	112
006104	120	011041	115	014206	119	016041	118	016246	111	016540	113	016984	113
006105	120	011043	115	014208	119	016042	118	016247	112	016560	113	016985	112
006106	120	011045	115	014400	119	016043	118	016248	112	016580	113	016986	113
006108	120	011047	115	014408	119	016052	118	016249	112	016610	111	016988	113
006202	120	011051	114	014806	119	016053	118	016260	113	016616	113	017000	118
006203	120	011059	114	014808	119	016054	118	016262	111	016618	113	017003	118
006204	120	011073	114	014811	119	016061	118	016264	111	016620	111	017004	118
006205	120	011085	114	014818	119	016065	118	016266	111	016630	111	017005	118
006206	120	011091	114	014822	119	016067	119	016268	111	016640	111	017006	118
006208	120	011093	114	014832	119	016068	119	016276	111	016642	113	017013	118
006303	120	011245	123	014842	119	016069	119	016277	111	016644	113	017015	118
006304	120	012012	117	014844	119	016070	119	016278	111	016660	111	017017	118
006305	120	012014	117	014852	119	016077	119	016279	111	016662	113	017019	118
006306	120	012015	117	014854	119	016079	118	016280	113	016664	113	017021	118
006314	120	012016	117	014862	119	016080	118	016281	111	016666	113	017023	118
006642	120	012017	114	014864	119	016081	118	016282	112	016670	111	017025	118
006652	120	012021	114	014866	119	016082	118	016283	112	016680	111	017027	118
006664	120	012022	117	014868	119	016083	118	016284	111	016686	113	017029	118
006842	120	012023	114	014884	119	016084	118	016285	112	016688	113	017043	113
006852	120	012035	114	014886	119	016085	118	016286	111	016806	114	017046	113
006854	120	012037	114	014888	119	016086	118	016287	112	016808	114	017051	118
006864	120	012041	114	014901	120	016087	118	016288	111	016810	111	017053	118
006866	120	012043	114	014906	120	016100	113	016289	112	016811	114	017055	118
006886	120	012045	114	014908	120	016101	113	016290	112	016812	112	017057	118
006908	120	012047	114	014911	120	016110	112	016291	112	016813	112	017059	118
006932	120	012049	114	014918	120	016112	112	016300	113	016818	114	017060	113
006942	120	012053	114	014932	120	016114	112	016301	113	016840	111	017063	118
006944	120	012055	114	014942	120	016120	112	016312	112	016842	114	017064	113
006952	120	012061	114	014944	120	016122	112	016314	112	016844	114	017065	118
006954	120	012064	117	014946	120	016124	112	016340	113	016846	114	017066	113
006962	120	012066	117	014952	120	016140	113	016342	112	016860	111	017067	118
006964	120	012067	115	014954	120	016142	112	016344	112	016862	114	017069	118
006966	120	012068	117	014962	120	016144	112	016360	113	016864	114	017073	119
006986	120	012071	115	014964	120	016146	112	016364	112	016866	114	017081	118
010085	117	012073	115	014966	120	016151	112	016366	112	016868	114	017083	118
010087	115	012087	115	014968	120	016160	113	016368	112	016880	111	017085	118
010089	115	012091	115	014984	120	016161	112	016380	113	016884	114	017086	113
010093	117	012093	115	014986	120	016162	112	016386	112	016886	114	017088	113
010094	115	012095	115	014988	120	016163	112	016388	112	016888	114	017089	116
010096	115	012097	115	015906	119	016164	112	016400	112	016908	113	017091	118
010098	115	013001	115	015908	119	016166	112	016401	112	016910	112	017093	118
011000	117	013003	115	015918	119	016168	112	016402	112	016916	113	017095	118
011001	114	013011	115	015942	119	016180	113	016403	112	016918	113	017096	118
011003	114	013026	115	015944	119	016184	112	016404	112	016920	112	017098	116
011005	114	013027	115	015964	119	016186	112	016405	112	016922	113	017118	114
011007	114	013041	114	015966	119	016187	112	016406	112	016930	112	017142	114
011009	114	013049	114	015986	119	016188	112	016407	112	016940	112	017144	114
011012	117	013057	114	015988	119	016189	112	016408	112	016942	113	017164	114
011013	115	013075	114	016001	118	016200	113	016409	112	016944	113	017166	114
011014	117	013077	114	016002	118	016201	113	016412	111	016945	119	017186	114
011016	117	014100	119	016003	118	016204	113	016440	113	016946	113	017188	114
011020	117	014103	119	016004	118	016206	113	016442	111	016947	111	017218	113
011023	115	014104	119	016021	118	016208	113	016444	111	016948	119	017223	118
011025	114	014105	119	016025	118	016212	111	016446	111	016950	111	017224	118
011025	115	014106	119	016029	118	016214	111	016460	113	016960	112	017225	118
011027	115	014108	119	016033	118	016222	111	016464	111	016962	113	017226	118
011029	115	014200	119	016037	118	016224	111	016466	111	016964	113	017227	118
011032	117	014203	119	016038	118	016240	113	016480	113	016966	113	017242	113
017244	113	017262	113	017264	113	017266	113	017286	113	017288	113	017808	113
017816	113	017842	113	017844	113	017862	113	017864	113	017866	113	017868	113
017886	113	017888	113	018006	119	018007	119	018008	119	018009	118	018010	118
018011	118	018012	118	018013	118	018023	118	018025	118	018027	118	018029	118
019002	127	019003	127	019004	127	019006	127	019009	127	019011	127	019013	127
019015	127	019017	127	019018	106	019057	127	019058	127	019059	127	019060	127
019061	127	019062	127	019064	127	019065	127	019067	127	019069	127	019070	127
019071	127	019072	127	019073	127	019088	127	020052	42	020053	42	020053-7	42
020055	42	020055-7	42	020057	42	020057-7	42	020057	42	020057-7	42	020057-7	42



PART NO. INDEX (cont.)

PART #	PG	PART #	PG	PART #	PG	PART #	PG	PART #	PG	PART #	PG	PART #	PG		
020059	42	021059	100	022120	123	022520	123	031023	58	032234	50	034051	43	035010	139
020059-7	42	021061	100	022124	123	022524	123	031025	58	032235	50	034052	44	035010	38
020062	42	021063	100	022128	123	022528	123	031027	58	032236	50	034053	44	035011	139
020062-7	42	021065	100	022136	123	022532	123	031031	58	032240	53	034054	44	035012	139
020064	42	021070	100	022140	123	022536	123	031033	58	032241	53	034056	45	035012	38
020064-6	42	021100	100	022144	123	022540	123	031035	58	032242	53	034057	45	035021	116
020065	42	021102	100	022148	123	022544	123	032015	47	032243	53	034058	45	035025	39
020065-7	42	021103	100	022204	123	022548	123	032018	47	032244	53	034059	45	035026	39
020066	42	021104	100	022206	123	022550	124	032019	47	032245	53	034062	44	035029	116
020066-7	42	021105	100	022306	123	022551	124	032020	47	032246	53	034063	45	035031	37
020104	97	021106	100	022308	123	022552	123	032022	50	032247	50	034064	53	035032	37
020104-7	97	021107	100	022310	123	022556	123	032023	50	032248	50	034065	53	035033	37
020106	97	021108	100	022312	123	022557	124	032037	50	032249	50	034066	45	035036	39
020106-7	97	021109	100	022316	123	022564	123	032039	50	032250	50	034067	45	035037	39
020108	97	021110	100	022320	123	022565	140	032051	48	032253	50	034068	44	035038	37
020108-7	97	021111	100	022324	123	022566	140	032058	57	032400	50	034069	45	035042	37
020110	97	021112	100	022328	123	022572	123	032060	55	032401	50	034070	49	035045	37
020110-7	97	021113	100	022332	123	022574	123	032081	57	032402	50	034072	49	035065	55
020112	97	021114	100	022336	123	022580	123	032082	57	032403	50	034073	49	035070	39
020112-7	97	021115	100	022340	123	022581	123	032083	57	032404	50	034073	49	035079	116
020116-7	97	021116	100	022344	123	022582	123	032086	49	032405	50	034074	54	035081	116
020117-7	97	021117	100	022348	123	022583	123	032086	54	032406	50	034075	48	035087	116
020118-7	97	021118	100	022352	123	022584	123	032088	49	034012	47	034077	46	035092	37
020119-7	97	021119	100	022360	123	022585	123	032110	54	034013	43	034078	47	035093	37
020132	42	022000	42	022364	123	022586	123	032131	46	034014	43	034079	43	035094	37
020134	42	022001	42	022372	123	022587	124	032135	57	034015	43	034080	43	035095	37
020134-6	42	022002	42	022380	123	022588	124	032138	50	034016	43	034081	44	035100	39
020136	42	022004	42	022388	123	022589	124	032139	53	034017	43	034082	44	035101	58
020136-7	42	022005	42	022396	123	022591	124	032140	53	034018	43	034083	46	035102	58
020138	42	022008	42	022400	124	022592	124	032141	53	034019	43	034084	47	035103	58
020138-7	42	022009	42	022404	123	022593	124	032142	49	034020	44	034085	43	035104	58
020142	42	022011	40	022410	124	022594	124	032143	49	034021	44	034087	56	035105	58
020144	42	022011-7	40	022412	124	022596	124	032144	49	034023	44	034088	56	035106	58
020144-6	42	022025	42	022416	124	022597	124	032145	49	034024	44	034089	56	035107	58
020146	42	022026	42	022420	124	022598	124	032146	49	034025	45	034090	56	035108	58
020154	42	022027	42	022424	124	022626	123	032160	57	034026	45	034091	56	035109	58
020154-6	42	022028	42	022425	124	022627	123	032170	57	034027	45	034092	56	035120	57
020156	42	022030	42	022430	124	022628	140	032185	57	034028	45	034093	56	035121	57
020156-7	42	022031	42	022435	124	022630	140	032190	48	034029	45	034094	48	035122	57
020157	42	022032	42	022440	124	022680	123	032191	48	034030	46	034095	135	035123	57
020158	42	022047	40	022445	124	022688	123	032192	48	034031	46	034101	51	035124	57
020158-7	42	022047-7	40	022450	124	022696	123	032194	48	034032	46	034111	51	035125	57
020164	42	022048	124	022462	125	023066	125	032195	53	034033	46	034112	51	035126	57
020164-6	42	022049	124	022463	125	023106	125	032201	54	034034	46	034113	51	035127	57
020166	42	022050	124	022464	125	023108	125	032205	54	034035	46	034114	51	035128	57
020166-7	42	022051	124	022465	125	023126	125	032206	54	034036	47	034122	51	035129	57
020168	42	022052	124	022470	125	023128	125	032216	54	034037	54	034123	51	035130	57
020168-7	42	022053	124	022471	125	030013	58	032217	54	034038	46	034124	51	035131	57
021001	100	022054	124	022472	125	030015	58	032218	54	034039	46	034126	51	035132	57
021003	100	022055	124	022473	125	030017	58	032219	54	034040	46	034130	52	035140	38
021005	100	022056	124	022474	125	030019	58	032220	54	034041	55	034131	52	035141	38
021007	100	022057	124	022475	125	030021	58	032221	54	034042	55	034132	52	035143	38
021009	100	022058	124	022476	125	030024	58	032222	54	034043	56	034133	52	035144	38
021011	100	022059	124	022477	125	030074	56	032225	50	034044	57	034134	52	035145	38
021013	100	022060	124	022478	125	030075	56	032227	50	034045	57	034135	52	035146	38
021015	100	022106	123	022506	123	030084	59	032228	50	034046	56	034136	52	035147	38
021017	100	022108	123	022508	123	030092	59	032229	50	034047	56	035005	38	035150	39
021019	100	022110	123	022510	123	030093	59	032231	50	034048	56	035007	38	035151	37
021021	100	022112	123	022512	123	030094	59	032232	50	034049	44	035009	139	035152	37
021023	100	022116	123	022516	123	031021	58	032233	50	034050	44	035009	38	035160	139

PART #	PG	PART #	PG	PART #	PG	PART #	PG	PART #	PG	PART #	PG	PART #	PG	PART #	PG
035161	139	051127	96	056003-50	93	056109	95	057081-50	93	058012	77	058117	74	058334-50	93
035162	139	051129	96	056004-50	93	056111-100	92	057082-50	92	058013	77	058118	74	058335-50	92
035163	139	051135	96	056005-50	93	056111-5	92	057083-50	92	058016	77	058119	74	058336-50	92
035164	38	051135-6	96	056006-50	93	056112-100	92	057084-50	92	058017	77	058128	74	058337-50	92
035165	38	051137	96	056007-50	93	056112-5	92	057085-50	92	058019	77	058129	74	058338-50	94
035166	38	051137-6	96	056008-50	93	056113-100	92	057086-50	92	058020	75	058151	74	058339-50	94
035167	38	051139	96	056009-50	93	056113-5	92	057087-50	92	058021	75	058152	74	058340-50	94
035168	38	051139-6	96	056010-50	93	056121	139	057088-50	94	058022	75	058156	74	058341-50	94
035169	37	051141	96	056011-50	93	056144-25	92	057089-50	94	058023	75	058160	102	058345-50	92
035170	37	051141-6	96	056012-50	93	056145-25	92	057090-50	94	058024	75	058171	101	058346-10	93
035173	37	051143	96	056033	75	056146-25	92	057091-50	94	058026	101	058172	101	058347-40	94
035174	37	051143-6	96	056034	75	056147-25	93	057092-50	94	058028-50	92	058173	101	058348-40	94
035175	39	051145	96	056035	75	056148-25	93	057093-50	94	058029-50	92	058208	74	058349-50	93
035176	39	051145-6	96	056036	75	056149-25	93	057096-40	94	058030	101	058212	74	058350-50	93
035177	39	051147	96	056037	75	056150-25	93	057097-25	98	058033	73	058233	73	058351-50	93
035178	39	051147-6	96	056038	75	056151-25	93	057098-25	98	058033-7	73	058233-7	73	058352-50	93
036003	57	051153	96	056039	75	056152-25	93	057110	99	058035	73	058235	73	058353-50	93
036019	57	051155	96	056040	75	056153-25	93	057111	99	058035-7	73	058235-7	73	058354-50	93
036021	57	051155-7	96	056041	75	056154-25	93	057112-10	98	058037	73	058237	73	058355-50	93
036036	55	051157	96	056042	75	056155-25	92	057113-10	98	058037-7	73	058237-7	73	058356-50	93
036043	55	051157-7	96	056043-50	92	056156-25	92	057114-10	98	058039	73	058239	73	058357-50	93
036045	55	051159	96	056044-50	92	056157-25	92	057115-10	98	058039-7	73	058239-7	73	058358-50	93
036049	55	051159-7	96	056045-50	92	056158-25	94	057116-10	98	058041	73	058241	73	058360-50	94
038001	106	051161	96	056046-50	92	056159-25	94	057117-10	98	058041-7	73	058241-7	73	058362-50	92
038003	106	051161-7	96	056047-50	92	056160-25	94	057118	70	058043	73	058243	73	058363-10	93
038005	106	051163	96	056049-50	93	056164-25	94	057119	70	058043-7	73	058243-7	73	058364-50	93
038008	106	051163-7	96	056050-50	93	056165-25	94	057120	70	058045	73	058245	73	058366-40	93
050001	73	051165	96	056051-50	92	056166-25	94	057121	70	058046	76	058247	73	058367-10	93
050001-7	73	051171	96	056052-50	92	056167-25	94	057123	101	058047	73	058251	77	058368	103
050007	73	051171-7	96	056053-50	92	056168-25	94	057124	101	058050	76	058252	77	058370	103
050007-7	73	051173	96	056054-10	92	056169-25	94	057125	101	058051	76	058253	77	058373	103
050019	73	051175	96	056055-10	92	056184-50	93	057126	102	058052	76	058254	77	058374	103
050019-7	73	051175-7	96	056056-10	92	056185-50	93	057127	102	058053	76	058296	77	058376	103
050029	68	051177	96	056060-50	94	056186-50	93	057128	102	058054	76	058301-50	93	058377	103
050037	73	051177-7	96	056061-50	94	056365-50	93	057131	99	058055	76	058302-50	93	058379	103
050037-7	73	054001	69	056062-50	94	057002	75	057132	99	058056	76	058303-50	93	058380	103
050042	73	054002	71	056063-50	94	057003	89	057133	99	058057	76	058304-50	93	058380-4	139
050042-7	73	054017	72	056064-50	94	057050	76	057146-10	98	058058	76	058305-50	93	058381	103
050051	73	055034	70	056065-50	94	057051	76	057147-10	98	058068	77	058306-50	93	058381-4	139
050052	73	055037	71	056066-50	94	057052	76	057148-5	98	058071	77	058307-50	93	060001	134
051050	97	055038	71	056067-50	94	057053	76	057149-25	98	058073	75	058308-50	93	060004	134
051050-7	97	055039	71	056068-50	94	057054	76	057150-25	98	058074	75	058310-50	92	060007	134
051052	97	055040	71	056069-50	94	057055	76	057151-25	98	058076	75	058311-50	92	060012	134
051054	97	055041	71	056070-50	94	057056	76	057152-2	98	058077	75	058312-50	92	060026	134
051058	97	055043	72	056071-50	94	057057	76	057153-2	98	058078	75	058313-40	92	060027	134
051058-7	97	055045	71	056074	96	057058-10	98	057158-10	98	058079	75	058314-40	92	060033	131
051060	97	055049	69	056076-50	94	057059-10	98	057159-5	98	058081	75	058315-40	94	060034	131
051062	97	055050	69	056078-50	94	057060-10	98	057160-2	98	058082	75	058316-40	94	060040	135
051101	96	055051	69	056079-50	94	057061-25	98	057174-2	98	058083	75	058317-10	94	060047	135
051103	96	055052	72	056080-50	94	057062-25	98	058001	76	058084	75	058318-50	94	060049	135
051105	96	055053	72	056082-10	93	057071	102	058002	76	058086	75	058319-50	94	060050	134
051117	96	055054	69	056083-10	93	057072	102	058003	76	058088	75	058320-10	94	060056	133
051117-6	96	055055	69	056084-10	93	057073-10	98	058004	76	058090	77	058325	75	060060	135
051119	96	055056	72	056086-50	94	057074-10	98	058005	76	058091	77	058326	75	060061	135
051119-6	96	055059	69	056088-50	94	057075-50	93	058006	76	058092	77	058327	75	060062	135
051121	96	055060	88	056092-50	96	057076-50	93	058007	76	058093	77	058328	75	060063	135
051121-6	96	055062	72	056093-50	93	057077-50	93	058008	76	058094	76	058329	75	060064	135
051123	96	055063	72	056094-10	93	057078-50	93	058009	76	058095	76	058330	75	060070	134
051123-6	96	056001-50	93	056107	95	057079-50	93	058010	76	058115	74	058331	75	060071	134
051125	96	056002-50	93	056108	95	057080-50	93	058011	76	058116	74	058332	75	080162	127

PART #	PG	PART #	PG	PART #	PG	PART #	PG	PART #	PG	PART #	PG	PART #	PG		
090002-100	99	090149	83	090220	83	091184-5	88	091513-10	87	101308	60	142148	41	147024	40
090004-100	99	090150	83	090221	83	091188	89	091514-10	87	10205	126	142324	41	147026	40
090006-25	99	090151	83	090222	83	091189	89	091520	87	10206	126	142336	41	147028	40
090008	108	090152	83	090225	84	091190	89	091521	87	10208	126	142436	41	147030	40
090010-25	99	090153	83	090226	70	091201	86	091522	87	10227	126	142518	41	147032	40
090014	96	090154	83	090227	70	091202	86	091523	87	10228	126	142524	41	147034	40
090014-100	99	090155	83	091001	90	091203	86	091524	87	10229	126	142536	41	147036	40
090016-100	99	090156	83	091002	90	091204	86	091530	87	10230	126	142552	41	147038	40
090028	42	090157	83	091003	87	091208	86	091531	87	10231	126	142554	41	147040	40
090029-50	99	090158	83	091004	87	091209	86	091532	87	10233	126	142572	41	147042	40
090030-50	99	090159	83	091005	87	091210	86	091533	87	10237	126	142584	41	147044	40
090040	81	090165	127	091006	87	091211	86	091534	87	10238	126	142618	41	147046	40
090041	81	090166	83	091007	87	091212	86	093022	69	10241	126	142624	41	147048	40
090043	81	090167	83	091008	87	091213	86	100022	63	10242	126	146018	40	147054	40
090048	81	090168	83	091011	87	091214	86	100028	63	10281	126	146020	40	147060	40
090054	84	090169	83	091015	87	091215	86	100036	63	10282	126	146022	40	147072	40
090056	84	090173	82	091020	87	091216	86	100037	63	10283	126	146024	40	148012	40
090060	107	090174	82	091025	87	091225	86	100101	63	10292	126	146026	40	148016	40
090061	107	090176	81	091030	87	091230	85	100102	63	10293	126	146028	40	148018	40
090064-100	99	090177	81	091040	87	091231	85	100122	61	10294	126	146030	40	148020	40
090066-100	99	090179	81	091050	87	091232	85	100123	61	10308	126	146032	40	148022	40
090067-100	99	090180	85	091051	87	091233	85	100124	61	10327	126	146034	40	148024	40
090068-100	99	090181	85	091052	87	091235	85	100125	61	10328	126	146036	40	148026	40
090070-25	99	090182	127	091053	87	091236	85	100126	61	10329	126	146038	40	148028	40
090071-25	99	090184	81	091054	87	091237	85	100131	61	10330	126	146040	40	148028	40
090073	84	090185	127	091055	87	091251	88	100132	61	10331	126	146042	40	148030	40
090076	85	090186	81	091056	87	091252	88	100136	61	10333	126	146044	40	148032	40
090078	84	090187	81	091057	87	091253	88	100137	61	10337	126	146046	40	148034	40
090079	84	090188	81	091071	87	091254	88	100144-7	63	109049	127	146048	40	148036	40
090080	84	090189	81	091072	87	091256	141	100204	60	109050	127	146054	40	148038	40
090081	84	090190	82	091073	87	091300-5	88	100206	60	109051	127	146060	40	148040	40
090082	84	090191	81	091074	87	091301-5	88	100208	60	131012	48	146072	40	148042	40
090083	84	090192	81	091075	87	091302-5	88	100226	60	131014	48	146084	40	148044	40
090085	84	090193	81	091076	87	091303-5	88	100228	60	131016	48	146518	40	148046	40
090104	82	090194	81	091080	87	091304-5	88	100306	60	131045	58	146520	40	148048	40
090109	83	090195	81	091081	87	091305-5	88	100308	60	13226	109	146522	40	148054	40
090110	83	090196	81	091082	87	091306-5	88	100310	60	13718	109	146524	40	148060	40
090111	83	090197	81	091083	87	091307-5	88	100326	60	140000	115	146526	40	148072	40
090113	108	090198	81	091130	89	091308-5	88	100328	60	140079	41	146528	40	148084	40
090114	108	090199	81	091131-5	88	091309-5	88	100424	62	140139	41	146530	40	148096	40
090115	108	090200	81	091132-5	88	091325	89	100603	62	140140	41	146532	40	148518	40
090116	108	090201	81	091133-5	88	091326	89	100613	62	140141	41	146534	40	148520	40
090119	108	090202	81	091135-5	88	091400-5	88	100614	62	140142	41	146536	40	148522	40
090120	82	090203	81	091137-5	88	091401-5	88	100615	62	142001	115	146538	40	148524	40
090123	83	090204	81	091140-5	88	091402-5	88	101002	63	142101	117	146540	40	148526	40
090124	83	090205	81	091141-5	88	091403-5	88	101003	63	142102	117	146542	40	148528	40
090125	83	090206	81	091142-5	88	091404-5	88	101004	63	142103	117	146544	40	148530	40
090127	83	090207	81	091143-5	88	091406-3	88	101054	63	142104	117	146546	40	148532	40
090128	83	090208	81	091144-5	88	091425	89	101055	63	142106	117	146548	40	148534	40
090132	83	090209	81	091170-5	88	091426	89	101058	63	142107	117	146554	40	148536	40
090133	83	090210	82	091171-5	88	091427	88	101059	63	142108	117	146560	40	148538	40
090134	83	090211	82	091172-5	88	091500-3	87	101066	61	142110	117	146572	40	148540	40
090135	83	090212	82	091173-5	88	091501	87	101067	61	142111	117	146584	40	148542	40
090136	83	090213	82	091174-5	88	091502	87	101068	61	142113	41	146596	40	148544	40
090137	83	090214	82	091175-5	88	091503	87	101069	61	142113-7	41	147009	40	148546	40
090142	127	090215	82	091177-5	88	091504	87	101070	61	142114	41	147012	40	148548	40
090145	127	090216	71	091180-5	88	091505	87	101071	61	142118	41	147016	40	148554	40
090146	83	090217	72	091181-5	88	091510-10	87	101078	63	142124	41	147018	40	148560	40
090147	83	090218	72	091182-5	88	091511-10	87	101208	60	142130	41	147020	40	148572	40
090148	83	090219	83	091183-5	88	091512-10	87	101306	60	142136	41	147022	40	148584	40



PART NO. INDEX (cont.)

PART #	PG	PART #	PG	PART #	PG	PART #	PG	PART #	PG	PART #	PG	PART #	PG		
148596	40	320172	64	580042	39	591010	70	600219	129	697017	78	704070	31	708331	5
149001	42	320173	64	580066	104	591019	72	600220	130	697032	78	704077	10	708334	5
149002	42	321034	59	580067	104	591022	72	600221	129	697066	79	704078	10	708335	4
149003	42	405049	131	580078	104	591090	71	600221	130	697087	79	704093	10	708336	4
149005	117	408060	131	580081	104	591105	69	600241	132	697097	79	704095	10	708337	4
149006	117	500001	115	580082	104	591109	69	600242	132	697103	79	704120	17	708368	3
149018	40	500003	115	580086	104	591113	71	600243	132	697104	78	704121	10	708369	3
149024	40	500004	116	580094	104	591115	70	600244	132	697105	78	704122	10	708341	7
149026	40	500005	115	580107	104	591116	70	600245	132	697106	78	704132-5	10	708442	7
149032	40	500007	41	580111	104	591117	70	600246	132	697107	79	704152-5	10	708444	7
149034	40	500008	41	580112	104	591161	69	601050	129	697112	79	704153-5	10	708446	7
149036	40	500009	115	580113	108	591162	69	601058	130	697124	80	704154	10	708448	7
149042	40	500011	115	580114	108	593017	69	601063	130	697125	80	704155	10	708449	7
149046	40	500015	115	580115	108	593019	69	601063	130	697187	80	704158	10	708450	7
149048	40	500017	115	580116	108	593024	69	601065	130	697197	80	704159	10	708453	7
149060	40	500019	116	580117	108	593052	71	601069	130	697287	79	704177-5	10	708455	7
149072	40	500021	115	580118	108	593054	71	602002	131	697297	79	704178-5	10	708457	7
149119	40	500022	115	580119	108	593057	69	690004	141	698055	80	704268	10	708463	7
149120	40	500024	115	580120	108	593059	69	690007	139	699087	79	704280	10	708470	7
149121	40	500025	116	580121	108	593060	69	690008	139	699097	79	704315	10	708473	7
149122	40	500027	116	580122	108	593083	72	690021	106	699107	79	704325	10	708476	7
149123	40	500030	115	581001	107	593084	72	690022	106	699112	79	705038	5	708478	7
149124	40	500031	115	581005	107	593101	69	690023	106	699287	79	705101	5	708479	7
149126	40	500035	115	581006	39	593106	72	690031	121	699297	79	705102	5	708500	142
175033	117	500037	115	581011	107	593111	69	690033	121	700064	16	705103	5	708501	7
320001	57	500039	115	581015	107	593116	69	690035	121	701001	16	705104	5	708502	7
320003	57	500042	115	581038	107	593121	71	690037	121	701006	16	705105	5	708503	7
320011	59	500046	115	581040	107	593122	71	690046	141	701050	16	705107	5	708504	7
320014	57	500050	115	58309-50	92	600007	129	690050	121	701054	16	705108	5	708508	7
320051	48	500051	115	590036	67	600009	129	690059	139	701071	16	705111	5	708509	7
320121	59	500052	115	590046	67	600011	129	690064	139	701072	16	705112	4	708510	7
320122	59	500053	115	590061	68	600017	129	690071	139	702023	10	705113	4	708511	7
320123	59	500054	116	590080	67	600021	129	690072	139	702042	4	705114	4	708513	7
320124	59	500055	115	590081	67	600040	129	690090	139	702044	4	705115	4	708514	7
320125	59	500061	115	590135	68	600041	129	690091	139	702045	4	705116	4	708515	7
320127	59	500062	116	590136	68	600053	130	690187	137	702047	4	705117	5	708516	7
320128	64	500063	116	590154	67	600081	130	690188	137	702051	10	705332	5	708520	7
320129	64	500064	116	590155	67	600110	129	690189	137	702057	10	705333	5	708521	7
320130	65	500065	116	590156	67	600112	131	690190	137	702076	10	705335	5	708525	5
320131	59	500066	116	590157	67	600133	129	690191	137	702086	15	708001	4	708526	5
320132	59	500070	116	590159	67	600135	130	690192	137	702098-5	10	708003	4	708551	7
320133	59	500071	115	590160	67	600136	130	690193	137	702148	8	708005	4	708552	7
320134	59	500078	116	590161	67	600148	130	690194	137	702149	8	708007	10	708553	7
320135	59	500079	116	590163	67	600149	131	690195	137	702155	28	708008	4	708554	7
320136	65	500080	116	590165	67	600150	131	690196	137	702157	29	708020	4	708555	7
320137	65	500081	116	590166	67	600168	130	690197	140	702158	8	708022	4	708556	7
320138	65	500082	116	590171	68	600169-6	131	690198	140	702159	8	708046	4	708557	7
320139	65	500083	116	590172	68	600172	130	690199	140	703005	10	708156	10	708558	7
320140	64	500084	116	590177	67	600173-6	131	690200	140	703006	10	708176-5	10	708559	7
320141	64	500085	116	590178	67	600175	130	690201	137	703007	10	708181	10	708560	7
320143	65	500088	115	590179	67	600176	129	691013	142	703008	10	708197-5	10	708601	8
320144	65	500094	115	590251	67	600180	130	691015	98	703101	10	708198-5	10	708602	8
320145	65	501051	58	590252	67	600181-6	131	691020	140	703102	10	708209	3	708603	8
320146	64	501071	116	590253	67	600183-6	131	696087	80	703103	10	708209-4	3	708604	8
320147	64	580009	39	590254	67	600184	130	696097	80	703104	10	708210	3	708605	8
320148	64	580037	106	590255	67	600185-6	131	696107	80	704032	10	708211	3	708606	8
320149	55	580038	106	590256	67	600186	130	697002	78	704065	31	708211-4	3	708608	8
320151	64	580039	106	590263	68	600191	131	697007	78	704066	31	708212	3	708609	8
320170	64	580040	106	590264	68	600196-6	129	697011	78	704068	31	708212-4	3	708610	8
320171	64	580041	106	591009	70	600198	130	697012	78	704069	31	708309	3		

PART #	PG	PART #	PG	PART #	PG	PART #	PG	PART #	PG	PART #	PG	PART #	PG		
708615	8	71-20	109	714521	23	714581	24	714916	22	715431	21	715915	22	716104	24
708617	8	712245	15	714522	23	714581	27	714917	22	715432	21	715916	22	716105	24
708618	29	712323	17	714523	23	714582	24	714918	22	715433	21	715917	22	716106	24
709002	9	712479	15	714524	23	714582	27	714919	22	715434	21	715918	22	716107	24
709006	9	712638	13	714525	23	714589	24	714920	22	715435	21	715919	22	716109	24
709091	10	712639	13	714526	23	714589	27	714921	22	715436	21	715920	22	716113	24
709216	7	712640	13	714527	23	714590	24	714942	27	715437	21	715921	22	716115	24
709217	7	712641	13	714528	23	714590	27	714943	27	715438	21	715922	22	716138-5	9
709218	7	712642	13	714529	23	714591	22	714944	27	715439	21	715923	21	716144	27
709226	7	712643	13	714530	23	714592	22	714945	27	715440	21	715924	21	716145	27
709275	9	712644	13	714531	23	714593	22	714946	27	715441	21	715925	21	716146	27
709276	9	712646	13	714532	23	714601	22	714947	27	715442	21	715926	21	716147	27
709329	3	712647	13	714533	23	714602	22	715101	13	715443	21	715927	21	716152	27
709407	24	712648	30	714534	23	714603	22	715131	23	715444	21	715928	21	716153	27
709422	24	712896	17	714535	23	714604	22	715132	23	715445	21	715929	21	716154	27
709448	27	712897	17	714536	23	714605	22	715133	23	715446	21	715930	21	716155	27
709449	27	712898	17	714537	23	714606	22	715141	23	715447	21	715931	21	716187	27
709450	27	712900	17	714538	23	714607	24	715148	12	715448	21	715932	21	716188	27
709589	24	712908	14	714539	23	714607	27	715150	12	715449	21	715934	21	716189	27
709623	27	712979	32	714540	23	714608	24	715153	23	715450	21	715935	22	716190	27
709624	27	713104	14	714541	23	714608	27	715154	23	715451	21	715936	22	716205	27
709650	27	713105	14	714542	23	714620	11	715166	12	715452	21	715937	22	716206	27
709651	27	713113	14	714543	23	714621	11	715168	12	715453	21	715938	22	716207	27
709673	24	713118	13	714544	23	714622	11	715198	9	715454	21	715939	22	716208	27
709674	24	713119	13	714545	22	714623	11	715203	9	715455	21	715940	22	716314	34
709701	27	713120	13	714546	22	714624	11	715212	14	715456	21	715941	22	716318	35
709702	27	713121	13	714547	22	714625	11	715213	14	715457	21	715942	22	716319	21
709732	27	713154	15	714548	22	714626	11	715372	26	715458	21	715943	22	716320	21
709733	27	713198	4	714549	22	714627	11	715373	26	715459	21	715944	22	716321	21
709748	24	713204	13	714550	22	714628	11	715374	26	715460	21	715945	22	716323	21
709785	24	713404	17	714551	22	714629	11	715401	21	715529	11	715946	22	716324	21
709855	24	713407	14	714552	22	714630	11	715402	21	715620	11	715953	21	716325	22
709910	33	713444	12	714553	22	714631	11	715403	21	715733	21	715954	21	716326	22
709912	34	713445	12	714554	22	714646	11	715404	21	715778	12	715955	21	716327	22
709915	34	713752	13	714555	22	714647	11	715405	21	715779	12	715962	22	716328	22
709916	34	713759	16	714556	22	714648	11	715406	21	715786	17	715963	22	716329	22
709921	35	713760	16	714557	22	714649	11	715407	15	715859	23	715964	22	716330	22
709931	24	713769	16	714558	22	714656	22	715408	21	715860	23	715971	21	716331	23
709932	24	713785	14	714559	22	714672	14	715409	21	715861	23	715972	21	716332	23
709941	33	713786	14	714560	22	714673	14	715410	21	715885	15	715973	21	716333	23
709942	33	713787	14	714561	22	714674	14	715411	21	715886	15	715980	22	716334	23
709948	33	713787	14	714562	22	714675	14	715412	21	715887	15	715982	22	716335	23
709949	33	713789	14	714563	22	714720	12	715413	21	715888	15	715983	22	716336	23
709950	34	713796	13	714564	22	714721	12	715414	21	715889	15	715985	24	716337	23
709951	34	713798	13	714566	22	714782	17	715415	21	715899	21	715986	24	716338	23
709952	34	713883	15	714567	22	714783	17	715416	21	715900	21	715987	24	716339	23
709953	34	713993	13	714568	22	714784	17	715417	21	715901	21	715988	24	716340	23
709954	35	714146	17	714569	22	714785	17	715418	21	715902	21	715989	24	716341	23
709964	34	714147	17	714570	22	714904	22	715419	21	715903	21	715990	24	716342	23
709965	34	714256	24	714571	22	714905	22	715420	21	715904	21	715991	24	716343	21
709993	24	714256	24	714572	22	714906	22	715421	21	715905	21	715992	24	716344	21
709994	24	714258	24	714573	22	714907	22	715422	21	715906	21	715997	24	716345	21
709995	24	714258	24	714574	22	714908	22	715423	21	715907	21	715998	24	716346	21
710011	34	714403	14	714575	24	714909	22	715424	21	715908	21	716011	24	716347	21
71-13	109	714515	23	714575	24	714910	22	715425	21	715909	21	716012	24	716348	21
71-14	109	714516	23	714576	24	714911	22	715426	21	715910	21	716053	24	716349	22
71-15	109	714517	23	714577	24	714912	22	715427	21	715911	22	716054	24	716350	22
71-16	109	714518	23	714578	24	714913	22	715428	21	715912	22	716055	24	716351	22
71-18	109	714519	23	714579	24	714914	22	715429	21	715913	22	716056	24	716352	22
		714520	23	714580	24	714915	22	715430	21	715914	22	716103	24	716353	22



PART NO. INDEX (cont.)

PART #	PG	PART #	PG	PART #	PG	PART #	PG	PART #	PG	PART #	PG	PART #	PG	PART #	PG
716354	22	716416	21	716577	23	716637	21	716697	23	716757	22	718506	25	728511	25
716355	23	716417	22	716578	23	716638	21	716698	23	716758	22	718507	25	728512	25
716356	23	716418	22	716579	23	716639	21	716699	23	716759	22	718508	25	728513	25
716357	23	716419	22	716580	23	716640	21	716700	23	716760	22	718509	25	728514	25
716358	23	716420	22	716581	23	716641	21	716701	23	716761	22	718510	25	728515	25
716359	23	716421	22	716582	23	716642	21	716702	23	716762	22	718511	25	728516	25
716360	23	716422	22	716583	23	716643	21	716703	23	716763	22	718512	25	728517	25
716361	23	716423	23	716584	23	716644	21	716704	22	716764	22	718513	25	728518	25
716362	23	716424	23	716585	23	716645	21	716705	22	716765	22	718514	25	728519	25
716363	23	716425	23	716586	23	716646	21	716706	22	716766	22	718515	25	728520	25
716364	23	716426	23	716587	23	716647	21	716707	22	716767	22	718516	25	728521	25
716365	23	716427	23	716588	23	716648	21	716708	22	716768	22	718517	25	728522	25
716366	23	716428	23	716589	23	716649	21	716709	22	716769	22	718518	25	728523	25
716367	21	716429	23	716590	21	716650	21	716710	22	716770	22	718519	25	728524	25
716368	21	716430	23	716591	21	716651	21	716711	22	716771	22	718520	25	728525	25
716369	21	716431	23	716592	21	716652	21	716712	22	716772	22	718521	25	728526	25
716370	21	716435	22	716593	21	716653	21	716713	22	716773	22	718522	25	728527	25
716371	21	716436	22	716594	21	716654	21	716714	22	716774	22	718523	25	728528	25
716372	21	716437	22	716595	21	716655	21	716715	22	716775	22	718524	25	728529	25
716373	22	716498	24	716596	21	716656	21	716716	22	716776	22	718525	25	728530	25
716374	22	716499	24	716597	21	716657	21	716717	22	716777	22	718526	25	730101	29
716375	22	716500	24	716598	21	716658	21	716718	22	716778	22	718527	25	730102	29
716376	22	716501	24	716599	21	716659	21	716719	22	716779	22	718528	25	730103	29
716377	22	716502	24	716600	21	716660	21	716720	22	716780	22	718529	25	730104	29
716378	22	716503	24	716601	21	716661	21	716721	22	716781	22	718530	25	730105	29
716379	21	716504	24	716602	21	716662	21	716722	22	716782	22	721090	17	730106	29
716380	21	716505	24	716603	21	716663	21	716723	22	716783	22	721092	17	730108	29
716381	21	716506	24	716604	21	716664	21	716724	22	716784	22	72-15	109	730111	29
716382	21	716507	24	716605	21	716665	21	716725	22	716785	22	72-16	109	730112	29
716383	21	716508	24	716606	21	716666	21	716726	22	716786	22	72-18	109	730114	29
716384	21	716509	24	716607	21	716667	21	716727	22	716787	22	72-20	109	730115	29
716385	22	716515	24	716608	21	716668	21	716728	22	716900	14	723047	30	730116	28
716386	22	716516	24	716609	21	716669	21	716729	22	716901	14	723049	30	730117	28
716387	22	716517	24	716610	21	716670	21	716730	22	716902	13	723050	9	730122	29
716388	22	716518	24	716611	21	716671	21	716731	22	716903	13	723055	30	730123	29
716389	22	716519	24	716612	21	716672	21	716732	22	716906	13	723057	30	730124	29
716390	22	716520	24	716613	21	716673	21	716733	22	716907	13	723060	9	730125	29
716391	21	716521	24	716614	21	716674	23	716734	22	716908	13	723065	9	730126	29
716392	21	716522	24	716615	21	716675	23	716735	22	716909	13	723068-6	9	730128	28
716393	21	716523	24	716616	21	716676	23	716736	22	716911	29	723075	9	730129	28
716394	21	716524	24	716617	21	716677	23	716737	22	716913	11	723095	9	730194	28
716395	21	716525	24	716618	21	716678	23	716738	22	716914	11	723097	9	730195	28
716396	21	716526	24	716619	21	716679	23	716739	22	716915	11	723100	30	730196	28
716397	22	716560	23	716620	21	716680	23	716740	22	716916	11	723103	8	730200	28
716398	22	716561	23	716621	21	716681	23	716741	22	716917	11	723104	8	730201	28
716399	22	716562	23	716622	21	716682	23	716742	22	716918	11	723106	15	730202	28
716402	23	716563	23	716623	21	716683	23	716743	22	716919	11	723107	15	730204	28
716403	23	716564	23	716624	21	716684	23	716744	22	716922	11	724007	17	730206	28
716404	23	716565	23	716625	21	716685	23	716745	22	716929	13	724008	17	730209	28
716405	23	716566	23	716626	21	716686	23	716746	22	718389-5	22	727067	17	730210	28
716406	23	716567	23	716627	21	716687	23	716747	22	718390-5	22	728501	25	730212	28
716407	23	716568	23	716628	21	716688	23	716748	22	718391-5	22	728502	25	730214	28
716408	23	716569	23	716629	21	716689	23	716749	22	718392-5	9	728503	25	730215	28
716409	23	716570	23	716630	21	716690	23	716750	22	718393-5	9	728504	25	744001	27
716410	23	716571	23	716631	21	716691	23	716751	22	718394-5	9	728505	25	744002	27
716411	21	716572	23	716632	21	716692	23	716752	22	718501	25	728506	25	744003	27
716412	21	716573	23	716633	21	716693	23	716753	22	718502	25	728507	25	744004	27
716413	21	716574	23	716634	21	716694	23	716754	22	718503	25	728508	25	744005	27
716414	21	716575	23	716635	21	716695	23	716755	22	718504	25	728509	25	744006	27
716415	21	716576	23	716636	21	716696	23	716756	22	718505	25	728510	25	744007	27



PART NO. INDEX (cont.)

PART #	PG	PART #	PG	PART #	PG	PART #	PG	PART #	PG	PART #	PG	PART #	PG
744008	27	747386	3	747855	24	747901	24	748416	31	75-24	109	76-22	109
744009	27	747387	3	747856	24	748009	32	75-14	109	757015	31	76-24	109
744010	27	747451	3	747863	24	748012	32	75-15	109	757016	31	76-28	109
744011	27	747524	24	747864	35	748029	31	75-16	109	76-14	109	790563	35
744012	27	747551	24	747865	35	748215	30	75-17	109	76-15	109	790564	35
744013	27	747632	24	747866	35	748216	15	75-18	109	76-16	109	790567	35
744014	27	747633	24	747867	35	748269	30	75-19	109	76-18	109	790573	35
747053	30	747785	27	747881	35	748304	24	75-20	109	76-19	109	Q781280	15
747070	30	747786	27	747882	35	748355	32	75-21	109	76-20	109	W15	109
747072	30	747850	35	747883	35	748377	32	75-22	109	76-21	109	W16	109
												W18	109
												W20	109
												W22	109
												W24	109
												W28	109
												WN13	109
												WN15	109
												WN16	109
												WN18	109

For 24 hour access log on to our **Business-to-Business website**

Go to www.velvac.com

On the left side navigation click on B2B

Or go directly to <https://secure.velvac.com>

PLACE ORDERS 24/7: No need to wait for the office to open to receive your order.

IMMEDIATE ACKNOWLEDGEMENT WITH ORDER NUMBER: No need to contact Velvac to verify receipt of the order, but if needed, you get quick response with your reference number.

ENTER ORDER DIRECTLY INTO VELVAC'S SYSTEM: Order can be entered online or uploaded from an excel file or a .csv file. No need to wait for a customer service rep to manually enter order, thus shortening time from when order is placed to when it ships to you.

ACCURACY IMPROVEMENT: Accuracy of orders improves, as you can review and verify your order online prior to submitting to Velvac.

24/7 ACCESS TO ORDER STATUS: Full access on line any day or time allows you to get information as to when your order shipped and/or how to track it if necessary.

24/7 ACCESS TO ORDER HISTORY: You can review order and part number history for the previous six months. There is an easy process to repeat an order previously submitted without re-entering all of the part numbers.

COMFORT OF A SECURE SITE: The site is secured and verified.

VELVAC

A LONG STANDING COMMITMENT TO CUSTOMERS AND QUALITY

The Vacuum Power Equipment Company opened its doors for business in 1934, beginning a long tradition of quality manufacturing and focused customer service. In 1940, the corporate name changed to “Velvac” to encompass its popular Velvet Vacuum Brakes brand. Our product line expanded over the years and now includes over 3,000 popular vehicle components. The Velvac® wide angle mirror system is recognized as the industry standard by walk-in-van manufacturer’s and delivery fleets nationwide.

As a leading supplier to the truck equipment aftermarket, heavy and medium duty truck OEM’s, recreational and specialty vehicle markets, Velvac continually upgrades and expands its operations and quality systems to exceed customer expectations while developing and manufacturing revolutionary new products to meet its markets’ changing needs. In addition, we strive to make doing business with us easy. Experienced, friendly customer service and technical support personnel team up with knowledgeable sales staff to answer questions and simplify ordering. Our business-to-business website allows customers access to account information 24/7, including order tracking details and order upload capabilities. EDI, data file transfers, electronic ship notices and a host of other services round out the technological support Velvac provides to meet a wide variety of customer requirements. Velvac is a multinational company with global offices and primary warehouse in



New Berlin, Wisconsin and a full-scale manufacturing and assembly facility in Reynosa, Mexico. Well-stocked remote warehouses strategically located in California, Texas and Ontario ensure fast delivery of popular items anywhere in North America.

Velvac product lines have continued to expand over the years and now includes over 3400 popular vehicle components and accessories. The Velvac Wide Angle mirror system, 2020 and 2020XG mirrors for cutaway vans and pick up truck’s, and recently acquired K-10 line of Eyeball mirrors are all examples of products that have become recognized as industry standards for their vehicle applications.

VELVAC

THE BRAND

For 75 years, Velvac has been providing high quality, innovative products with a focus on safety, value, and great customer service. Our commitment to meeting our customers' changing product and service needs has never been stronger, as evidenced by our greatly expanded range of offerings aimed at keeping our customers in the truck and transportation industries highly competitive.

Velvac's position as a broad based OEM product supplier, combined with highly efficient manufacturing and supply chain management, allow us to offer our customers both proprietary products, as well as a competitive, broad based line of industry standard products, making Velvac your one stop shop for mirrors, air and electrical products, fittings, fuel caps and other high volume and hard to find truck accessories.

At Velvac, our mission is to improve customer safety and well being by offering superior products that fully satisfy our customers' needs, and by being better, faster and easier to do business with than our competitors.



2405 South Calhoun Road
New Berlin, Wisconsin 53151-2709
tel 262.786.0700
fax 262.786.4101

©2009 Velvac, Inc. Printed in U.S.A. Part No. TE097

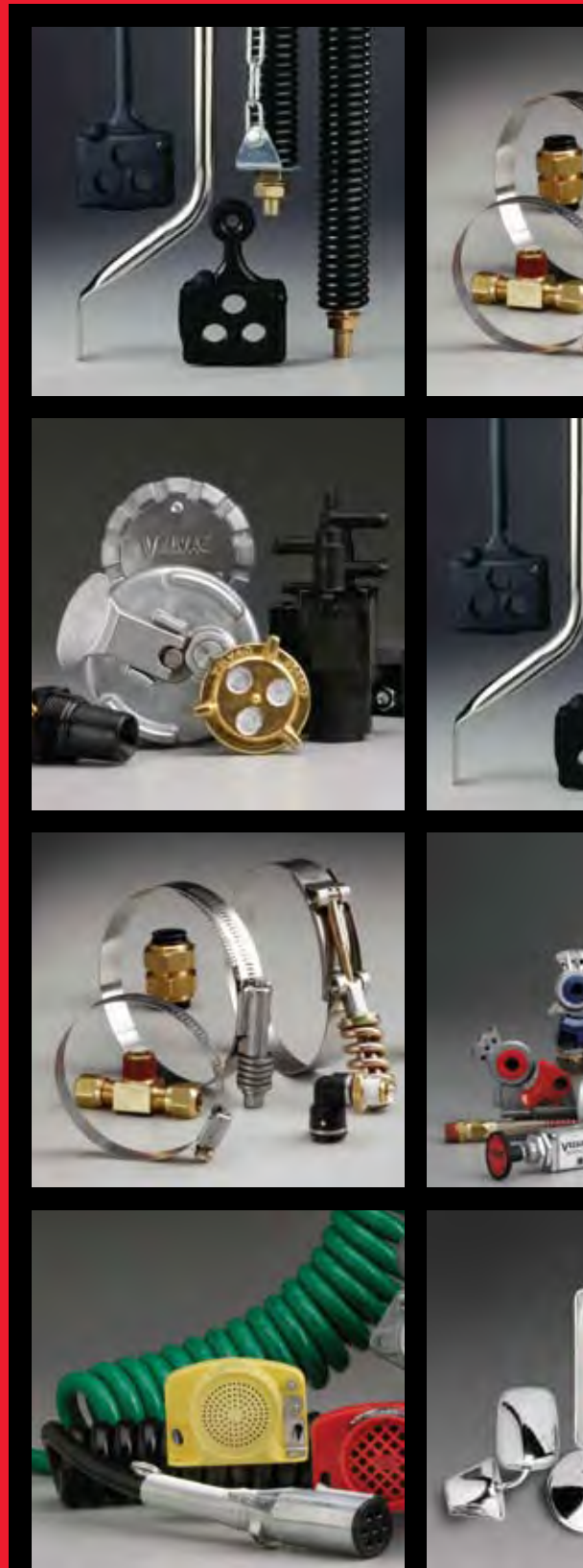

800.783.8871
www.velvac.com
sales@velvac.com