

Maestro Dual Tech Sensor Switch Additional Programming, Installation, and Troubleshooting Help

Maestro Dual Tech Sensor Switch Models

No Neutral Required:

- MS-A102-XX - Single Circuit
- MS-A102-V-XX - Single Circuit Vacancy Sensor
- MS-A202-XX - Dual Circuit

Neutral Required:

- MS-B102-XX – Single Circuit
- MS-B102-V-XX – Single Circuit Vacancy Sensor
- MS-B202-XX – Dual Circuit

Overview

This document serves as a supplement to both the Single and Dual circuit Maestro Dual Technology Sensor switch Installation Guides.

Note: For performance specifications, including load ratings, see the Maestro Dual Technology Sensor switch spec submittal (P/N 369773) at www.lutron.com/TechnicalDocumentLibrary/369773_ENG.pdf

Single Circuit Dual Technology Sensor Switch (shown without faceplate)

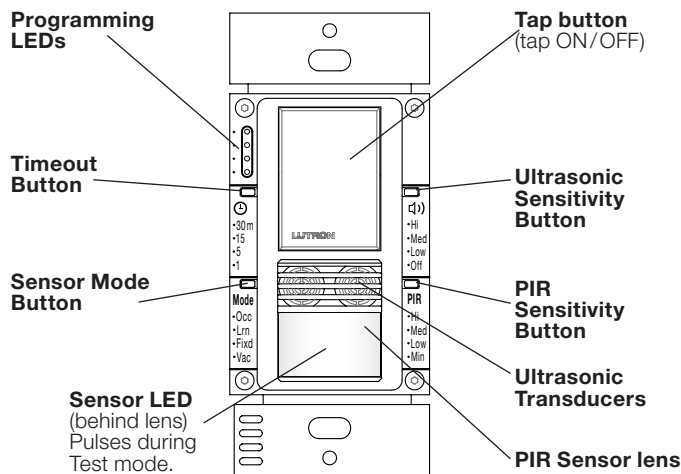

Dual Circuit Dual Technology Sensor Switch (shown without faceplate)

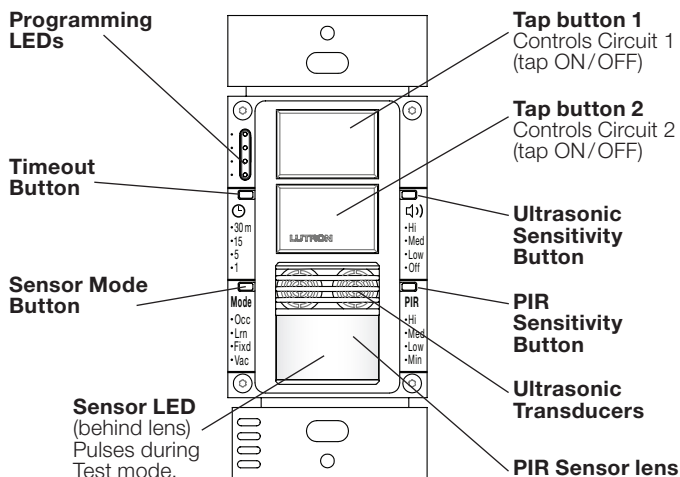

Table of Contents

GlossaryPage 3
Dual Technology Sensor switch Coverage Area.....Page 4

Single Circuit Dual Technology Sensor Switch

Programmable FeaturesPage 5-8
ProgrammingPage 9-12
Additional Programming OptionsPage 13
Restoring Default SettingsPage 13
Wiring DiagramsPage 14-17

Dual Circuit Dual Technology Sensor Switch

Programmable FeaturesPage 18-22
ProgrammingPage 23-27
Additional Programming OptionsPage 28
Restoring Default SettingsPage 28
Wiring DiagramsPage 29-31

Additional Help

Learning Ambient Light Detect (ALD) - How it worksPage 33
Considerations for ALD in Dual Circuit (MS-A202 , MS-B202)Page 34
Troubleshooting.....Page 35-36

Glossary

Timeout – Setting that determines how long the lights will remain ON after the room has been vacated, and motion has not been detected.

Sensor Mode – Setting that determines how your sensor will respond upon detecting initial occupancy. There are four available settings: Occupancy (Occ), Occupancy with Learning ALD (Lrn), Occupancy with Fixed ALD (Fixd), Vacancy (Vac)

Occupancy – The sensor automatically turns ON when you enter the room, and turns off when you vacate the room.

Occupancy with Learning ALD – The sensor automatically turns the lights ON when you enter the room, and there is not enough ambient light in the room. If there is enough light, it will NOT turn the lights ON. If it did not respond as you desired, press the tap button within 5 seconds of entering the room to change the state of the lights. The sensor will learn your preference for how much ambient light is enough, based on these interactions. The sensor will turn the lights off when the room is vacated.

Occupancy with Fixed ALD – The sensor automatically turns the lights ON when you enter the room, and there is not enough ambient light in the room. The sensor will determine how much ambient light is enough, based on a fixed level you select. The sensor will turn the lights off when the room is vacated.

Vacancy – The lights will only turn ON if the tap button is pressed. The sensor will turn the lights off when the room is vacated.

Ultrasonic Sensitivity – Setting that adjusts the level of Ultrasonic sensitivity your sensor will use to detect motion.

PIR Sensitivity – Setting that adjusts the level of Passive Infrared sensitivity your sensor will use to detect motion.

Test Mode – A short Timeout with LED feedback to help the user determine sensor coverage in the space.

Off-While-Occupied – Setting that determines whether or not the lights will stay off when the sensor has been manually turned off, but motion is still detected.

Indicator LEDs – LEDs that are used to program your sensor switch

Tap Button – Large button used for turning the load ON/OFF manually.

Sensor LEDs – LEDs under the sensor lens that are used to show when motion is detected during Test Mode.

Zone Mapping – Allows user to re-assign zones in dual circuit sensor switches without rewiring.

Major Motion – Large movements like walking, standing up, sitting down, etc.

Minor Motion – Small movements like drinking a cup of coffee, turning the page of a book, etc.

Fine Motion – Very small movements like reading a magazine.

Walk-Thru Mode – Setting that turns the lights off before Timeout has expired if occupancy is only detected for a brief period.

Dual Technology Sensor Switch Coverage Area

NEMA WD7 Coverage

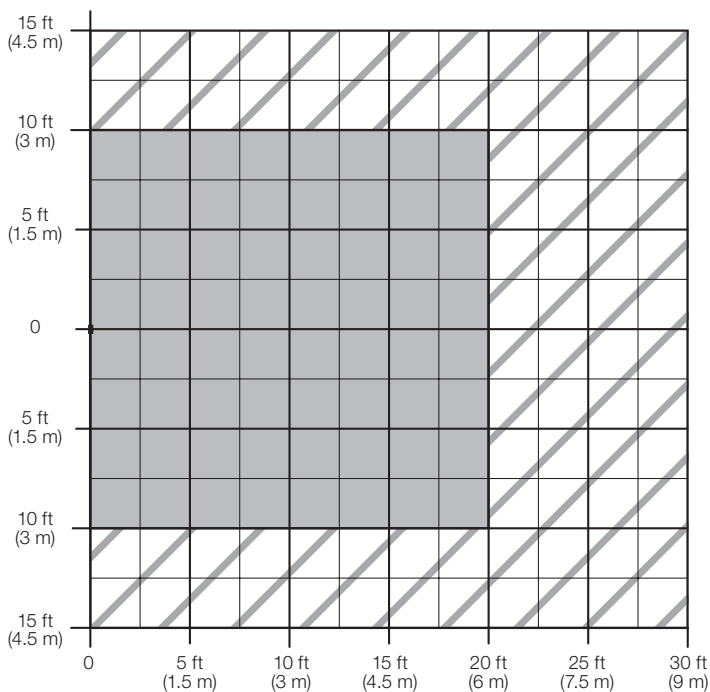
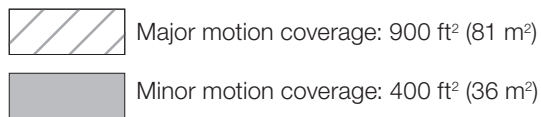

Test Room Dimensions: 37 ft x 38 ft (11.28 m x 11.6 m)
 Test Floor Surface Material: Carpet
 Sensor Coverage Angle: 180 °
 Major motion coverage: Initial trigger motion detection
 Minor motion coverage: Maintained motion detection

Passive Infrared Beam Diagram (For Reference Only)

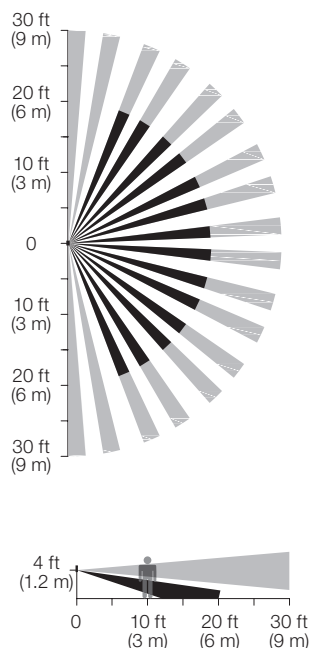

Ultrasonic Coverage (For Reference Only)

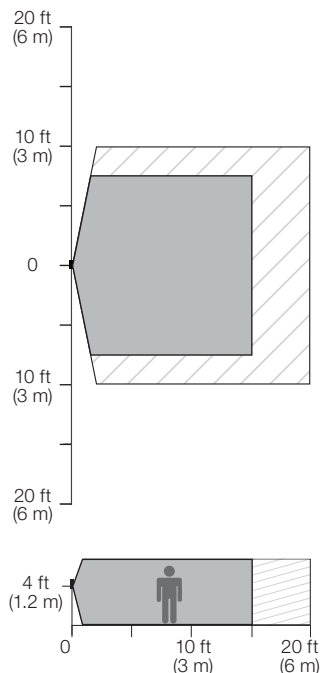

Ultrasonic Frequency: 40 kHz

Maestro Single Circuit Dual Technology Sensor Switch

Programmable Features

The Sensor switch has many features to allow you to configure the unit to meet your individual needs. The following is an overview of all the product features.

Default settings are shown in **bold**

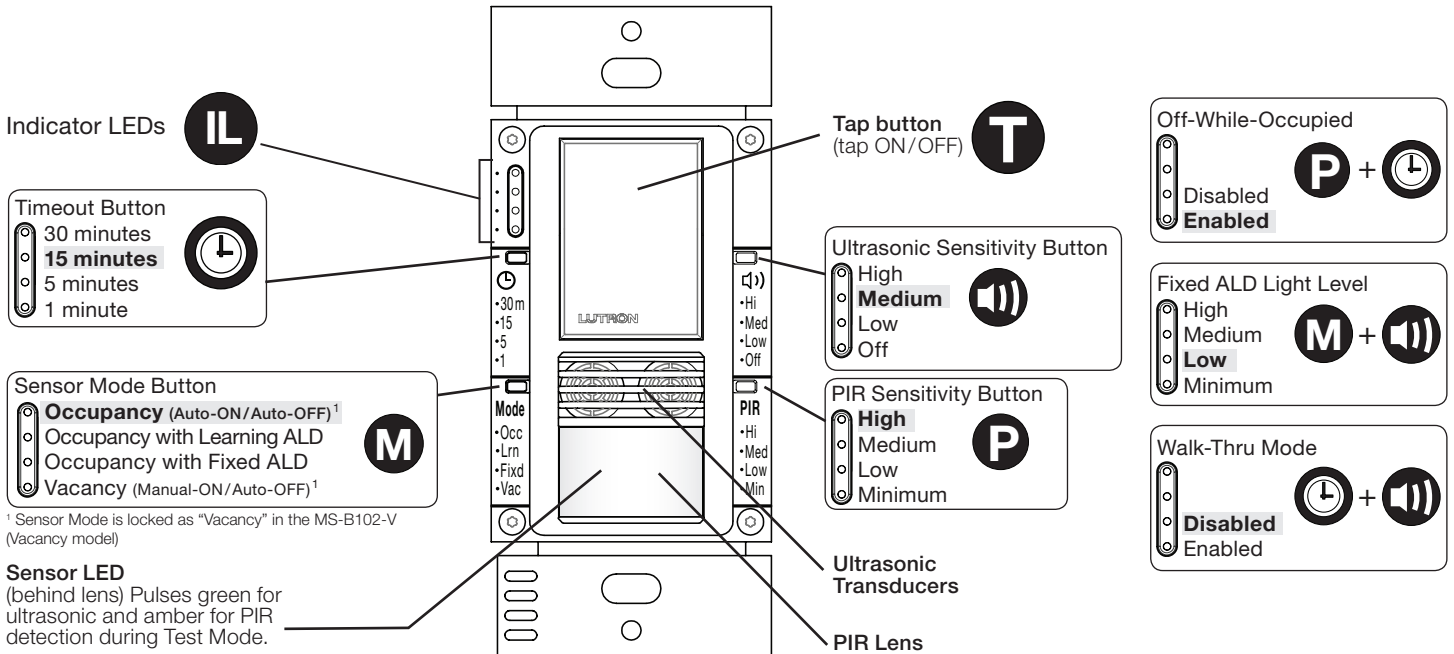

Maestro Single Circuit Dual Technology Sensor Switch

Explanation of Programmable Features

T - **Timeout:** The time after which the lights will go out after the last motion is detected. The Timeout can be adjusted to 1, 5, 15, or 30 minutes. The default Timeout is 15 minutes.

What do I want?

- The ideal Timeout for an application may vary depending on the size of the room in which the unit is installed. The position of the sensor in relation to activity as well as the typical duration of stay will influence your desired Timeout setting. In a room where occupants dwell for longer periods of time, a longer Timeout value is recommended. For most conference rooms and offices, a Timeout of no less than 5 minutes is advised to ensure the desired light level is maintained throughout occupancy of the space.
- In applications where the sensor switch is controlling fluorescent or CFL bulbs, a Timeout of no less than 15 minutes is recommended to maintain bulb life.

M - **Sensor Mode:** The automatic functionality of the sensor can be adjusted to change how the lights respond upon initial occupancy. There are four available Sensor Modes: Occupancy Mode (Occ), Occupancy with Learning ALD Mode (Lrn), Occupancy with Fixed ALD Mode (Fixd), and Vacancy Mode (Vac). All sensor modes will turn the lights OFF when no motion has been detected and the Timeout has expired.

- **Occupancy (Auto-ON/Auto-OFF):** The lights will always turn ON when motion is detected.
- **Occupancy with Learning ALD:** The lights will turn ON when motion is detected and ambient light is too low. The lights will remain OFF if there is sufficient ambient light in the room. Further details on how Learning ALD works can be found on page 31.

How the sensor learns your preference: If the lights turn ON when there is already enough natural light, or if they remain OFF when there is not enough natural light, simply press the Tap button to toggle the lights. If the tap button is pressed within 5 seconds of entering the space, the sensor will learn your preference for when to keep the lights off, and when to turn them ON, based on the natural light in the room.

- **Occupancy with Fixed ALD:** The lights will turn ON when motion is detected and ambient light is too low. If there is sufficient ambient light in the room, the lights will remain off when motion is detected. The default fixed level is "Low". To change your fixed light level, see "Setting the Fixed ALD Light Level" programming instructions (pg.10).
- **Vacancy (Manual-ON/Auto-OFF):** The lights will NOT turn ON automatically. Lights will only turn ON when the Tap button has been pressed.

What do I want?

- If you want the lights to always automatically turn ON when someone enters the room, the sensor mode should be set to "Occupancy (Auto-ON / Auto-OFF)."
- If you prefer that the lights only turn ON when the Tap button is pressed, choose Vacancy (Manual-ON / Auto-OFF). The unit will only turn off automatically when occupancy is no longer detected. Bedrooms are a typical application where Manual-ON mode would work better than Auto-ON mode for most users.
- If you'd like the lights to turn ON, but want to keep the lights off when there's plenty of daylight, "Occupancy with Learning ALD" is a great way to teach the sensor your preferred light level for when lights should remain off.
- If you'd like the lights to turn ON, but want to keep the lights off when there's plenty of daylight, and you'd like to LOCK the setting that determines how much light is needed to keep lights off, "Occupancy with Fixed ALD" is the best option. This setting is ideal for conference rooms with many different users and plenty of natural light. In a busy conference room, this setting will provide consistent, convenient energy savings and ambiance.
- Neither Occupancy with Learning ALD, nor Occupancy with Fixed ALD are recommended for any circuit controlling a fan load, unless the intent is that the fan turns ON or OFF based on the light level in the room.

Maestro Single Circuit Dual Technology Sensor Switch

Explanation of Programmable Features (continued)

P - PIR (Passive Infrared) Sensitivity: The PIR sensitivity of the sensor can be adjusted based on the expected level of activity in the room. The default setting is "High Sensitivity" which will perform best for most applications. Rarely, if the sensor is placed near external noise sources such as heating and cooling vents, it may turn the lights ON without occupancy. If this occurs, lowering the sensitivity to Medium, Low, or Minimum may resolve the problem.

- **High Sensitivity**
- **Medium Sensitivity**
- **Low Sensitivity**
- **Minimum Sensitivity**

What do I want?

- The type of activity and amount of foot traffic will help dictate at which setting the sensor should be set. "High Sensitivity" is recommended for spaces where the occupants will often be seated for long periods of time and performing fine motions such as turning a page. "Low Sensitivity" is recommended for spaces that generally only experience large motions such as foot traffic.
- Lutron Dual Tech Sensor switches operate by triggering initial occupancy using the Passive Infrared (PIR) technology. They maintain the occupied state with both PIR and Ultrasonic (US) sensors. If you are having problems where the lights turn ON when unwanted, lower the PIR sensitivity. If you are having problems where the lights are staying ON too long, once the room has been vacated, consider lowering the Ultrasonic Sensitivity (US) first.
- Additionally, if the sensor sees a specific area that is not desired (ex: a hallway outside of the room in which the sensor is installed), Lutron offers a lens mask kit (Lutron P/N 50013614) that can be ordered through Customer Assistance (1.844.LUTRON1). Alternatively, selectively placing opaque tape (painters tape, electrical tape, masking tape, etc.) over certain parts of the lens can limit its field of vision to block undesired detection areas. Masking the lens may affect ALD performance, but DOES NOT block ultrasonic frequencies.

U - Ultrasonic Sensitivity (US): The Ultrasonic sensitivity of the sensor can be adjusted based on the expected level of activity in the room. The default sensitivity setting is "Medium Sensitivity". Ultrasonic sensing is only used to maintain occupancy. Changing this setting will NOT affect how the sensor responds upon initial occupancy of the space.

- **High Sensitivity**
- **Medium Sensitivity**
- **Low Sensitivity**
- **Off**

What do I want?

- Ultrasonic sensing excels at detecting minor motion in the coverage area, and as a result, is more sensitive to external interference than Passive Infrared (PIR) detection. For this reason, Lutron Dual Tech Sensor switches only use ultrasonic detection to maintain occupancy. If you find that the lights in your space turn ON when expected, but sometimes stay ON too long, it is best to lower the ultrasonic sensitivity before lowering the PIR sensitivity.
- If your lights turn OFF while the room is occupied, consider extending the Timeout, or increasing ultrasonic sensitivity.

Maestro Single Circuit Dual Technology Sensor Switch

Explanation of Programmable Features (continued)

Off-While-Occupied: This setting determines how the sensor will respond when the lights are turned off, and the room remains occupied. Changing this setting will modify the behavior of all sensor modes, except for Vacancy mode.

- **Off-While-Occupied Enabled:** If the lights are manually turned off, the sensor will keep those lights off as long as the room is occupied, and the Timeout has not expired. This is the default setting of the Off-While-Occupied mode.
- **Off-While-Occupied Disabled:** If the lights are manually turned off, the sensor will wait for 25 seconds before trying to detect occupancy again. The 25 second period is designed to allow occupants to exit a room without re-triggering the lights, but still provide the necessary Auto-ON functionality for high-traffic areas. If the lights are turned off, and someone remains in the room, the lights will turn back ON when motion is detected, after about 25 seconds.

What do I want?

- If you want the lights to automatically turn ON when someone enters the room, and your application is a high-traffic area (bathroom, hallway, etc), "Off-While-Occupied Disabled" is recommended, to keep the sensor as responsive to brief occupancy as possible.
- If you want the lights to automatically turn ON when someone enters the room, but you also would like to be able to turn the lights off and have them stay off while the room is occupied (i.e. conference room presentations, movies, etc), then "Off-While-Occupied Enabled" is recommended. It is also likely that your Timeout for this application should be greater than 5 minutes in situations where movement is minimal.

Fixed ALD Light Level: When a unit is set to "Occupancy with Fixed ALD" mode, the light level at which the lights will remain off when the space is occupied can be adjusted. If the light in the room is higher than the level set by the user, the lights will remain off. If the light in the room is lower than the light level set, the lights will turn ON. The default setting is "Low".

- High
- Medium
- Low
- Minimum

What do I want?

- If you set the light level to "High", the lights will almost always turn ON when motion is detected. The only time the lights will not turn ON when motion is detected is when it is extremely bright in the room.
- If you set the light level to "Minimum", the lights will almost always remain OFF. The lights will only turn ON when motion is detected, and there is very little ambient light in the room.

Walk-Thru Mode: Walk-Thru Mode is a setting that allows lights set to a long Timeout to shut off after a short duration when the space is only occupied momentarily. After initial occupancy, this mode allows the sensor to turn the lights in the room back OFF if the space is occupied for a very brief amount of time (less than 3 minutes). If motion is detected consistently within 3 minutes of initial occupancy, the sensor will keep the lights ON for the normal Timeout setting. The default setting is "Disabled".

- **Walk-Thru Mode Enabled:** If the space is occupied momentarily, the lights will turn off after 3 minutes instead of the normal Timeout setting.
- **Walk-Thru Mode Disabled:** The lights will always remain ON for the full Timeout duration.

What do I want?

- If you would like the lights in your space to turn off quickly, when the space is only briefly occupied select "Enabled". This setting is ideal for conference rooms with long Timeouts that may experience periodic brief occupancy events, such as a second-shift cleaning crew or security guard checking the campus of a commercial building.
- If you prefer consistent sensor behavior, or utilize CFL or fluorescent lights in your application, Walk-Thru mode should be "Disabled".

Notes:

- To maintain bulb life, the recommended minimum Timeout for fluorescent bulbs is 15 minutes. As a result, Walk-Thru mode is not recommended for applications with CFL or fluorescent lights.
- If Walk-Thru mode is enabled, that setting will override a 1-minute Timeout setting, if that setting is also selected. The lights will remain ON for 3 minutes at a minimum if Walk-Thru mode is enabled.

Maestro Single Circuit Dual Technology Sensor Switch

Programming

Important note before programming:

To display current settings tap the Timeout (ⓐ), Sensor Mode (Ⓜ), Ultrasonic Sensitivity (Ⓤ), or PIR Sensitivity (Ⓟ) button. The indicator LED (Ⓛ) that corresponds to the current setting will illuminate.

Selecting a Timeout Duration

1. Press and hold the Timeout button (ⓐ) until an indicator LED (Ⓛ) begins to flash (about 3 seconds).
2. Tap the Timeout button (ⓐ) to cycle to your desired Timeout setting.
3. Press and hold the Timeout button (ⓐ) until the indicator LED (Ⓛ) goes solid to lock your selection (about 3 seconds).

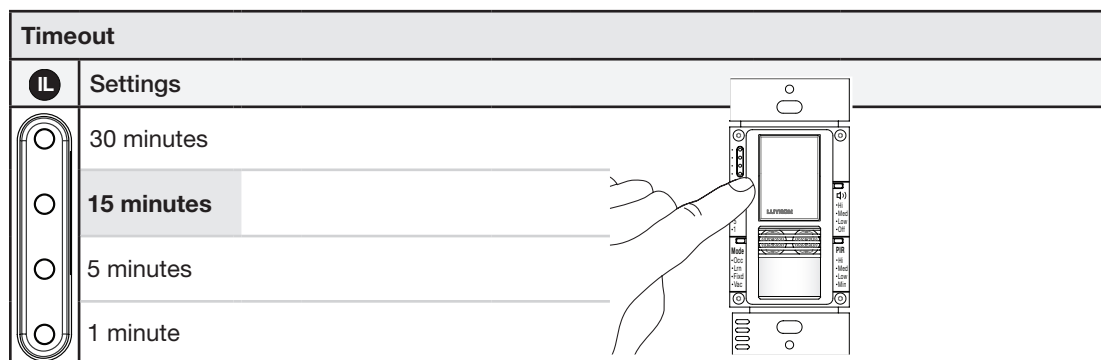

Default Setting: 15 minutes

Selecting a Sensor Mode

1. Press and hold the Mode button (Ⓜ) until an indicator LED (Ⓛ) begins to flash (about 3 seconds).
2. Tap the Mode button (Ⓜ) to cycle to your desired Sensor Mode setting.
3. Press and hold the Mode button (Ⓜ) until the indicator LED (Ⓛ) goes solid to lock your selection (about 3 seconds).

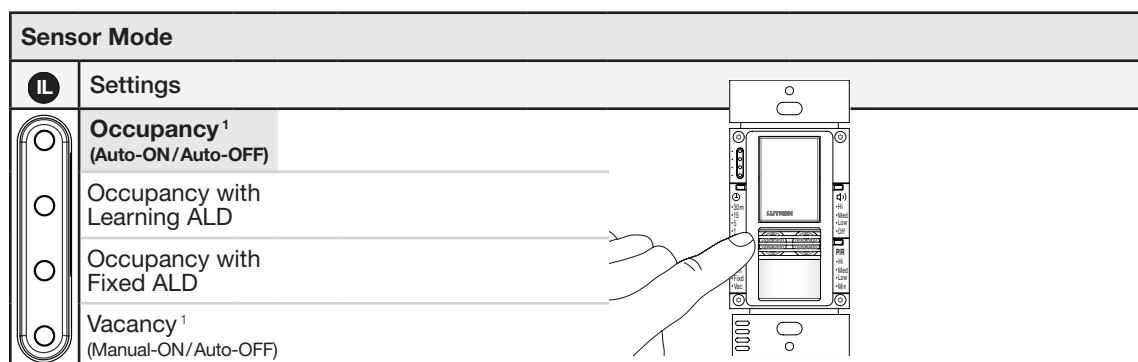

¹ Sensor Mode is locked as "Vacancy" in the MS-A102-V and MS-B102-V (Vacancy model)

Default Setting: Occupancy (Auto-ON/Auto-OFF)

Maestro Single Circuit Dual Technology Sensor Switch

Programming (continued)

Selecting the Ultrasonic Sensitivity

1. Press and hold the Ultrasonic Sensitivity button (Ⓢ) until an indicator LED (Ⓛ) begins to flash (about 3 seconds).
2. Tap the Ultrasonic Sensitivity button (Ⓢ) to cycle to your desired Ultrasonic Sensitivity setting.
3. Press and hold the Ultrasonic Sensitivity button (Ⓢ) until the indicator LED (Ⓛ) goes solid to lock your selection (about 3 seconds).

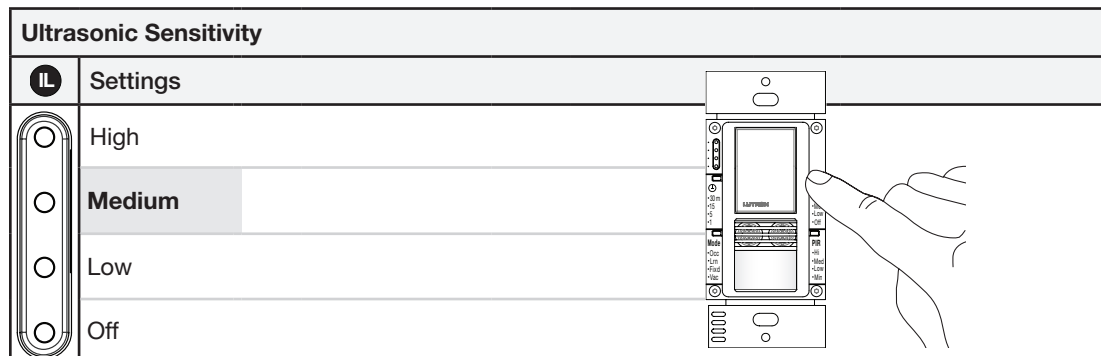

Default Setting: Medium

Selecting the PIR Sensitivity

1. Press and hold the PIR Sensitivity button (Ⓟ) until an indicator LED (Ⓛ) begins to flash (about 3 seconds).
2. Tap the PIR Sensitivity button (Ⓟ) to cycle to your desired PIR Sensitivity setting.
3. Press and hold the PIR Sensitivity button (Ⓟ) until the indicator LED (Ⓛ) goes solid to lock your selection (about 3 seconds).

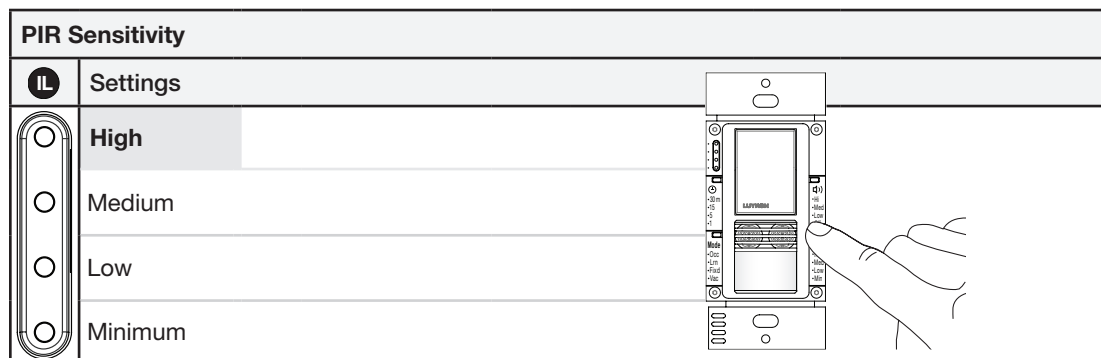

Default Setting: High

Maestro Single Circuit Dual Technology Sensor Switch

Programming *(continued)*

Changing the Off-While-Occupied Setting

1. Press and hold the Timeout (Ⓢ) and PIR (Ⓟ) buttons at the same time until an indicator LED (Ⓛ) begins to flash (about 3 seconds).
2. Tap the PIR (Ⓟ) button to cycle to your desired setting.
3. Press and hold PIR (Ⓟ) button until the indicator LED (Ⓛ) goes solid to lock your selection (about 3 seconds).

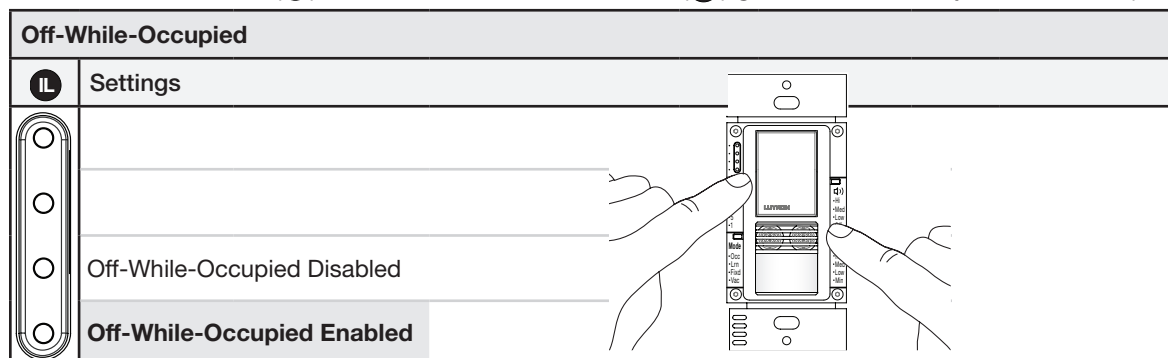

Default Setting: Off-While-Occupied Enabled

Setting the Fixed ALD Light Level

1. Press and hold the Sensor Mode (Ⓜ) and Ultrasonic (Ⓛ) buttons until the indicator LED (Ⓛ) begins to flash (about 3 seconds).
2. The Ambient Light Detect light level will now be displayed on the indicator LED (Ⓛ). Tap the Mode (Ⓜ) button to cycle to your desired setting.
3. Press and hold the Mode (Ⓜ) button until the indicator LED (Ⓛ) goes solid to lock your selection (about 3 seconds).

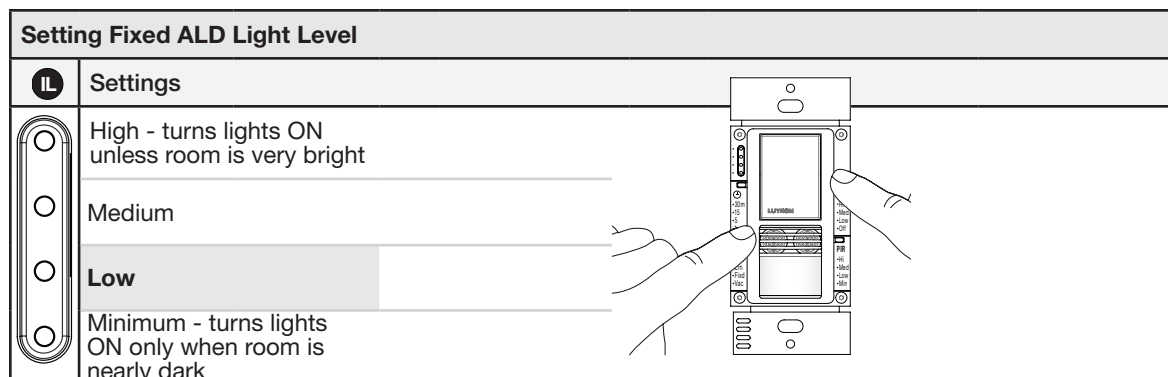

Default Setting: Low (only applies when "Fixed ALD Mode" has been selected as the active "Sensor Mode")

Maestro Single Circuit Dual Technology Sensor Switch

Programming (*continued*)

Setting Walk-Thru Mode

1. Press and hold Timeout (⌚) and Ultrasonic (🔊) buttons until an indicator LED (💡) begins to flash.
2. The Walk-Thru mode setting will now be displayed on the indicator LED (💡). Tap the Ultrasonic (🔊) button to cycle to your desired setting.
3. Press and hold the Ultrasonic (🔊) button until the indicator LED (💡) goes solid to lock your selection (about 3 seconds).

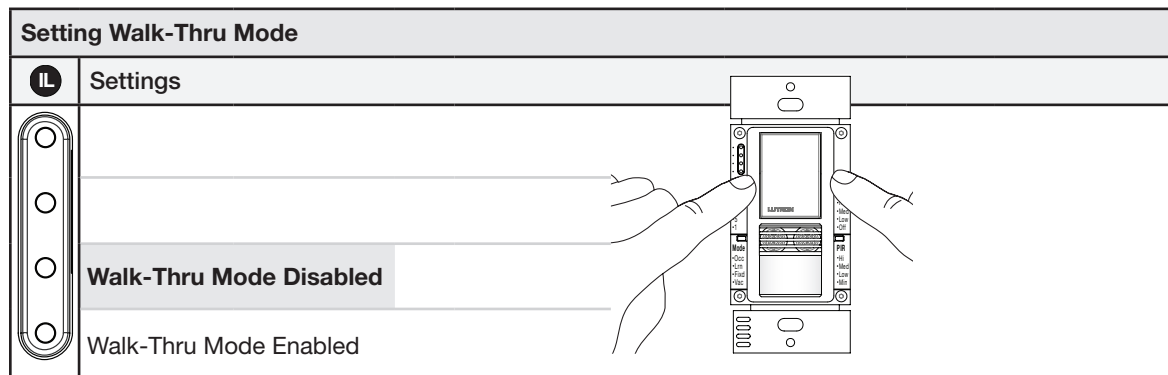

Default Setting: Disabled

Maestro Single Circuit Dual Technology Sensor Switch

Additional Programming Options

Entering and Using Test Mode

Test Mode is a short Timeout (less than 15 seconds) that will test the coverage area of the sensor with the current settings.

To enable Test Mode:

1. Press and hold the Tap button until the PIR lens flashes (about 7 seconds).
2. The device will exit Test Mode automatically after 5 minutes of inactivity, or when the Tap button is pressed.

Notes:

- An amber sensor LED flashes to indicate PIR detection, a green sensor LED flashes to indicate ultrasonic detection. If no motion is detected for the entire duration of the shorter Timeout (15 seconds), the load(s) being controlled by the sensor switch will turn off. The load(s) will turn back ON when motion is detected. You may hold **P** or **IL** for 2 seconds while in test mode to test the current sensitivity of that specific technology.
- If Test Mode is entered within 2 minutes of power-up, both sensor LEDs will blink quickly twice and repeat every 2 seconds until the sensor is ready.

Restoring Default Settings

The Sensor switch has the ability to be returned to its original default settings. This ability allows the programmer a risk-free experience to try multiple setting configurations.

Note: The default settings are:

Timeout	15 minutes
Sensor Mode.....	Occupancy (Auto-ON/Auto-OFF)
Ultrasonic Sensitivity	Medium
PIR Sensitivity	High
Off-While-Occupied	Off-While-Occupied Enabled
Fixed ALD Setting	Low
Walk-Thru Mode.....	Walk-Thru Mode Disabled

To Restore Default Settings:

Press and hold **IL** and **P** until all **IL** blink slowly (about 7 seconds). This will restore ALL of the settings back to the default settings.

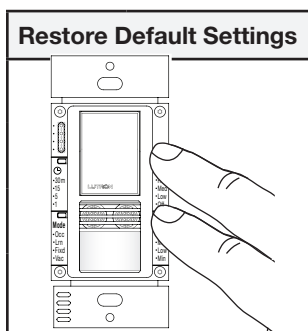

Maestro Single Circuit Dual Technology Sensor Switch

Wiring Diagrams

1 Turn power OFF

⚠ WARNING! Shock Hazard. May result in serious injury or death. Turn power OFF at circuit breaker before installing the unit.

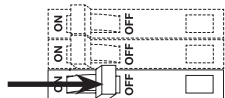

Single-Line

Ground or neutral is required for product to function. If neither wire is present, consult a licensed electrician. For model MS-A102, connect green-sleeved wire to ground only in retrofit and replacement applications. When neutral connection is available, remove green sleeve and connect the white wire to neutral.

2 Connect Single Circuit Sensor switch

Wiring Diagram 1

Single Pole Installation with Neutral (MS-A102)

When a neutral connection is available, remove green sleeve and connect the white wire to neutral.

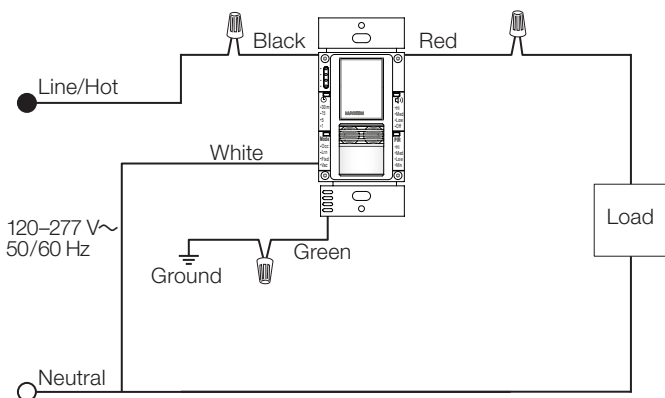

Single Pole Installation without Neutral (MS-A102)

Connect green-sleeved wire to ground only in retrofit and replacement applications.

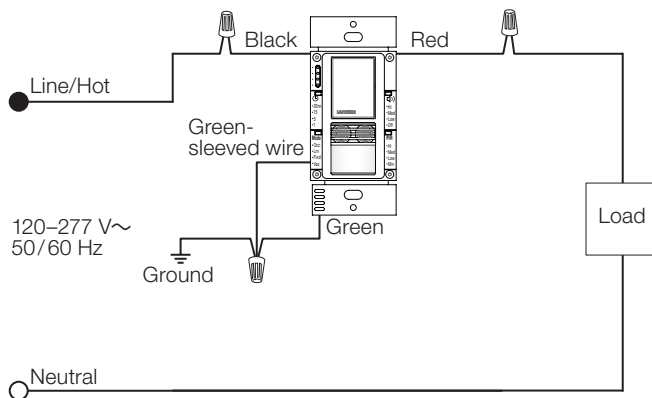

Single Pole Installation (MS-B102)

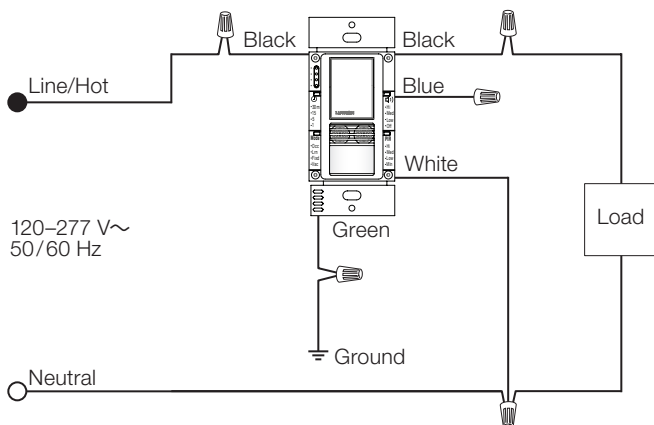

Continued on next page...

Maestro Single Circuit Dual Technology Sensor Switch

Wiring Diagrams (continued)

2 Connect Single Circuit Sensor switch - (continued)

Wiring Diagram 2

Multi-location Installation with Maestro Accessory Switches (120 V~)¹ (MS-B102, MS-B102-V)

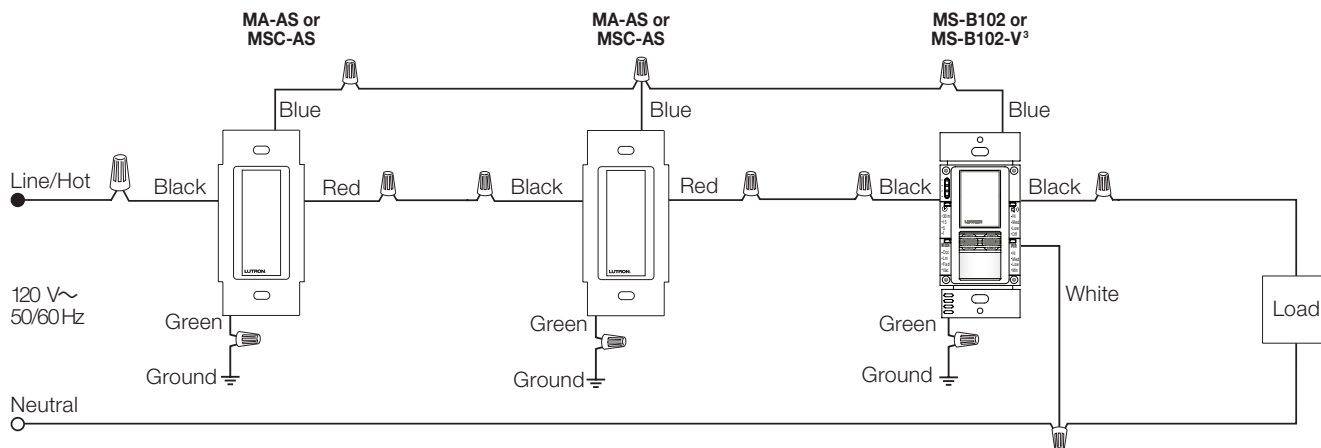

Wiring Diagram 3

Multi-location Installation with Maestro Accessory Switches (277 V~)¹ (MS-B102, MS-B102-V)

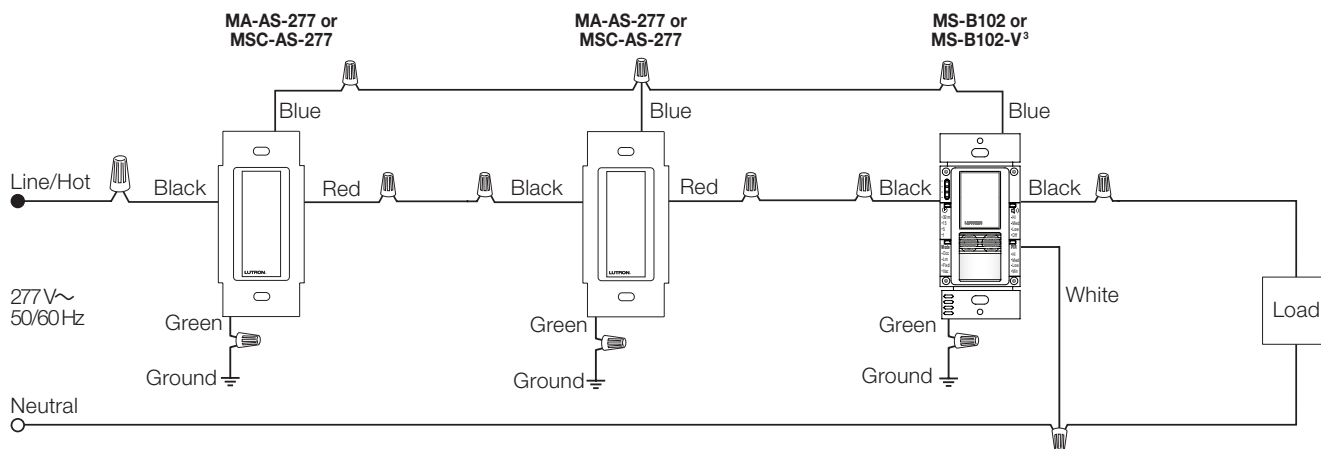

- ¹ MS-A102 and MS-A102-V do not work in 3-way installations.
- ² See page 17 for further instructions on 3-Way installations.
- ³ Dual Tech Sensor switch can be installed in any location.
- ⁴ Only one mechanical switch may be used with a Sensor switch.

Continued on next page...

Maestro Single Circuit Dual Technology Sensor Switch

Wiring Diagrams (continued)

2 Connect Single Circuit Sensor switch - (continued)

Wiring Diagram 4

3-Way installation with a Standard Mechanical Switch^{1,2} (MS-B102, MS-B102-V)

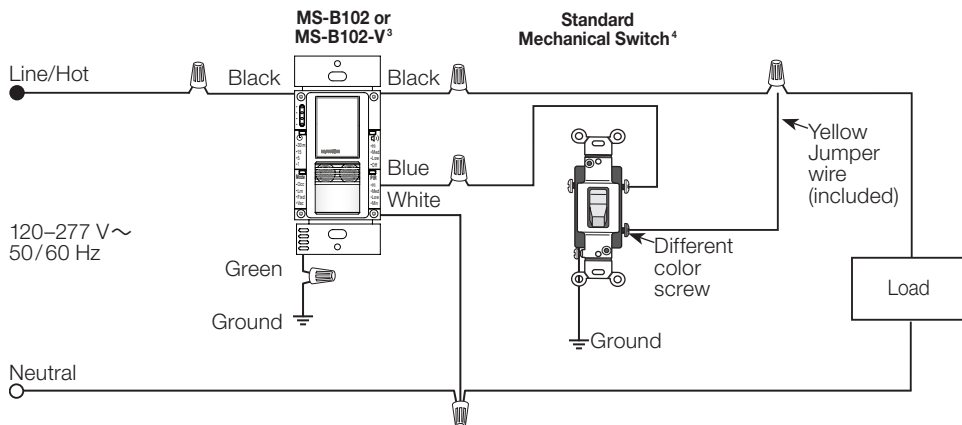

- ¹ MS-A102 and MS-A102-V do not work in 3-way installations.
- ² See next page for further instructions on 3-Way installations.
- ³ Dual Tech Sensor switch can be installed in any location.
- ⁴ Only one mechanical switch may be used with a Sensor switch.

3 Turn Power ON

⚠ Caution! Risk of electric shock. Leakage current present. Earth ground connection required before connecting power (MS-A102, MS-A102-V models only).

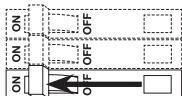

4 Wait for 2 minutes

NOTE:

After restoring power to the unit, when wiring is complete, the unit will not manually control the load for the first 10 seconds after power-up. The sensor will not be functional until 2 minutes after power-up.

Maestro Single Circuit Dual Technology Sensor Switch

3-Way Installation

For retrofit 3-Way installations the mechanical switch needs to be rewired as shown in the diagram below after wiring the Dual Tech Sensor switch. If the mechanical switch is not rewired, the 3-Way installation will not work as expected. Single-Pole mechanical switches may also be used in a 3-Way installation.

1. Turn Power Off

⚠ WARNING! Shock Hazard. May result in serious injury or death. Turn power OFF at circuit breaker before installing the unit.

2. Connect Ground: Ensure the bare copper or green ground wire from the wallbox is connected to the green ground screw of the mechanical switch.
3. Tag circuit Common: Your 3-Way mechanical switch should have three screw terminals, two of the same color, and one of a different color. Tag the wire that is connected to the screw terminal of a different color.
4. Identify the wire that matches the color of the wire you connected to the blue wire of the Sensor switch. Connect this wire to one of the two terminals of the same color.
5. Combine the tagged wire, the remaining wire and yellow jumper wire (included) using a wire connector. Connect the other end of jumper wire to the different color screw.

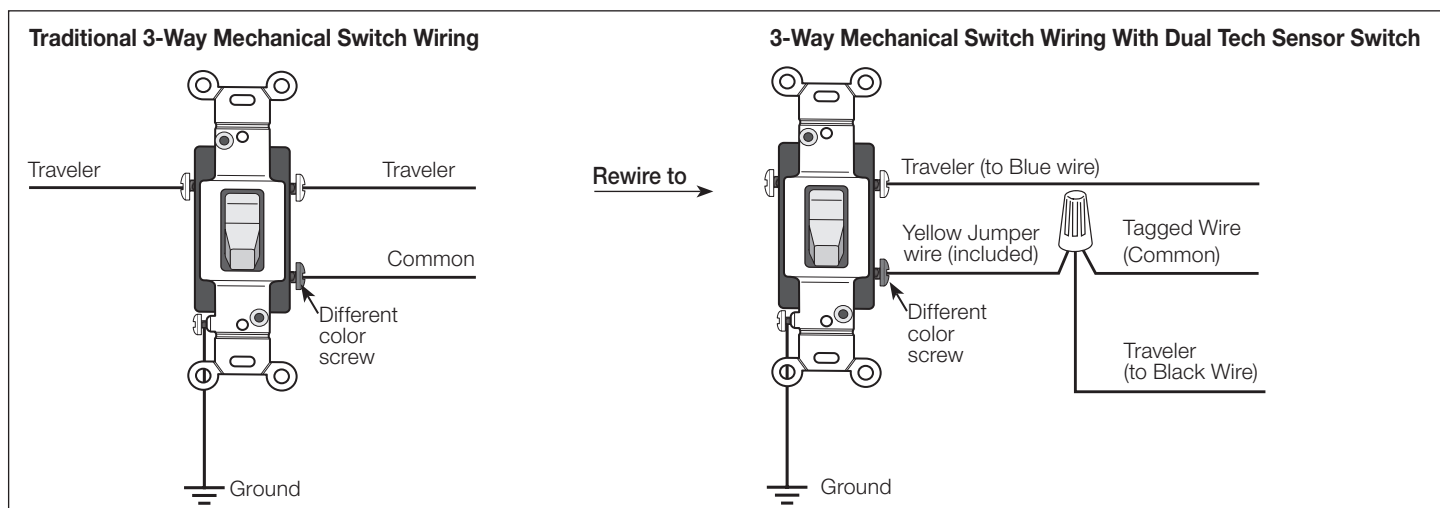

¹ MS-A102 and MS-A 102-V do not work in 3-way installations.

Troubleshooting for Sensor Switch

For troubleshooting on your Sensor switch product, see the **Troubleshooting** section on pages 35 and 36.

Maestro Dual Circuit Dual Technology Sensor Switch

Programmable Features

The Sensor switch has many features to allow you to configure the unit to meet your individual needs. The following is an overview of all the product features.

Default settings are shown in **bold**

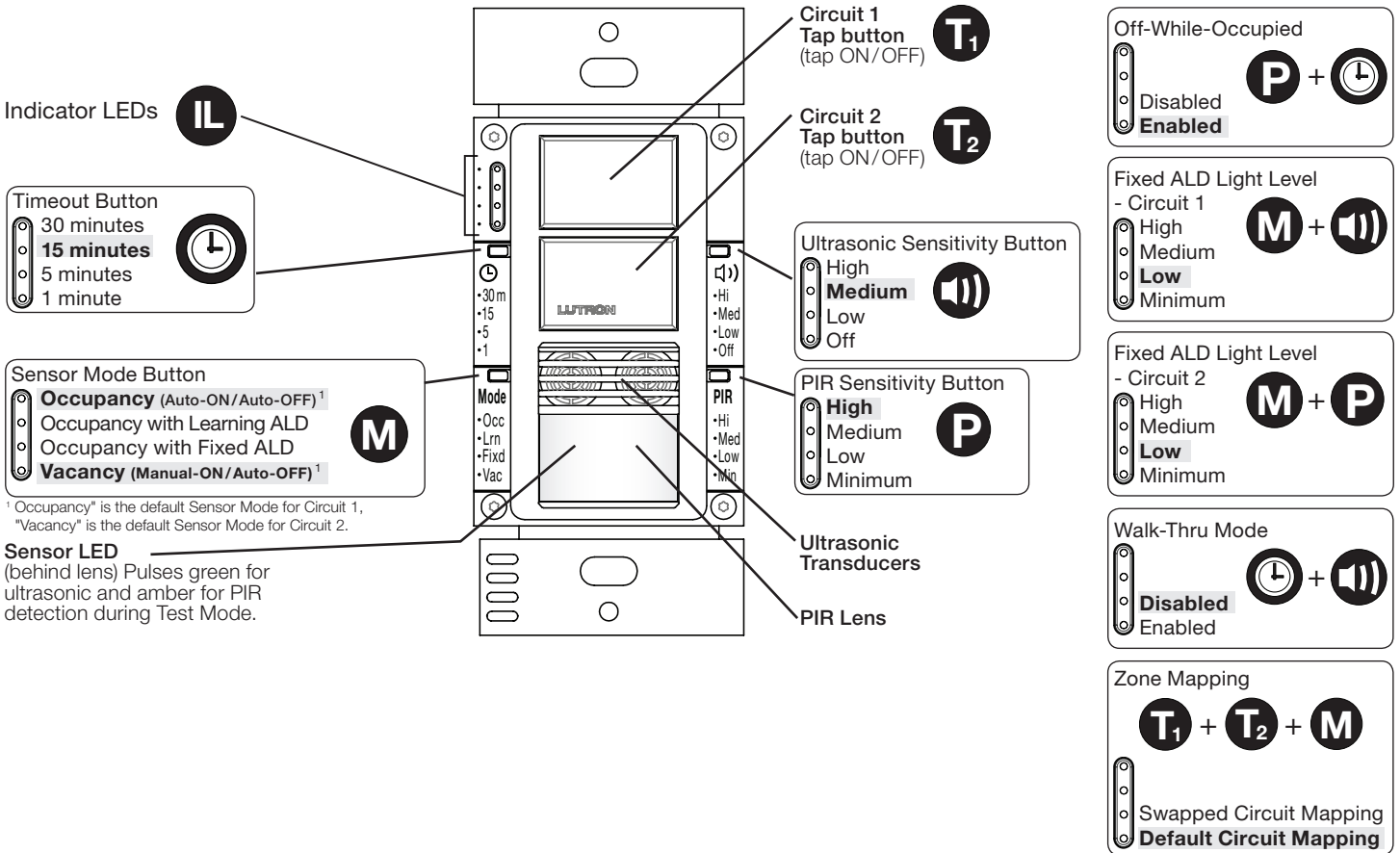

Maestro Dual Circuit Dual Technology Sensor Switch

Explanation of Programmable Features

T - **Timeout:** The time after which the lights will go out after the last motion is detected. The Timeout can be adjusted to 1, 5, 15, or 30 minutes. The default Timeout is 15 minutes.

What do I want?

- The ideal Timeout for an application may vary depending on the size of the room in which the unit is installed. The position of the sensor in relation to activity as well as the typical duration of stay will influence your desired Timeout setting. In a room where occupants dwell for longer periods of time, a longer Timeout value is recommended. For most conference rooms and offices, a Timeout of no less than 5 minutes is advised to ensure the desired light level is maintained throughout occupancy of the space.
- In applications where the sensor switch is controlling fluorescent or CFL bulbs, a Timeout of no less than 15 minutes is recommended to maintain bulb life.

M - **Sensor Mode:** The automatic functionality of the sensor can be adjusted to change how the lights respond upon initial occupancy. There are four available Sensor Modes: Occupancy Mode (Occ), Occupancy with Learning ALD Mode (Lrn), Occupancy with Fixed ALD Mode (Fixd), and Vacancy Mode (Vac). All sensor modes will turn the lights OFF when no motion has been detected and the Timeout has expired.

- **Occupancy (Auto-ON/Auto-OFF):** The lights will always turn ON when motion is detected.
- **Occupancy with Learning ALD:** The lights will turn ON when motion is detected and ambient light is too low. The lights will remain OFF if there is sufficient ambient light in the room. Further details on how Learning ALD works can be found on pages 31-32.

How the sensor learns your preference: If the lights turn ON when there is already enough natural light, or if they remain OFF when there is not enough natural light, simply press the Tap button of the "Occupancy with Learning ALD" circuit to toggle the lights. If the tap button is pressed within 5 seconds of entering the space, the sensor will learn your preference for when to keep the lights off, and when to turn them ON, based on the natural light in the room.

- **Occupancy with Fixed ALD:** The lights will turn ON when motion is detected and ambient light is too low. If there is sufficient ambient light in the room, the lights will remain off when motion is detected. The default fixed level is "Low". To change your fixed light level, see "Setting the Fixed ALD Light Level" programming instructions (pg.25).
- **Vacancy (Manual-ON/Auto-OFF):** The lights will NOT turn ON automatically. Lights will only turn ON when the appropriate Tap button (**T₁** or **T₂**) has been pressed.

What do I want?

- If you want the lights to automatically turn ON when someone enters the room, the sensor mode should be set to "Occupancy (Auto-ON/Auto-OFF)".
- If you prefer that the lights only turn ON when the Tap buttons (**T₁** or **T₂**) are pressed, choose "Vacancy (Manual-ON/Auto-OFF)". The unit will only turn off automatically, when occupancy is no longer detected. Bedrooms are a typical application where Manual-ON mode would work better than Auto-ON mode for most users.
- If you'd like the lights to turn ON, but want to keep the lights off when there's plenty of daylight, "Occupancy with Learning ALD" is a great way to teach the sensor your preferred light level for when lights should remain off.
- If you'd like the lights to turn ON, but want to keep the lights off when there's plenty of daylight, and you'd like to LOCK the setting that determines how much light is needed to keep lights off, "Occupancy with Fixed ALD" is the best option. This setting is ideal for conference rooms with many different users and plenty of natural light. In a busy conference room, this setting will provide consistent, convenient energy savings and ambiance.
- Neither Occupancy with Learning ALD, nor Occupancy with Fixed ALD are recommended for any circuit controlling a fan load, unless the intent is that the fan turns ON or OFF based on the light level in the room.

Maestro Dual Circuit Dual Technology Sensor Switch

Explanation of Programmable Features (*continued*)

P - PIR (Passive Infrared) Sensitivity: The PIR sensitivity of the sensor can be adjusted based on the expected level of activity in the room. The default setting is "High Sensitivity" which will perform best for most applications. Rarely, if the sensor is placed near external noise sources such as heating and cooling vents, it may turn the lights ON without occupancy. If this occurs, lowering the sensitivity to Medium, Low, or Minimum may resolve the problem. Changing this setting will affect both circuits; this is a setting for the entire unit and cannot be adjusted for individual circuits.

- High Sensitivity
- Medium Sensitivity
- Low Sensitivity
- Minimum Sensitivity

What do I want?

- The type of activity and amount of foot traffic will help dictate at which setting the sensor should be set. "High Sensitivity" is recommended for spaces where the occupants will often be seated for long periods of time and performing fine motions such as turning a page. "Low Sensitivity" is recommended for spaces that generally only experience large motions such as foot traffic.
- Lutron Dual Tech sensors operate by triggering initial occupancy using the Passive Infrared (PIR) technology. They maintain the occupied state with both PIR and Ultrasonic (US) sensors. If you are having problems where the lights turn ON when unwanted, lower the PIR sensitivity. If you are having problems where the lights are staying ON too long, once the room has been vacated, consider lowering the Ultrasonic Sensitivity (US) first.
- Additionally, if the sensor sees a specific area that is not desired (ex: a hallway outside of the room in which the sensor is installed), Lutron offers a lens mask kit (Lutron P/N 50013614) that can be ordered through Customer Assistance (1.844.LUTRON1). Alternatively, selectively placing opaque tape (painters tape, electrical tape, masking tape, etc.) over certain parts of the lens can limit its field of vision to block undesired detection areas. Masking the lens may affect ALD performance, but DOES NOT block ultrasonic frequencies.

U - Ultrasonic Sensitivity (US): The Ultrasonic sensitivity of the sensor can be adjusted based on the expected level of activity in the room. The default sensitivity setting is "Medium Sensitivity". Ultrasonic sensing is only used to maintain occupancy. Changing this setting will NOT affect how the sensor responds upon initial occupancy of the space. Changing this setting will affect both circuits; this is a setting for the entire unit and cannot be adjusted for individual circuits.

- High Sensitivity
- Medium Sensitivity
- Low Sensitivity
- Off

What do I want?

- Ultrasonic sensing excels at detecting minor motion in the coverage area, and as a result, is more sensitive to external interference than Passive Infrared (PIR) detection. For this reason, Lutron Dual Tech in-wall sensors only use ultrasonic detection to maintain occupancy. If you find that the lights in your space turn ON when expected, but sometimes stay ON too long, it is best to lower the ultrasonic sensitivity before lowering the PIR sensitivity.
- If your lights turn OFF while the room is occupied, consider extending the Timeout, or increasing ultrasonic sensitivity.

Maestro Dual Circuit Dual Technology Sensor Switch

Explanation of Programmable Features (*continued*)

Off-While-Occupied: This setting determines how the sensor will respond when the lights are turned off, and the room remains occupied. Changing this setting will modify the behavior of all sensor modes, except for Vacancy mode. Changing this setting will affect both circuits; this is a setting for the entire unit and cannot be adjusted for individual circuits.

- **Off-While-Occupied Enabled:** The lights of all Non-Vacancy circuits will turn ON when motion is detected. If the lights are manually turned off, the sensor will keep those lights off as long as the room is occupied, and the Timeout has not expired. This is the default setting of the Off-While-Occupied mode.
- **Off-While-Occupied Disabled:** The lights of all "Auto-ON" (Occupancy) circuits will turn ON when motion is detected. If the lights are manually turned off, the sensor will wait for 25 seconds before trying to detect occupancy again. The 25 second period is designed to allow occupants to exit a room without re-triggering the lights, but still provide the necessary Auto-ON functionality for high-traffic areas.

What do I want?

- If you want the lights to automatically turn ON when someone enters the room, and your application is a high-traffic area (bathroom, hallway, etc), "Off-While-Occupied Disabled" is recommended, to keep the sensor as responsive to brief occupancy as possible.
- If you want the lights to automatically turn ON when someone enters the room, but you also would like to be able to turn the lights off and have them stay off while the room is occupied (i.e. conference room presentations, movies, etc), then "Off-While-Occupied Enabled" is recommended. It is also likely that your Timeout for this application should be greater than 5 minutes, to increase the chances of maintaining an occupied status in situations where movement is minimal.

Fixed ALD Light Level: When a unit is set to "Occupancy with Fixed ALD" mode, the light level at which the lights will remain off when the space is occupied can be adjusted. If the light in the room is higher than the level set by the user, the lights will remain off. If the light in the room is lower than the light level set, the lights will turn ON. The default setting is "Low". Changing this setting will affect both circuits; this is a setting for the entire unit and cannot be adjusted for individual circuits.

- **High**
- **Medium**
- **Low**
- **Minimum**

What do I want?

- If you set the light level to "High", the lights will almost always turn ON when motion is detected. The only time the lights will not turn ON when motion is detected is when it is extremely bright in the room.
- If you set the light level to "Minimum", the lights will almost always remain OFF. The lights will only turn ON when motion is detected, and there is very little ambient light in the room.

Maestro Dual Circuit Dual Technology Sensor Switch

Explanation of Programmable Features (*continued*)

Walk-Thru Mode: Walk-Thru Mode is a setting that allows lights set to a long Timeout to shut off after a short duration, when the space is only occupied momentarily. After initial occupancy, this mode allows the sensor to turn the lights in the room back OFF, if the space is occupied for a very brief amount of time (less than 3 minutes). If motion is detected consistently within 3 minutes of initial occupancy, the sensor will keep the lights ON for the normal Timeout setting. The default setting is "Disabled". Changing this setting will affect both circuits; this is a setting for the entire unit and cannot be adjusted for individual circuits.

- **Walk-Thru Mode Enabled:** If the space is occupied momentarily, the lights will turn off after 3 minutes instead of the normal Timeout setting.
- **Walk-Thru Mode Disabled:** The lights will always remain ON for the full Timeout duration.

What do I want?

- If you would like the lights in your space to turn off quickly, when the space is only briefly occupied select "Enabled". This setting is ideal for conference rooms with long Timeouts that may experience periodic brief occupancy events, such as a second-shift cleaning crew or security guard checking the campus of a commercial building.
- If you prefer consistent sensor behavior, or utilize CFL or fluorescent lights in your application, Walk-Thru mode should be "Disabled".

Notes:

- To maintain bulb life, the recommended minimum Timeout for fluorescent bulbs is 15 minutes. As a result, Walk-Thru mode is not recommended for applications with CFL or fluorescent lights.
- If Walk-Thru mode is enabled, that setting will override a 1-minute Timeout setting, if that setting is also selected. The lights will remain ON for 3 minutes at a minimum, if Walk-Thru mode is enabled.

Zone Mapping: Zone Mapping is an additional programming option that allows the user to swap the assignments of the lighting zones (swap Circuit 1 with Circuit 2). This programming step will allow a user to swap BOTH the button assignment of each zone AND the functionality of that zone. This can be used to avoid having to re-wire the sensor switch, if the user would prefer that the zones be switched from their current configuration.

What Do I Want?

- If you've wired in your Dual Circuit Dual Tech Sensor switch (MS-A202, MS-B202), and you decide that you would like your button assignments to be swapped, you may use zone mapping to swap the button assignments instead of rewiring the product. Keep in mind that your settings will also be swapped, so you may need to reprogram the settings for each circuit, after swapping the buttons, to ensure that you end up with the settings you want.

Maestro Dual Circuit Dual Technology Sensor Switch

Programming

Important note before programming:

To display current settings tap the Timeout (⌚), Sensor Mode (M), Ultrasonic Sensitivity (U), or PIR Sensitivity (P) button. The indicator LED (IL) that corresponds to the current setting will illuminate. If the setting is different between circuit 1 and 2, Circuit 1 setting will illuminate for 1 second followed by Circuit 2 for 1 second.

Selecting a Timeout Duration for a Specific Circuit

1. Press and hold the Timeout button (⌚) along with the button of the desired circuit (T₁ or T₂) until an indicator LED (IL) begins to flash (about 3 seconds).
2. Tap the Timeout button (⌚) to cycle to your desired Timeout setting.
3. Press and hold the Timeout button (⌚) until the indicator LED (IL) goes solid to lock your selection (about 3 seconds).

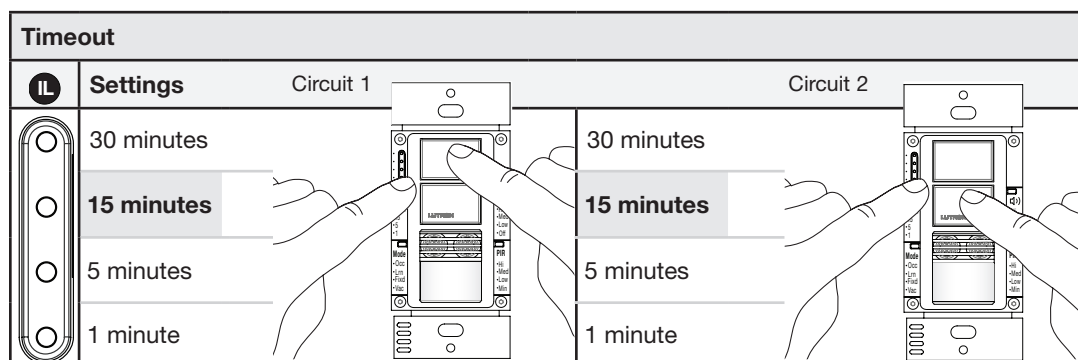

Circuit 1 Default : 15 minutes ; **Circuit 2 Default :** 15 minutes

Selecting a Timeout Duration for Both Circuits *

1. Press and hold the Timeout button (⌚) until an indicator LED (IL) begins to flash (about 3 seconds).
2. Tap the Timeout button (⌚) to cycle to your desired Timeout setting.
3. Press and hold the Timeout button (⌚) until the indicator LED (IL) goes solid to lock your selection (about 3 seconds).

* If the Timeout setting is different for both circuits, the unit will display the Timeout for Circuit 1. In order to save a new Timeout to both circuits, you must cycle to your selection before exiting (even if your selection is identical to the current setting for Circuit 1).

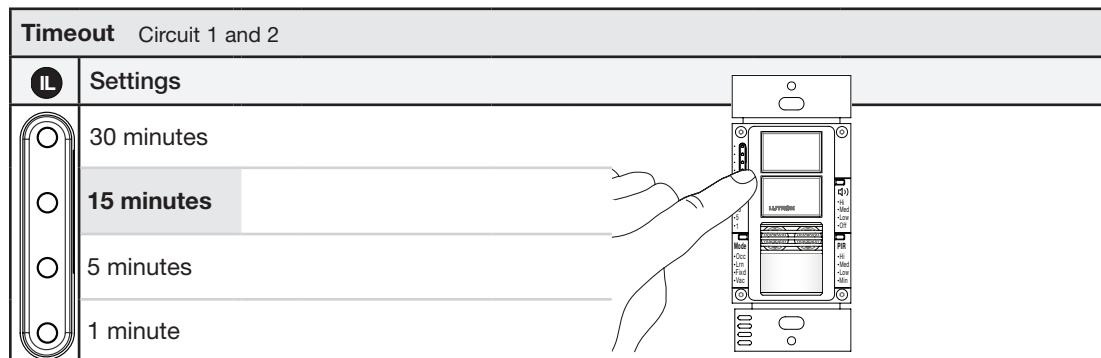

Circuit 1 Default : 15 minutes ; **Circuit 2 Default :** 15 minutes

Maestro Dual Circuit Dual Technology Sensor Switch

Programming (continued)

Selecting a Sensor Mode for a Specific Circuit

1. Press and hold the Sensor Mode button (M) along with the button (T₁ or T₂) of the desired circuit until an indicator LED (IL) begins to flash (about 3 seconds).
2. Tap the Sensor Mode button (M) to cycle to your desired Sensor Mode setting.
3. Press and hold the Sensor Mode button (M) until the indicator LED (IL) goes solid to lock your selection (about 3 seconds).

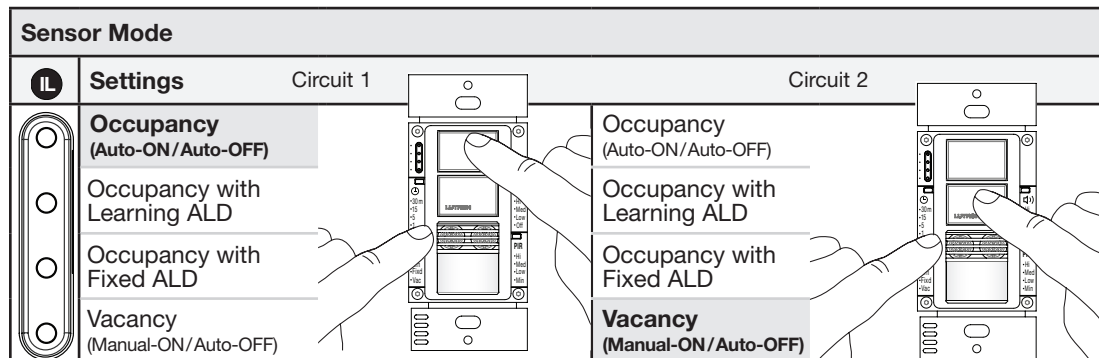

Circuit 1 Default : Occupancy ; **Circuit 2 Default :** Vacancy

Selecting a Sensor Mode for Both Circuits *

1. Press and hold the Sensor Mode button (M) until an indicator LED (IL) begins to flash (about 3 seconds).
2. Tap the Sensor Mode button (M) to cycle to your desired Sensor Mode setting.
3. Press and hold the Sensor Mode button (M) until the indicator LED (IL) goes solid to lock your selection (about 3 seconds).

* If the Sensor Mode setting is different for both circuits, the unit will display the Sensor Mode for Circuit 1. In order to save a new Sensor Mode to both circuits, you must cycle to your selection before exiting (even if your selection is identical to the current setting for Circuit 1).

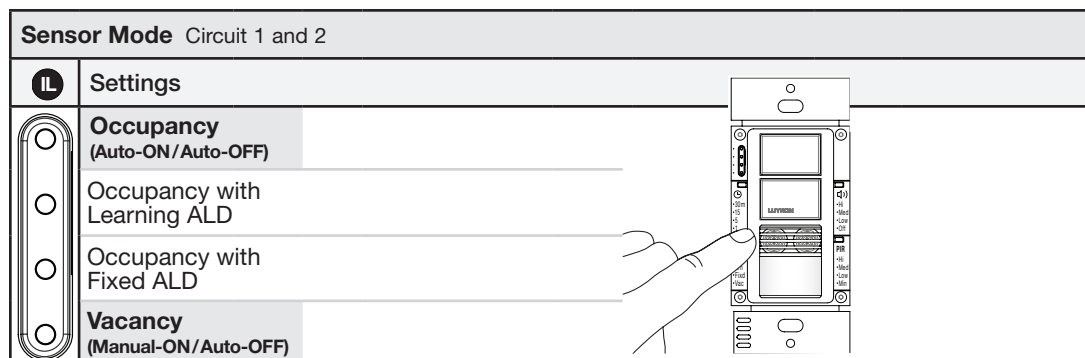

Circuit 1 Default : Occupancy ; **Circuit 2 Default :** Vacancy

Maestro Dual Circuit Dual Technology Sensor Switch

Programming (*continued*)

Selecting the Ultrasonic Sensitivity

1. Press and hold the Ultrasonic Sensitivity button (Ⓜ) until an indicator LED (Ⓛ) begins to flash (about 3 seconds).
2. Tap the Ultrasonic Sensitivity button (Ⓜ) to cycle to your desired Ultrasonic Sensitivity setting.
3. Press and hold the Ultrasonic Sensitivity button (Ⓜ) until the indicator LED (Ⓛ) goes solid to lock your selection (about 3 seconds).

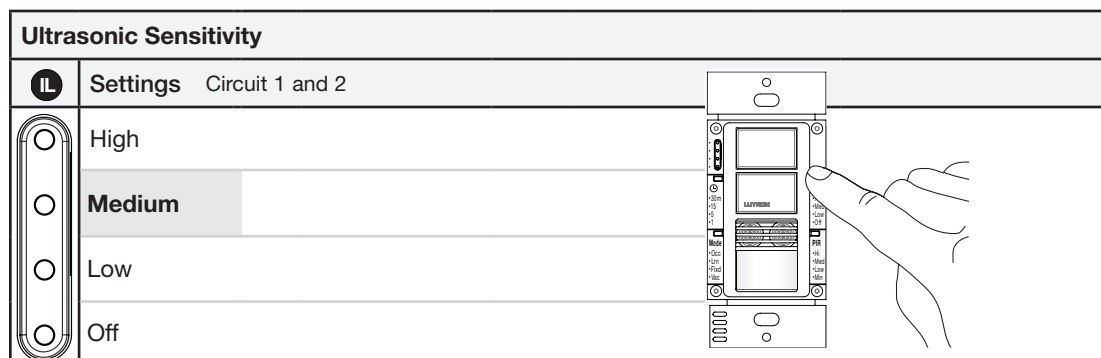

Default: Medium

Selecting the PIR Sensitivity

1. Press and hold the PIR Sensitivity button (Ⓟ) until an indicator LED (Ⓛ) begins to flash (about 3 seconds).
2. Tap the PIR Sensitivity button (Ⓟ) to cycle to your desired PIR Sensitivity setting.
3. Press and hold the PIR Sensitivity button (Ⓟ) until the indicator LED (Ⓛ) goes solid to lock your selection (about 3 seconds).

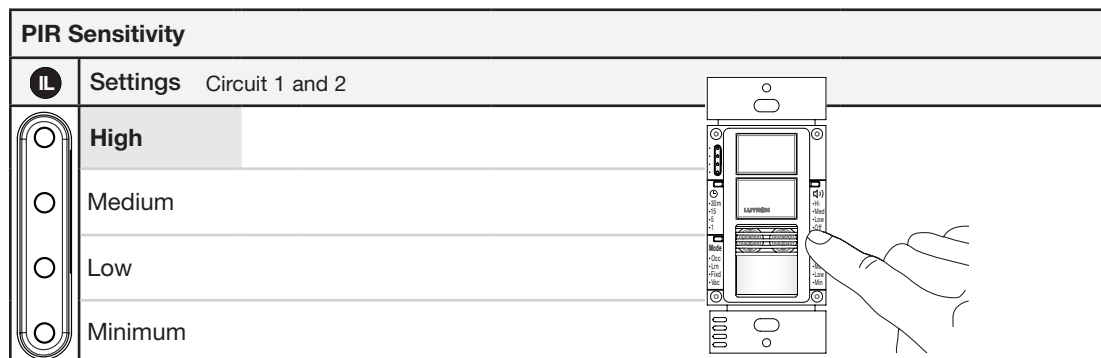

Default: High

Maestro Dual Circuit Dual Technology Sensor Switch

Programming (continued)

Changing the Off-While-Occupied Setting

1. Press and hold the Timeout (Ⓢ) and PIR (Ⓟ) buttons at the same time until an indicator LED (Ⓛ) begins to flash (about 3 seconds).
2. Tap the PIR (Ⓟ) button to cycle to your desired setting.
3. Press and hold PIR (Ⓟ) button until the indicator LED (Ⓛ) goes solid to lock your selection (about 3 seconds).

Off-While-Occupied	
Ⓛ	Settings Circuit 1 and 2
○	Off-While-Occupied Disabled
○	Off-While-Occupied Enabled

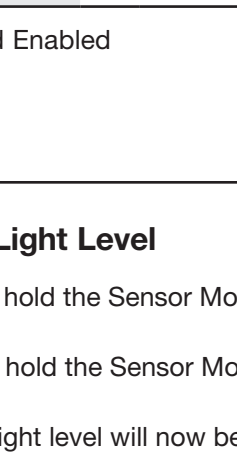

Default: Off-While-Occupied Enabled

Setting the Fixed ALD Light Level

1. a. For Circuit 1: Press and hold the Sensor Mode (Ⓜ) and Ultrasonic (Ⓢ) buttons until the indicator LED (Ⓛ) begins to flash (about 3 seconds).
 b. For Circuit 2: Press and hold the Sensor Mode (Ⓜ) and PIR (Ⓟ) buttons until the indicator LED (Ⓛ) begins to flash (about 3 seconds).
2. The Ambient Light Detect light level will now be displayed on the indicator LED (Ⓛ). Tap the Mode (Ⓜ) button to cycle to your desired setting.
3. Press and hold the Mode (Ⓜ) button until the indicator LED (Ⓛ) goes solid to lock your selection (about 3 seconds).

Setting Fixed ALD Light Level	
Ⓛ	Settings
	Circuit 1
○	High - turns lights ON unless room is very bright
○	Medium
○	Low (Default when in ALD Fixed mode)
○	Minimum - turns lights ON only when room is nearly dark
	Circuit 2
○	High - turns lights ON unless room is very bright
○	Medium
○	Low (Default when in ALD Fixed mode)
○	Minimum - turns lights ON only when room is nearly dark

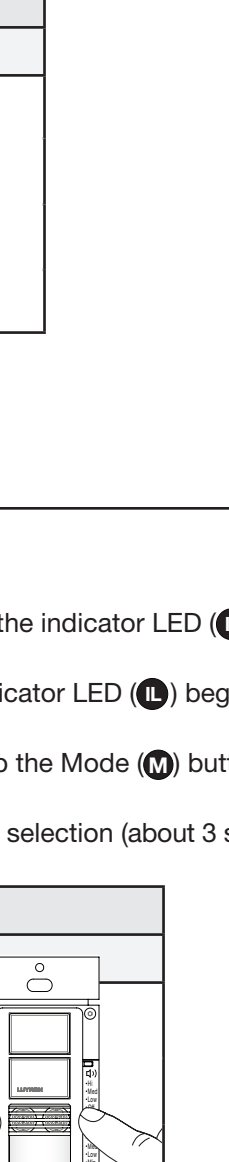

Circuit 1 Default : Low ; **Circuit 2 Default :** Low

Maestro Dual Circuit Dual Technology Sensor Switch

Programming (continued)

Setting Walk-Thru Mode

1. Press and hold Timeout (Ⓞ) and Ultrasonic (Ⓜ) buttons until an indicator LED (Ⓛ) begins to flash.
2. The Walk-Thru mode setting will now be displayed on the indicator LED (Ⓛ). Tap the Ultrasonic (Ⓜ) button to cycle to your desired setting.
3. Press and hold the Ultrasonic (Ⓜ) button until the indicator LED (Ⓛ) goes solid to lock your selection (about 3 seconds).

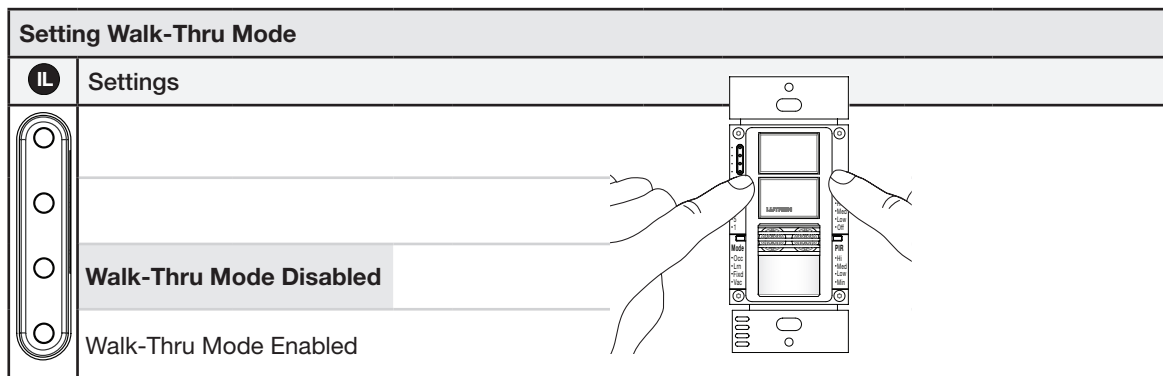

Default Setting: Disabled

Zone Mapping

1. Press and hold both Tap (Ⓣ₁) and (Ⓣ₂) buttons AND the Sensor Mode (Ⓜ) button until an indicator LED (Ⓛ) begins flashing.
2. Press either Tap (Ⓣ₁) or (Ⓣ₂) button to cycle to your desired setting.
3. Press and hold either Tap (Ⓣ₁) or (Ⓣ₂) button until the indicator LED (Ⓛ) goes solid to lock your selection (about 3 seconds).

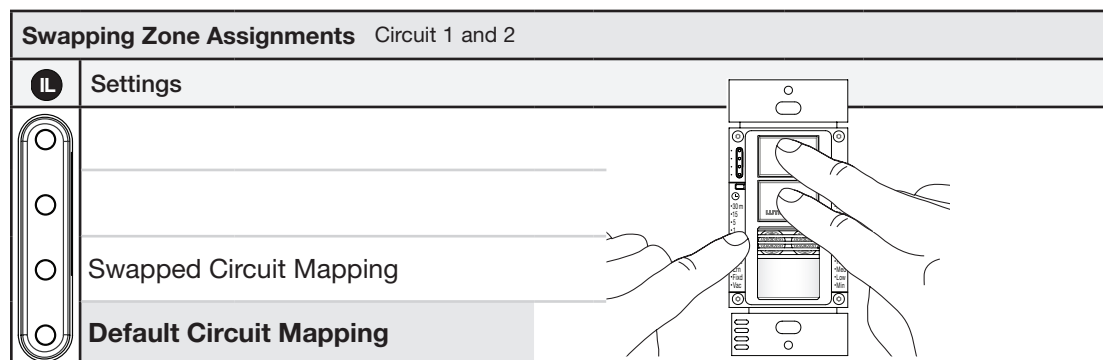

Notes:

- Zone swapping will change BOTH the button assignments (the top Tap button will now control the bottom circuit) AND the zone functionality (Circuit 1 and 2 would swap settings as well).
- To swap the zones back to default settings, release the button after the first flash for Default Circuit Mapping.

Default Setting: Default Circuit Mapping (not swapped).

Maestro Dual Circuit Dual Technology Sensor Switch

Additional Programming Options

Entering and Using Test Mode

Test Mode is a short Timeout (less than 15 seconds) that will test the coverage area of the sensor with the current settings.

To enable Test Mode:

1. Press and hold either **T₁** or **T₂** until the PIR lens flashes (about 7 seconds).
2. The device will exit Test Mode automatically after 5 minutes of inactivity, or when a Tap button is pressed.

Notes:

- An amber sensor LED flashes to indicate PIR detection, a green sensor LED flashes to indicate ultrasonic detection. If no motion is detected for the entire duration of the shorter Timeout (15 seconds), the load(s) being controlled by the sensor switch will turn off. The load(s) will turn back ON when motion is detected. You may hold **P** or **II** for 2 seconds while in test mode to test the current sensitivity of that specific technology.

Restoring Default Settings

The Dual Tech Sensor switch has the ability to be returned to its original default settings. This ability allows the programmer a risk-free experience to try multiple setting configurations.

Note: The default settings are:

Circuit 1 Timeout.....	15 minutes
Circuit 2 Timeout.....	15 minutes
Circuit 1 Sensor Mode	Occupancy (Auto-ON/Auto-OFF)
Circuit 2 Sensor Mode	Vacancy (Manual-ON/Auto-OFF)
Ultrasonic Sensitivity.....	Medium
PIR Sensitivity	High
Off-While-Occupied	Off-While-Occupied Enabled
Circuit 1 Fixed ALD Setting.....	Low
Circuit 2 Fixed ALD Setting.....	Low
Zone Mapping	Default Circuit Mapping
Walk-Thru Mode.....	Walk-Thru Mode Disabled

To Restore Default Settings:

Press and hold **II** and **P** until all **IL** blink slowly (about 7 seconds). This will restore ALL of the sensor's settings back to the default settings.

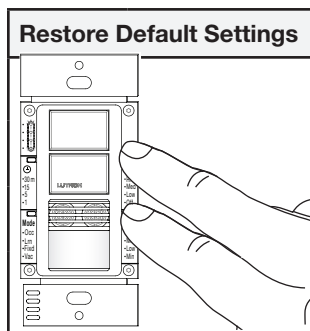

Maestro Dual Circuit Dual Technology Sensor Switch

Wiring Diagrams

1 Turn power OFF

⚠ WARNING! Shock Hazard. May result in serious injury or death. Turn power OFF at circuit breaker(s) before installing the unit.

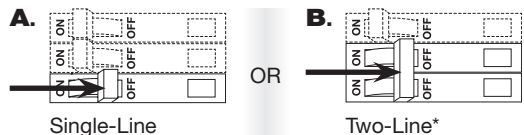

* Wiring must comply with 2011 NEC code 210.7 for wiring Multiple Branch Circuits: Where two or more branch circuits supply devices or equipment on the same yoke, a means to simultaneously disconnect the ungrounded conductors supplying those devices shall be provided at the point at which the branch circuits originate.

Ground or neutral is required for product to function. If neither wire is present, consult a licensed electrician. For model MS-A202, connect green-sleeved wire to ground only in retrofit and replacement applications. When neutral connection is available, remove green sleeve and connect the white wire to neutral.

2 Connect Dual Circuit Sensor switch

Wiring Diagram 1

Single Pole, Single Breaker Feed Installation with Neutral (MS-A202)

When a neutral connection is available, remove green sleeve and connect the white wire to neutral.

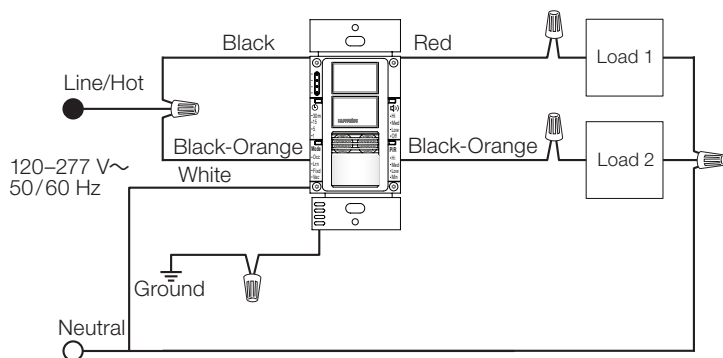

Single Pole, Single Breaker Feed Installation without Neutral (MS-A202)

Connect green-sleeved wire to ground only in retrofit and replacement applications.

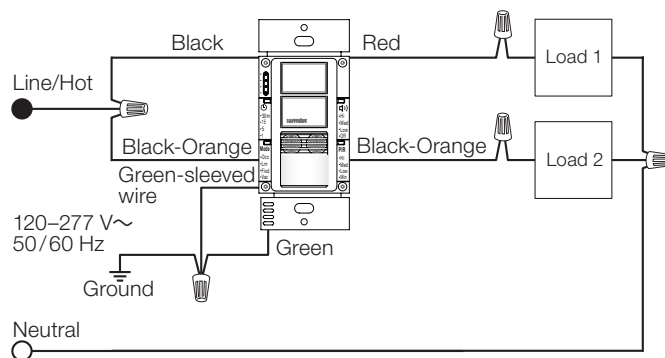

Single Pole, Single Breaker Feed Installation (MS-B202)

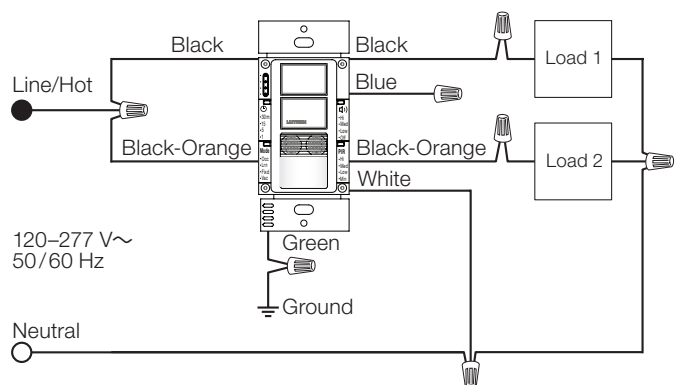

Continued on next page...

Maestro Dual Circuit Dual Technology Sensor Switch

Wiring Diagrams (continued)

2 Connect Dual Circuit Sensor switch - (continued)

Wiring Diagram 2

Single Pole, Two Breaker Feed Installation¹ with Neutral (MS-A202)

When a neutral connection is available, remove green sleeve and connect the white wire to neutral.

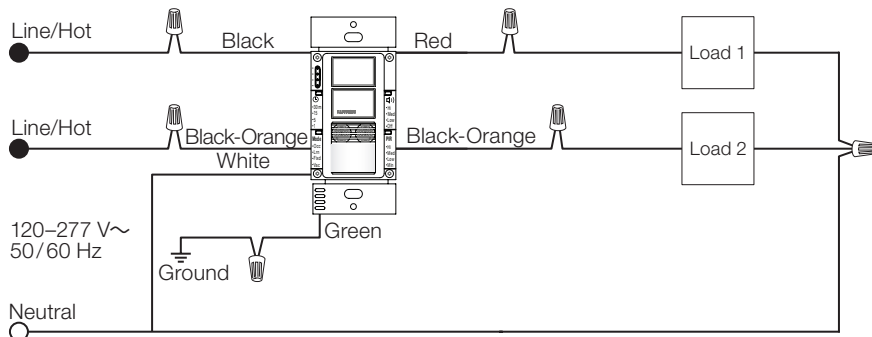

Single Pole, Two Breaker Feed Installation¹ without Neutral (MS-A202)

Connect green-sleeved wire to ground only in retrofit and replacement applications.

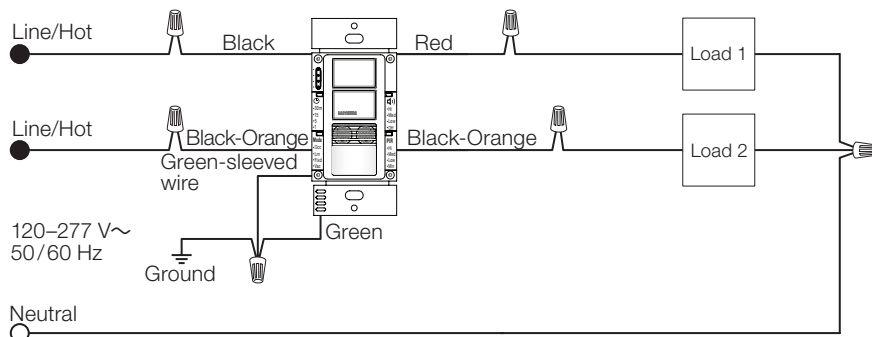

Single Pole, Two Breaker Feed Installation¹ (MS-B202)

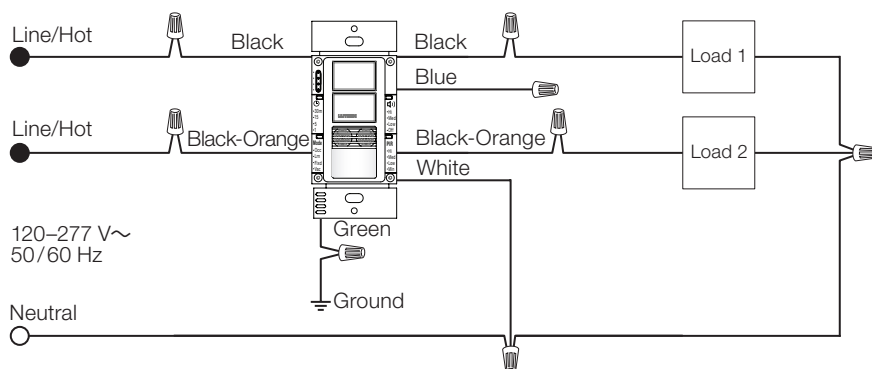

¹ MS-A202 does not work in 3-way installations.

² See next page for further instructions on 3-Way installations.

³ Dual Tech Sensor switch can be installed in either location.

⁴ Mechanical switch may be wired to **either** circuit, and will control both. **Do NOT** connect mechanical switch to **both** circuits.

⁵ Only one mechanical switch may be used with a Dual Tech Sensor switch.

Maestro Dual Circuit Dual Technology Sensor Switch

Wiring Diagrams (continued)

2 Connect Dual Circuit Sensor switch - (continued)

Wiring Diagram 3

3-Way, Single Breaker Feed Installation^{1,2} (MS-B202)

NOTE: The Dual Circuit Sensor switch can NOT be used with Maestro Accessory Switches.

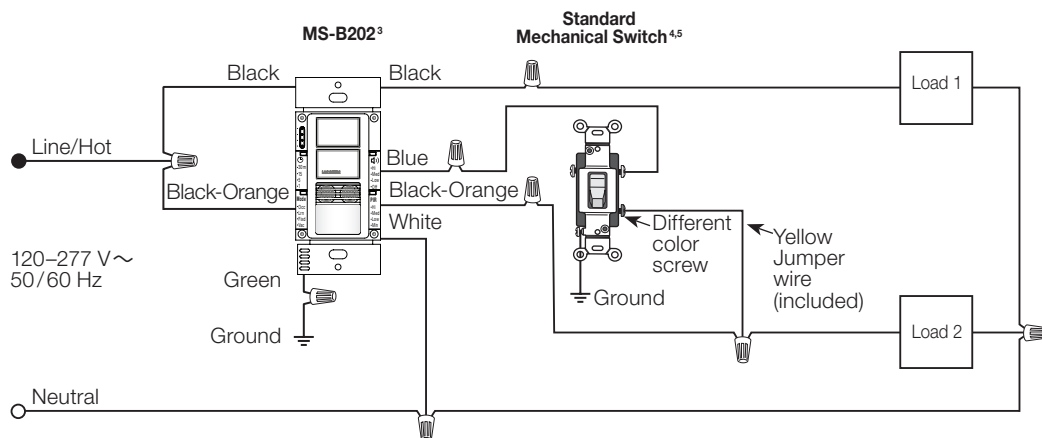

Wiring Diagram 4

3-Way, Two Breaker Feed Installation^{1,2} (MS-B202)

NOTE: The Dual Circuit Sensor switch can NOT be used with Maestro Accessory Switches.

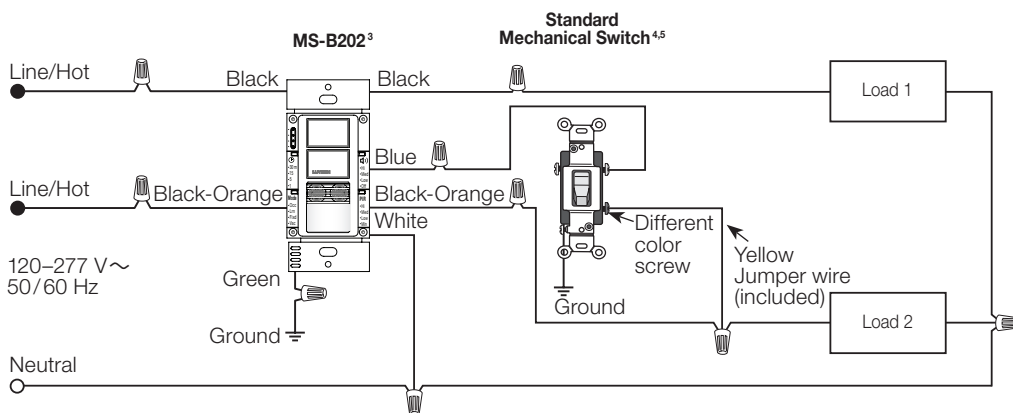

- ¹ MS-A202 does not work in 3-way installations.
- ² See next page for further instructions on 3-Way installations.
- ³ Dual Tech Sensor switch can be installed in either location.
- ⁴ Mechanical switch may be wired to **either** circuit, and will control both. **Do NOT** connect mechanical switch to **both** circuits.
- ⁵ Only one mechanical switch may be used with a Dual Tech Sensor switch.

3 Turn Power ON

⚠ Caution! Risk of electric shock. Leakage current present. Earth ground connection required before connecting power (MS-A202 model only).

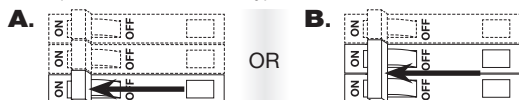

4 Wait for 2 minutes

NOTE:

After restoring power to the unit, when wiring is complete, the unit will not manually control the load for the first 10 seconds after power-up. The unit will also not operate the sensor until 2 minutes after power-up.

Maestro Dual Circuit Dual Technology Sensor Switch

3-Way Installation¹

For retrofit 3-Way installations the mechanical switch needs to be rewired as shown in the diagram below after wiring the Dual Tech Sensor switch. If the mechanical switch is not rewired, the 3-Way installation will not work as expected. Single-Pole mechanical switches may also be used in a 3-Way installation with MS-B102 and MS-B202 models.

1. Turn Power Off

⚠ WARNING! Shock Hazard. May result in serious injury or death. Turn power OFF at circuit breaker before installing the unit.

2. Connect Ground: Ensure the bare copper or green ground wire from the wallbox is connected to the green ground screw of the mechanical switch.
3. Tag circuit Common: Your 3-Way mechanical switch should have three screw terminals, two of the same color, and one of a different color. Tag the wire that is connected to the screw terminal of a different color.
4. Identify the wire that matches the color of the wire you connected to the blue wire of the Maestro® Dual Technology Sensor switch. Connect this wire to one of the two terminals of the same color.
5. Combine the tagged wire, the remaining wire and yellow jumper wire (included) using a wire connector. Connect the other end of jumper wire to the different color screw.

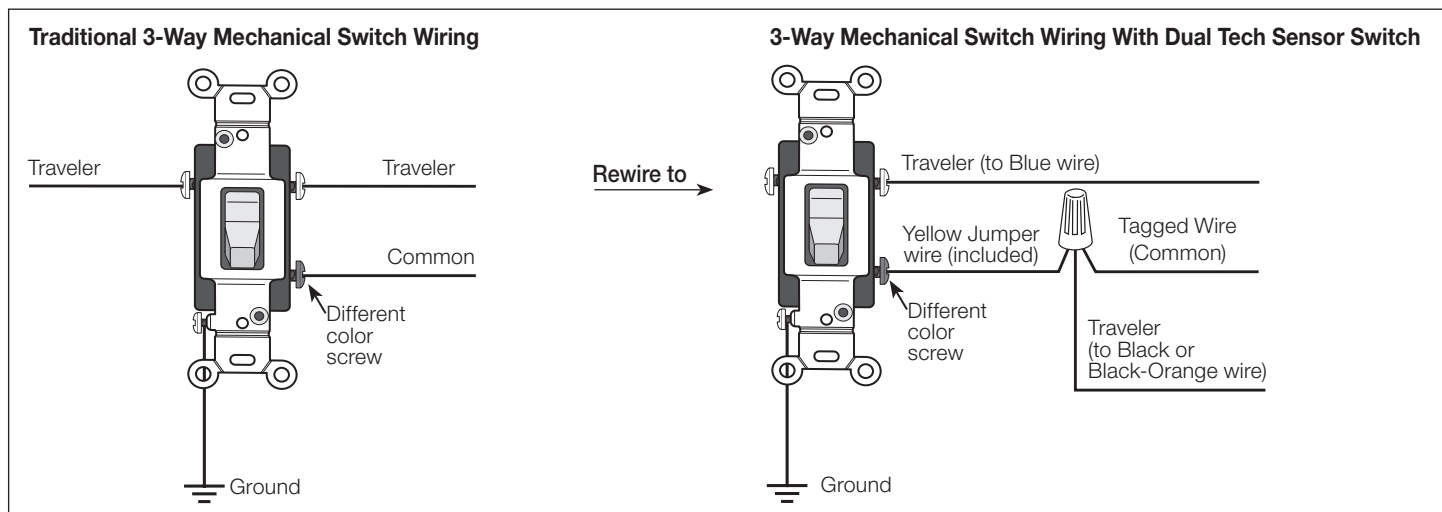

How Loads Operate in 3-Way Installations with Dual Circuit Sensor Switch¹ (MS-B202)

	Initial Load State		After flipping 3-Way mechanical switch	
	Circuit 1	Circuit 2	Circuit 1	Circuit 2
When All Lights are OFF	OFF	OFF	ON	ON
When All Lights are ON	ON	ON	OFF	OFF
When One Circuit is ON	ON	OFF	OFF	OFF
	OFF	ON	OFF	OFF

¹ MS-A202 does not work in 3-way installations.

Troubleshooting for Sensor Switch

For troubleshooting on your Sensor switch product, see the **Troubleshooting** section on Pages 35 and 36.

Learning Ambient Light Detect (ALD) – How it Works

Ambient Light Detect (ALD) is a feature that allows you to maximize savings by keeping lights off when there is enough natural light in a space to provide adequate lighting.

Lutron's Learning ALD feature learns your preference as you live with the product in your space. The learning algorithm utilizes user inputs to determine when ambient light is sufficient.

Will my sensor utilize Learning ALD?

Your sensor will utilize Learning ALD if you've selected "Occupancy with Learning ALD" (Lrn) mode while programming your unit.

How does the sensor learn my preference?

Whenever you enter a room with a Sensor switch utilizing the Learning ALD feature, the sensor will either turn the lights ON, or keep the lights off, based on its current ALD light level threshold. If you enter the room, and the lights do not respond as you'd like, press the Tap button on your unit to turn the lights ON (or OFF, if that was your preference) within 5 seconds of entering the room. The sensor has now begun learning your preferred ALD threshold. It may take multiple interactions for the sensor's adjustments to match your preferred ALD threshold. Here is an example to illustrate the learning process:

1. You enter the room and the lights stay off, but you decide you want the lights ON because there is not enough ambient light in the space.
2. You press the Tap button (within 5 seconds of entering room).
3. The unit has learned from this, and has begun to adjust its ALD light threshold towards your preference.

If I press a button AFTER 5 seconds of being in a room, will my unit "learn" that preference?

No, you must interact within the first 5 seconds of entering the room.

How many times do I have to interact with the sensor to get it to remember my settings?

The sensor typically learns the appropriate threshold in 6-10 consistent interactions.

I'm utilizing the Learning ALD feature, but when I enter the room and turn the lights off, they turn back ON. What's happening?

If you have "Off-While-Occupied" set to "Disabled", you may experience the lights turning back ON while in ALD mode if you turn the lights off and continue to occupy the space. This means that the sensor is getting closer to your preferred light level, but has not learned it yet. After a few more interactions with the unit, the lights will stay off at the desired light level, even if the space remains occupied.

I believe I'm using Learning ALD correctly, but I'm still not getting the response I expect. What could be happening?

- You may have multiple users with widely different preferences. If multiple users continue to "teach" the unit separate preferences, it will continue to try to adjust to meet the threshold, but may be stuck somewhere in between the preferences of the two users. Consider using "Occupancy with Fixed ALD" at one of the four light level thresholds.
- You may not be able to reach your unit within 5 seconds. If your interactions do not happen within 5 seconds, you may not be teaching the unit a new threshold. This lack of interaction may be reinforcing the current threshold (because the sensor thinks you like the current setting).

Many people use the room this sensor is in. How can I "lock" an ALD light level so it doesn't change daily?

Use the "Occupancy with Fixed ALD" feature. The fixed ALD light level threshold you choose will not change based on user interactions.

Learning Ambient Light Detect (ALD) in the Dual Circuit Dual Tech Sensor Switch: Some Things to Consider

In the Sensor switch, Ambient Light Detect (ALD) can be applied to individual circuits. If two separate circuits are set to "Occupancy with Learning ALD" mode, they cannot be taught different light level thresholds, they will share the same learned level. It is important to note that the sensor will ONLY learn from interactions with circuits set to "Occupancy with Learning ALD" mode.

I believe I'm using ALD correctly in my Dual-Circuit product, but I'm still not getting the response I expect. What could be happening?

- Please make sure that the button(s) you press when you enter the room correspond to a circuit set to "Occupancy with Learning ALD" mode. The sensor will NOT learn from interactions with any circuit not set to utilize "Learning ALD".
- If you have set your fan load to "Occupancy with Learning ALD" mode, your fan may be responding based on daylight in the room. Unless this is desired, it's likely that many of the interactions with this fan load are NOT based on the light level of the room, and the unit's learned threshold is being affected by these interactions.

Is it possible to have two separate ALD thresholds, one for each circuit?

Yes, it is possible to have two separate ALD thresholds, by doing either of the following:

1. Set one circuit to "Occupancy with Learning ALD" mode, set the other circuit to "Occupancy with Fixed ALD" mode.
2. Set two circuits to "Occupancy with Fixed ALD" mode and choose two different fixed thresholds for each circuit.

NOTE:

Lutron recommends all customers using ALD to keep fan loads on Manual-ON / Auto-OFF (Vacancy) mode, to make sure the learned threshold is not affected by unintentional interactions with the fan load.

Troubleshooting

Symptom	Possible Cause	Likely Solution
<ul style="list-style-type: none"> After installation, unit does not respond to button presses After installation, unit only worked once or doesn't work at all 	Switches will not be active for first 10 seconds after installation.	Wait for longer than 10 seconds.
	MS-A102, MS-A102-V, and MS-A202 Check wiring; ground or neutral must be connected for product to function.	Refer to wiring diagrams on instruction sheet at www.lutron.com/DTMaestroInstall
	MS-A102, MS-A102-V, and MS-A202 The product's black wire is not connected to "Line/Hot".	Swap the products black and red wires. Refer to wiring diagrams on instruction sheet at www.lutron.com/DTMaestroInstall
	MS-B102, MS-B102-V, and MS-B202 The product's white wire is not connected to neutral.	Connect the product's white wire to neutral. Refer to wiring diagrams on instruction sheet at www.lutron.com/DTMaestroInstall
<ul style="list-style-type: none"> After installation, sensor does not seem to function. 	Sensor will not be active for the first 2 minutes after installation.	Please wait 2 minutes after restoring power for the sensor to become operational.
	MS-A102, MS-A102-V, and MS-A202 Wiring may be incorrect. Check wiring; ground or neutral must be connected for product to function.	Refer to wiring diagrams on instruction sheet and at www.lutron.com/DTMaestroInstall for directions on how to wire your product.
	MS-B102, MS-B102-V, and MS-B202 Wiring may be incorrect, or the white wire is not connected to neutral.	
<ul style="list-style-type: none"> After installation or following power failure, the lights will turn ON suddenly after the lights are manually turned OFF. 	The sensor takes up to 2 minutes to perform a calibration following a power cycle. If the lights are OFF and the calibration completes while the space is occupied, the lights will turn ON.	Wait at least 2 minutes for the calibration to complete.
<ul style="list-style-type: none"> Lights do not turn ON when space is occupied 	Sensor mode is set to Vacancy (Vac) mode.	Refer to "Selecting Custom Settings" on your instruction sheet to set your Sensor Mode to "Occupancy" (Occ) mode.
	Sensor mode is set to "Occupancy with Learning ALD" (Lrn) mode and the light level in the room is too bright.	Turn the lights ON within 5 seconds of entering the room to teach your sensor that it should turn ON at the current light level.
	Sensor mode is set to "Occupancy with Fixed ALD" (Fixd) mode and the light level in the room is too bright.	Raise your Fixed ALD Light level until the lights turn ON in the current light level (Default level is "Low").
	Sensor does not have full view of room and its occupants. Room may be too large for this application.	Move objects blocking sensor's line-of-sight. You must be able to see the sensor for the sensor to "see" you.
	Off-While-Occupied is Enabled and the unit was recently manually turned off.	Refer to "Off-While-Occupied" on your instruction sheet to set "Off-While-Occupied" to "Disabled" or exit room and wait for sensor to Timeout, or manually turn light back ON with tap button.
	Wiring may be incorrect.	Refer to wiring diagrams on instruction sheet and at www.lutron.com/DTMaestroInstall for directions on how to wire your product.
<ul style="list-style-type: none"> Lights turn back ON after they are manually turned OFF 	Off-While-Occupied has been Disabled. The lights will continue to turn back ON 25 seconds after the lights are manually turned off, if the space is still occupied.	Use the instruction sheet "Off-While-Occupied" section to enable Off-While-Occupied.
<ul style="list-style-type: none"> Lights turn OFF while the space is occupied 	Sensor's Timeout is too short for this application (If Timeout is set to 1 minute, and you are not moving much for 1 minute, the sensor may Timeout without motion).	Refer to "Selecting Custom Settings" on your instruction sheet to increase your Timeout duration.
	Sensor does not have full view of room and its occupants.	Move objects blocking sensor's line-of-sight. The sensor will perform better, if it has line-of-sight to "see" you.
	Ultrasonic sensitivity is set too low.	Refer to "Selecting Custom Settings" on your instruction sheet to increase your Ultrasonic Sensitivity.
	PIR sensitivity is set too low.	Refer to "Selecting Custom Settings" on your instruction sheet to increase your PIR Sensitivity.

Troubleshooting (continued)

Symptom	Possible Cause	Likely Solution
<ul style="list-style-type: none"> Lights never turn OFF, or stay ON longer than desired. 	Sensor's Timeout has not yet expired.	Refer to "Custom Settings" on your instruction sheet to reduce your "Timeout" setting, if the current setting lasts too long.
	Sensors mounted close to doorways can respond to motion outside of the room.	Use "Test Mode" to determine which areas are triggering the sensor to respond when not desired. Selectively cover parts of the lens with electrical tape, or with the lens mask (Lutron P/N 50013614), which can be ordered through Customer Assistance (1.844.LUTRON1).
		Refer to "Selecting Custom Settings" on your instruction sheet to lower Ultrasonic sensitivity.
		Refer to "Selecting Custom Settings" on your instruction sheet to lower PIR sensitivity.
	Motion is being detected from an external noise source such as an HVAC vent. Some unintended environmental vibrations may trigger the ultrasonic sensor, keeping the lights ON.	Use "Test Mode" to determine which areas are triggering the sensor to respond when not desired. You may also use "Test Mode" to determine which sensor (Ultrasonic or PIR) is detecting motion. You may also use "Test Mode" to figure out which combination of PIR and Ultrasonic sensitivities works best for you. Test Mode will respond based on the current sensitivity settings of each sensor.
Refer to "Selecting Custom Settings" on your instruction sheet to lower Ultrasonic sensitivity. Because Ultrasonic is only used to maintain occupancy (does not trigger initial occupancy), Lutron recommends lowering Ultrasonic sensitivity to address lights staying ON too long.		
Refer to "Selecting Custom Settings" on your instruction sheet to lower PIR sensitivity.		
<ul style="list-style-type: none"> Lights turn ON in Vacancy mode 	Lights can turn ON in the 15 second "grace period" following Timeout.	This grace period is intended to allow a user to move after lights go out, if they want the lights to come back ON. If you'd like to verify that the unit is functioning properly, wait 30 seconds AFTER the Timeout has expired before re-entering the room, to verify that the lights do NOT turn ON.
	Sensor mode may be set to something other than Vacancy mode.	Refer to "Selecting Custom Settings" on your instruction sheet to change your sensor mode.
<ul style="list-style-type: none"> Lights turn ON when space is unoccupied. 	Motion is being detected from an external noise source such as an HVAC vent.	Refer to "Selecting Custom Settings" on your instruction sheet to lower PIR sensitivity. Only PIR sensors can trigger initial occupancy, so changing Ultrasonic sensitivity will not affect this issue.
		Use "Test Mode" to determine which areas are triggering the sensor to respond when not desired. Selectively cover parts of the lens with electrical tape, or with the lens mask (Lutron® P/N 50013614), which can be ordered through Tech support (1.800.523.9466). Masking the lens may affect ALD performance.
<ul style="list-style-type: none"> While utilizing Occupancy with Learning ALD modes, lights do NOT stay OFF when unit is turned OFF. 	Off-While-Occupied is Disabled, and the sensor switch has not yet learned your light level preference.	Continue to turn the lights OFF, as needed, until the unit learns your preference and keeps the lights OFF.
<ul style="list-style-type: none"> While utilizing Occupancy with Fixed ALD mode, lights do NOT stay OFF when unit is turned OFF. 	Off-While-Occupied is Disabled, and the light level currently set is too high.	Lower the Fixed ALD Light level using the instruction sheet, or find those instructions at www.lutron.com/DTMaestroInstall
<ul style="list-style-type: none"> My lights are stuck ON. 	MS-A102, MS-A102-V, and MS-A202 Product's green/yellow wire may have been wired to one of the black, or black-orange wires.	Rewire; check wiring diagrams on instruction sheet, or at www.lutron.com/DTMaestroInstall
	MS-B102, MS-B102-V, and MS-B202 Product's white wire may have been wired to one of the black, or black-orange wires.	
<ul style="list-style-type: none"> My 3-Way installation is not working as expected. Sensor and tap switch may not control load. 	Your 3-Way mechanical switch was not rewired to work with the sensor (wiring is different than conventional 3-Way wiring).	Check wiring at 3-Way mechanical switch, rewire if necessary using instruction sheet or diagrams at www.lutron.com/DTMaestroInstall NOTE: MS-A102, MS-A102-V, and MS-A202 do not work in 3-way installations.

Lutron and Maestro are registered trademarks of Lutron Electronics Co., Inc.

Lutron Contact Numbers

WORLD HEADQUARTERS USA

Lutron Electronics Co., Inc.
7200 Suter Road
Coopersburg, PA 18036-1299
TEL: +1.610.282.3800
FAX: +1.610.282.1243
support@lutron.com
www.lutron.com/support

North & South America Customer Assistance

USA, Canada, Caribbean:
1.844.LUTRON1 (1.844.588.7661)
Mexico:
+1.888.235.2910
Central/South America:
+1.610.282.6701

EUROPEAN HEADQUARTERS United Kingdom

Lutron EA Limited
125 Finsbury Pavement
4th floor, London EC2A 1NQ
United Kingdom
TEL: +44.(0)20.7702.0657
FAX: +44.(0)20.7480.6899
FREEPHONE (UK): 0800.282.107
Technical Support: +44.(0)20.7680.4481
lutronlondon@lutron.com

ASIAN HEADQUARTERS Singapore

Lutron GL Ltd.
390 Havelock Road
#07-04 King's Centre
Singapore 169662
TEL: +65.6220.4666
FAX: +65.6220.4333
Technical Support: 800.120.4491
lutronsea@lutron.com

Asia Technical Hotlines

Northern China: 10.800.712.1536
Southern China: 10.800.120.1536
Hong Kong: 800.901.849
Indonesia: 001.803.011.3994
Japan: +81.3.5575.8411
Macau: 0800.401
Taiwan: 00.801.137.737
Thailand: 001.800.120.665853
Other Countries: +65.6220.4666