

DS3608

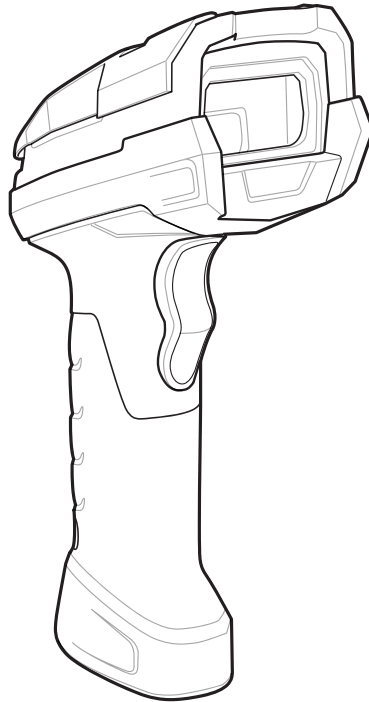

Digital Scanner

Product Reference Guide



DS3608 DIGITAL SCANNER PRODUCT REFERENCE GUIDE

MN002176A01

Revision A

February 2016

No part of this publication may be reproduced or used in any form, or by any electrical or mechanical means, without permission in writing from Zebra. This includes electronic or mechanical means, such as photocopying, recording, or information storage and retrieval systems. The material in this manual is subject to change without notice.

The software is provided strictly on an “as is” basis. All software, including firmware, furnished to the user is on a licensed basis. Zebra grants to the user a non-transferable and non-exclusive license to use each software or firmware program delivered hereunder (licensed program). Except as noted below, such license may not be assigned, sublicensed, or otherwise transferred by the user without prior written consent of Zebra. No right to copy a licensed program in whole or in part is granted, except as permitted under copyright law. The user shall not modify, merge, or incorporate any form or portion of a licensed program with other program material, create a derivative work from a licensed program, or use a licensed program in a network without written permission from Zebra. The user agrees to maintain Zebra’s copyright notice on the licensed programs delivered hereunder, and to include the same on any authorized copies it makes, in whole or in part. The user agrees not to decompile, disassemble, decode, or reverse engineer any licensed program delivered to the user or any portion thereof.

Zebra reserves the right to make changes to any product to improve reliability, function, or design.

Zebra does not assume any product liability arising out of, or in connection with, the application or use of any product, circuit, or application described herein. No license is granted, either expressly or by implication, estoppel, or otherwise under any patent right or patent, covering or relating to any combination, system, apparatus, machine, material, method, or process in which Zebra products might be used. An implied license exists only for equipment, circuits, and subsystems contained in Zebra products.

This product may include Seller Software, Third Party Software, and/or Publicly Available Software.

Use of any Software is subject to the applicable licenses, terms and conditions of the agreement in force between you and the Seller unless a separate License is included, in which case, use of the Software will be governed by the separate License.

Copies of the licenses for the following Publicly Available Software, and all attributions, acknowledgements, and software information details, are included below. Seller is required to reproduce the software licenses, acknowledgments and copyright notices as provided by the Authors and Owners. The information is provided in its native language form, without modification or translation.

Publicly available software list:

Name: Regular Expression Evaluator

Version: 8.3

Description: Compiles and executes regular expressions

Software Site: <http://www.freebsd.org/cgi/cvsweb.cgi/src/lib/libc/regex/>

Source Code: No Source Distribution Obligations. Seller will not provide nor distribute the Source Code for the Regular Expression Evaluator.

License: BSD Style License

© 1992 Henry Spencer.

© 1992, 1993 The Regents of the University of California. All rights reserved.

This code is derived from software contributed to Berkeley by Henry Spencer of the University of Toronto. Redistribution and use in source and binary forms, with or without modification, are permitted provided that the following conditions are met:

1. Redistributions of source code must retain the above copyright notice, this list of conditions and the following disclaimer.
2. Redistributions in binary form must reproduce the above copyright notice, this list of conditions and the following disclaimer in the documentation and/or other materials provided with the distribution.

3. All advertising materials mentioning features or use of this software must display the following acknowledgement:

This product includes software developed by the University of California, Berkeley and its contributors.

4. Neither the name of the University nor the names of its contributors may be used to endorse or promote products derived from this software without specific prior written permission.

THIS SOFTWARE IS PROVIDED BY THE REGENTS AND CONTRIBUTORS "AS IS" AND ANY EXPRESS OR IMPLIED WARRANTIES, INCLUDING, BUT NOT LIMITED TO, THE IMPLIED WARRANTIES OF MERCHANTABILITY AND FITNESS FOR A PARTICULAR PURPOSE ARE DISCLAIMED. IN NO EVENT SHALL THE REGENTS OR CONTRIBUTORS BE LIABLE FOR ANY DIRECT, INDIRECT, INCIDENTAL, SPECIAL, EXEMPLARY, OR CONSEQUENTIAL DAMAGES (INCLUDING, BUT NOT LIMITED TO, PROCUREMENT OF SUBSTITUTE GOODS OR SERVICES; LOSS OF USE, DATA, OR PROFITS; OR BUSINESS INTERRUPTION) HOWEVER CAUSED AND ON ANY THEORY OF LIABILITY, WHETHER IN CONTRACT, STRICT LIABILITY, OR TORT (INCLUDING NEGLIGENCE OR OTHERWISE) ARISING IN ANY WAY OUT OF THE USE OF THIS SOFTWARE, EVEN IF ADVISED OF THE POSSIBILITY OF SUCH DAMAGE.

Warranty

For the complete hardware product warranty statement, go to: <http://www.zebra.com/warranty>.

Revision History

Changes to the original guide are listed below:

Change	Date	Description
-01 Rev A	02/2016	Initial release.

TABLE OF CONTENTS

Warranty	iv
Revision History	v

About This Guide

Introduction	xix
Configurations	xix
Related Product Line Configurations	xx
Chapter Descriptions	xxi
Notational Conventions	xxii
Related Documents	xxiii
Service Information	xxiii

Chapter 1: Getting Started

Introduction	1-1
Interfaces	1-2
Unpacking	1-2
Setting Up DS3608 Digital Imager Scanner	1-3
Installing the DS3608 Interface Cable	1-3
Removing the DS3608 Interface Cable	1-4
Connecting Power (if required)	1-5
Configuring the Digital Scanner	1-5
Accessories	1-6

Chapter 2: Data Capture

Introduction	2-1
Beeper and LED Indicators	2-2
Scanning	2-4
Scanning in Hands-Free (Presentation) Mode	2-4
Scanning in Hand-Held Mode	2-5
Aiming with DS3608-SR	2-6
Decode Ranges	2-8

Chapter 3: Maintenance & Technical Specifications

Introduction	3-1
Maintenance	3-1
Known Harmful Ingredients	3-1
Approved Cleaning Agents	3-1
Tolerable Industrial Fluids and Chemicals	3-2
Cleaning the Digital Scanner	3-2
Troubleshooting	3-3
Report Software Version Bar Code	3-6
Technical Specifications	3-7
Digital Scanner Signal Descriptions	3-9

Chapter 4: User Preferences & Miscellaneous Options

Introduction	4-1
Scanning Sequence Examples	4-2
Errors While Scanning	4-2
User Preferences/Miscellaneous Options Parameter Defaults	4-2
User Preferences	4-5
Default Parameters	4-5
Report Version	4-6
Parameter Bar Code Scanning	4-6
Beep After Good Decode	4-7
Direct Decode Indicator	4-8
Beeper Volume	4-9
Beeper Tone	4-10
Beeper Duration	4-11
Suppress Power Up Beeps	4-11
Decode Pager Motor	4-12
Decode Pager Motor Duration	4-12
Low Power Mode	4-14
Time Delay to Low Power Mode	4-15
Hand-Held Trigger Mode	4-17
Hands-Free Mode	4-18
Hand-Held Decode Aiming Pattern	4-19
Hands-Free (Presentation) Decode Aiming Pattern	4-20
Picklist Mode	4-21
Continuous Bar Code Read	4-22
Unique Bar Code Reporting	4-22
Decode Session Timeout	4-23
Hands-free Decode Session Timeout	4-24
Timeout Between Decodes, Same Symbol	4-25
Timeout Between Decodes, Different Symbols	4-26
Decode Mirror Images (Data Matrix Only)	4-27
Mobile Phone/Display Mode	4-28
PDF Prioritization	4-29
PDF Prioritization Timeout	4-30
Presentation Mode Field of View	4-31
Decoding Illumination	4-32
Motion Tolerance (Hand-Held Trigger Modes Only)	4-33

Miscellaneous Scanner Parameters	4-34
Add an Enter Key	4-34
Transmit Code ID Character	4-34
Prefix/Suffix Values	4-35
Scan Data Transmission Format	4-36
FN1 Substitution Values	4-37
Transmit “No Read” Message	4-38
Unsolicited Heartbeat Interval	4-39

Chapter 5: Imaging Preferences

Introduction	5-1
Scanning Sequence Examples	5-2
Errors While Scanning	5-2
Imaging Preferences Parameter Defaults	5-2
Imaging Preferences	5-4
Operational Modes	5-4
Image Capture Illumination	5-5
Image Capture Autoexposure	5-5
Fixed Exposure	5-6
Fixed Gain	5-6
Gain/Exposure Priority for Snapshot Mode	5-7
Snapshot Mode Timeout	5-8
Snapshot Aiming Pattern	5-9
Silence Operational Mode Changes	5-9
Image Cropping	5-10
Crop to Pixel Addresses	5-11
Image Size (Number of Pixels)	5-12
Image Brightness (Target White)	5-13
JPEG Image Options	5-13
JPEG Target File Size	5-14
JPEG Quality and Size Value	5-14
Image Enhancement	5-15
Image File Format Selector	5-16
Image Rotation	5-17
Bits Per Pixel	5-18
Signature Capture	5-19
Signature Capture File Format Selector	5-20
Signature Capture Bits Per Pixel	5-21
Signature Capture Width	5-22
Signature Capture Height	5-22
Signature Capture JPEG Quality	5-23
Video View Finder	5-23
Video View Finder Image Size	5-24

Chapter 6: USB Interface

Introduction	6-1
Connecting a USB Interface	6-2
USB Parameter Defaults	6-4

USB Host Parameter	6-5
USB Device Type	6-5
Symbol Native API (SNAPI) Status Handshaking	6-7
USB Keystroke Delay	6-8
USB CAPS Lock Override	6-8
USB Ignore Unknown Characters	6-9
USB Convert Unknown to Code 39	6-9
Emulate Keypad	6-10
Emulate Keypad with Leading Zero	6-10
Quick Keypad Emulation	6-11
USB Keyboard FN 1 Substitution	6-11
Function Key Mapping	6-12
Simulated Caps Lock	6-12
Convert Case	6-13
USB Static CDC	6-13
Optional USB Parameters	6-14
Ignore Beep	6-14
Ignore Bar Code Configuration	6-14
USB Polling Interval	6-15
USB Fast HID	6-17
IBM Specification Version	6-17
ASCII Character Set for USB	6-18

Chapter 7: SSI Interface

Introduction	7-1
Communications	7-1
SSI Transactions	7-3
General Data Transactions	7-3
Transfer of Decode Data	7-4
Communication Summary	7-5
RTS/CTS Lines	7-5
ACK/NAK Option	7-5
Number of Data Bits	7-5
Serial Response Time-out	7-6
Retries	7-6
Baud Rate, Stop Bits, Parity, Response Time-out, ACK/NAK Handshake	7-6
Errors	7-6
Things to Remember When Using SSI Communication	7-6
Using Time Delay to Low Power Mode with SSI	7-7
Encapsulation of RSM Commands/Responses over SSI	7-8
Command Structure	7-8
Response Structure	7-8
Example Transaction	7-9
Simple Serial Interface Default Parameters	7-10
SSI Host Parameters	7-11
Select SSI Host	7-11
Baud Rate	7-12
Parity	7-13
Check Parity	7-14

Stop Bits	7-14
Software Handshaking	7-15
Host RTS Line State	7-16
Decode Data Packet Format	7-16
Host Serial Response Time-out	7-17
Host Character Time-out	7-18
Multipacket Option	7-19
Interpacket Delay	7-20
Event Reporting	7-21
Decode Event	7-21
Boot Up Event	7-22
Parameter Event	7-22

Chapter 8: RS-232 Interface

Introduction	8-1
Connecting an RS-232 Interface	8-2
RS-232 Parameter Defaults	8-3
RS-232 Host Parameters	8-4
RS-232 Host Types	8-6
Baud Rate	8-8
Parity	8-9
Stop Bit Select	8-10
Data Bits	8-10
Check Receive Errors	8-11
Hardware Handshaking	8-11
Software Handshaking	8-13
Host Serial Response Time-out	8-15
RTS Line State	8-16
Beep on <BEL>	8-16
Intercharacter Delay	8-17
Nixdorf Beep/LED Options	8-18
Ignore Unknown Characters	8-18
ASCII Character Set for RS-232	8-19

Chapter 9: IBM 468X / 469X Interface

Introduction	9-1
Connecting to an IBM 468X/469X Host	9-2
IBM Parameter Defaults	9-3
IBM 468X/469X Host Parameters	9-4
Port Address	9-4
Convert Unknown to Code 39	9-5
Ignore Beep Directive	9-5
Ignore Bar Code Configuration Directive	9-6

Chapter 10: Keyboard Wedge Interface

Introduction	10-1
Connecting a Keyboard Wedge Interface	10-2
Keyboard Wedge Parameter Defaults	10-3
Keyboard Wedge Host Parameters	10-4
Keyboard Wedge Host Types	10-4
Ignore Unknown Characters	10-4
Keystroke Delay	10-5
Intra-Keystroke Delay	10-5
Alternate Numeric Keypad Emulation	10-6
Quick Keypad Emulation	10-6
Simulated Caps Lock	10-7
Caps Lock Override	10-7
Convert Wedge Case	10-8
Function Key Mapping	10-8
FN1 Substitution	10-9
Send Make and Break	10-9
Keyboard Maps	10-10
ASCII Character Set for Keyboard Wedge	10-11

Chapter 11: Symbologies

Introduction	11-1
Scanning Sequence Examples	11-2
Errors While Scanning	11-2
Symbology Parameter Defaults	11-2
Enable/Disable All Code Types	11-8
UPC/EAN	11-9
Enable/Disable UPC-A	11-9
Enable/Disable UPC-E	11-9
Enable/Disable UPC-E1	11-10
Enable/Disable EAN-8/JAN-8	11-10
Enable/Disable EAN-13/JAN-13	11-11
Enable/Disable Bookland EAN	11-11
Decode UPC/EAN/JAN Supplementals	11-12
User-Programmable Supplementals	11-15
UPC/EAN/JAN Supplemental Redundancy	11-15
UPC/EAN/JAN Supplemental AIM ID Format	11-16
UPC Reduced Quiet Zone	11-17
Transmit UPC-A Check Digit	11-17
Transmit UPC-E Check Digit	11-18
Transmit UPC-E1 Check Digit	11-18
UPC-A Preamble	11-19
UPC-E Preamble	11-20
UPC-E1 Preamble	11-21
Convert UPC-E to UPC-A	11-22
Convert UPC-E1 to UPC-A	11-22
EAN-8/JAN-8 Extend	11-23
Bookland ISBN Format	11-23
UCC Coupon Extended Code	11-24

Coupon Report	11-25
ISSN EAN	11-25
Code 128	11-26
Enable/Disable Code 128	11-26
Set Lengths for Code 128	11-26
Enable/Disable GS1-128 (formerly UCC/EAN-128)	11-28
Enable/Disable ISBT 128	11-28
ISBT Concatenation	11-29
Check ISBT Table	11-30
ISBT Concatenation Redundancy	11-30
Code 128 Security Level	11-31
Code 128 Reduced Quiet Zone	11-32
Ignore Code 128 <FNC4>	11-32
Code 39	11-33
Enable/Disable Code 39	11-33
Enable/Disable Trioptic Code 39	11-33
Convert Code 39 to Code 32	11-34
Code 32 Prefix	11-35
Set Lengths for Code 39	11-36
Code 39 Check Digit Verification	11-37
Transmit Code 39 Check Digit	11-37
Code 39 Full ASCII Conversion	11-38
Code 39 Security Level	11-39
Code 39 Reduced Quiet Zone	11-40
Code 93	11-41
Enable/Disable Code 93	11-41
Set Lengths for Code 93	11-42
Code 11	11-43
Code 11	11-43
Set Lengths for Code 11	11-44
Code 11 Check Digit Verification	11-45
Transmit Code 11 Check Digits	11-46
Interleaved 2 of 5 (ITF)	11-47
Enable/Disable Interleaved 2 of 5	11-47
Set Lengths for Interleaved 2 of 5	11-48
I 2 of 5 Check Digit Verification	11-50
Transmit I 2 of 5 Check Digit	11-51
Convert I 2 of 5 to EAN-13	11-51
I 2 of 5 Security Level	11-52
I 2 of 5 Reduced Quiet Zone	11-53
Discrete 2 of 5 (DTF)	11-54
Enable/Disable Discrete 2 of 5	11-54
Set Lengths for Discrete 2 of 5	11-55
Codabar (NW - 7)	11-57
Enable/Disable Codabar	11-57
Set Lengths for Codabar	11-58
CLSI Editing	11-59
NOTIS Editing	11-59
Codabar Upper or Lower Case Start/Stop Characters Detection	11-60
MSI	11-61

Enable/Disable MSI	11-61
Set Lengths for MSI	11-62
MSI Check Digits	11-64
Transmit MSI Check Digit(s)	11-64
MSI Check Digit Algorithm	11-65
Chinese 2 of 5	11-66
Enable/Disable Chinese 2 of 5	11-66
Matrix 2 of 5	11-67
Enable/Disable Matrix 2 of 5	11-67
Set Lengths for Matrix 2 of 5	11-67
Matrix 2 of 5 Check Digit	11-69
Transmit Matrix 2 of 5 Check Digit	11-69
Korean 3 of 5	11-70
Enable/Disable Korean 3 of 5	11-70
Inverse 1D	11-71
GS1 DataBar	11-72
GS1 DataBar-14	11-72
GS1 DataBar Limited	11-72
GS1 DataBar Expanded	11-73
Convert GS1 DataBar to UPC/EAN	11-73
GS1 DataBar Limited Security Level	11-74
Composite	11-75
Composite CC-C	11-75
Composite CC-A/B	11-75
Composite TLC-39	11-76
UPC Composite Mode	11-76
Composite Beep Mode	11-77
GS1-128 Emulation Mode for UCC/EAN Composite Codes	11-77
2D Symbolologies	11-78
Enable/Disable PDF417	11-78
Enable/Disable MicroPDF417	11-78
Code 128 Emulation	11-79
Data Matrix	11-80
GS1 Data Matrix	11-80
Data Matrix Inverse	11-81
Maxicode	11-81
QR Code	11-82
GS1 QR	11-82
MicroQR	11-83
Aztec	11-83
Aztec Inverse	11-84
Han Xin	11-84
Han Xin Inverse	11-85
Postal Codes	11-86
US Postnet	11-86
US Planet	11-86
Transmit US Postal Check Digit	11-87
UK Postal	11-87
Transmit UK Postal Check Digit	11-88
Japan Postal	11-88

- Australia Post 11-89
- Australia Post Format 11-90
- Netherlands KIX Code 11-91
- USPS 4CB/One Code/Intelligent Mail 11-91
- UPU FICS Postal 11-92
- Mailmark 11-92
- Symbology-Specific Security Levels 11-93
 - Redundancy Level 11-93
 - Security Level 11-95
 - 1D Quiet Zone Level 11-96
 - Intercharacter Gap Size 11-97
- Macro PDF Features 11-98
 - Flush Macro Buffer 11-98
 - Abort Macro PDF Entry 11-98

Chapter 12: Intelligent Document Capture

- Introduction 12-1
- The IDC Process 12-1
 - Bar Code Acceptance Test 12-2
 - Capture Region Determination 12-2
 - Image Post Processing 12-3
 - Data Transmission 12-3
- PC Application and Programming Support 12-3
- Parameters 12-4
 - IDC Operating Mode 12-5
 - IDC Symbology 12-6
 - IDC X Coordinate 12-7
 - IDC Y Coordinate 12-7
 - IDC Width 12-8
 - IDC Height 12-8
 - IDC Aspect 12-9
 - IDC File Format Selector 12-9
 - IDC Bits Per Pixel 12-10
 - IDC JPEG Quality 12-10
 - IDC Find Box Outline 12-11
 - IDC Minimum Text Length 12-11
 - IDC Maximum Text Length 12-12
 - IDC Captured Image Brighten 12-12
 - IDC Captured Image Sharpen 12-13
 - IDC Border Type 12-14
 - IDC Delay Time 12-15
 - IDC Zoom Limit 12-15
 - IDC Maximum Rotation 12-16
- Quick Start 12-17
 - Sample IDC Setup 12-17
 - IDC Demonstrations 12-18
 - Other Suggestions 12-19
 - Quick Start Form 12-19

Chapter 13: OCR Programming

Introduction 13-1

OCR Programming Parameters 13-3

 Enable/Disable OCR-A 13-3

 OCR-A Variant 13-3

 Enable/Disable OCR-B 13-5

 OCR-B Variant 13-6

 Enable/Disable MICR E13B 13-9

 Enable/Disable US Currency Serial Number 13-10

 OCR Orientation 13-10

 OCR Lines 13-12

 OCR Minimum Characters 13-12

 OCR Maximum Characters 13-13

 OCR Subset 13-13

 OCR Quiet Zone 13-14

 OCR Template 13-15

 OCR Check Digit Modulus 13-25

 OCR Check Digit Multiplier 13-26

 OCR Check Digit Validation 13-27

 Inverse OCR 13-32

Chapter 14: 123Scan2

Introduction 14-1

Communication with 123Scan2 14-1

123Scan2 Requirements 14-2

Scanner SDK, Other Software Tools, and Videos 14-2

Chapter 15: Advanced Data Formatting

Introduction 15-1

Appendix A: Standard Default Parameters

Appendix B: Country Codes

Introduction B-1

USB and Keyboard Wedge Country Keyboard Types (Country Codes) B-2

Appendix C: Country Code Pages

Introduction C-1

Country Code Page Defaults C-1

Country Code Page Bar Codes C-5

Appendix D: CJK Decode Control

Introduction D-1

CJK Control Parameters D-2

Unicode Output Control	D-2
CJK Output Method to Windows Host	D-3
Non-CJK UTF Bar Code Output	D-6
Unicode/CJK Decode Setup with Windows Host	D-8
Setting Up the Windows Registry Table for Unicode Universal Output	D-8
Adding CJK IME on Windows	D-8
Selecting the Simplified Chinese Input Method on the Host	D-9
Selecting the Traditional Chinese Input Method on the Host	D-10

Appendix E: Programming Reference

Symbol Code Identifiers	E-1
AIM Code Identifiers	E-3

Appendix F: Sample Bar Codes

Code 39	F-1
UPC/EAN	F-1
UPC-A, 100%	F-1
EAN-13, 100%	F-2
Code 128	F-2
Interleaved 2 of 5	F-2
GS1 DataBar-14	F-3
PDF417	F-3
Data Matrix	F-3
Maxicode	F-4
QR Code	F-4
US Postnet	F-4
UK Postal	F-4

Appendix G: Numeric Bar Codes

Numeric Bar Codes	G-1
Cancel	G-2

Appendix H: ASCII Character Sets

Appendix I: Communication Protocol Functionality

Functionality Supported via Communication (Cable) Interface	I-1
---	-----

Appendix J: Signature Capture Code

Introduction	J-1
Code Structure	J-1
Signature Capture Area	J-1
CapCode Pattern Structure	J-2
Start / Stop Patterns	J-2
Dimensions	J-3

Data Format	J-3
Additional Capabilities	J-4
Signature Boxes	J-4

Appendix K: Non-Parameter Attributes

Introduction	K-1
Attributes	K-1
Model Number	K-1
Serial Number	K-1
Date of Manufacture	K-2
Date of First Programming	K-2
Configuration Filename	K-2
Beeper/LED	K-3
Parameter Defaults	K-4
Beep on Next Bootup	K-4
Reboot	K-4
Host Trigger Session	K-4
Firmware Version	K-5
Scankit Version	K-5

Index

ABOUT THIS GUIDE

Introduction

The *DS3608 Product Reference Guide* provides general instructions for setting up, operating, maintaining, and troubleshooting the DS3608 digital scanner.

Configurations

This guide includes the following DS3608 digital scanner configurations:

Configuration	Description
DS3608-HD20003VZWW	Rugged, Digital Scanner, High Density, Corded, Industrial Green, Vibration Motor
DS3608-HP20003VZWW	Rugged, Digital Scanner, High Performance, Corded, Industrial Green, Vibration Motor
DS3608-SR00003VZWW	Rugged, Digital Scanner, Standard Range, Corded, Industrial Green, Vibration Motor

Related Product Line Configurations

The product configurations related to the DS3608 digital scanner are as follows:

- ✓ **NOTE** Check Solution Builder for:
 - additional information regarding all available accessories
 - - the latest available configurations.

Product	Part Number	Description
Accessories		
Intellistand	STND-AS0036-07	Stand: Adjustable Intellistand, Black
Tool Balancer Pulley	50-15400-031	Pulley: Tool Balancer Pulley
Clip on Belt Holster	11-59382-01	Holder: Clip on Belt
Fork Lift Holder	21-52612-01R	Holder: Fork Lift
Lanyard	50-12500-066	Lanyard Strap
Universal Cables		
Shielded USB	CBA-U70-C127ZAR	Shielded USB: Series A Locking Connector for VC70, 12', Coiled, -30C
	CBA-U42-S07PAR	Shielded USB: Series A Connector, 7ft. (2.8m), Straight, 12V (Requires 12V Power Supply)
	CBA-U46-S07ZAR	Shielded USB: Series A Connector, 7ft. (2m), Straight, BC 1.2
	CBA-U47-S15ZAR	Shielded USB: Series A Connector, 15ft. (4.6m), Straight, BC 1.2
	CBA-U48-C15PAR	Shielded USB: Series A Connector, 15ft. (4.6m), Coiled, 12V (Requires 12V Power Supply)
	CBA-U49-C15ZAR	Shielded USB: Series A Connector, 15ft. (4.6m), Coiled, BC 1.2
	CBA-U43-S07ZAR	Shielded USB: Power Plus Connector, 7ft. (2.8m), Straight, 12V
	CBA-UF0-S07PAR	Cable - Shielded USB: Series A Connector, 7ft. (2m), Straight, 12V (Requires 12V Power Supply), Low Temp -30C
	CBA-UF1-S07ZAR	Cable - Shielded USB: Series A Connector, 7ft. (2m), Straight, BC 1.2 (High Current), -30C
Keyboard Wedge	CBA-K63-S07PAR	Auto-Host Detect - Keyboard Wedge: 7ft. (2m) Straight, PS/2 Power Port, 12V (Requires 12V Power Supply)
IBM	CBA-M65-S07ZAR	Auto-Host Detect - IBM: 468x/9x, 7ft (2m) Straight, Port 9B, 12V
RS-232	CBA-R07-S07PAR	RS232: DB9 Female Connector, 7 ft. (2m) Straight, TxD on 2, 12V (Requires 12V Power Supply)
	CBA-RF0-S07PAR	RS232: DB9 Female Connector, 9ft. (2.8m) Coiled, TxD on 2, 12V (Requires 12V Power Supply)
	CBA-RF1-C09PAR	Cable - RS232: DB9 Female Connector, 9ft. (2.8m) Coiled, TxD on 2, 12V (Requires 12V Power Supply), -30C
	CBA-RF2-C09ZAR	Cable - RS232: DB9 Female Connector, 9ft (2.8m) Coiled, Power Pin 9, -30C
	CBA-RF3-C09ZAR	Cable - RS232: DB9 Female Connector, 9ft. (2.8m) Coiled, Power Pin 9, TxD on 2, True Converter, Low Temp -30C
Power Supplies	PWRS-14000-148R	Power Supply: 100-240 VAC, 12VDC, 4.16A
	PWRS-14000-251	Power Supply: 18-75VDC, 12VDC, High
	PWRS-14000-252	Power Supply: 9-30VDC, 12VDC, Low

Chapter Descriptions

Topics covered in this guide are as follows:

- [Chapter 1, Getting Started](#) provides a product overview, unpacking instructions, and cable connection information.
- [Chapter 2, Data Capture](#) provides beeper and LED definitions, techniques involved in scanning bar codes, general instructions and tips about scanning, and decode ranges.
- [Chapter 3, Maintenance & Technical Specifications](#) provides suggested digital scanner maintenance, troubleshooting, technical specifications, and signal descriptions (pinouts).
- [Chapter 4, User Preferences & Miscellaneous Options](#) describes each user preference feature and provides programming bar codes for selecting these features.
- [Chapter 5, Imaging Preferences](#) describes imaging preference features and provides programming bar codes for selecting these features.
- [Chapter 6, USB Interface](#) describes how to set up the digital scanner with a USB host.
- [Chapter 7, SSI Interface](#) describes the system requirements of the Simple Serial Interface (SSI), which provides a communications link between Zebra decoders and a serial host.
- [Chapter 8, RS-232 Interface](#) describes how to set up the digital scanner with an RS-232 host.
- [Chapter 9, IBM 468X / 469X Interface](#) describes how to set up the digital scanner with an IBM 468X/469X host.
- [Chapter 10, Keyboard Wedge Interface](#) describes how to set up a keyboard wedge interface with the digital scanner.
- [Chapter 11, Symbologies](#) describes all symbology features and provides programming bar codes for selecting these features for the digital scanner.
- [Chapter 12, Intelligent Document Capture](#) describes IDC, an advanced image processing firmware, including IDC functionality, parameter bar codes to control its features, and a quick start procedure.
- [Chapter 13, OCR Programming](#) describes how to set up the digital scanner for OCR programming.
- [Chapter 14, 123Scan2](#) provides information on the PC-based digital scanner configuration tool 123Scan².
- [Chapter 15, Advanced Data Formatting](#) briefly describes ADF, a means of customizing data before transmission to the host device, and includes a reference to the *ADF Programmer Guide*.
- [Appendix A, Standard Default Parameters](#) provides a table of all host devices and miscellaneous scanner defaults.
- [Appendix B, Country Codes](#) provides bar codes for programming the country keyboard type for the USB keyboard (HID) device and the keyboard wedge host.
- [Appendix C, Country Code Pages](#) provides bar codes for selecting code pages for the country keyboard type.
- [Appendix D, CJK Decode Control](#) describes control parameters for Unicode/CJK (Chinese, Japanese, Korean) bar code decode through USB HID Keyboard Emulation mode.
- [Appendix E, Programming Reference](#) provides a table of AIM code identifiers, ASCII character conversions, and keyboard maps.
- [Appendix F, Sample Bar Codes](#) includes sample bar codes of various code types.

- [Appendix G, Numeric Bar Codes](#) includes the numeric bar codes to scan for parameters requiring specific numeric values.
- [Appendix H, ASCII Character Sets](#) provides ASCII character value tables.
- [Appendix I, Communication Protocol Functionality](#) lists supported scanner functionality by communication protocol.
- [Appendix J, Signature Capture Code](#) describes CapCode, a special pattern that encloses a signature area on a document and allows the scanner to capture a signature.
- [Appendix K, Non-Parameter Attributes](#) defines non-parameter attributes.

Notational Conventions

The following conventions are used in this document:

- *Italics* are used to highlight the following:
 - Chapters and sections in this and related documents
 - Dialog box, window and screen names
 - Drop-down list and list box names
 - Check box and radio button names
- **Bold** text is used to highlight the following:
 - Key names on a keypad
 - Button names on a screen.
- bullets (•) indicate:
 - Action items
 - Lists of alternatives
 - Lists of required steps that are not necessarily sequential
- Sequential lists (e.g., those that describe step-by-step procedures) appear as numbered lists.
- Throughout the programming bar code menus, asterisks (*) are used to denote default parameter settings.

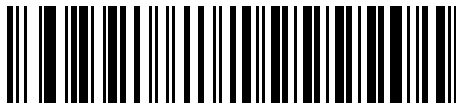

* Indicates Default — *Baud Rate 9600 — Feature/Option

Related Documents

- *DS3608 Quick Start Guide*, p/n MN002257Axx- provides general information for getting started with the DS3608 digital scanner, and includes basic set up and operation instructions.
- *Advanced Data Formatting Programmer Guide*, p/n 72E-69680-xx - provides information on ADF, a means of customizing data before transmission to a host.
- *Attribute Data Dictionary*, p/n 72E-149786-xx defines attribute numbers (device configuration parameters, monitored data, and born-on information) and describes management of various attribute domains for bar code scanners and OEM engines.

For the latest version of this guide and all guides, go to: <http://www.zebra.com/support>.

Service Information

If you have a problem using the equipment, contact your facility's technical or systems support. If there is a problem with the equipment, they will contact the Customer Support Center at: <http://www.zebra.com/support>.

When contacting support, please have the following information available:

- Serial number of the unit
- Model number or product name
- Software type and version number

Zebra responds to calls by e-mail, telephone or fax within the time limits set forth in service agreements.

If your problem cannot be solved by support, you may need to return your equipment for servicing and will be given specific directions. Zebra is not responsible for any damages incurred during shipment if the approved shipping container is not used. Shipping the units improperly can possibly void the warranty.

If you purchased your business product from a Zebra business partner, please contact that business partner for support.

CHAPTER 1 GETTING STARTED

Introduction

The DS3608 combine superior 1D and 2D omnidirectional bar code scanning and transfer with a light-weight, hands-free/hand-held design. The digital scanner's Intellistand seamlessly accommodates both counter top and hand-held use. Whether in hands-free (presentation) or hand-held mode, the digital scanner ensures comfort and ease of use for extended periods of time.

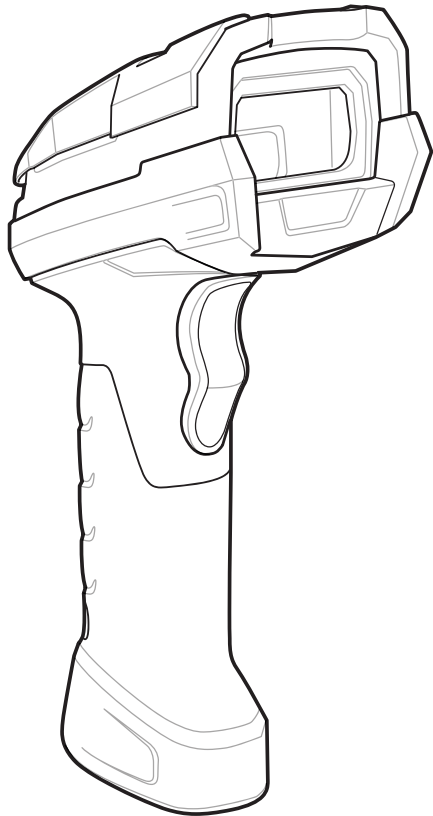

Figure 1-1 *DS3608 Digital Scanner*

Interfaces

The DS3608 digital scanner supports:

- USB connection to a host. The digital scanner autodetects a USB host and defaults to the HID keyboard interface type. Select other USB interface types by scanning programming bar code menus. This interface supports the following international keyboards (for Windows® environment): North America, German, French, French Canadian, Spanish, Italian, Swedish, UK English, Portuguese-Brazilian, and Japanese.
- Standard RS-232 connection to a host. Scan bar code menus to set up communication of the digital scanner with the host.
- Connection to IBM 468X/469X hosts. Scan bar code menus to set up communication of the digital scanner with the IBM terminal.
- Keyboard Wedge connection to a host. The host interprets scanned data as keystrokes. Scan bar code menus to set up communication of the digital scanner with the host. This interface supports the following international keyboards (for Windows® environment): North America, German, French International, French Canadian, French Belgian, Spanish, Italian, Swedish, UK English, Brazilian-Portuguese and Japanese.
See [Appendix B, Country Codes](#) for instructions on programming the keyboard to interface with a USB or keyboard wedge host
- Configuration via 123Scan².

✓ **NOTE** For a list of supported scanner functionality by communication protocol, see [Appendix I, Communication Protocol Functionality](#).

Unpacking

Remove the digital scanner from its packing and inspect it for damage. If the scanner was damaged in transit, contact support. See [page xxiii](#) for information. **KEEP THE PACKING.** It is the approved shipping container; use this to return the equipment for servicing.

Setting Up DS3608 Digital Imager Scanner

Installing the DS3608 Interface Cable

1. Insert cable fully so that the connector is flush with the scanner surface.

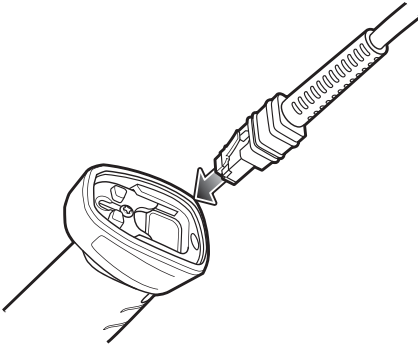

Figure 1-2 *Inserting Cable into DS3608*

2. Loosen metal lock plate screw using a PH1 driver.

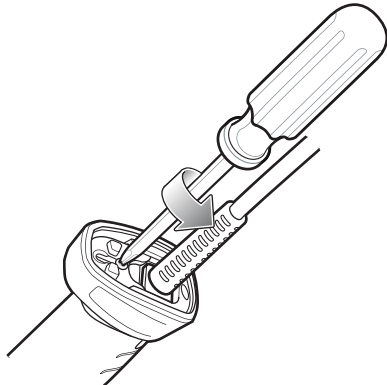

Figure 1-3 *Loosening DS3608 Lock Plate Screw*

3. Slide lock plate to fully locked position.

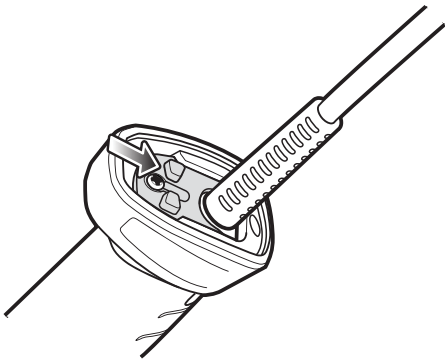

Figure 1-4 *Sliding Lock Plate into Locked Position*

4. Tighten lock plate screw using a PH1 driver (recommended Torque: 5 in-lbs).

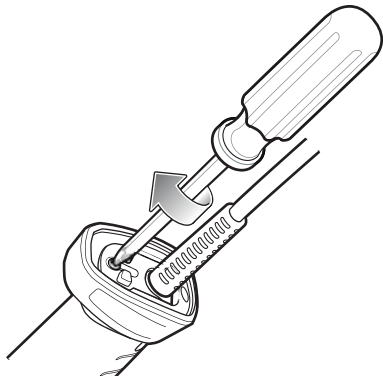

Figure 1-5 *Tightening Lock Plate*

Removing the DS3608 Interface Cable

1. Loosen lock plate screw using a PH1 driver.

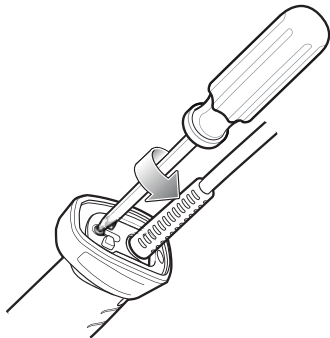

Figure 1-6 *Loosening Lock Plate*

2. Slide lock plate to fully unlocked position.

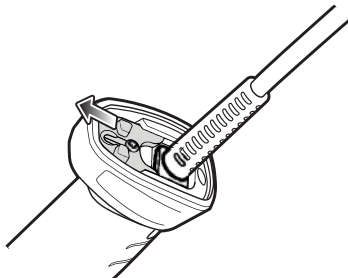

Figure 1-7 *Sliding Lock Plate into Unlocked Position*

3. Tighten lock plate to fully unlocked position.

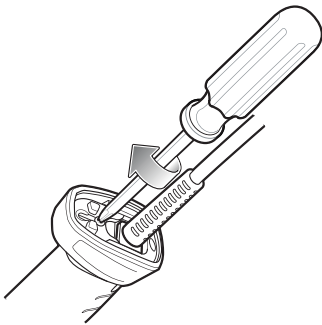

Figure 1-8 *Tightening Lock Plate into Unlocked Position*

4. Remove cable.

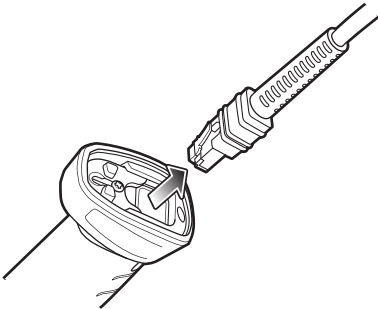

Figure 1-9 *Removing Cable from DS3608*

Connecting Power (if required)

If the host does not provide power to the digital scanner, connect an external power supply.

1. Plug the power supply into the power jack on the interface cable.
2. Plug the other end of the power supply into an AC outlet.

Configuring the Digital Scanner

To configure the digital scanner use the bar codes included in this manual, or use the 123Scan² configuration program. See [Chapter 4, User Preferences & Miscellaneous Options](#), and [Chapter 11, Symbologies](#) for information about programming the digital scanner using bar code menus. See [Chapter 14, 123Scan2](#) for information on using this configuration program. Also see each host-specific chapter to set up connection to a specific host type.

Accessories

The digital scanner ships with the *DS3608 Quick Start Guide*. The following required accessories must be ordered:

- Interface cable for the appropriate interface.
- Universal power supply, if the interface requires this.
- Intellistand for hands-free operation of the DS3608.

See [Related Product Line Configurations on page 3-xx](#). For additional items, contact a local Zebra representative or business partner.

CHAPTER 2 DATA CAPTURE

Introduction

This chapter provides beeper and LED definitions, techniques involved in scanning bar codes, general instructions and tips about scanning, and decode ranges.

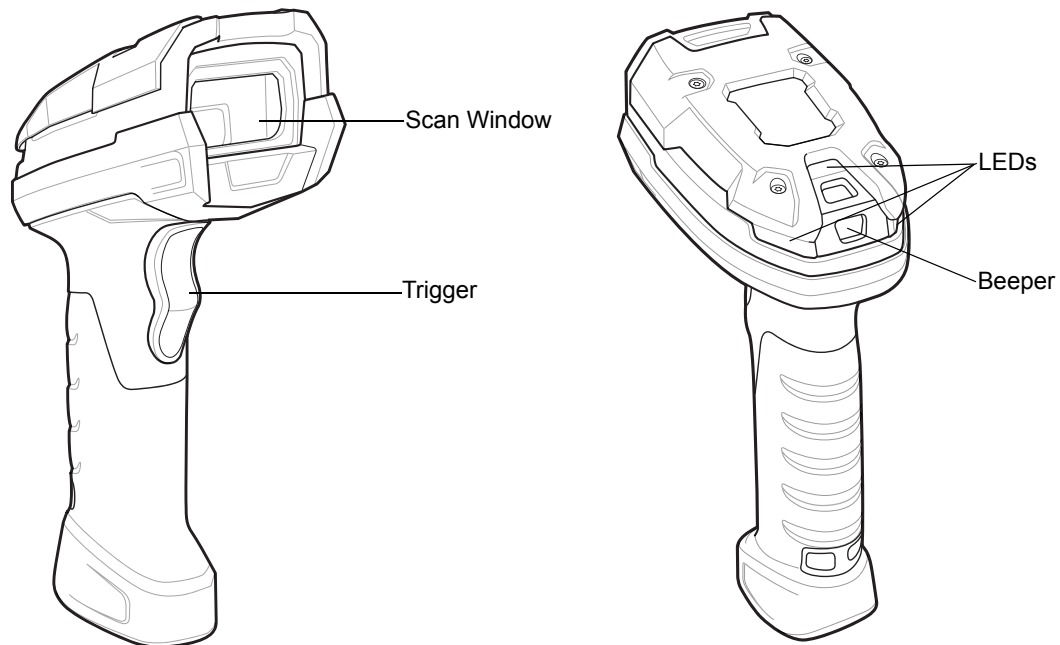

Figure 2-1 *Parts of the DS3608*

Beeper and LED Indicators

In addition to beep sequences, the digital scanner uses a two-color LED to indicate status.

[Table 2-1](#) defines beep sequences that occur during both normal scanning and while programming the digital scanner; LED colors that display during scanning.

Table 2-1 *Beeper and LED Indicators*

Event	Beeper Sequence	LED Indicator
Standard Use		
Power up.	Low, Medium, High beeps	Green
Decode a bar code.	(as configured)	Green
Hands-free Mode (Presentation Mode On).	None	Green (stays on)
Hand-held Mode (Presentation Mode Off).	None	Green (stays off)
Transmission error.	4 Low beeps	Red
Conversion or format error.	5 Low beeps	Red
RS-232 receive error (Parity Error).	Low, Low, Low, Extra-Low beeps	Red
A <BEL> character is received over RS-232.	High beep	None
Image Capture		
Snapshot mode started.	Low beep	Green Blinking
Snapshot mode completed.	Low beep	Default Green LED mode based upon Hand-held / Hands-free Mode state
Snapshot mode timed-out.	High, Low beeps	Default Green mode based upon Hand-held / Hands-free Mode state
Video mode started.	None	Green (stays on)
Video mode completed.	None	Default Green mode based upon Hand-held / Hands-free Mode state
Parameter Programming		
Input error: Incorrect bar code, programming sequence, or Cancel scanned.	Low, High beeps	Red
Number expected. Enter value using numeric bar codes.	High, Low beeps	Green
Successful program exit with change in parameter setting.	High, Low, High, Low beeps	Green

Table 2-1 *Beeper and LED Indicators (Continued)*

Event	Beeper Sequence	LED Indicator
ADF Programming		
Enter another digit. Add leading zeros to the front if necessary.	High, Low beeps	Green
Enter another alphabetic character or scan the End of Message bar code.	Low, Low beeps	Green
ADF criteria or action is expected. Enter another criterion or action, or scan the Save Rule bar code.	High, High beeps	Green Blinking
Rule saved. Rule entry mode exited.	High, Low, High, Low beeps	Green (turns off blinking)
All criteria or actions cleared for current rule, continue entering rule.	High, Low, Low beeps	Green
Delete last saved rule. The current rule is left intact.	Low beep	Green
All rules are deleted.	Low, High, High beeps	Green
Out of rule memory. Erase some existing rules, then try to save rule again	Low, High, Low, High beeps	Red
Cancel rule entry. Rule entry mode exited because of an error or the user asked to exit rule entry.	Low, High, Low beeps	Green (turns off blinking)
Entry error, wrong bar code scanned, or criteria/action list is too long for a rule. Re-enter criterion or action.	Low, High beeps	Red
Macro PDF		
File ID error. A bar code not in the current MPDF sequence was scanned.	2 Low beeps	None
File ID error. A bar code not in the current MPDF sequence was scanned.	2 Long Low beeps	None
Out of memory. There is not enough buffer space to store the current MPDF symbol.	3 Long Low beeps	None
Bad symbology. Scanned a 1D or 2D bar code in a MPDF sequence, a duplicate MPDF label, a label in an incorrect order, or trying to transmit an empty or illegal MPDF field.	4 Long Low beeps	None
Flushing MPDF buffer.	5 Long Low beeps	None
Aborting MPDF sequence.	Fast Warble	None
Flushing an already empty MPDF buffer.	Low, High beeps	None
Maintenance Indications		
Enter Bootloader	High, High beeps	Red (stays on)
Firmware Installation	None	Red Blinking

Scanning

The DS3608 digital scanner is in hands-free (presentation) mode when it is placed in the Intellistand. In this mode, the digital scanner operates in continuous (constant-on) mode, where it automatically decodes a bar code presented in its field of view.

When the digital scanner is not used for a user-definable period of time, it enters a low power mode in which the LEDs are turned off or illumination blinks at a low duty cycle until the digital scanner detects an image change (e.g. motion).

Scanning in Hands-Free (Presentation) Mode

The optional stand adds greater flexibility to DS3608 scanning operation. When the scanner is seated in the scanner cup, the scanner's built-in sensor places the scanner in hands-free (presentation) mode. When the scanner is removed from the stand, it automatically switches to its programmed hand-held triggered mode.

To operate the digital scanner in the Intellistand:

1. Connect the digital scanner to the host (see the appropriate host chapter for information on host connections). Scanning in Hands-Free Mode

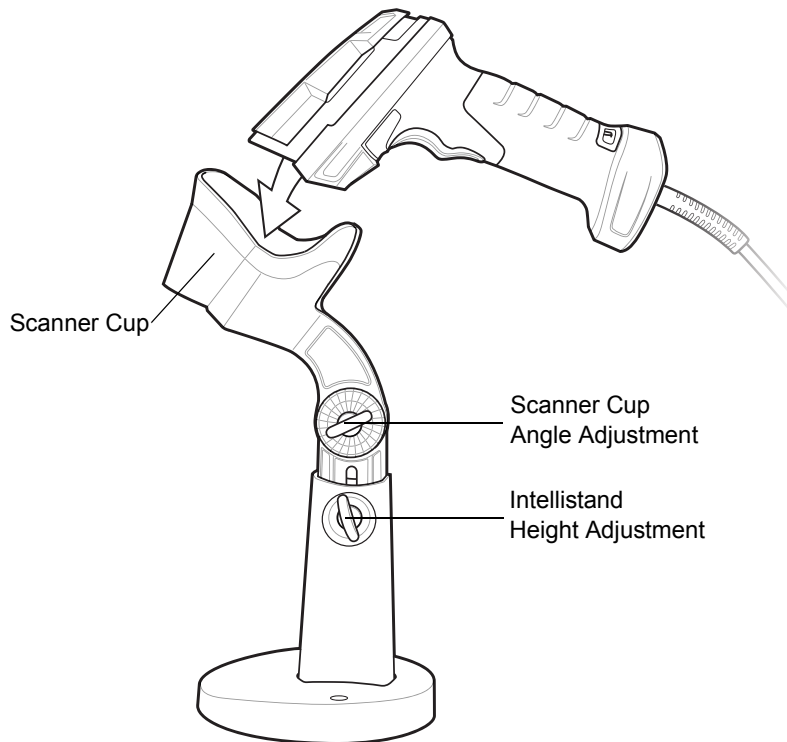

2. Insert the digital scanner in the Intellistand by placing the front of the digital scanner into the scanner cup (see [Figure 1](#)).
3. Use the Intellistand's adjustment knobs to adjust the height and angle of the digital scanner.
4. Center the symbol in the aiming pattern.
5. Upon successful decode, the digital scanner beeps and the LED turns green. For more information on beeper and LED definitions, see [Table 2-1 on page 2-2](#).

Scanning in Hand-Held Mode

Aim the digital scanner at a bar code and pull the trigger to decode.

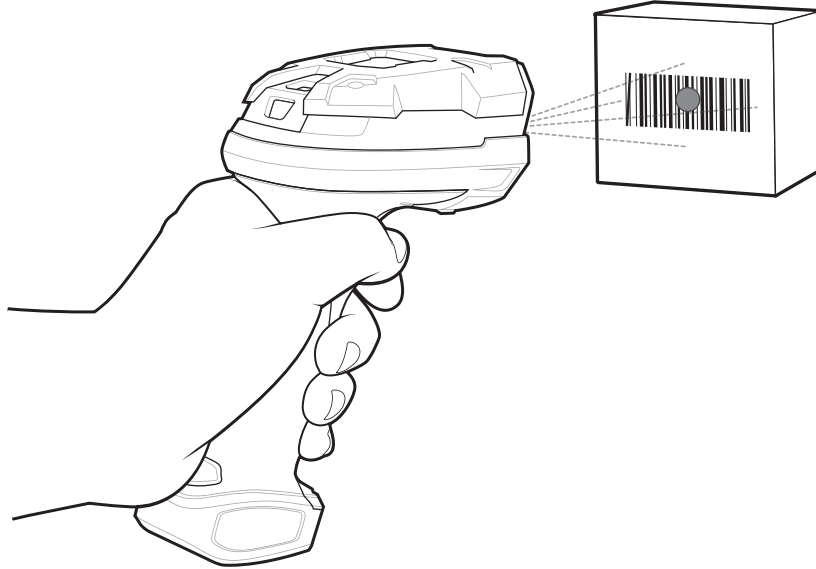

Figure 2-2 Scanning DS3608-SR in Hand-Held Mode

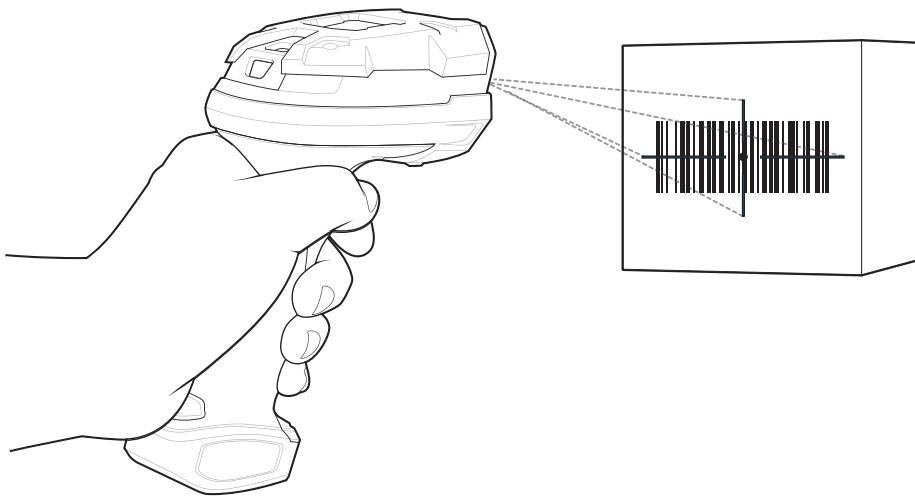

Figure 2-3 Scanning DS3608-HP and DS3608-HD in Hand-Held Mode

Aiming with DS3608-SR

When scanning, the DS3608-SR digital scanner projects an orange LED dot which allows positioning the bar code within its field of view. See [Decode Ranges on page 2-8](#) for the proper distance to achieve between the digital scanner and a bar code.

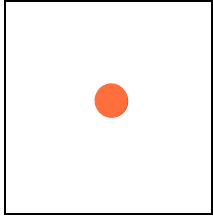

Figure 2-4 Aiming Dot

If necessary, the digital scanner turns on its orange illumination LEDs to illuminate the target bar code.

To scan a bar code, center the symbol and ensure the entire symbol is within the rectangular area formed by the illumination LEDs.

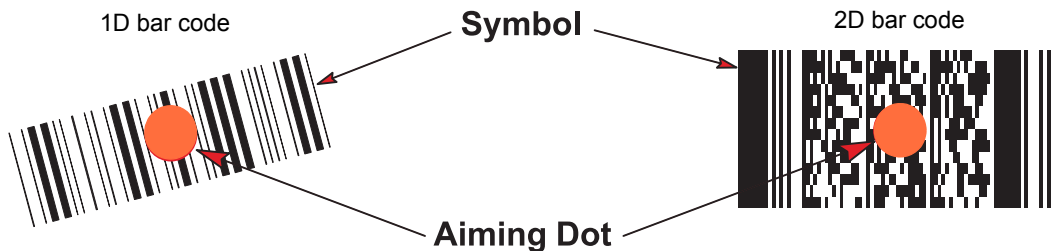

Figure 2-5 Scanning Orientation with Aiming Dot for DS3608-SR

The digital scanner can also read a bar code presented within the aiming dot not centered. The top examples in [Figure](#) show acceptable aiming options, while the bottom examples can not be decoded.

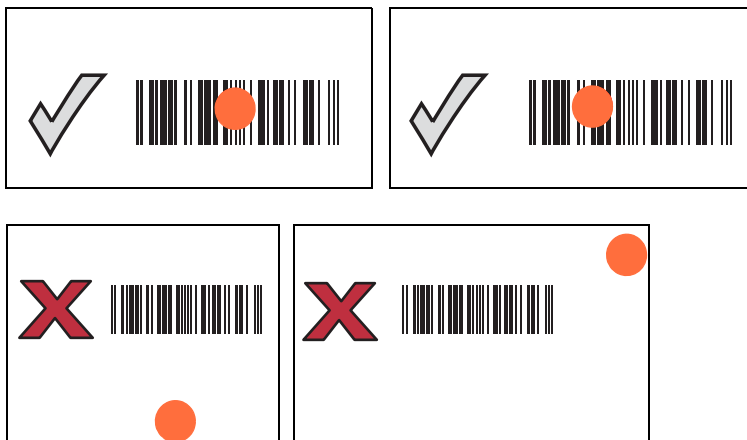

Figure 2-6 Acceptable and Incorrect Aiming for DS3608-SR

The aiming dot is smaller when the digital scanner is closer to the symbol and larger when it is farther from the symbol. Scan symbols with smaller bars or elements (mil size) closer to the digital scanner, and those with larger bars or elements (mil size) farther from the digital scanner.

The digital scanner beeps to indicate that it successfully decoded the bar code. For more information on beeper and LED definitions, see [Table 2-1](#).

Aiming with DS3608-HP and DS3608-HD

When scanning, the DS3608-HP and DS3608-HD projects a red laser aiming pattern which allows positioning the bar code within its field of view. See [Decode Ranges on page 2-8](#) for the proper distance to achieve between the digital scanner and a bar code.

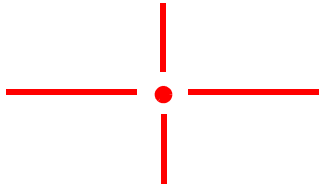

Figure 2-7 DS3608-HP/DS3608-HD Imager Aiming Pattern

If necessary, the digital scanner turns on its red LEDs to illuminate the target bar code.

To scan a bar code, center the symbol in any orientation within the aiming pattern. Be sure the entire symbol is within the rectangular area formed by the cross pattern.

The digital scanner can also read a bar code presented within the aiming pattern but not centered. The top examples in [Figure 2-5](#) show acceptable aiming options, while the bottom examples can not be decoded.

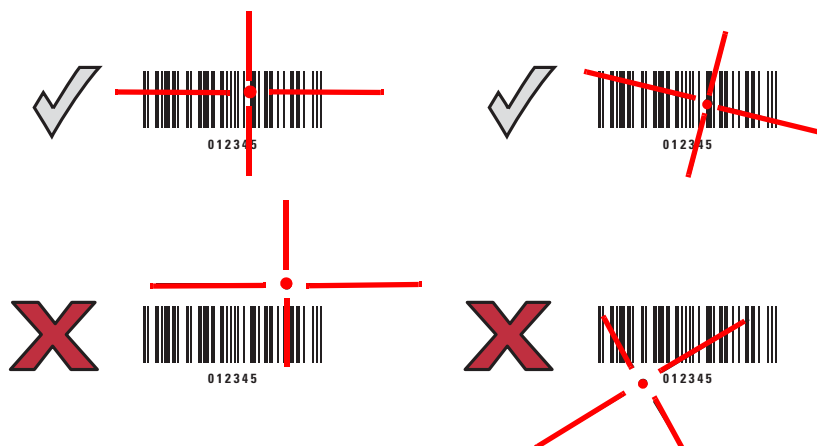

Figure 2-8 Acceptable and Incorrect Aiming for DS3608-HP/DS3608-HD

Decode Ranges

Table 2-2 DS3608-HD Decode Ranges

Bar Code Type	Symbol Density	DS3608-HD Typical Working Ranges	
		Near	Far
Code 128	5.0 mil	0.9 in. / 2.3 cm	7.0 in / 17.8 cm
	15.0 mil	0.9 in. / 2.3 cm	23 in. / 58.4 cm
Code 39	3.0 mil	1.3 in / 3.3 cm	4.7 in / 11.9 cm
	20.0 mil	0.25 in / 0.6 cm	34.0 in / 86.3 cm
100% UPC	13.0 mil	0.25 in / 0.6 cm	22.0 in / 55.8 cm
PDF 417	5.0 mil	2.0 in. / 5.1 cm	6.0 in. / 15.2 cm
	6.6 mil	0.9 in. / 2.3 cm	9.0 in. / 22.8 cm
Data Matrix	10.0 mil	1.0 in. / 2.5 cm	9.0 in. / 22.8 cm

Table 2-3 DS3608-HP Decode Ranges

Bar Code Type	Symbol Density	DS3608-HP Typical Working Ranges	
		Near	Far
Code 128	5.0 mil	6.0 in / 15.2 cm	14.0 in / 35.5 cm
Code 39	20.0 mil	2.0 in / 5.1 cm	43.0 in / 109 cm
100% UPC	13.0 mil	1.1 in / 2.8 cm	36.0 in / 91.0 cm
PDF 417	5.0 mil	8.0 in / 20.3 cm	11.5 in / 29.2 cm
Data Matrix	7.5 mil	7.0 in / 17.8 cm	11.0 in / 27.9 cm
	10.0 mil	6.0 in / 15.2 cm	15.0 in / 38.1 cm

Table 2-4 DS3608-SR Decode Ranges

Bar Code Type	Symbol Density	DS3608-SR Typical Working Ranges	
		Near	Far
Code 128	5.0 mil	1.3 in / 3.3 cm	6.7 in / 17.0 cm
Code 39	5.0 mil	0.5 in / 1.2 cm	12.0 in / 30.4 cm
	20.0 mil	2.8 in / 7.1 cm	28.0 in / 71.0 cm
100% UPC	13.0 mil	0.3 in / 0.8 cm	24.0 in / 61.0 cm
PDF 417	5.0 mil	1.9 in / 4.8 cm	6.9 in / 17.5 cm
Data Matrix	7.5 mil	1.9 in / 4.8 cm	6.0 in / 15.2 cm
	10.0 mil	1.4 in / 3.6 cm	8.6 in / 21.8 cm

CHAPTER 3 MAINTENANCE & TECHNICAL SPECIFICATIONS

Introduction

This chapter provides suggested digital scanner maintenance, troubleshooting, technical specifications, and signal descriptions (pinouts).

Maintenance

Known Harmful Ingredients

The following chemicals are known to damage the plastics on Zebra scanners and should not come in contact with the device:

- Acetone
- Ammonia solutions
- Aqueous or alcoholic alkaline solutions
- Aromatic and chlorinated hydrocarbons
- Benzene
- Bleach
- Carboic acid
- Compounds of amines or ammonia
- Ethanolamine
- Ethers
- Ketones
- TB-lysoform
- Toluene
- Trichloroethylene.

Approved Cleaning Agents

The following cleaning agents are approved for cleaning the plastics on Zebra scanners:

- Pre-moistened wipes
- Isopropyl alcohol 70%

Tolerable Industrial Fluids and Chemicals

✓ **NOTE** Not all fluid variants and brands have been tested.

The following industrial fluids and chemicals were evaluated and deemed tolerable for the DS3608:

- Motor/Engine Oil
- Automatic Transmission Fluid (ATF)
- Continuously Variable Transmission Fluid (CVT)
- Industrial De-Greaser (Engine Brite Heavy Duty)
- Brake Fluid (DOT4)

✓ **NOTE** It is recommended to clean the outside of the scanner daily using the [Approved Cleaning Agents on page 3-1](#) if the scanner comes in contact with the above fluids & chemicals frequently.

Cleaning the Digital Scanner

Routinely cleaning the exit window is required. A dirty window may affect scanning accuracy. Do not allow any abrasive material to touch the window.

To clean the scanner:

1. Dampen a soft cloth with one of the approved cleaning agents listed above or use pre-moistened wipes.
2. Gently wipe all surfaces, including the front, back, sides, top and bottom. Never apply liquid directly to the scanner. Be careful not to let liquid pool around the scanner window, trigger, cable connector or any other area on the device.
3. Be sure to clean the trigger and in between the trigger and the housing (use a cotton-tipped applicator to reach tight or inaccessible areas).
4. Do not spray water or other cleaning liquids directly into the exit window.
5. Wipe the scanner exit window with a lens tissue or other material suitable for cleaning optical material such as eyeglasses.
6. Immediately dry the scanner window after cleaning with a soft non-abrasive cloth to prevent streaking.
7. Allow the unit to air dry before use.
8. Scanner connectors:
 - a. Dip the cotton portion of a cotton-tipped applicator in isopropyl alcohol.
 - b. Rub the cotton portion of the cotton-tipped applicator back-and-forth across the connector on the Zebra scanner at least 3 times. Do not leave any cotton residue on the connector.
 - c. Use the cotton-tipped applicator dipped in alcohol to remove any grease and dirt near the connector area.
 - d. Use a dry cotton tipped applicator and rub the cotton portion of the cotton-tipped applicator back-and-forth across the connectors at least 3 times. Do not leave any cotton residue on the connectors.

Troubleshooting

Table 3-1 *Troubleshooting*

Problem	Possible Causes	Possible Solutions
The aiming pattern does not appear when pressing the trigger.	No power to the digital scanner.	If the configuration requires a power supply, re-connect the power supply.
	Incorrect host interface cable is used.	Connect the correct host interface cable.
	Interface/power cables are loose.	Re-connect cables.
	Digital scanner is disabled.	For IBM 468x and USB IBM hand-held, IBM table-top, and OPOS modes, enable the digital scanner via the host interface. Otherwise, see the technical person in charge of scanning.
	If using RS-232 Nixdorf B mode, CTS is not asserted.	Assert CTS line.
	Aiming pattern is disabled.	Enable the aiming pattern. See Hand-Held Decode Aiming Pattern on page 4-19 .
Digital scanner emits aiming pattern, but does not decode the bar code.	Digital scanner is not programmed for the correct bar code type.	Program the digital scanner to read that type of bar code. See Chapter 11, Symbologies .
	Bar code symbol is unreadable.	Scan test symbols of the same bar code type to determine if the bar code is defaced.
	The symbol is not completely inside aiming pattern.	Move the symbol completely within the aiming pattern. Move the symbol completely within the field of view (AIM pattern does NOT define FOV)
	Distance between digital scanner and bar code is incorrect.	Move the scanner closer to or further from the bar code. See Decode Ranges on page 2-8 .

Table 3-1 Troubleshooting (Continued)

Problem	Possible Causes	Possible Solutions
Digital scanner decodes bar code, but does not transmit the data to the host.	Digital scanner is not programmed for the correct host type.	Scan the appropriate host type programming bar code. See the chapter corresponding to the host type.
	Interface cable is loose.	Re-connect the cable.
	If the digital scanner emits 4 long low beeps, a transmission error occurred. This occurs if a unit is not properly configured or connected to the wrong host type.	Set the scanner's communication parameters to match the host's setting.
	If the digital scanner emits 5 low beeps, a conversion or format error occurred.	Configure the digital scanner's conversion parameters properly.
	If the digital scanner emits low/high/low beeps, it detected an invalid ADF rule.	Program the correct ADF rules. Refer to the <i>Advanced Data Formatting Programmer Guide</i> .
Host displays scanned data incorrectly.	Digital scanner is not programmed to work with the host.	Scan the appropriate host type programming bar code.
		For RS-232, set the digital scanner's communication parameters to match the host's settings.
		For a Keyboard Wedge configuration, program the system for the correct keyboard type, and turn off the CAPS LOCK key.
		Program the proper editing options (e.g., UPC-E to UPC-A Conversion).
Digital scanner emits short low/short medium/short high beep sequence (power-up beep sequence) more than once.	The USB bus may put the digital scanner in a state where power to the scanner is cycled on and off more than once.	Normal during host reset.
Digital scanner emits 4 short high beeps during decode attempt.	Digital scanner has not completed USB initialization.	Wait several seconds and scan again.
Digital scanner emits Low/low/low/extra low beeps when not in use.	RS-232 receive error.	Normal during host reset. Otherwise, set the digital scanner's RS-232 parity to match the host setting.
Digital scanner emits low/high beeps during programming.	Input error, incorrect bar code or Cancel bar code was scanned.	Scan the correct numeric bar codes within range for the parameter programmed.

Table 3-1 Troubleshooting (Continued)

Problem	Possible Causes	Possible Solutions
Digital scanner emits low/high/low/high beeps during programming.	Out of host parameter storage space.	Scan Default Parameters on page 4-5 .
	Out of memory for ADF rules.	Reduce the number of ADF rules or the number of steps in the ADF rules.
	During programming, indicates out of ADF parameter storage space.	Erase all rules and re-program with shorter rules.
Digital scanner emits low/high/low beeps.	ADF transmit error.	Refer to the Advanced Data Formatting Guide for information.
	Invalid ADF rule is detected.	Refer to the Advanced Data Formatting Guide for information.
Digital scanner emits a power-up beep after changing USB host type.	The USB bus re-established power to the digital scanner.	Normal when changing USB host type.
Digital scanner emits one high beep when not in use.	In RS-232 mode, a <BEL> character was received and Beep on <BEL> option is enabled.	Normal when Beep on <BEL> is enabled and the digital scanner is in RS-232 mode.
Digital scanner emits frequent beeps.	No power to the scanner.	Check the system power. If the configuration requires a power supply, re-connect the power supply.
	Incorrect host interface cable is used.	Verify that the correct host interface cable is used. If not, connect the correct host interface cable.
	Interface/power cables are loose.	Check for loose cable connections and re-connect cables.
Digital scanner emits five long low beeps after a bar code is decoded.	Conversion or format error was detected. The scanner's conversion parameters are not properly configured.	Ensure the scanner's conversion parameters are properly configured.
	Conversion or format error was detected. An ADF rule was set up with characters that can't be sent for the host selected.	Change the ADF rule, or change to a host that can support the ADF rule.
	Conversion or format error was detected. A bar code was scanned with characters that can't be sent for that host.	Change the bar code, or change to a host that can support the bar code.



NOTE If after performing these checks the digital scanner still experiences problems, contact the distributor or call support.

Report Software Version Bar Code

When contacting support, a support representative may ask you to scan the bar code below to determine the version of software installed in the digital scanner.



Report Software Version

Technical Specifications

Table 3-2 *Technical Specifications*

Item	Description
Physical Characteristics	
Dimensions DS3608	7.3 in. H x 3.0 in. W x 5.2 in. D (18.5 cm H x 7.7 cm W x 13.2 cm D)
Weight (without cable) DS3608-SR DS3608-HP DS3608-HD	Approximately 10.76 oz./305 g Approximately 10.9 oz./309 g Approximately 10.9 oz./309 g
Power	5 VDC +/- 10% @ 360 mA (RMS typical)
Performance Characteristics	
Light Source DS3608-SR DS3608-HP DS3608-HD	Aiming pattern: 610 nm LED / Illumination: 660 nm LEDs Aiming pattern: 655 nm Laser / Illumination: Warm white LEDs Aiming pattern: 655 nm Laser / Illumination: Warm white LEDs
Field of View (Horizontal x Vertical) Nominal DS3608-SR DS3608-HP DS3608-HD	42° (H) x 28° (V) 31° (H) x 23° (V) 48° (H) x 36.7° (V)
Roll Pitch Yaw	0 - 180° +/- 60° +/- 60°
Symbology Decode Capability	
1D	UPC/EAN, UPC/EAN with supplementals, Bookland EAN, ISSN, UCC Coupon Extended Code, Code 128, GS1-128, ISBT 128, ISBT Concatenation, Code 39, Code 39 Full ASCII, Trioptic Code 39, Code 32, Code 93, Code 11, Interleaved 2 of 5, Discrete 2 of 5, Codabar, MSI, Chinese 2 of 5, Matrix 2 of 5, Korean 3 of 5, GS1 DataBar variants
2D	PDF417, MicroPDF417, Composite Codes, TLC-39, Data Matrix, Maxicode, QR Code, MicroQR, Aztec, Han Xin, GS1-QR, GS1-DM
Postal	US Postnet, US Planet, UK Postal, Japan Post, Australia Post, Royal Mail 4 State Customer, KIX Code (Dutch), UPU 4 State Postal FICS (Post US4), USPS 4 State Postal (Post US3)
Typical Working Distance	See Decode Ranges on page 2-8 .

Table 3-2 *Technical Specifications (Continued)*

Item	Description
Interfaces Supported	USB, RS-232, RS-485 (IBM 46xx), keyboard wedge, SSI The scanner supports the following protocols over USB: HID Keyboard (default mode), SNAPI, COM Port Emulation, IBM SurePOS (Yellowstone) (IBM Hand-held, IBM Table-top, OPOS), USB CDC, SSI over USB CDC The scanner supports the following protocols over RS232: Standard, Wincor-Nixdorf, ICL, Fujitsu, Olivetti, Omron, CUTE
Minimum Resolution DS3608-HD DS3608-HP DS3608-SR	Code 39 3 mil UPC 40% 5.2 mil PDF417 5 mil Data Matrix 6 mil Code 39 3 mil UPC 40% 5.2 mil PDF417 5 mil Data Matrix 7.5 mil Code 39 4 mil UPC 60% 7.8 mil PDF417 5 mil Data Matrix 7.5 mil
User Environment	
Operating Temperature	-22° F to 122°F (-30° C to 50° C)
Storage Temperature	-40° F to 158° F (-40° C to 70° C)
Humidity	5 % to 95 % RH, non-condensing
Drop Specifications DS3608	Withstands multiple 8 ft / 2.4 m drops to concrete at room temperature. Withstands multiple 6.5 ft / 2.0 m drops to concrete at -30° C to 50° C
Environmental Sealing	IP65 and IP67
Ambient Light Immunity	Immune to normal indoor lighting up to 1600 Lux. Immune to sunlight up to 86,000 Lux.
Accessories	
DS3608 Hands-Free Option	Intellistand
Power Supplies	Power supplies are available for applications that do not supply power over the host cable.

Digital Scanner Signal Descriptions

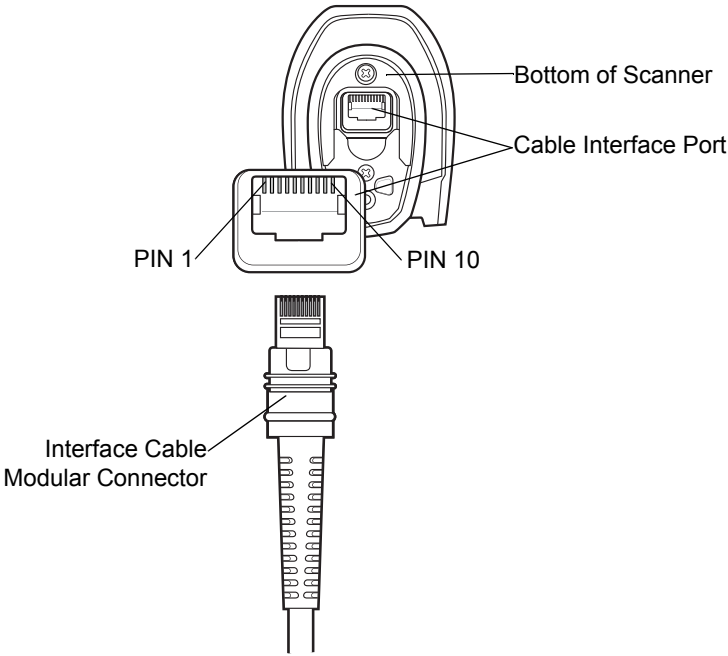

Figure 3-1 Digital Scanner Cable Pin-outs

The signal descriptions in [Table 3-3](#) apply to the connectors on the DS3608 digital scanner and are for reference only.

Table 3-3 DS3608 Digital Scanner Signal Pin-outs

Pin	USB	RS-232	Keyboard Wedge	IBM
1	Cable ID	Cable ID	Cable ID	Cable ID
2	Power (+5V)	Power (+5V)	Power (+5V)	Power (+5V)
3	Ground	Ground	Ground	Ground
4	IBM_OUT	TxD	KeyClock	Reserved
5	IBM_IN	RxD	TermData	D +
6	IBM_T/R	RTS	KeyData	Reserved
7	Reserved	CTS	TermClock	D -
8	Reserved	Reserved	Reserved	Reserved
9	Reserved	Reserved	Reserved	Reserved
10	Power (+12V)	Power (+12V)	Power (+12V)	Power (+12V)

CHAPTER 4 USER PREFERENCES & MISCELLANEOUS OPTIONS

Introduction

You can program the digital scanner to perform various functions, or activate different features. This chapter describes each user preference feature and provides programming bar codes for selecting these features.

The digital scanner ships with the settings shown in [Table 4-1 on page 4-2](#) (also see [Appendix A, Standard Default Parameters](#) for all defaults). If the default values suit requirements, programming is not necessary.

To set feature values, scan a single bar code or a short bar code sequence. The settings are stored in non-volatile memory and are preserved even when the digital scanner is powered down.

✓ **NOTE** Most computer monitors allow scanning the bar codes directly on the screen. When scanning from the screen, be sure to set the document magnification to a level where you can see the bar code clearly, and bars and/or spaces are not merging.

If not using a USB cable, select a host type (see each host chapter for specific host information) after the power-up beeps sound. This is only necessary upon the first power-up when connected to a new host.

To return all features to default values, see [Default Parameters on page 4-5](#). Throughout the programming bar code menus, asterisks indicate (*) default values.



* Indicates Default — *High Volume — Feature/Option
(0) — Option Value

Scanning Sequence Examples

In most cases, scanning one bar code sets the parameter value. For example, to set the beeper tone to high, scan the **High Frequency** (beeper tone) bar code listed under [Beeper Tone on page 4-10](#). The digital scanner issues a fast warble beep and the LED turns green, signifying a successful parameter entry.

Other parameters, such as **Decode Session Timeout** or **Data Transmission Formats**, require scanning several bar codes. See these parameter descriptions for this procedure.

Errors While Scanning

Unless otherwise specified, to correct an error during a scanning sequence, just re-scan the correct parameter.

User Preferences/Miscellaneous Options Parameter Defaults

[Table 4-1](#) lists defaults for user preferences parameters. To change the default values:

- Scan the appropriate bar codes in this guide. These new values replace the standard default values in memory. To recall the default parameter values, see [Default Parameters on page 4-5](#).
- Configure the digital scanner using the 123Scan² configuration program (see [Chapter 14, 123Scan2](#)).

✓ **NOTE** See [Appendix A, Standard Default Parameters](#) for all user preferences, hosts, symbologies, and miscellaneous default parameters.

Table 4-1 User Preferences Parameter Defaults

Parameter	Parameter Number ¹	SSI Number ²	Default	Page Number
User Preferences				
Set Default Parameter			Restore Defaults	4-5
Report Version				4-6
Parameter Bar Code Scanning	236	ECh	Enable	4-6
Beep After Good Decode	56	38h	Enable	4-7
Direct Decode Indicator	859	F2h 5Bh	Disable	4-8
Beeper Volume	140	8Ch	High	4-9
Beeper Tone	145	91h	Medium	4-10
Beeper Duration	628	F1h 74h	Medium	4-11
Suppress Power Up Beeps	721	F1h D1h	Do Not Suppress	4-11

1. Parameter number decimal values are used for programming via RSM commands.

2. SSI number hex values are used for programming via SSI commands.

Table 4-1 *User Preferences Parameter Defaults (Continued)*

Parameter	Parameter Number ¹	SSI Number ²	Default	Page Number
Decode Pager Motor	613	F1h 65h	Enable	4-12
Decode Pager Motor Duration	626	F1h 72h	150 msec	4-12
Low Power Mode	128	80h	Disable	4-14
Time Delay to Low Power Mode	146	92h	1 Hour	4-15
Hand-Held Trigger Mode	138	8Ah	Level	4-17
Hands-Free Mode	630	F1h 76h	Enable	4-18
Hand-Held Decode Aiming Pattern	306	F0h 32h	Enable	4-19
Hands-Free (Presentation) Decode Aiming Pattern	590	F1h 4Eh	Enable Hands-Free (Presentation) Decode Aiming Pattern on PDF	4-20
Picklist Mode	402	F0h 92h	Disabled Always	4-21
Continuous Bar Code Read	649	F1h 89h	Disable	4-22
Unique Bar Code Reporting	723	F1h D3h	Enable	4-22
Decode Session Timeout	136	88h	9.9 Sec	4-23
Hands-Free Decode Session Timeout	400	F0h 90h	15	4-24
Timeout Between Decodes, Same Symbol	137	89h	0.5 Sec	4-25
Timeout Between Decodes, Different Symbols	144	90h	0.1 sec	4-26
Decode Mirror Images (Data Matrix Only)	537	F1h 19h	Auto	4-27
Mobile Phone/Display Mode	716	F1h CCh	Normal	4-28
PDF Prioritization	719	F1h CFh	Disable	4-29
PDF Prioritization Timeout	720	F1h D0h	200 ms	4-30
Presentation Mode Field of View	609	F1h 61h	Full	4-31
Decoding Illumination	298	F0h 2Ah	Enable	4-32
Motion Tolerance (Hand-Held Trigger Mode Only)	858	F2h 5Ah	Less Motion Tolerance	4-33

1. Parameter number decimal values are used for programming via RSM commands.

2. SSI number hex values are used for programming via SSI commands.

Table 4-1 *User Preferences Parameter Defaults (Continued)*

Parameter	Parameter Number ¹	SSI Number ²	Default	Page Number
Miscellaneous Options				
Add an Enter Key	N/A	N/A	N/A	4-34
Transmit Code ID Character	45	2Dh	None	4-34
Prefix Value	99, 105	63h, 69h	7013 <CR><LF>	4-35
Suffix 1 Value Suffix 2 Value	98, 104 100, 106	62h, 68h 64h, 6Ah	7013 <CR><LF>	4-35
Scan Data Transmission Format	235	EBh	Data as is	4-36
FN1 Substitution Values	103, 109	67h, 6Dh	7013 <CR><LF>	4-37
Transmit "No Read" Message	94	5E	Disable	4-38
Unsolicited Heartbeat Interval	1118	F8h 04h 5Eh	Disable	4-39

1. Parameter number decimal values are used for programming via RSM commands.

2. SSI number hex values are used for programming via SSI commands.

User Preferences

Default Parameters

The digital scanner can be reset to two types of defaults: factory defaults or custom defaults. Scan the appropriate bar code below to reset the digital scanner to its default settings and/or set the digital scanner's current settings as the custom default.

- **Restore Defaults** - Resets all default parameters as follows:
 - If custom default values were configured (see **Write to Custom Defaults**), the custom default values are set for all parameters each time the **Restore Defaults** bar code below is scanned.
 - If no custom default values were configured, the factory default values are set for all parameters each time the **Restore Defaults** bar code below is scanned. (For factory default values, see [Appendix A, Standard Default Parameters.](#))
- **Set Factory Defaults** - Scan the **Set Factory Defaults** bar code below to eliminate all custom default values and set the digital scanner to factory default values (For factory default values, see [Appendix A, Standard Default Parameters.](#))
- **Write to Custom Defaults** - Custom default parameters can be configured to set unique default values for all parameters. After changing all parameters to the desired default values, scan the **Write to Custom Defaults** bar code below to configure custom defaults.



***Restore Defaults**



Set Factory Defaults



Write to Custom Defaults

Report Version

Scan the bar code below to report the version of software installed in the digital scanner.



Report Software Version

Parameter Bar Code Scanning

Parameter # 236 (SSI # ECh)

To disable the decoding of parameter bar codes, including the **Set Defaults** parameter bar codes, scan the **Disable Parameter Scanning** bar code below. To enable decoding of parameter bar codes, scan **Enable Parameter Scanning**.



***Enable Parameter Bar Code Scanning
(1)**



**Disable Parameter Bar Code Scanning
(0)**

Beep After Good Decode

Parameter # 56 (SSI # 38h)

Scan a bar code below to select whether or not the digital scanner beeps after a good decode. If selecting **Do Not Beep After Good Decode**, the beeper still operates during parameter menu scanning and to indicate error conditions.



***Beep After Good Decode (Enable)**
(1)



Do Not Beep After Good Decode (Disable)
(0)

Direct Decode Indicator

Parameter # 859 (SSI # F2h 5Bh)

This feature is only supported in Auto Aim and Standard (Level) trigger modes. Scan a bar code below to select optional blinking of the illumination on a successful decode:

- **Disable Direct Decode Indicator** - illumination does not blink on a successful decode.
- **1 Blink** - illumination blinks once upon a successful decode.
- **2 Blinks** - illumination blinks twice upon a successful decode.



***Disable Direct Decode Indicator
(0)**



**1 Blink
(1)**

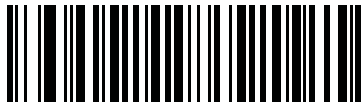

**2 Blinks
(2)**

Beeper Volume

Parameter # 140 (SSI # 8Ch)

To select a beeper volume, scan the **Low Volume**, **Medium Volume**, or **High Volume** bar code.



Low Volume
(2)



Medium Volume
(1)



***High Volume**
(0)

Beeper Tone

Parameter # 145 (SSI # 91h)

To select a beeper tone, scan one of the following bar codes.



**Off
(3)**



**Low Tone
(2)**

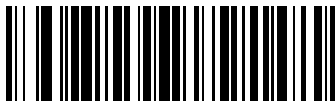

*** Medium Tone
(1)**



**High Tone
(0)**



**Medium to High Tone (2-tone)
(4)**

Beeper Duration

Parameter # 628 (SSI # F1h 74h)

To select the duration for the beeper, scan one of the following bar codes.

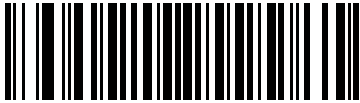

Short
(0)



*** Medium**
(1)

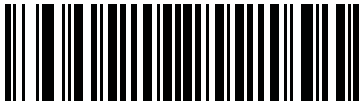

Long
(2)

Suppress Power Up Beeps

Parameter # 721 (SSI # F1h D1h)

Scan a bar code below to select whether or not to suppress the digital scanner's power-up beeps.



***Do Not Suppress Power Up Beeps**
(0)



Suppress Power Up Beeps
(1)

Decode Pager Motor

Parameter # 613 (SSI # F1h 65h)

The scanner includes a pager motor which, when enabled, vibrates the scanner for a period of time when a successful decode occurs.

✓ **NOTE** When the pager motor is enabled and the scanner is in the Intellistand, the pager motor disables until the scanner is removed from the Intellistand.

Scan a bar code below to enable or disable the pager motor. If enabled, scan the appropriate bar code to set the period of time in which to vibrate the scanner (see [Decode Pager Motor Duration](#) below).



**Pager Motor Disable
(0)**

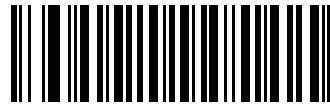

***Pager Motor Enable
(1)**

Decode Pager Motor Duration

Parameter # 626 (SSI # F1h 72h)

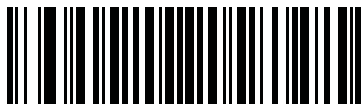

***150 msec
(15)**



**200 msec
(20)**

Decode Pager Motor Duration (continued)

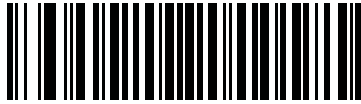

250 msec
(25)



300 msec
(30)

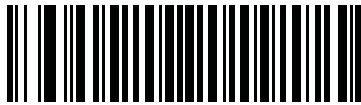

400 msec
(40)

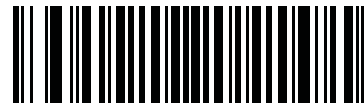

500 msec
(50)



600 msec
(60)



750 msec
(75)

Low Power Mode

Parameter # 128 (SSI # 80h)

This parameter determines whether or not the digital scanner enters low power mode after a decode attempt. If disabled, power remains on after each decode attempt.



* Disable Low Power Mode
(0)



Enable Low Power Mode
(1)

Time Delay to Low Power Mode

Parameter # 146 (SSI # 92h)

✓ **NOTE** This parameter only applies when Low Power Mode is enabled.

This parameter sets the time the digital scanner remains active before entering low power mode. The digital scanner wakes upon trigger pull or when the host attempts to communicate with the digital scanner.



1 Second
(17)

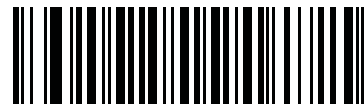

10 Seconds
(26)



1 Minute
(33)



5 Minutes
(37)



15 Minutes
(43)

Time Delay to Low Power Mode (continued)

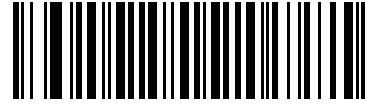

**30 Minutes
(45)**

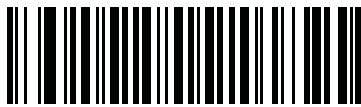

**45 Minutes
(46)**



*** 1 Hour
(49)**

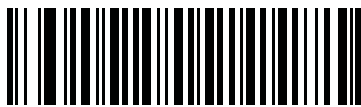

**3 Hours
(51)**

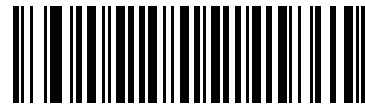

**6 Hours
(54)**



**9 Hours
(57)**

Hand-Held Trigger Mode

Parameter # 138 (SSI # 8Ah)

Select one of the following trigger modes for the digital scanner.

- **Standard (Level)** - A trigger pull activates decode processing. Decode processing continues until the bar code decodes, you release the trigger, or the [Decode Session Timeout on page 4-23](#) occurs.
- **Presentation (Blink)** - The digital scanner activates decode processing when it detects a bar code in its field of view. After a period of non-use, the digital scanner enters a low power mode, in which the LEDs turn off until the digital scanner senses motion.
- **Auto Aim** - This trigger mode projects the aiming dot when you lift the digital scanner. A trigger pull activates decode processing. After 5 seconds of inactivity the aiming dot shuts off.

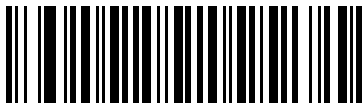

***Level (Standard)**
(0)



Presentation (Blink)
(7)



Auto Aim
(9)

Hands-Free Mode

Parameter # 630 (SSI # F1h 76h)

In hands-free mode, when you place the DS3608 in the Intellistand, it automatically triggers when presented with a bar code. Lifting the digital scanner causes it to behave according to the setting of the *Hand-Held Trigger Mode on page 4-17*.

If you select **Disable Hands-Free Mode**, the digital scanner behaves according to the setting of the *Hand-Held Trigger Mode on page 4-17* regardless of whether the DS3608 is in the Intellistand.



***Enable Hands-Free Mode
(1)**

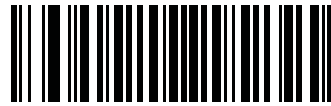

**Disable Hands-Free Mode
(0)**

Hand-Held Decode Aiming Pattern

Parameter # 306 (SSI # F0h 32h)

Select **Enable Hand-Held Decode Aiming Pattern** to project the aiming dot during bar code capture, **Disable Hand-Held Decode Aiming Pattern** to turn the aiming dot off, or **Enable Hand-Held Decode Aiming Pattern on PDF** to project the aiming dot when the digital scanner detects a 2D bar code.



NOTE With [Picklist Mode on page 4-21](#) enabled, the decode aiming dot flashes even when the **Hand-Held Decode Aiming Pattern** is disabled.



***Enable Hand-Held Decode Aiming Pattern**
(2)



Disable Hand-Held Decode Aiming Pattern
(0)

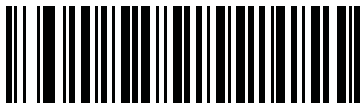

Enable Hand-Held Decode Aiming Pattern on PDF
(3)

Hands-Free (Presentation) Decode Aiming Pattern

Parameter # 590 (SSI # F1h 4Eh)

Select **Enable Hands-Free Decode Aiming Pattern** to project the aiming dot during bar code capture, **Disable Hands-Free Decode Aiming Pattern** to turn the aiming dot off, or **Enable Hands-Free Decode Aiming Pattern on PDF** to project the aiming dot when the digital scanner detects a 2D bar code.

✓ **NOTE** With [Picklist Mode on page 4-21](#) enabled, the decode aiming dot flashes even when the **Decode Aiming Pattern** is disabled.



Enable Hands-Free Decode Aiming Pattern
(1)



Disable Hands-Free Decode Aiming Pattern
(0)



***Enable Hands-Free Decode Aiming Pattern on PDF**
(2)

Picklist Mode

Parameter # 402 (SSI # F0h 92h)

Picklist mode enables the digital scanner to decode only bar codes that are aligned under the LED aiming dot. Select one of the following picklist modes for the digital scanner:

- **Disabled Always** - Picklist mode is always disabled.
- **Enabled in Hand-Held Mode** - Picklist mode is enabled in hand-held mode.
- **Enabled in Hands-free Mode** - Picklist mode is enabled when the digital scanner is in hands-free mode only (Presentation Mode whether in or out of scan stand).
- **Enabled Always** - Picklist mode is always enabled.



***Disabled Always**
(0)



Enabled in Hand-Held Mode
(1)

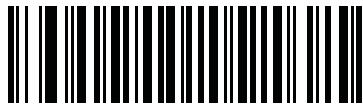

Enabled Always
(2)

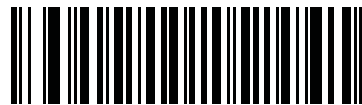

Enabled in Hands-free Mode
(3)



NOTE Picklist Mode temporarily overrides the Disable Decode Aiming Pattern parameter. You can not disable the decode aiming pattern when Picklist Mode is enabled.

Continuous Bar Code Read

Parameter # 649 (SSI # F1h 89h)

Enable this to report every bar code while the trigger is pulled.

- ✓ **NOTE** Zebra strongly recommends enabling [Picklist Mode on page 4-21](#) with this feature. Disabling Picklist Mode can cause accidental decodes when more than one bar code is in the digital scanner's field of view.



***Disable Continuous Bar Code Read
(0)**



**Enable Continuous Bar Code Read
(1)**

Unique Bar Code Reporting

Parameter # 723 (SSI # F1h D3h)

Enable this to report only unique bar codes while the trigger is pulled. This option only applies when **Continuous Bar Code Read** is enabled.



**Disable Continuous Bar Code Read Uniqueness
(0)**



***Enable Continuous Bar Code Read Uniqueness
(1)**

Decode Session Timeout

Parameter # 136 (SSI # 88h)

This parameter sets the maximum time decode processing continues during a scan attempt. It is programmable in 0.1 second increments from 0.5 to 9.9 seconds. The default timeout is 9.9 seconds.

To set a Decode Session Timeout, scan the bar code below. Next, scan two numeric bar codes from [Appendix G, Numeric Bar Codes](#) that correspond to the desired on time. Enter a leading zero for single digit numbers. For example, to set a Decode Session Timeout of 0.5 seconds, scan the bar code below, then scan the **0** and **5** bar codes. To correct an error or change the selection, scan [Cancel on page G-2](#).



Decode Session Timeout

Hands-free Decode Session Timeout

Parameter # 400 (SSI # F0h 90h)

This parameter is the hands-free compliment to the **Decode Session Timeout**. It configures the minimum and maximum decode processing time during a hands-free scan attempt. It only applies to the hands-free trigger mode or when a scanner is placed in an Intellistand.

The minimum decode processing time is defined as the time in which the scanner stops decoding when an object is removed or left stationary in the imaging field of view.

The maximum decode processing time is defined as the time in which the scanner stops decoding when an object is left in or is moving in the field of view.

Both the maximum and minimum times are configured using a single setting. The relationship of this setting is as follows:

Setting Value	Minimum Time	Maximum Time
$X < 25$	250 ms	2.5 Seconds
$X \geq 25$	$X * 10$ ms	$X * 100$ ms

For example, a setting value of 100 results in the scanner turning off approximately 1 second after an object is removed from the field of view or 10 seconds while an object is in the field of view moving.

The default value of the setting is **15** which results in a Minimum time of 250 ms and Maximum time of 1.5 seconds.

Adjust this setting based on your requirements. For example, when doing PDF prioritization, this parameter should be set to a value where the maximum time is above the PDF prioritization timeout.

Scan this bar code followed by three digits from [Appendix G, Numeric Bar Codes](#) that correspond to the desired value (valid range is 2 - 255).

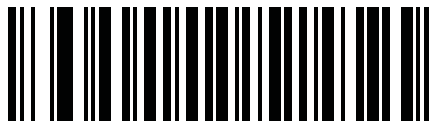

Hands-free Decode Session Timeout

Timeout Between Decodes, Same Symbol

Parameter # 137 (SSI # 89h)

Use this option in Continuous Bar Code Read mode to prevent the beeper from continuously beeping when a symbol is left in the digital scanner's field of view. The bar code must be out of the field of view for the timeout period before the digital scanner reads the same consecutive symbol. It is programmable in 0.1 second increments from 0.0 to 9.9 seconds. The default interval is 0.5 seconds.

To select the timeout between decodes for the same symbol, scan the bar code below, then scan two numeric bar codes from [Appendix G, Numeric Bar Codes](#) that correspond to the desired interval, in 0.1 second increments.



Timeout Between Decodes, Same Symbol

Timeout Between Decodes, Different Symbols

Parameter # 144 (SSI # 90h)

Use this option in presentation mode or Continuous Bar Code Read to control the time the digital scanner is inactive between decoding different symbols. It is programmable in 0.1 second increments from 0.1 to 9.9 seconds. The default is 0.1 seconds.

To select the timeout between decodes for different symbols, scan the bar code below, then scan two numeric bar codes from [Appendix G, Numeric Bar Codes](#) that correspond to the desired interval, in 0.1 second increments.



NOTE Timeout Between Decodes, Different Symbols cannot be greater than or equal to the Decode Session Timeout.



Timeout Between Decodes, Different Symbols

Decode Mirror Images (Data Matrix Only)

Parameter # 537 (SSI # F1h 19h)

Select an option for decoding mirror image Data Matrix bar codes:

- Always - decode only Data Matrix bar codes that are mirror images
- Never - do not decode Data Matrix bar codes that are mirror images
- Auto - decode both mirrored and unmirrored Data Matrix bar codes.



Never
(0)



Always
(1)



***Auto**
(2)

Mobile Phone/Display Mode

Parameter # 716 (SSI # F1h CCh)

This mode improves bar code reading performance off mobile phones and electronic displays. Select Enhanced in hand-held, hands-free, or both modes, or select Normal Mobile Phone/Display Mode.



***Normal Mobile Phone/Display Mode
(0)**

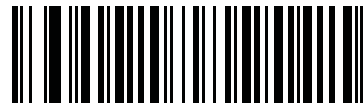

**Enhanced in Hand-Held Mode
(1)**



**Enhanced in Hands-Free Mode
(2)**

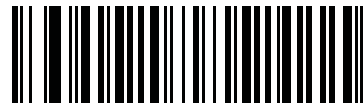

**Enhanced in Both Modes
(3)**

PDF Prioritization

Parameter # 719 (SSI # F1h CFh)

Enable this feature to delay decoding a 1D bar code (Code 128) by the value specified in [PDF Prioritization Timeout](#). During that time the digital scanner attempts to decode a PDF417 symbol (e.g., on a US driver's license), and if successful, reports this only. If it does not decode (can not find) a PDF417 symbol, it reports the 1D symbol after the timeout. The 1D symbol must be in the device's field of view for the digital scanner to report it. This parameter does not affect decoding other symbologies..



NOTE

The 1D Code 128 bar code lengths include the following:

- 7 to 10 characters
- 14 to 17 characters
- 27 to 28 characters

In addition, a Code 39 bar code with the following lengths are considered to potentially be part of a US driver's license:

- 8 characters
- 12 characters

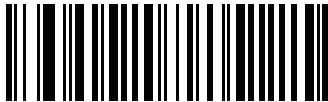

***Disable PDF Prioritization
(0)**

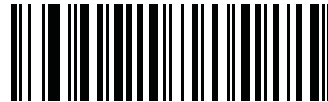

**Enable PDF Prioritization
(1)**

PDF Prioritization Timeout

Parameter # 720 (SSI # F1h D0h)



NOTE The [Hands-free Decode Session Timeout on page 4-24](#) should be set to a longer duration than **PDF Prioritization Timeout** when configured.

When [PDF Prioritization](#) is enabled, this timeout specifies how long the digital scanner attempts to decode a PDF417 symbol before reporting the 1D bar code in the field of view.

Scan the following bar code, then scan four digits from [Appendix G, Numeric Bar Codes](#) that specify the timeout in milliseconds. For example, to enter 400 ms, scan the following bar code, then scan 0400. The range is 0 to 5000 ms, and the default is 200 ms.



PDF Prioritization Timeout

Presentation Mode Field of View

Parameter # 609 (SSI # F1h 61h)

In presentation mode, by default the digital scanner searches the larger area of the aiming pattern (**Full Field of View**).

To search for a bar code in a smaller region around the aiming dot's center in order to speed search time, select **Small Field of View** or **Medium Field of View**.



Small Field of View
(0)

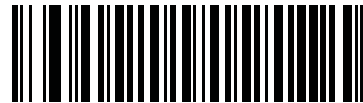

Medium Field of View
(1)

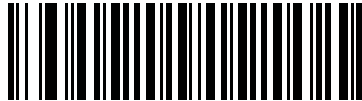

***Full Field of View**
(2)

Decoding Illumination

Parameter # 298 (SSI # F0h 2Ah)

Selecting **Enable Decoding Illumination** causes the digital scanner to flash illumination to aid decoding. Select **Disable Decoding Illumination** to prevent the digital scanner from using decoding illumination.

Enabling illumination usually results in superior images. The effectiveness of the illumination decreases as the distance to the target increases.



***Enable Decoding Illumination**
(1)



Disable Decoding Illumination
(0)

Motion Tolerance (Hand-Held Trigger Modes Only)

Parameter # 858 (SSI # F2h 5Ah)

Less Motion Tolerance provides optimal decoding performance on 1D bar codes.

To increase motion tolerance and speed decoding when scanning a series of 1D bar codes in rapid progression, scan **More Motion Tolerance**.



***Less Motion Tolerance
(0)**

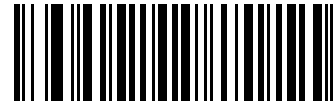

**More Motion Tolerance
(1)**

Miscellaneous Scanner Parameters

Add an Enter Key

To add an Enter key (carriage return/line feed) after scanned data, scan the following bar code.
To program other prefixes and/or suffixes, see [Prefix/Suffix Values on page 4-35](#).

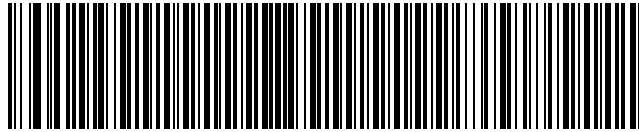

Add Enter Key (Carriage Return/Line Feed)

Transmit Code ID Character

Parameter # 45 (SSI # 2Dh)

A Code ID character identifies the code type of a scanned bar code. This is useful when decoding more than one code type. In addition to any single character prefix already selected, the Code ID character is inserted between the prefix and the decoded symbol.

Select no Code ID character, a Symbol Code ID character, or an AIM Code ID character. For Code ID characters, see [Symbol Code Identifiers on page E-1](#) and [Programming Reference on page E-1](#).

✓ **NOTE** If you enable Symbol Code ID Character or AIM Code ID Character, and enable [Transmit "No Read" Message on page 4-38](#), the digital scanner appends the code ID for Code 39 to the NR message.

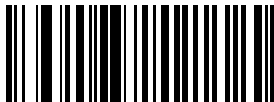

**Symbol Code ID Character
(2)**



**AIM Code ID Character
(1)**

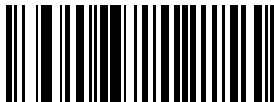

***None
(0)**

Prefix/Suffix Values

Key Category Parameter # P = 99, S1 = 98, S2 = 100 (SSI # P = 63h, S1 = 62h, S2 = 64h)

Decimal Value Parameter # P = 105, S1 = 104, S2 = 106 (SSI # P = 69h, S1 = 68h, S2 = 6Ah)

You can append a prefix and/or one or two suffixes to scan data for use in data editing. To set a value for a prefix or suffix, scan a four-digit number (i.e., four bar codes from [Appendix G, Numeric Bar Codes](#)) that corresponds to that value. See [Appendix H, ASCII Character Sets](#) for the four-digit codes.

When using host commands to set the prefix or suffix, set the key category parameter to 1, then set the 3-digit decimal value. See [Appendix H, ASCII Character Sets](#) for the four-digit codes.

The default prefix and suffix value is 7013 <CR><LF> (the Enter key). To correct an error or change a selection, scan [Cancel on page G-2](#).

✓ **NOTE** To use Prefix/Suffix values, first set the [Scan Data Transmission Format on page 4-36](#).

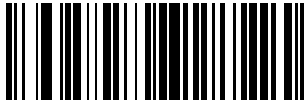

**Scan Prefix
(7)**

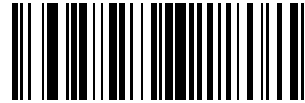

**Scan Suffix 1
(6)**



**Scan Suffix 2
(8)**



Data Format Cancel

Scan Data Transmission Format

Parameter # 235 (SSI # EBh)

To change the scan data format, scan one of the following eight bar codes corresponding to the desired format.

✓ **NOTE** If using this parameter do not use ADF rules to set the prefix/suffix.

To set values for the prefix and/or suffix, see [Prefix/Suffix Values on page 4-35](#).



***Data As Is**
(0)



<DATA> <SUFFIX 1>
(1)



<DATA> <SUFFIX 2>
(2)



<DATA> <SUFFIX 1> <SUFFIX 2>
(3)



<PREFIX> <DATA >
(4)

Scan Data Transmission Format (continued)



<PREFIX> <DATA> <SUFFIX 1>
(5)



<PREFIX> <DATA> <SUFFIX 2>
(6)



<PREFIX> <DATA> <SUFFIX 1> <SUFFIX 2>
(7)

FN1 Substitution Values

Key Category Parameter # 103 (SSI # 67h)

Decimal Value Parameter # 109 (SSI # 6Dh)

The wedge and USB HID keyboard hosts support a FN1 Substitution feature. Enabling this substitutes any FN1 character (0x1b) in an EAN128 bar code with a value. This value defaults to 7013 (Enter Key).

When using host commands to set the FN1 substitution value, set the key category parameter to 1, then set the 3-digit keystroke value. See the ASCII Character Set table for the current host interface for the desired value.

To select a FN1 substitution value via bar code menus:

1. Scan the bar code below.



Set FN1 Substitution Value

2. Locate the keystroke desired for FN1 Substitution in the ASCII Character Set table for the current host interface. Enter the 4-digit ASCII Value by scanning each digit in [Appendix G, Numeric Bar Codes](#).

To correct an error or change the selection, scan **Cancel**.

To enable FN1 substitution for USB HID keyboard, scan the **Enable FN1 Substitution** bar code on page [4-37](#).

Transmit “No Read” Message

Parameter # 94 (SSI # 5Eh)

Scan a bar code below to select whether or not to transmit a No Read message. Enable this to transmit the characters NR when a successful decode does not occur before trigger release or the **Decode Session Timeout** expires. See [Decode Session Timeout on page 4-23](#). Disable this to send nothing to the host if a symbol does not decode.



NOTE If you enable **Transmit No Read**, and also enable Symbol Code ID Character or AIM Code ID Character for [Transmit Code ID Character on page 4-34](#), the digital scanner appends the code ID for Code 39 to the NR message.



**Enable No Read
(1)**



***Disable No Read
(0)**

Unsolicited Heartbeat Interval

Parameter # 1118 (SSI # F8h 04h 5Eh)

The imager supports sending *Unsolicited Heartbeat Messages* to assist in diagnostics. To enable this feature and set the desired unsolicited heartbeat interval, scan one of the time interval bar codes below, or scan **Set Another Interval** followed by four numeric bar codes from [Appendix G, Numeric Bar Codes](#) (scan sequential numbers that correspond to the desired number of seconds). The range is 0 - 9999.

Scan **Disable Unsolicited Heartbeat Interval** to turn off the feature.

The heartbeat event is sent as decode data (with no decode beep) in the form of:

MOTEVTHB:nnn

where *nnn* is a three-digit sequence number starting at 001 and wrapping after 100.

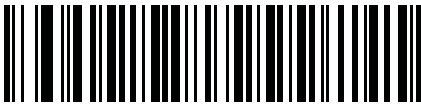

10 seconds
(10)

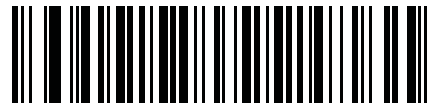

1 minute
(60)



Set Another Interval

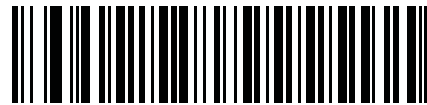

***Disable Unsolicited Heartbeat Interval**
(0)

CHAPTER 5 IMAGING PREFERENCES

Introduction

You can program the digital scanner to perform various functions, or activate different features. This chapter describes imaging preference features and provides programming bar codes for selecting these features.

✓ **NOTE** Only the Symbol Native API (SNAPI) with Imaging interface supports image capture. See [USB Device Type on page 6-5](#) to enable this host.

The digital scanner ships with the settings in [Imaging Preferences Parameter Defaults on page 5-2](#) (also see [Appendix A, Standard Default Parameters](#) for all host device and miscellaneous defaults). If the default values suit requirements, programming is not necessary.

To set feature values, scan a single bar code or a short bar code sequence. The settings are stored in non-volatile memory and are preserved even when you power down the digital scanner.

✓ **NOTE** Most computer monitors allow scanning the bar codes directly on the screen. When scanning from the screen, be sure to set the document magnification to a level where you can see the bar code clearly, and bars and/or spaces are not merging.

To return all features to default values, scan the [Set Factory Defaults on page 4-5](#). Throughout the programming bar code menus, asterisks (*) indicate default values.



Scanning Sequence Examples

In most cases scanning one bar code sets the parameter value. For example, to disable image capture illumination, scan the **Disable Image Capture Illumination** bar code under *Image Capture Illumination on page 5-5*. The digital scanner issues a fast warble beep and the LED turns green, signifying a successful parameter entry.

Other parameters require scanning several bar codes. See these parameter descriptions for this procedure.

Errors While Scanning

Unless otherwise specified, to correct an error during a scanning sequence, just re-scan the correct parameter.

Imaging Preferences Parameter Defaults

Table 5-1 lists the defaults for imaging preferences parameters. To change the default values, scan the appropriate bar codes in this guide. These new values replace the standard default values in memory. To recall the default parameter values, scan **Restore Defaults on page 4-5*.

✓ **NOTE** See *Appendix A, Standard Default Parameters* for all user preferences, hosts, symbologies, and miscellaneous default parameters.

Table 5-1 *Imaging Preferences Parameter Defaults*

Parameter	Parameter Number	SSI Number	Default	Page Number
Imaging Preferences				
Operational Modes	N/A	N/A	N/A	5-4
Image Capture Illumination	361	F0h 69h	Enable	5-5
Image Capture Autoexposure	360	F0h 68h	Enable	5-5
Fixed Exposure	567	F4h F1h 37h	100	5-6
Fixed Gain	568	F1h 38h	50	5-6
Gain / Exposure Priority for Snapshot Mode	562	F1h 32h	Autodetect	5-7
Snapshot Mode Timeout	323	F0h 43h	0 (30 seconds)	5-8
Snapshot Aiming Pattern	300	F0h 2Ch	Enable	5-9
Silence Operational Mode Changes	1293	F8h 05h 0Dh	Disable (do not silence)	5-9
Image Cropping	301	F0h 2Dh	Disable	5-10

Table 5-1 *Imaging Preferences Parameter Defaults*

Parameter	Parameter Number	SSI Number	Default	Page Number
Crop to Pixel Addresses	315 316 317 318	F4h F0h 3Bh F4h F0h 3Ch F4h F0h 3Dh F4h F0h 3Eh	0 top 0 left 799 bottom 1279 right	5-11
Image Size (Number of Pixels)	302	F0h 2Eh	Full	5-12
Image Brightness (Target White)	390	F0h 86h	180	5-13
JPEG Image Options	299	F0h 2Bh	Quality	5-13
JPEG Target File Size	561	F1h 31h	160 kB	5-14
JPEG Quality and Size Value	305	F0h 31h	65	5-14
Image Enhancement	564	F1h 34h	Low (1)	5-15
Image File Format Selection	304	F0h 30h	JPEG	5-16
Image Rotation	665	F1h 99h	Rotate 0°	5-17
Bits per Pixel (BPP)	303	F0h 2Fh	8 BPP	5-18
Signature Capture (DS3608 HP Only)	93	5Dh	Disable	5-19
Signature Capture Image File Format Selection (DS3608 HP Only)	313	F0h 39h	JPEG	5-20
Signature Capture Bits per Pixel (BPP) (DS3608 HP Only)	314	F0h 3Ah	8 BPP	5-21
Signature Capture Width (DS3608 HP Only)	366	F4h F0h 6Eh	400	5-22
Signature Capture Height (DS3608 HP Only)	367	F4h F0h 6Fh	100	5-22
Signature Capture JPEG Quality (DS3608 HP Only)	421	F0h A5h	65	5-23
Video View Finder	324	F0h 44h	Disable	5-23
Video View Finder Image Size	329	F0h 49h	1700 bytes	5-24

Imaging Preferences

The parameters in this chapter control image capture characteristics. Image capture occurs in all modes of operation, including decode, video, and snapshot.

Operational Modes

The digital scanner has three modes of operation:

- Decode Mode
- Snapshot Mode
- Video Mode.

Decode Mode

By default, when you pull the trigger the digital scanner attempts to locate and decode enabled bar codes within its field of view. The digital scanner remains in this mode until it decodes a bar code or you release the trigger.

Snapshot Mode

Use Snapshot Mode to capture a high-quality image and transmit it to the host. To temporarily enter this mode scan the **Snapshot Mode** bar code. While in this mode the digital scanner blinks the green LED at 1-second intervals to indicate it is not in standard operating (decode) mode.

In Snapshot Mode, the digital scanner turns on its aiming pattern to highlight the area to capture in the image. The next trigger pull instructs the digital scanner to capture a high quality image and transmit it to the host. A short time may pass (less than 2 seconds) between when the trigger is pulled and the image is captured as the digital scanner adjusts to the lighting conditions. Hold the digital scanner steady until the image is captured, denoted by a single beep.

If you do not press the trigger within the Snapshot Mode Timeout period, the digital scanner returns to Decode Mode. Use [Snapshot Mode Timeout on page 5-8](#) to adjust this timeout period. The default timeout period is 30 seconds.

To disable the aiming pattern during Snapshot Mode, see [Snapshot Aiming Pattern on page 5-9](#).



Snapshot Mode

Video Mode

In this mode the digital scanner behaves as a video camera as long as you press the trigger. Release the trigger to return the digital scanner to Decode Mode. Scan this bar code to temporarily enter Video Capture Mode.



Video Mode

Image Capture Illumination

Parameter # 361 (SSI # F0h 69h)

Selecting **Enable Image Capture Illumination** causes illumination to turn on during every image capture. Disable illumination to prevent the digital scanner from using illumination.

Enabling illumination usually results in superior images. The effectiveness of illumination decreases as the distance to the target increases.

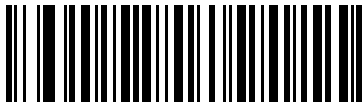

***Enable Image Capture Illumination
(1)**



**Disable Image Capture Illumination
(0)**

Image Capture Autoexposure

Parameter # 360 (SSI # F0h 68h)

Select **Enable Image Capture Autoexposure** to allow the digital scanner to control gain settings and exposure (integration) time to best capture an image for the selected operation mode.

Select **Disable Image Capture Autoexposure** to manually adjust the gain and exposure time (see the following pages). This option is only recommended for advanced users with difficult image capture situations.

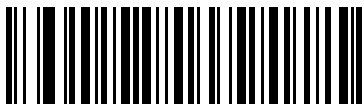

***Enable Image Capture Autoexposure
(1)**

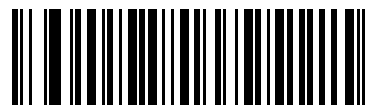

**Disable Image Capture Autoexposure
(0)**

Fixed Exposure

Parameter # 567 (SSI # F4h F1h 37h)

Type: Word

Range: 5 - 1000

This parameter configures the exposure used in manual mode for Snapshot and Video modes.

Each integer value represents 100 μ s worth of exposure. The default value is 100 which results in an exposure setting of 10 ms.

To set the Fixed Exposure parameter, scan **Fixed Exposure** followed by four numeric bar codes representing the value. Leading zeros are required. For example, to set a Fixed Exposure value of 99, scan 0, 0, 9, 9. See [Appendix G, Numeric Bar Codes](#) for numeric bar codes.



Fixed Exposure
(4 digits)

Fixed Gain

Parameter # 568 (SSI # F1h 38h)

Type: Byte

Range 1 - 100

This parameter configures the gain setting used in manual mode for Snapshot and Video modes.

A value of 1 indicates that gain is not used for image capture. A value of 100 indicates that maximum gain is used for image capture. The default value of this parameter is 50.

To set the Fixed Gain parameter, scan **Fixed Gain** below followed by three numeric bar codes representing the value. Leading zeros are required. For example, to set a Fixed Gain value of 99, scan 0, 9, 9. See [Appendix G, Numeric Bar Codes](#) for numeric bar codes.



Fixed Gain

Gain/Exposure Priority for Snapshot Mode

Parameter # 562 (SSI # F1h 32h)

This parameter alters the digital scanner's gain exposure priority when it acquires an image in Snapshot Mode in auto exposure mode.

- Scan **Low Exposure Priority** to set a mode in which the digital scanner favors higher gain over exposure to capture an image. This results in an image that is less susceptible to motion blur at the expense of noise artifacts. However, for most applications, the amount of noise is acceptable.
- Scan **Low Gain Priority** to set a mode in which the digital scanner favors longer exposure time rather than higher gain to capture an image. This ensures that the image is less noisy and produces fewer artifacts during post processing activities like image enhancement (sharpening). The mode is recommended for fixed mount / fixed object image capture since the image acquired is susceptible to motion blur.
- Scan **Autodetect** (default) to set a mode in which the digital scanner automatically selects Gain Priority or Low Exposure Priority mode for Snapshot Mode. If the digital scanner is in a magnetic reed switch enabled stand (or it is configured in Blink Mode), it uses Low Gain Priority mode. Otherwise, it uses the Low Exposure Priority mode.



Low Gain Priority
(0)



Low Exposure Priority
(1)



*** Autodetect**
(2)

Snapshot Mode Timeout

Parameter # 323 (SSI # F0h 43h)

This parameter sets the amount of time the digital scanner remains in Snapshot Mode. The digital scanner exits Snapshot Mode when you pull the trigger, or when the Snapshot Mode Timeout elapses. To set this timeout value, scan the **Set Snapshot Mode Timeout** bar code below followed by a bar code from [Appendix G, Numeric Bar Codes](#). The default value is 0 which represents 30 seconds; values increment by 30. For example, 1 = 60 seconds, 2 = 90 seconds, etc.

To quickly re-set the default timeout to 30 seconds, scan the **30 Seconds** bar code below.

If you select **No Timeout**, the digital scanner remains in Snapshot Mode until you pull the trigger.



Set Snapshot Mode Timeout

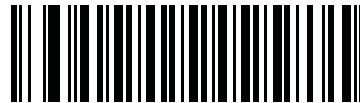

***30 Seconds**

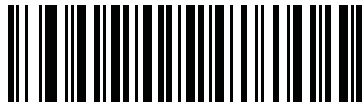

No Timeout

Snapshot Aiming Pattern

Parameter # 300 (SSI # F0h 2Ch)

Select **Enable Snapshot Aiming Pattern** to project the aiming pattern when in Snapshot Mode, or **Disable Snapshot Aiming Pattern** to turn the aiming pattern off.



***Enable Snapshot Aiming Pattern
(1)**



**Disable Snapshot Aiming Pattern
(0)**

Silence Operational Mode Changes

Parameter # 1293 (SSI # F8h 05h 0Dh)

Enable this feature to silence the beeper when switching between operational modes (e.g., from Decode Mode to Snapshot Mode).



**Silence Operational Mode Changes (Enable)
(1)**

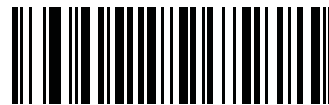

***Do Not Silence Operational Mode Changes (Disable)
(0)**

Image Cropping

Parameter # 301 (SSI # F0h 2Dh)

This parameter crops a captured image. Select **Disable Image Cropping** to present the full 1200 x 800 pixels. Select **Enable Image Cropping** to crop the image to the pixel addresses set in [Crop to Pixel Addresses on page 5-11](#).



Enable Image Cropping
(1)



***Disable Image Cropping**
(Use Full 1200 x 800 Pixels)
(0)

Crop to Pixel Addresses

Parameter # 315 (SSI # F4h F0h 3Bh) (Top)

Parameter # 316 (SSI # F4h F0h 3Ch) (Left)

Parameter # 317 (SSI # F4h F0h 3Dh) (Bottom)

Parameter # 318 (SSI # F4h F0h 3Eh) (Right)

If you selected **Enable Image Cropping**, set the pixel addresses from (0,0) to (1279 x 799) to crop to.

Columns are numbered from 0 to 1279, rows from 0 to 799. Specify four values for Top, Left, Bottom, and Right, where Top and Bottom correspond to row pixel addresses, and Left and Right correspond to column pixel addresses. For example, for a 4 row x 8 column image in the extreme bottom-right section of the image set the following values:

Top = 796, Bottom = 799, Left = 1272, Right = 1279

To set the crop to pixel address, scan each pixel address bar code below followed by four numeric bar codes representing the value. Leading zeros are required. For example, to crop the top pixel address to 3, scan 0, 0, 0, 3. See [Appendix G, Numeric Bar Codes](#) for numeric bar codes. The defaults are:

Top = 0, Bottom = 799, Left = 0, Right = 1279

✓ **NOTE** The digital scanner has a cropping resolution of 4 pixels. Setting the cropping area to less than 4 pixels (after resolution adjustment, see [Image Size \(Number of Pixels\) on page 5-12](#)) transfers the entire image.



Top Pixel Address
(0 - 799 Decimal)

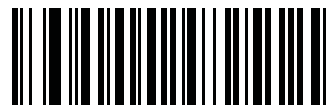

Left Pixel Address
(0 - 1279 Decimal)



Bottom Pixel Address
(0 - 799 Decimal)



Right Pixel Address
(0 - 1279 Decimal)

Image Size (Number of Pixels)

Parameter # 302 (SSI # F0h 2Eh)

This option alters image resolution before compression. Multiple pixels are combined to one pixel, resulting in a smaller image containing the original content with reduced resolution.

Select one of the following values:

Table 5-2 Resolution and Image Size

Resolution Value	Uncropped Image Size
Full	1280 x 800
1/2	640 x 400
1/4	320 x 200



***Full Resolution
(0)**



**1/2 Resolution
(1)**



**1/4 Resolution
(3)**

Image Brightness (Target White)

Parameter # 390 (SSI # F0h 86h)

Type: Byte

Range: 1 - 240

This parameter sets the Target White value used in Snapshot and Video Viewfinder mode when using auto exposure. White and black are defined as 240 decimal and 1, respectively. Setting the value to the factory default of 180 sets the white level of the image to ~180.

To set the Image Brightness parameter, scan **Image Brightness** below followed by three numeric bar codes representing the value. Leading zeros are required. For example, to set an Image Brightness value of 99, scan 0, 9, 9. See [Appendix G, Numeric Bar Codes](#) for numeric bar codes.



*180



Image Brightness
(3 digits)

JPEG Image Options

Parameter # 299 (SSI # F0h 2Bh)

Select an option to optimize JPEG images for either size or for quality. Scan the **JPEG Quality Selector** bar code to enter a quality value; the digital scanner then selects the corresponding image size. Scan the **JPEG Size Selector** bar code to enter a size value; the digital scanner then selects the best image quality.



*JPEG Quality Selector
(1)



JPEG Size Selector
(0)

JPEG Target File Size

Parameter # 561 (SSI # F1h 31h)

Type: Word

Range: 5-350

This parameter defines the target JPEG file size in terms 1 Kilobytes (1024 bytes). The default value is 160 kB which represents 160 Kilobytes.



CAUTION JPEG compress may take 10 to 15 seconds based on the amount of information in the target image. Scanning **JPEG Quality Selector** (default setting) on [page 5-13](#) produces a compressed image that is consistent in quality and compression time.

To set the JPEG Target File Size parameter, scan **JPEG Target File Size** below followed by three numeric bar codes representing the value. Leading zeros are required. For example, to set an image file size value of 99, scan 0, 9, 9 in [Appendix G, Numeric Bar Codes](#).



JPEG Target File Size
(3 digits)

JPEG Quality and Size Value

JPEG Quality = Parameter # 305 (SSI # F0h 31h)

If you selected **JPEG Quality Selector**, scan the **JPEG Quality Value** bar code followed by 3 bar codes from [Appendix G, Numeric Bar Codes](#) corresponding to a value from 5 to 100, where 100 represents the highest quality image.



JPEG Quality Value
(Default: 065)
(5 - 100 Decimal)

Image Enhancement

Parameter # 564 (SSI # F1h 34h)

This parameter configures the digital scanner's Image Enhance feature. This feature uses a combination of edge sharpening and contrast enhancement to produce an image that is visually pleasing.

The levels of image enhancement are:

- Off (0)
- Low (1) - Default
- Med (2)
- High (3).



**Off
(0)**



***Low
(1)**



**Medium
(2)**



**High
(3)**

Image File Format Selector

Parameter # 304 (SSI # F0h 30h)

Select an image format appropriate for the system (BMP, TIFF, or JPEG). The digital scanner stores captured images in the selected format.



BMP File Format
(3)



***JPEG File Format**
(1)



TIFF File Format
(4)

Image Rotation

Parameter # 665 (SSI # F1h 99h)

This parameter controls the rotation of the image by 0, 90, 180, or 270 degrees.



***Rotate 0°
(0)**



**Rotate 90°
(1)**



**Rotate 180°
(2)**



**Rotate 270°
(3)**

Bits Per Pixel

Parameter # 303 (SSI # F0h 2Fh)

Select the number of significant bits per pixel (BPP) to use when capturing an image. Select **1 BPP** for a black and white image, **4 BPP** to assign 1 of 16 levels of grey to each pixel, or **8 BPP** to assign 1 of 256 levels of grey to each pixel.



NOTE The digital scanner ignores these settings for JPEG file formats, which only support **8 BPP**.

The digital scanner ignores 1 BPP for TIFF file formats, which only support **4 BPP** and **8 BPP**. 1 BPP is coerced to 4 BPP for TIFF file formats.



1 BPP
(0)



4 BPP
(1)



***8 BPP**
(2)

Signature Capture

Parameter # 93 (SSI # 5Dh)

✓ **NOTE** Signature capture only applies to the DS3608-HP.

A signature capture bar code is a special-purpose symbology which delineates a signature capture area in a document with a machine-readable format. The recognition pattern is variable so it can optionally provide an index to various signatures. The region inside the bar code pattern is considered the signature capture area. See [Appendix J, Signature Capture Code](#) for more information.

Output File Format

Decoding a signature capture bar code de-skews the signature image and converts the image to a BMP, JPEG, or TIFF file format. The output data includes the file descriptor followed by the formatted signature image.

Table 5-3 *Output File Format*

File Descriptor			Signature Image
Output Format (1 byte)	Signature Type (1 byte)	Signature Image Size (4 bytes) (BIG Endian)	
JPEG - 1 BMP - 3 TIFF - 4	1-8	0x00000400	0x00010203....

To enable or disable Signature Capture, scan the appropriate bar code below.



Enable Signature Capture
(1)



***Disable Signature Capture**
(0)

Signature Capture File Format Selector

Parameter # 313 (SSI # F0h 39h)

✓ **NOTE** Signature capture only applies to the DS3608-HP.

Select a signature file format appropriate for the system (BMP, TIFF, or JPEG). The digital scanner stores captured signatures in the selected format.



BMP Signature Format
(3)



***JPEG Signature Format**
(1)



TIFF Signature Format
(4)

Signature Capture Bits Per Pixel

Parameter # 314 (SSI # F0h 3Ah)

✓ **NOTE** Signature capture only applies to the DS3608-HP.

Select the number of significant bits per pixel (BPP) to use when capturing a signature. Select **1 BPP** for a black and white image, **4 BPP** to assign 1 of 16 levels of grey to each pixel, or **8 BPP** to assign 1 of 256 levels of grey to each pixel.

✓ **NOTE** The digital scanner ignores these settings for JPEG file formats, which only support **8 BPP**.



1 BPP
(0)



4 BPP
(1)



***8 BPP**
(2)

Signature Capture Width

Parameter # 366 (SSI # F4h F0h 6Eh)

✓ **NOTE** Signature capture only applies to the DS3608-HP.

The aspect ratio of the Signature Capture Width and Signature Capture Height parameters must match that of the signature capture area. For example, a 4 x 1 inch signature capture area would require a 4 to 1 aspect ratio of width to height.

To set the width of the signature capture box, scan the **Signature Capture Width** bar code, followed by 4 bar codes from [Appendix G, Numeric Bar Codes](#) corresponding to a value in the range of 016 to 1280 decimal.



Signature Capture Width
(Default: 400)
(016 - 1280 Decimal)

Signature Capture Height

Parameter # 367 (SSI # F4h F0h 6Fh)

✓ **NOTE** Signature capture only applies to the DS3608-HP.

To set the height of the signature capture box, scan the **Signature Capture Height** bar code, followed by 3 bar codes from [Appendix G, Numeric Bar Codes](#) corresponding to a value in the range of 016 to 800 decimal.



Signature Capture Height (Default: 100)
(016 - 800 Decimal)

Signature Capture JPEG Quality

Parameter # 421 (SSI # F0h A5h)

✓ **NOTE** Signature capture only applies to the DS3608-HP.

Scan the **JPEG Quality Value** bar code followed by 3 bar codes from [Appendix G, Numeric Bar Codes](#) corresponding to a value from 005 to 100, where 100 represents the highest quality image.



JPEG Quality Value (Default: 065)
(5 - 100 Decimal)

Video View Finder

Parameter # 324 (SSI # F0h 44h)

Select **Enable Video View Finder** to project the video view finder while in Video Mode, or **Disable Video View Finder** to turn the video view finder off.

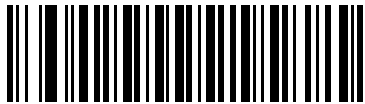

***Disable Video View Finder**
(0)

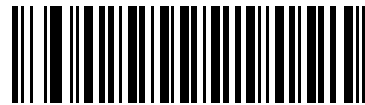

Enable Video View Finder
(1)

Video View Finder Image Size

Parameter # 329 (SSI # F0h 49h)

Select the number of 100-byte blocks. Values range from 800 to 12,000 bytes. Selecting a smaller value transmits more frames per second; selecting a larger value increases video quality.

To set the Video View Finder Image Size, scan the bar code below followed by three bar codes from [Appendix G, Numeric Bar Codes](#) corresponding to the 100-byte value from 800 to 12,000 bytes. For example, to select 1500 bytes, enter 0, 1, 5. To select 900 bytes, enter 0, 0, 9. The default is 1700 bytes.

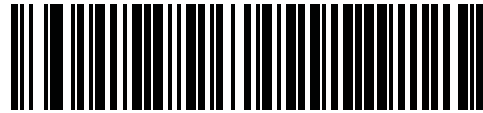

Video View Finder Image Size

CHAPTER 6 USB INTERFACE

Introduction

This chapter provides instructions for programming the digital imager to interface with a USB host. The digital imager scanner connects directly to a USB host, or a powered USB hub. The USB host can power the digital imager.

Throughout the programming bar code menus, default values are indicated with asterisks (*).

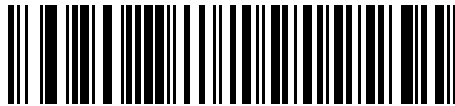

*Indicates Default — *North American Standard USB Keyboard — Feature/Option

Connecting a USB Interface

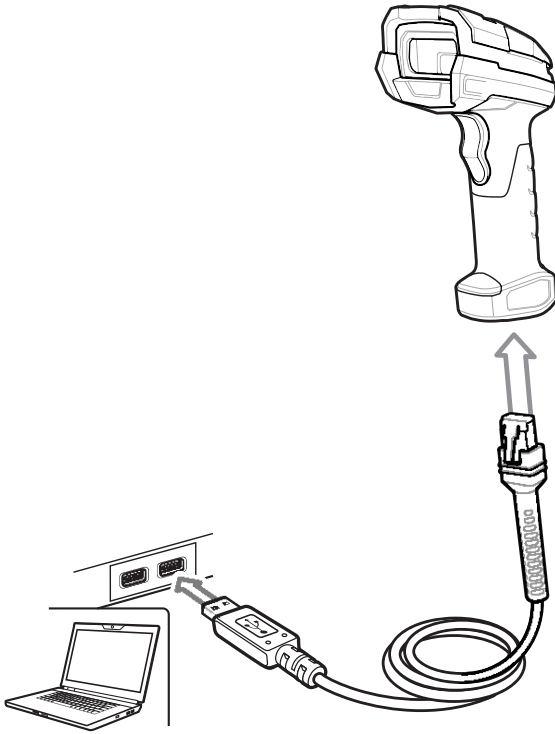

Figure 6-1 *USB Connection*

The digital imager scanner connects with USB capable hosts including:

- Desktop PCs and Notebooks
- Apple™ iMac, G4, iBooks (North America only)
- IBM SurePOS terminals
- Sun, IBM, and other network computers that support more than one keyboard.

The following operating systems support the digital imager scanner through USB:

- Windows 98, 2000, ME, XP, 7, 8, 8.1, 10
- MacOS 8.5 and above
- IBM 4690 OS.

The digital imager also interfaces with other USB hosts which support USB Human Interface Devices (HID).

To connect the USB interface:

1. Attach the modular connector of the USB interface cable to the host port on the bottom of the digital imager.
2. Plug the series A connector in the USB host or hub, or plug the Plus Power connector in an available port of the IBM SurePOS terminal.
3. Select the USB device type by scanning the appropriate bar code from [USB Device Type on page 6-5](#).

✓ **NOTE** The interface cable automatically detects the host interface type and uses the default setting. If the default (*) does not meet your requirements, scan another host bar code.

4. On first installation when using Windows, the software prompts to select or install the Human Interface Device driver. To install this driver, provided by Windows, click **Next** through all the choices and click **Finished** on the last choice. The scanner powers up during this installation.
5. To modify any other parameter options, scan the appropriate bar codes in this chapter.

If problems occur with the system, see [Troubleshooting on page 3-3](#).

USB Parameter Defaults

Table 6-1 lists the defaults for USB host parameters. If any option needs to be changed, scan the appropriate bar code(s) provided in the Parameter Descriptions section beginning on [page 6-5](#).

- ✓ **NOTE** See [Appendix A, Standard Default Parameters](#) for all user preferences, hosts, symbologies, and miscellaneous default parameters.
- ✓ **NOTE** See [Appendix B, Country Codes](#) for USB Country Keyboard Types (Country Codes).

Table 6-1 *USB Host Default Table*

Parameter	Default	Page Number
USB Host Parameters		
USB Device Type	HID Keyboard Emulation	6-5
Symbol Native API (SNAPI) Status Handshaking	Enable	6-7
USB Keystroke Delay	No Delay	6-8
USB CAPS Lock Override	Disable	6-8
USB Ignore Unknown Characters	Send	6-9
USB Convert Unknown to Code 39	Disable	6-9
Emulate Keypad	Enable	6-10
Emulate Keypad with Leading Zero	Enable	6-10
Quick Keypad Emulation	Enable	6-11
USB FN1 Substitution	Disable	6-11
Function Key Mapping	Disable	6-12
Simulated Caps Lock	Disable	6-12
Convert Case	No Case Conversion	6-13
USB Static CDC	Enable	6-13
Ignore Beep	Enable	6-14
Ignore Bar Code Configuration	Enable	6-14
USB Polling Interval	3 msec	6-15
USB Fast HID	Enable	6-17
IBM Specification Version	Version 2.2	6-17

USB Host Parameter

USB Device Type

Select the desired USB device type.

**NOTES**

1. When changing USB device types, the scanner automatically restarts. The digital imager issues a power-up beep sequence.
2. Before selecting *USB CDC Host (Note 2) on page 6-6*, install the CDC INF file on the host to ensure the scanner does not stall during power up (due to a failure to enumerate USB).
To recover a stalled scanner:
 - a) Install the CDC INF file
 - or
 - b) After power-up, hold the trigger for 10 seconds, which allows the scanner to power up using an alternate USB configuration. Upon power-up, scan another USB Device Type.
3. Select **IBM Hand-Held USB** to disable data transmission when an IBM register issues a Scan Disable command. Aim, illumination, and decoding is still permitted. Select **IBM OPOS (IBM Hand-held USB with Full Scan Disable)** to completely shut off the scanner when an IBM register issues a Scan Disable command, including aim, illumination, decoding, and data transmission.

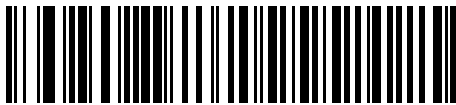

*HID Keyboard Emulation



IBM Table Top USB

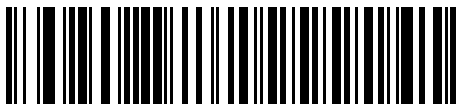

IBM Hand-Held USB



USB OPOS Handheld

USB Device Type (continued)

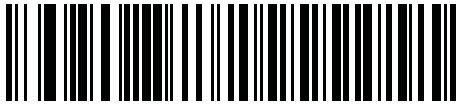

Simple COM Port Emulation

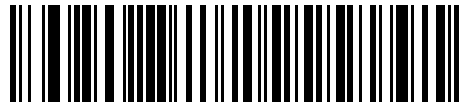

SSI over USB CDC

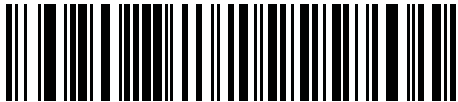

USB CDC Host
(Note 2)



Symbol Native API (SNAPI) without Imaging Interface



Symbol Native API (SNAPI) with Imaging Interface

Symbol Native API (SNAPI) Status Handshaking

After selecting a SNAPI interface as the USB device type, select whether to enable or disable status handshaking.



***Enable SNAPI Status Handshaking**



Disable SNAPI Status Handshaking

USB Keystroke Delay

This parameter sets the delay, in milliseconds, between emulated keystrokes. Scan a bar code below to increase the delay when hosts require a slower transmission of data.

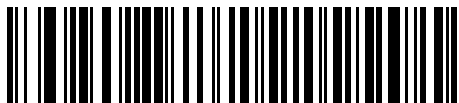

***No Delay**



Medium Delay (20 msec)

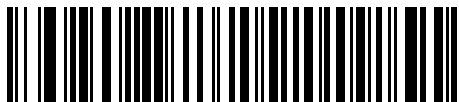

Long Delay (40 msec)

USB CAPS Lock Override

This option applies only to the HID Keyboard Emulation device. When enabled, the case of the data is preserved regardless of the state of the caps lock key. This setting is always enabled for the “Japanese, Windows (ASCII)” keyboard type and can not be disabled.



**Override Caps Lock Key
(Enable)**



***Do Not Override Caps Lock Key
(Disable)**

USB Ignore Unknown Characters

This option applies only to the HID Keyboard Emulation device and IBM device. Unknown characters are characters the host does not recognize. When **Send Bar Codes With Unknown Characters** is selected, all bar code data is sent except for unknown characters, and no error beeps sound. When **Do Not Send Bar Codes With Unknown Characters** is selected, bar code data is sent up to the first unknown character, then the digital imager scanner issues an error beep.

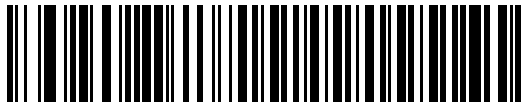

***Send Bar Codes with Unknown Characters**

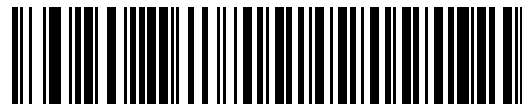

Do Not Send Bar Codes with Unknown Characters

USB Convert Unknown to Code 39

This option applies only to the IBM Handheld, IBM Tabletop, and OPOS devices. Scan a bar code below to enable or disable converting unknown bar code type data to Code 39.

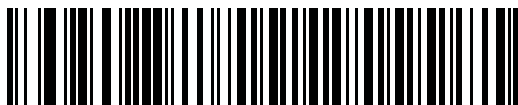

***Disable Convert Unknown to Code 39**

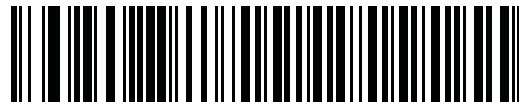

Enable Convert Unknown to Code 39

Emulate Keypad

When enabled, all characters are sent as ASCII sequences over the numeric keypad. For example ASCII A would be sent as “ALT make” 0 6 5 “ALT Break.”



Disable Keypad Emulation



***Enable Keypad Emulation**

Emulate Keypad with Leading Zero

Enable this to send character sequences sent over the numeric keypad as ISO characters which have a leading zero. For example ASCII A transmits as “ALT MAKE” 0 0 6 5 “ALT BREAK”.



Disable Keypad Emulation with Leading Zero



***Enable Keypad Emulation with Leading Zero**

Quick Keypad Emulation

This option applies only to the HID Keyboard Emulation Device and if Emulate Keypad is enabled. This parameter enables a quicker method of keypad emulation where ASCII sequences are only sent for ASCII characters not found on the keyboard. The default value is **Enable**.



***Enable**

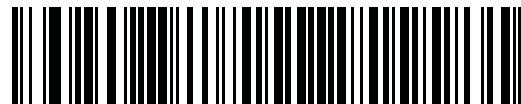

Disable

USB Keyboard FN 1 Substitution

This option applies only to the USB HID Keyboard Emulation device. When enabled, this allows replacement of any FN 1 characters in an EAN 128 bar code with a Key Category and value chosen by the user (see [FN1 Substitution Values on page 4-37](#) to set the Key Category and Key Value).



Enable FN1 Substitution



***Disable FN1 Substitution**

Function Key Mapping

ASCII values under 32 are normally sent as a control-key sequences. When this parameter is enabled, the keys in bold are sent in place of the standard key mapping. Table entries that do not have a bold entry remain the same whether or not this parameter is enabled.

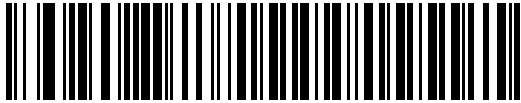

***Disable Function Key Mapping**

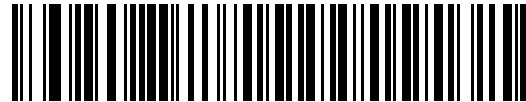

Enable Function Key Mapping

Simulated Caps Lock

When enabled, the digital imager scanner inverts upper and lower case characters on the digital imager scanner bar code as if the Caps Lock state is enabled on the keyboard. This inversion is done regardless of the current state of the keyboard's Caps Lock state.



***Disable Simulated Caps Lock**



Enable Simulated Caps Lock

Convert Case

When enabled, the digital imager scanner converts all bar code data to the selected case.

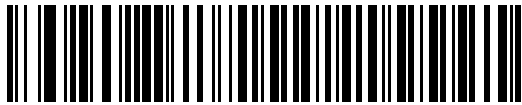

***No Case Conversion**



Convert All to Upper Case

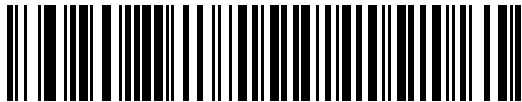

Convert All to Lower Case

USB Static CDC

Parameter # 670

When disabled, each device connected consumes another COM port (first device = COM1, second device = COM2, third device = COM3, etc.)

When enabled, each device connects to the same COM port.



***Enable USB Static CDC
(1)**



**Disable USB Static CDC
(0)**

Optional USB Parameters

If you configure the digital imager scanner and find the settings were not saved, or changed, when the system is restarted scan the bar codes that follow to override USB interface defaults.

Scan a bar code below after setting defaults and before configuring the digital imager scanner.

Ignore Beep

The host can send a beep request to the digital imager scanner. When this parameter is enabled, the request is not sent to the attached digital imager scanner. All directives are still acknowledged to the USB host as if it were processed.



Disable



***Enable**

Ignore Bar Code Configuration

The host has the ability to enable/disable code types. When this parameter is enabled, the request is not sent to the attached digital imager scanner. All directives are still acknowledged to the USB host as if it were processed.



Disable



***Enable**

USB Polling Interval

Scan a bar code below to set the polling interval. The polling interval determines the rate at which data can be sent between the scanner and host computer. A lower number indicates a faster data rate.



NOTE When changing USB Device Types, the digital imager automatically restarts and issues a disconnect-reconnect beep sequence.



IMPORTANT Ensure your host machine can handle the selected data rate.



1 msec

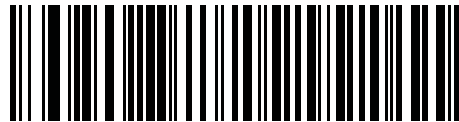

2 msec

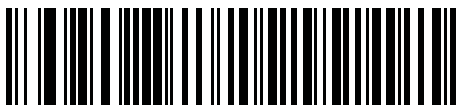

*3 msec

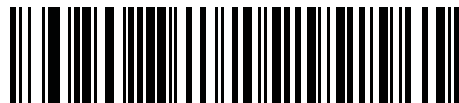

4 msec

USB Polling Interval (continued)

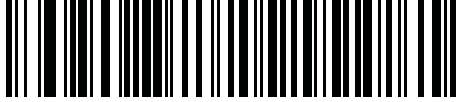

5 msec



6 msec

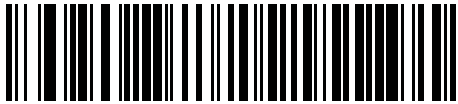

7 msec



8 msec

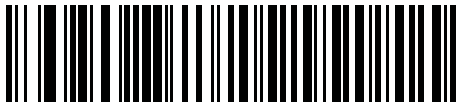

9 msec

USB Fast HID

This option transmits USB HID data at a faster rate.

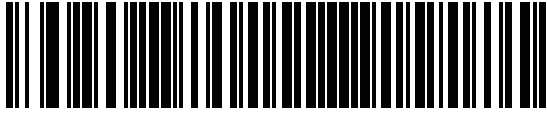

***Enable**

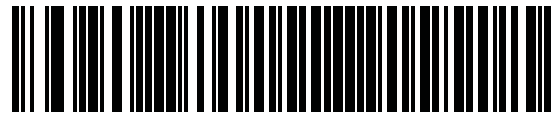

Disable

IBM Specification Version

The IBM USB interface specification version selected defines how code types are reported over the IBM USB interface.

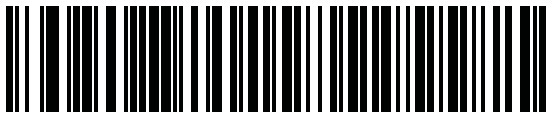

Original Specification

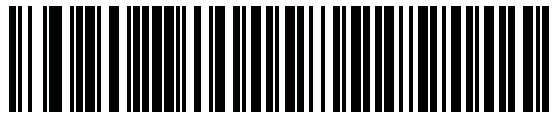

***Version 2.2**

ASCII Character Set for USB

See [Appendix H, ASCII Character Sets](#) for the following:

- ASCII Character Set ([Table H-1 on page H-1](#))
- ALT Key Character Set ([Table H-2 on page H-6](#))
- GUI Key Character Set ([Table H-3 on page H-7](#))
- F Key Character Set ([Table H-5 on page H-11](#)).

CHAPTER 7 SSI INTERFACE

Introduction

This chapter describes the system requirements of the Simple Serial Interface (SSI), which provides a communications link between Zebra decoders (e.g., scan engines, slot scanners, hand-held scanners, two-dimensional scanners, hands-free scanners, and RF base stations) and a serial host. It provides the means for the host to control the decoder or scanner.

Communications

All communication between the digital scanner and host occurs over the hardware interface lines using the SSI protocol. Refer to the *Simple Serial Interface Programmer's Guide*, p/n 72-40451-xx, for more information on SSI.

The host and the digital scanner exchange messages in packets. A packet is a collection of bytes framed by the proper SSI protocol formatting bytes. The maximum number of bytes per packet that the SSI protocol allows for any transaction is 257 (255 bytes + 2 byte checksum).

Decode data can be sent as ASCII data (unpacketed), or as part of a larger message (packeted), depending on the digital scanner configuration.

SSI performs the following functions for the host device:

- Maintains a bi-directional interface with the digital scanner
- Allows the host to send commands that control the digital scanner
- Passes data from the digital scanner to a host device in SSI packet format or straight decode message.

The working environment of the SSI consists of a digital scanner, a serial cable which attaches to the host device, and in some instances, a power supply.

SSI transmits all decode data including special formatting (e.g., AIM ID). Parameter settings can control the format of the transmitted data.

The digital scanner can also send parameter information, product identification information, or event codes to the host.

All commands sent between the digital scanner and host must use the format described in the SSI Message Formats section. [SSI Transactions on page 7-3](#) describes the required sequence of messages in specific cases.

Table 7-1 lists all the SSI opcodes the digital scanner supports. It identifies the SSI partner allowed to send a message of each type. The host transmits opcodes designated type H. The digital scanner transmits type D opcodes, and either partner can transmit Host/Decoder (H/D) types.

Table 7-1 SSI Commands

Name	Type	Opcode	Description
AIM_OFF	H	0xC4	Deactivate aim pattern.
AIM_ON	H	0xC5	Activate aim pattern.
BEEP	H	0xE6	Sound the beeper.
CAPABILITIES_REPLY	D	0xD4	Reply to CAPABILITIES_REQUEST; contains a list of the capabilities and commands the decoder supports.
CAPABILITIES_REQUEST	H	0xD3	Request capabilities report from the decoder.
CMD_ACK	H/D	0xD0	Positive acknowledgment of received packet.
CMD_NAK	H/D	0xD1	Negative acknowledgment of received packet.
DECODE_DATA	D	0xF3	Decode data in SSI packet format.
EVENT	D	0xF6	Event indicated by associated event code.
LED_OFF	H	0xE8	De-activate LED output.
LED_ON	H	0xE7	Activate LED output.
PARAM_DEFAULTS	H	0xC8	Set parameter default values.
PARAM_REQUEST	H	0xC7	Request values of certain parameters.
PARAM_SEND	H/D	0xC6	Send parameter values.
REPLY_ID	D	0xA6	Reply to REQUEST_ID; contains decoder's serial number.
REPLY_REVISION	D	0xA4	Reply to REQUEST_REVISION contains decoder's software/hardware configuration.
REQUEST_ID	H	0xA3	Request the decoder's serial number.
REQUEST_REVISION	H	0xA3	Request the decoder's configuration.
SCAN_DISABLE	H	0xEA	Prevent the operator from scanning bar codes.
SCAN_ENABLE	H	0xE9	Permit bar code scanning.
SLEEP	H	0xEB	Request to place the decoder into low power.
START_DECODE	H	0xE4	Tell decoder to attempt to decode a bar code.
STOP_DECODE	H	0xE5	Tell decoder to abort a decode attempt.
WAKEUP	H	N/A	Wakeup decoder after it has entered low power mode.

For details of the SSI protocol, refer to the *Simple Serial Interface Programmer's Guide* (72-40451-xx).

SSI Transactions

General Data Transactions

ACK/NAK Handshaking

If you enable ACK/NAK handshaking, all packeted messages must have a CMD_ACK or CMD_NAK response, unless the command description states otherwise. This parameter is enabled by default. Zebra recommends leaving this handshaking enabled to provide feedback to the host. Raw decode data and WAKEUP do not use ACK/NAK handshaking since they are not packeted data.

Following is an example of a problem which can occur if you disable ACK/NAK handshaking:

- The host sends a PARAM_SEND message to the digital scanner to change the baud rate from 9600 to 19200.
- The digital scanner cannot interpret the message.
- The digital scanner does not implement the change the host requested.
- The host assumes that the parameter change occurred and acts accordingly.
- Communication is lost because the change did not occur on both sides.

If you enable ACK/NAK handshaking, the following occurs:

- The host sends a PARAM_SEND message.
- The digital scanner cannot interpret the message.
- The digital scanner CMD_NAKs the message.
- The host resends the message.
- The digital scanner receives the message successfully, responds with CMD_ACK, and implements parameter changes.

Transfer of Decode Data

The Decode Data Packet Format parameter controls how decode data is sent to the host. Set this parameter to send the data in a DECODE_DATA packet. Clear this parameter to transmit the data as raw ASCII data.

✓ **NOTE** When transmitting decode data as raw ASCII data, ACK/NAK handshaking does not apply regardless of the state of the ACK/NAK handshaking parameter.

ACK/NAK Enabled and Packeted Data

The digital scanner sends a DECODE_DATA message after a successful decode. The digital scanner waits for a programmable time-out for a CMD_ACK response. If it does not receive the response, the digital scanner tries to send two more times before issuing a host transmission error. If the digital scanner receives a CMD_NAK from the host, it may attempt a retry depending on the cause field of the CMD_NAK message.

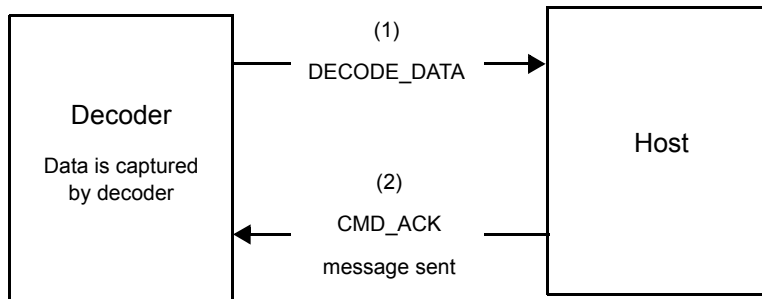

ACK/NAK Enabled and Unpacketed ASCII Data

Even though the ACK/NAK handshaking is enabled, no handshaking occurs because the handshaking applies only to packeted data. In this example the **packeted_decode** parameter is disabled.

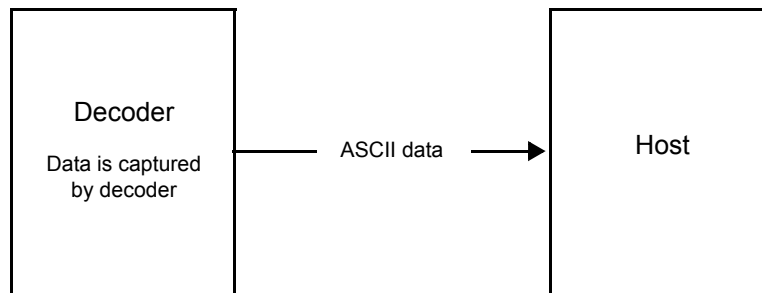

ACK/NAK Disabled and Packeted DECODE_DATA

In this example ACK/NAK does not occur even though `packeted_decode` is enabled because the ACK/NAK handshaking parameter is disabled.

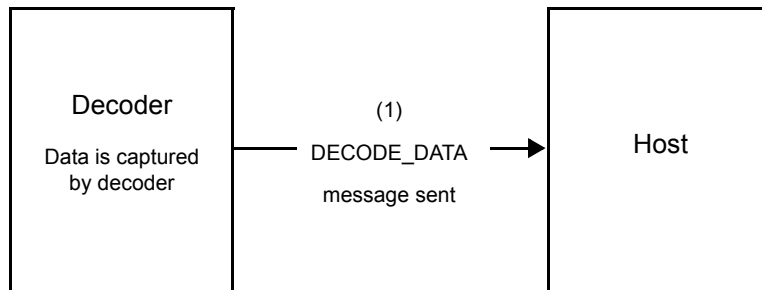

ACK/NAK Disabled and Unpacketed ASCII Data

Data captured by the digital scanner is sent to the host.

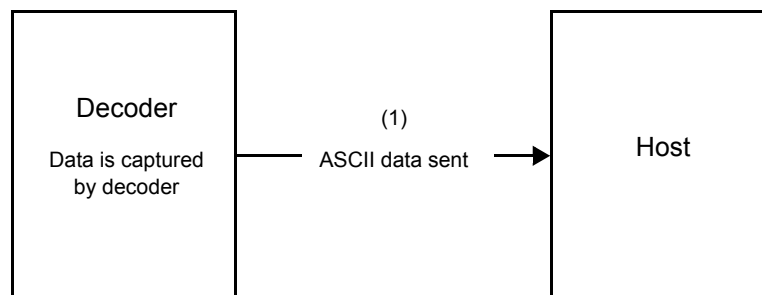

Communication Summary

RTS/CTS Lines

All communication must use RTS/CTS handshaking as described in the *Simple Serial Interface Programmer's Guide*, p/n 72-40451-xx. If hardware handshaking is disabled or bypassed, the WAKEUP command must be sent prior to all other communications, or the first byte of a communication message may be lost during the digital scanner wakeup sequence.

ACK/NAK Option

Enable or disable ACK/NAK handshaking. This handshaking is enabled by default and Zebra recommends leaving it enabled. Disabling this handshaking can cause communication problems, as handshaking is the only acknowledgment that a message was received, and if it was received correctly. ACK/NAK is not used with unpacketed decode data regardless of whether or not it is enabled.

Number of Data Bits

All communication with the digital scanner must use 8-bit data.

Serial Response Time-out

The Serial Response Time-out parameter determines how long to wait for a handshaking response before trying again, or aborting any further attempts. Set the same value for both the host and digital scanner.



NOTE You can temporarily change the Serial Response Time-out when the host takes longer to process an ACK or longer data string. Zebra does not recommend frequent permanent changes due to limited write cycles of non-volatile memory.

Retries

When sending data, the host should resend twice after the initial send if the digital scanner does not respond with an ACK or NAK (if ACK/NAK handshaking is enabled), or response data (e.g., PARAM_SEND, REPLY_REVISION). If the digital scanner replies with a NAK RESEND, the host resends the data. All resent messages must have the resend bit set in the Status byte.

The digital scanner resends data two times after the initial send if the host fails to reply with an ACK or NAK (if ACK/NAK handshaking is enabled).

Baud Rate, Stop Bits, Parity, Response Time-out, ACK/NAK Handshake

If you use PARAM_SEND to change these serial parameters, the ACK response to the PARAM_SEND uses the previous values for these parameters. The new values then take effect for the next transaction.

Errors

The digital scanner issues a communication error when:

- The CTS line is asserted when the digital scanner tries to transmit, and is still asserted on each of 2 successive retries
- Failure to receive an ACK or NAK after initial transmit and two resends.

Things to Remember When Using SSI Communication

When not using hardware handshaking, space messages sufficiently apart. The host must not communicate with the digital scanner if the digital scanner is transmitting.

When using hardware handshaking, frame each message properly with the handshaking signals. Do not try to send two commands within the same handshaking frame.

There is a permanent/temporary bit in the PARAM_SEND message. Removing power from the digital scanner discards temporary changes. Permanent changes are written to non-volatile memory. Frequent changes shorten the life of the non-volatile memory.

Using Time Delay to Low Power Mode with SSI

[Time Delay to Low Power Mode on page 4-15](#) provides bar codes to select a general time delay. To program a more specific delay value, use an SSI command according to [Table 7-2](#).

Table 7-2 Values for Selecting Time Delay to Low Power

Value	Timeout	Value	Timeout	Value	Timeout	Value	Timeout
0x00	15 Mins	0x10	1 Sec	0x20	1 Min	0x30	1 Hour
0x01	30 Mins	0x11	1 Sec	0x21	1 Min	0x31	1 Hour
0x02	60 Mins	0x12	2 Secs	0x22	2 Mins	0x32	2 Hours
0x03	90 Mins	0x13	3 Secs	0x23	3 Mins	0x33	3 Hours
N/A	N/A	0x14	4 Secs	0x24	4 Mins	0x34	4 Hours
N/A	N/A	0x15	5 Secs	0x25	5 Mins	0x35	5 Hours
N/A	N/A	0x16	6 Secs	0x26	6 Mins	0x36	6 Hours
N/A	N/A	0x17	7 Secs	0x27	7 Mins	0x37	7 Hours
N/A	N/A	0x18	8 Secs	0x28	8 Mins	0x38	8 Hours
N/A	N/A	0x19	9 Secs	0x29	9 Mins	0x39	9 Hours
N/A	N/A	0x1A	10 Secs	0x2A	10 Mins	0x3A	10 Hours
N/A	N/A	0x1B	15 Secs	0x2B	15 Mins	0x3B	15 Hours
N/A	N/A	0x1C	20 Secs	0x2C	20 Mins	0x3C	20 Hours
N/A	N/A	0x1D	30 Secs	0x2D	30 Mins	0x3D	30 Hours
N/A	N/A	0x1E	45 Secs	0x2E	45 Mins	0x3E	45 Hours
N/A	N/A	0x1F	60 Secs	0x2F	60 Mins	0x3F	60 Hours



CAUTION With hardware handshaking disabled, the DS3608 wakes from low power mode upon receiving a character. However, the DS3608 does not process this character or any others it receives during the 7 ms period following wakeup. Wait at least 7 ms after wakeup to send valid characters.

Encapsulation of RSM Commands/Responses over SSI

The SSI protocol allows the host to send a command that is variable in length up to 255 bytes. Although there is a provision in the protocol to multi-packet commands from the host, the scan engine does not support this. The host must fragment packets using the provisions in the RSM protocol.

Command Structure

Byte	7	6	5	4	3	2	1	0
0	Length (not including the checksum)							
1	SSI_MGMT_COMMAND (0x80)							
2	Message Source (4 - Host)							
3	Reserved (0)			Reserved (0)		Reserved (0)	Cont'd packet	Retransmit
4	Payload data (see the following example)							
...								
Length -1								
Length	2's complement checksum (MSB)							
Length +1	2's complement checksum (LSB)							

The expected response in the positive case is SSI_MGMT_COMMAND which may be a multi-packet response. For devices that do not support the SSI_MGMT_COMMAND, the response is the standard SSI_NAK.

Response Structure

Byte	7	6	5	4	3	2	1	0
0	Length (not including the checksum)							
1	SSI_MGMT_COMMAND (0x80)							
2	Message Source (0 - Decoder)							
3	Reserved (0)			Reserved (0)		Reserved (0)	Cont'd packet	Retransmit
4	Payload data (see the following example)							
...								
Length -1								
Length	2's complement checksum (MSB)							
Length +1	2's complement checksum (LSB)							

Example Transaction

The following example illustrates how to retrieve diagnostic information (Diagnostic Testing and Reporting (Attribute #10061) decimal) from the engine using encapsulation of RSM commands over SSI. Before sending any RSM command, the host must send the RSM Get Packet Size command to query the packet size supported by the device.

Command from Host to Query Packet Size Supported by Device

```
0A 80 04 00 00 06 20 00 FF FF FD 4E
```

Where:

- 0A 80 04 00 is encapsulation of RSM commands over SSI command header
- 00 06 20 00 FF FF is RSM Get Packet Size command
- FD 4E is SSI command checksum

Response from Device with Packet Size Information

```
0C 80 00 00 00 08 20 00 00 F0 00 F0 FD 6C
```

Where:

- 0C 80 00 00 is encapsulation of RSM command over SSI command header
- 00 08 20 00 00 F0 00 F0 is RSM Get Packet Size response
- FD 6C is SSI response checksum

Command from Host to Retrieve Diagnostic Information

```
0C 80 04 00 00 08 02 00 27 4D 42 00 FE B0
```

Where:

- 0C 80 04 00 is encapsulation of RSM commands over SSI command header
- 00 08 02 00 27 4D 42 00 is attribute Get command requesting attribute 10061 decimal
- FE B0 is SSI command checksum

Response from Device with Diagnostic Information

```
21 80 00 00 00 1D 02 00 27 4D 41 01 42 00 0E 00 00 00 00 01 03 02 03 03 03 04 03 05 03 06 03 FF FF FC 15
```

Where:

- 21 80 00 00 00 1D 02 00 27 4D 41 01 42 00 0E 00 00 is encapsulation of RSM responses over SSI command header
- 00 00 01 03 02 03 03 03 04 03 05 03 06 03 is attribute Get response which includes diagnostic report value
- FF FF is attribute Get response, packet termination
- FC 15 is SSI response checksum

Simple Serial Interface Default Parameters

This section describes how to set up the digital scanner with an SSI host. When using SSI, program the digital scanner via bar code menu or SSI hosts commands.

Throughout the programming bar code menus, asterisks (*) indicate default values.



- ✓ **NOTE** Most computer monitors allow scanning the bar codes directly on the screen. When scanning from the screen, be sure to set the document magnification to a level where you can see the bar code clearly, and bars and/or spaces are not merging.

[Table 7-3](#) lists the defaults for the SSI host. There are two ways to change the default values:

- Scan the appropriate bar codes in this guide. These new values replace the standard default values in memory. To recall the default parameter values, scan the [*Restore Defaults](#) bar code on [page 4-5](#).
- Download data through the device's serial port using SSI. Hexadecimal parameter numbers appear in this chapter below the parameter title, and options appear in parenthesis beneath the accompanying bar codes. Refer to the *Simple Serial Interface (SSI) Programmer's Guide* for detailed instructions for changing parameters using this method.

- ✓ **NOTE** See [Appendix A, Standard Default Parameters](#) for all user preferences, hosts, symbologies, and miscellaneous default parameters.

Table 7-3 SSI Default Table

Parameter	Parameter Number	SSI Number	Default	Page Number
Select SSI Host	N/A	N/A	N/A	7-11
Baud Rate	156	9Ch	9600	7-12
Parity	158	9Eh	None	7-13
Check Parity	151	97h	Disable	7-14
Stop Bits	157	9Dh	1	7-14
Software Handshaking	159	9Fh	ACK/NAK	7-15
Host RTS Line State	154	9Ah	Low	7-16
Decode Data Packet Format	238	EEh	Send Raw Decode Data	7-16
Host Serial Response Time-out	155	9Bh	2 sec	7-17

Table 7-3 SSI Default Table (Continued)

Parameter	Parameter Number	SSI Number	Default	Page Number
Host Character Time-out	239	EFh	200 msec	7-18
Multipacket Option	334	F0h 4Eh	Option 1	7-19
Interpacket Delay	335	F0h 4Fh	0 ms	7-20
Event Reporting				
Decode Event	256	F0h 00h	Disable	7-21
Boot Up Event	258	F0h 02h	Disable	7-22
Parameter Event	259	F0h 03h	Disable	7-22



NOTE SSI interprets Prefix, Suffix1, and Suffix2 values listed in [Table H-1 on page H-1](#) differently than other interfaces. SSI does not recognize key categories, only the 3-digit decimal value. The default value of 7013 is interpreted as CR only.

SSi Host Parameters

Select SSI Host

To select SSI as the host interface, scan the following bar code.



SSi Host

Baud Rate

Parameter # 156 (SSI # 9Ch)

Baud rate is the number of bits of data transmitted per second. Set the digital scanner's baud rate to match the baud rate setting of the host device. Otherwise, data may not reach the host device or may reach it in distorted form.



***Baud Rate 9600
(6)**



**Baud Rate 19,200
(7)**



**Baud Rate 38,400
(8)**



**Baud Rate 57,600
(10)**



**Baud Rate 115,200
(11)**



**Baud Rate 230,400
(12)**

Baud Rate (continued)



Baud Rate 460,800
(13)



Baud Rate 921,600
(14)

Parity

Parameter # 158 (SSI # 9Eh)

A parity check bit is the most significant bit of each ASCII coded character. Select the parity type according to host device requirements.

- Select **Odd** parity and the parity bit has a value 0 or 1, based on data, to ensure that an odd number of 1 bits is contained in the coded character.
- Select **Even** parity and the parity bit has a value 0 or 1, based on data, to ensure that an even number of 1 bits is contained in the coded character.
- If no parity is required, select **None**.



Odd
(2)



Even
(1)



***None**
(0)

Check Parity

Parameter # 151 (SSI # 97h)

Select whether or not to check the parity of received characters. Use the Parity parameter to select the type of parity.



***Do Not Check Parity
(0)**



**Check Parity
(1)**

Stop Bits

Parameter # 157 (SSI # 9Dh)

The stop bit(s) at the end of each transmitted character marks the end of transmission of one character and prepares the receiving (host) device for the next character in the serial data stream. Set the number of stop bits (one or two) to match host device requirements.



***1 Stop Bit
(1)**



**2 Stop Bits
(2)**

Software Handshaking

Parameter # 159 (SSI # 9Fh)

This parameter offers control of data transmission in addition to the control hardware handshaking offers. Hardware handshaking is always enabled; you cannot disable it.

- **Disable ACK/NAK Handshaking:** When this option is selected, the digital scanner neither generates nor expects ACK/NAK handshaking packets.
- **Enable ACK/NAK Handshaking:** When this option is selected, after transmitting data, the digital scanner expects either an ACK or NAK response from the host. The digital scanner also ACKs or NAKs messages from the host.

The digital scanner waits up to the programmable Host Serial Response Time-out to receive an ACK or NAK. If the digital scanner does not get a response in this time, it resends its data up to two times before discarding the data and declaring a transmit error.



Disable ACK/NAK
(0)



***Enable ACK/NAK**
(1)

Host RTS Line State

Parameter # 154 (SSI # 9Ah)

This parameter sets the expected idle state of the Serial Host RTS line.

The SSI Interface is used with host applications which also implement the SSI protocol. However, you can use the digital scanner in a "scan-and-transmit" mode to communicate with any standard serial communication software on a host PC (see [Decode Data Packet Format on page 7-16](#)). If transmission errors occur in this mode, the host PC may be asserting hardware handshaking lines which interfere with the SSI protocol. Scan the **Host: RTS High** bar code to address this problem.



***Host: RTS Low
(0)**



**Host: RTS High
(1)**

Decode Data Packet Format

Parameter # 238 (SSI # EEh)

This parameter selects whether to transmit decoded data in raw format (unpacketed), or with the packet format defined by the serial protocol.

Selecting the raw format disables ACK/NAK handshaking for decode data.



***Send Raw Decode Data
(0)**



**Send Packeted Decode Data
(1)**

Host Serial Response Time-out

Parameter # 155 (SSI # 9Bh)

This parameter specifies how long the digital scanner waits for an ACK or NAK before resending. Also, if the digital scanner wants to send, and the host has already been granted permission to send, the digital scanner waits for the designated time-out before declaring an error.

To set the delay period (options are 2, 5, 7.5, or 9.9 seconds), scan one of the following bar codes.

✓ **NOTE** Other values are available via SSI command.



***Low - 2 Seconds
(20)**



**Medium - 5 Seconds
(50)**



**High - 7.5 Seconds
(75)**



**Maximum - 9.9 Seconds
(99)**

Host Character Time-out

Parameter # 239 (SSI # EFh)

This parameter determines the maximum time the digital scanner waits between characters transmitted by the host before discarding the received data and declaring an error.

To set the delay period (options are 200, 500, 750, or 990 ms), scan one of the following bar codes.

✓ **NOTE** Other values are available via SSI command.



***Low - 200 ms
(20)**



**Medium - 500 ms
(50)**



**High - 750 ms
(75)**



**Maximum - 990 ms
(99)**

Multipacket Option

Parameter # 334 (SSI # F0h 4Eh)

This parameter controls ACK/NAK handshaking for multi-packet transmissions.

- **Multi-Packet Option 1:** The host sends an ACK / NAK for each data packet during a multi-packet transmission.
- **Multi-Packet Option 2:** The digital scanner sends data packets continuously, with no ACK/NAK handshaking to pace the transmission. The host, if overrun, can use hardware handshaking to temporarily delay digital scanner transmissions. At the end of transmission, the digital scanner waits for a CMD_ACK or CMD_NAK.
- **Multi-Packet Option 3:** Option 3 is the same as option 2 with the addition of a programmable interpacket delay.



***Multipacket Option 1
(0)**



**Multipacket Option 2
(1)**



**Multipacket Option 3
(2)**

Interpacket Delay

Parameter # 335 (SSI # F0h 4Fh)

This parameter specifies the interpacket delay if you selected **Multipacket Option 3**.

To set the delay period (options are 0, 25, 50, 75, or 99 ms), scan one of the following bar codes.

✓ **NOTE** Other values are available via SSI command.



*Minimum - 0 ms
(0)



Low - 25 ms
(25)



Medium - 50 ms
(50)



High - 75 ms
(75)



Maximum - 99 ms
(99)

Event Reporting

The host can request the digital scanner to provide certain information (events) relative to the digital scanner's behavior. Enable or disable the events listed in [Table 7-4](#) and on the following pages by scanning the appropriate bar codes.

Table 7-4 *Event Codes*

Event Class	Event	Code Reported
Decode Event	Non parameter decode	0x01
Boot Up Event	System power-up	0x03
Parameter Event	Parameter entry error	0x07
	Parameter stored	0x08
	Defaults set (and parameter event is enabled by default)	0x0A
	Number expected	0x0F

Decode Event

Parameter # 256 (SSI # F0h 00h)

When enabled, the digital scanner generates a message to the host upon a successful bar code decode. When disabled, no notification is sent.

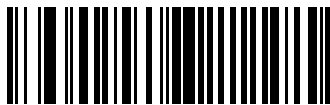

**Enable Decode Event
(1)**



***Disable Decode Event
(0)**

Boot Up Event

Parameter # 258 (SSI # F0h 02h)

When enabled, the digital scanner generates a message to the host whenever power is applied. When disabled, no notification is sent.

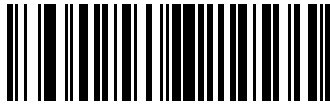

**Enable Boot Up Event
(1)**

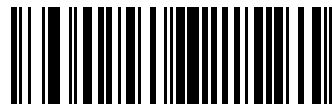

***Disable Boot Up Event
(0)**

Parameter Event

Parameter # 259 (SSI # F0h 03h)

When enabled, the digital scanner generates a message to the host when one of the events specified in [Table 7-4 on page 7-21](#) occurs. When disabled, no notification is sent.

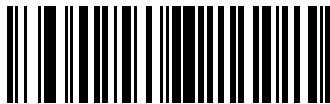

**Enable Parameter Event
(1)**

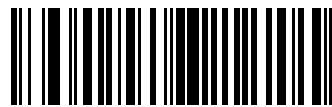

***Disable Parameter Event
(0)**

CHAPTER 8 RS-232 INTERFACE

Introduction

This chapter describes how to set up the digital scanner with an RS-232 host. Use the RS-232 interface to connect the digital scanner to point-of-sale devices, host computers, or other devices with an available RS-232 port (e.g., com port).

If your host does not appear in [Table 8-2](#), refer to the documentation for the host device to set communication parameters to match the host.

- ✓ **NOTE** The digital scanner uses TTL RS-232 signal levels, which interface with most system architectures. For system architectures requiring RS-232C signal levels, Zebra offers different cables providing TTL-to-RS-232C conversion. Contact support for more information.

Throughout the programming bar code menus, asterisks (*) indicate default values.



* Indicates default — *Baud Rate 9600 — Feature/Option

- ✓ **NOTE** Most computer monitors allow scanning the bar codes directly on the screen. When scanning from the screen, be sure to set the document magnification to a level where you can see the bar code clearly, and bars and/or spaces are not merging.

Connecting an RS-232 Interface

Connect the digital scanner directly to the host computer.

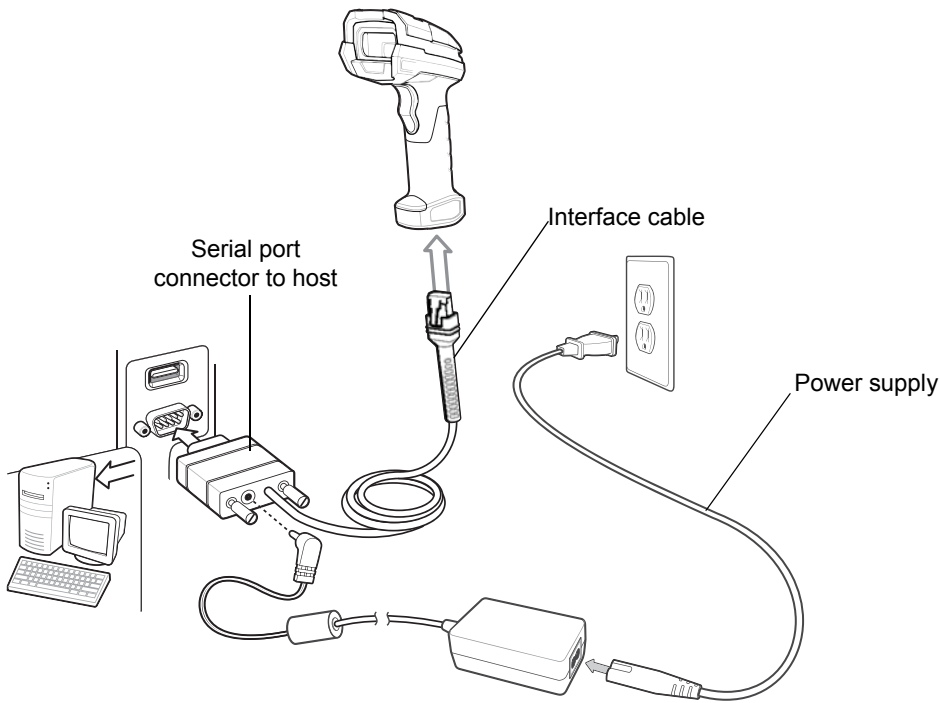

Figure 8-1 RS-232 Direct Connection

✓ **NOTE** Interface cables vary depending on configuration. The connectors illustrated in [Figure 8-1](#) are examples only. The connectors may be different than those illustrated, but the steps to connect the digital scanner are the same.

1. Attach the modular connector of the RS-232 interface cable to the cable interface port on the digital scanner (see [Installing the DS3608 Interface Cable on page 1-3](#)).
2. Connect the other end of the RS-232 interface cable to the serial port on the host.
3. Connect the power supply to the serial connector end of the RS-232 interface cable. Plug the power supply into an appropriate outlet.
4. The digital scanner automatically detects the host interface type and uses the default setting. If the default (*) does not meet your requirements, select another RS-232 host type by scanning the appropriate bar code from [RS-232 Host Types on page 8-6](#).
5. To modify any other parameter options, scan the appropriate bar codes in this chapter.

RS-232 Parameter Defaults

Table 8-1 lists the defaults for RS-232 host parameters. To change any option, scan the appropriate bar code(s) provided in the RS-232 Host Parameters section beginning on page [8-4](#).

✓ **NOTE** See [Appendix A, Standard Default Parameters](#) for all user preferences, hosts, symbologies, and miscellaneous default parameters.

Table 8-1 *RS-232 Host Default Table*

Parameter	Default	Page Number
RS-232 Host Parameters		
RS-232 Host Types	Standard	8-6
Baud Rate	9600	8-8
Parity Type	None	8-9
Stop Bits	1 Stop Bit	8-10
Data Bits	8-Bit	8-10
Check Receive Errors	Enable	8-11
Hardware Handshaking	None	8-11
Software Handshaking	None	8-13
Host Serial Response Time-out	2 Sec	8-15
RTS Line State	Low RTS	8-16
Beep on <BEL>	Disable	8-16
Intercharacter Delay	0 msec	8-17
Nixdorf Beep/LED Options	Normal Operation	8-18
Ignore Unknown Characters	Send Bar Code	8-18

RS-232 Host Parameters

Various RS-232 hosts use their own parameter default settings. Selecting standard, ICL, Fujitsu, Wincor-Nixdorf Mode A, Wincor-Nixdorf Mode B, OPOS/JPOS, Olivetti, Omron, or Common Use Terminal Equipment (CUTE-LP/LG bar code readers) sets the defaults listed in [Table 8-2](#).

Table 8-2 Terminal Specific RS-232

Parameter	ICL	Fujitsu	Wincor-Nixdorf Mode A	Wincor-Nixdorf Mode B/OPOS/JPOS	Olivetti	Omron	CUTE
Transmit Code ID	Yes	Yes	Yes	Yes	Yes	Yes	Yes
Data Transmission Format	Data/Suffix	Data/Suffix	Data/Suffix	Data/Suffix	Prefix/Data/Suffix	Data/Suffix	Prefix/Data/Suffix
Suffix	CR (1013)	CR (1013)	CR (1013)	CR (1013)	ETX (1002)	CR (1013)	CR (1013) ETX (1003)
Baud Rate	9600	9600	9600	9600	9600	9600	9600
Parity	Even	None	Odd	Odd	Even	None	Even
Hardware Handshaking	RTS/CTS Option 3	None	RTS/CTS Option 3	RTS/CTS Option 3	None	None	None
Software Handshaking	None	None	None	None	ACK/NAK	None	None
Serial Response Time-out	9.9 Sec.	2 Sec.	None	None	9.9 Sec.	9.9 Sec.	9.9 Sec.
Stop Bit Select	One	One	One	One	One	One	One
ASCII Format	8-Bit	8-Bit	8-Bit	8-Bit	7-Bit	8-Bit	7-Bit
Beep On <BEL>	Disable	Disable	Disable	Disable	Disable	Disable	Disable
RTS Line State	High	Low	Low	Low = No data to send	Low	High	High
Prefix	None	None	None	None	STX (1003)	None	STX (1002)

In the Nixdorf Mode B, if CTS is low, scanning is disabled. When CTS is high, scanning is enabled.

If you scan Nixdorf Mode B without connecting the digital scanner to the proper host, it may appear unable to scan. If this happens, scan a different RS-232 host type within 5 seconds of cycling power to the digital scanner.

The CUTE host disables all parameter scanning, including Set Defaults. If you inadvertently select CUTE, scan **Enable Parameter Bar Code Scanning (1)* on page 4-6, then change the host selection.

RS-232 Host Parameters (continued)

Selecting ICL, Fujitsu, Wincor-Nixdorf Mode A, Wincor-Nixdorf Mode B, OPOS/JPOS, Olivetti, Omron, or Common Use Terminal Equipment (CUTE-LP/LG bar code readers) enables the transmission of code ID characters listed in [Table 8-3](#). These code ID characters are not programmable and are separate from the Transmit Code ID feature. Do not enable the Transmit Code ID feature for these terminals.

Table 8-3 Terminal Specific Code ID Characters

Code Type	ICL	Fujitsu	Wincor-Nixdorf Mode A	Wincor-Nixdorf Mode B/ OPOS/JPOS	Olivetti	Omron	CUTE
UPC-A	A	A	A	A	A	A	A
UPC-E	E	E	C	C	C	E	None
EAN-8/JAN-8	FF	FF	B	B	B	FF	None
EAN-13/JAN-13	F	F	A	A	A	F	A
Code 39	C <len>	None	M	M	M <len>	C <len>	3
Code 39 Full ASCII	None	None	M	M	None	None	3
Codabar	N <len>	None	N	N	N <len>	N <len>	None
Code 128	L <len>	None	K	K	K <len>	L <len>	5
I 2 of 5	I <len>	None	I	I	I <len>	I <len>	1
Code 93	None	None	L	L	L <len>	None	None
D 2 of 5	H <len>	None	H	H	H <len>	H <len>	2
GS1-128	L <len>	None	P	P	P <len>	L <len>	5
MSI	None	None	O	O	O <len>	None	None
Bookland EAN	F	F	A	A	A	F	None
Trioptic	None	None	None	None	None	None	None
Code 11	None	None	None	None	None	None	None
IATA	H<len>	None	H	H	H<len>	H<len>	2
Code 32	None	None	None	None	None	None	None
GS1 Databar Variants	None	None	E	E	None	None	None
PDF417	None	None	Q	Q	None	None	6
Data Matrix	None	None	R	R	None	None	4
QR Codes	None	None	U	U	None	None	7
Aztec/Aztec Rune	None	None	V	V	None	None	8
MAXICODE	None	None	T	T	None	None	None
microPDF	None	None	S	S	None	None	6

RS-232 Host Types

To select an RS-232 host interface, scan one of the following bar codes.

✓ **NOTE** For a list of supported scanner functionality by communication protocol, see [Appendix I, Communication Protocol Functionality](#).

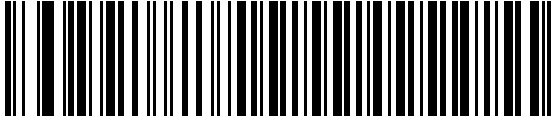

* Standard RS-232¹

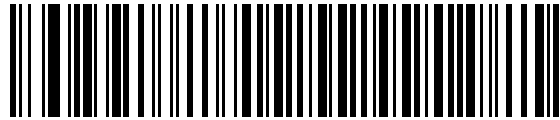

ICL RS-232

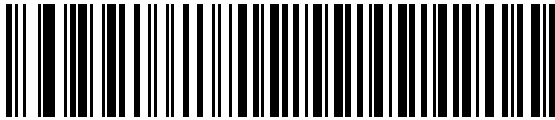

Wincor-Nixdorf RS-232 Mode A

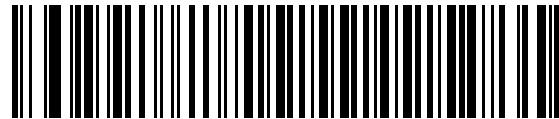

Wincor-Nixdorf RS-232 Mode B

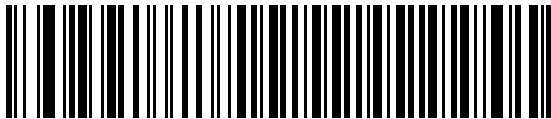

Olivetti ORS4500

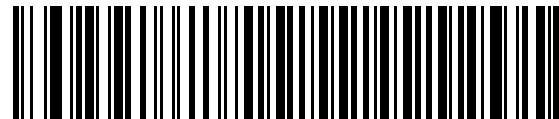

Omron

¹Scanning Standard RS-232 activates the RS-232 driver, but does not change port settings (e.g., parity, data bits, handshaking). Selecting another RS-232 host type bar code changes these settings.

RS-232 Host Types (continued)

OPOS/JPOS



Fujitsu RS-232

CUTE²

²The CUTE host disables all parameter scanning, including Set Defaults. If you inadvertently select CUTE, scan [*Enable Parameter Bar Code Scanning \(1\) on page 4-6](#), then change the host selection.

Baud Rate

Baud rate is the number of bits of data transmitted per second. Set the digital scanner's baud rate to match the baud rate setting of the host device. Otherwise, data may not reach the host device or may reach it in distorted form.

✓ **NOTE** The digital scanner does not support baud rates below 9600.



* Baud Rate 9600



Baud Rate 19,200



Baud Rate 38,400



Baud Rate 57,600



Baud Rate 115,200

Parity

A parity check bit is the most significant bit of each ASCII coded character. Select the parity type according to host device requirements.

- Select **Odd** parity to set the parity bit value to 0 or 1, based on data, to ensure that the coded character contains an odd number of 1 bits.
- Select **Even** parity to set the parity bit value is set to 0 or 1, based on data, to ensure that the coded character contains an even number of 1 bits.
- Select **None** when no parity bit is required.

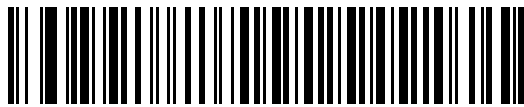

Odd

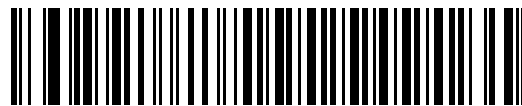

Even

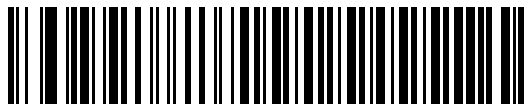

* None

Stop Bit Select

The stop bit(s) at the end of each transmitted character marks the end of transmission of one character and prepares the receiving device for the next character in the serial data stream. Select the number of stop bits (one or two) based on the number the receiving terminal is programmed to accommodate. Set the number of stop bits to match host device requirements.



*1 Stop Bit

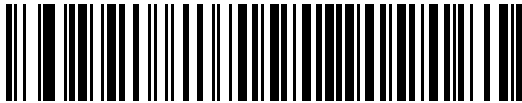

2 Stop Bits

Data Bits

This parameter allows the digital scanner to interface with devices requiring a 7-bit or 8-bit ASCII protocol.



7-Bit

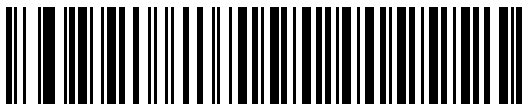

* 8-Bit

Check Receive Errors

Select whether or not to check the parity, framing, and overrun of received characters. The parity value of received characters is verified against the parity parameter selected above.

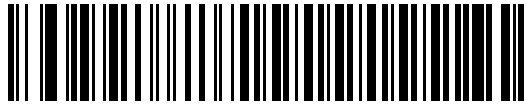

* Check For Received Errors



Do Not Check For Received Errors

Hardware Handshaking

The data interface consists of an RS-232 port designed to operate either with or without the hardware handshaking lines, *Request to Send* (RTS), and *Clear to Send* (CTS).

Disable Standard RTS/CTS handshaking to transmit scan data as it becomes available. Select Standard RTS/CTS handshaking to transmit scan data according to the following sequence:

- The digital scanner reads the CTS line for activity. If CTS is asserted, the scanner waits up to Host Serial Response Time-out for the host to de-assert the CTS line. If, after Host Serial Response Time-out (default), the CTS line is still asserted, the scanner sounds a transmit error, and discards any scanned data.
- When the CTS line is de-asserted, the digital scanner asserts the RTS line and waits up to Host Serial Response Time-out for the host to assert CTS. When the host asserts CTS, the scanner transmits data. If, after Host Serial Response Time-out (default), the CTS line is not asserted, the scanner sounds a transmit error, and discards the data.
- When data transmission completes, the digital scanner de-asserts RTS 10 msec after sending the last character.
- The host should respond by negating CTS. The digital scanner checks for a de-asserted CTS upon the next transmission of data.

During the transmission of data, the CTS line should be asserted. If CTS is deasserted for more than 50 ms between characters, the digital scanner aborts transmission, sounds a transmission error, and discards the data.

If this communication sequence fails, the digital scanner issues an error indication. In this case, the data is lost and must be rescanned.

If hardware handshaking and software handshaking are both enabled, hardware handshaking takes precedence.

✓ **NOTE** The DTR signal is jumpered to the active state.

Hardware Handshaking (continued)

- **None:** Scan this bar code to disable hardware handshaking.
- **Standard RTS/CTS:** Scan this bar code to select Standard RTS/CTS Hardware Handshaking.
- **RTS/CTS Option 1:** If you select RTS/CTS Option 1, the digital scanner asserts RTS before transmitting and ignores the state of CTS. The scanner de-asserts RTS when the transmission completes.
- **RTS/CTS Option 2:** If you select Option 2, RTS is always high or low (user-programmed logic level). However, the digital scanner waits for CTS to be asserted before transmitting data. If CTS is not asserted within Host Serial Response Time-out (default), the scanner issues an error indication and discards the data.
- **RTS/CTS Option 3:** If you select Option 3, the digital scanner asserts RTS prior to any data transmission, regardless of the state of CTS. The scanner waits up to Host Serial Response Time-out (default) for CTS to be asserted. If CTS is not asserted during this time, the scanner issues an error indication and discards the data. The digital scanner de-asserts RTS when transmission is complete.



* None

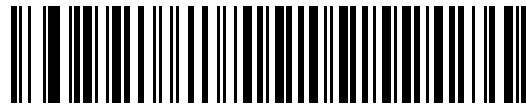

Standard RTS/CTS



RTS/CTS Option 1

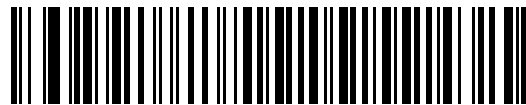

RTS/CTS Option 2



RTS/CTS Option 3

Software Handshaking

This parameter offers control of the data transmission process in addition to, or instead of, that offered by hardware handshaking. There are five options.

If software handshaking and hardware handshaking are both enabled, hardware handshaking takes precedence.

- **None:** Select this to transmit data immediately. The digital scanner expects no response from the host.
- **ACK/NAK:** If you select this option, after transmitting data, the digital scanner expects either an ACK or NAK response from the host. When it receives a NAK, the scanner transmits the same data again and waits for either an ACK or NAK. After three unsuccessful attempts to send data after receiving NAKs, the digital scanner issues an error indication and discards the data.

The digital scanner waits up to the programmable Host Serial Response Time-out to receive an ACK or NAK. If the scanner does not get a response in this time, it issues an error indication and discards the data. There are no retries when a time-out occurs.

- **ENQ:** If you select this option, the digital scanner waits for an ENQ character from the host before transmitting data. If it does not receive an ENQ within the Host Serial Response Time-out, the digital scanner issues an error indication and discards the data. The host must transmit an ENQ character at least every Host Serial Response Time-out to prevent transmission errors.
- **ACK/NAK with ENQ:** This combines the two previous options. For re-transmissions of data, due to a NAK from the host, an additional ENQ is not required.
- **XON/XOFF:** An XOFF character turns the digital scanner transmission off until the scanner receives an XON character. There are two situations for XON/XOFF:
 - The digital scanner receives an XOFF before has data to send. When the scanner has data to send, it waits up to Host Serial Response Time-out for an XON character before transmission. If it does not receive the XON within this time, the digital scanner issues an error indication and discards the data.
 - The digital scanner receives an XOFF during a transmission. Data transmission then stops after sending the current byte. When the digital scanner receives an XON character, it sends the rest of the data message. The digital scanner waits indefinitely for the XON.

Software Handshaking (continued)



* None

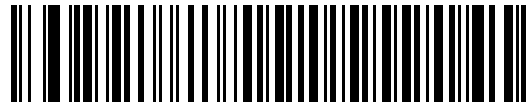

ACK/NAK

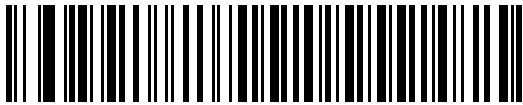

ENQ



ACK/NAK with ENQ

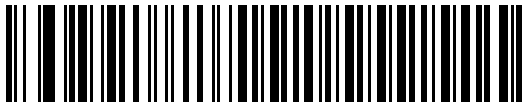

XON/XOFF

Host Serial Response Time-out

This parameter specifies how long the digital scanner waits for an ACK, NAK, or CTS before determining that a transmission error occurred. This only applies when in one of the ACK/NAK software handshaking modes, or RTS/CTS hardware handshaking mode.



* Minimum: 2 Sec



Low: 2.5 Sec

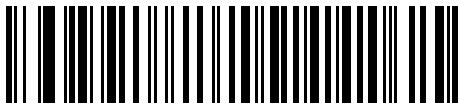

Medium: 5 Sec



High: 7.5 Sec

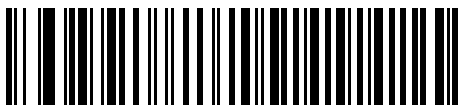

Maximum: 9.9 Sec

RTS Line State

This parameter sets the idle state of the Serial Host RTS line. Scan a bar code below to select **Low RTS** or **High RTS** line state.



* Host: Low RTS



Host: High RTS

Beep on <BEL>

If you enable this parameter, the digital scanner issues a beep when it detects a <BEL> character on the RS-232 serial line. <BEL> indicates an illegal entry or other important event.



Beep On <BEL> Character
(Enable)



* Do Not Beep On <BEL> Character
(Disable)

Intercharacter Delay

This parameter specifies the intercharacter delay inserted between character transmissions.



* Minimum: 0 msec



Low: 25 msec

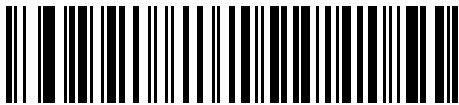

Medium: 50 msec



High: 75 msec

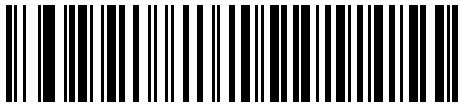

Maximum: 99 msec

Nixdorf Beep/LED Options

If you selected Nixdorf Mode B, this indicates when the digital scanner beeps and turns on its LED after a decode.



* Normal Operation
(Beep/LED immediately after decode)

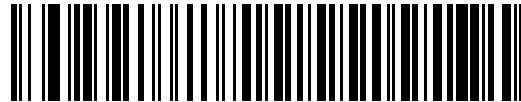

Beep/LED After Transmission

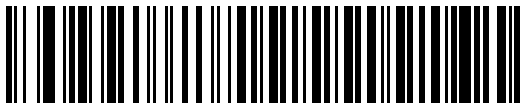

Beep/LED After CTS Pulse

Ignore Unknown Characters

Unknown characters are characters the host does not recognize. Select **Send Bar Codes with Unknown Characters** to send all bar code data except for unknown characters. The digital scanner issues no error beeps.

Select **Do Not Send Bar Codes With Unknown Characters** to send bar code data up to the first unknown character. The digital scanner issues an error beep.

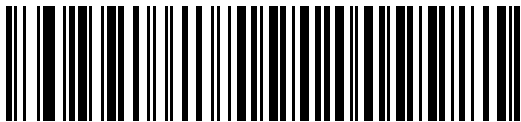

* Send Bar Code
(with unknown characters)



Do Not Send Bar Codes
(with unknown characters)

ASCII Character Set for RS-232

See [Appendix H, ASCII Character Sets](#) for Prefix/Suffix values. The values in [Table H-1](#) can be assigned as prefixes or suffixes for ASCII character data transmission.

CHAPTER 9 IBM 468X / 469X INTERFACE

Introduction

This chapter describes how to set up the digital scanner with an IBM 468X/469X host.

Throughout the programming bar code menus, asterisks (*) indicate default values.

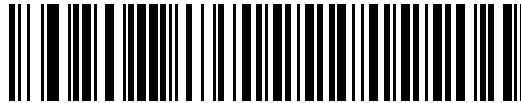

* Indicates default — * **Disable Convert Unknown to Code 39** — Feature/Option



NOTE Most computer monitors allow scanning the bar codes directly on the screen. When scanning from the screen, be sure to set the document magnification to a level where you can see the bar code clearly, and bars and/or spaces are not merging.

Connecting to an IBM 468X/469X Host

Connect the digital scanner directly to the host interface.

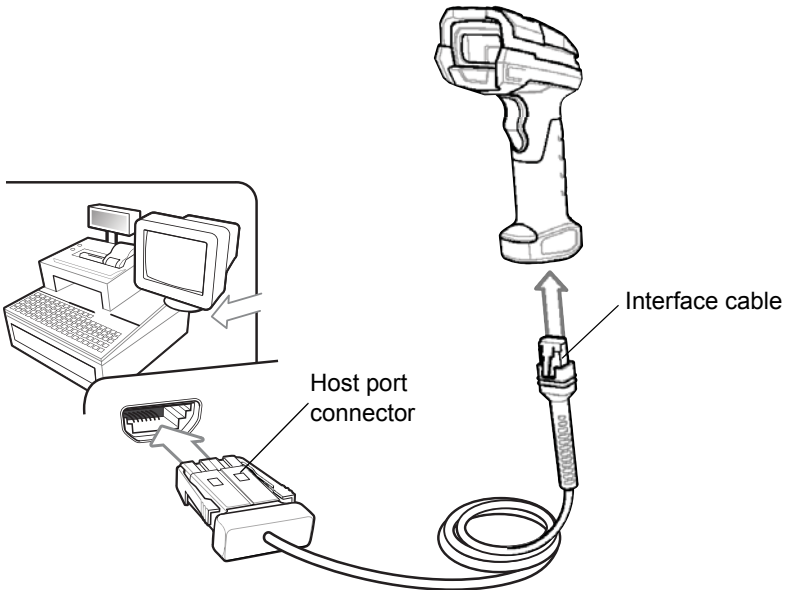

Figure 9-1 IBM Direct Connection

✓ **NOTE** Interface cables vary depending on configuration. The connectors illustrated in [Figure 9-1](#) are examples only. The connectors may be different than those illustrated, but the steps to connect the digital scanner are the same.

1. Attach the modular connector of the IBM 46XX interface cable to the cable interface port on the digital scanner. See [Installing the DS3608 Interface Cable on page 1-3](#).
2. Connect the other end of the IBM 46XX interface cable to the appropriate port on the host (typically Port 9).
3. The digital scanner automatically detects the host interface type, but there is no default setting. Scan the port address by scanning the appropriate bar code from [Port Address on page 9-4](#).
4. To modify any other parameter options, scan the appropriate bar codes in this chapter.

✓ **NOTE** The only required configuration is the port address. The IBM system typically controls other digital scanner parameters.

IBM Parameter Defaults

[Table 9-1](#) lists the defaults for IBM host parameters. To change any option, scan the appropriate bar code(s) provided in the Parameter Descriptions section beginning on page [9-4](#).

✓ **NOTE** See [Appendix A, Standard Default Parameters](#) for all user preferences, hosts, symbologies, and miscellaneous default parameters.

Table 9-1 *IBM Host Default Table*

Parameter	Default	Page Number
IBM 468X/469X Host Parameters		
Port Address	None Selected	9-4
Convert Unknown to Code 39	Disable	9-5
Ignore Beep Directive	Enable (Ignore)	9-5
Ignore Configuration Directive	Enable (Ignore)	9-6

IBM 468X/469X Host Parameters

Port Address

This parameter sets the IBM 468X/469X port used.

- ✓ **NOTE** Scanning one of these bar codes enables the RS-485 interface on the digital scanner.
- ✓ **NOTE** For a list of supported scanner functionality by communication protocol, see [Appendix I, Communication Protocol Functionality](#).

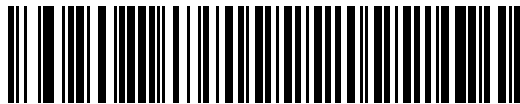

*None Selected



Hand-Held Scanner Emulation (Port 9B)

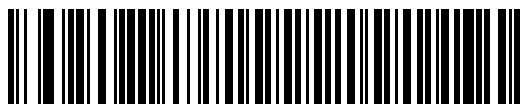

Non-IBM Scanner Emulation (Port 5B)



Table-Top Scanner Emulation (Port 17)

Convert Unknown to Code 39

Scan a bar code below to enable or disable the conversion of unknown bar code type data to Code 39.

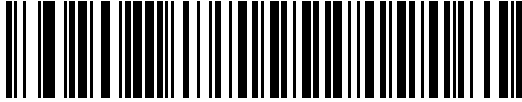

Enable Convert Unknown to Code 39

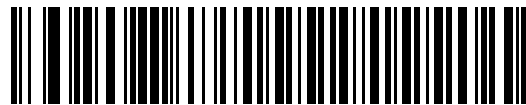

***Disable Convert Unknown to Code 39**

Ignore Beep Directive

Scan one of the following bar codes to honor or ignore a beep directive from the IBM RS-485 host. When enabled, the request is **not** sent to the digital scanner. All directives are still acknowledged to the host as if they were processed.



Disable Ignore Beep Directive



***Enable Ignore Beep Directive**

Ignore Bar Code Configuration Directive

Scan one of the following bar codes to honor or ignore a code type enable/disable directive made over the IBM RS-485 bus. When this parameter is enabled, this request is **not** sent to the digital scanner. All directives are still acknowledged to the IBM RS-485 host as if they were processed.

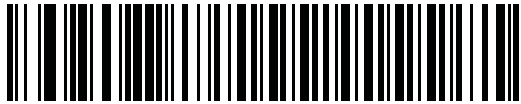

Disable Ignore Bar Code Configuration Directive

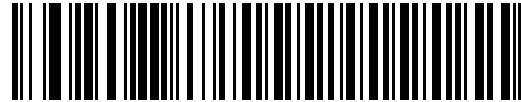

***Enable Ignore Bar Code Configuration Directive**

CHAPTER 10 KEYBOARD WEDGE INTERFACE

Introduction

This chapter describes how to set up a keyboard wedge interface with the digital scanner. With this interface, the digital scanner is connected between the keyboard and host computer, and translates bar code data into keystrokes. The host computer accepts the keystrokes as if they originated from the keyboard. This mode adds bar code reading functionality to a system designed for manual keyboard input. Keyboard keystrokes are simply passed through.

Throughout the programming bar code menus, asterisks (*) indicate default values.

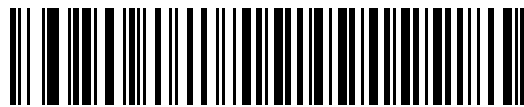

*Indicates default *Send Bar Codes with Unknown Characters Feature/Option



NOTE Most computer monitors allow scanning the bar codes directly on the screen. When scanning from the screen, be sure to set the document magnification to a level where you can see the bar code clearly, and bars and/or spaces do not merge.

Connecting a Keyboard Wedge Interface

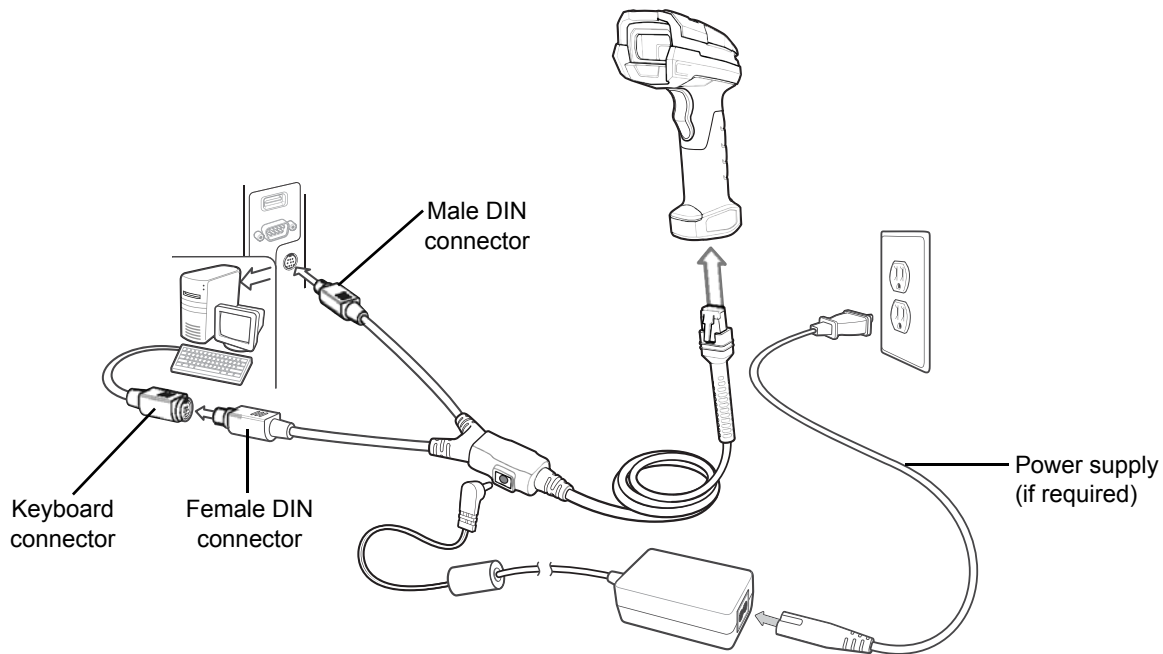

Figure 10-1 Keyboard Wedge Connection with Y-cable

To connect the keyboard wedge interface Y-cable:

✓ **NOTE** Interface cables vary depending on configuration. The connectors illustrated in [Figure 10-1](#) are examples only. The connectors may be different than those illustrated, but the steps to connect the digital scanner are the same.

1. Turn off the host and unplug the keyboard connector.
2. Attach the modular connector of the Y-cable to the cable interface port on the digital scanner. See [Installing the DS3608 Interface Cable on page 1-3](#).
3. Connect the round male DIN host connector of the Y-cable to the keyboard port on the host device.
4. Connect the round female DIN keyboard connector of the Y-cable to the keyboard connector.
5. If needed, attach the optional power supply to the connector in the middle of the Y-cable.
6. Ensure that all connections are secure.
7. Turn on the host system.
8. The digital scanner automatically detects the host interface type and uses the default setting. If the default (*) does not meet your requirements, scan [IBM PC/AT & IBM PC Compatibles on page 10-4](#).
9. To modify any other parameter options, scan the appropriate bar codes in this chapter.

Keyboard Wedge Parameter Defaults

Table 10-1 lists the defaults for Keyboard Wedge host parameters. To change any option, scan the appropriate bar code(s) in *Keyboard Wedge Host Parameters on page 10-4*.



NOTE See *Appendix B, Country Codes* for Keyboard Wedge Country Keyboard Types (Country Codes).

See *Appendix A, Standard Default Parameters* for all user preferences, hosts, symbologies, and miscellaneous default parameters.

Table 10-1 *Keyboard Wedge Host Default Table*

Parameter	Default	Page Number
Keyboard Wedge Host Parameters		
Keyboard Wedge Host Type	IBM AT Notebook	10-4
Ignore Unknown Characters	Transmit	10-4
Keystroke Delay	No Delay	10-5
Intra-Keystroke Delay	Disable	10-5
Alternate Numeric Keypad Emulation	Enable	10-6
Quick Keypad Emulation	Enable	10-6
Simulated Caps Lock	Disable	10-7
Caps Lock Override	Disable	10-7
Convert Wedge Case	No Convert	10-8
Function Key Mapping	Disable	10-8
FN1 Substitution	Disable	10-9
Send Make and Break	Send Make and Break Scan Codes	10-9

Keyboard Wedge Host Parameters

Keyboard Wedge Host Types

Select the Keyboard Wedge host by scanning one of the bar codes below.



NOTE For a list of supported scanner functionality by communication protocol, see [Appendix I, Communication Protocol Functionality](#).



IBM PC/AT & IBM PC Compatibles

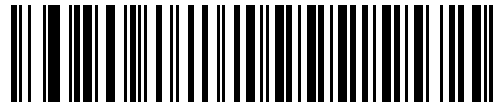

*IBM AT Notebook

Ignore Unknown Characters

Unknown characters are characters the host does not recognize. Select **Send Bar Codes With Unknown Characters** to send all bar code data except for unknown characters. The digital scanner issues no error beeps.

Select **Do Not Send Bar Codes With Unknown Characters** to send bar code data up to the first unknown character. The digital scanner issues an error beep.



* Send Bar Codes with Unknown Characters
(Transmit)

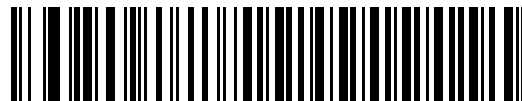

Do Not Send Bar Codes with Unknown Characters

Keystroke Delay

This is the delay in milliseconds between emulated keystrokes. Scan a bar code below to increase the delay when hosts require a slower transmission of data.



* No Delay



Medium Delay (20 msec)

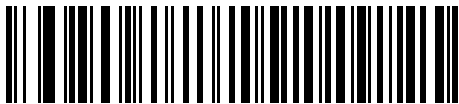

Long Delay (40 msec)

Intra-Keystroke Delay

Enable this to insert an additional delay between each emulated key depression and release. This sets the Keystroke Delay parameter to a minimum of 5 msec as well.



Enable



* Disable

Alternate Numeric Keypad Emulation

This allows emulation of most other country keyboard types not listed in [Appendix B, Country Codes](#) in a Microsoft® operating system environment.

- ✓ **NOTE** If your keyboard type is not listed in the country code list (see [Country Codes on page B-1](#)), disable [Quick Keypad Emulation on page 10-6](#) and ensure [Alternate Numeric Keypad Emulation on page 10-6](#) is enabled.

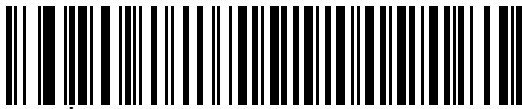

*Enable Alternate Numeric Keypad

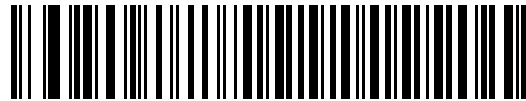

Disable Alternate Numeric Keypad

Quick Keypad Emulation

This parameter enables faster keypad emulation where character value sequences are only sent for characters not found on the keyboard.

- ✓ **NOTE** This option applies only when [Alternate Numeric Keypad Emulation](#) is enabled.

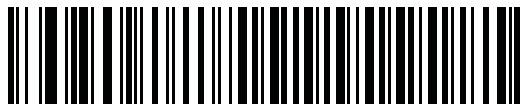

*Enable Quick Keypad Emulation



Disable Quick Keypad Emulation

Simulated Caps Lock

Enable this to invert upper and lower case characters on the bar code as if the Caps Lock state is enabled on the keyboard. This inversion occurs regardless of the keyboard's **Caps Lock** state. Note that this only applies to alpha characters.

✓ **NOTE** Simulated Caps Lock applies to ASCII characters only.

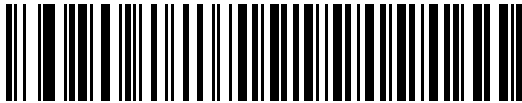

Enable Caps Lock On

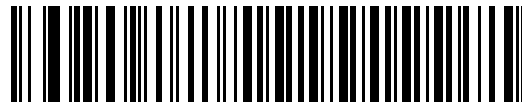

* Disable Caps Lock On

Caps Lock Override

Enable this on AT or AT Notebook hosts to preserve the case of the data regardless of the state of the **Caps Lock** key. Therefore, an 'A' in the bar code transmits as an 'A' regardless of the setting of the keyboard's **Caps Lock** key.

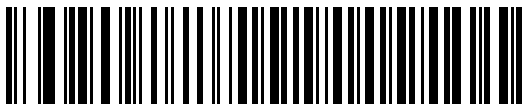

Enable Caps Lock Override



* Disable Caps Lock Override

✓ **NOTE** If both Simulated Caps Lock and Caps Lock Override are enabled, Caps Lock Override takes precedence.

Convert Wedge Case

Enable this to convert all bar code data to the selected case.

✓ **NOTE** Convert Case applies to ASCII characters only.

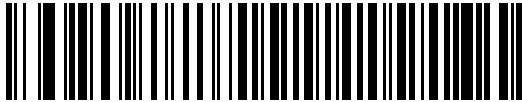

Convert to Upper Case

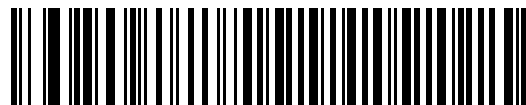

Convert to Lower Case



* No Convert

Function Key Mapping

ASCII values under 32 are normally sent as control key sequences. Enable this parameter to send the keys in bold in place of the standard key mapping. Table entries that do not have a bold entry remain the same whether or not you enable this parameter.



Enable

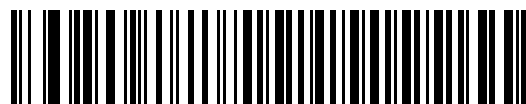

* Disable

FN1 Substitution

Enable this to replace FN1 characters in an EAN128 bar code with a user-selected keystroke (see [FN1 Substitution Values on page 4-37](#)).

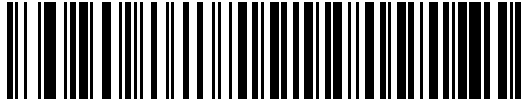

Enable

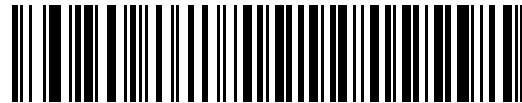

* Disable

Send Make and Break

Enable this to prevent sending the scan codes for releasing a key.



* Send Make and Break Scan Codes

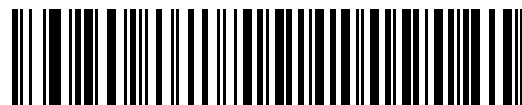

Send Make Scan Code Only



NOTE Windows-based systems must use **Send Make and Break Scan Codes**.

Keyboard Maps

Refer to the following keyboard maps for prefix/suffix keystroke parameters. To program the prefix/suffix values, see the bar codes on [page 4-35](#).

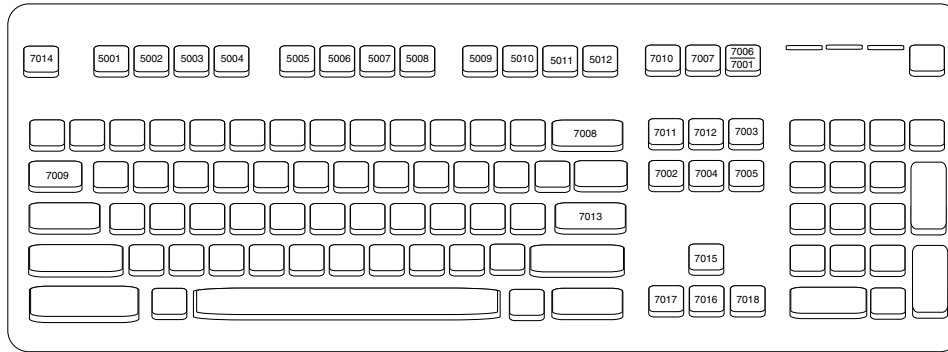

Figure 10-2 IBM PS2 Type Keyboard

ASCII Character Set for Keyboard Wedge

- ✓ **NOTE** Code 39 Full ASCII interprets the bar code special character (\$ + % /) preceding a Code 39 character and assigns an ASCII character value to the pair. For example, if you enable Code 39 Full ASCII and scan **+B**, it transmits as **b**, **%J** as **?**, and **%V** as **@**. Scanning **ABC%i** outputs the keystroke equivalent of **ABC >**.

See [Appendix H, ASCII Character Sets](#) for the following:

- ASCII Character Set ([Table H-1 on page H-1](#))
- ALT Key Character Set ([Table H-2 on page H-6](#))
- GUI Key Character Set ([Table H-3 on page H-7](#))
- F Key Character Set ([Table H-5 on page H-11](#))
- Numeric Key Character Set ([Table H-6 on page H-12](#))
- Extended Key Character Set ([Table H-7 on page H-13](#)).

CHAPTER 11 SYMBOLOGIES

Introduction

This chapter describes symbology features and provides programming bar codes for selecting these features. Before programming, follow the instructions in [Chapter 1, Getting Started](#).

To set feature values, scan a single bar code or a short bar code sequence. The settings are stored in non-volatile memory and are preserved even when the digital scanner powers down.

✓ **NOTE** Most computer monitors allow scanning the bar codes directly on the screen. When scanning from the screen, be sure to set the document magnification to a level where you can see the bar code clearly, and bars and/or spaces do not merge.

Select a host type (see each host chapter for specific host information) after the power-up beeps sound. This is only necessary upon the first power-up when connected to a new host.

To return all features to default values, see [Default Parameters on page 4-5](#). Throughout the programming bar code menus, asterisks (*) indicate default values.

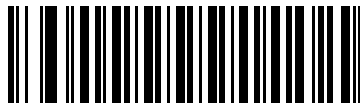

* Indicates Default — *Enable UPC-A — Feature/Option
(1) — Option Value

Scanning Sequence Examples

In most cases, scanning one bar code sets the parameter value. For example, to transmit bar code data without the UPC-A check digit, simply scan the Do Not Transmit UPC-A Check Digit bar code under *Transmit UPC-A Check Digit on page 11-17*. The digital scanner issues a fast warble beep and the LED turns green, signifying a successful parameter entry.

Other parameters, such as Set Length(s) for D 2 of 5 require scanning several bar codes. See the individual parameter, such as Set Length(s) for D 2 of 5, for this procedure.

Errors While Scanning

Unless otherwise specified, to correct an error during a scanning sequence, just re-scan the correct parameter.

Symbology Parameter Defaults

[Table 11-1](#) lists the defaults for all symbology parameters. To change the default values, scan the appropriate bar codes in this guide. These new values replace the standard default values in memory. To recall the default parameter values, see [Default Parameters on page 4-5](#).

✓ **NOTE** See [Appendix A, Standard Default Parameters](#) for all user preferences, hosts, and miscellaneous default parameters.

Table 11-1 Symbology Parameter Defaults

Parameter	Parameter Number	SSI Number	Default	Page Number
Enable/Disable All Code Types				11-8
1D Symbologies				
UPC/EAN				
UPC-A	1	01h	Enable	11-9
UPC-E	2	02h	Enable	11-9
UPC-E1	12	0Ch	Disable	11-10
EAN-8/JAN 8	4	04h	Enable	11-10
EAN-13/JAN 13	3	03h	Enable	11-11
Bookland EAN	83	53h	Disable	11-11
Decode UPC/EAN/JAN Supplementals (2 and 5 digits)	16	10h	Ignore	11-12
User-Programmable Supplementals			000	11-15
Supplemental 1:	579	F1h 43h		
Supplemental 2:	580	F1h 44h		

Table 11-1 Symbology Parameter Defaults (Continued)

Parameter	Parameter Number	SSI Number	Default	Page Number
UPC/EAN/JAN Supplemental Redundancy	80	50h	10	11-15
Decode UPC/EAN/JAN Supplemental AIM ID	672	F1h A0h	Combined	11-16
UPC Reduced Quiet Zone	1289	F8h 05h 09h	Disable	11-17
Transmit UPC-A Check Digit	40	28h	Enable	11-17
Transmit UPC-E Check Digit	41	29h	Enable	11-18
Transmit UPC-E1 Check Digit	42	2Ah	Enable	11-18
UPC-A Preamble	34	22h	System Character	11-19
UPC-E Preamble	35	23h	System Character	11-20
UPC-E1 Preamble	36	24h	System Character	11-21
Convert UPC-E to A	37	25h	Disable	11-22
Convert UPC-E1 to A	38	26h	Disable	11-22
EAN-8/JAN-8 Extend	39	27h	Disable	11-23
Bookland ISBN Format	576	F1h 40h	ISBN-10	11-23
UCC Coupon Extended Code	85	55h	Disable	11-24
Coupon Report	730	F1h DAh	New Coupon Format	11-25
ISSN EAN	617	F1h 69h	Disable	11-25
Code 128				
Code 128	8	08h	Enable	11-26
Set Length(s) for Code 128	209, 210	D1h, D2h	1 to 55	11-26
GS1-128 (formerly UCC/EAN-128)	14	0Eh	Enable	11-28
ISBT 128	84	54h	Enable	11-28
ISBT Concatenation	577	F1h 41h	Autodiscriminate	11-29
Check ISBT Table	578	F1h 42h	Enable	11-30
ISBT Concatenation Redundancy	223	DFh	10	11-30
Code 128 Security Level	751	F1h EFh	Security Level 1	11-31
Code 128 Reduced Quiet Zone	1208	F8h 04h B8h	Disable	11-32
Ignore Code 128 <FNC4>	1254	F8h 04h E6h	Disable	11-32
Code 39				
Code 39	0	00h	Enable	11-33

Table 11-1 Symbology Parameter Defaults (Continued)

Parameter	Parameter Number	SSI Number	Default	Page Number
Trioptic Code 39	13	0Dh	Disable	11-33
Convert Code 39 to Code 32 (Italian Pharmacy Code)	86	56h	Disable	11-34
Code 32 Prefix	231	E7h	Disable	11-35
Set Length(s) for Code 39	18, 19	12h, 13h	1 to 55	11-36
Code 39 Check Digit Verification	48	30h	Disable	11-37
Transmit Code 39 Check Digit	43	2Bh	Disable	11-37
Code 39 Full ASCII Conversion	17	11h	Disable	11-38
Code 39 Security Level	750	F1h EEh	Security Level 1	11-39
Code 39 Reduced Quiet Zone	1209	F8h 04h B9h	Disable	11-40
Code 93				
Code 93	9	09h	Enable	11-41
Set Length(s) for Code 93	26, 27	1Ah, 1Bh	1 to 55	11-42
Code 11				
Code 11	10	0Ah	Disable	11-43
Set Lengths for Code 11	28, 29	1Ch, 1Dh	4 to 55	11-44
Code 11 Check Digit Verification	52	34h	Disable	11-45
Transmit Code 11 Check Digit(s)	47	2Fh	Disable	11-46
Interleaved 2 of 5 (ITF)				
Interleaved 2 of 5 (ITF)	6	06h	Disable	11-47
Set Lengths for I 2 of 5	22, 23	16h, 17h	6 to 55	11-48
I 2 of 5 Check Digit Verification	49	31h	Disable	11-50
Transmit I 2 of 5 Check Digit	44	2Ch	Disable	11-51
Convert I 2 of 5 to EAN 13	82	52h	Disable	11-51
I 2 of 5 Security Level	1121	F8h 04h 61h	Security Level 1	11-52
I 2 of 5 Reduced Quiet Zone	1210	F8h 04h BAh	Disable	11-53
Discrete 2 of 5 (DTF)				
Discrete 2 of 5	5	05h	Disable	11-54
Set Length(s) for D 2 of 5	20, 21	14h 15h	1 to 55	11-55

Table 11-1 Symbology Parameter Defaults (Continued)

Parameter	Parameter Number	SSI Number	Default	Page Number
Codabar (NW - 7)				
Codabar	7	07h	Enable	11-57
Set Lengths for Codabar	24, 25	18h, 19h	4 to 55	11-58
CLSI Editing	54	36h	Disable	11-59
NOTIS Editing	55	37h	Disable	11-59
Codabar Upper or Lower Case Start/ Stop Characters Detection	855	F2h 57h	Upper Case	11-60
MSI				
MSI	11	0Bh	Disable	11-61
Set Length(s) for MSI	30, 31	1Eh, 1Fh	4 to 55	11-62
MSI Check Digits	50	32h	One	11-64
Transmit MSI Check Digit	46	2Eh	Disable	11-64
MSI Check Digit Algorithm	51	33h	Mod 10/Mod 10	11-65
Chinese 2 of 5				
Chinese 2 of 5	408	F0h 98h	Disable	11-66
Matrix 2 of 5				
Matrix 2 of 5	618	F1h 6Ah	Disable	11-67
Matrix 2 of 5 Lengths	619 620	F1h 6Bh F1h 6Ch	4 to 55	11-67
Matrix 2 of 5 Check Digit	622	F1h 6Eh	Disable	11-69
Transmit Matrix 2 of 5 Check Digit	623	F1h 6Fh	Disable	11-69
Korean 3 of 5				
Korean 3 of 5	581	F1h 45h	Disable	11-70
Inverse 1D	586	F1h 4Ah	Regular	11-71
GS1 DataBar				
GS1 DataBar-14	338	F0h 52h	Enable	11-72
GS1 DataBar Limited	339	F0h 53h	Enable	11-72
GS1 DataBar Expanded	340	F0h 54h	Enable	11-73
Convert GS1 DataBar to UPC/EAN	397	F0h 8Dh	Disable	11-73
GS1 DataBar Limited Security Level	728	F1h D8h	Level 3	11-74

Table 11-1 Symbology Parameter Defaults (Continued)

Parameter	Parameter Number	SSI Number	Default	Page Number
Composite				
Composite CC-C	341	F0h 55h	Disable	11-75
Composite CC-A/B	342	F0h 56h	Disable	11-75
Composite TLC-39	371	F0h 73h	Disable	11-76
UPC Composite Mode	344	F0h 58h	UPC Never Linked	11-76
Composite Beep Mode	398	F0h 8Eh	Beep As Each Code Type is Decoded	11-77
GS1-128 Emulation Mode for UCC/EAN Composite Codes	427	F0h ABh	Disable	11-77
2D Symbologies				
PDF417	15	0Fh	Enable	11-78
MicroPDF417	227	E3h	Disable	11-78
Code 128 Emulation	123	7Bh	Disable	11-79
Data Matrix	292	F0h 24h	Enable	11-80
GS1 Data Matrix	1336	F8h 05h 38h	Disable	11-80
Data Matrix Inverse	588	F1h 4Ch	Inverse Autodetect	11-81
Maxicode	294	F0h 26h	Disable	11-81
QR Code	293	F0h 25h	Enable	11-82
GS1 QR	1343	F8h 05h 3Fh	Disable	11-82
MicroQR	573	F1h 3Dh	Enable	11-83
Aztec	574	F1h 3Eh	Enable	11-83
Aztec Inverse	589	F1h 4Dh	Inverse Autodetect	11-84
Han Xin	1167	F8h 04h 8Fh	Disable	11-84
Han Xin Inverse	1168	F8h 04h 90h	Regular	11-85
Postal Codes				
US Postnet	89	59h	Disable	11-86
US Planet	90	5Ah	Disable	11-86
Transmit US Postal Check Digit	95	5Fh	Enable	11-87
UK Postal	91	5Bh	Disable	11-87
Transmit UK Postal Check Digit	96	60h	Enable	11-88
Japan Postal	290	F0h 22h	Disable	11-88

Table 11-1 Symbology Parameter Defaults (Continued)

Parameter	Parameter Number	SSI Number	Default	Page Number
Australia Post	291	F0h 23h	Disable	11-89
Australia Post Format	718	F1h CEh	Autodiscriminate	11-90
Netherlands KIX Code	326	F0h 46h	Disable	11-91
USPS 4CB/One Code/Intelligent Mail	592	F1h 50h	Disable	11-91
UPU FICS Postal	611	F1h 63h	Disable	11-92
Mailmark	1337	F8h 05h 39h	Disable	11-92
Symbology-Specific Security Levels				
Redundancy Level	78	4Eh	1	11-93
Security Level	77	4Dh	1	11-95
1D Quiet Zone Level	1288	F8h 05h 08h	1	11-96
Intercharacter Gap Size	381	F0h 7Dh	Normal	11-97
Macro PDF				
Flush Macro PDF Buffer	N/A	N/A	N/A	11-98
Abort Macro PDF Entry	N/A	N/A	N/A	11-98

Enable/Disable All Code Types

To disable all symbologies, scan Disable All Code Types below. This is useful when enabling only a few code types.

Scan Enable All Code Types turn on (enable) all code types. This is useful when you want to read all codes, or when you want to disable only a few code types.



Disable All Code Types



Enable All Code Types

UPC/EAN

Enable/Disable UPC-A

Parameter # 1 (SSI # 01h)

To enable or disable UPC-A, scan the appropriate bar code below.

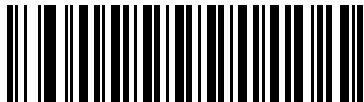

***Enable UPC-A
(1)**

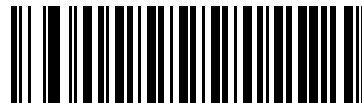

**Disable UPC-A
(0)**

Enable/Disable UPC-E

Parameter # 2 (SSI # 02h)

To enable or disable UPC-E, scan the appropriate bar code below.



***Enable UPC-E
(1)**



**Disable UPC-E
(0)**

Enable/Disable UPC-E1

Parameter # 12 (SSI # 0Ch)

UPC-E1 is disabled by default.

To enable or disable UPC-E1, scan the appropriate bar code below.

✓ **NOTE** UPC-E1 is not a UCC (Uniform Code Council) approved symbology.

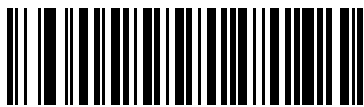

Enable UPC-E1
(1)



***Disable UPC-E1**
(0)

Enable/Disable EAN-8/JAN-8

Parameter # 4 (SSI # 04h)

To enable or disable EAN-8/JAN-8, scan the appropriate bar code below.

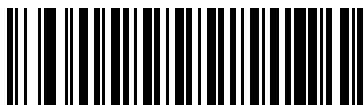

***Enable EAN-8/JAN-8**
(1)

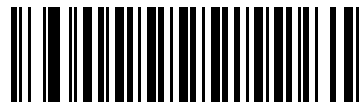

Disable EAN-8/JAN-8
(0)

Enable/Disable EAN-13/JAN-13

Parameter # 3 (SSI # 03h)

To enable or disable EAN-13/JAN-13, scan the appropriate bar code below.

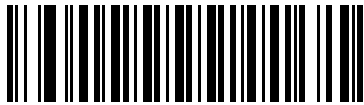

***Enable EAN-13/JAN-13**
(1)

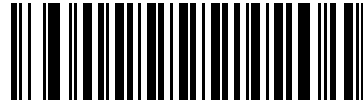

Disable EAN-13/JAN-13
(0)

Enable/Disable Bookland EAN

Parameter # 83 (SSI # 53h)

To enable or disable Bookland EAN, scan the appropriate bar code below.

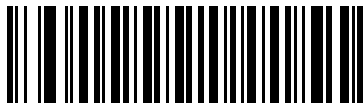

Enable Bookland EAN
(1)



***Disable Bookland EAN**
(0)



NOTE If you enable Bookland EAN, select a *Bookland ISBN Format* on page 11-23. Also select either Decode UPC/EAN Supplementals, Autodiscriminate UPC/EAN Supplementals, or Enable 978/979 Supplemental Mode in *Decode UPC/EAN/JAN Supplementals* on page 11-12.

Decode UPC/EAN/JAN Supplementals

Parameter # 16 (SSI # 10h)

Supplementals are bar codes appended according to specific format conventions (e.g., UPC A+2, UPC E+2, EAN 13+2). The following options are available:

- If you select **Ignore UPC/EAN with Supplementals**, and the digital scanner is presented with a UPC/EAN plus supplemental symbol, the digital scanner decodes UPC/EAN and ignores the supplemental characters.
- If you select **Decode UPC/EAN with Supplementals**, the digital scanner only decodes UPC/EAN symbols with supplemental characters, and ignores symbols without supplementals.
- If you select **Autodiscriminate UPC/EAN Supplementals**, the digital scanner decodes UPC/EAN symbols with supplemental characters immediately. If the symbol does not have a supplemental, the digital scanner must decode the bar code the number of times set via [UPC/EAN/JAN Supplemental Redundancy on page 11-15](#) before transmitting its data to confirm that there is no supplemental.
- If you select one of the following **Supplemental Mode** options, the digital scanner immediately transmits EAN-13 bar codes starting with that prefix that have supplemental characters. If the symbol does not have a supplemental, the digital scanner must decode the bar code the number of times set via [UPC/EAN/JAN Supplemental Redundancy on page 11-15](#) before transmitting its data to confirm that there is no supplemental. The digital scanner transmits UPC/EAN bar codes that do not have that prefix immediately.
 - **Enable 378/379 Supplemental Mode**
 - **Enable 978/979 Supplemental Mode**

✓ **NOTE** If you select 978/979 Supplemental Mode and are scanning Bookland EAN bar codes, see [Enable/Disable Bookland EAN on page 11-11](#) to enable Bookland EAN, and select a format using [Bookland ISBN Format on page 11-23](#).

- **Enable 977 Supplemental Mode**
- **Enable 414/419/434/439 Supplemental Mode**
- **Enable 491 Supplemental Mode**
- **Enable Smart Supplemental Mode** - applies to EAN-13 bar codes starting with any prefix listed previously.
- **Supplemental User-Programmable Type 1** - applies to EAN-13 bar codes starting with a 3-digit user-defined prefix. Set this 3-digit prefix using [User-Programmable Supplementals on page 11-15](#).
- **Supplemental User-Programmable Type 1 and 2** - applies to EAN-13 bar codes starting with either of two 3-digit user-defined prefixes. Set the 3-digit prefixes using [User-Programmable Supplementals on page 11-15](#).
- **Smart Supplemental Plus User-Programmable 1** - applies to EAN-13 bar codes starting with any prefix listed previously or the user-defined prefix set using [User-Programmable Supplementals on page 11-15](#).
- **Smart Supplemental Plus User-Programmable 1 and 2** - applies to EAN-13 bar codes starting with any prefix listed previously or one of the two user-defined prefixes set using [User-Programmable Supplementals on page 11-15](#).

✓ **NOTE** To minimize the risk of invalid data transmission, select either to decode or ignore supplemental characters.

Decode UPC/EAN/JAN Supplementals (continued)

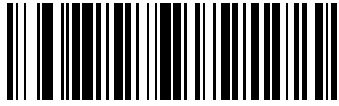

**Decode UPC/EAN/JAN Only With Supplementals
(1)**



***Ignore Supplementals
(0)**



**Autodiscriminate UPC/EAN/JAN Supplementals
(2)**



**Enable 378/379 Supplemental Mode
(4)**



**Enable 978/979 Supplemental Mode
(5)**



**Enable 977 Supplemental Mode
(7)**

Decode UPC/EAN/JAN Supplementals (continued)



**Enable 414/419/434/439 Supplemental Mode
(6)**



**Enable 491 Supplemental Mode
(8)**



**Enable Smart Supplemental Mode
(3)**



**Supplemental User-Programmable Type 1
(9)**



**Supplemental User-Programmable Type 1 and 2
(10)**



**Smart Supplemental Plus User-Programmable 1
(11)**



**Smart Supplemental Plus User-Programmable 1 and 2
(12)**

User-Programmable Supplementals

Supplemental 1: Parameter # 579 (SSI # F1h 43h)

Supplemental 2: Parameter # 580 (SSI # F1h 44h)

If you selected a Supplemental User-Programmable option from *Decode UPC/EAN/JAN Supplementals on page 11-12*, select User-Programmable Supplemental 1 to set the 3-digit prefix. Then select the 3 digits using the numeric bar codes beginning on [page G-1](#). Select User-Programmable Supplemental 2 to set a second 3-digit prefix. Then select the 3 digits using the numeric bar codes beginning on [page G-1](#). The default is 000 (zeroes).



User-Programmable Supplemental 1



User-Programmable Supplemental 2

UPC/EAN/JAN Supplemental Redundancy

Parameter # 80 (SSI # 50h)

If you selected Autodiscriminate UPC/EAN/JAN Supplementals, this option adjusts the number of times to decode a symbol without supplementals before transmission. The range is from two to thirty times. Five or above is recommended when decoding a mix of UPC/EAN/JAN symbols with and without supplementals. The default is 10.

Scan the bar code below to set a decode redundancy value. Next, scan two numeric bar codes in [Appendix G, Numeric Bar Codes](#). Enter a leading zero for single digit numbers. To correct an error or change a selection, scan [Cancel on page G-2](#).



UPC/EAN/JAN Supplemental Redundancy

UPC/EAN/JAN Supplemental AIM ID Format

Parameter # 672 (SSI # F1h A0h)

Select an output format when reporting UPC/EAN/JAN bar codes with Supplementals with *Transmit Code ID Character* on page 4-34 set to **AIM Code ID Character**:

- **Separate** - transmit UPC/EAN with supplementals with separate AIM IDs but one transmission, i.e.:
]E<0 or 4><data>]E<1 or 2>[supplemental data]
- **Combined** – transmit UPC/EAN with supplementals with one AIM ID and one transmission, i.e.:
]E3<data+supplemental data>
- **Separate Transmissions** - transmit UPC/EAN with supplementals with separate AIM IDs and separate transmissions, i.e.:
]E<0 or 4><data>
]E<1 or 2>[supplemental data]



Separate
(0)

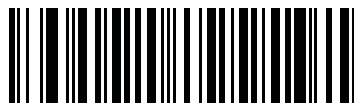

***Combined**
(1)



Separate Transmissions
(2)

UPC Reduced Quiet Zone

Parameter # 1289 (SSI # F8h 05h 09h)

Scan one of the following bar codes to enable or disable decoding UPC bar codes with reduced quiet zones. If you select **Enable**, select a *1D Quiet Zone Level* on page 11-96.

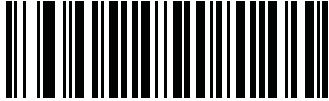

Enable UPC Reduced Quiet Zone
(1)

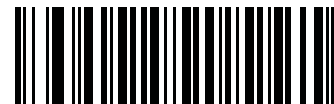

***Disable UPC Reduced Quiet Zone**
(0)

Transmit UPC-A Check Digit

Parameter # 40 (SSI # 28h)

The check digit is the last character of the symbol used to verify the integrity of the data. Scan the appropriate bar code below to transmit the bar code data with or without the UPC-A check digit. It is always verified to guarantee the integrity of the data.

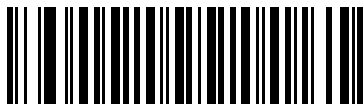

***Transmit UPC-A Check Digit**
(1)

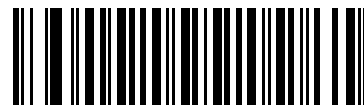

Do Not Transmit UPC-A Check Digit
(0)

Transmit UPC-E Check Digit

Parameter # 41 (SSI # 29h)

The check digit is the last character of the symbol used to verify the integrity of the data. Scan the appropriate bar code below to transmit the bar code data with or without the UPC-E check digit. It is always verified to guarantee the integrity of the data.



***Transmit UPC-E Check Digit
(1)**

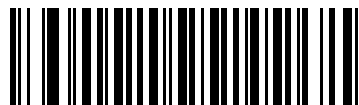

**Do Not Transmit UPC-E Check Digit
(0)**

Transmit UPC-E1 Check Digit

Parameter # 42 (SSI # 2Ah)

The check digit is the last character of the symbol used to verify the integrity of the data. Scan the appropriate bar code below to transmit the bar code data with or without the UPC-E1 check digit. It is always verified to guarantee the integrity of the data.



***Transmit UPC-E1 Check Digit
(1)**



**Do Not Transmit UPC-E1 Check Digit
(0)**

UPC-A Preamble

Parameter # 34 (SSI # 22h)

Preamble characters are part of the UPC symbol, and include Country Code and System Character. There are three options for transmitting a UPC-A preamble to the host device: transmit System Character only, transmit System Character and Country Code ("0" for USA), and transmit no preamble. Select the appropriate option to match the host system.

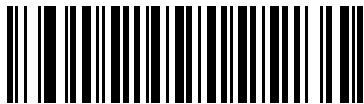

No Preamble (<DATA>)
(0)

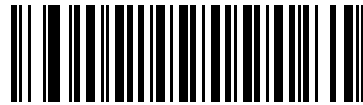

*System Character (<SYSTEM CHARACTER>
<DATA>)
(1)

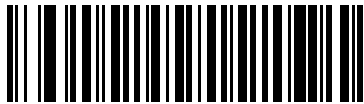

System Character & Country Code
(< COUNTRY CODE> <SYSTEM CHARACTER>
<DATA>)
(2)

UPC-E Preamble

Parameter # 35 (SSI # 23h)

Preamble characters are part of the UPC symbol, and include Country Code and System Character. There are three options for transmitting a UPC-E preamble to the host device: transmit System Character only, transmit System Character and Country Code ("0" for USA), and transmit no preamble. Select the appropriate option to match the host system.

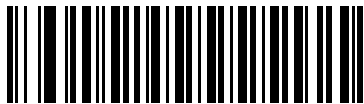

No Preamble (<DATA>)
(0)



*System Character (<SYSTEM CHARACTER>
<DATA>)
(1)

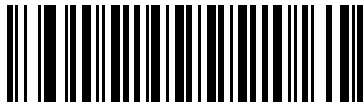

System Character & Country Code
(< COUNTRY CODE> <SYSTEM CHARACTER>
<DATA>)
(2)

UPC-E1 Preamble

Parameter # 36 (SSI # 24h)

Preamble characters are part of the UPC symbol, and include Country Code and System Character. There are three options for transmitting a UPC-E1 preamble to the host device: transmit System Character only, transmit System Character and Country Code ("0" for USA), and transmit no preamble. Select the appropriate option to match the host system.

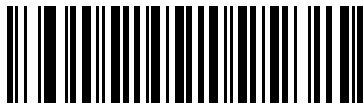

No Preamble (<DATA>)
(0)



***System Character (<SYSTEM CHARACTER> <DATA>)**
(1)

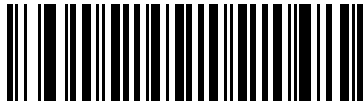

System Character & Country Code
(< COUNTRY CODE> <SYSTEM CHARACTER> <DATA>)
(2)

Convert UPC-E to UPC-A

Parameter # 37 (SSI # 25h)

Enable this to convert UPC-E (zero suppressed) decoded data to UPC-A format before transmission. After conversion, the data follows UPC-A format and is affected by UPC-A programming selections (e.g., Preamble, Check Digit).

Disable this to transmit UPC-E decoded data as UPC-E data, without conversion.

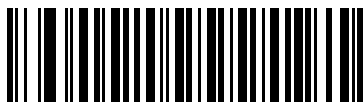

Convert UPC-E to UPC-A (Enable)
(1)



***Do Not Convert UPC-E to UPC-A (Disable)**
(0)

Convert UPC-E1 to UPC-A

Parameter # 38 (SSI # 26h)

Enable this to convert UPC-E1 decoded data to UPC-A format before transmission. After conversion, the data follows UPC-A format and is affected by UPC-A programming selections (e.g., Preamble, Check Digit).

Disable this to transmit UPC-E1 decoded data as UPC-E1 data, without conversion.

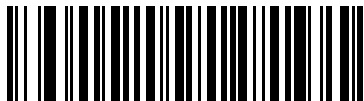

Convert UPC-E1 to UPC-A (Enable)
(1)



***Do Not Convert UPC-E1 to UPC-A (Disable)**
(0)

EAN-8/JAN-8 Extend

Parameter # 39 (SSI # 27h)

Enable this parameter to add five leading zeros to decoded EAN-8 symbols to make them compatible in format to EAN-13 symbols. Disable this to transmit EAN-8 symbols as is.

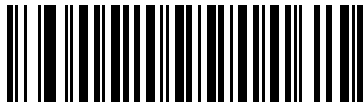

**Enable EAN/JAN Zero Extend
(1)**

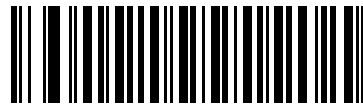

***Disable EAN/JAN Zero Extend
(0)**

Bookland ISBN Format

Parameter # 576 (SSI # F1h 40h)

If you enabled Bookland EAN using *Enable/Disable Bookland EAN on page 11-11*, select one of the following formats for Bookland data:

- **Bookland ISBN-10** - The digital scanner reports Bookland data starting with 978 in traditional 10-digit format with the special Bookland check digit for backward-compatibility. Data starting with 979 is not considered Bookland in this mode.
- **Bookland ISBN-13** - The digital scanner reports Bookland data (starting with either 978 or 979) as EAN-13 in 13-digit format to meet the 2007 ISBN-13 protocol.



***Bookland ISBN-10
(0)**



**Bookland ISBN-13
(1)**



NOTE For Bookland EAN to function properly, first enable Bookland EAN using *Enable/Disable Bookland EAN on page 11-11*, then select either Decode UPC/EAN Supplementals, Autodiscriminate UPC/EAN Supplementals, or Enable 978/979 Supplemental Mode in *Decode UPC/EAN/JAN Supplementals on page 11-12*.

UCC Coupon Extended Code

Parameter # 85 (SSI # 55h)

Enable this parameter to decode UPC-A bar codes starting with digit '5', EAN-13 bar codes starting with digit '99', and UPC-A/GS1-128 Coupon Codes. UPCA, EAN-13, and GS1-128 must be enabled to scan all types of Coupon Codes.

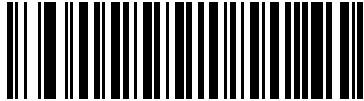

**Enable UCC Coupon Extended Code
(1)**



***Disable UCC Coupon Extended Code
(0)**



NOTE See *UPC/EAN/JAN Supplemental Redundancy* on page 11-15 to control autodiscrimination of the GS1-128 (right half) of a coupon code.

Coupon Report

Parameter # 730 (SSI # F1h DAh)

Select an option to determine which type of coupon format to support.

- Select **Old Coupon Format** to support UPC-A/GS1-128 and EAN-13/GS1-128.
- Select **New Coupon Format** as an interim format to support UPC-A/GS1-DataBar and EAN-13/GS1-DataBar.
- If you select **Autodiscriminate Format**, the digital scanner supports both **Old Coupon Format** and **New Coupon Format**.



Old Coupon Format
(0)



***New Coupon Format**
(1)



Autodiscriminate Coupon Format
(2)

ISSN EAN

Parameter # 617 (SSI # F1h 69h)

To enable or disable ISSN EAN, scan the appropriate bar code below.



Enable ISSN EAN
(1)



***Disable ISSN EAN**
(0)

Code 128

Enable/Disable Code 128

Parameter # 8 (SSI # 08h)

To enable or disable Code 128, scan the appropriate bar code below.

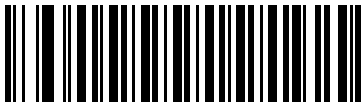

*Enable Code 128
(1)

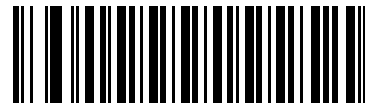

Disable Code 128
(0)

Set Lengths for Code 128

Parameter # L1 = 209 (SSI # D1h), L2 = 210 (SSI # D2h)

The length of a code refers to the number of characters (i.e., human readable characters), including check digit(s) the code contains. Set lengths for Code 128 to any length, one or two discrete lengths, or lengths within a specific range. The default is 1 to 55.

✓ **NOTE** When setting lengths for different bar code types, enter a leading zero for single digit numbers.

- **One Discrete Length** - Select this option to decode only Code 128 symbols containing a selected length. Select the length using the numeric bar codes in [Appendix G, Numeric Bar Codes](#). For example, to decode only Code 128 symbols with 14 characters, scan **Code 128 - One Discrete Length**, then scan **1** followed by **4**. To correct an error or change the selection, scan [Cancel on page G-2](#).
- **Two Discrete Lengths** - Select this option to decode only Code 128 symbols containing either of two selected lengths. Select lengths using the numeric bar codes in [Appendix G, Numeric Bar Codes](#). For example, to decode only Code 128 symbols containing either 2 or 14 characters, select **Code 128 - Two Discrete Lengths**, then scan **0, 2, 1**, and then **4**. To correct an error or change the selection, scan [Cancel on page G-2](#).
- **Length Within Range** - Select this option to decode a Code 128 symbol with a specific length range. Select lengths using numeric bar codes in [Appendix G, Numeric Bar Codes](#). For example, to decode Code 128 symbols containing between 4 and 12 characters, first scan **Code 128 - Length Within Range**. Then scan **0, 4, 1**, and **2** (enter a leading zero for single digit numbers). To correct an error or change the selection, scan [Cancel on page G-2](#).
- **Any Length** - Select this option to decode Code 128 symbols containing any number of characters within the digital scanner's capability.

Set Lengths for Code 128 (continued)

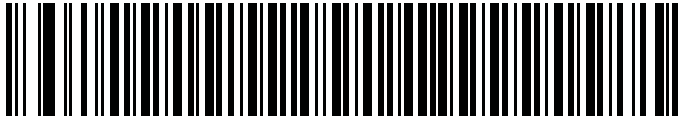

Code 128 - One Discrete Length

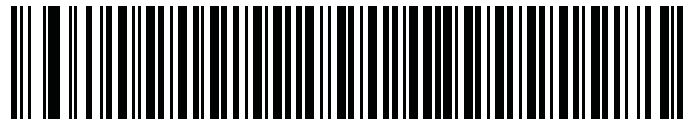

Code 128 - Two Discrete Lengths

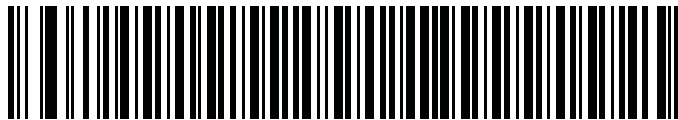

Code 128 - Length Within Range

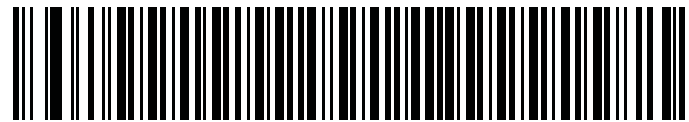

Code 128 - Any Length

Enable/Disable GS1-128 (formerly UCC/EAN-128)

Parameter # 14 (SSI # 0Eh)

To enable or disable GS1-128, scan the appropriate bar code below.

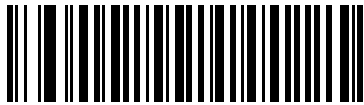

***Enable GS1-128
(1)**

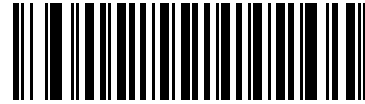

**Disable GS1-128
(0)**

Enable/Disable ISBT 128

Parameter # 84 (SSI # 54h)

ISBT 128 is a variant of Code 128 used in the blood bank industry. Scan a bar code below to enable or disable ISBT 128. If necessary, the host must perform concatenation of the ISBT data.



***Enable ISBT 128
(1)**



**Disable ISBT 128
(0)**

ISBT Concatenation

Parameter # 577 (SSI # F1h 41h)

Select an option for concatenating pairs of ISBT code types:

- If you select **Disable ISBT Concatenation**, the digital scanner does not concatenate pairs of ISBT codes it encounters.
- If you select **Enable ISBT Concatenation**, there must be two ISBT codes in order for the digital scanner to decode and perform concatenation. The digital scanner does not decode single ISBT symbols.
- If you select **Autodiscriminate ISBT Concatenation**, the digital scanner decodes and concatenates pairs of ISBT codes immediately. If only a single ISBT symbol is present, the digital scanner must decode the symbol the number of times set via [ISBT Concatenation Redundancy on page 11-30](#) before transmitting its data to confirm that there is no additional ISBT symbol.



Disable ISBT Concatenation
(0)

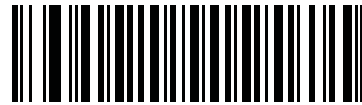

Enable ISBT Concatenation
(1)



***Autodiscriminate ISBT Concatenation**
(2)

Check ISBT Table

Parameter # 578 (SSI # F1h 42h)

The ISBT specification includes a table that lists several types of ISBT bar codes that are commonly used in pairs. If you set ISBT Concatenation to Enable, enable Check ISBT Table to concatenate only those pairs found in this table. Other types of ISBT codes are not concatenated.



***Enable Check ISBT Table
(1)**



**Disable Check ISBT Table
(0)**

ISBT Concatenation Redundancy

Parameter # 223 (SSI # DFh)

If you set ISBT Concatenation to Autodiscriminate, use this parameter to set the number of times the digital scanner must decode an ISBT symbol before determining that there is no additional symbol.

Scan the bar code below, then scan two numeric bar codes in [Appendix G, Numeric Bar Codes](#) to set a value between 2 and 20. Enter a leading zero for single digit numbers. To correct an error or change a selection, scan [Cancel on page G-2](#). The default is 10.



ISBT Concatenation Redundancy

Code 128 Security Level

Parameter # 751 (SSI # F1h EFh)

Code 128 bar codes are vulnerable to misdecodes, particularly when Code 128 Lengths is set to Any Length. The digital scanner offers four levels of decode security for Code 128 bar codes. There is an inverse relationship between security and digital scanner aggressiveness. Increasing the level of security can reduce scanning aggressiveness, so select only the level of security necessary.

- **Code 128 Security Level 0:** This setting allows the digital scanner to operate in its most aggressive state, while providing sufficient security in decoding most in-spec bar codes.
- **Code 128 Security Level 1:** A bar code must be successfully read twice, and satisfy certain safety requirements before being decoded. This default setting eliminates most misdecodes.
- **Code 128 Security Level 2:** Select this option with greater bar code security requirements if **Security Level 1** fails to eliminate misdecodes.
- **Code 128 Security Level 3:** If you selected **Security Level 2**, and misdecodes still occur, select this security level to apply the highest safety requirements. A bar code must be successfully read three times before being decoded.

✓ **NOTE** Selecting this option is an extreme measure against mis-decoding severely out-of-spec bar codes. Selecting this level of security significantly impairs the decoding ability of the digital scanner. If this level of security is required, try to improve the quality of the bar codes.

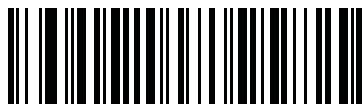

Code 128 Security Level 0
(0)



*Code 128 Security Level 1
(1)

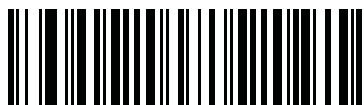

Code 128 Security Level 2
(2)



Code 128 Security Level 3
(3)

Code 128 Reduced Quiet Zone

Parameter # 1208 (SSI # F8h 04h B8h)

Scan one of the following bar codes to enable or disable decoding Code 128 bar codes with reduced quiet zones. If you select **Enable**, select a *1D Quiet Zone Level* on page 11-96.



Enable Code 128 Reduced Quiet Zone
(1)



***Disable Code 128 Reduced Quiet Zone**
(0)

Ignore Code 128 <FNC4>

Parameter # 1254 (SSI # F8h 04h E6h)

This feature applies to Code 128 bar codes with an embedded <FNC4> character. Enable this to strip the <FNC4> character from the decode data. The remaining characters are sent to the host unchanged. When disabled, the <FNC4> character is processed normally as per Code 128 standard.



Enable Ignore Code 128 <FNC4>
(1)



***Disable Ignore Code 128 <FNC4>**
(0)

Code 39

Enable/Disable Code 39

Parameter # 0 (SSI # 00h)

To enable or disable Code 39, scan the appropriate bar code below.



***Enable Code 39**
(1)

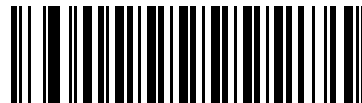

Disable Code 39
(0)

Enable/Disable Trioptic Code 39

Parameter # 13 (SSI # 0Dh)

Trioptic Code 39 is a variant of Code 39 used in the marking of computer tape cartridges. Trioptic Code 39 symbols always contain six characters. To enable or disable Trioptic Code 39, scan the appropriate bar code below.

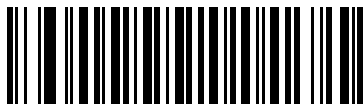

Enable Trioptic Code 39
(1)



***Disable Trioptic Code 39**
(0)



NOTE You cannot enable Trioptic Code 39 and Code 39 Full ASCII simultaneously.

Convert Code 39 to Code 32

Parameter # 86 (SSI # 56h)

Code 32 is a variant of Code 39 used by the Italian pharmaceutical industry. Scan the appropriate bar code below to enable or disable converting Code 39 to Code 32.

✓ **NOTE** Code 39 must be enabled for this parameter to function.



Enable Convert Code 39 to Code 32
(1)

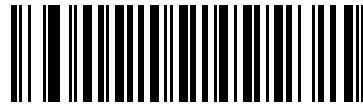

***Disable Convert Code 39 to Code 32**
(0)

Code 32 Prefix

Parameter # 231 (SSI # E7h)

Scan the appropriate bar code below to enable or disable adding the prefix character "A" to all Code 32 bar codes.

✓ **NOTE** Convert Code 39 to Code 32 must be enabled for this parameter to function.



Enable Code 32 Prefix
(1)

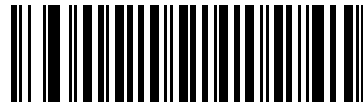

***Disable Code 32 Prefix**
(0)

Set Lengths for Code 39

Parameter # L1 = 18 (SSI # 12h), L2 = 19 (SSI # 13h)

The length of a code refers to the number of characters (i.e., human readable characters), including check digit(s) the code contains. Set lengths for Code 39 to any length, one or two discrete lengths, or lengths within a specific range. If Code 39 Full ASCII is enabled, Length Within a Range or Any Length are the preferred options. The default is 1 to 55.

✓ **NOTE** When setting lengths for different bar code types, enter a leading zero for single digit numbers.

- **One Discrete Length** - Select this option to decode only Code 39 symbols containing a selected length. Select the length using the numeric bar codes in [Appendix G, Numeric Bar Codes](#). For example, to decode only Code 39 symbols with 14 characters, scan **Code 39 - One Discrete Length**, then scan **1** followed by **4**. To correct an error or change the selection, scan [Cancel on page G-2](#).
- **Two Discrete Lengths** - Select this option to decode only Code 39 symbols containing either of two selected lengths. Select lengths using the numeric bar codes in [Appendix G, Numeric Bar Codes](#). For example, to decode only Code 39 symbols containing either 2 or 14 characters, select **Code 39 - Two Discrete Lengths**, then scan **0, 2, 1**, and then **4**. To correct an error or change the selection, scan [Cancel on page G-2](#).
- **Length Within Range** - Select this option to decode a Code 39 symbol with a specific length range. Select lengths using numeric bar codes in [Appendix G, Numeric Bar Codes](#). For example, to decode Code 39 symbols containing between 4 and 12 characters, first scan **Code 39 - Length Within Range**. Then scan **0, 4, 1**, and **2** (enter a leading zero for single digit numbers). To correct an error or change the selection, scan [Cancel on page G-2](#).
- **Any Length** - Select this option to decode Code 39 symbols containing any number of characters within the digital scanner's capability.



Code 39 - One Discrete Length



Code 39 - Two Discrete Lengths



Code 39 - Length Within Range



Code 39 - Any Length

Code 39 Check Digit Verification

Parameter # 48 (SSI # 30h)

Enable this feature to check the integrity of all Code 39 symbols to verify that the data complies with specified check digit algorithm. Only Code 39 symbols which include a modulo 43 check digit are decoded. Enable this feature if the Code 39 symbols contain a Modulo 43 check digit.

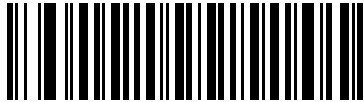

Enable Code 39 Check Digit
(1)



*Disable Code 39 Check Digit
(0)

Transmit Code 39 Check Digit

Parameter # 43 (SSI # 2Bh)

Scan a bar code below to transmit Code 39 data with or without the check digit.

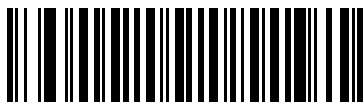

Transmit Code 39 Check Digit (Enable)
(1)



*Do Not Transmit Code 39 Check Digit (Disable)
(0)



NOTE Code 39 Check Digit Verification must be enabled for this parameter to function.

Code 39 Full ASCII Conversion

Parameter # 17 (SSI # 11h)

Code 39 Full ASCII is a variant of Code 39 which pairs characters to encode the full ASCII character set. To enable or disable Code 39 Full ASCII, scan the appropriate bar code below.



Enable Code 39 Full ASCII
(1)

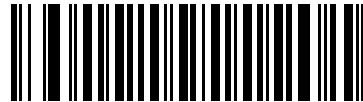

***Disable Code 39 Full ASCII**
(0)



NOTE You cannot enable Trioptic Code 39 and Code 39 Full ASCII simultaneously.

Code 39 Full ASCII to Full ASCII Correlation is host-dependent, and is therefore described in the ASCII Character Set Table for the appropriate interface. See the *ASCII Character Set for USB* on page 6-18.

Code 39 Security Level

Parameter # 750 (SSI # F1h EEh)

The digital scanner offers four levels of decode security for Code 39 bar codes. There is an inverse relationship between security and digital scanner aggressiveness. Increasing the level of security can reduce scanning aggressiveness, so select only the level of security necessary.

- **Code 39 Security Level 0:** This setting allows the digital scanner to operate in its most aggressive state, while providing sufficient security in decoding most in-spec bar codes.
- **Code 39 Security Level 1:** This default setting eliminates most misdecodes.
- **Code 39 Security Level 2:** Select this option with greater bar code security requirements if **Security Level 1** fails to eliminate misdecodes.
- **Code 39 Security Level 3:** If you selected **Security Level 2**, and misdecodes still occur, select this security level to apply the highest safety requirements.

✓ **NOTE** Selecting this option is an extreme measure against mis-decoding severely out-of-spec bar codes. Selecting this level of security significantly impairs the decoding ability of the digital scanner. If this level of security is required, try to improve the quality of the bar codes.



Code 39 Security Level 0
(0)



*Code 39 Security Level 1
(1)

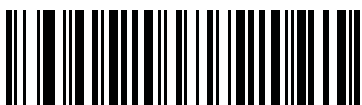

Code 39 Security Level 2
(2)



Code 39 Security Level 3
(3)

Code 39 Reduced Quiet Zone

Parameter # 1209 (SSI # F8h 04h B9h)

Scan one of the following bar codes to enable or disable decoding Code 39 bar codes with reduced quiet zones. If you select **Enable**, select a *1D Quiet Zone Level* on page 11-96.



Enable Code 39 Reduced Quiet Zone
(1)



***Disable Code 39 Reduced Quiet Zone**
(0)

Code 93

Enable/Disable Code 93

Parameter # 9 (SSI # 09h)

To enable or disable Code 93, scan the appropriate bar code below.

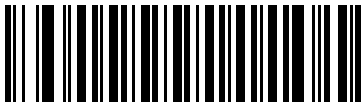

***Enable Code 93**
(1)

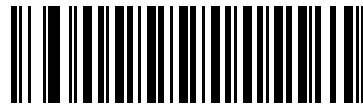

Disable Code 93
(0)

Set Lengths for Code 93

Parameter # L1 = 26 (SSI # 1Ah), L2 = 27 (SSI # 1Bh)

The length of a code refers to the number of characters (i.e., human readable characters), including check digit(s) the code contains. Set lengths for Code 93 to any length, one or two discrete lengths, or lengths within a specific range. The default is 1 to 55.

- **One Discrete Length** - Select this option to decode only Code 93 symbols containing a selected length. Select the length using the numeric bar codes in [Appendix G, Numeric Bar Codes](#). For example, to decode only Code 93 symbols with 14 characters, scan **Code 93 - One Discrete Length**, then scan **1** followed by **4**. To correct an error or to change the selection, scan [Cancel on page G-2](#).
- **Two Discrete Lengths** - Select this option to decode only Code 93 symbols containing either of two selected lengths. Select lengths using the numeric bar codes in [Appendix G, Numeric Bar Codes](#). For example, to decode only Code 93 symbols containing either 2 or 14 characters, select **Code 93 - Two Discrete Lengths**, then scan **0**, **2**, **1**, and then **4**. To correct an error or to change the selection, scan [Cancel on page G-2](#).
- **Length Within Range** - Select this option to decode a Code 93 symbol with a specific length range. Select lengths using the numeric bar codes in [Appendix G, Numeric Bar Codes](#). For example, to decode Code 93 symbols containing between 4 and 12 characters, first scan **Code 93 - Length Within Range**. Then scan **0**, **4**, **1**, and **2** (enter a leading zero for single digit numbers). To correct an error or change the selection, scan [Cancel on page G-2](#).
- **Any Length** - Scan this option to decode Code 93 symbols containing any number of characters within the digital scanner's capability.



Code 93 - One Discrete Length



Code 93 - Two Discrete Lengths



Code 93 - Length Within Range



Code 93 - Any Length

Code 11

Code 11

Parameter # 10 (SSI # 0Ah)

To enable or disable Code 11, scan the appropriate bar code below.

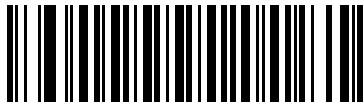

Enable Code 11
(1)



***Disable Code 11**
(0)

Set Lengths for Code 11

Parameter # L1 = 28 (SSI # 1Ch), L2 = 29 (SSI # 1Dh)

The length of a code refers to the number of characters (i.e., human readable characters), including check digit(s) the code contains. Set lengths for Code 11 to any length, one or two discrete lengths, or lengths within a specific range. The default is 4 to 55.

- **One Discrete Length** - Select this option to decode only Code 11 symbols containing a selected length. Select the length using the numeric bar codes in [Appendix G, Numeric Bar Codes](#). For example, to decode only Code 11 symbols with 14 characters, scan **Code 11 - One Discrete Length**, then scan **1** followed by **4**. To correct an error or to change the selection, scan [Cancel on page G-2](#).
- **Two Discrete Lengths** - Select this option to decode only Code 11 symbols containing either of two selected lengths. Select lengths using the numeric bar codes in [Appendix G, Numeric Bar Codes](#). For example, to decode only Code 11 symbols containing either 2 or 14 characters, select **Code 11 - Two Discrete Lengths**, then scan **0**, **2**, **1**, and then **4**. To correct an error or to change the selection, scan [Cancel on page G-2](#).
- **Length Within Range** - Select this option to decode a Code 11 symbol with a specific length range. Select lengths using numeric bar codes in [Appendix G, Numeric Bar Codes](#). For example, to decode Code 11 symbols containing between 4 and 12 characters, first scan **Code 11 - Length Within Range**. Then scan **0**, **4**, **1**, and **2** (enter a leading zero for single digit numbers). To correct an error or change the selection, scan [Cancel on page G-2](#).
- **Any Length** - Scan this option to decode Code 11 symbols containing any number of characters within the digital scanner's capability.



Code 11 - One Discrete Length



Code 11 - Two Discrete Lengths



Code 11 - Length Within Range



Code 11 - Any Length

Code 11 Check Digit Verification

Parameter # 52 (SSI # 34h)

This feature allows the digital scanner to check the integrity of all Code 11 symbols to verify that the data complies with the specified check digit algorithm. This selects the check digit mechanism for the decoded Code 11 bar code. The options are to check for one check digit, check for two check digits, or disable the feature.

To enable this feature, scan the bar code below corresponding to the number of check digits encoded in the Code 11 symbols.

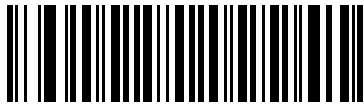

***Disable
(0)**

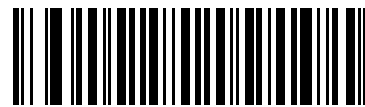

**One Check Digit
(1)**

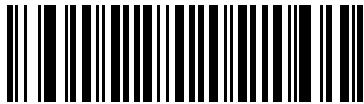

**Two Check Digits
(2)**

Transmit Code 11 Check Digits

Parameter # 47 (SSI # 2Fh)

This feature selects whether or not to transmit the Code 11 check digit(s).

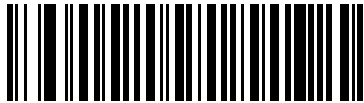

Transmit Code 11 Check Digit(s) (Enable)
(1)

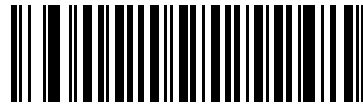

***Do Not Transmit Code 11 Check Digit(s) (Disable)**
(0)



NOTE Code 11 Check Digit Verification must be enabled for this parameter to function.

Interleaved 2 of 5 (ITF)

Enable/Disable Interleaved 2 of 5

Parameter # 6 (SSI # 06h)

To enable or disable Interleaved 2 of 5, scan the appropriate bar code below, and select an Interleaved 2 of 5 length from the following pages.

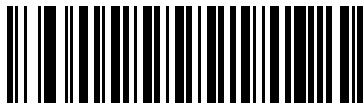

**Enable Interleaved 2 of 5
(1)**

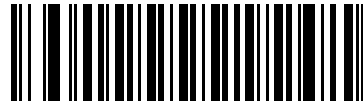

***Disable Interleaved 2 of 5
(0)**

Set Lengths for Interleaved 2 of 5

Parameter # L1 = 22 (SSI # 16h), L2 = 23 (SSI # 17h)

The length of a code refers to the number of characters (i.e., human readable characters), including check digit(s) the code contains. Set lengths for I 2 of 5 to any length, one or two discrete lengths, or lengths within a specific range. The range for Interleaved 2 of 5 lengths is 0 - 55. The default is 6 to 55.

- **One Discrete Length** - Select this option to decode only I 2 of 5 symbols containing a selected length. Select the length using the numeric bar codes in [Appendix G, Numeric Bar Codes](#). For example, to decode only I 2 of 5 symbols with 14 characters, scan **I 2 of 5 - One Discrete Length**, then scan **1** followed by **4**. To correct an error or to change the selection, scan [Cancel on page G-2](#).
- **Two Discrete Lengths** - Select this option to decode only I 2 of 5 symbols containing either of two selected lengths. Select lengths using the numeric bar codes in [Appendix G, Numeric Bar Codes](#). For example, to decode only I 2 of 5 symbols containing either 2 or 14 characters, select **I 2 of 5 - Two Discrete Lengths**, then scan **0, 2, 1**, and then **4**. To correct an error or to change the selection, scan [Cancel on page G-2](#).
- **Length Within Range** - Select this option to decode an I 2 of 5 symbol with a specific length range. Select lengths using numeric bar codes in [Appendix G, Numeric Bar Codes](#). For example, to decode I 2 of 5 symbols containing between 4 and 12 characters, first scan **I 2 of 5 - Length Within Range**. Then scan **0, 4, 1**, and **2** (enter a leading zero for single digit numbers). To correct an error or change the selection, scan [Cancel on page G-2](#).
- **Any Length** - Scan this option to decode I 2 of 5 symbols containing any number of characters within the digital scanner's capability.

✓ **NOTE** Due to the construction of the I 2 of 5 symbology, it is possible for a scan to cover only a portion of the code to transmit as a complete scan, yielding less data than is encoded in the bar code. To prevent this, select specific lengths (I 2 of 5 - One Discrete Length, Two Discrete Lengths) for I 2 of 5 applications.

Set Lengths for Interleaved 2 of 5 (continued)



I 2 of 5 - One Discrete Length



I 2 of 5 - Two Discrete Lengths



I 2 of 5 - Length Within Range



I 2 of 5 - Any Length

I 2 of 5 Check Digit Verification

Parameter # 49 (SSI # 31h)

Enable this feature to check the integrity of all I 2 of 5 symbols to verify the data complies with either the specified Uniform Symbology Specification (USS), or the Optical Product Code Council (OPCC) check digit algorithm.



***Disable
(0)**



**USS Check Digit
(1)**



**OPCC Check Digit
(2)**

Transmit I 2 of 5 Check Digit

Parameter # 44 (SSI # 2Ch)

Scan the appropriate bar code below to transmit I 2 of 5 data with or without the check digit.



Transmit I 2 of 5 Check Digit (Enable)
(1)

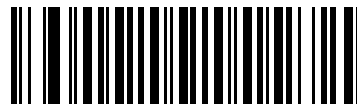

***Do Not Transmit I 2 of 5 Check Digit (Disable)**
(0)

Convert I 2 of 5 to EAN-13

Parameter # 82 (SSI # 52h)

Enable this parameter to convert 14-character I 2 of 5 codes to EAN-13, and transmit to the host as EAN-13. To accomplish this, the I 2 of 5 code must be enabled, and the code must have a leading zero and a valid EAN-13 check digit.



Convert I 2 of 5 to EAN-13 (Enable)
(1)



***Do Not Convert I 2 of 5 to EAN-13 (Disable)**
(0)

I 2 of 5 Security Level

Parameter # 1121 (SSI # F8h 04h 61h)

Interleaved 2 of 5 bar codes are vulnerable to misdecodes, particularly when I 2 of 5 Lengths is set to Any Length. The digital scanner offers four levels of decode security for Interleaved 2 of 5 bar codes. There is an inverse relationship between security and digital scanner aggressiveness. Increasing the level of security can reduce scanning aggressiveness, so select only the level of security necessary.

- **I 2 of 5 Security Level 0:** This setting allows the digital scanner to operate in its most aggressive state, while providing sufficient security in decoding most in-spec bar codes.
- **I 2 of 5 Security Level 1:** A bar code must be successfully read twice, and satisfy certain safety requirements before being decoded. This default setting eliminates most misdecodes.
- **I 2 of 5 Security Level 2:** Select this option with greater bar code security requirements if **Security Level 1** fails to eliminate misdecodes.
- **I 2 of 5 Security Level 3:** If you selected **Security Level 2**, and misdecodes still occur, select this security level. The highest safety requirements are applied. A bar code must be successfully read three times before being decoded.

✓ **NOTE** Selecting this option is an extreme measure against mis-decoding severely out-of-spec bar codes. Selecting this level of security significantly impairs the decoding ability of the digital scanner. If this level of security is required, try to improve the quality of the bar codes.

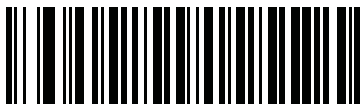

I 2 of 5 Security Level 0
(00h)



*I 2 of 5 Security Level 1
(01h)



I 2 of 5 Security Level 2
(02h)



I 2 of 5 Security Level 3
(03h)

I 2 of 5 Reduced Quiet Zone

Parameter # 1210 (SSI # F8h 04h BAh)

Scan one of the following bar codes to enable or disable decoding I 2 of 5 bar codes with reduced quiet zones. If you select Enable, select a *1D Quiet Zone Level on page 11-96*.



**Enable I 2 of 5 Reduced Quiet Zone
(1)**



***Disable I 2 of 5 Reduced Quiet Zone
(0)**

Discrete 2 of 5 (DTF)

Enable/Disable Discrete 2 of 5

Parameter # 5 (SSI # 05h)

To enable or disable Discrete 2 of 5, scan the appropriate bar code below.

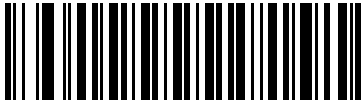

Enable Discrete 2 of 5
(1)

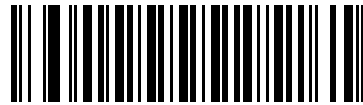

***Disable Discrete 2 of 5**
(0)

Set Lengths for Discrete 2 of 5

Parameter # L1 = 20 (SSI # 14h), L2 = 21 (SSI # 15h)

The length of a code refers to the number of characters (i.e., human readable characters), including check digit(s) the code contains. Set lengths for D 2 of 5 to any length, one or two discrete lengths, or lengths within a specific range. The range for Discrete 2 of 5 lengths is 1 - 55.

- **One Discrete Length** - Select this option to decode only D 2 of 5 symbols containing a selected length. Select the length using the numeric bar codes in [Appendix G, Numeric Bar Codes](#). For example, to decode only D 2 of 5 symbols with 14 characters, scan **D 2 of 5 - One Discrete Length**, then scan **1** followed by **4**. To correct an error or to change the selection, scan [Cancel on page G-2](#).
- **Two Discrete Lengths** - Select this option to decode only D 2 of 5 symbols containing either of two selected lengths. Select lengths using the numeric bar codes in [Appendix G, Numeric Bar Codes](#). For example, to decode only D 2 of 5 symbols containing either 2 or 14 characters, select **D 2 of 5 - Two Discrete Lengths**, then scan **0**, **2**, **1**, and then **4**. To correct an error or to change the selection, scan [Cancel on page G-2](#).
- **Length Within Range** - Select this option to decode a D 2 of 5 symbol with a specific length range. Select lengths using numeric bar codes in [Appendix G, Numeric Bar Codes](#). For example, to decode D 2 of 5 symbols containing between 4 and 12 characters, first scan **D 2 of 5 - Length Within Range**. Then scan **0**, **4**, **1**, and **2** (enter a leading zero for single digit numbers). To correct an error or change the selection, scan [Cancel on page G-2](#).
- **Any Length** - Scan this option to decode D 2 of 5 symbols containing any number of characters within the digital scanner's capability.

✓ **NOTE** Due to the construction of the D 2 of 5 symbology, it is possible for a scan to cover only a portion of the code to transmit as a complete scan, yielding less data than is encoded in the bar code. To prevent this, select specific lengths (**D 2 of 5 - One Discrete Length, Two Discrete Lengths**) for D 2 of 5 applications.

Set Lengths for Discrete 2 of 5 (continued)



D 2 of 5 - One Discrete Length



D 2 of 5 - Two Discrete Lengths



D 2 of 5 - Length Within Range



D 2 of 5 - Any Length

Codabar (NW - 7)

Enable/Disable Codabar

Parameter # 7 (SSI # 07h)

To enable or disable Codabar, scan the appropriate bar code below.

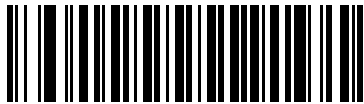

***Enable Codabar
(1)**

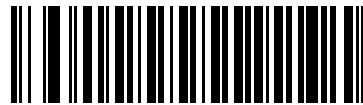

**Disable Codabar
(0)**

Set Lengths for Codabar

Parameter # L1 = 24 (SSI # 18h), L2 = 25 (SSI # 19h)

The length of a code refers to the number of characters (i.e., human readable characters), including check digit(s) the code contains. Set lengths for Codabar to any length, one or two discrete lengths, or lengths within a specific range. The default is 4 to 55.

- **One Discrete Length** - Select this option to decode only Codabar symbols containing a selected length. Select the length using the numeric bar codes in [Appendix G, Numeric Bar Codes](#). For example, to decode only Codabar symbols with 14 characters, scan **Codabar - One Discrete Length**, then scan **1** followed by **4**. To correct an error or to change the selection, scan [Cancel on page G-2](#).
- **Two Discrete Lengths** - Select this option to decode only Codabar symbols containing either of two selected lengths. Select lengths using the numeric bar codes in [Appendix G, Numeric Bar Codes](#). For example, to decode only Codabar symbols containing either 2 or 14 characters, select **Codabar - Two Discrete Lengths**, then scan **0**, **2**, **1**, and then **4**. To correct an error or to change the selection, scan [Cancel on page G-2](#).
- **Length Within Range** - Select this option to decode a Codabar symbol with a specific length range. Select lengths using numeric bar codes in [Appendix G, Numeric Bar Codes](#). For example, to decode Codabar symbols containing between 4 and 12 characters, first scan **Codabar - Length Within Range**. Then scan **0**, **4**, **1**, and **2** (enter a leading zero for single digit numbers). To correct an error or change the selection, scan [Cancel on page G-2](#).
- **Any Length** - Scan this option to decode Codabar symbols containing any number of characters within the digital scanner's capability.



Codabar - One Discrete Length



Codabar - Two Discrete Lengths



Codabar - Length Within Range



Codabar - Any Length

CLSI Editing

Parameter # 54 (SSI # 36h)

Enable this parameter to strip the start and stop characters and insert a space after the first, fifth, and tenth characters of a 14-character Codabar symbol. Enable this feature if the host system requires this data format.

✓ **NOTE** Symbol length does not include start and stop characters.

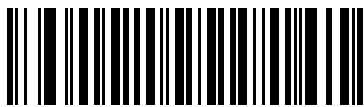

Enable CLSI Editing
(1)

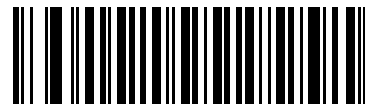

*Disable CLSI Editing
(0)

NOTIS Editing

Parameter # 55 (SSI # 37h)

Enable this parameter to strip the start and stop characters from a decoded Codabar symbol. Enable this feature if the host system requires this data format.



Enable NOTIS Editing
(1)

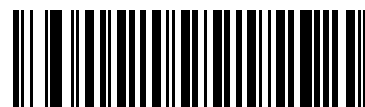

*Disable NOTIS Editing
(0)

Codabar Upper or Lower Case Start/Stop Characters Detection

Parameter # 855 (SSI # F2h 57h)

Select whether to detect upper case or lower case Codabar start/stop characters.



Lower Case
(1)



***Upper Case**
(0)

MSI

Enable/Disable MSI

Parameter # 11 (SSI # 0Bh)

To enable or disable MSI, scan the appropriate bar code below.

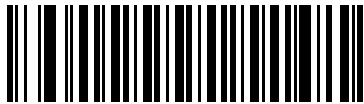

Enable MSI
(1)



***Disable MSI**
(0)

Set Lengths for MSI

Parameter # L1 = 30 (SSI # 1Eh), L2 = 31 (SSI # 1Fh)

The length of a code refers to the number of characters (i.e., human readable characters), including check digit(s) the code contains. Set lengths for MSI to any length, one or two discrete lengths, or lengths within a specific range. The default is 4 to 55.

- **One Discrete Length** - Select this option to decode only MSI symbols containing a selected length. Select the length using the numeric bar codes in [Appendix G, Numeric Bar Codes](#). For example, to decode only MSI symbols with 14 characters, scan **MSI - One Discrete Length**, then scan **1** followed by **4**. To correct an error or to change the selection, scan [Cancel on page G-2](#).
- **Two Discrete Lengths** - Select this option to decode only MSI symbols containing either of two selected lengths. Select lengths using the numeric bar codes in [Appendix G, Numeric Bar Codes](#). For example, to decode only MSI symbols containing either 2 or 14 characters, select **MSI - Two Discrete Lengths**, then scan **0**, **2**, **1**, and then **4**. To correct an error or to change the selection, scan [Cancel on page G-2](#).
- **Length Within Range** - Select this option to decode a MSI symbol with a specific length range. Select lengths using numeric bar codes in [Appendix G, Numeric Bar Codes](#). For example, to decode MSI symbols containing between 4 and 12 characters, first scan **MSI - Length Within Range**. Then scan **0**, **4**, **1**, and **2** (enter a leading zero for single digit numbers). To correct an error or change the selection, scan [Cancel on page G-2](#).
- **Any Length** - Scan this option to decode MSI symbols containing any number of characters within the digital scanner's capability.

Set Lengths for MSI (continued)



NOTE Due to the construction of the MSI symbology, it is possible for a scan to cover only a portion of the code to transmit as a complete scan, yielding less data than is encoded in the bar code. To prevent this, select specific lengths (**MSI - One Discrete Length, Two Discrete Lengths**) for MSI applications.



MSI - One Discrete Length



MSI - Two Discrete Lengths

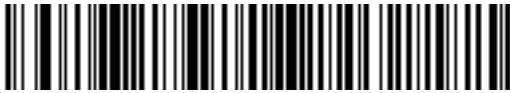

MSI - Length Within Range



MSI - Any Length

MSI Check Digits

Parameter # 50 (SSI # 32h)

With MSI symbols, one check digit is mandatory and always verified by the reader. The second check digit is optional. If the MSI codes include two check digits, scan the Two MSI Check Digits bar code to enable verification of the second check digit.

See [MSI Check Digit Algorithm on page 11-65](#) for the selection of second digit algorithms.



***One MSI Check Digit
(0)**

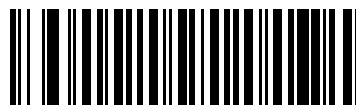

**Two MSI Check Digits
(1)**

Transmit MSI Check Digit(s)

Parameter # 46 (SSI # 2Eh)

Scan a bar code below to transmit MSI data with or without the check digit.

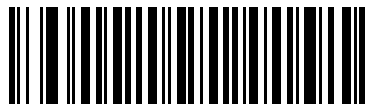

**Transmit MSI Check Digit(s) (Enable)
(1)**



***Do Not Transmit MSI Check Digit(s) (Disable)
(0)**

MSI Check Digit Algorithm

Parameter # 51 (SSI # 33h)

Two algorithms are possible for the verification of the second MSI check digit. Select the bar code below corresponding to the algorithm used to encode the check digit.



MOD 10/MOD 11
(0)

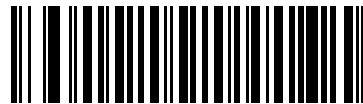

***MOD 10/MOD 10**
(1)

Chinese 2 of 5

Enable/Disable Chinese 2 of 5

Parameter # 408 (SSI # F0h 98h)

To enable or disable Chinese 2 of 5, scan the appropriate bar code below.

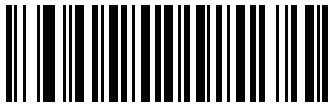

Enable Chinese 2 of 5
(1)

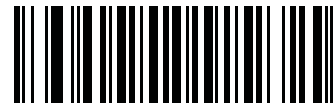

***Disable Chinese 2 of 5**
(0)

Matrix 2 of 5

Enable/Disable Matrix 2 of 5

Parameter # 618 (SSI # F1h 6Ah)

To enable or disable Matrix 2 of 5, scan the appropriate bar code below.



Enable Matrix 2 of 5
(1)



*Disable Matrix 2 of 5
(0)

Set Lengths for Matrix 2 of 5

Parameter # L1 = 619 (SSI # F1h 6Bh), L2 = 620 (SSI # F1h 6Ch)

The length of a code refers to the number of characters (i.e., human readable characters), including check digit(s) the code contains. Set lengths for Matrix 2 of 5 to any length, one or two discrete lengths, or lengths within a specific range. The default is 4 to 55.

- **One Discrete Length** - Select this option to decode only Matrix 2 of 5 symbols containing a selected length. Select the length using the numeric bar codes in [Appendix G, Numeric Bar Codes](#). For example, to decode only Matrix 2 of 5 symbols with 14 characters, scan **Matrix 2 of 5 - One Discrete Length**, then scan **1** followed by **4**. To correct an error or to change the selection, scan [Cancel on page G-2](#).
- **Two Discrete Lengths** - Select this option to decode only Matrix 2 of 5 symbols containing either of two selected lengths. Select lengths using the numeric bar codes in [Appendix G, Numeric Bar Codes](#). For example, to decode only Matrix 2 of 5 symbols containing either 2 or 14 characters, select **Matrix 2 of 5 - Two Discrete Lengths**, then scan **0, 2, 1**, and then **4**. To correct an error or to change the selection, scan [Cancel on page G-2](#).
- **Length Within Range** - Select this option to decode a Matrix 2 of 5 symbol with a specific length range. Select lengths using the numeric bar codes in [Appendix G, Numeric Bar Codes](#). For example, to decode Matrix 2 of 5 symbols containing between 4 and 12 characters, first scan **Matrix 2 of 5 - Length Within Range**. Then scan **0, 4, 1**, and **2** (enter a leading zero for single digit numbers). To correct an error or change the selection, scan [Cancel on page G-2](#).
- **Any Length** - Scan this option to decode Matrix 2 of 5 symbols containing any number of characters within the digital scanner's capability.

Set Lengths for Matrix 2 of 5 (continued)



***Matrix 2 of 5 - One Discrete Length**



Matrix 2 of 5 - Two Discrete Lengths



Matrix 2 of 5 - Length Within Range



Matrix 2 of 5 - Any Length

Matrix 2 of 5 Check Digit

Parameter # 622 (SSI # F1h 6Eh)

The check digit is the last character of the symbol used to verify the integrity of the data. Scan the appropriate bar code below to transmit the bar code data with or without the Matrix 2 of 5 check digit.



**Enable Matrix 2 of 5 Check Digit
(1)**



***Disable Matrix 2 of 5 Check Digit
(0)**

Transmit Matrix 2 of 5 Check Digit

Parameter # 623 (SSI # F1h 6Fh)

Scan a bar code below to transmit Matrix 2 of 5 data with or without the check digit.



**Transmit Matrix 2 of 5 Check Digit
(1)**



***Do Not Transmit Matrix 2 of 5 Check Digit
(0)**

Korean 3 of 5

Enable/Disable Korean 3 of 5

Parameter # 581 (SSI # F1h 45h)

To enable or disable Korean 3 of 5, scan the appropriate bar code below.

✓ **NOTE** The length for Korean 3 of 5 is fixed at 6.

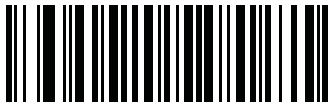

Enable Korean 3 of 5
(1)



***Disable Korean 3 of 5**
(0)

Inverse 1D

Parameter # 586 (SSI # F1h 4Ah)

This parameter sets the 1D inverse decoder setting. Options are:

- **Regular Only** - the digital scanner decodes regular 1D bar codes only.
- **Inverse Only** - the digital scanner decodes inverse 1D bar codes only.
- **Inverse Autodetect** - the digital scanner decodes both regular and inverse 1D bar codes.



***Regular**
(0)



Inverse Only
(1)



Inverse Autodetect
(2)

GS1 DataBar

The variants of GS1 DataBar are DataBar-14, DataBar Expanded, and DataBar Limited. The limited and expanded versions have stacked variants. Scan the appropriate bar codes to enable or disable each variant of GS1 DataBar.

GS1 DataBar-14

Parameter # 338 (SSI # F0h 52h)

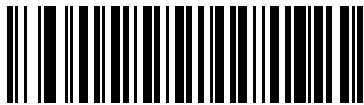

***Enable GS1 DataBar-14**
(1)

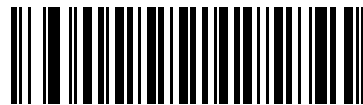

Disable GS1 DataBar-14
(0)

GS1 DataBar Limited

Parameter # 339 (SSI # F0h 53h)

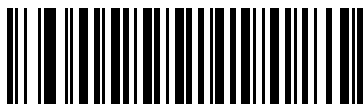

***Enable GS1 DataBar Limited**
(1)



Disable GS1 DataBar Limited
(0)

GS1 DataBar Expanded

Parameter # 340 (SSI # F0h 54h)

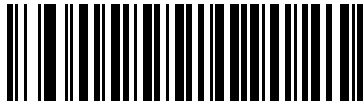

***Enable GS1 DataBar Expanded
(1)**

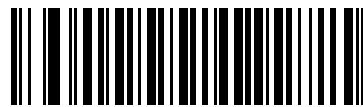

**Disable GS1 DataBar Expanded
(0)**

Convert GS1 DataBar to UPC/EAN

Parameter # 397 (SSI # F0h, 8Dh)

This parameter only applies to GS1 DataBar-14 and GS1 DataBar Limited symbols not decoded as part of a Composite symbol. Enable this to strip the leading '010' from DataBar-14 and DataBar Limited symbols encoding a single zero as the first digit, and report the bar code as EAN-13.

For bar codes beginning with two or more zeros but not six zeros, this parameter strips the leading '0100' and reports the bar code as UPC-A. The UPC-A Preamble parameter that transmits the system character and country code applies to converted bar codes. Note that neither the system character nor the check digit can be stripped.

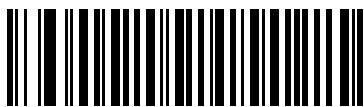

**Enable Convert GS1 DataBar to UPC/EAN
(1)**

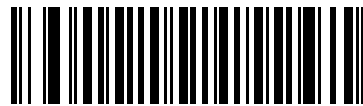

***Disable Convert GS1 DataBar to UPC/EAN
(0)**

GS1 DataBar Limited Security Level

Parameter # 728 (SSI # F1h D8h)

The digital scanner offers four levels of decode security for GS1 DataBar Limited bar codes. There is an inverse relationship between security and digital scanner aggressiveness. Increasing the level of security may result in reduced aggressiveness in scanning, so choose only that level of security necessary.

- Level 1 – No clear margin required. This complies with the original GS1 standard, yet might result in erroneous decoding of the DataBar Limited bar code when scanning some UPC symbols that start with digits “9” and “7”
- Level 2 – Automatic risk detection. This level of security may result in erroneous decoding of DataBar Limited bar codes when scanning some UPC symbols. The digital scanner defaults to Level 3, otherwise to Level 1.
- Level 3 – Security level reflects newly proposed GS1 standard that requires a 5 times trailing clear margin.
- Level 4 – Security level extends beyond the standard required by GS1. This level of security requires a 5 times leading and trailing clear margin.



GS1 DataBar Limited Security Level 1
(1)

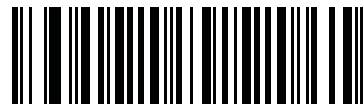

GS1 DataBar Limited Security Level 2
(2)



***GS1 DataBar Limited Security Level 3**
(3)

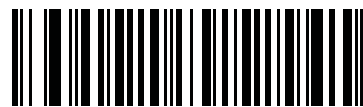

GS1 DataBar Limited Security Level 4
(4)

Composite

Composite CC-C

Parameter # 341 (SSI # F0h 55h)

Scan a bar code below to enable or disable Composite bar codes of type CC-C.

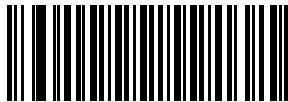

Enable CC-C
(1)



*Disable CC-C
(0)

Composite CC-A/B

Parameter # 342 (SSI # F0h 56h)

Scan a bar code below to enable or disable Composite bar codes of type CC-A/B.



Enable CC-A/B
(1)



*Disable CC-A/B
(0)

Composite TLC-39

Parameter # 371 (SSI # F0h 73h)

Scan a bar code below to enable or disable Composite bar codes of type TLC-39.

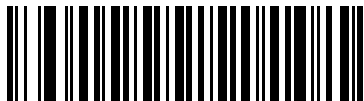

Enable TLC39
(1)

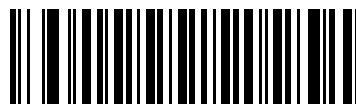

*Disable TLC39
(0)

UPC Composite Mode

Parameter # 344 (SSI # F0h 58h)

Select an option for linking UPC symbols with a 2D symbol during transmission as if they were one symbol:

- Select **UPC Never Linked** to transmit UPC bar codes regardless of whether a 2D symbol is detected.
- Select **UPC Always Linked** to transmit UPC bar codes and the 2D portion. If 2D is not present, the UPC bar code does not transmit.
- If you select **Autodiscriminate UPC Composites**, the digital scanner determines if there is a 2D portion, then transmits the UPC, as well as the 2D portion if present.



*UPC Never Linked
(0)



UPC Always Linked
(1)



Autodiscriminate UPC Composites
(2)

Composite Beep Mode

Parameter # 398 (SSI # F0h, 8Eh)

To select the number of decode beeps when a composite bar code is decoded, scan the appropriate bar code.

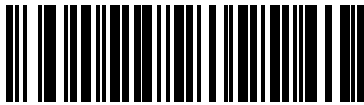

Single Beep after both are decoded
(0)

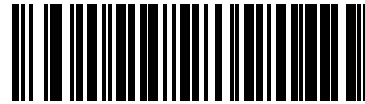

*Beep as each code type is decoded
(1)

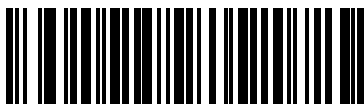

Double Beep after both are decoded
(2)

GS1-128 Emulation Mode for UCC/EAN Composite Codes

Parameter # 427 (SSI # F0h, ABh)

Select whether to enable or disable this mode.



Enable GS1-128 Emulation Mode for
UCC/EAN Composite Codes
(1)



*Disable GS1-128 Emulation Mode for
UCC/EAN Composite Codes
(0)

2D Symbologies

Enable/Disable PDF417

Parameter # 15 (SSI # 0Fh)

To enable or disable PDF417, scan the appropriate bar code below.



***Enable PDF417**
(1)



Disable PDF417
(0)

Enable/Disable MicroPDF417

Parameter # 227 (SSI # E3h)

To enable or disable MicroPDF417, scan the appropriate bar code below.



Enable MicroPDF417
(1)



***Disable MicroPDF417**
(0)

Code 128 Emulation

Parameter # 123 (SSI # 7Bh)

Enable this parameter to transmit data from certain MicroPDF417 symbols as Code 128. *AIM Code ID Character on page 4-34* must be enabled for this parameter to work.

Enable Code 128 Emulation to transmit these MicroPDF417 symbols with one of the following prefixes:

-]C1 if the first codeword is 903-905
-]C2 if the first codeword is 908 or 909
-]C0 if the first codeword is 910 or 911

Disable Code 128 Emulation to transmit these MicroPDF417 symbols with one of the following prefixes:

-]L3 if the first codeword is 903-905
-]L4 if the first codeword is 908 or 909
-]L5 if the first codeword is 910 or 911

Scan a bar code below to enable or disable Code 128 Emulation.



NOTE Linked MicroPDF codewords 906, 907, 912, 914, and 915 are not supported. Use GS1 Composites instead.



Enable Code 128 Emulation
(1)



***Disable Code 128 Emulation**
(0)

Data Matrix

Parameter # 292 (SSI # F0h, 24h)

To enable or disable Data Matrix, scan the appropriate bar code below.



***Enable Data Matrix
(1)**



**Disable Data Matrix
(0)**

GS1 Data Matrix

Parameter # 1336 (SSI # F8h 05h 38h)

To enable or disable GS1 Data Matrix, scan the appropriate bar code below.

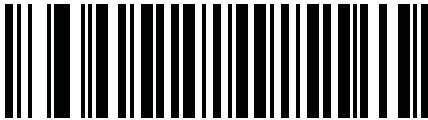

***Disable GS1 Data Matrix
(0)**

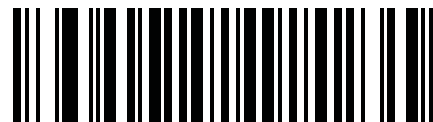

**Enable GS1 Data Matrix
(1)**

Data Matrix Inverse

Parameter # 588 (SSI # F1h 4Ch)

This parameter sets the Data Matrix inverse decoder setting. Options are:

- **Regular Only** - the digital scanner decodes regular Data Matrix bar codes only.
- **Inverse Only** - the digital scanner decodes inverse Data Matrix bar codes only.
- **Inverse Autodetect** - the digital scanner decodes both regular and inverse Data Matrix bar codes.



Regular
(0)



Inverse Only
(1)



*Inverse Autodetect
(2)

Maxicode

Parameter # 294 (SSI # F0h, 26h)

To enable or disable Maxicode, scan the appropriate bar code below.



Enable Maxicode
(1)



*Disable Maxicode
(0)

QR Code

Parameter # 293 (SSI # F0h, 25h)

✓ **NOTE** Inverse QR bar codes decode if **QR Code** is enabled.

To enable or disable QR Code, scan the appropriate bar code below.



***Enable QR Code**
(1)



Disable QR Code
(0)

GS1 QR

Parameter # 1343 (SSI # F8h 05h 3Fh)

To enable or disable GS1 QR, scan the appropriate bar code below.



***Disable GS1 QR**
(0)

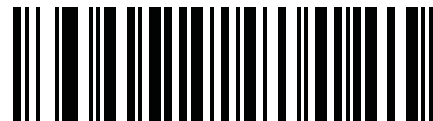

Enable GS1 QR
(1)

MicroQR

Parameter # 573 (SSI # F1h 3Dh)

To enable or disable MicroQR, scan the appropriate bar code below.



***Enable MicroQR
(1)**



**Disable MicroQR
(0)**

Aztec

Parameter # 574 (SSI # F1h 3Eh)

To enable or disable Aztec, scan the appropriate bar code below.



***Enable Aztec
(1)**



**Disable Aztec
(0)**

Aztec Inverse

Parameter # 589 (SSI # F1h 4Dh)

This parameter sets the Aztec inverse decoder setting. Options are:

- **Regular Only** - the digital scanner decodes regular Aztec bar codes only.
- **Inverse Only** - the digital scanner decodes inverse Aztec bar codes only.
- **Inverse Autodetect** - the digital scanner decodes both regular and inverse Aztec bar codes.



Regular
(0)



Inverse Only
(1)



*Inverse Autodetect
(2)

Han Xin

Parameter # 1167 (SSI # F8h 04h 8Fh)

To enable or disable Han Xin, scan the appropriate bar code below.



Enable Han Xin
(1)



*Disable Han Xin
(0)

Han Xin Inverse

Parameter # 1168 (SSI # F8h 04h 90h)

Select a Han Xin inverse decoder setting:

- **Regular Only** - the decoder decodes Han Xin bar codes with normal reflectance only.
- **Inverse Only** - the decoder decodes Han Xin bar codes with inverse reflectance only.
- **Inverse Autodetect** - the decoder decodes both regular and inverse Han Xin bar codes.

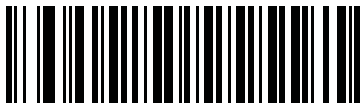

***Regular**
(0)



Inverse Only
(1)

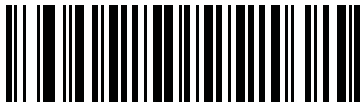

Inverse Autodetect
(2)

Postal Codes

US Postnet

Parameter # 89 (SSI # 59h)

To enable or disable US Postnet, scan the appropriate bar code below.



**Enable US Postnet
(1)**



***Disable US Postnet
(0)**

US Planet

Parameter # 90 (SSI # 5Ah)

To enable or disable US Planet, scan the appropriate bar code below.



**Enable US Planet
(1)**



***Disable US Planet
(0)**

Transmit US Postal Check Digit

Parameter # 95 (SSI # 5Fh)

Select whether to transmit US Postal data, which includes both US Postnet and US Planet, with or without the check digit.



***Transmit US Postal Check Digit
(1)**

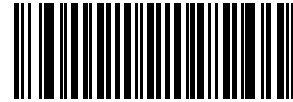

**Do Not Transmit US Postal Check Digit
(0)**

UK Postal

Parameter # 91 (SSI # 5Bh)

To enable or disable UK Postal, scan the appropriate bar code below.



**Enable UK Postal
(1)**



***Disable UK Postal
(0)**

Transmit UK Postal Check Digit

Parameter # 96 (SSI # 60h)

Select whether to transmit UK Postal data with or without the check digit.



***Transmit UK Postal
Check Digit
(1)**



**Do Not Transmit UK Postal Check Digit
(0)**

Japan Postal

Parameter # 290 (SSI # F0h, 22h)

To enable or disable Japan Postal, scan the appropriate bar code below.



**Enable Japan Postal
(1)**



***Disable Japan Postal
(0)**

Australia Post

Parameter # 291 (SSI # F0h, 23h)

To enable or disable Australia Post, scan the appropriate bar code below.



Enable Australia Post
(1)



***Disable Australia Post**
(0)

Australia Post Format

Parameter # 718 (SSI # F1h, CEh)

To select one of the following formats for Australia Post, scan the appropriate bar code below:

- **Autodiscriminate** (or Smart mode) - Attempt to decode the Customer Information Field using the N and C Encoding Tables.

✓ **NOTE** This option increases the risk of misdecodes because the encoded data format does not specify the Encoding Table used for encoding.

- **Raw Format** - Output raw bar patterns as a series of numbers 0 through 3.
- **Alphanumeric Encoding** - Decode the Customer Information Field using the C Encoding Table.
- **Numeric Encoding** - Decode the Customer Information Field using the N Encoding Table.

For more information on Australia Post Encoding Tables, refer to the *Australia Post Customer Barcoding Technical Specifications* available at <http://www.auspost.com.au>.



*Autodiscriminate
(0)



Raw Format
(1)



Alphanumeric Encoding
(2)



Numeric Encoding
(3)

Netherlands KIX Code

Parameter # 326 (SSI # F0h, 46h)

To enable or disable Netherlands KIX Code, scan the appropriate bar code below.



Enable Netherlands KIX Code
(1)



*Disable Netherlands KIX Code
(0)

USPS 4CB/One Code/Intelligent Mail

Parameter # 592 (SSI # F1h 50h)

To enable or disable USPS 4CB/One Code/Intelligent Mail, scan the appropriate bar code below.



Enable USPS 4CB/One Code/Intelligent Mail
(1)



*Disable USPS 4CB/One Code/Intelligent Mail
(0)

UPU FICS Postal

Parameter # 611 (SSI # F1h 63h)

To enable or disable UPU FICS Postal, scan the appropriate bar code below.

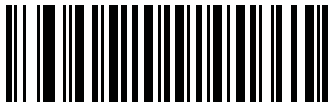

Enable UPU FICS Postal
(1)



***Disable UPU FICS Postal**
(0)

Mailmark

Parameter # 1337 (SSI # F8h 05h 39h)

To enable or disable Mailmark, scan the appropriate bar code below.

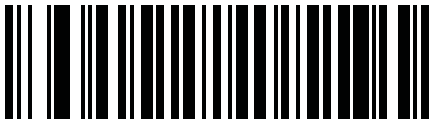

***Disable Mailmark**
(0)

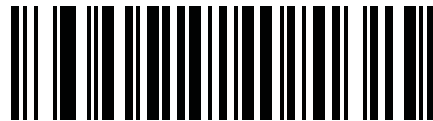

Enable Mailmark
(1)

Symbology-Specific Security Levels

Redundancy Level

Parameter # 78 (SSI # 4Eh)

The digital scanner offers four levels of decode redundancy. Select higher redundancy levels for decreasing levels of bar code quality. As redundancy levels increase, the digital scanner's aggressiveness decreases.

Select the redundancy level appropriate for the bar code quality.

Redundancy Level 1

The following code types must be successfully read twice before being decoded:

Table 11-2 *Redundancy Level 1 Codes*

Code Type	Code Length
Codabar	8 characters or less
MSI	4 characters or less
D 2 of 5	8 characters or less
I 2 of 5	8 characters or less

Redundancy Level 2

The following code types must be successfully read twice before being decoded:

Table 11-3 *Redundancy Level 2 Codes*

Code Type	Code Length
All	All

Redundancy Level 3

Code types other than the following must be successfully read twice before being decoded. The following codes must be read three times:

Table 11-4 *Redundancy Level 3 Codes*

Code Type	Code Length
MSI	4 characters or less
D 2 of 5	8 characters or less
I 2 of 5	8 characters or less
Codabar	8 characters or less

Redundancy Level 4

The following code types must be successfully read three times before being decoded:

Table 11-5 *Redundancy Level 4 Codes*

Code Type	Code Length
All	All

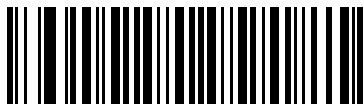

*Redundancy Level 1
(1)

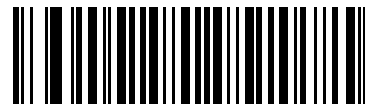

Redundancy Level 2
(2)

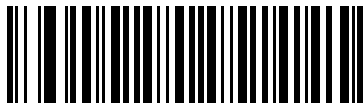

Redundancy Level 3
(3)

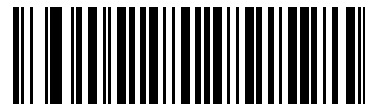

Redundancy Level 4
(4)

Security Level

Parameter # 77 (SSI # 4Dh)

The digital scanner offers four levels of decode security for delta bar codes, which include the Code 128 family, UPC/EAN, and Code 93. Select increasing levels of security for decreasing levels of bar code quality. There is an inverse relationship between security and digital scanner aggressiveness, so choose only that level of security necessary for any given application.

- **Security Level 0:** This setting allows the digital scanner to operate in its most aggressive state, while providing sufficient security in decoding most “in-spec” bar codes.
- **Security Level 1:** This default setting eliminates most misdecodes.
- **Security Level 2:** Select this option if Security level 1 fails to eliminate misdecodes.
- **Security Level 3:** If you selected Security Level 2 and misdecodes still occur, select this security level. Be advised, selecting this option is an extreme measure against mis-decoding severely out of spec bar codes. Selecting this level of security significantly impairs the decoding ability of the digital scanner. If you need this level of security, try to improve the quality of the bar codes.

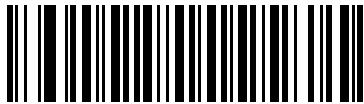

Security Level 0
(0)

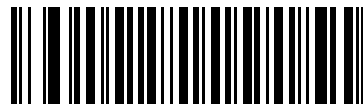

*Security Level 1
(1)

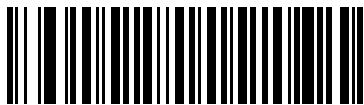

Security Level 2
(2)



Security Level 3
(3)

1D Quiet Zone Level

Parameter # 1288 (SSI # F8h 05h 08h)

This feature sets the level of aggressiveness in decoding bar codes with a reduced quiet zone (the area in front of and at the end of a bar code), and applies to symbologies enabled by a Reduced Quiet Zone parameter. Because higher levels increase the decoding time and risk of misdecodes, Symbol Technologies strongly recommends enabling only the symbologies which require higher quiet zone levels, and leaving Reduced Quiet Zone disabled for all other symbologies. Options are:

- 0 - The digital scanner performs normally in terms of quiet zone.
- 1 - The digital scanner performs more aggressively in terms of quiet zone.
- 2 - The digital scanner only requires one side EB (end of bar code) for decoding.
- 3 - The digital scanner decodes anything in terms of quiet zone or end of bar code.



1D Quiet Zone Level 0
(0)



*1D Quiet Zone Level 1
(1)

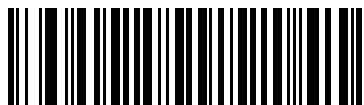

1D Quiet Zone Level 2
(2)

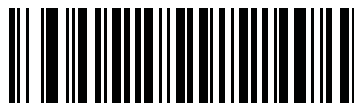

1D Quiet Zone Level 3
(3)

Intercharacter Gap Size

Parameter # 381 (SSI # F0h, 7Dh)

The Code 39 and Codabar symbologies have an intercharacter gap that is typically quite small. Due to various bar code-printing technologies, this gap can grow larger than the maximum size allowed, preventing the digital scanner from decoding the symbol. If this problem occurs, scan the Large Intercharacter Gaps parameter to tolerate these out-of-specification bar codes.



***Normal Intercharacter Gaps**
(6)



Large Intercharacter Gaps
(10)

Macro PDF Features

Macro PDF is a special feature for concatenating multiple PDF symbols into one file. The digital scanner can decode symbols that are encoded with this feature, and can store more than 64 Kb of decoded data stored in up to 50 MacroPDF symbols.



CAUTION When printing, keep each Macro PDF sequence separate, as each sequence has unique identifiers. Do not mix bar codes from several Macro PDF sequences, even if they encode the same data. When scanning Macro PDF sequences, scan the entire Macro PDF sequence without interruption. If, when scanning a mixed sequence, the digital scanner emits two long low beeps (Low/Low) this indicates an inconsistent file ID or inconsistent symbology error.

Flush Macro Buffer

This flushes the buffer of all decoded Macro PDF data stored to that point, transmits it to the host device, and aborts from Macro PDF mode.



Flush Macro PDF Buffer

Abort Macro PDF Entry

This clears all currently-stored Macro PDF data in the buffer without transmission and aborts from Macro PDF mode.



Abort Macro PDF Entry

CHAPTER 12 INTELLIGENT DOCUMENT CAPTURE

Introduction

Intelligent Document Capture (IDC) is Zebra advanced image processing firmware for select imager based decoders. This chapter describes the IDC functionality, provides parameter bar codes to control its features, and includes a quick start procedure to get you started with IDC.

✓ **NOTE** IDC pertains to the DS3608-HP configuration only.

The IDC Process

Intelligent Document Capture:

1. Verifies a bar code is appropriate to use as an IDC anchor or link. See [Bar Code Acceptance Test](#).
2. Determines the rectangular region to capture as an image. See [Capture Region Determination on page 12-2](#).
3. Processes the captured image. See [Image Post Processing on page 12-3](#).
4. Transmits the data. See [Data Transmission on page 12-3](#).

Bar Code Acceptance Test

Upon decoding a bar code, the decoder checks to ensure that the bar code fits the description of a bar code that anchors or links to an IDC form. To be accepted as an IDC bar code:

- The symbology must be enabled in the IDC symbology parameter and enabled for decode in the decoder. The IDC firmware allows enabling between zero and eight symbologies simultaneously: Code 128, Code 39, Interleaved 2 of 5, Discrete 2 of 5, Codabar, PDF417, Data Matrix, and EAN-128.
- The decoded data must satisfy the values set in the *IDC Minimum Text Length* and *IDC Maximum Text Length* parameters. To disable either of these checks, set the value to zero.

If the bar code does not satisfy both requirements, it is sent as a normal (non-IDC) decode.

An IDC bar code is required when *IDC Operating Mode on page 12-5* is set to **Anchored** or **Linked**.

Free-Form operating mode does not require a bar code, but transmits decoded data if one is found and satisfies the requirements. If no bar code is decoded, the document capture process starts but can be subject to the following condition: specify a non-zero value for the *IDC Delay Time on page 12-15*. The decoder must wait for at least this amount of time after trigger pull before capturing a document, unless a bar code is decoded before the time expires.

If *Picklist Mode on page 4-21* is enabled, the bar code must be directly under the aiming pattern, within the decoder's decode range, and the region to capture completely within the engine's field-of-view.

Capture Region Determination

After accepting an IDC bar code, the firmware establishes the region to capture as an image. The method used depends on the setting of the *IDC Operating Mode* as follows.

The IDC firmware emits a single low beep after successfully capturing a region. The engine is then no longer capturing images and can be moved without disturbing the IDC output. Be sure to hold the trigger button until the decode beep, otherwise the IDC process may be aborted.

IDC Operating Mode = Anchored

A coordinate system is built based on the bar code in its rectified (de-skewed) form. The origin is the center of the bar code, and the x-axis is set toward the right, from the bar code's point of view. The unit module width of the bar code is the unit for x. Similarly, the y-axis is set toward the up direction. The unit for the y-axis is specified via the parameter *IDC Aspect on page 12-9*. This is the aspect ratio of a thin bar or space - the bar code's height is divided by this value to get the unit in the y-axis. The aspect ratio is calculated automatically if *IDC Aspect* is set to zero. The bar code can be of different sizes for the same form, as long as the center of the bar code is the same when the bar code's length changes.

From this coordinate system, the IDC area is determined using four parameters: offsets in x and y (*IDC X Coordinate*, *IDC Y Coordinate*) to the region's top-left corner, and width and height (*IDC Width*, *IDC Height*).

If the capture area is relatively large as compared to the bar code area, the calculation to obtain the capture area is prone to significant errors. A recommended solution is to enclose the form with a single black-lined rectangular border (a box), which is not in contact with any other line on the outside of the form (although it can be connected to lines on the inside of the form). When the *IDC Find Box Outline* is set, the firmware searches for the box, and does not decode if any edges are broken (such as by a protruding thumb).

The *IDC Zoom Limit* parameter controls the quality of the captured form. The IDC firmware rejects capturing a form unless the width is at least the *IDC Zoom Limit* percentage of the *IDC Width* parameter. For example, if *IDC Zoom Limit* is set to 100 and *IDC Width* is set to 150, the form must be at least 300 pixels wide before it is captured (each unit module is scaled to two pixels).

The *IDC Maximum Rotation* parameter controls the maximum rotation any edge of the form can have in relation to the scanner's horizontal or vertical axis.

IDC Operating Mode = Free-Form or Linked

The document capture region is a rectangular piece of paper, or a portion of it enclosed by a rectangular border. In either case, all four sides of the capture region must be completely within the engine's field-of-view, and there must be sufficient contrast at the border of the capture region. For example, if a piece of white paper contains the document to capture, it must be put in front of a dark background.

By default, the engine captures the largest rectangular region within the field-of-view. To specify a particular border type, use the *IDC Border Type* parameter.

The region must contain at least 10% of the field-of-view in two dimensions.

If an IDC bar code is decoded, its location is used to start the search for the capture region. Otherwise, the capture region is searched from the center of the field-of-view. IDC also uses the orientation of a decoded IDC bar code to orient the output image.

Image Post Processing

After determining the document capture region, the firmware de-skews and re-samples the region as described below. Enabling *IDC Captured Image Brighten* calls normalization, where the brightness of the image is made uniform, and contrast is enhanced as a large percent of background pixels is made completely white (a smaller percent of pixels is made completely black if the firmware determines there is no danger of enhancing the contrast of a very bland area). Enabling *IDC Captured Image Sharpen* enhances the sharpness of the image.

The image is re-sampled about one output pixel per input pixel for **Free-Form** or **Linked** modes and two pixels-per-module in **Anchored** mode.

The image is compressed and transmitted in one of the standard image formats selected by the *IDC File Format Selector*, *IDC Bits Per Pixel*, and *IDC JPEG Quality* parameters.

Note that it may take several seconds for post processing to complete, depending on the size of the captured region, the options enabled, and the decoder model.

Data Transmission

After processing the captured image, it is assembled with the decoded bar code data (if applicable) into an ISO/IEC 15434 style packet and transmitted to the host. The decoder issues the standard decode beep and the trigger can be released. Be sure the *USB Device Type on page 6-5* is set to **Symbol Native API (SNAPI) with Imaging Interface**.

PC Application and Programming Support

For a sample application running on the Microsoft Windows operating system, contact your Zebra representative. This application displays bar code data and/or captured images from Intelligent Document Capture enabled decoders and allows setting and reading IDC parameters. Complete source code and documentation are also provided for developing custom applications. The application includes documentation for the ISO/IEC 15434 format as used by the IDC firmware and C# code to process it.

Parameters

This section describes the parameters controlling the IDC firmware and provides programming bar codes for setting them.

To set parameters requiring a range of values, scan the parameter bar code followed by two, three, or four bar codes from [Appendix G, Numeric Bar Codes](#) corresponding to the desired value. Scan two numeric bar codes for parameters with a maximum value of less than 100, for example, [IDC Minimum Text Length](#). [IDC Delay Time](#) requires scanning three digits since the maximum value is 200. Leading zeros are required.

Alternatively, use the sample application to set parameters using the parameter name. The application provides prompts and error checking to assist in setting the parameters correctly and easily. You must use an application to set a parameter to a negative value, as the [IDC X Coordinate](#) can require.

Table 12-1 *Intelligent Document Capture (IDC) Parameter Defaults*

Parameter	Parameter Name	Parameter Number	SSI Number	Default	Page Number
Intelligent Document Capture (IDC)					
IDC Operating Mode	DocCap_MODE	594	F1h 52h	Off	12-5
IDC Symbology	DocCap_SYMBOLOGY	655	F1h 8Fh	001	12-6
IDC X Coordinate	DocCap_X	596	F4h F1h 54h	-151	12-7
IDC Y Coordinate	DocCap_Y	597	F4h F1h 55h	-050	12-7
IDC Width	DocCap_WIDTH	598	F1h 56h	0300	12-8
IDC Height	DocCap_HEIGHT	599	F1h 57h	0050	12-8
IDC Aspect	DocCap_ASPECT	595	F1h 53h	000	12-9
IDC File Format Selector	DocCap_FMT	601	F1h 59h	JPEG	12-9
IDC Bits Per Pixel	DocCap_BPP	602	F1h 5Ah	8 BPP	12-10
IDC JPEG Quality	DocCap_JPEG_Qual	603	F1h 5Bh	065	12-10
IDC Find Box Outline	Sig_FINDBOX	727	F1h D7h	Disable	12-11
IDC Minimum Text Length	DocCap_MIN_TEXT	656	F1h 90h	00	12-11
IDC Maximum Text Length	DocCap_MAX_TEXT	657	F1h 91h	00	12-12
IDC Captured Image Brighten	Sig_BRIGHTEN	654	F1h 8Eh	Enable	12-12
IDC Captured Image Sharpen	Sig_SHARPEN	658	F1h 92h	Enable	12-13
IDC Border Type	DocCap_BORDER	829	F2h 3Dh	None	12-14
IDC Delay Time	DocCap_DELAY	830	F2h 3Eh	000	12-15
IDC Zoom Limit	Sig_MIN_PERCENT	651	F1h 8Bh	000	12-15
IDC Maximum Rotation	Sig_MAX_ROT	652	F1h 8Ch	00	12-16

IDC Operating Mode

Parameter Name: DocCap_MODE

Parameter # 594 (SSI # F1h 52h)

Select the operating mode of the Intelligent Document Capture firmware:

- **Off** - Disables the IDC feature.
- **Anchored** - Requires a bar code decode. The image capture region is based off this bar code.
- **Free-Form** - A printed border or page edge defines the image capture region. A bar code is optional.
- **Linked** - A printed border or page edge defines the image capture region. A bar code is required.

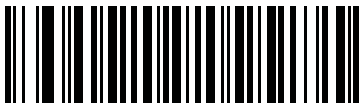

*Off
(0)

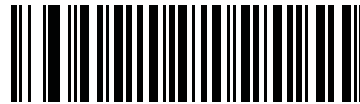

Anchored
(1)

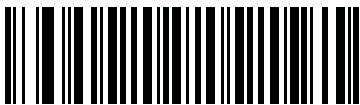

Free-Form
(2)

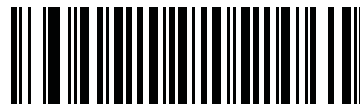

Linked
(3)

IDC Symbology

Parameter Name: DocCap_SYMBOLGY

Parameter # 655 (SSI # F1h 8Fh)

Select the bar code type(s) to use when Document Capture mode is not set to **Off**. To enable more than one symbology at a time, simply add the values together. For example, to enable PDF417, Data Matrix, and Code 39 write a value of 98 (32 + 64 + 2).

Scan the bar code below, followed by three bar codes from [Appendix G, Numeric Bar Codes](#) in the range of 000 to 255 decimal. The default is 001.

Table 12-2 *IDC Symbologies*

Symbology	Value (Decimal)
Code 128	1
Code 39	2
I 2 of 5	4
D 2 of 5	8
Codabar	16
PDF417	32
Data Matrix	64
EAN 128	128



IDC Symbology

IDC X Coordinate

Parameter Name: DocCap_X

Parameter # 596 (SSI # F4h F1h 54h)

Specify the horizontal offset to the top left corner of the region to capture relative to the center of the bar code. Negative values move toward the left. This parameter only applies when *IDC Operating Mode* is set to **Anchored**.

Scan the bar code below, followed by four bar codes from *Appendix G, Numeric Bar Codes* in the range of +/- 1279. The default is -151. Note that you must use an application to set a negative value.



IDC X Coordinate

IDC Y Coordinate

Parameter Name: DocCap_Y

Parameter # 597 (SSI # F4h F1h 55h)

Specify the vertical offset to the top left corner of the region to capture relative to the center of the bar code. Negative values move toward the top. This parameter only applies when *IDC Operating Mode* is set to **Anchored**.

Scan the bar code below, followed by four bar codes from *Appendix G, Numeric Bar Codes* in the range of +/- 1023. The default is -050. Note that you must use an application to set a negative value.

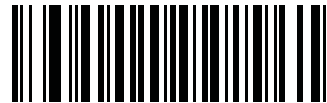

IDC Y Coordinate

IDC Width

Parameter Name: DocCap_WIDTH

Parameter # 598 (SSI # F1h 56h)

Specify the width of the region to capture. This parameter only applies when *IDC Operating Mode* is set to **Anchored**.

Scan the bar code below, followed by four bar codes from *Appendix G, Numeric Bar Codes* in the range of 0000 to 1279. The default is 0300.



IDC Width

IDC Height

Parameter Name: DocCap_HEIGHT

Parameter # 599 (SSI # F1h 57h)

Specify the height of the region to capture. This parameter only applies when *IDC Operating Mode* is set to **Anchored**.

Scan the bar code below, followed by four bar codes from *Appendix G, Numeric Bar Codes* in the range of 0000 to 1279. The default is 0050.



IDC Height

IDC Aspect

Parameter Name: DocCap_ASPECT

Parameter # 595 (SSI # F1h 53h)

Specify the bar code's aspect ratio of a thin bar or space. The bar code's height is divided by this value to get the unit in the y-axis. The aspect value is calculated automatically if this parameter is set to zero.

This parameter only applies when *IDC Operating Mode* is set to **Anchored**.

Scan the bar code below, followed by three bar codes from *Appendix G, Numeric Bar Codes* in the range of 000 to 255. The default is 000.

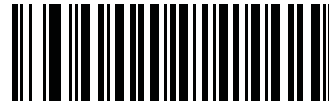

IDC Aspect

IDC File Format Selector

Parameter Name: DocCap_FMT

Parameter # 601 (SSI # F1h 59h)

Select a document capture file format appropriate for your system (BMP, TIFF, or JPEG). The decoder stores captured areas in the selected format.



*JPEG
(1)



BMP
(3)



TIFF
(4)

IDC Bits Per Pixel

Parameter Name: DocCap_BPP

Parameter # 602 (SSI # F1h 5Ah)

Select the number of significant bits per pixel (BPP) to use when capturing an image. Select 1 BPP for a black and white image, 4 BPP to assign 1 of 16 grey levels to each pixel, or 8 BPP to assign 1 of 256 levels of grey to each pixel.

✓ **NOTE** The decoder ignores these settings for JPEG file formats, which only support 8 BPP.



1 BPP
(0)



4 BPP
(1)



*8 BPP
(2)

IDC JPEG Quality

Parameter Name: DocCap_JPEG_Qual

Parameter # 603 (SSI # F1h 5Bh)

Set the amount of JPEG compression to perform on the captured image. Higher numbers produce a better quality image but larger files.

Scan the bar code below, followed by three bar codes from [Appendix G, Numeric Bar Codes](#) in the range of 005 to 100 decimal. The default is 065.



IDC JPEG Quality

IDC Find Box Outline

Parameter Name: Sig_FINDBOX

Parameter # 727 (SSI # F1h D7h)

Select **Enable Find Box Outline** to instruct the firmware to search for a rectangular border during document capture. This parameter only applies when *IDC Operating Mode* is set to **Anchored**.



*Disable Find Box Outline
(0)

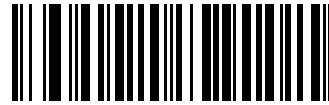

Enable Find Box Outline
(1)

IDC Minimum Text Length

Parameter Name: DocCap_MIN_TEXT

Parameter # 656 (SSI # F1h 90h)

Specify the minimum number of characters encoded in a bar code for the IDC firmware to use it as an anchored or linked bar code. Set this to zero (the default) to disable all checking and use all bar codes.

Scan the bar code below, followed by two bar codes from *Appendix G, Numeric Bar Codes* in the range of 00 to 55 decimal. The default is 00.

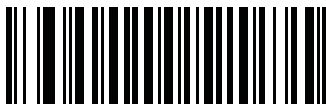

IDC Minimum Text Length

IDC Maximum Text Length

Parameter Name: DocCap_MAX_TEXT

Parameter # 657 (SSI # F1h 91h)

Specify the maximum number of characters encoded in a bar code for the IDC firmware to use it as an anchored or linked bar code. Set this to zero (the default) to disable all checking and use all bar codes.

Scan the bar code below, followed by two bar codes from [Appendix G, Numeric Bar Codes](#) in the range of 00 to 55 decimal. The default is 00.



IDC Maximum Text Length

IDC Captured Image Brighten

Parameter Name: Sig_BRIGH滕EN

Parameter # 654 (SSI # F1h 8Eh)

Enable **Captured Image Brighten** to make image brightness uniform and enhance contrast such that a large percent of the background pixels is made completely white (a smaller percentage of pixels is made completely black if the program determines there is no danger of enhancing the contrast of a very bland area).

✓ **NOTE** This parameter is also used for Signature Capture.



Disable Captured Image Brighten
(0)

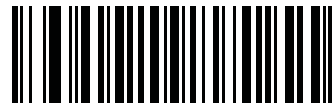

*Enable Captured Image Brighten
(1)

IDC Captured Image Sharpen

Parameter Name: Sig_SHARPEN

Parameter # 658 (SSI # F1h 92h)

Enable this to enhance the sharpness of the image.

✓ **NOTE** This parameter is also used for Signature Capture.



Disable Captured Image Sharpen
(0)



*Enable Captured Image Sharpen
(1)

IDC Border Type

Parameter Name: DocCap_BORDER

Parameter # 829 (SSI # F2h 3Dh)

Select the style of border used to determine the outline of the capture region in **Free-Form** and **Linked** modes:

- Select **None** to capture the largest rectangular region within the field-of-view.
- Select **Black** to indicate that the border must be black (such as a printed rectangular border).
- Select **White** to indicate that the border must be white (e.g., paper edge on a dark background).
- Select **Advanced Edge Detection (AED)** to capture a region defined by edges of any color and potentially broken.

This parameter is only used in **Free-Form** and **Linked** modes.



*None
(0)



Black
(1)



White
(2)



Advanced Edge Detection (AED)
(3)

IDC Delay Time

Parameter Name: DocCap_DELAY

Parameter # 830 (SSI # F2h 3Eh)

Set the delay for capturing a document after a trigger pull. Decoding a bar code aborts this delay. This parameter only applies in **Free-Form** mode.

Scan the bar code below, followed by three bar codes from [Appendix G, Numeric Bar Codes](#) in the range of 000 to 200 decimal in units of 10 msec. The default is 000.

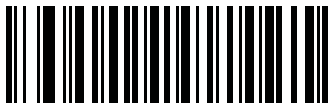

IDC Delay Time

IDC Zoom Limit

Parameter Name: Sig_MIN_PERCENT

Parameter # 651 (SSI # F1h 8Bh)

Set the minimal "zoom" percentage value of a form for it to be considered for capture. This controls the quality of the captured form. The IDC firmware rejects capturing a form unless the width is at least the *IDC Zoom Limit* percentage of the *IDC Width* parameter. For example, if you set this parameter to 100 and *IDC Width* to 150, the form must be at least 300 pixels wide before it is captured (each unit module is scaled to two pixels).

Set this to zero (the default) to disable all checking. This parameter only applies in **Anchored** mode.

Scan the bar code below, followed by three bar codes from [Appendix G, Numeric Bar Codes](#) in the range of 000 to 100 percent. The default is 000.



IDC Zoom Limit

IDC Maximum Rotation

Parameter Name: Sig_MAX_ROT

Parameter # 652 (SSI # F1h 8Ch)

Set the maximum rotation any edge of the form can have in relation to the decoder's horizontal or vertical axis for it to be considered for capture. Set this to zero (the default) to disable all checking. This parameter only applies in **Anchored** mode.

Scan the bar code below, followed by two bar codes from [Appendix G, Numeric Bar Codes](#) in the range of 00 to 45 decimal. The default is 00.

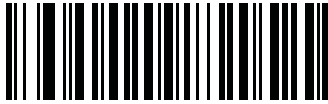

IDC Maximum Rotation

Quick Start

This section familiarizes you with some of the Intelligent Document Capture features. [IDC Demonstrations on page 12-18](#) includes instructions to demonstrate the Anchored, Free-Form, and Linked modes using a sample form to help provide an understanding of how to use IDC. These examples do not illustrate all capabilities of the advanced IDC firmware. Build upon these using different parameter settings and forms.

Sample IDC Setup

To set up IDC with the decoder:

1. Connect a decoder equipped with the Intelligent Document Capture feature to the host computer's USB port.
2. To set the decoder to the default settings and proper USB host type, scan **Set Defaults** followed by the **Symbol Native API (SNAPI) with Imaging Interface** bar code. Allow time for the decoder to reset and the USB connection to remunerate after each scan before continuing.



Set Defaults



Symbol Native API (SNAPI) with Imaging Interface

3. Start the sample application and select the decoder in the **SNAPI Scanners** drop-down menu.
4. Set the parameters as specified in [IDC Demonstrations on page 12-18](#) using the sample application or by scanning parameter bar codes in this guide. The bar code in the sample form is Code 128, which is enabled by default for decoding and as a Document Capture symbology. You can change these settings for your IDC application.
5. Perform the list of suggestions in each demo. When scanning, aim the engine at the bar code in the center of the rectangle. Pull the engine back so the rectangle is fully contained in the aiming pattern. When you pull the trigger, the decoder emits a low tone to indicate that the IDC firmware identified and captured an image, then a decode beep to indicate that the data is processed and transmitted. There may be several seconds between the two beeps, depending on the size of the captured image and options selected (de-skew, brighten, etc). You can move the decoder after the first beep, but continue to hold the trigger or the decoder may end the session before sending the data.

IDC Demonstrations

Anchored Mode Demo

Set parameters to these values:

Table 12-3 *Anchored Mode Sample Parameter Values*

Parameter	Value
IDC Operating Mode	Anchored
IDC Height	100
IDC Width	90
IDC X Coordinate	-175
IDC Y Coordinate	-50

- Pull the trigger. The decoder decodes the bar code and captures an image of the text scroll.
- Rotate the form clockwise so the word **Capture** is along the bottom edge, and pull the trigger. The decoder decodes the bar code and captures the same image, including orientation. (This example also works with the form rotated counterclockwise or upside down).
- Modify the values for height, width, x, and y. Pull the trigger. The captured area changes in size and location.
- Cover the bar code with a small piece of paper (or your finger) and pull the trigger. The decoder does not decode the bar code or capture an image.

What this demonstrates:

The Intelligent Document Capture Anchored mode captures an image of fixed size and location relative to a bar code on the page. Parameters control the height, width, and location. The IDC firmware requires that a bar code is present in order to capture an image, decodes it, and uses it to adjust the image to the upright orientation.

Free-Form Mode Demo

Set IDC Operating Mode to **Free-Form**.

- Pull the trigger. The decoder decodes the bar code and captures an image of the entire rectangle, including the contents.
- Modify the values for height, width, x, and y. Pull the trigger. Note that the captured image is not affected.
- Rotate the form clockwise so the word **Capture** is along the bottom edge, and pull the trigger. The decoder decodes the bar code and captures the same image, including orientation. (This example also works with the form rotated counterclockwise or upside down).
- Cover the bar code with a small piece of paper and pull the trigger. The decoder does not decode the bar code and does not re-orient the captured image to the normal position, i.e., with the logo in upper-left corner.

What this demonstrates:

The Intelligent Document Capture Free-Form mode captures an image whose size and position are determined by a rectangular border on the page. It adjusts the image to the upright orientation if a bar code is found and decoded in the image.

Linked Mode Demo

Set IDC Operating Mode to **Linked**.

The examples from Free-Form mode also work in Linked mode except that the last one (with the bar code covered) does not decode the bar code or capture an image.

What this demonstrates:

The Intelligent Document Capture Linked mode captures an image whose size and position are determined by a rectangular border on the page. The IDC firmware requires that a bar code is present in order to capture an image, decodes it, and uses it to adjust the image to the upright orientation

Other Suggestions

Hold the decoder at an angle (up/down or side to side) to the page instead of perpendicular to it. The IDC firmware de-skews and adjusts the brightness (enabled by default) to produce a quality image when the decoder is held at less than ideal conditions.

Quick Start Form

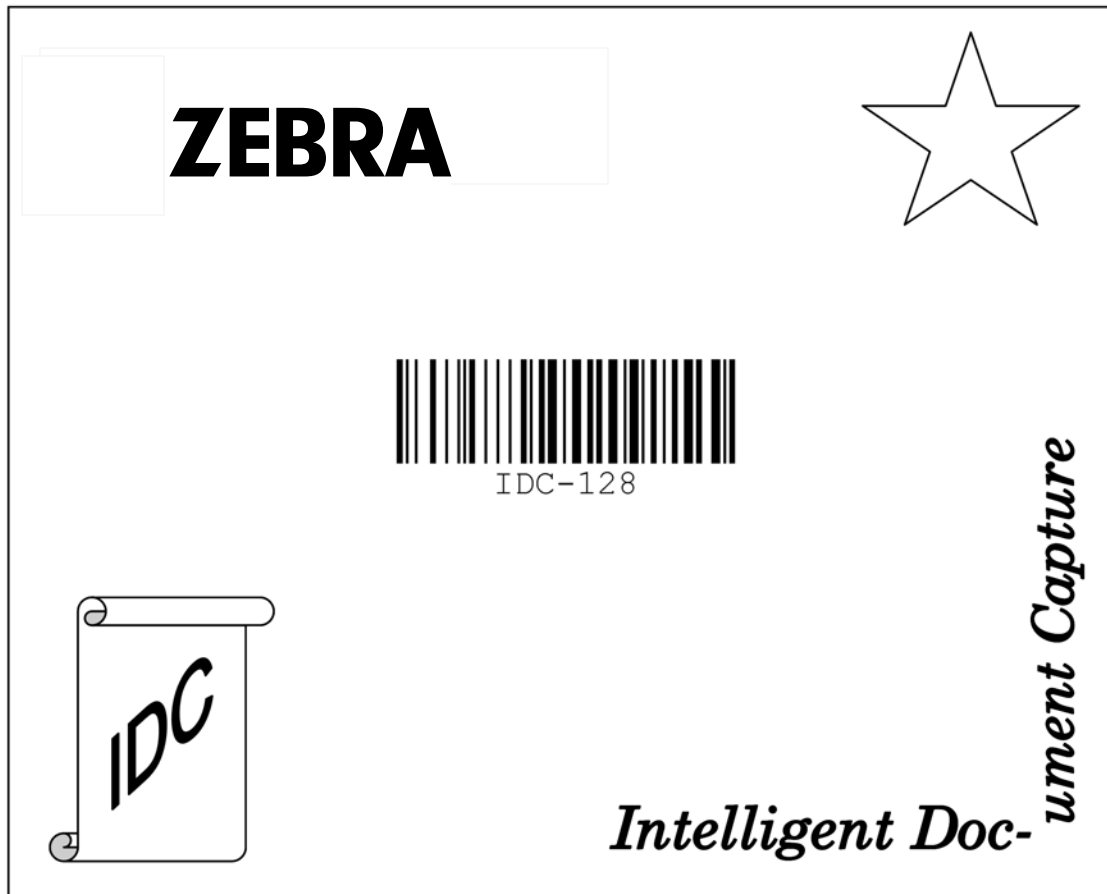

Figure 12-1 Quick Start Form

CHAPTER 13 OCR PROGRAMMING

Introduction

This chapter describes how to set up the digital scanner for OCR programming. The digital scanner can read 6 to 60 point OCR typeface. It supports font types OCR-A, OCR-B, MICR-E13B, and US Currency Serial Number.

OCR is not as secure as a bar code. To decrease OCR misdecodes and speed OCR reading, set an accurate OCR template and character subset, and use a check digit.

All OCR fonts are disabled by default. Enabling OCR can slow bar code decoding. Enabling more than one OCR font could also slow OCR decoding and impact OCR decoding accuracy.

Throughout the programming bar code menus, asterisks (*) indicate default values. OCR Parameter Defaults



* Indicates Default — *Disable OCR-A — Feature/Option

✓ **NOTE** OCR pertains to the DS3608-HP configuration only.

✓ **NOTE** Most computer monitors allow scanning the bar codes directly on the screen. When scanning from the screen, be sure to set the document magnification to a level where you can see the bar code clearly, and bars and/or spaces are not merging.

[Table 13-1](#) lists the defaults for OCR parameters. To change any option, scan the appropriate bar code(s) provided in the Parameter Descriptions section beginning on [page 13-3](#).

✓ **NOTE** See [Appendix A, Standard Default Parameters](#) for all user preferences, hosts, symbologies, and miscellaneous default parameters.

Table 13-1 *OCR Programming Default Table*

Parameter	Parameter Number	SSI Number	Default	Page Number
OCR Programming Parameters				
OCR-A	680	F1h A8h	Disable	13-3
OCR-A Variant	684	F1h ACh	Full ASCII	13-3
OCR-B	681	F1h A9h	Disable	13-5
OCR-B Variant	685	F1h ADh	Full ASCII	13-6
MICR E13B	682	F1h AAh	Disable	13-9
US Currency	683	F1h ABh	Disable	13-10
OCR Orientation	687	F1h AFh	0°	13-10
OCR Lines	691	F1h B3h	1	13-12
OCR Minimum Characters	689	F1h B1h	3	13-12
OCR Maximum Characters	690	F1h B2h	100	13-13
OCR Subset	686	F1h AEh	Selected font variant	13-13
OCR Quiet Zone	695	F1h B7h	50	13-14
OCR Template	547	F1h 23h	54R	13-15
OCR Check Digit Modulus	688	F1h B0h	1	13-25
OCR Check Digit Multiplier	700	F1h BCh	121212121212	13-26
OCR Check Digit Validation	694	F1h B6h	None	13-27
Inverse OCR	856	F2h 58h	Regular	13-32

OCR Programming Parameters

Enable/Disable OCR-A

Parameter # 680 (SSI # F1h A8h)

To enable or disable OCR-A, scan one of the following bar codes.

- ✓ **NOTE** OCR is not as secure as a bar code. To decrease OCR misdecodes and speed OCR reading, set an accurate OCR template and character subset, and use a check digit. See [OCR Subset on page 13-13](#) and [OCR Template on page 13-15](#).
- ✓ **NOTE** All OCR fonts are disabled by default. Enabling OCR can slow bar code decoding. Enabling more than one OCR font could also slow OCR decoding and impact OCR decoding accuracy.



Enable OCR-A
(1)

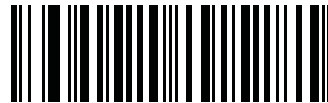

*Disable OCR-A
(0)

OCR-A Variant

Parameter # 684 (SSI # F1 ACh)

Font variant sets a processing algorithm and default character subset for the given font. To choose a variant, scan one of the following bar codes. Selecting the most appropriate font variant optimizes performance and accuracy.

OCR-A supports the following variants:

- OCR-A Full ASCII
!"#\$()*+,-./0123456789<>ABCDEFGHIJKLMNOPQRSTUVWXYZ^`
- OCR-A Reserved 1
\$*+,-./0123456789ABCDEFGHIJKLMNOPQRSTUVWXYZ
- OCR-A Reserved 2
\$*+,-./0123456789<>ABCDEFGHIJKLMNOPQRSTUVWXYZ
- OCR-A Banking
-0123456789<> ۞ ۞ ۞

OCR-A Variant (continued)

Special banking characters output as the following representative characters:

ƒ outputs as f

¢ outputs as c

℥ outputs as h

✓ **NOTE** Enable OCR-A before setting this parameter. If disabling OCR-A, set the variant to its default (OCR-A Full ASCII).



***OCR-A Full ASCII
(0)**



**OCR-A Reserved 1
(1)**

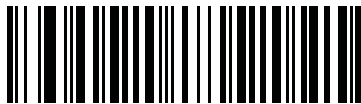

**OCR-A Reserved 2
(2)**



**OCR-A Banking
(3)**

Enable/Disable OCR-B

Parameter # 681 (SSI # F1h A9h)

To enable or disable OCR-B, scan one of the following bar codes.

- ✓ **NOTE** OCR is not as secure as a bar code. To decrease OCR misdecodes and speed OCR reading, set an accurate OCR template and character subset, and use a check digit. See [OCR Subset on page 13-13](#) and [OCR Template on page 13-15](#).
- ✓ **NOTE** All OCR fonts are disabled by default. Enabling OCR can slow bar code decoding. Enabling more than one OCR font could also slow OCR decoding and impact OCR decoding accuracy.



**Enable OCR-B
(1)**

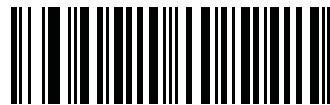

***Disable OCR-B
(0)**

OCR-B Variant

Parameter # 685 (SSI # F1h ADh)

OCR-B has the following variants. Selecting the most appropriate font variant affects performance and accuracy.

- OCR-B Full ASCII
!#\$%()*+,-./0123456789<>ABCDEFGHIJKLMNOPQRSTUVWXYZ^|ñ
- OCR-B Banking
#+-0123456789<>JNP|
- OCR-B Limited
+,-./0123456789<>ACENPSTVX
- OCR-B ISBN 10-Digit Book Numbers
-0123456789>BCEINPSXz
- OCR-B ISBN 10 or 13-Digit Book Numbers
-0123456789>BCEINPSXz
- OCR-B Travel Document Version 1 (TD1) 3-Line ID Cards
-0123456789<ABCDEFGHIJKLMNOPQRSTUVWXYZ
- OCR-B Travel Document Version 2 (TD2) 2-Line ID Cards
-0123456789<ABCDEFGHIJKLMNOPQRSTUVWXYZ
- OCR-B Travel Document 2 or 3-Line ID Cards Auto-Detect
!#\$%()*+,-./0123456789<>ABCDEFGHIJKLMNOPQRSTUVWXYZ^|ñ
- OCR-B Passport
-0123456789<ABCDEFGHIJKLMNOPQRSTUVWXYZñ
- OCR-B Visa Type A
-0123456789<ABCDEFGHIJKLMNOPQRSTUVWXYZ
- OCR-B Visa Type B
-0123456789<ABCDEFGHIJKLMNOPQRSTUVWXYZñ
- OCR-B ICAO Travel Documents
This allows reading either TD1, TD2, Passport, Visa Type A, or Visa Type B without switching between these options. It automatically recognizes the travel document read.

To choose a variant, scan one of the following bar codes. Selecting the following OCR-B variants automatically sets the appropriate [OCR Lines on page 13-12](#). These five variants invoke extensive special algorithms and checking for that particular document type:

Variant	OCR Lines Setting
Passport	2
TD1 ID Cards	3
TD2 ID Cards	2
Visa Type A	2
Visa Type B	2

Selecting one of the ISBN Book Numbers automatically applies the appropriate ISBN checksum, so you do not need to set this.

OCR-B Variant (continued)

For the best performance in passport reading, fix the target passport and the decoder in place (6.5 - 7.5”).

✓ **NOTE** Enable OCR-B before setting this parameter. If disabling OCR-B, set the variant to its default (OCR-B Full ASCII).

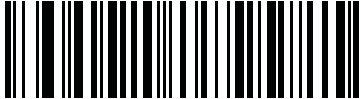

***OCR-B Full ASCII
(0)**

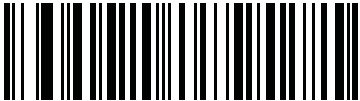

**OCR-B Banking
(1)**



**OCR-B Limited
(2)**



**OCR-B ISBN 10-Digit Book Numbers
(6)**



**OCR-B ISBN 10 or 13-Digit Book Numbers
(7)**



**OCR-B Travel Document Version 1 (TD1)
3 Line ID Cards
(3)**

OCR-B Variant (continued)



**OCR-B Travel Document Version 2 (TD2)
2-Line ID Cards
(8)**



**Travel Document 2 or 3-Line ID Cards Auto-Detect
(20)**



**OCR-B Passport
(4)**



**OCR-B Visa Type A
(9)**



**OCR-B Visa Type B
(10)**



**OCR-B ICAO Travel Documents
(11)**

Enable/Disable MICR E13B

Parameter # 682 (SSI # F1h AAh)

To enable or disable MICR E13B, scan one of the following bar codes.

MICR E13B uses the following characters:

0 1 2 3 4 5 6 7 8 9 t a o d

TOAD characters (Transit, On Us, Amount, and Dash) output as the following representative characters:

t outputs as t

a outputs as a

o outputs as o

d outputs as d

- ✓ **NOTE** OCR is not as secure as a bar code. To decrease OCR misdecodes and speed OCR reading, set an accurate OCR template and character subset, and use a check digit. See [OCR Subset on page 13-13](#) and [OCR Template on page 13-15](#).
- ✓ **NOTE** All OCR fonts are disabled by default. Enabling OCR can slow bar code decoding. Enabling more than one OCR font could also slow OCR decoding and impact OCR decoding accuracy.



Enable MICR E13B
(1)



***Disable MICR E13B**
(0)

Enable/Disable US Currency Serial Number

Parameter # 683 (SSI # F1h ABh)

To enable or disable US Currency Serial Number, scan one of the following bar codes.

- ✓ **NOTE** OCR is not as secure as a bar code. To decrease OCR misdecodes and speed OCR reading, set an accurate OCR template and character subset, and use a check digit. See [OCR Subset on page 13-13](#) and [OCR Template on page 13-15](#).
- ✓ **NOTE** All OCR fonts are disabled by default. Enabling OCR can slow bar code decoding. Enabling more than one OCR font could also slow OCR decoding and impact OCR decoding accuracy.



**Enable US Currency
(1)**

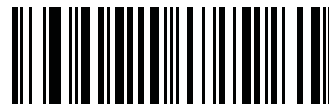

***Disable US Currency
(0)**

OCR Orientation

Parameter # 687 (SSI # F1h AFh)

Select one of five options to specify the orientation of an OCR string to be read:

- 0° to the imaging engine (default)
- 270° clockwise (or 90° counterclockwise) to the imaging engine
- 180° (upside down) to the imaging engine
- 90° clockwise to the imaging engine
- Omnidirectional

Setting an incorrect orientation can cause misdecodes.

OCR Orientation (continued)

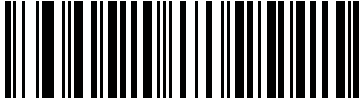

***OCR Orientation 0°
(0)**

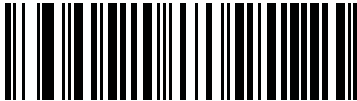

**OCR Orientation 270° Clockwise
(1)**



**OCR Orientation 180° Clockwise
(2)**

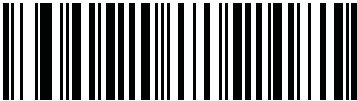

**OCR Orientation 90° Clockwise
(3)**

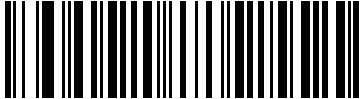

**OCR Orientation Omnidirectional
(4)**

OCR Lines

Parameter # 691 (SSI # F1h B3h)

To select the number of OCR lines to decode, scan one of the following bar codes. Selecting Visas, TD1, or TD2 ID cards automatically sets the appropriate **OCR Lines**. Also see [OCR-B Variant on page 13-6](#).



***OCR 1 Line
(1)**



**OCR 2 Lines
(2)**



**OCR 3 Lines
(3)**

OCR Minimum Characters

Parameter # 689 (SSI # F1h B1h)

To select the minimum number of OCR characters (not including spaces) per line to decode, scan the following bar code, then scan a three-digit number between 003 and 100 using the bar codes in [Appendix G, Numeric Bar Codes](#) representing the number of OCR characters to decode. Strings of OCR characters less than the minimum are ignored. The default is 003.



OCR Minimum Characters

OCR Maximum Characters

Parameter # 690 (SSI # F1h B2h)

To select the maximum number of OCR characters (including spaces) per line to decode, scan the following bar code, then scan a three-digit number between 003 and 100 using the bar codes in [Appendix G, Numeric Bar Codes](#) representing the number of OCR characters to decode. Strings of OCR characters greater than the maximum are ignored. The default is 100.

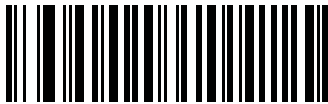

OCR Maximum Characters

OCR Subset

Parameter # 686 (SSI # F1h AEh)

Set an OCR subset to define a custom group of characters in place of a preset font variant. For example, if scanning only numbers and the letters A, B, and C, create a subset of just these characters to speed decoding. This applies a designated OCR Subset across all enabled OCR fonts.

To set or modify the OCR font subset, first enable the appropriate OCR font(s). Next, scan the following bar code, then scan numbers and letters to form the OCR Subset from the alphanumeric keyboard in the *Advanced Data Formatting Guide*. Then scan **End of Message** in the *Advanced Data Formatting Guide*.



OCR Subset

To cancel an OCR subset, for OCR-A or OCR-B, scan OCR-A variant **Full ASCII**, or OCR-B variant **Full ASCII**.

For MICR E13B or US Currency Serial Number, create a subset which includes all allowed characters in that character set, or scan an option from the [Default Parameters on page 4-5](#) and re-program the digital scanner.

OCR Quiet Zone

Parameter # 695 (SSI # F1h B7h)

This option sets the OCR quiet zone. The digital scanner stops scanning a field when it detects a sufficiently wide blank space. The width of this space is defined by the End of Field option. Used with parsers that tolerate slanted characters, the End of Field count is roughly a count of 8 for a character width. For example if set to 15, then two character widths are an end of line indicator for the parser. Larger end of field numbers require bigger quiet zones at each end of text line.

To set a quiet zone, scan the following bar code, then scan a two-digit number using the numeric keypad in the *Advanced Data Formatting Guide*. The range of the quiet zone is 20 - 99 and the default is 50, indicating a six character width quiet zone.

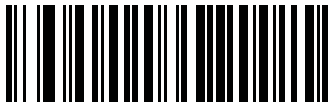

OCR Quiet Zone

OCR Template

Parameter # 547 (SSI # F1h 23h)

This option creates a template for precisely matching scanned OCR characters to a desired input format. Carefully constructing an OCR template eliminates scanning errors.

To set or modify the OCR decode template, scan the *OCR Template* bar code, then bar codes corresponding to numbers and letters on the following pages to form the template expression. Then scan **End of Message** in the *Advanced Data Formatting Guide*. The default is **54R** which accepts any character OCR strings.



OCR Template



End of Message

Required Digit (9)



9

Only a numeric character is allowed in this position.

Template	Valid data	Valid data	Invalid data
99999	12987	30517	123AB

Required Alpha (A)



A

Only an alpha character is allowed in this position.

Template	Valid data	Valid data	Invalid data
AAA	ABC	WXY	12F

Require and Suppress (0)

It is required that any character in this position, including space or reject, is suppressed from the output.

Template	Incoming data	Output
990AA	12QAB	12AB

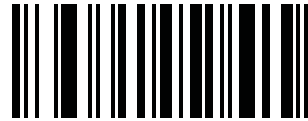

0

Optional Alphanumeric (1)



1

When this option appears in the template string, the data validator accepts an alphanumeric character if present. Optional characters are not allowed as the first character(s) in a field of like characters.

Template	Valid data	Valid data	Invalid data
99991	1234A	12345	1234<

Optional Alpha (2)



2

When this option appears in the template string, the data validator accepts an alpha character if present. Optional characters are not allowed as the first character(s) in a field of like characters.

Template	Valid data	Valid data	Invalid data
AAAA2	ABCDE	WXYZ	ABCD6

Alpha or Digit (3)



3

The data validator requires an alphanumeric character in this position to validate the incoming data.

Template	Valid data	Valid data	Invalid data
33333	12ABC	WXY34	12AB<

Any Including Space & Reject (4)



4

The template accepts any character in this position, including space and reject. Rejects are represented as an underscore (_) in the output. This is a good selection for troubleshooting.

Template	Valid data	Valid data
99499	12\$34	34_98

Any except Space & Reject (5)



5

The template accepts any character in this position except a space or reject.

Template	Valid data	Valid data	Invalid data
55999	A.123	*Z456	A BCD

Optional Digit (7)



7

When this option appears in the template string, the template accepts a numeric character if present. Optional characters are not allowed as the first character(s) in a field of like characters.

Template	Valid data	Valid data	Invalid data
99977	12345	789	789AB

Digit or Fill (8)



8

The data validator accepts any numeric or fill character in this position.

Template	Valid data	Valid data	Valid data
88899	12345	>>789	<<789

Alpha or Fill (F)



F

The data validator accepts any alpha or fill character in this position.

Template	Valid data	Valid data	Valid data
AAAF	ABCXY	LMN>>	ABC<5

Optional Space ()



Space

When this option appears in the template string, the template accepts a space if present. Optional characters are not allowed as the first character(s) in a field of like characters.

Template	Valid data	Valid data	Invalid data
99 99	12 34	1234	67891

Optional Small Special (.)



.

When this option appears in the template string, the data validator accepts a special character if present. Optional characters are not allowed as the first character(s) in a field of like characters. Small special characters are - , and .

Template	Valid data	Valid data	Invalid data
AA.99	MN.35	XY98	XYZ12

Other Template Operators

These template operators assist in capturing, delimiting, and formatting scanned OCR data.

Literal String (" and +)



“



+

Use either of these delimiting characters surrounding characters from the alphanumeric keyboard in the *Advanced Data Formatting Guide* to define a literal string within a template that must be present in scanned OCR data. There are two characters used to delimit required literal strings; if one of the delimiter characters is present in the desired literal string, use the other delimiter.

Template	Valid data	Invalid data
"35+BC"	35+BC	AB+22

New Line (E)



E

To create a template of multiple lines, add **E** between the template of each single line.

Template	Valid data	Valid data	Invalid data
999EAAAA	321	987	XYZW
	BCAD	ZXYW	12

String Extract (C)



C

This operator combined with others defines a string of characters to extract from the scanned data. The string extract is structured as follows:

CbPe

Where:

- C is the string extract operator
- b is the string begin delimiter
- P is the category (one or more numeric or alpha characters) describing the string representation
- e is the string end delimiter

Values for b and e can be any scannable character. They are included in the output stream.

Template	Incoming data	Output
C>A>	XQ3>ABCDE>	>ABCDE>
	->ATHRUZ>123	>ATHRUZ>
	1ABCZXYZ	No Output

Ignore to End of Field (D)**D**

This operator causes all characters after a template to be ignored. Use this as the last character in a template expression. Examples for the template 999D:

Template	Incoming data	Output
999D	123-PED	123
	357298	357
	193	193

Skip Until (P1)**P****1**

This operator allows skipping over characters until a specific character type or a literal string is detected. It can be used in two ways:

P1ct

Where:

- P1 is the Skip Until operator
- c is the type of character that triggers the start of output
- t is one or more template characters

P1"s"t

Where:

- P1 is the Skip Until operator
- "s" is one or more literal string characters (see [Literal String \(" and +\) on page 13-20](#)) that trigger the start of output
- t is one or more template characters

The trigger character or literal string is included in output from a Skip Until operator, and the first character in the template should accommodate this trigger.

Template	Incoming data	Output
P1 "PN"AA9999	123PN9876	PN9876
	PN1234	PN1234
	X-PN3592	PN3592

Skip Until Not (P0)



P



0

This operator allows skipping over characters until a specific character type or a literal string is not matched in the output stream. It can be used in two ways:

P0ct

Where:

- P0 is the Skip Until Not operator
- c is the type of character that triggers the start of output
- t is one or more template characters

P0"s"t

Where:

- P0 is the Skip Until Not operator
- "s" is one or more literal string characters (see [Literal String \(" and +\) on page 13-20](#)) that trigger the start of output
- t is one or more template characters

The trigger character or literal string is not included in output from a Skip Until Not operator.

Template	Incoming data	Output
P0A9999	BPN3456	3456
	PN1234	1234
	5341	No output

Template	Incoming data	Output
P0"PN"9999	PN3456	3456
	5341	No output
	PNPN7654	7654

Repeat Previous (R)



R

This operator allows a template character to repeat one or more times, allowing the capture of variable-length scanned data. The following examples capture two required alpha characters followed by one or more required digits:

Template	Incoming data	Output
AA9R	AB3	AB3
	PN12345	PN12345
	32RM52700	No output

Scroll Until Match (S)



S

This operator steps through scanned data one character at a time until the data matches the template.

Template	Incoming data	Output
S99999	AB3	No Output
	PN12345	12345
	32RM52700	52700

Multiple Templates

This feature sets up multiple templates for OCR decoding. To do this, follow the procedure described in [OCR Template on page 13-15](#) (scan the *OCR Template* bar code, then bar codes corresponding to numbers and letters to form the template expression, then **End of Message**) for each template in the multiple template string, using a capital letter **X** as a separator between the templates.

For example, set the *OCR Template* as **99999XAAAAA** to decode OCR strings of either **12345** or **ABCDE**.

Template Examples

Following are sample templates with descriptions of valid data for each definition.

Field Definition	Description
"M"99977	M followed by three digits and two optional digits.
"X"997777"X"	X followed by two digits, four optional digits, and an X .
9959775599	Two digits followed by any character, a digit, two optional digits, any two characters, and two digits.
A55 "-"999 "-"99	A letter followed by two characters, a dash, three digits, a dash, and two digits.
33A" ."99	Two alphanumeric characters followed by a letter, a period, and two digits.
999992991	Five digits followed by an optional alpha, two digits, and an optional alphanumeric.
"PN98"	Literal field - PN98

OCR Check Digit Modulus

Parameter # 688 (SSI # F1h B0h)

This option sets OCR module check digit calculation. The check digit is the last digit (in the right most position) in an OCR string and improves the accuracy of the collected data. The check digit is the end product of a calculation made on the incoming data. For check digit calculation, for example Modulus 10, alpha and numeric characters are assigned numeric weights (see [OCR Check Digit Multiplier on page 13-26](#)). The calculation is applied to the character weights and the resulting check digit is added to the end of the data. If the incoming data does not match the check digit, the data is considered corrupt.

The selected check digit option does not take effect until you set **OCR Check Digit Validation**.

To choose the Check Digit Modulus, such as 10 for modulo 10, scan the following bar code, then scan a three-digit number from 001 to 099 representing the check digit using the numeric keypad in the *Advanced Data Formatting Guide*. The default is 1.



OCR Check Digit

OCR Check Digit Multiplier

Parameter # 700 (SSI # F1h BCh)

This option sets OCR check digit multipliers for the character positions. For check digit validation, each character in scanned data has an equivalent weight used in the check digit calculation. DS3608 OCR ships with the following weight equivalents:

0 = 0	A = 10	K = 20	U = 30
1 = 1	B = 11	L = 21	V = 31
2 = 2	C = 12	M = 22	W = 32
3 = 3	D = 13	N = 23	X = 33
4 = 4	E = 14	O = 24	Y = 34
5 = 5	F = 15	P = 25	Z = 35
6 = 6	G = 16	Q = 26	Space = 0
7 = 7	H = 17	R = 27	
8 = 8	I = 18	S = 28	
9 = 9	J = 19	T = 29	

All other characters are equivalent to one (1).

You can define the multiplier string if it is different from the default.

121212121212 (default)

123456789A (for ISBN, Product Add Right to Left. See [OCR Check Digit Validation on page 13-27](#))

For example:

ISBN	0	2	0	1	1	8	3	9	9	4	
Multiplier	10	9	8	7	6	5	4	3	2	1	
Product	0	18	0	7	6	40	12	27	18	4	
Product add	0+	18+	0+	7+	6+	40+	12+	27+	18+	4=	132

ISBN uses modulo 11 for its check digit. In this case, 132 is divisible by 11, so it passes the check digit.

To set the check digit multiplier, scan the following bar code, then scan numbers and letters to form the multiplier string from the alphanumeric keyboard in the *Advanced Data Formatting Guide*. Then scan **End of Message** in the *Advanced Data Formatting Guide*.



OCR Check Digit Multiplier

OCR Check Digit Validation

Parameter # 694 (SSI # F1h B6h)

Use **OCR Check Digit Validation** to protect against scanning errors by applying a check digit validation scheme. The following is a list of options.

None

No check digit validation, indicating no check digit is applied. This is the default.



***No Check Digit
(0)**

Product Add Left to Right

Each character in the scanned data is assigned a numeric value (see [OCR Check Digit Multiplier on page 13-26](#)). Each digit representing a character in the scanned data is multiplied by its corresponding digit in the multiplier, and the sum of these products is computed. The check digit passes if this sum modulo Check Digit Modulus is zero.

Example:

Scanned data numeric value is 132456 (check digit is 6)

Check digit multiplier string is 123456

Digit	1	3	2	4	5	6
Multiplier	1	2	3	4	5	6
Product	1	6	6	16	25	36
Product add	1+	6+	6+	16+	25+	36= 90

The Check Digit Modulus is 10. It passes because 90 is divisible by 10 (the remainder is zero).



**Product Add Left to Right
(3)**

Product Add Right to Left

Each character in the scanned data is assigned a numeric value (see [OCR Check Digit Multiplier on page 13-26](#)). The check digit multiplier is reversed in order. Each value representing a character in the scanned data is multiplied by its corresponding digit in the reversed multiplier, resulting in a product for each character in the scanned data. The sum of these products is computed. The check digit passes if this sum modulo Check Digit Modulus is zero.

Example:

Scanned data numeric value is 132459 (check digit is 9)

Check digit multiplier string is 123456

Digit	1	3	2	4	5	9
Multiplier	6	5	4	3	2	1
Product	6	15	8	12	10	9
Product add	6+	15+	8+	12+	10+	9= 60

The Check Digit Modulus is 10. It passes because 60 is divisible by 10 (the remainder is 0).



**Product Add Right to Left
(1)**

Digit Add Left to Right

Each character in the scanned data is assigned a numeric value (see [OCR Check Digit Multiplier on page 13-26](#)). Each value representing a character in the scanned data is multiplied by its corresponding digit in the multiplier, resulting in a product for each character in the scanned data. The sum of each individual digit in all of the products is then calculated. The check digit passes if this sum modulo Check Digit Modulus is zero.

Example:

Scanned data numeric value is 132456 (check digit is 6)

Check digit multiplier string is 123456

Digit	1	3	2	4	5	6
Multiplier	1	2	3	4	5	6
Product	1	6	6	16	25	36
Digit add	1+	6+	6+	1+6+	2+5+	3+6= 36

The Check Digit Modulus is 12. It passes because 36 is divisible by 12 (the remainder is 0).



**Digit Add Left to Right
(4)**

Digit Add Right to Left

Each character in the scanned data is assigned a numeric value (see [OCR Check Digit Multiplier on page 13-26](#)). The check digit multiplier is reversed in order. Each value representing a character in the scanned data is multiplied by its corresponding digit in the reversed multiplier, resulting in a product for each character in the scanned data. The sum of each individual digit in all of the products is then calculated. The check digit passes if this sum modulo Check Digit Modulus is zero.

Example:

Scanned data numeric value is 132456 (check digit is 6)

Check digit multiplier string is 123456

Digit	1	3	2	4	5	6	
Multiplier	6	5	4	3	2	1	
Product	6	15	8	12	10	6	
Digit add	6+	1+5+	8+	1+2+	1+0+	6=	30

The Check Digit Modulus is 10. It passes because 30 is divisible by 10 (the remainder is 0).



**Digit Add Right to Left
(2)**

Product Add Right to Left Simple Remainder

Each character in the scanned data is assigned a numeric value (see [OCR Check Digit Multiplier on page 13-26](#)). The check digit multiplier is reversed in order. Each value representing a character in the scanned data is multiplied by its corresponding digit in the reversed multiplier, resulting in a product for each character in the scanned data. The sum of these products **except for the check digit's product** is computed. The check digit passes if this sum modulo Check Digit Modulus is equal to the check digit's product.

Example:

Scanned data numeric value is 122456 (check digit is 6)

Check digit multiplier string is 123456

Digit	1	2	2	4	5	6	
Multiplier	6	5	4	3	2	1	
Product	6	10	8	12	10	6	
Product add	6+	10+	8+	12+	10=	46	6

The Check Digit Modulus is 10. It passes because 46 divided by 10 leaves a remainder of 6.



**Product Add Right to Left Simple Remainder
(5)**

Digit Add Right To Left Simple Remainder

Each character in the scanned data is assigned a numeric value (see [OCR Check Digit Multiplier on page 13-26](#)). The check digit multiplier is reversed in order. Each value representing a character in the scanned data is multiplied by its corresponding digit in the reversed multiplier, resulting in a product for each character in the scanned data. The sum of each individual digit in all of the products **except for the check digit's product** is then calculated. The check digit passes if this sum modulo Check Digit Modulus is equal to the check digit's product.

Example:

Scanned data numeric value is 122459 (check digit is 6)

Check digit multiplier string is 123456

Digit	1	2	2	4	5	9
Multiplier	6	5	4	3	2	1
Product	6	10	8	12	10	9
Digit add	6+	1+0+	8+	1+2+	1+0=	19 9

The Check Digit Modulus is 10. It passes because 19 divided by 10 leaves a remainder of 9.



Digit Add Right to Left Simple Remainder
(6)

Health Industry - HIBCC43

This is the health industry module 43 check digit standard. The check digit is the modulus 43 sum of all the character values in a given message, and is printed as the last character in a given message.

Example:

Supplier Labelling Data Structure: + A 1 2 3 B J C 5 D 6 E 7 1

Sum of values: $41+10+1+2+3+11+19+12+5+13+6+14+7+1 = 145$

Divide 145 by 43. The quotient is 3 with a remainder of 16. The check digit is the character corresponding to the value of the remainder (see [Table 13-2](#)), which in this example is 16, or **G**. The complete Supplier Labelling Data Structure, including the check digit, therefore is:

A 1 2 3 B J C 5 D 6 E 7 1 G

Table 13-2 *Table of Numeric Value Assignments for Computing HIBC LIC Data Format Check Digit*

0 = 0	9 = 9	I = 18	R = 27	- = 36
1 = 1	A = 10	J = 19	S = 28	. = 37
2 = 2	B = 11	K = 20	T = 29	Space = 38
3 = 3	C = 12	L = 21	U = 30	\$ = 39
4 = 4	D = 13	M = 22	V = 31	/ = 40
5 = 5	E = 14	N = 23	W = 32	+ = 41
6 = 6	F = 15	O = 24	X = 33	% = 42
7 = 7	G = 16	P = 25	Y = 34	
8 = 8	H = 17	Q = 26	Z = 35	

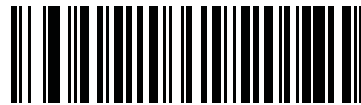

Health Industry - HIBCC43
(9)

Inverse OCR

Parameter # 856 (SSI # F2h 58h)

Inverse OCR is white or light words on a black or dark background. Select an option for decoding inverse OCR:

- **Regular Only** - decode regular OCR (black on white) strings only.
- **Inverse Only** - decode inverse OCR (white on black) strings only.
- **Autodiscriminate** - decodes both regular and inverse OCR strings.



***Regular Only**
(0)



Inverse Only
(1)



Autodiscriminate
(2)

CHAPTER 14 123SCAN2

Introduction

123Scan² is an easy to use, PC-based software tool that enables rapid customized setup of Zebra scanners.

123Scan² uses a wizard tool to guide users through a streamlined set up process. Settings are saved in a configuration file that can be distributed via e-mail, electronically downloaded via a USB cable, or used to generate a sheet of scannable programming bar codes.

Additionally 123Scan² can upgrade scanner firmware, check online to enable support for newly released products, generate a collection of multi-setting bar codes if the number of settings is very large, stage a large number of scanners simultaneously, generate reports with asset tracking information, and create custom products.

Communication with 123Scan²

To communicate with the 123Scan² program which runs on a host computer running a Windows XP SP2, Windows 7, 8, 8.1, or 10 operating system, use a USB cable to connect the scanner to the host computer.

123Scan² Requirements

- Host computer with Windows XP SP2 or Windows 7, 8, 8.1, 10
- Scanner
- USB cable.

For more information on 123Scan², go to:

<http://www.zebra.com/123Scan2>

For a 1 minute tour of 123Scan², go to:

<http://www.zebra.com/scannersoftwarevideos>

To download 123Scan² software and access the Help file integrated in the utility, go to:

<http://www.zebra.com/123Scan2>

Scanner SDK, Other Software Tools, and Videos

Tackle all your scanner programming needs with our diversified set of software tools. Whether you need to simply stage a device, or develop a fully featured application with image and data capture as well as asset management, these tools help you every step of the way. To download any of the free tools listed below, go to:

www.zebra.com/software.

- 123Scan2 configuration utility (described in this chapter)
- Scanner SDK for Windows
- How-to videos
- Virtual COM port driver
- OPOS driver
- JPOS driver
- Scanner user documentation.

✓ **NOTE** For a list of SDK supported scanner functionality by communication protocol, see [Appendix I, Communication Protocol Functionality](#).

CHAPTER 15 ADVANCED DATA FORMATTING

Introduction

Advanced Data Formatting (ADF) is a means of customizing data before transmission to the host device. Use ADF to edit scan data to suit requirements. Implement ADF by scanning a related series of bar codes which program the scanner with ADF rules.

For information and programming bar codes for ADF, refer to the *Advanced Data Formatting Programmer Guide*, p/n 72E-69680-xx.

APPENDIX A STANDARD DEFAULT PARAMETERS

Table A-1 *Parameter Defaults*

Parameter	Parameter Number	SSI Number	Default	Page Number
User Preferences				
Set Default Parameter	N/A	N/A	Restore Defaults	4-5
Report Version				4-6
Parameter Bar Code Scanning	236	ECh	Enable	4-6
Beep After Good Decode	56	38h	Enable	4-7
Direct Decode Indicator	859	F2h 5Bh	Disable	4-8
Beeper Volume	140	8Ch	High	4-9
Beeper Tone	145	91h	Medium	4-10
Beeper Duration	628	F1h 74h	Medium	4-11
Suppress Power Up Beeps	721	F1h D1h	Do Not Suppress	4-11
Decode Pager Motor	613	F1h 65h	Enable	4-12
Decode Pager Motor Duration	626	F1h 72h	150 msec	4-12
Low Power Mode	128	80h	Disable	4-14
Time Delay to Low Power Mode	146	92h	1 Hour	4-15
Hand-Held Trigger Mode	138	8Ah	Level	4-17
Hands-Free Mode	630	F1h 76h	Enable	4-18
Hand-Held Decode Aiming Pattern	306	F0h 32h	Enable	4-19

Table A-1 *Parameter Defaults (Continued)*

Parameter	Parameter Number	SSI Number	Default	Page Number
Hands-Free (Presentation) Decode Aiming Pattern	590	F1h 4Eh	Enable Hands-Free (Presentation) Decode Aiming Pattern on PDF	4-20
Picklist Mode	402	F0h 92h	Disabled Always	4-21
Continuous Bar Code Read	649	F1h 89h	Disable	4-22
Unique Bar Code Reporting	723	F1h D3h	Enable	4-22
Decode Session Timeout	136	88h	9.9 Sec	4-23
Hands-free Decode Session Timeout	400	F0h 90h	15	4-24
Timeout Between Decodes, Same Symbol	137	89h	0.5 Sec	4-25
Timeout Between Decodes, Different Symbols	144	90h	0.1 sec	4-26
Decode Mirror Images (Data Matrix Only)	537	F1h 19h	Auto	4-27
Mobile Phone/Display Mode	716	F1h CCh	Normal	4-28
PDF Prioritization	719	F1h CFh	Disable	4-29
PDF Prioritization Timeout	720	F1h D0h	200 ms	4-30
Presentation Mode Field of View	609	F1h 61h	Full	4-31
Decoding Illumination	298	F0h 2Ah	Enable	4-32
Motion Tolerance (Hand-Held Trigger Mode Only)	858	F2h 5Ah	Less	4-33
Miscellaneous Options				
Add an Enter Key	N/A	N/A	N/A	4-34
Transmit Code ID Character	45	2Dh	None	4-34
Prefix Value	99, 105	63h, 69h	7013 <CR><LF>	4-35
Suffix 1 Value Suffix 2 Value	98, 104 100, 106	62h, 68h 64h, 6Ah	7013 <CR><LF>	4-35
Scan Data Transmission Format	235	EBh	Data as is	4-36
FN1 Substitution Values	103, 109	67h, 6Dh	7013 <CR><LF>	4-37
Transmit "No Read" Message	94	5E	Disable	4-38
Unsolicited Heartbeat Interval	1118	F8h 04h 5Eh	Disable	4-39

Table A-1 *Parameter Defaults (Continued)*

Parameter	Parameter Number	SSI Number	Default	Page Number
Imaging Preferences				
Operational Modes	N/A	N/A	N/A	5-4
Image Capture Illumination	361	F0h 69h	Enable	5-5
Image Capture Autoexposure	360	F0h 68h	Enable	5-5
Fixed Exposure	567	F4h F1h 37h	100	5-6
Fixed Gain	568	F1h 38h	50	5-6
Gain / Exposure Priority for Snapshot Mode	562	F1h 32h	Autodetect	5-7
Snapshot Mode Timeout	323	F0h 43h	0 (30 seconds)	5-8
Snapshot Aiming Pattern	300	F0h 2Ch	Enable	5-9
Silence Operational Mode Changes	1293	F8h 05h 0Dh	Disable (Do Not Silence)	5-9
Image Cropping	301	F0h 2Dh	Disable	5-10
Crop to Pixel Addresses	315 316 317 318	F4h F0h 3Bh F4h F0h 3Ch F4h F0h 3Dh F4h F0h 3Eh	0 top 0 left 1023 bottom 1279 right	5-11
Image Size (Number of Pixels)	302	F0h 2Eh	Full	5-12
Image Brightness (Target White)	390	F0h 86h	180	5-13
JPEG Image Options	299	F0h 2Bh	Quality	5-13
JPEG Target File Size	561	F1h 31h	160 kB	5-14
JPEG Quality and Size Value	305	F0h 31h	65	5-14
Image Enhancement	564	F1h 34h	Low (1)	5-15
Image File Format Selection	304	F0h 30h	JPEG	5-16
Image Rotation	665	F1h 99h	Rotate 0°	5-17
Bits per Pixel (BPP)	303	F0h 2Fh	8 BPP	5-18
Signature Capture (DS3608 HP Only)	93	5Dh	Disable	5-19
Signature Capture Image File Format Selection (DS3608 HP Only)	313	F0h 39h	JPEG	5-20
Signature Capture Bits per Pixel (BPP) (DS3608 HP Only)	314	F0h 3Ah	8 BPP	5-21

Table A-1 *Parameter Defaults (Continued)*

Parameter	Parameter Number	SSI Number	Default	Page Number
Signature Capture Width (DS3608 HP Only)	366	F4h F0h 6Eh	400	5-22
Signature Capture Height (DS3608 HP Only)	367	F4h F0h 6Fh	100	5-22
Signature Capture JPEG Quality (DS3608 HP Only)	421	F0h A5h	65	5-23
Video View Finder	324	F0h 44h	Disable	5-23
Video View Finder Image Size	329	F0h 49h	1700 bytes	5-24
USB Host Parameters				
USB Device Type	N/A	N/A	USB Keyboard HID	6-5
Symbol Native API (SNAPI) Status Handshaking	N/A	N/A	Enable	6-7
USB Keystroke Delay	N/A	N/A	No Delay	6-8
USB CAPS Lock Override	N/A	N/A	Disable	6-8
USB Ignore Unknown Characters	N/A	N/A	Send	6-9
USB Convert Unknown to Code 39	N/A	N/A	Disable	6-9
Emulate Keypad	N/A	N/A	Enable	6-10
Emulate Keypad with Leading Zero	N/A	N/A	Enable	6-10
Quick Keypad Emulation	N/A	N/A	Enable	6-11
USB FN1 Substitution	N/A	N/A	Disable	6-11
Function Key Mapping	N/A	N/A	Disable	6-12
Simulated Caps Lock	N/A	N/A	Disable	6-12
Convert Case	N/A	N/A	None	6-13
USB Static CDC	670	N/A	Enable	6-13
USB Polling Interval	N/A	N/A	3 msec	6-15
USB Fast HID	N/A	N/A	Enable	6-17
IBM Specification Version	N/A	N/A	Version 2.2	6-17
SSI Parameters				
Select SSI Host	N/A	N/A	N/A	7-11

Table A-1 *Parameter Defaults (Continued)*

Parameter	Parameter Number	SSI Number	Default	Page Number
Baud Rate	156	9Ch	9600	7-12
Parity	158	9Eh	None	7-13
Check Parity	151	97h	Disable	7-14
Stop Bits	157	9Dh	1	7-14
Software Handshaking	159	9Fh	ACK/NAK	7-15
Host RTS Line State	154	9Ah	Low	7-16
Decode Data Packet Format	238	EEh	Send Raw Decode Data	7-16
Host Serial Response Time-out	155	9Bh	2 sec	7-17
Host Character Time-out	239	EFh	200 msec	7-18
Multipacket Option	334	F0h 4Eh	Option 1	7-19
Interpacket Delay	335	F0h 4Fh	0 ms	7-20
Decode Event	256	F0h 00h	Disable	7-21
Boot Up Event	258	F0h 02h	Disable	7-22
Parameter Event	259	F0h 03h	Disable	7-22
RS-232 Host Parameters				
RS-232 Host Types	N/A	N/A	Standard	8-6
Baud Rate	N/A	N/A	9600	8-8
Parity Type	N/A	N/A	None	8-9
Stop Bits	N/A	N/A	1 Stop Bit	8-10
Data Bits	N/A	N/A	8-Bit	8-10
Check Receive Errors	N/A	N/A	Enable	8-11
Hardware Handshaking	N/A	N/A	None	8-11
Software Handshaking	N/A	N/A	None	8-13
Host Serial Response Time-out	N/A	N/A	2 Sec	8-15
RTS Line State	N/A	N/A	Low RTS	8-16
Beep on <BEL>	N/A	N/A	Disable	8-16
Intercharacter Delay	N/A	N/A	0 msec	8-17
Nixdorf Beep/LED Options	N/A	N/A	Normal Operation	8-18
Ignore Unknown Characters	N/A	N/A	Send Bar Code	8-18

Table A-1 *Parameter Defaults (Continued)*

Parameter	Parameter Number	SSI Number	Default	Page Number
IBM 468X/469X Host Parameters				
Port Address	N/A	N/A	None Selected	9-4
Convert Unknown to Code 39	N/A	N/A	Disable	9-5
Ignore Beep Directive	N/A	N/A	Enable (Ignore)	9-5
Ignore Bar Code Configuration Directive	N/A	N/A	Enable (Ignore)	9-6
Keyboard Wedge Host Parameters				
Keyboard Wedge Host Type	N/A	N/A	IBM AT Notebook	10-4
Ignore Unknown Characters	N/A	N/A	Transmit	10-4
Keystroke Delay	N/A	N/A	No Delay	10-5
Intra-Keystroke Delay	N/A	N/A	Disable	10-5
Alternate Numeric Keypad Emulation	N/A	N/A	Enable	10-6
Quick Keypad Emulation	N/A	N/A	Enable	10-6
Simulated Caps Lock	N/A	N/A	Disable	10-7
Caps Lock Override	N/A	N/A	Disable	10-7
Convert Wedge Case	N/A	N/A	No Convert	10-8
Function Key Mapping	N/A	N/A	Disable	10-8
FN1 Substitution	N/A	N/A	Disable	10-9
Send Make and Break	N/A	N/A	Send Make and Break Scan Codes	10-9
Enable/Disable All Code Types				11-8
1D Symbolologies				
UPC/EAN				
UPC-A	1	01h	Enable	11-9
UPC-E	2	02h	Enable	11-9
UPC-E1	12	0Ch	Disable	11-10
EAN-8/JAN 8	4	04h	Enable	11-10
EAN-13/JAN 13	3	03h	Enable	11-11
Bookland EAN	83	53h	Disable	11-11

Table A-1 *Parameter Defaults (Continued)*

Parameter	Parameter Number	SSI Number	Default	Page Number
Decode UPC/EAN/JAN Supplementals (2 and 5 digits)	16	10h	Ignore	11-12
User-Programmable Supplementals Supplemental 1: Supplemental 2:	579 580	F1h 43h F1h 44h	000	11-15
UPC/EAN/JAN Supplemental Redundancy	80	50h	10	11-15
Decode UPC/EAN/JAN Supplemental AIM ID	672	F1h A0h	Combined	11-16
UPC Reduced Quiet Zone	1289	F8h 05h 09h	Disable	11-17
Transmit UPC-A Check Digit	40	28h	Enable	11-17
Transmit UPC-E Check Digit	41	29h	Enable	11-18
Transmit UPC-E1 Check Digit	42	2Ah	Enable	11-18
UPC-A Preamble	34	22h	System Character	11-19
UPC-E Preamble	35	23h	System Character	11-20
UPC-E1 Preamble	36	24h	System Character	11-21
Convert UPC-E to A	37	25h	Disable	11-22
Convert UPC-E1 to A	38	26h	Disable	11-22
EAN-8/JAN-8 Extend	39	27h	Disable	11-23
Bookland ISBN Format	576	F1h 40h	ISBN-10	11-23
UCC Coupon Extended Code	85	55h	Disable	11-24
Coupon Report	730	F1h DAh	New Coupon Format	11-25
ISSN EAN	617	F1h 69h	Disable	11-25
Code 128				
Code 128	8	08h	Enable	11-26
Set Length(s) for Code 128	209, 210	D1h, D2h	1 to 55	11-26
GS1-128 (formerly UCC/EAN-128)	14	0Eh	Enable	11-28
ISBT 128	84	54h	Enable	11-28
ISBT Concatenation	577	F1h 41h	Autodiscriminate	11-29

Table A-1 *Parameter Defaults (Continued)*

Parameter	Parameter Number	SSI Number	Default	Page Number
Check ISBT Table	578	F1h 42h	Enable	11-30
ISBT Concatenation Redundancy	223	DFh	10	11-30
Code 128 Security Level	751	F1h EFh	Security Level 1	11-31
Code 128 Reduced Quiet Zone	1208	F8h 04h B8h	Disable	11-32
Ignore Code 128 <FNC4>	1254	F8h 04h E6h	Disable	11-32
Code 39				
Code 39	0	00h	Enable	11-33
Trioptic Code 39	13	0Dh	Disable	11-33
Convert Code 39 to Code 32 (Italian Pharmacy Code)	86	56h	Disable	11-34
Code 32 Prefix	231	E7h	Disable	11-35
Set Length(s) for Code 39	18, 19	12h, 13h	1 to 55	11-36
Code 39 Check Digit Verification	48	30h	Disable	11-37
Transmit Code 39 Check Digit	43	2Bh	Disable	11-37
Code 39 Full ASCII Conversion	17	11h	Disable	11-38
Code 39 Security Level	750	F1h EEh	Security Level 1	11-39
Code 39 Reduced Quiet Zone	1209	F8h 04h B9h	Disable	11-40
Code 93				
Code 93	9	09h	Enable	11-41
Set Length(s) for Code 93	26, 27	1Ah, 1Bh	1 to 55	11-42
Code 11				
Code 11	10	0Ah	Disable	11-43
Set Lengths for Code 11	28, 29	1Ch, 1Dh	4 to 55	11-44
Code 11 Check Digit Verification	52	34h	Disable	11-45
Transmit Code 11 Check Digit(s)	47	2Fh	Disable	11-46
Interleaved 2 of 5 (ITF)				
Interleaved 2 of 5 (ITF)	6	06h	Disable	11-47
Set Lengths for I 2 of 5	22, 23	16h, 17h	6 to 55	11-48
I 2 of 5 Check Digit Verification	49	31h	Disable	11-50

Table A-1 *Parameter Defaults (Continued)*

Parameter	Parameter Number	SSI Number	Default	Page Number
Transmit I 2 of 5 Check Digit	44	2Ch	Disable	11-51
Convert I 2 of 5 to EAN 13	82	52h	Disable	11-51
I 2 of 5 Security Level	1121	F8h 04h 61h	Security Level 1	11-52
I 2 of 5 Reduced Quiet Zone	1210	F8h 04h BAh	Disable	11-53
Discrete 2 of 5 (DTF)				
Discrete 2 of 5	5	05h	Disable	11-54
Set Length(s) for D 2 of 5	20, 21	14h 15h	1 to 55	11-55
Codabar (NW - 7)				
Codabar	7	07h	Enable	11-57
Set Lengths for Codabar	24, 25	18h, 19h	4 to 55	11-58
CLSI Editing	54	36h	Disable	11-59
NOTIS Editing	55	37h	Disable	11-59
Codabar Upper or Lower Case Start/Stop Characters Detection	855	F2h 57h	Upper Case	11-60
MSI				
MSI	11	0Bh	Disable	11-61
Set Length(s) for MSI	30, 31	1Eh, 1Fh	4 to 55	11-62
MSI Check Digits	50	32h	One	11-64
Transmit MSI Check Digit	46	2Eh	Disable	11-64
MSI Check Digit Algorithm	51	33h	Mod 10/Mod 10	11-65
Chinese 2 of 5				
Chinese 2 of 5	408	F0h 98h	Disable	11-66
Matrix 2 of 5				
Matrix 2 of 5	618	F1h 6Ah	Disable	11-67
Matrix 2 of 5 Lengths	619 620	F1h 6Bh F1h 6Ch	4 to 55	11-67
Matrix 2 of 5 Check Digit	622	F1h 6Eh	Disable	11-69
Transmit Matrix 2 of 5 Check Digit	623	F1h 6Fh	Disable	11-69

Table A-1 *Parameter Defaults (Continued)*

Parameter	Parameter Number	SSI Number	Default	Page Number
Korean 3 of 5				
Korean 3 of 5	581	F1h 45h	Disable	11-70
Inverse 1D	586	F1h 4Ah	Regular	11-71
GS1 DataBar				
GS1 DataBar-14	338	F0h 52h	Enable	11-72
GS1 DataBar Limited	339	F0h 53h	Enable	11-72
GS1 DataBar Expanded	340	F0h 54h	Enable	11-73
Convert GS1 DataBar to UPC/EAN	397	F0h 8Dh	Disable	11-73
GS1 DataBar Limited Security Level	728	F1h D8h	Level 3	11-74
Composite				
Composite CC-C	341	F0h 55h	Disable	11-75
Composite CC-A/B	342	F0h 56h	Disable	11-75
Composite TLC-39	371	F0h 73h	Disable	11-76
UPC Composite Mode	344	F0h 58h	UPC Never Linked	11-76
Composite Beep Mode	398	F0h 8Eh	Beep As Each Code Type is Decoded	11-77
GS1-128 Emulation Mode for UCC/EAN Composite Codes	427	F0h ABh	Disable	11-77
2D Symbolologies				
PDF417	15	0Fh	Enable	11-78
MicroPDF417	227	E3h	Disable	11-78
Code 128 Emulation	123	7Bh	Disable	11-79
Data Matrix	292	F0h 24h	Enable	11-80
GS1 Data Matrix	1336	F8h 05h 38h	Disable	11-80
Data Matrix Inverse	588	F1h 4Ch	Inverse Autodetect	11-81
Maxicode	294	F0h 26h	Disable	11-81
QR Code	293	F0h 25h	Enable	11-82
GS1 QR	1343	F8h 05h 3Fh	Disable	11-82
MicroQR	573	F1h 3Dh	Enable	11-83

Table A-1 *Parameter Defaults (Continued)*

Parameter	Parameter Number	SSI Number	Default	Page Number
Aztec	574	F1h 3Eh	Enable	11-83
Aztec Inverse	589	F1h 4Dh	Inverse Autodetect	11-84
Han Xin	1167	F8h 04h 8Fh	Disable	11-84
Han Xin Inverse	1168	F8h 04h 90h	Regular	11-85
Postal Codes				
US Postnet	89	59h	Disable	11-86
US Planet	90	5Ah	Disable	11-86
Transmit US Postal Check Digit	95	5Fh	Enable	11-87
UK Postal	91	5Bh	Disable	11-87
Transmit UK Postal Check Digit	96	60h	Enable	11-88
Japan Postal	290	F0h 22h	Disable	11-88
Australia Post	291	F0h 23h	Disable	11-89
Australia Post Format	718	F1h CEh	Autodiscriminate	11-90
Netherlands KIX Code	326	F0h 46h	Disable	11-91
USPS 4CB/One Code/Intelligent Mail	592	F1h 50h	Disable	11-91
UPU FICS Postal	611	F1h 63h	Disable	11-92
Mailmark	1337	F8h 05h 08h	Disable	11-92
Symbology-Specific Security Levels				
Redundancy Level	78	4Eh	1	11-93
Security Level	77	4Dh	1	11-95
1D Quiet Zone Level	1288	F8h 05h 08h	1	11-96
Intercharacter Gap Size	381	F0h 7Dh	Normal	11-97
Macro PDF				
Flush Macro PDF Buffer	N/A	N/A	N/A	11-98
Abort Macro PDF Entry	N/A	N/A	N/A	11-98
Intelligent Document Capture (IDC)				
IDC Operating Mode	594	F1h 52h	Off	12-5
IDC Symbology	655	F1h 8Fh	001	12-6

Table A-1 *Parameter Defaults (Continued)*

Parameter	Parameter Number	SSI Number	Default	Page Number
IDC X Coordinate	596	F4h F1h 54h	-151	12-7
IDC Y Coordinate	597	F4h F1h 55h	-050	12-7
IDC Width	598	F1h 56h	0300	12-8
IDC Height	599	F1h 57h	0050	12-8
IDC Aspect	595	F1h 53h	000	12-9
IDC File Format Selector	601	F1h 59h	JPEG	12-9
IDC Bits Per Pixel	602	F1h 5Ah	8 BPP	12-10
IDC JPEG Quality	603	F1h 5Bh	065	12-10
IDC Find Box Outline	727	F1h D7h	Disable	12-11
IDC Minimum Text Length	656	F1h 90h	00	12-11
IDC Maximum Text Length	657	F1h 91h	00	12-12
IDC Captured Image Brighten	654	F1h 8Eh	Enable	12-12
IDC Captured Image Sharpen	658	F1h 92h	Enable	12-13
IDC Border Type	829	F2h 3Dh	None	12-14
IDC Delay Time	830	F2h 3Eh	000	12-15
IDC Zoom Limit	651	F1h 8Bh	000	12-15
IDC Maximum Rotation	652	F1h 8Ch	00	12-16
OCR Programming Parameters				
OCR-A	680	F1h A8h	Disable	13-3
OCR-A Variant	684	F1h ACh	Full ASCII	13-3
OCR-B	681	F1h A9h	Disable	13-5
OCR-B Variant	685	F1h ADh	Full ASCII	13-6
MICR E13B	682	F1h AAh	Disable	13-9
US Currency	683	F1h ABh	Disable	13-10
OCR Orientation	687	F1h AFh	0°	13-10
OCR Lines	691	F1h B3h	1	13-12
OCR Minimum Characters	689	F1h B1h	3	13-12
OCR Maximum Characters	690	F1h B2h	100	13-13
OCR Subset	686	F1h AEh	Selected font variant	13-13

Table A-1 *Parameter Defaults (Continued)*

Parameter	Parameter Number	SSI Number	Default	Page Number
OCR Quiet Zone	695	F1h B7h	50	13-14
OCR Template	547	F1h 23h	54R	13-15
OCR Check Digit Modulus	688	F1h B0h	1	13-25
OCR Check Digit Multiplier	700	F1h BCh	121212121212	13-26
OCR Check Digit Validation	694	F1h B6h	None	13-27
Inverse OCR	856	F2h 58h	Regular	13-32

APPENDIX B COUNTRY CODES

Introduction

This chapter provides instructions for programming the keyboard to interface with a USB or keyboard wedge host. The host powers the scanner. For host setup information, see [Chapter 6, USB Interface](#) and [Chapter 10, Keyboard Wedge Interface](#).

To select a code page for the country keyboard type, see [Appendix C, Country Code Pages](#).

Throughout the programming bar code menus, default values are indicated with asterisks (*).

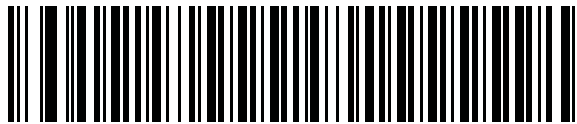

*Indicates Default — *US English (North American) — Feature/Option

USB and Keyboard Wedge Country Keyboard Types (Country Codes)

Scan the bar code corresponding to the keyboard type. For a USB host, this setting applies only to the USB Keyboard (HID) device. If the keyboard type is not listed, see [Emulate Keypad on page 6-10](#) for the USB HID host. For a keyboard wedge host, see [Alternate Numeric Keypad Emulation on page 10-6](#).



NOTE When changing USB country keyboard types the digital scanner automatically resets and issues the standard startup beep sequences.



NOTE For best results when using international keyboards, enable [Quick Keypad Emulation on page 6-11](#).



IMPORTANT 1. Some country keyboard bar code types are specific to certain Windows Operating Systems (i.e., XP, and Win 7 or higher). Bar codes requiring a specific Windows OS are noted so in their bar code captions.

2. Use the **French International** bar code for Belgian French keyboards.

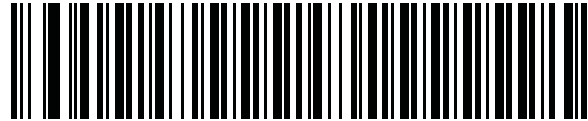

***US English (North American)**

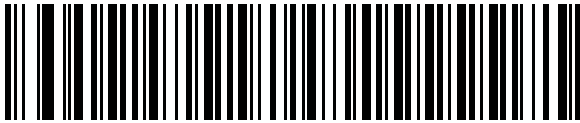

US English (Mac)

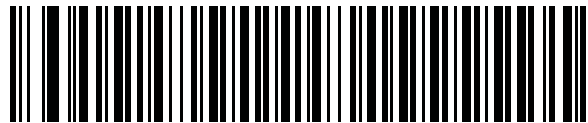

Albanian



Arabic (101)



Arabic (102)



Arabic (102) AZERTY

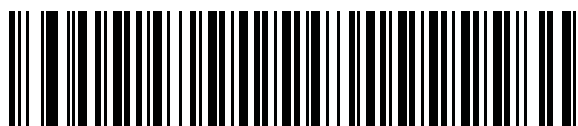

Azeri (Latin)



Azeri (Cyrillic)



Belarusian

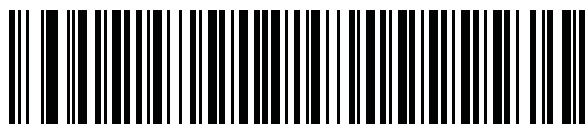

Bosnian (Latin)

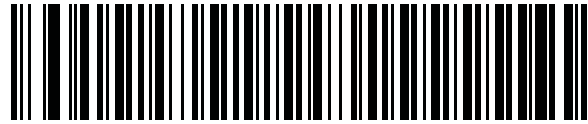

Bosnian (Cyrillic)

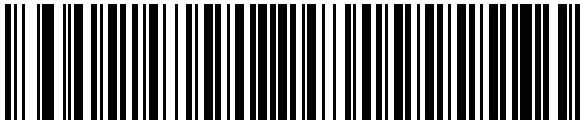

Bulgarian (Latin)



**Bulgarian Cyrillic (Typewriter)
(Bulgarian -Windows XP
Typewriter - Win 7 or higher)**



Canadian French Win7



Canadian French (Legacy)

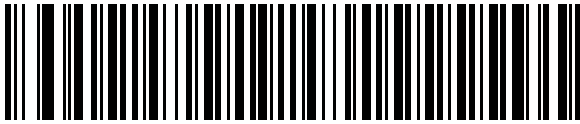

Canadian Multilingual Standard

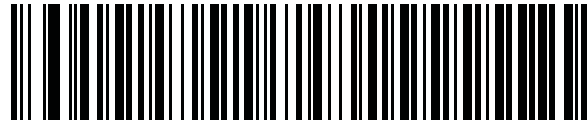

Chinese (ASCII)



Chinese (Simplified)*

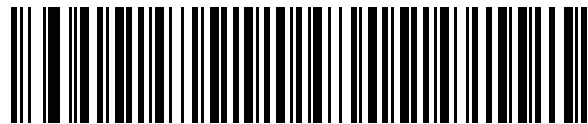

Chinese (Traditional)*

*For CJK keyboard types, see [Appendix D, CJK Decode Control](#).



Croatian



Czech



Czech (Programmer)

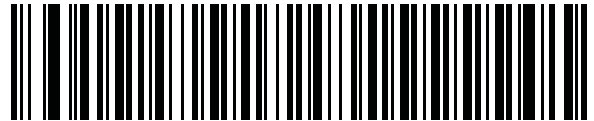

Czech (QWERTY)

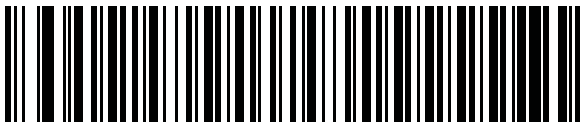

Danish

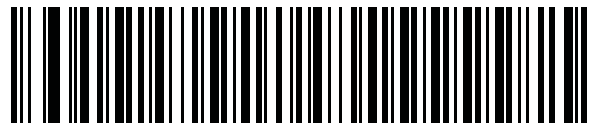

Dutch (Netherlands)



Estonian



Faeroese

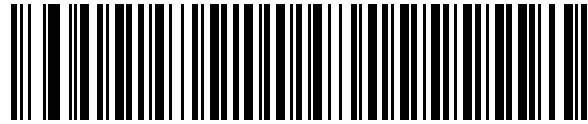

Finnish

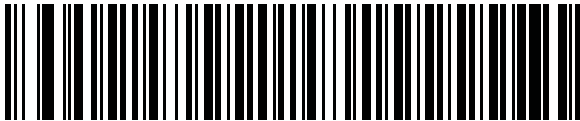

French (France)



**French International
(Belgian French)**



French (Canada) 95/98



French (Canada) 2000/XP*

*Note that there is also a country code bar code for *Canadian Multilingual Standard on page B-5*. Be sure to select the appropriate bar code for your host system.



Galician

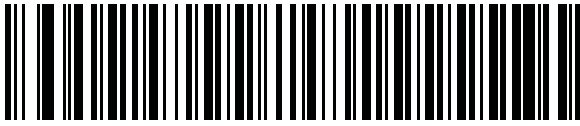

German

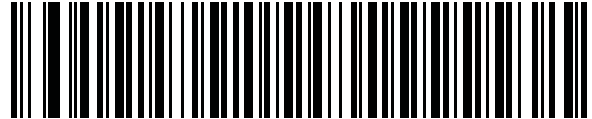

Greek Latin

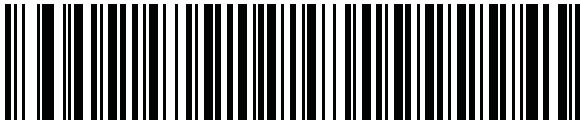

Greek (220) Latin

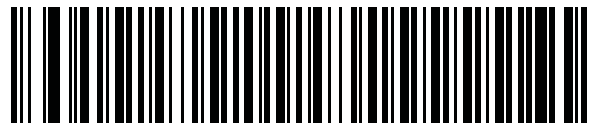

Greek (319) Latin

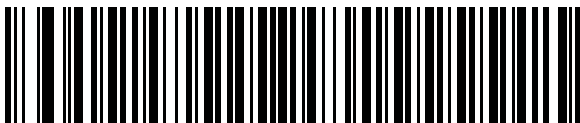

Greek

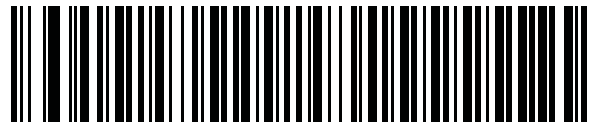

Greek (220)

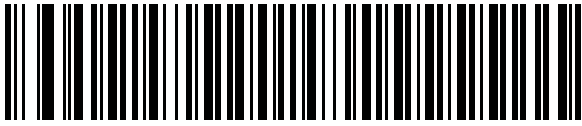

Greek (319)

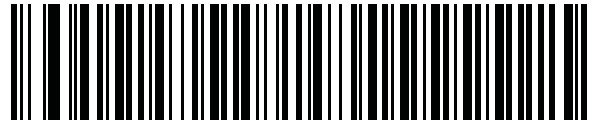

Greek Polytonic

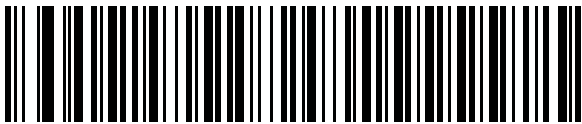

Hebrew Israel



Hungarian



Hungarian_101KEY



Icelandic

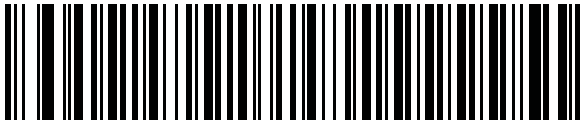

Irish

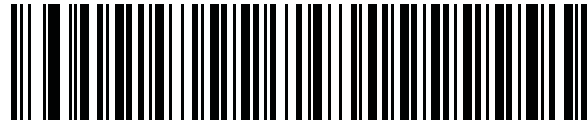

Italian



Italian (142)

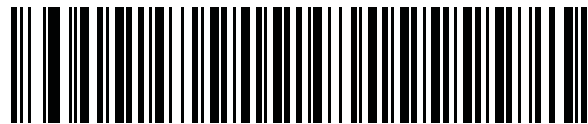

Japanese (ASCII)



Japanese (SHIFT-JIS)*

*For CJK keyboard types, see [Appendix D, CJK Decode Control](#).



Kazakh



Korean (ASCII)

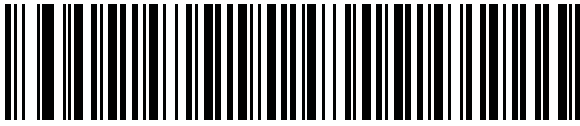

Korean (Hangul)*

*For CJK keyboard types, see [Appendix D, CJK Decode Control](#).

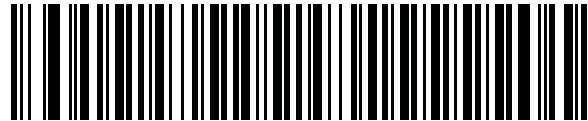

Kyrgyz

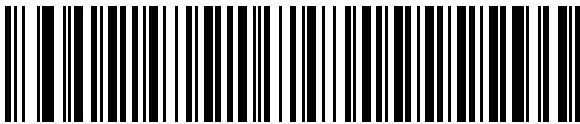

Latin American

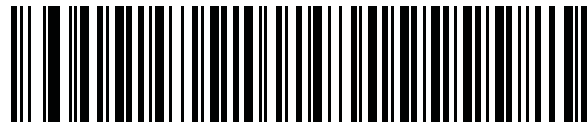

Latvian



Latvian (QWERTY)

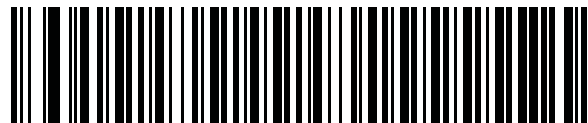

Lithuanian



Lithuanian (IBM)

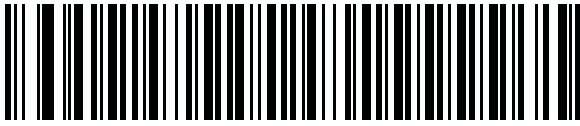

Macedonian (FYROM)

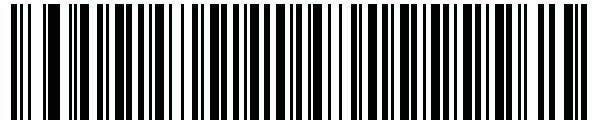

Maltese_47KEY



Mongolian



Norwegian

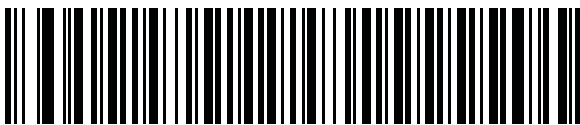

Polish (214)



Polish (Programmer)



**Portuguese (Brazil)
(Windows XP)**

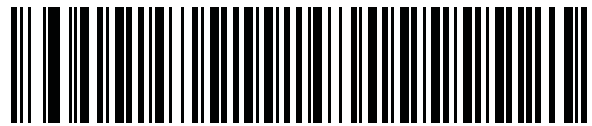

Portuguese (Brazilian ABNT)

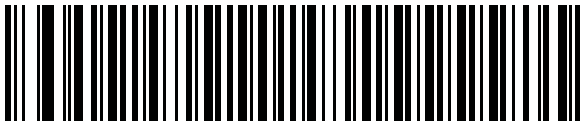

Portuguese (Brazilian ABNT2)



Portuguese (Portugal)

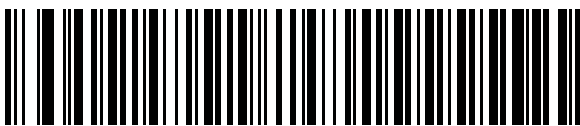

**Romanian
(Windows XP)**



**Romanian (Legacy)
(Win 7 or higher)**

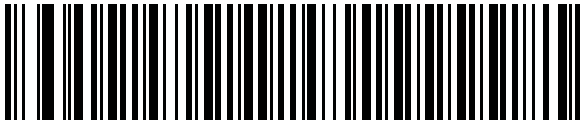

Romanian (Standard)
(Win 7 or higher)

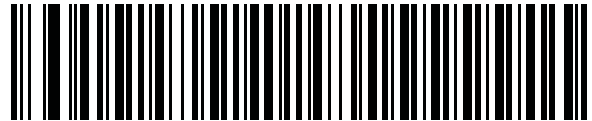

Romanian (Programmer)
(Win 7 or higher)

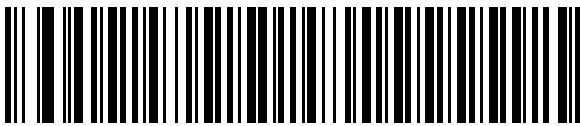

Russian

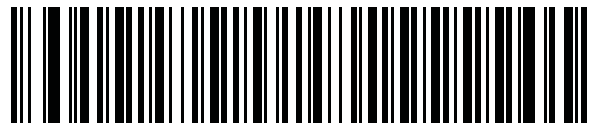

Russian (Typewriter)



Serbian (Latin)



Serbian (Cyrillic)

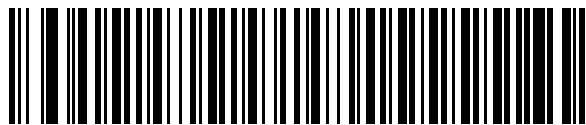

Slovak



Slovak (QWERTY)



Slovenian



Spanish



Spanish (Variation)



Swedish

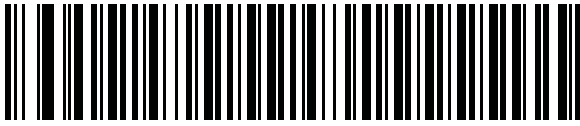

Swiss French

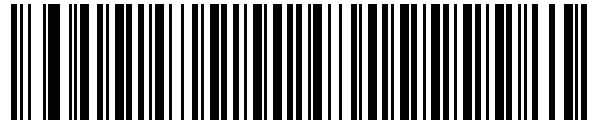

Swiss German

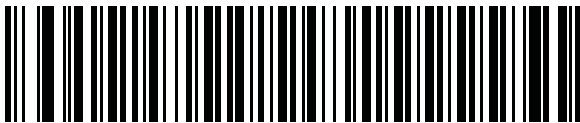

Tatar

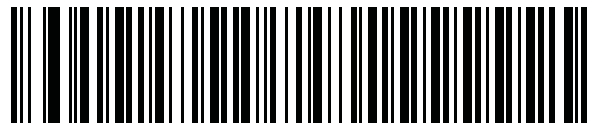

Thai (Kedmanee)



Turkish F



Turkish Q



UK English

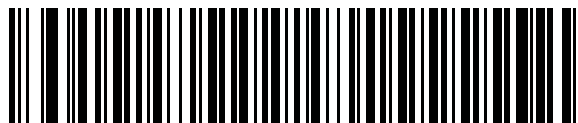

Ukrainian



US Dvorak



US Dvorak Left



US Dvorak Right

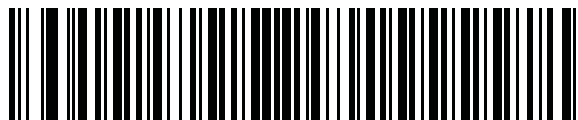

US International



Uzbek

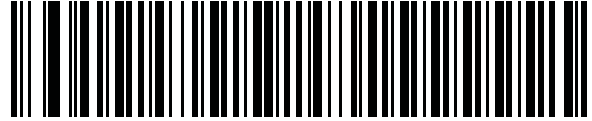

Vietnamese

APPENDIX C COUNTRY CODE PAGES

Introduction

This chapter provides bar codes for selecting code pages for the country keyboard type selected in [Appendix B, Country Codes](#). If the default code page in [Table C-1](#) is appropriate for your selected country keyboard type, you do not need to scan a country code page bar code.

✓ **NOTE** ADF rules can also specify a code page based on the symbology and other ADF criteria. Refer to the *Advanced Data Formatting Programmer Guide*.

Country Code Page Defaults

[Table C-1](#) lists the code page default for each country keyboard.

Table C-1 *Country Code Page Defaults*

Country Keyboard	Code Page Default
US English (North American)	Windows 1252
US English (Mac)	Mac CP10000
Albanian	Windows 1250
Arabic 101	Windows 1256
Arabic 102	Windows 1256
Arabic 102 AZERTY	Windows 1256
Azeri Latin	Windows 1254
Azeri Cyrillic	Windows 1251
Belarusian	Windows 1251
Bosnian Latin	Windows 1250

Table C-1 *Country Code Page Defaults*

Country Keyboard	Code Page Default
Bosnian Cyrillic	Windows 1251
Bulgarian Latin	Windows 1250
Bulgarian Cyrillic	Windows 1251
Canadian French Win7	Windows 1252
Canadian French (Legacy)	Windows 1252
Canadian Multilingual	Windows 1252
Croatian	Windows 1250
Chinese ASCII	Windows 1252
Chinese (Simplified)	Windows 936, GBK
Chinese (Traditional)	Windows 950, Big5
Czech	Windows 1250
Czech Programmers	Windows 1250
Czech QWERTY	Windows 1250
Danish	Windows 1252
Dutch Netherland	Windows 1252
Estonian	Windows 1257
Faeroese	Windows 1252
Finnish	Windows 1252
French (France)	Windows 1252
French (Canada) 95/98	Windows 1252
French (Canada) 2000/XP	Windows 1252
French International (Belgian French)	Windows 1252
Galician	Windows 1252
German	Windows 1252
Greek Latin	Windows 1252
Greek220 Latin	Windows 1253
Greek319 Latin	Windows 1252
Greek	Windows 1253
Greek220	Windows 1253
Greek319	Windows 1253

Table C-1 Country Code Page Defaults

Country Keyboard	Code Page Default
Greek Polytonic	Windows 1253
Hebrew Israel	Windows 1255
Hungarian	Windows 1250
Hungarian_101KEY	Windows 1250
Icelandic	Windows 1252
Irish	Windows 1252
Italian	Windows 1252
Italian_142	Windows 1252
Japanese ASCII	Windows 1252
Japanese (Shift-JIS)	Windows 932, Shift-JIS
Kazakh	Windows 1251
Korean ASCII	Windows 1252
Korean (Hangul)	Windows 949, Hangul
Kyrgyz Cyrillic	Windows 1251
Latin America	Windows 1252
Latvian	Windows 1257
Latvian QWERTY	Windows 1257
Lithuanian	Windows 1257
Lithuanian_IBM	Windows 1257
Macedonian -FYROM	Windows 1251
Maltese_47KEY	Windows 1252
Mongolian-Cyrillic	Windows 1251
Norwegian	Windows 1252
Polish_214	Windows 1250
Polish Programmer	Windows 1250
Portuguese Brazil	Windows 1252
Portuguese Brazilian ABNT	Windows 1252
Portuguese Brazilian ABNT2	Windows 1252
Portuguese Portugal	Windows 1252
Romanian	Windows 1250

Table C-1 *Country Code Page Defaults*

Country Keyboard	Code Page Default
Romanian Legacy	Windows 1250
Romanian Standard	Windows 1250
Romanian Programmer	Windows 1250
Russian	Windows 1251
Russian Typewriter	Windows 1251
Serbian Latin	Windows 1250
Serbian Cyrillic	Windows 1251
Slovak	Windows 1250
Slovak QWERTY	Windows 1250
Slovenian	Windows 1250
Spanish	Windows 1252
Spanish Variation	Windows 1252
Swedish	Windows 1252
Swiss French	Windows 1252
Swiss German	Windows 1252
Tatar	Windows 1251
Thai-Kedmanee	Windows 874
Turkish F	Windows 1254
Turkish Q	Windows 1254
Ukrainian	Windows 1251
United Kingdom	Windows 1252
United States	Windows 1252
US Dvorak	Windows 1252
US Dvorak Left Hand	Windows 1252
US Dvorak Right Hand	Windows 1252
US International	Windows 1252
Uzbek Cyrillic	Windows 1251
Vietnamese	Windows 1258

Country Code Page Bar Codes

Scan the bar code corresponding to the country keyboard code page.

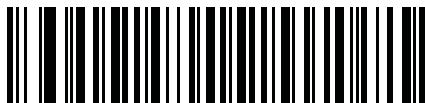

Windows 1250
Latin 2, Central European



Windows 1251
Cyrillic, Slavic

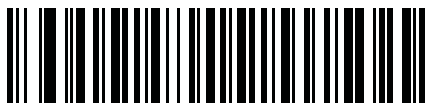

Windows 1252
Latin 1, Western European



Windows 1253
Greek



Windows 1254
Latin 5, Turkish

Country Code Pages (Continued)



**Windows 1255
Hebrew**

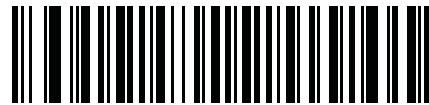

**Windows 1256
Arabic**

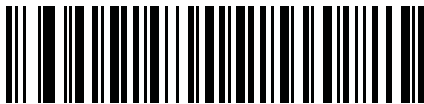

**Windows 1257
Baltic**

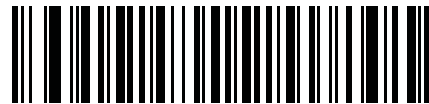

**Windows 1258
Vietnamese**



**Windows 874
Thai**

Country Code Pages (Continued)

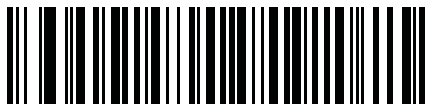

**Windows 20866
Cyrillic KOI8-R**



**Windows 932
Japanese Shift-JIS**

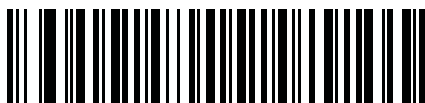

**Windows 936
Simplified Chinese GBK**



**Windows 54936
Simplified Chinese GB18030**



**Windows 949
Korean Hangul**



**Windows 950
Traditional Chinese Big5**

Country Code Pages (Continued)

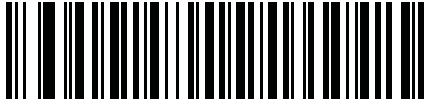

**MS-DOS 437
Latin US**

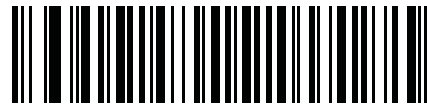

**MS-DOS 737
Greek**

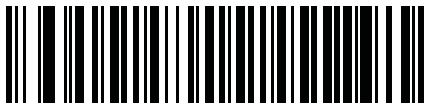

**MS-DOS 775
Baltic**

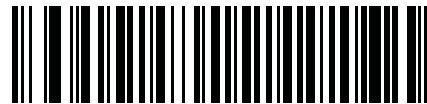

**MS-DOS 850
Latin 1**

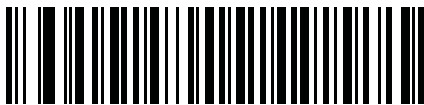

**MS-DOS 852
Latin 2**

Country Code Pages (Continued)



MS-DOS 855
Cyrillic



MS-DOS 857
Turkish

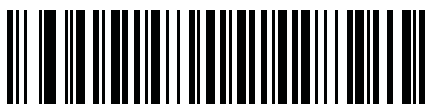

MS-DOS 860
Portuguese



MS-DOS 861
Icelandic

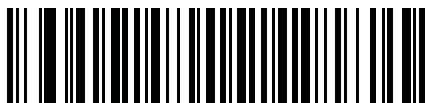

MS-DOS 862
Hebrew

Country Code Pages (Continued)

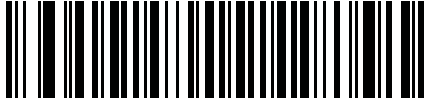

**MS-DOS 863
French Canada**

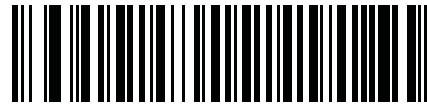

**MS-DOS 865
Nordic**

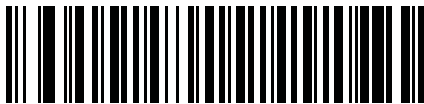

**MS-DOS 866
Cyrillic**

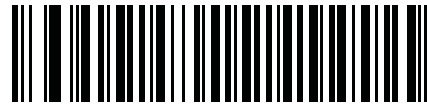

**MS-DOS 869
Greek 2**

Country Code Pages (Continued)

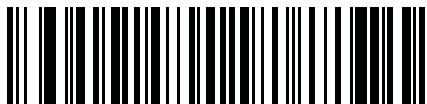

ISO 8859-1
Latin 1, Western European



ISO 8859-2
Latin 2, Central European

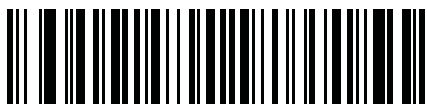

ISO 8859-3
Latin 3, South European



ISO 8859-4
Latin 4, North European

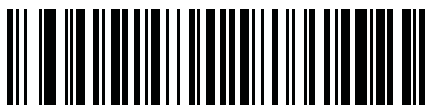

ISO 8859-5
Cyrillic

Country Code Pages (Continued)

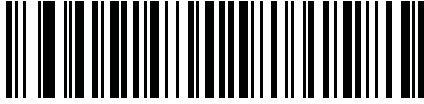

**ISO 8859-6
Arabic**

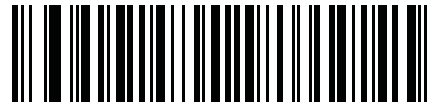

**ISO 8859-7
Greek**



**ISO 8859-8
Hebrew**

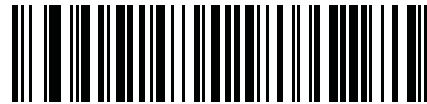

**ISO 8859-9
Latin 5, Turkish**

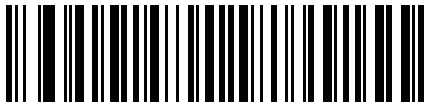

**ISO 8859-10
Latin 6, Nordic**

Country Code Pages (Continued)

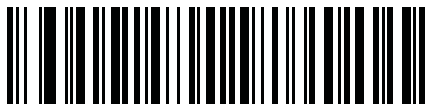

ISO 8859-11
Thai



ISO 8859-13
Latin 7, Baltic

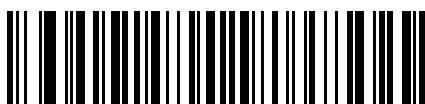

ISO 8859-14
Latin 8, Celtic



ISO 8859-15
Latin 9

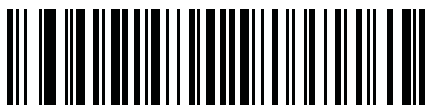

ISO 8859-16
Latin 10, South-Eastern European

Country Code Pages (Continued)

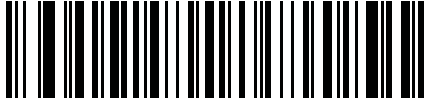

UTF-8

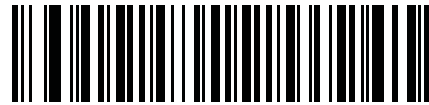

UTF-16LE
UTF-16 Little Endian

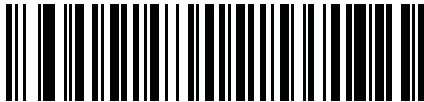

UTF-16BE
UTF-16 Big Endian

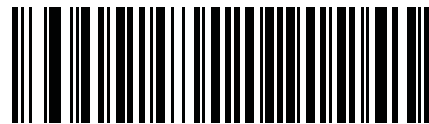

Mac CP1000
Roman

APPENDIX D CJK DECODE CONTROL

Introduction

This appendix describes control parameters for CJK (Chinese, Japanese, Korean) bar code decode through USB HID Keyboard Emulation mode.

✓ **NOTE** Because ADF does not support CJK character processing, there is no format manipulation for CJK output.

CJK Control Parameters

Unicode Output Control

Parameter # 973

For a Unicode encoded CJK bar code, select one of the following options for unicode output:

- **Universal Output to Unicode and MBCS Application** - This default method applies to Unicode and MBCS expected applications, such as MS Word and Notepad on a Windows host.
- ✓ **NOTE** To support Unicode universal output, set up the registry table for the Windows host. See [Unicode/CJK Decode Setup with Windows Host on page D-8](#).
- **Output to Unicode Application Only** - This method applies only to Unicode expected applications, such as MS Word and WordPad, but not Notepad.



***Universal Output
(0)**

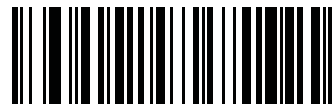

**Unicode Application Only
(1)**

CJK Output Method to Windows Host

Parameter # 972

For a national standard encoded CJK bar code, select one of the following options for CJK output to a Windows host:

- **Universal CJK Output** - This is the default universal CJK output method for US English IME or Chinese/Japanese/Korean ASCII IME on a Windows host. This method converts CJK characters to Unicode and emulates the characters when transmitting to the host. Use the [Unicode Output Control](#) parameter to control Unicode output.
- ✓ **NOTE** To support universal CJK output, set up the registry table for the Windows host. See [Unicode/CJK Decode Setup with Windows Host on page D-8](#).
- **Other options for CJK output** - With the following methods, the scanner sends the CJK character hexadecimal internal code (Nei Ma) value to host, or converts the CJK character to Unicode and sends the hexadecimal Unicode value to host. When using these methods, the Windows host must select the corresponding IME to accept the CJK character. See [Unicode/CJK Decode Setup with Windows Host on page D-8](#).
 - **Japanese Unicode Output**
 - **Simplified Chinese GBK Code Output**
 - **Simplified Chinese Unicode Output**
 - **Korean Unicode Code Output**
 - **Traditional Chinese Big5 Code Output** (Windows XP)
 - **Traditional Chinese Big5 Code Output** (Windows 7)
 - **Traditional Chinese Unicode Code Output** (Windows XP)
 - **Traditional Chinese Unicode Code Output** (Windows 7)

- ✓ **NOTE** The Unicode emulate output method depends on the host system (Windows XP or Windows 7).



***Universal CJK Output
(0)**



**Japanese Unicode Output
(34)**

(for Japanese Unicode Output, select Simplified Chinese Unicode IME on the Windows host)

CJK Output Method to Windows Host (continued)



**Chinese (Simplified) GBK Output
(1)**

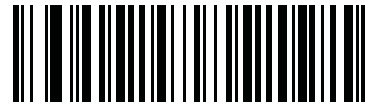

**Chinese (Simplified) Unicode Output
(2)**

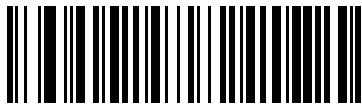

**Korean Unicode Output
(50)**

(for Korean Unicode Output, select Simplified Chinese Unicode IME on the Windows host)

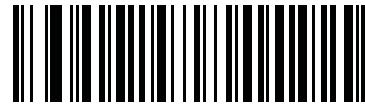

**Chinese (Traditional) Big5 Output (Windows XP)
(17)**



**Chinese (Traditional) Big5 Output (Windows 7)
(19)**

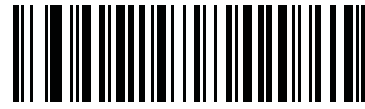

Chinese (Traditional) Unicode Output (Windows XP)
(18)



Chinese (Traditional) Unicode Output (Windows 7)
(20)

Non-CJK UTF Bar Code Output

Parameter # 960

Some country keyboard type layouts contain characters that do not exist in the default code page (see [Country Keyboard Type Missing Characters on page D-7](#)). Although the default code page can not encode these characters in a bar code, they can be encoded in the UTF-8 bar code. Scan this parameter bar code to output the Unicode values by emulation mode.

✓ **NOTE** Use this special country keyboard type to decode the non-CJK UTF-8 bar code. After decoding, re-configure the scanner to use the original country keyboard type.

Use US English IME on Windows. See [Unicode Output Control on page D-2](#).

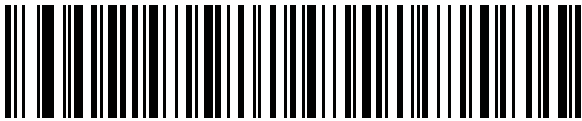

Non-CJK UTF-8 Emulation Output

Country Keyboard Type Missing CharactersCountry keyboard type: **Tatar, Uzbek, Mongolian, Kyrgyz, Kazakh and Azeri**

Default code page: CP1251

Missing characters:

ƒ	F
х	Х
к	К
h	Һ
ө	Ө
ә	Ә
Ү	У
н	Ң
ж	Ж
Ғ	
ң	Ң
Ү	У
к	К
ч	Ч
к	К

Country keyboard type: **Romanian (Standard)**

Default code page: CP1250

Missing characters:

ș	Ș
ț	Ț

Country keyboard type: **Portuguese-Brazilian (ABNT), Portuguese-Brazilian (ABNT2)**

Default code page: CP1252

Missing character: **€**Country keyboard type: **Azeri-Latin**

Default code page: CP1254

Missing characters: ә, Ә

Unicode/CJK Decode Setup with Windows Host

This section describes how to set up CJK decode with a Windows host.

Setting Up the Windows Registry Table for Unicode Universal Output

To support the Unicode universal output method, set up the Windows host registry table as follows:

1. Select **Start > Run > regedt32** to start the registry editor.
2. Under **HKEY_Current_User\Control Panel\Input Method**, set **EnableHexNumpad** to **1** as follows:
[HKEY_CURRENT_USER\Control Panel\Input Method]
"EnableHexNumpad"="1"
If this key does not exist, add it as type **REG_SZ** (string value).
3. Reboot the computer to implement the registry change.

Adding CJK IME on Windows

To add the desired CJK input language:

1. Click **Start > Control Panel**.
2. If the Control Panel opens in category view, select **Switch to Classic View** in the top left corner.
3. Select **Regional and Language Options**.
4. Click the **Language** tab.
5. Under **Supplemental Language Support**, select the **Install Files for East Asian Languages** check box if not already selected, and click **Apply**. This may require a Windows installation CD to install the required files. This step ensures that the East Asian Languages (CJK) are available.
6. Under **Text Services and Input Language**, click **Details**.
7. Under **Installed Services**, click **Add**.
8. In the **Add Input Language** dialog box, choose the CJK input language and keyboard layout or Input Method Editor (IME) to add.
9. Click **OK** twice. The language indicator appears in the system tray (at bottom right corner of the desktop by default). To switch between input languages (keyboard languages) select the language indicator in the system tray.
10. Select the language indicator in the system tray to select the desired country keyboard type.
11. Verify that the characters displayed on each country's keyboard appear.

Selecting the Simplified Chinese Input Method on the Host

To select the Simplified Chinese input method:

- Select Unicode/GBK input on Windows XP: **Chinese (Simplified) - NeiMa**, then click the input bar to select **Unicode** or **GBK NeiMa** input.

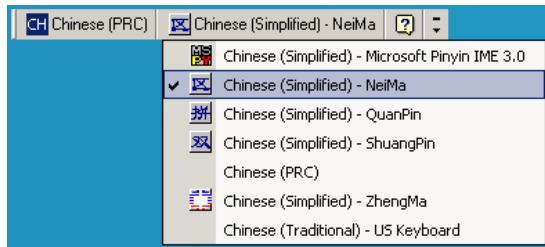

Or



- Select Unicode/GBK input on Windows7: **Chinese (Simplified) - Microsoft Pinyin New Experience Input Style**, then select **Tool Menu > Secondary Inputs > Unicode Input** or **GB Code Input**.

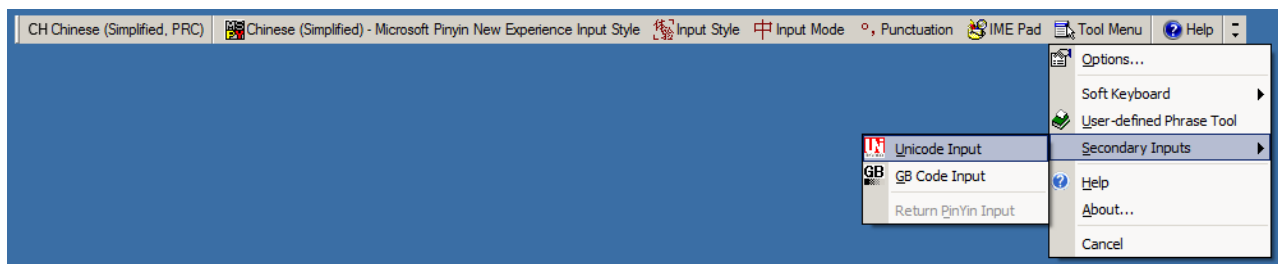

Selecting the Traditional Chinese Input Method on the Host

To select the Traditional Chinese input method:

- Select Unicode input on Windows XP: **Chinese (Traditional) - Unicode**

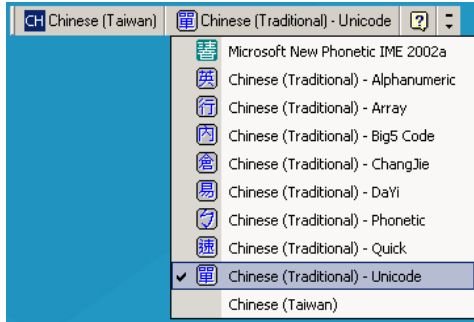

- Select Big5 input on Windows XP: **Chinese (Traditional) - Big5 Code**

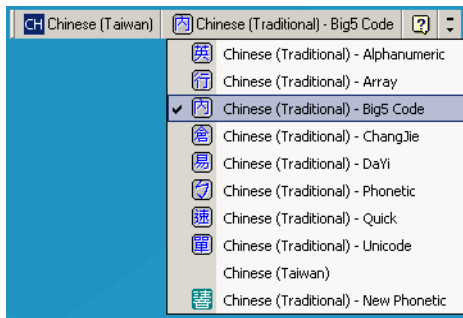

- Select Unicode/Big5 input on Windows 7: **Chinese (Traditional) - New Quick**. This option support both Unicode and Big5 input.



APPENDIX E PROGRAMMING REFERENCE

Symbol Code Identifiers

Table E-1 *Symbol Code Characters*

Code Character	Code Type
A	UPC-A, UPC-E, UPC-E1, EAN-8, EAN-13
B	Code 39, Code 32
C	Codabar
D	Code 128, ISBT 128, ISBT 128 Concatenated
E	Code 93
F	Interleaved 2 of 5
G	Discrete 2 of 5, or Discrete 2 of 5 IATA
H	Code 11
J	MSI
K	GS1-128
L	Bookland EAN
M	Trioptic Code 39
N	Coupon Code
R	GS1 DataBar Family
S	Matrix 2 of 5
T	UCC Composite, TLC 39
U	Chinese 2 of 5

Table E-1 *Symbol Code Characters (Continued)*

Code Character	Code Type
V	Korean 3 of 5
X	ISSN EAN, PDF417, Macro PDF417, Micro PDF417
z	Aztec, Aztec Rune
P00	Data Matrix
P01	QR Code, MicroQR
P02	Maxicode
P03	US Postnet
P04	US Planet
P05	Japan Postal
P06	UK Postal
P08	Netherlands KIX Code
P09	Australia Post
P0A	USPS 4CB/One Code/Intelligent Mail
P0B	UPU FICS Postal
P0C	Mailmark
P0H	Han Xin
P0G	GS1 Datamatrix
P0Q	GS1 QR
P0X	Signature Capture

AIM Code Identifiers

Each AIM Code Identifier contains the three-character string **Jcm** where:

- J = Flag Character (ASCII 93)
- c = Code Character (see [Table E-2](#))
- m = Modifier Character (see [Table E-3](#))

Table E-2 *Aim Code Characters*

Code Character	Code Type
A	Code 39, Code 39 Full ASCII, Code 32
C	Code 128, ISBT 128, ISBT 128 Concatenated, GS1-128, Coupon (Code 128 portion)
d	Data Matrix, GS1-DM
E	UPC/EAN, Coupon (UPC portion)
e	GS1 DataBar Family
F	Codabar
G	Code 93
H	Code 11
h	Han Xin
I	Interleaved 2 of 5
L	PDF417, Macro PDF417, Micro PDF417
L2	TLC 39
M	MSI
Q	QR Code, MicroQR, GS1-QR
S	Discrete 2 of 5, IATA 2 of 5
U	Maxicode
z	Aztec, Aztec Rune
X	Bookland EAN, ISSN EAN, Trioptic Code 39, Chinese 2 of 5, Matrix 2 of 5, Korean 3 of 5, US Postnet, US Planet, UK Postal, Japan Postal, Australia Post, Netherlands KIX Code, USPS 4CB/One Code/ Intelligent Mail, UPU FICS Postal, Signature Capture, Mailmark

E - 4 DS3608 Digital Scanner Product Reference Guide

The modifier character is the sum of the applicable option values based on [Table E-3](#).

Table E-3 *Modifier Characters*

Code Type	Option Value	Option
Code 39	0	No check character or Full ASCII processing.
	1	Reader has checked one check character.
	3	Reader has checked and stripped check character.
	4	Reader has performed Full ASCII character conversion.
	5	Reader has performed Full ASCII character conversion and checked one check character.
	7	Reader has performed Full ASCII character conversion and checked and stripped check character.
	Example: A Full ASCII bar code with check character W, A+I+MI+DW , is transmitted as J A7AIMID where 7 = (3+4).	
Trioptic Code 39	0	No option specified at this time. Always transmit 0.
	Example: A Trioptic bar code 412356 is transmitted as J X0412356	
Code 128	0	Standard data packet, no Function code 1 in first symbol position.
	1	Function code 1 in first symbol character position.
	2	Function code 1 in second symbol character position.
	Example: A Code (EAN) 128 bar code with Function 1 character ^{FNC1} in the first position, AIMID is transmitted as J C1AIMID	
I 2 of 5	0	No check digit processing.
	1	Reader has validated check digit.
	3	Reader has validated and stripped check digit.
	Example: An I 2 of 5 bar code without check digit, 4123, is transmitted as J I04123	
Codabar	0	No check digit processing.
	1	Reader has checked check digit.
	3	Reader has stripped check digit before transmission.
	Example: A Codabar bar code without check digit, 4123, is transmitted as J F04123	
Code 93	0	No options specified at this time. Always transmit 0.
	Example: A Code 93 bar code 012345678905 is transmitted as J G0012345678905	
MSI	0	Check digits are sent.
	1	No check digit is sent.
	Example: An MSI bar code 4123, with a single check digit checked, is transmitted as J M14123	

Table E-3 Modifier Characters (Continued)

Code Type	Option Value	Option
D 2 of 5	0	No options specified at this time. Always transmit 0.
	Example: A D 2 of 5 bar code 4123, is transmitted as JS04123	
UPC/EAN	0	Standard data packet in full EAN format, i.e. 13 digits for UPC-A, UPC-E, and EAN-13 (not including supplemental data).
	1	Two digit supplemental data only.
	2	Five digit supplemental data only.
	3	Combined data packet comprising 13 digits from EAN-13, UPC-A or UPC-E symbol and 2 or 5 digits from supplemental symbol.
	4	EAN-8 data packet.
Example: A UPC-A bar code 012345678905 is transmitted as JE00012345678905		
Bookland EAN	0	No options specified at this time. Always transmit 0.
	Example: A Bookland EAN bar code 123456789X is transmitted as JX0123456789X	
ISSN EAN	0	No options specified at this time. Always transmit 0.
	Example: An ISSN EAN bar code 123456789X is transmitted as JX0123456789X	
Code 11	0	Single check digit
	1	Two check digits
	3	Check characters validated but not transmitted.
GS1 DataBar Family		No option specified at this time. Always transmit 0. GS1 DataBar-14 and GS1 DataBar Limited transmit with an Application Identifier "01". Note: In GS1-128 emulation mode, GS1 DataBar is transmitted using Code 128 rules (i.e., JC1).
	Example: A GS1 DataBar-14 bar code 0110012345678902 is transmitted as Je00110012345678902 .	

Table E-3 *Modifier Characters (Continued)*

Code Type	Option Value	Option
EAN.UCC Composites (GS1 DataBar, GS1-128, 2D portion of UPC composite)		Native mode transmission. Note: UPC portion of composite is transmitted using UPC rules.
	0	Standard data packet.
	1	Data packet containing the data following an encoded symbol separator character.
	2	Data packet containing the data following an escape mechanism character. The data packet does not support the ECI protocol.
	3	Data packet containing the data following an escape mechanism character. The data packet supports the ECI protocol.
		GS1-128 emulation Note: UPC portion of composite is transmitted using UPC rules.
	1	Data packet is a GS1-128 symbol (i.e., data is preceded with]JC1).
PDF417, Micro PDF417	0	Reader set to conform to protocol defined in 1994 PDF417 symbology specifications. Note: When this option is transmitted, the receiver cannot reliably determine whether ECIs have been invoked or whether data byte 92 _{DEC} has been doubled in transmission.
	1	Reader set to follow the ECI protocol (Extended Channel Interpretation). All data characters 92 _{DEC} are doubled.
	2	Reader set for Basic Channel operation (no escape character transmission protocol). Data characters 92 _{DEC} are not doubled. Note: When decoders are set to this mode, unbuffered Macro symbols and symbols requiring the decoder to convey ECI escape sequences cannot be transmitted.
	3	The bar code contains a GS1-128 symbol, and the first codeword is 903-907, 912, 914, 915.
	4	The bar code contains a GS1-128 symbol, and the first codeword is in the range 908-909.
	5	The bar code contains a GS1-128 symbol, and the first codeword is in the range 910-911.

Table E-3 *Modifier Characters (Continued)*

Code Type	Option Value	Option
Data Matrix	0	ECC 000-140, not supported.
	1	ECC 200.
	2	ECC 200, FNC1 in first or fifth position.
	3	ECC 200, FNC1 in second or sixth position.
	4	ECC 200, ECI protocol implemented.
	5	ECC 200, FNC1 in first or fifth position, ECI protocol implemented.
	6	ECC 200, FNC1 in second or sixth position, ECI protocol implemented.
MaxiCode	0	Symbol in Mode 4 or 5.
	1	Symbol in Mode 2 or 3.
	2	Symbol in Mode 4 or 5, ECI protocol implemented.
	3	Symbol in Mode 2 or 3, ECI protocol implemented in secondary message.
QR Code	0	Model 1 symbol.
	1	Model 2 / MicroQR symbol, ECI protocol not implemented.
	2	Model 2 symbol, ECI protocol implemented.
	3	Model 2 symbol, ECI protocol not implemented, FNC1 implied in first position.
	4	Model 2 symbol, ECI protocol implemented, FNC1 implied in first position.
	5	Model 2 symbol, ECI protocol not implemented, FNC1 implied in second position.
	6	Model 2 symbol, ECI protocol implemented, FNC1 implied in second position.
Aztec	0	Aztec symbol.
	C	Aztec Rune symbol.
Han Xin	0	Generic data, no special features are set. The transmitted data does not follow the AIM ECI protocol.
	1	ECI protocol enabled. There is at least one ECI mode encoded. Transmitted data must follow the AIM ECI protocol.

APPENDIX F SAMPLE BAR CODES

Code 39



UPC/EAN

UPC-A, 100%



EAN-13, 100%



Code 128



Interleaved 2 of 5



GS1 DataBar-14

✓ **NOTE** DataBar-14 must be enabled to read the bar code below (see [GS1 DataBar-14 on page 11-72](#)).



7612341562341

PDF417

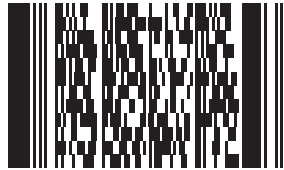

Data Matrix



Maxicode

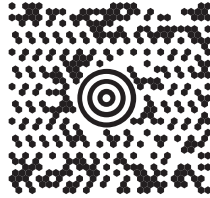

QR Code



US Postnet



UK Postal



APPENDIX G NUMERIC BAR CODES

Numeric Bar Codes

For parameters requiring specific numeric values, scan the appropriately numbered bar code(s).



Numeric Bar Codes (continued)



5



6



7



8

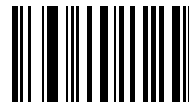

9

Cancel

To correct an error or change a selection, scan the bar code below.



Cancel

APPENDIX H ASCII CHARACTER SETS

Table H-1 *ASCII Character Set*

ASCII Value	Full ASCII Code 39 Encode Char	Keystroke
1000	%U	CTRL 2
1001	\$A	CTRL A
1002	\$B	CTRL B
1003	\$C	CTRL C
1004	\$D	CTRL D
1005	\$E	CTRL E
1006	\$F	CTRL F
1007	\$G	CTRL G
1008	\$H	CTRL H/ BACKSPACE ¹
1009	\$I	CTRL I/ HORIZONTAL TAB ¹
1010	\$J	CTRL J
1011	\$K	CTRL K
1012	\$L	CTRL L
1013	\$M	CTRL M/ ENTER ¹
1014	\$N	CTRL N
1015	\$O	CTRL O

The keystroke in bold transmits only if you enabled Function Key Mapping. Otherwise, the unbold keystroke transmits.

Table H-1 ASCII Character Set (Continued)

ASCII Value	Full ASCII Code 39 Encode Char	Keystroke
1016	\$P	CTRL P
1017	\$Q	CTRL Q
1018	\$R	CTRL R
1019	\$S	CTRL S
1020	\$T	CTRL T
1021	\$U	CTRL U
1022	\$V	CTRL V
1023	\$W	CTRL W
1024	\$X	CTRL X
1025	\$Y	CTRL Y
1026	\$Z	CTRL Z
1027	%A	CTRL [
1028	%B	CTRL \
1029	%C	CTRL]
1030	%D	CTRL 6
1031	%E	CTRL -
1032	Space	Space
1033	/A	!
1034	/B	"
1035	/C	#
1036	/D	\$
1037	/E	%
1038	/F	&
1039	/G	'
1040	/H	(
1041	/I)
1042	/J	*
1043	/K	+

The keystroke in bold transmits only if you enabled Function Key Mapping. Otherwise, the unbold keystroke transmits.

Table H-1 ASCII Character Set (Continued)

ASCII Value	Full ASCII Code 39 Encode Char	Keystroke
1044	/L	,
1045	-	-
1046	.	.
1047	/o	/
1048	0	0
1049	1	1
1050	2	2
1051	3	3
1052	4	4
1053	5	5
1054	6	6
1055	7	7
1056	8	8
1057	9	9
1058	/Z	:
1059	%F	;
1060	%G	<
1061	%H	=
1062	%I	>
1063	%J	?
1064	%V	@
1065	A	A
1066	B	B
1067	C	C
1068	D	D
1069	E	E
1070	F	F
1071	G	G

The keystroke in bold transmits only if you enabled Function Key Mapping. Otherwise, the unbold keystroke transmits.

Table H-1 *ASCII Character Set (Continued)*

ASCII Value	Full ASCII Code 39 Encode Char	Keystroke
1072	H	H
1073	I	I
1074	J	J
1075	K	K
1076	L	L
1077	M	M
1078	N	N
1079	O	O
1080	P	P
1081	Q	Q
1082	R	R
1083	S	S
1084	T	T
1085	U	U
1086	V	V
1087	W	W
1088	X	X
1089	Y	Y
1090	Z	Z
1091	%K	[
1092	%L	\
1093	%M]
1094	%N	^
1095	%O	_
1096	%W	'
1097	+A	a
1098	+B	b
1099	+C	c

The keystroke in bold transmits only if you enabled Function Key Mapping. Otherwise, the unbold keystroke transmits.

Table H-1 *ASCII Character Set (Continued)*

ASCII Value	Full ASCII Code 39 Encode Char	Keystroke
1100	+D	d
1101	+E	e
1102	+F	f
1103	+G	g
1104	+H	h
1105	+I	i
1106	+J	j
1107	+K	k
1108	+L	l
1109	+M	m
1110	+N	n
1111	+O	o
1112	+P	p
1113	+Q	q
1114	+R	r
1115	+S	s
1116	+T	t
1117	+U	u
1118	+V	v
1119	+W	w
1120	+X	x
1121	+Y	y
1122	+Z	z
1123	%P	{
1124	%Q	
1125	%R	}

The keystroke in bold transmits only if you enabled Function Key Mapping. Otherwise, the unbold keystroke transmits.

Table H-1 *ASCII Character Set (Continued)*

ASCII Value	Full ASCII Code 39 Encode Char	Keystroke
1126	%S	~
1127		Undefined
7013		ENTER

The keystroke in bold transmits only if you enabled Function Key Mapping. Otherwise, the unbold keystroke transmits.

Table H-2 *ALT Key Standard Default Tables*

ALT Keys	Keystroke
2050	ALT 2
2054	ALT 6
2064	ALT @
2065	ALT A
2066	ALT B
2067	ALT C
2068	ALT D
2069	ALT E
2070	ALT F
2071	ALT G
2072	ALT H
2073	ALT I
2074	ALT J
2075	ALT K
2076	ALT L
2077	ALT M
2078	ALT N
2079	ALT O
2080	ALT P
2081	ALT Q
2082	ALT R

Table H-2 ALT Key Standard Default Tables (Continued)

ALT Keys	Keystroke
2083	ALT S
2084	ALT T
2085	ALT U
2086	ALT V
2087	ALT W
2088	ALT X
2089	ALT Y
2090	ALT Z
2091	ALT [
2092	ALT \
2093	ALT]

Table H-3 USB GUI Key Character Set

GUI Key	Keystroke
3000	Right Control Key
3001	PA 1
3002	PA 2
3003	CMD 1
3004	CMD 2
3005	CMD 3
3006	CMD 4
3007	CMD 5
3008	CMD 6
3009	CMD 7
3010	CMD 8
3011	CMD 9
3012	CMD 10

Note: GUI Shift Keys - The Apple™ iMac keyboard has an apple key on either side of the space bar. Windows-based systems have a GUI key to the left of the left ALT key, and to the right of the right ALT key.

Table H-3 *USB GUI Key Character Set (Continued)*

GUI Key	Keystroke
3013	CMD 11
3014	CMD 12
3015	CMD 13
3016	CMD 14
3048	GUI 0
3049	GUI 1
3050	GUI 2
3051	GUI 3
3052	GUI 4
3053	GUI 5
3054	GUI 6
3055	GUI 7
3056	GUI 8
3057	GUI 9
3065	GUI A
3066	GUI B
3067	GUI C
3068	GUI D
3069	GUI E
3070	GUI F
3071	GUI G
3072	GUI H
3073	GUI I
3074	GUI J
3075	GUI K
3076	GUI L
3077	GUI M

Note: GUI Shift Keys - The Apple™ iMac keyboard has an apple key on either side of the space bar. Windows-based systems have a GUI key to the left of the left ALT key, and to the right of the right ALT key.

Table H-3 *USB GUI Key Character Set (Continued)*

GUI Key	Keystroke
3078	GUI N
3079	GUI O
3080	GUI P
3081	GUI Q
3082	GUI R
3083	GUI S
3084	GUI T
3085	GUI U
3086	GUI V
3087	GUI W
3088	GUI X
3089	GUI Y
3090	GUI Z

Note: GUI Shift Keys - The Apple™ iMac keyboard has an apple key on either side of the space bar. Windows-based systems have a GUI key to the left of the left ALT key, and to the right of the right ALT key.

Table H-4 *PF Key Standard Default Table*

PF Keys	Keystroke
4001	PF 1
4002	PF 2
4003	PF 3
4004	PF 4
4005	PF 5
4006	PF 6
4007	PF 7
4008	PF 8
4009	PF 9
4010	PF 10
4011	PF 11
4012	PF 12
4013	PF 13
4014	PF 14
4015	PF 15
4016	PF 16

Table H-5 *F key Standard Default Table*

F Keys	Keystroke
5001	F 1
5002	F 2
5003	F 3
5004	F 4
5005	F 5
5006	F 6
5007	F 7
5008	F 8
5009	F 9
5010	F 10
5011	F 11
5012	F 12
5013	F 13
5014	F 14
5015	F 15
5016	F 16
5017	F 17
5018	F 18
5019	F 19
5020	F 20
5021	F 21
5022	F 22
5023	F 23
5024	F 24

Table H-6 *Numeric Key Standard Default Table*

Numeric Keypad	Keystroke
6042	*
6043	+
6044	Undefined
6045	-
6046	.
6047	/
6048	0
6049	1
6050	2
6051	3
6052	4
6053	5
6054	6
6055	7
6056	8
6057	9
6058	Enter
6059	Num Lock

Table H-7 *Extended Keypad Standard Default Table*

Extended Keypad	Keystroke
7001	Break
7002	Delete
7003	Pg Up
7004	End
7005	Pg Dn
7006	Pause
7007	Scroll Lock
7008	Backspace
7009	Tab
7010	Print Screen
7011	Insert
7012	Home
7013	Enter
7014	Escape
7015	Up Arrow
7016	Dn Arrow
7017	Left Arrow
7018	Right Arrow

APPENDIX I COMMUNICATION PROTOCOL FUNCTIONALITY

Functionality Supported via Communication (Cable) Interface

[Table I-1](#) lists supported scanner functionality by communication protocol.

Table I-1 *Communication Interface Functionality*

Communication Interfaces	Functionality		
	Data Transmission	Remote Management	Image and Video Transmission
USB			
HID Keyboard Emulation	Supported	Not Available	Not Available
Simple COM Port Emulation	Supported	Not Available	Not Available
CDC COM Port Emulation	Supported	Not Available	Not Available
SSI over CDC COM Port Emulation	Supported	Supported	Supported
IBM Table-Top USB	Supported	Supported	Not Available
IBM Hand-Held USB	Supported	Supported	Not Available
USB OPOS Hand-Held	Supported	Supported	Not Available
Symbol Native API (SNAPI) without Imaging Interface	Supported	Supported	Not Available
Symbol Native API (SNAPI) with Imaging Interface	Supported	Supported	Supported
RS-232			
Standard RS-232	Supported	Not Available	Not Available
ICL RS-232	Supported	Not Available	Not Available
Fujitsu RS-232	Supported	Not Available	Not Available
Wincor-Nixdorf RS-232 Mode A	Supported	Not Available	Not Available

Table I-1 *Communication Interface Functionality (Continued)*

Communication Interfaces	Functionality		
	Data Transmission	Remote Management	Image and Video Transmission
Wincor-Nixdorf RS-232 Mode B	Supported	Not Available	Not Available
Olivetti ORS4500	Supported	Not Available	Not Available
Omron	Supported	Not Available	Not Available
CUTE	Supported	Not Available	Not Available
OPOS/JPOS	Supported	Not Available	Not Available
SSI	Supported	Supported	Supported
IBM 4690			
Hand-Held Scanner Emulation (Port 9B)	Supported	Not Available	Not Available
Table-Top Scanner Emulation (Port 17)	Supported	Supported	Not Available
Non-IBM Scanner Emulation (Port 5B)	Supported	Supported	Not Available
Keyboard Wedge			
IBM PC/AT & IBM PC Compatibles	Supported	Not Available	Not Available
IBM AT Notebook	Supported	Not Available	Not Available

APPENDIX J SIGNATURE CAPTURE CODE

Introduction

CapCode, a signature capture code, is a special pattern that encloses a signature area on a document and allows a scanner to capture a signature.

There are several accepted patterns that allow automatic identification of different signatures on the same form. For example, on the federal tax return 1040 form there are three signature areas, one each for two joint filers, and one for a professional preparer. By using different patterns, a program can correctly identify all three, so they can be captured in any sequence and still be identified correctly.

Code Structure

Signature Capture Area

A CapCode is printed as two identical patterns on either side of a signature capture box, as shown in [Figure J-1](#). Each pattern extends the full height of the signature capture box.

The box is optional, so you can omit it, replace it with a single baseline, or print a baseline with an "X" on top of it towards the left, as is customarily done in the US to indicate a request for signature. However, if an "X" or other markings are added in the signature box area, these are captured with the signature.



Figure J-1 CapCode

CapCode Pattern Structure

A CapCode pattern structure consists of a start pattern followed by a separator space, a signature capture box, a second separator space, and then a stop pattern. Assuming that X is the dimension of the thinnest element, the start and stop patterns each contains $9X$ total width in 4 bars and 3 spaces. A $7X$ quiet zone is required to the left and to the right of the CapCode pattern.

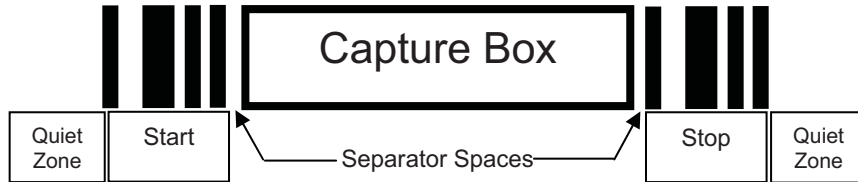

Figure J-2 CapCode Structure

The separator spaces on either side of the signature capture box can be between $1X$ and $3X$ wide.

Start / Stop Patterns

Table J-1 lists the accepted start / stop patterns. The bar and space widths are expressed as multiples of X . You must use the same pattern on either side of a signature capture box. The type value is reported with the captured signature to indicate the purpose of the signature captured.

Table J-1 Start / Stop Pattern Definitions

Bar/Space Patterns							Type
B	S	B	S	B	S	B	
1	1	2	2	1	1	1	2
1	2	2	1	1	1	1	5
2	1	1	2	1	1	1	7
2	2	1	1	1	1	1	8
3	1	1	1	1	1	1	9

[Table J-2](#) lists selectable parameters used to generate the image of the captured signature.

Table J-2 *User Defined CapCode Parameters*

Parameter	Defined
Width	Number of pixels
Height	Number of pixels
Format	JPEG, BMP, TIFF
JPEG quality	1 (most compression) to 100 (best quality)
Bits Per Pixel (not applicable to JPEG format)	1 (2 levels)
	4 (16 levels)
	8 (256 levels)

BMP format does not use compression, JPEG and TIFF formats do.

Dimensions

The size of the signature capture box is determined by the height and separation of the start and stop patterns. The line width of the signature capture box is insignificant.

The thinnest element width, referred to here as X, is nominally 10 mils (1 mil = 0.0254 mm). Select this as an exact multiple of the pixel pitch of the printer used. For example, when using a 203 DPI (dots-per-inch) printer and printing 2 dots per module, the resulting X dimension is 9.85 mils.

Data Format

The decoder output is formatted according to [Table J-3](#). Zebra decoders allow different user options to output or inhibit bar code type. Selecting "Symbol ID" as the bar code type for output identifies the CapCode with letter "i".

Table J-3 *Data Format*

File Format (1 byte)	Type (1 byte)	Image Size (4 bytes, BIG Endian)	Image Data
JPEG - 1 BMP - 3 TIFF - 4	See Table J-1 , last column		(Same bytes as in a data file)

Additional Capabilities

Regardless of how the signature is captured, the output signature image is de-skewed and right-side up.

A scanner that captures signatures automatically determines whether it is scanning a signature or a bar code. You can disable the signature capturing capability in a decoder.

Signature Boxes

Figure J-3 illustrates the five acceptable signature boxes:

Type 2:



Type 5:



Type 7:



Type 8:



Type 9:



Figure J-3 *Acceptable Signature Boxes*

APPENDIX K NON-PARAMETER ATTRIBUTES

Introduction

This appendix defines non-parameter attributes.

Attributes

Model Number

Attribute #533

Model number of the scanner. This electronic output matches the printout on the physical device label, for example **DS3608-SR00003VZWW**.

Type	S
Size (Bytes)	18
User Mode Access	R
Values	Variable

Serial Number

Attribute #534

Unique serial number assigned in the manufacturing facility. This electronic output matches the printout on the physical device label, for example **M1J26F45V**.

Type	S
Size (Bytes)	16
User Mode Access	R
Values	Variable

Date of Manufacture

Attribute #535

Date of device manufacture assigned in the manufacturing facility. This electronic output matches the printout on the physical device label, for example **30APR14** (which reads the 30th of April 2014).

Type	S
Size (Bytes)	7
User Mode Access	R
Values	Variable

Date of First Programming

Attribute #614

Date of first electronic programming represents the first time settings were electronically loaded to the scanner either by 123Scan or via SMS, for example **18MAY14** (which reads the 18th of May 2014).

Type	S
Size (Bytes)	7
User Mode Access	R
Values	Variable

Configuration Filename

Attribute #616

The name assigned to the configuration settings loaded electronically to the device either by 123Scan or via SMS.



NOTE Scanning the **Set Defaults** bar code automatically changes the configuration filename to *factory defaults*.

To indicate the configuration settings loaded to the device were changed, the configuration filename changes to *Modified* upon scanning any parameter bar code.

Type	S
Size (Bytes)	17
User Mode Access	RW
Values	Variable

Beeper/LED

Attribute #6000

Activates the beeper and/or LED.

Type X
Size (Bytes) N/A
User Mode Access W

Values:

Beep / LED Action	Value
1 high short beep	0
2 high short beeps	1
3 high short beeps	2
4 high short beeps	3
5 high short beeps	4
1 low short beep	5
2 low short beeps	6
3 low short beeps	7
4 low short beeps	8
5 low short beeps	9
1 high long beep	10
2 high long beeps	11
3 high long beeps	12
4 high long beeps	13
5 high long beeps	14
1 low long beep	15
2 low long beeps	16
3 low long beeps	17
4 low long beeps	18
5 low long beeps	19
Fast warble beep	20
Slow warble beep	21
High-low beep	22
Low-high beep	23
High-low-high beep	24
Low-high-low beep	25
High-high-low-low beep	26
Green LED off	42
Green LED on	43
Red LED on	47
Red LED off	48

Parameter Defaults

Attribute #6001

This attribute restores all parameters to their factory defaults.

Type	X
Size (Bytes)	N/A
User Mode Access	W
Values	0 = Restore Defaults 1 = Restore Factory Defaults 2 = Write Custom Defaults

Beep on Next Bootup

Attribute #6003

This attribute configures (enables or disables) beep on next boot up of scanner.

Type	X
Size (Bytes)	N/A
User Mode Access	W
Values	0 = Disable beep on next bootup 1 = Enable beep on next bootup

Reboot

Attribute #6004

This attribute initiates a device reboot.

Type	X
Size (Bytes)	N/A
User Mode Access	W
Values	N/A

Host Trigger Session

Attribute #6005

This attribute triggers a decode session similar to manually depressing the scanner trigger button.

Type	X
Size (Bytes)	N/A
User Mode Access	W
Values	1 = Start Host Trigger Session 0 = Stop Host Trigger Session

Firmware Version

Attribute #20004

The scanner's operating system version. For example, **NBRFMAAC** or **PAAAABS00-007-R03D0**.

Type	S
Size (Bytes)	Variable
User Mode Access	R
Values	Variable

Scankit Version

Attribute #20008

Identifies the 1D decode algorithms resident on the device, for example **SKIT4.33T02**.

Type	S
Size (Bytes)	Variable
User Mode Access	R
Values	Variable

INDEX

Numerics

123Scan2	14-1
2D bar codes	
aztec	11-83
aztec inverse	11-84
code 128 emulation	11-79
data matrix	11-80
data matrix inverse	11-81
han xin	11-84
han xin inverse	11-85
maxicode	11-81
microPDF417	11-78
microQR	11-83
PDF417	11-78
QR code	11-82

A

accessories	1-6
interface cable	1-6
power supply	1-6
ADF	15-1
invalid rule	3-5
transmit error	3-5
advanced data formatting	3-5, 15-1
aiming	
orientation	2-6
aiming options	
hand-held decode aiming pattern	4-20
snapshot aiming pattern	5-9
snapshot mode timeout	5-8
video view finder	5-23
aiming pattern	2-6, 2-7, 5-9
enabling	4-20
orientation	2-6, 2-7
ASCII values	

keyboard wedge	10-11
RS-232	8-19
attributes	
non-parameter	K-1
attributes, non-parameter	
beep on next bootup	K-4
configuration filename	K-2
date of first programming	K-2
date of manufacture	K-2
firmware version	K-5
host trigger session	K-4
model number	K-1
parameter defaults	K-4
reboot	K-4
scankit version	K-5
serial number	K-1
autoexposure	5-5

B

bar code defaults	
USB	6-4
bar codes	
Australia post	11-89
Australia post format	11-90
autoexposure	5-5
aztec	11-83
aztec inverse	11-84
beep after good decode	4-7
beeper duration	4-11
beeper tone	4-10
beeper volume	4-9
bits per pixel	5-18, 5-21
bookland EAN	11-11
bookland ISBN	11-23
cancel	G-2
Chinese 2 of 5	11-66

Index - 2 DS3608 Digital Scanner Product Reference Guide

- codabar 11-57
- codabar CLSI editing 11-59
- codabar lengths 11-58
- codabar NOTIS editing 11-59
- codabar start and stop characters 11-60
- code 11 11-43
- code 11 check digit verification 11-45
- code 11 lengths 11-44
- code 128 11-26
- code 128 emulation 11-79
- code 128 lengths 11-26
- code 128 reduced quiet zone 11-32
- code 128 security level 11-31
- code 32 prefix 11-35
- code 39 11-33
- code 39 check digit verification 11-37
- code 39 full ASCII 11-38
- code 39 lengths 11-36
- code 39 reduced quiet zone 11-40
- code 39 security level 11-39
- code 39 transmit check digit 11-37
- code 93 11-41
- code 93 lengths 11-42
- composite beep mode 11-77
- composite CC-A/B 11-75
- composite CC-C 11-75
- composite TLC-39 11-76
- continuous bar code read 4-22
- convert code 39 to code 32 11-34
- convert GS1 databar to UPC/EAN 11-73
- convert UPC-E to UPC-A 11-22
- convert UPC-E1 to UPC-A 11-22
- country code page defaults C-1
- country code pages C-5
- country codes B-2
- crop to address 5-11
- data matrix 11-80
- data matrix inverse 11-81
- decode mirror images 4-27
- decode pager motor 4-12
- decode pager motor duration 4-12
- decode session timeout 4-23, 4-24
- disable all code types 11-8
- discrete 2 of 5 11-54
- discrete 2 of 5 lengths 11-55
- EAN zero extend 11-23
- EAN-13/JAN-13 11-11
- EAN-8/JAN-8 11-10
- enable all code types 11-8
- enter 4-34
- event reporting
 - boot up event 7-22
 - decode event 7-21
 - parameter event 7-22
- fixed exposure 5-6
- fixed gain 5-6
- flush macro buffer/abort macro PDF entry 11-98
- FN1 substitution values 4-37
- gain and exposure priority for snapshot mode 5-7
- GS1 databar bar codes 11-72
- GS1 databar expanded 11-73
- GS1 databar limited 11-72
- GS1 databar limited security level 11-74
- GS1 databar-14 11-72
- GS1-128 11-28
- GS1-128 emulation mode 11-77
- han xin 11-84
- han xin inverse 11-85
- hand-held decode aiming pattern 4-20
- hands-free mode 4-18
- I 2 of 5 check digit verification 11-50
- I 2 of 5 convert to EAN-13 11-51
- I 2 of 5 reduced quiet zone 11-53
- I 2 of 5 security level 11-52
- I 2 of 5 transmit check digit 11-51
- IBM 468X/469X
 - convert unknown to code 39 9-5
 - default parameters 9-3
 - ignore bar code configuration directive 9-6
 - ignore beep directive 9-5
 - port address 9-4
- IDC
 - aspect 12-9
 - bits per pixel 12-10
 - border type 12-14
 - captured image brighten 12-12
 - captured image sharpen 12-13
 - delay time 12-15
 - file format selector 12-9
 - find box outline 12-11
 - height 12-8
 - JPEG quality 12-10
 - maximum rotation 12-16
 - maximum text length 12-12
 - minimum text length 12-11
 - operating mode 12-5
 - symbology 12-6
 - width 12-8
 - X coordinate 12-7
 - Y coordinate 12-7
 - zoom limit 12-15
- ignore code 128 fnc4 11-32
- illumination 4-32, 5-5
- image brightness (target white) 5-13
- image cropping 5-10
- image enhancement 5-15
- image file format 5-16, 5-20
- image resolution 5-12

- image rotation 5-17
- intercharacter gap size 11-97
- interleaved 2 of 5 11-47
 - convert to EAN-13 11-51, 11-52
- interleaved 2 of 5 lengths 11-48
- inverse 1D 11-71
- ISBT 128 11-28
- ISBT concatenation 11-29, 11-30
- ISBT concatenation redundancy 11-30
- ISSN EAN 11-25
- Japan postal 11-88
- JPEG image options 5-13
- JPEG quality and size 5-14
- JPEG target file size 5-14
- keyboard wedge
 - alternate numeric keypad emulation 10-6
 - caps lock override 10-7
 - default table 10-3
 - host types 10-4
 - ignore unknown characters 10-4
 - intra-keystroke delay 10-5
 - keystroke delay 10-5
 - quick keypad emulation 10-6
 - simulated caps lock 10-7
- Korean 3 of 5 11-70
- low power mode 4-14
- matrix 2 of 5 11-67
- matrix 2 of 5 check digit 11-69
- matrix 2 of 5 lengths 11-67, 11-68
- maxicode 11-81
- microPDF417 11-78
- microQR 11-83
- mobile phone/display mode 4-28
- motion tolerance 4-33
- MSI 11-61
- MSI check digit algorithm 11-65
- MSI check digits 11-64
- MSI lengths 11-62
- MSI transmit check digit 11-64
- Netherlands KIX code 11-91
- numeric bar codes G-2
- OCR
 - check digit 13-25
 - check digit multiplier 13-26
 - check digit validation 13-27
 - default table 13-1
 - inverse OCR 13-32
 - lines 13-12
 - maximum characters 13-13
 - MICR E13B 13-9
 - minimum character 13-12
 - OCR-A 13-3
 - OCR-A variant 13-3
 - OCR-B 13-5
 - OCR-B variant 13-6
 - orientation 13-10
 - parameters 13-3
 - quiet zone 13-14
 - subset 13-13
 - template 13-15
 - US currency serial number 13-10
- pager motor 4-12
- parameter scanning 4-6
- PDF prioritization 4-29
- PDF prioritization timeout 4-30
- PDF417 11-78
- picklist mode 4-21
- postal 11-86
 - prefix/suffix values 4-35
- presentation mode field of view 4-31
- QR code 11-82
- quiet zone level 11-96
- redundancy level 11-93
- report version 4-6
- RS-232
 - baud rate 8-8
 - beep on bel 8-16
 - check receive errors 8-11
 - data bits 8-10
 - default table 8-3
 - hardware handshaking 8-11, 8-12
 - host serial response time-out 8-15
 - host types 8-6
 - intercharacter delay 8-17
 - parity 8-9
 - RTS line state 8-16
 - software handshaking 8-13, 8-14
 - stop bit select 8-16
 - stop bits 8-10
- samples F-1
- scan data options 4-36
- security level 11-95
- set defaults 4-5
- signature capture 5-19
- signature capture height 5-22
- signature capture JPEG quality 5-23
- signature capture width 5-22
- silence operational mode changes 5-9
- snapshot aiming pattern 5-9
- snapshot mode timeout 5-8
- SSI
 - baud rate 7-12
 - check parity 7-14
 - data packet format 7-16
 - host character timeout 7-18
 - host RTS line state 7-16
 - host serial response time-out 7-17
 - interpacket delay 7-20

Index - 4 DS3608 Digital Scanner Product Reference Guide

- multipacket option 7-19
- parity 7-13
- selecting 7-11
- software handshaking 7-15
- stop bit select 7-14
- suppress power up beeps 4-11
- symbologies
 - default table 11-2
- time delay to low power mode 4-15
- timeout between decodes, different symbols 4-26
- timeout between decodes, same symbol 4-25
- transmit code 11 check digits 11-46
- transmit code ID character 4-34
- transmit matrix 2 of 5 check digit 11-69
- transmit no read message 4-38
- transmit UK postal check digit 11-88
- transmit US postal check digit 11-87
- trigger mode 4-17
- trioptic code 39 11-33
- UCC coupon extended code 11-24
- UK postal 11-87
- unicode output control D-2
- unique bar code reporting 4-22
- unsolicited heartbeat interval 4-39
- UPC composite mode 11-76
- UPC reduced quiet zone 11-17
- UPC/EAN
 - coupon code 11-24
- UPC/EAN supplemental AIM ID format 11-16
- UPC/EAN supplemental redundancy 11-15
- UPC/EAN supplementals 11-12
- UPC-A 11-9
- UPC-A check digit 11-17
- UPC-A preamble 11-19
- UPC-E 11-9
- UPC-E check digit 11-18
- UPC-E preamble 11-20
- UPC-E1 11-10
- UPC-E1 check digit 11-18
- UPC-E1 preamble 11-21
- UPU FICS postal 11-92
- US planet 11-86
- US postnet 11-86
- USB
 - caps lock override 6-8
 - convert case 6-13
 - country keyboard types (country codes) B-2
 - device type 6-5, 6-6
 - emulate keypad 6-10
 - emulate keypad with leading zero 6-10
 - fast HID 6-17
 - function key mapping 6-12
 - IBM specification version 6-17
 - keyboard FN 1 sub 6-11

- keystroke delay 6-8
- optional parameters 6-14
- polling interval 6-15, 6-16
- quick emulation 6-11
- simulated caps lock 6-12
- SNAPI handshaking 6-7
- static CDC 6-13
- unknown characters 6-9
- USPS 4CB/One Code/Intelligent Mail 11-91
- video image size 5-24
- video view finder 5-23
- battery definitions 2-2
- beeper
 - definitions 2-2
- bullets xxii

C

- cable configurations xx
- cables
 - interface 1-6
 - signal descriptions 3-9
- character sets
 - keyboard wedge 10-11
 - RS-232 8-19
- Chinese 2 of 5 bar codes 11-66
- CJK D-1
- codabar bar codes 11-57
 - CLSI editing 11-59
 - lengths 11-58
 - NOTIS editing 11-59
 - start and stop characters 11-60
- code 11 bar codes 11-43
 - check digit verification 11-45
 - lengths 11-44
 - transmit check digit 11-46
- code 128 bar codes 11-26
 - GS1-128 11-28
 - ignore fnc4 11-32
 - ISBT 128 11-28
 - ISBT concatenation 11-29, 11-30
 - ISBT concatenation redundancy 11-30
 - lengths 11-26
 - reduced quiet zone 11-32
 - security level 11-31
- code 128 emulation bar codes 11-79
- code 39 bar codes 11-33
 - check digit verification 11-37
 - code 32 prefix 11-35
 - code 39 11-33
 - code 39 security Level 11-39
 - convert code 39 to code 32 11-34
 - full ASCII 11-38
 - lengths 11-36

- reduced quiet zone 11-40
- transmit check digit 11-37
- trioptic 11-33
- code 93 bar codes 11-41
 - lengths 11-42
- code ID character 4-34
- code identifiers
 - AIM code IDs E-3
 - modifier characters E-4
 - Symbol E-1
- communication protocol I-1
- composite bar codes
 - beep mode 11-77
 - composite CC-A/B 11-75
 - composite CC-C 11-75
 - composite TLC-39 11-76
 - GS1-128 emulation mode 11-77
 - UPC composite mode 11-76
- configurations xix
 - product line xx
- connecting
 - IBM 468X/469X interface 9-2
 - keyboard wedge interface 10-2
 - power 1-5
 - RS-232 interface 8-2
- conventions
 - notational xxii
- country code page defaults C-1
- country code pages C-5
- country codes B-2
- cradle configurations xx
- cropping 5-10, 5-11

D

- data matrix bar codes 11-80
- default parameters
 - IBM 468X/469X 9-3
 - IDC 12-4
 - keyboard wedge 10-3
 - OCR 13-1
 - RS-232 8-3
 - setting 4-5
 - SSI 7-10
 - symbologies 11-2
 - USB 6-4
- digital scanner
 - parts 2-1
- discrete 2 of 5 bar codes 11-54
 - lengths 11-55

E

- error indications

- ADF 3-5
- format 3-5
- input 3-4
- unknown characters 6-9
- exposure options
 - autoexposure 5-5
 - fixed exposure 5-6
 - fixed gain 5-6
 - gain and exposure priority for snapshot mode 5-7
 - illumination 4-32, 5-5
 - presentation mode field of view 4-31

F

- fixed exposure 5-6
- fixed gain 5-6

G

- gain and exposure priority for snapshot mode 5-7
- gooseneck Intellistand 2-4
- GS1 databar 11-72
- GS1 databar bar codes
 - convert GS1 databar to UPC/EAN 11-73
 - GS1 databar expanded 11-73
 - GS1 databar limited 11-72
 - GS1 databar limited security level 11-74
 - GS1 databar-14 11-72

H

- host types
 - keyboard wedge 10-4
 - RS-232 8-6
 - USB 6-5, 6-6

I

- IBM 468X/469X
 - connection 9-2
 - default parameters 9-3
 - parameters 9-4
- IDC 12-1
 - bar code acceptance test 12-2
 - capture region 12-2
 - data transmission 12-3
 - demonstrations 12-18
 - image post processing 12-3
 - operating mode 12-5
 - quick start 12-17
 - quick start form 12-19
 - sample setup 12-17
 - support 12-3
- illumination 4-32, 5-5

Index - 6 DS3608 Digital Scanner Product Reference Guide

image brightness (target white)	5-13
image cropping	5-10, 5-11
image enhancement	5-15
image options	
bits per pixel	5-18
cropping	5-10, 5-11
file formats	5-16, 5-20
image brightness (target white)	5-13
image enhancement	5-15
image resolution	5-12
image rotation	5-17
JPEG image options	5-13
JPEG size/quality	5-14
JPEG target file size	5-14
image resolution	5-12
indicators	
ADF programming	2-3
image capture	2-2
macro pdf	2-3
maintenance	2-3
parameter programming	2-2
standard use	2-2
interleaved 2 of 5 bar codes	11-47
check digit verification	11-50
convert to EAN-13	11-51
lengths	11-48
reduced quiet zone	11-53
security level	11-52
transmit check digit	11-51

J

JPEG image options	5-13
size/quality	5-14
JPEG target file size	5-14

K

keyboard types (country codes)	
Albanian	B-2
Arabic (101)	B-2
Arabic (102)	B-3
Arabic (102) Azerty	B-3
Azeri (Cyrillic)	B-3
Azeri (Latin)	B-3
Belarusian	B-3
Bosnian (Cyrillic)	B-4
Bosnian (Latin)	B-3, B-4
Bulgarian (Latin)	B-4
Bulgarian Cyrillic (Typewriter)	B-4
Canadian French (Legacy)	B-4
Canadian French Win7	B-4
Canadian Multilingual Standard	B-5
Chinese (ASCII)	B-5

Croatian	B-5
Czech	B-5
Czech (Programmer)	B-6
Czech (QWERTY)	B-6
Danish	B-6
Dutch (Netherlands)	B-6
Estonian	B-6
Faeroese	B-6
Finnish	B-7
French (Canada) 2000/XP	B-7
French (Canada) 95/98	B-7
French (France)	B-7
French International	B-7
Galician	B-7
German	B-8
Greek	B-8
Greek (220) Latin	B-8
Greek (319) Latin	B-8
Greek 220	B-8
Greek 319	B-9
Greek Latin	B-8
Greek Polytonic	B-9
Hebrew Israel	B-9
Hungarian	B-9
Hungarian_101KEY	B-9
Irish	B-10
Islandic	B-9
Italian	B-10
Italian (142)	B-10
Japanese (ASCII)	B-10
Kazakh	B-10
Korean (ASCII)	B-10, B-11
Kyrgyz	B-11
Latin American	B-11
Latvian	B-11
Latvian (QWERTY)	B-11
Lithuanian	B-11
Lithuanian (IBM)	B-11
Macedonian (FYROM)	B-12
Maltese_47KEY	B-12
Mongolian	B-12
Norwegian	B-12
Polish (214)	B-12
Polish (Programmer)	B-12
Portuguese (Brazil)	B-13
Portuguese (Brazilian ABNT)	B-13
Portuguese (Brazilian ABNT2)	B-13
Portuguese (Portugal)	B-13
Romanian	B-13
Romanian (Legacy)	B-13
Romanian (Programmer)	B-14
Romanian (Standard)	B-14
Russian	B-14
Russian (Typewriter)	B-14

- Serbian (Cyrillic) B-14
 - Serbian (Latin) B-14
 - Slovak B-15
 - Slovak (QWERTY) B-15
 - Slovenian B-15
 - Spanish B-15
 - Spanish (Variation) B-15
 - Swedish B-15
 - Swiss French B-16
 - Swiss German B-16
 - Tatar B-16
 - Thai (Kedmanee) B-16
 - Turkish F B-16
 - Turkish Q B-16
 - UK English B-16
 - Ukranian B-17
 - US Dvorak B-17
 - US Dvorak Left B-17
 - US Dvorak Right B-17
 - US English B-2
 - US International B-17
 - Uzbek B-18
 - Vietnamese B-18
 - keyboard wedge
 - connection 10-2
 - default parameters 10-3
 - parameters 10-4
 - Korean 3 of 5 bar codes 11-70
- L**
- LED definitions 2-2
- M**
- macro PDF 11-98
 - flush buffer/abort PDF entry 11-98
 - maintenance 3-1
 - linear imager scanner 3-2
 - matrix 2 of 5 bar codes 11-67
 - check digit 11-69
 - lengths 11-67, 11-68
 - transmit check digit 11-69
 - maxicode bar codes 11-81
 - microPDF417 bar codes 11-78
 - MSI bar codes 11-61
 - check digit algorithm 11-65
 - check digits 11-64
 - lengths 11-62
 - transmit check digit 11-64
- N**
- non-parameter attributes K-1
 - beep on next bootup K-4
 - configuration filename K-2
 - date of first programming K-2
 - date of manufacture K-2
 - firmware version K-5
 - host trigger session K-4
 - model number K-1
 - parameter defaults K-4
 - reboot K-4
 - scankit version K-5
 - serial number K-1
 - notational conventions xxii
- O**
- OCR
 - default parameters 13-1
 - parameters 13-3
- P**
- parameter defaults
 - USB 6-4
 - parameters
 - USB 6-5
 - parts 2-1
 - PDF417 bar codes 11-78
 - PDF prioritization 4-29
 - pinouts
 - scanner signal descriptions 3-9
 - postal codes 11-86
 - Australia post 11-89
 - Australia post format 11-90
 - Japan postal 11-88
 - Netherlands KIX code 11-91
 - transmit UK postal check digit 11-88
 - transmit US postal check digit 11-87
 - UK postal 11-87
 - UPU FICS postal 11-92
 - US planet 11-86
 - US postnet 11-86
 - USPS 4CB/One Code/Intelligent Mail 11-91
 - power supply 1-6
 - connecting 1-5
 - presentation mode 2-4
 - presentation mode field of view 4-31
 - product line configurations xx
- Q**
- QR code bar codes 11-82
 - quick start guide 1-6

R

radio definitions 2-2

RS-232

 connection 8-2

 default parameters 8-3

 parameters 8-4, 8-6

RSM

 commands and responses over SSI 7-8

S

sample bar codes F-1

scanning

 aiming 2-6, 2-7

 errors 4-2, 5-2, 6-9, 11-2

 hand-held mode 2-4, 2-5

 hands-free mode 2-4

 presentation mode 2-4

 sequence example 4-2, 5-2, 11-2

security

 intercharacter gap size 11-97

 quiet zone level 11-96

 redundancy level 11-93

 security level 11-95

service information xxiii

setting defaults 4-5

setup

 connecting a USB interface 6-2

 connecting an RS-232 interface 8-2

 connecting keyboard wedge interface 10-2

 connecting power 1-5

 connecting to an IBM 468X/469X host 9-2

 unpacking 1-2

signal descriptions 3-9

signature capture 5-19

 bits per pixel 5-21

 file format selector 5-20

 height 5-22

 JPEG quality 5-23

 width 5-22

simple serial interface

 baud rate 7-12

 commands 7-2

 communications 7-1, 7-5

 default parameters 7-10

 handshaking 7-3, 7-5

 RSM commands and responses 7-8

 RTS CTS 7-5

 selecting 7-11

 transactions 7-3

snapshot mode timeout 5-8

specifications 3-7

SSI

 baud rate 7-12

 commands 7-2

 communications 7-1, 7-5

 default parameters 7-10

 handshaking 7-3, 7-5

 RSM commands and responses 7-8

 RTS CTS 7-5

 selecting 7-11

 transactions 7-3

support xxiii

 for IDC 12-3

Symbol Technologies support xxiii

symbology default parameters 11-2

T

technical specifications 3-7

trigger mode 4-17

troubleshooting 3-3

U

unicode

 output control D-2

unpacking 1-2

UPC/EAN bar codes

 bookland EAN 11-11

 bookland ISBN 11-23

 check digit 11-17, 11-18

 convert UPC-E to UPC-A 11-22

 convert UPC-E1 to UPC-A 11-22

 EAN zero extend 11-23

 EAN-13/JAN-13 11-11

 EAN-8/JAN-8 11-10

 ISSN EAN 11-25

 reduced quiet zone 11-17

 supplemental AIM ID format 11-16

 supplemental redundancy 11-15

 supplementals 11-12

 UCC coupon extended code 11-24

 UPC-A 11-9

 UPC-A preamble 11-19

 UPC-E 11-9

 UPC-E preamble 11-20

 UPC-E1 11-10

 UPC-E1 preamble 11-21

USB connection 6-2

USB defaults 6-4

USB parameters 6-5

V

video view finder 5-23

 image size 5-24

Tell Us What You Think...

We'd like to know what you think about this Manual. Please take a moment to fill out this questionnaire and fax this form to: (631) 627-7184, or mail to:

Zebra Technologies Corporation
One Zebra Plaza
Holtsville, NY 11742
Technical Publications Manager



important If you need product support, please call the appropriate customer support number provided. Unfortunately, we cannot provide customer support at the fax number above.

Manual Title: _____
(please include revision level)

How familiar were you with this product before using this manual?

Very familiar Slightly familiar Not at all familiar

Did this manual meet your needs? If not, please explain.

What topics need to be added to the index, if applicable?

What topics do you feel need to be better discussed? Please be specific.

What can we do to further improve our manuals?

Thank you for your input—We value your comments.



Zebra Technologies Corporation, Inc.
3 Overlook Point
Lincolnshire, IL 60069, U.S.A.
<http://www.zebra.com>

Zebra and the stylized Zebra head are trademarks of ZIH Corp., registered in many jurisdictions worldwide. All other trademarks are the property of their respective owners.
©2016 Symbol Technologies LLC, a subsidiary of Zebra Technologies Corporation.
All rights reserved.



MN002176A01 - Revision A - February 2016

