

INSTRUCTION FOR USE



THANK YOU FOR PURCHASING A HOTPOINT-ARISTON PRODUCT.

To receive more comprehensive help and support, please register your product at:
www.hotpoint.eu/register

Before using the appliance carefully read Health and Safety guide.

PRODUCT DESCRIPTION

APPLIANCE

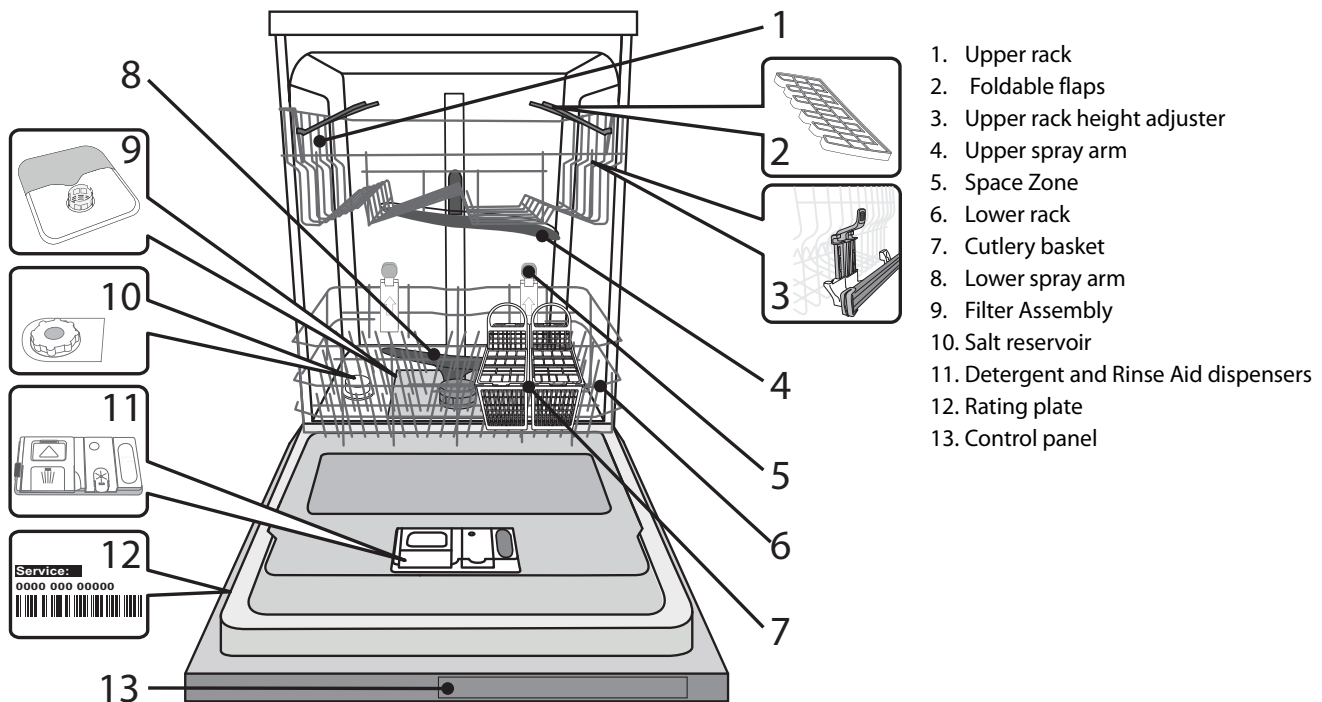

CONTROL PANEL

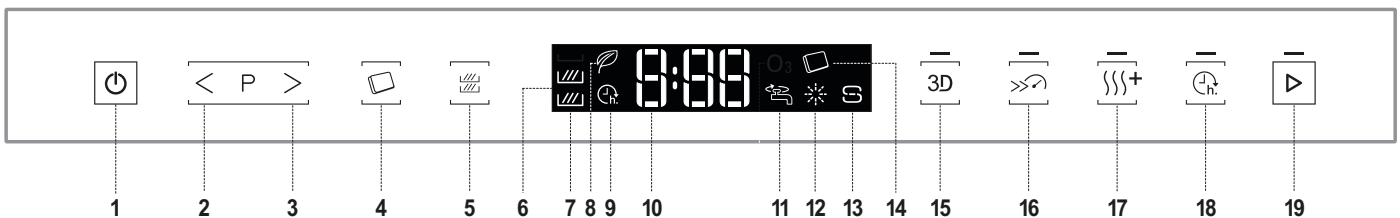

- | | |
|---|---|
| 1. ON/OFF button | 11. Closed water tap indicator light |
| 2. PREVIOUS button | 12. Rinse Aid refill indicator light |
| 3. NEXT button | 13. Salt refill indicator light |
| 4. Tablet Detergent (All-in-one) button | 14. Tablet Detergent (All-in-one) indicator light |
| 5. Zone Wash button | 15. Zone Wash 3D button with indicator light |
| 6. Zone Wash indicator light | 16. Turbo button with indicator light |
| 7. Display | 17. Extra Dry button with indicator light |
| 8. Eco program indicator light | 18. Start Delay button with indicator light |
| 9. Start Delay indicator light | 19. START button with indicator light |
| 10. Program number and remaining time indicator | |

FIRST TIME USE

SETTING MENU AND SALT

ADVICE REGARDING THE FIRST TIME USE

After installation, remove the stoppers from the racks and the retaining elastic elements from the upper rack.

SETTING MENU

1. Switch on the appliance by pressing the **ON/OFF** button.
2. Switch off the appliance by pressing the **ON/OFF** button.
3. Hold down **START** button for 5 seconds, until you hear a beep.
4. The display shows the first available setting (letter "A"), followed by its value (for example: 3).
5. Press **PREVIOUS/NEXT** to scroll the list of the available settings and to see their value (see the below table), then press **START** if you want to change the value of the displayed setting: its value will start blinking.
6. Use **PREVIOUS/NEXT** buttons to change the blinking value of the selected settings, then press **START** to save the new value: it will stop blinking.
7. To change another settings repeat steps 5-6.
8. To exit settings menu - press **ON/OFF** button.

LETTER	SETTING	VALUES (Default - in bold)
A	Water Hardness Level (see "Setting the Water Hardness" and "Water Hardness Table")	1 2 3 4 5
B	Rinse Aid Level (see "Adjusting the dosage of Rinse Aid")	1 2 3 4 5
C	Start Program To set the cycle to show at switch on of the appliance. "E"= Eco, "L"= Last cycle run	E L
D	Brightness Level To adjust the brightness level of the display. "Lo"=Low, "Hi"= High	Lo Hi
E	Sound Level To adjust the volume of the sounds. "OF" = sounds off, "Lo" = low volume, "Hi" = high volume.	OF Lo Hi
F	Internal Lights (see "Options and Functions") "On" = On, "OF" = Off	On OF
H	Light on the Front (see "Options and Functions") "On" = On, "OF" = Off	On OF
J	Factory Settings To restore to the factory default all the values of the settings included in the settings menu. After the activation of this setting (ON), the machine switches OFF and restores the factory settings. "On" = On, "OF" = Off	On OF

FILLING THE SALT RESERVOIR

The use of salt prevents the formation of LIMESCALE on the dishes and on the machine's functional components.

- It is important that the salt reservoir be never empty.
- It is important to set the water hardness.

The salt reservoir is located in the lower part of the dishwasher (see *PRODUCT DESCRIPTION*) and should be filled when the **SALT REFILL indicator light**  in the control panel is lit.

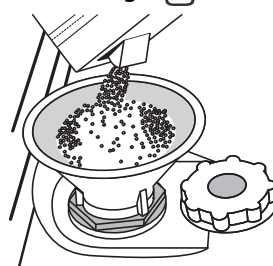

1. Remove the lower rack and unscrew the reservoir cap (anticlockwise).
2. Only the first time you do this: fill the salt reservoir with water.
3. Position the funnel (see figure) and fill the salt reservoir right up to its edge (approximately 1 kg); it is not unusual for a little water to leak out.
4. Remove the funnel and wipe any salt residue away from the opening.

Make sure the cap is screwed on tightly, so that no detergent can get into the container during the wash program (this could damage the water softener beyond repair).

As soon as this procedure is complete, run a program without loading. The "Soak" program alone is NOT sufficient.

Residual saline solution or grains of salt can lead to corrosion, irreparably damaging the stainless steel components.

The guarantee is not applicable if faults are caused by such circumstances.

After the salt has been poured into the machine, the **SALT REFILL indicator light** switches off.

Only use salt that has been specifically designed for dishwashers. If the salt container is not filled, the water softener and the heating element may be damaged as a result.

Whenever you need to add salt, we recommend carrying out the procedure just before the washing cycle is started.

SETTING THE WATER HARDNESS

To allow the water softener to work in a perfect way, it is essential that the water hardness setting is based on the actual water hardness in your house. This information can be obtained from your local water supplier.

The factory setting is "3" for average water hardness.

To change, follow instructions in section "SETTING MENU".

Water Hardness Table			
Level		°dH German degrees	°fH French degrees
1	Soft	0 - 6	0 - 10
2	Medium	7 - 11	11 - 20
3	Average	12 - 17	21 - 30
4	Hard	17 - 34	31 - 60
5	Very hard	35 - 50	61 - 90

FIRST TIME USE

RINSE AID AND DETERGENT

FILLING THE RINSE AID DISPENSER

Rinse aid makes dish DRYING easier. The rinse aid dispenser **A** should be filled when the **RINSE AID REFILL indicator light**  in the control panel is lit.

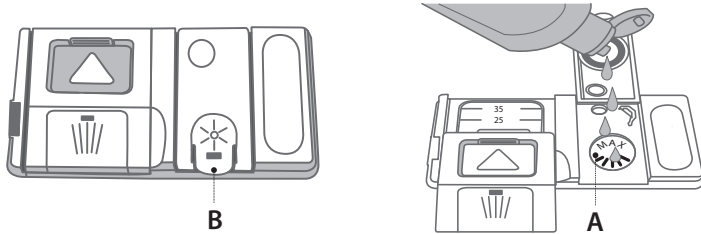

1. Open the dispenser **B** by pressing and pulling up the tab on the lid.
2. Carefully introduce the rinse aid as far as the maximum (110 ml) reference notch of the filling space - avoid spilling it. If this happens, clean the spill immediately with a dry cloth.
3. Press the lid down until you hear a click to close it.

NEVER pour the rinse aid directly into the tub.

ADJUSTING THE DOSAGE OF RINSE AID

If you are not completely satisfied with the drying results, you can adjust the quantity of rinse aid used.

To change, follow instructions in section "SETTING MENU".

If the rinse aid level is set to 1, no rinse aid will be supplied. The **LOW RINSE AID** indicator light will not be lit if you run out of rinse aid.

A maximum of 5 levels can be set according to the dishwasher model. The factory setting is "4".

- If you see bluish streaks on the dishes, set a low number (2-3).
- If there are drops of water or limescale marks on the dishes, set a high number (4-5).

FILLING THE DETERGENT DISPENSER

Only use detergent which has been specifically designed for dishwashers.

To achieve the best washing and drying results, the combined use of detergent, rinse aid liquid and refined salt is required.

We recommend using detergents that do not contain phosphates or chlorine, as these products are harmful to the environment.

Good washing results also depend on the correct amount of detergent being used.

Exceeding the stated amount does not result in a more effective wash and increases environmental pollution.

The amount can be adjusted to the soil level. In the case of normally soiled items, use approximately either 35g (powder detergent) or 35ml (liquid detergent) and additional tea spoon of detergent directly inside the tub. If tablets are used, one tablet will be enough. If the crockery is only lightly soiled or if it has been rinsed with water before being placed in the dishwasher, reduce the amount of detergent used accordingly (minimum 25 g/ml) e.g. skip the powder/gel puffed inside the tub.

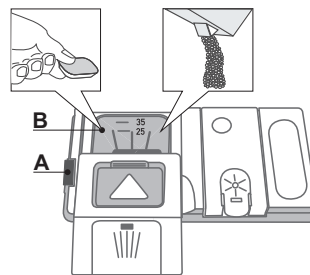

To open the detergent dispenser press button A. Introduce the detergent into the dry dispenser B only. Place the amount of detergent for pre-washing directly inside the tub.

1. When measuring out the detergent refer to the mentioned earlier information to add the proper quantity.

Inside the dispenser **B** there are indications to help the detergent dosing.

2. Remove detergent residues from the edges of the dispenser and close the cover until it clicks.
3. Close the lid of the detergent dispenser by pulling it up until the closing device is secured in place.

The detergent dispenser automatically opens up at the right time according to the program.

If all-in-one detergents are used, we recommend using the **TABLET DETERGENT** button, because it adjusts the program so that the best washing and drying results are always achieved.

If you are using an all-in-one detergents, we recommend that you add salt in any case, especially if the water is hard or very hard (follow the instructions given on the packaging).

PROGRAMS TABLE

Program	Drying phase	Available options ^{*)}	Detergent dispenser		Duration of wash program (h:min) ^{**)}	Water consumption (litres/cycle)	Energy consumption (kWh/cycle)
			B	Tub			
P1 Eco	ECO 50°	✓ +	✓	✓	3:10	9	0.93
P2 Auto Intensive	A 65°	✓ + 3D >>>	✓	-	2:00 - 3:10	14 - 17	1.50 - 1.85
P3 Auto Normal	A 55°	✓ + 3D >>>	✓	✓	1:30 - 2:30	14.5 - 16	1.15 - 1.30
P4 Auto Fast	A 50°	-	✓	-	0:40 - 1:20	13 - 14.5	1.15 - 1.25
P5 Delicates	45°	✓ +	✓	-	1:40	11 - 11.5	1.10 - 1.20
P6 Express 30'	50°	-	✓	-	0:30	9	0.50 - 0.55
P7 Good Night	50°	✓ +	✓	-	3:30	15	1.15
P8 Sanitizing	65°	✓	✓	-	1:40	10	1.30
P9 Soak	-	-	-	-	0:12	4.5	0.01
P10 Self-Clean	65°	-	✓	-	0:50	8	0.80 - 0.85

ECO program data is measured under laboratory conditions according to European Standard EN 50242.

*) Not all options can be used simultaneously.

**) The duration of the program shown on the display or in the booklet is an estimate calculated on standard conditions. The actual time may vary depending on many factors such as temperature and pressure of the incoming water, room temperature, amount of detergent, quantity and type of load, load balancing, additional selected options and sensor calibration. The sensor calibration can increase program duration up to 20 min.

Standby consumption: Left-on mode consumption: 5 W - Off mode consumption: 0.5 W

PROGRAMS DESCRIPTION

P1 ECO

Normally soiled crockery. Standard program, the most efficient in terms of its combined energy and water consumption.

P2 AUTO INTENSIVE

Automatic program for heavily soiled dishes and pans (not to be used for delicate items).

P3 AUTO NORMAL

Automatic program for normally soiled pans and dishes.

P4 AUTO FAST

Automatic program for limited quantity of normally soiled crockery. Ensures optimal cleaning performance in shorter time.

P5 DELICATES

Program for delicate items, which are more sensitive to high temperatures, for example glasses and cups.

P6 EXPRESS 30'

Program to be used for lightly-soiled dishes with no dried food residues.

P7 GOOD NIGHT

Suitable for night-time operation of the appliance. Optimum performance ensured.

P8 SANITIZING

Normally or heavily soiled crockery, with additional antibacterial wash.

P9 SOAK

Crockery to be washed later. No detergent to be used with this program.

P10 SELF-CLEAN

Program to be used to perform maintenance of the dishwasher. It cleans the interior of the appliance using hot water.

Notes:

Optimum performance levels when using the "Express" program can be achieved by observing the maximum amounts of specified place settings.

To reduce consumption even further, only run the dishwasher when it is full.

OPTIONS AND FUNCTIONS

OPTIONS can be selected directly by pressing the corresponding button (see *CONTROL PANEL*).

If an option is not compatible with the selected program see *PROGRAMS TABLE*, the corresponding LED flashes rapidly 3 times and beeps will sound. The option will not be enabled.



TABLET DETERGENT (All-in-one)

This setting allows you to optimize the performance of the program according to the type of detergent used. Press the TABLET DETERGENT button (the indicator light will light up) if you use All-in-one detergents in tablet form (rinse aid, salt and detergent in 1 dose).

If you use powder or liquid detergent, this option should be off.



ZONE WASH

If there are not many dishes to be washed, a half loading may be used in order to save water, electricity and detergent.

Select a compatible program (see "Programs table"), and then press the ZONE WASH button: the symbol of the chosen rack will appear on the display:



(only lower rack selected)



(only upper rack selected)



By default the appliance washes dishes in all racks. Option is OFF.



ZONE WASH 3D

Thanks to the additional 3D water jets placed on the bottom of the cavity, ZONE WASH 3D option allows to save energy or to increase the washing performance of the dishwasher. It is compatible with Normal and Intensive cycles, and it works with one rack at once.

- 3D ZONE WASH + NORMAL CYCLE: it allows to reduce energy consumption up to 40%.
- 3D ZONE WASH + INTENSIVE CYCLE: it increases the washing performances up to 40%. Ideal for very soiled mixed loads, e.g. pans and saucepans, dishes with heavy encrustation or difficult-to-clean crockery (grater, vegetable mill, dirty cutlery).

How to activate the option:

1. Select a compatible cycle (Normal or Intensive)
2. Press 3D button to activate the option: a basket icon will blink for a few seconds.
3. It is possible to change the selected rack pressing the ZONE WASH button.

Remember to load the crockery in the selected rack only.



WATER TAP CLOSED – Alarm

Flashes when there is no inlet water or water tap is closed.



TURBO

This option can be used to reduce the duration of the main programs while maintaining the same washing and drying performance levels.

Select a compatible program (see "Programs table"), press the TURBO button and the indicator light will switch on. To deselect the option, press the same button again.



EXTRA DRY

To improve the drying of the dishes, after selecting the program, press the EXTRA DRY button and the indicator light comes on.

A higher temperature during the final rinse and an extended drying phase allow for improving drying. To deselect the option, press the same button again. The EXTRA DRY option results in the lengthening of the wash cycle.



START DELAY

The start of the program may be delayed for a period of time between 0:30 and 24 hours.

1. Select the program and any desired options. Press the DELAY button (repeatedly) to delay the start of the program. Adjustable from 0:30 to 24 hours. When 24 hours is setting has been reached, press the START DELAY another time to deactivate the START DELAY function.
2. Press the START button and close the door within 4 sec.: the timer will begin counting down;
3. Once this time has elapsed, the indicator light switches off and the program begins automatically.

The START DELAY function cannot be set once a program has been started.

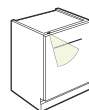

LIGHT ON THE FRONT

A LED light projected on the floor indicates that the dishwasher is working.

The light stays on during the cycle and switches off at the end of the cycle.

If the delayed start was set, the light goes on for the entire duration of the countdown.

This feature is active by default, but it is possible to deactivate it in the "SETTINGS MENU".

INTERNAL LIGHTS

When the feature is active the LEDs in the tub are automatically switched on/off as soon as the user open/close the door respectively.

If the door remains opened for more than 10 min, the LEDs in the tub switch off (to turn them on again, the door has to be closed and opened again).

This feature is active by default, but it is possible to deactivate it in the "SETTINGS MENU".

DAILY USE

1. CHECK WATER CONNECTION

Check that the dishwasher is connected to the water supply and that the top is open.

2. LOAD THE RACKS

(see *LOADING THE RACKS*)

3. FILLING THE DETERGENT DISPENSER

(see *PROGRAMS TABLE*).

4. SWITCH ON THE DISHWASHER

Open the door and press the **ON/OFF** button.

Please note that buttons are deactivated while door is opened more than 3/4 from vertical (closed) position.

5. CHOOSE THE PROGRAM AND CUSTOMISE THE CYCLE

Select the most appropriate program in accordance with the type of crockery and its soiling level (see *PROGRAMS DESCRIPTION*).

The display shows the letter "P" followed by the number of the program (e.g. "P 1"). Pressing the buttons **PREVIOUS / NEXT** changes the program.

Select the desired options (see *OPTIONS AND FUNCTIONS*).

6. START

Start the wash cycle by pressing **START** button (led is lit) and closing the door within 4 sec. When the program starts you hear a single beep. If the door was not closed within 4sec., the alarm sound will be played. In this case, open the door, press **START** button and close the door again within 4 sec.

7. END OF WASH CYCLE

The end of the wash cycle is indicated by beeps and the display shows "End". Open the door and switch off the appliance by pressing the **ON/OFF** button.

Wait for a few minutes before removing the crockery - to avoid burns. Unload the racks, beginning with the lower one.

The machine will switch off automatically during certain extended periods of inactivity, in order to minimise electricity consumption. If the crockery is only lightly soiled or if it has been rinsed with water before being placed in the dishwasher, reduce the amount of detergent used accordingly.

MODIFYING A RUNNING PROGRAM

If a wrong program was selected, it is possible to change it, provided that it has only just begun: open the door (**beware of HOT steam!**), press and hold the **ON/OFF** button, the machine will switch off. Switch the machine back on using the **ON/OFF** button and select the new wash cycle and any desired options; start the cycle by pressing the **START** button and closing the door.

ADDING EXTRA CROCKERY

Without switching off the machine, open the door (the ":" stop blinking and **START** led starts blinking) (**beware of HOT steam!**) and place the crockery inside the dishwasher. Press the **START** button and close the door within 4 sec., the cycle will resume from the point at which it was interrupted.

ACCIDENTAL INTERRUPTIONS

If the door is opened during the wash cycle, or if there is a power cut, the cycle stops. To resume the cycle from where it was interrupted, press the **START** button and close the door.

ADVICE AND TIPS

TIPS

Before loading the baskets, remove all food residues from the crockery and empty the glasses. **You do not need to rinse beforehand under running water.**

Arrange the crockery so that it is held in place firmly and does not tip over; and arrange the containers with the openings facing downwards and the concave/convex parts placed obliquely, thus allowing the water to reach every surface and flow freely.

Warning: lids, handles, trays and frying pans do not prevent the sprayer arms from rotating.

Place any small items in the cutlery basket.

Very soiled dishes and pans should be placed in the lower basket because in this sector the water sprays are stronger and allow a higher washing performance.

After loading the appliance, make sure that the sprayer arms can rotate freely.

HYGIENE

To avoid odour and sediment which can be accumulated in the dishwasher please run a high temperature program at least once a month. Use a tea spoon of detergent and run it without the loading to clean your appliance.

UNSUITABLE CROCKERY

- Wooden crockery and cutlery.
- Delicate decorated glasses, artistic handicraft and antique crockery. Their decorations are not resistant.
- Parts in synthetic material which do not withstand high temperatures.
- Copper and tin crockery.
- Crockery soiled with ash, wax, lubricating grease or ink.

The colours of glass decorations and aluminium/silver pieces can change and fade during the washing process. Some types of glass (e.g. crystal objects) can become opaque after a number of wash cycles too.

DAMAGE TO GLASS AND CROCKERY

- Only use glasses and porcelain guaranteed by the manufacturer as dishwasher safe.
- Use a delicate detergent suitable for crockery
- Collect glasses and cutlery from the dishwasher as soon as the wash cycle is over.

LOADING THE RACKS

UPPER RACK

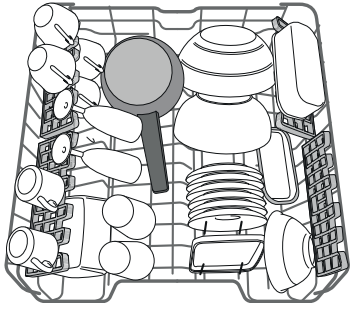

(loading example for the upper rack)

Load delicate and light dishes: glasses, cups, saucers, low salad bowls.
The upper rack has tip-up supports which can be used in a vertical position when arranging tea/ dessert saucers or in a lower position to load bowls and food containers.

FOLDABLE FLAPS WITH ADJUSTABLE POSITION

The side foldable flaps can be positioned at three different heights to optimize the arrangement of crockery inside the rack. Wine glasses can be placed safely in the foldable flaps by inserting the stem of each glass into the corresponding slots.
For optimum drying results incline the foldable flaps more. To change the inclination, pull up the foldable flap, slide it slightly and position it as you wish.

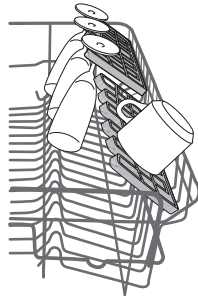

ADJUSTING THE HEIGHT OF THE UPPER RACK

The height of the upper rack can be adjusted: high position to place bulky crockery in the lower basket and low position to make the most of the tip-up supports by creating more space upwards and avoid collision with the items loaded into lower rack.

The upper rack is equipped with a **Upper Rack height adjuster** (see figure), without pressing the levers, lift it up by simply holding the rack sides, as soon as the rack is stable in its upper position.
To restore to the lower position, press the levers **A** at the sides of the rack and move the basket downwards.

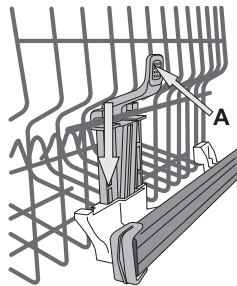

We strongly recommend that you do not adjust the height of the rack when it is loaded.

NEVER raise or lower the basket on one side only.

SLIDING TRAY

The upper rack is fitted with a sliding tray which can be used to hold small crockery and cutlery. For optimum washing performance, avoid positioning bulky crockery directly below the tray. The tray is removable.

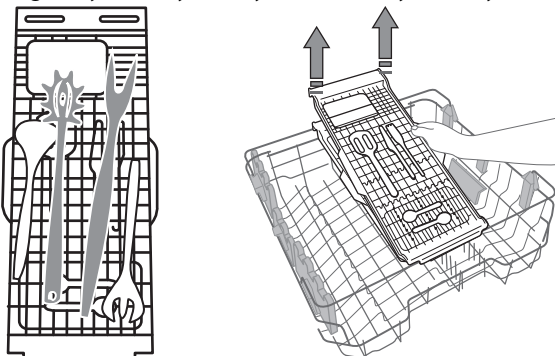

LOWER RACK

For pots, lids, plates, salad bowls, cutlery etc. Large plates and lids should ideally be placed at the sides to avoid interferences with the spray arm. The lower rack has tip-up supports which can be used in a vertical position when arranging plates or in a horizontal position (lower) to load pans and salad bowls easily.
The lower rack has a Space Zone (A), a special pull-out support in the rear of the rack that can be used to support frying pans or baking pans in upright position, thus taking up less space.
In order to use it, just get hold of the coloured grip and pull it upwards (B) while rotating it forward. The supports can slide right and left to fit the size of the crockery.

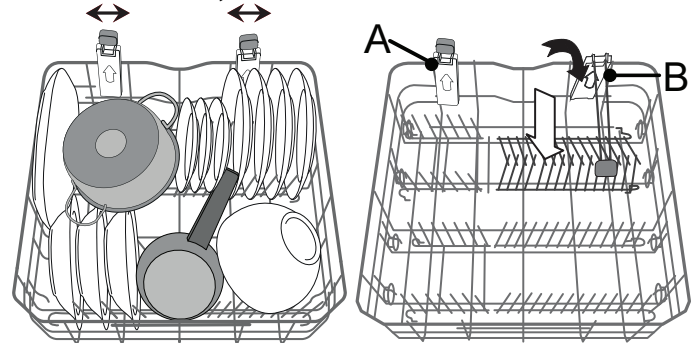

(loading example for the lower rack)

CUTLERY BASKET

The modular basket can slide to optimise the space inside the lower rack. It is equipped with top grilles for improved cutlery arrangement.

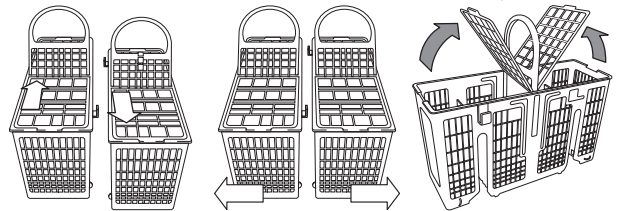

Knives and other utensils with sharp edges must be placed in the cutlery basket with the points facing downwards or they must be positioned horizontally in the tip-up compartments on the upper rack.

ZONE WASH 3D

Zone Wash 3D uses additional water jets located both: in the lower and upper part of the dishwasher (marked with orange color) to wash more intensively heavily soiled items by increasing water coverage on dishes. Example: Load pots and casseroles facing lower part of Zone Wash 3D components and activate the Zone Wash 3D option on the panel.

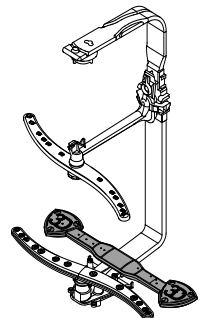

GLASS CARE

Dedicated accessory that allows you to safely store different types of stem glasses in the lower rack. It enables cleaning & drying results by allowing an optimised and stable positioning of the glasses.

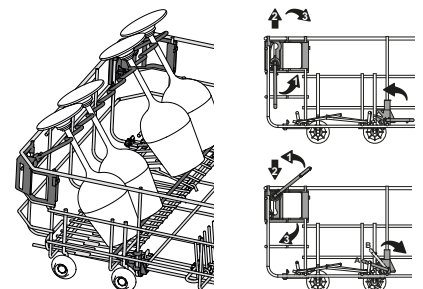

CARE AND MAINTENANCE

ATTENTION: Always unplug the appliance when cleaning it and when performing maintenance work. Do not use flammable liquids to clean the machine.

CLEANING THE DISHWASHER

Any marks on the inside of the appliance may be removed using a cloth dampened with water and a little vinegar.

The external surfaces of the machine and the control panel can be cleaned using a non-abrasive cloth which has been dampened with water. Do not use solvents or abrasive products.



PREVENTING UNPLEASANT ODOURS

Always keep the door of the appliance ajar in order to avoid moisture from forming and being trapped inside the machine.

Clean the seals around the door and detergent dispensers regularly using a damp sponge. This will avoid food becoming trapped in the seals, which is the main cause behind the formation of unpleasant odours.

CHEKING THE WATER SUPPLY HOSE

Check the inlet hose regularly for brittleness and cracks. If damaged, replace it by a new hose available through our After-Sales Service or your specialist dealer. Depending on the hose type:

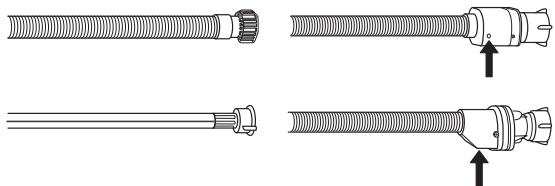

If the inlet hose has a transparent coating, periodically check if the colour intensifies locally. If yes, the hose may have a leak and should be replaced.

For water stop hoses: check the small safety valve inspection window (see arrow). If it is red, the water stop function was triggered, and the hose must be replaced by a new one.

For unscrewing this hose, press the release button while unscrewing the hose.

CLEANING THE WATER INLET HOSE

If the water hoses are new or have not been used for an extended period of time, let the water run to make sure it is clear and free of impurities before performing the necessary connections. If this precaution is not taken, the water inlet could become blocked and damage the dishwasher.

CLEANING THE FILTER ASSEMBLY

Regularly clean the filter assembly so that the filters do not clog and that the waste water flows away correctly.

The filter assembly consists of three filters which remove food residues from the washing water and then recirculate the water: to obtain the best washing results, you need to keep them clean.

The dishwasher must not be used without filters or if the filter is loose.

After several washes, check the filter assembly and if necessary clean it thoroughly under running water, using a non-metallic brush and following the instructions below:

1. Turn the cylindrical filter **A** in an anti-clockwise direction and pull it out (Fig 1).
2. Remove the cup filter **B** by exerting a slight pressure on the side flaps (Fig 2).
3. Slide out the stainless-steel plate filter **C** (Fig 3).
4. Inspect the trap and remove any food residues. **NEVER REMOVE** the wash-cycle pump protection (black detail) (Fig 4).

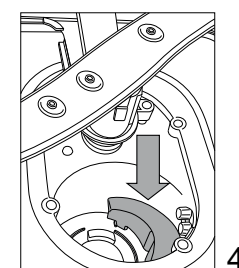
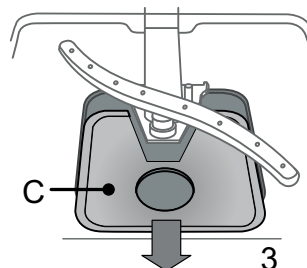
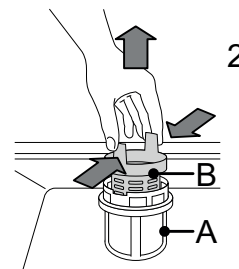
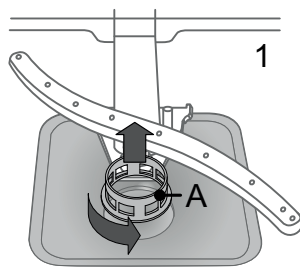

After cleaning the filters, re-place the filter assembly and fix it in position correctly; this is essential for maintaining the efficient operation of the dishwasher.

CLEANING THE SPRAY ARMS

On occasions, food residue may become encrusted onto the spray arms and block the holes used to spray the water. It is therefore recommended that you check the arms from time to time and clean them with a small non-metallic brush.

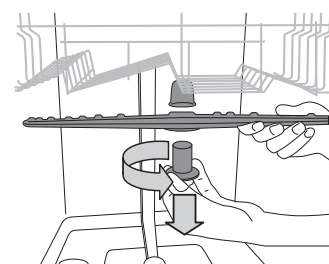

To remove the upper spray arm, turn the plastic locking ring in an anti-clockwise direction. The upper spray arm should be replaced so that the side with the greater number of holes is facing upwards. The lower spray arm may be removed by pulling it upwards.

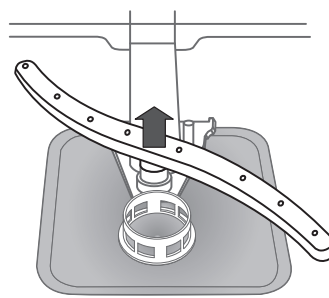

INSTALLATION

ATTENTION: If the appliance must be moved at any time, keep it in an upright position; if absolutely necessary, it may be tilted onto its back.

CONNECTING THE WATER SUPPLY

Adaptation of the water supply for installation should only be performed by a qualified technician.

The water inlet and outlet hoses may be positioned towards the right or the left in order to achieve the best possible installation.

Make sure the dishwasher does not bend or squash the hoses.

CONNECTING THE WATER INLET HOSE

- Run the water until it is perfectly clear.
- Screw the inlet hose tightly into position and turn on the tap.

If the inlet hose is not long enough, contact a specialist store or an authorised technician.

The water pressure must be within the values indicated in the Technical Data table - otherwise the dishwasher may not function properly.

Make sure the hose is not bent or compressed.

SPECIFICATIONS FOR THE CONNECTION OF THE WATER SUPPLY HOSE:

WATER SUPPLY	cold or hot (max. 60°C)
WATER INTAKE	3/4"
POWER OF WATER PRESSURE	0,05 ÷ 1 MPa (0.5 ÷ 10 bar) 7,25 – 145 psi

CONNECTING THE WATER OUTLET HOSE

Connect the outlet hose to a drain duct with a minimum diameter of 2 cm **A**.

The outlet hose connection must be at a height ranging from 40 to 80 cm from the floor or surface where the dishwasher rests.

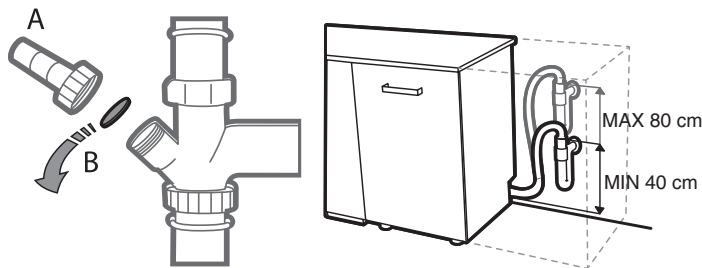

Before connecting the water outlet hose to the sink drain, remove the plastic plug **B**.

ANTI-FLOODING PROTECTION

Anti-flooding protection. To ensure floods do not occur, the dishwasher:

- is provided with a special system which blocks the water supply in the event of anomalies or leaks from inside the appliance.

Some models are also equipped with the supplementary safety device **New Aqua Stop**, which guarantees anti-flooding protection even in the event of a supply hose rupture.

Under no circumstances should the water inlet hose be cut as it contains live electrical parts.

ELECTRICAL CONNECTION

⚡ WARNING: Under no circumstances should the water inlet hose be cut as it contains live electrical parts.

Before inserting the plug into the electrical socket, make sure that:

- The socket is **earth** \perp and complies with current regulations;
- The socket can withstand the maximum load of the appliance as shown on the data plate located on the inside of the door (see *PRODUCT DESCRIPTION*).
- The power supply voltage falls within the values indicated on the data plate on the inside of the door.
- The socket is compatible with the plug of the appliance.

If this is not the case, ask an authorised technician to replace the plug (see *AFTER-SALES SERVICE*). Do not use extension cables or multiple sockets. Once the appliance has been installed, the power supply cable and the electrical socket should be easily accessible.

The cable should not be bent or compressed.

If the power supply cable is damaged, have it replaced by the manufacturer or its authorised Technical Assistance Service in order to prevent all potential hazards.

The Company shall not be held responsible for any incidents, if these regulations are not observed.

POSITIONING AND LEVELLING

1. Position the dishwasher on a level sturdy floor. If the floor is uneven, the front feet of the appliance may be adjusted until it reaches a horizontal position. If the appliance is levelled correctly, it will be more stable and much less likely to move or cause vibrations and noise while it is operating.
2. Before recessing the dishwasher, stick the adhesive transparent strip under the wooden shelf in order to protect it from any condensation which may form.
3. Place the dishwasher so that its sides or back panel are in contact with the adjacent cabinets or the wall. This appliance can also be recessed under a single worktop.
4. To adjust the height of the rear foot, turn the red hexagonal bushing on the lower central part at the front of the dishwasher using a hexagonal spanner with an opening of 8 mm. Turn the spanner in a clockwise direction to increase the height and in an anticlockwise direction to decrease it.

DIMENSIONS AND CAPACITY:

WIDTH	595 mm
HEIGHT	820 mm
DEPTH	555 mm
CAPACITY	14 standard place-settings

TROUBLESHOOTING

Your dishwasher may not work properly.

Before contacting the Service Centre check if the problem can be solved by going through the following list.

PROBLEMS	POSSIBLE CAUSES	SOLUTIONS
The dishwasher won't start or does not respond to commands.	The appliance has not been plugged in properly.	Insert the plug into the socket.
	Power outage.	The dishwasher starts automatically when the power returns.
	The dishwasher door is not closed.	Vigorously push the door until you hear the "click".
The door doesn't lock.	It does not respond to commands.	Switch off the appliance by pressing the ON/OFF button, switch it back on after approximately one minute and reset the program.
	Racks are not fit to the end.	Verify that racks are fit to the end.
The dishwasher makes excessive noise.	The door is not lock.	Vigorously push the door until you hear the "clack" sound.
	The dishes are rattling against each.	Arrange the crockery correctly (see <i>LOADING THE RACKS</i>).
The dishes have not been dried.	An excessive amount of foam has been produced.	The detergent has not been measured out correctly or it is not suitable for use in dishwashers (see <i>FILLING THE DETERGENT DISPENSER</i>). Reset the current cycle by switching OFF the dishwasher, then switch it on again, select a new program, press START and close the door. Please do not add any detergent.
	The selected program hasn't any drying phase.	Verify on the programs table if the selected program has the drying phase.
The dishes are not clean.	The rinse aid has run out or the resolution is not adequate.	Add the rinse aid or adjust the dosage levels higher (see <i>FILLING THE RINSE AID DISPENSER</i>).
	The dishes are made of non-stick or plastic.	It is normal the presence of drops of water (see <i>TIPS</i>).
	The crockery has not been arranged properly.	Arrange the crockery correctly (see <i>LOADING THE RACKS</i>).
The dishwasher does not fill the water, shows "H2O" Warning or "F06"	The spray arms cannot rotate freely, being hindered by the dishes.	Arrange the crockery correctly (see <i>LOADING THE RACKS</i>).
	The wash cycle is too gentle and/or detergent efficiency is low.	Select an appropriate wash cycle (see <i>PROGRAMS TABLE</i>).
	An excessive amount of foam has been produced.(see AFTER-SALES SERVICE)	The detergent has not been measured out correctly or it is not suitable for use in dishwashers (see <i>FILLING THE DETERGENT DISPENSER</i>). Reset the current cycle by switching OFF the dishwasher, then switch it on again, select a new program, press START and close the door. Please do not add any detergent.
	The cap on the rinse aid compartment has not been shut correctly.	Make sure the cap of the rinse aid dispenser is closed.
	The filter is soiled or clogged.	Clean the filter assembly (see <i>CARE AND MAINTENANCE</i>).
	There is no salt.	Fill the salt reservoir (see <i>FILLING THE SALT RESERVOIR</i>).
The dishes and glasses show calcination or a whitish film.	No water in the water supply or the tap is closed.	Make sure there is water in the water supply or the tap running.
	The inlet hose is bent.	Make sure the drain hose is not bent (see <i>INSTALLATION</i>) reprogram the dishwasher and reboot.
	The sieve in the water inlet hose is clogged; it is necessary to clean it	After having carried out the verification and cleaning, turn off and turn on the dishwasher and restart a new program.
The dishes and glasses are blue streaked or have a bluish tinge.	The salt level is too low.	Fill the salt reservoir (see <i>FILLING THE SALT RESERVOIR</i>).
	The adjustment of the water hardness is not adequate.	Increase the values (see <i>WATER HARDNESS TABLE</i>).
	The cap of the salt reservoir is not properly closed.	Check to have properly closed the salt reservoir cap.
	The rinse aid is used up or the dosage is insufficient.	Add the rinse aid or adjust the dosage levels higher.
	The rinse aid dosage is excessive.	Adjust the dosage rates below.

TECHNICAL DATASHEET

The technical data containing the energy consumption data can be downloaded from the website: docs.hotpoint.eu

CONTACTING AFTER-SALES SERVICE

You can find our contact details in the warranty manual. When contacting our Client After-sales Service, please state the codes provided on your product's rating plate.

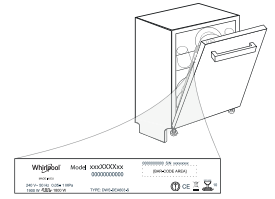

195157565.00

07/2017 as - Xerox Fabriano

