

New SunWize Grid-Tie Systems

Featuring SANYO N Series Modules and Lower Prices



Complete, Engineered, Packaged Systems For Residential and Commercial Applications

- Field-proven system reliability • Increased installation efficiency
- Permit-ready documentation • Next day shipment from stock
- Free delivery to the shop or job site • Single part number ordering

Finding ways to reduce costs and streamline operations is imperative in today's increasingly competitive world of residential solar installation. Traditionally, residential solar electric systems involve design, documentation, sourcing of components, off-site receiving and staging, and one-of-a-kind installations. This method is complex, prone to error, and time consuming.

SunWize Grid-Tie System packages offer a superior approach – a proven formula for success saving photovoltaic installers substantial time and money. Contact us and find out how we can help you with your solar business. Be successful, choose SunWize!

OFFICES THROUGHOUT THE US AND CANADA
800.817.6527 • www.sunwize.com



Reliable People ::: Reliable Products ::: Reliable Power!



SunWize headquarters, manufacturing and distribution facility located in Kingston, NY (top), the Distributed Power Group headquarters in San Jose, CA (middle) and our main West Coast distribution warehouse located in Rancho Cucamonga, CA

The SunWize Difference: The Benefits of Being a SunWize Customer

SunWize offers our independent solar installers the largest selection of solar systems and high-quality solar products and components available. With 20 locations throughout North America and two distribution warehouses - one on each coast, our customer support is the best in the solar industry.

At 85,000 square feet, SunWize has the largest inventory of products of any solar distributor in North America. SunWize also has the solar industry's largest selection of complete, engineered, residential grid-tie system packages.

The Finest Customer Support in the Solar Industry

Our dedicated sales managers and knowledgeable customer service representatives are available to support you in your endeavors in growing your business and becoming more successful.

One of the best features of our business is that we offer the largest selection and variety of solar products for you

to choose from. We also offer the best pricing and selection of solar products in the US and an experienced engineering staff to provide technical support when needed. We provide literature for our products and distribute the best solar catalog in the industry, featuring our prepackaged solar systems, balance of system components, switchgear and solar design guide. You'll also find a wealth of solar information, design guides and other useful tools on our web site.

The Advantages of Being a SunWize Customer:

- Competitive prices
- Large inventory in three warehouses
- Great selection of products
- Same day shipping from both coasts
- Unmatched customer service
- Dedicated technical support
- Dealer training and conferences
- Direct mail & co-op advertising programs
- Lead distribution program
- Comprehensive product catalog and design guide - in print and online

SunWizeConnect®

SunWizeConnect is a web portal where dealers can access the account information they need 24/7. Using a browser, they can check inventory by part number or by description, search for SunWize part numbers, view basic account status information like balances and credit limits, display open order status, or research past orders.

Solar Training Workshops and Conferences

Our commitment to your success in the solar business also extends to the many training conferences and solar workshops we offer in various locations throughout the year. Our workshops are taught by experts and experienced professionals from the solar industry and the renewable energy field. Many of these courses give you the opportunity to become more knowledgeable and earn continuing education credits (CECs) towards becoming a NABCEP certified installer. Our solar energy seminars also feature representatives from our solar product vendors to keep you informed on product revisions and new product releases. For more info visit: www.sunwize.com/aboutsw/sunwize-solar-training.php



Our industry-leading customer service provides order fulfillment and support



We have the largest inventory in North America with over 85,000 sq. ft. of solar products



Our customers are served from two warehouses – one on each coast



Pre-packaged Grid-Tie Systems are readily available – saving our customers time and money



The SunWize catalog is printed and manufactured using 100% renewable energy generated by 25% wind power & 75% biomass.



Grid-Tie Systems	5
Grid-Tie Systems with Battery Back-up	9
Power Center Assemblies	10
Solar Modules.....	20
Module Mounts.....	30
Module Interconnects	44
PV String Combiners.....	48
Inverters	52
Charge Controllers.....	70
Meters.....	82
Monitoring	85
Batteries.....	86
Battery Cables	89
Battery Enclosures.....	90
Battery Chargers	93
DC to DC Converters.....	95
Wind Turbines.....	96
Water Pumps.....	99
Lighting	104
Switchgear	108
Electrical/Switchgear	114
Electrical/Wire & Cable	118
Hardware.....	124
Refrigeration.....	125
Solar Thermal Systems.....	126
SunWize Industrial Power Systems.....	128
Commercial Services.....	140
Addendum/SunWize Design Guide	142

©2010 SunWize Technologies

The SunWize Catalog is published and produced by the SunWize Marketing Team: David Kulik, *President & CEO*; David Kaltsas, *Executive Vice President*, Dave Holt, *Senior Director of Sales*; Matt Ziskin, *Senior Director of Marketing*; Bruce Gould, *Director-Sales and Marketing*, Jeffrey Fahey, *Art Director*; Mike Bauer, *Marketing Manager*; Laurie DuBois, *Marketing Manager*; Efreem Tagliamonte, *Engineering Manager*; Luc Colin, *Product Manager*; Steve Bell, *Technical Support Specialist*; Richard Dean, *Technical Support Specialist*. Visit us at www.sunwize.com.
Cover Photo Credits: (L-R) SunWize; Solar Connections, LLC; Second Sight Systems; Solar Connections, LLC; Renewable Energy Services; R & M Technologies.

What's New about this Edition of the SunWize Solar Electric Product Catalog

We are very pleased to present the 12th edition of the SunWize Solar Electric Product Catalog. As the solar industry continues to grow, we strive to provide the highest quality products and the largest inventory so that our customers can ensure reliable and timely installations.

FOR SOLAR PROFESSIONALS

The SunWize catalog is designed for solar professionals to easily find the right component for the job. Our goal is to offer one-stop solution shopping by providing every item needed for a superior solar installation including unmatched customer service.

SECTION TABS FOR FASTER NAVIGATION

We added tabs to each product category to help speed the process of locating components. Simply flip through the catalog pages to easily spot a specific category such as Solar Modules, Inverters or Batteries.

PART NUMBERS FOR EASY ORDERING

You will find SunWize part numbers preceding all product information so you can easily locate the product on the SunWize price list. The part numbers will also help to identify any product you may discuss with your SunWize sales manager or customer service representative.

COMPREHENSIVE PRODUCT INFORMATION FOR ON-GRID AND OFF-GRID APPLICATIONS

This catalog contains the solar industry's most comprehensive collection of on-grid and off-grid products for residential, commercial and industrial applications. You will find details about many SunWize pre-packaged products such as SunWize® Grid-Tie Systems which are available in a large selection of configurations using UL listed components. For our customers' convenience, SunWize systems are delivered to the installation site complete with engineered drawings. Other systems include Power Center Assemblies, Power Ready Systems and Power Online Systems, the latest in DC power supplies with battery backup.

WE ARE HERE TO HELP YOU

As one of the original US pioneers in the solar industry, SunWize has grown into one of today's premier providers of solar energy power solutions. Our customer's satisfaction is our priority which is why we consider ourselves as a solutions provider for meeting today's increasing power demand. From quality solar modules and balance of systems components to pre-engineered solar systems, put SunWize's experience to work for you!

Glossary of Terms

Weights

All weights are **unit** weight in pounds. Shipping weights are noted on some items.

Dimensions

All sizes and unit dimensions are in "inches".

Solar Module Ratings @ STC

Vmp Voltage at maximum power when connected to load

Imp Current (amps) at maximum power when connected to load

Voc Open circuit voltage – maximum voltage potential when disconnected (Important for BOS selection)

Isc Short circuit current (amps) (Important for over-current sizing) Maximum current when PV output is shorted together, power = 0

STC Standard Test Condition = 25°C, 1000W/m², AM 1.5

PV Rated Power (Watts) = Imp x Vmp

SunWize RE Dealer/Installer Sales Managers

Dealer Sales & Homeowners for Installer Referral:

Mark H. Paddison
Ameliasburgh, Ontario
Tel: 800-507-2585

Helga Canfield
Sparks, Nevada
Tel: 800-232-7652

Mike Troutner
St. Petersburg, Florida
Tel: 877-270-2241

Stephanie Winston
Rancho Cucamonga, CA
Tel: 866-476-9493 x 20

Spencer Evans
Victoria, British Columbia
Tel: 866-993-5636

Jim Westover
San Jose, California
Tel: 877-400-5150

Steve Naccarato
Kingston, New York
Tel: 877-857-6527

Michelle Bollella
Kingston, New York
Tel: 866-290-8583

Wayne Robertson,
Vicki Wallace
Willits, California
Tel: 800-344-2003

David Martindale
Kingston, New York
Tel: 800-817-6527

Dealer Sales, Installer Referral and Missionary Sales
Mona Rotkopf
Kingston, New York
Tel: 800-333-1245

Grid-Tie Sales Manager, Dealer Sales
John White
Oxnard, California
Tel: 866-456-6816

Sales Outside the US and Canada
Bruce Gould
Petaluma, California
Tel: 707-326-5434

Dealer Sales in Latin America
Latinoamérica y el Caribe
Se habla español
lvasconcellos@sunwize.com
Tel: 360-705-9343
Fax: 909-484-57212



SunWize® Grid-Tie Systems

Complete, Engineered, Packaged Solar Electric Systems

Finding ways to reduce cost and streamline operations is imperative in today's increasingly competitive world of residential solar installation. Traditionally, residential solar electric systems involve design, documentation, sourcing of individual components, off-site receiving and staging, and one-of-a-kind on-site installation. This method is complex, prone to error, and time consuming. SunWize Grid-Tie System packages are a more efficient approach, saving photovoltaic (PV) installers substantial time and money. Here's how:

Complete, Packaged Systems: Delivered to your shop or the job site using a single part number

Everything needed is included. Time and effort is saved by not having to generate a bill of materials and order multiple items. A single part number gets the whole system shipped right to your shop or the job site with no staging or double handling. Moreover, it eliminates the possibility of errors in ordering or in loading the truck. The job never comes to a halt because something is missing.

Engineered Systems: Proven reliability and permit-ready

SunWize Grid-Tie Systems are fully engineered and documented systems. They are proven, standard systems that free installers from having to design and engineer a system, and generate drawings. Installers have everything they need to obtain a permit and facilitate an inspection. The resources usually expended in design, engineering and documentation can go right to the bottom line or be redirected to revenue generating activities.

Standard Systems: Increased installation efficiency

Grid-Tie Systems stay the same. Crews that continually work with Grid-Tie Systems quickly move through the learning curve and become very skilled, reducing installation time.

No Hidden Costs: Free delivery and no surcharges

Delivery is included and there are no handling or other charges.

Module and Balance of System Availability: No waiting

SunWize Grid-Tie Systems are in-stock and ship 1-2 days ARO. Having modules and balance of system components immediately available improves cash flow and increases customer satisfaction. The revenue from booked business is realized quicker. More importantly, the customer does not have to wait to start receiving the benefit of their PV system.

Broad Range of Systems: Choose from Over 300 configurations

Dealers can select a given system size using a wide variety of module and inverter options. There is a configuration for virtually every residential customer situation.

SunWize Grid-Tie System Packages

SunWize Grid-Tie Systems contain high quality, UL listed components. Every component needed for a successful installation is included in the package. In addition to modules and inverters, each package includes Unirac® SolarMount® flush PV racks, and necessary hardware and electrical components. The installer supplies the wiring from the solar array to the main panel and roofing anchors. Packages also include complete documentation, an installation guide and operation/owner's manual.



Multiple systems can be installed for higher power output and systems may also be expanded in the future as budget or electrical requirements grow. Grid-Tie System packages can be installed on any type of composition or tile roof. The array is securely attached to the roof of the building with the mounts in compliance with US building codes.



SunWize® Grid-Tie Systems

SunWize Grid-Tie System packages allow you to choose from a multiple selection of solar modules matched with a variety of grid-tie inverters. Your pre-engineered SunWize Grid-Tie System will include:

1. Solar Modules - choose one of the following:

- SANYO 200W, 210W or 215W • SHARP 175W, 224W or 230W (Blk. on Blk.) • SOLON 230W. Solar modules are supplied equipped with "MC" type interconnects.

2. Unirac® SolarMount® code-compliant, flush PV mounting structure of clear anodized aluminum including rail set with L-feet and attachments for tile roofs, top-clamps and splice kits. Adjustable tilt leg sets for mounting to horizontal surfaces are sold separately.

3. Outdoor-rated Grid-Tie Inverter with LCD digital output display- choose one of the following:

- Xantrex GT series with integrated AC/DC disconnect switch • SMA-Sunny Boy series with integrated AC/DC disconnect switch and 4 PV string fused combiner • Enphase Energy microinverter • Fronius IG+ or Fronius IG series with a pre-wired SunWize Power Center consisting of an aluminum back panel, NEMA 3R, AC and DC disconnect switches. The Power Center is designed to facilitate easy on-site installation of the inverter. Also available is an optional digital kWh meter with socket box (Part # 400010). Inverters come with standard 10-year warranties. Fronius offers the option to extend the warranty to 15-years.

For three-phase installations, SMA inverters are field configurable for AC output voltage, (see selection table). More Grid-Tie Systems for 208Vac versions are available with Fronius IG or Xantrex GT inverters. See SunWize web site for details.

4. Wiring – Includes #10 AWG MC interconnect extension sub-array cords, wire management system with cable ties and wire clips, PV copper grounding lug system, PV fused combiner (if needed) and array wiring pull boxes. The home-run wiring from the solar array to the main panel is supplied by the installer.

5. Documentation – Includes electrical drawings, data sheets, warranties, installation instructions and owner's manual.

The following selection guide is a partial listing of Grid-Tie System packages. It contains modules from different manufacturers used in a variety of configurations in combination with a variety of inverters. Please refer to the current SunWize dealer price list for a complete listing of all available SunWize Grid-Tie Systems.

Sample of SunWize Grid-Tie System Configurations

GTS Model Part #	PV Module Model	PV # Series x Parallel	Array Power (STC Watts)	Array Power (CEC Watts)	Inverter Model	Inverter Power (kW)	Output Vac
999GTS1000	SANYO 215N	6 x 1	1290	1197.6	Xantrex GT2.8	2.8	240
999GTS1001	SANYO 215N	7 x 1	1505	1397.2	Xantrex GT2.8	2.8	240
999GTS1004	SANYO 215N	10 x 1	2150	1996.0	Xantrex GT2.8	2.8	240
999GTS1007	SANYO 215N	8 x 2	3440	3193.6	Xantrex GT3.3	3.3	240
999GTS1009	SANYO 215N	10 x 2	4300	3992.0	Xantrex GT3.8	3.8	240
999GTS1010	SANYO 215N	7 x 3	4515	4191.6	Xantrex GT4.0	4.0	240
999GTS1011	SANYO 215N	8 x 3	5160	4790.4	Xantrex GT5.0	5.0	240
999GTS1020	SANYO 215N	6 x 2	2580	2395.2	SMA SB3000US	3.0	240
999GTS1022	SANYO 215N	8 x 2	3440	3193.6	SMA SB3000US	3.0	240
999GTS1023	SANYO 215N	9 x 2	3870	3592.8	SMA SB4000US	4.0	240
999GTS1024	SANYO 215N	10 x 2	4300	3992.0	SMA SB4000US	4.0	240
999GTS1026	SANYO 215N	9 x 3	5805	5389.2	SMA SB5000US	5.0	240
999GTS1027	SANYO 215N	10 x 3	6450	5988.0	SMA SB6000US	6.0	240
999GTS1028	SANYO 215N	8 x 4	6880	6387.2	SMA SB6000US	6.0	240
999GTS1029	SANYO 215N	9 x 4	7740	7185.6	SMA SB7000US	7.0	240

Add Z – for packages without mounting structure. Contact SunWize sales rep for roof mounting accessories.

NOTE: GTS packages are designed for best operation in regions with average ambient temperatures from 5°F to 104°F. SunWize Grid-Tie Systems systems must be installed by a qualified electrical or solar contractor.

SunWize® Grid-Tie Systems

GTS Model Part #	PV Module Model	PV # Series x Parallel	Array Power (STC Watts)	Array Power (CEC Watts)	Inverter Model	Inverter Power (kW)	Output Vac
999GTS1031	SANYO 215N	6 x 1	1290	1197.6	Fronius IG2000	1.8	240
999GTS1033	SANYO 215N	8 x 1	1720	1596.8	Fronius IG2000	1.8	240
999GTS1036	SANYO 215N	7 x 2	3010	2794.4	Fronius IG3000	2.7	240
999GTS1041	SANYO 215N	8 x 3	5160	4790.4	Fronius IG5100	5.1	240
999GTS1050	SANYO 215N	7 x 1	1505	1397.2	Fronius IG+ 3.0	3.0	240
999GTS1054	SANYO 215N	7 x 2	3010	2794.4	Fronius IG+ 3.0	3.0	240
999GTS1055	SANYO 215N	8 x 2	3440	3193.6	Fronius IG+ 3.8	3.8	240
999GTS1056	SANYO 215N	9 x 2	3870	3592.8	Fronius IG+ 3.8	3.8	240
999GTS1057	SANYO 215N	10 x 2	4300	3992.0	Fronius IG+ 5.0	5.0	240
999GTS1059	SANYO 215N	8 x 3	5160	4790.4	Fronius IG+ 5.0	5.0	240
999GTS1060	SANYO 215N	9 x 3	5805	5389.2	Fronius IG+ 6.0	6.0	240
999GTS1062	SANYO 215N	10 x 3	6450	5988.0	Fronius IG+ 6.0	6.0	240
999GTS1065	SANYO 215N	9 x 4	7740	7185.6	Fronius IG+ 7.5	7.5	240
999GTS1067	SANYO 215N	7 x 6	9030	8383.2	Fronius IG+ 10.0	10.0	240
999GTS1071	SANYO 215N	10 x 5	10750	9980.0	Fronius IG+ 10.0	10.0	240
999GTS1072	SANYO 215N	9 x 6	11610	10778.4	Fronius IG+ 11.4	11.4	240
999GTS1073	SANYO 215N	8 x 7	12040	11177.6	Fronius IG+ 11.4	11.4	240
999GTS312	Sharp NT-175U1	9 x 2	3150	2779.2	SMA SB3000US	3.0	240/208
999GTS314	Sharp NT-175U1	11 x 2	3850	3396.8	SMA SB4000US	4.0	240/208
999GTS317	Sharp NT-175U1	11 x 3	5775	5095.2	SMA SB5000US	5.0	240/208/277
999GTS319	Sharp NT-175U1	10 x 4	7000	6176.0	SMA SB6000US	6.0	240/208/277
999GTS323	Sharp NT-175U1	6 x 2	2100	1852.8	Fronius IG2000	2.0	240
999GTS325	Sharp NT-175U1	9 x 5	7875	6948.0	SMA SB7000US	7.0	240/208/277
999GTS326	Sharp NT-175U1	9 x 3	4725	4168.8	Xantrex GT4.0	4.0	240
999GTS327	Sharp NT-175U1	10 x 3	5220	4632.0	Xantrex GT5.0	5.0	240
999GTS332	Sharp NT-175U1	11 x 3	5775	5095.2	Xantrex GT5.0	5.0	240
999GTS342	Sharp NT-175U1	9 x 2	3150	2779.2	Fronius IG3000	2.7	240
999GTS366	Sharp NT-175U1	9 x 3	4725	4168.8	Fronius IG4000	4.0	240
999GTS380	Sharp NT-175U1	7 x 2	2450	2161.6	Xantrex GT2.8	2.8	240
999GTS382	Sharp NT-175U1	9 x 2	3150	2779.2	Xantrex GT2.8	2.8	240
999GTS384	Sharp NT-175U1	7 x 3	3675	3242.4	Xantrex GT3.3	3.3	240
999GTS387	Sharp NT-175U1	9 x 1	1575	1389.6	Xantrex GT2.8	2.8	240
999GTS389	Sharp NT-175U1	11 x 1	1925	1698.4	Xantrex GT2.8	2.8	240
999GTS391	Sharp NT-175U1	11 x 2	3850	3396.8	Xantrex GT4.0	4.0	240
999GTS392	Sharp NT-175U1	8 x 3	4200	3705.6	Xantrex GT4.0	4.0	240
999GTS397	Sharp NT-175U1	8 x 4	5600	4940.8	Fronius IG5100	5.0	240

Add Z – for packages without mounting structure. Contact SunWize sales rep for roof mounting accessories.

NOTE: GTS packages are designed for best operation in regions with average ambient temperatures from 5°F to 104°F. SunWize Grid-Tie Systems systems must be installed by a qualified electrical or solar contractor.

SunWize® Grid-Tie Systems

Sample of SunWize Grid-Tie System Configurations

GTS Model Part #	PV Module Model	PV # Series x Parallel	Array Power (STC Watts)	Array Power (CEC Watts)	Inverter Model	Inverter Power (kW)	Output Vac
999GTS1201	SOLON 230	9 X 1	2070	1830.6	Xantrex GT2.8	2.8	240
999GTS1202	SOLON 230	10 X 1	2300	2034	Xantrex GT2.8	2.8	240
999GTS1203	SOLON 230	11 X 1	2530	2237.4	Xantrex GT2.8	2.8	240
999GTS1204	SOLON 230	12 X 1	2760	2440.8	Xantrex GT2.8	2.8	240
999GTS1205	SOLON 230	13 X 1	2990	2644.2	Xantrex GT2.8	2.8	240
999GTS1207	SOLON 230	9 X 2	4140	3661.2	Xantrex GT3.8	3.8	240
999GTS1208	SOLON 230	10 X 2	4600	4068	Xantrex GT4.0	4.0	240
999GTS1209	SOLON 230	11 X 2	5060	4474.8	Xantrex GT5.0	5.0	240
999GTS1210	SOLON 230	12 X 2	5520	4881.6	Xantrex GT5.0	5.0	240
999GTS1221	SOLON 230	7 X 1	1610	1423.8	Fronius IG2000	1.8	240
999GTS1222	SOLON 230	8 X 1	1840	1627.2	Fronius IG2000	1.8	240
999GTS1227	SOLON 230	7 X 2	3220	2847.6	Fronius IG3000	2.7	240
999GTS1234	SOLON 230	10 X 1	2300	2034.0	Fronius IG+ 3.0	3.0	240
999GTS1235	SOLON 230	11 X 1	2530	2237.4	Fronius IG+ 3.0	3.0	240
999GTS1237	SOLON 230	13 X 1	2990	2644.2	Fronius IG+ 3.0	3.0	240
999GTS1238	SOLON 230	10 X 2	4600	4068	Fronius IG+ 5.0	5.0	240
999GTS1239	SOLON 230	11 X 2	5060	4474.8	Fronius IG+ 5.0	5.0	240
999GTS1240	SOLON 230	12 X 2	5520	4881.6	Fronius IG+ 5.0	5.0	240
999GTS1241	SOLON 230	13 X 2	5980	5288.4	Fronius IG+ 6.0	6.0	240
999GTS1246	SOLON 230	10 X 3	6900	6712.2	Fronius IG+ 6.0	6.0	240
999GTS1248	SOLON 230	12 X 3	8280	7322.4	Fronius IG+ 7.5	7.5	240
999GTS1265	SOLON 230	9 X 1	2070	1830.6	SMA SB3000US	3.0	240
999GTS1266	SOLON 230	10 X 1	2300	2034	SMA SB3000US	3.0	240
999GTS1267	SOLON 230	11 X 1	2530	2237.4	SMA SB3000US	3.0	240
999GTS1268	SOLON 230	12 X 1	2760	2440.8	SMA SB4000US	4.0	240
999GTS1269	SOLON 230	13 X 1	2990	2644.2	SMA SB4000US	4.0	240
999GTS1271	SOLON 230	11 X 2	5060	4474.8	SMA SB5000US	5.0	240
999GTS1272	SOLON 230	12 X 2	5520	4881.6	SMA SB5000US	5.0	240

Add Z – for packages without mounting structure. Contact SunWize sales rep for roof mounting accessories.

NOTE: GTS packages are designed for best operation in regions with average ambient temperatures from 5°F to 104°F. SunWize Grid-Tie Systems systems must be installed by a qualified electrical or solar contractor.

Shown below are a selection of the outdoor-rated grid-tie inverters available with SunWize Grid-Tie System packages.



Fronius IG PLUS 3.0



SMA 3000US/4000US



Xantrex GT Series inverter

SunWize® Grid-Tie Systems with Battery Backup

Featuring the MidNite Solar E-Panel and OutBack GTFX 3048-1 and GVFX 3648-1 Inverter

SunWize Grid-Tie Systems with Battery Backup offer SunWize modules and high-quality system components to provide reliable power. All major components needed for a successful installation are included with each system. In addition to solar modules and batteries, each system includes a pre-assembled, factory-tested SunWize Power Center with AC/DC disconnects and PV ground fault protection, a UniRac SolarMount support structure, MC cables, and a lockable, indoor battery enclosure. The installer provides the common AC wiring.

For power needs beyond 7.2kW, additional power systems can be installed for other critical loads. An optional PSX240 transformer can be added for 120/240Vac applications.

All SunWize systems include complete documentation, an installation guide and owner's manual. SunWize modules carry a 25-year warranty on power output. The SunWize Power Center carries a 1-year SunWize warranty and the Concorde batteries have an 18-month warranty. The OutBack inverters carry a 5-year warranty and 10 years in California and the FM60 controllers have a 5-year warranty. Sealed AGM batteries provide 9 kWh (@ 24 hr. rate) of reserve power. Expandable up to 27 kWh. Maintenance-free batteries are designed to last 10+ years in float condition.

Battery Enclosure Dimensions: 33.6"W x 34.2"H x 15.2"D, weight without batteries: 30 lbs.

SunWize Power Center Assembly Dimensions: 26" x 18" x 18", weight: 100 lbs.

Only experienced solar energy dealers or electrical contractors should install SunWize Grid-Tie Systems.



MidNite Solar E-Panel, Outback FX inverter and FM60 controller

Part #	PV Array (watts)	Solar Module	Battery Storage	OutBack Inverter	Output Power (kW)	Output (Vac) *	PV# Series x Parallel	PV String (Voc) (Vdc)	PV String (Isc) (Adc)	PV Array (Isc) (Adc)
999GTB032	2400	SW100C	9 kWh	GTFX3048-1	3.0	120	4 x 6	114	4.94	29.64
999GTB033	2800	SW100C	9 kWh	GTFX3048-1	3.0	120	4 x 7	114	4.94	34.58
999GTB042	2800	SW100C	9 kWh	GVFX3648-1	3.6	120	4 x 7	114	4.94	34.58
999GTB043	3200	SW100C	9 kWh	GVFX3648-1	3.6	120	4 x 8	114	4.94	39.52

For orders without mounting structures add the suffix Z to part number.



SunWize Grid-Tie System #999GTS440-Z no rack
INSTALLED BY: Giuffrida Electric Company



SunWize 6kW Grid-Tie System #999GTS670
INSTALLED BY: National Park Service



SunWize 7.7kW Grid-Tie System #999GTS1965
INSTALLED BY: Dan Hicks, Sun Saver Solar Systems



All components are housed in a lockable, vented, indoor enclosure with thermally active cooling fan (shown with top removed for display)



Enclosure shown with Outback MATE digital system

SunWize® Solar Ready Battery Systems

Provide backup power when utility power is unavailable

SunWize® Solar Ready Battery Systems are utility interactive and designed to operate with a solar array. During the day, the solar array (sold separately) delivers utility grade electricity to dedicated loads. Extra power not consumed will feed back into the grid and lower your electric bill. At night, utility power keeps the batteries charged and supplies electricity to dedicated loads. Solar Ready Battery Systems provide power when utility power is unavailable.

Automatic Operation

Solar Ready Battery Systems operate quietly and automatically providing safety for your family or business by keeping the lights on and providing power for critical loads. No need to think about where your power is coming from when utility power shuts off.

Backup Power in a Box

Solar Ready Battery Systems include all the components necessary for battery backup power in one self-contained unit for indoor installation. The enclosures are lockable for security and offer an optional breaker access door. All electrical components are listed for safety to UL specifications. The SunWize assembly is pre-wired and is ETL certified to UL-508A industrial control enclosure for the US and Canada.

High Quality Components

SunWize Solar Ready Battery Systems offer high-quality system components to provide reliable power. Each system includes a sealed 3000W or vented 3600W pure sine wave inverter with five-stage battery charger, manual AC bypass switch, FM60 charge controller, MATE digital system control and display, GFI outlet, PV-GFP circuit breaker, AC DC breakers and sealed, AGM deep-cycle batteries.

OutBack inverters carry a 5-year warranty (10-year in California), and the FM60 controller has a 2-year warranty. Concorde batteries carry an 18-month warranty and provide 13 or 26 kWh (@ 24-hour rate) of reserve power depending on the model you choose. SRB3.0 and 3.6 are expandable to 39 kWh. Maintenance-free batteries are designed to last 10+ years in float condition. Batteries are shipped – not installed.

SunWize Solar Ready Battery Systems include:

- OutBack GFX series inverter/charger
- FM60 controller for solar connection
- MATE digital system control and display
- Concorde Sun-Xtender® sealed batteries
- Lockable, vented indoor enclosure
- Complete documentation – an installation guide with diagrams and owner's manual



System include a sealed or vented inverter. OutBack vented GVFX inverter shown.

SunWize Solar Ready Battery Systems provide backup power for many household and small business devices

- Computer systems
- Lights
- Well pumps
- Refrigerators
- Health and medical equipment
- Communication systems

Other SunWize Solar Ready Battery Systems are available for:

- Stand-alone, off-grid solar applications
- On-grid UPS or off-grid with generator applications

SPECIFICATIONS				
Models	SRB 3.0	SRB3.6	SRB 6.0	SRB 7.2
Part Number	996716004	996716005	996716006	996716007
with Breaker Door	996716004-A	996716005-A	996716006-A	996716007-A
Stand Alone Version*	996716034	996716035	996716037	996716038
AC Ratings				
Inverter	1 sealed GTFX3048	1 vented GVFX3648	2 sealed GTFX3048	2 vented GVFX3648
Wave form	Pure sine wave	Pure sine wave	Pure sine wave	Pure sine wave
AC Voltage	120 Vac nominal 1	120 Vac nominal	120/240 Vac	120/240 Vac
AC Phase Configuration	Single	Single	Split	Split
Frequency	60Hz +/- 0.04%	60Hz +/- 0.04%	60Hz +/- 0.04%	60Hz +/- 0.04%
Total Harmonic Distortion	<5%	<5%	<5%	<5%
Surge Power	6000 Watts	7200 Watts	12000 Watts	14400 Watts
Continuous Power	3000 Watts	3600 Watts	6000 Watts	7200 Watts
AC Pass-Through Current	50 Amps	50 Amps	120 Amps	120 Amps
Inverter Efficiency	93%	93%	93%	93%
Transfer Time at Power Failure	16 ms	16 ms	18 ms	18 ms
DC Ratings				
Battery Breaker	125A	125A	125A x 2	125A x 2
Battery Voltage (Nominal)	48 Vdc	48 Vdc	48 Vdc	48 Vdc
Battery Charging Current (Max)	30 Amps DC	60 Amps DC	70 Amps DC	90 Amps DC
Battery Bank				
Battery Capacity (C/24)	305 AH @ 48V	305 AH @ 48V	610 AH @ 48V	610 AH @ 48V
Usable to 80% DOD	13 kWh**	13 kWh**	26 kWh	26 kWh
Battery Type	AGM maintenance free	AGM maintenance free	AGM maintenance free	AGM maintenance free
Dimensions W x H x D	32" x 58" x 15"	32" x 58" x 15"	64" x 58" x 15"	64" x 58" x 15"
Number of Battery Cabinets	Single	Single	Dual	Dual
Approximate Weight (including batteries)	920 lb.	920 lb.	1820 lb.	1820 lb.
Solar Input				
Maximum Solar Watts	3300W	3300W	6600W	6600W
DC Input Voltage (Voc)	80-125 Vdc	80-125 Vdc	80-125 Vdc	80-125 Vdc
PV-DC Ground Fault Protection	Yes	Yes	Yes	Yes
PV-DC Breaker Rating	63A	63A	63A x 2	63A x 2
Back-up Run Times (example)				
1000 watt 120V AC Load	13 hrs.	13 hrs.	26 hrs.	26 hrs.

*Stand Alone Version cannot be connected to the grid in interactive mode and uses the FX/VFX versions of the OutBack inverter.

Options:

**Additional Battery Banks-13 kWh additional per bank – maximum of two 240 Vac transformers – Converts 120 Vac to 240 Vac (for 3.0/3.6 only).
 Breaker Access Door – Allows access to breakers when doors are locked. (Part # -A). Maximum of three additional DIN rail mount 15A-120 Vac load breakers can be field installed into “Solar Ready” at dedicated AC Sub-Panel.



Optional breaker access door



MATE digital system control and display



Thermally active cooling fan

Advertisement

SunWize® FLEXware Assemblies with OutBack Inverter/Chargers

Pre-assembled Power Centers

SunWize, an OutBack/ETL Integrating Partner, offers pre-assembled power center assemblies listed to UL-508A. SunWize FLEXware power centers are assembled, wired and tested by SunWize in a code-compliant package. These FLEXware power centers are a modular building block for the OutBack FX and GFX series inverter/chargers allowing modular expansion from single inverter back-up systems to a multiple inverter village power system. SunWize FLEXware power center's versatile design allows the choice of many installed options and offer a generous number of knock-outs allowing the installation of conduit, cable glands and other installation accessories.

OutBack's new, attractive FLEXware design also enables a lighter weight installation. The corrosion-resistant aluminum, silver powder-coated enclosures makes for a great looking installation that will last and look great for years to come. All FLEXware power centers are designed to be wall mounted for an indoor installation. The compact and flexible design of the mounting plate allows the inverters to be positioned in either a vertical or horizontal orientation for a professional-looking installation.



SunWize FLEXware 500 Power Center Assembly shown with optional charge controllers

FLEXware 500

For applications with medium power requirements such as homes or light commercial power systems, the FLEXware 500 supports up to two OutBack inverter/chargers and two FM60 or FM80 controllers. Standard FW500 power center assemblies include all of the protective overcurrent devices, two AC bypass breakers, two AC input breakers, two AC output breakers, AC I/O bus bars, and DC main breaker(s). Also included are a 500A DC negative shunt, negative bus bar, ground bus bar, positive/negative DC bus bar, DC main breaker bus bar, and a remote battery temperature sensor. Dual inverter assemblies include a HUB4 communications manager.

The FW500-AC section functions as a 120/240V AC load breaker sub-panel with space for adding eight OB-AC DIN mount breakers. The FW500-DC section allows DC load circuit breakers by the addition of eight OB-DC panel mount breakers. Space limited when used with FM60 charge controllers and/or PV-GFP.

Size: 20.3" H x 46.3" W. Unit weight: 177 lbs.

FLEXware 1000

For applications with more power requirements such as large homes, commercial or village power systems, the FLEXware 1000 supports up to four inverter/chargers and four FM60 or FM80 controllers. Standard SunWize FW1000 power center assemblies include all of the protective over-current devices, four AC bypass breakers, four AC input breakers, four AC output breakers, five AC I/O bus bars, and DC main breakers.

Also included is a HUB10 communications manager, 500A negative shunt, negative bus bar, ground bus bar, positive/negative DC bus bar, DC breaker bus bar and a remote battery temperature sensor. The FW1000-AC section functions as a 120/240V load breaker sub-panel with space for adding sixteen of OB-AC DIN mount breakers.

The FW1000-DC section allows additional DC load circuit breakers, eleven OB-DC .75" panel mount breakers and three 1" wide breakers. Space limited when used with FM60 charge controllers and/or PV-GFP. Size: 40.6" H x 46.3" W. Unit weight: 329 lbs.

Many installed options are available for adding charge controllers, AC/DC load breakers, PV ground fault protection, surge protection, step up/down or load balancing transformers and system monitoring. Please refer to the SunWize FLEXware options on page 15.



SunWize FLEXware 1000 Power Center Assembly

SunWize FLEXware Assemblies with OutBack Inverter/Chargers

Part #	AC Power	Model	Description
FW500 with OutBack FX Sealed Inverter/Chargers			
For stand-alone, UPS or generator powered battery systems			
996715070-F	2500W	OBPP-FX2524T-1	One FX 2500W 24 Vdc-120 Vac, 175 Adc breaker, 60A bypass breaker
996715071-F	5000W	OBPP-FX2524T-2	Two FX 2500W 24 Vdc-120/240 Vac, 175 Adc breaker, 60A bypass breaker
996715075-F	3000W	OBPP-FX3048T-1	One FX 3000W 48 Vdc-120 Vac, 100 Adc breaker, 60A bypass breaker
996715076-F	6000W	OBPP-FX3048T-2	Two FX 3000W 48 Vdc-120/240 Vac, 100 Adc breaker, 60A bypass breaker
FW500 with OutBack GT Sealed Inverter/charger and FW-SP-ACA surge protector			
For PV Grid-Tie battery back-up (must include MX60 option – sold separately)			
996715058-F	2500W	OBPP-GTFX2524-1	One GTFX 2500W 24 Vdc-120 Vac, 175 Adc breaker, 60A bypass breaker
996715059-F	5000W	OBPP-GTFX2524-2	Two GTFX 2500W 24 Vdc-120/240 Vac, 175 Adc breaker, 60A bypass breaker
996715046-F	3000W	OBPP-GTFX3048-1	One GTFX 3000W 48 Vdc-120 Vac, 100 Adc breaker, 60A bypass breaker
996715047-F	6000W	OBPP-GTFX3048-2	Two GTFX 3000W 48 Vdc-120/240 Vac, 100 Adc breaker, 60A bypass breaker
FW500 with OutBack FX Inverter/Charger - 50 Hz Systems			
For stand-alone, UPS or generator powered battery systems			
996715084-F	2300W	OBPP-FX2348ET-1	One FX 2300W 48 Vdc-230 Vac 50 Hz, 100 Adc breaker, 30A bypass breaker
996715085-F	4600W	OBPP-FX2348ET-2	Two FX 2300W 48 Vdc-230 Vac 50 Hz, 100 Adc breaker, 30A bypass breaker
996715086-F	3000W	OBPP-VFX3048E-1	One VFX 3000W 48 Vdc-230 Vac 50 Hz, 175 Adc breaker, 30A bypass breaker
FW500 with VFX Vented Inverter/Chargers			
For stand-alone, UPS and generator powered battery systems			
996715031-F	2800W	OBPP-VFX2812-1	One VFX 2800W 12 Vdc-120 Vac, 250 Adc breaker, 60A bypass breaker
996715032-F	5600W	OBPP-VFX2812-2	Two VFX 2800W 12 Vdc-120/240 Vac, 250 Adc breaker, 60A bypass breaker
996715033-F	3500W	OBPP-VFX3524-1	One VFX 3500W 24 Vdc-120 Vac, 250 Adc breaker, 60A bypass breaker
996715034-F	7000W	OBPP-VFX3524-2	Two VFX 3500W 24 Vdc-120/240 Vac, 250 Adc breaker, 60A bypass breaker
996715035-F	3600W	OBPP-VFX3648-1	One VFX 3600W 48 Vdc-120 Vac, 175 Adc breaker, 50A bypass breaker
996715036-F	7200W	OBPP-VFX3648-2	Two VFX 3600W 48 Vdc-120/240 Vac, 175 Adc breaker, 60A bypass breaker
FW500 with 'GVFX' Vented Inverter/Charger and FW-SP-ACA surge protector			
For PV Grid-Tie battery back up systems (must include MX60 option – sold separately)			
996715045-F	3600W	OBPP-GVFX3648-1	One GVFX 3600W 48 Vdc-120 Vac, 175 Adc breaker, 60A bypass breaker
996715044-F	7200W	OBPP-GVFX3648-2	Two GVFX 3600W 48 Vdc-120/240 Vac, 175 Adc breaker, 60A bypass breaker
996715062-F	3500W	OBPP-GVFX3524-1	One GVFX 3500W 24 Vdc-120 Vac, 250 Adc breaker, 60A bypass breaker
996715063-F	7000W	OBPP-GVFX3524-2	Two GVFX 3500W 24 Vdc-120/240 Vac, 250 Adc breaker, 60A bypass breaker
FW1000 with FX Sealed Inverter/Chargers			
For stand-alone, UPS and generator powered battery systems			
996715072-F	5000W	OBPP-FX2524T-2FP	Two FX 2500W 24 Vdc-120/240 Vac, 175 Adc breaker, 60A bypass breaker
996715073-F	7500W	OBPP-FX2524T-3	Three FX 2500W 24 Vdc-120 Vac, 175 Adc breaker, 60A bypass breaker
996715074-F	10000W	OBPP-FX2524T-4	Four FX 2500W 24 Vdc-120/240 Vac, 175 Adc breaker, 60A bypass breaker
996715077-F	6000W	OBPP-FX3048T-2FP	Two FX 3000W 48 Vdc-120/240 Vac, 100 Adc breaker, 60A bypass breaker
996715078-F	9000W	OBPP-FX3048T-3	Three FX 3000W 48 Vdc-120 Vac, 100 Adc breaker, 60A bypass breaker
996715079-F	12000W	OBPP-FX3048T-4	Four FX 3000W 48 Vdc-120/240 Vac, 100 Adc breaker, 60A bypass breaker
FW1000 WITH 'VFX' Vented Inverter/Chargers			
For stand-alone, UPS and generator powered battery systems			
996715048-F	8400W	OBPP-VFX2812-3	Three VFX 2800W 12 Vdc-120 Vac, 250 Adc breaker, 60A bypass breaker
996715049-F	11200W	OBPP-VFX2812-4	Four VFX 2800W 12 Vdc-120/240 Vac, 250 Adc breaker, 60A bypass breaker
996715054-F	7000W	OBPP-VFX3524-2FP	Two VFX 3500W 24 Vdc-120/240 Vac, 250 Adc breaker, 60A bypass breaker
996715050-F	10500W	OBPP-VFX3524-3	Three VFX 3500W 24 Vdc-120 Vac, 250 Adc breaker, 60A bypass breaker
996715051-F	14000W	OBPP-VFX3524-4	Four VFX 3500W 24 Vdc-120/240 Vac, 250 Adc breaker, 60A bypass breaker
996715066-F	7200W	OBPP-VFX3648-2FP	Two VFX 3600W 48 Vdc-120/240 Vac, 175 Adc breaker, 60A bypass breaker
996715052-F	10800W	OBPP-VFX3648-3	Three VFX 3600W 48 Vdc-120 Vac, 175 Adc breaker, 60A bypass breaker
996715053-F	14400W	OBPP-VFX3648-4	Four VFX 3600W 48 Vdc-120/240 Vac, 175 Adc breaker, 60A bypass breaker

SunWize/OutBack FLEXware Installed Options

Part #	Description	Part #	Description
CONTROLLERS - OUTBACK, mounts to RH side of FW-DC enclosure		AC TRANSFORMERS	
7150PPO-107	One FM80 w/ Temp Sensor	7150PPO-24	X-240 Step Up Transformer (Specify for Input or Output Voltage, not for grid interface use)
7150PPO-108	One FM80/PVGP w/ Temp Sensor	GENERATOR ACCESSORY	
7150PPO-109	Two FM80 w/ Temp Sensor	7150PPO-59	Gen. Start Relay
7150PPO-110	Two FM80/PVGP w/ Temp Sensor	METERS - Xantrex, installed on FW-DC enclosure	
7150PPO-111	Three FM80 - w/ Temp Sensor	7150PPO-53	TM500A-48 Vdc System Monitor
7150PPO-112	Three FM80/PVGF - w/ Temp Sensor	7150PPO-54	TM500A-12/24 Vdc System Monitor
7150PPO-113	Four FM80 - w/ Temp Sensor	SURGE ARRESTORS	
7150PPO-114	Four FM80/PVGF - w/ Temp Sensor	7150PPO-37	AC Surge Arrestor-Delta SOV
7150PPO-120	One FM60 w/ Temp Sensor	7150PPO-38	DC Surge Arrestor-Delta SOV
7150PPO-121	One FM60/PVGP w/ Temp Sensor	7150PPO-102	FW-SP-ACA Surge Protector AC/DC (included on all GTFX/GVFX assemblies)
7150PPO-122	Two FM60 w/ Temp Sensor	ACCESSORIES	
7150PPO-123	Two FM60/PVGP w/ Temp Sensor	715068	OutBack MATE system controller - Gray oval
7150PPO-124	Three FM60 - w/ Temp Sensor	715126	OutBack MATE2 system controller - Black rectangular flush mount
7150PPO-125	Three FM60/PVGF - w/ Temp Sensor	715157	OutBack PSX-240 6kW step up/down transformer
7150PPO-126	Four FM60 - F w/ Temp Sensor	7150PPO-115	FLEXnet DC System Monitor
7150PPO-127	Four FM60/PVGF - w/ Temp Sensor	DC CIRCUIT BREAKERS, 150Vdc - 'OBB-DC', panel mount	
7150PPO-8	100A-DC BKR, 1.0" wide, 5/16 stud	7150PPO-88 80A-DC BKR, 3/4" wide, 1/4 stud	
7150PPO-88	80A-DC BKR, 3/4" wide, 1/4 stud	7150PPO-9 60A-DC BKR, 3/4" wide, 1/4" stud	
7150PPO-9	60A-DC BKR, 3/4" wide, 1/4" stud	7150PPO-10 40A-DC BKR, 3/4" wide, 1/4" stud	
7150PPO-10	40A-DC BKR, 3/4" wide, 1/4" stud	7150PPO-11 30A-DC BKR, 3/4" wide, 1/4" stud	
7150PPO-11	30A-DC BKR, 3/4" wide, 1/4" stud	7150PPO-46 20A-DC BKR, 3/4" wide, 1/4" stud	
7150PPO-46	20A-DC BKR, 3/4" wide, 1/4" stud	7150PPO-12 15A-DC BKR, 3/4" wide, 1/4" stud	
7150PPO-12	15A-DC BKR, 3/4" wide, 1/4" stud	7150PPO-50 10A-DC BKR, 3/4" wide, 1/4" stud	
7150PPO-50	10A-DC BKR, 3/4" wide, 1/4" stud	PV-DC GROUND FAULT PROTECTION	
7150PPO-23	OBB-GFP-80D-125 Vdc, 80A two pole	AC CIRCUIT BREAKERS - 'OBB-AC' DIN rail mounting	
7150PPO-80	60A-277 Vac BKR, single pole-1/2"	7150PPO-62 50A-277 Vac BKR, single pole-1/2"	
7150PPO-62	50A-277 Vac BKR, single pole-1/2"	7150PPO-91 30A-277 Vac BKR, two pole-1/2"	
7150PPO-91	30A-277 Vac BKR, two pole-1/2"	7150PPO-15 30A-277 Vac BKR, single pole-1/2"	
7150PPO-15	30A-277 Vac BKR, single pole-1/2"	7150PPO-17 25A-277 Vac BKR, two pole-1"	
7150PPO-17	25A-277 Vac BKR, two pole-1"	7150PPO-92 20A-277 Vac BKR, two pole-1/2"	
7150PPO-92	20A-277 Vac BKR, two pole-1/2"	7150PPO-61 20A-277 Vac BKR, single pole-1/2"	
7150PPO-61	20A-277 Vac BKR, single pole-1/2"	7150PPO-19 15A-277 Vac BKR, single pole-1/2"	
7150PPO-19	15A-277 Vac BKR, single pole-1/2"	7150PPO-89 10A-277 Vac BKR, single pole-1/2"	
7150PPO-89	10A-277 Vac BKR, single pole-1/2"		
			
		OutBack PSX-240	
			
		OutBack MATE system display and controller	
			
		OutBack FM60 controller	

Advertisement



SunWize Power Center Assembly with MidNite E-Panel, Magnum MS inverter and charge controller (shown without mounting brackets). These power centers combine the disconnects, overcurrent protection devices & controls into an easy-to-install and operate panel. All include 50' MS Remote Control (shown top left).

SunWize® Power Center Assembly with Magnum Inverter

For Stand-Alone Solar Power Systems

SunWize Power Centers are designed for medium-sized, stand-alone solar power applications with battery backup. Assembled and tested in the ETL-508A listed SunWize factory, these Power Centers feature a Magnum Energy MS pure sine wave inverter/charger and an OutBack FM60 charge controller. The solar array, battery, and battery connections are sold separately.

The inverter/charger with an FM60 allows stored solar energy to power dedicated loads directly, day or night, and can also be connected to a generator. The inverter/charger without FM60 allows utility power for dedicated UPS load operation and battery charging needs. All components are ETL or UL listed for USA and Canadian standards.

SunWize offers Magnum inverter/charger models for 12V, 24V or 48 Vdc systems, mounted on a MidNite Solar E-Panel with optional FM60 charge controller. The compact design of the E-Panel allows simple wall mounting. Indoor-rated MS series inverters include automatic cooling fan. The MS series inverters are 120 Vac/60 Hz single phase output with a gray steel E-panel-right hand door. Optional 6kW transformer PSX-240 can be added for 120/240 Vac split phase output on 12V or 24V MS inverter models. MS4448AE and MS4024AE are a single inverter with 120/240 Vac/60 Hz split phase output with a white steel E-panel, left hand door.

Unit size: 14.5" x 18" x 18" / Weight: 88 lbs. • Unit size with FM60: 20.5" x 18" x 18" / Weight: 100 lbs. Warranty info: • MS inverter – 2-year • FM60 – 5-year

Part #	Inverter Model	Output Power	Output Vac	Battery Charger	Solar Power (Max.)	Solar Voltage (Voc)	DC Breaker
FOR OFF GRID SOLAR/BATTERY (with FM60)							
996717001	MS2812	2800	120	125	800W	20-44	250
996717002	MS4024	4000	120	105	1600W	44-88	250
996717003	MS4448AE	4400	120/240	60	3200W	80-125	175
996717007	MS4024AE	4000	120/240	105	1600W	44-88	250
FOR OFF GRID GENERATOR/BATTERY UPS (without FM60)							
996717004	MS2812	2800	120	125	NA	NA	250
996717005	MS4024	4000	120	105	NA	NA	250
996717006	MS4448AE	4400	120/240	60	NA	NA	175
996717008	MS4024AE	4000	120/240	105	NA	NA	250

SunWize Power Center Assembly Features:

- MS series inverter/charger with optional OutBack FM60 charge controller with battery temperature sensor and cable
- Mounting brackets aid in 1-person installations
- Gray powder-coated steel enclosure
- Full-function digital remote control (50 ft.) for MS inverter
- AC distribution wiring terminal block
- 50A Input/Output 120 Vac bypass breakers
- 500A-50mV Negative DC current shunt
- Heavy-duty 125V main DC battery breaker
- 63A PV Ground fault breaker, dual GFCI outlets and 63 Adc Solar/battery DIN rail mounted breakers included with FM60

Benefits and Advantages:

- Generate your own electricity and backup power
- Rebates may be available if used with a solar system
- Pre-assembly saves time/money
- Hinged door for easy access to wiring
- E-Panel serves as AC sub panel for dedicated loads
- All AC/DC circuit breakers are pre-wired
- Compact design saves space

Power Center Accessories:

- 172002, ME-AGS Generator start control module
- 715157, PSX-240 transformer 120/240 Vac/60 Hz split phase



The SunWize Power Center Assembly combines the disconnects, overcurrent protection devices and controls into an easy-to-install and operate panel.



E-Panel, FX Series inverter & charge controller



Optional SunWize Digital kWh Meter

SunWize® Power Center Assembly with E-Panel and OutBack Inverters

SunWize Power Centers are designed for UPS or stand-alone applications and are ideal for medium-sized solar grid-tie systems with battery backup. SunWize Power Centers are assembled and tested in the ETL-508A listed SunWize factory and feature OutBack FX series inverter/chargers and the FM60 controller. The solar array, batteries and battery system connections are sold separately.

SunWize Power Centers offer sealed or vented FX series inverters with or without the FM60 charge controller assembled on a MidNite Solar E-Panel. The compact design of the E-Panel allows simple wall mounting of a single inverter/controller assembly for indoor installations.

All components are listed to UL specifications for USA and Canadian standards. For 120/240 Vac split-phase output, an additional 4kW PSX240 transformer can be added. Unit measures 26" x 18" x 18" and weighs 100 lbs.

Benefits and Advantages:

- Rebates may be available if used with a solar system
- Pre-assembly saves time/money
- Hinged door for easy access to wiring
- E-Panel serves as AC sub-panel for dedicated loads
- All AC/DC circuit breakers are pre-wired

SunWize Power Center Assembly Features:

- OutBack sealed or vented inverter with or without FM60 MPPT charge controller, battery temp. sensor & cable
 - Mounting brackets aid in 1-person installations
 - Gray powder-coated steel enclosure
 - AC distribution wiring terminal blocks
 - 50A Input/Output AC bypass breakers
 - 500A-50mV Negative DC current shunt
 - Heavy duty 175A or 250A main battery circuit breaker
 - 63A PV Ground fault breaker and dual GFCI outlets*
 - 63 Adc Solar/battery DIN rail-mounted breakers
- *included with FM60 models

Warranty Info:

- FX Series inverters – 5-year
- FM60 – 2-year
- SunWize system – 1-year

Available Options:

- 715134 - MATE_B universal display black square flush mount
- 715068 - Mate universal system display & monitor with 50 ft. RS232 cable
- 715157 - PSX-240 6kW transformer for 120/240 Vac 60 Hz split-phase output, includes auto-cooling fan, 25A dual breaker and indoor enclosure
- 716010 - Load circuit breaker-15A DIN120Vac single pole



Optional OutBack MATE system display and controller



Optional OutBack PSX-240 auto transformer

FOR BATTERY BACKUP WITH GENERATOR OR GRID-TIED UPS

The single FX inverter/charger system enables the AC grid or a generator to charge a battery bank. When utility power is not available dedicated loads are powered directly by the battery, when utility is restored battery is recharged.

E-Panel with OutBack FX Series Inverter/Charger

Part #	E-Panel	Inverter model	Power (watts)	Input-Output	Main Breaker (A/c)
996716009	MNE125ST-R	FX3048T sealed turbo	3000	48 Vdc-120 Vac/60 Hz	125
996716010	MNE175ST-R	FX2524T sealed turbo	2500	24 Vdc-120 Vac/60 Hz	175
996716011	MNE175ST-R	VFX3648 vented	3600	48 Vdc-120 Vac/60 Hz	175
996716012	MNE250ST-R	FX2012T sealed turbo	2000	12 Vdc-120 Vac/60 Hz	250
996716013	MNE250ST-R	VFX2812 vented	2800	12 Vdc-120 Vac/60 Hz	250
996716014	MNE250ST-R	VFX3524 vented	3500	24 Vdc-120 Vac/60 Hz	250

Unit size/weight: 10"W x 26"H x 17"D/73 lbs.

FOR OFF-GRID SOLAR WITH BATTERY BACKUP

During the day, the single FX inverter/charger system enables solar energy to power dedicated loads directly and at night allows the battery bank to provide power for dedicated loads. A generator can be incorporated for battery charging and powering dedicated loads.

E-panel with OutBack FX Series Inverter/Charger and FM60 solar charge controller

Part #	E-Panel	Inverter model	Power (watts)	Input-Output	Main Breaker (A/c)	PV-GVP (Amps)
996716015	MNE125ST-R	FX3048T sealed turbo	3000	48 Vdc-120 Vac/60 Hz	125	63
996716016	MNE175ST-R	FX2524T sealed turbo	2500	24 Vdc-120 Vac/60 Hz	175	63
996716000	MNE175ST-R	VFX3648 vented	3600	48 Vdc-120 Vac/60 Hz	175	63
996716017	MNE250ST-R	FX2012T sealed turbo	2000	12 Vdc-120 Vac/60 Hz	250	63
996716018	MNE250ST-R	VFX2812 vented	2800	12 Vdc-120 Vac/60 Hz	250	63
996716001	MNE250ST-R	VFX3524 vented	3500	24 Vdc-120 Vac/60 Hz	250	63

All models listed above for FX series inverters are with gray powder-coated steel enclosures, right-hand door

Unit size/weight: 16"W x 26"H x 17"D/87 lbs.

For models with E-panel assemblies in white powder-coated aluminum enclosure, left-hand door – refer to price list

FOR GRID-TIE SOLAR WITH BATTERY BACKUP

During the day, the single GFX inverter/charger system enables solar energy to power dedicated loads directly or send excess electricity into the utility grid, lowering the electric bill. The Power Center also allows nighttime load operation. When utility power is not available, dedicated loads are directly powered by the solar array during the day and by a battery bank at night.

E-Panel with OutBack GFX Series Inverter/Charger with FM60 solar charge controller and FW-SP-ACA surge protector

Part #	E-Panel	Inverter model	Power (watts)	Input-Output	Main Breaker (A/c)	PV-GVP (Amps)
996716002	MNE125STS-R	GTFX3048 sealed turbo	3000	48 Vdc-120 Vac/60 Hz	125	63
996716019	MNE175STS-R	GTFX2524 sealed turbo	2500	24 Vdc-120 Vac/60 Hz	175	63
996716003	MNE175STS-R	GVFX3648 vented	3600	48 Vdc-120 Vac/60 Hz	175	63
996716020	MNE250STS-R	GVFX3524 vented	3500	24 Vdc-120 Vac/60 Hz	250	63

Above models in STS enclosure are standard in gray steel right-hand door; white aluminum not available.

Unit size/weight: 20.5"W x 26"H x 17"D/105 lbs.

FM60 solar charge controller maximum PV input

Battery Vdc	Typical PV Voc	PV Watts Max
12	20-44	800
24	44-88	1600
48	80-125	3200

Note: PV input current not to exceed 40A short circuit (Isc) due to NEC over-current safety factor of 1.56. PV array not to exceed 150 Vdc open circuit (Voc) after temperature correction factor applied per NEC article 690.7.A

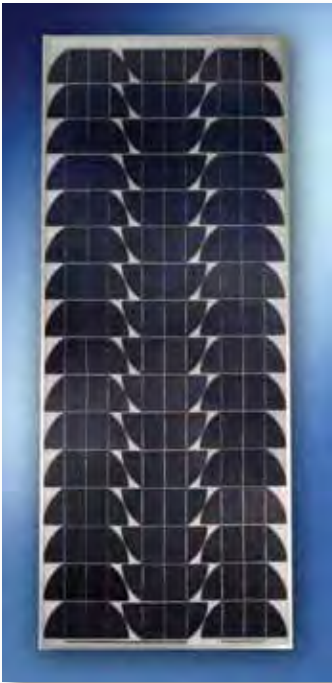

SunWize SW100C

SunWize®

SW Series Solar Modules

SunWize Solar Modules deliver top-quality performance for all photovoltaic applications including rural electrification, water pumping, telemetry, communications, and general battery charging. SunWize modules can be used in single-module and multiple-module installations. Each module consists of 36 solar cells connected in series (except the SW90/90C/95C/100C which have 48 cells in series), providing maximum charging power.

Features include:

- The glass surface is impact resistant and allows maximum light transmission
- Single crystalline solar cells are encapsulated and bonded to the glass in multiple layers of ethylene vinyl acetate (EVA) and laminated with a white Tedlar™ backing insuring long life in severe environmental conditions
- A weather resistant junction box accommodates all wiring methods including moisture-tight strain relief connectors and electrical conduit. Bypass diodes insure reliable operation
- Anodized aluminum tubular frames add strength and durability to the modules with pre-drilled mounting holes
- UL listed to UL-1703 and cUL listed (except SW90C), FM approved for hazardous locations Class 1 Div. 2 (except SW90C), and ISPPA certified to IEC61215. All SunWize modules carry a limited 25-year, 80% power output warranty
- SW modules have a Voltage Temperature Coefficient (Voc) of $-.364\%/^{\circ}\text{C}$ and a Current Temperature Coefficient of $.18\%/^{\circ}\text{C}$.

Part #	Model	Watts	Vmp	Imp	Voc	Isc	Max. Fuse Rating	Dimensions	Weight
103050SW50A	SW50A	50	16.4	3.05	21.0	3.40	9A	35.1 x 22.6 x 1.3	13.2
103055SW55A	SW55A	55	16.7	3.30	21.0	3.65	9A	35.1 x 22.6 x 1.3	13.2
103060SW60A	SW60A	60	16.7	3.60	21.0	3.95	9A	35.1 x 22.6 x 1.3	13.2
103060SW60	SW60	60	16.7	3.60	21.0	3.95	9A	39.4 x 19.7 x 1.3	13.7
103075SW75A	SW75A	75	16.7	4.50	22.5	4.83	10A	50.1 x 23.2 x 1.3	17.6
103090SW90	SW90	90	17.4	5.17	21.4	5.90	10A	56.9 x 22.8 x 1.3	23.0
103090SW90C	SW90C	90	23.0	3.90	28.5	4.45	10A	56.9 x 22.8 x 1.3	23.0
103095SW95C	SW95C	95	22.5	4.23	28.2	4.74	10A	56.9 x 22.8 x 1.3	25.5
103100SW100C	SW100C	100	22.5	4.45	28.2	4.96	10A	56.9 x 22.8 x 1.3	25.5

SW Series Module Junction Box

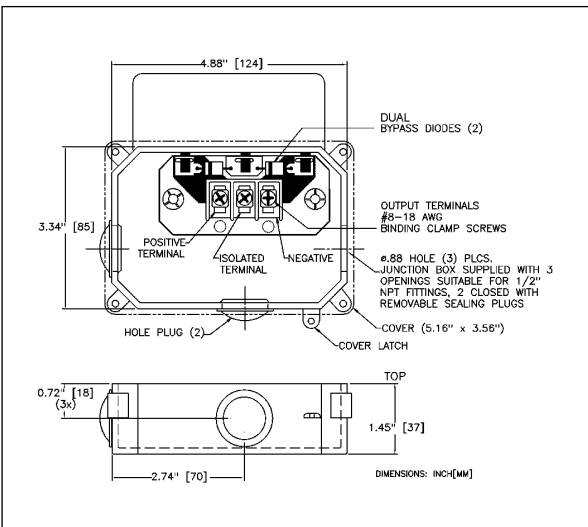

Mechanical Specifications for SW90/SW90C/SW95C/SW100C

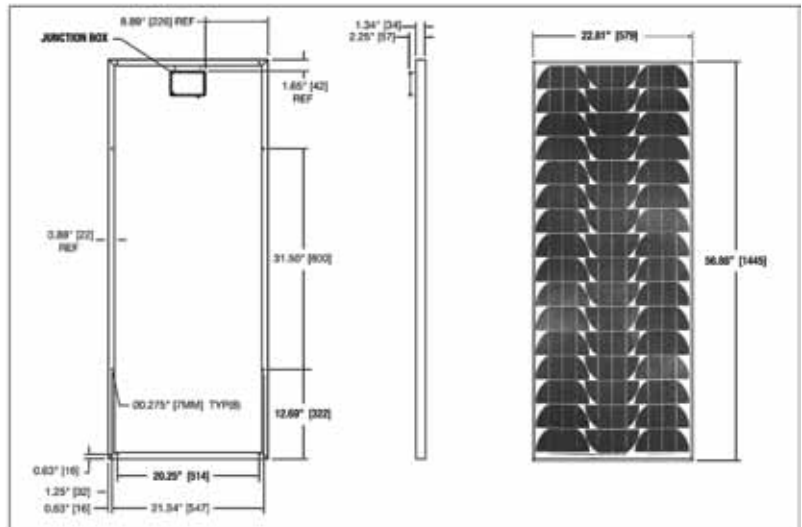



SunWize SW180 Solar Module

SunWize®

SW180 Solar Module

The SunWize SW180 module falls into the mid-range of price and efficiency and is aimed at residential and commercial grid-tie applications. It comes in outputs of 175 and 180 watts and is made of high efficiency mono-crystalline silicon solar cells. Every cell is tested and electronically matched to maximize output. The modules are manufactured according to the strict requirements of international and U.S. quality standards. 25-year limited warranty.

Features include:

- Cells are laminated between sheets of ethyl vinyl acetate (EVA) for moisture free protection, UV stability and electrical isolation
- Tempered, high-transmittance glass is used for strength and high power output
- The module is framed with a strong, corrosion resistant, clear anodized aluminum with multiple mounting holes for ease of installation
- Modules are equipped with multi-string by-pass diodes so that the modules will function even if partially shaded
- Highly resistant to hail, moisture, wind speed and other environmental factors
- Junction box is equipped with + and - MC3 mm (36" male/female) cables
- Wide operating range: from -45°C to 95°C with 100% relative humidity
- US listed to UL 1703, cUL and IEC international standards

Part #	Model	Watts	Vmp	Imp	Voc	Isc
103175SW175	SW175	175	36.50	4.80	43.9	5.20
103180SW180	SW180	180	36.60	4.92	44.0	5.30

Standard Test Conditions: 1000 W/m², 25°C, AM 1.5.

SW180

Dimension	inch	mm
A	62.20	1580
B	31.81	808
C	1.65	42
D	31.49	800
E	30.15	766
F	.27	70
I	1.25	32
Weight (approx)	37.5 lbs.	17 kg.

Mechanical Specifications

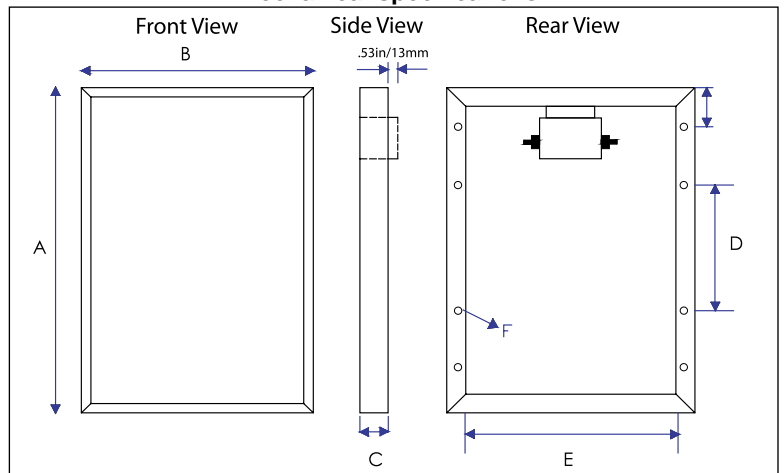

Electrical/Thermal Parameters

Cell Type	Monocrystalline Silicon
Circuit Interconnection	72 – 125 x 125 mm cells, connected in series
Max. System Voltage	600Vdc
Series Fuse Rating	12 Amps
NOCT	49°C
Voltage Temperature coefficient (Voc)	-0.34%/°C
Current Temperature coefficient (Isc)	0.09%/°C
Power Temperature coefficient (Pmax)	-0.37%/°C

Electrical Performance

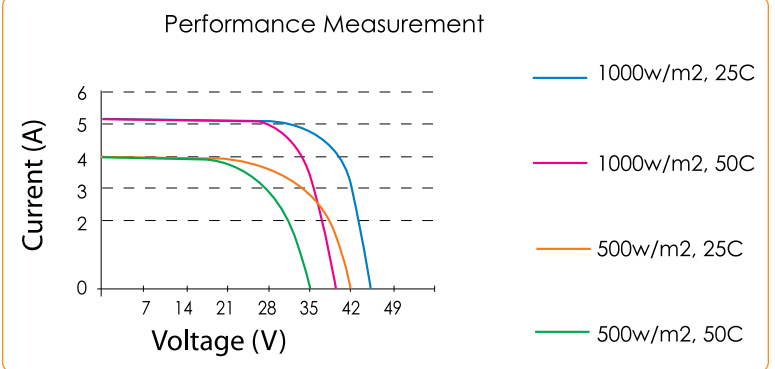



SunWize OEM Series 40W, v20W and 10W (l to r)

SunWize

OEM Series Solar Modules

SunWize OEM modules deliver top-quality performance for all photovoltaic applications including rural electrification, water pumping, telemetry, communications, and general battery charging. Ideal for AC and DC installations, SunWize OEM modules can be used in single module and multiple-module systems. OEM10 and OEM20 modules have 34 solar cells and the OEM40 has 36 solar cells connected in series providing maximum charging power. The glass surface is impact resistant and allows maximum light transmission. Single crystalline solar cells are encapsulated and bonded to the glass in multiple layers of ethylene vinyl acetate (EVA) and laminated with a white Tedlar™ backing insuring long life in severe environmental conditions. Bypass diodes contained within the junction box insure reliable operation. Anodized extruded aluminum frames add strength and durability to the modules. Includes pre-drilled mounting holes. Weather proof junction box has multiple 1/2" knock-outs to accommodate liquid tight fittings and conduit or cable. OEM series modules are ISPRRA certified to IEC 61215 standards and are FM approved for Class I, Div. II hazardous locations. OEM series modules carry a 20-year, 80% power output warranty. PLEASE NOTE: the OEM20A is not ISPRRA Certified and is awaiting FM Approval for Class 1 Div 2.

	10W and 20W	40W
Temperature Coefficient (Voc):	-.340%/°C	-.371%/°C
Temperature Coefficient (Isc):	.05%/°C	.018%/°C

Part #	Model	Watts	Vmp	Imp	Voc	Isc	Max, Fuse Rating	Dimensions	Weight
103000SW10	OEM10	10	16.7	0.60	19.6	0.75	2A	15.2 x 14.8 x 1.3	4.5
136001	OEM20A	20	16.7	1.20	20.0	1.35	3A	20.9 x 16.9 x 1.3	6.5
103000SW40	OEM40	40	16.7	2.40	21.0	2.68	5A	38.3 x 17.1 x 1.3	12.5

PHYSICAL SPECIFICATIONS

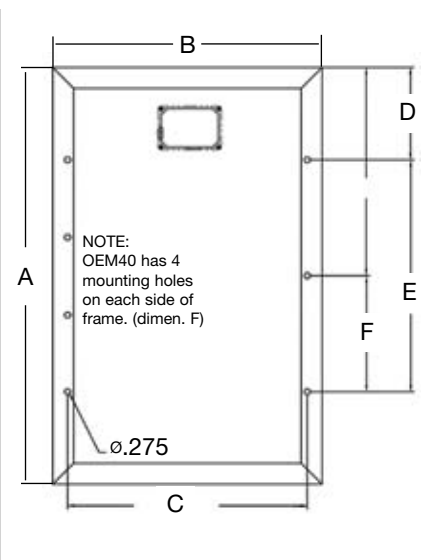

OEM Module Physical Specifications

OEM	A	B	C	D	E	F
10	17.69	11.44	10.18	3.93	9.84	4.92
20	17.69	16.94	15.67	3.93	9.84	4.92
40	38.30	17.16	15.90	7.33	23.62	9.84



Shown from left to right are the SunWize OEM10, OEM20, OEM40





SunWize OEM 10 Kit

SunWize® OEM and SW Solar Module Kits

SunWize® PV Kits include an OEM or SW solar module and a junction box mounted charge regulator and are pre-wired with an output cable. As an option, the 10 – 40 watt OEM kits are offered with a fixed tilt, 45° side-of-pole mount or an adjustable mount. The SW50 – 110 watt kits are available with an adjustable mount only.

SunWize single crystalline, high-efficiency solar modules are manufactured to exceed industry standards providing exceptional reliability and maximum power output. A 20-year warranty reflects the superior quality and assures long product life.

The waterproof regulator features a multi-function LED indicator and fuse protection.

The aluminum side-of-pole mounts are designed to fit 2 - 4" diameter SCH40 poles. Standard banding is provided to fit this range. Optional u-bolts are available.

Modules from 10 – 40 watts include a 15 ft. (#14 AWG) cable standard. Modules from 50 -110 watts include a 15 ft. (#10 AWG) cable standard.

Part #	Model	Watts	Vmp	Imp	Voc	Isc	Dimensions	Weight
PVK-10-12A-6S	OEM10 KIT	10	16.7	0.60	19.6	0.75	15.2 x 14.8 x 1.3	7.3
PVK-10-12A-FA-6S	with FIX MOUNT							8.5
PVK-10-12A-PA-6S	with ADJ MOUNT							8.5
PVK-20-12A-6S	OEM 20 KIT	20	16.7	1.20	20.0	1.35	20.9 x 17.0 x 1.3	10.5
PVK-20-12A-FA-6S	with FIX MOUNT							12.5
PVK-20-12A-PA-6S	with ADJ MOUNT							12.5
PVK-40-12A-6S	OEM 40 KIT	40	16.7	2.40	21.0	2.68	38.3 x 17.1 x 1.3	16.5
PVK-40-12A-FA-6S	with FIX MOUNT							18.5
PVK-40-12A-PA-6S	with ADJ MOUNT							18.5
PVK-50-12A-6S	SW 50 KIT	50	16.4	3.05	21.0	3.40	35.1 x 22.6 x 1.3	13.5
PVK-50-12A-PA-6S	with ADJ MOUNT							15.5
PVK-55-12A-6S	SW 55 KIT	55	16.7	3.30	21.0	3.65	35.1 x 22.6 x 1.3	13.5
PVK-55-12A-PA-6S	with ADJ MOUNT							15.5
PVK-60-12A-6S	SW 60 KIT	60	16.7	3.60	21.0	3.95	35.1 x 22.6 x 1.3	13.5
PVK-60-12A-PA-6S	with ADJ MOUNT							15.5
PVK-75-12A-6S	SW 75 KIT	75	16.7	4.5	22.5	4.83	50.7 x 23.15 x 1.3	17.8
PVK-75-12A-PA-6S	with ADJ MOUNT							21.8
PVK-85-12A-6S	SW 85 KIT	85	17.0	4.7	22.5	5.08	50.7 x 23.15 x 1.3	16.0
PVK-85-12A-PA-6S	with ADJ MOUNT							20.0
PVK-90-12A-6S	SW 90 KIT	90	17.4	5.17	21.4	5.90	56.9 x 22.8 x 1.3	18.0
PVK-90-12A-PA-6S	with ADJ MOUNT							23.0
PVK-110-12A-12S	SW 110 KIT	110	16.8	6.55	20.5	7.00	58.89 x 21.65 x 1.3	19.0
PVK-110-12A-PA-12S	with ADJ MOUNT							24.0

Note: modules, charge controllers and mounts can be purchased separately.

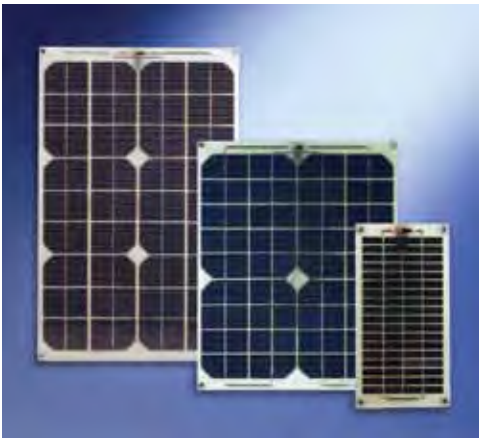

SunWize SolCharger 18W, 12W and 3W solar modules (l to r)

SunWize®

SolCharger Modules

SolCharger modules, available in rated output power from 3W to 24W, operate DC loads with small to moderate energy requirements. Lightweight and durable, SunWize SolCharger modules are designed to perform in any environment and for any remote power application. Instead of the standard glass surface, a polymer coating produces a module that is impact resistant and flame retardant. The polymer allows maximum light transmission to the single crystalline cells for high efficiency operation. SolChargers are easy to integrate into load equipment since there is no need for a metal frame, creating a smaller profile than other modules.

SolChargers are ideal for areas where vandalism is a concern such as roadside call boxes, automated parking meters and fence chargers. Each module features a three-foot output cable and four mounting holes with stainless steel grommets. The SC3, SC6 and SC12 models are available in 6V and 12V.

Features include:

- High efficiency performance
- Vandal Resistant
- Flame Retardant
- Durable
- Lightweight

Part #	Model	Watts	Vmp	Imp	Voc	Isc	Dimensions	Weight
126003SC3-6	SC3-6V	3.0	9.34	0.30	11.2	0.33	9.4 x 5.6	0.6
126003SC3-12	SC3-12V	3.0	18.7	0.15	22.4	0.16	9.4 x 5.6	0.6
126006SC6-6	SC6-6V	6.0	9.34	0.61	11.2	0.65	9.4 x 9.4	1.0
126006SC6-12	SC6-12V	6.0	18.7	0.30	22.4	0.33	9.4 x 9.4	1.0
126012SC12-6	SC12-6V	12.0	9.34	1.28	11.2	1.37	13.3 x 11.7	2.0
126012SC12-12	SC12-12V	12.0	18.7	0.62	22.4	0.66	13.3 x 11.7	2.0
126018SC18	SC18	18.0	18.7	0.93	22.4	0.99	13.3 x 16.6	2.8
126024SC24	SC24	24.0	18.7	1.24	22.4	1.32	13.3 x 21.2	3.7

Electrical Specifications: ±10% @25°C @ 1000W/m²

SL Series Solar Modules

SunWize SL series modules deliver top-quality performance for all photovoltaic applications including rural electrification, water pumping, telemetry, lighting, and battery charging.

Features:

- Factory tested to verify superior performance
- Vandal Resistant
- Lightweight
- Durable
- Flame Retardant
- Pre-drilled mounting holes

Ideal for DC installations, each module consists of 36 solar cells connected in series providing maximum charging power. The glass surface allows maximum light transmission and is impact resistant to hailstone forces of a 1" diameter hailstone at terminal velocity (5 ft-lbs). Single crystalline solar cells are encapsulated and bonded to the glass in multiple layers of ethylene vinyl acetate (EVA) and laminated with a white Tedlar™ backing insuring long life in severe environmental conditions. Anodized aluminum frames add strength and durability to the modules and are constructed to withstand constant wind speeds of 110 mph and gusts to 133 mph.

The weather resistant junction box includes a moisture-tight strain relief connector. SunWize SL series modules are manufactured in accordance to ISO 9002 standards, and comply with U.S. and international standards. SL series modules are FM approved non-incendive for Class 1, Div. 2, Groups ABC & D hazardous (classified) locations, and carry a 10-year, 80% power output warranty.



SunWize SL12 watt module

Part #	Model	Watts	Vmp	Imp	Voc	Isc	Dimensions	Weight
125012SL12-12	SL12	12	18.7	0.61	22.4	0.65	14.2 x 12.5	3.7

Electrical Specifications: ±10% @25°C @ 1000W/m²

Advertisement



Sanyo HIT Power N Series Module

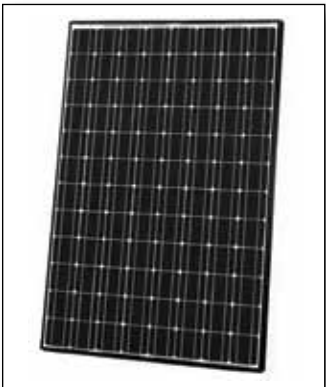

Sanyo 200W HIT Module



Sanyo HIT Double Bifacial Module

SANYO

HIT® Solar Modules

HIT solar modules feature SANYO's proprietary HIT technology—hybrid solar cells with single crystalline silicon surrounded by ultra-thin amorphous silicon layers. This unique structure minimizes defects at the p/n junction and produces highly efficient solar cells. With panels achieving up to 20.4 watts per square foot, SANYO solar systems produce maximum power within a fixed space. HIT cells offer superior temperature characteristics compared to conventional crystalline silicon cells. HIT Power modules have enhanced materials for high heat performance, increasing the areas where HIT modules can be installed to include areas with monthly average high temperatures (MAHT) up to 45°C (113° F). The result is up to 10% more energy produced at higher temperatures. All HIT modules come with a +10%/-0% power guarantee at the time of purchase to ensure customers get what they pay for (or more). With more kWh per rated watt, SANYO's HIT solar panels are ideal for areas with performance-based incentives and renewable energy credits. 20-year limited power output warranty, and 5-year workmanship.

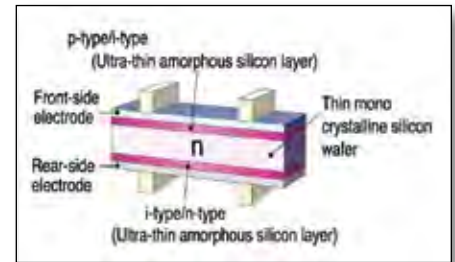

HIT Power N

New to the North American market, the HIT Power N series has the highest PTC/STC ratios in the industry. The HIT Power N series module contain 72 of the larger five inch cells and have been successfully deployed in Europe since 2004. Their lower voltage/higher current design allows larger string sizes. In addition, their 2:1 aspect ratio allows more modules to be mounted in a given rack area, reducing installation costs. HIT Power N modules have a black anodized frame with four grounding holes and four mounting holes. They use 12 AWG cables with MC4mm locking connectors and incorporate 4 bypass diodes. Maximum system voltage: 600 Vdc, 60 PSF load rating, operating temperature: -20°C to 46°C; UL-1703 listed, cUL, CEC.

HIT Power BA19

Featuring improved performance and easier installation, the HIT Power 200 achieves 17.2% efficiency and the HIT Power 195 achieves 16.8%. HIT Power's black anodized aluminum frame has been increased to 1.8" for more strength and an inside ledge added to tuck and clip away cables. This ledge has two pre-drilled ground holes and four symmetrical mounting holes. For added safety, each HIT Power module uses #12 AWG cables with increased insulation and MC 4mm latching connectors. Maximum system voltage: 600 Vdc, 60 PSF load rating, operating temperature: -20°C to 46°C; UL-1703 listed, cUL, CEC.

HIT Double®

SANYO's HIT Double bifacial solar modules have a double-glass structure that captures both direct sunlight and reflected light from surrounding surfaces, generating electricity from both sides of the panel simultaneously. HIT Double can increase the amount of electricity produced by up to 30% compared to single-sided HIT panels depending on system design, location, and albedo. HIT Double panels open up new solar system design possibilities for many customers, including carports, awnings, trellises, walkways, porch and deck coverings, etc. HIT Double modules have a silver anodized lipped frame (includes 4 internal bypass diodes and touch-safe junction box with MC 3mm connectors), withstand 1" dia. hailstones @ 52 mph, and the static load for wind/snow is 50 PSF. UL-1703, cUL, CEC. Maximum system voltage is 600 Vdc.

Part #	Model	Watts	Vmp	Imp	Voc	Isc	Dimensions	Module Eff.	Weight
140024	HIT Power 210N	210	41.3	5.09	50.9	5.57	62.2 x 31.4 x 1.8	16.7%	35.3
140025	HIT Power 215N	215	42.0	5.13	51.6	5.61	62.2 x 31.4 x 1.8	17.1%	35.3
140017	HIT Power 190	190	54.8	3.47	67.5	3.75	51.9 x 34.6 x 1.8	16.4%	33
140016	HIT Power 195	195	55.3	3.53	68.1	3.79	51.9 x 34.6 x 1.8	16.8%	33
140015	HIT Power 200	200	55.8	3.59	68.7	3.83	51.9 x 34.6 x 1.8	17.2%	33
140186DSE	HIT Double 186	186	54.8	3.40	67.5	3.68	53.2 x 35.4 x 2.4	up to 19.6%	51
140190DSE	HIT Double 190	190	55.3	3.44	68.1	3.70	53.2 x 35.4 x 2.4	up to 20.0%	51
140195DSE	HIT Double 195	195	55.8	3.50	68.7	3.73	53.2 x 35.4 x 2.4	up to 20.5%	51

*HIT Double bifacial solar panels' Rated Power is measured at Standard Test Conditions, not including power produced from the backside. The I-V characteristics with backside irradiation increase Isc values. This amount of Isc increase depends upon the level of incident light irradiance (albedo) available to the backside, upon system design, location etc. HIT Double panels may produce up to 130% of their STC rating, and Isc should be sized accordingly when calculating system components to account for the increase in power.

Sharp

Solar Modules

Sharp has a broad line-up of modules designed for a variety of electrical power and system requirements. The modules tout the Sharp name brand and quality. All are built in ISO 9001 certified facilities. Sharp modules come with #14 AWG lead wires with male and female Multi-Contact 4mm connectors (except the 80W and 130W modules, which come with a conduit ready J-box). They also feature bypass diodes to minimize power drop caused by shade; a BSF (Back Surface Field) to improve cell conversion efficiency; anodized aluminum frames with pre-drilled mounting holes, UL-1703 and cUL listings, and a 25-year limited warranty.

The 170W NE-170UC1 polycrystalline has replaced the popular NT-175UC1 monocrystalline, which remains available for sale while supplies last. The 224W (ND-224UC1) is a popular polycrystalline, black framed module. The 230W polycrystalline (ND-U230C1) has been phased out, but still can be purchased while inventory remains. Also available are the new monocrystalline 230W (NU-U230F3, black frame, black back sheet) and the monocrystalline 235W (NU-U235F1, silver frame, white backsheet).

The 176W and 198W OnEnergy line of modules (designed for the Sharp OnEnergy mounting system) have been designated to be replaced with new models in late 2010. The OnEnergy left and right triangular 72W modules (ND-72ELUC, ND-72ERUC) and the square shaped 142W (ND-N2ECUC) have also been phased out. Sharp OnEnergy systems are available in made-to-order kits customized to your specific system needs. For more information about Sharp OnEnergy Systems, speak with your SunWize sales representative.

The 80W (NE-80EJEA), 123W (ND-123UJF) and 130W (ND-130UJF) polycrystalline modules are intended for off-grid applications.

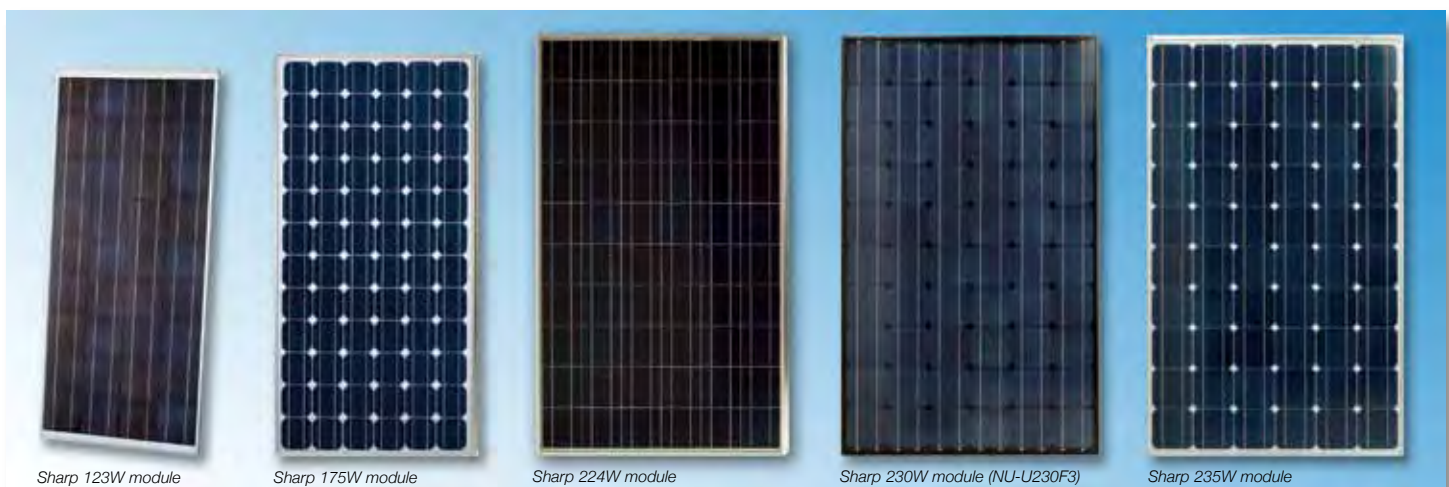

Sharp 123W module

Sharp 175W module

Sharp 224W module

Sharp 230W module (NU-U230F3)

Sharp 235W module

Part #	Model	Watts	Vmp	Imp	Voc	Isc	Dimensions	Weight
13580SH	NE-80EJEA	80	17.3	4.63	21.6	5.16	47.3 x 21.1 x 1.8	21.0
135123SH	ND-123UJF	123	17.2	7.15	21.8	7.99	59 x 26.1 x 1.8	30.9
135130SH	ND-130UJF	130	17.4	7.50	21.9	8.20	59 x 26.1 x 1.8	30.9
135170SH-LOC	NE-170UC1	170	34.8	4.90	43.2	5.47	62 x 32.5 x 1.8	35.3
135175SH-LOC	NT-175UC1	175	35.4	4.95	44.4	5.40	62 x 32.5 x 1.8	35.3
135224SH-LOC	ND-224UC1	224	29.3	7.66	36.6	8.33	64.6 x 39.1 x 1.8	44.1
135230SH-LOC	ND-U230C1	230	30.3	7.60	37.0	8.24	64.6 x 39.1 x 1.8	44.1
135037	NU-U230F3	230	30.0	7.67	37.0	8.40	64.6 x 39.1 x 1.8	44.1
135038	ND-U235F1	235	30.0	7.84	37.0	8.60	64.6 x 39.1 x 1.8	44.1
OnEnergy Modules								
135176SH-LOC	ND-176UC1*	176	23.4	7.27	29.3	8.22	52.3 x 39.1 x 2.3	36.4
135198SH-LOC	ND-198UC1*	198	26.3	7.52	32.9	8.23	58.7 x 39.1 x 2.3	39.6

*The OnEnergy 176W and 198W will transition to new modules planned for release in 2010. Operating temperature: -40°F to 194°F. Maximum system voltage: 600 Vdc.



SOLON Blue solar module

SOLON

Solar Modules

SOLON Blue 220/01 high efficiency polycrystalline modules are quality made in Solon's Tuscon, Arizona factory. They feature German engineering, Q-Cells solar cells and module efficiencies ranging from 13.41 to 14.63 %. Additional features include: very good low light response, 4mm solar glass and twin-wall frame for high load capacity.

SOLON Black 230/01 "black on black" quality monocrystalline modules are also made in Solon's Tuscon, Arizona factory. They utilize Ersol or Suniva solar cells and the 225W module has an efficiency of 13.72% and the 230W module has an efficiency of 14.02%. A black backsheet and anodized frame make the Black 230/01 ideal for residential applications where aesthetics are important. They will be available beginning in June 2010.

All modules are UL-1703 listed, utilize Tyco connectors, and carry an industry leading 10-year workmanship and 25-year limited warranty.



SOLON Black solar module

Part #	Model	Watts	Vmp	Imp	Voc	Isc	Dimensions	Weight
124005	225Blue	225	28.90	7.80	36.60	8.40	64.57 x 39.37 x 1.65	51.81
124004	230Blue	230	29.00	7.95	36.70	8.55	64.57 x 39.37 x 1.65	51.81
124008	225Black	225	28.05	7.85	35.80	8.60	64.57 x 39.37 x 1.65	51.81
124007	230Black	230	28.75	8.00	36.35	8.75	64.57 x 39.37 x 1.65	51.81



Kaneka G-SA060

Kaneka

Thin-film Module

The Kaneka G-SA060 is a single junction amorphous silicon cell. Amorphous silicon (a-Si) has superior light absorption which maximizes performance and higher power in hot climates and cloudy conditions compared to crystal silicon (c-Si) cell modules.

The G-SA060 has a maximum system voltage of 530 Vdc and features by-pass diodes, lead free solder, dark anodized aluminum frame, four mounting and two grounding holes, 29" output wires with 3mm MC connectors. It is UL/cUL listed to UL-1703 and comes with a 25-year output warranty.

Part #	Model	Watts	Vmp	Imp	Voc	Isc	Dimensions	Weight
107001	G-SA060	60	67	0.9	91.8	1.19	37.8 x 39 x 1.6	30.2



Yingli 80/85W module

Yingli Solar

Solar Modules

Yingli solar modules contain 36 high-efficiency polycrystalline silicon solar cells producing maximum power even under low light conditions. EVA and TPT encapsulants create an environmental seal while the anti-reflective coating and high transmission glass increase power output and enhance the mechanical strength of the module. Anodized aluminum frame. Multi-function junction box with waterproof lid. All modules are UL-1703 and CE listed and carry a 10-year, 90% output warranty and a 25-year, 80% output warranty.

Part #	Model	Watts	Vmp	Imp	Voc	Isc	Dimensions	Weight
134085YL	YL85	85	17.5V	4.9A	22.0V	5.3A	39.8 x 26.0 x 1.38	17

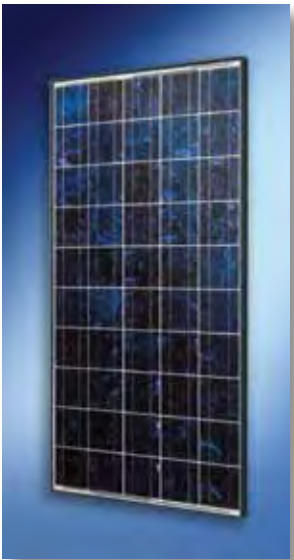

Mitsubishi PV-UD180MF5

Mitsubishi

Solar Modules

Mitsubishi modules do not use lead solder resulting in an eco-friendly module. The modules feature polycrystalline solar cells and dark anodized aluminum frames with pre-drilled holes. US listed to UL-1703. 20-year limited warranty.

Features include:

- Triple layer BSF (Back Surface Field) structure
- Junction box with bypass diodes – 125W only
- Anti-reflective coating
- Back film reflected light
- High-transmittance glass
- Static load test 5400 Pa passed with rear protection bar (175W, 180W)
- Max. system voltage 600V
- Locking MC4 mm connectors
- Conformity with IEC61215

Part #	Model	Watts	Vmp	Imp	Voc	Isc	Dimensions	Weight
145125ME	PV-UE125MF5N	125	17.3	7.23	21.8	7.90	58.9 x 26.5 x 1.8	29.8

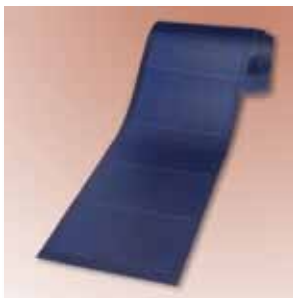

Uni-Solar Field Applied PV Roofing Laminate

Uni-Solar®

Field Applied PV Roofing Laminate

These thin-film solar laminates can be applied to 16" standing seam metal roofing materials in the field for a total custom look. You don't have to compromise the aesthetics of a home to get the energy independence desired. The PVL Roofing Laminates are made exceptionally durable by encapsulation in UV stabilized polymers. Bypass diodes are connected across each cell, allowing the modules to produce power even when partially shaded. They come with the bonding adhesive factory applied on the back of the laminate. Maximum system voltage: 600 Vdc.

Features include:

- Top mounted 22" cables with MC 3mm connectors
- Lightweight, flexible product construction
- Easy peel and stick installation, roll shippable
- Maximum roof temperature of 185°F
- UL listed, 20-year warranty (only on products installed by a Uni-Solar certified installer)

Part #	Model	Watts	Vmp	Imp	Voc	Isc	Dimensions	Weight
1200PVL68T	PVL-68T	68	16.5	4.13	23.1	5.1	112.1 x 15.5	9.0
1200PVL136T	PVL-136T	136	33.0	4.13	46.2	5.1	216 x 15.5	17.0

System Spotlight

LOCATION:
El Pueblo, CO

APPLICATION:
Solar housing project
using SOLON modules





SW Side-of-Pole Mount Back View

SunWize

SunWize offers a wide variety of mounting options

PV modules are attached to metal structures called mounts or racks. Mounts are available in a variety of materials including aluminum, anodized aluminum, painted or galvanized steel.

When properly installed the mounts provide a stable base for the PV array in high wind zones. Mounts can be fastened to a pole, on the ground, a wall or roof depending on style chosen.

Adjustable tilt mounts can be positioned to an appropriate angle to maximize seasonal solar radiation. Fixed position mounts cannot be adjusted.

Choosing which size and style will depend on your specific application. Consult with your SunWize® sales manager for other mounting options not listed.

All SunWize® brand mounts are of aircraft grade structural members in heavy gauge-mill finish aluminum supplied with type stainless steel fasteners.

Selection Guide - Rail Length

Manufacturer	Module Model #	Power (Watts)	Module Width	Area (sq. ft.)	Minimum Rail Length Required (inches)			
					1 Module	2 Modules	3 Modules	4 Modules
SunWize	SC6	6	9.43	0.6	13	N/A	N/A	N/A
SunWize	SC12	12	13.3	1.1	18	N/A	N/A	N/A
SunWize	SC18	18	13.3	1.5	18	N/A	N/A	N/A
SunWize	SC24	24	13.3	2.0	18	N/A	N/A	N/A
SunWize	SL12	12	12.46	1.2	18	N/A	N/A	N/A
SunWize	OEM10	10	14.8	1.6	18	N/A	N/A	N/A
SunWize	OEM20	20	16.93	2.5	18	N/A	N/A	N/A
SunWize	OEM40	40	17.16	4.6	18	N/A	N/A	N/A
SunWize	SW50A/55A/60A	50/55/60	22.59	5.5	26	53	77	96
SunWize	SW75A/80A	75/80	23.15	8.2	26	53	77	96
SunWize	SW90C/95C/100C	90/95/100	22.8	9.0	26	53	77	104
SunWize	SW110	110	21.65	8.9	26	53	77	96
SunWize	SW170/180	170/180	31.81	13.7	53**	77	96	N/A
Sharp	NE-80EJEA	80	21.14	7.0	26	53	77	96
Sharp	ND-130UJF	130	26.06	10.7	26	53	77	104
Sharp	NT-175U1	175	32.52	14.0	53**	77	104	N/A
Mitsubishi	PV-EE125MF5F	125	26.5	10.9	26	60	80	N/A

*Mounted Portrait



SunWize Flush Mount Kits

Universal Single-Module Flush Mount Kits

Aluminum flush mount kits include four "Z" brackets and four stainless steel bolts. Fits all modules.

Part #	Model	Weight
951UNIRUMTC-FEET	Flush Mount Kits	0.5

SunWize OEM Side-of-Pole Mount – One Module, Fixed tilt 45 Degree

Single module aluminum side-of-pole mount for SunWize OEM series of modules. OEM5/10 mount consists of pole bracket positioning the module to 45-degrees of tilt. Mount can be attached to pole, wall or roof, includes 2" pipe U bolt. The 13" long bracket has slots to allow adjustable band clamps for larger poles. The OEM5/10 mount also holds SolCharger 3, 6 and SC12 modules. OEM20/40 mount includes adjustable pipe clamps from 2" to 4" diameter. Pole bracket allows for use of 2" pipe U bolt.

Part #	Model	Rail Length	Pipe Size (sch40)	Max. Module Area	Weight
950SW5/10MTASSY	OEM 5/10	13	2-4	1.1	2.0
950UNILRGOEM-A	OEM 20/40	N/A	2-4	4.6	1.25



SW OEM 20/40 SOP Mount

SunWize Universal Side-of-Pole Mount – One Module, Adjustable Small, Medium and Large

Single module aluminum side-of-pole mounts feature a unique module frame clamping method that fits a variety of modules, no mounting holes required. Three sizes of mounts are offered for module widths up to 13", 18" or 26" wide, with adjustable tilt arm from 15 to 90-degrees. Mount includes a pole saddle bracket with captive stainless nuts for easy assembly, module mounting fasteners and pipe clamps adjustable from 2" to 4" OD poles.

Part #	Rail Length	Pipe Size (sch40)	Max. Module Area	Weight
950086	13	2-4	2.5	2.3
950087	18	2-4	4.5	3.0
950088	26	2-4	5.5	4.1
950089 (SC12)	18	2-4	1.1	3.5
950090 (SC18)	18	2-4	1.5	3.5
950091 (SC24)	18	2-4	2.0	3.5



SW OEM 5/10 SOP Mount

SunWize Universal Side-of-Pole Mount – Multi-Module Adjustable, 26.5" – 104" Rails

Multi module side-of-pole mounts feature heavy duty brushed aluminum mounting channels with a universal slotted pattern allowing a variety of modules to be adapted with many rails lengths offered. Mount consists of a panel rail set specified by length, pole saddle brackets specific for a range of pole diameters, tilt legs adjustable from 25 to 60-degrees, stainless fasteners, adjustable pipe clamps and thread locking compound. U-bolts for high wind zones are recommended as an option. (See accessory table for U-bolts offered.)

Part #	Rail Length	Pipe Size (sch40)	Max. Module Area	Weight
950037	26	2-4	10	9
950082	26	4-6	10	11
950076	26	8-10	10	11
950056	35	2-4	10	9.5
950083	35	4-6	10	9.5
950077	35	8-10	10	9.5
950036	53	2-4	20	12.5
950063	53	4-6	20	14.5
950078	53	8-10	20	14.5
950058	60	4-6	30	18
950084	60	8-10	30	18
950045	77	4-6	35	20
950085	77	8-10	35	20
950061	80	4-6	35	22
950068	80	8-10	35	22
950046	96	4-6	40	24
950079	96	8-10	40	24
950047	104	4-6	45	26
950080	104	8-10	45	26



SW Multi-Module Adjustable SOP Mount



SW Single Module Adjustable SOP Mount

Accessory	Part #
2" U-BOLT	851073
2.5" U-BOLT	851074
3" U-BOLT	851075
4" U-BOLT	851077
6" U-BOLT	851079
8" U-BOLT	851101
10" U-BOLT	851102
12" - 24"	
POLE ADAPTER	951028
(Use with 8-10" mount only)	



SW Top-of-Pole Mount Front View

SunWize Universal Top-of-Pole Mount – Multi-Module Adjustable, 26.5” – 104” Rails

Multi module Top-of-Pole mounts feature heavy duty pole brackets of powder coated over galvanized steel and offer various rail lengths with a universal slotted pattern to allow a variety of modules to be adapted to a single mount specified by length.

Mount consists of a panel rail set (channels), pole saddle brackets, adjustable tilt brackets from 15 to 60 degrees, fasteners and thread locking compound. Pole gimbal kit is specified by pipe size and module area (sold separately).

Part #	Rail Length	Max. Module Area (sq. ft.)	Weight
950069	26	10	18
950070	35	10	20
950071	53	15	22
950072	60	30	24
950073	77	35	26
950074	96	40	28
950075	104	45	29



SW Top-of-Pole Mount Back View

Pipe Gimbal Kit

Part #	Pipe Size (sch40)	Max. Module Area (sq. ft.)	Weight
951023	2	15	5
951024	2.5	15	5.5
951025	3	20	6
951026	4	40	8
951030	6	60	10
951031	8	60	12

SunWize Universal Roof-Ground-Mount – Multi-Module Adjustable, 26” – 128” rails

Multi-module roof-ground mounts are made of heavy duty brushed aluminum channels and feature various rail lengths with a universal slotted pattern to allow a variety of modules to be adapted to a single mount specified by length.

USA (adjustable) Mounts consists of a panel rail set (channels) four L-brackets to mount to any flat surface, telescoping adjustable tilt legs from 25 to 55 degrees, fasteners and thread locking compound.

USF (flush) Mounts consists of a panel rail set, four slotted L-brackets mount to any flat surface allowing pre-assembly of PV panel onto rails then onto pre-located mounting feet, all fasteners and thread locking compound.



SW Universal Adjustable Support Structure

Part #	Rail Length	Max. Module Area (sq. ft.)	Weight
950051	26	10	4.5
950050	53	20	7
950SWUSA-59	60	25	11
950SWUSA-80	80	30	15.5
950SWUSA96	96	35	16.5
950SWUSA-962T	96” 2-TIER	70	32
950SWUSA104	104	45	18.5
950SWUSA-1042T	104” 2-TIER	90	36
950SWUSA118	118	50	20.5
950SWUSA-1182T	118” 2-TIER	100	40
950SWUSA-128	128”	55	24
950SWUSF-59	60	25	7
950SWUSF-80	80	30	11.5
950SWUSF-96	96	35	12.5
950SWUSF104	104	45	14.5
950SWUSF118	118	50	16.5
950SWUSF-128	128	55	20

Advertisement

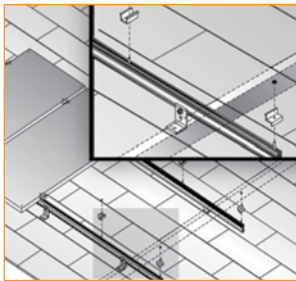

SolarMount Top Down Mount

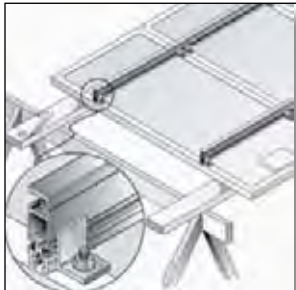

SolarMount Bottom Up Mount

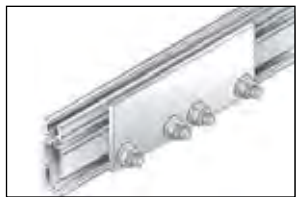

Solar Mount SP2 Plate Splice Kit



Bottom Mounting Clip Set

UniRac®

SolarMount™ offers a fast and easy way to install a PV array on the roof of any building. Top Down clamps facilitate rooftop assembly. An entire array can be fully installed and wired on the roof one module at a time. With Bottom Up clamps, the racks may be preassembled on the ground. Continuous, slotted rails provide infinite adjustability for captive bolt positioning. Offers the possibilities to mount modules both horizontally and/or vertically in limited space situations. Designed to securely attach an array to a roof in compliance with U.S. Building Codes up to 130 mph wind zones. Length up to SM106 can be shipped UPS or other courier while SM108 and larger are usually shipped via motor freight due to their length. Contact SunWize for module configurations and options not shown below.

Solar Module	Clamp Size	For this # of modules per row, order rail length below										
		2	3	4	5	6	7	8	9	10	11	12
Top Down Mounting												
Kaneka 60	D	84	132	168	204	252	288	324	372	408		
Mitsubishi 125	F	72	106	144	168	204	240	264	300	336	372	396
Sanyo HIT 190/195/200	F	84	108	144	180	216	252	288	324	360	396	432
Sanyo N 205/210/215	F											
Sanyo Double HIT 190/195/200	H	84	108	144	180	216	252	288	324	360	396	432
Sharp 130	F	60	84	120	144	168	192	226	252	276	300	336
Sharp 170/175	F	72	106	144	180	204	240	276	312	348	372	408
Sharp 216/224/230/235	F	84	132	168	204	252	288	324	372	408		
Solon 230	J	84	132	168	204	252	288	324	372	408		
SunWize 85/90/90C/95C/100C	C	60	84	106	132	156	180	204	226	240	264	288
SunWize 175/180	J	72	106	144	168	204	240	276	300	336	372	396
Yingli 80/85	C	48	72	96	120	144	168	192	204	226	252	276
Bottom Up Mounting												
Kaneka 60		84	120	156	204	240	276	312	360	396	432	
Mitsubishi 125		72	96	132	168	192	226	264	288	324	360	384
Sanyo HIT 190/195/200		72	106	144	180	216	252	288	312	348	384	420
Sanyo N 205/210/215												
Sharp 80		48	72	84	106	132	156	168	192	216	240	252
Sharp 130		60	84	106	132	168	192	216	240	264	288	324
Sharp 170/175		72	106	132	168	204	240	264	300	336	360	396
Sharp 216/224/230/235		84	120	168	204	240	276	324	360	396		
Solon 230		84	132	168	204	252	288	324	372	408		
SunWize 85/90/90C/95C/100C		48	72	96	120	144	168	192	216	240	252	
SunWize 175/180		72	96	132	168	192	228	264	288	324	360	384
Yingli 85		48	72	96	120	132	156	180	204	216	240	264

Ordering: Use the table to determine rail length for desired model and quantity of modules. Clamp sets sold separately. Rail sets longer than 216" will be a '4-rail' set with splice kit and extra L-feet.

Part #	Model	# of L-Feet	Shipping Weight
963UNISM/48	300201	4	13
963UNISM/60	300202	4	14
963UNISM/72	300203	4	16
963UNISM/84	300204	4	17
963UNISM/96	300205	4	19
963UNISM/106	300206	4	20
963UNISM/108	300223	4	21
963UNISM/120	300207	6	22
963UNISM/132	300208	6	24
963UNISM/144	300209	6	25
963UNISM/156	300210	6	27
963UNISM/168	300211	6	28
963UNISM/180	300212	6	30
963UNISM/192	300213	8	31
963UNISM/204	300214	8	33
963UNISM/216	300215	8	34

Part #	Model	# of L-Feet	Shipping Weight
963UNISM/226	300224	10	40
963UNISM/240	300225	10	42
963UNISM/252	300226	10	44
963UNISM/264	300227	10	46
963UNISM/276	300228	10	47
963UNISM/288	300229	10	48
963UNISM/300	300230	12	50
963UNISM/312	300231	12	52
963UNISM/324	300232	12	53
963UNISM/336	300233	12	54
963UNISM/348	300234	14	56
963UNISM/360	300235	14	58
963UNISM/372	300236	14	59
963UNISM/384	300237	14	60
963UNISM/396	300238	14	62
963UNISM/408	300239	14	64
963UNISM/420	300240	16	65
963UNISM/432	300241	16	66

Bottom up Mounting Clamp Sets – For all modules w/ mounting holes. Includes: clamps, stainless steel bolts & flange nuts. Order four clamps for each module.

Part #	Model	# Clamps	Shipping Weight
963UNISM-CB1	321001	1	.5
963UNISM-CB4PAK	321218	4	1
963UNISM-CB20	321002	20	5

Rail Splice Sets - clear anodized

Order one splice wherever two segments are to be joined into a single rail. Two types are offered: "plate" with bolts and flange nuts, and "bar" with self-tapping screws. The dual plate kit includes 2 mid clamps.

Part #	Model	# Splices	Type	Shipping Weight
963UNISF051	310230	1	Bar	1
963UNISP1	310214	1	Plate	1
963UNISP2	310215	2	Plate	2
963UNISP20	310216	20	Plate	5

Above rail sets include 2 rails, L-feet and hardware. Above rail sets include 4 rails, 2 slice bars, L-feet & bolts.

UniRac® SolarMount Accessories

Pro-Pak Rail Bundles

Standard Pro-Pak bundles consist of 8 rails and do not include L-feet or hardware. See the sizing chart on the previous page to determine rail length appropriate for your installation. If desired rail length exceeds 240 inches, order a splice kit and two equal rail segments. Spliced segments should be equal or as close to equal as possible.

Part #	Model	Rail Length	Shipping Weight	Part #	Model	Rail Length	Shipping Weight
963UNISM/60-8	300102	60	36	963UNISM/156-8	300110	156	102
963UNISM/72-8	300103	72	44	963UNISM/168-8	300111	168	100
963UNISM/84-8	300104	84	50	963UNISM/180-8	300112	180	108
963UNISM/96-8	300105	96	55	963UNISM/192-8	300113	192	114
963UNISM/106-8	300106	106	61	963UNISM/204-8	300114	204	120
963UNISM/120-8	300107	120	67	963UNISM/216-8	300115	216	128
963UNISM/132-8	300108	132	72	963UNISM/228-8	300116	228	135
963UNISM/144-8	300109	144	78	963UNISM/240-8	300117	240	142

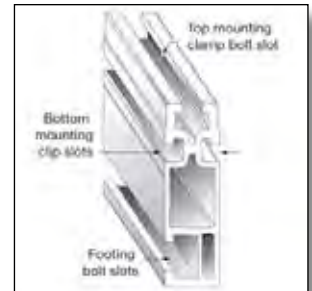

Cutaway view of SolarMount Rail

Pro-Pak Serrated L-Feet

Each L-foot includes a stainless steel bolt and flange nut to attach the foot to a SolarMount rail. Lag bolts are not included. Rail set pricing on previous page lists the appropriate number of L-feet per pair of rails. L-feet are clear anodized aluminum; *denotes bronze anodized L-feet (also available see "SunFrame").

Part #	Model	Quantity	Shipping Weight
963UNISF050	310068	1	1
963UNISF049	310067	20	5
963UNISF069*	310065	20	5



SolarMount L-Feet

Pro-Pak Top Down Mounting Clamp Sets

Clamps with T-bolts and flange nuts. All are clear anodized except those noted* which are bronze anodized. See previous page for the clamp size for your module type. Single clamps are available.

Part #	Model	# Clamps	Clamp Size	Shipping Weight	Part #	Model	# Clamps	Clamp Size	Shipping Weight
End Clamps					Mid Clamps				
963UNISM/EC20B	320013	20	B	2	963UNISM/MC20C	320020	20	A-C	2
963UNISM/EC20C	320014	20	C	2	963UNISM/MC20E	320021	20	D-F	2
963UNISM-EC20D	320015	20	D	2	963UNISM044	320087	20	G	2
963UNISM/EC20F	320017	20	F	2	963UNISM008*	320085	20	D-F	2
963UNISM/EC20G*	320083	20	G	2	Sanyo HIT Double Clamp				
963UNISM007*	320123	20	F	3	963UNISM/MC20G*	320086	20	H	2

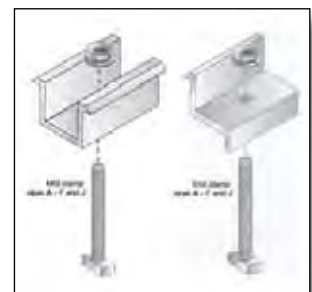

SolarMount Top Mounting Clamps
Mid Clamp, End Clamp

Raised Flange and Flat Top Standoffs

Standoffs in 3", 4", 6" and 7" in lengths are used for irregular roof surfaces or to elevate the array to promote better cooling. Raised flange standoffs ARE used in place of L-feet; flat top standoffs are used in conjunction with L-feet. Both are zinc plated steel, packed with stainless steel bolts, flange nuts and plated lag bolts. The last numeral in the model number denotes the length of the standoff. Bulk packages of twelve are designated with a -12 in the model number.

Part # (Raised Flange)	Model	Shipping Weight	Part # (Flat Top)	Model	Shipping Weight
963UNIST/3	310017	2	963UNISTF3	310009	2
963UNIST/3-12	310047	16	963UNISTF3-12	310051	16
963UNIST/4	310018	2	963UNISTF4	310010	2
963UNIST/4-12	310048	18	963UNISTF4-2	310052	18
963UNIST/6	310019	2	963UNISTF6	310011	2
963UNIST/6-12	310049	22	963UNISTF6-12	310053	22
963UNIST/7	310020	2	963UNISTF7	310012	2
963UNIST/7-12	310050	25	963UNISTF7-12	310054	24

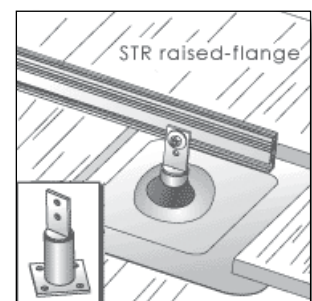

SolarMount Raised Flange Standoff

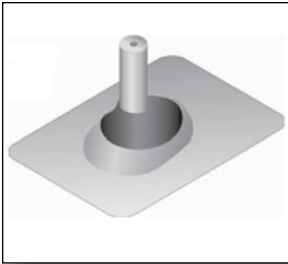

No-Calk Collared Flashing

UniRac® SolarMount Accessories

No-Calk® Collared Flashing

These flashings work with our steel and aluminum standoffs. Soft aluminum flashings can be molded to fit curved roofing material, such as Spanish tile. 12 flashings per package.

Part #	Model	Description	Shipping Weight
963ACC001	990101	Galvanized, 12 1/2 x 8 3/4 base, No-Calk collar	11
963ACC002	990102	Aluminum, 12 1/2 x 8 3/4 base, No-Calk collar	6
963151	990103	Soft aluminum, 18 x 18 base, No-Calk collar	12



SolarMount High Profile Tilt kit for 48" to 106" rails

SolarMount Tilt Leg Kits

Tilt Leg Kits are used to tilt the array to a more optimum angle to enhance overall system performance. These kits feature a quick one-tool locking adjustment that makes even seasonal adjustments fast and easy. For Low Profile Adjustable tilt legs choose the correct maximum leg extension for your tilt angle and then the number of kits required from the charts below. Then choose the correct kit from the price list. When using High Profile Adjustable tilt legs, the tilt angle depends on the length of the legs and the rails. Order one high profile tilt leg kit for each rail kit. Do not use high profile legs with rails longer than 180" or with splices.

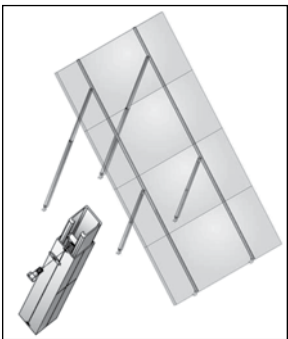

SolarMount High Profile Tilt kit for 120" to 180" rails

Tilt Angles for High Profile Legs				
Choose the correct maximum tilt leg extension from this table. Then select the model from the price list. Rails longer than 106" require two legs per rail (TLH4).				
Rail Length (in)	Maximum length of leg			
	12 in	44 in	72 in	
48	9–21°	30–60°	N/A	
60	7–17°	24–60°	37–60°	
72	6–14°	19–54°	31–60°	
84	5–12°	17–46°	26–60°	
96	4–10°	14–40°	23–60°	
106	4–9°	13–36°	21–60°	
Rail Length (in)	Maximum length of rear leg			
	18 in	64 in	104 in	
120	26–60°	5–12°	16–47°	
132	24–60°	5–11°	15–42°	
144	22–60°	4–10°	13–38°	
156	20–60°	4–9°	12–35°	
168	18–55°	4–9°	11–33°	
180	17–51°	3–8°	11–30°	
High Profile Tilt Leg Kits				
Part #	Model	Max. Leg Extension	# Legs	Weight
963UNISMTLH2-12	310107	12	2	3
963UNISMTLH2-44	310108	44	2	7
963UNISMTLH2-72	310109	72	2	10
963UNISMTLH4-18	310111	18	4	7
963UNISMTLH4-64	310112	64	4	16
963UNISMTLH4-104	310110	104	4	20



SolarMount Low Profile Tilt

Tilt Angles for Low Profile Legs

In low profile arrays, tilt angle depends on leg length and the location of the module mounting holes. Use this table to choose the appropriate maximum extension for your module and desired tilt angle.

Module	Low Profile Leg Lengths		
	12 in	30 in	44 in
Kaneka 60	19–24°	40–60°	58–60°
Mitsubishi 110/125	13–17°	27–43°	39–60°
Mitsubishi 175/180	12–15°	26–40°	37–60°
Sanyo 190/200	14–18°	30–47°	42–60°
Sanyo N 205/210/215			
Sharp 130	13–17°	28–44°	40–60°
Sharp 170/175	15–19°	31–50°	45–60°
Sharp 208/216/224	13–16°	27–42°	39–60°
SunWize 85/90/90C/ 95C/100C	12–15°	25–40°	36–60°
SunWize 175/180			
Yingli 80/85	16–20°	33–52°	48–60°

Quantity of Low Profile Adjust. Tilt Legs Required

The number of tilt legs in a low profile array depends on the length of the mounting rails.

Rail Length	Tilt Legs
48" to 106"	2
120" to 180"	3
192" to 216"	4
226" to 288"	5
300" to 336"	6
348" to 408"	7
420" to 432"	8

Low Profile Tilt Leg Kits

Part #	Model	Max. Leg Extension	# Legs	Weight
963UNISMTLL2-12	310121	12	1	2
963UNISMTLL2-30	310122	30	1	3
963UNISMTLL2-44	310123	44	1	4

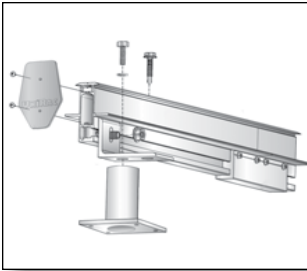

SunFrame components

UniRac®

SunFrame®

The SunFrame shared-rail system is the answer when aesthetics is a priority. It is a PV module mounting system designed to enhance the appearance of the home. The system consists of four major components. Standard length 96" and 192" rails to support modules and are cut or spliced as required. Extruded aluminum rails attach to L-Feet which may be installed directly to asphalt roof surfaces or in conjunction with roof attachment/flashing systems. Full length cap strips secure modules and finish the array leaving a gap-free frame. Self-tapping screws 16" o/c provide holding power. Push-fit end caps neatly finish the rail ends. Optional aluminum or steel standoffs are available in range of heights to support L-feet above tile or shake roofs. All rails, cap strips and L-feet are available in either dark bronze or clear anodized finish. End caps are available in black only, stainless steel cap screws are available in black phosphate or bright finish. When installed according to manufacturer's directions, the SunFrame complies with the Uniform and California Building Codes.

Part #	Model	Description	Package	Shipping Weight
963UNISF063	302011	192" threaded slot rail	Dark 8 ea. 192"	144
963UNISF068	302012	192" threaded slot rail	Dark 1 ea. 192"	
963UNISF041	302013	96" threaded slot rail	Dark 8 ea. 96"	72
963UNISF067	302014	96" threaded slot rail	Dark 1 ea. 96" (2 rail min.)	10
963UNISF038	302015	192" threaded slot rail	Clear 8 ea. 192"	144
963UNISF061	302016	192" threaded slot rail	Clear 1 ea. 192"	
963UNISF044	302017	96" threaded slot rail	Clear 8 ea. 96"	72
963UNISF045	302018	96" threaded slot rail	Clear 1 ea. 96" (2 rail min.)	10
963UNISF042	321126	Cap Strips for 45–47 mm modules	Dark 8 ea. 192"	45
963UNISF032	321127	Cap Strips for 45–47 mm modules	Dark 8 ea. 96"	25
963UNISF043	321128	Cap Strips for 45–47 mm modules	Dark 1 ea. 96"	6
963UNISF008	321109	Cap Strips for 45–47 mm modules	Clear 8 ea. 192"	45
963UNISF021	321120	Cap Strips for 45–47 mm modules	Clear 8 ea. 96"	25
963UNISF022	321121	Cap Strips for 45–47 mm modules	Clear 1 ea. 96"	6
963UNISF040	310226	End Caps with matching screws	Dark 20	1
963UNISF053	310225	End Caps with matching screws	Dark 2	1
963UNISF056	321154	1" cap strip screws	Dark 100 ea.	2
963UNISF064	321157	1" cap strip screws	Dark 10 ea.	1
963UNISF054	321160	1" cap strip screws	Clear 100 ea.	2



L-Foot with bolt

Serrated L-feet for SunFrame rails (bronze finish for dark rails)

Select finish to match rails. Includes s/s bolts and flange nuts. Lag bolts not included.

Part #	Model	Description	Shipping Weight
963UNISF069	310065	20 each, Bronze	5
963UNISF066	310066	1 each, Bronze	0.2
963UNISF049	310067	20 each, Clear	5
963UNISF050	310068	1 each, Clear	0.2



Splice Bar

Splice bars for SunFrame rail with self-tapping screws

Part #	Model	Description	Shipping Weight
963UNISF059	310227	20 each, Bronze	10
963UNISF057	310228	1 each, Bronze	0.5
963UNISF055	310229	20 each, Clear	10
963UNISF051	310230	1 each, Clear	0.5



Unirac CLICKSYS components

UniRac®

CLICKSYS®

The CLICKSYS is an innovative, flush-roof, top-mounting system. The system is a recent downward extension of the UniRac line aimed at the mainstream residential market. Its low cost combined with faster installation time make it superior to competing products.

The unique I-beam design optimizes strength and reduces material. Rails can span 48" and withstand 110MPH, Cat-C winds. Rails come in 12' lengths and snap into single or dual flange attachments (no nuts and bolts significantly reduce installation time).

Flange attachments can be mounted directly onto composition roofs using lag bolts or self-drilling Concealor screws with installer supplied sealant or optional butyl pads. Single hole flanges can be attached

to a variety of standoff/flashing systems as well as tile hooks and QuickMount PV systems. Modules are top mounted using similar clamps found in other Unirac systems and can be grounded using an optional integral grounding system (no need to ground individual modules).

The CLICKSYS system is fully supported, including an on-line specification tool (pricing, bill of materials and engineering documentation for quick permitting) and installation and code compliance/quick engineering guide. Accessories are sold in bulk packs only. Ten-year warranty.



Unirac CLICKSYS I-beam

Part #	Model	Description	Finish*	Quantity	Shipping Weight
963375	010144M-0050	CLICKSYS 100 Series Beam - 12' beam	mill	12	10
963385	003020C-0025	Splice kit	mill	25	2
963386	003021C-0025	Splice kit w/grounding	mill	25	2
963376	004000M-0048	2-flange connection w/3" screws	mill	48	8
963377	004001M-0048	2-flange connection w/3" screws & butyl pads	mill	48	11
963378	004010M-0048	1-flange connection w/lag bolt	mill	48	9
963381	005003C-0024	3" Standoff 2-Piece Alum w/1 Flange Connection	mill	24	20
963382	005004C-0024	4" Standoff 2-Piece Alum w/1 Flange Connection	mill	24	20
963383	005006C-0024	6" Standoff 2-Piece Alum w/1 Flange Connection	mill	24	20
963384	005007C-0024	7" Standoff 2-Piece Alum w/1 Flange Connection	mill	24	20
963379	005010C-0025	Tile hook top mount w/lag bolt & 1 flange connection	cast	24	21
963380	005020S-0018	QuickMount Alum flashing 9.5"x12.5" w/1 flange connection	mill	18	13
963387	002001C-0048	Module top mounting end clamp A	clear/mill	48	7
963388	002002C-0048	Module top mounting end clamp B	clear/mill	48	7
963389	002003C-0048	Module top mounting end clamp C	clear/mill	48	7
963390	002004C-0048	Module top mounting end clamp D	clear/mill	48	7
9633446	002005C-0048	Module top mounting end clamp E	clear/mill	48	7
9633455	002006C-0048	Module top mounting end clamp F	clear/mill	48	7
9633456	002009C-0048	Module top mounting end clamp J	clear/mill	48	7
9633457	002010C-0048	Module top mounting end clamp K	clear/mill	48	7
9633458	002026C-0048	Module top mounting mid-clamp A	clear/mill	48	7
9633459	002027C-0048	Module top mounting mid-clamp B, C	clear/mill	48	7
9633460	002028C-0048	Module top mounting mid-clamp D, K	clear/mill	48	7
9633461	002030C-0048	Module top mounting mid-clamp E, F, J	clear/mill	48	7
963462	008000S-0050	UGC-2 grounding clip for CLICKSYS	stainless steel	50	2

*NOTE: CLICKSYS is also available in a Dark Anodized finish



UniRac Side of Pole Mount Series 4002

UniRac®

Side-of-Pole Mounts

UniRac mounting structures incorporate SolarMount slotted rails that fit most PV modules on the market and are manufactured of clear anodized (rails and legs) aluminum to withstand corrosion.

Features include:

- 120 mph wind load design
- PV module mounting hardware and U-Bolts for pole mounting are included
- Stainless steel hardware
- 10-year limited warranty
- Adjustable tilt 15° to 60°
- Models mount 1-4 PV modules
- Ships UPS (*= must ship freight)



UniRac Side of Pole Mount Series 4011

*Order 1 extra module bolt. ** Order 2 extra module bolts.

Part #	Model	Rail /Channel Length	Pipe Size (sch 40)	Weight	Part #	Model	Rail /Channel Length	Pipe Size (sch 40)	Weight
963303	400111	22"/24"	2½	6	963028	400230	96"/40"	4	30
963UNIUPS26XXL	400204	28"/30"	2½	12	963027	400231	104"/32"	4	32
963UNIUPS32M	400206	32"/25"	2½	15	963272	400232*	108"/40"	4	35
963305	400207	32"/35"	2½	16	963306	400233	56"/40"	3	24
963214	400209	40"/35"	2½	20	963030	400236	28"/40"	2½	15
963SP75USP2MA	400211	44"/25"	2½	20	963031	400237	32"/40"	2½	15
963UNIUPS52L	400212	52"/32"	3	21	963026	400238	36"/30"	2½	19
963020	400214	52"/40"	3	22	963367	400239	38"/30"	2½	20
963UNIUPS60L	400215	60"/32"	3	24	963307	400244	64"/32"	3	24
963UNIUPS64XL	400219	64"/40"	3	25	963432	400246	104"/40"	4	34
963UNIUPS80L	400222	80"/32"	4	25	963308	400247	98"/24"	4	28
963033	400224	80"/40"	4	27	963371	400249	72"/40"	4	30
963UNIUPS88L	400226	88"/32"	4	26	963309	400250	66"/24"	3	24
963228	400227	88"/24"	4	26	963312	400257	26"/35"	2½	14
963430	400228	96"/32"	4	27	963313	400259	92"/32"	4	35

*Ships truck freight.



UniRac Side of Pole Mount Series 4001

Model # Selection Guide

Module Type	Module Quantity:	1	2	3	4
Mitsubishi 125		400236	400233	400224	400232
Mitsubishi 175/180		400248	400224	400246	–
Sanyo 190/195/200		400238	400222	400246	–
Sanyo N 205/210/215		400248	400219	400230	–
Sharp 130		400236	400233	400224	400232
Sharp 170/175		400248	400224	400246	–
Sharp 208/216/224		400248	400224	–	–
SunWize 85/90/90C/95C/100C		400103	400212	400222	400228
SunWize 110		400112	400212	400222	400228
SunWize 175/180		400207	400244	400228	–
Yingli 85		400111	400211	400250	400227

Zomeworks

Universal Track Rack

Tracking can increase electrical output of modules by 25% over that of a fixed rack. The sun's heat moves liquid from side to side, allowing gravity to turn the Track Rack and follow the sun. Tracking mounts are cost-effective components for domestic and industrial PV power systems, utility applications and water pumping and cathodic protection systems. The UTR comes in 6 standard sizes for holding 2 to 16 modules and accommodates most PV modules. The numeric values in each model number refer to the square feet of module space on that rack (i.e. UTRK040 has 40 sq. ft. of module space). All Zomeworks racks are guaranteed for 10 years.



Universal Track Rack

Zomeworks Model:	UTR-020 Model	UTRK-040 Model	UTRF-64 Model	UTRF-90 Model	UTRF-120 Model	UTRF-168 Model
Pole Size:	2.5"	3"	6"	6"	6"	8"
SW Part #	951TRU020UNITRA	951UNITRU040	954UTRF64	954UTRF90	951UTRF120	951UTRF168
Kaneka 60	1	2-3	4-6	8	10*-12*	14**-16**
Mitsubishi 125	1	2-3	4-6	8	10	12-14
Mitsubishi 175/180	N/A	2	3-4	5*-6*	8*	10
SANYO HIP-190/195/200	1	2-3	4	6	8	9*-10-12H
SANYO N -205/210/215	1	2-3	4	6	8	10
SANYO HIT Double	Call for details					
Sharp 80	1-2	3-4-5	6-8	10-12	14-16	18*-20*-21*-22*-24*
Sharp 130	1	2-3	4-6*	8	10	12-14*-15*
Sharp 170/175	1	2	3-4	6	8	9*-10
Sharp 208/216/224	1	2	3	4	6	8-9*
Yingli 80/85	1-2	3-4-5	6-8	10-12	14-16	18*-20*-21*-22*-24*
SunWize SW50A/55A/60A	1-2	3-4-5	NA	NA	NA	NA
SunWize SW85/90/90C/95C/100C	1-2	3-4	6*	8-9*	10-12	14-15*-16*
SunWize SW110	2	4	6	10	12	16, 18*
SunWize 175/180	1	2	4	6	8	12
SOLON Blue 220	1	2	3	4-5*	6*	8-9*

* Denotes extra rail set is required. 951UTRF_RAILS, Extra rail set, specify either: 64, 90, 120 or 168



S-5! Solar Mount



S-5-Z mini and S-5-U mini clamps (l to r)



PV Anchor Kit

S-5!

S-5! clamps attach to the panel seam of standing seam metal roofing by the tightening of two "bullet-nosed" stainless steel setscrews against the seam material. The round point setscrews compress the seam material against the opposite wall of the clamp. They will "dimple" the seam material, but will not penetrate it. Threaded holes in the clamp (stainless hardware is provided) enable the easy attachment of various ancillary structural items to the clamps. S-5! clamps can be used to attach mounting rails to standing seam roofs.

The S-5-PV Kit mounts to any of the S-5! Mini clamps (sold separately) and can be used to mount modules directly to the roof without rails. The S-5-PV Kit also comes in a version for edge applications where one clamp arm is broken off and a flange nut is added for the edge condition.

The S-5! VersaBracket™ is a penetrating attachment that can be used to mount virtually anything to a face-fastened (non-standing seam) metal roof system. It is compatible with almost any trapezoidal, face-fastened profile. The VersaBracket™ comes with factory-applied sealant already in the base for a water-tight attachment. Mounting hardware is not provided.

Part #	Model	Item	Weight
704018	S-5-U	Metal Roof Clamp-Universal, 10mm Bolt	0.46
704045	S-5-U mini	Metal Roof Clamp- 8mm Bolt	0.18
950029	S-5-Z	Metal Roof Clamp-Bulb Seam, 10mm Bolt	0.58
704072	S-5-Z mini	Metal Roof Clamp-Bulb Seam, 8mm Bolt	0.56
704063	PV Anchor Kit	PV Grab 41-60mm w/8mm Stud, Flange Nut & Disc	0.18
951058	PV Anchor Kit (edge)	PV Grab 41-60mm w/8mm Stud, Flange Nut & Disc	0.20
704066	Versabacket	3 Mounting Holes, Slotted Flange, 1.86" Height	0.16

Power-Fab/Direct Power and Water Corporation

Power-Fab Mounting Structures

Power-Fab produces sensibly designed and rugged mounting structures, with a focus on strength and ease of installation. Refer to the Selection Guide for a partial listing of the various PV modules and quantities supported.

Top-of-Pole Mount - TPM

Top-of-Pole Mounts have six tilt-angle settings from 15° to 65° in 10° increments. The elevation adjustment is positive locking in each position eliminating the possibility of slippage. The racks are balanced about the pivot bolt to make elevation adjustments easy. Strongbacks, elevation pivots, and mounting sleeves are made of heavy gauge steel, mig-welded, and deburred. All steel is painted with two coats of black industrial urethane enamel. Solar module mounting rails are made of mill-finish 6061-T6 structural aluminum angle or channel.

Specify TPM Rack Model # = **TPM(PV Qty) - (PV Model)**

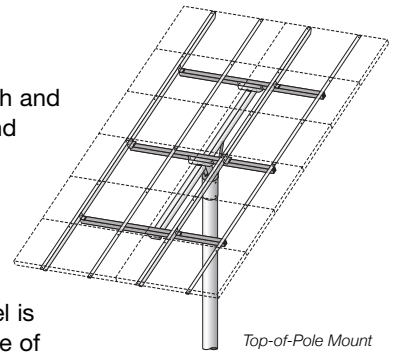

Top-of-Pole Mount

Roof/Ground Mounts - RGM

Roof/Ground Mounts are in mill aluminum. Both one-piece (OP) and telescoping-leg (TL) sets are available. Racks come with stainless steel module mounting hardware and Grade 5 zinc-plated rack assembly hardware. Standard mounting feet are made of steel and are hot-dip-galvanized after fabrication. Module rails and legs are made of mill-finish 6061-T6 structural aluminum angle. Some large racks are aluminum channel. Clear anodizing is available as an option. One-piece leg (OP) has 3 Set-Points: 30°, 45°, 60°, telescoping leg (TL) with adjustable tilt range: 20° to 65°.

Specify TPM Rack Model # = **RGM(PV Qty) - (PV Model) - Tilt leg (OP or TL)**

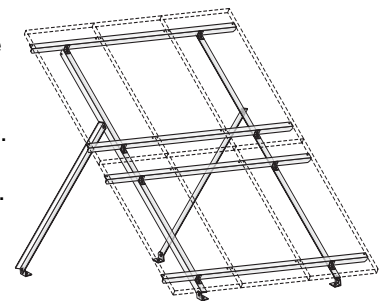

Roof/Ground Mount

Two-Tier Roof/Ground - TTRGM

Same materials and tilt ranges as RGM. PV modules are racked in two rows with the module length vertical. TTRGMs use one set of tilt legs.

Specify TPM Rack Model # = **TTRGM(PV Qty) - (PV Model) - Tilt leg (OP or TL)**

Low Profile Roof/Ground - LPRGM

Same materials and tilt ranges as RGM, PV modules are racked side-by-side in one row with the module length vertical.

Specify TPM Rack Model # = **LPRGM(PV Qty) - (PV Model) - Tilt leg (OP or TL)**

Available options: • Anodized aluminum • Tamper-resistant hardware • Powder coating

Selection Guide

* indicates item cannot ship UPS.

PV Module / Qty.	1	2	3	4	6	8	10	12
Kaneka G-SA060	1 - KA60	2 - KA60	3 - KA60	4 - KA60	6 - KA60	8 - KA60	10 - KA60	12 - KA60
Pipe Size Sch. 40	2	2	2.5	3	4	6	6	6
Mitsubishi 125	1 - MT125	2 - MT125	3 - MT125	4 - MT125	6 - MT125	8 - MT125	*10 - MT125	*12 - MT125
Pipe Size Sch. 40	2	2.5	3	4	4	6	6	6
Mitsubishi 170/180MF5	1 - MT180	2 - MT180	3 - MT180	4 - MT180	6 - MT180	8 - MT180	10 - MT180	12 - MT180
Pipe Size Sch. 40	2	3	4	4	6	6	8	8
Sanyo HIP-200BA3	1 - SY200	2 - SY200	3 - SY200	4 - SY200	6 - SY200	8 - SY200	*10 - SY200	*12 - SY200
Pipe Size Sch. 40	2	3	4	4	6	6	8	8
Sharp 80 Watt	1 - SH80	2 - SH80	3 - SH80	4 - SH80	6 - SH80	8 - SH80	10 - SH80	12 - SH80
Pipe Size Sch. 40	2	2	2.5	3	4	4	6	6
Sharp 130 Watt	1 - SH123	2 - SH123	3 - SH123	4 - SH123	6 - SH123	8 - SH123	*10 - SH123	*12 - SH123
Pipe Size Sch. 40	2	2.5	3	4	4	6	6	6
Sharp NT-170/175U1	1 - SH175	2 - SH175	3 - SH175	4 - SH175	6 - SH175	8 - SH175	*10 - SH175	*12 - SH175
Pipe Size Sch. 40	2	3	4	4	6	6	8	8
Sharp ND-224U1	1 - SH208	2 - SH208	3 - SH208	4 - SH208	6 - SH208	8 - SH208	10 - SH208	12 - SH208
Pipe Size Sch. 40	2	3	4	4	6	6	8	8
SunWize SW50A/55A/60A	1 - SW60	2 - SW60	3 - SW60	4 - SW60	6 - SW60	8 - SW60	10 - SW60	12 - SW60
Pipe Size Sch. 40	2	2	2.5	3	4	4	6	6
SunWize SW75A-80A	1 - SW80	2 - SW80	3 - SW80	4 - SW80	6 - SW80	8 - SW80	10 - SW80	12 - SW80
Pipe Size Sch. 40	2	2	2.5	3	4	6	6	6
SunWize SW85/90/90C/95C/100C	1 - SW100	2 - SW100	3 - SW100	4 - SW100	6 - SW100	8 - SW100	10 - SW100	*12 - SW100
Pipe Size Sch. 40	2	2.5	3	3	4	6	6	6
Yingli YL85	1 - YL85	2 - YL85	3 - YL85	4 - YL85	6 - YL85	8 - YL85	10 - YL85	12 - YL85
Pipe Size Sch. 40	2	2	2.5	3	4	4	6	6

Advertisement

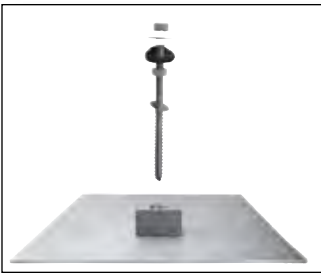

Quick Mount flashing and mounting assembly

Quick Mount PV®

Quick Mount PV offers all-in-one waterproof flashing and mounting hardware for anchoring of solar racking systems to various roofing materials. These flashings work with all standard PV racking methods and installs easily, minimizing labor and preventing water damage to existing roofing materials while not compromising integrity. This product's rated life is 50 years and is IBC code compliant.

Quick Mount PV features an all aluminum flashing assembly including an integral 1.25" standoff attached to the flashing and is also supplied with a stainless steel 5/16" x 6" hanger bolt and hardware. Flashing assemblies, including conduit mounts, are available for composition or shake shingle roofing materials in either mill aluminum, clear or bronze anodized finishes.

Part #	Model	Description	Finish	Quantity	Shipping Weight
Composition Mounts					
961000	QMSC A 12	Flashing Composition Mount 12 x 12	Mill	12	14
961001	QMSC B 12	Flashing Composition Mount 12 x 12	Bronze Ano.	12	14
961009	QMSC C 12	Flashing Composition Mount 12 x 12	Clear Ano.	12	14
Shake Mounts					
961002	QMLC A 12	Flashing Shake Shingle Mount 18 x 18	Mill	12	24
961003	QMLC B 12	Flashing Shake Shingle Mount 18 x 18	Bronze Ano.	12	24
961010	QMLC C 12	Flashing Shake Shingle Mount 18 x 18	Clear Ano.	12	24
Conduit Mounts-Composition					
961007	QMCC A 12	Flashing Conduit Mount-Comp. 9 x 12	Mill	12	10
961012	QMCC B 12	Flashing Conduit Mount-Comp. 9 x 12	Bronze Ano.	12	10
961011	QMCC C 12	Flashing Conduit Mount-Comp. 9 x 12	Clear Ano.	12	10
Conduit Mounts-Shake					
961008	QMLCC A 12	Flashing Conduit Mount-Shake 12 x 18	Mill	12	16
961014	QMLCC B 12	Flashing Conduit Mount-Shake 12 x 18	Bronze Ano.	12	16
961013	QMLCC C 12	Flashing Conduit Mount-Shake 12 x 18	Clear Ano.	12	16



Composition Mount shown with rail



Conduit Mount shown with conduit

Quick Mount PV Aluminum Flat and Curved Tile Flashings with mounts and hardware. Flat Tile Flashing is designed to replace one existing Flat Concrete Tile. Replaces most Flat Tile profiles and fully compatible with Monier, Eagle, Hanson, and Life Tile. Curved Tile Flashing is made and designed from dead soft aluminum to work with any existing Curved Tile profile based on it's formability. All products come with detailed instructions for installation.

Part #	Model	Description	Finish	Quantity	Shipping Weight
Tile Mounts (with all hardware included)					
961026	QMFTM A 12	Flat Tile Mounts w/Flashings	Mill	12	27
961028	QMFTM B 12	Flat Tile Mounts w/Flashings	Bronze Anodized	12	27
961029	QMFTM C 12	Flat Tile Mounts w/Flashings	Clear Anodized	12	27
961027	QMCTM A 12	Curved Tile Mounts w/Flashings	Mill	12	27
961030	QMCTM B 12	Curved Tile Mounts w/Flashings	Bronze Anodized	12	27



Shake Mount

Accessories

Quick Mount height extensions are all aluminum and available in 2.5" or 4" inches tall in mill or bronze anodize finish. Additional 5/16" diameter stainless steel hanger bolts are offered as spares to 6" lengths (normally supplied) or longer 8" to 10" inches for use with height extensions.

Part #	Model	Description	Finish	Quantity	Shipping Weight
961005	QMEXT-2.5 A 12	Height Extension 2-1/2" Aluminum	Mill	12	4
961018	QMEXT-2.5 B 12	Height Extension 2-1/2" Aluminum	Bronze Ano.	12	4
961006	QMEXT-4.0 A 12	Height Extension 4" Aluminum	Mill	12	6
961019	QMEXT-4.0 B 12	Height Extension 4" Aluminum	Bronze Ano.	12	6
961020	QMHS-6 12	Hanger Bolt 5/16" x 6" with HDW	ST-ST	12	2
961021	QMHS-8 12	Hanger Bolt 5/16" x 8" with HDW	ST-ST	12	2.5
961022	QMHS-10 12	Hanger Bolt 5/16" x 10" with HDW	ST-ST	12	3



Flat Tile Mount shown with rail



SunWize MC Cable Assemblies

SunWize®

Module Interconnects - Multi-Contact Cable Assemblies (MC)

SunWize MC cables are factory assembled with automatic tooling for the highest degree of reliability. Use as module interconnects or PV output extension leads. UL listed MC cables are available with a male or female MC3 (3mm) or MC4 (4mm) fitting on one end, 1/2" non-metallic cord connector on the other end. All cables are black #10 AWG type 'USE-2 / RHW-2' 600V sunlight resistant outdoor stranded copped wire.

Type M/F have a male fitting on one end and female on the other - no cord connector. Install to extend PV sub array, wire can be cut anywhere along length to suit distance to disconnect or combiner.

SolarLok MN designation indicates male neutral, non-keyed.

Branch plugs and sockets are used in conjunction with MC cables assemblies for safe and reliable parallel connection of PV modules.



SunWize MC4 Locking Connector

Part #	Length	Cable Assemblies	Fitting	Part #	Length	Cable Assemblies	Fitting
795#10USE2X24M	24"	MC3 interconnect	M/-	795029	24"	MC4 locking interconnect	M/-
795#10USE2X24F	24"	MC3 interconnect	F/-	795034	24"	MC4 locking interconnect	F/-
795#10USE2X36M	36"	MC3 interconnect	M/-	795014	36"	MC4 locking interconnect	M/-
795#10USE2X36F	36"	MC3 interconnect	F/-	795035	36"	MC4 locking interconnect	F/-
795#10USE2X48M	48"	MC3 interconnect	M/-	795015	48"	MC4 locking interconnect	M/-
795#10USE2X48F	48"	MC3 interconnect	F/-	795036	48"	MC4 locking interconnect	F/-
795#10USE2X72M	72"	MC3 interconnect	M/-	795016	72"	MC4 locking interconnect	M/-
795#10USE2X72F	72"	MC3 interconnect	F/-	795037	72"	MC4 locking interconnect	F/-
795#10USE2X120M	120"	MC3 interconnect	M/-	795017	120"	MC4 locking interconnect	M/-
795#10USE2X120F	120"	MC3 interconnect	F/-	795038	120"	MC4 locking interconnect	F/-
795#10USE2X240M	240"	MC3 interconnect	M/-	795018	240"	MC4 locking interconnect	M/-
795#10USE2X240F	240"	MC3 interconnect	F/-	795039	240"	MC4 locking interconnect	F/-
795#10USE2X360M	360"	MC3 interconnect	M/-	795019	360"	MC4 locking interconnect	M/-
795#10USE2X360F	360"	MC3 interconnect	F/-	795040	360"	MC4 locking interconnect	F/-
795#10USE2X420M	420"	MC3 interconnect	M/-	795020	420"	MC4 locking interconnect	M/-
795#10USE2X420F	420"	MC3 interconnect	F/-	795041	420"	MC4 locking interconnect	F/-
795#10USE36M/F	36"	MC3 interconnect	M/F	796005	120"	TYCO Solarlok Interconnect	MN/F
795#10USE120M/F	120"	MC3 interconnect	M/F	796003	180"	TYCO Solarlok Interconnect	MN/F
795#10USE240M/F	240"	MC3 interconnect	M/F	796001	360"	TYCO Solarlok Interconnect	MN/F
795#10USE360M/F	360"	MC3 interconnect	M/F	796002	600"	TYCO Solarlok Interconnect	MN/F
795#10USE600M/F	600"	MC3 interconnect	M/F	796004	1200"	TYCO Solarlok Interconnect	MN/F
795#10USE1200MF	1200"	MC3 interconnect	M/F				
Part #	Length	Description	Fitting	Part #	Description	Fitting	
795009	36"	MC4 locking interconnect	M/F	710081	MC3 Branch Connector	(2) Male / Female	
795004	120"	MC4 locking interconnect	M/F	710082	MC3 Branch Connector	(2) Female / Male	
795005	240"	MC4 locking interconnect	M/F	710083	MC4 Branch Connector	(2) Male / Female	
795006	360"	MC4 locking interconnect	M/F	710084	MC4 Branch Connector	(2) Female / Male	
795007	600"	MC4 locking interconnect	M/F	795010	MC4 4MM Lock Sleeve		
795008	1200"	MC4 locking interconnect	M/F	795011	MC4 4MM Unlock Tool		



Ground Lug-Lay-In Direct Burial

- Manufactured from high-strength copper alloy tin plated with stainless steel screw
- UL listed and CSA certified for direct burial in earth or concrete
- Tested to UL-467/UL File E34440
- Lay-in feature for ease in installation
- For copper conductor only #4 to #14 AWG
- Rated for grounding and bonding
- Rated for 600 Volts

Part #	Model	Ground Wire Range	Length	Width	Height	Bolt Size	Hex Size	Features
704LUG#4#14DB	GBL-4DBT	4-14 STR. COPPER	1.150	.375	.825	10	Screw	Tin Plate

Module Interconnects – Liquid Tight Conduit Assemblies (LT)

Liquid-tight conduit assemblies provide supplemental protection for individual wiring conductors between adjacent PV modules. In high-voltage installations, they may be required to satisfy the NEC. Standard assemblies include two #10 AWG THHN-2 conductors (rated 90°C, 600 volt), red/black, contained within 1/2” flexible non-metallic conduit with gray PVC straight fittings and locknuts.

Part #	Length-inches	Fits PV Modules With J-Box
795MICLT10-2X23	23	OEM20/40
795MICLT10-2X28	28	Sharp80, SW50A-60A
795MICLT10-2X33	33	SW75A To SW100C, SH130, MT110/125



SunWize LT Conduit Assemblies

Panel Output Cables

Panel Output Cables are used for connection from the solar array to the controller or PV combiner assemblies. Cables are sunlight-resistant, PVC tray cable and direct burial with red/black THHN conductors (rated 90° C, 600 volt). All are cut to length and outfitted with two strain-relief cord connectors for 1/2” NPT, one end terminated for connection into PV junction box, #10 AWG with fork terminals, #8-6 AWG with copper lugs.

Part #	AWG-Conductors	Length	Weight
790POC#10-2X10	#10-2	10 ft.	2
790POC#10-2X20	#10-2	20 ft.	4
790POC#10-2X30	#10-2	30 ft.	6
790POC#8-2X10	#8-2	10 ft.	3
790POC#8-2X20	#8-2	20 ft.	6
790POC#8-2X30	#8-2	30 ft.	9
790POC#8-2X50	#8-2	50 ft.	15
790POC#6-2X10	#6-2	10 ft.	4
790POC#6-2X20	#6-2	20 ft.	8
790POC#6-2X30	#6-2	30 ft.	12
790POC#6-2X350	#6-2	50 ft.	20



SunWize Panel Output Cables

Module Interconnects – Cable Assemblies (MIC)

Module interconnect cables are used to wire modules to adjacent modules. Two conductor cables with #10 AWG, red/black insulated, THHN-2 stranded copper wires. Designed for easy installation to all junction boxes, these cables (rated 90°C, 600 volt) feature sunlight-resistant, PVC jacketed cable with two liquid-tight cord connectors for 1/2” NPT openings. The cable jacketing is removed 3” from each end, exposing unterminated wires.

Part #	Length	Fits PV Modules With J-Box
795MIC10-2X23	23	OEM20/40
795MIC10-2X29	29	Sharp80, SW50A-60A
795MIC10-2X33	33	SW75A To SW100C, SH130, MT110/125



SunWize MIC Cable Assemblies

Grounding Hardware

UniRac grounding clip 1 (UGC-1): Order a grounding clip for every two top mounting clamps (end clamps + mid clamps) in your installation. Only one of the two rails in each row requires grounding clips.

Part #	Model	Quantity	Weight
963395	980005	10	1
963319	980002	100	1
963090	980003	250	2
963334	980004	500	4



UniRac Grounding Clip



WEEB-UMC for Unirac mounting systems

Wiley Electronics

WEEB Grounding Technology

Quickly and effectively ground PV system components, including module frames, mounting rails, or pole/ground mount supports, using patent pending “Washer Equipment Electrical Bond” (WEEB) technology. Stainless steel washers have “teeth” that bite into aluminum or steel creating a gas-tight seal when sandwiched between surfaces. No scraping of anodized surfaces required! All WEEB parts listed to UL-467. All connections require a torque wrench.



WEEB-DMC for DP&W, Two Seas rail systems

WEEB Grounding Clips, for roof-mount PV systems

Specially designed for use with UniRac or DP&W Power Rail mounting systems! Simply place the appropriate WEEB Grounding Clip onto the mid-clamp bolt, tightening the mid-clamp to effectively ground both modules to the rail. Each pair of PV modules requires two WEEB Grounding Clips.

WEEB Grounding Clip, for pole/ground-mount PV systems and universal applications

The WEEB-9.5 Grounding Clip is placed between a PV module and its supporting rail, with the standard fastener (1/4” or 5/16”) passing through the hole in the WEEB. When the fastener is tightened, the metal parts become electrically connected. Mounting rails may be similarly connected to cross members. Connect the overall structure to ground using a WEEB Grounding Lug.



WEEB-9.5NL ground clip

WEEB Grounding Lug

Attach WEEB Grounding Lug to a metal surface (mounting rails, supports, poles) using provided hardware, or slide head of mounting screw into slots of UniRac SolarMount or DP&W Power Rail. Tighten to 10 ft-lbs to obtain electrical bond to metal surface and attach a grounding wire (6AWG to 14AWG, solid or stranded copper wire). WEEB Grounding Lug includes tin-plated copper lug, 1/4-28 screw for attaching grounding wire, WEEB-6.7 Grounding Clip, and 1/4-20 mounting hardware.



WEEBLUG-6.7 equipment rail bond

WEEB Bonding Jumper

The WEEB Bonding Jumper can be used to electrically connect any two pieces of anodized aluminum, galvanized steel, steel and other electrically conductive metal. WEEB Bonding Jumper includes tin-plated copper cable, 2 WEEB-6.7 grounding clips, and 2 sets 1/4-20 stainless steel mounting hardware.

Acme Cable Clip

Easily clips to module frames using special screwdriver tab. Snugly holds one or two USE-2 or PV cables. Thick stainless steel material prevents damage to cable insulation. Screwdriver tab also allows for removal of clip.



WEEB Bonding Jumper

Part #	Model	Item	Size	Weight
704052	WEEB-UMC	Ground Clip - UniRac	N/A	N/A
704053	WEEB-DMC	Ground Clip - DP&W, Two Seas	N/A	N/A
704060	WEEB-9.5	Ground Clip - Universal, 1/4” or 5/16” bolt	N/A	N/A
704070	WEEB-9.5NL	Ground Clip - Universal, 3/8” bolt	N/A	N/A
426023	WEEBLug-6.7	Ground Lug - Equipment Rail Bond	0.71 x 1.58 x 0.49	0.125
426024	WEEB-6.7	Bonding Jumper - Rail to Rail Ground	9.13 x 0.75	0.17
704061	ACC	Acme Cable Clip - 2 x #10AWG	0.40 x 0.72 x 0.38	N/A

System Spotlight

LOCATION: Wisconsin

APPLICATION: 5.82kW residential grid-tie system

SYSTEM:

28 SHARP 208W modules

Installed by Bob Kelly/Solar Energy Today!



Advertisement



MNPV3 and MNPV6 Combiners

MidNite Solar

MNPV3 & MNPV6 Combiners

The MNPV3 & MNPV6 combiner is rated for outdoor use. Although designed primarily for combining PV strings up to 150 Vdc, the MNPV6 may be used for combining four high voltage strings using ATM fuses up to 15 amps. The use of touch safe DIN rail mount fuse holders and fuses allow operation up to 600 Volts. The MNPV6 combiner comes with two copper bus bars. One for circuit breakers (6) and one for fuses (4). The MNPV3 will accept three 150VDC breakers (for off-grid) or two 600VDC fuse holders (for grid-tie). Type 3R aluminum chassis with flip up cover. ETL listed for US and Canada.

Applications:

- PV combiner up to six strings using DIN breakers rated for 150 Vdc
- 120 amps total output PV combining up to four strings using ATM 6, 10 or 15 touch safe fuse holders rated for 600 Vdc
- DC load center using 150 Vdc DIN breakers

Features include:

- All aluminum powder coated housing; light gray
- Flip up cover that can stay in the open position during installation
- PV Negative bus bar with 14 useable openings (10 #14-6 and 4 #1/0-14)
- Chassis ground bus bar with 14 useable openings (10 #14-6 and 4 #1/0-14)
- Standard DIN rail to mount up to 6 breakers or 4 fuse holders (MNPV6)
- Tin plated copper bus bar to combine breaker outputs (MNPV6 busbar may be split in two)
- Dead front cover snaps into place after wiring is complete for safety
- Knock outs for PV in and PV out on bottom and sides
- Top surface is available to bring conduit in from directly above the enclosure



The MNPV6 comes with two copper bus bars

Part #	Model	Item	Length	Width	Depth	Weight
716032	MNPV3	PV Combiner - 3 strings	10.44	7.88	3.4	2
716029	MNPV6	PV Combiner - 6 strings	12.7	7.8	3.4	4

OutBack Power Systems

FLEXware PV Combiners

The OutBack Power Systems FLEXware PV combiner series is ideal for both small or large power systems. The FLEXware PV8 and FLEXware PV12 accommodates the overcurrent protection requirements of PV source circuits. From 150 Vdc breakers for low voltage PV systems, to 600 Vdc fuse holders for high voltage PV systems, the FLEXware PV Combiner series handles it all.

Designed to survive in outdoor environments, the rainproof, UL type 3R powder coated aluminum chassis can be mounted on a wall, pole or sloped on 3/12 roof pitch. The angled negative terminal bus bar design makes wiring fast and easy. Dual output combining bus bars with lug terminals are included for up to 2/0 AWG conductors. The tinted flame-retardant polycarbonate dead front panel creates a clean appearance while preventing accidental contact with the live terminals. All include GND bus bar. Order circuit breakers or fuse and fuse holders separately. ETL listed in the U.S. and Canada.

FWPV-8 enclosure (size: 15 x 9 x 4") has two 1" and ten 1/2" knockouts

FWPV-12 enclosure (size: 15 x 13 x 4") has two 1" knockouts and fourteen 1/2" knockouts



FLEXware PV Combiners

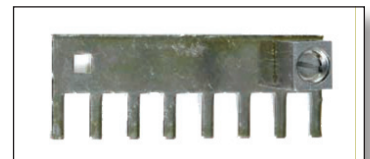

FLEXware CBUS

Part #	Model	Item	Max # of DC Fuseholders	Max # of DC Breakers	# PV Output Circuits	Weight
715221	FWPV-8	PV Combiner - 8 string	6	8	1	5.5
715222	FWPV-12	PV Combiner - 12 string	8	12	2	7.4
715223	FW-CBUS-8	Bus Bar-reversible 6/8	6	8	1	1
715224	FW-CBUS-12	Bus Bar Dual - reversible 4/6	8	12	2	2



SCCB Combiners

SMA America

SCCB Combiners

The SCCB combiners are available in sizes ranging from 6 to 52 PV inputs to provide greater flexibility and expandability in system design. An oversized bus-work adds high efficiency and dependability where it's needed most. The large NEMA 3R/4 enclosure provides ample room for conductors which reduces installation time.

Features:

- Compact, rugged low cost design
- Reliable bus-work for efficient high current conductor combining
- PV positive wires all land directly on Touch Safe™ fuse holders
- Sturdy NEMA 3R/4 wall mount steel enclosure
- ETL Listed to UL-1741

Model	SBCB-6 (SB6000)	SCCB-12 (Sunny Central)	SCCB-18 through 28 (Sunny Central)	SCCB-52 (Sunny Central)
Part #	176044	176107	176051	176056
Number of Inputs (Pos & Neg)	6	10 through 16	18 through 28	52
Pos. and Neg. Input Wire Size	10 to 6 AWG	10 to 6 AWG	10 to 6 AWG	10 to 6 AWG
Max. Input Fuse Rating (Midget)	15 A, 600 VDC	20 A, 600 VDC	15 A, 600 VDC	8 A, 600 VDC
Max. Continuous Output Current	72 ADC	160 through 256 ADC	216 through 336 ADC	333 ADC
PV Array Configuration	Neg. Grounded*	Neg. Grounded*	Neg. Grounded*	Neg. Grounded*
Enclosure Type	NEMA3R, Steel	NEMA3R/4, Steel	NEMA3R/4, Steel	NEMA3R/4, Steel
Weight (Approximate)	11 lbs	48 lbs	56 lbs	70 lbs
Dimensions H x W x D (Inches)	10" x 8" x 6"	16" x 16" x 6"	20" x 20" x 8"	42" x 30" x 8"

*Fusing available on positive or negative input, specify when ordering

PV String Combiners



SMA Combi-Switch

Combi-Switch

The new SMA Combi-Switch is designed specifically for the Sunny Boy 6000U but will work with any high-power string inverter system where multiple high voltage PV strings are required. It conveniently combines an external DC disconnect and PV string fusing into a single, compact NEMA 3R enclosure. Up to four PV strings may be landed on individual Touch Safe™ fuse holders. 10 amp 600 Vdc Midget fuses provided. Switch is rated for a max voltage of 600 Vdc and a max continuous current of 32 amps. Input wire size #10-#8 AWG, output wire size #6-#2 AWG. ETL listed to UL-1741.

Part #	Model	Dimensions	Weight
176039	Combi-Switch	15 x 7.75 x 5.75	10

System Spotlight

LOCATION:
Indiana

APPLICATION:
8.92kW solar system
for a library

SYSTEM:
48 SANYO 186W Bifacial modules
Installed by Morton Energy



RSTC SolaDeck

Roof Mount Combiner/Enclosure Box

Roof-mount enclosure/combiner box is designed to satisfy typical roofing standards by flashing into the roof system. Aesthetically appealing low profile design (2 5/8") and in many applications is installed beneath the PV panel. Includes a complete hardware package for installation and offers 3 separate size knockouts for conduit, a UL listed dual ground lug, DIN rail and a wire strain relief clip, which are all fixed on the base unit. Two cutouts on the cover along with centering dimples on the base unit increase versatility and provide a means for on site installation of watertight conduit to enter and exit SolaDeck's cavity as needed. SolaDeck is a listed UL 50-Type 3R enclosure constructed of stamped 18 gauge galvanized steel and powder coated to industry specifications.



SolaDeck Lid Off

Part #	Model	Description	Weight
704058	SD780	Enclosure w /flashing 15 x 15, Cavity 8 x 9 x 2.5	9

SD-780 Combiner Bus Bar Kit

Use with the SolaDeck SD-780 roof junction box to transform into a 4 string PV combiner. This bus bar kit allows combining of DIN rail mounted components from 1 to 4 PV string 600V midget fuse holders, 30A max. Kit includes: a four position Positive bus bar of electro-tin plated copper with aluminum box lug #2 AWG attached, a Negative-isolated power block 4-1 position (4 x #10 AWG to #2 AWG) with stainless steel mounting screws.



SolaDeck Lid On

Part #	Item	Weight
704062	Combiner Kit SD-780 4-String	1.0



SD-780 Combiner Bus Bar Kit

OutBack Power Systems

PV Source Circuit Breakers DC – DIN

DIN rail mount circuit breakers are hydraulic-magnetic and are not affected by high ambient temperatures, allowing full current rating at maximum voltage without de-rating. All DC-DIN breakers are 0.5" (13 mm) wide, screw-clamp terminals accept #14 AWG to #6 AWG stranded copper conductor.

Part #	Outback Model #	Current Rating (Amps)	DC Voltage (Max. Voc)
715183	OBB-2-150VDC-DIN	2	150
715144	OBB-4-150VDC-DIN	4	150
715057	OBB-6-150VDC-DIN	6	150
715109	OBB-8-150VDC-DIN	8	150
715070	OBB-9-150VDC-DIN	9	150
715058	OBB-10-150VDC-DIN	10	150
715059	OBB-15-150VDC-DIN	15	150
715181	OBB-20-125VDC-DIN	20	125
715062	OBB-30-125VDC-DIN	30	125
715164	OBB-50-125VDC-DIN	50	125
715165	OBB-60-125VDC-DIN	60	125
715225	FWDC DIN	End clamp for DIN rail	



DIN Circuit Breaker

SunWize PV String Combiner Accessories – High Voltage DC Midget Fuses & Holder

High voltage DC fuse holder & fuses are rated 600 Vdc. ATM fuses are 13/32" diameter x 1-1/4" long.

Part #	Description	Current Rating (Amps)	DC Voltage (Max. Voc)
707BLK30A600VPL	Fuseholder	30	600
706FUS6A600V	Fuse	6	600
706FUS10A600V	Fuse	10	600
706FUS009	Fuse	12	600
706FUS15A600V	Fuse	15	600
706FUS1AATM	Fuse Type ATM	1	600
706FUS20AATM	Fuse Type ATM	20	600
706FUS25AATM	Fuse Type ATM	25	600
706FUS30AATM	Fuse Type ATM	30	600



High Voltage DC Fuse Holder

PV String Combiners

Advertisement



SB 4000US

SMA America

Sunny Boy

SMA inverters are available in sizes from 700 to 8000 watts, making them ideal for a wide range of applications from small residential to very large 3 phase industrial systems. All SMA inverters come standard with built in LCD digital monitors that display instantaneous power output, energy delivered during the current day, and the total energy produced since installation.

The SB 700US has 3 DC input voltage ranges with 120 Vac output. The SB3000 and SB4000 are auto sensing for 208 or 240 Vac applications. The SB 5000, 6000 and 7000 can be field configured for use in 208, 240 and 277 Vac applications. The SB 8000 can be field configured for use in 240 Vac and 277 Vac applications. The SB 3000 through 8000 have a DC disconnect switch with an integrated 4 input fused series string combiner. The DC disconnect connects to the bottom of the inverter for easy installation or service. The SB 3000 through 8000 are field configurable for positive ground arrays. Indoor/outdoor NEMA 3R Enclosure, powder-coated aluminum (convection with regulated fan cooling). All sensitive electronic components are in a sealed compartment to ensure long life in harsh environments. Ambient temperature range: -13°F, +114°F. All models have a 10-year standard warranty and are certified to the new UL-1741/IEEE 1547 standards.

Part #	Model	CEC Efficiency	DC Input Voltage	Continuous Power Watts	AC Output Voltage	Dimensions	Weight
176034	SB 700U*	91.5%	75 - 150 100 - 200 125 - 250	460 600 700	120	12.7 x 12.6 x 7.1	43
176001	SB 3000US	95.0% @ 208 95.5% @ 240	200 - 500	3000	208/240	17.8 x 13.8 x 9.3	88
176004	SB 4000US	95.5% @ 208 96.0% @ 240	250 - 600	4000	208/240	17.8 x 13.8 x 9.3	88
176006	SB 5000US	95.5% @ 208 95.5% @ 240 95.5% @ 277	250 - 600	5000	208/240/277	18.4 x 24.1 x 9.5	148
176015	SB 6000US	95.5% @ 208 95.5% @ 240 96.0% @ 277	250 - 600	6000	208/240/277	18.4 x 24.1 x 9.5	148
176027	SB 7000US	95.5% @ 208 96.0% @ 240 96.0% @ 277	250 - 600	7000	208/240/277	18.4 x 24.1 x 9.5	148
176007	SB 8000US	96.0% @ 240 96.0% @ 277	300 - 600	8000	240/277	18.4 x 24.1 x 9.5	152

* This model has an adjustable DC input voltage window



SI 5048U

Sunny Island

The Sunny Island 5048U is the ideal solution for off-grid and grid-tie battery back-up systems and allows AC coupling of all energy sources. It has high surge capability and a peak efficiency of 95% making it both powerful and cost efficient. The Sunny Island 5048U utilizes removable MMC/SD cards for storage of performance data by the integrated data logger and for easy firmware upgrades. Intuitive interface features preconfigured settings for faster commissioning. Wherever reliable, high quality electricity is needed, depend on the new Sunny Island 5048U to deliver. Single phase, split phase and 3-phase (with modular expansion and parallel connectivity). 5-year warranty. UL-1741/UL-1998 listed.

Features include:

- NEMA 1 indoor enclosure • Operation temperature range: -25°C, +50°C
- No load power draw (standby) 25W (<4W)

Part #	Model	Peak Efficiency	DC Input Voltage	Continuous Power Watts	Charge Current	AC Output Voltage	Dimensions	Weight
176066	SI 5048U	95%	48 VDC	5000	120A	120	18.4 x 24.1 x 9.5	139



Sunny Boy HF Series Inverters

Sunny Boy High Frequency Inverters

Sunny Boy HF high frequency inverters are the latest in SMA technology. Featuring high efficiency, a slim-line enclosure and reduced weight, the Sunny Boy HF series of inverters can be mounted in between wall studs, making them ideal for new construction and space-constrained retrofits. Installation is made simple by automatic grid detection, field configuration for positive ground and a wide input voltage range of 175 to 600 volts, which provides a lot of system design flexibility. The modern graphic display and wireless Bluetooth® communication system also make the new Sunny Boy easy to use.

Part #	Model	Peak Efficiency	DC Input Voltage	Continuous Power Watts	Charge Current	Dimensions	Weight
SB2000HFUS	2000HFUS	95	175-600	2000	208/240	13.7 x 28.6 x 7.2	<50 lbs.
SB2500HFUS	2500HFUS	95	215-600	2500	208/240	13.7 x 28.6 x 7.2	<50 lbs.
SB3000HFUS	3000HFUS	95	220-600	3000	208/240	13.7 x 28.6 x 7.2	<50 lbs.

Sunny Boy Accessories

RS 485

The RS 485 communication system is for those situations where a power line carrier won't work and you have to link not just several inverters, but several Sunny Boy Controls. This current-source bus line system allows simultaneous communication with many nodes to one central controller. Its ability to link several Sunny Boy Controls makes the number of Sunny Boy inverters that you can control from one computer virtually infinite.

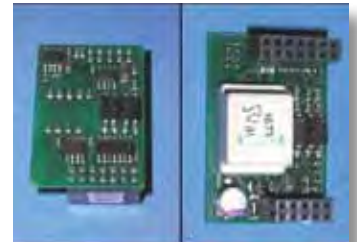

RS 485

Sunny WebBox

The Sunny WebBox can interface with up to 50 Sunny Boy inverters and automatically posts their performance data to SMA's Web – based portal called Sunny Portal. The Sunny WebBox can communicate via Ethernet or an internal analog modem. The data collected is stored in common file formats for use in spread sheets, graphs or other websites.



Sunny WebBox

Sunny SensorBox

The Sunny SensorBox is compact in size and installs easily at the PV array. Its integrated sensors continuously monitor solar irradiation and module temperature. The Sunny SensorBox sends data to the Sunny WebBox via an RS485 data link. From there, the data can be transferred to a PC for further processing or to the Sunny Portal for automatic performance analysis. The Sunny SensorBox can accommodate up to 3 additional sensors such as ambient temperature, wind speed and an additional irradiance sensor making the performance data even more accurate.



Sunny SensorBox

New Sunny Beam with Bluetooth

The long awaited redesign of Sunny Beam local, wireless monitoring system is here. The large graphic display shows you all essential data at a glance: daily profile, current output, daily and overall energy yield. You can also retrieve a monthly summary as well as the energy yield in dollars or the saved quantity of CO2. In case of system failure, the Sunny Beam can be programmed to emit an audio alarm.



Sunny Beam with Bluetooth

Part #	Model	Description
176013	Sunny Boy RS 485	Internal RS 485 communications board
176031	RS 485 Cable	15 meter communication cable
176049	Sunny WebBox	External device for collecting data and exporting onto the Sunny Portal
176063	Sunny Sensor Box	External device for measuring solar irradiation and module temperature
176110	Sunny Beam with Bluetooth	
176113	Sunny Beam Communication Module	

Advertisement



IG 2000/2500/3000



IG 4000/4500/5100

Fronius

IG Solar Inverters

Fronius IG Solar Inverters are lightweight, allowing them to be sent via regular shipping services and can be easily lifted on and off the mounting bracket, saving time and money on shipping and installation. Integrated, UL-approved DC and AC disconnects reduce installation time and complexity, often eliminating the need for additional disconnects. A wide voltage range and plug-and-play expansion slots allow for multiple system configuration possibilities. The integrated LCD display comes standard with every Fronius IG and tracks more than 20 critical system performance parameters. The exclusive Module Manager™ keeps Fronius IG inverters at the maximum power point (MPP) with fast and accurate MPP tracking (MPPT) – up to 99.9%, ensuring that you get the most power out of each ray of sunlight. And the MIX™ Concept allows for maximum power harvest out of partial load ranges, such as cloudy days or shaded areas, through a unique combination of multiple power stages in each inverter. The power stages in FRONIUS inverters divide up the work depending on operating hours and only operate as many power stages as required to efficiently process available power from the PV array. UL listed. 10-year warranty.

Features include:

- IEEE1547 Compliant, FCC Complaint
- Integrated UL-1741 Approved DC/AC Disconnects
- Operation temperature range: -20°C, +50°C
- Maximum DC input voltage: 500 Vdc @ 14°F
- NEMA 3R outdoor powder-coated aluminum enclosure
- Optional 5-year warranty extension

Part #	Model	CEC Efficiency	MPP Voltage Range	Power (Watts)	AC Output (Volts)	Dimensions (l x w x h)	Weight
158001	IG 2000	93.5%	150 - 400	2000	240	18.5 x 16.5 x 8.8	26
158003	IG 2500-LV	93%	150 - 400	2350	208	18.5 x 16.5 x 8.8	26
158002	IG 3000	94%	150 - 400	2700	240	18.5 x 16.5 x 8.8	26
158008	IG 4000	94%	150 - 400	4000	240	28.4 x 16.5 x 8.8	42
158010	IG 4500-LV	93.5%	150 - 400	4500	208	28.4 x 16.5 x 8.8	42
158009	IG 5100	94.5%	150 - 400	5100	240	28.4 x 16.5 x 8.8	42



IG Plus 3.0 - 3.8 / 5.0 - 7.5 / 10.0 - 12.0-3 (l to r)

IG Plus Solar Inverters

The IG Plus represents years of refinement of the existing Fronius IG series with a significant number of improvements including higher efficiency, improved power harvest, easier installation, six circuit built in string combiner and programmable output voltage of 208, 240, and 277 volts all with the same output power (applies to inverters up to 10kW only) and power output available to 12kW in a single inverter (3 phase). Additional features include anodized aluminum outdoor enclosure protection (Class IP44), a removeable power stage for easy installation, and the ability to extend the standard 10-year warranty to 15 years for a nominal investment. All IG Plus are 96% maximum efficiency, UL listed and have a maximum input voltage of 600 Vdc @ 14°F. Operational ambient temperature rating is -20°C to +50°C. Fuses for the string combiner are sold separately.

Part #	Model	MPP Voltage Range Vdc	Power (Watts)	# of Power Stages	# of Phases	Dimensions	Weight
158061	IG Plus 3.0-1 UNI	230 - 500	3000	1	1	10 x 17 x 25	55
158062	IG Plus 3.8-1 UNI	230 - 500	3800	1	1	10 x 17 x 25	55
158063	IG Plus 5.0-1 UNI	230 - 500	5000	2	1	10 x 17 x 38	84
158064	IG Plus 6.0-1 UNI	230 - 500	6000	2	1	10 x 17 x 38	84
158065	IG Plus 7.5-1 UNI	230 - 500	7500	2	1	10 x 17 x 38	84
158069	IG Plus 12.0-3 WYE277	230 - 500	12000	3	3	10 x 17 x 48	108
158068	IG Plus 11.4-3 Delta	230 - 500	11400	3	3	10 x 17 x 48	108
158066	IG Plus 10.0-1 UNI	230 - 500	10000	3	1	10 x 17 x 48	108
158067	IG Plus 11.4-1 UNI	230 - 500	11400	3	1	10 x 17 x 48	108



COM Card

Fronius

Data Communications and Accessories

COM Card, Retrofit Fronius IG Solar Inverter Interface and power supply option card for aftermarket installation of the DatCom data communication system; DatCom System requires one COM Card per FRONIUS IG inverter and one Datalogger Box per DatCom System.



Datalogger Box/Sensor Box

Datalogger Web One Datalogger Web is required per DatCom system. Network-compatible for comprehensive PV system monitoring. Easily integrated into existing network structures via an Ethernet interface. Full system control via the PC offers real-time and archived PV system data to be accessed worldwide. Three combination options for numerous communication channels: via Fronius Solar.access, Fronius Datalogger website or Fronius Solar.web. Features easy installation, patented direct connection between Datalogger and PC, simple alarm option and automatic messaging function.

Datalogger pro Box Works in tandem with COM Cards within DatCom System to provide real-time and archived data and enable use of PC based monitoring and free web-hosted data access. Supports up to 100 Fronius IG Solar Inverters per Datalogger Box



Datalogger easy Card

Datalogger pro Card – RS 232 Works in tandem with COM Cards within DatCom System to provide real-time and archived data and enable use of PC based monitoring and free web-hosted data access. Supports up to 100 Fronius IG Solar Inverters per Datalogger Card.



Datalogger pro Card

Datalogger easy Box Works in tandem with COM Cards within DatCom System to provide real-time and archived data and enable use of PC based monitoring and free web-hosted data access. Supports 1 Fronius IG Solar Inverter.



Sensor Card

Datalogger easy Card Works in tandem with COM Cards within DatCom System to provide real-time and archived data and enable use of PC based monitoring and free web-hosted data access. Supports 1 Fronius IG Solar Inverter.

Sensors

Sensor Box A Sensor Box is required for use with environmental or other sensors used in your data acquisition. Each Sensor Box allows connection of up to six sensors: 2 temperature channels (PT 1000), 1 irradiance channel (Voltage input 0-1V), 2 digital inputs, 1 standard 20mA current interface.

Sensor Card A Sensor Card functions the same as a Sensor Box but is located inside the inverter in the plug and play section. Each Sensor Card allows connection of up to six sensors: 2 temperature channels (PT 1000), 1 irradiance channel (Voltage input 0-1V), 2 digital inputs, 1 standard 20mA current interface.



Sensor, Wind Speed

Sensor, Wind Speed The sensor measures the wind speed at a specific PV system location. Used to determine wind load and analyze PV system cooling capacity, this sensor can be used in combination with other sensors to make an almost complete weather station.

Sensor, Ambient Temperature By having a wide temperature measurement range, the ambient temperature sensor is well suited for measuring both outdoor and indoor temperatures.



Sensor, Ambient Temperature

Sensor, Irradiance This sensor is designed for measuring solar irradiated energy. In most cases the sensor is mounted on the frame of the solar module. Comparing the amount of irradiated power with the power produced by the inverter provides a detailed analysis on the performance of the PV system.

Sensor, Module Temperature This sensor measures the surface temperature of the PV modules. By affixing the sensor to the backside of the PV module, the module temperature can be measured. Module temperature can affect power output. By measuring module temperature one can monitor the effects on the solar system's performance.



Sensor, Irradiance



Sensor, Module Temperature



Datalogger & Interface (Box)



Interface Card / Box



Personal Display

Fronius

Data Communications and Accessories

Datalogger and Interface (Box) The Datalogger Interface box combines all the benefits of the Datalogger Pro and the full interface box. The Interface card is already in the datalogger housing, increasing the simplicity of installation and reducing the cost.

Interface Card/Box The Interface Box enables a user to output data into an open protocol for a system of anywhere between one and 100 Fronius IG Inverters. This data could then be used by third-party sources for different monitoring options (e.g. Fat Spaniel). This box does not replace the need for a Datalogger Box or Card. This interface offers real time open protocol data without data storage for up to 100 inverters and 10 sensor boxes.

Displays

Fronius IG Personal Display Wireless display for use with up to 15 Fronius IG Inverters. The Personal Display uses the same easy-to-navigate LCD as the inverter, and offers two levels of data – Easy and Pro – meaning homeowners will always have the right level of detail. Like other Fronius IG options, the Personal Display Card uses the Plug-and-Play area in the Fronius IG for easy integration. With a transmission range of up to 150 ft. indoors or 450 ft. outdoors, the Fronius IG Personal Display is the perfect accessory for any PV system. At night the Personal Display stores the data from earlier that day, meaning system output can be viewed at any time – day or night. The Personal Display is FCC compliant, so it will not interfere with other household devices. The Personal Display operates independent of or in tandem with the DatCom data communication system. The display comes complete with rechargeable batteries and charger.

Part #	Model	Description
Data Communications		
158004	Com Card	Internal plug-in card for data communications
158071	Datalogger Web	External network compatible device for collecting and archiving data (one inverter)
158005	Datalogger Pro Box	External device for collecting and archiving data from multiple inverters
158025	Datalogger Pro Card-R232	Internal plug-in card for collecting and archiving data from multiple inverters
158006	Datalogger Easy Box	External device for collecting and archiving data (one inverter)
158028	Datalogger Easy Card	Internal plug-in card for collecting and archiving data (one inverter)
Sensors		
158007	Sensor Box	External device for collecting sensor data
158057	Sensor Card	Internal plug-in card for collecting sensor data
158011	Sensor, Windspeed	External sensor for measuring wind
158012	Sensor, Ambient Temperature	External sensor for measuring ambient temperature
158013	Sensor, Irradiance	External sensor for measuring solar irradiated energy
158014	Sensor, Module Temperature	External sensor for measuring temperature of PV modules
Interfaces		
158016	Interface Box	External device used to output data to open protocol
158056	Datalogger and Interface Box	Combines Datalogger pro and Interface Boxes
158031	Interface Card	Internal plug-in card used to output data to an open protocol (multiple inverters)
158055	Interface Card Easy	Internal plug-in card used to output data to an open data protocol (single inverter)
Displays		
158018	Personal Display	Wireless display for up to 15 inverters
158017	Wireless Card	Internal plug-in card for use with Personal Display
158030	Public Display	Larger display for up to 100 inverters
Buss Bars for IG Plus Inverters		
158076		Buss bar for IG Plus inverter
158077		Buss bar with pair #4 lugs and hardware for IG Plus inverter



Enphase Energy

Microinverter System

Enphase Energy offers the leading Microinverter System for residential and commercial PV applications. Instead of the traditional, centralized inverter approach that converts power from strings of modules, microinverters convert the DC power from each individual module in a distributed approach. The system consists of three components: microinverter, communications gateway and remote monitoring system. The compact microinverters attach directly to solar modules or racking and are wired in parallel directly to a breaker panel sending individual module performance information to the Enphase Envoy communications gateway over a wireline network. The Envoy, mounted indoors, collects the data and transmits it through a broadband router to the Enlighten™ website, where users or installers can view and manage the performance of their solar power system 24/7. The Enlighten website automatically detects any shortfall in energy production, identifies possible causes, and sends email alerts. Microinverter system components carry an industry leading 15-year warranty.

Features include:

- Increased energy production, every microinverter has Maximum Power Point Tracking (MPPT)
- High reliability, no single point of failure, MTBF of 331 years, 99.8% system availability
- Simplified design, no string calculations needed, allows multiple roof pitches and orientations as well as module types

- Enables sites with some shade to be viable for solar
- Safety, no high voltage DC source wiring, reduced fire risk
- Lower installation cost, no DC disconnect or combiner boxes needed, less wiring time
- UL1741/IEEE1547, FCC Part 15 Class B
- Expansion architecture allows modules to be easily added
- Module level performance monitoring (first 3 months free).

M190 – The M190 microinverter is compatible with a wide range of 60 and 72 cell modules up to 230 watts STC. It comes in 208 Vac and 240 models. The 208 Vac model allows 21 microinverters to be connected together in a single branch circuit while the 240 Vac model allows 15 microinverters to be wired in a circuit. The two come with either MC3 or MC4 locking connectors.

M210 – The M210 microinverter is compatible with the 72 cell SANYO N-Series high efficiency module (HIP-200NKHA5, HIP-205NKHA5, HIP-210NKHA5, HIP-215NKHA5). The M210 in combination with SANYO N-Series modules constitutes one of the highest efficiency solar electric systems available. The 208 Vac model allows 18 microinverters to be connected together in a single branch circuit while the 240 Vac model allows 13 microinverters to be wired in a circuit. The M210 comes with MC4 locking connectors.

D380 “Twin Pack” – The D380 “TwinPack” is comprised of two microinverters with switchable inputs (208V or 240V) in a single enclosure and a trunk and drop cabling system. Lower balance-of-system costs and reduced installation time are realized by halving the number of microinverter units and fewer connections and junction boxes. The 12 AWG trunk cable enables 20A branch circuit allowing more modules per branch circuit –240v: 20 modules (10 TwinPacks); 208v: 30 modules (15 TwinPacks). The D380 comes with MC4 and Tyco Solarlock connectors.

Part #	Model	CEC Efficiency	Max. DC Input Voltage	Continuous Power Watts	AC Output Nominal Voltage	Dimensions	Weight (lbs.)
153027	M190-72-240-S13	95	54	190	240	8" x 5.25" x 1.25"	4.4
153021	M190-72-240-S12	95	54	190	240	8" x 5.25" x 1.25"	4.4
153023	M190-72-208-S12	95	54	190	208	8" x 5.25" x 1.25"	4.4
153026	M210-84-208-S12	95.5	62	210	208	8" x 5.25" x 1.25"	4.4
153007	M210-84-240-S12	95.5	62	210	240	8" x 5.25" x 1.25"	4.4
153032	D380-72-2LL-S12	95	54	380	208/240	12.25" x 6" x 1.33"	6.25
153033	D380-72-2LL-S13	95	54	380	208/240	12.25" x 6" x 1.33"	6.25
Communications							
153001	IEMU-02	Energy Management Unit, indoor enclosure					
153025	ELCF-120-001	Line Communication Filter, IEMU included					
Installation Kits							
153004	EKIT-01-001	240 VAC Installation Kit, AC branch circuit					
153005	K208-12-001	208 VAC Installation Kit, AC branch circuit					
Accessories							
153014	EEXC-01-06	6 foot cable extension					
153028	EEXC-01-20	20 foot cable extension					
153034	EEXC-G2-12	12 foot extension cable for D380 only					
153015	ECWP-01-06	6 foot AC Interconnect cable					
153016	ECWP-01-12	12 foot AC Interconnect cable					
153017	ECWP-01-20	20 foot AC Interconnect cable					
153006	EMBK-50-001	Mounting bracket (one)					
153024	ECAP-10-001	Sealing end caps (one)					

Advertisement



PVP1100-5200 string inverters with integrated disconnects

PV Powered

PVP1100 - 5200 String Inverters with Disconnect

PV Powered manufactures a broad line of residential inverters. Significant software integration and a modular design combine to create a scalable platform with relatively few components. By employing fewer parts and ensuring those parts are of high quality, PV Powered has created a line of residential grid-tied inverters that are both reliable and efficient. PV Powered most recent line features an integrated AC and DC system disconnect and other features aimed at lowering the total cost of installation. 10-year warranty.

Features include:

- ETL-listed integration platform saves installation time and errors
- Integrated AC and DC disconnects • Meets revised UL-1741 standard
- Customizable data monitoring interface improves branding and customer experience
- Easy Installation – includes wall mount brackets • No thermal fold back or power de-rating
- No neutral required with three-wire AC installations • Optional performance monitoring hardware
- Improved start up, shut down and MPPT algorithms deliver increased energy
- Field-configurable grounding scheme with simple jumper selection
- Steel indoor/outdoor NEMA 3R enclosure • Operating ambient temperature: -25°C to 40°C

Integrated AC and DC PV System Disconnect

PV Powered inverter-integrated AC/DC PV System Disconnect is listed to the UL 98 Standard. The UL 98 Standard, called “Enclosed and Dead-front Switches” ensures the integrated PV Powered

disconnect meets all installation and inspection requirements of a PV System Disconnect. Housed within an NEC Compliant wire raceway, PV Powered’s innovative disconnect consists of one enclosure with generous working room for installation. In addition to providing a single point of connection from the utility service and PV array, the wire raceway’s optimized knockout locations also provide options for side, bottom and back entry with minimized conduit bending. The wire raceway enables flush side-by-side mounting, eliminating the need for extra equipment and resulting in a cleaner, less expensive installation.

Features include:

- Listed to UL 98 Standard for use with PV Powered UL 1741 Listed string inverters
- Single AC/DC switch visible and lockable in the OFF position
- NEC Compliant internal wire raceway enables flush side-by-side mounting
- Direct-to-wall surface enclosure design allows for easy access and installation

PVM1010 Data Monitoring Module

Monitoring is available and includes secure web-based access to the system’s status and performance history. The PVM1010 monitoring option helps maximize system uptime and performance. The PVM1010 module integrates into the inverter and, along with the secure Internet-based server, is equivalent to stand-alone data logging meter and communication interface. Reports of power output and energy production trends, local weather conditions and forecasts, and export of data for service and maintenance planning are available over the Internet.

Features include:

- Low cost, integrated design • Remote monitoring over the Internet • No charge for monitoring service



PVP1010 monitoring system

Part #	Model #	CEC Efficiency %	Maximum DC Input Voltage	Continuous Power Watts	AC Nominal Voltage	Dimensions	Weight
159019	PVP1100	91.5	500	1100	120	30 3/8" x 15 5/8" x 8 1/4"	84.5
159020	PVP2000	92.5	500	2100	240	30 3/8" x 15 5/8" x 8 1/4"	92.5
159026	PVP2500	94.5	500	2500	240	30 3/8" x 15 5/8" x 8 1/4"	106.5
159021	PVP3000	93.5	500	3000	240	30 3/8" x 15 5/8" x 8 1/4"	106.5
159025	PVP3500	95.5	500	3500	240	30 3/8" x 15 5/8" x 8 1/4"	120.5
159024	PVP4600	95.5	500	4600	208	35" H x 18 1/8" x 8 5/8"	162
159023	PVP4800	96.0	500	4800	240	35" H x 18 1/8" x 8 5/8"	162
159022	PVP5200	96.0	500	5200	208	35" H x 18 1/8" x 8 5/8"	162
159011	PVM1010 Monitoring						

Advertisement



Xantrex GT Series

Schneider Electric (Xantrex)

GT Series Grid-Tie Solar Inverter

Xantrex single phase GT Series inverters convert photovoltaic (PV) electricity produced by solar modules into utility-grade power used by the home or sold to the local electrical utility. Available in 2.8kW, 3.3kW, 3.8kW, 4.0kW and 5.0kW models, the GT Series offers high efficiency (up to 95.5% CEC), clean aesthetics, 240 & 208 volt operation, high reliability backed with a 10-year warranty, compact size, and an NEC compliant integrated DC/AC disconnect. The GT Series may be installed as a single inverter, for a single PV array, or in a multiple-inverter configuration for larger PV arrays. Standard 10-year warranty.

Features include:

- Liquid crystal display (LCD) provides instantaneous information – LCD vibration sensor allows the tap of a finger to cycle through display screens. Displays power level, daily and lifetime, energy production, PV array voltage and current, utility voltage and frequency, time online “selling,” fault messages, and installer-customized screens
- Free PC software for remote monitoring and system troubleshooting available online
- Sealed, NEMA 3R outdoor inverter enclosure can be quickly separated from the wiring box allowing PV and utility connections to remain intact (includes wall-mount bracket)
- Operational temperature range: -25°C to +65°C • Convection cooled, no fan required

Part #	Model	Efficiency CEC % (240 / 208)	DC Input (V)	Continuous Power Watts CEC (240 / 208)	AC Output (V)	Dimensions	Weight
GT Single Phase - Aluminum Enclosure							
1500GT2.8	GT 2.8	94.0 / 93.5	195-550	2800 / 2700	240 / 208	28.5 x 16 x 5.7	49.0
1500GT3.3	GT 3.3	95.5 / 95.0	200-550	3300 / 3100	240 / 208	28.5 x 16 x 5.7	51.0
1500GT3.8	GT 3.8	95.0 / 95.0	195-550	3800 / 3500	240 / 208	28.5 x 16 x 5.7	58.0
1500GT4.0	GT 4.0	95.5 / 95.0	235-550	4000 / 3800	240 / 208	28.5 x 16 x 5.7	58.0
1500GT5.0	GT 5.0	95.5 / 95.0	235-550	5000 / 4500	240 / 208	28.5 x 16 x 5.7	58.0
152037	Xantrex GT Solar Inverter Monitor					6 x 4 x 1 9/16	0.5
GT100 & 250 - Three Phase - Steel Enclosure							
150028	GT100-208	95.0	300-600	100,000	208	73.3 x 67.0 x 46.1	3000
150029	GT100-480	96.0	300-600	100,000	480	73.3 x 67.0 x 46.1	3000
150030	GT250-480	96.0	300-600	250,000	480	86.3 x 90.0 x 46.1	4000

XW Hybrid Inverter/Charger

The XW Hybrid Inverter/Charger is the heart of the XW System. The XW Hybrid Inverter/Charger (XW) is a true sine wave, 120/240-volt AC, split-phase, inverter/charger that incorporates a DC to AC inverter, a battery charger, and an AC auto-transfer switch. It is the foundation for battery-based residential and commercial applications up to 18 kilowatts (kW). Capable of being grid-interactive or grid-independent, the XW can operate with generators and renewable energy sources to provide full time or backup power (includes 60A transfer relay). 5-year warranty.

Features include:

- NEMA 1 indoor enclosure
- Dual AC inputs/60A breakers
- Operational temperature range: -20°C to +70°C
- Integrated design, wall-mount bracket included
- XanBus™-enabled network communication
- Surge capacity: 2X power rating -10 seconds
- Certified to UL-1741 and CSA 107.1-01 for utility-interactive applications
- Efficient, power factor corrected, high-current, multistage battery charging
- Less than 8W idle consumption in search mode
- 230V - 50Hz models are available



Xantrex XW Inverter/Charger

Part #	Model	Efficiency (%)	DC Input (V)	Continuous Power (W)	Charger Current (A)	AC Output (V)	Inverter Dimensions	Weight
150013	XW6048-120/240-60	92.5 CEC (240/208)	48	5752 (CEC)	100	120/240	23 x 16 x 9	122
150014	XW4548-120/240-60	93.0 CEC (240/208)	48	4400 (CEC)	85	120/240	23 x 16 x 9	118
150015	XW4024-120/240-60	91.0 CEC (240/208)	24	4000 (CEC)	150	120/240	23 x 16 x 9	116
150041	XW6048-230-50	95.4	48	6000	100	230	23 x 16 x 9	122
150042	XW4548-230-50	95.6	48	4400	85	230	23 x 16 x 9	118
150035	XW4024-230-50	94.0	24	4000	100	230	23 x 16 x 9	116

XW Power Distribution Panel (XW PDP)

The XW Power Distribution Panel with conduit box is factory-wired and labeled to support a code compliant single inverter installation. Internal wiring and breakers can be added to expand the system to with up to three inverters, four charge controllers or other equipment to support larger systems, including three phase. Comes with an XW Conduit Box.

XW Solar Charge Controller (XW SCC)

The XW Solar Charge Controller tracks the electrical maximum power of a PV array to deliver the maximum available current for charging batteries. It can be used with 12, 24, 36, 48 and 60 volt DC battery systems. For a complete product description turn to page 77. Two controllers can attach to the right side of the XW-PDP.

XW Connection Kit (XW Connection)

The XW Connection Kit is a wiring kit and conduit box used to connect additional inverters into an XW Power Distribution Panel. The wires for a second inverter are pre-cut and labeled to facilitate easy installation. Longer custom-made cables for a third inverter must be supplied by the installer.

XW Conduit Box (XW Conduit)

The XW Conduit Box is a bare conduit box (no wires) that can be used to create systems larger than two inverters or to retrofit XW Inverters into existing systems which may already have AC/DC disconnects.

XW System Control Panel (XW SCP)

The XW System Control Panel is a Xanbus™-enabled device featuring a graphical, backlit LCD screen that displays system configuration and diagnostic information for all devices connected to the network. When installed as an XW System accessory, the XW SCP eliminates the need for separate control panels for each device and gives a single point of control to set up and monitor an entire XW Power System.

XW Automatic Generator Start (XW AGS)

The XW Automatic Generator Start is a Xanbus™-enabled device that can automatically activate a generator to provide an XW Series Inverter/Charger with power to recharge depleted batteries or assist with heavy loads. Compatible with popular generators, the XW AGS adds intelligence to power management and eliminates time spent monitoring batteries and inverter loads.



XW Power Distribution Panel



XW Solar Charge Controller



XW Connection Kit



XW Conduit Box



XW System Control Panel



XW Automatic Generator Start



Xantrex™ Communication Gateway

The Xantrex™ Communication Gateway bridges the gap between a Xantrex GT or XW System and the system owner's computer, making it the central component for a residential or small commercial remote monitoring system. The Gateway logs performance data directly from the Xantrex GT or XW System, and transmits it to the included Yahoo™ Widget based monitoring software for a simple and graphically rich view of system performance. The Gateway offers a web page with the ability to configure automated email reports and fault status to the user or installer. The Gateway includes both built-in Wi-Fi and Ethernet connectivity allowing for flexible and simple set up for wireless or wired connection to a router or direct to a PC.

Part #	Model	Item	Dimensions	Shipping Weight
152028	XWPDP	Power Distribution Panel w/Conduit Box	30 x 16 x 8.25	67
152029	XWCONN	Connection Kit – INV # 2	8.5 x 16 x 8.25	23
152001		XW Configuration Tool		
152030	XWCOND	Base Conduit Box	8.5 x 16 x 8.25	10
152032	XWSCP	System Control Panel	6 x 4 x 1.56	1
152033	XWAGS	Automatic Generator Start	3.75 x 5.75 x 1.5	1
152048		Xantrex Communications Gateway	4 x 6 x 1	1
152ACC007	CD60	Circuit Breaker 60A, 160 Vdc, Panel Mount		1
152ACC006	CD80	Circuit Breaker 80A, 125 Vdc, Panel Mount		1
152ACC005	CD125	Circuit Breaker 125A, 160 Vdc, Panel Mount		2

Schneider Electric (Xantrex)

Trace Series - TR

The Trace Series Inverter/Charger is an economical power conversion solution designed to provide dependable modified sine wave electricity to essential circuits in the home or business during a power outage. It can also be used in conjunction with a generator or any renewable energy source in an off-grid application. 2-year warranty.

- New digital display shows kilowatts (kW) when inverting and amps (A) when charging, plus incorporates a robust ON/OFF membrane switch and status indicators
- New power factor corrected (PFC) charging, combined with a more sophisticated multi-stage battery charging algorithm, reduces electricity draw and generator run-time
- Better thermal performance allows full output power to 50°C (122°F) without de-rating
- High surge capacity starts more difficult loads and handles overload conditions reliably
- Circuit boards are conformally-coated to protect them from corrosion for longer life & improved reliability
- Idle consumption in search mode <9W



TR Series Inverter/Charger

Part #	Model	Peak Efficiency CEC %	DC Input Voltage	Charger (Adj.) Current (Amps)	Continuous Power Watts	AC Output Volts	Dimensions	Shipping Weight
150017	TR1512-120-60	> 90	12	70	1500	120	8.4 x 21.6 x 7.7	40
150018	TR1524-120-60	> 92	24	35	1500	120	8.4 x 21.6 x 7.7	42
150019	TR2412-120-60	> 92	12	120	2400	120	8.4 x 21.6 x 7.7	40
150020	TR2424-120-60	> 93	24	70	2400	120	8.4 x 21.6 x 7.7	45
150021	TR3624-120-60	> 94	24	70	3600	120	8.4 x 21.6 x 7.7	45
150022	TR1512-230-50	> 92	12	70	1500	230	8.4 x 21.6 x 7.7	38
150023	TR1524-230-50	> 91	24	35	1500	230	8.4 x 21.6 x 7.7	38
150024	TR2424-230-50	> 94	24	70	2400	230	8.4 x 21.6 x 7.7	44
Accessories								
152044	TR-CONDUIT BOX							
152045	TR-REMOTE ON/OFF SWITCH							



Prosine 3.0 Inverter

Prosine Inverter/Chargers

Prosine inverter/chargers deliver clean true sine wave output power for all types of appliances along with three-stage charging (compatible with all battery types). Inverters include a full function remote control panel and built-in transfer switch. CSA/NRTL certified. All Prosine models CSA/NRTL listed to UL-1741, 458. AC output @ 120 Vac - 60Hz single phase. 2-year warranty.

The Prosine 3.0 has a no-load drain of approximately 60 watts and <3W in search mode. The remote on/off switch can be used so that these inverters are only powered up when needed. Temperature sensor optional on these models.

The Prosine 2.0 has a no load drain which is consistent to most sine wave inverters on the market and it only draws 20 watts of power to operate and <2W in sleep mode.

It includes the temperature sensor and a remote LCD control module/status display. All models are fan cooled and intended for AC hardwire connections.



Prosine 2.0 Inverter



Prosine Remote Control Panel

Part #	Model	Peak Efficiency %	Input Vdc	Continuous Power (Watts)	Surge 5 sec. (Watts)	Charger Current (Amps)	Dimensions	Shipping Weight
160000PS2000-12	Prosine 2.0	87	12	2000	4500	100	17.7 x 11 x 5.7	24
160000PS2000-12G	Prosine 2.0 w/GFCI outlets	87	12	2000	4500	100	17.7 x 11 x 5.7	24
160000PS3000-24	Prosine 3.0/24V	88	24	3000	4000	60	20.0 x 15 x 7.0	32



Prosine 1000 Inverter

Schneider Electric (Xantrex)

Prosine Inverters

Offering quality true sine wave output, the Prosine inverter is ideally suited for electrical systems that already have a quality multistage battery charger. Designed for recreational and industrial applications, its output is capable of handling both heavy duty and smaller, multiple AC loads. A removable LCD display can be mounted remotely for control and monitoring. The powersave mode draws only 1.5 watts under no load, < 22W - idle. CSA listed to UL-1741, UL-458 and CSA 107.1. Operating temperature range: 0°C to +60°C. All models are 120 Vac - 60Hz single phase output. 2-year warranty.

Part #	Model	Peak Efficiency %	Input Vdc	Continuous Power Watts	Surge (Watts)	Dimensions	Weight
160000PS100012G	Prosine 1000 w/GFCI	89	12	1000	1500	15.4 x 11.5 x 4.5	14.5
1600000PS1800-12	Prosine 1800	89	12	1800	2900	15.4 x 11.5 x 4.5	16.5
1600000PS1800-24	Prosine 1800	90	24	1800	2900	15.4 x 11.5 x 4.5	16.5
Models with hardware/15 amp AC Transfer Relay:							
160000PS1000-12	Prosine 1000 HW/TR	89	12	1000	1500	15.4 x 11.5 x 4.5	14.5
160000PS1000-24	Prosine 1000/24V HW/TR	90	24	1000	1500	15.4 x 11.5 x 4.5	14.5
160000PS180012H	Prosine 1800 HW/TR	89	12	1800	2900	15.4 x 11.5 x 4.5	16.5
160000PS180024H	Prosine 1800/24V HW/TR	90	24	1800	2900	15.4 x 11.5 x 4.5	16.5
Accessory							
160000PSRPNLI	Remote Interface Kit – includes 25' of cable						



Xantrex T240

Xantrex Accessories

Schneider Electric offers a number of accessories for their inverters. The T240 is a simple way to operate 240 Vac loads from a single inverter. It also works in reverse and can turn 240 Vac into 120 Vac, this allows the full output of a 240 Vac generator to be used for 120 Vac battery

chargers. Includes built-in dual pole 25 amp circuit breaker disconnect. UL listed to UL-1741, 2-year warranty.

Battery Temperature Sensors (BTS) are available as options for products which don't include the BTS standard, or as replacements when necessary. Ground fault protection fits into XW-PDP connection box.



Battery Temperature Sensor (photo left) PVGFP4 (left) and PVGFP1 (right)
Ground Fault Protection (photo right)

Part #	Model		Weight
152ACCBTS	BTS/15	Battery temperature sensor with 15' cable for TR, XW inverters & C Series Charge Controllers	1
152ACCBTS/35	BTS/35	Battery temperature sensor with 35' cable for TR, XW inverters & C Series Charge Controllers	1
152ACCDPVGFP1	PVGFP1	Ground fault protection, one pole for one solar array	4
152ACCPVGFP2	PVGFP2	Ground fault protection, two pole for two solar sub-arrays	5
152ACCPVGFP3	PVGFP3	Ground fault protection, three pole for three solar sub-arrays	6
152ACCPVGFP4	PVGFP4	Ground fault protection, four pole for four solar sub-arrays	7
152ACCT240	T240	120/240 step-up or step-down transformer	39.4



VFX Inverter



VFX Inverter, cover removed

OutBack Power Systems

Grid Interactive Inverters

GTFX and GVFX inverters provide automatic backup power when utility outages occur. The FX inverter from OutBack Power has established itself in the off-grid world. Now they bring their expertise to the multi-purpose grid-tie market place with the GTFX and the GVFX models that provide automatic back-up power when utility outages occur. The GTFX is sealed and includes a turbo fan kit. GVFX models are vented and have no fan. Use of an MPPT controller such as the OutBack's MX60 will greatly increase the energy harvested from the PV array. Maximum of two GTFX or GVFX inverters can be connected in series for 240 Vac split phase output. All models are ETL listed to UL-1741. 5-year warranty. Extended warranty available direct from manufacturer.

FX Series Inverters

OutBack Power's line-up of inverters has grown considerably over the past few years. Now six different power levels are offered at a variety of voltages ranging from 12 to 48 Vdc. All FX inverters offer pure sinewave output, a high current battery charger and AC transfer switch. Multiple pairs of FX inverters can be connected together (using HUB) configured for 220/240 Vac split phase output (using MATE) for a maximum of 10 inverters. Three FX inverters can be connected in parallel for 120 Vac single phase output or configured for 208 Vac three-phase output. All models have a single 60 Amp AC input and transfer relay. The gasketed die-cast aluminum chassis protects and keeps the power conversion components cool. Sealed units are water proof to IEC529 IP65 standards and have an operational temperature range of -40°C to -60°C. FX sealed inverters include external TURBO cooling system. "Bug-proof" vented version has stainless steel screens to protect the air intake and internal fan. The air inlet comes with a removable, washable foam filter insert. FX inverters are compatible with OutBack FLEXware enclosures and racks. Available in 120 Vac/60 Hz single phase, 230 Vac/50 Hz versions and mobile versions with built-in AC neutral/ground switching system. FX series can surge two times their power rating. Call for more information.

Part #	Model	Peak Efficiency%	DC Voltage Input	Continuous Power (Watts)	Charger Current (Amps)	Dimensions	Shipping Weight
Sealed							
715120	GTFX2524	91	24	2500	55	16.3 x 8.3 x 9.7	67
715122	GTFX3048	91 (CEC)	48	3000	35	16.3 x 8.3 x 9.7	67
715029	FX2012T	90	12	2000	80	16.3 x 8.3 x 13	67
715152	FX2524T	92	24	2500	55	16.3 x 8.3 x 13	67
715153	FX3048T	93	48	3000	35	16.3 x 8.3 x 13	67
Vented							
715121	GVFX3524	91	24	3500	85	16.3 x 8.3 x 9.7	62
715123	GVFX3648	91 (CEC)	48	3600	45	16.3 x 8.3 x 9.7	62
715096	VFX2812	90	12	2800	125	16.3 x 8.3 x 12	64
715097	VFX3524	92	24	3500	85	16.3 x 8.3 x 12	64
715098	VFX3648	93	48	3600	45	16.3 x 8.3 x 12	64
Sealed – 230Vac/50Hz							
715137	FX2012ET	90	12	2000	100	16.3 x 8.3 x 13	67
715037	FX2024ET	92	24	2000	55	16.3 x 8.3 x 13	67
715105	FX2348ET	93	48	2300	35	16.3 x 8.3 x 13	67
Vented – 230Vac/50Hz							
715061	VFX2612E	90	12	2600	120	16.3 x 8.3 x 12	64
715127	VFX3048E	92	24	3000	85	16.3 x 8.3 x 12	64
715132	VFX3024E	93	48	3000	45	16.3 x 8.3 x 12	64

Inverters

OutBack Inverter Accessories

HUB System Communications Managers

The HUB system communications managers are the backbone of your networked OutBack power conversion system. The OutBack HUB communicates stacking, load share and power save off/on signals. Interconnection cabling is standard Ethernet CAT5 with RJ45 modular jacks. Through the use of a HUB, your system is completely coordinated and managed by the MATE. HUB4 allows four combined inputs of inverter with charge controllers, HUB10 permits up to 10 combined inputs.



OutBack HUB System

FLEXnet DC

The FLEXnet™ DC is the ultimate in DC System monitoring devices. Integrated networked communications make valuable, usable data available from your system, viewable on an OutBack MATE communications device providing you with performance and efficiency information. FLEXnet DC easily integrates into either FW500-DC or FW1000-DC enclosures consuming one breaker space and can monitor up to three shunts. The FLEXnet DC features a programmable SPST auxiliary relay, data logging memory up to 128 days and allows you to easily see your systems current condition with at-a-glance displays including a:

Battery Status Screen-Easily see your system’s current condition with this at-a-glance display. This screen shows an easy to interpret “fuel gauge” style status bar, current state-of-charge and whether you are currently charging or discharging your batteries. This is useful for those system owners who want a way to quickly understand the current state of their battery bank.

Now Summary Screen-Monitor the amount of power your system is currently producing and consuming as well as the amount of power going IN and OUT of your battery bank. This screen also displays your battery bank’s voltage and current state-of-charge, providing you with real-time production monitoring of DC sources, such as a solar array or small wind turbine, as well as consumption by loads.

Today Summary Screen-Monitor the cumulative energy your system has produced and consumed as well as the total amount of energy that has gone to charging your batteries today. This screen also displays today’s lowest state-of-charge and allows you to see how your overall system production compares to system consumption.

History Summary Screen-Review historical energy production/consumption data for the most recent 128 days, including the minimum battery state-of-charge reached for each day. This screen can be used to watch power system production and consumption trends.

MATE

The Mate is a complete system controller and display for FX Inverters and OutBack charge controllers (see Controller section). MATE provides a display of operation, allows control and adjustment of inverter set points, coordinates entire system operation to maximize overall performance and prevents multiple products from conflicting. All MATE’s include a 3 ft. and 10 ft. long CATV.5e cable, 50 ft. cable sold separately.

A single MATE is able to connect to multiple FX inverters with a HUB communication manager. It includes a 4-line backlit LCD display, status LED indicators, opto-isolated RS232 port with a DB9 jack and real time clock with calendar allowing inverter programming for time of day or day of week. All programmed set points are stored in permanent memory. MATE has an off-white oval surface mount housing. MATE_B is same as MATE, but Black. MATE2 has a rectangular black flush mount housing, MATE2M is the same as MATE2, but for M series inverter/chargers. 2-year warranty.

Remote Temperature Sensor

The OutBack Remote Temperature Sensor (RTS) is a necessary tool for proper battery charging. All OutBack products with integrated battery charging have a temperature compensation system built-in which benefits from the installation of the optional RTS. The RTS ensures that your OutBack system knows the precise ambient temperature so that it can recharge your batteries safely and efficiently. Systems with multiple OutBack inverters/charge controllers connected to one HUB4 or HUB10 require only a single RTS to be installed.



FLEXnet DC



MATE



MATE2



Remote Temperature Sensor (RTS)

Part #	Model	Item	Unit Size	Weight
715215	FN-DC	FLEXnet DC Advanced System Monitor	.75 x 3.7 x 6.6	2
715068	MATE	Digital System Control and Monitor - Oval Surface Mount	5.75 x 4.25 x 2	1
715134	MATE_B	Digital System Control and Monitor - Black Oval Surface Mt.	5.75 x 4.25 x 2	1
715126	MATE2	Digital System Control and Monitor - Black Rect. Flush Mt.	5.75 x 4.25 x 2	1
715072	HUB4	OutBack Communication Manager - 4 Devices + MATE 1, 2	10.5 x 6.3 x 1.3	3
715093	HUB10	OutBack Communication Manager - 10 Devices + MATE 1, 2	10.5 x 6.3 x 1.3	3
715079	RTS	Remote Temperature Sensor - 15 ft. Cable	-	1
715102	OBCATV-3	Communications Cable CATV.5e - RJ45 plug, 3ft. Long	-	1
715089	OBCATV-6	Communications Cable CATV.5e - RJ45 plug, 6ft. Long	-	1
715133	OBCATV-50	Communications Cable CATV.5e - RJ45 plug, 50ft. Long	-	5

PLEASE NOTE: See pages 110 to 112 for additional OutBack inverter accessories.

Magnum Energy

Power Factor Corrected (PFC) Charger

The PFC charger is built into all of Magnum inverter chargers. It uses less energy from a generator than a standard charger – using 25-30% less AC current than standard chargers. All MS Series inverters/chargers are designed to operate with connection to either utility or gen-set. They are housed in a powder coated aluminum enclosure and base designed for indoor use.

MS Series

The MS Series Inverter/Charger – a pure sine wave, 120V-60Hz inverter designed specifically for the most demanding mobile and off grid applications or grid-connected back-up systems. -20°C to +60°C operating temperature range. MS Series idle power in search mode is 7W, no load is 25W. ETL listed to UL/cUL 458, UL-1741, CSA C22.2 #107.1-01. 3-year warranty.

MS-AE Series

The MS-AE 120/240V Series Inverter/Charger is a pure sine wave inverter designed specifically for the most demanding renewable energy applications. The unique design of the MS-AE Series can provide 120 or 240 volt split phase output in one unit, eliminating the need to stack two units together or adding transformers to obtain 240 volts. ETL listed to ANSI / UL-1741, CSA C22.2 #107.1-0. 3-year warranty.

RD Series

The RD Series Modified Sine Wave Inverter/Charger is a new generation inverter designed specifically for renewable energy use. The RD Series comes in four power models with either 12 or 24 volt inputs. It mounts on a shelf or wall. The lightweight aluminum base and cover also provides noise-reduction and corrosion resistance. ETL Listed to UL-1741. 2-year warranty.



MS Series shown with Remote Display



MS-AE Series Inverter/Charger



Magnum RD Series Inverter/Charger

Part #	Model	Peak Efficiency %	AC Output (Volts)	Input Vdc	Continuous Power	5 sec. Surge (Watts)	Charger Current (Amps)	Dimensions HxWxD	Shipping Weight
MS Series									
172011	MS2012	89	120	12	2000	3300	100	13.7 x 12.7 x 8	47
172003	MS2812	88	120	12	2800	3900	125	13.7 x 12.7 x 8	60
172000	MS4024	87	120	24	4000	5800	105	13.7 x 12.7 x 8	60
MS-AE Series									
172009	MS4024AE	90	120/240	24	4000	5800	105	19 x 17 x 12	60
172005	MS4448AE	93	120/240	48	4400	8500	60	19 x 17 x 12	60
RD Series									
172015	RD2212	95	120	12	2200	3700	110	19 x 17 x 12	42
172016	RD1824	94	120	24	1800	4000	50	19 x 17 x 12	40
172017	RD2824	93	120	24	2800	6000	80	19 x 17 x 12	47
172007	RD3924	93	120	24	3900	9000	105	19 x 17 x 12	58

Part #	Model	Description
Accessories		
172002	ME-AGS	Automatic Generator Start Module 2-relay/Network Version
172013	ME-AGS-S	Automatic Generator Start Module 2-relay/Stand Alone Version
172018	ME-AGS-N	Automatic Generator Start Module 3-relay /Network Version
172010	ME-CB	Conduit Box (White) for AC/DC
172001	ME-RC50	Digital LCD Display Remote Panel with 50' Cable
172021	ME-SSI	Series Stacking Interface - 120/240 Vac. Fits for 2 MS4024 Only.



ME-AGS



ME-RC50



Conduit Box

Inverters



SureSine Inverter

Morningstar

SureSine Inverter

The SureSine inverter, a pure sine wave inverter was designed specifically to meet the needs of rural PV electrification requiring AC power including solar home systems, schools, community centers and health clinics. This inverter is also a good choice for small PV systems for telecom, remote cabins and weekend homes, and RV/caravans and boats. CE compliant, UL, cUL listed. 2-year warranty.

Load Operation:

- Pure Sine Wave – Provides quality AC equivalent to grid power. A sine wave will extend the life of the household appliances (lights, TV, fans) and improve load performance.

- Toroidal transformer design – Generates good wave form throughout the range of input voltages.
- Outstanding Surge Capability – Handles a 200% surge during load start-up, to a maximum of 600 watts.

Power Available:

- High Efficiency – A high peak efficiency will reduce heating and make more solar energy available for powering loads.
- Low Self-Consumption – The SureSine consumes 450mA while powering loads. During no load conditions, solar energy is not wasted because the SureSine automatically powers down to stand-by mode, reducing self-consumption to one tenth of operating consumption. Self-consumption: No load = 450mA, Off = 25mA, Standby = 55mA.

High Reliability:

- Extensive Electronic Protections – The SureSine has extensive electronic protections that will automatically protect against faults and user mistakes such as short circuit, overload, high temperature and low voltage disconnect. Recovery from most faults is automatic.
- No Internal Cooling Fan – A key design objective since fans often fail in harsh environments and are noisy, consume power and blow dirt into the electronics.
- Tropicalization – The SureSine uses epoxy encapsulation, conformal coating, stainless steel hardware, and an IP20 cast anodized aluminum enclosure to protect against harsh tropical and marine environments.
- Operating temperature range: -40°C to +45°C

Part #	Model	Input VDC Watts	Continuous Power Watts	10 min. Surge	AC Output	Dimensions	Weight
320019	SI-300-115V-UL (60Hz)	12	300	600	115V @ 60Hz	8.4 x 6.0 x 4.1	10
320015	SI-300-220V (50Hz)	12	300	600	220V @ 50Hz	8.4 x 6.0 x 4.1	10
320021	RM-1	Remote meter with 30' cord					1.0



XP Series Inverter

Exeltech

XP Series

Exeltech XP Series are lightweight, high-performance, pure sine wave inverters that operate any type of load. All models are 120 Vac, 60 Hz. 85% efficiency, 100% solid state. These inverters include protection circuitry for over and under voltage, over temperature and short circuits. UL listed. Painted aluminum finish and a full 1-year parts and labor warranty.

Part #	Model	DC Input Voltage	Continuous Power Watts	AC Surge Voltage	No Load Power Draw (Watts)	Dimensions	Weight
170012XP125-12	XP125-12	12	125	150	5	7.9 x 4.9 x 2.2	2
170012XP125-24	XP125-24	24	125	150	5	7.9 x 4.9 x 2.2	2
170012XP250-12	XP250-12	12	250	300	6	12 x 5.2 x 2.8	5
170250XP250-24V	XP250-24	24	250	300	6	12 x 5.2 x 2.8	5
170600XP600-12V	XP600-12*	12	600	1100	8	12.1 x 7.7 x 3.6	7
170600XP600-24V	XP600-24*	24	600	1100	8	12.1 x 7.7 x 3.6	7
170012XP1100-12	XP1100-12*	12	1100	2200	20	15.1 x 7.7 x 3.6	10
170024XP1100-24	XP1100-24*	24	1100	2200	20	15.1 x 7.7 x 3.6	10

* Denotes that the inverter has a built-in cooling fan



ProStar

Morningstar

ProStar

Morningstar's ProStar is a mid-range PWM battery charging solar controller for both professional and consumer applications. This second generation ProStar adds new features and protections using advanced technology, providing longer battery life and improved system performance. Operating temperature: -40°C, +60°C. Built-in disconnect switch. Versions available: 15 or 30 Amp - 12/24 or 48 volt negative or positive ground. 5-year warranty.

- Features include:**
- Current compensated low voltage disconnect (LVD)
 - 100% solid state
 - Capable of 25% overloads
 - Remote battery voltage sense terminals
 - Allows #6 AWG wire.
 - 3-position battery select: gel, sealed or flooded
 - Temperature compensation - internal

- Electronic Protections:**
- Short-circuit — solar and load
 - Overload — solar and load
 - Reverse polarity
 - Reverse current at night
 - High voltage disconnect
 - High temperature disconnect
 - Lightning and transient surge protection
 - Loads protected from voltage spikes
 - Automatic recovery with all protections

Part #	Model	Battery Vdc	PV Amps	Load Amps	Dimensions	Weight
320015PS15	PS-15	12/24	15	15	6.0 x 4.1 x 2.1	1
320015PS15WM	PS-15M	12/24	15	15	6.0 x 4.1 x 2.1	1
320015PS15M48V	PS-15M-48V	48	15	15	6.0 x 4.1 x 2.1	1
320015PS15M48PG	PS-15M-48V-PG	48	15	15	6.0 x 4.1 x 2.1	1
320030PS30	PS-30	12/24	30	30	6.0 x 4.1 x 2.1	1
320030PS30WM	PS-30M	12/24	30	30	6.0 x 4.1 x 2.1	1
320030PS30M-PG	PS-30M-PG (Pos. Grnd.)	12/24	30	30	6.0 x 4.1 x 2.1	1



TriStar Controller with optional meter

TriStar Controller

The TriStar controller is a three-function controller that provides reliable solar battery charging, load control or diversion regulation. The controller operates in one of these modes at a time and two or more controllers may be used to provide multiple functions. The optional TriStar TS-M-2 and TS-RM-2 meter provides system and controller information and works with the TriStar, TriStar MPPT and the MeterHub. The controller is UL listed and is designed for both solar home systems and professional applications. UL, cUL listed. 5-year warranty.

Features include:

- Full function tri-color LED system status display
- Operational temperature range: -40°C, +60°C
- Rated to 60A at 48 Vdc, will handle solar arrays up to 4kW
- NEMA 1 indoor enclosure
- Fully adjustable – switch selectable setpoints
- Compatible with sealed and flooded batteries
- Simple mechanical interface – knockouts provided, #2 AWG wire lugs
- RS-232 connection
- Constant voltage series PWM algorithm
- Accessory digital meter connection via RJ-11 phone jack

TriStar MPPT Controller

The TriStar MPPT solar controller with TrakStar Technology™ is an advanced maximum power point tracking (MPPT) battery charger for off-grid photovoltaic (PV) systems up to 3kW. The controller provides a peak efficiency of 99% and low power loss, featuring a smart tracking algorithm that maximizes the energy harvest from the PV by rapidly finding the solar array peak power point with extremely fast sweeping of the entire I-V curve. UL, CE listed. 5-year warranty.

Features include:

- 45 or 60A at up to 150 volts open circuit
- Continuous operation at full power to 45° C with no derate
- Extensive protections, including PV short circuit protection
- Robust thermal design; no fans
- Optional TriStar meter and remote meter provides detailed operating data, alarms, faults
- Meterbus communications between compatible Morningstar products
- RS-232 communications to a PC
- EIA-485: communications between multiple devices on a bus (TS-MPPT-60 only)
- Ethernet: fully web-enabled interface to a local network or internet (TS-MPPT-60 only)

Part #	Model	Battery Vdc	PV Amps	Load Amps	Dimensions	Weight
320002	TS-45	12/24/48	45	45	10.3 x 5.0 x 2.8	3.5
320003	TS-60	12/24/48	60	60	10.3 x 5.0 x 2.8	3.5
320024	TS-MPPT-45	12/24/48	45	45	11.4 x 5.1 x 5.6	9.2
320025	TS-MPPT-60	12/24/48	60	60	11.4 x 5.1 x 5.6	9.2
320004	TS-Meter	12/24/48	N/A	N/A	4.5 x 4.5 x 0.78	1
320005	TS-Remote Meter	12/24/48	N/A	N/A	4.5 x 4.5 x 0.78	1
320026	TS-MPPT-Meter	12/24/48	N/A	N/A	4.5 x 4.5 x 0.78	1
320027	TS-MPPT-Remote Meter	12/24/48	N/A	N/A	4.5 x 4.5 x 0.78	1

Advertisement



SunSaver

SunSaver

SunSaver's technology provides reliable, 100% solid state PWM battery charging, and consistent high quality. The SunSaver's low cost design delivers outstanding performance and value. The SunSaver's low cost is made possible by Morningstar's unique approach to design and manufacturing. 5-year warranty.

Features include:

- Operating temperature range: -40°C, +85°C
- Versions available: 12 and 24 volts
- Rated for 25% overloads; no need to derate
- Fully epoxy encapsulated
- Marine rated terminals/anodized aluminum case
- Temperature compensation
- Sealed/Flooded battery select
- Approved for use in hazardous locations – Class 1, Division 2, Groups A, B
- Accepts #10 AWG wire

Part #	Model	LVD	Vdc	PV Amps	Load Amps	Dimensions	Weight
320006SS612	SS-6-12V	No	12	6.5	6	5.9 x 2.1 x 1.3	1
320006SS6LVD12	SS-6L-12V	Yes	12	6.5	6	5.9 x 2.1 x 1.3	1
320006SS1012	SS-10-12V	No	12	10	10	5.9 x 2.1 x 1.3	1
320006SS10LVD12	SS-10L-12V	Yes	12	10	10	5.9 x 2.1 x 1.3	1
320006SS10LVD24	SS-10L-24V	Yes	24	10	10	5.9 x 2.1 x 1.3	1
320006SS2012	SS-20L-12V	Yes	12	20	20	5.9 x 2.1 x 1.3	1
320006SS2024	SS-20L-24V	Yes	24	20	20	5.9 x 2.1 x 1.3	1



SunSaver Duo

Morningstar's SunSaver Duo is an advanced, four stage PWM dual battery back controller for RV's, caravans, boats and cottages. It will charge two separate and isolated batteries such as a "house" and an engine battery. When one battery is fully charged, the solar charging is switched to the other battery. The SunSaver Duo employs Morningstar's SunSaver controller technology. 5-year warranty.

Features include:

- Easy to read, backlit remote meter
- Epoxy encapsulated
- User adjustable settings
- Remote meter with 30' cord
- Optional remote temperature sensor
- Fuseless protection
- Operating temperature range: -40°C, +45°C

Part #	Model	Item	Vdc	Amps	Dimensions	Weight
320016	SSD-25RM	Controller with Remote Meter	12	25	6.7 x 2.2 x 1.6	1.5
320017	SSD-25	Controller only	12	25	6.7 x 2.2 x 1.6	1.0



SunSaver MPPT

SunSaver MPPT

Morningstar's SunSaver MPPT (15 Amps at 12/24 volts) solar controller with TrakStar Technology™ is an maximum power point tracking battery charger for off-grid photovoltaic (PV) systems. The controller features a smart tracking algorithm that maximizes the energy from the PV and also provides load control to prevent over discharge of the battery. The SunSaver MPPT is well suited for both professional and consumer PV applications. Its charging process has been optimized for long battery life and improved system performance. 5-year warranty.

Features include:

- Temperature compensation
- Compatible with high voltage PV modules and all battery types
- Records 30 days of PV system data logging
- Operating temperature range: -40°C, +60°C
- Converts 36V or 24V to 12V
- Epoxy encapsulated
- User adjustable settings
- Efficient MPPT tracking and four stage charging
- System status LED's

Part #	Model	Max. Voc	Battery Vdc	PV Amps	Load Amps	Dimensions	Weight
320018	SS-MPPT-15L	75	7 – 36	15	15	6.6 x 2.2 x 2.8	1.3
Accessory							
320021	RM-1	Remote meter w/30' cord (for Duo, MPPT, SureSine)					1.0



SunLight

SunLight

Morningstar's SunLight solar lighting controller combines the SunSaver design with a microcontroller for automatic lighting control functions. SunLight's technology provides high reliability, PWM battery charging. 5-year warranty.

Features include:

- Operating temperature range: -40°C, +85°C
- Fully automatic operation
- Special on/off/on, pre-dawn/at dusk functions
- Adjustable timer from 2 – 10 hours in 2-hour increments or dusk/dawn, 3+1, 4+2, 6+2 pre-dawn settings
- Field adjustable lighting control options
- Detects day and night using the PV array
- Suitable for sealed or flooded battery
- Low voltage load disconnect (LVD)
- Internally temperature compensated
- 5-minute day test button

Part #	Model	Vdc	Amps	Load Amps	Dimensions	Weight
320010SL1012	SL-10L-12V	12	10	10	6.6 x 2.1 x 1.3	1
320010SL1024	SL-10L-24V	24	10	10	6.6 x 2.1 x 1.3	1
320020SL2012	SL-20L-12V	12	20	20	6.6 x 2.1 x 1.3	1



SunKeeper

SunKeeper

Morningstar's SunKeeper is a three stage PWM charge controller that provides a low cost, regulated output directly from the solar module to maximize battery life in small solar applications. The SunKeeper is epoxy encapsulated and rated for outdoor use; designed for solar power systems in the oil and gas industry. By mounting directly to the module junction box and wiring through the junction box knockout, the connection is weather-proof and eliminates the need for an additional housing for the controller. 5-year warranty.

Features include:

- 6 or 12 Amp versions
- Certified for use in Class 1, Div. 2 hazardous locations
- Rated to 70°C
- Rugged IP65, UV resistant case

Part #	Model	Vdc	Amps	Dimensions	Weight
320013	SK-6	12	6	3.9 x 2.0 x 0.5	0.5
320012	SK-12	12	12	3.9 x 2.0 x 0.5	0.5



SunGuard

SunGuard

SunGuard provides reliable, 100% solid state PWM battery charging. It is distinguished by its small size and low cost. 5-year warranty.

Features include:

- ISO 9002 quality programs
- Temperature compensation
- Rated for 25% overloads: no need to derate
- Lightning protected with 1500 W transorbs
- Fully epoxy encapsulated
- ABS plastic, impact-resistant case
- Outdoor rated, Hypalon connecting wires

Part #	Model	Vdc	Amps	Dimensions	Weight
320004SG412V	SG-4	12	4.5	2.5 x 2.0 x 1.4	0.5

Morningstar Accessories



Remote Temperature Sensor



Relay Driver



MeterHub (Hub-1)



RSC-1

Part #	Model	Max. Vdc	System Voltage	Load Amps	Dimensions	Weight
320001	Remote Temperature Sensor				33 ft. wire length	1
320010	Relay Driver	68	12 – 48	8	6.4 x 3.2 x 1.3	0.5
320028	MeterHub (Hub-1)				5.3 x 4.3 x 1.5	0.5
320022	PC Meterbus Adaptor					0.5
320029	EIA-485/RS-232 Communications Adapter (RSC-1)		8-16		2.8 x 1.4 x .9	0.5



Solar Boost 50 with digital display & IPN Pro-Remote

Blue Sky Energy

Solar Boost™ Maximum Power Tracking (MPPT) charge controllers

All Blue Sky Energy controllers employ patented MPPT technology which offer high efficiency power conversion with filtered Pulse Width Modulation (PMW) charge voltage control. Electronic current limit protects against excess PV current and eliminates nuisance fuse blow. These controllers include conformal coated electronics to resist corrosion and are rated for full power at 40°C ambient, or 60°C at reduced power.

The Solar Boost 50, 3048 and 6024H are high power dual voltage 3-stage MPPT controllers with manual equalize capability. These controllers can charge a lower voltage battery from a higher voltage PV array, the 6024H is designed to charge 12 or 24V batteries. 3-year limited warranty.

Features include:

- ETL Listed to UL-1741, CSA, CE Labeled
- Powder coated chassis/anodized heatsink
- Operation temperature range: 0°C, +40°C
- User adjustable setpoints
- Optional temperature compensation

Part #	Model	Item	Voc	Battery Vdc	PV Amps	Dimensions	Weight
501SB5012/24V	SB50L	Controller	57	12/24	50	10 x 8.75 x 3.5	8.75
501SB50D12/24V	SB50DL	Controller w/display	57	12/24	50	10 x 8.75 x 3.5	9.0
501SB3048	SB3048L	Controller	140	24/48	30	10 x 8.75 x 3.5	8.75
501SB3048DL	SB3048DL	Controller w/display	140	24/48	30	10 x 8.75 x 3.5	9.0
501SB6024HL	SB6024HL	Controller	140	12/24	60	10 x 8.75 x 3.5	8.75
501SB6024HDL	SB6024HDL	Controller w/display	140	12/24	60	10 x 8.75 x 3.5	9.0
501SB50RD25	SB50RD25	Remote display - 25'				4.5 x 4.5 x 1.4	2.0
501SBATTEMPSSEN	Bat Temp Sensor	For all SB controllers (20' cable)					1.0
501SB50PDCOVER	SB50PDL	Display cover - converts SB50L into SB50DL					1.0
501SB30PDCOVER	SB3048PDL	Display cover - converts SB3048L into SB3048DL					1.0
501SB6024H	SB6024HPDL	Display cover - converts SB6024HL into SB6024HDL					



Solar Boost 3024i with digital display

The Solar Boost 3024i and 2512i(X) are mid sized 3-stage MPPT controllers and are based on Blue Sky Energy's Integrated Power Network (IPN) architecture which allows multiple controllers to communicate with each other and operate as a single coordinated charging machine. The 3024i and 2512iX can also provide flexible lighting control via a multi-function auxiliary output using the PV as the day/night sensor. An IPN-ProRemote is required as a setup tool to enable lighting control or configure certain parameters.

The 3024i provides automatic or manual equalization and is constructed in a white powder coated chassis with a black anodized heatsink. It is available with or without a digital display in the cover. The 3024iL includes a lighting control function. 2-year limited warranty.

The 2512i provides 3 stage charge control and is constructed on a clear anodized plate which mounts into the included 4 11/16" square electrical box. An attractive black powder coated wall mount box is also available. The SB2512iX is the full featured version of the product, with LVD load control, auto/manual equalization, full IPN network interface, temp sensor input and auxiliary charge output. 1-year limited warranty.

Features include:

- Auxiliary output provides (iX only): LVD load control, or flexible lighting control, or charges a second battery at 2 Amps
- IPN Network allows multiple controllers to coordinate charging, share single display & temp. sensor
- Compatible with IPN-Remote and IPN-ProRemote displays.
- User adjustable setpoints
- Optional temperature compensation sensor
- Optional wall mount box for 2512i
- Operation temperature range: -40°C, +40°C



Solar Boost 2512iX

Part #	Model	Battery Vdc	Voc	PV Amps	Load Amps	Dimensions	Weight
501SB2512I	SB2512i	12	35	25	-	5.3 x 5.3 x 2.4	1.3
501SB2512IX	SB2512iX	12	35	25	25	5.3 x 5.3 x 2.4	1.3
501930-0039-10	Wall Mount Box - 2512i						
501SB3024iL	SB3024iL	12/24	57	30	20	7 x 6.5 x 3.5	4.5
501SB3024DiL	SB3024DiL	12/24	57	30	20	7 x 6.5 x 3.5	4.5

Advertisement



IPN-ProRemote

Blue Sky Energy

IPN-ProRemote and IPN-Remote

The IPN-ProRemote is a full featured IPN compatible charge controller and battery system monitor which provides parameter setup and monitoring capability for up to 8 controllers. It provides a variety of battery and controller data capture functions and computes remaining battery amp-hours displayed as a “fuel gage” type indicator. Only one IPN-ProRemote may reside on a single IPN network. A 500A/50mV battery shunt is required. 2-year limited warranty. Features include:

- Backlit multi-line LCD display
- Accesses advanced controller parameters
- Monitors up to 8 controllers
- Complete battery system monitor
- Coordinates and displays charge control and battery monitor activities

The IPN-Remote is a low cost volt/amp display for IPN compatible charge controllers. Output current can show the total of all charge controllers on the IPN network, or the current of a single controller. Multiple IPN-Remote’s can reside on a single IPN network whether an IPN-ProRemote is present or not. LED display with auto night time dimming. Monitors up to 8 controllers. 1-year limited warranty.



IPN-Remote

Part #	Model	Dimensions	Weight
501SBIPNPRO	IPN-ProRemote	4.5 x 4.5 x 1.5	1.0
501SBIPNPRO-S	IPN-ProRemote w/shunt	4.5 x 4.5 x 1.5	2.0
501SBIPNREM	IPN-Remote	2.5 x 3 x 1.2	1.0

Solar Boost 2000E

The Solar Boost 2000E is a 2-stage constant voltage MPPT controller with manual equalize capability. A Charge Status LED shows when the unit is charging and when the battery is full. Flush mounting requires a cutout. May be surface mounted using optional black powder coated mounting box (Part # 5015B2000WMBOX). 3-year limited warranty. Features include:

- Large LCD digital display
- User adjustable setpoint
- Black anodized face plate
- Optional temperature compensation



Solar Boost 2000E

Part #	Model	Vdc	Amps	Dimensions	Weight
501SB200012V	SB2000E	12	25	4.6 x 6.4 x 1.8	2.0
501SB2000WMBOX	Wall Mount Box for SB2000			2.75" deep	2.0

OutBack Power Systems

FLEXmax Maximum Power Point Tracking Charge Controller - FM60/FM80

The FLEXmax FM60/FM80 are the latest innovation in Maximum Power Point Tracking (MPPT) charge controllers from OutBack Power Systems. The FLEXmax MPPT software algorithm is both continuous and active, increasing your photovoltaic array power yield up to 30% compared to non-MPPT controllers. With new enhanced cooling management, FM60/FM80 charge controllers can operate at their maximum current rating, 60 amps or 80 amps respectively, in ambient temperatures as high as 104°F (40°C). FLEXmax controllers will de-rate power capacity automatically above 40°C to 60°C maximum and are designed to charge nominal battery voltages of 12, 24, 36, 48 or 60 Vdc with fully adjustable set points for battery type. They can also charge a lower voltage battery from a higher voltage PV array with maximum PV open circuit voltage of 150 Vdc (Voc) in the coldest conditions. FLEXmax controllers can be configured for positive ground PV systems (cannot be used with HUB for positive grounding).

A built-in backlit 80 character digital meter displays the current system status and data-logging performance for the last 128 days. Integrated network communications (using CAT5e/RJ45) allows FM60/FM80 controllers to be remotely programmed and monitored via a MATE system display. Indoor type 1 enclosure includes a 1” knockout in rear, left side and two at bottom. UL-1741 listed USA/CAN. Standard 5-year warranty with a 5-year extension available.



FLEXmax FM80

Part #	Model	Vdc	Max Current Rating	Max PV Power (Watts) at STC			Size L x W x D	Weight
				12V	24V	48V		
715228	FM60-150	12 to 60	60A	900	1800	3600	13.5 x 5.8 x 4.0	11.7
715217	FM80-150	12 to 60	80A	1000	2000	4000	16.3 x 5.8 x 4.0	12.2

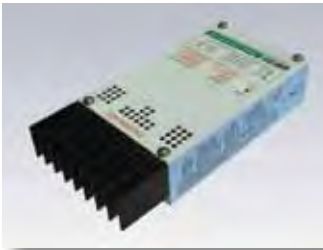

Xantrex C-Series

Schneider Electric (Xantrex)

C-Series Charge, Diversion or Load Controllers

The C Series pulse width modulated (PWM), field adjustable controllers work as a solar charge regulator or a DC load controller or a battery diversion controller. In controller mode all models automatically initiate a three-stage battery charging cycle. A manual switch makes routine battery equalization easy. The C Series is used extensively in micro hydro and wind generator applications where basic diversion control is desired. All models feature a LED status light which displays charging functions and battery state-of charge. Control set points are adjustable by trim-pots. BTS option adds battery temperature compensation to all models. UL listed to UL-1741. 2-year limited warranty.



Xantrex C12

C12 – PWM 3 stage solar charge, DC load and auto lighting controller

The C12 has an LED status light displaying both charging functions and battery charge state at a glance. The load control function (LVD) will disconnect DC loads if batteries reach low-voltage condition and reconnect once batteries are recharged. A simple one-time reconnect switch turns power back on for ten minutes once in LVD. An optional temperature sensor ensures precise battery charging regardless of battery temperature fluctuations. Field adjustable set points with removable knobs. Automatic reset of overload protection. Automatic control of lighting systems with adjustable run duration from 2 to 8 hours or dusk to dawn. ETL listed to UL-1741. 2-year limited warranty.

Part #	Model	Battery Vdc	PV Amps	Load Amps	Dimensions	Weight
152ACCC12	C12	12	12	or 12	6.3 x 4.3 x 1.5	2.0
152ACCC35	C35	12/24	35	or 35	8.0 x 5 x 2.5	2.5
152ACCC40	C40	12/24/48	40	or 40	10 x 5 x 2.5	3.0
152ACCC60	C60	12/24	60	or 60	10 x 5 x 2.5	3.0
Xantrex Accessories						
152ACCCDVMC40	CM	Controller mounted LCD digital display for C35, C40 & C60				1
152ACCC40R50	CM/R-50	Remote LCD digital display with 50' cable for C35, C40 & C60				2
152ACCC40R100	CM/R-100	Remote LCD digital display with 100' cable for C35, C40 & C60				3
152ACCBTS	BTS/15	Battery Temperature Sensor with 15' Cable				0.5
152ACCBTS35	BTS/35	Battery Temperature Sensor with 35' Cable				0.5

XW Solar Charge Controller

The Xantrex XW Solar Charge Controller (XW SCC) is a photovoltaic (PV) charge controller that tracks the electrical maximum power point of a PV array to deliver the maximum available current for charging batteries. When charging, the XW SCC regulates battery voltage and output current based on the amount of energy available from the PV array and state-of-charge of the battery. The XW SCC can be used with 12, 24, 36, 48, and 60-volt DC battery systems and is able to charge a lower nominal-voltage battery from a higher nominal-voltage array. For example, the XW SCC can charge a 12-volt battery from a 36-volt array. This provides flexibility for installers to use longer wiring runs without compromising efficiency. The XW Solar Charge Controller can be installed (in single or multi-unit configurations) with Xantrex XW Hybrid Inverter/Charger(s) or can be used in other solar energy systems where a solar charge controller is needed. The XW SCC incorporates a dynamic Maximum Power Point Tracking (MPPT) algorithm designed to maximize energy harvest from the PV array. 5-year warranty.

Features:

- Operating temperature range: -20°C, +45°C • Integrated PV ground-fault protection
- Communicates settings and activity to other Xanbus™-enabled devices, such as the XW Hybrid Inverter/Charger, the XW System Control Panel (XW SCP), XW Automatic Generator Start (XW AGS), and other XW Solar Charge Controllers (CAT5e cable interconnections)
- Ultra-reliable, convection cooled design does not require a cooling fan. Large, aluminum, die-cast heat-sink allows full output current up to 45°C without thermal derating, indoor enclosure.



XW SCC

Part #	Model	Battery Vdc	Voc	Amps	Dimensions	Weight
152031	XW-MPPT-60-150	12 – 60	150	60	14.5 x 5.75 x 5.5	10.8

Steca

Steca Solsum Controller

The Steca Solsum Controller is an economical pulse-width modulated shunt controller designed for small and mid-sized systems. The overcharge protection operates as a pulse-width-modulated (PWM) shunt controller and guarantees faster charging of the battery. A tricolor LED indicates three ranges of battery voltage and a green LED indicates array current. These controllers include temperature compensated charging, MOSFET transistors and fuse protection. Other features include automatic adjustment for 12 or 24 Vdc systems, protection against extreme temperature, battery voltage, module overcurrent and load current. Temperature compensated overcharge and over-discharge protection is also built in. Solsum Controllers, certified for World Bank projects, ensure maintenance-free operation and long product life. 2-year warranty.



Steca Solsum 6.6 LVD

Part #	Model	Vdc	PV Amps	Load Amps	Dimensions	Weight
321008SOLSUMLVD	Solsum 8.8F	12/24	8	8	3.3 x 3.9 x 1.3	.5
321005SOLSUMLVD	Solsum 6.6F	12/24V	6	6	3.3 x 3.9 x 1.3	.5

Steca Solarix PRS Controller

The simplicity and high performance of the new Steca Solarix PRS solar charge controller make it particularly attractive. Several LEDs in various colors emulate a tank display, which gives information on the charge status of the battery. Steca's latest algorithms are employed in order to guarantee optimal battery maintenance. The Solarix PRS charge controllers are equipped with an electronic fuse, thus ensuring the optimal protection. For larger projects, the charge controllers can also be equipped with special functions. These include the night light function and selectable charging plateau and deep discharge protection voltages. 2-year warranty.



Steca Solarix PRS 3030

Part #	Model	Vdc	PV Amps	Load Amps	Dimensions	Weight
321071	Solarix PRS 1010	12/24	10	10	7.4 x 3.8 x 1.8	1.0
321072	Solarix PRS 1515	12/24	15	15	7.4 x 3.8 x 1.8	1.0
321073	Solarix PRS 2020	12/24	20	20	7.4 x 3.8 x 1.8	1.0
321074	Solarix PRS 3030	12/24	30	30	7.4 x 3.8 x 1.8	1.0

Steca PR Controller

The Steca PR charge controllers were launched in the year 2004 as the fifth generation of charge controller technology (up to 900Wp). This high class state-of-the-art product upgrades the Steca Solarix series by a customer-designed LCD which show the accurate state of charge (SOC) in percent and as battery gauge symbol. The heart of the controller is the integrated circuit called ATONIC-II, which contains the improved regulation software based on a self learning algorithm. 2-year warranty.



Steca PR 3030

Part #	Model	Vdc	PV Amps	Load Amps	Dimensions	Weight
321010PR1010	PR 1010	12/24	10	10	7.4 x 4 x 1.9	1
321015PR1515	PR 1515	12/24	15	15	7.4 x 4 x 1.9	1
321020PR2020	PR 2020	12/24	20	20	7.4 x 4 x 1.9	1
321030PR3030	PR 3030	12/24	30	30	7.4 x 4 x 1.9	1

Steca Tarom Controller

The Steca Tarom is the high end solar charge controller optimally designed for demanding telecom applications and complex off-grid PV hybrid system architectures. A huge variety of exiting features allows the user to adapt this controller to the special needs of the specific installation. The optimised SOC calculation of Steca is implemented in the Tarom. Additionally it is possible to connect further devices like a temperature sensor, a data logger and a remote switch to configure and monitor the photovoltaic system optimally. A built-in Ah counter gives additional valuable energy balance information to the user. 2-year warranty.



Part #	Model	Vdc	PV Amps	Load Amps	Dimensions	Weight
321035TAROM235	Tarom 235	12/24	35	35	7.4 x 5 x 1.9	1
321045TAROM245	Tarom 245	12/24	45	45	7.4 x 5 x 1.9	1
321009	Tarom 440	48	40	40	7.4 x 5 x 1.9	1

Specialty Concepts

Automatic Sequencing Charger™ (ASC)



ASC Charger

The Automatic Sequencing Charger™ (ASC) is a very compact, efficient 100% solid-state battery charger regulator for use in PV systems. The ASC is a negative-ground switching shunt regulator, housed in an anodized aluminum chassis and encapsulated in a hard epoxy resin. The terminal block accepts up to 10-gauge wire or a space connector, providing simple installation. The ASC is FM approved for Class I / Div II hazardous locations, UL listed, and provides lightning and reverse leakage protection. The ASC PLUS features a low-voltage load disconnect, a waterproof battery fuse, and a linear LED display indicating battery status.



Mark 15

The MARK/15™ is a solid-state charge controller for use in PV systems with currents up to 15 amps. It includes a full-featured LCD meter to display battery voltage, array current and charge set-point. It is intended to flush-mount within a wall for a very distinctive appearance. General specifications include fuse protection on both battery and array and bar graph battery condition indicator. The Mark/15 is UL recognized.

The MARK/22 is similar to the MARK/15 but is rated for 22 amps of PV current. It also has a low-power consumption LCD digital display, which can show two different system parameters- battery voltage and array current.

Part #	Model	Description	Voltage	PV Amps	Load Amps	Dimensions	Weight
305004ASC12-4	ASC-12/4	Charge Controller – 4A	12	4	N/A	6" x 3.5" x 3"	1.0
305004ASC12-8	ASC-12/8	Charge Controller – 8A	12	8	N/A	6" x 3.5" x 3"	1.0
305008ASC12-8A	ASC-12/8 A	Charge Controller Temp Compensation	12	8	N/A	6" x 3.5" x 3"	1.0
305008ASC12-8AE	ASC-12/8 AE	Charge Controller w/ Temp Comp, LVD	12	8	10	6" x 3.5" x 3"	1.0
305008ASC12-8E	ASC-12/8 E	Charge Controller w/ LVD	12	8	10	6" x 3.5" x 3"	1.0
305012ASC12-12	ASC-12/12	Charge Controller – 12A	12	12	N/A	6" x 3.5" x 3"	1.0
305012ASC12-12A	ASC-12/12 A	Charge Controller Temp Compensation	12	12	N/A	6" x 3.5" x 3"	1.0
305012ASC1212AE	ASC-12/12 AE	Charge Controller w/ Temp Comp, LVD	12	12	10	6" x 3.5" x 3"	1.0
305012ASC1212E	ASC-12/12 E	Charge Controller w/ LVD	12	12	10	6" x 3.5" x 3"	1.0
305016ASC12-16	ASC-12/16	Charge Controller – 16A	12	16	N/A	6.5" x 5" x 3"	1.0
305016ASC12-16A	ASC-12/16 A	Charge Controller Temp Compensation	12	16	N/A	6.5" x 5" x 3"	1.0
305016ASC1216AE	ASC-12/16 AE	Charge Controller w/ Temp Comp, LVD	12	16	10	6.5" x 5" x 3"	1.0
305016ASC1216E	ASC-12/16 E	Charge Controller w/ LVD	12	16	10	6.5" x 5" x 3"	1.0
305008ASC24-8	ASC-24/8	Charge Controller – 8A	24	8	N/A	6" x 3.5" x 3"	1.0
305008ASC24-8A	ASC-24/8 A	Charge Controller Temp Compensation	24	8	N/A	6" x 3.5" x 3"	1.0
305008ASC248AE	ASC-24/8 AE	Charge Controller w/ Temp Comp, LVD	24	8	10	6" x 3.5" x 3"	1.0
305008ASC24-8E	ASC-24/8 E	Charge Controller w/ LVD	24	8	10	6" x 3.5" x 3"	1.0
305016ASC24-16	ASC-24/16	Charge Controller – 16A	24	16	N/A	6.5" x 5" x 3"	1.0
305016ASC2416A	ASC-24/16 A	Charge Controller Temp Compensation	24	16	N/A	6.5" x 5" x 3"	1.0
305016ASC2416AE	ASC-24/16 AE	Charge Controller w/ Temp Comp, LVD	24	16	10	6.5" x 5" x 3"	1.0
305016ASC2416E	ASC-24/16 E	Charge Controller w/ LVD	24	16	10	6.5" x 5" x 3"	1.0
305012SC3/15-12	MARK/15-12	Charge Controller – 15A	12	15	N/A	9.5" x 6" x 4"	1.25
305012SC3/20-12	MARK/22-12	Charge Controller – 22A	12	22	N/A	9.5" x 6" x 4"	1.5



Apollo Solar T80 Turbocharger

Apollo Solar

MPPT Battery Charge Management System

The Apollo Solar T80 TurboCharger and T80HV TurboCharger are premium MPPT charge controllers designed especially for large power systems. The T80 and T80HV integrate Maximum Power Point Tracking, battery charge management, state of charge information and communications into a single device. With 80 Amps continuous output, they have the largest capacity in the industry.

The T80HV is the only MPPT charge controller that works with the newer higher voltage PV modules. For example, the SANYO HIT BA19 200 modules have a Vmp of 51.75v at 50°C which will not charge a 48 volt battery, but they generate up to 79.88 volts open circuit at -40°C. Two of these modules in a series string will generate 103 volts at Vmp, but the Voc is almost 160 volts, which will destroy 140/150 volt charge controllers. The T80HV is designed to operate up to 200 Voc and 160 Vmp and works with the SANYO HIT modules. 5-year warranty.

Features include:

- Up to 16 T80's or T80HV's can be paralleled for higher currents
- Continuous power rating up to 45°C
- Patent pending MPPT
- Supports flooded lead-acid, gel & absorbed-glass-mat batteries in 12, 24, 36 & 48 Vdc configurations
- Four-stage charging with adjustable set points for all parameters
- Built-in energy monitors using TriMetric Technology
- Wireless remote communications including system data monitoring (see below)
- Firmware updates via the full-featured Apollo Solar Remote Data Display and the Internet.

Installers like the integrated energy monitor, the automatic one-minute set-up, the fail-safe calculated defaults, the optimized MPPT energy harvest, the Wireless Remote Display, and the 80/100 Amps at higher temperatures. The internal temperature-controlled variable speed fan runs just fast enough to maintain optimum reliability.

Part #	Model	Battery Voltage Vdc	PV Amps	Max. Voc	Dimensions	Shipping Weight
304001	T80	12 to 48	70	140	15.3 x 8.3 x 4.2	22
304014	T80HV	12 to 48	70	200	15.3 x 8.3 x 4.2	22



Apollo Solar Wireless Remote Display

Apollo Solar Wireless Remote Display

In a convenient, portable unit, the Apollo Solar Wireless Remote Display monitors the PV-Battery System from anywhere by tracking power production and consumption and then calculating the energy remaining in the battery. The data showing the comprehensive status of the PV Array, the controller, and the battery system is transmitted via WiFi from the battery energy meter that is built into the Apollo Solar T80 charge controllers.

Available in two models, the RD100 and the RD300, the Wireless Remote shows State-of-Charge (SOC) in Percent Full, Amp-Hours, and Bar-Graph format, an easy-to read "gas gauge" essential for optimal performance of battery-based systems. Also displayed are the PV current and voltage as well as the battery charge/discharge amps.

Part #	Model	Distance Range	SD Memory Card	Environmental Rating	Dimensions	Weight
304003	RD100	300 ft outside/ 100 ft in buildings	Up to 2.0GB	Indoor Type 1	7 x 4 x 2.5	1.4
304009	RD300	1 mile outside/ 300 ft in buildings	Up to 2.0GB	Indoor Type 1	7 x 4 x 2.5	1.4
304004	Wired	1000 feet (Cat5 cable)	Up to 2.0GB	Indoor Type 1	7 x 4 x 2.5	0.75
304006	ASNET Network Kit includes Network option card and a 7' CAT5 cable - 1 kit required per parallel T80					??
304002	Battery Temperature Sensor					1.0



CML Series

Phocos

CML Solar Charge Controller

The CML series is a sophisticated solar charge regulator family for low cost applications. The electronic circuit is equipped with a microcontroller that provides high-efficiency charging technology together with a number of outstanding status display, warning and safety functions. The temperature-compensated three-stage PWM charging method (boost-equalization-float) is adjustable to sealed and vented lead-acid batteries. The controller allows either an SOC or voltage controlled low voltage disconnect function. The battery status is clearly indicated by three LEDs. Model CML20-2.1 comes with an acoustic low voltage load disconnect (LVD) pre-warning feature. 1-year warranty.

Part #	Model	Vdc	PV Amps	Load Amps	Dimensions	Weight
307000	CML20	12/24	20	20	3.2 x 3.9 x 1.3	1
307002	CML20-2.1	12/24	20	20	3.2 x 3.9 x 1.3	1



CMM Series

CMM Remote Display

Phocos' CMM multi-meter is designed to measure and display panel current, load current and battery voltage of your PV system as true values. This provides you more detailed information of your PV system. 1-year warranty.

Part #	Model	Voltage Range	Current Range Amps	Case Protection	Connection Wire Length	Dimensions	Weight
307001	CMM	0 – 35	0 – 25	IP22	20 feet	3.3 x 1.7 x 1.3	1



MPPT

Maximum Power Point Tracker

With innovative maximum-power-tracking technology, Phocos' MPP tracker ensures maximum performance from your solar array at all times and in all weather conditions. The MPPT can yield an energy gain of up to 30% from your PV array (with the average gain being 10%-25%). MPPT includes a sweep-function which runs through the whole solar-panel voltage range once every 2h to find the point of the absolute maximum power output. When a Master Controller is used, up to 16 MPPTs can be operated in parallel. This will enable you to increase your system capacity substantially. The charge regulation of each MPPT unit can be controlled by a master controller via data bus. The temperature-compensated three-stage I-U curve charge regulation algorithm significantly extends the lifespan of your battery.

Can be used to charge solar-panels with up to 95V open circuit voltage for 12V or 24V stand-alone battery systems will significantly reduce the cost of the total system.

Part #	Model	Battery Voltage	Voc	Amps	Peak Efficiency	Dimensions	Weight
307005	MPPT100/30	12/24	95	30	Up to 97%	7.3 x 5.9 x 4.5	6



Rogue 1950-136

Rogue Engineering

SLA LVD Battery Charger

Rogue Engineering's Sealed Lead Acid (SLA) Battery Charge Regulator with Low Voltage Disconnect (LVD) option is designed to be powered by a solar panel or AC adapter and charges 12 or 24 volt batteries in both cyclic and standby/backup applications. It switches from fast charge to float charge mode when batteries are fully charged and the output voltage automatically adjusts to compensate for temperature of battery. The SLA LVD optimizes battery performance and service life.

Features include:

- Pluggable connectors allow for easy installation
- Operates in temperatures between -40°C and 60°C
- Less than 400 microamps self-consumption
- LED's to indicate: Reverse battery, Low Voltage condition, 2-color LED showing fast and float charge conditions.
- LV alert relay contact on all 10A models
- Class I / Div II approved on 5A model



1950-143

Part #	Model	Vdc	PV Amps (Adc)	Load Amps (Adc)	Dimensions (W x L x H)	Weight
308001	1950-136	6/12	5	N/A	3.5 x 2.5 x 1.9	1
308002	1950-143	12	5	5	5.25 x 2.75 x 1.9	1
308003	1950-145	24	5	5	5.25 x 2.75 x 1.9	1
308004	1950-162	12/24	10	10	5.25 x 2.75 x 1.9	1



Xantrex LinkLITE

Xantrex

LinkLITE/LinkPRO

The LinkLITE and LinkPRO selectively display: voltage-3% accurate, charge and discharge current – 4% accurate, consumed amp-hours and remaining battery capacity of your 12 or 24V battery bank. A second battery input is provided to monitor voltage on a second battery. A new shunt selection feature enables the LinkPRO to measure currents up to 10,000 Amps. Equipped with an internal programmable alarm relay, to run a generator when needed or to turn off devices when the battery voltage exceeds programmable boundaries. CE certified. 1-year warranty.

Standard features LinkLITE and LinkPRO:

- Provides critical information about the status of your battery bank
- Displays voltage, current, amp-hours and remaining capacity
- Two battery inputs
- Auto sensing battery voltage inputs
- Large backlit LCD Display
- Quick nut-mounting construction
- Programmable alarm relay
- 500 Amp shunt included
- Displays time remaining
- Communication/expansion port
- Battery temperature sensor input



Xantrex LinkPRO

Part #	Model #	Input Voltage VDC	Input Current Range +/- ADC	Self Consumption at 12 Vdc	Self Consumption at 24 Vdc	Size Dia. x L	Weight
152013	LinkLITE	0 - 35	999	9ma	7ma	2.54 x 3.11	0.53
162006	LinkPRO	0 - 35	9999	9ma	7ma	2.54 x 3.11	0.53
Accessories							
152026	854-2021-01	Connection Kit - 50 ft.					
152018	854-2022-01	LinkPro and XBM 32 ft Temperature Sensor					
152017	854-2019-01	LinkPro and XBM Communication Kit					



Xantrex TM500A

TM500A Digital Energy Meter

The TM500A is both an energy supply “fuel gauge” and a sophisticated user-option “energy storage computer” that records system characteristics and data. It provides data on all critical system functions, and is capable of monitoring total accumulated charge power from sources such as photovoltaic arrays, wind power systems, and generator sets. The TM500A comes with 50’ (15 m) of cable, a Deltek 50 mV/500 Amp shunt, a pre-wired cable, and a plug-in adapter board.

- Battery Voltage: 8 to 32 Vdc or to 70 Volts DC with optional 48 Vdc adapter
- Net Battery Current: 0.1 to 999 Amps DC
- Battery Charge Level: 5% increments
- Cumulative Amp Hours: Monitors battery bank use and provides estimated battery life information
- Days since Full: Days since the battery bank was fully charged—encourages proper battery management by indicating system problems
- Battery Highest Voltage: Resettable, monitors charge controllers and battery chargers
- Battery Lowest Voltage: Resettable, monitors system to detect malfunction or system failure

Part #	Model	Dimensions	Weight
152ACCTM500W/S	TM500A - with shunt, 50’ cable, shunt board	3.9 x 5.4 x 1.3	2.5
152ACCTM500NSDC	TM500A-NS - no shunt, 50’ cable, shunt board	3.9 x 5.4 x 1.3	2.5
152ACCTM48VDC	TM-48 - high voltage shunt board for 48Vdc systems	—	1.0

System Spotlight

LOCATION:
Southern California

APPLICATION:
Monitoring for a water input line

SYSTEM:
PR300-24-240-FPWA-111
SunWize® Power Ready System
Installed by Second Sight



Bogart Engineering

TriMetric TM-2020 Battery Meter

The TriMetric battery monitors are designed to assist in battery care, conservation, and system maintenance of battery powered systems. The TM-2020 measures volts, amps, and amp-hours and features a “battery % full” display and a “battery reminders” display.

Part #	Model	Voltage	Dimensions	Weight
510ACCTRI MET	TM-2020	12-24	4.8 x 4.5 x 1.8	1.0
510ACC48VADPTRI	48V Adapter - Use to adapt MT-2020 for 48 Vdc use			
510ACCWIREBOX	Wiremold Box for flush mounting TM-2020			



TriMetric TM-2020 with optional box

PentaMetric

The new PentaMetric battery monitor system offers a lot more capability than the TriMetric monitor. A wall mount enclosure is included. It measures 1 or 2 battery systems with a common negative. With one battery system, battery current plus two charging sources/loads can be measured. The Pentametric System consists of a 2-line LCD display and control buttons. This connects to input unit with 4 wire cable up to 1000 feet away. Optional computer interface with software to control and read out all data. Data may be accessed and controlled using either (or both) the optional LCD or the computer interface. Temperature range: -20°C, +65°C.

Part #	Model	Item	Dimensions	Weight
510001	PM500U	Battery Meter	5.5 x 4.3 x 1.8	1.0
510002	PM100D	Display Unit		
510003	PM100C	Computer Interface		
510004	BTS	Battery Temperature Sensor		



PentaMetric with wall mount box

Deltec

Shunts for all meters

Useful for measuring current flow in/out of battery system.

Part #	Model	Weight
510ACCSH500	500 Amp shunt, 50 mV	1.0
510ACCSH100	100 Amp shunt, 100 mV	1.0



Deltec Shunt

SunWize

AC Kilowatt Hour Meters

Analog and Digital kWh meters are an active energy “kWh-only” meter. Utility grade outdoor meters monitor the solar energy production supplied through pure sine wave DC-AC single phase inverters. All meters are UL listed and CEC approved. Analog kWh meters are recalibrated and certified, displaying the cumulative kWh energy produced. The Digital kWh meter is solid state FCC compliant and designed in accordance to UL, IEEE, ANSI, and Canadian standards for electric meters. The Digital kWh meter supports four energy displays:

- +kWh (energy delivered to load)
- -kWh (energy received from load)
- NET kWh (the net energy consumed by load, or negative kWh subtracted from positive kWh)
- ADDED kWh (negative kWh added to positive kWh-also called security mode)

Part #	Meter Type	Volts AC	Form	Class	Wire	Weight
400008	Digital Meter	240	2S	200	3	2.2
400KW-HRMETER-A	Analog Meter	120	1S	100	2	4.5
400KW-HRMETER	Analog Meter	240	2S	200	3	4.5
Meter Sockets						
400KW-HR SOCKET	Socket Box Round	120/240	1S/2S	200	3	1.5
400009	Socket Box-Rectangular	120/240	1S/2S	200	3	3.5



SunWize AC Kilowatt Hour Meter



SunWize Digital Meter



Kill A Watt

P3 International

P3 – Kill A Watt™

Can cut down on electricity costs by finding out what appliances are actually worth keeping plugged in. Large LCD display displays consumption by the kilowatt-hour, the same as your local utility. Calculate your electrical expenses by the day, week, month, even an entire year. Also check the quality of your power by monitoring voltage, line frequency, and power factor. Forecast costs.

Features include:

- Large LCD display
- Cumulative kilowatt-hour monitor
- Displays volts, amps, watts, Hz, VA
- 0.2% accuracy

P3 – Kill A Watt EZ™

Cut your energy costs connecting appliances to the Kill A Watt EZ to assess how efficient they really are. The large LCD display displays consumption by the Kilowatt-hour. Shows the operating costs of your household appliances. Calculates cost and forecasts by week, month and year

Features include:

- Accurate to within 0.2%
- Large LCD display
- Built-in battery backup
- Displays eight critical units of measure

P3 – Kill A Watt PS™

Connect appliances into the Kill A Watt PS to assess how efficient they are while the built-in surge protection keeps them safe. Advanced features such as over current, over voltage and no load detection provide clean, safe power to your expensive equipment. Check the quality of your power by monitoring voltage, line frequency, amperage, kWh, current leakage and more.

Features include:

- Advanced surge protection circuitry
- Soft power-up
- Displays max/min volts, amps, watts, PF, leakage, current
- 6 foot cord with low profile plug
- Backlit LCD display
- Light-up power switch



Kill A Watt PS



Kill A Watt EZ

Part #	Model	Description	Voltage (AC)	Current (Amps)	Max. Input Power (Watts)	Dimensions L x W x D	Weight
426018	P4400	Kill A Watt	115	15	1875	5.1 x 2.4 x 1.6	1
426026	P4460	Kill A Watt EZ	115	15	1875	5.1 x 2.5 x 1.5	1

Part #	Model	Description	RMS Voltage	RMS Current	Active Power	Watt Hours	Dimensions (H x W x D)	Weight
426027	P4320	P3 Kill A Watt PS	108 - 132 Vac	0 - 15 Amps	0-1980 watts	0-9999 kWh	3 x 12.8 x 2.5	2

System Spotlight

LOCATION:
Havertown, PA

APPLICATION:
4.1kW residential solar system

SYSTEM:
21 SANYO 195W modules

INSTALLED BY:
Larry O'Donell, Roof Top Solar Solutions





DECK Monitoring Screenshot

DECK Monitoring

Solar Monitoring Solutions

DECK Monitoring provides a solar electric monitoring and reporting solution that addresses the needs of system owners, installers and project developers in one effective package. Energy meters, environmental sensors, inverters and other devices on site report to their communication gateway. The gateway sends the data to remote DECK monitoring servers, where clients can access it 24/7 via any web enabled computer. Each deployment features a public interface which is optimized for sharing over the internet or lobby and kiosk display. An administration panel provides password protected access to all types of authorized parties. The administration panel provides users access to custom user defined alarms and notifications, string performance, sub-array performance, inverter data, benchmarking tools, downloadable data reports and other settings. Each DECK Monitoring deployment includes the ability to aggregate multiple projects into one

administration panel, for multi-site management. Pricing is based on the services and hardware provided on a per device and data point basis. The core package includes a communication gateway and a revenue grade meter. Additional services such as string monitoring or weather reporting require additional hardware. Each package includes all the necessary hardware and software required for the service, but does not include installation costs. **Call your Sales Manager for pricing and more information.**

End User - The end user benefits by gaining the ability to track their systems performance and to address any problems quickly.

Installer - The installer or integrator benefits by being able to keep track of all their valued customers in one place, quickly, and efficiently. Alarms and notices can alert the installer to potential system problems and outages instantly, and troubleshooting features can save time for both contractor and customer. Public and web displays can be a powerful tool to generate interest from new clients and provide a showcase of past projects.

Project Developer - The large project developer or PPA provider benefits by being able to benchmark the performance of their systems, and compare the output of systems. The graphing center allows customizable visualization of any data points captured on site. The data download center allows instant access to all data captured on site, for export and further analysis.

Advertisement



Sun-Xtender 1040T Battery



Sun-Xtender PVX-3050T Battery

Expected life cycles versus depth of discharge (DOD) @ 3-hour rate/25°C (77°F):

- 5200 @ 10% DOD
- 1850 @ 30% DOD
- 1050 @ 50% DOD

Full charge termination voltage (@ 25°C) 14.40 Vdc,
Float charge termination voltage (@ 25°C) 13.40 Vdc,
Temperature compensation +/- 3.75mv per cell/°C degrees @ 25°C, from (0°C to 40°C)

Concorde

Sun-Xtender VRLA-AGM

Sun Xtender® Series Batteries have been designed and developed to meet the needs of the Renewable Energy Industry. Sealed, maintenance free, valve regulated, deep cycle, long life lead acid batteries; they never require water or addition of electrolyte.

Safe by design, Sun Xtender® Batteries are sealed and non-spillable. They operate upright, placed on their side or end. Because they are sealed and not prone to gassing or the potential corrosion of flooded batteries, Sun Xtender® Batteries are ideal for inside storage, on racks, in battery boxes, or outdoors. Sun Xtender Series Batteries are environmentally friendly, recyclable, and UL Recognized Systems Components.

Uses for the Sun Xtender® Series Renewable Energy Storage Batteries include both grid tied and off grid renewable power systems and backup power. Some application examples are telecommunications, area lighting, message boards, traffic control, residential power systems, village power, supervisory control & data acquisition (SCADA), aids to navigation (sea & air, including runway lighting), telemetry RTU monitoring and solar powered 2-way radio repeaters.

Part #	Model	Vdc	A/h Capacity @ C/120	A/h Capacity @ C/24	Dimensions	Weight
201003GPC1234	PVX-340T	12	38	34	7.7 x 5.2 x 6.9	25
201003PVX1240T	PVX-420T	12	45	42	7.7 x 5.2 x 6.9	30
201003GPC1248	PVX-490T	12	55	49	9.0 x 5.5 x 8.8	36
201003PVX1255	PVX-560T	12	63	56	9.0 x 5.5 x 8.8	40
201003PVX1265	PVX-690T	12	79	69	10.2 x 6.6 x 8.9	51
201003GPC1285	PVX-890T	12	102	89	12.9 x 6.8 x 9.0	62
201003GPC1295	PVX-1040T	12	120	104	12.0 x 6.8 x 8.9	66
201003GPC12105	PVX-1080T	12	126	108	12.9 x 6.8 x 9.0	70
201003GPC4D	PVX-2120L*	12	253	212	20.8 x 8.7 x 10.7	138
201003GPC8D	PVX-2580L*	12	305	258	20.7 x 11.0 x 10.2	165
201003PVX6220L	PVX-2240T	6	263	224	10.3 x 7.0 x 10.0	67
201003PVX3050T	PVX-3050T	6	350	305	10.3 x 7.1 x 13.0	91
201003PVX5340T	PVX-5340T	2	612	534	12.9 x 6.8 x 9.0	62
201003PVX6480T	PVX-6480T	2	756	648	12.9 x 6.8 x 9.0	70

* rope handles

IBE

Water Miser Vent Cap

Battery safety vent caps reduce the maintenance of constantly replenishing the water in flooded batteries. Condensing pellets within the cap capture and return electrolyte droplets into each cell during the charging to assure better electrolyte maintenance. A flip-top design allows easier watering without needing to remove the cap; no need to remove during battery equalize.



Water Miser Vent Cap

Part #	Model	Dimensions	Weight
210005WMSVENTS	Water Miser Vent Cap	1.4 diameter x 1.0	0.25 oz



MK VRLA-Gel Battery

MK Battery

VRLA-Gel

The MK Battery series of valve-regulated, gelled-electrolyte batteries is designed to offer reliable, maintenance-free power for renewable energy applications where frequent deep cycles are required and minimum maintenance is desirable. The sealed construction eliminates periodic watering, corrosive acid fumes, and spills. The electrolyte will not stratify so no equalization charging is required. Less than 2% per month standing loss means little deterioration during transport and storage.

They are ideal for small to medium sized PV systems and are rated non-spillable by ICAO, IATA and DOT. These batteries feature

polypropylene containers with handles and self sealing vents. They are constructed with lead-calcium plate alloy within sulfuric acid thixotropic gel. Terminal bolts included with all batteries. 2-year limited warranty. 5-year limited warranty is available.

VRLA-Gel

Expected life cycles versus depth of discharge (DOD) @ 2-hour rate/25°C:

- 5700 @ 10% DOD
- 2100 @ 25% DOD
- 1000 @ 50% DOD



MK VRLA-AGM Battery

Part #	Model	Vdc	A/h Capacity @ C/20	A/h Capacity @ C/100	Bolt Size (in)	Dimensions L x W x H	Weight
202001DE8GU1	8GU1-DEKA	12	31	36.5	1/4	7.8 x 5.1 x 7.3	24
202001DE8G22NF	8G22NF-DEKA	12	50	58	5/16	9.4 x 5.5 x 9.3	37
202001DE8G24	8G24-DEKA	12	74	84.5	5/16	10.9 x 6.8 x 9.9	52
202001DE8G27	8G27-DEKA	12	86	99.5	5/16	12.8 x 6.8 x 9.9	63
202001DE8G30H	8G31-DEKA	12	98	108	5/16	12.9 x 6.8 x 9.8	70
202001DE8G4D	8G4DLTP-DEKA	12	183	210	5/16	20.8 x 8.5 x 10.6	127
202001DE8G8D	8G8DLTP-DEKA	12	225	265	5/16	20.8 x 11.0 x 10.6	157
202001DE8GCC	8GCC2-DEKA	6	180	198	5/16	10.3 x 7.1 x 10.9	68

VRLA-AGM

Expected life cycles versus depth of discharge (DOD) @ 3-hour rate/25°C to 60% Capacity

- 1200 @ 30% DOD
- 750 @ 50% DOD
- 375 @ 80% DOD

VRLA-AGM

Sealed, maintenance-free, valve-regulated type AGM batteries are available in smaller size capacity ratings, perfect for use with solar applications for powering lighter loads such as telemetry, SCADA, remote monitoring, UPS systems, LED, and emergency lighting. Capacity discharge ratings are at the 20-hr. rate & operating temperature range is -15°C to 50°C. Rated non-spillable by DOT. 1-year warranty.

Part #	Model	Vdc	A/h Capacity @ C/20	Terminal Size (in)	Dimensions L x W x H	Weight
201002ES12-6AP	ES12-6	6	12	0.187 tab	6.0 x 2.0 x 3.7	4.5
201002ES7-12	ES7-12	12	7	0.187 tab	6.0 x 2.6 x 3.7	6.0
202026	ES9-12	12	9	0.250 tab	6.0 x 2.6 x 3.7	6.5
202025	ES10-12S	12	10	0.250 tab	6.0 x 2.6 x 4.4	7.5
202001ES12-12	ES12-12	12	12	0.250 tab	6.0 x 3.9 x 3.7	8.5
202021	ES17-12	12	18	# 10 bolt	7.1 x 3.0 x 6.6	14.0
201002ES26-12	ES26-12	12	26	# 10 bolt	6.5 x 6.9 x 4.9	21.0

System Spotlight

LOCATION:
Janesville, WI

APPLICATION:
10.2 kW Residential Grid-Tie

SYSTEM:
60 SHARP 170W modules
Installed by Agsun





4000 Series

Rolls

Series 4000 and 5000 Batteries

These flooded, deep-cycle batteries feature extended standard warranties and double insulated-enveloped positive plates that eliminate the possibility of separator misalignment, cracked separators, treeing, or shorting at the bottom or sides. Each battery cell has increased liquid reserve levels resulting in fewer watering intervals. The 4000 Series is rated for a 10-year average life in cyclic applications and the 5000 Series is rated for up to 15 years. The 4000 series have rope handles, handles on 5000 series are molded into the outer case.

The 5000 series are constructed in a non-breakable modular dual container. Each 2-volt cell is assembled in its own inner polypropylene container within a moisture tight, heavy-duty protective outer container eliminating damage during handling or possibility of short circuits due to water or falling metal objects.

Series 4000 batteries carry a 24-month free replacement warranty (FOB factory) and include an 84-month adjustment period from date of installation. Series 5000 batteries carry a 36-month free replacement warranty (FOB factory) and include a 120-month adjustment period from date of installation (USA only). Freight allowance FOB destination with minimum weight quantities—call for details. Available dry charged. Terminal bolts not included-specify 5/16" x 1" st-st.



5000 Series

**4000 series
expected life cycles
vs. depth of discharge
(100 hr. rate/25°C)**

2688 @ 10% DOD
2048 @ 30% DOD
1536 @ 50% DOD

**5000 series
expected life cycles
vs. depth of discharge
(100 hr. rate/25°C)**

6600 @ 10% DOD
5040 @ 30% DOD
3840 @ 50% DOD

Part #	Model	Battery Series	Voltage DC	Plates Per Cell	Capacity 100 hr to 1.75 VPC (AH)	Capacity 20 hr to 1.75 VPC (AH)	Length	Width	Height	Weight Wet	Weight Dry	Warranty Months
6 volt (3 cell) Polypropylene Container												
209S460W	S-460	4000	6	15	460	350	12.3	7.1	16.8	117	90	84
209S530W	S-530	4000	6	17	530	400	12.3	7.1	16.8	127	100	84
2 volt (1 cell) Dual Container												
209007	2KS 33PS	5000	2	33	2490	1766	15.4	8.3	24.8	208	145	120
209016	2YS 31PS	5000	2	31	3426	2430	15.5	9	31.6	285		120
4 volt (2 cell) Dual Container												
2094CS17PS	4CS 17PS	5000	4	17	770	546	14.4	8.3	18.3	128	98	120
2094KS21PS	4KS 21PS	5000	4	21	1557	1104	15.8	9.4	24.8	267	186	120
2094KS25PS	4KS 25PS	5000	4	25	1900	1350	15.8	106	24.8	315	220	120
6 volt (3 cell) Dual Container												
2096CS17PS	6CS 17PS	5000	6	17	770	546	22	8.3	18.3	221	178	120
2096CS21PS	6CS 21PS	5000	6	21	963	683	22	9.8	18.3	271	217	120
2096CS25PS	6CS 25PS	5000	6	25	1156	820	22	11.3	18.3	318	254	120
8 volt (4 cell) Dual Container												
2098CS17PS	8CS 17PS	5000	8	17	770	546	28.25	8.25	18.25	294	238	120
2098CS25PS	8CS 25PS	5000	8	25	1156	820	28.25	11.25	18.25	424	342	120



R+ Recombination Cap

R+ Recombination Caps are able to catalytically recombine the hydrogen and oxygen gasses into pure water that returns to the battery cell. This drastically reduces the amount of "topping up" and virtually eliminates the danger of a hydrogen gas explosion. Corrosion is eliminated because the acid spray and fumes are contained within the cell. In general and under normal conditions, R+ Recombination Caps increase watering interval by three times - possibly up to one watering / maintenance interval per year. To avoid damaged and melted caps, always remove R+ Recombination Caps during equalization charge.

Part #	Model	Dimensions	Weight
209018	R+ Recombination Cap	1.6 diameter x 1.5	0.5 oz



SW Battery Cables

SunWize®

Battery Cables

SunWize high quality battery interconnect cables are the best value available featuring xtra-flex, multi-stranded copper cable – rated 105°C degrees, 600 volt, (UL) type MTW/THW, CSA-TEW. All cables are assembled with large, tin-plated copper lugs for 3/8” bolts (for 2/0 and 4/0), 5/16” bolts (for 4 AWG), double crimped and heat sealed with color-coded melt wall tubing, ensuring long life. Maximum conductor ampacity in free air: 4 AWG = 120A, 2/0 = 265A, 4/0 = 360A.

Part #	AWG	Length	Color	Weight	Part #	AWG	Length	Color	Weight
700KIT004BB8D	4	8	black	0.4	700KIT2/0BB48D	2/0	48	black	2.2
700KIT004RR8D	4	8	red	0.4	700KIT2/0RR48D	2/0	48	red	2.2
700KIT004BB13D	4	13	black	0.5	700KIT2/0BB60D	2/0	60	black	2.7
700KIT004RR13D	4	13	red	0.5	700KIT2/0RR60D	2/0	60	red	2.7
700KIT004BB16D	4	16	black	0.6	700KIT4/0BB8D	4/0	8	black	0.8
700KIT004RR16D	4	16	red	0.6	700KIT4/0RR8D	4/0	8	red	0.8
700KIT004BB24D	4	24	black	0.8	700KIT4/0BB13D	4/0	13	black	1.1
700KIT004RR24D	4	24	red	0.8	700KIT4/0RR13D	4/0	13	red	1.1
700KIT2/0BB8D	2/0	8	black	0.6	700KIT4/0BB18D	4/0	18	black	1.3
700KIT2/0RR8D	2/0	8	red	0.6	700KIT4/0RR18D	4/0	18	red	1.3
700KIT2/0BB13D	2/0	13	black	0.7	700KIT4/0BB24D	4/0	24	black	1.7
700KIT2/0RR13D	2/0	13	red	0.7	700KIT4/0RR24D	4/0	24	red	1.7
700KIT2/0BB16D	2/0	16	black	0.8	700KIT4/0BB36D	4/0	36	black	2.4
700KIT2/0RR16D	2/0	16	red	0.8	700KIT4/0RR36D	4/0	36	red	2.4
700KIT2/0BB24D	2/0	24	black	1.3	700KIT4/0BB48D	4/0	48	black	3.1
700KIT2/0RR24D	2/0	24	red	1.3	700KIT4/0RR48D	4/0	48	red	3.1
700KIT2/0BB36D	2/0	36	black	1.6	700KIT4/0BB60D	4/0	60	black	3.9
700KIT2/0RR36D	2/0	36	red	1.6	700KIT4/0RR60D	4/0	60	red	3.9



SW Inverter to Battery Cables

Inverter to Battery Cables

Pre-cut and crimped, UL rated MTW cables reduce system installation time, improve system integrity and assure code compliance. These flexible cables are made with machine crimped 3/8 tinned copper ring terminals and color-coded melt-wall heatshrink. NEC rated in conduit for 230 Amp (#4/0 AWG), 175 Amp (#2/0 AWG), and in free air for 360 Amp (#4/0 AWG) or 265 Amp (#2/0 AWG). Cables sold as pairs.

Part #	Model	Wire Size AWG	Description	Weight
700KIT2/OST120D	IBC10-2/0	2/0	10' pair, one red and one black cable	10.0
700KIT4/OST120D	IBC10-4/0	4/0	10' pair, one red and one black cable	15.0
700KIT2/OST180D	IBC15-2/0	2/0	15' pair, one red and one black cable	15.0
700KIT4/OST180D	IBC15-4/0	4/0	15' pair, one red and one black cable	22.5



SW Battery Hardware Kit

Battery Terminal Hardware Kits

SunWize battery hardware kits are necessary for connecting cabling to battery flag terminals. Kits contain two bolt sets of high quality stainless steel to eliminate corrosion. Each bolt set consists of a hex head screw, flat washers, lock-washer and hex nut.

Part #	Size	Weight
200ACCBATHDW1/4	1/4-20 x 1	0.5
200ACCBATHDW5/16	5/16-18 x 1	1.0
200ACCBATHDW3/8	3/8-16 x 1	1.5



SunWize Premium Enclosures

SunWize®

Premium Battery Enclosures F-series

Available in 3 sizes, SunWize F-series premium enclosures are cost-effective solutions for housing one to four batteries (up to group size 31) with supporting equipment, engineered specifically for the PV industry. The white powder coated aluminum enclosures all feature hinged, key lockable doors with dust covers on locks, NEMA3R style rainproof design, with gasketed door, special high-low passive cooling ventilation configuration with vent filtration. Mounting features include a tamper resistant mounting bracket (sold separately) allow the use of 2" – 8" pipe U-bolts or band clamps. An integral mounting hangar allows the box to be installed easily without removing the control equipment.

All enclosures come with 2 rear 1/2" electrical knockout and provisions for a 15" x 6.5" aluminum back side equipment mounting plate (sold separately) and provisions for a right side equipment mounting plate (sold separately). Space is provided to allow for 1" foam insulation around the battery.

Part #	Model	Quantity x Battery Group	Dimensions	Weight
6061BE21169PA	F1 Enclosure	1 x G31	20.8 x 16.0 x 9.4	25
6062BE211615PA	F2 Enclosure	2 x G31	20.8 x 16.0 x 14.4	30
6064BE321615PA	F4 Enclosure	4 x G31	32.0 x 16.0 x 14.4	40
605KEY	E3-5-15	Extra Door Key – Cylinder type		



SunWize Economy Enclosures

Economy Battery Enclosures E/C-Series

Available in five sizes, E/C-series economy battery enclosures are cost-effective solutions for housing one to four batteries with supporting equipment. The aluminum enclosures all feature removable covers attached using stainless steel screws, NEMA3R style rainproof design and a brushed finish. An integral mounting hangar allows the box to be installed easily without removing the control equipment.

E1-38 house up to 1 Group UI battery, feature external mounting tabs to accommodate 2" pipe U-bolts, no security locking features, 3 bottom and 2 rear 1/2" electrical knockout.

E1-63 house up to 1 Group 22 battery, feature external mounting tabs to accommodate 2" pipe U-bolts, no security locking features, 2 bottom and 2 rear 1/2" electrical knockout, and rear louver-vent. The C1-125 through C1-500 house from 1 to 4 group 31 batteries, feature a security stainless steel door lock-hasp, 2 rear 1/2" electrical knockouts, and rear louver-vent and can accommodate a 15" x 6.5" aluminum equipment mounting plate (sold separately). Space is provided to allow for 1" foam insulation around the battery.

Part #	Model	Quantity x Battery Group	Dimensions	Weight
606019	E1-38	1 x GU1	1.3 x 9.1 x 5.9	4
6061BE141007-A	E1-63	1 x G22	14.5 x 10.3 x 7.5	6
6061BES17169-A	C1-125	1 x G31	17.0 x 16.0 x 9.5	12
606020	C2-250	2 x G31	17.0 x 16.0 x 15.0	17
606021	C4-500	4 x G31	32.0 x 16.0 x 15.0	25

Mounting Brackets for F and E Series Enclosures-pole

Brackets are both constructed of aluminum, and feature a slot design that allows the use of 2" – 8" pipe diameter U-Bolts or band clamps, and a slot that will allow up to 1" thickness banding for large diameter pole mounting.

All brackets feature tamper-resistant design and include all stainless steel mounting hardware (U-bolts not included). Premium brackets feature a white powder-coated finish. Economy brackets feature a brushed aluminum finish.

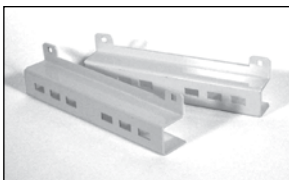
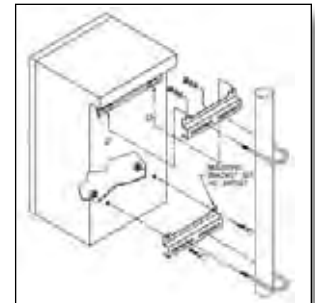

SW Premium Mounting Brackets

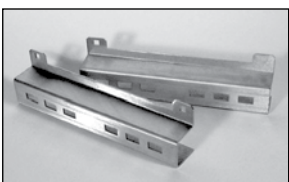

SW Economy Mounting Brackets

Part #	Model	Description	Dimensions	Weight
626004	F-BKTSET	Premium	2 x 2 x 13	2.0
626005	E-BKTSET	Economy	2 x 2 x 13	2.0

Mounting Brackets F and E Series Enclosures-Pad

Pre-cut aluminum channel allows enclosures to be mounted to the ground without impeding the door operation or ventilation from working as designed.

All kits come with 2 pre-cut and drilled struts and all mounting hardware to mount the enclosure to the bracket. Pad mounting hardware not provided. All enclosures must be drilled to accept mounting hardware.

Part #	Model	Dimensions	Weight
625PADMTGBKTSET	PD-MTGBKTSET	1.6 x 1.6 x 20	4.0

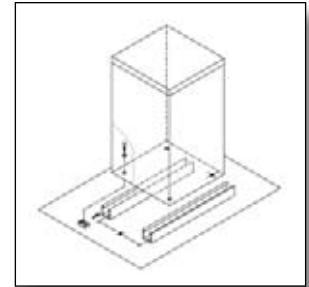

SW Pad Brackets

Mounting Panels

Panels are made of 0.080" MIN brushed aluminum with mounting holes aligned for each enclosure's interior studs. Rear panels can be purchased as blank or with optional pre-drilled configuration for mounting of most brands of solar control equipment.

F-RP-B and F-RP-D are universal fits in any enclosure, accommodating a G31 size battery or larger. Available in blank and predrilled.

F-RSP models are for use in F-series enclosures only, with sizes for each enclosure listed. Available in blank only.

T-LP models can be used in any T-series chests on both the left side and lid. Available in pre-drilled only.

Part #	Model	Description	Dimensions	Weight
606SW2BEBPND-A	F-RP-B	Rear panel-blank	15.5 x 6.5	1
606SWBPPDRILL	F-RP-D	Rear panel-drilled	15.5 x 6.5	1
85629600344	F-RSP-1B	F-1 Right side-blank	8.8 x 3.8	1
85629600345	F-RSP-2/4B	F2, F4 Right side blank	9.5 x 6.3	0.5
60629600585	T-SP-D	T-series, Top panel-drilled	17.0 x 17.0	3



SW Enclosure Mounting Panels

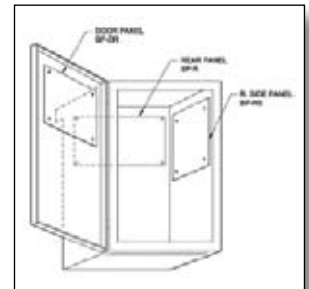

SW Enclosure with Panels

Premium Battery Enclosures T-series

Available in 5 sizes, T-series premium enclosures are cost-effective solutions for housing two to eight batteries (up to group size 8D) with supporting equipment, engineered specifically for the PV industry.

The white powder-coated aluminum enclosures feature hinged, pad lockable (sold separately) lids with, NEMA3R style rainproof design which allows a continuous gap for air egress. Lids can be propped open for safe service of equipment with a locking hinge. Mounting features include elevated skid feet, and provisions for 1/2" hardware mounting to a concrete pad or steel beam.

All enclosures come with 2 left side 1/2" electrical knockout and provisions for a 15" x 6.5" or 17" x 17" left side aluminum equipment mounting plate (sold separately) and provisions for a 17" x 17" lid mounted equipment mounting plate (sold separately). Space is provided to allow for 1" foam insulation around the battery.

Part #	Model	Quantity x Battery Group	Dimensions	Weight
606SW3BEC312418	T-2X8D	2 x 8D or 3 x 4D	31.3 x 23.8 x 20.5	55
606018	T-4X8D	4 x 8D or 4 x 4D	48.3 x 23.8 x 20.5	75
606SW6BEC463118	T-6X4D	6 x 4D or 4 x 8D	48.3 x 30.3 x 20.5	100
606SW6BEC484018	T-8X4D	8 x 4D or 6 x 8D	48.3 x 40.3 x 20.5	125
606017	T-8X8D	8 x 8D	48.3 x 46.0 x 20.5	150



SW Enclosure Mounting Panels



MNBE-A

MidNite Solar

MNBE-A

Battery Enclosure with locking door. Holds three group 31 or 27 sealed batteries per shelf side by side or two per shelf end to end. Also holds one 8D per shelf. Two cabinets can be stacked horizontal or vertical for expansion. Remove middle shelf for taller batteries. 2" knock outs on top and sides. Gray powder-coated steel. Ships knocked down. ETL listed for the US and Canada for indoor use only.

MNBE-B

Battery Enclosure with locking door. Holds eight group 31 or sealed golf cart sized batteries. Gray powder-coated steel. Two cabinets can be stacked horizontal or vertical for expansion. Ships knocked down in two cartons. ETL listed for the US and Canada for indoor use only.

MNBE-C

Battery Enclosure with locking door. Holds twelve group 31 or sealed golf cart sized batteries and even the 14" tall PVX-3050T from Concorde. Gray powder-coated steel. Two cabinets can be stacked horizontal for expansion. Ships freight truck only. ETL listed for the US and Canada for indoor use only.

MNBE-D

Battery Enclosure with locking door. Two-shelf holds eight group 31 or sealed golf cart sized batteries; three-shelf holds twelve group 31 or sealed golf cart sized batteries. Gray powder-coated steel. Ships knocked down in two cartons. ETL listed for the US and Canada for indoor use only.



MNBE-C

Part #	Model	Enclosure outside dimensions (W x D x H)	Shipping Weight
716015	MNBE-A	29.0 x 14.5 x 27.1	71
716017	MNBE-B	33.6 x 15.3 x 34.1	62
716019	MNBE-C	33.6 x 15.3 x 57.9	190
716081	MNBE-D	33.6 x 15.3 x 41.1	116

Advertisement



Iota DLS-55

IOTA Engineering

DLS Series

The DLS Series automatic battery charger/power supply uses switch-mode technology to insure service-free operation even when subjected to extremely harsh conditions. The clean DC output operates electronic and motor loads from a compact housing. They feature regulated converter/power supply, tight line-load regulation, a Dual Voltage jack for two-stage charging, proportional cooling fan control, current limiting, transient voltage protection, and short circuit/over-current protection. The optional IQ4 Smart Controller adds 3-stage charge control to the DLS Series Chargers by plugging it into the Dual Voltage jack on the DLS unit. Charger efficiency approximately 85%. 24 Vdc and 48 Vdc models available. 2-year warranty.

Part #	Model	Output Vdc	Output (Amps)	Input Vac	Dimensions	Weight
350015DLS-15	DLS-15	13.6/14.2	15	120	8.0 x 5.0 x 3.3	4.5
350030DLS30	DLS-30	13.6/14.2	30	120	8.0 x 5.0 x 3.3	4.5
350045DLS45	DLS-45	13.6/14.2	45	120	8.0 x 5.0 x 3.3	5
350055DLS-55	DLS-55	13.6/14.2	55	120	8.0 x 5.0 x 3.3	5
350075DLS75	DLS-75	13.6/14.2	75	120	10.0 x 6.5 x 3.5	8
350090DLS90	DLS-90	13.6/14.2	90	120	10.0 x 6.5 x 3.5	8



Iota IQ4

IQ4 Smart Controller

The IQ4 Smart Controller offers automatic charging control for the DLS Series chargers to provide longer and safer use of the system's battery. The IQ4 plugs directly into the DLS charger's Dual Voltage jack. The IQ4 Smart Charger allows the DLS to operate as an automatic 3-stage charger, providing Bulk, Absorption, and Float stage charging. Compatible with all DLS voltages. 2-year warranty.

Part #	Model	Dimensions	Weight
350012IQ4CONTRL	IQ4 Smart Controller	2.6 x 1.3 x .7	4 oz



Analytic BCA610-110-24

Analytic Systems

BCA Series

The BCA series input battery chargers use the latest Current Mode PWM controller integrated circuit technology. They can be left permanently connected and can also function as a power supply. 3-year warranty.

Features:

- High tolerance for shock and vibration
- Quiet, low EMI operation
- User selectable 2 or 3 stage charging profile
- Audible & visual indicators for output overload, low input voltage, low output voltage & over-temperature
- Thermostatically controlled fan; over-temperature shutdown
- Temperature compensated charging
- Short circuit protection
- Output over-voltage crowbar
- Inrush current limiting with solid state bypass
- Wide operating temperature range: -25°C to +40°C

Part #	Model	Output Voltage (Vdc)	Output Current (A dc)	Input Voltage (Vac)	Dimensions (W x L x H)	Weight
350029	BCA310-110-12	12	20	105 – 125	8.2 x 9.6 x 3.5	7.5
350030	BCA310-110-24	24	10	105 – 125	8.2 x 9.6 x 3.5	7.5
350031	BCA310-110-48	48	5	105 – 125	8.2 x 9.6 x 3.5	7.5
350032	BCA610-110-12	12	40	105 – 125	9.9 x 14.5 x 3	7.2
350033	BCA610-110-24	24	20	105 – 125	9.9 x 14.5 x 3	7.2
350028	BCA610-110-48	48	10	105 – 125	9.9 x 14.5 x 3	7.2



SENS NRG Battery Charger system

Stored Energy Systems (SENS)

NRG Battery Charger

SENS' NRG offers high accuracy, outstanding dependability and unmatched field configurability. NRG instantly adapts to any common lead-acid battery. NRG is simple to install and when used with a large battery creates a reliable non-stop DC power system for low current loads. Automatically adjusts its output to meet constantly changing battery needs.

Should battery problems ever occur, the exclusive Battery SENS system cuts downtime and field service expense. By detecting battery problems like high resistance cables and open battery cells, service personnel can be sent to the site before commercial power outage causes a crisis.

UL, cUL, CE listed. 3-year warranty.

Features include:

- All-electronic operation with generous component de-rating
- Disconnected/reversed/incorrect voltage battery alarm and protection
- Protection of connected equipment against load dump transients
- Over temperature protection • Superior lightning and voltage transient protection
- Demonstrated field MTBF >1 million hours • Wide operating temperature range: -25°C to +50°C

Part #	Model	Output Voltage (Vdc)	Output Current (A dc)	Input Voltage (Vac)	Dimensions (W x L x H)	Weight
350011	NRG-22-10-RC	24/12	10	110 – 120 / 208 – 240	6.5 x 12.5 x 5.6	24
350037	NRG-22-20-RC	24/12	20	110 – 120 / 208 – 240	13.1 x 13.9 x 7.4	42



Xantrex TRUECHARGE2

Schneider Electric (Xantrex)

Truecharge 10/10TB and TRUECHARGE2 battery chargers

Truecharge battery chargers feature wide AC input voltage range (90-135 VAC), adjustable temperature compensation and independent settings prevent battery damage due to overcharging and also help extend the life of expensive batteries. Microprocessor controlled, multistage charging, 10 amp DC output. 1-year warranty.

Protection Features:

- Over-temperature and overload protection • Ignition protected (10TB) • Transformer isolated for safety • Reverse polarity protection • Short-circuit and surge protection

TRUECHARGE2 battery chargers feature low electrical interference and efficient, power factor corrected multistage charging. Designed primarily for marine and commercial applications worldwide, TRUECHARGE2 battery chargers are available in three 12-volt models versatile enough to be used in a wide variety of conditions and locations. Settings for flooded, gel, AGM or lead-calcium batteries. Installation is facilitated by AC and DC wiring compartments and reverse-polarity battery protection. An optional remote display panel and battery temperature sensor is available. 2-year warranty.

Features include: • 12 volt models available in 20A, 40A and 60A • Battery-equalization feature • Microprocessor-controlled, multistage charging algorithms • Settings for two and three-stage charging • Temperature-compensated charging • Power factor corrected for efficient charging • Ability to charge 'dead' batteries • Auto-ranging AC input voltage capability (90 – 265 volts AC)

Protection Features:

- Reverse battery polarity • Over and under-temperature, • DC over-voltage • Battery overcharging • Ignition, drip-proof design

Part #	Model	Output Vdc	Output Amps	Input Vac	Dimensions	Weight
350010TC10	804-0100 Truecharge 10	13.8 - 14.8	10	90-135	9.0 x 6.5 x 2.8	3.0
350010TC10TB	804-0111 Truecharge 10TB	13.1 - 14.2	10	90-135	15.1 x 6.7 x 2.8	3.0
350041	804-1240 TRUECHARGE2 – 20A	14.2 -15.5	20	90-265	9.8 x 6.7 x 2.8	4.8
350047	804-1220 TRUECHARGE2 – 40A	14.2 -15.5	40	90-265	9.8 x 6.7 x 2.8	4.8
350050	804-1260 TRUECHARGE2 – 60A	14.2 -15.5	60	90-265	13.4 x 6.7 x 3.5	4.8
Xantrex Truecharge Accessories						
350055	808-0232-01 - Battery Temperature Sensor (BTS)					



VTC60-24-12

Analytic Systems

DC-DC voltage converters

Analytic Systems' DC-DC voltage converters are used to step-up or step-down DC voltage to meet your specific needs. These non-isolated models are designed with a common negative (non-isolated). 3-year warranty.

Features include:

- Input voltage range allows operation from a range of batteries
- Inrush Current Limiting
- Reverse input protection
- Short circuit protection
- Output over-voltage crowbar
- Extremely rugged and well suited for marine and other demanding environments
- High tolerance for shock and vibration
- Ultra-quiet low EMI operation
- Wide operating temperature range: -25°C to +40°C

Part #	Model	Output Voltage (Vdc)	Output Power (Watt)	Input Voltage (Vdc)	Dimensions (W x L x H)	Weight
170094	VTC60-12-5	5	60	12	4.0 x 5.5 x 2.1	1
170095	VTC60-24-12	12	60	24	4.0 x 5.5 x 2.1	1
170096	VTC65-48-12	12	65	48	4.0 x 5.5 x 2.1	1
170097	VTC65-48-24	24	60	48	4.0 x 5.5 x 2.1	1



SD25

Samlex America

DC-DC voltage converters

Fully isolated for positive and negative ground operation, these economical converters are used to step up or step down DC voltage to meet your specific needs. 1-year warranty.

Features include:

- 2:1 wide input range
- Fixed switching frequency at 83 kHz
- Built-in EMI filter, low ripple noise
- Protections: Short circuit/Over load/Over voltage
- 1500 Vdc I/O isolation
- 100% full load burn-in test
- High reliability
- Wide operating temperature range: -10°C to +40°C

Part #	Model	Output Voltage (Vdc)	Output Power (Watt)	Input Voltage (Vdc)	Dimensions (W x L x H)	Weight
170060	SD25A-5	5	25	12	3.9 x 3.9 x 1.4	1
170086	SD25B-5	5	25	24	3.9 x 3.9 x 1.4	1
170099	SD25B-12	12	25	24	3.9 x 3.9 x 1.4	1
170100	SD25C-12	12	25	48	3.9 x 3.9 x 1.4	1
170101	SD25C-24	24	25	48	3.9 x 3.9 x 1.4	1
170076	SD50B-12	12	50	24	6.3 x 3.9 x 1.4	1.2
170089	SD50C-12	12	50	48	6.3 x 3.9 x 1.4	1.2
170090	SD50C-24	24	50	48	6.3 x 3.9 x 1.4	1.2

System Spotlight

LOCATION:

Panama, Central America

APPLICATION:

Remote power system with battery backup

Installed by:

Electrysol





Skystream 3.7



Skystream Wireless Display

Southwest Windpower

Skystream 3.7™

Skystream 3.7, developed by Southwest Windpower in collaboration with the U.S. Department of Energy's National Renewable Energy Laboratory, is the newest generation in residential wind technology.

Skystream 3.7 has a 2.4 kW rating and is a fully integrated (with controls and inverter built-in) small wind generator specifically designed for the grid-connected market. It is designed for home and small business owners looking to reduce or eliminate their monthly electric bills.

Skystream 3.7 is a down-wind (wind hits the blades on the downwind side of the tower) direct drive (gearless, no transmission) permanent magnet wind generator. It uses an innovative 12-foot diameter rotor and produces approximately 400 kWh per month in a 12 mph average wind. The Skystream requires 8 mph winds for start up and is rated for winds of up to 140 mph. It's low RPM operation makes it relatively quiet.

Skystream is sold in kits that include towers ranging from 33 feet to 60 feet. Different kits are available for land-based and marine applications. The fully-integrated universal inverter delivers power compatible with any utility grid from 120 – 240 Vac. These grid connected systems can also incorporate a "battery charging controller kit" for battery back up. 5-year limited warranty.

Site Criteria

- At least 10 mph average wind speed (best results at 12 mph or more)*
- Your property is at least .5 acre and has unobstructed views
- The local zoning allows a structure that is at least 42' tall
- Your local utility has an existing interconnection agreement for homeowners (Your Skystream dealer can help determine this)

* Visit www.skystreamenergy.com for wind maps for your area, or consult your local Skystream dealer.

Part #	Model	Item	Volts AC Output	Rated Power Continuous (watts)	Peak Power Maximum (watts)	Shipping Weight
SKYSTREAM Wind Turbines - On Grid (Battery Charge Controller Optional)						
455048	1-SSL-10-240	Skystream 3.7, 240V / 60 Hz Land	240	1900	2600	193
455051	1-SSM-10-240	Skystream 3.7, 240V / 60 Hz Marine	240	1900	2600	193
455052	1-SSL-10-208	Skystream 3.7, 208V / 60 Hz Land	208	1900	2600	193
455053	1-SSM-10-208	Skystream 3.7, 208V / 60 Hz Marine	208	1900	2600	193
SKYSTREAM Wind Turbines - Off Grid (requires Battery Charge Controller)						
455010	1-SSL-10-120	Skystream 3.7, 120V / 60 Hz, 1P Land	120	1900	2600	193
455013	1-SSM-10-120	Skystream 3.7, 120V / 60 Hz, 1P Marine	120	1900	2600	193

Part #	Model	Description	Shipping Weight
SKYSTREAM Tower Kits (can also use Whisper 32, 40 & 70ft. Guyed Tower kits); price includes shipping			
455ACC011	3-CMBP-3043	Monopole Tower 33' - 6"	500
455ACC023	3-CMBP-3206	Monopole Tower 45'	932
455ACC027	3-CMBP-3207	Monopole Tower 60'	1500
Tower Kit Accessories			
455ACC013	3-CMBP-3048-02	Foundation Bolt Kit 32" for monopole tower mat found	20
455ACC012	3-CMBP-3048-01	Foundation Bolt Kit 42", for monopole tower pier found	28
455ACC014	2-TWS-101	Gin Pole Kit with pole, shackles and wires	120
455ACC015	2-SSOT-100	Hinge Plate Kit with hardware	41
455ACC016	2-TWS-100	Tower Adaptor Kit (5") aluminum casting with hardware	11
SKYSTREAM Communications			
455ACC017	2-SSUP-100-02	Wireless Remote Display Kit 916 Mz w/antenna + AC adaptor	5
455067	2-SSUP-103-01	ZigBee® PC Interface Software Kit	1
455015	1-CRBC-10	Battery Charging Controller Kit	5



Air Breeze Land

Air Breeze

The all-new Air Breeze is quieter and more efficient. It is engineered to deliver more energy at lower wind speeds and intended for use in a variety of battery charging applications, including remote homes, sailboats, telecommunication towers, monitoring stations and areas of the developing world. Microprocessor-based smart internal regulator with peak power tracking. 3-year limited warranty.

Features include:

- Durable composite blades
- Delivers 38 kWh/mo @ 12 mph avg. wind speed
- Maximum wind speed is 110 mph
- Aircraft-quality aluminum alloy castings
- Brushless neodymium alternator
- Minimal maintenance with two moving parts

Part #	Model	Item	Rated Power Watts @ Speed	Start Up Wind Speed	Factory Vdc Regulation	Voltage Range Adjustable Vdc	Rec. Breaker Size - Amps	Shipping Weight	
AIR BREEZE And AIR X Wind Turbines									
455059	1-ARBL-10-12	Air Breeze Land 12V w/regulator	200 @ 28 mph	6 mph	14.1	13.6 - 17.0	50	18	
455060	1-ARBL-10-24	Air Breeze Land 24V w/regulator	200 @ 28 mph	6 mph	28.2	27.2 - 34.0	25	18	
455061	1-ARBM-10-12	Air Breeze Marine 12V w/regulator	200 @ 28 mph	6 mph	14.1	13.6 - 17.0	50	18	
455062	1-ARBM-10-24	Air Breeze Marine 24V w/regulator	200 @ 28 mph	6 mph	28.2	27.2 - 34.0	25	18	
455001	1-ARXL-10-12	Air-X Land 12V, w/regulator	400 @ 28 mph	8 mph	14.1	13.6 - 17.0	50	18	
455002	1-ARXL-10-24	Air-X Land 24V, w/regulator	400 @ 28 mph	8 mph	28.2	27.2 - 34.0	30	18	
455040	1-ARXL-10-48	Air-X Land 48V, w/regulator	400 @ 28 mph	8 mph	56.4	54.4 - 68.0	15	18	
455003	1-ARXM-10-12	Air-X Marine 12V, w/regulator	400 @ 28 mph	8 mph	14.1	13.6 - 17.0	50	18	
455004	1-ARXM-10-24	Air-X Marine 24V, w/regulator	400 @ 28 mph	8 mph	28.2	27.2 - 34.0	30	18	
455042	1-ARXM-10-48	Air-X Marine 48V, w/regulator	400 @ 28 mph	8 mph	56.4	54.4 - 68.0	15	18	
455006	1-DLA-10	Air Diversion Load	NA	NA	use C60	NA	60	10	
AIR TOWER KITS									
456027TOWERKIT	1-TWA-10-01	27' Air Guyed Tower Kit	Does Not Include Poles & Anchors						16
456045TOWERKIT	1-TWA-10-02	45' Air Guyed Tower Kit	Does Not Include Poles & Anchors						27
455ACCPOLESET	1-TWA-20-02	9ft. AIR Marine Pole Set							9
455ACCAWTOWERKIT	1-TWA-20-03	Air Marine Tower Hardware Kit	For Alum. Powder Coated Masts						4
455403ROOFMOUNT	1-TWA-19-01	Roof Mount Kit (with seal)	Without Pole or Lag Screws						5
455403ROOFMTW/O	1-TWA-19-02	Roof Mount Kit (without seal)	Without Pole or Lag Screws						5
455ACCRSEAL	2-TWA-100	Roof Seal Kit	For Roof Mount Kit (Air only)						1
AIR ACCESSORIES									
455ACC30AAWBRKR	2-ARAC-103	DC Circuit Breaker (30 Amp)	For Air 12/24V Only						2
456050ABREAKER	3-ELOT-1147-05	DC Circuit Breaker (50 Amp)	For Air 12/24V Only						2
455ACC100AWBRKR	3-ELOT-1108	Circuit Breaker (100 Amp)	For Air 12/24V Only						2
455ACC50ASTOPSW	2-ARAC-101	Stop Switch	For Air 12/24V Only						1
455ACC30AAWMETR	2-ARAC-102	30 Amp Meter Kit	For Air Only						1



SunWize AIR-X
Junction Box Assembly

SunWize®

Wind Junction Box Assembly-AIRX-12/24

This fully assembled wind turbine junction box is designed for use with single AIRX-12V or 24V generator installations. The aluminum-3R enclosure, intended for U-bolt mounting at tower base, can be wall mounted on buildings or enclosures. The junction box provides a large wire terminal block for up to #4 AWG and features a 25A current meter, a 50A run/stall switch, a 50A battery circuit breaker and SOV type lightning surge arrestor with grounding lug. 2-year warranty.

Part #	Model	Vdc	Max Current Amp	Box Size	Weight
996WJBAIRX	WJB-AIRX	12/24	50	11 x 9 x 5	5

Wind Combiner Box Assembly-Two AIRX-12/24

For installations with more than one wind turbine, this assembly has all the features of the Junction Box Assembly. It combines the output of two-AIRX wind turbines and allows for independent monitoring, control and disconnection. Circuit breaker rated 100A, DC amp meter is 0-50A. 2-year warranty.

Part #	Model	Vdc	Max Current Amp	Box Size	Weight
996WCB2AIRX	WCB-2AIRX	12/24	100	14 X 10 X 7	10



Whisper 200

Southwest Windpower

Whisper

Whisper wind turbines feature a patented side furling angle governor to protect the turbine in high winds by turning the alternator and blades out of the wind. Other features include field adjustable voltage, a four bearing spindle for efficiency, upgraded yaw shaft and a new bushing for smoother operation. Voltage is factory set at 24 Vdc and is adjustable to 12/36/48 Vdc. High voltage versions of the Whisper 200 and 500 produce 220 Vac transmitting to a step down transformer that changes it to nominal system voltage (transformer sold separately). High voltage versions are used in applications where there is a long distance from the turbine to the batteries.

Every Whisper 100 and 200 comes with the Whisper Charge Controller except for "HV" and pump models. The SCR-based shunt type controller, housed in a single unit, is dedicated to wind only. LED lights indicate regulation operation and Power ON. Other features include individually rectified phases, battery/turbine shunt isolation, quiet diversion-powered fan, a large heat sink and easy access block connectors for turbine and battery wires.



Whisper Charge Controller

The marine versions, designed for coastal and offshore applications, feature powder coating for corrosion protection, stainless steel hardware, marine-grade wire and watertight housings. 5-year warranty.

Part #	Model	Item	Voltage Range Adjustable	Factory Set Voltage	Rotor Dia. feet	Start Up mph	Rated Power Watts @ speed	Shipping Weight	
Whisper Wind Turbines									
455032	1-WH100L-20-24	WHI-100 w/controller	12/36/48	24	7	7.5	900 @ 28 mph	75	
455034	1-WH100M-10-24	WHI-100 MARINE w/controller	12/36/48	24	7	7.5	900 @ 28 mph	75	
455033	1-WH200L-10-24	WHI-200 w/controller	12/36/48	24	9	7	1000 @ 26 mph	86	
455025	1-WH200L-20-120	WHI-200 Pump	N/A	120	9	7	1000 @ 24 mph	75	
455220H80VT	1-WH200L 20-230	WHI-200 HV no controller *	N/A	220	9	7	1000 @ 26 mph	75	
455026	1-WH200M-10-24	WHI-200 MARINE w/controller	12/36/48	24	9	7	1000 @ 24 mph	86	
455024WHISPR175	1-WH500-10-24	WHI-500 w/controller (24V)	N/A	24	15	7.1	3000 @ 24 mph	286	
455048WHISPR175	1-WH500-10-48	WHI-500 w/controller (48V)	N/A	48	15	7.1	3000 @ 24 mph	286	
455220H175HVT	1-WH500-10-230	WHI-500 High Voltage w/controller *	N/A	220	15	7	3000 @ 24 mph	286	
* must specify step down voltage 24V, 36V, or 48V with all HV controllers and Transformers									
Whisper Controllers									
455018	1-CWRC-11	Whisper Controller Display	LCD display for WHI-100/WHI-200 controller						1
455019	1-CRWC-10-01	WHI-100/WHI-200 Controller	12-48 field adjustable multi voltage controller						12
455021	1-WH200L-40	WHISPER-200 Transformer	Transformer and enclosure for WHI-200HV						47
455020	1-WH500-40	WHISPER-500 Transformer *	Transformer and enclosure for WHI-500						65
Whisper Tower Kits - for 'WHI-100 & WHI-200' turbines									
456024TOWERKIT	1-TWW-10-01	24' WHISPER Guyed Tower Kit	Does not include pipe & anchors						50
456030TKH40/H80	1-TWW-10-02	30' WHISPER Guyed Tower Kit	Does not include pipe & anchors						85
456050TOWERKIT	1-TWW-10-04	50' WHISPER Guyed Tower Kit	Does not include pipe & anchors				2 boxes		130
456065TOWERKIT	1-TWW-10-06	65' WHISPER Guyed Tower Kit	Does not include pipe & anchors				3 boxes		203
456080TOWERKIT	1-TWW-10-07	80' WHISPER Guyed Tower Kit	Does not include pipe & anchors				3 boxes		470
Whisper Tower Kits - for 'WHI-500' or SKYSTREAM turbines									
456030TKWHISPER	1-TWW-11-01	30' WHISPER Guyed Tower Kit	Does not include pipe & anchors				2 boxes		163
456042TOWERKIT	1-TWW-11-02	42' WHISPER Guyed Tower Kit	Does not include pipe & anchors				2 boxes		179
456070TOWERKIT	1-TWW-11-03	70' WHISPER Guyed Tower Kit	Does not include pipe & anchors				3 boxes		248
Tower Accessories									
456036AUGERSET	1-TWW-12-01	36" EARTH Augers	Set of four earth anchors for 24' towers						28
456048AUGERSET	1-TWW-12-03	48" EARTH Augers	Set of four earth anchors for 30'- 50' towers						37
456036AUGERSETG	1-TWW-12-02	36" Galvanized EARTH Augers	Set of four GALV. earth anchors for 24' towers						30
456048AUGERSETG	1-TWW-12-04	48" Galvanized EARTH Augers	Set of four GALV. earth anchors for 30'- 50' towers						40
456060AUGERSET	1-TWW-12-05	60" Galvanized EARTH Augers	Set of four GALV. earth anchors for 65'- 80' towers						65



SHURflo 2088 Pump

SHURflo

SHURflo quality positive displacement diaphragm pumps are self-priming, run-dry capable, energy efficient, designed with permanent magnetic motor for solar water pumping applications. All SHURflo products carry 1-year warranty.

SHURflo 2088 Series 3 chamber-demand pumps offer UL Marine listed, rugged pressure pump that can deliver up to 3.6 GPM from a 12 or 24 Vdc battery pack (self-priming to 9 feet vertical). These are ideal pumps for a cabin, watering project, or a small home system. Features adjustable pressure switch, 30-50 psi.

The SHURflo Power Twin Pump is one of the most efficient 12 Vdc high-flow, self-priming pumps and features a dual manifold system with 5/8" hose barb ports and a thermally protected motor with heat sink for extended operation. It is capable of delivering up to 6.25 GPM.

The SHURflo 9300 submersible pump will fit any 4" diameter or larger well. It will provide many years of service and can be rebuilt in the field with simple tools. This pump has become a favorite with ranchers, remote homeowners and missionaries for the small solar arrays needed and ease of use. This pump produces 2 GPM at open flow and up to 220 feet of lift, and can be run with a supply voltage of 12 Vdc or 24 Vdc.

The SHURflo 5900 Series 5-chamber pump delivers up to 5.7 GPM @ 60 psi from a 12 Vdc or 24 Vdc battery bank. The variable speed feature provides smooth and quiet operation and consumes only the power needed at any flow. It is the perfect pump for cabin or small home systems.



SHURflo 9300 Series Submersible



SHURflo 902-200 Controller

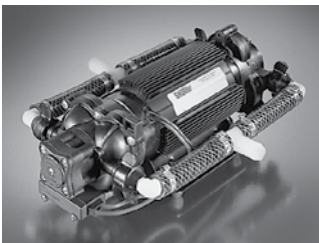

SHURflo Power Twin Pump



SHURflo 5900 Series Pump

Part #	Model	Item	Vdc	Current (amps)	Flow Rate (gpm)	Weight
Demand Pumps						
4610122088443	2088-443-144	Standard Pump	12	9.1	3.6	4.8
4610122088514	2088-514-145	High Flow Pump	12	9	3.6	6.8
461012SHUR20884	2088-414-534	Premium Splash-Proof	12	9	3.6	6.8
4610242088474	2088-474-144	Standard Pump	24	2.71	3	4.9
4610242088574	2088-574-534	Premium Splash-Proof	24	4.5	3.6	6.4
461115208859415	2088-594-154	Standard Pump	115 Vac	0.94	3.3	5.1
4610124111035	4111-035	Power Twin Pump	12	12.1	6.25	7.9
461008	5904-0201	Smart Sensor Pump	12	10	5.7	8.5
461009	5904-1211	Smart Sensor Pump	24	10	5.7	8.5
Accessories						
461ACC17006109	255-313	In-Line Strainer for 2088's				.5
461010	8-021-00	1/2" NPT to 1/2" Barb Fitting				.5
461ACC2088FILTE	255-223	In-line Filter for 2088's				.5
Submersible Pumps						
4610249300SUB	9325-043-011	Submersible pump 4" Well or Larger	24	12.1	2.0	7.9
4610249300CONT	902-100	Linear Current Booster with float switch terminals	24			2
461012249300CON	902-200	Linear Current Booster with weatherproof enclosure, float switch terminals and water level probes	12/24			4



Grundfos

SQFlex - Solar Water Pump

The SQFlex system is truly a flexible and reliable water supply system based on renewable and alternate energy sources, such as solar, wind turbines, generators and batteries. It is designed for continuous as well as intermittent operation, and is especially suitable for water supply applications in remote locations.

Features include:

- Up to 600 feet of head • Built-in dry run protection
- Operates from 30-300 Vdc or 90-240 Vac power supply
- Overload protection • Over temperature protection • Over/under voltage protection
- Maximum Power Point Tracking to optimize pump operation according to available DC Power

SQ Flex Pumps

Part #	Model	Item	Max head feet	Nominal GPM	Pump Length	Discharge size NPT	Pump type diameter	Weight
463004	3 SQF-2	Solar Pump	360	3	47	1"	helical rotor/ 3"	21
463048	3 SQF-3	Solar Pump	600	3	48	1"	helical rotor/ 3"	22
463005	6 SQF-2	Solar Pump	360	6	48	1"	helical rotor/ 3"	22
463006	11 SQF-2	Solar Pump	300	11	49	1-1/4"	helical rotor/ 3"	22
463049	16 SQF-10	Solar Pump	210	16	38	1-1/2"	helical rotor/ 3"	24
463007	25 SQF-3	Solar Pump	45	25	33	1-1/2"	centrifugal/ 4"	21
463008	25 SQF-6	Solar Pump	90	25	35	1-1/2"	centrifugal/ 4"	23
463009	40 SQF-3	Solar Pump	45	40	37	2"	centrifugal/ 4"	24
463050	40 SQF-5	Solar Pump	90	40	40	2"	centrifugal/ 4"	26
463051	60 SQF-3	Solar Pump	45	60	39	2"	centrifugal/ 4"	27
ACCESSORIES								
463012	IO 100	Simple On/Off switch box for Grundfos SQFlex solar electric system.						4.4
463014	IO 101	Generator Interface Box for Grundfos SQFlex. Includes On/Off switch (replaces IO 100) and allows for operation of SQFlex pump for either solar or manual-start generator.						4.4
463015	IO 102	Wind Generator Breaker Box. This box includes a rectifier for the wind generator and a stop switch, and allows the Grundfos SQFlex pump to operate from either the H200 wind generator or a combination of wind and solar.						4.4
463011	CU 200	SQFlex Control Box. This controller and system monitor can be used with solar alone or in combination with the IO101 (for manual generator backup) and/or the IO102 (for wind generator). The CU200 will allow you to add a float switch to shut off the pump when the storage tank is full. The system monitor display on the CU200 shows the following: • Pump operation • Full Tank • Input Power (Watts) • Alarm Indicator for dry running, overvoltage, overload and overtemperature.						4.4
463013	Water Level Switch - Mechanical float switch							

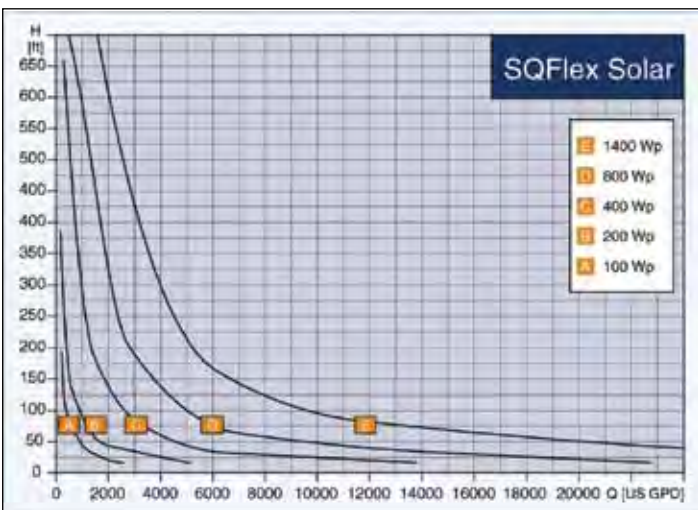

SQFlex Performance Range



SQFlex IO 101 Generator Box and the CU 200 Control Box (l to r)

SIZING YOUR SOLAR PUMPING SYSTEM WORKSHEET

Type of Water Source (Check one): Stream, Lake or Pond Cistern or Dug Well Drilled/Deep Well
 Other _____ Season of operation (months) _____

Depth to Water: _____ Ft. (Be sure to account for variations) Distance of Float Switch Cable _____

Estimated Well Capacity: _____ GPM Amount of Water Required: _____ GPD (Winter) _____ GPD (Spring)
 Well Inside Diameter (If applicable) _____ in. _____ GPD (Summer) _____ GPD (Fall)

Type of Application (Check one): Domestic Water Livestock Irrigation Other _____

Vertical Lift Required From Water Surface to Outlet: _____ ft. Type of Storage: Above Ground Other _____

Geographical Location of System _____ Temperature: _____ °F Min. _____ °F Max

Elevation Above Sea Level: _____ Ft. Distance from Solar Array to Pump: _____ ft.

Options: (please check if you would like one of the following) Float Switch Generator Backup

General Solar Pumping Information

Flow Rates

GPD - Gallons per Day (To estimate GPD, multiply GPH by peak sun hours for location)
 GPH - Gallons per Hour (To estimate GPH, multiply GPM by 60 min./hour)
 GPM - Gallons per Minute

Pump Performance Vs. Solar Array Output

As voltage varies, flow rate will vary proportionally
 Average stays nearly constant
 Watts = Volts x Amps

Conversion Factors

Feet of Lift to PSIG - Divide Feet by 2.31
 US Gallons to Liters - Multiply Gallons by 3.785
 Feet to Meters - Divide Feet by 3.28

Consumption Estimates

People - 10-100 GPD per person for all purposes
 Large Livestock (horses, cattle) - 10 GPD per animal
 Dairy Cattle - 35 GPD per animal
 Small Livestock (sheep, hogs, etc.) - 2-4 GPD per animal
 100 Chickens - 4 GPD

System Spotlight



LOCATION:
 US BLM in Montana and the Dakotas

APPLICATION:
 Communications

SYSTEM:
 80W SunWize® Power Ready Systems



SunPumps SDS-Quad (L) and Duplex (R)

SunPumps™

SDS Series DC Submersible Pumps

SunPumps SDS series submersible pumps are highly efficient, low voltage, DC powered, diaphragm type positive displacement pumps designed specifically for water delivery in remote locations.

They operate on 12 to 30 volts of DC that may be supplied from a variety of independent power sources including solar panels, wind generators, batteries or any combination of the three. Power requirements can be as little as 35 watts. Constructed of marine grade bronze and 304 stainless steel, these pumps are the highest quality submersible pumps in their class.

SunPumps SDS series pumps can be installed below the water level in a pond, river or cistern, or installed by hand into a ground water well. They can be used to fill an open tank or in a pressurized water delivery system, are easy to install, require very little maintenance and are repairable.

SunPumps SDS series pumps are designed for use in stand-alone water delivery systems. Pollution-free, corrosion-resistant, self-lubricating and quiet, an ideal solution to provide water for remote homes, campsites, livestock, small farms or for many other needs beyond the commercial power grid.

D-Series (Duplex)

Suitable for installation in 4" (100mm) inside diameter & larger wells. Flow rates up to 2 GPM, and heads up to 230 feet.

Q-Series (Quad)

Suitable for installation in 5" (127mm) inside diameter & larger wells. Flow rates up to 5 GPM, and heads up to 100 feet.

Part #	Model	Volt DC	Max Current Amps	Max Power Watts	Max Flow GPM	Max Head Feet	Diameter	Length	Weight
460039	SDS D-128	12 to 30	3	95	2	115	3.8	10.8	14
460006	SDS D-228	12 to 30	3	95	1.3	230	3.8	10.8	14
460010	SDS Q-128	12 to 30	3	116	3.7	100	4.5	12.3	16.5
460008	SDS Q-130	12 to 30	6	146	4.3	100	4.5	12.3	16.5
460009	SDS Q-135	12 to 30	6	184	5	100	4.5	12.3	16.5



SunPump PCB, PCA and PVA Series pump controllers (l to r)

PCA & PCB Series Pump Controllers

SunPumps PCA and PCB series pump controllers are high quality, micro processor-controlled DC-power converters designed as the interface between a DC powered pump and the power source. The DC source may be solar modules, batteries or systems using wind generators. 1-year warranty.

The primary function of the PC series controller is to boost the current of solar modules in low sunlight conditions while holding the voltage of the solar modules at the maximum power point. This allows a pump to start earlier in the morning and stay running longer in the evening.

SunPumps PC series pump controllers have many unique features designed specifically for water pumping. All PC series controllers include a pump speed control circuit, a remote switch circuit, a sensor-less low water cut-off circuit, an electronic circuit breaker and indicator lights. The PCB series controllers have specific models for brushless DC as well as brush-type DC motors.

Part #	Model	Voltage Range DC	Max Voltage Voc	Max Current Amps	Max Power Watts	Horse-power	Length	Width	Weight
460029	PCA 30-M1D	15 to 30	45	8	250	N/A	6	5	4
460012	PCA 30-M1	15 to 30	45	8	250	N/A	6	5	4
460007	PVA 30-M1	12/24 to 30 out	45	8	250	N/A	6	5	4
460020	PCA 60-M1	30 to 60	90	8	500	0.5	8.3	6.5	8
460026	PCB 90BL-M1	45 to 90	200	10	1000	1	8.3	6.5	8
460002	PCB 120BL-M1	90 to 135	250	10	1200	1	8.3	6.5	8
460030	PCB 180BL-M1	135 to 180	300	14	2500	2	8.3	6.5	8
460024	PCB 90BT-M1	45 to 90	200	10	1000	1	8.3	6.5	8
460004	PCB 120BT-M1	90 to 135	250	10	1200	1	8.3	6.5	8
460054	PCB 180-BT-M1	135 to 180	300	14	2500	2	8.3	6.5	8
460014	PCB 180BT-M1-HD	135 to 180	300	14	2500	3	8.3	6.5	8



SunPumps SCS Series

SCS Series Brushless DC Submersible Pumps

SunPumps SCS series submersibles are high-quality, maintenance-free, DC-powered pumps specifically made for stand-alone water delivery in remote locations. They are installed below the water level in a water well, lake, river, or cistern and used to fill an open tank or pressurize water systems for remote homes, small farms, and villages. SCS Series operate on 400 to 2000 watts of DC power at 30 to 180 volts. The power may be supplied from a variety of sources, including solar modules, wind generators, batteries or any combination of the three. The submersible motors incorporate permanent magnet, brushless DC technology and are constructed of corrosion-resistant, marine-grade bronze and stainless steel. Internal pressure equalization allows motor submersion to any depth without damage to seals. The pump ends are multi-stage centrifugals constructed of stainless steel or marine-grade bronze and stainless steel on select models. The impellers are wear-resistant, glass-filled, engineered composite, which is resistant to mineral and algae deposits. 1-year warranty.

Part #	Pump Model	Voltage DC	Max Current Adc	Max Power Watts	Horse-power	Flow Range GPM	Max Head feet	Diameter	Length	Discharge NPT	Shipping Weight
460025	SCS 2-280	30-45	10.5	475	0.5	1.5 to 4	280	3.9	31	1-1/4"	30
460028	SCS 4.5-160	30-60	8.1	486	0.5	3 to 6	160	3.9	21	1-1/4"	24
460040	SCS 8-90	30-45	8.6	390	0.5	5 to 11	90	3.9	23	1-1/4"	25
460041	SCS 9-100	30-60	8.7	522	0.5	6 to 15	100	3.9	19	1-1/4"	23
461042	SCS 18-45	30-45	8.5	380	0.5	10 to 24	45	3.9	24	2"	26
461043	SCS 3-425	60-105	8.8	924	1	2 to 5	425	3.9	33	1-1/4"	25
461044	SCS 6-185	60-120	6.1	732	1	4 to 8	185	3.9	24	1-1/4"	29
461045	SCS 10-230	60-105	9.5	998	1	6 to 14	230	3.9	29	1-1/4"	32
460031	SCS 14-160	60-105	9.1	955	1	10 to 22	160	3.9	28	1-1/4"	31
460001	SCS 30-115	60-120	10	1200	1	18 to 40	115	3.9	28	2"	36
460050	SCS 4-500	120-180	7.5	1345	1.5	3 to 6	500	3.9	34	1-1/4"	38
460051	SCS 11-300	120-180	8.1	1458	1.5	8 to 14	300	3.9	30	1-1/4"	37
460052	SCS 17-200	120-180	8.2	1476	1.5	12 to 21	200	3.9	28	1-1/4"	35
460053	SCS 40-90	120-180	8.1	1458	1.5	26 to 57	90	3.9	25	2"	33
460037	SCS 4-550	120-180	8	1440	2	3 to 7	550	3.9	27	1-1/4"	39
460032	SCS 16-300	120-180	11.5	2070	2	10 to 23	300	3.9	32	1-1/4"	39
460018	SCS 50-100	120-180	9.7	1746	2	30-60	100	3.9	27	2	37



SunPumps SCB Series

SCB Series Multi-Stage Centrifugal Booster Pump

SunPumps SCB series pressure pumps are multi-stage centrifugals designed primarily for boosting pressure from surface water as long as the water supply is at or above the level of the pump. They are ideal pumps for home pressure systems, sprinkler systems or in-line booster pumps. Like the SCS series, SunPumps SCB series pressure pumps are high-quality, maintenance-free, DC pumps specifically designed for water delivery in remote locations. They operate on 100 to 1500 watts of DC power with 24V through 180V models available. Models can be powered by batteries or directly from solar panels. 1-year warranty.

BATTERY POWERED Part #	Model	Voltage DC	Power Watts	Flow GPM	Gallons Per Hour at Total Head (feet) or PSI						Weight
					46 ft. 20PSI	69 ft. 30PSI	92 ft. 40PSI	115 ft. 50PSI	162 ft. 70PSI	185 ft. 80PSI	
460055	SCB 6-40P-24	24v batt.	300	6	510	420	360	240	na	na	35
460027	SCB 8-40P-24	24v batt	400	8	590	510	470	400	210	70	36
460011	SCB 20-25P-24	24v batt	900	20	1483	989					35
461048	SCB 24-50P-48	48v batt	1450	24	2400	2166	1932	1680	1000	540	55
PV DIRECT					Max Head (ft.)						
460019	SCB 8-90	60 to 90	CALL	8			120				34
461049	SCB 20-45	60 to 105	FOR	20			60				34
460003	SCB 20-150	75 to 105	SIZES	20			170				54
460033	SCB 21-150	90 to 120		21			170				54



55W DLS Fluorescent Flood Fixture

SunWize Designer Light Fixtures

This series of light fixtures feature color matched architectural bronze powder paint over an aluminum fixture body. Designer light fixtures for outdoor use are intended for remote ballast operation (DC ballast not included) for either fluorescent or low pressure sodium lamps. Light fixture features a welded rear collar for 2" pipe attachment and hinged captive screw cover with unbreakable clear polycarbonate lens. Fluorescent and LPS fixtures include a multi-faceted polished reflector enhancing area of light coverage. All DLS fixtures include lamp(s) and an outdoor rated 30-foot output cable. See DC ballasts and replacement lamps for LPS or fluorescent. LPS fixtures require 10 minutes to warm up to full intensity. Designer fixture dimensions: 19" L x 13" W x 4" D, pipe collar extends 4" and fits 2.38" O.D. pipe. IES files and photometric iso-foot candle charts are available. Fluorescent fixture not recommended below 25°F.

Part #	Model	Lamp Type	Power Watts	Input Vdc	Light Color	Color Temp	Rated Hours	Weight
251DLS001	LPS35-12	Low Pressure Sodium	35	11-14.5	Yellow	1800K	18,000	10
251DLS002	LPS55-24	Low Pressure Sodium	55	22 - 29	Yellow	1800K	18,000	10
251DLS003	FL28-12	36W Fluorescent	27.5	10.5 - 14	White	4100K	10,000	10
251DLS004	FL55-12	Dual 36W Fluorescent	55	10.5 - 14	White	4100K	10,000	11



Low Pressure Sodium Replacement Lamp

DLS Replacement Lamps – Low Pressure Sodium

Part #	Model	Lamp Type	Watts	Base	Lumens (mean)	Color Temp.	Rated Hours
251BULBLPS135LT	SOX-35	Low Pressure Sodium	35	BY22d	4000	1800K	18,000
251BULBLPS55	SOX-55	Low Pressure Sodium	55	BY22d	6655	1800K	18,000



251RL002 39W Fluorescent

DLS Replacement Lamp – Fluorescent

Part #	Model	Lamp Type	Watts	Base	Lumens (mean)	Color Temp.	Rated Hours
251RL002	F39BX	Fluorescent-4 pin	39	2G11	2510	4100K	10,000



55W LPS DC Ballast

DLS – DC Inverter Ballast for LPS or Fluorescent Lamps

100% solid state DC ballast operates AC lamps from DC supply. DC fuse required, 1-year warranty.

Part #	Model	Lamp Type	Watts	Volts DC	Size L x W x D	Weight
260FIXBLSTLPS35	12LPS35E	SOX-35	35	12	5 x 1.5 x 1.5	1
260FIXBLSTLPS55	24LPS55B	SOX-55	55	24	9 x 2.5 x 1.5	3
251RB002	2D12-1-32	F39BX	32	12	5.4 x 1.9 x 1.4	1
251RB006	2D24-1-32	F39BX	32	24	5.4 x 1.9 x 1.4	1



LED Lamp

LED Wall or Ceiling Lamp

This durable light fixture contains either 4 or 6–1 watt high power, white LED's. The average life of 100,000 hours results in a 20-year lifetime estimate when operated all night. The WP6X LED's wide-view angle is perfect for coverage of large areas up to 20 x 20 feet. The WP4X includes dual 10° spot LEDs and dual wide-angle LEDs. Ideal for bus stops, porches, and outbuildings. Housed in a vandal resistant enclosure.

Part #	Model	Vdc	Amps	Lumens	Dimensions	Weight
251010	WP4X	12	0.52	625	8.5 x 4.5 x 4	1
251011	WP6X	12/24	0.58/.29	720	8.5 x 4.5 x 4	1



Solsum ESL

Steca

Solsum Energy Saving Lamp

The Solsum Energy Saving Lamp is a 12V compact fluorescent bulb with a long life and an 80% reduced consumption of electricity. Operating temperature range is 14°F to 122°F. Installs in any standard incandescent socket.

Part #	Model	Vdc	Watts	Current mA	Lumens	Avg. Life Span hrs.
321007WSOLSUM	ESL7 Cool White	12	7	580	400	6000
321011WSOLSUM	ESL11 Cool White	12	11	920	600	6000
321007WSOLSUM-W	ESL 7 Warm White	12	7	580	400	6000
321011WSOLSUM-W	ESL11 Warm White	12	11	920	600	6000



Vandal-Resistant Fluorescent Fixture

SunWize

Vandal-Resistant Wall Ceiling Fixture – Fluorescent

These indoor/outdoor fixtures with compact fluorescent lamp (CFL) are ideal with solar-powered battery charging systems for public buildings, restrooms, garages and parks. VAN2 fixtures are with choice of 7W or 15W CFL lamp for timer-based or on/off switch installations.

All fixtures feature heavy-gauge steel base, reflector with gasket in white finish with clear vandal-resistant polycarbonate refractor and tamperproof screws. UL listed wet locations. (24 Vdc models available special order).

Part #	Model	Vdc	Watts	Dimensions	CFL Lamp	Weight
292001	VAN2-7	12	7	8.5 X 8.5 X 4.1	LTM-07-12	2.0
292002	VAN2-15	12	15	8.5 X 8.5 X 4.1	LTT-15-12	2.1



Vandal-Resistant Fixture with PIR sensor

Vandal-Resistant Wall Ceiling Fixture with PIR – Fluorescent

The VAN3 fixture features a PIR motion-sensor and 7W or 15W compact fluorescent model. Select the VAN5 fixture for higher power 23W with PIR motion-sensor. Both models include bronze color die-cast aluminum housing and tamperproof screws. PIR continuous tare loss = 3 mA. UL listed wet locations. 1-year warranty. 24V models available.

Part #	Model	Vdc	Watts	Dimensions	CFL Lamp	Weight (lbs)
292004	VAN3-15 PIR	12	15	8.5 X 8.5 X 4.1	LTT-15-12	4.1
292005	VAN5-23 PIR	12	23	12 X 12 X 9	LTT-23-12	6.0



Outdoor Economy Floodlight

Economy Floodlight – Fluorescent Outdoor

This non-metallic molded black fixture features a self-contained ballast, a polished reflector, clear lens screw cover and 1/2" NPT pivot mount. Twin tube replacement lamps are 4100K color temperature, 10,000-hour rated life.

Part #	Model	Vdc	Watts	Dimensions	Weight
251ELF003	LIT-ELF12/9	12	9	9.3 x 4 x 4	1.5
251ELF001	LIT-ELF12/13	12	13	9.3 x 4 x 4	1.5

Replacement Lamps-Compact Fluorescent 4 Pin Base

Part #	Model	Watts	Lumens	Base	Length
251RL005	PL9	9	600	2G7	5.7
251BULBW1SE13DC	PL13	13	900	2GX7	6.2



PL Compact Fluorescent - 4 pin



13W Outdoor Fluorescent Floodlight

SunWize®

Floodlight – Fluorescent Outdoor

This directional floodlight is ideal for signs, wall washing, driveway or security lighting. Fixtures feature black powder coated aluminum housing with 1/2” NPT swivel mount, a specular aluminum parabolic reflector, clear polymer lens, solid state electronic ballast and compact PL lamp. UL listed – wet locations. Available 12V or 24 Vdc.

Part #	Model	Vdc	Watts	Lumens	Amps	Dimensions	Weight
292FIX1001-1312	1001-13	12	13	900	1.2	9.3 x 6.6 x 4.6	1
292FIX1001-1324	1001-13	24	13	900	0.6	9.3 x 6.6 x 4.6	1
292FIX1001-3612	1001-36	12	36	2900	2.2	18.0 x 6.6 x 4.6	1
292FIX1001-3624	1001-36	24	36	2900	1.1	18.0 x 6.6 x 4.6	1



Outdoor Wall Ceiling Fixture

SunWize Wall Ceiling Fixture – Fluorescent Outdoor

Attractive and virtually indestructible, this wall/ceiling mount fixture is rated for use in wet locations and features a molded prismatic polycarbonate lens and internal specular aluminum reflector. Fixture body can accept conduit wiring and includes energy efficient ballast and PL compact fluorescent lamp. Tamperproof screws. UL listed. 1-year warranty.

Part #	Model	Vdc	Watts	Lumens	Amps	Dimensions	Weight
292FIX2020-712	2020-7	12	7	400	0.65	11 x 5 x 3	2
292FIX2020-912	2020-9	12	9	600	0.85	11 x 5 x 3	2
292FIX2020-1312	2020-13	12	13	900	1.20	11 x 5 x 3	2
292FIX2020-1324	2020-13	24	13	900	1.20	11 x 5 x 3	2



251RL001

Replacement Lamps-Compact Fluorescent

Twin tube “PL” lamps are 4100K-color temperature. For fixture models 1001 and 2020.

Part #	Model	Watts	Rated Life	Lumens	Base	Length
251RL004	RL004	7	10,000 hours	400	G23	5.3
251RL006	RL006	9	10,000 hours	600	G23	6.0
251RL001	RL001	13	10,000 hours	900	GX23	7.3



13W Fluorescent DC Ballast (above) and 18-36W (photo top right)

DC Ballasts – Fluorescent

These energy efficient, long life, solid state electronic 12 and 24 Vdc ballasts are for use with single compact fluorescent lamps.

All are 2-wire connection. 1-year warranty.



Part #	Model	Volts	Wattage	Dimensions	Weight
251RB004	2D12-1-9	12	5/7/9	1.9 x 1.9 x 2.5	0.5
251RB001	2D12-1-13	12	13	1.9 x 1.9 x 2.5	0.5
251RB005	2D24-1-13	24	13	1.9 x 1.9 x 2.5	0.5

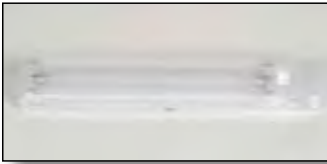

Economy fluorescent indoor fixture

SunWize

Economy Fixture – Fluorescent Indoor

The slim line Trilight, 12 Vdc fixture offers a unique design allowing the operation of one, two or three 8 watt tubes. If one tube fails, the others will still work. Low power consumption; one tube is <0.5 amp, three tubes are 0.85 amps (supplied with one tube). Includes on/off switch and unbreakable lens. 1-year warranty.

Part #	Model	Vdc	Rated Tube Life	Design Lumens	Dimensions	Weight
251EFF001	KL8	12	5000+ hours	400	15 x 3 x 1	1
251BULF8T5	8W	Replacement Lamp				0.3



LTM, LTT and LTQ CFL lamps

Compact Fluorescent (CFL) Lamps – 12 Vdc and 24 Vdc

A wide range of medium screw-base compact fluorescent lamps featuring integral DC ballasts. For a traditional bulb look, select LTB-11 or for spiral design, select LTS lamps. All are reverse polarity protected. 24 Vdc lamps available as special order.



LTB model (left), LTS model (right)

Part #	Model	DC Volts	Watts	Amps	Color Temp.	Lumens	Length	Weight
251020	LTM-03	12	3	0.25	6400K	150	4.0	0.15
251024	LTB-11	12	11	0.70	4100K	500	5.5	0.20



Dusk/Dawn Switch

Dusk/Dawn Switch

Turns ON light at dusk, OFF at dawn. Two models available; 3A or 6A. Waterproof construction fits into 1/2" knockout. Both are available as Option for "ON" at dawn, "OFF" at dusk. Weight: 1.0 lb.

Part #	Model	Max. Load Amps	Voltage
320006	LALC-03	3	12/24
462009	LALC-06	6	12/24



Motion Sensor

SunWize 12 Vdc Motion Sensor-PIR

This passive infrared motion sensor detects heat and movement to activate 12 Vdc lighting and is rated for outdoor use in wet locations. The sensor includes sensitivity adjustment to deter false trigger and will allow day or night only operation. Adjustable timer for 5 seconds to 12 minutes. Unit is self-resetting during movement. Range 50' x 110° wide. Self consumption = 70 mA. Includes swivel base and fits into 1/2" knockout. UL listed.

Part #	Model	Vdc	Max. Load Amps	Dimensions	Weight
256012VSENSOR	PIR-2000/12	12	8	9.0 x 5.5 x 1.6	2



Diehl Digital Time Switch - 1 Channel

Diehl Digital Time Switch – 1 Channel

Compact digital time switch provides precise timing with the flexibility of daily and/or weekly programming. Simple and fast setting by means of push buttons and display prompts. Available in 12 or 24 Vdc operation, applications include: indoor outdoor lighting, pumps, fans, signs, security systems and process controls. UL, CSA listed. Size = 2.4" x 2.4" inches. Weight = 1 lb.

- Features:**
- 24 hour display (military or AM/PM) – 7 day timing combined with 8 on/off operations
 - Repeat programs provide up to 56 switching cycles per wee
 - Manual override and "skip a day"
 - Minimum time setting: 1 minute
 - Lithium battery provides minimum 5 year reserve (unpowered)

Part #	Description	Volts DC	Switch Amps @ 55°C	Switching	Operating Temperature
325010A12VTIMR8	Time Switch	12	10A	SPST / SPDT	14°F(-10°C) to 131°F(55°C)
325010A24VTIMER	Time Switch	24	10A	SPST / SPDT	14°F(-10°C) to 131°F(55°C)
325010A24VHOUSI	Housing - Time Switch	12/24	N/A	N/A	N/A



OutBack FLEXpower ONE System

OutBack Power Systems

OutBack FLEXpower ONE System

The OutBack FLEXpower ONE System accommodates all of the essential protective devices in the smallest possible space making it ideal for applications with modest power requirements such as cabins, chalets, homes, remote communication sites and back-up power systems. Utilizing an extremely compact design and an easy-to-install mounting bracket, the fully pre-wired and factory tested FLEXpower ONE System is designed for a quick installation, saving both time and money

FLEXpower ONE includes a single inverter, AC and DC wiring boxes, a single FLEXmax Charge Controller, MATE, HUB, FLEXnet DC and Surge Protector while maintaining a small system footprint. The FLEXpower ONE System is also equipped with battery and PV array breakers, a PV GFDI breaker, an Input-Output-Bypass Assembly, mounting locations for both AC GFCI Type B and EU Type F style outlets and additional AC breakers. FLEXpower ONE components carry all of the necessary ETL Certifications allowing for a code compliant installation that saves both time and money while still looking great.



Part #	Model	Description	Dimensions	Weight
715246	FP1-1	FLEXpower ONE, 120Vac Bypass and Type B Outlet, 250ADC breaker, GFDI, 80 amp charge controller breaker, VFX3524	12.88 x 19.69 x 33.44"	98
715247	FP1-2	FLEXpower ONE, 175Vac Bypass and Type B Outlet, 175ADC breaker, GFDI, 80 amp charge controller breaker, VFX3648	12.88 x 19.69 x 33.44"	98
715248	FP1-3	FLEXpower ONE, 120Vac Bypass and Type B Outlet, 250ADC breaker, GFDI, 80 amp charge controller breaker, GVFX3524	12.88 x 19.69 x 33.44"	98
715245	FP1-4	FLEXpower ONE, 120Vac Bypass and Type B Outlet, 175ADC breaker, GFDI, 80 amp charge controller breaker, GVFX3648	12.88 x 19.69 x 33.44"	98
715249	FP1-5	FLEXpower ONE, 230Vac Bypass and Type F Outlet, 250ADC breaker, GFDI, 80 amp charge controller breaker, VFX3024E	12.88 x 19.69 x 33.44"	98
715250	FP1-6	FLEXpower ONE, 230Vac Bypass and Type F Outlet, 175ADC breaker, GFDI, 80 amp charge controller breaker, VFX3048E	12.88 x 19.69 x 33.44"	98



OutBack SmartRE

OutBack SmartRE

Designed with an emphasis on ease of installation, a SmartRE solution installs and operates similarly to basic grid-tie solar inverters but with the additional benefit of providing UPS quality battery back-up during utility outages. An integrated ultra-fast AC transfer switch guarantees that even sensitive back-up loads, like computers, never know when a utility outage occurs. Recommended AGM batteries are maintained and charged by an innovative OutBack multi-stage charging process.

The SmartRE can be installed both indoors and outdoors and is available in power levels up to 3kW and capable of providing as much as 69 kWh of back-up power during outages. With matching type 3R rainproof power electronics and battery enclosures constructed of aluminum, a SmartRE solution can be either wall or pad mounted. A standard 5-year warranty, with an option to add an additional five-year warranty.

Part #	Model	Description	Weight Electronics/Enclosure
715238	SRE3000-120-NA	Enclosure w/cover, outdoor rated, 120Vac 3000W inverter and 1 battery cabinet	134/44
715242	SRE3000-120/240-NA	Enclosure w/cover, outdoor rated, 120/240Vac 3000W inverter and 1 battery cabinet	166/44
715243	SRE-BE1	Outdoor rated battery enclosure with top cap and front cover	44

OutBack Power Systems – FLEXware

FLEXware FW250

For single inverter applications the FW250 enclosure accommodates all of the essential protective devices in the smallest possible space. Utilizing an extremely compact design, one FW250 enclosure can be mounted on each end of a single FX Series Inverter/Charger. The FW250 enclosure is Type-1 indoor (IP30) constructed of silver powder-coated aluminum, includes a generous collection of wiring knockouts and has been ETL listed to UL specifications for USA and Canada. It provides eight breaker spaces (3/4" W PNL mount) for battery, PV array or PV GFP breakers and mounting locations for AC GFCI outlet, AC breakers and an Input-Output-Bypass Assembly. Also space for one 175A or 250 Amp panel mount breaker and a GFCI-AC outlet (not included). Unit size - inches (H x W x D) = 7.5 x 6.5 x 8.6

Includes: Ground bus bar, DC breaker handle guard, breaker mounting hardware and enclosure mounting hardware.



FLEXware FW250

FLEXware FW500

For larger power systems, the FW500 system architecture can support one or two FX Series Inverter/Chargers, one or two OutBack charge controllers (side-mounted) and all associated AC and DC components. A compact design, FW500 AC and DC enclosures attach with a FLEXware MP mounting panel for a fast and professional looking wall-mounted installation. Each inverter requires a set of DCA and ACA conduit adapters. The FW500 enclosure is Type-1 indoor (IP30) constructed of silver powder-coated aluminum, includes a generous collection of wiring knockouts and has been ETL listed to UL specifications for USA and Canada. All DC cables, AC and DC breakers, Input-Output-Bypass assemblies and all other additional components sold separately.

FW500-AC

Enclosure allows wiring AC end of one or two FX series inverters. Unit has sixteen spaces for 1/2" wide DIN breakers, supports six terminal bus bars and one FW-X240.

Unit size - inches (H x W x D) = 18.2 x 11.4 x 12.1

Includes: Ground bus bar, DIN mounting rail, flexible conduit and enclosure mounting hardware.

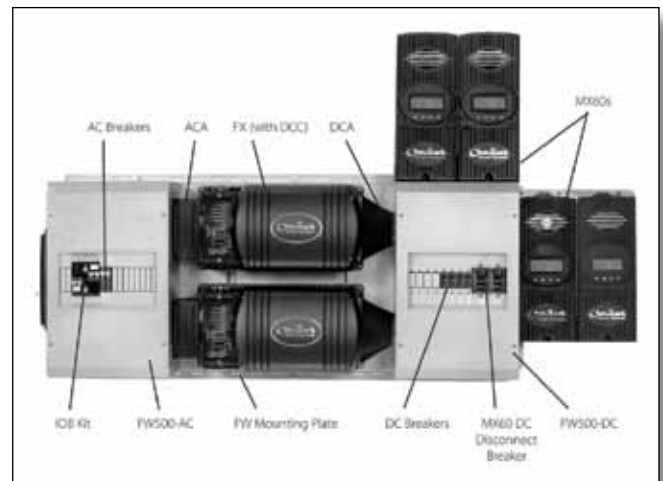

FLEXware FW500

FW500-DC

Enclosure allows wiring DC side of one or two OutBack FX series inverters, supports six terminal bus bars and three shunt assemblies. Unit has eight spaces for 3/4" wide PNL breakers, three spaces for 1" wide - or two spaces for 1.5" wide PNL breakers.

Unit size - inches (H x W x D) = 18.2 x 11.4 x 12.1

Includes: Ground bus bar, 500 Amp DC shunt assembly, positive bus bar, breaker mounting panel and hardware, FW-BBUS and enclosure mounting hardware.

FLEXware FW1000

For applications with large power requirements the FLEXware 1000 system is capable of supporting up to four OutBack FX series inverter attached with two FLEXware MP mounting panels, four OutBack charge controllers (side-mounted) and all the required AC and DC components and wiring. Each Inverter requires an FW-ACA (or FW-SP-ACA) and DCA conduit adapters.

FW1000 AC and DC enclosures accommodate all of the essential protective devices with lots of room for additional breakers and large cable connections. The FW1000 enclosure is Type-1 indoor (IP30) constructed of silver powder-coated aluminum, includes a generous collection of wiring knockouts and has been ETL listed to UL specifications for USA and Canada.

FW1000-AC

Enclosure allows wiring the AC side of three or four FX series inverters. Unit has 32 spaces for 1/2" wide DIN breakers, supports eight terminal bus bars, one FW-X240. Unit size - inches (H x W x D) = 38.5 x 11.4 x 12.1

Includes: Ground bus bar, two DIN mounting rails and communication wiring raceway.

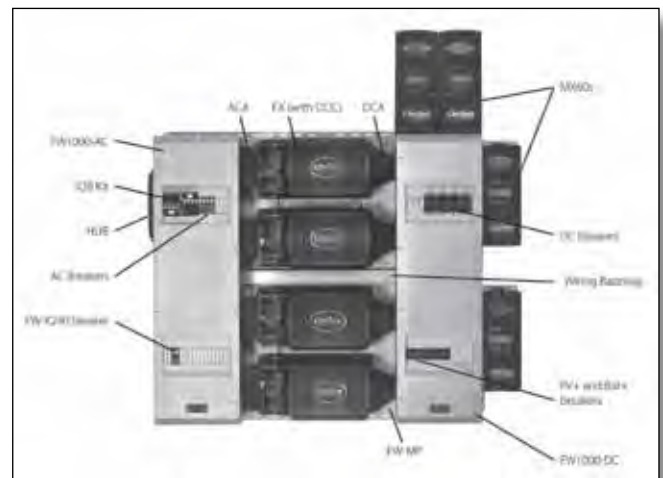

FLEXware FW500

FW1000-DC

Enclosure allows wiring the DC side of three or four FX series inverters. Unit has 11 spaces for 3/4" wide PNL breakers, nine 1" wide spaces for 100A breakers or six 1.5" wide spaces for 175A - 250A breakers and supports up to eight terminal bus bars and up to three shunt assemblies.

Includes: Ground bus bar, 1000 Amp DC shunt assembly, positive bus, breaker mounting hardware, enclosure mounting hardware, two FW-SBUS and one FW breaker bus.

Unit size - inches (H x W x D) = 38.5 x 11.4 x 12.1

FLEXware Mounting Panel FW - MP

Integrates OutBack FX series inverters to FLEXware 500 & 1000 enclosures A one-piece, silver powder-coated aluminum plate, one needed for mounting FW500 and two FW1000 enclosures.

Unit size - inches (H x W x D) = 20.3 x 46.3 x 0.8

FLEXware Surge Protector

FW-SP-ACA

The FLEXware Surge Protector was designed specifically for OutBack FX Series Inverter/Chargers (required for GVFX, GTFX models). The FW-SP-ACA replaces the FW-ACA (AC Conduit Adaptor) for FW500 & FW1000 systems and provides multiple levels of protection in the event of an electrical surge or nearby lightning strike. The sophisticated design allows for both AC and DC protection on multiple circuits (two AC and one DC) via thermally fused Metal Oxide Varistors (MOVs). LED visual indicators provide at-a-glance status monitoring allowing system users to determine operational status in real-time. The FW-SP-ACA is designed to operate between 120-240 Vac at 50/60 Hz and 12-48 Vdc.



FW-MP Mounting Panel



FW Surge Protector

Part #	Model	Item	Shipping Size	Weight
715198	FW 250	Enclosure - AC/DC, Single FX	9.8 x 8.4 x 11.6	5
715186	FW 500-AC	Enclosure - AC, Dual FX	14.5 x 13.4 x 20.3	15
715187	FW 500-DC	Enclosure - DC, Dual FX	14.5 x 13.4 x 20.3	15
715188	FW1000-AC	Enclosure - AC, 3 - 4 FX	14.5 x 13.6 x 40.8	21
715189	FW1000-DC	Enclosure - DC, 3 - 4 FX	14.5 x 13.6 x 40.8	21
715190	FW-MP	Mounting Panel - one FW500	1.2 x 22.9 x 48.4	14
715065	FW-ACA	AC Conduit Adaptor - FX series	-	2
715066	DCA	DC Conduit Adaptor - FX series	-	27
15213	FW-SP-ACA	Surge Protector AC/DC - for FW500 and FW1000	8.5 x 6.75 x 2.5	2.2
715220	FW-SP-250	Surge protector for FLEXware250	5.5 x 6.5 x 7.5	2.0

FLEXware AC Input/Output-Bypass Assemblies FW-IOB

Field installable kit for bypassing the inverter, connecting the AC (utility or generator) input to the AC (load) output, for inverter maintenance. Also provides required over-current protection. FW-IOB assemblies include all of the circuit breakers and interconnect wiring needed for installation into FLEXware AC enclosures.

For FLEXware 250

FW-IOB-S-120VAC Includes: Three 60A 120 Vac single pole PANEL mount breakers, sliding bypass interlock plate, wire and hardware. System Rating: Bypass Input/Output Breaker - Single-Phase 120 Vac One Pole @ 60 Amps 7.2 kW.

FW-IOB-S-230VAC Includes: Three 30A 230 Vac single pole PANEL mount breakers, sliding bypass interlock plate, wire and hardware kit. System Rating: Bypass Input/Output Breaker - Single-Phase 230 Vac One Pole @ 30 Amps 6.9 kW.

For FLEXware 500

FW-IOB-D-120VAC Includes: Four 60A 120 Vac single pole DIN mount breakers, one 60A 120 Vac dual pole DIN mount breaker, sliding bypass interlock plate, wire and hardware kit.

System Rating: Bypass Input/Output Breaker - Single-Phase 120 Vac Two Poles @ 60 Amps 14.4 kW.

FW-IOB-D-120/240VAC Includes: Six 60A 120 Vac single pole DIN mount breakers, sliding bypass interlock plate, wire and hardware kit. System Rating: Bypass Input/Output Breaker - Split Phase 120/240 Vac Two Poles @ 60 Amps 14.4 kW.

FW-IOB-D-230VAC Includes: Six 30A 230VAC single pole DIN mount breakers, sliding bypass interlock plate, wire and hardware kit. System Rating: Bypass Input/Output Breaker - Single-Phase 230 Vac Two Poles @ 30 Amps 13.8 kW.



FW ACA Conduit Adaptor

For FLEXware 1000

FW-IOB-T-120/208VAC Includes: Nine 60A 120 Vac single pole DIN mount breakers, sliding bypass interlock plate, wire and hardware kit. System Rating: Bypass Input/Output Breaker - Three-Phase 120/208 Vac Three Poles @ 60 Amps 21.6 kW.

FW-IOB-Q-120/240VAC Includes: Eight 60A 120 Vac single pole DIN mount breakers, two 60A 120 Vac dual pole DIN mount breakers, sliding bypass interlock plate, wire and hardware kit.

System Rating: Bypass Input/Output Breaker-Split Phase 120/240 Vac Four Poles @ 60 Amps 28.8 kW.

FW-IOB-T-230/400VAC Includes: Nine 30A 230 Vac single pole DIN mount breakers, sliding bypass interlock plate, wire and hardware kit. System Rating: Bypass Input/Output Breaker - Three-Phase 230/400 Vac Three Poles @ 30 Amps 20.7 kW.

FW-IOB-Q-230VAC Includes: Twelve 30A 230 Vac single pole DIN mount breakers, sliding bypass interlock plate, wire and hardware kit. System Rating: Bypass Input/Output Breaker - Single-Phase 230 Vac Four Poles @ 30 Amps 27.6 kW.

Part #	Model	Item	Description
715203	FW-IOB-S-120VAC	Bypass Breaker Kit Input/output	Single inverter-single phase
715204	FW-IOB-S-230VAC	Bypass Breaker Kit Input/output	Single inverter-single phase
715191	FW-IOB-D-120VAC	Bypass Breaker Kit Input/output	Dual inverter-single phase
715205	FW-IOB-D-120/240VAC	Bypass Breaker Kit Input/output	Dual inverter-split phase
715206	FW-IOB-D-230VAC	Bypass Breaker Kit Input/output	Dual inverter-single phase
715199	FW-IOB-T-120/208VAC	Bypass Breaker Kit Input/output	three inverters-three phase
715197	FW-IOB-Q-120/240VAC	Bypass Breaker Kit Input/output	four inverters-split phase
715209	FW-IOB-T-230/400VAC	Bypass Breaker Kit Input/output	three inverters-three phase
715208	FW-IOB-Q-230VAC	Bypass Breaker Kit Input/output	four inverters-single phase

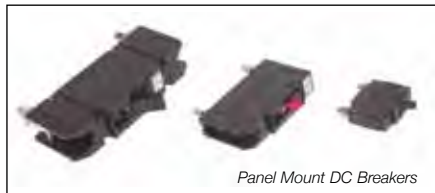

Panel Mount DC Breakers

DC Breakers – Panel Mount (PNL)

Panel mounted hydraulic-magnetic type breakers can be used for DC sources, inverters or load circuit breakers are rated for 100% duty cycle without need for de-rating. ETL listed, some breaker models are dual rated for 120 Vac as well. Mounting screws are not included.

Part #	Description	Max. Current	Voltage	Terminals	Width
715101	OBB-1-150VDC-PNL DC breaker	1 Amp	150 Vdc/120 Vac	1/4" stud	3/4" wide
715091	OBB-5-150VDC-PNL DC breaker	5 Amp	150 Vdc/120 Vac	1/4" stud	3/4" wide
715075	OBB-10-150VDC-PNL DC breaker	10 Amp	150 Vdc/120 Vac	1/4" stud	3/4" wide
715017	OBB-15-150VDC-PNL DC breaker	15 Amp	150 Vdc/120 Vac	1/4" stud	3/4" wide
715092	OBB-20-150VDC-PNL DC breaker	20 Amp	150 Vdc/120 Vac	1/4" stud	3/4" wide
715016	OBB-30-150VDC-PNL DC breaker	30 Amp	150 Vdc/120 Vac	1/4" stud	3/4" wide
715074	OBB-40-150VDC-PNL DC breaker	40 Amp	150 Vdc/120 Vac	1/4" stud	3/4" wide
715100	OBB-50-150VDC-PNL DC breaker	50 Amp	150 Vdc/120 Vac	1/4" stud	3/4" wide
715015	OBB-60-150VDC-PNL DC breaker	60 Amp	150 Vdc/120 Vac	1/4" stud	3/4" wide
715175	OBB-80-125VDC-PNL DC breaker	80 Amp	150 Vdc	5/16" stud	3/4" wide
715014	OBB-100-125VDC-PNL DC breaker	100 Amp	125 Vdc	5/16" stud	1.0" wide
715182	OBB-125-125VDC-PNL DC breaker	125 Amp	125 Vdc	5/16" stud	1.0" wide
715013	OBB-175-125VDC-PNL DC breaker	175 Amp	125 Vdc	3/8" stud	1.5" wide
715012	OBB-250-125VDC-PNL DC breaker	250 Amp	125 Vdc	3/8" stud	1.5" wide



OutBack PV-GFP Ground Fault Protection System

OutBack PV-GFP Ground Fault Protection System

Ground fault protection is required by the NEC for PV arrays mounted on or within a specified vicinity of residential dwelling roofs as a safety precaution. The OutBack PV Ground Fault Protection System rated at 80 Amps protects wiring and system components for one or two PV inputs (at 64 Amps max. short circuit) when used in a FLEXware 250, 500 or 1000 assembly. Consumes three PNL mount breaker spaces.

Part #	Descriptions
715054	OBB-GFDI-80D-150VDC-PNL, DC Ground Fault Protection system for PV arrays-protects wiring & system components.Dual 60A PV circuits 125 VDC max-uses 3 small breaker spaces.Includes ground bus bar.
715241	OBB-GFDI-80D-150VDC-PNL, Single Pole DC Ground Fault Protection system for PV arrays-protects wiring & system components.Dual 60A PV circuits 125 VDC max-uses 3 small breaker spaces.Includes ground bus bar.



DIN Rail Mount AC Breakers

OutBack AC Breakers – DIN Rail Mount

DIN rail mountable, hydraulic-magnetic type breakers that can be used for input, output or load circuits. All breakers rated for 100% duty cycle operation at 50/60 Hz.

Part #	Descriptions	Current & Voltage Rating	Variation	Width
715095	OBB-15-120VAC-DIN	15A, 120 Vac 50/60Hz	Single pole	0.5" (13mm)
715108	OBB-15D-240VAC-DIN	15A, 120/240 Vac 50/60Hz	Dual pole	1.0" (26mm)
715094	OBB-20-120VAC-DIN	20A, 120 Vac 50/60Hz	Single pole	0.5" (13mm)
715117	OBB-20D-240VAC-DIN	20A, 120/240 Vac 50/60Hz	Dual pole	1.0" (26mm)
715032	OBB-25D-240VAC-DIN	25A, 120/240 Vac 50/60Hz	Dual pole	1.0" (26mm)
715005	OBB-30-277VAC-DIN	30A, 277 Vac 50/60Hz	Single pole	0.5" (13mm)
715118	OBB-30D-480VAC-DIN	30A, 277/480 Vac 50/60Hz	Dual pole	1.0" (26mm)
715103	OBB-50-277VAC-DIN	50A, 277 Vac 50/60Hz	Single pole	0.5" (13mm)
715104	OBB-50D-480VAC-DIN	50A,277/480 Vac 50/60Hz	Dual pole	1.0" (26mm)
715212	OBB-60-277VAC-DIN	60A, 277 Vac 50/60Hz	Single pole	0.5" (13mm)



FW-X240 Transformer

FW-X240 Auto-Transformer

Designed to be housed within the FLEXware 500 or FLEXware 1000 AC enclosures. The FW-X240 Auto-transformer is rated 4kVA 120/240 with a 120 volt/30 Amp primary and secondary winding can be used for step-up, step-down, generator and split-phase output balancing for series stacked inverters.

The FW-X240 can transfer 2kW from one 120 Vac leg of a generator or the total rating of an OutBack stacked series/parallel 120/240 Vac inverter/charger configuration. Model PSX-240 is with indoor enclosure and cooling fan, 6kVA rated 120/240 60 Hz, mounts outside FLEXware enclosure. Both models supplied with a 2-pole 25A AC breaker.

Part #	Model	Item	Shipping Size	Shipping Weight
715026	FW-X240	4kVA step up/down Auto-transformer	10 x 10 x 11	32
715157	PSX-240	6kVA step up/down Auto-transformer	16 x 12 x 11	41



DC Bus Bars



TBB Terminal Bus Bars



Charge Controller Mounting Brackets

DC Current Shunts, DC and Terminal Bus Bars, Charge Controller Mounting Brackets



DC Current Shunt

Part #	Model	Item
715210	FW-SHUNT250	250 Amp 50mV DC current shunt w/mounting hardware & terminal bus bar
715200	FW-SHUNT500	500 Amp 50mV DC current shunt w/terminal bus bar & one white insulator
715192	FW-BBUS	Breaker Bus - parallels two 175-250 Amp, or three 100-125A DC breakers
715168	FW-SBUS	Shunt Bus allows up to four high current cable connections rated 1000 Amps
715223	FW-CBUS-8	Breaker Bus Bar allows up to 8 – 150 Vdc breakers
715224	FW-CBUS-12	Breaker Bus Bar allows up to 12 – 150 Vdc breakers
715011	TBB-GROUND	Ground / Neutral Bus Bar + mounting screws (no insulators)
715010	TBB-BLACK	Terminal Bus Bar with two Black insulators and mounting screws
715083	TBB-RED	Terminal Bus Bar with two Red insulators and mounting screws
715082	TBB-WHITE	Terminal Bus Bar with two White insulators and mounting screws
715201	FW-CCB	Charge Controller Bracket - Single side mount onto FW500/FW1000-DC
715196	FW-CCB2	Charge Controller Bracket - Dual side mount onto FW500/FW1000-DC
715202	FW-CCB2-T	Charge Controller Bracket - Dual Top mount onto FW500/FW1000-DC
715009	FW-MB1	FLEXware Mate mounting bracket



MidNite Solar E-Panel

MidNite Solar E-Panel

The compact E-Panel is a pre-wired disconnect and over current solution for mounting a single inverter in a code compliant, off-grid installation. It was designed as a modular breaker box that could expand as required and yet take up the smallest footprint on the wall. This was achieved by mounting the inverter onto the door of the box. E-Panels easily expand to accommodate additional inverters; units can be stacked vertically or horizontally.

E-Panel features include: a pre-wired 50 amp 240Vac AC-bypass switch and 50 amp 240VAC AC input disconnect, bus bars for battery+, battery-, and ground, 500 amp shunt for battery status monitors, slots for up to 6 additional MNEAC and MNEPV AC and DC din rail breakers, pre-wired 125, 175 or 250 amp inverter battery breaker with cables, and a heavy duty 175 amp AC distribution block. They also include: charge controller and wall mounting brackets, battery cable cover, inverter mounting hardware, grommets, bushings and installation instructions.

The standard configuration is left-hand hinged (right-hand also available). E-Panels are available in white powder-coated aluminum and gray powder-coated steel enclosures. ETL listed for US and Canada.

Part #	Model	Description	Shipping Size	Weight
OutBack version 9.5" wide				
716069	MNE125ST-L	Gray steel with 125A/125 Vdc inverter breaker - LEFT HINGE	14 X 12 X 28"	28
716070	MNE175ST-L	Gray steel with 175A/125 Vdc inverter breaker - LEFT HINGE	14 X 12 X 28"	29
716071	MNE250ST-L	Gray steel with 250A/125 Vdc inverter breaker - LEFT HINGE	14 X 12 X 28"	29
716003	MNE250ST-R	Gray steel with 250A/125 Vdc inverter breaker - RIGHT HINGE	14 X 12 X 28"	29
716004	MNE125AL	White aluminum with 125a/125Vdc inverter breaker - LEFT HINGE	14 X 12 X 28"	19
716005	MNE175AL	White aluminum with 175a/125Vdc inverter breaker - LEFT HINGE	14 X 12 X 28"	20
716006	MNE250AL	White aluminum with 250a/125Vdc inverter breaker - LEFT HINGE	14 X 12 X 28"	20
Stretched OutBack version 14.5" wide additional PV input Bus and battery bus bar. Accommodates surge arrestor.				
716072	MNE125STS-L	Stretched gray steel with 125a/125 Vdc breaker - LEFT HINGE	18 X 11 X 28"	39
716073	MNE175STS-L	Stretched gray steel with 175a/125 Vdc breaker - LEFT HINGE	18 X 11 X 28"	39
716074	MNE250STS-L	Stretched gray steel with 250a/125 Vdc breaker - LEFT HINGE	18 X 11 X 28"	39
716033	MNE250STS-R	Stretched gray steel with 250a/125 Vdc inverter breaker - RIGHT HINGE	18 X 11 X 28"	39
Stretched OutBack version 14.5" wide with FM60/80/Classic controller mounting on the door				
716075	MNE175AL-PLUS	Stretched white aluminum with 175a/125Vdc inverter breaker - LEFT HINGE	18 X 11 X 28"	25
716076	MNE250AL-PLUS	Stretched white aluminum with 250a/125Vdc inverter breaker - LEFT HINGE	18 X 11 X 28"	25
Magnum version 14.5" wide				
716048	MNE175STM-L	Gray steel with 175A/125 Vdc inverter breaker - LEFT HINGE	18 X 11 X 28"	39
716080	MNE250STM-L	Gray steel with 250A/125 Vdc inverter breaker - LEFT HINGE	18 X 11 X 28"	39
716020	MNE175STM-R	Stretched gray steel with 175a/125 Vdc inverter breaker - RIGHT HINGE	18 X 11 X 28"	39
716078	MNE175STM-L-240	Gray steel with 175A bkr, 120/240VAC - LEFT HINGE	18 X 11 X 28"	42
716077	MNE250ALM-L	White aluminum with 250a/125Vdc inverter breaker - LEFT HINGE	18 X 11 X 28"	31
716046	MNE250STM-L-240	White steel for MS4024AE with 250a/125Vdc inverter breaker - LEFT HINGE	18 X 11 X 28"	42
Magnum AE version 120/240 Vac Use 2 pole ganged AC breakers for pre-wired AC bypass switch & AC input disconnect. With red terminal bus bars for 120/240 AC IN and AC OUT hook up.				
Xantrex version				
716049	MNE175DR/TR-L	Stretched gray steel with 175a breaker for DR/TR - LEFT HINGE	11 X 14 X 28"	28
716083	MNE250DR/TR-L	Stretched gray steel with 250a breaker for DR/TR - LEFT HINGE	11 X 14 X 28"	30
716082	MNE250XW	Stretched gray steel with 250a breaker for for XW - LEFT HINGE	16 X 18 X 8"	42
Mini – DC Disconnect Power Center with inverter breaker and din rail for adding up to 5 additional MidNite 150 Vdc breakers, battery negative chassis bonding stud, mounts for standard 500 amp/50mV shunt, mounts for battery plus bus bar, conduit knock outs and hinged door.				
716012	MNDC125	White alum chassis with 125A/125 Vdc breaker	10 X 5 X 18"	6
716013	MNDC175	White alum chassis with 175A/125 Vdc breaker	10 X 5 X 18"	7
716014	MNDC250	White alum chassis with 250A/125 Vdc breaker	10 X 5 X 18"	7
716086	MNDC250-Left	White alum chassis with 125A/125 Vdc breaker	10 X 5 X 18"	6
716036	MNDC125	For Apollo T80	10 X 5 X 18"	6



Xantrex DC250 Disconnect

Schneider Electric (Xantrex)

DC Disconnects and Accessories

The DC rated circuit breaker/disconnect with indoor enclosure ensures your compliance with NEC and other safety standard requirements. Designed for most solar charge controllers and inverters for residential and commercial applications. Optional second inverter breaker, grounding/bonding block and circuit breaker allow field customization. ETL listed.

Part #	Model	Description
152ACDC250	DC250	250 Amp DC breaker with enclosure
152ACDC175	DC175	175 Amp DC breaker with enclosure
152ACCCD60DC	CD60DC	60A circuit breaker for solar array input disconnect for C40/C60
152ACCCD15	CD15	15A circuit breaker for small DC load - mounts on side of DC disconnect enclosure
152ACCCD20	CD20	20A circuit breaker for small DC load - mounts on side of DC disconnect enclosure
152ACDCBB	DCBB	DC bonding block



250V Safety Switch

General Duty UL Listed SQ-D Safety Switches – 120/240 Vac

Switches are rainproof NEMA 3R with external lockable switch handle and door. Switches serve as service disconnects (non-fusible) and overcurrent devices (fusible) for 120/240 Vac systems. Only the fusible switches include a factory installed neutral assembly. Switches include main lugs and ground screw. 3R switches accept top bolt-on hubs.

Part #	Model	# Poles	Rated Current (Amps)	Wire Size	Dimensions	Weight
Fusible						
720SWT30AF2P3R	D221NRB	2	30	#14-6 AWG	10 x 7.3 x 3.8	6.0
720SWT60A2PFUSE	D222NRB	2	60	#14-2 AWG	14.8 x 6.7 x 5	11.0
720SWT60A3PFUSE	D322NRB	3	60	#14-2 AWG	14.8 x 6.7 x 5	15.0
Non-Fusible						
720SWT30ANF2P3R	DU221RB	2	30	#14-6 AWG	10 x 7.3 x 3.8	6.0
720SWT60ANF2P	DU222RB	2	60	#14-2 AWG	14.8 x 6.7 x 5	6.0
720SWT60ANF3P3R	DU322RB	3	60	#14-2 AWG	14.8 x 6.7 x 5	11.0
704GROUNDKIT-B	PK3GTA1	Neutral/grounding kit				



Class R Fuse

Fuses - Class R

UL listed 125 Vdc/250 Vac dual, element-time delay type fuse for use in general duty safety switches. 20,000 AIC interrupt rating.

Part #	Model	Rated Current (Amps)	Dimensions
706FUS20ATDFUSE	TR20R	20	0.56 dia. x 2.0
706FUS30ATDFUSE	TR30R	30	0.56 dia. x 2.0
706FUS40ATDFUSE	TR40R	40	0.81 dia. x 3.0
706FUS60ATDFUSE	TR60R	60	0.81 dia. x 3.0



B075 Bolt-On Hub

Bolt-On Hubs

Rainproof bolt-on hubs for use on SQ-D NEMA 3R safety switches.

Part #	Model	Conduit Size	Part #	Model	Conduit Size
703HUB004	B075	.75"	703HUB001	B125	1.25"
703HUB003	B100	1"	703HUB005	B150	1.5"



600V AC/DC Fuse

Fuses- High Voltage AC/DC

For use with heavy duty fusible safety switches, 13/16" diameter x 5".

Part #	Model	Rated Current (Amps)	Max. DC Voltage	Dimensions
706FUS12A600VDC	TRS12R	12	600	5 x 13/16
706FUS15ATD600D	TRS15R	15	300	5 x 13/16
706FUS010	A6D15R	15A	600	5 X 13/16



SQ-D Safety Switches – 600V AC-DC

SQ-D Safety Switches – 600V AC-DC

Heavy duty UL-listed safety disconnect switches are offered fusible and non-fusible, NEMA 1 indoor rated or NEMA 3R outdoor rated, with external lockable handle and door. Service disconnect for AC or DC systems rated to 600 volts. 3R switches accept top bolt-on hubs.

Part #	Model	# Poles	NEMA	Rated Current (Amps)	Wire Size	Dimensions	Weight
Fusible							
720SWT30A3P6001	H361	3	1	30	#14-6 AWG	14.9 x 6.7 x 5	10
720SWT30A3P600V	H361RB	3	3R	30	#14-6 AWG	14.9 x 6.7 x 5	10
Non-Fusible							
720SWT30ANF3P1R	HU361	3	1	30	#14-6 AWG	14.9 x 6.7 x 5	10
720SWT30ANF3P3R	HU361RB	3	3R	30	#14-6 AWG	14.9 x 6.7 x 5	10
720SWT60ANF3P	HU362RB	3	3R	60	#14-2 AWG	14.9 x 6.7 x 5	15



'SEA' Fuse Block

'SEA' Fuse Block System

The most economical system for 100-300 ampere fusing for use with 12/24V DC systems. Features red glass filled nylon base with 5/16" non-ferrous studs supplied with two protective terminal boots for wiring up to #2/0 AWG.

Part #	Model	Dimensions	Weight
707003	5001	1.25 x 4.0	0.5



'SEA' Fuses

'SEA' Fuses – For 12/24 Vdc systems. Interrupt capacity 2000 Amps.

Part #	Model	Current Rating Amp	Dimensions
706FUS150A32VDC	5103	150	0.75 x 2.70
706FUS200A32VDC	5105	200	0.75 x 2.70
706FUS250A32VDC	5107	250	0.75 x 2.70
706FUS300A32VDC	5108	300	0.75 x 2.70



Powerhouse Fuse Blocks

Powerhouse Fuse Blocks – Class T

Powerhouse inverter fuse blocks provide safe and reliable overcurrent protection for DC loads connected to battery systems of 12, 24 or 48 Vdc. This 'one size fits all' fuse block holds Class T fuses (sold separately) from 100 to 400 Amps, and includes heavy-duty set screw lugs for up to #4/0 cable with a removable protective cover.

Part #	Model	Dimensions	Weight
706FUSEBLOCK	PH-FB	6.4 x 1.7 x 3.1	0.4



Class T Fuse

Class T Fuses

For use on Powerhouse fuse blocks, rated 160 Vdc max. UL rated for DC service. Fast short-circuit response.

Part #	Model	Current Rating (Amp)	Dimensions	Weight
706FUS110-TFUSE	5112	110	1.06 x 2.44	0.2
706FUS200-TFUSE	5116	200	1.06 x 2.44	0.2
706FUS300-TFUSE	5119	300	1.31 x 2.75	0.3
706FUS400-TFUSE	5121	400	1.31 x 2.75	0.3



SOV Lightning Surge Arrestor

Lightning Arrestors

Silicon Oxide Varistor (SOV) lightning surge arrestors can handle high current surges that are too large for an MOV or capacitor. They provide protection to electrical equipment by reducing problems due to lightning strikes or power surges. Surge arrestors react in as little as five nanoseconds and begin to conduct when voltage rises above the nominal line voltage after a specific time delay, and handle an unlimited number of surges. The waterproof case is designed to install into a 1/2" knockout opening. Includes 18" long #12 AWG wires. UL-listed.

Part #	Model	Description	Rated Voltage	Dimensions	Weight
510ACCLA100V	LA302DC	DC Arrestor	up to 250 Vdc	2.25 dia. x 2.25	1
510ACCLA602DC	LA602DC	DC Arrestor	up to 600 Vdc	2.25 dia. x 4.50	1
520LA120V302R	LA302R	AC Arrestor	up to 300 Vac	2.25 dia. x 2.25	1
510LAMOUNT	510LAMOUNT	Side mount bracket for DC or AC Arrestor			.25
510LASQDMOUNT	510LASQDMOUNT	Top mount bracket for DC or AC Arrestor			.25



Side Mount

Top Mount



ATO/ATC Fuse Block

Fuse Block System – ATO/ATC

This fuse block system features a stylish, clear, insulating cover that protects conductive parts and includes label recess for marking. Tin-plated copper buses allow 30 Amp fuse rating per circuit, 100A max. rating per block. Two styles -6 circuit with/without NEG bus, less fuses.

Part #	Model	Description	Dimensions	Weight
707001	5025	6 circuit w/ Neg. bus	2.0 x 6.0	1
707002	5028	6 circuit	2.0 x 4.0	1



In Line Fuse Holder

Fuse Holder – In Line , ATO/ATC

For direct in line wiring for one type ATO/ATC fuse holder rated 30A max. with 4" #12 AWG lead wires.

Part #	Model	Description
707FUSAT0INLNHL	46021	Fuse Holder
707FUSHLDCOVER	46019	Fuse Cover Clear



Water Resistant Fuse Holder

Fuse Holder – Water Resistant ATO/ATC

Sealed, weather resistant body and cap with mounting tab for one type ATO/ATC fuse, rated 30 Amp max. with 8" x #12 AWG lead wires.

Part #	Model	Description	Weight
707010	46033	Water Resistant Fuse Holder	0.5



Blade Type Fuses

Fuses – Blade Type ATO/ATC

Automotive standard 1/4" blade fuses for use in marine, RV and other systems with 12/24V DC circuits (32V max.).

Part #	Model	Current Rating Amp	Color
706FUS1A ATO	ATO-1	1	black
706FUS2A ATO	ATO-2	2	gray
706FUS3A ATO	ATO-3	3	violet
706FUS5ABLADE	ATO-5	5	tan
706FUS7.5A FUSE	ATO-7.5	7.5	brown
706FUS10AATO	ATO-10	10	red
706FUS15A FUSE	ATO-15	15	lt. blue
706FUS20ABLADE	ATO-20	20	yellow
706FUS25AATO	ATO-25	25	natural
706FUS30A FUSE	ATO-30	30	lt. green



DC Battery Switch

DC Battery Switch

UL listed to 32 Vdc, these compact, high-amperage, vapor-proof rotary on/off switches allow a means of disconnection between battery systems and DC loads up to 300 amps continuous rating (400A intermittent). Rugged molded Lexan® case design allows flush or surface mounting. Model 9001 allows switching from combining two separate battery banks.

Part #	Model	Dimensions	Description	Weight
720SWT300A1BATT	9003E	4.0" x 4.0" x 2.7"	ON/OFF	2
720SWT300A2BATT	9001E	4.0" x 4.0" x 2.7"	OFF, #1, #2, BOTH	2



Mini-Battery Switch

Mini-Battery Switch

Vapor proof case design and small size allows compact installations for indoor or outdoor use. For use with 12/24 Vdc battery systems, includes color-coded label with international ON-OFF symbols. Contoured knob rotates 360 degrees for ease of operation. Rated 250 Amps continuous, 600A surge, with 3/8" stud terminals.

Part #	Model	Dimensions	Weight
720SWT250AMBATT	6006	2.7 x 2.7	1.5



Waterproof DC Circuit Breaker

DC Circuit Breaker – Waterproof

Weatherproof, vapor proof DC circuit breaker combines switching and circuit protection function into one unit. Useful with 12/24/48V DC battery systems, this panel-mount, switchable, manual reset thermal breaker meets SAE marine & ignition standards. Designed to trip on fault current even if lever is held 'ON'. High torque 5/16" studs accept up to # 2/0 AWG cables. Smaller sizes available. See price list or call SunWize for more information.

Part #	Model	Current Rating Amp	Dimensions	Weight
709021	7109	30A	2.3 x 3.4 x 1.8	0.50
709019	7100	50A	2.3 x 3.4 x 1.8	0.50
709011	7104	150A	2.3 x 3.4 x 1.8	0.50



Solid Neutral Kit

Solid Neutral Kit

Isolated solid neutral bus contains three AL. lugs for # 3-14 AWG. Field installable for use with heavy-duty 600V disconnect switches.

Part #	Model	Weight
704NEUTRALKIT	SN03	1



IOTA ITS-50R

IOTA Engineering

ITS Series

ITS Series Automatic Transfer Switches provide switching between two separate power sources such as a powercords, generators or inverters. The ITS senses the presence of the available supplies and automatically selects the proper one. It can also be used in conjunction with a second ITS to switch between additional power sources. Models include a Time Delay Control module to allow generators to start before supplying power to the load. 2-year warranty.

Part #	Model	Max Power Cord Size	Max. Generator	Max. Main Breaker	Case Material	Wiring	Dimension	Weight
351ACCTS30S	ITS-30R	30A	4kW	30A 1P	Hard Plastic	2	9.3 x 7.6 x 4.3	2
351ACCTS50S	ITS-50R	50A	12kW	50A 2P	Hard Plastic	3	9.3 x 7.6 x 4.3	3
351ACCTS100S	ITS-100R	100A	24kW	100A 2P	Steel	15	10 x 12 x 4	15



SunWize USE-2 Wire

SunWize®

Service Entrance, USE-2, or RHH/RHW-2

General purpose wiring, suitable for power and control circuits in residential and commercial buildings, industrial plants, meters and utility substations. Suitable for outdoor, raceway or direct burial use. Single conductor 7-strand copper with XLP insulation. Rated 600 volts, 90°C wet/dry. Minimum order 100 ft.

Part #	AWG / Color	O.D. (in.)	Weight (lb.)/1000 ft.	Ampacity (75°C)
700WIR#12USE R	#12USE Red	0.19	31	30
700WIR#12USE B	#12USE Black	0.19	31	30
700WIR#10USE2R	#10USE Red	0.21	45	40
700WIR#10USE B	#10USE Black	0.21	45	40
700WIR#10USE W	#10USE White	0.21	45	40
700WIR#10USE G	#10USE Green	0.21	45	40
700WIR#8USE R	#8USE Red	0.27	72	55
700WIR#8USE B	#8USE Black	0.27	72	55
700WIR#6USE R	#6USE Red	0.31	107	75
700WIR#6USE B	#6USE Black	0.31	107	75



SunWize Tray Cable

Tray Cable

Designed for power & control, traffic control, switching, lighting and signal transmission. May be used in Class 1, Div. 2 locations. Stranded copper conductors are THHN insulated with overall black PVC jacket. UL listed, sunlight resistant, direct burial or cable trays, 90°C, 600 volts. #10 has two conductor cables that are red/black, oval construction. #8 and #6 AWG cables are round with black/black with black stripe color coding. Minimum order is 100 ft.

Part #	AWG / Conductor	O.D. (in.)	Weight (lb.)/1000 ft.	Ampacity
700CBL#18/2TC	#18/2 TC	0.18 x 0.28	41	14
700CBL#16/2TC	#16/2 TC	0.20 x 0.33	49	18
700CBL#14/2TC	#14/2 TC	0.21 x 0.32	64	25
700CBL#12/2TC	#12/2 TC	0.23 x 0.36	83	30
700CBL#10/2TC	#10/2 TC	0.26 x 0.43	120	40
700CBL#8/2TC	#8/2 TC	0.56	220	55
700CBL#6/2TC	#6/2 TC	0.63	310	75



SunWize Pump Cable

Pump Cable-Submersible

For use with submersible pumps in power and control circuits, stranded copper conductors with EPR insulation, color-coded red/black/yellow and overall PVC jacket. Flat construction, rated 90°C, 600 volts. (W/G = with ground).

Part #	AWG	Dimensions (in.)	Weight (lb.)/1000 ft.
700CBL#10/2SJ	#10/2 SUB	0.56 x 0.31	180
700CBL#10/2SGJ	#10/2 SUB W/Gnd	0.63 x 0.31	232
700CBL#8/2S6J	#8/2 SUB W/Gnd	0.88 x 0.38	346



SunWize Splice Kit

Splice Kits - Pump Cable

Waterproof heat shrink kit includes copper, crimp type, brazed-seam butt connectors, 3/8" conductor, insulation shrink tubing and overall 1" cable jacket heat-shrinkable tubing. Both tubings have inner melt wall adhesive.

Part #	Model	# Conductors x AWG
464000SPLICEKT2	SPLK-14	2 X #14
462ACCSPICEKIT	SPLK-10	3 x #10
464000SPLICEKT8	SPLK-8	4 x #8
464000SPLICEKT6	SPLK-6	4 x #6



SunWize Battery Cable

Battery Cable – UL

Recommended for hard service use. Suitable for connecting to battery or inverter systems. CSA type AWM/TEW, 105°C, UL listed type MTW 90°C, 600 volts, single conductor stranded copper with black PVC insulation. Minimum order 100 ft.

Part #	AWG	O.D. (in.)	Weight (lb.)/1000 ft.	Stranding
700WIR2/0USEFLX	2/0	0.58	496	1320 x 0.010
700WIR4/0USEBL	4/0	0.69	760	2090 x 0.010



SunWize Ground Wire

Ground Wire

Bare-twisted, 7-strand medium hard drawn copper wire used for grounding connections. Minimum order 100 ft.

Part #	AWG	O.D. (in.)	Weight (lb.)/1000 ft.
700WIR#8BARECP	#8 Bare	0.15	51
700WIR#6BARECP	#6 Bare	0.19	81

Grounding Rod Kit

The grounding kit includes 5/8" x 8' copper clad steel ground rod, acorn fitting, coupling and #2 copper lug.

Part #	Item
700KITGROUNDKIT	Grounding Kit



Cord Connectors

Fittings

Cord Connectors

Weather-resistant, liquid-tight cable strain relief fittings are black nylon with flexible rubber bushing that allow for flat or round cables. Used for cable entry connection to junction boxes or enclosures. Without locknuts.

Part #	Size	Cable Diameter
703LTF1/2-.2/.5	1/2NPT	0.17 - 0.45
703CORD1/2NM.75	1/2NPT	0.50 - 0.75
703CORD3/4NM.25	3/4NPT	0.25 - 0.48
703CORD3/4NM.55	3/4NPT	0.45 - 0.70



Euro-Style Terminal Block

Terminal Blocks

Euro-Style Terminal Block

Euro-Style terminal blocks feature a finger-safe screw terminal design and are rated 600 Vac/DC. The nylon body meets insulating requirements without use of an external cover. Dual row screw and pressure plate combination accepts stripped wire without need for crimp-on terminals. A mounting hole is located between each terminal post, supplied in 12 positions and is easily cut for fewer connections.

Part #	Model	Wire Range	Mtg. Screw Size	Max. Amp Rating	Dimensions	Weight
705BLKST12-18	2812	#12-18	#4	27	0.80 x 4.61	0.12
705BLKST8-14	2912	#8-14	#6	40	0.90 X 5.50	0.25



Dead Front Terminal Block

Dead Front Terminal Block

This heavy-duty black molded phenolic, dual row terminal block features a finger-safe design with tin plated brass pressure screw connections into an aluminum barrel. Supplied three position only. UL rated 600 Vac/DC.

Part #	Model	Wire Size	Mtg Screw Size	Max. Amp Rating	Dimensions	Weight
707BLK3DBL85A	9-85-3	#4-14 AWG	#8	85	1.25 x 1.80	.027



Power Post Cable Connector

Power Post Cable Connector

Sturdy glass reinforced nylon base supports a 1" tall stainless steel 5/16"-18 stud. Connects high amperage cables securely to a common post. Can stack multiple terminals. Rated 48 Vdc.

Part #	Model	Size	Mtg. Screw Size
704014	2002	1.75 x 3.0	1/4



Power Distribution Block

Power Distribution Terminal Block

This terminal block allows a main conductor to be tapped with multiple conductors, useful for combining circuits. Set screw-type, aluminum lug mounted into an insulating phenolic holder.

Part #	Model	AWG Main (qty.)	AWG Tap (qty.)	Dimensions	Weight
705BLK1-1 PWR 1	PDB1-1	#2/0-14 (1)	#2/0-14 (1)	1.0" X 2.88"	0.25
705BLK1-4 PWR 1	PDB1-4	#2/0-14 (1)	#8-14 (4)	1.0" X 2.88"	0.25
705BLK1-6PWR 1	PDB1-6	#2/0-12 (1)	#4-14 (6)	1.75" X 4.00"	1.25



Common Bus Bar Terminal

Common Bus Bar Terminal

The stud type, 4 position terminal design allows for common bus connection of positive or negative DC circuits, rated for 48 Vdc. Tin plated copper bus bar is mounted to an isolated phenolic base with recessed #10 mounting screw holes. Stainless steel studs allow high torque connections.

Part #	Model	Amp Rating	Stud Size	Dimensions	Weight
704011	2305	100	#10	0.88 x 4.20	0.15
704012	2303	150	1/4"	1.25 x 6.10	0.34
704013	2106	250	5/16"	1.50 x 7.9	0.60
704016	2104	600	3/8"	2.00 x 7.00	1.71

System Spotlight



APPLICATION:
California residential PV system w/battery backup

SYSTEM:
7.2 kW – 36 SANYO BA19 200W panels

INSTALLED BY:
Richard Dean of R & M Technologies



Advertisement

Wiring Reference Guide

Proper wire selection is critical for safety and good system performance. The wire needs to be sized not only handle the maximum current flow include any required safety factors, but should also be sized to limit the voltage drop between various components in the system. Typically, renewable energy systems are design to limit the voltage drop to about 2%. 12-volt DC systems are especially sensitive to voltage drop. The wire's insulation (wire rating) also needs to be rated for the environmental conditions in which it will be installed. If unsure of the required wire rating, consult the NEC or a licensed electrician.

The sizing guide below provides the minimum wire size needed to limit the voltage drop to 2% for a given one-way distance in 12v, 24V, 48V or 120V systems. The blank areas of the tables indicate wire sizes that are not appropriate for the amperage.

How the tables work:

1. On the left, locate the current you will be dealing with (either array or load current).
2. Move across to locate the desired one-way distance to be traveled.
3. Move up to locate the size of the wire to be used.

Maximum one-way distance (in feet) for a 2% voltage drop in copper wire.

Wire sizes shown in AWG.

System voltages are the nominal system voltages.

12-Volt System - 2% Voltage Drop

AMPS	#14	#12	#10	#8	#6	#4	#2	1/0	2/0	4/0
1	45	70	115	180	290	456	720	•	•	•
2	22.5	35	57.5	90	145	228	360	580	720	1060
4	10	17.5	27.5	45	72.5	114	180	290	360	580
6	7.5	12	17.5	30	47.5	75	120	193	243	380
8	5.5	8.5	15	22.5	35.5	57	90	145	180	290
10	4.5	7	12	18	28.5	45.5	72.5	115	145	230
15	3	4.5	7	12	19	30	48	76.5	96	150
20	2	3.5	5.5	9	14.5	22.5	36	57.5	72.5	116
25	1.8	2.8	4.5	7	11.5	18	29	46	58	92
30	1.5	2.4	3.5	6	9.5	15	24	38.5	48.5	77
40	•	•	2.8	4.5	7	11.5	18	29	36	56
50	•	•	2.3	3.6	5.5	9	14.5	23	29	46
100	•	•	•	•	2.9	4.6	7.2	11.5	14.5	23
150	•	•	•	•	•	•	4.8	7.7	9.7	15
200	•	•	•	•	•	•	3.6	5.8	7.3	11

24 -Volt System - 2% Voltage Drop

AMPS	#14	#12	#10	#8	#6	#4	#2	1/0	2/0	4/0
1	90	140	230	360	580	912	1440	•	•	•
2	45	70	115	180	290	456	720	1160	1440	2120
4	20	35	55	90	145	228	360	580	720	1160
6	15	24	35	60	95	150	240	386	486	760
8	11	17	30	45	71	114	180	290	360	580
10	9	14	24	36	57	91	145	230	290	460
15	6	9	14	24	38	60	96	153	192	300
20	4	7	11	18	29	45	72	115	145	232
25	3.6	5.6	9	14	23	36	58	92	116	184
30	3	4.8	7	12	19	30	48	77	97	154
40	•	•	5.6	9	14	23	36	58	72	112
50	•	•	4.6	7.2	11	18	29	46	58	92
100	•	•	•	•	5.8	9.2	14.4	23	29	46
150	•	•	•	•	•	•	9.6	15.4	19.4	30
200	•	•	•	•	•	•	7.2	11.6	14.6	22

48-Volt System - 2% Voltage Drop

AMPS	#14	#12	#10	#8	#6	#4	#2	1/0	2/0	4/0
1	180	280	460	720	1160	1824	2880	•	•	•
2	90	140	230	360	580	912	1440	2320	2880	4240
4	40	70	110	180	290	456	720	1160	1440	2320
6	30	48	70	120	190	300	480	772	972	1520
8	22	34	60	90	142	228	360	580	720	1160
10	18	28	48	72	114	182	290	460	580	920
15	12	18	28	48	76	120	192	306	384	600
20	8	14	22	36	58	90	144	230	290	464
25	7.2	11.2	18	28	46	72	116	184	232	368
30	6	9.6	14	24	38	60	96	154	194	308
40	•	•	11.2	18	28	46	72	116	144	224
50	•	•	9.2	14.4	22	36	58	92	116	184
100	•	•	•	•	11.6	18.4	28.8	46	58	92
150	•	•	•	•	•	•	19.2	30.8	38.8	60
200	•	•	•	•	•	•	14.4	23.2	29.2	44

120-Volt System - 2% Voltage Drop

AMPS	#14	#12	#10	#8	#6	#4	#2	1/0	2/0	4/0
1	450	700	1150	1800	2900	4560	7200	•	•	•
2	225	350	575	900	1450	2280	3600	5800	7200	10600
4	100	175	275	450	725	1140	1800	2900	3600	5800
6	75	120	175	300	475	750	1200	1930	2430	3800
8	55	85	150	225	355	570	900	1450	1800	2900
10	45	70	120	180	285	455	725	1150	1450	2300
15	30	45	70	120	190	300	480	765	960	1500
20	20	35	55	90	145	225	360	575	725	1160
25	18	28	45	70	115	180	290	460	580	920
30	15	24	35	60	95	150	240	385	485	770
40	•	•	28	45	70	115	180	290	360	560
50	•	•	23	36	55	90	145	230	290	460
100	•	•	•	18	29	46	72	115	145	230
150	•	•	•	•	•	•	48	77	97	150
200	•	•	•	•	•	•	36	58	73	110

System Spotlight

LOCATION:
US Fish and Wildlife in AZ.

APPLICATION:
2 water pumping systems used to provide drip irrigation for a 20 acre restoration site





Module Hardware Kit



Medium Hardware Kit



Security Hardware Kit



Hex Key



U-Bolts



5" Square Bolts

SunWize®

Hardware Kits

Fasteners are type 316 fully threaded, stainless steel, hex head bolts including flat and lock washers and full hex nuts. All are packaged in bag kits with the quantity of bolts noted.

Part #	Model	Description	Bolt Size	Bolt Qty.	Weight
950HK-1/4	HK-1/4"	Module Hardware Kit	1/4"-20 x 3/4"	4	0.13
950HK-3/8	HK-3/8"	Medium Hardware Kit	3/8"-16 x 1"	8	0.77
950HK-1/2	HK-1/2"	Large Hardware Kit	1/2"-13 x 1.5"	8	1.70

Security Hardware Kits

Tamperproof fasteners are 18-8 stainless steel and employ a special head design requiring a special tool. Button head screws are pin-in hex drive and cannot be removed with conventional tools. Each bolt includes flat washers and a nylon-locking hex nut requiring two tools for assembly.

Part #	Model	Description	Bolt Size	Bolt Qty.	Weight
950SHK-1/4	SHK-1/4"	Module Security Hardware Kit	1/4"-20 x 3/4"	4	0.15
950SHK-3/8	SHK-3/8"	Medium & Large Security Hardware Kit	3/8"-16 x 1"	8	0.80

Security Hardware Tools

Hardened steel 1/4" hex bits for cordless drills and hand drivers or 'L' keys for tight locations, both for pin-in-hex drive screws.

Part #	Model/Hex Size	Screw Size
851HEXBIT5/32	Hex bit-5/32"	1/4" -20
851HEXBIT7/32	Hex bit-7/32"	3/8"-16
851HEXKEY5/32	'L' key-5/32"	1/4"-20
851HEXKEY7/32	'L' key-7/32"	3/8"-16

U-Bolts

3/8"-16 stainless steel U-bolts are packaged in pairs including hex nuts, flat and lock washers.

Part #	Model/ Nom. Pipe Size	Between Legs	Width Bolt Length	Weight
851UBLT3/8X2.0S	U Bolt 2	2.5	3.12	0.50
851UBLT3/8X2.5S	U Bolt 2-1/2	3.0	3.63	0.60
851UBLT3/8X3.0S	U Bolt 3	3.5	4.12	0.80
851UBLT3/8X3.5S	U Bolt 3-1/2	4.0	5.12	0.90
851UBLT3/8X4.0S	U Bolt 4	4.5	6.0	1.20

5" Square Bolts

304 stainless steel square bolt is used mostly for enclosure attachment to 5" square lighting poles.

Part #	Model	Length	Thread Size	Weight
851UBLTSQ3/8X5	5" Square Bolt	6	3/8"-16	1.0
851UBLTSQ1/2X6	6" Square Bolt	7	1/2"-13	1.0



Battery Enclosure Accessories

Mini-Louvers

Round aluminum vents are rainproof, keep out insects, and relieve heat build-up in enclosures.

Part #	Model	Color	Weight
6259004VENTLDBA	Mini-Louver 4" diameter	black	0.2



Power Vent Fan

Commonly used to vent battery enclosures to outside air, this one-piece unit fits onto PVC pipe, 1.5" = 3cfm or 2" = 6cfm. Includes back draft damper. When used with the control relays on the inverter, the fan can be programmed to operate only when flooded batteries are gassing. Power consumption = 2.2 watts.

Part #	Model/Voltage	Weight
210005POWER12V	Power Vent Fan 12V	3
210005POWER24V	Power Vent Fan 24V	3
210005POWER48V	Power Vent Fan 48V	3

Refrigeration



Steca

Steca Solar Fridge/Freezer

The PF166 can be used as a refrigerator or as a freezer just by pressing a button. The digital temperature display allows you to choose the exact temperature you want, and there is no need for seasonal adjustments. The refrigerator can run using a single 70-watt module (given sufficient sun hours). 2-year warranty.

Features include:

- Selectable 12 or 24 Vdc
- Low voltage disconnect and automatic reconnection
- Power outage display and temperature alarm
- Inside temperature is independent of outside temperature
- Can display °F or °C
- Patented StopFrost system reduces frost buildup
- Lockable lid, 2 hanging baskets, and 3 freezer trays

Part #	Volume	System Voltage	External Dimensions	Weight
270005	5.9 cubic feet	12 or 24 Vdc	36 x 34.3 x 28	134

System Spotlight

INSTALLED BY:
BP Wind Energy

SYSTEM:
SunWize Power Online system-
PO300-24-108-FWY-a





Bosch FKC flat plate collector

Bosch

Bosch Solar Packages

Bosch solar thermal systems are the latest generation of solar domestic hot water (DHW) technology that is the result of over 25 years of innovation and experience. Bosch pre-packages its components into systems to provide residential and small commercial installers high quality, high efficiency, and simple solar heating solutions for DHW.

In addition to presenting your customers with a brand they will recognize immediately as one offering superior products, Bosch solar systems are designed for fast and easy installation. Their strong composite fiber frame means Bosch flat panels are lightweight and easy to hoist to the roof. Connection sets are designed for assembly with no sweating and a minimum of tools, and only a single hex wrench (which is even supplied) is needed for the mounting components.

A Bosch solar thermal system uses energy from the sun to produce DHW and can also be used for hydronic space heating back-up. The normal demand for DHW is a good match for solar collector systems. Almost 100% of the energy demand for DHW during the summer can be covered by a solar heating system. An auxiliary heating system must be present to cover the DHW demand independently of solar heating and Bosch can provide several solutions for this need. Long periods of bad weather may occur during which the convenience of hot water still has to be assured.

It is a simple 3-step process to select the most suitable system for your customer:

- 1) Select the appropriate Bosch Solar Package configuration based on household size (2-4 or 3-5)
- 2) Select the appropriate Solar Storage Tank based on the number of collectors in your Solar Package (80 gallons for 2 and 120 for 3)
- 3) Select the appropriate Mounting Hardware System depending on roof type and surface (mounting hardware for composition roofs is stocked, mounting options for tile and flat roofs are also available from Bosch)



Bosch KS-105 solar pump station

Each Bosch Solar Package contains the following:

- Either 2 or 3 FKC 1 Vertical Flat Plate Collectors
- FKC 1 Collector Connection Set
- FKC 1 Air Vent Set
- TR0301 U Solar Controller
- KS-105 Pump Station (with temperature valve)
- Expansion Tank (18 liter, white)
- ASS/Expansion Tank Connection Set
- Twin-Tube 1/2" Line Set (with sensor, 50' roll)
- Tyfocor-L Solar Fluid (20 liters)



Bosch TR0301 solar controller



Bosch 18 liter expansion tank

Part #	Description	Shipping Weight
138001	FKC 1-2 Bosch Solar Package with 2 FKC 1 flat plate collectors	379 lbs.
138002	FKC 1-3 Bosch Solar Package with 3 FKC 1 flat plate collectors	471 lbs.
138003	SOL-RET80 80 gallon storage tank	155 lbs.
138004	SOL-RET120 120 gallon storage tank	360 lbs.
138005	ORMK2CS mounting kit for two collectors, composition shingle roof	20 lbs.
138006	ORMK3CS mounting kit for three collectors, composition shingle roof	30 lbs.

Advertisement



SunWize PR110 Power Ready System

SunWize® Power Ready Systems

For continuous loads of 1 to 75 watts

SunWize Power Ready Systems are stand alone systems using solar technology to provide continuous and reliable power to remote site loads. There is no need to connect to utility power. SunWize Power Ready systems are designed for site loads requiring 12, 24 or 48 volts DC or 110V-240V 50Hz/60Hz AC.

Proven solution: Solar has successfully powered thousands of critical applications worldwide for more than 30 years.

Reliability: SunWize systems allow your equipment to operate where power quality and reliability are a concern or where utility power does not exist in the most rugged environments.

Cost-effective: SunWize systems are cost-effective solutions providing continuous power to critical loads. SunWize systems minimize set up and installation time for rapid deployment.

Installation flexibility: SunWize systems can be mounted to pole sides and tops, rooftops and the ground. They can also be adapted to towers and other structures. OEM equipment can be housed in weatherproof enclosures in remote locations.

Shipping and handling: SunWize Systems are designed to withstand rugged transportation to remote sites. Each subsystem is fully assembled and factory tested before shipment.



SunWize PR300 Power Ready System

Key Features and Benefits:

- Meets your equipment electrical power requirements
- System load verified for voltage tolerances and duty cycle of operation
- System design verified for performance criteria, reliability and function
- Geographic location analysis provided
- Standard product line flexibility allows customization
- Cost-effective design maximizes space efficiency
- Solid state electronics
- UL, FM and CSA listed components
- 20/25-year solar module warranty
- Full system warranty for one year
- Pre-assembled for easy installation
- No environmental impact
- Low operating and maintenance costs
- Complete systems reduce specifying and buying time



SunWize PR660 Power Ready System

SunWize Power Ready System Technical Specifications

Environmental Specification

Ambient Temperature	-30°C to 50°C
Relative humidity	100% condensing
Altitude	3000m max
Wind Speed	110MPH sustained class C exposure
Seismic	Zone 4

Electrical Specification

Operating voltage range	From 6V up to 48VDC nominal
Array current	From 5A up to 120A
Load current	From 5A to 60A
Temperature compensation	Standard on all models
Array wattage	From 3 to 720 watts
Battery capacity	From 5 to 1060Ah



SunWize PR120 Power Ready System

The System

- Provides uninterrupted power to the load with a power reliability of 99.5% worst case month based on weather and insolation data specific to the site.
- Engineered for 5 days (120hrs) of autonomy based on average low temperature.

The Modules

- Include conduit ready junction boxes.
- Comply with industry standard wind exposure of 110MPH sustained, 133MPH gust.
- Impact resistant for 25mm hail at terminal velocity.

The Batteries

- Designed for solar applications in deep-cycle operation.
- Battery life rated for greater than 500 cycles to 80% DOD. Total battery life varies with application temperature & load characteristics.
- Maintenance free and require no watering or equalizing charge.

The Controls

- Low voltage load disconnect, factory set for the battery type and system voltage used.
- Low voltage disconnect is set standard at 80% battery depth-of-discharge.
- Standard controls up to 20A are sealed, Class I, Div II rated.

Protection and Safety

- NEC compliant circuit protection.
- Finger safe terminal blocks and covers on all switches and breakers.
- All wiring is routed in liquid tight conduit for protection from damage and the elements

Power Ready Systems Model Information

STANDARD CONFIGURATIONS

SUNWIZE POWER READY SYSTEMS
FOR CONTINUOUS LOADS
OF 1 TO 75 WATTS



Solar modules are fully encapsulated to resist harsh weather conditions

Cooling airflow

Air ventilation outlet

Universal anti-theft mounting hardware available for outdoor pole or wall mounting

Rainproof bottom-to-top passive airflow cooling with filtered vents

Air ventilation inlet

NEC code compliant overcurrent protection and safety disconnect

Solid state electronics display battery state-of-charge and controller status/errors



Corrosion resistant control/battery enclosure. Premium enclosures are powder coated white aluminum for durability

Sealed, lead-acid battery designed for deep discharge cycling

Power Ready Systems Model Information

STANDARD CONFIGURATIONS

PR – – – – – – – –

 ARRAY SYSTEM BATTERY ENCLOSURE STRUCTURE ENCLOSURE STRUCTURE STANDARD
 POWER VOLTAGE CAPACITY STYLE STYLE FINISH FINISH OPTIONS

Example: PR240-24-108-FPWA-111

Array Power (Watts)

System Voltage: 12 Volts / 24 Volts / 48 Volts

Battery Capacity in AmpHrs (based on 120hr discharge rate)

Enclosure Style

- F – Front opening hinged door, pole mounted
- T – Top opening hinged door battery enclosure, ground mounted
- C – Front opening door, captive screw cover, mil-finish aluminum, pole mounted

Structure Style

- P – Side of pole mount, separate from enclosure
- G – Ground/roof mount, separate from enclosure
- T – Top of pole mount
- I – Integrated mount (3 – 24W only)

Enclosure Finish

- W – Powder-coated white aluminum
- A – Mil-finish aluminum
- S – SS-304 stainless steel
- F – Reinforced fiberglass

Structure Finish

- A – Mill-finish aluminum
- P – Powder-coated finish
- G – Hot dipped galvanized

System Standard Options:

Wire Protection

- 0 – PV direct to controller w/in-line battery fuse
- 1 – DC-rated circuit breakers for PV & battery

Lightning Protection

- 0 – Integral controller MOV surge protection
- 1 – External surge arrester 125VDC

Load Distribution and Control

- 0 – Load wired directly to controller
- 1 – Four terminal load distribution block
- 2 – Four terminal load distribution block, w/DC-rated circuit breaker
- 3 – External multi-cycle load timer, w/DC-rated circuit breaker
- 4 – Integral controller, w/multi-cycle load timer w/DC-rated circuit breaker
- 5 – Dusk-dawn sensor, w/DC-rated circuit breaker
- 6 – Dusk-dawn sensor, w/external multi-cycle load timer, w/DC-rated circuit breaker



This SunWize Power Ready PR230, located in central Wyoming, powers weather modification equipment (cloud seeding)



This 1200 watt SunWize Power Station located in a remote location, powers telemetry equipment



SunWize 880W Power Station

SunWize® Power Stations

For continuous loads of 75 to 3000 watts

SunWize Power Stations are complete, integrated solar power systems designed for site loads requiring 12/24/48VDC or 110V-240V, 50Hz/60Hz AC voltage. Wired to NEC standards, each Power Station provides safe and reliable power without the expense of installing utility power. The solar array tilt is easily adjustable to maximize solar energy output. The systems are mounted on galvanized steel structures or trailers engineered to withstand harsh environments and high wind loads.

Proven solution: Solar has successfully powered thousands of critical applications worldwide for more than 30 years.

Reliability: SunWize systems allow your equipment to operate where power quality and reliability are a concern or where utility power does not exist in the most rugged environments.

Cost-effective: SunWize systems are cost-effective solutions providing continuous power to critical loads. Set up and installation time are minimized for rapid deployment.

Installation flexibility: Power Station ground mounts are designed according to site characteristics. Considerations can include surface uniformity, anchoring requirements, site area size, and wind loads to ensure longevity and durability.

Shipping and handling: SunWize systems are designed to withstand rugged transportation to remote sites. Each subsystem is fully assembled and factory tested before shipment.



SunWize 1920W Power Station

Key Features and Benefits:

- Meets your equipment electrical power requirements
- System load verified for voltage tolerances and duty cycle of operation
- System design verified for performance criteria, reliability and function
- Geographic location analysis provided
- Standard product line flexibility allows customization
- Cost-effective design maximizes space efficiency
- Solid state electronics
- UL, FM and CSA listed components
- 20/25-year solar module warranty
- Full system warranty for one year
- Pre-assembled for easy installation
- No environmental impact
- Low operating and maintenance costs
- Complete systems reduce specifying and buying time
- Data logging and remote control software
- Hybrid options and project services available



SunWize PSG7680 Hybrid Power Station

SunWize Power Stations Technical Specifications

Environmental Specification		Electrical Specification	
Ambient Temperature	-30°C to 50°C	Operating voltage range	From 12V up to 48VDC nominal
Relative humidity	100% condensing	Array load current	From 60A up to 320A
Altitude	3000m max	Temperature compensation	Standard on all models
Wind Speed	110MPH sustained class C exposure	Array wattage	880 – 8200W
Seismic	Zone 4	Battery capacity	260 – 7000Ah

The System

- Provides uninterrupted power to the load with a power reliability of 99.5% worst case month based on weather and insolation data specific to the site.
- Battery designed for 5 days (120hrs) of autonomy based on average low temperature.
- Hybrid system: designed to work with engine genset or fuel cell to offset PV contribution and provide uninterrupted power to the load with power reliability of 100% worst case; battery designed for 3 days (72hrs) of autonomy based on average low temperature.

The Modules

- Include conduit ready junction boxes.
- Comply with industry standard wind exposure of 110MPH sustained, 133MPH gust.
- Impact resistant for 1 inch (25mm) hail at terminal velocity.

The Batteries

- Designed for solar applications in deep-cycle operation.
- Battery life rated for greater than 500 cycles to 80% DOD (12V cells) and 1200 cycles to 80% DOD (2V cells). Total battery life varies with application temperature and load characteristics.
- Maintenance free and require no watering or equalizing charge.

The Controls

- Low voltage load disconnect, factory set for battery type and system voltage used. Set standard at 80% battery depth-of-discharge.
- Standard PV charge controls up to 80A each are passive cooled. Higher power configurations up to 320A are fan cooled with advanced MPPT controls to optimize energy contribution.
- Standard AC controls: AC inverter with up-to 12kW of power output, 10kW of battery charging capability with integral genset controls.

Protection and Safety

- NEC compliant circuit protection.
- Finger safe terminal blocks and covers on all switches and breakers.
- All wiring is routed in liquid tight conduit for protection from damage and the elements.
- Surge protection options protect both solar and load equipment from transients.

SunWize Power Station Model Information

STANDARD CONFIGURATIONS

SUNWIZE POWER STATIONS FOR CONTINUOUS LOADS OF 75 TO 3000 WATTS

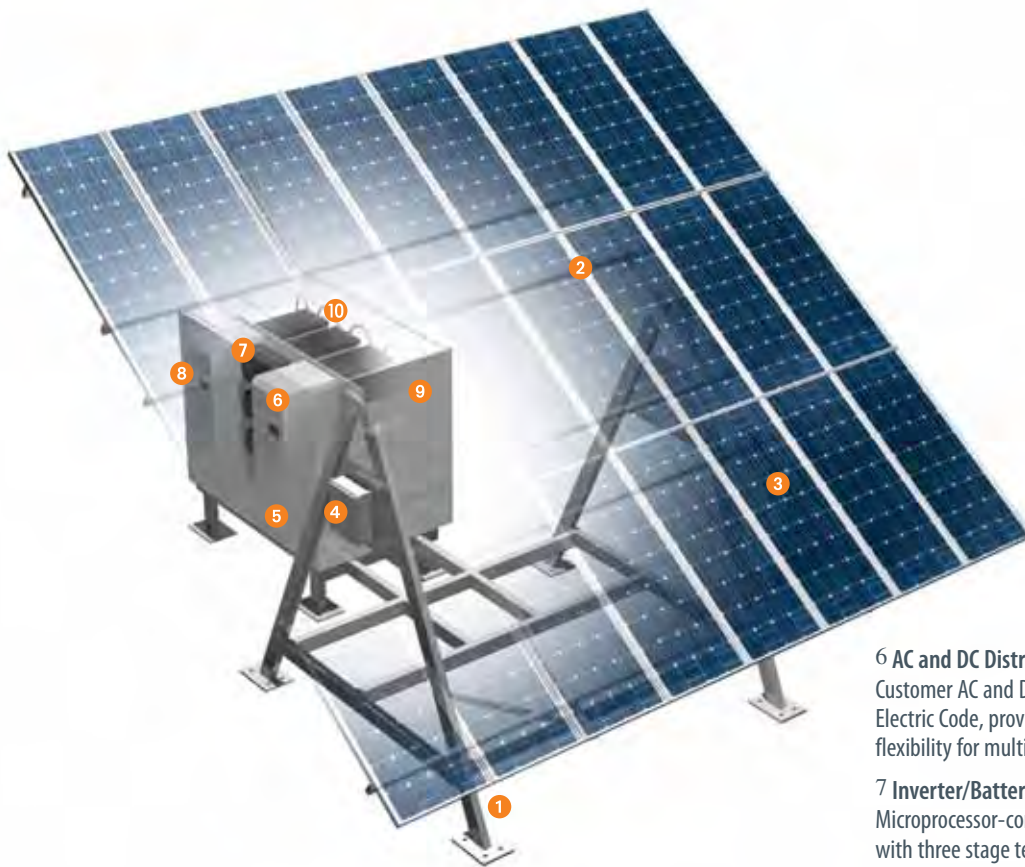

1 Structure

Industrial grade, heavy-gauge steel coated with a durable hot-dip galvanized finish. Available in standard platforms from 900-4320Wp (peak watts) on a single structure.

2 Adjustable Solar Array

Solar array tilt is easily adjustable from 15-55 degrees.

3 Solar Modules

Solar array, consisting of high-efficiency, crystalline silicon modules, provides reliable charging in all climates. Includes bypass diode protection.

4 DC Combiner Box

Provides solar array circuit disconnects and surge protection. Simplifies assembly and testing.

5 System Control Enclosure

The control enclosure is a NEMA 3R powder-coated steel box housing the power distribution components, charge control and inverter/charger electronics, disconnects, system monitoring and control components. Enclosure features rainproof vents and key lockable doors.

6 AC and DC Distribution Panels

Customer AC and DC breaker panels conform to U.S. National Electric Code, providing overload and surge protection. Offers flexibility for multiple loads.

7 Inverter/Battery Charger

Microprocessor-controlled high-efficiency, sine wave inverter with three stage temperature compensated battery charger. Peak conversion efficiency of 96%, protection circuitry, LCD display with user and setup menus. Configurable from 3-12kW.

8 DC Charge Controller

Solid state, low frequency, pulse-width modulated solar charge control with battery temperature compensation and automatic nighttime disconnect. Configurations available from 60A to 320A. Utilizes standard and maximum power point tracking (MPPT) technologies.

9 Battery Enclosure

Standard battery PSF-style enclosure features white powder-coated steel construction, lockable front-opening doors, NEMA 3R louvered vented design. T-Style chest enclosures for smaller battery configurations feature white powder-coated aluminum construction and a pad-lockable, NEMA 3R vented lid. Enclosure sizes vary to accommodate batteries sized from 210AH to 3000AH.

10 Battery Bank

Standard system includes maintenance-free, 12V sealed, lead-acid batteries. For larger capacities, 2V industrial cells are available.

SunWize Power Station Model Information

STANDARD CONFIGURATIONS



STANDARD OPTIONS



Example: PS-7680-48-4320-F-L01-W-G-LM01

Array Power (Watts)

System Voltage: 12 Volts / 24 Volts / 48 Volts

Battery Capacity in AmpHrs

(based on 120hr discharge rate)

Enclosure Mounting Style

- F – Front opening hinged door
- T – Top opening hinged

Structure Type

- S01 – 60" x 85" steel ground mount w/leveling feet
- S02 – 60" x 85" steel ground mount w/leveling feet and rear skid
- M01 – 80" x 102" steel ground mount
- M02 – 80" x 102" steel ground mount w/rear skid
- L01 – 80" x 120" steel ground mount
- L02 – 80" x 120" steel ground mount w/rear skid
- T01 – HD on-road trailer w 80" x 102" steel mount

Enclosure Finish

- W – Powder-coated white aluminum, Nema 3R
- P – Powder-coated white steel, Nema 3R
- S – SS-304 stainless steel, Nema 3R

Structure Finish

- G – Hot dipped galvanized
- P – Gray Powder coat over hot dipped galvanized

Local Metering

- LM01 – LCD charge control display
- LM02 – LCD charge control display w/external mounting

System Standard Options:

Remote Monitoring Option

- RM01 – RS232 / SNMP 6 channel data logging
- RM02 – Web based charge control display w/5-year service

Power Panel Options

- P3.0kW1P – 3.0kW max 120VAC 60Hz
- P4.5kW2P – 4.5kW max 120/240 60Hz



Power Panel Options: (continued)

- P6.0kW2P – 6.0kW max 120/240 60Hz
- P12kW2P – 12kW max 120/240 60Hz
- P9.0kW3P – 9.0kW max 208 3-PHASE 60Hz
- P3.0kW1PE – 3.0kW max 230VAC 50Hz

Genset Options

- G01 – Light duty, 3600 RPM, air-cooled LP engine 8.5–12kW
- G02 – Medium duty, 1800 RPM, liquid-cooled LP engine 10–20kW
- G03 – Heavy duty, 1800 RPM, liquid-cooled LP engine 30–60kW
- G04 – Medium duty, 1800 RPM, air-cooled diesel engine 6–15kW
- G05 – Medium duty, 1800 RPM, liquid-cooled diesel engine 10–20kW
- G06 – Heavy duty, 1800 RPM, liquid-cooled diesel engine 30–60kW

Fuel Cell Options

- F01 – Fuel cell, DC, 1.2kW
- F02 – Fuel cell, DC, 2.0kW



60 watt, 12V Power Online System

SunWize® Power Online Systems

For continuous loads of 1-1000 watts

SunWize Power Online Systems provide continuous DC power with battery backup from an AC source. These fully integrated, weatherproof units convert AC primary power to charge a 12, 24 or 48 Vdc sealed battery bank while powering a DC load or an AC load with integral inverter option.

Reliability: SunWize systems allow your equipment to operate where power quality and reliability are a concern or where utility power does not exist in the most rugged environments.

Cost-effective: SunWize systems are cost-effective solutions providing continuous power to critical loads. SunWize systems minimize set up and installation time for rapid deployment.

Installation flexibility: SunWize systems can be mounted to pole sides, rooftops and the ground. They can also be adapted to towers and other structures. OEM equipment can be housed in weatherproof enclosures in remote locations.

Shipping and handling: SunWize Systems are designed to withstand rugged transportation to remote sites. Each subsystem is fully assembled and factory tested before shipment.

Key Features and Benefits:

- Meets your equipment electrical power requirements
- System load verified for voltage tolerances and duty cycle of operation
- System design verified for performance criteria, reliability and function
- Geographic location analysis provided
- Standard product line flexibility allows customization
- Cost-effective design maximizes space efficiency
- Solid state electronics
- UL, FM and CSA listed components
- Full system warranty for one year
- Pre-assembled for easy installation
- No environmental impact
- Low operating and maintenance costs
- Complete systems reduce specifying and buying time



600 watt, 24V Power Online System



600 watt, 48V Power Online System

SunWize Power Online System Technical Specifications

Environmental Specification

Ambient Temperature	-30° C to 50° C
Relative humidity	100% condensing
Altitude	3000m max

Electrical Specification

Operating voltage range	From 12V to 48VDC nominal
Charger current	From 5A up to 160A
Load current	From 5A to 100A
Temperature compensation	Standard on all models
Charger wattage	From 45 to 2000 watts
Battery capacity	From 5 to 1060Ah



The System

- System is designed to provide un-interrupted power to the load with a power reliability of 100% worst case. This is based on weather and insolation data, specific to the design site.
- System battery is designed for 8, 24 or 48hrs of autonomy based on average low temperature for that site. Custom back up times available.

The Chargers

- All chargers are industrial quality with wide operation temperature range and durability.
- All systems are temperature compensated for voltage set point.
- All chargers work over wide voltage input range (either 85 – 264VAC universal input or 120/240V switch select).

The Batteries

- Batteries used are intended for deep-cycle operation.
- Battery life is rated for greater than 500 cycles to 80% DOD. Total battery life varies with application temperature and load characteristics.
- Batteries are maintenance free and require no watering or equalizing charge.

The Low Voltage Disconnect

- Standard systems include Low voltage disconnect, with system factory set for the battery type and system voltage used.
- Standard disconnect up to 20A are sealed, Class I, Div II rated. Optional 15A 48VDC available.
- Low voltage disconnect is set standard to disconnect load at 80% DOD.

Protection and Safety

- NEC compliant circuit protection.
- Finger safe terminal blocks and covers on all switches and breakers.
- All wiring is routed in liquid tight conduit for protection from damage and the elements.

Power Online Systems Model Information

STANDARD CONFIGURATIONS

PO – – – – – – –

CHARGER POWER SYSTEM VOLTAGE BATTERY AH CAPACITY ENCLOSURE MOUNTING STYLE ENCLOSURE FINISH CHARGER FEATURE OPTIONS SYSTEM OPTIONS

Example: PO600-24-108-FWY-a

Charger Power (Watts) 45, 60, 100, 120, 150, 240, 300, 600 and 1000

System Voltage: 12 Volts / 24 Volts / 48 Volts

Battery Capacity in AmpHrs (based on 120hr discharge rate)

Enclosure Mounting Style

- F – Front opening hinged door, pole mounted
- T – Top opening hinged door battery enclosure, ground mounted with pole mounted controls

Enclosure Finish

- W – Powder-coated white aluminum
- S – 304 stainless steel
- F – Fiberglass reinforced polyester

Charger Feature Options:

- W – Class I Div II rated charger 90-264VAC 50/60Hz, w/integral alarm
- X – Standard charger 90-264VAC 50/60Hz, no integral alarms
- Y – Industrial charger 120/240VAC 60HZ, integral alarms and LCD Display
- Z – Mil-Spec sealed charger, 90-264VAC 50/60Hz, no integral alarms

System Custom Options

- a – DC-to-DC converter for additional 12, 24 or 48V output
- b – DC-to-AC inverter for 120VAC/60HZ or 230VAC/50HZ
- e – Customer equipment integration
- g – LOC, load output cable
- h – BD, bird deterrent spikes on top of enclosure
- j – LVA, low battery voltage relay
- k – M, remote monitoring via SNMP or RS-232
- n – SP, surge protector for RF/coax protection
- o – DIN-rail kit on side/top plate
- p – PoE single port injector
- q – Door alarm relay
- r – AC Utility fault alarm relay
- x – Custom option

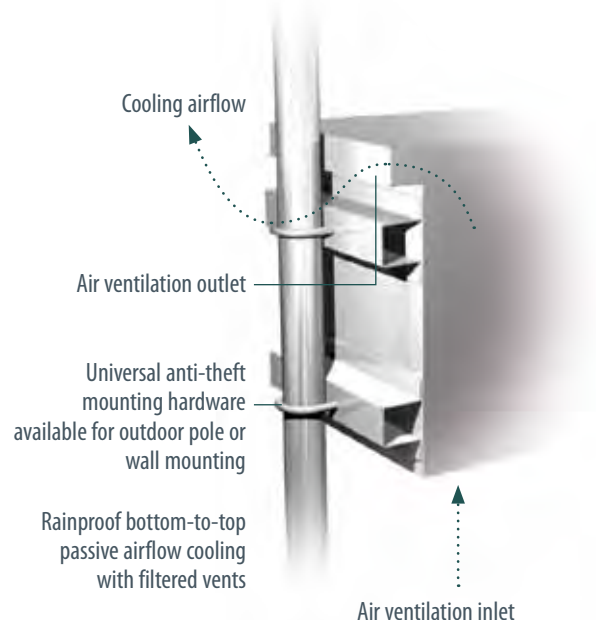
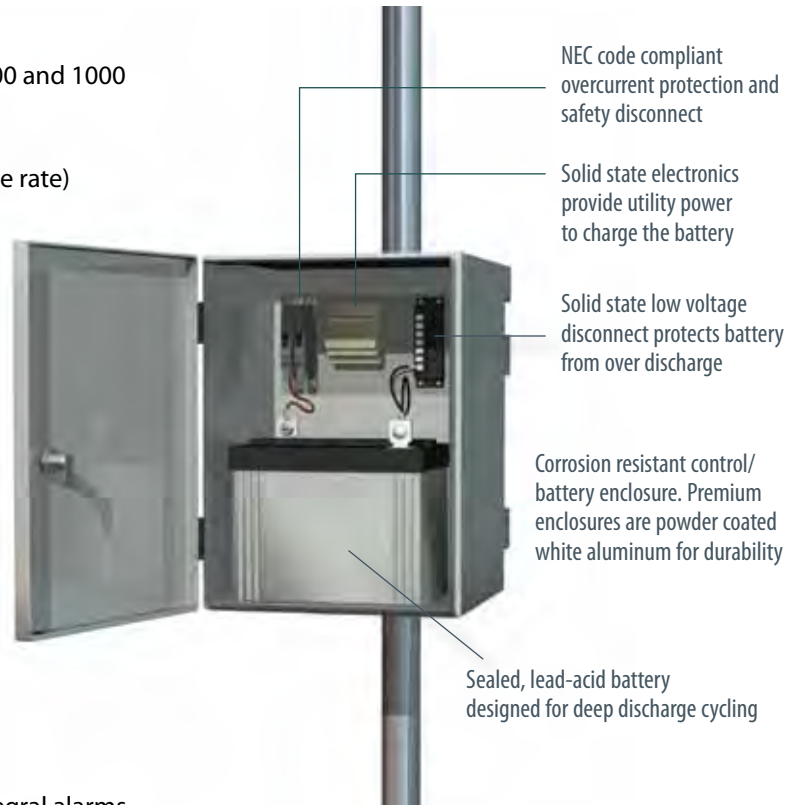



SunWize® RV Solar Power

Discover a new world in your RV. A SunWize RV Solar Power System will give you the power you need to go anywhere you desire. Charge your batteries while enjoying the peaceful tranquility of a remote campsite, or power up at a tailgate party. With the power of a SunWize RV solar system the choice and freedom are yours.

SunWize RV Solar Power Systems are designed for the most rugged climates. Solar modules withstand the summer desert heat and winter hail and still produce power day in and day out, year in and year out.

All SunWize RV Solar Power Systems feature:

- Rugged, reliable and easy to install systems
- Mono-crystalline solar technology to maximize your daily power output
- Solar modules carry a 25-year factory warranty
- SunWize tilting RV solar mount. Using our tilt mount the solar module output can increase by up to 35% over conventional flat mount RV systems. Performance will vary upon season and location.
- Three-stage 20 Amp solar controller with 20' remote LCD display has a 3-year warranty

System Specifications	PV Watts	Vmp	Imp	Dimensions	Weight
991SWRV55 RV system	55	16.7	3.30	35.12 x 25.59 x 1.30	13.7
991SWRV80 RV system	80	16.4	4.88	56.89 x 22.80 x 1.33	23.0
991SWRV110 RV system	110	16.8	6.55	58.90 x 21.65 x 1.33	23.1
991SWRV55-A RV expansion system	55	16.7	3.30	39.40 x 19.68 x 1.33	13.7
991SWRV80-A RV expansion system	80	16.4	4.88	56.89 x 22.80 x 1.33	23.0
991SWRV110-A RV expansion system	110	16.8	6.55	58.90 x 21.65 x 1.33	23.1

Advertisement

Teaming With SunWize on Large Commercial Projects

SunWize is committed to helping its independent installers grow their business as the industry grows. In accordance, we offer a number of services to our customers that are designed to enable their business growth from a small residential and commercial installer to larger commercial installations.

Whether you are new to the industry or a veteran looking to grow the size and complexity of the jobs you do, you may find yourself with an opportunity larger than your company is currently comfortable taking on. These could be Federal, State, or Local Government opportunities as well as commercial or nonprofit projects in your neighborhood. The nature of the job might pose several challenges to you including:

- Large Size
- Complex Design and Engineering
- Large Bonding Capacity Requirements
- Construction Finance Requirements
- Working Capital Constraints
- Equipment or Project Financing

If any of these challenges are keeping you from bidding the work you want, contact your SunWize sales manager and discuss teaming with the SunWize Commercial Power Systems Division. Our commercial installation group tackles projects from 50kW to 1MW across the entire country.

They have completed major commercial projects for a broad range of customers, including the US Military, the National Park Service, the Department of Veteran's Affairs, numerous Municipalities, and a large commercial grocery chain. Their customer's universal experience is that they are expert, reliable and committed to their success and satisfaction.

First we'll evaluate whether your project is a good fit. Should your project qualify, you and SunWize Commercial Power Systems would reach a teaming agreement. SunWize would be the prime contractor on the turnkey integration project and would handle the Engineering, Procurement and Construction Management portion of the contract. You, our customer, would then be the installation sub and/or receive a referral fee.

Teaming with SunWize and leveraging our financial strength, experience and engineering expertise in this way can enable you and your team to gain experience developing larger systems so that you can grow your business and project portfolio. We look forward to being your partner in success.



Commercial Products and Services

SunWize provides comprehensive support for your commercial project. We support you with special module pricing, a full line-up of commercial inverters and commercial roof racking systems as well as a suite of project services.

For large commercial or light industrial solar installations, careful evaluation is required in the area of modules, inverters, mounting, remote monitoring and financing alternatives. SunWize provides the invaluable independent 3rd party recommendation that will help maximize your system's cost effectiveness and energy production.

Special Module Pricing

For commercial installations 30 kW and above, SunWize offers special off price list pricing that is based on the specific quantity of modules. Price quotes are provided by your Sales manager on a case-by-case basis. In addition to crystalline modules, we can provide with thin film module and laminate products.

Commercial Inverters

SunWize has access to the full range of commercial inverters from all the major manufacturers such as:



- SMA America – The versatile, pre-integrated Sunny Tower 36 and 42 plus the Sunny Central 250U/500U and 500 HE-US.
- Satcon – PowerGate Plus PV inverters ranging from 30 kW to 1 MW as well as the new Solstice distributed energy management system.
- Schneider Electric/Xantrex – The GT and GTE Series 30kW, 100kW, 250kW and 500kW.
- PV Powered – PVP 30kW, 75kW, 100kW and 260kW.
- Advanced Energy – Solaron 250 kW, 333kW and 500kW.

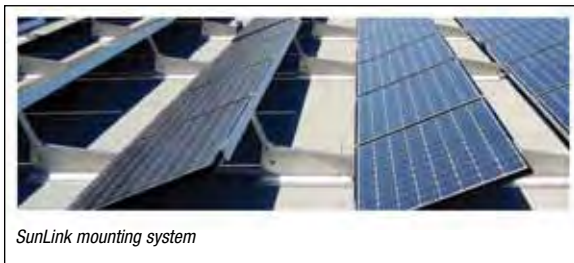

Commercial Mounting Systems

SunWize provides both ballasted and penetrating commercial roof top systems as well as large ground mount systems from leading manufacturers. Here is a sampling:

- UNIRAC – RapidRac G10, ISYS, UL-A
- DP&W – Power-Fab (CRS and Power Grid ballasted commercial, Large Ground Mount)
- SunLink – SunLink rooftop and ground mount systems.

Project Services

SunWize offers a suite of commercial project services starting with project teaming (see opposite page). In addition we have the ability to pre-assemble modules with rails into panels, resulting in dollar and labor savings as well as higher quality, easier craning, less wear and tear on the roof and reduced risk of theft. Financial SunWize can help you obtain project financing through financial,

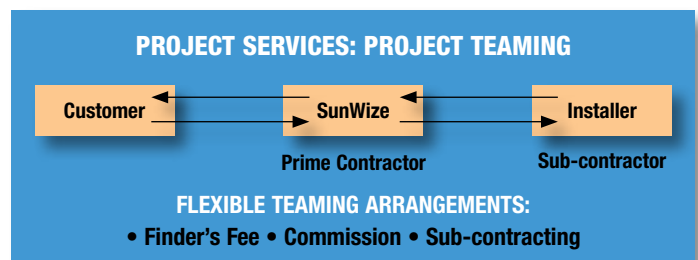

Steps-to-Success: Residential Installation

Introduction

While the steps involved in residential and commercial PV installation are virtually identical, what transpires within each step is significantly different. Residential and commercial installations are like apples and oranges, but both require disciplined progression through a process where steps must be followed in sequence and not short-cut or skipped. This document examines each step in more detail for residential installations, often highlighting common pitfalls as well as proven practices. It is intended as a companion and contrast to Steps-to-Success: Commercial Installation.

Lead Generation

The key to every residential solar installation business is to have a steady volume of incoming leads keeping the “funnel” full. Leads come from three general sources: referrals, promotion (e.g. advertising, PR, events), and networking (e.g. Chamber, general contractors, and architects). Referrals are the highest quality lead and should represent 50% of all new business.

Common Pitfall: Many installers do not proactively follow-up with their customers. They do not take measures to systemically ensure that their customers are satisfied and an active source of referrals.

Proven Practice: Successful installers cultivate referral business through a wide range of practices that include yard signs, referral fees, testimonials, homeowner solar parties and tours.

Lead Qualification

Once a residential lead comes in, it needs to be quickly and carefully evaluated over the phone in terms of its potential. Common criteria to qualify leads include electricity usage, orientation, shading, roof type, building height, budget, and timing.

Common Pitfall: A frequent mistake made by installers is to inadequately qualify a prospect in the haste to schedule a site visit. Site visits to unqualified candidates are a significant waste of resources. Also, many installers fail to follow-up on leads in a timely manner; leads should be called back within 12-24 hours.

Proven Practice: In addition to having a checklist of criteria, successful installers use a web-based, satellite mapping application like Google Earth to make a preliminary assessment of the solar potential of a home. Reviewing design options and costs while on the phone can also prove valuable in qualifying and progressing homeowners in the sales cycle.

Site Evaluation

Successful site evaluation entails: initially establishing rapport with the homeowner(s) and then gathering the information needed to complete a design and proposal. Both take time and rigor to do well. Site visits should last 1½ to 2 hours and should never be omitted.

Common Pitfall: Many installers make the error of not collecting the data they need to accurately complete a design and proposal. Typically, this entails not getting on the roof and taking proper measurements, performing a shade analysis when applicable or examining the electrical service. Often installers do not discuss conduit runs and equipment locations, particularly in regard to aesthetic considerations.

Proven Practice: Most successful companies take an educational approach to selling, making sure their customers understand the basics of solar and the system they are purchasing. A critical objective is to establish trust and confidence by understanding the homeowner’s situation and providing the information they need to make informed decisions that realistically serve their goals.

Customer Proposal

The proposal is a crucial tool in closing the deal. In addition to the system description (preliminary design) and contractual details, it needs to make a simple and compelling case for purchasing a solar system while accurately depicting the performance and financial return of the system. It should also serve to differentiate and position the installation company.

Common Pitfall: Many installers neglect the economics of solar, not clearly showing financial benefits such as savings, payback, and return-on-investment. Successful installers accurately portray the expected performance of the system and the anticipated economic benefits.

Proven Practice: Successful installers use home-grown templates or solar proposal software to shorten the time to generate a professional proposal.

Financing

A number of projects fail to move forward because homeowners require some form of financing. Upfront cost is still one of the biggest hurdles to solar adoption. Successful installers familiarize themselves with a variety of consumer loan alternatives available to the industry, including refinancing, HELOCs, property assessment type loans (currently limited to certain states and cities), unsecured solar and home improvement loans, bridge loans and solar leases.

Common Pitfall: Installers often fail to communicate loan options to their prospects or the impact of interest payments on the economics of the system.

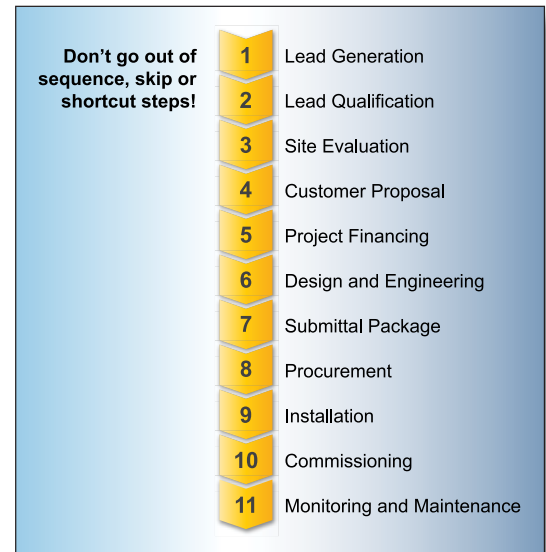

continued

Steps-To-Success: Residential Installation

Financing (continued)

Proven Practice: Many installers significantly reduce upfront cost by carrying rebates for their customers and providing a source for a bridge loan for the Federal tax credit. The rebates can often be assigned to SunWize as payment for equipment.

Design and Engineering

Once a project is in contract and financed, the final design and engineering follows. Residential grid-tie systems are relatively simple, single phase systems that are backfed through a dedicated breaker in the electrical panel.

Common Pitfall: Newer installers fail to incorporate the finer points of design and equipment matching that comes from experience. Using pre-engineered systems or consulting with experienced PV designers pre-empts potential problems.

Proven Practice: To reduce their design and engineering overhead, many installers utilize SunWize system packages and/or develop several of their own package designs, limiting the number of designs to 6-8 and ranging in size from 2 to 8 kW.

Submittal Package

Residential solar requires handling a constant volume of paperwork which can comprise up to half of the man hours of any given project. Successful installers have mastered the paperwork involved in obtaining rebates, building permits and in some cases, loans. Permit applications often require electrical, mechanical and roof drawings.

Common Pitfall: Sometimes installers specify modules for state rebates that are in short supply or are at end-of-life. It is important to make sure and check that the equipment specified will be available when rebates are processed and not wait too long to schedule the installation.

Proven Practice: Installers are often caught by surprise by the differing submittal (and code) requirements of the various building departments in their territory. Adopting a high standard of documentation helps clear most hurdles. It is important to maintain positive relationships with local authorities.

Procurement

Most installers do not purchase equipment or begin work until state or utility incentives are officially reserved. Some installers maintain an inventory. However, in today's market most installers buy materials for each job to take advantage of falling module prices and to preserve cash. Many have the product delivered right to the job site.

Common Pitfall: While the industry is not currently experiencing shortages, specific products can be in short supply or unavailable while inventory is being replenished. Using SunWize Connect to periodically check inventory levels and placing orders accordingly prevents project delays.

Proven Practice: Cash flow can be significantly improved by assigning rebates to SunWize toward equipment purchases. Establish multiple lines of credit and pay bills on time to increase credit limits.

Installation

A residential PV installation typically takes 1-3 days. Virtually all installers have their crews specialize: 2-3 people to install the racking and modules and 1-2 people to handle the electrical work, usually working in parallel. Installation is a critical core competency of successful solar operations.

Common Pitfall: Roof rafters have to be carefully located and roof attachments properly flashed to ensure the structural integrity and water tightness of the system. An experienced journeyman electrician needs to be on the crew or working with a contractor to ensure code compliance and safety.

Proven Practice: Successful installers improve the efficiencies of their crew by continually using the same components and designs.

Commissioning

Installation is concluded with a diligent inspection and then start-up of the system. Once a system is successfully commissioned it will need to be inspected by the building department. After the interconnection paperwork is submitted, another inspection by the utility may be required.

Common Pitfall: Too often, the homeowner is not taken on a walk-through of the system and instructed in its monitoring and maintenance.

Proven Practice: Quality is controlled when the final inspection and commissioning of the system is guided and documented using a detailed checklist.

Monitoring and Maintenance

System level monitoring is increasingly included as an integral part of the system, either through a local wireless display or through a remote, web-based portal. The monitoring and maintenance of a residential system can be performed by the installer as a service or by the homeowner.

Common Pitfall: Many installers do not stress the importance of tracking the functioning of their system or adequately educating their customers in the monitoring and maintenance of their systems.

Proven Practice: Successful installers schedule a free check-up visit to make sure the system is functioning properly. Such visits increase customer satisfaction and referral business.

Steps-To-Success Commercial Installation

Introduction

While the steps involved in residential and commercial PV installation are virtually identical, what transpires within each step is significantly different. Residential and commercial installations are like apples and oranges, but both require disciplined progression through a process where steps must be followed in sequence and not short-cut or skipped. This document examines each step in more detail for commercial installations, highlighting common pitfalls as well as proven practices. It is intended as a companion and contrast to Steps-to-Success: Residential Installation.

Lead Generation

Like its residential counterpart, the key to success in a commercial solar installation business is to have a steady volume of incoming leads. However, generation of commercial leads is completely different than residential. Commercial leads come from direct solicitation of businesses, responding to public RFPs (Requests for Proposals), and through third parties such as PPA (Power Purchase Agreement) providers.

Common Pitfall: Many installers do not sufficiently focus their efforts into opportunities where they have the experience and competencies to be successful. Partnering with experienced commercial installers on projects is one way to avoid this pitfall.

Proven Practice: Successful commercial installers target specific groups of customers through vertical marketing (e.g. wineries, national retailers, storage companies, education, government agencies).

Lead Qualification

Once a commercial opportunity comes in, it needs to be carefully evaluated using a different set of criteria than that used for residential homeowners. Installers examine factors such as project size, location, customer credit worthiness, competition, performance warranty requirements, need for partners, and technology. The most important factor is the potential financial return, as virtually all commercial systems are sold on the basis of their economic merits.

Common Pitfall: Pursuing a commercial opportunity requires a significant investment of resources. A common mistake is not obtaining the previous 12 months of utility bills to analyze the financial return and determine upfront whether it is sufficiently attractive.

Proven Practice: Residential installers successfully expanding into commercial installations begin with small commercial projects in the 10 to 50 kW range and work up from there.

Site Evaluation

Each commercial roof is different, with many considerations. Unlike residential, shade analysis is seldom needed, structural analysis is a requisite, and the electrical service often requires upgrading. Commercial projects out to bid typically have a formal walk-through that includes all bidders.

Common Pitfall: Inexperienced installers often fail to pay adequate attention to the roof and its warranty.

Proven Practice: An effective way not to void the roof warranty is to contact the contractor who installed the roof and have them specify and install any flashings and waterproofing. Non-penetrating racking solutions may also help.

Customer Proposal

Commercial proposals contain sophisticated financial analysis and are at the heart of a long and complex sale. Commercial proposals undergo frequent revisions taking anywhere from 6-12+ months, including preliminary designs and technology selection. In addition, the sales cycle is measured in months and often exceeds a year in duration. Instead of a homeowner, the proposal has to be sold to multiple stakeholders, including owners/top management, CFOs/controllers, operations and facilities managers.

Common Pitfall: Many installers do not develop the financial expertise to understand the more complex commercial rates structures, tax accounting, and the advanced financial modeling focused on return on investment, internal rates of return, net present value, etc.

Proven Practice: Many commercial systems are sold using the “peak shaving” model of financial justification; using solar to eliminate the most expensive electricity.

Financing

Financing is often the most critical consideration and biggest obstacle in a commercial project. Financial leases are available to companies who want to own the systems at the end of the lease period. Power Purchase Agreements, where third parties own and operate the system and sell the electricity at an attractive rate to the business, are the most common form of financing for businesses. Also, Federal cash grants (30% of the system cost) are now available to businesses that need a cash rebate to help pay for the system or do not have enough of a tax bill to be able to make use of a tax credit.

Common Pitfall: Most installers underestimate the difficulty in obtaining financing for a large project. Credit markets are currently very tight and PPA providers and lenders are extremely selective, working only with the lowest risk and highest creditworthy businesses.

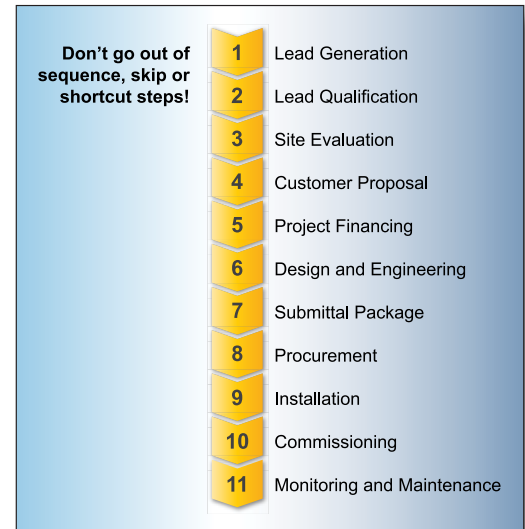

continued

Financing (continued)

Proven Practice: It is better to locate financing partners prior to pursuing commercial projects. They help screen projects and shorten the time to funding.

Design and Engineering

The design and engineering of commercial systems is much more complex than residential, involving more advanced electrical engineering, structural engineering (including wind and, in some regions, earthquake), and a different set of electrical and fire codes. Commercial systems are three phase systems that regularly require tapping into the supply side of the main service and string level, revenue grade monitoring.

Common Pitfall: Installers often fail to understand that multiple disciplines need to be involved (structural engineering and roofing have been mentioned).

Proven Practice: There are number of PV design and engineering firms that specialize in large commercial systems and can assist inexperienced installers.

Submittal Package

Compared with residential, project paperwork for commercial is more complex and there is more of it when it comes to permitting. Successful installers have mastered the paperwork involved in obtaining rebates, building permits and, in some cases, loans. Permit applications often require full size electrical, mechanical and roof drawings and are always formally reviewed (not “over-the-counter”) and often returned for corrections and/or more detail. Often multiple permits (with much higher fees than residential) need to be obtained with the process taking weeks.

Common Pitfall: Sometimes installers specify modules for state rebates that are in short supply or are end-of-life. It is important to make sure and check that the equipment specified will be available when rebates are processed and not to wait too long to schedule the installation.

Proven Practice: Installers are often caught by surprise by the differing submittal (and code) requirements of the various building departments in their territory. Adopting a high standard of documentation helps clear most hurdles.

Procurement

Large quantities and long lead times (8-10 weeks) characterize procurement for commercial PV systems. Items like inverters and racking are non-stock items FOB from the manufacturer. Since delivery is usually to the job site and sometimes in stages, coordination with the installation schedule is key.

Common Pitfall: Installers take module availability for granted. Even in times of adequate supply, inventories are constantly turning over. Large quantity orders regularly cannot be fulfilled while inventory is replenished.

Proven Practice: Careful cash/credit management and planning are necessary to make sure modules are in inventory and can be purchased. Buy modules ahead of when they’re needed and have the distributor put them aside.

Installation

While residential PV installation typically takes 1-3 days, commercial installations take weeks or months. Project management is the critical success factor as crews and materials need to be closely coordinated and scheduled when accounting for progressive inspections and weather delays (depending on the time of year).

Common Pitfall: Installers regularly underestimate the logistics and constraints involved in installing commercial systems. For example, work usually occurs in the context of operating businesses with many safety considerations and restrictions on where and when work can happen.

Proven Practice: Installers often preassemble arrays consisting of three or four modules. This practice saves cost, shortens rooftop installation time, and lessens wear-and-tear of the roof.

Commissioning

The commissioning of a commercial system takes substantially more time than a residential system. Unlike residential systems, each commercial system is one-of-a-kind. This makes inspection more difficult. More significantly, problems are much more difficult to troubleshoot because of the order-of-magnitude greater complexity. Finally, there are more entities that need sign-off on the system (e.g. engineers).

Common Pitfall: Installers new to commercial PV expect the system to start-up without a problem. This rarely occurs and a period of troubleshooting is standard procedure.

Proven Practice: Experienced commercial installers plan for a man week or more of troubleshooting problems in the commissioning phase.

Monitoring and Maintenance

The monitoring of commercial systems is much more critical and specialized because of the greater amount of dollars at stake. As a result, “revenue grade” monitoring is required by utilities and PPA providers. In addition, “string level” monitoring is required to aid troubleshooting and better monitor performance. Finally, maintenance (module washing) is regularly scheduled on arrays in arid areas.

Common Pitfall: Installers often do not understand the specialized nature of commercial monitoring and that it is not provided as a free service by the inverter manufacturer.

Proven Practice: Monitoring requirements are specified and designed into the system, often with the assistance of third-party companies/project partners that provide commercial monitoring solutions (e.g. Energy Recommerce, Inc.).

Solar Basics

PV power generation systems are made up of interconnected components, each with a specific function. One of the major strengths of PV systems is modularity. As your needs grow, individual components can be replaced or added to provide increased capacity. Following is a brief overview of a typical PV system. NOTE: "This basic design guide is only for battery-based systems that do not use MPPT (Maximum Power Point Tracking) charge controllers.

Solar Array

The solar array consists of one or more PV modules which convert sunlight into electric energy. The modules are connected in series and/or parallel to provide the voltage and current levels to meet your needs. The array is usually mounted on a metal structure and tilted to face the sun.

Charge Controller

Although charge controllers can be purchased with many optional features, their main function is to maintain the batteries at the proper charge level, and to protect them from overcharging.

Battery Bank

The battery bank contains one or more deep-cycle batteries, connected in series and/or parallel depending on the voltage and current capacity needed. The batteries store the power produced by the solar array and discharge it when required.

Inverter

An inverter is required when you want to power AC devices. The inverter converts the DC power from the solar array/batteries into AC power.

AC and DC Loads

These are the appliances (such as lights or radios), and the components (such as water pumps and microwave repeaters), which consume the power generated by your PV array.

Balance of System

These components provide the interconnections and standard safety features required for any electrical power system. These include: array combiner box, properly sized cabling, fuses, switches, circuit breakers and meters.

Five Steps to Sizing a PV System

We have provided you with an easy-to-follow, step-by-step guide for sizing your system. Keep in mind this is to be used as a general guide for residential application. For commercial or industrial systems, contact a SunWize Sales Manager. Follow these five steps to determine your requirements and specify the components you will need.

1. Determine Your Power Consumption Demands

Make a list of the appliances and/or loads you are going to run from your PV system. Find out how much power each item consumes while operating. Most appliances have a label on the back which lists the wattage. Specification sheets, local appliance dealers, and the product manufacturers are other sources of information. We have provided a chart that lists typical power consumption demands of common devices which you can use as a guide. Once you have the wattage ratings, fill out the load sizing worksheet.

Load-Sizing Worksheet

List all of the electrical appliances to be powered by your PV system. Separate AC and DC devices and enter them in the appropriate table. Record the operating wattage of each item. Most appliances have a label on the back that lists the wattage. Local appliance dealers and the product manufacturers are other sources of this information. Specify the number of hours per day each item will be used. Multiply the first three columns to determine the watt-hour usage per day. Enter the number of days per week you will be using each item to determine the total watt-hours per week each appliance will require.

	DC Appliance	Watts	X	Qty	X	Hrs/Day	=	Wh/Day	X	Days/Wk	=	Wh/Wk
A.	_____							_____		_____		_____
B.	_____							_____		_____		_____
C.	_____							_____		_____		_____
D.	_____							_____		_____		_____
E.	_____							_____		_____		_____

Total the numbers in the last column. This is your DC power requirement. Total _____

Multiply the total by 1.2 to compensate for system losses during battery charge/discharge cycle. DC WH/WK _____

Power Consumption

Load Sizing Worksheet

AC Appliance	Watts	X	Qty	X	Hrs/Day	=	Wh/Day	X	Days/Wk	=	Wh/Wk
A. _____							_____				_____
B. _____							_____				_____
C. _____							_____				_____
D. _____							_____				_____
E. _____							_____				_____

Total the numbers in the last column. This is your AC power requirement. Total _____

Multiply the total by 1.2 to compensate for system losses during battery charge/discharge cycle. AC WH/WK _____

1. Add AC WH/WK and DC WH/WK together. This is your total power requirement per week. Total _____

2. Enter the voltage of your battery bank (usually 12 or 24 volts). VOLTS _____

3. Divide line 1 by line 2. This is your amp-hour requirement per week. AH/WK _____

4. Divide line 3 by 7 days. This is your average amp-hour requirement per day that will be used to size your battery bank and your PV module array. AH/DAY _____

2. Optimize Your Power System Demands

At this point, it is important to examine your power consumption and reduce your power needs as much as possible. (This is true for any system, but it is especially important for home and cabin systems, because the cost savings can be substantial.) First identify large and/or variable loads (such as water pumps, outdoor lights, electric ranges, AC refrigerators, clothes washers, etc.) and try to eliminate them or examine alternatives such as propane or DC models. The initial cost of DC appliances tends to be higher than AC, but you avoid losing energy in the DC to AC conversion process, and typically DC appliances are more efficient and last longer. Replace incandescent fixtures with fluorescent lights wherever possible. Fluorescent lamps provide the same level of illumination at lower wattage levels. If there is a large load that you cannot eliminate, consider using it only during peak sun hours or only during the summer. (In other words, be creative!) Revise your Load Sizing Worksheet now with your optimized results.

3. Size Your Battery Bank

Read "Characteristics of Batteries" and then choose the appropriate battery for your needs. Fill out the Battery Sizing Worksheet.

Characteristics of Batteries

Sizing Your Battery Bank

The first decision you need to make is how much storage you would like your battery bank to provide. Often this is expressed as "days of autonomy," because it is based on the number of days you expect your system to provide power without receiving an input charge from the solar array. In addition to the days of autonomy, you should also consider your usage pattern and the criticality of your application. If you are installing a system for a weekend home, you might want to consider a larger battery bank, because your system will have all week to charge and store energy. Alternatively, if you are adding a PV array as a supplement to a generator-based system, your battery bank can be slightly undersized since the generator can be operated if needed for recharging.

Temperature Effects

Batteries are sensitive to temperature extremes, and you cannot take as much energy out of a cold battery as a warm one. Use the chart on the Battery-Sizing Worksheet to correct for temperature effects. Although you can get more than rated capacity from a hot battery, operation at hot temperatures will shorten battery life.

■ ■ ■ Battery Bank *continued*

Temperature Effects *continued*

Try to keep your batteries near room temperature. Charge controllers can be purchased with a temperature compensation option to optimize the charging cycle at various temperatures and lengthen your battery life.

Depth of Discharge

Depth of Discharge is the percentage of the rated battery capacity that is withdrawn from the battery. The capability of a battery to withstand discharge depends on its construction. Two terms, shallow-cycle and deep-cycle, are commonly used to describe batteries. Shallow-cycle batteries are lighter, less expensive and have a short lifetime. For this reason, we do not sell shallow-cycle batteries. Deep-cycle batteries should always be used for stand-alone PV systems. These units have thicker plates and most will withstand daily discharges up to 80% of their rated capacity. Most deep-cycle batteries are flooded electrolyte which means the plates are covered with the electrolyte and the level of fluid must be monitored and distilled water added periodically to keep the plates fully covered. We also offer sealed, lead-acid batteries that do not require liquid refills. There are other types of deep-cycle batteries such as nickel cadmium used in special applications. The maximum depth of discharge value used for sizing should be the worst case discharge that the battery will experience. The system control should be set to prevent discharge below this level.

Rated Battery Capacity

The ampere-hour capacity of a battery is usually specified together with some standard hour reference such as ten or twenty hours. For example, suppose the battery is rated at 100 ampere-hours and a 20-hour reference is specified. This means the battery is fully charged and will deliver a current of 5 amperes for 20 hours. If the discharge current is lower, for example 4.5 amperes, then the capacity will go to 110 ampere-hours. The relationship between the capacity of a battery and the load current can be found in the manufacturer's literature.

Battery Life

The lifetime of any battery is difficult to predict, because it is dependent on a number of factors such as charge and discharge rate, depth of discharge, number of cycles and operating temperature extremes. It would be unusual for a lead-acid battery to last longer than fifteen years in a PV system but many last for five to eight years.

Maintenance

Batteries require periodic maintenance. Even the sealed battery should be checked to make sure connections are tight and there is no indication of overcharging. For flooded batteries, the electrolyte level should be maintained well above the plates and the voltage and specific gravity of the cells should be checked for consistent values. Wide variations between readings may indicate cell problems. The specific gravity of the cells should be checked with a hydrometer particularly before the onset of winter. In cold environments, the electrolyte in lead-acid batteries may freeze. The freezing temperature is a function of a battery state of charge. When a battery is completely discharged, the electrolyte becomes water and the battery may freeze.

Battery Sizing Worksheet

1. Enter your daily amp-hour requirement. (From the Load Sizing Worksheet, line 4) AH/Day _____
2. Enter the maximum number of consecutive cloudy weather days expected in your area, or the number of days of autonomy you would like your system to support. _____
3. Multiply the amp-hour requirement by the number of days. This is the amount of amp-hours your system will need to store. AH _____
4. Enter the depth of discharge for the battery you have chosen. This provides a safety factor so that you can avoid over-draining your battery bank. (Example: If the discharge limit is 20%, use 0.2.) This number should not exceed 0.8. _____
5. Divide line 3 by line 4. AH _____

... Battery Bank *continued*

Battery-Sizing Worksheet

6. Select the multiplier below that corresponds to the average wintertime ambient temperature your battery bank will experience.

Ambient Temperature	Multiplier
80°F / 26.7°C	1.00
70°F / 21.2°C	1.04
60°F / 15.6°C	1.11
50°F / 10.0°C	1.19
40°F / 4.4°C	1.30
30°F / -1.1°C	1.40
20°F / -6.7°C	1.59

7. Multiply line 5 by line 6. This calculation ensures that your battery bank will have enough capacity to overcome cold weather effects. This number represents the total battery capacity you will need.

AH _____

8. Enter the amp-hour rating for the battery you have chosen.

9. Divide the total battery capacity by the battery amp-hour rating and round off to the next highest number. This is the number of batteries wired in parallel required.

10. Divide the nominal system voltage (12V, 24V or 48V) by the battery voltage and round off to the next highest number. This is the number of batteries wired in series.

11. Multiply line 9 by line 10. This is the total number of batteries required.

4. Determine The Sun Hours Available Per Day

Several factors influence how much sun power your modules will be exposed to:

- When you will be using your system – summer, winter, or year-round.
- Typical local weather conditions.
- Fixed mountings vs. trackers.
- Location and angle of PV array.

We have provided the following charts which show ratings that reflect the number of hours of full sunlight available to generate electricity. Your solar array's power generation capacity is dependent on the angle of the rays as they hit the modules. Peak power occurs when the rays are at right angles or perpendicular to the modules. As the rays deviate from perpendicular, more and more of the energy is reflected rather than absorbed by the modules. Depending on your application, sun tracking mounts can be used to enhance your power output by automatically positioning your array.

The charts reflect the difference in sunlight during spring, summer, autumn and winter. It is more difficult to produce energy during the winter because of shorter days, increased cloudiness and the sun's lower position in the sky. The charts list the sun hour ratings for several cities in North America for summer, winter and year round average. If you use your system primarily in the summer, use the summer value; if you are using your system year-round, especially for a critical application, use the winter value. If you are using the system most of the year (spring, summer and fall) or the application is not critical, use the average value. With the chart and the map, you should be able to determine a reasonable estimate of the sun's availability in your area.

SUN HOURS PER DAY - NATIONAL

State, City	Summer Avg.	Winter Avg.	Yr. Round Avg	State, City	Summer Avg.	Winter Avg.	Yr. Round Avg
AL, Montgomery	4.69	3.37	4.23	CA, La Jolla	5.24	4.29	4.77
AK, Bethel	6.29	2.37	3.81	CA, Los Angeles	6.14	5.03	5.62
AK, Fairbanks	5.87	2.12	3.99	CA, Riverside	6.35	5.35	5.87
AK, Mantanuska	5.24	1.74	3.55	CA, Santa maria	6.52	5.42	5.94
AZ, Page	7.30	5.65	6.36	CA, Soda Springs	6.47	4.40	5.60
AZ, Phoenix	7.13	5.78	6.58	CO, Boulder	5.72	4.44	4.87
AZ, Tucson	7.42	6.01	6.57	CO, Granby	7.47	5.15	5.69
AR, Little Rock	5.29	3.88	4.69	CO, Grand Junction	6.34	5.23	5.86
CA, Davis	6.09	3.31	5.10	CO, Grand Lake	5.86	3.56	5.08
CA, Fresno	6.19	3.42	5.38	D.C. Washington	4.69	3.37	4.23
CA, Inyokem	8.70	6.97	7.66	FL, Apalachicola			

Sun Hours Per Day - National *continued*

State, City	Summer Avg.	Winter Avg.	Yr Round Avg.	State, City	Summer Avg.	Winter Avg.	Yr Round Avg.
FL, Belle Island	5.31	4.58	4.99	PA, Pittsburgh	4.19	1.45	3.28
FL, Gainesville	5.81	4.71	5.27	PA, State College	4.44	2.78	3.91
FL, Miami	6.26	5.05	5.62	RI, Newport	4.69	3.58	4.23
FL, Tampa	6.16	5.26	5.67	SC, Charleston	5.72	4.23	5.06
GA, Atlanta	5.16	4.09	4.74	SD, Rapid City	5.91	4.56	5.23
GA, Griffin	5.41	4.26	4.99	TN, Nashville	5.20	3.14	4.45
HI, Honolulu	6.71	5.59	6.02	TN, Oak Ridge	5.06	3.22	4.37
IA, Ames	4.80	3.73	4.40	TX, Brownsville	5.49	4.42	4.92
ID, Twin Falls	5.42	3.41	4.70	TX, El Paso	7.42	5.87	6.72
ID, Boise	5.83	3.33	4.92	TX, Port Worth	6.00	4.80	5.83
IL, Chicago	4.08	1.47	3.14	TX, Midland	6.33	5.23	5.83
IN, Indianapolis	5.02	2.55	4.21	TX, San Antonio	5.88	4.65	5.30
KS, Dodge City	4.14	5.28	5.79	UT, Flaming Gorge	6.63	5.48	5.83
KS, Manhattan	5.08	3.62	4.57	UT, Salt Lake City	6.09	3.78	5.26
KY, Lexington	5.97	3.60	4.94	VA, Richmond	4.50	3.37	4.13
LA, Lake Charles	5.73	4.29	4.93	WA, Prosser	6.21	3.06	5.03
LA, New Orleans	5.71	3.63	4.92	WA, Pullman	6.07	2.90	4.73
LA, Shreveport	4.99	3.87	4.63	WA, Richland	6.13	2.01	4.43
MA, Blue Hill	4.38	3.33	4.05	WA, Seattle	4.83	1.60	3.57
MA, Boston	4.27	2.99	3.84	WA, Spokane	5.53	1.16	4.48
MA, E. Wareham	4.48	3.06	3.99	WV, Charleston	4.12	2.47	3.65
MA, Lynn	4.60	2.33	3.79	WI, Madison	4.85	3.28	4.29
MA, Natick	4.62	3.09	4.10	WY, lander	6.81	5.50	6.06
MD, Silver Hill	4.71	3.84	4.47				
ME, Caribou	5.62	2.57	4.19	Province, City			
ME, Portland	5.2	3.56	4.51	Alberta, Edmonton	4.95	2.13	3.75
MI, E. Lansing	4.71	2.70	4.00	Alberta, Suffield	5.19	2.75	4.10
MI, Sault Ste. Marie	4.83	2.33	4.20	British Columbia,			
MN, St. Cloud	5.43	3.53	4.53	Kamloops	4.48	1.46	3.29
MO, Columbia	5.5	3.97	4.73	British Columbia,			
MO, St. Louis	4.87	3.24	3.78	Prince George	4.13	1.33	3.14
MS, Meridian	4.86	3.64	4.44	British Columbia,			
MT, Glasgow	5.97	4.09	5.15	Vancouver	4.23	1.33	3.14
MT, Great Falls	5.70	3.66	4.93	Manitoba, The Pas	5.02	2.02	3.56
MT, Summit	5.17	2.36	3.99	Manitoba, Winnipeg	5.23	2.77	4.02
NC, Cape Hatteras	5.81	4.69	5.31	New Brunswick,			
NC, Greensboro	5.05	4.00	4.71	Fredericton	4.23	2.54	3.56
ND, Bismark	5.48	3.97	5.01	Newfoundland,			
NE, Lincoln	5.40	4.38	4.79	Goose Bay	4.65	2.02	3.33
NE, North Omaha	5.28	4.26	4.90	Newfoundland,			
NJ, Sea Brook	4.76	3.20	4.21	St. Johns	3.89	1.83	3.15
NM, Albuquerque	7.16	6.21	6.77	Northwest Territory,			
NV, Ely	6.48	5.49	5.98	Fort Smith	5.16	0.88	3.29
NV, Las Vegas	7.13	5.83	6.41	Northwest Territory,			
NY, Bridgehampton	3.93	1.62	3.16	Norman Wells	5.04	0.06	2.89
NY, Ithaca	4.57	2.29	3.79	Nova Scotia,			
NY, New York	4.97	3.03	4.08	Halifax	4.02	2.16	3.38
NY, Rochester	4.22	1.58	3.31	Ontario, Ottawa	4.63	2.35	3.70
NY, Schenectady	3.92	2.53	3.55	Ontario, Toronto	3.98	2.13	3.44
OH, Cleveland	4.79	2.69	3.94	Prince Edward Isl.,			
OH, Columbus	5.26	2.66	4.15	Charlottetown	4.31	2.29	3.56
OK, Oklahoma City	6.26	4.98	5.59	Quebec, Montreal	4.21	2.29	3.50
OK, Stillwater	5.52	4.22	4.99	Quebec, Sept-Isles	4.29	2.33	3.50
OR, Astoria	4.76	1.99	3.72	Saskatchewan,			
OR, Corvallis	5.71	1.90	4.03	Swift Current	5.25	2.77	4.23
OR, Medford	5.84	2.02	4.51	Yukon, Whitehorse	4.81	0.69	3.10

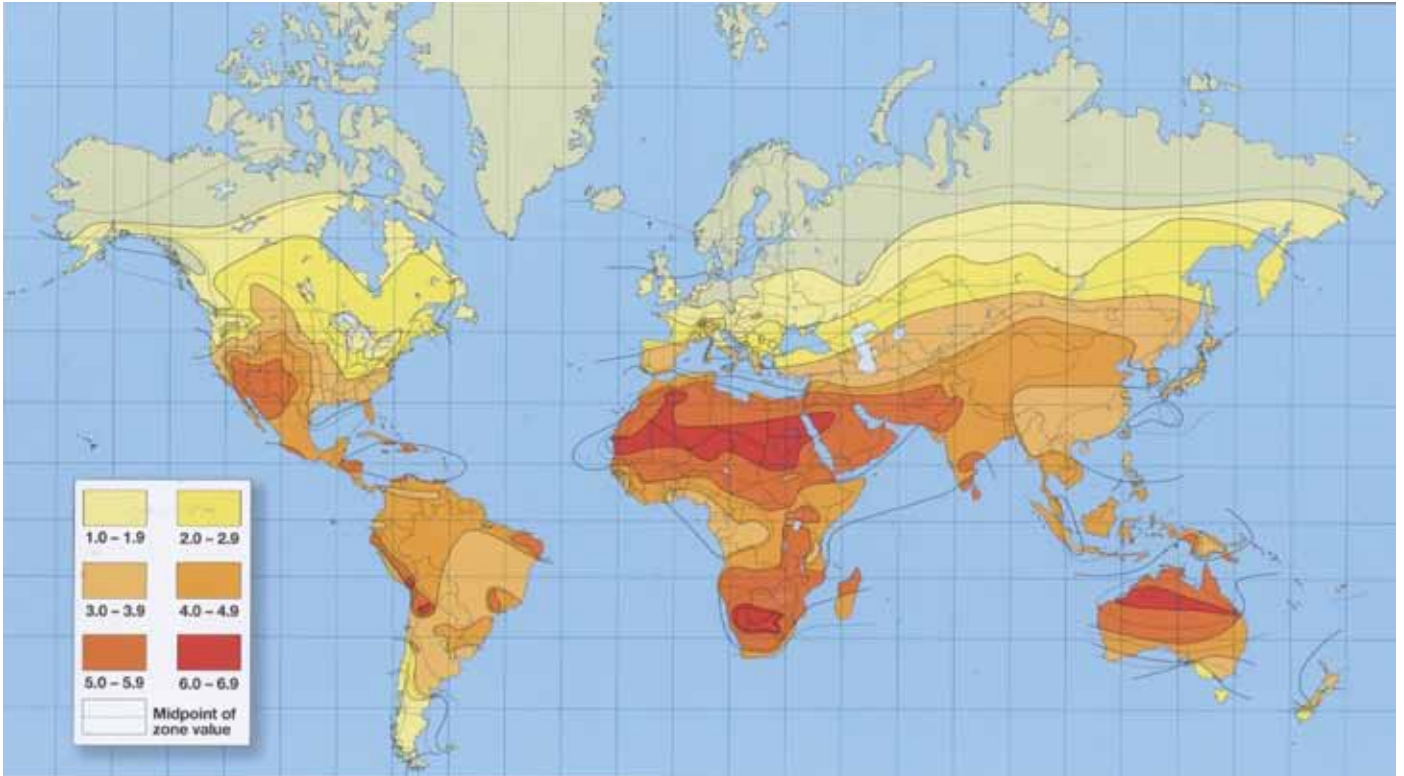

This map divides the world into six solar performance regions based on winter peak sun hours in the worst case month. A larger map in full color is located on the back cover of this catalog.

5. Size Your Array

1. Enter your daily amp-hour requirement (from your Load Sizing Worksheet, line 4). AH/Day _____
2. Enter the sun-hours per day for your area. Refer to chart. H/Day _____
3. Divide line 1 by line 2. This is the total amperage required from your solar array. _____
4. Enter the peak amperage of the solar module you have selected. Peak A _____
5. Divide line 3 by line 4. This is the number of solar modules needed in parallel. _____
6. Select the required modules in series from the following chart. _____

Battery Bank Voltage	No. of Modules in Series
12V	1
24V	2
48V	4

7. Multiply line 5 by line 6 to find the total number of modules needed in your array. Total _____
8. Enter the nominal power rating (in watts) of the module you have chosen. W _____
9. Multiply line 7 by line 8. This is the nominal power output of your system. W _____