

# **IPCMini Ion Pump Controller**

## **Models**

**X3602-64000, X3602-64001, X3602-64002,  
X3602-64003, X3602-64010, X3602-64011  
X3602-64012, X3602-64013, X3602-64020,  
X3602-64021, X3602-64022, X3602-64023,  
X3602-64030, X3602-64031, X3602-64032,  
X3602-64033**

**Manuale di Istruzioni  
Bedienungshandbuch  
Notice de Mode D'Emploi  
User Manual**

**87-900-153-01 (A)  
02/2018**



**Agilent Technologies**

## Notices

© Agilent Technologies, Inc. 2018

No part of this manual may be reproduced in any form or by any means (including electronic storage and retrieval or translation into a foreign language) without prior agreement and written consent from Agilent Technologies, Inc. as governed by United States and international copyright laws.

### Manual Part Number

Publication Number: 87-900-153-01 (A)

### Edition

Edition 02/2018

Printed in ITALY

Agilent Technologies Italia S.p.A.

Vacuum Products Division

Via F.lli Varian, 54

10040 Leini (TO)

ITALY

## Warranty

**The material contained in this document is provided “as is,” and is subject to being changed, without notice, in future editions. Further, to the maximum extent permitted by applicable law, Agilent disclaims all warranties, either express or implied, with regard to this manual and any information contained herein, including but not limited to the implied warranties of merchantability and fitness for a particular purpose. Agilent shall not be liable for errors or for incidental or consequential damages in connection with the furnishing, use, or performance of this document or of any information contained herein. Should Agilent and the user have a separate written agreement with warranty terms covering the material in this document that conflict with these terms, the warranty terms in the separate agreement shall control.**

or any equivalent agency regulation or contract clause. Use, duplication or disclosure of Software is subject to Agilent Technologies' standard commercial license terms, and non-DOD Departments and Agencies of the U.S. Government will receive no greater than Restricted Rights as defined in FAR 52.227-19(c)(1-2) (June 1987). U.S. Government users will receive no greater than Limited Rights as defined in FAR 52.227-14 (June 1987) or DFAR 252.227-7015 (b)(2) (November 1995), as applicable in any technical data.

## Trademarks

Windows and MS Windows are U.S. registered trademarks of Microsoft Corporation.

### CAUTION

## Technology Licenses

The hardware and/or software described in this document are furnished under a license and may be used or copied only in accordance

## Safety Notices

A **CAUTION** notice denotes a hazard. It calls attention to an operating procedure, practice, or the like that, if not correctly performed or adhered to,

### WARNING

with the terms of such license.

## Restricted Rights Legend

If software is for use in the performance of a U.S. Government prime contract or subcontract, Software is delivered and licensed as “Commercial computer software” as defined in DFAR 252.227-7014 (June 1995), or as a “commercial item” as defined in FAR 2.101(a) or as “Restricted computer software” as defined in FAR 52.227-19 (June 1987)

could result in damage to the product or loss of important data. Do not proceed beyond a **CAUTION** notice until the indicated conditions are fully understood and met.

**A WARNING notice denotes a hazard. It calls attention to an operating procedure, practice, or the like that, if not correctly performed or adhered to, could result in personal injury or death. Do not proceed beyond a WARNING notice until the indicated conditions are fully understood and met.**

# IPCMini Ion Pump Controller



# Contents

## 1 Istruzioni per l'uso 7

Informazioni Generali 8

Immagazzinamento 9

Preparazione per l'installazione 9

Installazione 10

Uso 14

Accensione del controller dal pannello frontale  
(modalità LOCAL) 16

Manutenzione 18

Smaltimento 19

## 2 Gebrauchsanleitung 20

Allgemeines 21

Lagerung 22

Vor der Installation 22

Installation 23

Gebrauch 26

Einschalten des Controllers von der vorderen  
Schalttafel (LOKAL-Modus) 28

Wartung 30

Entsorgung 31

**3 Mode d'emploi 32**

Indications Generales 33

Emmagasinage 34

Preparation pour l'Installation 34

Installation 35

Utilisation 38

Allumage du Contrôleur du Panneau Frontal  
(Modalité LOCAL) 40

Entretien 42

Mise au Rebut 43

**4 Instructions for Use 44**

General Information 45

Storage 46

Prior to Installation 46

Installation 47

Usage 50

Powering On the Controller from the Front Panel (LOCAL  
Mode) 52

Maintenance 54

Disposal 55

**5. Instructions for Use 56**

- IPCMini Controller Description 57
- Specifications 58
- Controller Outline 59
- Front Panel Description 60
- Rear Panel Description (Universal range version) 64
- Rear Panel Description (24V version) 65
  - Interlock connection 65
  - Operating Mode 66
- Selecting “Operating Mode” via Serial 66
  - Functions 67
- Protect 68
- Set- point 68
- Autostart 69
- iSTEP 70
- Device Number 71
- Connection of Input Remote 73
  - Serial 74
- Connector Examples 75
- Procedure to Connect the Serial and I/O ports to an External Cable 76
- Window Protocol 77
- LAN communication 81
- Error Code 81
- Cleaning 82
- Accessories and Spare Parts 84

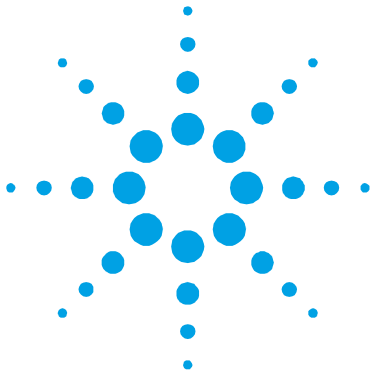

# 1

## Istruzioni per l'uso

Informazioni Generali	8
Immagazzinamento	9
Preparazione per l'installazione	9
Installazione	10
Uso	14
Accensione del controller dal pannello frontale (modalità LOCAL)	16
Manutenzione	18
Smaltimento	19



## Informazioni Generali

Questa apparecchiatura è destinata ad uso professionale. L'utente deve leggere attentamente il presente Manuale di istruzioni ed ogni altra informazione addizionale fornita dalla Agilent prima dell'utilizzo dell'apparecchiatura. La Agilent declina ogni responsabilità dovuta alla mancata osservanza totale o anche parziale delle istruzioni fornite in questo documento, all'uso improprio dell'apparecchiatura da parte di personale non addestrato, all'esecuzione di interventi non autorizzati o alla mancata osservanza delle specifiche normative nazionali.

Nei paragrafi seguenti sono riportate tutte le informazioni necessarie a garantire la sicurezza dell'operatore durante l'utilizzo dell'apparecchiatura. Nel appendice "Technical Information" vengono fornite delle informazioni dettagliate. In seguito con il termine "il controller" si intende l'apparecchiatura IPCMini.

**Questo manuale utilizza le seguenti convenzioni:**

---

### **AVVERTENZA!**



I messaggi di avvertenza attirano l'attenzione dell'operatore su una procedura o una pratica specifica che, se non eseguita in modo corretto, potrebbe provocare gravi lesioni personali.

---

### **ATTENZIONE!**

I messaggi di attenzione sono visualizzati prima di procedure che, se non osservate, potrebbero causare danni all'apparecchiatura.

---

### **NOTA**

Le note contengono informazioni importanti estrapolate dal testo.

---



## Immagazzinamento

Per trasportare e immagazzinare il controller occorre osservare le seguenti condizioni ambientali:

- Temperatura: da -40°C a +70 °C
- Umidità relativa: da 0 a 95% (senza condensa)

## Preparazione per l'installazione

Il controller viene fornito in un imballo protettivo speciale; nel caso in cui si presentassero segni di danni che potrebbero essere stati causati durante il trasporto, contattare l'ufficio vendite locale.

Durante l'operazione di disimballo, prestare particolare attenzione a non lasciar cadere il controller e a non sottoporlo ad urti.

Il materiale dell'imballo è completamente riciclabile e risponde alla direttiva CEE 85/399 per la tutela dell'ambiente.

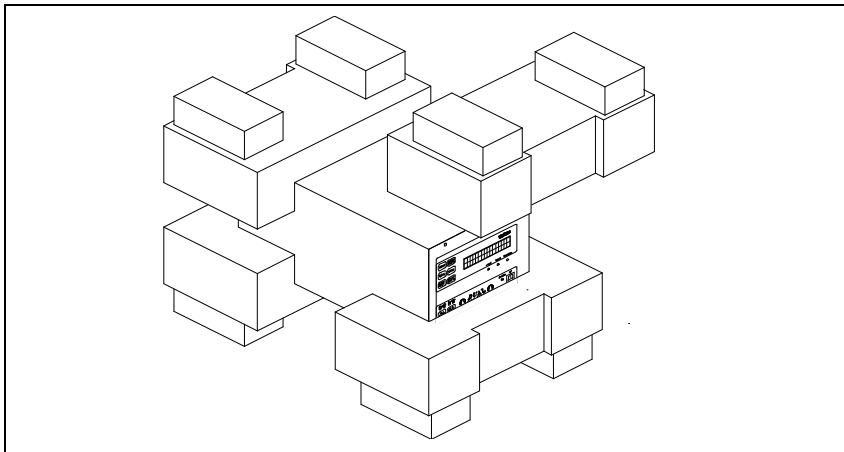

**Figura 1** Imballo del controller

## Installazione

**AVVERTENZA!**



Per la sicurezza dell'operatore il controller IPCMini (versione 100-240Vac) deve essere alimentato con un cavo di alimentazione a 3 fili dotato di una spina approvata a livello internazionale. Utilizzare questo cavo e spina insieme ad una presa adeguatamente connessa a terra per evitare scosse elettriche e soddisfare i requisiti delle norme CE. Le alte tensioni che si sviluppano nel controller possono provocare gravi lesioni o la morte. Dopo lo spegnimento dell'unità rimane dell'energia residua all'interno del controller per un po' di tempo. Attendere circa 1 minuto per essere sicuri che l'energia residua sia stata dissipata.

**AVVERTENZA!**



Il controller deve essere installato in modo che possa essere facilmente scollegato il cavo di alimentazione.  
Se questo controller non è usato come indicato dal costruttore, le protezioni del controller potrebbero non funzionare correttamente.

**AVVERTENZA!**



Per la versione a 100-240 V CA  
Cavo di alimentazione deve essere formato da tre cavi conduttori (Ph-N-Earth): La sezione dei cavi deve essere almeno AWG18, 0,83 mm<sup>2</sup>.  
Per la versione a 24 V CC  
L'alimentazione utilizzata per la versione a 24 V CC deve prevedere una separazione dalle tensioni di rete mediante isolamento doppio o rinforzato.  
Cavo di alimentazione: il cavo corretto per i collegamenti elettrici è a tre conduttori (fase + neutro + terra).  
La sezione del cavo deve essere almeno AWG18, 0,83 mm<sup>2</sup>  
PIN 1 = Connettore positivo  
PIN 2 = Connettore negativo  
PIN 3 = Terra di protezione  
Tensione in ingresso: 24 V CC  $\pm$  10%

**ATTENZIONE!**

Il controller può essere utilizzato sia come unità da tavolo che come modulo installato in un rack. In ogni caso deve essere posizionato in modo tale che l'aria possa circolare liberamente attraverso i fori di areazione presenti sulla copertura.

Nel caso in cui il controller venga utilizzato come modulo rack, deve essere installato in un'adattatore alto 3 unità rack per evitare che cada all'interno del rack stesso. Il pannello frontale del controller non è previsto per reggere il peso dell'unità.

Non installare o utilizzare il controller in ambienti esposti ad agenti atmosferici (pioggia, neve, ghiaccio) in presenza di polvere, gas corrosivi o in ambienti esplosivi o ad alto rischio di infiammabilità.

---

**ATTENZIONE!**

Il controller appartiene alla seconda categoria di installazione (o sovratensione) prevista dalla normativa EN 61010-1. Connettere quindi il dispositivo ad una linea di alimentazione che soddisfi tale categoria.

Il controller ha dei connettori per gli ingressi/uscite e per la comunicazione seriale che devono essere connessi ai circuiti esterni in modo che nessuna parte sotto tensione sia accessibile. Assicurarsi che l'isolamento del dispositivo connesso al controller abbia un isolamento adeguato anche in condizione di guasto singolo come previsto dalla normativa EN 61010-1.

---

## 1 Technical Information

### Installazione

#### NOTA

Nel caso in cui il controller venga installato in un rack, rimuovere i quattro piedini in modo che venga posizionato con almeno 30 mm di spazio sotto e sopra.

---

#### ATTENZIONE!

In casi rari di guasto il controller potrebbe emettere fumo. Se il cliente usa il controller in camere pulite è necessario prevedere adeguate protezioni per evitare di contaminare l'ambiente con l'eventuale fumo.



---

Durante il funzionamento, occorre che siano rispettate le seguenti condizioni ambientali:

- Temperatura: da 0 °C a +45 °C
- Umidità relativa: 0 – 90 % (senza condensa)

## Simboli utilizzati

I simboli qui di seguito riportati vengono utilizzati coerentemente in tutte le immagini:

	Attenzione, rischio di scossa elettrica.
	Avvertenza "consultare le istruzioni per l'uso/l'installazione"

## 1 Technical Information

### Uso

## Uso

In questo paragrafo vengono riportate le principali procedure operative. Per ulteriori informazioni e per le procedure riguardanti collegamenti o particolari opzioni fare riferimento ai paragrafi “UTILIZZO” nell’appendice “Technical Information”.

Prima di utilizzare il controller effettuare tutti i collegamenti elettrici e fare riferimento al manuale della pompa collegata.

### **AVVERTENZA!**

**Accendere il canale di alta tensione solo se connessi alle pompe ioniche tramite gli appositi cavi di alta tensione dotati del cavo di interlock.**



**L’uso del controller è inteso con cavo di alta tensione provvisto di interlock.**

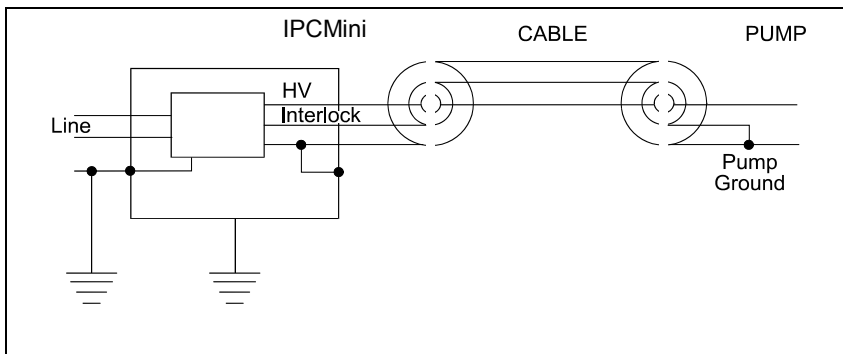

**Figura 2** Collegamenti delle masse

**NOTA**

Se si vuole utilizzare un cavo HV senza interlock nel sacchetto accessori è fornito un apposito kit di cavetti per interlock preassemblato. Con questo utilizzo si perde la funzionalità di sicurezza offerta dall'utilizzo dell'interlock.

Fare riferimento alla seguente figura per montare correttamente il cavo di interlock fornito nel sacchetto accessori, qualora si voglia rinunciare al cavo di alta tensione dotato di interlock.

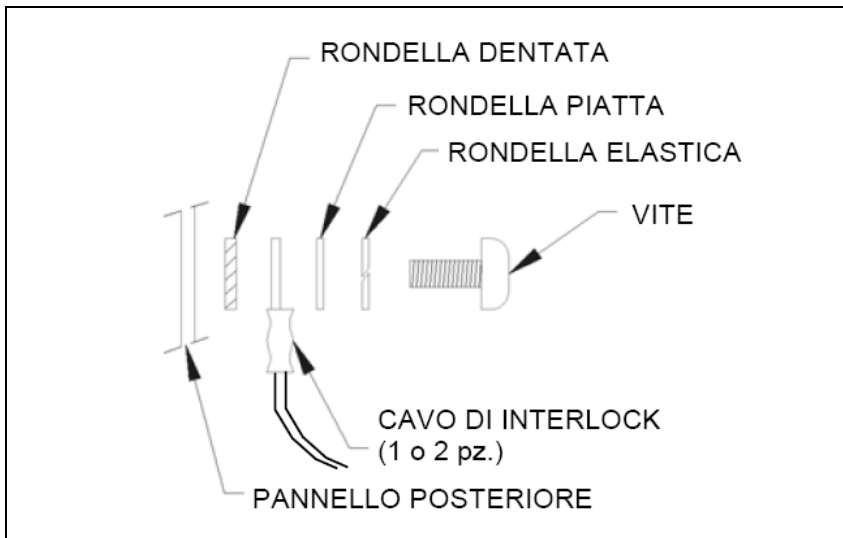

**Figura 3**

**NOTA**

L'interlock del cavo viene chiuso sulla massa della pompa. Se il collegamento è interrotto l'alta tensione viene disabilitata.

L'interlock del cavo viene chiuso sulla massa della pompa. Se il collegamento è interrotto l'alta tensione viene disabilitata. Per collegare il controller alla pompa, utilizzare un cavo HV dotato di interlock (vedere nelle parti ordinabili).

## 1 Technical Information

### Uso

Nella figura “Collegamenti delle masse” sono riportati i corretti collegamenti delle masse, del cavo HV tra il controller e la pompa e del cavo di interlock.

**ATTENZIONE!** Se si monta il cavo di interlock fornito nel sacchetto accessori fare molta attenzione affinché nessuna parte cada accidentalmente all'interno del controller.

---

## Accensione del controller dal pannello frontale (modalità LOCAL)

### NOTA

Per accendere l'alta tensione (HV) occorre che l'interlock del cavo HV (cable interlock) sia chiuso (connettore inserito).

---

Procedere come segue per alimentare il controller e abilitare la tensione sui connettori di alta tensione (H.V.):

- Spegnere il controller.
- Collegare il cavo HV e l'interlock del cavo H.V. nei relativi connettori sul pannello posteriore.
- Selezionare la modalità LOCAL entrando nel menù e nel sottomenu “Mode”. Selezionare l'opzione “Local”.
- Tenere premuto il pulsante HV ON/OFF (1) per almeno 3 secondi.





Figura 4 Front Panel IPCMini Ion Pump Controller



Figura 5 Rear Panel IPCMini Ion Pump Controller

## 1 Technical Information

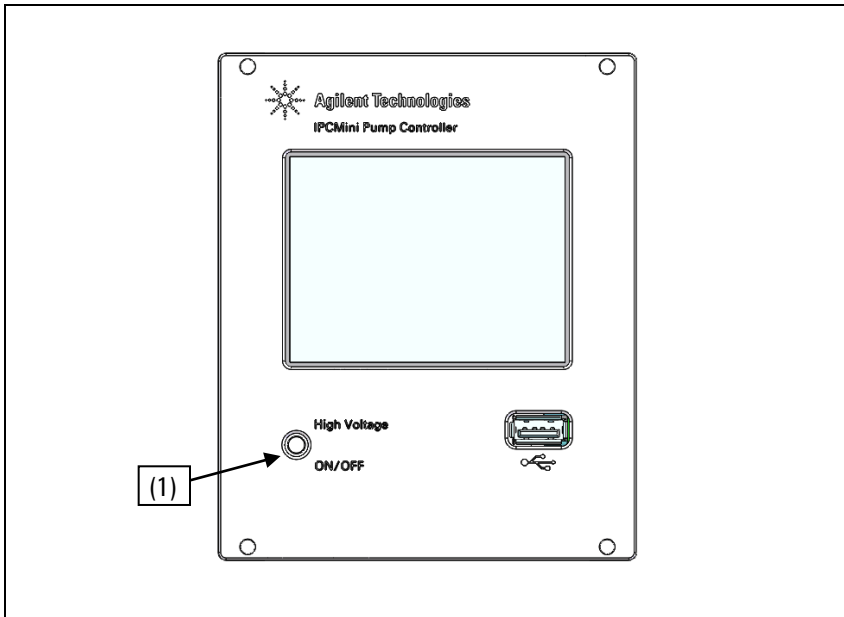
### Manutenzione

Per spegnere il canale HV:

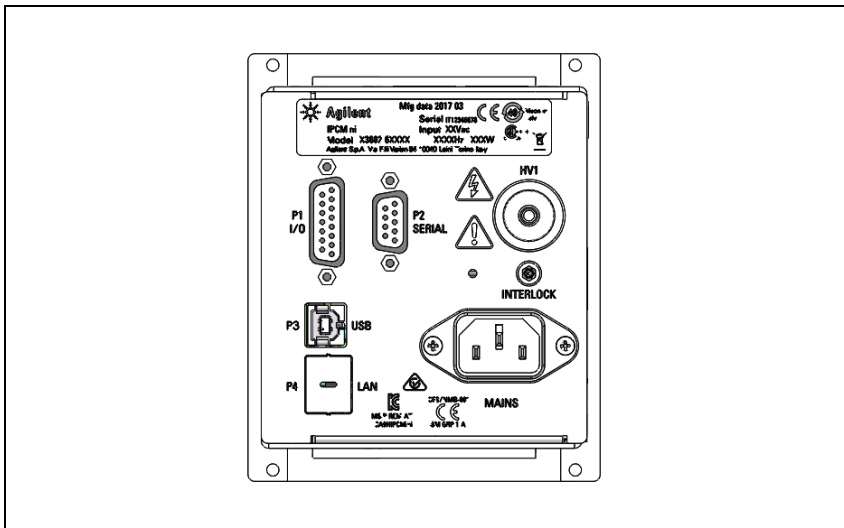
- Tenere premuto il pulsante HV ON/OFF (1) per almeno 3 secondi.

Per ulteriori dettagli sull'uso del controller e sulla descrizione delle informazioni del display fare riferimento alla sezione "Technical Information".

---

**AVVERTENZA!**

**In condizioni di emergenza per spegnere l'unità e il canale ad alta tensione rimuovere il cavo di alimentazione del controller.**



---

## Manutenzione

Il controller non richiede alcun intervento di manutenzione. Qualsiasi tipo di intervento sull'unità deve essere eseguito da personale tecnico autorizzato. In caso di guasto è possibile usufruire del servizio di riparazione Agilent o del "Agilent advanced exchange service", che permette di ottenere un controller rigenerato in sostituzione di quello guasto.

Qualora un controller dovesse essere rottamato, procedere nel rispetto delle normative nazionali specifiche.

## Smaltimento

**Significato del logo "WEEE" presente sulle etichette.** Il simbolo qui sotto riportato è applicato in ottemperanza alla direttiva CE denominata "WEEE". Questo simbolo (**valido solo per i paesi della Comunità Europea**) indica che il prodotto sul quale è applicato, **NON** deve essere smaltito insieme ai comuni rifiuti domestici o industriali, ma deve essere avviato ad un sistema di raccolta differenziata. Si invita pertanto l'utente finale a contattare il fornitore del dispositivo, sia esso la casa madre o un rivenditore, per avviare il processo di raccolta e smaltimento, dopo opportuna verifica dei termini e condizioni contrattuali di vendita.



Per maggiori informazioni riferirsi a:

<http://www.agilent.com/environment/product/index.shtml>

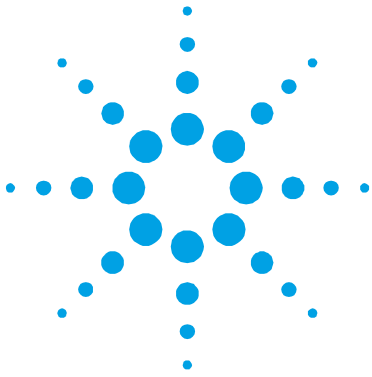

## 2 Gebrauchsanleitung

Allgemeines	21
Lagerung	22
Vor der Installation	22
Installation	23
Gebrauch	26
Einschalten des Controllers von der vorderen Schalttafel (LOKAL-Modus)	28
Wartung	30
Entsorgung	31

Übersetzung der Originalanleitungen



## Allgemeines

Dieser Apparat ist für Fachbetriebe bestimmt. Vor Gebrauch sollte der Benutzer dieses Handbuch sowie alle weiteren mitgelieferten Zusatzdokumentationen genau lesen. Bei Nichtbeachtung - auch teilweise - der enthaltenen Hinweise, unsachgemäßem Gebrauch durch ungeschultes Personal, nicht autorisierten Eingriffen und Missachtung der einheimischen, hier zur Geltung kommenden Bestimmungen übernimmt die Firma Agilent keinerlei Haftung.

In den folgenden Abschnitten sind alle erforderlichen Informationen für die Sicherheit des Bedieners bei der Anwendung des Geräts aufgeführt. Detaillierte technische Informationen sind im Anhang " Technical Information " enthalten. Im Folgenden versteht man unter "Controller" das Gerät IPCMini.

**In dieser Gebrauchsanleitung werden Sicherheitshinweise folgendermaßen hervorgehoben:**

---

### **WARNUNG!**



Die Warnhinweise lenken die Aufmerksamkeit des Bedieners auf bestimmte Vorgänge oder Praktiken, die bei unkorrekter Ausführung schwere Verletzungen hervorrufen können.

---

### **VORSICHT!**

Die Vorsichtshinweise vor bestimmten Prozeduren machen den Bediener darauf aufmerksam, dass bei Nichteinhaltung Schäden an der Anlage entstehen können.

---

### **HINWEIS**

Die HINWEISE enthalten wichtige Informationen, die im Text hervorgehoben werden.

---

## 2 Technical Information

### Lagerung

## Lagerung

Bei Transport und Lagerung der Controller müssen folgende Umgebungsbedingungen eingehalten werden:

- Temperatur: -40°C bis +70°C
- Rel. Luftfeuchtigkeit: 0-95 % (nicht kondensierend)

## Vor der Installation

Der Controller wird mit einer speziellen Schutzverpackung geliefert. Eventuelle Transportschäden müssen sofort der zuständigen örtlichen Verkaufsstelle gemeldet werden.

Das Verpackungsmaterial muss korrekt entsorgt werden. Es ist vollständig recyclebar und entspricht der EG-Richtlinie 85/399 für Umweltschutz.



Abbildung 1 Verpackung des Controllers

## Installation

---

**WARNUNG!**

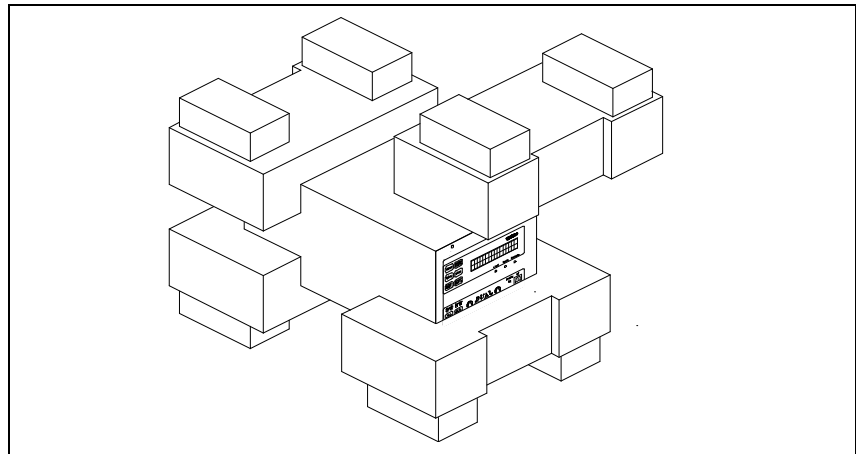

Zur Sicherheit des Controller-Bedieners muss der IPCMini (Version 100-240Vac) an ein 3-Draht-Speisekabel mit einem international anerkannten Stecker angeschlossen sein. Dieses Kabel und dieser Stecker müssen an eine angemessen geerdete Steckdose angeschlossen sein, um Stromschläge zu vermeiden und den Anforderungen der CE-Normen gerecht zu werden. Die Hochspannungen, die im Controller entstehen, können schwere Verletzungen oder den Tod verursachen. Nach Ausschalten des Geräts bleibt noch einige Zeit lang Reststrom im Controller. Warten Sie etwa 1 Minute, um sicher zu sein, dass der restliche Strom dissipiert ist.

---

**WARNUNG!**



Der Controller muss so installiert werden, dass er leicht vom Netzkabel getrennt werden kann. Bei Benutzung des Gerätes auf eine nicht vom Hersteller angegebene Weise könnte die Leistung der mit dem Gerät mitgelieferte Schutzvorrichtung beeinträchtigt sein.

---

**WARNUNG!**



Für die Version 100-240 Vac

Das Netzkabel muss aus drei Leiter gebildet werden (Ph-N-Earth). der Kabelquerschnitt muss mindestens 0,83 mm<sup>2</sup> (AWG18) betragen.

Für die Version 24 Vdc

Der für die Version DC 24 V verwendete Spannung muss durch verstärkte Dämmung oder Doppelisolierung von den Netzspannungen getrennt werden. Stromanschlusskabel: Das richtige Kabel zur elektrischen Verkabelung ist ein dreidrahtiges Kabel (P+N+Erde). Der Kabelquerschnitt muss mindestens 0,83 mm<sup>2</sup> (AWG18) betragen.

PIN 1= Positiver Steckverbinder

PIN 2= Negativer Steckverbinder

PIN 3= Schutzleiter

Eingangsspannung 24Vdc  $\pm 10\%$

---

## 2 Technical Information

### Installation

#### **VORSICHT!**

Der Controller kann auf einen Tisch oder ein Gestell montiert werden. In beiden Fällen muss eine ungehinderte Zirkulation der Kühlluft durch die im Gehäuse vorne und unten eingelassenen Luftöffnungen gewährleistet sein.

Wenn der Controller in einem Gestell montiert wird, MUSS er in einer drei Rackeinheiten hohen Adapter-Einheit installiert werden, um zu vermeiden, dass der Controller nicht in das Gestell fällt. Die vordere Schalttafel des Controllers ist nicht geeignet, das gesamte Gewicht der Einheit zu tragen.

Der Controller darf nicht in Umgebungen installiert u/o benutzt werden, die Witterungseinflüsse (Regen, Frost, Schnee), Staub und aggressiven Gasen ausgesetzt sind und in denen Explosions- und erhöhte Brandgefahr besteht.

---

#### **VORSICHT!**

Der Controller gehört zu der zweiten Einbaukategorie (oder auch Überspannung), die von der Norm EN 61010-1 geregelt ist. Schließen Sie daher das Gerät an eine Stromleitung an, die dieser Kategorie gerecht wird.

Der Controller hat Anschlüsse für die Ein-/Ausgänge und die Serienkommunikation, die an externe Kreisläufe angeschlossen sein müssen, so dass man zu keinem unter Strom stehenden Teil Zugriff hat. Vergewissern Sie sich, dass die Isolierung des Gerätes, das an den Controller angeschlossen ist, auch bei Einzelstörungen, wie sie von der Vorschrift EN 61010-1 vorgesehen sind, angemessen isoliert ist.

---

#### **HINWEIS**

Wenn der Controller in einem Gestell installiert werden soll, müssen alle vier Füße abmontiert und über- und unterhalb wenigstens 30 mm (1,2 Zoll) Platz gelassen werden.

---



**VORSICHT!**



In seltenen Fällen könnte der Controller bei Störungen Rauch ausstoßen. Wenn der Controller in sauberen Räumlichkeiten verwendet wird, muss er mit angebrachten Schutzvorrichtungen versehen werden, um zu verhindern, dass die Räumlichkeiten durch den Rauch verschmutzt werden.

Während des Betriebs müssen folgende Umgebungsbedingungen eingehalten werden:

- Temperatur: 0 °C to +45 °C
- Rel. Luftfeuchtigkeit: 0 - 90 % (nicht kondensierend)

## Verwendete Symbole

Die unten aufgeführten Symbole werden durchgängig in allen Bildern verwendet:

	Achtung, Gefahr eines elektrischen Schlags.
	Warnung "Bitte die Hinweise zur Verwendung/Installation" konsultieren.

## Gebrauch

In diesem Kapitel sind die wichtigsten Betriebsvorgänge aufgeführt. Für weitere Hinweise bezüglich Anschluss und Montage des bestellbaren Zubehörs verweisen wir auf das Kapitel "Gebrauch" im Anhang zu "Technical Information". Vor Benutzung des Controllers müssen sämtliche elektrischen Anschlüsse ausgeführt und die Betriebsanleitung der angeschlossenen Pumpe durchlesen werden.

**WARNUNG!**



Schalten Sie die Hochspannungsleitungen erst ein, wenn diese mit Hilfe der dafür bestimmten Hochspannungskabel des Interlock-Kabels an die Ionenpumpen angeschlossen sind.

Der Gebrauch des Controllers muss unter Verwendung eines Hochspannungskabels mit Interlock erfolgen.



Abbildung 2 Erdung

**WARNUNG!**

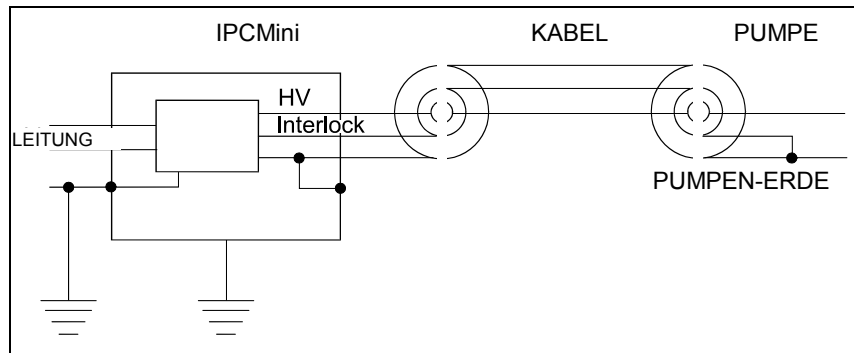

Soll ein HV-Kabel ohne Interlock zum Einsatz kommen, befindet sich in dem Zubehörbeutel ein dafür bestimmtes Kabelset für vormontierte Interlock-Teile. Bei diesem Gebrauch geht die Sicherheitsfunktion verloren, die man bei der Interlock-Verwendung hat.

Sehen Sie sich folgende Abbildung genau an, um das im Zubehörbeutel mitgelieferte Interlock-Kabel richtig zu montieren, wenn auf das Hochspannungskabel mit Interlock verzichtet werden soll.



Abbildung 3

**HINWEIS**

Die Verriegelung des Kabels wird auf der Masse der Pumpe geschlossen. Wenn die Verbindung unterbrochen wird, wird die Hochspannung deaktiviert.

Die Verriegelung des Kabels wird auf der Masse der Pumpe geschlossen. Wenn die Verbindung unterbrochen wird, wird die Hochspannung deaktiviert. Beim Anschluss des Controllers an die Pumpe ist ein HV-Kabel mit Interlock (siehe Bestellteile) zu verwenden.

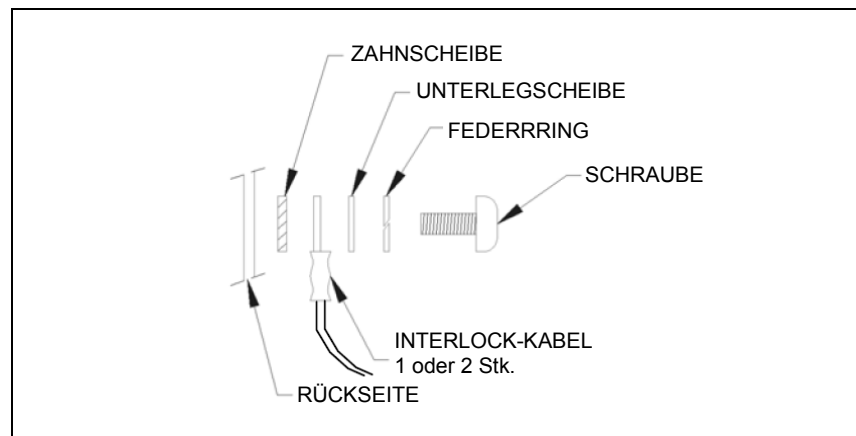
## 2 Technical Information

### Gebrauch

Auf der Abbildung “Anschlüsse” sind die richtigen Anschlüsse der Erdungen, des HV-Kabels des Controllers an die Pumpe und des Interlock-Kabels ersichtlich.

#### **VORSICHT!**

Beim Montieren des im Zubehörbeutel mitgelieferten Interlock-Kabels gehen Sie sehr vorsichtig vor, damit dabei kein Teil in den Controller fällt.

---

## **Einschalten des Controllers von der vorderen Schalttafel (LOKAL-Modus)**

#### **HINWEIS**

Um die Hochspannung (HV) einzuschalten, muss der Interlock des HV-Kabels (Kabel-Interlock) geschlossen sein (Verbinder eingesteckt).

---

Gehen Sie wie folgt vor, um den Controller mit Strom zu versorgen und die Spannung an den Hochspannungsverbindern (H.V.) freizugeben:

- Schalten Sie den Controller aus.
- Schließen Sie das HV-Kabel und den Interlock des H.V-Kabels an die jeweiligen Verbinder am Rückenteil.
- Wählen Sie den LOCAL-Modus über Eingabe in das Menü und Untermenü von “Mode”. Wählen Sie die Option “Local”.
- Halten Sie die Taste HV ON/OFF (1) für mindestens 3 Sekunden gedrückt.



Abbildung 4 Vorderteil IPCMini Ionenpumpen-Controller



Abbildung 5 Rückenteil IPCMini Ionenpumpen-Controller

## 2 Technical Information

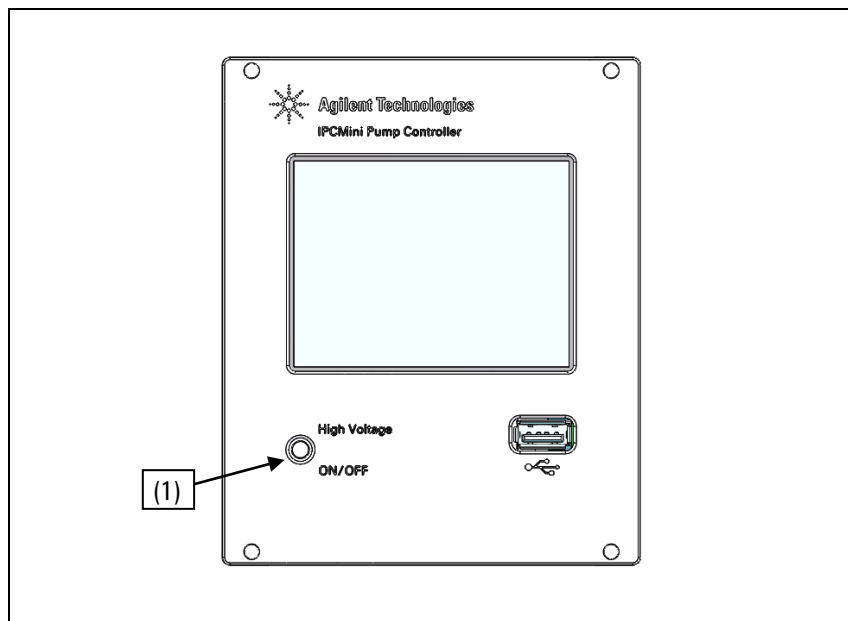
### Wartung

Um die HV-Leitungen auszuschalten:

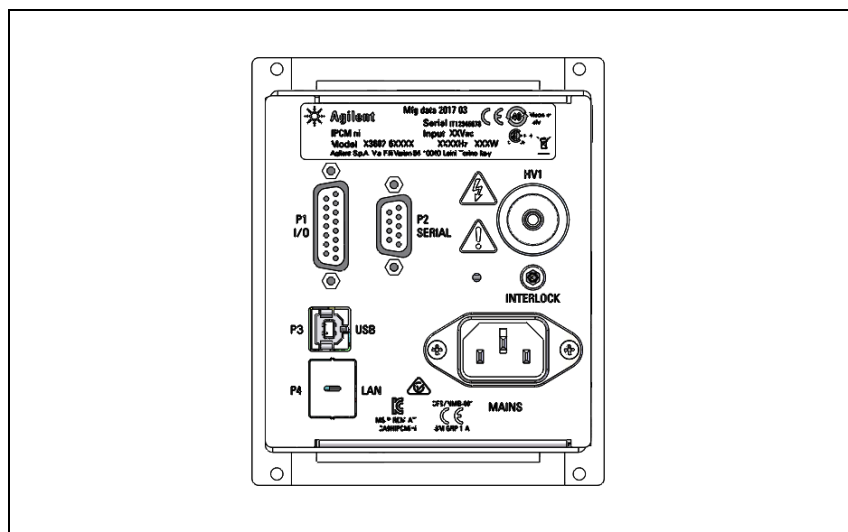
- Halten Sie die Taste HV ON/OFF (1) für mindestens 3 Sekunden gedrückt.

Weitere Einzelheiten zum Gebrauch des Controllers und zur Beschreibung der Display-Angaben entnehmen Sie bitte dem Abschnitt “ Technical Information ”.

---

**WARNUNG!**



**Um das Gerät und die Hochspannungsleitung in Notfallsituationen auszuschalten ist das Netzkabel des Controllers zu entfernen.**

---

## Wartung

Der Controller ist wartungsfrei. Eventuell erforderliche Eingriffe müssen von dazu befugtem Fachpersonal ausgeführt werden. Bei Störungen kann der Agilent-Reparaturdienst in Anspruch genommen werden oder schließen Sie einen Vertrag für “Agilent Advanced Exchange Service” ab, mit dem ein defekter Controller gegen einen general-überholten ausgetauscht wird. Eine eventuelle Verschrottung muss unter Einhaltung der einschlägigen landesüblichen Vorschriften erfolgen.

## Entsorgung

**Bedeutung des "WEEE" Logos auf den Etiketten.** Das folgende Symbol ist in Übereinstimmung mit der EU-Richtlinie WEEE (Waste Electrical and Electronic Equipment) angebracht. Dieses Symbol (**nur in den EU-Ländern gültig**) zeigt an, dass das betreffende Produkt nicht zusammen mit Haushaltsmüll entsorgt werden darf sondern einem speziellen Sammelsystem zugeführt werden muss.

Der Endabnehmer sollte daher den Lieferanten des Geräts - d.h. die Muttergesellschaft oder den Wiederverkäufer - kontaktieren, um den Entsorgungsprozess zu starten, nachdem er die Verkaufsbedingungen geprüft hat.



Weitere Informationen finden Sie unter:

<http://www.agilent.com/environment/product/index.shtml>

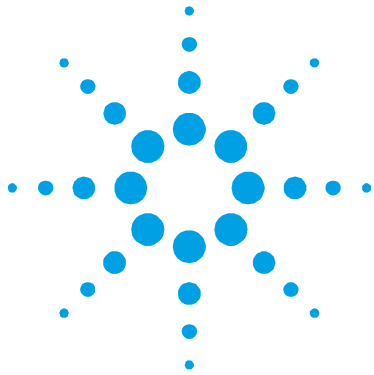

## 3 Mode d'emploi

Indications Generales	33
Emmagasinage	34
Preparation pour l'Installation	34
Installation	35
Utilisation	38
Allumage du Contrôleur du Panneau Frontal (Modalité LOCAL)	40
Entretien	42
Mise au Rebut	43

Traduction de la mode d'emploi originale





## Indications Generales

Cet appareillage a été conçu en vue d'une utilisation professionnelle. Il est conseillé à l'utilisateur de lire attentivement cette notice d'instructions ainsi que toute autre indication supplémentaire fournie par Agilent, avant l'utilisation de l'appareillage. Agilent décline par conséquent toute responsabilité en cas d'observation totale ou partielle des instructions données, d'utilisation incorrecte de la part d'un personnel non formé, d'opérations non autorisées ou d'un emploi contraire aux réglementations nationales spécifiques.

Les paragraphes suivants donnent toutes les indications nécessaires à garantir la sécurité de l'opérateur pendant l'utilisation de l'appareillage. Le terme « contrôleur » utilisé ci-après correspond à l'appareil IPCMini.

**Cette notice utilise les signes conventionnels suivants:**

---

### **AVERTISSEMENT!**



Les messages d'avertissement attirent l'attention de l'opérateur sur une procédure ou une manoeuvre spéciale qui, si elle n'est pas effectuée correctement, risque de provoquer de graves lésions.

---

### **ATTENTION!**

Les messages d'attention apparaissent avant certaines procédures qui, si elles ne sont pas observées, pourraient endommager sérieusement l'appareillage.

---

### **NOTE**

Les notes contiennent des renseignements importants, isolés du texte.

---

### 3 Technical Information

#### Emmagasinage

## Emmagasinage

Pour transporter et emmagasiner le contrôleur il faut observer les conditions suivantes d'environnement:

- température: de  $-40^{\circ}\text{C}$  à  $+70^{\circ}\text{C}$
- humidité relative: 0 - 95 % (non condensante).

## Preparation pour l'Installation

Le contrôleur est fourni dans un emballage de protection spécial; si l'on constate des dommages pouvant s'être produits pendant le transport, contacter tout de suite le bureau de vente local. Pendant l'opération d'ouverture de l'emballage, veiller tout particulièrement à ne pas laisser tomber le contrôleur et à ne lui faire subir aucun choc. Le matériel est entièrement recyclable et il est conforme aux directives CEE 85/399 en matière de protection de l'environnement.

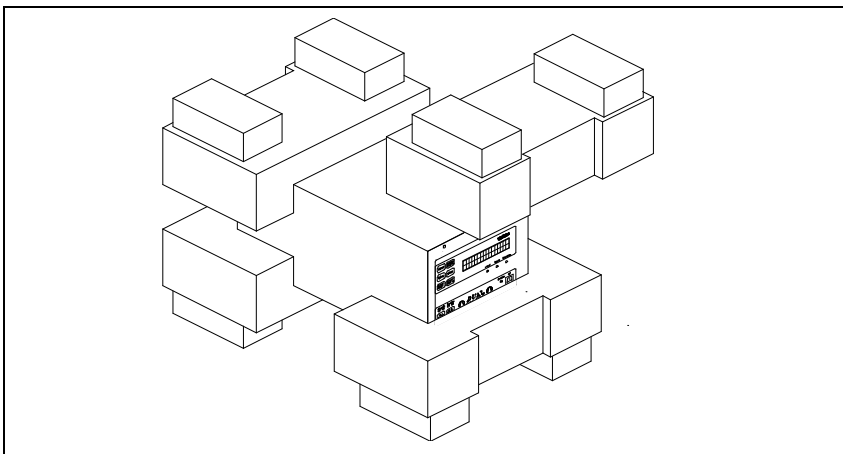

Figure 1 Emballage du contrôleur

## Installation

---

**AVERTISSEMENT!**



Pour la sécurité de l'opérateur, le contrôleur IPCMini (version 100-240 Vca) doit être alimenté par un câble d'alimentation à 3 fils doté d'une prise mâle approuvée à un niveau international. Brancher le câble avec prise mâle à une prise femelle raccordée à la terre de façon adéquate afin d'éviter tout risque d'électrocution et de pouvoir remplir les conditions de conformité prescrites par les normes CE. Les hautes tensions qui se développent à l'intérieur du contrôleur peuvent être susceptibles de provoquer des blessures graves voire de causer la mort. Après l'extinction de l'unité, il reste de l'énergie à l'intérieur du contrôleur pendant quelques instants. Attendre environ 1 minute pour être sûr que l'énergie résiduelle s'est dissipée.

---

**AVERTISSEMENT!**



Le contrôleur doit être installé de manière à ce que le câble d'alimentation puisse être facilement débranché.  
Si cet équipement est utilisé d'une manière non conforme aux prescriptions du fabricant, la protection assurée par l'équipement risque d'être compromise.

---

**AVERTISSEMENT!**



Pour la version 100-240 Vca

Le câble d'alimentation doit être constitué de trois conducteurs (Ph-N-Terre). La section du fil doit être d'au moins AWG18, 0,83 mm<sup>2</sup>

Pour la version 24 Vcc

L'alimentation de la version CC 24 V doit garantir une séparation des tensions de réseau par le biais d'une isolation renforcée ou d'une double isolation.

Câble d'alimentation : le câble d'alimentation électrique doit être constitué de trois fils (P+N+Terre). La section du fil doit être d'au moins AWG18, 0,83 mm<sup>2</sup>

PIN 1= Connecteur positif

PIN 2= Connecteur négatif

PIN 3= Terre de protection

Tension d'entrée 24Vcc  $\pm 10$  %

---

### 3 Technical Information

#### Installation

#### ATTENTION!

Le contrôleur peut être utilisé soit comme unité de table que comme module installé dans une armoire. De toute façon, il doit être placé de manière à ce que l'air puisse circuler librement à travers les trous d'aération présents dans la couverture.

Lorsque le contrôleur est utilisé comme module armoire il DOIT être installé dans un adaptateur d'une hauteur de trois unités armoire afin d'éviter qu'il ne tombe à l'intérieur de l'armoire même. Le panneau frontal du contrôleur n'est pas prévu pour supporter le poids de l'unité. Ne pas installer ou utiliser le contrôleur dans des milieux exposés aux agents atmosphériques (pluie, neige, glace). En présence de poussière, de gaz corrosifs ou dans des milieux explosifs ou à fort risque d'inflammabilité.

---

#### ATTENTION!

Le contrôleur appartient à la seconde catégorie d'installation (ou surtension) prévue par la norme EN 61010-1. Il est donc nécessaire de brancher le dispositif à une ligne d'alimentation qui soit adaptée à cette catégorie d'appareils.

Le contrôleur dispose de connecteurs pour entrées/sorties et pour la communication en série qui doivent être branchés à des circuits externes de façon à ce qu'aucune des parties sous tension ne soit accessible. Veiller à ce que le système d'isolation du dispositif branché au contrôleur soit adapté, même en cas de pannes individuelles, et ce, tel que prévu par la norme EN 61010-1.

---

**NOTE**

Si le contrôleur est installé dans une armoire, enlever les quatre pieds de manière à ce qu'il soit placé avec au moins 30 mm d'espace en haut et en bas.

**ATTENTION!**



Dans quelques rares cas de panne, il est possible que le contrôleur dégage de la fumée. Si l'unité est utilisée dans des environnements propres, il est nécessaire de prévoir la mise en place de protections adéquates afin d'éviter que la fumée ne puisse contaminer la pièce.

Pendant le fonctionnement, il est nécessaire de respecter les conditions d'environnement suivantes:

- température: de 0 °C à +40 °C
- humidité relative: 0 – 90 % (non condensante).

## Symboles utilisés

Les symboles reportés ci-après sont utilisés sur toutes les images :

	Attention, risque de choc électrique.
	Avertissement « consulter les instructions d'utilisation/de montage.

## Utilisation

Dans ce paragraphe, on indique les principales procédures opérationnelles. Pour tous autres détails et pour les procédures concernant des connexions ou des éléments en option, se reporter au paragraphe "Usage" de l'appendice "Technical Information". Avant d'utiliser le contrôleur, effectuer toutes les connexions électriques et se reporter à la notice de la pompe connectée.

**AVERTISSEMENT!**



**N'allumer les canaux haute tension que s'ils ont été branchés aux pompes ioniques par l'intermédiaire des câbles haute tension prévus à cet effet et dotés de câble Interlock.**

**L'usage du contrôleur est subordonné à l'usage d'un câble haute tension doté d'Interlock.**

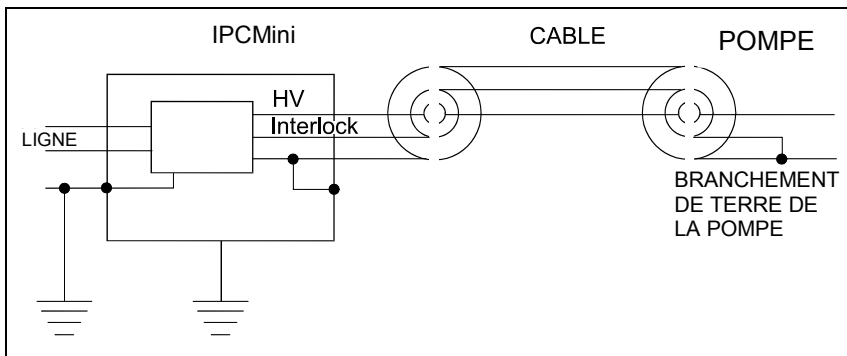
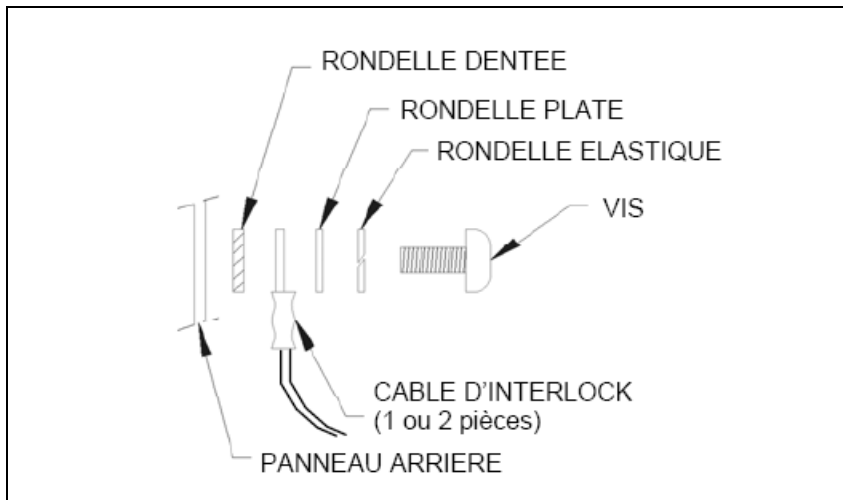

**Figure 2** Connexions des masses

**NOTE**

Si l'opérateur veut utiliser un câble HV sans interlock, le sachet d'accessoires contient un kit spécial de câbles pour interlocks préassemblés. L'utilisation de ces accessoires provoque la perte des fonctions de sécurité offertes par l'utilisation de l'interlock.

Consulter la figure ci-dessous pour monter correctement le câble d'interlock contenu dans le sachet d'accessoires en cas de non utilisation du câble de haute tension équipé d'un interlock.



**Figure 3**

**NOTE**

L'interlock du câble est serré sur la masse de la pompe. Si le branchement est coupé, la haute tension est interrompue.

L'interlock du câble est serré sur la masse de la pompe. Si le branchement est coupé, la haute tension est interrompue.

Pour relier le contrôleur à la pompe, utiliser un câble HV équipé d'un interlock (voir le bordereau de commande des pièces).

### 3 Technical Information

#### Utilisation

Les branchements corrects des masses, du câble HV entre le contrôleur et la pompe, ainsi que du câble d'interlock sont reportés sur la figure "Connexions des masses".

#### ATTENTION!

En cas d'utilisation du câble d'interlock contenu dans le sachet d'accessoires, il faut veiller en particulier à ce qu'aucune pièce ne tombe à l'intérieur du contrôleur.

---

## Allumage du Contrôleur du Panneau Frontal (Modalité LOCAL)

#### NOTE

Pour allumer la haute tension (HV), il faut que l'interlock du câble HV (câble interlock) soit fermé (connecteur branché).

---

Procéder comme suit pour alimenter le contrôleur et habilitier la tension au niveau des connecteurs de haute tension (H.V.) :

- Eteindre le contrôleur.
- Brancher le câble HV et l'interlock du câble H.V. sur les connecteurs correspondants situés sur le panneau arrière.
- Sélectionner le mode LOCAL en entrant dans le menu et le sous-menu « Mode ». Sélectionner l'option « Local ».
- Maintenir le bouton HV ON/OFF (1) enfoncé pendant au moins 3 secondes.



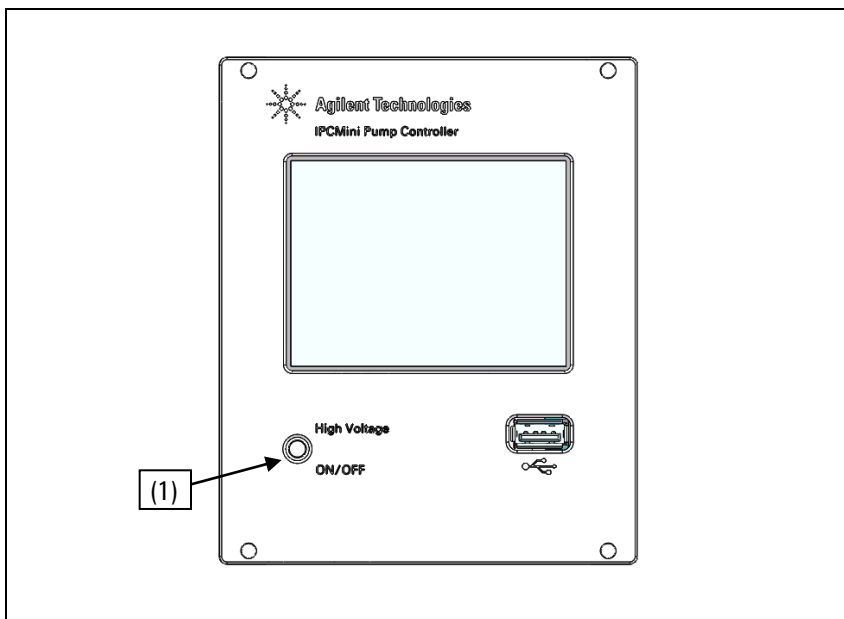

Figure 4 Panneau avant IPCMini sur le contrôleur de pompe

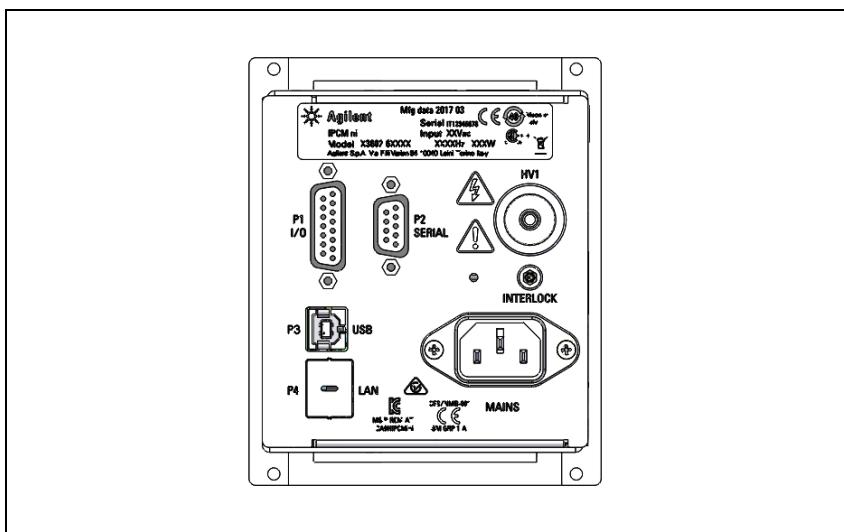

Figure 5 Panneau arrière IPCMini sur le contrôleur de pompe

### 3 Technical Information

#### Entretien

Pour éteindre le canal HV :

- Maintenir le bouton HV ON/OFF (1) enfoncé pendant au moins 3 secondes.

Pour plus de renseignements sur l'usage du contrôleur et sur la description des informations de l'écran, consulter la section " Technical Information " .

---

#### **AVERTISSEMENT!**



**Pour éteindre l'unité et le canal haute tension dans des conditions d'urgence, débrancher le câble d'alimentation du contrôleur.**

---

## Entretien

Le contrôleur 4UHV n'a besoin d'aucun entretien. N'importe quel entretien sur l'unité doit être effectué par un personnel technique autorisé. En cas de panne contacter le Support technique Agilent ou bien s'abonner au Agilent Advanced Exchange Service" où le contrôleur endommagé est remplacé par un contrôleur reconditionné. En cas de mise au rebut du contrôleur, procéder à son élimination conformément aux réglementations nationales en la matière.

## Mise au Rebut

### Signification du logo "WEEE" figurant sur les étiquettes.

Le symbole ci-dessous est appliqué conformément à la directive CE nommée "WEEE". Ce symbole (**uniquement valide pour les pays de la Communauté européenne**) indique que le produit sur lequel il est appliqué NE doit PAS être mis au rebut avec les ordures ménagères ou les déchets industriels ordinaires, mais passer par un système de collecte sélective. Après avoir vérifié les termes et conditions du contrat de vente, l'utilisateur final est donc prié de contacter le fournisseur du dispositif, maison mère ou revendeur, pour mettre en œuvre le processus de collecte et mise au rebut.



Pour en savoir plus, consulter :

<http://www.agilent.com/environment/product/index.shtml>

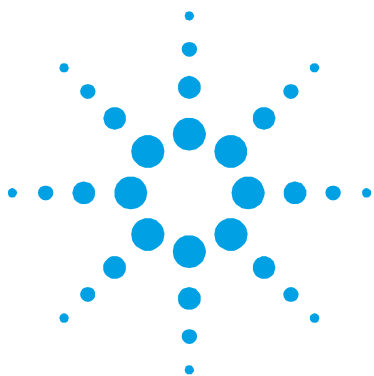

## 4 Instructions for Use

General Information	45
Storage	34
Prior to Installation	46
Installation	47
Usage	50
Powering On the Controller from the Front Panel (Local Mode)	52
Maintenance	54
Disposal	55

Original Instructions



## General Information

This equipment is intended for professional use. Prior to using this equipment the user must carefully read this Instruction Manual in its entirety and any additional information provided by Agilent. Agilent declines all responsibility for damage caused by the total or partial misuse of the instructions provided herein, by the improper use of the equipment by untrained personnel, by unauthorized interventions or by negligence in complying with any specific national rule or regulation.

The following sections provide you with all the information needed to guarantee the operator's safety when using the equipment. Detailed information is provided in the appendix entitled "Technical Information". From this point forward the term "controller" indicates the IPCMini.

**The following conventions are used in this manual:**

---

**WARNING!**

Warning messages call the operator's attention to a specific procedure or operation that could cause serious injury if not performed correctly.

---

**CAUTION!**

Caution messages are provided before procedures that could cause damage to the equipment if not complied with.

---

**NOTE**

Notes provide you with important information extracted from the text.

---

## 4 Technical Information

### Storage

## Storage

The following environmental conditions must be met when transporting and storing the controller:

- Temperature: -20 °C to +70 °C
- Relative humidity: 0 - 95% (non-condensing)

## Prior to Installation

The controller comes in a special protective packaging; if there is any sign of damage that could have been caused during transportation, contact your local sales office immediately.

When unpacking the controller, be particularly careful to avoid dropping it or knocking it against anything.

The packaging material is totally recyclable and complies with EEC directives 85/399 for the safeguard of the environment.

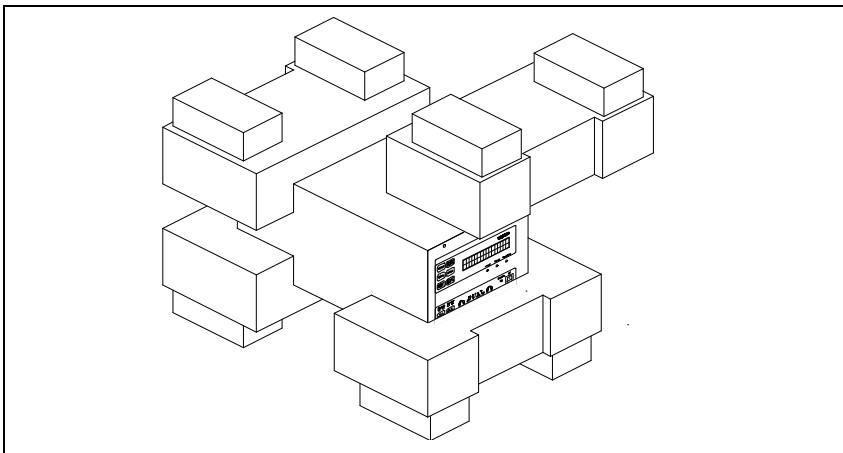

**Figure 1** Controller Packaging

## Installation

---

**WARNING!**



For the safety of the operator, the IPCMini (version 100-240Vac) controller must be powered with a 3-wire power cable connected to a plug approved at international level. Use this cable and plug together with an adequately earthed socket so as to prevent electrical shocks and satisfy the requirements of EC norms. The high voltages that develop in the controller can provoke serious injuries or death. After switching off the unit, residual energy is present inside the controller for some time. Wait approx. 1 minute to be sure that the residual energy has been dissipated.

---

**WARNING!**



The controller must be installed in a way that allows an easy interruption of the line voltage.

If this equipment is used in a manner not specified by the manufacturer, the protection provided by the equipment may be impaired.

---

**WARNING!**



For 100-240 Vac version

Power supply cord: the correct cable for electrical wiring is a three wires (Ph+N+Earth) cable.

The wire section has to be at least AWG18, 0.83 mm<sup>2</sup>.

For 24 Vdc version

The power supply used for the DC 24 V Version shall provide separation from mains voltages by reinforced or double insulation.

Power supply cord: the correct cable for electrical wiring is three wires (P+N+Earth) cable. The Wire section has to be at least AWG18, 0.83 mm<sup>2</sup>

PIN 1= Positive connector

PIN 2= Negative Connector

PIN 3= Protective Earth

Input Voltage 24Vdc  $\pm 10\%$

---

## 4 Technical Information

### Installation

#### CAUTION!

The controller can be used either as a desktop unit or as a rack module. In any case it must be positioned in a way that the air can circulate freely through the ventilation slots on the cover.

If the controller is used as a rack module, it **MUST** be inserted into a three-rack high adapter to prevent it from falling inside the rack itself. The controller front panel is not designed to support the weight of the unit.

Do not install or use the controller in an environment exposed to atmospheric agents (rain, snow, ice), in the presence of dust, corrosive gases or in a highly flammable or explosive environment.

---

#### CAUTION!

The controller belongs to the second installation category (or overvoltage) as provided for in normative EN 61010-1. Therefore, the device must be connected to a power supply line satisfying the requirements for this category.

The controller has connectors for inputs/outputs and for serial communications that must be connected to the external circuits in such a way that no powered part is accessible. Make sure that the insulation of the device connected to the controller provides an adequate insulation even in the case of a single fault condition as stipulated in the EN 61010-1 normative.

---

#### NOTE

If the controller is installed in a rack, remove its four feet and place it leaving at least 30 mm (1.2 inches) of free space above and below.

---



**CAUTION!**

In rare circumstances, a controller fault could result in the emission of smoke. If the customer is using the controller in clean environments, they should take adequate measures to avoid the environment being contaminated by any eventual smoke.



---

The controller must be used in the following environmental conditions:

- Temperature: 0 °C to +45 °C
- Relative humidity: 0 – 90 % (non-condensing).

## Used symbols

Symbols see below have the following specific meaning.

	Warning, risk of electric shock
	Warning, "see technical use/information"

## 4 Technical Information

### Usage

# Usage

This section provides you with the major operating procedures. For more information and for the procedures that concern connections or specific options, refer to the section “USAGE” in the “Technical Information” appendix. Before using the controller, perform all electrical connections and refer to the manual of the connected pump.

### **WARNING!**



**Switch on the high voltage channel only if it is connected to the ion pump by means of the special purpose high voltage cables equipped with interlock cable.**

**It is assumed that the controller will be used together with the high voltage cable having a safety interlock.**

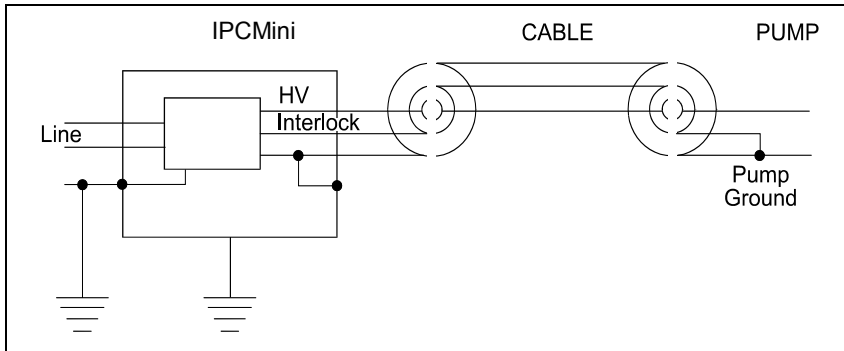

**Figure 2** Ground Connections

**WARNING!**



If an HV cable without interlock is to be used, the accessories bag contains a specific kit of preassembled interlock lead. However, with this type of use, the safety capability furnished using the interlock is lost.

Refer to the figure below for correct assembly of the interlock cable furnished in the accessories bag in the case in which an HV cable with interlock is not used.

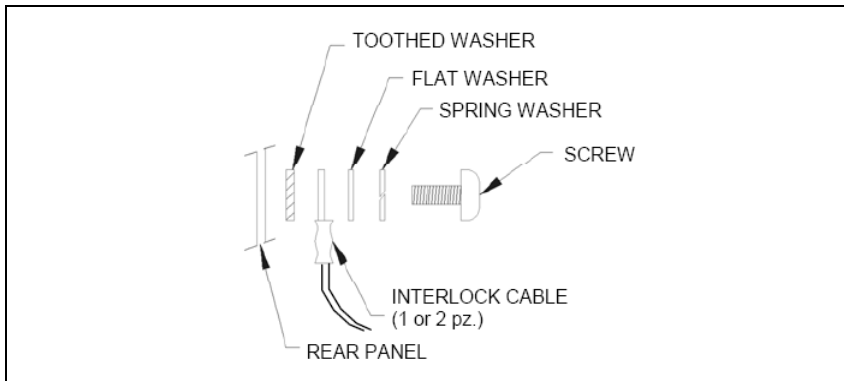

**Figure 3**

**NOTE**

The cable interlock closes on pump ground. The high voltage is disabled if the connection is interrupted.

The cable interlock closes on pump ground. The high voltage is disabled if the connection is interrupted. To connect the controller to the pump, use a HV cable with interlock (see parts that can be ordered).

Correct connection of masses, of the HV cable between the controller and pump and of the interlock cable is illustrated in the “Ground Connections” figure.

## 4 Technical Information

### Usage

#### **CAUTION!**

When using the interlock cable furnished in the accessories bag, make sure that no parts drop accidentally inside the controller.

---

## **Powering On the Controller from the Front Panel (LOCAL Mode)**

#### **NOTE**

To switch on the High Voltage (HV), the interlock of the HV cable (cable interlock) must be closed (connector inserted).

---

Proceed as follows to power the controller and apply voltage to the high voltage (HV) connectors:

- Switch off the controller.
- Connect the HV cable and the interlock of the HV cable in the related connectors on the rear panel.
- Verify that the LOCAL mode is enabled, by pressing “MENU” then “MODE” push button in sequence.
- Keep the HV ON/OFF push button pressed for at least 3 seconds.

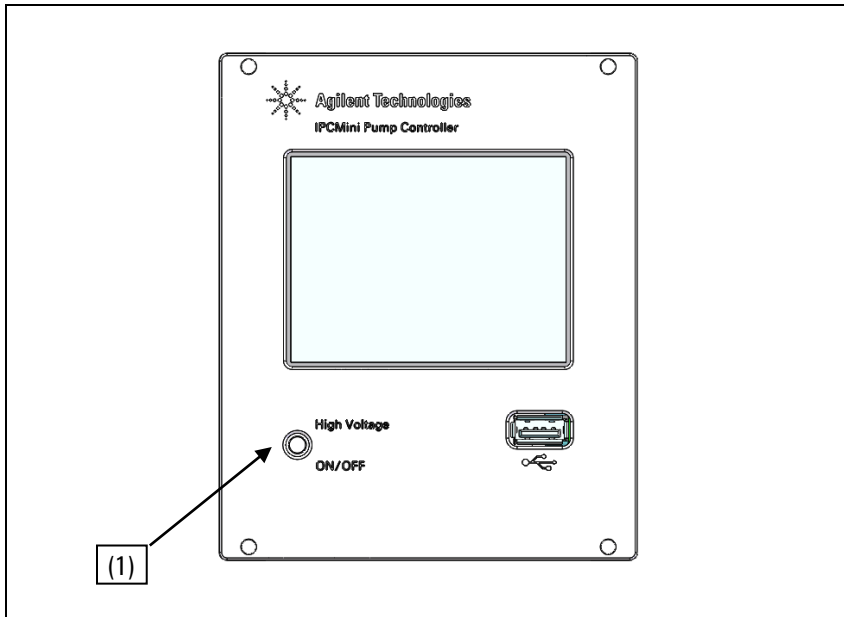

Figure 4 Front Panel IPCMini Ion Pump Controller

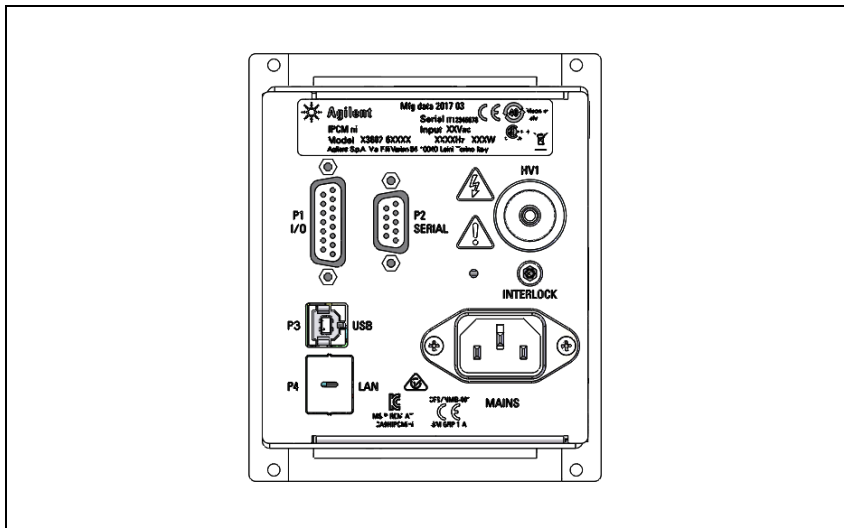

Figure 5 Rear Panel IPCMini Ion Pump Controller

## 4 Technical Information

### Maintenance

To switch off the HV channel:

- Keep the HV ON/OFF push button pressed for at least 3 seconds.

For further details on using the controller and for a description of the information appearing on the display, refer to the section “Technical Information”.

---

#### **WARNING!**



**In situations of emergency, to switch off the unit and the high voltage channel, remove the power cable from the rear panel.**

---

## Maintenance

The controller does not require any maintenance. Any form of servicing on the unit must be performed by authorized personnel.

If servicing is needed, contact Agilent Technical Support or subscribe to the “Agilent Advanced Exchange Service” where the faulty controller is replaced by a refurbished one.

If the controller needs to be scrapped, proceed to do so in compliance with the specific national norms.

## Disposal

### Meaning of the "WEEE" logo found in labels

The following symbol is applied in accordance with the EC WEEE (Waste Electrical and Electronic Equipment) Directive.

This symbol (**valid only in countries of the European Community**) indicates that the product it applies to must NOT be disposed of together with ordinary domestic or industrial waste but must be sent to a differentiated waste collection system.

The end user is therefore invited to contact the supplier of the device, whether the Parent Company or a retailer, to initiate the collection and disposal process after checking the contractual terms and conditions of sale.



For more information refer to:

<http://www.agilent.com/environment/product/index.shtml>

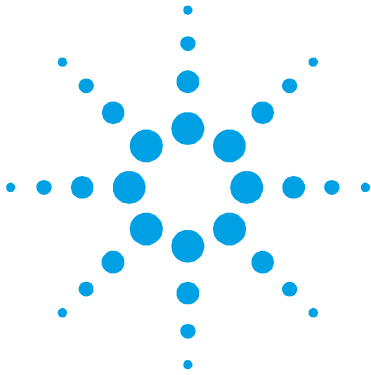

## 5 Technical Information

IPCMini Controller Description	57
Specifications	58
Controller Outline	59
Front Panel Description	60
Rear Panel Description (Universal range version)	64
Rear Panel Description (24V version)	65
Interlock connection	65
Operating Mode	66
Selecting “Operating Mode” via Serial	66
Functions	67
Protect	68
Set- point	68
Autostart	69
iSTEP	70
Device Number	71
Connection of Input Remote	73
Serial	74
Connector Examples	75
Procedure to Connect the Serial and I/O ports to an External Cable	75
Window Protocol	77
Error Code	81
LAN communication	81
Accessories and SpareParts	84





## IPCMini Controller Description

The IPCMini controller is a power supply for ion pumps. It supplies a high voltage on output, selectable as 3 kV, 5 kV or 7 kV, and measures the output current.

The controller has the following features:

- Front panel with touch screen display 3.5" for displaying the operating values (voltage, current, pressure)
- Remote I/O with analog output, relay for set point
- RS232, RS485, USB and LAN(option) communications.

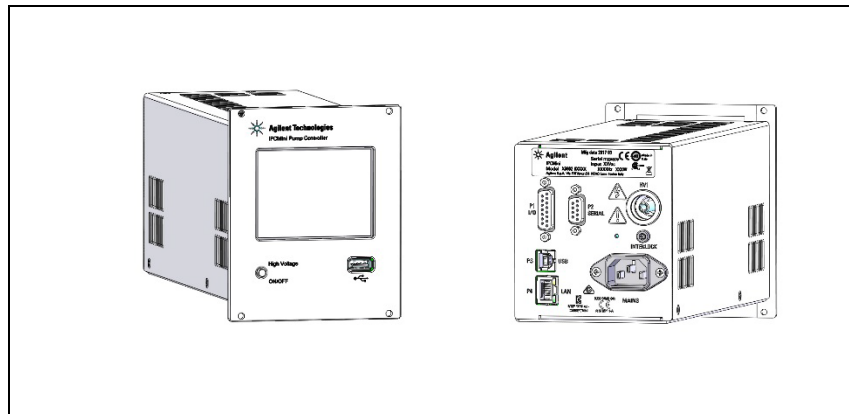

Figure 6 IPCMini Controllers

The high voltage module has 40W output power.

The controller can be operated in the modes: LOCAL, SERIAL or REMOTE.

## Specifications

The IPCMini Controller is for internal use only.

**Tab. 1** Specifications

<b>Component</b>	<b>Description</b>
Input Voltage	100 - 240 Vac (+/-10 %)
Input Frequency	50/60 Hz
Input Power	160VA
Input Voltage dc version	24Vdc ( $\pm$ 10%)
Input Frequency dc version	Direct Current
Input Power dc version	60W
Output HV Voltage	+/- 7000 Vdc +/- 5 %
Output HV Short circuit current	20mA
Output HV Power max	40W
Operating temperature	0 °C to 45 °C
Storage temperature	-40 °C to +70 °C
Voltage measurement	Resolution 100 V Accuracy: +/- 5 %
Current resolution	1nA
Weight	2 Kg
Installation Category	II
Max Altitude	2000m
Pollution Degree	2
Compliance with:	EN 61010-1 2010: Safety requirements for electrical equipment for measurement control and laboratory use. EN 61326-1 2013: Electrical equipment for measurement control and laboratory use EMC requirements – Class A

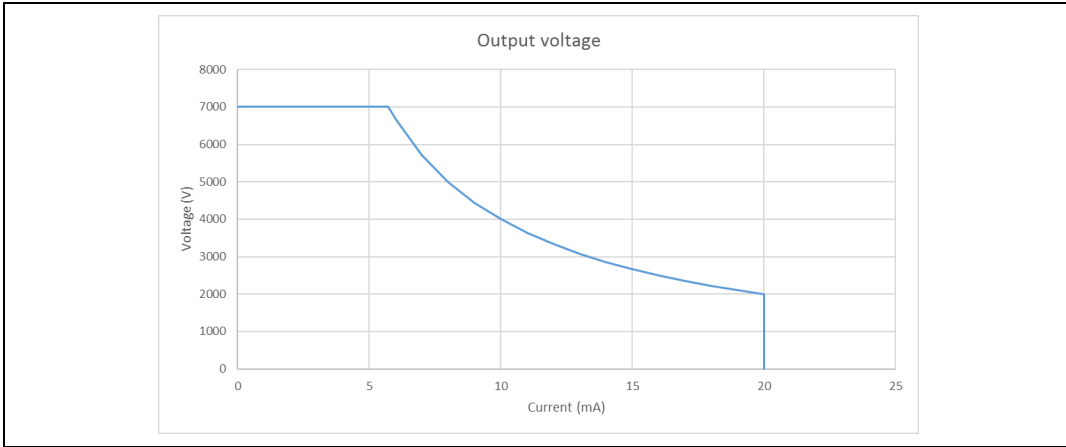

Figure 7 Output voltage vs Output current

## Controller Outline

The outline dimensions for the IPCMini controller are shown in the following figures:

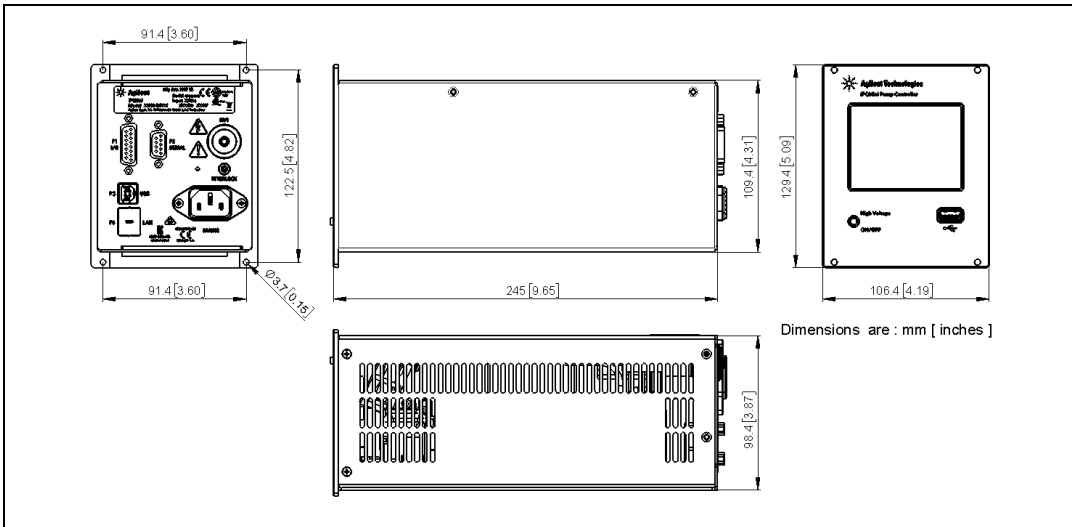
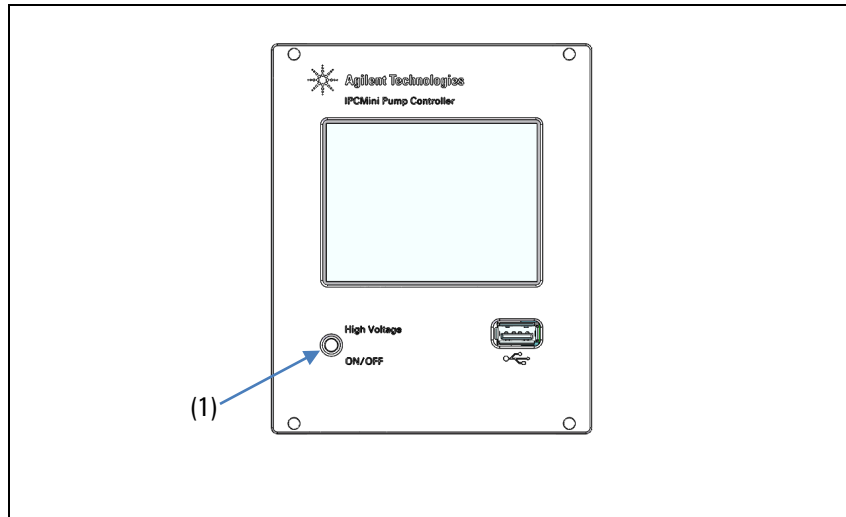

Figure 8 Controller Model Dimensions

## Front Panel Description



**Figure 9** Front Panel

## Turn on/off HV Output

To turn on the High Voltage output keep the HV ON/OFF push button pressed for at least 3 seconds.

To turn off the High Voltage output keep the HV ON/OFF push button pressed for at least 3 seconds.

# Display

## Menu

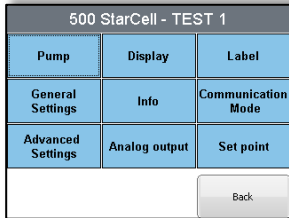

## Pump

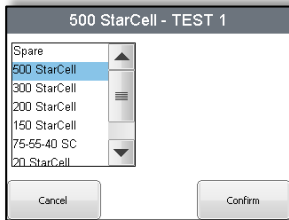

For Pump selection. The list contains only the pumps' models compatible with controller polarity.

StarCell: Negative

Diode, Noble Diode: positive

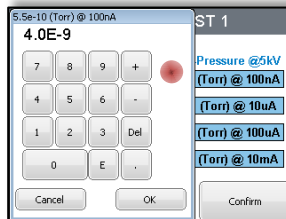
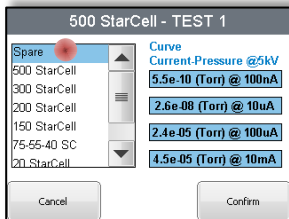

Where SPARE pump is selected a custom current-pressure curve can be used.

Enter a Pressure value (expressed in Torr) at 5kV corresponding to following 4 current values: 100nA, 10uA, 100uA, 10mA

## Display

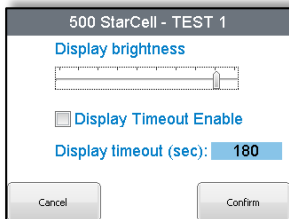

Display brightness can be increased or decreased.

Standby display mode can be enabled by if desired flagging the option and setting the time.

## 5 Technical Information

### Display

#### Label



Connected pump can be identified by a label shown in the “Headline bar”  
(Max 10 characters)

#### General Settings

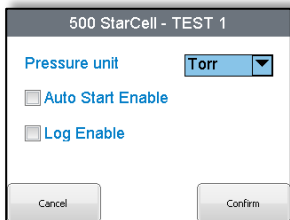

**Pressure unit** measurements can be selected (Torr, mbar, Pa)  
**Auto Start Enable:** after power shut-down the HV is restored automatically when option is selected.  
**Log Enable:** this option enables the data log acquisition via USB key of the ion pump main parameters (Voltage, Current, Pressure) with a sampling time acquisition of 1 second.

#### Info

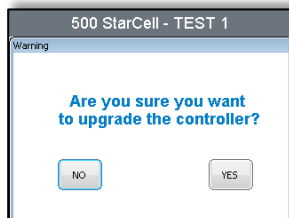
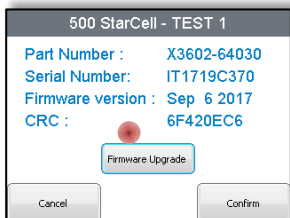

General factory information of the controller:  
Part Number, Serial number, Firmware version, CRC. Firmware upgrade option is available through the manual.  
Please contact [VPT-customer@agilent.com](mailto:VPT-customer@agilent.com) for more details and guideline.

#### Communication mode

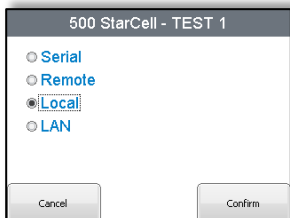

The following communication mode can be selected:  
Serial (RS232/RS485)  
Remote  
Local (through the front panel – Factory set)  
LAN (optional)

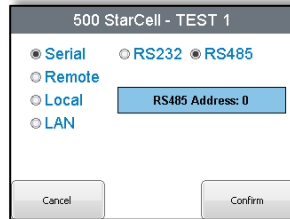
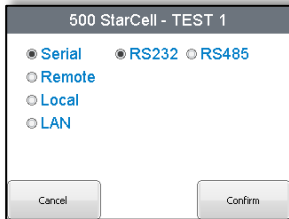

For RS232 or RS485 selection.  
When RS485 is selected, addresses from 0 to 31 can be set.

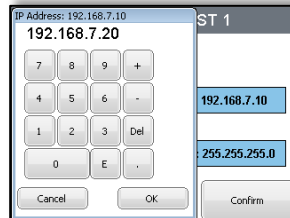
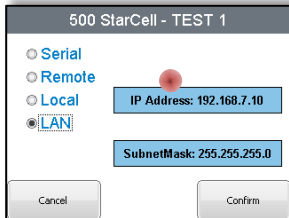

When LAN (Ethernet) is selected IP address and the Subnet mask can be set.

### Advanced Settings

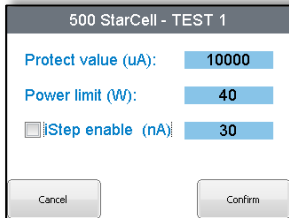

Select the values for:  
**Protect value:** see dedicated paragraph.  
**Power limit:** output power to the pump can be set at lower value than the maximum of 40 Watts.  
**iSTEP:** see dedicated paragraph

### Analog output

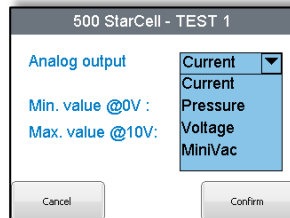
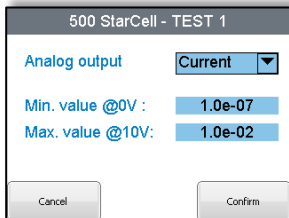

**Analog Output** can be set according to:

- *Current*: analog output proportional to the current logarithm.
- *Pressure*: analog output proportional to the pressure logarithm.
- *Voltage*: analog output linearly proportional to the Voltage.
- *MiniVac*: it duplicates the MiniVac output signal values (linearly proportional to the current). Minimum and maximum range values can be selected.

## 5 Technical Information

### Display

#### Set point

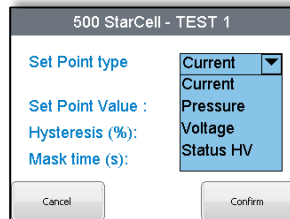
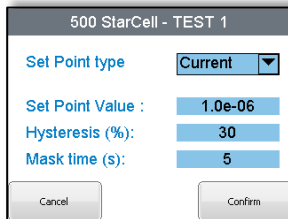

**Set Point** parameter section.  
See dedicated paragraph.

## Rear Panel Description (Universal range version)

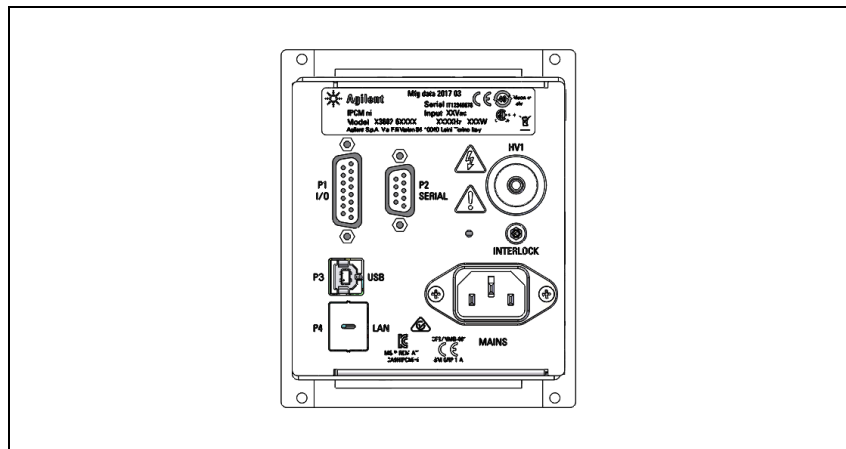

**Figure 10** Rear Panel

- HV1 connector: High voltage output
- P1 connector: DB15 connector for Remote I/O signals.
- P2 connector: DB9 connector for RS232 and RS485 serial communication
- P3 connector: USB connector
- P4 connector: LAN connector
- Interlock connector
- Mains: main input connector (universal range 110-220VAC)



## Rear Panel Description (24V version)

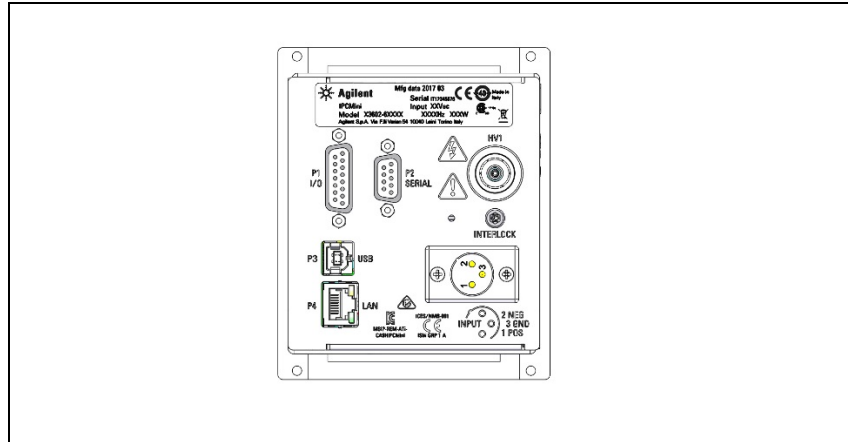

Figure 6 Rear Panel

HV1 connector: High voltage output

P1 connector: DB15 connector for Remote I/O signals.

P2 connector: DB9 connector for RS232 and RS485 serial communication

P3 connector: USB connector

P4 connector: LAN connector

Interlock connector

Mains: Power input connector (24V+/-10%)

## Interlock connection

To guarantee a proper working of the interlock connection, the user must take care that the total resistance between the ground controller and the input of the interlock cable (connected to the ion pump) is less than 10 Ohm.

## Operating Mode

The controller for ion pumps can be operated in 4 different modes:

- Serial
- Remote
- Local
- LAN (otpion).

The commands sent to the controller (for example, HV ON/OFF, Target voltage etc) can only be given in the mode chosen, while the data (for example, current, pressure, voltage etc...) can be read in all the modes.

E.g.: If you select Local mode, the HV channel can only be switched on via the keys on the Front Panel, but the current supplied can be read via the Front Panel, Serial and Remote.

Change from one mode to the next can be done either via the Front Panel or a serial command.

### NOTE

Change from one mode to another can be done with the high voltage switched on. However, the channel switch off if Remote mode is selected but no commands for switching on are present on the remote connector.

## Selecting “Operating Mode” via Serial

Using serial communications via the protocol “WIN protocol” (see chapter: SERIAL – Window Protocol), write the chosen value in window 8:

**Tab. 2** Keys

Value	Description
0	Serial
1	Remote
2	Local
3	LAN

# Functions

## Step-mode / Fixed mode

The high voltage provided to an ion pump can change from 3kV up to 7kV.

The user can set the Fixed mode with the voltage of 3kV or 5kV or 7kV using the front panel or through the serial commands or through the remote I/O.

To optimize the pumping speed of the ion pump and to minimize the influence of the leakage current, the controller implements the Step-mode function.

With this function the controller provides 7kV for about 5 seconds, then it changes the voltage among 3 – 5 – 7 kV depending on the current drawn by the ion pump and on the ion pump type.

**Tab. 3**

Pump Type	Current for switching from 7kV to 5kV	Current for switching from 5kV to 3kV
500 diode	1.4E-3 A	3.9E-5 A
300 diode	7.2E-4 A	2.1E-5 A
150 diode	3.6E-4 A	9.5E-6 A
75-55-40 diode	2.2E-4 A	6.7E-6 A
20 diode	2.0E-4 A	2.7E-6 A
10 diode	2.0E-5 A	6.0E-6 A
500 StarCell	9.0E-4 A	2.5E-5 A
300 StarCell	5.5E-4 A	1.6E-5 A
150 StarCell	3.0E-4 A	8.5E-6 A
75-55-40 StarCell	1.3E-4 A	3.8E-6 A
20 StarCell	6.5E-5 A	1.9E-6 A

## Protect

The protect function is useful to avoid damages in the ion pump due to the overcurrent.

If this function is enabled, the controller waits 120 seconds from the HV ON, then it begins to check the current provided. If the current exceeds the threshold in the following table, the HV channel turns off and the controller gives the “Protect Error”.

This kind of error is not a controller error but it is only a warning, informing that the HV channel is turned off because the protect current threshold was exceeded.

<b>Pump type</b>	<b>Protect current</b>
500 diode	100mA
300 diode	100mA
150 diode	50mA
75-55-40 diode	30mA
20 diode	20mA
10 diode	5mA
500 StarCell	100mA
300 StarCell	100mA
150 StarCell	50mA
75-55-40 StarCell	30mA
20 StarCell	20mA

## Set- point

The controller has 1 relays and they can be configured as set-points.

### Description

The microprocessor begins to drive the relay “Mask time” seconds after reaching the target voltage. “Mask time” is a value that can be set in the “Set-point” menu.

This feature avoids the incorrect activation due to voltage ramping.  
The set-point threshold has a configurable hysteresis (in following example of 5%).

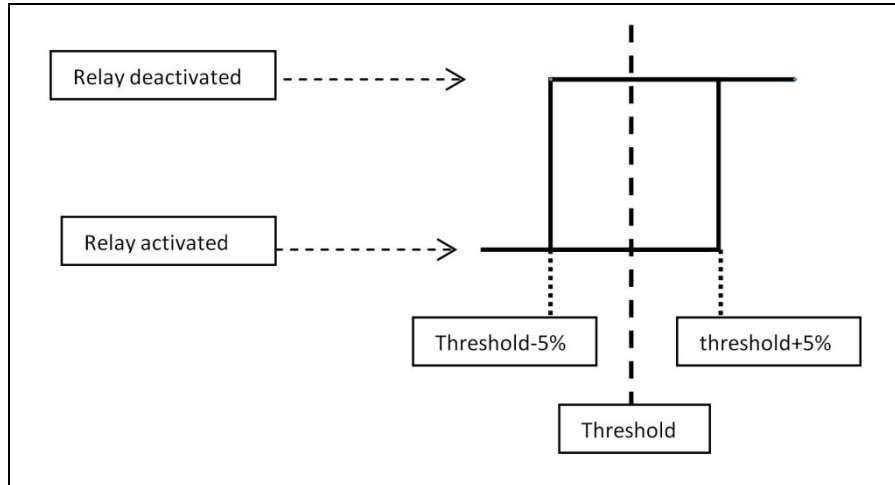

Figure 7

## Autostart

This function allows to restore the high voltage output when the main power supply is restored after a fail.

If the Autostart is enabled:

- When the main power fails and the hv channel is in on status, after the main is restored, the hv turns on automatically
- When the main power fails but the hv channel is in off status, after the main is restored, the hv channel remains disabled

If the Autostart is disabled

- After the power is restored after a fail, the hv remains disabled

## iSTEP

The iSTEP is a new way of successfully control and start the ion pumps in the very low pressure range.

Normally, when normal STEP function is active, if pump has difficulty to start after a fixed time the controller automatically switches from 7 to 5kV and then again from 5 to 3 kV.

The consequence is that, if the pump did not start at 7 kV in the fixed time, the pump does not start at all and the reading.

To overcome this issue the controller stays on 7kV until a current threshold is reached (default 30nA)→ current threshold instead of time.

This new feature is called iSTEP (or «intelligent» STEP mode).

The threshold is configurable so to set a current value slightly lower than the expected current according to the pressure.

### **Example:**

- working pressure  $1 \cdot 10^{-9}$ mbar with a medium size pump (55 l/s)
- expected current is approximately  $1 \cdot 10^{-6}$ A
- the threshold to be set is 500nA

## Device Number

Pump Type	Device number
Spare	0
<b>Negative Pumps</b>	
500 StarCell	1
300 StarCell	2
200 StarCell	16
150 StarCell	3
75-55-40 StarCell	4
20 StarCell	5
20 NEXTorr-SC	20
<b>Positive Pumps</b>	
500 diode	6
300 diode	7
200 diode	15
150 diode	8
75-55-40 diode	9
20 diode	10
10 diode	11
75 Sem	12
25 Sem	13
10 Sem	14
2 Diode	17
0.2 Diode 1250 Gauss	18
0.2 Diode 800 Gauss	19

FEMALE CONNECTOR

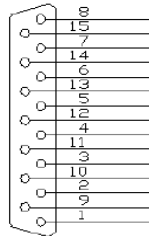

## Remote I/O connection

All the input/output remote signals to/from the controller must be connected at P1 mating connector. With the provided J1 mating connector make the connection with AWG 24 (0.25 mm<sup>2</sup>) or smaller wire to the pins indicated in the figure to obtain the desired capability. It is a 15-pins D type connector; the available signals are detailed in the table, the following paragraphs describe the signal characteristics and use.

Component	Description
<b>Remote I/O Signal Listing</b>	
Pin 1	Start/Stop
Pin 2	Not used
Pin 3	Not used
Pin 4	Not used
Pin 5	Not used
Pin 6	Not used
Pin 7	Not used
Pin 8	Not used
Pin 9	+24 V +/- 10 %, max. current 80 mA
Pin 10	Output relay
Pin 11	Output open drain
Pin 12	Output relay
Pin 13	Not used
Pin 14	Analog output
Pin 15	GND

<b>I/O Ratings</b>				
I/O Type	ON	OFF	Max Load	Note
Analog Output			1mA	Range 0-10V
Output Relay				24V , 100mA max
+24V dc				24V +/- 10% - 80mA max



## Connection of Input Remote

To activate the inputs remote (CH on/off) connect the pins as following:

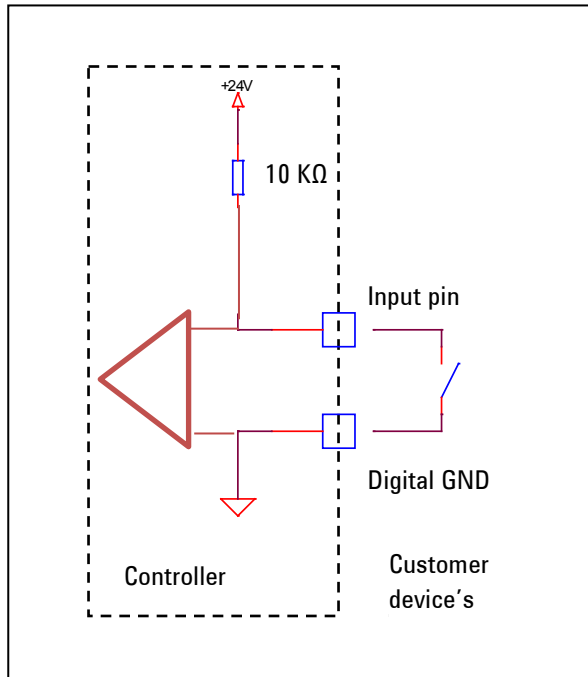
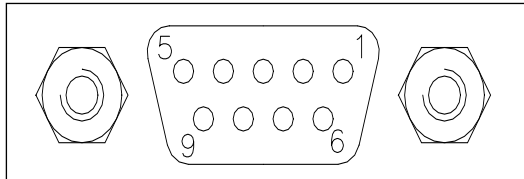

Figure 8 Input

## Serial

The following figure shows the controller interconnections.



This is a 9-pin D-type serial input/output connector that allows the to be controlled via an RS232 or RS485 connection.

Tab. 4

PIN No.	Signal Name
1	Reserved
2	TX (RS232)
3	RX (RS232)
4	Reserved
5	GND
6	A + (RS485)
7	Reserved
8	B - (RS485)
9	Reserved

## Connector Examples

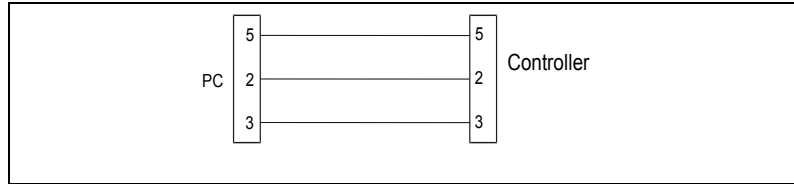

Figure 9 RS-232 Connection

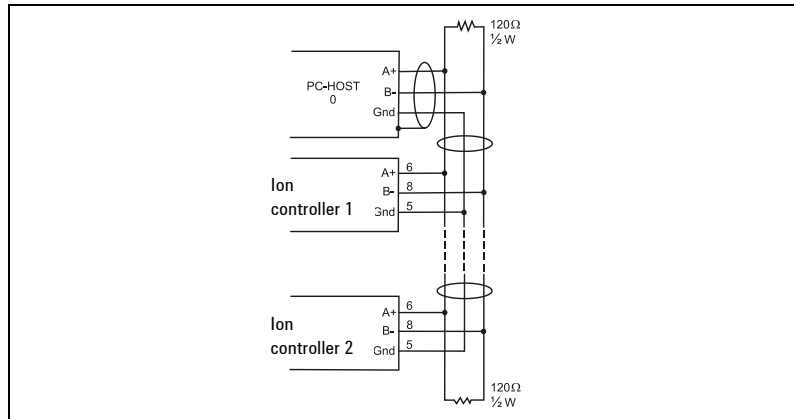

Figure 10 RS-485 Connection

## Procedure to Connect the Serial and I/O ports to an External Cable

In the following picture, it has showed the right procedure to connect a cable to the I/O or to the serial port. A shielded cable of 30 m maximum length has to be utilized for both serial and I/O port connection.

**NOTE**

Take care to have a good contact between the metallic case and the external shield of the wire. Moreover, this operation should be done at least on the controller side.

The I/O and communication terminal provided at the equipment are only required to be connected with external circuits which are separated from hazardous live voltages by reinforced or double insulation.

In this way, you will be sure to reduce the influence of the external noise and to accomplish the EMC requests. In picture d is showed the cable assembled.

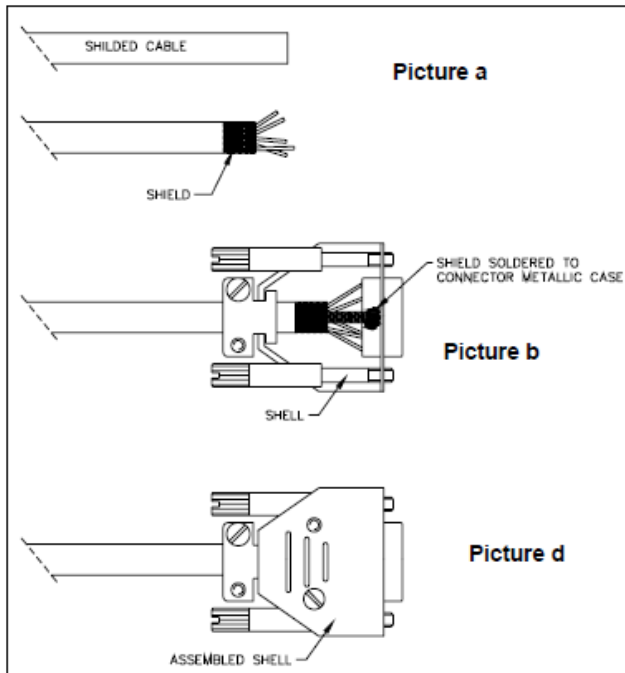

Figure 6

## Window Protocol

Both RS232 and the RS485 interfaces are available on the 9-pin D-type serial input/output connector. The communications protocol is the same (see the structure below), but only the RS485 handles the address field. Therefore, to enable the RS485, you need to select both the type of communication and the device address using the front panel menu or the T-Plus software.

The Window Protocol is the same of the Turbo Pump, but the meaning of the Window is different (see the below chapter: Windows Description).

### Communications Format

- 8 data bit
- No parity
- 1 stop bit
- Baud rate: 9600

### Communications Protocol

The communications protocol is of MASTER/ SLAVE type, where:

- Host = MASTER
- Controller = SLAVE

The communication takes place as follows:

- 1 The host (MASTER) sends a MESSAGE + CRC to the controller (SLAVE)
- 2 The controller answers with an ANSWER + CRC to the host.
- 3 The MESSAGE is a string in the following format:
- 4 <STX>+<ADDR>+<WIN>+<COM>+<DATA>+<ETX>+<CRC>

#### NOTE

When data is indicated between two quotes ('...'), it implies that the data indicated is the corresponding ASCII character.

## 5 Technical Information

### Serial

Where:

- <STX> (Start of transmission) = 0x02
- <ADDR> (Unit address) = when you select the RS232 communication, this field is not handled and the controller always answers with its address stored in EEPROM  
<ADDR> (Unit address) = 0x80 + device number (0 to 31) (for RS485)
- <WIN> (Window) = a string of 3 numeric indicating the window number (from '000' to '999'); for the meaning of each window, see the relevant paragraph.
- <COM> (Command) = 0x30 to read the window, 0x31 to write in the window
- <DATA> = an alphanumeric ASCII string with the data to be written in the window. In the case of a read command, this field is not present. The field length varies according to the data type, as shown in the following table:

**Tab. 5**

Data Type	Field Length Max	Valid Characters
Logic (L)	1	'0' = OFF '1' = ON
Numeric (N)	6	','; '.', '0' ... '9' right justified with '0'
Alphanumeric (A)	48	From blank to '_' (ASCII)

- <ETX> (End of transmission) = 0x03
- <CRC> = XOR of all characters following <STX> and including the <ETX> terminator. The value is hexadecimal coded and represented by two ASCII characters.

The SLAVE addressed responds with an ANSWER whose structure depends on the MESSAGE type.

When the MESSAGE is a read command, the SLAVE responds transmitting a string with the same structure as the MESSAGE.

**NOTE**

Using the RS485 interface, the message structure is identical to that used for the RS232 interface, the only difference being the value assigned to the ADDRESS <ADDR>.

**Tab. 6**

Type	Length max	Value	Description
Logic		-	After a read instruction of a logic window.
Numeric	6 bytes	-	After a read instruction of a numeric window.
Alphanumeric	48 bytes	-	After a read instruction of an alphanumeric window.
ACK	1 byte	(0x6)	Execution of the command has been successful.
NACK	1 byte	(0x15)	Execution of the command has failed.
Unknown Window	1 byte	(0x32)	The window specified in the command is not a valid window.
Data Type Error	1 byte	(0x33)	The data type specified in the command (Logic, Numeric or Alphanumeric) is not in agreement with the Window specified.
Out of Range			The value expressed during a write command is not within the range value for the specified window.
Win Disabled	1 byte	(0x35)	The window specified is Read Only or is temporarily disabled.

## 5 Technical Information

### Serial

The controller can reply with the following types of response:

**Tab. 7** Windows Description

WIN	R/W	Type	Description	Range
8	R/W	N	Mode	0=Serial, 1=Remote, 2=Local,3=LAN
11	R/W	L	HV ON/OFF CH1	0 = OFF(def) ; 1=ON
108	R/W	N	Baud rate	(1-4) [1200-2400-4800-9600]
205	R	N	Status	0=OK, 6=Fail
206	R	N	Error code	See following
319	R/W	A	Controller Model	
323	R/W	A	Controller Serial number	
503	R/W	N	RS485 Serial Address	[0-31]; 1=def
504	R/W	L	Serial Type Select	0= RS232(def) ; 1= RS485
600	R/W	N	Unit pressure	0 = Torr ; 1=mBar (def) ; 2=Pa
601	R/W	L	Autostart	0 = Disabled, 1 = Enabled
602	R/W	A	Protect	0 = Disabled, 1 = Enabled
603	R/W	A	Fixed/Step	0 = Disabled, 1 = Enabled
610	R/W	N	Device Number CH1	(see Chapter "Device number")
612	R/W	N	Max Power	10W – 40W
613	R/W	N	V target CH1	[3000,7000] V def=7000
614	R/W	N	I protect CH1	[1,10000 uA] step 1 uA
615	R/W	A	Set Point CH1	[X.XE-XX]
800	R	N	Temperature Power section	[0, 200] °C
801	R	N	Temperature internal controller	[0, 200] °C
804	R	L	Status Set point	0 = OFF 1 = ON
810	R	N	V measured CH1	[0, 7000] V ;



WIN	R/W	Type	Description	Range
				step 100 V
811	R	A	I measured CH1	[1E-10, 9E-1] A
812	R	A	Pressure CH1	[X.XE-XX]
890	R/W	A	Label	Max 10 char

## LAN communication

The IPCMini with the LAN option is able to encapsulated the “windows serial protocol” within a TCP/IP framework. You need to configure the IP address and the subnet mask from the display (Menu→Communication–LAN). To be sure that the configuration is done correctly you can ping the controller at the IP address selected.

After the configuration you can communicate with the controller with TCP at port 23.

## Error Code

The error code is displayed in decimal format. Binary representation of this number provides indications regarding the type of error that has occurred.

The error table is shown below:

Tab. 8 Error Code

Error code in decimal format	Binary	Description
0	00000000000000	No error
4	00000000000100	Over Temperature
32	00000001000000	Interlock cable
64	00000010000000	ShortCircuit
128	00000100000000	Protect

## Cleaning

For safety reasons, before cleaning the controller:

- Turn the controller off;
- disconnect the controller power plug from the electrical outlet
- disconnect all cables.
- If the exterior of the controller becomes dirty, use a dry soft cloth.

### **Electromagnetic Compatibility**

#### **EN55011/CISPR11**

**Group 1 ISM equipment:** group 1 contains all ISM equipment in which there is intentionally generated and/or used conductively coupled radio- frequency energy which is necessary for the internal functioning of the equipment itself.

**Class A equipment** is equipment suitable for use in all establishments other than domestic and those directly connected to a low voltage power supply network which supplies buildings used for domestic purposes. This device complies with the requirements of CISPR11, Group 1, Class A as radiation professional equipment. Therefore, there may be potential difficulties in ensuring electromagnetic compatibility in other environments, due to conducted as well as radiated disturbances.

**South Korean Class A EMC declaration**

This equipment is Class A suitable for professional use and is for use in electromagnetic environments outside of the home.

A 급 기기

( 업무용 방송통신기자재 )

이 기기는 업무용 (A 급) 전자파적합기기로서 판매자 또는 사용자는 이 점을 주의하시기 바라며, 가정외의 지역에서 사용하는 것을 목적으로 합니다.

A 급 기기

( 업무용 방송통신기자재 )

이 기기는 업무용 (A 급) 전자파적합기기로서 판매자 또는 사용자는 이 점을 주의하시기 바라며, 가정외의 지역에서 사용하는 것을 목적으로 합니다.

**ICES/NMB-001**

This ISM device complies with Canadian ICES- 001.

Cet appareil ISM est conforme à la norme NMB-001 du Canada.

## Accessories and Spare Parts

<b>Part</b>	<b>Description</b>
X3602-64000	IPCMini ION PUMP CONTROLLER, 100-240V, FISCHER HV CONNECTOR, NEGATIVE POLARITY
X3602-64001	IPCMini ION PUMP CONTROLLER, 100-240V, FISCHER HV CONNECTOR, POSITIVE POLARITY
X3602-64002	IPCMini ION PUMP CONTROLLER, 24 VDC, FISCHER HV CONNECTOR, NEGATIVE POLARITY
X3602-64003	IPCMini ION PUMP CONTROLLER, 24 VDC, FISCHER HV CONNECTOR, POSITIVE POLARITY
X3602-64010	IPCMini ION PUMP CONTROLLER, 100-240V, FISCHER HV CONNECTOR, NEGATIVE POLARITY, ETHERNET
X3602-64011	IPCMini ION PUMP CONTROLLER, 100-240V, FISCHER HV CONNECTOR, POSITIVE POLARITY, ETHERNET
X3602-64012	IPCMini ION PUMP CONTROLLER, 24 VDC, FISCHER HV CONNECTOR, NEGATIVE POLARITY, ETHERNET
X3602-64013	IPCMini ION PUMP CONTROLLER, 24 VDC, FISCHER HV CONNECTOR, POSITIVE POLARITY, ETHERNET
X3602-64020	IPCMini ION PUMP CONTROLLER, 100-240V, SHV HV CONNECTOR, NEGATIVE POLARITY
X3602-64021	IPCMini ION PUMP CONTROLLER, 100-240V, SHV HV CONNECTOR, POSITIVE POLARITY
X3602-64022	IPCMini ION PUMP CONTROLLER, 24 VDC, SHV HV CONNECTOR, NEGATIVE POLARITY
X3602-64023	IPCMini ION PUMP CONTROLLER, 24 VDC, SHV HV CONNECTOR, POSITIVE POLARITY
X3602-64030	IPCMini ION PUMP CONTROLLER, 100-240V, SHV HV CONNECTOR, NEGATIVE POLARITY, ETHERNET
X3602-64031	IPCMini ION PUMP CONTROLLER, 100-240V, SHV HV CONNECTOR, POSITIVE POLARITY, ETHERNET
X3602-64032	IPCMini ION PUMP CONTROLLER, 24 VDC, SHV HV CONNECTOR, NEGATIVE POLARITY, ETHERNET
X3602-64033	IPCMini ION PUMP CONTROLLER, 24 VDC, SHV HV CONNECTOR, POSITIVE POLARITY, ETHERNET
<b>HV Cables Fisher connector</b>	
929-0705	HV bakeable cable, radiation resistant, 4 meter
929-0707	HV bakeable cable, radiation resistant, 7 meter
929-0708	HV bakeable cable, radiation resistant, 10 meter
929-0709	HV bakeable cable, radiation resistant, 20 meter
<b>Power Cord</b>	
9699958	Mains Cable US/NEMA plug (3m long)
9699957	Mains Cable EU plug (3m long)
8121-0703	Mains Cable CHINA plug (3m long)
9499399	Power Cable IEC 320



***Vacuum Products Division***

*Dear Customer,*

*Thank you for purchasing an Agilent vacuum product. At Agilent Vacuum Products Division we make every effort to ensure that you will be satisfied with the product and/or service you have purchased.*

*As part of our Continuous Improvement effort, we ask that you report to us any problem you may have had with the purchase or operation of our products. On the back side you find a Corrective Action request form that you may fill out in the first part and return to us.*

*This form is intended to supplement normal lines of communications and to resolve problems that existing systems are not addressing in an adequate or timely manner.*

*Upon receipt of your Corrective Action Request we will determine the Root Cause of the problem and take the necessary actions to eliminate it. You will be contacted by one of our employees who will review the problem with you and update you, with the second part of the same form, on our actions.*

*Your business is very important to us. Please, take the time and let us know how we can improve.*

*Sincerely,*

A handwritten signature in black ink, appearing to read "Giampaolo LEVI".

*Giampaolo LEVI*

*Vice President and General Manager  
Agilent Vacuum Products Division*

Note: Fax or mail the Customer Request for Action (see backside page) to Agilent Vacuum Products Division (Torino) – Quality Assurance or to your nearest Agilent representative for onward transmission to the same address.

## CUSTOMER REQUEST FOR CORRECTIVE / PREVENTIVE / IMPROVEMENT ACTION

TO: AGILENT VACUUM PRODUCTS DIVISION TORINO – QUALITY ASSURANCE FAX

N°: XXXX-011-9979350

ADDRESS: AGILENT TECHNOLOGIES ITALIA S.p.A. – Vacuum Products Division –  
Via F.lli Varian, 54 – 10040 Leini (TO) – Italy

E-MAIL: [vpd-qualityassurance\\_pdl-ext@agilent.com](mailto:vpd-qualityassurance_pdl-ext@agilent.com)

NAME	COMPANY	FUNCTION
ADDRESS:		
TEL. N° :		
FAX N° :		
E-MAIL:		
PROBLEM / SUGGESTION :		
REFERENCE INFORMATION (model n°, serial n°, ordering information, time to failure after installation, etc.):		
DATE		
CORRECTIVE ACTION PLAN / ACTUATION (by AGILENT VPD)		LOG N°

XXX = Code for dialing Italy from your country (es. 01139 from USA; 00139 from Japan, etc.)

## Vacuum Products Division Instructions for returning products

Dear Customer,

Please follow these instructions whenever one of our products needs to be returned.

Complete the attached **Request for Return form** and send it to Agilent Technologies (see below), taking particular care to include the completed **Health and Safety** declaration Section. No work can be started on your unit until we receive a completed copy of this form.

After evaluating the information, Agilent Technologies will provide you with a **Return Authorization (RA) number** via email or fax, as requested. Note: Depending on the type of return, a Purchase Order may be required at the time **the Request for Return is submitted**. We will quote any necessary services (evaluation, repair, special cleaning, eg).

### Product preparation

- Remove all accessories from the core product (e.g. inlet screens, vent valves).
- Prior to shipment and if applicable for your product, drain any oils or other liquids, purge or flush all gasses, and wipe off any excess residue.
- If ordering an Advance Exchange product, please use the packaging from the Advance Exchange to return the defective product.
- Seal the product in a plastic bag, and package product carefully to avoid damage in transit. You are responsible for loss or damage in transit.
- Include a copy of the Health and Safety Declaration in the shipping documentation on the outside of the shipping box of your returning product.
- Clearly label package with RA number. Using the shipping label provided will ensure the proper address and RA number are on the package. Packages shipped to Agilent without a RA clearly written on the outside cannot be accepted and will be returned.
- Return only products for which the RA was issued.

### Shipping

- Ship to the location specified on the printable label, which will be sent, along with the RA number, as soon as we have received all of the required information. Customer is responsible for freight charges on returning product.
- Return shipments must comply with all applicable Shipping Regulations (IATA, DOT, ADR, etc.) and carrier requirements.

RETURN THE COMPLETED **REQUEST FOR RETURN** FORM TO YOUR NEAREST LOCATION:

#### EUROPE:

Fax: 00 39 011 9979 330  
Fax Free: 00 800 345 345 00  
Toll Free: 00 800 234 234 00

#### NORTH AMERICA:

Fax: 1 781 860 9252  
Toll Free: 800 882 7426, Option 3

#### PACIFIC RIM:

Please visit our website for individual office information

[vpt-customer@agilent.com](mailto:vpt-customer@agilent.com)

[vpl-ra@agilent.com](mailto:vpl-ra@agilent.com)

<http://www.agilent.com>



**TERMS AND CONDITIONS**

**Please read the terms and conditions below as they apply to all returns and are in addition to the Agilent Technologies Vacuum Product Division – Products and Services Terms of Sale.**

- Unless otherwise pre-negotiated, customer is responsible for the freight charges for the returning product. Return shipments must comply with all applicable **Shipping Regulations** (IATA, DOT, etc.) and carrier requirements.
- Agilent Technologies is not responsible for returning customer provided packaging or containers.
- Customers receiving an Advance Exchange product agree to return the defective, rebuildable part to Agilent Technologies **within 15 business days**. Failure to do so, or returning a non-rebuildable part (crashed), will result in an invoice for the non-returned/non-rebuildable part.
- Returns for credit toward the purchase of new or refurbished Products are subject to prior Agilent approval and may incur a restocking fee. Please reference the original purchase order number.
- Units returned for evaluation will be evaluated, and a quote for repair will be issued. If you choose to have the unit repaired, the cost of the evaluation will be deducted from the final repair pricing. A Purchase Order for the final repair price should be issued within 3 weeks of quotation date. Units without a Purchase Order for repair will be returned to the customer, and the evaluation fee will be invoiced.
- Products returned that have not been drained from oil will be disposed.
- A Special Cleaning fee will apply to all exposed products.
- If requesting a calibration service, units must be functionally capable of being calibrated.



Customer information		
Company :	Contact Name:	
Address:	Tel:	Fax:
	Email:	

Equipment			
Product description	Agilent PartNo	Agilent Serial No	Original Purchasing Reference
Failure description	Type of process (for which the equipment was used)		

Type of return
<input type="checkbox"/> Non Billable <input type="checkbox"/> Billable <input checked="" type="checkbox"/> New PO # (hard copy must be submitted with this form): _____ <input type="checkbox"/> Exchange <input type="checkbox"/> Repair <input type="checkbox"/> Upgrade <input type="checkbox"/> Demo <input type="checkbox"/> Calibration <input type="checkbox"/> Evaluation <input type="checkbox"/> Return for Credit

Health and safety	Substances (please refer to MSDS forms)			
The product has been exposed to the following substances: (by selecting 'YES' you MUST complete the table to the right)	* Agilent will not accept delivery of any product that is exposed to radioactive, biological, explosive substances or dioxins, PCB's without written evidence of decontamination.			
	Trade name	Chemical name	Chemical Symbol	CAS Number
Toxic	<input type="checkbox"/> YES <input type="checkbox"/> NO			
Harmful	<input type="checkbox"/> YES <input type="checkbox"/> NO			
Corrosive	<input type="checkbox"/> YES <input type="checkbox"/> NO			
Reactive	<input type="checkbox"/> YES <input type="checkbox"/> NO			
Flammable	<input type="checkbox"/> YES <input type="checkbox"/> NO			
Explosive (*)	<input type="checkbox"/> YES <input type="checkbox"/> NO			
Radioactive (*)	<input type="checkbox"/> YES <input type="checkbox"/> NO			
Biological (*)	<input type="checkbox"/> YES <input type="checkbox"/> NO			
Oxidizing	<input type="checkbox"/> YES <input type="checkbox"/> NO			
Sensitizer	<input type="checkbox"/> YES <input type="checkbox"/> NO			
Other dangerous substances	<input type="checkbox"/> YES <input type="checkbox"/> NO			

Goods preparation
If you have replied YES to one of the above questions. Has the product been purged? <input type="checkbox"/> YES <input type="checkbox"/> NO If yes, which cleaning agent/method:
Has the product been drained from oil? <input type="checkbox"/> YES <input type="checkbox"/> NOT APPLICABLE I confirm to place this declaration on the outside of the shipping box. <input type="checkbox"/>

<b>I declare that the above information is true and complete to the best of my knowledge and belief.</b> <b>I understand and agree to the terms and conditions on page 2 of this document.</b>	
Name:	Authorized Signature:
Position:	
Date:	

**NOTE:** If a product is received at Agilent which is contaminated with a toxic or hazardous material that was not disclosed, **the customer will be held responsible** for all costs incurred to ensure the safe handling of the product, and is liable for any harm or injury to Agilent employees as well as to any third party occurring as a result of exposure to toxic or hazardous materials present in the product.

**United States**

**Agilent Technologies**  
121 Hartwell Avenue  
Lexington, MA 02421 - USA  
Ph. +1 781 861 7200  
Fax: +1 781 860 5437  
Toll-Free: +1 800 882 7426  
[vppl-customer@agilent.com](mailto:vppl-customer@agilent.com)

**Netherlands**

**Agilent Technologies Netherlands B.V.**  
Customer Contact Center  
Laan van Langerhuize 1, toren A-8  
1186 DS Amstelveen  
Tel. +31 020 547 2600  
Fax +31 020 654 5748  
[customer@agilent.com](mailto:customer@agilent.com)

**Belgium**

**Agilent Technologies Belgium S.A./N.V.**  
Customer Contact Center  
Pegasus Park  
De Kleetlaan 12A bus 12  
B-1831 Diegem  
Tel. +32 2 404 92 22  
Fax +32 2 626 46 30  
[customer@agilent.com](mailto:customer@agilent.com)

**Brazil**

**Agilent Technologies Brasil**  
Avenida Marcos Penteados de Ulhoa  
Rodrigues, 939 - 6° andar  
Castelo Branco Office Park  
Torre Jacarandá - Tamboré  
Barueri, Sao Paulo CEP: 06460-040  
Toll free: 0800 728 1405

**China**

**Agilent Technologies (China) Co. Ltd**  
No.3, Wang Jing Bei Lu, Chao Yang District  
Beijing, 100102, China  
Tel: +86 (0)10 64397888  
Fax: +86 (0)10 64392765  
Toll free: 800 820 6778 (ph); 400 820 6778 (cell.ph.)  
[vacuum.cnmarketing@agilent.com](mailto:vacuum.cnmarketing@agilent.com)  
[vpk-customer@agilent.com](mailto:vpk-customer@agilent.com)

**France**

**Agilent Technologies**  
Parc Technopolis - Z.A. de Courtaboeuf  
3, avenue du Canada - CS 90263  
91978 Les Ulis cedex, France  
Tel: +33 (0) 1 64 53 61 15  
Fax: +33 (0) 1 64 53 50 01  
[vpf.sales@agilent.com](mailto:vpf.sales@agilent.com)

**Southeast Asia**

**Agilent Technologies Sales Sdn Bhd**  
Unit 201, Level 2 uptown 2,  
2 Jalan SS21/37, Damansara Uptown  
47400 Petaling Jaya, Selangor, Malaysia  
Ph. +603 7712 6181  
Fax: +603 7727 1239  
Toll free: 1 800 880 805  
[vps-customer@agilent.com](mailto:vps-customer@agilent.com)

**India (Sales)**

**Agilent Technologies India Pvt. Ltd.**  
Unit Nos 110- 116, & Part of 101 & 109  
First Floor, Splendor Forum,  
Plot No.-3 , District Centre, Jasola  
New Delhi-110025  
Ph. +91 11 4623 7100  
Fax: +91 4623 7105  
Toll Free: 1 800 180 1517

**Italy**

**Agilent Technologies Italia S.p.A.**  
Via F.lli Varian, 54  
10040 Leini, (Torino) - Italy  
Tel: +39 011 9979 111  
Fax: +39 011 9979 350  
Toll free: 00 800 234 234 00  
[vpt-customer@agilent.com](mailto:vpt-customer@agilent.com)

**Japan**

**Agilent Technologies Japan, Ltd.**  
9-1 Takakura-cho Hachioji-city,  
Tokyo, Japan  
Tel.: +81-3-5232-1253  
Fax: +81-120-565-154  
Toll-Free: +81-120-477-111  
[jp-vvt-sales.pdl-ext@agilent.com](mailto:jp-vvt-sales.pdl-ext@agilent.com)

**Singapore**

**Agilent Technologies Singapore Pte. Ltd.**  
1 Yishun Avenue 7,  
Singapore 768923  
Tel : (65) 6215 8045  
Fax : (65) 6754 0574  
Toll free: 1 800 2762622  
[vps-customer@agilent.com](mailto:vps-customer@agilent.com)

**Korea**

**Agilent Technologies Korea, Ltd.**  
Ilshin Building 4F  
Yongsan-gu Hannam-daero  
Seoul Korea 04418  
Tel: +82 (0)2 2194 9449  
Fax: +82 (0)2 2194 9853  
Toll free: 080 222 2452  
[vpk-customer@agilent.com](mailto:vpk-customer@agilent.com)

**UK and Ireland**

**Agilent Technologies LDA UK Limited**  
Lakeside Cheadle Royal Business Park  
Cheadle, Cheshire SK8 3GR,  
United Kingdom  
Ph. +44 01865291570  
Fax +44 01865291571  
Toll free: 00 800 234 234 00  
Toll free fax: 00 800 345 345 00  
[vpt-customer@agilent.com](mailto:vpt-customer@agilent.com)

**India (Service)**

**Agilent Technologies India Pvt. Ltd.**  
C-Block, RMZ Centennial Plot Number-  
8A, 8B, 8C, 8D,  
Doddanakundi Industrial Area, ITPL  
Road,  
Mahadevapura Post, Bangalore- 560048  
Ph. +91 80 40614000  
Fax: +91 80 40148991

**Taiwan**

**Agilent Technologies Taiwan Limited**  
No. 20 Gao-shuang Road, Ping-zhen Dist  
Tao-Yuan City  
32450 Taiwan, R.O.C.  
Tel: +886 3 4959004  
Toll free: 0800 018 768  
[vpw-customer@agilent.com](mailto:vpw-customer@agilent.com)

**Germany and Austria**

**Agilent Technologies  
Sales & Services GmbH & Co. KG**  
Lyoner Str. 20  
60 528 Frankfurt am Main  
GERMANY  
Tel: +49 69 6773 43 2230  
Fax: +49 69 6773 43 2250

**Mexico**

**Agilent Technologies**  
Concepcion Beistegui No 109  
Col Del Valle  
C.P. 03100 – Mexico, D.F.  
Tel.: +52 5 523 9465  
Fax: +52 5 523 9472

**Other Countries**

**Agilent Technologies Italia S.p.A.**  
Via F.lli Varian, 54  
10040 Leini, (Torino) - Italy  
Tel.: +39 011 997 9111  
Fax: +39 011 997 9350  
Toll-Free: 00 800 234 234 00  
[vpt-customer@agilent.com](mailto:vpt-customer@agilent.com)

**Customer Support & Service**

**NORTH AMERICA:**  
Toll Free: 800 882 7426  
[vp1-ra@agilent.com](mailto:vp1-ra@agilent.com)  
[Lexington-service@agilent.com](mailto:Lexington-service@agilent.com)

**EUROPE:**

Toll Free: 00 800 234 234 00  
[vpt-customer@agilent.com](mailto:vpt-customer@agilent.com)

**PACIFIC RIM:**

please visit our website for individual  
office information  
<http://www.agilent.com/chem/vacuum>

**Worldwide Web Site, Catalog and Order  
On-line:**

[www.agilent.com/chem/vacuum](http://www.agilent.com/chem/vacuum)  
Representatives in most countries

© Agilent Technologies, Inc. 2016

Printed in ITALY  
02/2018

Publication Number: 87-900-153-01 (A)



Agilent Technologies