



owner.ford.com



ford.ca

December 2020
First Printing
Litho in U.S.A.



MK3J 19A321 AA



2021 **TRANSIT** Owner's Manual



The information contained in this publication was correct at the time of going to print. In the interest of continuous development, we reserve the right to change specifications, design or equipment at any time without notice or obligation. No part of this publication may be reproduced, transmitted, stored in a retrieval system or translated into any language in any form by any means without our written permission. Errors and omissions excepted.

© Ford Motor Company 2020

All rights reserved.

Part Number: MK3J19A321 AA 202010 20201104171908

California Proposition 65



WARNING: Operating, servicing and maintaining a passenger vehicle or off-highway motor vehicle can expose you to chemicals including engine exhaust, carbon monoxide, phthalates, and lead, which are known to the State of California to cause cancer and birth defects or other reproductive harm. To minimize exposure, avoid breathing exhaust, do not idle the engine except as necessary, service your vehicle in a well-ventilated area and wear gloves or wash your hands frequently when servicing your vehicle. For more information go to www.P65Warnings.ca.gov/passenger-vehicle.



WARNING: Battery posts, terminals and related accessories contain lead and lead compounds, chemicals known to the State of California to cause cancer and reproductive harm.
Wash your hands after handling.

Table of Contents

Introduction

About This Manual	9
Symbols Glossary	9
Special Notices	11

Data Privacy

Data Privacy	14
Service Data	15
Event Data	15
Settings Data	16
Connected Vehicle Data - Vehicles With: Modem	16
Mobile Device Data - Vehicles With: SYNC 3	17
Emergency Call System Data	17

Environment

Protecting the Environment	18
----------------------------------	----

Child Safety

General Information	19
Installing Child Restraints	21
Booster Seats	37
Child Restraint Positioning	39
Child Safety Locks	41

Seatbelts

Principle of Operation	43
Fastening the Seatbelts	44
Seatbelt Height Adjustment	46
Seatbelt Warning Lamp and Indicator Chime	46
Seatbelt Reminder	47
Child Restraint and Seatbelt Maintenance	49
Seatbelt Extensions	49

Supplementary Restraints System

Principle of Operation	50
------------------------------	----

Driver and Passenger Airbags	51
Side Airbags	57
Safety Canopy™	58
Crash Sensors and Airbag Indicator	59
Airbag Disposal	60

911 Assist

What Is 911 Assist	61
Emergency Call Requirements	61
Emergency Call Limitations	62

Keys and Remote Controls

Principle of Operation	63
General Information on Radio Frequencies	63
Remote Control - Vehicles Without: Passive Anti-Theft System (PATS)	64
Remote Control - Vehicles With: Passive Anti-Theft System (PATS)	65
Remote Control - Vehicles With: Power Sliding Door	67
Replacing a Lost Key or Remote Control	69

MyKey™

Principle of Operation	70
MyKey Settings	70
Creating a MyKey	71
Programming a MyKey	71
Clearing All MyKeys	73
Checking MyKey System Status	74
Using MyKey With Remote Start Systems	75
MyKey – Troubleshooting	75

Doors and Locks

Locking and Unlocking	76
-----------------------------	----

Table of Contents

Sliding Door - Vehicles

Without: Power Sliding Door

Sliding Door Precautions	80
Opening the Sliding Door	80
Closing the Sliding Door	80

Sliding Door - Vehicles With: Power Sliding Door

Sliding Door Precautions	82
Opening the Sliding Door	82
Closing the Sliding Door	83
Stopping the Sliding Door Movement	84
Resetting the Power Sliding Door	84
Sliding Door – Troubleshooting	85

Keyless Entry

Locating the Keyless Entry Keypad	87
Master Access Code	87
Keyless Entry Settings	87
Locking and Unlocking the Doors Using Keyless Entry	87
Keyless Entry – Troubleshooting	88

Security

Passive Anti-Theft System - Vehicles With: Passive Anti-Theft System (PATS)	89
Anti-Theft Alarm - Vehicles Without: Anti-Theft Alarm Horn with Integral Battery	90
Anti-Theft Alarm - Vehicles With: Anti-Theft Alarm Horn with Integral Battery	91

Power Running Boards

Using Power Running Boards	93
----------------------------------	----

Steering Wheel

Adjusting the Steering Wheel	96
------------------------------------	----

Locking the Steering Wheel	96
----------------------------------	----

Wipers and Washers

Windshield Wipers	97
Autowipers	97
Windshield Washers	99

Lighting

General Information	100
Lighting Control	100
Autolamps	101
Instrument Lighting Dimmer	102
Daytime Running Lamps	102
Automatic High Beam Control	103
Front Fog Lamps	104
Direction Indicators	105
Interior Lamps - Van	105
Cargo Lamps	106

Windows and Mirrors

Power Windows	107
Exterior Mirrors	108
Interior Mirror	109

Instrument Cluster

Gauges	110
Warning Lamps and Indicators	111

Information Displays

General Information	115
Trip Computer	117
Personalized Settings	118

Remote Start

What Is Remote Start	120
Remote Start Limitations	120
Enabling Remote Start	120
Remotely Starting and Stopping the Vehicle	120

Table of Contents

Remote Start Settings	120
-----------------------------	-----

Climate Control

Manual Climate Control	122
Hints on Controlling the Interior Climate	123
Rear Passenger Climate Controls	124
Heated Rear Window	124
Heated Exterior Mirrors - Vehicles Without: Heated Rear Window	124
Heated Exterior Mirrors - Vehicles With: Heated Rear Window	124

Interior Air Quality

What Is the Cabin Air Filter	125
Locating the Cabin Air Filter	125
Replacing the Cabin Air Filter	125

Seats

Sitting in the Correct Position	126
Head Restraints	126
Manual Seats - Vehicles With: 2-Way Manual Seat	127
Manual Seats - Vehicles With: 4-Way Manual Seat	128
Power Seats	131
Rear Seats	132
Heated Seats	135

Rear Occupant Alert System

What is the Rear Occupant Alert System	136
How Does the Rear Occupant Alert System Work	136
Rear Occupant Alert System Precautions	136
Rear Occupant Alert System Limitations	136
Switching Rear Occupant Alert System On and Off - Vehicles With: SYNC 3	136

Switching Rear Occupant Alert System On and Off - Vehicles With: SYNC	137
Rear Occupant Alert System Indicators - Vehicles With: SYNC	137
Rear Occupant Alert System Indicators - Vehicles With: SYNC 3	137
Rear Occupant Alert System Audible Warnings	137

Auxiliary Power Points

Auxiliary Power Points	138
Cigar Lighter	140

Storage Compartments

Overhead Console	141
------------------------	-----

Storage

Bottle Holders	142
Overhead Storage	142
Rear Overhead Storage	142

Starting and Stopping the Engine

General Information	144
Ignition Switch	144
Starting a Gasoline Engine	144
Switching Off the Engine	146
Engine Block Heater	146

Auto-Start-Stop - 3.5L EcoBoost™

What Is Auto-Start-Stop	148
Auto-Start-Stop Precautions	148
Switching Auto-Start-Stop On and Off	148
Stopping the Engine	148
Restarting the Engine	148
Auto-Start-Stop Indicators	149
Auto-Start-Stop - Troubleshooting	149

Table of Contents

Fuel and Refueling

Safety Precautions	151
Fuel Quality - E85	151
Fuel Quality - Gasoline	153
Fuel Filler Funnel Location	153
Running Out of Fuel	153
Refueling	155

Engine Emission Control

Emission Law	158
Catalytic Converter - 3.5L Duratec/3.5L Ecoboost™	159

Transmission

Automatic Transmission	161
Tow/Haul	163

All-Wheel Drive

Using All-Wheel Drive	165
-----------------------------	-----

Brakes

General Information	170
Hints on Driving With Anti-Lock Brakes	170
Hill Start Assist	171
Auto Hold	172

Parking Brake - Vehicles With: Conventional Mechanical Parking Brake

Applying the Parking Brake	174
Releasing the Parking Brake	174
Parking Brake Audible Warning	174
Parking Brake – Troubleshooting	174

Parking Brake - Vehicles With: Push Down Parking Brake

Applying the Parking Brake	175
Releasing the Parking Brake	175

Pushing the Parking Brake Lever Down	175
Parking Brake Audible Warning	175
Parking Brake – Troubleshooting	176

Electric Parking Brake

What Is the Electric Parking Brake	177
Applying the Electric Parking Brake	177
Applying the Electric Parking Brake in an Emergency	177
Manually Releasing the Electric Parking Brake	177
Automatically Releasing the Electric Parking Brake	177
Electric Parking Brake Audible Warning	178
Releasing the Electric Parking Brake if the Vehicle Battery Has Run Out of Charge	178
Electric Parking Brake – Troubleshooting	178

Traction Control

Principle of Operation	180
Using Traction Control	180

Stability Control

Principle of Operation	181
Using Stability Control	182

Parking Aids

Principle of Operation	183
Parking Aid	184
Rear Parking Aid	185
Front Parking Aid	187
Side Sensing System	189
Active Park Assist	191
Rear View Camera - Vehicles With: Parking Aid Camera	193
180 Degree Camera	196

Table of Contents

Cruise Control

Principle of Operation	198
Using Cruise Control	198
Using Adaptive Cruise Control	199

Driving Aids

Speed Limiter	206
Driver Alert	207
Lane Keeping System	208
Blind Spot Information System	212
Cross Traffic Alert	216
Eco	219
Steering	220
Pre-Collision Assist	221
Front View Camera	225
Drive Control	226

Load Carrying

Roof Racks and Load Carriers - Bus	228
Roof Racks and Load Carriers - Van	228
Load Retaining Fixtures	228
Load Limit	229

Towing

Towing a Trailer	234
Recommended Towing Weights - Chassis Cab/Crew Van/Cutaway/Van	235
Recommended Towing Weights - M2 Bus	237
Essential Towing Checks	239
Towing the Vehicle on Four Wheels	245

Driving Hints

Reduced Engine Performance	246
Economical Driving	246
Cold Weather Precautions	246
Breaking-In	247
Driving Through Water	247

Floor Mats	247
------------------	-----

Roadside Emergencies

Roadside Assistance	249
Hazard Flashers	250
Emergency Exit - M2 Bus	250
Fuel Shutoff	250
Jump Starting the Vehicle	251
Transporting the Vehicle	253
Towing Points	254

Crash and Breakdown Information

Post-Crash Alert System	255
-------------------------------	-----

Customer Assistance

Ford Credit	256
Getting the Services You Need	256
In California (U.S. Only)	257
The Better Business Bureau (BBB) Auto Line Program (U.S. Only)	258
Utilizing the Mediation/Arbitration Program (Canada Only)	259
Getting Assistance Outside the U.S. and Canada	259
Ordering Additional Owner's Literature	261
Reporting Safety Defects (U.S. Only)	261
Reporting Safety Defects (Canada Only)	262

Fuses

Fuse Box Locations	263
Fuse Specification Chart	264
Changing a Fuse	276

Maintenance

General Information	278
Opening and Closing the Hood	278

Table of Contents

Under Hood Overview - 3.5L Duratec	280
Under Hood Overview - 3.5L EcoBoost™	281
Engine Oil Dipstick - 3.5L Duratec	282
Engine Oil Dipstick - 3.5L EcoBoost™	282
Engine Oil Check	282
Changing the Engine Oil and Oil Filter	283
Oil Change Indicator Reset	284
Changing the Engine Air Filter	284
Engine Cooling Fan	285
Engine Coolant Check	285
Automatic Transmission Fluid Check	289
Brake Fluid Check	290
Changing the 12V Battery	290
Adjusting the Headlamps	293
Washer Fluid Check	294
Fuel Filter	294
Checking the Wiper Blades	294
Changing the Front Wiper Blades	295
Removing a Headlamp	295
Changing a Bulb	296
Drive Belt Routing - Vehicles With: Dual Generators	301
Drive Belt Routing - Vehicles With: Single Generator	301
Vehicle Care	
Cleaning Products	302
Cleaning the Exterior	303
Waxing	304
Cleaning the Engine	304
Cleaning the Windows and Wiper Blades	305
Cleaning the Interior	305
Cleaning the Instrument Panel and Instrument Cluster Lens	307
Repairing Minor Paint Damage	308

Cleaning the Wheels	308
Vehicle Storage	308
Body Styling Kits	310

Wheels and Tires

General Information	311
Tire Sealant and Inflator Kit	312
Tire Care	315
Using Winter Tires	332
Using Snow Chains	333
Tire Pressure Monitoring System	334
Changing a Road Wheel	339
Lug Nuts	350

Capacities and Specifications

Engine Specifications - 3.5L Duratec	352
Engine Specifications - 3.5L EcoBoost™	353
Motorcraft Parts - 3.5L Duratec	354
Motorcraft Parts - 3.5L EcoBoost™	355
Vehicle Identification Number	356
Transmission Code Designation	357
Capacities and Specifications - 3.5L Duratec	358
Capacities and Specifications - 3.5L EcoBoost™	363
Bulb Specification Chart	369

Connected Vehicle

What Is a Connected Vehicle	371
Connected Vehicle Requirements	371
Connected Vehicle Limitations	371
Connecting the Vehicle to a Mobile Network	371
Connecting the Vehicle to a Wi-Fi Network	372
Connected Vehicle – Troubleshooting - Vehicles With: Modem	372

Table of Contents

Connected Vehicle – Troubleshooting – Vehicles With: SYNC/SYNC 3	373	Settings	427
		SYNC™ 3 Troubleshooting	429
Vehicle Wi-Fi Hotspot		Accessories	
Creating a Vehicle Wi-Fi Hotspot	375	Accessories	442
Changing the Vehicle Wi-Fi Hotspot Name or Password	375	Auxiliary Switches	443
Audio System		Ford Protect	
General Information	376	Ford Protect	444
Audio Unit - Vehicles Without: SYNC	376	Scheduled Maintenance	
Audio Unit - Vehicles With: SYNC 3	378	General Maintenance Information	446
AM/FM Radio - Vehicles Without: SYNC	379	Normal Scheduled Maintenance	449
Audio Unit Clock and Date Displays - Vehicles Without: SYNC	380	Special Operating Conditions Scheduled Maintenance	451
Connecting a Bluetooth® Device - Vehicles Without: SYNC	380	Customer Information	
Streaming Bluetooth Audio - Vehicles Without: SYNC	380	Type Approvals	454
Playing Media From a USB Device - Vehicles Without: SYNC	381	California Proposition 65 - United States of America	458
USB Port	381	Perchlorate	459
Using Voice Recognition	382	Replacement Parts Recommendation	459
		Mobile Communications Equipment	460
		Export Unique Options	460
SYNC™		Appendices	
General Information	383	Electromagnetic Compatibility	461
Using Voice Recognition	384	End User License Agreement	464
Using SYNC™ With Your Phone	386	Declaration of Conformity	489
SYNC™ Applications and Services	387		
Using SYNC™ With Your Media Player	390		
SYNC™ Troubleshooting	391		
SYNC™ 3			
General Information	400		
Using Voice Recognition	402		
Entertainment	408		
Phone	418		
Navigation	419		
Apps	425		

Introduction

ABOUT THIS MANUAL

Thank you for choosing Ford. We recommend that you take some time to get to know your vehicle by reading this manual. The more that you know about your vehicle, the greater the safety and pleasure you will get from driving it.



WARNING: Driving while distracted can result in loss of vehicle control, crash and injury. We strongly recommend that you use extreme caution when using any device that may take your focus off the road. Your primary responsibility is the safe operation of your vehicle. We recommend against the use of any hand-held device while driving and encourage the use of voice-operated systems when possible. Make sure you are aware of all applicable local laws that may affect the use of electronic devices while driving.

Note: This manual describes product features and options available throughout the range of available models, sometimes even before they are generally available. It may describe options not fitted to the vehicle you have purchased.

Note: Some of the illustrations in this manual may show features as used in different models, so may appear different to you on your vehicle.

Note: Always use and operate your vehicle in line with all applicable laws and regulations.

Note: Pass on this manual when selling your vehicle. It is an integral part of your vehicle.

Note: Either Ford Motor Company or an authorized Ford dealer may have originally sold this incomplete vehicle to a vehicle modifier who upfitted it. As a result, it may have different options and features than described in this manual.

This manual may qualify the location of a component as left-hand side or right-hand side. The side is determined when facing forward in the seat.

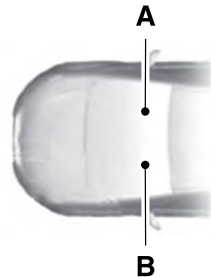

- A Right-hand side.
- B Left-hand side.

SYMBOLS GLOSSARY

These are some of the symbols you may see on your vehicle.



Air conditioning system



Air conditioning system lubricant type



Anti-lock braking system



Avoid smoking, flames or sparks

Introduction



Battery



Engine oil



Battery acid



Explosive gas



Brake fluid - non petroleum based



Fan warning



Brake system



Fasten seatbelt



Brake system



Flammable



Cabin air filter



Front airbag



Check fuel cap



Front fog lamps



Child safety door lock or unlock



Fuel pump reset



Child seat lower anchor



Fuse compartment



Child seat tether anchor



Hazard flashers



Cruise control



Heated rear window



Do not open when hot



Windshield defrosting system



Engine air filter



Interior luggage compartment release



Engine coolant



Jack



Engine coolant temperature



Keep out of reach of children

Introduction



Lighting control



Low tire pressure warning



Maintain correct fluid level



Note operating instructions



Horn control



Panic alarm



Parking aid



Parking brake



Power steering fluid



Power windows front/rear



Power window lockout



Requires registered technician



Safety alert



See Owner's Manual



See Service Manual



Service engine soon



Passenger airbag activated



Passenger airbag deactivated



Side airbag



Shield the eyes



Stability control



Hill descent control



Trail control



Windshield wiping system



Windshield wash and wipe

SPECIAL NOTICES

New Vehicle Limited Warranty

For a detailed description of what is covered and what is not covered by your vehicle's New Vehicle Limited Warranty, refer to the Warranty Manual that is provided to you along with your Owner's Manual.

Special Instructions

For your added safety, your vehicle is fitted with sophisticated electronic controls.

Introduction



WARNING: You risk death or serious injury to yourself and others if you do not follow the instruction highlighted by the warning symbol. Failure to follow the specific warnings and instructions could result in personal injury.



WARNING: Never place front seat mounted rear-facing child or infant seats in front of an active passenger airbag.

On Board Diagnostics Data Link Connector



WARNING: Do not connect wireless plug-in devices to the data link connector. Unauthorized third parties could gain access to vehicle data and impair the performance of safety related systems. Only allow repair facilities that follow our service and repair instructions to connect their equipment to the data link connector.

Your vehicle has an OBD Data Link Connector (DLC) that is used in conjunction with a diagnostic scan tool for vehicle diagnostics, repairs and reprogramming services. Installing an aftermarket device that uses the DLC during normal driving for purposes such as remote insurance company monitoring, transmission of vehicle data to other devices or entities, or altering the performance of the vehicle, may cause interference with or even damage to vehicle systems. We do not recommend or endorse the use of aftermarket plug-in devices unless approved by Ford. The vehicle Warranty will not cover damage caused by an aftermarket plug-in device.

Notice to Owners of Pickup Trucks and Utility Type Vehicles



WARNING: Utility vehicles have a significantly higher rollover rate than other types of vehicles.

Before you drive your vehicle, please read this Owner's Manual carefully. Your vehicle is not a passenger car. As with other vehicles of this type, failure to operate this vehicle correctly may result in loss of vehicle control, vehicle rollover, personal injury or death.

Using Your Vehicle With a Snowplow

Do not use this vehicle for snowplowing.

Your vehicle is not equipped with a snowplowing package.

Using Your Vehicle as an Ambulance

If your light truck is equipped with the Ford Ambulance Preparation Package, it may be utilized as an ambulance. Ford urges ambulance manufacturers to follow the recommendations of the Ford Incomplete Vehicle Manual, Ford Truck Body Builder's Layout Book and the Qualified Vehicle Modifiers (QVM) Guidelines as well as pertinent supplements.

For additional information, please contact the Truck Body Builders Advisory Service:

Web Address
www.fleet.ford.com/truckbbas

You can also call us at
1-877-840-4338.

Introduction

Other Vehicle Modifications

If converting or modifying your vehicle from production specification, refer to the Truck Body Builder Advisory website:

Web Address
www.fleet.ford.com/truckbbas

Data Privacy



WARNING: Do not connect wireless plug-in devices to the data link connector. Unauthorized third parties could gain access to vehicle data and impair the performance of safety related systems. Only allow repair facilities that follow our service and repair instructions to connect their equipment to the data link connector.

We respect your privacy and are committed to protecting it. The information contained in this manual was correct at the time of publication, but as technology rapidly changes, we recommend that you visit the local Ford website for the latest information.

Your vehicle has electronic control units that have data recording functionality and the ability to permanently or temporarily store data. This data could include information on the condition and status of your vehicle, vehicle maintenance requirements, events and malfunctions. The types of data that can be recorded are described in this section. Some of the data recorded is stored in event logs or error logs.

Note: *Error logs are reset following a service or repair.*

Note: *We may provide information in response to requests from law enforcement, other government authorities and third parties acting with lawful authority or through a legal process. Such information could be used by them in legal proceedings.*

Data recorded includes, for example:

- Operating states of system components, for example fuel level, tire pressure and battery charge level.
- Vehicle and component status, for example wheel speed, deceleration, lateral acceleration and seatbelt status.

- Events or errors in essential systems, for example headlamps and brakes.
- System responses to driving situations, for example airbag deployment and stability control.
- Environmental conditions, for example temperature.

Some of this data, when used in combination with other information, for example an accident report, damage to a vehicle or eyewitness statements, could be associated with a specific person.

Services That We Provide

If you use our services, we collect and use data, for example account information, vehicle location and driving characteristics, that could identify you. We transmit this data through a dedicated, protected connection. We only collect and use data to enable your use of our services to which you have subscribed, with your consent or where permitted by law. For additional information, see the terms and conditions of the services to which you have subscribed.

For additional information about our privacy policy, refer to the local Ford website.

Services That Third Parties Provide

We recommend that you review the terms and conditions and data privacy information for any services equipped with your vehicle or to which you subscribe. We take no responsibility for services that third parties provide.

Data Privacy

SERVICE DATA

Service data recorders in your vehicle are capable of collecting and storing diagnostic information about your vehicle. This potentially includes information about the performance or status of various systems and modules in the vehicle, such as engine, throttle, steering or brake systems. In order to properly diagnose and service your vehicle, Ford Motor Company (Ford of Canada in Canada), and service and repair facilities may access or share among them vehicle diagnostic information received through a direct connection to your vehicle when diagnosing or servicing your vehicle. Additionally, Ford Motor Company (Ford of Canada, in Canada) may, where permitted by law, use vehicle diagnostic information for vehicle improvement or with other information we may have about you, for example, your contact information, to offer you products or services that may interest you. Data may be provided to our service providers such as part suppliers that may help diagnose malfunctions, and who are similarly obligated to protect data. We retain this data only as long as necessary to perform these functions or to comply with law. We may provide information where required in response to official requests to law enforcement or other government authorities or third parties acting with lawful authority or court order, and such information may be used in legal proceedings. For U.S. only (if equipped), if you choose to use connected apps and services, you consent that certain diagnostic information may also be accessed electronically by Ford Motor Company and Ford authorized service facilities, and that the diagnostic information may be used to provide services to you, personalizing your experience, troubleshoot, and to improve products and services and offer you products and services that may interest

you, where permitted by law. For Canada only, for more information, please review the Ford of Canada privacy policy at www.ford.ca, including our U.S. data storage and use of service providers in other jurisdictions who may be subject to legal requirements in Canada, the United States and other countries applicable to them, for example, lawful requirements to disclose personal information to governmental authorities in those countries.

EVENT DATA

This vehicle is equipped with an event data recorder. The main purpose of an event data recorder is to record, in certain crash or near crash-like situations, such as an airbag deployment or hitting a road obstacle; this data will assist in understanding how a vehicle's systems performed. The event data recorder is designed to record data related to vehicle dynamics and safety systems for a short period of time, typically 30 seconds or less.

The event data recorder in this vehicle is designed to record such data as:

- How various systems in your vehicle were operating.
- Whether or not the driver and passenger seatbelts were buckled/fastened.
- How far (if at all) the driver was depressing the accelerator and/or the brake pedal.
- How fast the vehicle was traveling.
- Where the driver was positioning the steering wheel.

This data can help provide a better understanding of the circumstances in which crashes and injuries occur.

Data Privacy

Note: *Event data recorder data is recorded by your vehicle only if a non-trivial crash situation occurs; no data is recorded by the event data recorder under normal driving conditions and no personal data or information (for example name, gender, age, and crash location) is recorded. However, parties, such as law enforcement, could combine the event data recorder data with the type of personally identifying data routinely acquired during a crash investigation.*

To read data recorded by an event data recorder, special equipment is required, and access to the vehicle or the event data recorder is needed. In addition to the vehicle manufacturer, other parties, such as law enforcement, that have such special equipment, can read the information if they have access to the vehicle or the event data recorder.

SETTINGS DATA

Your vehicle has electronic control units that have the ability to store data based on your personalized settings. The data is stored locally in the vehicle or on devices that you connect to it, for example, a USB drive or digital music player. You can delete some of this data and also choose whether to share it through the services to which you subscribe. See **Settings** (page 427).

Comfort and Convenience Data

Data recorded includes, for example:

- Seat and steering wheel position.
- Climate control settings.
- Radio presets.

Entertainment Data

Data recorded includes, for example:

- Music, videos or album art.
- Contacts and corresponding address book entries.
- Navigation destinations.

CONNECTED VEHICLE DATA - VEHICLES WITH: MODEM



The modem has a SIM. The modem was enabled when your vehicle was built and periodically sends messages to stay connected to the cell phone network, receive automatic software updates and send vehicle-related information to us, for example diagnostic information. These messages could include information that identifies your vehicle, the SIM and the electronic serial number of the modem. Cell phone network service providers could have access to additional information, for example cell phone network tower identification. For additional information about our privacy policy, visit www.FordConnected.com or refer to your local Ford website.

Note: *The modem continues to send this information unless you disable the modem or stop the modem from sharing vehicle data by changing the modem settings. See **Connected Vehicle** (page 371).*

Note: *The service can be unavailable or interrupted for a number of reasons, for example environmental or topographical conditions and data plan coverage.*

Note: *To find out if your vehicle has a modem, visit www.FordConnected.com.*

Data Privacy

MOBILE DEVICE DATA - VEHICLES WITH: SYNC 3

If you connect a mobile device to your vehicle, you can display data from your device on the touchscreen for example, music and album art. You can share your vehicle data with mobile apps on your device through the system. See **Apps** (page 425).

The mobile apps function operates by your connected device sending data to us in the United States. The data is encrypted and includes, for example, the vehicle identification number of your vehicle, the SYNC module serial number, odometer, enabled apps, usage statistics and debugging information. We retain it only as long as necessary to provide the service, to troubleshoot, for continuous improvement and to offer you products and services that may be of interest to you according to your preferences and where allowed by law.

If you connect a cell phone to the system, the system creates a profile that links to that cell phone. The cell phone profile enables more mobile features and efficient operation. The profile contains, for example data from your phonebook, read and unread text messages and call history, including history of calls when your cell phone was not connected to the system.

If you connect a media device, the system creates and retains a media device index of supported media content. The system also records a short diagnostic log of approximately 10 minutes of all recent system activity.

The cell phone profile, media device index and diagnostic log remain in your vehicle unless you delete them and are generally accessible only in your vehicle when you connect your cell phone or media device. If you no longer plan to use the system or your vehicle, we recommend you use the master reset function to erase the stored information. See **Settings** (page 427).

System data cannot be accessed without special equipment and access to your vehicle's module.

For additional information about our privacy policy, refer to the local Ford website.

Note: *To find out if your vehicle has connectivity technology, visit www.FordConnected.com.*

EMERGENCY CALL SYSTEM DATA

When the emergency call system is active, it may disclose to emergency services that your vehicle has been in a crash involving the deployment of an airbag or activation of the fuel pump shut-off. Certain versions or updates to the emergency call system may also be capable of electronically or verbally disclosing to emergency services operators your vehicle location or other details about your vehicle or crash to assist emergency services operators to provide the most appropriate emergency services. If you do not want to disclose this information, do not activate the emergency call system.

Note: *You cannot deactivate emergency call systems that are required by law.*

Environment

PROTECTING THE ENVIRONMENT

You should play your part in protecting the environment. Correct vehicle usage and the authorized disposal of waste, cleaning and lubrication materials are significant steps toward this aim.

For additional information about our sustainability progress and initiatives, visit www.sustainability.ford.com.

Child Safety

GENERAL INFORMATION

See the following sections for directions on how to properly use safety restraints for children.



WARNING: Always make sure your child is secured properly in a device that is appropriate for their height, age and weight. Child safety restraints must be bought separately from your vehicle. Failure to follow these instructions and guidelines may result in an increased risk of serious injury or death to your child.



WARNING: All children are shaped differently. The National Highway Traffic Safety Administration and other safety organizations, base their recommendations for child restraints on probable child height, age and weight thresholds, or on the minimum requirements of the law. We recommend that you check with a NHTSA Certified Child Passenger Safety Technician

(CPST) to make sure that you properly install the child restraint in your vehicle and that you consult your pediatrician to make sure you have a child restraint appropriate for your child. To locate a child restraint fitting station and CPST, contact NHTSA toll free at 1-888-327-4236 or go to www.nhtsa.dot.gov. In Canada, contact Transport Canada toll free at 1-800-333-0371 or go to www.tc.gc.ca to find a Child Car Seat Clinic in your area. Failure to properly restrain children in child restraints made especially for their height, age and weight, may result in an increased risk of serious injury or death to your child.



WARNING: On hot days, the temperature inside the vehicle can rise very quickly. Exposure of people or animals to these high temperatures for even a short time can cause death or serious heat related injuries, including brain damage. Small children are particularly at risk.

Child Safety

Recommendations for Safety Restraints for Children

Child	Child Size, Height, Weight, or Age	Recommended Restraint Type
Infants or toddlers	Children weighing 40 lb (18 kg) or less (generally age four or younger).	Use a child restraint (sometimes called an infant carrier, convertible seat, or toddler seat).
Small children	Children who have outgrown or no longer properly fit in a child restraint (generally children who are less than 57 in (1.45 m) tall, are greater than age four and less than age 12, and between 40 lb (18 kg) and 80 lb (36 kg) and upward to 100 lb (45 kg) if recommended by your child restraint manufacturer).	Use a belt-positioning booster seat.
Larger children	Children who have outgrown or no longer properly fit in a belt-positioning booster seat (generally children who are at least 57 in (1.45 m) tall or greater than 80 lb (36 kg) or 100 lb (45 kg) if recommended by child restraint manufacturer).	Use a vehicle seatbelt having the lap belt snug and low across the hips, shoulder belt centered across the shoulder and chest, and seat backrest upright.

- You are required by law to properly use child restraints for infants and toddlers in the United States and Canada.
- Many states and provinces require that small children use approved booster seats until they reach age eight, a height of 57 in (1.45 m) tall, or 80 lb (36 kg). Check your local and state or provincial laws for specific requirements about the safety of children in your vehicle.
- When possible, always properly restrain children 12 years of age and under in a rear seating position of your vehicle. Accident statistics suggest that children are safer when properly restrained in the rear seating positions than in a front seating position.
- When installing a rear facing child restraint, adjust the vehicle seats to avoid interference between the child restraint and the vehicle seat in front of the child restraint.

Child Safety

INSTALLING CHILD RESTRAINTS

Child Safety Restraint



E142594

Use a child safety restraint (sometimes called an infant carrier, convertible seat, or toddler seat) for infants, toddlers, or children weighing 40 lb (18 kg) or less (generally age four or younger).

Using Lap and Shoulder Belts



WARNING: Do not place a rearward facing child restraint in front of an active airbag. Failure to follow this instruction could result in personal injury or death.



WARNING: Properly secure children 12 years old and under in a rear seating position whenever possible. If you are unable to properly secure all children in a rear seating position, properly secure the largest child on the front seat. If you must use a forward facing child restraint on the front seat, move the seat as far back as possible. Failure to follow these instructions could result in personal injury or death.



WARNING: Depending on where you secure a child restraint, and depending on the child restraint design, you may block access to certain seatbelt buckle assemblies and LATCH lower anchors, rendering those features potentially unusable. To avoid risk of injury, make sure occupants only use seating positions where they are able to be properly restrained.

When installing a child safety restraint with combination lap and shoulder belts:

- Use the correct seatbelt buckle for that seating position.
- Insert the belt tongue into the correct buckle until you hear a distinct click and feel it latch. Make sure the tongue is securely fastened in the buckle.
- Keep the buckle release button pointing up and away from the safety restraint, with the tongue between the child restraint and the release button, to prevent accidental unbuckling.
- Place the vehicle seat upon which the child restraint will be installed in the upright position.
- Put the seatbelt in the automatic locking mode. See Step 5. Your vehicle does not require the use of a locking clip.

Perform the following steps when installing the child restraint with combination lap and shoulder belts:

Note: *Although the child restraint illustrated is a forward facing child restraint, the steps are the same for installing a rearward facing child restraint.*

Child Safety



1. Position the child safety restraint in a seat with a combination lap and shoulder belt.



2. Pull down on the shoulder belt and then grasp the shoulder belt and lap belt together.



3. While holding the shoulder and lap belt portions together, route the tongue through the child restraint according to the child restraint manufacturer's instructions. Make sure the belt webbing is not twisted.

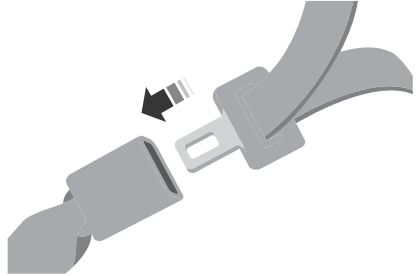

4. Insert the belt tongue into the correct buckle (the buckle closest to the direction the tongue is coming from) for that seating position until you hear a distinct click and feel the latch engage. Make sure the tongue is latched securely by pulling on it.



5. To put the retractor in the automatic locking mode, grasp the shoulder portion of the belt and pull downward until all of the belt is pulled out.

Note: *The automatic locking mode is available on the front passenger and rear seats.*

Child Safety

6. Allow the belt to retract to remove slack. The belt clicks as it retracts to indicate it is in the automatic locking mode.
7. Try to pull the belt out of the retractor to make sure the retractor is in the automatic locking mode (you should not be able to pull more belt out). If the retractor is not locked, unbuckle the belt and repeat Steps 5 and 6.

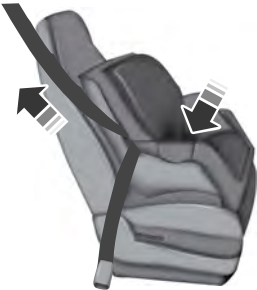

8. Remove remaining slack from the belt. Force the seat down with extra weight, for example, by pressing down or kneeling on the child restraint while pulling up on the shoulder belt. This is necessary to remove the remaining slack that exists once the extra weight of the child is added to the child restraint. It also helps to achieve the correct snugness of the child restraint to your vehicle. Sometimes, a slight lean toward the buckle helps to remove remaining slack from the belt.
9. Attach the tether strap (if the child restraint is equipped).

10. Before placing the child in the seat, forcibly move the seat forward and back to make sure the seat is securely held in place. To check this, grab the seat at the belt path and attempt to move it side to side and forward and back. There should be no more than 1 in (2.5 cm) of movement for correct installation.

We recommend checking with a NHTSA Certified Child Passenger Safety Technician to make certain the child restraint is correctly installed. In Canada, check with Transport Canada for referral to a Child Car Seat Clinic.

Using Lower Anchors and Tethers for Children (LATCH)

 **WARNING:** Do not attach two child safety restraints to the same anchor. In a crash, one anchor may not be strong enough to hold two child safety restraint attachments and may break, causing serious injury or death.

Child Safety



WARNING: Depending on where you secure a child restraint, and depending on the child restraint design, you may block access to certain seatbelt buckle assemblies and LATCH lower anchors, rendering those features potentially unusable. To avoid risk of injury, make sure occupants only use seating positions where they are able to be properly restrained.

LATCH compatible child safety restraints have two rigid or webbing mounted attachments that connect to the two lower anchors at the LATCH equipped seating positions in your vehicle. This type of attachment method eliminates the need to use seatbelts to attach the child restraint, however the seatbelt can still be used to attach the child restraint. For forward-facing child restraints, the top tether strap must also be attached to the correct top tether anchor, if a top tether strap has been provided with your child restraint.

The LATCH system is composed of three vehicle anchor points: two lower anchors where the seat backrest and seat cushion meet (called the seat bight) and one top tether anchor behind that seating position.

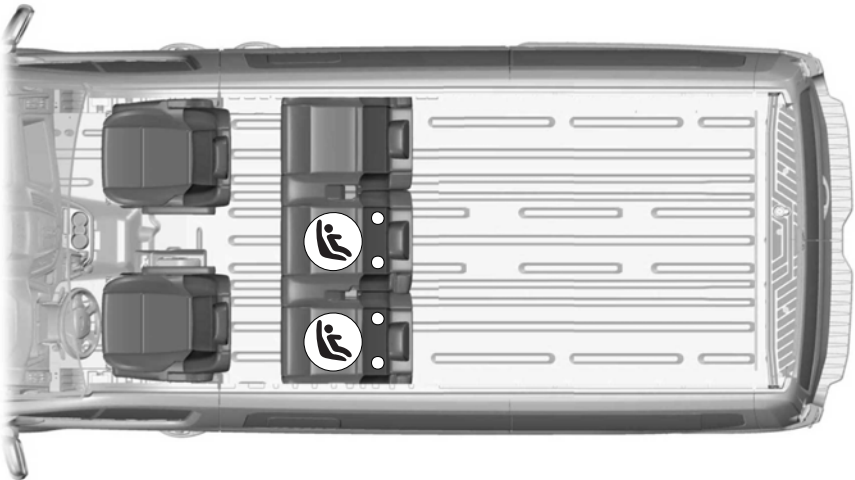

Child Safety

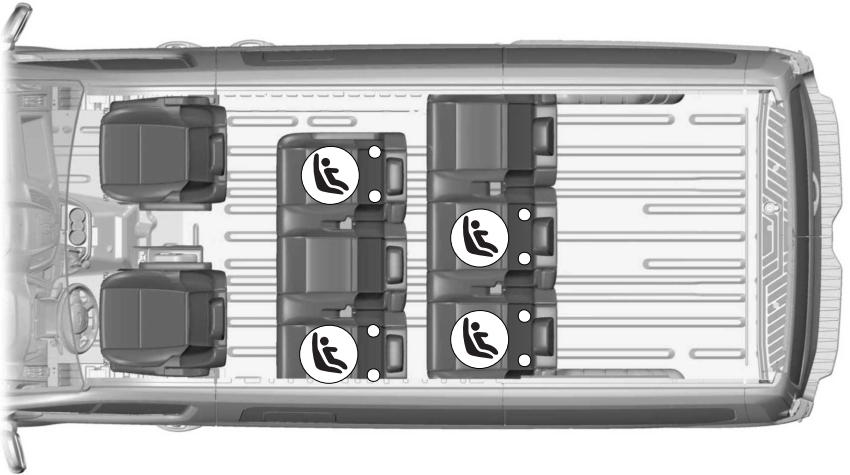

E258858

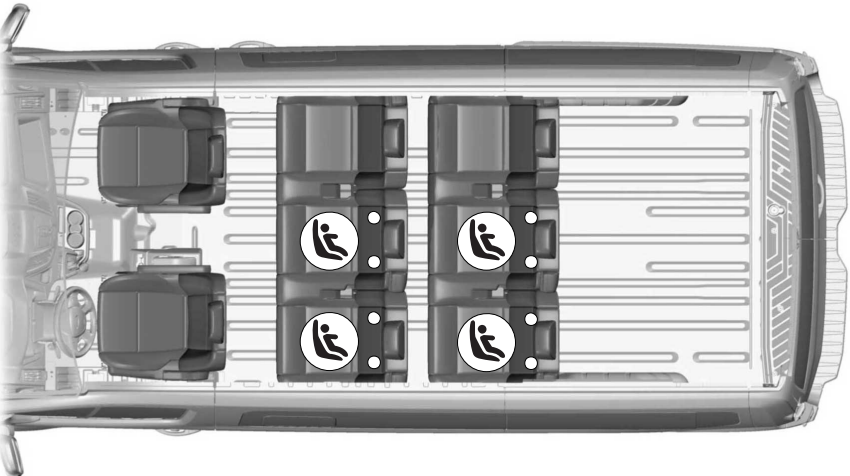

E254574

Child Safety

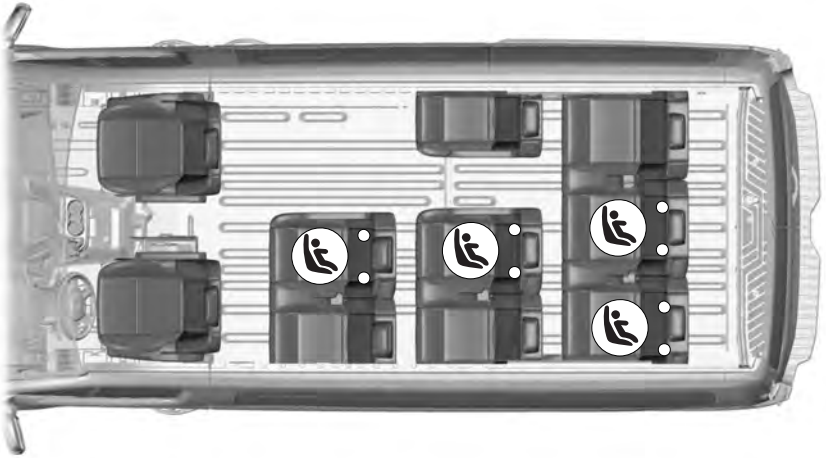

E258864

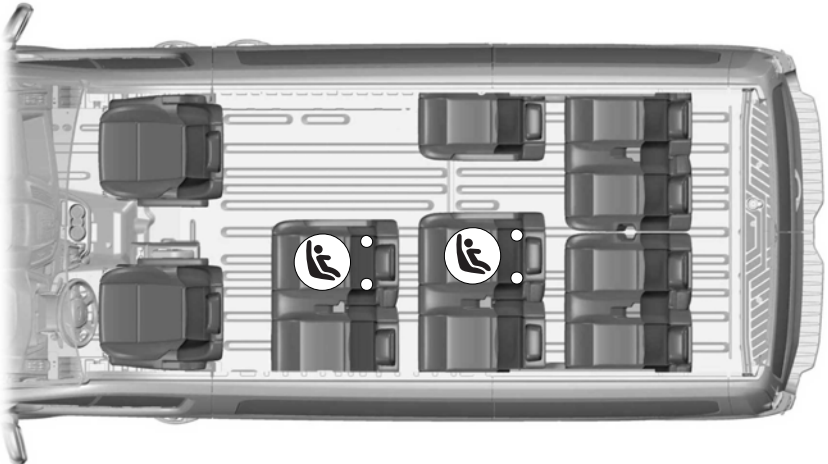

E282290

Child Safety

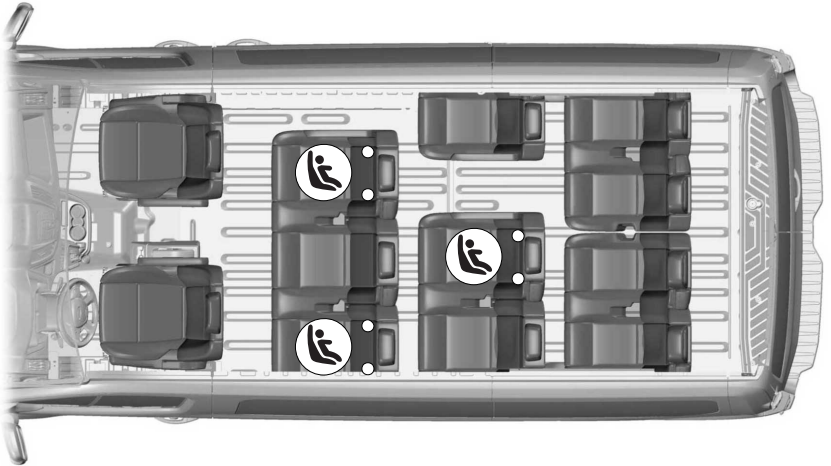

E254575

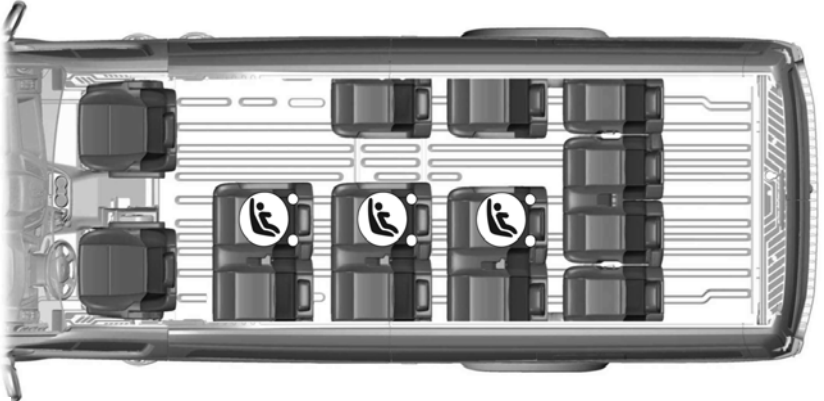

E266915

Child Safety

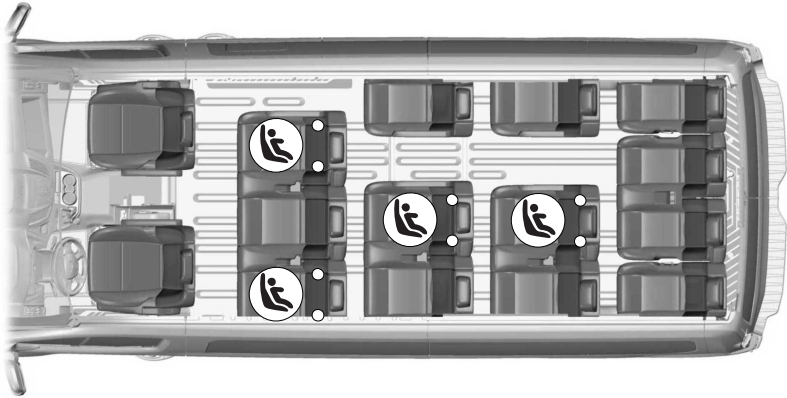

E254576

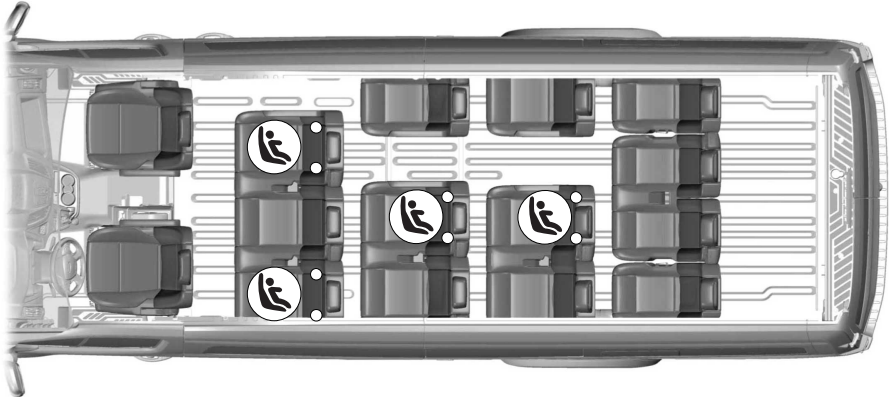

E258867

Child Safety

Your vehicle has LATCH lower anchors for child restraint installation at the seating positions marked with the child restraint symbol.

Note: In addition to those shown, other seating positions may also have LATCH lower anchor points. You can identify these with the child restraint symbol shown on those seating positions.



E177639

The LATCH anchors are at the rear section of the rear seat between the cushion and seat backrest above the symbols as shown. Follow the child restraint manufacturer's instructions to correctly install a child restraint with LATCH attachments. Follow the instructions on attaching child safety restraints with tether straps.

Attach LATCH lower attachments of the child restraint only to the anchors shown.

Use of Inboard Lower Anchors from the Outermost Seating Positions (Center Seating Use)

WARNING: The standardized spacing for LATCH lower anchors is 11 in (280 mm) center to center. Do not use LATCH lower anchors for the center seating position unless the child restraint manufacturer's instructions permit and specify using anchors spaced at least as far apart as those in this vehicle.

Do not attach a child restraint to any lower anchor if an adjacent child restraint is attached to that anchor.

Each time you use the safety restraint, check that the seat is correctly attached to the lower anchors and tether anchor, if applicable. Tug the child restraint from side to side and forward and back where it is secured to your vehicle. The seat should move less than 1 in (2.5 cm) when you do this for a correct installation.

If the safety restraint is not anchored correctly, the risk of a child being injured in a crash greatly increases.

Combining Seatbelt and LATCH Lower Anchors for Attaching Child Safety Restraints

When used in combination, either the seatbelt or the LATCH lower anchors may be attached first, provided a correct installation is achieved. Attach the tether strap afterward, if included with the child restraint.

Child Safety

Using Tether Straps



Many forward-facing child safety restraints include a tether strap which extends from the back of the child safety restraint and hooks to an anchoring point called the top tether anchor. Tether straps are available as an accessory for many older safety restraints.

Contact the manufacturer of your child restraint for information about ordering a tether strap, or to obtain a longer tether strap if the tether strap on the safety restraint does not reach the appropriate top tether anchor in your vehicle.

Once the child safety restraint has been installed using either the seatbelt, the lower anchors of the LATCH system, or both, you can attach the top tether strap.

The tether strap anchors in your vehicle are in the following positions (shown from top view):

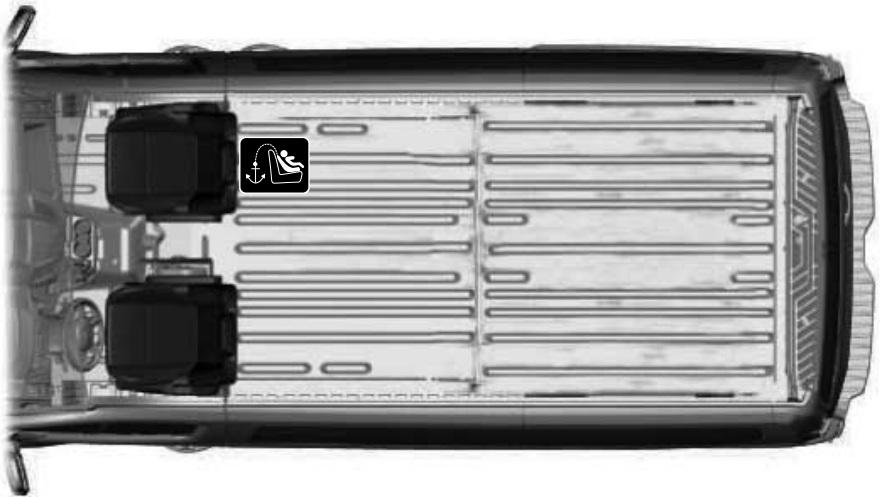

E254595

Child Safety

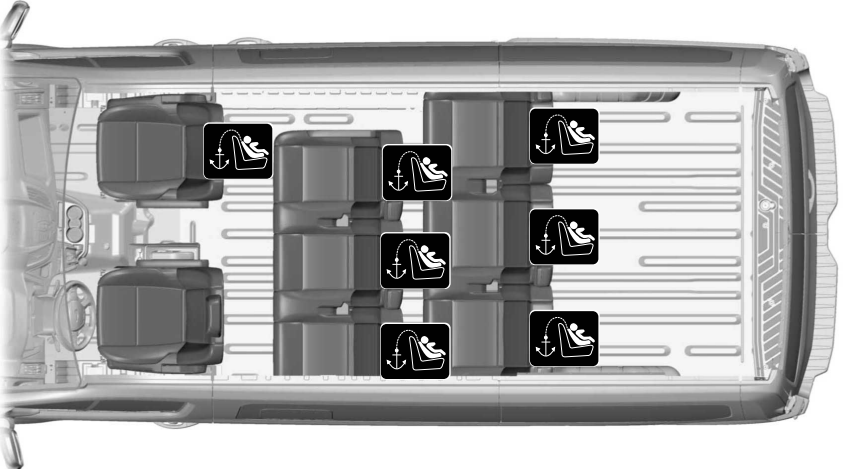
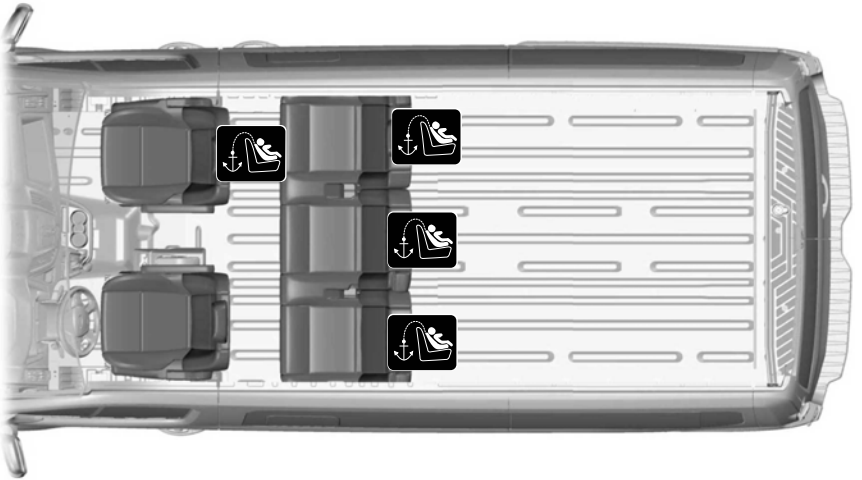

E258857

Child Safety

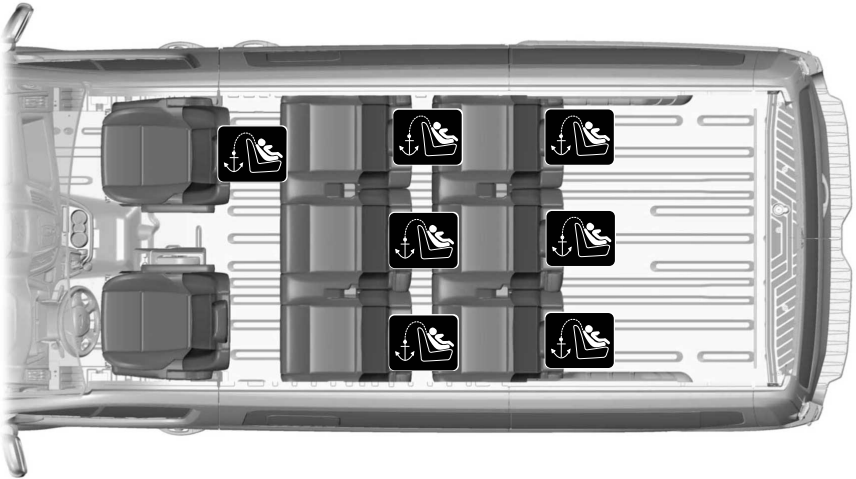

E258859

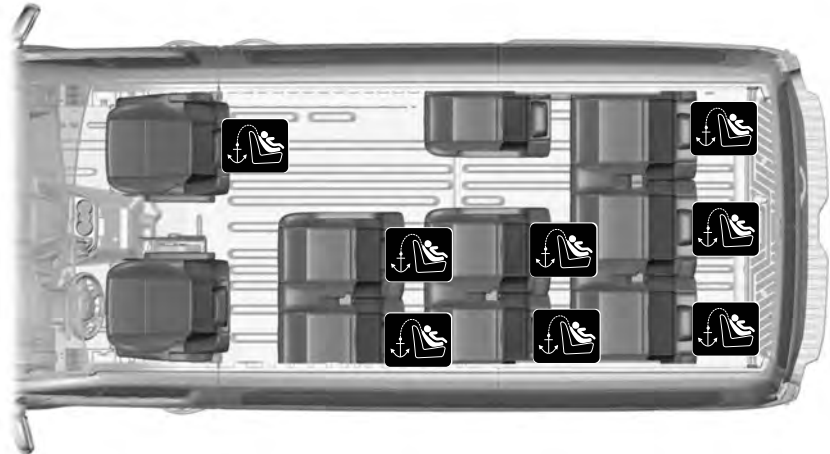

E258865

Child Safety

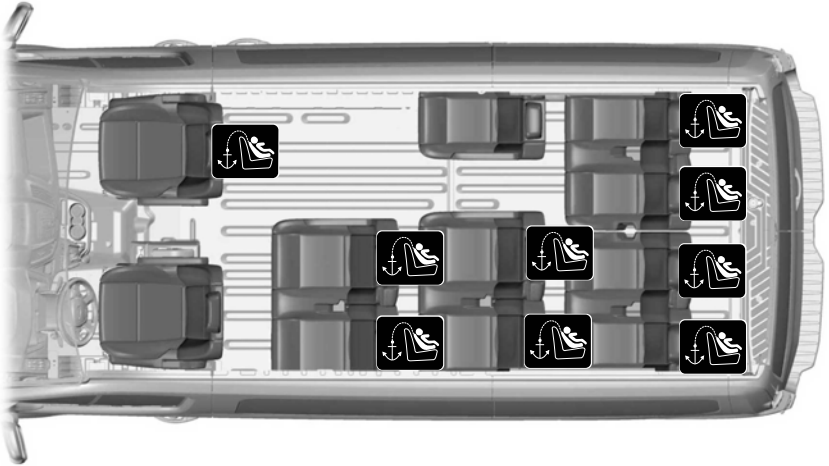

E282292

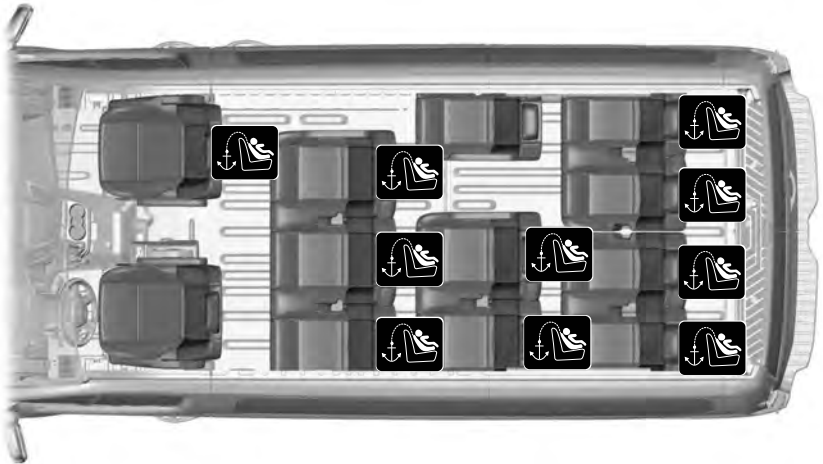

E258863

Child Safety

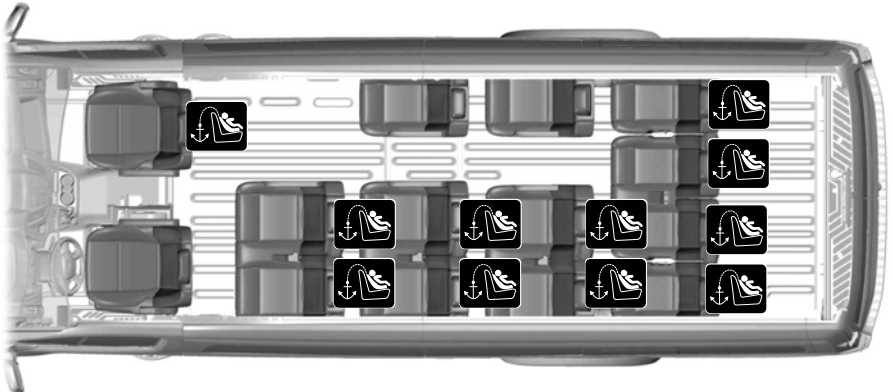

E267027



E258866

Child Safety



E258868

Perform the following steps to install a child safety restraint with tether anchors:

Note: *If you install a child restraint with rigid LATCH attachments, do not tighten the tether strap enough to lift the child restraint off your vehicle seat cushion when the child is seated in it. Keep the tether strap just snug without lifting the front of the child restraint. Keeping the child restraint just touching your vehicle seat gives the best protection in a severe crash.*

Front Passenger Seating Position

1. Adjust the front passenger seat fully forward.
2. Route the child safety restraint tether strap over the back of the seat, under the head restraint and between the head restraint posts.

Child Safety

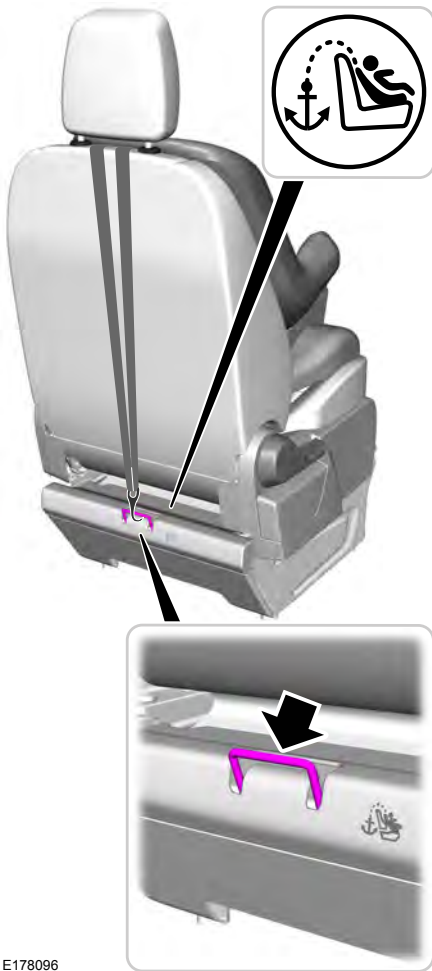

3. Locate the correct anchor on the back panel of the seat for the selected seating position. The anchors are labeled with the tether strap symbol and are partially covered by the gap panel. Pull the panel back to fully expose the anchors.
4. Clip the tether strap to the anchor as shown.
5. Adjust the front passenger seat fully rearward.
6. Tighten the child safety restraint tether strap according to the manufacturer's instructions. If your child restraint system is equipped with a tether strap, and the child restraint manufacturer recommends its use, we also recommend its use.

Rear Seats

1. Route the child safety restraint tether strap over the back of the seat, under the head restraint and between the head restraint posts.

E178096

Child Safety



E177640

2. Locate the correct anchor on the back panel of the seat for the selected seating position. The anchors are labeled with the tether strap symbol and are partially covered by the gap panel. Pull the panel back to fully expose the anchors.
3. Clip the tether strap to the anchor as shown.
4. Tighten the child safety restraint tether strap according to the manufacturer's instructions. If your child restraint system has a tether strap, and the child restraint manufacturer recommends its use, we also recommend its use.

BOOSTER SEATS

 **WARNING:** Do not put the shoulder section of the seatbelt or allow the child to put the shoulder section of the seatbelt under their arm or behind their back. Failure to follow this instruction could reduce the effectiveness of the seatbelt and increase the risk of injury or death in a crash.

Use a belt-positioning booster seat for children who have outgrown or no longer properly fit in a child safety restraint (generally children who are less than 57 in (1.45 m) tall, are greater than age 4 and less than age 12, and between 40 lb (18 kg) and 80 lb (36 kg) and upward to 100 lb (45 kg) if recommended by your child restraint manufacturer). Many state and provincial laws require that children use approved booster seats until they reach age eight, a height of 57 in (1.45 m) tall, or 80 lb (36 kg).

Booster seats should be used until you can answer YES to ALL of these questions when seated without a booster seat:

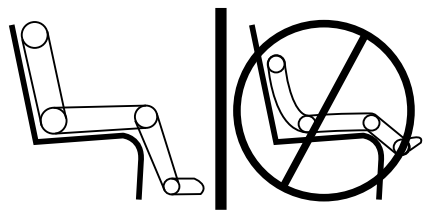

- Can the child sit all the way back against their vehicle seat backrest with knees bent comfortably at the edge of the seat cushion?
- Can the child sit without slouching?

Child Safety

- Does the lap belt rest low across the hips?
- Is the shoulder belt centered on the shoulder and chest?
- Can the child stay seated like this for the whole trip?

Always use booster seats in conjunction with your vehicle lap and shoulder belt.

Types of Booster Seats



- Backless booster seats

If your backless booster seat has a removable shield, remove the shield. If a vehicle seating position has a low seat backrest or no head restraint, a backless booster seat may place your child's head (as measured at the tops of the ears) above the top of the seat. In this case, move the backless booster to another seating position with a higher seat backrest or head restraint and lap and shoulder belts, or consider using a high back booster seat.



- High back booster seats

If, with a backless booster seat, you cannot find a seating position that adequately supports your child's head, a high back booster seat would be a better choice.

Children and booster seats vary in size and shape. Choose a booster that keeps the lap belt low and snug across the hips, never up across the stomach, and lets you adjust the shoulder belt to cross the chest and rest snugly near the center of the shoulder. The following drawings compare the ideal fit (center) to a shoulder belt uncomfortably close to the neck and a shoulder belt that could slip off the shoulder. The drawings also show how the lap belt should be low and snug across the child's hips.

Child Safety



If the booster seat slides on the vehicle seat upon which it is being used, placing a rubberized mesh sold as shelf or carpet liner under the booster seat may improve this condition. Do not introduce any item thicker than this under the booster seat. Check with the booster seat manufacturer's instructions.

CHILD RESTRAINT POSITIONING



WARNING: Do not place a rearward facing child restraint in front of an active airbag. Failure to follow this instruction could result in personal injury or death.



WARNING: Properly secure children 12 years old and under in a rear seating position whenever possible. If you are unable to properly secure all children in a rear seating position, properly secure the largest child on the front seat. If you must use a forward facing child restraint on the front seat, move the seat as far back as possible. Failure to follow these instructions could result in personal injury or death.



WARNING: Always carefully follow the instructions and warnings provided by the manufacturer of any child restraint to determine if the restraint device is appropriate for your child's size, height, weight, or age. Follow the child restraint manufacturer's instructions and

Child Safety

warnings provided for installation and use in conjunction with the instructions and warnings provided by your vehicle manufacturer. A safety seat that is improperly installed or utilized, is inappropriate for your child's height, age, or weight or does not properly fit the child may increase the risk of serious injury or death.



WARNING: Do not allow a passenger to hold a child on their lap when your vehicle is moving. Failure to follow this instruction could result in personal injury or death in the event of a sudden stop or crash.



WARNING: Do not use pillows, books or towels to boost your child's height. Failure to follow this instruction could result in personal injury or death.



WARNING: Properly secure child restraints or booster seats when they are not in use. They could become projectiles in a sudden stop or crash. Failure to follow this instruction could result in personal injury or death.



WARNING: Do not put the shoulder section of the seatbelt or allow the child to put the shoulder section of the seatbelt under their arm or behind their back. Failure to follow this instruction could reduce the effectiveness of the seatbelt and increase the risk of injury or death in a crash.



WARNING: Do not leave children or pets unattended in your vehicle. Failure to follow this instruction could result in personal injury or death.

Child Safety

Recommendations for Attaching Child Safety Restraints for Children

Restraint Type	Combined Weight of Child and Child Restraint	Use Any Attachment Method as Indicated Below by X				
		LATCH (Lower Anchors and Top Tether Anchor)	LATCH (Lower Anchors Only)	Seatbelt and Top Tether Anchor	Seatbelt and LATCH (Lower Anchors and Top Tether Anchor)	Seatbelt Only
Rear facing child restraint	Up to 65 lb (29.5 kg)		X			X
Rear facing child restraint	Over 65 lb (29.5 kg)					X
Forward facing child restraint	Up to 65 lb (29.5 kg)	X		X	X	
Forward facing child restraint	Over 65 lb (29.5 kg)			X	X	

Note: The child restraint must rest tightly against the vehicle seat upon which it is installed. It may be necessary to lift or remove the head restraint. See **Seats** (page 126).

CHILD SAFETY LOCKS

 **WARNING:** You cannot open the rear doors from inside if you have put the child safety locks on.

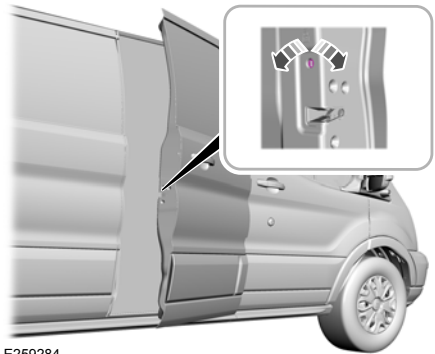

E259284

The child safety lock is on the rear side door.

Child Safety

Left-Hand Side

Turn the key counterclockwise to lock and clockwise to unlock.

Right-Hand Side

Turn the key clockwise to lock and counterclockwise to unlock.

Seatbelts

PRINCIPLE OF OPERATION

 **WARNING:** Always drive and ride with the seatback upright and the lap belt snug and low across the hips.

 **WARNING:** To reduce the risk of injury, make sure children sit where they can be properly restrained.

 **WARNING:** Never let a passenger hold a child on his or her lap while your vehicle is moving. The passenger cannot protect the child from injury in a crash which may result in serious injury or death.

 **WARNING:** All occupants of the vehicle, including the driver, should always properly wear their seatbelts, even when an airbag supplemental restraint system is provided. Failure to properly wear your seatbelt could seriously increase the risk of injury or death.

 **WARNING:** It is extremely dangerous to ride in a cargo area, inside or outside of a vehicle. In a crash, people riding in these areas are more likely to be seriously injured or killed. Do not allow people to ride in any area of your vehicle that is not equipped with seats and seatbelts. Be sure everyone in your vehicle is in a seat and using a seatbelt properly.

 **WARNING:** In a rollover crash, an unbelted person is significantly more likely to die than a person wearing a seatbelt.

 **WARNING:** Each seating position in your vehicle has a specific seatbelt assembly which is made up of one buckle and one tongue that are designed to be used as a pair. 1) Use the shoulder belt on the outside shoulder only. Never wear the shoulder belt under the arm. 2) Never swing the seatbelt around your neck over the inside shoulder. 3) Never use a single belt for more than one person.

 **WARNING:** When possible, all children 12 years old and under should be properly restrained in a rear seating position. Failure to follow this could seriously increase the risk of injury or death.

 **WARNING:** Seatbelts and seats can become hot in a vehicle that has been closed up in sunny weather; they could burn a small child. Check seat covers and buckles before you place a child anywhere near them.

 **WARNING:** Front and rear seat occupants, including pregnant women, should wear seatbelts for optimum protection in an accident.

All seating positions in this vehicle have lap and shoulder belts. All occupants of the vehicle should always properly wear their seatbelts, even when an airbag supplemental restraint system is provided.

The seatbelt system consists of:

- Lap and shoulder seatbelts.
- Shoulder seatbelt with automatic locking mode, (except driver seatbelt).
- Height adjuster at the front outboard seating positions.
- Seatbelt pretensioner at the front outboard seating positions.

Seatbelts



- Seatbelt warning light and chime.



- Crash sensors and monitoring system with readiness indicator.

The seatbelt pretensioners at the front seating positions are designed to tighten the seatbelts when activated. In frontal and near-frontal crashes, the seatbelt pretensioners may be activated alone or, if the crash is of sufficient severity, together with the front airbags. In side crashes and rollovers, the seatbelt pretensioners activate when the Safety Canopy is activated.

FASTENING THE SEATBELTS

The front outermost and rear safety restraints in your vehicle are combination lap and shoulder belts.



1. Insert the seatbelt tongue into the proper buckle (the buckle closest to the direction the tongue is coming from) until you hear a snap and feel it latch.

Note: Make sure that the seatbelt tongue is properly fastened in the seatbelt buckle.

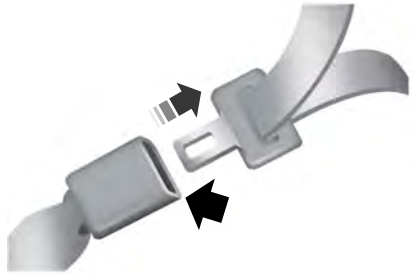

2. Press the button to release the seatbelt tongue.

Using Seatbelts During Pregnancy



WARNING: Always ride and drive with your seatback upright and properly fasten your seatbelt. Fit the lap portion of the seatbelt snugly and low across the hips. Position the shoulder portion of the seatbelt across your chest. Pregnant women must follow this practice. See the following figure.

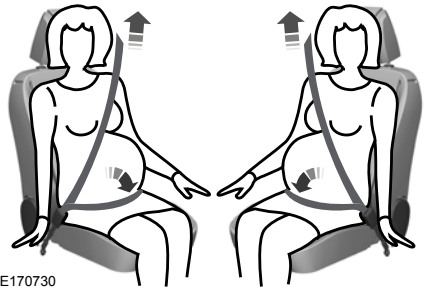

E170730

Seatbelts

Pregnant women should always wear their seatbelt. The lap belt portion of a combination lap and shoulder belt should be positioned low across the hips below the belly and worn as tight as comfort allows. The shoulder belt should be positioned to cross the middle of the shoulder and the center of the chest.

Seatbelt Locking Modes



WARNING: After a crash, have a qualified technician check all the seatbelts to make sure the seatbelts including the automatic locking retractor feature for child restraints operate properly. We recommend replacing any system that has damage or does not operate properly. Failure to do so can result in personal injury or death in the event of a sudden stop or another crash.



WARNING: You must replace the seatbelt if the automatic locking retractor or any other seatbelt function is not operating correctly. Failure to replace the seatbelt and retractor assembly could increase the risk of injury in a crash.

All seatbelts in your vehicle are combination lap and shoulder belts. The driver seatbelt has the first type of locking mode, and the front outermost passenger and rear seat seatbelts have both types of locking modes described as follows:

Vehicle Sensitive Mode

This is the normal retractor mode which allows free shoulder belt length adjustment to your movements and locking in response to vehicle movement. For example, if you brake suddenly or turn a corner sharply, or your vehicle receives an impact of approximately 5 mph (8 km/h) or more, the combination seatbelts lock to help reduce forward movement of the driver and passengers.

In addition, the retractor is designed to lock if you pull the webbing out too quickly. If the seatbelt retractor locks, slowly lower the height adjuster to allow the seatbelt to retract. If the retractor does not unlock, pull the seatbelt out slowly then feed a small length of webbing back toward the stowed position. For rear seatbelts, recline the rear seat backrest or push the seat backrest cushion away from the seatbelt. Feed a small length of webbing back toward the stowed position.

Automatic Locking Mode

In this mode, the shoulder belt automatically pre-locks. The seatbelt still retracts to remove any slack in the shoulder belt. The automatic locking mode is not available on the driver seatbelt.

Using Automatic Locking Mode

You should use automatic locking mode when a child safety seat, except a booster, is on the front passenger seat or rear seat. Children 12 years old and under should be correctly restrained in a rear seating position whenever possible. See **Child Safety** (page 19).

Seatbelts



1. Buckle the combination lap and shoulder belt.
2. Grasp the shoulder portion and pull downward until you pull the entire seatbelt out.
3. Let the seatbelt retract.

Note: As the seatbelt retracts, you will hear a clicking sound. This indicates the seatbelt is now in the automatic locking mode.

Disengaging Automatic Locking Mode

Unbuckle the combination lap and shoulder belt and allow it to retract completely to disengage the automatic locking mode and return the seatbelt to the vehicle sensitive mode.

SEATBELT HEIGHT ADJUSTMENT



WARNING: Position the seatbelt height adjuster so that the seatbelt rests across the middle of your shoulder. Failure to adjust the seatbelt correctly could reduce its effectiveness and increase the risk of injury in a crash.

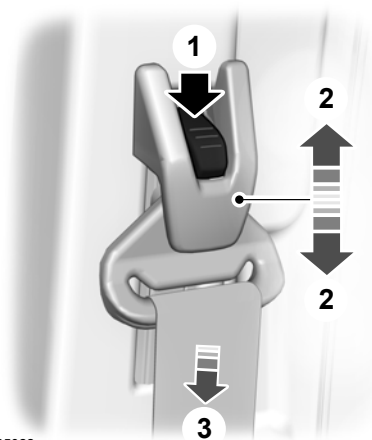

E165022

1. Press the button.
2. Slide the height adjuster up or down.
3. Release the button and pull down on the height adjuster to make sure it is locked in place.

SEATBELT WARNING LAMP AND INDICATOR CHIME



This lamp illuminates and an indicator chime will sound if the driver seatbelt has not been fastened when the vehicle's ignition is turned on.

Seatbelts

Conditions of operation

If	Then
The driver seatbelt is not buckled before the ignition switch is turned to the on position...	The seatbelt warning lamp illuminates and the indicator chime sounds for a few seconds.
The driver seatbelt is buckled while the warning lamp is illuminated and the indicator chime is sounding...	The seatbelt warning lamp and indicator chime turn off.
The driver seatbelt is buckled before the ignition switch is turned to the on position...	The seatbelt warning lamp and indicator chime remain off.

SEATBELT REMINDER

Belt-Minder™

This feature supplements the safety belt warning function by providing additional reminders that intermittently sound a tone and illuminate the safety belt warning light when you are in the driver seat or you have a front seat passenger and a safety belt is unbuckled.

The system uses information from the front passenger sensing system to determine if a front seat passenger is present and therefore potentially in need of a warning. To avoid activating the Belt-Minder feature for objects you place in the front passenger seat, only the front seat passengers receive warnings as determined by the front passenger sensing system.

If the Belt-Minder warnings expire (warnings for about five minutes) for one passenger (driver or front passenger), the other passenger can still cause the Belt-Minder feature to turn on.

Seatbelts

If...	Then...
You and the front seat passenger buckle your safety belts before you switch the ignition on or less than 1-2 minutes elapse after you switch the ignition on...	The Belt-Minder feature will not activate.
You or the front seat passenger do not buckle your safety belts before your vehicle reaches at least 6 mph (9.7 km/h) and 1-2 minutes elapse after you switch the ignition on...	The Belt-Minder feature activates, the safety belt warning light illuminates and a warning tone sounds for 6 seconds every 25 seconds, repeating for about 5 minutes or until you and the front seat passenger buckle your safety belts.
The safety belt for the driver or front passenger is unbuckled for about 1 minute while the vehicle is traveling at least 6 mph (9.7 km/h) and more than 1-2 minutes elapse after you switch the ignition on...	The Belt-Minder feature activates, the safety belt warning light illuminates and a warning tone sounds for 6 seconds every 25 seconds, repeating for about 5 minutes or until you and the front seat passenger buckle your safety belts.

Deactivating and Activating the Belt-Minder Feature



WARNING: While the system allows you to deactivate it, this system is designed to improve your chances of being safely belted and surviving an accident. We recommend you leave the system activated for yourself and others who may use your vehicle.

Note: *The driver and front passenger warnings switch on and off independently. When you perform this procedure for one seating position, do not buckle the other position as this will terminate the process.*

Read Steps 1 - 4 thoroughly before proceeding with the programming procedure.

Before following the procedure, make sure that:

- The parking brake is set.
- The transmission is in park (P).

- The ignition is off.
 - The driver and front passenger safety belts are unbuckled.
1. Switch the ignition on. Do not start the engine.
 2. Wait until the safety belt warning light turns off (about one minute). After Step 2, wait an additional five seconds before proceeding with Step 3. Once you start Step 3, you must complete the procedure within 60 seconds.
 3. For the seating position you are switching off, buckle then unbuckle the safety belt three times at a moderate speed, ending in the unbuckled state. After Step 3, the safety belt warning light turns on.
 4. While the safety belt warning light is on, buckle and then unbuckle the safety belt. After Step 4, the safety belt warning light flashes for confirmation.

Seatbelts

- This will switch the feature off for that seating position if it is currently on.
- This will switch the feature on for that seating position if it is currently off.

CHILD RESTRAINT AND SEATBELT MAINTENANCE

Inspect the vehicle seatbelts and child safety seat systems periodically to make sure they work properly and are not damaged. Inspect the vehicle and child restraint seatbelts to make sure there are no nicks, tears or cuts. Replace if necessary. All vehicle seatbelt assemblies, including retractors, buckles, front seatbelt buckle assemblies, buckle support assemblies (slide bar-if equipped), shoulder belt height adjusters (if equipped), shoulder belt guide on seat backrest (if equipped), child safety seat LATCH and tether anchors, and attaching hardware, should be inspected after a crash. Read the child restraint manufacturer's instructions for additional inspection and maintenance information specific to the child restraint.

We recommend that all seatbelt assemblies in use in vehicles involved in a crash be replaced. However, if the crash was minor and an authorized dealer finds that the belts do not show damage and continue to operate properly, they do not need to be replaced. Seatbelt assemblies not in use during a crash should also be inspected and replaced if either damage or improper operation is noted.

Properly care for seatbelts.

SEATBELT EXTENSIONS



WARNING: Persons who fit into the vehicle's seatbelt should not use an extension. Unnecessary use could result in serious personal injury in the event of a crash.



WARNING: Only use extensions provided free of charge by our dealers. The dealer will provide an extension designed specifically for this vehicle, model year and seating position. The use of an extension intended for another vehicle, model year or seating position may not offer you the full protection of your vehicle's seatbelt restraint system.



WARNING: Never use seatbelt extensions to install child restraints.



WARNING: Do not use a seatbelt extension with an inflatable seatbelt.





WARNING: Do not use extensions to change the way the seatbelt fits across the torso, over the lap or to make the seatbelt buckle easier to reach.

If, because of body size or driving position, it is not possible to properly fasten the seatbelt over your lap and shoulder, an extension that is compatible with the seatbelts is available free of charge from our dealers. Only use our seatbelt extensions made by the original equipment seatbelt manufacturer with our seatbelts. Ask your authorized dealer if your extension is compatible with your vehicle restraint system.

Supplementary Restraints System

PRINCIPLE OF OPERATION

 **WARNING:** Airbags do not inflate slowly or gently, and the risk of injury from a deploying airbag is the greatest close to the trim covering the airbag module.

 **WARNING:** All occupants of your vehicle, including the driver, should always properly wear their seatbelts, even when an airbag supplemental restraint system is provided. Failure to properly wear your seatbelt could seriously increase the risk of injury or death.

 **WARNING:** Even with advanced restraints systems, properly restrain children 12 and under in a rear seating position. Failure to follow this could seriously increase the risk of injury or death.

 **WARNING:** Do not place your arms on the airbag cover or through the steering wheel. Failure to follow this instruction could result in personal injury.

 **WARNING:** Keep the areas in front of the airbags free from obstruction. Do not affix anything to or over the airbag covers. Objects could become projectiles during airbag deployment or in a sudden stop. Failure to follow this instruction could result in personal injury or death.

 **WARNING:** Airbags can kill or injure a child in a child restraint. Never place a rear-facing child restraint in front of an active airbag. If you must use a forward-facing child restraint in the front seat, move the seat upon which the child restraint is installed all the way back.

 **WARNING:** Do not attempt to service, repair, or modify the supplementary restraint system or associated components. Failure to follow this instruction could result in personal injury or death.

 **WARNING:** Several airbag system components get hot after inflation. To reduce the risk of injury, do not touch them after inflation.

 **WARNING:** If a supplementary restraint system component has deployed, it will not function again. Have the system and associated components inspected as soon as possible. Failure to follow this instruction could result in personal injury or death.

The airbags are a supplemental restraint system and are designed to work with the seatbelts to help protect the driver and right front passenger from certain upper body injuries. Airbags do not inflate slowly; there is a risk of injury from a deploying airbag.

Note: *You will hear a loud bang and see a cloud of harmless powdery residue if an airbag deploys. This is normal.*

The airbags inflate and deflate rapidly upon activation. After airbag deployment, it is normal to notice a smoke-like, powdery residue or smell the burnt propellant. This may consist of cornstarch, talcum powder (to lubricate the bag) or sodium compounds (for example, baking soda) that result from the combustion process that inflates the airbag. Small amounts of sodium hydroxide may be present which may irritate the skin and eyes, but none of the residue is toxic.

Supplementary Restraints System

While the system is designed to help reduce serious injuries, contact with a deploying airbag may also cause abrasions or swelling. Temporary hearing loss is also a possibility as a result of the noise associated with a deploying airbag. Because airbags must inflate rapidly and with considerable force, there is the risk of death or serious injuries such as fractures, facial and eye injuries or internal injuries, particularly to occupants who are not properly restrained or are otherwise out of position at the time of airbag deployment. Thus, it is extremely important that occupants be properly restrained as far away from the airbag module as possible while maintaining vehicle control.

Routine maintenance of the airbags is not required.

DRIVER AND PASSENGER AIRBAGS



WARNING: Keep the areas in front of the airbags free from obstruction. Do not affix anything to or over the airbag covers. Objects could become projectiles during airbag deployment. Failure to follow this instruction could result in personal injury or death.



WARNING: Do not place your arms on the airbag cover or through the steering wheel. Failure to follow this instruction could result in personal injury.



WARNING: Do not place a rearward facing child restraint in front of an active airbag. Failure to follow this instruction could result in personal injury or death.

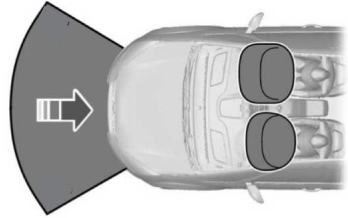

The driver and front passenger airbags will deploy during significant frontal and near frontal crashes.

The driver and passenger front airbag system consists of:

- Driver and passenger airbag modules.
- Crash sensors and monitoring system with readiness indicator. See **Crash Sensors and Airbag Indicator** (page 59).



Passenger Airbag On and Off Switch (If Equipped)



WARNING: Even with advanced restraints systems, properly restrain children 12 and under in a rear seating position. Failure to follow this could seriously increase the risk of injury or death.



WARNING: The front passenger airbag is not designed to offer protection to an occupant in the center seating position.

Supplementary Restraints System



WARNING: Your vehicle may have an airbag deactivation switch. Before driving, always look at the switch to make sure it is in the appropriate position. Failure to put the switch in the proper position can increase the risk of serious injury or death in a crash.

The front passenger airbag on and off switch has indicators that will illuminate, indicating that the front passenger frontal airbag is either on or off. The indicator lamp is on the overhead panel.

Note: *The passenger airbag status indicator OFF and ON lamps illuminate for a short period of time when you switch the ignition on to confirm it is functional.*



E279408

Switch position	Passenger airbag status indicator	Passenger airbag
Off	OFF: Lit	Disabled
	ON: Unlit	
On	OFF: Unlit	Enabled
	ON: Lit	

Turning the Passenger Airbag Off



WARNING: If the light does not illuminate when the passenger airbag switch is off and you switch the ignition on, have the passenger airbag switch serviced immediately by a qualified technician.



WARNING: To avoid switching on the airbag, always remove the ignition key with the switch in the off position.



WARNING: **Never** place front seat mounted rear-facing child or infant seats in front of an active passenger airbag.



WARNING: You must switch the passenger airbag off when using a rearward facing child restraint on the front seat.

Supplementary Restraints System

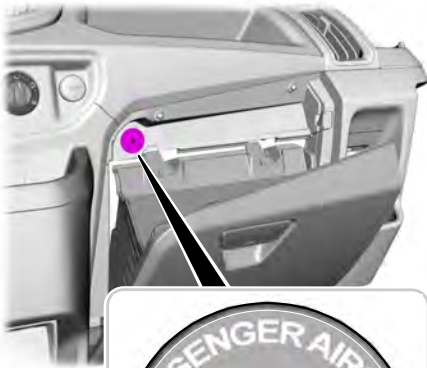

E181523



1. Insert the ignition key, turn the switch to OFF and hold in OFF while removing the key.

2. When the ignition is turned on, the pass airbag off light illuminates briefly, momentarily shuts off and then turns back on. This indicates that the passenger airbag is deactivated.

Turning the Passenger Airbag Back On

⚠ WARNING: The seatbelts for the driver and right front passenger seating positions are specifically designed to operate together with the airbags in certain types of crashes. When you switch off your airbag, you not only lose the protection of the airbag, you also may reduce the effectiveness of your seatbelt system. If the passenger does not meet the requirements stated in the National Highway Traffic Safety Administration or Transport Canada deactivation criteria, switching off the airbag can increase the risk of serious injury or death in a crash.

⚠ WARNING: If your vehicle has rear seats, always transport children who are 12 and younger in the rear seat. Always use seatbelts and child restraints properly. Do not place a child in a rear facing infant seat in the front seat unless your vehicle is equipped with an airbag on and off switch and the passenger airbag is turned off. This is because the back of the infant seat is too close to the inflating airbag and the risk of a fatal injury to the infant when the airbag inflates is substantial.

⚠ WARNING: If the passenger airbag off light is illuminated when the passenger airbag switch is on and the ignition is on, have the passenger airbag switch serviced immediately by a qualified technician.

The passenger airbag remains off until you turn it back on.

Supplementary Restraints System



1. Insert the ignition key and turn the switch to ON.
2. The pass airbag off light will briefly illuminate when the ignition is turned on. This indicates that the passenger airbag is operational.

The passenger airbag should always be on (the pass airbag off light should not be illuminated) unless the passenger meets the requirements stated either in Category 1, 2 or 3 of the National Highway Traffic Safety Administration or Transport Canada deactivation criteria which follows.

The vast majority of drivers and passengers are much safer with an airbag than without. To do their job and reduce the risk of life threatening injuries, airbags must open with great force, and this force can pose a potentially deadly risk in some situations, particularly when a front seat passenger is not using the seatbelt correctly. The most effective way to reduce the risk of unnecessary airbag injuries without reducing the overall safety of your vehicle is to make sure all passengers are correctly restrained in the vehicle, especially in the front seat. This provides the protection of seatbelts and permits the airbags to provide the additional protection they were designed to provide. If you

choose to deactivate your airbag, you are losing the very significant risk reducing benefits of the airbag and you are also reducing the effectiveness of the seatbelts, because seatbelts in modern vehicles are designed to work as a safety system with the airbags.

National Highway Traffic Safety Administration Deactivation Criteria (Excluding Canada)



WARNING: This vehicle has special energy management seatbelts for the driver and right front passenger. These particular seatbelts are specifically designed to work with airbags to help reduce the risk of injury in a crash. The energy management seatbelt gives or releases additional seatbelt webbing in some accidents to reduce the concentration of force on an occupant's chest and to reduce the risk of certain bone fractures and injuries to underlying organs. In a crash, if the airbag is off, this energy management seatbelt might permit the passenger wearing the seatbelt to move forward enough to have a serious or fatal injury. The more severe the crash, and the heavier the occupant, the greater the risk. Make sure the airbag is on for any passenger who does not qualify under the National Highway Traffic Safety Administration deactivation criteria.

1. **Infant.** An infant (less than 1 year old) must ride in the front seat because:

Supplementary Restraints System

- The vehicle has no rear seat;
- The vehicle has a rear seat too small to accommodate a rear-facing infant seat; or
- The infant has a medical condition which, according to the infant's physician, makes it necessary for the infant to ride in the front so that the driver can constantly monitor the child's condition.

2. Child age 1 to 12. A child age 1 to 12 must ride in the front seat because:

- The vehicle has no rear seat;
- Although children ages 1 to 12 ride in the rear seat(s) whenever possible, children ages 1 to 12 sometimes must ride in the front because no space is available in the rear seat(s) of the vehicle; or
- The child has a medical condition which, according to the child's physician, makes it necessary for the child to ride in the front seat so that the driver can constantly monitor the child's condition.

3. Medical condition. A passenger has a medical condition which, according to his or her physician:

- Causes the passenger airbag to pose a special risk for the passenger;
- Makes the potential harm from the passenger airbag in a crash greater than the potential harm from turning off the airbag and allowing the passenger, even if belted, to hit the dashboard or windshield in a crash.

Transport Canada Deactivation Criteria (Canada Only)



WARNING: This vehicle has special energy management seatbelts for the driver and right front passenger. These particular seatbelts are specifically designed to work with airbags to help reduce the risk of injury in a crash. The energy management seatbelt gives or releases additional seatbelt webbing in some accidents to reduce the concentration of force on an occupant's chest and to reduce the risk of certain bone fractures and injuries to underlying organs. In a crash, if the airbag is off, this energy management seatbelt might permit the passenger wearing the seatbelt to move forward enough to have a serious or fatal injury. The more severe the crash, and the heavier the occupant, the greater the risk. Make sure the airbag is on for any passenger who does not qualify under the Transport Canada deactivation criteria.

1. Infant: An infant (less than 1 year old) must ride in the front seat because:

- My vehicle has no rear seat;
- The rear seat in my vehicle cannot accommodate a rear-facing infant seat;
- The infant has a medical condition which, according to the infant's physician, makes it necessary for the infant to ride in the front seat so that the driver can monitor the infant's condition.

2. Child age 12 or under: A child age 12 or under must ride in the front seat because:

Supplementary Restraints System

- My vehicle has no rear seat;
- Although children age 12 and under ride in the rear seat whenever possible, children age 12 and under have no option but to sometimes ride in the front seat because rear seat space is insufficient;
- The child has a medical condition that, according to the child's physician, makes it necessary for the child to ride in the front seat so that the driver can monitor the child's condition.

3. **Medical condition:** A passenger has a medical condition that, according to his or her physician:

- Poses a special risk for the passenger if the airbag deploys; and
- Makes the potential harm from the passenger airbag deployment greater than the potential harm from turning off the airbag and experiencing a crash without the protection offered by the airbag

Proper Driver and Front Passenger Seating Adjustment



WARNING: National Highway Traffic Safety Administration (NHTSA) recommends a minimum distance of at least 10 in (25 cm) between an occupant's chest and the driver airbag module.

To properly position yourself away from the airbag:

- Move your seat to the rear as far as you can while still reaching the pedals comfortably.
- Recline the seat slightly (one or two degrees) from the upright position.

After all occupants have adjusted their seats and put on seatbelts, it is very important that they continue to sit properly. Properly seated occupants sit upright, lean against the seat back, and center themselves on the seat cushion, with their feet comfortably extended on the floor. Sitting improperly can increase the chance of injury in a crash event. For example, if an occupant slouches, lies down, turns sideways, sits forward, leans forward or sideways, or puts one or both feet up, the chance of injury during a crash is greatly increased.

Children and Airbags



WARNING: Do not place a rearward facing child restraint in front of an active airbag. Failure to follow this instruction could result in personal injury or death.



WARNING: Properly secure children 12 years old and under in a rear seating position whenever possible. If you are unable to properly secure all children in a rear seating position, properly secure the largest child on the front seat. If you must use a forward facing child restraint on the front seat, move the seat as far back as possible. Failure to follow these instructions could result in personal injury or death.

Supplementary Restraints System



Children must always be properly restrained. Accident statistics suggest that children are safer when properly restrained in the rear seating positions than in the front seating position. Failure to follow these instructions may increase the risk of injury in a crash.

SIDE AIRBAGS

WARNING: Do not place objects or mount equipment on or near the airbag cover, on the side of the front or rear seatbacks, or in areas that may come into contact with a deploying airbag. Failure to follow these instructions may increase the risk of personal injury in the event of a crash.

WARNING: Accessory seat covers not released by Ford could prevent the deployment of the airbags and increase the risk of injuries in a crash.

WARNING: Do not lean your head on the door. The side airbag could injure you as it deploys from the side of the seatback.

WARNING: Do not attempt to service, repair, or modify the supplementary restraint system or associated components. Failure to follow this instruction could result in personal injury or death.

WARNING: If a supplementary restraint system component has deployed, it will not function again. Have the system and associated components inspected as soon as possible. Failure to follow this instruction could result in personal injury or death.

The side airbags are located on the outboard side of the seatbacks of the front seats. In certain sideways crashes, the airbag on the side affected by the crash will be inflated. The airbag was designed to inflate between the door panel and occupant to further enhance the protection provided occupants in side impact crashes.



The system consists of the following:

- A label or embossed side panel indicating that side airbags are found on your vehicle.
- Side airbags located inside the seatback of the driver and front passenger seats.

Supplementary Restraints System



Crash sensors and monitoring system with readiness indicator. See **Crash Sensors and Airbag Indicator** (page 59).

The design and development of the side airbag system included recommended testing procedures that were developed by a group of automotive safety experts known as the Side Airbag Technical Working Group. These recommended testing procedures help reduce the risk of injuries related to the deployment of side airbags.

SAFETY CANOPY™



WARNING: Do not place objects or mount equipment on or near the headliner at the siderail that may come into contact with a deploying curtain airbag. Failure to follow these instructions may increase the risk of personal injury in the event of a crash.



WARNING: Do not lean your head on the door. The curtain airbag could injure you as it deploys from the headliner.



WARNING: Do not attempt to service, repair, or modify the supplementary restraint system or associated components. Failure to follow this instruction could result in personal injury or death.



WARNING: All occupants of your vehicle, including the driver, should always properly wear their seatbelts, even when an airbag supplemental restraint system is provided. Failure to properly wear your seatbelt could seriously increase the risk of injury or death.



WARNING: To reduce risk of injury, do not obstruct or place objects in the deployment path of the airbag.



WARNING: If a supplementary restraint system component has deployed, it will not function again. Have the system and associated components inspected as soon as possible. Failure to follow this instruction could result in personal injury or death.

The Safety Canopy deploys during significant side crashes or when a certain likelihood of a rollover event is detected by the rollover sensor. The Safety Canopy is mounted to the roof side rail sheet metal, behind the headliner, above each row of seats. In certain sideways crashes or rollover events, the Safety Canopy will be activated, regardless of which seats are occupied. The Safety Canopy is designed to inflate between the side window area and occupants to further enhance protection provided in side impact crashes and rollover events.

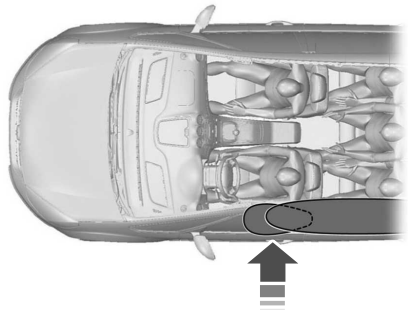

Supplementary Restraints System

The system consists of the following:

- Safety Canopy curtain airbags above the trim panels over the front and rear side windows identified by a label or wording on the headliner or roof-pillar trim.
- A flexible headliner which opens above the side doors to allow air curtain deployment



• Crash sensors and monitoring system with a readiness indicator. See **Crash Sensors and Airbag Indicator** (page 59).

Properly restrain children 12 years old and under in the rear seats. The Safety Canopy will not interfere with children restrained using a properly installed child or booster seat because it is designed to inflate downward from the headliner above the doors along the side window opening.

The design and development of the Safety Canopy included recommended testing procedures that were developed by a group of automotive safety experts known as the Side Airbag Technical Working Group. These recommended testing procedures help reduce the risk of injuries related to the deployment of side airbags (including the Safety Canopy).

CRASH SENSORS AND AIRBAG INDICATOR



WARNING: Modifying or adding equipment to the front end of your vehicle (including hood, bumper system, frame, front end body structure, tow hooks and hood pins) may affect the performance of the airbag system, increasing the risk of injury. Do not modify or add equipment to the front end of your vehicle.

Your vehicle has a collection of crash and occupant sensors which provide information to the restraints control module which deploys (activates) the front safety belt pretensioners, driver airbag, passenger airbag, seat mounted side airbags, and the Safety Canopy®. Based on the type of crash (frontal impact, side impact or rollover), the restraints control module will deploy the appropriate safety devices.

The restraints control module also monitors the readiness of the above safety devices plus the crash and occupant sensors. The readiness of the safety system is indicated by a warning indicator light in the instrument cluster or by a backup tone if the warning light is not working. Routine maintenance of the airbags is not required.

A difficulty with the system is indicated by one or more of the following:



The readiness light will not illuminate immediately after the ignition is turned on.

- The readiness light will either flash or stay lit.
- A series of five beeps will be heard. The tone pattern will repeat periodically until the problem, the light or both are repaired.

If any of these things happen, even intermittently, have the supplemental restraint system serviced at an authorized dealer immediately. Unless serviced, the system may not function properly in the event of a crash.

Supplementary Restraints System

The fact that the safety belt pretensioners or front airbags did not activate for both front seat occupants in a crash does not mean that something is wrong with the system. Rather, it means the restraints control module determined the accident conditions (crash severity, belt usage) were not appropriate to activate these safety devices.

- The design of the front airbags is to activate only in frontal and near-frontal crashes (not rollovers, side impacts or rear impacts unless the crash causes sufficient frontal deceleration).
- The design of the safety belt pretensioners is to activate in frontal, near-frontal and side crashes, and in rollovers.
- The design of the side airbags is to inflate in certain side impact crashes or rollover events. Side airbags may activate in other types of crashes if the vehicle experiences sufficient sideways motion or deformation, or a certain likelihood of rollover.
- The design of the Safety Canopy is to inflate in certain side impact crashes or rollover events. The Safety Canopy may activate in other types of crashes if the vehicle experiences sufficient sideways motion or deformation, or a certain likelihood of rollover.

AIRBAG DISPOSAL

Contact your authorized dealer as soon as possible. Airbags must be disposed of by qualified personnel.

911 Assist

WHAT IS 911 ASSIST

911 Assist is a SYNC system feature that can call for help if you're in an accident. If a crash deploys an airbag (excluding knee airbags and rear inflatable seatbelts [if equipped]) or activates the fuel pump shut-off, your SYNC-equipped vehicle may be able to contact emergency services by dialing 911 through a paired and connected Bluetooth-enabled phone. You can learn more about the 911 Assist feature, by visiting:

Website
www.owner.ford.com www.syncmyride.ca www.syncmaroute.ca

Not all crashes will deploy an airbag or activate the fuel pump shut-off (the triggers for 911 Assist). If a connected cell phone sustains damage or loses its connection to SYNC during a crash, SYNC will search for and try to connect to a previously paired cell phone; SYNC will then attempt to call the emergency services.

Before making the call:

- SYNC provides a short window of time (about 10 seconds) to cancel the call. If you fail to cancel the call, SYNC attempts to dial 911.
- SYNC says the following, or a similar message: "SYNC will attempt to call 911, to cancel the call, press Cancel on your screen or press and hold the phone button on your steering wheel."

If you do not cancel the call, and SYNC makes a successful call, a pre-recorded message plays for the 911 operator, and then the occupant(s) in your vehicle is able to talk with the operator. Be prepared to provide your name, phone number and location immediately, because not all 911 systems are capable of receiving this information electronically.

During an emergency call, the system transmits vehicle data to the emergency service. See **Event Data** (page 15).

EMERGENCY CALL REQUIREMENTS



WARNING: Do not wait for 911 Assist to make an emergency call if you can do it yourself. Dial emergency services immediately to avoid delayed response time which could increase the risk of serious injury or death after a crash. If you do not hear 911 Assist within five seconds of the crash, the system or phone may be damaged or non-functional.



WARNING: Always place your phone in a secure location in your vehicle so it does not become a projectile or get damaged in a crash. Failure to do so may cause serious injury to someone or damage the phone which could prevent 911 Assist from working properly.



WARNING: Unless the 911 Assist setting is set on before a crash, the system will not dial for help which could delay response time, potentially increasing the risk of serious injury or death after a crash.

911 Assist

- SYNC must be powered and working properly at the time of the incident and throughout feature activation and use.
- The 911 Assist feature must be set on before the incident.
- You must pair and connect a Bluetooth enabled and compatible cell phone to SYNC.
- A connected Bluetooth enabled phone must have the ability to make and maintain an outgoing call at the time of the incident.
- A connected Bluetooth enabled phone must have adequate network coverage, battery power and signal strength.
- The vehicle must have battery power and be located in the U.S., Canada or in a territory in which 911 is the emergency number.

Note: *If any user sets 911 Assist to on or off, that setting applies for all paired phones. If 911 Assist is switched off and the phone is connected to SYNC, an icon displays on the status bar.*

Note: *Every phone operates differently. While SYNC 911 Assist works with most cellular phones, some may have trouble using this feature.*

EMERGENCY CALL LIMITATIONS

The SYNC 911 Assist feature only operates in the U.S., Canada or in a territory in which 911 is the emergency number.

- Your cellular phone or 911 Assist hardware sustains damage in a crash.
- The vehicle's battery or the SYNC system has no power.
- The phone(s) thrown from your vehicle are the ones paired and connected to the system.

Keys and Remote Controls

PRINCIPLE OF OPERATION

The remote control allows you to:

- remotely lock or unlock the vehicle doors
- unlock the doors without actively using a key or remote control (intelligent access only)
- remotely open the power liftgate (if equipped)
- remotely start or stop the engine (if equipped)
- arm and disarm the anti-theft system
- activate the panic alarm.

GENERAL INFORMATION ON RADIO FREQUENCIES

This device complies with Part 15 of the FCC Rules and with Licence exempt RSS Standards of Industry Canada. Operation is subject to the following two conditions:

- This device may not cause harmful interference, and
- This device must accept any interference received, including interference that may cause undesired operation.



WARNING: Changes or modifications not expressly approved by the party responsible for compliance could void the user's authority to operate the equipment. The term "IC:" before the radio certification number only signifies that Industry Canada technical specifications were met.

The typical operating range for your transmitter is approximately 33 ft (10 m). Vehicles with the remote start feature will have a greater range. One of the following could cause a decrease in operating range:

- Weather conditions.
- Nearby radio towers.
- Structures around the vehicle.
- Other vehicles parked next to your vehicle.

Other short distance radio transmissions, for example amateur radios, medical equipment, wireless headphones, remote controls and alarm systems can also use the radio frequency used by your remote control. If the frequencies are jammed, you will not be able to use your remote control. You can lock and unlock the doors with the key.

Note: *Make sure to lock your vehicle before leaving it unattended.*

Note: *If you are in range, the remote control will operate if you press any button unintentionally.*

Note: *The remote control contains sensitive electrical components. Exposure to moisture or impact may cause permanent damage.*

Keys and Remote Controls

REMOTE CONTROL-VEHICLES WITHOUT: PASSIVE ANTI-THEFT SYSTEM (PATS)

Integrated Keyhead Transmitter (If Equipped)



E177585

Use the key blade to start your vehicle and unlock or lock the driver door from outside your vehicle.

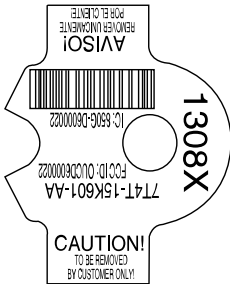

E138615

Note: Your vehicle keys came with a security label that provides important key cut information. Keep the label in a safe place for future reference.

Programming a New Remote Control

Read and understand the entire procedure before you begin.

Make sure all new and existing remote controls are present before beginning this procedure. This procedure erases all existing programmed remote controls. Reprogram all the existing remote controls during this procedure.

1. Unlock the vehicle with the power door unlock control.
2. Switch the ignition from off to on eight times within six seconds, finishing in the off position. A tone sounds to indicate that it is now possible to program a remote control.
3. Press and hold any button on the remote control within 10 seconds. A tone sounds as confirmation.
4. Repeat step 3 within 10 seconds for each remote control.

Note: Programming ends when you switch the ignition on, or after 10 seconds.

If you have successfully programmed the remote control, it operates the remote entry system.

If programming was unsuccessful, wait 10 seconds and repeat the process.

Note: You can program a maximum of eight remote controls to your vehicle.

Changing the Remote Control Battery

The remote control uses one coin-type three-volt lithium battery CR2032 or equivalent.

Note: Refer to local regulations when disposing of remote control batteries.

Note: Do not wipe off any grease on the battery terminals or on the back surface of the circuit board.

Note: Replacing the battery does not erase the programmed remote control from your vehicle. The remote control should operate normally.

Keys and Remote Controls

Integrated Keyhead Transmitter



E138619

1. Twist a thin coin in the slot of the transmitter near the key ring to remove the battery cover.
2. Remove the old battery.

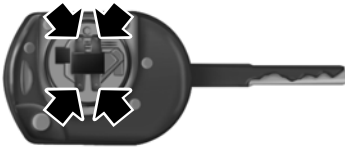

E138620

3. Insert the new battery. Refer to the instructions inside the transmitter for the correct orientation of the battery. Press the battery down to make sure it is fully in the housing.
4. Reinstall the battery housing cover onto the transmitter.

Locating Your Vehicle

Press the lock button on the remote control twice within three seconds. The horn sounds and the direction indicators flash.

Note: If locking was not successful, any door is open, or if the hood is open on vehicles with an alarm or remote start then the horn sounds but the direction indicators do not flash.

Switching the Panic Alarm On and Off



Press the button on the remote control to switch the panic alarm on. Press the button again or switch the ignition on to switch the panic alarm off.

We recommend you do not use this method to locate your vehicle.

Note: The panic alarm only operates when the ignition is off.

REMOTE CONTROL-VEHICLES WITH: PASSIVE ANTI-THEFT SYSTEM (PATS)

Integrated Keyhead Transmitter (If Equipped)

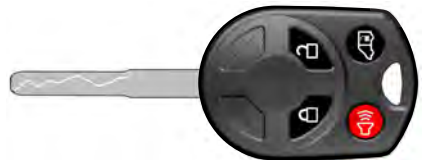

E177585

Use the key blade to start your vehicle and unlock or lock the driver door from outside your vehicle.

Keys and Remote Controls

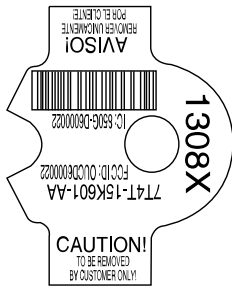

E138615

Note: Your vehicle keys came with a security label that provides important key cut information. Keep the label in a safe place for future reference.

Programming a New Remote Control

To program a new remote control, See **Passive Anti-Theft System** (page 89).

Changing the Remote Control Battery

The remote control uses one coin-type three-volt lithium battery CR2032 or equivalent.

Note: Refer to local regulations when disposing of remote control batteries.

Note: Do not wipe off any grease on the battery terminals or on the back surface of the circuit board.

Note: Replacing the battery does not erase the programmed remote control from your vehicle. The remote control should operate normally.

Integrated Keyhead Transmitter



E138619

1. Twist a thin coin in the slot of the transmitter near the key ring to remove the battery cover.
2. Remove the old battery.

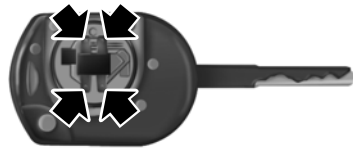

E138620

3. Insert the new battery. Refer to the instructions inside the transmitter for the correct orientation of the battery. Press the battery down to make sure it is fully in the housing.
4. Reinstall the battery housing cover onto the transmitter.

Locating Your Vehicle

Press the lock button on the remote control twice within three seconds. The horn sounds and the direction indicators flash.

Keys and Remote Controls

Note: If locking was not successful, any door is open, or if the hood is open on vehicles with an alarm or remote start then the horn sounds but the direction indicators do not flash.

Switching the Panic Alarm On and Off



Press the button on the remote control to switch the panic alarm on. Press the button again or switch the ignition on to switch the panic alarm off.

We recommend you do not use this method to locate your vehicle.

Note: The panic alarm only operates when the ignition is off.

REMOTE CONTROL - VEHICLES WITH: POWER SLIDING DOOR

Use the key blade to start your vehicle and unlock or lock the driver door from outside your vehicle. The buttons on the key operate the remote control function.



Changing the Remote Control Battery



WARNING: Keep batteries away from children to prevent ingestion. Failure to follow this instruction could result in personal injury or death. If ingested, immediately seek medical attention.



WARNING: If the battery compartment does not securely close, stop using the remote control and replace it as soon as possible. In the meantime, keep the remote control away from children. Failure to follow this instruction could result in personal injury or death.



Make sure that you dispose of old batteries in an environmentally friendly way. Seek advice from your local authority about recycling old batteries.

The remote control uses one coin-type three-volt lithium battery CR2032 or equivalent.



1. Press the release button.

Keys and Remote Controls



2. Insert a suitable tool, for example a screwdriver, in the position shown and gently push the clip.
3. Press the clip down to release the battery cover.

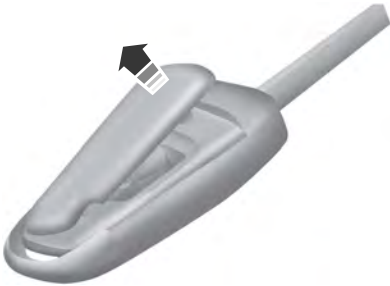

4. Carefully remove the cover.



5. Insert a screwdriver in the position shown to release the battery.

Note: Do not touch the battery contacts or the printed circuit board with the screwdriver.

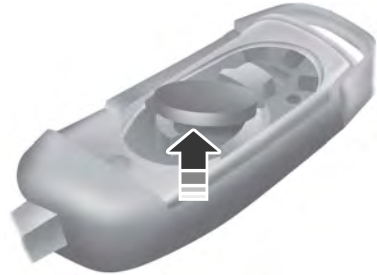

6. Remove the battery.
7. Insert a new battery with the + facing upward.

Note: Do not wipe off any grease on the battery terminals or on the back surface of the circuit board.

8. Reinstall the battery cover.

Locating Your Vehicle



Press the lock button on the key twice within three seconds. The direction indicators flash.

Keys and Remote Controls

Remote Control Information Messages

Message	Action
Key Battery Low Replace Soon	Displays when the remote control battery requires replacing.

REPLACING A LOST KEY OR REMOTE CONTROL

You can purchase replacement keys or remote controls from an authorized dealer. Authorized dealers can program remote controls for your vehicle. See **Remote Control** (page 67).

To re-program the passive anti-theft system see an authorized dealer.

PRINCIPLE OF OPERATION

The system is designed to promote good driving behaviors using keys that you have programmed with some restricted settings.

MYKEY SETTINGS

Non-Configurable Settings

Seatbelt Reminder

The audio system mutes when the seatbelt reminder turns on. The seatbelt reminder cannot be switched off with a MyKey.

Early Low Fuel

The low fuel level indicator turns on earlier.

Driving and Parking Aids

Parking aids, blind spot information system and cross traffic alert turn on when you start the engine and cannot be switched off with a MyKey.

Pre-collision assist and lane keeping alert turn on when you start the engine, but can be switched off with a MyKey.

Satellite Radio

Adult content is restricted when using a MyKey.

Configurable Settings

You can configure the following settings after creating a MyKey. See **Creating a MyKey** (page 71).

Speed Limit



WARNING: Do not set MyKey maximum speed limit to a limit that will prevent the driver from maintaining a safe speed considering posted speed limits and prevailing road conditions. The driver is always responsible to drive in accordance with local laws and prevailing conditions. Failure to do so could result in accident or injury.

You can set a speed limit for your vehicle. Warning messages appear in the information display and a tone sounds if your vehicle reaches the set speed. You cannot override the set speed when using a MyKey.

Speed Reminder

You can set a speed reminder for your vehicle. Warning messages appear in the information display and a tone sounds if your vehicle exceeds the set speed.

Audio System Volume Limit

The audio system maximum volume is reduced. A message appears in the information display if you attempt to exceed the volume limit. Automatic volume control turns off.

Emergency Assistance

If you set emergency assistance to be always on, it cannot be switched off with a MyKey.

Do Not Disturb

If you set do not disturb to be always on, it cannot be switched off with a MyKey.

Traction Control

If you set traction control to be always on, it cannot be switched off with a MyKey.

MyKey™

CREATING A MYKEY

Switch the ignition on using an admin key.

To create a MyKey, use the information display controls on the steering wheel to select the following:

Menu Item	Action
Settings	Press the menu button.
MyKey	Press the OK button.
Create MyKey	Press and hold the OK button until a confirmation message appears in the information display.
	Switch the ignition off.

Note: We recommend that you label this key.

MyKey Information Messages

Message	Description
Key is Already a MyKey	Displays when trying to create a MyKey with a key already designated as a MyKey.
This Key restricted at Next Key Cycle. Label Key as MyKey	Displays to confirm that the key is restricted after you switch the ignition off.

Switch the ignition on using an admin key.

PROGRAMMING A MYKEY

You can only program MyKeys to the same settings.

MyKey™

To program a MyKey, use the information display controls on the steering wheel to select the following:

Menu Item	Action
Settings	Press the menu button.
MyKey	Press the OK button. Select a setting and press the OK button. Configure the setting. Switch the ignition off.

CLEARING ALL MYKEYS

When you clear all MyKeys, you remove all

restrictions and return all MyKeys to their original admin key status.

Switch the ignition on using an admin key.

To clear all MyKeys, use the information display controls on the steering wheel to select the following:

Menu Item	Action
Settings	Press the menu button.
MyKey	Press the OK button.
Clear MyKeys	Press and hold the OK button until a confirmation message appears in the information display.

CHECKING MYKEY SYSTEM STATUS

Switch the ignition on.

To find information about the distance traveled using a MyKey and also the number of admin keys and MyKeys created for your vehicle, use the information display controls on the steering wheel to select the following:

Menu Item	Action
Settings	Press the menu button.
MyKey	Press the OK button.
MyKey Info	Press the OK button.

USING MYKEY WITH REMOTE START SYSTEMS

The system is not compatible with non-Ford remote start systems.

MYKEY – TROUBLESHOOTING

What is an admin key?

- An admin key is a key that has not been created as a MyKey. See **Creating a MyKey** (page 71).

Why can I not create a MyKey?

- The key used to switch the ignition on is not an admin key.
- The key used to switch the ignition on is the only admin key. There always has to be at least one admin key.

Why can I not program a MyKey?

- The key used to switch the ignition on is not an admin key.
- No MyKeys are created. See **Creating a MyKey** (page 71).

Why can I not clear the MyKeys?

- The key used to switch the ignition on is not an admin key.
- No MyKeys are created. See **Creating a MyKey** (page 71).

Why does the MyKey distance not accumulate?

- The key used to start the engine is an admin key.
- No MyKeys are created. See **Creating a MyKey** (page 71).
- The MyKeys have been cleared.

Doors and Locks

LOCKING AND UNLOCKING

Locking

Locking With the Key

Turn the top of the key toward the rear of your vehicle.

Locking With the Remote Control



Press the button once. The direction indicators will flash. Press the button again within three seconds to confirm that all the doors are closed. The horn sounds and the direction indicators flash.

Note: You can lock the driver door with the key. Use the key when the remote control is not functioning.

Note: Make sure you have locked your vehicle before leaving it unattended.

Note: Do not leave the keys in your vehicle.

Note: Do not use the door latch assembly to attach any accessory, such as handles or steps, as this can cause damage to your vehicle.

Unlocking

Unlocking With the Key

Turn the top of the key toward the front of your vehicle.

Unlocking With the Remote Control



Press the button once. The direction indicators will flash.

Note: You can unlock the driver door with the key. Use the key when the remote control is not functioning.

Note: When you leave your vehicle unattended for several weeks, the remote control turns off.

Note: Unlock your vehicle and start the engine using the key. Unlocking and starting your vehicle once enables the remote control.

Unlocking the Cargo Doors



Press the button.

Reprogramming the Unlocking Function

You can program the unlocking function so that all doors unlock or only the driver door unlocks. See **Reprogramming the Unlocking Function** (page 87).

Locking and Unlocking the Doors From Inside

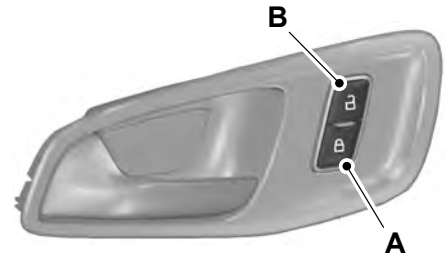

E148829

- A Lock.
- B Unlock.

Doors and Locks

Opening the Double Rear Doors



E148805

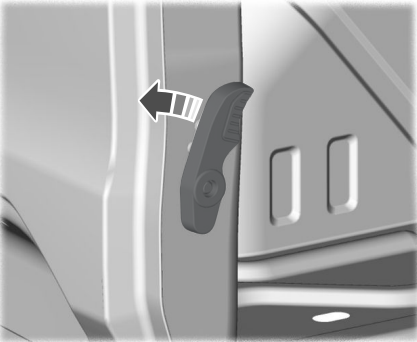

E148806

Fully Opening the Double Rear Doors

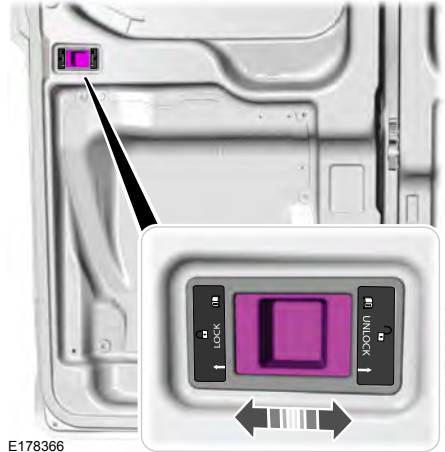

E178366

1. Slide the lever to release the catch.
2. Fully open the cargo door.

Unlocking and Opening the Double Rear Doors From Inside

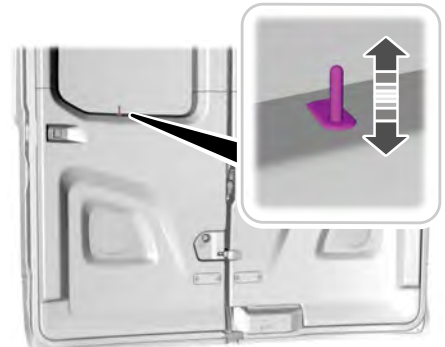

E175828

1. Lift the locking button up.

Doors and Locks

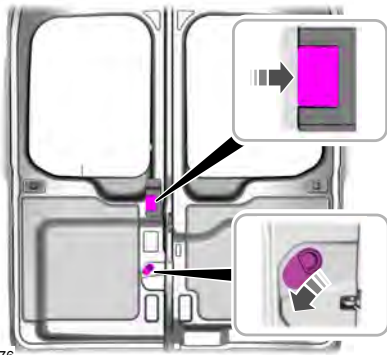

E255876

2. Pull the upper release lever toward you or slide the lower release lever downward to open the door.

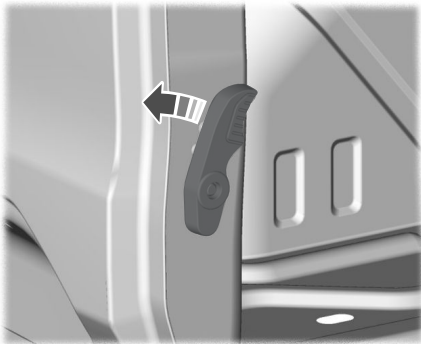

E148806

3. Pull the release lever to open the other door.

Rear Emergency Exit Wagon and Bus

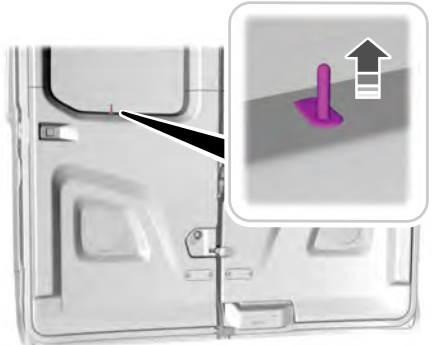

E236264

1. Lift the locking button up.

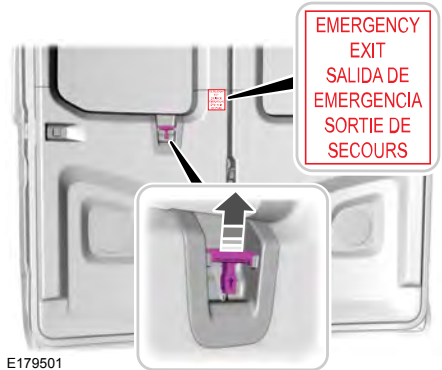

E179501

2. Pull the interior handle up to open the door in an emergency.

Autolock (If Equipped)

Autolock locks all the doors when all of the following occur:

- All doors are closed.
- The ignition is on.

Doors and Locks

- You shift into any gear putting your vehicle in motion.
- Your vehicle reaches a speed greater than 5 mph (8 km/h).

Use the interior door unlock button or switch the ignition off and use the key or remote control to unlock the rear or sliding door.

Autounlock

Autounlock unlocks all doors within 10 minutes of the end of a drive cycle, when the driver door is opened and the ignition is off.

Switching Autounlock On and Off

1. Using the information display controls on the steering wheel, select **Settings**.
2. Select **Vehicle Settings**.
3. Select **Locks**.
4. Switch **Autounlock** on or off.

One-Stage Unlocking

You can switch on this function using the information display.

If you have switched on this function, you unlock all doors including the rear doors and the sliding door.

You unlock all of the doors when you:

- Press the unlock button on the remote control once.
- Press the interior unlock button once.

Two-Stage Unlocking

You unlock the front doors when you:

- Press the unlock button on the remote control once.
- Press the interior unlock button once.

You unlock the front doors and cargo area when you:

- Press the unlock button on the remote control once.
- Press the unlock button on the remote control twice within three seconds.

Zone Re-Locking (If Equipped)

If you enable zone re-locking and open one door, all other doors remain locked. See an authorized dealer for further information.

The locks on van, bus or wagon have two zones, cabin and cargo. For van, the cargo area includes the rear doors and the sliding door. For bus or wagon, the cargo area includes the rear doors.

- Exit your vehicle and press the lock button.
- Press the unlock button or the cargo area unlock button once to open the respective zone.

If you now open a door within the unlocked zone, the other doors in that zone automatically lock.

Configurable Unlocking

Configurable unlocking is set when you purchase your vehicle. It allows you to select which doors unlock when you press, once or twice, the unlock button or the cargo area unlock button on your remote control. You cannot switch this feature back on if you had it switched off. See an authorized dealer for further information.

Sliding Door - Vehicles Without: Power Sliding Door

SLIDING DOOR PRECAUTIONS



WARNING: Fully close the sliding door before driving, to prevent passengers and cargo from falling out. Failure to follow this instruction could result in personal injury or death.



WARNING: Do not open or close the sliding door when your hands are near the tracks or rollers. Failure to follow this instruction could result in personal injury.

Note: Do not leave the sliding door open when you are driving. This could damage the sliding door and its components.

OPENING THE SLIDING DOOR

Opening the Sliding Door From Inside Your Vehicle

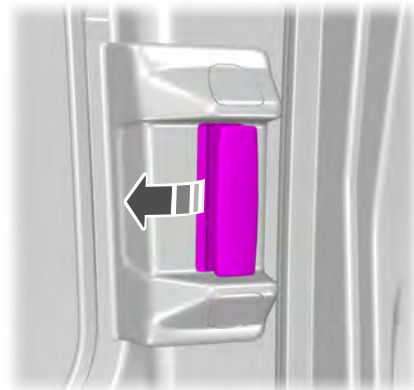

Pull the interior door handle to open the sliding door.

Opening the Sliding Door From Outside Your Vehicle

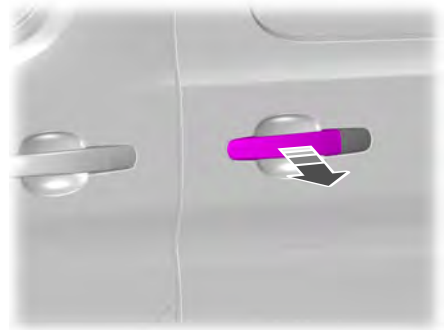

Pull the exterior door handle to open the sliding door.

CLOSING THE SLIDING DOOR

Closing the Sliding Door From Inside Your Vehicle

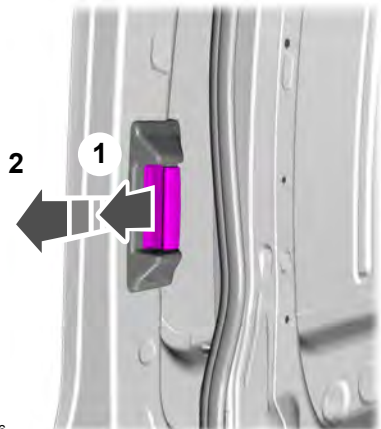

E171966

Sliding Door - Vehicles Without: Power Sliding Door

1. Pull the interior door handle to release the door check feature.
2. Slide the door to close.

Closing the Sliding Door From Outside Your Vehicle

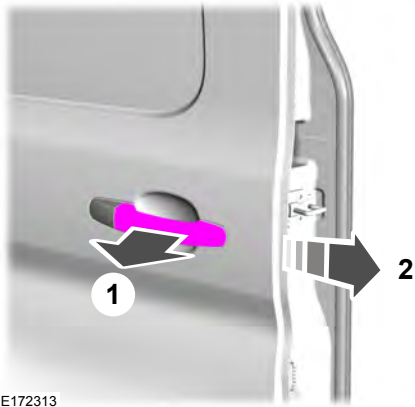

E172313

1. Pull the exterior door handle to release the door check feature.
2. Slide the door to close.

Sliding Door - Vehicles With: Power Sliding Door

SLIDING DOOR PRECAUTIONS



WARNING: Fully close the power sliding door before driving, to prevent passengers and cargo from falling out. Failure to follow this instruction could result in personal injury or death.



WARNING: Do not open or close the power sliding door when your hands are near the tracks or rollers. Failure to follow this instruction could result in personal injury.



WARNING: When closing the power sliding door, verify that it is free of obstruction and make sure that people and pets are not in the proximity of the sliding door opening.

Note: Do not leave the sliding door open when you are driving. This could damage the sliding door and its components.

Note: If you operate the sliding door often during a short period of time, the system could become not available for a certain time to prevent damage due to overheating.

Allow the system to open the sliding door. Do not manually push or pull the sliding door when it is moving. This could damage the sliding door and its components.

OPENING THE SLIDING DOOR

Opening the Sliding Door From Inside Your Vehicle

Opening the Sliding Door From Inside Your Vehicle Using the Instrument Panel Button



Press the button on the instrument panel twice to open the sliding door.

Opening the Sliding Door From Inside Your Vehicle Using the Sliding Door Handle

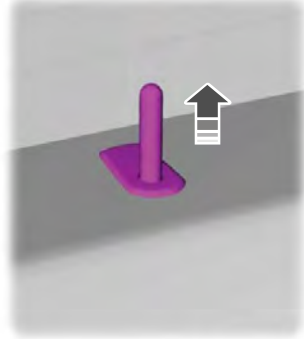

1. Lift the locking button up.

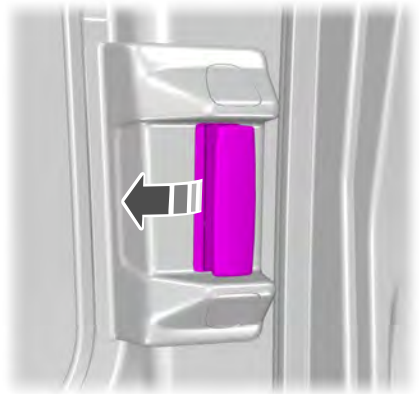

2. Pull and release the interior sliding door handle to open the sliding door.

Sliding Door - Vehicles With: Power Sliding Door

Opening the Sliding Door From Outside Your Vehicle

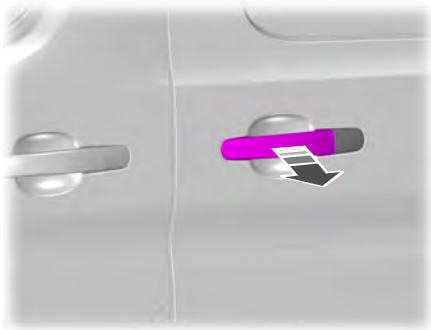

Pull and release the exterior door handle to open the sliding door.

Opening the Sliding Door With the Remote Control



Press the button on the remote control twice within three seconds.

Closing the Sliding Door From Inside Your Vehicle Using the Sliding Door Handle

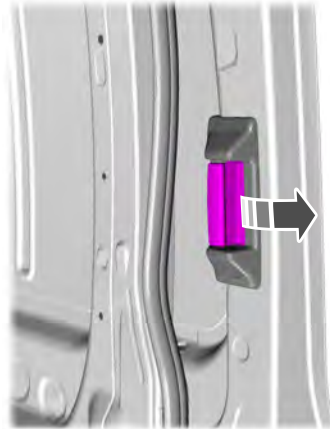

Pull and release the interior sliding door handle to close the sliding door.

CLOSING THE SLIDING DOOR

Closing the Sliding Door From Inside Your Vehicle

Closing the Sliding Door From Inside Your Vehicle Using the Instrument Panel Button



Press the button on the instrument panel to close the sliding door. A tone sounds when the sliding door begins to close.

Sliding Door - Vehicles With: Power Sliding Door

Closing the Sliding Door From Outside Your Vehicle



Pull and release the exterior door handle to close the sliding door.

Closing the Sliding Door With the Remote Control



Press the button on the remote control twice within three seconds. A tone sounds when the sliding door begins to close.

STOPPING THE SLIDING DOOR MOVEMENT

You can stop the sliding door movement by doing any of the following:

- Pressing the sliding door button on the remote control twice within three seconds.
- Pressing the sliding door button on the instrument panel.
- Pulling the sliding door interior or exterior door handle.

RESETTING THE POWER SLIDING DOOR

Make sure that you complete the procedure within 10 seconds.

To reset the power sliding door do the following:

1. Manually close the sliding door.

Note: Make sure that the sliding door is fully closed.

2. Pull the interior door handle in closing direction three times within three seconds.

Sliding Door - Vehicles With: Power Sliding Door

SLIDING DOOR – TROUBLESHOOTING

Sliding Door – Information Messages

Message	Action
Right Power Sliding Door Calibration Needed	The system has malfunctioned. Manually close the power sliding door. Pull and release the power sliding door handle to open the power sliding door. If the message continues to appear, have your vehicle checked as soon as possible.
Left Power Sliding Door Calibration Needed	
Right Rear Door Motor Disconnected See Manual	The system has malfunctioned. Reset the power sliding door. See Resetting the Power Sliding Door (page 84). If the message continues to appear, have your vehicle checked as soon as possible.
Left Rear Door Motor Disconnected See Manual	

Sliding Door - Vehicles With: Power Sliding Door

Sliding Door – Frequently Asked Questions

Why does the power sliding door stop moving?

The power sliding door stops when it detects an obstacle. A tone sounds and the power sliding door starts moving in the opposite direction. After you remove the obstacle, you can continue to operate the power sliding door.

Why is the power sliding door moving with reduced speed?

You let the power sliding door open for more than five minutes. Fully close the power sliding door using the button on the instrument panel or the power sliding door handles. Open the power sliding door as normal.

Why can I not close the power sliding door?

If the power sliding door does not close, restart the engine and then close it as normal. See **Closing the Sliding Door From Inside Your Vehicle** (page 83). If the power sliding door still does not close, manually close the power sliding door and then open it as normal. If the power sliding door still does not close the system has malfunctioned. Have your vehicle checked as soon as possible.

What can I do if the power sliding door does not operate as normal?

If there is a malfunction on the power sliding door, restart the engine.

How can I open the sliding door if the system loses power?

If the sliding door loses power, you could need to apply more force when trying to open it. Push the back of the sliding door and the interior sliding door handle in opening direction at the same time and open it as normal.

Keyless Entry

LOCATING THE KEYLESS ENTRY KEYPAD



The keypad is under the driver door window. It may illuminate when you press a button.

MASTER ACCESS CODE

What Is the Master Access Code

The master access code is a factory-set five-digit entry code. You can operate the keypad with the master access code at any time.

KEYLESS ENTRY SETTINGS

Reprogramming the Unlocking Function

You can program the unlocking function so that only the driver door unlocks.

Press and hold the unlock and lock buttons on the remote control simultaneously for at least four seconds with the ignition off. The direction indicators flash twice to confirm the change.

To return to the original unlocking function, repeat the process.

You can also change between the unlocking modes in the information display.

1. Using the information display controls on the steering wheel, select **Settings**.
2. Select **Vehicle Settings**.
3. Select **Locks**.
4. Select **Remote Unlock**.
5. Select **All Doors** or **Driver's Door**.

Creating Personal Access Codes

1. Enter the master access code.

Note: You can find the master access code on the owner's wallet card or at an authorised dealer.

2. Within five seconds press and hold the 1-2 button for one second.

Note: A red light flashes twice.

3. Enter your personal access code.

Note: Your personal access code must be a five-digit code. You must enter each number within five seconds of each other.

The doors unlock, lock and then unlock and the red light flashes twice to confirm that a personal access code has been created.

Clearing All Personal Access Codes

1. Enter the master access code.
2. Within five seconds press and hold the 1-2 button for five seconds.

LOCKING AND UNLOCKING THE DOORS USING KEYLESS ENTRY

Unlocking the Doors

Enter the master access code or your personal access code to unlock the driver's door, then press the 3-4 button within five seconds to unlock all doors.

Keyless Entry

Note: *If you program the unlocking function so that all doors unlock, you do not have to press the 3-4 button. See **Reprogramming the Unlocking Function** (page 87).*

The interior lamps illuminate to confirm that the doors have been unlocked.

Unlocking the Rear Cargo Doors

Enter the master access code or your personal access code, then press the 5-6 button within five seconds.

Locking the Doors

Press and hold the 7-8 and 9-0 buttons at the same time with the driver door closed.

KEYLESS ENTRY – TROUBLESHOOTING

Keyless Entry – Frequently Asked Questions

Why does the keypad not read the access code?

If you enter the access code too fast on the keypad, the unlock function may not work. Slowly re-enter the access code. You must only press a button once to enter the second digit on that button.

Why does the keypad not function?

The keypad goes into an anti-scan mode if you enter a wrong code seven times. The anti-scan mode disables the keypad for one minute and the red light flashes.

Security

PASSIVE ANTI-THEFT SYSTEM - VEHICLES WITH: PASSIVE ANTI-THEFT SYSTEM (PATS)

Note: *The system is not compatible with non-Ford aftermarket remote start systems. Use of these systems may result in vehicle starting problems and a loss of security protection.*

Note: *Metallic objects, electronic devices or a second coded key on the same key chain may cause vehicle starting problems if they are too close to the key when starting the engine. Prevent these objects from touching the coded key while starting the engine. Switch the ignition off, move all objects on the key chain away from the coded key and restart the engine if a problem occurs.*

Note: *Do not leave a duplicate coded key in the vehicle. Always take your keys and lock all doors when leaving the vehicle.*

SecuriLock®

The system is an engine immobilization system. It is designed to help prevent the engine from being started unless a correctly coded key for your vehicle is used. Using an incorrectly coded key may prevent the engine from starting. A message may appear in the information display.

If you are unable to start the engine with a correctly coded key, a malfunction has happened and a message may appear in the information display.

Automatic Arming

The engine immobilization system arms immediately after you switch the ignition off.

Automatic Disarming

Switching the ignition on with a correctly coded key disarms the engine immobilization system.

Replacement Keys

The integrated keyhead transmitter functions as a programmed ignition key that operates all the locks and starts your vehicle, as well as a remote control.

If your keys are lost or stolen and you do not have a spare correctly coded key, you will need to have your vehicle towed to an authorized dealer. You need to erase the coded keys from your vehicle and program new coded keys.

Store an extra correctly coded key away from the vehicle in a safe place to help prevent any inconveniences. See an authorized dealer to purchase additional spare or replacement keys.

Programming a Spare Integrated Keyhead Transmitter

You can program your own integrated keyhead transmitter or standard SecuriLock coded keys to your vehicle. This procedure will program both the engine immobilizer keycode and the remote entry portion of the remote control to your vehicle.

Only use integrated keyhead transmitters or standard SecuriLock keys.

You must have two previously programmed correctly coded keys and the new unprogrammed key readily accessible. See an authorized dealer to have the spare key programmed if two previously programmed correctly coded keys are not available.

Read and understand the entire procedure before you begin.

1. Insert the first previously programmed correctly coded key into the ignition.

Security

2. Switch the ignition from off to on. Keep the ignition on for at least three seconds, but no more than 10 seconds.
3. Switch the ignition off and remove the first correctly coded key from the ignition.
4. After three seconds but within 10 seconds of switching the ignition off, insert the second previously programmed correctly coded key into the ignition.
5. Switch the ignition from off to on. Keep the ignition on for at least three seconds, but no more than 10 seconds.
6. Switch the ignition off and remove the second previously programmed correctly coded key from the ignition.
7. After three seconds but within 10 seconds of switching the ignition off and removing the previously programmed correctly coded key, insert the new unprogrammed key into the ignition.
8. Switch the ignition from off to on. Keep the ignition on for at least six seconds.
9. Remove the newly programmed correctly coded key from the ignition.

If the key has been successfully programmed it will start the engine and operate the remote entry system (if the new key is an integrated keyhead transmitter).

If the key was not successfully programmed, wait 10 seconds and repeat Steps 1 through 8. If you are still unsuccessful, take your vehicle to an authorized dealer.

Note: *You can program a maximum of eight coded keys to your vehicle. All eight can be integrated keyhead transmitters.*

ANTI-THEFT ALARM - VEHICLES WITHOUT: ANTI-THEFT ALARM HORN WITH INTEGRAL BATTERY

Alarm System

The perimeter alarm is a deterrent against unauthorized access to your vehicle through the doors, luggage compartment and the hood.

Triggering the Alarm

Once armed, the alarm is triggered in any of the following ways:

- If someone opens a door, cargo area or the hood without a valid key or remote control.
- If you switch the ignition on without a valid key.

If the alarm is triggered, the horn will sound for 30 seconds and the hazard warning flasher will flash for five minutes.

Any further attempts to perform one of the above will trigger the alarm again.

Arming the Alarm

To arm the alarm, lock your vehicle. See **Doors and Locks** (page 76).

Disarming the Alarm

Disarm and silence the alarm by unlocking the doors with the key and switching the ignition on with a correctly coded key or by unlocking the doors or the cargo area with the remote control.

Security

ANTI-THEFT ALARM - VEHICLES WITH: ANTI-THEFT ALARM HORN WITH INTEGRAL BATTERY

Alarm System

Your vehicle may have one of the following alarm systems:

- Category one alarm with interior sensors and battery back-up sounder.
- Perimeter alarm.

Perimeter Alarm

The perimeter alarm is a deterrent against unauthorized access to your vehicle through the doors and the hood.

Interior Sensors (If Equipped)



E131656

Note: Do not cover up the interior scanning sensors.

The sensors act as a deterrent against unauthorized intrusion by sensing any movement within your vehicle.

Battery Back-up Sounder

The battery back-up sounder is an additional alarm system this will sound a siren when the alarm is triggered. When you lock your vehicle the system is armed. The sounder has its own battery and will sound an alarm siren even if someone disconnects your vehicle battery or the battery back-up sounder itself.

Triggering the Alarm

Once armed, the alarm is triggered in any of the following ways:

- If someone opens a door or the hood without a valid key or remote control.
- If you switch the ignition on without a valid key.
- If the interior sensors detect movement within your vehicle.
- On vehicles with a battery back-up sounder, if someone disconnects your vehicle battery or the battery back-up sounder itself.

If the alarm is triggered, the alarm horn will sound for 30 seconds and the hazard warning flashers will flash for five minutes.

Any further attempts to perform one of the above will trigger the alarm again.

Guard Settings

Note: Do not arm the alarm with full guard if passengers, animals or other moving objects are inside your vehicle, as this could trigger the alarm.

Security

Message	Description
Full guard	The interior sensors are on when you arm the alarm.
Reduced	The interior sensors are off when you arm the alarm. You can set the alarm to reduced guard for the current ignition cycle only. The alarm will reset to full guard the next time you switch the ignition on.
Ask on exit	You can set the information display to ask you each time which level of guard you wish to set. A message appears in the information display each time you switch the ignition off. If you wish to arm the alarm with reduced guard, press the OK button when this message appears. If you wish to arm the alarm with full guard, leave your vehicle without pressing the OK button.

Selecting Full or Reduced Guard

Note: *Selecting reduced guard does not set the alarm permanently to reduced guard. It sets it to reduced guard only for the current ignition cycle. If you regularly set the alarm to reduced guard, select the option to ask when you exit.*

You can select full or reduced guard using the information display. See **Information Displays** (page 115).

Arming the Alarm

To arm the alarm, lock your vehicle. See **Doors and Locks** (page 76).

Disarming the Alarm

Disarm and silence the alarm by unlocking the doors and switching your vehicle on or by unlocking the doors or the liftgate with the remote control.

Power Running Boards

USING POWER RUNNING BOARDS



WARNING: In extreme climates, excessive ice buildup may occur, causing the running boards not to deploy. Make sure that the running boards have deployed, and have finished moving before attempting to step on them. The running boards will resume normal function once the blockage is cleared.



WARNING: Switch off the running boards before jacking or placing any object under your vehicle. Never place your hand between the extended running board and your vehicle. A moving running board may cause injury.

Note: Do not use the power running boards, front and rear hinge assemblies, running board motors or the running board underbody mounts to lift your vehicle when jacking. Always use proper jacking points.

Note: The power running boards may operate more slowly in cool temperatures.

Note: The running board mechanism may trap debris such as mud, dirt, snow, ice and salt. This may cause unwanted noise. If this happens, manually set the power running boards to the deployed position. Then wash the system in particular the front and rear hinge arms with a high-pressure car wash wand.

Note: If you drive off when the power running boards are deployed the engine may stop.

Note: In the event of a malfunction you can stow the power running boards manually.

Automatic Power Deploy

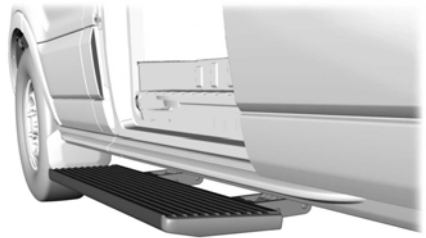

E171469

The power running board extends when you open the door.

Automatic Power Stow



E171470

When you close the door, the power running board returns to the stowed position after a two-second delay.

Power Running Boards

Manual Power Deploy

To set the power running boards to the deployed position, use the information display controls on the steering wheel to select the following:

Message	Action
Settings	Press the menu button.
Vehicle Settings	Press the OK button.
Power Steps	Press the OK button.
Out	Press the OK button.

Enabling and Disabling

To enable or disable the power running board feature, use the information display controls on the steering wheel to select the following:

Message	Action and Description
Settings	Press the menu button.
Vehicle Settings	Press the OK button.
Power Steps	Press the OK button.
Select one of the following:	
Off	Press the OK button. When disabled the power running boards move to the stowed position regardless of the door position.
Auto	Press the OK button. When enabled the power running boards move to the correct position based on the door position.

When you switch the ignition on, the system turns on.

Bounce-back

The running board will reverse direction and move to the end of travel if it encounters an object while moving.

Manual Operation

If the power running board does not return to the stowed position, you can manually stow it.

Power Running Boards

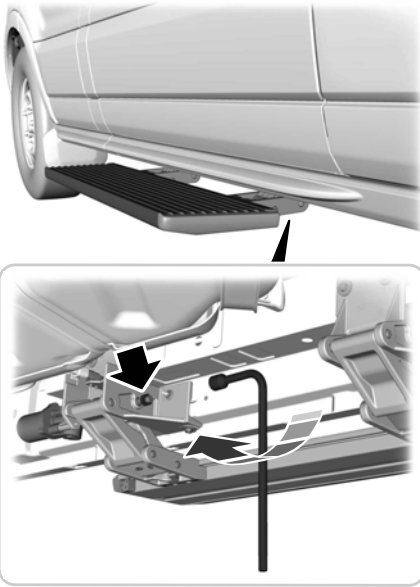

E171471

Insert the lug wrench into the guide hole and turn the handle clockwise until the running board is in the stowed position.

Resetting the System

You can reset the system by opening and closing the sliding door.

Steering Wheel

ADJUSTING THE STEERING WHEEL



WARNING: Do not adjust the steering wheel when your vehicle is moving.

Note: Make sure that you are sitting in the correct position. See **Sitting in the Correct Position** (page 126).



E95178

1. Unlock the steering column.
2. Adjust the steering wheel to the desired position.



E95179

3. Lock the steering column.

LOCKING THE STEERING WHEEL

1. Remove the key from the ignition.
2. Slightly rotate the steering wheel to engage the lock.

Unlocking the Steering Wheel



WARNING: Always check that the steering is unlocked before attempting to move your vehicle.

1. Insert the key in the ignition.
2. Turn the key to position **I**.

Note: You may have to slightly rotate the steering wheel to assist unlocking it.

Wipers and Washers

WINDSHIELD WIPERS

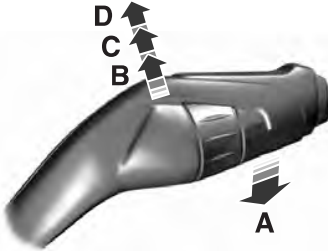

E197525

- A Single wipe.
- B Intermittent wipe.
- C Normal wipe.
- D High-speed wipe.

Note: Fully defrost the windshield before you switch the windshield wipers on.

Note: Make sure that you switch the windshield wipers off before entering a car wash.

Note: If streaks or smears appear on the windshield, clean the windshield and the wiper blades. See **Checking the Wiper Blades** (page 294). If that does not resolve the issue, install new wiper blades. See **Changing the Front Wiper Blades** (page 295).

Note: Do not operate the wipers on a dry windshield. This may scratch the glass or damage the wiper blades. Always use the windshield washers before wiping a dry windshield.

Intermittent Wipe

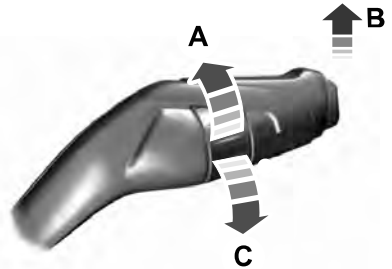

E197526

- A Short wipe interval.
- B Intermittent wipe.
- C Long wipe interval.

Use the rotary control to adjust the intermittent wipe interval.

Note: When your vehicle speed increases, the interval between intermittent wipes may decrease.

AUTOWIPERS

Autowipers uses a rain sensor in the area around the interior mirror. The wipers operate when the rain sensor detects water on the windshield in front of it. The rain sensor continues to monitor the amount of water and adjusts the speed of the wipers.

Note: The wipers remain in a slightly raised position during operation and only return to the park position a short time after the rain sensor detects no water on the windshield.

You can switch autowipers on or off in the information display.

Note: If you switch autowipers off in the information display, the windshield wipers operate in intermittent mode.

Wipers and Washers

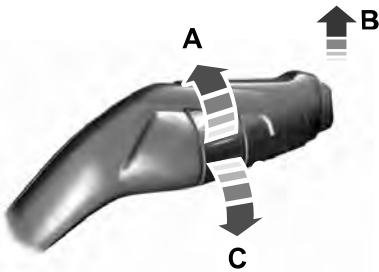

E197526

- A High sensitivity.
- B Autowipers on.
- C Low sensitivity.

Move the wiper lever upward to the first position to switch autowipers on.

Use the rotary control to adjust the sensitivity of the autowipers. When you select low sensitivity, the wipers operate when the sensor detects a large amount of water on the windshield. When you select high sensitivity, the wipers operate when the sensor detects a small amount of water on the windshield.

Note: Keep the outside of the windshield clean. The rain sensor is very sensitive and the wipers may operate if dirt, mist or insects hit the windshield.

Settings

To switch autowipers on or off, use the information display controls on the steering wheel to select the following:

Menu Item	Action
Settings	Press the menu button.
Vehicle Settings	Press the OK button.
Wipers	Press the OK button.
Rain Sensing	Press the OK button.

If you leave autowipers on, it may not operate when you switch the ignition on during freezing temperatures. This is because the system has deactivated the rain sensor to prevent damage to the windshield wipers. Defrost the windshield before reactivating the rain sensor. You can reactivate the rain sensor by moving the rotary control or switching autowipers off and on.

Note: Fully defrost the windshield before you switch the windshield wipers on.

Note: Make sure that you switch the windshield wipers off before entering a car wash.

Wet or winter weather conditions could cause unexpected wiping or smearing.

To keep the windshield clear:

- Lower the sensitivity of the autowipers to reduce the amount of smearing on the windshield.
- Switch autowipers off.

Note: If streaks or smears appear on the windshield, clean the windshield and the wiper blades. See **Checking the Wiper Blades** (page 294). If that does not resolve the issue, install new wiper blades. See **Changing the Front Wiper Blades** (page 295).

Wipers and Washers

WINDSHIELD WASHERS



E197528

Pull the lever toward you to operate the windshield washers. When you release the lever, the wipers operate for a short time. A courtesy wipe occurs a short time after the wipers stop to clear any remaining washer fluid.

You can switch courtesy wipe on or off in the information display.

Note: Do not operate the washers when the washer reservoir is empty. This could cause the washer pump to overheat.

Settings

To switch courtesy wipe on or off, use the information display controls on the steering wheel to select the following:

Menu Item	Action
Settings	Press the menu button.
Vehicle Settings	Press the OK button.
Wipers	Press the OK button.
Courtesy Wipe	Press the OK button.

Lighting

GENERAL INFORMATION

Condensation in the Exterior Front Lamps and Rear Lamps

Exterior front lamps and rear lamps have vents to accommodate normal changes in air pressure.

Condensation can be a natural by-product of this design. When moist air enters the lamp assembly through the vents, there is a possibility that condensation can occur when the temperature is cold. When normal condensation occurs, a fine mist can form on the interior of the lens. The fine mist eventually clears and exits through the vents during normal operation.

Clearing time may take as long as 48 hours under dry weather conditions.

Examples of acceptable condensation are:

- The presence of a fine mist (no streaks, drip marks or large droplets).
- A fine mist covers less than 50% of the lens.

Examples of unacceptable condensation are:

- A water puddle inside the lamp.
- Streaks, drip marks or large droplets present on the interior of the lens.

If you see any unacceptable condensation, have your vehicle checked by an authorized dealer.

LIGHTING CONTROL

Lighting Control Positions

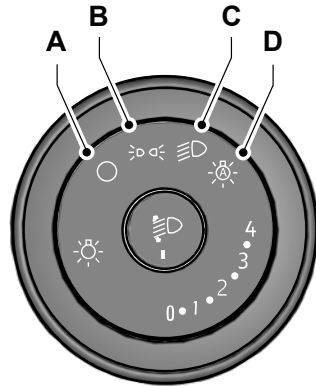

- A Lamps off.
- B Parking lamps, instrument panel lamps and license plate lamps.
- C Headlamps.
- D Autolamps. See **Autolamps** (page 101).

Switching the Parking Lamps On

1. Switch the ignition off.
2. Set the lighting control to the parking lamps position.

Note: *Parking lamps could turn off to prevent the vehicle battery from running out of charge.*

Lighting

Switching High Beam Headlamps On and Off



E163718

Push the lever away from you to switch the high beam headlamps on.

Push the lever forward again or pull the lever toward you to switch the high beam headlamps off.

Note: If you switch the autolamps on, you cannot switch the high beam headlamps on until the system turns the headlamps on.

Flashing High Beam Headlamps



E163719

Pull the lever toward you and release it to flash the high beam headlamps.

High Beam Headlamp Indicator



It illuminates when you switch the high beam headlamps on.

Lamps On Indicator



It illuminates when you switch the low beam headlamps or the side and rear lamps on.

Exterior Lamps On Audible Warning

Sounds when you open the driver door and the exterior lamps are on.

AUTOLAMPS



WARNING: The system does not relieve you of your responsibility to drive with due care and attention. You may need to override the system if it does not turn the headlamps on in low visibility conditions, for example daytime fog.

Autolamps turn the headlamps on in low light situations or when the wipers operate.

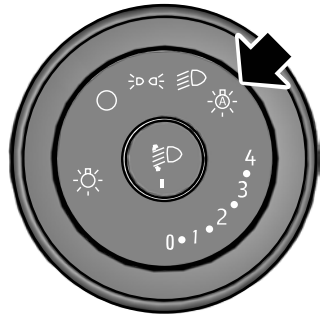

Note: When you switch the autolamps on, the headlamps turn on within 10 seconds of switching the wipers on.

Note: If you switch the autolamps and the autowipers on, the headlamps turn on when the windshield wipers continuously operate.

Note: The headlamps turn off approximately 60 seconds after you switch the wipers off.

Lighting

The headlamps remain on for a period of time after you switch the ignition off. Use the information display controls to adjust the period of time that the headlamps remain on.

Adjusting the Period of Time That the Headlamps Remain On

1. Using the information display controls on the steering wheel, select **Settings**.
2. Select **Vehicle Settings**.
3. Select **Lighting**.
4. Select **Autolamp Delay**.
5. Select a setting.
6. Press the **OK** button.

INSTRUMENT LIGHTING DIMMER

The instrument lighting dimmer buttons are on the lighting control.



Repeatedly press one of the buttons to adjust the brightness.



DAYTIME RUNNING LAMPS (IF EQUIPPED)



WARNING: The daytime running lamps system does not activate the rear lamps and may not provide adequate lighting during low visibility driving conditions. Also, the autolamps switch position may not activate the headlamps

in all low visibility conditions, such as daytime fog. Make sure the headlamps are switched to auto or on, as appropriate, during all low visibility conditions. Failure to do so may result in a crash.

Type 1 - Conventional (Non-Configurable)

The daytime running lamps turn on when:

1. The ignition is switched to the on position.
2. The lighting control is in the off, parking lamp or autolamps positions.
3. The headlamps are off.

Type 2 - Configurable

Switch the daytime running lamps on or off using the information display controls. See **Information Displays** (page 115).

The daytime running lamps turn on when:

1. They are switched on in the information display. See **Information Displays** (page 115).
2. The ignition is switched to the on position.
3. The lighting control is in the autolamps position.
4. The headlamps are off.

The other lighting control switch positions do not activate the daytime running lamps, and you can use them to temporarily override autolamp control.

When switched off in the information display, the daytime running lamps are off in all lighting control switch positions.

Lighting

AUTOMATIC HIGH BEAM CONTROL



WARNING: The system does not relieve you of your responsibility to drive with due care and attention. You may need to override the system if it does not turn the high beams on or off.



WARNING: You may need to override the system when approaching other road users.



WARNING: You may need to override the system during inclement weather.



WARNING: Do not use the system in poor visibility, for example fog, heavy rain, spray or snow.



WARNING: The system may not switch the high beams off if the lights of oncoming vehicles are hidden by obstacles, for example guard rails.



WARNING: Inspect and replace the windshield wiper blades regularly to make sure the camera sensor has a clear view. The windshield wiper blades must be the correct length.

The system is designed to turn the high beams on if all of the following occur:

- You switched the system on in the information display.
- You set the lighting control to the autolamps position.
- The ambient light level is low enough that high beams are required.
- There is no traffic in front of your vehicle.
- Your vehicle speed is greater than approximately 32 mph (51 km/h).

The system is designed to turn the high beams off if any of the following occur:

- You switch the system off in the information display.
- You set the lighting control to any position except autolamps.
- The ambient light level is high enough that high beams are not required.
- The system detects an approaching vehicle's headlamps or rear lamps.
- The system detects severe rain, snow or fog.
- The system detects street lighting.
- The camera has reduced visibility.
- Your vehicle speed falls below approximately 27 mph (44 km/h).

Note: *High beam reactivation may be delayed in certain curvy road situations.*

Note: *Using much larger tires or equipping vehicle accessories such as snowplows can modify your vehicle's ride height and degrade automatic high beam control performance.*

Lighting

Switching Automatic High Beam Control On or Off

To switch the system on or off, use the information display controls on the steering wheel to select the following:

Menu Item	Action
Settings	Press the menu button.
Vehicle Settings	Press the OK button.
Lighting	Press the OK button.
Auto Highbeam	Press the OK button.

Automatic High Beam Indicator



It illuminates to confirm when the system is ready to assist.

Overriding Automatic High Beam Control

Push the lever away from you to switch between high beam and low beam.

Automatic High Beam Control Information Messages

Message	Description
Front Camera Low Visibility Clean Screen	The camera has reduced visibility. Clean the windshield. If the message continues to appear, have your vehicle checked as soon as possible.
Front Camera Temporarily Not Available	The camera has malfunctioned. Wait a short period of time for the camera to cool down. If the message continues to appear, have your vehicle checked as soon as possible.

FRONT FOG LAMPS

Switching the Front Fog Lamps On or Off

Only switch the front fog lamps on during reduced visibility.

You can switch the front fog lamps on if any of the following occur:

- You set the lighting control to the parking lamps position.
- You set the lighting control to the headlamps position.
- You set the lighting control to the autolamps position and the headlamps are on.

The front fog lamp button is on the lighting control.



Press the button to switch the front fog lamps on or off.

Lighting

Note: The brightness of the daytime running lamps may decrease when the front fog lamps are switched on.

Front Fog Lamp Indicator



It illuminates when you switch the front fog lamps on.

DIRECTION INDICATORS

Switching the Direction Indicators On and Off



E162681

Push the lever up or down to switch the direction indicators on.

Note: Tap the lever up or down to make the direction indicators flash three times.

Set the lever to the middle position to switch the direction indicators off.

Direction Indicator



Flashes when you switch the direction indicators on.

Note: An increase in the rate of flashing warns of a failed indicator bulb.

INTERIOR LAMPS - VAN

Switching the Courtesy Lamps On and Off



Fully press the button on the overhead console to switch the courtesy lamps on.



Fully press the button on the overhead console to switch the courtesy lamps off.

Courtesy Lamp Function

When you switch the courtesy lamp function on, the courtesy lamps turn on if:

- You open a door.
- You press the unlock button on the remote control.
- You switch the ignition off.

Switching the Courtesy Lamp Function On



E293629

Set the switch to the middle position.

Switching the Front Map Reading Lamps On and Off



E112208

CARGO LAMPS

Switching the Cargo Lamps Off

Press the button to switch the cargo lamps off when a door is open.

Note: *The cargo lamps switch only operates when the ignition is off.*

The switch is inside the cargo area, behind the left-hand rear door.

The cargo lamps turn off after a short period of time to prevent the battery from running out of charge.

Switching the Cargo Lamps On

Press the button to switch the cargo lamps on.

If the cargo lamps turned off to prevent the battery from running out of charge or you switched them off by pressing the button, reset the switch first.

Resetting the Switch

To reset the switch, do one of the following:

- Lock or unlock a door.
- Open or close a front door.
- Switch the ignition on then off.

Press the button to switch the cargo lamps on.

Windows and Mirrors

POWER WINDOWS

Opening and Closing the Windows



WARNING: Do not leave children unattended in your vehicle and do not let them play with the power windows. Failure to follow this instruction could result in personal injury.



WARNING: When closing the power windows, verify they are free of obstruction and make sure that children and pets are not in the proximity of the window openings.



Press the control to open the window. Lift the control to close the window.

Note: *The power windows operate with the ignition on, and for several minutes after you switch the ignition off or until you open a front door.*

To reduce wind noise or pulsing noise when one window is open, slightly open the opposite window.

One-Touch Open

Fully press the control and release it. Press again or lift it to stop the window.

One-Touch Close

Fully lift the control and release it. Press again or lift it to stop the window.

Resetting One-Touch Close

1. Lift and hold the switch until the window is fully closed.
2. Release the switch.
3. Lift the switch again for one more second.
4. Release the switch.

5. Lift the switch again for one more second.

Note: *Repeat the procedure if the window does not close when you use one-touch.*

Bounce-Back

The window stops and reverses if it detects an obstruction while closing.

Overriding Bounce-Back



WARNING: If you override bounce-back, the window does not reverse if it detects an obstacle. Take care when closing the windows to avoid personal injury or damage to your vehicle.

1. Close the window until it reaches the point of resistance and let it reverse.
2. Close the window a third time to the point of resistance. Bounce-back is now disabled and you can close the window manually.

Note: *The window goes past the point of resistance and you can fully close it.*

Note: *If the window does not close, have your vehicle checked as soon as possible.*

Resetting Bounce-Back



WARNING: Bounce-back is off until you reset the memory. Take care when closing the windows to avoid personal injury or damage to your vehicle.

1. Lift and hold the switch until the window is fully closed.
2. Release the switch.
3. Lift the switch again for one more second.
4. Release the switch.

Windows and Mirrors

5. Lift the switch again for one more second.

Note: Repeat the procedure if the window does not close when you use one-touch.

Note: If you have disconnected the battery, you must reset the bounce-back memory.

EXTERIOR MIRRORS

Power Exterior Mirrors

 **WARNING:** Do not adjust the mirrors when your vehicle is moving. This could result in the loss of control of your vehicle, serious personal injury or death.

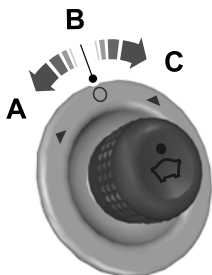

E71280

- A Left-hand mirror
- B Off
- C Right-hand mirror

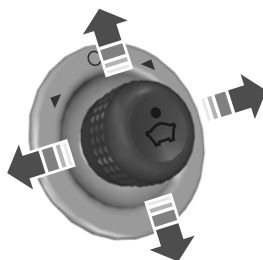

E71281

Move the controller in the direction of the arrows to adjust the mirror.

Power Folding Mirrors (If Equipped)

Folding and Unfolding

The power folding mirrors operate with the ignition on, and for several minutes after you switch the ignition off.

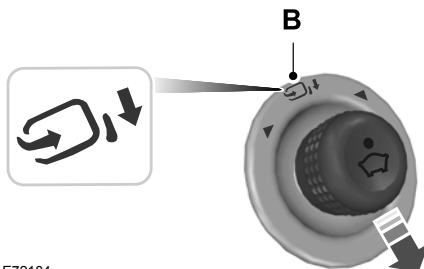

E72184

Move the controller downward to fold or unfold the mirrors.

Note: You can only fold the mirrors when the controller is set to position B.

Note: If you fold and unfold the mirrors several times within one minute, the power fold function may turn off to protect the motors from overheating.

Note: Do not manually fold or unfold power folding mirrors.

Windows and Mirrors

Loose Mirror

If your power-folding mirrors are manually folded, they may not work properly, even after you re-position them. You need to reset them if:

- The mirrors vibrate when you drive.
- The mirrors feel loose.
- The mirrors do not stay in the folded or unfolded position.
- One of the mirrors is not in its normal driving position.

To reset the power-fold feature, use the power-folding mirror control to fold and unfold the mirrors. You may hear a loud noise as you reset the power-folding mirrors. This sound is normal. Repeat this process as needed each time the mirrors are manually folded.

Fold-Away Exterior Mirrors

Push the mirror toward the door window glass. Make sure that you fully engage the mirror in its support when you unfold it.

INTERIOR MIRROR



WARNING: Do not adjust the mirrors when your vehicle is moving. This could result in the loss of control of your vehicle, serious personal injury or death.

Pull the tab below the mirror toward you to reduce the effect of bright light from behind.

Instrument Cluster

GAUGES

Instrument Cluster

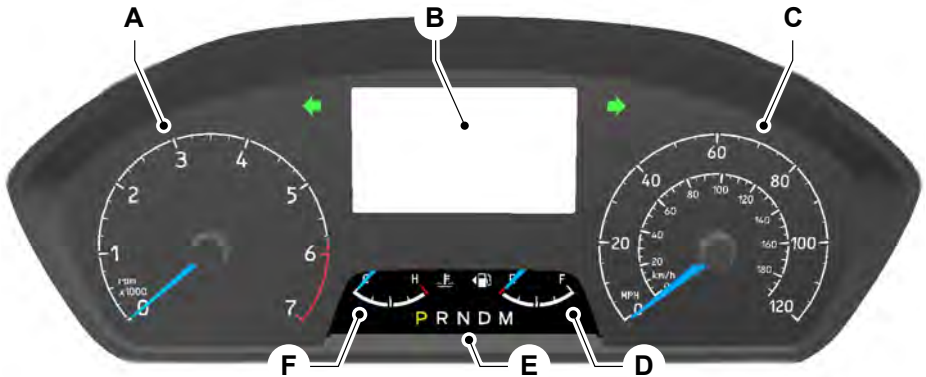

- A Tachometer.
- B Information display.
- C Speedometer.
- D Fuel gauge.
- E Automatic transmission position indicators.
- F Engine coolant temperature gauge.

Tachometer

Shows the engine speed.

Information Display

Shows the following information:

- Odometer.
- Trip computer.
- MyView information.
- Driver assistance information.
- Navigation information.

- Audio information.
- Phone information.
- Vehicle and system settings.
- Outside air temperature.
- Shift indicators.

Odometer

Records the total distance traveled by your vehicle.

Instrument Cluster

The system detects unauthorized odometer adjustments to avoid total distance reading fraud. If the system detects an unauthorized odometer adjustment, the total distance reading displays XXXX. Recovery of the original mileage could result in system damage not covered by the vehicle Warranty and may carry a significant expense.

Trip Computer

See **Trip Computer** (page 117).

Vehicle and System Settings

See **General Information** (page 115).

Speedometer

Shows the vehicle speed.

Fuel Gauge

The fuel gauge indicates approximately how much fuel is in the fuel tank.

The arrow adjacent to the fuel pump symbol indicates on which side of your vehicle the fuel filler door is located.



A



B

E236403

- A The fuel filler door is on the left-hand side of your vehicle.
- B The fuel filler door is on the right-hand side of your vehicle.

Automatic Transmission Position Indicators

The instrument cluster displays the current position. See **Automatic Transmission** (page 161).

Engine Coolant Temperature Gauge

At normal operating temperature, the needle remains in the center section. If the needle enters the red section, the engine is overheating. Stop your vehicle as soon as it is safe to do so, switch the engine off and allow it to cool.

Note: *The system reduces the engine speed if you continue to operate the engine at a high engine speed.*

Note: *Do not restart the engine until the cause of overheating has been determined and resolved.*

Engine Coolant Temperature Warning Lamp



If it illuminates when your vehicle is moving, this indicates that the engine is overheating. Stop your vehicle as soon as it is safe to do so and switch the engine off. Have your vehicle checked as soon as possible.

WARNING LAMPS AND INDICATORS



Adaptive cruise control indicator. It illuminates when you switch the system on. It illuminates white when the system is in standby mode. It illuminates green when you set the adaptive cruise speed.

Instrument Cluster



Airbag warning lamp. If it does not illuminate when you switch the ignition on, continues to flash or remains on when the engine is running, this indicates a malfunction. Have your vehicle checked as soon as possible.



Anti-lock brake system warning lamp. If it illuminates when you are driving, this indicates a malfunction. Your vehicle continues to have normal braking without the anti-lock brake system function. Have your vehicle checked as soon as possible.



Auto-Start-Stop indicators. It illuminates green when the engine stops. It flashes amber and a message appears when you need to take action. It illuminates gray with a



strikethrough when the system is not available.



Automatic high beam control on indicator. It illuminates to confirm when the system is ready to assist.



Blind spot information system indicator. When the system detects a vehicle, the indicator illuminates in the exterior mirror on the side the approaching vehicle is coming from. If you turn the direction indicator on for that side of your vehicle, the indicator flashes.



Blind spot information system and cross traffic alert warning lamp. If the system malfunctions, the warning lamp illuminates in the instrument cluster and a message appears in the information display. Have your vehicle checked as soon as possible.



Change engine oil indicator. It displays when the engine oil life is becoming depleted. Have the engine oil changed as soon as possible.

Note: Do not ignore engine oil change indicators and information messages. Resulting component damage is not covered by the Warranty.



Change engine oil now indicators. If both indicators display, the engine oil life is seriously depleted. Engine torque reduces to 70% to further indicate the serious risk of engine



damage. Have the engine oil changed immediately.

Note: Do not ignore engine oil change indicators and information messages. Resulting component damage is not covered by the Warranty.



Cross traffic alert indicator. When the system detects an approaching vehicle a tone sounds, the indicator illuminates in the relevant exterior mirror and arrows appear in the information display to show which side the approaching vehicle is coming from.



Cruise control indicator. It illuminates when you switch the system on.



Direction indicator. It flashes when you switch the direction indicators on.



Door ajar warning lamp. It illuminates when you switch the ignition on and remains on if any door or the hood is open.



Eco mode indicator. It illuminates when the drive mode is selected.



Efficient drive mode indicator. It indicates that you have to slowly decelerate.

Instrument Cluster



Engine coolant temperature warning lamp. If it illuminates when your vehicle is moving, this indicates that the engine is overheating. Stop your vehicle as soon as it is safe to do so and switch the engine off. Have your vehicle checked as soon as possible.



Engine oil pressure warning lamp. It illuminates when you switch the ignition on. If it illuminates when the engine is running this indicates a malfunction. Stop your vehicle as soon as it is safe to do so and switch the engine off. Check the engine oil level. If the oil level is sufficient, this indicates a system malfunction. Have your vehicle checked as soon as possible.



Engine warning lamps. If both lamps illuminate when the engine is running, stop your vehicle as soon as it is safe to do so. Continuing to drive your vehicle may cause reduced power or the engine to stop. Switch the ignition off and attempt to restart the engine. Have your vehicle checked as soon as possible.



Fasten seatbelt warning lamp. It illuminates until you fasten your seatbelt.



Front fog lamp indicator. It illuminates when you switch the front fog lamps on.



Hazard flasher indicator. It flashes when you switch the hazard flashers on.



High beam headlamp indicator. It illuminates when you switch the high beam headlamps on.



Ignition warning lamp. It illuminates when you switch the ignition on. If it illuminates when the engine is running this indicates a malfunction. Have your vehicle checked as soon as possible.



Lamps on indicator. It illuminates when you switch the low beam headlamps or the side and rear lamps on.



Lane keeping aid indicator. It illuminates in the information display when you switch the system on and Aid Mode or Alert and Aid Mode are selected.



Lane keeping alert indicator. It illuminates in the information display when you switch the system on and Alert Mode is selected.



Lane keeping system warning lamp. It could illuminate when you switch the system off. If it illuminates when you are driving, this indicates a malfunction. Have your vehicle checked as soon as possible.



Low fuel level warning lamp. If it illuminates when you are driving, refuel as soon as possible.



Malfunction indicator lamp. If it illuminates when the engine is running this indicates a malfunction. If it flashes, engine misfire may be occurring. Increased exhaust gas temperatures could damage the diesel particulate filter or other vehicle components. Avoid heavy acceleration and deceleration and have your vehicle checked as soon as possible.



Mud/Ruts mode indicator. It illuminates when the drive mode is selected.

Instrument Cluster

BRAKE

Parking brake warning lamp. It illuminates when you engage the parking brake and the ignition is on. If it illuminates when your vehicle is moving, make sure the parking brake is disengaged. If the parking brake is disengaged, this indicates low brake fluid level or a brake system fault. Have your vehicle checked as soon as possible.



Powertrain warning lamp. If it illuminates when the engine is running this indicates a malfunction. If it flashes when you are driving, immediately reduce the vehicle speed. Avoid heavy acceleration and deceleration and have your vehicle checked as soon as possible.



Pre-collision assist warning lamp. It illuminates if your vehicle rapidly approaches another vehicle, to warn you of the risk of a crash with the vehicle in front of you. It could illuminate red if the distance to the vehicle ahead is small. It illuminates amber when you switch the system off or if the system is not available.



Slippery mode indicator. It illuminates when the drive mode is selected.



Stability control and traction control indicator. It flashes during operation. If it does not illuminate when you switch the ignition on, or remains on when the engine is running, this indicates a malfunction. Have your vehicle checked as soon as possible.



Stability control and traction control off warning lamp. It illuminates when you switch the system off.



Tire pressure monitoring system warning lamp. It illuminates if the tire pressure in one or more tires is below the correct tire pressure. If it does not illuminate when you switch the ignition on, or flashes when the engine is running, this indicates a malfunction. Have your vehicle checked as soon as possible.



Tow/haul mode indicator. It illuminates when the drive mode is selected.

Information Displays

GENERAL INFORMATION



WARNING: Driving while distracted can result in loss of vehicle control, crash and injury. We strongly recommend that you use extreme caution when using any device that may take your focus off the road. Your primary responsibility is the safe operation of your vehicle. We recommend against the use of any hand-held device while driving and encourage the use of voice-operated systems when possible. Make sure you are aware of all applicable local laws that may affect the use of electronic devices while driving.

Note: For your safety, some features are speed-dependent. Their use is limited to when your vehicle speed is not moving.

Information Display Controls



E257718



E250032

- A Return button.
- B OK button.
- C Menu button.

Return Button

Use the return button to go back or to exit.

OK Button

Use the **OK** button to make a selection. You can also use it to scroll through a menu.

Menu Button

Use the menu button on the main screen to display the submenu. You can also use it to go back to the main screen.

Information Display Menus

Main Menu

Menu Item
Trip 1 or Trip 2
MyView
Driver Assist.
Navigation

Information Displays

Menu Item
Audio
Phone
Settings

Submenus

Trip 1 and Trip 2

Menu Item
Trip 1
Trip 2
Reset Individual Values
Configure View

MyView

Menu Item
Digital Speedometer
Fuel Economy
Trip/Audio
Eco Coach
Calm Screen

Driver Assist.

Menu Item
Traction Control
Blind Spot
Trailer Blind Spot
Pre-Collision Assist
Traffic Sign Recognition
Lane Keeping System

Menu Item
Driver Alert
Hill Start Assist
Cross Traffic Alert
Eco Coach
Trailer Sway
Cruise Control
Speed Limiter
Rear Parking Aid

Navigation

Menu Item
Home
Favorite Destinations
Previous Destinations

Audio

Menu Item
Radio
USB device.
Bluetooth device.

Phone

Menu Item
All Calls
Incoming Calls
Missed Calls
Outgoing Calls

Information Displays

Settings

Menu Item
Information
Display
Driver Assistance
Vehicle Settings
Vehicle Maintenance
MyKey

TRIP COMPUTER

You can reset the trip computer and personalize it using the information display. See **Information Displays** (page 117).

Resetting the Trip Computer

Navigate to the following main menu item.

Menu Item	Action
Trip 1	Press and hold the OK button until the system reset confirmation appears.
Trip 2	Press and hold the OK button until the system reset confirmation appears.

Alternatively you can reset individual trip values.

Menu Item	Action
Trip 1	Press the menu button.
Trip 2	Press the menu button.
Reset Individual Values	Press the OK button.
Reset Trip Odometer	Press and hold the OK button until the system reset confirmation appears.
Reset Trip Timer	Press and hold the OK button until the system reset confirmation appears.
Reset Average Fuel	Press and hold the OK button until the system reset confirmation appears.
Reset Average Speed	Press and hold the OK button until the system reset confirmation appears.

Information Displays

Personalization

Navigate to the following main menu item.

Menu Item	Action
Trip 1	Press the menu button.
Trip 2	Press the menu button.
Configure View	Press the OK button.
Trip Odometer	Press the OK button.
Trip Timer	Press the OK button.
Average Fuel	Press the OK button.
Average Speed	Press the OK button.
Distance to Empty	Press the OK button.
Instantaneous Fuel	Press the OK button.

Note: You can display a maximum of four values.

Trip Odometer

Registers the total distance since you last reset the value.

Trip Timer

Registers the total time since you last reset the value.

Average Fuel

Indicates the average fuel consumption since you last reset the value.

Average Speed

Indicates the average vehicle speed since you last reset the value.

Distance to Empty

Indicates the approximate distance your vehicle could travel on the fuel remaining in the fuel tank. Changes in driving pattern may cause the value to vary.

Instantaneous Fuel

Indicates the current fuel consumption.

PERSONALIZED SETTINGS

Language

Menu Item	Action
Settings	Press the menu button.
Display	Press the OK button.
Language	Press the OK button. Choose your applicable setting.

Information Displays

Measure Unit

Menu Item	Action
Settings	Press the menu button.
Display	Press the OK button.
Measurement Unit	Press the OK button. Choose your applicable setting.

Temperature Unit

Menu Item	Action
Settings	Press the menu button.
Display	Press the OK button.
Temperature Unit	Press the OK button. Choose your applicable setting.

Tire Pressure Unit (If Equipped)

Menu Item	Action
Settings	Press the menu button.
Display	Press the OK button.
Tire Pressure	Press the OK button. Choose your applicable setting.

Chimes

Menu Item	Action
Settings	Press the menu button.
Vehicle Settings	Press the OK button.
Chimes	Press the OK button.
Park Slot Found	Press the OK button.
Information	Press the OK button.

Remote Start

WHAT IS REMOTE START

The system allows you to remotely start your vehicle and therefore to heat or cool the interior to a predetermined temperature.

REMOTE START LIMITATIONS

Remote start does not work if:

- The alarm horn is sounding.
- The hood is open.
- The transmission is not in park (P).
- Remote start is not enabled.
- The ignition is on.

Note: Do not use remote start if your fuel level is low.

ENABLING REMOTE START

1. Using the information display controls on the steering wheel, select **Settings**.
2. Select **Vehicle Settings**.
3. Select **Remote Start**.
4. Switch **System** on.

Note: To use remote start, make sure that the modem is enabled. See **Enabling and Disabling the Modem** (page 371).

REMOTELY STARTING AND STOPPING THE VEHICLE



WARNING: Do not start the engine in a closed garage or in other enclosed areas. Exhaust fumes are toxic. Always open the garage door before you start the engine. Failure to follow this instruction could result in personal injury or death.

Use the FordPass App to start the vehicle.

Note: The turn signal lamps flash twice.

Note: The parking lamps turn on when the vehicle is running.

Note: The horn sounds if the system fails to start.

Note: All other vehicle systems remain off when you have remotely started the vehicle.

Note: You may have to wait a short period of time before remotely starting the vehicle after the vehicle stops running.

Note: The vehicle remains secured when you have remotely started it. A valid key must be inside your vehicle to switch the ignition on and drive your vehicle.

Note: A maximum of two remote starts are allowed. After that you need to turn the ignition on and off before you can use remote start again.

Use the FordPass App to switch the vehicle off.

REMOTE START SETTINGS

Climate Control Settings

1. Using the information display controls on the steering wheel, select **Settings**.
2. Select **Vehicle Settings**.
3. Select **Remote Start**.
4. Select **Climate Control**.
5. Select **Auto** or **Last Settings**.

Note: If you select **Auto**, the system attempts to heat or cool the interior to 72°F (22°C).

Note: If you select **Last Settings**, the system remembers the last used settings.

Note: You cannot adjust the climate control settings when you have remotely started the engine.

Remote Start

Note: *When you switch the ignition on, the climate control system returns to the last used settings.*

Heated Seat Settings

1. Using the information display controls on the steering wheel, select **Settings**.
2. Select **Vehicle Settings**.
3. Select **Remote Start**.
4. Select **Seats**.
5. Select **Auto** or **Off**.

Note: *If you switch the heated seat settings on, the heated seats turn on during cold weather.*

Note: *You cannot adjust the heated seat settings when you have remotely started the engine.*

Setting the Remote Start Duration

You can set a duration for Remote Start to run.

1. Using the information display controls on the steering wheel, select **Settings**.
2. Select **Vehicle Settings**.
3. Select **Remote Start**.
4. Select **Duration**.

Climate Control

MANUAL CLIMATE CONTROL

Switching the Climate Control On and Off



Switching the Recirculated Air On and Off



Note: The air currently in the passenger compartment recirculates.

Switching the Air Conditioning On and Off



Note: Under certain conditions, the air conditioning compressor could continue to operate after you switch air conditioning off.

Switching Maximum Defrost On and Off



Turn the temperature control clockwise past the highest setting to maximize defrosting.

Note: The temperature control springs back to the highest setting.

Note: When you switch maximum defrost on, the heated windshield, heated rear window and air conditioning turn on. The blower motor is set to the highest speed.

Note: When you switch maximum defrost off, the heated windshield and heated rear window remain on.

Switching Maximum Cooling On and Off



Turn the temperature control counterclockwise past the lowest setting to maximize cooling.

Note: The temperature control springs back to the lowest setting.

Note: When you switch maximum cooling off, air conditioning remains on.

Setting the Blower Motor Speed



Note: Lights on the control illuminate to indicate the blower motor speed.

Note: When you switch the blower motor off, air conditioning turns off and the windows could fog up.

Directing Air to the Windshield Air Vents



Directing Air to the Instrument Panel Air Vents



Directing Air to the Footwell Air Vents



Climate Control

Setting the Temperature

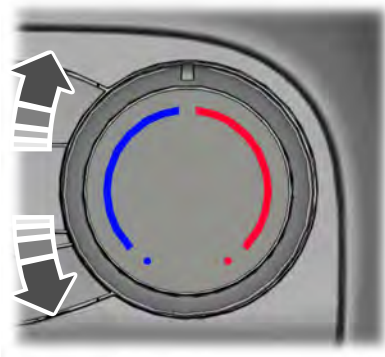

Turn the temperature control counterclockwise for cooler temperature settings.

Turn the temperature control clockwise for warmer temperature settings.

HINTS ON CONTROLLING THE INTERIOR CLIMATE

General Hints

Do not place objects under the front seats as this may interfere with directing air to the rear seats.

Remove any snow, ice or leaves from the air intake area at the base of the windshield.

Note: You may feel a small amount of air from the footwell air vents regardless of the air distribution setting.

Note: To reduce humidity build-up inside your vehicle, do not drive with the system switched off or with recirculated air always switched on.

Note: To reduce fogging of the windshield during humid weather conditions, direct air to the windshield air vents.

Note: Prolonged use of recirculated air may cause the windows to fog up.

Note: Use air conditioning with recirculated air to improve cooling performance and efficiency.

Quickly Heating the Interior

- Select the highest blower motor speed.
- Select the highest temperature.
- Direct air to the footwell air vents.

Recommended Settings for Heating

- Select a medium blower motor speed.
- Select the required temperature.
- Direct air to the footwell and windshield air vents.

Quickly Cooling the Interior

- Select maximum cooling.

Note: To improve the time to reach a comfortable temperature in hot weather, drive with the windows open until you feel cold air through the air vents.

Recommended Settings for Cooling

- Select a medium blower motor speed.
- Select the required temperature.
- Direct air to the instrument panel air vents.
- Press A/C.

Defogging the Side Windows in Cold Weather

- Select maximum defrost.

Climate Control

Defogging or Clearing the Windshield of Thin Ice

- Select maximum defrost.

REAR PASSENGER CLIMATE CONTROLS

Adjusting the Blower Motor Speed



Directing Air to the Overhead Air Vents



When you direct air to the overhead air vents, the system distributes cold air.

Directing Air to the Footwell Air Vents



When you direct air to the footwell air vents, the system distributes hot air.

Directing Air to the Overhead Air Vents and the Footwell Air Vents



When you direct air to the Overhead and footwell air vents, the system distributes warm air.

HEATED REAR WINDOW



Press the button to clear the rear window of thin ice and fog. The heated rear window turns off after a short period of time.

Note: Make sure the engine is on before operating the heated windows.

Note: Do not use razor blades or other sharp objects to clean or remove decals from the inside of the heated rear window. The vehicle Warranty may not cover damage caused to the heated rear window grid lines.

HEATED EXTERIOR MIRRORS - VEHICLES WITHOUT: HEATED REAR WINDOW



Press the button to clear the exterior mirrors of thin ice and fog. Press the button again to switch them off. They switch off after a short period of time.

Note: Do not remove ice from the mirrors with a scraper or adjust the mirror glass when it is frozen in place. These actions could cause damage to the glass and mirrors.

Note: Do not clean the mirror housing or glass with harsh abrasives, fuel or other petroleum-based cleaning products.

HEATED EXTERIOR MIRRORS - VEHICLES WITH: HEATED REAR WINDOW

When you switch the heated rear window on, the heated exterior mirrors turn on.

Note: Do not remove ice from the mirrors with a scraper or adjust the mirror glass when it is frozen in place.

Note: Do not clean the mirror housing or glass with harsh abrasives, fuel or other petroleum-based cleaning products. The vehicle warranty may not cover damage caused to the mirror housing or glass.

Interior Air Quality

WHAT IS THE CABIN AIR FILTER

The cabin air filter improves the quality of air in your vehicle by trapping dust, pollen and other particles.

LOCATING THE CABIN AIR FILTER

You can locate the cabin air filter behind the glove box.

REPLACING THE CABIN AIR FILTER

Replace the filter at regular intervals. See **Scheduled Maintenance** (page 446).

Note: *Make sure you have a cabin air filter installed at all times. This prevents foreign objects from entering the system. Running the system without a filter in place could result in degradation or damage to the system.*

Note: *Using an aftermarket cabin air filter could reduce cabin air filtration and climate control performance.*

Seats

SITTING IN THE CORRECT POSITION



WARNING: Do not recline the seat backrest too far as this can cause the occupant to slide under the seatbelt, resulting in personal injury in the event of a crash.



WARNING: Always sit upright against your seatback with your feet on the floor.



WARNING: Do not place objects higher than the top of the seat backrest. Failure to follow this instruction could result in personal injury or death in the event of a sudden stop or crash.

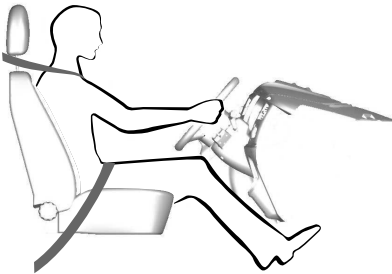

When you use them properly, the seat, head restraint, seatbelt and airbags will provide optimum protection in the event of a crash.

We recommend that you follow these guidelines:

- Sit in an upright position with the base of your spine as far back as possible.
- Do not recline the seat backrest so that your torso is more than 30 degree from the upright position.
- Adjust the head restraint so that the top of it is level with the top of your head and as far forward as possible. Make sure that you remain comfortable.
- Keep sufficient distance between yourself and the steering wheel. We recommend a minimum of 10 in (25 cm) between your breastbone and the airbag cover.
- Hold the steering wheel with your arms slightly bent.
- Bend your legs slightly so that you can press the pedals fully.
- Position the shoulder strap of the seatbelt over the center of your shoulder and position the lap strap tightly across your hips.

Make sure that your driving position is comfortable and that you can maintain full control of your vehicle.

HEAD RESTRAINTS



WARNING: The adjustable head restraint is a safety device. Whenever possible it should be installed and correctly adjusted when the seat is occupied. An incorrectly adjusted head restraint may provide reduced protection to an occupant during certain rear impacts.

Seats

The head restraint consists of:

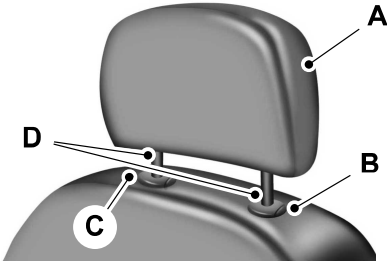

E215998

- A Energy absorbing head restraint.
- B Guide sleeve adjust and unlock button.
- C Guide sleeve unlock and remove button.
- D Steel stems.

Adjusting the Head Restraint

WARNING: Adjust the head restraints for all passengers before you drive your vehicle. This will help minimize the risk of neck injury in the event of a crash. Do not adjust the head restraints when your vehicle is moving.

Note: Adjust the seat backrest to an upright driving position before adjusting the head restraint. Adjust the head restraint so that the top of it is level with the top of your head and as far forward as possible.

Raising the Head Restraint

Lift the head restraint up.

Lowering the Head Restraint

1. Press and hold button B.
2. Push the head restraint down.

Removing the Head Restraint

WARNING: Do not remove the head restraint from an occupied seat.

1. Lift the head restraint up until it reaches its highest position.
2. Press and hold buttons B and C.
3. Remove the head restraint.

Installing the Head Restraint

WARNING: Install head restraints correctly to help minimize the risk of neck injury in the event of a crash.

1. Align the steel stems into the guide sleeves.
2. Press and hold buttons B and C.
3. Push the head restraint down.

MANUAL SEATS - VEHICLES WITH: 2-WAY MANUAL SEAT

WARNING: Do not adjust the driver seat when your vehicle is moving.

WARNING: Do not place cargo or any objects behind the seatback before returning it to the original position.

Moving the Seat Backward and Forward

WARNING: Make sure the seat fully locks into place by rocking it backward and forward. Not securing the seat into the locked position can be dangerous in a crash and could cause serious personal injury or death.

Seats



E177638

Note: The driver seat has removable stop bolts on the track to enable access to the vehicle battery. See **Changing the 12V Battery** (page 290).

Adjusting the Seat Backrest



E175474

Adjusting the Lumbar Support



E146386

Adjusting the Armrest

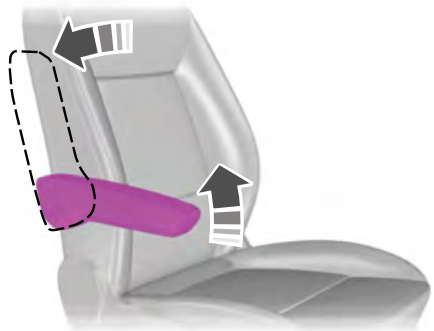

MANUAL SEATS - VEHICLES WITH: 4-WAY MANUAL SEAT



WARNING: Do not adjust the driver seat when your vehicle is moving.

Seats



WARNING: Do not place cargo or any objects behind the seatback before returning it to the original position.

Moving the Seat Backward and Forward



WARNING: Make sure the seat fully locks into place by rocking it backward and forward. Not securing the seat into the locked position can be dangerous in a crash and could cause serious personal injury or death.



E130249

Note: The driver seat has removable stop bolts on the track to enable access to the vehicle battery. See **Changing the 12V Battery** (page 290).

Adjusting the Seat Backrest



E146385

Adjusting the Seat Height

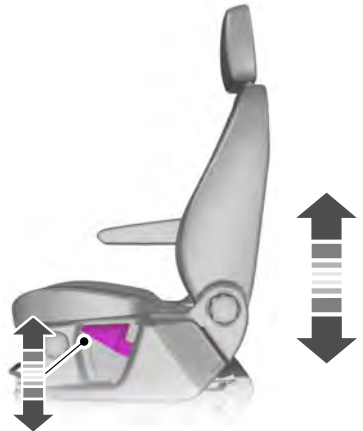

E146384

Seats

Adjusting the Seat Cushion

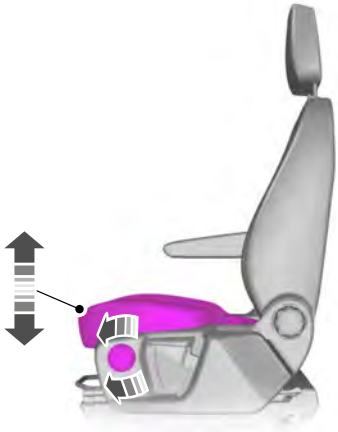

E146959

Adjusting the Armrest

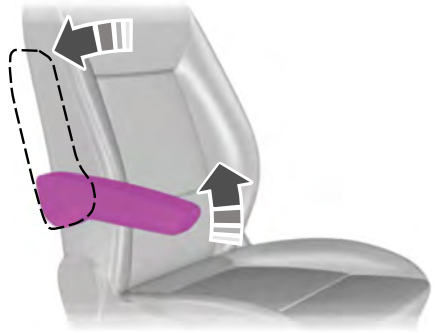

Swiveling the Seat

⚠ WARNING: Make sure the seat locks into place and is facing forward when your vehicle is moving.

Adjusting the Lumbar Support



E146386

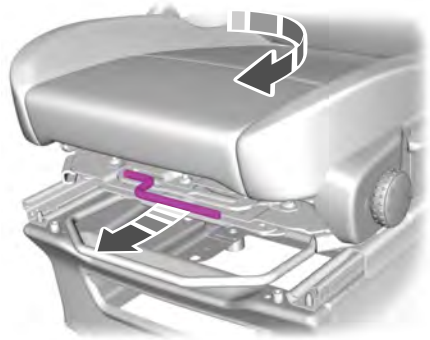

The seat can swivel through 180 degrees in an inboard direction. You may need to adjust the seat to allow sufficient clearance for it to swivel in a single motion.

Seats

Note: We recommend that the seat is unoccupied.

Swivel Seat Audible Warning

Sounds when the driver or passenger seat is not locked into place, and the ignition is on.

POWER SEATS

WARNING: Do not adjust the driver seat when your vehicle is moving.

WARNING: Do not place cargo or any objects behind the seat backrest before returning it to the original position.

WARNING: The driver seat has removable stop bolts on the track to enable access to the vehicle battery. See **Changing the 12V Battery** (page 290).

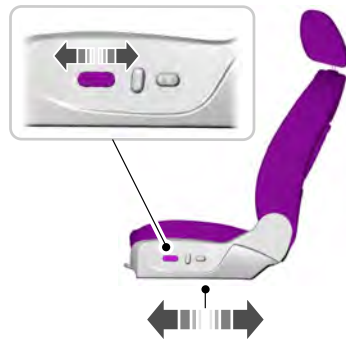
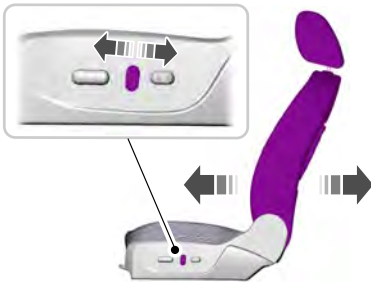
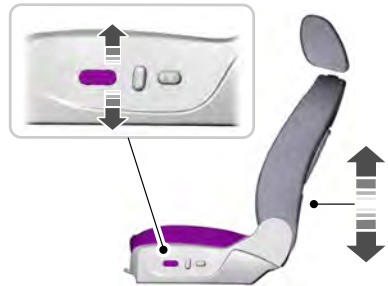
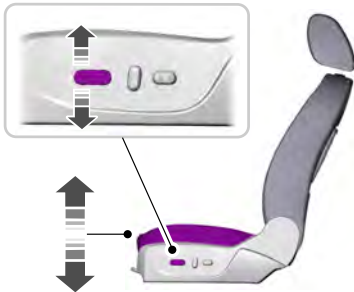

E138647

Seats

Power Lumbar



E138648

REAR SEATS

WARNING: Do not use the bench seats as a bed when your vehicle is moving. Failure to follow this warning could result in serious personal injury or death.

WARNING: Do not place any objects on a folded seat. Hard objects may become projectiles in a crash or sudden stop, which may increase the risk of serious personal injury.

Note: Rear seat arrangements vary depending on the vehicle.

Recline Adjustment (If Equipped)

WARNING: When reclining the seat backrest forward and backward, take care not to get your hands caught between the seat backrest and the frame, catches or mechanism. Failure to take care may result in personal injury.

WARNING: Make sure that any cargo or objects are not trapped behind the seat backrest. Make sure the seatbelts are not trapped in any way when unfolding the seat backrest up. Failure of an occupant to be able to use a trapped seatbelt increases the risk of serious personal injury or death.

WARNING: Make sure that the seat backrest is fully engaged in its catch. A seat backrest which is not fully engaged in its catch could move in the event of an accident. This may result in serious personal injury or death.

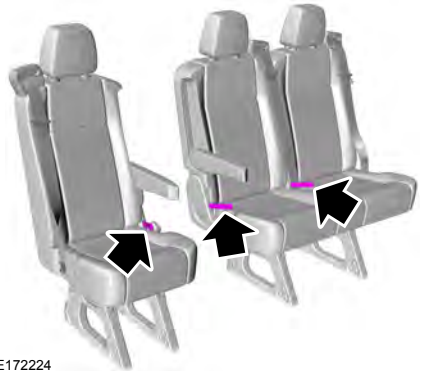

E172224

With the seat occupied, pull the lever or strap to recline or raise the seat backrest.

Seats

Removing Seats (Passenger Vehicles)



WARNING: Seats can weigh up to 176 lb (80 kg). Do not attempt to lift or carry a seat on your own.



WARNING: Do not use the release handles to lift or carry the seat.

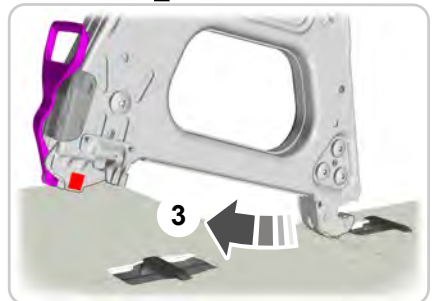
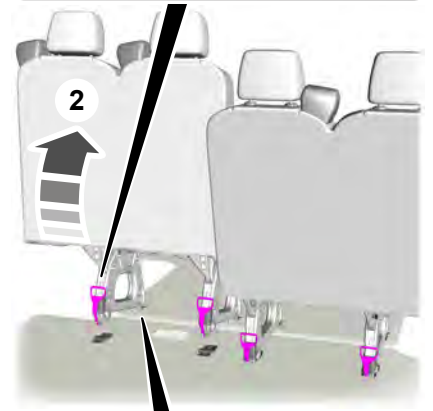
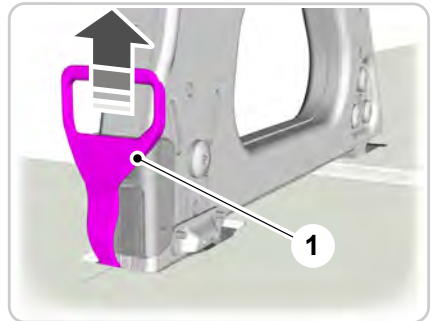

E173870

1. Pull the release handle up at an angle from the floor.

Seats

2. While holding the handle in this position, tilt the top of the seat forward to release the seat frame rear catches from the floor.
3. When the rear seat latches are clear of the floor, release the handle.
4. Pull the seat backward to release the seat frame front catches.
5. Remove the seat from the vehicle.

Note: Two persons are required to release the seat handles and remove the seat.

Note: You can only remove seats that have integral release handles.

Note: The seatback does not fold forward.

Installing the Seats



WARNING: Make sure that the floor catches are free from foreign material before installing the seats.



WARNING: Make sure that you securely fasten the seat catches when installing. Check the latches are correctly engaged by checking the red latch indicators.

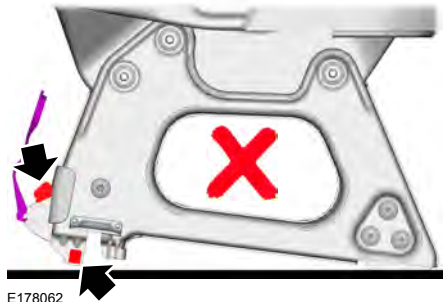

E178062

1. Align the seat frame front catches.
2. Push the seat forward to engage the seat frame front catches.
3. Align the seat frame rear catches.
4. Allow the seat to drop under its own weight for the last 6-8 in (15-20 cm).

HEATED SEATS



WARNING: Use caution when using the heated seat if you are unable to feel pain to your skin because of advanced age, chronic illness, diabetes, spinal cord injury, medication, alcohol use, exhaustion or other physical conditions. The heated seat could cause burns even at low temperatures, especially if used for long periods of time. Failure to follow this instruction could result in personal injury.



WARNING: Do not place anything on the seat that blocks the heat, for example a seat cover or a cushion. This could cause the seat to overheat. Failure to follow this instruction could result in personal injury.



WARNING: Do not poke sharp objects into the seat cushion or seat backrest. This could damage the heated seat element and cause it to overheat. Failure to follow this instruction could result in personal injury.

Do not switch the heated seat on if the seat is wet.

The heated seat button is on the climate control assembly.



Repeatedly press the button to adjust the temperature.

Rear Occupant Alert System (If Equipped)

WHAT IS THE REAR OCCUPANT ALERT SYSTEM

The rear occupant alert system monitors vehicle conditions and notifies you to check for rear seat occupants when you switch the ignition off.

HOW DOES THE REAR OCCUPANT ALERT SYSTEM WORK

The system monitors when rear doors have been opened and closed to indicate the potential presence of an occupant in the rear seat.

A message displays in the information and entertainment display screen and an audible warning sounds when you switch the ignition off after any of the following conditions have been met:

- A rear door is opened or closed while the ignition is on.
- You switch the ignition on within 15 minutes of a rear door opening and closing.
- You switch the ignition on within 15 minutes of the alert having displayed or sounded.

REAR OCCUPANT ALERT SYSTEM PRECAUTIONS



WARNING: On hot days, the temperature inside the vehicle can rise very quickly. Exposure of people or animals to these high temperatures for even a short time can cause death or serious heat related injuries, including brain damage. Small children are particularly at risk.



WARNING: Do not leave children or pets unattended in your vehicle. Failure to follow this instruction could result in personal injury or death.

REAR OCCUPANT ALERT SYSTEM LIMITATIONS

The system does not detect the presence of objects or passengers in the rear seat. It monitors when rear doors are opened and closed.

Note: *It is possible to receive an alert when there is no rear seat occupant, but alert conditions are met.*

Note: *It is possible to receive no alert when there is an occupant in the rear seat, if alert conditions are not met. For example, if a rear seat occupant does not enter the vehicle through a rear door.*

Note: *The audible warning does not sound when the front door is opened before you switch the ignition off.*

SWITCHING REAR OCCUPANT ALERT SYSTEM ON AND OFF - VEHICLES WITH: SYNC 3

1. Press **Settings** on the touchscreen.
2. Press **Vehicle**.
3. Switch **Rear Occupant Alert** on or off.

Note: *The default setting is on.*

Note: *Performing a master reset causes the system to switch on again.*

Semiannual Reminder (If Equipped)

When you switch the system off, a message appears every six months as a reminder that the system is off. You can switch the system back on or leave it off.

Rear Occupant Alert System (If Equipped)

SWITCHING REAR OCCUPANT ALERT SYSTEM ON AND OFF - VEHICLES WITH: SYNC



Press the button on the audio unit.

1. Using the controls on the audio unit, select **Settings**.
2. Switch **Rear Occupant Alert** on or off.

Semiannual Reminder (If Equipped)

When you switch the system off, a message appears every six months as a reminder that the system is off. You can switch the system back on or leave it off.

REAR OCCUPANT ALERT SYSTEM INDICATORS - VEHICLES WITH: SYNC

Message
Check rear seats for occupants.

Displays when you switch the vehicle off after the alert conditions are met.



The message displays for a short period of time. Press the **OK** button to acknowledge and remove some messages from the information display.

REAR OCCUPANT ALERT SYSTEM INDICATORS - VEHICLES WITH: SYNC 3



Message
Check rear seats for occupants.

Displays when you switch your vehicle off after the alert conditions are met.

The message displays for a short period of time. Press **Close** to acknowledge and remove the message.

REAR OCCUPANT ALERT SYSTEM AUDIBLE WARNINGS

Sounds when you switch your vehicle off after the alert conditions are met.

The warning sounds for a short period of time.

Auxiliary Power Points

WARNING: Do not plug optional electrical accessories into the cigar lighter socket. Incorrect use of the cigar lighter can cause damage not covered by the vehicle warranty, and can result in fire or serious injury.

WARNING: Do not use a power point for operating a cigar lighter. Incorrect use of the power points can cause damage not covered by the vehicle warranty, and can result in fire or serious injury.

Do not use the power point over the vehicle capacity of 12 volt DC 180 watts or a fuse may blow.

Note: Do not hang any accessory from the accessory plug.

Note: Always keep the power point caps closed when not in use.

Note: The power points turn off after 30 minutes when the ignition is switched off. The power points could turn off earlier if the vehicle battery charge level is low.

Run the vehicle for full capacity use of the power point.

To prevent the battery from running out of charge:

- Do not use the power point longer than necessary when the vehicle is not running.
- Do not leave devices plugged in overnight or when you park your vehicle for extended periods.

Power points may be in the following locations:

- Inside the instrument panel storage compartment.
- On the front of the center console.
- Inside the cargo area.

110 Volt - 150 Watt Capacity AC Power Outlet

WARNING: Do not keep electrical devices plugged in the power point whenever the device is not in use. Do not use any extension cord with the 110 volt AC power point, since it will defeat the safety protection design. Doing so may cause the power point to overload due to powering multiple devices that can reach beyond the 150 watt load limit and could result in fire or serious injury.

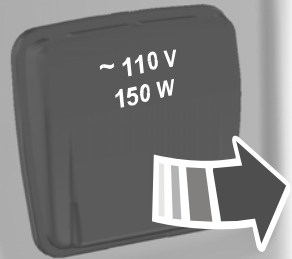

The power point is on the parking brake console.

When the indicator light on the power point is:

- On: The power point is working and the ignition is on.
- Off: The power point is off and the ignition is off.
- Flashing: The power point is in fault mode.

Auxiliary Power Points

The power outlet temporarily turns off power when in fault mode if the device exceeds the 150 watt limit. Unplug your device and switch the ignition off. Switch the ignition back on, but do not plug your device back in. Let the system cool off and switch the ignition off to reset the fault mode. Switch the ignition back on and make sure the indicator light remains on.

Do not use the power point for certain electric devices, including:

- Cathode-ray, tube-type televisions.
- Motor loads, such as vacuum cleaners, electric saws and other electric power tools or compressor-driven refrigerators.
- Measuring devices, which process precise data, such as medical equipment or measuring equipment.
- Other appliances requiring an extremely stable power supply such as microcomputer-controlled electric blankets or touch-sensor lamps.

110 Volt - 400 Watt Capacity AC Power Outlet



WARNING: Do not keep electrical devices plugged in the power point whenever the device is not in use. Do not use any extension cord with the 110 volt AC power point, since it will defeat the safety protection design. Doing so may cause the power point to overload due to powering multiple devices that can reach beyond the 400 watt load limit and could result in fire or serious injury.

Note: This feature has a maximum output of 400 watts when the vehicle is in park (P).

Note: While in drive (D), the maximum outlet output is 300 watts.



The power point is on the parking brake console.

When the indicator light on the power point is:

- On: The power point is working and the ignition is on.
- Off: The power point is off and the ignition is off.
- Flashing: The power point is in fault mode.

The power outlet temporarily turns off power when in fault mode if the device exceeds the 400 watt limit. Unplug your device and switch the ignition off. Switch the ignition back on, but do not plug your device back in. Let the system cool off and switch the ignition off to reset the fault mode. Switch the ignition back on and make sure the indicator light remains on.

Do not use the power point for certain electric devices, including:

- Cathode-ray, tube-type televisions.
- Motor loads, such as vacuum cleaners, electric saws and other electric power tools or compressor-driven refrigerators.

Auxiliary Power Points

- Measuring devices, which process precise data, such as medical equipment or measuring equipment.
- Other appliances requiring an extremely stable power supply such as microcomputer-controlled electric blankets or touch-sensor lamps.

Note: When you switch the ignition on, you can use the socket to power 12 volt appliances with a maximum current rating of 15 amps.

CIGAR LIGHTER



WARNING: Do not plug optional electrical accessories into the cigar lighter socket. Incorrect use of the cigar lighter can cause damage not covered by the vehicle warranty, and can result in fire or serious injury.



E103382

Press the element in to use the cigar lighter. It pops out after a short period of time.

Do not hold the cigar lighter element pressed in.

Note: If the power supply does not work after you switch the ignition off, switch the ignition on.

Note: If you use the socket when the engine is not running, the battery may run out of charge.

Storage Compartments

OVERHEAD CONSOLE



WARNING: Do not place heavy objects in the overhead console. Failure to follow this instruction could result in personal injury or death in the event of a sudden stop or crash.



E189357

Storage

BOTTLE HOLDERS

Bottle Holder Precautions

 **WARNING:** Do not place glass objects in the bottle holder. Items could become loose during hard braking, acceleration or crashes. Failure to follow this instruction could result in personal injury.

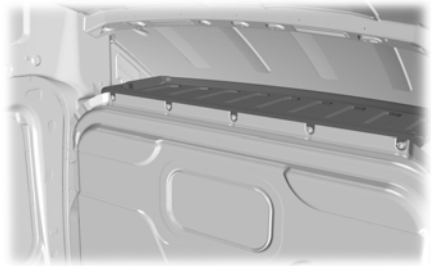

E169073

Locating the Bottle Holders



E171160

OVERHEAD STORAGE

Locating the Overhead Storage

 **WARNING:** Do not place heavy objects in the overhead console. Failure to follow this instruction could result in personal injury or death in the event of a sudden stop or crash.

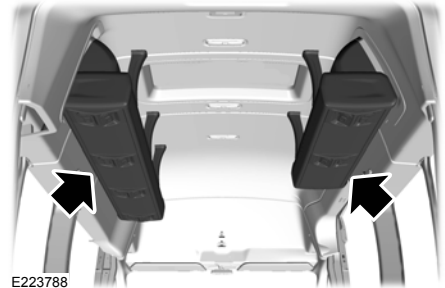

E223788

Overhead Storage Load Capacities

The maximum evenly distributed shelf load is 44 lb (20 kg).

REAR OVERHEAD STORAGE

Locating the Rear Overhead Storage

 **WARNING:** Do not place heavy objects on the shelf. Failure to follow this instruction could result in personal injury or death in the event of a sudden stop or crash.

Storage

Rear Overhead Storage Load Capacities

The maximum evenly distributed shelf load is 40 lb (18 kg).

Starting and Stopping the Engine

GENERAL INFORMATION



WARNING: Extended idling at high engine speeds can produce very high temperatures in the engine and exhaust system, creating the risk of fire or other damage.



WARNING: Do not park, idle or drive your vehicle on dry grass or other dry ground cover. The emission system heats up the engine compartment and exhaust system, creating the risk of fire.



WARNING: Do not start the engine in a closed garage or in other enclosed areas. Exhaust fumes can be toxic. Always open the garage door before you start the engine.



WARNING: Exhaust leaks may result in entry of harmful and potentially lethal fumes into the passenger compartment. If you smell exhaust fumes inside your vehicle, have your vehicle inspected immediately. Do not drive if you smell exhaust fumes.

If you disconnect the battery, your vehicle may exhibit some unusual driving characteristics for approximately 5 mi (8 km) after you reconnect it. This is because the engine management system must realign itself with the engine. You can disregard any unusual driving characteristics during this period.

The powertrain control system meets all Canadian interference-causing equipment standard requirements regulating the impulse electrical field or radio noise.

When you start the engine, avoid pressing the accelerator pedal before and during operation. Only use the accelerator pedal when you have difficulty starting the engine.

IGNITION SWITCH



E72128

Note: Make sure the key is clean before inserting it into any lock cylinder.

0 (off) - The ignition is off.

Note: When you switch the ignition off and leave your vehicle, do not leave your key in the ignition. This could cause your vehicle battery to lose charge.

I (accessory) - Allows the electrical accessories such as the radio to operate while the engine is not running.

Note: Do not leave the ignition key in position **I** or **II** (without the engine running) for too long to avoid vehicle battery losing charge.

II (on) - All electrical circuits operational. Warning lamps and indicators are illuminated.

III (start) - cranks the engine. Release the key as soon as the engine starts.

STARTING A GASOLINE ENGINE

The speed at which the engine idles immediately after starting is optimized to minimize vehicle emissions and maximize cabin comfort and fuel economy.

Starting and Stopping the Engine

Note: You can only attempt to start the engine for a limited amount of time before the starting system temporarily disables. If you exceed the starting time limit, a message may appear and you cannot attempt to start the engine for at least 15 minutes.

Before starting your vehicle, check the following:

- Make sure the headlamps and electrical accessories are off.
- Make sure the parking brake is on.
- Make sure the transmission is in park (P).

Starting the Engine

1. Fully press the brake pedal.

Note: Do not touch the accelerator pedal.

2. Turn the key to position **III**.

Note: The engine may continue cranking for up to 15 seconds or until it starts.

Note: The engine takes longer to start at lower temperatures. It may crank for several seconds when very cold.

Failure to Start

If you cannot start the engine after 3 attempts, wait 10 seconds and do the following:

1. Fully press the brake pedal.
2. Apply the parking brake.
3. Shift into park (P).
4. Fully press the accelerator pedal and hold it there.
5. Turn the key to position **III** and wait until the engine stops cranking.
6. Release the accelerator pedal.
7. Start the engine.

Stopping the Engine When Your Vehicle is Stationary

1. Shift into park (P).
2. Turn the key to position **0**.
3. Apply the parking brake.

Stopping the Engine When Your Vehicle is Moving



WARNING: Switching off the engine when your vehicle is still moving results in a significant decrease in braking assistance. Higher effort is required to apply the brakes and to stop your vehicle. A significant decrease in steering assistance could also occur. The steering does not lock, but higher effort could be required to steer your vehicle. When you switch the ignition off, some electrical circuits, for example airbags, also turn off. If you unintentionally switch the ignition off, shift into neutral (N) and restart the engine.

1. Shift into neutral and use the brakes to bring your vehicle to a safe stop.
2. Shift into park (P).
3. Turn the key to position **0**.
4. Apply the parking brake.

Guarding Against Exhaust Fumes



WARNING: Exhaust leaks may result in entry of harmful and potentially lethal fumes into the passenger compartment. If you smell exhaust fumes inside your vehicle, have your vehicle inspected immediately. Do not drive if you smell exhaust fumes.

Starting and Stopping the Engine

Important Ventilating Information

If you stop your vehicle and then leave the engine idling for long periods, we recommend that you do one of the following:

- Open the windows at least 1 in (3 cm).
- Set your climate control to outside air.

Engine Warning Lamps



Malfunction Indicator Lamp
Check Engine

If it illuminates when the engine is running this indicates a malfunction. The On Board Diagnostics system has detected a malfunction of the vehicle emission control system.

If it flashes, engine misfire may be occurring. Increased exhaust gas temperatures could damage the catalytic converter or other vehicle components. Avoid heavy acceleration and deceleration and have your vehicle immediately serviced.



Powertrain Warning Lamp

If it illuminates when the engine is running this indicates a malfunction. If it flashes when you are driving, immediately reduce the vehicle speed. Avoid heavy acceleration and deceleration and have your vehicle immediately serviced.

If both lamps illuminate when the engine is running, stop your vehicle as soon as it is safe to do so. Continuing to drive your vehicle may cause reduced power or the engine to stop. Switch the ignition off and attempt to restart the engine. Have your vehicle immediately checked.

SWITCHING OFF THE ENGINE

Vehicles With a Turbocharger



WARNING: Do not switch the engine off when it is running at high speed. If you do, the turbocharger will continue running after the engine oil pressure has dropped to zero. This will lead to premature turbocharger bearing wear.

Release the accelerator pedal. Wait until the engine has reached idle speed and then switch it off.

ENGINE BLOCK HEATER (IF

EQUIPPED)



WARNING: Failure to follow engine block heater instructions could result in property damage or serious personal injury.



WARNING: Do not use your heater with ungrounded electrical systems or two-pronged adapters. There is a risk of electrical shock.



WARNING: Do not fully close the hood, or allow it to drop under its own weight when using the engine block heater. This could damage the power cable and may cause an electrical short resulting in fire, injury and property damage.

Note: *The heater is most effective when outdoor temperatures are below 0°F (-18°C).*

Starting and Stopping the Engine

The heater acts as a starting aid by warming the engine coolant. This allows the climate control system to respond quickly. The equipment includes a heater element, installed in the engine block and a wire harness. You can connect the system to a grounded 120-volt AC electrical source.

We recommend that you do the following for a safe and correct operation:

- Use a 16-gauge outdoor extension cord that is product certified by Underwriter's Laboratory (UL) or Canadian Standards Association (CSA). This extension cord must be suitable for use outdoors, in cold temperatures, and be clearly marked Suitable for Use with Outdoor Appliances. Do not use an indoor extension cord outdoors. This could result in an electric shock or become a fire hazard.
- Use as short an extension cord as possible.
- Do not use multiple extension cords.
- Make sure that when in operation, the extension cord plug and heater cord plug connections are free and clear of water. This could cause an electric shock or fire.
- If the block heater cord is under the hood, Do Not remove the wiring from its original location. Do Not close the hood on the extension wiring.
- Make sure your vehicle is parked in a clean area, clear of combustibles.
- Make sure the heater, heater cord and extension cord are firmly connected.
- Check for heat anywhere in the electrical hookup once the system has been operating for approximately 30 minutes.

- Make sure the system is unplugged and properly stowed before starting and driving your vehicle. Make sure the protective cover seals the prongs of the block heater cord plug when not in use.
- Make sure the heater system is checked for proper operation before winter.

Using the Engine Block Heater

Make sure the receptacle terminals are clean and dry prior to use. Clean them with a dry cloth if necessary.

The heater uses 0.4 to 1.0 kilowatt-hours of energy per hour of use. The system does not have a thermostat. It achieves maximum temperature after approximately three hours of operation. Using the heater longer than three hours does not improve system performance and unnecessarily uses electricity.

Auto-Start-Stop - 3.5L EcoBoost™

WHAT IS AUTO-START-STOP

The system is designed to help reduce fuel consumption and CO₂ emissions by stopping the engine when it is idling, for example at traffic lights.

AUTO-START-STOP PRECAUTIONS



WARNING: Apply the parking brake, shift into park (P), switch the ignition off and remove the key before you leave your vehicle. Failure to follow this instruction could result in personal injury or death.



WARNING: Apply the parking brake, shift into park (P), switch the ignition off and remove the key before you open the hood or have any service or repair work completed. If you do not switch the ignition off, the engine could restart at any time. Failure to follow this instruction could result in personal injury or death.

SWITCHING AUTO-START-STOP ON AND OFF

The system turns on when you switch the ignition on.



Press the switch to switch the system off.

Note: *OFF* illuminates in the switch.

Press the switch again to switch the system back on.

Note: *The system is designed to turn off if it detects a malfunction. If the system malfunctions, have your vehicle checked as soon as possible.*

STOPPING THE ENGINE

Stop your vehicle, keep your foot on the brake pedal and the transmission in drive (D).

Note: *Power assist steering turns off when the engine stops.*

RESTARTING THE ENGINE

Release the brake pedal or press the accelerator pedal.

A message appears in the information display if the system requires you to take action.

Message	Condition	Action
Auto StartStop Press Brake to Start Engine	The system needs to restart the engine but requires your confirmation.	Press the brake pedal to restart the engine.
Auto StartStop Press a Pedal to Start Engine	The system needs to restart the engine but requires your confirmation.	Press the brake pedal or the accelerator pedal to restart the engine.

Auto-Start-Stop - 3.5L Ecoboost™

AUTO-START-STOP INDICATORS



WARNING: The system may require the engine to automatically restart when the auto-start-stop indicator illuminates green or flashes amber. Failure to follow this instruction could result in personal injury.



The Auto-Start-Stop indicator illuminates green when the engine stops. It flashes amber and a message appears when you need to take action.



The Auto-Start-Stop indicator illuminates gray with a strikethrough when the system is not available.

Note: You can display the reason why the system is not available in the information display.

AUTO-START-STOP – TROUBLESHOOTING

Auto-Start-Stop – Information Messages

Message	Condition	Action
Auto StartStop Shift to P, then Restart Engine	The system is not functioning.	Shift into park (P) and restart the engine yourself.
Auto StartStop Manual Restart Required	The system is not functioning.	Restart the engine yourself.

Auto-Start-Stop - 3.5L EcoBoost™

Auto-Start-Stop – Frequently Asked Questions

Why does the engine not always stop when I expect it to?

The system is designed to work in a way that complements other vehicle systems, allowing them to operate at optimum performance.

The system does not stop the engine if:

- The driver door is open.
- The driver seatbelt is unfastened.
- Your vehicle is at high altitude.
- The heated windshield is on.
- The transmission is in manual (M).
- Your vehicle is on a steep grade.
- The engine is warming up.
- The outside temperature is too low or too high.
- The battery charge is low.
- The battery temperature is outside the optimal operating range.
- The engine is required to run to maintain interior climate and reduce fogging.

Why does the engine sometimes restart when I do not expect it to?

The system is designed to work in a way that complements other vehicle systems, allowing them to operate at optimum performance.

The system restarts the engine if:

- You switch the heated windshield on.
- You switch maximum defrost on.
- Your vehicle starts to roll downhill in neutral.

- The engine is required to run to maintain adequate brake system assistance.
- The engine is required to run to maintain interior climate and reduce fogging.

Can I permanently switch the system off?

No. The system plays an important role in reducing the fuel consumption and the CO₂ emissions.

Will the frequent engine starts cause parts to wear out?

Your vehicle has an enhanced battery and starter motor that are designed for the increased number of engine starts.

Fuel and Refueling

SAFETY PRECAUTIONS



WARNING: Do not overfill the fuel tank. The pressure in an overfilled tank may cause leakage and lead to fuel spray and fire.



WARNING: The fuel system may be under pressure. If you hear a hissing sound near the fuel filler inlet, do not refuel until the sound stops. Otherwise, fuel may spray out, which could cause serious personal injury.



WARNING: Fuels can cause serious injury or death if misused or mishandled.



WARNING: Fuel may contain benzene, which is a cancer-causing agent.



WARNING: When refueling always shut the engine off and never allow sparks or open flames near the fuel tank filler valve. Never smoke or use a cell phone while refueling. Fuel vapor is extremely hazardous under certain conditions. Avoid inhaling excess fumes.

- Avoid inhaling fuel vapors. Inhaling fuel vapor can lead to eye and respiratory tract irritation. In severe cases, excessive or prolonged breathing of fuel vapor can cause serious illness and permanent injury.
- Avoid getting fuel in your eyes. If you splash fuel in your eyes, immediately remove contact lenses (if worn), flush with water for 15 minutes and seek medical attention. Failure to seek proper medical attention could lead to permanent injury.
- Fuels can be harmful if absorbed through the skin. If you splash fuel on your skin, clothing or both, promptly remove contaminated clothing and thoroughly wash your skin with soap and water. Repeated or prolonged skin contact causes skin irritation.
- Be particularly careful if you are taking Antabuse or other forms of Disulfiram for the treatment of alcoholism. Breathing fuel vapors could cause an adverse reaction, serious personal injury or sickness. Immediately call a physician if you experience any adverse reactions.

Follow these guidelines when refueling:

- Extinguish all smoking materials and any open flames before refueling your vehicle.
- Always switch the engine off before refueling.
- Automotive fuels can be harmful or fatal if swallowed. Fuel is highly toxic and if swallowed can cause death or permanent injury. If fuel is swallowed immediately call a physician, even if no symptoms are immediately apparent. The toxic effects of fuel may not be apparent for hours.

FUEL QUALITY - E85

Choosing the Right Fuel - Flex Fuel Vehicles

Flex fuel vehicles have one of the following identifiers:

- Yellow fuel filler cap.
- Yellow bezel around the fuel filler inlet.
- Yellow fuel filler housing.
- Yellow E85 label on the fuel tank filler door.

Fuel and Refueling



Your vehicle is designed to operate on regular unleaded gasoline with a minimum pump (R+M)/2 octane rating of 87 or regular unleaded gasoline blended with a maximum of 85% ethanol (E85).

Some fuel stations, particularly those in high altitude areas, offer fuels posted as regular unleaded gasoline with an octane rating below 87. The use of these fuels could result in engine damage that will not be covered by the vehicle warranty.

For best overall vehicle and engine performance, premium fuel with an octane rating of 91 or higher is recommended. The performance gained by using premium fuel is most noticeable in hot weather as well as other conditions, for example when towing a trailer. See **Towing** (page 234).

Do not be concerned if the engine sometimes knocks lightly. However, if the engine knocks heavily while using fuel with the recommended octane rating, contact an authorized dealer to prevent any engine damage.

We recommend Top Tier detergent gasolines, where available to help minimize engine deposits and maintain optimal vehicle and engine performance. For additional information, refer to www.toptiergas.com.

Note: *Use of any fuel for which the vehicle was not designed can impair the emission control system, cause loss of vehicle performance, and cause damage to the engine which may not be covered by the vehicle Warranty.*

Do not use:

- Diesel fuel.
- Fuels containing kerosene or paraffin.
- Fuels containing more than 85% ethanol or E100 fuel.
- Fuels containing methanol.
- Fuels containing metallic-based additives, including manganese-based compounds.
- Fuels containing the octane booster additive, methylcyclopentadienyl manganese tricarbonyl (MMT).
- Leaded fuel, using leaded fuel is prohibited by law.

The use of fuels with metallic compounds such as methylcyclopentadienyl manganese tricarbonyl (commonly known as MMT), which is a manganese-based fuel additive, will impair engine performance and affect the emission control system.

Switching Between E85 and Gasoline

We do not recommend repeatedly alternating between E85 and gasoline. If you switch from using E85 to gasoline, or from gasoline to E85, add as much fuel as possible, at least half a tank. Drive your vehicle immediately for a minimum of 5 mi (8 km) to allow it to adapt to the change in ethanol concentration. If you use E85 exclusively, we recommend that you fill the fuel tank with regular unleaded gasoline at each scheduled oil change.

Fuel and Refueling

FUEL QUALITY - GASOLINE

Choosing the Right Fuel

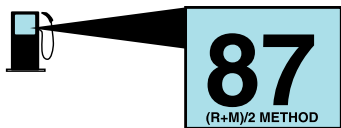

Your vehicle is designed to operate on regular unleaded gasoline with a minimum pump (R+M)/2 octane rating of 87.

Some fuel stations, particularly those in high altitude areas, offer fuels posted as regular unleaded gasoline with an octane rating below 87. The use of these fuels could result in engine damage that will not be covered by the vehicle warranty.

For best overall vehicle and engine performance, premium fuel with an octane rating of 91 or higher is recommended. The performance gained by using premium fuel is most noticeable in hot weather as well as other conditions, for example when towing a trailer. See **Towing** (page 234).

Do not be concerned if the engine sometimes knocks lightly. However, if the engine knocks heavily while using fuel with the recommended octane rating, contact an authorized dealer to prevent any engine damage.

We recommend Top Tier detergent gasolines, where available to help minimize engine deposits and maintain optimal vehicle and engine performance. For additional information, refer to www.toptiergas.com.

Note: Use of any fuel for which the vehicle was not designed can impair the emission control system, cause loss of vehicle performance, and cause damage to the engine which may not be covered by the vehicle Warranty.

Do not use:

- Diesel fuel.
- Fuels containing kerosene or paraffin.
- Fuel containing more than 15% ethanol or E85 fuel.
- Fuels containing methanol.
- Fuels containing metallic-based additives, including manganese-based compounds.
- Fuels containing the octane booster additive, methylcyclopentadienyl manganese tricarbonyl (MMT).
- Leaded fuel, using leaded fuel is prohibited by law.

The use of fuels with metallic compounds such as methylcyclopentadienyl manganese tricarbonyl (commonly known as MMT), which is a manganese-based fuel additive, will impair engine performance and affect the emission control system.

FUEL FILLER FUNNEL LOCATION

The fuel filler funnel is in the glove compartment or in the front right-hand side stepwell storage compartment.

RUNNING OUT OF FUEL

Running out of fuel can cause damage not covered by the vehicle Warranty.

Fuel and Refueling

If your vehicle runs out of fuel:

- Add a minimum of 1.3 gal (5 L) of fuel to restart the engine.
- You may need to switch the ignition from off to on several times after refueling to allow the fuel system to pump the fuel from the tank to the engine. When restarting, cranking time takes a few seconds longer than normal.

Note: *If your vehicle is on a steep slope, more fuel may be required.*

Filling a Portable Fuel Container



WARNING: Flow of fuel through a fuel pump nozzle can produce static electricity. This can cause a fire if you are filling an ungrounded fuel container.

Use the following guidelines to avoid electrostatic charge build-up, which can produce a spark, when filling an ungrounded fuel container:

- Only use an approved fuel container to transfer fuel to your vehicle. Place the container on the ground when filling it.
- Do not fill a fuel container when it is inside your vehicle (including the cargo area).
- Keep the fuel pump nozzle in contact with the fuel container when filling it.
- Do not use a device that holds the fuel pump nozzle lever in the fill position.

Adding Fuel From a Portable Fuel Container



WARNING: Do not insert the nozzle of a fuel container or an aftermarket funnel into the fuel filler neck. This may damage the fuel system filler neck or its seal and cause fuel to run onto the ground.



WARNING: Do not try to pry open or push open the capless fuel system with foreign objects. This could damage the fuel system and its seal and cause injury to you or others.



WARNING: Do not dispose of fuel in the household refuse or the public sewage system. Use an authorized waste disposal facility.

When refueling the vehicle fuel tank from a fuel container, use the fuel filler funnel included with your vehicle. See **Fuel Filler Funnel Location** (page 153).

Note: *Do not use aftermarket funnels as they may not work with the capless fuel system and can damage it.*

When refueling the vehicle fuel tank from a fuel container, do the following:

1. Fully open the fuel filler door.
2. Fully insert the fuel filler funnel into the fuel filler inlet.

Fuel and Refueling



3. Add fuel to your vehicle from the fuel container.
4. Remove the fuel filler funnel.
5. Fully close the fuel filler door.
6. Clean the fuel filler funnel and place it back in your vehicle or correctly dispose of it.

Note: *Extra funnels can be purchased from an authorized dealer if you choose to dispose of the funnel.*

REFUELING

WARNING: Do not overfill the fuel tank. The pressure in an overfilled tank may cause leakage and lead to fuel spray and fire.

WARNING: Do not pry open the fuel tank filler valve. This could damage the fuel system. Failure to follow this instruction could result in fire, personal injury or death.

WARNING: Do not remove the fuel pump nozzle from its fully inserted position when refueling.

WARNING: When refueling always shut the engine off and never allow sparks or open flames near the fuel tank filler valve. Never smoke or use a cell phone while refueling. Fuel vapor is extremely hazardous under certain conditions. Avoid inhaling excess fumes.

WARNING: Wait at least five seconds before removing the fuel pump nozzle to allow any residual fuel to drain into the fuel tank.

WARNING: Stop refueling when the fuel pump nozzle automatically shuts off for the first time. Failure to follow this will fill the expansion space in the fuel tank and could lead to fuel overflowing.



E162791

1. Open the left-hand front door.
2. Fully open the fuel filler door.

Note: *Your vehicle does not have a fuel tank filler cap.*

Fuel and Refueling

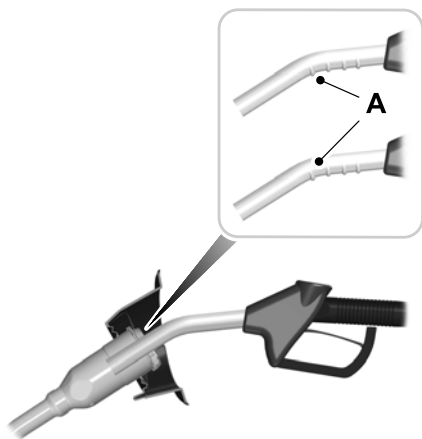

3. Insert the fuel pump nozzle up to the first notch on the nozzle A. Keep it resting on the cover of the fuel tank filler pipe opening.

Note: The fuel filler nozzle inhibitor only opens when you insert the correct fuel pump nozzle.

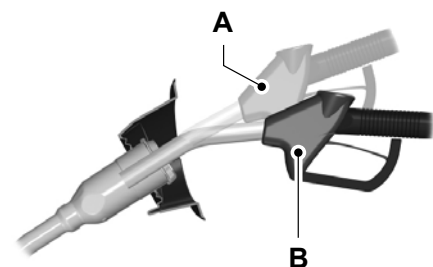

E139203

4. Hold the fuel pump nozzle in position B when refueling. Holding the fuel pump nozzle in position A could affect the flow of fuel and shut off the fuel pump nozzle before the fuel tank is full.

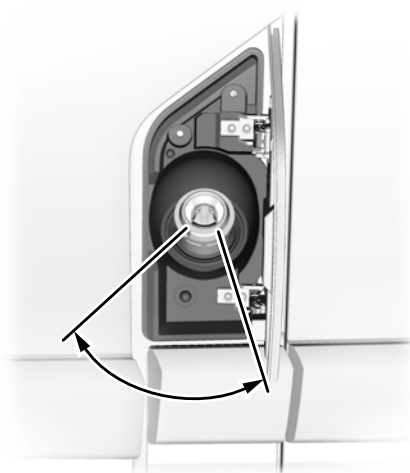

E162792

5. Operate the fuel pump nozzle within the area shown.

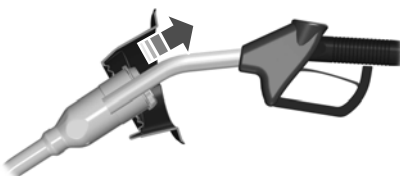

6. Slightly raise the fuel pump nozzle and then slowly remove it.
7. Fully close the fuel filler door.

Note: Do not attempt to start the engine if you have filled the fuel tank with incorrect fuel. Incorrect fuel use can cause damage not covered by the vehicle Warranty. Have your vehicle immediately checked.

System Warnings (If Equipped)

If the fuel filler nozzle inhibitor does not fully close a warning message appears in the information display.

Fuel and Refueling

1. Stop your vehicle as soon as it is safe to do so and switch the engine off.
2. Shift into park (P) or neutral (N).
3. Apply the parking brake.
4. Open the left-hand front door.
5. Fully open the fuel filler door.
6. Check the fuel filler inlet and the area around it for any items or debris that may be obstructing its movement.
7. Fully insert a fuel pump nozzle or the fuel filler funnel provided with your vehicle into the fuel filler inlet. See **Fuel Filler Funnel Location** (page 153). This action should dislodge any debris that may be preventing the fuel filler inlet from fully closing.
8. Remove the fuel pump nozzle or fuel filler funnel from the fuel filler inlet.
9. Fully close the fuel filler door.

Note: *The low fuel reminder appears at different fuel gauge positions depending on fuel economy conditions. This variation is normal.*

Note: *If this action corrects the problem the message may not immediately reset. If the message remains and the service engine soon warning lamp illuminates, have your vehicle checked as soon as possible.*

Low Fuel Level Warning Lamp



If it illuminates when you are driving, refuel as soon as possible.

Low Fuel Level Audible Warning

A warning tone sounds and a message appears in the information display when the distance to empty reaches 50 mi (80 km). A warning tone sounds and a message appears in the information display again at the following distance to empty parameters:

- 20 mi (40 km)
- 10 mi (20 km)
- 0 mi (0 km)

Engine Emission Control

EMISSION LAW



WARNING: Do not remove or alter the original equipment floor covering or insulation between it and the metal floor of the vehicle. The floor covering and insulation protect occupants of the vehicle from the engine and exhaust system heat and noise. On vehicles with no original equipment floor covering insulation, do not carry passengers in a manner that permits prolonged skin contact with the metal floor. Failure to follow these instructions may result in fire or personal injury.

U.S. federal laws and certain state laws prohibit removing or rendering inoperative emission control system components. Similar federal or provincial laws may apply in Canada. We do not approve of any vehicle modification without first determining applicable laws.



Tampering with emissions control systems including related sensors or the Diesel Exhaust Fluid system can result in reduced engine power and the illumination of the service engine soon light.

Tampering With a Noise Control System

Federal laws prohibit the following acts:

- Removal or rendering inoperative by any person other than for purposes of maintenance.
- Repair or replacement of any device or element of the design incorporated into a new vehicle for the purpose of noise control prior to its sale or delivery to the ultimate purchaser or while it is in use.
- The use of the vehicle after any person removes or renders inoperative any device or element of the design.

The U.S. Environmental Protection Agency may presume to constitute tampering as follows:

- Removal of hood blanket, fender apron absorbers, fender apron barriers, underbody noise shields or acoustically absorptive material.
- Tampering or rendering inoperative the engine speed governor, to allow engine speed to exceed manufacturer specifications.

If the engine does not start, runs rough, experiences a decrease in engine performance, experiences excess fuel consumption or produces excessive exhaust smoke, check for the following:

- A plugged or disconnected air inlet system hose.
- A plugged engine air filter element.
- Water in the fuel filter and water separator.
- A clogged fuel filter.
- Contaminated fuel.
- Air in the fuel system, due to loose connections.
- An open or pinched sensor hose.
- Incorrect engine oil level.

Engine Emission Control

- Incorrect fuel for climatic conditions.
- Incorrect engine oil viscosity for climactic conditions.

Note: *Some vehicles have a lifetime fuel filter that is integrated with the fuel tank. Regular maintenance or replacement is not needed.*

Note: *If these checks do not help you correct the concern, have your vehicle checked as soon as possible.*

Noise Emissions Warranty, Prohibited Tampering Acts and Maintenance

On January 1, 1978, Federal regulation became effective governing the noise emission on trucks over 10,000 lb (4,536 kg) Gross Vehicle Weight Rating (GVWR). The preceding statements concerning prohibited tampering acts and maintenance, and the noise warranty found in the Warranty Guide, are applicable to complete chassis cabs over 10,000 lb (4,536 kg) GVWR.

CATALYTIC CONVERTER - 3.5L DURATEC/3.5L ECOBOOST™



WARNING: Do not park, idle or drive your vehicle on dry grass or other dry ground cover. The emission system heats up the engine compartment and exhaust system, creating the risk of fire.



WARNING: The normal operating temperature of the exhaust system is very high. Never work around or attempt to repair any part of the exhaust system until it has cooled. Use special care when working around the catalytic converter. The catalytic converter heats up to a very high temperature after only a short period of engine operation and stays hot after the engine is switched off.



WARNING: Exhaust leaks may result in entry of harmful and potentially lethal fumes into the passenger compartment. If you smell exhaust fumes inside your vehicle, have your vehicle inspected immediately. Do not drive if you smell exhaust fumes.

Your vehicle has various emission control components and a catalytic converter that enables it to comply with applicable exhaust emission standards.

To avoid damaging the catalytic converter:

- Do not crank the engine for more than 10 seconds at a time.
- Do not run the engine with a spark plug lead disconnected.
- Do not push-start or tow-start your vehicle. Use booster cables. See **Jump Starting the Vehicle** (page 251).
- Do not switch the ignition off when your vehicle is moving.
- Do not use leaded fuel.
- Avoid running out of fuel.

Note: *Resulting component damage may not be covered by the vehicle Warranty.*

Engine Emission Control

On-Board Diagnostics System

Your vehicle has an on-board diagnostics system that monitors the emission control system. If any of the following warning lamps illuminate, this may indicate that the on-board diagnostics system has detected an emission control system malfunction.



Continuing to drive your vehicle may cause reduced power or the engine to stop. Failure to respond to a warning lamp may cause component damage not covered by the vehicle Warranty. Have your vehicle checked as soon as possible.

Transmission

AUTOMATIC TRANSMISSION



WARNING: Do not apply the brake pedal and accelerator pedal simultaneously. Applying both pedals simultaneously for more than a few seconds will limit engine performance, which may result in difficulty maintaining speed in traffic and could lead to serious injury.



WARNING: When your vehicle is stationary, keep the brake pedal fully pressed when shifting gears. Failure to follow this instruction could result in personal injury, death or property damage.



WARNING: Apply the parking brake, shift into park (P), switch the ignition off and remove the key before you leave your vehicle. Failure to follow this instruction could result in personal injury or death.

Selector Lever Positions

The instrument cluster displays the current position.

Park (P)

In park (P), power is not transmitted to the driven wheels and the transmission is locked. You can start the engine with the transmission in this position.

Shift into park (P) only when your vehicle is stationary.

Reverse (R)

Shift into reverse (R) only when your vehicle is stationary and the engine is at idle speed.

Neutral (N)



WARNING: In neutral (N) your vehicle has the ability to roll freely. If you intend to leave your vehicle, make sure you apply the parking brake.

In neutral (N), power is not transmitted to the driven wheels but the transmission is not locked. You can start the engine with the transmission in this position.

Drive (D)

Drive (D) is the normal position for driving.

Manual (M)

In manual (M), you can upshift or downshift using the buttons on the selector lever.

SelectShift™

Use this feature to upshift or downshift using the buttons on the selector lever.

Shift into manual (M) to switch the feature on.

- Press the **+** button to upshift.
- Press the **-** button to downshift.

Shift into another gear to switch the feature off.

Progressive Range Selection

Use this feature to lock out gears using the buttons on the selector lever. This may provide you with an improved driving experience, for example, on slippery roads or steep slopes.

With the transmission in drive (D), press the **-** button to switch the feature on.

Note: *The instrument cluster displays the available and selected gears.*

Transmission

Press the **-** button again to lock out gears beginning with the highest gear. For example, press the **-** button twice to lock out 10th and 9th gears.

Note: The instrument cluster only displays the available gears and the transmission automatically shifts between the available gears.

Press the **+** button to unlock gears to allow the transmission to shift to higher gears.

Note: The transmission automatically shifts within the gear range you select.

Brake Shift Interlock



WARNING: Do not drive your vehicle until you verify that the stoplamps are working.



WARNING: When doing this procedure, you need to take the transmission out of park (P) which means your vehicle can roll freely. To avoid unwanted vehicle movement, always fully apply the parking brake prior to doing this procedure. Use wheels chocks if appropriate.



WARNING: If the parking brake is fully released, but the brake warning lamp remains illuminated, the brakes may not be working properly. Have your vehicle checked as soon as possible.

Brake shift interlock prevents you from shifting out of park (P) when you have switched the ignition on and not pressed the brake pedal.

Use the brake shift interlock lever to move the selector lever out of park (P) if you cannot start the engine.

In the event of an electrical malfunction, it is possible that a fuse has blown or the stoplamps are not working. See **Fuse Specification Chart** (page 264).

If the vehicle battery has no charge, jump start your vehicle. See **Jump Starting the Vehicle** (page 251).

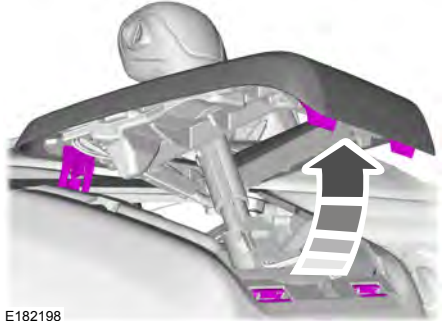

E182198

1. Using a flat-bladed screwdriver, remove the panel.

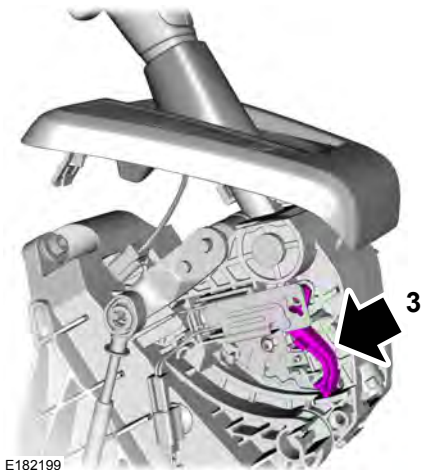

E182199

2. Locate the brake shift interlock lever.

Transmission

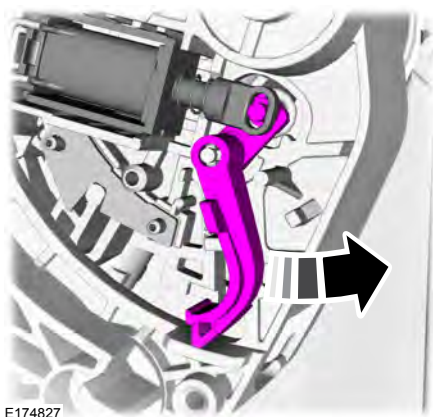

E174827

3. Push the brake shift interlock lever toward the rear of your vehicle and hold it there.
4. Move the selector lever from park (P) to neutral (N).
5. Install the panel.
6. Press the brake pedal, start the engine and release the parking brake.

Transmission Not in Park (P) Audible Warning

Sounds when you open the driver door and you have not moved the selector lever to park (P).

Automatic Transmission Information Messages

Message	Description
Transmission Service Required	The system has detected a fault that requires service. Have your vehicle checked as soon as possible.
Transmission Not in Park	Displays as a reminder to shift into park (P).
Press Brake to Unlock Gearshift Lever	Press the brake pedal to unlock the transmission.

TOW/HAUL



WARNING: Do not use tow/haul when the road surface is slippery. Failure to follow this instruction could result in the loss of control of your vehicle.



WARNING: Do not use diesel engine exhaust braking when the road surface is slippery. Failure to follow this instruction could result in the loss of control of your vehicle.

Tow/haul delays upshifts to reduce the frequency of transmission shifting.

Tow/haul provides engine braking in all forward gears, which slows your vehicle and assists you in controlling your vehicle when descending a slope.

Tow/haul improves transmission operation when towing a trailer or a heavy load.

Depending on driving conditions and load conditions, tow/haul may downshift the transmission, slow your vehicle and control your vehicle speed when descending a hill, without pressing the accelerator pedal. The amount of downshift braking provided varies based upon the amount the brake pedal is pressed.

Transmission

Switching Tow/Haul On and Off



Select the tow/haul drive mode to switch tow/haul on. See **Drive Control** (page 226).

Select a different drive mode to switch tow/haul off.

All-Wheel Drive

USING ALL-WHEEL DRIVE



WARNING: Vehicles with a higher center of gravity (utility and four-wheel drive vehicles) handle differently than vehicles with a lower center of gravity (passenger cars). Avoid sharp turns, excessive speed and abrupt steering in these vehicles. Failure to drive cautiously increases the risk of losing control of your vehicle, vehicle rollover, personal injury and death.

The intelligent AWD system continuously monitors vehicle conditions and adjusts the power distribution between the front and rear wheels. It combines transparent all-surface operation with highly capable all-wheel drive.

The AWD system is always active and requires no driver input. It is capable of handling all road conditions. You can optimize the AWD performance for specialized driving conditions by selecting different drive modes. See **Drive Control** (page 226).

Operating All-Wheel Drive (AWD) Vehicles with Mismatched Tires



WARNING: Only use replacement tires and wheels that are the same size, load index, speed rating and type (such as P-metric versus LT-metric or all-season versus all-terrain) as those originally provided by Ford. The recommended tire and wheel size may be found on either the Safety Compliance Certification Label (affixed to either the door hinge pillar, door-latch post, or the door edge that meets the door-latch post, next to the driver's seating position), or the Tire Label which is located on the B-Pillar or edge of the

driver's door. If this information is not found on these labels, then you should contact your authorized dealer as soon as possible. Use of any tire or wheel not recommended by Ford can affect the safety and performance of your vehicle, which could result in an increased risk of loss of vehicle control, vehicle rollover, personal injury and death.

Major dissimilar tire sizes between the front and rear axles could cause the AWD system to stop functioning and default to rear-wheel drive or damage the AWD system.

For optimum AWD performance, it is recommended to follow the tire rotation maintenance schedule. To avoid potential AWD malfunction or AWD system damage, it is recommended to replace all four tires rather than mixing significantly worn tires with new tires.

Driving In Special Conditions With All-Wheel Drive (AWD)

Note: AWD vehicles are equipped for driving on sand, snow, mud and rough roads and have operating characteristics that are somewhat different from conventional vehicles, both on and off the highway.

Basic Operating Principles in Special Conditions

- Drive slower in strong crosswinds which can affect the normal steering characteristics of your vehicle.
- Be extremely careful when driving on pavement made slippery by loose sand, water, gravel, snow or ice.

All-Wheel Drive

If Your Vehicle Goes Off the Edge of the Pavement

- If your vehicle goes off the edge of the pavement, slow down, but avoid severe brake application, ease the vehicle back onto the pavement only after reducing your speed. Do not turn the steering wheel too sharply while returning to the road surface.
- It could be safer to stay on the apron or shoulder of the road and slow down gradually before returning to the pavement. You could lose control if you do not slow down or if you turn the steering wheel too sharply or abruptly.
- It often could be less risky to strike small objects, such as highway reflectors, with minor damage to your vehicle rather than attempt a sudden return to the pavement which could cause the vehicle to slide sideways out of control or rollover. Remember, your safety and the safety of others should be your primary concern.

If Your Vehicle Gets Stuck



WARNING: Apply the parking brake, shift into park (P), switch the ignition off and remove the key before you leave your vehicle. Failure to follow this instruction could result in personal injury or death.



WARNING: If the parking brake is fully released, but the brake warning lamp remains illuminated, the brakes may not be working properly. Have your vehicle checked as soon as possible.



WARNING: Do not spin the wheels at over 34 mph (55 km/h). The tires may fail and injure a passenger or bystander.

If your vehicle gets stuck in mud or snow it could be rocked out by shifting between forward and reverse gears, stopping between shifts, in a steady pattern. Press lightly on the accelerator in each gear.

If your vehicle is equipped with AdvanceTrac® with Roll Stability Control™, it could be beneficial to disengage the AdvanceTrac® with Roll Stability Control™ system while attempting to rock the vehicle.

Note: *Do not rock the vehicle if the engine is not at normal operating temperature or damage to the transmission could occur.*

Note: *Do not rock the vehicle for more than a few minutes or damage to the transmission and tires could occur or the engine could overheat.*

Emergency Maneuvers

- In an unavoidable emergency situation where a sudden sharp turn must be made, remember to avoid "over-driving" your vehicle (i.e., turn the steering wheel only as rapidly and as far as required to avoid the emergency). Excessive steering can result in less vehicle control, not more. Additionally, smooth variations of the accelerator and/or brake pedal pressure should be utilized if changes in vehicle speed are called for. Avoid

All-Wheel Drive

abrupt steering, acceleration or braking which could result in an increased risk of loss of vehicle control, vehicle rollover and/or personal injury. Use all available road surface to return the vehicle to a safe direction of travel.

- In the event of an emergency stop, avoid skidding the tires and do not attempt any sharp steering wheel movements.
- If the vehicle goes from one type of surface to another (i.e., from concrete to gravel) there is a change in the way the vehicle responds to a maneuver (steering, acceleration or braking). Again, avoid these abrupt inputs.

Sand

Do not continuously drive your AWD vehicle in deep sand for more than 2.5 mi (4 km). This can cause the driveline components to overheat.

When driving over sand, try to keep all four wheels on the most solid area of the trail. Avoid reducing the tire pressures but shift to a lower gear and drive steadily through the terrain. Apply the accelerator slowly and avoid spinning the wheels.

Avoid excessive speed because vehicle momentum can work against you and cause the vehicle to become stuck to the point that assistance could be required from another vehicle. Remember, you could be able to back out the way you came if you proceed with caution.

Mud and Water

If you must drive through high water, drive slowly. Traction or brake capability could be limited.

Note: *Driving through deep water could damage your vehicle.*

If the front or rear axle has been submerged in water, the axle lubricant and AWD transfer case lubricant should be checked and changed if necessary.

When driving through water, determine the depth; avoid water higher than the bottom of the hubs (if possible) and proceed slowly. If the ignition system gets wet, the vehicle could stall.

Once through water, always try the brakes. Wet brakes do not stop the vehicle as effectively as dry brakes. Drying can be improved by moving your vehicle slowly while applying light pressure on the brake pedal.

Be cautious of sudden changes in vehicle speed or direction when you are driving in mud. Even AWD vehicles can lose traction in slick mud. As when you are driving over sand, apply the accelerator slowly and avoid spinning your wheels. If the vehicle does slide, steer in the direction of the slide until you regain control of the vehicle.

After driving through mud, clean off residue stuck to rotating driveshafts and tires. Excess mud stuck on tires and rotating driveshafts causes an imbalance that could damage drive components.

Driving on Hilly or Sloping Terrain

Although natural obstacles could make it necessary to travel diagonally up or down a hill or steep incline, you should always try to drive straight up or straight down.

Note: *Avoid driving crosswise or turning on steep slopes or hills. A danger lies in losing traction, slipping sideways and possibly rolling over. Whenever driving on a hill, determine beforehand the route you will use. Do not drive over the crest of a hill without seeing what conditions are on the other side. Do not drive in reverse over a hill without the aid of an observer.*

All-Wheel Drive

When climbing a steep slope or hill, start in a lower gear rather than downshifting to a lower gear from a higher gear once the ascent has started. This reduces strain on the engine and the possibility of stalling.

If you do stall out, do not try to turn around because you might roll over. It is better to back down to a safe location.

Apply just enough power to the wheels to climb the hill. Too much power can cause the tires to slip, spin or lose traction, resulting in loss of vehicle control.



Descend a hill in the same gear you would use to climb up the hill to avoid excessive brake application and brake overheating. Do not descend in neutral; instead, disengage overdrive or manually shift to a lower gear. When descending a steep hill, avoid sudden hard braking as you could lose control. The front wheels have to be turning in order to steer the vehicle.

Driving on Snow and Ice



WARNING: If you are driving in slippery conditions that require tire chains or cables, then it is critical that you drive cautiously. Keep speeds down, allow for longer stopping distances and avoid aggressive steering to reduce the

chances of a loss of vehicle control which can lead to serious injury or death. If the rear end of your vehicle slides while cornering, steer in the direction of the slide until you regain control of your vehicle.

Note: Excessive tire slippage can cause driveline damage.

AWD vehicles have advantages over 2WD vehicles in snow and ice but can skid like any other vehicle.

Should you start to slide while driving on snowy or icy roads, turn the steering wheel in the direction of the slide until you regain control.

Avoid sudden applications of power and quick changes of direction on snow and ice. Apply the accelerator slowly and steadily when starting from a full stop.

Avoid sudden braking as well. Although an AWD vehicle could accelerate better than a two-wheel drive vehicle in snow and ice, it won't stop any faster, because as in other vehicles, braking occurs at all four wheels. Do not become overconfident as to road conditions.

Make sure you allow sufficient distance between you and other vehicles for stopping. Drive slower than usual and consider using one of the lower gears. In emergency stopping situations, apply the brake steadily.

Your vehicle has anti-lock brakes, therefore apply the brakes steadily. Do not "pump" the brakes.

All-Wheel Drive

Maintenance and Modifications

The suspension and steering systems on your vehicle have been designed and tested to provide predictable performance whether loaded or empty and durable load carrying capability. For this reason, we strongly recommend that you do not make modifications such as adding or removing parts (such as lowering kits or stabilizer bars) or by using replacement parts not equivalent to the original factory equipment.

Any modifications to a vehicle that raise the center of gravity can make it more likely the vehicle will rollover as a result of a loss of control. We strongly recommend that caution be used with any vehicle equipped with a high load or device (such as ladder or luggage racks).

Failure to maintain your vehicle properly could void the warranty, increase your repair cost, reduce vehicle performance and operational capabilities and adversely affect driver and passenger safety. Frequent inspection of vehicle chassis components is recommended if the vehicle is subjected to off-highway usage.

All-Wheel Drive Gauge

This feature shows how the engine power is split between the front and rear axles in real time.

1. Using the information display controls on the steering wheel, select **Settings**.
2. Select **Information**.
3. Select **Intelligent AWD**.

All-Wheel Drive Information Messages

Message	Description
AWD Temporarily Locked	The system is temporarily locked. This could be due to the system increasing its capacity in order to improve performance.
AWD Temporarily Disabled	The system temporarily turns off. This could be due to the system overheating. Stop your vehicle as soon as it is safe to do so and allow the system to cool.
AWD Restored	The system resumes normal function.
AWD Malfunction Service Required	The system has malfunctioned. Have your vehicle checked as soon as possible.
AWD OFF	The system temporarily turns off to protect itself from overheating or if you are using a mismatched tire.

Brakes

GENERAL INFORMATION

Note: Occasional brake noise is normal. If a metal-to-metal, continuous grinding or continuous squeal sound is present, the brake linings may be worn-out. Have the system checked by an authorized dealer. If your vehicle has continuous vibration or shudder in the steering wheel while braking, have it checked by an authorized dealer.

Note: Brake dust may accumulate on the wheels, even under normal driving conditions. Some dust is inevitable as the brakes wear and does not contribute to brake noise. See **Cleaning the Wheels** (page 308).



Wet brakes result in reduced braking efficiency. Gently press the brake pedal a few times when driving from a car wash or standing water to dry the brakes.

Brake Over Accelerator

In the event the accelerator pedal becomes stuck or entrapped, apply steady and firm pressure to the brake pedal to slow the vehicle and reduce engine power. If you experience this condition, apply the brakes and bring your vehicle to a safe stop. Move the gearshift lever to park (P), switch the engine off and apply the parking brake. Inspect the accelerator pedal for any interference. If none are found and the condition persists, have your vehicle towed to the nearest authorized dealer.

Brake Assist

Brake assist detects when you rapidly brake by measuring the rate at which you press the brake pedal. It provides maximum braking efficiency as long as you press the pedal, and can reduce stopping distances in critical situations.

Anti-lock Brake System

This system helps you maintain steering control during emergency stops by keeping the brakes from locking.



This lamp momentarily illuminates when you turn the ignition on. If the light does not illuminate during start up, remains on or flashes, the system may be disabled. Have the system checked by an authorized dealer.



If the system is disabled, normal braking is still effective. This lamp momentarily illuminates when you turn the ignition on. If the lamp remains on when you release the parking brake, have the system checked by an authorized dealer.

HINTS ON DRIVING WITH ANTI-LOCK BRAKES

The anti-lock braking system does not eliminate the risks when:

- You drive too closely to the vehicle in front of you.
- Your vehicle is hydroplaning.
- You take corners too fast.
- The road surface is poor.

Note: If the system activates, the brake pedal may pulse and may travel further. Maintain pressure on the brake pedal. You may also hear a noise from the system. This is normal.

Brakes

HILL START ASSIST



WARNING: The system does not replace the parking brake. When you leave your vehicle, always apply the parking brake.



WARNING: You must remain in your vehicle when the system turns on. At all times, you are responsible for controlling your vehicle, supervising the system and intervening, if required. Failure to take care may result in the loss of control of your vehicle, serious personal injury or death.



WARNING: The system turns off if there is a malfunction or if you excessively rev the engine.

The system makes it easier for you to pull away when your vehicle is on a slope without using the parking brake.

Switching Hill Start Assist On or Off

Vehicles with Manual Transmission

To switch hill start assist on or off, use the information display controls on the steering wheel to select the following:

Menu Item	Action
Driver Assist.	Press the menu button.
Hill Start Assist	Press the OK button.

The system remembers the last setting when you start your vehicle.

Note: *There is no indicator to indicate whether the system is on or off.*

When the system activates, your vehicle remains stationary for a few seconds after you release the brake pedal. This gives you time to move your foot from the brake pedal to the accelerator pedal. The brakes release when the engine has developed sufficient torque to prevent your vehicle from rolling down the slope.

Using Hill Start Assist

1. Bring your vehicle to a complete standstill. Keep the brake pedal pressed.
2. Select a gear.

Note: *The system activates if the sensors detect that your vehicle is on a slope.*

3. Pull away in the normal manner.

Note: *When you remove your foot from the brake pedal, your vehicle remains on the slope without rolling away for a few seconds. This hold time increases if you are in the process of driving off.*

Vehicles with Automatic Transmission

The system turns on when you switch the ignition on and you cannot switch the system off.

Brakes

Hill Start Assist Information Messages

Message	Action
Hill Start Assist Not Available	Displays when the system is not available. Have your vehicle checked as soon as possible.

AUTO HOLD



WARNING: The system does not replace the parking brake. When you leave your vehicle, always apply the parking brake.



WARNING: You must remain in your vehicle when the system turns on. At all times, you are responsible for controlling your vehicle, supervising the system and intervening, if required. Failure to take care may result in the loss of control of your vehicle, serious personal injury or death.



WARNING: The system turns off if there is a malfunction or if you excessively rev the engine.

The system is designed to apply the brakes to hold your vehicle at a standstill after you stop your vehicle and release the brake pedal. This could be beneficial in certain situations, for example when waiting on a hill or in traffic.

Switching Auto Hold On and Off



Press the button on the center console. The button illuminates when you switch the system on.

Note: You can only switch the system on after you close the driver door, fasten your seatbelt and start the engine.

Note: The system remembers the last setting when you start your vehicle.

Make sure you switch the system off before towing with your vehicle or before using an automatic car wash.

Using Auto Hold

1. Use the brakes to bring your vehicle to a complete stop. The auto hold active indicator illuminates in the information display.
2. Release the brake pedal. The system holds your vehicle at a standstill. The auto hold active indicator remains illuminated in the information display.

Note: The system only activates if you apply enough brake pressure. If your vehicle is on a steep slope, you could need to press the brake pedal harder before the system activates.

Note: Under certain conditions, the system could apply the electric parking brake. The brake system warning lamp illuminates. The electric parking brake releases when you press the accelerator pedal. See **Applying the Electric Parking Brake** (page 177).

Note: If auto-start-stop turns off the engine, auto hold remains active.

Note: The system deactivates if you shift into reverse (R) and press the brake pedal.

3. Pull away in the normal manner. The system releases the brakes and the auto hold active indicator turns off.

Auto Hold Indicator

The auto hold indicator illuminates in the information display when the system is on and is either active or unavailable.

Brakes



Illuminates when the system is active. Your vehicle remains stationary after you release the brake pedal.



Illuminates when the system is on but unavailable to hold your vehicle at a standstill.

The system could be unavailable when any of the following occur:

- During an active park assist maneuver.
- Your vehicle is in stay in neutral mode. See **Automatic Transmission** (page 161).
- The driver door is open.
- The driver seatbelt has not been fastened.
- You shift into reverse (R) before the system is active.

Auto Hold Information Messages

Message	Action
Auto Hold Close Door And Fasten Seat Belt To Enable	Displays as a reminder to fully close the driver door and fasten the driver seatbelt.
Auto Hold Not Available	Displays when the system is not available.
Auto Hold Press Brake And Switch To Release	Displays when the system is active. Press the brake pedal and the auto hold button on the center console to switch the system off.
Auto Hold System Fault Press Brake	Fully press the brake pedal. The system has detected a fault that requires service. Have your vehicle checked as soon as possible.
Auto Hold System Malfunction	The system has detected a fault that requires service. Have your vehicle checked as soon as possible.

Parking Brake - Vehicles With: Conventional Mechanical Parking Brake

APPLYING THE PARKING BRAKE



WARNING: Always fully apply the parking brake and make sure you shift into park (P). Failure to follow this instruction could result in personal injury or death.

1. Firmly press the brake pedal.
2. Pull the parking lever upward to its fullest extent.

Note: Do not press the release button while pulling the parking brake lever upward.

Note: If you park your vehicle on a hill and facing uphill, shift into park (P) and turn the steering wheel away from the curb.

Note: If you park your vehicle on a hill and facing downhill, shift into park (P) and turn the steering wheel toward the curb.

RELEASING THE PARKING BRAKE

1. Firmly press the brake pedal.
2. Slightly pull the parking brake lever upward.
3. Press the release button and push the parking brake lever downward.

Parking Brake – Information Messages

Message	Description
Park Brake Engaged	You have not released the parking brake and your vehicle reaches 3 mph (5 km/h). If the message continues to appear after you have released the parking brake, have your vehicle checked as soon as possible.

PARKING BRAKE AUDIBLE WARNING

Sounds when the parking brake is on and your vehicle is moving.

If the warning tone continues after you have released the parking brake, this indicates a malfunction. Have your vehicle checked as soon as possible.

PARKING BRAKE – TROUBLESHOOTING

Parking Brake – Warning Lamps



WARNING: If you drive extended distances with the parking brake applied, you could cause damage to the brake system.



It illuminates when you engage the parking brake and the ignition is on.

If it illuminates when your vehicle is moving, make sure the parking brake is disengaged. If the parking brake is disengaged, this indicates low brake fluid level or a brake system fault. Have your vehicle checked as soon as possible.

Parking Brake - Vehicles With: Push Down Parking Brake

APPLYING THE PARKING BRAKE



WARNING: Always fully apply the parking brake and make sure you shift into park (P). Failure to follow this instruction could result in personal injury or death.

1. Firmly press the brake pedal.
2. Pull the parking lever upward to its fullest extent.

Note: Do not press the release button while pulling the parking brake lever upward.

Note: If you park your vehicle on a hill and facing uphill, shift into park (P) and turn the steering wheel away from the curb.

Note: If you park your vehicle on a hill and facing downhill, shift into park (P) and turn the steering wheel toward the curb.

RELEASING THE PARKING BRAKE

1. Firmly press the brake pedal.
2. Pull the parking brake lever upward to its fullest extent.
3. Press the release button and push the parking brake lever downward.

PUSHING THE PARKING BRAKE LEVER DOWN



E172225

If required, you can lower the parking brake lever to the fully down position, for example to swivel the seat. Push the parking brake lever downward without pressing the release button. The parking brake remains applied until you release it.

PARKING BRAKE AUDIBLE WARNING

Sounds when the parking brake is on and your vehicle is moving.

If the warning tone continues after you have released the parking brake, this indicates a malfunction. Have your vehicle checked as soon as possible.

Parking Brake - Vehicles With: Push Down Parking Brake

PARKING BRAKE – TROUBLESHOOTING

Parking Brake – Warning Lamps

 **WARNING:** If you drive extended distances with the parking brake applied, you could cause damage to the brake system.



It illuminates when you engage the parking brake and the ignition is on.

If it illuminates when your vehicle is moving, make sure the parking brake is disengaged. If the parking brake is disengaged, this indicates low brake fluid level or a brake system fault. Have your vehicle checked as soon as possible.

Parking Brake – Information Messages

Message	Description
Park Brake Engaged	You have not released the parking brake and your vehicle reaches 3 mph (5 km/h). If the message continues to appear after you have released the parking brake, have your vehicle checked as soon as possible.

Electric Parking Brake

WHAT IS THE ELECTRIC PARKING BRAKE

The electric parking brake is used to hold your vehicle on slopes and flat roads.

APPLYING THE ELECTRIC PARKING BRAKE



WARNING: Always fully apply the parking brake and make sure you shift into park (P). Failure to follow this instruction could result in personal injury or death.



WARNING: If you drive extended distances with the parking brake applied, you could cause damage to the brake system.



The switch is next to the steering wheel on the lower part of the instrument panel.

1. Pull the switch up.

The red warning lamp flashes during operation and illuminates when the parking brake is applied.

Note: You can apply the electric parking brake when the ignition is off.

Note: The electric parking brake could apply when you shift into park (P). See **Automatic Transmission** (page 161).

APPLYING THE ELECTRIC PARKING BRAKE IN AN EMERGENCY

You can use the electric parking brake to slow or stop your vehicle in an emergency.

1. Pull the switch up and hold it.

The electric parking brake continues to slow your vehicle down unless you release the switch.

The red warning lamp illuminates, a tone sounds and the stoplamps turn on when you use the electric parking brake in an emergency.

Note: Do not apply the electric parking brake when your vehicle is moving, except in an emergency.

MANUALLY RELEASING THE ELECTRIC PARKING BRAKE

1. Switch the ignition on.
2. Press and hold the brake pedal.
3. Push the switch down.

The red warning lamp turns off.

Pulling Away on a Hill When Towing a Trailer

1. Press and hold the brake pedal.
2. Pull the switch upward and hold it.
3. Shift into gear.
4. Press the accelerator pedal until engine has developed sufficient torque to prevent your vehicle from rolling down the hill.
5. Release the switch and pull away in a normal manner.

AUTOMATICALLY RELEASING THE ELECTRIC PARKING BRAKE

1. Close the driver door.
2. Shift into gear.
3. Press the accelerator pedal and pull away in a normal manner.

Electric Parking Brake

ELECTRIC PARKING BRAKE AUDIBLE WARNING

Sounds when the parking brake is on and your vehicle is moving. If the warning tone continues after you have released the parking brake, this indicates a malfunction. Have your vehicle checked as soon as possible.

RELEASING THE ELECTRIC PARKING BRAKE IF THE VEHICLE BATTERY HAS RUN OUT OF CHARGE



WARNING: The electric parking brake does not operate if the vehicle battery has run out of charge.

Connect a booster battery to the vehicle battery to release the electric parking brake if the vehicle battery has run out of charge. See **Jump Starting the Vehicle** (page 251).

ELECTRIC PARKING BRAKE – TROUBLESHOOTING

Electric Parking Brake – Warning Lamps



The red warning lamp illuminates when the electronic parking brake is applied or for a few seconds on start up.

If it remains illuminated or flashes when the electronic parking brake is not applied, it indicates a malfunction. Have your vehicle checked as soon as possible.

Electric Parking Brake – Information Messages

Message	Action
Park Brake Malfunction Service Now	The electric parking brake has malfunctioned. Have your vehicle checked as soon as possible.
Park Brake Not Released	The electric parking brake has not released. Manually release the electric parking brake. If the message continues to appear, have your vehicle checked as soon as possible.
Park Brake Not Applied	The electric parking brake has not applied. Apply the electric parking brake. If the message continues to appear, have your vehicle checked as soon as possible.
Park Brake Use Switch to Release	The electric parking brake has not automatically released. Manually release the electric parking brake.
To Release: Press Brake and Switch	You have not pressed the brake pedal. Press the brake pedal to release the parking brake.
Park Brake Limited Function Service Required	The electric parking brake has malfunctioned. Have your vehicle checked as soon as possible.

Electric Parking Brake

Message	Action
Park Brake System Overheated	The electric parking brake has overheated. Wait for the electric parking brake to cool down.
Park Brake Off	The electric parking brake is released.
Release Park Brake	The electric parking brake has not released. Manually release the electric parking brake. If the message continues to appear, have your vehicle checked as soon as possible.
Park Brake On	The electric parking brake is applied.

Traction Control

PRINCIPLE OF OPERATION

The traction control system helps avoid drive wheel spin and loss of traction.

If your vehicle begins to slide, the system applies the brakes to individual wheels and, when needed, reduces engine power at the same time. If the wheels spin when accelerating on slippery or loose surfaces, the system reduces engine power in order to increase traction.

USING TRACTION CONTROL



WARNING: The stability and traction control light illuminates steadily if the system detects a failure. Make sure you did not manually disable the traction control system using the information display controls or the switch. If the stability control and traction control light is still illuminating steadily, have the system serviced by an authorized dealer immediately. Operating your vehicle with the traction control disabled could lead to an increased risk of loss of vehicle control, vehicle rollover, personal injury and death.

The system automatically turns on each time you switch the ignition on.

If your vehicle is stuck in mud or snow, switching traction control off may be beneficial as this allows the wheels to spin.

Note: *When you switch traction control off, stability control remains fully active.*

Switching the System Off or On

When you switch the system off or on, a message appears in the information display showing system status.



Press the traction control button on the instrument panel to switch the system off or on.

System Indicator Lights and Messages



The stability and traction control light:

- Temporarily illuminates on engine start-up.
- Flashes when a driving condition activates either of the systems.
- Illuminates if a problem occurs in either of the systems.



The stability and traction control off light temporarily illuminates on engine start-up and stays on when you switch the traction control system off.

Stability Control

PRINCIPLE OF OPERATION



WARNING: Vehicle modifications involving braking system, aftermarket roof racks, suspension, steering system, tire construction and wheel and tire size may change the handling characteristics of your vehicle and may adversely affect the performance of the electronic stability control system. In addition, installing any stereo loudspeakers may interfere with and adversely affect the electronic stability control system. Install any aftermarket stereo loudspeaker as far as possible from the front center console, the tunnel, and the front seats in order to minimize the risk of interfering with the electronic stability control sensors. Reducing the effectiveness of the electronic stability control system could lead to an increased risk of loss of vehicle control, vehicle rollover, personal injury and death.



WARNING: Remember that even advanced technology cannot defy the laws of physics. It's always possible to lose control of a vehicle due to inappropriate driver input for the conditions. Aggressive driving on any road condition can cause you to lose control of your vehicle increasing the risk of personal injury or property damage. Activation of the electronic stability control system is an indication that at least some of the tires have exceeded their ability to grip the road; this could reduce the operator's ability to control the vehicle potentially resulting in a loss of vehicle control, vehicle rollover, personal injury and death. If your electronic stability control system activates, SLOW DOWN.

The system automatically turns on each time you switch the ignition on.

If the stability control or traction control system detects a fault, the following may occur:

- The stability and traction control light illuminates steadily.
- The stability control and traction control systems do not enhance your vehicle's ability to maintain traction of the wheels.

If the stability control or traction control system activates, the following may occur:

- The stability and traction control light flashes.
- Your vehicle slows down.
- Reduced engine power.
- A vibration in the brake pedal.
- The brake pedal is stiffer than usual.
- If the driving condition is severe and your foot is not on the brake pedal, the pedal may move as the system applies higher brake force.

The stability control system has several features built into it to help you maintain control of your vehicle.

Electronic Stability Control

The system helps to prevent your vehicle skidding or laterally sliding by individually applying the brakes to one or more wheels and, if necessary, reducing engine power.

Roll Stability Control

The system helps to prevent rollovers by detecting your vehicle's roll motion, and individually applying the brakes to one or more wheels.

Stability Control

Side-Wind Stabilization

The system applies the brakes on one side of your vehicle to reduce the effect of a sudden side-wind gust on your vehicle's path. When the system turns on, the stability and traction control light flashes, and a message may appear in the information display. You may notice a slight deceleration and may still need to make a steering correction to maintain the intended vehicle path. The system does not turn on for a continuous side-wind or during turns.

Traction Control

The system enhances your vehicle's ability to maintain traction of the wheels by detecting and controlling wheel spin. See **Using Traction Control** (page 180).

USING STABILITY CONTROL

The system automatically turns on each time you switch the ignition on.

You cannot switch the stability control and roll stability control systems off, but when you shift into reverse (R), the systems deactivate.

You can switch the traction control system off or on. See **Using Traction Control** (page 180).

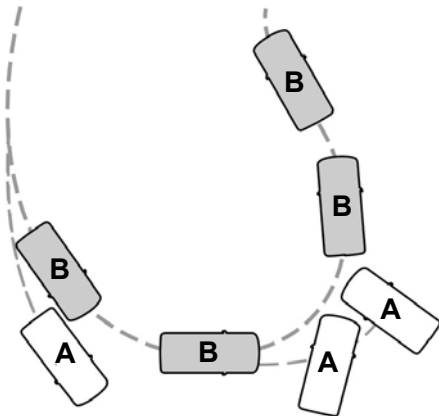

E72903

- A Vehicle without stability control skidding off its intended route.
- B Vehicle with stability control maintaining control on a slippery surface.

Parking Aids

PRINCIPLE OF OPERATION



WARNING: To help avoid personal injury, always use caution when in reverse (R) and when using the sensing system.



WARNING: The system may not detect objects with surfaces that absorb reflection. Always drive with due care and attention. Failure to take care may result in a crash.



WARNING: Traffic control systems, inclement weather, air brakes, external motors and fans may affect the correct operation of the sensing system. This may cause reduced performance or false alerts.



WARNING: The system may not detect small or moving objects, particularly those close to the ground.



WARNING: If damage occurs in the immediate area surrounding the sensor, have your vehicle checked as soon as possible.



WARNING: The parking aid system can only assist you to detect objects when your vehicle is moving at parking speeds. To help avoid personal injury you must take care when using the parking aid system.



WARNING: In cold and severe weather conditions the system may not function. Rain, snow and spray can all limit sensor performance.



WARNING: The system may not function if the sensor is blocked.

Note: If your vehicle has MyKey™, the sensing system cannot be switched off when a MyKey™ is present. See **Principle of Operation** (page 70).

Note: Do not clean the sensors with sharp objects.

Note: If your vehicle sustains damage to the bumper or fascia and you leave it misaligned or bent, the sensing zone may be altered causing inaccurate measurement of obstacles or false alerts.

Note: Certain add-on devices installed around the bumper or fascia may create false alerts. For example, large trailer hitches, bike or surfboard racks, license plate brackets, bumper covers or any other device that may block the normal detection zone of the system. Remove the add-on device to prevent false alerts.

Note: When you connect a trailer to your vehicle, the rear parking aid may detect the trailer and therefore provide an alert. Disable the rear parking aid when you connect a trailer to prevent the alert.

The sensing system warns you of obstacles within a certain range of your vehicle. The system turns on when you switch the ignition on.

You can switch the system off through the information display menu or from the pop-up message that appears once you shift the transmission into reverse (R). See **General Information** (page 115). If your vehicle has a parking aid button, you can switch the system off by pressing the button. The system turns on when you switch the ignition on.

If a fault is present in the system, a warning message appears in the information display.

Parking Aids

PARKING AID



WARNING: The parking aid system can only assist you to detect objects when your vehicle is moving at parking speeds. To help avoid personal injury you must take care when using the parking aid system.



WARNING: Traffic control systems, inclement weather, air brakes, external motors and fans may affect the correct operation of the sensing system. This may cause reduced performance or false alerts.



WARNING: The system may not detect small or moving objects, particularly those close to the ground.



Press the parking aid button to switch the system on and off.

The system becomes active when you shift into reverse (R) and the vehicle speed is 7 mph (12 km/h) or less. The system remains active when you shift out of reverse (R) until the vehicle speed is greater than 7 mph (12 km/h), or until you press the parking aid button.

Note: The system could turn off when you shift out of reverse (R).

The system warns you of objects that are within the detection zone of the bumper areas.

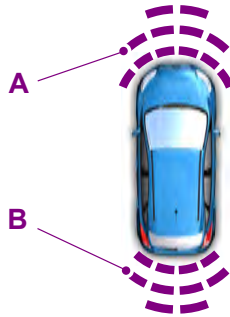

E174857

- A Sensor coverage area is up to 27 in (70 cm) from the front bumper. There is decreased coverage area at the outer corners.
- B Sensor coverage area is up to 71 ± 1 in (180 ± 2 cm) from the rear bumper.

Note: Accessories that block the detection zone of the system may create false alerts.

Note: Keep the sensors free from snow, ice and large accumulations of dirt.

Note: If your vehicle sustains damage leaving the sensors misaligned, this may cause inaccurate measurements or false alerts.

A tone sounds in the following manner when objects are near the front or rear bumpers:

- Objects detected by the front sensors produce a high-pitched tone from the front speakers.
- Objects detected by the rear sensors produce a low-pitched tone from the rear speakers.

Parking Aids

- The system reports the object that is closest to the front or rear of your vehicle. For example, if an object is 24 in (60 cm) from the front of your vehicle and at the same time, an object is only 16 in (40 cm) from the rear of your vehicle, a lower-pitched tone sounds from the rear speakers.
- A continuous tone sounds from a front or rear speaker if an object is 12 in (30 cm) or less from the front or rear of your vehicle.

As your vehicle moves closer to an object, the rate of the tone increases.

When the parking aid system sounds a tone, the audio system may reduce the set volume. When the warning ends, the audio system returns to the previously set volume.

Note: *Volume reduction is not a standard feature of all audio systems.*

The system detects objects when you shift into reverse (R) and:

- Your vehicle is moving toward a stationary object at a speed of 3 mph (5 km/h) or less.
- Your vehicle is stationary but an object is approaching your vehicle at a speed of 3 mph (5 km/h) or less.
- Your vehicle is moving at a speed of 3 mph (5 km/h) or less, and an object is approaching your vehicle at a speed of 3 mph (5 km/h) or less.

REAR PARKING AID



WARNING: The system may not detect objects with surfaces that absorb reflection. Always drive with due care and attention. Failure to take care may result in a crash.



WARNING: The system may not detect small or moving objects, particularly those close to the ground.



WARNING: To help avoid personal injury, always use caution when in reverse (R) and when using the sensing system.



WARNING: The parking aid system can only assist you to detect objects when your vehicle is moving at parking speeds. To help avoid personal injury you must take care when using the parking aid system.

If the system malfunctions, a message appears in the information display.

Note: *Keep the sensors free from snow, ice and large accumulations of dirt.*

Note: *Do not cover up the sensors.*

Note: *Do not clean the sensors with sharp objects.*

Note: *If your vehicle sustains damage leaving the sensors misaligned, this may cause inaccurate measurements or false alerts.*

Note: *Some add-on accessories, for example large trailer hitches or bike or surfboard racks can cause reduced performance or false alerts.*

The sensors are active when the transmission is in reverse (R) and the vehicle speed is less than 3 mph (5 km/h). When the parking aid system sounds a tone, the audio system may reduce the set volume.

Parking Aids

A warning tone sounds when an object approaches your vehicle. As your vehicle moves closer to an object, the rate of the tone increases. The warning tone continuously sounds when an object is 12 in (30 cm) or less from the center of the rear bumper.

Note: *There is a decreased coverage area at the outer corners.*



Sensor coverage area is up to 70 in (180 cm) from the rear bumper.

The system detects large objects when you shift into reverse (R) and any of the following occur:

- Your vehicle is moving backward at low speed.
- Your vehicle is stationary but an object is approaching the rear of your vehicle at low speed.
- Your vehicle is moving backward at low speed and an object is moving toward your vehicle, for example another vehicle at low speed.

If your vehicle remains stationary for two seconds the audible warning turns off. If your vehicle moves backward the tone sounds again.

Note: *If the detected object is 12 in (30 cm) or less from the rear bumper, the audible warning does not turn off.*

Object Distance Indicator (If Equipped)

When you shift into reverse (R), the system provides object distance indication through the information display.

- As the distance to the object decreases, the indicator blocks illuminate and move toward the vehicle icon.
- If there is no object detected, the distance indicator blocks are gray.

Parking Aids

Rear Parking Aid Information Messages

Message	Description
Park Aid Fault	The system has malfunctioned. Have your vehicle checked as soon as possible.
Check Park Aid	The system has malfunctioned. Have your vehicle checked as soon as possible.
Check Rear Park Aid	The system has malfunctioned. Have your vehicle checked as soon as possible.
Rear Park Aid Not Available Sensor Blocked See Manual	A sensor is blocked or the system has malfunctioned. Clean the bumper or remove any obstruction. If the message continues to appear, have your vehicle checked as soon as possible.

FRONT PARKING AID



WARNING: The system may not detect objects with surfaces that absorb reflection. Always drive with due care and attention. Failure to take care may result in a crash.



WARNING: The system may not detect small or moving objects, particularly those close to the ground.



WARNING: The parking aid system can only assist you to detect objects when your vehicle is moving at parking speeds. To help avoid personal injury you must take care when using the parking aid system.

The sensors are on the front bumper.

Note: *Keep the sensors free from snow, ice and large accumulations of dirt.*

Note: *Do not cover up the sensors.*

Note: *Do not clean the sensors with sharp objects.*

Note: *If your vehicle sustains damage leaving the sensors misaligned, this may cause inaccurate measurements or false alerts.*

The sensors are active when the transmission is in any position other than park (P). When the parking aid system sounds a tone, the audio system may reduce the set volume.

A warning tone sounds when an object approaches your vehicle. As your vehicle moves closer to an object, the rate of the tone increases. The warning tone continuously sounds when an object is 12 in (30 cm) or less from the front bumper.

The system turns off when the vehicle speed reaches 5 mph (8 km/h).

Parking Aids



- As the distance to the object decreases, the indicator blocks illuminate and move toward the vehicle icon.
- If there is no object detected, the distance indicator blocks are gray.

When you shift into reverse (R), the system provides audio warnings and visual indication when your vehicle is moving and the detected object is moving toward your vehicle. When you stop your vehicle, the audio warnings stop after two seconds. Visual indication remains on when the transmission is in reverse (R).

When you shift into any forward gear, the system provides audio warnings and visual indication when your vehicle is moving at a speed of approximately 5 mph (8 km/h) or below and the system detects an object within the detection zone. When you stop your vehicle, the audio warnings stop after two seconds and visual indication stops after four seconds.

Note: *If the detected object is 12 in (30 cm) or less from your vehicle, visual indication remains on.*

When you shift into neutral (N), the system only provides visual indication if your vehicle is moving at a speed of approximately 5 mph (8 km/h) or below, for example, your vehicle is moving on a slope, and the system detects an object moving toward your vehicle. When you stop your vehicle, visual indication stops after four seconds.

Sensor coverage area is up to 28 in (70 cm) from the center of the bumper.

If the transmission is in reverse (R), the system detects objects when your vehicle is moving at low speed or an object is moving toward your vehicle, for example another vehicle at low speed. When you stop your vehicle, the audible warning turns off after two seconds.

If the transmission is in any forward gear, the system provides audible warnings when your vehicle is moving and an object is within the detection area. When you stop your vehicle, the audible warning turns off after two seconds and the visual warning turns off after four seconds.



Press the parking aid button to switch the system off.

If the system malfunctions, a message appears in the information display.

Object Distance Indicator (If Equipped)

The system provides object distance indication through the information display.

Parking Aids

Front Parking Aid Information Messages

Message	Description
Park Aid Fault	The system has malfunctioned. Have your vehicle checked as soon as possible.
Check Park Aid	The system has malfunctioned. Have your vehicle checked as soon as possible.
Check Front Park Aid	The system has malfunctioned. Have your vehicle checked as soon as possible.
Front Park Aid Not Available Sensor Blocked See Manual	A sensor is blocked or the system has malfunctioned. Clean the bumper or remove any obstruction. If the message continues to appear, have your vehicle checked as soon as possible.

SIDE SENSING SYSTEM



WARNING: The system may not detect objects with surfaces that absorb reflection. Always drive with due care and attention. Failure to take care may result in a crash.



WARNING: The system may not detect small or moving objects, particularly those close to the ground.



WARNING: To help avoid personal injury, always use caution when in reverse (R) and when using the sensing system.



WARNING: The parking aid system can only assist you to detect objects when your vehicle is moving at parking speeds. To help avoid personal injury you must take care when using the parking aid system.

The system uses the front and rear outermost parking aid sensors to detect objects that are near to the sides of your vehicle. The system displays them on a virtual map in the information display as your vehicle moves past them.

The sensors are on the front and rear bumpers.

Note: *Keep the sensors free from snow, ice and large accumulations of dirt.*

Note: *Do not cover up the sensors.*

Note: *Do not clean the sensors with sharp objects.*

Note: *If your vehicle sustains damage leaving the sensors misaligned, this may cause inaccurate measurements or false alerts.*

The system may not function if:

- You switch the ignition on, off and back on within a few seconds.
- Your vehicle remains stationary for over two minutes.
- The anti-lock brake system activates.
- The traction control system activates.

Note: *If you switch traction control off, the side sensing system also turns off.*

Parking Aids

Note: Some accessories, for example large trailer hitches or bike or surfboard racks can cause reduced performance or false alerts.

To reinitialize the system, you may have to drive your vehicle approximately 10 ft (3 m).



The sensor coverage area is up to 24 in (60 cm) from the side of your vehicle.

When the system detects an object within the coverage area and the driving path of your vehicle, an audible warning sounds. As your vehicle moves closer to the object, the rate of the tone increases.

Note: The system does not detect an object that is moving toward the side of your vehicle, for example another vehicle moving at low speed, if it does not pass a front or rear sensor.

Object Distance Indicator (If Equipped)



The system provides object distance indication through the information display.

- As the distance to the object decreases, the indicator blocks illuminate and move toward the vehicle icon.
- If there is no object detected, the distance indicator blocks are gray.

When you shift into reverse (R), the system provides audible warnings and a visual indication when detected objects are within 24 in (60 cm) and are inside the driving path of your vehicle. When you stop your vehicle, the audible warnings turn off after two seconds.

When you shift into any forward gear, the system provides audible warnings and a visual indication when your vehicle is moving at a speed of approximately 5 mph (8 km/h) or below and the system detects an object within the detection zone. When you stop your vehicle, the audible warnings turn off after two seconds and the visual indication turns off after four seconds.

Parking Aids

When you shift into neutral (N), the system only provides a visual indication if your vehicle is moving at a speed of approximately 5 mph (8 km/h) or below. For example, your vehicle is moving on a slope, and the system detects an object moving toward your vehicle. When you stop your vehicle, the visual indication turns off after four seconds.

If the system is not available, the side distance indicator blocks do not display.

ACTIVE PARK ASSIST

The system assists parking into and out of parking spaces. Sensors are used to detect parking spaces. The system then steers as required to maneuver into or out of a parking space. You control the accelerator, brakes and changing gears.

Using Active Park Assist



WARNING: You must remain in your vehicle when the system turns on. At all times, you are responsible for controlling your vehicle, supervising the system and intervening, if required. Failure to take care may result in the loss of control of your vehicle, serious personal injury or death.



WARNING: The sensors may not detect objects in heavy rain or other conditions that cause interference.



WARNING: You are responsible for controlling your vehicle at all times. The system is designed to be an aid and does not relieve you of your responsibility to drive with due care and attention. Failure to follow this instruction could result in the loss of control of your vehicle, personal injury or death.



The active park assist button is next to the gearshift lever.

Driving into a Parking Space

1. Press the active park assist button.

Note: *The system searches for parallel parking spaces on the passenger side. Press the active park assist button again to make the system search for perpendicular spaces.*

2. Use the direction indicator lever to search for a parking space on the driver or passenger side of your vehicle.
3. Drive your vehicle approximately 3 ft (1 m) away from and parallel to the other parked vehicles when searching for a parking space.

Note: *A tone sounds and a message appears in the information display when active park assist finds a suitable parking space.*

4. Bring your vehicle to a complete standstill.
5. Release the steering wheel and shift into reverse (R).
6. Drive backward and your vehicle steers itself into the parking space.
7. Follow the instructions on the information display.

Note: *When parking is complete, a tone sounds and an information message appears.*

Leaving a Parking Space

The system assists leaving only parallel parking spaces.

1. Press the active park assist button.
2. Use the direction indicator lever to choose the direction to leave.
3. Release the steering wheel and shift into reverse (R).

Parking Aids

4. Follow the instructions on the information display.

Note: After the system drives your vehicle to a position where you can exit the parking space in a forward movement, a message appears instructing you to take full control of your vehicle.

Canceling Active Park Assist

To cancel parking assistance at any time, press the active park assist button or turn the steering wheel.

Active Park Assist Troubleshooting

Note: It also cancels when your vehicle exceeds 6 mph (9 km/h).

Brake System Intervention

When active park assist is controlling the steering, it may under certain conditions apply the brakes to slow or stop your vehicle.

Note: This could cause the parking assistance to cancel.

Symptom	Possible Cause
The system does not search for a parking space.	You may have switched traction control off.
	The transmission is in reverse (R). Your vehicle must be moving forward to be able to detect a parking space.
The system does not offer a parking space.	The sensors may be blocked. For example, snow, ice or large accumulations of dirt. Blocked sensors can affect how the system functions.
	The sensors in the front or rear bumper could be damaged.
	There is not enough room in the parking space for your vehicle to safely park.
	There is not enough space for the parking maneuver on the opposite side of the parking space.
	The parking space is more than 5 ft (1.5 m) or less than 2 ft (0.5 m) away.
	The vehicle speed is greater than 22 mph (35 km/h) for parallel parking or greater than 19 mph (30 km/h) for perpendicular parking.
	You recently disconnected or replaced the battery. After you reconnect the battery you must drive your vehicle on a straight road for a short period of time.
The system does not correctly position your vehicle in a parking space.	An irregular curb along the parking space prevents the system from correctly aligning your vehicle.

Parking Aids

Symptom	Possible Cause
	Vehicles or objects bordering the space may not be correctly parked.
	Your vehicle stopped too far past the parking space.
	The tires may not be correctly installed or maintained. For example, not inflated correctly, improper size, or of different sizes.
	A repair or alteration changes the detection capabilities.
	A parked vehicle has a high attachment. For example, a salt sprayer, snowplow or moving truck bed.
	The parking space length or position of parked objects changes after your vehicle passes the space.
	You are using a spare tire or a tire that is significantly worn more than the other tires.
	The temperature around your vehicle quickly changes. For example, driving from a heated garage into cold outside temperature, or after leaving a car wash.

REAR VIEW CAMERA - VEHICLES WITH: PARKING AID CAMERA



WARNING: The rear view camera system is a reverse aid supplement device that still requires the driver to use it in conjunction with the interior and exterior mirrors for maximum coverage.



WARNING: Objects that are close to either corner of the bumper or under the bumper, might not be seen on the screen due to the limited coverage of the camera system.



WARNING: The operation of the camera depends on the outside temperature, vehicle and road conditions.



WARNING: Reverse your vehicle slowly. Failure to follow this instruction could result in the loss of control of your vehicle, personal injury or death.



WARNING: Use caution when the rear cargo door is ajar. If the rear cargo door is ajar, the camera will be out of position and the video image could be incorrect. All guide lines disappear when the rear cargo door is ajar. Failure to follow this instruction could result in personal injury.

Parking Aids

WARNING: Use caution when turning camera features on or off when the transmission is not in park (P). Make sure your vehicle is not moving.

WARNING: To help avoid personal injury always use caution when in reverse (R) and when using the rear view camera.

The rear view camera provides an image of the area behind your vehicle. During operation, lines appear in the display that represents the path of your vehicle and proximity to objects behind it.

Rear View Camera Locations

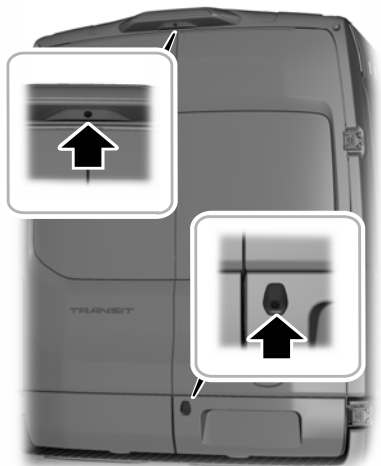

E254267

The rear view camera is below the central high mounted stop lamp or on the rear cargo door.

Using the Rear View Camera

The rear view camera system displays what is behind your vehicle when you shift the transmission into reverse (R).

Note: *The reverse sensing system is not effective at speeds above 3 mph (5 km/h) and may not detect certain angular or moving objects.*

Note: *If the transmission is in reverse (R) and the rear cargo door is open, no rear view camera features will display.*

Note: *When towing, the camera only sees what you are towing. This might not provide adequate coverage as it usually provides in normal operation and some objects might not be seen. In some vehicles, the guidelines may disappear when you connect the trailer tow connector.*

The system may not correctly operate in any of the following conditions:

- Nighttime or dark areas if the reverse lamps are not operating.
- If the camera is obstructed. Clean the lens with a soft, lint-free cloth and non-abrasive cleaner.
- The camera is misaligned due to damage to the rear of your vehicle.

Rear View Camera Guidelines

WARNING: Objects above the camera may not be visible. Check the area behind your vehicle when necessary.

Parking Aids

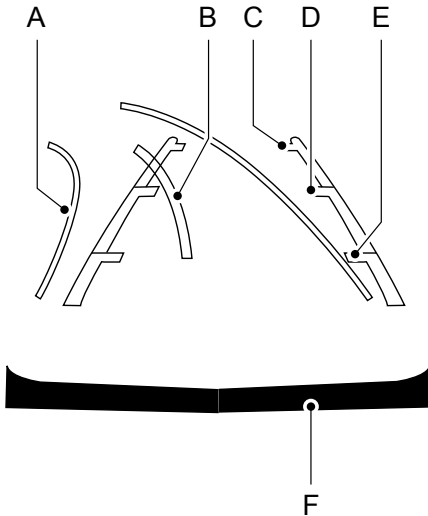

E142436

- A Active guidelines.
- B Centerline.
- C Fixed guideline: Green zone.
- D Fixed guideline: Yellow zone.
- E Fixed guideline: Red zone.
- F Rear bumper.

If the vehicle battery is disconnected, the guidelines are not fully functional directly after the battery is reconnected. The guidelines become fully functional after you drive your vehicle as straight as possible for five minutes at a minimum speed of 31.1 mph (50 km/h).

The system uses three types of guidelines to help you see what is behind your vehicle:

- Active guidelines show the intended path of your vehicle when reversing.
- The centerline helps align the center of your vehicle with a trailer.
- Fixed guidelines show the actual path of your vehicle when reversing in a straight line. This can be helpful when backing into a parking space or aligning your vehicle with another object.

Active guidelines are only available with fixed guidelines. To use active guidelines, turn the steering wheel to point the guidelines toward an intended path. If you change the steering wheel position when driving in reverse (R), your vehicle might deviate from the original intended path.

The fixed and active guidelines fade in and out depending on the steering wheel position. When the steering wheel position is straight the active guidelines are not visible. Objects in the red zone are closest to your vehicle and objects in the green zone are further from your vehicle.

Note: Guidelines are only available when the transmission is in reverse (R).

System Settings

You can adjust the camera settings using the vehicle settings menu. See **Settings** (page 427).

Manual Zoom

 **WARNING:** When manual zoom is on, the full area behind your vehicle may not show. Be aware of your surroundings when using the manual zoom feature.

Manual zoom is only available when you shift the transmission into reverse (R).

Parking Aids

Selectable settings for this feature are Zoom In (+) and Zoom Out (-). Press the symbol in the camera screen to change the view. The default setting is Zoom OFF. The rear bumper remains in the image as a reference point.

Note: Only the centerline shows when you switch on manual zoom.

Rear View Camera Delay

You can switch this feature on or off using the vehicle settings menu. See **Settings** (page 427). The default setting is off.

When shifting the transmission out of reverse (R) and into any gear other than park (P), the camera image remains in the display until:

- Your vehicle speed sufficiently increases.
- You shift your vehicle into park (P).

Enhanced Parking Aids or Park Pilot (If Equipped)

You can switch this feature on or off using the vehicle settings menu. See **Settings** (page 427).

When the reverse sensing system detects an object, it displays red, yellow and green indicators at the top of the image.

180 DEGREE CAMERA



WARNING: The rear view camera system is a reverse aid supplement device that still requires the driver to use it in conjunction with the interior and exterior mirrors for maximum coverage.



WARNING: Objects that are close to either corner of the bumper or under the bumper, might not be seen on the screen due to the limited coverage of the camera system.



WARNING: Use caution when turning camera features on or off when the transmission is not in park (P). Make sure your vehicle is not moving.



WARNING: You are responsible for controlling your vehicle at all times. The system is designed to be an aid and does not relieve you of your responsibility to drive with due care and attention. Failure to follow this instruction could result in the loss of control of your vehicle, personal injury or death.

Note: Use caution using the 180 view when any of the doors are ajar. If a door is ajar, the camera will be out of position and the video image may be incorrect.

Front View Camera



WARNING: The front camera system still requires the driver to use it in conjunction with looking out of your vehicle.

Note: The system turns off the front video image when your vehicle is in motion at low speed, except when in reverse (R).

Note: The area displayed on the screen may vary according to your vehicle's orientation or road condition.

Note: The camera system may not operate correctly if mud, water or debris obstructs the camera's view. You can clean the lens with a soft, lint-free cloth and non-abrasive cleaner or by using your front washer. See **Wipers and Washers** (page 97).

Parking Aids

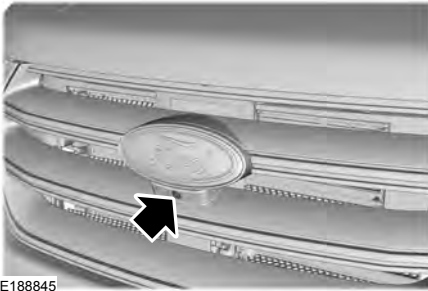

E188845

The front view camera is located in the grille. It provides a video image of the area in front of your vehicle. It adds assistance to the driver while driving forward at low speeds.

Using the 180 degree camera system

The 180 degree camera system consists of front and rear cameras. The system:

- Allows you to see what is directly in front or behind your vehicle.
- Provides cross traffic view in front and behind your vehicle.
- Provides visibility during parking maneuvers.



The camera system button is located near the display screen and turns on the front camera when your vehicle is not in reverse (R).

The front view camera will switch off if your vehicle speed exceeds 10 km/h (6 mph).

Switch the system back on by pressing the camera system button once below speed threshold.

Camera Views

Press the camera system button to activate the camera views and the camera view buttons.

When in park (P), neutral (N) or drive (D), only the front images display when you press the button.

When in reverse (R), only the rear images display.



Press the camera view button to toggle between the different camera views.



Normal View: Provides an image of what is directly in front or behind your vehicle.



Expanded View: Provides an extended view of what is in front or behind your vehicle.



Zooms in on the image.

Cruise Control

PRINCIPLE OF OPERATION

Cruise control lets you maintain a set speed without keeping your foot on the accelerator pedal. You can use cruise control when your vehicle speed is greater than 20 mph (30 km/h).

USING CRUISE CONTROL



WARNING: Do not use cruise control on winding roads, in heavy traffic or when the road surface is slippery. This could result in loss of vehicle control, serious injury or death.



WARNING: When you are going downhill, your vehicle speed could increase above the set speed. The system does not apply the brakes.

The cruise controls are on the steering wheel.

Switching Cruise Control On



Press the button.

Switching Cruise Control Off



Press the button when the system is in standby mode. The system also turns off when you switch the ignition off.

Note: The set speed erases when you switch the system off.

Setting the Cruise Speed

Drive to the required speed.

SET+

Press the toggle button upward or downward to set the current speed.

SET-

Take your foot off the accelerator pedal.

Note: The set speed appears in the information display.

Changing the Set Speed

SET+

Press the toggle button upward to increase the set speed.

SET-

Press the toggle button downward to decrease the set speed.

You can adjust the set speed in small or large increments. Press the toggle button upward or downward once to adjust the set speed in small increments. Press and hold the toggle button upward or downward to adjust the set speed in large increments.

Note: If you accelerate by pressing the accelerator pedal, the set speed does not change. When you release the accelerator pedal, your vehicle returns to the speed that you previously set.

Canceling the Set Speed

CAN

Press the button, or press the brake pedal to cancel the set speed.

Note: The set speed is stored.

Note: The system cancels if the vehicle speed drops below 10 mph (16 km/h) under the set speed when driving uphill.

Resuming the Set Speed

RES

Press to resume the set speed.

Cruise Control

Cruise Control Indicator



The indicator appears when you switch the system on.

USING ADAPTIVE CRUISE CONTROL (IF EQUIPPED)



WARNING: You are responsible for controlling your vehicle at all times. The system is designed to be an aid and does not relieve you of your responsibility to drive with due care and attention. Failure to follow this instruction could result in the loss of control of your vehicle, personal injury or death.



WARNING: Pay close attention to changing road conditions such as entering or leaving a highway, on roads with intersections or roundabouts, roads without visible lanes of travel, roads that are winding, slippery, unpaved, or steep slopes.



WARNING: The system may not detect stationary or slow moving vehicles below 6 mph (10 km/h).



WARNING: Do not use the system when towing a trailer that has aftermarket electronic trailer brake controls. Failure to follow this instruction could result in the loss of control of your vehicle, personal injury or death.



WARNING: The system is not a crash warning or avoidance system.



WARNING: The system does not detect pedestrians or objects in the road.



WARNING: The system does not detect oncoming vehicles in the same lane.



WARNING: Do not use the system in poor visibility, for example fog, heavy rain, spray or snow.



WARNING: Do not use tire sizes other than those recommended because this can affect the normal operation of the system. Failure to do so may result in a loss of vehicle control, which could result in serious injury.

The system adjusts the vehicle speed to maintain the set gap between you and the vehicle in front of you in the same lane. You can select four gap settings.

The system uses a radar that projects a beam directly in front of your vehicle.



E248321

The adaptive cruise controls are on the steering wheel.

Switching Adaptive Cruise Control On



Press to set the system in standby mode.

Cruise Control



E260516

The indicator, current gap setting and set speed appear in the information display.

Setting the Adaptive Cruise Speed

Drive to the required speed.

SET+

Press the toggle button upward to set the current speed.

Take your foot off the accelerator pedal.

The indicator, current gap setting and set speed appear in the information display.



E249552

A vehicle graphic appears in the information display if the system detects a vehicle in front of you.

Note: When adaptive cruise control is active, the speedometer may vary slightly from the set speed displayed in the information display.

Following a Vehicle



WARNING: When following a vehicle that is braking, your vehicle does not always decelerate quickly enough to avoid a crash without driver intervention. Apply the brakes when necessary. Failure to follow this instruction could result in personal injury or death.



WARNING: The system only warns of vehicles detected by the radar sensor. In some cases there may be no warning or a delayed warning. Apply the brakes when necessary. Failure to follow this instruction could result in personal injury or death.

When a vehicle ahead of you enters the same lane or a slower vehicle is ahead in the same lane, the vehicle speed adjusts to maintain a preset gap distance. A vehicle graphic appears in the information display.

Note: When you are following a vehicle and you switch on a direction indicator, adaptive cruise control may provide a small temporary acceleration to help you pass.

Your vehicle maintains a consistent gap from the vehicle ahead until:

- The vehicle in front of you accelerates to a speed above the set speed.
- The vehicle in front of you moves out of the lane you are in.
- You set a new gap distance.

The system applies the brakes to slow your vehicle to maintain a safe gap distance from the vehicle in front. The system only applies limited braking. You can override the system by applying the brakes.

If the system determines that its maximum braking level is not sufficient, an audible warning sounds when the system continues to brake. Take immediate action.

Cruise Control

Note: The brakes may emit noise when applied by the system.

Setting the Gap Distance



You can decrease or increase the distance between your vehicle and the vehicle in front by pressing the gap control.

Note: It is your responsibility to select a gap appropriate to the driving conditions.



E249552

The selected gap appears in the information display as shown by the bars in the image. You can select four gap settings.

Adaptive Cruise Control Distance Between Vehicle Settings

Set Speed mph (km/h)	Graphic Display - Bars Indicated Between Vehicles	Time Gap - Seconds	Distance Gap yd (m)	Dynamic Beha- vior
62 (100)	1	1	31 (28)	Sport.
62 (100)	2	1.4	43 (39)	Normal.
62 (100)	3	1.8	55 (50)	Normal.
62 (100)	4	2.2	67 (61)	Comfort.

When you switch the ignition on, the system selects the last chosen gap setting.

Overriding the System



WARNING: If you override the system by pressing the accelerator pedal, it does not automatically apply the brakes to maintain a gap from any vehicle ahead.

Use the accelerator pedal to intentionally exceed the set speed limit.

When you override the system, the vehicle graphic disappears from the information display.

Changing the Set Speed

SET+

Press the toggle button upward to increase the set speed.

SET-

Press the toggle button downward to decrease the set speed.

You can adjust the set speed in small or large increments. Press the toggle button upward or downward once to adjust the set speed in small increments. Press and hold the toggle button upward or downward to adjust the set speed in large increments.

Cruise Control

The system may apply the brakes to slow your vehicle to the new set speed. The set speed continuously displays in the information display when the system is active.

Canceling the Set Speed



Press the button, or tap the brake pedal.

The last set speed displays with a strikethrough and the last gap setting appears but does not erase.

Note: The set speed also cancels if you press the clutch pedal for an extended period.

Resuming the Set Speed



Press the button.

The vehicle speed returns to the previously set speed and gap setting. The set speed continuously shows in the information display when the system is active.

Note: Only use resume if you are aware of the set speed and intend to return to it.

Automatic Cancellation

The system does not operate if the vehicle speed is below 12 mph (20 km/h). A tone sounds and adaptive braking releases if the vehicle speed falls below 12 mph (20 km/h).

Automatic cancellation can also occur when:

- The tires lose traction.
- The engine speed is too low.
- You apply the parking brake.

Note: If the engine speed drops too low, the information display advises you to shift to a lower gear.

Hilly Condition Usage

Select a lower gear when the system is active and you are driving downhill on steep grades, for example in mountainous areas. The system needs additional engine braking in these situations to reduce the load on the brake system to prevent it from overheating.

Note: A tone sounds and the system turns off if it applies brakes for an extended period of time. This allows the brakes to cool. The system operates after the brakes cool.

Switching Adaptive Cruise Control Off



Press the button.

Note: The set speed erases when you switch the system off.

Detection Issues



WARNING: On rare occasions, detection issues can occur due to the road infrastructures, for example bridges, tunnels and safety barriers. In these cases, the system may brake late or unexpectedly. At all times, you are responsible for controlling your vehicle, supervising the system and intervening, if required.



WARNING: If the system malfunctions, have your vehicle checked as soon as possible.

The radar has a limited field of view. It does not detect all vehicles in all situations and could detect vehicles later than you expect. The lead vehicle graphic does not display if the system does not detect a vehicle in front of you.

Cruise Control

A

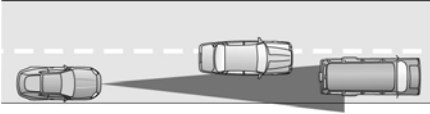

B

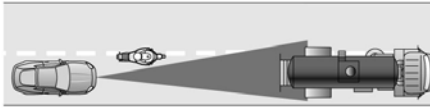

C

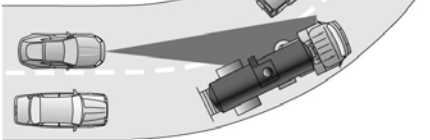

Detection issues can occur:

- A When driving on a different line than the vehicle in front.
- B With vehicles that edge into your lane. The system can only detect these vehicles once they fully move into your lane.
- C There may be issues with the detection of vehicles in front when driving into and coming out of a bend or curve in the road.

In these cases, the system may brake late or unexpectedly. You should stay alert and take action when necessary.

If something hits the front of your vehicle or damage occurs, the radar-sensing zone may change. This could cause the system to malfunction. Have your vehicle checked as soon as possible.

System Not Available

The system may not turn on if there is:

- A blocked sensor.
- High brake temperature.
- A failure in the system or a related system.

Adaptive Cruise Control System Sensors



WARNING: The system may not operate properly if the sensor is blocked. Keep the windshield free from obstruction.



E243054

The camera is mounted behind the interior mirror.

Cruise Control



E244279

The radar is behind the front grille below the license plate.

A message displays if something obstructs the radar signals from the sensor. The system cannot detect a vehicle ahead and does not function when something blocks the sensor.

Note: You cannot see the sensor, it is behind a fascia panel.

Note: Keep the front of your vehicle free of dirt, metal badges or objects. Vehicle front protectors, aftermarket lights, additional paint or plastic coatings could also degrade sensor performance.

Cause	Action
The surface of the radar in the radiator grille is dirty or obstructed.	Clean the radiator grille in front of the radar or remove any obstruction.
The surface of the radar is clean but the message remains in the display.	Wait a short period of time. It may take several minutes for the radar to detect that it is free from obstruction.
Heavy rain or snow interfere with the radar signals.	Do not use the system in these conditions because it may not detect any vehicles ahead.
Swirling water, snow or ice on the surface of the road interfere with the radar signals.	Do not use the system in these conditions because it may not detect any vehicles ahead.
You are in a desert or remote area with no other vehicles and no roadside objects.	Wait a short period of time or switch to normal cruise control.

Due to the nature of radar technology, a blocked sensor message could display when the sensor is not blocked. This can happen, for example, when driving in sparse rural or desert environments. A false blocked condition self clears or clears after you switch the ignition off and on.

Switching to Normal Cruise Control



WARNING: Normal cruise control will not brake when your vehicle is approaching slower vehicles. Always be aware of which mode you have selected and apply the brakes when necessary.

Cruise Control

You can change from adaptive cruise control to cruise control using the information display.

To switch between adaptive cruise control and normal cruise control, use the information display controls on the steering wheel to select the following:

Menu Item	Action
Driver Assist.	Press the menu button.
Cruise Control	Press the OK button.
Mode	Press the OK button. Press the toggle button upward or downward to choose your required setting. Press the OK button.



The cruise control indicator replaces the adaptive cruise control indicator if you select normal cruise control. The gap setting does not display, the system does not automatically respond to lead vehicles and adaptive braking does not activate. The system remembers the last setting when you start your vehicle.

Adaptive Cruise Control Indicator



The indicator appears when you switch the system on.

The indicator appears in the information display when the system is in standby mode and when you set the adaptive cruise speed.

Adaptive Cruise Control Information Messages

Message	Action
Adaptive Cruise Not Available Sensor Blocked See Manual	The radar has reduced visibility.
Adaptive Cruise Not Available	The system is not available.
Adaptive Cruise Malfunction	The system has malfunctioned. Have your vehicle checked as soon as possible.
Normal Cruise Active Adaptive Braking Off	You have switched normal cruise control on. Adaptive braking turns off.

Driving Aids

SPEED LIMITER

Principle of Operation



WARNING: When you are going downhill, your vehicle speed could increase above the set speed. The system does not apply the brakes.



WARNING: The system is designed to aid the driver. It is not intended to replace your attention and judgment. You are still responsible to drive with due care and attention.

The system allows you to set a speed to which your vehicle becomes limited. The set speed sets the effective maximum speed of your vehicle. You can temporarily exceed the set speed if required, for example to overtake.

Using Speed Limiter

The controls are on the steering wheel.

Switching the System On and Off

LIM

Press to set the system in standby mode. Press again to switch the system off.

Setting the Speed Limiter

SET+

Press the toggle button upward or downward with the system in standby mode to set the speed limiter to the current vehicle speed. The set speed is stored and displayed in the information

display.

SET-

You can adjust the set speed in small or large increments. Press the toggle button upward or downward once to adjust the set speed in small increments. Press and hold the toggle button upward or downward to adjust the set speed in large increments.

Canceling the Set Speed

CAN

Press to cancel the set speed limiter. The system returns to standby mode.

Resuming the Set Speed

RES

Press to resume the set speed limiter.

Intentionally Exceeding the Speed Limit

Firmly press the accelerator pedal to temporarily exceed the set speed limit. The system resumes when the vehicle speed drops below the set speed limit, or when you press the **RES** button.

System Warnings

If you intentionally exceed the set speed, a warning appears in the information display.

If you unintentionally exceed the set speed, for example when you are going downhill, a warning appears in the information display and a tone sounds.

Driving Aids

DRIVER ALERT



WARNING: You are responsible for controlling your vehicle at all times. The system is designed to be an aid and does not relieve you of your responsibility to drive with due care and attention. Failure to follow this instruction could result in the loss of control of your vehicle, personal injury or death.



WARNING: The system may not operate properly if the sensor is blocked. Keep the windshield free from obstruction.



WARNING: Take regular rest breaks if you feel tired. Do not wait for the system to warn you.



WARNING: Certain driving styles may result in the system warning you even if you are not feeling tired.



WARNING: In cold and severe weather conditions the system may not function. Rain, snow and spray can all limit sensor performance.



WARNING: The system will not operate if the sensor cannot track the road lane markings.



WARNING: If damage occurs in the immediate area surrounding the sensor, have your vehicle checked as soon as possible.



WARNING: The system may not correctly operate if your vehicle is fitted with a suspension kit not approved by us.

The system is designed to alert you if it calculates that you are becoming drowsy or if your driving deteriorates.

The system calculates your alertness level based upon your driving behavior in relation to the lane markings and other factors when the vehicle speed is greater than approximately 40 mph (65 km/h).

Driver Alert System Warnings

The warning system has two stages:

1. A temporary warning is issued to advise you to take a rest. This message only appears for a short time.
2. If you do not rest and the system continues to detect that your driving deteriorates, it issues a further warning. This remains in the information display until you cancel it.

Note: *The system does not warn you if the vehicle speed falls below approximately 40 mph (65 km/h).*

Driver Alert System Display

1. Using the information display controls on the steering wheel, select **Settings**.
2. Select **Information**.
3. Select **Driver Alert**.

Your calculated alertness level is shown by six steps as a colored bar. The bar travels from right to left as your calculated alertness level decreases.

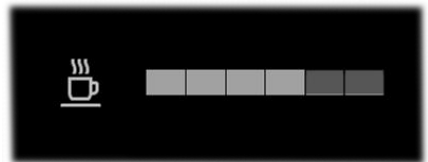

E249476

Your calculated alertness level is good.

Driving Aids



E249477

Your calculated alertness level is low. You should stop your vehicle and take a rest as soon as it is safe to do so.

Your calculated alertness level shows in gray if:

- The sensor cannot track the road lane markings.
- The vehicle speed is less than approximately 40 mph (65 km/h).

Driver Alert System Messages

Message	Action
Driver Alert Warning Rest Suggested	Displays when we recommend that you take a break due to low alertness levels.
Driver Alert Warning Rest Now	Displays when you must take a break due to low alertness levels.

LANE KEEPING SYSTEM



WARNING: You are responsible for controlling your vehicle at all times. The system is designed to be an aid and does not relieve you of your responsibility to drive with due care and attention. Failure to follow this instruction could result in the loss of control of your vehicle, personal injury or death.



WARNING: The system may not function if the sensor is blocked.

Switching Driver Alert On and Off

1. Using the information display controls on the steering wheel, select **Driver Assist.**
2. Switch **Driver Alert** on or off.

Note: *The system remains on or off depending on how it was last set.*

Resetting Driver Alert

You can reset the system by:

- Switching the ignition off and on when your vehicle is stationary.
- Opening and closing the driver door when your vehicle is stationary.



WARNING: The sensor may incorrectly track lane markings as other structures or objects. This can result in a false or missed warning.



WARNING: In cold and severe weather conditions the system may not function. Rain, snow and spray can all limit sensor performance.



WARNING: Large contrasts in outside lighting can limit sensor performance.

Driving Aids



WARNING: The system will not operate if the sensor cannot track the road lane markings.



WARNING: If damage occurs in the immediate area surrounding the sensor, have your vehicle checked as soon as possible.



WARNING: The system may not correctly operate if your vehicle is fitted with a suspension kit not approved by us.

The system is designed to alert you by providing temporary steering assistance or steering wheel vibration when it detects an unintended lane departure. The system detects and tracks the road lane markings using a camera mounted behind the interior mirror. The system only operates when the vehicle speed is greater than approximately 37 mph (60 km/h). You can view the system status in the information display.

Note: *The system works when the camera can detect at least one lane marking or the edge of the road.*

The system may not correctly operate in any of the following conditions:

- The system does not detect at least one lane marking or the edge of the road.
- You switch the direction indicator on.
- You apply direct steering, accelerate fast or brake hard.
- The vehicle speed is less than 37 mph (60 km/h).
- The anti-lock brake, stability control or traction control system activates.
- Narrow lane width.

The system may not correct lane positioning in any of the following conditions:

- High winds.
- Uneven road surfaces.
- Heavy or uneven loads.
- Incorrect tire pressure.

Switching Lane Keeping System On or Off



E132099

Press the button on the direction indicator stalk.

Note: *A warning indicator may remain illuminated in the information display when you switch the system off.*

Note: *The system may turn on when you start your vehicle.*

Lane Keeping System Settings

The system has different settings that you can view or adjust using the information display.

Note: *The system remembers the last setting when you start your vehicle. If the system detects a MyKey, the mode is set to alert.*

Alert Mode

Provides steering wheel vibration when the system detects an unintended lane departure.

Driving Aids

Adjusting the Steering Wheel Vibration Intensity

1. Using the information display controls on the steering wheel, select **Driver Assist..**
2. Select **Lane Keeping System.**
3. Select **Intensity.**
4. Select a setting and press the **OK** button.

Note: This setting does not affect aid mode.

Note: The system remembers the last setting when you start your vehicle.

Adjusting the Lane Keeping System Sensitivity

1. Using the information display controls on the steering wheel, select **Driver Assist..**
2. Select **Lane Keeping System.**
3. Select **Sensitivity.**
4. Select a setting and press the **OK** button.

Aid Mode

Provides temporary steering assistance toward the lane center when the system detects an unintended lane departure.

Note: When aid mode is on and the system does not detect any steering activity for a short period of time, for example lightly holding the steering wheel, the system alerts you to put your hands on the steering wheel.

Alert and Aid Mode

Provides temporary steering assistance toward the lane center when the system detects an unintended lane departure. If your vehicle continues drifting out of the lane, the steering wheel vibrates.

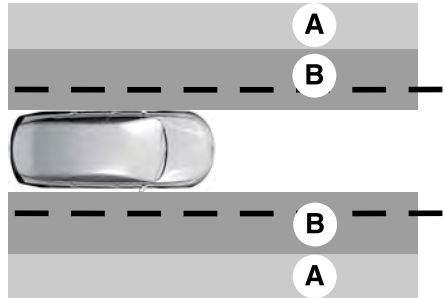

A Alert mode.

B Aid mode.

Note: The diagram illustrates general zone coverage. It does not provide exact zone parameters.

Switching the Lane Keeping System Mode

1. Using the information display controls on the steering wheel, select **Driver Assist..**
2. Select **Lane Keeping System.**
3. Select **Mode.**
4. Select a setting and press the **OK** button.

Lane Keeping System Display



When the system is on, a graphic of lane markings appears in the information display.

Driving Aids

Lane Keeping System Warning Lamps and Indicators

Lane Keeping Alert Indicators



It illuminates in the information display when you switch the system on and Aid Mode or Alert and Aid Mode are selected.



It illuminates in the information display when you switch the system on and Alert Mode is selected.

Lane Keeping Aid Warning Lamp



It could illuminate when you switch the system off. If it illuminates when you are driving, this indicates a malfunction. Have your vehicle checked as soon as possible.

Black and White Information Display

Indicator	System Status
Gray.	Unavailable.
White.	Available.
White and inverted.	Temporary steering assistance.
White and flashing.	Temporary steering assistance and steering wheel vibration.

Color Information Display

Indicator	System Status
Gray.	Unavailable.
Green.	Available.
Amber.	Temporary steering assistance.
Red.	Temporary steering assistance and steering wheel vibration.

Lane Keeping System Messages

Message	Action
Lane Keeping Sys. Malfunction Service Required	The system has detected a fault that requires service. Have your vehicle checked as soon as possible.

Driving Aids

BLIND SPOT INFORMATION SYSTEM



WARNING: Do not use the blind spot information system as a replacement for using the interior and exterior mirrors or looking over your shoulder before changing lanes. The blind spot information system is not a replacement for careful driving.



WARNING: The system may not operate properly during severe weather conditions, for example snow, ice, heavy rain and spray. Always drive with due care and attention. Failure to take care may result in a crash.

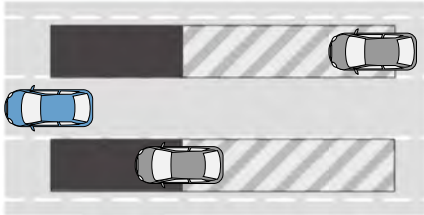

The system is designed to detect vehicles that may have entered the blind spot zone. The detection area is on both sides of your vehicle, extending rearward from the exterior mirrors to approximately 13 ft (4 m) beyond the rear bumper. The detection area extends to approximately 59 ft (18 m) beyond the rear bumper when the vehicle speed is greater than 30 mph (48 km/h) to alert you of faster approaching vehicles.

Note: The system does not prevent contact with other vehicles. It is not designed to detect parked vehicles, pedestrians, animals or other infrastructures.

Using the Blind Spot Information System

Vehicles with Automatic Transmission

The system turns on when all of the following occur:

- You start your vehicle.
- You shift into drive (D).
- The vehicle speed is greater than 6 mph (10 km/h).

Note: The system does not operate in park (P) or reverse (R).

Vehicles with Manual Transmission

The system turns on when all of the following occur:

- You start your vehicle.
- The vehicle speed is greater than 6 mph (10 km/h).

Note: The system does not operate in reverse (R).

Blind Spot Information System Sensors

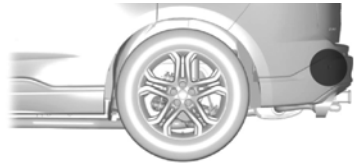

The sensors are behind the rear bumper on both sides of your vehicle.

Note: Keep the sensors free from snow, ice and large accumulations of dirt.

Driving Aids

Note: Do not cover the sensors with bumper stickers, repair compound or other objects.

Note: Blocked sensors could affect system performance.

If the sensors are blocked, a message may appear in the information display. The indicators remain illuminated in the exterior mirror but the system does not alert you.

Switching the Blind Spot Information System On and Off

1. Using the information display controls on the steering wheel, select **Settings**.
2. Select **Driver Assistance**.
3. Select **Blind Spot**.
4. Switch **Blind Spot** on or off.

When you switch the system off, a warning lamp illuminates in the instrument cluster and the alert indicators flash twice.

The system remembers the last setting when you start your vehicle.

Note: The system may not correctly operate when towing a trailer. The system turns off when you attach a trailer, if your vehicle has an approved trailer tow module and tow bar. For vehicles with an aftermarket trailer tow module or tow bar, turn the system off when you attach a trailer.

To permanently switch the system off, contact an authorized dealer.

Blind Spot Information System Indicator



When the system detects a vehicle, an alert indicator illuminates in the exterior mirror on the side the approaching vehicle is coming from. If you turn the direction indicator on for that side of your vehicle, the alert indicator flashes.

Note: The system may not alert you if a vehicle quickly passes through the detection zone.

Blind Spot Information System with Trailer Tow

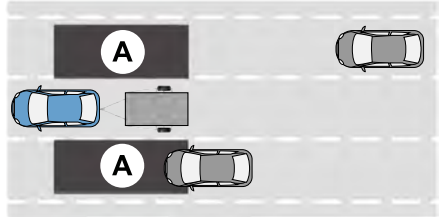

E293525

The blind spot information system with trailer tow is designed to detect vehicles that may have entered the blind spot zone. The detection area is on both sides of your vehicle and trailer, extending rearward from the exterior mirrors to the end of your trailer. When you attach a trailer and have set up a trailer, the blind spot information system with trailer tow becomes active when driving forward above 6 mph (10 km/h).

You can set up the trailer length, select a trailer or switch blind spot information system with trailer tow off.

Note: The system remembers the last trailer setting when you start your vehicle.

Driving Aids

Setting up the Trailer Length

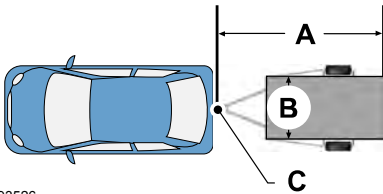

E293526

- A Trailer length.
- B Trailer width.
- C Trailer hitch.

The system operates only if the trailer front width is less than 8.2 ft (2.5 m), and the total length from the trailer hitch to the rear of the trailer is less than 33 ft (10 m).

1. Using the information display controls on the steering wheel, select **Settings**.
2. Select **Driver Assistance**.
3. Select **Blind Spot**.
4. Select **Trailer Lengths**.
5. Select **Trailer A**, **Trailer B** or **Trailer C**.
6. Select the trailer length at the closest available value.

Note: Proper measurement and measurement entry are required for the system to function as designed.

7. Press the **OK** button.

Note: If you attach load carriers such as bike racks or cargo racks with electrical lighting, enter a length of 3 ft (1 m). Cross Traffic Alert remains on.

Selecting a Trailer

If you select a trailer in the information display prior to connecting a trailer, the system loads that configuration and an information message appears in the information display when you connect the trailer.

1. Using the information display controls on the steering wheel, select **Settings**.
2. Select **Driver Assistance**.
3. Select **Blind Spot**.
4. Select **Trailer**.
5. Select **Trailer A**, **Trailer B** or **Trailer C**.
6. Press the **OK** button.

Switching the Blind Spot Information System with Trailer Tow Off

1. Using the information display controls on the steering wheel, select **Settings**.
2. Select **Driver Assistance**.
3. Select **Blind Spot**.
4. Select **Trailer**.
5. Select **None**.
6. Press the **OK** button.

When you switch the system off, a warning lamp illuminates and the alert indicators flash twice.

Note: The system turns off and a message appears when a trailer is connected, but not set up or selected.

Driving Aids

Blind Spot Information System Limitations

Some trailers may cause a slight change in system performance:

- Wide box trailers, especially those wider than the towing vehicle, may cause false alerts to occur when driving next to infrastructure or near parked cars. A false alert may also occur while making a 90-degree turn or driving through a roundabout.
- Wide trailers that have a total length greater than 20 ft (6 m) may cause delayed alerts when a vehicle is passing at high speed.

- Box trailers that have a width greater than 8.2 ft (2.5 m) may cause early alerts when you pass a vehicle.
- Clam shell or V-Nose box trailers with a width greater than 8.2 ft (2.5 m) may cause delayed alerts when a vehicle traveling the same speed as your vehicle merges lanes.

Blind Spot Information System Warning Lamp



It illuminates in the instrument cluster if you switch the system off.

If it illuminates when the system is on this indicates a malfunction. Have your vehicle checked as soon as possible.

Blind Spot Information System Information Messages

Message	Description
Trailer Blind Spot Add Trailer Exit Press OK to Select	Displays if the new trailer is attached but not selected. Select a trailer.
Blind Spot Not Available Sensor Blocked See Manual	Displays if the blind spot information system sensors are blocked.
Blind spot & cross Traffic alert deact. Trailer attached	Displays if you attach a trailer to your vehicle.
Blind Spot System Fault	The system has detected a fault that requires service. Have your vehicle checked as soon as possible.

Driving Aids

CROSS TRAFFIC ALERT



WARNING: Do not use the cross traffic alert system as a replacement for using the interior and exterior mirrors or looking over your shoulder before reversing out of a parking space. The cross traffic alert system is not a replacement for careful driving.



WARNING: The system may not operate properly during severe weather conditions, for example snow, ice, heavy rain and spray. Always drive with due care and attention. Failure to take care may result in a crash.

The system is designed to alert you of vehicles approaching from the sides behind your vehicle when you shift into reverse (R).

Using Cross Traffic Alert

The system is designed to detect vehicles that approach at a speed between 4 mph (6 km/h) and 37 mph (60 km/h). Coverage decreases when the sensors are partially, mostly or fully obstructed. Slowly reversing helps increase the coverage area and effectiveness.

The system turns on when you start the engine and you shift into reverse (R). The system turns off when you shift out of reverse (R).

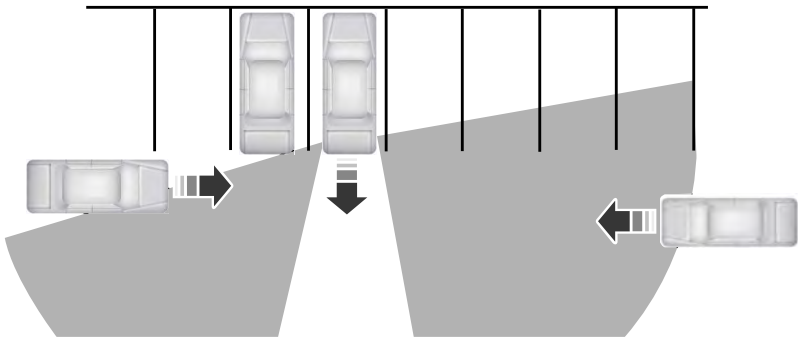

The sensor on the left-hand side is only partially obstructed and zone coverage on the right-hand side is maximized.

Driving Aids

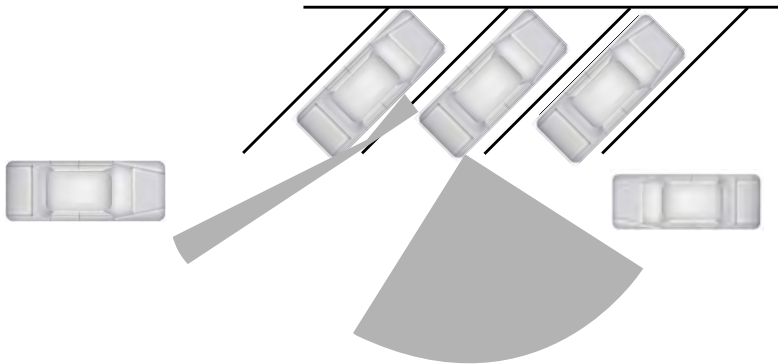

Zone coverage also decreases when parking at narrow angles. The sensor on the left-hand side is mostly obstructed and zone coverage on that side is severely reduced.

Cross Traffic Alert System Sensors

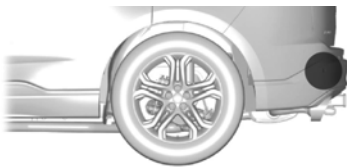

The sensors are behind the rear bumper on both sides of your vehicle.

Note: *Keep the sensors free from snow, ice and large accumulations of dirt.*

Note: *Do not cover the sensors with bumper stickers, repair compound or other objects.*

Note: *Blocked sensors could affect system performance.*

If the sensors are blocked, a message may appear in the information display when you shift into reverse (R).

Cross Traffic Alert System Limitations

The system may not correctly operate when any of the following occur:

- The sensors are blocked.
- Adjacently parked vehicles or objects are obstructing the sensors.
- Vehicles approach at speeds less than 4 mph (6 km/h) or greater than 37 mph (60 km/h).
- The vehicle speed is greater than 7 mph (12 km/h).
- You reverse out of an angled parking space.

Driving Aids

Cross Traffic Alert behavior when trailer is attached

Note: The system may not correctly operate when towing a trailer. For vehicles with an approved trailer tow module and tow bar, the system turns off when you attach a trailer. For vehicles with an aftermarket trailer tow module or tow bar, we recommend that you switch the system off when you attach a trailer.

Cross traffic alert remains on when you attach a trailer in vehicles equipped with a Blind Spot Information System with Trailer Tow under the following conditions:

- You connect a trailer.
- The trailer is a bike rack or cargo rack with a maximum length of 3 ft (1 m).
- You set the trailer length to 3 ft (1 m) in the information display.

See **Blind Spot Information System** (page 212).

Switching the System On and Off

To switch cross traffic alert on or off, use the Information display. See **General Information** (page 115).

Cross Traffic Alert Information Messages

Message	Action
Cross Traffic Alert	Displays instead of indication arrows when the system detects a vehicle. Check for approaching traffic.
Cross Traffic Not Available Sensor Blocked See Manual	Displays if the cross traffic alert system sensors are blocked. Clean the sensors. If the message continues to appear, have your vehicle checked as soon as possible.
Cross Traffic System Fault	The system has malfunctioned. Have your vehicle checked as soon as possible.
Cross Traffic Alert Deactivated Trailer Attached	Displays if you attach a trailer to your vehicle.

Note: The system turns on every time you switch the ignition on. To permanently switch the system off, contact an authorized dealer.

Cross Traffic Alert Indicator



When the system detects an approaching vehicle a tone sounds, a warning lamp illuminates in the relevant exterior mirror and arrows appear in the information display to show which side the approaching vehicle is coming from.

Note: If arrows do not display, a message appears in the information display.

If the system malfunctions, a warning lamp illuminates in the instrument cluster and a message appears in the information display. Have your vehicle checked as soon as possible.

Note: In exceptional conditions, the system could alert you, even when there is nothing in the detection zone, for example a vehicle passing further away from your vehicle.

Driving Aids

ECO

Eco Mode

How Does Eco Mode Work

The system is designed to monitor certain driving characteristics to help you drive more efficiently. See **Economical Driving** (page 246).

Note: *The efficiency levels do not result in a defined fuel consumption figure.*

Note: *The system only indicates the efficiency level for the current trip. The system resets each time you switch the ignition on.*

Instantaneous Efficiency Level

The display ring increases as the instantaneous efficiency level increases and illuminates when it reaches maximum efficiency. The level continuously updates to indicate the efficiency level for the current trip.

Viewing the Instantaneous Efficiency Level

1. Using the information display controls on the steering wheel, select **MyView**.
2. Select **Eco Coach**.

Trip Summary

The calculated trip summary is shown as four colored bars. The bars travel from left to right as the calculated efficiency levels increase. The bars indicate the average efficiency level for acceleration, deceleration, speed and gear shifting during the total distance traveled by your vehicle for the current trip.

Note: *Vehicles with an automatic transmission do not have a bar for gear shifting.*

Viewing the Trip Summary

1. Using the information display controls on the steering wheel, select **MyView**.
2. Select **Eco Coach**.

Efficient Drive Mode

What Is Efficient Drive Mode

Efficient drive mode is a predictive coach that provides near real-time traffic information to help you drive more efficiently by releasing the accelerator pedal.

Switching Efficient Drive Mode On and Off

1. Using the information display controls on the steering wheel, select **Driver Assist..**
2. Select **Eco Coach**.
3. Switch **Eco Advice** on and off.

Displaying the Efficient Drive Mode

1. Using the information display controls on the steering wheel, select **Driver Assist..**

The display ring can provide information about speed limit, freeway ramp, slope, curve, crosswalk, etc.

Efficient Drive Mode Indicator



It indicates that you have to slowly decelerate.

Driving Aids

Trip Summary

The calculated trip summary is shown as five colored bars. The bars travel from left to right as the calculated efficiency levels increase. The bars indicate the average efficiency level for acceleration, deceleration, speed, gear shifting and compliance score during the total distance traveled by your vehicle for both last and current trips.

Note: *Vehicles with an automatic transmission do not have a bar for gear shifting.*

Viewing the trip summary

1. Using the information display controls on the steering wheel, select **MyView**.
2. Select **Eco Coach**.
3. Switch the engine off.
4. Press the **OK** button.

STEERING

Electric Power Steering



WARNING: The electric power steering system has diagnostic checks that continuously monitor the system. If a fault is detected, a message displays in the information display. Stop your vehicle as soon as it is safe to do so. Switch the ignition off. After at least 10 seconds, switch the ignition on and watch the information display for a steering system warning message. If a steering system warning message returns, have the system checked as soon as possible.



WARNING: If the system detects an error, you may not feel a difference in the steering, however a serious condition may exist. Have your vehicle checked as soon as possible. Failure to do so may result in loss of steering control.

Your vehicle has an electric power steering system, there is no fluid reservoir, no maintenance is required.

If your vehicle loses electrical power while you are driving, electric power steering assistance is lost. The steering system still operates and you can steer your vehicle manually. Manually steering your vehicle requires more effort.

Extreme continuous steering may increase the effort required for you to steer your vehicle, this increased effort prevents overheating and permanent damage to the steering system. You do not lose the ability to steer your vehicle manually. Typical steering and driving maneuvers allow the system to cool and return to normal operation.

Steering Tips

If the steering wanders or pulls, check for:

- Correct tire pressures.
- Uneven tire wear.
- Loose or worn suspension components.
- Loose or worn steering components.
- Improper vehicle alignment.

Note: *A high crown in the road or high crosswinds may also make the steering seem to wander or pull.*

Driving Aids

Adaptive Learning (If Equipped)

The electronic power steering system adaptive learning helps correct road irregularities and improves overall handling and steering feel. It communicates with the brake system to help operate

advanced stability control and accident avoidance systems. Additionally, whenever the battery is disconnected or a new battery installed, you must drive your vehicle a short distance before the system relearns the strategy and reactivates all systems.

Steering Information Messages

Message	Description
Steering Fault Service Now	The system has malfunctioned. Stop your vehicle as soon as it is safe to do so. You continue to have full steering but you need to exert greater force on the steering wheel. Have your vehicle checked as soon as possible.
Steering Loss Stop Safely	
Steering Assist Fault Service Required	

PRE-COLLISION ASSIST



WARNING: You are responsible for controlling your vehicle at all times. The system is designed to be an aid and does not relieve you of your responsibility to drive with due care and attention. Failure to follow this instruction could result in the loss of control of your vehicle, personal injury or death.



WARNING: The system does not operate during hard acceleration or steering. Failure to take care may lead to a crash or personal injury.



WARNING: The system may fail or operate with reduced function during cold and severe weather conditions. Snow, ice, rain, spray and fog can adversely affect the system. Keep the front camera and radar free of snow and ice. Failure to take care may result in the loss of control of your vehicle, serious personal injury or death.



WARNING: The system may not operate properly if your vehicle has a non-Ford windshield. Do not carry out windshield repairs in the area around the sensor.



WARNING: In situations where the vehicle camera has limited detection capability, this may reduce system performance. These situations include but are not limited to direct or low sunlight, vehicles at night without tail lights, unconventional vehicle types, pedestrians with complex backgrounds,

Driving Aids

running pedestrians, partly obscured pedestrians, or pedestrians that the system cannot distinguish from a group. Failure to take care may result in the loss of control of your vehicle, serious personal injury or death.



WARNING: The Pre-Collision Assist system with brake support cannot help prevent all collisions. Do not rely on this system to replace your judgment and the need to maintain correct distance and speed.

The pre-collision assist system is active when your vehicle reaches a speed greater than approximately 6 mph (10 km/h). Pedestrian detection is active at speeds up to 50 mph (80 km/h).

Note: The system is not designed to detect animals.

Note: The system is not designed to detect vehicles or cyclists that are traveling in a different direction.



E156130

If your vehicle is rapidly approaching another stationary vehicle, a vehicle or cyclist traveling in the same direction as yours, or a pedestrian within your driving path, the system is designed to provide three levels of functionality.

Level of Functionality	Description
Alert	When activated, a warning lamp flashes and an audible warning sounds.
Brake support	The system is designed to help reduce the impact speed by preparing the brakes for rapid braking. The system does not automatically apply the brakes. If you press the brake pedal, the system could apply additional braking up to maximum braking force, even if you lightly press the brake pedal.
Active braking - vehicles without adaptive cruise control	The system is designed to apply the brakes if it detects a crash is imminent. This may help reduce impact or avoid the crash. The system is active at speeds up to 80 mph (130 km/h).
Active braking - vehicles with adaptive cruise control	The system is designed to apply the brakes if it detects a crash is imminent. This may help reduce impact or avoid the crash.

Switching Active Braking On and Off

- Using the information display controls on the steering wheel, select **Driver Assist**.
- Select **Pre-Collision Assist**.

- Switch **Active Braking** on or off.

Distance Alert (If Equipped)

A warning lamp illuminates if the distance to the vehicle ahead is small.

Driving Aids

Note: *The warning lamp does not illuminate if cruise control or adaptive cruise control is active.*

Setting the Distance Alert Sensitivity

- Using the information display controls on the steering wheel, select **Driver Assist.**
- Select **Pre-Collision Assist.**
- Select **Alert Sensitivity.**

- Select a setting and press the **OK** button.

Distance Indication (If Equipped)

A graphical indication displays the time gap to vehicles ahead of you traveling in the same direction.

Note: *The graphic does not display if you switch on cruise control or adaptive cruise control.*

Vehicle Speed	System Sensitivity	Distance Indicator Color	Distance Gap	Time Gap
62 mph (100 km/h)	Normal.	Gray.	Greater than 82.0 ft (25 m).	Greater than 0.9 seconds.
		Yellow.	55.8–82.0 ft (17–25 m).	0.6–0.9 seconds.
		Red.	Less than 55.8 ft (17 m).	Less than 0.6 seconds.

Switching Distance Indication On and Off

- Using the information display controls on the steering wheel, select **Driver Assist.**
- Select **Pre-Collision Assist.**
- Switch **Distance Indication** on or off.

Pre-Collision Assist System Sensors

Vehicles without Adaptive Cruise Control



E243054

The camera is mounted behind the interior mirror.

Note: *Keep the sensors free from snow, ice and large accumulations of dirt.*

Note: *Do not clean the sensors with sharp objects.*

Driving Aids

Note: If your vehicle sustains damage leaving the sensors misaligned, this may cause inaccurate measurements or false alerts.

Blocked sensors could affect system accuracy. A message may appear in the information display.

Vehicles with Adaptive Cruise Control



E243054

The camera is mounted behind the interior mirror.



E244279

Pre-Collision Assist Information Messages

Message	Action
Pre-Collision Assist Not Available	The system has malfunctioned. Have your vehicle checked as soon as possible.
Pre-Collision Assist Not Available Sensor Blocked	The sensors are dirty. Clean the sensors. If the message continues to appear, have your vehicle checked as soon as possible.

The radar sensor is behind the front grille below the license plate.

Note: Keep the sensors free from snow, ice and large accumulations of dirt.

Note: Do not clean the sensors with sharp objects.

Note: If your vehicle sustains damage leaving the sensors misaligned, this may cause inaccurate measurements or false alerts.

Blocked sensors could affect system accuracy. A message may appear in the information display.

Pre-Collision Assist Warning Lamp



It illuminates if your vehicle rapidly approaches another vehicle, to warn you of the risk of a crash with the vehicle in front of you.

It could illuminate red if the distance to the vehicle ahead is small.

It illuminates when the system is not available.

Driving Aids

The following table lists possible causes and actions for when a blocked sensor message may display.

Cause	Action
The surface of the radar in the radiator grille is dirty or obstructed.	Clean the radiator grille in front of the radar or remove any obstruction.
The surface of the radar is clean but the message remains in the display.	Wait for a short period of time. It may take several minutes for the system to detect that there is no obstruction.
Heavy rain, spray, snow, or fog is interfering with the radar signals.	The system is temporarily disabled. The system should reactivate after a short period of time when the weather conditions improve.
The radar is misaligned.	Have your vehicle checked as soon as possible.
The windshield in front of the camera is dirty or obstructed.	Clean the outside of the windshield in front of the camera.
The windshield in front of the camera is clean but the message remains in the display.	Wait for a short period of time. It may take several minutes for the camera to detect that there is no obstruction.
Excessive heat around the camera.	Wait for a short period of time. The message should clear when the temperature around the camera decreases.

FRONT VIEW CAMERA



WARNING: The front camera system still requires the driver to use it in conjunction with looking out of your vehicle.

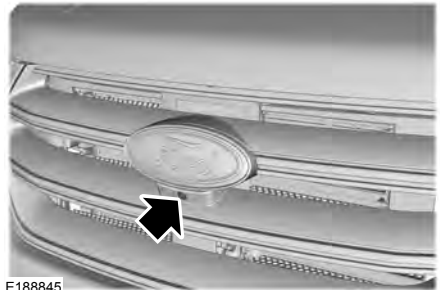

E188845

The front view camera is located in the grille.

Driving Aids

Using the Front View Camera

The front view camera provides a video image of the area in front of your vehicle.

To use the front view camera system, place the transmission in any gear except reverse (R). An image of the front of your vehicle appears once you press the camera enable button and your vehicle speed is below 6 mph (10 km/h).

Note: *The area displayed on the screen may vary according to your vehicle's orientation or road condition.*

Note: *The front view camera will switch off if your vehicle speed exceeds 6 mph (10 km/h). You will have to switch the system back on by using the enable button once below the speed threshold.*

Note: *The camera system may not operate correctly if mud, water or debris obstructs the camera's view. You can clean the lens with a soft, lint-free cloth and non-abrasive cleaner or by using your front washer. See **Wipers and Washers** (page 97).*



The camera button is located on the audio unit.

Camera Views

Press the camera button to toggle between different views.

- Front Normal View: Provides an image of what is directly in front of your vehicle.
- Front Split View: Provides an extended view of what is in front of your vehicle. Access this view by pressing the camera button from the Front Normal View screen.

DRIVE CONTROL

Selectable Drive Modes

Your vehicle has various drive modes that you can select for different driving conditions. Depending on the drive mode that you select, the system adjusts various vehicle settings, for example steering, gear shifting, handling and powertrain response.

Selecting a Drive Mode

The button is on the instrument panel.



Repeatedly press the button to scroll through the available drive modes. Release the button to confirm your selected drive mode.

Normal



Vehicle settings suited for balanced driving.

Note: *This is the default mode each time you switch the ignition on.*

Eco



Vehicle settings suited for economical driving.

Slippery



Vehicle settings suited for driving on slippery roads.

Tow/Haul



Vehicle settings suited for towing or hauling.

Mud/Ruts



Vehicle settings suited for driving through mud and ruts.

Driving Aids

Selectable Drive Modes Information Messages

Message	Action
Drive Mode Not Available	The system is not available. If it is still not available the next time you switch the ignition on, the system has detected a fault that requires service. Have your vehicle checked as soon as possible.

Load Carrying

ROOF RACKS AND LOAD CARRIERS - BUS



WARNING: Your vehicle is not approved for roof racks. Never install a roof rack to your vehicle.

ROOF RACKS AND LOAD CARRIERS - VAN



WARNING: When loading the roof racks, we recommend you evenly distribute the load, as well as maintain a low center of gravity. Loaded vehicles, with higher centers of gravity, may handle differently than unloaded vehicles. Take extra precautions, such as slower speeds and increased stopping distance, when driving a heavily loaded vehicle.



WARNING: Do not exceed the maximum front and rear axle loads for your vehicle.



WARNING: Read and follow the manufacturer's instructions when you are fitting a roof rack.

Maximum Roof Load

Variant	lb (kg)
Low-Roof.	419 (190)
Medium-Roof.	331 (150)
High-Roof.	220 (100)

Make sure that you securely fasten the load. Check that the straps are secure before driving and at each fuel stop.

We recommend that you use genuine Ford accessory crossbars specifically designed for your vehicle.

Never place loads directly on the roof panel.

LOAD RETAINING FIXTURES

Securing Cargo

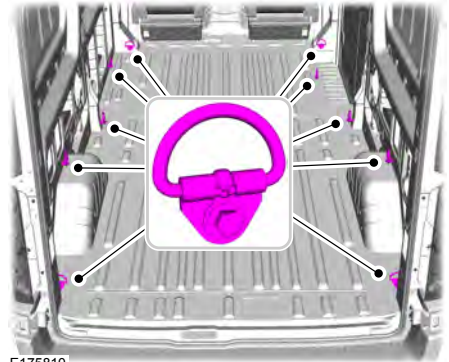

E175810

Variant	Maximum Load Value
All Van	1,125 lb (5,000 N)

Note: The number of load retaining fixtures may vary depending on your vehicle model.

Load Carrying

LOAD LIMIT

Vehicle Loading - with and without a Trailer

This section guides you in the proper loading of your vehicle, trailer, or both. Keep your loaded vehicle weight within its design rating capability, with or without a trailer. Properly loading your vehicle provides maximum return of vehicle design performance. Before you load your vehicle, become familiar with the following terms for determining your vehicle's weight rating, with or without a trailer, from the vehicle's Tire and Loading Information label or Safety Compliance Certification label.

Tire and Loading Label Information Example:



TIRE AND LOADING INFORMATION

SEATING CAPACITY TOTAL: 5 FRONT: 2 REAR: 3

The combined weight of occupants and cargo should never exceed: **385 kg or 850 lbs.**

TIRE	SIZE	COLD TIRE PRESSURE	SEE OWNERS MANUAL FOR ADDITIONAL INFORMATION
FRONT	235/45R18 94V	235 KPA, 34 PSI	
REAR	235/45R18 94V	235 KPA, 34 PSI	
SPARE	NONE	NONE	



TIRE AND LOADING INFORMATION RENSEIGNEMENTS SUR LES PNEUS ET LE CHARGEMENT

SEATING CAPACITY / NOMBRE DE PLACES TOTAL: 5 FRONT: 2 REAR: 3

The combined weight of occupants and cargo should never exceed 396 kg or 875 lbs. / Le poids total des occupants et du chargement ne doit jamais dépasser 396 kg ou 875 lbs.

TIRE / PNEU	SIZE / DIMENSIONS	COLD TIRE PRESSURE / PRESSION DES PNEUS À FROID	SEE OWNER'S MANUAL FOR ADDITIONAL INFORMATION VOIR LE MANUEL DE L'USAGER POUR PLUS DE RENSEIGNEMENTS
FRONT / AVANT	235/40R19 96V	255 KPA, 37 PSI	
REAR / ARRIÈRE	235/40R19 96V	255 KPA, 37 PSI	
SPARE / DE SECOURS	T125/80R16 97M	415 KPA, 60 PSI	

Payload

Payload is the combined weight of cargo and passengers that your vehicle is carrying. The maximum payload for your vehicle appears on the Tire and Loading label. The label is either on the B-pillar or the edge of the driver door. Vehicles exported outside the US and Canada may not have a tire and loading label. Look for "The combined weight of occupants and cargo should never exceed XXX kg OR XXX lb" for maximum payload. The payload listed on the Tire and Loading Information label

Load Carrying

is the maximum payload for your vehicle as built by the assembly plant. If you install any additional equipment on your vehicle, you must determine the new payload. Subtract the weight of the equipment from the payload listed on the Tire and Loading label. When towing, trailer tongue weight or king pin weight is also part of payload.

The total load on each axle must never exceed its Gross Axle Weight Rating.

GVWR (Gross Vehicle Weight Rating)

GVWR is the maximum allowable weight of the fully loaded vehicle. This includes all options, equipment, passengers and cargo. It appears on the Safety Compliance Certification label. The label is located on the door hinge pillar, door-latch post, or the door edge that meets the door-latch post, next to the driver seating position.

The gross vehicle weight must never exceed the Gross Vehicle Weight Rating.



Safety Compliance Certification Label Example:



WARNING: The appropriate loading capacity of your vehicle can be limited either by volume capacity (how much space is available) or by payload capacity (how much weight the vehicle should carry). Once you have reached the maximum payload of your vehicle, do not add more cargo, even if there is space available. Overloading or improperly loading your vehicle can contribute to loss of vehicle control and vehicle rollover.

GAWR (Gross Axle Weight Rating)

GAWR is the maximum allowable weight that a single axle (front or rear) can carry. These numbers are on the Safety Compliance Certification label. The label is located on the door hinge pillar, door-latch post, or the door edge that meets the door-latch post, next to the driver seating position.

<p>MFD. BY FORD MOTOR CO. DATE: XXXX GAWR: XXXXKG/XXXXLB FRONT GAWR: XXXXKG/XXXXLB REAR GAWR: XXXXKG/XXXXLB XXXXKG/XXXXLB WITH XXXXKG/XXXXLB W/ET XXXXKG/XXXXLB TRIS XXXXKG/XXXXLB TRIS XXXXKG TRIS XXXXKG TRIS AT XXXX KPa/ XXX PSI(COLD) AT XXXX KPa/ XXX PSI(COLD)</p> <p>THE VEHICLE CONFORMS TO ALL APPLICABLE FEDERAL MOTOR VEHICLE SAFETY AND TRAFFIC PREVENTION STANDARDS IN EFFECT ON THE DATE OF MANUFACTURE SHOWN ABOVE.</p> <p>VIN: XXXXXXXXXXXXXXXXXXXX XXXXX TRIS: XXXX XXXXX</p>  <p>DATE: XX XXXXX XX XX XXXX MO MFR: XXXX TRIS TRIS XXXX XXX XX XXX X XX X XXX XXXX XXXXXXXXXXXX XXX XXXXXXXXXXXX</p>	<p>MFD. BY FORD MOTOR CO. DATE: XXXX GAWR: XXXXKG/XXXXLB FRONT GAWR: XXXXKG/XXXXLB REAR GAWR: XXXXKG/XXXXLB XXXXKG/XXXXLB WITH XXXXKG/XXXXLB W/ET XXXXKG/XXXXLB TRIS XXXXKG/XXXXLB TRIS XXXXKG TRIS XXXXKG TRIS AT XXXX KPa/ XXX PSI(COLD) AT XXXX KPa/ XXX PSI(COLD)</p> <p>THE VEHICLE CONFORMS TO ALL APPLICABLE FEDERAL MOTOR VEHICLE SAFETY AND TRAFFIC PREVENTION STANDARDS IN EFFECT ON THE DATE OF MANUFACTURE SHOWN ABOVE.</p> <p>VIN: XXXXXXXXXXXXXXXXXXXX XXXXX TRIS: XXXX XXXXX</p>  <p>DATE: XX XXXXX XX XX XXXX MO MFR: XXXX TRIS TRIS XXXX XXX XX XXX X XX X XXX XXXX XXXXXXXXXXXX XXX XXXXXXXXXXXX</p>
---	---

Load Carrying



WARNING: Exceeding the Safety Compliance Certification label vehicle weight limits can adversely affect the performance and handling of your vehicle, cause vehicle damage and can result in the loss of control of your vehicle, serious personal injury or death.

Maximum Loaded Trailer Weight

Maximum loaded trailer weight is the highest possible weight of a fully loaded trailer the vehicle can tow. Consult an authorized dealer (or the RV and Trailer Towing Guide available at an authorized dealer) for more detailed information.

GCWR (Gross Combined Weight Rating)

GCWR is the maximum allowable weight of the vehicle and the loaded trailer, including all cargo and passengers, that the vehicle can handle without risking damage. (Important: The towing vehicle's braking system is rated for operation at Gross Vehicle Weight Rating, not at Gross Combined Weight Rating.) Separate functional brakes should

be used for safe control of towed vehicles and for trailers where the Gross Combined Weight of the towing vehicle plus the trailer exceed the Gross Vehicle Weight Rating of the towing vehicle.

The gross combined weight must never exceed the Gross Combined Weight Rating.

Note: For trailer towing information refer to the *RV and Trailer Towing Guide* available at an authorized dealer.



WARNING: Do not exceed the GVWR or the GAWR specified on the certification label.



WARNING: Do not use replacement tires with lower load carrying capacities than the original tires because they may lower your vehicle's GVWR and GAWR limitations. Replacement tires with a higher limit than the original tires do not increase the GVWR and GAWR limitations.



WARNING: Exceeding any vehicle weight rating can adversely affect the performance and handling of your vehicle, cause vehicle damage and can result in the loss of control of your vehicle, serious personal injury or death.

Load Carrying

Steps for determining the correct load limit:

1. Locate the statement "The combined weight of occupants and cargo should never exceed XXX kg or XXX lb." on your vehicle's placard.
2. Determine the combined weight of the driver and passengers that will be riding in your vehicle.
3. Subtract the combined weight of the driver and passengers from XXX kg or XXX lb.
4. The resulting figure equals the available amount of cargo and luggage load capacity. For example, if the "XXX" amount equals 1,400 lb. and there will be five 150 lb. passengers in your vehicle, the amount of available cargo and luggage load capacity is 650 lb. $(1400 - 750 (5 \times 150) = 650 \text{ lb.})$
5. Determine the combined weight of luggage and cargo being loaded on the vehicle. That weight may not safely exceed the available cargo and luggage load capacity calculated in Step 4.
6. If your vehicle will be towing a trailer, load from your trailer will be transferred to your vehicle. Consult this manual to determine how this reduces the available cargo and luggage load capacity of your vehicle.

Helpful examples for calculating the available amount of cargo and luggage load capacity

Suppose your vehicle has a 1400-pound (635-kilogram) cargo and luggage capacity. You decide to go golfing. Is there enough load capacity to carry you, four of your friends and all the golf bags? You and four friends average 220 pounds (99 kilograms) each and the golf bags weigh approximately 30 pounds (13.5 kilograms) each. The calculation would be: $1400 - (5 \times 220) - (5 \times 30) = 1400 - 1100 - 150 = 150$ pounds. Yes, you have enough load capacity in your vehicle to transport four friends and your golf bags. In metric units, the calculation would be: $635 \text{ kilograms} - (5 \times 99 \text{ kilograms}) - (5 \times 13.5 \text{ kilograms}) = 635 - 495 - 67.5 = 72.5$ kilograms.

Suppose your vehicle has a 1400-pound (635-kilogram) cargo and luggage capacity. You and one of your friends decide to pick up cement from the local home improvement store to finish that patio you have been planning for the past two years. Measuring the inside of the vehicle with the rear seat folded down, you have room for twelve 100-pound (45-kilogram) bags of cement. Do you have enough load capacity to transport the cement to your home? If you and your friend each weigh 220 pounds (99 kilograms), the calculation would be: $1400 - (2 \times 220) - (12 \times 100) = 1400 - 440$

Load Carrying

- 1200 = - 240 pounds. No, you do not have enough cargo capacity to carry that much weight. In metric units, the calculation would be: 635 kilograms - (2 x 99 kilograms) - (12 x 45 kilograms) = 635 - 198 - 540 = -103 kilograms. You will need to reduce the load weight by at least 240 pounds (104 kilograms). If you remove three 100-pound (45-kilogram) cement bags, then the load calculation would be: 1400 - (2 x 220) - (9 x 100) = 1400 - 440 - 900 = 60 pounds. Now you have the load capacity to transport the cement and your friend home. In metric units, the calculation would be: 635 kilograms - (2 x 99 kilograms) - (9 x 45 kilograms) = 635 - 198 - 405 = 32 kilograms.

The above calculations also assume that the loads are positioned in your vehicle in a manner that does not overload the front or the rear gross axle weight rating specified for your vehicle on the Safety Compliance Certification label.

Special Loading Instructions for Owners of Pick-up Trucks and Utility-type Vehicles



WARNING: When loading the roof racks, we recommend you evenly distribute the load, as well as maintain a low center of gravity. Loaded vehicles, with higher centers of gravity, may

handle differently than unloaded vehicles. Take extra precautions, such as slower speeds and increased stopping distance, when driving a heavily loaded vehicle.

Towing

TOWING A TRAILER



WARNING: Towing trailers beyond the maximum recommended gross trailer weight exceeds the limit of your vehicle and could result in engine damage, transmission damage, structural damage, loss of vehicle control, vehicle rollover and personal injury.



WARNING: Do not exceed the GVWR or the GAWR specified on the certification label.

Note: See **Recommended Towing Weights** (page 235).

Your vehicle may have electrical items, such as fuses or relays, related to towing. See **Fuses** (page 264).

Your vehicle's load capacity designation is by weight, not by volume, so you cannot necessarily use all available space when loading a vehicle or trailer.

Towing a trailer places an extra load on your vehicle's engine, transmission, axle, brakes, tires and suspension. Inspect these components periodically during, and after, any towing operation.

Load Placement

To help minimize how trailer movement affects your vehicle when driving:

- Load the heaviest items closest to the trailer floor.
- Load the heaviest items centered between the left and right side trailer tires.
- Load the heaviest items above the trailer axles or just slightly forward toward the trailer tongue. Do not allow the final trailer tongue weight to go above or below 10-15% of the loaded trailer weight.
- Select a ball mount with the correct rise or drop and load capacity. When both the loaded vehicle and trailer are connected, the trailer frame should be level, or slightly angled down toward your vehicle, when viewed from the side.

When driving with a trailer or payload, a slight takeoff vibration or shudder may be present due to the increased payload weight. Additional information regarding proper trailer loading and setting your vehicle up for towing is located in another chapter of this manual. See **Load Limit** (page 229).

You can also find information in the **RV & Trailer Towing Guide** available at your authorized dealer, or online.

Towing

RV & Trailer Towing Guide Online

Website | <http://www.fleet.ford.com/towing-guides/>

RECOMMENDED TOWING WEIGHTS - CHASSIS CAB/ CREW VAN/CUTAWAY/VAN

Note: Make sure to take into consideration trailer frontal area. Vehicles equipped with the Trailer Tow Package or the Heavy Duty Payload Package should not exceed 55 ft² (5.1 m²) trailer frontal area.

Note: Exceeding this limitation may significantly reduce the performance of your towing vehicle. Selecting a trailer with a low aerodynamic drag and rounded front design helps optimize performance and fuel economy.

Note: For high altitude operation, reduce the gross combined weight by 2% per 1,000 ft (300 m) starting at the 1,000 ft (300 m) elevation point.

Note: Certain states require electric trailer brakes for trailers over a specified weight. Be sure to check state regulations for this specified weight. The maximum trailer weights listed may be limited to this specified weight, as your vehicle's electrical system may not include the wiring connector needed to use electric trailer brakes.

Your vehicle may tow a trailer provided the maximum trailer weight is less than or equal to the maximum trailer weight listed for your vehicle configuration on the following charts.

Towing

Engine	Final Drive Ratio	Rear Wheels	Maximum GCWR lb (kg)	Maximum Loaded Trailer Weight lb (kg) ¹
2.0L EcoBlue.	3.31	Single Rear Wheels.	10,600 (4,808)	4,800 (2,177)
2.0L EcoBlue.	3.31	Dual Rear Wheels.	10,600 (4,808)	4,800 (2,177)
2.0L EcoBlue.	3.73	Single Rear Wheels.	13,500 (6,123)	7,500 (3,402)
2.0L EcoBlue.	3.73	Dual Rear Wheels.	13,500 (6,123)	7,500 (3,402)
3.5L Duratec.	3.73	Single Rear Wheels.	10,800 (4,899)	5,300 (2,404)
3.5L Duratec.	3.73	Dual Rear Wheels.	10,800 (4,899)	5,300 (2,404)
3.5L Duratec.	4.10	Single Rear Wheels.	12,000 (5,443)	6,600 (2,994)
3.5L Duratec.	4.10	Dual Rear Wheels.	12,000 (5,443)	6,600 (2,994)
3.5L EcoBoost™.	3.31	Single Rear Wheels.	11,200 (5,080)	5,800 (2,631)
3.5L EcoBoost™.	3.73	Single Rear Wheels.	12,600 (5,715)	7,100 (3,221)
3.5L EcoBoost™.	3.73	Dual Rear Wheels.	13,000 (5,897)	7,300 (3,311)
3.5L EcoBoost™. ²	3.73	Dual Rear Wheels.	15,000 (6,804)	7,500 (3,402)

¹ Calculated with SAE J2807 method.

² Vehicles with the gross vehicle weight rating of 11,000lbs (4,990kg).

Towing

Calculating the Maximum Loaded Trailer Weight for Your Vehicle

1. Start with the gross combined weight rating for your vehicle model and axle ratio. See the previous charts.
2. Subtract all of the following that apply to your vehicle:
 - Vehicle curb weight
 - Hitch hardware weight, such as a draw bar, ball, locks or weight distributing hardware
 - Driver weight
 - Passenger(s) weight
 - Payload, cargo and luggage weight
 - Aftermarket equipment weight.

This equals the maximum loaded trailer weight for this combination.

Note: *The trailer tongue load is considered part of the payload for your vehicle. Reduce the total payload by the final trailer tongue weight.*

Note: *Consult an authorized dealer to determine the maximum trailer weight allowed for your vehicle if you are not sure.*

RECOMMENDED TOWING WEIGHTS - M2 BUS

Note: *Make sure to take into consideration trailer frontal area. Vehicles equipped with the Trailer Tow Package or the Heavy Duty Payload Package should not exceed 55 ft² (5.1 m²) trailer frontal area.*

Note: *Exceeding this limitation may significantly reduce the performance of your towing vehicle. Selecting a trailer with a low aerodynamic drag and rounded front design helps optimize performance and fuel economy.*

Note: *For high altitude operation, reduce the gross combined weight by 2% per 1,000 ft (300 m) starting at the 1,000 ft (300 m) elevation point.*

Note: *Certain states require electric trailer brakes for trailers over a specified weight. Be sure to check state regulations for this specified weight. The maximum trailer weights listed may be limited to this specified weight, as your vehicle's electrical system may not include the wiring connector needed to use electric trailer brakes.*

Your vehicle may tow a trailer provided the maximum trailer weight is less than or equal to the maximum trailer weight listed for your vehicle configuration on the following charts.

Towing

Engine	Final Drive Ratio	Rear Wheels	Maximum GCWR lb (kg)	Maximum Loaded Trailer Weight lb (kg)¹
2.0L EcoBlue.	3.31	Single Rear Wheels.	10,600 (4,808)	3,700 (1,678)
2.0L EcoBlue.	3.31	Dual Rear Wheels.	10,600 (4,808)	3,700 (1,678)
2.0L EcoBlue.	3.73	Single Rear Wheels.	11,200 (5,080)	4,200 (1,905)
2.0L EcoBlue.	3.73	Dual Rear Wheels.	11,200 (5,080)	4,200 (1,905)
3.5L Duratec.	3.73	Single Rear Wheels.	10,800 (4,899)	4,600 (2,087)
3.5L Duratec.	3.73	Dual Rear Wheels.	10,800 (4,899)	4,600 (2,087)
3.5L Duratec.	4.10	Single Rear Wheels.	11,200 (5,080)	4,500 (2,041)
3.5L Duratec.	4.10	Dual Rear Wheels.	11,200 (5,080)	4,500 (2,041)
3.5L EcoBoost™.	3.31	Single Rear Wheels.	11,200 (5,080)	4,500 (2,041)
3.5L EcoBoost™.	3.31	Dual Rear Wheels.	11,200 (5,080)	4,500 (2,041)
3.5L EcoBoost™.	3.73	Single Rear Wheels.	11,200 (5,080)	4,400 (1,996)
3.5L EcoBoost™.	3.73	Dual Rear Wheels.	11,200 (5,080)	4,400 (1,996)

¹ Calculated with SAE J2807 method.

Towing

Calculating the Maximum Loaded Trailer Weight for Your Vehicle

1. Start with the gross combined weight rating for your vehicle model and axle ratio. See the previous charts.
2. Subtract all of the following that apply to your vehicle:
 - Vehicle curb weight
 - Hitch hardware weight, such as a draw bar, ball, locks or weight distributing hardware
 - Driver weight
 - Passenger(s) weight
 - Payload, cargo and luggage weight
 - Aftermarket equipment weight.

This equals the maximum loaded trailer weight for this combination.

Note: *The trailer tongue load is considered part of the payload for your vehicle. Reduce the total payload by the final trailer tongue weight.*

Note: *Consult an authorized dealer to determine the maximum trailer weight allowed for your vehicle if you are not sure.*

ESSENTIAL TOWING CHECKS

Follow these guidelines for safe towing:

- Do not tow a trailer until your vehicle has covered at least 1,000 mi (1,600 km). See **Breaking-In** (page 247).
- Consult your local motor vehicle laws for towing a trailer.
- See the instructions included with towing accessories for the correct installation and adjustment specifications.
- Service your vehicle more frequently if you tow a trailer. See **Scheduled Maintenance** (page 449).
- If you use a rental trailer, follow the instructions the rental agency gives you.

Refer to **Load Carrying** for load specification terms found on the tire label, Safety Compliance label and instructions on calculating your vehicle's maximum load. See **Load Limit** (page 229).

Remember to account for the trailer tongue weight as part of your vehicle load when calculating the total vehicle weight.

Trailer Towing Connector (If Equipped)



Your vehicle is fitted with both a 7 pin and 4 pin trailer wiring connector.

Towing

When attaching the trailer wiring connector to your vehicle, only use a correctly fitting connector that works with the vehicle and trailer functions. Some seven-position connectors may have the SAE J2863 logo, which confirms that it is the correct wiring connector and works correctly with your vehicle.

Color	Function
Yellow	Left turn signal and brake lamp.
White	Ground (-).
Blue	Electric brakes.
Green	Right turn signal and brake lamp.
Orange	Battery (+).
Brown	Running lamps.
Grey	Reverse lamps.

Tow Hitch



WARNING: Do not exceed the lowest rating capacity for your vehicle or trailer hitch. Overloading your vehicle or trailer hitch can impair your vehicle stability and handling. Failure to follow this instruction could result in the loss of control of your vehicle, personal injury or death.



WARNING: Do not cut, drill, weld or modify the trailer hitch. Modifying the trailer hitch could reduce the hitch rating.

Do not use a tow hitch that either clamps on to the bumper or attaches to the axle. You must distribute the load in your trailer so that between 10% and 15% of the total weight of the trailer is on the tongue.

Weight Distributing Hitches

A weight distribution hitch is not recommended for use with your vehicle.

Safety Chains

Always connect the safety chains to the frame or hook retainers of your vehicle's tow hitch.

To connect the safety chains, cross the chains under the trailer tongue and allow enough slack for turning tight corners. Do not allow the chains to drag on the ground.

Note: Do not attach safety chains to the bumper.

Trailer Brakes (If Equipped)



WARNING: Do not connect a trailer's hydraulic brake system directly to your vehicle's brake system. Your vehicle may not have enough braking power and your chances of having a collision greatly increase.

Electric, manual, automatic or surge-type trailer brakes are safe if you install them correctly and adjust them to the manufacturer's specifications. Trailer brakes must meet local and federal regulations.

The rating for the tow vehicle's braking system operation is at the gross vehicle weight rating, not the gross combined weight rating.

Separate functioning brake systems are required for safe control of towed vehicles and trailers weighing more than 1,500 lb (680 kg) when loaded.

Towing

Integrated Trailer Brake Controller



WARNING: Use the integrated trailer brake controller to properly adjust the trailer brakes and check all connections before towing a trailer. Failure to follow this instruction could result in the loss of control of your vehicle, personal injury or death.

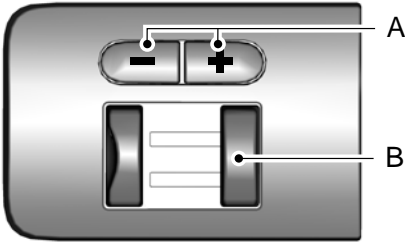

E163166

- A Gain adjustment buttons.
- B Manual control lever.

When used correctly, the trailer brake controller assists in smooth and effective trailer braking by powering the trailer's electric or electric-over-hydraulic brakes with a proportional output based on the towing vehicle's brake pressure

Slide the manual control lever to the left to turn on the trailer's electric brakes. They work independently of the tow vehicle's braking system. See **Procedure for Adjusting the Gain Setting** for instructions on correct use of this feature. If you use the manual control while the brake is also applied, the greater of the two inputs determines the power sent to the trailer brakes.

1. Press the **+** and **-** buttons to adjust the brake controller's power output to the trailer brakes in 0.5 increments. You can increase the gain setting to 10 (maximum trailer braking) or decrease it to zero (no trailer braking). Pressing and holding a button raises or lowers the setting continuously.

The gain setting displays in the information display as:

Message
Trailer Brake
Gain:

Note: *Using the manual control lever illuminates the trailer's brake lamps and your vehicle's brake lamps, except the center high-mounted brake lamp, if you make the correct electrical connection to the trailer.*

Towing

The controller shows gain setting, output bar graph and the trailer connectivity status in the information display as follows:

Message	Action and Description
Trailer Brake Gain: No Trailer	Displays the current gain setting during a given ignition cycle and when adjusting the gain setting. This also displays if you use the manual control lever or make gain adjustments with no trailer connected.
Trailer Brake Gain: Output:	Displays when you press your vehicle's brake pedal, or upon use of the manual control lever. Bar indicators illuminate in the information display to indicate the amount of power going to the trailer brakes relative to the brake pedal or manual control input. One bar indicates the least amount of output; six bars indicate maximum output.
Trailer Connected	Displays when the system senses a correct trailer wiring connection during a given ignition cycle. For example a trailer with electric trailer brakes.
Trailer Disconnected	Displays when the system senses a trailer connection and then a disconnection, either intentional or unintentional, during a given ignition cycle, this is accompanied by a single audible tone. It also displays if a vehicle or trailer-wiring fault occurs causing the trailer to appear disconnected. This message can also display if you use the manual control lever without a trailer connected.

Procedure for Adjusting the Gain Setting

The gain setting sets the trailer brake controller for the specific towing condition. You should change the setting as towing conditions change. Changes to towing conditions include trailer load, vehicle load, road conditions and weather.

The gain should be set to provide the maximum trailer braking assistance while making sure the trailer wheels do not lock when using the brakes. Locked trailer wheels may lead to trailer instability.

Note: *Only carry out this procedure in a traffic-free environment at speeds of approximately 20-25 mph (30-40 km/h).*

1. Make sure the trailer brakes are in good working condition, functioning normally and correctly adjusted. See a trailer dealer if necessary.
2. Hook up the trailer and make the electrical connections according to the trailer manufacturer's instructions.
3. Use the gain adjustment **+** and **-** buttons to increase or decrease the gain setting to the desired starting point. A gain setting of six is a good starting point for heavier loads.
4. In a traffic-free environment, tow the trailer on a dry, level surface at a speed of 20-25 mph (30-40 km/h) and slide the manual control lever completely.

Towing

5. If the trailer wheels lock, indicated by squealing tires, reduce the gain setting. If the trailer wheels turn freely, increase the gain setting. Repeat steps four and five until the gain setting is at a point just below trailer wheel lock. If towing a heavier trailer, trailer wheel lock may not be attainable even with the maximum gain setting of 10.

System Warning Messages

Message	Action and Description
Trailer Brake Module Fault	Displays in response to faults sensed by the trailer brake controller, accompanied by a single tone. If this message appears, contact an authorized dealer as soon as possible for diagnosis and repair. The controller may still function, but performance may be degraded.
Wiring Fault on Trailer	Displays when there is a short circuit on the electric brake output wire. If the message displays, accompanied by a single tone, with no trailer connected, the problem is with your vehicle wiring between the trailer brake controller and the 7-pin connector. If the message only displays with a trailer connected, the problem is with the trailer wiring. Consult a trailer dealer for assistance. This can be a short to ground, for example a chaffed wire, short to voltage, for example a pulled pin on trailer emergency breakaway battery or the trailer brakes may be drawing too much current.

Note: An authorized dealer can diagnose the trailer brake controller to determine exactly which trailer fault has occurred. However, the Ford Warranty does not cover this diagnosis if the fault is with the trailer.

Points to Remember

- Do not attempt removal of the trailer brake controller without consulting the Workshop Manual. Damage to the unit may result.
- Adjust gain setting before using the trailer brake controller for the first time.
- Adjust gain setting, using the procedure above, whenever road, weather and trailer or vehicle loading conditions change from when the gain was initially set.
- Only use the manual control lever for correct adjustment of the gain during trailer setup. Misuse, such as application during trailer sway, could cause instability of trailer or tow vehicle.
- Avoid towing in adverse weather conditions. The trailer brake controller does not provide anti-lock control of the trailer wheels. Trailer wheels can lock up on slippery surfaces, resulting in instability of trailer or tow vehicle.

Towing

- The trailer brake controller is fitted with a feature that reduces output at vehicle speeds below 11 mph (18 km/h) so trailer and vehicle braking is not jerky or harsh. This feature is only available when applying the brakes using your vehicle's brake pedal, not the controller.
- The controller interacts with the brake control system and powertrain control system of your vehicle to provide the best performance on different road conditions.
- Your vehicle's brake system and the trailer brake system work independently of each other. Changing the gain setting on the controller does not affect the operation of your vehicle's brake system whether you attach a trailer or not.
- When you switch the engine off, the controller output is disabled and the display and module shut down. The controller module and display turn on when you switch the ignition on.
- The trailer brake controller is only a factory-installed or dealer-installed item. Ford is not responsible for warranty or performance of the controller due to misuse or customer installation.

Trailer Lamps



WARNING: Never connect any trailer lamp wiring to the vehicle's tail lamp wiring; this may damage the electrical system resulting in fire. Contact your authorized dealer as soon as possible for assistance in proper trailer tow wiring installation. Additional electrical equipment may be required.

Trailer lamps are required on most towed vehicles. Make sure all running lamps, brake lamps, turn signals and hazard warning lamps are working.

Before Towing a Trailer

Practice turning, stopping and backing up to get the feel of your vehicle-trailer combination before starting on a trip. When turning, make wider turns so the trailer wheels clear curbs and other obstacles.

When Towing a Trailer

- Do not drive faster than 70 mph (113 km/h) until you drive your vehicle at least 495 mi (800 km). See **Breaking-In** (page 247).
- Do not make full-throttle starts.
- Check the tow hitch, electrical connections and trailer wheel lug nuts thoroughly after you have traveled 50 mi (80 km).
- When stopped in congested or heavy traffic during hot weather, place the gearshift in position park (**P**) to aid engine and transmission cooling and to help A/C performance.
- Turn off the speed control with heavy loads or on hilly terrain. The speed control may turn off automatically when you are towing on long, steep grades.
- Shift to a lower gear when driving down a long or steep hill. Do not apply the brakes continuously, as they may overheat and become less effective.
- If the transmission is fitted with a Grade Assist, **Tow/Haul** feature, use this feature when towing. This provides engine braking and helps eliminate excessive transmission shifting for optimum fuel economy and transmission cooling.

Towing

- If your vehicle is fitted with AdvanceTrac with roll stability control (RSC), this system may turn on during typical cornering maneuvers with a heavily loaded trailer. This is normal. Turning the corner at a slower speed while towing may reduce this tendency.
- If you are towing a trailer frequently in hot weather, hilly conditions, at the gross combined weight rating (or any combination of these factors), consider refilling your vehicle's rear axle with synthetic gear lubricant (if the axle is not already filled with it). See **Capacities and Specifications** (page 352).
- Allow more distance for stopping with a trailer attached. Anticipate stops and brake gradually.
- Avoid parking on a grade. However, if you must park on a grade:
 - Turn the steering wheel to point your vehicle tires away from traffic flow.
 - Set your vehicle parking brake.
 - Place the automatic transmission in position park (**P**).
 - Place wheel chocks in front of and at the back of the trailer wheels. (Trailer wheel chocks are not included with your vehicle.)

Launching or Retrieving a Boat or Personal Water Craft (PWC)

When backing down a ramp during boat launching or retrieval:

- Do not allow the static water level to rise above the bottom edge of the rear bumper.
- Do not allow waves to break higher than 6 in (15 cm) above the bottom edge of the rear bumper.

Note: *Disconnect the wiring to the trailer before backing the trailer into the water.*

Note: *Reconnect the wiring to the trailer after the trailer is removed from the water.*

Exceeding these limits may allow water to enter vehicle components:

- Causing internal damage to the components.
- Affecting driveability, emissions, and reliability.

Replace the rear axle lubricant anytime the rear axle has been submerged in water. Water may have contaminated the rear axle lubricant, which is not normally checked or changed unless a leak is suspected or other axle repair is required.

TOWING THE VEHICLE ON FOUR WHEELS

If you need to tow your vehicle, contact a professional towing service or, if you are a member of a roadside assistance program, your roadside assistance service provider.

Driving Hints

REDUCED ENGINE PERFORMANCE



WARNING: If you continue to drive your vehicle when the engine is overheating, the engine could stop without warning. Failure to follow this instruction could result in the loss of control of your vehicle.

If the engine coolant temperature gauge needle moves to the upper limit position, the engine is overheating. See **Gauges** (page 110).

You must only drive your vehicle for a short distance if the engine overheats. The distance you can travel depends on ambient temperature, vehicle load and terrain. The engine continues to operate with limited power for a short period of time.

If the engine temperature continues to rise, the fuel supply to the engine reduces. The air conditioning switches off and the engine cooling fan operates continually.

1. Gradually reduce your speed and stop your vehicle as soon as it is safe to do so.
2. Immediately switch the engine off to prevent severe engine damage.
3. Wait for the engine to cool down.
4. Check the coolant level. See **Engine Coolant Check** (page 285).
5. Have your vehicle checked as soon as possible.

ECONOMICAL DRIVING

The following helps to improve fuel consumption:

- Regularly check your tire pressures and make sure that they are inflated to the correct pressure.
- Follow the recommended maintenance schedule and carry out the recommended checks.
- Plan your journey and check the traffic before you set off.
- Avoid idling the engine in cold weather or for extended periods. Start the engine only when you are ready to set off.
- Do not carry unnecessary weight in your vehicle as extra weight wastes fuel.
- Do not add unnecessary accessories to the exterior of your vehicle, for example running boards. If you use a roof rack, remember to fold it down or remove it when not in use.
- Drive smoothly, accelerate gently and anticipate the road ahead to avoid heavy braking.
- Switch off all electric systems when not in use, for example air conditioning. Make sure that you unplug any accessories from the auxiliary power points when not in use.

COLD WEATHER PRECAUTIONS

The functional operation of some components and systems can be affected at temperatures below approximately -13°F (-25°C).

Driving Hints

BREAKING-IN

You need to break in new tires for approximately 300 mi (480 km). During this time, your vehicle may exhibit some unusual driving characteristics. The engine also needs to break in. Avoid hard accelerations and driving too fast for the first 1,000 mi (1,600 km). If possible, avoid carrying heavy loads up steep grades during the break-in period.

DRIVING THROUGH WATER



WARNING: Do not drive through flowing or deep water as you may lose control of your vehicle.

Note: *Driving through standing water can cause vehicle damage.*

Note: *Engine damage can occur if water enters the air filter.*

Before driving through standing water, check the depth. Never drive through water that is higher than the bottom of the wheel hubs.

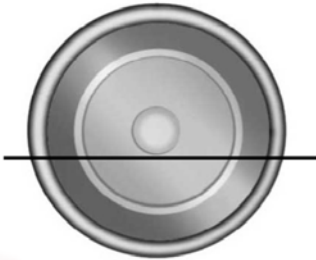

When driving through standing water, drive very slowly and do not stop your vehicle. Your brake performance and traction may be limited. After driving through water and as soon as it is safe to do so:

- Lightly press the brake pedal to dry the brakes and to check that they work.
- Check that the horn works.
- Check that the exterior lights work.
- Turn the steering wheel to check that the steering power assist works.

FLOOR MATS



WARNING: Use a floor mat designed to fit the footwell of your vehicle that does not obstruct the pedal area. Failure to follow this instruction could result in the loss of control of your vehicle, personal injury or death.



WARNING: Pedals that cannot move freely can cause loss of vehicle control and increase the risk of serious personal injury.



WARNING: Secure the floor mat to both retention devices so that it cannot slip out of position and interfere with the pedals. Failure to follow this instruction could result in the loss of control of your vehicle, personal injury or death.



WARNING: Do not place additional floor mats or any other covering on top of the original floor mats. This could result in the floor mat interfering with the operation of the pedals. Failure to follow this instruction could result in the loss of control of your vehicle, personal injury or death.



WARNING: Always make sure that objects cannot fall into the driver foot well while your vehicle is moving. Objects that are loose can become trapped under the pedals causing a loss of vehicle control.

Driving Hints



To install the floor mats, position the floor mat eyelet over the retention post and press down to lock in position.

To remove the floor mat, reverse the installation procedure.

Note: *Regularly check the floor mats to make sure they are secure.*

Roadside Emergencies

ROADSIDE ASSISTANCE

Vehicles Sold in the United States: Getting Roadside Assistance

To fully assist you should you have a vehicle concern, Ford Motor Company offers a complimentary roadside assistance program. This program is separate from the New Vehicle Limited Warranty.

The service is available:

- 24 hours a day, seven days a week.
- For the coverage period supplied with your vehicle.

Roadside Assistance covers:

- A flat tire change with a good spare (except vehicles supplied with a tire inflation kit).
- Battery jump start.
- Lock-out assistance (key replacement cost is the customer's responsibility).
- Fuel delivery — independent service contractors, if not prohibited by state, local or municipal law, shall deliver up to 2 gal (8 L) of gasoline or 5 gal (20 L) of diesel fuel to a disabled vehicle. Roadside Assistance limits fuel delivery service to two no-charge occurrences within a 12-month period.
- Winch out — available within 100 ft (30 m) of a paved or county maintained road, no recoveries.

- Towing — independent service contractors, if not prohibited by state, local or municipal law, shall tow Ford eligible vehicles to an authorized dealer within 35 mi (56 km) of the disablement location or to the nearest authorized dealer. If a member requests a tow to an authorized dealer that is more than 35 mi (56 km) from the disablement location, the member shall be responsible for any mileage costs in excess of 35 mi (56 km).
- Roadside Assistance includes up to \$200 for a towed trailer if the disabled eligible vehicle requires service at the nearest authorized dealer. If the towing vehicle is operational but the trailer is not, then the trailer does not qualify for any roadside services.

Vehicles Sold in the United States: Using Roadside Assistance

Complete the roadside assistance identification card and place it in your wallet for quick reference. This card is in the Owner's Manual kit.

United States vehicle customers who require Roadside Assistance, call 1-800-241-3673.

If you need to arrange roadside assistance for yourself, Ford Motor Company reimburses a reasonable amount for towing to the nearest dealership within 35 mi (56 km). To obtain reimbursement information, United States vehicle customers call 1-800-241-3673. Customers need to submit their original receipts.

Roadside Emergencies

Vehicles Sold in Canada: Getting Roadside Assistance

To fully assist you should you have a vehicle concern, Ford Motor Company of Canada, Limited offers a complimentary roadside assistance program. This program is eligible within Canada or the continental United States.

The service is available 24 hours a day, seven days a week.

This program is separate from the New Vehicle Limited Warranty, but the coverage is concurrent with the powertrain coverage period of your vehicle. Canadian roadside coverage and benefits may differ from the U.S. coverage.

If you require more information, please call us in Canada at 1-800-665-2006, or visit our website at www.ford.ca.

HAZARD FLASHERS



The hazard warning button is located on the instrument panel. Switch the hazard warning

flashers on when your vehicle is creating a safety hazard.

Press the button to switch the hazard warning flashers on. The front and rear direction indicators will flash.

Press the button again to switch the hazard warning flashers off.

Note: *Prolonged use of the hazard warning flashers will cause the battery to run out of charge. There may be insufficient power to restart the engine.*

EMERGENCY EXIT - M2 BUS

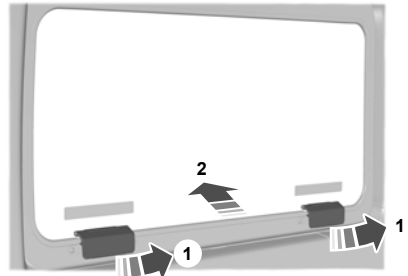

1. Pull the release handles.
2. Push the window.

FUEL SHUTOFF



WARNING: If your vehicle has been involved in a crash, have the fuel system checked. Failure to follow this instruction could result in fire, personal injury or death.

In the event of a moderate to severe crash, your vehicle is fitted with a fuel pump shut-off feature that stops the flow of fuel to the engine. Not every impact will cause a shutoff.

Should the engine turn off after a crash, you may restart the engine by carrying out the following.

Ignition Switch

1. Switch the ignition off.
2. Switch the ignition to position **III**.
3. Switch the ignition off.
4. Switch the ignition on again to re-enable the fuel pump.

Roadside Emergencies

Note: Various system checks are automatically carried out before the vehicle will restart. If your vehicle fails to restart after the third attempt, the system has detected a fault that requires service. We recommend you contact an authorized dealer.

Keyless Starting (If Equipped)

1. Without applying the brake pedal, press and release the button once.
2. Press the brake pedal, and then press and release the button once.
3. Without applying the brake pedal, press and release the button once.
4. Press the brake pedal and then press the button until the engine starts.

Note: Various system checks are automatically carried out before the vehicle will restart. If your vehicle fails to restart after the third attempt, the system has detected a fault that requires service. We recommend you contact an authorized dealer.

JUMPSTARTING THE VEHICLE



WARNING: Batteries normally produce explosive gases which can cause personal injury. Therefore, do not allow flames, sparks or lighted substances to come near the battery. When working near the battery, always shield your face and protect your eyes. Always provide correct ventilation.



WARNING: Keep batteries out of reach of children. Batteries contain sulfuric acid. Avoid contact with skin, eyes or clothing. Shield your eyes when working near the battery to protect against possible splashing of acid solution. In case of acid contact with skin or eyes, flush immediately with water for a minimum of 15 minutes and get prompt medical attention. If acid is swallowed, call a physician immediately.



WARNING: Use only adequately sized cables with insulated clamps.

Preparing Your Vehicle

Note: Do not attempt to push-start your automatic transmission vehicle. Attempting to push-start a vehicle with an automatic transmission may cause transmission damage.

Note: Use only a 12 V battery to start your vehicle.

Note: Do not disconnect the battery of the disabled vehicle as this could damage the vehicle electrical system.

Park the booster vehicle close to the hood of the disabled vehicle, making sure the two vehicles do not touch, and switch off all accessories.

Your vehicle has a positive (+) access terminal and a negative (-) grounding connection point that you can access under the hood, even though the actual battery is under the driver seat. You can jump your vehicle using these points.

The positive (+) access terminal is next to the fuse box, under a red cap. To access the positive (+) terminal, lift the red cap up.

Roadside Emergencies

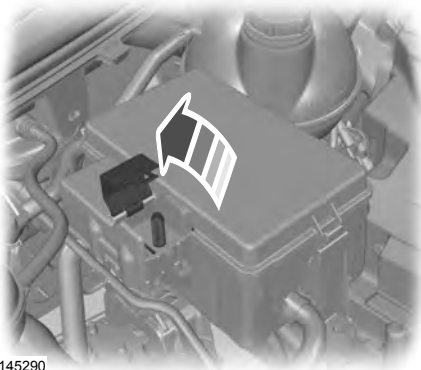

E145290

The negative (-) terminal is a post, located on the driver side, near the hood hinge. It is a grounding connection point, so you will need to remove the rubber covering first.

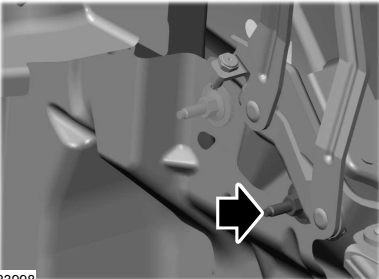

E183998

Connecting the Jumper Cables



WARNING: Make sure that the cables are clear of any moving parts and fuel delivery system parts.

Note: In the illustration, the bottom vehicle represents the booster vehicle.

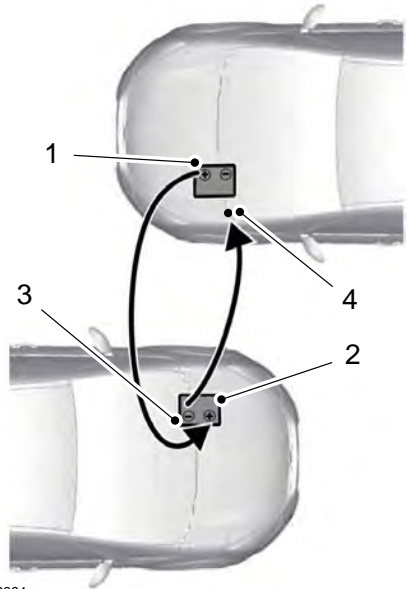

E142664

1. Connect the positive (+) jumper cable to the positive (+) access terminal of the vehicle with the discharged battery.
2. Connect the other end of the positive (+) cable to the positive (+) terminal of the assisting battery.
3. Connect the negative (-) cable to the negative (-) terminal of the assisting battery.
4. Make the final connection of the negative (-) cable to the ground connection point of the vehicle with the discharged battery.



WARNING: Do not connect the negative jumper cable to any other part of your vehicle. Use the ground point.

Roadside Emergencies

Jump Starting

1. Start the engine of the booster vehicle and rev the engine moderately, or press the accelerator gently to keep your engine speed between 2000 and 3000 rpms, as shown in your tachometer.
2. Start the engine of the disabled vehicle.
3. Once you start the disabled vehicle, run both vehicle engines for an additional three minutes before disconnecting the jumper cables.

Removing the Jumper Cables

Remove the jumper cables in the reverse order that they were connected.

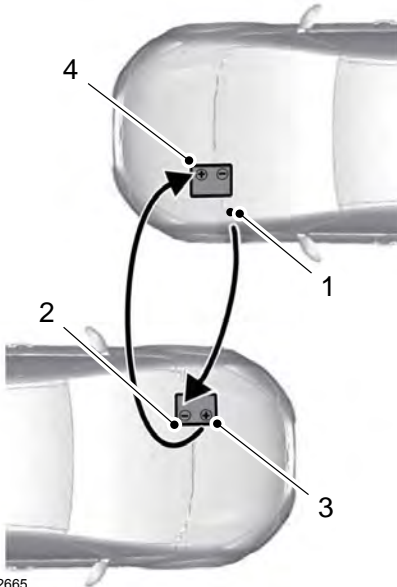

1. Remove the jumper cable from the grounding connection point of the vehicle with the discharged battery.

2. Remove the jumper cable on the negative (-) terminal of the booster vehicle's battery.
3. Remove the jumper cable from the positive (+) terminal of the booster vehicle's battery.
4. Remove the jumper cable from the positive (+) access terminal of the vehicle with the discharged battery.

After you start the disabled vehicle and remove the jumper cables, allow your vehicle to idle for several minutes so the battery can recharge.

TRANSPORTING THE VEHICLE

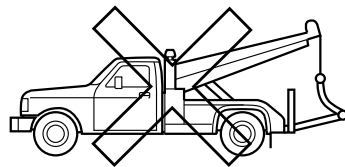
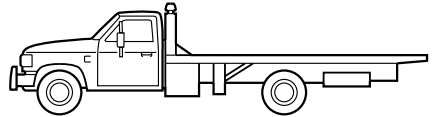
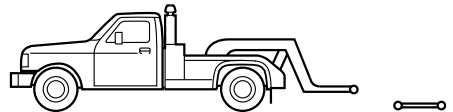

Roadside Emergencies

If you need to have your vehicle towed, contact a professional towing service or, if you are a member of a roadside assistance program, your roadside assistance service provider.

We recommend the use of a wheel lift and dollies or flatbed equipment to tow your vehicle. Do not tow with a slingbelt. Ford Motor Company has not approved a slingbelt towing procedure. Vehicle damage may occur if towed incorrectly, or by any other means.

Ford Motor Company produces a towing manual for all authorized tow truck operators. Have your tow truck operator refer to this manual for proper hook-up and towing procedures for your vehicle.

It is acceptable to have your front-wheel drive vehicle towed from the front if using proper wheel lift equipment to raise the front wheels off the ground. When towing in this manner, the rear wheels can remain on the ground.

Front-wheel drive vehicles must have the front wheels placed on a tow dolly when towing your vehicle from the rear using wheel lift equipment. This prevents damage to the transmission.

Towing an all-wheel or four-wheel drive vehicle requires that all wheels be off the ground, such as using a wheel lift and dollies or flatbed equipment. This prevents damage to the transmission, all-wheel or four-wheel drive system and vehicle.

TOWING POINTS

Rear Towing Point



E142319

Crash and Breakdown Information

POST-CRASH ALERT SYSTEM

What Is the Post-Crash Alert System

The system helps draw attention to your vehicle in the event of a serious impact.

How Does the Post-Crash Alert System Work

The system is designed to turn the hazard flashers on and to intermittently sound the horn in the event of a serious impact that deploys an airbag or the seatbelt pretensioners.

Post-Crash Alert System Limitations

Depending on applicable laws in the country your vehicle was built for, the horn does not sound in the event of a serious impact.

Switching the Post-Crash Alert System Off

Press the hazard flasher switch or the unlock button on the remote control to switch the system off.

Note: *The alert turns off when the vehicle battery runs out of charge.*

Customer Assistance

FORD CREDIT

US Only

Ford Credit offers a full range of financing and lease plans to help you acquire your vehicle. If you have financed or leased your vehicle through Ford Credit, thank you for your business.

We offer a number of convenient ways for you to contact us, and to manage your account.

Call 1-800-727-7000.

For more information about Ford Credit and access to Account Manager, go to www.ford.com/finance.

GETTING THE SERVICES YOU NEED

Warranty repairs to your vehicle must be performed by an authorized dealer. While any authorized dealer handling your vehicle line will provide warranty service, we recommend you return to your selling authorized dealer who wants to ensure your continued satisfaction.

Please note that certain warranty repairs require special training and equipment, so not all authorized dealers are authorized to perform all warranty repairs. This means that, depending on the warranty repair needed, you may have to take your vehicle to another authorized dealer.

A reasonable time must be allowed to perform a repair after taking your vehicle to the authorized dealer. Repairs will be made using Ford or Motorcraft® parts, or remanufactured or other parts that are authorized by Ford.

Away From Home

If you are away from home when your vehicle needs service, contact the Ford Customer Relationship Center or use the online resources listed below to find the nearest authorized dealer.

In the United States:

Mailing address

Ford Motor Company
Customer Relationship Center
P.O. Box 6248
Dearborn, MI 48126

Telephone

1-800-392-3673 (FORD)
(TDD for the hearing impaired:
1-800-232-5952)

If your vehicle is configured as a motorhome please call 1-800-444-3311 for support.

Additional information and resources are available online:

Website
www.owner.ford.com

These are some of the items that can be found online:

- U.S. dealer locator by Dealer Name, City/State or Zip Code.
- Owner Manuals.
- Maintenance Schedules.
- Recalls.
- Ford Extended Service Plans.
- Ford Genuine Accessories.
- Service specials and promotions.

In Canada:

Mailing address

Customer Assistance

Customer Relationship Centre
Ford Motor Company of Canada, Limited
P.O. Box 2000
Oakville, Ontario L6K 0C8

Telephone

1-800-565-3673 (FORD)
(TDD for the hearing impaired:
1-888-658-6805)

Website
www.ford.ca

Facebook

FordServiceCA (English)
FordServiceQC (Français)

Twitter

@FordServiceCA

Additional Assistance

If you have questions or concerns, or are unsatisfied with the service you are receiving, follow these steps:

1. Contact your Sales Representative or Service Advisor at your selling or servicing authorized dealer.
2. If your inquiry or concern remains unresolved, contact the Sales Manager, Service Manager or Customer Relations Manager.
3. If you require assistance or clarification on Ford Motor Company policies, please contact the Ford Customer Relationship Center.

In order to help us serve you better, please have the following information available when contacting a Customer Relationship Center:

- Vehicle Identification Number.
- Your telephone number (home and business).

- The name of the authorized dealer and city where located.
- The vehicle's current odometer reading.

In some states within the United States, you must directly notify Ford in writing before pursuing remedies under your state's warranty laws, and Ford is also allowed a final repair attempt.

Additionally, in some states within the United States, a consumer has the option of submitting a warranty dispute to the BBB Auto Line before taking action under the Magnuson-Moss Warranty Act, or to the extent allowed by state law, before pursuing replacement or repurchase remedies provided by certain state laws. This dispute handling procedure is not required prior to enforcing state created rights or other rights which are independent of the Magnuson-Moss Warranty Act or state replacement or repurchase laws.

IN CALIFORNIA (U.S. ONLY)

California Civil Code Section 1793.2(d) requires that, if a manufacturer or its representative is unable to repair a motor vehicle to conform to the vehicle's applicable express warranty after a reasonable number of attempts, the manufacturer shall be required to either replace the vehicle with one substantially identical or repurchase the vehicle and reimburse the buyer in an amount equal to the actual price paid or payable by the consumer (less a reasonable allowance for consumer use). The consumer has the right to choose whether to receive a refund or replacement vehicle.

Customer Assistance

California Civil Code Section 1793.22(b) presumes that the manufacturer has had a reasonable number of attempts to conform the vehicle to its applicable express warranties if, within the first 18 months of ownership of a new vehicle or the first 18,000 mi (29,000 km), whichever occurs first:

1. Two or more repair attempts are made on the same non-conformity likely to cause death or serious bodily injury OR
2. Four or more repair attempts are made on the same nonconformity (a defect or condition that substantially impairs the use, value or safety of the vehicle) OR
3. The vehicle is out of service for repair of nonconformities for a total of more than 30 calendar days (not necessarily all at one time).

In the case of 1 or 2 above, the consumer must also notify the manufacturer of the need for the repair of the nonconformity at the following address:

Ford Motor Company
16800 Executive Plaza Drive
Mail Drop 3NE-B
Dearborn, MI 48126

You are required to submit your warranty dispute to BBB AUTO LINE before asserting in court any rights or remedies conferred by California Civil Code Section 1793.22(b). You are also required to use BBB AUTO LINE before exercising rights or seeking remedies created by the Federal Magnuson-Moss Warranty Act, 15 U.S.C. sec. 2301 et seq. If you choose to seek redress by pursuing rights and remedies not created by California Civil Code Section 1793.22(b) or the Magnuson-Moss Warranty Act, resort to BBB AUTO LINE is not required by those statutes.

THE BETTER BUSINESS BUREAU (BBB) AUTO LINE PROGRAM (U.S. ONLY)

Your satisfaction is important to Ford Motor Company and to your dealer. If a warranty concern has not been resolved using the three-step procedure outlined earlier in this chapter in the Getting the Services you need section, you may be eligible to participate in the BBB AUTO LINE program.

The BBB AUTO LINE program consists of two parts – mediation and arbitration. During mediation, a representative of the BBB will contact both you and Ford Motor Company to explore options for settlement of the claim. If an agreement is not reached during mediation or you do not want to participate in mediation, and if your claim is eligible, you may participate in the arbitration process. An arbitration hearing will be scheduled so that you can present your case in an informal setting before an impartial person. The arbitrator will consider the testimony provided and make a decision after the hearing.

Disputes submitted to the BBB AUTO LINE program are usually decided within forty days after you file your claim with the BBB. You are not bound by the decision, and may reject the decision and proceed to court where all findings of the BBB Auto Line dispute, and decision, are admissible in the court action. Should you choose to accept the BBB AUTO LINE decision, Ford is then bound by the decision, and must comply with the decision within 30 days of receipt of your acceptance letter.

BBB AUTO LINE Application: Using the information provided below, please call or write to request a program application. You will be asked for your name and address, general information about your new vehicle, information about your warranty concerns, and any steps you have

Customer Assistance

already taken to try to resolve them. A Customer Claim Form will be mailed that will need to be completed, signed and returned to the BBB along with proof of ownership. Upon receipt, the BBB will review the claim for eligibility under the Program Summary Guidelines.

You can get more information by calling BBB AUTO LINE at 1-800-955-5100, or writing to:

**BBB AUTO LINE
3033 Wilson Boulevard, Suite 600
Arlington, Virginia 22201**

BBB AUTO LINE applications can also be requested by calling the Ford Motor Company Customer Relationship Center at 1-800-392-3673.

For additional information refer to the Better Business Bureau website.

Note: *Ford Motor Company reserves the right to change eligibility limitations, modify procedures, or to discontinue this process at any time without notice and without obligation.*

UTILIZING THE MEDIATION/ARBITRATION PROGRAM (CANADA ONLY)

For vehicles delivered to authorized Canadian dealers. In those cases where you continue to feel that the efforts by Ford of Canada and the authorized dealer to resolve a factory-related vehicle service concern have been unsatisfactory, Ford of Canada participates in an impartial third party mediation/arbitration program administered by the Canadian Motor Vehicle Arbitration Plan (CAMVAP).

The CAMVAP program is a straight forward and relatively speedy alternative to resolve a disagreement when all other efforts to produce a settlement have failed. This procedure is without cost to you and is designed to eliminate the need for lengthy and expensive legal proceedings.

In the CAMVAP program, impartial third-party arbitrators conduct hearings at mutually convenient times and places in an informal environment. These impartial arbitrators review the positions of the parties, make decisions and, when appropriate, render awards to resolve disputes. CAMVAP decisions are fast, fair, and final as the arbitrator's award is binding on both you and Ford of Canada.

CAMVAP services are available in all Canadian territories and provinces. For more information, without charge or obligation, call your CAMVAP Provincial Administrator directly at 1-800-207-0685 or visit www.camvap.ca.

GETTING ASSISTANCE OUTSIDE THE U.S. AND CANADA

Before exporting your vehicle to a foreign country, contact the appropriate foreign embassy or consulate. These officials can inform you of local vehicle registration regulations and where to find unleaded fuel or petrol/gas engines or the proper sulfur fuel for diesel engines.

If you cannot find the proper fuel recommended for your vehicle, contact our Customer Relationship Center.

Customer Assistance

The use of improper fuels in your vehicle without proper conversion may damage the effectiveness of your emission control system and may cause engine knocking or serious engine damage. Ford Motor Company or Ford of Canada is not responsible for any damage caused by use of improper fuel. Using improper fuels may also result in difficulty importing your vehicle back into the United States.

If your vehicle must be serviced while you are traveling or living in Asia-Pacific Region, Sub-Saharan Africa, U.S. Virgin Islands and/or Puerto Rico, Central America, the Caribbean, and Israel and the Middle East, contact the nearest authorized dealer. If the authorized dealer cannot help you, contact the corresponding Ford Customer Assistance Center:

FORD MOTOR COMPANY
Customer Relationship Centers in:

Customer Relationship Center	Phone	Fax	E-mail
Asia Pacific	N/A	N/A	apemcrc@ford.com
Caribbean and Central America	+1-800-841-3673	N/A	atnclien@ford.com
Middle East	Ford 80004443673	971 4 3327 266	menacac@ford.com
	Lincoln 80004441067		
	UAE 80004441066		
	Saudi Arabia 8008443673		
	Mobily and Zain cell phone users in Saudi 800850078		
Kuwait 22280384			
North Africa	N/A	N/A	nafcrc@ford.com
Puerto Rico and U.S. Virgin Islands	+1-800-841-3673	N/A	atnclien@ford.com
Sub-Saharan Africa	N/A	N/A	ssacrc@ford.com
South Korea	+82-02-1600-6003	N/A	infokr1@ford.com or infokr@lincoln.com

Customer Assistance

If you buy your vehicle in North America and then relocate to any of the above locations, register your vehicle identification number (VIN) and new address with Ford Global Trade Services by emailing, expcso@ford.com.

If you are in another foreign country, contact the nearest authorized dealer. In the event your inquiry is unresolved, communicate your concern with the dealership's Sales Manager, Service Manager or Customer Relations Manager. If you require additional assistance or clarification, please contact the respective Customer Relationship Center as previously listed.

**Customers in the U.S. should call
1-800-392-3673.**

ORDERING ADDITIONAL OWNER'S LITERATURE

To order the publications in this portfolio, contact Helm, LLC at:

HELM, LLC
47911 Halyard Drive, Suite 200
Plymouth, Michigan 48170
Attention: Customer Service

Or to order a free publication catalog, call toll free: 1-800-782-4356

Monday-Friday 8:00 a.m. - 6:00 p.m. EST
Helm, LLC can also be reached by their website:

www.helminc.com

(Items in this catalog may be purchased by credit card, check or money order.)

Obtaining a French Owner's Manual

French Owner's Manual can be obtained from your authorized dealer or by contacting Helm, LLC using the contact information listed previously in this section.

REPORTING SAFETY DEFECTS (U.S. ONLY)

If you believe that your vehicle has a defect which could cause a crash or could cause injury or death, you should immediately inform the National Highway Traffic Safety Administration (NHTSA) in addition to notifying Ford Motor Company.

If NHTSA receives similar complaints, it may open an investigation, and if it finds that a safety defect exists in a group of vehicles, it may order a recall and remedy campaign. However, NHTSA cannot become involved in individual problems between you, your dealer, or Ford Motor Company.

To contact NHTSA, you may call the Vehicle Safety Hotline toll-free at 1-888-327-4236 (TTY: 1-800-424-9153); go to www.safercar.gov; or write to:

Administrator

1200 New Jersey Avenue,
Southeast

Washington, D.C. 20590

You can also obtain other information about motor vehicle safety from www.safercar.gov.

Customer Assistance

REPORTING SAFETY DEFECTS (CANADA ONLY)

which could cause a crash or could cause injury or death, you should immediately inform Transport Canada and Ford of Canada.

If you believe that your vehicle has a defect

Transport Canada Contact Information	
Website	http://www.tc.gc.ca/eng/motorvehiclesafety/reporting-defects-motor-vehicles.html (English)
Website	http://www.tc.gc.ca/fra/securiteautomobile/signaler-defauts-vehicules-automobiles.html (French)
Phone	1-800-333-0510

Ford of Canada Contact Information	
Website	www.ford.ca
Phone	1-800-565-3673

Fuses

FUSE BOX LOCATIONS

Engine Compartment Fuse Box

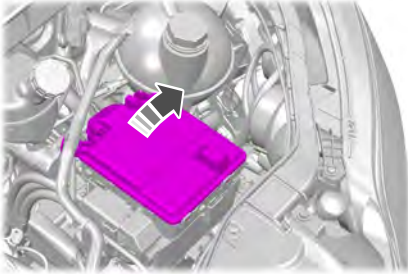

Body Control Module

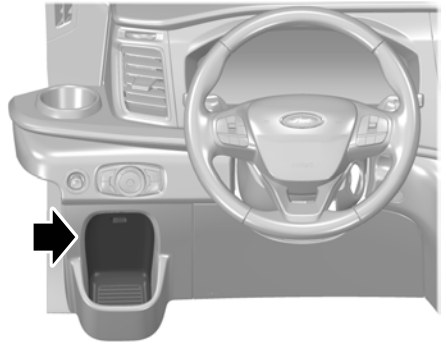

Driver Compartment Fuse Box

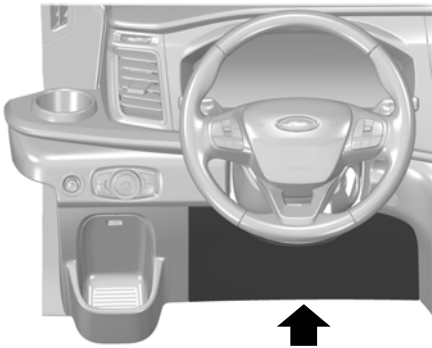

The fuse box is behind the removable trim panel.

Passenger Compartment Fuse Box



Pre-fuse Box

The fuse box is under the driver seat.

Fuses

FUSE SPECIFICATION CHART

Engine Compartment Fuse Box

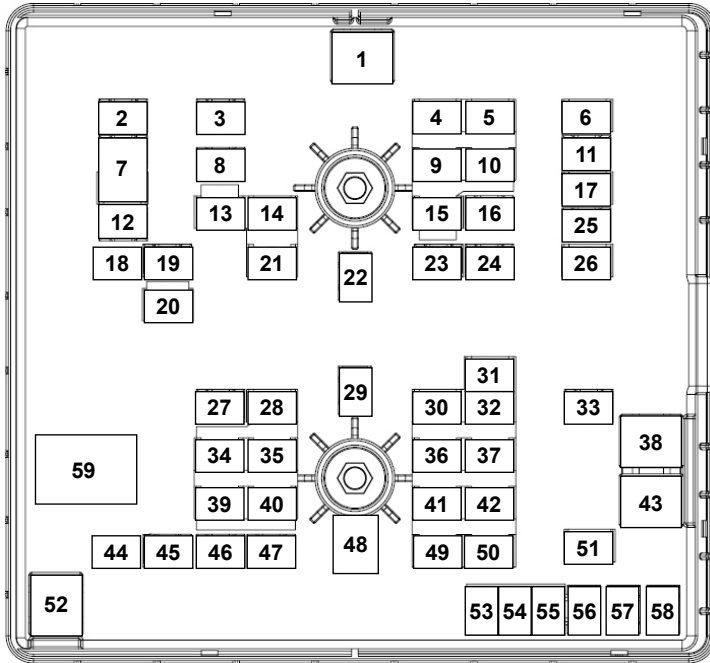

Item	Fuse Rating	Protected Component
1	50 A	Wipers.
2	-	Not used.
3	40 A	All-Wheel Drive.
4	30 A	Parking lamps.
5	10 A	Reversing lamp.
6	-	Not used.
7	40 A	Front blower motor.

Fuses

Item	Fuse Rating	Protected Component
8	-	Not used.
9	15 A	Rear door latch.
10	-	Not used.
11	40 A	Auxiliary power point. USB port.
12	20 A	Horn.
13	-	Not used.
14	15 A	Vehicle power 5.
15	-	Not used.
16	-	Not used.
17	10 A	Right-hand high-intensity discharge headlamps.
18	40 A	Rear window defroster.
19	20 A	Front fog lamp.
20	10 A	Power folding mirrors.
21	15 A	Vehicle power 4.
22	40 A	Rear blower motor.
23	20 A	Fuel pump.
24	40 A	Run/Start relay.
25	40 A	Auxiliary power points.
26	10 A	Left-hand high-intensity discharge headlamps.
27	-	Not used.
28	20 A	Vehicle power 1.
29	-	Not used.
30	15 A	Coolant pump.
31	5 A	Anti-lock brake system.
32	15 A	Transmission control module.
33	30 A	Starter motor.

Fuses

Item	Fuse Rating	Protected Component
34	-	Not used.
35	15 A	Vehicle power 2.
36	5 A	Engine coolant bypass valve.
37	5 A	Glow plugs. Powertrain control module.
38	40 A	Anti-lock brake system with electronic stability control (excluding 510 series).
	60 A	Cooling fan (510 series).
39	-	Not used.
40	10 A	Vehicle power 3.
41	-	Not used.
42	-	Not used (excluding 510 series).
	15 A	Cooling fan (510 series).
43	60 A	Anti-lock brake system pump.
44	25 A	Cooling fan (excluding 510 series).
	-	Not used (510 series).
45	30 A	Trailer socket.
46	-	Not used.
47	-	Not used.
48	50 A	Cooling fan (excluding 510 series).
	40 A	Anti-lock brake system with electronic stability control (510 series).
49	-	Not used.
50	-	Not used.
51	10 A	Air conditioning clutch.
52	50 A	Cooling fan (excluding 510 series).
	60 A	Cooling fan (510 series).
53	-	Not used.

Fuses

Item	Fuse Rating	Protected Component
54	20 A	Battery back-up sounder.
55	25 A	Transmission fluid pump.
56	-	Not used.
57	-	Not used.
58	30 A	Trailer socket.
59	-	Cooling fan relay.

Driver Compartment Fuse Box

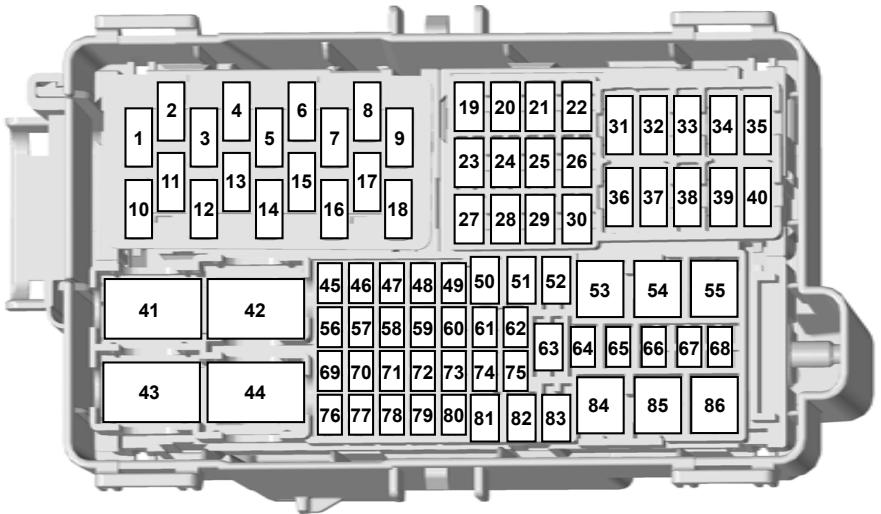

Item	Fuse Rating	Protected Component
1	5 A	USB port.
2	-	Not used.
3	5 A	USB port.
4	-	Not used.

Fuses

Item	Fuse Rating	Protected Component
5	-	Not used.
6	-	Not used.
7	-	Not used.
8	-	Not used.
9	10 A	Heated exterior mirrors.
10	5 A	Cooling fan.
11	-	Not used.
12	-	Not used.
13	-	Not used.
14	-	Not used.
15	-	Not used.
16	5 A	Rain sensor.
17	-	Not used.
18	20 A	Relay.
19	-	Not used.
20	-	Not used.
21	20 A	Heated rear window.
22	20 A	Heated rear window.
23	20 A	Auxiliary power point.
24	20 A	Auxiliary power point.
25	-	Not used.
26	25 A	Windshield wiper motor.
27	-	Not used.
28	30 A	Modified vehicle connections.
29	20 A	Fuel fired heater.
30	30 A	Power running boards.
31	-	Not used.

Fuses

Item	Fuse Rating	Protected Component
32	-	Not used.
33	-	Not used.
34	-	Not used.
35	-	Not used.
36	-	Not used.
37	-	Not used.
38	-	Not used.
39	-	Not used.
40	-	Not used.
41	25 A	Load shed relay.
42	40 A	Starter relay.
43	40 A	Upfitter relay.
44	40 A	Starter relay.
45	10 A	Upfitter interface module.
46	-	Not used.
47	-	Not used.
48	5 A	Modified vehicle connections.
49	10 A	Brake pedal switch.
50	30 A	Passenger power seat.
51	40 A	Modified vehicle connections.
52	30 A	Driver power seat.
53	60 A	Battery.
54	60 A	Power inverter.
55	50 A	Body control module.
56	10 A	Modified vehicle connections.
57	-	Not used.
58	10 A	Connector camper body interface.

Fuses

Item	Fuse Rating	Protected Component
		Upfitter interface. Secondary junction box.
59	10 A	Rear climate control. Front view camera. Rear view camera. Adaptive cruise control module. Blind spot information system.
60	10 A	Trailer brake control module.
61	-	Not used.
62	15 A	Enhanced cut off relay system module.
63	20 A	Auxiliary power point.
64	30 A	Modified vehicle connections.
65	-	Not used.
66	10 A	Enhanced cut off relay system. Camper. Load shed relay.
67	-	Not used.
68	5 A	Trailer tow module.
69	5 A	Steering wheel module.
70	5 A	Swivel seats.
71	10 A	Passenger heated seat.
72	10 A	Driver heated seat.
73	20 A	Adaptive front lighting module. Headlamp leveling.
74	-	Not used.
75	20 A	Engine compartment fuse box.
76	10 A	Power sliding door control switch.
77	5 A	Headlamp switch.
78	7.5 A	Modified vehicle connections.
79	5 A	Driver compartment fuse box relay.

Fuses

Item	Fuse Rating	Protected Component
80	-	Not used.
81	40 A	Trailer tow module.
82	30 A	Power sliding door.
83	30 A	Trailer brake control module.
84	50 A	Body control module.
85	30 A	Power sliding door.
86	50 A	Body control module.

Body Control Module

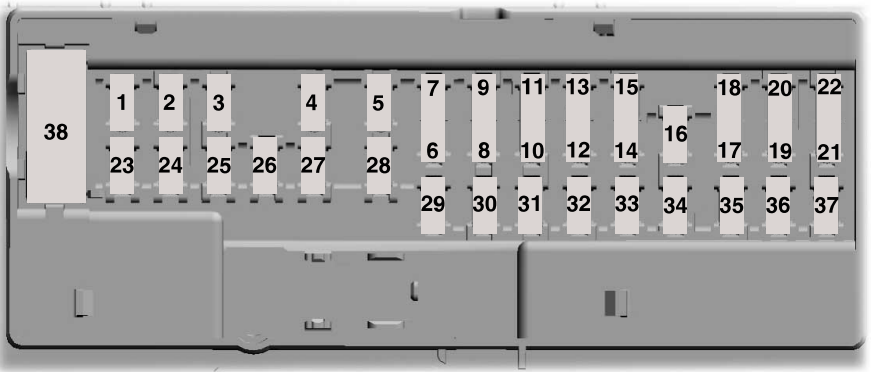

Item	Fuse Rating	Protected Component
1	-	Not used.
2	10 A	Power inverter.
3	7.5 A	Power window switch. Power exterior mirrors.
4	20 A	Not used.

Fuses

Item	Fuse Rating	Protected Component
5	-	Not used.
6	10 A	Not used.
7	10 A	Not used.
8	5 A	Telematics control unit module.
9	5 A	Rear air conditioning.
10	-	Not used.
11	-	Not used.
12	7.5 A	Climate control.
13	7.5 A	Data link connector. Steering column. Instrument cluster.
14	15 A	Not used.
15	15 A	SYNC 3 module. Integrated control panel.
16	-	Not used.
17	7.5 A	Not used.
18	7.5 A	Not used.
19	5 A	Not used.
20	5 A	Ignition switch.
21	5 A	Not used.
22	5 A	Not used.
23	30 A	Not used.
24	30 A	Not used.
25	20 A	Not used.
26	30 A	Not used.
27	30 A	Not used.
28	30 A	Not used.
29	15 A	Not used.

Fuses

Item	Fuse Rating	Protected Component
30	5 A	Not used.
31	10 A	Data link connector. Remote key receiver.
32	20 A	Radio.
33	-	Not used.
34	30 A	Run/Start relay. Parking aid. Steering column.
35	5 A	Not used.
36	15 A	Parking aid.
		Steering column control module.
37	20 A	Not used.
38	30 A	Power windows.

Passenger Compartment Fuse Box

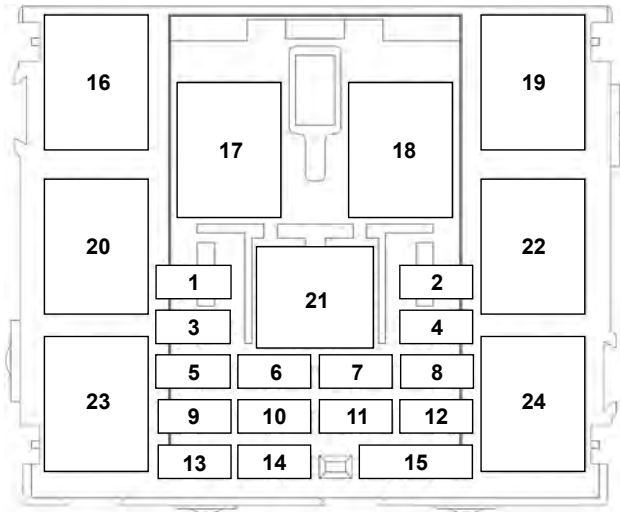

Fuses

Item	Fuse Rating	Protected Component
1	40 A	Relay 2.
2	40 A	Relay 3.
3	20 A	Relay 1.
4	20 A	Relay 4.
5	20 A	Relay 5.
6	-	Not used.
7	-	Not used.
8	20 A	Relay 7.
9	20 A	Relay 8.
10	-	Not used.
11	-	Not used.
12	20 A	Relay 9.
13	20 A	Relay 6.
14	5 A	Ignition.
15	5 A	Power supply.
16	20 A	Auxiliary switch 3 relay.
17	40 A	Auxiliary switch 3 relay.
18	40 A	Auxiliary switch 3 relay.
19	20 A	Auxiliary switch 4 relay.
20	20 A	Auxiliary switch 5 relay.
21	20 A	Auxiliary fuse box relay.
22	20 A	Auxiliary switch 7 relay.
23	20 A	Auxiliary switch 8 relay.
24	20 A	Auxiliary switch 9 relay.

Fuses

Pre-fuse Box

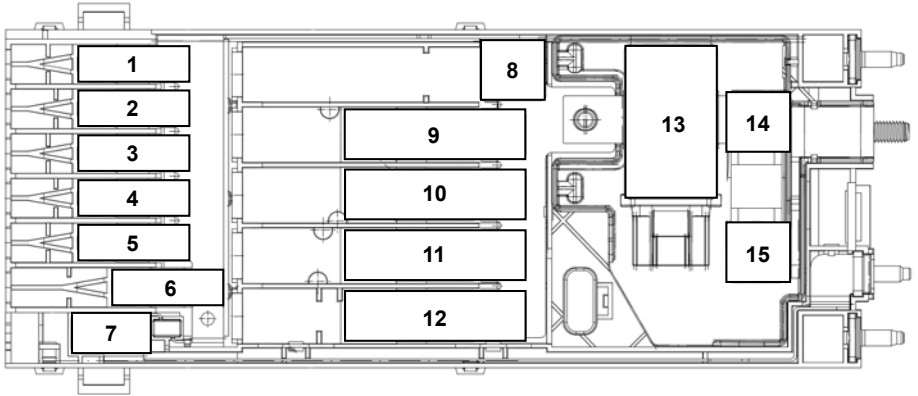

Item	Fuse Rating	Protected Component
1	125 A	Body control module.
2	80 A	Electronic power assist steering.
3	-	Not used.
4	-	Not used.
5	-	Not used.
6	150 A	Passenger compartment fuse box.
7	60 A	Camper.
8	-	Not used.
9	500 A	Starter motor. Alternator.
10	300 A	Engine compartment fuse box.
11	250 A	Dual generators.

Fuses

Item	Fuse Rating	Protected Component
12	150 A	Driver compartment fuse box.
13	190 A	Load shed relay.
14	175 A	Auxiliary power point 1.
15	60 A	Auxiliary power point 2.

CHANGING A FUSE

Fuses



WARNING: Always replace a fuse with one that has the specified amperage rating. Using a fuse with a higher amperage rating can cause severe wire damage and could start a fire.



E217331

If electrical components in the vehicle are not working, a fuse may have blown. Blown fuses are identified by a broken wire within the fuse. Check the appropriate fuses before replacing any electrical components.

Fuse Types

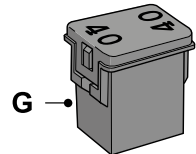
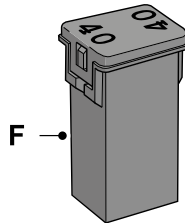
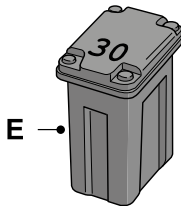
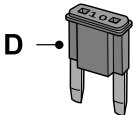
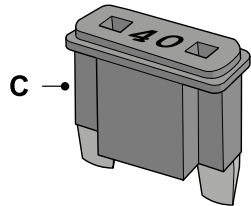
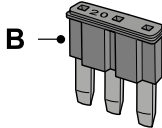
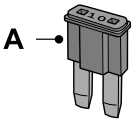

E207206

Fuses

Callout	Fuse Type
A	Micro 2
B	Micro 3
C	Maxi
D	Mini
E	M Case
F	J Case
G	J Case Low Profile

Maintenance

GENERAL INFORMATION

Have your vehicle serviced regularly to help maintain its roadworthiness and resale value. There is a large network of authorized dealers that are there to help you with their professional servicing expertise. We believe that their specially trained technicians are best qualified to service your vehicle properly and expertly. They are supported by a wide range of highly specialized tools developed specifically for servicing your vehicle.

If your vehicle requires professional service, an authorized dealer can provide the necessary parts and service. Check your warranty information to find out which parts and services are covered.

Use only recommended fuels, lubricants, fluids and service parts conforming to specifications. Motorcraft® parts are designed and built to provide the best performance in your vehicle.

Precautions

- Do not work on a hot engine.
- Make sure that nothing gets caught in moving parts.
- Do not work on a vehicle with the engine running in an enclosed space, unless you are sure you have enough ventilation.
- Keep all open flames and other burning material (such as cigarettes) away from the battery and all fuel related parts.

Working with the Engine Off

1. Set the parking brake and shift the transmission to park (P).
2. Switch off the engine.
3. Block the wheels.

Working with the Engine On



WARNING: To reduce the risk of vehicle damage and personal burn injuries, do not start your engine with the air cleaner removed and do not remove it while the engine is running.

1. Set the parking brake and shift the transmission to park (P).
2. Block the wheels.

OPENING AND CLOSING THE HOOD

Opening the Hood

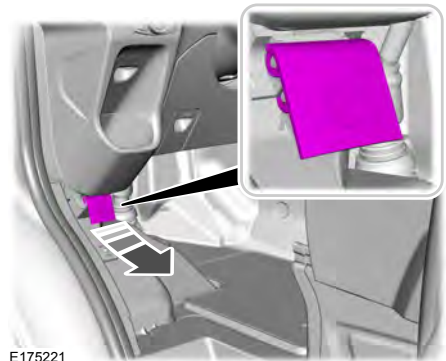

1. Pull the hood release lever.

Maintenance

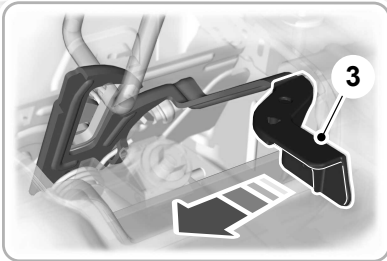
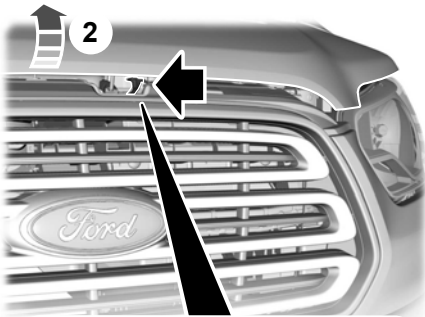

E217707

2. Slightly lift the hood.
3. Move the catch to the left.



E87786

4. Open the hood. Support the hood with the strut.

Closing the Hood

1. Remove the strut from the catch and secure it correctly in the clip.
2. Lower the hood and allow it to drop under its own weight for the last 8–12 in (20–30 cm).

Note: Make sure that the hood is correctly closed.

Maintenance

UNDER HOOD OVERVIEW - 3.5L DURATEC

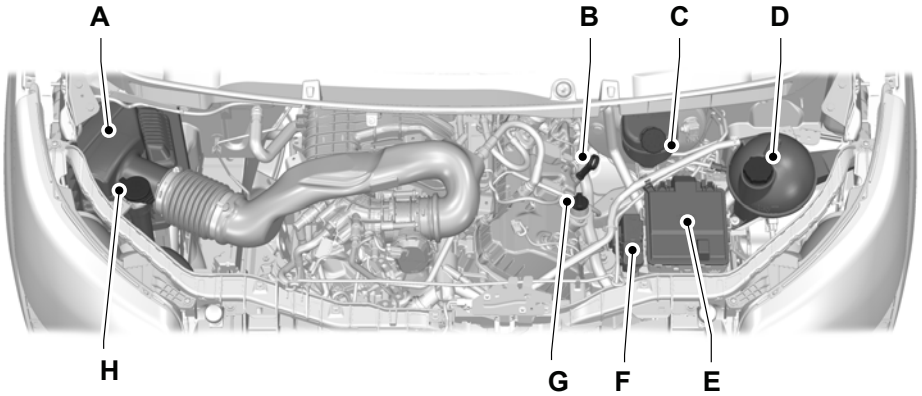

- A Air filter assembly.
- B Engine oil dipstick. See **Engine Oil Dipstick** (page 282).
- C Brake fluid reservoir. See **Brake Fluid Check** (page 290).
- D Engine coolant reservoir. See **Engine Coolant Check** (page 285).
- E Engine compartment fuse box. See **Fuses** (page 263).
- F Battery connection. See **Jump Starting the Vehicle** (page 251).
- G Engine oil filler cap. See **Engine Oil Check** (page 282).
- H Washer fluid reservoir. See **Washer Fluid Check** (page 294).

Maintenance

UNDER HOOD OVERVIEW - 3.5L ECOBOOST™

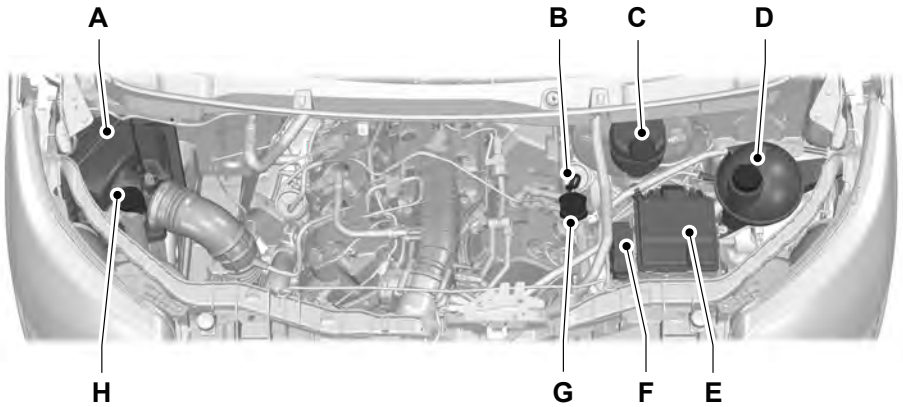

- A Air filter assembly.
- B Engine oil dipstick. See **Engine Oil Dipstick** (page 282).
- C Brake fluid reservoir. See **Brake Fluid Check** (page 290).
- D Engine coolant reservoir. See **Engine Coolant Check** (page 285).
- E Engine compartment fuse box. See **Fuses** (page 263).
- F Battery connection. See **Jump Starting the Vehicle** (page 251).
- G Engine oil filler cap. See **Engine Oil Check** (page 282).
- H Washer fluid reservoir. See **Washer Fluid Check** (page 294).

Maintenance

ENGINE OIL DIPSTICK - 3.5L DURATEC

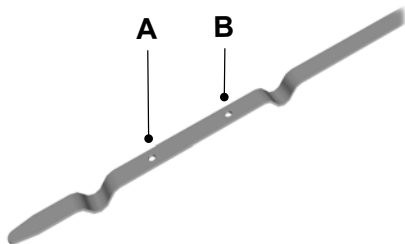

E174604

- A Minimum
- B Maximum

ENGINE OIL DIPSTICK - 3.5L ECOBOOST™

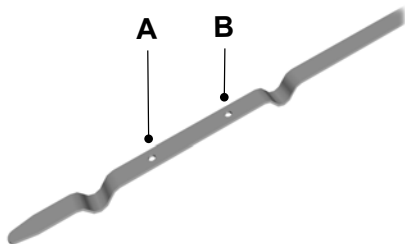

E174604

- A Minimum
- B Maximum

ENGINE OIL CHECK

1. Make sure that your vehicle is on level ground.
2. Check the oil level before starting the engine, or switch the engine off after warm up and wait 10 minutes for the oil to drain into the oil pan.
3. Remove the dipstick and wipe it with a clean, lint-free cloth.
4. Reinstall the dipstick and make sure it is fully seated.
5. Remove the dipstick again to check the oil level.

Note: If the oil level is between the maximum and minimum marks, the oil level is acceptable. Do not add oil.

6. If the oil level is at the minimum mark, immediately add oil.
7. Reinstall the dipstick. Make sure it is fully seated.

Note: The oil consumption of new engines reaches its normal level after approximately 3,000 mi (5,000 km).

Adding Engine Oil



WARNING: Do not add engine oil when the engine is hot. Failure to follow this instruction could result in personal injury.



WARNING: Do not remove the filler cap when the engine is running.

Do not use supplemental engine oil additives because they are unnecessary and could lead to engine damage that the vehicle warranty may not cover.

1. Clean the area surrounding the engine oil filler cap before you remove it.
2. Remove the engine oil filler cap.
3. Add engine oil that meets our specifications. See **Capacities and Specifications** (page 352).

Maintenance

4. Reinstall the engine oil filler cap. Turn it clockwise until you feel a strong resistance.

Note: Do not add oil further than the maximum mark. Oil levels above the maximum mark may cause engine damage.

Note: Immediately soak up any oil spillage with an absorbent cloth.

Engine Oil Pressure Warning Lamp



WARNING: If it illuminates when you are driving do not continue your journey, even if the oil level is correct. Have your vehicle checked.



It illuminates when you switch the ignition on.

If it illuminates when the engine is running this indicates a malfunction. Stop your vehicle as soon as it is safe to do so and switch the engine off. Check the engine oil level. If the oil level is sufficient, this indicates a system malfunction. Have your vehicle checked as soon as possible.

CHANGING THE ENGINE OIL AND OIL FILTER



WARNING: Prolonged and repeated skin contact with mineral oil will result in the removal of natural fats from the skin, leading to dryness, irritation and dermatitis. In addition, used engine oil contains potentially harmful contaminants, which may cause skin cancer. If skin contact occurs, wash the area thoroughly with soap or skin cleanser and water immediately.



WARNING: Do not dispose of engine oils or oil filters in the household refuse or the public sewage system. Use an authorized waste disposal facility.



WARNING: Do not remove the oil pan drain plug when the engine is running.



WARNING: Do not remove the oil filter when the engine is running.

1. Remove the oil pan drain plug and wait for the oil to drain into a suitable container.
2. Renew the oil filter.
3. Reinstall the oil pan drain plug.
4. Refill the engine with new oil that meets Ford specifications. See **Capacities and Specifications** (page 353).

Note: Do not add oil further than the maximum mark. Oil levels above the maximum mark may cause engine damage.

Note: Soak up any spillage with an absorbent cloth immediately.

5. Reset the Intelligent Oil Life Monitor. See **Oil Change Indicator Reset** (page 284).

Engine Lubrication for Severe Service Operation

The following conditions define severe service operation. The Intelligent Oil Life Monitor will determine engine oil and oil filter change intervals.

- Frequent or extended idling.
- Frequent low-speed operation at 25 mph (40 km/h) or less.
- Frequent severe dust condition operation.
- Frequent off-road operation.

Maintenance

- Sustained ambient temperatures of -9°F (-23°C) or below.
- Sustained ambient temperatures of 100°F (38°C) or above.
- Sustained towing operation above 1,000 mi (1,600 km).
- Sustained high-speed driving at Gross Vehicle Weight Rating (maximum loaded weight for vehicle operation).
- Sustained use of diesel fuel other than ultra-low sulfur diesel (ULSD).

OIL CHANGE INDICATOR RESET

Only reset the system after changing the engine oil and oil filter.

Resetting the Oil Life Monitoring System

1. Switch the ignition on. Do not start the engine.
2. Fully press the accelerator and brake pedals at the same time.
3. Keep the accelerator and brake pedals fully pressed.
4. After 25 seconds, the oil change reminder resets.
5. Release the accelerator and brake pedals.
6. Switch the ignition off.
7. Switch the ignition on to confirm that the oil change reminder does not display.

CHANGING THE ENGINE AIR FILTER



WARNING: To reduce the risk of vehicle damage and personal burn injuries, do not start your engine with the air cleaner removed and do not remove it while the engine is running.

Note: Failure to use the correct air filter element may result in severe engine damage. The vehicle Warranty may be void for any damage to the engine if the correct air filter element is not used.

Only use the specified air filter. See **Capacities and Specifications** (page 353).

Change the air filter element at the proper interval. See **Scheduled Maintenance** (page 446).

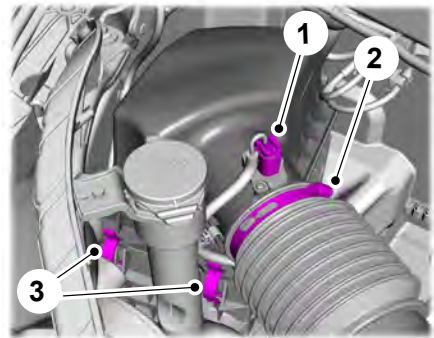

E174607

1. Disconnect the intake air temperature sensor electrical connector and cable from the air filter cover.

Maintenance

2. Clean the area around the air tube to air filter cover connection to prevent debris from entering the system and then loosen the bolt on the air tube clamp so the clamp is no longer snug to the air tube. It is not necessary to completely remove the clamp. Pull the air tube off from the air filter cover.
3. Release the clamps that secure the air filter cover to the air filter housing.

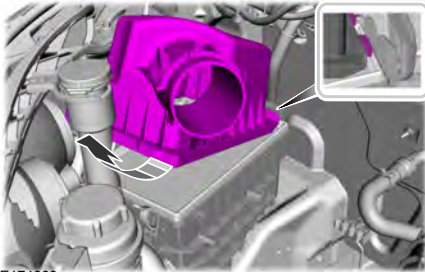

E174669

4. Carefully lift the air filter housing cover. Remove the air filter element from the air filter housing.
5. Install a new air filter element.
6. Replace the air filter housing cover. Engage the clamps that secure the air filter housing cover to the air filter housing. Be careful not to crimp the filter element edges between the air filter housing and cover. Make sure that the tabs on the edge are correctly aligned into the slots.
7. Slip the air tube onto the air filter cover and snugly tighten the bolt on the air tube clamp, but do not overtighten.
8. Reconnect the intake air temperature sensor electrical connector to the outlet tube. Make sure the locking tab on the connector is in the locked position.

ENGINE COOLING FAN

 **WARNING:** Keep your hands and clothing clear of the engine cooling fan.

Under certain conditions, the engine cooling fan may continue to run for several minutes after you switch your vehicle off.

ENGINE COOLANT CHECK

 **WARNING:** Do not remove the coolant reservoir cap when the engine is on or the cooling system is hot. Wait 10 minutes for the cooling system to cool down. Cover the coolant reservoir cap with a thick cloth to prevent the possibility of scalding and slowly remove the cap. Failure to follow this instruction could result in personal injury.

 **WARNING:** Do not put coolant in the windshield washer reservoir. If sprayed on the windshield, coolant could make it difficult to see through the windshield.

 **WARNING:** To reduce the risk of personal injury, make sure the engine is cool before unscrewing the coolant pressure relief cap. The cooling system is under pressure. Steam and hot liquid can come out forcefully when you loosen the cap slightly.

 **WARNING:** Do not add coolant further than the **MAX** mark.

When the engine is cold, check the concentration and level of the coolant at the intervals listed in the scheduled maintenance information. See **Scheduled Maintenance** (page 446).

Maintenance

Note: Make sure that the coolant level is between the **MIN** and **MAX** marks on the coolant reservoir.

Note: Coolant expands when it is hot. The level may extend beyond the **MAX** mark.

Maintain coolant concentration within 48% to 50%, which equates to a freeze point between -29°F (-34°C) and -35°F (-37°C). Coolant concentration should be checked using a refractometer. We do not recommend the use of hydrometers or coolant test strips for measuring coolant concentration.

Adding Coolant



WARNING: Do not add engine coolant when the engine is on or the cooling system is hot. Failure to follow this instruction could result in personal injury.



WARNING: Do not remove the coolant reservoir cap when the engine is on or the cooling system is hot. Wait 10 minutes for the cooling system to cool down. Cover the coolant reservoir cap with a thick cloth to prevent the possibility of scalding and slowly remove the cap. Failure to follow this instruction could result in personal injury.



WARNING: Do not put coolant in the windshield washer reservoir. If sprayed on the windshield, coolant could make it difficult to see through the windshield.

Note: Do not use stop leak pellets, cooling system sealants, or non-specified additives as they can cause damage to the engine cooling or heating systems. Resulting component damage may not be covered by the vehicle Warranty.

Note: Automotive fluids are not interchangeable.

It is very important to use prediluted coolant approved to the correct specification in order to avoid plugging the small passageways in the engine cooling system. Do not mix different colors or types of coolant in your vehicle. Mixing of engine coolants or using an incorrect coolant may harm the engine or cooling system components and may not be covered by the vehicle Warranty.

Note: If prediluted coolant is not available, use the approved concentrated coolant diluting it to 50/50 with distilled water. Using water that has not been deionised may contribute to deposit formation, corrosion and plugging of the small cooling system passageways.

Note: Coolants marketed for all makes and models may not be approved to our specifications and may cause damage to the cooling system. Resulting component damage may not be covered by the vehicle Warranty.

If the coolant level is at or below the minimum mark, add prediluted coolant immediately.

To top up the coolant level do the following:

1. Unscrew the cap slowly. Any pressure escapes as you unscrew the cap.
2. Add prediluted coolant approved to the correct specification.
3. Add enough prediluted coolant to reach the correct level.
4. Replace the coolant reservoir cap. Turn the cap clockwise until it contacts the hard stop.
5. Check the coolant level in the coolant reservoir the next few times you drive your vehicle. If necessary, add enough prediluted engine coolant to bring the coolant level to the correct level.

Maintenance

If you have to add more than 1.1 qt (1 L) of engine coolant per month, have your vehicle checked as soon as possible. Operating an engine with a low level of coolant can result in engine overheating and possible engine damage.

In case of emergency, you can add a large amount of water without engine coolant in order to reach a vehicle service location. In this instance, qualified personnel:

1. Must drain the cooling system.
2. Chemically clean the coolant system.
3. Refill with engine coolant as soon as possible.

Water alone, without engine coolant, can cause engine damage from corrosion, overheating or freezing.

Do not use the following as a coolant substitute:

- Alcohol.
- Methanol.
- Brine.
- Any coolant mixed with alcohol or methanol antifreeze.

Alcohol and other liquids can cause engine damage from overheating or freezing.

Do not add extra inhibitors or additives to the coolant. These can be harmful and compromise the corrosion protection of the coolant.

Recycled Coolant

We do not recommend the use of recycled coolant as an approved recycling process is not yet available.

Note: *Dispose of used coolant in the appropriate manner.*

Follow your community's regulations and standards for recycling and disposing of automotive fluids.

Severe Climates

If you drive in extremely cold climates:

- It may be necessary to increase the coolant concentration above 50%.
- A coolant concentration of 60% provides improved freeze point protection. Coolant concentrations above 60% decrease the overheat protection characteristics of the coolant and may cause engine damage.

If you drive in extremely hot climates:

- You can decrease the coolant concentration to 40%.
- Coolant concentrations below 40% decrease the freeze and corrosion protection characteristics of the coolant and may cause engine damage.

Vehicles driven year-round in non-extreme climates should use prediluted coolant for optimum cooling system and engine protection.

Coolant Change

At specific mileage intervals, as listed in the scheduled maintenance information, the coolant should be changed. Add prediluted coolant approved to the correct specification.

Fail-Safe Cooling

Fail-safe cooling allows you to temporarily drive your vehicle before any incremental component damage occurs. The fail-safe distance depends on ambient temperature, vehicle load and terrain.

How Fail-Safe Cooling Works



If the engine begins to overheat, the coolant temperature gauge moves toward the red zone:

Maintenance



A warning lamp illuminates and a message may appear in the information display.

If the engine reaches a preset over-temperature condition, the engine automatically switches to alternating cylinder operation. Each disabled cylinder acts as an air pump and cools the engine.

When this occurs, your vehicle still operates, however:

- Engine power is limited.
- The air conditioning system turns off.

Continued operation increases the engine temperature, causing the engine to completely shut down. Your steering and braking effort increases in this situation.

When the engine temperature cools, you can re-start the engine. Have your vehicle checked as soon as possible to minimize engine damage.

When Fail-Safe Mode Is Activated



WARNING: Fail-safe mode is for use during emergencies only. Operate your vehicle in fail-safe mode only as long as necessary to bring your vehicle to rest in a safe location and seek immediate repairs. When in fail-safe mode, your vehicle will have limited power, will not be able to maintain high-speed operation, and may completely shut down without warning, potentially losing engine power, power steering assist, and power brake assist, which may increase the possibility of a crash resulting in serious injury.



WARNING: Do not remove the coolant reservoir cap when the engine is on or the cooling system is hot. Wait 10 minutes for the cooling system to cool down. Cover the coolant reservoir cap with a thick cloth to prevent the possibility of scalding and slowly remove the cap. Failure to follow this instruction could result in personal injury.

Your vehicle has limited engine power when in the fail-safe mode, drive your vehicle with caution. Your vehicle does not maintain high-speed operation and the engine may operate poorly.

Remember that the engine is capable of automatically shutting down to prevent engine damage. In this situation:

1. Pull off the road as soon as safely possible and switch the engine off.
2. If you are a member of a roadside assistance program, we recommend that you contact your roadside assistance service provider.
3. If this is not possible, wait for a short period of time for the engine to cool.
4. Check the coolant level. If the coolant level is at or below the minimum mark, add prediluted coolant immediately.
5. When the engine temperature cools, you can re-start the engine. Have your vehicle checked as soon as possible to minimize engine damage.

Note: *Driving your vehicle without repair increases the chance of engine damage.*

Maintenance

Engine Coolant Temperature Management (If Equipped)



WARNING: To reduce the risk of crash and injury, be prepared that the vehicle speed may reduce and the vehicle may not be able to accelerate with full power until the coolant temperature reduces.

If you tow a trailer with your vehicle, the engine may temporarily reach a higher temperature during severe operating conditions, for example ascending a long or steep grade in high ambient temperatures.

At this time, you may notice the coolant temperature gauge moves toward the red zone and a message may appear in the information display.

You may notice a reduction in vehicle speed caused by reduced engine power in order to manage the engine coolant temperature. Your vehicle may enter this mode if certain high-temperature and high-load conditions take place. The amount of speed reduction depends on vehicle loading, grade and ambient temperature. If this occurs, there is no need to stop your vehicle. You can continue to drive.

The air conditioning may automatically turn on and off during severe operating conditions to protect the engine from overheating. When the coolant temperature decreases to the normal operating temperature, the air conditioning turns on.

If the coolant temperature gauge moves fully into the red zone, or if the coolant temperature warning or service engine soon messages appear in your information display, do the following:

1. Stop your vehicle as soon as it is safe to do so. Fully apply the parking brake, shift into park (P) or neutral (N).
2. Leave the engine running until the coolant temperature gauge needle returns to the normal position. If the temperature does not drop after several minutes, follow the remaining steps.
3. Switch the engine off and wait for it to cool. Check the coolant level.
4. If the coolant level is at or below the minimum mark, add prediluted coolant immediately.
5. If the coolant level is normal, restart the engine and continue.

AUTOMATIC TRANSMISSION FLUID CHECK

The automatic transmission does not have a transmission fluid dipstick.

Have an authorized dealer check and change the transmission fluid at the correct service interval. Your transmission does not consume fluid. However, if the transmission slips, shifts slowly or if you notice a sign of leaking fluid, contact an authorized dealer.

Do not use supplemental transmission fluid additives, treatments or cleaning agents. The use of these materials may affect transmission operation and result in damage to internal transmission components.

Maintenance

BRAKE FLUID CHECK



WARNING: Do not use any fluid other than the recommended brake fluid as this will reduce brake efficiency. Use of incorrect fluid could result in the loss of vehicle control, serious personal injury or death.



WARNING: Only use brake fluid from a sealed container. Contamination with dirt, water, petroleum products or other materials may result in brake system damage or failure. Failure to adhere to this warning could result in the loss of vehicle control, serious personal injury or death.



WARNING: Do not allow the fluid to touch your skin or eyes. If this happens, rinse the affected areas immediately with plenty of water and contact your physician.



WARNING: A fluid level between the **MAX** and **MIN** lines is within the normal operating range and there is no need to add fluid. A fluid level not in the normal operating range could compromise the performance of the system. Have your vehicle checked immediately.



To avoid fluid contamination, the reservoir cap must remain in place and fully tight, unless you are adding fluid.

Only use fluid that meets Ford specifications. See **Capacities and Specifications** (page 358).

CHANGING THE 12V BATTERY

The battery is under the driver seat.

Note: *If you have power seats and the battery has no charge, jump-start your vehicle to move the seat. See **Jump Starting the Vehicle** (page 251).*

Maintenance

Removing the Battery

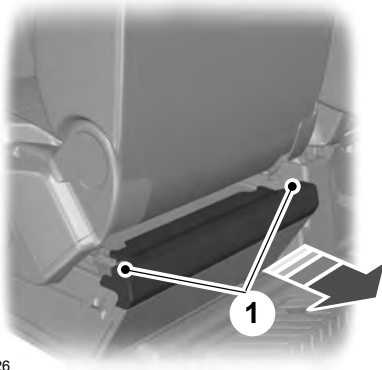

E152526

1. Fully raise the driver seat and move it fully forward. Pull the tabs upward and remove the cover.

Note: Your vehicle may not have this cover.

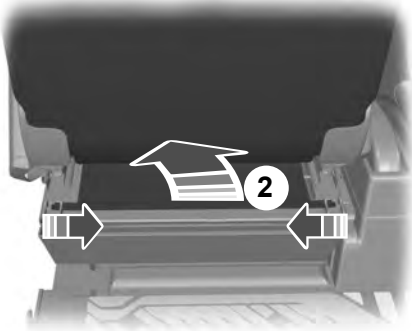

E152529

2. Unhook the cover and tuck it under the seat.

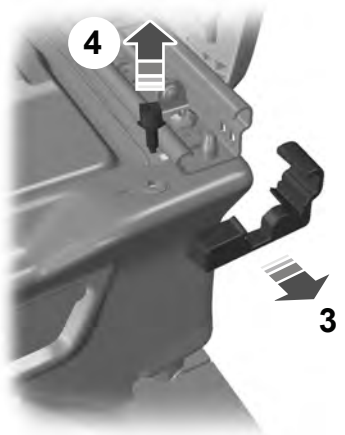

E146781

3. Remove both seat track end caps.
Note: Your vehicle may not have these end caps.
4. Remove both seat adjustment end stop bolts at the front of the seat.

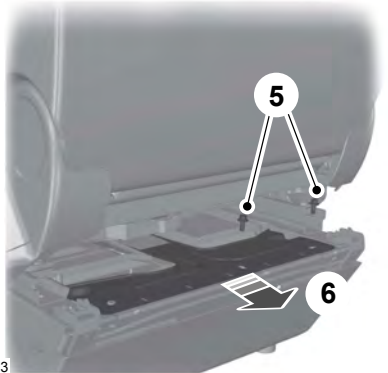

E146773

5. Remove the battery clamp and cover bolts.
6. Remove the battery clamp and cover.

Maintenance

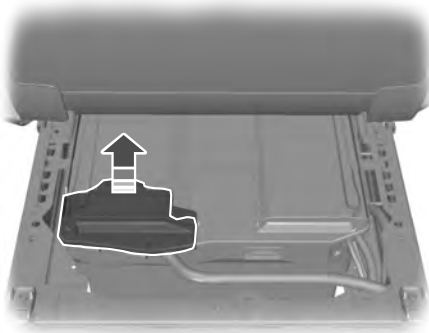

E162774

7. Remove the battery terminal cover and remove the negative (-) terminal.

Note: Single batteries could be mounted the opposite way around in the battery tray. The negative terminal is toward the rear of your vehicle.

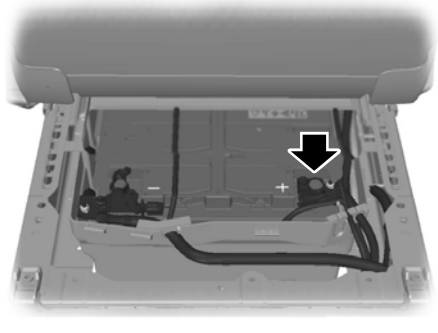

E162776

10. Remove the positive (+) terminal and remove the battery.

Note: Batteries are heavy.

11. Move the second battery toward the rear of your vehicle and remove the negative (-) terminal.
12. Remove the positive (+) terminal and remove the battery.

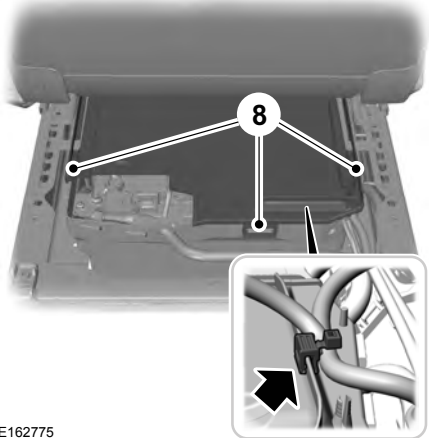

E162775

8. Release the retaining clips and remove the cover.
9. Remove the cable securing clips from the cover.

Replacing the Battery



WARNING: Make sure that you securely fasten the seat runner bolts before installing the covers.

You must replace the battery with one of exactly the same specification.

To install, reverse the removal procedure.

Note: Make sure that you correctly install the battery terminal covers, battery cover and battery cable clips.

Maintenance

ADJUSTING THE HEADLAMPS

Vertical Aim Adjustment

If your vehicle has been involved in a crash, have the aim of the headlamp beam checked by an authorized dealer.

Headlamp Aiming Target

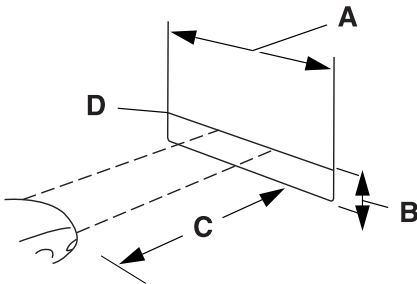

- A 8 ft (2.4 m)
- B Ground to the center of the headlamp low beam bulb
- C 25 ft (7.6 m)
- D Horizontal reference line

Vertical Aim Adjustment Procedure

1. Park your vehicle on level ground approximately 25 ft (7.6 m) from a wall or screen.
2. Measure the distance from the ground to the center of the headlamp low beam bulb and mark an 8 ft (2.4 m) long horizontal reference line on the wall or screen at this height.

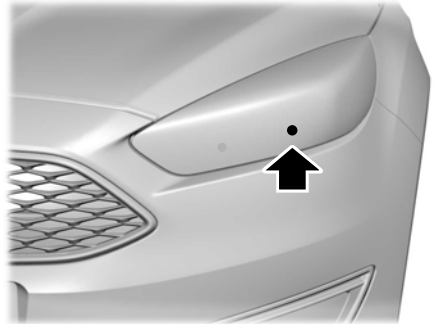

E199411

Note: There may be an identifying mark on the lens to help you locate the center of the bulb.

Note: To see a clearer light pattern while adjusting one headlamp, you may want to block the light from the other headlamp.

3. Switch on the low beam headlamps and open the hood.



4. On the wall or screen you will observe a flat zone of high intensity light located at the top of the beam pattern. If the top edge of the flat zone of high intensity light is not on the horizontal reference line, adjust the aim of the headlamp beam.

Maintenance

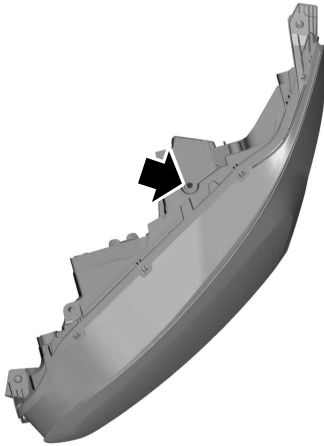

E164485

5. Locate the vertical adjuster on each headlamp. Use a suitable tool, for example a screwdriver or hexagonal socket, to turn the adjuster clockwise or counterclockwise to adjust the vertical aim of the headlamp. The horizontal edge of the brighter light should touch the horizontal reference line.
6. Close the hood and switch off the lamps.

Horizontal Aim Adjustment

The horizontal aim of the headlamp beam on your vehicle is not adjustable.

WASHER FLUID CHECK

When adding fluid, use a mixture of washer fluid and water to help prevent freezing in cold weather and improve the cleaning capability. For information on fluid dilution, refer to the product instructions. We recommend that you only use high quality washer fluid.

Note: *The reservoir supplies the front and rear washer systems.*

FUEL FILTER

Your vehicle is equipped with a lifetime fuel filter that is integrated with the fuel tank. Regular maintenance or replacement is not needed.

CHECKING THE WIPER BLADES



Run the tip of your fingers over the edge of the blade to check for roughness.

Clean the wiper blades with washer fluid or water applied with a soft sponge or cloth.

Maintenance

CHANGING THE FRONT WIPER BLADES

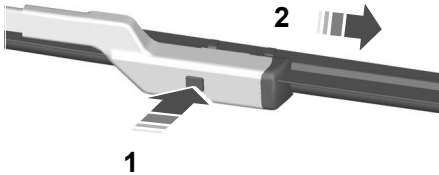

E72899

1. Lift the wiper arm. Press the wiper blade locking button.

Note: Do not hold the wiper blade when lifting the wiper arm.

2. Remove the wiper blade.

Note: Make sure that the wiper arm does not spring back against the glass when the wiper blade is not attached.

3. To install, reverse the removal procedure.

Note: Make sure that the wiper blade locks into place.

REMOVING A HEADLAMP



WARNING: Switch all of the lamps and the ignition off. Failure to follow this warning could result in serious personal injury.

1. Open the hood. See **Opening and Closing the Hood** (page 278).

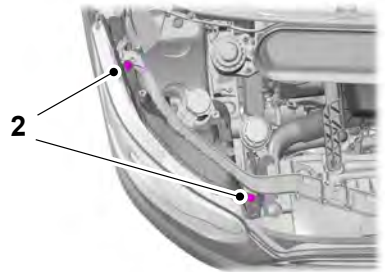

E169198

2. Remove the screws.

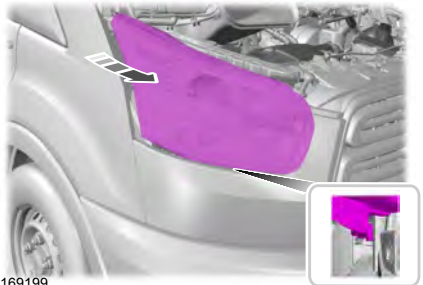

E169199

3. Pull the headlamp toward the front of your vehicle to disengage it from its locating points and then lift the headlamp up.

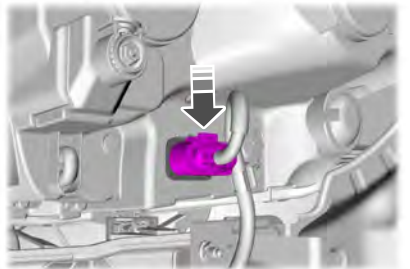

E169200

4. Disconnect the electrical connectors.

Maintenance

Note: When you install the headlamp, make sure that you correctly attach the electrical connector.

Note: When you install the headlamp, make sure that you correctly engage its locating points.

CHANGING A BULB



WARNING: Switch the lamps and the ignition off. Failure to do so could result in serious personal injury.



WARNING: Lamps and associated components become hot when in use. Let them cool down before you remove them.

Use the correct specification bulb. See **Bulb Specification Chart** (page 369).

The following instructions describe how to remove the bulbs. To install, reverse the removal procedure.

Note: LED lamps are not serviceable. Contact an authorized dealer.

Headlamp

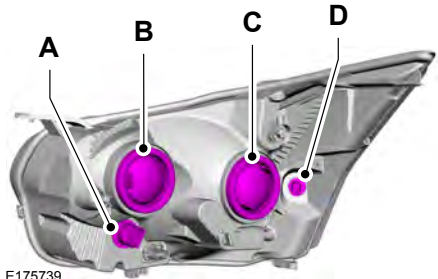

- A Parking lamp and direction indicator lamp.
- B Headlamp high beam.
- C Headlamp low beam and daytime running lamp.
- D Side marker lamp.

Note: You may have to remove a cover to gain access to the bulb.

Side Marker Lamp

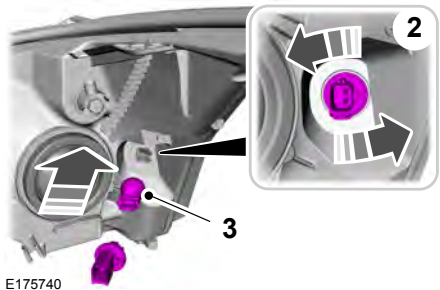

1. Remove the headlamp. See **Removing a Headlamp** (page 295).
2. Turn the bulb holder counterclockwise and remove it.
3. Remove the bulb by pulling it straight out.

Maintenance

Parking Lamp and Direction Indicator Lamp

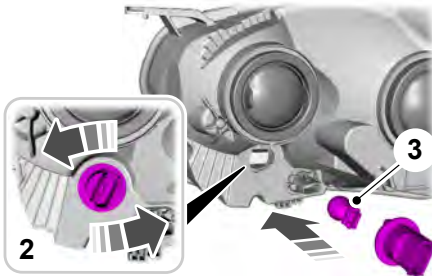

E175741

1. Remove the headlamp. See **Removing a Headlamp** (page 295).
2. Turn the bulb holder counterclockwise and remove it.
3. Remove the bulb by pulling it straight out.

Headlamp Low Beam and Daytime Running Lamp

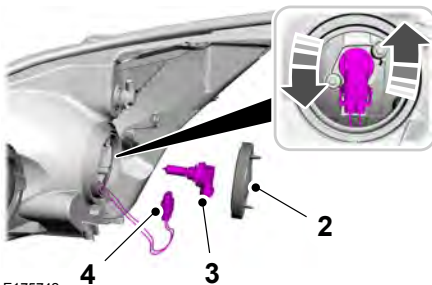

E175742

1. Remove the headlamp. See **Removing a Headlamp** (page 295).
2. Carefully remove the cover.
3. Turn the bulb counterclockwise and remove it.
4. Disconnect the electrical connector.

Note: Do not touch the bulb glass.

Note: You cannot separate the bulb from the bulb holder.

Headlamp High Beam

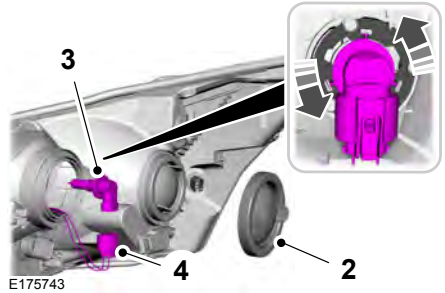

E175743

1. Remove the headlamp. See **Removing a Headlamp** (page 295).
2. Carefully remove the cover.
3. Turn the bulb counterclockwise and remove it.
4. Disconnect the electrical connector.

Note: Do not touch the bulb glass.

Note: You cannot separate the bulb from the bulb holder.

High Intensity Discharge Headlamps

These lamps operate at a high voltage. Contact an authorized dealer if they fail.

Maintenance

Front Clearance Lamp (If Equipped)

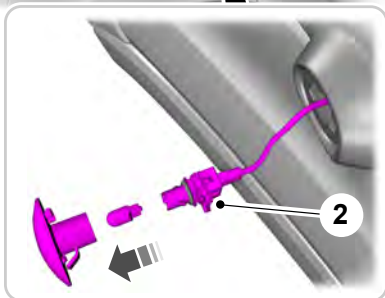
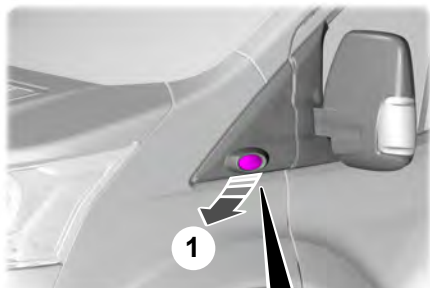

E181397

1. Carefully remove the lamp.
2. Turn the bulb holder counterclockwise and remove it.
3. Remove the bulb by pulling it straight out.

Side Direction Indicator (If Equipped)

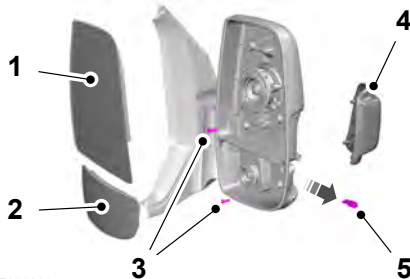

E169209

1. Remove the large mirror glass. Tilt the mirror glass fully up, pull the mirror glass toward you from the bottom.
2. Remove the small mirror glass. Tilt the mirror glass fully down, pull the mirror glass toward you from the top.
3. Remove the screws.
4. Remove the lamp lens.
5. Remove the bulb.

Rear Lamps

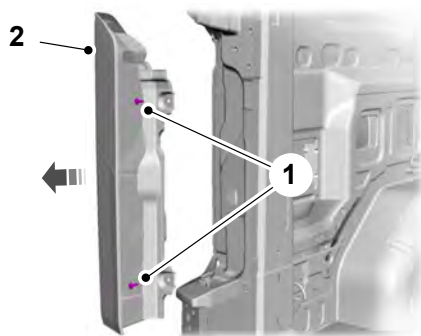

E175758

1. Remove the screws.
2. Remove the lamp.

Maintenance



E175745

3. Turn the bulb holder counterclockwise and remove it.

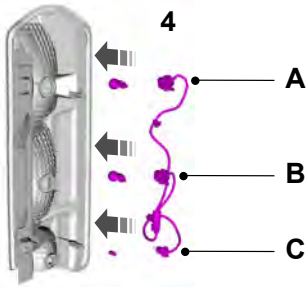

E175746

- A Tail and brake lamp.
- B Reversing lamp.
- C Rear clearance lamp.

4. Remove the bulb by pulling it straight out.

High Mounted Stoplamps

This is not a serviceable item, contact an authorized dealer if it fails.

License Plate Lamp

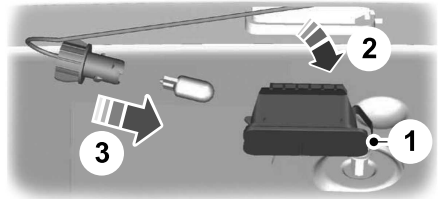

1. Carefully release the spring clip.
2. Remove the lamp.
3. Turn the bulb holder counterclockwise and remove it. Pull the bulb straight out.

Interior Lamp

Vehicles with Interior Sensors



E154370

1. Carefully remove the lens.
2. Remove the bulb.

Maintenance

Reading Lamps

Vehicles with Interior Sensors

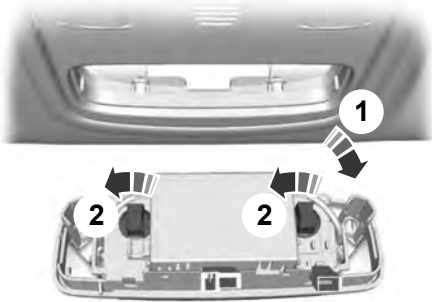

E72786

1. Carefully remove the lamp.
2. Turn the bulb holder counterclockwise and remove it.

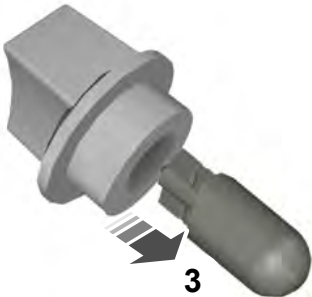

E73939

3. Remove the bulb.

Vehicles without Interior Sensors

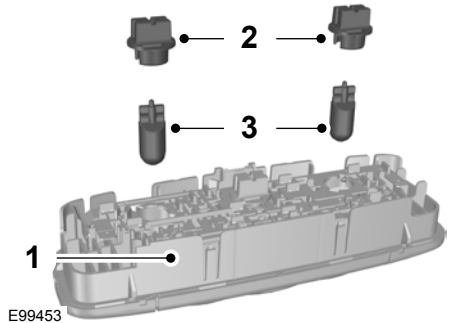

E99453

1. Carefully remove the lamp.
2. Turn the bulb holder counterclockwise and remove it.
3. Remove the bulb.

Sun Visor Mirror Lamp

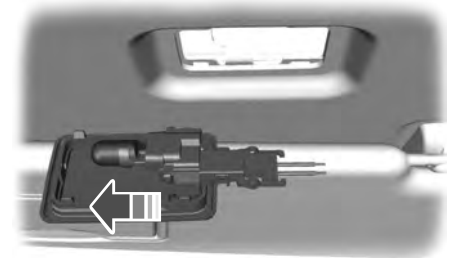

E72785

1. Carefully remove the lamp.
2. Remove the bulb.

Maintenance

DRIVE BELT ROUTING - VEHICLES WITH: DUAL GENERATORS

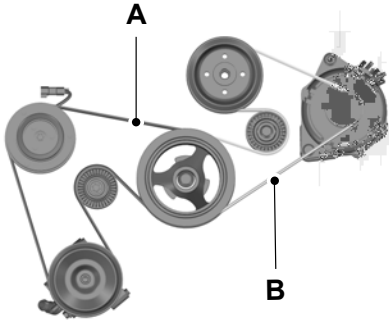

- A Drives the air conditioning compressor and a generator.
- B Drives the coolant pump and a generator.

DRIVE BELT ROUTING - VEHICLES WITH: SINGLE GENERATOR

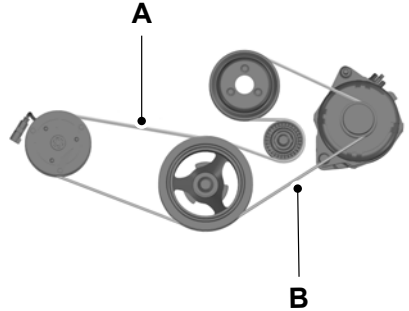

- A Drives the air conditioning compressor.
- B Drives the coolant pump and the generator.

Vehicle Care

CLEANING PRODUCTS

For best results, use the following products or products of equivalent quality:

Materials

Name	Specification
Motorcraft® Bug and Tar Remover (U.S.) Motorcraft® Bug and Tar Remover / Dissolvant de goudron et éliminateur d'insectes Motorcraft® (Canada) ZC-42 (U.S. & Canada)	-
Motorcraft® Custom Bright Metal Cleaner (U.S.) Motorcraft® Custom Bright Metal Cleaner / Nettoyant pour métal brillant Motorcraft® (Canada) ZC-15 (U.S. & Canada)	ESR-M5B194-B
Motorcraft® Detail Wash (U.S.) Motorcraft® Detail Wash / Shampooing superfin Motorcraft® (Canada) ZC-3-A (U.S. & Canada)	ESR-M14P4-A
Motorcraft® Engine Shampoo and Degreaser (U.S.) (Canada) ZC-20 (U.S.)	ESR-M14P3-A
(U.S.) Motorcraft® Engine Shampoo / Shampooing pour moteur Motorcraft® (Canada) CXC-66-A (Canada)	-
(U.S.) Motorcraft® Multi-Purpose Cleaner / Nettoyant multi-usage Motorcraft® (Canada) CXC-101 (Canada)	-
Motorcraft® Premium Windshield Wash Concentrate with Bitterant (U.S.) Motorcraft® Premium Quality Windshield Washer Fluid / Liquide lave-glace de haute qualité Motorcraft® (Canada) ZC-32-B2 (U.S.) CXC-37-A/B/D/F (Canada)	WSS-M14P19-A
Motorcraft® Professional Strength Carpet & Upholstery Cleaner (U.S.) Motorcraft® Professional Strength Carpet & Upholstery Cleaner / Nettoyant professionnel pour sellerie et moquette Motorcraft® (Canada)	-

Vehicle Care

Name	Specification
ZC-54(U.S. & Canada)	
Motorcraft® Spot and Stain Remover(U.S.) (Canada) ZC-14(U.S.)	-
Motorcraft® Ultra-Clear Spray Glass Cleaner(U.S.) Motorcraft® Premium Glass Cleaner / Nettoie-vitres de qualité supérieure Motorcraft®(Canada) ZC-23(U.S.) CXC-100(Canada)	ESR-M14P5-A
Motorcraft® Wheel and Tire Cleaner(U.S.) Motorcraft® Wheel and Tire Cleaner / Nettoyant pour roues et pneus Motorcraft®(Canada) ZC-37-A(U.S. & Canada)	-

CLEANING THE EXTERIOR

We recommend that you wash your vehicle with a sponge and lukewarm water containing a car shampoo.

Note: *If you use a car wash with a waxing cycle, make sure that you remove the wax from the windshield and the wiper blades.*

Note: *Before using a car wash, check that it is suitable for your vehicle.*

Note: *Some car washes use water at high pressure. Due to this, water droplets may enter inside your vehicle and could also damage certain parts of your vehicle.*

Note: *Remove the antenna before using an automatic car wash.*

Note: *Switch the blower motor off to prevent contamination of the cabin air filter.*

Cleaning the Headlamps

Note: *Do not scrape the headlamps.*

Note: *Do not use abrasives, alcoholic solvents or chemical solvents to clean the headlamps.*

Note: *Do not wipe the headlamps when they are dry.*

Cleaning the Rear Window

Note: *Do not scrape the inside of the rear window.*

Note: *Do not use abrasives, alcoholic solvents or chemical solvents to clean the inside of the rear window.*

Clean the inside of the rear window with a soft, lint-free cloth and non-abrasive cleaner

Cleaning the Chrome Trim

Note: *Do not use abrasives, alcoholic solvents or chemical solvents to clean the chrome trim. Use soapy water.*

Dry the chrome trim with a clean, soft cloth

Note: *Do not apply cleaning product to hot surfaces and do not leave cleaning product on chrome surfaces for a period of time exceeding that which is recommended.*

Note: *Industrial-strength (heavy-duty) cleaners, or cleaning chemicals, may cause damage over a period of time.*

Vehicle Care

Body Paintwork Preservation

Frequently remove particles such as bird droppings, tree sap, insect deposits, tar spots, road salt and industrial fallout to avoid paint surface damage.

Frequently wash the underbody of your vehicle if salt is applied on the road.

We recommend that you wax the paintwork once or twice a year.

Note: Do not apply polish in strong sunlight as this dries the polish too quickly.

Note: Do not allow polish to come in contact with unpainted plastic surfaces as it can be difficult to remove.

Note: Do not apply polish to the windshield or rear window. A contaminated windshield or contaminated wiper blades may lead to increased wiper noise, reduced wipe quality or reduced rain sensor performance.

Sliding Door Tracks



WARNING: Do not open or close the sliding doors when your hands are near the tracks or rollers.

To clean the sliding door tracks, wipe the surface using a clean, cotton cloth with a mild soap and water solution.

Do not use a commercial or high-pressure washer.

WAXING

Regular waxing is necessary to protect your car's paint from the elements. We recommend that you wash and wax the painted surface once or twice a year.

When washing and waxing, park your vehicle in a shaded area out of direct sunlight. Always wash your vehicle before applying wax.

- Use a quality wax that does not contain abrasives.
- Follow the manufacturer's instructions to apply and remove the wax.
- Apply a small amount of wax in a back-and-forth motion, not in circles.
- Do not allow wax to come in contact with any non-body (low-gloss black) colored trim. The wax will discolor or stain the parts over time.
 - Roof racks.
 - Bumpers.
 - Grained door handles.
 - Side moldings.
 - Mirror housings.
 - Windshield cowl area.
- Do not apply wax to glass areas.
- After waxing, your car's paint should feel smooth, and be free of streaks and smudges.

CLEANING THE ENGINE

Engines are more efficient when they are clean because grease and dirt buildup keep the engine warmer than normal.

When washing:

- Take care when using a power washer to clean the engine. The high-pressure fluid could penetrate the sealed parts and cause damage.
- Do not spray a hot engine with cold water to avoid cracking the engine block or other engine components.
- Spray Motorcraft Engine Shampoo and Degreaser on all parts that require cleaning and pressure rinse clean. In Canada, use Motorcraft Engine Shampoo.

Vehicle Care

Note: *If your vehicle has an engine cover remove the cover before application of Motorcraft Engine Shampoo and Degreaser. Immediately rinse away any over spray.*

- Never wash or rinse the engine while it is hot or running; water in the running engine may cause internal damage.
- Never wash or rinse any ignition coil, spark plug wire or spark plug well, or the area in and around these locations.
- Cover the battery, power distribution box, and air filter assembly to prevent water damage when cleaning the engine.

CLEANING THE WINDOWS AND WIPER BLADES

Car wash chemicals and environmental fallout can result in windshield and wiper blade contamination. Dirty windshield and wipers will result in poor windshield wiper operation. Keep the windshield and wiper blades clean to maintain windshield wiper performance.

To clean the windshield and wiper blades:

- Clean the windshield with a non-abrasive glass cleaner. When cleaning the interior of the windshield, avoid getting any glass cleaner on the instrument panel or door panels. Wipe any glass cleaner off these surfaces immediately.
- For windshields contaminated with tree sap, chemicals, wax or bugs, clean the entire windshield using steel wool (no greater than 0000 grade) in a circular motion and rinse with water.
- Clean the wiper blades with isopropyl rubbing alcohol or windshield washer concentrate.

Note: *Do not use razor blades or other sharp objects to clean or remove decals from the inside of the heated rear window. The vehicle warranty does not cover damage caused to the heated rear window grid lines.*

CLEANING THE INTERIOR

Note: *Do not allow air fresheners and hand sanitizers to spill on interior surfaces. If a spill occurs, wipe off immediately. Damage may not be covered by the vehicle Warranty.*

Note: *Do not use household cleaning products or glass cleaners, which can stain and discolor the fabric and affect the flame retardant abilities of the seat materials.*

Note: *We recommend distilled water when cleaning.*

Fabric, Carpets, Cloth Seats, Headliners and Floor Mats

Note: *Avoid soaking any surface. Do not use excessive amounts of water to clean the vehicle interior.*

Note: *To avoid spots or discoloration, clean the entire surface.*

To clean:

- Remove dust and loose dirt with a vacuum cleaner or brush.
- Wipe the surface with a soft, damp cloth and a mild soap and water solution. Dry the area with a clean, soft cloth.
- If a ring forms on the fabric after spot cleaning, clean the entire area immediately, but do not soak or the ring will set.

Vehicle Care

Seatbelts



WARNING: Do not use cleaning solvents, bleach or dye on the vehicle's seatbelts, as these actions may weaken the belt webbing.



WARNING: On vehicles equipped with seat-mounted airbags, do not use chemical solvents or strong detergents. Such products could contaminate the side airbag system and affect performance of the side airbag in a crash.

Note: Do not use abrasives, or chemical solvents to clean them.

Note: Do not allow moisture to penetrate the seatbelt retractor mechanism.

Cleaning may safely be carried out using mild soap and water. Let them dry naturally, away from artificial heat.

Leather Interior (If Equipped)

Note: Follow the same procedure as cleaning leather seats for cleaning leather instrument panels and leather interior trim surfaces.

For routine cleaning, wipe the surface with a soft, damp cloth and a mild soap and water solution. Dry the area with a clean, soft cloth.

For cleaning and removing stains such as dye transfer, use a leather cleaning product for automotive interiors.

Do not use the following products as these may damage the leather:

- Oil and petroleum or silicone-based leather conditioners.
- Household cleaners.

- Alcohol solutions.
- Solvents or cleaners intended specifically for rubber, vinyl and plastics.

Suede Micro Fiber Fabric (If Equipped)

Note: Do not steam clean.

Note: To avoid spots or discoloration, clean the entire surface.

Do not use the following products:

- Leather care products.
- Household cleaners.
- Alcoholic solutions.
- Spot removers.
- Shoe polish.

To clean:

- Remove dust and loose dirt with a vacuum cleaner.
- Wipe the surface with a soft, damp cloth and a mild soap and water solution. Dry the area with a clean, soft cloth.
- If a ring forms on the fabric after spot cleaning, clean the entire area immediately, but do not soak or the ring will set.

Instrument Cluster Screens, LCD Screens and Radio Screens

Note: Do not use abrasives, alcoholic solvents or chemical solvents to clean the instrument cluster screens, LCD screens or radio screens. These cleaning products can damage the screens.

Clean the instrument panel and cluster lens with a clean, damp and soft cloth, then use a clean, dry and soft cloth to dry these areas.

Do not spray any liquid directly onto the screens.

Vehicle Care

Do not use a microfiber cloth to clean the bezel around the display screens as it could damage the surface.

Rear Windows

Note: Do not use any abrasive materials to clean the interior of the rear windows.

Note: Do not install stickers or labels to the interior of the rear windows.

Mirrors

Do not clean the housing or glass of any mirror with harsh abrasives, fuel or other petroleum or ammonia-based cleaning products.

Storage Compartments, Cup Holders and Ashtrays

To clean:

- Take out any removable inserts.
- Wipe the surface with a soft, damp cloth and a mild soap and water solution. Dry the area with a clean, soft cloth.

CLEANING THE INSTRUMENT PANEL AND INSTRUMENT CLUSTER LENS



WARNING: Do not use chemical solvents or strong detergents when cleaning the steering wheel or instrument panel to avoid contamination of the airbag system.

Note: Follow the same procedure as cleaning leather seats for cleaning leather instrument panels and leather interior trim surfaces.

Clean the instrument panel and cluster lens with a clean, damp and soft cloth, then use a clean, dry and soft cloth to dry these areas.

- Avoid cleaners or polishes that increase the gloss of the upper portion of the instrument panel. The dull finish in this area helps protect you from undesirable windshield reflection.
- Do not use any household cleaning products or glass cleaners as these may damage the finish of the instrument panel, interior trim and cluster lens.
- Wash or wipe your hands clean if you have been in contact with certain products such as insect repellent and suntan lotion to avoid possible damage to the interior painted surfaces.
- Do not allow air fresheners and hand sanitizers to spill onto interior surfaces. If a spill occurs, wipe off immediately. Your warranty may not cover these damages.

If a staining liquid like coffee or juice has been spilled on the instrument panel or on interior trim surfaces:

1. Wipe up spilled liquid using a clean, soft cloth as quickly as possible.
2. Use Motorcraft Premium Leather and Vinyl Cleaner or a commercially available leather cleaning product for automotive interiors. Test any cleaner or stain remover on an inconspicuous area.
3. Alternatively, wipe the surface with a clean, soft cloth and a mild soap and water solution. Dry the area with a clean, soft cloth.
4. If necessary, apply more soap and water solution or cleaning product to a clean, soft cloth and press it onto the soiled area. Allow this to set at room temperature for 30 minutes.

Vehicle Care

5. Remove the soaked cloth, then with a clean, damp cloth, use a rubbing motion for 60 seconds on the soiled area.
6. Dry the area with a clean, soft cloth.

REPAIRING MINOR PAINT DAMAGE

You should repair paintwork damage caused by stones from the road or minor scratches as soon as possible. A choice of products are available from an authorized dealer.

Remove particles such as bird droppings, tree sap, insect deposits, tar spots, road salt and industrial fallout before repairing paint chips.

Always read and follow the manufacturer's instructions before using the products.

CLEANING THE WHEELS

Note: Do not apply a cleaning chemical to warm or hot wheel rims and covers.

Note: Industrial-strength (heavy-duty) cleaners, or cleaning chemicals, in combination with brush agitation to remove brake dust and dirt, could wear away the clear coat finish over a period of time.

Note: Do not use hydrofluoric acid-based or high caustic-based wheel cleaners, steel wool, fuels or strong household detergent.

Note: If you intend parking your vehicle for an extended period after cleaning the wheels with a wheel cleaner, drive your vehicle for a few minutes before doing so. This will reduce the risk of increased corrosion of the brake discs, brake pads and linings.

Note: Some automatic car washes may cause damage to the finish on your wheel rims and covers.

Alloy wheels and wheel covers are coated with a clear coat paint finish. To maintain their condition we recommend that you:

- Clean them weekly with the recommended wheel and tire cleaner.
- Use a sponge to remove heavy deposits of dirt and brake dust accumulation.
- Rinse them thoroughly with a pressurized stream of water when you have completed the cleaning process.

Consult your authorized dealer for approved cleaning products.

Using other non-recommended cleaning products can result in severe and permanent cosmetic damage.

VEHICLE STORAGE

If you plan on storing your vehicle for 30 days or more, read the following maintenance recommendations to make sure your vehicle stays in good operating condition.

We engineer and test all motor vehicles and their components for reliable, regular driving. Under various conditions, long-term storage may lead to degraded engine performance or failure unless you use specific precautions to preserve engine components.

General

- Store all vehicles in a dry, ventilated place.
- Protect from sunlight, if possible.
- If vehicles are stored outside, they require regular maintenance to protect against rust and damage.

Vehicle Care

Body

- Wash your vehicle thoroughly to remove dirt, grease, oil, tar or mud from exterior surfaces, rear-wheel housing and the underside of front fenders.
- Periodically wash your vehicle if it is stored in exposed locations.
- Touch-up exposed or primed metal to prevent rust.
- Cover chrome and stainless steel parts with a thick coat of auto wax to prevent discoloration. Re-wax as necessary when you wash your vehicle.
- Lubricate all hood, door and luggage compartment hinges and latches with a light grade oil.
- Cover interior trim to prevent fading.
- Keep all rubber parts free from oil and solvents.

Engine

- Change the engine oil and filter prior to storage because used engine oil contains contaminants which may cause engine damage.
- Start the engine every 15 days for a minimum of 15 minutes. Run at fast idle with the climate controls set to defrost until the engine reaches normal operating temperature.
- With your foot on the brake, shift through all the gears while the engine is running.
- We recommend that you change the engine oil before you use your vehicle again.

Fuel system

- Fill the fuel tank with high-quality fuel until the first automatic shutoff of the fuel pump nozzle.

Cooling system

- Protect against freezing temperatures.
- When removing your vehicle from storage, check coolant fluid level. Confirm that there are no cooling system leaks and that fluid is at the recommended level.

Battery

- Check and recharge as necessary. Keep connections clean.
- If storing your vehicle for more than 30 days without recharging the battery, we recommend that you disconnect the battery cables to maintain battery charge for quick starting.

Note: *It is necessary to reset memory features if battery cables are disconnected.*

Brakes

- Make sure the brakes and parking brake release fully.

Tires

- Maintain recommended air pressure.

Miscellaneous

- Make sure all linkages, cables, levers and pins under your vehicle are covered with grease to prevent rust.
- Move vehicles at least 25 ft (7.5 m) every 15 days to lubricate working parts and prevent corrosion.

Removing Vehicle From Storage

When your vehicle is ready to come out of storage, do the following:

- Wash your vehicle to remove any dirt or grease film build-up on window surfaces.
- Check windshield wipers for any deterioration.

Vehicle Care

- Check under the hood for any foreign material that may have collected during storage such as mice or squirrel nests.
- Check the exhaust for any foreign material that may have collected during storage.
- Check tire pressures and set tire inflation per the Tire Label.
- Check brake pedal operation. Drive your vehicle 15 ft (4.5 m) back and forth to remove rust build-up.
- Check fluid levels (including coolant, oil and gas) to make sure there are no leaks, and fluids are at recommended levels.
- If you remove the battery, clean the battery cable ends and check for damage.

Contact an authorized dealer if you have any concerns or issues.

BODY STYLING KITS

The distance between the underside of your vehicle and the ground is less than that of other models. Drive with extreme care to avoid damage to your vehicle.

Wheels and Tires

GENERAL INFORMATION

Notice to Utility Vehicle, Van and Truck Owners



WARNING: Utility vehicles have a significantly higher rollover rate than other types of vehicles. To reduce the risk of serious injury or death from a rollover or other crash you must avoid sharp turns and abrupt maneuvers, drive at safe speeds for the conditions, keep tires properly inflated, never overload or improperly load your vehicle, and make sure every passenger is properly restrained.



WARNING: In a rollover crash, an unbelted person is significantly more likely to die than a person wearing a seat belt. All occupants must wear seat belts. Children and infants must use appropriate restraints to minimize the risk of injury or ejection.



E145298

Utility vehicles and trucks handle differently than passenger cars in the various driving conditions that are encountered on streets, highways and off-road. Utility vehicles and trucks are not designed for cornering at speeds as high as passenger cars any more than low-slung sports cars are designed to perform satisfactorily under off-road conditions.

How Your Vehicle Differs from Other Vehicles

Sport-utility vehicles, vans and trucks can differ from some other vehicles in a few noticeable ways. Your vehicle may be:

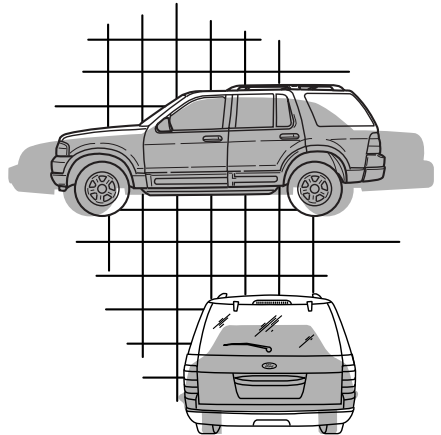

E145299

Wheels and Tires

- Higher - to allow higher load carrying capacity and to allow it to travel over rough terrain without getting hung up or damaging underbody components.
- Shorter - to give it the capability to approach inclines and drive over the crest of a hill without getting hung up or damaging underbody components. All other things held equal, a shorter wheelbase may make your vehicle quicker to respond to steering inputs than a vehicle with a longer wheelbase.
- Narrower - to provide greater maneuverability in tight spaces, particularly in off-road use.

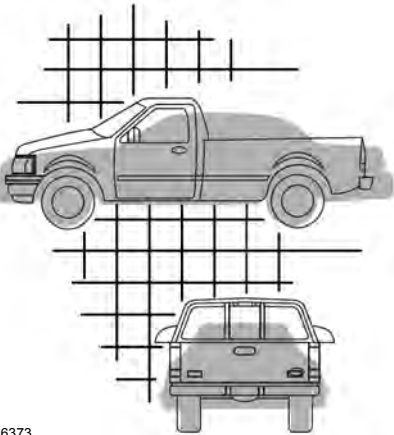

E166373

As a result of the above dimensional differences, sport-utility vehicles, vans and trucks often will have a higher center of gravity and a greater difference in center of gravity between the loaded and unloaded condition.

These differences that make your vehicle so versatile also make it handle differently than an ordinary passenger car.

TIRE SEALANT AND INFLATOR KIT

WARNING: Do not use the inflator kit on run flat tires. This could cause loss of vehicle control.

WARNING: Depending on the type and extent of tire damage, some tires can only be partially sealed or not sealed at all. Loss of tire pressure can affect vehicle handling, leading to loss of vehicle control.

WARNING: Do not use the kit on a previously damaged tire, for example when it has been driven under inflated. This could cause loss of vehicle control, personal injury or death.

Note: *Motorhome owners may have to follow separate instructions issued with the temporary mobility kit.*

If your vehicle does not have a spare wheel it has a tire sealant and inflator kit. The kit is in the right-hand side stepwell. Only use the kit supplied with your vehicle.

Note: *The kit can only temporarily repair one tire puncture with a maximum puncture size of up to 0.24 in (6 mm).*

Wheels and Tires

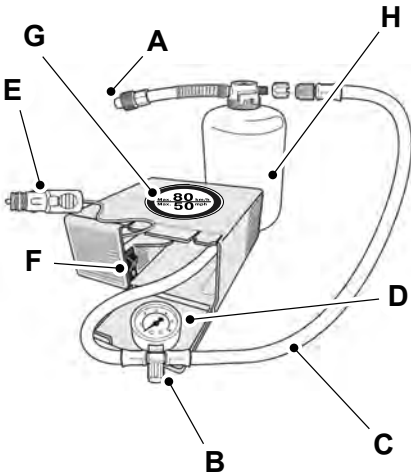

E146784

- A Protective cap
- B Pressure relief valve
- C Hose
- D Pressure gauge
- E Power plug with cable
- F Compressor switch
- G Label
- H Sealant bottle

Note: Make sure you regularly check the expiry date on the sealant bottle.



If the low tire pressure warning lamp illuminates do the following:

1. Gradually reduce the vehicle speed and stop your vehicle as soon as it is safe to do so.
2. Apply the parking brake and switch the ignition off.

3. Check for a punctured tire.

Note: Do not remove objects, for example nails or screws from a punctured tire.

Using the Tire Sealant and Inflator Kit

WARNING: Check the sidewall of the tire prior to inflation. If there are any cracks, bumps or similar damage, do not attempt to inflate the tire. This could cause personal injury.

WARNING: Watch the sidewall of the tire when inflating. If any cracks, bumps or similar damage appears, switch the compressor off and let the air out by means of the pressure relief valve. Do not continue driving with this tire. This could cause loss of vehicle control.

WARNING: Do not stand directly beside the tire while the compressor is operating. This could cause personal injury if the tire bursts.

WARNING: Do not leave the kit unattended when it is in use. Failure to follow this instruction could result in personal injury or death.

WARNING: Do not keep the compressor operating for more than 10 minutes. This could cause the compressor to malfunction causing serious personal injury.

WARNING: The sealant contains natural rubber latex. Avoid contact with skin and clothing. If this happens, rinse the affected areas immediately with plenty of water and consult a physician.

1. Open the lid of the tire sealant and inflator kit.

Wheels and Tires

2. Peel off the label G showing the maximum permissible speed of 50 mph (80 km/h) from the casing and attach it to the instrument panel in the driver's field of view. Make sure the label does not obscure anything important.
3. Take the hose C and the power plug with cable E out of the temporary mobility kit.
4. Screw the hose C onto the sealant bottle.
5. Remove the valve cap from the damaged tire.
6. Remove the protective cap A from the sealant bottle hose and screw the hose firmly onto the valve of the damaged tire.
7. Make sure that the compressor switch F is in position 0.
8. Insert the power plug E into the auxiliary power point. See **Auxiliary Power Points** (page 138).
9. Start the engine.
10. Move the compressor switch F to position 1.
11. After a minimum of two minutes move the compressor switch F to position 0 and unscrew the hose C from the sealant bottle. Unscrew the sealant bottle hose from the tire valve.
12. Screw the hose C onto the tire valve and move the compressor switch F to position 1.
13. Inflate the tire for no longer than 10 minutes or to the recommended inflation pressure. Move the compressor switch F to position 0 and check the current tire pressure with pressure gauge D. Unscrew the hose C from the tire valve.
14. Remove the power plug E from the auxiliary power point.
15. Make sure the tire sealant and inflator kit, the bottle lid and the orange cap are stored safely, but still easily accessible in your vehicle. The tire sealant and inflator kit will be required again when you check the tire pressure.
16. Immediately drive approximately six miles (10 kilometers) so that the sealant can seal the damaged area.

Note: *When pumping in the sealant through the tire valve, the pressure may rise up to 87 psi (6 bar) but will drop again after about 30 seconds.*

Note: *If the tire pressure has dropped to 26 psi (1.8 bar) or below, the tire could be damaged beyond a temporary repair. Have your vehicle immediately checked. Do not drive your vehicle.*

Note: *If the tire pressure has dropped but is still above 26 psi (1.8 bar), use the kit to inflate the tire again.*

After Using the Tire Sealant and Inflator Kit



WARNING: If you experience any unusual vibration, ride disturbance or noise while driving, reduce your speed until you can safely pull off to the side of the road and call for roadside assistance. Failure to do so could cause you to lose control of your vehicle and increase the risk of personal injury or death.

1. Stop your vehicle after driving approximately six miles (10 kilometers). Check, and where necessary, adjust the pressure of the damaged tire.
2. Attach the tire sealant and the inflator kit and check the tire pressure from the pressure gauge D.

Wheels and Tires

3. If the pressure of the sealant-filled tire is more than the recommended pressure, adjust it to the recommended pressure.
4. Follow the inflation procedure once again to inflate the tire.
5. Check the tire pressure again from the pressure gauge D. If the tire pressure is too high, deflate the tire to the specified pressure using the pressure relief valve B.
6. If the tire pressure is less than the recommended pressure, repeat steps 13 to 16 and steps 1 to 5 (Checking the Tire Pressure).
7. Once you have inflated the tire to its correct tire pressure, move the compressor switch F to position 0, remove the power plug E from the auxiliary power point, unscrew the sealant bottle hose, fasten the valve cap and replace the protective cap A.
8. Drive to the nearest tire specialist to get the damaged tire replaced. Before the tire is removed from the wheel, inform the tire specialist that the tire contains sealant. Renew the sealant bottle as soon as possible after it has been used once.

Note: *The temporary mobility kit only provides an emergency repair. Regulations concerning tire repair after using the temporary mobility kit may differ from country to country. You should consult a tire specialist for advice.*

TIRE CARE

Information About Uniform Tire Quality Grades



Tire Quality Grades apply to new pneumatic passenger car tires. The tire Quality Grades can be found where applicable on the tire sidewall between tread shoulder and maximum section width. For example: **Treadwear 200 Traction AA Temperature A.** They do not apply to deep tread, winter-type snow tires, space-saver or temporary use spare tires, light truck or LT type tires, tires with nominal rim diameters of 10 to 12 inches or limited production tires as defined in Title 49 Code of Federal Regulations Part 575.104 ©)(2).

Tire Quality Grades are determined by standards that the United States Department of Transportation has set.

Wheels and Tires

United States Department of Transportation Tire Quality Grades

The United States of America Department of Transportation requires Ford Motor Company to give you the following information about tire grades exactly as the government has written it.

Treadwear

The treadwear grade is a comparative rating based on the wear rate of the tire when tested under controlled conditions on a specified government test course. For example, a tire graded 150 would wear 1½ times as well on the government course as a tire graded 100. The relative performance of tires depends upon the actual conditions of their use, however, and may depart significantly from the norm due to variations in driving habits, service practices, and differences in road characteristics and climate.

Traction AA A B C



WARNING: The traction grade assigned to this tire is based on straight-ahead braking traction tests, and does not include acceleration, cornering, hydroplaning or peak traction characteristics.

The traction grades, from highest to lowest are AA, A, B, and C. The grades represent the tire's ability to stop on wet pavement as measured under controlled conditions on specified government test surfaces of asphalt and concrete. A tire marked C may have poor traction performance.

Temperature A B C



WARNING: The temperature grade for this tire is established for a tire that is properly inflated and not overloaded. Excessive speed, underinflation, or excessive loading, either separately or in combination, can cause heat buildup and possible tire failure.

The temperature grades are A (the highest), B and C, representing the tire's resistance to the generation of heat and its ability to dissipate heat when tested under controlled conditions on a specified indoor laboratory test wheel. Sustained high temperature can cause the material of the tire to degenerate and reduce tire life, and excessive temperature can lead to sudden tire failure. The grade C corresponds to a level of performance which all passenger car tires must meet under the

Wheels and Tires

Federal Motor Vehicle Safety Standard No. 139. Grades B and A represent higher levels of performance on the laboratory test wheel than the minimum required by law.

Glossary of Tire Terminology

- **Tire label:** A label showing the OE (Original Equipment) tire sizes, recommended inflation pressure and the maximum weight the vehicle can carry.
- **Tire Identification Number (TIN):** A number on the sidewall of each tire providing information about the tire brand and manufacturing plant, tire size and date of manufacture. Also referred to as DOT code.
- **Inflation pressure:** A measure of the amount of air in a tire.
- **Standard load:** A class of P-metric or Metric tires designed to carry a maximum load at set pressure. For example: for P-metric tires 35 psi (2.4 bar) and for Metric tires 36 psi (2.5 bar). Increasing the inflation pressure beyond this pressure will not increase the tire capability.
- **Extra load:** A class of P-metric or Metric tires designed to carry a heavier maximum load at 42 psi (2.9 bar). Increasing the inflation pressure beyond this pressure will not increase the tire's load carrying capability.
- **bar** Metric unit of atmospheric pressure.
- **kPa:** Kilopascal, a metric unit of air pressure.
- **PSI:** Pounds per square inch, a standard unit of air pressure.
- **Cold tire pressure:** The tire pressure when the vehicle has been stationary and out of direct sunlight for an hour or more and prior to the vehicle being driven for 1 mi (1.6 km).
- **Recommended inflation pressure:** The cold inflation pressure found on the Safety Compliance Certification Label (affixed to either the door hinge pillar, door-latch post, or the door edge that meets the door-latch post, next to the driver seating position) or Tire Label located on the B-Pillar or the edge of the driver door.
- **B-pillar:** The structural member at the side of the vehicle behind the front door.
- **Bead area of the tire:** Area of the tire next to the rim.
- **Sidewall of the tire:** Area between the bead area and the tread.
- **Tread area of the tire:** Area of the perimeter of the tire that contacts the road when mounted on the vehicle.
- **Rim:** The metal support (wheel) for a tire or a tire and tube assembly upon which the tire beads are seated.

Wheels and Tires

Information Contained on the Tire Sidewall

United States of America, and Canada Federal regulations require tire manufacturers to place standardized information on the sidewall of all tires. This information identifies and describes the fundamental characteristics of the tire and also provides a United States of America DOT Tire Identification Number for safety standard certification and in case of a recall.

P Type Tires

P215/65R15 95H is an example of a tire size, load index and speed rating. The definitions of these items are listed below.

Note: *Tire size, load index and speed rating for your vehicle may be different from the following example.*

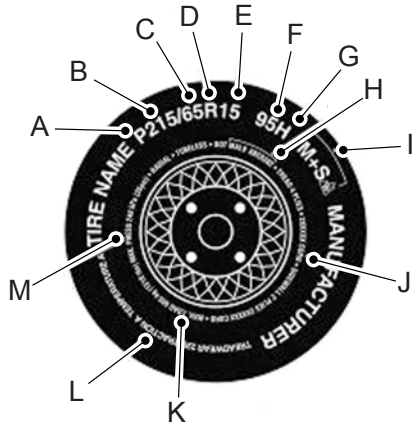

- A **P:** Indicates a tire, designated by the Tire and Rim Association, that may be used for service on cars, sport utility vehicles, minivans and light trucks.
- B **215:** Indicates the nominal width of the tire in millimeters from sidewall edge to sidewall edge. In general, the larger the number, the wider the tire.
- C **65:** Indicates the aspect ratio which gives the tire's ratio of height to width.
- D **R:** Indicates a radial type tire.

Wheels and Tires

- E 15:** Indicates the wheel or rim diameter in inches. If you change the wheel size, you will have to purchase new tires to match the new wheel diameter.
- F 95:** Indicates the tire's load index. It is an index that relates to how much weight a tire can carry. You may find this information in the Owner's Guide. If not, contact a local tire dealer.
- G H:** Indicates the tire's speed rating. The speed rating denotes the speed at which a tire is designed to be driven for extended periods of time under a standard condition of load and inflation pressure. The tires on your vehicle may operate at different conditions for load and inflation pressure. These speed ratings may need to be adjusted for the difference in conditions. The ratings range from 81 mph (130 kph) to 186 mph (299 kph). These ratings are listed in the following chart.
- H United States of America DOT Tire Identification Number (TIN):** This begins with the letters DOT and indicates that the tire meets all federal standards. The next two numbers or letters are the plant code designating where it was manufactured, the next two are the tire size code and the last four numbers represent the week and year the tire was built. For example, the numbers 317 mean the 31st week of 1997. After 2000 the numbers go to four digits. For example, 2501 means the 25th week of 2001. The numbers in between are identification codes used for traceability. This information is used to contact customers if a tire defect requires a recall.
- I M+S or M/S:** Mud and Snow, **AT:** All Terrain, **AS:** All Season.
- J Tire Ply Composition and Material Used:** Indicates the number of plies or the number of layers of rubber-coated fabric in the tire tread and sidewall. Tire

Wheels and Tires

manufacturers also must indicate the ply materials in the tire and the sidewall, which include steel, nylon, polyester, and others.

K **Maximum Load:** Indicates the maximum load in kilograms and pounds that can be carried by the tire. Refer to the Safety Compliance Certification Label (affixed to either the door hinge pillar, door-latch post, or the door edge that meets the door-latch post, next to the driver seating position), for the correct tire pressure for your vehicle.

L **Treadwear, Traction and Temperature Grades:****Treadwear** The treadwear grade is a comparative rating based on the wear rate of the tire when tested under controlled conditions on a specified government test course. For example, a tire graded 150 would wear one and one-half times as well on the government course as a tire graded 100. **Traction:** The traction grades, from highest to lowest are AA, A, B, and C. The grades represent the tire's ability to stop on wet pavement

as measured under controlled conditions on specified government test surfaces of asphalt and concrete. A tire marked C may have poor traction performance.

Temperature: The temperature grades are A (the highest), B and C, representing the tire's resistance to the generation of heat and its ability to dissipate heat when tested under controlled conditions on a specified indoor laboratory test wheel.

M **Maximum Inflation Pressure:** Indicates the tire manufacturer's maximum permissible pressure or the pressure at which the maximum load can be carried by the tire. This pressure is normally higher than the manufacturer's recommended cold inflation pressure, which can be found on the Safety Compliance Certification Label (affixed to either the door hinge pillar, door-latch post, or the door edge that meets the door-latch post, next to the driver seating position), or Tire Label which is located on the B-Pillar or the edge of

Wheels and Tires

the driver door. The cold inflation pressure should never be set lower than the recommended pressure on the vehicle label.

Tire speed ratings	
Letter rating	mph (km/h)
M	81 mph (130 km/h)
N	87 mph (140 km/h)
Q	99 mph (159 km/h)
R	106 mph (171 km/h)
S	112 mph (180 km/h)
T	118 mph (190 km/h)
U	124 mph (200 km/h)
H	130 mph (210 km/h)
V	149 mph (240 km/h)
W	168 mph (270 km/h)
Y	186 mph (299 km/h)

Note: For tires with a maximum speed capability over 149 mph (240 km/h), tire manufacturers sometimes use the letters ZR. For those with a maximum speed capability over 186 mph (299 km/h), tire manufacturers always use the letters ZR.

Note: If the tire size does not begin with a letter, this may mean it is designated by either ETRTO (European Tire and Rim Technical Organization) or JATMA (Japan Tire Manufacturing Association). You may not find this information on all tires because it is not required by federal law.

Note: The tire suppliers may have additional markings, notes or warnings, for example standard load, radial tubeless, etc.

T Type Tires

T145/80D16 is an example of a tire size. T type tires have some additional information beyond those of P type tires. The definitions of these items are listed below.

Note: The temporary tire size for your vehicle may be different from this example. Tire Quality Grades do not apply to this type of tire.

Wheels and Tires

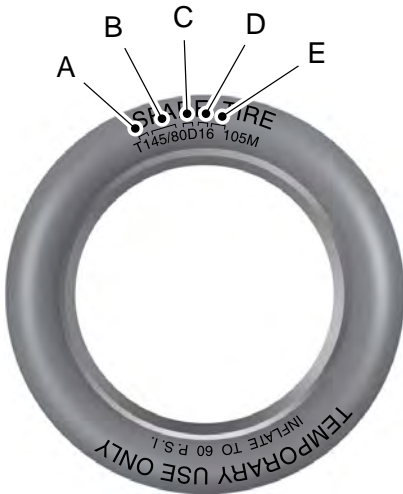

- A **T:** Indicates a type of tire, designated by the Tire and Rim Association, that is intended for temporary service on cars, sport-utility vehicles, minivans and light trucks.
- B **145:** Indicates the nominal width of the tire in millimeters from sidewall edge to sidewall edge. In general, the larger the number, the wider the tire.

- C **80:** Indicates the aspect ratio which gives the tire's ratio of height to width. Numbers of 70 or lower indicate a short sidewall.
- D **D:** Indicates a diagonal type tire. **R:** Indicates a radial type tire.
- E **16:** Indicates the wheel or rim diameter in inches. If you change the wheel size, you will have to purchase new tires to match the new wheel diameter.

Additional Information for LT Type Tires

LT235/85 R16 is an example of a tire size. LT type tires have some additional information beyond those of P type tires. The definitions of these items are listed below.

Note: *Tire Quality Grades do not apply to this type of tire.*

Wheels and Tires

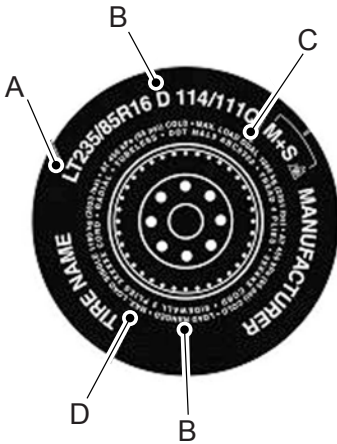

- A **LT:** Indicates a tire, designated by the Tire and Rim Association (T&RA), that is intended for service on light trucks.
- B **Load Range and Load Inflation Limits:** Indicates the tire's load-carrying capabilities and its inflation limits.

- C **Maximum Load Dual lb (kg) at psi (kPa) cold:** Indicates the maximum load and tire pressure when the tire is used as a dual, defined as four tires on the rear axle (a total of six or more tires on the vehicle).
- D **Maximum Load Single lb (kg) at psi (kPa) cold:** Indicates the maximum load and tire pressure when the tire is used as a single, defined as two tires (total) on the rear axle.

Additional Information for ETRTO Euro-Metric Commercial Vehicle Tires

Euro-metric commercial vehicle tires end in the letter "C" (for example, 235/65R16**C**). The "C" does not signify the tire's Load Range like the T&RA LT tire dimension (for example, LT245/75R17**E**).

Tire Load Capacities are identified by the Single/Dual Load indexes that follow the tire size on the tire's sidewall (for example, 235/65R16C **121/119**).

Note: *Tire Quality Grades do not apply to this type of tire.*

Wheels and Tires

United States of America DOT Tire Identification Number (TIN)

United States of America, and Canada Federal regulations require tire manufacturers to place standardized information on the sidewall of all tires. This information identifies and describes the fundamental characteristics of the tire and also provides a United States of America DOT Tire Identification Number for safety standard certification and in case of a recall.

This begins with the letters DOT and indicates that the tire meets all federal standards. The next two numbers or letters are the plant code designating where it was manufactured, the next two are the tire size code and the last four numbers represent the week and year the tire was built. For example, the numbers 317 mean the 31st week of 1997. After 2000 the numbers go to four digits. For example, 2501 means the 25th week of 2001. The numbers in between are identification codes used for traceability. This information is used to contact customers if a tire defect requires a recall.

Location of the Tire Label

You will find a Tire Label containing tire inflation pressure by tire size and other important information located on the B-Pillar or the edge of the driver's door.

Inflating the Tires



WARNING: Under-inflation is the most common cause of tire failures and may result in severe tire cracking, tread separation or blowout, with unexpected loss of vehicle control and increased risk of injury. Under-inflation increases sidewall flexing and rolling resistance, resulting in heat buildup and internal damage to the tire. It also may result in unnecessary tire stress, irregular wear, loss of vehicle control and accidents. A tire can lose up to half of its air pressure and not appear to be flat!

Safe operation of your vehicle requires that the tires are correctly inflated.

Every day before you drive, check the tires. If one looks lower than the others, use a tire gauge to check pressure of all tires and adjust if required.

At least once a month and before long trips inspect each tire including the spare tire. Check the tire pressure with a tire pressure gauge. Inflate all tires to the correct inflation pressure.

Wheels and Tires

You are strongly urged to buy a reliable tire pressure gauge, as automatic service station gauges may be inaccurate. We recommend the use of a digital or dial-type tire pressure gauge rather than a stick-type tire pressure gauge.

Use the recommended cold inflation pressure for optimum tire performance and wear. Under-inflation or over-inflation may cause uneven treadwear patterns.

Always inflate the tires to the recommended inflation pressure even if it is less than the maximum inflation pressure information found on the tire. The recommended tire inflation pressure is found on the Safety Compliance Certification Label (affixed to either the door hinge pillar, door-latch post, or the door edge that meets the door-latch post, next to the driver seating position), or Tire Label which is located on the B-Pillar or the edge of the driver door. Failure to follow the tire pressure recommendations can cause uneven treadwear patterns and adversely affect the way your vehicle handles

Note: *Do not reduce tire pressure to change the ride characteristics of your vehicle. If you do not maintain the tire pressures as specified by Ford, your vehicle may experience a condition known as shimmy. This will cause severe vibration and oscillations in the steering wheel when your vehicle travels over a bump or dip in the road and is unable to dampen out by itself. Significantly under-inflated tires, incorrect tire usage or any vehicle modifications such as lift-kits can cause your vehicle to shimmy. If your vehicle begins to shimmy, slowly reduce the speed of your vehicle by pressing the brake pedal or releasing the accelerator pedal. As your vehicle speed reduces the shimmy will cease.*

The maximum inflation pressure is the tire manufacturer's maximum permissible pressure or the pressure at which the maximum load can be carried by the tire. This pressure is normally higher than the manufacturer's recommended cold inflation pressure, which can be found on the Safety Compliance Certification Label (affixed to either the door hinge pillar, door-latch post, or the door edge that meets the door-latch post, next to the driver seating position), or Tire Label which is located on the B-Pillar or the edge

Wheels and Tires

of the driver door. The cold inflation pressure should never be set lower than the recommended pressure on the Safety Compliance Certification Label or Tire Label.

When weather temperature changes occur, tire inflation pressures also change. A 10°F (6°C) temperature drop can cause a corresponding drop of 1 psi (7 kPa) in inflation pressure. Check the tire pressures frequently and adjust them to the correct pressure which can be found on the Safety Compliance Certification Label or Tire Label.

To check the tire pressures:

1. Make sure the tires are cool, meaning they are not hot from driving even a mile.
2. Remove the cap from the valve on one tire, then firmly press the tire gauge onto the valve and measure the tire pressure.
3. Add enough air to reach the recommended tire pressure.
4. Replace the valve cap.
5. Repeat this procedure for each tire, including the spare.
6. Visually inspect the tires to make sure there are no nails or other objects embedded that could poke a hole in the tire and cause an air leak.
7. Check the sidewalls to make sure there are no gouges, cuts or bulges.

Note: *On the Dual Rear Wheel Vehicles, the valve is fitted with a flow through valve cap. There is no need to remove the cap before firmly pressing the tire gauge onto the valve.*

Note: *If you are checking tire pressure when the tire is hot, for example you have driven more than 1.0 mi (1.6 km), never bleed or reduce tire pressure. The tires are hot from driving and it is normal for pressures to increase above recommended cold pressures. A hot tire at or below recommended cold inflation pressure could be significantly under-inflated.*

Note: *If you have to drive a distance to get air for the tires, check and record the tire pressure first and add the appropriate air pressure when you get to the pump. It is normal for tires to heat up and the tire pressure to increase as you drive.*

Note: *If you over inflate the tire, release air by pressing on the metal stem in the center of the valve. Then recheck the pressure with your tire gauge.*

Wheels and Tires

Note: *Some spare tires operate at a higher inflation pressure than the other tires. For T-type mini-spare tires, refer to the Dissimilar spare wheel and tire assembly information for a description. Store and maintain at 60 psi (4.15 bar). For full-size and dissimilar spare tires, refer to the Dissimilar spare wheel and tire assembly information for a description. Store and maintain at the higher of the front and rear inflation pressure as shown on the Tire Label.*

Inspecting the Tires and Wheel Valve Stems

Periodically inspect the tire treads for uneven or excessive wear and remove objects, for example stones, nails or glass that may be wedged in the tread grooves. Check the tire and valve stems for holes, cracks, or cuts that may permit air leakage and repair or replace the tire and replace the valve stem. Inspect the tire sidewalls for cracking, cuts, bruises and other signs of damage or excessive wear. If internal damage to the tire is suspected, have the tire removed and inspected in case it needs to be repaired or replaced. For your safety, tires that are damaged or show signs of excessive wear should not be used because they are more likely to blow out or fail.

Incorrect or inadequate vehicle maintenance can cause tires to wear abnormally. Inspect all the tires, including the spare, frequently, and replace them if one or more of the following conditions exist:

Tire Wear

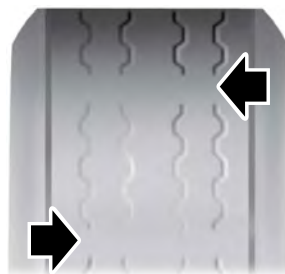

When the tread is worn down to 0.08 in (2 mm), tires must be replaced to help prevent your vehicle from skidding and hydroplaning. Built-in treadwear indicators, or wear bars, which look like narrow strips of smooth rubber across the tread will appear on the tire when the tread is worn down to 0.08 in (2 mm).

When the tire tread wears down to the same height as these wear bars, the tire is worn out and must be replaced.

Wheels and Tires

Tire Damage

Periodically inspect the tire treads and sidewalls for damage, for example bulges in the tread or sidewalls, cracks in the tread groove or separation in the tread or sidewall. If damage is observed or suspected have the tire inspected by a tire professional. Tires can be damaged during off-road use, so inspection after off-road use is also recommended.

Tire Age



WARNING: Tires degrade over time depending on many factors such as weather, storage conditions, and conditions of use (load, speed, inflation pressure) the tires experience throughout their lives.



WARNING: In general, tires should be replaced after six years regardless of tread wear. However, heat caused by hot climates or frequent high loading conditions can accelerate the aging process and may require tires to be replaced more frequently.



WARNING: You should replace your spare tire when you replace the road tires or after six years due to aging even if it has not been used.

Tire Replacement Requirements



WARNING: Only use replacement tires and wheels that are the same size, load index, speed rating and type (such as P-metric versus LT-metric or all-season versus all-terrain) as those originally provided by Ford. The recommended tire and wheel size may be found on either the Safety Compliance Certification Label (affixed to either the door hinge pillar, door-latch post, or the door edge that meets the door-latch post, next to the driver's seating position), or the Tire Label which is located on the B-Pillar or edge of the driver's door. If this information is not found on these labels, then you should contact your authorized dealer as soon as possible. Use of any tire or wheel not recommended by Ford can affect the safety and performance of your vehicle, which could result in an increased risk of loss of vehicle control, vehicle rollover, personal injury and death.



WARNING: Always inflate steel carcass tires with a remote air fill with the person inflating standing at a minimum of 12 ft (3.66 m) away from the wheel and tire assembly.

Wheels and Tires

Your vehicle is fitted with tires designed to provide a safe ride and handling capability.

We recommend that the two front tires or two rear tires generally be replaced as a pair.

Note: *The wheel valve stems must also be replaced when the road tires are replaced on your vehicle.*

Fitting Replacement Tires



WARNING: To reduce the risk of serious injury, when mounting replacement tires and wheels, you should not exceed the maximum pressure indicated on the sidewall of the tire to set the beads without additional precautions listed below. If the beads do not seat at the maximum pressure indicated, re-lubricate and try again.



WARNING: When inflating the tire for mounting pressures up to 20 psi (1.38 bar) greater than the maximum pressure on the tire sidewall, the following precautions must be taken to protect the person mounting the tire:

1. Make sure that you have the correct tire and wheel size.
2. Lubricate the tire bead and wheel bead seat area again.

3. Stand at a minimum of 12 ft (3.66 m) away from the wheel and tire assembly.
4. Use both eye and ear protection.

Tire Pressure Monitoring System (if Equipped)

The use of wheels or tires not recommended by Ford Motor Company may affect the operation of the tire pressure monitoring system. If the tire pressure monitoring system indicator is flashing, the tire pressure monitoring system is malfunctioning. The replacement tire might be incompatible with the tire pressure monitoring system, or a component of the tire pressure monitoring system may be damaged. See **Tire Pressure Monitoring System** (page 334).

The tire pressure sensors mounted in the wheels (originally installed on your vehicle) are not designed to be used in aftermarket wheels.

Tire Safety Practices



WARNING: If your vehicle is stuck in snow, mud or sand, do not rapidly spin the tires; spinning the tires can tear the tire and cause an explosion. A tire can explode in as little as three to five seconds.

Wheels and Tires



WARNING: Do not spin the wheels at over 34 mph (55 km/h). The tires may fail and injure a passenger or bystander.

Driving habits have a great deal to do with your tire mileage and safety:

- Observe posted speed limits.
- Avoid fast starts, stops and turns.
- Avoid potholes and objects on the road.
- Do not run over curbs or hit the tire against a curb when parking.

Highway Hazards

No matter how carefully you drive there is always the possibility that you may eventually have a flat tire on the highway. Drive slowly to the closest safe area out of traffic. This may further damage the flat tire, but your safety is more important.

If you feel a sudden vibration or ride disturbance while driving, or you suspect a tire or your vehicle has been damaged, immediately reduce your speed. Drive with caution until you can safely pull off the road. Stop and inspect the tires for damage. If a tire is under-inflated or damaged, deflate it, remove wheel and

replace it with the spare tire and wheel. If you cannot detect a cause, have the vehicle towed to the nearest repair facility or tire dealer to have the vehicle inspected.

Tire and Wheel Alignment

A bad jolt from hitting a curb or pothole can cause the front end of your vehicle to become misaligned or cause damage to the tires. If your vehicle seems to pull to one side when you are driving, the wheels may be out of alignment. Have an authorized dealer check the wheel alignment periodically.

Wheel misalignment in the front or the rear can cause uneven and rapid treadwear of the tires and should be corrected by an authorized dealer. Front-wheel drive vehicles and those with an independent rear suspension may require alignment of all four wheels.

The tires should also be balanced periodically. An unbalanced tire and wheel assembly may result in irregular tire wear.

Wheels and Tires

Tire Rotation



WARNING: If the tire label shows different tire pressures for the front and rear tires and the vehicle has a tire pressure monitoring system, then you need to update the settings for the system sensors. Always perform the system reset procedure after tire rotation. If you do not reset the system, it may not provide a low tire pressure warning when necessary.

Rotating the tires at the recommended interval detailed in the Scheduled Maintenance chapter will help the tires wear more evenly, providing better tire performance and longer tire life.

Sometimes irregular tire wear can be corrected by rotating the tires.

Note: After rotating the tires the inflation pressure must be checked and adjusted to the vehicle requirements.

Note: If the tires show uneven wear ask an authorized dealer to check for and correct any wheel misalignment, tire imbalance or mechanical problem involved before tire rotation.

Note: Your vehicle may have a dissimilar spare wheel and tire assembly. A dissimilar spare wheel and tire assembly is defined as a spare wheel and tire assembly that is different in brand, size or appearance from the road tires and wheels. If you have a dissimilar spare wheel and tire assembly it is intended for temporary use only and should not be used in a tire rotation.

Rear-wheel drive and four-wheel drive vehicles with single rear wheels (front tires at left of diagram).

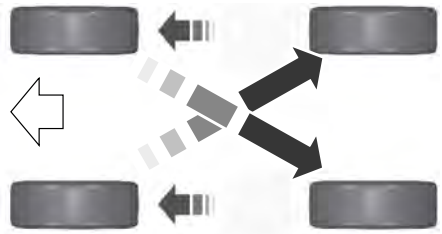

Wheels and Tires

Rear-wheel drive and four-wheel drive vehicles with dual rear wheels.

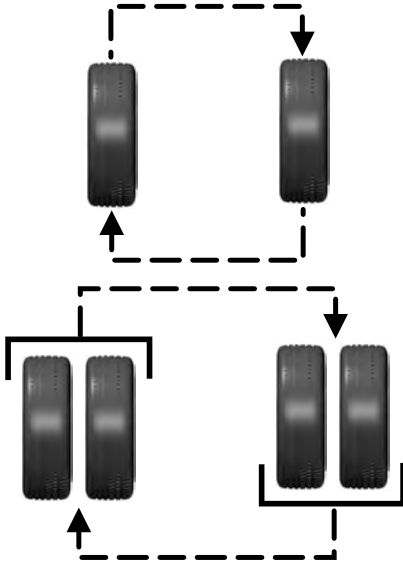

E166988

USING WINTER TIRES



WARNING: Snow tires must be the same size, load index and speed rating as those originally provided by Ford. Use of any tire or wheel not recommended by Ford can affect the safety and performance of your vehicle, which could result in an increased risk of loss of control, vehicle rollover, personal injury and death. Additionally, the use of non-recommended tires and wheels can cause steering, suspension, axle, transfer case or power transfer unit failure.

Follow the Ford recommended tire inflation pressure found on the Safety Compliance Certification Label (on the door hinge pillar, door latch post or the door edge that meets the door latch post, next to the driver seat), or Tire Label on the B-Pillar or the edge of the driver door. Failure to follow the tire pressure recommendations can cause uneven treadwear patterns and adversely affect the way your vehicle handles.



WARNING: If you choose to install snow tires on your vehicle, they must be the same size, construction, and load range as the original tires listed on the tire placard, and they must be installed on all four wheels. Mixing tires of different size or construction on your vehicle can adversely affect your vehicle's handling and braking, and may lead to loss of vehicle control.

Your vehicle has all-season tires that are optimized for use in all weather conditions. As the seasons change you may choose to use winter tires or snow tires. Winter tires and snow tires are available to purchase from an authorized dealer.

We recommend that you use winter tires when the temperature is 45°F (7°C) or lower, or in snow and ice conditions.

If you use winter tires or snow tires, inflate them to the recommended tire pressures listed on the tire information label. The label is on the driver side B-pillar.

Wheels and Tires

USING SNOW CHAINS



WARNING: Do not exceed 30 mph (50 km/h). Failure to follow this instruction could result in the loss of control of your vehicle, personal injury or death.



WARNING: Do not use snow chains on snow-free roads.



WARNING: Only fit snow chains to specified tires.



WARNING: If your vehicle is fitted with wheel trims, remove them before fitting snow chains.

Your vehicle has all-weather tires designed to provide traction in all weather conditions. In some conditions you may need to use snow chains or cables.

Snow Chain Use by Tire Size

Tire Size	Variant ³			
	Front Wheel Drive	Rear Wheel Drive - Vehicles With Single Rear Wheels	Rear Wheel Drive - Vehicles With Dual Rear Wheels	All-Wheel Drive
195/75R16C	N/A	N/A	Yes. ¹	N/A
205/75R16C	N/A	N/A	Yes. ¹	Yes. ²
215/65R15C	Yes.	N/A	N/A	N/A
215/65R16C	Use special snow chain use wheel kit 16x5.5J with 185/75R16C 104/102 tires. ⁴	N/A	N/A	N/A

Wheels and Tires

Tire Size	Variant ³			
	Front Wheel Drive	Rear Wheel Drive - Vehicles With Single Rear Wheels	Rear Wheel Drive - Vehicles With Dual Rear Wheels	All-Wheel Drive
235/65R16C 115/113	Use special snow chain use wheel kit 16x5.5J with 185/75R16C 104/102 tires. ⁴	Yes.	N/A	Yes. ²
235/65R16C 121/119	Use special snow chain use wheel kit 16x5.5J with 195/75R16C 107/105. ⁴	Yes.	N/A	Yes. ²

¹ Only fit snow chains to the outer tires.

² Only fit snow chains to the rear tires.

³ To ascertain the variant of your vehicle, refer to the vehicle identification plate.

⁴ Alternative wheels that permit the use of snow chains or cables are available to purchase from an authorized dealer as part of a special snow chain use wheel kit.

Note: Maintain correct tire pressures.

Note: The anti-lock brake system continues to correctly operate.

Note: We recommend that you switch the traction control system off. See **Using Traction Control** (page 180).

Do not use self-tensioning snow chains.

Avoid fully loading your vehicle.

Only use SAE Class S snow chains or cables of 0.4 in (10 mm) or smaller in diameter.

We recommend that steel wheels of the correct size and specification are used. Snow chains or cables could damage alloy wheels.

TIRE PRESSURE MONITORING SYSTEM (IF EQUIPPED)



WARNING: The tire pressure monitoring system is not a substitute for manually checking tire pressures. You should periodically check tire pressures using a pressure gauge. Failure to correctly maintain tire pressures could increase the risk of tire failure, loss of control, vehicle rollover and personal injury.



WARNING: If the tire pressure monitor sensor becomes damaged it may not function.

Note: The use of tire sealants can damage the tire pressure monitoring system.

Wheels and Tires



You must check the tire pressures (including the spare tire where applicable) every two weeks when the tires are cold. See **Wheels and Tires** (page 311). The tire pressures are also on the tire inflation pressure label (located on the edge of driver door or the B-Pillar).

As a driver assistance feature your vehicle has a tire pressure monitoring system. A warning lamp will illuminate when one or more of the tires are significantly under-inflated. If the low tire pressure warning lamp illuminates, you should stop your vehicle as soon as it is safe to do so, check the tires and inflate them to the correct pressure.

Driving on under-inflated tires can:

- Cause them to overheat.
- Lead to tire failure.
- Reduce fuel efficiency.
- Reduce tire life.
- Affect vehicle handling or stopping ability.

The system is not substitute for correct tire maintenance.

You must maintain the correct tire pressures, even if low tire pressure has not illuminated the warning lamp.

The tire pressure monitoring system has a system malfunction indicator to warn you when the system is not operating correctly. The malfunction indicator and low tire pressure warning lamp have a combined function. When the system detects a malfunction, the warning lamp will flash for approximately one minute and then remain illuminated. This sequence will occur every time you switch the ignition on while the malfunction remains. The system has detected a fault that requires service.

When the malfunction indicator is illuminated, the system may not be able to detect or signal low tire pressures. A malfunction may occur for a variety of reasons, including the installation of a replacement tire or wheel that prevents the system from functioning correctly. Always check the tire pressure monitoring system malfunction warning after replacing one or more tires or wheels on your vehicle. Make sure the replacement tires or wheels allow the system to continue to function correctly.

This device complies with Part 15 of the FCC Rules and with Licence exempt RSS Standards of Industry Canada. Operation is subject to the following two conditions:

- This device may not cause harmful interference.
- This device must accept any interference received, including interference that may cause undesired operation.



WARNING: Changes or modifications not expressly approved by the party responsible for compliance could void the user's authority to operate the equipment. The term "IC:" before the radio certification number only signifies that Industry Canada technical specifications were met.

How Temperature Affects the Tire Pressures

Under normal driving conditions tire pressures may increase by up to 4 psi (0.3 bar) from a cold start situation.

Wheels and Tires

If the vehicle is stationary overnight and the temperature significantly lower than the daytime temperature, tire pressures may decrease by up to 3 psi (0.2 bar) when there is a drop in the ambient temperature of 63°F (17°C) or more. The system detects this pressure decrease as being significantly below the correct inflation pressure and the warning lamp illuminates.

When Inflating Tires



WARNING: Do not use the tire pressure displayed in the information display as a tire pressure gauge. Failure to follow this instruction could result in personal injury or death.

When inflating the tires the system may not respond immediately to the air added to the tires.

Only inflate tires when they are cold.

If the warning lamp is on:

- Check each tire to verify that none are flat.
- If one or more tires are flat, repair as necessary.
- Check the tire pressures and inflate all tires to the correct pressure.
- Carry out the tire pressure monitoring system reset procedure.

When Changing Tires



You should always have tires serviced by an authorized dealer.

Note: Each road wheel and tire is fitted with a tire pressure sensor located inside the wheel and tire assembly cavity. The pressure sensor attaches to the valve stem. The tire covers the pressure sensor and it is not visible unless the tire is removed. Take care when changing the tire to avoid damaging the sensor.

When Changing Wheels

When changing the wheels of your vehicle, the tire pressure monitoring system needs to re-learn the tire pressure sensors. To achieve this perform the following:

1. Make sure all tires are inflated to the proper pressure. If not, inflate the tires to the correct pressure.
2. Park your vehicle for at least 20 minutes.
3. Carry out the tire pressure monitoring system reset procedure.
4. The tire pressure monitoring system will automatically re-learn the tire pressure sensors the next time you drive your vehicle for approximately 15 minutes above 40km/h (25 mph).

Wheels and Tires

Understanding the Tire Pressure Monitoring System

The system measures the pressure in the four road tires and displays the readings in the instrument cluster.

The system detects this lower pressure as being significantly below the correct inflation pressure and the warning lamp illuminates. You must inflate the tires to the correct pressure.

When the Temporary Spare Tire is Installed

If you need to replace a road wheel and tire with the temporary spare wheel, the system will continue to identify a defect. This is to remind you to repair the damaged road wheel and tire and refit the repaired road wheel and tire assembly to your vehicle. To restore the correct operation of the system, you must have the repaired road wheel and tire assembly refitted to your vehicle.

When You Believe the System is Not Operating Correctly

The main function of the system is to warn you when the tire pressures are low. It can also warn you in the event the system is no longer capable of operating correctly. See the following chart for information concerning the system:

Wheels and Tires

Warning lamp	Description	Action
Solid warning lamp.	Tire(s) under-inflated.	<ol style="list-style-type: none"> 1. Make sure tires are at the correct pressure. See Wheels and Tires (page 311). The tire pressures are also on the tire inflation pressure label (located on the edge of driver door or the B-Pillar). 2. After inflating the tires to the correct pressure you must carry out the tire pressure monitoring system reset procedure.
	Spare tire in use.	Repair the damaged road wheel and tire and refit the repaired road wheel and tire assembly to your vehicle to restore the correct operation of the system.
	Tire pressure monitoring system malfunction.	If the tires are correctly inflated and the spare tire is not in use but the light remains on, the system has detected a fault that requires service.
Solid warning lamp initially followed by a flashing warning lamp.	Spare tire in use.	Repair the damaged road wheel and tire and refit the repaired road wheel and tire assembly to your vehicle to restore the correct operation of the system.
	Tire pressure monitoring system malfunction.	If the tires are correctly inflated and the spare tire is not in use but the light remains on, the system has detected a fault that requires service.

Wheels and Tires

Tire Pressure Monitoring System Reset Procedure

Overview



WARNING: To determine the required pressure(s) for your vehicle, see the Safety Compliance Certification Label (on the door hinge pillar, door-latch post or the door edge that meets the door-latch post, next to the driver seat) or the Tire Label on the B-Pillar or the edge of the driver door.

You must carry out the system reset procedure after each tire replacement or adjustment of the tire pressures.

To maintain your vehicle load carrying capability, your vehicle requires different tire pressures in the front tires compared to the rear tires.

The system illuminates the warning lamp at different pressures for the front and rear tires.

If the tires are rotated, the Tire Pressure Monitoring System needs to be reset to relearn the new tire pressures. It does not know which sensor is where and assumes you have set the pressures correctly.

Carrying Out the System Reset Procedure

Switch the ignition on. Using the information display control select:

Message	Action
Settings	Press the OK button.
Driver assist	Press the OK button.
Tire Monitor	Press and hold the OK button until a confirmation message appears in the information display. Alternatively, if your vehicle has a tire pressure monitoring system reset button, press and hold the button until a confirmation message appears in the information display.

CHANGING A ROAD WHEEL



WARNING: If the tire pressure monitor sensor becomes damaged it may not function.

Note: The use of tire sealants can damage the tire pressure monitoring system.

Note: The tire pressure monitoring system indicator light will illuminate when the spare tire is in use. To restore the full function of the monitoring system, all road wheels equipped with tire pressure monitoring sensors must be mounted on this vehicle.

If you get a flat tire while driving, do not apply the brake heavily. Instead, gradually decrease your speed. Hold the steering wheel firmly and slowly move to a safe place on the side of the road.

Wheels and Tires

Have a flat serviced by an authorized dealer in order to prevent damage to the system sensors. See **Tire Pressure Monitoring System** (page 334). Replace the spare tire with a road tire as soon as possible. During repairing or replacing of the flat tire, have the authorized dealer inspect the system sensor for damage.

Dissimilar Spare Wheel and Tire Assembly Information



WARNING: Failure to follow these guidelines could result in an increased risk of loss of vehicle control, injury or death.

If you have a dissimilar spare wheel and tire, then it is intended for temporary use only. This means that if you need to use it, you should replace it as soon as possible with a road wheel and tire assembly that is the same size and type as the road tires and wheels that were originally provided by Ford. If the dissimilar spare tire or wheel is damaged, it should be replaced rather than repaired.

A dissimilar spare wheel and tire assembly is defined as a spare wheel and tire assembly that is different in brand, size or appearance from the road tires and wheels and can be one of three types:

1. **T-type mini-spare:** This spare tire begins with the letter T for tire size and may have Temporary Use Only molded in the sidewall.

2. **Full-size dissimilar spare with label on wheel:** This spare tire has a label on the wheel that states: THIS WHEEL AND TIRE ASSEMBLY FOR TEMPORARY USE ONLY.

When driving with one of the dissimilar spare tires listed above, do not:

- Exceed 50 mph (80 km/h).
- Load the vehicle beyond maximum vehicle load rating listed on the Safety Compliance Label.
- Tow a trailer.
- Use snow chains on the end of the vehicle with the dissimilar spare tire.
- Use more than one dissimilar spare tire at a time.
- Use commercial car washing equipment.
- Try to repair the dissimilar spare tire.

Use of one of the dissimilar spare tires listed above at any one wheel location can lead to impairment of the following:

- Handling, stability and braking performance.
- Comfort and noise.
- Ground clearance and parking at curbs.
- Winter weather driving capability.
- Wet weather driving capability.
- All-wheel driving capability.

3. Full-size dissimilar spare without label on wheel

When driving with the full-size dissimilar spare wheel and tire assembly, do not:

- Exceed 70 mph (113 km/h).
- Use more than one dissimilar spare wheel and tire assembly at a time.
- Use commercial car washing equipment.
- Use snow chains on the end of the vehicle with the dissimilar spare wheel and tire assembly.

The usage of a full-size dissimilar spare wheel and tire assembly can lead to impairment of the following:

- Handling, stability and braking performance.
- Comfort and noise.

Wheels and Tires

- Ground clearance and parking at curbs.
- Winter weather driving capability.
- Wet weather driving capability.
- All-wheel driving capability.

When driving with the full-size dissimilar spare wheel and tire assembly additional caution should be given to:

- Towing a trailer.
- Driving vehicles equipped with a camper body.
- Driving vehicles with a load on the cargo rack.

Drive cautiously when using a full-size dissimilar spare wheel and tire assembly and seek service as soon as possible.

Locking Lug Nuts (If Equipped)

You can obtain replacement locking lug nuts or a locking lug nut key using the reference number certificate.

The locking lug nut key is located in the glove box or in the storage compartment in the front right-hand side stepwell.

Vehicles With a Spare Wheel

The spare wheel is under the rear of your vehicle.

If the spare wheel is the same type and size as your vehicle road wheel, you can fit the spare wheel and continue to drive in the normal manner.

If the spare wheel is not the same type and size as your vehicle road wheel, it has a label showing the maximum driving speed limit.

Note: *If your vehicle is fitted with a tire pressure monitoring system, the warning indicator will flash if you fit the spare wheel to your vehicle. To restore the correct operation of the tire pressure monitoring system, you must have the repaired road wheel and tire assembly refitted to your vehicle. See **Tire Pressure Monitoring System** (page 334). To prevent damage occurring to the tire pressure monitoring system sensors, make sure you have a damage tire repaired or replaced by a tire professional.*

Van, Bus or Wagon



E145138

1. Open the rear doors and remove the grommet.

Wheels and Tires

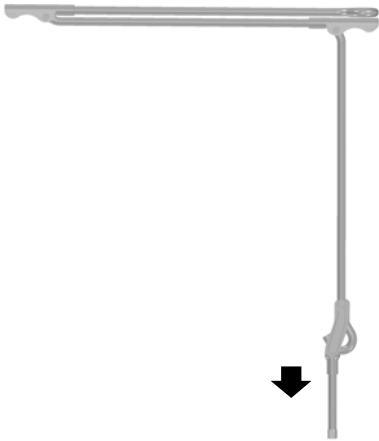

2. Insert the square end of the wheel brace or the short arm of the jack handle into the socket. Turn counterclockwise until the spare wheel rests on the ground and the cable is loose.



E146812

4. Rotate the cable through 90 degrees. Slide the cable through the slot to release the spare wheel bracket from the winch.



E146811

3. Raise the cable end cover.

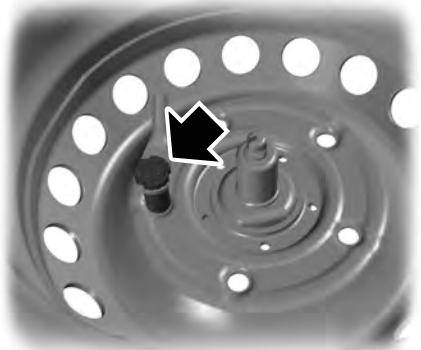

E146813

5. Remove the retaining nut to release the spare wheel bracket.
6. Leave the cable extended; it will be used to stow the flat wheel and tire assembly.

Wheels and Tires

Note: Do not raise the spare wheel bracket without a wheel attached. Damage to the winch mechanism could occur.

Chassis Cab and Cutaway

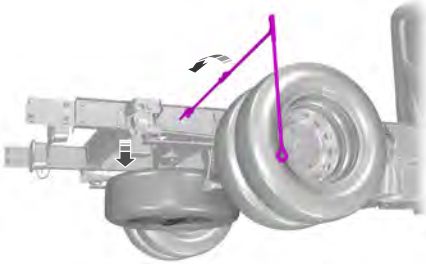

1. Insert the square end of the wheel brace or the short arm of the jack handle into the socket. Turn counterclockwise until the spare wheel rests on the ground and the cable is loose.



E146812

3. Rotate the cable through 90 degrees. Slide the cable through the slot to release the spare wheel bracket from the winch.



E146811

2. Raise the cable end cover.



E146813

4. Remove the retaining nut to release the spare wheel bracket.
5. Leave the cable extended; it will be used to stow the flat wheel and tire assembly.

Wheels and Tires

Note: Do not raise the spare wheel bracket without a wheel attached. Damage to the winch mechanism could occur.

Vehicle Jack

WARNING: Do not work on your vehicle when the jack is the only support as your vehicle could slip off the jack. Failure to follow this instruction could result in personal injury or death.

WARNING: To help prevent your vehicle from moving when changing a wheel, shift the transmission into park (P), set the parking brake and use an appropriate block or wheel chock to secure the wheel diagonally opposite to the wheel being changed. For example, when changing the front left wheel, place an appropriate block or wheel chock on the right rear wheel.

WARNING: Do not attempt to change a tire on the side of the vehicle close to moving traffic. Pull far enough off the road to avoid the danger of being hit when operating the jack or changing the wheel.

WARNING: Always use the jack provided as original equipment with your vehicle. If using a jack other than the one provided, make sure the jack capacity is adequate for the vehicle weight, including any vehicle cargo or modifications. If you are unsure if the jack capacity is adequate, contact the authorized dealer.

WARNING: Switch off the running boards before jacking or placing any object under your vehicle. Never place your hand between the extended running board and your vehicle. A moving running board may cause injury.

Note: Passengers should not remain in the vehicle when the vehicle is being jacked.

Note: Vehicles with a Temporary Mobility Kit do not have a vehicle jack or a lug wrench.

Vehicle Jack Storage

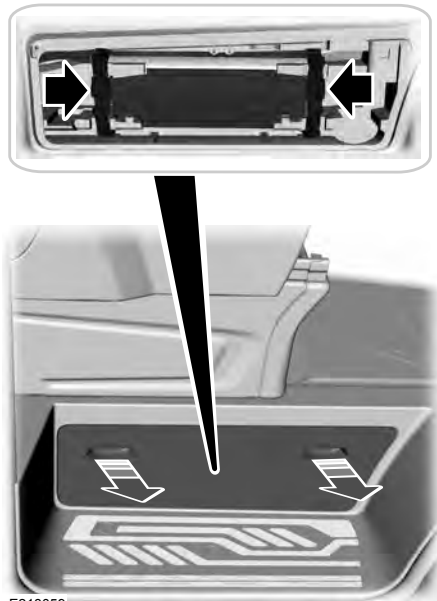

E218059

The jack, jack handle and wheel brace are in a storage compartment in the front right-hand side stepwell.

Note: The vehicle jack is in the load space area on vehicles with rear climate control.

Wheels and Tires

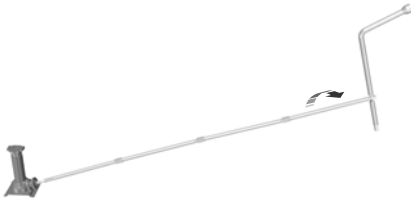

1. Assemble the jack handle.
2. Insert the jack handle into the jack.
3. Insert the end of the jack handle into the wheel brace and rotate clockwise to raise your vehicle.

Front Jacking Points



WARNING: You must use the specified jacking points.

Note: *If your vehicle has rear air conditioning make sure the vehicle jack does not come in contact with the air conditioning lines.*

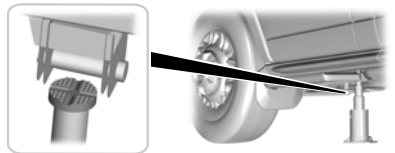
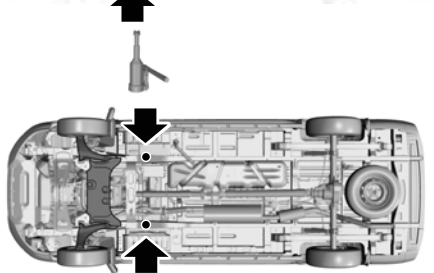

Position the head of the vehicle jack under the protrusions at the rear of front sub-frame.

Rear Jacking Points



WARNING: You must use the specified jacking points.

Wheels and Tires

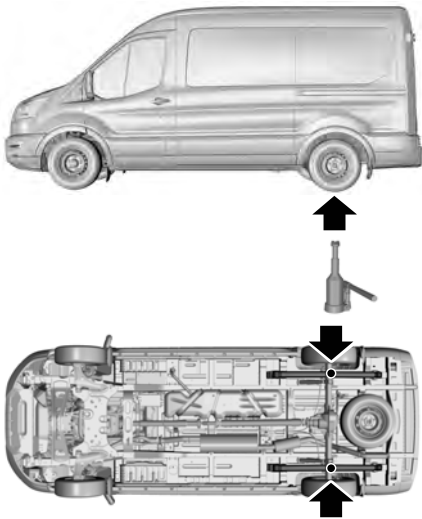

Position the head of the vehicle jack under the rear axle.

Removing a Wheel Trim (If Equipped)

Vehicles With Steel Wheels

1. Insert the flat end of the lug wrench between the wheel rim and the wheel trim.
2. Carefully remove the wheel trim.

Vehicles With Dual Rear Alloy Wheels

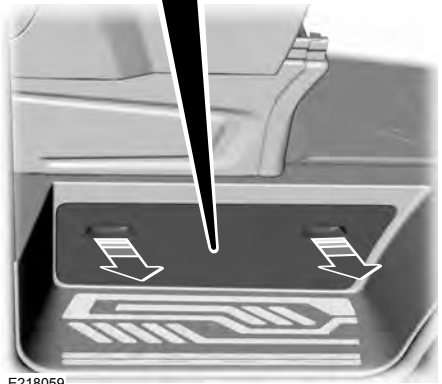
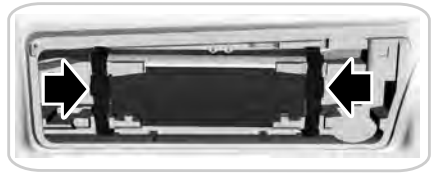

E218059



E256347

Wheels and Tires



E252527

The wheel trim removal tool is in the storage compartment in the front right-hand side stepwell near the lug wrench.

Front Wheel Trim

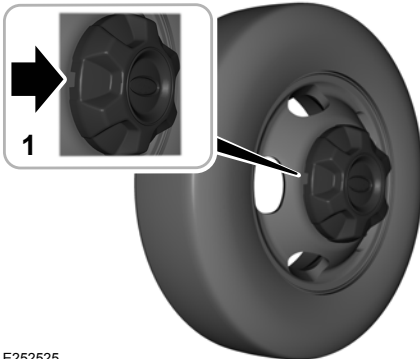

E252525

1. Locate the notch in the wheel trim.

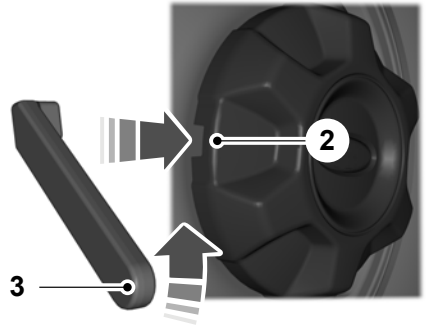

E252535

2. Insert the wheel trim removal tool into the notch in the wheel trim.
3. Rotate the wheel trim removal tool and remove the wheel trim.

Rear Wheel Trim

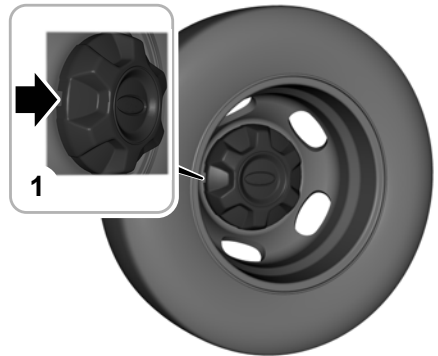

E252526

1. Locate the notch in the wheel trim.

Wheels and Tires

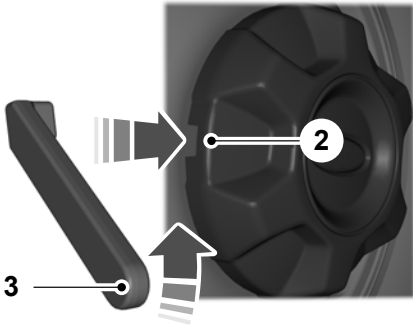

E252535

2. Insert the wheel trim removal tool into the notch in the wheel trim.
3. Rotate the wheel trim removal tool and remove the wheel trim.

Removing a Road Wheel

WARNING: Park your vehicle so that you do not obstruct the flow of traffic or place yourself in any danger and set up a warning triangle.

WARNING: Switch the ignition off and apply the parking brake.

WARNING: If your vehicle has a manual transmission, shift into first or reverse gear. If your vehicle has an automatic transmission, shift into park (P).

WARNING: Make sure all passengers are out of your vehicle.

WARNING: Make sure that your vehicle is on firm and level ground with the front wheels pointing straight ahead.

WARNING: Chock the diagonally opposite wheel to the punctured tire with an appropriate block or wheel chock. A wheel chock may be in the B-pillar or in a storage compartment in the front right-hand side stepwell.

WARNING: Make sure that the arrows on directional tires point in the direction of rotation when your vehicle is moving forward. If you have to fit a spare tire with the arrows pointing in the opposite direction have the tire refitted as soon as possible.

1. Use the locking lug nut key to loosen the locking lug nut.
2. Loosen the remaining lug nuts, but do not remove them.
3. Raise your vehicle until the tire is clear of the ground.
4. Remove the lug nuts and the road wheel.

Note: Do not lay alloy road wheels face down on the ground.

Installing a Road Wheel

WARNING: Use only approved wheel and tire sizes. Using other sizes could damage your vehicle and will make the National Type Approval invalid.

WARNING: Make sure there is no grease or oil on the threads or the surface between the wheel lugs and nuts. This can cause the lug nuts to loosen while driving.

Wheels and Tires



WARNING: When you install a wheel, always remove any corrosion, dirt or foreign materials present on the mounting surfaces of the wheel or the surface of the wheel hub, brake drum or brake disc that contacts the wheel. Make sure to secure any fasteners that attach the rotor to the hub so they do not interfere with the mounting surfaces of the wheel. Installing wheels without correct metal-to-metal contact at the wheel mounting surfaces can cause the wheel nuts to loosen and the wheel to come off while your vehicle is in motion, resulting in loss of vehicle control, personal injury or death.



WARNING: Only use the specific lug nuts and wheels supplied with your vehicle. If in doubt, contact an authorized dealer.



WARNING: Do not install alloy wheels using lug nuts designed for use with steel wheels.



WARNING: The lug nuts of alloy wheels and spoked steel wheels can also be used for the steel spare wheel for a short time (maximum two weeks).

1. Install the wheel.

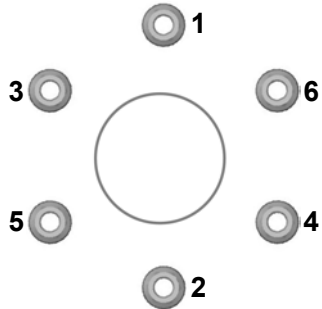
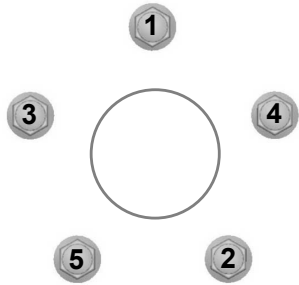

E70961

2. Install all of the lug nuts and partially tighten them in the sequence shown.
3. Lower your vehicle and remove the vehicle jack.
4. Fully tighten all of the lug nuts in the sequence shown.
5. Install the wheel trim.

Note: Make sure that the lug nuts are fully seated against the wheel.

Note: Alloy wheel lug nuts are suitable for use on a steel spare wheel.

Note: If the spare wheel is not the same type and size as your vehicle road wheel replace it as soon as possible.

Wheels and Tires

Note: Check the lug nuts for correct tightness and check the tire pressure as soon as possible.

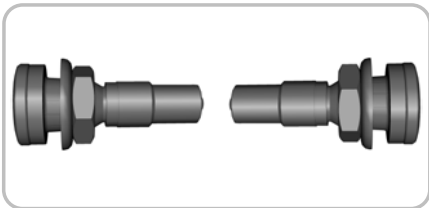
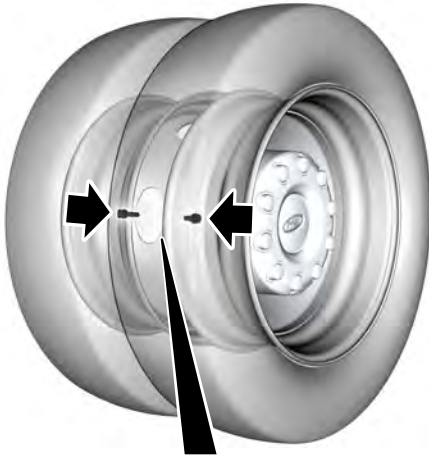

E227387

Note: When installing dual rear wheels, align the valve stems facing each other.

Stowing the Wheel and Vehicle Jack

Note: Do not raise the spare wheel bracket without a wheel attached. If you lower the spare wheel bracket without a wheel attached, you may damage the winch mechanism.

1. Attach the spare wheel bracket to the wheel using the retaining nut.

2. Slide the cable through the slot and attach the spare wheel bracket to the winch.
3. Rotate the cable through 90 degrees and lower the cable end cover.



E145138

4. Insert the flat end of the lug wrench into the socket. Turn it clockwise until you feel a strong resistance.

Note: Make sure the spare wheel is secure by tightening the winch until you feel a slip.

5. Stow the vehicle jack, jack handle and lug wrench in their correct locations and secure them with the straps.

LUG NUTS

Lug Nut Torque



WARNING: When you install a wheel, always remove any corrosion, dirt or foreign materials present on the mounting surfaces of the wheel or the surface of the wheel hub, brake drum or brake disc that contacts the wheel. Make sure to secure any fasteners that attach the rotor to the hub so they do not interfere with the mounting surfaces of

Wheels and Tires

the wheel. Installing wheels without correct metal-to-metal contact at the wheel mounting surfaces can cause the wheel nuts to loosen and the wheel to come off while your vehicle is in motion, resulting in loss of vehicle control, personal injury or death.

Bolt size	lb.ft (Nm)
M14 x 1.5	150 (204)

Locking Lug Nuts

You can obtain a replacement locking lug nut key and replacement locking lug nuts from an authorized dealer using the reference number certificate.

Capacities and Specifications

ENGINE SPECIFICATIONS - 3.5L DURATEC

Engine	3.5L V6 TiVCT
Cubic inches.	213
Required fuel.	Minimum 87 octane
Firing order.	1-4-2-5-3-6
Ignition system.	Coil on plug
Spark plug gap.	.049-.053 in. (1.25 - 1.35 mm)
Compression ratio.	11.8:1

Capacities and Specifications

ENGINE SPECIFICATIONS - 3.5L ECOBOOST™

Engine	3.5L V6 EcoBoost
Cubic inches.	213
Required fuel.	Minimum 87 octane
Firing order.	1-4-2-5-3-6
Ignition system.	Coil on plug
Spark plug gap.	.030-.033 in. (.75-.85 mm)
Compression ratio.	10.0:1

Capacities and Specifications

MOTORCRAFT PARTS - 3.5L DURATEC

Component	Motorcraft Part number
Air filter element.	FA-1916
Automatic transmission fluid filter.	FT-216
Battery - standard.	BXT-48H6-610
Battery - alternative.	BAGM-48H6-760
Oil filter.	FL-500S
Spark plugs.	SP-520
Cabin air filter.	FP-74
Windshield wiper blades - roof med-low.	WW-2955 - driver side WW-2112 - passenger side
Windshield wiper blades - roof low, medium and high.	WW-2901 - driver side WW-2049 - passenger side

We recommend Motorcraft replacement parts available at your Ford dealer or at fordparts.com for scheduled maintenance. These parts meet or exceed Ford Motor Company's specifications and are engineered for your vehicle. Use of other parts may impact vehicle performance, emissions and durability. Your warranty may be void for any damage related to use of other parts.

If a Motorcraft oil filter is not available, use an oil filter that meets industry performance specification SAE/USCAR-36.

For spark plug replacement, contact an authorized dealer. Replace the spark plugs at the appropriate intervals. See **Normal Scheduled Maintenance** (page 449).

Capacities and Specifications

MOTORCRAFT PARTS - 3.5L ECOBOOST™

Component	Motorcraft Part number
Air filter element.	FA-1916
Automatic transmission fluid filter.	FT-216
Battery.	BAGM-48H6-760
Oil filter.	FL-500S
Spark plugs.	SP-580
Cabin air filter.	FP-74
Windshield wiper blades - roof med-low.	WW-2955 - driver side WW-2112 - passenger side
Windshield wiper blades - roof low, medium and high.	WW-2901 - driver side WW-2049 - passenger side

We recommend Motorcraft replacement parts available at your Ford dealer or at fordparts.com for scheduled maintenance. These parts meet or exceed Ford Motor Company's specifications and are engineered for your vehicle. Use of other parts may impact vehicle performance, emissions and durability. Your warranty may be void for any damage related to use of other parts.

If a Motorcraft oil filter is not available, use an oil filter that meets industry performance specification SAE/USCAR-36.

For spark plug replacement, contact an authorized dealer. Replace the spark plugs at the appropriate intervals. See **Normal Scheduled Maintenance** (page 449).

Capacities and Specifications

VEHICLE IDENTIFICATION NUMBER

The vehicle identification number is located on the left-hand side of the instrument panel.

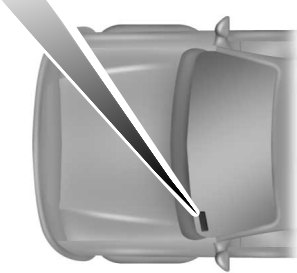

E142476

Please note that in the graphic, XXXX is representative of your vehicle identification number.

The Vehicle Identification Number contains the following information:

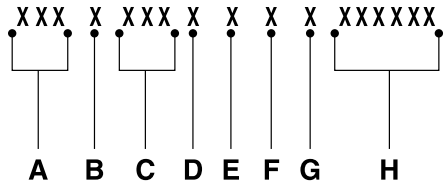

- A World manufacturer identifier
- B Brake system, Gross Vehicle Weight Rating, Restraint Devices and their locations
- C Make, vehicle line, series, body type
- D Engine type
- E Check digit
- F Model year
- G Assembly plant
- H Production sequence number

Capacities and Specifications

TRANSMISSION CODE DESIGNATION

The transmission code is on the Safety Compliance Certification Label. The following table shows the transmission code along with the transmission description.

MFD. BY FORD MOTOR CO.

DATE: XX/XX GVWR: XXXX KG (XXXX LB)
 FRONT GAWR: REAR GAWR:
 XXXX KG (XXXX LB) WITH XXXX KG (XXXX LB) WITH
 XXXXXXXXXXXXXXXX TIRES XXXXXXXXXXXXXXXX TIRES
 XXXXXXXX RIMS XXXXXXXX RIMS
 AT XXXX kPa/ XXX PSI COLD AT XXXX kPa/ XXX PSI COLD

THIS VEHICLE CONFORMS TO ALL APPLICABLE FEDERAL MOTOR VEHICLE SAFETY AND THEFT PREVENTION STANDARDS IN EFFECT ON THE DATE OF MANUFACTURE SHOWN ABOVE.

VIN: XXXXXXXXXXXXXXXX XXXXX
 TYPE: XXXX XXXXX



EXT PNT: XX XXXXXX RC: XY DSO: XXXX
 WB INT TR TP/PS TR AXLE TR SPR XXXX
 XXX XX XXX X XX X XXXX XXXX
 XXXXXXXXXXXX XX =XXXX-XXXXXX-XX



E167814

Description	Code
Ten-speed automatic transmission 10R80	U

Capacities and Specifications

CAPACITIES AND SPECIFICATIONS - 3.5L DURATEC

Use oil and fluid that meets the defined specification and viscosity grade.

If you do not use oil and fluid that meets the defined specification and viscosity grade, it could result in:

- Component damage not covered by the vehicle Warranty.
- Longer engine cranking periods.
- Increased emission levels.

- Reduced engine performance.
- Reduced fuel economy.
- Reduced brake performance.

Air Conditioning System



WARNING: The air conditioning refrigerant system contains refrigerant under high pressure. Only qualified personnel should service the air conditioning refrigerant system. Opening the air conditioning refrigerant system can cause personal injury.

Capacities

Variant	Refrigerant	Refrigerant Oil
Vehicles with rear air conditioning.	39.2 oz (1.11 kg)	9.5 fl oz (280 ml)
Vehicles without rear air conditioning.	28.2 oz (0.8 kg)	5.4 fl oz (160 ml)

Materials

Name	Specification
Motorcraft® R-134a Refrigerant(U.S.) R-134a Refrigerant / Frigorigène R-134a(Canada) YN-19(U.S.) CYN-19-R(Canada)	WSH-M17B19-A
Motorcraft® PAG Refrigerant Compressor Oil(U.S.) Motorcraft® PAG Refrigerant Compressor Oil / Huile PAG pour compresseur frigorifique Motor- craft®(Canada) YN-12-D(U.S. & Canada)	WSH-M1C231-B

Capacities and Specifications

Engine

Engine Oil



An oil that displays this symbol conforms to current engine, emission system and fuel economy performance standards of the International Lubricants Specification Advisory Committee (ILSAC).

We recommend Motorcraft® motor oil for your vehicle. If Motorcraft® oil is not available, use motor oils of the recommended viscosity grade that meet API SP requirements and display the API Certification Mark for gasoline engines.

Do not use supplemental engine oil additives because they are unnecessary and could lead to engine damage that may not be covered by the vehicle Warranty.

Capacities

Variant	Including the Oil Filter
All.	6.0 qt (5.7 L)

Note: The quantity of engine oil required to raise the indicated level on the dipstick from minimum to maximum is 1.0 qt (0.9 L).

Materials

Name	Specification
Motorcraft® SAE 5W-20 Synthetic Blend Motor Oil(U.S.) Motorcraft® SAE 5W-20 Super Premium Motor Oil / Huile moteur de très haute qualité SAE 5W-20 Motorcraft®(Canada) XO-5W20-Q1SP(U.S.) CXO-5W20-LSP6(Canada)	WSS-M2C960-A1

Note: Do not use more than 0.3 gal (1 L) of the alternative engine oil between scheduled service intervals.

Alternative Engine Oil for Extremely Cold Climates

To improve engine cold start performance, we recommend that you use the following alternative engine oil where the ambient temperature reaches -22°F (-30°C) or below.

Capacities and Specifications

Materials

Name	Specification
Motorcraft® SAE 0W-20 Synthetic Blend Motor Oil(U.S.) (Canada) XO-0W20-Q1SP(U.S.)	WSS-M2C962-A1

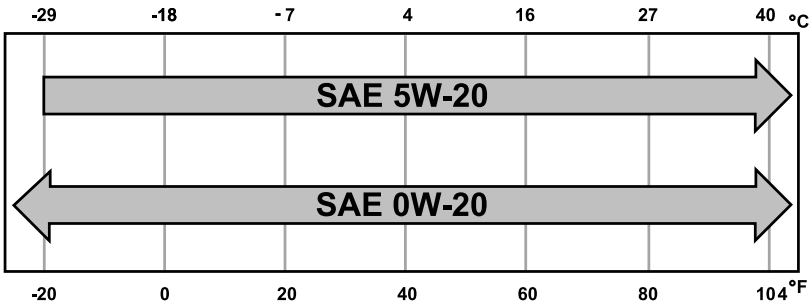

Engine Coolant

Capacities

Variant	Quantity
All.	15.1 qt (14.25 L)

Materials

Name	Specification
Motorcraft® Yellow Prediluted Antifreeze/ Coolant(U.S.) Motorcraft® Yellow Prediluted Antifreeze/Coolant / Antigel/liquide de refroidissement prédilué jaune Motorcraft®(Canada) VC-13DL-G(U.S.) CVC-13DL-G(Canada)	WSS-M97B57-A2

Capacities and Specifications

Fuel Tank

Capacities

Variant	Quantity
Vehicles with standard fuel tank.	25.1 gal (95 L)
Vehicles with larger fuel tank.	30.5 gal (115.4 L)

Washer Reservoir

Capacities

Variant	Quantity
All.	4.8 qt (4.5 L)

Materials

Name	Specification
Motorcraft® Premium Windshield Wash Concentrate with Bitterant(U.S.) Motorcraft® Premium Quality Windshield Washer Fluid / Liquide lave-glace de haute qualité Motorcraft®(Canada) ZC-32-B2(U.S.) CXC-37-A/B/D/F(Canada)	WSS-M14P19-A

Brake System

Materials

Name	Specification
Motorcraft® DOT 4 LV High Performance Motor Vehicle Brake Fluid(U.S.) Motorcraft® DOT 4 LV High Performance Motor Vehicle Brake Fluid / Liquide de frein automobile haute performance DOT 4 LV Motorcraft®(Canada) PM-20(U.S. & Canada)	WSS-M6C65-A2

Capacities and Specifications

Rear Axle

Capacities

Variant	Quantity
Rear axle fluid, vehicles with limited slip differential.	2.9 qt (2.72 L)
Rear axle fluid, vehicles with conventional differential.	3.0 qt (2.84 L)
Rear axle friction modifier.	0.1 qt (118 ml)

Note: *Ford rear axles contain a synthetic lubricant that does not require changing unless you submerge the axle in water.*

Materials

Name	Specification
Motorcraft® SAE 75W-85 Premium Synthetic Hypoid Gear Lubricant(U.S.) Motorcraft® SAE 75W-85 Premium Synthetic Hypoid Gear Lubricant / Huile synthétique de haute qualité pour engrenages hypoides SAE 75W-85 Motorcraft®(Canada) XY-75W85-QL(U.S. & Canada)	WSS-M2C942-A
Motorcraft® Additive Friction Modifier(U.S.) Motorcraft® Additive Friction Modifier / Additif modificateur de friction Motorcraft®(Canada) XL-3(U.S.) CXL-3(Canada)	EST-M2C118-A

Locks

Materials

Name	Specification
Motorcraft® Penetrating and Lock Lubricant(U.S.) Motorcraft® Penetrating Fluid / Liquide dégrippant Motorcraft®(Canada) XL-1(U.S.) CXC-51-A(Canada)	-

Grease

Capacities and Specifications

Materials

Name	Specification
Motorcraft® Premium Long-Life Grease (U.S.) Motorcraft® Premium Long-Life Grease / Graisse longue durée de qualité première Motor- craft® (Canada) XG-1-E1 (U.S. & Canada)	ESA-M1C75-B

CAPACITIES AND SPECIFICATIONS - 3.5L ECOBOOST™

Use oil and fluid that meets the defined specification and viscosity grade.

If you do not use oil and fluid that meets the defined specification and viscosity grade, it could result in:

- Component damage not covered by the vehicle Warranty.
- Longer engine cranking periods.

- Increased emission levels.
- Reduced engine performance.
- Reduced fuel economy.
- Reduced brake performance.

Air Conditioning System



WARNING: The air conditioning refrigerant system contains refrigerant under high pressure. Only qualified personnel should service the air conditioning refrigerant system. Opening the air conditioning refrigerant system can cause personal injury.

Capacities

Variant	Refrigerant	Refrigerant Oil
Vehicles with rear air conditioning.	39.2 oz (1.11 kg)	9.5 fl oz (280 ml)
Vehicles without rear air conditioning.	28.2 oz (0.8 kg)	5.4 fl oz (160 ml)

Capacities and Specifications

Materials

Name	Specification
Motorcraft® R-134a Refrigerant (U.S.) R-134a Refrigerant / Frigorigène R-134a (Canada) YN-19 (U.S.) CYN-19-R (Canada)	WSH-M17B19-A
Motorcraft® PAG Refrigerant Compressor Oil (U.S.) Motorcraft® PAG Refrigerant Compressor Oil / Huile PAG pour compresseur frigorifique Motor- craft® (Canada) YN-12-D (U.S. & Canada)	WSH-M1C231-B

Engine

Engine Oil



An oil that displays this symbol conforms to current engine, emission system and fuel economy performance standards of the International Lubricants Specification Advisory Committee (ILSAC).

We recommend Motorcraft® motor oil for your vehicle. If Motorcraft® oil is not available, use motor oils of the recommended viscosity grade that meet API SP requirements and display the API Certification Mark for gasoline engines.

Do not use supplemental engine oil additives because they are unnecessary and could lead to engine damage that may not be covered by the vehicle Warranty.

Capacities

Variant	Including the Oil Filter
All.	6.0 qt (5.7 L)

Note: The quantity of engine oil required to raise the indicated level on the dipstick from minimum to maximum is 1.0 qt (0.9 L).

Capacities and Specifications

Materials

Name	Specification
Motorcraft® SAE 5W-30 Synthetic Blend Motor Oil(U.S.) Motorcraft® SAE 5W-30 Super Premium Motor Oil / Huile moteur de très haute qualité SAE 5W-30 Motorcraft®(Canada) XO-5W30-Q1SP(U.S.) CXO-5W30-LSP6(Canada)	WSS-M2C961-A1

Note: Do not use more than 0.3 gal (1 L) of the alternative engine oil between scheduled service intervals.

Alternative Engine Oil for Extremely Cold Climates

To improve engine cold start performance, we recommend that you use the following alternative engine oil where the ambient temperature reaches -22°F (-30°C) or below.

Materials

Name	Specification
Engine Oil - SAE 0W-30 - Synthetic Blend	WSS-M2C963-A1

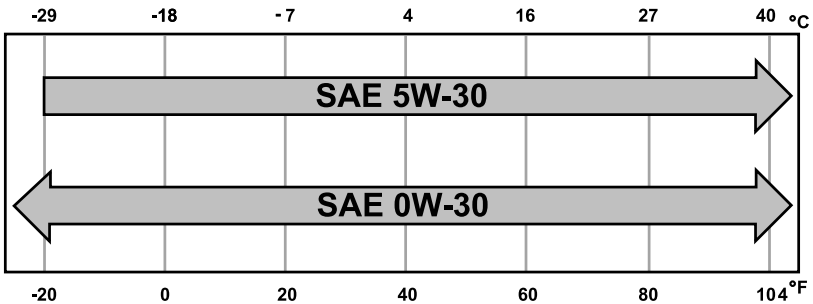

Capacities and Specifications

Engine Coolant

Capacities

Variant	Quantity
Vehicles with auxiliary heater.	16.4 qt (15.5 L)
Vehicles without auxiliary heater.	14.9 qt (14.1 L)

Materials

Name	Specification
Motorcraft® Yellow Prediluted Antifreeze/ Coolant(U.S.) Motorcraft® Yellow Prediluted Antifreeze/Coolant / Antigel/liquide de refroidissement prédilué jaune Motorcraft®(Canada) VC-13DL-G(U.S.) CVC-13DL-G(Canada)	WSS-M97B57-A2

Fuel Tank

Capacities

Variant	Quantity
Vehicles with standard fuel tank.	25.1 gal (95 L)
Vehicles with larger fuel tank.	30.5 gal (115.4 L)

Washer Reservoir

Capacities

Variant	Quantity
All.	4.8 qt (4.5 L)

Capacities and Specifications

Materials

Name	Specification
Motorcraft® Premium Windshield Wash Concentrate with Bitterant(U.S.) Motorcraft® Premium Quality Windshield Washer Fluid / Liquide lave-glace de haute qualité Motorcraft®(Canada) ZC-32-B2(U.S.) CXC-37-A/B/D/F(Canada)	WSS-M14P19-A

Brake System

Materials

Name	Specification
Motorcraft® DOT 4 LV High Performance Motor Vehicle Brake Fluid(U.S.) Motorcraft® DOT 4 LV High Performance Motor Vehicle Brake Fluid / Liquide de frein automobile haute performance DOT 4 LV Motorcraft®(Canada) PM-20(U.S. & Canada)	WSS-M6C65-A2

Rear Axle

Capacities

Variant	Quantity
Rear axle fluid, vehicles with limited slip differential.	2.9 qt (2.72 L)
Rear axle fluid, vehicles with conventional differential.	3.0 qt (2.84 L)
Rear axle friction modifier.	0.1 qt (118 ml)

Note: Ford rear axles contain a synthetic lubricant that does not require changing unless you submerge the axle in water.

Capacities and Specifications

Materials

Name	Specification
Motorcraft® SAE 75W-85 Premium Synthetic Hypoid Gear Lubricant (U.S.) Motorcraft® SAE 75W-85 Premium Synthetic Hypoid Gear Lubricant / Huile synthétique de haute qualité pour engrenages hypoides SAE 75W-85 Motorcraft® (Canada) XY-75W85-QL (U.S. & Canada)	WSS-M2C942-A
Motorcraft® Additive Friction Modifier (U.S.) Motorcraft® Additive Friction Modifier / Additif modificateur de friction Motorcraft® (Canada) XL-3 (U.S.) CXL-3 (Canada)	EST-M2C118-A

Locks

Materials

Name	Specification
Motorcraft® Penetrating and Lock Lubricant (U.S.) Motorcraft® Penetrating Fluid / Liquide dégrissant Motorcraft® (Canada) XL-1 (U.S.) CXC-51-A (Canada)	-

Grease

Materials

Name	Specification
Motorcraft® Premium Long-Life Grease (U.S.) Motorcraft® Premium Long-Life Grease / Graisse longue durée de qualité première Motorcraft® (Canada) XG-1-E1 (U.S. & Canada)	ESA-M1C75-B

Capacities and Specifications

BULB SPECIFICATION CHART

Exterior Lamps

Lamp	Specification	Power (watt)
Body side marker lamp.	W5W	5
Rear lamp and stoplamp.	P21/5W	21/5
High mounted stoplamp.	LED.	LED.
Chassis cab rear marker lamp.	W5W	5
Cornering lamp.	H11	55
Front direction indicator lamp. ¹	PY24W	24
Front direction indicator lamp. ²	3457NAK	21
Front fog lamp.	H8	35
Front side lamp.	LED.	LED.
Front side marker lamp.	LED.	LED.
Daytime running lamps. ¹	LED.	LED.
License plate lamp.	W5W	5
Headlamp low beam and headlamp high beam. ¹	D5S	25
Headlamp low beam and daytime running lamps. ²	H11	55
Headlamp high beam. ²	9005	60
Rear direction indicator lamp.	PY21W	21
Rear fog lamp.	P21W	21
Reversing lamp.	P21W	21
Roof outline marker lamp.	W5W	5

Capacities and Specifications

Lamp	Specification	Power (watt)
Side repeater lamp - high watt.	W16W	16
Side repeater lamp - low watt.	WY5W	5

¹ Vehicles with High Intensity Discharge Headlamps.

² Vehicles with Halogen Headlamps.

Note: *If the LED fails have your vehicle checked as soon as possible.*

Interior Lamps

Lamp	Specification	Power (watt)
Front interior lamp.	W6W	6
Front interior lamp - vehicles with anti-theft alarm.	Festoon	6
Luggage compartment lamp.	211 Festoon	10
Map reading lamp.	W6W	6
Side door entrance lamp.	211 Festoon	10

Note: *If the LED fails have your vehicle checked as soon as possible.*

Connected Vehicle

WHAT IS A CONNECTED VEHICLE

A connected vehicle has technology that allows your vehicle to connect to a mobile network and for you to access a range of features. When used in conjunction with the FordPass app, it could allow you to monitor and control your vehicle further, for example checking the tire pressures, the fuel level and the vehicle location. For additional information, refer to the local Ford website.

CONNECTED VEHICLE REQUIREMENTS

Connected service and related feature functionality requires a compatible vehicle network.

Some remote features require additional service activation. Log in to your Ford account for details. Some restrictions, third party terms and message or data rates may apply.

CONNECTED VEHICLE LIMITATIONS

Evolving technology, cellular networks, or regulations could affect functionality and availability, or continued provision of some features. These changes could even stop some features from functioning.

CONNECTING THE VEHICLE TO A MOBILE NETWORK

What Is the Modem



The modem allows access to a range of features built into your vehicle.

Enabling and Disabling the Modem - Vehicles With: 4.2 Inch Instrument Cluster Display Screen

1. Using the information display controls on the steering wheel, select **Settings**.
2. Select **FordPass Connect**.
3. Select **Connectivity**.
4. Switch connectivity features on or off.

Enabling and Disabling the Modem - Vehicles With: 4.2 Inch Information and Entertainment Display Screen

1. Select **Settings**.
2. Select **Connectivity Features**.
3. Select **Data sharing**.
4. Switch connectivity features on or off.

Enabling and Disabling the Modem - Vehicles With: 8 Inch Information and Entertainment Display Screen

1. Press **Settings**.
2. Press **FordPass Connect**.
3. Press **Connectivity Settings**.
4. Switch connectivity features on or off.

Connecting FordPass to the Modem

1. Make sure that the modem is enabled using the vehicle settings menu.
2. Open the FordPass app on your device and log in.
3. Add your vehicle or select your vehicle if already added.
4. Select the option for vehicle details.
5. Select the option to activate your vehicle.

Connected Vehicle

6. Make sure that the name on the screen matches the name shown in your FordPass account.
 7. Confirm that FordPass account is connected to the modem.
 2. Press **Wi-Fi**.
 3. Switch **Wi-Fi** on.
 4. Press **View Available Networks**.
 5. Select an available Wi-Fi network.
- Note:** Enter the network password to connect to a secure network.

CONNECTING THE VEHICLE TO A WI-FI NETWORK

1. Press **Settings**.

CONNECTED VEHICLE – TROUBLESHOOTING - VEHICLES WITH: MODEM

Symptom	Possible Cause and Resolution
I cannot confirm the connection of my FordPass account to the modem.	<ul style="list-style-type: none">– Modem is not enabled.<ul style="list-style-type: none">• Switch connectivity features on.– Weak network signal.<ul style="list-style-type: none">• Move your vehicle closer to a place where the network signal is not obstructed.

Connected Vehicle

CONNECTED VEHICLE – TROUBLESHOOTING - VEHICLES WITH: SYNC/SYNC 3

Symptom	Possible Cause and Resolution
I cannot connect to a Wi-Fi network.	<ul style="list-style-type: none"> – Password error. <ul style="list-style-type: none"> • Enter the correct network password. – Weak network signal. <ul style="list-style-type: none"> • Move your vehicle closer to the Wi-Fi hotspot or to a place where the network signal is not obstructed. – Multiple access points in range with the same SSID. <ul style="list-style-type: none"> • Use a unique name for your SSID. Do not use the default name unless it contains a unique identifier, for example as part of the MAC address.
The Wi-Fi connection disconnects after successful connection.	<ul style="list-style-type: none"> – Weak network signal. <ul style="list-style-type: none"> • Move your vehicle closer to the Wi-Fi hotspot or to a place where the network signal is not obstructed.
I am close to a Wi-Fi hotspot but the network signal strength is weak.	<ul style="list-style-type: none"> – Obstructed network signal. <ul style="list-style-type: none"> • If your vehicle has a heated windshield, position your vehicle so that the windshield is not facing the Wi-Fi hotspot. • If your vehicle has metallic tinting on the windows but not on the windshield, position your vehicle so that the windshield is facing the Wi-Fi hotspot or open the windows that are facing the hotspot. • If your vehicle has metallic tinting on the windows and the windshield, open the windows that are facing the hotspot. • If your vehicle is in a garage and you have the garage door closed, open the garage door.
I cannot see a network in the list of available networks that I expect to see.	<ul style="list-style-type: none"> – Hidden network. <ul style="list-style-type: none"> • Make the network visible and try again.

Connected Vehicle

Symptom	Possible Cause and Resolution
I cannot see the Wi-Fi hotspot name when I search for Wi-Fi networks on my cell phone or other device.	<ul style="list-style-type: none">- System limitation.<ul style="list-style-type: none">• Make sure Wi-Fi hotspot visibility is on.• The system does not provide a Wi-Fi hotspot at this time.
Software downloads take too long.	<ul style="list-style-type: none">- Weak network signal.<ul style="list-style-type: none">• Move your vehicle closer to the Wi-Fi hotspot or to a place where the network signal is not obstructed.- Wi-Fi hotspot in high demand or has a slow Internet connection.<ul style="list-style-type: none">• Use a more reliable Wi-Fi hotspot.
The system seems to connect to a Wi-Fi network and the signal strength is excellent but the software does not update.	<ul style="list-style-type: none">- No software update available.- Wi-Fi network requires a subscription or acceptance of terms and conditions.<ul style="list-style-type: none">• Test the connection using another device. If the network requires a subscription or acceptance of terms and conditions, contact the network service provider.

Vehicle Wi-Fi Hotspot

CREATING A VEHICLE WI-FI HOTSPOT

You can create a Wi-Fi hotspot in your vehicle and allow devices to connect to it for access to the Internet.

1. Select **Settings**.
2. Select **FordPass Connect**.
3. Select **Vehicle Hotspot**.

Note: The vehicle hotspot default setting is on.

4. Select **Settings**.
5. Select **Edit**.
6. Select **Wi-Fi Visibility**.

Note: The Wi-Fi Visibility default setting is on.

Finding the Wi-Fi Hotspot Name and Password

1. Select **Settings**.
2. Select **FordPass Connect**.
3. Select **Vehicle Hotspot**.
4. Select **Settings**.

Note: The SSID is the hotspot name.

5. Select **View Password**.

Connecting a Device to the Wi-Fi Hotspot

1. On your device, turn on Wi-Fi and select the hotspot from the list of available Wi-Fi networks.
2. When prompted, enter the password.

Purchasing a Data Plan

1. Connect a device to the hotspot.

Note: The vehicle network carrier's portal opens on your device.

2. If the portal does not open on your device, open a website and it redirects to the vehicle network carrier's portal.

Note: Secure websites do not redirect.

Note: If you have an active plan, the system does not redirect to the vehicle network carrier's portal when you connect a device. Visit the vehicle network carrier's website to purchase more data.

Note: If data usage information is available in the vehicle hotspot menu, it is approximate.

Note: If you carry out a master reset, the system does not remove your vehicle from your vehicle network carrier's account. To remove your vehicle from the account, contact your vehicle network carrier.

Note: The vehicle network carrier provides Vehicle Hotspot services, subject to your vehicle network carrier agreement, coverage and availability.

CHANGING THE VEHICLE WI-FI HOTSPOT NAME OR PASSWORD

1. Select **Settings**.
2. Select **FordPass Connect**.
3. Select **Vehicle Hotspot**.
4. Select **Settings**.
5. Select **Edit**.
6. Select **Change SSID Name**.
7. Enter your required SSID.
8. Select **Done**.
9. Select **Change Password**.
10. Enter your required password.
11. Select **Done**.

Audio System

GENERAL INFORMATION

Radio Frequencies and Reception Factors

AM and FM frequencies are established by the Federal Communications Commission (FCC) and the Canadian Radio and Telecommunications Commission (CRTC). Those frequencies are:

- AM: 530-1710 kHz
- FM: 87.9-107.9 MHz

Note: *Listening to loud audio for long periods of time could damage your hearing.*

Radio Reception Factors	
Distance and strength	The further you travel from an AM or FM station, the weaker the signal and the weaker the reception.
Terrain	Hills, mountains, tall buildings, bridges, tunnels, freeway overpasses, parking garages, dense tree foliage and thunderstorms can interfere with the reception.
Station overload	When you pass a ground-based broadcast repeating tower, a stronger signal may overtake a weaker one and result in the audio system muting.

AUDIO UNIT - VEHICLES WITHOUT: SYNC

Switching the Audio Unit On and Off



Adjusting the Volume

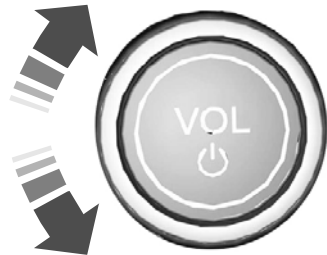

Audio System

Selecting the Radio



Press the button to select radio mode.

Press the button again to display the available radio sources. Repeatedly press the button to scroll through the available radio sources.

Changing Radio Stations

Manual Tuning



E248947

Note: You can change radio stations using the seek buttons.

Note: You can recall radio stations using the numeric preset buttons.

Selecting Media



Press the button to select media mode.

Press the button again to display the available media sources. Repeatedly press the button to scroll through the available media sources.

Scrolling Through the Menu Options



E248947

Selecting a Menu Option



E248946

Returning to the Previous Screen



Seek Up and Next Track Button



Select to skip to the next track.
Press and hold the button to fast forward through the track.

Audio System

Seek Down and Previous Track Button



Select to return to the beginning of a track.

Repeatedly press the button to return to previous tracks.

Press and hold the button to fast rewind.

Pausing or Playing Media



In media mode, press the button to pause playback. Press the button again to resume playback.

In radio mode, press the button to mute the radio. Press the button again to unmute.

Switching the Screen On and Off



System Settings



Sound Settings



Press the button to adjust the sound settings. You can optimize the sound for different seating positions.

You can also activate and set the sensitivity of the speed compensated volume.

Using a Cell Phone



You can make a call from a recent call list, contact list or dial a number.

AUDIO UNIT - VEHICLES WITH: SYNC 3

Switching the Audio Unit On and Off



Adjusting the Volume

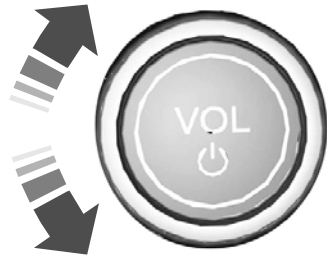

Audio System

Changing Radio Stations

Manual Tuning

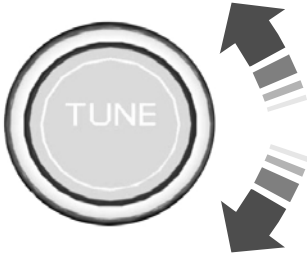

Note: You can change radio stations using the seek buttons.

Note: You can recall radio stations using the preset buttons on the touchscreen.

Seek Up and Next Track Button



Select to skip to the next track.

Press and hold the button to fast forward through the track.

Seek Down and Previous Track Button



Select to return to the beginning of a track.

Repeatedly press the button to return to previous tracks.

Press and hold the button to fast rewind.

Pausing or Playing Media



Select to play a track. Press the button again to pause the track.

In radio mode, press the button to mute the radio. Press the button again to unmute.

Switching the Screen On and Off



Sound Settings



Press the button to adjust the sound settings. You can optimize the sound for different seating positions.

You can also activate and set the sensitivity of the speed compensated volume.

AM/FM RADIO - VEHICLES WITHOUT: SYNC

Selecting a Radio Source



Press the button to display the available radio sources.

Repeatedly press the button to scroll to the desired radio source.

Press the **OK** button.

Station Presets

To store a radio station, press and hold one of the numeric preset buttons.

Note: Six presets can be stored for each radio source.

Audio System

Manually Changing Radio Stations



E248947

Rotate the control to change the frequency.

Automatically Changing Radio Stations



Press to seek the next station up the frequency band.

Press and hold to quickly seek up the frequency band.



Press to seek the next station down the frequency band.

Press and hold to quickly seek down the frequency band.

Selecting a Station from the List

Press the **OK** button to view available stations.

AUDIO UNIT CLOCK AND DATE DISPLAYS - VEHICLES WITHOUT: SYNC

Adjusting the Clock



Press the button.

Select the clock and follow the instructions on the screen.

CONNECTING A BLUETOOTH® DEVICE - VEHICLES WITHOUT: SYNC

Pairing a Device



Press the button.

Select Bluetooth and follow the instructions on the screen.

Note: *When pairing a new device, you can choose to download contacts, set this as the primary device.*

STREAMING BLUETOOTH AUDIO - VEHICLES WITHOUT: SYNC

Selecting a Bluetooth Source



Press the button to display the menu.

Repeatedly press the button to scroll to the Bluetooth device.

Press the **OK** button.



Press the button to play the track. Press the button again to pause the track.

Audio System



Press the button to skip to the next track.

Press and hold the button to fast forward through the track.



Press the button once to return to the beginning of the track.

Repeatedly press the button to return to previous tracks.

Press and hold the button to fast rewind.

Note: *Not all functions are supported by all phones.*

PLAYING MEDIA FROM A USB DEVICE - VEHICLES WITHOUT SYNC

Supported Audio File Formats

You can play audio file formats including MP3, WMA, WAV, M4A, M4B, AAC, and FLAC.

Note: *The NTFS file system is not supported.*

Selecting the USB Device



Press the button to display the menu.

Repeatedly press the button to scroll to your USB device.

Press the **OK** button.

Playing from the USB Device



Press the button to play a track. Press the button again to pause the track.



Press the button to skip to the next track.

Press and hold the button to fast forward through the track.



Press the button once to return to the beginning of a track.

Repeatedly press the button to return to previous tracks.

Press and hold the button to fast rewind.

Sorting by Categories

You can also sort and play music by specific categories, for example artist or album.

Press the **OK** button to view the available categories.

USB PORT

 **WARNING:** Driving while distracted can result in loss of vehicle control, crash and injury. We strongly recommend that you use extreme caution when using any device that may take your focus off the road. Your primary responsibility is the safe operation of your vehicle. We recommend against the use of any hand-held device while driving and encourage the use of voice-operated systems when possible. Make sure you are aware of all applicable local laws that may affect the use of electronic devices while driving.

USB Ports could be in the following locations:

- In the instrument panel storage bin.
- On the instrument panel below the climate controls.

The USB port allows you to plug in media playing devices, memory sticks and charge devices. See **General Information** (page 383).

The audio extension cable must be long enough to allow the device to be safely stored when your vehicle is moving.

Audio System

USING VOICE RECOGNITION

Phone Voice Service

This system allows you to use the voice recognition features of your phone and focus on your driving.



Press the voice control button on the steering wheel.

Note: *This only works when connected via Bluetooth®. See **Connecting a Bluetooth® Device** (page 380).*

Note: *When using voice recognition use the language set on the device.*

Note: *We recommend that you check your data plan before using your phone voice service through the system. Using them could result in additional charges.*

GENERAL INFORMATION

SYNC is an in-vehicle communications system that works with your Bluetooth enabled cellular phone and portable media player. This allows you to:

- Make and receive calls.
- Access and play music from your portable music player.
- Use 911 Assist or Emergency Assistance and applications via SYNC AppLink.*
- Access phonebook contacts and music using voice commands.
- Stream music from your connected phone.
- Text message.
- Use the advanced voice recognition system.
- Charge your USB device (if your device supports this).

*These features are not available in all markets and may require activation. Available AppLink enabled apps vary by market.

Make sure that you review your device's manual before using it with SYNC.

Support

SYNC support is available at your regional Ford website. See **SYNC™ Troubleshooting** (page 391).

SYNC Owner Account

Why do I need a SYNC owner account?

- Essential for keeping up with the latest software downloads available for SYNC.
- Access to customer support for any questions you may have.

Driving Restrictions

For your safety, certain features are speed-dependent and restricted when your vehicle is traveling over 3 mph (5 km/h).

Safety Information



WARNING: Driving while distracted can result in loss of vehicle control, crash and injury. We strongly recommend that you use extreme caution when using any device that may take your focus off the road. Your primary responsibility is the safe operation of your vehicle. We recommend against the use of any hand-held device while driving and encourage the use of voice-operated systems when possible. Make sure you are aware of all applicable local laws that may affect the use of electronic devices while driving.

When using SYNC:

- Do not operate playing devices if the power cords or cables are broken, split or damaged. Place cords and cables out of the way, so they do not interfere with the operation of pedals, seats, compartments or safe driving abilities.
- Do not leave playing devices in your vehicle during extreme conditions as it could cause them damage. See your device's manual for further information.
- Do not attempt to service or repair the system. See an authorized dealer.

Privacy Information

When a cellular phone is connected to SYNC, the system creates a profile within your vehicle that is linked to that cellular phone. This profile is created in order to offer you more cellular features and to operate more efficiently. Among other things, this profile may contain data about your cellular phone book, text messages

(read and unread), and call history, including history of calls when your cellular phone was not connected to the system. In addition, if you connect a media device, the system creates and retains an index of supported media content. The system also records a short development log of approximately 10 minutes of all recent system activity. The log profile and other system data may be used to improve the system and help diagnose any problems that may occur.

The cellular profile, media device index, and development log will remain in the vehicle unless you delete them and are generally accessible only in the vehicle when you connect the cellular phone or media player. If you no longer plan to use the system or the vehicle, we recommend you perform a Master Reset to erase all stored information.

No one can access system data without special equipment and access to the vehicle's SYNC module. Ford Motor Company and Ford of Canada will not access the system data for any purpose other than as described absent consent, a

court order, or where required by law enforcement, other government authorities, or other third parties acting with lawful authority. Other parties may seek to access the information independently of Ford Motor Company and Ford of Canada. For further privacy information, see the section on 911 Assist. See **SYNC™ Applications and Services** (page 387).

USING VOICE RECOGNITION

This system helps you control many features using voice commands. This allows you to keep your hands on the wheel and focus on what is around you.

Initiating a Voice Session



Press the voice button. A list of available voice commands appears in the display.

Global Voice Commands

These voice commands are always available. You can say them at any time.

Global voice commands	
Help	Gives you available commands you can use on the current screen.
List of Commands	Gives you a list of possible voice commands.
Cancel	This command ends the voice session. You can also cancel a session by pressing seek up, seek down, or holding the voice button for two or more seconds.

Helpful Hints

- Make sure the interior of your vehicle is as quiet as possible. Wind noise from open windows and road vibrations may prevent the system from correctly recognizing spoken commands.
- Before giving a voice command, wait for the system announcement to finish, followed by a single tone. Any command spoken before this does not register with the system.
- Speak naturally, without long pauses between words.
- You can interrupt the system at any time while it is speaking by pressing the voice button. You can cancel a voice session by pressing and holding the voice button.

System Interaction and Feedback

The system provides feedback through audible tones, prompts, questions and spoken confirmations depending on the situation and the chosen level of interaction. You can customize the voice recognition system to provide more or less instruction and feedback.

The default setting is to a higher level of interaction in order to help you learn to use the system. You can change these settings at any time.

Adjusting the Interaction Level



Press the voice button. When prompted, say:

Voice Command	Action and Description
Interaction Mode Standard	Provides more detailed interaction and guidance. (Recommended for first time users.)
Interaction Mode Advanced	Provides less audible interaction and guidance.

Phone Confirmation

Using phone confirmations the system asks you to verify before placing any calls.

To adjust this setting press the voice button, when prompted say:

Voice Command	Action and Description
Phone Confirmation Off	When enabled, this feature will prompt you to confirm any voice initiated call command prior to the call being placed.
Phone Confirmation On	The system will make a best guess; you may still occasionally be asked to confirm settings.

USING SYNC™ WITH YOUR PHONE

Hands-free calling is one of the main features of SYNC. While the system supports a variety of features, many are dependent on your cellular phone's functionality. At a minimum, most cellular phones with Bluetooth wireless technology support the following functions:

- Answering an incoming call.
- Ending a call.
- Dialing a number.
- Redialing.
- Call waiting notification.
- Caller identification.

Other features, such as text messaging using Bluetooth and automatic phonebook download, are phone-dependent features.

Pairing a Phone

Wirelessly pairing your phone with SYNC allows you to make and receive hands-free calls.

Note: *Make sure to switch on the ignition and the radio. Shift the transmission into park (P) for automatic transmission or neutral (N) for manual transmission.*

Using the Audio System

Note: *To scroll through the menus, press the up and down arrows on your audio system.*

1. Make sure to switch on your phone's Bluetooth feature before starting the search. See your device's manual if necessary.
2. Press the **Settings** button.
3. Select Bluetooth from the menu.
4. Press the **OK** button.
5. Select the option to add. This starts the pairing process.

6. When a message to begin pairing appears in the audio display, search for SYNC on your device.

Depending on your phone's capability and your market, the system may prompt you with questions, such as setting the current phone as the primary phone and downloading your phonebook.

Using Voice Commands



Make sure to switch on your phone's Bluetooth feature before starting the search. See your device's manual if necessary.

Press the voice button and when prompted say:

Voice Command	Action and Description
Pair Phone	Follow the instructions on the audio display.

Phone Voice Commands



Press the voice button. You can do things like place a phone call and access text messages.

When prompted, say a command. See the following table for examples of commands.

Voice Command
___ List of Commands
Help
Call ___
Dial ___
Text Messages

__ is a dynamic listing, meaning that it could be the name of anything, such as a contact or phone number.

Phone Controls

Use the phone buttons on your steering wheel to answer, reject, or hang up a call.

Accessing Features through the Phone Menu

You can access your call history, phonebook, sent text messages, as well as access phone and system settings.

1. Press the **PHONE** button to enter the phone menu.
2. Scroll through the menu to view contacts, text messages, and the phone dialer.

SYNC™ APPLICATIONS AND SERVICES

- 911 Assist: Can alert 911 in the event of an emergency.
- SYNC AppLink: Allows you to connect to and use certain applications (if your phone is compatible).

These features may require activation. Available AppLink enabled apps vary by market.

911 Assist



WARNING: Unless the 911 Assist setting is set on before a crash, the system will not dial for help which could delay response time, potentially increasing the risk of serious injury or death after a crash.



WARNING: Do not wait for 911 Assist to make an emergency call if you can do it yourself. Dial emergency services immediately to avoid delayed response time which could increase the risk of serious injury or death after a crash. If you do not hear 911 Assist within five seconds of the crash, the system or phone may be damaged or non-functional.



WARNING: Always place your phone in a secure location in your vehicle so it does not become a projectile or get damaged in a crash. Failure to do so may cause serious injury to someone or damage the phone which could prevent 911 Assist from working properly.

Note: The SYNC 911 Assist feature must be set on before the incident.

Note: The SYNC 911 Assist feature only operates in the U.S., Canada or in a territory in which 911 is the emergency number.

Note: Before setting this feature on, make sure that you read the 911 Assist Privacy Notice later in this section for important information.

Note: If any user switches 911 Assist to on or off, that setting applies for all paired phones. If 911 Assist is switched off, either a voice message plays or a display message or an icon comes on when your vehicle is started and after a previously paired phone connects.

Note: Every phone operates differently. While SYNC 911 Assist works with most cellular phones, some may have trouble using this feature.

If a crash deploys an airbag (excluding knee airbags and rear inflatable safety belts [if equipped]) or activates the fuel pump shut-off, your SYNC-equipped vehicle may be able to contact emergency services by dialing 911 through a paired and connected Bluetooth-enabled phone.

See **Supplementary Restraints System** (page 50). Important information about airbag deployment is in this chapter.

See **Roadside Emergencies** (page 249). Important information about the fuel pump shut-off is in this chapter.

Setting 911 Assist On or Off

Press the Settings button then select:

Menu Item	Action and Description
911 Assist	Select the desired option, on or off.

To make sure that 911 Assist works properly:

- SYNC must be powered and working properly at the time of the incident and throughout feature activation and use.
- The 911 Assist feature must be set on before the incident.
- You must pair and connect a Bluetooth enabled and compatible cell phone to SYNC.
- A connected Bluetooth enabled phone must have the ability to make and maintain an outgoing call at the time of the incident.
- A connected Bluetooth enabled phone must have adequate network coverage, battery power and signal strength.
- The vehicle must have battery power and be located in the U.S., Canada or in a territory in which 911 is the emergency number.

In the Event of a Crash

Not all crashes deploy an airbag or activate the fuel pump shut-off (the triggers for 911 Assist). If a connected cell phone sustains damage or loses its connection to SYNC during a crash, SYNC searches for and tries to connect to a previously paired cell phone; SYNC then attempts to call the emergency services.

Before making the call:

- SYNC provides a short window of time (about 10 seconds) to cancel the call. If you fail to cancel the call, SYNC attempts to dial 911.
- SYNC says the following, or a similar message: "SYNC will attempt to call 911, to cancel the call, press Cancel on your screen or press and hold the phone button on your steering wheel".

If you do not cancel the call, and SYNC makes a successful call, a pre-recorded message plays for the 911 operator, and then the occupant(s) in your vehicle are able to talk with the operator. Be prepared to provide your name, phone number and location immediately, because not all 911 systems are capable of receiving this information electronically.

911 Assist May Not Work If

- Your cellular phone or 911 Assist hardware sustains damage in a crash.
- The vehicle's battery or the SYNC system has no power.
- The phone(s) thrown from your vehicle are the ones paired and connected to the system.

911 Assist Privacy Notice

When you switch on 911 Assist, it may disclose to emergency services that your vehicle has been in a crash involving the deployment of an airbag or activation of the fuel pump shut-off. Certain versions or updates to 911 Assist may also be capable of electronically or verbally disclosing to 911 operators your vehicle location or other details about your vehicle or crash to assist 911 operators to provide the most appropriate emergency services. If you do not want to disclose this information, do not switch the feature on.

SYNC Mobile Apps

The system enables voice and steering wheel control of SYNC AppLink enabled smartphone apps. When an app is running through AppLink, you can control main features of the app through voice commands and steering wheel controls.

Note: You must pair and connect your smartphone to SYNC to access AppLink.

Note: Android users need to connect the phone to SYNC using Bluetooth.

Note: For information on available apps, supported smartphone devices and troubleshooting tips please visit the Ford website.

Note: Availability of SYNC AppLink enabled Apps will vary by region.

Note: Make sure you have an active account for the app that you have downloaded. Some apps work automatically with no setup. Other apps want you to configure your personal settings and personalize your experience by creating stations or favorites. We recommend you do this at home or outside of your vehicle.

To Access Using the SYNC Menu

Press the Mobile Apps button to access the menu on-screen. Then select:

Menu Item	Action and Description
Find Mobile Apps	Scroll through the list of available applications and select a particular app.

Note: If you cannot find a compatible SYNC AppLink app, make sure the required app is running on the mobile device.

To Access Using Voice Commands

Press the voice button, then when prompted say:

Voice Command	Action and Description
Mobile Applications	Say the name of the application after the tone. The app should start. When an app is running through SYNC, you can press the voice button and speak commands specific to the app, for example "Play Playlist Road Trip".
List Applications	SYNC lists all of the currently available mobile apps.
Find Applications	Searches your connected mobile device for SYNC-compatible mobile apps.
Help	Use this command to discover the available voice commands.

App Permissions

App permissions are organized by groups. You can grant these group permissions individually. You can change a permission group status any time when not driving, by using the settings menu.

When you launch an app using SYNC, the system may ask you to grant certain permissions, for example:

- To allow your vehicle to provide vehicle information to the app such as, but not limited to: Fuel level, fuel economy, fuel consumption, engine speed, rain sensor, odometer, VIN, external temperature, gear position, tire pressure, and head lamp status.
- To allow your vehicle to provide driving characteristic information such as, but not limited to: MyKey, seatbelt status, engine revolutions per minute, gear position, braking events, steering wheel angle, and accelerator pedal position.
- To allow your vehicle to provide location information, including: GPS and speed.
- To allow the app to send push notifications using the vehicle display and voice capabilities while running in a background state. Push notifications may be particularly useful for news or location based apps.

Note: *You only need to grant permissions the first time you use an app with SYNC.*

Note: *Ford is not responsible or liable for any damages or loss of privacy relating to usage of an app, or dissemination of any vehicle data that you approve Ford to provide to an app.*

Enabling SYNC Mobile Apps

In order to enable mobile apps, SYNC requires user consent to send and receive app authorization information and updates using the data plan associated with the connected device.

Data is sent to Ford in the United States through the connected device. The information is encrypted and includes, for example, the vehicle identification number of your vehicle, the SYNC module serial number, odometer, enabled apps, usage statistics and debugging information. Updates may take place.

Note: *You must enable mobile apps for each connected device the first time you select a mobile app using the system.*

Note: *Standard data rates apply. Ford is not responsible for any additional charges you may receive from your service provider, when your vehicle sends or receives data through the connected device. This includes any additional charges incurred due to driving in areas when roaming out of a home network.*

USING SYNC™ WITH YOUR MEDIA PLAYER

SYNC supports digital media sources including: iPod, Bluetooth devices, and most USB drives. SYNC also supports audio formats, such as MP3, WMA, WAV and ACC.

Media Sources

The **AUX** or **MEDIA** button allows you to view and select available media sources.

Press the **AUX** or **MEDIA** button to view your sources. Use the directional arrows and OK button to select your source. You can also use the steering wheel audio controls.

Audio Voice Commands



Press the voice button. You can do things like play a specific song or album, or tune to a radio station. When prompted, say a command. See the following table for example commands. Not all commands may be available on your vehicle.

Command
___ List of Commands
Help
Pause
Play
AM ___
FM ___
CD Player
Sirius Channel ___
USB
Bluetooth Audio

___ is a dynamic listing, meaning that it could be the name of anything, such as an artist, station, or media source.

SYNC™ TROUBLESHOOTING

Your SYNC system is easy to use. However, should questions arise, see the tables below.

Use your regional Ford website at any time to check your phone's compatibility, register your account and set preferences as well as access a customer representative via an online chat (during certain hours).

Market	Website(s)
North America	www.SYNCMyRide.com www.SYNCMyRide.ca www.sync-maroute.ca

Phone issues		
Issue	Possible cause(s)	Possible solution(s)
There is excessive background noise during a phone call.	The audio control settings on your phone may be affecting SYNC performance.	Review your phone's manual about audio adjustments.
During a call, I can hear the other person but they cannot hear me.	This may be a possible phone malfunction.	Try turning off the device, resetting the device, removing the device's battery, then trying again.
SYNC is not able to download my phonebook.	This is a phone-dependent feature.	Go to the website to review your phone's compatibility.

SYNC™

Phone issues		
Issue	Possible cause(s)	Possible solution(s)
	This may be a possible phone malfunction.	<p>Try turning off the device, resetting the device or removing the device's battery, then trying again.</p> <p>Try pushing your phonebook contacts to SYNC by using the Add Contacts feature.</p> <p>Use the SYNCmyphone feature available on the website.</p>
The system says Phonebook Downloaded but the phonebook in SYNC is empty or missing contacts.	This may be a limitation on your phone's capability.	<p>Try pushing your phonebook contacts to SYNC by using the Add Contacts feature.</p> <p>If the missing contacts are stored on your SIM card, try moving them to the device memory.</p> <p>Remove any pictures or special ring tones associated with the missing contact.</p> <p>Depending upon your phone, you may have to grant SYNC permission to access your phonebook contacts. Make sure to confirm when prompted by your phone during the phonebook download.</p>
I am having trouble connecting my phone to SYNC.	This is a phone-dependent feature.	<p>Go to the website to review your phone's compatibility.</p> <p>Try turning off the device, resetting the device or removing the device's battery, then trying again.</p>

SYNC™

Phone issues		
Issue	Possible cause(s)	Possible solution(s)
	This may be a possible phone malfunction.	<p>Try deleting your device from SYNC, deleting SYNC from your device and trying again.</p> <p>Check the security and auto accept and prompt always settings relative to the SYNC Bluetooth connection on your phone.</p> <p>Update your device's firm-ware.</p> <p>Turn off the Auto phone-book download setting.</p>
Text messaging is not working on SYNC.	<p>This is a phone-dependent feature.</p> <p>This may be a possible phone malfunction.</p>	<p>Go to the website to review your phone's compatibility.</p> <p>Try turning off the device, resetting the device or removing the device's battery, then trying again.</p>
I cannot return to the Phone menu when selecting a contact.	You are on the Select a Character screen.	Press the Phone button to return to the Phone menu.

USB and media issues		
Issue	Possible cause(s)	Possible solution(s)
I am having trouble connecting my device.	This may be a possible device malfunction.	<p>Try turning off the device, resetting the device, removing the device's battery, then trying again.</p> <p>Make sure you are using the manufacturer's cable.</p> <p>Make sure you insert the USB cable correctly into the device and the USB port.</p>

SYNC™

USB and media issues		
Issue	Possible cause(s)	Possible solution(s)
		Make sure that the device does not have an auto-install program or active security settings.
SYNC does not recognize my device when I turn on the car.	This is a device limitation.	Make sure you are not leaving the device in your vehicle during very hot or cold temperatures.
Bluetooth audio does not stream.	This is a phone-dependent feature. The device is not connected.	Review the device compatibility chart on the SYNC website to confirm your phone supports the Bluetooth audio streaming function. Make sure you correctly connect the device to SYNC, and that you have pressed play on your device.
SYNC does not recognize music that is on my device.	Your music files may not contain the correct artist, song title, album or genre information. The file may be corrupted. The song may have copyright protection, which does not allow it to play.	Make sure that all song details are populated. Some devices require you to change the USB settings from mass storage to MTP class.
I cannot change the Sirius station.	Sirius Replay is active.	Switch radio bands and return to Sirius or switch the feature off. You can then change the Sirius station using the directional buttons.

Voice command issues		
Issue	Possible cause(s)	Possible solution(s)
SYNC does not understand what I am saying.	<p>You may be using the wrong voice commands.</p> <p>You may be speaking too soon or at the wrong time.</p>	<p>Review the phone voice commands and the media voice commands at the beginning of their respective sections.</p> <p>After pressing the voice icon, wait until after the tone sounds and Listening appears before saying a command. Any command spoken before this does not register with the system.</p>
SYNC does not understand the name of a song or artist.	<p>You may be using the wrong voice commands.</p> <p>You may be saying the name differently than the way you saved it.</p> <p>The system may not be reading the name the same way you are saying it.</p>	<p>Review the media voice commands at the beginning of the media section.</p> <p>Say the song or artist exactly as listed. If you say "Play Artist Prince", the system does not play music by Prince and the Revolution or Prince and the New Power Generation.</p> <p>Make sure you are saying the complete title, such as "California remix featuring Jennifer Nettles".</p> <p>If the song titles are in all CAPS, you have to spell them. LOLA requires you to say "L-O-L-A".</p> <p>Do not use special characters in the title. The system does not recognize them.</p>
SYNC does not understand or is calling the wrong contact when I want to make a call.	You may be using the wrong voice commands.	Review the Phone voice commands at the beginning of the phone section.

SYNC™

Voice command issues		
Issue	Possible cause(s)	Possible solution(s)
	<p>You may be saying the name differently than the way you saved it.</p> <p>The system may not be reading the name the same way you are saying it.</p> <p>Contacts in your phonebook may be very short and similar, or they may contain special characters.</p> <p>Your phonebook contacts may be in CAPS.</p>	<p>Make sure you are saying the contacts exactly as they are listed. For example, if you save a contact as Joe Wilson, say "Call Joe Wilson".</p> <p>Using the SYNC phone menu, open the phonebook and scroll to the name SYNC is having trouble understanding. SYNC will read the name to you, giving you some idea of the pronunciation SYNC is expecting.</p> <p>The system works better if you list full names, such as "Joe Wilson" rather than "Joe".</p> <p>Do not use special characters, such as 123 or ICE, as the system does not recognize them.</p> <p>If a contact is in CAPS, you have to spell it. JAKE requires you to say "Call J-A-K-E".</p>

AppLink issues		
Issue	Possible cause(s)	Possible solution(s)
<p>AppLink Mobile Applications: When I select "Find New Apps," SYNC does not find any applications.</p>	<p>An AppLink capable phone is not connected to SYNC.</p>	<p>Ensure you have a compatible smartphone; an Android with OS 2.3 or higher or an iPhone 3GS or newer with iOS 5.0 or higher. Additionally, ensure your phone is paired and connected to</p>

SYNC™

AppLink issues		
Issue	Possible cause(s)	Possible solution(s)
		SYNC in order to find AppLink-capable apps on your device. iPhone users must also connect to SYNC's USB port with an Apple USB cable.
My phone is connected, but I still cannot find any apps.	AppLink-enabled apps are not installed and running on your mobile device.	Ensure you have downloaded and installed the latest version of the app from your phone's app store. Ensure the app is running on your phone. Some apps require you to register or login on the app on the phone before using them with AppLink. Also, some may have a Ford SYNC setting, so check the app's settings menu on the phone.
My phone is connected, my app(s) are running, but I still cannot find any apps.	Sometime apps do not properly close and re-open their connection to SYNC, over ignition cycles, for example.	Closing and restarting apps may help SYNC find the application if you cannot discover it inside the vehicle. On an Android device, if apps have an Exit or Quit option, select that then restart the app. If the app does not have that option, you can also manually Force Close the app by going to the phone's settings menu, selecting Apps, then finding the particular app and choosing Force stop. Remember to restart the app afterwards, then select Find New Apps on SYNC.

SYNC™

AppLink issues		
Issue	Possible cause(s)	Possible solution(s)
		On an iPhone with iOS7+, to force close an app, double tap the home button then swipe up on the app to close it. Touch the home button again, then select the app again to restart it. After a few seconds, the app should appear in the SYNC Mobile App menu.
My Android phone is connected, my app(s) are running, I restarted them, but I still cannot find any apps.	There is a Bluetooth bug on some older versions of the Android operating system that may cause apps that were found on your previous vehicle drive to not be found again if you have not turned off Bluetooth.	Reset the Bluetooth on your phone by turning it off and then turning Bluetooth back on. If you are in your vehicle, SYNC should be able to automatically re-connect to your phone if you press the Phone button.

SYNC™

AppLink issues		
Issue	Possible cause(s)	Possible solution(s)
My iPhone phone is connected, my app is running, I restarted the app but I still cannot find it on SYNC.	The USB connection to SYNC may need to be reset.	Unplug the USB cable from the phone, wait a moment, and plug the USB cable back in to the phone. After a few seconds, the app should appear in SYNC's Mobile Apps Menu. If not, "Force Close" the application and restart it.
I have an Android phone. I found and started my media app on SYNC, but there is no sound or the sound is very low.	The Bluetooth volume on the phone may be low.	Try increasing the Bluetooth volume of the device by using the device's volume control buttons which are most often found on the side of the device.
I can only see some of the AppLink apps running on my phone listed in SYNC's Mobile Apps Menu.	Some Android devices have a limited number of Bluetooth ports apps can use to connect. If you have more AppLink apps on your phone than the number of available Bluetooth ports, you will not see all of your apps listed in SYNC's mobile apps menu.	Force close or uninstall the apps you do not want SYNC to find. If the app has a "Ford SYNC" setting, disable that setting in the app's settings menu on the phone.

SYNC System Reset
The SYNC system in your vehicle has System Reset feature that can be performed if the function of a SYNC feature is lost. This reset is intended to restore functionality and will not erase any information previously stored in the system (Such as paired devices, phonebook, call history, text messages, or user settings). To perform a System Reset, press and hold the Seek Up (>>) button while pressing and holding the Radio Power button. Release both buttons after 2-3 seconds. Please allow a few minutes for the reset to complete. After a few minutes has passed you can resume using the SYNC system.

GENERAL INFORMATION



WARNING: Driving while distracted can result in loss of vehicle control, crash and injury. We strongly recommend that you use extreme caution when using any device that may take your focus off the road. Your primary responsibility is the safe operation of your vehicle. We recommend against the use of any hand-held device while driving and encourage the use of voice-operated systems when possible. Make sure you are aware of all applicable local laws that may affect the use of electronic devices while driving.

About SYNC

The system allows you to interact with the entertainment, information and communication systems on your vehicle using voice commands and a touchscreen. The system provides easy interaction with audio, phone, navigation, mobile apps and settings.

Note: You can switch the system on and use it for up to an hour without switching the ignition on.

Note: You can use the system after you switch the ignition off for up to 10 minutes or until you open a door.

Note: For your safety, some features are speed-dependent. Their use is limited to when your vehicle speed is less than 3 mph (5 km/h).

Using the Touchscreen

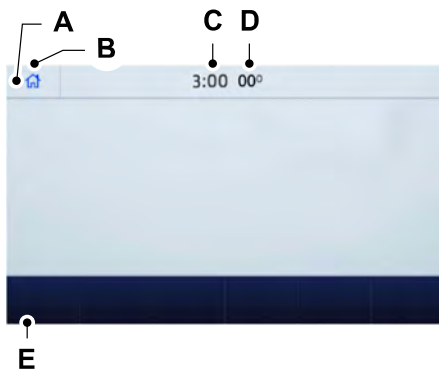

- A Status bar.
- B Home screen.
- C Clock. See **Settings** (page 427).
- D Outside air temperature.
- E Feature bar.

Status Bar



Cell phone microphone muted.



Audio system muted.



Software update installed.



Wi-Fi connected.



Cell phone roaming.



Text message received.



Automatic crash notification system off.



Cell phone network signal strength.



Vehicle data sharing on.



Vehicle location sharing on.



Vehicle data and vehicle location sharing on.



Wireless charger active.

Feature Bar



Select to use the radio, a USB, a media player or a Bluetooth device. See **Entertainment** (page 408).



Select to adjust climate settings



Select to make calls and access the phonebook on your cell phone. See **Phone** (page 418).



Select to use the navigation system. See **Navigation** (page 419).



Select to search for and use compatible apps on your iOS or Android device. See **Apps** (page 425).



Select to adjust system settings. See **Settings** (page 427).

Cleaning the Touchscreen

See **Cleaning the Interior** (page 305).

Updating the System

Updating the System Using a USB Drive

Downloading an Update

1. Go to the SYNC update page on the local Ford website.
2. Download the update.

Note: *The website notifies you if an update is available.*

3. Insert a USB drive into your computer.

Note: *The USB drive needs to be empty and meet the minimum requirements detailed on the website.*

4. Follow the instructions provided to download the update to the USB drive.

Installing an Update

Note: *You can use the system when an installation is in progress.*

1. Disconnect all other USB devices from the USB ports.
2. Connect the USB drive with the update to a USB port.

Note: *Installation starts automatically within 10 minutes.*

Updating the System Using a Wi-Fi Network Connection

Connecting to a Wi-Fi Network



Select the settings option on the feature bar.

1. Select **Automatic Updates**.
2. Select **System Wi-Fi**.
3. Switch **System Wi-Fi** on.
4. Select **Available Wi-Fi Networks**.
5. Select an available Wi-Fi network.

Note: *Enter the network password to connect to a secure network.*

Switching Automatic System Updates On



Select the settings option on the feature bar.

1. Select **Automatic Updates**.
2. Switch **Automatic System Updates** on.

The system is now set to check for and receive system updates when it is connected to a Wi-Fi network.

Note: You can use the system when a download is in progress.

Note: If the system is disconnected from the Wi-Fi network when a download is in progress, the download continues the next time the system is connected to a Wi-Fi network.

Additional Information and Assistance

For additional information and assistance, we recommend that you contact an authorized dealer or refer to the local Ford website.

USING VOICE RECOGNITION

The system allows you to interact with the entertainment, information and communication systems on your vehicle using voice commands. This allows you to keep your hands on the steering wheel and focus on what is in front of you.



Press the voice control button on the steering wheel and wait for the voice prompt.

Note: Press the voice control button again to interrupt a voice prompt and begin speaking.

Note: Turn the volume control when a voice prompt plays to adjust the volume.

Note: Press and hold the voice control button on the steering wheel to use Siri on your iOS device.

The following voice commands are designed to help you from any screen:

- **List of Commands**
- **Help**

The following tables list some of the more frequently used voice commands. For a complete list of voice commands, refer to our website.

General

Voice Command	Description
___ List of Commands	Get a list of voice commands for a specific feature. ¹
Cancel	Cancel an active voice session.
___ Help	Get a list of voice commands for a specific feature. ¹
Go back	Return to the previous screen.
Main Menu	Go to the main menu.

SYNC™ 3

Voice Command	Description
Next Page	Go to the next page.
Previous Page	Go to the previous page.

¹ Add the name of the feature to the command.

Entertainment

Audio Source

Voice Command	Description
Radio	Use the radio.
CD Player	Use the CD player.
Bluetooth Stereo	Use a Bluetooth device.
USB	Use a USB or media player.

Radio

Voice Command	Description
AM	Listen to AM radio.
AM ____	Tune to a specific AM frequency. ¹
Sirius Channel ____	Listen to SiriusXM radio. ²
FM	Listen to FM radio.
FM ____	Tune to a specific FM frequency. ¹

¹ Add the radio frequency to two decimal places to the command.

² You can say the Sirius channel name or number such as "Sirius Channel 16" or "Sirius The Pulse".

SYNC™ 3

USB and Media Player

Voice Command	Description
Play Album ___	Play your music by category. ¹
Play Artist ___	
Play Genre ___	
Play Playlist ___	
Play Song ___	
Play Audiobook ___	
Play Podcast ___	
Browse All Albums	Browse music on a USB device.
Browse All Artists	
Browse All Audiobooks	
Browse All Genres	
Browse All Playlists	
Browse All Podcasts	
Browse All Songs	
Browse Album ___	Browse your music by category on a USB device. ¹
Browse Artist ___	
Browse Audiobook ___	
Browse Genre ___	
Browse Playlist ___	
Browse Podcast ___	

¹ Add an album name, artist name, audiobook name, genre name, playlist name, podcast name or track name to the command. Say the name exactly as it appears on your device.

Climate (If Equipped)

You can control the temperature of the vehicle using voice commands.

___ is a dynamic listing, meaning that for climate voice commands it can be the desired degrees for the temperature setting.

SYNC™ 3

To adjust the temperature, say:

Voice command	Description
Set Temperature ___	Adjust the temperature between 60–85°F (15.5–29.5°C).

Phone

Voice Command	Description
Pair Phone	Pair a cell phone or Bluetooth enabled device.
Redial	Redial the last number that you dialed.
Dial ___	Dial a number. ¹
Call ___	Call a specific contact from your phonebook. ²
Call ___ ___	Call a specific contact from your phonebook at a specific location. ³
Listen to Message	Listen to a text message.
Listen to Message ___	Listen to a specific text message from a list of text messages.
Reply to Message	Reply to the last text message.

¹ Add the number you want to dial to the command.

² Add a contact name from your phonebook to the command. Say the first and last name of your contact exactly as it appears on your device.

³ Add a contact name and location from your phonebook to the command. Say the first and last name of your contact exactly as it appears on your device.

Navigation (If Equipped)

Setting a Destination

Voice Command	Description
Find an Address	Enter a destination address. When prompted, provide the house number, the street and city.
Find a Place	Search for a point of interest by name or by category.
Find the Next ___	Search for a nearby point of interest by category. ¹
Find a POI Category	Search for a point of interest category. ¹
Drive Home	Set your saved home address as your destination.
Drive to Work	Set your saved place of work as your destination.
Show Previous Destinations	Display and select from a list of previous destinations.
Show Favorites	Display and select from a list of favorite destinations.

¹ Add a point of interest category or the name of a major brand or chain to the command.

Route Guidance

Voice Command	Description
Cancel Route	Cancel the current route.
Detour	Select an alternate route.
Repeat Instruction	Repeat the last guidance prompt.
Show Route	Display an overview of the route.
Show Traffic	Display a list of traffic events on your route.
Show Map	Display the map on the touchscreen.
North Up	Display a two-dimensional map with north toward the top of the touchscreen.
Heading Up	Display a two-dimensional map with the direction you are traveling toward the top of the touchscreen.
Show 3D	Display a three-dimensional map with the direction you are traveling toward the front.

SYNC™ 3

Apps

General

Voice Command	Description
Mobile Applications	Start an app. The system prompts you for the app name.
List Applications	Get a list of apps running on your device.
Find Applications	Search and connect to apps running on your device.

Active App

Voice Command	Description
___ Help	Get a list of voice commands for a specific app. ¹
Exit ___	Close an app. ¹

¹Add an app name to the command.

SiriusXM Traffic and Travel Link (If Equipped)

Voice command	Description
Show Traffic	Displays a list of traffic incidents.
Show Weather Map	Displays the current weather map.
Show Fuel Prices	Displays a list of fuel prices.
Show 5 Day Forecast	Displays the 5 day weather forecast.

Voice Settings

Voice Command	Description
Voice Settings	Go to the voice settings menu.
Interaction Mode Novice	Switch long voice prompts on.
Interaction Mode Advanced	Switch short voice prompts on.
Phone Confirmation On	Switch call confirmation on. The system prompts you to confirm before making a call.
Phone Confirmation Off	Switch call confirmation off. The system does not prompt you to confirm before making a call.
Voice Command Lists On	Switch the display of voice commands on.
Voice Command Lists Off	Switch the display of voice commands off.

Automatic Blower Motor Speed Reduction

If necessary, the system decreases the blower motor speed when you are using voice commands to reduce the amount of background noise in your vehicle. It returns to normal when you are done.

Switching Automatic Blower Motor Speed Reduction Off

Simultaneously press the **A/C** and recirculated air buttons.

ENTERTAINMENT

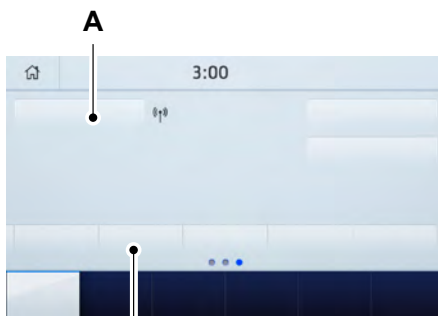

- A Audio source. Select to choose a different audio source.
- B Presets. Swipe left to view more presets.

You can access these options using the touchscreen or voice commands.

SYNC™ 3

Sources

Press this button to select the source of media you want to listen to.

Menu Item	
AM	
FM	
SIRIUS ¹	
CD	
USB	The name of the USB that is plugged in displays here.
Bluetooth Stereo	
Apps	If you have SYNC 3 compatible apps on your connected smart phone, they display here as individual source selections.

¹ This feature may not be available in all markets and requires an active subscription.

AM/FM Radio

Tuning a Station

You can use the tune or seek controls on the radio bezel to select a station.

To tune a station using the touchscreen, select:

Menu Item
Direct Tune

A pop up appears, allowing you to type in the frequency of a station. You can only enter a valid station for the source you are currently listening to.

You can press the backspace button to delete the previously entered number.

Once you have entered the station's call numbers, you can select:

Menu Item	Action and Description
Enter	Press to begin playing the station you have entered.
Cancel	Press to exit without changing the station.

Presets

To set a new preset, tune to the station and then press and hold one of the memory preset buttons. The audio mutes briefly while the system saves the station and then returns.

You may be able to add additional preset pages using the settings option on the feature bar.

SiriusXM® Satellite Radio (If Activated)

Note: *This feature may not be available in all markets and requires an active subscription.*



E234451

SiriusXM satellite radio is a subscription-based satellite radio service that broadcasts a variety of music, sports, news, weather, traffic and entertainment programming. Your factory-installed SiriusXM satellite radio system includes hardware and a limited subscription term that begins on the date of sale or lease of your vehicle. See an authorized dealer for availability.

For more information on extended subscription terms (a service fee is required), the online media player and a list of SiriusXM satellite radio channels, and other features, please visit www.siriusxm.com in the United States, www.siriusxm.ca in Canada, or call SiriusXM at 1-888-539-7474.

Note: *SiriusXM reserves the unrestricted right to change, rearrange, add or delete programming. This includes canceling, moving or adding particular channels, and its prices, at any time, with or without notice to you. We are not responsible for any such programming changes.*

Note: *This receiver includes the eCos real-time operating system. eCos is published under the eCos License.*

The following buttons are available for SiriusXM:

Menu Item	Action and Description	
Browse	Touch this button to see a list of available stations.	
Direct Tune	A pop-up appears, allowing you to type in the call numbers of a station. Once you enter the stations call numbers, you can select:	
	Enter	The system tunes to the station you select.
	Cancel	You exit the pop-up and the current station continues to play.
	You can press the backspace button to delete the previous number.	

SYNC™ 3

Menu Item	Action and Description	
Replay	Replay audio on the current channel. You can replay approximately 45 minutes of audio as long as you remain tuned to the current station. Changing stations erases the previous audio.	
	Live	When you are in replay mode, you are not able to select a different preset until you return to live audio. Pressing this button returns you to the live broadcast.
ALERT	Save the current song, artist, or team as a favorite. The system alerts you when it plays again on any channel. Selecting this button allows you to enable and edit alerts.	

Memory Presets

To set a preset, tune to the station then press and hold one of the memory preset buttons. The audio mutes briefly while the system saves the station and returns once the station is stored.

You may be able to add additional preset pages using the settings option on the feature bar.

SiriusXM Satellite Radio Reception Factors and Troubleshooting

Potential Reception Issues	
Antenna obstructions	For optimal reception performance, keep the antenna clear of snow and ice build-up and keep luggage and other materials as far away from the antenna as possible.
Terrain	Hills, mountains, tall buildings, bridges, tunnels, freeway overpasses, parking garages, dense tree foliage and thunderstorms can interfere with your reception.
Station overload	When you pass a ground-based broadcast-repeating tower, a stronger signal may overtake a weaker one and the audio system may mute.
Satellite radio signal interference	Your display may show ACQUIRING... to indicate the interference and the audio system may mute.

SYNC™ 3

Troubleshooting Tips		
Message	Cause	Action
Acquiring Signal	Radio requires more than two seconds to produce audio for the selected channel.	No action required. This message should disappear shortly.
Satellite antenna fault SIRIUS system failure	There is an internal module or system failure present.	If this message does not clear shortly, or with an ignition key cycle, your receiver may have a fault. See an authorized dealer for service.
Invalid Channel	The channel is no longer available.	Tune to another channel or choose another preset.
Unsubscribed Channel	Your subscription does not include this channel.	Contact SiriusXM at 1-888-539-7474 to subscribe to the channel, or tune to another channel.
Satellite acquiring signal...	The signal is lost from the SiriusXM satellite or SiriusXM tower to your vehicle antenna.	The signal is blocked. When you move into an open area, the signal should return.
Updating...	Update of channel programming in progress.	No action required. The process may take up to three minutes.
Questions? Call 1-888-539-7474	Your satellite service is no longer available.	Contact SiriusXM at 1-888-539-7474 to resolve subscription issues.
None found. Check channel guide.	All the channels in the selected category are either skipped or locked.	Use the channel guide or the Sirius XM Settings tile to turn off the Lock or Skip function on that station.
SIRIUS Subscription updated	SiriusXM has updated the channels available for your vehicle.	No action required.

Note: HD Radio broadcasts are not available in all markets.

HD Radio™ Information (If Available)

To activate HD radio, please see the Radio Settings in the Settings Chapter. See **Settings** (page 427).

SYNC™ 3

HD Radio technology is the digital evolution of analog AM/FM radio. Your system has a special receiver that allows it to receive digital broadcasts (where available) in addition to the analog broadcasts, it already receives. Digital broadcasts provide a better sound quality than analog broadcasts with free, crystal-clear audio and no static or distortion. For more information, and a guide to available stations and programming, please visit:

Website
www.hdradio.com

When HD Radio is on and you tune to a station broadcasting HD Radio technology, you may notice the following indicators on your screen:



The HD logo is grey when acquiring a digital station, and then changes to orange when digital audio is playing. When this logo is available, you may also see Title and Artist fields on-screen.

The multicast indicator appears in FM mode (only) if the current station is broadcasting multiple digital broadcasts. The highlighted numbers signify available digital channels where new or different content is available. HD1 signifies the main programming status and is available in analog and digital broadcasts. Other multicast stations (HD2 through HD7) are only available digitally.

Note: *There is also an additional feature for stations that have more than 1 HD multicast (For example, HD1 or HD2). The HD logo and Radio text appears as a button. Pressing this button allows you to cycle through all of the HD stations on that specific frequency. For example, if you are on 101.1 and it has HD1, HD2, HD3, pressing the button repeatedly causes the radio to cycle through the HD stations in a cyclic increasing order.*

When HD Radio broadcasts are active, you can access the following functions:

Message	Action and Description
Presets	Allows you to save an active channel as a memory preset. Touch and hold a memory preset slot until the sound returns. There is a brief mute while the radio saves the station. Sound returns when the channel saves. When switching to an HD2 or HD3 memory preset, the sound mutes before the digital audio plays, because the system has to reacquire the digital signal.

Note: *As with any station you save, you cannot access the saved station if your vehicle is outside the station's reception area.*

SYNC™ 3

HD Radio Reception and Station Troubleshooting

Potential Reception Issues	
Reception area	<p>If you are listening to a multicast station and you are on the fringe of the reception area, the station may mute due to weak signal strength.</p> <p>If you are listening to HD1, the system changes back to the analog broadcast until the digital broadcast is available again. However, if you are listening to any of the possible HD2-HD7 multicast channels, the station mutes and stays muted unless it is able to connect to the digital signal again.</p>
Station blending	<p>When the system first receives a station (aside from HD2-HD7 multicast stations), it first plays the station in the analog version. Once the receiver verifies the station is an HD Radio station, it shifts to the digital version. Depending on the station quality, you may hear a slight sound change when the station changes from analog to digital. Blending is the shift from analog to digital sound or digital back to analog sound.</p>

In order to provide the best possible experience, use the contact form to report any station issues found while listening to a station broadcasting with HD Radio technology. Independent entities own and operate each station. These stations are responsible for ensuring all audio streams and data fields are accurate.

Potential Station Issues		
Issues	Cause	Action
Echo, stutter, skip or repeat in audio. Increase or decrease in audio volume.	This is poor time alignment by the radio broadcaster.	No action required. This is a broadcast issue.
Sound fading or blending in and out.	The radio is shifting between analog and digital audio.	No action required. The reception issue may clear up as you continue to drive.
There is an audio mute delay when selecting HD2 or HD3, multicast preset or Direct Tune.	The digital multicast is not available until the HD Radio broadcast is decoded. Once decoded, the audio is available.	No action required. This is normal behavior. Wait until the audio is available.

SYNC™ 3

Potential Station Issues		
Issues	Cause	Action
Cannot access HD2 or HD3 multicast channel when recalling a preset or from a direct tune.	The previously stored multicast preset or direct tune is not available in your current reception area.	No action required. The station is not available in your current location.
Text information does not match currently playing audio.	Data service issue by the radio broadcaster.	Fill out the station issue form. ¹
There is no text information shown for currently selected frequency.	Data service issue by the radio broadcaster.	Fill out the station issue form. ¹

¹ You can find the form here:

Website
http://hdradio.com/stations/feedback

HD Radio Technology manufactured under license from iBiquity Digital Corporation and foreign patents. HD Radio and the HD and HD Radio logos are proprietary trademarks of DTS. The vehicle manufacturer and DTS are not responsible for the content sent using HD Radio technology. Content may be changed, added or deleted at any time at the station owner's discretion.

CD (If Equipped)

Once you select this option, the system returns you to the main audio screen.

The current audio information appears on the screen.

The following buttons are also available:

Button	Function
Browse	You can use the browse button to select a track.
Repeat	Select this button and a small number one displays to indicate the track is set to repeat.

SYNC™ 3

Button	Function
	For MP3 CDs, this button allows you to toggle through repeat off, repeat one track (a small number one displays), and repeat current folder (a small folder displays).
Shuffle	Select the shuffle symbol to have the audio on the disk play in random order.

You can use the forward, reverse, pause or play buttons to control the audio playback.

Bluetooth Stereo or USB

Bluetooth Stereo and USB allow you to access media that you store on your Bluetooth device or USB device such as music, audio books or podcasts.

The following buttons are available for Bluetooth and USB:

Button	Function
Repeat	Pressing the repeat button toggles the repeat setting through three modes: repeat off (button not highlighted), repeat all (button highlighted) and repeat track (button highlighted with a small number one).
Shuffle	Play the tracks in random order.

You can use the forward, reverse, pause or play buttons to control the audio playback.

To get more information about the currently playing track, press the cover art or Info button.

For some devices, SYNC 3 is able to provide 30-second skip buttons when you listen to audio books or podcasts. These buttons allow you to skip forward or backward within a track.

While playing audio from a USB device you can look for certain music by selecting the following:

Button	Function
Browse	If available, displays the list of tracks in the Now Playing playlist.
New Search	This option, which is available under browse, allows you to play all tracks or to filter the available media into one of the below categories.
	Play All

SYNC™ 3

Button	Function
	Playlists
	Artist
	Albums
	Songs
	Genres
	Podcasts
	Audio books
	Composers
A-Z Jump	This button allows you to choose a specific letter to view within the category you are browsing.
Explore Device	If available, this allows you to browse the folders and files on your USB device.

USB Ports



E211463

The USB ports are in the center console or behind a small access door in the instrument panel.

This feature allows you to plug in USB media devices, memory sticks, flash drives or thumb drives, and charge devices if they support this feature.

Select this option to play audio from your USB device.

Apps

The system supports the use of certain audio apps such as iHeartRadio through a USB or Bluetooth enabled device.

Each app gives you different on-screen options depending on the app's content. See **Apps** (page 425).

Supported Media Players, Formats and Metadata Information

The system is capable of hosting nearly any digital media player, including iPod, iPhone, and most USB drives.

Supported audio formats include MP3, WMA, WAV, AAC, and FLAC.

Supported audio file extensions include MP3, WMA, WAV, M4A, M4B, AAC, and FLAC.

SYNC™ 3

Supported USB file systems include: FAT, exFAT, and NTFS.

SYNC 3 is also able to organize the media from your USB device by metadata tags. Metadata tags, which are descriptive software identifiers embedded in the media files, provide information about the file.

If your indexed media files contain no information embedded in these metadata tags, SYNC 3 may classify the empty metadata tags as unknown.

SYNC 3 is capable of indexing up to 50,000 songs per USB device, for up to 10 devices.

PHONE



WARNING: Driving while distracted can result in loss of vehicle control, crash and injury. We strongly recommend that you use extreme caution when using any device that may take your focus off the road. Your primary responsibility is the safe operation of your vehicle. We recommend against the use of any hand-held device while driving and encourage the use of voice-operated systems when possible. Make sure you are aware of all applicable local laws that may affect the use of electronic devices while driving.

Check the compatibility of your device on the regional website.

Pairing Your Cell Phone for the First Time

Go to the settings menu on your cell phone and switch Bluetooth on.



Select the phone option on the feature bar.

1. Select **Add Phone**.

Note: A prompt alerts you to search for your vehicle on your cell phone.

2. Select your vehicle on your cell phone.

Note: A number appears on your cell phone and on the touchscreen.

3. Confirm that the number on your cell phone matches the number on the touchscreen.

Note: The touchscreen indicates that you have successfully paired your cell phone.

4. Download the phonebook from your cell phone when you are prompted.

Note: If you pair more than one cell phone, use the phone settings to specify the primary phone. You can change this setting at any time.

Using Your Cell Phone

Recent Call List

Display and select an entry from a list of previous calls.

Contacts

Display a smart search form to look up your contacts. Use the List button to alphabetically sort your contacts.

Change Phone

Display the list of paired or connected devices that you can select.

Phone Settings

Change ring tones, alerts or pair another phone.

Do Not Disturb

Reject incoming calls and switch ring tones and alerts off.

Phone Keypad

Directly dial a number.

Mute

Mute the microphone when in a call or voice recognition session.

Text Messaging

Setting Text Message Notification

iOS

1. Go to the settings menu on your cell phone.
2. Select Bluetooth.

Using Text Messaging

Menu Item	Description
Hear It	Hear the text message.
View	View the text message.
Call	Call the sender.
Reply	Reply to the text message with a standard text message.

Apple CarPlay (If Equipped)

1. Connect your device to a USB port.
2. Follow the instructions on the touchscreen.

Note: Certain features of the system are not available when you are using Apple CarPlay.

Switching Apple CarPlay Off



Select the settings option on the feature bar.

1. Select **Apple CarPlay Preferences**.
2. Switch **Apple CarPlay** off.

Android Auto (If Equipped)

1. Connect your device to a USB port.

3. Select the information icon to the right of your vehicle.
4. Switch text message notification on.

Android

1. Go to the settings menu on your cell phone.
2. Select Bluetooth.
3. Select the profiles option.
4. Select the phone profile.
5. Switch text message notification on.

2. Follow the instructions on the touchscreen.

Note: You might need to enable Android Auto from the settings menu.

Note: Certain features of the system are not available when you are using Android Auto.

Switching Android Auto Off



Select the settings option on the feature bar.

1. Select **Android Auto**.
2. Switch **Android Auto** off.

NAVIGATION

Note: For more information, refer to our website.



Select the navigation option on the feature bar.

- C Zoom in.
- D Route guidance menu.
- E Destination entry menu.



D

- A Map view menu.
- B Zoom out.

Setting a Destination

Destination Entry Menu

Item	Description
Search	Enter a destination address.
Previous Destinations	Display and select from a list of previous destinations.
Home	Set your saved home address as your destination
Work	Set your saved place of work as your destination.
Favorites	Display and select from a list of favorite destinations.

Setting a Destination Using the Text Entry Screen

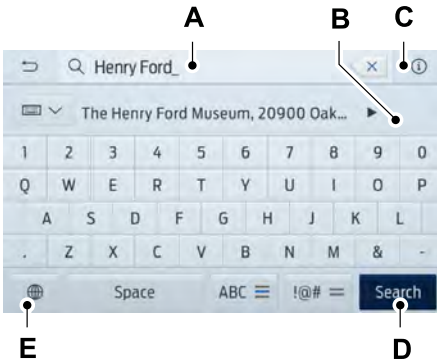

- A Text entry field.
- B Automatic suggestions based on the text you enter.
- C Information icon.
- D Search.
- E Keyboard settings.

Note: Select one of the suggestions to copy the detail to the text entry field.

You can search by entering all or part of the destination, such as the Address, POI Category or Name, Intersection, City, Latitude/Longitude, etc. Tips: If you do not specify a location, the system will use the current vehicle location. You can specify a location by address, city, state or zip code. For additional search support, please visit: support.ford.com.

Note: Press the button in the top right-hand corner of the main map to display estimated time of arrival, remaining travel time or distance to destination.

Setting a Destination Using the Map Screen

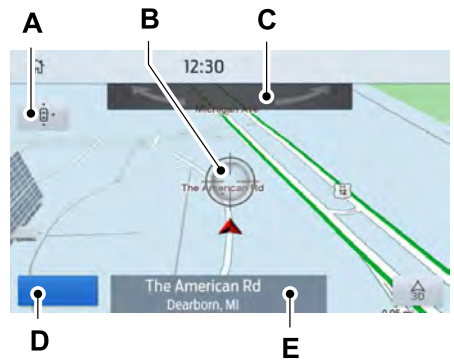

- A Re-center the map.
- B Selected location.
- C 3D map rotation. Swipe left or right.
- D Start route guidance.
- E Destination name.

Select the location on the map.

Select **Start** to begin route guidance.

Changing the Format of the Map

Display the map in one of the following formats:

- A two-dimensional map with the direction you are traveling toward the top of the screen.
- A two-dimensional map with north toward the top of the screen.
- A three-dimensional map with the direction you are traveling toward the front.

Zoom

Display more or less detail on the map.

Note: You can use pinch gestures to zoom in and out. Place two fingers on the screen and move them apart to zoom in. Place two fingers on the screen and bring them together to zoom out.

Route Guidance

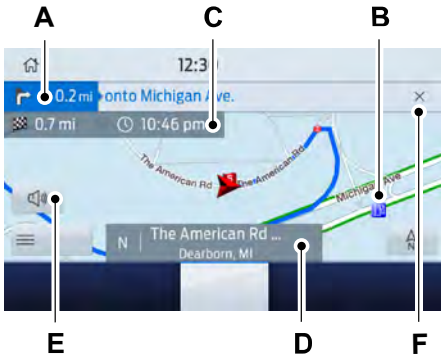

- C Estimated time of arrival, distance to destination or time to destination.
- D Current road.
- E Mute guidance prompts.
- F Cancel route guidance.

Note: To change guidance prompt volume, turn the volume control when a guidance prompt plays.

- A Turn indicator. Select to hear the last voice prompt.
- B Point of interest.

Route Guidance Menu

Menu Item	Description
Screen View	Adjust your map preferences for when route guidance is active.
Full Map	View a full screen map when route guidance is active.
Highway Exit Info	View highway exit information for your current route.
Turn List	View the turn list for your current route. Select a road to avoid it.
Traffic List	You can find the SiriusXM Traffic and Travel Link information by pressing this button. This information requires an active subscription to SiriusXM Traffic and Travel Link. When a route is not active, a list of nearby traffic incidents displays. When a route is active, you can choose to display a list of traffic nearby or on the route.

Menu Item	Description
Navigation Settings	Adjust navigation settings. See Settings (page 427).
Where Am I?	View information about your current location.
Cancel Route	Cancel route guidance.
View Route	View the entire current route on the map.
Detour	View an alternative route compared to your current one.
Edit Waypoints	Change the order or remove waypoints.
Optimize Order	The system determines the order of waypoints for you.
Go	Go to the next screen and start the new route.

Adjusting the Guidance Prompt Volume

Turn the volume control when a guidance prompt plays to adjust the volume.

Note: *If you have inadvertently adjusted the volume to zero, press the turn indicator button to play the last voice prompt and then adjust the volume to the desired level.*

Muting Guidance Prompts



Select the mute option on the screen to mute guidance prompts.

Note: *The system mutes the next and all future guidance prompts.*

Adding Waypoints

You can add a waypoint to a navigation route as a destination along your route. You can add up to five waypoints.

1. Select the search option on the map.
2. Set a destination.
3. Select **Add Waypoint**.
4. Select **Go**.

Canceling Route Guidance



Select the route guidance menu option on the active guidance screen.

Select **Cancel Route**.

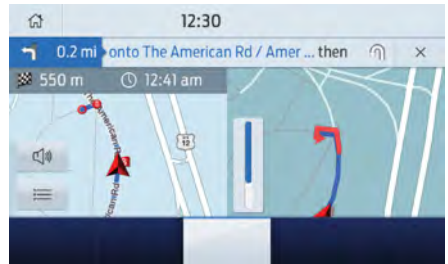

Note: *The route guidance menu option is always in the bottom right-hand corner of the main map.*

cityseeker (If Equipped)

Note: *cityseeker point of interest (POI) information is limited to approximately 1,110 cities (1,049 in the United States, 36 in Canada and 15 in Mexico).*



E225487

cityseeker, when available, is a service that provides more information about certain points of interest such as restaurants, hotels and attractions.

When you have selected a point of interest, the location and information appear, such as address, phone number and a star rating.

Press **More Information** to see a photo, a review, a list of services and facilities, the average room or meal price and the web address. This screen displays the point of interest icons.

For restaurants, cityseeker can provide information such as star rating, average cost, review, handicap access, hours of operation, and website address.

For hotels, cityseeker can provide information such as star rating, price category, review, check-in and checkout times, hotel service icons and website address. Hotel service icons include:

- Restaurant
- Business center
- Handicap facilities
- Laundry
- Refrigerator
- 24 hour room service
- Fitness center
- Internet access
- Pool
- Wi-Fi

Attractions include nearby landmarks, amusement parks, historic buildings and more. cityseeker can provide information such as star rating, reviews, hour of operation and admission price.

SiriusXM Traffic and Travel Link (if Equipped)

SiriusXM Traffic and Travel Link is available on vehicles equipped with navigation and only in select markets. You must activate and subscribe to receive SiriusXM Traffic and Travel Link information. It helps you locate the best gas prices, find movie listings, get current traffic alerts, view the weather map, get accurate ski conditions and see current sports scores.

The system calculates a reasonable efficient route based on available speed limits, traffic, and road conditions. You may know a local short cut that is more efficient at a given time than the route provided by SYNC 3, but you should expect a slight difference in minutes or miles with the SYNC 3 route.

Michelin Travel Guide (if Equipped)

The Michelin travel guide is a service which provides additional information about certain places of interest, for example restaurants, hotels and tourist sites. Points of interest that have Michelin travel guide information display a button to show you more information. Push the button to see the additional information. If you have paired your phone with the system, you can press the phone button to directly establish a call with the selected point of interest.

Navigation Map Accuracy and Updates

HERE is the digital map provider for the navigation application. If you find map data errors, you may report them directly to HERE by going to www.here.com. HERE evaluates all reported map errors and responds with the result of their investigation by e-mail.

The navigation system map data may contain inaccurate or incomplete information due to the passage of time, changing circumstances, sources used and the nature of collecting comprehensive geographic data, any of which may lead to incorrect results. Inaccurate speed limit information, turn restrictions and other road attributes may affect the determined route and associated guidance.

Annual navigation map updates are available for purchase through your dealership. Depending on your purchase agreement, you might be eligible for free Map update. You can choose to download the Map data update onto a USB, order a USB, or use Wi-Fi to deliver automatic updates. To update your Map data over Wi-Fi, your vehicle must be connected to a Wi-Fi access point. Map Data files are large, so it is highly recommended to perform the update when free Wi-Fi is available otherwise high data rates may apply. For USB updates, free map update eligibility, and other details, contact dealers at 1-866-462-8837 in the United States and Canada or 01-800-557-5539 in Mexico or visit our local website for more information.

APPS

The system allows you interact with select mobile apps while keeping your eyes on the road. Voice commands, your steering wheel buttons, or a quick tap on your touchscreen give you advanced control of compatible mobile apps. You can also stream your favorite music or podcasts, share your time of arrival with friends, and keep connected safely.

When you start an app through the system for the first time, you could be asked to grant certain permissions. You can review and change the permissions that you have granted at any time when your vehicle is not moving. We recommend that you check your data plan before using your apps through the system. Using them could result in additional charges. We also recommend that you check the app provider's terms and conditions and privacy policy before using their app. Make sure that you have an active account for apps that you want to use through the system. Some apps will work with no setup. Others require you to configure some personal settings before you can use them.

Note: For more information about available apps, visit catalog.ford.com.

Using Apps on an iOS Device



Select the apps option on the feature bar.

1. If your device is connected via USB, switch Apple CarPlay off. See **Phone** (page 418).
2. Connect your device to a USB port or pair and connect using Bluetooth.
3. If prompted to enable CarPlay, select **Disable**.
4. Start the apps on your device that you want to use through SYNC.

Note: If you close the apps on your device, you will not be able to use them through the system.

5. Select the app that you want to use on the touchscreen.

Note: Connect your device to a USB port if you want to use a navigation app. When using a navigation app, keep your device unlocked and the app open.

Using Apps on an Android Device



Select the apps option on the feature bar.

1. If your device is connected via USB, switch Android Auto off. See **Phone** (page 418).
2. Pair your device. See **Phone** (page 418).
3. Start the apps on your device that you want to use through SYNC.

Note: If you close the apps on your device, you will not be able to use them through the system.

4. Select **Find Mobile Apps**.

Note: The system searches and connects to compatible apps that are running on your device.

5. Select the app that you want to use on the touchscreen.

Note: Mobile Apps on your device use the USB port to establish a connection with SYNC. Some devices may lose the ability to play music over USB when Mobile Apps are enabled.

Using Mobile Navigation on an Android Device

1. Connect your device to a USB port.
2. Switch Android Auto off. See **Phone** (page 418).
3. Switch on **Enable Mobile Apps via USB** in the Mobile Apps Settings tile.

4. Select the apps option on the feature bar.
5. Select the navigation app that you want to use on the touchscreen.

Note: When using a navigation app, keep your device unlocked and the app open.

SiriusXM Traffic and Travel Link (If Equipped)



WARNING: Driving while distracted can result in loss of vehicle control, crash and injury. We strongly recommend that you use extreme caution when using any device that may take your focus off the road. Your primary responsibility is the safe operation of your vehicle. We recommend against the use of any hand-held device while driving and encourage the use of voice-operated systems when possible. Make sure you are aware of all applicable local laws that may affect the use of electronic devices while driving.

Note: SiriusXM Traffic and Travel Link may not be available in all markets.

Note: In order to use SiriusXM Traffic and Travel Link, your vehicle must have navigation.

Note: A paid subscription is required to access and use these features. Go to www.siriusxm.com/travellink for more information.

Note: Visit www.siriusxm.com/traffic and click on Coverage map and details for a complete listing of all traffic areas covered by SiriusXM Traffic and Travel Link.

Note: Neither Sirius nor Ford is responsible for any errors or inaccuracies in the SiriusXM Traffic and Travel Link services or its use in vehicles.

SYNC™ 3

When you subscribe to SiriusXM Traffic and Travel Link, it can help you locate the best gas prices, find movie listings, get

current traffic alerts, view the current weather map, get accurate ski conditions and see scores to current sports games.

Menu Item	Action and Description	
Traffic on Route	Touch these buttons to identify traffic incidents on your route, near your vehicle's current location or near any of your favorite places, if programmed.	
Traffic Nearby		
Fuel Prices	Touch this button to view fuel prices at stations close to your vehicle's location or on an active navigation route.	
Movie Listings	Touch this button to view nearby movie theaters and their show times, if available.	
Weather	Touch this button to view the nearby weather, current weather, or the five-day forecast for the chosen area.	
	Map	Select to see the weather map, which can show storms, radar information, charts and winds.
	Area	Select to choose from a listing of weather locations.
Sports Info	Touch this button to view scores and schedules from a variety of sports. You can also save up to 10 favorite teams for easier access. The score automatically refreshes when a game is in progress.	
Ski Conditions	Touch this button to view ski conditions for a specific area.	

SETTINGS



Press the button to enter the settings menu.



Once you select a tile, press the button next to a menu item to view an explanation of the feature or setting.

Sound

Select this tile to adjust the sound settings.

Clock

Select this tile to adjust the clock settings.

Bluetooth

Select this tile to switch Bluetooth on and off and adjust the settings.

Phone

Select this tile to connect, disconnect, and manage the connected device settings.

Audio

Select this tile to adjust the audio settings.

Driver Assist (If Equipped)

Select this tile to adjust Driver Assist features like Parking Aids, Lane Keeping System, Pedestrian Detection, and Auto-Start-Stop.

Vehicle

Select this tile to adjust vehicle settings like windows, alarm, lighting, and MyKey settings.

FordPass

Select this tile to adjust the FordPass settings.

General

Select this tile to adjust settings like language, measurement units, or to reset the system.

911 Assist (If Equipped)

Select this tile to switch 911 Assist on and off.

Automatic Updates

Select this tile to adjust the automatic update settings.

Mobile Apps

Select this tile to adjust permissions, enable, disable, and update mobile apps.

Display

Select this tile to adjust display settings like brightness and auto dim.

Charge Settings (If Equipped)

Select this tile to adjust the electric vehicle charge settings.

Voice Control

Select this tile to adjust voice control settings like command confirmations and displayed lists.

Navigation (If Equipped)

Select this tile to adjust navigation settings like map preferences and route guidance.

Multi Contour Seats (If Equipped)

Select this tile to adjust the position and massage function of your multi contour seats.

Seats (If Equipped)

Select this tile to adjust the lumbar function of your seats.

Message Center (If Equipped)

Select this tile to view vehicle messages.

Personal Profiles (If Equipped)

Select this tile to adjust recalled memory features when using personal profiles.

Valet Mode (If Equipped)

Select this tile to enable and disable valet mode.

Ambient Lighting (If Equipped)

Select this tile to change the color or intensity of the interior lighting.

SYNC™ 3 TROUBLESHOOTING

Voice Recognition

Symptom	Possible Cause and Resolution
<p>The system does not understand what I am saying.</p>	<ul style="list-style-type: none"> – You are using the wrong voice commands. <ul style="list-style-type: none"> • See Using Voice Recognition (page 402). • For a complete list of voice commands, refer to our website. – You are speaking too soon. <ul style="list-style-type: none"> • Wait for the voice prompt before you speak.
<p>The system does not understand the name of a track or artist.</p>	<ul style="list-style-type: none"> – Device limitation. Bluetooth does not support voice commands. <ul style="list-style-type: none"> • Connect your device to a USB port. • If you have an iOS device, press and hold the voice control button on the steering wheel to use Siri to play specific tracks. – You are using the wrong voice commands. <ul style="list-style-type: none"> • See Using Voice Recognition (page 402). • For a complete list of voice commands, refer to our website. – You are not saying the name exactly as it appears on your device. <ul style="list-style-type: none"> • Say the name of the track or artist exactly as it appears on your device. Spell out any abbreviations in the name. <p>The song or artist name may have some special characters that are not being recognized by the system.</p> – The name contains special characters, for example *, - or +. <ul style="list-style-type: none"> • Rename the files on your device or use the touchscreen to select and play the track.

SYNC™ 3

Symptom	Possible Cause and Resolution
The system does not understand the name of a contact in the phonebook on my device and calls the wrong contact.	<ul style="list-style-type: none"> – You are not saying the name exactly as it appears on your device. <ul style="list-style-type: none"> • Say the first and last name of the contact exactly as it appears on your device. Spell out any abbreviations in the name. – The name contains special characters, for example *, - or +. <ul style="list-style-type: none"> • Rename the contact on your device or use the touchscreen to select and call the contact.
The system does not understand foreign names of contacts in the phonebook on my device.	<ul style="list-style-type: none"> – You are not saying the name exactly as it appears on your device. <ul style="list-style-type: none"> • Say the first and last name of the contact exactly as it appears on your device. The system applies phonetic pronunciation rules of the selected language to the names of contacts in the phonebook on your device. Select the name of the contact on the touchscreen and use the Hear it option to get an idea of how the system expects you to pronounce it.
The system voice prompts and the pronunciation of some words does not seem to be very accurate.	<ul style="list-style-type: none"> – Device limitation. <ul style="list-style-type: none"> • The system uses text-to-speech technology and uses a synthetically generated voice rather than pre-recorded human voice.

USB and Bluetooth Audio

Symptom	Possible Cause and Resolution
I cannot connect my device.	<ul style="list-style-type: none"> – Device malfunction. <ul style="list-style-type: none"> • Disconnect your device. Switch your device off, reset it and try again. – Cable connection issue. <ul style="list-style-type: none"> • Correctly connect the cable to your device and the vehicle USB port. – Incompatible cable. <ul style="list-style-type: none"> • Use the cable recommended by the manufacturer of your device.

SYNC™ 3

Symptom	Possible Cause and Resolution
	<ul style="list-style-type: none"> – Incorrect device settings. <ul style="list-style-type: none"> • Make sure that your device does not have an auto-install program or active security settings. • Check that your device is not set only to charge. – Device lock screen enabled. <ul style="list-style-type: none"> • Unlock your device before connecting it.
The system does not recognize my device.	<ul style="list-style-type: none"> – Device limitation. <ul style="list-style-type: none"> • Do not leave your device in your vehicle during very hot or very cold weather conditions. – Cable connection issue. <ul style="list-style-type: none"> • Correctly connect the cable to your device and the vehicle USB port. – Incompatible cable. <ul style="list-style-type: none"> • Use the cable recommended by the manufacturer of your device.
The system does not understand the name of a track or artist.	<ul style="list-style-type: none"> – Device limitation. Bluetooth does not support voice commands. <ul style="list-style-type: none"> • Connect your device to a USB port. • If you have an iOS device, press and hold the voice control button on the steering wheel to use Siri to play specific tracks.
I cannot stream audio from my Bluetooth device.	<ul style="list-style-type: none"> – Incompatible device. <ul style="list-style-type: none"> • Check the compatibility of your device on our website. – Device not connected. <ul style="list-style-type: none"> • Pair your device. See Phone (page 418). – Media player not running. <ul style="list-style-type: none"> • Start the media player on your device.
The system does not recognize the music on my device.	<ul style="list-style-type: none"> – Missing or incorrect audio file metadata, for example artist, song title, album or genre. <ul style="list-style-type: none"> • Repair the files on your device. – Corrupt files. <ul style="list-style-type: none"> • Repair the files on your device.

SYNC™ 3

Symptom	Possible Cause and Resolution
	<ul style="list-style-type: none"> – Copyright protected files. <ul style="list-style-type: none"> • Use a device that contains files that are not copy-right protected. – Unsupported file format. <ul style="list-style-type: none"> • Repair or convert the files to a supported format. See Entertainment (page 408). – Device indexing required. <ul style="list-style-type: none"> • Re-index your device. See Settings (page 427). – Device lock screen enabled. <ul style="list-style-type: none"> • Unlock your device before connecting it.
Sometimes I cannot hear a track playing on my device.	<ul style="list-style-type: none"> – Device malfunction. <ul style="list-style-type: none"> • Disconnect your device. Switch your device off, reset it and try again.
When I disconnect my iOS device the audio volume is set to maximum.	<ul style="list-style-type: none"> – Device limitation. <ul style="list-style-type: none"> • Turn the volume down on your device
The system does not play the tracks on my USB drive in the correct order.	<p>If the system does not play the tracks on your USB device in the correct order, the following information could help:</p> <ul style="list-style-type: none"> – If you are selecting USB as the audio source when the system is still indexing, SYNC plays tracks sorted alphabetically by file name in the root directory. – If you are selecting USB as the audio source after the system has finished indexing, SYNC plays all tracks sorted alphabetically by the title in the ID3 tag regardless of where they are located. SYNC uses the file name if the title in the ID3 Tag does not exist. – If you are selecting the option to play all tracks from the browsing menu, SYNC plays all tracks sorted alphabetically by the title in the ID3 tag regardless of where they are located. SYNC uses the file name if the title in the ID3 Tag does not exist. – If you are selecting a track when using the explore device option, SYNC plays tracks sorted alphabetically by file name in the folder you have selected. SYNC then plays all tracks in any subfolders in the folder you have selected.

SYNC™ 3

Phone

Symptom	Possible Cause and Resolution
During a call, I can hear excessive background noise.	<ul style="list-style-type: none"> – Incorrect cell phone settings. <ul style="list-style-type: none"> • Check and adjust the audio settings on your cell phone. Refer to your cell phone's user manual.
During a call, I can hear the other person but they cannot hear me.	<ul style="list-style-type: none"> – Cell phone malfunction. <ul style="list-style-type: none"> • Switch your cell phone and Bluetooth on and off and try again. – Cell phone microphone muted. <ul style="list-style-type: none"> • Unmute your cell phone microphone.
During a call, I cannot hear the other person and they cannot hear me.	<ul style="list-style-type: none"> – System restart required. <ul style="list-style-type: none"> • Restart the system. Switch the ignition off and open the door. Close the door and lock the vehicle. Wait until the touchscreen is off and any illuminated USB ports are not illuminated. Unlock the vehicle, switch the ignition on and try again.
I cannot download phonebook.	<ul style="list-style-type: none"> – Incompatible cell phone. <ul style="list-style-type: none"> • Check the compatibility of your cell phone on our website. – Incorrect cell phone settings. <ul style="list-style-type: none"> • Allow the system to retrieve contacts from your cell phone. Refer to your cell phone's user manual. – Incorrect system settings. <ul style="list-style-type: none"> • Switch automatic phonebook download on. See Settings (page 427). – Cell phone malfunction. <ul style="list-style-type: none"> • Switch your cell phone off, reset it and try again.
A message displays suggesting that my phonebook has downloaded but it is empty or it has missing contacts.	<ul style="list-style-type: none"> – Incorrect cell phone settings. <ul style="list-style-type: none"> • Allow the system to retrieve contacts from your cell phone. Refer to your cell phone's user manual. • Check the location of the missing contacts on your cell phone. If they are stored on the SIM card, move them to the cell phone memory. – Incorrect system settings. <ul style="list-style-type: none"> • Switch automatic phonebook download on. See Settings (page 427).

SYNC™ 3

Symptom	Possible Cause and Resolution
I cannot connect my cell phone.	<ul style="list-style-type: none">– Incompatible cell phone.<ul style="list-style-type: none">• Check the compatibility of your cell phone on our website.– Cell phone malfunction.<ul style="list-style-type: none">• Switch your cell phone off, reset it and try again.• Install the latest cell phone firmware.• Delete your device from system and delete SYNC from your device and try again.• Switch automatic phonebook download off. See Settings (page 427).
Text messaging does not work.	<ul style="list-style-type: none">– You did not switch on text message notifications.<ul style="list-style-type: none">• Switch text message notifications on. See Phone (page 418).– Incompatible cell phone.<ul style="list-style-type: none">• Check the compatibility of your cell phone on our website.– Cell phone malfunction.<ul style="list-style-type: none">• Switch your cell phone off, reset it and try again.
I cannot hear text messages.	<ul style="list-style-type: none">– Device message sharing is not enabled.<ul style="list-style-type: none">• Check the permissions on your device to ensure text message sharing is enabled.– Incompatible cell phone.<ul style="list-style-type: none">• Check the compatibility of your cell phone on our website.

SYNC™ 3

Navigation (If Equipped)

Symptom	Possible Cause and Resolution
I cannot enter a street name when I am abroad.	– Incorrect entry method. <ul style="list-style-type: none">• Enter the street name with the country.
The system does not recognize coordinates.	– You are using the wrong coordinates format. <ul style="list-style-type: none">• Use the format <code>##.#####</code>, <code>##.#####</code> (for N/S, E/W). Add a minus before coordinates if the direction is West and keep a positive value if the direction is East, for example 12.5412 means East and -12.5412 means West.

SYNC™ 3

Apps

Symptom	Possible Cause and Resolution
The system cannot find any apps.	<ul style="list-style-type: none">- Incompatible device.<ul style="list-style-type: none">• You will need an Android device with OS 4.3 or higher or an iOS device with iOS 8.0 or higher. Pair and connect your Android device to find AppLink compatible apps. Connect your iOS device to a USB port or pair and connect using Bluetooth.
I have a compatible device and it is correctly connected but the system still cannot find any apps.	<ul style="list-style-type: none">- AppLink compatible apps not installed on your device.<ul style="list-style-type: none">• Download and install the latest version of the app.- AppLink compatible apps not running on your device.<ul style="list-style-type: none">• Start the apps to allow the system to find them and make sure you sign in to any apps if required.- Incorrect app settings.<ul style="list-style-type: none">• Check and adjust the app settings on your device and allow SYNC to access the app if required.
I have a compatible device, it is correctly connected and my apps are running but the system still cannot find any apps.	<ul style="list-style-type: none">- Apps failed to fully close.<ul style="list-style-type: none">• Restart the apps and try again.• If you have an Android device with apps that have an exit or quit option, use this and then restart the apps. Alternatively, use the force stop option in the settings menu on your device.• If you have an iOS device with iOS 7.0 or higher, tap the home button on your device twice and then swipe the app upward to close it.
I have an Android device that is correctly connected, I have restarted my apps and they are running but the system still cannot find them.	<ul style="list-style-type: none">- An issue on some older versions of the Android operating system could result in apps not being found.<ul style="list-style-type: none">• Switch Bluetooth off and on again to force the system to reconnect to your device.

SYNC™ 3

Symptom	Possible Cause and Resolution
I have an iOS device that is correctly connected, I have restarted my apps and they are running but the system still cannot find them.	<ul style="list-style-type: none">– Cable connection issue.<ul style="list-style-type: none">• Disconnect the cable from your device, wait for a moment and then connect it again to force the system to reconnect to your device.
I have an Android device running a media app which the system has found but I cannot hear the sound or the sound is very quiet.	<ul style="list-style-type: none">– Device volume is low.<ul style="list-style-type: none">• Turn the volume up on your device.
I have an Android device running a number of compatible apps but the system cannot find all of them.	<ul style="list-style-type: none">– Device limitation. Some Android devices have a limited number of Bluetooth ports that apps can use to connect. If you have more apps running on your device than the number of available Bluetooth ports, the system cannot find all of them.<ul style="list-style-type: none">• Close some of the apps to allow the system to find those that you want to use.

Wi-Fi Connectivity

Symptom	Possible Cause and Resolution
I cannot connect to a Wi-Fi network.	<ul style="list-style-type: none"> – Password error. <ul style="list-style-type: none"> • Enter the correct network password. – Weak network signal. <ul style="list-style-type: none"> • Move your vehicle closer to the Wi-Fi hotspot or to a place where the network signal is not obstructed. – Multiple access points in range with the same SSID. <ul style="list-style-type: none"> • Use a unique name for your SSID. Do not use the default name unless it contains a unique identifier, for example as part of the MAC address.
The Wi-Fi connection disconnects after successful connection.	<ul style="list-style-type: none"> – Weak network signal. <ul style="list-style-type: none"> • Move your vehicle closer to the Wi-Fi hotspot or to a place where the network signal is not obstructed.
I am close to a Wi-Fi hotspot but the network signal strength is weak.	<ul style="list-style-type: none"> – Obstructed network signal. <ul style="list-style-type: none"> • If your vehicle has a heated windshield, position your vehicle so that the windshield is not facing the Wi-Fi hotspot. • If your vehicle has metallic tinting on the windows but not on the windshield, position your vehicle so that the windshield is facing the Wi-Fi hotspot or open the windows that are facing the hotspot. • If your vehicle has metallic tinting on the windows and the windshield, open the windows that are facing the hotspot. • If your vehicle is in a garage and you have the garage door closed, open the garage door.
I cannot see a network in the list of available networks that I expect to see.	<ul style="list-style-type: none"> – Hidden network. <ul style="list-style-type: none"> • Make the network visible and try again.

SYNC™ 3

Symptom	Possible Cause and Resolution
I cannot see SYNC when I search for Wi-Fi networks on my cell phone or other device.	<ul style="list-style-type: none"> – System limitation. <ul style="list-style-type: none"> • SYNC does not provide a Wi-Fi hotspot at this time.
Software downloads take too long.	<ul style="list-style-type: none"> – Weak network signal <ul style="list-style-type: none"> • Move your vehicle closer to the Wi-Fi hotspot or to a place where the network signal is not obstructed. – Wi-Fi hotspot in high demand or has a slow Internet connection. <ul style="list-style-type: none"> • Use a more reliable Wi-Fi hotspot.
The system seems to connect to a Wi-Fi network and the signal strength is excellent but the software does not update.	<ul style="list-style-type: none"> – No software update available. – Wi-Fi network requires a subscription or acceptance of terms and conditions. <ul style="list-style-type: none"> • Test the connection using another device. If the network requires a subscription or acceptance of terms and conditions, contact the network service provider.

Personal Profiles (If Equipped)

Symptom	Possible Cause and Solution
I cannot create a profile.	You have not set up Personal Profiles.
	You entered an invalid profile.
	You did not select a memory button when prompted.
	You did not have the ignition on or in park (P), or you shifted out park (P) when creating a profile.
	Personal Profiles has been switched off.
I cannot link a remote control.	You did not select the lock button on the remote control.
	The remote control selected was already associated with another profile and the system declined to overwrite.
	The system performed a profile recall when linking a remote control.
	You did not have the ignition on or in park (P), or you shifted out park (P) when creating a profile.

SYNC™ 3

Symptom	Possible Cause and Solution
	You are using the old linking method.
My personalized settings do not save.	Personal Profiles does not support your unsaved settings.
	A different personal profile is active.
	Another user changed the settings for the wrong personal profile.
My profile will not recall.	You did not create a personal profile.
	Personal Profiles is turned off.
	The profile you requested is already active.
	You did not link the memory button you are using to a profile.
	You did not link the remote control you are using to a profile.
	You are using the wrong remote control.
	You are pressing a button other than the unlock or remote start on a linked remote control.
My preset positions recall, but my profile does not.	You switched the personal profiles off.
My profile recalls but my preset positions do not.	The vehicle is in motion.
	The preset positions are the same as the guest or previously active profile.
I lost a remote control.	Unlink and relink your remote control in the Personal Profiles menu. You may need to see your authorized dealer.
I lost all profiles.	You erased and reprogrammed the remote controls. This could happen if you let a dealership add a new remote control to replace a lost one.
	Someone performed a master reset without your knowledge.

Resetting the System

1. Simultaneously press and hold the seek up and the audio unit power buttons until the screen goes black.
2. Wait three minutes to allow the system to complete the reset.
3. Press the audio unit power button to switch the system on.

Note: *You can reset the system to restore functionality that has stopped working. The system reset is designed to restore functionality and not delete any data that you have stored.*

Additional Information and Assistance

For additional information and assistance, we recommend that you contact an authorized dealer or refer to our website.

Accessories

For a complete listing of the accessories that are available for your vehicle, please contact your authorized dealer or visit the online store web site:

Web Address (United States)

www.Accessories.Ford.com
--

Web Address (Canada)

www.Accessories.Ford.ca
--

We will repair or replace any properly authorized dealer-installed Ford Original Accessory found to be defective in factory-supplied materials or workmanship during the warranty period, as well as any component damaged by the defective accessories.

We will warrant your Ford Original Accessory through the warranty that provides the greatest benefit:

- 24 months, unlimited mileage.
- The remainder of your new vehicle limited warranty.

Contact an authorized dealer for details and a copy of the warranty.

Ford Licensed Accessories are the accessory manufacturer's designs. The manufacturer develops and therefore warrants Ford Licensed Accessories, and does not design or test these accessories to Ford Motor Company engineering requirements. Contact an authorized Ford dealer for the manufacturer's limited warranty details, and request a copy of the Ford Licensed Accessories product limited warranty from the accessory manufacturer.

For maximum vehicle performance, keep the following information in mind when adding accessories or equipment to your vehicle:

- When adding accessories, equipment, passengers and luggage to your vehicle, do not exceed the total weight capacity of the vehicle or of the front or rear axle (GVWR or GAWR as indicated on the Safety Compliance Certification label). Ask an authorized dealer for specific weight information.
- The Federal Communications Commission (FCC) and Canadian Radio Telecommunications Commission (CRTC) regulate the use of mobile communications systems that are equipped with radio transmitters, for example two-way radios, telephones and theft alarms. Any such equipment installed in your vehicle should comply with Federal Communications Commission (FCC) and Canadian Radio Telecommunications Commission (CRTC) regulations and should be installed only by an authorized dealer.
- An authorized dealer needs to install mobile communications systems. Improper installation may harm the operation of your vehicle, particularly if the manufacturer did not design the mobile communication system specifically for automotive use.
- If you or an authorized Ford dealer add any non-Ford electrical or electronic accessories or components to your vehicle, you may adversely affect battery performance and durability. In addition, you may also adversely affect the performance of other electrical systems in the vehicle.

Accessories

AUXILIARY SWITCHES

The auxiliary switchboard on the center console makes aftermarket customization easier, with four prewired switches attached to the power distribution box for electrical accessories.



E163431

When using the auxiliary switches for an extended period of time, we recommend that the engine is running to prevent the battery from running out of charge.

A fuse and relay kit is included with this option. The kit contains fuses and relays for the pre-fusebox, located under the driver's seat. Refer to the instructions included with the kit. See an authorized dealer for service.

There is one power lead connector for each switch. These can be found at either the 43-way connector for the AUX 1 and AUX 2 switches or the 6-way connector for the AUX 3 and AUX 4 switches. Both connectors are behind the passenger side cup holder.

The relays are coded as follows:

	Circuit Number	Wire Color	Fuse Rating
AUX 1 ¹	CAC05	Yellow	20A
AUX 2 ¹	CAC06	Green with brown trace	20A
AUX 3 ¹	CAC13	Blue with orange trace	40A
AUX 4 ²	CAC14	Yellow with orange trace	40A

¹ Operates when you switch the ignition on.

² Operates only when the engine is running.

If different switch functionality is required please contact the Truck Body Builders Advisory Service. See **Special Notices** (page 11).

Ford Protect

PROTECT YOURSELF FROM THE RISING COST OF VEHICLE REPAIRS WITH A FORD PROTECT EXTENDED SERVICE PLAN.

Ford Protect Extended Service Plans (U.S. Only)

Ford Protect extended service plan means peace of mind. It's the extended service plan backed by Ford Motor Company, and provides more protection beyond the New Vehicle Limited Warranty coverage. When you visit your Ford Dealer, Insist on Ford Protect extended service plans!

Ford Protect Can Quickly Pay for Itself

One trip to the Service Center could easily exceed the price of your Ford Protect extended service plan. With Ford Protect extended service plan you minimize your risk for unexpected repair bills and rising repair costs.

Up to 1,000+ Covered Vehicle Components

There are four mechanical Ford Protect extended service plans with different levels of coverage. Ask your authorized dealer for details.

1. PremiumCARE - Our most comprehensive coverage. With over 1,000 covered components, this plan is so complete it's probably easier to list what's not covered.
2. ExtraCARE - Covers 113 components, and includes many high-tech items.
3. BaseCARE - Covers 84 components.
4. PowertrainCARE - Covers 29 critical components.

Ford Protect extended service plans are honored by all authorized Ford dealers in the U.S., Canada and Mexico.

That means you get:

- Reliable, quality service at any Ford or Lincoln dealership.
- Repairs performed by factory trained technicians, using genuine parts.

Rental Car Reimbursement

1st day Rental Benefit

If you bring your car into your dealer for service, we'll give you a loaner to use for the day.

Extended Rental Benefits

If your vehicle is kept overnight for covered repairs, you are eligible for rental car coverage, including warranty repairs, and Field Service Actions.

Roadside Assistance

Exclusive 24/7 roadside assistance, including:

- Towing, flat-tire change and battery jump starts.
- Out of fuel and lock-out assistance.
- Travel expense reimbursement for lodging, meals and rental car.
- Assistance for taxi, shuttle, rental car coverage or other transportation.

Transferable Coverage

If you sell your vehicle before your Ford Protect extended service plan coverage expires, you can transfer any remaining coverage to the new owner. Which should give you and your potential buyer a little more peace of mind.

Ford Protect

Less Cost to Properly Maintain Your Vehicle

Ford Protect extended service plan also offers a Premium Maintenance Plan that covers all scheduled maintenance, and selected wear items. The coverage is prepaid, so you never have to worry about the cost of your vehicle's maintenance.

Covered maintenance includes:

- Windshield wiper blades.
- Spark plugs.
- The clutch disc (if equipped).
- Brake pads and linings.
- Shock absorbers.
- Struts.
- Engine Belts.
- Engine coolant hoses, clamps and o-rings.
- Diesel exhaust fluid replenishment (if equipped).
- Cabin air filter replacement every 20,000 mi (32,000 km) (electric vehicles only).

Interest Free Finance Options

Just a 5% down payment will provide you with an affordable, no interest, no fee payment program allowing you all the security and benefits Ford Protect extended service plan has to offer while paying over time. You are pre-approved with no credit check or hassles. To learn more, call our Ford Protect extended service plan specialists at 800-367-3377.

Ford Protect Extended Service Plan
P.O. Box 321067
Detroit, MI 48232

Ford Protect Extended Service Plan (CANADA ONLY)

You can get more protection for your vehicle by purchasing a Ford Protect extended service plan. Ford Protect extended service plan is the only service contract backed by Ford Motor Company of Canada, Limited. Depending on the plan you purchase, Ford Protect extended service plan provides benefits such as:

- Rental reimbursement.
- Coverage for certain maintenance and wear items.
- Protection against repair costs after your New Vehicle Limited Warranty Coverage expires.
- Roadside Assistance benefits.

There are several Ford Protect extended service plans available in various time, distance and deductible combinations. Each plan is tailored to fit your own driving needs, including reimbursement for towing and rental. When you purchase Ford Protect extended service plan, you receive added peace-of-mind protection throughout Canada, the United States and Mexico, provided by a network of participating authorized Ford Motor Company dealers.

Note: *Repairs performed outside of Canada and the United States are not eligible for Ford Protect extended service plan coverage.*

This information is subject to change. For more information; visit your local Ford of Canada dealer or www.ford.ca to find the Ford Protect extended service plan that is right for you.

Scheduled Maintenance

GENERAL MAINTENANCE INFORMATION

Why Maintain Your Vehicle?

Carefully following the maintenance schedule helps protect against major repair expenses resulting from neglect or inadequate maintenance and may help to increase the value of your vehicle when you sell or trade it. Keep all receipts for completed maintenance with your vehicle.

We have established regular maintenance intervals for your vehicle based upon rigorous testing. It is important that you have your vehicle serviced at the correct times. These intervals serve two purposes; one is to maintain the reliability of your vehicle and the second is to keep the cost of owning your vehicle down.

It is your responsibility to have all scheduled maintenance performed and to make sure that the materials used meet the specifications identified in this owner's manual. See **Capacities and Specifications** (page 352).

Failure to perform scheduled maintenance invalidates warranty coverage on parts affected by the lack of maintenance.

Why Maintain Your Vehicle at Your Dealership?

Factory-trained Technicians

Service technicians participate in extensive factory-sponsored certification training to help them become experts on the operation of your vehicle. Ask your dealership about the training and certification their technicians have received.

Genuine Ford and Motorcraft Replacement Parts

Dealerships stock Ford, Motorcraft and Ford-authorized branded re-manufactured replacement parts. These parts meet or exceed our specifications. Parts installed at your dealership carry a nationwide 12-month or 12,000 mi (20,000 km) parts and labor limited warranty.

If you do not use Ford authorized parts they may not meet our specifications and depending on the part, it could affect emissions compliance.

Convenience

Many dealerships have extended evening and Saturday hours to make your service visit more convenient and they offer one stop shopping. They can perform any services that are required on your vehicle, from general maintenance to crash repairs.

Note: *Not all dealers have extended hours or body shops. Please contact your dealer for details.*

Protecting Your Investment

Maintenance is an investment that pays dividends in the form of improved reliability, durability and resale value. To maintain the correct performance of your vehicle and its emission control systems, make sure you have scheduled maintenance performed at the designated intervals.

Your vehicle is equipped with the Intelligent Oil-Life Monitor system, which displays a message in the information display at the correct oil change interval. This interval may be up to one year or 10,000 mi (16,000 km).

Scheduled Maintenance

When the oil change message appears in the information display, it is time for an oil change. Make sure you perform the oil change within two weeks or 500 miles (800 kilometers) of the message appearing. Make sure you reset the Intelligent Oil-Life Monitor after each oil change. See **Changing the Engine Oil and Oil Filter** (page 283).

If your information display resets prematurely or becomes inoperative, you should perform the oil change interval at six months or 5,000 mi (8,000 km) from your last oil change. Never exceed one year or 10,000 mi (16,000 km) between oil change intervals.

Your vehicle is very sophisticated and built with multiple, complex, performance systems. Every manufacturer develops these systems using different specifications and performance features. That is why it is important to rely upon your dealership to correctly diagnose and repair your vehicle.

Ford Motor Company has recommended maintenance intervals for various parts and component systems based upon engineering testing. Ford Motor Company relies upon this testing to determine the most appropriate mileage for replacement of oils and fluids to protect your vehicle at the lowest overall cost to you and recommends against maintenance schedules that deviate from the scheduled maintenance information.

We strongly recommend the use of only genuine Ford, Motorcraft or Ford-authorized re-manufactured replacement parts engineered for your vehicle.

Additives and Chemicals

This owner's manual and the Ford Workshop Manual list the recommended additives and chemicals for your vehicle. We do not recommend using chemicals or additives not approved by us as part of your vehicle's normal maintenance. Please consult your warranty information.

Oils, Fluids and Flushing

In many cases, fluid discoloration is a normal operating characteristic and, by itself, does not necessarily indicate a concern or that the fluid needs to be changed. However, a qualified expert, such as the factory-trained technicians at your dealership, should inspect discolored fluids that also show signs of overheating or foreign material contamination immediately.

Make sure to change your vehicle's oils and fluids at the specified intervals or in conjunction with a repair. Flushing is a viable way to change fluid for many vehicle sub-systems during scheduled maintenance. It is critical that systems are flushed only with new fluid that is the same as that required to fill and operate the system or using a Ford-approved flushing chemical.

Owner Checks and Services

Make sure you perform the following basic maintenance checks and inspections every month or at six-month intervals.

Check every month
Engine oil level.
Function of all interior and exterior lights.
Tires (including spare) for wear and correct pressure.
Windshield washer fluid level.

Scheduled Maintenance

Check every six months
Battery connections. Clean if necessary.
Body and door drain holes for obstructions. Clean if necessary.
Cooling system fluid level and coolant strength.
Door weatherstrips for wear. Lubricate if necessary.
Front door check arms for correct operation.
Hinges, latches and outside locks for correct operation. Lubricate if necessary.
Parking brake for correct operation.
Seatbelts and seat latches for wear and function.
Safety warning lamps (brake, ABS, airbag and seatbelt) for operation.
Washer spray and wiper operation. Clean or replace blades as necessary.

Multi-point Inspection

In order to keep your vehicle running correctly, it is important to have the systems on your vehicle checked regularly. This can help identify potential issues and prevent major problems. We recommend having the following multi-point inspection performed at every scheduled maintenance interval to help make sure your vehicle keeps running correctly.

Multi-point inspection
Accessory drive belt(s).
Battery performance.
Engine air filter.

Multi-point inspection
Exhaust system.
Exterior lamps and hazard warning system operation.
Fluid levels*; fill if necessary.
For oil and fluid leaks.
Horn operation.
Radiator, cooler, heater and A/C hoses.
Suspension component for leaks or damage.
Steering and linkage.
Tires (including spare) for wear and correct pressure**.
Windshield for cracks, chips or pits.
Washer spray and wiper operation.

* Brake, coolant recovery reservoir, automatic transmission, power steering (if equipped with hydraulic power assist steering) and window washer.

**If your vehicle is equipped with a temporary mobility kit, check the tire sealant expiration Use By date on the canister. Replace as needed.

Be sure to ask your dealership service advisor or technician about the multi-point vehicle inspection. It is a comprehensive way to perform a thorough inspection of your vehicle. Your checklist gives you immediate feedback on the overall condition of your vehicle.

Scheduled Maintenance

NORMAL SCHEDULED MAINTENANCE

Intelligent Oil-Life Monitor™

Your vehicle is equipped with an Intelligent Oil-Life Monitor that determines when you should change the engine oil based on how your vehicle is used. By using several important factors in its calculations, the

monitor helps reduce the cost of owning your vehicle and reduces environmental waste at the same time.

The following table provides examples of vehicle use and its impact on oil change intervals. It is a guideline only. Actual oil change intervals depend on several factors and generally decrease with severity of use.

When to expect the oil change message	
Interval	Vehicle use and example
7,500–10,000 mi (12,000–16,000 km)	Normal
	Normal commuting with highway driving. No, or moderate, load or towing. Flat to moderately hilly roads. No extended idling.
5,000–7,500 mi (8,000–12,000 km)	Severe
	Moderate to heavy load or towing. Mountainous or off-road conditions. Extended idling. Extended hot or cold operation.
3,000–5,000 mi (4,800–8,000 km)	Extreme
	Maximum load or towing. Extreme hot or cold operation.

Normal Maintenance Intervals

At every oil change interval as indicated by the information display ¹
Change engine oil and filter.**
Rotate tires, inspect tire wear and measure tread depth.
Perform a multi-point inspection (recommended).
Inspect the automatic transmission fluid level (if equipped with dipstick). Consult your dealer for requirements.
Inspect the brake pads, shoes, rotors, drums, brake linings, hoses and parking brake.

Scheduled Maintenance

At every oil change interval as indicated by the information display¹

Inspect the engine cooling system strength and hoses.

Inspect the exhaust system and heat shields.

Inspect front axle and U-joints. Lubricate if equipped with grease fittings.

Inspect the steering linkage, ball joints, suspension, tire-rod ends, driveshaft and U-joints. Lubricate any areas with grease fittings.

Inspect the wheels and related components for abnormal noise, wear, looseness or drag.

¹ Do not exceed one year or 10,000 mi (16,000 km) between service intervals.

** Reset the Intelligent Oil-Life Monitor after engine oil and filter changes.

Brake fluid maintenance¹

Every 3 years

Change the brake fluid.²

¹ Perform this maintenance item every 3 years. Do not exceed the designated time for the interval.

² Brake fluid servicing requires special equipment available at your authorized dealer.

Other maintenance items¹

Every 20,000 mi
(32,000 km)

Replace cabin air filter.

Every 30,000 mi
(48,000 km)

Torque rear axle U-bolts to specification.

Replace engine air filter.

At 200,000 mi
(320,000 km)

Change engine coolant.²

Every 100,000 mi
(160,000 km)

Replace spark plugs.

Inspect accessory drive belt(s).³

Every 150,000 mi
(240,000 km)

Change automatic transmission fluid and filter.

Change front axle fluid.

Change rear axle fluid.

Scheduled Maintenance

Other maintenance items ¹	
	Change the transfer case fluid. ⁴
	Replace accessory drive belt(s).

¹ Perform these maintenance items within 3,000 mi (4,800 km) of the last engine oil and filter change. Do not exceed the designated distance for the interval.

² Initial replacement at ten years or 200,000 mi (320,000 km), then every five years or 100,000 mi (160,000 km).

³ After initial inspection, inspect every other oil change until replaced.

⁴ Four-wheel drive only.

SPECIAL OPERATING CONDITIONS SCHEDULED MAINTENANCE

If you operate your vehicle **primarily** in any of the following conditions, you need to perform extra maintenance as indicated. If you operate your vehicle **occasionally** under any of these conditions, it is not necessary to perform the extra maintenance. For specific recommendations, see your dealership service advisor or technician.

Perform the services shown in the following tables when specified or within 3000 miles (4800 kilometers) of the oil change required message appearing in the information display.

- **Example 1:** The message appears at 28,750 mi (46,270 km). Perform the 30,000 mi (48,000 km) automatic transmission fluid replacement.
- **Example 2:** The message does not appear, but the odometer reads 30,000 mi (48,000 km) (for example, the Intelligent Oil-Life Monitor was reset at 25,000 mi (40,000 km)). Perform the engine air filter replacement.

Towing a trailer or using a car-top carrier	
As required	Change engine oil and filter as indicated by the information display and perform services listed in the Normal Scheduled Maintenance chart.
Inspect frequently, service as required	Inspect and lubricate U-joints.
	See axle maintenance items under Exceptions .
Every 60000 miles (96000 km)	Replace spark plugs.

Scheduled Maintenance

Extensive idling or low-speed driving for long distances, as in heavy commercial use (such as delivery, taxi, patrol car or livery)	
As required	Change engine oil and filter as indicated by the information display and perform services listed in the Normal Scheduled Maintenance chart.
Inspect frequently, service as required	Replace engine air filter.
Every 60000 miles (96000 km)	Replace spark plugs.

Operating in dusty or sandy conditions (such as unpaved or dusty roads)	
Inspect frequently, service as required	Replace engine air filter.
Every 5000 miles (8000 km)	Inspect the wheels and related components for abnormal noise, wear, looseness or drag.
	Rotate tires, inspect tires for wear and measure tread depth.
Every 5000 miles (8000 km) or six months	Change engine oil and filter.*

*Reset your Intelligent Oil-Life Monitor after each engine oil and filter change.

Off-road operation	
Inspect frequently, service as required	Inspect steering linkage, ball joints and U-joints. Lubricate if equipped with grease fittings.
	Replace engine air filter.
Every 5000 miles (8000 km) or six months	Change engine oil and filter.*
	Inspect the wheels and related components for abnormal noise, wear, looseness or drag.
	Rotate tires, inspect tires for wear and measure tread depth.

*Reset your Intelligent Oil-Life Monitor after each engine oil and filter change.

Scheduled Maintenance

Exclusive use of E85 (Flex fuel vehicles only)	
Every oil change interval	If ran exclusively on E85, fill the fuel tank full with regular unleaded fuel.

Exceptions

There are several exceptions to the Normal Schedule:

Axle and Transfer Case Maintenance

Axle(s) and transfer case (Four-wheel drive vehicles) fluid changes or level checks are not required unless a leak is suspected or the assembly has been submerged in water. Contact an authorized dealer for service.

California fuel filter replacement

If you register your vehicle in California, the California Air Resources Board has determined that the failure to perform this maintenance item does not nullify the emission warranty or limit recall liability before the completion of your vehicle's useful life. Ford Motor Company, however, urges you to have all recommended maintenance services performed at the specified intervals and to record all vehicle service.

Hot climate oil change intervals

Vehicles operating in the Middle East, North Africa, Sub-Saharan Africa or locations with similar climates using an American Petroleum Institute (API) Certified for Gasoline Engines (Certification mark) oil of SM or SN quality, the normal oil change interval is 5,000 mi (8,000 km).

If the available API SM or SN oils are not available, then the oil change interval is 3,000 mi (4,800 km).

Engine air filter replacement

The life of the engine air filter is dependent on exposure to dusty and dirty conditions. Vehicles operated in these conditions require frequent inspection and replacement of the engine air filter.

Customer Information

TYPE APPROVALS

Radio Frequency Certification Labels for Audio Unit

Canada and United States of America



WARNING: Changes or modifications not expressly approved by the party responsible for compliance could void the user's authority to operate the equipment. The term "IC:" before the radio certification number only signifies that Industry Canada technical specifications were met.

IC: 3043A-AHUCHRFORD

FCC ID: NT8-AHUCHRFORD

This device complies with Part 15 of the FCC Rules and with Innovation, Science and Economic Development Canada's licence-exempt RSS(s). Operation is subject to the following two conditions:

1. This device may not cause harmful interference, and
2. This device must accept any interference received, including interference that may cause undesired operation.

Mexico

IFT: RCPFORA17-1142

United Arab Emirates



Radio Frequency Certification Labels for Blind Spot Information System Sensors

Canada and United States of America



WARNING: Changes or modifications not expressly approved by the party responsible for compliance could void the user's authority to operate the equipment. The term "IC:" before the radio certification number only signifies that Industry Canada technical specifications were met.

IC: 4135A-SRR3B

FCC ID: OAYSRR3B

This device complies with Part 15 of the FCC Rules and with Innovation, Science and Economic Development Canada's licence-exempt RSS(s). Operation is subject to the following two conditions:

1. This device may not cause harmful interference, and
2. This device must accept any interference received, including interference that may cause undesired operation.

Customer Information

Mexico

IFETEL: RLVCSR15-0904

United Arab Emirates



Mexico

IFT: RLVDEL217-0751

United Arab Emirates



Radio Frequency Certification Labels for Cruise Control Module

Canada and United States of America

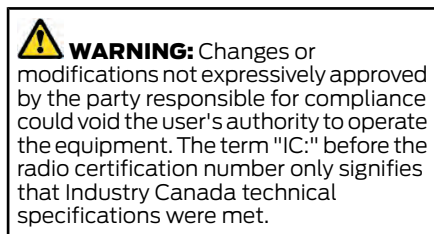

IC: 3432A-0065TR

FCC ID: L2C0065TR

This device complies with Part 15 of the FCC Rules and with Innovation, Science and Economic Development Canada's licence-exempt RSS(s). Operation is subject to the following two conditions:

1. This device may not cause harmful interference, and
2. This device must accept any interference received, including interference that may cause undesired operation.

Radio Frequency Certification Labels for Keys and Remote Controls

Canada and United States of America

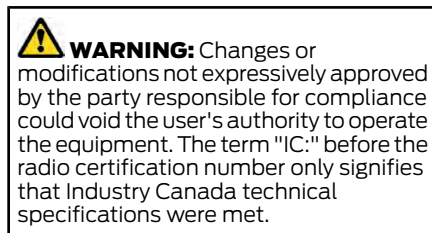

IC: 3248A-A08TAA

FCC ID: N5F-A08TAA

Customer Information

This device complies with Part 15 of the FCC Rules and with Innovation, Science and Economic Development Canada's licence-exempt RSS(s). Operation is subject to the following two conditions:

1. This device may not cause harmful interference, and
2. This device must accept any interference received, including interference that may cause undesired operation.

Mexico

CFT: RLVVAA012-0480

United Arab Emirates

FCC ID: KR5A2C95937800

This device complies with Part 15 of the FCC Rules and with Innovation, Science and Economic Development Canada's licence-exempt RSS(s). Operation is subject to the following two conditions:

1. This device may not cause harmful interference, and
2. This device must accept any interference received, including interference that may cause undesired operation.

Mexico

IFT: RLVCOA219-2103

United Arab Emirates

TRA
REGISTERED No:
ER49357/16
DEALER No:
DA37380/15

TRA
REGISTERED No.:
ER63544/18
DEALER No.:
DA37380/15

Radio Frequency Certification Labels for Passive Anti-Theft System

Canada and United States of America



WARNING: Changes or modifications not expressly approved by the party responsible for compliance could void the user's authority to operate the equipment. The term "IC:" before the radio certification number only signifies that Industry Canada technical specifications were met.

IC: 7812D-A2C95937800

Radio Frequency Certification Labels for Radio Transceiver Module

Mexico

IFT: RLVAPFO20-1304

Customer Information

United Arab Emirates

TRA
REGISTERED No:
ER81341/20

DEALER No:
DA88113/20

This device complies with Part 15 of the FCC Rules and with Innovation, Science and Economic Development Canada's licence-exempt RSS(s). Operation is subject to the following two conditions:

1. This device may not cause harmful interference, and
2. This device must accept any interference received, including interference that may cause undesired operation.

Mexico

IFT: RCPPAFA16-2032-A1

United States of America

FCC ID: L2C0082R

This device complies with Part 15 of the FCC Rules. Operation is subject to the following two conditions:

1. This device may not cause harmful interference, and
2. This device must accept any interference received, including interference that may cause undesired operation.

Radio Frequency Certification Labels for SYNC

Canada and United States of America



WARNING: Changes or modifications not expressly approved by the party responsible for compliance could void the user's authority to operate the equipment. The term "IC:" before the radio certification number only signifies that Industry Canada technical specifications were met.

IC: 216B-FG185SG32MH

FCC ID: ACJ-FG-185-SG32MH

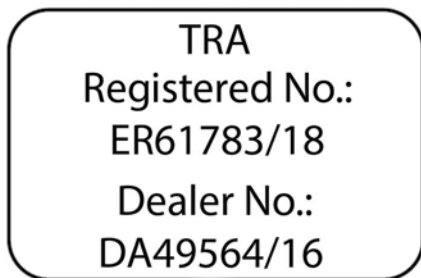

Radio Frequency Certification Labels for Telematics Control Unit

Canada and United States of America



WARNING: Changes or modifications not expressly approved by the party responsible for compliance could void the user's authority to operate the equipment. The term "IC:" before the radio certification number only signifies that Industry Canada technical specifications were met.

IC: 1422A-14H074NA1

Customer Information

FCC ID: KMH-14H074-NA1

This device complies with Part 15 of the FCC Rules and with Innovation, Science and Economic Development Canada's licence-exempt RSS(s). Operation is subject to the following two conditions:

1. This device may not cause harmful interference, and
2. This device must accept any interference received, including interference that may cause undesired operation.

Mexico

IFT: RTIFOFB20-1756

United Arab Emirates

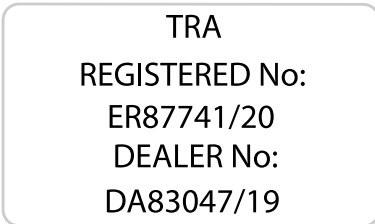

Radio Frequency Certification Labels for Tire Pressure Monitoring System Sensors

Canada and United States of America

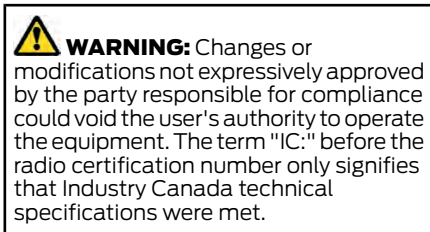

IC: 2546A-AG2SZ4

FCC ID: MRXAG2SZ4

This device complies with Part 15 of the FCC Rules and with Innovation, Science and Economic Development Canada's licence-exempt RSS(s). Operation is subject to the following two conditions:

1. This device may not cause harmful interference, and
2. This device must accept any interference received, including interference that may cause undesired operation.

Mexico

IFT: RLVSCMR15-1238

United Arab Emirates



CALIFORNIA PROPOSITION 65 - UNITED STATES OF AMERICA

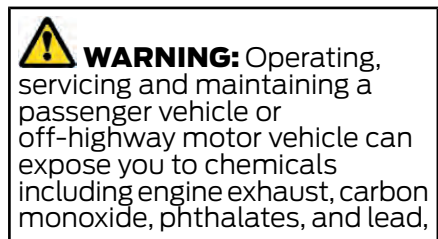

Customer Information

which are known to the State of California to cause cancer and birth defects or other reproductive harm. To minimize exposure, avoid breathing exhaust, do not idle the engine except as necessary, service your vehicle in a well-ventilated area and wear gloves or wash your hands frequently when servicing your vehicle. For more information go to www.P65Warnings.ca.gov/passenger-vehicle.



WARNING: Battery posts, terminals and related accessories contain lead and lead compounds, chemicals known to the State of California to cause cancer and reproductive harm. **Wash your hands after handling.**

PERCHLORATE

Certain components in your vehicle such as airbag modules, seatbelt pretensioners and remote control batteries may contain perchlorate material. Special handling may apply for service or vehicle end of life disposal.

For more information visit:
www.dtsc.ca.gov/hazardouswaste/perchlorate.

REPLACEMENT PARTS RECOMMENDATION

We have built your vehicle to the highest standards using quality parts. We recommend that you demand the use of genuine Ford and Motorcraft parts whenever your vehicle requires scheduled maintenance or repair. You can clearly identify genuine Ford and Motorcraft parts by looking for the Ford, FoMoCo or Motorcraft branding on the parts or their packaging.

Scheduled Maintenance and Mechanical Repairs

One of the best ways for you to make sure that your vehicle provides years of service is to have it maintained in line with our recommendations using parts that conform to the specifications detailed in this Owner's Manual.

Genuine Ford and Motorcraft parts meet or exceed these specifications.

Collision Repairs

We hope that you never experience a collision, but accidents happen sometimes.

Genuine Ford replacement collision parts meet our stringent requirements for fit, finish, structural integrity, corrosion protection and dent resistance. During vehicle development we validate that these parts deliver the intended level of protection as a whole system. A great way to know for sure you are getting this level of protection is to use genuine Ford replacement collision parts.

Warranty on Replacement Parts

Genuine Ford and Motorcraft replacement parts are the only replacement parts that benefit from a Ford Warranty.

Customer Information

The Ford Warranty may not cover damage caused to your vehicle as a result of failed non-Ford parts.

For additional information, refer to the terms and conditions of the Ford Warranty.

MOBILE COMMUNICATIONS EQUIPMENT



WARNING: Driving while distracted can result in loss of vehicle control, crash and injury. We strongly recommend that you use extreme caution when using any device that may take your focus off the road. Your primary responsibility is the safe operation of your vehicle. We recommend against the use of any hand-held device while driving and encourage the use of voice-operated systems when possible. Make sure you are aware of all applicable local laws that may affect the use of electronic devices while driving.

Using mobile communications equipment is becoming increasingly important in the conduct of business and personal affairs. However, you must not compromise your own or others' safety when using such equipment. Mobile communications can enhance personal safety and security when appropriately used, particularly in emergency situations. Safety must be paramount when using mobile communications equipment to avoid negating these benefits. Mobile communication equipment includes, but is not limited to, cellular phones, pagers, portable email devices, text messaging devices and portable two-way radios.

EXPORT UNIQUE OPTIONS

For your particular global region, your vehicle may be equipped with features and options that are different from the features and options that are described in this Owner's Manual. A market unique supplement may be supplied that complements this book. By referring to the market unique supplement, if provided, you can properly identify those features, recommendations and specifications that are unique to your vehicle. This Owner's Manual is written primarily for the U.S. and Canadian markets. Features or equipment listed as standard may be different on units built for export. **Refer to this Owner's Manual for all other required information and warnings.**

Appendices

ELECTROMAGNETIC COMPATIBILITY



WARNING: Do not place objects or mount equipment on or near the airbag cover, on the side of the front or rear seatbacks, or in areas that may come into contact with a deploying airbag. Failure to follow these instructions may increase the risk of personal injury in the event of a crash.



WARNING: Do not fasten antenna cables to vehicle wiring, fuel pipes and brake pipes.



WARNING: Keep antenna and power cables at least 4 in (10 cm) from any electronic modules and airbags.

Note: We test and certify your vehicle to meet electromagnetic compatibility legislation. It is your responsibility to make sure that any equipment an authorized dealer installs on your vehicle complies with applicable local legislation and other requirements. Installation of some aftermarket electronic devices could degrade the performance of vehicle functions, which use radio frequency signals such as broadcast radio receiver, tire pressure monitoring system, push button start, Bluetooth connectivity or satellite navigation.

Note: Any radio frequency transmitter equipment in your vehicle (such as cellular telephones and amateur radio transmitters) must keep to the parameters in the following illustrations and table. We do not provide any other special provisions or conditions for installations or use.

Car/SUV

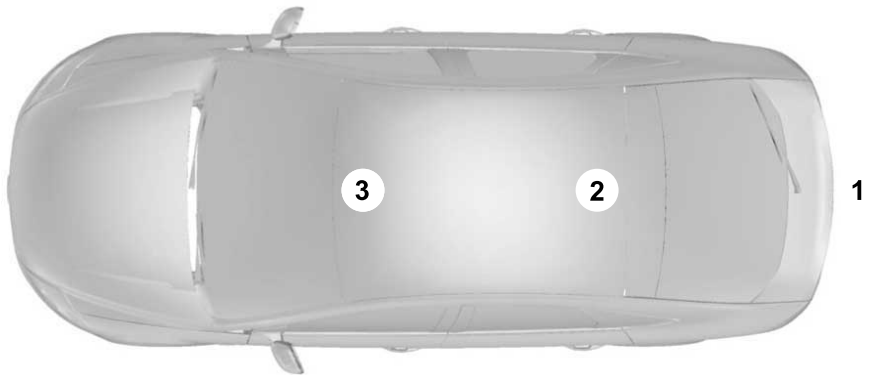

Appendices

Van



Truck

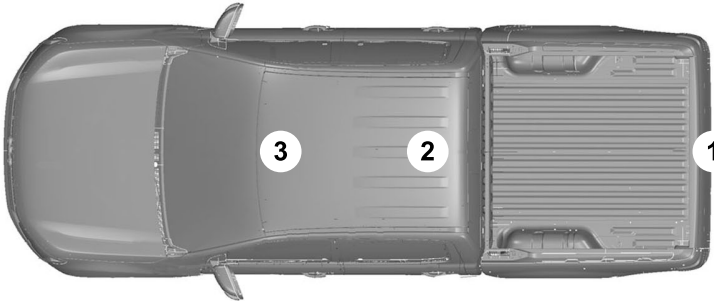

Appendices

Frequency Band MHz	Maximum output power Watt (Peak RMS)	Antenna Positions
1-30	50	1
50-54	50	2, 3
68-88	50	2, 3
142-176	50	2, 3
380-512	50	2, 3
806-870	10	2, 3

Appendices

END USER LICENSE AGREEMENT

VEHICLE SOFTWARE END USER LICENSE AGREEMENT (EULA)

- You ("You" or "Your" as applicable) have acquired a vehicle having several devices, including SYNC ® and various control modules, ("DEVICES") that include software licensed or owned by Ford Motor Company and its affiliates ("FORD MOTOR COMPANY"). Those software products of FORD MOTOR COMPANY origin, as well as associated media, printed materials, and "online" or electronic documentation ("SOFTWARE") are protected by international intellectual property laws and treaties. The SOFTWARE is licensed, not sold. All rights reserved.
- The SOFTWARE may interface with and/or communicate with, or may be later upgraded to interface with and/or communicate with additional software and/or systems provided by FORD MOTOR COMPANY.

IF YOU DO NOT AGREE TO THIS END USER LICENSE AGREEMENT ("EULA") DO NOT USE THE DEVICES OR COPY THE SOFTWARE. ANY USE OF THE SOFTWARE, INCLUDING BUT NOT LIMITED TO USE ON THE DEVICES, WILL CONSTITUTE YOUR AGREEMENT TO THIS EULA (OR RATIFICATION OF ANY PREVIOUS CONSENT).

GRANT OF SOFTWARE LICENSE: This EULA grants you the following license:

- You may use the SOFTWARE as installed on the DEVICES and as otherwise interfacing with systems and/or services provide by or through FORD MOTOR COMPANY or its third party software and service providers.

Description of Other Rights and Limitations

- **Speech Recognition:** If the SOFTWARE includes speech recognition component(s), you should understand that speech recognition is an inherently statistical process and that recognition errors are inherent in the process. Neither FORD MOTOR COMPANY nor its suppliers shall be liable for any damages arising out of errors in the speech recognition process. It is your responsibility to monitor any speech recognition functions included in the system.
- **Limitations on Reverse Engineering, Decompilation and Disassembly:** You may not reverse engineer, decompile, translate, disassemble or attempt to discover any source code or underlying ideas or algorithms of the SOFTWARE nor permit others to reverse engineer, decompile or disassemble the SOFTWARE, except and only to the extent that such activity is expressly permitted by applicable law notwithstanding this limitation or to the extent as may be permitted by the licensing terms governing use of any open source components included with the SOFTWARE.
- **Limitations on Distributing, Copying, Modifying and Creating Derivative Works:** You may not distribute, copy, make modifications to or create derivative works based on the SOFTWARE, except and only to the extent that such activity is expressly permitted by applicable law notwithstanding this limitation or to the extent as may be permitted by the licensing terms governing use of any open source components included with the SOFTWARE.

Appendices

- **Single EULA:** The end user documentation for the DEVICES and related systems and services may contain multiple EULAs, such as multiple translations and/or multiple media versions (e.g., in the user documentation and in the software). Even if you receive multiple EULAs, you are licensed to use only one (1) copy of the SOFTWARE.
- **SOFTWARE Transfer:** You may permanently transfer your rights under this EULA only as part of a sale or transfer of the DEVICES, provided you retain no copies, you transfer all of the SOFTWARE (including all component parts, the media and printed materials, any upgrades, and, if applicable, the Certificate(s) of Authenticity), and the recipient agrees to the terms of this EULA. If the SOFTWARE is an upgrade, any transfer must include all prior versions of the SOFTWARE.
- **Termination:** Without prejudice to any other rights, FORD MOTOR COMPANY may terminate this EULA if you fail to comply with the terms and conditions of this EULA.
- **Internet-Based Services Components:** The SOFTWARE may contain components that enable and facilitate the use of certain Internet-based services. You acknowledge and agree that FORD MOTOR COMPANY, third party software and service suppliers, its affiliates and/or its designated agent may automatically check the version of the SOFTWARE and/or its components that you are utilizing and may provide upgrades or supplements to the SOFTWARE that may be automatically downloaded to your DEVICES.
- **Additional Software/Services:** The SOFTWARE may permit FORD MOTOR COMPANY, third party software and service suppliers, its affiliates and/or its designated agent to provide or make available to you SOFTWARE updates, supplements, add-on components, or Internet-based services components of the SOFTWARE after the date you obtain your initial copy of the SOFTWARE ("Supplemental Components".) SOFTWARE updates may cause you to incur additional charges from your wireless service provider. If FORD MOTOR COMPANY or third party software and services suppliers provide or make available to you Supplemental Components and no other EULA terms are provided along with the Supplemental Components, then the terms of this EULA shall apply. FORD MOTOR COMPANY, its affiliates and/or its designated agent reserve the right to discontinue without liability any Internet-based services provided to you or made available to you through the use of the SOFTWARE.

Appendices

- **Links to Third Party Sites:** The SOFTWARE may provide you with the ability to link to third party sites. The third party sites are not under the control of FORD MOTOR COMPANY, its affiliates and/or its designated agent. Neither FORD MOTOR COMPANY nor its affiliates nor its designated agent are responsible for (i) the contents of any third party sites, any links contained in third party sites, or any changes or updates to third party sites, or (ii) webcasting or any other form of transmission received from any third party sites. If the SOFTWARE provides links to third party sites, those links are provided to you only as a convenience, and the inclusion of any link does not imply an endorsement of the third party site by FORD MOTOR COMPANY, its affiliates and/or its designated agent.
- **Obligation to Drive Responsibly:** You recognize your obligation to drive responsibly and keep attention on the road. You will read and abide with the DEVICES operating instructions particularly as they pertain to safety and you agree to assume any risk associated with the use of the DEVICES.

UPGRADES AND RECOVERY MEDIA:

If the SOFTWARE is provided by FORD MOTOR COMPANY separate from the DEVICES on media such as a ROM chip, CD ROM disk(s) or via web download or other means, and is labeled "For Upgrade Purposes Only" or "For Recovery Purposes Only" you may install one (1) copy of such SOFTWARE onto the DEVICES as a replacement copy for the existing SOFTWARE, and use it in accordance with this EULA, including any additional EULA terms accompanying the upgrade SOFTWARE.

INTELLECTUAL PROPERTY RIGHTS:

All title and intellectual property rights in and to the SOFTWARE (including but not limited to any images, photographs, animations, video, audio, music, text and "applets" incorporated into the SOFTWARE), the accompanying printed materials, and any copies of the SOFTWARE, are owned by FORD MOTOR COMPANY, or its affiliates or suppliers. The SOFTWARE is licensed, not sold. You may not copy the printed materials accompanying the SOFTWARE. All title and intellectual property rights in and to the content which may be accessed through use of the SOFTWARE is the property of the respective content owner and may be protected by applicable copyright or other intellectual property laws and treaties. This EULA grants you no rights to use such content outside its intended use. All rights not specifically granted under this EULA are reserved by FORD MOTOR COMPANY, its affiliates, and third party software and service providers and suppliers. Use of any on-line services which may be accessed through the SOFTWARE may be governed by the respective terms of use relating to such services. If this SOFTWARE contains documentation that is provided only in electronic form, you may print one copy of such electronic documentation.

EXPORT RESTRICTIONS: You acknowledge that the SOFTWARE is subject to U.S. and European Union export jurisdiction. You agree to comply with all applicable international and national laws that apply to the SOFTWARE, including the U.S. Export Administration Regulations, as well as end-user, end-use and destination restrictions issued by U.S. and other governments.

Appendices

TRADEMARKS: This EULA does not grant you any rights in connection with any trademarks or service marks of FORD MOTOR COMPANY, its affiliates, and third party software and service providers.

PRODUCT SUPPORT: Please refer to FORD MOTOR COMPANY instructions provided in the documentation for the DEVICES product support, such as the vehicle owner guide.

Should you have any questions concerning this EULA, or if you desire to contact FORD MOTOR COMPANY for any other reason, please refer to the address provided in the documentation for the DEVICES.

No Liability for Certain Damages: EXCEPT AS PROHIBITED BY LAW, FORD MOTOR COMPANY, ANY THIRD PARTY SOFTWARE OR SERVICES SUPPLIERS, AND THEIR AFFILIATES SHALL HAVE NO LIABILITY FOR ANY INDIRECT, SPECIAL, CONSEQUENTIAL OR INCIDENTAL DAMAGES ARISING FROM OR IN CONNECTION WITH THE USE OR PERFORMANCE OF THE SOFTWARE. THIS LIMITATION SHALL APPLY EVEN IF ANY REMEDY FAILS OF ITS ESSENTIAL PURPOSE. THERE ARE NO WARRANTIES OTHER THAN THOSE THAT MAY BE EXPRESSLY PROVIDED FOR YOUR NEW VEHICLE.

SYNC® Automotive Important Safety Information Read and follow instructions:

- Before using your SYNC® system, read and follow all instructions and safety information provided in this end user manual ("Owner Guide".) Not following precautions found in the Owner Guide can lead to an accident or other serious injuries.

General Operation

- **Voice Command Control:** Certain functions within the SYNC® system may be accomplished using voice commands. Using voice commands while driving helps you to operate the system without removing your hands from the wheel or eyes from the road.
- **Prolonged Views of Screen:** Do not access any function requiring a prolonged view of the screen while you are driving. Pull over in a safe and legal manner before attempting to access a function of the system requiring prolonged attention.
- **Volume Setting:** Do not raise the volume excessively. Keep the volume at a level where you can still hear outside traffic and emergency signals while driving. Driving while unable to hear these sounds could cause an accident.
- **Navigation Features:** Any navigation features included in the system are intended to provide turn by turn instructions to get you to a desired destination. Please make certain all persons using this system carefully read and follow instructions and safety information fully.
- **Distraction Hazard:** Any navigation features may require manual (non-verbal) setup. Attempting to perform such set-up or insert data while driving can distract your attention and could cause an accident or other serious injury. Stop the vehicle in a safe and legal manner before attempting these operations.
- **Let Your Judgment Prevail:** Any navigation features are provided only as an aid. Make your driving decisions based on your observations of local conditions and existing traffic regulations. Any such feature is not a

Appendices

substitute for your personal judgment. Any route suggestions made by this system should never replace any local traffic regulations or your personal judgment or knowledge of safe driving practices.

- **Route Safety:** Do not follow the route suggestions if doing so would result in an unsafe or illegal maneuver, if you would be placed in an unsafe situation, or if you would be directed into an area that you consider unsafe. The driver is ultimately responsible for the safe operation of the vehicle and therefore, must evaluate whether it is safe to follow the suggested directions.
- **Potential Map Inaccuracy:** Maps used by this system may be inaccurate because of changes in roads, traffic controls or driving conditions. Always use good judgment and common sense when following the suggested routes.
- **Emergency Services:** Do not rely on any navigation features included in the system to route you to emergency services. Ask local authorities or an emergency services operator for these locations. Not all emergency services such as police, fire stations, hospitals and clinics are likely to be contained in the map database for such navigation features.

Your Responsibilities and Assumptions of Risk

- You agree to each of the following: (a) Any use of the SOFTWARE while driving an automobile or other vehicle in violation of applicable law or otherwise driving in an unsafe manner presents a significant risk of distracted driving and should not be attempted under any circumstances; (b) Use of the SOFTWARE at excessive volume poses a significant risk of hearing damage and should not be attempted under any circumstances; (c) The SOFTWARE may not be compatible with new or different versions of an operating system, third party software, or third party services, and the SOFTWARE may potentially cause a critical failure of an operating system, third party software, or third party service. (d) Any third party service accessed by or third party software used with the SOFTWARE (i) may charge an additional fee for access, (ii) may not work correctly, on an uninterrupted basis, or error free, (iii) may change streaming formats or discontinue operation, (iv) may contain adult, profane or offensive content; and (v) may contain inaccurate, false or misleading traffic, weather, financial or safety information or other content; and (e) Use of the SOFTWARE may cause you to incur additional charges from your wireless service provider (WSP) and any data or minute calculators that may be included in the software program are for reference only, are not warranted in any way and should not be relied upon in anyway.
- When using the SOFTWARE, you agree to be responsible for and assume the entire risk to the items set forth in Section (a) – (e) above.

Appendices

Disclaimer of Warranty

YOU EXPRESSLY ACKNOWLEDGE AND AGREE THAT USE OF THE DEVICES AND SOFTWARE IS AT YOUR SOLE RISK AND THAT THE ENTIRE RISK AS TO SATISFACTORY QUALITY, PERFORMANCE, COMPATIBILITY, ACCURACY AND EFFORT IS WITH YOU. TO THE MAXIMUM EXTENT PERMITTED BY APPLICABLE LAW, THE SOFTWARE AND ANY THIRD PARTY SOFTWARE OR THIRD-PARTY SERVICES ARE PROVIDED "AS IS" AND "AS AVAILABLE", WITH ALL FAULTS AND WITHOUT WARRANTY OF ANY KIND, AND FORD MOTOR COMPANY HEREBY DISCLAIMS ALL WARRANTIES AND CONDITIONS WITH RESPECT TO THE SOFTWARE, THIRD PARTY SOFTWARE, AND THIRD-PARTY SERVICES, EITHER EXPRESS, IMPLIED OR STATUTORY, INCLUDING, BUT NOT LIMITED TO, THE IMPLIED WARRANTIES AND/OR CONDITIONS OF MERCHANTABILITY, OF SATISFACTORY QUALITY, OF FITNESS FOR AN PARTICULAR PURPOSE, OF ACCURACY, OF QUIET ENJOYMENT, AND NON-INFRINGEMENT OF THIRD-PARTY RIGHTS. FORD MOTOR COMPANY DOES NOT WARRANT (a) AGAINST INTERFERENCE WITH YOUR ENJOYMENT OF THE SOFTWARE, THIRD PARTY SOFTWARE, OR THIRD-PARTY SERVICES, (b) THAT THE SOFTWARE, THIRD PARTY SOFTWARE, OR THIRD-PARTY SERVICES WILL MEET YOUR REQUIREMENTS, (c) THAT THE OPERATION OF THE SOFTWARE, THIRD PARTY SOFTWARE, OR THIRD-PARTY SERVICES WILL BE UNINTERRUPTED OR ERROR-FREE, (d) OR THAT DEFECTS IN THE SOFTWARE, THIRD PARTY SOFTWARE, OR THIRD-PARTY SERVICES WILL BE CORRECTED. NO ORAL OR WRITTEN INFORMATION OR ADVICE GIVEN BY FORD MOTOR COMPANY OR ITS AUTHORIZED REPRESENTATIVE SHALL

CREATE A WARRANTY. SHOULD THE SOFTWARE, THIRD PARTY SOFTWARE, OR THIRD-PARTY SERVICES PROVE DEFECTIVE, YOU ASSUME THE ENTIRE COST OF ALL NECESSARY SERVICING, REPAIR OR CORRECTION. SOME JURISDICTIONS DO NOT ALLOW THE DISCLAIMER OF IMPLIED WARRANTIES OR LIMITATIONS ON APPLICABLE STATUTORY RIGHTS OF A CONSUMER, SO THE ABOVE DISCLAIMER MAY NOT FULLY APPLY TO YOU. THE SOLE WARRANTY PROVIDED BY FORD MOTOR COMPANY SHALL BE FOUND IN THE WARRANTY INFORMATION INCLUDING WITH YOUR OWNER GUIDE. TO THE EXTENT THAT THERE IS ANY CONFLICT BETWEEN THE TERMS OF THIS SECTION AND THE WARRANTY BOOKLET, THE WARRANTY BOOKLET SHALL CONTROL.

Applicable Law, Venue, Jurisdiction

- The laws of the State of Michigan govern this EULA and Your use of the SOFTWARE. Your use of the SOFTWARE may also be subject to other local, state, national, or international laws. Any litigation arising out of or related to this EULA shall be brought and maintained exclusively in a court of the State of Michigan located in Wayne County or in the United States District Court for the Eastern District of Michigan. You hereby consent to submit to the personal jurisdiction of a court in the State of Michigan located in Wayne County and the United States District Court for the Eastern District of Michigan for any dispute arising out of or relating to this EULA.

Appendices

Binding Arbitration and Class Action Waiver

(a) Application. This Section applies to any dispute EXCEPT IT DOES NOT INCLUDE A DISPUTE RELATING TO COPYRIGHT INFRINGEMENT, OR TO THE ENFORCEMENT OR VALIDITY OF YOUR, FORD MOTOR COMPANY, OR ANY OF FORD MOTOR COMPANY'S LICENSORS' INTELLECTUAL PROPERTY RIGHTS. Dispute means any dispute, action, or other controversy between You and FORD MOTOR COMPANY, other than the exceptions listed above, concerning the SOFTWARE (including its price) or this EULA, whether in contract, warranty, tort, statute, regulation, ordinance, or any other legal or equitable basis.

(b) Notice of Dispute. In the event of a Dispute, You or FORD MOTOR COMPANY must give the other a "Notice of Dispute", which is a written statement of the name, address, and contact information of the party giving it, the facts giving rise to the dispute, and the relief requested. You and FORD MOTOR COMPANY will attempt to resolve any dispute through informal negotiation within 60 days from the date the Notice of Dispute is sent. After 60 days, You or FORD MOTOR COMPANY may commence arbitration.

(c) Small claims court. You may also litigate any dispute in small claims court in your county of residence or FORD MOTOR COMPANY'S principal place of business, if the dispute meets all requirements to be heard in the small claims court. You may litigate in small claims court whether or not You negotiated informally first.

(d) Binding arbitration. If You and FORD MOTOR COMPANY, do not resolve any dispute by informal negotiation or in small claims court, any other effort to resolve the dispute will be conducted exclusively by binding arbitration. You are giving up

the right to litigate (or participate in as a party or class member) all disputes in court before a judge or jury. Instead, all disputes will be resolved before a neutral arbitrator, whose decision will be final except for a limited right of appeal under the Federal Arbitration Act. Any court with jurisdiction over the parties may enforce the arbitrator's award.

(e) Class action waiver. Any proceedings to resolve or litigate any dispute in any forum will be conducted solely on an individual basis. Neither you nor FORD MOTOR COMPANY, will seek to have any dispute heard as a class action, as a private attorney general action, or in any other proceeding in which any party acts or proposes to act in a representative capacity. No arbitration or proceeding will be combined with another without the prior written consent of all parties to all affected arbitrations or proceedings.

(f) Arbitration procedure. Any arbitration will be conducted by the American Arbitration Association (the "AAA"), under its Commercial Arbitration Rules. If You are an individual and use the SOFTWARE for personal or vehicle use, or if the value of the dispute is \$75,000 or less whether or not You are an individual or how You use the SOFTWARE, the AAA Supplementary Procedures for Consumer-Related Disputes will also apply. To commence arbitration, submit a Commercial Arbitration Rules Demand for Arbitration form to the AAA. You may request a telephonic or in-person hearing by following the AAA rules. In a dispute involving \$10,000 or less, any hearing will be telephonic unless the arbitrator finds good cause to hold an in-person hearing instead. For more information, see adr.org or call 1-800-778-7879. You agree to commence arbitration only in your county of residence or FORD MOTOR COMPANY'S principal place of business. The arbitrator

Appendices

may award the same damages to You individually as a court could. The arbitrator may award declaratory or injunctive relief only to You individually, and only to the extent required to satisfy Your individual claim.

(g) Arbitration fees and incentives.

- I. Disputes involving \$75,000 or less. FORD MOTOR COMPANY will promptly reimburse your filing fees and pay the AAA's and arbitrator's fees and expenses. If you reject FORD MOTOR COMPANY'S last written settlement offer made before the arbitrator was appointed ("last written offer"), your dispute goes all the way to an arbitrator's decision (called an "award"), and the arbitrator awards you more than the last written offer, FORD MOTOR COMPANY will give you three incentives: (1) pay the greater of the award or \$1,000; (2) pay twice your reasonable attorney's fees, if any; and (3) reimburse any expenses (including expert witness fees and costs) that your attorney reasonably accrues for investigating, preparing, and pursuing your claim in arbitration. The arbitrator will determine the amounts.
- ii. Disputes involving more than \$75,000. The AAA rules will govern payment of filing fees and the AAA's and arbitrator's fees and expenses.
- iii. Disputes involving any amount. In any arbitration you commence, FORD MOTOR COMPANY will seek its AAA or arbitrator's fees and expenses, or Your filing fees it reimbursed, only if the arbitrator finds the arbitration frivolous or brought for an improper purpose. In any arbitration FORD MOTOR COMPANY commences, it will pay all

filing, AAA, and arbitrator's fees and expenses. It will not seek its attorney's fees or expenses from you in any arbitration. Fees and expenses are not counted in determining how much a dispute involves.

(h) Claims or disputes must be filed within one year. To the extent permitted by law, any claim or dispute under this EULA to which this Section applies must be filed within one year in small claims court (Section c) or in arbitration (Section d). The one-year period begins when the claim or dispute first could be filed. If such a claim or dispute is not filed within one year, it is permanently barred.

(i) Severability. If the class action waiver (Section e) is found to be illegal or unenforceable as to all or some parts of a dispute, then that portion of Section e will not apply to those parts. Instead, those parts will be severed and proceed in a court of law, with the remaining parts proceeding in arbitration. If any other provision of that portion Section e is found to be illegal or unenforceable, that provision will be severed with the remainder of Section e remaining in full force and effect.

Telenav Software End User License Agreement

Please read these terms and conditions carefully before you use the TeleNav Software. Your use of the TeleNav Software indicates that you accept these terms and conditions. If you do not accept these terms and conditions, do not break the seal of the package, launch, or otherwise use the TeleNav Software. TeleNav may revise this Agreement and the privacy policy at any time, with or without notice to you. You agree to visit <http://www.telenav.com> from time to time to review the then current version of this Agreement and of the privacy policy.

Appendices

1. Safe and Lawful Use

You acknowledge that devoting attention to the TeleNav Software may pose a risk of injury or death to you and others in situations that otherwise require your undivided attention, and you therefore agree to comply with the following when using the TeleNav Software:

- (a) observe all traffic laws and otherwise drive safely;
- (b) use your own personal judgment while driving. If you feel that a route suggested by the TeleNav Software instructs you to perform an unsafe or illegal maneuver, places you in an unsafe situation, or directs you into an area that you consider to be unsafe, do not follow such instructions;
- (c) do not input destinations, or otherwise manipulate the TeleNav Software, unless your vehicle is stationary and parked;
- (d) do not use the TeleNav Software for any illegal, unauthorized, unintended, unsafe, hazardous, or unlawful purposes, or in any manner inconsistent with this Agreement;
- (e) arrange all GPS and wireless devices and cables necessary for use of the TeleNav Software in a secure manner in your vehicle so that they will not interfere with your driving and will not prevent the operation of any safety device (such as an airbag).

You agree to indemnify and hold TeleNav harmless against all claims resulting from any dangerous or otherwise inappropriate use of the TeleNav Software in any moving vehicle, including as a result of your failure to comply with the directions above.

2. Account Information

You agree: (a) when registering the TeleNav Software, to provide TeleNav with true, accurate, current, and complete information about yourself, and (b) to inform TeleNav promptly of any changes to such information, and to keep it true, accurate, current and complete.

3. Software License

- Subject to your compliance with the terms of this Agreement, TeleNav hereby grants to you a personal, non-exclusive, non-transferable license (except as expressly permitted below in connection with your permanent transfer of the TeleNav Software license), without the right to sublicense, to use the TeleNav Software (in object code form only) in order to access and use the TeleNav Software. This license shall terminate upon any termination or expiration of this Agreement. You agree that you will use the TeleNav Software only for your personal business or leisure purposes, and not to provide commercial navigation services to other parties.

3.1 License Limitations

- **(a)** reverse engineer, decompile, disassemble, translate, modify, alter or otherwise change the TeleNav Software or any part thereof; **(b)** attempt to derive the source code, audio library or structure of the TeleNav Software without the prior express written consent of TeleNav; **(c)** remove from the TeleNav Software, or alter, any of TeleNav's or its suppliers' trademarks, trade names, logos, patent or copyright notices, or other notices or markings; **(d)**

Appendices

distribute, sublicense or otherwise transfer the TeleNav Software to others, except as part of your permanent transfer of the TeleNav Software; or **(e)** use the TeleNav Software in any manner that

- i. infringes the intellectual property or proprietary rights, rights of publicity or privacy or other rights of any party,
- ii. violates any law, statute, ordinance or regulation, including but not limited to laws and regulations related to spamming, privacy, consumer and child protection, obscenity or defamation, or
- iii. is harmful, threatening, abusive, harassing, tortuous, defamatory, vulgar, obscene, libelous, or otherwise objectionable; and (f) lease, rent out, or otherwise permit unauthorized access by third parties to the TeleNav Software without advanced written permission of TeleNav.

4. Disclaimers

- To the fullest extent permissible pursuant to applicable law, in no event will TeleNav, its licensors and suppliers, or agents or employees of any of the foregoing, be liable for any decision made or action taken by you or anyone else in reliance on the information provided by the TeleNav Software. TeleNav also does not warrant the accuracy of the map or other data used for the TeleNav Software. Such data may not always reflect reality due to, among other things, road closures, construction, weather, new roads and other changing conditions. You are responsible for the entire risk arising out of your use of the TeleNav Software. For example but without limitation, you agree not to rely on the TeleNav Software for critical navigation in areas where the well-being or survival of you or others

is dependent on the accuracy of navigation, as the maps or functionality of the TeleNav Software are not intended to support such high risk applications, especially in more remote geographical areas.

- TELENAV EXPRESSLY DISCLAIMS AND EXCLUDES ALL WARRANTIES IN CONNECTION WITH THE TELENAV SOFTWARE, WHETHER STATUTORY, EXPRESS OR IMPLIED, INCLUDING ALL WARRANTIES WHICH MAY ARISE FROM COURSE OF DEALING, CUSTOM OR TRADE AND INCLUDING, BUT NOT LIMITED TO, THE IMPLIED WARRANTIES OF MERCHANTABILITY, FITNESS FOR A PARTICULAR PURPOSE AND NON-INFRINGEMENT OF THIRD PARTY RIGHTS WITH RESPECT TO THE TELENAV SOFTWARE.
- Certain jurisdictions do not permit the disclaimer of certain warranties, so this limitation may not apply to you.

5. Limitation of Liability

- TO THE EXTENT PERMITTED UNDER APPLICABLE LAW, UNDER NO CIRCUMSTANCES SHALL TELENAV OR ITS LICENSORS AND SUPPLIERS BE LIABLE TO YOU OR TO ANY THIRD PARTY FOR ANY INDIRECT, INCIDENTAL, CONSEQUENTIAL, SPECIAL OR EXEMPLARY DAMAGES (INCLUDING IN EACH CASE, BUT NOT LIMITED TO, DAMAGES FOR THE INABILITY TO USE THE EQUIPMENT OR ACCESS DATA, LOSS OF DATA, LOSS OF BUSINESS, LOSS OF PROFITS, BUSINESS INTERRUPTION OR THE LIKE) ARISING OUT OF THE USE OF OR INABILITY TO USE THE TELENAV SOFTWARE, EVEN IF TELENAV HAS BEEN ADVISED OF THE POSSIBILITY OF SUCH DAMAGES. NOTWITHSTANDING ANY DAMAGES THAT YOU MIGHT INCUR FOR ANY

Appendices

REASON WHATSOEVER (INCLUDING, WITHOUT LIMITATION, ALL DAMAGES REFERENCED HEREIN AND ALL DIRECT OR GENERAL DAMAGES IN CONTRACT, TORT (INCLUDING NEGLIGENCE) OR OTHERWISE), THE ENTIRE LIABILITY OF TELENAV AND OF ALL OF TELENAV'S SUPPLIERS SHALL BE LIMITED TO THE AMOUNT ACTUALLY PAID BY YOU FOR THE TELENAV SOFTWARE. SOME STATES AND/OR JURISDICTIONS DO NOT ALLOW THE EXCLUSION OR LIMITATION OF INCIDENTAL OR CONSEQUENTIAL DAMAGES, SO THE ABOVE LIMITATIONS OR EXCLUSIONS MAY NOT APPLY TO YOU.

6. Arbitration and Governing Law

- You agree that any dispute, claim or controversy arising out of or relating to this Agreement or the TeleNav Software shall be settled by independent arbitration involving a neutral arbitrator and administered by the American Arbitration Association in the County of Santa Clara, California. The arbitrator shall apply the Commercial Arbitration Rules of the American Arbitration Association, and the judgment upon the award rendered by the arbitrator may be entered by any court having jurisdiction. Note that there is no judge or jury in an arbitration proceeding and the decision of the arbitrator shall be binding upon both parties. You expressly agree to waive your right to a jury trial. This Agreement and performance hereunder will be governed by and construed in accordance with the laws of the State of California, without giving effect to its conflict of law provisions. To the extent judicial action is necessary in connection with the binding arbitration, both TeleNav and you agree to submit

to the exclusive jurisdiction of the courts of the County of Santa Clara, California. The United Nations Convention on Contracts for the International Sale of Goods shall not apply.

7. Assignment

- You may not resell, assign, or transfer this Agreement or any of your rights or obligations, except in totality, in connection with your permanent transfer of the TeleNav Software, and expressly conditioned upon the new user of the TeleNav Software agreeing to be bound by the terms and conditions of this Agreement. Any such sale, assignment or transfer that is not expressly permitted under this paragraph will result in immediate termination of this Agreement, without liability to TeleNav, in which case you and all other parties shall immediately cease all use of the TeleNav Software. Notwithstanding the foregoing, TeleNav may assign this Agreement to any other party at any time without notice, provided the assignee remains bound by this Agreement.

8. Miscellaneous

8.1

This Agreement constitutes the entire agreement between TeleNav and you with respect to the subject matter hereof.

8.2

Except for the limited licenses expressly granted in this Agreement, TeleNav retains all right, title and interest in and to the TeleNav Software, including without limitation all related intellectual property rights. No licenses or other rights which are not expressly granted in this Agreement are intended to, or shall be, granted or

Appendices

conferred by implication, statute, inducement, estoppel or otherwise, and TeleNav and its suppliers and licensors hereby reserve all of their respective rights other than the licenses explicitly granted in this Agreement.

8.3

By using the TeleNav Software, you consent to receive from TeleNav all communications, including notices, agreements, legally required disclosures or other information in connection with the TeleNav Software (collectively, "Notices") electronically. TeleNav may provide such Notices by posting them on TeleNav's Website or by downloading such Notices to your wireless device. If you desire to withdraw your consent to receive Notices electronically, you must discontinue your use of the TeleNav Software.

8.4

TeleNav's or your failure to require performance of any provision shall not affect that party's right to require performance at any time thereafter, nor shall a waiver of any breach or default of this Agreement constitute a waiver of any subsequent breach or default or a waiver of the provision itself.

8.5

If any provision herein is held unenforceable, then such provision will be modified to reflect the intention of the parties, and the remaining provisions of this Agreement will remain in full force and effect.

8.6

The headings in this Agreement are for convenience of reference only, will not be deemed to be a part of this Agreement, and will not be referred to in connection with the construction or interpretation of this Agreement. As used in this Agreement, the words "include" and "including" and variations thereof, will not be deemed to be terms of limitation, but rather will be deemed to be followed by the words "without limitation".

9. Other Vendors Terms and Conditions

- The Telenav Software utilizes map and other data licensed to Telenav by third party vendors for the benefit of you and other end users. This Agreement includes end-user terms applicable to these companies (included at the end of this Agreement), and thus your use of the Telenav Software is also subject to such terms. You agree to comply with the following additional terms and conditions, which are applicable to Telenav's third party vendor licensors::

9.1 End User Terms Required by HERE North America, LLC

The data ("Data") is provided for your personal, internal use only and not for resale. It is protected by copyright, and is subject to the following terms and conditions which are agreed to by you, on the one hand, and Telenav ("Telenav") and its licensors (including their licensors and suppliers) on the other hand.

© 2013 HERE. All rights reserved.

The Data for areas of Canada includes information taken with permission from Canadian authorities, including: © Her Majesty the Queen in Right of Canada, © Queen's Printer for Ontario, © Canada Post Corporation, GeoBase®, © Department of Natural Resources Canada.

Appendices

HERE holds a non-exclusive license from the United States Postal Service® to publish and sell ZIP+4® information.

©United States Postal Service® 2014. Prices are not established, controlled or approved by the United States Postal Service®. The following trademarks and registrations are owned by the USPS: United States Postal Service, USPS, and ZIP+4

The Data for Mexico includes certain data from Instituto Nacional de Estadística y Geografía.

9.2 End User Terms Required by NAV2 (Shanghai) Co., Ltd

The data (“Data”) is provided for your personal, internal use only and not for resale. It is protected by copyright, and is subject to the following terms and conditions which are agreed to by you, on the one hand, and NAV2 (Shanghai) Co., Ltd (“NAV2”) and its licensors (including their licensors and suppliers) on the other hand. 20xx. All rights reserved

Terms and Conditions

Permitted Use. You agree to use this Data together with the Telenav Software solely for the internal business and personal purposes for which you were licensed, and not for service bureau, time-sharing or other similar purposes. Accordingly, but subject to the restrictions set forth in the following paragraphs, you agree not to otherwise reproduce, copy, modify, decompile, disassemble, create any derivative works of, or reverse engineer any portion of this Data, and may not transfer or distribute it in any form, for any purpose, except to the extent permitted by mandatory laws.

Restrictions. Except where you have been specifically licensed to do so by Telenav, and without limiting the preceding paragraph, you may not use this Data (a) with any products, systems, or applications installed or otherwise connected to or in communication with vehicles, capable of vehicle navigation, positioning, dispatch, real time route guidance, fleet management or similar applications; or (b) with or in communication with any positioning devices or any mobile or wireless-connected electronic or computer devices, including without limitation cellular phones, palmtop and handheld computers, pagers, and personal digital assistants or PDAs.

Warning. The Data may contain inaccurate or incomplete information due to the passage of time, changing circumstances, sources used and the nature of collecting comprehensive geographic data, any of which may lead to incorrect results.

No Warranty. This Data is provided to you “as is,” and you agree to use it at your own risk. Telenav and its licensors (and their licensors and suppliers) make no guarantees, representations or warranties of any kind, express or implied, arising by law or otherwise, including but not limited to, content, quality, accuracy, completeness, effectiveness, reliability, fitness for a particular purpose, usefulness, use or results to be obtained from this Data, or that the Data or server will be uninterrupted or error-free.

Disclaimer of Warranty: TELENAV AND ITS LICENSORS (INCLUDING THEIR LICENSORS AND SUPPLIERS) DISCLAIM ANY WARRANTIES, EXPRESS OR IMPLIED, OF QUALITY, PERFORMANCE, MERCHANTABILITY, FITNESS FOR A

Appendices

PARTICULAR PURPOSE OR NON-INFRINGEMENT. Some States, Territories and Countries do not allow certain warranty exclusions, so to that extent the above exclusion may not apply to you.

Disclaimer of Liability: TELENV AND ITS LICENSORS (INCLUDING THEIR LICENSORS AND SUPPLIERS) SHALL NOT BE LIABLE TO YOU: IN RESPECT OF ANY CLAIM, DEMAND OR ACTION, IRRESPECTIVE OF THE NATURE OF THE CAUSE OF THE CLAIM, DEMAND OR ACTION ALLEGING ANY LOSS, INJURY OR DAMAGES, DIRECT OR INDIRECT, WHICH MAY RESULT FROM THE USE OR POSSESSION OF THE INFORMATION; OR FOR ANY LOSS OF PROFIT, REVENUE, CONTRACTS OR SAVINGS, OR ANY OTHER DIRECT, INDIRECT, INCIDENTAL, SPECIAL OR CONSEQUENTIAL DAMAGES ARISING OUT OF YOUR USE OF OR INABILITY TO USE THIS INFORMATION, ANY DEFECT IN THE INFORMATION, OR THE BREACH OF THESE TERMS OR CONDITIONS, WHETHER IN AN ACTION IN CONTRACT OR TORT OR BASED ON A WARRANTY, EVEN IF TELENV OR ITS LICENSORS HAVE BEEN ADVISED OF THE POSSIBILITY OF SUCH DAMAGES. Some States, Territories and Countries do not allow certain liability exclusions or damages limitations, so to that extent the above may not apply to you.

Export Control. You shall not export from anywhere any part of the Data or any direct product thereof except in compliance with, and with all licenses and approvals required under, applicable export laws, rules and regulations, including but not limited to the laws, rules and regulations administered by the Office of Foreign Assets Control of the U.S. Department of Commerce and the Bureau of Industry and Security of the U.S. Department of Commerce. To the extent that any such

export laws, rules or regulations prohibit HERE from complying with any of its obligations hereunder to deliver or distribute Data, such failure shall be excused and shall not constitute a breach of this Agreement.

Entire Agreement. These terms and conditions constitute the entire agreement between Telenav (and its licensors, including their licensors and suppliers) and you pertaining to the subject matter hereof, and supersedes in their entirety any and all written or oral agreements previously existing between us with respect to such subject matter.

Governing Law. The above terms and conditions shall be governed by the laws of the State of Illinois [insert "Netherlands" where European HERE Data is used], without giving effect to (i) its conflict of laws provisions, or (ii) the United Nations Convention for Contracts for the International Sale of Goods, which is explicitly excluded. You agree to submit to the jurisdiction of the State of Illinois [insert "The Netherlands" where European HERE Data is used] for any and all disputes, claims and actions arising from or in connection with the Data provided to you hereunder.

Government End Users. If the Data is being acquired by or on behalf of the United States government or any other entity seeking or applying rights similar to those customarily claimed by the United States government, this Data is a "commercial item" as that term is defined at 48 C.F.R. ("FAR") 2.101, is licensed in accordance with these End-User Terms, and each copy of Data delivered or otherwise furnished shall be marked and embedded as appropriate with the following "Notice of Use," and shall be treated in accordance with such Notice:

Appendices

NOTICE OF USE

CONTRACTOR (MANUFACTURER/
SUPPLIER) NAME: HERE

CONTRACTOR (MANUFACTURER/
SUPPLIER) ADDRESS: c/o Nokia, 425
West Randolph Street, Chicago, Illinois
60606

This Data is a commercial item as
defined in FAR 2.101 and is subject to
these End-User Terms under which this
Data was provided.

© 1987 – 2014 HERE – All rights reserved.

If the Contracting Officer, federal government agency, or any federal official refuses to use the legend provided herein, the Contracting Officer, federal government agency, or any federal official must notify HERE prior to seeking additional or alternative rights in the Data.

I. US/Canada Territory

A. United States Data. The End-User Terms for any Application containing Data for the United States shall contain the following notices:

“HERE holds a non-exclusive license from the United States Postal Service® to publish and sell ZIP+4® information.”

“©United States Postal Service® 20XX. Prices are not established, controlled or approved by the United States Postal Service®. The following trademarks and registrations are owned by the USPS: United States Postal Service, USPS, and ZIP+4.”

B. Canada Data. The following provisions apply to the Data for Canada, which may include or reflect data from third party licensors (“Third Party Data”), including Her Majesty the Queen in Right of Canada (“Her Majesty”), Canada Post Corporation (“Canada Post”) and the Department of Natural Resources of Canada (“NRCan”):

1. Disclaimer and Limitation: Client agrees that its use of the Third Party Data is subject to the following provisions:

a. Disclaimer: The Third Party Data is licensed on an “as is” basis. The licensors of such data, including Her Majesty, Canada Post and NRCan, make no guarantees, representations or warranties respecting such data, either express or implied, arising by law or otherwise, including but not limited to, effectiveness, completeness, accuracy or fitness for a particular purpose.

b. Limitation on Liability: The Third Party Data licensors, including Her Majesty, Canada Post and NRCan, shall not be liable: (i) in respect of any claim, demand or action, irrespective of the nature of the cause of the claim, demand or action alleging any loss, injury or damages, direct or indirect, which may result from the use or possession of such Data; or (ii) in any way for loss of revenues or contracts, or any other consequential loss of any kind resulting from any defect in the Data.

Appendices

2. Copyright Notice: In connection with each copy of all or any portion of the Data for the Territory of Canada, Client shall affix in a conspicuous manner the following copyright notice on at least one of: (i) the label for the storage media of the copy; (ii) the packaging for the copy; or (iii) other materials packaged with the copy, such as user manuals or end user license agreements: "This data includes information taken with permission from Canadian authorities, including © Her Majesty the Queen in Right of Canada, © Queen's Printer for Ontario, © Canada Post Corporation, GeoBase®, © The Department of Natural Resources Canada. All rights reserved!"

3. End-User Terms: Except as otherwise agreed by the parties, in connection with the provision of any portion of the Data for the Territory of Canada to End-Users as may be authorized under the Agreement, Client shall provide such End-Users, in a reasonably conspicuous manner, with terms (set forth with other end user terms required to be provided under the Agreement, or as otherwise may be provided, by Client) which shall include the following provisions on behalf of the Third Party Data licensors, including Her Majesty, Canada Post and NRCan:

The Data may include or reflect data of licensors, including Her Majesty the Queen in the Right of Canada ("Her Majesty"), Canada Post Corporation ("Canada Post") and the Department of Natural Resources Canada ("NRCan"). Such data is licensed on an "as is" basis. The licensors, including Her Majesty, Canada Post and NRCan, make no guarantees, representations or warranties respecting such data,

either express or implied, arising by law or otherwise, including but not limited to, effectiveness, completeness, accuracy or fitness for a particular purpose. The licensors, including Her Majesty, Canada Post and NRCan, shall not be liable in respect of any claim, demand or action, irrespective of the nature of the cause of the claim, demand or action alleging any loss, injury or damages, direct or indirect, which may result from the use or possession of the data or the Data. The licensors, including Her Majesty, Canada Post and NRCan, shall not be liable in any way for loss of revenues or contracts, or any other consequential loss of any kind resulting from any defect in the data or the Data.

End User shall indemnify and save harmless the licensors, including Her Majesty, Canada Post and NRCan, and their officers, employees and agents from and against any claim, demand or action, irrespective of the nature of the cause of the claim, demand or action, alleging loss, costs, expenses, damages or injuries (including injuries resulting in death) arising out of the use or possession of the data or the Data.

4. Additional Provisions: The terms contained in this Section are in addition to all of the rights and obligations of the parties under the Agreement. To the extent that any of the provisions of this Section are inconsistent with, or conflict with, any other provisions of the Agreement, the provisions of this Section shall prevail.

Appendices

II. Mexico. The following provision applies to the Data for Mexico, which includes certain data from the Instituto Nacional de Estadística y Geografía (“INEGI”):

A. Any and all copies of the Data and/or packaging containing Data for Mexico shall contain the following notice: “Fuente: INEGI (Instituto Nacional de Estadística y Geografía)”

III. Latin America Territory

A. Third Party Notices. Any and all copies of the Data and/or packaging relating thereto shall include the respective Third Party Notices set forth below and used as described below corresponding to the Territory (or portion thereof) included in such copy:

Territory Notice

Argentina IGN “INSTITUTO GEOGRAFICO NACIONAL ARGENTINO”

Ecuador “INSTITUTO GEOGRAFICO MILITAR DEL ECUADOR AUTORIZACION N° IGM-2011-01- PCO-01 DEL 25 DE ENERO DE 2011”
“source: © IGN 2009 - BD TOPO ®”

Guadeloupe, French Guiana and Martinique Mexico “Fuente: INEGI (Instituto Nacional de Estadística y Geografía)”

IV. Middle East Territory

A. Third Party Notices. Any and all copies of the Data and/or packaging relating thereto shall include the respective Third Party Notices set forth below and used as described below corresponding to the Territory (or portion thereof) included in such copy:

Country Notice

Jordan “© Royal Jordanian Geographic Centre”. The foregoing notice requirement for Jordan Data is a material term of the Agreement. If Client or any of its permitted sublicensees (if any) fail to meet such requirement, HERE shall have the right to terminate Client’s license with respect to the Jordan Data.

B. Jordan Data. Client and its permitted sublicensees (if any) are restricted from licensing and/or otherwise distributing HERE’s database for the country of Jordan (“Jordan Data”) for use in Enterprise Applications to (i) non-Jordanian entities for use of the Jordan Data solely in Jordan or (ii) Jordan-based customers. In addition, Client, its permitted sublicensees (if any) and End-Users are restricted from using the Jordan Data in Enterprise Applications if such party is (i) a non-Jordanian entity using the Jordan Data solely in Jordan or (ii) a Jordan-based customer. For purposes of the foregoing, “Enterprise Applications” shall mean Geomarketing applications, GIS applications, mobile business asset management applications, call center applications, telematics applications, public organization Internet applications or for providing geocoding services.

Appendices

V. Europe Territory

A. Use of Certain Traffic Codes in Europe

1. General Restrictions Applicable to Traffic Codes. Client acknowledges and agrees that in certain countries of the Europe Territory, Client will need to obtain rights directly from third party RDS-TMC code providers to receive and use the Traffic Codes in the Data and to deliver to End-Users Transactions in any way derived from or based on such Traffic Codes. For such countries, HERE shall deliver the Data incorporating Traffic Codes to Client only after receiving certification from Client of its having obtained such rights.

2. Display of Third Party Rights Legends for Belgium. Client shall, for each Transaction that uses Traffic Codes for Belgium, provide the following notice to the End-User: "Traffic Codes for Belgium are provided by the Ministerie van de Vlaamse Gemeenschap and the Ministère de l'Équipement et des Transports."

B. Paper Maps. With respect to any license granted to Client relating to making, selling or distributing paper maps (i.e., a map fixed on a paper or paper-like medium): (a) such license with respect to Data for the Territory of Great Britain is conditioned on Client's entering into and complying with a separate written agreement with the Ordnance Survey ("OS") to create and sell paper maps, Client's paying to the OS any and all applicable paper map royalties, and Client's complying with the OS copyright notice requirements; (b) such license for selling or otherwise distributing for charge with respect to Data for the Territory of Czech Republic

is conditioned on Client's obtaining prior written consent from Kartografie a.s.; (c) such license for selling or distributing with respect to Data for the Territory of Switzerland is conditioned on Client's obtaining a permit from Bundesamt für Landestopografie of Switzerland; (d) Client is restricted from using Data for the Territory of France to create paper maps with a scale between 1:5,000 and 1:250,000; and (e) Client is restricted from using any Data to create, sell or distribute paper maps that are the same or substantially similar, in terms of data content and specific use of color, symbols and scale, to paper maps published by the European national mapping agencies, including without limitation, Landvermessungämter of Germany, Topografische Dienst of the Netherlands, Nationaal Geografisch Instituut of Belgium, Bundesamt für Landestopografie of Switzerland, Bundesamt für Eich-und Vermessungswesen of Austria, and the National Land Survey of Sweden.

C. OS Enforcement. Without limiting Section IV(B) above, with respect to Data for the Territory of Great Britain, Client acknowledges and agrees that the Ordnance Survey ("OS") may bring a direct action against Client to enforce compliance with the OS copyright notice (see Section IV(D) below) and paper map requirements (see Section IV(B) above) contained in this Agreement.

D. Third Party Notices. Any and all copies of the Data and/or packaging relating thereto shall include the respective Third Party Notices set forth below and used as described below corresponding to the Territory (or portion thereof) included in such copy:

Country(ies) Notice

Appendices

Austria	“© Bundesamt für Eich- und Vermessungswesen”	Spain	“Información geográfica propiedad del CNIG”
Croatia		Sweden	“Based upon electronic data © National Land Survey Sweden.”
Cyprus,		Switzerland	“Topografische Grundlage: © Bundesamt für Landestopographie.
Estonia,			E. Respective Country Distribution. Client acknowledges that HERE has not received approvals to distribute map data for the following countries in such respective countries: Albania, Belarus, Kyrgyzstan, Moldova and Uzbekistan. HERE may update such list from time to time. The license rights granted to Client under this TL with respect to the Data for such countries are contingent upon Client’s compliance with all applicable laws and regulations, including, without limitation, any required licenses or approvals to distribute the Application incorporating such Data in such respective countries.
Latvia,	“© EuroGeographics”		
Lithuania,			
Moldova,			
Poland,			
Slovenia			
and/or			
Ukraine			
France	“source: © IGN 2009 – BD TOPO ®”		
Germany	“Die Grundlagendaten wurden mit Genehmigung der zuständigen Behörden entnommen”		
Great Britain	“Contains Ordnance Survey data © Crown copyright and database right 2010 Contains Royal Mail data © Royal Mail copyright and database right 2010”		
Greece	“Copyright Geomatics Ltd.”	VI. Australia Territory	
Hungary	“Copyright © 2003; Top-Map Ltd.”		A. Third Party Notices. Any and all copies of the Data and/or packaging relating thereto shall include the respective Third Party Notices set forth below and used as described below corresponding to the Territory (or portion thereof) included in such copy:
Italy	“La Banca Dati Italiana è stata prodotta usando quale riferimento anche cartografia numerica ed al tratto prodotta e fornita dalla Regione Toscana.”		Copyright. Based on data provided under license from PSMA Australia Limited (www.pasma.com.au).
Norway	“Copyright © 2000; Norwegian Mapping Authority”		
Portugal	“Source: IgeoE – Portugal”		

Appendices

Product incorporates data which is © 20XX Telstra Corporation Limited, GM Holden Limited, Intelomatics Australia Pty Ltd and Continental Pty Ltd.

B. Third Party Notices for Australia. In addition to the foregoing, the End-User Terms for any Application containing RDS-TMC Traffic Codes for Australia shall contain the following notice: “Product incorporates traffic location codes which is © 20XX Telstra Corporation Limited and its licensors.”

AT&T Vehicle Network Carrier Telematics Disclosure

END USER FOR PURPOSES OF THIS SECTION MEANS YOU AND YOUR HEIRS, EXECUTORS, LEGAL PERSONAL REPRESENTATIVES AND PERMITTED ASSIGNS. FOR PURPOSES OF THIS SECTION “UNDERLYING WIRELESS SERVICE CARRIER” INCLUDES ITS AFFILIATES AND CONTRACTORS AND THEIR RESPECTIVE OFFICERS, DIRECTORS, EMPLOYEES, SUCCESSORS AND ASSIGNS. END USER HAS NO CONTRACTUAL RELATIONSHIP WITH THE UNDERLYING WIRELESS SERVICE CARRIER AND END USER IS NOT A THIRD PARTY BENEFICIARY OF ANY AGREEMENT BETWEEN FORD AND UNDERLYING CARRIER. END USER UNDERSTANDS AND AGREES THAT THE UNDERLYING CARRIER HAS NO LEGAL, EQUITABLE, OR OTHER LIABILITY OF ANY KIND TO END USER. IN ANY EVENT, REGARDLESS OF THE FORM OF THE ACTION, WHETHER FOR BREACH OF CONTRACT, WARRANTY, NEGLIGENCE, STRICT LIABILITY IN TORT OR OTHERWISE, END USER'S EXCLUSIVE REMEDY FOR CLAIMS ARISING IN ANY WAY IN CONNECTION WITH THIS AGREEMENT, FOR ANY CAUSE WHATSOEVER, INCLUDING BUT NOT LIMITED TO ANY FAILURE OR

DISRUPTION OF SERVICE PROVIDED HEREUNDER, IS LIMITED TO PAYMENT OF DAMAGES IN AN AMOUNT NOT TO EXCEED THE AMOUNT PAID BY END USER FOR THE SERVICES DURING THE TWO-MONTH PERIOD PRECEDING THE DATE THE CLAIM AROSE.

(ii) END USER AGREES TO INDEMNIFY AND HOLD HARMLESS THE UNDERLYING WIRELESS SERVICE CARRIER AND ITS OFFICERS, EMPLOYEES, AND AGENTS AGAINST ANY AND ALL CLAIMS, INCLUDING WITHOUT LIMITATION CLAIMS FOR LIBEL, SLANDER, OR ANY PROPERTY DAMAGE, PERSONAL INJURY OR DEATH, ARISING IN ANY WAY, DIRECTLY OR INDIRECTLY, IN CONNECTION WITH THIS AGREEMENT OR THE USE, FAILURE TO USE, OR INABILITY TO USE THE DEVICE EXCEPT WHERE THE CLAIMS RESULT FROM THE UNDERLYING CARRIER'S GROSS NEGLIGENCE OR WILLFUL MISCONDUCT. THIS INDEMNITY WILL SURVIVE THE TERMINATION OF THE AGREEMENT.

(iii) END USER HAS NO PROPERTY RIGHT IN ANY NUMBER ASSIGNED TO THE DEVICE.

(iv) END USER UNDERSTANDS THAT FORD AND THE UNDERLYING CARRIER CANNOT GUARANTEE THE SECURITY OF WIRELESS TRANSMISSIONS, AND WILL NOT BE LIABLE FOR ANY LACK OF SECURITY RELATING TO THE USE OF THE SERVICES

THE SERVICE IS FOR [END USER'S] USE ONLY AND END USER MAY NOT RESELL THE SERVICE TO ANY OTHER PARTY END USER UNDERSTANDS THAT THE UNDERLYING CARRIER DOES NOT GUARANTEE ANY END USER UNINTERRUPTED SERVICE OR COVERAGE. THE UNDERLYING CARRIER DOES NOT WARRANT THAT END USERS CAN OR WILL BE LOCATED USING THE SERVICE. THE UNDERLYING CARRIER

Appendices

MAKES NO WARRANTY, EXPRESS OR IMPLIED, OF MERCHANTABILITY OR FITNESS FOR A PARTICULAR PURPOSE, SUITABILITY, OR PERFORMANCE REGARDING ANY SERVICES OR GOODS, AND IN NO EVENT SHALL AT&T BE LIABLE, WHETHER OR NOT DUE TO ITS OWN NEGLIGENCE, FOR ANY: (A) ACT OR OMISSION OF A THIRD PARTY; (B) MISTAKES, OMISSIONS, INTERRUPTIONS, ERRORS, FAILURES TO TRANSMIT, DELAYS, OR DEFECTS IN THE SERVICE PROVIDED BY OR THROUGH THE UNDERLYING CARRIER; (C) DAMAGE OR INJURY CAUSED BY SUSPENSION OR TERMINATION BY THE UNDERLYING CARRIER; OR (D) DAMAGE OR INJURY CAUSED BY A FAILURE OR DELAY IN CONNECTING A CALL TO ANY ENTITY, INCLUDING 911 OR ANY OTHER EMERGENCY SERVICE. TO THE FULL EXTENT ALLOWED BY LAW, THE END USER RELEASES, INDEMNIFIES AND HOLDS THE UNDERLYING CARRIER HARMLESS FROM AND AGAINST ANY AND ALL CLAIMS OF ANY PERSON OR ENTITY FOR DAMAGES OF ANY NATURE ARISING IN ANY WAY FROM OR RELATING TO, DIRECTLY OR INDIRECTLY, SERVICES PROVIDED BY THE UNDERLYING CARRIER OR ANY PERSON'S USE THEREOF, INCLUDING CLAIMS ARISING IN WHOLE OR IN PART FROM THE ALLEGED NEGLIGENCE OF THE UNDERLYING CARRIER.

VII. China Territory

Personal Use Only

You agree to use this Data together with [insert name of Client Application] for the solely personal, non-commercial purposes for which you were licensed, and not for service bureau, time-sharing or other similar purposes. Accordingly, but subject to the restrictions set forth in the following paragraphs, you may copy this Data only as necessary for your personal use to (i)

view it, and (ii) save it, provided that you do not remove any copyright notices that appear and do not modify the Data in any way. You agree not to otherwise reproduce, copy, modify, decompile, disassemble or reverse engineer any portion of this Data, and may not transfer or distribute it in any form, for any purpose, except to the extent permitted by mandatory laws.

Restrictions

Except where you have been specifically licensed to do so by NAV2, and without limiting the preceding paragraph, you may not (a) use this Data with any products, systems, or applications installed or otherwise connected to or in communication with vehicles, capable of vehicle navigation, positioning, dispatch, real time route guidance, fleet management or similar applications; or (b) with or in communication with any positioning devices or any mobile or wireless-connected electronic or computer devices, including without limitation cellular phones, palmtop and handheld computers, pagers, and personal digital assistants or PDAs. You agree to cease using this Data if you fail to comply with these terms and conditions.

Limited Warranty

NAV2 warrants that (a) the Data will perform substantially in accordance with the accompanying written materials for a period of ninety (90) days from the date of receipt, and (b) any support services provided by NAV2 shall be substantially as described in applicable written materials provided to you by NAV2, and NAV2's support engineers will make commercially reasonable efforts to solve any problem issues.

Appendices

***rig*Customer Remedies**

NAV2 and its suppliers' entire liability and your exclusive remedy shall be, at NAV2's sole discretion, either (a) return of the price paid, if any, or (b) repair or replacement of the Data that do not meet NAV2's Limited Warranty and that are returned to NAV2 with a copy of your receipt. This Limited Warranty is void if failure of the Data has resulted from accident, abuse, or misapplication. Any replacement Data will be warranted for the remainder of the original warranty period or thirty (30) days, whichever is longer. Neither these remedies nor any product support services offered by NAV2 are available without proof of purchase from an authorized international source.

No Other Warranty:

EXCEPT FOR THE LIMITED WARRANTY SET FORTH ABOVE AND TO THE EXTENT PERMITTED BY APPLICABLE LAW, NAV2 AND ITS LICENSORS (INCLUDING THEIR LICENSORS AND SUPPLIERS) DISCLAIM ANY WARRANTIES, EXPRESS OR IMPLIED, OF QUALITY, PERFORMANCE, MERCHANTABILITY, FITNESS FOR A PARTICULAR PURPOSE, OWNERSHIP OR NON-INFRINGEMENT. Certain warranty exclusions may not be permitted under applicable law, so to that extent the above exclusion may not apply to you.

Limited Liability:

TO THE EXTENT PERMITTED BY APPLICABLE LAW, NAV2 AND ITS LICENSORS (INCLUDING THEIR LICENSORS AND SUPPLIERS) SHALL NOT BE LIABLE TO YOU: IN RESPECT OF ANY CLAIM, DEMAND OR ACTION, IRRESPECTIVE OF THE NATURE OF THE CAUSE OF THE CLAIM, DEMAND OR ACTION ALLEGING ANY LOSS, INJURY OR DAMAGES, DIRECT OR INDIRECT, WHICH MAY RESULT FROM THE USE OR POSSESSION OF THE INFORMATION; OR

FOR ANY LOSS OF PROFIT, REVENUE, CONTRACTS OR SAVINGS, OR ANY OTHER DIRECT, INDIRECT, INCIDENTAL, SPECIAL OR CONSEQUENTIAL DAMAGES ARISING OUT OF YOUR USE OF OR INABILITY TO USE THIS INFORMATION, ANY DEFECT IN THE INFORMATION, OR THE BREACH OF THESE TERMS OR CONDITIONS, WHETHER IN AN ACTION IN CONTRACT OR TORT OR BASED ON A WARRANTY, EVEN IF NAV2 OR ITS LICENSORS HAVE BEEN ADVISED OF THE POSSIBILITY OF SUCH DAMAGES. UNDER NO CIRCUMSTANCES SHALL NAV2'S OR ITS SUPPLIERS' LIABILITY HEREUNDER EXCEED THE PRICE PAID. Certain liability exclusions may not be permitted under applicable law, so to that extent the above exclusion may not apply to you.

Export Control

You agree not to export to anywhere any part of the Data provided to you or any direct product thereof except in compliance with, and with all licenses and approvals required under, applicable export laws, rules and regulations.

IP Protection

The Data are owned by NAV2 or its suppliers and are protected by applicable copyright and other intellectual property law and treaties. The Data are provided solely on the basis of a license to use, not sale.

Entire Agreement

These terms and conditions constitute the entire agreement between NAV2 (and its licensors, including their licensors and suppliers) and you pertaining to the subject matter hereof, and supersedes in their entirety any and all written or oral agreements previously existing between us with respect to such subject matter.

Appendices

Governing Law.

The above terms and conditions shall be governed by the laws of the People's Republic of China, without giving effect to (i) its conflict of laws provisions, or (ii) the United Nations Convention for Contracts for the International Sale of Goods, which is explicitly excluded. Any dispute arising from or in connection with the Data provided to you hereunder shall be submitted to the Shanghai International Economic and Trade Arbitration Commission for arbitration.

Gracenote® Copyright

CD and music-related data from Gracenote, Inc., copyright©

2000-2007 Gracenote. Gracenote Software, copyright © 2000-2007 Gracenote. This product and service may practice one or more of the following U.S. Patents 5,987,525; 6,061,680; 6,154,773; 6,161,132; 6,230,192; 6,230,207; 6,240,459; 6,330,593 and other patents issued or pending. Some services supplied under license from Open Globe, Inc. for U.S. Patent 6,304,523.

Gracenote and CDDB are registered trademarks of Gracenote. The Gracenote logo and logotype, and the "Powered by Gracenote™" logo are trademarks of Gracenote.

Gracenote® End User License Agreement (EULA)

This device contains software from Gracenote, Inc. of 2000 Powell Street Emeryville, California 94608 ("Gracenote").

The software from Gracenote (the "Gracenote Software") enables this device to do disc and music file identification and obtain music-related information, including name, artist, track, and title information ("Gracenote Data") from online servers

("Gracenote Servers"), and to perform other functions. You may use Gracenote Data only by means of the intended End User functions of this device. This device may contain content belonging to Gracenote's providers. If so, all of the restrictions set forth herein with respect to Gracenote Data shall also apply to such content and such content providers shall be entitled to all of the benefits and protections set forth herein that are available to Gracenote. You agree that you will use the content from Gracenote ("Gracenote Content"), Gracenote Data, the Gracenote Software, and Gracenote Servers for your own personal, non-commercial use only. You agree not to assign, copy, transfer or transmit the Gracenote Content, Gracenote Software or any Gracenote Data (except in a Tag associated with a music file) to any third party. YOU AGREE NOT TO USE OR EXPLOIT GRACENOTE CONTENT, GRACENOTE DATA, THE GRACENOTE SOFTWARE, OR GRACENOTE SERVERS, EXCEPT AS EXPRESSLY PERMITTED HEREIN.

You agree that your non-exclusive licenses to use the Gracenote Content, Gracenote Data, the Gracenote Software, and Gracenote Servers will terminate if you violate these restrictions. If your licenses terminate, you agree to cease any and all use of the Gracenote Content, Gracenote Data, the Gracenote Software, and Gracenote Servers.

Gracenote, respectively, reserve all rights in Gracenote Data, the Gracenote Software, and the Gracenote Servers and Gracenote Content, including all ownership rights. Under no circumstances will either Gracenote become liable for any payment to you for any information that you provide,

Appendices

including any copyrighted material or music file information. You agree that Gracenote may enforce its respective rights, collectively or separately, under this agreement against you, directly in each company's own name.

Gracenote uses a unique identifier to track queries for statistical purposes. The purpose of a randomly assigned numeric identifier is to allow Gracenote to count queries without knowing anything about who you are. For more information, see the web page at www.gracenote.com for the Gracenote Privacy Policy.

THE GRACENOTE SOFTWARE, EACH ITEM OF GRACENOTE DATA AND THE GRACENOTE CONTENT ARE LICENSED TO YOU "AS IS". NEITHER GRACENOTE MAKES ANY REPRESENTATIONS OR WARRANTIES, EXPRESS OR IMPLIED, REGARDING THE ACCURACY OF ANY GRACENOTE DATA FROM THE GRACENOTE SERVERS OR GRACENOTE CONTENT. GRACENOTE COLLECTIVELY AND SEPARATELY RESERVE THE RIGHT TO DELETE DATA AND/OR CONTENT FROM THE COMPANIES' RESPECTIVE SERVERS OR, IN THE CASE OF GRACENOTE, CHANGE DATA CATEGORIES FOR ANY CAUSE THAT GRACENOTE DEEMS SUFFICIENT. NO WARRANTY IS MADE THAT EITHER GRACENOTE CONTENT OR THE GRACENOTE SOFTWARE OR GRACENOTE SERVERS ARE ERROR-FREE OR THAT THE FUNCTIONING OF THE GRACENOTE SOFTWARE OR GRACENOTE SERVERS WILL BE UNINTERRUPTED. GRACENOTE IS NOT OBLIGATED TO PROVIDE YOU WITH ANY ENHANCED OR ADDITIONAL DATA TYPES THAT GRACENOTE MAY CHOOSE TO PROVIDE IN THE FUTURE AND IS FREE TO DISCONTINUE ITS ONLINE SERVICES AT ANY TIME. GRACENOTE DISCLAIMS ALL WARRANTIES EXPRESS OR IMPLIED, INCLUDING, BUT NOT LIMITED TO,

IMPLIED WARRANTIES OF MERCHANTABILITY, FITNESS FOR A PARTICULAR PURPOSE, TITLE, AND NON-INFRINGEMENT. NEITHER GRACENOTE WARRANTS THE RESULTS THAT WILL BE OBTAINED BY YOUR USE OF THE GRACENOTE SOFTWARE OR ANY GRACENOTE SERVER. IN NO CASE WILL GRACENOTE BE LIABLE FOR ANY CONSEQUENTIAL OR INCIDENTAL DAMAGES OR FOR ANY LOST PROFITS OR LOST REVENUES FOR ANY REASON WHATSOEVER. © Gracenote 2007.

Taiwan Territory

Note: In accordance with the management approach of low-power radio wave radiation motors:

Article 12: For approved and certified low-power radiation motor models, companies, firms or users must not alter the frequency, increase the power or change the characteristics and functions of the original design without authorization.

Article 14: The usage of low-power radio-frequency motors must not affect aviation safety and interfere with legal telecommunications. Should interference be detected, immediately stop using the device and only resume usage after ensuring that there is no longer any interference. For the legal telecommunication and wireless telecommunication of the telco, the low-power radio frequency motor must be able to tolerate legal limits of interference from telecommunication, industrial, scientific and radio wave equipment.

Appendices

SUNA TRAFFIC CHANNEL – TERMS AND CONDITIONS

By activating, using and/or accessing the SUNA Traffic Channel, SUNA Predictive or other content or material provided by Intelematics (together, **SUNA Products and/or Services**), you must accept certain terms and conditions. The following is a brief summary of the terms and conditions that apply to you. To view the full terms and conditions relevant to your use of the SUNA Products and/or Services, please consult:

Website
www.sunattraffic.com.au/termsandconditions/

1. Acceptance

By using SUNA Products and/or Services, you will be deemed to have accepted and agreed to be bound by the terms and conditions fully detailed at:

Website
www.sunattraffic.com.au/termsandconditions/

2. Intellectual Property

SUNA Products and/or Services are for your personal use. You may not record, or retransmit the content, nor use the content in association with any other traffic information or route guidance service or device not approved by Intelematics. You obtain no right of ownership in any Intellectual Property Rights (including copyright) in the data that is used to provide SUNA Products and/or Services.

3. Appropriate Use

SUNA Products and/or Services are intended as an aid to personal motoring and travel planning, and do not provide comprehensive or accurate information on all occasions. On occasions, you may experience additional delay as a result of using SUNA Products and/or Services. You acknowledge that it is not intended, or suitable, for use in applications where time of arrival or driving directions may impact the safety of the public or yourself.

4. Use of SUNA Products and Services while driving

You, and other authorised drivers of the vehicle in which SUNA Products and/or Services are available or installed and active, remain at all times responsible for observing all relevant laws and codes of safe driving. In particular, you agree to only actively operate SUNA Products and/or Services when the Vehicle is at a complete stop and it is safe to do so.

5. Service Continuity and Reception of the SUNA Traffic Channel

We will use reasonable endeavours to provide the SUNA Traffic Channel 24 hours a day, 365 days a year. The SUNA Traffic Channel may occasionally be unavailable for technical reasons or for planned maintenance. We will try to perform maintenance at times when congestion is light. We reserve the right to withdraw SUNA Products and/or Services at any time.

Also, we cannot assure the uninterrupted reception of the SUNA Traffic Channel RDS-TMC signal at any particular location.

6. Limitation of Liability

Neither Intelematics (nor its suppliers or the manufacturer of your device (the **“Suppliers”**)) shall be liable to you or to any third party for any damages either direct, indirect, incidental, consequential or otherwise arising out of the use of or inability to use SUNA Products and/or

Appendices

Services even if Intelematics or a Supplier has been advised of the possibility of such damages. You also acknowledge that the neither Intelematics nor any Supplier guarantees nor make any warranties that relate to the availability, accuracy or completeness of SUNA Products and/or Services, and to the extent which it is lawful to do so, both Intelematics and each Supplier excludes any warranties which might otherwise be implied by any State or Federal legislation in relation to SUNA Products and/or Services.

7. Please Note

Great care has been taken in preparing this manual. Constant product development may mean that some information is not entirely up-to-date. The information in this document is subject to change without notice.

DECLARATION OF CONFORMITY

Radio Frequency Statement

SYNC Version	FCC Identification Number	IC Identification Number
3.0	ACJ-SYNCG3-L	216B-SYNCG3-L
3.1	ACJ-FA-170-BCARHS	216B-FA170BCARHS
3.2	ACJ-FG-185-SG32MH	216B-FG185SG32MH



WARNING: Changes or modifications not expressly approved by the party responsible for compliance could void the user's authority to operate the equipment. The term "IC:" before the radio certification number only signifies that Industry Canada technical specifications were met.

These devices comply with Part 15 of the FCC Rules and with RSS-210 of Industry Canada. Operation is subject to the following two conditions:

1. The device does not cause harmful interference.
2. The device accepts any interference received, including interference that could cause undesired operation.

Index

1

180 Degree Camera.....	196
Camera Views.....	197
Front View Camera.....	196
Using the 180 degree camera system.....	197

9

911 Assist.....	61
-----------------	----

A

A/C	
See: Climate Control.....	122
About This Manual.....	9
ABS	
See: Brakes.....	170
ABS driving hints	
See: Hints on Driving With Anti-Lock Brakes.....	170
Accessories.....	442
ACC	
See: Using Adaptive Cruise Control.....	199
Active Park Assist.....	191
Using Active Park Assist.....	191
Adjusting the Headlamps.....	293
Horizontal Aim Adjustment.....	294
Vertical Aim Adjustment.....	293
Adjusting the Steering Wheel.....	96
Airbag Disposal.....	60
Air Conditioning	
See: Climate Control.....	122
Air Filter	
See: Changing the Engine Air Filter.....	284
Alarm	
See: Anti-Theft Alarm - Vehicles With: Anti-Theft Alarm Horn with Integral Battery.....	91
See: Anti-Theft Alarm - Vehicles Without: Anti-Theft Alarm Horn with Integral Battery.....	90
All-Wheel Drive.....	165
AM/FM Radio - Vehicles Without:	
SYNC.....	379
Selecting a Radio Source.....	379

Anti-Theft Alarm - Vehicles With:	
Anti-Theft Alarm Horn with Integral Battery.....	91
Alarm System.....	91
Arming the Alarm.....	92
Disarming the Alarm.....	92
Guard Settings.....	91
Triggering the Alarm.....	91
Anti-Theft Alarm - Vehicles Without:	
Anti-Theft Alarm Horn with Integral Battery.....	90
Alarm System.....	90
Arming the Alarm.....	90
Disarming the Alarm.....	90
Triggering the Alarm.....	90
Appendices.....	461
Applying the Electric Parking Brake.....	177
Applying the Electric Parking Brake in an Emergency.....	177
Applying the Parking Brake.....	174
Apps.....	425
SiriusXM Traffic and Travel Link.....	426
Using Apps on an Android Device.....	426
Using Apps on an iOS Device.....	425
Using Mobile Navigation on an Android Device.....	426
Audio System.....	376
General Information.....	376
Audio Unit Clock and Date Displays - Vehicles Without: SYNC.....	380
Adjusting the Clock.....	380
Audio Unit - Vehicles With: SYNC	
3.....	378
Adjusting the Volume.....	378
Changing Radio Stations.....	379
Pausing or Playing Media.....	379
Seek Down and Previous Track Button.....	379
Seek Up and Next Track Button.....	379
Sound Settings.....	379
Switching the Audio Unit On and Off.....	378
Switching the Screen On and Off.....	379
Audio Unit - Vehicles Without:	
SYNC.....	376
Adjusting the Volume.....	376
Changing Radio Stations.....	377
Pausing or Playing Media.....	378
Returning to the Previous Screen.....	377

Index

Scrolling Through the Menu Options.....	377
Seek Down and Previous Track Button.....	378
Seek Up and Next Track Button.....	377
Selecting a Menu Option.....	377
Selecting Media.....	377
Selecting the Radio.....	377
Sound Settings.....	378
Switching the Audio Unit On and Off.....	376
Switching the Screen On and Off.....	378
System Settings.....	378
Using a Cell Phone.....	378
Auto Hold.....	172
Auto Hold Indicator.....	172
Auto Hold Information Messages.....	173
Switching Auto Hold On and Off.....	172
Using Auto Hold.....	172
Autolamps.....	101
Adjusting the Period of Time That the Headlamps Remain On.....	102
Automatically Releasing the Electric Parking Brake.....	177
Automatic High Beam Control.....	103
Automatic High Beam Control Information Messages.....	104
Automatic High Beam Indicator.....	104
Overriding Automatic High Beam Control.....	104
Switching Automatic High Beam Control On or Off.....	104
Automatic Transmission.....	161
Automatic Transmission Information Messages.....	163
Brake Shift Interlock.....	162
Progressive Range Selection.....	161
Selector Lever Positions.....	161
SelectShift™.....	161
Transmission Not in Park (P) Audible Warning.....	163
Automatic Transmission Fluid Check.....	289
Auto-Start-Stop.....	148
Auto-Start-Stop – Troubleshooting.....	149
Auto-Start-Stop Indicators.....	149
Auto-Start-Stop Precautions.....	148
Auto-Start-Stop – Troubleshooting.....	149
Auto-Start-Stop – Frequently Asked Questions.....	150
Auto-Start-Stop – Information Messages.....	149
Autowipers.....	97
Settings.....	98
Auxiliary Power Points.....	138
110 Volt - 150 Watt Capacity AC Power Outlet.....	138
110 Volt - 400 Watt Capacity AC Power Outlet.....	139
Auxiliary Switches.....	443
AWD See: All-Wheel Drive.....	165
B	
Battery See: Changing the 12V Battery.....	290
Blind Spot Information System Blind Spot Information System Indicator.....	213
Blind Spot Information System Information Messages.....	215
Blind Spot Information System Sensors.....	212
Blind Spot Information System Warning Lamp.....	215
Blind Spot Information System with Trailer Tow.....	213
Switching the Blind Spot Information System On and Off.....	213
Using the Blind Spot Information System.....	212
BLIS See: Blind Spot Information System.....	212
Body Styling Kits.....	310
Bonnet Lock See: Opening and Closing the Hood.....	278
Booster Seats.....	37
Types of Booster Seats.....	38
Bottle Holders.....	142
Bottle Holder Precautions.....	142
Locating the Bottle Holders.....	142
Brake Fluid Check.....	290

Index

Brakes.....	170	Side Direction Indicator.....	298
General Information.....	170	Sun Visor Mirror Lamp.....	300
Breaking-In.....	247	Changing a Fuse.....	276
Bulb Specification Chart.....	369	Fuses.....	276
C		Changing a Road Wheel.....	339
California Proposition 65 - United States of America.....	458	Dissimilar Spare Wheel and Tire Assembly Information.....	340
Capacities and Specifications - 3.5L		Front Jacking Points.....	345
Duratec.....	358	Installing a Road Wheel.....	348
Air Conditioning System.....	358	Locking Lug Nuts.....	341
Brake System.....	361	Rear Jacking Points.....	345
Engine.....	359	Removing a Road Wheel.....	348
Engine Coolant.....	360	Removing a Wheel Trim.....	346
Fuel Tank.....	361	Stowing the Wheel and Vehicle Jack.....	350
Grease.....	362	Vehicle Jack.....	344
Locks.....	362	Vehicles With a Spare Wheel.....	341
Rear Axle.....	362	Changing the 12V Battery.....	290
Washer Reservoir.....	361	Removing the Battery.....	291
Capacities and Specifications - 3.5L		Replacing the Battery.....	292
Ecoboost™.....	363	Changing the Engine Air Filter.....	284
Air Conditioning System.....	363	Changing the Engine Oil and Oil Filter.....	283
Brake System.....	367	Engine Lubrication for Severe Service Operation.....	283
Engine.....	364	Changing the Front Wiper Blades.....	295
Engine Coolant.....	366	Changing the Vehicle Wi-Fi Hotspot Name or Password.....	375
Fuel Tank.....	366	Checking MyKey System Status.....	74
Grease.....	368	Checking the Wiper Blades.....	294
Locks.....	368	Child Restraint and Seatbelt Maintenance.....	49
Rear Axle.....	367	Child Restraint Positioning.....	39
Washer Reservoir.....	366	Child Safety.....	19
Capacities and Specifications.....	352	General Information.....	19
Cargo Lamps.....	106	Child Safety Locks.....	41
Switching the Cargo Lamps Off.....	106	Left-Hand Side.....	42
Switching the Cargo Lamps On.....	106	Right-Hand Side.....	42
Car Wash		Cigar Lighter.....	140
See: Cleaning the Exterior.....	303	Cleaning Products.....	302
Catalytic Converter - 3.5L Duratec/3.5L Ecoboost™.....	159	Cleaning the Engine.....	304
On-Board Diagnostics System.....	160	Cleaning the Exterior.....	303
Changing a Bulb.....	296	Body Paintwork Preservation.....	304
Front Clearance Lamp.....	298	Cleaning the Chrome Trim.....	303
Headlamp.....	296	Cleaning the Headlamps.....	303
High Mounted Stoplamps.....	299	Cleaning the Rear Window.....	303
Interior Lamp.....	299	Sliding Door Tracks.....	304
License Plate Lamp.....	299	Cleaning the Instrument Panel and Instrument Cluster Lens.....	307
Reading Lamps.....	300		
Rear Lamps.....	298		

Index

Cleaning the Interior.....	305	Crash and Breakdown Information.....	255
Fabric, Carpets, Cloth Seats, Headliners and Floor Mats.....	305	Post-Crash Alert System.....	255
Instrument Cluster Screens, LCD Screens and Radio Screens.....	306	Crash Sensors and Airbag Indicator.....	59
Leather Interior.....	306	Creating a MyKey.....	71
Mirrors.....	307	MyKey Information Messages.....	71
Rear Windows.....	307	Creating a Vehicle Wi-Fi Hotspot.....	375
Seatbelts.....	306	Connecting a Device to the Wi-Fi Hotspot.....	375
Storage Compartments, Cup Holders and Ashtrays.....	307	Finding the Wi-Fi Hotspot Name and Password.....	375
Suede Micro Fiber Fabric.....	306	Cross Traffic Alert.....	216
Cleaning the Wheels.....	308	Cross Traffic Alert behavior when trailer is attached.....	218
Cleaning the Windows and Wiper Blades.....	305	Cross Traffic Alert Indicator.....	218
Clearing All MyKeys.....	73	Cross Traffic Alert Information Messages.....	218
Climate Control.....	122	Cross Traffic Alert System Limitations.....	217
Closing the Sliding Door.....	80	Cross Traffic Alert System Sensors.....	217
Closing the Sliding Door From Inside Your Vehicle.....	80	Switching the System On and Off.....	218
Closing the Sliding Door From Outside Your Vehicle.....	81	Using Cross Traffic Alert.....	216
Closing the Sliding Door With the Remote Control.....	84	Cruise Control.....	198
Cold Weather Precautions.....	246	Principle of Operation.....	198
Connected Vehicle.....	371	Cruise control See: Using Cruise Control.....	198
Connecting the Vehicle to a Mobile Network.....	371	Customer Assistance.....	256
Connected Vehicle Data - Vehicles With: Modem.....	16	Customer Information.....	454
Connected Vehicle Limitations.....	371		
Connected Vehicle Requirements.....	371	D	
Connected Vehicle – Troubleshooting - Vehicles With: Modem.....	372	Data Privacy.....	14
Connected Vehicle – Troubleshooting - Vehicles With: SYNC/SYNC 3.....	373	Services That Third Parties Provide.....	14
Connecting a Bluetooth® Device - Vehicles Without: SYNC.....	380	Services That We Provide.....	14
Pairing a Device.....	380	Daytime Running Lamps.....	102
Connecting the Vehicle to a Mobile Network.....	371	Type 1 - Conventional (Non-Configurable).....	102
Connecting FordPass to the Modem.....	371	Type 2 - Configurable.....	102
Enabling and Disabling the Modem.....	371	Declaration of Conformity.....	489
What Is the Modem.....	371	Radio Frequency Statement.....	489
Connecting the Vehicle to a Wi-Fi Network.....	372	Direction Indicators.....	105
Coolant Check See: Engine Coolant Check.....	285	Direction Indicator.....	105
		Switching the Direction Indicators On and Off.....	105
		Doors and Locks.....	76
		Drive Belt Routing - Vehicles With: Dual Generators.....	301
		Drive Belt Routing - Vehicles With: Single Generator.....	301

Index

Drive Control.....	226	End User License Agreement.....	464
Selectable Drive Modes.....	226	VEHICLE SOFTWARE END USER LICENSE	
Selectable Drive Modes Information		AGREEMENT (EULA)	464
Messages.....	227	Engine Block Heater.....	146
Driver Alert.....	207	Using the Engine Block Heater.....	147
Driver Alert System Display.....	207	Engine Coolant Check.....	285
Driver Alert System Messages.....	208	Adding Coolant.....	286
Driver Alert System Warnings.....	207	Coolant Change.....	287
Switching Driver Alert On and Off.....	208	Engine Coolant Temperature	
Driver and Passenger Airbags.....	51	Management.....	289
Children and Airbags.....	56	Fail-Safe Cooling.....	287
Passenger Airbag On and Off Switch	51	Recycled Coolant.....	287
Proper Driver and Front Passenger Seating		Severe Climates.....	287
Adjustment.....	56	Engine Cooling Fan.....	285
Driving Aids.....	206	Engine Emission Control.....	158
Driving Hints.....	246	Engine Immobilizer	
Driving Through Water.....	247	See: Passive Anti-Theft System - Vehicles	
DRL		With: Passive Anti-Theft System	
See: Daytime Running Lamps.....	102	(PATS).....	89
E		Engine Oil Check.....	282
Eco.....	219	Adding Engine Oil.....	282
Eco Mode.....	219	Engine Oil Pressure Warning Lamp.....	283
Efficient Drive Mode.....	219	Engine Oil Dipstick - 3.5L Duratec.....	282
Economical Driving.....	246	Engine Oil Dipstick - 3.5L	
Electric Parking Brake Audible		Ecoboost™	282
Warning.....	178	Engine Specifications - 3.5L	
Electric Parking Brake.....	177	Duratec.....	352
Electric Parking Brake –		Engine Specifications - 3.5L	
Troubleshooting.....	178	Ecoboost™	353
Electric Parking Brake –		Entertainment.....	408
Troubleshooting.....	178	AM/FM Radio.....	409
Electric Parking Brake – Information		Apps.....	417
Messages.....	178	Bluetooth Stereo or USB.....	416
Electric Parking Brake – Warning		CD.....	415
Lamps.....	178	HD Radio™ Information (If	
Electromagnetic Compatibility.....	461	Available).....	412
Emergency Call Limitations.....	62	SiriusXM® Satellite Radio (If	
Emergency Call Requirements.....	61	Activated).....	410
Emergency Call System Data.....	17	Sources.....	409
Emergency Exit - M2 Bus.....	250	Supported Media Players, Formats and	
Emission Law.....	158	Metadata Information.....	417
Noise Emissions Warranty, Prohibited		USB Ports.....	417
Tampering Acts and Maintenance.....	159	Environment.....	18
Tampering With a Noise Control		Essential Towing Checks.....	239
System.....	158	Before Towing a Trailer.....	244
Enabling Remote Start.....	120	Launching or Retrieving a Boat or Personal	
		Water Craft (PWC).....	245
		Safety Chains.....	240

Index

Tow Hitch.....	240
Trailer Brakes.....	240
Trailer Lamps.....	244
Trailer Towing Connector.....	239
When Towing a Trailer.....	244
Event Data.....	15
Export Unique Options.....	460
Exterior Mirrors.....	108
Fold-Away Exterior Mirrors.....	109
Power Exterior Mirrors.....	108
Power Folding Mirrors.....	108

F

Fan	
See: Engine Cooling Fan.....	285
Fastening the Seatbelts.....	44
Seatbelt Locking Modes.....	45
Using Seatbelts During Pregnancy.....	44
Flat Tire	
See: Changing a Road Wheel.....	339
Flat Tire Inflation	
See: Tire Sealant and Inflator Kit.....	312
Floor Mats.....	247
Fog Lamps - Front	
See: Front Fog Lamps.....	104
Ford Credit.....	256
US Only.....	256
Ford Protect.....	444
Ford Protect Extended Service Plan (CANADA ONLY).....	445
Ford Protect Extended Service Plans (U.S. Only).....	444
Front Fog Lamps.....	104
Front Fog Lamp Indicator.....	105
Switching the Front Fog Lamps On or Off.....	104
Front Parking Aid.....	187
Front Parking Aid Information Messages.....	189
Object Distance Indicator.....	188
Front View Camera.....	225
Using the Front View Camera.....	226
Front Wiper Blades	
See: Changing the Front Wiper Blades.....	295
Fuel and Refueling.....	151
Fuel Filler Funnel Location.....	153
Fuel Filter.....	294

Fuel Quality - E85.....	151
Choosing the Right Fuel - Flex Fuel Vehicles.....	151
Switching Between E85 and Gasoline.....	152
Fuel Quality - Gasoline.....	153
Choosing the Right Fuel.....	153
Fuel Shutoff.....	250
Ignition Switch.....	250
Keyless Starting.....	251
Fuse Box Locations.....	263
Body Control Module.....	263
Driver Compartment Fuse Box.....	263
Engine Compartment Fuse Box.....	263
Passenger Compartment Fuse Box.....	263
Pre-fuse Box.....	263
Fuses.....	263
Fuse Specification Chart.....	264
Body Control Module.....	271
Driver Compartment Fuse Box.....	267
Engine Compartment Fuse Box.....	264
Passenger Compartment Fuse Box.....	273
Pre-fuse Box.....	275

G

Gauges.....	110
Automatic Transmission Position Indicators.....	111
Engine Coolant Temperature Gauge.....	111
Fuel Gauge.....	111
Information Display.....	110
Instrument Cluster.....	110
Speedometer.....	111
Tachometer.....	110
Gearbox	
See: Transmission.....	161
General Information on Radio	
Frequencies.....	63
General Maintenance Information.....	446
Multi-point Inspection.....	448
Owner Checks and Services.....	447
Protecting Your Investment.....	446
Why Maintain Your Vehicle?.....	446
Why Maintain Your Vehicle at Your Dealership?.....	446
Getting Assistance Outside the U.S. and Canada.....	259

Index

Getting the Services You Need.....	256
Away From Home.....	256
H	
Hazard Flashers.....	250
Headlamp Adjusting	
See: Adjusting the Headlamps.....	293
Headlamp Removal	
See: Removing a Headlamp.....	295
Headrest	
See: Head Restraints.....	126
Head Restraints.....	126
Adjusting the Head Restraint.....	127
Installing the Head Restraint	127
Removing the Head Restraint.....	127
Heated Exterior Mirrors - Vehicles With:	
Heated Rear Window.....	124
Heated Exterior Mirrors - Vehicles	
Without: Heated Rear Window.....	124
Heated Rear Window.....	124
Heated Seats.....	135
Heating	
See: Climate Control.....	122
Hill Start Assist.....	171
Hill Start Assist Information	
Messages.....	172
Switching Hill Start Assist On or Off.....	171
Using Hill Start Assist.....	171
Hints on Controlling the Interior	
Climate.....	123
Defogging or Clearing the Windshield of	
Thin Ice.....	124
Defogging the Side Windows in Cold	
Weather.....	123
General Hints.....	123
Quickly Cooling the Interior.....	123
Quickly Heating the Interior.....	123
Recommended Settings for Cooling.....	123
Recommended Settings for Heating.....	123
Hints on Driving With Anti-Lock	
Brakes.....	170
Hood Lock	
See: Opening and Closing the Hood.....	278
How Does the Rear Occupant Alert	
System Work.....	136
I	
Ignition Switch.....	144
In California (U.S. Only).....	257
Information Displays.....	115
General Information.....	115
Installing Child Restraints.....	21
Child Safety Restraint.....	21
Using Lap and Shoulder Belts.....	21
Using Lower Anchors and Tethers for	
Children (LATCH).....	23
Using Tether Straps.....	30
Instrument Cluster.....	110
Instrument Lighting Dimmer.....	102
Interior Air Quality.....	125
Interior Lamps - Van.....	105
Courtesy Lamp Function.....	105
Switching the Courtesy Lamps On and	
Off.....	105
Switching the Front Map Reading Lamps	
On and Off.....	105
Interior Mirror.....	109
Introduction.....	9
J	
Jump Starting the Vehicle.....	251
Connecting the Jumper Cables.....	252
Jump Starting.....	253
Preparing Your Vehicle.....	251
Removing the Jumper Cables.....	253
K	
Keyless Entry.....	87
Keyless Entry Settings.....	87
Keyless Entry - Troubleshooting.....	88
Locking and Unlocking the Doors Using	
Keyless Entry.....	87
Master Access Code.....	87
Keyless Entry Settings.....	87
Clearing All Personal Access Codes.....	87
Creating Personal Access Codes.....	87
Reprogramming the Unlocking	
Function.....	87
Keyless Entry - Troubleshooting.....	88
Keyless Entry - Frequently Asked	
Questions.....	88

Index

Keys and Remote Controls.....	63
Principle of Operation.....	63
L	
Lane Keeping System.....	208
Lane Keeping System Display.....	210
Lane Keeping System Messages.....	211
Lane Keeping System Settings.....	209
Lane Keeping System Warning Lamps and Indicators.....	211
Switching Lane Keeping System On or Off.....	209
Lighting Control.....	100
Exterior Lamps On Audible Warning.....	101
Flashing High Beam Headlamps.....	101
High Beam Headlamp Indicator.....	101
Lamps On Indicator.....	101
Lighting Control Positions.....	100
Switching High Beam Headlamps On and Off.....	101
Switching the Parking Lamps On.....	100
Lighting.....	100
General Information.....	100
Load Carriers	
See: Roof Racks and Load Carriers - Bus.....	228
See: Roof Racks and Load Carriers - Van.....	228
Load Carrying.....	228
Load Limit.....	229
Special Loading Instructions for Owners of Pick-up Trucks and Utility-type Vehicles.....	233
Vehicle Loading - with and without a Trailer.....	229
Load Retaining Fixtures.....	228
Securing Cargo.....	228
Locating the Cabin Air Filter.....	125
Locating the Keyless Entry Keypad.....	87
Locking and Unlocking.....	76
Autolock.....	78
Autounlock.....	79
Configurable Unlocking.....	79
Locking.....	76
Locking and Unlocking the Doors From Inside.....	76
One-Stage Unlocking.....	79
Opening the Double Rear Doors.....	77
Rear Emergency Exit.....	78
Two-Stage Unlocking.....	79
Unlocking.....	76
Zone Re-Locking.....	79
Locking and Unlocking the Doors Using Keyless Entry.....	87
Locking the Doors.....	88
Unlocking the Doors.....	87
Locking the Steering Wheel.....	96
Unlocking the Steering Wheel.....	96
Lug Nuts	
See: Changing a Road Wheel.....	339
Lug Nuts.....	350
Locking Lug Nuts.....	351
Lug Nut Torque.....	350
M	
Maintenance.....	278
General Information.....	278
Manual Climate Control.....	122
Directing Air to the Footwell Air Vents.....	122
Directing Air to the Instrument Panel Air Vents.....	122
Directing Air to the Windshield Air Vents.....	122
Setting the Blower Motor Speed.....	122
Setting the Temperature.....	123
Switching Maximum Cooling On and Off.....	122
Switching Maximum Defrost On and Off.....	122
Switching the Air Conditioning On and Off.....	122
Switching the Climate Control On and Off.....	122
Switching the Recirculated Air On and Off.....	122
Manually Releasing the Electric Parking Brake.....	177
.....	177
Manual Seats - Vehicles With: 2-Way Manual Seat.....	127
Adjusting the Armrest.....	128
Adjusting the Lumbar Support.....	128
Adjusting the Seat Backrest.....	128

Index

Moving the Seat Backward and Forward.....	127
Manual Seats - Vehicles With: 4-Way Manual Seat.....	128
Adjusting the Armrest.....	130
Adjusting the Lumbar Support.....	130
Adjusting the Seat Backrest.....	129
Adjusting the Seat Cushion.....	130
Adjusting the Seat Height.....	129
Moving the Seat Backward and Forward.....	129
Swiveling the Seat.....	130
Swivel Seat Audible Warning.....	131
Master Access Code.....	87
What Is the Master Access Code.....	87
Message Center See: Information Displays.....	115
Mirrors See: Windows and Mirrors.....	107
Mobile Communications Equipment.....	460
Mobile Device Data - Vehicles With: SYNC 3.....	17
Motorcraft Parts - 3.5L Duratec.....	354
Motorcraft Parts - 3.5L Ecoboost™.....	355
MyKey Settings.....	70
Configurable Settings.....	70
Non-Configurable Settings.....	70
MyKey - Troubleshooting.....	75
What is an admin key?.....	75
Why can I not clear the MyKeys?.....	75
Why can I not create a MyKey?.....	75
Why can I not program a MyKey?.....	75
Why does the MyKey distance not accumulate?.....	75
MyKey™.....	70
Principle of Operation.....	70
N	
Navigation.....	419
Changing the Format of the Map.....	421
cityseeker.....	423
Michelin Travel Guide.....	424
Navigation Map Accuracy and Updates.....	425
Route Guidance.....	422
Setting a Destination.....	420
SiriusXM Traffic and Travel Link.....	424
Zoom.....	421
Normal Scheduled Maintenance.....	449
Intelligent Oil-Life Monitor™.....	449
Normal Maintenance Intervals.....	449
O	
Oil Change Indicator Reset.....	284
Resetting the Oil Life Monitoring System.....	284
Oil Check See: Engine Oil Check.....	282
Opening and Closing the Hood.....	278
Closing the Hood.....	279
Opening the Hood.....	278
Opening the Sliding Door.....	80
Opening the Sliding Door From Inside Your Vehicle.....	80
Opening the Sliding Door From Outside Your Vehicle.....	80
Opening the Sliding Door With the Remote Control.....	83
Ordering Additional Owner's Literature.....	261
Obtaining a French Owner's Manual.....	261
Overhead Console.....	141
Overhead Storage.....	142
Locating the Overhead Storage.....	142
Overhead Storage Load Capacities.....	142
P	
Parking Aid.....	184
Parking Aids.....	183
Principle of Operation.....	183
Parking Brake Audible Warning.....	174
Parking Brake.....	174
Parking Brake - Troubleshooting.....	174
Parking Brake - Troubleshooting.....	174
Parking Brake - Information Messages.....	174
Parking Brake - Warning Lamps.....	174
Passive Anti-Theft System - Vehicles With: Passive Anti-Theft System (PATS).....	89
SecuriLock®.....	89

Index

PATS	
See: Passive Anti-Theft System - Vehicles	
With: Passive Anti-Theft System	
(PATS).....	89
Perchlorate.....	459
Personalized Settings.....	118
Chimes.....	119
Language.....	118
Measure Unit.....	119
Temperature Unit.....	119
Tire Pressure Unit.....	119
Phone.....	418
Android Auto.....	419
Apple CarPlay.....	419
Pairing Your Cell Phone for the First	
Time.....	418
Text Messaging.....	419
Using Your Cell Phone.....	418
Playing Media From a USB Device -	
Vehicles Without: SYNC.....	381
Selecting the USB Device.....	381
Supported Audio File Formats.....	381
Post-Crash Alert System.....	255
How Does the Post-Crash Alert System	
Work.....	255
Post-Crash Alert System Limitations.....	255
Switching the Post-Crash Alert System	
Off.....	255
What Is the Post-Crash Alert	
System.....	255
Power Door Locks	
See: Locking and Unlocking.....	76
Power Running Boards.....	93
Power Seats.....	131
Power Lumbar.....	132
Power Windows.....	107
Bounce-Back.....	107
Opening and Closing the Windows.....	107
Overriding Bounce-Back.....	107
Resetting Bounce-Back.....	107
Pre-Collision Assist.....	221
Distance Alert.....	222
Distance Indication.....	223
Pre-Collision Assist Information	
Messages.....	224
Pre-Collision Assist System Sensors.....	223
Pre-Collision Assist Warning Lamp.....	224
Switching Active Braking On and Off.....	222
Programming a MyKey.....	71
Protecting the Environment.....	18
Puncture	
See: Changing a Road Wheel.....	339
Pushing the Parking Brake Lever	
Down.....	175
R	
Rear Occupant Alert System Audible	
Warnings.....	137
Rear Occupant Alert System Indicators	
- Vehicles With: SYNC 3.....	137
Rear Occupant Alert System Indicators	
- Vehicles With: SYNC.....	137
Rear Occupant Alert System	
Limitations.....	136
Rear Occupant Alert System	
Precautions.....	136
Rear Occupant Alert System.....	136
Rear Overhead Storage.....	142
Locating the Rear Overhead Storage.....	142
Rear Overhead Storage Load	
Capacities.....	143
Rear Parking Aid.....	185
Object Distance Indicator.....	186
Rear Parking Aid Information	
Messages.....	187
Rear Passenger Climate Controls.....	124
Adjusting the Blower Motor Speed.....	124
Directing Air to the Footwell Air	
Vents.....	124
Directing Air to the Overhead Air	
Vents.....	124
Directing Air to the Overhead Air Vents and	
the Footwell Air Vents.....	124
Rear Seats.....	132
Installing the Seats.....	134
Recline Adjustment.....	132
Removing Seats (Passenger	
Vehicles).....	133
Rear View Camera	
See: Rear View Camera - Vehicles With:	
Parking Aid Camera.....	193
Rear View Camera - Vehicles With:	
Parking Aid Camera.....	193
Enhanced Parking Aids or Park Pilot.....	196
Rear View Camera Locations.....	194

Index

System Settings.....	195	Removing a Headlamp.....	295
Using the Rear View Camera.....	194	Repairing Minor Paint Damage.....	308
Recommended Towing Weights - Chassis Cab/Crew Van/Cutaway/ Van.....	235	Replacement Parts Recommendation.....	459
Calculating the Maximum Loaded Trailer Weight for Your Vehicle.....	237	Collision Repairs.....	459
Recommended Towing Weights - M2 Bus.....	237	Scheduled Maintenance and Mechanical Repairs.....	459
Calculating the Maximum Loaded Trailer Weight for Your Vehicle.....	239	Warranty on Replacement Parts.....	459
Reduced Engine Performance.....	246	Replacing a Lost Key or Remote Control.....	69
Refueling.....	155	Replacing the Cabin Air Filter.....	125
System Warnings.....	156	Reporting Safety Defects (Canada Only).....	262
Releasing the Electric Parking Brake if the Vehicle Battery Has Run Out of Charge.....	178	Reporting Safety Defects (U.S. Only).....	261
Releasing the Parking Brake.....	174	Resetting the Power Sliding Door.....	84
Remote Control - Vehicles With: Passive Anti-Theft System (PATS).....	65	Restarting the Engine.....	148
Changing the Remote Control Battery.....	66	Roadside Assistance.....	249
Integrated Keyhead Transmitter.....	65	Vehicles Sold in Canada: Getting Roadside Assistance.....	250
Locating Your Vehicle.....	66	Vehicles Sold in the United States: Getting Roadside Assistance.....	249
Programming a New Remote Control.....	66	Vehicles Sold in the United States: Using Roadside Assistance.....	249
Switching the Panic Alarm On and Off.....	67	Roadside Emergencies.....	249
Remote Control - Vehicles With: Power Sliding Door.....	67	Roof Racks and Load Carriers - Bus.....	228
Changing the Remote Control Battery.....	67	Roof Racks and Load Carriers - Van.....	228
Locating Your Vehicle.....	68	Running-In See: Breaking-In.....	247
Remote Control Information Messages.....	69	Running Out of Fuel.....	153
Remote Control - Vehicles Without: Passive Anti-Theft System (PATS).....	64	Adding Fuel From a Portable Fuel Container.....	154
Changing the Remote Control Battery.....	64	Filling a Portable Fuel Container.....	154
Integrated Keyhead Transmitter.....	64		
Locating Your Vehicle.....	65	S	
Programming a New Remote Control.....	64	Safety Canopy™.....	58
Switching the Panic Alarm On and Off.....	65	Safety Precautions.....	151
Remotely Starting and Stopping the Vehicle.....	120	Scheduled Maintenance.....	446
Remote Start Limitations.....	120	Seatbelt Extensions.....	49
Remote Start.....	120	Seatbelt Height Adjustment.....	46
Remote Start Settings.....	120	Seatbelt Reminder.....	47
Climate Control Settings.....	120	Belt-Minder™.....	47
Heated Seat Settings.....	121	Seatbelts.....	43
Setting the Remote Start Duration.....	121	Principle of Operation.....	43

Index

Seatbelt Warning Lamp and Indicator	
Chime.....	46
Conditions of operation.....	47
Seats.....	126
Security.....	89
Service Data.....	15
Settings Data.....	16
Comfort and Convenience Data.....	16
Entertainment Data.....	16
Settings.....	427
911 Assist.....	428
Ambient Lighting.....	428
Audio.....	427
Automatic Updates.....	428
Bluetooth.....	427
Charge Settings.....	428
Clock.....	427
Display.....	428
Driver Assist.....	428
FordPass.....	428
General.....	428
Message Center.....	428
Mobile Apps.....	428
Multi Contour Seats.....	428
Navigation.....	428
Personal Profiles.....	428
Phone.....	427
Seats.....	428
Sound.....	427
Valet Mode.....	428
Vehicle.....	428
Voice Control.....	428
Side Airbags.....	57
Side Sensing System.....	189
Object Distance Indicator.....	190
Sitting in the Correct Position.....	126
Sliding Door Precautions.....	80
Sliding Door.....	80
Closing the Sliding Door.....	80
Opening the Sliding Door.....	80
Sliding Door – Troubleshooting.....	85
Sliding Door – Troubleshooting.....	85
Sliding Door – Frequently Asked Questions.....	86
Sliding Door – Information Messages.....	85
Snow Chains	
See: Using Snow Chains.....	333
Spare Wheel	
See: Changing a Road Wheel.....	339
Special Notices.....	11
New Vehicle Limited Warranty.....	11
Special Operating Conditions Scheduled Maintenance.....	451
Exceptions.....	453
Speed Control	
See: Cruise Control.....	198
Speed Limiter.....	206
Principle of Operation.....	206
Using Speed Limiter.....	206
Stability Control.....	181
Principle of Operation.....	181
Starter Switch	
See: Ignition Switch.....	144
Starting a Gasoline Engine.....	144
Engine Warning Lamps.....	146
Failure to Start.....	145
Guarding Against Exhaust Fumes.....	145
Important Ventilating Information.....	146
Starting the Engine.....	145
Stopping the Engine When Your Vehicle is Moving.....	145
Stopping the Engine When Your Vehicle is Stationary.....	145
Starting and Stopping the Engine.....	144
General Information.....	144
Steering.....	220
Adaptive Learning.....	221
Electric Power Steering.....	220
Steering Information Messages.....	221
Steering Wheel.....	96
Stopping the Engine.....	148
Stopping the Sliding Door	
Movement.....	84
Storage Compartments.....	141
Storage.....	142
Bottle Holders.....	142
Overhead Storage.....	142
Rear Overhead Storage.....	142
Streaming Bluetooth Audio - Vehicles	
Without: SYNC.....	380
Selecting a Bluetooth Source.....	380
Supplementary Restraints System.....	50
Principle of Operation.....	50
Switching Auto-Start-Stop On and Off.....	148

Index

Switching Off the Engine.....	146
Vehicles With a Turbocharger.....	146
Switching Rear Occupant Alert System On and Off - Vehicles With: SYNC 3.....	136
Semiannual Reminder.....	136
Switching Rear Occupant Alert System On and Off - Vehicles With: SYNC.....	137
Semiannual Reminder.....	137
Symbols Glossary.....	9
SYNC™ 3.....	400
General Information.....	400
SYNC™ 3 Troubleshooting.....	429
Additional Information and Assistance.....	441
Apps.....	436
Navigation.....	435
Personal Profiles.....	439
Phone.....	433
Resetting the System.....	441
USB and Bluetooth Audio.....	430
Voice Recognition.....	429
Wi-Fi Connectivity.....	438
SYNC™ Applications and Services.....	387
911 Assist.....	387
SYNC Mobile Apps.....	389
SYNC™.....	383
General Information.....	383
SYNC™ Troubleshooting.....	391
T	
Technical Specifications See: Capacities and Specifications.....	352
The Better Business Bureau (BBB) Auto Line Program (U.S. Only).....	258
Tire Care.....	315
Glossary of Tire Terminology.....	317
Inflating the Tires.....	324
Information About Uniform Tire Quality Grades.....	315
Information Contained on the Tire Sidewall.....	318
Inspecting the Tires and Wheel Valve Stems.....	327
Location of the Tire Label.....	324
Tire Age.....	328
Tire and Wheel Alignment.....	330
Tire Damage.....	328
Tire Pressure Monitoring System.....	329
Tire Replacement Requirements.....	328
Tire Rotation.....	331
Tire Safety Practices.....	329
Tire Wear.....	327
United States Department of Transportation Tire Quality Grades.....	316
Tire Inflation When Punctured See: Tire Sealant and Inflator Kit.....	312
Tire Pressure Monitoring System.....	334
How Temperature Affects the Tire Pressures.....	335
Tire Pressure Monitoring System Reset Procedure.....	339
Understanding the Tire Pressure Monitoring System.....	337
When Changing Tires.....	336
When Changing Wheels.....	336
When Inflating Tires.....	336
Tire Repair Kit See: Tire Sealant and Inflator Kit.....	312
Tire Sealant and Inflator Kit.....	312
After Using the Tire Sealant and Inflator Kit.....	314
Using the Tire Sealant and Inflator Kit.....	313
Tires See: Wheels and Tires.....	311
Tow/Haul.....	163
Switching Tow/Haul On and Off.....	164
Towing a Trailer.....	234
Load Placement.....	234
Towing Points.....	254
Rear Towing Point.....	254
Towing the Vehicle on Four Wheels.....	245
Towing.....	234
Traction Control.....	180
Principle of Operation.....	180
Transmission Code Designation.....	357
Transmission.....	161
Transporting the Vehicle.....	253
Trip Computer.....	117
Average Fuel.....	118

Index

Average Speed.....	118
Distance to Empty.....	118
Instantaneous Fuel.....	118
Personalization.....	118
Resetting the Trip Computer.....	117
Trip Odometer.....	118
Trip Timer.....	118
Type Approvals.....	454
Radio Frequency Certification Labels for Audio Unit.....	454
Radio Frequency Certification Labels for Blind Spot Information System Sensors.....	454
Radio Frequency Certification Labels for Cruise Control Module.....	455
Radio Frequency Certification Labels for Keys and Remote Controls.....	455
Radio Frequency Certification Labels for Passive Anti-Theft System.....	456
Radio Frequency Certification Labels for Radio Transceiver Module.....	456
Radio Frequency Certification Labels for SYNC.....	457
Radio Frequency Certification Labels for Telematics Control Unit.....	457
Radio Frequency Certification Labels for Tire Pressure Monitoring System Sensors.....	458
U	
Under Hood Overview - 3.5L Duratec.....	280
Under Hood Overview - 3.5L Ecoboost™.....	281
USB Port.....	381
Using Adaptive Cruise Control.....	199
Adaptive Cruise Control Indicator.....	205
Adaptive Cruise Control Information Messages.....	205
Adaptive Cruise Control System Sensors.....	203
Automatic Cancellation.....	202
Canceling the Set Speed.....	202
Changing the Set Speed.....	201
Detection Issues.....	202
Following a Vehicle.....	200
Hilly Condition Usage.....	202
Overriding the System.....	201
Resuming the Set Speed.....	202
Setting the Adaptive Cruise Speed.....	200
Setting the Gap Distance.....	201
Switching Adaptive Cruise Control Off.....	202
Switching Adaptive Cruise Control On.....	199
Switching to Normal Cruise Control.....	204
System Not Available.....	203
Using All-Wheel Drive.....	165
All-Wheel Drive Gauge.....	169
All-Wheel Drive Information Messages.....	169
Driving In Special Conditions With All-Wheel Drive (AWD).....	165
Operating All-Wheel Drive (AWD) Vehicles with Mismatched Tires.....	165
Using Cruise Control.....	198
Canceling the Set Speed.....	198
Changing the Set Speed.....	198
Cruise Control Indicator.....	199
Resuming the Set Speed.....	198
Setting the Cruise Speed.....	198
Switching Cruise Control Off.....	198
Switching Cruise Control On.....	198
Using MyKey With Remote Start Systems.....	75
Using Power Running Boards.....	93
Automatic Power Deploy.....	93
Automatic Power Stow.....	93
Bounce-back.....	94
Enabling and Disabling.....	94
Manual Operation.....	94
Manual Power Deploy.....	94
Resetting the System.....	95
Using Snow Chains.....	333
Using Stability Control.....	182
Using SYNC™ With Your Media Player.....	390
Audio Voice Commands.....	391
Media Sources.....	390
Using SYNC™ With Your Phone.....	386
Accessing Features through the Phone Menu.....	387
Pairing a Phone.....	386
Phone Controls.....	387
Phone Voice Commands.....	386

Index

Using Traction Control.....	180
Switching the System Off or On.....	180
System Indicator Lights and Messages.....	180
Using Voice Recognition.....	382
Apps.....	407
Automatic Blower Motor Speed Reduction.....	408
Climate.....	404
Entertainment.....	403
General.....	402
Initiating a Voice Session.....	384
Navigation.....	406
Phone.....	405
Phone Voice Service.....	382
SiriusXM Traffic and Travel Link.....	407
System Interaction and Feedback.....	385
Voice Settings.....	408
Using Winter Tires.....	332
Utilizing the Mediation/Arbitration Program (Canada Only).....	259
V	
Vehicle Care.....	302
Vehicle Identification Number.....	356
Vehicle Storage.....	308
Battery.....	309
Body.....	309
Brakes.....	309
Cooling system.....	309
Engine.....	309
Fuel system.....	309
General.....	308
Miscellaneous.....	309
Removing Vehicle From Storage.....	309
Tires.....	309
Vehicle Wi-Fi Hotspot.....	375
Ventilation	
See: Climate Control.....	122
VIN	
See: Vehicle Identification Number.....	356
W	
Warning Lamps and Indicators.....	111
Washer Fluid Check.....	294
Washers	
See: Cleaning the Exterior.....	303
See: Wipers and Washers.....	97
Waxing.....	304
What Is 911 Assist.....	61
What Is a Connected Vehicle.....	371
What Is Auto-Start-Stop.....	148
What Is Remote Start.....	120
What Is the Cabin Air Filter.....	125
What Is the Electric Parking Brake.....	177
What is the Rear Occupant Alert System.....	136
Wheel Nuts	
See: Changing a Road Wheel.....	339
Wheels and Tires.....	311
General Information.....	311
Windows and Mirrors.....	107
Windshield Washers.....	99
Settings.....	99
Windshield Wipers.....	97
Intermittent Wipe.....	97
Winter Tires	
See: Using Winter Tires.....	332
Wiper Blades	
See: Checking the Wiper Blades.....	294
Wipers and Washers.....	97

